

JUNE 19, 1980

**FLEXIBLE IEEE-488 CONTROLLER EASES IN-HOUSE ATE DESIGN/147**

Recruiters mob 1980 engineering grads/91

Double-buffered d-a converters aim at any microprocessor/140



FOUR DOLLARS A MCGRAW-HILL PUBLICATION

# Electronics®

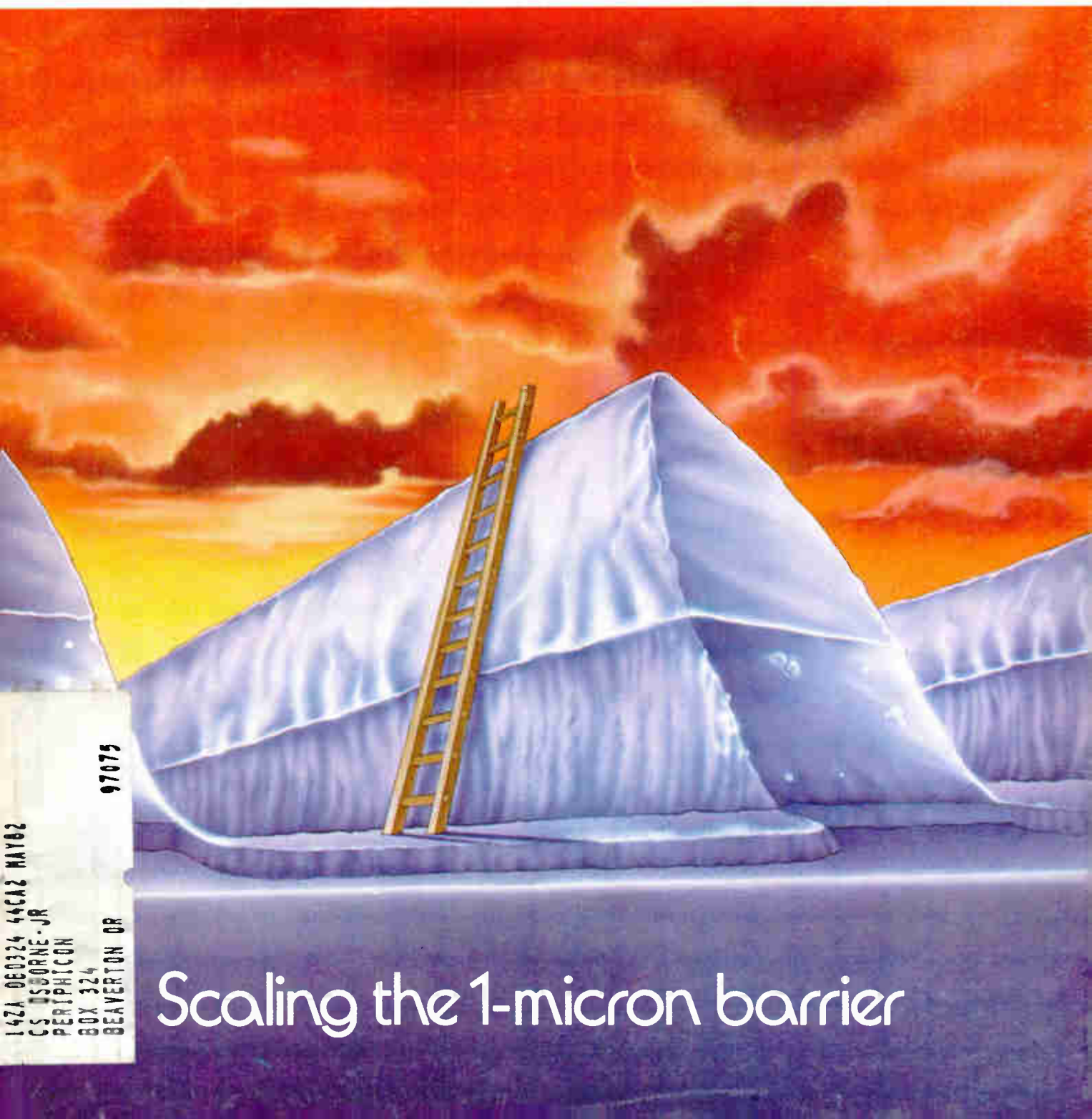

147A 060324 446A2 MAY82  
CS OSBORNE - JR  
PERTHICON  
BOX 324  
BEAVERTON OR 97075

## Scaling the 1-micron barrier

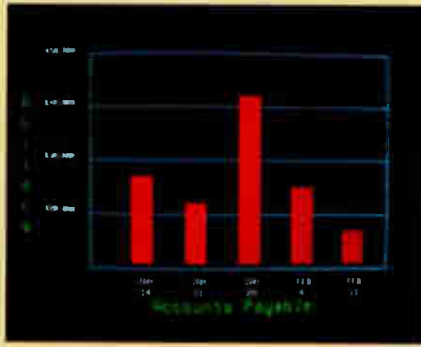

Management Information Display

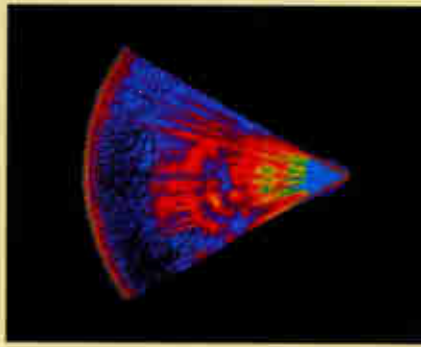

Ultrasonic heart sector scan



High-resolution display with alphanumerics

## Get the professional color display that has **BASIC/FORTRAN** simplicity

### LOW-PRICED, TOO

Here's a color display that has everything: professional-level resolution, enormous color range, easy software, NTSC conformance, and low price.

Basically, this new Cromemco Model SDI\* is a two-board interface that plugs into any Cromemco computer.

The SDI then maps computer display memory content onto a convenient color monitor to give high-quality, high-resolution displays (756 H x 482 V pixels).

When we say the SDI results in a high-quality professional display, we mean you **can't get higher resolution than this system offers in an NTSC-conforming display.**

The resolution surpasses that of a color TV picture.

### BASIC/FORTRAN programming

Besides its high resolution and low price, the new SDI lets you control with optional Cromemco software packages that use simple BASIC- and FORTRAN-like commands.

Pick any of 16 colors (from a 4096-color palette) with instructions like DEFCLR (c, R, G, B). Or obtain a circle of specified size, location, and color with XCIRC (x, y, r, c).

\*U.S. Pat. No. 4121283

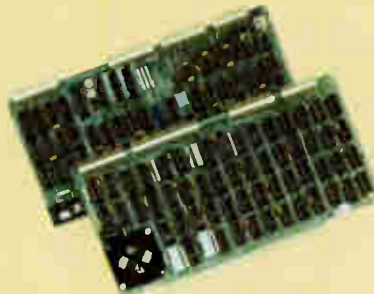

Model SDI High-Resolution Color Graphics Interface

### HIGH RESOLUTION

The SDI's high resolution gives a professional-quality display that strictly meets NTSC requirements. You get 756 pixels on every visible line of the NTSC standard display of 482 image lines. Vertical line spacing is 1 pixel.

To achieve the high-quality display, a separate output signal is produced for each of the three component colors (red, green, blue). This yields a sharper image than is possible using an NTSC-composite video signal and color TV set. Full image quality is readily realized with our high-quality RGB Monitor or any conventional red/green/blue monitor common in TV work.



Model SDI plugs into Z-2H 11-megabyte hard disk computer or any Cromemco computer

### DISPLAY MEMORY

Along with the SDI we also offer an optional fast and novel **two-port** memory that gives independent high-speed access to the computer memory. The two-port memory stores one full display, permitting fast computer operation even during display.

### CONTACT YOUR REP NOW

The Model SDI has been used in scientific work, engineering, business, TV, color graphics, and other areas. It's a good example of how Cromemco keeps computers in the field up to date, since it turns any Cromemco computer into an up-to-date color display computer.

The SDI has still more features that you should be informed about. So contact your Cromemco representative now and see all that the SDI will do for you.

 **Cromemco**  
i n c o r p o r a t e d

280 BERNARDO AVE., MOUNTAIN VIEW, CA 94040 • (415) 964-7400

Tomorrow's computers today

Circle 900 on reader service card

# Why settle for an ordinary switch...



## when you can have a

# LOLLAPALOOOSA!

Our basic miniature snap action precision switch (up above) is the standard of the industry. 34,816 variations make it the standard of the switching world.

**Example:** Our miniature comes in 17 standard actuators... plus 43 more special forms and shapes already tooled (like the examples down below)... plus Cherry will produce any design your application needs. The standard actuators alone range from as high as 400 grams operating force at 15 amps to an operating force as low as 2 grams at 3 amps.

**Example:** Our miniature comes in your choice of five (count them!) five ratings—from 0.1 amp gold crosspoint contacts... to a full 15 amps. With 3, 5 and 10 amps in between.

Then there's our choice of terminals: screw, solder or QC. And, our choice of circuitry: SPDT, SPST/NO or SPST/NC. Add it all up and you'll come to three conclusions:

1. This is the most versatile miniature switch you can spec—34,816 times over.
2. Only Cherry—with 25 years of snap switch experience—could offer such a lollapalooza at the right price...with the right delivery dates.
3. You need our complete catalog...and free sample switch. Just call...write...or TWX...say "Lollapalooza!"...and we'll send you both. Free. No strings.



Circle 1 on reader service card

# CHERRY PRECISION SWITCHES

**CHERRY ELECTRICAL PRODUCTS CORP.** 3608 Sunset Avenue, Waukegan, IL 60085—312/689-7700—TWX 910/235-1572  
Our worldwide affiliates and phone numbers: Cherry Semiconductor Corp., Cranston, RI, U.S.A., 401 463 6000 • Cherry Mikroschalter GmbH, Auerbach, Germany, 09 643 181 • Cherry Electrical Products Ltd., Sandridge (Herts) England, 44 727 32231 • Chercro Brasil Industria E Comercio Ltda., Sao Paulo, Brazil, 011 246 4343 • Hirose Cherry Precision Co., Ltd., Kawasaki, Japan, 044 933 3511

# The most significant price breakthrough in DOUBLE-BALANCED MIXERS!

...from Mini-Circuits of course!

**\$3.95** 100 Pieces  
\$4.50 (10-49)

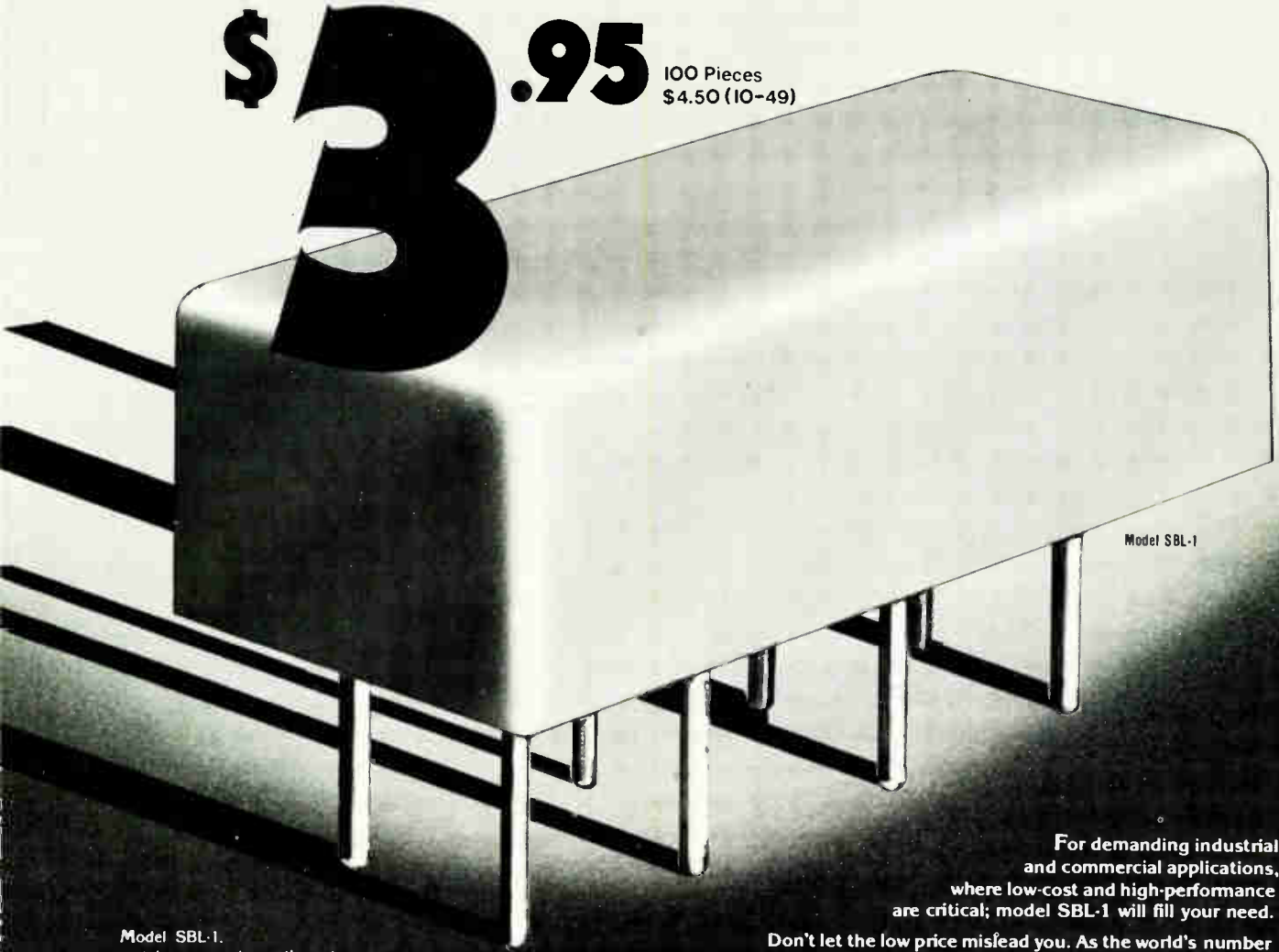

Model SBL-1

Model SBL-1, metal case, non hermetic seal

Frequency Range, MHz			
LO	RF	1-500	IF DC-500
Conversion Loss, dB		Typ.	Max.
One Octave from Band Edge		5.5	7.5
Total Range		6.5	8.5
Isolation, dB		Typ.	Min.
Lower Band Edge to	LO-RF	50	35
One Decade Higher	LO-IF	45	30
Mid Range	LO-RF	45	30
	LO-IF	40	25
Upper Band Edge to	LO-RF	35	25
One Octave Lower	LO-IF	30	20

Signal, 1dB Compression Level +1dBm  
Impedance, All Ports 50 ohms  
Electronic Attenuation Min (20mA) 3dB

For demanding industrial and commercial applications, where low-cost and high-performance are critical; model SBL-1 will fill your need.

Don't let the low price mislead you. As the world's number one manufacturer of double-balanced mixers, Mini Circuits' has accumulated extensive experience in high-volume production and testing, a key factor in achieving a successful low cost/high performance line of products.

The tough SBL-1 covers the broad frequency range of 1-500 MHz with 6 dB conversion loss and isolation greater than 40 dB. Only well-matched, hot-carrier diodes and ruggedly constructed transmission-line transformers are used. Internally, every component is bonded to the header for excellent protection against shock, vibration and acceleration. Here are some of the steps taken to ensure quality: Every SBL-1 is RF tested two times, every solder connection is 100 per cent inspected under a high power microscope, all transformer leads are double-wrapped, and all components are rated for more than +85 °C operation. Of course, our one-year guarantee applies to these units.

World's largest manufacturer of Double-Balanced Mixers

 **Mini-Circuits**  
MINI-CIRCUITS LABORATORY

A Division of Scientific Components Corp 21 Rev H

2625 East 14th Street Brooklyn, New York 11235 (212) 769-0200  
Domestic and International Telex 125460 International Telex 620156

Circle 2 on reader service card

## 115 Technical Articles

PACKAGING & PRODUCTION

**Scaling the barriers to VLSI's fine lines, 115**

COMPUTERS & PERIPHERALS

**Integrated adapter shares peripheral control with CPU, 129**

COMPONENTS

**C-MOS d-a converters match most microprocessors, 140**

INSTRUMENTS

**IEEE-488 controller promotes building of in-house ATE, 147**

INDUSTRIAL

**Adding data acquisition to a single-board computer, 155**

DESIGNER'S CASEBOOK: 134

ENGINEER'S NOTEBOOK: 158

## 41 Electronics Review

BUSINESS SYSTEMS: Intelligence makes word processors out of daisy-wheel printers, 41

COMPONENTS: All-polymer part acts as circuit breaker on boards of ICs, 42

COMMUNICATIONS: Single-chip subsystems use variety of technologies, 42

BUSINESS SYSTEMS: Word processor line starts with typewriter, 43

PACKAGING: Moisture-resistant plastic DIPs win OKs from two IC houses, 44

GOVERNMENT: Top court tightens rules on releasing public records, 44

COMMUNICATIONS: Fast error correction devised for fast tapes, 46

PERSONAL COMPUTERS: Japanese offering can fit into briefcase, 46

Talking personal computer listens, too, 48

PERIPHERALS: Hard-disk controller is easily palmed, 48

PACKAGING: Reusable polyimide frame eases testing of hybrid assemblies, 50

NEWS BRIEFS: 55

COMPUTER-AIDED DESIGN: VLSI makers are eyeing hierarchical approach, 56

## 69 Electronics International

FRANCE: Three-chip teletext set aims to win out through low cost and flexibility, 79

WEST GERMANY: Car-route computer requires no roadside gear, 80

BRITAIN: Low-cost system aids pc-board design, 82

JAPAN: Step-and-repeat unit takes new tacks, 84

## 91 Inside the news

CAREERS: Class of '80 wooed ardently, 91

## 100 Probing the News

BUSINESS: Recession's bite is shallow—so far, 100

LETTER FROM BOSTON: Body shortage looms, 102

MEMORIES: Is 5¼-inch Winchester drive ready? 104

## 171 New Products

IN THE SPOTLIGHT: Stimulus unit simplifies the job of failure analysis, 171

8-bit digitizer samples at 20 MHz, 180

Wideband isolator has high gain linearity, 190

SOFTWARE: Package speeds test generation, 198

SEMICONDUCTORS: 8-K EE-PROM uses 10 mW, 204

INDUSTRIAL: Sensor transmitter simplifies systems, 210

PACKAGING & PRODUCTION: Carbon dioxide laser scribe sells for \$49,000, 216

COMPONENTS: Two DIPs perform 8-channel, 50-kHz data acquisition, 222

## Departments

Highlights, 4

Publisher's letter, 6

Readers' comments, 8

People, 14

Editorial, 30

Meetings, 32

Electronics newsletter, 35

Washington newsletter, 61

Washington commentary, 62

International newsletter, 69

Engineer's newsletter, 162

Products newsletter, 229

## Services

Reprints available, 106 Employment opportunities, 232

Reader service card, 151

EDITOR-IN-CHIEF: Samuel Weber

MANAGING EDITORS

*Technical:* Raymond P. Capece,  
Alfred Rosenblatt  
*News:* Gerald M. Walker  
*International:* Arthur Erikson

ASSISTANT MANAGING EDITORS: Howard Wolff,  
Margaret Eastman

SENIOR EDITOR: Ray Connolly

ART DIRECTOR: Fred Sklenar

ASSOCIATE EDITOR: Benjamin A. Mason

DEPARTMENT EDITORS

*Aerospace/Military:* Ray Connolly  
*Circuit Design:* Vincent Biancomano  
*Communications & Microwave:*  
Harvey J. Hindin

*Components:* Roger Allan  
*Computers & Peripherals:* Anthony Durniak  
*Industrial/Consumer:* Gil Bassak  
*Test, Measurement & Control:*  
Richard W. Comerford

*New Products:* Alan Serchuk,  
Ana Bishop  
*Packaging & Production:* Jerry Lyman  
*Solid State:* John G. Posa

CHIEF COPY EDITOR: Margaret Eastman

COPY EDITORS: Mike Robinson,  
Charlotte Wiggers, Jeremy Young

ART: Charles D. Ciatto, *Associate Director*  
Paula Piazza, *Assistant Director*

EDITORIAL SECRETARIES: Maryann Tusa,  
Alan Kleinberger

EDITORIAL ASSISTANT: Marilyn B. Steinberg

REGIONAL EDITORS

*New York:* Pamela Hamilton (212) 997-2666  
*Boston:* James B. Brinton,  
Linda Lowe (617) 262-1160  
*Chicago:* Larry Marion (312) 751-3805  
*Dallas:* Wesley R. Iversen (214) 742-1747  
*Los Angeles:* Larry Waller (213) 487-1160  
*Palo Alto:* Bruce LeBoss, *Manager*  
Martin Marshall, *Computers & Instruments*  
(415) 968-2712

*Washington:* Ray Connolly (202) 624-7592

*Frankfurt:* John Gosch 72-5566

*London:* Kevin Smith 493-1451

*Paris:* Arthur Erikson,  
Kenneth Dreyfack 720-20-70

*Tokyo:* Charles Cohen 581-9816

McGRAW-HILL WORLD NEWS

*Editor:* Michael Johnson

*Brussels:* James Smith

*Milan:* Jeff Ryser

*Moscow:* Peter Hann

*Stockholm:* Robert Skole

*Tokyo:* Robert Neff

PUBLISHER: Paul W. Reiss

GENERAL MANAGER, DIRECT MARKETING  
OPERATIONS: Horace T. Howland

CIRCULATION MANAGER: Herbert A. Hunter

RESEARCH MANAGER: Margery D. Sholes

MARKETING ADMINISTRATION MANAGER:  
Frances M. Vallone

BOOKS & SPECIAL PROJECTS MANAGER:  
Janet Eyer

SERVICE REVENUE SPECIALIST:  
Penny Reitman

## Cover: Scaling the production barriers to fine-line VLSI, 115

Although optical lithography as is remains very useful, the IC industry is hard at work developing improved lithographic and etching techniques as well as other imaging and processing methods that work beyond optical limits. Fabrication using electron, X-ray, ion, and laser beams is being studied, as are better materials such as metal silicides. Both commercial and military markets are motivating research into practical ways to build the coming generation of very large-scale integrated circuits, which will have line widths near and below 1 micrometer.

Cover illustration is by Sean Daly.

## EE grads look beyond the pretty pay scale, 91

Facing high demand for their skills, electrical engineering graduates are looking for opportunities for advancement and continuing education in an employer's offer. Any recruiter with no more than a fat pay and benefits package is in an uphill battle for talent—as are the schools themselves.

## Data-path adapter shares peripheral control with CPU, 129

Combining functions of an input/output channel and a peripheral controller, IBM designers have come up with a more adaptable adapter (and lower hardware requirements) by leaving much of the peripheral control work to the 4331 central processor. The adapter's microprocessor takes over repetitive and time-critical tasks to keep data rates high.

## Double-buffered converter mates with many microprocessors, 140

Two incompatible data formats—left- and right-justified—have prevented digital-to-analog converters from being directly compatible with all microprocessor systems. A new line of complementary-MOS d-a converters has double-buffered inputs that accept both data formats.

## IEEE-488 controller aids in-house design of test setups, 147

The IEEE-488 bus standard has spawned a generation of electrically compatible test gear, but leaves the designer of an automatic test rig with a big job. Fluke's 1720A controller makes the design, programming, and operation of ATE easier—with separate control of two buses, with enhanced Basic and special command structures, and with an operator-friendly touch-sensitive cathode-ray-tube display.

## ... and in the next issue

A special report on microprocessor development systems . . . computer-aided customization of fast, dense C-MOS master-slice chips . . . a versatile two-chip dual-tone multifrequency receiver . . . a highly linear, wideband isolation amplifier.

June 19, 1980 Volume 53, Number 14 101,540 copies of this issue printed

Electronics (ISSN 0013-5070). Published every other Thursday with an additional issue this April by McGraw-Hill, Inc. Founder: James H. McGraw 1860-1948. Publication office 1221 Avenue of the Americas, N.Y., N.Y. 10020. Second class postage paid at New York, N.Y., and additional mailing offices.

Executive, editorial, circulation and advertising addresses: Electronics, McGraw-Hill Building, 1221 Avenue of the Americas, New York, N.Y. 10020. Telephone (212) 597-1221. Teletype 12-7980 TWX 710-581-4879. Cable address: MCGRAW HILL NEW YORK.

Subscriptions limited to professional persons with active responsibility in electronics technology. No subscriptions accepted without complete identification of subscriber name, title or job function, company or organization, and product manufactured or services performed. Based on information supplied, the publisher reserves the right to reject non-qualified requests. Subscription rates, in the United States and possessions: \$18 one year, \$31 two years, \$46 three years; company addressed and company libraries \$23 one year, \$41 two years, \$58 three years. APO/FPO addressed \$35 one year only. Canada and Mexico \$19 one year, \$32 two years, \$47 three years. Europe \$50 one year, \$85 two years, \$115 three years. Japan, Israel and Brazil \$70 one year, \$115 two years, \$165 three years. Australia and New Zealand \$95 one year, \$170 two years, \$240 three years, including air freight, all other countries \$50 one year, \$85 two years, \$125 three years. Limited quota of subscriptions available at higher-than-basic rate for persons allied to field served. Check with publisher for these rates. Single copies \$4.00, special Anniversary issue: \$9.00 each. Please allow four to eight weeks for shipment.

Officers of McGraw-Hill Publications Company: Paul F. McPherson, President, Executive Vice Presidents James E. Boddorf, Gene W. Simpson, Group Vice President Daniel A. McMillan, Senior Vice President-Editorial: Ralph R. Schulz; Vice Presidents: Kemp Anderson, Business

Systems Development, Stephen C. Croft, Manufacturing, Robert B. Doll, Circulation, James E. Hackett, Controller, William H. Hammond, Communications, Eric B. Herr, Planning and Development, John W. Patten, Sales, Edward E. Schirmer, International.

Officers of the Corporation: Harold W. McGraw, Jr., President, Chief Executive Officer, and Chairman of the Board; Robert N. Landes, Senior Vice President and Secretary; Ralph J. Webb, Treasurer.

Title registered in U.S. Patent Office; Copyright © 1980 by McGraw-Hill Inc. All rights reserved. The contents of this publication may not be reproduced in whole or in part without the consent of copyright owner.

Where necessary, permission is granted by the copyright owner for libraries and others registered with the Copyright Clearance Center (CCC), P.O. Box 8891, Boston, MA 02114, to photocopy any article herein for the base fee of \$0.50 per copy of the article plus \$0.25 per page. Payment should be sent directly to the CCC. Copying done for other than personal or internal reference use without the express permission of McGraw-Hill is prohibited. Requests for special permission or bulk orders should be addressed to the publisher. ISSN 0013-5070/80\$0.50+.25.

Subscribers: The publisher, upon written request to our New York office from any subscriber, agrees to refund that part of the subscription price applying to copies not yet mailed. Please send change-of-address notices or complaints to Fulfillment Manager; subscription orders to Circulation Manager, Electronics, at address below. Change-of-address notices should provide old as well as new address, including zip codes. Attach address label from recent issue. Allow one month for change to become effective. Subscriber Service: call (809) 448-8110, 9 a.m. to 4 p.m. EST.

Postmaster: Please send form 3579 to Fulfillment Manager, Electronics, P.O. Box 430, Hightstown, N.J. 08520.

IMMEDIATE  
DELIVERY

# The Silent Commander.

## 743 KSR

### Keyboard Send-Receive Data Terminal

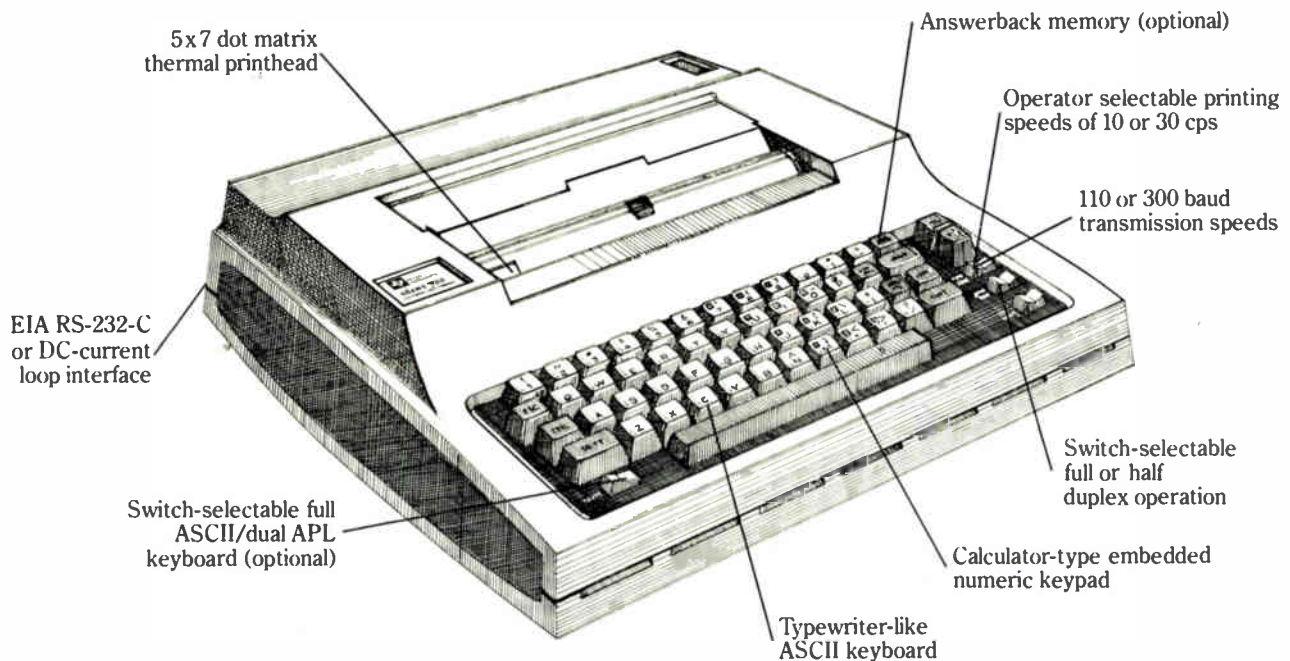

TI's *Silent 700*\* Model 743 KSR Data Terminal can help you take command of your data entry application needs today. The compact 743 offers a variety of easy-to-use standard features and options, and is an ideal input/output console. And with virtually silent thermal printing, the low-cost 743 leads the way for efficiency and reliability. The field-proven 743 is also available as a Receive-Only model.

With either 743, you can depend on high-quality *Silent 700* performance.

TI is dedicated to producing quality, innovative products like the 743 KSR Data Terminal. TI's hundreds of thousands of data terminals shipped worldwide are backed by the technology and reliability that come from 50 years of experience, and are supported by our worldwide organization of factory-trained sales and service representatives.

For more information on the 743 terminals, contact the TI sales office nearest you or write Texas Instruments Incorporated, P.O. Box 1444, M/S 7784, Houston, Texas 77001, or phone (713) 937-2016. In Europe, write Texas Instruments Incorporated, M/S 74, B.P. 5, Villeneuve-Loubet, 06270, France.



\*Trademark of Texas Instruments †Service Mark of Texas Instruments Copyright ©1980, Texas Instruments Incorporated

# TEXAS INSTRUMENTS

We put computing within everyone's reach.

Circle 5 on reader service card



The use of our large experience in the electronic industry for know-how, engineering, licences, technology, studies, design, manufacturer's marks, complete assembling lines, technical assistance, training of the staff, services, would certainly give you a complete satisfaction.

High qualified specialists of large experience are ready to answer accurately your most exigent demands just contact them!

Ask for technical data and any other informations on the following address:

**ELECTRONUM**  
EXPORT - IMPORT  
Specialized Foreign  
Trade Company  
70317 Bucharest-Romania  
11-15, Olari Street  
P.O.B.: 34-36  
Telex: 11547, 11584



This era of business prosperity, the tight supply of engineers, and the continued worldwide proliferation of electronics technology call for a new focus on engineering careers. Starting in this issue with the Inside the News story on this year's crop of EE graduates (p. 91), we will cover careers regularly. New York bureau manager Pamela Hamilton will conduct this effort.

It has been said that engineers make noise about careers and professionalism only during hard times and layoffs. But this view does not seem to be true. Pam points out that EEs are very much aware of the need for career planning.

Many of the June graduates, Pam reports, are already anticipating the need to advance their livelihoods via continuing education along both technical and managerial lines.

With engineer recruiting running hot and heavy, the high salaries being offered these days—about \$20,000 for starting BSEEs is the current estimate—are getting a lot of attention. "Yet it's not necessarily the salaries that attract the new grads," says Pam. "Well-marked career paths in the company and the company's prospects for growth are just as important. Companies that don't stress these points are having trouble recruiting."

The current seller's market, however, has its dark side. For one, the engineering schools are hurting for lack of teachers. The excellent opportunities in industry raise concern over schools' ability to lure good people into teaching. The situation holds disturbing implications over the future quality of engineering education. The top-flight schools will be able to bank on prestige, but for the majority of institutions the problem is becoming acute.

Another sector hurting for engineers is the military. The Air Force in particular is having trouble competing for the personnel it needs, Pam reports. "Although a faculty member could augment a university's salary with consulting work, military engineers obviously cannot."

Putting this story together involved interviewing engineering

school department heads and placement personnel, company recruiters, and most important, a sampling of EEs. Future career coverage will include stories on continuing education, school and company curricula, and controversies affecting EEs such as patent rights.

**O**n the beam—that's how packaging and production editor Jerry Lyman describes the situation in very large-scale integration processing. Electron-beam lithography, ion-beam milling, laser-beam annealing, and other topics are discussed in Jerry's special report (p. 115). He points out that future VLSI processing may be done in a single machine that will perform ion implantation, ion-beam lithography, and ion-beam milling.

Jerry also found that improving the quality of substrates is a high priority. "If the industry wants to go below 1-micrometer lines, it will need substrates that are nearly defect-free," he comments.

Pressure from VLSI users for the fine-line geometries required by fast devices has already been felt by production equipment companies. And now the Defense Department's very high-speed integrated circuits program is in effect calling for more progress sooner—submicrometer lines by 1985. "These two pressures are making life interesting for the process equipment designers," Jerry observes.

**A** new section in the New Products department appears in this issue. Though we have been covering the subject for some time, we have decided to highlight software in a space of its own (p. 198). Items on memory test programs, high-level language compilers, interpreters, and other software introductions will appear in this section.



# Motorola presents a character building alternative to the low-cost CRT compromise.



Actual characters

These low cost modules actually can display more characters than comparable competitive units. The new 12", 90° series provides excellent geometry and linearity within a wider range of horizontal frequencies—18.9 and 20.7 KHz. This increased scan rate means up to two extra character rows for your terminal. (The M3573 offers an 80 x 25 format; the M3574 displays an 80 x 26.)

Motorola's new M3573 and 74 offer economy without compromising quality. They demonstrate excellent resolution—900 lines center; 750 corners (50 more than the competition). Video amplifier response up to 22 MHz also increases the display capability while providing consistently distinct characters.

Choose either lightweight chassis or kit versions of the M3573 and 74 series. No other display can provide all these performance extras at such a low unit cost. *Just one more example in which experience—Motorola experience—can benefit you.*



**Motorola displays the character of your business.**



**MOTOROLA**  
**Display Systems**

1155 Harvester Road West Chicago, IL 60185  
312/231-4400

# DATUM TIMING EQUIPMENT IN THE 747/757/767 FLIGHT TEST PROGRAMS

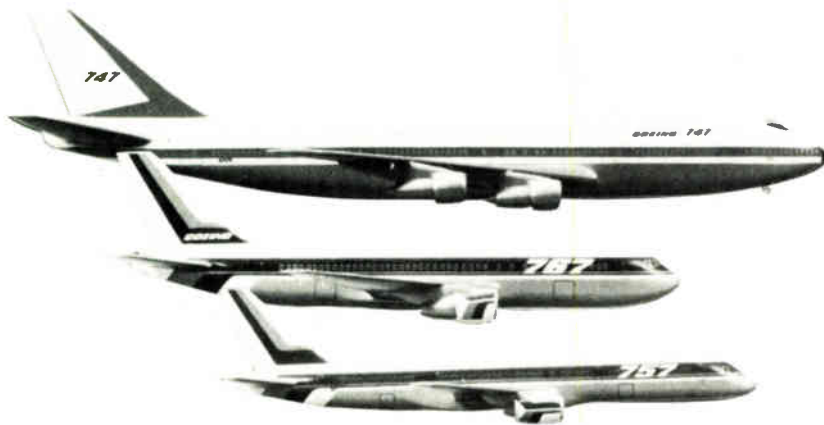

The Boeing Airplane Company has selected Datum Timing Products for time annotation and synchronization during data recording, transmission, processing and display in the 747, 757 and 767 flight test programs. The compactness, ruggedness, performance, reliability and versatility of Datum timing equipment for airborne (and all other) applications has been proven again during the comprehensive flight testing of these outstanding aircraft. Some of the equipment Datum supplies for the Boeing flight test programs is:

## TIME CODE GENERATORS



- IRIG A, B, E and H modulated serial time code outputs
- Sync to IRIG B serial time code input or external pulse input
- Full or 1/2 ATR case, AC or DC input power

## TIME CODE TRANSLATORS



- IRIG A or B modulated serial time code inputs in real time or at high speeds
- Selectable playback and search filters
- Error frame bypass selection
- 1/2 ATR case, AC or DC input power

## CAMERA TIME DISPLAYS



- IRIG A or B serial modulated time code input
- Synchronized to input time code frame marker
- Displays hours, minutes, seconds, hundredths of seconds and prewired camera number
- Unit is 4.4 inches high, 1.5 inches wide, 5.2 inches deep
- Other configurations are available

## MINIATURE TIME DISPLAYS



- IRIG B modulated serial time code input
- Displays hours, minutes and seconds
- 1.5 inches high, 4.4 inches wide and 5.37 inches deep
- $28 \pm 4$  VDC input power
- Other configurations available

## PRECISION TIMING EQUIPMENT FOR EVERY APPLICATION

FOR MORE INFORMATION  
CONTACT:

**datum inc** TIMING DIVISION

1363 S. State College Blvd. • Anaheim, CA 92806 • (714) 533-6333

TD 104

## Readers' comments

### Microprocessor claims

To the Editor: I must question claims made in "How a 16-bit microprocessor makes it in an 8-bit world" [Sept. 27, 1979, p. 122] regarding the performance of the new 6809 microprocessor. Specifically, I dispute the speed comparison of the 6809 with the Z80 and the 8085. I would also like to express some thoughts on the general problem of comparing the performance of microprocessors.

First, note that 3 megahertz is used as a "fast clock" for the 8080/8085 values in Table 1. Since Intel supplies a 5-MHz device, the 8085A-2, I think it only fair that these values be improved by a factor of 5/3, or 1.666 to 1. Further, though the 6809 undoubtedly has an edge in multiplication, it is unreasonable to allow this one operation to so grossly dominate the 8080/8085 average execution times as shown in Table 2. Leaving multiplication out and using a 5-MHz clock reduces the quoted advantage of 4.87 of the 6809 with respect to the 8085 to only 1.48 to 1 (provided that one accepts the other benchmark values quoted by the author).

Second, at least one of the speed comparisons with the Z80 is in serious error. The author claims that the 6809 is faster than the Z80 by a factor of 1.74 at searching a block of characters for a substring. However, I have written a routine that takes 5.25 microseconds per unmatched byte searched on a 4-MHz Z80. A 2-MHz 6809 would take only 5.25/1.74, or 3.02,  $\mu$ s per byte (or less if my code is not optimal).

Since a 2-MHz 6809 requires 3.00  $\mu$ s for just one of its clever indexed and auto-incremented loads or compares (which are likely components of an optimal 6809 routine), it does not seem likely that the 6809 can execute a search at anywhere near the claimed rate. I believe that the author is in error by a factor of approximately  $1.52 \times 1.74 = 2.64$  and that the Z80 is in fact faster than the 6809 for the important case of substring searching.

The specific criticism above gives rise to my more general concern

# CURTIS Electronic TERMINAL BLOCKS...

## Compact Spacings/PC, Feed-Thru & Surface Types/Materials/Ratings for Selective OEM Designers

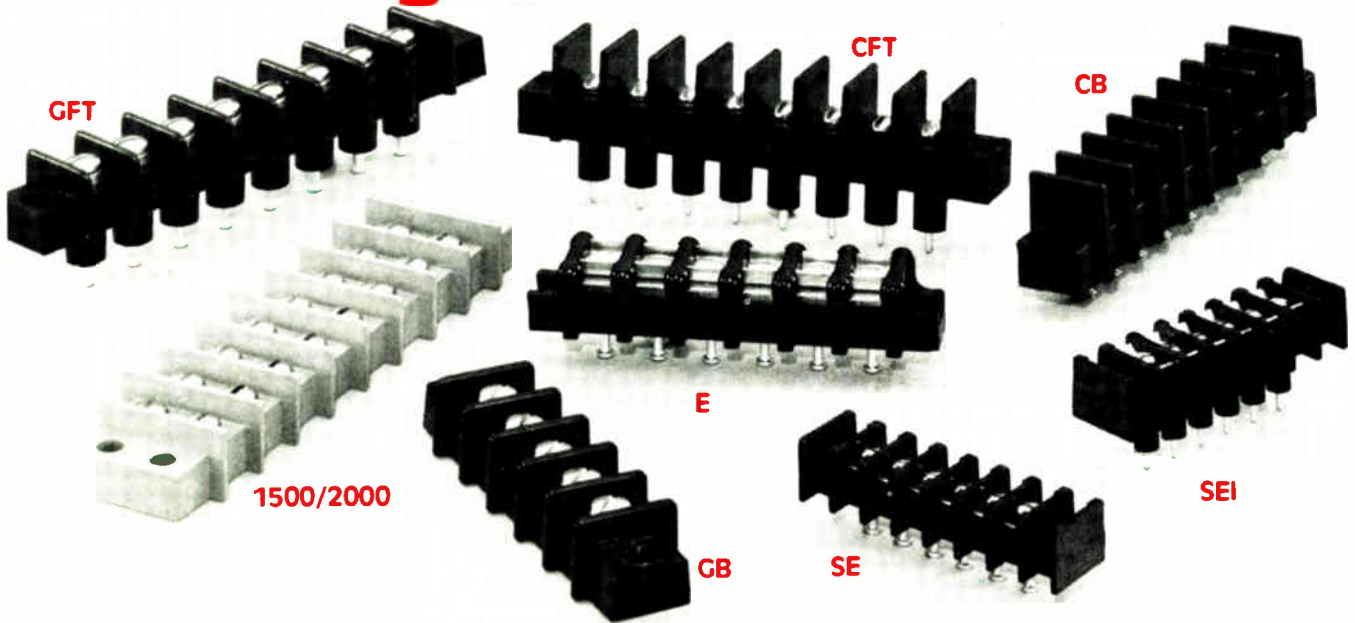

With Curtis you get the broadest line of electronic terminal blocks in the industry — Spacings from 1/4" to 7/16"... Numerous internal and external terminal variations... Phenolic or thermoplastic housings... Wide range of accessories. More features, too! Twist-free brass inserts, closed-back designs, high barrier construction — All you need to solve the toughest OEM design problems.

SERIES/TYPE	CFT	CB	GFT	GB	1500/2000	E	SEI	SE
<b>SPACINGS</b> (Center-to-Center)	3/8" 9.52mm	3/8" 9.52mm	7/16" 11.11mm	7/16" 11.11mm	3/8" & 7/16" 9.52 & 11.11mm	3/8" 9.52mm	1/4" 6.35mm	1/4" 6.35mm
Wire Range (AWG)	22 to 12	22 to 12	22 to 12	22 to 12	22 to 10	22 to 16	22 to 16	22 to 16
No. of Terminals	1 thru 26	1 thru 26	1 thru 26	1 thru 26	1 thru 22	1 thru 22	1 thru 26	1 thru 26
<b>TYPE</b>								
Feed-Thru (fully insulated)	●		●				●	
Feed-Thru		●		●	●	●		●
Printed Circuit	●	●	●	●	●	●	●	●
Surface (fully insulated)				●	●	●		●
<b>MATERIAL</b>								
Phenolic (150°C; 302°F)			●	●		●	●	●
Polyphenylene Oxide (110°C; 230°F)			●	●	●	●	●	●
Thermoplastic-Polyester (140°C; 284°F)	●	●						
<b>ELECTRICAL RATINGS</b> Current (Amps) Nominal Voltage 300V for All Types	20	20	20	20	30	15	5	5



**CURTIS INDUSTRIES, INC.**

Write or call for complete engineering application data.

8000 West Tower Avenue Milwaukee, Wisconsin 53223 Phone (414) 354-1500

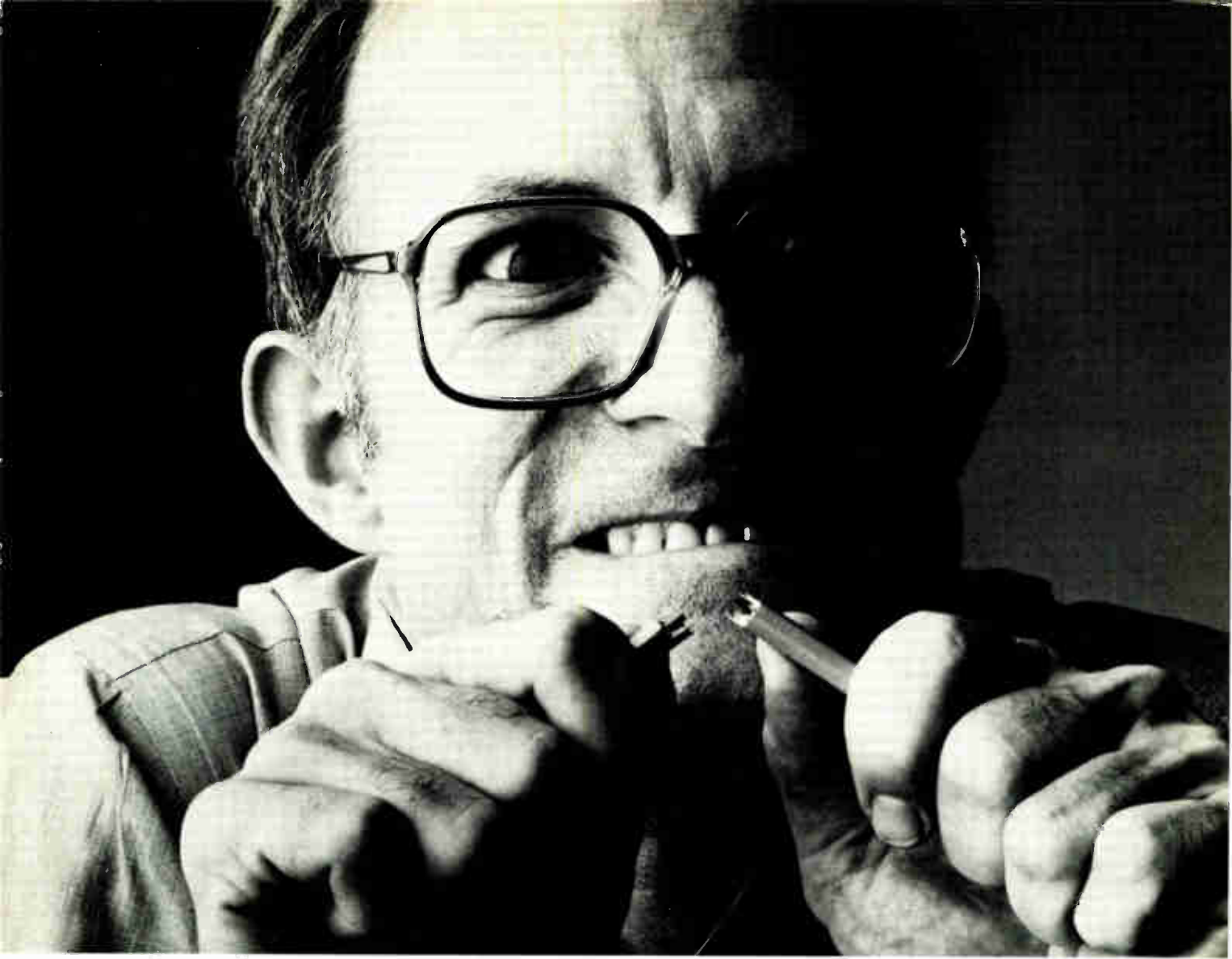

**DON'T LET YOUR RAM  
GET YOUR GOAT.**

You're designing a dynamic RAM system and you've just about run out of time, money, space and patience.

You want a lot of storage. But the more chips you use and the denser your RAMs, the more you worry about soft errors. You want it to be fast. But the faster you make it, the tougher the skew, undershoot and board layout problems.

Well, calm down. Relax. Help is on the way.

## Advanced Micro Devices makes dynamic RAM system design easier, faster, simpler, cheaper.

When Advanced Micro Devices started the bipolar LSI business back in 1975, our Am2900 Family revolutionized high-performance CPU design. Now we're doing the same thing for memory systems.

Our new Am2960 Family of bipolar LSI and interface devices makes designing with dynamic RAMs as easy as designing with static.

It will help you maximize your system's performance and reliability, minimize its chip count and cost.

And our solutions are a whole lot simpler to use than MSI because our systems designers have already done most of the designing for you.

### See for yourself.

The Am2960 Error Detection and Correction Unit (EDC). It detects errors in 30ns, detects *and* corrects them in 50ns. It replaces 40 MSI chips. It's expandable to 32 or 64 bits but has byte-level controls. It's got built-in diagnostics and

initialization. And it'll be available this fall.

The Am2961/62 Data Bus Buffer. In slim 24-pin packages, you get all the functions required to interface between the memory array, EDC unit and system data bus. Enough said.

The Am2964 A Dynamic Memory Control (DMC). It's got the address MUX, address latches, refresh counter and RAS/CAS Controls required for 16K and 64K RAMs. And it runs at Schottky speeds.

The Am2965/66 Ram Drivers. They let you drive your RAMs without undershoot at the right voltage levels, without external resistors. It's got AC specs at up to 500 pF loading. And they come in the industry standard 74S240/244 pin-out.

If you're designing a dynamic RAM system, or any high-performance system, and you feel like cashing in your chips, remember there's a simple solution: Advanced Micro Devices.

## Bipolar LSI: The Simple Solution.

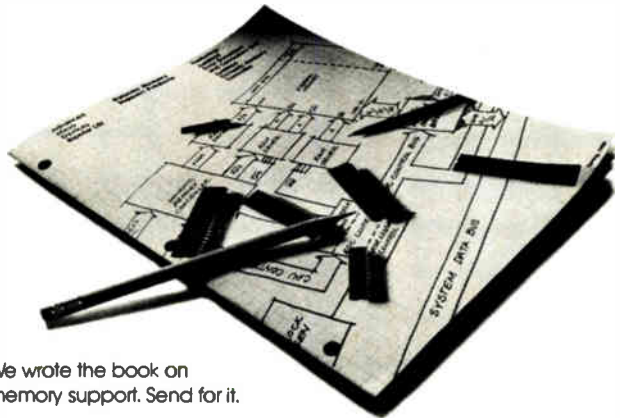

We wrote the book on memory support. Send for it.

# Advanced Micro Devices

901 Thompson Place, Sunnyvale, California 94086  
Right, from the start.

# OPTEK

**Our Business is  
OPTOELECTRONICS**



**Custom Designed  
Infrared Optoelectronic  
Components are our  
Speciality.**

Let Optek design a custom solid state assembly using our gallium arsenide LEDs and silicon phototransistors for your specific application. Our engineers will assist you in designing the most cost-effective method of meeting your electrical and mechanical requirements. A preliminary discussion of your application and requirements can be done on the telephone. Call us at (214) 542-9461 and ask for custom design engineering.

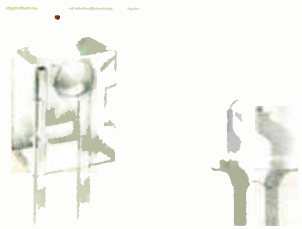

**Optek has  
Standard Devices**

Optek manufactures a full line of standard devices, including infrared LEDs, phototransistors, photodiodes, photodarlington, reflective switches and interrupter switches.

Optek 1980 catalogs available upon request.



Optek, A Division of Crown Semiconductor, Inc.  
345 Industrial Blvd., McKinney, Texas 75069  
(214) 542-9461

## Readers' comments

about the difficulty a potential customer has in assessing the claims put forth by the microprocessor manufacturers. Decisions are particularly difficult for the organization that already has an investment in the support of one chip and is wondering whether to adopt a newly announced device.

In this case, not only is the magnitude of the relative performance of the chips of interest but also there is definite value in the accrued experience of writing software and in the software itself. An experienced programmer who is thoroughly familiar with the somewhat disorderly instruction set of the Z80, say, may well be able to produce faster and more compact code than someone else working with the tidy instruction set of the 6809.

The difficulty is that to compare the merits of one processor with those of another, one should write a sizable amount of code relevant to one's field of application, comparing the aggregate of software and hardware costs. One must also count the one-time costs of embracing a new processor instead of staying with a familiar one. In these days of heavy promotion of 8-bit and 16-bit systems, the need for level-headed evaluation is clear.

J. W. Locke  
Toronto, Ont.

## Correction

*Specifications for Digital Equipment Corp.'s VAX-11/780 32-bit computer, as given in a table in the May 8 issue (p. 185) and in an article in the May 22 issue (p. 130), were based on outdated information. The maximum program size is now 2 gigabytes, not 32 megabytes, and the maximum number of terminals is 384.*

*In "An acronym abbreviation guide for electronics engineers" (March 13, p. 148), the term MDS was listed as an abbreviation for "microprocessor development system." It is, in fact, a registered trademark of the Mohawk Data Sciences Corp., Parsippany, N. J., and its use as a generic abbreviation should be avoided.*

# Leaders in Electronics

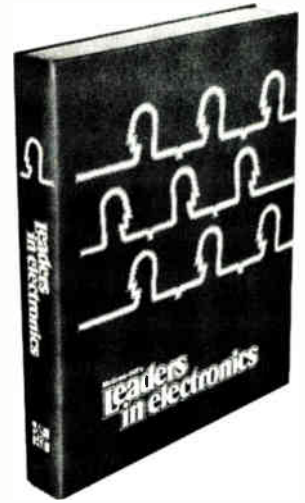

**The only reference devoted solely to biographies of the most influential people in electronics**

• corporate executives • technical managers • designers/developers • government and military officials • academics • consultants • editors/publishers • trade/professional group directors • securities analysts

Plus an 80-page index of biographies by affiliation, including independent consultants in every electronics speciality.

Prepared by the staff of Electronics magazine. 5,240 biographies. 651 pages, clothbound. \$39.50

**Electronics Magazine Books**  
P.O. Box 669, Hightstown, NJ 08520

Send me...

\_\_\_ copies of *Leaders in Electronics* @ \$39.50 plus applicable sales tax. McGraw-Hill pays regular shipping and handling charges on pre-paid orders.

I must be fully satisfied or you will refund full payment if the book is returned after ten-day trial examination.

Payment enclosed     Bill firm     Bill me  
Charge to my credit card:     American Express  
 Diners Club     Visa     Master Charge  
Acct. No. \_\_\_\_\_ Date Exp. \_\_\_\_\_

On Master Charge only,  
first numbers above name \_\_\_\_\_

Name \_\_\_\_\_

Company \_\_\_\_\_

Street \_\_\_\_\_

City \_\_\_\_\_

State \_\_\_\_\_

Zip \_\_\_\_\_

Signature \_\_\_\_\_

Just a flutter of  
pressure...



...and **snap**

Less than 2 grams of force actuates this Cherry snap-action miniature switch. Outside, a  $2\frac{3}{8}$ " long aluminum lever provides unusually low operating force. Inside, an extra internal actuator reduces operating force even more while maintaining solid contact pressure for reliable performance.

Our unique light force miniature design is available with other external levers offering operating forces ranging from 3.5 to 15 grams... rated 3 amps, 125VAC. Gold crosspoint contact versions bring this same, dependable switching to your low energy (0.1 amp) solid state circuits. Or, choose higher electrical ratings of 5, 10 or 15 amps with increased... but still low... operating forces.

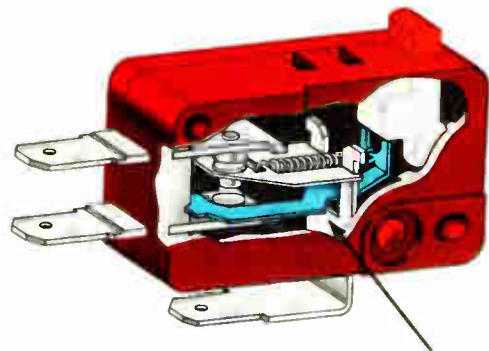

**EXTRA INTERNAL ACTUATOR**  
reduces force required at button plunger while  
maintaining solid contact pressure.

**CHERRY** 

**MINIATURE  
LIGHT FORCE  
SWITCHES**

**CHERRY ELECTRICAL PRODUCTS CORP.** 3608 Sunset Avenue, Waukegan, IL 60085—312/689-7700—TWX 910/235-1572

Our worldwide affiliates and phone numbers: Cherry Semiconductor Corp. Cranston, RI, U.S.A. 401 463 6000 • Cherry Mikroschalter GmbH, Auerbach, Germany 09 643 181 • Cherry Electrical Products Ltd., Sandridge (Herts) England, 44 727 32231 • Chercos Brasil Industria & Comercio Ltda., Sao Paulo, Brazil, 011 246 4343 • Hirose Cherry Precision Co., Ltd. Kawasaki, Japan 044 933 3511

Circle 13 on reader service card



**DIP ISOLATORS**  
**DIP ISOLATORS**  
**DIP ISOLATORS**

*TRW Optron's complete line of optically coupled plastic DIP isolators offers immediate availability of standard devices for almost every application... plus competitive pricing, high reliability and excellent customer service.*

**Check these features and choose the device best suited for your application.**



**GENERAL PURPOSE**

A full selection of DIP isolators with transistor and darlington outputs to match all popular industry standards. Current transfer ratios range from 2.0% to 500%.

**HIGH VOLTAGE**

For applications requiring an interface with high voltage circuits, select the OPI 6100 DIP isolator with a 200 volt output transistor.



**AC OPERATION**

The OPI 2500 DIP isolator features two input LED's operating in inverse parallel and is ideal for applications where the LED is driven from an AC line.

**CUSTOM SELECTION**

If your application demands "something a little different," TRW Optron specializes in DIP isolators to meet special customer requirements.



*For reliability data and technical specifications on TRW Optron's complete line of plastic DIP isolators, contact your nearest TRW Optron sales representative or the factory direct.*

**TRW OPTRON**  
 A DIVISION OF TRW INC.

1201 Tappan Circle  
 Carrollton, Texas 75006, U.S.A.  
 TWX-910-860-5958  
 214/242-6571



## People

Barnoski to aim TRW's new R&D work at optics

A new research and development operation is slated to open soon in Southern California and its major direction is indicated by the man chosen to head it. Tapped by TRW Inc. for the job is Michael K. Barnoski, an authority on optical electronics at Hughes Aircraft Co.'s noted research laboratories in Malibu, Calif., where he was a fast-rising department head.

It is apparent that the plum dangled by TRW officials to lure him away would sorely tempt any researcher. "I'm setting up programs to exploit guided-wave optics," says Barnoski. At the TRW Technology Research Center, which has the charter to provide the corporate focal point for this work, he is now staffing four product areas: automotive, telecommunications, aerospace, and communications systems.

What also attracted the soft-spoken scientist away from his militarily oriented work at Hughes is TRW's diversity, especially into such commercial fields as retail point-of-sale and electronic funds-transfer equipment and industrial fiber-optic components. "Here I can keep a foot in both worlds," he observes.

Barnoski spent his first four months traveling about TRW's divisions and has mapped out what he considers "very exciting structured programs." Particularly fascinating are different ends of the application spectrum: optics for sophisticated military command, control, and communications systems, as well as for more down-to-earth automotive uses where a big opportunity exists "to tie together microprocessors in the really rough electromagnetic interference that cars present."

In addition to building a staff, Barnoski is currently finding a larger facility to house the ambitious research effort. About creating a staff, he confesses initial concern about "our ability to attract young Ph.D.s," who naturally gravitate to established research organizations. But recruiting has gone well, he says.



**New look at TRW.** Michael Barnoski, whose field is optical electronics, is the head of TRW's new research and development operation, the Technology Research Center.

Nailing down a new building is tougher, however. Now in cramped quarters in Torrance, Calif., south of the TRW Systems and Energy complex in Redondo Beach, he wants to locate somewhere between it and TRW Electronics' headquarters about 15 miles north, in the Westwood suburb of Los Angeles.

Barnoski's own professional pace, apart from TRW, remains a stiff one, particularly in teaching, which many aerospace scientists like to do. He is an instructor at two University of California extension schools, in Los Angeles and Santa Barbara.

Balancing work and play helps Kildall achieve success

Gary Kildall believes in balancing the elements of environment, work, and play in his company. So on any given day, the 37-year-old founder and president of Digital Research will probably be hard at work preparing operating systems and compilers for the next generation of microcomputers. But he could also very well be piloting the company plane over California's Monterey Bay, roller skating on the sidewalks of Pacific Grove, playing baseball, or jogging.

That may be an unusual approach to commercial success, but for Kildall and his company it has worked. Digital Research has doubled its sales each year since its incorporation in 1977. Kildall, although the driving force behind the company, is



# PDP11/03<sup>®</sup> PDP11/23<sup>®</sup> MICROCOMPUTER SYSTEMS



**FIRSTMICRO**™  
**PDP11**®

FIRST COMPUTER CORPORATION NOW OFFERS  
MICROCOMPUTER DEVELOPMENT SYSTEMS IN BOTH  
11/03 AND 11/23 CONFIGURATIONS.

The Basic PDP-11/03 systems offer the designer a low cost compatible alternative to the larger members of the PDP-11 family. The larger faster PDP-11/23 systems offer the power, expandability and operating systems of the larger members of the PDP-11 family while retaining the proven cost effective Q-Bus architecture. These systems save you money, improve programming efficiency, and boost productivity.

	11T03-L	11V03-L	11T23-L	11V23-L
PART #	SRVXLLB	SRVXSSB	SRWXLLA	SRWXSSA
	KD11-HA CPU 11/03	KO11-HA CPU 11/03	KDF11 CPU 11/23	KOF11 CPU 11/23
	MSV11-DD 32KW Memory	MSV11-DD 32KW Memory	MSV11-DO 32KW Memory	MSV11-OO 32KW Memory
	RL01 Controller	RX02 Controller	MSV11-DD 32KW Memory	MSV11-DD 32KW Memory
	RL01 Controller	DLV11-J Serial (4)	RL01 Controller	RX02 Controller
	DLV11-J Serial (4)	OPEN	RL01 Controller	DLV11-J Serial (4)
BACKPLANE	OPEN	OPEN	DLV11-J Serial (4)	OPEN
	OPEN	OPEN	OPEN	OPEN
	OPEN	OPEN	OPEN	OPEN
	BDV11-AA Bootstrap	BDV11-AA Bootstrap	BDV11-AA Bootstrap	BDV11-AA Bootstrap

Serving the world with cost effective computer systems.

**First**™ **computer corporation**  
corporate square/825 north cass avenue/westmont, illinois 60559/(312) 920-1050

TWX NUMBER 910-651-1916

™Trademark First Computer Corporation    Registered trademark of Digital Equipment Corporation

55-3

Circle 15 on reader service card

## People

not nearly as well known as the three-letter acronyms that he has helped to create.

**Usable form.** The most renowned of these is probably CP/M, a piece of software that has become the *de facto* standard operating system for microcomputers. Close followers of the exploding field of microcomputer

software are also familiar with MP/M, the multiterminal operating system, and CP/NET, the local-networking operating system. Most recently, Kildall succeeded in doing what many had thought was impossible—boiling down the PL/I language into a form usable by microcomputers—in his PL/I-80 compiler



**Innovator.** Gary Kildall is behind some best-selling microcomputer software.

# Let's talk Telecom

If you design telecommunications equipment, give us a call. (408) 496-6660. Siliconix telecom engineers are available to discuss your telecom applications and specific systems needs. Whether you want advanced loop disconnect dialers, CODECs, analog switches, current regulators or VMOS FETs, we have discrete devices and integrated circuits to fit your design requirements. Best of all, products are in stock and ready for immediate delivery. And by summer we'll be introducing our brand new line of telecom filters. So give us a call. And let's talk telecom.

If you can't find a phone, just grab your pen and write "TELECOM" on your business card. Mail it to us and we'll rush you the new Siliconix Telecommunications Data Book absolutely free. This invaluable reference guide is filled with the latest telecom applications information and technical data. Send your card today to: Siliconix Inc., P.O. Box 4777, Santa Clara, CA 95054.

**Siliconix**  
TELECOM ICs

[*Electronics*, April 24, 1980, p. 41].

Blazing trails in the software world has become a habit for Kildall. It was, in fact, the temptation to get in on the ground floor of microprocessor software work that led him to obtain leave from his post as a professor of computer science at the Naval Postgraduate School in Monterey in order to consult at Intel Corp. His consultation led to the development of PL/I for Intel's 8-bit microprocessors, in 1973-74. He continued his teaching at the naval school, where the idea for CP/M germinated in 1975 and resulted in the first level of that software in 1976.

**Room with a view.** Kildall formed Digital Research in 1976 to market CP/M and chose a two-story Victorian house with stained-glass windows in Pacific Grove to hold the company. It makes an unusual software shop, with a view of the Pacific Ocean on one side. On the other is a view of the Cannery Row made famous in the Steinbeck novels, and of Monterey Bay.

At the rate his company is growing, he will need to find more space soon. The microcomputer world has shown a voracious appetite for new software and shows no signs of slowing its development of new hardware. "The way it looks, the 16-bit microprocessor is really just a stop-over point on the way to the 32-bit processor," he notes. "Look at mini-computers. Do you see anyone introducing 16-bit machines?" □



# MEASUREMENT COMPUTATION NEWS

product advances from Hewlett-Packard

JUNE 1980

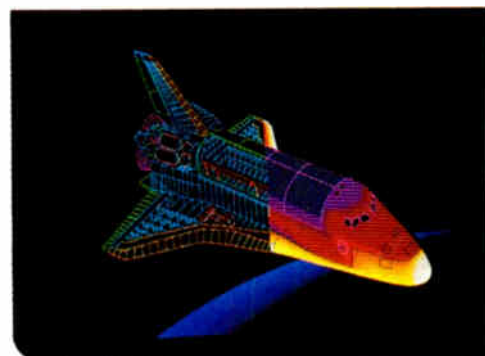
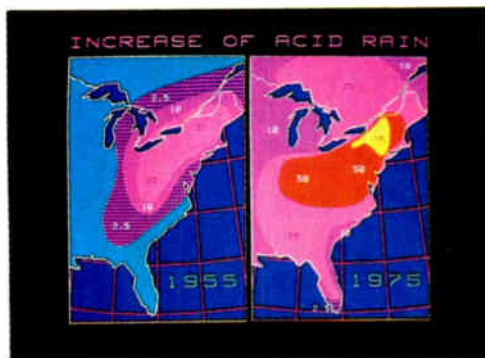
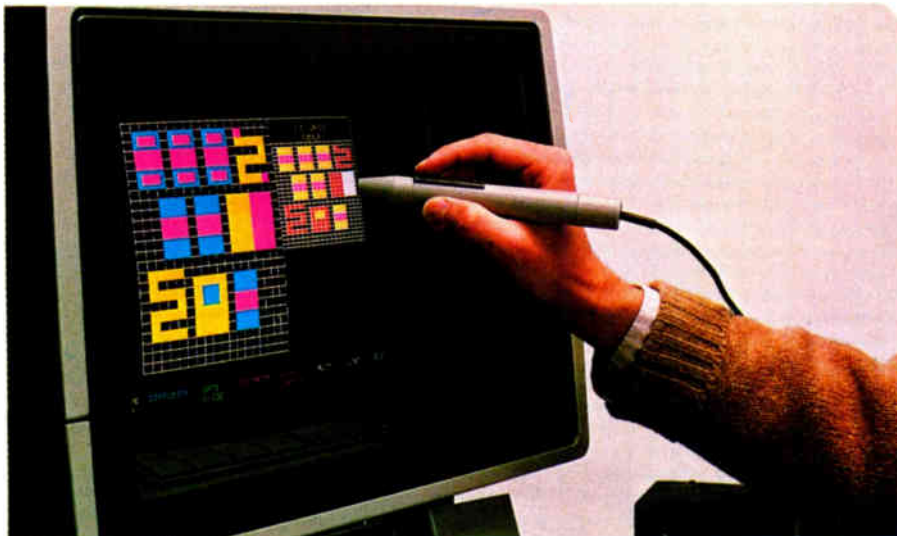

HP's powerful new graphics computation system provides fast and easy comprehension of data with brilliantly colored displays. A built-in light pen allows the user to interactively pick, move and draw directly on the CRT.



Create brilliant, graphic interpretation of data with ease and speed

HP's newly introduced 9800 Series 45C Computer System features powerful graphics computation capable of displaying results in up to 4,913 crisp, clear colors.

Based on HP's proven 9800/45 Series

Computers, the 9800/45C is an easy-to-use graphics computer system that sits on your desk. Built-in, color graphics CRT display, light pen, operating system, up to 449K-byte user read/write memory,

*(continued on third page)*

## IN THIS ISSUE

- New, non-contact distance meter • Automatic performance in versatile, low cost counter •

# Now you can create and manage *technical* data bases on the HP 9800/45 computer—with HP's award-winning IMAGE data base management

Hewlett-Packard's new data base management and data communications capabilities can put your technical data to work!

HP's new 9800 System 45 Data Base Management System gives you an HP IMAGE-based software/firmware pac-

kage that allows you to transform your raw technical data into a useable, beneficial resource. Now, for the first time, you can interactively design, define, access and manage a data base right at your desk.

The HP 9800 System 45 version of IMAGE (called IMAGE/45) consists of two

plug-in Read Only Memories (ROMs) for the HP 9800 System 45 Computer. These ROMs contain the HP Enhanced BASIC statements needed to define, manipulate and maintain your data base.

## Reduced programming time

To facilitate "ad hoc" or unanticipated data base inquiries, this package features QUERY/45, a special data base access software pack that reduces programming time and effort by providing highly interactive data base manipulation routines. By simply typing in English-like commands, you can read, enter, delete or modify data—all without writing application programs.

The 9800 System 45 DBMS also includes a helpful Data Base Design Kit that takes you step-by-step from the definition of your data handling problem to the full implementation of a DBM solution. The 9800 System 45 DBMS doesn't just put your data on file . . . it puts it to work!

## Desktop data communication

A new data communications capability for the HP 9800 System 35 and 45 Computers successfully bridges the gap between a small computer work center and a large host mainframe. The 9800 System 35/45 Data Communications package (firmware and software plus a new interface card) is designed specifically for flexibility and ease of use in both asynchronous and synchronous (RJE Bisynchronous) modes.

The asynchronous package, which is particularly attractive in time-sharing applications, features data transmission rates of up to 9600 bits/second, split speed operation, automatic parity checking, automatic modem control, auto answer and full-duplex line management.

The RJE Bisynchronous capability offers IBM 2780-3780 terminal emulation, transparent mode, short record truncation, blank compression, data transfer rates of up to 9600 bits/second and half- or full-duplex line management.

*For complete details on how you can put these new capabilities on your desk (or on your HP 9800 Series Computer), check A on the HP Reply Card.*



**This new Data Base management capability for the 9800/ System 45 means you can have a full-time, workhorse computer and a "brilliant", part-time terminal . . . all in the same instrument.**

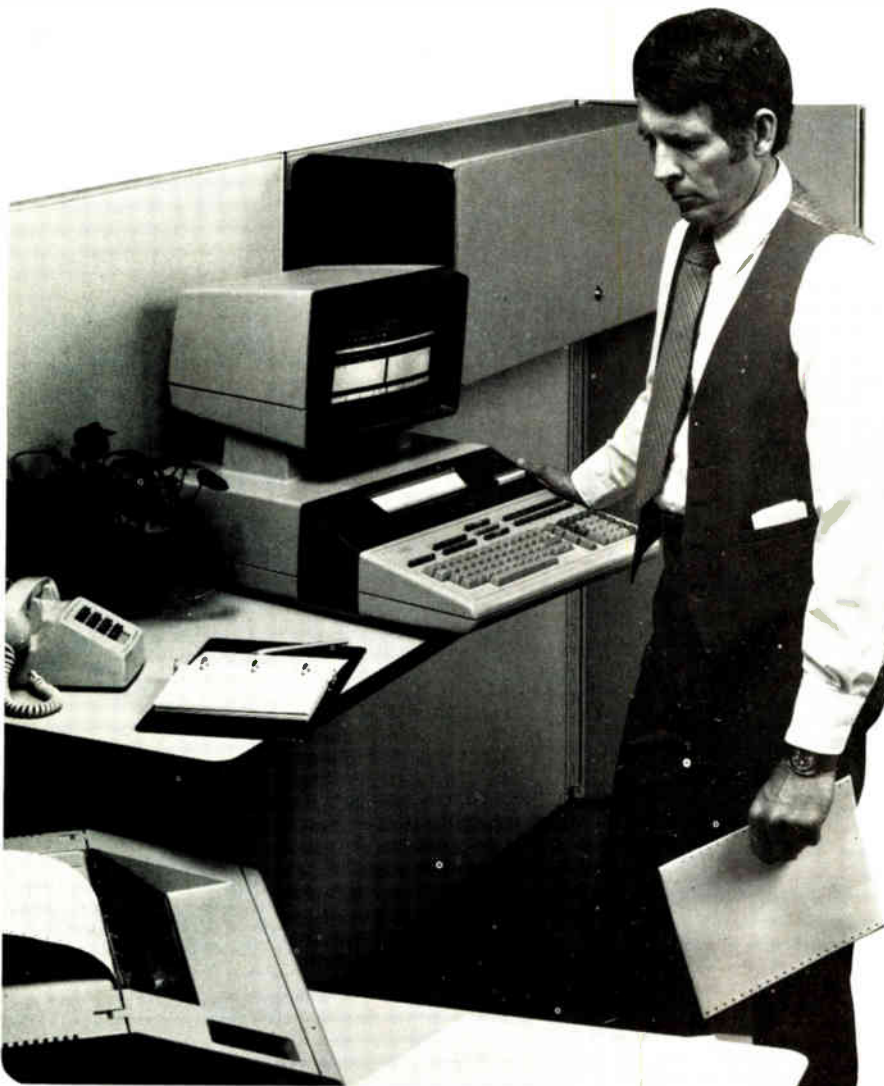

## Get fast solutions to complex graphics computation problems

*(continued from first page)*

enhanced BASIC language, keyboard, mass storage and thermal line printer are all integrated into a single workstation that can help solve your problems in a convenient and uninterrupted fashion.

The 9800/45C brings eye-opening color and clarity to practically any application you choose. Designed primarily for the scientist and engineer, this new system can help create more effective data presentations, increase productivity and solve complex problems. Color can be used for faster data interpretation of mathematical relationships, to provide greater definition of detailed designs or add realism. The viewer will enjoy fast, easy comprehension of displays that, with color, can be more informative and memorable.

In addition to a high quality display with many color combinations, the 9800/45C also features HP Graphics Language which cuts programming time and effort. This built-in firmware provides 70 graphics statements that enable the user to get faster solutions to complex graphics-computation problems. The 9800/45C can provide three-dimensional representations in solid or wire-frame form. Statements such as POLYGON and RECTANGLE automatically draw the geometric figures. FILL parameter allows you to fill the insides of the figures with color without calculating points. This firmware also enables both alphanumeric and graphic rasters to be displayed simultaneously, making the user's graphics computation more convenient and interactive. And statements for use with the built-in light pen allow the user to interactively pick, move and draw directly on the CRT.

With all this built-in performance, the 9800/45C still remains friendly and easy to use. With the flick of a single switch, all the elements of this computer system begin working together to bring you quick solutions to your problems.

For more detailed information on the 9800/45C, call your local HP Sales Office or check **B** on the HP Reply Card.

## Serial data analyzer adds new features for monitoring and simulating data networks

Hewlett-Packard's 1640B Serial Data Analyzer is a tool for troubleshooting data communications networks, through transparent monitoring of RS-232-C (V24) serial lines or simulation of network components. The menu-driven analyzer is programmed for a versatile measurement set and is easy use. New features have been added, based on field experience, extending the applications of the original analyzer and offering even more convenience for the operator. Retrofit field kits are available to add the new features to present 1640A Serial Data Analyzers.

These new features include two branching modes for simulation operation. The 1640A can transmit a first message repeatedly and then automatically send one of the two remaining messages based on a match between the response and the analyzer reply-condition parameters set by the user. The addition of the branching modes provides a much needed simulation capability for effective network testing.

A new memory bit shift can be used to shift either TX or RX data, bit by bit, to check for dropped bits, clock slips, lo-



HP's model 1640B Serial Data Analyzer will help you move quickly from a symptom to the cause in troubleshooting computer networks which use RS-232-C (V24) serial data transmission.

cate unknown sync patterns and similar detailed tests. Also, any selected character in the list display is simultaneously decoded in binary, octal and hexadecimal, a handy prompt when editing text. Clock accuracy for Model 1640B is improved to  $\pm 0.01\%$ .

Check **C** on the HP Reply Card for more technical data.

## RF impedance analyzer measures 14 parameters over 1-1,000 MHz range with basic accuracy of <math><2\%</math>

This new Hewlett-Packard 4191A RF Impedance Analyzer measures 14 impedance parameters over a frequency range of 1 MHz to 1000 MHz with a basic accuracy of less than 2%. An internal frequency synthesizer, automatic calibration, automatic error correction and spe-

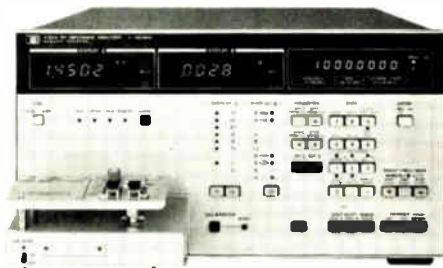

Designed for making high frequency evaluation of electronic materials, components and circuitry, this 4191A RF Impedance Analyzer provides high accuracy with  $4\frac{1}{2}$ -digit resolution.

cially designed test fixtures make stable, accurate impedance measurements possible over a measurement range of 1 m $\Omega$  to 100 k $\Omega$  (1  $\mu$ S to 50S).

In addition, the 4191A features an internal bipolar dc bias source (0 to  $\pm 40$  V), linear and log sweep capability of both frequency and bias, self-test and deviation measurements capability ( $\Delta$ ,  $\Delta\%$ ) on all 14 parameters. These features make the 4191A RF Impedance Analyzer an excellent design and testing tool for high frequency evaluation of electronic materials, components and circuitry. Typical applications include high resolution crystal measurements, low loss measurements of an air capacitor, thin or thick film circuit analysis and PIN diode impedance measurements.

Check **D** on the HP Reply Card for complete information.

# A complete audio measurement system all in one instrument



This new audio analyzer uses an internal microprocessor to control measuring sequences by turning on and off the audio source and by measuring and displaying the result.

A new audio analyzer which makes complicated audio measurements with a single keystroke is available now for audio test and transceiver test applications. HP's 8903A Audio Analyzer achieves this by a low distortion audio source with a highly flexible analyzer in one instrument which can measure DC volts, AC volts, distortion, signal to noise, SINAD, and audio frequency from 20 Hz to 100 kHz.

Using its powerful microprocessor-controller, the 8903A accomplishes tedious routines of complicated quantities like signal/noise. With a single keystroke, it controls and gates the audio source, then measures and computes the ratios of the resulting signals from the transceiver under test.

The audio source section provides 0.6 mV to 6V open circuit from 20 Hz to 100 kHz with frequencies and levels set by keyboard. Log sweeps can be pro-

grammed, as well as frequency increment changes, with single keys. Front panel frequency display resolution is 5 digits, while the amplitude display is 4 digits, giving plenty of resolution whether in linear or dB units.

The 8903A drives an X-Y recorder directly. Y-axis output is scaled to 0-10 V for the units selected by key, and measurements can be in absolute terms or dB and percent relative to a prior measurement or a key-entered number.

## General audio testing

For general audio testing the 8903A can measure frequency response, swept distortion, hum and noise, gain, and power output. For AC level and distortion tests, a true RMS detector provides best accuracy. Distortion measurements can be made to typically less than 0.003% (-90 dB) between 20 Hz and

20 kHz. AC level accuracy is specified at  $\pm 0.5\%$  from 20 Hz to 20 kHz.

In transceiver test applications, the 8903A source can be used to modulate the test transmitter while the demodulated output of the companion 8901A Modulation Analyzer is measured for distortion and frequency response. An internal psophometric filter allows testing to CEPT recommendations. The counter measures squelch tones, while other filtering rejects squelch tones for the audio tests.

Since both SINAD (FM receivers) and signal-to-noise (AM receivers) test sequences involve noisy readouts, special digital smoothing takes place in the microprocessor to prevent "jumpy" displays and to deliver a digital reading that is known to be valid.

The analyzer section accepts signals from 1 mV to 1V at DC and 20 Hz to 100 kHz. In the automatic mode it autotunes to the input signal and autoranges to the distortion or level function range for best accuracy and resolution.

In addition, the 8903A is fully programmable under HP-IB control for use within automatic test systems.

Check **E** on the HP Reply Card for additional information

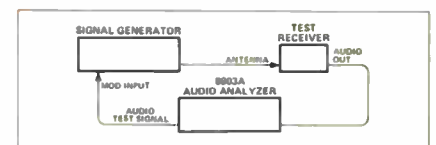

Receiver Testing With the 8903A

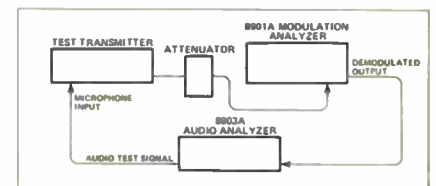

Transmitter Testing With the 8903A

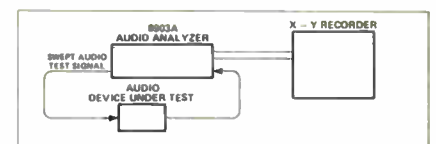

Swept Audio Testing With the 8903A

# Cut the cost of data transmission

The new HP 37230A Short Haul Modem reduces the cost of limited distance data transmission by replacing a conventional modem. However, it retains many of the features of a conventional modem such as automatic equalization and a diagnostic test capability. Providing synchronous transmission of data at rates of 2.4, 4.8, 9.6, and 19.2kb/s, the 37230A is designed for half-duplex, full-duplex, and multi-drop operation over local circuits.

Automatic equalization in the 37230A compensates for variable characteristics of the telephone circuits. This optimizes the performance throughout the specified range and removes the need to perform any adjustments on the modem, thereby simplifying the installation.

Diagnostic test features in the 37230A include local and remote digital loopback, local analog loopback, and a test pattern generator/error detector. These facilities are used for system testing and fault-finding without the need for any other test equipment.

The HP short haul modem is used over unloaded metallic circuits which can be either installed privately or leased from the telephone company. The modem operates half-duplex on 2-wire circuits, and half-duplex, full-duplex, and multi-drop on 4-wire circuits. Suitable circuits can normally be obtained from the telephone company but may be restricted to within one end office (exchange) area. The 37230A complies with the requirements of BSTR Pub 43401 for use on telco-supplied circuits in the USA; and Hewlett-Packard is applying for connection approval in other countries.

For other details, check **F** on the HP Reply Card.



Typically, the operating range of HP's 37230A Short Haul Modem can be from 4 miles over 26 AWG wire at 19.2kb/s up to 22 miles over 19 AWG wire at 2.4kb/s.

# A counter with some new twists



HP's 5315A/B Universal Counters use a microprocessor and a new, HP-developed IC to bring you a remarkable set of measurement capabilities at a surprisingly low price.

At first glance, HP's 5315 Counter may seem like just another very capable universal counter. It measures frequency and period to 100 MHz (1 GHz optional), time interval with resolution of 100 ns single shot or 10 ps averaged, period average, frequency ratio, frequency burst, and totalizing. However, the 5315's circuit innovations and manufacturing design, using a microprocessor and the remarkable HP multiple register counter IC, make possible performance and versatility you'd expect to find only in a much more expensive instrument. For example:

- 7 digits of frequency resolution per second via the reciprocal measurement technique.
- continuously variable gate times.
- dual-mode input conditioning to optimize both frequency and time interval measurement.
- input filter, time interval delay and automatic resolution control for noisy inputs
- very low RFI/EMC for applications absolutely requiring electrical quietness.
- optional, built-in, sealed, lead-acid battery with protective and charging circuits.

Below 10 MHz, the 5315 uses the reciprocal taking frequency measurement technique which measures the input's period, but inverts the result to display frequency. This gives you up to 8 digits resolution for frequencies as low as 0.1 Hz, without using long gate times or phase-locked multipliers. Above 10 MHz, the 5315 automatically switches to the conventional cycle-counting technique, providing you with the highest resolution over the counter's entire range.

For full information, check **G** on the HP Reply Card.

# New structural dynamics analyzer simplifies design of control systems and mechanical components



Optimized for the study of vibration and noise, HP's new 5423A Structural Dynamics Analyzer features broad measurement, post-processing and display capabilities. Easily studied problems include those involving modes of mechanical structure vibrations, control system design, and the monitoring and balancing of rotating machinery. Frequency range is DC to 25 kHz.

For structural analysis, an animated, mode shape display shows structural deformation at each resonant frequency. Display features include perspective, rotation, true three dimensions, selection of viewing direction/distance, "zoom" split-screen viewing and stop-motion.

A powerful waveform calculator enables mathematical computation of many useful functions which cannot be measured directly. For example, with just a few keystrokes it is possible to compute a control system's open loop frequency response from a closed loop measurement, yielding quick information about the system's gain and phase margins. A **Synthesis** key allows the frequency response of trial compensation networks to be calculated and displayed.

Other features include simple keystroke programming via an **Autosequence** capability, easy data annotation, data storage to a built-in digital tape cartridge, and fast plotting to a wide choice of HP-IB compatible digital plotters.

Obtain further information by checking **H** on the HP Reply Card.



Combining simple keyboard operation with extensive measurement and display capabilities, this new HP analyzer makes it easy to identify and solve difficult structural and control system problems.

HP designs a new, non-contact, distance meter for industrial control, tracking and monitoring



The 3850A is designed for industrial applications such as manufacturing processes where accurate and rapid measurement of distance is critical.

A new electronic distance measurement device for measuring and controlling the position of objects in industrial environments is now available from Hewlett-Packard. The 3850A Industrial Distance Meter makes accurate, non-contact distance measurements using an invisible infrared beam transmitted to a target that reflects the beam back to the instrument. By modulating the beam and comparing the phase relationship between returned energy and an internal reference, the 3850A accurately determines the distance between itself and the target. The instrument achieves a resolution of 1 mm (.040 in) over a range of 8 km (26,240 ft) in either manual or computer programmable modes.

Other automatic features include:

- non-contact distance measurement—updating 9 times per second
- determination of the elapsed time between distance measurements—providing velocity and acceleration data
- status information on the measurement system—enabling the user to monitor system conditions.

When coupled to the HP 9800/25S Computer, the system combines data with time information to determine position velocity and acceleration, providing a powerful feedback control system.

Check I on the HP Reply Card for details.

## Hybrid RF designs easy to produce with two new HP transistors

As more RF and microwave systems employ chips and beam leaded devices to achieve better performance, smaller size and lower costs, the need for silicon bipolar transistors with excellent RF performance and device-to-device uniformity has expanded as well.

In merging these objectives with a desire to produce devices which are easier for the hybrid builder to bond into a circuit, Hewlett-Packard has developed two new transistors. The latest additions to HP's HXTR series of devices, the HXTR-3001 and HXTR-3002, provide the VHF, UHF and microwave circuit fabricator with economical silicon bipolar transistor chips, featuring enlarged gold bonding pads. These larger pads readily permit use of 1 mil (25  $\mu$ m) bonding wire, the standard diameter wire in many RF hybrid applications. Suitable for use from 100 MHz to 4 GHz, the general purpose HXTR-3001 offers typical noise figures of 1.2 dB at 500 MHz to 2.2 dB at 2 GHz. Maximum gain at 2 GHz is typically 16 dB and 1 dB gain compression power is 21 dBm at 1 GHz.

The linear power/general purpose HXTR-3002 is an extremely rugged device, typically providing 16.5 dB  $S_{21E}$  gain at 500 MHz, and 22 dBm output power with 18 dB of associated 1 dB compressed gain at 1 GHz.

Available at authorized Hewlett-Packard distributors.

Obtain further details by checking J on the HP Reply Card.

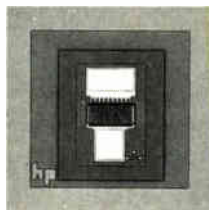

HXTR-3001

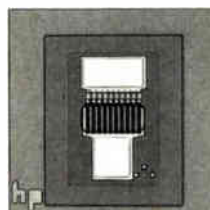

HXTR-3002

## Two new application notes for radio frequency measurements

A new Application Note 286-1, **Applications and Operation of the 8901A Modulation Analyzer**, provides detailed procedures for using the 8901A in transmitter testing, signal generator calibration, broadcast monitoring, measuring VCO differential linearity, measuring residual FM noise of oscillators, separating residual AM or FM, or measuring peak modulation transients from 150 kHz to 1300 MHz.

A second new Application Note 283-2, **External Frequency Doubling of the 8662A Synthesized Signal Generator**, describes performance of the 11721A, 1280-2560 MHz frequency doubler as it affects modulation, distortion, spectral purity, conversion loss, and output dynamic range.

For your free copy of AN 286-1, check K on the HP Reply Card and for AN 283-2, check L.

## HP HFBR-0010 link is now available for only \$275

Now you can purchase HP's 10-metre fiber optic link for only \$275\*, saving you over 50 percent on the regular price.

The HFBR-0010 is a complete 10-metre simplex link consisting of a transmitter, a receiver, a 10-metre connector/cable assembly, and technical literature. Because HP's system is completely plug-together and interchangeable, distances up to 1,000 metres are possible. For systems up to 100 metres, simply change cable assemblies. For longer systems, up to 1,000 metres, substitute HP's new HFBR-1002 1,000-metre transmitter. In either case, no adjustment or calibration is required.

For further details, check M on the HP Reply Card.

\*Offer expires August 31, 1980  
U.S.A. Domestic price





## New 1980 Optoelectronics Designer's Catalog is available



New products described in complete detail in the new 1980 optoelectronics catalog include the digital bar code wand (left), AC/DC threshold sensing and hermetic optocouplers (top right), and 18-segment alphanumeric display microprocessor unit (bottom right).

Intended for use as a source book in design situations, HP's new Optoelectronics Designer's Catalog includes the latest HP optoelectronic application notes, as well as complete technical information about HP's Optoelectronic products.

This 496-page catalog is sub-divided into six categories:

- **Emitters/Detectors**
- **Fiber Optics**
- **Optocouplers**
- **Solid State Lamps**
- **Solid State Displays**
- **High-Reliability Products**

Of special interest to designers will be several new product additions to the catalog. These include HP's first digital bar code wand, a 1000-metre fiber optic link with cable/connector assembly, an AC/DC threshold sensing optocoupler, a new hermetic optocoupler, 5 V and 12 V



color resistor lamps, color light bar modules in single, quad and twin arrangements, and an 18-segment alphanumeric display microprocessor unit. Applications information on all of these products is included in the applications section. Photographs, package dimensions, features, operating characteristics and performance graphs provide a complete description of each component.

Other catalog features include an alphanumeric index which lists all components by part number, an introductory capabilities section on all product lines, and a selection guide for each component group giving a brief overview of the different categories. In addition, a complete listing of all HP sales and service offices and HP components franchised distributors is included.

Obtain your free copy by checking **N** on the HP Reply Card.

## Two new application notes simplify your amplifier designs and ease your hybrid circuit assembly problems

Application Note #973 describes two 12 GHz amplifier designs using the HFET-2201, a one-half micrometer, GaAs, Schottky gate, field-effect transistor. The first design, a low noise amplifier, achieves a noise figure of 3.1 dB at 12 GHz with 7.5 dB of associated gain. The second design, a high gain stage, obtains greater than 11.5 dB of gain also at 12 GHz.

This note also contains a detailed Smith Chart and computer-aided design techniques to optimize performance. Construction details for these amplifiers are also included.

The second Application Note, #974 discusses the techniques for incorporating semiconductor devices into hybrid integrated circuits. In addition to a discussion of die attach and bonding techniques for chips, this note also considers the problems of using beam lead devices, ministrips, leadless inverted devices (LID's), and microstrip posts.

Handling precautions, as well as time, pressure and temperature settings, are presented for each package style. The note concludes with a brief description of an impedance matching technique for a LID mixer diode.

Obtain your free copy of AN #973 by checking **O** on the HP Reply Card and AN #974 by checking **P**.

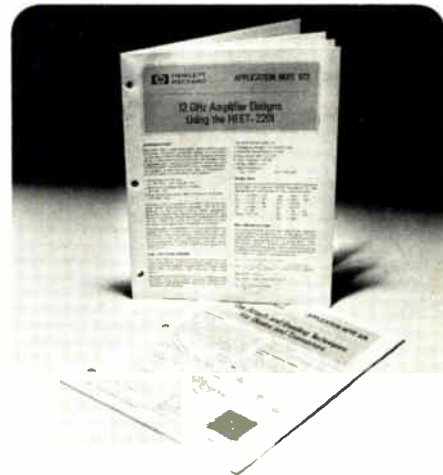

## New counter automates measurements and calculates—all at a surprisingly low cost



Microprocessor-based, the high performance HP 5335A Universal Counter offers more automatic features than any universal counter available today, yet its price is much less than other counters having built-in calculating capabilities. Even its most demanding measurements, many of them new to electronic counters, are initiated at the press of a button.

In addition to very high performance in all the measurements a universal counter usually makes, HP's 5335A automatically performs measurements that require extensive data manipulation: phase, duty cycle, rise and fall times, slew rate and statistics - all via an easy-to-use front panel keyboard. The keyboard also provides for data manipulation. Offset (+, -), scale ( $\times$ ), and normalize ( $\div$ ) data can be quickly entered to modify any measurement. This gives direct readout—up to 12 digits—in engineering terms such as RPM, pressure, flow rate and velocity. Or, it can display or add IF or difference frequencies.

### High-performance frequency and time interval measurements

Despite the automatic measurement emphasis, there is no sacrifice whatsoever in measurement performance. The 5335A is a reciprocal-taking counter providing 9-digits-per-second resolution for all frequency measurements up to 200 MHz (standard) or to 1.3 GHz (optional). Single-shot, time interval resolution is an outstanding 2 ns, while time interval averaging yields a resolution

down to 100 ps when measuring repetitive events.

### New convenience and versatility

- Extensive auto triggering modes let the user set the trigger levels, or setting can be automatic. Exact levels are shown on the counter's LED display.
- External arming and self-arming are provided for dynamic measurements such as tone burst, pulsed RF or swept frequency up to 1.3 GHz, with excellent resolution.
- Statistical data on any of the measurements are automatic after pressing several keys to define sample size and to select mean or standard deviation values.
- Stable readout of an unstable input is provided by pressing the **Smooth** key.

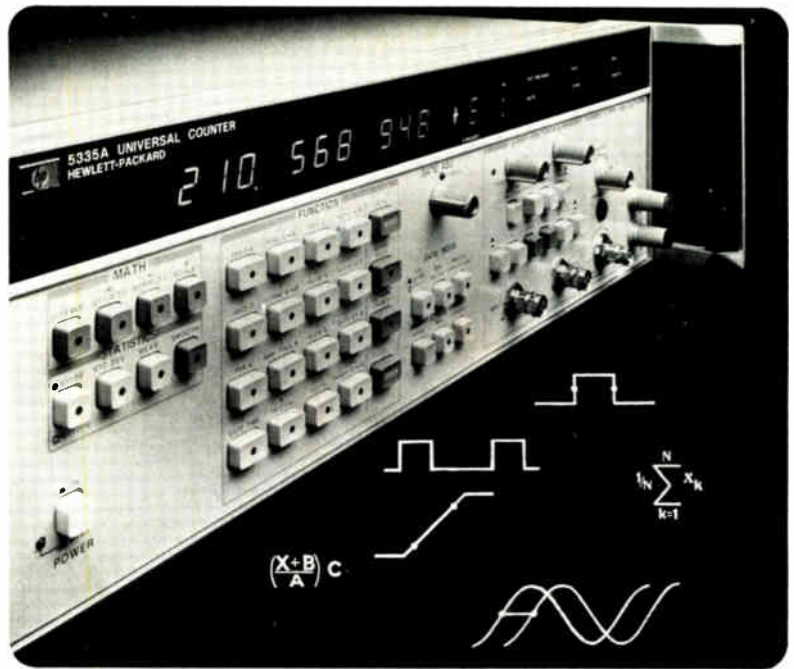

The counter then repetitively calculates and displays a stable weighted average of sequential measurements.

For systems use, extensive HP-IB programmability is standard, and includes all measurement functions, math and statistics.

A built-in  $\pm 1000$  V, autoranging, floating input, integrating DVM is optional. Its infinitely variable integration times can optimize speed, resolution and normal mode noise rejection. HP-IB programmable, of course.

Get full details by checking **Q** on the HP Reply Card.

East-4 Choke Cherry Road, Rockville, MD 20850.  
Ph. (301) 258-2000  
South-P.O. Box 10505, 450 Interstate North Pkwy.,  
Atlanta, GA 30348, Ph. (404) 434-4000.  
Midwest-5201 Tollview Dr., Rolling Meadows, IL 60008,  
Ph. (312) 255-9800.  
West-3939 Lankershim Blvd., North Hollywood, CA  
91604, Ph. (213) 877-1282.  
Europe-Central Mailing Depot., P.O. Box 529,  
Amstelveen-1134, Netherlands,  
Ph. (020) 47 20 21.  
Japan-Yokogawa-Hewlett-Packard Ltd., Ohashi  
29-21 Takaido-Higashi 3-chome  
Suginami-ku, Tokyo 168, Ph. 03-331-6111.

**hp** MEASUREMENT NEWS  
COMPUTATION  
product advances from Hewlett-Packard

May/June 1980

New product information from

**HEWLETT-PACKARD**

Editor:  
**Bojana Fazarinc**

Editorial Offices:  
1507 Page Mill Road  
Palo Alto, California, 94304 U.S.A.

**hp** HEWLETT  
PACKARD

# THE ONLY PROGRAMMABLE FUNCTION GENERATOR THAT REALLY LEARNS

## We call it The Teacher's Pet.

Intelligence... it distinguishes Krohn-Hite's new Model 5900 micro-processor-based programmable function generator from the other instruments in its class — that's why we call it The Teacher's Pet.

The Auto-programmer and Storage Registers give the 5900 autonomy. With or without a system controller, it can learn and execute entire routines (over 300 program steps), freeing your controller for other ATE tasks. Nine Storage Registers hold generator parameters, and a key-stroke command, or an order from the system controller, retrieves the information rapidly.

The Teacher's Pet earns a gold star in arithmetic and in auto increment and decrement functions. It provides precise linear sweeps over a 10,000:1 range, log sweeps over the entire instrument range, and nested loops which can intermix log and lin-

ear sweeps; it can operate on frequency, period, pulse widths, duty cycle, amplitude, DC offset, and burst cycle count. Over the frequency range of 100 $\mu$ Hz to 5MHz, the 5900 produces sine, square, triangle, pulse, and sawtooth waveforms. Modes include continuous, gated, triggered, digital lin/log sweep, and triggered burst.

You be the teacher. Call 617-580-1660 for a free demonstration of the 5900. Try your program on the 5900 and experience the only function generator that REALLY LEARNS. You'll agree The Teacher's Pet is the smartest one on the GPIB bus.

**Krohn-Hite... Benchmark of Value in Programmable Function Generators**

**KH KROHN-HITE CORPORATION**

Avon Industrial Park . Avon, MA 02322  
(617) 580-1660 TWX 710 345 0831



© Krohn-Hite Corp. 1980

Circle 27 on reader service card

AL, Huntsville (205)534-9771; AZ, Phoenix (602)279-1531; CA, Inglewood (213)874-6850, San Jose (408)292-3220; CO, Denver (303)773-1218; CT, Canton Center (203)693-0719; FL, Orlando (305)859-7450, Sunrise (305)742-2115; GA, Atlanta (404)555-1206; HI, Honolulu (808)941-1574; IL, Chicago (312)283-0713; IN, Carmel (317)844-0114; KS, Overland Park (913)849-6996; LA, Gretna (504)387-3975; MD, Towson (301)321-1411; MA, Chelmsford (617)256-9061; MI, Detroit (313)961-3042; MN, Minneapolis (612)835-4818; MO, St. Louis (314)569-1408; NM, Albuquerque (505)255-2330; NJ, Cherry Hill (609)482-0059, Englewood (201)871-3916; NY, Rochester (716)473-5720, Saratoga Springs (518)584-8519, Syracuse (315)437-6666; NC, Burlington (919)227-3839; OH, Chesterland (216)729-2222, Dayton (513)294-2478; OK, Jenks (918)299-2636; OR, Portland (503)297-2248; PA, Pittsburgh (412)261-2604; SC, Greenville (803)271-8543; TX, Dallas (214)661-0400, Houston (713)688-1431; UT, Salt Lake City (801)466-8729; VA, Falls Church (703)573-8787; WA, Bellevue (206)454-3400; WI, Milwaukee (414)545-8400; CANADA, Montreal, Quebec (514)744-5829, Ottawa, Ontario (613)725-1931, Toronto, Ontario (416)625-0800, Calgary, Alberta (403)276-7567.

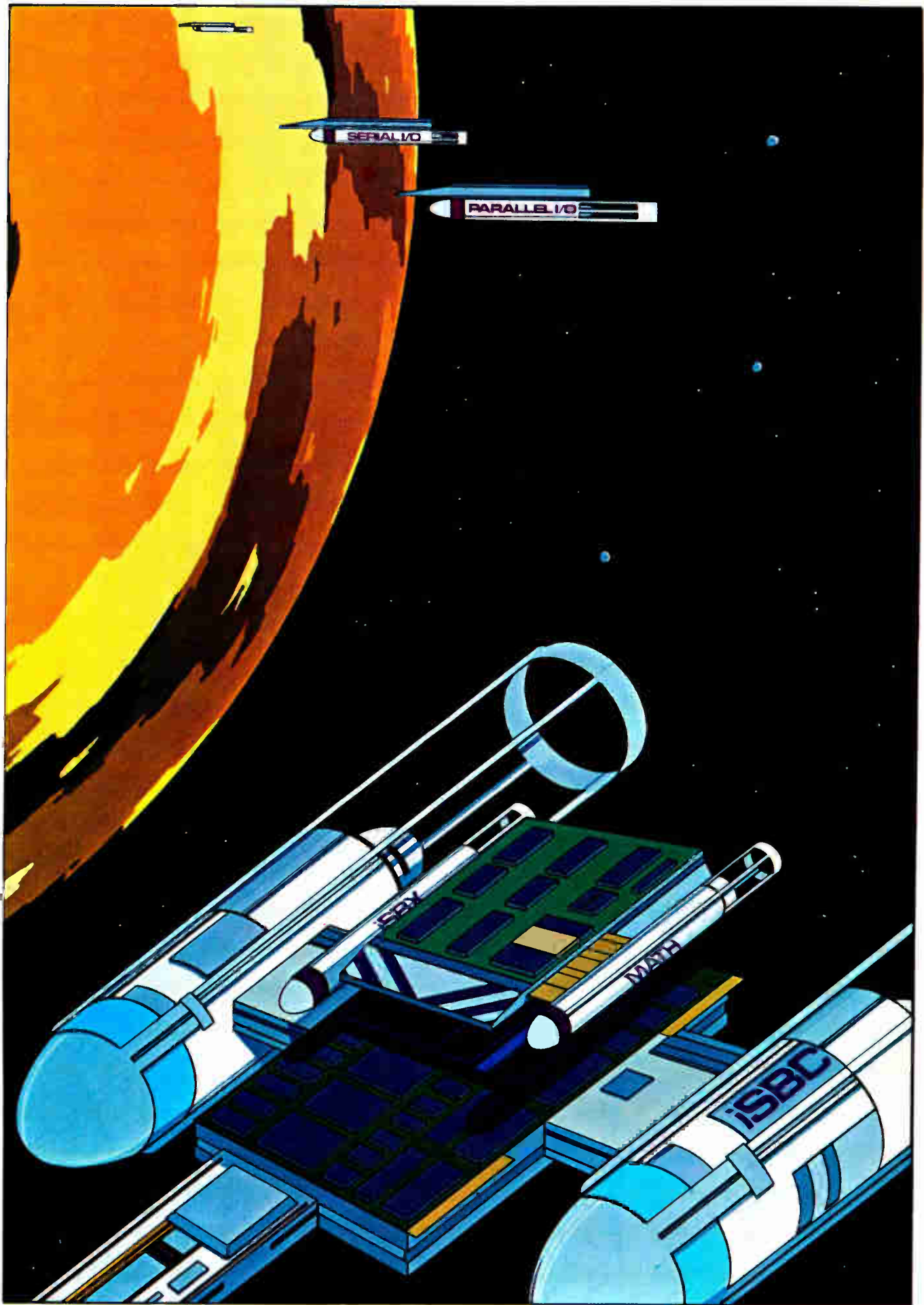

# One Step Beyond the iSBC™ System

## Introducing iSBX™ Multimodule™ boards. A whole new dimension in configuring single board computers.

Intel pioneered the concept of flexible microcomputer system design in 1976. That's when we began introducing iSBC™ systems, a family of single board computers. These are expandable via the Multibus™ interface, presently accepted as the industry standard for micro-computers.

Now Intel has extended this well-accepted concept to board-level design—with Multimodule™ boards and the iSBX™ bus. With this new line of plug-in modules, you can now expand iSBC systems simply and efficiently at the board level. Without making any demands on the system structure. And all at much lower cost than was previously possible.

Multimodules let you add special performance features today to your iSBC host board—features like high-speed math functions. And serial or parallel I/O. Soon you'll also be able to add Multimodules for D-to-A and A-to-D conversion, communications, and peripheral interfaces—and more. With these modules, you'll be able to precisely tailor hardware configurations to your application, and cut down critical development time.

### The iSBX™ launch pad

The key to Multimodule flexibility is the iSBX bus—the first physical/electrical interface for direct on-board expansion of iSBC systems. Available on all future Intel single board computers, the iSBX bus assures you of compatibility between iSBCs and the emerging Multimodule product line.

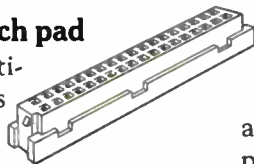

### Two new iSBC™ command modules

Intel's new 8-bit iSBC 80/10B™ and iSBC 80/24™ single board computers are just the first of many iSBCs to offer iSBX Multimodule expansion capabilities. Both are improved, iSBX-compatible versions of popular single board computers.

### Backed by life-support equipment

To support your implementation efforts, Intel provides an extensive set of hardware development tools. Such as the Intellec® system, with ICE™ in-circuit emulation. Or

You can also count on improved system performance. Since Multimodules tie directly into the iSBC's internal bus, you get faster, more efficient memory access and I/O operation than is possible with full expansion boards.

For those who want to explore their own expansion module designs, Intel also offers iSBX 960-5™ connectors. These let you create custom Multimodule boards to meet your own unique requirements.



high-level programming languages like PL/M, BASIC, and FORTRAN. And the RMX/80™ real-time software.

### A small step for microcomputers

Intel's new iSBX bus and family of Multimodules represent a small step for incremental design of micros. But a giant step toward making you and your iSBC system more productive. Available from Intel today are the first three Multimodules, and our two iSBX-compatible single board computers. The next step is up to you.

For more information, or to order, return this coupon or call your local Intel sales office/distributor. Or contact Intel Corporation, 3065 Bowers Avenue, Santa Clara, CA 95051. Telephone (408) 987-8080.

## intel® delivers solutions.

Europe: Intel International, Brussels, Belgium.  
Japan: Intel Japan, Tokyo. United States and Canadian distributors: Alliance, Almac/Siroum, Arrow Electronics, Avnet Electronics, Component Specialties, Hamilton/Avnet, Hamilton/Electro Sales, Harvey, Industrial Components, Pioneer, L.A. Varah, Wyle Distribution Group, Zentratics.

Please send information on: ELEX

- iSBX Multimodule package
- Configuration Guide
- Other \_\_\_\_\_
- Please have a Sales Representative call.

Name \_\_\_\_\_

Title/Organization \_\_\_\_\_

Address \_\_\_\_\_

City/State/Zip \_\_\_\_\_

Phone \_\_\_\_\_

Mail to: Intel Corporation, 3065 Bowers Ave., Santa Clara, CA 95051.

## Semiconductor quality: the issues and answers

U. S. versus Japanese semiconductor device quality continues to be an issue in the battle for world semiconductor markets, and the attention being paid it is understandable, in view of what's at stake in this high-risk, capital-intensive industry.

Let's take a closer look at the reports, comments, and opinion extant about this controversy:

- Several major users of 16-K dynamic random-access memories have reported the incoming inspection failure rate of U. S. devices has been significantly higher than that of Japanese devices. This echoes the earlier experience of these firms with 4-K RAMs. However, it should be stressed that similar results have not been reported for any other category of semiconductor products.
- On the question of U. S. versus Japanese reliability, the data is somewhat inconsistent. For example, one large user has reported the field failure rate based on operating-life testing was much lower for Japanese RAMs than for U. S. devices. Another reports that soft-error field failures were comparable for devices from both sources, while the rate of hard-data errors was higher for U. S. devices.
- All the users who have turned to Japanese sources cite—in addition to top quality—excellent service, on-time delivery, and competitive pricing. Many say they plan to increase their orders in the future, despite their preference for dealing with U. S. vendors. Some industry observers see in all this a serious threat to U. S. leadership in semiconductor technology, which, if unanswered, could have dire consequences.

U. S. semiconductor executives have offered these reasons for the apparent differences in quality and the way to solve the problem:

- The Japanese have not paid their dues in innovation. Whereas U. S. firms pioneered all the great advances in semiconductor technology, the Japanese came in late on the

learning curve, concentrating on refinements of U. S. developments and turning out products discerned as being in short supply—in effect riding on the back of U. S. investment.

- The Japanese semiconductor industry is not constrained by the same rules that govern a free-enterprise system. All the companies are vertically integrated and show profit margins that by American standards are laughable, due in part to the high debt-to-equity ratio under which they are capitalized. Thus they can invest in automation and other quality controls more than the U. S. firms, which must satisfy stockholders.

- The Japanese government encourages and advances industry progress through tax incentives, direct aid, and protective trade policies. The U. S., on the other hand, deters R&D investment, hinders capital formation, and blocks advances by excessive regulation.

We agree that the U. S. government does not fully appreciate the importance of the semiconductor industry, and its current policies are unenlightened and harmful. We strongly endorse the calls being made by the industry for changes that will free up capital to meet the R&D and plant-capacity requirements of the industry. We, too, would like to see a national industrial policy that promotes, rather than stifles, technological innovation by encouraging investment.

But we also believe the industry cannot delay in addressing the quality problem. It cannot use as a defense business practices in Japan over which it has no control, nor can it afford to wait for Washington to respond.

The U. S. semiconductor industry will put to rest the quality issue because it must. The customers are demanding it, and responding to customer needs is what has made it the greatest growth industry in history. We should be grateful to the Japanese for reminding us of this and for elevating the parameter of quality to the primacy it has always deserved.

# 6 NEW AND BETTER WAYS TO BETTER EQUIPMENT DESIGN!

Better answers for better performance.

**A. New High Voltage, Fast Recovery Rectifiers** for use in "diode-split" transformers, "multiplier" and "half-wave" extra high voltage power supplies for TV, microwave ovens, CRT displays, photocopiers, etc. Voltages from 3kV to 18kV with a current rating of 20mA.

Circle 240 on reader service card

**B. New 50 Amp/450 Volt Bipolar NPN Power Transistors** feature fall times of 200 nanoseconds when switching 50 Amp loads. The extremely fast switching times make the HPT 545 Series applicable to switching regulators and high power inverters for UPS systems and AC motor controllers, where several smaller, paralleled devices may be replaced by a single HPT 545.

Circle 241 on reader service card

**C. New low-cost, triple diffused IR 13006 and IR 13007 Power Transistors** solve size and cost problems related to small EDP switching power supplies for data terminals, word processors and copiers. Rated at 8 Amps, 300 or 400 volts, these TO-220AB packaged devices are electrically equivalent and cost competitive with the established Motorola MJE13006/MJE13007

Circle 242 on reader service card

**D. New IR6543-5-7 "SUPERSPEC" TO-3 Power Transistors** feature improved turn-off switching times and saturation voltage ratings over JEDEC 2N6543-5-7 devices to optimize switching power supply performance. For example, rise time is 0.6  $\mu$ s vs. 0.7 to 1.0  $\mu$ s for JEDEC types, and fall time is only 0.2  $\mu$ s vs. the JEDEC 0.4  $\mu$ s. Saturation voltage is 0.75V vs. 1.0V to 1.5V for JEDECs. Other SUPERSPEC types with superior switching times include the IR6582 and IR6583, improved versions of the 2N6582-2N6583.

Circle 243 on reader service card

**E. Molded Diode Bridges** rated from 1 to 100 Amps include 1 to 3 Amp bridges in three case styles for PC board mounting, U.L. recognized, isolated base "JB" units rated from 10 to 25 Amps with surge ratings up to 300 Amps, and "HB" models for applications in the 80 and 100 Amp range. Send for detailed Selection Guide and Cross Reference to other industry types.

Circle 244 on reader service card

## F. Standard Rectifier Assemblies

available off-the-shelf include single and three phase types rated from 15 to 1500 Amps, 400 thru 1200 volts. 85 models. Cost-effective candidates for "make or buy" decisions. Send for Data Sheet PD-7.003 for complete information.

Circle 245 on reader service card

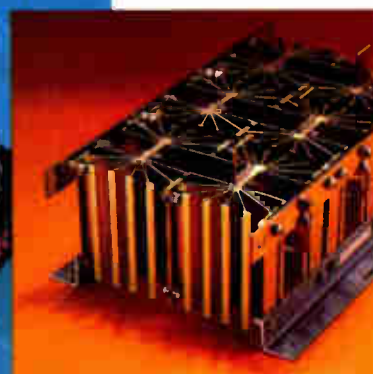

Contact the IR Sales Office or Rep in your area for application assistance. For price and delivery information, contact an IR Distributor near you.

# INTERNATIONAL RECTIFIER

WORLD HEADQUARTERS: 230 BANSBURY ST., EL SEGUNDO, CA 90245, U.S.A. PHONE: (213) 772-2000 TELE: 86-4464  
 EUROPEAN HEADQUARTERS: HURST GREEN, OXFORD, ENGLAND. PHONE: 4431 3915 TELE: 92319  
 Manufacturing Subsidiaries, Sales Offices, Representatives, Agents and Distributors Throughout the World



The **VERSATILE**  
S-100 Analog I/O  
A/D - D/A

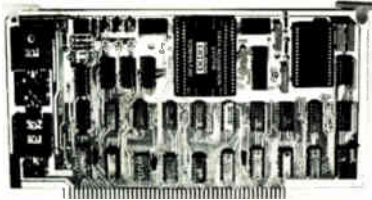

High quality commercial grade S-100 bus compatible systems are designed for industrial and laboratory use.

**A/D SYSTEM**

12 Bit A/D with 16 channel single-ended or 8 channel differential, sample and hold amplifier and programmable gain instrumentation amplifier ( $\pm 5$  mv to  $\pm 5$ v input range FS). 8080 and Z80 interrupts. Selectable input ranges and output configurations. System thru-put rate up to 25 kHz.

**D/A SYSTEM**

2 and 4 channel D/A modules, 12 bit, 1/2 LSB accuracy. Output ranges:  $\pm 5$ v,  $\pm 10$ v,  $+10$ v,  $-10$ v. Plug in output op-amps. Typical conversion speed is 3 microseconds.

A/D's from \$575  
D/A's from \$395



**CALIFORNIA DATA CORPORATION**  
3475 Old Conejo Road, Suite C10  
Newbury Park, California 91320  
(805) 498-3651

Circle 32 on reader service card

# MOVING?

Please give us 4 weeks advance notice. Attach the label for your old address, write in your new address below, and send to Fulfillment Manager, Electronics, P.O. Box 430, Hightstown, N.J. 08520.

**OLD  
ADDRESS  
LABEL**

**NEW ADDRESS**

Name \_\_\_\_\_  
Address \_\_\_\_\_  
City \_\_\_\_\_  
State/Province \_\_\_\_\_  
Zip/Postcode \_\_\_\_\_  
Country \_\_\_\_\_

## Meetings

**17th Design Automation Conference**, IEEE Computer Society *et al.*, Radisson Hotel Downtown, Minneapolis, June 23-25.

**38th Annual Device Research Conference**, IEEE *et al.*, Cornell University, Ithaca, N. Y., June 23-25.

**11th International Quantum Electronics Conference 1980**, IEEE *et al.*, Sheraton-Boston Hotel, Boston, June 23-26.

**Conference on Precision Electromagnetic Measurements—CPEM 1980**, IEEE and Physikalische-Technische Bundesanstalt, Stadthalle, Braunschweig, West Germany, June 23-27.

**IBI World Conference on Transborder Data Flow Policies**, Intergovernmental Bureau for Informatics (P. O. Box 10253, 00144 Rome, Italy), Auditorium della Tecnica, EUR, Rome, June 23-27.

**34th Annual Convention**, Armed Forces Communications and Electronics Association (5205 Leesburg Pike, Suite 300, Falls Church, Va. 22041), Sheraton-Washington Hotel, Washington, D. C., June 24-26.

**Electronic Materials Conference '80**, Metallurgical Society of TMS-AIME (Box 430, 420 Commonwealth Dr., Warrendale, Pa. 15086), Cornell University, Ithaca, N. Y., June 24-27.

**Third International Conference on Hot Carriers in Semiconductors**, Université des Sciences et Techniques du Languedoc (Centre d'Etudes d'Electronique des Solides, 34060 Montpellier, France), Montpellier, July 7-10.

**Siggraph '80—Seventh Annual Conference on Computer Graphics and Interactive Techniques**, Association for Computing Machinery (Siggraph '80, P. O. Box 88203, Seattle, Wash. 98188), Olympic and Park Hilton Hotels, Seattle, July 14-18.

**Annual Conference on Nuclear and**

**Space Radiation Effects**, IEEE *et al.*, Cornell University, Ithaca, N. Y., July 15-18.

**Electromagnetic Interference Metrology Seminar**, National Bureau of Standards (M. Gerald Arthur, EMI/Radiation Hazards Group, Electromagnetic Fields Division, NBS, Boulder, Colo. 80303), NBS, Gaithersburg, Md., July 22-24.

**Second Telecommunications Conference**, IEEE (Umid Nejib, Engineering Dept., Wilkes College, Wilkes-Barre, Pa. 18766), Best Western Motel, Wilkes-Barre, July 28-31.

**SPIE's 24th International Symposium and Instrument Display**, Society of Photo-Optical Instrumentation Engineers (Box 10, Bellingham, Wash. 98225), Town and Country Hotel, San Diego, Calif. July 28-Aug. 1.

**23rd Midwest Symposium on Circuits and Systems**, University of Toledo (A. R. Thorbjornsen, Electrical Engineering Dept., Univ. of Toledo, Toledo, Ohio 43606), Toledo, Aug. 4-5.

**Fifth Annual Conference on Innovation and Regulatory Issues and Technical Seminar on Solar Energy and Energy Conservation**, National Bureau of Standards (Sandra A. Berry, B-226, Building Technology, NBS, Washington, D. C. 20234), Plaza Cosmopolitan Hotel, Denver, Colo. Aug. 6.

**1980 Joint Automatic Control Conference IEEE, et al.**, Sheraton-Palace Hotel, San Francisco, Aug. 12-15.

**Electronics/China 80**, U.S.-China Trade Consultants Inc. (Clapp & Poliak Inc., Box 277, Princeton Junction, N. J. 08550), Canton, China, Aug. 14-24.

**First Annual Hewlett-Packard 100 International Users Group Conference** (Glen A. Mortensen, Intermountain Technologies Inc., P. O. Box 1604, Idaho Falls, Idaho 83401), San Jose Hyatt House, San Jose, Calif. Aug. 25-27.



# Now you can get 3870 momentum with a serial I/O port.

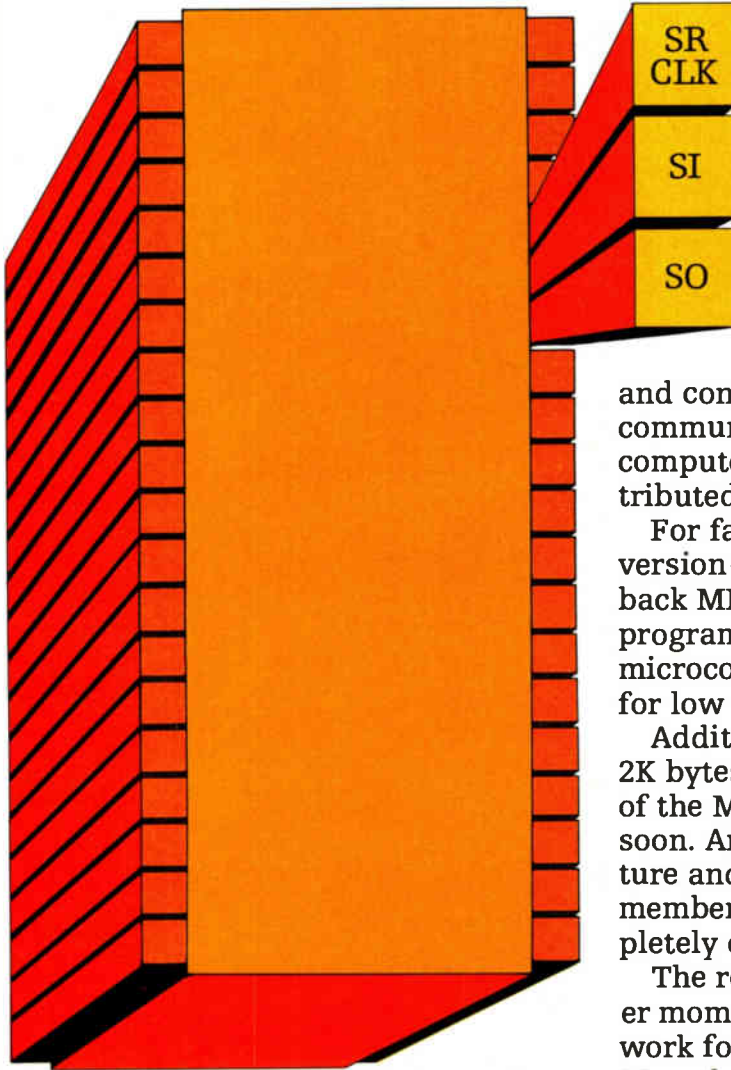

For single chip applications, no other microcomputer family offers you more design momentum than the Mostek 3870. Now there's even more flexibility with the serial I/O port on our new MK3873 microcomputer.

The MK3873 is a 3870 single chip microcomputer with three I/O pins dedicated as Serial In, Serial Out and Serial Clock. Another 29 pins are available for user-defined parallel I/O.

The MK3873 hardware serial I/O port handles either synchronous or asynchronous data transfers. Uses an internal baud rate generator or an external clock for asynchronous data rates up to 9600 baud. And has eight programmable word lengths from 4 to 16 bits to let you define the optimum communications format for your application.

All of these features make the MK3873 ideal for remote data acquisition and control. By using the serial port to provide communications between multiple MK3873 microcomputers in a single system, you can have distributed processing at the microcomputer level.

For fast prototype development, a P-PROM version — MK38P73 — is available with a piggyback MK2716 EPROM to field test and change programs prior to ordering masked-ROM MK3873 microcomputers. The MK38P73 is also excellent for low volume production applications.

Additional memory options beyond the current 2K bytes of ROM and 64 bytes of scratchpad RAM of the MK3873 microcomputer will be available soon. And since it has the same familiar architecture and instruction set as the other 3870 family members, the MK3873 microcomputer is completely compatible with all of them.

The result is microcomputer momentum. Put it to work for you. Write Mostek, 1215 West Crosby Road, Carrollton, Texas 75006. Or call 214-323-6000. In Europe, contact Mostek Brussels, phone 660.69.24.

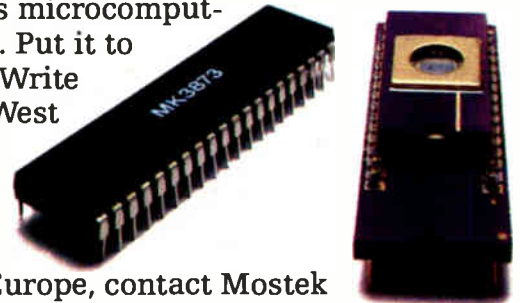

## MOSTEK.

Circle 33 on reader service card

# Ohio Scientific: The leader in Winchester based micro- computers.

Ohio Scientific produced the first Winchester based microcomputer in 1977. Since then, we have shipped more of these systems than the rest of the industry combined. Among them are our C3-B and our C3-C microcomputers.

## **The C3-C. 23 Megabytes. Under \$10,000.**

The C3-C computer has been designed and engineered to fill the void that existed between floppy disk systems and larger hard disk systems.

In its normal configuration, the C3-C includes the Challenger III processors, 52K RAM, the 23 Megabyte Winchester drive and dual floppy drives for file system back up. And the cost is less than \$10,000.

The CPU employs three microprocessors, the 6502, the Z-80 and the 6800. And the processor bus has been designed so new, more powerful micros (like 16 bit CPU's) can be added to the system later on.

There are also 10 open slots in the basic C3-C. The system supports up to 768K bytes of memory, in a multi user configuration.

## **The C3-B. 74 Megabytes. Under \$13,000.**

For those who require even more hard disk storage, Ohio Scientific offers another microcomputer in the C3



Series, the C3-B. Its specifications are the same as those of the C3-C. However, the C3-B offers a 74 Megabyte Winchester drive.

For those who do not need hard disk capacity now, but in all probability will need it in the future, Ohio Scientific offers the C3-A. It is like the C3-B and the C3-C in all respects but two. 48K RAM is standard in the C3-A, and it offers 12 open slots. When more storage is needed, the C3-A is easily expandable to either a 23 Megabyte or 74 Megabyte hard disk system. The C3-A is priced at less than \$6,000.

**For literature and the name of your local dealer, CALL 1-800-321-6850 TOLL FREE.**

**OHIO SCIENTIFIC**  
1333 SOUTH CHILLICOTHE ROAD  
AURORA, OH 44202 • [216] 831-5600

## **Disk that stores 2.5 billion bytes announced by IBM**

Taking a giant step forward in increasing the state of the disk drive art, IBM Corp. has announced its 3380 disk drive that stores 1.26 billion bytes on each of its two spindles for a total of 2.52 billion, almost four times more than the 3350. Its transfer rate of 3 megabytes per second makes it 2.5 times faster than the 3350, and with purchase prices starting at \$97,650, its storage costs roughly half of what it did on the older units. In addition, the company unveiled an 819-megabyte model 3375 that costs roughly 20% less than the 3370. At the same time, IBM doubled the addressing capability of its top-of-the-line 3033 processor to 32 megabytes—an action that may signal a delay in the introduction of the new high-end H series machines expected for later this year or early next year.

## **'Super capacitor' from Nippon achieves 1 F at 5 V**

Just a decade ago, a 1-F capacitor was unimaginable: it would have occupied an entire room. Now engineers at Nippon Electric Co. Ltd. in Tokyo have managed to achieve 1 F of electrolytic capacitance (at 5 V) in a package just 17.5 mm high and 44.5 mm in diameter. Dubbed Super Capacitor, it is available in several values from 0.047 F to 1 F, in 5-V and 10-V versions, **some 10 to 25 times smaller than conventional aluminum electrolytic capacitors.** NEC is targeting the devices to replace nickel-cadmium batteries in programmable timer and control circuits and in power-backup applications for volatile memory circuits.

## **Harris to build C-MOS version of Intel's 8086**

By 1982 the Melbourne, Fla., Semiconductor division of Harris Corp. will become an alternate supplier of Intel's 8086 16-bit microprocessor. **But Harris is going to use complementary-MOS technology for its version,** which will consume 1,000 times less power. Using an oxide-isolated double-polysilicon C-MOS process—much like National's but with 2.5- to 3.75- $\mu\text{m}$  feature sizes—Harris is shooting for a die size of 55,000 mil<sup>2</sup> and an instruction cycle time of 500 ns. Also planned is a C-MOS version of the 8748 single-chip microcomputer. Meanwhile, Mitel Semiconductor Ltd. of Ottawa, Canada, is said to be working on a C-MOS version of Motorola's 68000.

## **AMD unveils array of chips for telecommunications**

Aiming to become a major supplier of ICs to the telecommunications industry worldwide, Advanced Micro Devices Inc., Sunnyvale, Calif., has in design several key chips that are expected to surface in 1981. Among major entries will be: an Am7950 SLIC (subscriber-loop interface circuit); the Am7901 subscriber-loop audio-processing circuit, a codec with on-chip filters; and the Am7910, a single-chip frequency-shift keying modem.

## **GenRad STI to show first system**

Look for GenRad Semiconductor Test Inc. to introduce its first product at the Nov. 11-13 IEEE automated test conference, which moves from Cherry Hill, N. J., to Philadelphia this year. The Santa Clara, Calif., company—formed early this year by GenRad and an entrepreneurial group headed by Brian Sear—will unveil a **high-speed, general-purpose test system for very large-scale ICs that is compatible with the recently announced GRnet** [*Electronics*, June 5, p. 169] and modularly modifiable for particular applications. Deliveries are to begin early in 1981.

# Electronics newsletter

---

## **Intersil readles 450-V power MOS FETs**

While several manufacturers offer high-voltage power MOS field-effect transistors specified at 400 v breakdown, Intersil Inc. of Cupertino, Calif., is about ready to unveil a new family of power MOS FETs with a guaranteed breakdown rating of no less than 450 v. That means the Intersil parts will be the first capable of operating directly from 120-v ac lines and staying within industry-accepted safety margins.

## **Is Memorex layoff of 220 employees only the beginning?**

Industry sources believe that this month's layoff of 220 employees at Memorex Corp. in Santa Clara, Calif., is just a forerunner of the big one to come. The cut was implemented primarily among middle- and lower-level administrative personnel at Santa Clara, where about 5,500, half the company's employees, worked.

Regarding future layoffs, a spokesman says that Memorex has "begun to implement cost-reduction programs. The company, however, has no position regarding future layoffs." One former Memorex executive says, "When I was there, the number I heard was 1,000." A second, independent source currently connected with the company indicates that the cuts may total 1,500 in the near future.

## **Zenith, MIT collaborate on personal computer**

Zenith Data Systems Corp. has delivered to the Massachusetts Institute of Technology preproduction engineering prototypes of what may be the most sophisticated single-user computer yet. Designed at MIT's Laboratory for Computer Science in Cambridge, the system, called  $\nu$ , uses a 64-bit-wide, multiplexed bus with 32 address and 32 data bits. The machine accommodates up to 8 megabytes of 64-K MOS random-access main memory, and 20 megabytes of disk storage. Its display has 800 by 1,000 picture elements and can handle both text and graphics. Finally,  $\nu$  includes a network communications interface that can process 5 to 10 Mb/s for distributed applications. Initial production prototypes should be available in late 1980 or early 1981 for \$25,000 to \$50,000.

## **Addenda**

Adding a new dimension to switching power supplies, Hewlett-Packard Co.'s New Jersey division will soon announce a series of suppliers using power MOS FET technology. One, a modular, 200-kHz 50-w switching unit, meets strict international VDE requirements while another, an auto-ranging laboratory supply, can also be used in systems test and analysis applications. . . . As expected [*Electronics*, Feb. 28, p. 33], Texas Instruments Inc.'s list of products to be announced at the Consumer Electronics Show included two new solid-state talking learning aids—the Speak & Math and Speak & Read. They are priced at \$85 and \$95, respectively. . . . Mostek Corp. of Carrollton, Texas, which has decided not to build a high-speed 2148-type MOS static random-access memory, will go ahead with plans to begin third-quarter production shipments of a 2147 device, which is a 4-K-by-1-bit predecessor of the 2148. . . . Motorola Inc.'s bipolar IC division in Mesa, Ariz., is developing a new high-performance family of 10,000-gate emitter-coupled logic called MECL 10KH. It will be twice as fast as the MECL 10K. . . . Magnuson Computer Systems Inc. of San Jose, Calif., is coming out with the first response from an IBM-plug-compatible competitor to the IBM 4331 Group 2 mainframes. Magnuson's entry, the M80/31, claims 20% more computing power.

---

# SO YOU NEED ROMs. WHY STAND IN LINE AT THE SUPERMARKET?

---

No need to wait  
for the big semi-  
conductor com-

panies to schedule your ROM production among their RAMs and EPROMs and Microprocessors.

Come to Electronic Arrays, with an N-channel silicon gate fabrication facility 100% dedicated to ROMs. With sort and final test 100% dedicated to ROMs. With in-house ROM program verification and in-house mask making for fast-turn tooling . . . 100% dedicated to ROMs!

Face it. When you specialize in one thing, you get very good at it. And very fast. At EA, we think, live and breathe 8K, 16K and 32K ROMs. Electronic Arrays, 550 East Middlefield Rd., Mountain View, CA 94043. (415) 964-4321; Philadelphia (215) 643-1447; Chicago (312) 858-8508.

---

## ELECTRONIC ARRAYS.

---

---

## THE HOUSE OF ROMs.

---





**Thyratron**—A hot cathode gas tube in which a control electrode initiates the anode current but won't limit it. Used as an electronic switch in early control circuits. Replaced by thyristors.



**American eagle**—The eagle narrowly defeated the turkey as America's national symbol. Although fabled to carry off children and lambs, eagles cannot lift more than seven or eight pounds. Comprehensive federal protection didn't begin until 1952, after the species was threatened by egg collectors, hunters and sterilization by DDT.

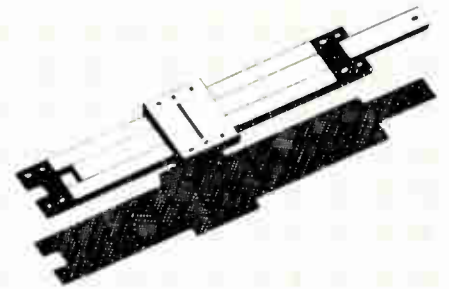

**Slide Rule**—An analog calculator based on the logarithm. Developed in 1630 and perfected by a French army officer in 1850. Used to multiply, divide, calculate squares, cubes, square roots, trig functions, etc. Virtually disappeared after the appearance of the inexpensive electronic calculator.



**Thermionic valve** — Early vacuum tube designed to control the emission of electrons and ions (called thermions) from heated substances. Principle discovered by Edison while working on the light bulb. Basis of many electron tubes. Outmoded by the semiconductor.



**Whale**—Huge mammals which reversed evolutionary trend by returning to the sea 60 million years ago. Once proliferating in all the oceans of the world, whales were reduced to 2,000 animals before controls were imposed. Valued for their oil, whales were first hunted in the 10th century by Basques standing on shore. Today they are caught and processed entirely at sea by huge floating factory ships.

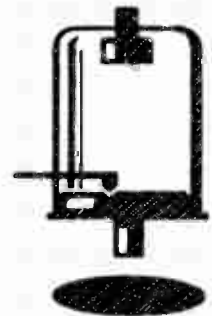

**Ignitron**—A type of mercury arc rectifier with only one anode. Developed in early 1950s. Arc is started at each cycle by an ignitor dropped into a pool of mercury (the cathode). Frequently broke down at higher voltages.



**Alligator**—A cousin of the crocodile, alligators eat fish and small animals, and only attack humans in self-defense. Once they averaged 18 ft. from snout to tail. Today 9 ft. is considered uncommonly large. Threatened by urbanization destroying their habitats, and by hunters seeking their skins for purses and shoes.



**Leyden jar**—A crude capacitor developed at the University of Leyden in 1742. Although important in the development of electronic theory, the Leyden Jar is considered cumbersome and inefficient by modern standards. Currently used only for laboratory demonstrations. Replaced by the modern capacitor in all its forms.

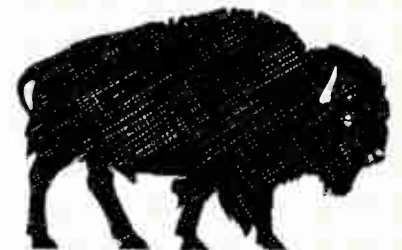

**American buffalo (bison)**—Related to the domestic cow. Males often top six feet at the shoulder and weigh 3,000 pounds. Once a primary source of food and hides for the American Indian, they were hunted into near extinction by the white man. There were 60 million buffalo in 1800, only 250 in 1900. Today 20,000 survive in parks.

# The low-density bipolar PROM will never become an endangered species.

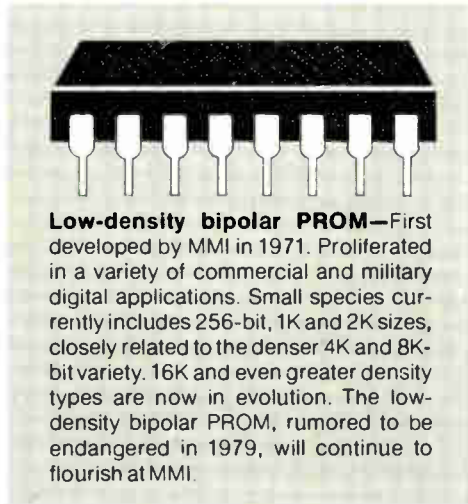

## MMI is committed to producing bipolar PROMs from 256 bits up, in volume, as long as you need them.

You may have heard rumors you'll be forced to specify only 4K-or-denser bipolar PROMs, because low-density PROMs won't be available much longer.

Don't believe it.

MMI makes PROMs from 256 to 8K bits now, and we'll continue to make them in the future. That's a commitment that means something, coming from the company that ships more bipolar PROMs than anyone else in the world.

### Our PROM product line is alive and well.

MMI's leadership in bipolar technology is clear. We introduced the 1K bipolar PROM in 1971, and the world's first 2K, 4K and 8K bipolar PROMs shortly thereafter. Now we have a 16K bipolar PROM in development. But even though we will continue to develop denser and faster versions, we'll never lose sight of the low-density PROM. In fact, watch for MMI's announcement of a new family of faster 1K

and 2K PROMs to complement our current line.

These new PROMs will have access times ranging from 45 ns to 60 ns and a power consumption range of 65 mA to 130 mA.

### Find out why our commitment to bipolar is important to you.

Discover how the PROM and other bipolar products are flourishing at MMI. Ask your nearest MMI rep or distributor for our new, comprehensive LSI Data Book. You'll find the answers to your detailed questions about MMI's bipolar memory and logic.

**Monolithic Memories** 

Monolithic Memories, Inc.  
1165 E. Arques Ave., Sunnyvale, California 94086.

# Announcing a major breakthrough in \$250 frequency counters.



## A \$149\* price.



Keep the change! Our MAX-100 is remarkable, even compared to \$250 digital frequency counters. With its turn-on-and-read operating simplicity. Direct 8-digit readings. Big, bright, display. And under-20 Hz to over-100 MHz range (past 500 MHz with optional prescaler).

It has all the features you'd take for granted, even at \$250. Like high sensitivity, accuracy and stability. Lead-zero blanking. Plus visual indications of overflow and low battery. (The flashing low-voltage indication also prolongs the counter's

useful battery life!)

MAX-100 is comfortable anywhere, monitoring nearby RF transmitters with its built-in mini-whip antenna. Or any other CW, AM, or FM signal via clip-lead cable or accessory low-loss tap-off cable. Powered by your choice of alkaline cells or rechargeable nicads with battery eliminator/chargers that operate from car cigarette lighter, 110 or 220 VAC mains.

Our incredible MAX-100 solves all your problems but one: what to do with the \$101 change.

### Smarter tools for testing and design.

## GLOBAL SPECIALTIES CORPORATION

Call toll-free for details  
**1-800-243-6077**  
During business hours

70 Fulton Terr. New Haven, CT 06509 (203) 624-3103, TWX 710-465-1227  
OTHER OFFICES: San Francisco (415) 421-8872, TWX 910-372-7992  
Europe Phone Saffron-Walden 0799-21682, TLX 817477  
Canada Len Finkler Ltd., Downsview, Ontario

\*Suggested U.S. resale Prices. specifications subject to change without notice © Copyright 1980 Global Specialties Corporation

Circle 40 on reader service card



## Smart interface adds control functions to daisy-wheel printers

by Bruce LeBoss, San Francisco regional bureau manager

Adding a Z80-based module to printers serving in small business systems cuts host CPU's work

A fledgling company in Hayward, Calif., is offering a new type of peripheral made for word processing: the intelligent printer. Wilker Inc.'s Daisy Brain, an intelligent interface for daisy-wheel printers, can perform some 50 standard word-processing functions, among them high-resolution graphics plotting, proportional spacing, and bold-character printing.

Thus the model DB2000 relieves the host computer of its printer-control functions, requiring only brief instructions from the central processing unit, says the firm's president, Len Wilker. "Daisy Brain has the intelligence and storage capacity to shrink CPU memory space" required for peripheral control, he says. As with intelligent terminals, "the valuable CPU time and resources released will provide added execution time to fill immediate and future data-processing demands."

**CPU control.** Unlike these terminals, the DB2000 does require some CPU supervision, and text editing is restricted to what the system already can do. However, Wilker argues, these are small prices to pay for the lower cost of a printer-based word processor.

The Z80-based Daisy Brain will be offered to manufacturers of small business systems for about \$600 each in lots of 1,000. It may be combined with a printer, or with a print-

er and keyboard to add word processing features to such systems. It may also be linked in networks that include intelligent terminals.

The Mostek 3880 version of the Z80 "acts as a traffic cop, controlling the printer so that it can accept text and control signals, hold them, and control the protocols between the Daisy Brain and the host CPU," Wilker says. The 5-by-8-inch module changes the printer parallel interface into an RS-232-C serial interface that can communicate at up to 9.6 kilobits per second.

The formatting capability and other word-processing functions fit into Intel 2716 16-K erasable programmable read-only memories. Daisy Brain also has 3 kilobytes of random-access memory and a 2,048-character buffer.

Another advantage for manufacturers seeking to get into the word-processing market is the ready-made

software. "For them to write a word-processing software package, it could take 8 to 12 months and cost about \$400,000," he estimates.

Wilker is a former national sales manager for Qume Corp., and the Daisy Brain is compatible with Qume daisy-wheel printers as well as with models from Diablo Systems and Dataproducts Corp. A Diablo spokesman says the Wilker brainchild appears to break ground in bringing word-processing capabilities to daisy-wheel printers.

**Japanese.** What's more, Wilker is working with one Japanese company on an interface module for its daisy-wheel printer and is talking with another about a similar module for its new 25-character-per-second unit that sells for less than \$1,000 in quantity. "These Japanese suppliers are Johnny-come-latelies to the daisy-wheel printer field, and they see the Daisy Brain as an added value

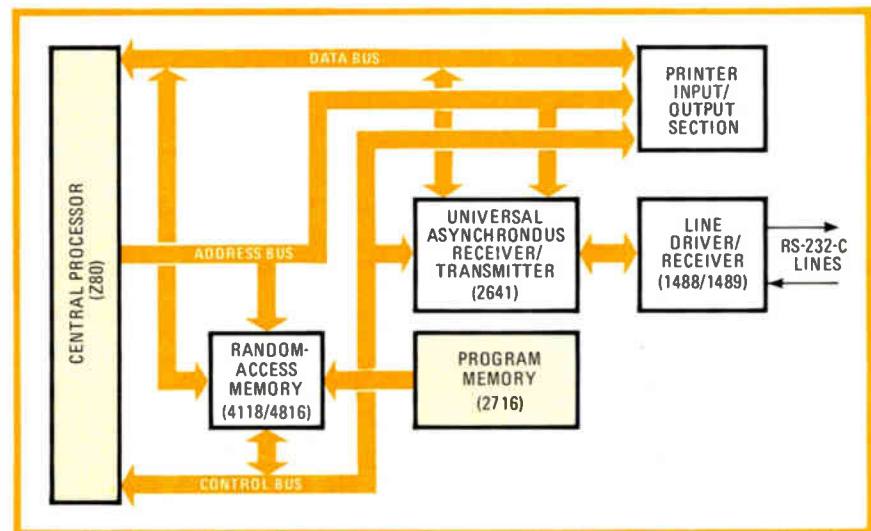

**More than a printer.** Add-on module brings print-control functions to daisy-wheel printers, off-loading this processing from the host computer in business systems.

that will enable them to be more competitive with the established suppliers," Wilker says.

The firm has other products under development for the business systems market. Wilker will not discuss them, saying only that they will enhance other computer peripherals and "will have capabilities other than word processing."

---

**Components**

---

## All-polymer part acts as circuit breaker

Nestled among the integrated circuits on a board, a tiny lump of a polymer olefin plastic on two radial leads can handle current surges and come back for more. The Polyswitches from Raychem Corp. react to gradual surges of current more slowly than to sharp jumps.

Priced competitively with slow-blowing fuses, the new parts are like self-resetting circuit breakers. When exposed to a current surge, they increase in resistance by as much as eight orders of magnitude, interrupting the flow.

The speed with which the new parts do this is proportional to the amount of the surge. They stay latched in the high resistance state for three or four minutes, but once cool enough they automatically re-

**Hot spot.** Made of a conductive plastic that increases in resistance upon current surge, Raychem Corp.'s new Polyswitches protect ICs against overloading.

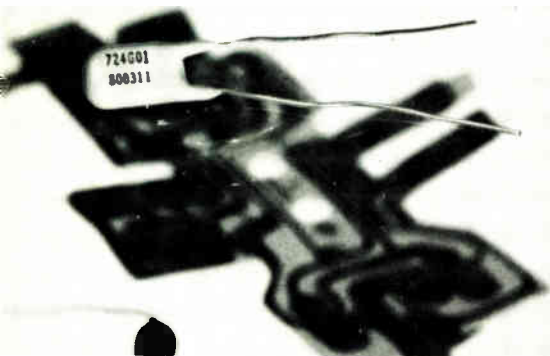

turn to their initial low resistance, permitting current flow to resume.

The Polyswitch's polymer matrix that includes a conductive filler material, one of whose elements is carbon black. In normal circuit operation, the filler particles are coupled closely, allowing good-sized paths through which the current passes. Heating by currents higher than the material's rating causes an expansion and separation of the filler that has the effect of reducing the flow path and blocking the current.

The greater the overcurrent, the faster the part's switching time, which can range from 10 milliseconds to more than a minute—the 2.5-ampere version takes about 60 seconds to react to 6 A, 10 seconds for 12 A, and 2 seconds for 24 A. The maximum current capacity of the line is 400 A.

The new parts have initial resistances as low as 0.03 ohm, about 1/300 that of a positive-temperature-coefficient thermistor, which also can be used for current limiting. Thus the Polyswitch is more suitable for high current operation, since it is nearly invisible to the circuit in which it is operating.

**Blowing.** The slow-blowing effect occurs at higher temperatures than with comparable fuses, which can blow within seconds at currents as low as twice their ratings. However, the heat-sensitive Polyswitches are limited to an operating range of -40° to 60°C. Forced-air cooling will permit operation at high temperatures, the company says.

The new venture is something of a departure for Raychem, which makes insulated wire and self-limiting heaters. But the Menlo Park, Calif., firm is known for its heat-shrink tubing, also made from cross-linked polymer material.

Besides surge controllers, potential applications include energy limiters, battery discharge circuits, multiprotector circuits, and thermostats. In transceiver battery packs for explosive atmospheres, the part can combine with 1.2- $\Omega$  wirewound resistors to replace more expensive two-transistor silicon controlled rectifiers.

-Roger Allan

## One-chip subsystems mix technologies

Drawing from a mixed bag of semiconductor processing technologies, telecommunications equipment suppliers pulled out a healthy handful of new single-chip subsystems at last week's International Conference on Communications in Seattle, Wash. The large-scale integrated circuits, most of them experimental, promise new heights in both the cost-performance ratio and the reliability that are needed to supplant their electromechanical forebears in a broad spectrum of applications.

One chip discussed at the conference was the Bell Telephone Laboratories' digital n-channel MOS coder-decoder with on-board filtering [*Electronics*, June 5, p. 46]. Others included a pulse-code-modulation codec from Fujitsu, a programmable digital signal processor from Bell Labs, and Toshiba's modulator-demodulator for facsimile machines.

**Codec.** The experimental PCM codec from Fujitsu Ltd., Kawasaki, Japan, can operate at speeds high enough to accommodate a four-channel transceiver. Fabricated in a combination of p-channel MOS and standard bipolar technologies, as well as integrated injection logic, the one-chip codec contains two sample-and-hold circuits that permit any analog signals to be directly coupled to the device.

It uses one common companding digital-to-analog converter for sending and receiving. What's more, its compression scheme can be switched between the A-law and  $\mu$ -law conventions via an externally controlled pin, says Hirohisa Gambe, project engineer in Fujitsu's transmission systems development department.

The Bell Labs' programmable digital signal processor can decode an instruction, fetch data, and perform a 16-by-20-bit multiplication and full 36-bit product accumulation in one machine cycle of 800 nanoseconds. Fabricated in depletion-load

n-MOS technology, it "permits the realization of signal-processing functions of such applications as dual-tone multiple-frequency receivers or low-speed data modems with a single chip," says John S. Thompson, business communications systems researcher in Bell's Holmdel, N. J., laboratories.

The arithmetic precision of the processor "is sufficient for many voice signal applications, as well," he adds. Bell is working on practical uses for the chip.

**Modem.** The experimental chip for a facsimile modem, developed by Toshiba Corp., Kawasaki, contains all the functions necessary for low- and medium-speed facsimile systems, claims Hideo Suzuki, digital signal processing engineer in Toshiba's research and development center. Built in n-MOS technology with 4-micrometer geometries, the modem handles 16-bit serial data at a clock frequency of 5 megahertz, he adds.

It is composed of five functional blocks—a digital filter in a multiplexed biquad structure, a modem whose core is a phase-locked loop with a multiplexed bilinear infinite-impulse-response filter, an interface, buffer memories, and a controlled signal generator. —Bruce LeBoss

## Business systems

### Word processor starts with a typewriter

Venturing into the already crowded office systems market, a new company started by the founders of mini-computer maker Interdata is launching an innovative product line. Syntrex Inc. is stressing easy entry into the office of the future for neophyte users and increased reliability.

On display at next week's Syntopicon show in Minneapolis, the Piscataway, N. J., company's low-end Aquarius is a stand-alone 8086-based work station that uses an IBM Selectric electronic typewriter as both keyboard and printer. Thus a user can move into word processing



**Easy fit.** A standard desk extension will hold the new Aquarius word processor, which employs the electronic version of the IBM Selectric typewriter as keyboard and printer.

systems with a unit that will fit on the 40-inch wing of a desk (see photograph) and sell for less than \$6,000, without the typewriter. Two 160-page removable diskettes also come with Aquarius.

Although a Johnny-come-lately to the word-processing arena, Syntrex is confident it will have no trouble competing with the likes of IBM, Wang Laboratories, Exxon's Vydex subsidiary, and Xerox. In fact, its product may be more competitive because it has, in essence, learned from the other companies' mistakes. As vice president for marketing and sales James P. Folts points out, the design emphasizes a combination of features not available elsewhere that make it easier to use.

**Features.** For instance, the Selectric-based design makes the user's transition to the machine easier, Folts claims, and its cathode-ray tube has high resolution and smooth scrolling not widely available. Also novel is a windowing technique that divides the CRT display into separate portions that can, for example, show the original version and the edited version of a document side by side.

Syntrex sees the electronic version of the Selectric as a natural for their target user because it is widely sold and similar to the even more popular electromechanical versions. The firm

simply adds a 12-key function keypad to the machine, which may continue as a typewriter should the word-processing electronics malfunction.

Next to come will be the Gemini, which the company calls an electronic filing cabinet. Selling for between \$20,000 and \$25,000, it will support as many as 14 Aquarius units by storing 5,000 to 60,000 pages of information on two to eight 8-in. Winchester disk drives.

**Redundancy.** To enhance reliability, Gemini is in effect two separate, redundant 8086-based memory subsystems. Each has an 8086 for interfacing control and one for disk control, as well as redundant Winchester drives and bus structures.

Each subsystem stores the same data, checking continuously on the other. If one malfunctions, the other shuts it down and calls Syntrex's central service facility. Often the problem can be diagnosed remotely and the user informed, even before he has noticed it.

The company believes that this redundancy costs little more than the typical backup storage system. Add floppies or tape and the necessary control electronics, and the parts bill will nearly equal that of Gemini's second subsystem, Folts argues.

Following Gemini will be Capri-

corn, which will also use redundant architecture to function as an electronic filing system with processing capabilities. It will come with 8086-based cards for electronic mail, phototypesetting, optical character recognition for externally generated documents, and more. Initially it will offer a card that will check word spellings and hyphenation against a 25,000-word dictionary. It also will do automatic key-word indexing by scanning every document and finding the most frequent key words.

Capricorn will be able to turn a set of Geminis into a network. It will sell for \$30,000 to \$40,000.

To prompt and aid the user, the entire instruction manual will be stored in memory. Always available, a list of function commands will be kept as simple and as closely related to English as possible.

Should mistakes occur anyway, an "undo" key will restore the text to its condition before the last operation. Also, Folts feels, such features as the spelling checker and the file management system—more sophisticated than most—will set the company's offerings apart.

Furthermore, Syntrex draws on the experience of its founders to get off to a good start. President and chief executive officer Daniel Sinnot and executive vice president James Bruno were among the founders of Interdata, now the Computer Systems division of Perkin Elmer Corp., and Folts was also with Interdata and Perkin Elmer. —**Pamela Hamilton**

### Packaging

## Damp-hating plastic DIPs win two OKs

A silicone-epoxy material highly resistant to moisture is making inroads into the semiconductor plastic package market, where B-type epoxy novolac molding compounds have long held sway. The Mostek subsidiary of United Technology Corp. is planning to join American Microsystems Inc. in converting its plastic packages for its commercial

## Top court limits release of public records

From now on, users of the Freedom of Information Act—mainly private corporations—will have greater difficulty in obtaining documents from Federal files. On June 9, the Supreme Court ruled unanimously that a Federal agency, before disclosing data supplied to it by a manufacturer, must take "reasonable steps" to verify its records and give the manufacturer an opportunity to comment.

Specifically, the action upheld lower court rulings in favor of GTE Sylvania of Batavia, N. Y. The TV set manufacturer sought to bar the Consumer Product Safety Commission from supplying (in this case) two consumer organizations with data on receiver accidents due to shock, fire, and other causes. The company's arguments in the case were that the commission was not complying with its own rules on notice and comment from producers before disclosure and that the data was not only confidential but sometimes also inaccurate or misleading since manufacturers keep their records in question in different ways.

The court rejected the commission's contention that predisclosure steps mandated in the lower courts' decisions would pose insurmountable burdens. It called that argument entirely speculative, adding that any relief from such burdens must come from Congress, not the courts. —**Ray Connolly**

integrated circuits to Dow Corning 631 compound.

So confident are Mostek officials of the performance of the compound that they predict some mainframe customers will switch from their traditional hermetically sealed ceramic dual in-line packages. Still, the material is far from making a clean sweep of the market: some IC makers who have looked at it since its introduction in 1977 are staying with the B-type epoxies.

**Improvement.** Extensive tests have shown that Dow Corning 631 generally performs three times better in delaying die corrosion than Mostek's current high-volume B-type packages, says John B. Finn, manager of package quality enhancement for the Carrollton, Texas, company. An AMI spokesman similarly cites improved reliability related to corrosion failure as the principal reason for the Santa Clara, Calif., firm's switch to the silicone-epoxy material in 1978.

"We're really convinced that this is the plastic compound of the eighties," says Finn, who became familiar with it while he was an AMI employee. Other companies known to be looking at it include Rockwell International Corp.'s microelectronics operation, which is using it for a few production circuits.

Among the less impressed manufacturers is Advanced Micro De-

vices, of Sunnyvale, Calif., whose international engineering manager, Kenneth O. McKinney, says AMD found the Dow Corning compound's slight superiority in some regards did not offset its 30% higher cost. He also notes that the performance of a given packaging compound can vary from IC maker to IC maker, depending on such circuit factors as the differing die physics, as well as differences in preparing die surfaces.

Still, the cost factor is not that simple. Industry sources quote Dow Corning 631 at about \$2.60 per pound, against about \$2 per pound for standard B-type epoxies. Mostek points out, however, that the cost of the resulting packages still makes up only a small percentage of a product's cost; what's more, they can be 50¢ to 80¢ cheaper per package than comparable ceramic DIPs.

**Moldability.** Some IC makers began using the new compound but "converted back to epoxy B after experiencing problems with consistent moldability," says Daniel J. Rose of Rose Associates, a Los Altos, Calif., materials consulting firm. Finn says Mostek is aware of differences in moldability qualities but that they present no difficulties so long as they are comprehended.

The company's forthcoming MK4516 single-supply 16-K dynamic random-access memory will not

# THERMAL PRINTERS FROM TELPAR

Stand-alone systems  
and OEM mechanisms



**PL-20E**



**PS-48E**



**PPS-80**

KEY FEATURES INCLUDE	20 COLUMN PL-20E	48 COLUMN PS-48E	80 COLUMN PPS-80E
Microprocessor controlled thermal printing	•	•	•
RS-232C interface		•	•
20 mil interface		•	•
TTL serial interface		•	•
TTL parallel interface	•	•	•
ASCII character set	•	•	•
Custom character set			•
Serial mode baud rate		110-300	300-9600
Parallel mode CPS	4000	960	960
Automatic carriage return/line feed	•	•	•
Invert capability	•		
Vector generated graphics			•
Self test mode	•		•
Optional buffer memory			Up to 16K
Answer back			•
Forms Control			•
Single unit pricing	\$297	\$485	\$750
100 unit pricing	\$249	\$385	\$600

Proven thermal printers from TELPAR are handling a wide range of printing requirements for end users and OEM's. Call today for a system designed to meet your needs.

**telpar, inc.**

*The thermal printer company*

4132 Billy Mitchell Road, Box 796, Addison, Texas 75001  
Telephone 214/233-6631 Telex 73-2561 (TELSERV) DAL

even be offered in a hermetic version. Working closely with customers, the company hopes to have converted all its plastic-packaged memory products to the new compound by year's end and to be ready to go on to convert the packages of its other circuit types, including microprocessors and telecommunications devices.   
 -Wesley R. Iversen

Communications

Fast tapes getting fast error correction

"Begin at the beginning," the Mad Hatter told Alice, and that's just what researchers at Honeywell Inc.'s Test Instruments division had to do when they set out to develop a technique to slash signal dropouts and the resulting bit-error rates in high-density digital recording. The scarcity of published data on predicting HDDR bit-error rates "made it difficult to select an appropriate strategy for error detection and correction," says Leighton Meeks, project manager for these recording systems at the Denver division.

A computer study gave Meeks's team the body of data it needed, and it devised a technique claimed to improve the bit-error rates of typical

tapes from between  $10^{-5}$  and  $10^{-6}$  to between  $10^{-8}$  and  $10^{-11}$ . Such an improvement will give a big boost to HDDR applications like handling high-speed data flows from satellites to ground stations.

**Study.** The Honeywell researchers' computerized dropout test was used to pin down such variables as head and tape type, tape speed, track number, and the maximum and minimum lengths of dropouts. They discovered that "dropouts tend to be isolated and . . . randomly distributed," Meeks says. In fact, the distance between dropouts in any given track is likely to be hundreds of feet.

The researchers also discovered that the dropouts decrease logarithmically in length as they increase in number and that edge tracks have many more dropouts than do middle tracks. Also, a track separation greater than the maximum diameter of the tape flaws causing dropouts (typically 40 mils for iron-oxide-coated tapes) practically eliminates multitrack dropouts.

From such findings, Meeks's team developed a variation of the checkword method of error detection and correction. It will appear in an HDDR system later this year.

The signal dropout detector, details of which are proprietary, monitors the amplitude on the signal-reproduction side (see figure). When

the signal falls below a threshold, there may be an error on a particular track.

Monitoring for errors before the signal is reproduced "would create enormous hardware and memory complications, but could be done if you're willing to pay for a high degree of redundancy," Meeks says. It would involve mapping the tape, locating all potential areas for errors, and then recording information twice. "By monitoring as you reproduce, rather like exposing a negative, you can correct errors on the fly," he notes.

**Check track.** The Honeywell system's multitrack error-correction encoding consists of forming the odd parity for every 7 information bits in each track. Forming the odd parity of each track at the same time, bit for bit, generates an extra track of information, or check track, for comparison when parity is reformed during signal reproduction. The dropout signal locates the track in which an error exists, but this check track indicates which bit or burst of bits is in error.

The dropout method reduces the memory-buffer size that is necessary because the signal can be used immediately. In contrast, the use of a check word at the end of each block (frame) of data requires processing a data stream through a cyclic-redundancy-check shift register, so "you don't know if you have an error until you have stored about 500 bits," Meeks notes.   
 -Bruce LeBoss

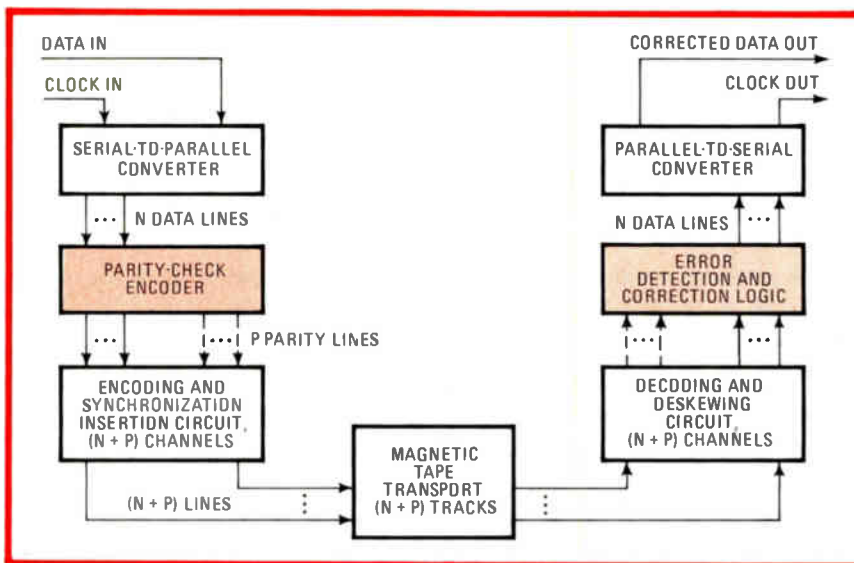

**Correcting.** Multitrack error-correction scheme for high-density data recording requires little additional electronics (tinted) over and above the deskewing circuitry already used.

Personal computers

Japanese offering fits into briefcase

A Japanese manufacturer is charging into the U. S. personal computer market with all flags flying. At this week's Consumer Electronics Show in Chicago, Matsushita Electric Industrial Co. is showing an impressive briefcase-sized package that contains a 6502 8-bit microprocessor with a liquid-crystal display, up to eight banks of user memory with 32

To: Ron Engelbrecht, Sales Director  
Jerry Crowley, President

From: Jim Brennan, VP/Engineering

Re: INTRODUCTION OF OKI'S CMOS MICROCOMPUTER FAMILY -

The best way to present our new CMOS microcomputer family: show how it is used in most common applications. I think the following system clearly illustrates the microcomputer, peripheral and memory implementation.

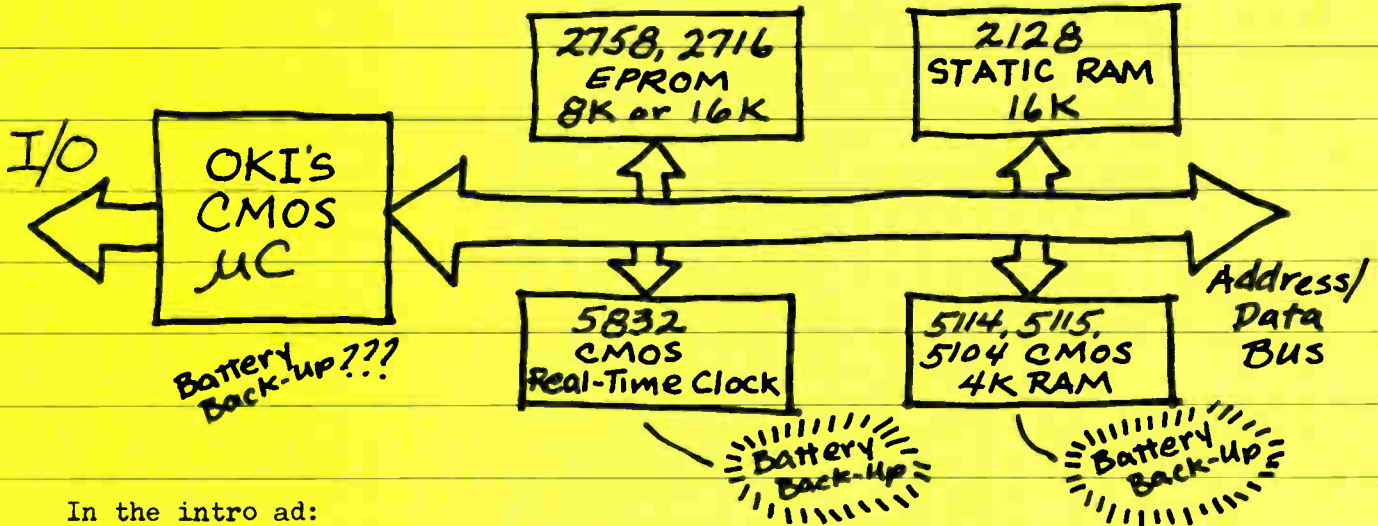

In the intro ad:

SHOW - A typical microcomputer application like this.

SHOW - The use of OKI's 5832 CMOS real-time clock with battery back-up.

SHOW - Use of CMOS RAMs on microcomputer bus with battery back-up as above.

SUGGEST - Application alternatives using standard static or dynamic RAM as either: CMOS - OKI 5104, 5114, 5115...  
NMOS VLSI static RAM. Like OKI's 2128 16K.

Finally, consider using an ad coupon like this...

*Jim*



P.S. For the guys who want faster data/product/service, get our (408) 984-4842 phone number into the copy too.

P.P.S. NO! I don't have any Rex the Wonder Dog stories; that's Marketing's job.

Please send me:

Data Sheets on new OKI CMOS Microcomputer Family

Prices on 7 Microcomputer Manuals (and put me on availability list)

Technical articles/literature re: OKI 2128 and 5114/5115

Name \_\_\_\_\_

Title \_\_\_\_\_

Attach coupon to company letterhead and send to:

**OKI**  
OKI Semiconductor, 1333 Lawrence Expressway,  
Santa Clara, California 95051. (408) 984-4842.

kilobytes of address space in each, an interface so that a standard television set may serve as a display, a hard-copy thermal printer, and an interface with a cassette tape unit.

Equally impressive is the price: a typical package should cost about \$800. What's more, Matsushita will be marketing it through its Quasar and Panasonic U. S. subsidiaries, making full use of their outlets in appliance and department stores.

The core of the new offering is a central processing unit that looks like Matsushita's hand-held language translator—hence the model designation of HHC, for hand-held computer. Though the CPU alone can function as calculator, watch, or electronic memo pad, it becomes a personal computer in a case by adding capsules of additional program read-only memories, the interface and so on.

**First.** HHC is only the first of many such personal computers to come onto the American market from Japanese firms. In fact, U. S. makers of personal computers are already saying privately that by 1982, the Japanese will corner at least 30% of the U. S. market for under-\$3,000 machines—and perhaps as much as 50%.

One feature of some prototypes that may be changed is a keyboard with alphabetic ordering, rather than the standard typewriter arrangement. The company claims it will be easier for nontypists, but industry observers call it an Achilles heel because nearly all prospective users are bound to be familiar with the standard keyboard.

The company is launching the machine with an extensive line of educational and entertainment programs. It also includes a modem with acoustic coupling to permit a link to electronic mail systems and to data bases. "It offers access to a vast information store," claims Quasar Co. president Alex Stone.

**Large memory.** Four read-only-memory capsules of up to 16 kilobytes each can be plugged directly into the CPU, with an additional four in an expander module. Bank switching enables the 6502 to handle this

large amount of ROM, plus random-access-memory expanders of 12 kilobytes each. There is no need for bank switching during execution, so the standard processor is fast enough, the company says.

The 1-megahertz 6502 microprocessor designed by MOS Technology Inc. and second-sourced by Rockwell International Corp. and Synertek is a popular choice for personal computers like the Apple II, but it has not been considered suitable for machines with larger memories. Thus companies such as Apple are turning to the 2-MHz 6502 A [*Electronics*, May 22, p. 44], though Matsushita claims its bus design offsets the 6502's lower speed.

One unresolved question is using department and appliance store salesmen accustomed to standard electronic consumer fare to push the Matsushita personal computer at the typical store customer. The company points to an elaborate point-of-purchase display designed to ease that burden. If competitors wonder about its effectiveness, they have no doubt that the hardware and price of the new machine make it yet another formidable challenge from the Far East. -Larry Marion, Charles Cohen

---

## Personal computer talks and listens

Personal computer buffs will be talking and listening to Ohio Scientific Inc.'s latest offering at this week's Consumer Electronics Show in Chicago. The Aurora, Ohio, company is showing its Challenger 8P-HD, which has an unprecedented level of voice-synthesis and -recognition capability for personal computers.

What's more, the new top-of-the-line model features a 10.67-megabyte Winchester disk drive, made possible by replacing one of the dual 8-inch floppy disk drives in the earlier 8P-DF with a Shugart Associates SA-1000 8-in. unit. The new machine also has a minimum working memory of 104 kilobytes of random-access memory; the earlier model had a maximum of 48 kilobytes.

The new machine has a Votrax voice synthesizer, which uses a phoneme-based approach to achieve a virtually unlimited vocabulary. Ohio Scientific is mum on the voice recognition unit, although a spokesman does claim that it can receive commands from both a microphone and the telephone handset with its lower quality of voice reproduction.

**Capacity.** The voice capabilities help explain the move to the Winchester drive and the jump in RAM capacity, because they require substantial amounts of memory. In fact, the number of applications programs, as well as the general complexity of the software, could eat up a smaller working memory in a very short time.

Ohio Scientific thinks its new machine will serve as a robotlike home computer, controlling appliances, answering the telephone, and accepting and responding to verbal instructions. The consumer show demonstration includes voice entry of a program and verbal computer review of the instructions. However, neither the company nor the talking computer is ready to talk about the price tag.

Taken individually, such features as an automatic telephone-number dialer and a home security module are not novel. However, integrating them into a personal computer with considerable capability and flexibility expands the limits of the individual functions because they can play off one another. -Gil Bassak

---

## Peripherals

---

### Hard-disk controller is easily palmed

It's a simple black box easily held in one hand—but like many such modules in the era of large-scale integration, it packs a big punch. The Micromodule 9000 from Microcomputer Systems Corp. incorporates some 75% of the circuitry of a controller board for 8-inch Winchester disk drives.

"Everything neither drive- nor



## WE'LL GIVE YOU THE EDGE YOU NEED.

Actually, we can give you just about any edge devised. Because at ITT Cannon Electric, we happen to carry the broadest line of edgcard (PCB) connectors in the industry.

You can get direct, indirect, discrete and backpanel types in straight, right-angle and in-between configurations. Specify connectors with two to two hundred contacts and .098" through .200" spacing. Solder, eyelet and mini-wrap posts with gold, silver or tin contacts. You can even select black, green, grey, white and transparent connectors for use with round wire or flat cable.

So when you need edgcard connectors that meet MIL-Spec, DIN or commercial requirements, look into Cannon® quality and reliability. See our listing in EEM. Or for our ninety-six page catalog, contact your local Cannon distributor or write ITT Cannon Electric, a division of International Telephone and Telegraph Corporation, 666 E. Dyer Road, Santa Ana, California 92702. When you're really on edge, call (714) 557-4700, ext. 2633. TWX: 910-595-1131. TELEX: 65-5358.

# CANNON ITT

You can always connect with Cannon.

Circle 49 on reader service card

## Controller boards cause legal controversy

Even as it launches the Micromodule 9000, Microcomputer Systems Corp. is embroiled in a legal controversy over controller boards for disk drives. The controversy stems from the introduction of the 1400 series of controllers for floppy and Winchester disk drives by Shugart Associates [*Electronics*, April 24, p. 208]. These boards are designed and manufactured by Data Technology Corp., a Sunnyvale, Calif., company formed last year by several former Microcomputer Systems employees.

In a suit filed in Santa Clara County civil court, Microcomputer Systems alleges that its former employees misappropriated confidential business information, whereas Data Technology counters that its designs are original. Although not a party to the suit, Shugart sides with Data Technology and continues to market the series 1400. In fact, it has just announced an expansion of the line.

host-computer-dependent is contained in this module," says James S. Toreson, president of the Sunnyvale, Calif., company. Thus it could halve the price of controller boards.

**Savings.** When Micromodule 9000 goes into production soon, the per-unit quantity cost will be \$200, making possible \$600 controller boards for Winchester drives. Microcomputer Systems is a major producer of disk controller boards (see "Controller boards cause legal controversy") and at first will be offering complete boards based on the new module, which will become available separately early in 1981.

The Micromodule is a reaffirmation of concentration on the controller business that has been the company's staple since it was founded in 1974. Last year, Microcomputer Systems began a digression, announcing the innovative MSC-8000 drive that combines an 8-in. Winchester with a backup tape [*Electronics*, June 21, 1979, p. 39].

**Search.** Although the product is still under development, it is now on a back burner while the company searches for a computer maker interested in using it. "There is a lot of technological missionary work to do with that technology," Toreson now says.

The new design reduces the number of chips in a complete disk control system from 200 to typically less than 25, plus the module. The Micromodule 9000's architecture and programming are secret, but the company does say that the 3-in.

square hybrid package contains an MOS microprocessor, some read-only memory, and universal gate arrays implemented in integrated Schottky logic.

Despite its compactness, the module incorporates such full-board features as full-sectored buffering and a 32-bit error-correcting Fire code that performs 11-bit burst-error correction on messages up to 7 kilobytes long. It also handles overlapping seek commands, verifies position automatically, and writes on alternate tracks.

External circuitry determines the number of disk drives assigned to each Micromodule and performs data separation. "In fact, we expect that the forthcoming ANSI standard on 8-in. Winchester drive will force the data-separator function into the drives," Toreson says.

**Reaction.** Early industry reaction gives high marks to the design. "We believe that Toreson has the right idea with the Micromodule 9000 and that he has implemented it well," observes Keith Plant, a marketing vice president at Memorex Corp. In fact, Microcomputer Systems is designing a demonstration controller board for the Memorex 101 disk drive.

Also, Toreson says his firm is working with an unnamed major disk-drive maker to design a complete drive system aimed at creating a *de facto* standard for the burgeoning 8-in. Winchester drives. (The partner may be Memorex, but no one is talking.) Only when the indus-

try has a prime candidate for standardization will the ANSI committee settle on a standard, he reasons.

Microcomputer Systems is also negotiating with a company on a second-sourcing agreement. Toreson will describe the firm only as "a major assembler of integrated circuits onto boards."

**Others.** Although the Micromodule 9000 represents a significant improvement in the design of controller boards for 8-in. Winchester drives, other companies appear to be hot on its trail. One clue comes from Memorex's Keith Plant, who describes the new design as "the first one off the drawing boards."

Western Digital, for example, is known to be working on a single-chip controller for the current 8-in. and the coming 5¼-in. Winchester drives (see p. 104). It will contain fewer functions than the Micromodule 9000, however.

Western Digital, Intel, NEC, and Synertek have already produced chips for floppy-disk controllers, but Toreson is quick to argue that there is an order-of-magnitude difference in the complexity of control circuitry for floppy and hard disks. There is more circuitry in the Micromodule chips than can possibly be placed on a single chip with today's technology, he says.

-Martin Marshall

## Packaging

### Reusable frame aids IC testing

Researchers conducting a laboratory hybrid program at the Westinghouse Systems Development Center in Baltimore have devised a way of testing standard integrated circuits that have been mass-bonded to bumped copper tape (tape etched with the necessary interconnection pattern and supplied with bonding pads, or bumps). The problem is the commonality of the chips on the uninsulated copper tape. Their solution is to chop the tape-mounted chips apart and use a test frame that accommodates seven standard IC

# NATIONAL ANTHEM

SEMICONDUCTOR NEWS FROM THE PRACTICAL WIZARDS OF SILICON VALLEY.

## Microcontrollers and freedom of choice.

THE COPS™ FAMILY IS THE PRACTICAL APPROACH TO MICROCONTROLLER APPLICATIONS.



High quality RAMs now available in all speed ranges

Linear bestsellers for 1980

High-speed buffer amps drive heavy loads

National commitment to ROM production

State-of-the-art op amps for high-speed designs

Important news from the National Archives

- Data Acquisition
- RAMs/ROMs/PROMs
- Memory Boards
- Logic
- Transistors
- Transducers
- Microprocessors
- Hybrids
- Displays
- Development Systems
- Linear
- Custom
- Microcomputers
- Interface
- Circuits
- Microcomputers
- Bubble Memory
- Optoelectronics
- Modules

## NATIONAL ANTHEM

# National emerges as the logical choice for memories.

**By substantially increasing their production capacity, National is meeting the demand for high-quality 16K dynamic RAMs.**

National Semiconductor has made a major commitment to the high-density RAM marketplace by significantly stepping up their production capacity.

As a result, their competitively priced MM5290 16K dynamic RAMs are available in production quantities right now through your National distributor or sales representative. (Call for pricing information.)

And with their exclusive combination of design and manufacturing procedures, the MM5290s are setting new industry standards for quality and reliability.

For example, the popular MM5290 Family is designed so that soft errors induced by stray alpha particles are virtually eliminated.

This, combined with National's extensive component test procedures, assure

unsurpassed operational integrity and dependability in every high-speed, high-density RAM application.

**The first and only MST.™** In addition to National's use of conventional final testing and QA component level processing, many customers request National's unique MST (Memory Systems Test) program.\* MST eliminates or greatly reduces the customer's own requirements for internal testing. So their incoming test, board test and system rework costs are substantially reduced.

For more detailed information about

MST and the MM5290 Family – plus a Reliability News Brief on alpha particle test results – be sure to check the National Archives coupon.

**Quality RAMs from a quality source.** National has, of course, been known as a quality production house for a long time.

And now they've made an unprecedented full-force commitment to the RAM marketplace. A commitment based on the industry's most advanced design, fabrication and testing techniques.

And thanks to their unmatched production capacity, this kind of quality in every kind of RAM is now even easier to get than you ever thought possible.

From start to finish, the Practical Wizards from National are doing more to meet all your memory needs than anyone has ever done before.

\*Patent pending

MST is a trademark of National Semiconductor Corporation



# COPS™ microcontrollers. Practicality runs in the family.

National's small, low-power COPS microcontrollers offer superior program efficiency and versatility in over 21 architecturally compatible varieties.

As every design engineer knows, there is always more than one way to do a job and do it well. Especially when there are not a lot of design limitations imposed by key components.

This is exactly what the Practical Wizards at National had in mind when they developed their COPS Family of microcontrollers. The COPS Family literally surrounds the engineer with over 21 different yet architecturally compatible microcontrollers to choose from.

**A multi-dimensional array of products.** Each family member shares a common CPU architecture and instruction set that are significantly more efficient than any other microcontroller available.

In order to make the most of this efficiency, COPS presents these features in a multi-dimensional array of over 21 practical, low-cost components (all of which may be



programmed using National's COP400-PDS development system).

So now the engineer can pick and

choose from a wide variety of key specs: CPU size, fabrication technology (CMOS, low-power NMOS, high-speed NMOS), the temperature range, the voltage range, the speed, the I/O options and the package size and type.

In short, the COPS Family offers a truly broad range of compatible microcontrollers and dedicated peripherals to closely match the requirements of each design.

This is exactly why the COPS Family is the much more practical and cost-efficient approach to all microcontroller and many  $\mu$ P applications.

**Available now in production quantities.**

Thanks to National's massive production capacity all COPS Family microcontrollers are currently available in large quantities.

And as always, all orders for these low-cost, low-power COPS components are accompanied by National's unequalled documentation, plus FAE and factory applications support.

COPS is a trademark of National Semiconductor Corporation

# Linear Data Book tops National bestseller list.

National announces the new 1980 Linear, Data Acquisition, Voltage Regulator and Audio data books. And until Labor Day, they're all yours for \$20\* complete.

National, the long-time Linear leader, is known for their clear, concise and comprehensive data books. And the 1980 books are certainly no exception to the rule.

Their 1980 Linear Data Book, the analog designer's "right-hand man," gives you over 1200 pages packed with useful, up-to-date information on National's broad line of Linear components. (The broadest line in the industry.)

And until Labor Day, you can add this perennial bestseller to your reference library for only \$6.00 (\$3.00 off the regular price).

**Linear and Data Acquisition — a perfect match.** If you're into data acquisition and control systems, National has you covered.

From now till September 1, you can get their comprehensive Data Acquisition Handbook in addition to the Linear Data Book. Two indispensable references for only \$10.00 (a \$6.00 saving).

But the Practical Wizards don't stop there.

**The package deal.** National is also offering a special package deal on a set of four valuable references. No technical library would be complete without them.

And between now and Labor Day, National will sell you four of their bestselling 1980 books — Linear, Data Acquisition, Voltage Regulator and Audio — for only \$20.00 complete. That's a full \$8.00 off the regular selling price.

The 1980 Voltage Regulator Handbook covers power supply and regulator design all the way from the transformer to the heat sinks.

The 1980 Audio Handbook presents — in a single volume — real-world design approaches plus the more exotic audio subjects (such as pickups, phase splitters, fuzz, reverb, etc.).

To get your copies, simply fill out and send in this issue's National Archives coupon. Please indicate the quantities desired and include a check or money order for the appropriate amount.

All orders postmarked by Labor Day — September 1 — will qualify for this special offer, so don't delay.

\*Prices shown are U.S. prices only.



## The LH0024 and LH0032 op amps—the best in the business.

State-of-the-art techniques go into the industry's only single-package versions of these popular high-speed op amps.

Ever since National began making their LH0024 and LH0032 high-speed op amps, they've been the industry favorites. And for good reason.

For starters, they use state-of-the-art thin and thick film technology in making the only single package versions of these op amps currently available.

Both the LH0024 and the FET-input LH0032 offer a very high slew rate (500V/ $\mu$ sec), a wide bandwidth (70MHz), low input offset voltage (2mV), a null offset with a single pot, and both are available in military and commercial temperature versions.

In addition, both are available in versions to meet military standard 883 level B specs. So not only are these op amps put through special testing and REL processing, they are also subject to National's own stringent REL and QA standards and procedures.

These low-priced op amps are ideally suited for a variety of high-speed applications. Active filters, oscillators, comparators, summing amplifiers, sample and hold circuits, D/A's and A/D's, and many others.

Check the National Archives coupon for LH0024 and LH0032 data sheets and assorted application ideas and information. All free from the Practical Wizards of Silicon Valley.

## 6000V/ $\mu$ sec buffer amps drive heavy loads.

The LH0002, LH0033, and LH0063 have been the industry's most popular buffer amps for some time now, simply because their high-speed special function circuits drive the kind of high-capacitive lines that can choke typical buffers. And to make a great thing even better, National has just assembled two brand new documents full of innovative applications and other detailed information about their buffers. (Check out the Special Functions Databook and Applications Note 227 on the coupon below.)

The LH0002/33/63 buffer amps will drive up to  $\pm 500$  mA into a 50  $\Omega$  line at slew rates from 200 to 6000V/ $\mu$ sec.

National's laser-trimmed buffer amps solve design problems with high-capacitive coax line drivers, video amps, high impedance input buffers for fast A/D's and comparators, and diddle yoke drivers.

The Practical Wizards of the Special Functions Group also offer LH0002/33/63's that meet mil. std. 883 level B specifications. The multiple testing and REL processing performed on these devices complement the inherent quality of every buffer amp that National produces.

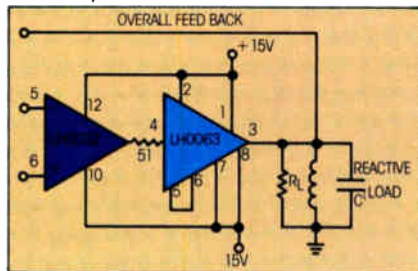

LH0032 and LH0063 used as an isolation buffer

## National stays ahead of ROM demand.

When it comes to buying ROMs, a peculiar situation all too frequently arises.

It seems that most major suppliers of ROMs seldom stay major for very long. One month they'll produce ROMs like there's no tomorrow, but the next month they'll leave you high and dry.

Whether it's due to a new product push or whatever else, it always seems to be their ROM production that suffers. And that means you suffer, too.

All because they're just not serious about the ROM business.

**National is committed to memory.** National Semiconductor, on the other hand, is fully committed to keeping up with the ROM demand. Today, tomorrow, and every day thereafter.

Their large-scale ROM dedicated production facilities offer both consistent supply and consistent lead times.

That's why National is establishing a reputation as the industry's most dependable supplier of ROM components.

And not only can you count on a supplier that doesn't shift with the tides, you can also count on a fine-tuned support organization to back you up. One that's ready and able to answer all of your questions all of the time.

For further information regarding National's supply of ROMs, send in the coupon below. For samples, contact your local sales representative or distributor.

If you're looking for a consistent, dependable ROM supply at very competitive prices, come to National. We're committed to memory.

## What's new from the National Archives?

- 006  Special Functions Data Book (\$6.00)
- 009  ROM MM52116 Data Sheet
- 010  ROM MM52132 Data Sheet
- 011  ROM MM52164 Data Sheet
- 015  MST Program Brochure
- 021  LH0002/33/63 Information and AN227
- 028  Additional COPS Family Information
- 035  Additional Series/80 Information
- 036  Optoelectronics Handbook (\$3.00)
- 037  Additional STARPLEX and ISE Information

- 038  MM5290 Data Sheet and Additional Information
  - 042  LH0024, LH0032 Information and App Note
  - 043  Memory Data Book (\$6.00)
  - 044  1980 Linear Data Book only (\$6.00)\* qty \_\_\_
  - 045  1980 Data Book Package (4 books; \$20.00)\* qty \_\_\_
- \*Prices effective until September 1, 1980

- 047  1980 Linear/Data Acquisition Data Books Package (2 books; \$10.00)\* qty \_\_\_
- TOTAL \$ \_\_\_\_\_

For desired information, mail coupon to:  
**National Semiconductor Corporation**  
 2900 Semiconductor Drive  
 Mail Stop 16250  
 Santa Clara, California 95051  
 In Europe, mail coupon to:  
**National Semiconductor GmbH**  
 Industriestrasse 10  
 D-8080 Fürstenfeldbruck  
 West Germany

 **National Semiconductor**  
 The Practical Wizards  
 of Silicon Valley

Enclose check or money order based upon appropriate currency. Make checks payable to National Semiconductor. Allow 4-6 weeks for delivery.

NAME \_\_\_\_\_ TITLE \_\_\_\_\_  
 COMPANY \_\_\_\_\_ PHONE \_\_\_\_\_  
 ADDRESS \_\_\_\_\_  
 CITY \_\_\_\_\_ STATE \_\_\_\_\_ ZIP \_\_\_\_\_

## News briefs

### Volcanic ash disrupts automated tellers

One of the more unexpected fallouts from the two volcanic eruptions at Mount St. Helens in Washington is ash damage to outdoor automated bank teller machines. Finer than flour, the ash is corrosive, electronically conductive, and abrasive, reports Diebold Inc., the Canton, Ohio, manufacturer of teller machines. The fallout hit outdoor tellers in Oregon, Washington, Montana, and Idaho, says Diebold. In Oregon, the First National Bank reports it tried to seal off its units with plastic and tape after the May 25 eruption, but customers simply ripped off the covering. Repairs to 39 machines could cost \$25,000, says the bank.

### Data nets' growth to spur processor sales

U. S. sales of communications processors, now at the \$590 million level, will reach \$1.2 billion by 1984, says the market research firm Creative Strategies International. The San Jose, Calif., firm says the principal reason will be the rapid increase in data-communications networks [*Electronics*, June 5, p. 89]. Front-end processors, 51% of present sales, will continue to dominate, but growth for network controllers and message switchers will boom along at compound annual rates of 20% and 22%, respectively, the company predicts. The expected incursion of American Telephone and Telegraph Corp. into the market should have little impact on the processor market in the next five years, says Creative Strategies.

### AMI has big plans for TI's 9900

With an n-channel version of the single-chip S9940 microcomputer in engineering, American Microsystems Inc. is renewing a second-source agreement for the 16-bit microprocessor family with Texas Instruments Inc. The Santa Clara, Calif., firm intends to become a full-line alternate source for the family and "is concluding agreements with TI on second-sourcing of additional family members," says an AMI spokesman.

### National, French firm agree on bubble parts

National Semiconductor Corp., Santa Clara, Calif., and Paris-based SAGEM (Société d'Applications Générales d'Electricite et de Mécanique) SA have signed a second-source agreement covering bubble memories. Functionally and physically compatible, the parts offered by the two firms will use the same support circuitry. A SAGEM 256-K part will be available in sample quantities in late 1980. The accord also extends to the 1-megabit level, where National will introduce its NBM 2201 later this year.

### GE jumps into video-disk fray

A third, incompatible contender joining the RCA and Philips technologies in the video disk market looks all but certain with the announcement that General Electric Co. is joining Matsushita Electrical Industrial Co., the Victor Co. of Japan, and Thorn EMI Ltd. of Great Britain in a proposed joint venture. The all-out effort would use JVC's technology, which is based on a capacitive pickup system, as is RCA's forthcoming Selectavision. But the JVC system uses a grooveless disk, so the software in the two approaches will be incompatible.

Meanwhile, U. S. Pioneer Electronics Corp. is beginning distribution of its \$749 LaserDisk system, which uses laser pickup technology—incompatible with capacitive pickups—developed by Philips and MCA Corp. and first marketed by Philips in the U. S. under its Magnavox label.

### Applied Materials goes after ion-implant business

Applied Materials Inc. of Santa Clara, Calif., has a new subsidiary that will manufacture and market ion-implantation equipment, particularly high-current predeposition systems. Called Applied Implant Technology Inc., the new firm will be based in Santa Clara and headed by Charles H. Sutcliffe, formerly vice president in charge of corporate development for the manufacturer of wafer processing equipment.

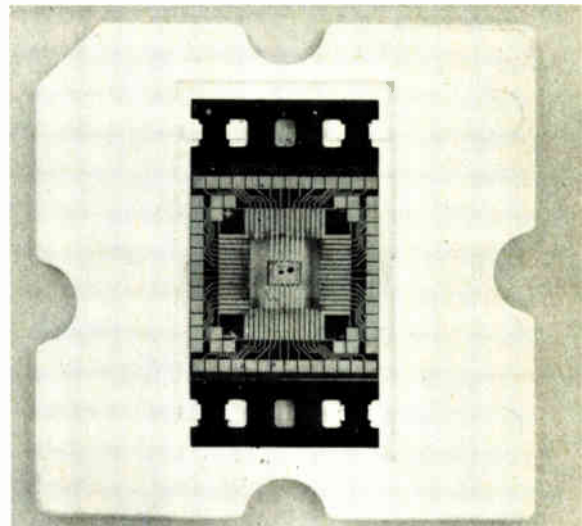

**Testable.** Hybrid-bound chip, excised from bumped copper tape, may be tested after bonding to a reusable test pattern that is etched on polyimide frame.

sizes, says the principal researcher.

In hybrid assemblies all the tape-mounted chips must be tested before being bonded to the substrate. Otherwise the yield is extremely low.

**Rugged.** Excising the chip and its copper leads from the tape produces in effect a small, easily testable, rugged chip-carrier. Westinghouse researcher Frank Lindberg bonds this assembly to the test frame, a piece of polyimide 35 by 19 millimeters in area. Then the frame goes into a slide carrier (see photograph).

The frame has an array of 64 probe pads connected to tin-plated copper conductors running to the edges of the square hole in which the chip is inserted. The seven standard chip sizes accommodated range from 80 to 320 square mils. The test frame may be reused for successively larger ICs once the chip under test has been excised for bonding to a hybrid substrate. Its reuse can continue until its conductors succumb entirely to the excising process.

Lindberg says his test frame allows uninsulated copper tape to be used for hybrid research and short production runs; for large-scale production, multilayer insulated bumped tape is more economical because of amortization of setup costs. The typical use of the all-copper tape—invented by the Dyna-

# SERIES SE3000

## Lightweight, instrumentation recorders

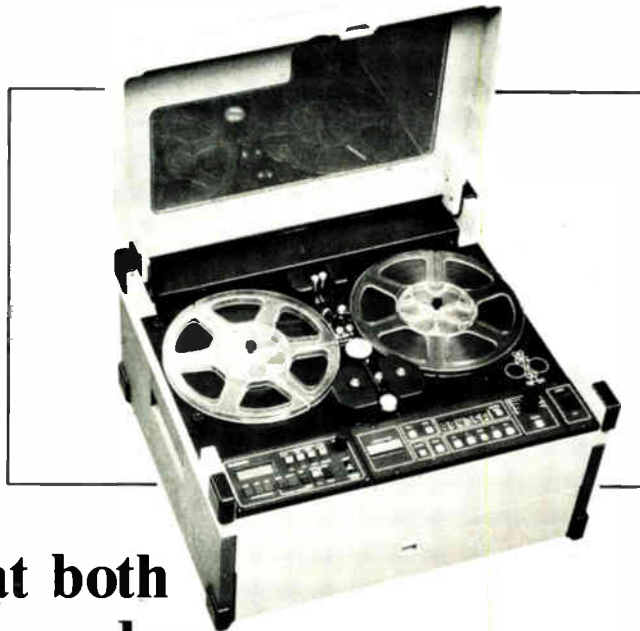

that both  
you and your  
budget can carry

These IRIG compatible  $\frac{1}{4}$  and  $\frac{1}{2}$  inch portable instrumentation recorders are the first to offer the features and performance of 1 inch laboratory recorders that weigh and cost much more.

- 8 tachometer or tape servo controlled speeds, from 15/32 to 60 inches/second
- IRIG compatible recording up to 40 kHz FM, 300 kHz direct, and 0.5 Mbit/second HDDR
- 4, 7, 8, or 14 record/reproduce channels, plug in for any mix of FM, direct, and HDDR, fully aligned for 8 speed operation
- Built-in calibration, complete electronics-to-electronics checkout (FM and direct)
- Choice of interchangeable ac or dc power supplies

Call today. You'll be surprised how little a 55 lb, 14 channel portable instrumentation recorder can cost.  
Or write for our new 4 page brochure.

### EMI Technology Inc.

100 Research Drive P.O. Box 2046 Stamford, CT 06906  
Telephone (203) 356-1300 TWX: 710-474-0128  
Toll Free Instrumentation Service: 800-243-2572

A Member of the THORN EMI Group.

#### Sales Offices:

- Newport Beach, CA 92660  
Telephone (714) 760-1955
- Atlanta, GA 30339  
Telephone (404) 952-8502

#### International:

- SE Labs (EMI) Ltd.  
Spur Road, Feltham, Middlesex  
TW14 0TD, England  
Telephone 01-890-1477 Telex: 23995

### Electronics review

Tape division of Dynacraft Inc., Santa Clara, Calif.—is in large production runs of small-scale integrated circuits where economies of scale make testing after packaging practicable.

-Jerry Lyman

### Computer-aided design

## VLSI makers eye hierarchical approach

In at least one important aspect, the development of very large-scale integrated circuits is lagging: the computer-aided design programs used are patchworks of earlier efforts to produce smaller-scale ICs. So attention is focusing on what is being called hierarchical CAD, one form of which has just emerged from the Silicon Structures Project of the California Institute of Technology.

Though hierarchical design is something most semiconductor and computer firms try to employ, the companies "don't try hard enough," says James A. Rowson, a newly minted Ph.D. from the Pasadena, Calif., school. He did the principal research on the SSP approach.

To date, VLSI designs typically have packed more and more logic functions in a near-random fashion into the smallest possible area. The resulting shortcuts and compromises yield a virtually incomprehensible maze of interconnects and wires that defies debugging, Rowson contends.

Top down. The SSP hierarchical approach begins with a top-down look, determining a chip's functions and splitting them into independent modules that communicate over well-defined interfaces. Most existing CAD systems work from the active devices up, thereby ending up with an unmanageable complexity, Rowson says. "Designers are locked into their CAD tools, and also people don't like to give up things they're familiar with."

He won a generally enthusiastic response to his ideas from a meeting of the semiconductor- and computer-maker sponsors of Cal Tech's SSP. "We really like the ideas, but there



# The logic of logic analysis

LOGIC ANALYZER

DOLCH introduces the world's first 48-channel logic analyzer

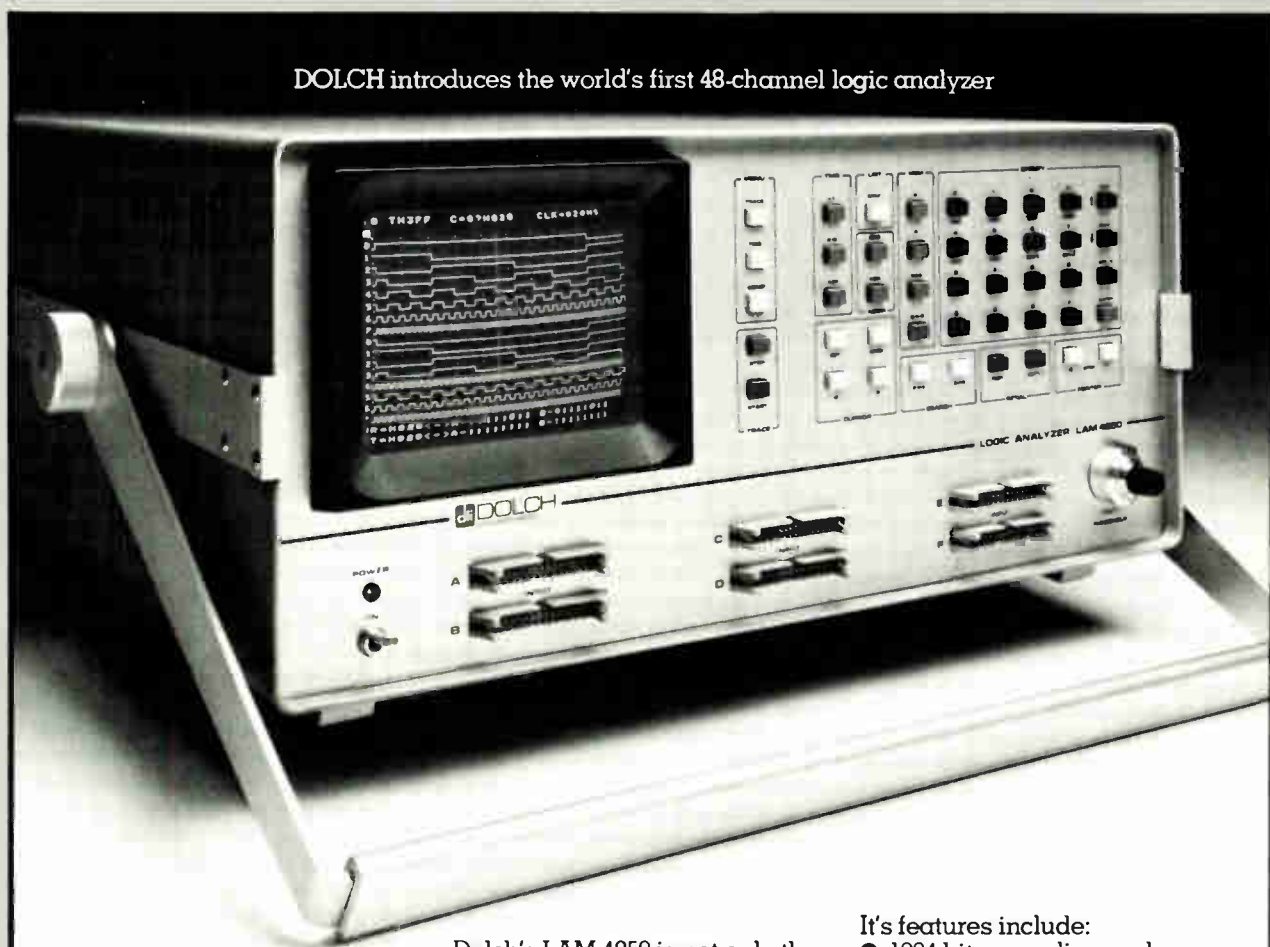

Trace it all, and fast . . .

If you're switching from 8 to 16 bit microprocessors, make sure your logic analyzer can support the move. An adequate number of input channels is the prime prerequisite for 16-bit-uP testing.

Dolch's LAM 4850 is not only the record holder with 48 input channels, it offers you even more of the world's first features such as 3 level simultaneous clocking to untangle multiplexed bus signals or "trigger tracing" that lets you examine nested program execution in real time.

It's features include:

- 1024 bits recording and reference memory per channel
- sampling rates DC to 50 MHz
- 5 ns glitch capability
- 4 level sequential triggering
- binary, hex, octal, ASCII and mnemonics display
- 16-channel x 2048 timing display
- IEEE interface (optional)

**dli** **DOLCH**  
LOGIC INSTRUMENTS

In the United States contact:  
Kontron Electronic Inc.,  
700 South Claremont Street,  
San Mateo, California 94402



**PERFORMANCE! PRICE! PAY-BACK!**

**THE QUALITY AUTOMATIC  
INTERCONNECT TEST ANALYZER  
ACCESS FIXTURE SYSTEMS**

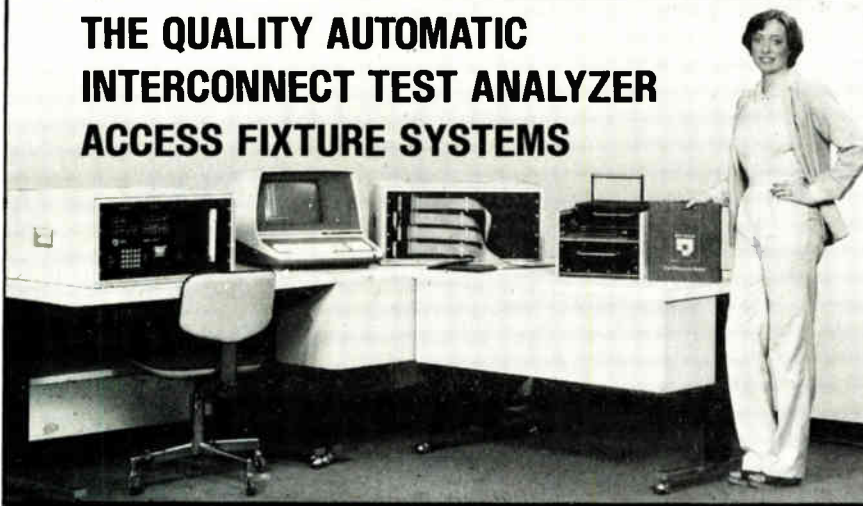

**CONTROL • CRT • SWITCHING • ACCESS FIXTURE**



**DIT-MCO  
MODEL  
1042**

*A Fully Automatic,  
Microprocessor Controlled,  
High Speed, Solid State,  
Self Programmable Circuit Tester . . .*

- Test program printout in both analyzer and UUT language
- Pluggable solid state switching expandable to over 16,000T capacity
- Diskette Test Program Storage
- Data Base Edit
- Product error printout
- Test program listing on printer
- Self program and playback
- Asynchronous communications link with host computer and port

for download batch transfer of test programs.

**Access Fixture:**

*Select from the series of versatile standard DIT-MCO fixtures to complete the system. The fixture shown above is Model AF-100. It is manually operated and features quick change product adaptation through transition boxes or offset pin boards.*

Price performance factors of DIT-MCO analyzer/fixture systems bring TEST/QA cost savings to areas where costs to test previously were marginal or prohibitive. DIT-MCO test packages offer the speed, versatility, flexibility and overall test performance to sharply reduce throughput time and rework costs.

On the line proof! For over a quarter century the world's leading manufacturer of interconnect test systems.

**Call or Write Today —**

**DIT-MCO INTERNATIONAL  
CORPORATION**  
*Quality Testing Quality!*

5612 Brighton Terrace • Kansas City, Missouri 64130 • Telephone: (816) 444-9700  
Telex Number 42-6149

European Technical Representative, RADIX HOUSE, Central Trading Estate, Staines Middlesex, TW18-4-XA,  
England. Telephone (0784) 51444

TEL Shinjuku Nomura Bldg., 26-2, 1-Chome, Nishishinjuku, Shinjuku-ku, Tokyo 160, Japan, Tel: (03) 343-4411

**Electronics review**

are problems," summed up one attending company representative.

The biggest hurdle is the lack of sufficiently powerful commercial CAD systems, he says. Also, semiconductor firms resist such changes because of their investment in capital equipment. Then too, hierarchical design is software-intensive, and semiconductor houses have a hardware bent, he says.

As a result, the computer sponsors of SSP are further along in picking up the hierarchical ideas. Burroughs Corp.'s on-campus representative, Ricky Mosteller, says his firm is implementing SSP's basic design, and Digital Equipment Corp. is said to be well along in putting the approach into operation.

**Locality.** The essence of hierarchical design is locality—that is, ensuring that similar functions are adjacent and truly independent of other functions. This principle avoids what Rowson calls one of the main troubles dogging present VLSI circuitry: "unplanned, unexpected interactions between even well-documented parts, when they are packed together." Examples include leakage of signals among functional elements and poorly defined interfaces that stymie the chip's operation.

Rowson's designs start with a lowest common denominator that he calls a leaf cell. It can perform virtually any basic function for which the designer can write a CAD program.

So far, Rowson has configured leaf cells into programmed logic arrays and shift registers, typically with only 20 to 30 transistors apiece. In turn, these submodules are clustered into larger functional modules.

**Variety.** Choices for cells and submodules are vast. They come in many on-chip combinations and in n-channel or complementary-MOS technologies, Rowson says. "It's easy to fine-tune them for speed, power, size, and cost."

His plan also indicates a way of mapping the VLSI modules, much like tiling a floor. In the CAD program, a "floor plan" is devised, and the "tiles" that are the elements are laid down and shrunk to fit the available space.

**-Larry Waller**

MAGNAYOK FAIRCHILD  
 TEXAS INSTRUMENTS  
 WESTINGHOUSE RCA  
 MCDONNELL DOUGLAS  
 PENNSYLVANIA SPERRY  
 MOTOROLA HAMILTON  
 STANDARD PERKINELM  
 GENER  
 BRATT  
 GRUMM  
 MONEY  
 GENER  
 ELECT  
 COLLIN  
 LOCKE  
 HUGHE  
 DYNAM



**A few of our customers say  
 Abbott MIL Spec power supplies  
 are 99% perfect.**

The others say only 98%. For almost fifteen years we have maintained a customer failure rate of 2% for our "C," "S" and "W" MIL Spec power supplies. That's tried and true proof of reliability... in the field.

Our Model "W" family of 400 Hz to DC power supplies is a standard throughout the world for critical military and aerospace applications. They're available with output voltages from 5 to

100 VDC, current levels from 0.3 to 20 amps.

Our "C" family of 28V DC to DC converters and our "S" family of 28V to 400 Hz inverters come in package sizes as small as 2 1/8" x 3 1/2" x 3 1/2" and meet the requirements of eleven separate MIL Specs.

For reliability, call Abbott. For delivery, call Abbott. For additional information, write or call Abbott.

*See FEM or GOLD BOOK power supply sections*

**abbott transistor**  
 MILITARY PRODUCTS DIVISION

Circle 59 on reader service card

Eastern Offices 1224 Anderson Ave. Fort Lee New Jersey 07024 (201) 224-6900 TELEX 13 5332  
 Western Offices 5200 West Jefferson Blvd. Los Angeles CA 90016 (213) 936-8185 TELEX 69-1398

## Fujitsu's Sheet Keyboards

# We're putting a beautiful face on everything you touch

When you think about keyboards, it's time to look well beyond conventional uses. At Fujitsu, we are custom designing sheet keyboards for everything from home appliances and automobiles to factory and numerical control equipment. In fact, wherever there is information equipment, we are manufacturing reliable sheet keyboards to make that job easier and more efficient.

Besides its versatility, we've built in much more. For maximum protection against water, dust and oil there is a specially designed covering sheet. Beneath that protection you'll find a rhythmical snap-action touch thanks to a

unique plate spring/actuator construction. For greater reliability and longer life we've metal-coated the multi-point contact system, and to top it off you can select from a wide variety of modern colors and styles including numerals, full words or special characters. And you'll get all this at an attractively low price. Options include LED indicators, close-fitting transparent keytops, interface matrix circuitry and seven-segment LED. Fujitsu sheet keyboards. Versatile. Reliable. And economical. Contact your nearest Fujitsu representative today for full details.

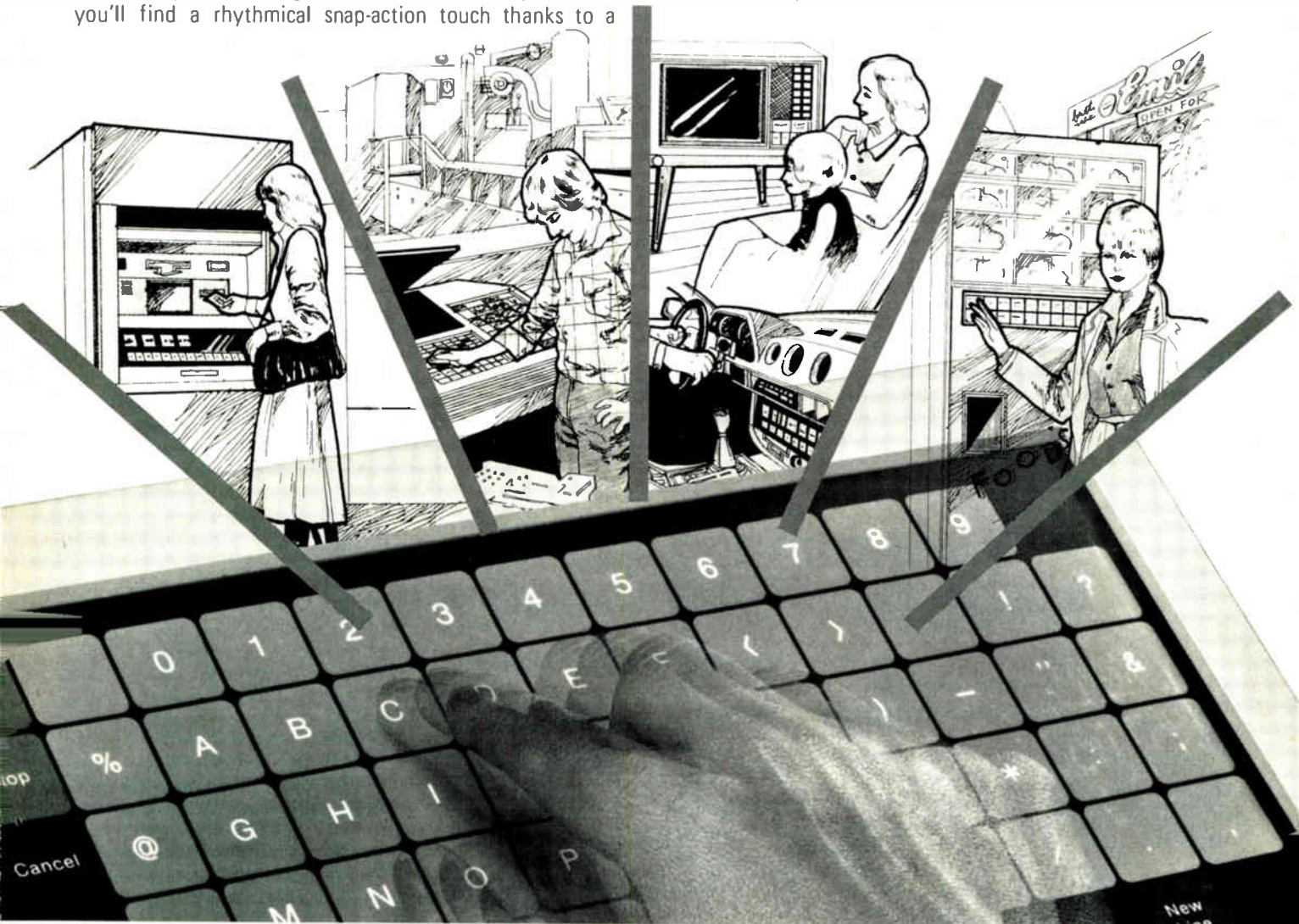

Fujitsu America Inc. Chicago Office:

910 Sherwood Drive 23, Lake Bluff, Illinois 60044 Phone: 312-295-2610 Telex: 20-6196 TWX: 910-651-2259

Circle 60 on reader service card



## Washington newsletter

---

### **Millicom says IBM, Johnson will aid land-mobile plan**

Millicom Inc. of New York City, a newcomer to the radiotelephone business, is raising eyebrows at the Federal Communications Commission with its proposal to join International Business Machines Corp. and E. F. Johnson Co. in developing an innovative broadband cellular system. Millicom wants FCC approval to install its developmental system for tests in the Raleigh-Durham, N. C., area, using the first hand-held transceiver. The unit, being developed by E. F. Johnson, the Waseca, Minn., mobile radio maker, would cost \$350 to \$700—far less than the \$2,000 to \$3,000 of existing larger transceivers with less channel capacity.

**Millicom says it is negotiating with IBM to work on development of “the supervisory and control software and hardware for the system,”** which will feature automatic channel transfer on traffic demand. It will incorporate signaling, automatic alarms and switching, and the use of alternative routing techniques. IBM, which is not in the mobile radio systems market, did not comment when asked about negotiations.

### **U. S. chooses Canadian system for videotext test**

Telidon, the Canadian videotext/teletext technology, has been selected for the first U. S. government-sponsored consumer trial of such a system. The two-way television system allows viewers to retrieve information stored in computer data bases by means of a keypad and their TV sets. It will be placed in 60 selected homes and public sites in a test to be conducted in Washington, D. C., in the last quarter of this year.

### **Recession slows corporate spending plans for 1980**

Growth of the U. S. electronics industries will slow in 1980 in the face of the recession, as it will in most other manufacturing industries, says the Department of Commerce. Capital spending plans for new plants and equipment by electrical machinery manufacturers—the Federal category embracing most electronics companies—will total \$6.1 billion this year, according to a survey by the department's Bureau of Economic Analysis. That second quarter estimate is some **\$450 million less than what companies said in January they planned to spend for the year.** Although it is still ahead of the 1979 total of \$5.17 billion by 18%, the rate of expansion is well under the 30% growth reported between 1978 and 1979. Capital spending in the aircraft industry, which includes makers of missiles and spacecraft, will not slow quite so sharply and will reach \$2.76 billion this year, according to the BEA. Though that total is more than 31% higher than in 1979, it is down from the 39% growth that year compared with 1978.

### **R&D funds jump for communications**

Communications research and development by 11 civilian agencies will jump 22% to \$71.8 million in fiscal 1981 from this year's level. That is the estimate of the House subcommittee on transportation, aviation, and communications following a survey of agencies. **Biggest spender will be the National Aeronautics and Space Administration,** with its renewed mandate to perform satellite and aeronautical R&D, which will spend nearly \$30 million, an increase of 45%. The Transportation Department, which includes the Federal Aviation Administration, will receive the biggest percentage increase, however, with its \$16.7 million total up by 60%. The Commerce Department, which funds the National Bureau of Standards and the National Oceanic and Atmospheric Administration, is third with almost \$9.5 million, unchanged from this year, while the U. S. Postal Service communications R&D budget of \$7.5 million is down 16%.

## Why Pentagon pump-priming can't help Jimmy Carter

"I am afraid that P<sup>3</sup> is not going to work in this election," says one senior military budget logistician, referring to the Pentagon-as-pump-priming tactic for a national economy in recession. In fact, the plan so popular for so many years among congressional leaders with bases, shipyards, and contractor plants in their bailiwicks "may not work anymore at all in high-technology industries," he adds. "Military equipment has become quite complex, and the skills needed to design and build and operate it are quite special. Using P<sup>3</sup> to pump out more contracts is pointless in areas like electronics" where defense backlogs are already high and the shortage of qualified engineers and skilled technicians has some jobs going begging.

Another reason why P<sup>3</sup> will not work is time. "It takes time to get new contract money into the economy," explains another Pentagon procurement specialist. "Even if we were to accelerate source selections, it would take more time before that would be reflected in a contractor's hiring and the money began to be spent. Any contracts involving technology that go out in June won't affect hiring or local area spending before November."

### The President may try anyway

Despite those and similar views expressed in conversations with three senior military program specialists in three separate agencies—the Office of Management and Budget, the Department of Defense, and the Army—all felt that the White House may try to use P<sup>3</sup> anyway to create more jobs, turn the economic tide, and salvage Jimmy Carter's reelection. Nevertheless, Government economists are being pushed hard to find ways to slow the accelerating slide of the U. S. economy into recession. Some military spending specialists already think they see the White House hand behind an unofficial push to accelerate spending what is left for fiscal 1980 outlays, a total that will reach nearly \$138 billion when the supplemental appropriation now pending has passed Congress.

If military electronics and other high technologies cannot be employed this year to offset downturns that may come in nonmilitary electronics markets, the outlook for the longer term is brighter in the Pentagon's view. "No one wants or enjoys this recession," points out one official, "but the military might possibly benefit in a couple of ways. First, we are getting more industry interest in competing for electronics programs—particularly from subcontractors for components, terminals, and other parts—as

domestic markets slow down. The second benefit is admittedly more tenuous at the moment: it is the prospect that some commanders see of a higher enlistment rate producing a better educated enlistee to operate some of this equipment if—a big 'if'—unemployment continues to rise at the present rate and is at all prolonged. Again, no one wants that to happen but the services could benefit if it does."

All sources are quick to admit that a cutback in private sector job opportunities is not a positive approach to filling sagging enlistment quotas, but, as one put it, "it could be a secondary consequence of the recession."

### Industry outlook

Electronics suppliers who have not assigned a high priority to military business in recent years, when domestic markets were rapidly expanding, are moving back to it with reluctance. "How many make that move and how quickly they do it depends on how the recession affects their other businesses," explains one official. "Nevertheless, evidence of the interest is there already. We can see it in industry responses to our notices of inquiry on systems as well as in response to requests for quotes by supply depots for stock parts."

When Congress completes its fiscal 1981 appropriations bill later this month for the year that begins in October, revisions should push outlays above the \$153 billion mark. If an increasing proportion of this goes, as the military wants, to operations and maintenance accounts—large users of spare and replacement parts—the overall electronics share next year could gain as much as 5% in constant dollars after discounting inflation. That amounts to nearly \$23 billion for electronics. But, as one economist is quick to remind the listener, "that won't impact the recession this year at all."

Adds another in an ironic aside, "Politicians must understand that one of the big reasons why economic pump-priming with the defense budget won't work anymore is precisely because of the advances in data processing and telecommunications. They have made it possible for us to look at many more options much faster, of course, but they have also vastly expanded the amount of data at hand. Also, our decision networks are much larger, requiring that much more information be exchanged, reviewed, and approved at many more levels. These can be valuable safeguards. But they slow down the procurement process, too, and that is why P<sup>3</sup> is largely obsolete."

**-Ray Connolly**

# Now from Sprague— the reel people...



## Type 173D solid-electrolyte TANTALEX<sup>®</sup> capacitors in bullet-nose molded cases.

- Lead-taped and reeled for use in automatic insertion equipment.
- Low leakage current.
- Low dissipation factor.
- Capacitance values from .1  $\mu$ F to 56  $\mu$ F.
- Voltage range, 6 to 50V.
- Operating temperature range of  $-55^{\circ}$  C to  $+85^{\circ}$  C; to  $+125^{\circ}$  C with derating.

*For complete technical data, write for Engineering Bulletin 3533.10 to Technical Literature Service, Sprague Electric Company, 35 Marshall Street, North Adams, Mass. 01247.*

**THE BROAD-LINE PRODUCER OF ELECTRONIC PARTS**



a subsidiary of **GK Technologies**  
Incorporated

Circle 63 on reader service card





# When you need a custom circuit, make sure it's you pulling the strings.

For the control you need over your custom circuit, go C.O.T. — Customer Owned Tooling. Today, more and more customers are doing just that: performing the circuit design themselves and taking it to the semiconductor industry for production.

It makes sense to take it to Synertek. We're one of the top custom houses in the industry. We can meet head-on your volume custom demands with our N-channel Silicon Gate production lines. Efficiently. Economically. It takes outstanding engineering talent, all out service, attention to detail and the ultimate in reliability controls. It takes Synertek.

We can do it because our engineering staff works closely with you. To provide insight into design rules and process capabilities. To insure your design works the first time out. So you can meet your production schedule. On time.

The whole point is to save you money. And time. Customer Owned Tooling gives you minimum design cost and production timing yet maximizes your design security, profits and control. Enough to cut the Average Selling Price of the circuit to less than half.

As the industry matures and develops, design of custom proprietary circuits is moving out of the semiconductor houses and back to the user. It's created a tremendous demand for design talent that can only continue to outstrip the available talent pool. To learn how VLSI may impact you and your design team, send for our brochure, "The Future of VLSI!"

And remember. To get ahead of the competition, take your C.O.T. to the company that made its mark in

custom. Take it to Synertek. To control the design. To control the costs. With no one but you pulling the strings. Contact Custom Product Marketing direct at (408) 988-5671. TWX:910-338-0135.

**Synertek performs** as a major MOS supplier of high volume parts with advanced technologies and techniques behind everything we make. ROMs. Static RAMs. EPROMs. Custom circuits. Single-chip Microcomputers. Systems. 6500 Microprocessors and Peripherals.

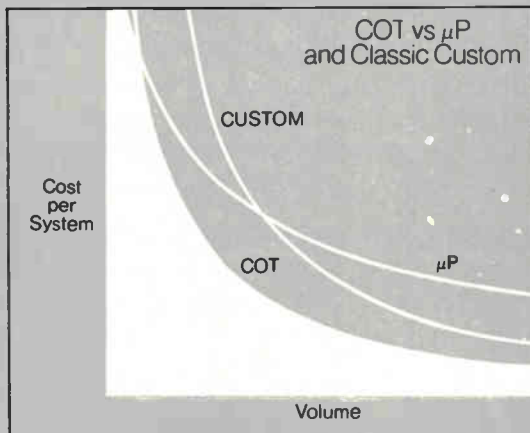

**SYNERTEK**

3001 Stender Way, Santa Clara, California 95051  
(408) 988-5600. TWX: 910-338-0135.

Circle 65 on reader service card

## International newsletter

---

firm will ship its SR-1201, which can recognize 16 different words, and next year it will be ready to ship a commercial version of its SR-1301, which uses technology developed in a government-sponsored pattern-recognition project and can recognize 128 words. The systems all can be time-shared, which cuts the cost per channel. The standard models of the two smaller systems have a capacity of 10 channels, the largest model 5 channels, giving them a per-channel cost of \$18,600, \$23,300, and \$70,000 to \$93,000, respectively.

### **Intel, French firm said to agree on technology exchange**

Intel Corp., Santa Clara, Calif., has apparently reached a basic agreement with a major French company for an integrated-circuit technology exchange arrangement similar to Intel's agreement with West Germany's Siemens AG [*Electronics*, July 20, 1978, p. 92]. But the French government, which would instead prefer some kind of joint venture, has yet to OK the agreement. **Chances are that the unnamed partner is either Thomson-CSF, the largest French electronics group, or Matra SA, which has a limited joint venture with Harris Semiconductor.** Intel seriously discussed the possibility of a joint venture with French industrial giant St.-Gobain-Pont-à-Mousson several months ago but decided it could not afford to release semiconductor engineers and technicians from its U. S. facilities to get such a project going.

### **AEG-Telefunken may join Thomson to make TV sets**

AEG-Telefunken, which joined forces with Thomson-Brandt for color tube production earlier this year in a move to cut its losses on its television activities, may team up with the French group for set production as well. Company officials say they are talking with Thomson (and others) about a deal that would strengthen European defenses against the Japanese assault in consumer electronics. Meanwhile, the West German firm has emerged from its period of crisis [*Electronics*, Jan. 3, p. 72] and is once again investing in North America. During the next five years, it **will spend more than \$6 million to expand the production facilities of its wholly owned subsidiary, Bayly Engineering Ltd., a communications equipment maker** in Ajax, Ontario. It aims to quadruple Bayly's sales by 1985 to \$45 million from \$12 million this year. The work force is slated to double from 300 to 600. The investments are also to help Bayly become active in new fields—in optical communications, for example. Earlier this year, the Canadian firm delivered a \$3.6 million automatic letter-sorting system to the U. S. Postal Service.

### **NEC introduces cache memory for disk drives**

An integrated cache memory for the disk drives on Acos system 900 mainframes is the first of this type in Japan. It **increases the throughput of some Cobol jobs by 10% to 35% and cuts the response time on timesharing systems by 15% to 25%.** This increased performance makes the \$4,545 monthly rental relatively low, says a spokesman for Nippon Electric Co., the maker of both the computer and its peripherals. For the price, the user gets a 4-megabyte MOS random-access cache memory, a disk-to-cache controller, and hardware that lets the computer's input/output processor interface properly with the controller. Larger versions of 8, 12, or 16 megabytes are also available. For data requested by the central processing unit that is stored in the cache, access time varies between 1.5 and 2.2 ms—versus almost 40 ms for data directly from the disk.

# Two Chips Off the Old Block.

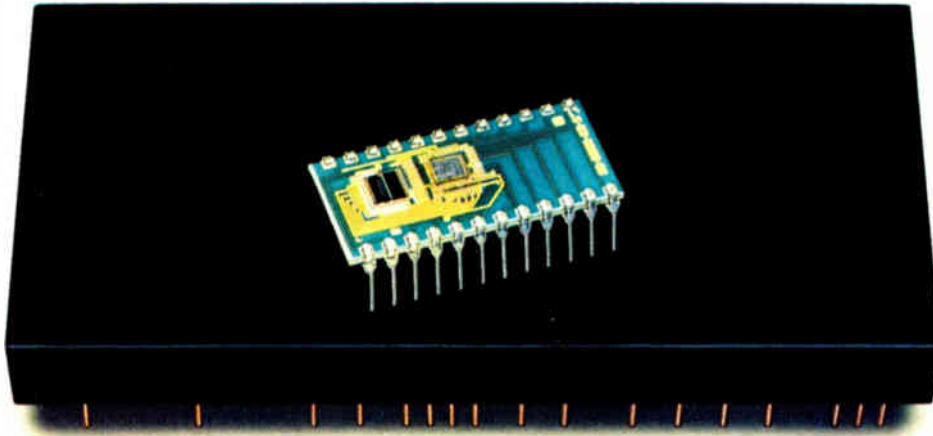

## A DAC with true 16-bit linearity... with just 2 chips... for \$99. So Long, Old Block.

**Performance.** Our new CMOS D/A converter can help you make design history. With  $\pm 0.0008\%$  max. non-linearity . . . four-quad multiplication . . . input storage registers in "byte-sized," 8-bit segments for micro-processor interface . . . 5 and 15V CMOS compatible as well as TTL . . . less than 1 ppm/ $^{\circ}\text{C}$  linearity drift . . . 50mW power consumption . . . settling time less than 2 $\mu\text{Sec}$  . . .  $\pm 10\text{V}$  reference input capability. And all with a single +15V supply.

**Package.** Our 24-pin package\* is the new commercial standard for reliability. Based on a major innovation in monolithic processing, DAC9331-16 uses only two chips, featuring our own thin-film resistor network and proprietary monolithic switch set.\* Result: unparalleled reliability, cost-effectiveness, and savings in size and weight.

\*U.S. Patents Pending



**Price.** For fast turnaround, call or write.

Quantity	Price	Quantity	Price
1-9	\$169.00	25-99	\$119.00
10-24	\$139.00	100-249	<b>\$ 99.00</b>

**For performance,  
experience and reliability,  
go with the leader.**

## Hybrid Systems

CORPORATION

Crosby Drive, Bedford, MA 01730  
Phone (617) 275-1570  
(TWX 710-326-7584 HYBRIDSYS BFRD)

In Germany: Hybrid Systems GmbH.  
6100 Darmstadt, Luisenplatz 4, Germany  
Tel. 6151-291595 (TELEX 419390 HYSY D)

In France: Hybrid Systems S.A.R.L.  
14 Rue du Morvan SILIC 525  
94633 Rungis CEDEX, France  
Tel. 1-6878337 (TELEX 250969 HYSYS)

In the United Kingdom:  
Hybrid (Component) Systems U.K. Ltd.  
12A Park Street, Camberley, Surrey  
Tel. (0276) 28128 (TELEX 858720 HYBRID G)

# Whose 4-bit MCUs have the power

## AMI'S SUPERCIRCUITS FROM THE S2000 FAMILY.

Fast, versatile, reliable and more powerful than any other 4-bit MCU. That's Mighty MOS, created by AMI's engineers to aid companies looking for superior performance at minimal cost.

You'll find AMI's super chips controlling all kinds of appliances—washers, dryers, dishwashers, ranges, microwave ovens, toasters and blenders. They're running auto instrumentation, stereos, videotape recorders, cameras, garage doors, televisions, home security systems, timers, thermostats, electronic games and musical instruments.

## HOW DID WE GIVE IT SO MUCH MUSCLE?

By designing advanced architecture. We devised an I/O structure that's in a class by itself. It reduces system costs by giving you Touch Control, direct drive of SCR and Triac, and a choice of LED or fluorescent drivers.

We really put you in the driver's seat with a 50/60 Hz timer or counter, zero voltage crossing detection to let you use smaller, less expensive Triac or SCR, and a three-level subroutine stack to pack more punch in its programming muscle.

We made it easy to develop that muscle, too. The S2000 is the only micro-computer family supported on the Tektronix 8002A™, the Motorola Exorciser™ and Intel MDS™ development systems.

## WE BUILT STRONG FAMILY TIES.

AMI's S2000, S2150 and S2152 have already proved to be powerful performers, offering from 1K bytes of ROM and 64 4-bit nibbles of RAM to 1.5K bytes of ROM and 80 nibbles of RAM. As well as such added features as digital-to-frequency conversion.

Soon our engineers will be sending even mightier MOS into the fight against high-priced under-achievers. They'll have more memory, analog I/O, interrupts, table look-up and five subroutine levels. And, since our family software is all upward compatible,

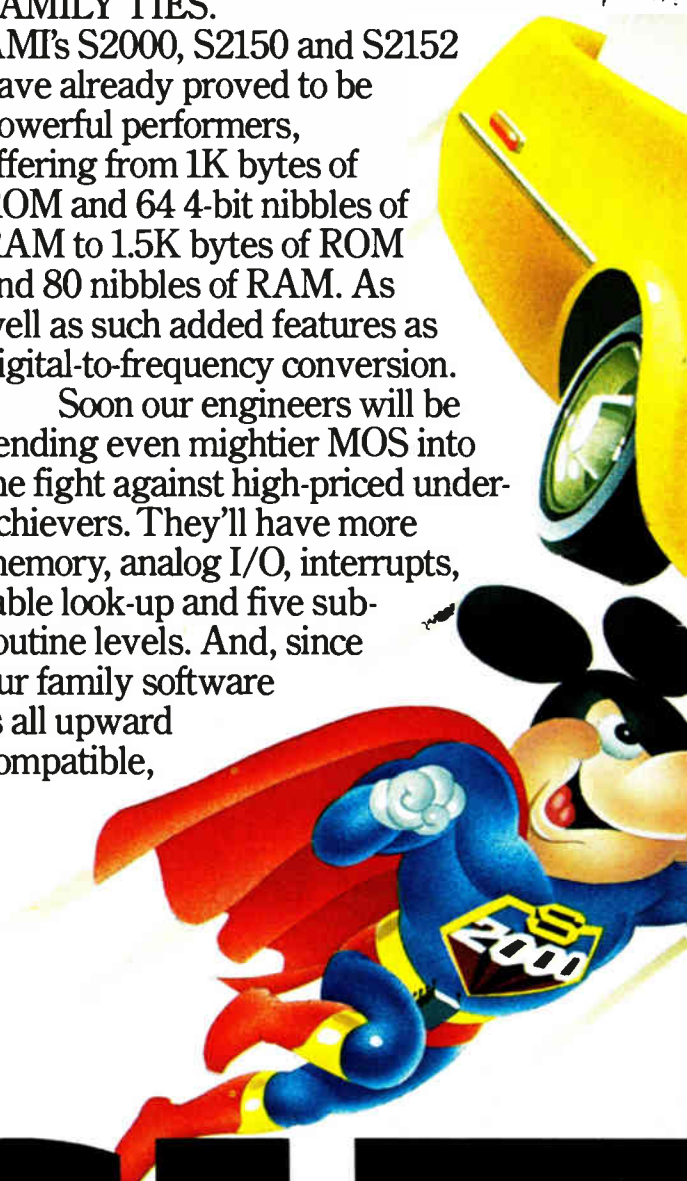

# MIGHTY

# to control all this?



you'll be able to upgrade your systems without upsetting your budget.

So take control of your new product with Mighty MOS. Call your nearest AMI sales office for all the dynamic details. Cal., (213)595-4768 and (408)738-4151; Fla., (305) 830-8889; Ill., (312) 437-6496; Ind., (317) 773-6330; Mass., (617) 762-0726; Mich., (313) 478-9339; N.Y., (914) 352-5333; Penn., (215) 643-0217; Tex., (214) 231-5721;

Wash., (206) 687-3101.

Or contact  
AMI S2000  
Marketing,  
3800

Homestead Rd.,  
Santa Clara CA  
95051. Phone  
(408) 246-0330.

We'll prove that powerful things come in small packages.



**AMI**  
AMERICAN MICROSYSTEMS, INC.

# YIMOS

**Compare our Qikeject™  
with any other  
release-type LSI socket  
on the market today.**

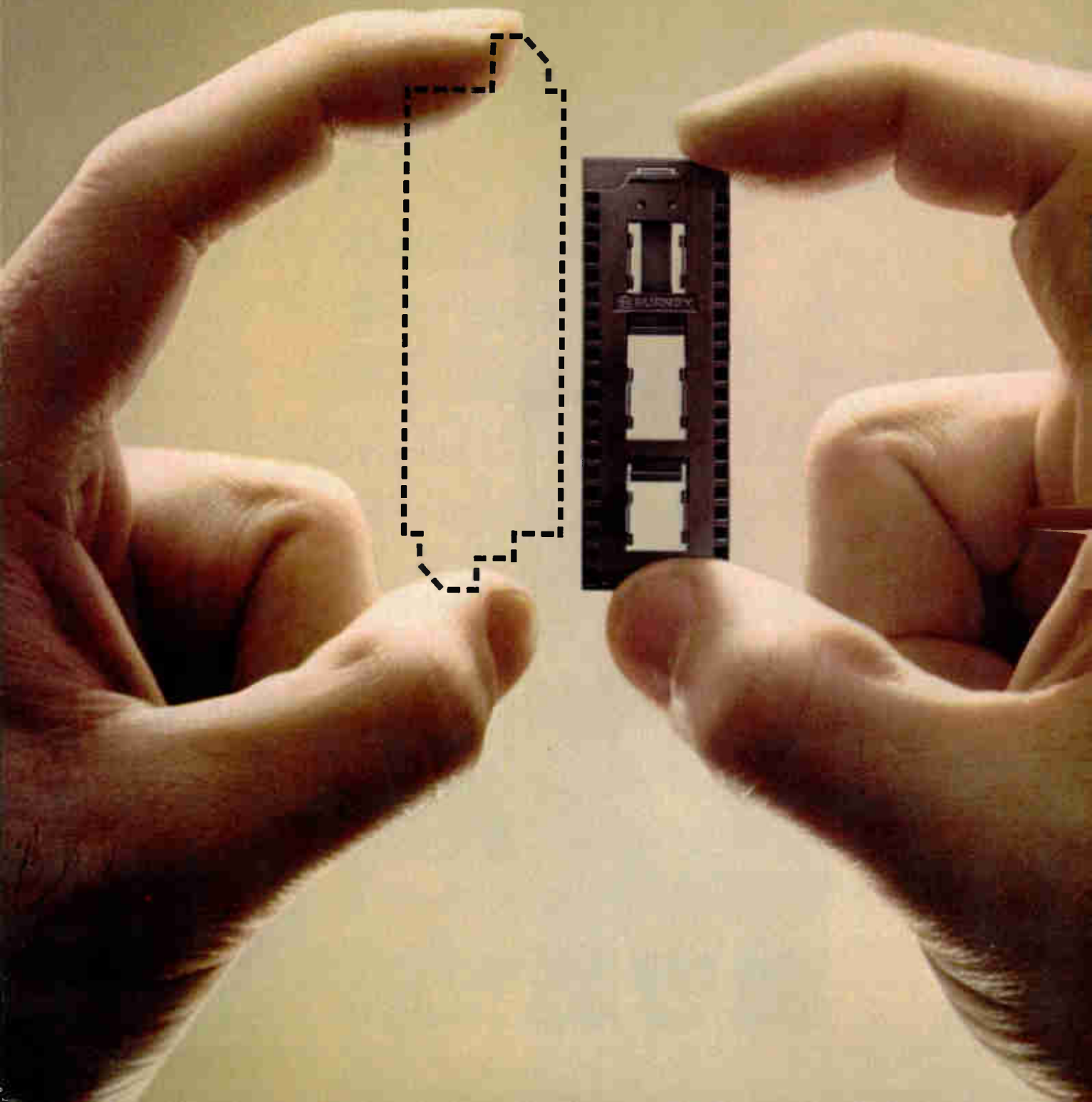

## Pin-for-pin, it's the smallest available. And, it costs a lot less, too!

Barely larger than an ordinary DIP socket, Burndy's new Qikeject LSI socket simplifies high-lead-count-package insertion and extraction as never before. Without special tools. Without bulky levers, cams and slide releases. And without squandering precious real estate.

*Simply line up the pins and plug in the package. To remove, release a simple spring catch and the package lifts right out. Without damaging package leads.* Another nice thing. Qikeject sockets reset automatically for your next cycle.

But that's only half of the Qikeject connector story. The other half has to do with GTH reliability and low cost. Thanks to Burndy's exclusive GTH contact system, you get good-as-gold reliability — without gold. Without gold prices. And at a small fraction of the cost of ordinary ZIF-type sockets.

Too good to be true? Not at all. Prove it to yourself. Check the size comparison with any ordinary release-type socket on the market today. Check the performance data below. Then contact me for complete details. Call or write:  
 Joe Bradley, V.P. Marketing, Burndy Corporation,  
 Norwalk, Connecticut 06856. (203) 838-4444.



INSERT

RELEASE

REMOVE

### Proof of Performance Contact Resistance Test Data (Milliohms).

Test Performed Per MIL-S-83734.	Min.	Max.	Avg.
Group 1 Initial Contact Resistance	6.300	8.500	7.360
After Thermal Shock	6.200	8.500	7.222
Vibration	-----	Passed	-----
After Mechanical Shock	6.300	8.400	7.360
After 100 Mating Cycles	7.500	11.800	8.298
Group 2 After Corrosive Atmosphere and 100 Mating Cycles	7.800	12.000	8.560

Consult your local Burndy distributor for Qikeject LSI sockets.

 **BURNDY**  
 Offices in principal cities throughout the United States

INTERNATIONAL SALES AND MANUFACTURING BRUSSELS BARCELONA PARIS ROTTERDAM STOCKHOLM STUTTGART TURIN ZURICH ST HELENS (ENG.) TORONTO SYDNEY TOKYO MEXICO CITY SAO PAULO

# BURNDY CONNECTS

# IMAGINE

As your ideas race into the future, you need products to match your stride. Today Zilog offers you the most advanced family of microprocessor products made: components, support devices, software, development systems. All available in production quantities with worldwide support.

Elegant but soundly conservative scaled n-channel manufacturing processes combine with generation-ahead architecture to give Zilog products uncommon performance levels. The 8-bit Zilog Z80 revolution-

ized the microprocessor industry.

Today it's become the still more powerful Zilog Z80B. Its cousin, the Zilog Z8, packs an ingeniously flexible, complete 8-bit microcomputer onto a single chip. And, as you would expect, the incredible 16-bit Zilog Z8000 has set the microprocessor performance standards for the 1980's.

Give your imagination some of our hard, profitable facts to work with. Write: Zilog, Dept. E, 10460 Bubb Road, Cupertino, CA 95014. Or, call your nearby Zilog distributor.

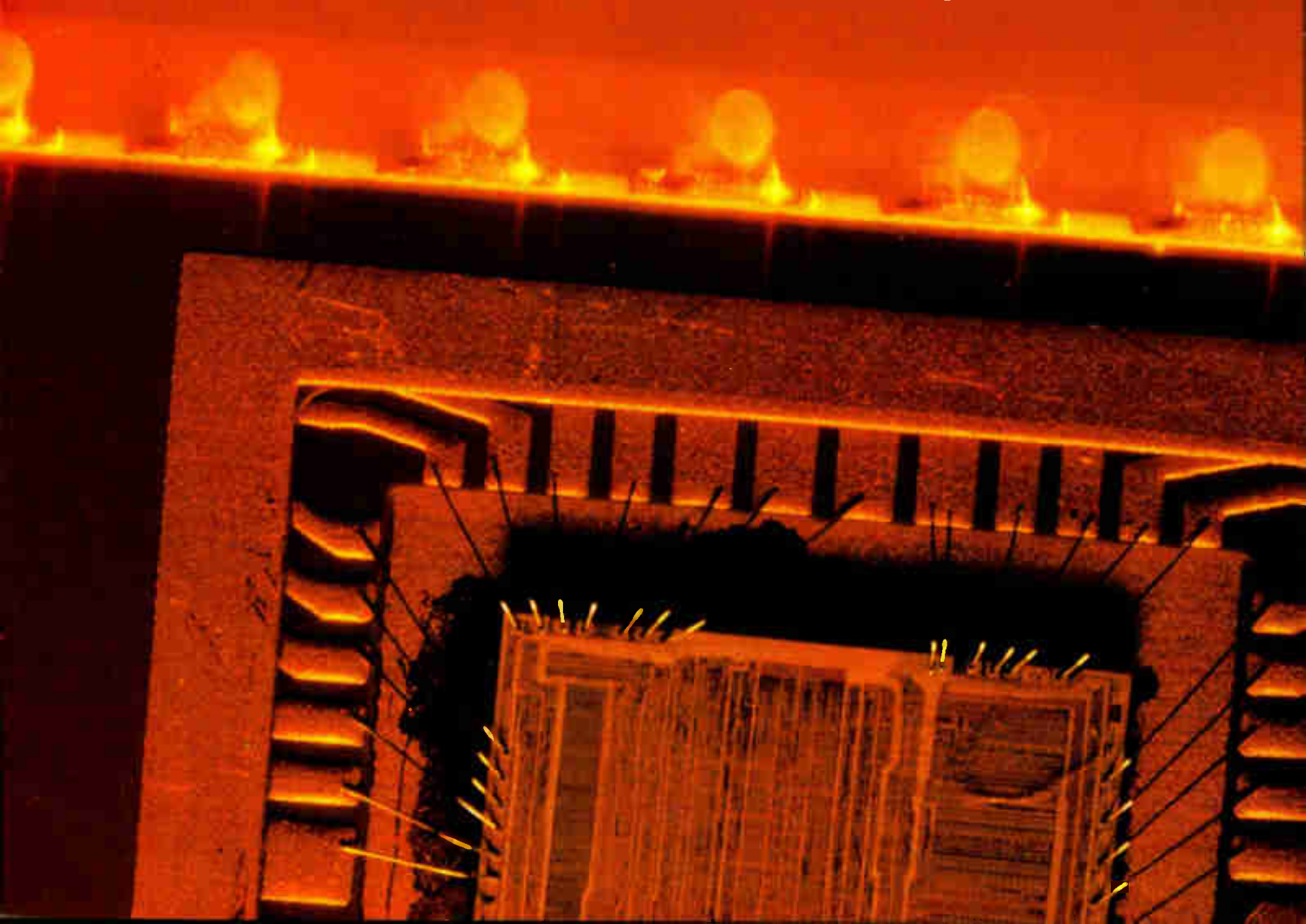



**THE POWER TO DESIGN  
THE MOST ADVANCED MICROPROCESSOR-  
BASED SYSTEMS IN THE WORLD.  
AT YOUR COMMAND TODAY. FROM ZILOG.**

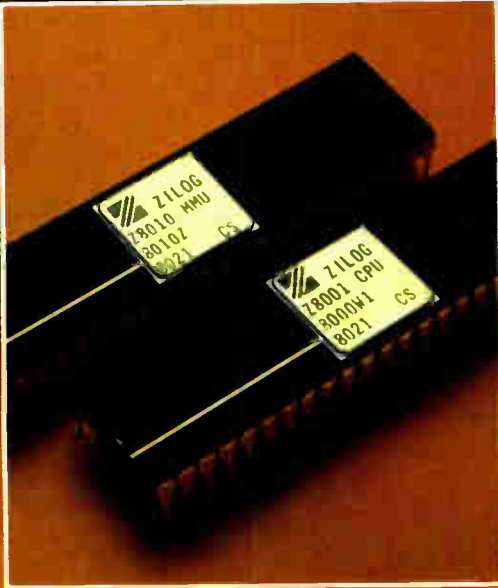

JULY 1980:

**The Zilog Z8010 Memory  
Management Unit  
unfolds the next phase  
of the Z8000 concept.**

With the advent of the Zilog Z8010 Memory Management Unit (MMU), each of the 128 memory segments of the 8M-byte Z8001 microprocessor can now be given its own broad range of programmed characteristics. Sophisticated data and program storage management is now possible, opening up new vistas for advanced systems design.



An affiliate of **EXXON** ENTERPRISES INC.

Circle 77 on reader service card

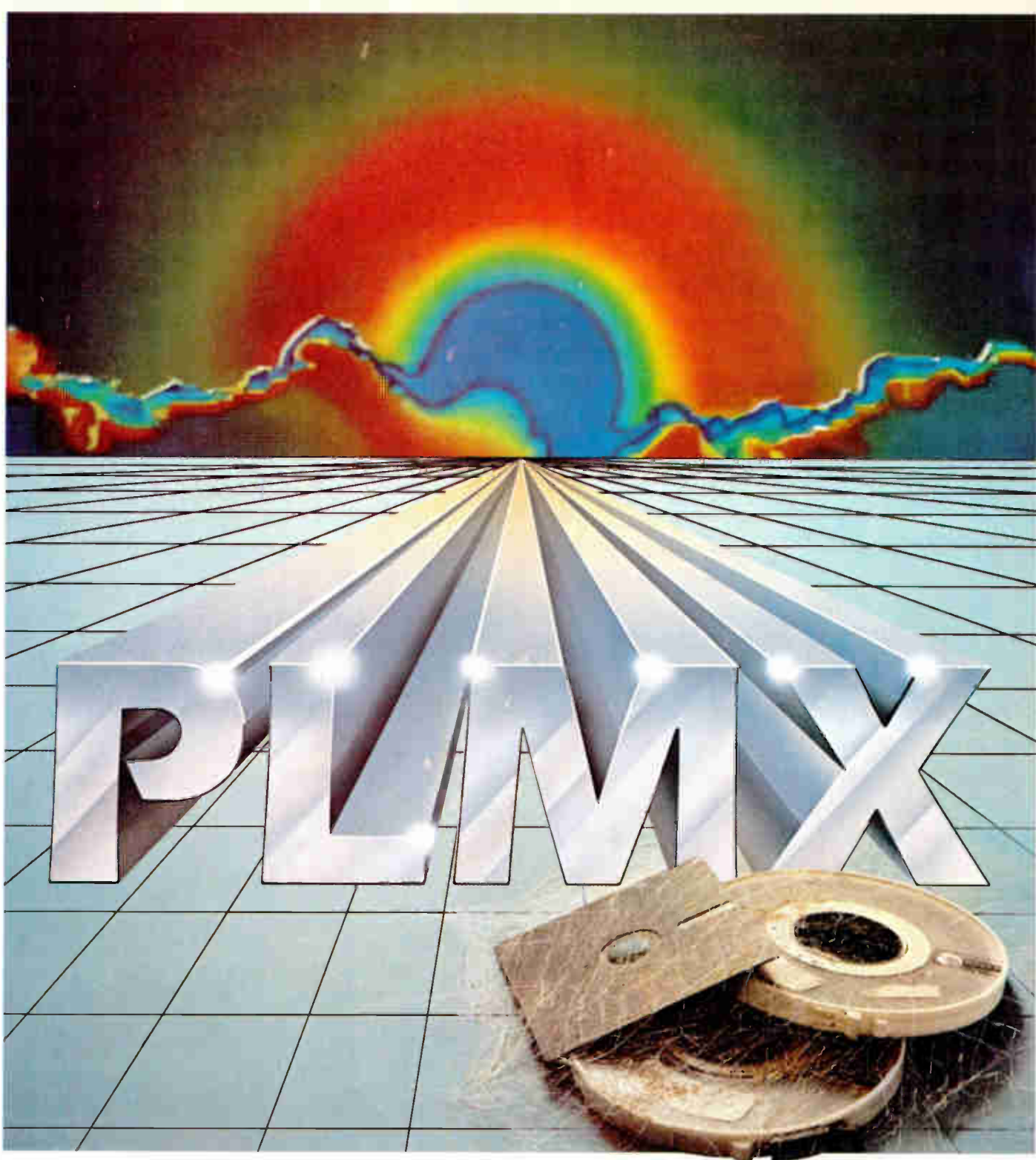

It's about time. And money.

## **PLMX**

The universal microprocessor language that keeps today's software  
up to date with tomorrow's new hardware.

And it's available now.



For more information write:  
Systems Consultants Incorporated  
Product Development Group  
4015 Hancock Street, San Diego,  
CA 92110. Or call: (714) 292-PLMX  
TWX: 910-335-1660

## Three-chip teletext set aims to win out through flexibility and low cost

by Kenneth Dreyfack, Paris bureau

Set being readied by TI includes a single-chip video display processor that helps out the CPU

The race is not necessarily to the swift, as Ecclesiastes pointed out more than 2,000 years ago. Thus Texas Instruments France is not much perturbed by the possibility that its two major competitors will be on the market first with chip sets to equip television receivers for Antiope, the French teletext system scheduled to go into full operation in 1982.

TI has based its solution on a complex video display processor (VDP) chip that will not be ready for market for another two years, even though it has been in development since 1978. But paired with standard memory and a microprocessor, the chip provides the heart of a system that, the firm believes, will best the earlier entries in cost and flexibility.

**Traded.** "Clearly, we had to make a tradeoff," says Pierre Frandon, MOS design manager and Antiope program manager at TI France's facility in Villeneuve-Loubet, outside Nice. "The single-chip VDP means our product will be ready later than the others."

However, TI is not lagging on two other, less complex chips needed to demodulate and decode Antiope signals when they are broadcast (see "The data on Antiope"). One, a linear bipolar device called a "data slicer," separates a bit clock and the digital data from the analog TV signal. The second is a single layer

n-channel "prefix processor," so named because it separates out the service information and display data packet.

TI began supplying samples of these two chips several weeks ago. Its two major competitors—Thomson-CSF's EFCIS subsidiary and Philips' RTC-La Radiotechnique Comptelec subsidiary—have yet to deliver any Antiope chips, but both expect to have complete chip sets—with two-chip VDPs—by early next year.

TI's video display processor is an n-channel circuit containing 8,000 transistors with gate lengths of less than 5 micrometers. It is tied into the system through two buses: the data bus links it to the memory in which pages to be displayed are stored, and the second bus links it to the system's central processing unit (see diagram).

The idea is to have the VDP handle system coordination and control,

leaving the CPU, the slowest circuit in the system, free to perform such tasks as address computation and data decoding. In essence, the designers wanted to unload the CPU (in the prototype system, a TMS 9980) of all functions that could be performed elsewhere.

Antiope's data input rate—as high as 4 megabits/second—is so fast that incoming data cannot be directly placed into page display memory, especially as its format needs to be modified for display, Frandon explains. Therefore a section of dynamic random-access memory is used as a buffer for incoming data from the prefix processor, with the 8-megahertz clock of the VDP providing the time base. The CPU then decodes the data in the buffer into the format for actual display, which is stored in the page display memory at its screen location address.

The display data is decoded into 2

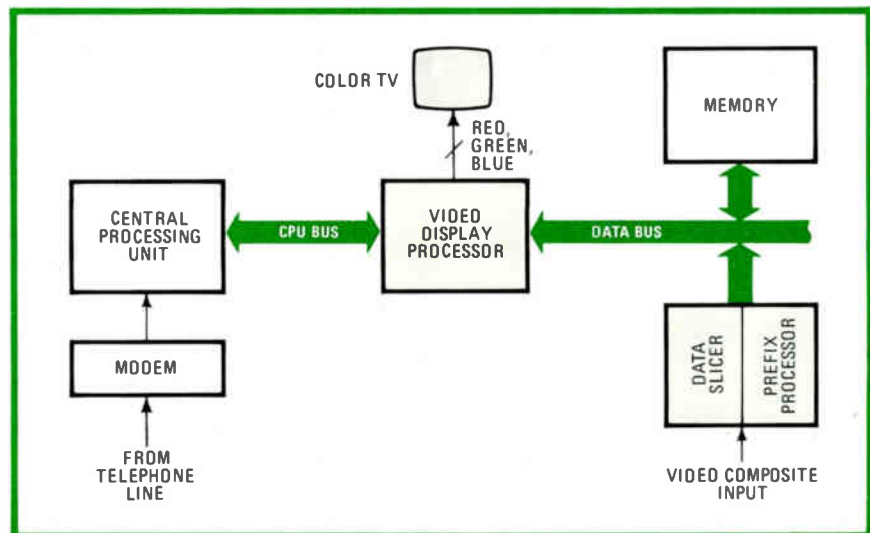

**Displaying the data.** TI France is at work on three chips (tinted) needed for French teletext terminals. The system is compatible with viewdata as well.

## The data on Antiope

Antiope—for Acquisition Numérique et Télévisualisation d'Images Organisées en Pages d'Écriture—is the French version of teletext, the service that ties TV sets to data banks through television broadcasts. In Antiope, the digital display data can be transmitted during the vertical blanking interval of a regular TV broadcast, or the television channel can be used to transmit nothing but Antiope data. The maximum transmission capacity in the former case is 14 pages per second; in the latter, it is 590 pages per second.

Antiope differs from Britain's Ceefax and Oracle systems mainly in that data is transmitted asynchronously in packets, with one packet defining each of the 25 lines into which a page is divided, rather than synchronously line by line. Each packet contains 8 service bytes followed by up to 32 bytes of display data. The packet organization is designed to permit transmission at data rates varying from 2 to 4 megabits/second and to permit Antiope operation with PAL, Secam, or NTSC TV broadcasting systems. What's more, Antiope's packet transmission can be used for viewdata services, which tie TV sets interactively to data banks via telephone lines.

bytes: 1 byte contains the format information for the character, such as its color and whether it is to be displayed flashing; the other identifies the character itself. The Antiope system is designed to operate with two sets of 128 characters.

**DMA.** Though a first-in, first-out memory could conceivably be used to accommodate the three functional blocks requiring asynchronous memory access—the prefix processor, the VDP, and the CPU—Frandon notes that large-capacity, fast FIFOs are expensive and difficult to manufacture. So TI incorporates a direct-memory-access controller in the VDP to avoid conflicts among them.

The RAM cycles in 250 nanoseconds. The VDP requires access to the character code and page display every microsecond; the decoder, at the maximum data transmission rate, requires access every 1.1 ms; and the access time required by the CPU is slower than either of these. The DMA controller places each user's access demands in the dead time of the others' demands, assigning a priority when two demands are received simultaneously.

Frandon boasts that one advantage of TI's system over its competitors' is that the VDP can address a cathode-ray-tube screen point by point. Used in this mapping mode, any TV receiver can become a "true graphics terminal," he says, with the quality of the image limited only by

the resolution of the CRT itself.

All that is needed to operate in this mode is sufficient memory to store the additional data. Since 2 bytes are necessary to identify each alphanumeric character and since the display consists of 1,000 characters, a total of 2 kilobytes of memory is required to display a single page of characters.

In the mapping mode, the display is divided into 100,000 points, with 3 bits defining the color of each point, so that the memory requirement for a page of mapping display is upwards of 30 kilobytes. This helps explain why Frandon suggests mixing mapping and teletext modes on the same page of display, although he adds that replacing solid-state RAMs with bubble memories should permit the use of a full mapping mode within a few years.

## West Germany

### Car-route computer uses no roadside gear

Elegant simplicity and ease of operation characterize a route-guidance system now in the works at the research laboratories of Daimler-Benz AG in Stuttgart, West Germany. In a radical departure from systems being developed or tried out by others [*Electronics*, Aug. 18, 1977, p.

65 or 5E], two young Daimler engineers have devised an approach that eliminates the need for any equipment in or along the road.

Gone are the inductive loops in the roadbed for data transfer between the car and roadside processing units. Gone, too, are the control centers needed to monitor these units and the vehicle-mounted antennas for data transmission and pickup. All the intelligence is in the car itself, point out research engineers Hans-Georg Metzler and Peter Häussermann.

Basically, the system consists of a small dashboard-mounted touch panel and display combination (see photo) and the routing computer, a unit built around a 16-bit microcomputer installed under the dashboard. The names of 1,048 exits and entrances and about 150 intersections along the Autobahn, West Germany's tightly meshed system of superhighways, are stored in 16 16-K random-access memories.

**Starting out.** Before a trip, the driver enters into the computer the name of the Autobahn entrance at which the trip starts and that of the destination exit. A touch of the display, whereupon the exit and entrance names show up in alphabetical order, initiates this process. When the desired names appear, they are entered into the computer by further touches of the display. The computer then figures out the optimal route to the desired exit.

The display also shows the distance to the desired exit from each intersection along the way and how long it takes to reach it and gives the designation of the Autobahn leg along which the driver must travel. Each time the car passes through an intersection, the display shows its name and the distance and time remaining to the exit.

In figuring out the distance to the destination exit, the computer relies on pulses derived from, say, a wheel rotation counter or from a pulse generator at the speedometer drive. In first calculating the time it takes to reach the desired exit, the computer assumes an average driving speed of 100 kilometers (about 60 miles) per

# YOU KNOW THE LARGEST ELECTRONIC COMPANIES IN THE WORLD. DO YOU KNOW ISKRA?

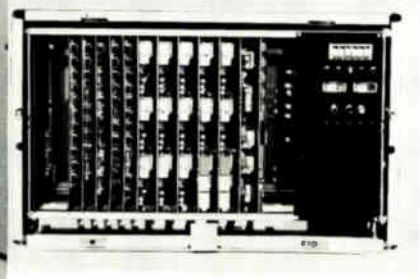
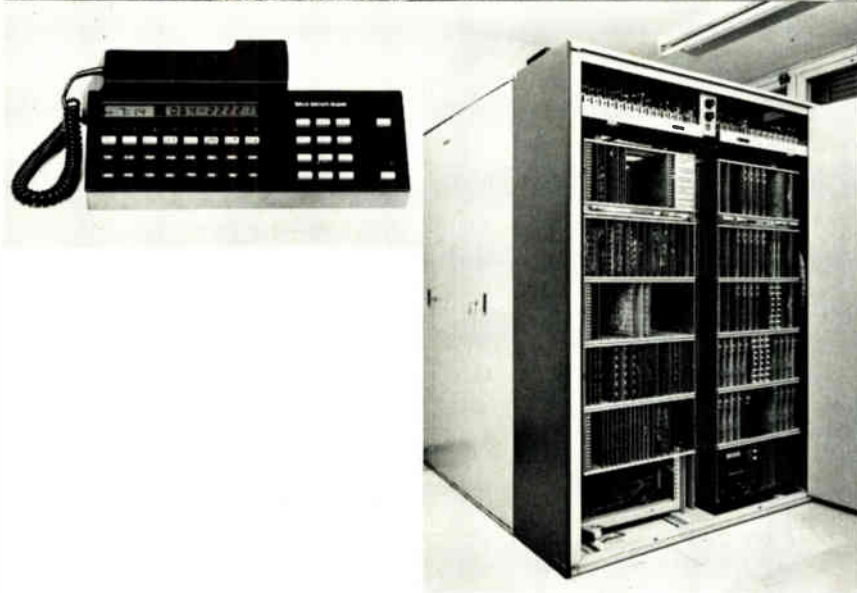

Iskra group has some 29,000 employees including 2,000 research and development engineers in 81 factories, research, marketing and other organizations, and the most up-to-date technologies to work with. With a total turnover of 1.294 billion dollars last year, it has been classified among 16 largest manufacturers of electronic products in Europe.

In its development, Iskra is oriented towards tomorrow's activities which go far beyond the traditional limits of electromechanics and extend to the widest application of electronics with priority being given to the promotion of the development of computers, communications, automation, microelectronics, optoelectronics and engineering activities. All to ensure that every project we handle comes within schedule and budget requirements and meets performance and client expectations.

Iskra has 24 trading companies, representative offices and production plants in 18 countries all over the world. In the period 1974-1979, Iskra's exports increased by 153% reaching 120 million dollars in 1979. In 1980, the total turnover is expected to be 1.486 billions of dollars and the export figure approximately 145 million dollars.

For more information call or write:

Iskra Commerce, Trg revolucije 3, 61001 Ljubljana, Yugoslavia, Telephone-international: + 38 61 324 261; Telex: 31 356 yu iskexp  
**USA:** Iskra Electronics Inc., 8 Greenfield Road, Syosset, N.Y. 11791, Tel.: (516) 364 2616—**Germany:** Iskra Elektronik, GmbH, Furtbachstrasse 2b, 7000 Stuttgart 1, Tel.: (711) 60 30 61—**CEFRA,** GmbH, Ungererstrasse 40, 8000 München 40, Tel.: 39 20 61—**Italy:** Iskra Elettronica Italiana, S.r.l., Piazza de Angeli 3, 20 146 Milano, Tel.: 49 80 036—**France:** Iskra France, 354, rue Lecourbe, 75015 Paris, Tel.: 554 04 27—**United Kingdom:** Iskra Limited, Surrey CR 3 2 HT, Redlands, Coulsdon, Tel.: 66 87 141—**Switzerland:** Iskra Electronics AG, Stalden 11, CH 4500 Solothurn, Tel.: (065) 22 81 22—**Czechoslovakia:** Iskra, Lazarska 5, 11000 Prague, Tel.: 20 27 71—**Poland:** Iskra, Swietokrzyska 36 m 15, Warsaw, Tel.: 20 12 53—**Germany DR:** Iskra, Hermann-Maternstrasse 46, 104 Berlin, Tel.: 28 28 322—**Rumania:** Iskra, Str. Visarion nr. 6, Bucharest, Tel.: 50 26 75—**U.S.S.R.:** Iskra, Mosfilmovskaja 42, Moscow, Tel.: 147 84 03—**Egypt:** Iskra, 34 Adly Street, Cairo, Tel.: 74 76 95—**Iran:** Iskra Teheran, 9th Street No. 6, Maydan Sanai, Teheran, Tel.: 82 67 65—**Turkey:** Iskra Istanbul, Yenicarsi Biltex Han No. 40, Galatasaray, Tel.: 44 75 00—**Venezuela:** Eurocommerce S.A., Apartado 68901, Altamira, Caracas, Tel.: 72 88 21.



## Iskra

Circle 81 on reader service card

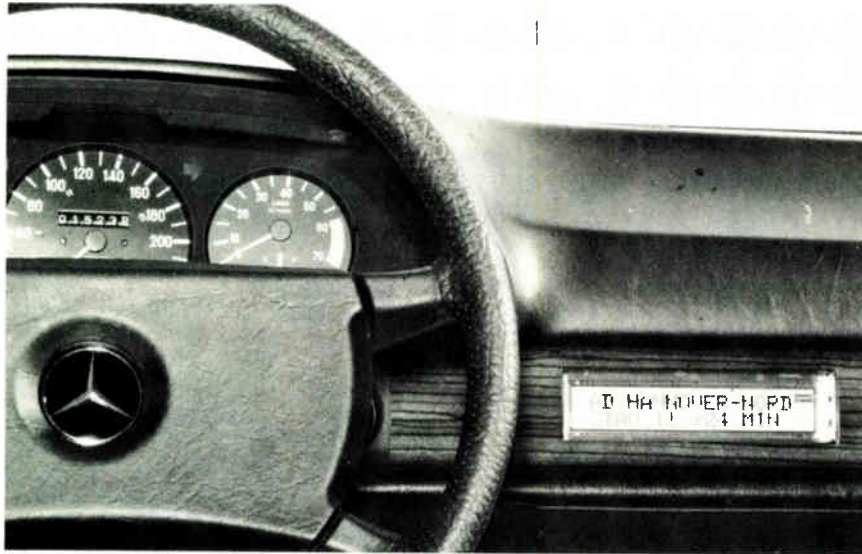

**Informers.** Route-guidance system being readied by Daimler-Benz calculates optimum route on West Germany's Autobahn, as well as other trip data. Here, the display (at right) warns of a traffic jam at the Hanover-North intersection that will cause a 24-minute delay.

hour. It then updates the time information according to how fast the car is actually going.

**Map.** Given the multitude of data that the computer contains and displays, the system amounts to what the firm calls an "electronic road map," with the car in a sense constituting a finger or pointer tracing out the optimum route.

Ease of operation is achieved by using a touch panel rather than an array of push buttons or keys for entering information into the computer, as is done with on-board trip computers. Besides taking up a lot of space, such arrays can be confusing and can divert the driver's attention from traffic conditions.

With the Daimler scheme, the driver simply touches the display panel at designated spots. If he touches a spot marked by a right-going arrow, the memory goes through its repertoire of exit and entrance names in one direction. Touching a spot marked by a left-going arrow reverses the direction.

If a spot marked by the letter "e" is touched, the names of the starting entrance and of the destination exit are entered into the computer. Upon touching still another spot, the computer suggests an alternative route.

The display, a liquid-crystal type, is as big as the front panel of a car

radio. A grid of light beams parallel with the display panel and emanating from infrared-light-emitting diodes along the display's edges senses where it is being touched. When a finger interrupts a particular combination of beams, the corresponding IR receiving LEDs produce specific coded outputs telling the computer which spot was touched.

**Going on the road.** Seven months after the system's initial conception, Metzler, Häussermann, and their associates have readied an experimental version using simulated car-speed data. Some time this summer, a refined version mounted in a car will undergo actual road tests.

The two engineers estimate that a commercial system could be readied within two to four years. Such a system could well store a lot more information than the present one. For example, it could include data relating to ordinary highways—and for other countries as well. It could also have a list of service stations, rest areas, motels, and points of interest along the way. Updating the memory could be done via a cassette used in conjunction with the car's audio tape unit, Häussermann notes.

The system could also operate as a warning device alerting the driver to traffic jams along the way or to conditions like fog, snow, or icy roads.

This information could come by way of inaudible coded signals broadcast by radio stations and picked up by the car's radio, as is the case with West Germany's ARI service [*Electronics*, Feb. 15, 1979, p. 72] developed by Blaupunkt. —John Gosch

## Great Britain

### Low-cost system aids pc-board design

The day may not be so far away when most electronics engineers will have on their benches a stand-alone computer-aided design system. Taking a giant stride in that direction is the UK firm Racal-Redac Ltd., which has come up with a microprocessor-based printed-circuit-board design system that is three times faster than manual layout methods and that at a cost of \$44,000 is economical for firms processing as few as five pc boards a year.

"We are bringing computer-assisted design to the masses," cracks William E. Hillier, Racal-Redac's technical director. He adds that the company's earlier systems based on PDP-11 and PDP-15 minicomputers start at around \$190,000, a price within the range of only large firms.

Key to the Cadet's cost breakthrough is of course the microprocessor—in this case, Intel's 16-bit 8086 [*Electronics*, June 5, p. 63]. The entire package comprises a keyboard and graphics display from Hewlett-Packard, a layout tablet, and a microcomputer system that doubles as the display base and incorporates a data-cassette cartridge drive. The entire unit will fit on a shelf or pack into the trunk of a car, says Hillier, stressing its ruggedness.

With the aid of this interactive system, a designer can lay out single- or double-sided boards up to 25 inches on a side, accommodating up to 500 components or 150 integrated circuits calling typically for 1,000 electrical connections through copper track paths made up of five segments. The Cadet can also be used to lay out simple multilayer boards

# hybrids V/F

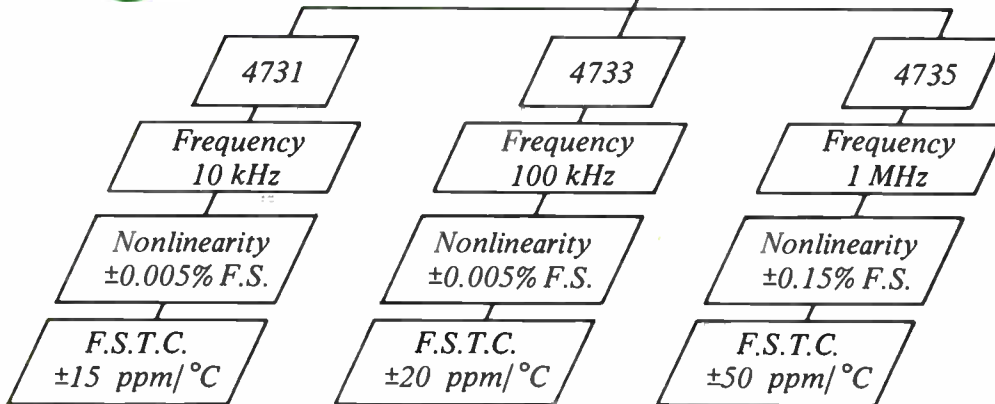

For more information and special OEM pricing, contact Mitch Bloom, Product Marketing Manager, at (617) 329-1600, ext. 331.

Allied Drive at Route 128, Dedham, Massachusetts 02026  
Tel: (617)329-1600 TWX: (710)348-6726 Telex: 92-4439

Circle 83 on reader service card

## THE **ZENDEX** Model ZX-204 DISKETTE CONTROLLER FOR THE OEM USING THE MULTIBUS\*

Single or Double Density IBM Formats for standard and Mini FDD Interfaces. Controls up to 4M Bytes of on-line storage.

For use by the OEM systems designer who demands the maximum in speed and efficiency with a minimum of hardware costs.

Features INTEL 8272 FDC chip, DMA Controller, Digital Data separators and Bus Arbitrator. 5 volts only Optional CP/M\*\* System Disk available.

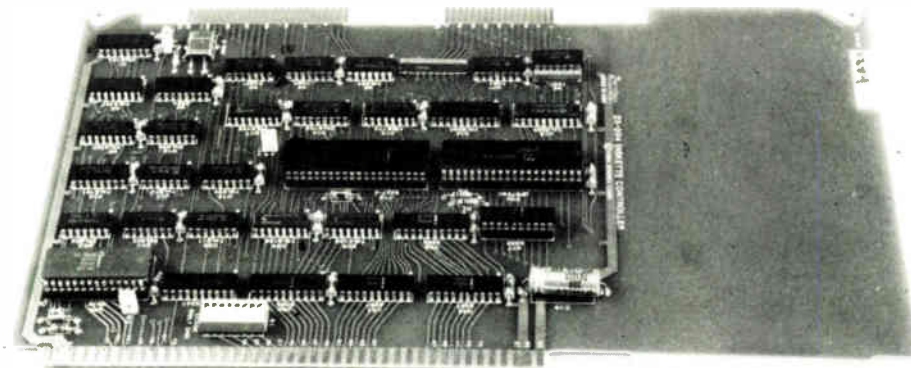

\*TM INTEL CORP. \*\*TM DIGITAL RESEARCH



Made in Dublin,† by ...

**Zendex**  
corporation

† 6398 Dougherty Road, #32, Dublin, CA 94566

• (415) 829-1284

# Logical Deduction.

Are bills turning your life story into "The Case of the Disappearing Paycheck"? Does all your hard-earned money seem to vanish without a trace left to save?

Then perhaps you should investigate United States Savings Bonds.

Because saving with Bonds is so simple, it's elementary. Especially if you join the Payroll Savings Plan.

Once you sign up, you see, a small part of each paycheck is automatically set aside to buy Bonds.

Which means as soon as you're paid, you save. Before you're left trying to deduce where it all went.

Buy U.S. Savings Bonds through the Payroll Savings Plan. And take the mystery out of saving.



Take  
stock  
in America.

## Electronics International

with two signal levels and a power and ground plane.

That is sufficient to meet the requirements of a huge slice of the electronics market, Hillier reckons. He says that only a small percentage of users need a design system for more complex multilayer boards, and to such customers the firm would continue to sell its larger, minicomputer-based systems.

**Savings.** The savings with Cadet are considerable. A circuit board with 100 dual in-line packages, for example, might take 24 days to lay out manually, but using the Cadet it would take 8 days—and with the assurance that supporting documentation would be produced to an extremely high standard.

Inevitably, some of the features of Racal-Redac's bigger systems—which have been under continuous development for 15 years and have gone through 10 versions—got left out. For example, the Cadet does not have the automatic placement and routing routines of the larger machines, nor are the error-checking routines as comprehensive.

To provide access to these more advanced features, the Tewkesbury, Glos., firm is offering postdesign service with bureaus in England, West Germany, and the U. S. Once the designer has defined his pc board using the Cadet terminal, he can dump his data base onto a blank data-cassette cartridge and dispatch it to the nearest bureau.

**Options.** He can enter into the bureau system at one of several levels. If he has completed the placement manually—a simple enough task, though it takes longer than automatic placement—his tape can be used to directly drive the artwork plotter. This will generate all manufacturing documentation, including all artwork and a numerically controlled drill drive tape. The firm also plans to provide a pc-board prototyping service, returning finished boards within three days of receipt of the debugged data cartridge.

Alternatively, the system designer need only create the pc-board data base—that is, specify components and their shapes from a library store,

interconnections, and board specifications—then dump the data into the Cadet's cartridge. The bureau computer could then finish the task, placing and routing automatically and involving the designer for only the more difficult routing tasks.

Hillier will only hint at future developments, but the broad outlines are clear. Many users would want to install their own artwork plotters, but that must await the appearance of hardware with cassette cartridge drives—in the works at several firms. The Cadet could then be set to work overnight to produce the tape needed to drive the plotter, a time-consuming number-crunching task. There is also a need for a hard-copy printout, and that, too, is a likely development. —Kevin Smith

## Japan

### Step-and-repeat unit takes new tacks

New modes of operation rather than the same thing done more carefully set apart a new step-and-repeat optical wafer-lithography unit from Hitachi Ltd. from those earlier on the market, including one from GCA Corp. in the U. S. The improvements make for high throughput while maintaining the high precision and accuracy needed for high yields.

The total time for stepping through the exposure of 10-millimeter-square (394-mil-square) chips on a 3-inch wafer is typically about 1 minute, 40 seconds. Still, the unit can maintain an alignment accuracy of 0.2 micrometer for line widths down to 1.5  $\mu\text{m}$  with a 3- $\mu\text{m}$  pitch.

**Finer.** In fact, when the wafer is perfectly planar, with no vertical steps produced in earlier processes, it can produce line widths of 1  $\mu\text{m}$  with a 2- $\mu\text{m}$  pitch. Hitachi has confirmed its ability to cut such a fine pattern by fabricating bubble memory chips with minimum line widths and gaps of only 1  $\mu\text{m}$ . Akio Takanashi, a senior researcher in the prototype development department at the firm's Central Research Laboratory,



# ATTENTION

Users of HP 2640 and  
Tektronix® 4000 Series CRT's



## The **COMPLØT**® 8600 Series CRT Copiers provide clean, fast hard copies

### For only pennies per copy

Houston Instrument's 8600 Series represent a major breakthrough in CRT quality, speed and price. Using the proven electrostatic printing technique, the 8600 Series gives the user the advantages of:

- No warm up time
- Minimum moving parts
- Low operational noise

The use of electrostatic paper allows:

- Sharp, high contrast copies
- Permanent non-fading images
- Lower copy cost (approximately 1/3 that of dry silver paper)
- No temperature problem during storage or use
- The ability to write on the paper with pen or pencil

Prices for the 8600 Series start at only \$4495\* with a rental purchase option available. For complete information contact Houston Instrument, One Houston Square, Austin, Texas 78753 (512) 837-2820. For rush literature request (outside Texas) call toll free 1-800-531-5205. In Europe contact Houston Instrument, Rochesterlaan 6, 8240 Gistel Belgium. Phone 059/277 445.

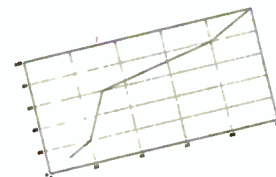

Actual Series 8640 Output

**houston  
instrument**

DIVISION OF BAUSCH & LOMB

*"the graphics - recorder company"*

Simulated Display & Output

Circle number 235 for literature

- Registered Trademark of Houston Instrument
- Registered Trademark of Tektronix, Inc.  
U.S. Domestic Price only

Circle number 85 to have a representative call

# DON'T TAKE HORACE GREELEY TOO SERIOUSLY!

## Electronics international

says that future improvements should enable the machine to produce lines less than  $1\ \mu\text{m}$  wide.

Four innovations distinguish Hitachi's system from those of its competitors. For one, the 10:1 reduction unit has a fast X-Y table whose speed is increased by eliminating the precision-position fine-adjustment mechanism. Instead, the error signal from the laser measurement system that monitors table position is used to drive a reticle fine-positioner.

Second, the focus of the projected image is constantly monitored automatically by an air micrometer and corrected by a servo system. The former measures the average level of the area of the photoresist layer directly under the exposure lens regardless of steps, wafer warping, or other local deviations. Takanashi says that the mechanical scheme is better than an optical method because it is difficult to measure optically the position of transparent surfaces. Optimal focus ensures the best possible alignment and minimum line width.

**Alignment.** Third, for maximum precision and accuracy, wafer alignment is performed automatically through the same lens through which the reduced image of the reticle is projected onto the wafer using the same g-line light source (436 nanometers). Mechanical shielding of the light source prevents exposure of other portions of the wafer, and an area of only  $0.1\ \text{mm}^2$  ( $155\ \text{mil}^2$ ) per mark is required.

In addition, each time a reticle is placed in the system, it is automatically positioned—the fourth departure—accurately to within  $0.5\ \mu\text{m}$ . This translates into an accuracy of  $0.05\ \mu\text{m}$  on the wafer.

Automatic positioning of the reticle is extremely important on chips of more than 10 mm on a side, which is the case for some image sensors used in TV cameras. For chips of this type, photocomposition using two reticles is needed to expose the wafer, and the automatic positioning of the wafer eliminates the need for alignment of the second reticle.

The system can accept wafers up to 6 in. in diameter. -Charles Cohen



Today, the newest frontier doesn't touch the Pacific. It lies in a state which is unspoiled and ready with —

- the nation's best balance of energy resources,
- willing workers who realize the importance of profit,
- stable government which began reducing taxes before tax reduction became fashionable,
- and surpluses exceeding a billion dollars.

If these qualities can be found in a state which offers a superb lifestyle as well as reasonable property values, maybe your business should take a look at us.

## NEW MEXICO Commitment to quality

Al Dietz, Director, Economic Development Division, Commerce & Industry Department, Bataan Memorial Bldg., Santa Fe, New Mexico 87503, 505-827-5571

---

---

**There is only one  
high performance  
VLSI computer  
solution.**

**Intel delivers it.**

---

---

# Architecture for hi

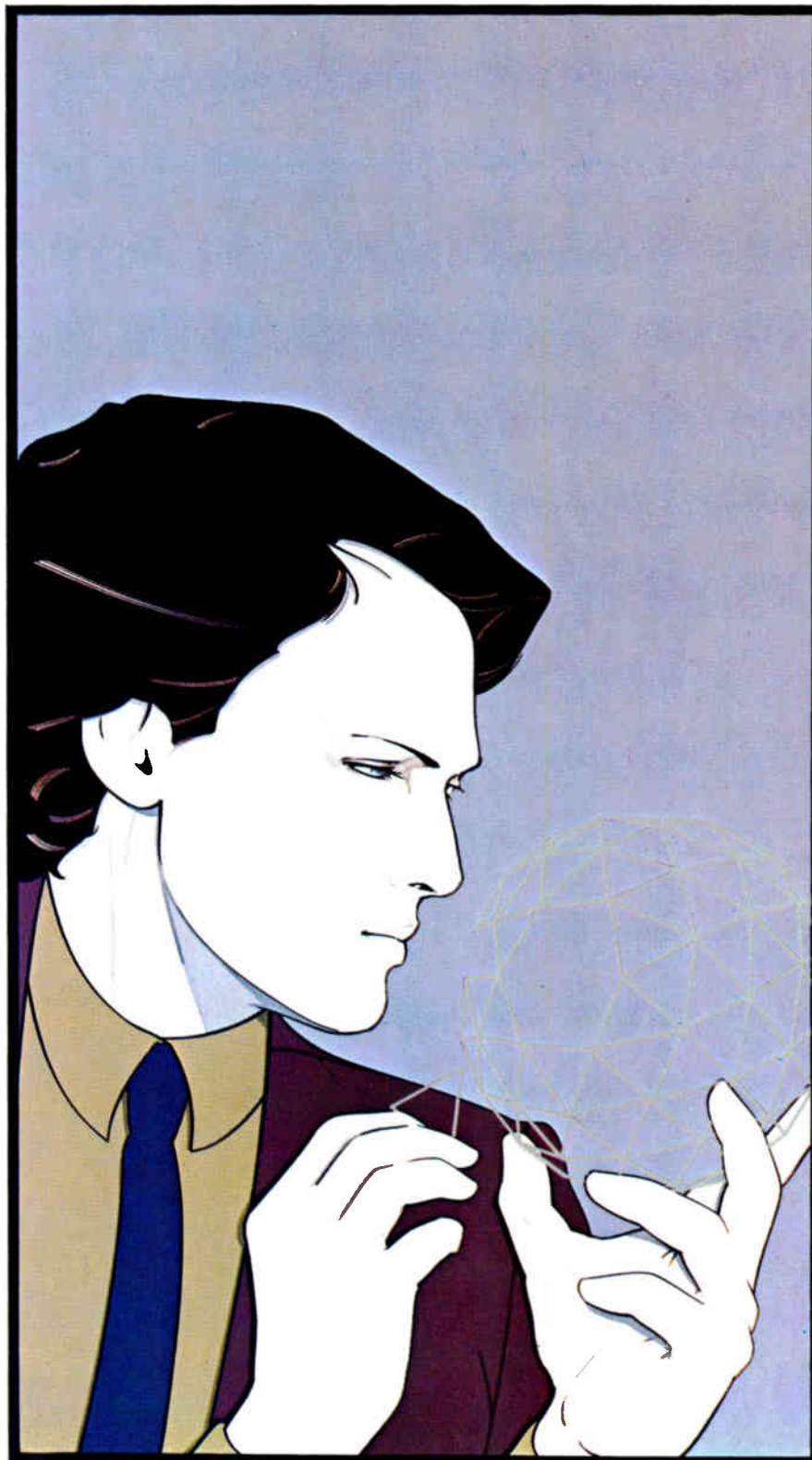

**How Intel's 8086 microsystem, with its powerful structured architecture, helps designers meet the complex performance requirements of the '80s.**

You need more than a CPU alone to meet the performance requirements of the '80s, because today's success lies in powerful new, structured approaches to system design. By logically segmenting and distributing system functions, structured design allows greatly increased throughput—and shorter design cycles. For example, with the 8086 family, using classical mainframe multiprocessing techniques, you can achieve I/O bandwidths of from 2 to 20 megabytes per second. That's at least 10 times wider than other systems. The object code for the 8086 family is 30% denser than the code for any other microcomputer available today. And, using our 8087 co-processor, you'll be able to perform 64-bit floating point arithmetic in less than 15 microseconds, surpassing existing systems by factors of 10 to 1000.

Intel's 8086 microsystem is the only 16-bit solution designed specifically to accommodate efficient multiprocessing schemes. What's more, only the 8086 is supported today by the VLSI building blocks you need to implement these high powered multiprocessing designs. Intel's new HMOS\* 8089 I/O processor, for example, can increase through-

# gher performance.

put by a full order of magnitude in I/O intensive designs. And look to Intel for high-integration co-processors, such as 8087 numerical data processors. They're to help you increase performance in multi-processing systems using our 8086 CPU. Or, for even faster processing, use our new 8086-2. It's the 8MHz CPU, available today, that delivers the top price/performance of any 16-bit microprocessor. Count on Intel for optimum price/performance in the future, too, as we add memory management and protection, and software modules in silicon.

Intel lets you implement powerful designs in an 8-bit format, too, with our 8088. The 8088 is hardware compatible with your 8-bit designs and software compatible with our 8086, to help you get tomorrow's performance in your system today.

You'll find other ways to unburden your CPU and increase throughput with Intel's 5 data communication peripherals, 7 device controllers, 6 slave processors, and 8 system interface circuits—all compatible with the industry standard Multibus™ bus. For high performance program memory, choose from Intel's 16K and 32K EPROMs, including our new high speed 2732A. Intel also delivers the world's largest selection of 5-volt static and dynamic RAMs,

including our new 16K 2118 Dynamic RAM.

## New fluency in high level languages

The trend toward structured high level languages is one more reason to choose Intel's 8086 system solution. Of all the 16-bit microcomputers, only the architecture of the 8086 is made to let designers work effectively in high level languages and achieve fastest possible system through-

put with them. Because the 8086 is memory based, it allows up to 30% shorter high level language object programs and correspondingly faster instruction fetching. And Intel lets you match your language precisely to your task with Pascal, PL/M, our ASM86 macroassembler, and ASM89 assembler. You'll get even more flexibility in the future with Intel's FORTRAN and COBOL.

## Development tools for higher performance

To help designers shorten design cycles and save development costs in the '80s, Intel delivers a full complement of structured software and hardware development tools. Our revolutionary new RMX/86™ multi-tasking operating system, for example, puts you months closer to market with complete file

manipulation, task scheduling, and interrupt capabilities. And since this software package is here today, you can start developing your applications software immediately.

To improve the performance and productivity of your entire development team, use Intel's Intellec® Microcomputer Development System and our ICE-86™ and ICE-88™ In-Circuit Emulators. They're the fastest tools available for developing and debugging 16-bit microcomputer systems. For even faster time to market, get Intel's already tested and debugged iSBC86/12A™ single board computer.

## Meeting the demands of a new decade today

Everything you need to improve performance, reduce complexity, and speed your time to market is here from Intel today. For more information on our complete 8086 VLSI system solution, mail us the coupon on the other side of this page.

\*HMOS is a patented Intel process.

intel delivers solutions

Europe: Intel International, Brussels, Belgium.  
Japan: Intel Japan, Tokyo. United States and Canadian distributors: Alliance, Almac/Stroum, Arrow Electronics, Avnet Electronics, Component Specialties, Hamilton/Avnet, Hamilton/Electro Sales, Harvey, Industrial Components, Pioneer, L.A. Varah, Wyle Distribution Group, Zentronics.

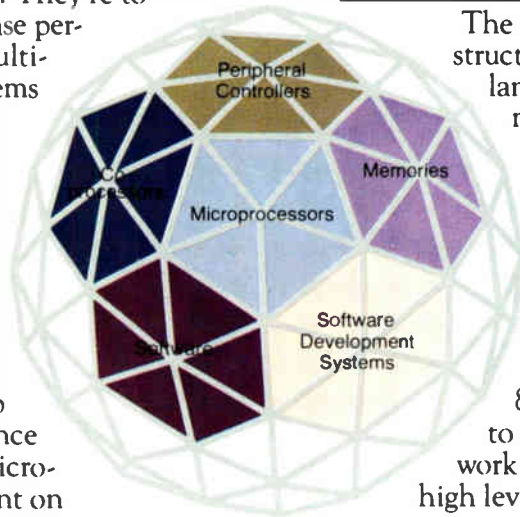

## Intel Structured System

# Your first step toward higher performance

## How to get more information on 8086 VLSI system solutions.

To find out more about our solutions, fill out the information

requested below and send it to Intel Corporation, Literature Department, 3065 Bowers Avenue, Santa Clara, CA 95051. Indicate what your particular interests are, including workshops, and we'll make sure you get the appropriate material. If you don't have a pair

of scissors handy, give us a call at 408/734-8102 (Literature Department) and we'll rush the material out to you. Or call your local Intel distributor.

Intel wants to help you meet the performance requirements of the '80s. It all starts right here.

Name \_\_\_\_\_

Title \_\_\_\_\_

Company \_\_\_\_\_

Division \_\_\_\_\_

Address \_\_\_\_\_

City, State, ZIP \_\_\_\_\_

I have an immediate requirement, please telephone me at ( \_\_\_\_\_ ) \_\_\_\_\_

I need additional information.

Please put the letter corresponding to your yearly requirements in the line to the left of those products of interest.

w for 1-10 per year  
x for 11-99 per year  
y for 99-999 per year  
z for over 1,000 per year

- A 16-bit Microprocessors
- B 8-bit Microprocessors
- C Single-Chip Microcontrollers
- D Peripheral Controllers
- E RAMS

- F EPROMS
- G Bubbles
- H Single Board Computers
- I Development Systems
- J Debug Tools
- K High-Level Languages

- L Macroassembler
- M Operating Systems (RMX/86™)
- N Telecom Products
- O Military Products
- P Workshops

( \_\_\_\_\_ )  
Indicate languages

# Class of '80 ardently wooed

Pay offers range up to 20% higher than in 1979 as prospective employers find recruiting demands more time and effort

by Pamela Hamilton, New York bureau manager

This year's bumper crop of engineering graduates is looking at a seller's market. The demand for freshly minted electrical engineers and computer scientists has never been higher, nor the prospects brighter. More companies have been recruiting for more engineers than ever before, with the inevitable result that, in some instances, salary offers have been 15% to 20% above last year's.

Approximately 56,000 engineers of all varieties will receive bachelor's degrees. Last year there were close to 53,000 graduates, according to a study by the Engineering Manpower Commission, New York. Of those who graduated then, over 15,000 were in the electrical, aerospace, and computer engineering fields. If that trend continues with the class of 1980, it can be expected that 16,000 graduates will be available for the electronics field.

These graduates have been eagerly sought by companies, many of which realize that they cannot hire the experienced engineers they need to fulfill growth goals. According to a survey published last fall by the College Placement Council Inc., Bethlehem, Pa., overall engineering hirings are expected to increase 26% at the bachelor's level over 1979, 22% at the master's level, and 57% at the doctoral level.

Against that background, college engineering faculties are quicker to respond to technological change than they used to be, tending to teach more of the skills that are demanded of a new engineer the first day on the job. The companies themselves are recruiting more intensely, selling career growth as hard as salary to students who want more than just

good money. Finally, all this good news for the new graduate is bad news for academia, which must scratch for teaching talent (see "The Ph.D. shortfall," p. 92), and the military, which cannot match those salaries and many of the benefits.

**On campus.** This increasing need has been evident on the campuses since last autumn, when many companies began their recruiting efforts. "That turned out to be the prime recruiting time," agrees Carol A. Walck, director of engineering placement at Cornell University, Ithaca, N. Y. "Many companies peruse the student's resumes, offer open houses, and dispense information before formally beginning to recruit," she adds.

At Cornell, the graduates did well

for themselves. The average starting salary for the 166 who will receive the bachelor of science in electrical engineering is \$20,900; for the 45 getting the master of engineering and the four receiving the MSEE, it is \$23,500; for the four getting the Ph.D., it is \$30,900. Comparable figures for 1979 were \$18,500, \$20,500, and \$26,600. Cornell hosted 385 companies, about 11% more than last year. "Electrical engineers were really the stars this year," says Walck.

For Rensselaer Polytechnic Institute, Troy, N. Y., Alice P. Donohue, recruiting coordinator, notes that "companies are offering salaries 10% greater and more than last year's. An area that has a higher cost of living, such as Boston or Cali-

PROJECTED JOB OPENINGS

Occupation	Estimated employment 1978 (in thousands)	Growth rate (%) 1978-90	Average annual openings to 1990
<b>Engineering</b>			
Aerospace	60	20.7	1,900
Agricultural	14	26.8	600
Biomedical	4	26.8	175
Ceramic	14	26.8	550
Chemical	53	20.0	1,800
Civil	155	22.8	7,800
Electrical	300	21.5	10,500
Industrial	185	26.0	8,000
Mechanical	195	19.1	7,500
Metallurgical	17	29.0	750
Mining	6	58.3	600
Petroleum	17	37.6	900
<b>Computer and related occupations</b>			
Programmers	247	29.6	9,200
Systems analysts	182	37.4	7,900

SOURCE: U.S. LABOR DEPARTMENT, BUREAU OF LABOR STATISTICS, UNPUBLISHED DATA



**On the trail.** Betsey Palmer, employment director at RCA Labs, says 60 campuses were combed for 45 engineers needed.

ifornia, would have a higher salary than that." In electrical engineering at RPI, 145 will graduate with a bachelor's, 113 with a master's, and 36 with a Ph.D. In computer and systems engineering, there will be 47 bachelor's, 19 master's, and 16 Ph.D.s. The average offer for a BSEE has been \$20,700, and for a master of science in electrical engineering \$22,700. A BS in computer and systems engineering will pull in about \$20,400, whereas a master's is worth about \$22,950.

On the West Coast, the story is similar. "We've had so many companies recruiting that there aren't enough students to go around," observes Kathleen Stanton, the University of California at Berkeley's technical career adviser for electrical engineering and computer science. Over 700 companies have sought to recruit Berkeley's graduating students over the past year. "And many of them have been here twice," she adds. Some of the companies even pay prerecruiting visits to the placement office, where they scan the students' resume books. Other companies stage informal wine-and-cheese meetings before getting down to the serious business of individual interviews.

Stanton reports her 350 BSEE candidates have already reported receiv-

ing 276 offers, with more coming in daily. Salary statistics have yet to be compiled for 1980, but last year's average salary figures were \$20,400 for a BSEE, \$20,800 for an MSEE, and \$31,200 for a Ph.D.

At the University of Southern California in Los Angeles only about half of the graduating electrical engineers register with the career development center for placement—the others find jobs on their own. The average salary figures have not been compiled yet, but the minimum salary thus far for a BSEE has been \$19,200. The top salary for an MSEE so far has been \$30,000, and one Ph.D. in computer design received \$36,000 to start.

The trend at the University of California, Los Angeles, is for a BS in computer science to receive a slightly higher starting salary than a BSEE, with that gap widening further up the educational ladder. Last year, all BSEEs and BSCSs averaged slightly more than \$20,000 in a \$16,000-to-\$23,000 range. MSEEs averaged \$24,700 in a \$20,000-to-\$29,000 range, and Ph.D.s \$30,200 in an \$18,000-to-\$36,000 range. Salaries for 1980 are running 10% to 15% above last year's offers. The MS grad in computer science is averaging \$27,200, and at the Ph.D. level the average offer is \$35,000.

**Smiles of Texas.** The picture in Texas is just as good, says Willard P. Worley, associate professor of electrical engineering at Texas A&M University, College Station, who handles recruiting relations between the students and the companies. A&M graduated 50 BSEEs this spring, and for the 25 who reported

their starting salaries, the average was \$21,100. "That's \$100 more per month than our students in December got," Worley reports.

The placement office at Texas A&M has more complete figures for this year and last, although those for 1980 are still being compiled. A BSEE this year will average \$20,900, an MSEE \$23,200; last year for a BSEE the figure was \$18,100, for an MSEE \$20,200. For computer science graduates, 1980 figures are \$19,000 for a BS and \$22,000 for an MS. In 1979, a BS received \$17,000 and an MS \$20,000.

Between 450 and 500 companies interviewed engineering students at the University of Illinois at Champaign-Urbana. Some 189 electrical engineers and 72 computer scientists graduated this year. BSEE candidates received 236 job offers and computer science grads received 63. The average BSEE is worth about \$20,400. For the computer science BS, the average is in the area of \$19,100.

Major areas of demand for graduates from the Massachusetts Institute of Technology this year are in software engineering and microprocessor development and software, according to Robert K. Weatherall, the Cambridge, Mass., institute's director of career planning and placement. The automotive industry, which came on strong last year in recruiting and was attracting a lot of graduates, "has unfortunately backed off now, because of its recessionary problems," he notes. The median salary for Ph.D.s this year is \$31,200. For graduates with masters, the median starting salary is \$24,600, and for those with bache-

### The Ph.D. shortfall

One of the problem areas created by the high demand for engineers is the fact that not many bachelor's-level or master's-level candidates continue on for Ph.D.s and teaching posts. The main reason for this, according to George A. Bekey, chairman of the University of Southern California's electrical engineering and systems department, is salary competition from industry. "Our salaries for new faculty members start at \$19,000 or so. That's for [working] only nine months, but still about what a BSEE gets to start these days," he observes.

"Because job offers are so good and salaries are so high, many students are opting to go into industry," notes Cornell University's G. Conrad Dalman, director of the school of electrical engineering. "That gap in Ph.D. programs is being filled by foreign students." He adds, "The major problems are faculty salary problems. Salaries are not keeping up with inflation. However, most professors do supplement their income through consulting work."





## *The unique fully automatic direct wafer steppers from Optimetrix are now in production.*

When we announced the Optimetrix 10:1 and 7:1 automatic projection systems last Spring, some people thought we were biting off more than we could chew.

After all, the Optimetrix systems were to be a substantial advance in the state-of-the-art of projection aligners, with unique through-the-lens viewing, broad field coverage, resolution to 1 micron, alignment accuracy to  $\pm 0.1$  micron, automatic operation including wafer, reticle, and die alignment, and automatic wafer and reticle handling.

All this and more was to be housed in a unit occupying only 46"

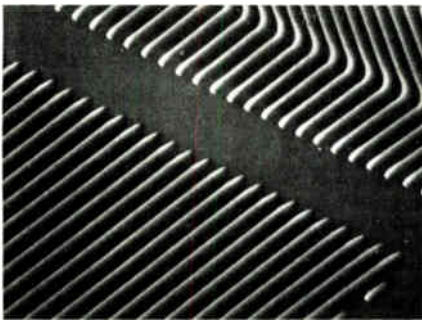

*0.7 $\mu$  lines and spaces made with G- and H-line exposure light at an aperture setting of na 0.27. Resolution may be improved by using the H-line only and/or an aperture setting of na 0.32.*

by 38" of floor space, and which would perform with temperature variations as great as  $\pm 1^\circ\text{C}$ .

While we can understand the original skepticism, we are happy to report that it was unfounded.

Our production is humming. We are now shipping.

Our backlog continues to grow, and our customer names are beginning to read like a who's who of the semiconductor industry.

And the performance of our units is as good or better than our original claims including higher throughput. The SEM photographs and the drawing of our unique optical path tell the performance story graphically.

See a demonstration for yourself. Call for an appointment. Optimetrix Corporation, 500 Ellis Street, Mountain View, California 94043. (415) 965-4061.

### Simplified Optical Arrangement

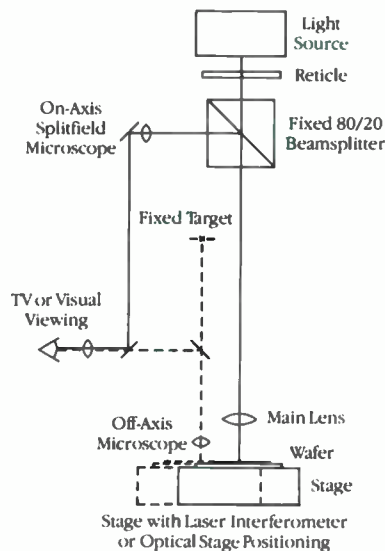

*The Optimetrix 8010 permits automatic or manual on-axis through-the-lens alignment via fixed beamsplitter and automatic or manual off-axis alignment with fully automatic instant baseline correction.*

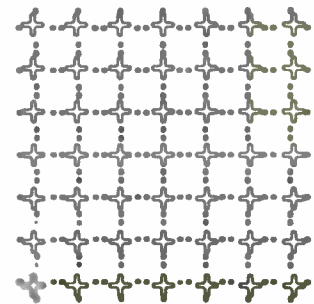

*Automatically aligned Vernier test pattern of boxes, superimposed on a primary exposure pattern of crosses with no measurable error, as indicated by the perfectly aligned center patterns.*



# SETTING NEW STANDARDS

# ISO-CMOS™ OCTAL INTERFACE

## THE LS REPLACEMENTS

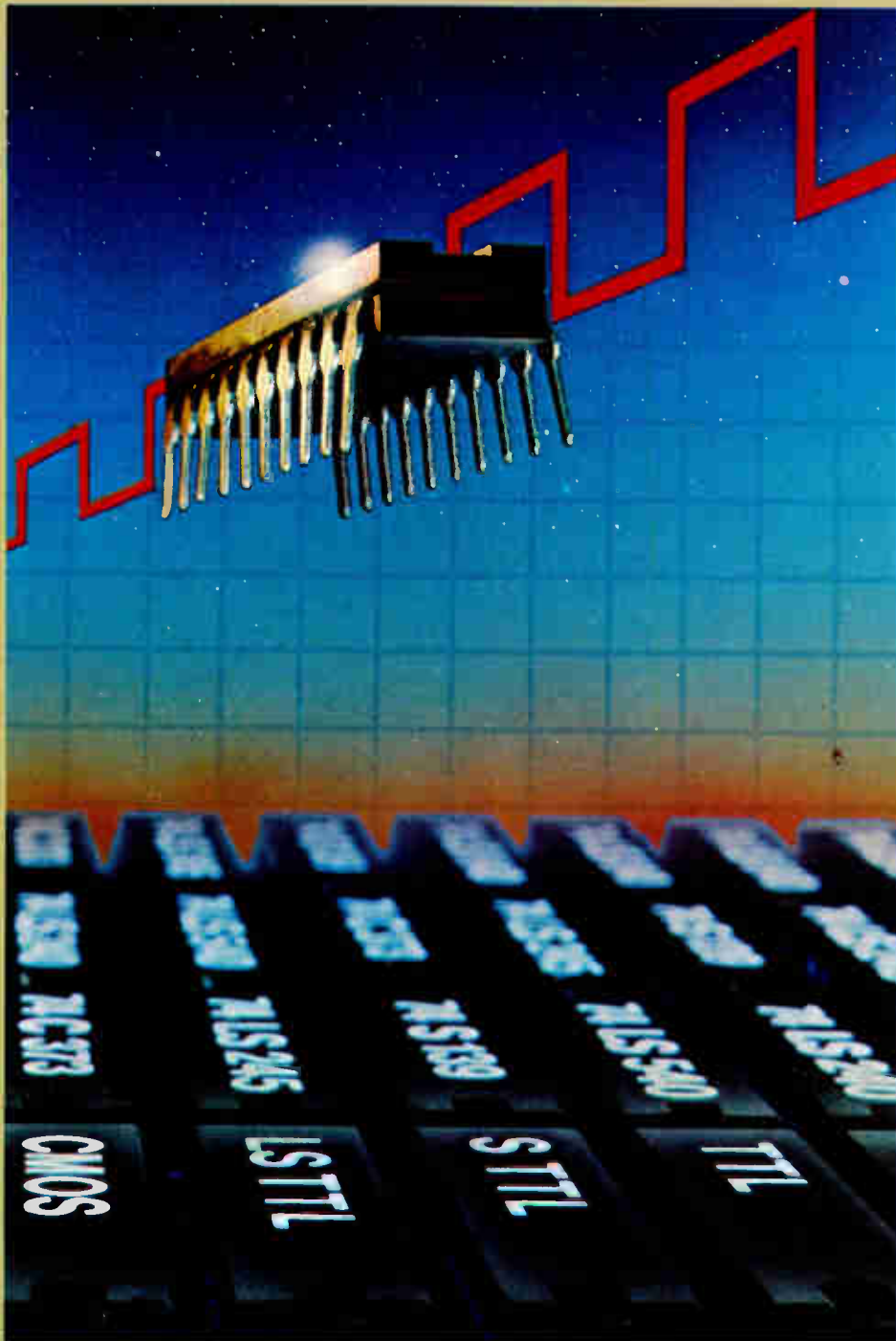

Remember when microprocessor designs were an either-or proposition — either high speed but power hungry bipolar TTL or low power but painfully slow CMOS?

Mitel Semiconductor has come up with a solution that gives you your highs with your lows — HIGH SPEED and LOW POWER ISO-CMOS technology. Established pin-outs and logic layouts of a range of 20 standard Octal circuits have been incorporated with a proven production process that does justice to today's LSI.

ISO-CMOS achieves fast propagation by use of a recessed oxide silicon-gate process that minimizes the inherent long time constants of traditional metal-gate CMOS. All the advantages of noise immunity and practically no quiescent power dissipation have been retained.



Our family of latches offer transparent or clocked operation and include inverted or non-inverted 3-state outputs. The decoder family has single one of eight, latched or unlatched, or dual one of four configurations. Bus buffering is catered for with high-current drivers having assorted configurations of chip selects for single or bi-directional connection.

A comprehensive range of circuits allows improvement of design, by direct pin for pin compatibility with their 74LS series counterparts. For redesign to maximize ISO-CMOS advantages, a simplification of layout is achieved by the preferred bus-oriented 74SC5XX selections.

- MD 74 SC 137 1 of 8 Inverting Decoder with input latches
- MD 74 SC 138 1 of 8 Inverting Decoder
- MD 74 SC 139 Dual 1 of 4 Inverting Decoder
- MD 74 SC 237 1 of 8 Decoder with input latches
- MD 74 SC 238 1 of 8 Decoder
- MD 74 SC 239 Dual 1 of 4 Decoder
- MD 74 SC 240 Octal Inverting Buffer
- MD 74 SC 241 Octal Buffer
- MD 74 SC 244 Octal Buffer
- MD 74 SC 245 Octal Transceiver
- MD 74 SC 373 Octal Transparent Latch
- MD 74 SC 374 Octal D Type Flip Flop
- MD 74 SC 533 Octal Inverted Output, Transparent Latch
- MD 74 SC 534 Octal Inverted Output, D-Type Flip Flop
- MD 74 SC 540 Octal Buffer
- MD 74 SC 541 Octal Buffer
- MD 74 SC 563 Octal Inverted Output, Transparent Latch
- MD 74 SC 564 Octal Inverted Output, D Type Flip Flop
- MD 74 SC 573 Octal Transparent Latch
- MD 74 SC 574 Octal D Type Flip Flop



# MITEL SEMICONDUCTOR

United States: 2321 Morena Blvd., Suite M, San Diego, California, U.S.A. 92110. Telephone (714) 276 3421, TWX: 910-335-1242, 1223 Westchester Pike, Havertown, Pennsylvania, U.S.A. 19083. Telephone (215) 449-5556, TWX: 510-662 6653.

Canada: P.O. Box 13089, Kanata, Ottawa, Ontario, Canada K2K 1X3. Telephone (613) 592-2122, Telex: 053-4596, TWX: 610-562-8529.

Europe: Hamilton Road, Slough, Berkshire, England SL1 4QY. Telephone 0753-36137, 0753-36138, Telex: 847730. Fredericiagade 16, Suite 309, 1310 Copenhagen K, Denmark. Telephone (01) 119302, Telex: 22321.

Asia: TST P.O. Box 98577, Kowloon, Hong Kong. Telephone 3-318256, Telex: 64235.

Circle 94 on reader service card

TM Trademark of Mitel Corporation  
Copyright 1980 Mitel Corporation

## Inside the news

### EE INCOME VERSUS EXPERIENCE

Years of experience	Mean income
Under 2	\$19,382
2 - 4	20,529
5 - 9	25,217
10 - 14	29,295
15 - 19	34,201
20 - 24	35,431
25 - 29	36,771
30 or more	41,866

SOURCE: IEEE

lor's degrees, it is \$21,000.

The universities are reflecting technological trends in the industry and although many schools lack the funds to purchase costly computer equipment, most have some available for students. At Cornell there are several small computers—PDP-11/40s and Hewlett-Packard 1000s—that the students can use to further their programming experience. "What's happening at Cornell is characteristic of what's happening at other schools," says G. Conrad Dalman, professor and director of the school of electrical engineering. "There's a strong interest in computer engineering, microprocessors, and digital signal processing." He notes that a lot of study is theoretical and experimental, but with computer architecture and computer programming, the students do get some hands-on experience.

The hottest area at the University of Southern California is very large-scale integrated circuits—the first course was offered to about 50 students this past year. George A. Bekey, professor and chairman of the electrical engineering and systems department, notes, "VLSI training pulls together many disciplines: some computer, some solid state, hardware and architecture, and software." Other areas of interest at USC include microelectronics, lasers, and signal processing.

At Stanford, "we are increasing our emphasis on the confluence of integrated circuits and computer systems, particularly in the VLSI area," notes John Linvill, chairman of the electrical engineering department.

"I'd say the two most popular topics among students in our department are microcomputers and operating systems." He observes that the other areas that interest his students include custom ICs, simulation of ICs, the physics of semiconductors, the physics of processing, digital filtering, and the implementation of coding algorithms in silicon.

But at MIT, such a vocational approach is eschewed. At a session of the Electro/80 show, Gerald Wilson, head of the department of electrical engineering and computer science, had these comments on education there: "Almost 30 years ago there was a major change within the department to what was then called the core curriculum—a curriculum that did not concentrate on the details of superheterodyne circuits or other particular aspects of that day's technologies, but instead concentrated on the underlying principles that are involved in electronics, electromagnetic field theory, control theory, and basic physics. We have been doing that ever since."

**The hiring game.** Companies doing recruiting on college campuses may approach it in different ways, but everyone agrees that the competition is fierce. One pressure tactic, according to Victor R. Lundquist, director of placement at Northwestern University in Evanston, Ill., is "to offer kids a huge-salaried summer job if they make a commitment to take a full-time job after graduation."

But most companies are emphasizing work environments, career paths, and overall employment opportunities. Salaries and benefits appear to be of secondary interest to most graduates. That is especially true of graduates oriented toward work at research laboratories. "I could probably count on one hand the number of times salaries and benefits have come up in a recruiting interview over the last 22 years," notes E. Ben Peterson, a technical recruiter for Bell Laboratories, Holmdel, N. J. "The graduates are really focusing their attention on work. Salary is unimportant [compared with that]."

Of course, Bell Labs is not the ordinary employer. It is even unique in its approach to recruiting—it uses technical people to recruit other



**Up ramp.** Willard Worley, professor at Texas A&M who handles liaison with companies, says grads' pay is up \$100 a month.

technical people. Peterson, a 1949 mechanical engineering graduate of Cornell, is a supervisor for support planning in data communications when he is not recruiting. He spends about two weeks a year going back to his alma mater to cull the skilled graduates there.

This year, Bell Labs is looking for between 1,200 and 1,500 professional people from about 150 schools. "The predominant portion of those hired are going to be electrical engineers with software orientation and computer scientists," says William A. Blinn, director of technical employment and university relations at the Murray Hill, N. J., facility. About half of them will have BS degrees and will immediately go to graduate school at Bell's expense. The starting salaries for these grads will be in range around \$20,000 according to Blinn. The master's graduates will receive salaries in the low- to mid-\$20,000 area, and Ph.D.s will fall in the \$30,000 region.

**Seeking 45.** At RCA Corp.'s RCA Laboratories in Princeton, N. J., about 45 engineering persons will be hired this year, according to Betsey C. Palmer, manager of employment and employee development. Of those, about 30 will be EEs and computer scientists at the bachelor's and master's level and about 10 will be Ph.D.s—6 in electrical engineering and computer science, 3 polymer chemists, and 1 mathematician. For bachelors, starting salaries will be between \$19,000 and \$22,000; for



**Wild blue job offers.** James Fowler says that, despite military's lower salaries, he can recruit nose to nose with industry.

masters, between \$23,000 and \$25,000; for Ph.D.s, between \$26,000 and \$30,000.

RCA Labs recruited at 60 schools this year in a team effort with other RCA divisions at the bachelor's and master's level. "At the Ph.D. level we organize our own recruiting," says Palmer. She notes that the labs will be able to recruit enough engineers to fill its needs and attributes that to its reputation.

For Dallas-based E-Systems Inc., the need this year is for up to 400 more engineers and technicians, many of whom will be recruited from the ranks of working engineers. But as the competition for the pool gets tougher, E-Systems will find itself relying to a greater extent on new graduates.

The company's ECI division in St. Petersburg, Fla., is starting its newly hired grads at \$20,250, reports William J. Peterson, acting director of industrial relations and personnel manager. ECI visited 45 campuses this year and interviewed nearly 325 students, selecting 155 for plant tours. Offers were made to 67 of that group, with 12 acceptances as of the middle of May. Last year, the division visited 25 schools and interviewed 100 to 120 students. Plant

tours were given to 70 of those, and 45 offers were made. Fifteen ultimately accepted jobs, receiving an average salary of \$18,900.

**Experience scarce.** Peterson attributes the lower acceptance rate to increased competition. "Most companies in our business now realize that the experienced engineers are just not there, and therefore we're all going more and more to the campus," he says. Evidence of that trend is that company recruiters must now schedule trips up to 18 months in advance to some of the more prestigious engineering schools.

Texas Instruments Inc.'s president and chief operating officer, J. Fred Bucy, told stockholders at the annual meeting in April that TI hired 2,148 college graduates during the most recent recruiting year, which ended Aug. 31, 1979. Of those, 395 have master's or doctoral degrees and more than 70% have technical degrees. In 1977, TI hired 1,169 graduates, and in 1978 1,640. George L. Berryman, manager of corporate college relations for the Dallas firm, says it is likely that the trend will continue into this year.

Berryman finds that recruiting competition on the campuses this year is continuing to be intensive, but not noticeably stronger than last year. In 1979 TI visited more than 200 campuses, compared with 150 to 160 in 1978. During the 1980 recruiting year, it will again visit about 200 schools. The company is doing little different this year in its college recruiting—"We're just doing more of it," says Berryman. By that, he means that TI is stepping up its prerecruiting campus trips, making preliminary stops at half of the 200 schools, he says. Such visits typically involve talking before student technical societies or holding open houses for interested students.

At Mostek Corp. in Carrollton, Texas, college relations manager David P. Crivelli says that the competition on campus for engineering grads has increased slightly this year over last. He attributes this fact primarily to the economy. Because of the higher housing costs and interest rates, it has become more difficult to recruit experienced engineers who live outside the area. He figures many companies have turned even

more to the schools this year.

Mostek visited 101 campuses this spring, interviewed about 1,400 students, and will hire around 200 persons. These figures compare with 70 campuses visited, 500 interviewed, and 135 hired last year. Of the 200, about 80% are technically oriented—60% to 65% of them are EEs and the remainder are computer science majors. The remaining 20% are mainly business majors. BSEEs are getting an average starting salary of about \$20,000 this year, Crivelli estimates.

**Dallas by night.** Mostek is also continuing a program begun last spring in which new graduates coming to the company for interviews are taken out for a night on the town, with a tour of Dallas and dinner, where they get a chance to mingle with Mostek personnel. The idea of this after-hours tour is to show students that there is much more to Texas than deserts, tumbleweed, and cattle.

In Irvine, Calif., Computer Automation Inc. finds "it always inordinately difficult to recruit BSEEs and BSCSs," according to Jack Coke, director of human resources. Salaries are running from \$19,000 to \$20,500 for the 10 to 12 new graduates the company hires each year. The company finds it is an advantage being small when recruiting against industry giants.

"Here the grads have a broader role, whereas at the bigger companies they see a narrow slice," Coke says, adding, "I sell the company, not the salary or job." Especially attractive is a rotational program in which a new graduate gets to sample all engineering functions before settling down to one.

**Military quagmire.** If industry at large is having trouble recruiting recently graduated engineers, the problems facing the military would seem insurmountable. The \$12,700 earned by a second lieutenant engineering officer in the Air Force and other services the first year pales in comparison with industry salaries. During the second year, as a first lieutenant, that officer will be paid close to \$16,000, and it is not until the fourth year and captain's bars—if promotions are on schedule—that the salary reaches \$26,000.

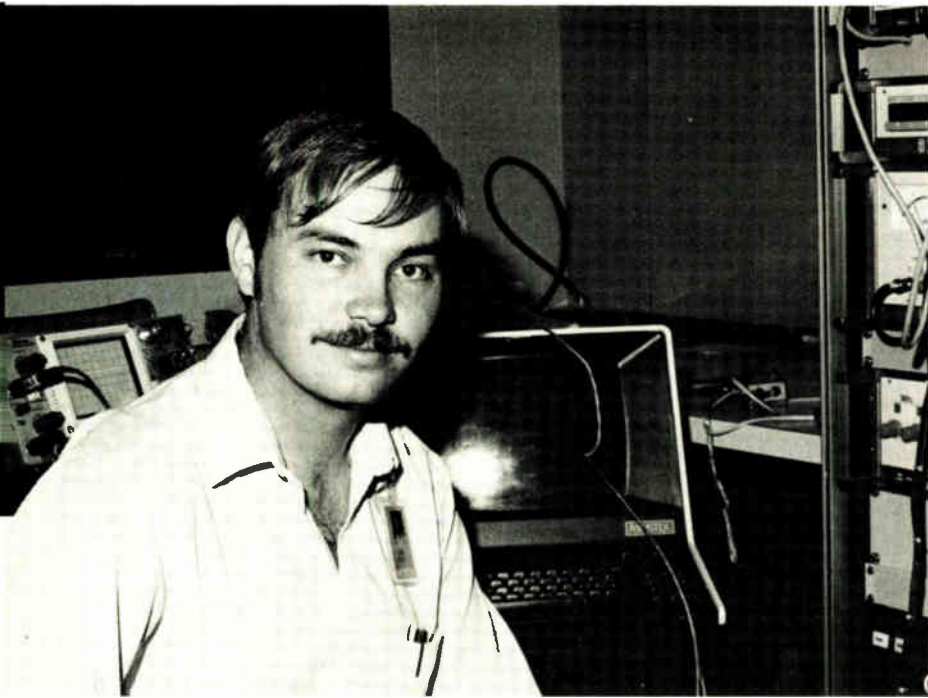

However, Capt. James A. Fowler, chief of the engineering recruiting branch, 3504th Recruiting Group, Lackland Air Force Base, Texas, is not totally pessimistic. "I'm often in there one on one with civilian industries up to the final hiring stage," he says. He cites the quick rise into broad-based problem solving and management as the No. 1 selling point for a military career. "We have brand new engineers—out of school for one or two years—tackling complex problems and doing a lot more engineering than their civilian counterparts with 10, 20, or 25 years' experience."

The Air Force is considered an aggressive recruiter. It has three commissioning services: the recruiting arm, the Air Force Academy, and the Reserve Officers Training Corps on campus. Capt. Wallace Pope, chief of the management and evaluation branch of the officer procurement division at Randolph Air Force Base, Texas, is in charge of the first and hopes to recruit the close to 250 engineers he has as his goal. "We think we're going to make about 218 to 221. Our greatest needs are for electrical, aeronautical, and aerodynamic engineers," he notes. The EEs will go into three areas: research and development for test, evaluation, and modification; communications and electronics for tele-

phones, message traffic, and communications networks; and facilities engineering for power systems. (See "How the Air Force tries to keep up," p. 98.)

**Graduates, then and now.** Most engineers who graduated in the 1970s would not want a different career path. The picture has become only brighter for them over the past few years, and it is not dimming. But there are areas in which most EEs seem to find themselves inadequate, and a desire to improve certain skills is not uncommon. One of those weak spots mentioned frequently by engineers is writing and communications skills, followed closely by management training.

"A rigorous and broad background is the best you can hope for at school," notes Robert W. Patterson, 25, supervisor of the network management systems group in the network management department at Bell Labs, Holmdel, N. J. "You learn how to learn. As soon as you're out of the academic environment, you have to find the best tool for applications." Patterson graduated from the University of Tennessee in 1976 with a BSEE; Bell Labs sent him to MIT, where he graduated with an MSEE in 1977. He was offered \$15,000 to work at Bell in 1976. "I had been looking for between \$14,000 and \$14,800," he says. He is

**Likes challenge.** Lynn Reed, a Texas A&M alumnus, went to work for Mostek because he relished the challenge of a small firm.

now earning from \$30,000 to \$35,000.

High on Patterson's list of things to do is to improve his technical writing. "I have some growing to do in writing. Technical writing is very hard to come by at school. Most people think they can write well—I was in honors English at school." Patterson also wants to take a management-training course.

**Experience helps.** For Harold A. Hoeschen, 28, working at Bell Labs as a member of the technical staff in microprocessor development is still a new experience. Hoeschen graduated from the Georgia Institute of Technology with an MSEE earlier this year. He had some experience that he found "extremely helpful in deciding what I wanted to do." That experience also pushed salary offers up by from \$3,000 to \$5,000, he says—his job offers went from \$20,000 to almost \$30,000.

"Bell's job offer was not the highest I had," he says. "The career potential was very important to me; I'm in the process of developing a career. My long-term goal is corporate management through engineering management," he observes, adding, "I don't feel management and engineering are mutually exclusive." Hoeschen also feels he needs to develop communication skills. "I have to write better, and I need better people skills in addition to my engineering skills," he says.

James E. Harris is a 22-year-old Corpus Christi, Texas, native who graduated this spring near the top of his class with a BSEE degree from Texas A&M. Harris interviewed with four companies on campus and visited three for follow-up interviews before accepting a job as an associate engineer in the automated flight controls department at Bell Helicopter-Telectron in Hurst, Texas, a Fort Worth suburb. At the three firms he visited, the salary offers were comparable—within \$100 of each other, he says. His salary will be in the \$20,000 range most BSEE graduates are now getting.

Location, benefits, and career opportunities headed Harris's list of

## Inside the news

pluses in taking the Bell Helicopter job. He will be able to live close to where he works and still go to the University of Texas at Arlington at night. The benefits he feels are important include insurance coverage and vacation time. And he will be able to follow a technical career path and still be assured of getting a salary matching those who go into management. "With most companies, you're an engineer for so long, and then you have to go into management in order to keep your salary rising," he observes.

Lynn G. Reed, another Texas A&M graduate, is a product engineering manager for Mostek's telecommunications group. The 28-year-old Reed came to the firm in 1975 with an MSEE degree.

Among his reasons for choosing Mostek, Reed mentions "the challenge of working for a smaller company," as well as a perceived "greater opportunity for personal growth" in Mostek's "unrestricted environment." He says he has not been disappointed—he has 13 engineers reporting to him and a chance to work with a diversity of product types, including telecommunications circuits, analog-to-digital converters, counter circuits, and a variety of custom parts. His salary started in the mid-teens and has doubled in his five years with Mostek.

Like Patterson at Bell Labs, Reed believes his education trained his mind rather than giving him a particular skill. "The thing you must get out of school is how to learn," he says. "I did not learn how to be an MOS product engineer in school, but I did learn how to tackle difficult projects and master them."

**School at night.** James P. Bednarz, 23, a senior technical associate in optoelectronics devices and systems at RCA Labs, has been out of school for about a year now—he graduated from Rutgers University with a BSEE in May 1979. Bednarz has been at the labs for nearly six months, having completed a rotational program exposing newly hired engineering graduates to the different facets of the company. He worked in industrial, government, solid-state, and re-

## How the Air Force tries to keep up

A soon-to-be-published study, "Education in High Technology," conducted by Col. L. Ralph Chason, director of educational plans and operations at the Air Force Institute of Technology, Wright-Patterson Air Force Base, Ohio, compares the technological personnel needs of the Air Force and seven high-technology companies and describes what each one is doing to meet those needs. In it, Chason points out that "if the 10 top American corporations were to satisfy their requirements for additional technologically educated personnel from the projected graduates from United States engineering schools, they could consume essentially the entire output." He offers as a summary: "The Air Force is more technologically intensive across the board than any single company. It also parallels high-technology industry in depth and breadth of educational needs, specifically in scientific and technical disciplines. The current trend is continuously eroding the Air Force resource of scientifically and technically educated people." The accompanying Air Force table includes those with significant scientific and technical educations. The percentages of employees with such degrees that are listed are based on information elicited by the Air Force.

Responding to its engineering needs, the Air Force has taken to growing its own—at the doctoral, master's, and even bachelor's levels. The institute last year graduated 195 engineers with master's degrees—63 in electrical engineering—and 11 Ph.D.s. This year, a total of 175 masters graduated—54 in EE and one in computer science—and 7 Ph.D.s. Thirty officers are in an ongoing undergraduate EE program started last year; another 30 will begin this year, with an additional 30 slated for an aeronautical program.

COMPARISON OF AIR FORCE AND INDUSTRY NEEDS

	Scientific-technical personnel (% of total)	Recruiting goals, engineers and scientists, 1980
Air Force	24,600 (30%)	3,100
General Electric	42,000 (80% - 90%)	1,500
Westinghouse	36,000 (95% - 100%)	800
IBM	30,000 (80% - 100%)	—
Western Electric	24,000 (95% - 100%)	1,200
Hughes	11,000 (80% - 100%)	1,500 - 2,000
General Motors	20,000 (20% - 30%)	2,200

SOURCE: U.S. AIR FORCE

search areas before opting for the labs. He is currently working on fiber-optic technology and going to school at night to get his master's. He received four offers between \$17,000 and \$19,800 last year, "and RCA was in that range," he says.

"My background was in digital electronics, and RCA offered me different opportunities—industrial, analog, television, and microprocessor design," he says. Benefits and salary were not the major factor in his decision. "I was looking for a company that offered advancement and had prestige. RCA is also helping to pay for my continuing education," he observes.

Leonard R. Rockett, 29, has been with RCA Labs for nearly seven years, but most of those have been spent continuing his education with

RCA's backing. He graduated in 1973 with a BSEE from Howard University, joining RCA immediately afterward. He received his MSEE in 1975 and his Ph.D. in 1978, both from Columbia University. He is now in IC design and testing.

Rockett's original job offers in 1973 ranged from \$12,000 to \$18,000, but he stresses that he chose RCA "not because of salary, but because of education—it has to be a total and constant learning process." Rockett believes that on-the-job learning is equally valuable, but cautions that "a BS is paramount for a career in engineering. You find you need to be a jack of many trades, clear across the board. Education provides you with enough self-confidence and ability to make those decisions." □

# Still using CMOS?

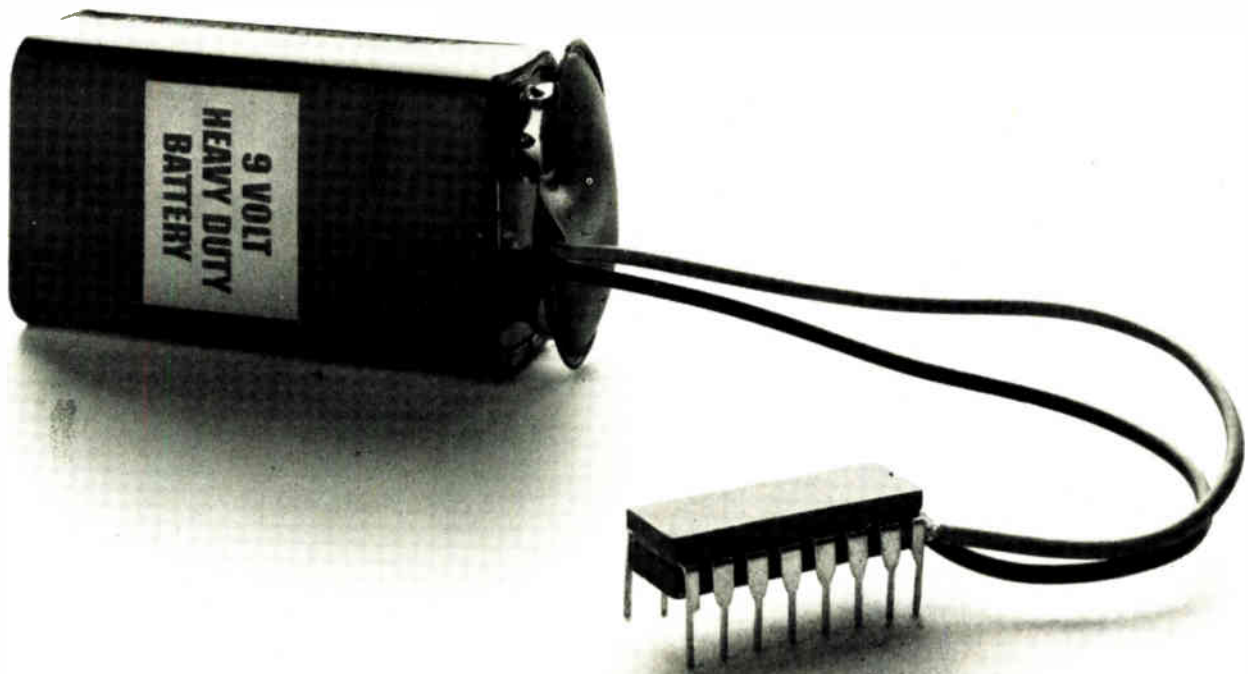

## Pity.

Now you can eliminate the one major failing of CMOS—the battery backup.

By eliminating the CMOS. And using Plessey MNOS instead.

The listing shows the start of the new Plessey family of non-volatile MOS. We call it NOVOL because it is. Devices are *guaranteed* to hold their data for at least one year when the power is removed. They all operate from *standard* MOS supplies and are fully compatible with your TTL/CMOS designs.

With our NOVOL devices, you can eliminate the battery

backup, the mechanical relays, the pegboards and thumbwheel switches that you've had to depend on. It's the perfect solution for security code storage, metering, elapsed time indicators and any other application where

you need a little storage with a lot going for it.

For more data, just contact Plessey Semiconductors, 1641 Kaiser Avenue, Irvine, CA 92714. Telephone (714) 540-9979.



Plessey NOVOL MNOS	
MN9102	4-Bit Data Latch (+5V, -12V)
MN9105	4-Decade Up/Down Counter (+5V, -12V)
MN9106	8-Decade Up Counter (12V only)
MN9107	100-Hour Timer (12V only)
MN9108	10,000-Hour Timer (12V only)
MN9110	8-Decade Up Counter with Carry (12V only)
MN9210	64 x 4-Bit Memory
COMING SOON	8 x 4-Bit Memory
COMING SOON	8-Decade Up/Down Counter, BCD Output
COMING SOON	8-Decade Up/Down Counter with Preset, BCD Output

# Plessey MNOS doesn't forget.

## Recession's bite is shallow—so far

Backlogs, new markets, and strong international sales help; semiconductor equipment orders remain strong

by Bruce LeBoss, San Francisco regional bureau manager

The recession that was predicted for the second half of 1978 has officially arrived. Not only do Commerce Department analysts say privately that it is accelerating faster than they expected and probably will be more severe than anticipated, but the order rates of electronics manufacturers and suppliers would tend to agree. But thanks to a healthy backlog, strong international markets, and the apparently insatiable appetite of customers for sophisticated devices and equipment, the downturn is not expected to be nearly as severe as the 1974 recession. In fact, in some industry segments, the recession might barely be noticed.

"There are very definite signs of a slowdown," states Donald W. Fuller, chairman and chief executive officer of minicomputer manufacturer Microdata Corp. of Irvine, Calif. "When prime interest rates hit the magic number, 20%, back in mid-March," he says, "there was a very definite halt in spending. It wasn't so much the big companies that began holding back, but the smaller ones indeed were, and the order rate began ramping down immediately before the leveling off."

Although 20% interest rates are "tough to deal with," E. Floyd Kvamme, president of National Advanced Systems, the Palo Alto, Calif., computer subsidiary of National Semiconductor Corp., believes "we're over the effects of that." Kvamme not only sees some renewed activity but "the tight money situation could be a boon for the plug-compatible manufacturers. It seems that many people are looking at alternatives to IBM," he says.

Though order rates for the last

few months "could have been better" for his company, Kvamme still expects to meet expectations. That is because "business outside the U. S. is very strong, and any decline domestically will be offset by international orders," he states. Similar conditions are being felt at instrument and computer manufacturer Hewlett-Packard Co. of Palo Alto, Calif., where chairman David Packard cites a "definite slowdown in domestic orders of late" but notes that the international market, where HP does more than half its business, continues strong.

For IBM Corp., "the recession has not affected us in any retroactive sense," says John R. Opel, president and chief executive officer. C. Arthur Northrop, treasurer, says, "If the GNP fell 4% or 5% or more it would have some effect on us." But

Northrop does note that IBM is hiring fewer persons this year than last.

Nonetheless, there are definite signs of a slowdown among semiconductor manufacturers. F. Joseph van Poppelen, vice president of marketing for National Semiconductor's Semiconductor division in Santa Clara, notes that "order rates have decreased slightly, but nothing significantly. "There's no doubt that for some market segments the demand has slackened," van Poppelen states. "The automobile business is horrendous, and things related to housing starts, such as garage-door openers that use our devices, have slowed somewhat. Also, the consumer people, such as manufacturers of hand-held games, are being more cautious about how much they order," he says.

Federico Faggini, president of Zi-

SEMICONDUCTOR FORECAST BY TECHNOLOGY

	1979 (\$ million)	Growth (%)	1980 (\$ million)	Growth (%)	1981 (\$ million)	Growth (%)	1982 (\$ million)
<b>Integrated circuits</b>							
Digital bipolar	1,345	32	1,775	15	2,040	18	2,401
Logic	1,046	30	1,355	14	1,547	16	1,800
Memory	299	40	420	17	493	22	601
Digital MOS	2,400	43	3,441	25	4,306	32	5,689
Logic	1,121	36	1,526	24	1,893	32	2,498
Memory	1,279	50	1,915	26	2,413	32	3,191
Analog	926	18	1,090	16	1,263	23	1,552
Worldwide total	4,671	34.9	6,306	20.6	7,609	26.7	9,642
<b>Discrete devices</b>							
Diodes	219	7	235	3	243	8	262
Small-signal transistors	378	-2	370	-2	362	1	366
Power transistors	414	11	459	10	507	13	575
Rectifiers	338	5	355	7	380	10	419
Thyristors	172	6	182	8	196	11	218
Optoelectronics	331	30	430	19	510	25	640
All others	92	5	97	1	98	5	103
Worldwide total	1,944	9.4	2,128	7.9	2,296	12.5	2,583

SOURCE: SEMICONDUCTOR INDUSTRY ASSOCIATION



SEMICONDUCTOR FORECAST BY AREA

	1979 (\$ million)	Growth (%)	1980 (\$ million)	Growth (%)	1981 (\$ million)	Growth (%)	1982 (\$ million)
U.S. original-equipment manufacturers	3,273	30	4,255	16	4,940	23	6,077
U.S. distributors	1,011	23	1,244	20	1,487	25	1,856
Total U.S.	4,284	28	5,499	17	6,427	23	7,933
Europe	1,542	25	1,930	17	2,257	22	2,761
Japan	395	32	514	21	633	24	788
Other international	395	24	491	20	588	26	743
Worldwide total	6,616	27.5	8,434	17.4	9,905	23.4	12,225

SOURCE: SEMICONDUCTOR INDUSTRY ASSOCIATION

log Inc. of Cupertino, Calif., says, "Now that it's official, I think the recession is going to start hitting our industry this month and next, particularly in the automotive, housing, and consumer industries. Contrary to what we might have thought, we are not immune," he adds.

**Still buying.** Despite the softening market, semiconductor manufacturers are still expected to make heavy investments in new generations of semiconductor production equipment, as indicated at the recent Semicon/West '80 exhibition in San Mateo, Calif. Though some softening of orders was cited by suppliers of wafers and other materials, equipment producers are, for the most part, experiencing record bookings. There appear to be some stretchouts, or deferrals of new-equipment orders, but no cancellations.

Charles F. Drexel, president of Tylan Corp. of Torrance, Calif., believes the Japanese threat is a driving force behind new-equipment purchases by U.S. semiconductor manufacturers. Semiconductor equipment purchases by the Japanese were up 50% or both more in 1978 and 1979, as compared with about 20% for U.S. makers during the same period. He says, "The U.S. suppliers are out buying now, and they want the best equipment."

A spokesman for GCA Corp.'s IC Systems division, Bedford, Mass., notes that his firm's Wafertrac wafer processing systems are "virtually booked through 1980" and lead times on its DNS wafer steppers are about 18 months. "The window for the direct-step-on-wafer systems is 64-K and 256-K dynamic RAMs, as well as bubble memories."

Things are just fine in the tester business. William R. Thurston, president of GenRad Inc. in Concord,

Mass., quotes growth estimates for 1980 of from 25% to 31% due to "the proliferation of semiconductors, the increasing use of microprocessors, a scarcity of technician talent, and a continuing replacement of mechanical devices by electronic ones." Thurston offers five areas that indicate continued growth of the test-equipment industry. They are digital communications, autos, IBM's outside purchases, consumer electronics, and defense.

Despite this bullish outlook for production equipment, Gordon E. Moore, chairman of Intel Corp. of Santa Clara, fears U.S. semiconductor producers may be spending too much and may soon be faced with excess capacity. He notes U.S. and Japanese producers alone plan to invest about \$2.5 billion this year for plant and equipment in attempts to keep pace with a booming demand for integrated circuits that was not satisfied last year.

However, Moore warns that in their investing so much to make up for lost gains, semiconductor companies may overshoot the market. Either the demand for semiconductors will grow faster than expected, he states, "or we'll have some excess capacity in years to come."

**In and out.** The Midwest's component makers see unsettled conditions continuing throughout the year. Some customers are increasing orders, while others are putting off deliveries because of slowdowns in the auto and housing industries. Morton Steinberg, executive vice president of Magnecraft Electric Co. of Chicago, describes business as "desperate and sensational," while another marketer says, "If things don't worsen, it's not terrible."

For Augat Inc. in Attleboro, Mass., chairman Roger D. Welling-

ton sees the pervasiveness of electronics helping some companies weather the slump while making the industry as a whole "more sensitive to the movements of the economy." He sees a great opportunity in the auto industry, and telecommunications is strong. "It's not all good news, though," he adds. "Some vertical sectors are being hit hard. Major appliances, for example, are heavily dependent on the health of the housing industry."

The auto industry is cited also by Andy Sass, group director of business and technical research at General Instrument Corp.'s Microelectronics division in Hicksville, N. Y. He sees the growing infiltration of electronics into autos more than covering falling car sales.

One of GI's customers is Mattel Toys. At the Electronics division in Hawthorne, Calif., president Jeffrey A. Rochlis says parents will give up their own pleasures to buy toys for children, so in that sense the industry is fairly recession-proof. Also, more silicon is going into toys.

But for the bread and butter of consumer electronics, television, sales are slumping—they were off 16.6% in May compared with a year ago. However, a General Electric Co. spokesman insists that the recession was forecast well enough in advance to permit set makers to prevent overstocking.

How long will the slump last? Few are willing to make a hard prediction, but one Commerce Department economist puts it this way: "The economy is not a tennis ball; it is not guaranteed to bounce back faster if it drops sharply now. I think of it more as a plastic container falling on the carpet—something will spill and you have to make an effort to pick it up. But it won't break."

For electronics, Charles Hill, vice president and high-technology analyst at Bache Halsey Stuart Shields Inc. in Boston, says, "We are not looking for a slowdown at this time, but expect it by the third or fourth quarter. There are some segments that are stronger than during the last two recessions. On the other hand, computers are slightly softer. There also appears to be better control of inventories, but this could be offset by increased foreign competition." □

Letter from Boston

# Bay State battles body shortage

High taxes in Massachusetts discourage engineers from staying or moving there, though New Social Contract is starting to help

by James B. Brinton, Boston bureau manager

When executives of high-technology companies in Massachusetts get together for lunch these days, the talk invariably gets around to the problem of bodies. And they don't mean Bo Derek's. For even though the Bay State already has one of the lowest unemployment rates among industrial states, firms there foresee a huge shortfall in technical talent.

According to Alex d'Arbeloff, president of Boston's Teradyne Inc. and chairman of the Massachusetts High-Technology Council, "Massachusetts firms will have to find 3,500 new engineers and computer scientists every year for at least the next three years. But the total number of graduates with electrical engineering and computer science degrees granted by all Massachusetts colleges is expected to average only about 850 a year. Of these, only about 70% will stay in the state."

That leaves just over 2,900 high-level jobs open each year, meaning that Massachusetts firms must compete with companies in the Sunbelt and the Far West for scarce engineers. And when headquartered in a state nicknamed Taxachusetts, a company is playing the game at a disadvantage.

D'Arbeloff says that by the time real-estate, sales, and income taxes are included, the take-home pay of an engineer in Massachusetts can be \$4,000 to \$5,000 a year less for the same gross pay than in Texas, Arizona, or Florida.

It was this disadvantage that gave birth to the MHTC two years ago [*Electronics*, Jan. 5, 1978, p. 112]. Though there was less hard evidence in 1978 for the expected shortfall, Massachusetts businessmen knew

they were losing talent to other states with lower personal taxes. This, in turn, led to what is called the New Social Contract between the approximately 90 firms in the MHTC and the administration of Governor Edward J. King.

In February 1979, the MHTC committed itself to create 60,000 technical jobs plus an added 90,000 manufacturing and support positions. In

Electrical and electronics	38
Computer science	28
Chemical/chemistry	8
Mechanical	1
Other technical	25

SOURCE: MASSACHUSETTS BOARD OF HIGHER EDUCATION AND MASSACHUSETTS HIGH-TECHNOLOGY COUNCIL

exchange, state government was to take "substantive steps to restore competitive conditions and a healthy growth climate"—largely through cuts in personal taxes.

If both sides meet the terms of the contract, the MHTC and the governor's office predict a \$2 billion increase in state personal income, and a \$300 million increase in state and local revenues which, in theory, could support further tax cuts.

And taxes are there to be cut. In 1979, the state's per capita personal income tax rates were the eighth highest in the nation; property taxes were the second highest. And each of many specialized taxes takes its nibble out of individual income.

**Moving ahead.** Now, about 15 months after the commitment, industry is ahead of the plan on its end of the contract, while government is

starting to sag. On the industry side, the members of the MHTC have increased employment from 71,700 to 87,000; the addition of 15,300 jobs is 2,200 more than pledged. Meanwhile, the state has begun reducing its capital gains tax to the Federal level; over three years, that will mean a reduction of 60% and should enhance the formation of capital needed for expansion and new starts.

Even if King can whip Massachusetts' tax situation into shape, industry still is expecting a shortfall in skilled professionals. A partial answer to this situation may lie in the proposed Bay State Project, according to Secretary of Economic Affairs George S. Kariotis. An engineer and founder of Alpha Industries Inc. of Woburn, Kariotis hopes to develop a system that would allow otherwise unemployed professionals like teachers and older and out-of-work engineers to find new work in high-technology industry. If legislated, the program would be funded 50-50 by the state and industry and probably be managed by a mix of private enterprise and the colleges. In addition to direct educational efforts, there would be "awareness programs" to help teenagers learn about high-technology careers, loans and awards to help students with the cost of higher education, industry tax credits for scholarships, expansion and improvement grants to colleges interested in augmenting their high-technology-related plant and curricula, and a variety of other features.

But, as Kariotis points out, the legislation is pending, and the \$3 million requested as seed money may be a long time coming. □



**ComputerAutomation**  
Industrial Products Division

**TERADINE**

**GenRad**

WHICH  
OF THE TOP 3  
TESTER COMPANIES  
IS THE BEST BET  
FOR SOLVING  
YOUR TESTER  
PROBLEMS?

No two problems are ever quite the same. So it follows that no one solution can ever be the best solution.

Which explains why there's a "big three" to start with. And why smart buyers get bids and presentations from all three.

Of course, the plain truth is that you really can't lose, no matter which one of the top three tester companies you go with; it's simply a matter of how much you're going to win.

Because even though all three "solutions" are known quantities

with proven performance, there are significant differences. In technology. Product modularity. And upward compatibility. In the software approach. In the ongoing support package.

And some of those differences can make a difference to you.

Which is why you owe it to yourself to talk to all of the top three tester companies.

And besides, if you don't get the complete picture, you just won't know what you've been missing...

Contact Computer Automation, Industrial Products Division, 2181 Dupont Dr., Irvine, California 92713, (714) 833-8830.

***For productivity...today and tomorrow.***

U.S. regional offices in Santa Clara, CA (408) 727-6800, Bensenville, IL (312) 860-1830, Bloomfield, NJ (201) 338-8870. District Offices in Newport Beach, CA, Boston, MA, Raleigh, NC, Dayton, OH, Dallas, TX. In Europe: CAI Ltd., Rickmansworth, Herts., England 011 449 237-71211. Offices in Frankfurt, Germany and Rue Fourny, France.

Circle 103 on reader service card

Memories

# Is 5¼-inch Winchester drive ready?

Platter makers gear up to turn out the smaller disks,  
and Shugart says he has \$2 million in contracts

by Martin Marshall, West Coast Computers & Peripherals Editor

With announcements in hotel suites near the recent National Computer Conference in Anaheim, Calif., Shugart Technology of Scotts Valley, Calif., and Tandon Magnetics Inc. of Chatsworth, Calif., proclaimed that the world is entering the age of the 5¼-inch Winchester disk drive—even as most original-equipment manufacturers are still waiting for deliveries of 8-in. Winchester drives. Shugart Technology, a company formed by Alan F. Shugart, who had formerly founded giant Shugart Associates, led the way by demonstrating the ST 506, a so-called micro-Winchester drive with a capacity of 6.38 megabytes.

To head off conjecture that his drive might be more announcement than product, Shugart notes that his drives have been hard- rather than sand-cast. Sand casting, a more individual and expensive process, is generally reserved for engineering prototypes, whereas hard casting is the first step toward mass production of a disk drive. Shugart intends to make evaluation units of the ST 506 available this month, with production quantities due early next year to OEM designers. "We've already closed over \$2 million in contracts," he asserts.

Tandon, the second largest producer of 5¼-in. floppy-disk drives behind Shugart Associates, promises to second-source the Shugart Technology drive in a big way. "Shugart Technology has a three- to four-month start on us, but we intend for people to eventually think of us as the first source of this disk drive," declares Jerry Lembas, senior vice president at Tandon.

Still, as OEM designers painfully

learned with the 8-in. Winchester drive, there are several questions to be answered before the small version can be considered a reality. The first is whether the disk manufacturers are willing to tool up to produce platters that will, of necessity, return so much less profit per platter than the larger drives. Another is when controller boards will become available for these drives, and whether the boards' cost—now at \$1,125 each for 8-in. Winchester drives—will negate the price advantage of the smaller drive. Yet another is which companies are waiting in the wings to follow the Shugart Technology-Tandon Magnetics act with volume production of their own. And perhaps the most important question is who will buy the drives, for what products, and in what quantities.

It isn't necessary to look far to find interest on the part of a platter

manufacturer in the new drives. In fact, it was money from Dyan Corp. of Santa Clara, Calif., that financed the research and development of the ST 506. Of all the platter manufacturers, Dyan is most openly committed to the new product.

**Different method.** "It's true that the profit margins per platter are much lower on the 5¼ than on the 8, particularly if you make them in the same way that you make the 8," notes Dyan vice president of marketing William Harry. "We have made a large commitment, however, to making these disks in volume and to making them differently."

A large-volume supplier of both the platters and disk drives such as Memorex Corp. of Santa Clara, Calif., might be expected to be interested, but the reaction there seems rather cool. "The 5¼-in. Winchester represents 20% less cost than an 8-

## 1981 looks like a 5¼-in. year

With the combination of a low-cost controller board, committed medium suppliers, and a host of manufacturers in varying stages of production readiness, it seems that 1981 will be the year that 5¼-in. Winchester disk drives become available in volume.

Few knowledgeable people, at any rate, are willing to challenge Alan Shugart's statement that "within a few years, the market for 5¼-in. Winchesters will be larger than the market for 8-in. Winchesters." Shugart himself intends to supply over 40,000 micro-Winchester drives in 1981, but that is still a long way from the 300,000 to 400,000 spindles projected for 8-in. models. As his production volume goes up, Shugart also sees the price of his drives falling to \$700 in volume quantities by the end of 1981.

The first appearance of the small versions will likely be in a word processor, a market that promises to be the largest for this kind of drive. Second will be personal computers, or desktop-sized small-business computers. As Don Bryson, the product marketing manager for the Apple III computer, puts it: "One need only look at how well Corvus and Lobo are doing selling 10-megabyte 8-in. Winchesters to Apple customers. There are a lot of Apple users who only need 3 to 5 megabytes. We expect the use of these drives to be limited only by the ability to produce them."

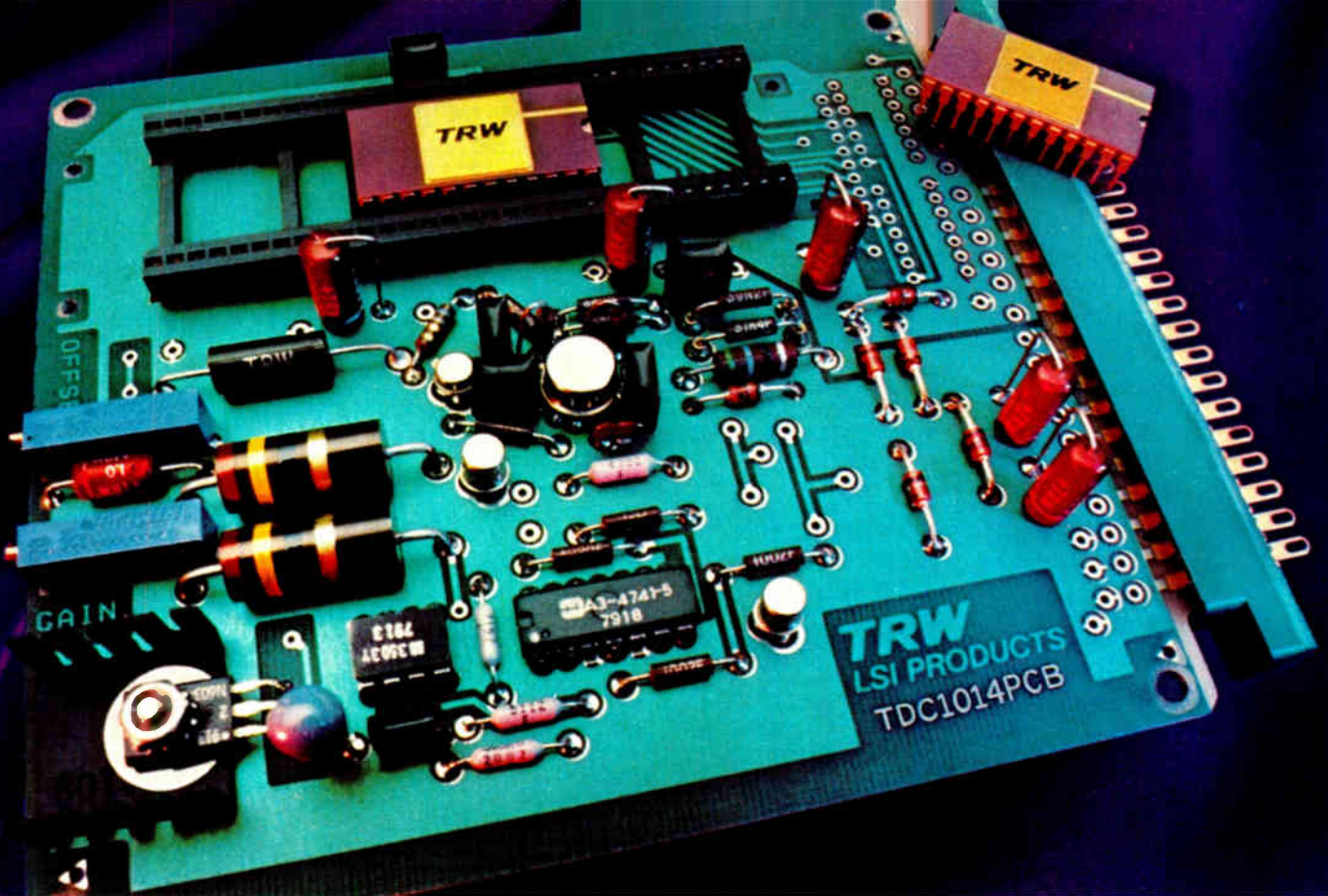

# This monolithic 6-bit, 33 nsec A/D converter has everything

(And a test board to prove it.)

Order our monolithic 6-bit 33 nsec A/D converter on its own fully assembled evaluation board (4½" x 5½", complete with 44 pin edge connector). Using +5 and ±15V power supplies, the board accepts and digitizes a 1V peak to peak signal from a 75Ω source at sample rates from DC to 30 megasamples per second.

Use it for performance evaluation of the converter. For system prototyping. As a test fixture. Price for **TDC1014PCB** 6-bit converter and board: **just \$218** (only \$168 in 100's).

Or if you prefer, order just the 6-bit converter (**TDC1014J**) by itself. Competitively priced at **just \$93** (in 100's), the TDC1014J is a fully parallel (flash) A/D converter.

If you're working in data conversion with **video bandwidths** take a look at these features:

With or without the evaluation board, these 6-bit video speed converters are **in stock** at your local Hamilton/Avnet distributor.

- 6-bit resolution
- ±1/4 LSB linearity
- 30 megasamples per second (33 nsec)
- **no sample-and-hold** circuit required
- binary or two's complement output
- monolithic, bipolar, TTL
- 24 pin ceramic DIP
- 0.75W power dissipation

Prices quoted are U.S. prices.

**For immediate information, call us at (213) 535-1831. Or send in the coupon. Or just attach your business card to this page and mail it back to us.**

**TRW LSI Products**

P O Box 1125  
Redondo Beach, CA 90278

Please send data sheets on the **TDC1014PCB** and **TDC1014J** 6-bit A/D converter

Name

Company

Div/Dept  Mail Code

Address

City

State  Zip

E-6

*TRW keeps you ahead in digital signal processing*

**TRW LSI PRODUCTS**  
An Electronic Components Division of TRW Inc.

Circle 105 on reader service card

# Workhorses.

Sometimes you need a dependable workhorse that will do the job efficiently, reliably, day after day. Like the compact drum printers from C. Itoh. Our Model 102 18-column digital, for example, weighs in at only 3.3 lbs., but it's more dependable than many units costing far more. Or our Model EP-101: it's at home in a lot of applications, but, like all our drum printers, it doesn't take much power—only 17 VDC. Or our most

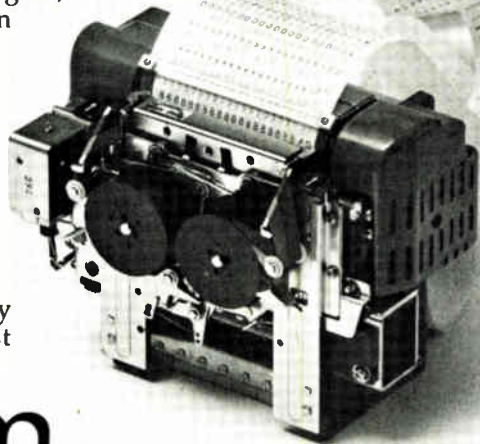

## Drum printers from C. Itoh.

versatile unit, the Model AN-101F alphanumeric, the perfect OEM printer for anything from computer output to label printer to data logger. And more. Every one is solid, dependable, and right for any application where a minimum of downtime is a prime requirement; each features two-color printing, a compact design suitable for bench top or rack panel mounting, and one more dependable thing: the C. Itoh brand.

### C. Itoh Electronics, Inc.

*C. Itoh means excellence in printers.*

5301 Beethoven Street, Los Angeles, CA 90066  
Call: (213) 390-7778 · Telex: WU 65-2451  
East Coast  
666 Third Avenue, New York, NY 10017  
Call: (212) 682-0420 · Telex: WU 12-5059

*C. Itoh Electronics is part of the C. Itoh & Co., Ltd. world-wide trading organization.*

Circle 106 on reader service card

### Probing the news

in. Winchester, but far less surface space and capacity," observes William Bayer, the president of the OEM group at Memorex. "Memorex has not chosen to invest in the 5/4-in. Winchester as a product."

This may be understandable on the grounds that such a product would take business from its 10-megabyte 8-in. Winchester, the Memorex 101, which is just coming on line. It may also be understandable in light of recent retrenchments, but the rumors persist that Memorex will eventually supply the medium and make the drive.

Two others. Although no public announcements have been made, disk manufacturers BASF AG and 3M are also understood to be gearing up to supply 5/4-in. platters. BASF, which recently completed a highly automated production facility in Los Gatos, Calif., for its line of 8-in. drives, prefers to be noncommittal. Notes Carter O'Brien, product manager for fixed-disk drives at Los Gatos, "I think it would be fair to say that BASF would not turn down business as a supplier."

Across the street from BASF, the engineering firm of Britton-Lee Inc. is testing the winds with several 5/4-in. Winchester designs. "Our intent is not to become a manufacturer of the drives, but to sell our designs to people who will mass-produce them," says company president Dave Britton. Britton, who as cofounder of International Memories Inc. produced the first commercially available 8-in. Winchester drive, says that his company is marketing four or five designs.

Perhaps even more significant than the announcement of the drives themselves was the quiet circulation at the computer meeting of data sheets of the WD 1000 from Western Digital Corp. of Newport Beach, Calif. The 1000 is a controller board that interfaces either a Shugart Associates SA 1000 8-in. Winchester drive or a Shugart Technology ST 506 5/4-in. drive with an Apple, TRS-80, or any computer using an S-100 bus. The controller board will become available in September for \$350 in quantities of 100. □

Circle 107 on reader service card →

## FREE

### Brochure describes Electronics editorial reprints, services, books...

- More than 70 article reprints in 15 subject categories
- Handy wall charts
- Custom-made reprint services
- Books especially for Electronics' readers
- Convenient postage-paid order cards



For your free copy, circle #275 on the reader service card.

# Run your fastest memories on our test track.



If you've got memory devices that race along at high speeds, put them through their paces on our Xincor 5582. For characterization or production testing, you get an uncompromised 25MHz test system. With an on-the-job track record that has turned it into an industry standard in less than a year.

The 5582 runs at 25MHz for all programmable features, patterns and modes. With exceptional accuracy and stability throughout. You get 156-picosecond resolution on phase edges. And 1.25ns resolution on period. So you can grade your devices more precisely and efficiently. Get the best price for them. And reduce your overall cost per device.

Fueling the 5582 is our Xincor

software. User-oriented. Proven on the job. Versatile, flexible and compatible with all Xincor test programs. You can run your existing Xincor source test programs on the 5582 without modification. And fit the 5582 into the Xincor III host computer network.

You don't have to drag through long, expensive program development. Or take extended pit stops for calibration. You can get on line quickly and keep running at top speed.

So whether you're characterizing or production testing static RAMs,

dynamic RAMs, ROMs or PROMs, let the 5582 keep you up to speed. Call us at (408) 998-0123. Or write to Fairchild Test Systems Group, 1725 Technology Drive, San Jose, California 95110. With our enhanced hardware, proven software and worldwide support, there's no better track for your fastest memories.

**FAIRCHILD**

A Schlumberger Company

**The  
First Family  
of ATE.**

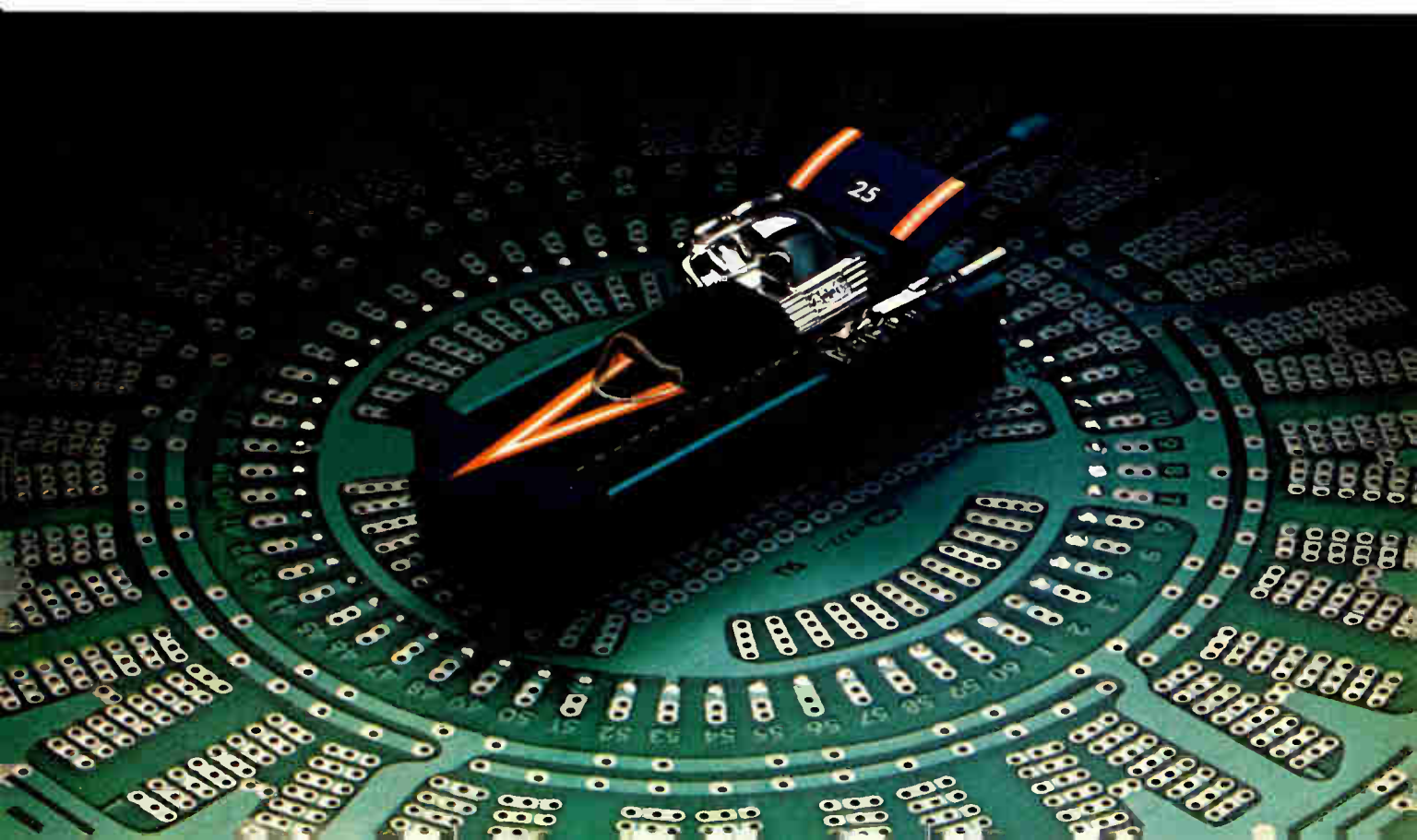

# 6 questions the V. may ask you about



## **Are bubbles supported by reputable companies?**

Bubble technology is out of the lab and into the marketplace. Eight major semiconductor companies have committed to bubble production by 1981 and six of them are shipping products now.

Rockwell International is the only bubble producer to have arranged two second source suppliers.



## **Are bubble memories competitive with other memories?**

Bubble memories fill the price/access-time gap between RAMs and some electromechanical memory media. Based on cost-of-ownership, bubble memory pricing is attractive in many applications today.

Within two years, bubble memory costs are expected to be less than 15 millicents per bit in production quantities.

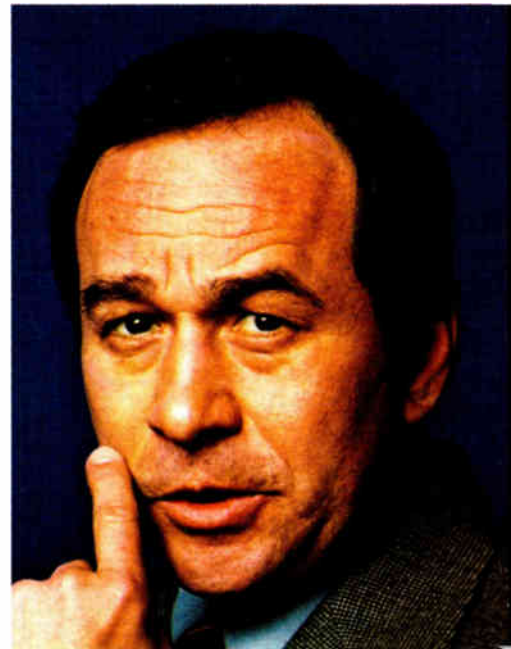

## **What industries have started using bubbles?**

Bubble memories have already been designed into industrial controls, terminals, business data systems, instrumentation, telecommunications systems and computers.

Rockwell International has shipped its bubble memory products to 175 companies in these market segments.

**Micro  
POWER**



# P. of Engineering bubble memories.



## **What bubble products are available now?**

Another company has a 92K bit device in production, and Rockwell International is in production of a 256K bit device. Two other companies are now sampling their 256K bit devices. Three companies have announced megabit devices.

Rockwell devices are also available on memory board systems.

## **What kinds of applications are best suited for bubbles?**

Applications where modularity in 32K byte increments up to 8M bytes is required; where electronic equipment must withstand unclean conditions; where size or packaging flexibility is important; where memories must operate for long periods without maintenance; where non volatile, solid state data storage is mandatory.

## **How about support circuits for bubble memories?**

Most bubble memory manufacturers have committed to the production availability of LSI support circuits by the end of 1980. Rockwell International will have all support circuits and they will be alternate sourced. They will interface with the major microprocessor buses.

To learn more, ask Rockwell. Rockwell International, Bubble Memory Products, Electronic Devices Div., P.O. Box 3669, RC-55 Anaheim, CA 92803. (714) 632-3729.



**Rockwell International**

...where science gets down to business

# MICROPROCESSORS

**MEMORY TIMING CONTROLLER**



**MEMORY REFRESH CONTROLLER**



**16-8 MULTIPLEXED LATCH**



**MEMORY  
4K 16K 64K**

# Dynamic RAM refresh and timing. Microprocessor to memory interface. More LS LSI innovation from TI.

Save design time. Production costs. Board space. And get all the benefits of Low-Power Schottky. All in a new series of LS LSI devices from Texas Instruments.

Devices that are designed to stand-alone. Or be part of a three-chip set. Devices that will make memory timing and refresh easier. Faster. More cost-effective.

Four variations of a new memory refresh controller, SN54/74LS600 through LS603, also designated TIM99600 through TIM99603 for the 9900 Family, provide bus driving peripheral control capabilities for refresh of 4K, 16K and 64K dynamic RAMs to create a static appearance.

Each IC contains one 8-bit synchronous counter, nine 3-state buffer drivers, four RC controlled multivibrators and other control circuitry... all on a single chip.

In addition, the new LS600 through LS603 Series gives you a choice of transparent, cycle steal or burst refresh modes for 4K, 16K or 64K-bit memory. In the transparent refresh mode, row refresh cycles occur during inactive CPU-memory times so that, in most cases, the entire memory refresh sequence can be done "transparently" (without interrupting CPU operations).

When the REF REQ pins are taken high to indicate an idle CPU/memory, as many rows as possible are refreshed. A low level on BUSY signals the CPU to wait until the end of the current row refresh cycle before resuming operations.

When the RC time constant programmed at RC BURST indicates that the safe refresh time of the memory has been exceeded, the memory refresh controller will automatically signal the CPU for an emergency burst-mode refresh by taking HOLD low. Auto-

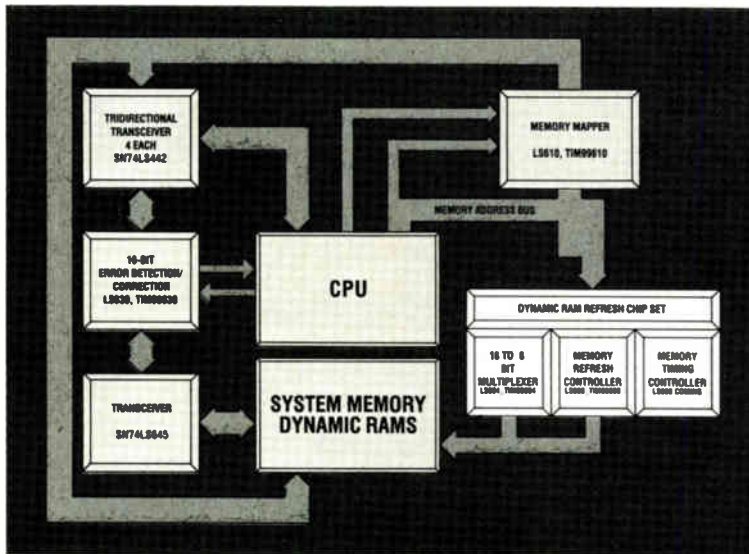

*This is the fourth in a series of announcements of innovative Low-Power Schottky devices Texas Instruments has introduced over the last few months. All of these circuits are designed to work with today's state-of-the-art microprocessor systems.*

matic burst refresh will then be generated even when transparent or cycle-steal refresh operations are already in progress.

This series of devices is available now in a space-saving 20-pin DIP.

16-8 multiplexed latches are designed for storing data in 2 sets of 8-bit registers from 16 input signals. This provides the output bus with stored data from either set of registers.

These devices, designated SN54/74LS604 through LS607, TIM99604 through TIM99607 for the 9900 Family, contain 16 D-type registers on a single chip.

These devices also serve as an interface between the 16 address bits of a microprocessor and a memory board. Row and column addresses can be loaded as one word from the microprocessor — then multiplexed sequentially to the RAM during RAS and CAS.

Choose 3-state (LS604, LS606) or open-collector (LS605, LS607) outputs in either of two operational speeds. Where speed is critical, LS604 and LS605 offer

high-speed capability. LS606 and LS607 are especially designed to eliminate decoding voltage spikes.

All devices in the LS604 Series operate from a single 5-V supply and are offered in 28-pin DIPs.

Memory timing controller, LS608, coming in the second half of 1980, will simplify timing of read, write and refresh operations in microprocessor/dynamic RAM systems.

It will serve as a stand-alone interface between the MPU and dynamic RAM to provide correct timing. When used as part of the chip set, it will provide a higher performance dynamic RAM controller. Critical times will be user RC programmable to provide ease and flexibility for optimum memory cycle performance.

Like all TI LS circuits, these new devices are low-cost and feature less heat generation, increased densities and improved system performance capabilities.

TI's continuing commitment to innovative Low-Power Schottky technology lets you design with confidence. Because it serves more of your LS needs. It's the broadest line in the industry. For every low-power, high-performance application. Military systems, data processing, telecommunications and process control — and more.

Whether you use these new devices as stand alones, or as a three-chip set, they'll make your design job easier. Keep costs lower.

For the widest range of effective bipolar state-of-the-art solutions, turn to the leader. Turn to Texas Instruments for more Low-Power Schottky innovation.

For more information write to Texas Instruments Incorporated, P. O. Box 225012, M/S 308, Dallas, Texas 75265.



TEXAS INSTRUMENTS  
INCORPORATED

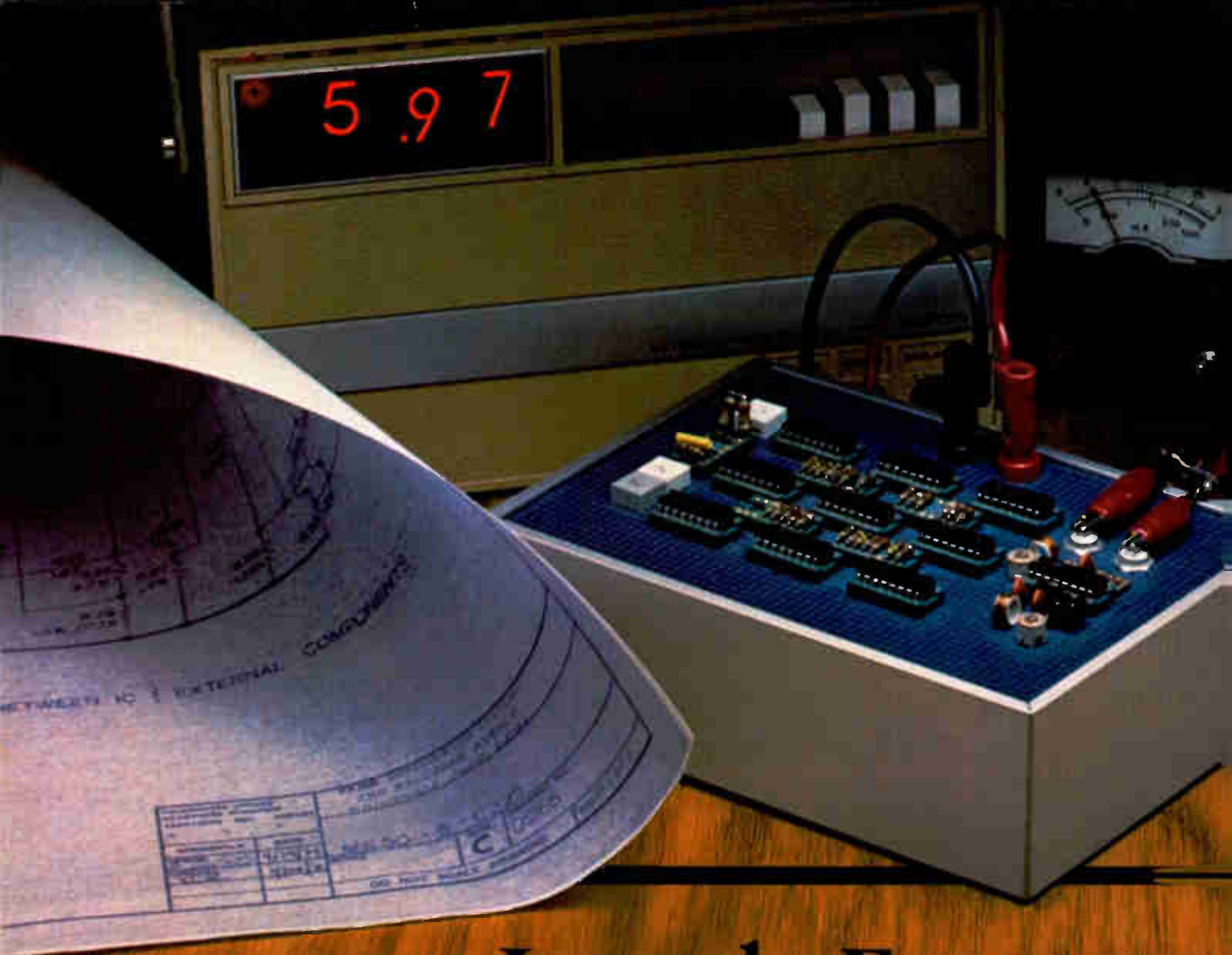

# In weeks Exar can into a custom

**C**ut up to one year off development time on linear custom circuits, reduce costs, and avoid design errors.

Exar's standardized semi-custom Master Chips contain undedicated NPN

and PNP transistors, resistors, Schottky diodes, and bonding pads. You interconnect these components to create your own custom circuit. Development time compresses drastically, becomes far less expensive

and virtually risk free. Exar's alternative source agreements with other IC manufacturers let you specify and order custom circuits with confidence.

## Go to full custom later.

As your product matures and your need for circuits increases, Exar can convert your semi-custom chip to a full custom IC, reducing chip size, saving money, and often providing added performance.

**EASY 3-STAGE DESIGN**

**SCHEMATIC DIAGRAM.**

**TYPICAL PENCIL LAYOUT ON MASTER CHIP WORKSHEET.**

**FINISHED CHIP.**

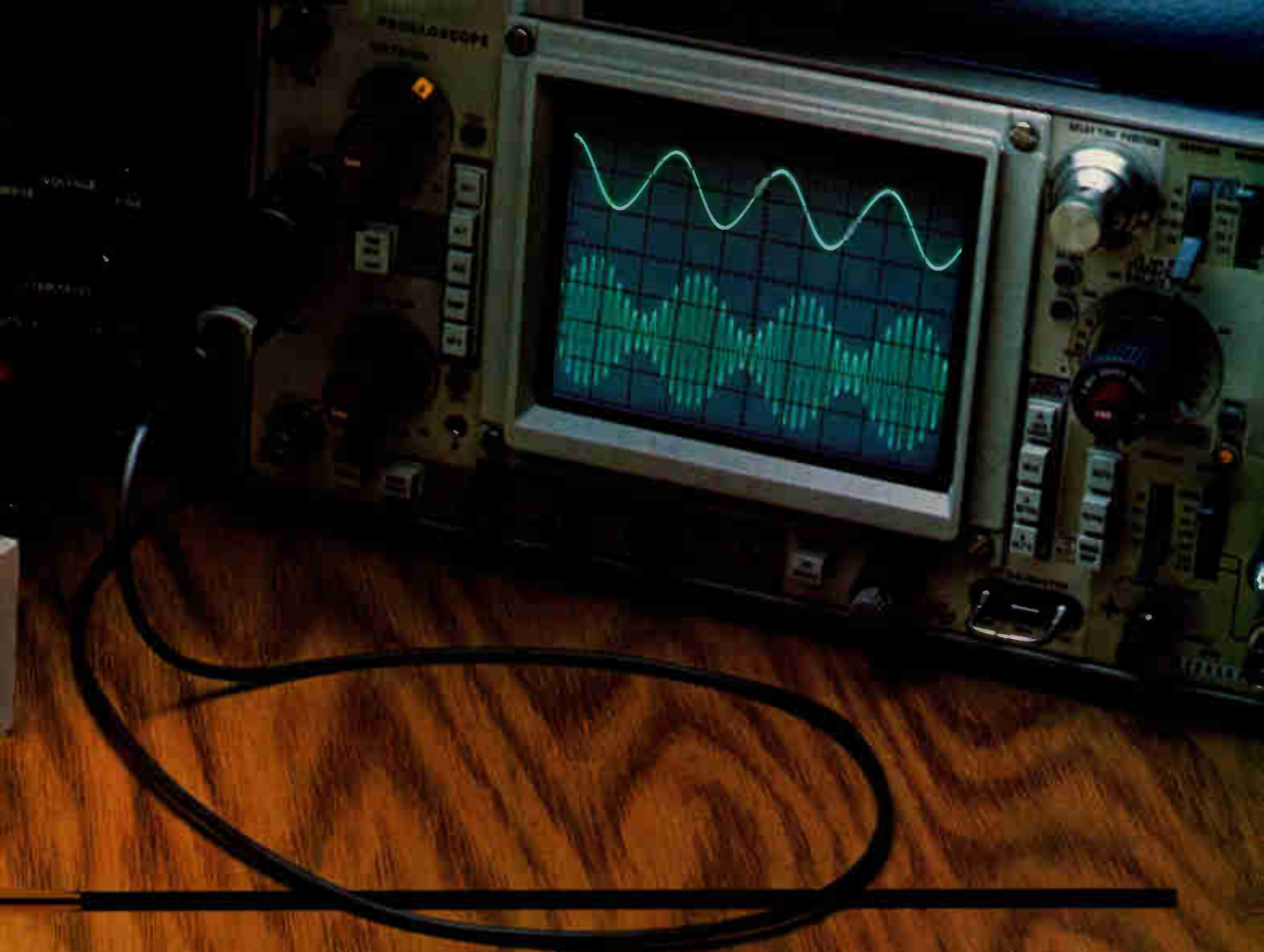

# transform your design linear circuit.

Choose from seven  
linear chips.

Chip Type	Transistors		Active Sites	Resistors	Routing Pads	Second Source
	nPn	pNp				
XR-A100	59	18	15	159	16	YES
XR-B100	69	12	16	191	24	YES
XR-C100A	22	8	6	71	14	YES
XR-D100	50	16	0	126	16	YES
XR-F100	96	36	0	296	24	YES
XR-G100	85	18	5	233	18	YES
XR-J100	38	13	0	116	18	YES

Exar also has four digital  
chips.

They combine digital circuits with high density  $1^2L$  logic arrays and bipolar transistors.

Design kits make it easy  
to get started.

Exar's design kits include circuit components for breadboarding, a comprehensive design manual, and layout worksheets corresponding to Exar's Master Chips.

Learn the economics  
and advantages of  
semi-custom.

For a copy of our 40-page data book, "Semi-Custom IC Design Programs" and our product

guide, write on company letterhead to Exar, 750 Palomar Ave., Sunnyvale, CA 94086 or phone (408) 732-7970.



Circle 113 on reader service card



## INTRODUCING VIDEOPRINT: The picture perfect peripheral.

Videoprint is the convenient economical means of obtaining distortion-free line or continuous tone hardcopy from raster line computer graphics displays in full, brilliant color. The entire system is self contained in the convenient desk-top unit shown above.

Videoprints eliminate such off-the-screen photography problems as barrel distortion, color de-saturation and loss of color fidelity. Videoprints also minimize the effects of raster lines and video noise.

Videoprints are instantly produced with Polaroid® SX-70 or Polacolor 4" x 5" films, as well as with conventional color negative or 35 mm slide transparency films, offering you a range of handy sizes. The pictures can be made by untrained personnel at the push of a button.

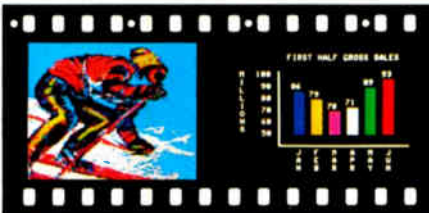
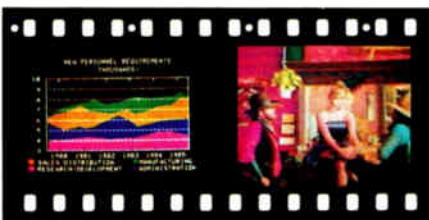
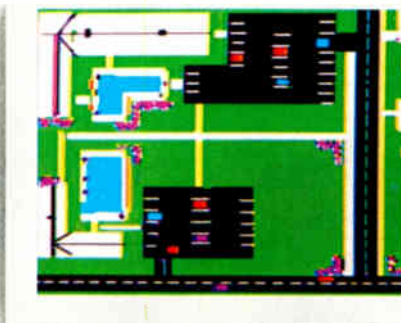

If you've ever wanted to distribute copies of computer graphics or TV video stills or file them in your permanent records, or send them through the mail or project them as slides, you need Videoprint.

If you've ever wanted to document alternatives in an interactive graphics process, or monitor periodic events without 24-hour observation, you need Videoprint.

In fact, if you use computer graphics in any form, you really need Videoprint. Find out all about this exciting new tool. Write or call us today.



### IMAGE RESOURCE

The Videoprint People.

Image Resource Corporation  
2260 Townsgate Road, Westlake Village, CA 91361  
(805) 496-3317

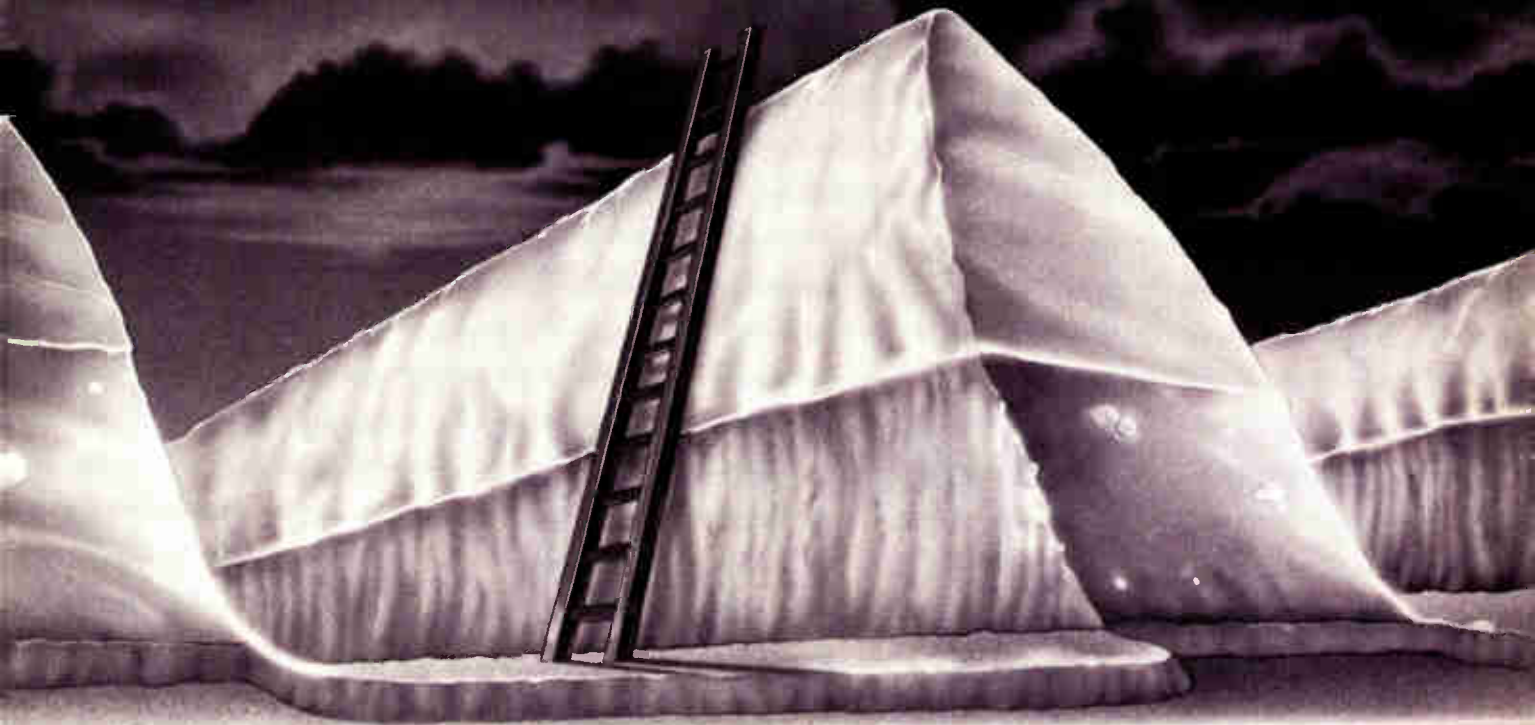

## Scaling the barriers to VLSI's fine lines

---

The limits of IC technology are being forced outward by new and improved lithography and etching, beam processing, and silicides

---

by Jerry Lyman, *Packaging & Production Editor*

□ The integrated circuit industry is in the first surge of a great wave of change that will carry it into a new era of very large-scale integrated circuits with low-micrometer to submicrometer features—denser, faster, and more complex devices. To produce these fine-line chips, new processes, equipment, and materials will gradually replace much of today's IC processing equipment.

Among the most important new IC processing techniques are:

■ Major new lithography (optical and nonoptical) methods capable of low-micrometer and submicrometer exposures.

■ Replacement of wet etching by three dry methods—plasma etching, reactive ion etching (RIE), and ion-beam milling—to bypass the deficiencies of wet etching.

■ The use of low-resistivity silicides and refractory metals as replacements for high-resistivity polysilicon interconnections.

■ Multiple-resists to compensate for wafer surface variations that thwart accurate fine-line lithography.

■ Laser and electron-beam processing to purify and reduce defects in IC materials.

■ Nonoptical methods of inspecting line widths and layer-to-layer registration to replace optical methods incapable of measuring these parameters at low-micrometer levels.

The main driving force for VLSI has always been the two undeniable advantages of scaling device dimensions down—reduced cost and increased performance.

Scaling down boosts circuit density by the square of

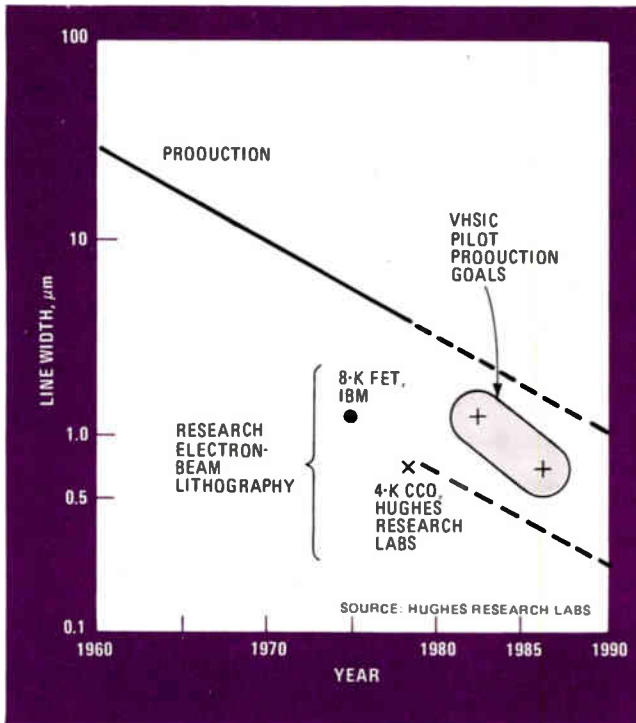

**1. Shrinking lines.** Current minimum production line widths for ICs are about  $3\ \mu\text{m}$  and are expected to drop to  $1\ \mu\text{m}$  by 1990. Pilot production-line goals set by the VHSIC program are  $1.25\ \mu\text{m}$  by 1982 and  $0.7\ \mu\text{m}$  by 1985, widths already achieved in the lab.

the scale factor. The scale factor is defined as the ratio of the original dimension to the reduced dimension. The result, of course, is more gates per chip area and more devices per wafer, the latter cutting the cost of manufacture—the bottom line in any business.

Scaling down also cuts a circuit's operating power, capacitance, and delay. An example of what happens to circuit factors when a typical MOS device is scaled from 4- to 1-micrometer line widths is shown in Table 1. Note that line resistance goes up and line response time is constant (the RC time constant is unchanged).

With these advantages it is no surprise that the IC industry has gradually been shrinking line widths. At present, the minimum production line width is 3 to  $3.5\ \mu\text{m}$  in high-performance MOS circuits. However, since 1978 an additional stimulus to VLSI has appeared: a \$210 million U.S. Department of Defense triservice program to develop very high-speed integrated circuits (VHSIC) with up to 250,000 gates and with device dimensions as small as  $0.5\ \mu\text{m}$ .

The program is now in Phase 0 [*Electronics*, March 27, 1980, p. 41]. Nine teams have been awarded study contracts to define approaches to system and chip architecture, circuit processing technologies, and testing. Between four and six of the competitors of Phase 0 will be chosen to compete in Phase 1A in 1981, during which pilot lines producing circuits with  $1.25\text{-}\mu\text{m}$  features are to be set up. Later phases (1982–1983) are expected to push submicrometer ICs into pilot-line production.

The VHSIC program is providing an extra stimulus to the appearance of low-micrometer and submicrometer semiconductor devices. Since such IC firms as Texas

TABLE 1: DEVICE AND CIRCUIT SCALING

Parameter	Change with linear scaling, factor of 4*
Circuit density	16
Operating voltage	1/4
Device current	1/4
Power per circuit	1/16
Circuit capacitance	1/4
Delay per circuit	1/4
Line resistance	4
Line response time	1

\* Line width scaled from  $4\ \mu\text{m}$  to  $1\ \mu\text{m}$ ; oxide thickness scaled from 100 nm to 25 nm

Instruments, Motorola, Signetics, National Semiconductor, Fairchild Semiconductor, and TRW are all members of teams working on VHSIC Phase 0, these companies will gain valuable know-how in VLSI processing that will surely be applied to in-house programs for commercial devices. It should be kept in mind that VHSIC is a research and development program and that the next production chips using newer forms of lithography will probably have about  $2\text{-}\mu\text{m}$  details.

### A new ballgame

As lithography limits were pushed back in the middle 1970s—typically  $7\ \mu\text{m}$  for production devices and close to  $1\ \mu\text{m}$  for research devices—IC processing engineers quickly discovered that the methods of the 1970s were not going to work. Wafer properties, resists, etching, alignment of mask levels, inspection, and cleanliness problems all became magnified. This led to the development of the methods listed above.

From about  $1\ \mu\text{m}$  down, the mechanical, physical, chemical, and electrical properties of the wafer become critical. For instance, poor wafer surface flatness (the potato-chip effect), which is relatively unimportant in the neighborhood of  $10\text{-}\mu\text{m}$  features, can virtually prevent workable lithography at low-micrometer levels.

Resistivity of the silicon wafer, again not critical in the  $10\text{-}\mu\text{m}$  process, now affects circuit speed in the new chips, since as line width goes down, interconnection resistance and RC delays go up.

In order to put down fine details, the thicknesses of both resist and oxide must be cut down. These thin coatings are easy to damage and often fill the hills and valleys of an etched surface unevenly.

Photoresist layers create still another problem at the  $1\text{-}\mu\text{m}$  level and below. Consider the case of a  $1\text{-}\mu\text{m}$  image exposed in a  $0.5\text{-}\mu\text{m}$  resist layer spun onto a silicon wafer. If standard wet etching were used, the resist image would be undercut by the isotropic (equal in all directions) action of the wet etch. Thus this type of etching does not faithfully reproduce the dimensions of a photomask and cannot be used for low-micrometer work. Some other type of etching is required to reproduce completely vertical side walls.

Still another problem that becomes critical near or below  $1\ \mu\text{m}$  is level-to-level registration. Aligning  $4\text{-}\mu\text{m}$  details on alternate mask levels is no problem with optical 1:1 and direct-step-on-wafer optical projection systems. But holding a  $1\text{-}\mu\text{m}$  detail to  $0.1\ \mu\text{m}$  is currently



impossible in production with optical lithography. That sort of accuracy can only be achieved with a scanning-electron-beam lithography system, which is low in throughput and extremely high in cost.

Assuming the low-micrometer devices can be fabricated, a further problem exists in inspecting them. Optical instruments fall off in accuracy in this range and scanning electron microscopes are simply too expensive to be production instruments. In addition, the cleanliness problem is compounded at this level. Particulates 1- $\mu\text{m}$  in size (which could be ignored at 10  $\mu\text{m}$ ) now become a serious problem.

Making fine-line VLSI devices is quite complicated. The costs of implementing the 10 to 20 mask levels and 130 to 150 steps of the late 1980s will be staggering. But it will be done under industry and VHSIC pressure.

### Improving images

IC lithography has always been the driving force behind each step forward in the IC industry. From 1976 to 1980, great strides were made in lithography [*Electronics*, April 12, 1979, p. 105] with the emergence of improved 1:1 optical projection, electron-beam, direct-step-on-wafer (DSW), and X-ray systems in commercial and in-house versions (Fig. 1).

At the present time, it appears that the transition to ICs with 0.5- to 0.8- $\mu\text{m}$  details will take place in two stages at firms involved in the VHSIC competition. The rest of the IC world will be trying to push the geometries of production chips from 3 to about 2  $\mu\text{m}$  and will proceed more cautiously.

The VHSIC participants will most likely use DSW, direct electron-beam writing, and a simple flood-beam X ray to expose 1.25- $\mu\text{m}$  features. There is also a possibility that Perkin-Elmer Corp.'s 1:1 optical projection system, fitted with a deep-ultraviolet source and optics, may be used for this purpose, since it will have a resolution limit of about 1.2  $\mu\text{m}$ .

In the second stage, which will be for chips with 0.5- to 0.8- $\mu\text{m}$  line widths, direct electron-beam writing and X-ray lithography may dominate, though there is a good

possibility that optical lithography (DSW in particular) will be extended down to 0.75 or 0.8  $\mu\text{m}$ . An outside possibility for these submicrometer VLSI chips could be a DSW with either an X-ray or ion-beam source.

On the production side of the industry, the major producers will use DSW for only the most critical masking levels and 1:1 projection for the other levels of their next-generation 2- $\mu\text{m}$  VLSI. This lithography mix will achieve a reasonably high throughput, since most operations will be on fast (60 levels per hour) projection aligners instead of the slower wafer steppers.

### The Federal effort

VHSIC competitors are a mix of research and development firms plus independent IC production houses. Hughes Research Laboratories, Malibu, Calif., will do its initial VHSIC work on in-house direct-writing electron-beam systems. A long range possibility for Hughes' later chips could be an ion-beam lithography system [*Electronics*, March 27, 1980, p. 142].

Barry Dunbridge, laboratory manager of TRW's Defense and Space System group, Redondo Beach, Calif., and leader of a VHSIC team, notes that his group has been developing 1- $\mu\text{m}$  chips since 1976 using a Canon FPA DSW machine equipped with a 4:1 reduction lens. That same system is targeted for the early VHSIC 1.25- $\mu\text{m}$  chips. Dunbridge's group has been fabricating bipolar VLSI using a triple-diffused method which is presently being employed at the TRW LSI Products division to produce a commercial 8-bit high-speed analog-to-digital converter with 2- $\mu\text{m}$  details.

Rockwell International's Electronics Research Center, Anaheim, Calif., is another prime contractor on VHSIC. Its lithography effort is based on two Cambridge Scientific Instruments scanning electron-beam systems used exclusively for direct writing of IC patterns onto resist-covered wafers. The most advanced machine is a Rockwell modification of Cambridge's latest unit, the EBMF-2. The modification allows design iterations to be done interactively on a terminal adjacent to the lithography system. In the fall of 1977, Rockwell fabricated an

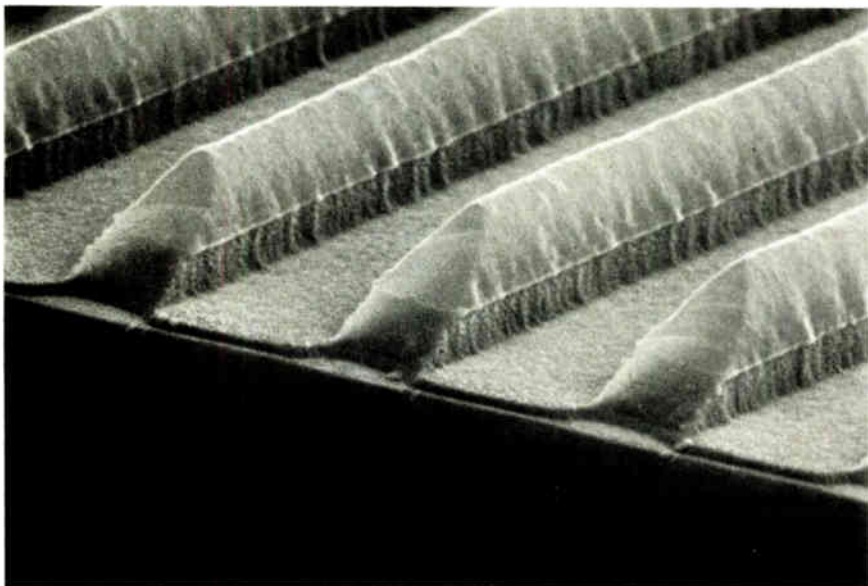

**2. Plasma-etched polysilicon.** Polysilicon, heavily doped with phosphorus, was etched by an LFE planar plasma-etching machine to produce the 1- $\mu\text{m}$ -wide lines shown in this scanning electron micrograph. The pattern was exposed in AZ1370 photoresist using a step-and-repeat system.

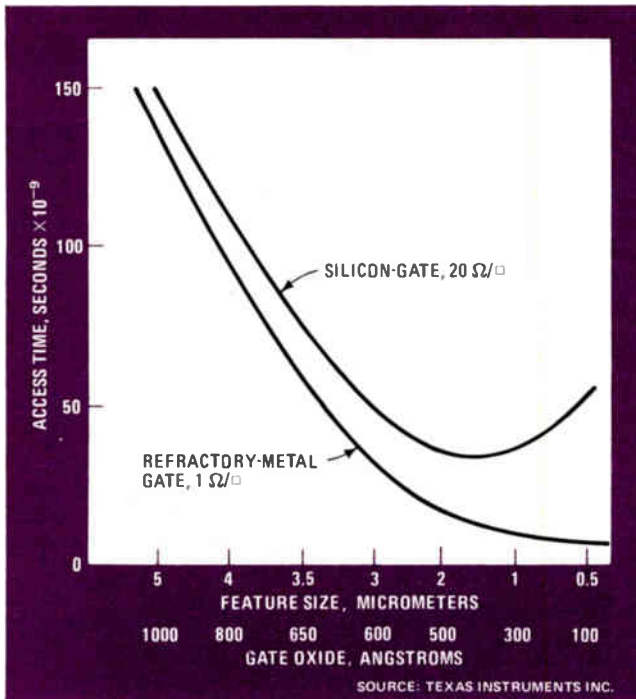

**3. Faster metal.** Given sheet resistivities of 20 and 1 ohm per square, silicon and refractory-metal gate materials in a 4-K static RAM have the plotted effect on access time with decreasing feature size. Silicon gates cause access times to rise below 1  $\mu\text{m}$ .

n-channel-MOS ring oscillator boasting 0.25- $\mu\text{m}$  channel lengths with direct electron-beam writing and dry processing. Rockwell also has an X-ray lithography program, but this is in the research stage. For producing small-geometry units, Rockwell has received or ordered DSW machines from both the Burlington, Mass., division of GCA Corp. and Electromask Inc.

Jim Dey, manager of image technology at National Semiconductor, is in charge of his company's lithography effort for VHSIC. According to Dey, "the early generation of VHSIC chips will be done on wafer steppers." National will try both the GCA and the Optimetrix 8010 in its VHSIC effort. For the submicrometer phase of the VHSIC program, National plans direct writing on wafers with an electron-beam system.

Two of the electronic giants in the VHSIC competition—Texas Instruments Inc., Dallas, and International Business Machines Corp.—will base their efforts on scanning electron-beam systems developed in house for direct wafer writing. Both firms are leaders in the development of electron-beam technology.

What is surprising is that another electronics giant, Bell Laboratories—whose EBES electron-beam machine [*Electronics*, May 12, 1977, p. 95] led to commercial electron-beam mask-making machines from the Extrion division of Varian Inc., Gloucester, Mass., and Etec Corp., Hayward, Calif.—is putting X-ray lithography onto a production line. Martin Lepselter, director of Bell's advanced LSI development lab, Murray Hill, N. J., says that by 1981, the company will set up X-ray lithography systems at Western Electric for production of 1- $\mu\text{m}$  n-MOS integrated circuits. The machines will be improved versions of Bell's X-ray II systems [*Electronics*, April 12, 1979, p. 115] using an improved X-ray source. With new faster X-ray resists, Lepselter feels a goal of 1,000 wafers per hour could be achieved with a relatively low \$1.5 million investment in these new machines.

Intel, the third largest independent IC manufacturer in the U. S., is not a VHSIC competitor and is currently at the 3- $\mu\text{m}$  level with its standard high-performance HMOS chips, which are imaged with Perkin-Elmer 1:1 projection systems. Intel is already purchasing and considering lithography equipment for its next chips, but will not reveal what line widths it is shooting for. Contenders for Intel's next chips are Perkin-Elmer's deep-ultraviolet 1:1 system and wafer steppers from GCA, Optimetrix or Censor. Gerry Parker, director of technology development for Intel, emphasizes that there is now a two-year wait for GCA and Perkin-Elmer equipment.

#### Across the water

In Europe and Japan, investigations are already under way to select lithography for resolving 1  $\mu\text{m}$  and below. Both NV Philips Gloeilampenfabrieken of the Netherlands and Intermetall GmbH, the headquarters company of the ITT Semiconductor Group, favor direct electron-beam writing for submicrometer VLSI.

Joseph Borel, vice president for research and development at EFCIS, the Grenoble-based company that is

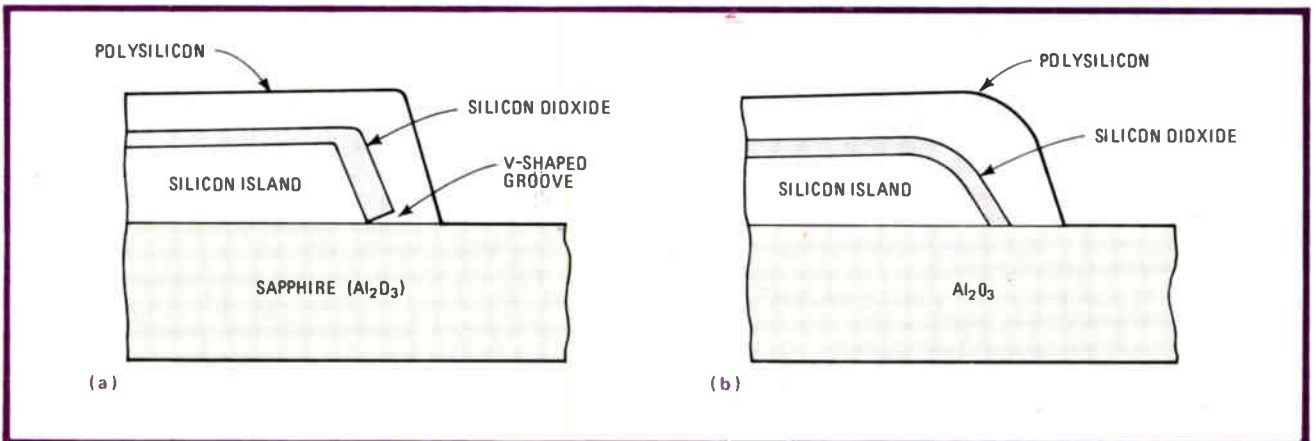

**4. Laser smoothed.** An unwanted V-shaped groove in the oxide covering a silicon island (a) is common in C-MOS-on-sapphire work. Energy from a laser rounds off the edge and eliminates the groove (b), preventing electrical breakdown and increasing channel mobility.

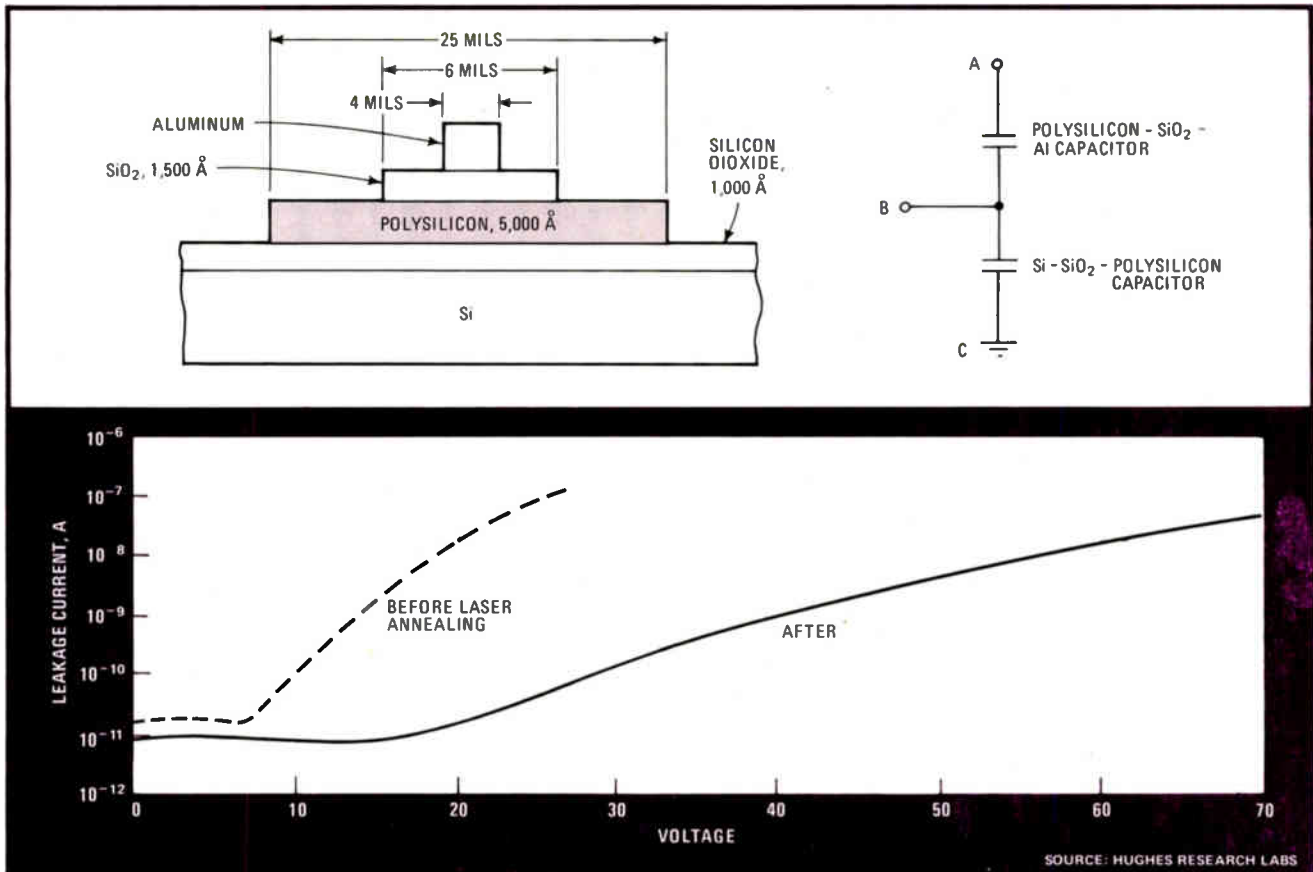

**5. Annealed stack.** Stacked capacitors with a polysilicon layer that has been exposed to pulses from a ruby laser show a dramatic improvement in electrical properties over unannealed devices. Breakdown voltage goes up and leakage current is cut by a factor of 1,000.

jointly run by Thomson-CSF and the French Atomic Energy agency, says, "Capital costs will become an overriding factor in determining which technologies will prevail for submicron circuits." He points out that the shift from direct exposure of wafers with 1:1 masks to reduction exposure using reticles and step-and-repeat machines has tripled fabrication machine costs. He figures the increase will be even higher when equipment like direct-writing electron-beam machines and X-ray equipment arrives at the mass production stage. Borel, like many others, thinks it will be possible to get a little under 1  $\mu\text{m}$  by means of improved reduction lenses in DSW machines.

Researchers at Plessey's Allen Clark Research Centre Caswell, Northants., England, recently completed a detailed study for the European Economic Community of the lithography needed for VLSI. Three systems looked at include 1:1 optical projection, DSW, and electron-beam lithography systems. The report concludes that for optical dimensions down to 1.5  $\mu\text{m}$ , full-wafer-exposure optical projection systems will remain the cheapest. But the study also shows that full-wafer stepper systems are on a steeper price decline, with a crossover point in the early submicrometer region.

Direct-writing electron-beam systems, by contrast, are an order of magnitude more expensive and show no sign of catching up either in absolute cost or in rate of price decline. So the report concludes that these systems will be used for mask making and for specialized applications

like discretionary wiring, but will have no major production role until optical techniques finally run out of steam, as they will below 0.75  $\mu\text{m}$ , or until there is a technological breakthrough in high-speed resists.

In Japan, as in the rest of the VLSI world, direct electron-beam writing is seen as the first route to submicrometer dimensions. Shojiro Asai, senior researcher at Hitachi's central research lab, says that "E-beam will remain the only means to get 1- $\mu\text{m}$  or lower circuits for several years, until X-ray lithography's problems are solved." Asai lists the major problems to be worked out in X-ray technology as the source, the mask construction, and the mask-to-wafer alignment.

To Asai, ion-beam lithography is an attractive possibility for the long haul. He sees it providing a means to dope isolated regions addressed by the beam. In addition, the beam is free of scattering effects in its pattern-writing mode, he notes.

### Etch considerations

Etching is second in importance only to lithography in the processing of fine-line chips. Micrometer and submicrometer lines on resists are worthless unless their images can be transferred accurately to the underlying substrate. Traditionally, wet etches using sulphuric, hydrochloric, or phosphoric acid have been assigned this task. However, as early as 1976-77, the poor resolution and undercutting of wet etching on the 5-to-7- $\mu\text{m}$  chips being produced at the time allowed a form of dry plasma

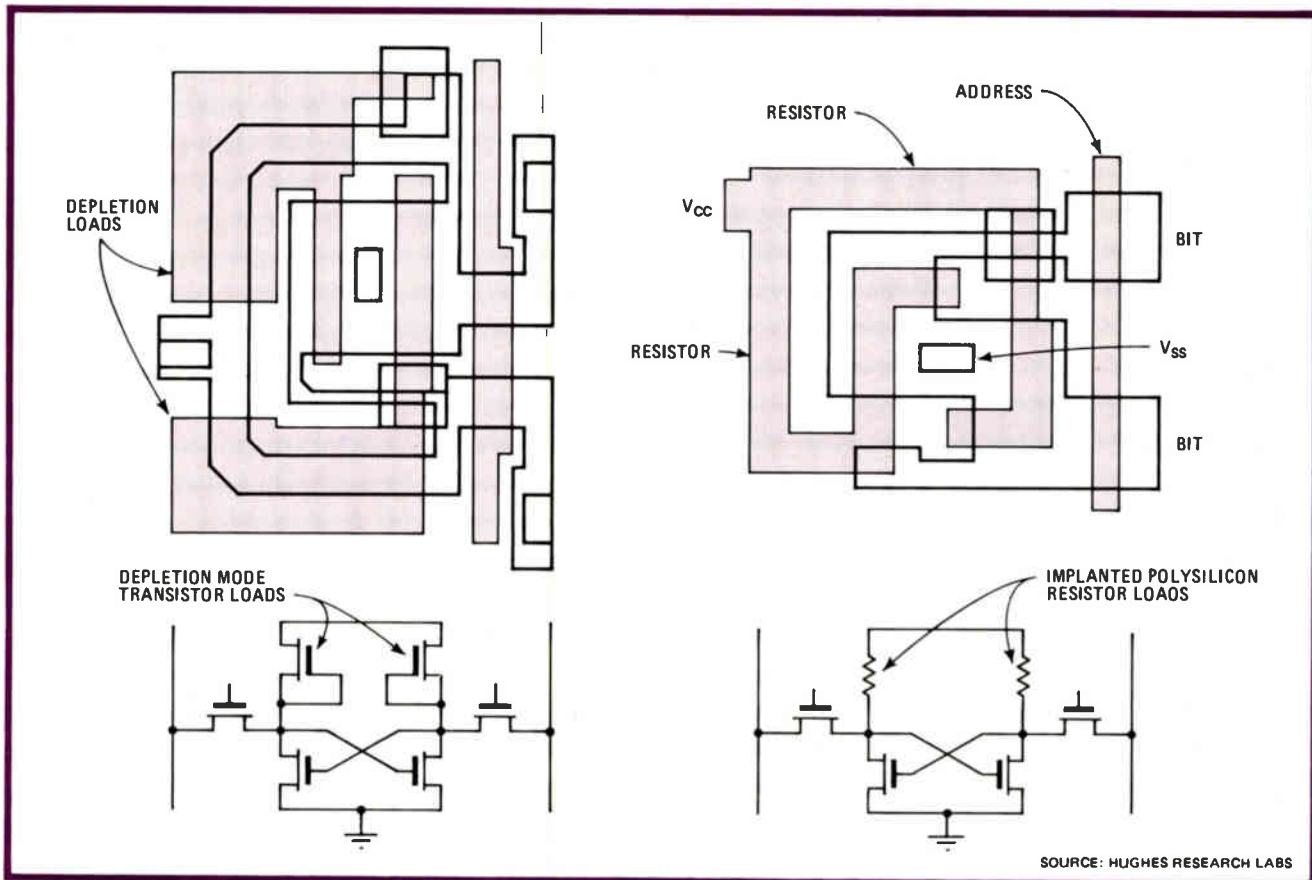

**6. Polysilicon resistors.** The relatively high resistivity of polysilicon is very useful in the design of static random-access memories. When the depletion-mode transistor loads in the cell at left are replaced by implanted polysilicon resistor loads, the cell size can be cut by 40% (right).

etching to get its foot in the door.

Since that time, plasma etching has been considerably refined and is in place on most IC fabrication lines, particularly the new H-MOS types (2.5 to 3.0  $\mu\text{m}$ ). So it is natural that both the future commercial producers of fine-line chips and the VHSIC teams will initially use plasma etching in the 1-to-2- $\mu\text{m}$  range. But it appears that two other dry etching techniques—reactive ion etching (RIE) and reactive ion milling—will be applied to VLSI in the submicrometer range. Both techniques etch a wide range of materials anisotropically—a vital factor for submicrometer VLSI fabrication.

A plasma is a volume of ionized gas atoms capable of supporting a current. The plasma contains a substantial group of free radicals—electrically neutral atoms that can form chemical bonds. The free radicals react with photoresists and substrate coatings to etch them.

Early commercial plasma reactors, called barrel reactors, were built around a chamber with external electrodes. Wafers were stored vertically in a suitable carrier inside the chamber. Although such units had high throughput, they could not be used for anisotropic etching, for etching aluminum, or for selective etching of silicon dioxide over silicon at practical rates. Still, many hundreds of these systems are in use for dry etching in the 3-to-5- $\mu\text{m}$  range. Below 3  $\mu\text{m}$ , the planar plasma reactor takes over.

The planar plasma or parallel-plate reactor has two internal flat electrodes. Normally the top electrode is

driven by a radio-frequency voltage while the lower one holds the wafer. The parallel-plate reactor can perform high-resolution (1-to-2- $\mu\text{m}$ ) anisotropic etching in silicon, polysilicon, silicon nitride, silicon dioxide, and aluminum. An example of plasma-etched 1- $\mu\text{m}$  lines in doped polysilicon on a planar plasma reactor from LFE Corp. is shown in Fig. 2.

A new type of dry etching was reported at IBM in 1976. It was called reactive ion etching and it combined chemical (plasma) etching and plasma sputtering with chemically reactive ions bombarding the surface of the substrate. Reactive ion etching takes place in a plasma-filled planar reactor run at a higher voltage and a lower pressure than a comparable plasma reactor. For RIE, the electrode bearing the wafer is driven by rf and the other electrode is grounded (the opposite of a planar plasma reactor). The new method results in improved image-size control, anisotropic etching capability, higher etching rates, and better selectivity than straight plasma etching [*Electronics*, Aug. 31, 1978, p. 117], making it ideal for the narrow lines of VLSI and the submicrometer circuitry of the VHSIC program.

IBM has been using RIE and its IC processing on a production basis since 1976. In fact, IBM developed its own dry-etching system that does RIE, plasma, or a combination of both processes. Bell Labs and Hitachi both have considerable experience in RIE and have applied it both in production and prototype IC devices.

Manufacturers of plasma etchers have been quick to

recognize the potential new market for RIE by coming out with new machines that can operate either as plasma or RIE systems. Examples are LFE's model 501P, Plasma-Therm Inc.'s model PK-2440PE/RIE and the model 4440 from the Ultek division of Perkin-Elmer Corp., Mountain View, Calif. The latter is Perkin-Elmer's first entry into this field and it undoubtedly heralds the entrance of large equipment firms into the plasma and RIE business.

### **Ion-beam milling**

The third contender for the etching process of the 1980s is ion-beam milling. In this technique a collimated beam of argon ions is focused onto a resist-covered wafer in a vacuum chamber. The beam selectively mills out unmasked material by displacing ions of the substrate under bombardment.

Ion-beam milling has many advantages. It can etch any material (plasma and RIE cannot claim this); it can generate anisotropic or tapered walls up to 45° and has no undercut. Its ability to mill fine lines is only limited by lithography.

However, straight ion-beam milling has several major disadvantages. For one, the ion beam is not selective and will continue to mill through the desired material into the underlying layer. Plasma and RIE systems have chemical etch stops that prevent this effect. Other disadvantages of ion-beam milling are trenching and redeposition of the milled material.

In spite of these disadvantages, ion-beam milling is being used extensively in magnetic-bubble work, in milling gallium arsenide (GaAs) ICs, and for making ultra-thin masks for X-ray lithography.

A modified form of ion-beam milling has been developed, however, that eliminates its lack of selectivity. This method, called reactive ion-beam milling, substitutes a reactive gas mixture (typically argon mixed with hexafluoroethane, C<sub>2</sub>F<sub>6</sub>) for the normal pure argon. This makes possible etching of silicon dioxide over silicon or aluminum with a selectivity of up to 8:1. In addition, typical etching rates are increased as much as two to three times—1,000 angstroms per minute for silicon dioxide. Reactive ion-beam milling is already available in machines from Extrion, Veeco Instruments Inc., Plainview, N. Y., and Technics Inc., Springfield, Va.

Of the three dry-etching techniques, plasma etching represents the greatest body of experience; it is still being refined. However, for the submicrometer chips of the future, most industry experts agree that either RIE or reactive ion-beam milling is necessary. It is worth noting that any dry-etching method for the 1981–85 period will have to etch a wide range of new materials—silicides, refractory metals, and polyimides.

Actually the three methods may coexist. At Rockwell International's Electronics Research Center, Thousand Oaks, Calif., planar GaAs LSI integrated circuits are fabricated in a process flow using all three dry-etching techniques. In an early step, a silicon nitride "cap" is etched shallowly with plasma. Later, RIE is used to etch via windows in a layer of silicon nitride separating two levels of interconnections. Finally, second-level titanium-gold metalization is ion-milled to desired widths.

**TABLE 2: RESISTIVITY OF REFRACTORY-METAL FILMS**

Metal, deposition method	Bulk resistivity at 20°C, $\mu\Omega\text{-cm}$	Film thickness	Ohms/square	
			As deposited	After annealing
Molybdenum, • Electron-beam evaporation • Radio-frequency sputtering • Magnetron (S-gun) sputtering	4.8	3,048	0.95	0.27
		3,302	1.7	0.43
		3,000	0.72	0.35
Tungsten, • Electron-beam evaporation • Rf sputtering • S-gun sputtering	5.5	3,302	2.6	0.4
		3,810	5.0	0.87
		3,000	0.98	0.69
Tantalum	50	5,524	24.0	14.0
Titanium-tungsten	—	3,125	6.32	3.87
Polysilicon, diffusion or implantation	—	4,500	—	20–30
Aluminum, electron-beam evaporation	2.26	5,334	0.054	—

Conventional MOS silicon-gate devices cannot be scaled down indefinitely. One reason is the performance limitation presented by the rising resistance of the thinning polysilicon interconnections, which stretch out propagation delays. Two solutions to lower interconnection resistance are currently being evaluated: replacing the polysilicon interconnections with a silicide (an alloy of metal and silicon) or depositing metal over them.

### **Silicide and refractory-metal gates**

The resulting sheet resistivity of either approach is orders of magnitude lower than that of polysilicon, which measures about 20 to 30 ohms per square. Often referred to as refractory—high-temperature—metals, those most often used in either application are molybdenum, tungsten, tantalum, titanium, and mixtures thereof.

Most companies favor the silicide approach, since it is more easily inserted into an existing process line. The pure refractory metal, however, has the lower sheet resistivity of the two. Silicides can be formed on polysilicon by several methods: sputtering or evaporation of a metal, co-sputtering metal and silicon, or co-evaporating metal and silicon.

Shyam Murarka, a member of the technical staff at Bell Lab's Murray Hill, N. J., facility has done extensive research on finding optimum materials and methods for the fabrication of silicides. His results show that sheet resistivities of 1 and 2  $\Omega/\text{sq}$  can be obtained by using 1,000-Å titanium and tantalum films, respectively, on polysilicon.

Murarka notes that tantalum silicide (TaSi) is mechanically strong and can resist the conditions and temperatures of MOS processing. Thus a retrofit in existing processing is possible. The potentially more valuable titanium silicide films, although mechanically strong, react violently with acids used in wet etching.

Dry etching of tantalum or titanium silicides has proven successful. Bell has used plasma etching to etch both the silicide and its underlying polysilicon and to stop at the gate oxide. Etching was carried out in a radial-flow (planar) or standard barrel reactor. Bell Labs has successfully made and tested MOS ICs with

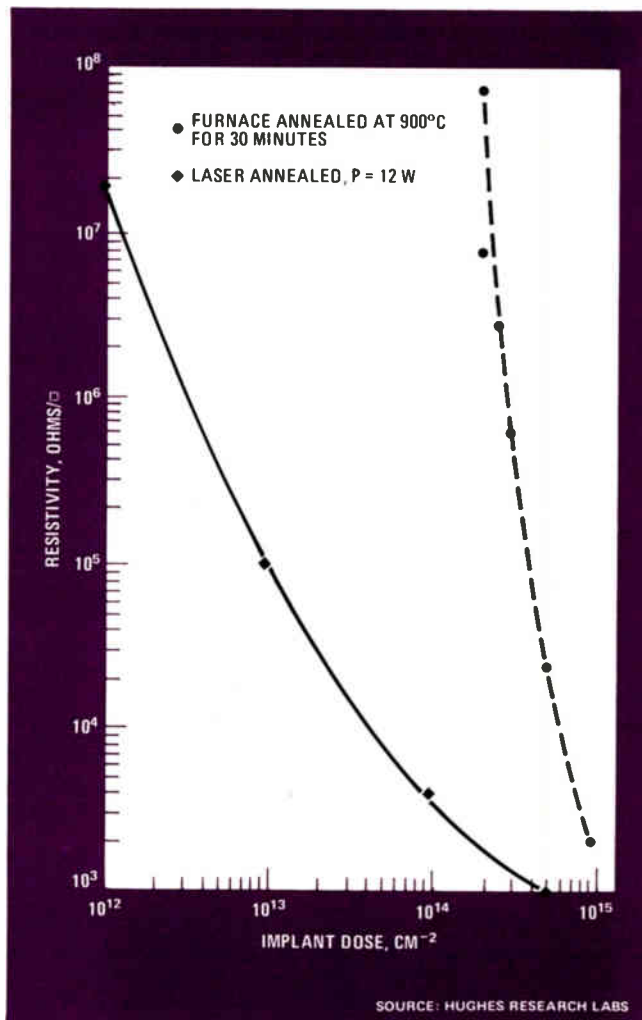

**7. Implantation sensitivity.** A 10% variation in implantation dose changes the resistivity of furnace-annealed polysilicon by a factor of 10. The resistivity of laser-annealed polysilicon resistors, given the same 10% variation in dose, changes by only a factor of 2.

tantalum silicides. The lower-resistance titanium silicide is still in an evaluation stage.

Other silicide experiments are going on at Texas Instruments, IBM, and in Japan. Texas Instruments has built test devices using molybdenum silicide with a sheet resistance of 5  $\Omega$ /sq. IBM is fabricating VLSI MOS devices with tungsten silicide gates. A dual-electron-beam evaporator co-evaporates tungsten and silicon onto polysilicon. Arnold Reisman, manager of exploratory semiconductor technology at IBM's Thomas J. Watson Research Center, Yorktown Heights, N. Y., notes, "Silicides are not a panacea; they will help you in places where polysilicon is used, but will not solve the problem of scaling aluminum, for instance."

In Japan, Nippon Electric Co. (NEC) and Hitachi Ltd. are both involved in silicide research. NEC is already using silicides, specifically platinum silicide, in bipolar products. For MOS, it is studying molybdenum gates, which can be used at 1-to-1.5- $\mu$ m levels. The molybdenum silicide's resistivity of 0.3  $\Omega$ /sq substantially better than platinum silicide's 3  $\Omega$ /sq.

At Hitachi, Shojiro Asai says, "We won't be able to

get rid of silicide in VLSI." Hitachi is devoting considerable efforts to such silicide problems as deposition, interfacing with oxides, and oxidation of surfaces. Molybdenum and tungsten are attracting the most attention at Hitachi, but platinum is also of some interest for interconnecting metals and heavily doped regions.

Refractory metals used for gates and interconnections were first investigated in the early years of MOS circuitry. However, the advantage of their low resistivity was more than offset by the process simplicity and passivation capability of silicon-gate technology. In 1977, the fundamental limitation of polysilicon interconnections in VLSI became apparent and metal gates reemerged.

Pradeep Shah, manager of MOS device technology at Texas Instruments, comments, "Interconnection technology is one of the neglected aspects of IC technology. This led us to look into both refractory metal gates and silicides."

Texas Instruments has run an extensive investigation of refractory-metal gate processes for VLSI end use. Molybdenum, tungsten, titanium-tungsten, and tantalum were chosen as likely refractory-gate candidates. Table 2 lists TI's figures for the resistivity of the sampled refractory metals deposited by different methods, before and after annealing at 1,000° and 450°C. Electron-beam-evaporated tungsten and molybdenum had the lowest sheet-resistance. Tantalum and titanium-tungsten films had comparatively higher sheet resistivities and so were eliminated as contenders.

In TI's refractory-metal work, molybdenum and tungsten films 3,500 Å thick were patterned at 1-to-2- $\mu$ m geometries using electron-beam techniques and photoresists coupled with conventional plasma etching, ion milling, and wet etching. The sheet resistances of 0.25 and 0.4  $\Omega$ /sq for molybdenum and tungsten are 50 to 100 times lower than conventional polysilicon.

MOS test devices were fabricated with 1-to-2- $\mu$ m gates and molybdenum-aluminum-silicon double-level metal structures. These units demonstrated significantly better performance than silicon-gate chips with the same geometries.

Figure 3 is a simulation of a 4-K static random-access memory's performance with both silicon and refractory-gate structures. Notice that the silicon-gate RAM's address time reverses its downward trend at about the 1.5- $\mu$ m level, whereas the refractory-gate device's address time decreases with geometry.

Refractory-metal gates and silicide gates will both improve VLSI circuit performance. Refractory-metal gates offer a hundredfold reduction in sheet resistance over polysilicon, but silicides are only an order of magnitude better. However, pure refractory metals cannot be easily passivated by oxidation as polysilicon can be; this leads to additional processing steps. Silicides, on the other hand, are self-passivating, which results in higher device stability and makes self-aligned and two-level structures possible.

With the advent of VLSI, the classic material problems of IC processing such as ion-implantation damage, interconnection resistance, impurities in the substrate, and leakage current and dielectric breakdown at interfaces become magnified. Laser and charged-particle beams

can potentially provide the localized processing technology to solve these problems.

At the present time, laser processing is more advanced than electron-beam processing, due to the ready availability of all types of laser hardware. Laser processing has the following advantages:

- Localized heating.
- High temperature for short time periods.
- Improved device performance (compared with conventional processing).
- Increased packing density, yield, and reliability.
- The ability to produce new material properties.

The possible applications of laser processing include ion-implantation annealing without dopant redistribution, large-grain polysilicon crystal regrowth on dielectric material, reflow of island structures, ohmic contact formation, gettering, and replanarization.

Annealing refers to the repair of lattice damage and dopant activation following ion implantation. A pulsed laser anneals by melting the surface of the wafer to a depth significantly beyond ion-implantation damage. As the melted area refreezes, the single-crystal structure is reestablished by liquid-phase epitaxy. The implanted dopant is distributed very evenly throughout the melted area.

### Removing damage

Annealing ion-implantation damage by continuous-wave laser heating involves a process known as solid-state epitaxy. This technique has the advantage that it does not redistribute the implanted dopant atoms.

Laser annealing, since it only heats the top of the wafer, eliminates the potato-chip effect of furnace annealing. This factor (wafer flatness) is vital to accurate lithography at levels near and below 1  $\mu\text{m}$ . In addition laser annealing achieves a greater degree of dopant activation than furnace annealing.

Although the annealing of ion-implantation damage is basic to IC processing, uses of the laser in semiconductor processing that go beyond annealing are already on the horizon. In a paper given at the conference on laser and electro-optical systems and inertial confinement fusion (CLEOS/ICF) held during February 1980 in San Diego, Calif., Laverne Hess, head of the laser chemistry section of Hughes Research Laboratories, Malibu, Calif., discussed the results of work conducted by scientists at three Hughes facilities. Their research shows how lasers can improve step coverage in silicon-on-sapphire circuitry by eliminating the V-shaped groove common in such technology; how lasers can improve polysilicon stacked-structure oxide by annealing prior to oxidation; and how lasers can make polysilicon resistors less sensitive to implantation dose.

In Hughes' complementary-MOS-on-sapphire process, silicon islands are first defined photolithographically on the sapphire wafers and then etched. The islands are exposed to radiation from an excimer laser operating at a 2,490- $\text{\AA}$  wavelength with an energy density in the range of 0.5 to 1 joule per square centimeter. The islands are ion-implanted with gate oxidation; polysilicon deposition, contact, and metalization steps then follow.

It was found that exposure at an energy density of

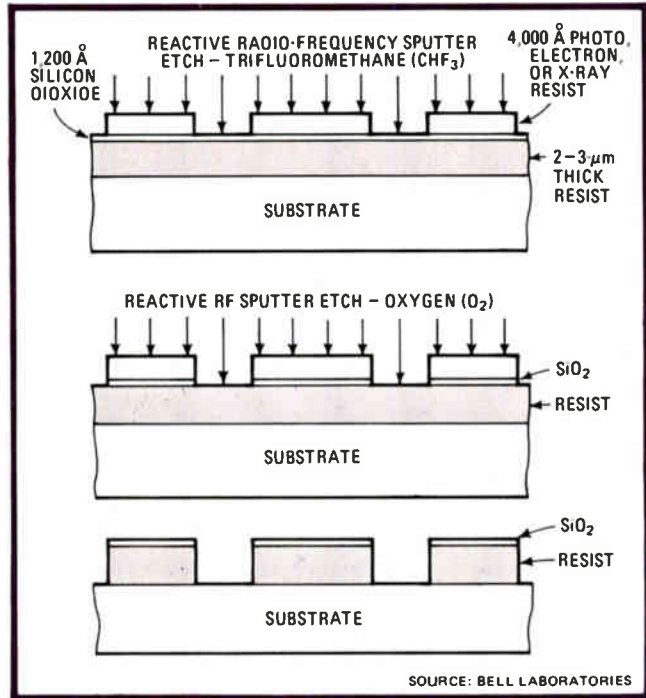

**8. Multilayer.** To prepare a wafer for X-ray imaging, Bell Labs first spins on a thick layer of organic resist, making the surface more planar. Layers of  $\text{SiO}_2$  and X-ray resist are added. The results are good line-width control and step coverage and high resolution.

about 0.8  $\text{J}/\text{cm}^2$  results in rounding the silicon island edges, thus eliminating a grooved profile of the gate oxide and improving aluminum step coverage. The electrical characteristics of MOS transistors fabricated over laser-annealed islands showed a 30% increase in channel mobility. The gate oxide contour for an unannealed island is illustrated in Fig. 4a. In Fig. 4b, laser annealing has smoothed and rounded the island's edges, eliminating the oxide groove.

### Stacking oxides

Polycrystalline silicon is a material of great importance in solid-state electronics. Devices like floating-gate memory systems, charge-coupled devices, and static and dynamic RAMs depend on the electrical characteristics of polysilicon and on oxides grown over polysilicon.

A major problem with these ICs, which rely on alternating layers of silicon and oxide, is that asperities on the surface of polysilicon lead to electric-field enhancement and consequent breakdown problems. One solution to the problem is to expose the polysilicon film to an intense laser beam prior to oxidation so as to melt down and smooth the surface asperities without creating unwanted heating in underlying material.

In order to test this theory, Hughes workers built up the stacked structure shown in Fig. 5. Radiation from a ruby laser was used to smooth the surface of a 5,000- $\text{\AA}$  polysilicon film. The resulting structure, consisting of two capacitors, was dramatically improved by exposure to the laser process (Fig. 5). Leakage current was reduced by  $10^3$  and breakdown voltage increased.

Another application of polysilicon is in load resistors replacing active load elements. This can save 40% in the

## Fine lines demand defect-free wafers

Ultrapure, defect-free silicon will be vital to high-yield fabrication of submicrometer very large-scale integrated circuits. That is why all large U. S. silicon suppliers, such as Siltec Corp., Menlo Park, Calif., Monsanto Electronics division, Palo Alto, Calif., and Wacker Siltronic Corp., Portland, Ore., are currently engaged in research to stay ahead of the IC industry's tightening silicon specifications.

And that is why the subject of defects in silicon and gallium arsenide rates an entire session at the June 24-25, 1980, Electronics Materials Conference (EMC) at Cornell University, Ithaca, N. Y. Two of the papers point out the effects on silicon wafer defects of trace impurities such as

carbon and thermal and oxidation process steps.

Robert Lorenzini, president of Siltec, states, "One of the things becoming increasingly evident is that the quality of the raw silicon wafers starting into a fabrication line becomes critical as we head into the VLSI era. All small wafer defects become a problem at narrow line widths."

Siltec engineers are finding that the yields of certain high-speed devices are enhanced by combining a higher oxygen content in wafers with a proprietary form of gettering. In addition, Siltec is engaged in research involving the ultrasonic measurement of microcracks (mechanical defects) in silicon ingots.

basic cell size of memories (Fig. 6), for example—an important consideration in VLSI design. Normally, implanted polysilicon resistors are furnace-annealed; but laser annealing produces a superior resistor, as Fig. 7 illustrates. The reason is that a 10% variation in ion-implant dose results in a change in resistance of furnace-annealed resistor of a factor of 10. Laser-annealed resistors, on the other hand, change by only a factor of 2 over the same dosage variation.

Bob Kaplan, manager of engineering for Quantronix Corp., Smithtown, N. Y., which makes the only commercial laser cold-processing (LCP) system—the Epi-therm Model 610 [*Electronics*, February 28, 1980, p. 137]—sees gettering as the first significant application of LCP, followed by diffusion and annealing. Quantronix has sold machines to both Motorola and Western Electric.

### Better gettering

Gettering is an important part of most semiconductor processes. The term refers to the reduction of mobile defects and certain impurities in the crystalline structure of wafers at their active or critical portions of the circuits built on them by physically damaging or chemically treating the back side of the wafer.

Gettering is more important in leakage-sensitive devices such as dynamic RAMs and C-MOS circuits. As junctions get shallower (as in VLSI) and narrower, defects are more of a problem and gettering becomes a necessity.

Two of the most heavily used chemical gettering methods involve diffusion of phosphorus at a high doping level into the back side of the wafer and ion-implanting the back side of the wafer with argon. Both have drawbacks. The first method often results in contamination of the front side of the wafer; in the second, the argon ions may often be annealed out in a later process step.

A more satisfactory method is to use a pulsed laser to getter the back side of the wafer. There is no problem of contamination or doping of the front side with laser gettering. The individual pockets of damage created seem to resist annealing longer than the damage created by the other two methods. In addition, lasers cost less than ion implanters.

In the laser diffusion method, a doped silicate is spun on the wafer and then radiated with a laser. The silicate

becomes transparent and the laser energy goes into the silicon, melting the dopant. Laser diffusion puts a larger concentration of dopant into the material, resulting in lower resistivity.

Another form of beam processing being considered for VLSI wafers in the not-so-distant future is done with pulsed electron beams. Instead of heating a spot, as in laser processing, this system heats the entire surface of a wafer to a high temperature with a single submicrosecond pulse of a 7- to 10-cm beam. This method was developed by Spire Corp., Bedford, Mass., in 1974. Like laser processing, pulsed electron beams have applications in annealing ion-implantation damage in silicon and gallium arsenide, in epitaxial regrowth and in the formation of silicides.

In Japan and Europe, laser and electron-beam processing is being investigated extensively. At Plessey Co. in Ilford, Essex, England, laser annealing is still at the research stage and, according to a Plessey spokesman, "probably a good three years away from being a production process." Plessey is looking at both the continuous and pulsed laser techniques of annealing. Plessey engineers make the significant point that there is now evidence that the perfection of the crystal lattice of laser-annealed silicon is higher than that of thermally annealed silicon.

Hitachi last year published a paper on its research in laser-beam annealing with arsenic-ion implantation to make source and drain regions for MOS devices. Hitachi favors electron-beam annealing for building three-dimensional (stacked) VLSI by constructing single-crystal regions on insulating substrates. This, however, is a long way off. The Japanese firm is also looking into both laser epitaxy and electron-beam annealing each for different applications but of the two it is keenest on laser epitaxy.

### Multiple resists

As the microelectronic evolution has proceeded from 10 to 3 to 1  $\mu\text{m}$  and below, another complication occurs. Finer features require thinner resist coatings, which are fragile, causing a serious lithography problem. If a thin resist film is spun over a nonplanar surface, the resist will be distributed unevenly over the wafer. This results in a distorted exposure image.

Bell Labs and IBM have addressed this problem with



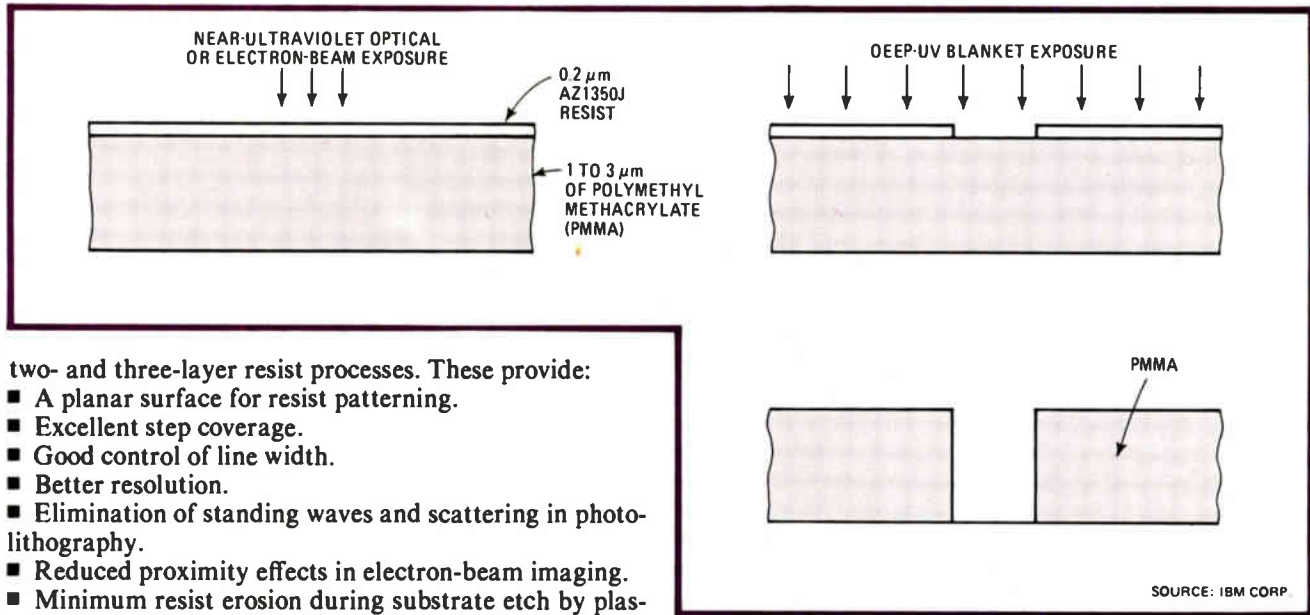

two- and three-layer resist processes. These provide:

- A planar surface for resist patterning.
- Excellent step coverage.
- Good control of line width.
- Better resolution.
- Elimination of standing waves and scattering in photolithography.
- Reduced proximity effects in electron-beam imaging.
- Minimum resist erosion during substrate etch by plasma or ions.

In the Bell approach (Fig. 8), a 2- to 3- $\mu\text{m}$  layer of polymer is first placed over the surface of the wafer, making it more planar. This is then covered with 1,200- $\text{\AA}$  photo, electron-beam, or X-ray resist. The thin photoresist is now highly planar and is capable of high-resolution lithography. After exposure and development of the top layer, the silicon dioxide is etched by trifluoromethane ( $\text{CHF}_3$ ) reactive ion etching. The thick layer is etched by oxygen-ion reactive etching. Bell Labs has demonstrated 1- $\mu\text{m}$  line and spaces using this technique.

IBM uses two multiple-resist methods. In its earliest system, developed specifically for electron-beam lithography, a two-layer resist has been developed. A thin (typically 400-nanometer) top layer of an IBM copolymer resist is the imaging layer, and a much thicker bottom layer of polymethyl methacrylate (PMMA) is used to provide an undercut profile suitable for metal lift-off patterning. The thickness of the bottom level is usually in the 700-to-1,300-nm range.

Again, the image is developed in the thin top resist, allowing better size and image control. After complete development of the top layer, the developer is changed and the PMMA main layer is developed in a solvent that does not attack the top layer. Thus, the thick bottom resist serves to make the thin top resist more planar.

IBM's other multiple-resist system employs two types of exposure. Called the portable conformable masking technique, it combines either electron-beam or near-ultraviolet (370-nm) lithography with a deep-UV (240-nm) blanket exposure.

Electron-beam lithography can write low- and submicrometer features into resist-covered surfaces. However, backscattered electrons from the substrate limit the resist images exposed by an electron beam to a relatively low height-to-width aspect ratio. On the other hand, deep-UV conformable printing has demonstrated a nearly 4:1 aspect ratio for 0.5- to 5- $\mu\text{m}$  features.

In this method a thin resist is directly applied to a deep-UV resist as shown in Fig. 9. IBM used a 0.2-to-0.4- $\mu\text{m}$  layer of AZ1350J (a standard positive photo-

**9. Portable conformable mask.** IBM puts a thin resist layer (sensitive to light or an electron beam) atop a layer of deep-ultraviolet resist. The top layer, once patterned, serves as a portable mask that can be carried with the wafer to a deep-UV blanket-exposure station.

resist from Shipley Co., Newton, Mass.) as the electron-beam or near-UV resist and a 1-to-3- $\mu\text{m}$  layer of PMMA as the deep-UV resist.

In the process, the image is directly written by an electron beam or patterned by UV light into the top layer. The underlying PMMA layer is not sensitive to the electron-beam or near-UV exposure. After development, the AZ1350J layer serves as the deep-UV mask for the PMMA resist. The wafer is then moved to a blanket deep-UV station where it is exposed with deep-UV light and then developed. Lines 0.6  $\mu\text{m}$  wide with 2- $\mu\text{m}$  pitch on a 2.2- $\mu\text{m}$ -thick PMMA resist have been demonstrated with this method. The AZ1350J cap of the portable conformable masks was removed during PMMA development.

If process or resist requirements call for it, a 50- to 200-nm layer of aluminum can be inserted between resists. An example of this would be to expose the top resist with X rays and then the second resist, unaffected because of the shielding aluminum, with deep-UV light.

Most IC companies are in the process of evaluating the use of multiple resists. However, many feel they can reach the 1-to-1.25- $\mu\text{m}$  area with single resists. Multiple resists add several process steps and therefore raise cost and complexity. But when IC processing reaches the 0.5-to-0.8- $\mu\text{m}$  level, this processing step will be almost impossible to avoid.

### Measuring the unmeasurable

Anyone fabricating VLSI devices must routinely measure 1- $\mu\text{m}$  line widths and narrower and check layer-to-layer registration to within  $\pm 0.1 \mu\text{m}$ . At these levels, the optical microscope can no longer be used to make absolute measurements; it can be used only for comparative measurements. A manufacturer must either go to special chip-test patterns or use a scanning electron

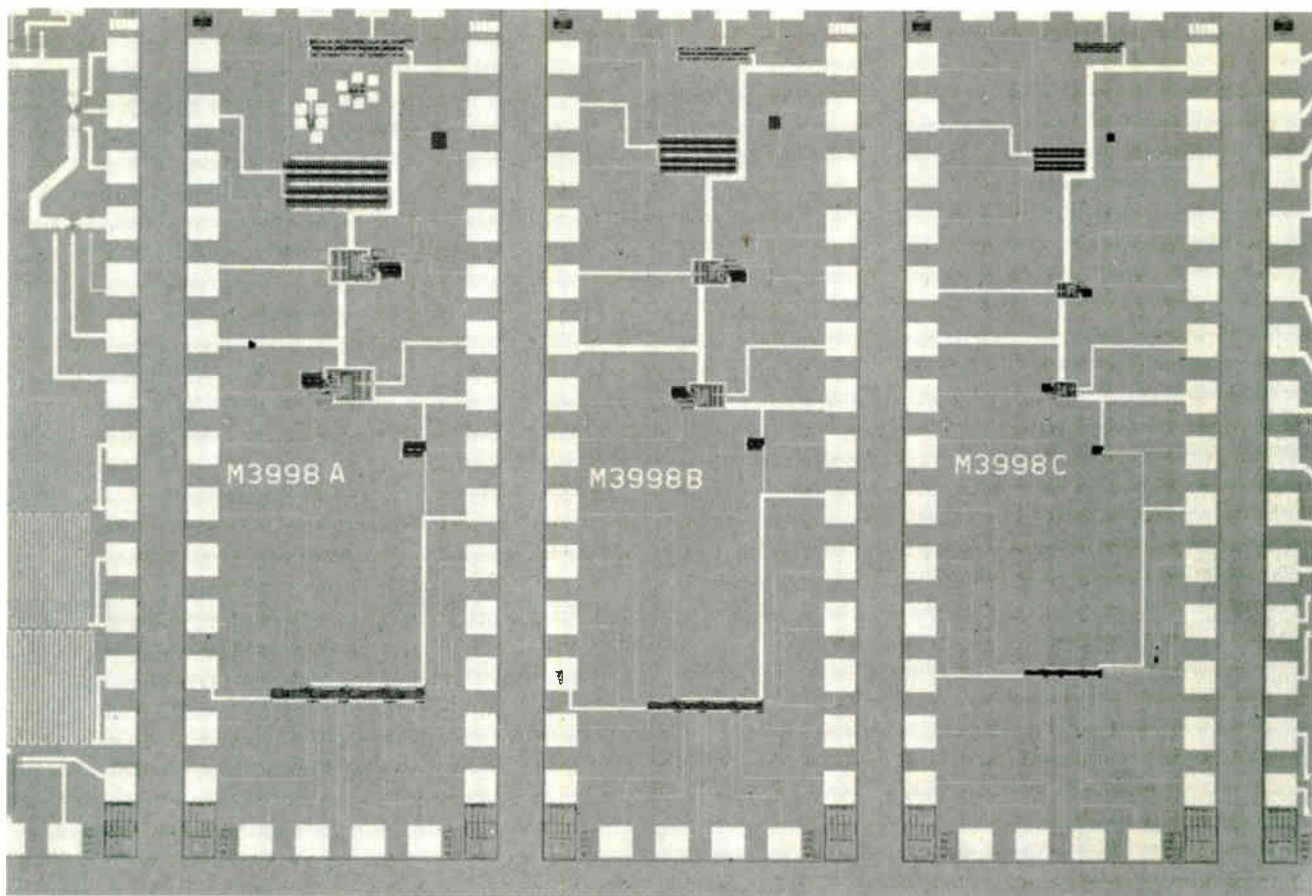

**10. Monitors.** This section of a Bell Labs wafer is devoted to testing. At left are resistive patterns that allow electrical measurement of line width, resistivity, and layer-to-layer alignment. Active devices shown are for measuring circuit speed at 2-, 1.5-, and 1- $\mu$ m line widths.

microscope (SEM).

Bell Labs and Rockwell International's Electronics Research Center are already using so-called process monitors to electrically check parameters such as line width, sheet resistance, oxide thickness, and device performance. In Japan, Hitachi is also using these structures but is considering a special type of SEM. In general, most IC manufacturers opt for the SEM.

Electrical methods are based on voltage measurements made across a resistor, voltage divider, or resistance bridge. These measurements can be converted to resolution, layer alignment, and sheet resistivity. Oxide thickness can be checked by capacitance measurements. The National Bureau of Standards pioneered the resistive-pattern measurement of optical parameters.

Bell Labs has an extensive program for putting test structures on VLSI chips. An example is shown in Fig. 10: a process monitor comprising three resistive patterns for measuring line width, resistivity, and layer-to-layer alignment shares a wafer with 2-, 1½, and 1- $\mu$ m versions of a test circuit for confirming speed predictions for each line width. Harry Boll, supervisor of the VLSI group at Bell Labs, Murray Hill, N. J., points out that test structures for process development can be used to monitor a process in full production as well as in a prototype stage. This method generates continuous data for each wafer at a relatively low cost.

At Rockwell's Thousand Oaks facility, a process-

monitor chip takes up about 11% of a GaAs digital LSI wafer. This chip tests the capacitance-voltage (CV) profile of the implant, alignment of layers, overcrossings, via integrity, active test circuits, and resistivities of all implants and metalization.

The SEM, on the other hand, can check only wafer line resolution and layer-to-layer alignment—and it is a slow and expensive instrument. The industry would like to see in-line cassette-to-cassette versions of the SEM so that it could be integrated into a production line.

Hitachi has done some exploratory work on an advanced SEM specifically aimed at submicrometer measurements. This unit would have laser-positioned stages for greater positioning accuracy.

#### **A beaming future**

Past 1985 some radical changes may take place in IC processing. For instance, a futuristic piece of apparatus has already been constructed at Hughes Malibu, consisting of an electron-beam evaporator and an ion implanter in a vacuum chamber. A window allows the entrance of a laser beam. This is a piece of research and development equipment, but as more experience is gained on laser and electron-beam processing and ion beams, more IC processing steps will involve some form of beam. Possibly by this time, one or more ion beams in a single chamber will deposit, remove, and etch materials in addition to being able to expose a pattern in a resist. □

# Announcing an Intel Seminar on Microcomputer Solutions for the '80s.

The 1980s will require total microcomputer system solutions to enable you—the system designer—to keep pace with ever increasing application complexities. To help you plan for the '80s, Intel is sponsoring a series of one-day seminars discussing the directions for future VLSI computer solutions.

In these seminars, you'll learn how our VLSI solutions uniquely address the needs of the future. Topics discussed will include system-level integration in 16-bit, 16/32-bit, and 32-bit microcomputers; peripherals; software; single board computers—and more. In short, you'll find all the information you need to get a head start on your next generation of products.

## Who should attend.

The seminar is intended specifically for software, hardware, and system engineers and managers who will be responsible for designing systems for the '80s. The seminar is structured to give you a comprehensive look into future directions in VLSI computer system development, such as:

- New microprocessor families designed to meet increasing application complexity.
- Tools to speed your product to market by increasing programmer productivity.

- Highest performance micro-system configurations achieved through co-processing and multi-processing.
- Integration of system programming and software functions into silicon.
- Integration of memory management and protection facilities.

Course materials will include a seminar notebook, and an *Advanced Data Catalog* which will outline Intel's comprehensive line of new products.

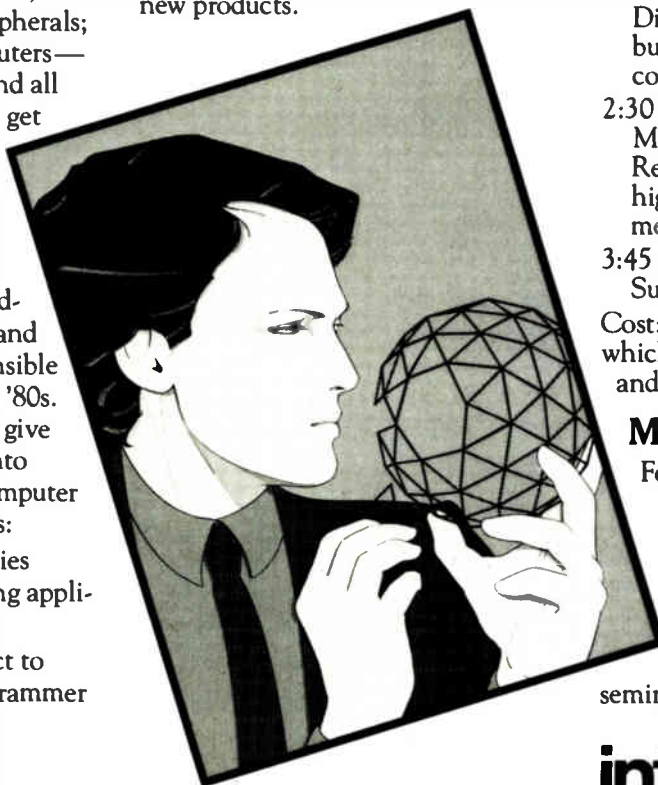

## Agenda

- 8:00 a.m.  
Registration
- 8:30 a.m.  
Introduction of Intel's total solution approach
- 10:30 a.m.  
New Microprocessor Products  
Preview of three microprocessors covering 16-bit, 16/32-bit, to 32-bit complexity
- 12:00 Noon—Lunch
- 1:00 p.m.  
Microsystem architecture  
Discussion of new peripheral building blocks and system interconnects
- 2:30 p.m.  
Microsystem software  
Review of new operating systems, high level languages and development tools
- 3:45 p.m.  
Summary and questions/answers
- Cost: There is a \$15.00 registration fee which will cover seminar material and lunch.

## More information.

For registration information and to guarantee reserved space at the seminar, please contact your local Intel sales office a minimum of one week prior to the seminar in your area. The person to contact for your seminar is listed below, so call today.

**intel® delivers solutions.**

Seminar Date	Location	Contact	Phone	Seminar Date	Location	Contact	Phone
May 13	Santa Clara, Ca.	Bob Citranic	(408) 987-8086	June 19	Houston, Tx.	Larry Gast	(713) 784-3400
May 16	Seattle, Wa.	Steve Prue	(206) 453-8086	June 19	Philadelphia, Pa.	Gene Murphy	(215) 542-9444
May 20	Baltimore, Md.	Steve Kay	(301) 796-7500	June 20	Dallas, Tx.	Dave Takacs	(214) 241-9521
May 21	Cincinnati, Oh.	Dave O'Hanian	(513) 890-5350	June 24	Toronto, Canada	Franca Martinek	(416) 675-2105
May 22	Detroit, Mi.	Stan Korus	(313) 353-0920	June 25	Montreal, Canada	John Freeman	(613) 829-9714
May 28	Minneapolis, Mn.	Blain Erskine	(612) 835-6722	June 27	Long Island, N.Y.	Don Buckhout	(513) 231-3300
May 29	Chicago, Ill.	Tom Atwicker	(312) 981-7200	July 10	Phoenix, Az.	Phil Richards	(602) 997-9695
May 29	Orange County, Ca.	Dave Neubauer	(714) 835-9642	July 15	Portland, Ore.	Steve Dallman	(503) 641-8086
May 30	Cleveland, Oh.	Steve Turcola	(216) 464-2736	July 16	Salt Lake City, Ut.	Bob Spina	(303) 321-8086
June 16	Los Angeles, Ca.	John Alfoidy	(213) 986-9510	July 22	Milwaukee, Wisc.	Karl von Spreckelsen	(414) 784-9060
June 16	Boston, Mass.	Bruce Giron	(617) 667-8126	July 23	Kansas City, Ks.	Tom Izzo	(913) 642-8080
June 17	Manhattan, N.Y.	Don Buckhout	(516) 231-3300	July 24	San Diego, Ca.	John Linn	(714) 268-3563
June 17	Denver, Colo.	Pat Maley	(303) 321-8086	August 5	Melbourne, Fla.	Don Dabney	(305) 628-2393
June 18	North New Jersey, N.J.	Tom Trainor	(201) 225-3000	August 6	New Haven, Conn.	Bill D'Eramo	(203) 792-8366
				August 7	Rochester, N.Y.	Bill D'Eramo	(716) 254-6120

# We'll help put the "C" in your CF-18 systems.

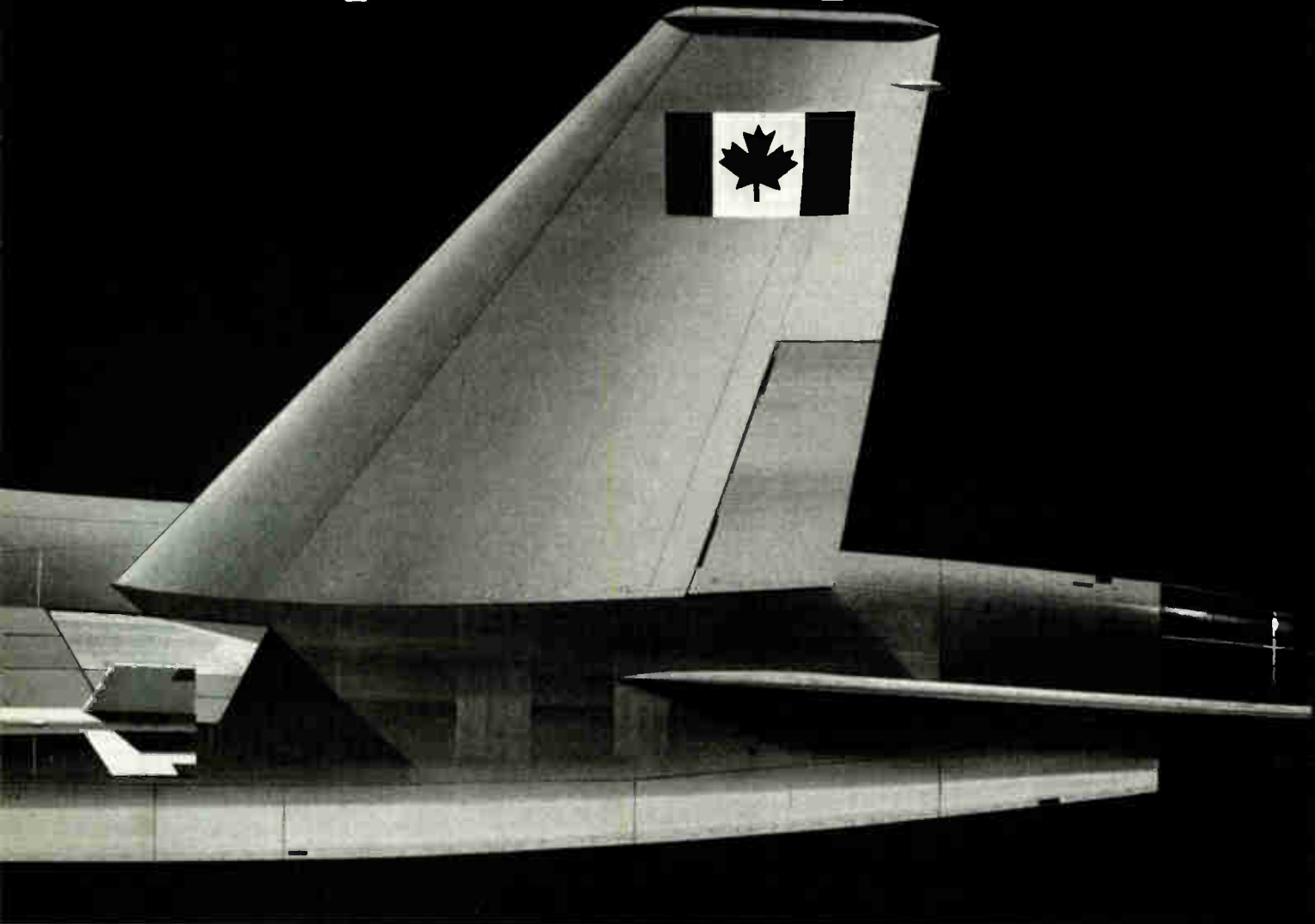

At Garrett Manufacturing Limited, you'll find an experienced partner to help meet your Canadian content requirement in electronic sub-systems aboard the new Canadian fighter aircraft.

In fact, with our famous temperature control systems, we're already part of the F-18 aircraft. As well as the overwhelming majority of Western military and commercial aircraft.

For the F-18's sophisticated electronics, GML has the technical base and the facilities needed to handle all of your sub-contract manufacturing and testing needs. From custom thin and thick film hybrid microcircuits, printed circuit board assemblies and

black boxes to control display units/ consoles for a variety of requirements. Including radar, fire control, navigation, communications, air data computers, missiles, training simulators and ground support equipment.

And when it comes to testing, you'll find that we're up to the job. We have extensive automatic test facilities with complete diagnostic capabilities for both analog and digital systems and RF equipment. Our advanced manufacturing centre also has facilities for production burn-in/ environmental testing, and our qualification test labs are fully equipped and MIL approved.

As a military supplier for over

20 years, our expertise in efficient program management ranges from material procurement and subcontractor supervision to complete life cycle support.

Finally, GML is backed up by the vast technical resources of The Garrett Corporation, whose worldwide support network includes 14 sales and service offices in the U.S.

For more information on how GML can play a leading role in your defense sharing plans by offering high technology at a competitive price, contact: Sales Manager, Garrett Manufacturing Limited, 255 Attwell Drive, Rexdale, Ontario, Canada M9W 5B8. Or call: (416) 675-1411.

**GARRETT MANUFACTURING LIMITED**



The Garrett Corporation  
One of The Signal Companies

Circle 128 on reader service card

# Integrated adapter shares peripheral control with CPU

Disk and tape unit combines drive-controller and I/O-channel features, uses less hardware, and makes the system designer's job easier

by Bernd Spaeth and Leopold Reichl, Böblingen Development Laboratory, IBM Deutschland GmbH, Böblingen, West Germany

□ Attaching peripheral storage devices to computers has always presented a paradox to systems designers. They want on the one hand to ensure a high-speed data path by off-loading peripheral interfacing from the central processing unit and, on the other, to avoid adding significantly to the system's size, cost, and complexity. IBM's most recent small mainframe, the model 4331, groups 1 and 2, uses a new approach with its integrated disk- and tape-drive adapter.

Instead of relying on an input/output channel for data transfer and a separate device controller, the 4331 has the integrated adapter perform both tasks. Much of the logic is shared between the data path and control logic, reducing substantially the amount of hardware while maintaining the high data-transfer rates needed for the latest peripherals. In fact, the adapter can be thought of as a high-speed data path and microprocessor merged.

The new integrated device adapter does not function completely independently of the CPU but shares the control tasks with it, thanks to the adapter's microprogram-based design and writable control store. The CPU manages the bulk of the peripheral control functions but it delegates to the adapter the time-critical and highly repetitive functions by passing it blocks of microcode.

Although integrated device adapters have been used in previous systems, these earlier hard-wired units could not share control with the CPU. They also could not handle the variety of devices and the high data-transfer rates the new approach permits. The new method also reduces hardware complexity and cost.

The adapter forms the physical and logical connection between the model 4331 CPU and the string of magnetic

storage devices (Fig. 1). It performs initial device selection, transfers I/O commands, monitors device response, and detects every abnormal condition. It also acts as the high-speed data-transfer path between the peripheral device and main memory. The adapter operates at a data rate of up to 1.86 megabytes per second—twice that of IBM's previous small System/370 mainframes—and can be used to attach up to 24 direct-access storage devices, or disk drives. These include the 64.5-megabyte model 3310, the 571.3-megabyte model 3370, the 69.4-megabyte model 3340, 277.6-megabyte model 3344, and the model 8809 tape drive that has a recording rate of 1,600 bits per inch.

## Disk-drive demands

Of the two types of devices, the disk drives pose the more critical design problems. First, as a result of their ever increasing bit densities, they require higher data rates than tapes. In addition, there are two situations that demand a fast response time by the controller when a disk is in the read/write mode. One is the chaining of channel command words from the CPU to facilitate the transfer of multiple blocks of data. The other is the handling of the IO device's protocol between two data fields. These devices typically require large amounts of control code that, for these speeds, take large amounts of expensive high-speed memory.

A major design objective was to achieve low cost with no sacrifice in performance. The solution was to divide the work load, since the bulk of the functions for controlling a disk can be executed on a medium-speed or even relatively slow processor. For example, about 30% to

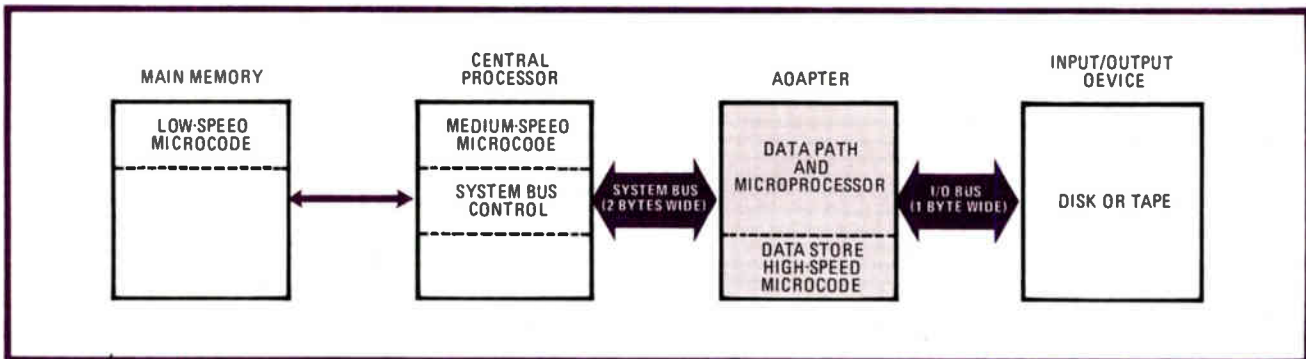

1. Versatile go-between. The integrated device adapter being applied to IBM's 4331 computer system forms the data path between the computer's main memory and the input/output device while also controlling either the disk or tape drive.

40% of the control microcode is required for error handling, error correction, and automatic retry. These functions are not critical to performance and thus do not require fast, expensive control storage.

So most functions necessary to control disks and tapes in the 4331 system whose timing is not critical are executed by the central processor, with a minimum performance penalty. Moreover, a large part of this control code can be stored in the low-cost and lower-speed main memory. Only the code for highly repetitive routines, such as parts of the channel-command chaining procedures, reside in the CPU's faster control store.

The adapter handles just those functions that need very fast response from the system to the I/O devices or continuous monitoring of the I/O-bus lines. These functions, set up by the control code running in the CPU, can be called subtasks. For example, each device presents to the I/O bus its own characteristics, such as data and track formats, interface commands, sense, control, and status information, and cylinder and head values. Some of these must be managed almost instantaneously to maintain high data rates.

To facilitate fast management, the instruction set of the special-purpose microprocessor used in the adapter is tailored to handling the protocols for the I/O bus and the system bus. It includes sending commands for device selection and for polling, as well as instructions for initiating and monitoring data transfer.

### Microcode overlays

Since different device types can be attached to an adapter, separate microcode is needed for each. Rather than keep this in a large, high-speed, expensive microcode store in the adapter, the adapter microcode resides in the slower and lower-cost main memory and is fetched on demand in small portions called overlays. The microcode overlay concept also allows the simultaneous operation of model 3310, 3370, 3340, and 3344 disk drives on the same adapter in a multiplexing mode.

But CPU microcode support is necessary for such tasks as command decoding and handling of exceptional situations. The adapter is not a stand-alone unit—it merely controls the individual subtasks efficiently once the I/O commands have been preprocessed by the CPU. Once it starts, the adapter sends trap requests to the CPU to signal the end of operations or to reference support functions in the CPU's control code. Trap requests are treated as CPU interrupts on the microprogram level, but not on the machine program level.

For data transfer, part of the adapter's local storage is also used as a first-in, first-out data buffer of variable size, which fluctuates to accommodate the different data rates of memory and the devices.

The disk/tape adapter, like other I/O adapters in the 4331 processor, connects to the CPU and main memory via the system bus. This bus gives the CPU microcode direct control over every adapter using a bus control instruction and lets it obtain status information using a bus-sense command. These functions are performed only when the adapter is stopped, however. These instructions are also used to reset and start the microprocessor in the adapter for a special subtask or to initiate a microcode

overlay. Furthermore, the bus lets the adapter signal the CPU microcode at the end of a subtask using the trap requests. Finally, it is used to transfer data between main memory and adapter under direct control of the adapter, using bus-cycle stealing.

Illustrating this team in operation is a typical I/O procedure, of which Fig. 2 is a flow chart. The CPU detects a start I/O command in the instruction stream and gives it to the channel microprogram. The channel program then selects the file-microcode routine, which issues control commands to the stopped adapter, initiates the loading of the device-selection microcode overlay, and starts the adapter microprocessor. Once the adapter selects the device, it awaits the response from the device and then traps the CPU. The CPU microprogram then examines the adapter's status. If it is clean and the next channel command word (CCW) calls for data transfer, the CPU will initiate the necessary microcode overlay and prepare the data path to main memory. The CPU may also modify the adapter microcode depending on the transfer direction (inbound or outbound).

### Final transaction

Lastly, the CPU starts the adapter's microprocessor, which now takes over, initiating all necessary protocols via the I/O bus to bring up the read/write gates and set up orientation. The final data transfer is started through the start-data-transfer instruction. The adapter, now running strictly under hardware rather than microcode control, then issues bus-cycle-steal requests and receives or sends data over the system bus. The adapter's read/write microcode can manage the complete data transfer or multiple data records up to the cylinder boundary without support from the CPU microcode. All the time-critical protocols within the gaps (gap processing) are handled by the adapter microprocessor.

The data organization of disk files attached to the IBM 4331 processor follows the new so-called fixed-block architecture. A major aspect of the approach is that all data records are of fixed (512-byte) instead of variable length, as on previous IBM disk drives, and data records are accessed by physical rather than logical addressing. The record identifier fields are transparent at the architectural interface because they do not concern the system user, who does not even have access to them. Furthermore, no channel command word chaining is necessary between data fields, and prefetching of channel command words for data chaining is permitted.

As a result, one of the most critical real-time problems—command chaining within an interrecord gap—does not exist in this architecture. Since the data records are of fixed length and prefetching of command words is possible, a defined time slot is available to perform the rather time-consuming task of decoding the next channel command word in the CPU. Then all the handling of the identifier fields can be performed by the microprocessor in the adapter without support from the channel and control unit program in the CPU.

As mentioned earlier, the adapter executes special subtasks under CPU microcode control. To obtain high performance within these subtasks and keep the code volume small, the adapter's instruction set is optimized

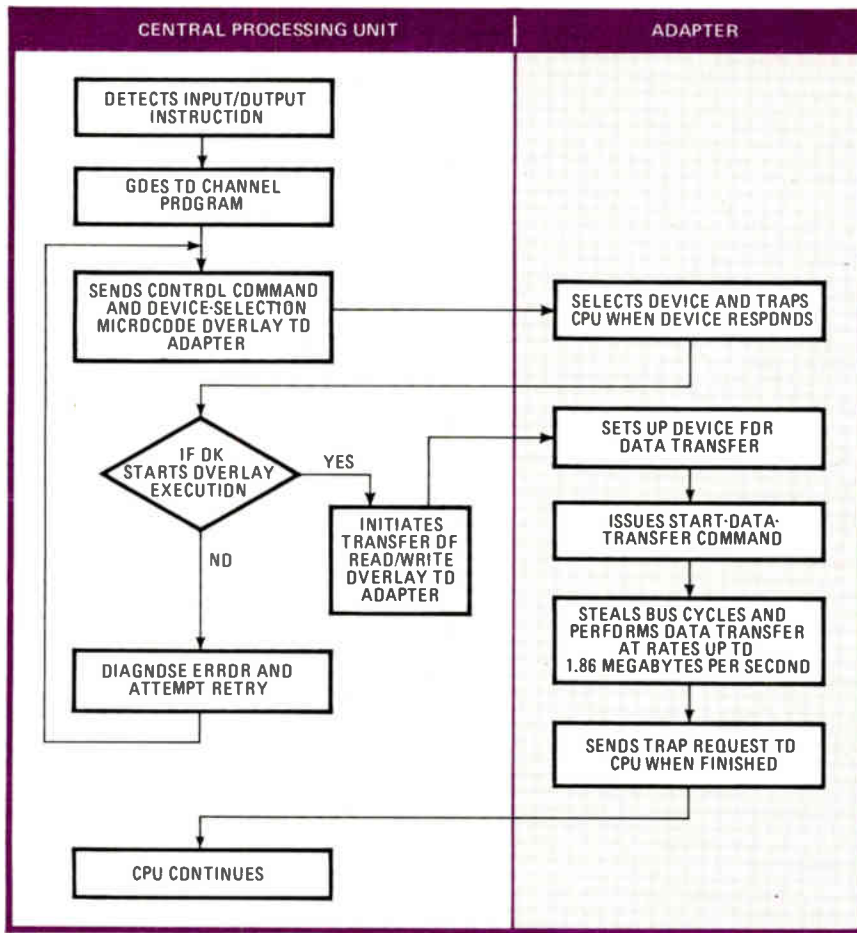

**2. Teamwork.** A typical data transfer illustrates how the central processing unit and adapter share the tasks. Once the CPU detects the type of input/output operation to be performed, it transfers blocks of microcode, called overlays, to the adapter. These let the adapter perform the data transfer independently of the CPU.

to handle the protocols of the I/O bus and the system bus. The size of the microcode store—or microstore—is also minimized by using a self-modifying microcode or control instructions from the CPU microcode. All microinstructions are a full word long (4 bytes).

### Three kinds

The three basic types of instructions are I/O-bus-specific instructions, start-data-transfer instructions, and those for decision making in the adapter microcode. The last group performs arithmetic, tests bits, and does branching, but is too conventional to examine further.

A tag-sequence instruction initiates communication and exchanges information with the devices. All I/O-bus handshaking required for a tag sequence is performed by an I/O-bus-specific tag-sequence instruction consisting of an operation code, a time-out counter, a tag-bus byte, and data-bus byte. If the tag-valid response line from the device is not received within the time defined by the counter byte (multiplied by 400 ns), a trap to the CPU is generated to investigate the error condition further. If the tag-valid response is received in time, the microprocessor proceeds to the next microinstruction.

The conditional-continue instruction is normally executed after the tag-sequence instruction. This instruction investigates the status on the sense bus of the I/O interface and continues under certain conditions. It consists of an operation code, a time-out counter, one mask for expected conditions, and one mask for unexpected condi-

tions. There are two tests. In the first, all bits selected by the expected-condition mask must be on before the time-out counter reaches zero. If not, a trap to the CPU is issued and adapter microcode execution stops. If all tested bits arrive in time, the unexpected-condition mask is tested, and if any bit is on, a trap to the CPU is issued, stopping microcode execution. If no bit is on, the microprocessor proceeds to the next microinstruction.

Once communication with the device is established, the second type of command—the start-data-transfer instruction—initiates a data transfer into or out of the adapter or within its microstore. The microcode execution stops and the adapter operates solely as a data-transfer path under hardware control. With all data bytes transferred, the adapter returns to the microcode mode and the next instruction. This might be a conditional-continue instruction to test interface status.

In its data-transfer mode, the count in the microstore referenced by the device-count address portion of the instruction controls the length of the field to be transferred. The channel and device pointers in the instruction are required to control the data transfer via the system bus and the I/O bus.

This instruction may operate in the load-microstore mode that loads new microinstructions—such as an overlay from main storage—as well as in the data-transfer mode. This might be initiated by the CPU microcode to execute a new subtask or by the adapter microcode itself. The starting and ending addresses are defined by the two







**Find half your  
board faults.  
At one-fifth the  
normal cost.**

## GenRad's 2245 In-Circuit/Continuity Tester.

GenRad's 2245 costs less than one-fifth what you'd pay for a functional or in-circuit test system.

Yet typically it can find 50% of your board faults. It pinpoints shorts, opens, and faulty resistors, including pullups. In just seconds.

So you can use the 2245 to prescreen your loaded boards before they go on to your big system. The result: you can catch simple faults earlier, and you can dedicate your more sophisticated tester to solving more sophisticated problems.

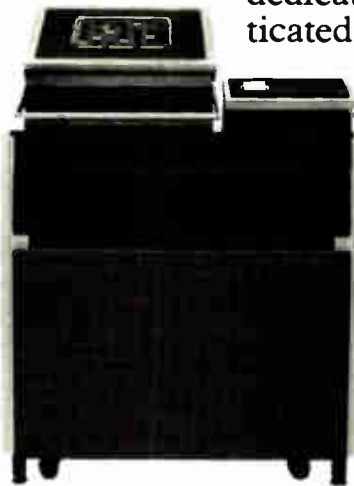

GenRad's 2245 In-Circuit/Continuity Tester offers you some other benefits as well. You can use it to test cables, box wiring and backplanes. You can program it in minutes. And thanks to its fixturing interface and cassette program storage, you can set up for a new board almost immediately.

What's more, our 2245 is fully compatible with our 2270 In-Circuit Test System, so you won't have to spend a penny extra on fixturing.

GenRad's 2245. It finds half your board faults, for one-fifth the cost.

For more information, write GenRad, Concord, MA 01742.



**GenRad**

Put our leadership to the test.

Circle 133 on reader service card

## Inverting amplifier flips filter's response curve

by Henrique Sarmiento Malvar  
Department of Electrical Engineering, University of Brazilia, Brazil

The voltage-controlled bandpass filter so popular in music synthesizers and useful in remote-tuned receivers can be also made to work in the band-reject mode by placing an inverting operational amplifier stage in the existing filter's input/output feedback loop. In that way, a controlled notch, which is often equally valuable in the aforementioned applications, may be put together at low cost.

The transfer function of the typical VCF is given by:

$$H(s) = (s/\omega_0) / [(s/\omega_0)^2 + 2k(s/\omega_0) + 1]$$

where  $\omega_0$  is the voltage-controlled resonant frequency and  $k$  is the damping factor, which is usually adjusted with a potentiometer. It is seen that when  $k$  is at its maximum, the response approaches that of a wideband filter. As  $k$  decreases, the filter's  $Q$  increases, and the bandwidth therefore decreases. At the limit, for a value of  $k$  that is slightly negative, the system oscillates at  $\omega_0$ .

By adding the operational amplifier and its gain-controlling resistors to the feedback loop of the VCF as

shown in (a), the output voltage generated is:

$$V_o(s) = -V_o(s)H(s) - V_i(s)$$

This expression leads to the transfer function:

$$H'(s) = \frac{V_o(s)}{V_i(s)} = \frac{(s/\omega_0)^2 + 2k(s/\omega_0) + 1}{(s/\omega_0)^2 + (2k+1)(s/\omega_0) + 1}$$

This function has two zeros and two correspondingly equal poles. But although the absolute value of both pairs is the same, for  $k > -0.25$  the poles will be more damped than the zeros, and thus the filter's frequency response will be mainly determined by the zeros. Therefore, the system will operate as a band-reject filter (b).

The deepest null is attained at  $k = 0$ , and a theoretically infinite attenuation is thereby achieved at  $\omega = \omega_0$ . Thus the filter can be tuned to null the fundamental frequency of any synthesized signal, leaving only its harmonics. If the frequency control is simultaneously fed with a low-frequency sine or triangle wave, the so-called phaser sound used for special effects is obtained.

As  $k$  is increased toward infinity, the null becomes less sharp and the filter offers almost no attenuation at any frequency, thereby behaving as a quasi-all-pass network. Note that as  $k$  increases beyond  $k = 10$ , the filter response approaches that of  $k = -0.25$ . Clearly,  $k$  should not be less than  $-0.25$ , because the poles of the function will again become prominent and the system will once more behave as a bandpass filter. At  $k < -0.50$ , the system will oscillate.  $\square$

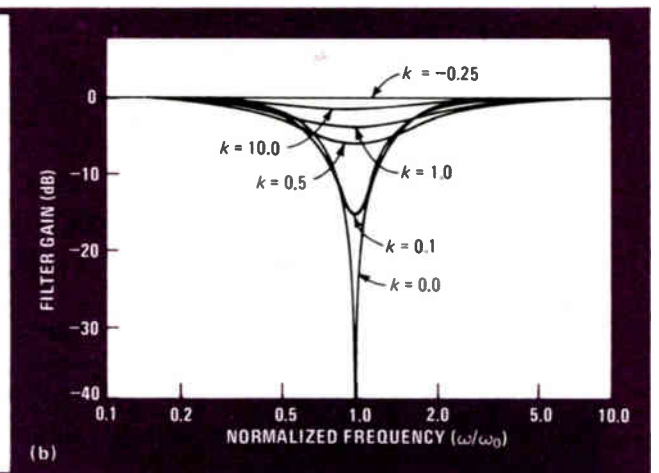
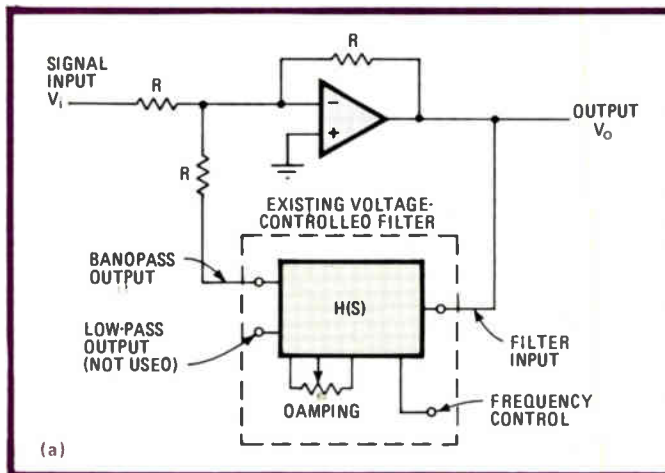

**Double duty.** Adding inverting op-amp stage into feedback loop of music synthesizer voltage-controlled bandpass filter (a) adapts it for band-rejection duties. Notch depth (b), selected by filter's damping potentiometer, may be adjusted for a maximum value of  $-60$  dB.

## Dual-feedback amplifier zeros comparator hysteresis

by Svein Olsen  
Royal Institute of Technology, Stockholm, Sweden

Amplifiers with positive feedback may be combined to create voltage comparators and zero-crossing detectors devoid of hysteresis. Alternatively, the amount of hysteresis, either positive or negative, may be selected. In both cases, feedback ensures that true bistable (switching) operation is achieved without undue sacrifice of noise immunity—a necessary condition for optimum comparator and zero-detector performance.

The ideal voltage comparator cannot be realized with a single amplifier because bistable operation does not occur until hysteresis starts. Witness today's typical comparator—a fast differential amp and a transistor-switch output stage that actually operates as a linear amplifier within a small region about the transition level. Achieving a step transition for slowly varying input signals is difficult with these high-gain, wideband devices, too, because of the radio-frequency oscillations and multiple transitions that occur in association with very small noise signals.

Introducing positive feedback to increase loop gain and thus ensure bistable operation, as some have tried, will yield clean switching independent of input slope. But hysteresis also is introduced, and, worst of all,  $\Delta t$ , a varying input/output delay—which depends on the slope of the input signal and the instantaneous value of hysteresis—comes into play.

The block diagram (a) shows how to achieve bistable operation while eliminating all of these problems. Amplifiers 1 and 2, each having positive feedback ( $\alpha$ ,  $\beta$ , respectively), are applied to their individual summing junctions, where they are combined with the input signal. Amplifier 1 also drives the second summing junction with a dc-level shift signal ( $\pm k$ ) that is a function of the amp's hysteresis. Note that this feedback signal can be derived by either a switching or a linear stage.

Depending upon its polarity, the signal may add to or subtract from the amount of hysteresis inherent in amplifier 2. In the special case, total circuit hysteresis

may be eliminated with little loss of noise immunity. At the same time, the circuit will retain high gain for true bistable operation. (The lengthy mathematical analysis of the circuit may be found elsewhere.)

A practical circuit having TTL-compatible outputs is shown in (b). Feedback in both amplifiers is determined by resistors  $r$  and  $R$ . In this application,  $r$  is 150 ohms and  $R$  is 15 kilohms, so that  $V_{HI} = 40$  millivolts ( $V_{in\ min} = 15$  mV root mean square) and  $V_x = 20$  mV, where  $V_{HI}$  is the hysteresis for amplifier 1 and  $V_x$  is the noise immunity.

Amplifier  $Q_1$ – $Q_2$  provides an inverted feedback signal to the second summing junction, with the magnitude of the signal set by potentiometer  $R'$ . The negative voltage at the junction of amplifier 1 required to establish a level-shift voltage at amplifier 2 is provided by  $Q_3$ – $Q_4$ . The output hysteresis is adjustable to zero.

A fast (3-nanosecond) zero-crossing detector with zero hysteresis is shown in (c). This application requires an LM10116 emitter-coupled-logic receiver to be used, and although its low amplification factor makes it a little more difficult to achieve high loop gain, three sections are used to make up for the shortcoming.

Amplifier 1 is the input stage biased for Class A amplification. The input RC values are selected according to the impedance-matching requirements and to provide the required low-frequency response. Amplifiers 2 and 3 serve the functions previously mentioned. □

**References**

1. Svein Olsen, "The Zero Hysteresis Comparator," RVK-78 Conference Notes, Stockholm, March 29, 1978.

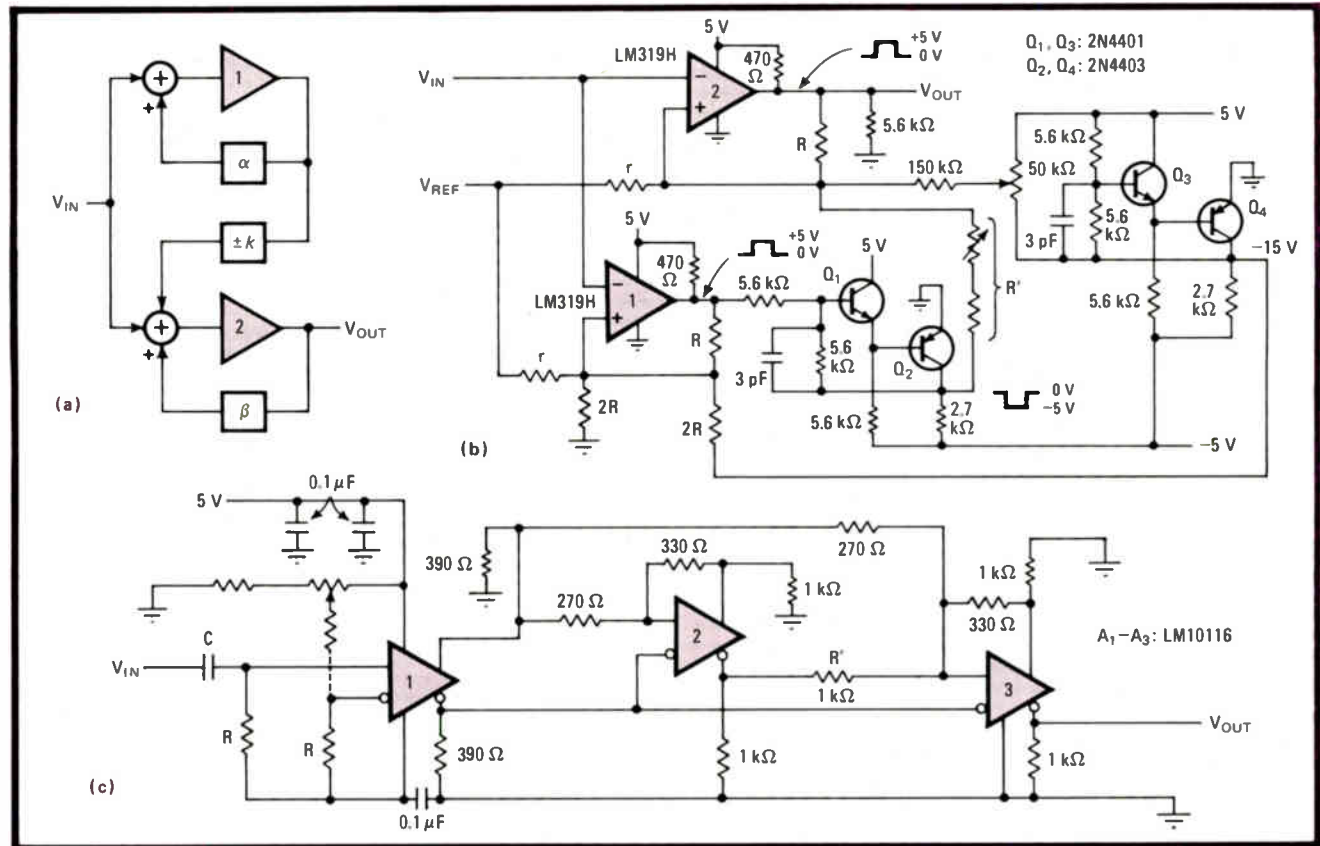

**Ideal.** Amplifiers with high loop gain work as nearly perfect comparators and zero-crossing detectors when they are suitably combined to cancel hysteresis (a). The implementation of a practical comparator (b) and a zero-crossing element (c) are relatively simple.

# The only $\mu$ P-controlled 100 MHz • 3 ns TIMING PULSE GENERATOR

All parameters displayed *simultaneously!* E-H's new Model 1560 is capable of adding 7 slave units.

A short form catalog of pulse generators & waveform analyzers is now available.

Circle 136 on reader service card

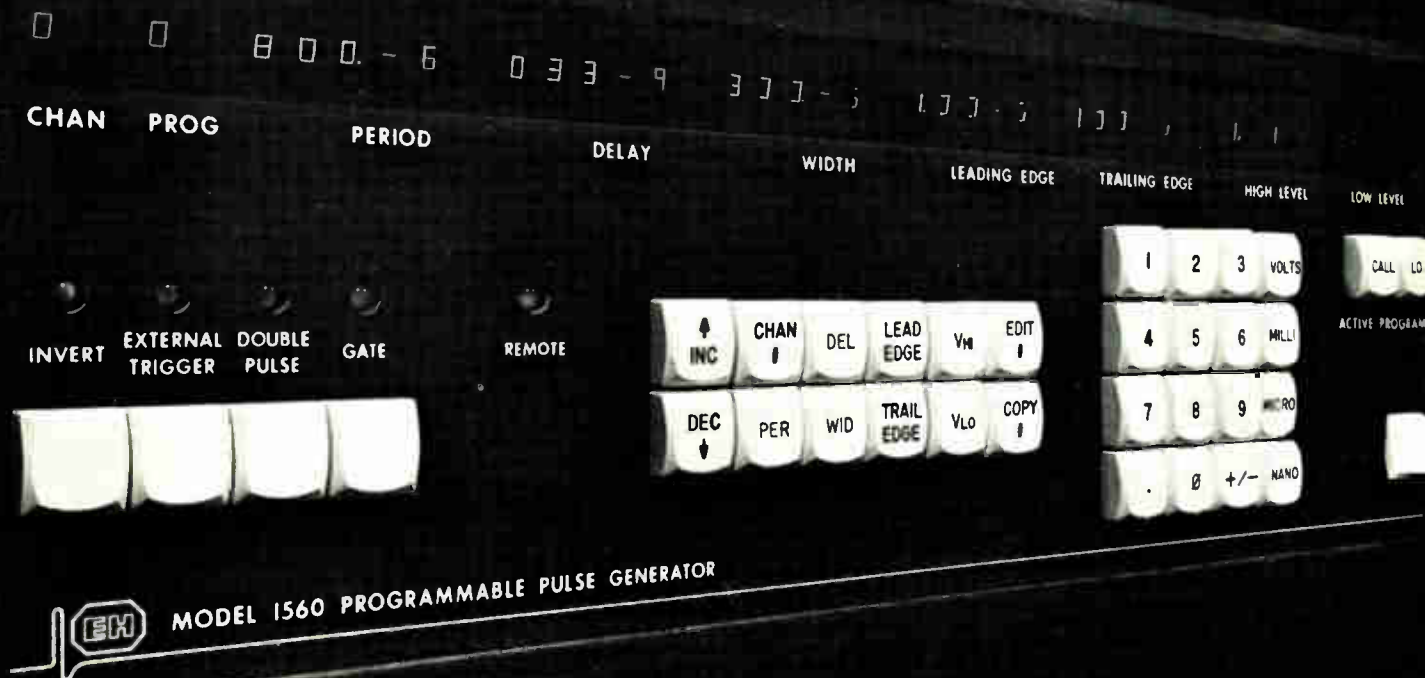

# TTL line drivers link fiber optics

by Vernon P. O'Neil and Imre Gorgenyi  
Motorola Inc., Discrete Semiconductor Division, Phoenix, Ariz.

Designers who need to convert an existing twisted-pair communications interface into an optical-fiber link can minimize their efforts by simply combining their fiber-optic detector-preamplifiers with TTL line receivers like the industry-standard MC75107 devices. Such an arrangement has other advantages besides simplicity, namely, providing the builder with access to two receivers, complete with strobing inputs, in a single 75107. And although no similar optical line receivers are yet offered as a standard product, this interface will yield good performance at low cost. Building fiber-optic transmitters using TTL line drivers is equally simple.

The union of the 75107 with Motorola's MFOD404F optical detector is shown in (a) of the figure. The detector is packaged in a nose-cone type of fixture that can be

directly mounted in standard AMP-connector bushings, making the connection to the optical-fiber cables extremely simple.

The resulting optical receiver will handle data rates of up to 10 megabits per second at a sensitivity as low as 1 microwatt. For even greater data rates, an MFOD405F can be used to extend the data-rate capacity to 50 Mb/s at a sensitivity of  $6 \mu\text{W}$ .

Because the receiver is ac-coupled to the detector, it is necessary to restrict the duty cycle of incoming signals to the range of 40% to 60%. Coupling components between the detector and the 75107 are selected to ensure that the reference level developed at the input of the receiver tracks the average voltage of the input data stream. In this way the circuit self-adjusts to a wide range of input optical power levels.

At the other end of the system (b), a compatible ac-coupled optical transmitter can be constructed from an ordinary 75452 line driver. A 0-to-2-Mb/s fiber-optic transmitter suitable for handling bipolar-pulse (dc-coupled) encoded data (c) is almost as simple. □

Designer's casebook is a regular feature in *Electronics*. We invite readers to submit original and unpublished circuit ideas and solutions to design problems. Explain briefly but thoroughly the circuit's operating principle and purpose. We'll pay \$50 for each item published.

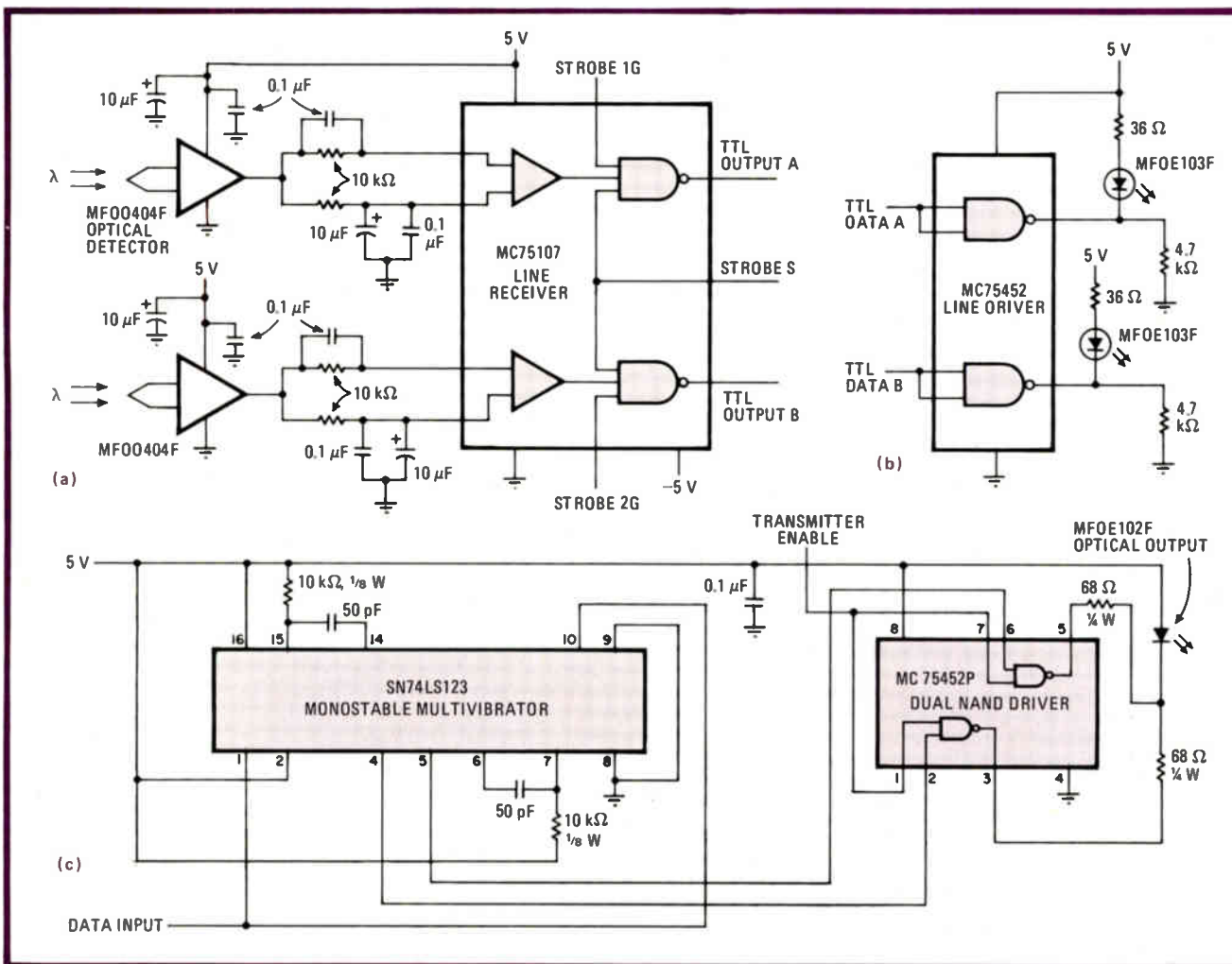

**Light line.** Standard line receivers such as the 75107 serve well in interface for fiber-optic systems (a). Off-the-shelf TTL line drivers at the transmitting end (b) makes possible low-cost systems. A 0-to-2-Mb/s bipolar-pulse-encoded transmitter (c) is almost as simple to build.

# Doing micro system development?

## Use the complete hardware/software integration station that's in tune with today's economy:

# DISTRIBUTED ICE™

In today's inflationary economy, tools for developing micro systems not only need to be more sophisticated than ever before—they also need to be more cost effective. Get both with Millennium's pragmatic products.

Our new MicroSystem Emulator ( $\mu$ SE), with built-in real-time trace, supports designs based on the Z80A, 6800, 8080A, 8085A, 6802, 8041A, 8048, 8049, 8035, 8039, 8748, 8741A and 8021 with more on the way. It's the only way to add Distributed ICE to your existing micro system development capabilities.

### What's Distributed ICE?

Distributed ICE solves some common microsystem design problems. It provides multi-user capabilities so that in-circuit emulation can be performed concurrently by a number of users while your development system is being used for software development. And it permits emulation of multiple microprocessors. With Distributed ICE, Millennium  $\mu$ SEs can turn your PDP-11, Nova or other minicomputer, or dedicated Intel, Motorola or Zilog software development system into a multi-user development network. Your engineers and development system become more productive.

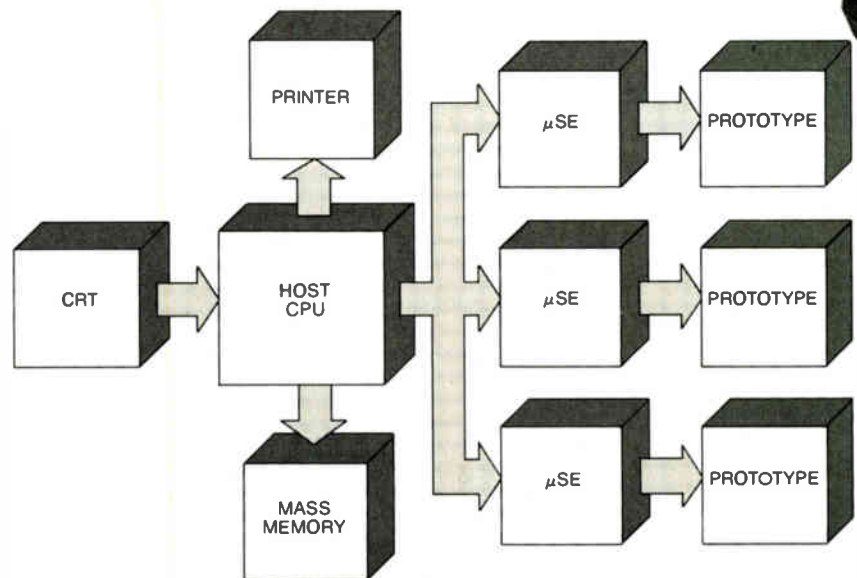

### Here's how you do it.

You develop applications programs on your host system using cross-assemblers (which we also supply) and then download them into the  $\mu$ SE using standard hex over an RS232C serial link at rates up to 9600 baud. Our  $\mu$ SE becomes an intelligent terminal providing the distributed in-circuit emulation you need for rapid, efficient hardware/software integration. There is virtually no limit to the number of engineers one development system can support, because each low-cost  $\mu$ SE uses the host computer (or development system) only for downloading.

And you'll find that hardware/software integration of micro system designs is faster using our function-oriented keyboard with simple commands such as MEMORY, RUN/DISPLAY, PROM/MEM, I/O, BREAK, REGISTER, RUN and STEP to make complex jobs easier. (Time saved translates directly into dollars saved. That's our bottomline orientation at work.)

### Real-time trace: fast, accurate debugging.

Today's micros are fast, and you need an in-circuit emulator that

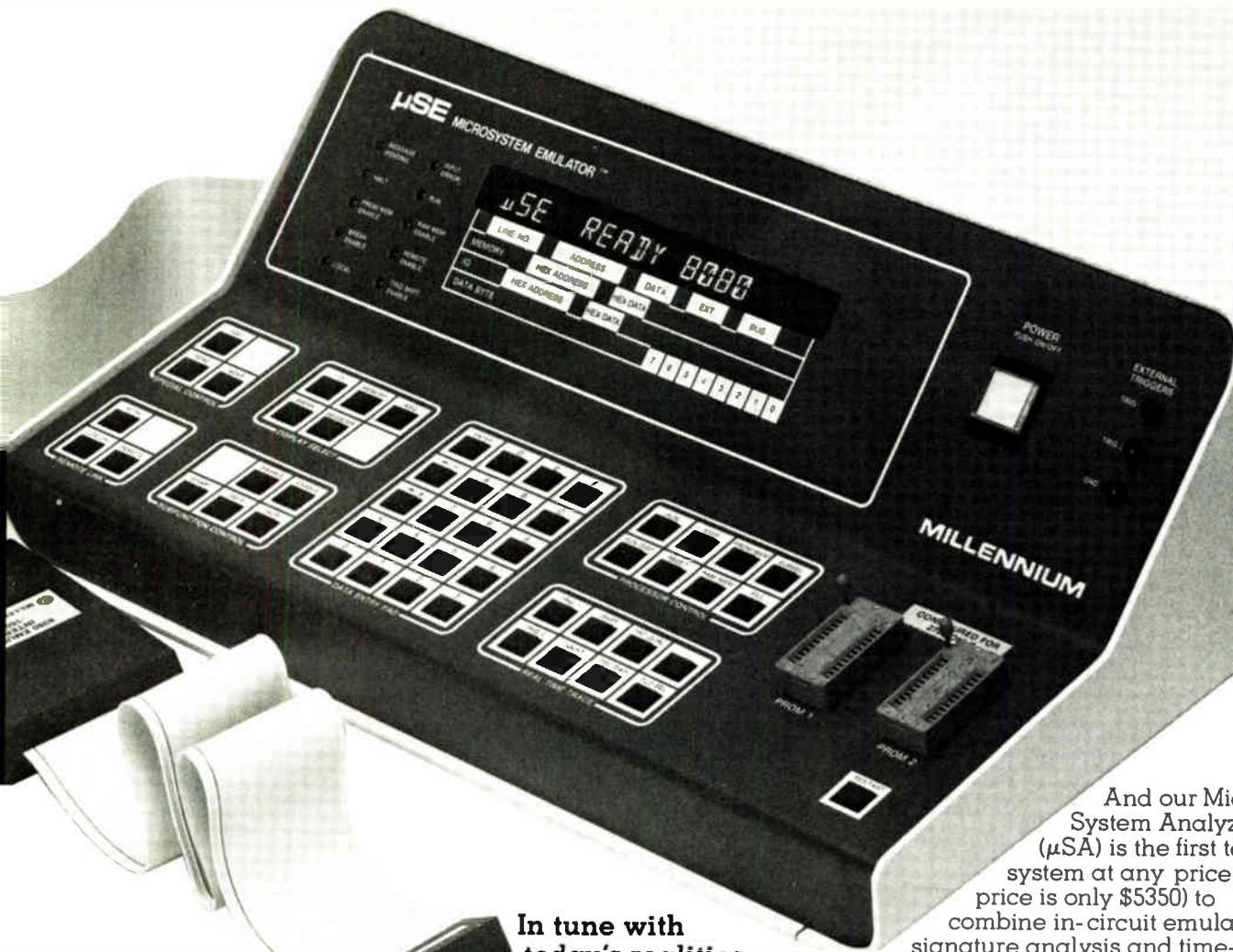

**In tune with today's realities.**

We want to help you save money and get increased capability. By using our  $\mu$ SE's for Distributed ICE, you not only extend the capability and usefulness of your present development system or minicomputer, you will also be able to get your new design out the door ahead of the competition. And in budget. The  $\mu$ SE costs only \$5000\*, and emulation modules start at \$1375.

**We help design and test micro systems, too. Economically.**

Our MicroSystem Designer ( $\mu$ SD) is a low-cost (under \$2000) desk-top design and evaluation tool that's helpful in breadboarding, debugging and training. Supports many of the important 8- and 16-bit micros.

And our Micro-System Analyzer ( $\mu$ SA) is the first test system at any price (our price is only \$5350) to combine in-circuit emulation, signature analysis and time-domain analysis in a single, portable package. We'll be glad to supply complete data on either system. Or both. Just ask.

**And that's the bottom line. Economy. Performance. Universality.** That's the bottom line in today's economy.

To get yourself started on the right development track, call or write Millennium Systems today and ask about the  $\mu$ SE. Besides telling you all about Distributed ICE, we'll include—FREE—a reprint of Millennium's "Designer's Guide to Testing and Troubleshooting  $\mu$ P-based Products". Our address: 19050 Pruneridge Ave., Cupertino, CA 95014. Telephone: (408) 996-9109.

meets the challenge. The  $\mu$ SE lets you do accurate debugging because you do it in real time. No artificial wait states. Emulates at the highest clock rates specified by the micro supplier. True real-time emulation.

Advanced emulation control tools are part of the package. You have dual breakpoints and dual triggers, both using 35-bit comparators. And the  $\mu$ SE's real-time trace records 128 cycles 35 bits wide for faster debugging. A wide range of trace qualifiers, pass counts and delay counts expands your debugging capabilities.

# We're Millennium

The bottom line in micro support

Millennium is a subsidiary of American Microsystems, Inc.

\*All prices quoted are single-unit, U.S. prices only.

# C-MOS d-a converters match most microprocessors

With double buffering, 8-, 9-, and 10-bit multiplying units are useful for microprocessor control of gain and attenuation

by Thomas M. Frederiksen and James B. Cecil, *National Semiconductor Corp., Santa Clara, Calif.*

□ A new family of complementary-MOS multiplying digital-to-analog converters has arrived on the scene and promises to make microprocessor interfacing truly universal. The double-buffered Micro-Dac units eliminate many common problems, bridging the way to a host of new applications that include microprocessor-controlled gain, attenuation, and multiplication.

The proliferation of the microprocessor in electronic circuits has brought with it an equal proliferation of microprocessor-compatible d-a converters. Many of these converters, however, have shortcomings in that they often require additional external components to be truly microprocessor-compatible. Furthermore, depending on a converter's resolution and data format, a designer is sometimes forced to adopt additional interfacing circuitry for total microprocessor compatibility. Transient output-voltage errors can occur during the updat-

ing of a 10-bit d-a converter from an 8-bit microprocessor bus, when the two words are transferred to the converter. Left-justified (fractional binary) and right-justified (positionally weighted binary) d-a converter data formats require different interfacing schemes. All of these problems must be considered in interfacing a microprocessor and a d-a unit.

## Two levels of buffering

The Micro-Dac family of multiplying d-a converters consists of 8-, 9-, and 10-bit-accurate units designed to interface directly with the 8080, 8048, 8085, Z80, and other popular microprocessors. The converters appear to the microprocessor as a memory location or as an input/output port and require no interfacing logic. Each has two levels of input buffers—an input latch and a register (Fig. 1).

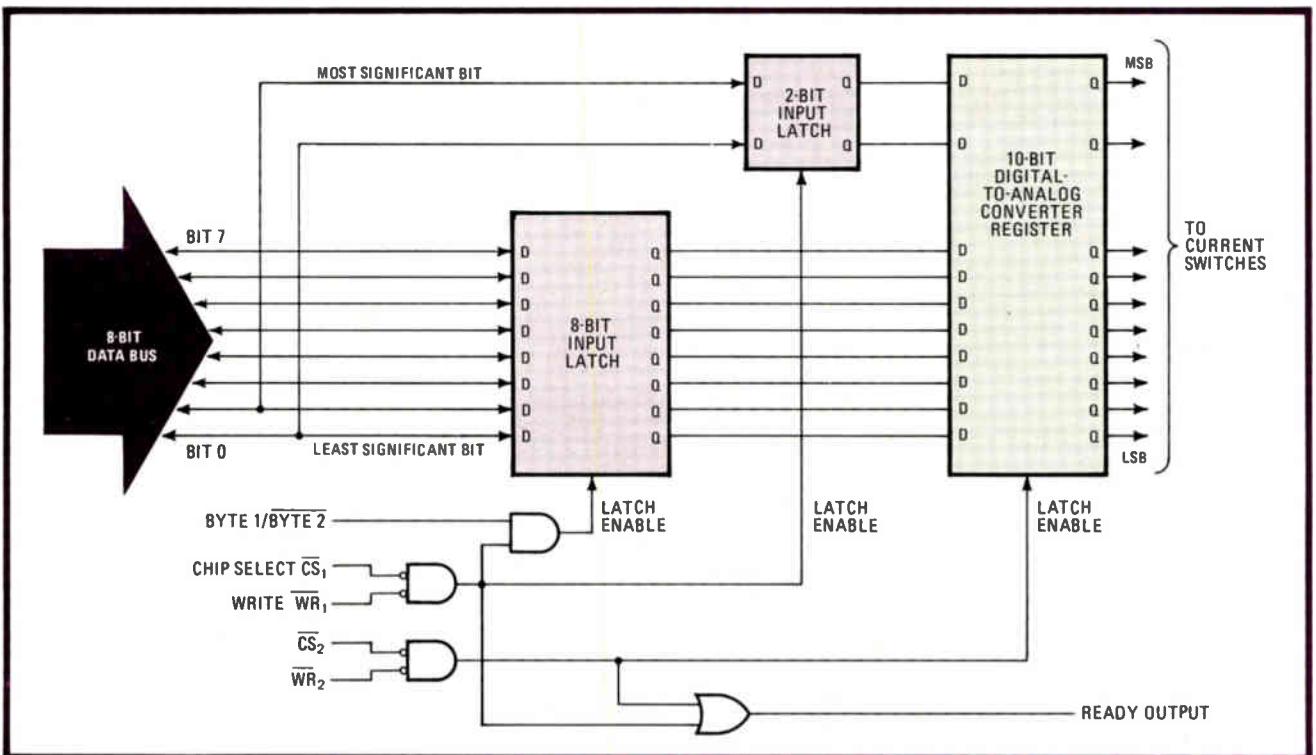

1. Double buffered. The Micro-Dac family of 8-, 9-, and 10-bit digital-to-analog converters has two levels of input buffers—an input latch and a register. They are designed to interface with 8080, 8048, 8085, Z80, and other popular microprocessors, with no interfacing logic.



The converter's register holds the digital data undergoing conversion while the input latch is kept busy acquiring new input data. The digital input data is used to update the d-a converter. The double-buffering feature allows 10 bits of microprocessor data to be assembled from 2 data bytes. It also prevents the analog output from changing while the digital input word is updated.

Even when used with 16-bit microprocessors, the double-buffering feature is necessary for the simultaneous updating of many d-a converters. Double buffering establishes the proper conditions for the next test or lets new system parameters be set up at the same time.

Two groups of Micro-Dac converters are available. The DAC1000, DAC1001, and DAC1002 are 24-pin units with 10-, 9-, and 8-bit accuracy levels, respectively. Each contains all of the necessary logic functions for interfacing with right-justified and left-justified microprocessor data. The DAC1006, DAC1007, and DAC1008 20-pin units are designed for left-justified data at accuracy levels of 10, 9, and 8 bits, respectively.

All the members of this family of multiplying d-a converters feature standard chip-select (CS) and write (WR) microprocessor control signals. Data on the microprocessor bus can be written into the d-a converter in a standard write cycle.

### Handling the different data formats

Different data formats exist for many d-a converter products, all of which must be readily handled when interfacing with a microprocessor. Left-justified (fractional number  $\times V_{ref}$ ) and right-justified (positional number  $\times V_{ref}/1,024$ ) are the main ones. Initially, converter manufacturers favored a left-justified approach, in which the most significant bit was labeled bit 1. Newer converters have changed to the right-justified approach to match the data format of microprocessor data buses. Nevertheless, the left-justified approach is still widely used. As previously mentioned, the Micro-Dac family can readily handle left- and right-justified data formats, with no additional interfacing circuitry.

When a Micro-Dac converter uses either an 8-bit (two write cycles) or a 16-bit (one write cycle) data bus, all 10 locations of the converter's input latch are enabled on the first write cycle from the microprocessor. Depending

on the data format, the next write cycle, if used, overwrites 2 of the 10 locations at the proper data rate.

Digital data is transferred from the input latch to the register internally in one of three ways: automatically when the second write byte occurs; through microprocessor control, which allows the updating of several d-a converters if this is necessary; and through the use of an external strobe.

The converter's C-MOS logic levels are made compatible with those of TTL by a special biasing circuit that uses the parasitic npn bipolar transistor available on a C-MOS chip. The bipolar transistor supplies a base-emitter voltage ( $V_{BE}$ ) that acts as a reference for the converter's digital inputs. It supplies an input threshold voltage of  $2V_{BE}$  that has the same amplitude as that of TTL devices.

Details of the biasing circuit are shown in Fig. 2. Note that the reference n-channel field-effect transistor  $Q_1$

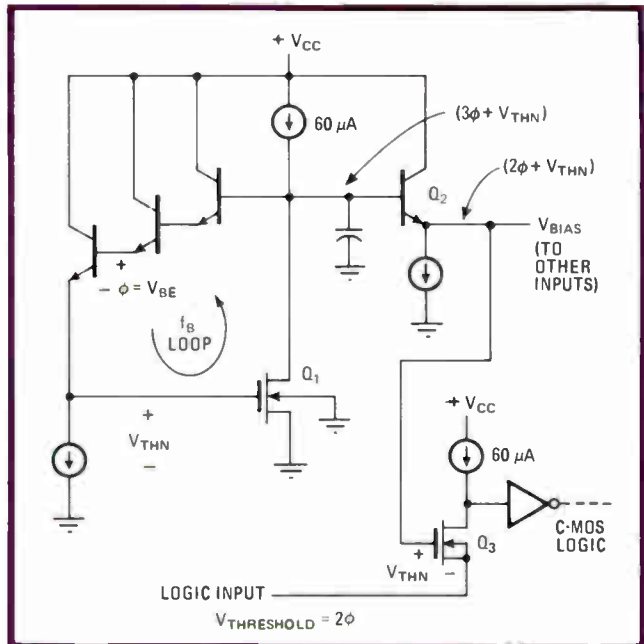

**2. Threshold.** This basic logic threshold loop provides the biasing for the Micro-Dac family of MOS d-a converters to interface with TTL voltage levels. This circuit uses the parasitic bipolar structure, which delivers an input threshold of  $2V_{BE}$  to the biasing circuit.

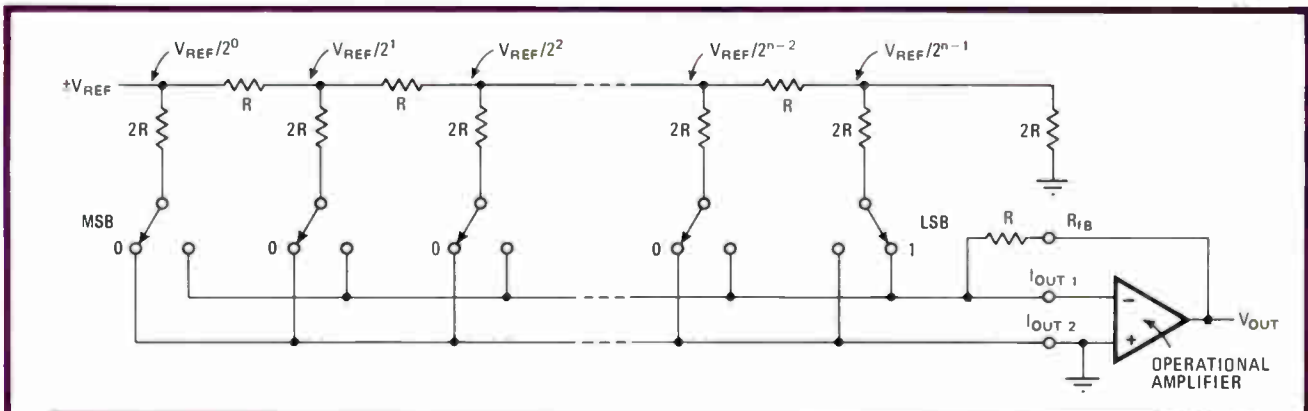

**3. Ladder.** The current-switching, current-mode R-2R resistor ladder of the Micro-Dac family of d-a converters is simple, yet provides high levels of converter accuracy. The external operational amplifier is chosen for minimal offset voltage for the least converter linearity error.

## End point vs best straight line

To maximize their product yields, manufacturers of digital-to-analog converters like to use a best-straight-line linearity guarantee. Unfortunately, this method is based on iteration of the zero and full-scale converter adjustments, so that errors are optimally split and equidistant from a straight line. To the converter user, a best-straight-line specification means that the d-a converter must undergo a

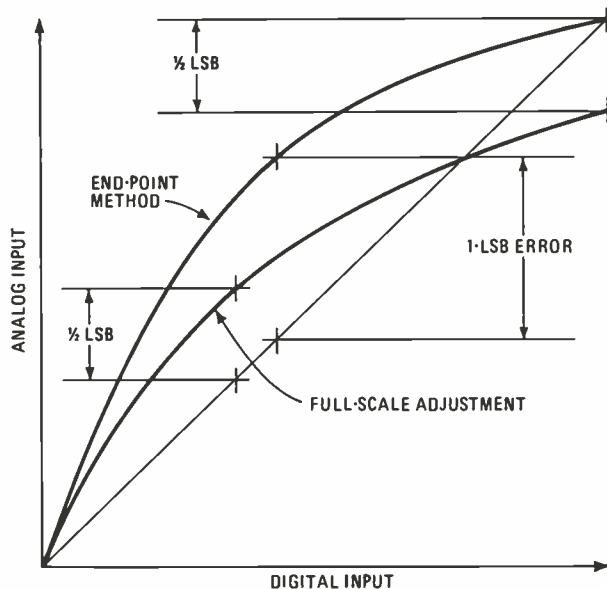

sophisticated adjustment procedure for its linearity to be proven. Furthermore, each d-a converter has a different best-straight-line fit, making it necessary to adjust every one of them individually.

Another way to specify converter linearity is by an end-point method. For a current-output converter, the offset voltage of the current-to-voltage output amplifier is first adjusted for a 0-volt output. Then the converter is adjusted with a full-scale input digital code to produce a full-scale output voltage. This simple technique ensures that each of the 10-bit unit's 1,024 steps are within the stated linearity specification. Further, a pretrimmed output amplifier can be used to eliminate the zero offset adjustment, leaving only the full-scale adjustment.

The differences between the best-straight-line and end-point specification techniques are shown in the illustration (left), where a d-a converter with an error of 1 least significant bit is shown failing the end-point linearity test. Note that by readjusting the converter's full-scale output, the d-a converter's error is optimally split on either side of the ideal line in a best-straight-line fit, which is a time-consuming procedure, particularly when done on a large number of individual converters. For many an application where the d-a converter is already mounted on a printed-circuit board, the end-point adjustment of zero and full scale is much less time-consuming. Furthermore, this end-point procedure is a more stringent guarantee of converter linearity than the best-straight-line approach. The end-point method is used for d-a converters in the Micro-Dac family.

is tied in a feedback loop so as to have its gate voltage biased at a level of  $V_{THN}$ , causing it to conduct the 60 microamperes shown in its drain circuit. The three npn transistors in the loop add a voltage of  $3V_{BE}$  to  $V_{THN}$ . The output emitter follower  $Q_2$  causes a loss of  $V_{BE}$ , thus producing a voltage reference of  $2V_{BE} + V_{THN}$  for use by all of the logic input circuits. Each of the input stages has FETs like  $Q_3$ , whose source has the digital input applied to it and whose geometry is the same as that of FET  $Q_1$ . Like  $Q_1$ ,  $Q_3$  also has  $60 \mu A$  of current feeding its drain. When the logic input voltage equals  $2V_{BE}$ ,  $Q_3$  conducts, thereby pulling the input of a standard C-MOS inverter to a low level. This  $2V_{BE}$  threshold continues to be independent of the d-a converter's supply voltage.  $2V_{BE}$  is the logic threshold voltage of standard TTL gates.

### Achieving high accuracy

The design of the Micro-Dac's resistor network is simple, even though it provides high levels of converter accuracy. Figure 3 shows the current-switching inverted R-2R ladder used, which consists of passive components.

The operation of the ladder network requires that all of the 2R legs connect to a 0-v, or ground, level. This means that the external operational amplifier shown must have a minimal offset voltage. Only 1 millivolt of offset voltage can introduce a 0.01% linearity error into the converter's operation. Operational amplifiers like National's LM308A series are available with low offset voltages, and they require no zero adjustments.

When zero adjustment of the operational amplifier's

offset voltage is required, a 1-kilohm resistor can be temporarily switched in between the converter's  $I_{out 1}$  terminal (which is tied to the amplifier's negative input terminal) and ground. No dc balancing resistance should be used in the operational amplifier's grounded positive input terminal, since it may create errors. The operational amplifier, a bi-FET LF356 (made with bipolar and field-effect transistors), has a low input bias current, which makes it an ideal choice for use as a current-to-voltage converter. The amplifier's offset voltage should be adjusted with a digital input of all zeros, to force  $I_{out 1}$  of the converter to a zero current level. The manually switched-in resistor provides a dc gain of about 15 to the offset voltage and makes the zeroing easier to sense. The converter chip provides the feedback resistor for good initial matching as well as for tracking over temperature.

### Looking at the inside

An examination of the internal details of the single-pole, double-throw current-mode switches employed in the converters shows that the n-channel FETs' gates are driven from the d-a converter's supply voltage. In contrast to a 5-v supply, a 15-v level reduces the FETs' on-resistances and thereby improves the converter's performance.

Micro-Dac converters are relatively stable in gain and linearity during variations in the 15-v supply voltage. For example, a drop in supply voltage all the way down to 5 v results in a gain error of only  $-0.1\%$ . Even

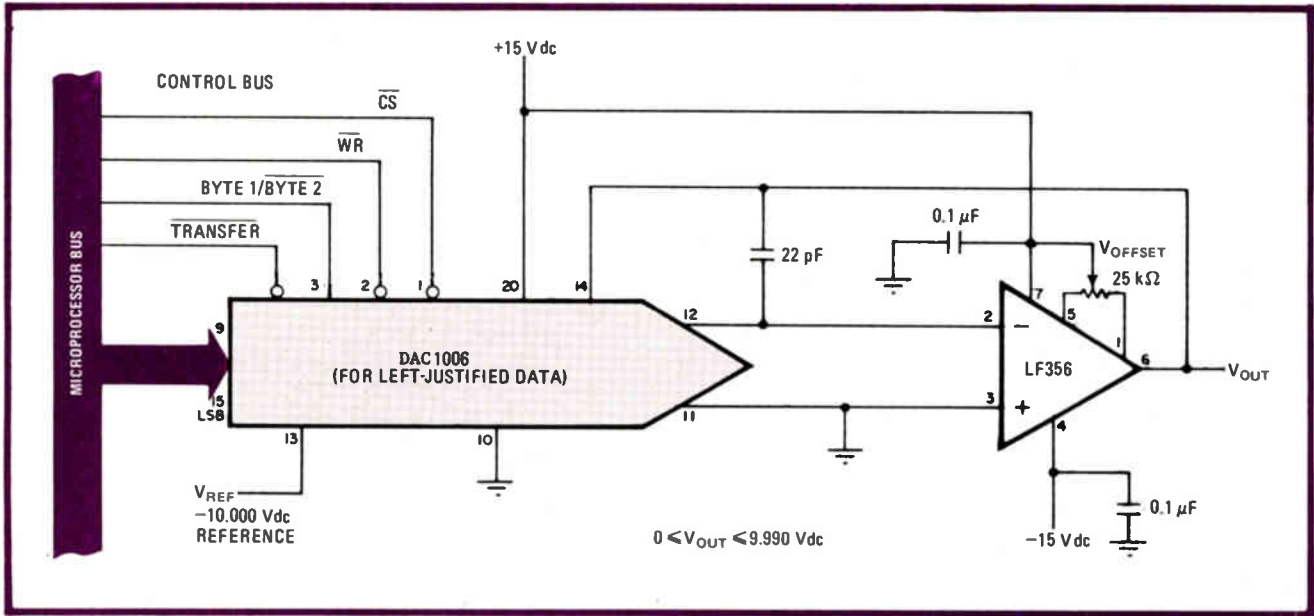

**4. Unipolar.** In a typical unipolar application, a Micro-Dac d-a converter inverts the negative reference voltage to a positive one. This positive output is 1,023/1,024 of the negative reference voltage multiplied by 9.990 V dc. The output amplifier slews within 3  $\mu$ s.

smaller is the change in linearity error for the same supply voltage swing—just -0.005%.

The usefulness of a d-a converter can be determined by the magnitude of the linearity errors resulting from changes in the reference voltage. For applications, like multiplication, that require small values of reference voltage, small linearity errors are essential. In the case of the Micro-Dac converters, reducing the reference voltage from 10 to 1 v results in a worst-case linearity error change of approximately 0.005%.

Figure 4 shows a typical application of a Micro-Dac as a unipolar voltage-output device. This circuit inverts the negative reference voltage to a positive output, with a

maximum value of 1,023/1,024 of the reference voltage multiplied by  $V_{ref}$ . The bi-FET operational amplifier used is an LF356 that slews and settles within 3 microseconds.

Operating the Micro-Dac's R-2R resistor ladder in a voltage-switching mode as shown in Fig. 5 gives a faster, slewing and settling time—1.8  $\mu$ s. The ladder is being used backwards. The reference voltage that is derived from the LM336 reference diode is applied to the  $I_{out1}$  pin 15, where the reference voltage was previously located in Fig. 4. This output voltage ranges from 0 to (1,023/1,024)(2.49 v dc). The LF356 operational amplifier used supplies a gain of a little more than 4, for an

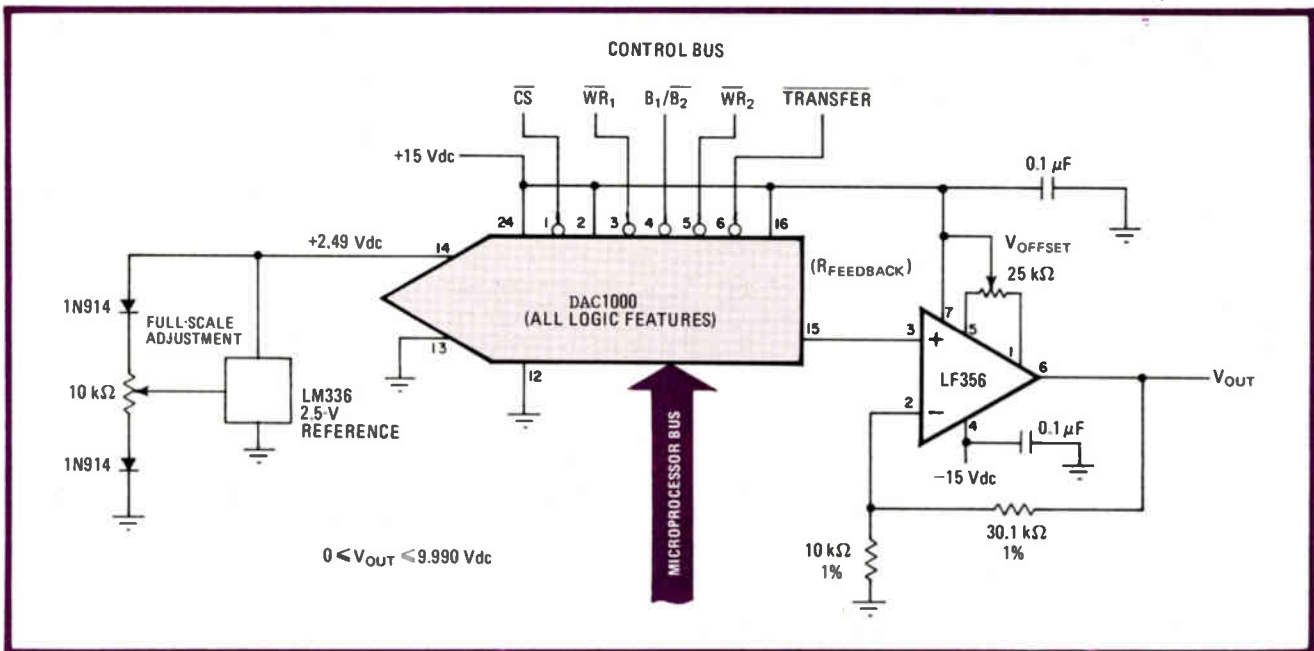

**5. Voltage mode.** Operating the Micro-Dac d-a converter's resistor ladder in a voltage-switching mode provides a faster slewing and settling time (1.8  $\mu$ s) than that of Fig. 4. Note that the d-a converter's R-2R ladder is being used backwards.

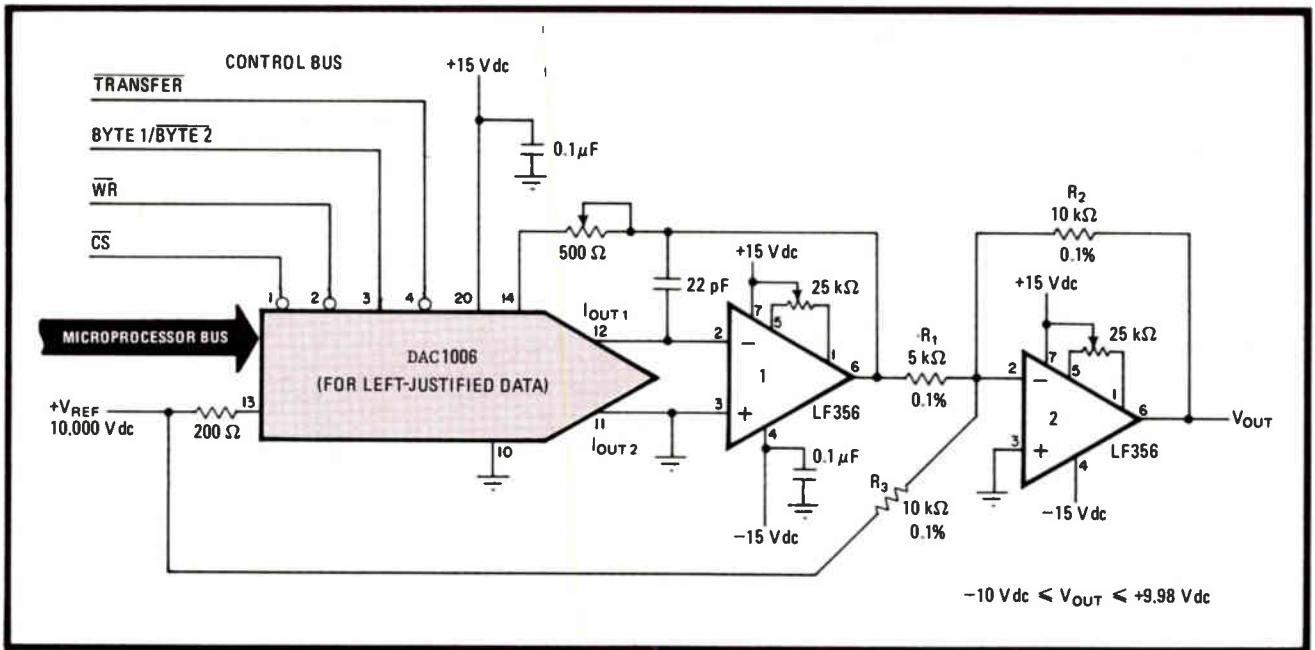

**6. Bipolar.** By adding or subtracting the Micro-Dac d-a converter's reference voltage from its output voltage, a bipolar output results. For this circuit to work properly, however, resistors  $R_1$ ,  $R_2$ , and  $R_3$  in the circuit of op amp 2 must stay matched during temperature changes.

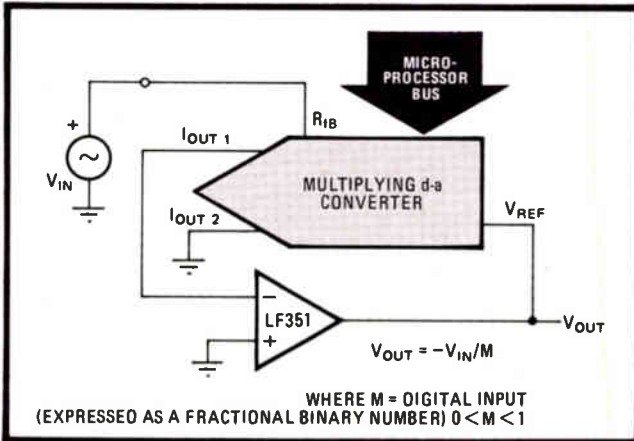

**7. Control.** A Micro-Dac d-a converter can be used for microprocessor control of an amplifier circuit. Since the converter has four-quadrant multiplication capability, ac and dc signals can be handled. The feedback resistor referred to but not shown is in the converter.

overall output voltage ranging from 0 to 1 LSB less than 10 v (or 9.990 v dc). The two compensating diodes at the ends of the full-scale-adjustment potentiometer on the LM336 reference improve the temperature stability of the reference voltage.

For a bipolar output voltage, the circuit in Fig. 6 may be used. The bipolar output voltage results from adding or subtracting the reference voltage from the converter's output voltage.

The output of operational amplifier 1 ranges from 0 to  $-1,023/1,024 \times V_{ref}$  (or  $-9.990$  v dc). This voltage is then applied to operational amplifier 2, where a gain of  $-2$  doubles the voltage range. A  $-10$ -v dc offset voltage at the output of operational amplifier 2 is provided by adding the converter's reference voltage to the amplifier's input. Resistors  $R_1$ ,  $R_2$ , and  $R_3$  in the circuit of operational amplifier 2 must stay matched even dur-

ing temperature changes for the circuit of Fig. 6 in order to work properly.

The bipolar converter of Fig. 6 is adjusted by first entering a digital code composed of all zeros into the d-a converter. Next the offset potentiometer of operational amplifier 1 is adjusted for a zero amplifier output voltage and then the offset potentiometer of operational amplifier 2 is adjusted for an amplifier output voltage of  $-10,000$  v dc. Finally, a digital code of all 1s is applied, and the  $500$ -ohm potentiometer in series with  $R_b$  of the d-a converter is adjusted for an output voltage of  $+9.98$  v dc. This voltage is  $V_{ref} - 1$  LSB, where  $1 \text{ LSB} = V_{ref}/512$ .

### Using the microprocessor for control

The Micro-Dac multiplying d-a converter can be used in a microprocessor-controlled amplifier circuit as the feedback element for the amplifier (Fig. 7). Since the converter has four-quadrant multiplication capability, both ac and dc signals can be handled. The feedback resistor (not shown) is the internal one on the d-a converter's chip.

The d-a converter in Fig. 7 automatically provides an output voltage that causes the current from the converter's  $I_{out1}$  terminal to the  $V_{ref}$  terminal to equal the input current  $V_{in}/R_b$ . Note that when the microprocessor provides data to the d-a converter with the LSB set to a 1, a relatively large value of the reference voltage is needed to balance the input current. This value corresponds to the maximum gain of  $-1,024$ . The minimum gain of  $-1,024/1,023$  is obtained for a d-a converter digital input of all 1s. In all,  $1,023$  gain steps are provided.

The addition of another amplifier in the converter's  $I_{out2}$  leg produces a microprocessor-controlled amplifier and attenuator. Compared with the gain of the circuit that appears in Fig. 7, the gain here is noninverted and ranges from 0 to  $1,022$ . □

# One $\mu$ P-based power meter does all this!

- Displays power, or dB with variable reference
- Autoranges
- Zeroes automatically
- Calibrates automatically, against internal reference
- Displays Hi and Lo selectable dB out-of-limits
- Accepts all Boonton power sensors, covering -60 dBm to +20 dBm, 200 kHz to 18 GHz, with 70 dB dynamic range
- Accepts specially modified General Microwave Model 4240 Thermal Power Sensors
- Stores Cal Factors and sensitivities for up to four interchangeable power sensors in nonvolatile memory
- Recalls and corrects for interpolated Cal Factors with only a frequency entry
- Develops 10 V dc output linear with power or dB on each range
- Accepts optional, plug-in IEEE 488 Bus Interface
- Accepts optional, plug-in rechargeable battery supply
- Accepts signature analysis troubleshooting techniques

## PLUS

- **Accepts optional, plug-in 2nd input channel and with two power sensors then displays either input, or their instantaneous difference expressed in dB**

# Ours.



# BOONTON

Boonton Electronics,  
Rt. 287 at Smith Rd., Parsippany, NJ 07054; (201) 887-5110.

# Small talk.

**Bussmann speaks your language in miniature fuse protection. And selection.**

When you think small, think Buss. With today's miniaturization of electronic equipment and components, you don't have to sacrifice quality for size. Not if you get protection from the most complete source for fuses and accessories in the industry — Bussmann. As a part of our overall line, we offer you a *full line* of miniature and subminiature fuses and fuse clips. All with the same state-

of-the-art dependability as our larger fuses.

Bussmann makes everything you need to protect delicate printed circuit boards and other sensitive electronic equipment. Also equipment for overseas markets. When you're specifying Buss fuses, specify Buss clips at the same time. That way you get complete compatibility and high quality. It's that easy.

But you get more than single-source convenience. You'll get expert technical help whenever you need it. Just contact your Bussmann representative. He's the prime source for application data. And he has the full backup of specialists at the plant.

For the best protection money can buy, talk to your local distributor or Bussmann representative today. Because Bussmann is the only name you need to know in circuit protection. No matter how big the job. Or how small.

**McGRAW-EDISON**

**Bussmann.  
The Protection  
Experts.**

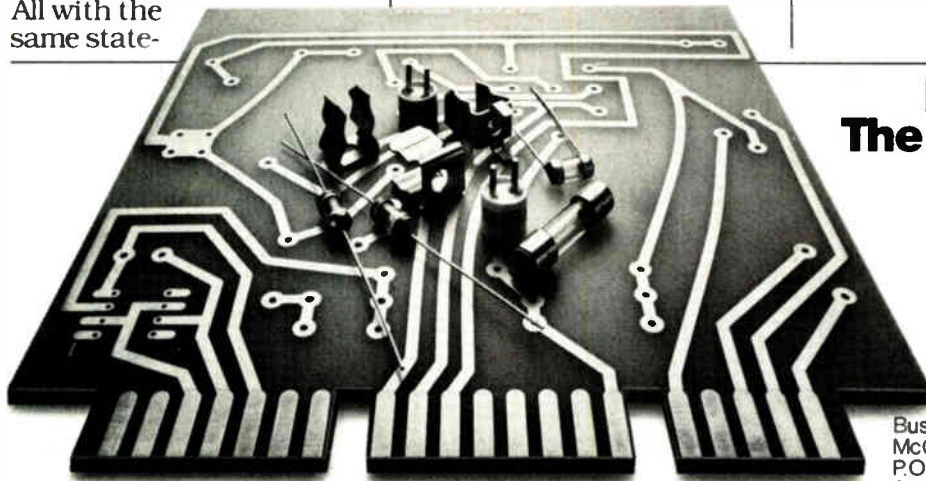

Bussmann Division  
McGraw-Edison Company  
P.O. Box 11460  
St. Louis MO 63178

# IEEE-488 controller promotes building of in-house ATE

Two controllers in one, unit incorporates software for IEEE-488 programming and debugging, touch-sensitive screen that works as user-designed keyboard

by Hugo Draye

*John Fluke Manufacturing Co., Mountlake Terrace, Wash.*

□ Two major trends in the field of test and measurement today are the demand for automation and the widespread implementation of the IEEE-488 standard interface. For the first time, a commercial controller meshes the two developments.

Unlike most other IEEE-488 controllers, which are generally adaptations of existing desktop or personal computers, the 1720A was constructed specifically for the system engineer who wants to build his (or her) own automated test equipment. Both the design and the operation of such a system are eased by the 1720A's unique software and hardware features, perhaps most notably its IEEE-488 command structures and a touch-sensitive cathode-ray-tube overlay.

## Why build?

The commercially available alternatives for automating a test and measurement task are either low-cost testers, dedicated to performing specific tests on a particular class of device, or the much more expensive systems typically programmable by the user to perform dynamic and static tests on many types of devices or assemblies. Between these extremes is a middle ground that can usually be covered most economically with a system built in house because it can provide the proper mix of versatility and dedication needed for a particular application.

What has made in-house systems particularly economical today is the advent of the IEEE-488 standard digital interface for programmable instrumentation. Introduced officially in 1975, this interface system is being adopted by an array of instrument makers worldwide, and the number of devices now incorporating it probably surpasses 1,000. This situation not only lets the system builder shop around for the most economical set of components that fulfill his test requirements but also reduces the hardware design task to the mechanical interconnection of functional building blocks (Fig. 1).

Yet the task of designing and developing such a system is still not trivial because of the standard's flexi-

bility and the need to provide the software by which the functional blocks communicate. While the interface standard does establish a device-independent protocol by defining the control and data lines, a handshake protocol, and communication functions such as talker or listener, it also permits this protocol to be applied to a greater or lesser degree—defined as subsets of the standard—by each device manufacturer.

For example, a unit may be only a talker, just putting information onto the 488 bus when it is addressed by a controller, or only a listener, just accepting data addressed to it by another unit, or both. Similarly, it may respond either to a broadcast request called a parallel poll or to a specific request called a serial poll or to both. The onus, therefore, is on the system designer to fully understand the standard and its options, as well as the extent to which each system component implements the interface, if he or she is to choose the correct unit for the application at hand.

Even so, it will be extremely difficult to foresee all possible idiosyncracies that some instruments may exhibit. But this limitation can be overcome if the system controller provides the hooks and handles necessary to view the system's full operation and the performance of individual components and to fully orchestrate both. These tasks fall logically to the controller, since its primary function is to govern all communications in the system.

Another difficulty that arises in getting the system elements to work together is the fact that they may speak in different tongues; that is, the format and coding of information may take on different forms in different

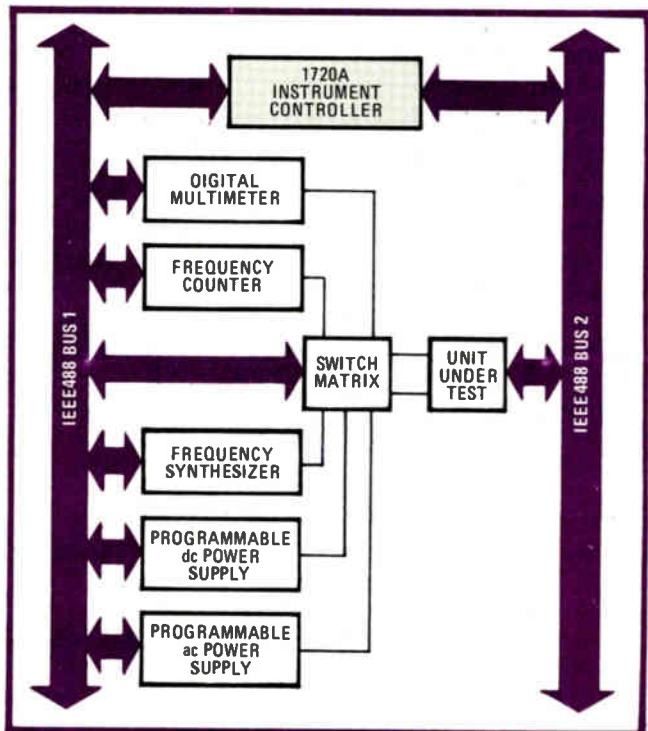

**1. Do it yourself.** In-house ATE systems like the one above are now easier and less expensive to construct thanks to the wide availability of IEEE-488-compatible units. With the 1720A, operation of a bus-compatible unit under test can be easily automated also, as shown.

**2. Self explanatory.** The display on the 1720A shown here is a functional block diagram of the controller itself. Any similar display can be created, stored on disk, and called up by pressing the start button at the lower right. The touch-sensitive CRT overlay allows the operator to make appropriate choices—in this instance, the function he wishes to examine in detail.

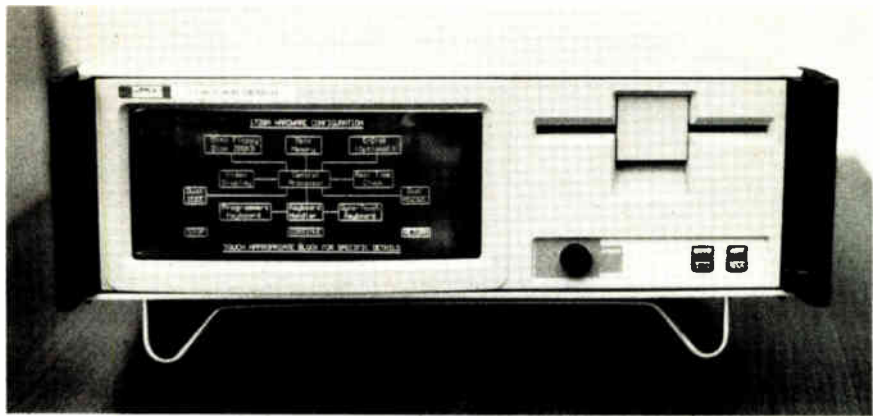

devices and even in similar devices. This difficulty arises because the 488 standard was intended to address only device-independent functions. When it was first written, its framers felt that defining device-dependent formats would constrain individual instrument manufacturers, dictating what sorts of programmable features and output data they could implement in their products.

As a result, manufacturers developed their own coding and formats, of which builders must be aware. In fact, the committee that framed the original 488 standard is at present working on standards and guidelines for encoding and formatting information from system components. But those now constructing systems that must not be made obsolete by future modifications to the standard need a system controller capable of coping with a wide range of information shapes.

### Meeting the ATE challenge

The design of the 1720A controller (Fig. 2) meets the 488 standards for talker, listener, and controller functions. More importantly, in a larger sense it provides the hardware and software flexibility required to meet the challenge of building automatic test equipment in house.

Actually, the 1720A is two controllers in one. Its hardware implements the control function in duplicate, providing two 488 ports that operate independently of each other. This dual bus structure gives ATE designers unusual freedom, allowing them to double the number of instruments in the system and the overall distance between the units. The IEEE-488's electrical specifications result in limits of 20 meters of cable and 15 instruments per system. Obviously, a dual bus structure doubles both these limits, allowing a designer to construct larger, more complex systems that spread out over larger areas if test tasks demand it. Moreover, this doubling also applies to systems incorporating the recently introduced extenders, which raise the single-controller cabling distance to approximately 1,000 meters.

Second, the redundancy of the structure lets a designer configure reliable, fully automated testers for the maintenance and calibration of bus-compatible devices. A system using a single bus controller and bus to communicate with both the system elements and the unit under test (UUT) is not the most dependable configuration—if the unit being checked out should fail to respond to a command, it could hang up the entire system,

leaving the operator to determine the source of failure and slowing the entire test procedure. With a dual bus structure, one of the buses can be dedicated to the UUT. If this unit—an electrically unknown quantity—fails to respond to commands, that failure can be spotted immediately because activity on the dedicated bus ceases.

Third, this dual structure allows the designer to compensate for the speed differences between system elements. Some instruments request service at frequent but brief intervals, whereas others operate much more slowly, tying up the bus while large quantities of information are transferred to or from them. For example, a digital multimeter might need the controller's attention only for a brief period to transmit a single reading, whereas a plotter-printer may hold that attention for extended periods while multiple data points or text are transmitted to it. Allotting slow system components to one bus and the fast elements to a second bus means that each set can operate at an optimum rate and thus improve overall system throughput.

In addition to these hardware tools, the 1720A provides a combination of software and hardware features aimed at easing the design, implementation, and debugging of ATE application software. For ATE, application software spells out the sequence and nature of operations and decisions that implement the automation of a specific test and measurement function.

### Softening the software burden

The 1720A's programming features include an enhanced Basic programming language with an extensive set of verbs specially designed to support IEEE-488 bus communication and control, as well as a screen editor and powerful file managers. Backing up these software features are a full ASCII keyboard, special keys for calling the editing operations, a programming display of 16 lines of 80 characters, and a diskette storage system that may be augmented with 128 or 256 kilobytes of read/write memory called an Electronic- or E-disk. This memory is so named because it is a file-structured mass-storage device with performance parameters that surpass those of fixed-head disks.

Basic was chosen as the high-level programming language because market research indicated it is the dominant language used in ATE and many programmers are already familiar with it. Moreover, Basic is easy for technical people to learn and use, since it expresses



## IEEE commands

**INIT:** Clears the bus and sets the remote-enable line. The command is sent to the designated port or to all ports in the default case.

**REMOTE:** Is set as on the designated port or on all ports in the default case. If a device list is specified, each specified device will be addressed as a listener.

**CLEAR:** Issues a device-clear message on the designated bus port or on all ports in the default case. If a device list is specified, a selective device clear is sent to each device.

**LOCKOUT:** Sets all devices in local lockout on the designated port or on all ports in the default case. This disables the "local" buttons on every device on the port.

**LOCAL:** Sets the remote enable line false on designated ports. If devices are specified, it sends the go-to-local command to designated devices.

**TRIG:** Addresses the selected devices as listeners and invokes a group-execute trigger.

**CONFIG:** Configures the selected device for parallel polling as specified. The priority specification is from 1 to 8 inclusive. If no priority specification is given, the device will be deconfigured.

**INPUT:** Unlistens all devices on the port; addresses designated device as a talker and reads the required data.

**PRINT:** Initially unlistens all devices on the ports that correspond to the devices listed. Then it addresses the specified devices as listeners, clears ATN, and sends the data listed.

**RBYTE:** Reads data bytes from the indicated port.

**WBYTE:** Writes an 8-bit data byte to the bus. EOI and ATN can be controlled separately with this command.

**INPUT WBYTE:** Writes the bus message contained in the WBYTE part of the command, which may include addressing, bus commands, and device-dependent data in the proper WBYTE format, and then inputs a reading to the first variable specified. WBYTE and INPUT will then be repeated until all variables have been assigned.

**RBIN:** Reads real data transmitted in 4- or 8-byte floating-point standard format directly with real variables.

**WBIN:** Transmits 4- or 8-byte floating-point data in a standard format.

**ON SRQ:** If an SRQ is issued on the bus, transfers control to the line specified. After handling the SRQ, a RESUME statement will cause the interrupted program to continue.

**ON PPOL:** After execution of every Basic statement, invokes a parallel poll. If the result of this poll is not equal to zero, then control is given to the specified line. A RESUME statement will cause continuation of the interrupted program.

**OFF:** Ceases sampling of either SRQ or PPOL.

**WAIT:** Causes the program to halt. The program continues after a service request, parallel poll request, a CTRL/C by the user, or an input from the display or when the specified time has transpired.

**TERM:** Specifies the termination to be used between data messages in the INPUT statement. Default is the LF character.

**TIMEOUT:** For IEEE-488 commands, if the time period specified by the argument value is exceeded while waiting for the device to respond, the I/O handler will be excited and an error condition will be returned.

operations, decisions, and functions in a familiar algebraic format using English key words such as INPUT, LET, and READ. Such readily recognizable terms also serve as their own documentation, which makes Basic programs easier to maintain.

Further, the 1720A uses an interpretive Basic, with individual Basic statements being interpreted into specific sets of machine commands. Thus, system programming can be optimized because the programmer can interact directly with the computer during development and debugging.

### Enhancements

To further increase programmer productivity in an IEEE-488 environment, the language, which is built around the proposed ANSI standard for minimal Basic, has been enhanced to form a superset. This superset can accommodate three types of variables—real, integer, and string—as single variables as well as in one- or two-dimensional arrays, all of which increases the computational power of the unit. To simplify control functions, statements such as IF-THEN-ELSE, ON ERROR GOTO, PRINT USING (to commence formatted printing), and OPEN (to create files) have been added. Data handling has been simplified by adding logical operators such as OR and AND as well as string functions.

In view of the present nature of IEEE-488 coding and formatting, the string functions are particularly valuable. They permit the 1720A to accept almost any sequence, or string, of characters transmitted to it and

process, or parse, that group. For example, the function  $Y\$ = \text{MID}(A\$,N1\%,N2\%)$  defines a string variable  $Y\$$  as a substring of the string  $A\$$  beginning at character number  $N1\%$  and  $N2\%$  characters long. Thus particular data of interest in a series of bus-transmitted characters can be picked out and operated on, regardless of the message's format.

### Direct command of the bus

In addition to standard programming structures, such as string functions, which are particularly advantageous for bus systems, a set of commands tailored particularly for IEEE-488 systems has been added to the Basic set (see table). These high-level commands are in effect macroinstructions: they group under one term a set of input/output statements that control the bus lines as required by the IEEE-488 standard. Their implementation eliminates the need to write multiple statements each time a bus function is required, thereby making programming the function less tedious and reducing the risk of error. Further, the bus commands let the programmer concentrate on system functions rather than on the individual states that occur during them.

In some instances, however, it may be desirable to exercise control over individual bus lines, and the IEEE command set permits that also. The WBYTE command, for example, causes an 8-bit data byte to be written onto the bus data lines and also allows the EOI or ATN bus lines to be controlled separately.

A case where individual control of bus lines is particu-

## Touch programming

The electronics that govern the touch-sensitive cathode-ray-tube overlay (TSCO) also control the programmer's ASCII keyboard and the CRT display. Those electronics are all contained on the single board shown, whose central control element is a TMS 9981 microprocessor.

Like the programmer's keyboard, the TSCO is a switch matrix polled periodically by the microprocessor looking for a contact closure. But its switch construction is very different from the keyboard's.

The TSCO is made up of two transparent Mylar sheets stretched over the CRT screen and separated from each other by spacers at the edges of the complete assembly. A 6-row-by-10-column matrix of switches is formed by scribing 6 thin gold lines horizontally on one sheet and 10 lines vertically on the other. Touching the TSCO causes a vertical line to contact a horizontal one, completing a conductive path detected by the processor.

The processor scans both the keyboard and the TSCO matrix row by row. Directed by its firmware, the TMS 9981 keeps a map of the matrixes in read-only memory, noting the status of each contact and updating that status with each pass. The processor thus debounces the keys and can perform a key-repeat function, in which entries are recognized and repeated at an increasing rate as long as the key is held down.

The processor, however, treats a TSCO entry somewhat differently from a keyboard entry. The keyboard entry, on

the one hand, is mapped to the standard ASCII hexadecimal value for the key's character, then sent to the main processor and the CRT. The sensed TSCO contact, on the other hand, is mapped to one of 60 hexadecimal values ( $80_{16}$  through  $BB_{16}$ ) that correspond only to a position in the TSCO matrix. This value is then sent to a special register assigned the system variable function named KEY.

So doing allows the system programmer to call the content of this register using the mnemonic KEY in his program. The program can then compare this value with those for the various alternative functions that it has displayed on the CRT and that are defined by it. The comparison's result points the program to a user-defined subroutine that performs that function.

The use of the TMS 9981 as the board's processor also provides a troubleshooting advantage: it lets the user execute diagnostic software from a remote terminal. The TMS 9981 contains a communications register unit (CRU) designed to handle data from a universal asynchronous receiver-transmitter chip on the board. The board is thus made to replicate an RS-232-C port inside the 1720A.

On power-up, the 1720A's main processor checks to see if the interface-control board is in place and functioning. If not, the main processor simply declares an external RS-232-C port, port O, to be the system's man-machine interface. Thus even with the CRT and keyboard interfaces down, the user can diagnose problems.

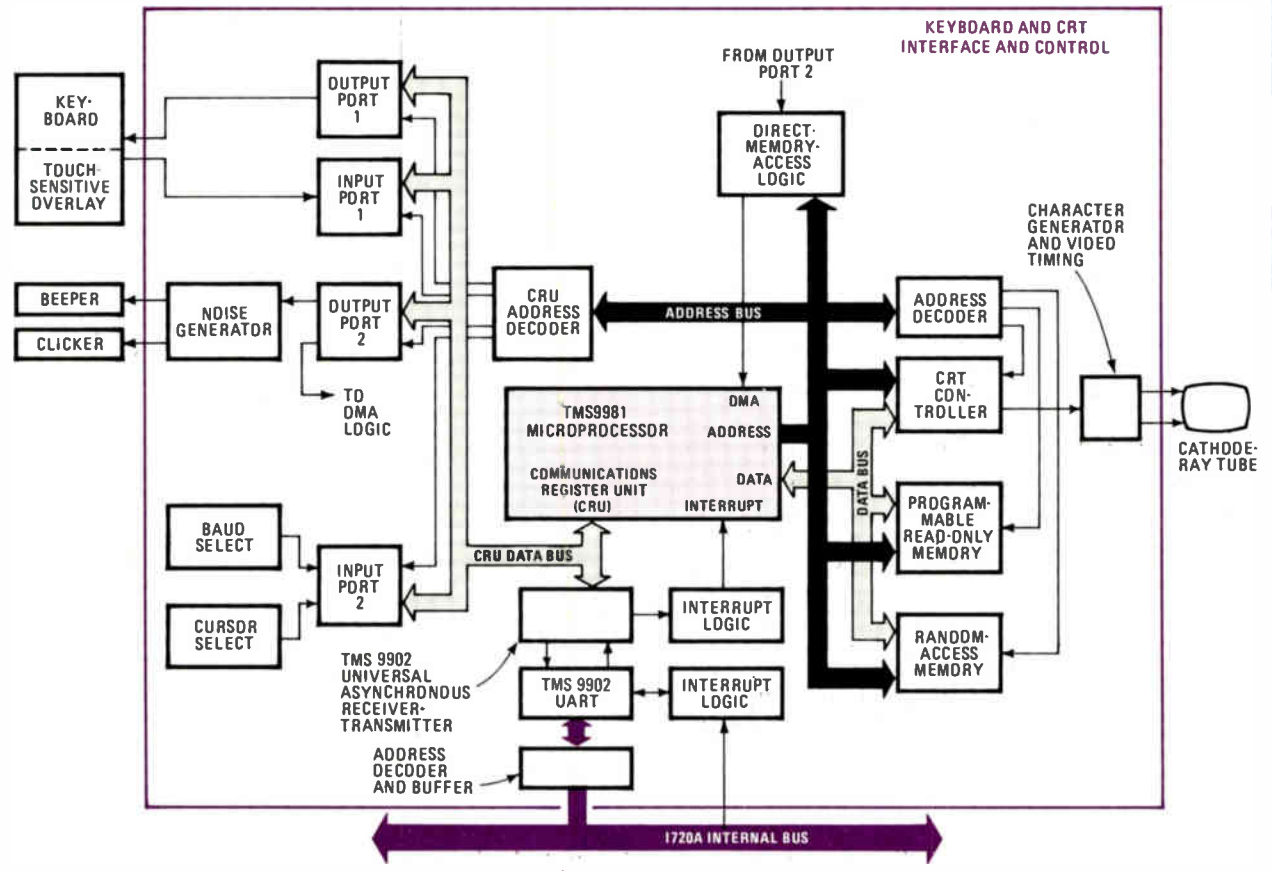

larly useful today is in the termination of a message. The format of the terminator command for currently available instruments often varies from one to another. Some

use the ASCII character combination for carriage return (CR) and line feed (LF) sent over the data lines as the message terminator; others use the LF (also called "new

line," or NL) alone as a terminator; and still others regard only the bus's EOI line going high as a terminator.

If the 1720A's TERM command is used by itself, the LF format is chosen as the terminating command by default. But the TERM command can also be modified by adding the desired termination characters format after it and thus can be used easily in any system, while still increasing the programmer's productivity.

Another factor that affects a programmer's output is the ease with which a program can be edited. For this task, the 1720A provides an easily called-up editing routine and six special editing keys.

To enter the editing mode after a program has been typed in, recalled from storage, or halted because of an error in program execution, the user simply types EDIT on the ASCII keyboard. This keyboard is attached to the controller by a plug-in umbilical cord that lets the user assume a comfortable position away from the controller.

Typing in EDIT alone brings up the first 16 lines of the program. Following EDIT with a line number brings up 16 lines starting at that line number. At the leftmost character in the first line a cursor appears.

To add or delete information from the program, the user positions the cursor anywhere in it using one of four direction keys—up, down, left, or right. Depressing a key continuously causes the cursor to move at an increasing rate until the key is released or the cursor reaches the end of the program field—the first or last program line or the first or last character in a line, depending on which key is pressed. When the cursor reaches the desired position, the character to which it points can be deleted by pressing the DEL CHAR key or the entire line eliminated using the DEL LINE key. New information can be inserted at the same point by typing it in on the standard ASCII keyboard.

The program's Basic interpreter will examine each altered program line for correct syntax. If any error is found, the interpreter will display an error message and freeze the cursor at the faulty line until it is fixed. Further, the interpreter automatically renumbers program lines, and program statements can be executed immediately as they are entered or a step at a time after the entire program has been written. Line numbers and changes in variable values can be traced during program execution and breakpoints can be set to halt the program for closer examination.

Once written and edited, programs may be transferred from the 1720A's 60-kilobyte main memory to a mini-diskette driven by a disk drive that is built into the controller's mainframe. The 5.25-inch diskette provides 200 kilobytes of archival storage for often used test routines, eliminating the need to regenerate them repeatedly and allowing test procedures to be standardized. Although not as fast as the rigid disks at present being incorporated in some commercial testers (average latency time of the mini-floppy is 250 ms, versus 50 ms or so for a hard disk), the diskette is competitive with tape media like the cartridge tape often found in today's ATE, whose access time can be an order of magnitude greater.

For applications in which fast data storage and retrieval are essential—in testing microwave equipment, for example—the optional electronic mass storage sys-

tem called the E-disk is offered. Implemented with moderately high-speed RAM chips, it appears operationally as a rotating disk and has an average latency time of approximately 100 microseconds. Data can be transferred to and from it four times faster than to or from a floppy disk—at 130 versus 31.25 kilobytes/second.

However, the E-disk lacks the floppy's nonvolatility; if power to it is lost, so is its data. So a backup battery built into the controller's internal power supply ensures that data will be retained for up to an hour if line power is removed or lost.

The E-disk can be installed in the field and work side by side with the diskette. Consisting of one or two 128-kilobyte memory boards, it slips into the 1720A's main chassis to provide 256 extra kilobytes of bulk storage. Even though it can consist of two boards, the operating system treats it as one logical device with one device name and one directory structure. Programs in execution can call routines from either storage device and stored programs can be precompiled—interpreted from Basic into a lexical memory-image format—to speed loading time and execution.

### The other side of ATE

An important and often neglected consideration in the design of an ATE system is its final environment—basically either the laboratory or the production arena, including field support. Though programming tools such as those already discussed may be acceptable to the technical people in the lab, a more friendly user interface is needed for the less sophisticated operator.

Since the controller in an IEEE-488 system is usually the point of interface, special consideration was given to the user interface of the 1720A. In addition to its detachable keyboard, a built-in CRT-based "keyboard" allows the system programmer to tailor the user interface for simple, direct communication with the test system.

The "keyboard" is actually a touch-sensitive CRT overlay that provides a transparent array of 6 by 10 switches in front of the green-phosphor screen. As part of his application program, the system programmer can create keys—the names of test program choices, such as dc volts, surrounded by boxes—for display on the high-contrast screen. In use, the operator chooses between tests he needs to perform by merely touching the appropriate box on the screen; the touch-sensitive overlay transmits his choice to the program, so that it can branch to the appropriate test subroutine (see "Touch programming," p. 150)

If the system programmer wishes to use this feature, he branches at the appropriate decision point in his program to a subroutine he creates (Fig. 3) He initializes the system for such a display by enabling double-sized characters and graphics—to give greater visibility to the keys, characters are written 4.2 by 5.4 millimeter as opposed to the 2.1-by-2.7-mm characters displayed when creating or editing a program. Doubling the character size reduces screen text capacity by three quarters—to 8 lines of 40 characters—but this is still sufficient for simple labels in plain English.

After initialization and preliminary instruction printing, the program shown in Fig. 3 goes to nested subrou-

```

100 REM 1720A TOUCH SENSE DEMO
105 REM PROGRAM INITIALIZATION
115 E$=CHR$(27$)+'['\PRINT CPOS(1$,1$);E$+'J';
120 PRINT E$+'1;3p' I ENABLE DOUBLE SIZE CHAR. & GRAPHICS
125 REM TEST SELECTION
130 PRINT CPOS(2$,13$);'TEST SELECTION';
135 GOSUB 300 I DISPLAY LEFT\MIDDLE\RIGHT BOXES
140 PRINT CPOS(7$,15$);'TOUCH ONE';
145 REM DECODE TOUCH SENSE
150 K$=KEY\IF K$=0$ GOTO 150
155 K=K$-10*(K$/10$)
160 IF K<4 THEN GOSUB 1000 ELSE IF K<7 THEN GOSUB 2000 ELSE GOSUB 3000
175 STOP
300 REM DISPLAY SELECTION BOXES
305 PRINT CPOS(3$,6$);\GOSUB 500 I LEFT BOX
310 PRINT CPOS(4$,9$);'DC';
315 PRINT CPOS(5$,8$);'VOLTS';
320 PRINT CPOS(3$,15$);\GOSUB 500 I MIDDLE BOX
325 PRINT CPOS(4$,18$);'AC';
330 PRINT CPOS(5$,17$);'VOLTS';
335 PRINT CPOS(3$,24$);\GOSUB 500 I RIGHT BOX
340 PRINT CPOS(4$,27$);'DC';
345 PRINT CPOS(5$,25$);'CURRENT';\RETURN
500 REM BOX
505 PRINT '1';E$+'1B';E$+'1D'; I LEFT VERTICAL LINE
510 GOSUB 750
515 PRINT '3';
520 FOR I$=0$ TO 6$\PRINT '8';\NEXT I$ I BOTTOM HORIZONTAL LINE
525 PRINT E$+'7D';E$+'3A'; I TOP HORIZONTAL LINE
530 FOR I$=0$ TO 6$\PRINT '8';\NEXT I$
535 PRINT '0';E$+'1B';E$+'1D'; I RIGHT VERTICAL LINE
540 GOSUB 750
545 PRINT '2';\RETURN
750 REM VERTICAL LINE
755 FOR I$=1$ TO 2$\PRINT'9';E$+'1B'+E$+'1D';\NEXT I$\RETURN
1000 REM DC VOLTAGE TEST
1099 RETURN
2000 REM AC VOLTAGE TEST
2099 RETURN
3000 REM DC CURRENT TEST
3099 RETURN

```

**3. Programming pictures.** The Basic routine at right creates the three-key display shown below it, interprets the input from the touch-sensitive CRT overlay, and directs the system to perform the appropriate subroutine. Although double-sized characters are used here for greater readability on the production line, single-sized characters may also be used if greater information density is required, say, in an engineering lab.

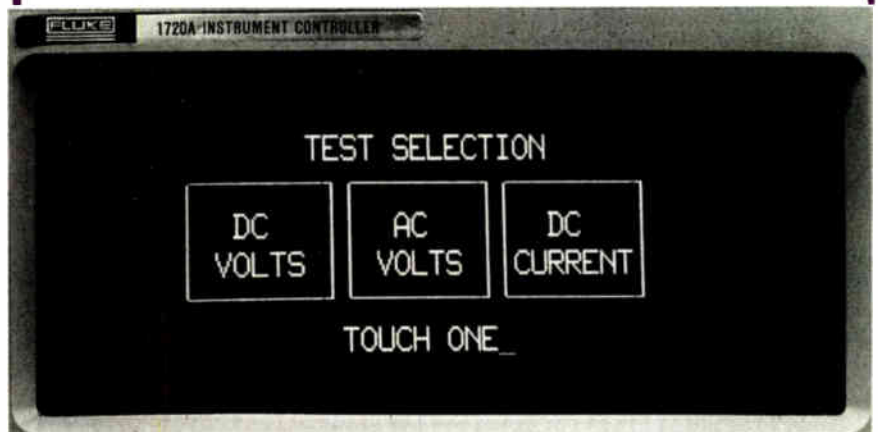

tines to create three major keys. The print routine at the point specified by the cursor, as well as the task of positioning the cursor, has been simplified by including the CPOS (x, y) function, which positions the cursor on line x at character position y. For this routine, the cursor positions are given in double-sized character format (lines 1 through 8, character positions 1 through 40).

Once the cursor is positioned, the subroutine hands off operation to another subroutine that draws the boxes. The cursor commands, along with other CRT display commands, are implemented in accordance with section 1.4 of ANSI standard Z3.64-1977. They follow the general format ESCAPE[<numeric><character>. For the cursor, the characters A, B, C, and D designate direction: up, down, forward, and backward, respectively.

Once the keys are drawn and labeled and final instructions are written on the screen, the program waits for the screen to be touched. When it is, it evaluates the key

input and branches to the appropriate test subroutine. In the example shown, the screen is viewed as consisting of three sections: left, right, and middle. The left key consists of columns 1, 2, and 3 of the 6-row-by-10-column overlay matrix; the middle key, of columns 5, 6, and 7; and the right key, of the 7, 8, 9, and 0 columns. Array positions are encoded in standard matrix notation as (nm), and line 155 of the program extracts m to determine the column touched.

It should be noted that, in addition to easing the operator's effort, this scheme allows the software for the system to be locked up by removing the detachable keyboard. Thus test programs cannot be altered on the production floor without the programmer's knowledge, which helps maintain control over the production process. The bootstrap program needed to call test procedures are part of the system firmware, so that operation can be started by merely pressing the start button. □

# TELESCOPE TIME AND SPACE WITH A TELECONFERENCE.



You are having your regular weekly conference with the field office.

Though you are at headquarters and your field office is a thousand miles away, it's as if you all meet in one location.

You deliver the latest directives. The field reports that a project is completed. They ask for instructions on a continuing problem. You clarify a point by going over to the blackboard.

What makes this work is that it all takes place over the phone.

It's a teleconference.

A teleconference, whether held regularly or on a spot basis, eliminates the barriers of time and

space. The U.S. Geological Survey has found that it speeds up work. Makes executives' time more productive. Cuts travel expenses. Clears up problems and takes care of emergencies immediately.

You can have a teleconference simply by using a Speakerphone, which enables several people to hear what is being said at once. So there's no need to repeat information.

At its most complex, you could have a completely equipped conference room utilizing private lines. You might even include an electronic blackboard, which you write on with chalk. Your writing is reproduced simultaneously on a TV monitor at your field office a thousand miles away.

Bell's advanced communications technology is changing ideas about how to transact business. It's becoming clear, for instance,

that what we call the "conference" is one of the many aspects of information management and communications. And that's our business—the knowledge business.

*For more information, call toll free 800-331-1750. In Oklahoma, call collect: 918-664-8300.*

**The knowledge business**





# Rugged enough for the Army

A highly sophisticated mass bubble memory system has been designed for *Project Wavell*, the mobile and extremely flexible automatic data processing system now in development for the British Army.

It's a 6-megabyte system to meet the military's need for rugged, reliable construction. It can withstand mechanical shock, nuclear radiation and a wide variety of hostile environments.

The system is called PBS 90M. It stands for high performance under the toughest handling, and uses the only memory technology suitable for operating reliably under the vibration conditions of a tracked vehicle. Its modular construction provides versatility and makes maintenance easy in the most severe operating conditions.

It's from Plessey, one of the world's major suppliers of bubble memory systems. Determined to stay upfront.



**PLESSEY  
MICROSYSTEMS**

Plessey Microsystems Limited, Water Lane,  
Towcester, Northants NN12 7JN  
Telephone Towcester (0327) 50312  
Telex: 31628

Plessey Microsystems Inc, 19546 Clubhouse  
Road, Gaithersburg, Maryland 20760  
Telephone (301) 948 2791  
TWX: 710 828 9708

and at  
1641 Kaiser Avenue, Irvine, California 92714  
Telephone (714) 540 9931  
TWX: 910 595 1930

0654 2 0127

# Adding data acquisition to a single-board computer

A few extra components plus a software implementation of a popular analog-to-digital conversion technique open up a small computer to many industrial applications

by Mike Parsin, *Precision Monolithics Inc., Santa Clara, Calif.*

□ The ability to handle many analog inputs can be added to an existing 8-bit microprocessor board at a relatively low cost if software helps out with the analog-to-digital conversion. Though the result does not have the performance of an expensive a-d input board, the 2,000 conversions per second of this eight-channel design are more than adequate for many process control, energy management, and other industrial applications.

Moreover, making the conversions in software increases the system's flexibility. The number of input channels that can be handled may readily be expanded to 128 and even more.

The a-d method used is successive approximation. It is the fastest available conversion method after the ultra-high-speed parallel, or flash, technique. Reliance on software, of course, slows the process, compared with an all-hardware implementation.

Use of an 8-bit microcomputer of course limits the accuracy of the conversion process to about 0.19%. But in fact that is good enough since low-cost sensors are accurate to only about 2% when temperature effects are taken into account.

## Necessary elements

A minimal eight-channel microprocessor-based data-acquisition system does not live by software alone. But the extra hardware involved is less expensive than either hybrid-package multiplexed systems or the use of eight single-channel monolithic a-d devices. Component costs come to about \$25.

To handle its many inputs, the system needs a multiplexer, whose analog output must pass through a sample-and-hold amplifier on the way to a comparator. The other input to the comparator is supplied through a

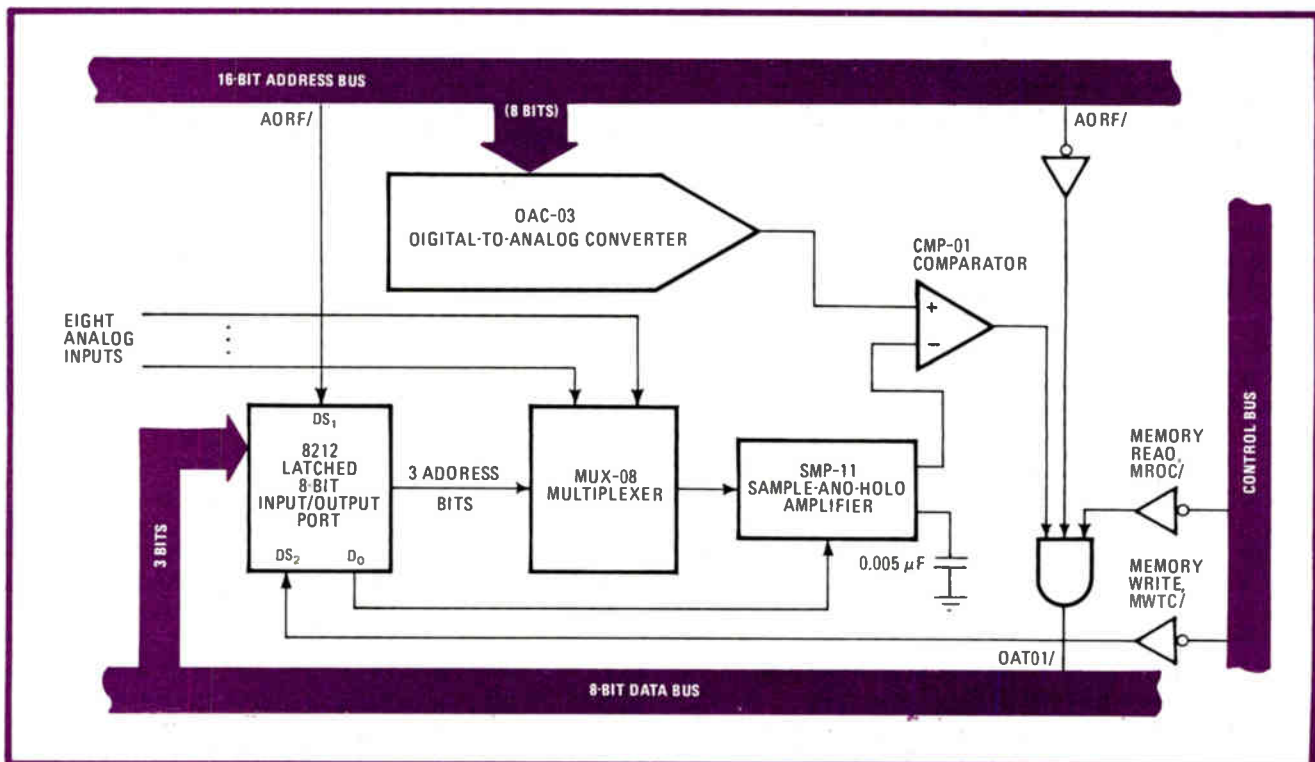

**1. Successive approximation in software.** Commands from an 8080 microprocessor's data bus select one of eight analog inputs for presentation to a comparator together with a series of known values fed through the d-a converter by the 8080's address bus.

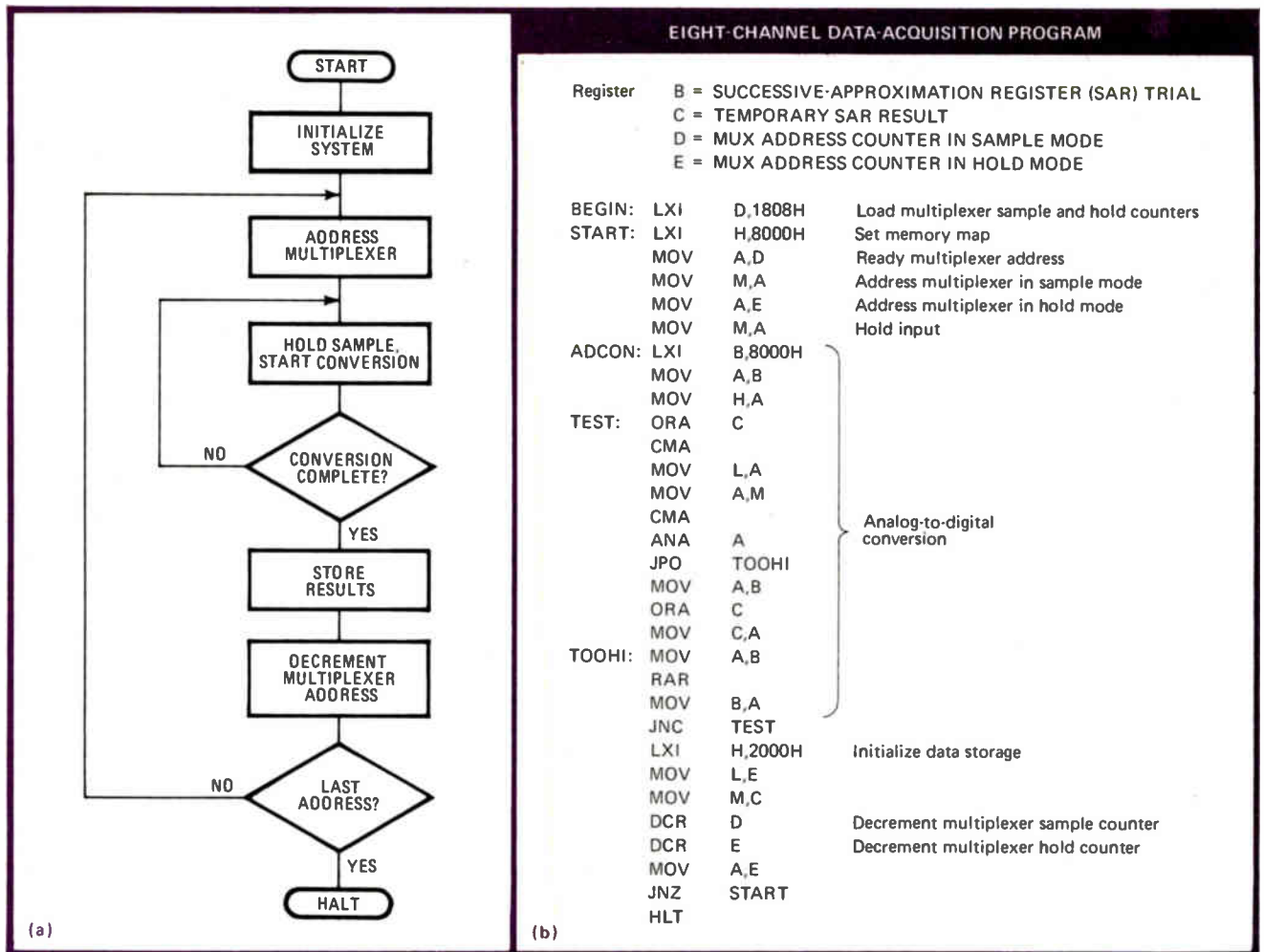

**2. Step by step.** The flow chart at the left explains the sequence of operations in the successive-approximation a-d conversion program at the right. The 8080 instruction set is employed, as written for use with a Multibus, which inverts the signal levels from those at the 8080 chip.

digital-to-analog converter. A few bus interface devices are also required. The microprocessor's role in all this is: to select each multiplexer channel in turn and send out sample and hold commands; to retrieve the comparator's final output; and, between those two points, to conduct a successive-approximation a-d conversion.

In this technique, a digital word  $n$  bits long is built up bit by bit until it becomes the binary equivalent of an analog signal. First the most significant bit is applied to a d-a converter that drives one comparator input. Meanwhile, the analog sample to be digitized enters the other comparator input. If the MSB yields an analog value below the sample's, it is retained (set at 1) and the next most significant bit added to it. If their combined analog value again falls short of the sample, both bits are retained (11), the third most significant bit is added to them, and so on through the  $n$ th and least significant bit.

At any point in this sequence, of course, the analog value of the bit or sum of bits being tried out may overshoot the sample's. When that happens, the latest bit to be tried is discarded (set at 0).

From the opposite perspective, the analog sample scores a 1 every time it exceeds a new cumulative input from the growing digital word and a 0 every time it falls short. Its final tally—a string of 1s and 0s—amounts to

its digitization to within the accuracy of the components used and the resolution of the least significant bit.

Thus a complete a-d conversion takes only  $n$  successive approximations to achieve  $n$  bits of resolution. This is highly efficient since there is a total of  $2^n$  possible digital words to choose from.

### Layout

Figure 1 shows the configuration of an 8-bit eight-channel data-acquisition system under software control. The hardware is addressed by a technique called memory-mapped input/output because the various components appear as memory to the microprocessor. They are accessed by memory read and write operations and are given addresses above  $7FFF_{16}$  in the memory space of the 8080 microprocessor. This constraint halves the 8080's memory capacity to 32 kilobytes from its normal 64 kilobytes but simplifies system implementation.

The microcomputer first selects one of eight analog input lines by sending an address over its data bus to the multiplexer via the latched 8-bit input/output port. With this address are sample and hold commands. Then the a-d conversion routine sends a series of test words over the first 8 bits of the address bus to the d-a converter and guides the comparator through the steps of a successive



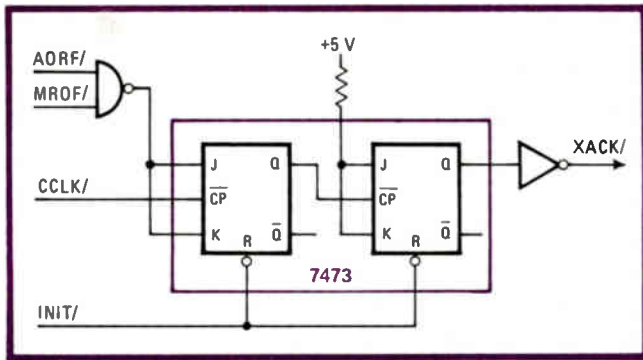

**3. Wait for the results.** To make allowance for the conversion time of the digital-to-analog converter, a divide-by-4 counter puts the microprocessor into a wait state during the read instructions at memory locations  $8000_{16}$  and above.

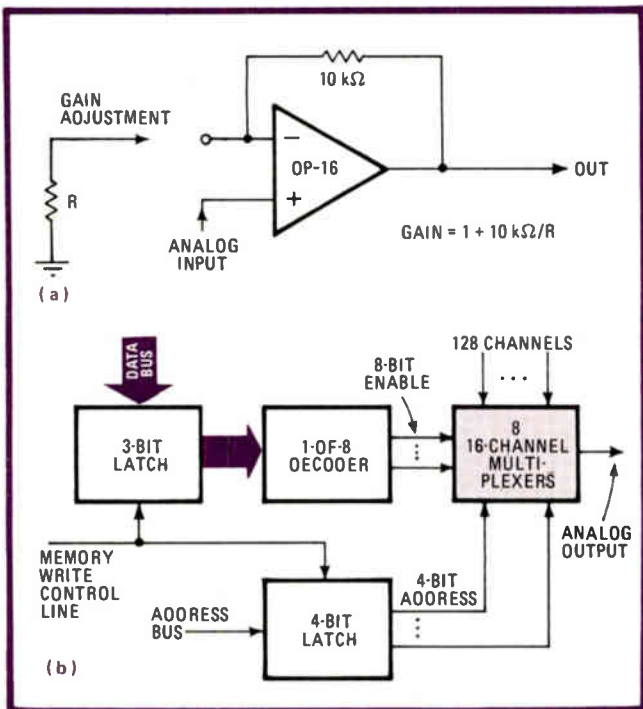

**4. Options.** To give all analog signals the same full-scale value, an amplifier can be configured for fixed or programmable gain (a). Latching data and address bus bits, decoded to enable one of eight 16-channel multiplexers, accommodate 128 input channels (b).

approximation. The comparator's decisions are retrieved by the 8080, which puts them onto its data bus by means of a memory-read instruction.

The program that coordinates these hardware functions conforms to the flow chart in Fig. 2 and is given in detail in the accompanying table. It uses the 8080 instruction set as executed in a Multibus system, which inverts signal levels. (Although this particular system uses a Multibus structure, the approach is valid for any microcomputer having separate data and address buses.)

The program begins by setting up the multiplexer address in the 8080's D and E working registers. The starting address specifies the eighth input line first and then decrements to address one as each analog signal line is digitized and stored.

The address where the digitized number is stored is

formed for each signal by maintaining a base address of  $2000_{16}$  and adding to this the address of the multiplexed line currently being accessed. In this way the digitized values for lines 1 through 8 are stored in memory locations  $2001_{16}$  through  $2008_{16}$ , respectively.

Once an analog line is addressed by the multiplexer, a hold command is sent to the sample-and-hold device.

The successive approximation begins by sending the value  $0080_{16}$  to the d-a converter over the address bus. This represents the first test value for the successive approximations—in other words, the ninth most significant of 16 bit positions alone is set high. At a later instruction (MOV A,M), a memory read operation, the comparator output is read and stored in the 8080's accumulator, or the A register, for testing.

### A vital delay

The circuit shown in Fig. 3 is needed to slow the processor during memory read operations in the data-acquisition mode because the memory read cycles are faster than the  $1.5\text{-}\mu\text{s}$  d-a converter settling time and, unlike data, the address bus is not latched. Reading memory locations above  $7FFF_{16}$  causes the microcomputer to wait two clock periods (at least  $2.6\text{ }\mu\text{s}$  all told) to allow the d-a converter to settle. A faster but more expensive d-a unit, the DAC-08, with a 100-ns settling time, can be used if necessary and this circuit eliminated. A third alternative is to operate the single-board computer with a 500-kilohertz clock at all times.

The command ANA A (logical ANDing of the accumulator with itself) sets the condition flags in the processor without affecting the contents of the accumulator. This is followed by a JPO (jump on odd parity) command, which tests if the sampled analog input is greater or less than the test value at the d-a output. If less, the digital word feeding the d-a converter is logically ORed with the contents of the C register, where the results of the successive approximations are stored.

If the d-a value is greater than the analog input, the subroutine TOOHI shifts the high bit to the next most significant position and then jumps back to TEST, where the process of successive approximation continues. Adding those weights of binarily decreasing values by ORing them with the contents of the C register constructs the binary equivalent of the analog signal.

When the high bit is finally rotated out of the 8-bit field of the accumulator and into the carry register, the successive approximations are complete for the analog signal currently addressed, and its digital equivalent is stored in memory. Both the multiplexer address and the data storage address are decremented and the process is repeated for eight analog channels.

### Adjustments

Analog signals that fall outside the 0-to-10-v range for which this system was designed can be adjusted by using the programmable gain amplifier circuit of Fig. 4a. Finally, the system is expandable to 128 analog input channels as shown in Fig. 4b. Also the program must be altered to include extra memory addresses for data storage, and the multiplexer address scheme must be modified to include the added channels. □

## PLL performs accurate phase measurements

by N. H. Sabah  
Engineering and Architecture Faculty, American University of Beirut, Lebanon

The excellent tracking ability inherent in a phase-locked loop is utilized in this meter to measure phase differ-

ences accurate to 0.1°. Although intended for use in the dc-to-1-kilohertz audio-frequency range, the upper limit of the unit can be extended by suitable selection of a high-frequency PLL and appropriate circuitry to reduce phase jitter.

The reference and the signal to be measured,  $f_a$  and  $f_b$  respectively, are applied to the LM208 operational amplifiers, which form the isolating stages. The LM211 comparators that follow provide a rise time of less than 100 nanoseconds and a phase-shift equivalent time between points A'(f) and B'(f) of less than 20 ns. A

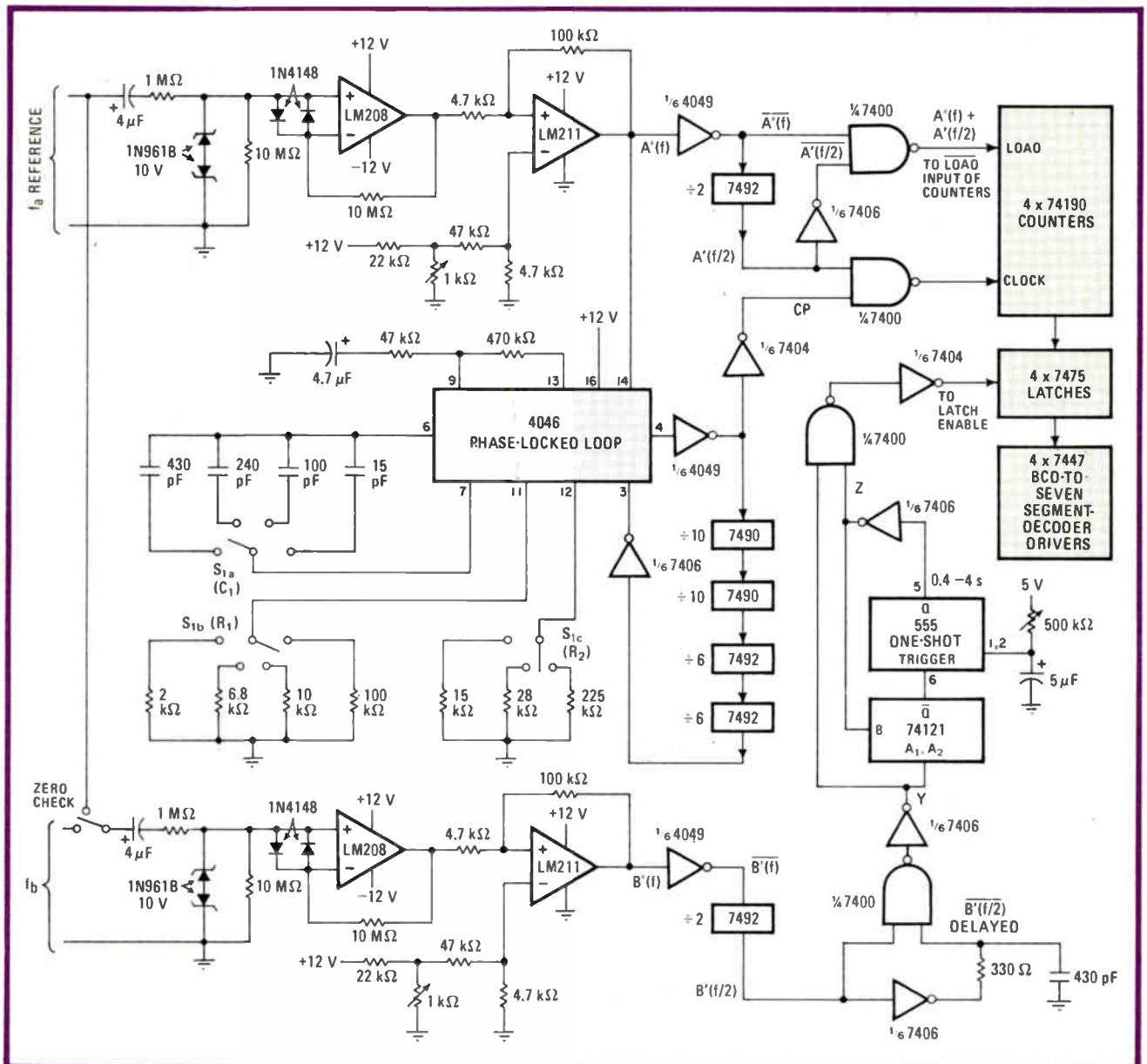

**Angular accuracy.** Meter utilizes tracking ability of PLL to perform phase measurements accurate to 0.1°. 4046 delivers clock signal equal to 3,600  $f_a$  to conventional display (not shown), where count time is determined by  $f_b$ . Thus phase angle of  $f_b$  with respect to  $f_a$  is displayed.

# You don't have to be an IBM to cash in on custom IC's.

**Item:** Of course, all the big guys are heavy users of custom IC's, but most of our clients have sales volumes from \$10 million to \$100 million per year.

**Item:** SSi can provide you with cost-effective custom circuits even when your annual usage is only \$100,000 per year.

**Item:** SSi does it all—from circuit concept through design and on-going production.

If you want it your way, call SSi, Director of Marketing, or send for our capability brochure today.

Silicon Systems incorporated, 14351 Myford Road, Tustin, California 92680. Phone: (714) 731-7110 or TWX 910-595-2809.

**Silicon Systems**  
incorporated

PHASE METER'S RANGING COMPONENTS				
Frequency (Hz)	C <sub>1</sub> (pF)	R <sub>1</sub> (kΩ)	R <sub>2</sub> (kΩ)	Jitter (ppm)
1 – 10	430	100	∞	15,000
10 – 100	240	10	225	10,000
100 – 300	100	6.8	28	8,000
300 – 1,000	15	2	15	5,000

zero-phase check switch is provided so that the reference may be applied to both channels simultaneously. This allows the user to minimize the aforementioned offset time with channel B's 1-kilohm potentiometer, which is located at the input of its corresponding LM211 comparator.

The reference waveform is then applied to the 4046 PLL, which has a 3,600:1 frequency divider in its feedback loop. The output of the 4046 is thus 3,600  $f_a$  and is virtually in phase with the incoming signal. In order to reduce the phase jitter to a minimal value, the PLL is operated over four ranges selected by means of switches S<sub>1a</sub> to S<sub>1c</sub> (see table).

The output of the 4046 serves as the clock for driving a four-digit display circuit, which can be made up conventionally with cascaded sections of 74190 synchronous up/down counters, a set of 7475 4-bit bistable latches,

7447 BCD-to-seven-segment decoder/drivers and suitable displays. (The one-chip ICM7217 provides the counter, latch, and decoding functions and could conceivably be used to reduce the chip count, but requires multiple supply voltages.)

The count is initiated on the rising edge of  $f_a$  and is terminated by the leading edge of a pulse from channel B. Pulses are counted on alternate cycles of the incoming wave, to minimize control circuitry. Because the circuit is designed for steady-state phase measurements, there is no loss in accuracy. The (lagging) phase angle of  $f_b$  with respect to  $f_a$  is then displayed. The 74190 counter circuitry may be simply modified to preset the counters to 360 in the countdown mode, instead of counting up from 0, so that the phase of  $f_a$  with respect to  $f_b$  may be shown. Flicker is eliminated by appropriate selection of the 555 one-shot's timing components. □

## Low-pass Chebyshev filters use standard-value capacitors

by Ed Wetherhold  
Honeywell Inc., Signal Analysis Center, Annapolis, Md.

If a low-pass filtering requirement is such that a roll-off attenuation of 40 decibels per octave is adequate, this table will enable rapid design of seven-element filters of the Chebyshev variety using standard-value capacitors. Both L and C values are given directly for operation in the 1-to-10-megahertz region and are scaled for frequencies outside this range. Element values, specified for filters having a source and load impedance of 50 ohms, are easily calculated for any impedance.

Component values for the Chebyshev filter (see table), which is characterized by low-level equi-ripple response throughout its passband, have been derived by an 85-line program written in Basic. In this configuration and for the equally terminated case, C<sub>1</sub> = C<sub>7</sub>, C<sub>3</sub> = C<sub>5</sub> and L<sub>2</sub> = L<sub>6</sub>. Once a standard-capacitor value for C<sub>3</sub>/C<sub>5</sub> is specified, capacitors C<sub>1</sub>/C<sub>7</sub> and inductors L<sub>2</sub>, L<sub>4</sub>, and L<sub>6</sub> are found for a given reflection coefficient selected to ensure that C<sub>1</sub> is also a standard value. The frequencies corresponding to the 1-, 3-, and 50-dB attenuation points are also calculated.

A simple example illustrates the use of the table.

Consider the case of a filter whose 3-dB cutoff frequency, F<sub>3</sub>, is 6 megahertz and whose terminating impedance, Z<sub>x</sub>, is 75 ohms. The user must:

- Find the scaled impedance factor  $R = Z_x/50$ .
- Calculate the 3-dB cutoff frequency of the 50-Ω filter from  $F_3^n = R \cdot F_3$ , dividing Z<sub>x</sub> by 10<sup>n</sup> where n = 1, 2, . . . if necessary to ensure  $F_3^n < 10$  MHz.
- From the table, select the design closest to that meeting the calculated F<sub>3</sub><sup>n</sup> requirement. Note the tabulated values of C will be used directly in this design, and the L values will be scaled.
- Calculate the exact value of  $F_3 = F_3^n/R$ , where F<sub>3</sub><sup>n</sup> is the tabulated value.
- Calculate the new L<sub>2</sub>/L<sub>6</sub> and L<sub>4</sub> values for the given terminating impedance from  $L = R^2 L_{50}$ .

Given F<sub>3</sub> = 6.0 MHz and Z<sub>x</sub> = 75 Ω, it is seen that  $R = 75/50 = 1.5$ ,  $R^2 = 2.25$  and  $F_3^n = 1.5(6)$  MHz = 9.0 MHz. Filter number 109 is selected because its F<sub>3</sub><sup>n</sup> value is closest to the desired specified value. Thus C<sub>1,7</sub> = 390 pF, and C<sub>3,5</sub> = 750 pF. Inductors L<sub>2,6</sub> =  $R^2(1.39) = 3.13$  microhenries; L<sub>4</sub> =  $R^2(1.57) = 3.53$  μH. These components may be conveniently hand-wound on standard toroidal cores that are readily available. Note that design 109 has a reflection coefficient of 9.99%. If the filter must be operated at a low voltage standing-wave ratio, then design 113, which has a reflection coefficient of only 1.93%, should be used. □

Engineer's notebook is a regular feature in *Electronics*. We invite readers to submit original design shortcuts, calculation aids, measurement and test techniques, and other ideas for saving engineering time or cost. We'll pay \$50 for each item published.

DESIGN TABLE: LOW-PASS CHEBYSHEV FILTERS

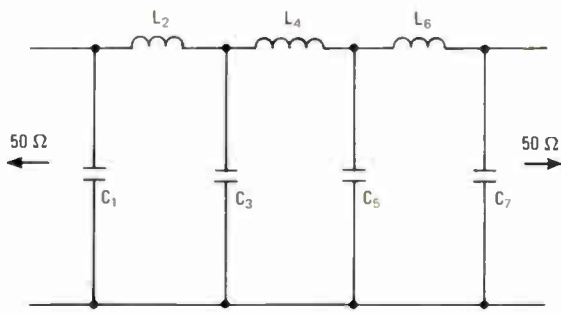

Filter No.	Frequency (MHz)			Reflection coefficient %	C <sub>1,7</sub> (pF)	C <sub>3,5</sub> (pF)	L <sub>2,6</sub> (μH)	L <sub>4</sub> (μH)
	1 dB	3 dB	50 dB					
1	.95	1.04	2.28	.455E-02	1500	5600	10.1	15.3
2	.99	1.06	2.17	.255E 00	1800	5600	10.9	14.8
3	1.04	1.10	2.08	.179E 01	2200	5600	11.4	14.0
4	1.12	1.16	2.06	.663E 01	2700	5600	10.9	12.6
5	1.29	1.33	2.19	.183E 02	3300	5600	8.86	9.69
6	1.07	1.15	2.43	.630E-01	1500	5100	9.61	13.7
7	1.11	1.18	2.33	.720E 00	1800	5100	10.2	13.2
8	1.17	1.23	2.26	.341E 01	2200	5100	10.3	12.3
9	1.29	1.34	2.30	.110E 02	2700	5100	9.29	10.4
10	1.61	1.64	2.62	.302E 02	3300	5100	6.45	6.92
11	1.12	1.23	2.75	.206E-03	1200	4700	8.28	12.9
12	1.18	1.26	2.58	.233E 00	1500	4700	9.14	12.4
13	1.23	1.30	2.49	.147E 01	1800	4700	9.52	11.9
14	1.31	1.37	2.45	.560E 01	2200	4700	9.27	10.8
15	1.50	1.54	2.57	.166E 02	2700	4700	7.75	8.53
16	1.25	1.36	2.93	.185E-01	1200	4300	7.92	11.6
17	1.31	1.40	2.77	.643E 00	1500	4300	8.58	11.1
18	1.38	1.45	2.69	.280E 01	1800	4300	8.71	10.5
19	1.50	1.56	2.70	.917E 01	2200	4300	8.06	9.14
20	1.82	1.86	3.01	.260E 02	2700	4300	5.93	6.40
21	1.35	1.48	3.31	.314E-03	1000	3900	6.89	10.7
22	1.41	1.52	3.14	.138E 00	1200	3900	7.49	10.4
23	1.48	1.57	2.99	.151E 01	1500	3900	7.90	9.85
24	1.57	1.64	2.95	.516E 01	1800	3900	7.73	9.04
25	1.77	1.83	3.07	.152E 02	2200	3900	6.60	7.30
26	1.49	1.62	3.50	.162E-01	1000	3600	6.62	9.74
27	1.55	1.66	3.34	.397E 00	1200	3600	7.10	9.43
28	1.64	1.73	3.21	.271E 01	1500	3600	7.29	8.82
29	1.77	1.84	3.22	.810E 01	1800	3600	6.86	7.83
30	2.09	2.15	3.50	.227E 02	2200	3600	5.30	5.75
31	1.58	1.74	3.95	.554E-06	820	3300	5.73	9.14
32	1.66	1.79	3.73	.108E 00	1000	3300	6.30	8.80
33	1.73	1.83	3.57	.949E 00	1200	3300	6.64	8.47
34	1.85	1.93	3.49	.471E 01	1500	3300	6.58	7.72
35	2.04	2.11	3.58	.128E 02	1800	3300	5.83	6.50
36	1.78	1.94	4.22	.978E-02	820	3000	5.47	8.15
37	1.87	1.99	4.01	.397E 00	1000	3000	5.91	7.85
38	1.95	2.05	3.87	.204E 01	1200	3000	6.09	7.47
39	2.12	2.20	3.86	.810E 01	1500	3000	5.72	6.52
40	2.46	2.52	4.14	.207E 02	1800	3000	4.59	5.00
41	1.94	2.13	4.81	.326E-04	680	2700	4.72	7.46
42	2.03	2.19	4.56	.112E 00	820	2700	5.16	7.19
43	2.12	2.25	4.35	.111E 01	1000	2700	5.45	6.90
44	2.24	2.34	4.26	.411E 01	1200	2700	5.41	6.40
45	2.53	2.61	4.41	.141E 02	1500	2700	4.66	5.18
46	2.25	2.44	5.23	.277E-01	680	2400	4.45	6.47
47	2.34	2.50	4.98	.520E 00	820	2400	4.76	6.25
48	2.46	2.59	4.82	.271E 01	1000	2400	4.86	5.88
49	2.65	2.76	4.82	.810E 01	1200	2400	4.57	5.22
50	3.24	3.31	5.36	.254E 02	1500	2400	3.35	3.62

Filter No.	Frequency (MHz)			Reflection coefficient %	C <sub>1,7</sub> (pF)	C <sub>3,5</sub> (pF)	L <sub>2,6</sub> (μH)	L <sub>4</sub> (μH)
	1 dB	3 dB	50 dB					
51	2.39	2.62	5.88	.148E-03	560	2200	3.87	6.06
52	2.50	2.69	5.57	.148E 00	680	2200	4.23	5.84
53	2.61	2.76	5.34	.117E 01	820	2200	4.44	5.61
54	2.77	2.89	5.23	.471E 01	1000	2200	4.38	5.15
55	3.06	3.16	5.38	.128E 02	1200	2200	3.88	4.33
56	2.69	2.93	6.29	.203E-01	560	2000	3.69	5.41
57	2.81	3.00	5.98	.494E 00	680	2000	3.96	5.22
58	2.94	3.09	5.79	.243E 01	820	2000	4.06	4.99
59	3.18	3.31	5.79	.810E 01	1000	2000	3.81	4.35
60	3.68	3.78	6.22	.207E 02	1200	2000	3.06	3.33
61	2.94	3.22	7.13	.124E-02	470	1800	3.21	4.93
62	3.06	3.29	6.79	.163E 00	560	1800	3.47	4.78
63	3.20	3.38	6.51	.131E 01	680	1800	3.64	4.57
64	3.39	3.54	6.39	.478E 01	820	1800	3.59	4.21
65	3.80	3.92	6.62	.141E 02	1000	1800	3.11	3.45
66	3.40	3.68	7.76	.614E-01	470	1600	3.01	4.29
67	3.53	3.76	7.43	.664E 00	560	1600	3.19	4.15
68	3.72	3.90	7.21	.309E 01	680	1600	3.24	3.88
69	4.04	4.19	7.27	.925E 01	820	1600	3.00	3.39
70	4.85	4.97	8.04	.254E 02	1000	1600	2.23	2.41
71	3.52	3.86	8.57	.938E-03	390	1500	2.67	4.11
72	3.68	3.95	8.14	.181E 00	470	1500	2.90	3.97
73	3.83	4.05	7.82	.119E 01	560	1500	3.03	3.82
74	4.06	4.24	7.67	.464E 01	680	1500	2.99	3.52
75	4.50	4.65	7.89	.129E 02	820	1500	2.64	2.94
76	4.04	4.43	9.96	.106E-03	390	1300	2.28	3.58
77	4.21	4.54	9.50	.908E-01	390	1300	2.47	3.47
78	4.38	4.65	9.08	.901E 00	470	1300	2.61	3.34
79	4.60	4.82	8.87	.338E 01	560	1300	2.62	3.14
80	5.03	5.21	8.99	.103E 02	680	1300	2.39	2.70
81	4.47	4.86	10.5	.119E-01	390	1200	2.19	3.25
82	4.64	4.97	10.1	.294E 00	390	1200	2.35	3.16
83	4.84	5.11	9.70	.174E 01	470	1200	2.43	3.01
84	5.13	5.35	9.59	.550E 01	560	1200	2.37	2.76
85	5.79	5.97	10.0	.155E 02	680	1200	2.02	2.23
86	4.97	5.36	11.2	.908E-01	390	1100	2.09	2.94
87	5.16	5.48	10.8	.752E 00	390	1100	2.20	2.84
88	5.42	5.68	10.5	.320E 01	470	1100	2.22	2.66
89	5.85	6.07	10.6	.893E 01	560	1100	2.07	2.35
90	6.95	7.13	11.6	.240E 02	680	1100	1.58	1.71
91	5.34	5.82	12.7	.628E-02	270	1000	1.81	2.72
92	5.58	5.97	12.0	.353E 00	390	1000	1.97	2.62
93	5.80	6.13	11.7	.169E 01	390	1000	2.03	2.51
94	6.18	6.44	11.5	.573E 01	470	1000	1.97	2.29
95	6.88	7.09	12.0	.146E 02	560	1000	1.71	1.89
96	6.00	6.47	13.6	.744E-01	270	910	1.72	2.43
97	6.26	6.65	13.0	.926E 00	390	910	1.83	2.34
98	6.56	6.88	12.7	.327E 01	390	910	1.84	2.20
99	7.13	7.39	12.8	.964E 01	470	910	1.69	1.91
100	8.35	8.56	13.9	.235E 02	560	910	1.32	1.43
101	6.50	7.09	15.5	.487E-02	220	820	1.48	2.23
102	6.81	7.28	14.7	.344E 00	270	820	1.61	2.15
103	7.14	7.52	14.1	.213E 01	390	820	1.66	2.04
104	7.58	7.89	14.0	.614E 01	390	820	1.61	1.86
105	8.56	8.82	14.7	.165E 02	470	820	1.36	1.49
106	7.26	7.84	16.6	.598E-01	220	750	1.41	2.01
107	7.59	8.06	15.8	.867E 00	270	750	1.51	1.93
108	8.03	8.40	15.4	.386E 01	390	750	1.51	1.79
109	8.69	9.00	15.6	.999E 01	390	750	1.39	1.57
110	10.39	10.6	17.2	.257E 02	470	750	1.04	1.12
111	7.81	8.53	18.8	.264E-02	180	680	1.22	1.86
112	8.18	8.76	17.8	.278E 00	220	680	1.33	1.79
113	8.58	9.04	17.1	.193E 01	270	680	1.38	1.70
114	9.22	9.60	17.0	.687E 01	390	680	1.32	1.52
115	10.33	10.6	17.8	.165E 02	390	680	1.12	1.24
116	8.76	9.48	20.1	.484E-01	180	620	1.16	1.67
117	9.15	9.73	19.1	.758E 00	220	620	1.24	1.60
118	9.63	10.1	18.6	.362E 01	270	620	1.25	1.49
119	10.67	11.0	18.9	.113E 02	390	620	1.12	1.26
120	12.64	12.9	20.9	.262E 02	390	620	.851	.918

# Engineer's newsletter

---

## **NBS specifies graphic and geometric data exchange**

As the field of computer-aided design and manufacturing has advanced, the lack of a generally accepted method for data exchange has become, in the view of the Air Force, the Army, the Navy, and the National Aeronautics and Space Administration, a major problem in realizing its full potential. To solve this problem, they have funded the National Bureau of Standards, which in turn produced a specification to "facilitate the exchange of graphic or geometric information from one computer-aided design or computer-aided-manufacturing system to another." Called the **Initial Graphics Exchange Specification (IGES)**, it also allows for the **archiving of data found in these systems**. With IGES, a company can develop codes to translate data from its systems into the specification. Data can then be moved between any two systems through an intermediate IGES step. For information or a copy of the document, write to Dr. Roger Nagel at the NBS, Bldg. 220, Rm. A-123, Washington, D. C. 20234.

## **Manual offers help for designing magnetic shields**

Magnetic shielding can be a serious problem for the electronics engineer, particularly when encountered for the first time. A new shielding manual and catalog from Ad-Vance Magnetics **devotes 65% of its 64 pages to technical and engineering information on the subject**. There are sections on the theory of magnetic shielding, shaping magnetic shields, and a design procedure for shields, plus a highly technical treatment entitled "Basic Relations between E and H Vectors for a Plane Wave." **In addition, 20 case histories give the first-timer in this field some helpful design hints**. For a free copy, write on company stationery to Ad-Vance Magnetics Inc., 625 Monroe St., Rochester, Ind. 46975.

## **Communicating by light**

For those interested in one of the hottest topics in electronics, optical communications, the Laser Institute of America is giving a five-day course from Aug. 4 to 8 at The Lodge, Vail, Colo. The course will consist of **lectures on the theory and practical application of optical communication systems**, including transmitters (light-emitting and laser diodes), modulation techniques, transmission media, and receivers. The cost is \$550. For more information, contact Laser Institute of America, Short Course Division, P. O. Box 9000, Waco, Texas 76710.

## **Executing LPRINT on the TRS-80 without a printer**

Frequently there's a need for running a Basic program containing imbedded LPRINT (print-on-a-line-printer) statements on the TRS-80 without actually using a printer. This cannot be done directly because a TRS-80 goes into a wait state upon encountering an LPRINT statement when not finding a powered-up printer attached. It is possible to remove all LPRINTS from the program and later put them back in, but the procedure is rather complicated.

Cass Lewart has found a simple solution to "fool" the computer. He simply puts a plug on the printer edge connector of the TRS-80 expansion interface, then shorts three pins on the connector: busy (pin 21), out-of-paper (pin 23), and ground (pin 27). For additional details, contact him at System Development Corp., Route 35, Monmouth Mall, Eatontown, N. J. 07724.

-Jerry Lyman

# DIP Compatible.

AVX DIPGuards® are multi-layer ceramic capacitors, in a two-pin dual-in-line package, that are compatible with standard IC dual-in-line components. Their .300" lead spacings make PC board layouts easier—and that means shorter interconnections for more efficient high frequency noise decoupling. Conforming to the standard IC package also cuts handling costs. For example, DIPGuard's lead standoffs eliminate soldering problems, and



allow more efficient PCB cleaning and inspection. DIPGuard's short, preformed leads cut handling costs further by eliminating lead trimming, crimping,

and straightening.

AVX DIPGuards can be automatically inserted along with other DIP components with only a single setup required, and DIPGuards can be hand inserted at a rate four times that of radial leaded components.

To take advantage of DIPGuard's component compatibility, give your local AVX Representative a call, or write: AVX Ceramics, Dept. D-1, P.O. Box 867, Myrtle Beach, SC 29577



Technology for the times

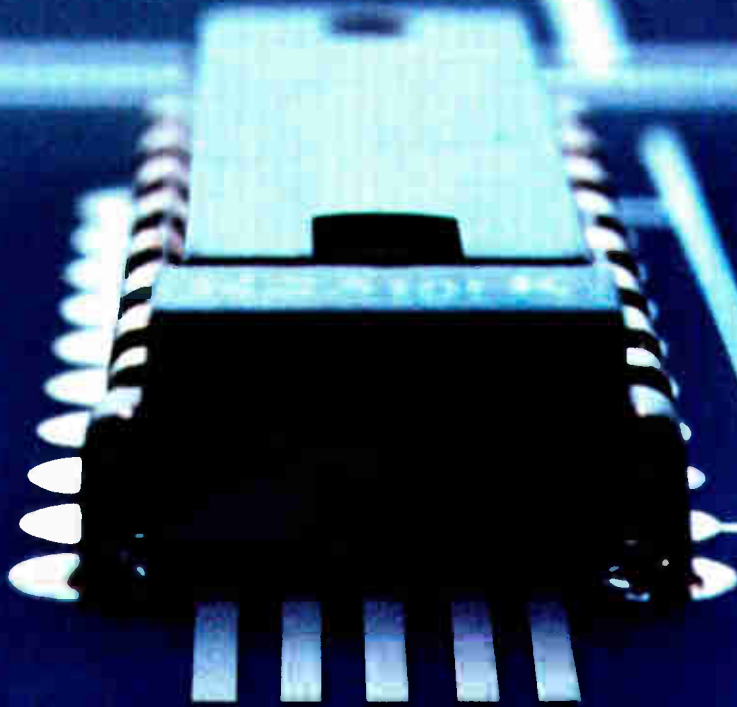

# More reasons to choose CMOS over NMOS.

**RCA Microprocessor  
Development Systems  
make designing with CMOS  
easier than ever.**

**COSMAC DOS Development System.** Includes a chassis with 28K RAM, dual drive floppy disk, Disk Operating Software, plus utility programs and extensive documentation.

**High Level Languages.** In addition to microFORTH, we're adding a Basic 1 Compiler/Interpreter and PLM 1800 Compiler.





Designers everywhere are learning of the advantages of CMOS over NMOS for their microprocessor designs.

Advantages such as low heat generation, low power drain, high noise immunity, wide operating temperature range and wide power supply voltage range.

Now, RCA is adding still more benefits to our 1800 series.

We're adding three new time-saving development tools to our already substantial line.

### **New Disk Operating System.**

On the hardware side, we're introducing our new COSMAC DOS System (CDP 18S007). This new system is a powerful development and prototyping tool for designing hardware/software systems with our 1802 microprocessor and RCA Microboards.

If you have our CDP 18S005 Development System, we also offer an upgrade package CDP 18S837 with Disk Operating Software and other accessories that gives your older model operating capability equivalent to our new DOS system.

**High Level Languages: PLM and BASIC.** On the software side,

we've developed two new packages designed to operate on our new DOS development system.

Designed for the experienced programmer, our new PLM-1800 Compiler (CDP 18S839) is the most powerful structured programming tool available for 1802 designs.

If you're designing in BASIC, our Basic 1 Compiler/Interpreter package (CDP 18S834) can both simplify and shorten your programs.

You can also use Basic 1 to compile programs into machine code for compactness and faster program execution in your final design.

### **A go-anywhere Micromonitor.**

Here's a portable development tool that works as well in the field as it does in the lab. Our acclaimed COSMAC Micromonitor (CDP 18S030).

The Micromonitor is a complete diagnostic and design tool, capable of real-time, in-circuit hardware and software debugging, factory check-outs and field testing.

### **CMOS Evaluation Kit: \$350.**

For just \$350 (optional with distributors), the CDP 18S025 gives you everything you need to build a microprocessor evaluation system: CPU,

RAMs, ROMs, I/O, passive components, p.c. board, hardware, even a fully assembled micro-terminal.

You can use the kit to learn about basic system design, hardware interfacing and programming.

### **Other timesavers.**

Additional RCA development tools include: a Micromonitor Operating System software package, fixed point and floating point arithmetic subroutines, a PROM programmer. And even more design aids are in the works.

Plus, 36 RCA "Systems Appointed Distributors" offer technical assistance, systems demonstrations and off-the-shelf delivery.

A complete list of Systems Appointed Distributors appears on the following page.

For more information on our broad line of development tools for the RCA 1800 series, contact your local RCA Solid State Distributor.

Or contact RCA Solid State headquarters in Somerville, New Jersey. Brussels, Belgium. Or Tokyo, Japan.

# **RCA**

Circle 165 on reader service card

**Portable Micromonitor.** Our Micromonitor is a powerful, portable 1802 microprocessor real-time, in-circuit hardware/software diagnostic tool. Yet it weighs only 16 pounds.

**Low cost Evaluation System.** To see how compact our CMOS systems can be, compare our Evaluation Kit power supply with a typical NMOS supply (white outline).



# RCA Systems Appointed Distributors.

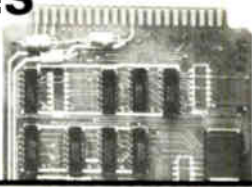

## California

Arrow/San Francisco  
Sunnyvale (408) 739-3011

Wyle Electronics, Inc.  
Santa Clara (408) 727-2500

Hamilton-Avnet Electronics  
Sunnyvale (415) 743-3300

Hamilton Electro Sales  
Culver City (213) 558-2020

Hamilton-Avnet Electronics  
Costa Mesa (714) 754-6051

Schweber Electronics Corp.  
Irvine (714) 556-3880

Schweber Electronics Corp.  
Santa Clara (408) 496-0200

## Colorado

Wyle Electronics  
Commerce City  
(303) 287-9611

## Florida

Arrow Electronics, Inc.  
Ft. Lauderdale  
(305) 776-7790

Schweber Electronics Corp.  
Hollywood (305) 927-0511

## Georgia

Arrow Electronics, Inc.  
Norcross (404) 449-8252

## Illinois

Hamilton-Avnet Electronics  
Schiller Park (312) 678-6310

Schweber Electronics Corp.  
Elk Grove Village  
(312) 593-2740

## Maryland

Arrow Electronics, Inc.  
Baltimore (301) 247-5200

Hamilton-Avnet Electronics  
Hanover (301) 796-5000

Schweber Electronics Corp.  
Gaithersburg (301) 840-5900

## Massachusetts

Arrow Electronics, Inc.  
Woburn (617) 933-8130

Hamilton-Avnet Electronics  
Woburn (617) 935-9700

Schweber Electronics Corp.  
Bedford (617) 275-5100

## Michigan

Hamilton-Avnet Electronics  
Livonia (313) 522-4700

Schweber Electronics Corp.  
Livonia (313) 525-8100

## Minnesota

Arrow Electronics  
Edina (612) 830-1800

Schweber Electronics Corp.  
Eden Prairie (612) 941-5280

## New Jersey

Arrow Electronics, Inc.  
Moorestown (609) 235-1900

Arrow Electronics, Inc.  
Saddlebrook (201) 797-5800

Schweber/NJ Electronics  
Fairfield (201) 227-7880

Wilshire Electronics/NJ  
Clifton (201) 340-1900

## New York

Arrow Electronics, Inc.  
Farmingdale, L.I.  
(516) 694-6800

Schweber Electronics Corp.  
Rochester (716) 424-2222

Schweber Electronics Corp.  
Westbury, L.I.  
(516) 334-7474

## Ohio

Arrow Electronics, Inc.  
Dayton (513) 253-9176

Schweber Electronics Corp.  
Beachwood (216) 464-2970

## Pennsylvania

Schweber Electronics Corp.  
Horsham (215) 441-0600

## Texas

Arrow/Texas  
Dallas (214) 386-7500

Hamilton-Avnet Electronics  
Houston (713) 780-1771

Schweber Electronics Corp.  
Dallas (214) 661-5010

Sterling Electronics, Inc.  
Houston (713) 627-9800

Wyle Electronics  
Bellevue (206) 453-8300

Now you can sound off  
right from your  
printed circuit boards.

## The Mallory Sonalert® Signal.

This new Sonalert design gives you a choice of three medium loud sounds—continuous, fast pulse, or slow pulse at 2900 Hz. It will even give you pulsing or continuous sound in the same package. You can spec it into just about anything in which you need sound. And its pin mounting makes it easy to insert and solder into printed circuit boards. Units may be hand or wave soldered.

Mallory Sonalert Electronic Signals are available direct, or through authorized Mallory distributors in U.S., Canada and overseas. Give us a hearing. Write or call. Mallory Capacitor Co., a division of Mallory Components Group, P.O. Box 372, Indianapolis, Indiana 46206. (317) 636-5353.

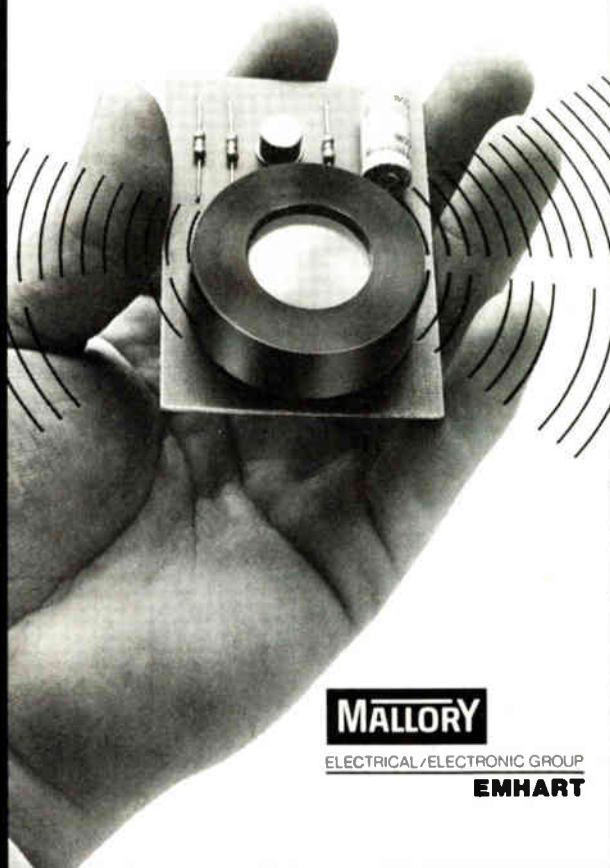

**MALLORY**  
ELECTRICAL/ELECTRONIC GROUP  
**EMHART**

See our ad on previous pages.

**RCA**

**MALLORY**

# Cerdip goes **SUPERDRY™**



Kyocera challenges the future with SuperDry™ cerdip packages. Due to an innovative and exclusive manufacturing process,

Kyocera cerdip packages require no moisture reducing additives. You save the cost of the desiccant. Test results indicate that the moisture levels in our SuperDry™ packages are similar to or better than packages with desiccant.



Kyocera believes in service. For additional information regarding Kyocera's SuperDry™ packages, contact your local Sales or Customer Service representative.



Semiconductor Headquarters  
Kyocera International, Inc.  
10050 North Wolfe Road  
Cupertino, California 95014  
408-257-8000  
Corporate Headquarters  
Kyocera International, Inc.  
8611 Balboa Avenue  
San Diego, California 92123  
714-279-8310

---

**KYOCERA International, Inc.**  
"Challenging the Future"

---

From the motion picture "The Graduate." ©1967 Avco-Embassy Pictures Corp.



**“I JUST WANT TO SAY  
ONE WORD TO YOU...  
PLASTICS!”**

# "HITACHI CMOS PLASTICS!"

## INTRODUCING HITACHI CMOS PLASTIC TECHNOLOGY

Now, more than ever before, the world depends on electronic technological advancement to reduce our energy problems. And, we've responded. Through Hitachi CMOS technology.

### "HI-CMOS"

A technology so unique, it's enabled us to combine the low power of CMOS and the high speeds of HMOS with cost-effective NMOS densities.

With the low power of Hitachi CMOS we can now offer high-speed static RAMs in plastic with densities up to 16K.

## CMOS PLASTIC VS. NMOS POWER LIMITS

Hitachi CMOS plastic technology allows plastic packaging of high-speed static RAMs to densities of 64K and beyond, whereas NMOS reaches the limit at 16K.

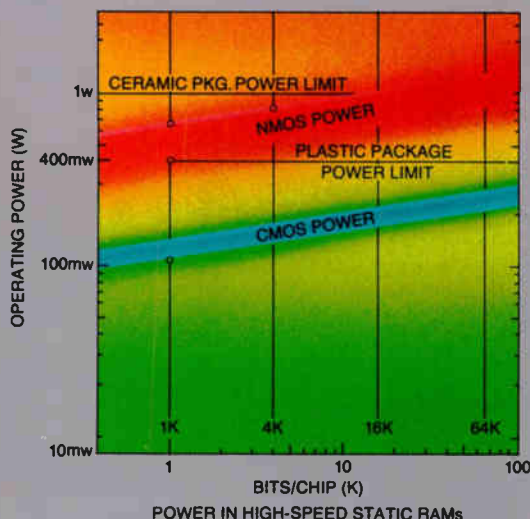

This advanced CMOS plastic technology means you'll need only 200mw to operate our 16K devices compared to the 700mw operating power required by standard 16K NMOS cerdip RAMs.

## MORE REASONS TO CHANGE TO CMOS PLASTIC

Pin-for-pin compatibility. Comparable high speeds. Radically lower-power dissipation. Lower operating temperatures. Reduced need for high-current power supplies. Prices competitive with NMOS cerdip RAMs.

The list goes on, but only you can make the comparison for use in your application.

Part No.	Organization	Speed	Operating Power	Availability
6147	4K x 1	55/70	75mw	Now
6148	1K x 4	55/70	150mw	Samples
6116	2K x 8	120/150/200	200mw	Samples
4334	1K x 4	300/450	20mw	Now
4315	4K x 1	350/450	20mw	Now

The IR100 award winning HM6147 CMOS memory exemplifies this line of state-of-the-art products. A unique combination of high-speed NMOS memory cells and low-power CMOS peripheral circuits yield fast (55ns) access times with the low-power dissipation (75mw) characteristic of CMOS technology.

Compare our plastic packaged HM6147, 4K x 1 CMOS RAM with your present 2147 device. You'll find ours offers unduplicated power advantages plus comparable speeds.

Then compare our HM6148, 1K x 4 with any 2148. Our 55ns access time meets that of your 4K high-speed NMOS static, but only Hitachi adds lower-power characteristics: including 150mw operation and only 5µW during complete standby.

And, our 16K HM6116, 2K x 8 has an address access time of 120ns with low-power dissipation during operation of 200mw, just 20µW during complete standby.

## SAY GOODBYE TO HIGH POWER DISSIPATION PROBLEMS

Just say "HITACHI CMOS PLASTICS" to your Hitachi representative or distributor for data sheets, samples and prices. He'll make delivery, reduced power dissipation and lower cost a sure thing.



**Hitachi. The sure thing.**

Hitachi America, Ltd. • Electronic Devices, Sales and Service Division  
707 W. Algonquin Road • Arlington Heights, IL 60005 • (312) 593-7660 • TLX20-6825

Stocking Distributors: Anthem • Bell • CAM/RPC • Diplomat • Future • Jaco • Marshall • Milgray • RC Components • Resco • RM Electronics • Sterling • Time • Western Micro Technology

Circle 169 on reader service card

AEG-TELEFUNKEN



Wherever maximum reliability is  
a minimum requirement

## Plane LED's. Telerel tested. The new brilliant idea.

We are the leading manufacturers in the field of Optoelectronics. And we want to stay that way. We think we can do this with a combination of experience and progress.

The new plane 3 and 5 mm LED's are proof of our constant development work.

In addition to normal and rectangular components, we can now also supply you with square, round and triangular components which you can piece together to form different groups of symbols.

Whether you place small or large orders, we always supply you with TELEREL quality. The inestimable advantages are high expected life service, insensitivity to shocks and high luminous intensity.

We can supply you with 48 (Forty-eight!) types in colors red, orange-red, green and yellow.

As you can see, we have the complete range. And the know-how you need.

Simply ask for our new information material from:

AEG-TELEFUNKEN  
Corporation  
Route 22 - Orr Drive  
Somerville  
New Jersey 08876

Just call us up - If you wish, you can contact one of our nearest agent



# Stimulus unit simplifies failure analysis

Servicing microprocessor-based boards using signature analysis no longer requires a built-in stimulus

by Martin Marshall, West Coast Computers & Instruments Editor

The introduction of Hewlett-Packard's model 5004A unveiled the concept of digital signature analysis to the instrumentation world [*Electronics*, March 3, 1977, p. 89]. Because it allowed faults to be traced by checking four hexadecimal characters against those in a trouble-shooting tree, it could greatly simplify field maintenance. But that revealed only half of the measurement picture.

Companies that wished to use signature analysis in the servicing of their microprocessor-based products were told that the stimulus required for the analysis needed to be designed into the product. The design effort is comparatively small, but its absence denied the use of signature analysis for servicing the large body of microprocessor-based equipment that was already in the field.

As manufacturers became familiar with the techniques of signature analysis, they also began finding ways to retrofit the technique into their existing product lines [*Electronics*, Feb. 14, 1980, p. 102]. Now, however, with the introduction of the HP 5001A microprocessor exerciser even these retrofitting efforts may become unnecessary. The HP 5001A is the first of a line of such instruments planned by HP to provide the field service technician with a simple external means of stimulus for his signature analysis measurements.

Availability of the new HP instrument will also give the equipment manufacturer a convenient way to apply signature analysis to his products without undertaking costly hardware redesign.

HP's present design provides the necessary stimulus routines for sys-

tems based upon 6800-type microprocessors only, but other versions to accommodate the 8085, 8080, and

Z80 microprocessors are forthcoming. The 8085 version should be available this fall, while the 8080

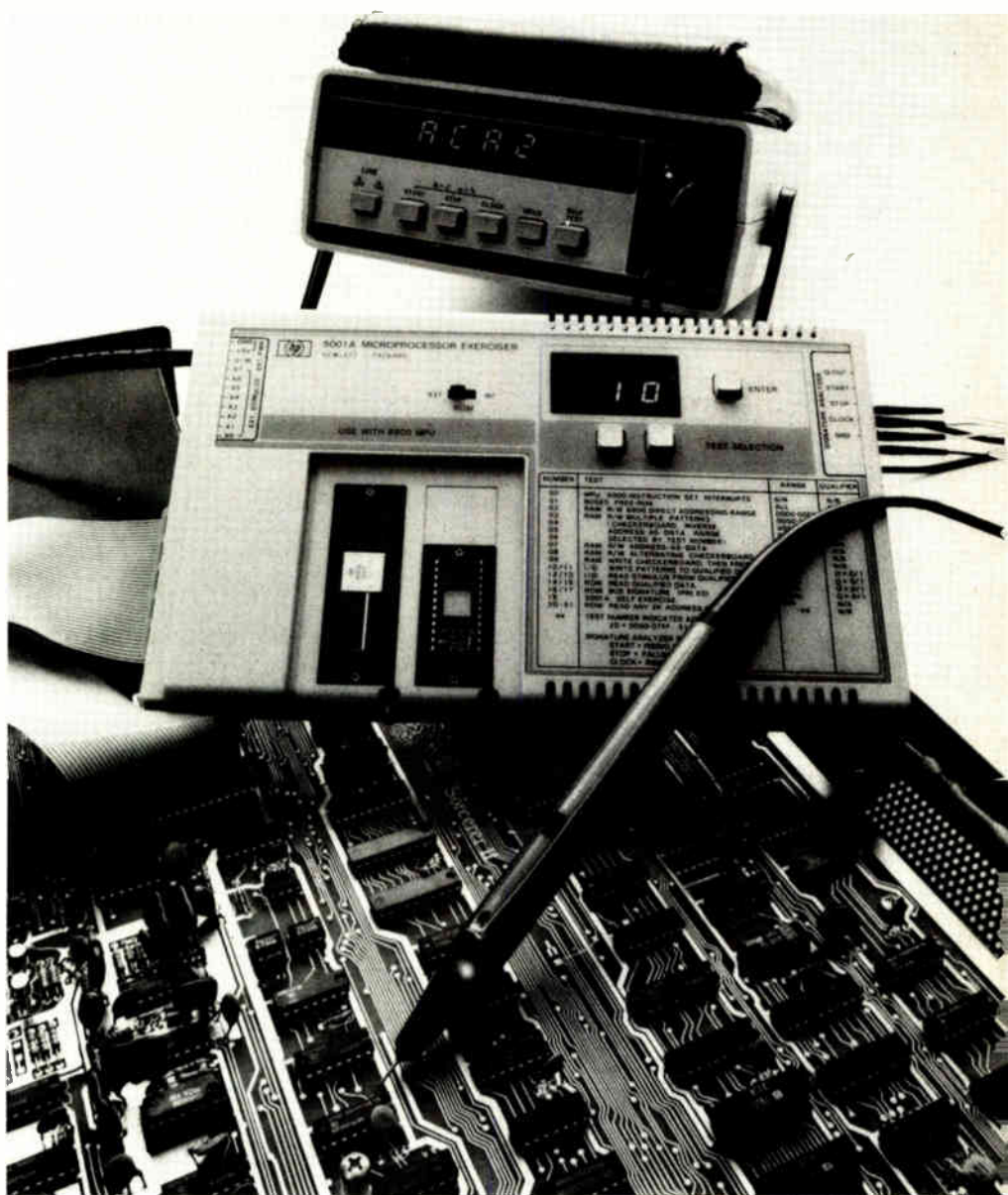

# VACTEC Photodetectors

Vactec can be objective in helping you design the correct detector for your application with the greatest variety in the industry. We also produce custom arrays and assemblies. Write for bulletins.

- BLUE ENHANCED Si Photovoltaic Cells

- STD. Si Photovoltaic Cells

- LO CAPACITANCE Si Photovoltaic Cells

- BLUE ENHANCED Si Photodiodes

- FAST Photodiodes

- CdS & CdSe Photoconductive (LDR's)

- Se CELLS

- NPN Si Phototransistors

VACTROLS  
(Opto-couplers)

- LDR/LED

- LDR/NEON

- LDR/LAMP

**VACTEC,  
INC.**

10900 Page Blvd.  
St. Louis, MO 63132  
(314) 423-4900  
TWX 910-764-0811

## New products

and Z80 versions should be available by mid-1981. With a \$900 price tag, these "stimulus pods" are sufficiently low-priced to reach the first-line service technician's tool box.

To prepare for use, the 5001A is connected to the system under test through the socket of the system's microprocessor, which in turn, plugs into a similar socket in the 5001A. Stop, start, clock, and ground leads from the signature analyzer are plugged into the 5001A, instead of the board under test, and the 5001A controls these lines through the microprocessor. The 5001A derives its power and clocking from the system under test.

To take a signature, the user presses two scrolling numeric keys (for tens and ones) until the test number (00-51) is displayed. After placing the signature analyzer's data probe on the proper circuit node, he presses the "enter" button on the 5001A. The stimulus is generated and the signature displayed on the analyzer.

For tests customized to a product, a second socket on the exerciser accepts a 2716-type erasable programmable read-only memory containing the user's customized routines. A switch on the exerciser shifts the input stimuli from internal to external ROM, and the user then selects the test numbers that are labeled on his custom ROM.

The prepackaged tests available on the 5001A include a test of all interrupts and instructions on the 6800 microprocessor itself, as well as a free-run test for processor bus integrity, 36 ROM read tests, 8 read/write tests for random-access memory, and a self-exercising routine for the 5001A. These tests were designed by HP to provide 80% of the stimuli required to test the microprocessor-controlled portion of a product. (In fact, HP's first application of the exerciser at a customer's plant revealed that the canned routines covered 90% of the necessary stimuli.) "Using conservative figures, we used one man-week with the canned programs to achieve 90% testability of the microprocessor-controlled portion of the target product, including

documentation," notes Ed White, product manager for signature analysis at Hewlett-Packard's Santa Clara, Calif., division. "It took another man-week to write, verify, and document the other 10% of the stimulus needed."

A particularly convenient feature of the 5001A is its ability to generate single-line bus signatures. Using a signature analyzer alone, a signature must be obtained for each line on the bus by repeating a given test eight times, in the case of an 8-bit bus. The 5001A, however, does this job for the user in one pass. It reads the data from the processor's bus, serializes it, and puts it out as a single bit stream, thus enabling a single signature to characterize an entire bus transaction. In a similar fashion, the contents of a ROM may be characterized by a single signature.

Aside from patterns for exercising the system through the microprocessor socket, the 5001A has eight separate output-port tests that feed all possible 8-bit patterns into the port after it has been qualified.

The 5001A also has qualifier input and output lines to aid in selectively addressing system components. For example, in an output-port test, the qualifier line connects to the chip-enable pin of the port to be tested. When the enter button is pressed, the microprocessor searches its address field until that chip is enabled, then writes all possible 8-bit patterns to that port.

Since the 5001A is a generically new type of instrument, it is difficult to assess its impact on the field service world, but its immediate benefits, such as one-signature bus measurement and even a single-signature microprocessor test, should speed the adoption of signature analysis as a uniform servicing tool. Many of its prepackaged tests are not exhaustive—the RAM test, for example, is only the reading in and writing out of a checkerboard pattern—but they are in keeping with the product's use as a low-cost first-line field service instrument.

Hewlett-Packard, 1501 Page Mill Rd., Palo Alto, Calif. 94304. Phone (415) 857-1501 [338]



**AMP Latch is the  
strongest link between**



**mass termination,  
tooling and assemblies.**

# Because performance is a function of quality.

An interconnection system designed to deliver outstanding performance because the equipment it works in—your equipment—has to deliver outstanding performance. For that reason, you'll find unmatched quality standards in every part of the AMP Latch connector system. From the connectors to the cable to the tooling. Just take a look...



## AMP Latch connectors.

Available in cable-to-cable, card edge, DIP and receptacle styles, each works with twisted pair, ribbon or bonded cables. And all are intermateable with a full range of headers, including right-angle, feed-through and barrier types. To complete a truly versatile, expandable system, they are compatible with discrete, flat flex, coaxial and transmission cable connectors.

What's more, you get all the features that are setting industry standards for performance, reliability and ease of application. Features like redundant, duplex-plated contacts and heavy-duty strain relief covers for electrical and mechanical dependability. Polarization and positive latching for accuracy and built-in inspection ports for simplified test and repair.

## Tooling.

We have it to complement these quality features — with automatic and positive alignment to lower your rejection rate, and one-step mass termination for cost-effective production without wire stripping or extra steps. No matter what your production needs are, from prototype to full run, we have the tooling you need.

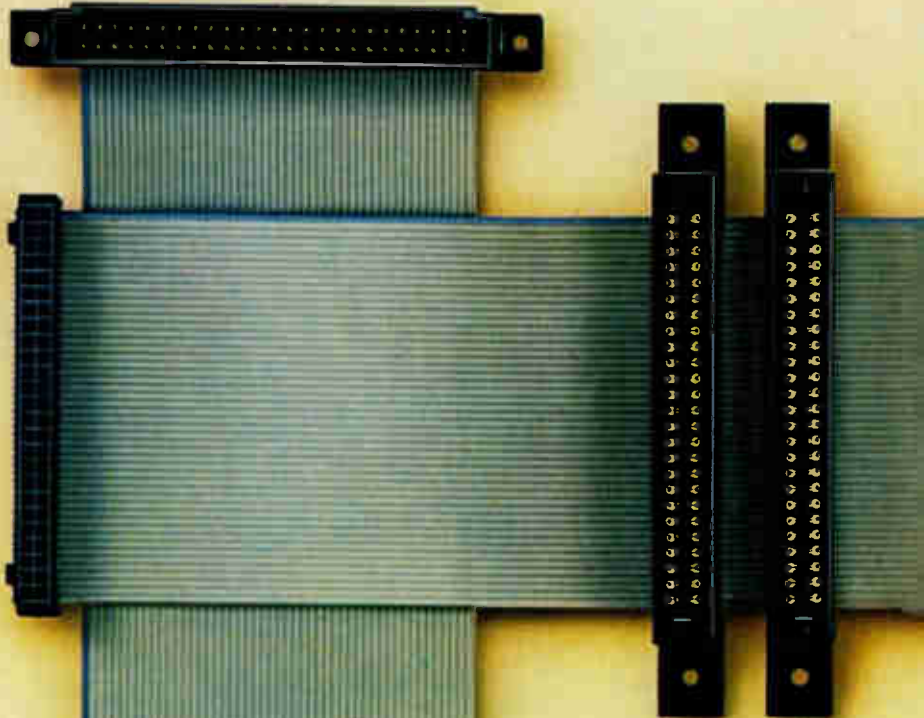

## Card edge styles.

Either cable-end or daisy chain configurations, these are just two of the variations available for your application. But the one thing they all have in common is AMP precision tooling to give you these assemblies in minutes. Complete with the savings of mass termination.

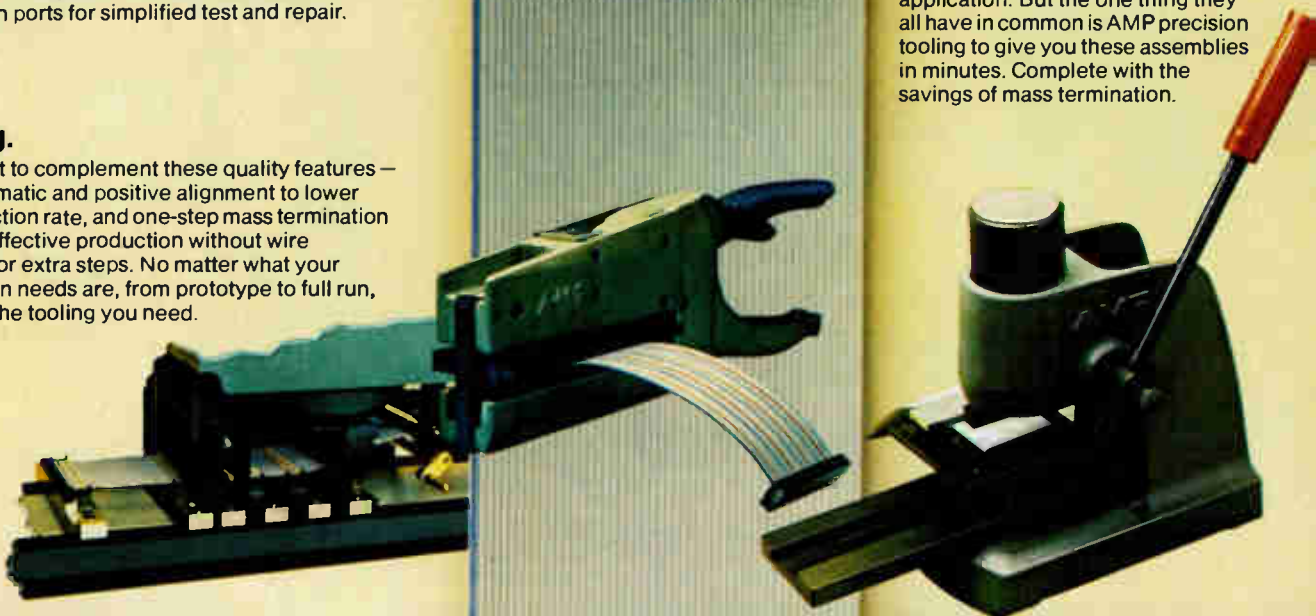

## New quality cable for AMP assemblies.

With AMP Latch connectors on one end and compatible connectors like our subminiature D series on the other, we give you the best possible combination of benefits.

First of all, they're made by AMP, so there's no need for you to set up a manufacturing facility.

But beyond that, you get a quality interconnection system, the reliability of a full range of matching products and the cost-effectiveness of mass termination in fully tested assemblies. Quality, because it's designed to strict specifications and manufactured to deliver those specs consistently. So every inch of cable is consistent in spacing width, thickness, flex, marking, conductor location—every parameter you can think of.

Compare these standards to any other cable on the market. You'll find only AMP cable meets all the criteria.

### Some facts worth knowing about AMP Latch Connectors

**Performance:** Meets or exceeds performance requirements of MIL-S-83503.

**Function:** Simultaneous mass termination of all conductors without cable stripping.

**Wire types:** Small gauge solid or stranded discrete wires as well as flat ribbon, woven ribbon and other types flat cable with round conductors on .050" centers.

**No. of positions:** 10 to 60.

**Connector types:** Wide variety of cable-to-cable, card edge, DIP and receptacle connectors available.

**Mates with:** Full range of headers and pcb posts.

**Electrical Current Rating:** 1 Ampere (Continuous).

**Operating Temperature Range:** -55°C to +105°C.

**Dielectric Withstanding Voltage:** 500 Volts, RMS.

**Tooling available:** Pneumatic and Manual Bench Mounted Models and a Hand Tool, each with interchangeable die sets.

**Who to contact:** Call the AMP Latch Information Desk at (717) 780-8400. Or write AMP Incorporated, Harrisburg, PA 17105.

### Fully shrouded Universal Headers.

These are also part of the AMP Latch interconnection system, featuring positive locking and one-handed squeeze-to-release action. And there are hundreds of other header styles. Barrier inserts to allow mixing of several connector styles and sizes in one header. Styles that accept polarized and detent connectors, panel feed-through headers and much, much more.

AMP has a better way.

# AMP

Circle 175 on reader service card

# J389

TERADYNE J389 TEST SYSTEM



# IN RAM TEST ACCURACY, ENTER THE NEXT GENERATION.

The new J389 Memory Test System gives you the narrowest guardbands ever. Plus high-integrity waveforming and test flexibility for next generation devices: the 64k and 16k-5v dynamic RAMs, the high-speed one-wide and byte-wide static RAMs.



Quarter-nanosecond timing accuracy and address and data alignment minimize guardbands.

New Remote Test Electronics delivers system accuracy with 10 nanosecond I/O active load switching and half-nanosecond data detector skew.

Flexibility for complex RAMs comes from 16 timing and formatting sets operating at 20MHz.

Automatic Edge Lock continuously self-calibrates clock edges and address and data skew to within a quarter-nanosecond, monitoring voltages for outstanding correlation.

Teradyne's PASCAL-T software minimizes programming time and allows symbolic debugging in the language of the written program.

Real-Time Bit Mapping for state-of-the-art characterization is well-proven. And the J389's new architecture and thermal design keep the whole system Teradyne-reliable.

Added to an installed base of several hundred J380-series systems, the J389 continues to give you the Definite Edge in RAM testing.

Contact Teradyne, Inc., 21255 Califa Street, Woodland Hills, California 91367.

## TERADYNE



**NASA was willing to bet a billion dollars on our switches.**

The planet Mars has long been the object of Man's curiosity. Perhaps because it is the most likely of all planets to have life on it.

After traveling over 400 million miles, and after rejecting three sites as too dangerous, the Viking I spacecraft set down safely in the northern hemisphere. Its search for life began when it reached out a mechanical arm for samples of Martian soil.

That arm depended on two of our limit switches.

Three years earlier, project technicians came to us in search of switches that could survive the long trip, the rough landing, and the intensely cold Martian nights.

Working together, we found a way to make two of our miniature hermetically-sealed limit switches do the job. And to make the trip that Man has made so many times in science fiction.

That's no easy task when you consider what those switches had to go through, even before they helped control the movement of that mechanical arm.

Earlier, Mariner space probes took long-distance shots that revealed a terrain with towering volcanoes, some perhaps still active. At least one three times as high as Mount Everest.

And a gigantic canyon system nearly four miles deep, 150 miles wide, and as long as the United States is wide.

A rugged landing could put a fragile switch out of commission. Then there was the orange-red dust that covered the entire planet. A hermetic seal kept our switches clean.

So they survived the trip. And they worked. When no one could afford a failure.

Helping to make the Mars mission a success is only one of the ways we've helped our customers.

We've been working with medical specialists who are designing and testing an artificial heart. One of our sensors makes it beat.

We're also working with leading auto manufacturers in the development of the computerized car engine.

Working with customers early in their design process nearly always results in a better product. For them, and for us. That's one of the reasons why we have the widest variety of switches and sensors in the world. And, if we don't already have one that solves your problem, chances are we can design a solution together.

For information about how we can help you get your project off the ground, write MICRO SWITCH, The Sensor Consultants, Freeport, Illinois 61032. Or call 815-235-6600.

MICRO SWITCH products are available worldwide through Honeywell International.

**MICRO SWITCH**  
a Honeywell Division

**If George could only talk . . .**

He'd tell you that a dollar spent on Wabash relays is a dollar well spent. Wabash quality is unsurpassed in the electrical components industry. Fast delivery, dependable service and competitive pricing are Wabash by-laws. And, because our relays are 100% American made, Wabash will do more than keep your machinery running strong. We're doing our best to keep the U.S. dollar going strong as well. If you're in the market for relays, give Wabash a call. Dollar for dollar we make the best sense . . . by George.

**Wabash Relay & Electronics**  
 First and Webster Streets  
 Wabash, Indiana 46992  
 (219) 563-2191

**wabash®**  
*The Reed Relay Specialists*

Circle 182 on reader service card

## Jensen Electronic Tool Kits and Tool Cases



Jensen is the leader in finest quality tool kits used by electronic technicians, engineers, scientists, laboratories, and government agencies. More than 50 stock models to choose from in a wide selection of one, two and three-pallet cases, or Jensen will custom design tool kits to your specifications.

**Free  
Catalog!**

Features tool kits, tool cases and test equipment, plus a selection of hard-to-find precision tools.

**JENSEN TOOLS INC.**

1230 S. Priest Dr. Tempe, AZ 85281 U.S.A.

## New products

ues runs continuously, so that the memory always contains the most recent 1,024 samples. Depending upon the amount of pre-trigger memory or post-trigger delay selected, the instrument can stop sample conversion either immediately or after a specified interval. The stop trigger may be initiated upon either a positive or negative slope, as selected by the user.

The analog output of the WD 8256 for display purposes is actually a digital-to-analog reconstruction of the signal stored in memory. The full-scale output voltage of this port is  $1 \pm 0.5$  v into 10 k $\Omega$  or higher impedance, with a maximum analog error of  $\pm 2\%$ . When viewing the waveform on an oscilloscope, a vertical offset of  $\pm 1$  v may be applied to the signal. This is particularly useful with high scope-amplifier gain setting for high-resolution viewing. At the start of each memory-read cycle, a TTL-level pulse is generated. Using it as the external trigger for a scope eliminates the need to readjust the scope's trigger controls as new signals are digitized.

For plotting the performance of the WD 8256, a toggle switch or remote programming command starts a single scan of the memory contents through a digital-to-analog converter for recording the analog signal on either an X-Y or strip-chart recorder.

Input impedance on the WD 8256 is 1 M $\Omega$  at 45 pF of capacitance, but an external adaptor may also convert it to a 50- $\Omega$  input. The unit can be clocked either internally or externally. Deliveries begin in August.

Already available in the digitizer market, though operating at sampling rates that are different from the WD 8256, are: Biomation's model 8100, which has a 100-MHz clock rate and an aperture uncertainty of 2 ns and Tektronix' 7612D, which is a 200-MHz dual-channel unit. Nicolet's dual-channel 20-MHz Explorer/204A is designed to plug into an oscilloscope and has a 1- to 3-ns aperture uncertainty.

LeCroy Research Systems of California Inc.,  
 1806 Embarcadero Rd., Palo Alto, Calif.  
 94303. Phone (415) 856-1900 [339]



Facts from Fluke on low-cost DMM's

# Three good reasons to buy your handheld DMM from Fluke.

Ask yourself what you're really looking for in a handheld DMM, and then take a good long look at ours.

**CHOICES?** The Fluke line of handheld DMM's now offers three clear performance choices. There's the 8022A Troubleshooter, a solid value for basic voltage/current/resistance measurements that offers 0.25% basic dc accuracy. The 8020A Analyst is the world's best-selling DMM and first to offer conductance for high-resistance measurements to 10,000 Megohms — now with accuracy improved to 0.1%. And the new 8024A Investigator, a powerful instrument also with 0.1% accuracy that boasts three unique capabilities: *logic level/continuity detection* with an audible "beeper" for

instant continuity testing, and slow-speed logic checking, *peak hold* to lock onto elusive transient signals, and *direct temperature readings* to 1265°C via K-type thermocouples.

**CONVENIENCE?** Pick one up and you'll know what *true* one-hand operation means — tough, lightweight, palm-size packages designed with in-line push buttons for quick range and function changes.

**RELIABILITY?** Count on it. A substantial number of components are used exclusively to insure reliability and to guard against overloads.

Calibration is traceable directly to the National Bureau of Standards.

**LOW COST?** Compare these U.S. prices: \$139 for the 8022A, \$179 for the 8020A and \$219 for the powerful 8024A.

Fluke standards of quality and customer service, of course, are uncompromising — for our line of handheld DMM's and all our products. For more facts call toll free **800-426-0361**; use the coupon below; or contact your Fluke stocking distributor, sales office or representative.



IN THE U.S. AND NON-EUROPEAN COUNTRIES:

John Fluke Mfg. Co., Inc.  
P.O. Box 43210 MS #2B  
Mountlake Terrace, WA 98043  
(206) 774-2481  
Telex: 152662

IN EUROPE:

Fluke (Holland) B.V.  
P.O. Box 5053,  
5004 EB Tilburg,  
The Netherlands  
(013) 673 973 Tlx: 52237

- Please send all the facts on Fluke low-cost DMM's.
- Please have a salesman call.

Name \_\_\_\_\_

Title \_\_\_\_\_ Mail Stop \_\_\_\_\_

Company \_\_\_\_\_

Address \_\_\_\_\_

City \_\_\_\_\_ State \_\_\_\_\_ Zip \_\_\_\_\_

Telephone ( ) \_\_\_\_\_ Ext. \_\_\_\_\_

For technical data circle no. 183

**Can we be sure  
they won't  
disappoint  
us?**

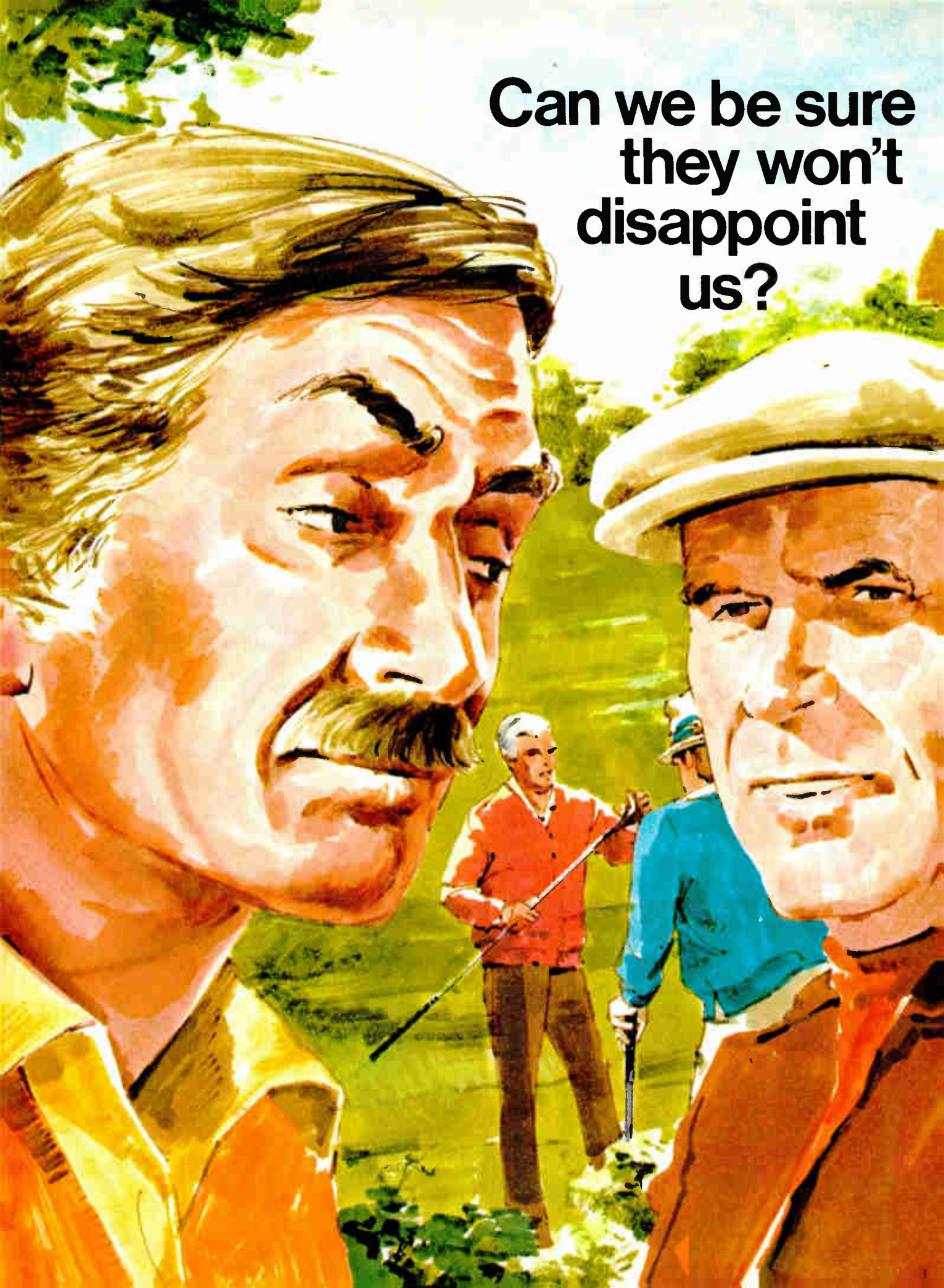



# When it's TRW, the answer is yes.

At TRW, we think we have an enviable record for dependability and client concern. The need to meet your delivery dates, with the right product, is foremost in our thinking, at all involved levels within the organization.

Because we produce similar product lines in more than one facility, we'll even shift production to meet emergency situations. But we don't wait for the emergency to add people, production lines or extra shifts. It's a regular procedure when we know our products are needed.

As the first step in establishing a confidence-based relationship with a supplier that won't let you down, call any TRW/ECG sales office or Renfrew Electronics in Canada.

You'll find them listed in EEM, Gold Book, Electronics Buyers' Guide, Who's Who in Electronics, the Electronic Industry Telephone Directory and the Electronic Buyers' Handbook.

**TRW** CAPACITORS  
**TRW** CINCH CONNECTORS  
**TRW** CINCH-GRAPIK  
**TRW** GLOBE MOTORS  
**TRW** INDUCTIVE PRODUCTS  
**TRW** IRC NETWORKS

**TRW** IRC RESISTORS  
**TRW** LSI PRODUCTS  
**TRW** OPTRON  
**TRW** POWER SEMICONDUCTORS  
**TRW** RF SEMICONDUCTORS

**TRW ELECTRONIC COMPONENTS GROUP**

DIVISIONS OF TRW INC.

5725 East River Road • Chicago, Illinois 60631

# 'Vise-grip' Contacts



## TEST RESULTS

Test	Procedure	Results
Corrosive Atmosphere	Ammonium Polysulfide Nitric Acid	Final $R_C=9.3 \text{ m}\Omega$ Final $R_C=8.4 \text{ m}\Omega$
Salt Spray	MIL-STD-1344, Method 1001	No Damage $R_C=11.7 \text{ m}\Omega$
Humidity	MIL-STD-1344, Method 1002	No Damage $R_C=14.8 \text{ m}\Omega$
Thermal Shock	MIL-STD-1344, Method 1003	No Damage $R_C=11.7 \text{ m}\Omega$
Mechanical Shock	MIL-STD-1344, Method 2004	No Discontinuity
Vibration	MIL-STD-1344, Method 2005	No Discontinuity
Socket Durability	500 mating/ unmating cycles	Initial $R_C=11.8 \text{ m}\Omega$ Final $R_C=11.8 \text{ m}\Omega$
Temperature Life	MIL-STD-1344, Method 1005, 1000 hours	Insulation Resistance > $5 \times 10^9 \Omega$ Initial $R_C=11.1 \text{ m}\Omega$ Final $R_C=14.9 \text{ m}\Omega$

**Unique RN "vise grip" contact clamps cable firmly for gas-tight reliability** (microphoto above). Total normal force is applied directly against cable. Vector arrows show normal force is maximized to clamp conductors tightly. No chance for gas penetration or corrosive buildup... even in hostile environments. And a special cut-out evenly distributes stress for long spring life and maximum reliability.

# ...assure gas-tight reliability

## in **RN** IDC flat cable system

Robinson Nugent's unique contact design (microphoto shown at left) offers consistent, long-term dependability in your IDC flat cable interconnect system. Tests prove conclusively that RN "vise-grip" contacts maintain low contact resistance — even in corrosive atmospheres or under severe vibration. Plugs, sockets, edge card and transition connectors all provide the same

low electrical resistance and gas-tight reliability — for a highly reliable, trouble-free flat cable system.

Simple, one-piece connector design allows high speed assembly using IDC tooling already in place. Fewer pieces mean reduced inventory. And you get assured compatibility of cable, connectors and headers . . . because RN supplies them all.

**Call or write today** for the new Robinson Nugent IDC Flat Cable System catalog — complete with all specifications and technical details.



# **RN** <sup>®</sup> **ROBINSON NUGENT, INC.**

800 East Eighth Street, New Albany, Indiana 47150 • Phone: (812) 945-0211 — TWX: 810-540-4082

Circle 187 on reader service card

# “It’s Our Customs... Th

Since our Screened Image Displays were invented, four years ago, we’ve developed all kinds of custom designs for companies that represent the spectrum of industrial applications: Electronic Games, Instrumentation, Point-of-Sale equipment, Avionics. You name it. We’ve done it. Some have been large displays. Others small. Some just numeric. Others alphanumeric. Still others have special words, symbols and artwork, including logos and outline pictures.



Each one of those custom designs had a distinctive style or font. All were designed to make the display the focal point of a unique product . . . thereby putting it well above the noise-level of competition.



## The Display and Product – Both Winners!

Today, several of those customs are available as standard products. You can benefit from their proven track-records at a fraction of the cost of a custom design. More importantly, one of our Screened Image standards can be just as effective in your product because of the unique designs and flexibility inherent in all Screened Image Displays.

Five Screened Image standard products are illustrated, above right. Look 'em over. Decide whether or not one or more of them can improve the appearance, viewability, functionality or cost-effectiveness of your next product. Or, if your product requires the special treatment that only a custom design can provide, we'll be happy to talk with you about that, too.

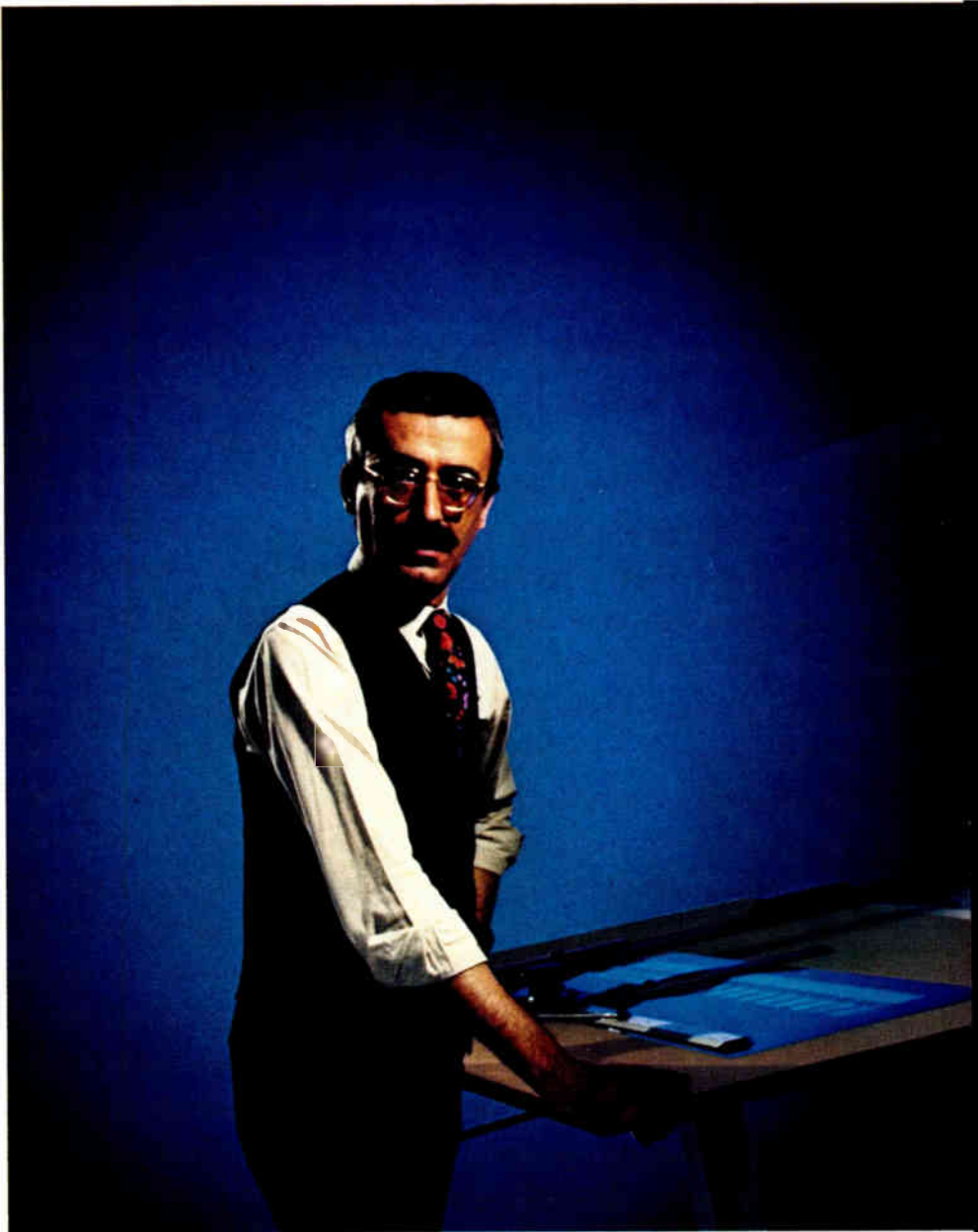

**SP-431.** This numeric Screened Image Display was custom-designed for a maker of industrial clocks. Because its four, 2.0-inch digits can be seen at distances up to 100 feet, the SP-431 can also find ready application in a variety of electronic equipments including large-digit information readouts such as stock-quotation boards. Readability is further improved by 180 footlamberts of neon-orange brightness. And, application is

enhanced by a plus and minus sign in the most significant digit; and, a colon between the second and third digits.

**SP-492.** A standard Screened Image Display that's ideally suited for instrumentation and point-of-sale equipment as well as electronic games. Readability is assured at distances up to 50 feet by the 0.7-inch height of the six digits and 210 footlamberts of brightness. The SP-492 is designed for multiplex operation. It has a wide,

# at Set New Standards"

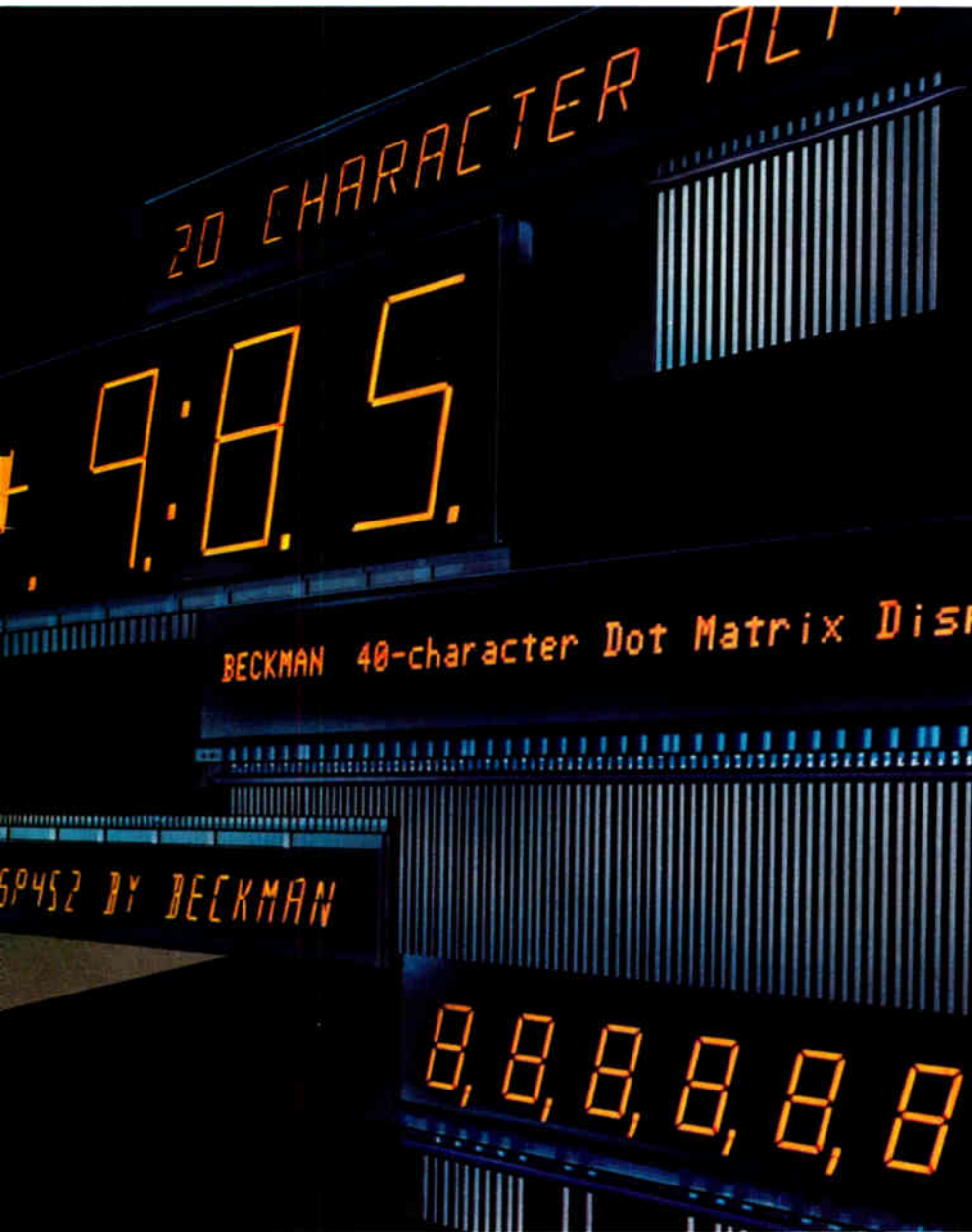

130° angle of visibility, plus a decimal point and comma in five digit positions.

**SP-450-018.** Designed for use in a stand-alone terminal, this former custom Screened Image Display can also set new standards for your instrumentation designs. Or, it can be used in any alphanumeric-message application that requires 20 half-inch characters viewable up to 20 feet, with 70 footlamberts of brightness and a viewing angle of 120°

**SP-452.** The flexibility of the Screened Image technology and the half-inch character height made this display an ideal custom design for point-of-sale equipment. Now, as a standard, its 16 characters, each with a decimal point and comma, provide ample opportunity for any application where large-field alphanumeric capability is needed. The SP-452's character set can be as versatile as you want to make it, with 10 numerals, the

alphabet and special symbols. And, viewability is enhanced by 105 footlamberts of brightness and a 130° viewing angle.

**SP-480-001 & SP-480-002.** Here's a 40-character (and, a 20-character) 5 x 7 Dot Matrix display, originally designed as part of a sub-system for scientific instrumentation. These SP-480 types are ideal, also, for process control equipment, communications gear and several kinds of computer peripherals. In fact, almost any application requiring extensive message flexibility can now set new standards . . . partly because of the high viewability, resulting from 100 footlamberts of brightness and 130° angle of visibility. New standards can also be set because of the versatility provided by SP-480's (0.25" & 0.50") Dot Matrix design. Upper and lower case letters, numerals, commonly used symbols and almost unlimited custom characters can be developed using the 5 x 7 Dot Matrix.

For complete details and technical literature about Screened Image Displays, off-the-shelf standards or custom designs, write:

Display Systems Division  
Beckman Instruments, Inc.  
350 North Hayden Rd  
Scottsdale, AZ 85257  
Or, call (602) 947-8371  
TWX: 910-950-1293

In Europe, write:

Beckman Instruments (Belgium) S.A.  
14, Avenue Hamoir, 1180  
Bruxelles, Belgium PHONE:  
(02) 275.44.30. TELEX: 23577



Screened Image Displays  
The Medium That Fits Your Message  
**BECKMAN**

# The NEW Electronics Buyers' Guide is now available!

Completely new listings of catalogs, new phone numbers, new addresses, new manufacturers, sales reps, and distributors! The total market in a book—four directories in one!



**The only book of its  
kind in the field.**

**If you haven't got it,  
you're not in the market.**

**To insure prompt delivery  
enclose your check with  
the coupon now.**

Yes, please send me \_\_\_\_\_ copies of  
1980 EBG.

I've enclosed \$30 per copy delivered in  
USA or Canada. Address: EBG, 1221 Avenue  
of the Americas, New York, N.Y. 10020.

I've enclosed \$52 for air delivery  
elsewhere. Address: EBG, Shoppenhangers  
Road, Maidenhead, Berkshire S16,  
2Q1 England.

Name \_\_\_\_\_

Company \_\_\_\_\_

Street \_\_\_\_\_

City \_\_\_\_\_

State \_\_\_\_\_

Zip \_\_\_\_\_

Country \_\_\_\_\_

## New products

# Wideband isolator has high gain linearity

Two-transformer amplifier works over 20-kHz range,  
is 0.012% nonlinear, and has 2.5-kV 3-port isolation

by Roger Allan, Components Editor

Conventional two-transformer isolation amplifiers normally provide high stability at low cost, but bandwidth is limited. Now, Analog Devices has introduced a two-transformer unit that overcomes the bandwidth limitation.

The model 289 isolation amplifier features a  $-3$ -dB bandwidth of 20 kHz; maximum gain nonlinearities of  $\pm 0.05\%$ ,  $\pm 0.025\%$ , and  $\pm 0.012\%$  (for the J, K, and L versions, respectively); and true three-port isolation that allows  $\pm 2,500$  v dc of common-mode potential between its input and output. All three offer full power output to 5 kHz (at a gain of 1 V/V) and maximum gain drift of  $\pm 0.005\%$ .

Thanks to the two-transformer isolation method employed, common-mode rejection at 60 Hz between input and output is 120 dB. A single resistor can be used to adjust the amplifier's gain from 1 to 100 V/V for transducer interfacing over a wide voltage range. The output voltage is a minimum of 10 v peak to peak under a 2-k $\Omega$  load, and the output impedance is under 1  $\Omega$  from dc to 100 Hz.

**Isolation.** A floating power-supply stage provides isolated outputs at  $+15$  and  $-15$  v at  $\pm 5$  mA, regulated to within  $\pm 5\%$ . This feature allows the amplifier to excite floating signal conditioners, front-end buffer amplifiers, and remote transducers, eliminating the need for separate isolated dc-dc converters.

A synchronization terminal on the 289 enables it to be used in multi-channel applications. Connecting the sync terminals of several units synchronizes their internal oscillators and eliminates troublesome

beat-frequency interference.

A buffered output on the 289 drives a 2-k $\Omega$  load and exhibits a 5-mv p-p ripple (no input signal). Output ripple measures 50 mV p-p with 10 v in.

**Impedances.** Differential input impedance is 33 pF in parallel with  $10^8 \Omega$ ; common-mode impedance is 20 pF in parallel with  $10^{10} \Omega$ . Maximum input-to-output leakage current (at 115 v root mean square, 60 Hz) comes to 2  $\mu$ A rms. Over the frequency band of 0.05 to 100 Hz, voltage noise is 8  $\mu$ V p-p, and current noise is 3 pA rms; from 10 Hz to 1 kHz, it is 3  $\mu$ V rms.

Although the 20-kHz bandwidth is not as high as that of some single-transformer designs, the 289's gain nonlinearity, coupled with its 50-ppm/ $^{\circ}$ C maximum gain change with temperature (between  $0^{\circ}$  and  $70^{\circ}$ C) and its stable offset voltage, is as good if not better. Maximum offset voltages are  $\pm 20$  ( $\pm 200/G$ ),  $\pm 15$  ( $\pm 100/G$ ), and  $\pm 10$  ( $\pm 50/G$ )  $\mu$ V, for the J, K, and L versions, respectively (G is the gain factor).

The amplifier is designed to interface with single and multichannel data-acquisition systems using small-signal dc sensors, such as thermocouples and strain gages, in harsh industrial environments.

All specifications are for operation within the  $0^{\circ}$ -to- $70^{\circ}$ C range.

Prices are \$59, \$69, and \$99 for J, K, and L versions in lots of 1 to 9, respectively. For quantities of 10 to 24, the price drops to \$49, \$59, and \$89, respectively. The amplifiers are available from stock.

Analog Devices, Route 1 Industrial Park,  
P. O. Box 280, Norwood, Mass. 02062.  
Phone (617) 329-4700 [340]





# FREE SAMPLES.

See for yourself  
why design engineers  
specify more CTS cermet resistor networks  
than any other make.

There is one large overriding reason. Reliability!

Each CTS SIP and DIP network is 100% value and tolerance tested before shipment. And, with more than 1 billion element hours of extended load life testing, CTS resistors have exhibited a failure rate of only 0.00047%/1,000 hours @ a 95% confidence level.

CTS networks are built reliable...using top quality materials, precision screening equipment, proprietary cermet formulations and computer controlled lasers for fine tolerance adjustment. Terminals are anchor-locked into the substrate

for maximum mechanical and electrical reliability.

CTS has been a leader in custom designed circuits for over 15 years. Ask us about customizing your special network requirements or choose from 400 standard part numbers available off the shelf from authorized CTS distributors.

For the utmost in cermet network reliability, quality and availability, you can't choose a better network source than CTS. Send for your free samples and resistor network catalog today. Write CTS of Berne, Inc., 406 Parr Road, Berne, Indiana 46711. Telephone: (219) 589-8220.

**CTS CORPORATION**  
ELKHART, INDIANA



A world leader in cermet and variable resistor technology.

**We developed the world's broadest line of  
OEM computers to meet a single application.  
Yours.**



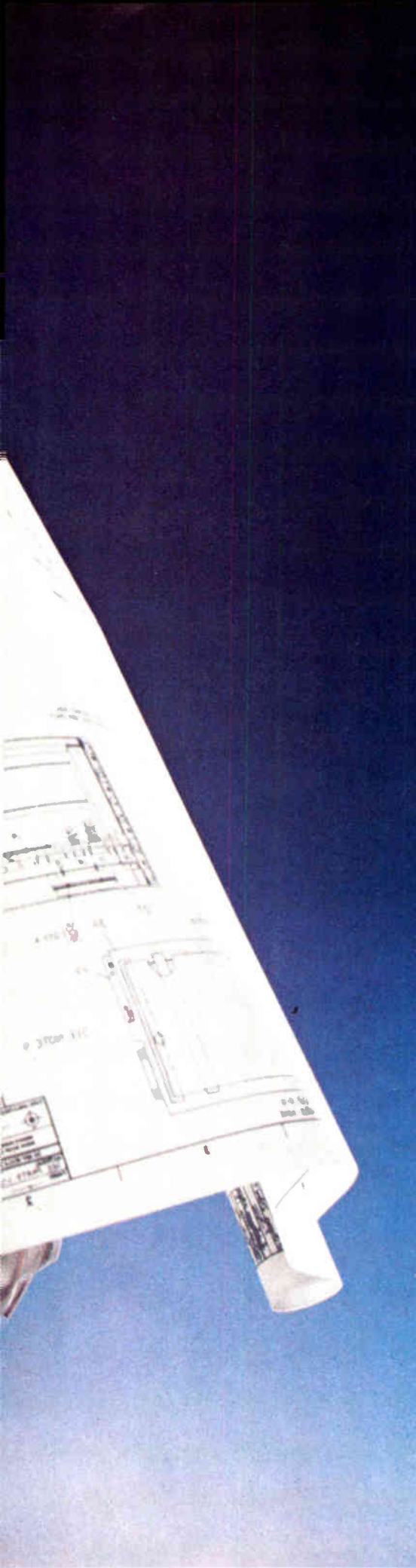

Sometimes, the hardest part about designing a computer-based product can be finding the right computer to go into it.

Too often, you're forced to make compromises.

You either have to buy more performance than you want. Or you settle for less than you need.

But at Digital, we don't think you should have to compromise. That's why we offer you a wider choice of OEM computer equipment than any other company. So you're always sure of finding the one combination of products that won't make you compromise on anything.

For example, we offer CPUs and systems that range from our 16-bit PDP-11 microcomputers all the way up to our 32-bit VAX family of super-minis. A wide choice of operating systems, software options, and sophisticated development tools. Mass storage devices from 512 kilobytes to 176 megabytes. State-of-the-art video and hardcopy terminals. And a set of communications options to tie our hardware and software products together.

In addition, we offer software compatibility across our whole line of products, so you can migrate up or down, and build distributed processing systems, with unequalled ease. Without having to scrap your original software investment.

At Digital, our approach has always been to give OEMs more than just great products. Just as important are the extra quality features, the extra testing that can make your design and marketing job easier. The worldwide service capability that can be tailored exactly to the way you run your business.

You probably already know a lot about Digital performance. To find out the rest, send for our brochure, "The Thinking Behind the Industry's Largest Selling Line of OEM Computers."

**Digital Equipment Corporation**, Technical OEM Group, 129 Parker St., (PK3/M-86), Maynard, MA 01754. (617) 493-5997.

In Europe: 12 av. Des Morgines, 1213 Petit-Lancy/Geneva. Tel. 93 33 11.

In Canada: Digital Equipment of Canada, Ltd.

**We build a lot more than performance into an OEM computer.**

**digital**

Circle 193 on reader service card



*Another major milestone in MOS memory technology  
from Texas Instruments ...*

# TI's 64K dynamic RAM is ready for delivery. Now.

TI has paced the industry through generation after generation of semiconductor innovation, pioneering a lion's share of the major milestones in technology and production capability.

The new TMS4164 from Texas Instruments represents the fourth generation of dynamic RAM computer memories, and continues to fulfill the bright promise of innovative MOS technology.

TMS4164. Advanced architecture. Superior performance. High speed. High reliability. Low power. *And ready for delivery.*

Ready with 4 times the capacity of 16K RAMs in the same size package.

Ready with 65,536 bits of random access memory — and that's more than many board-level computers.

Ready with 256 cycle, 4 ms refresh architecture — the optimum organization evolving from all previous industry-standard dynamic RAMs.

Performance has been dramatically enhanced. Speed's up. Power's down. And design innovation makes this the *smallest 64K chip (35K mil<sup>2</sup>) available anywhere.* From anyone.

Improvements in density, reliability,

system cost and ease of use are some of the features, functions and benefits system designers will appreciate. Here's more:

- 64K bits in a standard, 300-mil, 16-pin package saves valuable board space and reduces system size
- Single 5-volt operation lowers power supply cost and system cooling requirements and improves reliability

## TMS4164 256 CYCLE REFRESH ARCHITECTURE

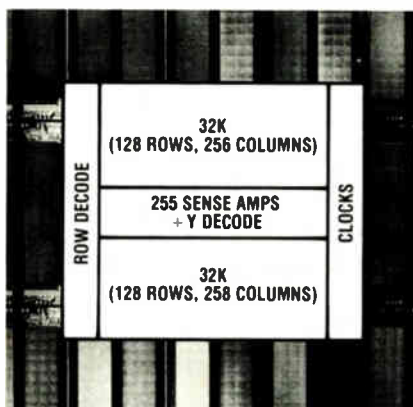

- JEDEC-approved pinout with N/C on pin one assures standardization and guaranteed availability
- High speed: 150-ns access and 280-ns cycle times (min.)
- TTL compatible I/O and clocks

- Lowest power dissipation available: 125 mW typical
- 256 cycle architecture means lower current peaks and reduced system noise
- State-of-the-art SMOS (Scaled MOS) processing

TI's new TMS4164 is perfectly suited for use in mainframe computers and large minicomputers. It also finds ideal application in microprocessor-based systems where smaller size, lower cost and improved performance are important considerations.

TMS4164. The deliverable, practical, usable 64K dynamic RAM. Compare our 256 cycle refresh architecture ... then compare our performance.

TMS4164. Truly another major milestone in MOS memory technology. Truly another example of the total commitment Texas Instruments is making to leadership MOS memory products.

**For more information about the deliverable 64K RAM,** call your nearest TI field sales office, or write to Texas Instruments Incorporated, P.O. Box 1443, M/S 6965, Houston, Texas 77001.



TEXAS INSTRUMENTS  
INCORPORATED

# At Boeing, forty dedicated systems Tektronix 8001s

**The Microprocessor Design Support Center (MDSC) is Boeing's innovative answer to large scale microprocessor development. Tektronix makes it possible.**

---

**Boeing now supports over 120 engineers working on 35 projects.**

Before the creation of the MDSC, Boeing used a variety of different vendors' stand-alone development systems. Each one supported only three engineers at a time, and more than one system was often needed for a single project.

Now, software is developed on a DEC PDP 11/70<sup>®</sup> computer and transferred to six 8001 Microprocessor Development Labs for in-circuit emulation, debugging, and prototype integration.

By using one multi-user host computer with six distributed 8001s, Boeing is able to more efficiently support 120 engineers. With 8001s costing half as much as stand-alone development systems.



# couldn't do what six are doing.



## Development isn't limited by dedicated, single-vendor systems.

The 8001 supports every microprocessor Boeing uses, so, they're free to choose the right microprocessor for the job. And whether it's the Texas Instruments TMS9900, Zilog Z80A, Intel 8048, Motorola 6800, RCA 1802, or 14 others — the 8001 emulates it. Tek's multi-vendor support doesn't lock Boeing into one vendor's family of microprocessors.

## Engineers get on board much faster

When every engineer uses the same equipment and the same operating system for every project, it translates into a faster learning curve. And a more efficient, flexible team. For Boeing — or for you.



The world over, Tektronix supports your team with our team, assisting you with everything from development system configuration planning to training to service. Whether your development plans include our 8001 MDL, or our stand-alone 8002A MDL, we'll back you with quality — every step of the way. For a closer look at Boeing's innovative use of the 8001, please call your local Tektronix Field Office or write to us for our Boeing Application Note.

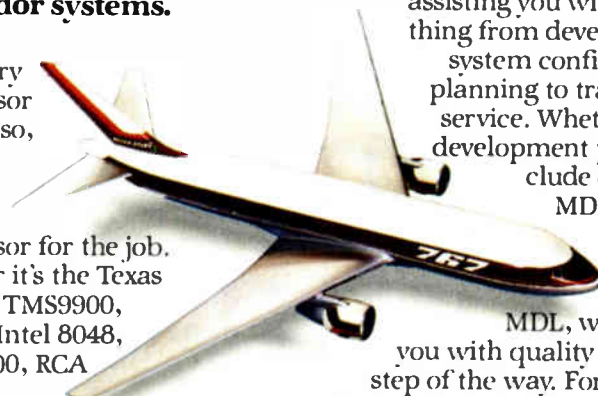

**U.S.A.**  
Tektronix, Inc.  
PO Box 1700  
Beaverton, OR 97075  
Phone: 503/644-0161  
Telex: 910-467-8708  
Cable TEKTRONIX

**Africa, Europe  
Middle East**  
Tektronix Int'l. Inc.  
European Marketing Center  
Postbox 827  
1180 AV Amstelveen  
The Netherlands  
Telex 18312

**Asia, Australia, Canada, Central &  
South America, Japan**  
Tektronix, Inc.  
America's/Pacific  
PO Box 500  
Beaverton, OR 97077  
Telex: 910-467-8708  
Cable TEKTRONIX

**Tektronix®**  
COMMITTED TO EXCELLENCE

For technical data circle 196 on reader service card  
For demonstration circle 197 on reader service card

---

## New products

---

Software

# Package speeds test generation

---

Given data-sheet figures, interactive software sets up memory test program

---

Although many sophisticated systems test today's fast memories at nanosecond speeds, if not faster, relatively little has been done to hasten the development of memory test programs. A new software package from Eaton Corp.'s Semiconductor Test Systems division, however, is said to cut the time required to write dc parametric and functional memory test programs by several orders of magnitude.

Designated the Interactive On-line Program Generator (IOPG), the software package has been developed for use with the Eaton Macrodata M-1, a 25-MHz memory device tester, which has an LSI-11/23 with 64 kilowords of main memory. Employing microcomputer-controlled cathode-ray-tube terminal menus and protected formats that enable test engineers to enter values directly off a data sheet, the IOPG automatically translates, compiles, and generates the test program. As a result, "programs that normally require one week to prepare can be written, checked, and debugged in less than one hour," claims Wayne E. Sohl, M-1 product manager.

**Ease of use.** Test engineers "do not have to be familiar with the machine operating-system language" when using the IOPG, says Sohl. "They need not be programmers or tester experts." That is because the program generator is a high-level translator that converts

---

### Software coverage

*As of this issue, we will dedicate a segment of the New Products section to software to keep readers up to date in an area whose role in system design continues to grow rapidly.*

VOL TEST			
TEST NUMBER	1	15	FAIL BIN
VCC(V)	5.25	8	IOL(MA)
HI TEST LIMIT(V)	.4		
CLK HI LEVEL(V)	2	.8	CLK LO LEVEL(V)
DATAIN HI LEVEL(V)	2	.8	DATAIN LO LEVEL(V)
ADDR. HI LEVEL(V)	2	.8	ADDR. LO LEVEL(V)
MODIFY CONDITIONS (Y/N)?			

**Testing.** The Interactive On-line Program Generator displays a screen format on which users enter operating characteristics from data sheets to conduct memory tests.

common testing terms into object code for the test program. What's more, menus guide in selecting screen formats, and directives are either those used on the device data sheet or simple mnemonics that reflect actual device or tester conditions.

When using the IOPG to prepare incoming inspection test programs, the engineer loads a device known to be in good condition into the test fixture and installs appropriate output loading components. The IOPG then displays a screen format for such dc operating characteristics as normally appear on a device data sheet. He finally enters values and test conditions for power supply, voltage, logic levels, and current parameters. Data can be entered and the completed portion of the program can be checked in less than 30 seconds.

In much the same manner, the test engineer can develop read-and-write-cycle functional-test programs. Using timing diagrams and tables from the data sheet, the engineer enters waveform voltage levels into video screen formats, along with descriptions of the timing conditions and worst-case timing values. For the writing cycle, he then selects one or more test patterns—such as marching, read/modify/write, checkerboard, galloping-column, or row—to exercise the device from a menu displayed on the screen.

Before functional testing programs are executed, the M-1 automatically performs an end-to-end calibration that adjusts edge-genera-

tor timing with 140-ps resolution to place edges within 1 ns. All 18 edge generators can be calibrated in less than 1 s, Sohl says. Simultaneously, the system's computer assembles the timing libraries into the test program's send list and the created test program can be stored cartridge tape as a completed test program with or without the IOPG module.

Priced at \$7,500 and available 30 days after an order is received, the IOPG is supplied on 3M type cartridge tape. The initial version is for 4,096-bit high-speed static random-access memories, such as Intel Corp.'s 2147. However, a universal IOPG "capable of testing any RAM or read-only memory" is in development and, Sohl says, will be introduced in the fall of this year.

Eaton Macrodata, 21135 Erwin St., Woodland Hills, Calif. 91365 [381]

---

## VAX-11/780 computers get seven software products

Digital Equipment Corp.'s VAX-11/780 computers now have seven new or enhanced software products. The 32-bit minicomputers will have available for use new Basic and Cobol compilers, a new version of Fortran, the Coral 66 language support, an enhanced version of the VAX/VMS operating system, and extended capabilities for data retrieval and form generation.

The new version of the VAX/VMS virtual memory operating system supports up to 4 megabytes of



# RESOLUTION



## When and where you need it.

There are times when a 3½ digit multimeter just can't cut it.

When you really need resolving power, you need a 4½ digit DMM. To illustrate: When measuring a 15VDC supply—a 4½ digit multimeter lets you see each millivolt of change while a 3½ digit instrument would not display a change less than 10 millivolts.

As the leader in 4½ digit multimeters, Data Precision gave you that resolving power 7 years ago with the first truly portable 4½ digit multimeter...our Model 245. Then as your applications became more varied and demanding, we designed other units to meet them. The result is a line of tough, full function 4½ digit DMMs that have given almost 200,000 world-wide users more sensitive measurements.



### MODEL 245

The first of its kind, features high input impedance, 50kHz frequency response, 0.05% basic DC accuracy and a planar gas discharge display...\$365.

### MODEL 248

This high resolution instrument features 10µV and 10 nanoamp sensitivity, True RMS AC measurement, with a basic DC accuracy of 0.05% and an easy to read LED display...\$329.

### MODEL 258

Features True RMS AC measurement, 0.05% basic accuracy, 40 hour battery operation between charges and an LCD display ideal for outdoor as well as indoor applications...\$345.

If your needs are primarily for a bench instrument, Data Precision offers a truly versatile performer—the Model 2480R Bench/Portable with True RMS AC measurement and 0.03% basic DC accuracy. Wide measurement ranges on all functions and a benchtop case make it a logical choice for an in-house DMM...\$319 or the Model 2480 with AC average sensing...\$299. Both feature optional battery pack.

When you need more than a 3½ DMM can give, get a 4½ digit multimeter from Data Precision. We've made more 4½ digit multimeters than anyone else in the world.

For immediate delivery, demonstration, or further information, just contact your local Data Precision distributor or call:

(800) 343-8150

(800) 892-0528 in Massachusetts

Prices USA

 **DATA PRECISION**<sup>®</sup>  
A DIVISION OF ANALOGIC CORPORATION

Data Precision Corporation, A Division of Analogic Corporation, Electronics Avenue, Danvers, MA 01923, (617) 246-1600, TELEX (0650) 921819

Circle 199 for demonstration

Circle 247 for further information

## New products

MA780 multiport memory, 8 megabytes of local memory, a high-speed interface, and other peripheral devices. The language compilers produce 32-bit object code, thus taking advantage of the large VAX address space and instruction set. The DEC forms-management system that was developed for PDP-11 computers has been extended to VAX systems. The licenses for that version and for a new version of Datatrieve inquiry, data maintenance, and reporting language are priced at \$4,500. Licenses for the VAX languages range from \$7,000 to \$12,000. The VAX/VMS operating system is available with support separately for \$20,000.

Digital Equipment Corp., 146 Main St., Maynard, Mass. 01754. Phone (617) 897-5111 [384]

### Basic interpreter works with Z8000

A Basic language interpreter for the Z8000—possibly the first available commercially—takes advantage of the 16-bit microprocessor's powerful instruction set to perform trigonometric functions in 1 to 3 ms. Microsoft's Basic-Z8000 uses an expanded internal notation—a three- rather than two-word internal format—that takes maximum advantage of the Z8000's 32-bit instructions. The accuracy of internal calculations exceeds 8 digits for single precision and 18 digits for double precision. Variables are stored using proposed IEEE standards, allowing for a double precision range of exponents from -308 to +308.

The interpreter is fully language-compatible with Microsoft's Basic-80 and Basic-86 interpreters, and the company's Basic programs can be run on the interpreters without modification. Evaluation copies of customized extended implementations will be available at the end of this month for \$350, and stand-alone implementations on disk will be available soon after that for \$600.

Microsoft, 10800 N.E. Eighth, Suite 819, Bellevue, Wash. 98004 [385]

### TI's 9900s get real-time executive and file manager

A real-time executive and a file manager for Texas Instruments' 9900 microprocessors and microcomputers are designed to reduce programming time and total software costs. The executive is a 6-kilobyte nucleus of software routines for a real-time multitasking application program. TI says it provides the advantages of an operating system without the attendant memory overhead. The file manager provides independent file management from both assembly language and a microprocessor Pascal application program. It supports a floppy-disk controller and will later support magnetic bubble memories. The real-time executive will sell for \$915 and the file manager for \$860. They are both available from distributors.

Texas Instruments Inc., P. O. Box 1443, M/S 6404 Houston, Tex. 77001 [386]

### Software lets Apple IIs create and print graphics

A software package lets users of Apple personal computers create, revise, and print detailed charts and graphs. The Apple Plot package displays plotted information in various colors on a television monitor and prints hard copies automatically via an optional printer. Up to 100 data points can be entered, and one of six graphics formats can be selected: line, multiline, bar, multibar, bar with line overlay, and scatter graph.

Apple Plot will run on either a 48-kilobyte Apple II or Apple-II Plus, with or without an Apple Language system. Also required are: an Apple Disk II with controller, a video monitor or television set, and a compatible printer with controller card. The Plot will be available in July. For \$70, a customer will receive a write-protected diskette and an instruction manual.

Apple Computer Inc., 10260 Bandley Dr., Cupertino, Calif. 95014. [387]

## Call your Beckman Converter Distributor

- ALABAMA**  
**Half-Mark Electronics**  
 Huntsville  
 (205) 837-8700  
**Powell Electronics**  
 Huntsville  
 (205) 539-2731
- ARIZONA**  
**Wyle Distribution Group**  
 Phoenix  
 (602) 955-9185  
**Marshall Industries**  
 Tempe  
 (602) 968-6181
- CALIFORNIA**  
**Marshall Industries**  
 Canoga Park  
 (213) 999-5001  
 Irvine  
 (714) 556-6400  
 San Diego  
 (714) 278-6350  
 Sunnyvale  
 (408) 732-1100  
**Wyle Distribution Group**  
 El Segundo  
 (213) 322-8100  
 Irvine  
 (714) 641-1600  
 San Diego  
 (714) 565-9171  
 Santa Clara  
 (408) 727-2500  
**Kierulff Electronics**  
 Los Angeles  
 (213) 725-0325  
 Tustin  
 (714) 731-5711  
**Arrow Electronics**  
 Sunnyvale  
 (408) 739-3011
- COLORADO**  
**Marshall Industries**  
 Arvada  
 (303) 423-9670  
**Wyle Distribution Group**  
 Commerce City  
 (303) 287-9611
- CONNECTICUT**  
**Harvey Electronics**  
 Norwalk  
 (203) 853-1515  
**Arrow Electronics**  
 Wallingford  
 (203) 265-7741  
**Marshall Industries**  
 Wallingford  
 (203) 265-7738
- FLORIDA**  
**Lynch-Gentry Associates**  
 Clearwater  
 (813) 443-2697  
**Arrow Electronics**  
 Fort Lauderdale  
 (305) 778-7790  
 Palm Bay  
 (305) 725-1480  
**Powell Electronics**  
 Miami Springs  
 (305) 592-3260  
**Half-Mark Electronics**  
 Ft. Lauderdale  
 (305) 971-9280  
 Orlando  
 (305) 855-4020
- GEORGIA**  
**Arrow Electronics**  
 Norcross  
 (404) 449-8252
- ILLINOIS**  
**Kierulff Electronics**  
 Elk Grove Village  
 (312) 640-0200  
**Magnuson Electronics**  
 Mount Prospect  
 (312) 956-0700  
**Arrow Electronics**  
 Schaumburg  
 (312) 893-9420
- INDIANA**  
**Magnuson Electronics**  
 Indianapolis  
 (317) 247-5108
- KANSAS**  
**Half-Mark Electronics**  
 Kanasa City  
 (913) 888-4747
- MARYLAND**  
**Arrow Electronics**  
 Baltimore  
 (301) 247-5200  
 (202) 737-1700  
**Half-Mark Electronics**  
 Baltimore  
 (301) 796-9300  
**Powell Electronics**  
 Beltsville  
 (301) 937-4030
- MASSACHUSETTS**  
**Kierulff Electronics**  
 Billerica  
 (617) 667-8331  
**Marshall Industries**  
 Newton  
 (617) 965-5115  
**Arrow Electronics**  
 Woburn  
 (617) 933-8130
- MICHIGAN**  
**Arrow Electronics**  
 Ann Arbor  
 (313) 971-8220
- MINNESOTA**  
**Arrow Electronics**  
 Edina  
 (612) 830-1818  
**Marshall Industries**  
 Plymouth  
 (612) 559-2211
- MISSOURI**  
**Half-Mark Electronics**  
 St. Louis  
 (314) 291-5350
- NEW HAMPSHIRE**  
**Arrow Electronics**  
 Manchester  
 (603) 668-6968
- NEW JERSEY**  
**Kierulff Electronics**  
 Fairfield  
 (201) 575-6750  
**Arrow Electronics**  
 Moorestown  
 (609) 235-1900  
 (215) 928-1800  
 Saddle Brook  
 (201) 797-5800  
**Harvey Electronics**  
 Pine Brook  
 (201) 575-3510
- NEW MEXICO**  
**Arrow Electronics**  
 Albuquerque  
 (505) 243-4566
- NEW YORK**  
**Harvey Electronics**  
 Binghamton  
 (607) 748-8211  
 Fairport  
 (716) 381-7070  
 Woodbury  
 (516) 921-8700  
**Arrow Electronics**  
 Hauppauge  
 (516) 231-1000  
**Marshall Industries**  
 Farmingdale  
 (516) 293-4141  
**Rochester Radio Supply**  
 Rochester  
 (716) 454-7800
- NORTH CAROLINA**  
**Arrow Electronics**  
 Winston-Salem  
 (919) 725-8711  
**M&C Sales**  
 Winston-Salem  
 (919) 722-9445  
**Half-Mark Electronics**  
 Raleigh  
 (919) 832-4465
- OHIO**  
**Arrow Electronics**  
 Cincinnati  
 (513) 761-5432  
 Cleveland (Solon)  
 (216) 248-3990  
 Kettering  
 (513) 253-9176  
**Marshall Industries**  
 Dayton  
 (513) 236-8088
- OKLAHOMA**  
**Norvell Electronics**  
 Tulsa  
 (918) 663-1247
- OREGON**  
**Aimac/Strom Electronics**  
 Beaverton  
 (503) 641-9070
- PENNSYLVANIA**  
**Half-Mark Electronics**  
 Philadelphia  
 (215) 355-7300  
**Powell Electronics**  
 Philadelphia  
 (215) 365-1900  
**Arrow Electronics**  
 Pittsburgh  
 (412) 351-4000
- TEXAS**  
**Norvell Electronics**  
 Austin  
 (512) 458-8106  
 Dallas  
 (214) 233-0020  
 Houston  
 (713) 777-1666  
**Marshall Industries**  
 Dallas  
 (214) 233-5200  
 Houston  
 (713) 777-0358
- WASHINGTON**  
**Aimac/Strom Electronics**  
 Seattle  
 (206) 763-2300  
**Wyle Distribution Group**  
 Bellevue  
 (206) 453-8300
- WISCONSIN**  
**Arrow Electronics**  
 Oak Creek  
 (414) 764-6600  
**Kierulff Electronics**  
 Waukesha  
 (414) 784-8160
- CANADIAN DISTRIBUTORS**  
**Cam Gard Supply**  
**Intek Electronics**  
**Semad Electronics**  
**Specialty Electronics**



**BECKMAN**

12-Bit Output Data Bus  
 Figure 1 shows connections for the processor data bus to the HBI and LBI (after 12-bit output).

**DIGITAL-TO-ANALOG CONVERTERS**

Model	Ladder & Switches	Output Amplifiers	Microprocessor Compatible Unit	Internal Reference	Description
7541C	X				12-Bit CMOS Multiplying DAC
7545C	X		X		Microprocessor Compatible 12-Bit CMOS DAC
7546C	X	X	X	X	Microprocessor Compatible 12-Bit CMOS DAC
7580I	X			X	Low Cost 12-Bit CMOS DAC (Current Output)
7580V	X	X		X	Low Cost 12-Bit CMOS DAC (Voltage Output)
7580VS	X	X		X	Low Cost 12-Bit CMOS DAC (Voltage Output)
7581C	X	X	X	X	Low Cost Microprocessor Compatible 12-Bit CMOS DAC

**ANALOG-TO-DIGITAL CONVERTERS**

Model	Successive Approximation Register	Ladder & Switches	Tri-State Output Buffers	Comparator	Internal Reference	Description
7555C	X	X	X			Microprocessor Compatible 12-Bit CMOS ADC
7556CB	X	X	X	X	X	Microprocessor Compatible 12-Bit CMOS ADC
7556CU	X	X	X	X	X	Microprocessor Compatible 12-Bit CMOS ADC

**True 12-Bit Converters You Can Get Your Hands On. Right Now.**

Beckman has a stock alternative to lengthy lead times for true 12-bit converters. Your local Beckman distributor can fill your order immediately, from off the shelf.

Designed into every Beckman converter is over a decade of proven microcircuit experience. The result: true 12-bit accuracy ( $\pm 1/2$  LSB), better endpoint linearity ( $\pm 0.012\%$ ), plus superior reduction in offset and gain drift over the entire operating temperature range.

And by employing CMOS

technology, Beckman DACs and ADCs also reduce power consumption — up to 80% in certain applications.

Designed for convenience and application flexibility, Beckman converters offer TTL and CMOS logic level compatibility, require less board space than other converters, yet remain competitively priced.

Large or small, general purpose or microprocessor compatible, Beckman can support your requirements — right now — with true 12-bit converters.

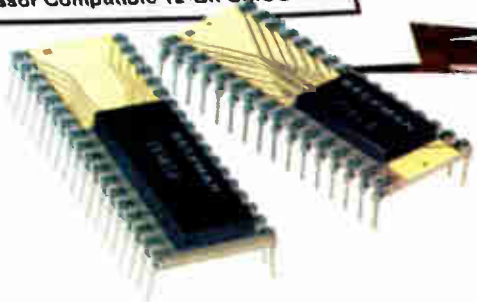

For more information on our complete line of A/D and D/A converters, contact your local Beckman distributor or write Advanced Electro-Products Division, Beckman Instruments, Inc., 2500 Harbor Blvd., Fullerton, CA 92634. (714) 773-8126.

**Design Beckman converters in. Design problems out.**

**BECKMAN**

Circle 201 on reader service card

# VAX

## Software excellence. Extended.



### Digital introduces VAX/VMS™ software, Release II.

Since its introduction, VAX/VMS Performance Software has been setting new standards for excellence.

VAX/VMS was designed from the ground up by hardware and software engineers working together. The result: truly integrated computer software. Featuring highly efficient virtual memory, powerful I/O capabilities, and a basic operating system that's incredibly easy to work with.

Now with VAX/VMS Release II comes another major advance in VAX technology. With several new software capabilities added, and existing features enhanced, you have more ways than ever to use the power of VAX/VMS.

### Powerful new languages.

With VAX/VMS Release II, our already remarkable FORTRAN is now a full ANSI 77 implementation and compiles twice as fast as before. We've also added COBOL and BASIC that compile at the rate of two to three thousand lines per minute.

The interactive BASIC gives you performance that approaches FORTRAN.

And COBOL performance on VAX is comparable to mainframe COBOL. Based on the ANSI 74 standard, it offers full support for: nucleus; sequential, relative and indexed I/O; segmentation; interprogram communication; table-handling; library; and sort/merge capabilities.

Other VAX languages include PASCAL, BLISS, and CORAL, the British real-time language standard.

But languages are only part of the story. **Advanced programming tools.**

VAX/VMS gives you the ability to share commonly used subroutines in any language. And the ability to call any of the system services from any language.

In addition, there's an improved interactive editor that lets you create, proof and modify source programs right at the terminal. An interactive symbolic debugger that lets you debug your programs using source code statement numbers and symbolic names. And FMS for simplified screen formatting.

We've even enhanced the already easy-to-use Digital Command

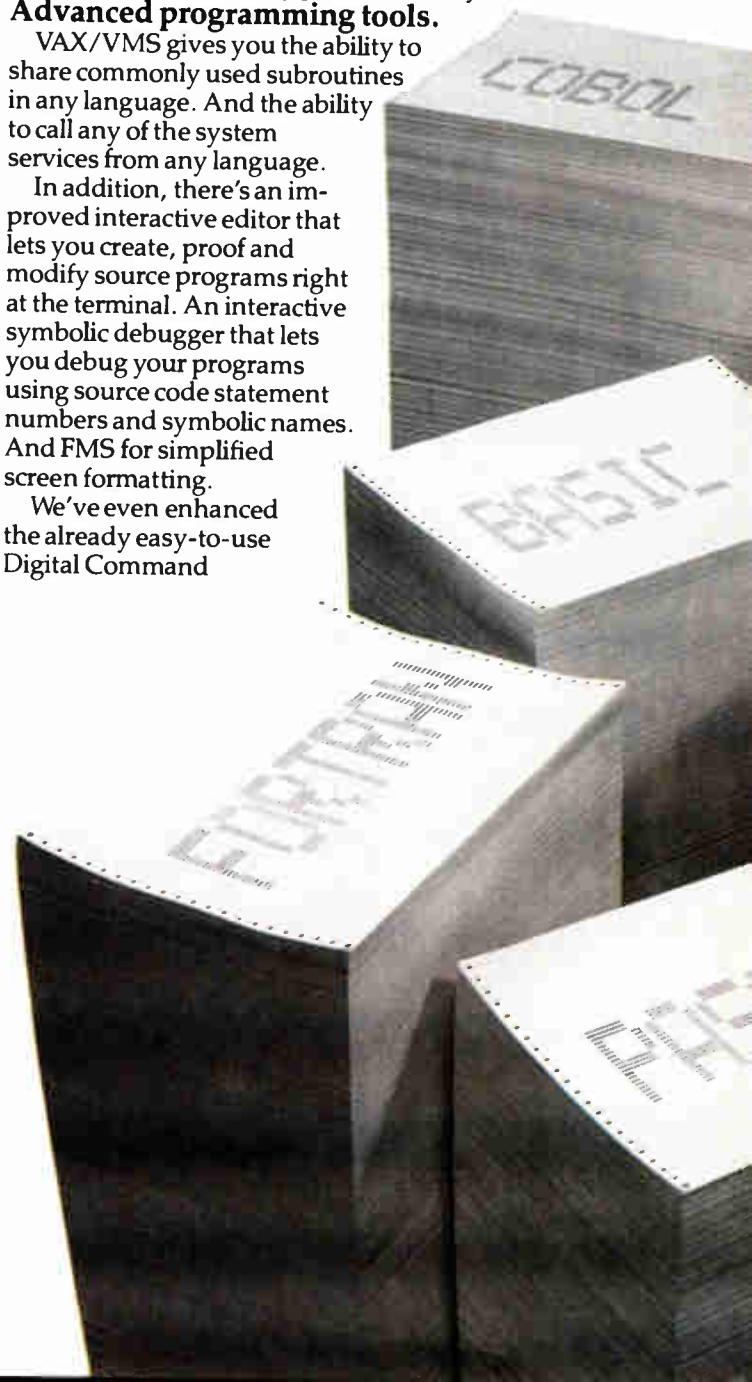

Language by providing for user added commands.

### Extensive data management.

To help you put all these programming tools to work, VAX/VMS Release II includes a wide range of data management facilities.

RMS, for example, allows you to set up sequential, random or multikey ISAM file structures in any VAX language. And you can use up to 255 keys for each entry.

Then to access RMS files you can use DATA-TRIEVE, a query and report writing utility that's both highly versatile and easy to use.

There's also a new VAX SORT/MERGE utility for easy record formatting.

### State-of-the-art communications.

VAX/VMS is more than a powerful system in its own right. It also fits into any network or communications plans you may have.

Using DECnet, you can link VAX into a resource-sharing network with other computers from Digital. This network interface is transparent to programmers, which greatly simplifies your development work.

Then you can use 2780/3780 and MUX200 pro-

ocols to connect VAX to your mainframe system.

In addition, VAX/VMS Release II offers a new Mail utility for interterminal communications, even with a terminal on another CPU through DECnet.

And you can use the new DR780 hardware/software interface, with an unmatched 6Mb/sec throughput, to set up high-speed VAX-to-VAX communications or to support devices like array processors and graphics terminals.

### Complete system control.

Best of all, VAX/VMS gives you complete control over system resources.

You can lock part or all of a program into main memory. You can set priorities on 32 different levels—the first 16 for real-time. You can establish disk, memory and processor quotas. You can even control user privileges to the point where it's virtually impossible for a low-level user to interfere with people doing high-level work.

All this control lets you get the best possible performance from VAX/VMS. Regardless of your application or the number of people using the system.

### The architecture of the '80s.

VAX/VMS Performance Software is part of a new kind of computer architecture. It combines the large program capacity of mainframes with the interactive access of minicomputers. It's completely integrated with VAX hardware for unprecedented system performance.

And now that Release II is here, all that power becomes available to a lot more people.

Just send the coupon for complete information.



I'd like to know more about the power of VAX/VMS Performance Software.

- Please send me your new brochure, "VAX Software: The Measure of Value".
- Please have a Sales Representative call.

Name \_\_\_\_\_

Title \_\_\_\_\_

Company \_\_\_\_\_

Address \_\_\_\_\_

City \_\_\_\_\_ State \_\_\_\_\_ Zip \_\_\_\_\_

My application is \_\_\_\_\_

Send to: Digital Equipment Corporation, 146 Main Street, Maynard, MA 01754, Attn: Communication Services, NR-2/2. Tel. (617) 497-6885. Digital Equipment Corporation International, 12 av. des Morgines, 1213 Petit-Lancy, Switzerland. In Canada: Digital Equipment of Canada, Ltd.

N-6-19-0

**digital**

Circle 203 on reader service card

## New products

Semiconductors

# 8-K EE-PROM uses little power

Electrically erasable  
ROM draws 10 mW to read,  
500  $\mu$ W on standby

The Hughes Aircraft Co. has come up with what it sees as a near-perfect memory device for microprocessor systems—an electrically erasable complementary-MOS read-only memory. Organized as 1,024 by 8 bits, the HNOV0463 is a direct replacement for the popular 8-K 2708 ultraviolet-light-erasable ROM, but it consumes much less power: 10 mW for reading and only 500  $\mu$ W on standby.

The culmination of three years of process development, "this device combines the best features of nonvolatile memory technologies," according to E. K. Shelton. He spearheads work on the memory as a technical staff member at Hughes' Newport

**EE-PROM.** Complementary-MOS technology provides an 8-K device with 0.1-second erase/reprogramming time.

Beach, Calif., research center. "It is easily programmed in circuit," he adds. Also, information retention exceeds 10 years at 125°C and the chip can endure more than  $10^6$  writing and erasing cycles.

"The objective," says Shelton, "was to get a floating-gate structure, with its superior charge retention, and combine this with the reliable electrical-erasing capability of MNOS [metal-nitride-oxide-semiconductor] technology." The difficulty lay in finding an efficient mechanism for transferring charge that would not degrade with repeated use. These criteria were met with a new process called Fetox, for floating-gate electron-tunneling oxide.

The chip's 600-ns access time and long-term retention compete with some E-PROM specifications. Bulk erasure (single-byte erasure is not possible) and the writing of a byte of data each take about 100  $\mu$ s, so the entire array can be erased and reprogrammed in about 0.1 second. Programming draws less than 5 mA from a +17-v source that is connected to the chip's single power-supply pin. The EE-PROM has three-state output lines and edge-triggered inputs, and all signal lines are TTL-compatible.

In many ways, this product represents Hughes' debut into the com-

mercial semiconductor memory business. Its Solid State Products division has supplied outside customers in the past with specialized devices, but its main charter has been to supply other Hughes divisions, most frequently for militarily oriented applications.

In single-unit quantities, the introductory price is \$400. Larger quantities of the device will be available in July at a lower price.

Hughes Aircraft Co., Solid State Products Division, 500 Superior Ave., Newport Beach, Calif. 92660. Phone (714) 759-2411 [411]

Large-scale integration  
comes to analog controllers

What may be the industry's first single-chip, large-scale integrated universal analog controller, the NE-5522N, is aimed at those industrial applications requiring closed-loop control of machine speed and acceleration. Such applications include programmable speed control of ac and dc motors, magnetic-tape transport control, and rigid- and floppy-disk controllers.

For closed-loop control, a tachometer-generated ac analog input to the NE-5522N is processed by an on-chip frequency-to-voltage converter

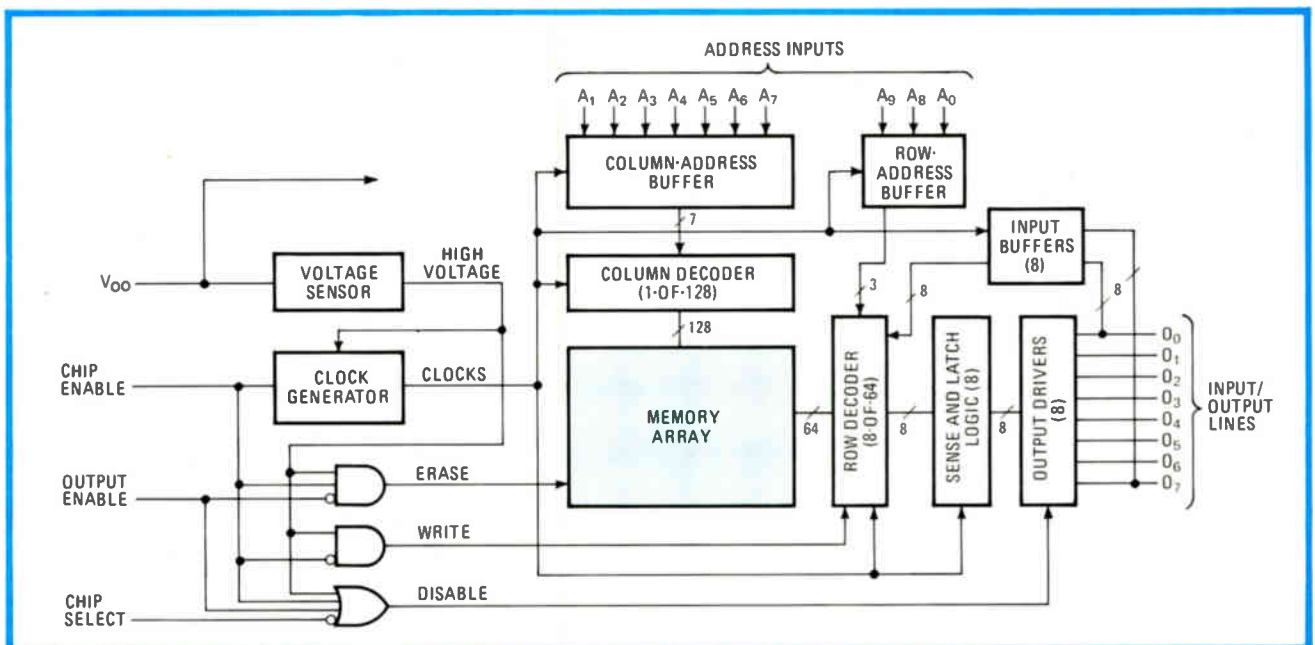

# PIC... the microcontroller.

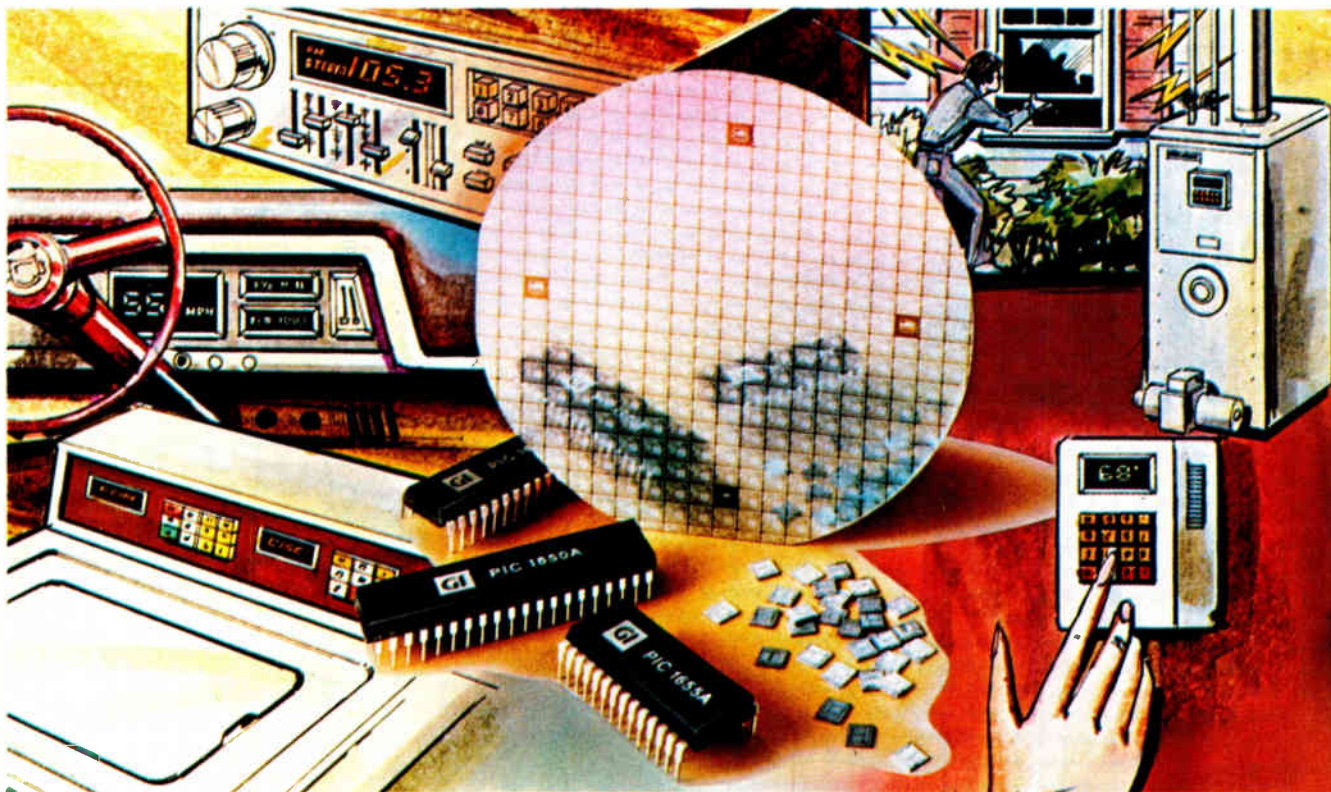

**More engineers are designing with PIC microcomputers than ever before.** And they're using them in an ever-widening range of applications; including consumer appliances, energy management systems, electronic games, security systems, keyboards, display drives, TV/radio tuning systems, and automotive dashboard instrumentation, to name but a few.

That's why General Instrument delivered more than four-million 8-bit microcomputers last year; more than twice as many as our leading competitor.

Big numbers, certainly, but more than that, our record is a direct reflection of the success and designer acceptance of General

Instrument's business philosophy: Deliver high quality products at competitive prices, backed by comprehensive customer service and support. For example, PIC can revolutionize the performance and energy efficiency of universal motors. As a closed loop controller, PIC provides soft starting and current limiting, improves efficiency under variable loads, protects against motor-jam, prevents overheating plus controls speed. What about cost? Remember the facts: General Instrument's PIC microcomputers are already proven cost effective in high volume applications.

To support our many users, we offer a complete set of hardware and software aids, including the

PICAL two-pass assembler program and PICES In-Circuit Emulation System. These help customers in their design, development, and evaluation of a particular application. In short, we deliver more microcomputers, because our microcomputers deliver more to our customers. And that's the *real* bottom line.

For more information on the PIC Series, write to: Microelectronics Division, General Instrument Corporation, 600 West John Street, Hicksville, New York 11802, Attention: Literature Department, or call 516-733-3107.

**We help you compete.®**

## GENERAL INSTRUMENT

---

## New products

---

whose output is compared with a reference dc voltage and then corrected. An integral 256-bit memory on the device allows the chip's sequencing mode to be modified during normal operation while retaining previously set information. The memory and the on-chip digital-to-analog converter can operate at up to 100 kHz to accommodate rapid command-input sequencing.

The 130-by-170-mil chip is packaged in a 24-pin dual in-line package. It is available from stock for \$10 each in quantities of 100 or more.

Signetics Corp., 811 E. Arques Ave., P. O. Box 409, Sunnyvale, Calif. 94086. Phone (408) 739-7700 [413]

---

### 16-K EE-PROM samples sell for \$70 apiece

Samples of Hitachi Ltd.'s 16-k electrically erasable programmable read-only memory will be available for delivery in July, priced at \$70 in 100-unit quantities. In order to attain the 350-ns maximum access time and high density of the HN-48016, Hitachi has developed its own n-channel silicon-gate metal-nitride-oxide semiconductor process [*Electronics*, Feb. 15, 1979, p. 39].

The EE-PROM can be read with +5 v and can be erased or programmed with +5 or +25 v. The electrical pulse, however, erases the entire memory—that is, the unit is not byte-erasable. The HN-48016's memory organization—2,048 words by 8 bits—and 24-pin dual in-line package are the same as those of the 2716 16-K E-PROM family.

Hitachi America Ltd., 707 W. Algonquin Rd., Arlington Heights, Ill. 60005. Phone (312) 593-7660 [414]

---

### 4-K static RAM uses 83 mW per megahertz

The MSM 5114 4-k static random-access memory uses complementary-MOS technology to require a maximum of 200  $\mu$ W of standby power or

83 mW per megahertz. Intended to replace the industry-standard 2114L RAM, the new RAM is completely interchangeable with existing parts, says the manufacturer. The 4,096-bit RAM is organized as 1,024 words by 4 bits and features an access time of 300 ns. It has TTL-compatible inputs and outputs and operates directly from a single +5-v supply. The device is priced between \$20.15 and \$18.10 in quantities of 100 or more. Delivery is immediate.

Oki Semiconductor, 1333 Lawrence Expressway, Suite 401, Santa Clara, Calif. 95051. Phone (408) 984-4840 [415]

---

### C-MOS integrated circuit attenuates audio signals

A monolithic integrated circuit, made using a thin-film-on-complementary-MOS process, attenuates audio signals. The manufacturer of the model AD-7110, believing the attenuator the first of its kind, has a patent pending. The unit provides 0-to-88.5-dB attenuation, plus full muting, in 1.5-dB increments. Total harmonic distortion is -98 dB, maximum, and intermodulation distortion is -92 dB, maximum. The device has loudness-compensation switches to boost low frequencies at low-volume settings. The signal-to-noise ratio is 100 dB from 20 Hz to 20 kHz. In a 16-pin dual in-line package designed for operation between 0° and +50° C, the AD-7110 sells for \$10 in quantities of 100. It is available from stock.

Analog Devices Semiconductor, 804 Woburn St., Wilmington, Mass. 01887. Phone (617) 935-5565 [416]

---

### Pnp 300-to-400-V transistors sell for less than \$4

Three pnp high-voltage switch-mode power transistors—the MJE5850, MJE5851, and MJE5852—are rated for 8 A of continuous current and 16 A peak. They have sustaining voltage ratings of 300, 350, and 400 v and can dissipate 80 w of power. The

devices are designed for high-voltage, high-speed power switching in inductive circuits such as inverters and motor controls, where fall time



is critical. Typically, the inductive fall time at 25° C is 100 ns, and the inductive cross-over time, 125 ns.

The units come in TO-220 plastic packages and operate between -65° and +150° C. They are available from stock, and priced between \$2.85 and \$4.00 when ordered in quantities of 100 to 999.

Motorola Semiconductor Products Inc., P. O. Box 20912, Phoenix, Ariz. 85036. Phone Jack Takesuye at (602) 244-4911 [419]

---

### V-MOS power transistors have 350- to 500-V ratings

For applications that require transistors with ratings from 350 to 500 v, Supertex has a line of high-current, high-voltage v-MOS power transistors. The devices can supply 8 A of continuous current and 16 A of pulse current. The family is divided into four voltage ratings (350, 400, 450, and 500 v) and three on-resistance ratings (1.0, 1.5, and 2.0  $\Omega$ ). To make the transistors competitive with bipolar transistors, the 400-v 1- $\Omega$  unit is priced at \$8.95 and the 500-v 1- $\Omega$  part is \$11.84 in 1,000-piece quantities. They are housed in TO-3 packages.

Production quantities are available on 6- to 10-week delivery, although evaluation quantities can be supplied from stock.

Supertex Inc., 1225 Bordeaux Dr., Sunnyvale, Calif. 94086. Phone (408) 744-0100 [418]



# TM 500 now gives you the quickest distortion measurements ever.

## Introducing the AA 501 Distortion Analyzer and SG 505 Oscillator. Fast, automated and accurate.

This new pair of TM 500 Plug-ins makes distortion measurement truly automatic to save you both time and money. For production testing, the AA 501's automatic speed provides substantial labor reduction with no loss in accuracy. Together, the AA 501 and SG 505 have the lowest harmonic distortion plus noise (THD+N) rating in the entire industry: 0.0025%.

The SG 505 Oscillator outputs a sine wave with the lowest residual distortion on today's market (.0008%). The AA 501 Distortion Analyzer uses digital processing to lock in on test signals, set levels and adjust the notch filter for nulling. All measurements, including dB levels are precalculated and then displayed on an LED readout.



The AA 501 and SG 505 are both TM 500 Plug-ins that can be installed in any of five main-frames, including rackmount, bench and portable. They can also be separated and still used as a team, even though miles apart. Or configured with over 40 other TM 500 Plug-ins currently available.

To find out more about the AA 501 Distortion Analyzer and SG 505 Oscillator, contact your local Tektronix Field Office or write Tektronix, Inc.

## TM 500 Designed for Configurability

# Tektronix®

COMMITTED TO EXCELLENCE

U.S.A.  
Tektronix, Inc.  
PO Box 1700  
Beaverton, OR 97075  
800 547 1512  
Oregon 800 644-9051

Asia, Australia, Canada,  
Central &  
South America, Japan  
Tektronix, Inc.  
America's Pacific  
PO Box 1700  
Beaverton, OR 97075



# Abqaiq, Saudi Arabia

No baseball, no morning paper,  
no pizza, no autumn leaves.

But here's the great life that makes  
Aramco people stay on and on.



If you never considered working in Saudi Arabia because you think it's all sand and hardships, consider this.

3,900 Americans like you work for Aramco in Saudi Arabia now. Ask them why they stay and they'll tell you that, besides money, it's the casual lifestyle, American-style hometowns, top-notch schools, and vacation travel they used to only daydream about.

#### Where on earth is Abqaiq?

Located close to the world's largest oil field (Ghawar), Abqaiq is the center of a giant oil-gathering and processing system that handles 60% of all the oil produced by Aramco, the world's largest producer.

#### Does Aramco's paycheck justify living in a desert kingdom?

Yes! You get a base salary competitive with top U.S. oil firms. We compensate you for overseas cost-of-living differences.

On top of that, Aramco pays an **incentive of up to 40%** for overseas employment, and you are reimbursed for any foreign or U.S. Federal income tax on the premium. So your premium is tax-protected.

Another benefit: employees overseas participate in Aramco's Retirement Income Plan on an **accelerated** basis.

With this financial package, no wonder 3,900 Americans like you work for Aramco in Saudi Arabia today.

#### What can you do with all that money stuck out in the desert?

Aramco people use 40-day paid vacations



*Aramcons vacation in Asia, Africa, the Middle East and Europe*

(every 12½ months) and 12 paid holidays (average) to visit fabulous places like the Pyramids, Greek Islands, Mt. Everest, the Serengeti Plain, Hong Kong.

#### Doesn't a child's education suffer so far away?

No! Aramco has a modern American school system. Teachers are primarily American and more than 75% of them have master's degrees. The teacher-student ratio is 1 to 15 in grades 1 to 6; 1 to 20 in grades 7 to 9.

#### Where do you go if you get seriously ill, or need dental surgery?

Aramco's Dhahran Health Center is one of three hospital systems outside the

U.S. accredited by the Joint Commission on Accreditation of Hospitals. The Dental Clinic is as fine as any in the States. Better than most.

#### Aramco recruiting ads mention "comfortable housing." Is that on the level?

At first, you'll live approximately 18 months in adequate but not terribly attractive off-camp temporary housing. Next, it's on to comfortable on-camp temporary housing. Then, based on a housing priority-point system using job level and length of service, you'll get your permanent residence. Many of these are like homes you'd want to live in, in the States.

#### What jobs are open today? Can a person advance?

Aramco's operations are so big that our job opportunities are probably unduplicated anywhere. Challenging jobs are open in administration, refineries, gas plants, support facilities, everywhere.

We need accountants, medical personnel, technicians, teachers, vocational trainers, communications specialists and materials forecasting specialists. And scores of engineers: in construction, project management, operations and maintenance—for operations in oil, gas, petrochemicals, EDP, computers, transportation, utilities, name it.

You'll have challenges, responsibilities, and management advancement opportunities.

**Interested?** Send your résumé in confidence to: Aramco Services Company, Department ELT061980GENA, 1100 Milam Building, Houston, Texas 77002.

**CHALLENGE BY CHOICE**

**ARAMCO**  
SERVICES COMPANY



# New PASS-THRU<sup>TM</sup> unlocks hidden productivity in board assembly systems.

Automatic machines shouldn't be kept waiting when they could be inserting components into circuit boards. This is why Universal Instruments developed its new Pass-Thru board handling system. Pass-Thru takes only a few seconds to feed a fresh board into an automatic component inserter while it is simultaneously pulling a completed board out of the machine's work area. It does this smoothly and gently, board after board, hour after hour, without fatigue and without error.

Pass-Thru feeds individual boards from a stack of blank or partially assembled boards and deposits finished boards in special compartmental magazines. This way, many boards can be carried in a single, protected load, ready for wave soldering or for automatic feed into another Pass-Thru equipped insertion machine. An operator can carry it, or we can supply a buffer-transfer unit to do it automatically, untouched by human hand. Ask your Universal sales engineer to show you our Pass-Thru video tape, or send for literature.

Circle 209 on reader service card



Subsidiary of **DOVER CORPORATION**

Universal Instruments Corporation ■ Box 825, Binghamton, New York 13902 ■ Tel: 607/772/7522 ■ TWX: 510/252/1990

Industrial

## Sensor transmitter simplifies systems

Temperature unit adapts sensor's output to 4- to 20-mA standard range

The model 2B57 two-wire "temperature transmitter" from Analog Devices interfaces with the firm's AD590 temperature sensor, converting that device's microampere output signals into a standard 4-to-20-mA output current span. This, coupled with the 2B57's ability to operate over a wide power-supply voltage range of 12 to 50 V dc, makes the transmitter compatible with standard two-wire loops used in process control and energy management systems, according to Janusz S. Kobel, marketing manager for signal-conditioning products.

The semiconductor-based 2B57, says Kobel, offers potential cost advantages, smaller size, and better stability than currently available transmitters operating with resistance-temperature detectors (RTDs). Whereas the conversion of outputs from thermocouples and RTDs generally requires linearization, elaborate signal-conditioning circuitry to check drift, and lead-wire or cold-junction compensation, the 2B57's

output current, like that of its companion AD590 sensor [*Electronics*, Dec. 8, 1977, p. 178], is directly proportional to measured temperature. Thus, it requires fewer internal components than RTD- and thermocouple-associated transmitters, a major cost- and size-cutting factor.

At \$59 each in lots of one to nine, the 2B57 can cost a third less than temperature transmitters used with RTDs, Kobel notes. In lots of 100 or more, the price drops to \$39 per unit. Housed in an epoxy-encapsulated module 1.5 by 1.5 by 0.4 in., it can mount easily in standard utility or thermostat boxes for remote temperature-sensing applications, he adds.

With a 16-mA output-current spread, the unit can cover measured temperatures from  $-55^{\circ}$  to  $+150^{\circ}\text{C}$ , a span of  $205^{\circ}\text{C}$ . Potentiometer adjustment trims the device to span any input range from the maximum down to a minimum span of  $20^{\circ}\text{C}$ . Although RTDs measure wider temperature ranges, the 2B57's capacity suits it to any application below  $+150^{\circ}\text{C}$ , an upper limit in many process control and energy-monitoring systems, Kobel says.

The nonlinearity of the 2B57 is typically  $\pm 0.02\%$  of the output span and  $\pm 0.05\%$  at the maximum. Factory-calibrated to be accurate to within  $\pm 0.5\%$  of full scale over its maximum  $205^{\circ}\text{C}$  sensor measurement span, the unit can achieve finer accuracy with user-trimmed adjustments. Drift over the full input range is a maximum of  $\pm 0.005\%/^{\circ}\text{C}$ , and

stability is  $\pm 0.001\%$  of full scale per volt change in the supply above 24 V. Its operating temperature range is from  $-30^{\circ}$  to  $+85^{\circ}\text{C}$ .

The 2B57 incorporates filtering circuitry that shields it from the radio-frequency interference found in industrial environments. Also included in the transmitter are an amplifier, a voltage regulator, a precision voltage reference, and an output-current generator. The same two wires carry both input power and output signals.

Several makers of energy management systems are using and evaluating the 2B57, according to Kobel. With increasing emphasis on distributed networks in process and energy control, the transmitter's noise immunity makes it a strong contender in remote-sensing applications, he feels. He also notes that for environments demanding additional protection from rfi, customers may elect to use the model 2B57A-1; this version is encased in aluminum and costs \$95 each in lots of one to nine. Delivery for both versions is from stock to two weeks.

Analog Devices Inc., Route 1 Industrial Park, P. O. Box 280, Norwood, Mass. 02062  
Phone 329-4700 [401]

## Indirectly heated thermistors have fast response times

A bead thermistor inside a miniature heating coil to which it is electrically connected constitutes an indirectly heated thermistor. The electrical assembly thermally biases the thermistor to its most sensitive operating range, a construction that allows fast response time, according to the manufacturer.

Encapsulated in glass, the unit is suitable for liquid-level sensing and gas-flow rate monitoring in low-temperature environments because of its small thermal mass. The operating temperature range is from  $-55^{\circ}$  to  $+300^{\circ}\text{C}$ .

In quantities of 100, the fast acting thermistor sells for about \$10, but this price varies with the application. Delivery takes from six to eight



# Digital accuracy in an analog recorder.

Gould's newest digital writing systems provide superior accuracy in full-scale overlapping traces without overshoot.

Gould's fixed linear array writing systems give you trace precision and reliability unmatched by conventional writing methods. Both the ES 1000 and the TA 600 provide faster rise time, higher resolution, full-scale overlapping display of all channels at user's discretion, excellent square wave and peak capture, simultaneous grid generation, and complete annotation of necessary information from internal and external sources.

**The ES 1000 electrostatic analog recorder.**

- Records frequencies up to 15 kHz on as many as 16 channels through versatile plug-in signal conditioners.
- Records transient signals lasting more than 40  $\mu$ s at full value.
- Chart speeds from 5 to 250 mm/s.
- Produces clear, high contrast permanent records

on 11-inch wide roll or Z-fold electrostatic paper which is 1/4 the cost of photo sensitive paper.

**The TA 600 thermal array analog recorder.**

- Records up to 320 Hz on as many as 32 channels through versatile plug-in signal conditioners.
- Displays at full value any pulse lasting over 625  $\mu$ s.
- Produces permanent records on 6-inch wide roll or Z-fold thermal paper.
- Chart speeds from 50 mm/s to 1 mm/h.
- Optional microprocessor gives the TA 600 the versatility for the most advanced recording applications.

For more information, write Gould Inc., Instruments Division, 3631 Perkins Ave., Cleveland, Ohio 44114.

**For brochures call toll-free: (800) 331-1000.**

In Oklahoma, call collect: (918) 664-8300.

In Europe, contact Gould Instruments S.A.F., 57 rue St. Sauveur, 91160 Ballainvilliers, France.

 **GOULD**

An Electrical/Electronics Company

Circle 211 on reader service card



ES 1000

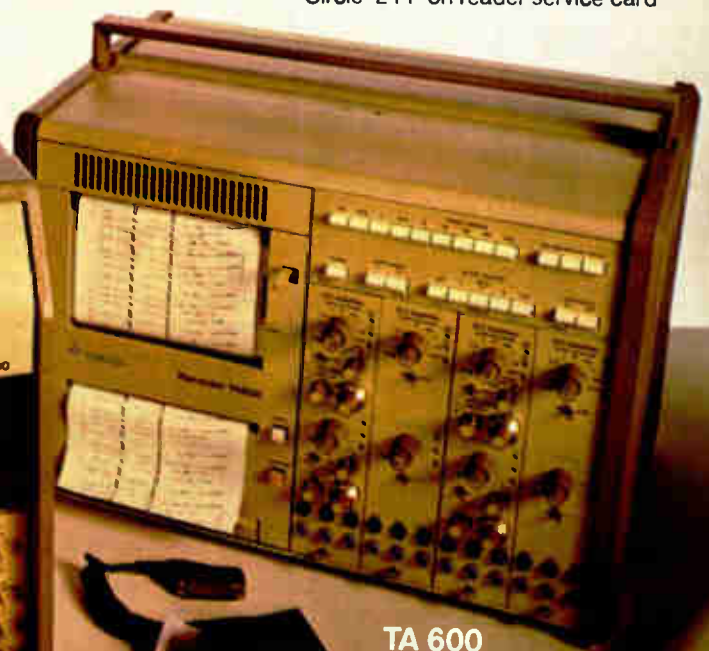

TA 600

---

## New products

---

weeks for standard units.

Gulton Industries Inc., Piezo Products Division, 212 Durham Ave., Metuchen, N. J. 08840. Phone (201) 548-2800 [373]

---

### Mechanical counter gives electrical readout

The 7509 series mechanical counter connects to a variety of displays or data systems, transmitting digital information from a rotating shaft to remote locations. The counter has individual circuit modules that con-

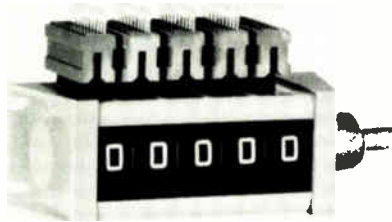

vert the mechanical information into an electrical readout suitable for computers. The unit has a direct drive with speeds of up to 150 rpm; a modular 10-position switch at each wheel position allows the unit to read 1,500 cpm. As the count advances, the circuit corresponding to the wheel position closes.

The unit also accurately subtracts, so that precise shaft or machine position is always displayed and transmitted regardless of rotation direction. Available with five or six figures more than 1/4 in. (6 mm) high for local display, the unit sells for less than \$100. The price is approximate, subject to the fluctuating cost of gold.

Veeder-Root, Hartford, Conn. 06102. Phone (203) 527-7201 [374]

---

### Acoustic-emission transducers are general-purpose units

Designated the 9200 A series, a line of acoustic-emission transducers optimizes sensitivity, frequency response, ruggedness, nondirectionality, resistance to electromagnetic

interference, environmental capabilities, and operating temperature range.

The D9201A version provides broadband frequency response from 100 kHz to 950 kHz with 51-dB/V/m/A sensitivity across the range. Its applications include data counting, relative amplitude measurements, and spectrum analysis. The D9202A sensitivity is 51 dB/V/m/A between 350 kHz and 700 kHz and is fit for use near high-level environmental noise such as from rubbing, flow, or vibration. Offering maximum sensitivity of 62 dB/V/m/A in the range between 100 and 300 kHz, the D9203A is suitable



for applications requiring a high signal-to-noise ratio such as in studies of corrosion and creep or in the testing of quiet acoustic materials.

Dunegan/Endevco, Rancho Viejo Road, San Juan Capistrano, Calif. 92675 [375]

---

### Surface-temperature-sensing thermostats are laser-welded

The series 5200 hermetically sealed thermostats are laser-welded, thus avoiding excessive heat that could damage their bi-metal disk during construction. They are resistant to vibration and shock and can be used in applications ranging from business machines and copiers to instruments and control systems. They are

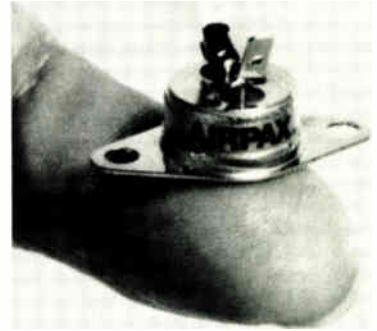

also suited for use on hot-melt glue machines and similar production equipment. The thermostats offer fast, positive response over an operating temperature range of 15° to 500°F. Each is individually calibrated and tested to standard tolerances as low as  $\pm 5^\circ\text{F}$ .

Airpax/North American Philips Controls Corp., Frederick, Md. 21701 [376]

---

### Monolithic sensors operate up to 100 lb/in.<sup>2</sup>

A line of monolithic sensors that operate at pressures up to 100 lb/in.<sup>2</sup> are suitable for such applications as pneumatic control systems, refrigeration, hydraulics, tire- and oil-pressure monitoring, and plant safety systems. Previously available with operating pressures limited to 30 lb/in.<sup>2</sup>, the LX0520 and LX0620 monolithic devices come in either TO-5 metal cans or ceramic packages. Both versions have a sensitivity of 0.2 to 0.8 mV and operate from a single 7.5-v supply. On-chip temperature compensation reduces typical span temperature coefficients (in the 0°-to-85°C range) to 0.02 mV/°C.

In quantities of 1 to 24, the absolute-pressure LX0520A in a TO-5 package is \$30 each; the LX0620GB gage unit and LX0620D differential unit in ceramic packages sell for \$36 each. Delivery is from stock to six weeks.

National Semiconductor, 2900 Semiconductor Dr., Santa Clara, Calif. 95051. Phone (408) 737-5000 [378]

---

# Now—Gould quality in a 100 MHz oscilloscope.

No scope on the market has more of the features you need than the new Gould OS3600 with optional DMM. You can use the OS3600 on any electrical/electronic circuit from digital to conventional with exceptional results.

With vertical sensitivity of 2mV/cm up to 85 MHz, the OS3600 can examine extremely low level signals. The 4-trace capability allows comparison of original and delayed sweeps.

The bright, flicker-free CRT

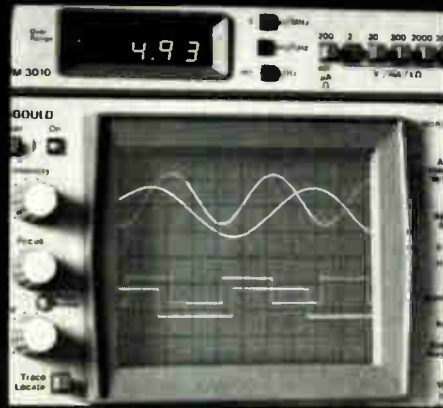

displays even narrow pulses with low repetition rates. The optional 3½ digit DMM is available as a factory fit or retrofit. Plus, the OS3600 is backed by a worldwide service network and a unique 2-year warranty that covers all parts and labor (exclusive of fuses, calibration, or minor maintenance).

Write Gould Inc., Instruments Division, 3631 Perkins Avenue, Cleveland, OH 44114. Call toll free 800-331-1000 (in Oklahoma, call collect 918-664-8300).

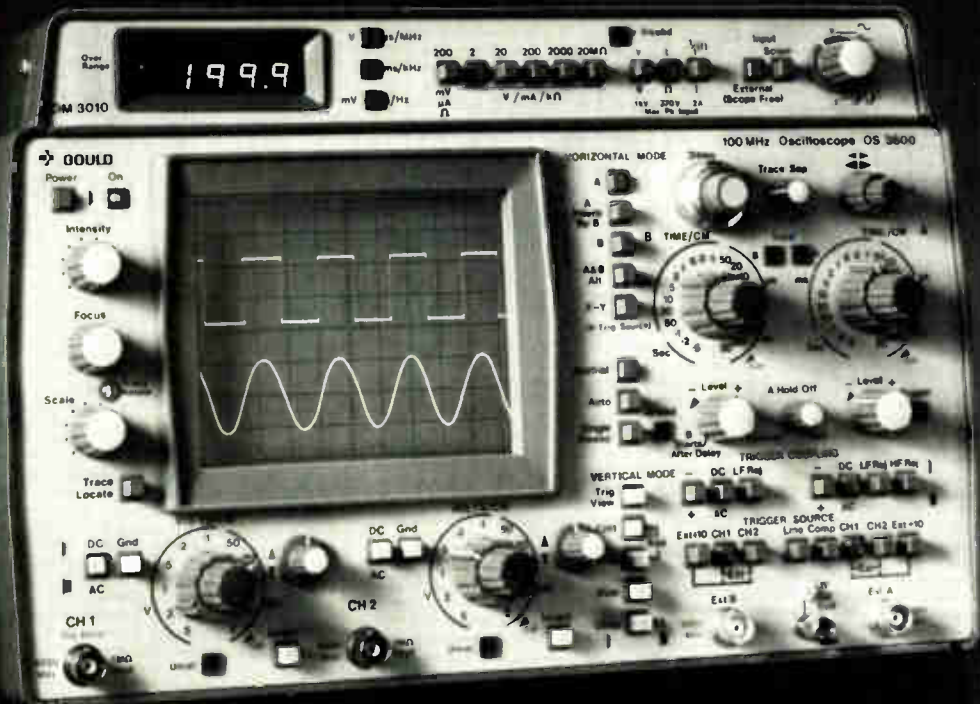

 **GOULD**

An Electrical/Electronics Company

Circle 213 on reader service card

# Multimillion \$ radar ...

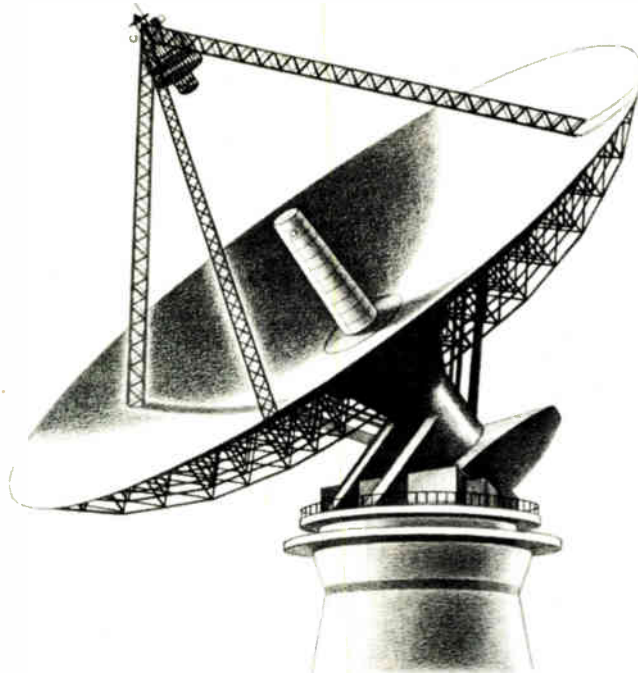

## ... or tiny silicon chip, the key to successful sales in Japan lies here:

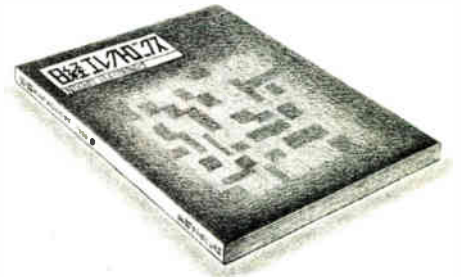

No matter what the product, the stakes are high for the foreign corporation trying to gain a foothold in the Japanese market.

And in a tight-knit society like Japan's, having the right connections can often spell the difference between success or failure.

Nikkei Electronics can provide you these connections.

Japan's leading vernacular electronics magazine, it is published bi-weekly and distributed on subscriber basis to more than 40,000 key decision makers in

Japan's foremost electronics publication

# Nikkei Electronics

NIKKEI-McGRAW-HILL, INC.  
The Publisher of Nikkei Electronics  
Wataru Makishima, Manager, Advertising  
Nikkei Annex Bldg. 2-1-2, Uchi-Kanda, Chiyoda-ku,  
Tokyo, Japan. Telex: J26296 NKMCGRAW

the electronics industry.

Nikkei Electronics. Your first step to success in Japan.

Subscriptions: 43,080 (Apr. 14, 1980 issue)  
Circulation: 39,625 (Jan.-June 1979)  
Japan ABC  
Regularly audited by the Japan ABC

For further information, write to:  
H.T. Howland, Marketing Services Manager,  
Electronics, McGraw-Hill Publications Co.,  
1221 Avenue of the Americas, New York,  
N.Y. 10020, U.S.A. Tel: (212) 997-6642



# When you need LEDs or more than LEDs...



Dialight is the first place to look. We can help you do more with LEDs... because we've done more with them.

Discrete LEDs come in a variety of sizes, shapes, colors (red, yellow, green in clear or diffused), with or without built-in resistors.

Low cost logic state fault indicators for trouble shooting complex circuits. Designed for close density PC board mounting.

High-brightness bi-color LEDs (red/green) suitable for go/no-go situations. Designed with unique

lenses for the extra visibility you'll want for your most critical applications.

Snap-in mounting LED indicators reduce labor cost. Available in red, yellow or green with or without built-in resistors.

Whatever you need in LEDs, Dialight's probably got it already. For your free 60-page selector guide and listing of our nationwide stocking distributors, contact us today.

**DIALIGHT**  
A North American Philips Company

## Dialight meets your needs.

Dialight, 203 Harrison Place, Brooklyn, N.Y. 11237 (212) 497-7600

Circle 215 on reader service card

---

## New products

---

Packaging & production

# CO<sub>2</sub> laser scriber sells for \$49,000

---

Programmable system for ceramic substrates can be tailored for user's needs

---

Manufacturers of hybrid microcircuits, particularly smaller houses, usually have two choices for scribing ceramic substrates. They may buy custom pre-scribed substrates or send them to an outside service. Larger firms, however, can build their own laser-based scribers, at costs up to \$100,000 each, but few such systems (perhaps a dozen) exist, industry sources say.

A new turnkey computerized laser scribing system that sells for \$49,000 should offer a better solution for this key production task, according to its designer, Apollo Lasers Inc. The model 350 can be built and packaged for half the price of other systems for several reasons, explains Thomas J. Kujawa, chief engineer of the Los Angeles firm.

Primarily, "the background of Apollo as a supplier of carbon dioxide lasers to industry gives us a head start with a mature laser unit we've sold for more than eight years." Also, the firm has determined that a pulsed laser of modest power can do most hybrid scribing, in contrast to higher powered 150- to 200-watt continuous-wave units, whose more elaborate optics and support circuitry make them more expensive. The CO<sub>2</sub> laser works well in scribing ceramics; monolithic silicon integrated circuits, on the other hand, require yttrium-aluminum-garnet (YAG) lasers because of their different optical response.

A microprocessor-based controller from Automation Unlimited Inc. is used to program the Apollo scriber. The scriber operates manually or automatically from programs stored in a magnetic-tape cassette, at a maximum scribing rate of 2 in./s.

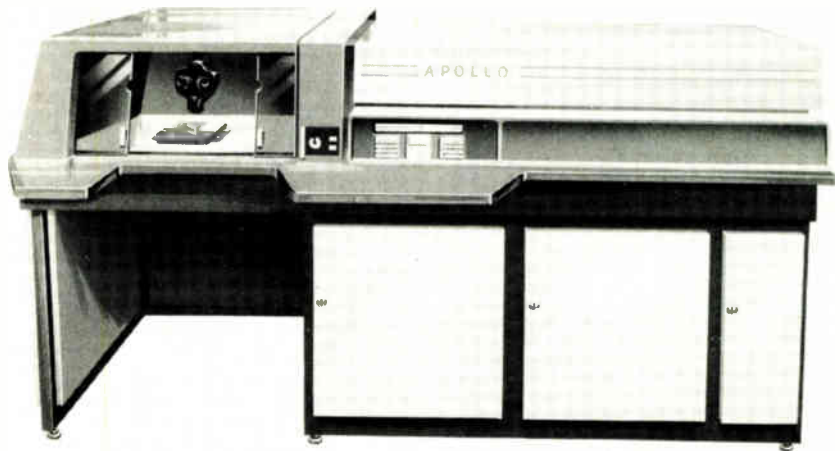

Scribed lines consist of tapered holes with 0.004- to 0.006-in. diameters at the surface and a depth of 0.008 to 0.012 in. Spacing is adjustable from 50 to 200 holes/in. Substrates 0.5 to 5 in. square and up to 0.062 in. thick can be handled.

The laser itself has a repetition rate variable to 1,000 pulses per second and synchronized to the stepping rate of the positioning table. It has a 250- $\mu$ s pulse width and pulse power of 400 w peak at 350 pulses/s; 150 w at 1,000 pulses/s. For control of scribing, the X-Y axis position translator has resolution of 0.001 in. with a positioning error of  $\pm 0.002$  in. maximum. The repeatability error is a maximum of 0.005 in.

The Apollo system comprises the CO<sub>2</sub> laser, a work station that includes power supply, an X-Y translation stage with controller and magnetic-tape drive, substrate holding fixture, and alignment mechanism with viewing optics. A helium-neon pointing light projected through the optics defines the laser beam location for the operator.

An important feature, Kujawa notes, is a design that guarantees operator safety by enclosing the laser beam, table, and substrate in a windowed, interlocked recess. Operating costs are under \$2 an hour for the scriber.

Kujawa points out that an in-house scriber gives a manufacturer better control of production and therefore of circuit yields. "For one

thing, it allows a user to hold off scribing until the last operation before packaging, which helps avoid damaging those expensive hybrid components." A faster turnaround time with affordable in-house equipment aids in holding down costs.

He also explains that the design of these systems depends so heavily on specific requirements that they must be built to order from available components; delivery is typically four months.

Apollo Lasers Inc., 6357 Arizona Circle, Los Angeles, Calif. 90045. Phone (213) 776-3343 [391]

---

## Socket's elements can be removed and replaced

A burn-in and test socket's conductive elements can be removed and replaced if damaged by excess wear or IC shorting. The socket is to be used when integrated circuits mounted in 68-lead ceramic chip-carriers are tested and burned in. The socket material is high-temperature Ryton thermoplastic. It has an integral hinged lid with resilient, compliant elements. The Zebra series 8000 connector elements are composites of metal and silicon elastomers that maintain positive contact pressure at elevated temperatures. Electrical contact from the pads on the chip-carrier to the pads on the printed-circuit board is made

# AUGAT'S SOLUTION TO PACKAGING DENSITY AND DESIGN FLEXIBILITY... THE PLANAR STITCH-WIRE SYSTEM.

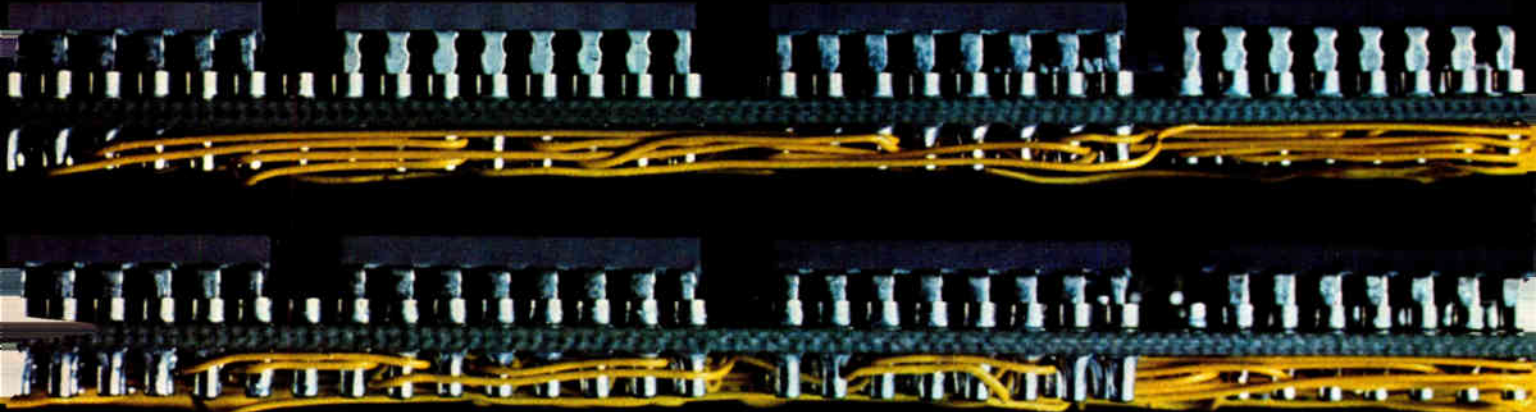

Planar socket-type boards on 0.5 inch centers

Photograph shown 2x size.

Augat's Planar stitch-wire concept is unique. This patented, high-speed, low-cost system reduces the substantial engineering time of complete circuit card prototyping and debugging. As a result, turn-around time can be cut by one-third to one-half. Augat's stitch-wire system works like this: after components or sockets are mounted on the Planar boards, a stitch-wire machine welds Teflon-insulated nickel wire to stainless steel pads. In certain configurations, the bare board may be wired first.

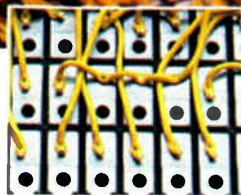

Wiring instructions can be furnished using key-punch card or wire lists. Your logic design can be debugged using our Data-Logic program. We provide all final wiring documentation, or can supply total wiring service at any of our four service facilities located in—Van Nuys, CA, Houston, TX, Attleboro, MA, Fresnes, France.

Changes can be made by stitch-wire machines or by hand soldering. Adopting stitch-wire is easy, because Augat provides the wiring machines, including portable models (LC 8000 shown), a high-speed, numerically controlled model, and a wide range of general-purpose Planar boards, including boards compatible with most mini- and micro-computers. These boards feature large etched power and ground planes making them ideal for high-speed logic. We can design and produce

stitch-wire boards to your specifications, or provide the boards and equipment you need to do the job in your own shop. Augat stitch-wire offers density and flexibility advantages you can't get anywhere else. To find out how to start with Planar stitch-wire, write or call, Augat Inc.,

Interconnection Systems Division,  
40 Perry Avenue, P.O. Box 1037,  
Attleboro, MA 02703.  
Tel. (617) 222-2202.

Europe—Augat SA, B.P. 440  
Cedex/94263 Fresnes, France.  
Tel. 668.30.90. Telex. 201.227.  
AUGSAF.

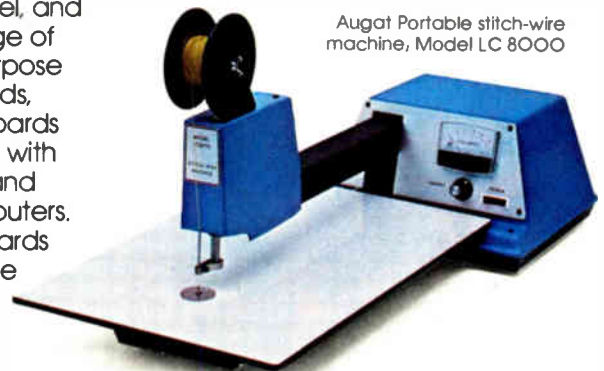

Augat Portable stitch-wire machine, Model LC 8000

## AUGAT®

Augat interconnection products, isotronics microcircuit packaging, Alco subminiature switches and Datatex computer-aided design and wire-wrapping services.

Circle 217 on reader service card



**The MICROTEMP®: the #1 thermal cutoff in the 60° to 240°C range.**

OEM's look for reliability in a thermal cutoff. Which is why they've relied on the MICROTEMP® over a billion times.

They know the MICROTEMP is designed to protect the average product for its projected life. The MICROTEMP will cut off any thermal hazard above the set  
Circle 218 on reader service card



temperature instantly. So if you're looking for a low cost thermal cutoff you can really count on, look no further. Go with the one that's #1 around the world. The MICROTEMP.



**New products**

through the elements. Operating from -65° to +200°C, the device sells for \$20.50 each in quantities of 100 or more. Delivery time is from three to four weeks.

Tecknit, 129 Dermody St., Cranford, N. J. 07016. Phone (201) 272-5500 [393]

Heat sinks mount on leadless chip-carriers in any position

The 2280/2286 series of heat sinks for leadless chip-carriers and flat-packs can be mounted in virtually any position. Units can be bonded onto most Jedec packages with thermally conductive epoxy. Both series are finished in gold chromate. Thermal performance varies with device size and power rating. For example, for a 0.192-in.<sup>2</sup> die at 3.5 w, the thermal resistance at the junction with the ambient temperature at a 750-ft/min air velocity would be 15°C/w for the 2280C heat sink.

In quantities of 1,000 to 5,000, the 2280 sells for 17¢ and the 2286 for 20¢. Delivery is from stock.

Thermalloy Inc., P. O. Box 340839, Dallas, Texas 75235. Phone (214) 243-4321 [394]

Epoxy die bonder handles 3,600 lead frames per hour

The LF-260-A high-speed, automated epoxy die bonder has a maximum throughput rate of 3,600 lead frames per hour. Each individual cycle consists of stamping epoxy onto the substrate and picking up and placing a die in the epoxy. The wafer die are taken from an elevated taped wafer. Proper alignment of the die for pick-up is ensured through the use of closed-circuit television system and a manual X-Y control.

The epoxy die bonder operates from a standard 115-v ac line; for overseas use, a 220-v ac model is available. The LF-26-A with a lead-frame handling system sells for \$20,000 to \$25,000. Delivery takes 14 to 16 weeks.

Laurier Associates Inc., Executive Drive, Hudson, N. H. 03051. [396]



**If you'd like your career to experience a Rocky Mountain high, don't miss the special Colorado Career Opportunities Advertorial located in ELECTRONICS' Classified Section.**

# Reduce costly solder bridging with VACREL™ Solder Mask.

No Solder Bridging with VACREL Solder Mask

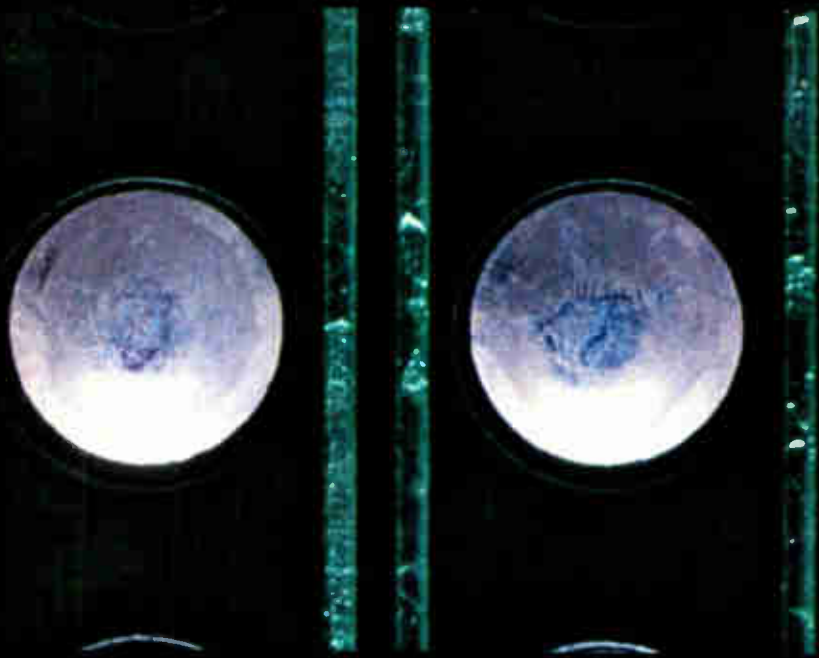

**DuPont's photopolymer dry film solder mask cuts board assembly problems, too. Result: you get fewer rejects.**

VACREL dry film solder mask provides increased protection to fine line circuitry, down to 5 mil tolerances between lines and pads. Result—reduced solder bridging, less touch-up and fewer rejects.



With conventional screened solder mask you can get adequate circuitry protection on boards where distances between pads or between lines and pads are greater than 15 mils. But with tighter circuitry design and tolerances of less than 15 mils, solder bridging becomes an expensive problem. As these distances decrease below 15 mils, the cost of achieving boards free of solder bridging becomes increasingly expensive.

VACREL helps in other ways, too. It gives you circuit protection. Its uniform thick coating can give you added circuit protection on both the solder side and the component side of the board.

Find out how else VACREL photopolymer solder mask can help you. Write VACREL Solder Mask, RISTON® Products, DuPont Co., Rm. 37884, Wilmington, DE 19898.

**Innovations for Electronics**



Circle 219 on reader service card

# THINK BAUSCH & LOMB PERFORMANCE

StereoZoom® Microscopes were an innovation when Bausch & Lomb first introduced them in 1959. They were the world's first zooming stereo microscopes and they quickly met the challenges of electronic assembly, packaging, and inspection functions. That's still true today.

The reasons all relate to Bausch & Lomb performance. Like patented coaxial illumination for accurate, thorough assembly. Photomicrographic accessories for reliable inspection documentation. And a wide selection of versatile accessories to exactly meet virtually any production requirement.

Constant attention to performance requirements has made StereoZoom Microscopes the first choice in the electronics industry for over twenty years. Call or write today for our latest catalog, applications assistance, or a personal demonstration.

**Quality. Precision. Versatility.**  
Three good reasons to . . . THINK BAUSCH & LOMB PERFORMANCE

**BAUSCH & LOMB**   
Scientific Optical Products Division  
140 CHESTER NEW YORK 14602

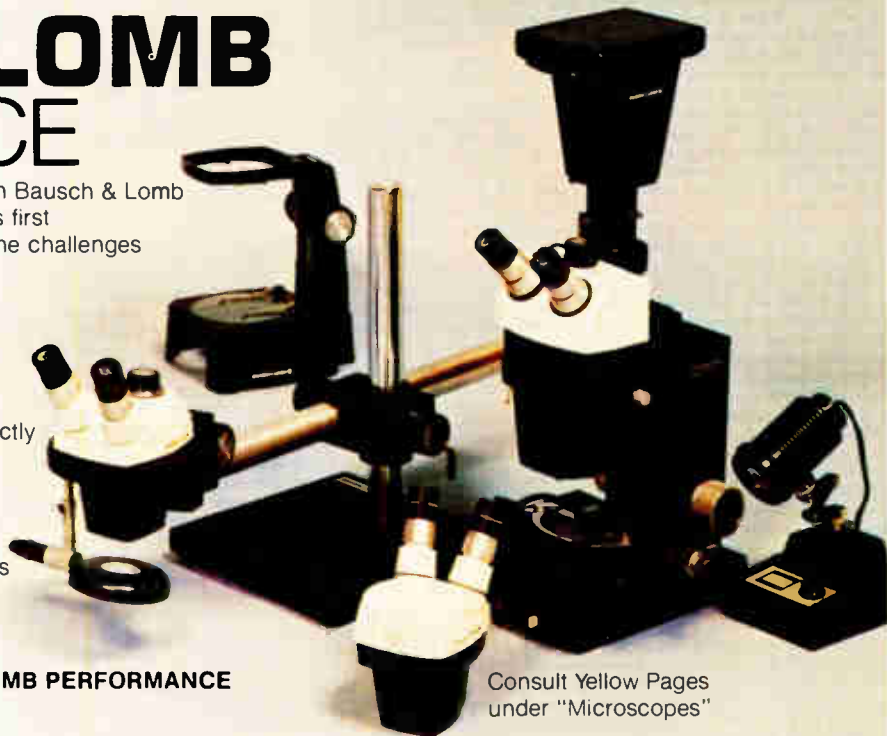

Consult Yellow Pages  
under "Microscopes"

Circle 251 for more information

**Shunt Networks**  
DIP/SIP  
(they're programmable)

CTS Series 198 programmable shunt networks replace jumper buss wiring with one error-free package available in complete matrix or parallel connections. You program them by breaking a visible connection with a stylus. Or we'll program them for you. Nothing we know of could be more economical.

SIP and DIP styles on 100-pin centers and 300-pin side-to-side SIPs available in 2-12 pins. DIPs in 4-24 pins. Machine insertable too. Get complete data from CTS Keene Inc., 3230 Riverside Ave., Paso Robles, CA 93446 Phone (805) 238-0350

**CTS CORPORATION**  
ELKHART INDIANA



Circle 252 on reader service card

## OVENAIRE...

YOUR QUALITY SOURCE FOR CRYSTAL  
OSCILLATORS AND CRYSTAL AND  
COMPONENT OVENS



- **STATE-OF-THE-ART HIGH STABILITY CRYSTAL OSCILLATORS** with stabilities to  $5 \times 10^{-10}$ /day and  $7 \times 10^{-11}$ /°C.
- **OVENIZED CRYSTAL OSCILLATORS**  $3 \times 10^{-9}$ /°C at low cost.
- **TCXO's** with temperature stabilities to  $\pm 1 \times 10^{-7}$  0 to 50°C.
- **ELECTRONIC CONTROL MINIATURE OVENS FOR:** HC-18U, HC-25U, HC-42U, HC-43U crystals TO5 & TO8 crystal, transistor or IC 14 Pin & 16 Pin DIP IC.

Plus a complete range of ovens for commercial and military applications.

### OVENAIRE-AUDIO-CARPENTER

Division of Walter Kidde & Company Inc.

706 Forrest St., Charlottesville, Va. 22901  
804/977-8050 TWX 510-587-5461

**KIDDE**

Circle 253 on reader service card

# The power of positive linking.



## Amphenol® 229 Series connectors. Qualified to MIL-C-22992, Class L. Preferred under MIL-STD-1353A.

Positively rugged—these high-power grounded connectors are constructed with high-impact aluminum and high-strength plastic. So they'll withstand rough use. Expect far fewer replacements and less downtime than with other connectors.

Positively waterproof, too. Mated or unmated. Capped or uncapped. Our environmental sealing system eliminates a major cause of connector failure.

Recessed socket contacts provide arc-quenching and personnel protection. Five-key shell polarization means these connectors can *only* be mated with connectors having the same voltage, current, frequency, phase, and grounding characteristics. And they are field repairable. Available in four connector shell sizes: 28(40-amp), 32(60-amp), 44(100-amp), and 52(200-amp).

Applications include mobile or fixed communications, radar, lighting, portable generators, power generation and distribution equipment, battery chargers, and more.

For complete information, technical data, dimensions, and prices, contact your nearest Amphenol North America sales office.

229 Series available in cable plug and receptacle as well as wall-mount plug and receptacle (photo 1/4 size)



## AMPHENOL NORTH AMERICA

A Division of Bunker Ramo Corporation

Amphenol North America Division Headquarters: Oak Brook, Illinois 60521

Sales Offices: Atlanta (404) 394-6298 • Boston (617) 475-7055 • Chicago (312) 986-2330 • Dallas (214) 235-8318 • Dayton (513) 294-0461  
Denver (303) 752-4114 • Greensboro (919) 292-9273 • Houston (713) 444-4096 • Indianapolis (317) 842-3245 • Kansas City (816) 737-3937  
Knoxville (615) 690-6765 • Los Angeles (213) 649-5015 • Minneapolis (612) 835-4595 • New York (516) 364-2270 • Orlando (305) 647-5504  
Philadelphia (215) 732-1427 • Phoenix (602) 265-3227 • St. Louis (314) 569-2277 • San Diego (714) 272-5451 • San Francisco (408) 732-8990  
Seattle (206) 455-2525 • Syracuse (315) 455-5786 • Washington, DC (703) 524-8700  
Canada: Montreal (514) 482-5520 • Toronto (416) 291-4401 • Vancouver (604) 278-7636 • International: Oak Brook, Illinois TELEX 206-054

Circle 221 on reader service card

**Components**

## Two DIPs perform 8-channel, 50-kHz data acquisition

The trend in hybrid data-acquisition system design continues to be to pack more into less—more performance into less space—as demonstrated by a two-package system developed by Harris Semiconductor Products division.

The firm now has a differential 8-channel, 12-bit, 50-kHz system mounted on two dual in-line packages. One has 32 pins, the other 40. Both are rated for operation over the  $-55^{\circ}$ -to- $+125^{\circ}$ C temperature range specified by the military. One unit (HI-5900) serves as the front-end processor and the other (HI-5712) as an analog-to-digital converter. Both are hybrid designs, carrying several integrated circuits mounted in leadless chip-carriers on the top and bottom of the ceramic substrates [*Electronics*, June 5, p. 40].

The HI-5900 analog data-acquisition signal processor includes a programmable-gain instrumentation amplifier that provides programmable gains of 1, 2, 4, and 8. Voltage gain can be selected using a 2-bit digital word. In addition, the low-side output of the programmable-gain amplifier is isolated by a buffer amplifier that preserves the unit's 80-dB common-mode rejection ratio.

Operating in a noninverting unity-gain mode, a monolithic sample-and-hold amplifier on the HI-5900 also uses an external capacitor to provide a 50-ns aperture delay in the hold mode and 10 pC of charge transfer.

Minimum input common-mode

range is  $\pm 10$  v over the unit's full operating range. Other specifications include  $-80$  dB of crosstalk and a  $9\text{-}\mu\text{s}$  acquisition time to 0.01% of full scale. The device is powered by  $\pm 15$  v and dissipates 650 mw.

The companion DIP is an  $8\text{-}\mu\text{s}$ , 12-bit successive-approximation a-d converter. It features a gain temperature coefficient of 10 ppm/ $^{\circ}$ C and has differential linearity to within  $\pm 1/2$  least significant bit over the military operating temperature range. Monotonicity is guaranteed over this range.

The converter's input voltages are pin-programmable to  $\pm 5$ ,  $\pm 10$ , 0 to 10, and 0 to 20 v. Among other features are its internal clock, which can be overridden by an external one, and the internal reference with a temperature coefficient of 5 ppm/ $^{\circ}$ C, which delivers 10 mA. A remote sense terminal allows the reference to be disconnected, internally jumped to the d-a converter, or used as a reference elsewhere in the data acquisition system.

Output coding for the a-d converter includes binary and 2's complement. Further, the HI-5712 exhibits a short-cycle capability of 6.8, 5.6, and  $4.4\ \mu\text{s}$  for 10-, 8-, and 6-bit conversions, respectively. Drift specifications are stated as  $\pm 2$  and  $\pm 5$  ppm/ $^{\circ}$ C for unipolar and bipolar offset drift and  $\pm 10$  ppm/ $^{\circ}$ C for gain drift.

The three-state output of the TTL and C-MOS-compatible unit features independent control for bit groups 1 through 8 and 9 through 12. The converter has the necessary signal lines for interfacing with 8-, 12-, or 16-bit microprocessor systems. Power supply voltages are  $\pm 15$  and 5 v; power dissipation is 1,100 mw.

Commercial-grade HI-5900 and HI-5712 parts will also be available

for operation over the  $0^{\circ}$ -to- $70^{\circ}$ C range. Prices for such devices will be approximately \$100 each for the HI-5900 analog signal processor and about \$175 to \$200 for the HI-5712 a-d converter. Prices are for 100-piece lots; availability is from stock.

Harris Semiconductor Products Division, P. O. Box 883, Melbourne, Fla. 32901. Phone (305)724-7407 [341]

---

## 16-bit hybrid converter digitizes in 50 $\mu\text{s}$

Continuing to expand its line of 16-bit hybrid converters, Burr-Brown is offering the ADC71, a low-cost TTL-compatible successive-approximation analog-to-digital unit. The integrated circuit offers a maximum nonlinearity of  $\pm 0.003\%$  and a maximum conversion speed of 50  $\mu\text{s}$ . It contains a reference, a comparator, and thin-film scaling resistors.

It is available in two versions: the ADC71KG (with 14-bit accuracy) and the ADC71JG (13-bit accuracy). Both have a maximum gain error of  $\pm 0.2\%$ . The 71KG's maximum nonlinearity is  $\pm 0.003\%$  of full-scale reading, whereas the 71JG's is  $\pm 0.006\%$  of full scale. Both versions have a differential nonlinearity of  $\pm 0.003\%$ , gain and offset drift of  $\pm 15$  ppm/ $^{\circ}$ C, and a temperature coefficient of  $\pm 10$  ppm/ $^{\circ}$ C. The following analog ranges may be selected:  $\pm 2.5$  v,  $\pm 5$  v,  $\pm 10$  v, 0 to 5 v, 0 to 10 v, and 0 to 20 v. The units operate from  $\pm 15$ - and 5-v dc supplies over a temperature range of  $-25^{\circ}$  to  $+85^{\circ}$ C. For orders of 100 or more, the ADC71JG sells for \$159 and the ADC71KG for \$189.

Burr-Brown, P. O. Box 11400, Tucson, Ariz. 85734. Phone (602) 746-1111 [342]

---

## 14-segment display system initializes itself

The W4XX-1053 is a 14-segment interactive alphanumeric gas-discharge unit that displays 16 (the model W416-1053), 20 (the W420-

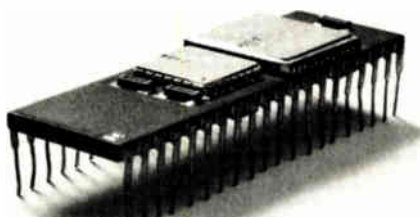



# THE DATA I/O SYSTEM 19 PROGRAMMER: SAVES ENGINEERS TIME. SAVES DEVELOPMENT SYSTEM TIME.



## Data I/O's System 19 Programmer frees your microprocessor development system for more important tasks.

Here's an example: An engineer is building six prototypes for a new microprocessor based product. If each unit has eight 2708 PROMs, it will take more than an hour to program those 48 PROMs—one at a time—on the development system.

That's time and money wasted.

Instead of tying up the development system to program PROMs, the engineer could simply download the information into the System 19's RAM and free the development system for more creative tasks.

That's time and money saved.

## System 19 interfaces more easily with more development systems than any other programmer, and accommodates 16 bit microprocessor data too!

System 19 is intelligent. It can communicate using RS232C or 20mA current loop with a variety of formats without the need for intermediaries like paper tape.

And Data I/O makes interfacing easy because we supply application notes explaining exactly how to do it.

System 19 can transmit and receive data formatted in: Binary, DEC Binary, ASCII-BNPF, ASCII-BFLF, ASCII-B10F, 5-level BNPF, Spectrum, ASCII-Hex, ASCII Octal, RCA Cosmac, Fairchild Fairbug, MOS Technology, Motorola Exorciser, Intel Intellec 8/MDS, Signetics Absolute Object and Tektronix Hexadecimal.

**System 19 is a valuable editing tool.** Instead of waiting for development system time to refine a program, an engineer can also edit the program using the System 19 keyboard.

**The System 19 modular concept keeps it state of the art.** The System 19 is designed around a standard mainframe and plug-in modules:

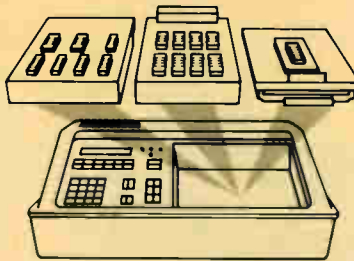

—UniPak: a single, seven socket module that programs more than 200 different bipolar and MOS PROMs and gives you design and purchasing freedom for evaluating new devices and developing second sources.

—Individual PROM Programming Paks: for generic PROM families.

—Individual Logic Programming Paks: for devices such as FPLAs and PALs.

—Gang Module: programs up to eight MOS devices at once.

## Let us show you the future.

The Data I/O System 19 is available now. To make arrangements for a demonstration or to get your free copy of this valuable 32-page book, circle reader service number or

contact Data I/O, P.O. Box 308, Issaquah, WA 98027. Phone 206/455-3990 or TOLL FREE 800/426-9016.

# DATA I/O

Circle 223 on reader service card



As of today, \$800\* may buy all the real-time, multi-tasking executive capability you'll ever need:

## Announcing **AMIX** for 8080 and Z80 systems

- Supports PLM, Fortran and Assembler
- Adapts to your memory and I/O
- ROMable for control applications
- Multiterminal device independent I/O
- Conversational builder simplifies system development
- Design proven in 10 years of industrial use
- Unlimited use licence agreement
- Source delivered on CPM compatible diskette

\*\$800 price includes source and set of four manuals.  
\$35 for 190 page AMX Reference Manual only.

PASCAL interface available separately.

For further information, call or write:  
W. L. (Bill) Renwick



**KADAK Products Ltd.**  
206-1847 West Broadway Avenue,  
Vancouver, B.C., Canada V6J 1Y5  
Telephone (604) 734-2796

*Dealer enquiries invited.*

Circle 224 on reader service card

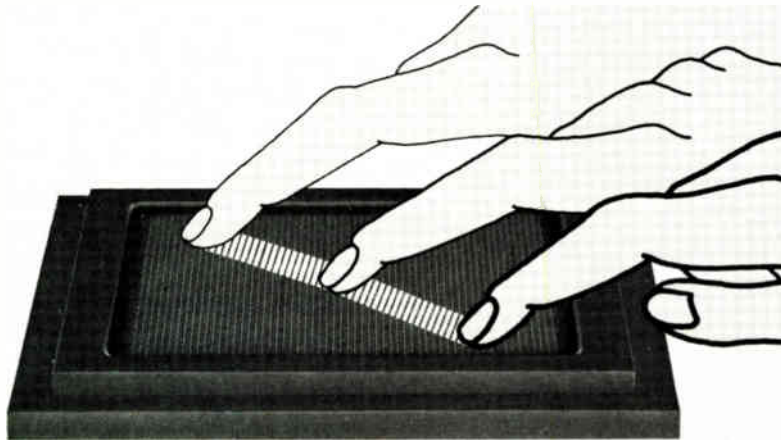

## A new X-Y controller that operates from fingertip glide

A lower-cost, long-life alternative to trackballs,  
joysticks, light pens, etc.

With this new X-Y controller all you do is slide your fingertip in the desired direction.

Then 3600 solid-state sensors embedded in a tough plastic block along with VLS hybrid circuitry detect the presence, motion, and direction of motion of your fingertip on the Touch Graphics™ surface, producing X- and Y- digital control signals for all graphics applications.

The result is a cost-effective alternative to trackballs, light pens, thumb wheels, etc.

### CALL TODAY

This is a new micro-proximity touch-sensing technology you should know about. Call now for sales literature on this and other control devices.

**tasa**

2346 Walsh Ave., Santa Clara, CA 95051  
(408) 727-TASA • TWX 910 338 7620

224 Circle 254 on reader service card

## New products

1053), or 24 (the W424-1053) characters. An advanced version of the receive-only W4XX-1051, the display operates in the full- or half-duplex mode, self-initializing and recognizing 19 ASCII control codes.

Five levels of brightness may be programmed to provide better than a 6-to-1 range of light-output control in 4-dB steps. The brightness can be set with a hardwired strap and modified through the control codes. All units have full address capability so that data may be entered in an asynchronous sequential manner.

The W4XX-1053 operates from 12 v dc at 1 A and provides a dual output. It can accept serial data entry with switch-selectable rates of 110 to 9,600 b/s.

Depending on quantity, the W416 sells for \$240 to \$360 and the W420 from \$256 to \$396.

Cherry Electrical Products Corp., 3600 Sunset Ave., Waukegan, Ill. 60085. Phone (312) 689-7700 [343]

## Precision resistor has up to 250 kΩ on single chip

The model E102C precision resistor has a resistance value of 100 to 250 kΩ on a single chip. The device has resistance tolerances from  $\pm 0.005\%$  to  $\pm 1.0\%$ . The nominal temperature coefficient of resistance is  $+0.6$  ppm/°C ( $0^\circ$  to  $25^\circ$ C) and  $-0.6$  ppm/°C from  $25^\circ$  to  $60^\circ$ C. The standard TCR spread from nominal is  $\pm 1.5$  ppm/°C over the full temperature range, and selected TCR tracking can be as close as  $0.5$  ppm/°C. Other specifications for the resistor include a load-life stability of 0.05  $\Delta R$  maximum at full rated power of 0.3 w at  $125^\circ$ C (100 to 150 kΩ) and 0.2 w at  $85^\circ$ C (150 to 250 kΩ) for 2,000 hours. Current noise is less than  $0.025 \mu\text{V}$  (root mean square) per applied volt.

With a 0.1% tolerance and a 200-kΩ resistance value, the units sell for \$12.15 in lots of 100 or more. Delivery is from stock to eight weeks.

Vishay Resistive Systems Group of Vishay Intertechnology Inc., 63 Lincoln Hwy., Malvern, Pa. 19355. [344]

Electronics/June 19, 1980

# Measure transmission and reflection with stark simplicity, 1-1500 MHz. It's a Wiltron.

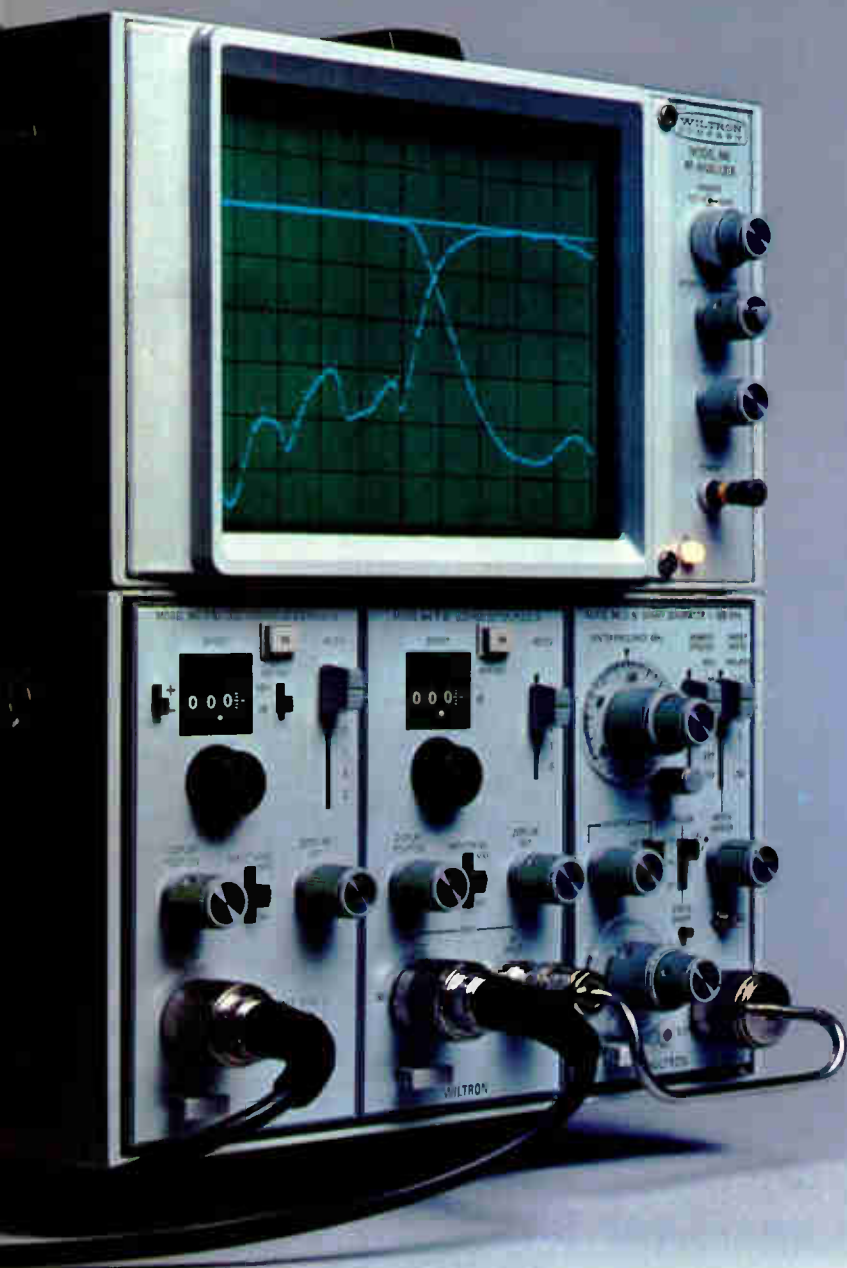

Here in one compact instrument, Wiltron gives you a complete RF Analyzer for swept measurements on  $50\Omega$  or  $75\Omega$  devices over the 1 to 1500 MHz range.

Use the Wiltron 640 to make transmission gain/loss, reflection (return loss/SWR), absolute power and absolute frequency measurements. You'll find the 640 is one of the easiest instruments you've ever used. Simply connect the test device. You won't need an armful of couplers, amplifiers, cables or other equipment. All the circuitry — sweeper, directional signal separator, calibrated amplifiers, detectors and display system — is inside the case.

#### **No more muddled measurements.**

Wiltron's 640 offers features you won't find in far bigger, more expensive instruments.

It gives you the most versatile marker system available, stable, crystal accurate, on a dual-trace display with a  $\pm 90$  dB calibrated offset.

You can precisely sweep over the entire 1500 MHz range or over just 1 MHz. Dynamic measuring range is 70 dB (+15 to -55 dBm). Measure return loss to below 30 dB (1.06 SWR).

#### **Low cost plug-in flexibility.**

Five plug-ins are offered: a swept signal source, log reflection unit, log transmission unit, linear amplifier unit and log transmission/reflection unit for use with external detector and SWR Autotester.

#### **Ask for Technical Review #7.**

For complete details ask for a copy of Technical Review #7. For an early demonstration, call Walt Baxter, Wiltron, 825 East Middlefield Road, Mountain View, CA 94043. Phone (415) 969-6500.

**WILTRON**

Circle 225 on reader service card

# STRATHCLYDE

## Scotland's integrated circuit of electronic achievement.

Many of the achievements of electronics companies in Strathclyde have been formidable in terms of technology. Immense in terms of trade.

I.B.M., Honeywell, MESL, Motorola, National Semiconductor are just a few of the world names in electronics who have found Strathclyde an ideal base for profitable operations.

Why? Good labor relations, high productivity, large labor pool (deep in quality as much as quantity), world-wide communications, low labor costs, and abundant energy supplies coupled with excellent research and development facilities makes

Strathclyde the ideal environment for electronics industries.

But there's more . . .

Strathclyde's Special Development Area status entitles industry to maximum UK government assistance.

There's a special report which has been prepared on the electronics industry in Strathclyde. If you are expansion-minded you should read it. You'll learn how you can become part of the integrated circuit of electronics achievers in Strathclyde.



For your copy write to: Strathclyde Regional Council Industrial Development Unit,  
21 Bothwell Street, Glasgow G2 6NJ, Scotland.

Or telephone 01144-41-221 4296. Telex 777237 Ans Back SRC V.

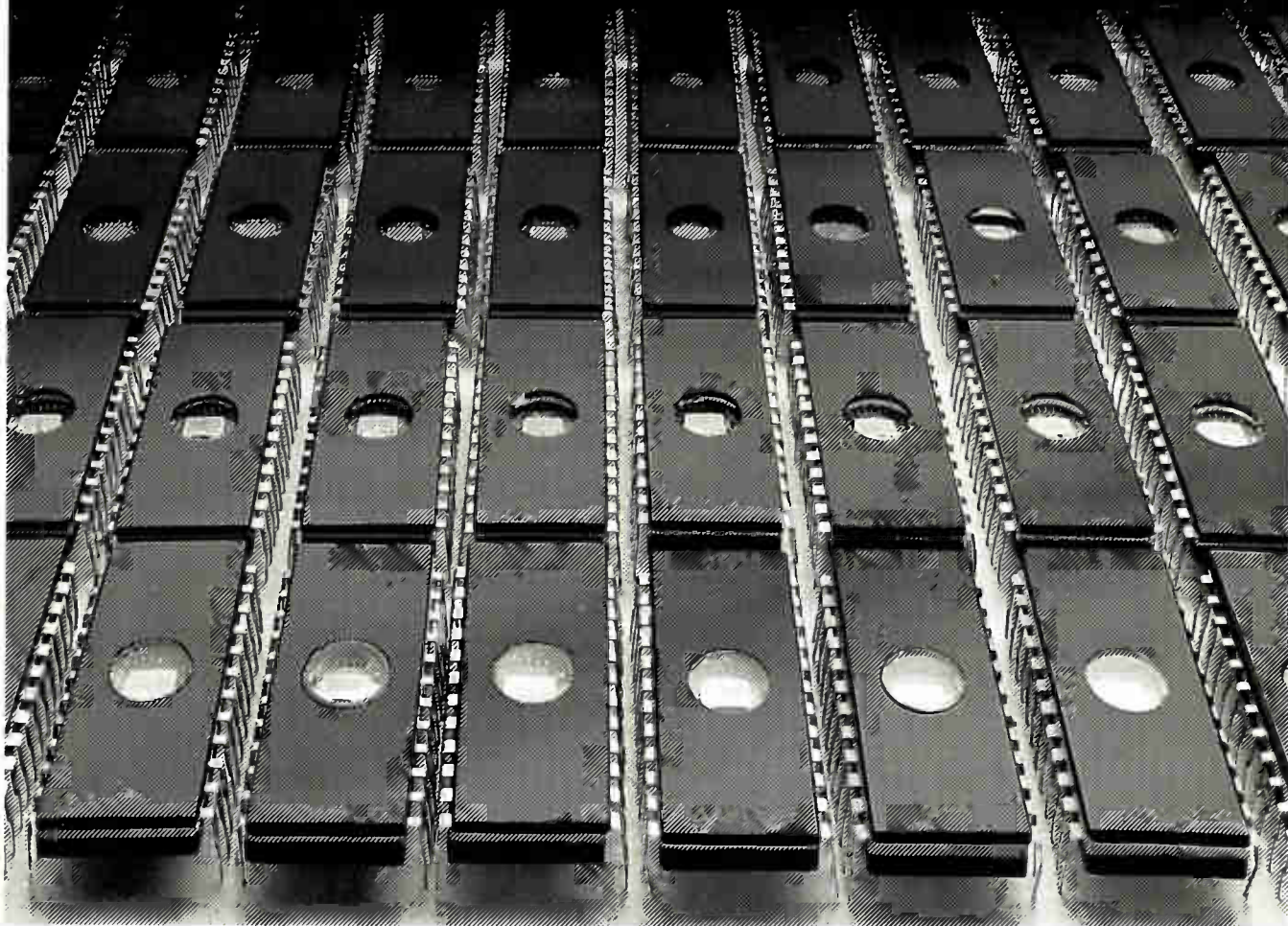



## GenRad's 2230.

# The only component tester that finds all the faults you haven't been looking for.

There are many kinds of components, networks and small PC boards you aren't testing now. Because until now, it just wasn't cost effective to test them all. You had to buy several dedicated testers. And hire several operators.

But GenRad's 2230 has changed all that. It's five testers in one compact unit, and it costs about half as much as the five dedicated testers. And the 2230 requires only one operator.

So now, 100% incoming testing of these passive components (RLC), diodes, and networks is not only affordable, it's smart. And the reason is simple. A faulty component costs you only 50¢ to find on incoming. The same fault costs you \$5.00 to find on the board, and \$500.00 in the field. And the more complex the component, the higher the failure rate.

You can also customize the 2230 to handle virtually any device you use. It tests small PC boards, passive networks, transformers, hybrid circuits, cables, and many other kinds of components.

You also get hard copy printout, so the documentation you need is always there.

With the 2230, you can finally test all those components you haven't been testing. And save the cost of finding them later.

For more information, call toll free 800-225-7335. In Mass. call 617-779-2825. On the West Coast 800-538-9424. Or write GenRad, 300 Baker Ave., Concord, MA 01742.

GenRad's 2230. It's exactly what you've been looking for to test what you've been overlooking.



## GenRad

Put our leadership to the test.

Circle 227 on reader service card

# Berg's Clincher\* connector mass terminates flat conductors quickly and reliably.

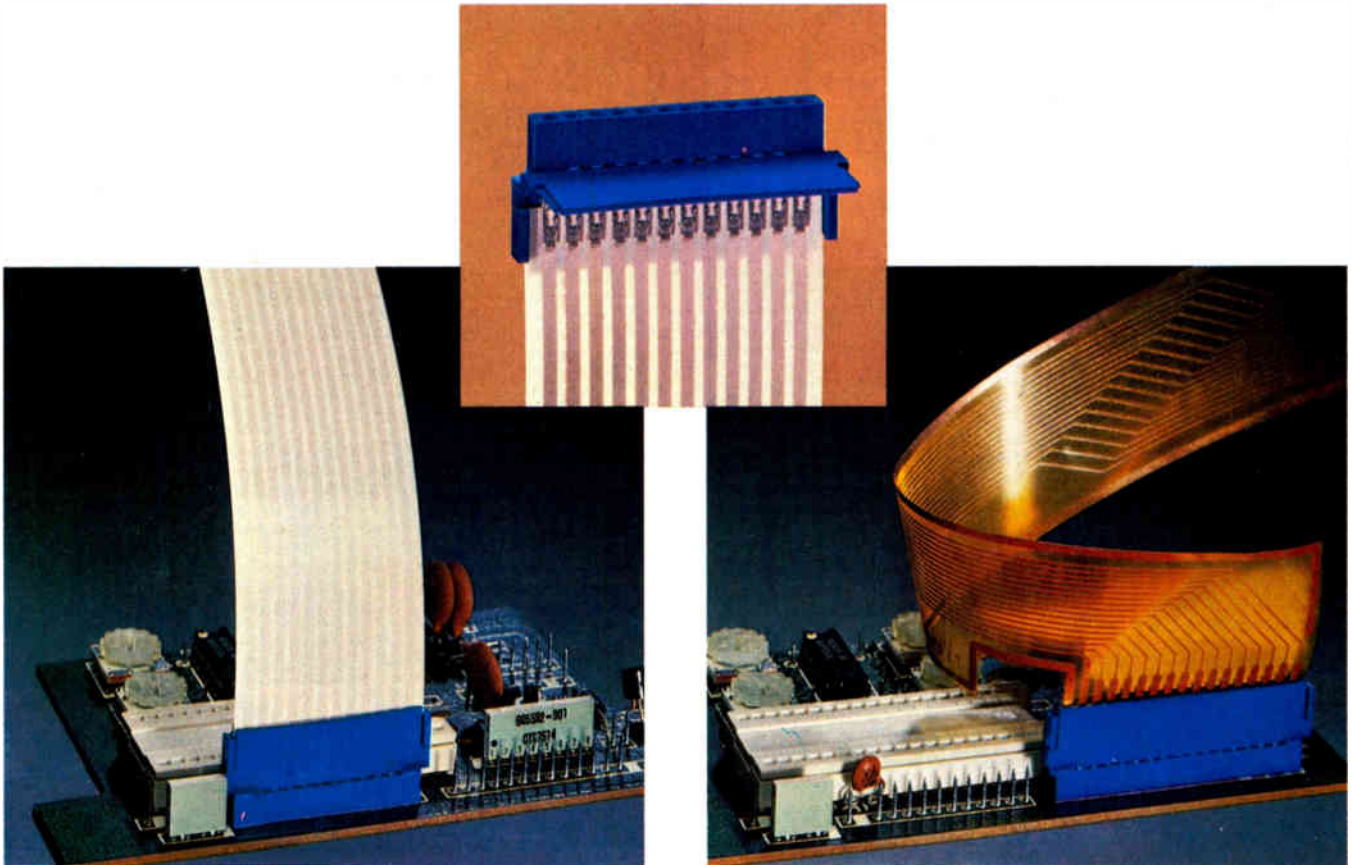

The "Clincher" on flat conductor, flat cable.

The "Clincher" on flat conductor, flex circuitry.

The "Clincher" is a superior connector system for flat conductor, flat cable or flex circuits. It offers high reliability and the lower applied cost of mass termination.

With the "Clincher," all of the flat conductors are terminated simultaneously, within 15 seconds. Cable stripping is not required. The "Clincher" system offers a substantial reduction in total installed cost over individually terminated conductors.

The "Clincher" design uses Berg's proprietary PV\* receptacle, a connector of proven reliability for over a decade in data processing and telecommunications applications. The dual-metal construction of the "PV" provides a high normal force to assure highly reliable mechanical and electrical performance.

Berg's "Clincher" accepts a 1 to 2 oz. copper 0.062" wide cable. It is stackable on 0.100" centers

in double-row configurations for dense packaging. The "Clincher" mates with 0.025" pins or standard Berg headers to form a complete interconnection system.

Rely on Berg for quality performance to meet your most demanding application needs. For a brochure describing the "Clincher" system, write or call:

The Du Pont Company, Berg Electronics Division,  
New Cumberland, Pennsylvania 17070.  
Telephone: (717) 938-6711.



**BERG**  
ELECTRONICS

\*Du Pont Trademark

## **Harris 64-K static RAM is in full production**

Harris Corp.'s Semiconductor Products division in Melbourne, Fla. is in full production of an array of 16 4-K complementary-MOS random-access memories that, packaged on a 1.8-in.-square ceramic substrate, constitute a 64-K static RAM. Users can organize the memory as either an 8-K-by-8-bit or a 16-K-by-4-bit array. The HM5-6564 is available in production quantities of 100 or more for \$525 each. Introduced a year ago at an \$800 price in prototype lots of 100 [*Electronics*, May 10, 1979, p. 201], the device features low power consumption (300 mW maximum) and a 350-ns access time.

## **CSPI offers custom shared-memory scheme to OEMs**

Manufacturers of scientific computing systems can now incorporate shared-memory interfaces between host minicomputers and associated array processors, eliminating input/output data-transfer bottlenecks. Computer Signal Processing Inc. says it will work with original-equipment manufacturers on **customized hardware interfaces and provide full Fortran support to make array processor memory directly accessible to a host computer.** The Billerica, Mass., firm will draw on the experience it gained when it developed a shared-memory scheme with Systems Inc. of Fort Lauderdale, Fla., whose vector-processing systems use CSPI's 32- and 64-bit array processors and recently became the first such systems to include shared memory [*Electronics*, May 8, p. 198].

## **Mil-spec Eclipse's processing is enhanced**

The Data General Eclipse computer that Rolm Corp.'s Mil-Spec Computer division manufactures to military specifications will have its processing power extended by new software and hardware features. On the software side, a real-time operating system named Advanced Real-Time System (ARTS) will provide memory support ranging from 64 to 2,048 kilobytes. It will also offer **high-level language support, memory-resident file structure, and a flexible process and task schedule. It is a compatible subset of Data General Corp.'s Advanced Operating System.** ARTS' initial license fee is \$2,500.

The Santa Clara, Calif., company is also offering a 2-kiloword writable control store (model 1728) for \$4,640, a microcontrol panel (model 1744) for \$3,585, and a software support package (model 9725) for \$1,000 that helps users of the mil-spec Eclipse generate microcode and implement it with the writable store. All of the offerings are available in 120 days.

## **Price changes**

■ Intel Corp., Santa Clara, Calif., reduced the prices of static memory modules in its series 90 memory systems. The 23% to 25% reduction affects all CM-2 static model types that contain 2147 HMOS devices and "is a reflection of the drop in static component costs since the series 90 was introduced," says a spokesman for the firm's memory system operation.

■ Price increases on chassis, smaller power supplies, and consoles will affect nearly all the original-equipment manufacturers who are customers of Computer Automation Inc.'s **Naked Mini division**, Irvine, Calif. For example, three configurations of the NM4/10 system (with core and random-access memory) went up between \$170 and \$225. The net result is a 4.5% to 7.5% increase in prices over the total product line.

**— ATTENTION!! —**  
**POWER SUPPLY DESIGNERS!**

The EDUCATIONAL DIVISION of

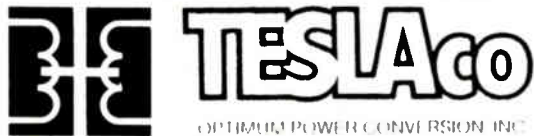

*proudly announces*

**A NEW PRACTICAL  
3-DAY SHORT COURSE**

*entitled*

**SWITCHED-MODE  
POWER CONVERSION:  
DESIGN & MEASUREMENT**

to be conducted by

Dr. R. D. Middlebrook and Dr. Slobodan Cuk  
 Power Electronics Group  
 California Institute of Technology

WHEN	WHERE
JULY 23-25 1980	SOUTH COAST PLAZA HOTEL COSTA MESA, CALIFORNIA (714) 540-2500
AUG. 26-28 1980	57 PARK PLAZA HOTEL BOSTON, MASSACHUSETTS (617) 482-1800
SEPT. 15-17 1980	RICKEYS HYATT HOUSE PALO ALTO, CALIFORNIA (415) 493-8000

Hotel reservations should be made in advance. Please indicate you are attending the TESLACO, INC. course.

Patterned after the well-received one-day POWER-CON 6 and 1979 IEEE Power Electronics Specialists Conference seminars on modeling and measurement techniques of dc-to-dc switching converters and regulators, this brand new extended Short Course has been organized to offer the practicing power supply designer an even broader exposure to practical power conversion systems. The emphasis throughout the lectures, technical demonstrations, and in-class exercises will be on *how to obtain* meaningful and useful engineering *answers* to "real-life" power supply analysis and design problems.

**ENROLLMENT IS LIMITED!!!  
MAKE PLANS TODAY TO ATTEND!**

Reserve my place at TESLACO, Inc.'s 3-day course:

- COSTA MESA, CALIFORNIA — July 23-25
- BOSTON, MASSACHUSETTS — August 26-28
- PALO ALTO, CALIFORNIA — Sept. 15-17
- Check enclosed (\$450 per course)     Invoice my company.
- Contact me about in-house presentations
- Send further information about the courses

Name \_\_\_\_\_  
 Company \_\_\_\_\_  
 Address \_\_\_\_\_  
 City \_\_\_\_\_  
 Zip \_\_\_\_\_ Phone (\_\_\_\_) \_\_\_\_\_

Send to: TESLACO, INC., Educational Division  
 P.O. Box 3817, Thousand Oaks, CA 91359  
 Telephone: (805) 499-4150



**COMPAS**  
microsystems

*There is nothing like a*  
**DAIM**



A complete disk system for the Rockwell Aim 65. Uses the Rockwell Expansion Motherboard. Base price of \$850 (U.S.) includes controller with software in Eprom, disk power supply and one packaged Shugart SA400 Drive.

224 SE 16th St.                      AMES, IA 50010  
 P.O. BOX 687                      (515) 232-8187

Circle 222 on reader service card

CUBIT INTRODUCES

**AIM-65  
PROGRAMMING  
POWER**

THE EPROM PROGRAMMER DESIGNED  
EXCLUSIVELY FOR THE AIM-65

'Zero Insertion Force Socket' for EPROM programming

'Powerful Monitor' contains all programming routines.

'EPROM Expansion' for 8K of user programmed EPROM.

'Female Connector' plugs directly onto the AIM-65 expansion bus. Male connector plugs into motherboards.

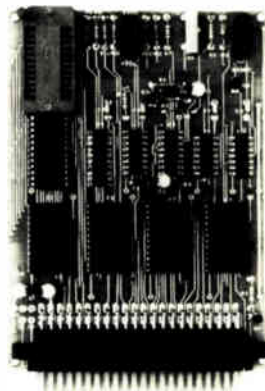

For more information on AIM-65 programming power call or write:

**CUBIT**                      (415) 962-8237  
 2267 Old Middlefield Way  
 Mountain View, CA 94043  
AIM 65 is a trademark of Rockwell International Corporation



Your Marketing department wants a new black box design. They want it to handle 37 bytes of information. It has to be solar energized. It has to fly. It has to speak. It has to reproduce. Naturally, it'll need special cable configurations. Call Belden.

We've developed workable wire, cable and cord answers for a lot of extraordinary new products. In fact, a lot of designers have found that working with Belden in the early stages of a design project usually pays dividends in compatibility, workability and lower overall costs.

And once your product is rolling, we're ready to dig in to wire processing, assembly and installation

problems to help insure that your idea makes it to market economically.

You see, Belden's capabilities in wire, cable and cord are comprehensive. Sure, we make thousands of standards, but we can also provide just about any custom that you can imagine. And our technical knowhow ranges from innovative packaging to in-depth value analysis.

Just imagine a wire, cable or cord—and we'll come through with it. Belden Corporation, Electronic Division, P.O. Box 1327, Richmond, IN 47374; 317-966-6661. Out West, contact our Regional Sales Office in Irvine, CA at 714-833-7700.

8-7-98

# Your special designs need a special wire source



*Imagine  
what we  
can do  
for you*

**BELDEN** 

**Coming through...**

*with new ideas for moving electrical energy*

© 1979 Belden Corporation

Circle 231 on reader service card

# COLORADO

The state that has everything for engineers



Photo by Jacquelyn Peake

Colorado is known as the state that has everything. There is, however, one resource that this extraordinarily beautiful area lacks and badly needs. That resource is electronic/electrical engineers.

Because of its location, its majestic beauty, the varied cultural and leisure-time activities available, and the easy lifestyle, the Centennial State is noted for having first-time visitors return to work and live there.

More recently Colorado has attracted a growing number of engineering companies that are seeking the right economic and environmental climate to establish subsidiary branches or to develop new plant facilities. The reason is that many of these companies have outgrown their facilities in other states and are coming to Colorado to stay in order to meet the enormous demand for electronic equipment and products that

are required by both private industry and the federal government. The demand for these products and equipment is expected to continue throughout the 1980s and beyond. Consequently these high-technology companies have a dire need for all kinds of EEs, including both entry-level and experienced professionals.

Cities like Colorado Springs, Fort Collins, Boulder and Loveland are where the majority of electronic firms have settled. All are within one and a half hours of Denver, the capital of Colorado, situated on the plains to the east of the Rocky Mountains.

Colorado Springs is set like a jewel on rolling terrain just a glance away from Pikes Peak in the nearby Rocky Mountains. Aside from its cleanliness and physical beauty, one of the many reasons electronic companies have located in this clean city of 238,000 is the cost of living:

it is 4 percent below the national average. The utility rate is some 37 percent below the national average, according to the Economic Development Department of the Chamber of Commerce.

Housing is another bargain for the incoming engineer. In 1979, for example, the average residential sale price of a brand-new home was \$63,400. The average price of a resale was \$46,300. These prices are well below the average for other desirable areas in the United States that cannot compete with Colorado for its sheer physical beauty.

As one engineer who lives in Colorado Springs recently remarked, "The climate is excellent and a good drawing card. There is no sense of the rat race here. The pace is slower. It is for people who enjoy the outdoors. Since I moved here from the Midwest four years ago, I have become a runner."

Loveland, the Sweetheart City, is becoming one of the industrial centers in the state with over 53 industries located in the area. The population is a comfortable 36,000 and the city boasts more than 300 days of sunshine each year. Loveland is also the gateway to Rocky Mountain National Park through the spectacular Big Thompson Canyon. The city is also located near 30 lakes, the best-known one being Lake Loveland, a lovely 548-acre stretch of water that encourages fishing and boating, including sailing, and water skiing.

Eight miles to the west and reaching grandly to the sky are the Rocky Mountains that hide millions of acres of beautiful forestland and splendid scenery that is sprinkled with lakes, campgrounds, hiking trails and game areas for use by both residents and visitors.

In winter Loveland becomes a sportsman's paradise. Cross-country skiing, ski touring and alpine skiing are all popular sports less than an hour away by car.

In the summer, swimming, golf and seven campgrounds provide a broad range of recreational facilities.

Housing is also a bargain in this area. In 1979, for example, the average selling price of homes was \$57,246, well below many other areas of the country.

Nearby Fort Collins is a cosmopolitan university town with a population of 70,000, some ten miles from the foothills. It enjoys and shares all of the nearby recreational facilities that Loveland does. Fort Collins is another city that has drawn electronic firms seeking attractive sites to build plants for both research and production.

Boulder, one of the leading scientific communities, is spectacularly situated against the Flatiron Mountains. With a population of 200,000 in Boulder County, it has historically been one of Colorado's outstanding centers of economic, social and cultural activity and a leader in education, manufacturing, and research and development.

Among the types of large companies located in Boulder are aerospace, computer, word processing, as well as several important government research organizations. Also, it is heavily populated with smaller companies involved in the production of electronic components.

Denver, the Mile High city, is no more than an hour and a half's drive from any of these cities that are home for the best and most famous electronic firms in the world. Of the more than 2,600,000 people who live in Colorado, some 1,600,000 live

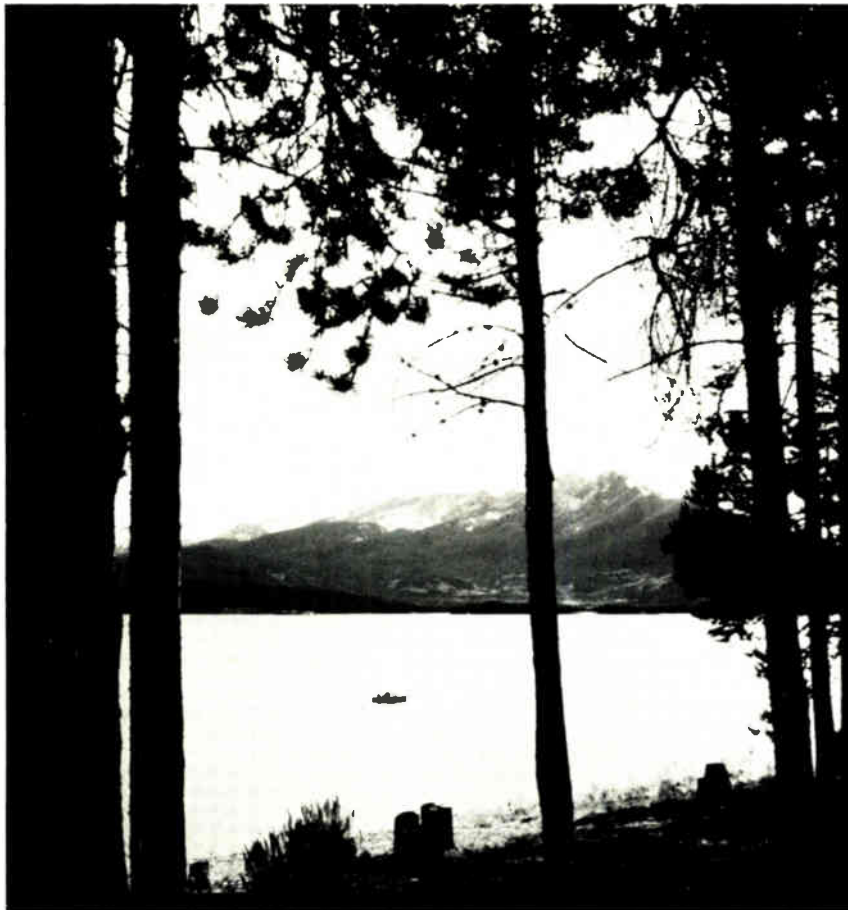

**Colorado is a sportsman's paradise that offers every kind of summer and winter sport and recreation available.**

in Denver. The city is the home of the brand-new Denver Center for the Performing Arts, a beautiful architectural and cultural complex that contains three theaters for live performances and a movie theater.

The city also contains the Denver Art Museum, a six-story building that features a wide variety of exhibits. History buffs interested in the Old West will enjoy the recently completed Colorado Heritage Center. And the Denver Symphony performs in Boettcher Concert Hall. The symphony orchestra also performs free concerts in the city-owned parks.

Denver is also a great sports town and the home of the Denver Broncos, the professional football team of the National Football League, and the National Basketball Association's Denver Nuggets.

In addition, the city operates 100 parks comprising 3,790 acres that feature picnic and playground areas, golf courses, tennis courts, fishing and boating lakes and swimming pools.

Colorado has 30 first-class colleges and universities which means that the engineer who lives and works here can

pursue his or her education for a master's degree or a PhD. Most of the electronic companies in the state also promote in-house training to help engineers advance their careers.

The electronic companies in the area also put heavy emphasis on research and development. Engineers in these companies work with top-notch people in pleasant surroundings. These companies want and expect engineers to advance in their fields and go out of their way to encourage both business and personal development.

Colorado offers excellent salaries and benefits and a beautiful place to work and live. Its cultural, educational and recreational facilities are outstanding. It also has a strong and growing economy.

To sum up, Colorado is the state that has everything for EE engineers. If you're an entry-level engineer, an engineer with a few years of experience or a seasoned veteran seeking a career opportunity, you can't afford to miss the following Colorado Career Opportunities Section. It features blue-chip companies that want and need EE engineers with your specific talents.

— John Brand.

# MOSTEK IS PUTTING VLSI INTO A VBE.

It's not as confusing as it reads. We just want to tell you that Mostek Corporation, the acknowledged industry leader in MOS technology, is opening a new VLSI operation. And we've put it into a VBE — a Very Beautiful Environment. Colorado Springs, Colorado, in the shadow of Pike's Peak.

Mostek offers a challenging environment to work in, and Colorado Springs offers a great environment to play in. With Mostek, you can have the job you've always wanted in the perfect location.

We're proud of our new operation. We've invested over \$25 million in our fab lines, all our equipment is state-of-the-art, and our design and support environment is one of the best in the industry.

And our benefit package is impressive, too. We offer competitive salaries, full insurance (including dental), and a profit sharing/retirement program.

We have positions open in all fields, including design, product, and process engineering. Right now, we're hiring from our Carrollton offices, but our Mostek people will be working in Colorado Springs by the latter part of 1980, hiring the people we need to allow us to go into full production by the first part of 1981.

If you'd like the challenges and advancement opportunities of a ground-floor operation, send your resume and salary history to:

Bob Massie  
Personnel Director Colorado Springs  
1215 West Crosby Road, Carrollton, Texas 75006  
Or call collect: 1/214/323-6516

## MOSTEK®

We are an equal opportunity employer m/f/v.

© 1980 Mostek Corporation

# A world of opportunity for tomorrow-minded Electronic Engineers at Martin Marietta Aerospace in Denver

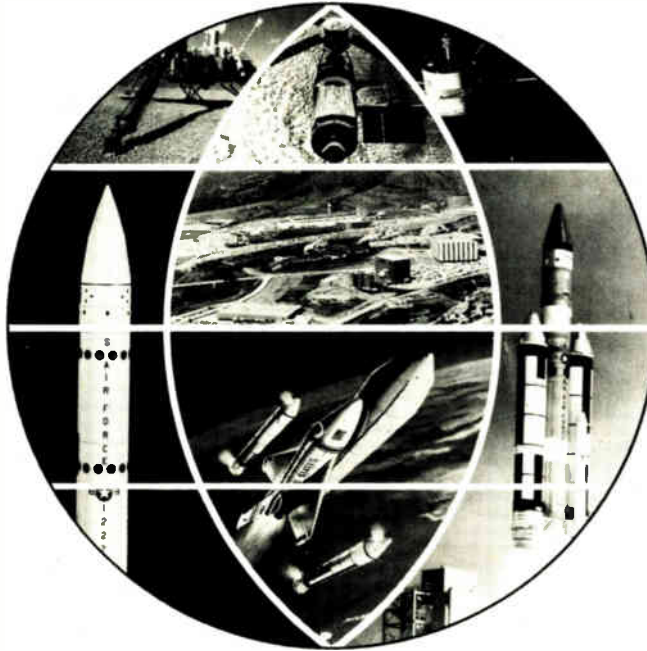

You'll find a career with Martin Marietta secure, challenging and rewarding. Today, you could be working on any number of long-term projects including the Space Shuttle, Missile X, and in areas such as command and information systems, spacecraft, launch vehicles and solar energy.

And working in our Denver facility, adjacent to the Rocky Mountains, means you'll have every opportunity to enjoy a wide array of recreational activities, as well as educational and cultural facilities that rival any metropolitan area.

We have the following selective openings:

## **Ground Support Electronics Design Engineers and Power Systems Design Engineers**

### **Instrumentation Engineers**

A number of engineers are needed who have a BSEE and experience with a variety of transducers including strain gauges, accelerometers, position, acoustic, vibration, pressure and temperature instrumentation. Specific related design experience to process transducer signals should include analog signal conditioning, high rate digitizing, and high speed recording techniques. Specific tasks will include Instrumentation Subsystem design, requirements definition, interface definition, and vendor coordination. Commercial instrumentation experience is acceptable.

### **Ground Digital Systems Engineers**

A number of engineers are needed who have a BSEE. Background should include experience with ground digital equipment and test operations. Specific tasks should include system architecture design, requirements definition, test planning analysis and interface definition. Systems typically involve computers and associated peripheral equipment including displays, control consoles, RF equipment and power equipment.

### **Power Systems Engineers**

Requires BSEE or MSEE with five to ten years experience or equivalent in the design of power systems including the use of solar arrays, secondary batteries and complex distribution and power conditioning hardware. Good background in power management and power systems analysis is desirable.

### **Power Distribution & Cabling Engineers**

Requires experience in both electrical and schematic drafting as well as equipment and wire harness installation.

### **Power Conditioning Design Engineers**

BSEE or MSEE required. Requires at least 5 years experience in the design of power supplies, battery chargers and regulators.

### **High Voltage Power Supply Design Engineers**

BSEE or MSEE required. Experience in the design of power supplies ranging from 2KV to 30KV with both low and high power outputs.

### **Photovoltaics**

BSEE or MSEE required. At least 5 years experience in Photovoltaic related areas required.

### **Electrical Materials and Process Engineer**

BS degree or equivalent experience. Responsibilities include the evaluation, development, selection and application of materials and processes for aerospace electronic hardware. Engineers for all M&P disciplines including the following: Fiber Optics, High Voltage, and Organic Coatings & Encapsulants.

### **Communication Systems Engineers**

Will prepare specifications at the system and subsystem level for procurement by government agency. This position available at a government site in Maryland.

If interested please send your resume in complete confidence to: Martin Marietta Aerospace, Personnel Department, P.O. Box 179, Mail #D-6310, Denver, CO 80201.

**An Affirmative Action Employer  
actively seeking the Handicapped and Veterans**

**MARTIN MARIETTA**

# PROCESS ENGINEER

**Here's a chance to Pioneer Electronic Display Systems with NCR in Colorado Springs.**

NCR Microelectronics is not only a leading developer and producer of LSI/MOS devices and deeply engaged in developing the full potentialities of VLSI, but is also involved in the development and manufacturer of plasma display systems.

We have an important ground floor opportunity for a creative engineer to work with a small group of professionals in a developing technology. Background must include experience in thick film screen printing, screen making, and screen parameters and techniques. Must have 3 to 5 years manufacturing experience and BS degree in Physics, Chemistry or Engineering.

Our location is as stimulating as the work we're doing. Colorado Springs, just 40 miles south of Denver, offers one of the finest, 4-season living environments in the U.S.

**Please send confidential resume and salary history to, or call COLLECT Ms. Sue Grlerson, (303) 471-8440, NCR Corporation, Dept. 78P, 4750 Edison Avenue, Colorado Springs, Colorado 80915.**

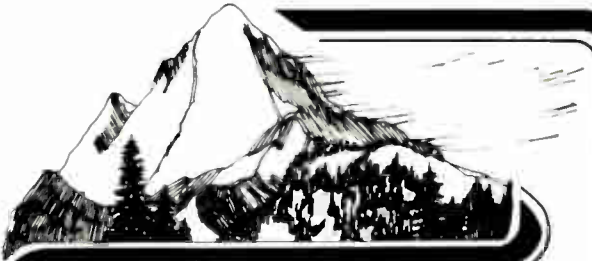

## MAKE YOUR HOME NEAR THE MOUNTAINS WITH Hewlett-Packard

We offer you the opportunity for a challenging career with one of the foremost electronics companies and the opportunity to enjoy a small community atmosphere.

The Loveland Instrument Division of Hewlett-Packard develops and manufactures state-of-the-art measurement instrumentation in the fields of: voltmeters, circuit board test, signal analyzers and signal sources. As a fast-growing company, new or recent graduates benefit from our philosophy of promoting managers from within our company. Presently we have career opportunities in research and development, manufacturing, and quality assurance.

**ELECTRICAL ENGINEER:** With minimum Bachelor's degree and up to 5 years experience in one of the following to work in R & D:

- Analog Digital circuit design
- Signal processing
- Software development

**COMPONENT ASSURANCE ENGINEER:** With knowledge of the theory, design, fabrication, application and physics of failure of a wide range of electronic components, person will define failure mechanisms and appropriate stress tests, analyze test results physically and statistically.

**PRODUCTION ENGINEER:** With minimum Bachelor's degree in electrical or mechanical engineering and up to 5 years experience. Will provide technical support for manufacturing including problem solving and optimization.

If you'd like to spend your future with a dynamic, growing electronics company and experience the joys of small-town living, send your resume to: HEWLETT-PACKARD COMPANY, Department 205, P.O. Box 301, Loveland, CO 80537.

Equal Opportunity Employer Dedicated to Affirmative Action.



## TELECOMMUNICATION SYSTEM ENGINEERS

Tri-State, a rapidly expanding supplier of power for 25 rural electric systems, is seeking qualified individuals as Telecommunication System Engineers. Will be responsible for performing detailed engineering of complex telecommunications facilities to ensure total integration for our Energy Management System. Requires BSEE or Electronics Engineering Technology Degree and 5 years experience in design of microwave radio and 2-way radio systems.

Tri-State offers a competitive salary and an outstanding combination of benefits including fully paid medical, dental, and life insurance. Please submit resume and salary history as soon as possible to: PERSONNEL DEPT. BB, TRI-STATE GENERATION & TRANSMISSION ASSN., INC., P.O. BOX 33695, DENVER, CO 80233.

An Equal Opportunity/Affirmative Action Employer



**TRI-STATE**  
GENERATION & TRANSMISSION  
ASSOCIATION INCORPORATED

# EVERYTHING IS STATE OF THE ART AT DIGITAL/COLORADO SPRINGS.

## THE PRODUCTS.

We're supporting Digital's world leadership in minicomputers and DDP by producing some of the most advanced mass storage systems in the computer industry.

Specific products include disk drives, media, servo and read/write systems, and thin film magnetic recording heads.

Our facility is modern, well equipped, and expanding. Our commitment to developing state-of-the-art hardware and software means you'll always work on the leading edge of mass storage technology.

## THE JOBS.

Every opening we have available will involve developing highly advanced new products. And every professional who joins us will have the freedom to determine his or her own priorities. Develop new ideas. And work one to one with people who can provide invaluable support and guidance.

You'll also have the opportunity to investigate the career paths we offer... and then choose from more responsible roles in either technical or business management.

How fast and how far you grow with Digital/Colorado Springs is all up to you.

## THE LIVING.

Colorado Springs is a cosmopolitan city located at the foot of Pikes Peak.

And there may not be a better place in the U.S. for either single or family living.

Surrounded by the scenic beauty of the Rockies, the area offers recreational and cultural activities diverse enough to satisfy almost anyone's interests.

The air is clean and the cost of living is reasonable.

Best of all, our excellent relocation package will help make your move here easy and affordable.

### MEDIA ENGINEERS

Will perform advanced development of high-performance recording media. Must be experienced in magnetic thin film techniques. Close interaction with all related Engineering & Manufacturing Groups. Requires departmental "hands-on" involvement in process and the required documentation.

### MECHANICAL ENGINEERS

Will design computer disk drives for high-volume manufacturability. Candidates must be capable of creating, analyzing, and conducting laboratory experiments and finding practical solutions through interpretation of analytical and experimental results. Requires B.S.M.E. or equivalent, along with several years of experience in mechanical design of commercial products for high-volume manufacturing involving dynamic precision mechanisms with emphasis on low-product cost.

### SR. SOFTWARE ENGINEERS (Diagnostic)

Will develop, maintain, and support test and diagnostic software for mass

storage devices. Will work closely with design engineers, production technicians, and Field Service Personnel. Requires B.S.E.E. or equivalent. Must have diagnostic experience plus hardware knowledge of disks and tapes.

### SR. ENGINEERS

(Mass Storage Subsystems Manager)  
Will be involved in a multidisciplinary computer systems development program aimed at creating new mass storage subsystems for the commercial marketplace. Will implement product goals by helping to establish them, validating plans to meet these goals, and providing top-level coordination and control for the total development effort in a dynamic commercial-oriented environment. Requires B.S.E.E. degree, M.S. preferred, and at least 5 years' hardware/software systems engineering experience with computer products. Must also have experience as a program manager on one large, successful, multi disciplinary product development project.

**IF YOU HAVE A  
BACKGROUND IN ONE  
OF THE AREAS LISTED  
HERE, WRITE TO US.**

**IF YOU DON'T,  
WRITE TO US ANYWAY.**

Because in addition to the openings listed here, we have a variety of opportunities for engineers with a degree in E.E., Computer Science, or equivalent, and several years of experience designing similar products in closely related industries.

Send your resume and salary history to: Judy Fox, Digital Equipment Corporation, 301 Rockrimmon Blvd. South, Colorado Springs, Colorado 80919.

We are an equal opportunity employer, m/f.

**digital**

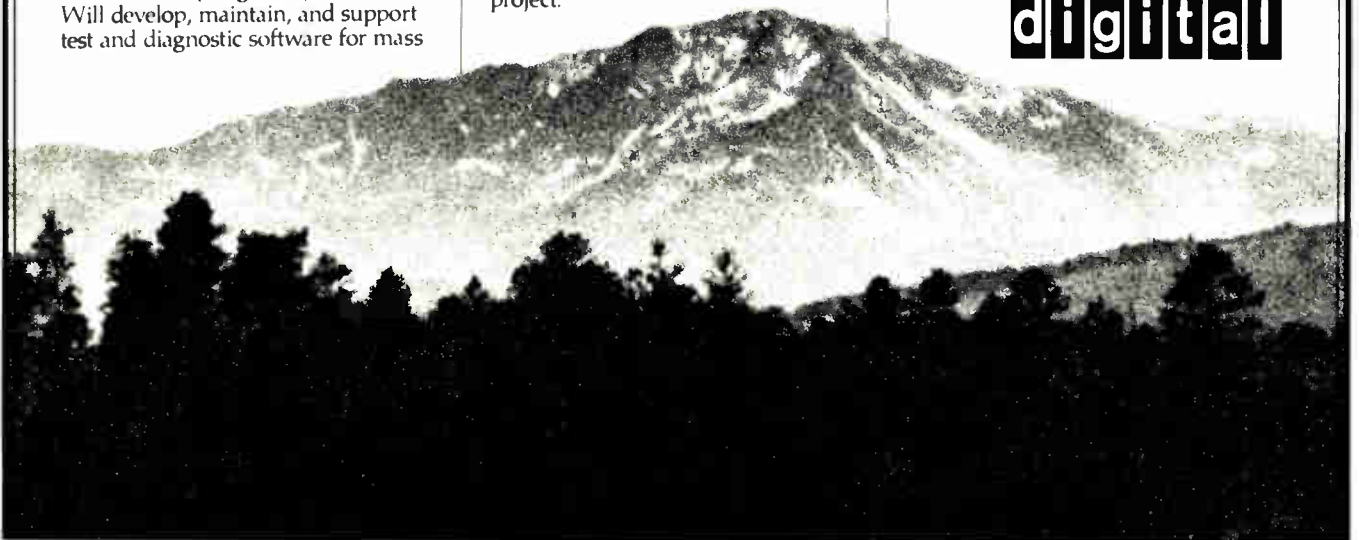

**WE'RE  
BRIDGING  
THE GAP IN  
VOICE & DATA  
TELECOMMUNICATIONS  
AT GTE LENKURT IN DENVER.**

GTE Lenkurt, a leader in the field of telecommunications, invites you to join us at our new location in Denver, Colorado. This unique opportunity exists for individuals who can contribute to the establishment of our product lines, and to the development of this new division. Products including voice signaling, data transmission/distribution, and terminating telecommunications equipment require innovative designs using the latest state-of-the-art technology for both electronic and packaging design. Some of the openings currently available include:

**Engineering Technology Manager**  
MSEE or its equivalent and minimum 5 years electronics experience in supervisory capacity. Telecommunications and CAD experience preferred.

**Manufacturing Engineering Manager**  
BSME or BSIE or its equivalent and 7 years manufacturing/industrial experience including 5 years as manager.

**Instrumentation Manager**  
MSEE or its equivalent and 7 years experience in engineering development and manufacturing support for instrumentation with minimum 3 years in supervisory capacity.

For immediate consideration on these positions and other positions available, please forward your resume, including salary history to:

**Ms. Charlotte Dellinger**  
GTE Lenkurt, Inc.  
876 Ventura Street  
Aurora, Colorado 80011  
An Affirmative Action Employer M/F/H/V

**GTE Lenkurt Incorporated**

**GTE**      **Communications  
Transmission Systems**



## MICROELECTRONICS ENGINEERS

# NCR has key openings at its LSI/VLSI R&D facility in Colorado Springs

If you prefer challenges to stop-and-go commuting, the NCR/Microelectronics operations for MOS wafer fabrication and assembly has openings you should investigate at once. You'll be joining a mature microelectronics organization that has established three full-scale multi-million dollar production facilities.

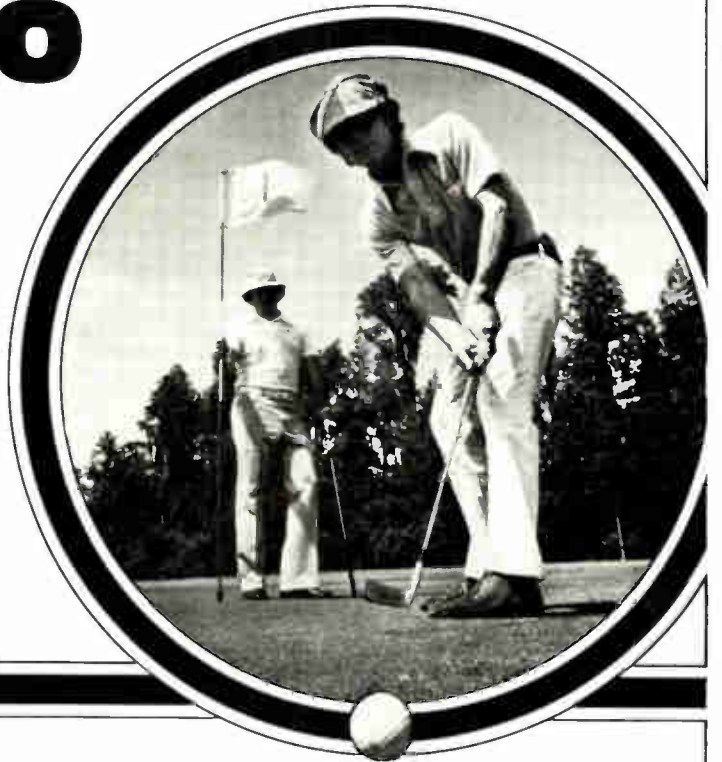

*We have immediate openings for:*

### **MOS/VLSI Circuit Design Engineer**

Project responsibilities in MOS/VLSI memory or logic circuit design in short channel NMOS or CMOS. Project responsibilities will be for full VLSI circuit designs from conception and customer interface to release to production. Candidate should be BSEE with a minimum of 2 to 5 years MOS circuit design experience with attendant processing knowledge and an understanding of its relationship to circuit design.

### **Product Engineers**

Set up and maintain interdivisional liaison to assist in test and evaluation of customs products. Develop internal specifications, analyze failures and recommend corrective action as required. Requires Bachelors' degree and 2-3 years related experience.

### **Diffusion Process Engineer**

Expertise must span all areas of diffusion processing—oxidation, boron and phosphorous diffusion, LPCVD systems.

### **Reliability and Failure Analysis Engineer**

BSEE and a minimum of 3-years experience in IC semiconductor analysis preferred. Will be responsible for the generation of statistical data on reliability IC's, life testing, failure analysis, and FA laboratory. Should have experience in management reporting techniques.

### **Photo Resist Engineer**

3-5 years in MOS photolithography, and experience in negative and positive resist systems, proximity/projection printing techniques and plasma etching.

### **Device Modeling**

Requires experience in process, device or circuit modeling, using computer simulation. Prefer a degree combination of electrical and solid state physics.

Modeling will be used to assist in the development of new devices, process and the enhancement of circuit performance.

■ ■ ■

Our Colorado Springs facility is an hours' drive South of Denver—located in one of the finest living environments in the U.S.

To investigate these exciting LSI/VLSI R&D opportunities first hand, send your resume and salary history in confidence to: Ms. Sue Grierson, Personnel Resources, Dept. 78K, NCR Corporation, Microelectronics, 2850 North El Paso Street, Colorado Springs, Colorado 80907.

# NCR

Complete Computer Systems

An Equal Opportunity Employer

# There's Only One Way at STC . . . UP!

You seek a secure future with a stable organization offering a challenging work environment and exceptional growth potential. Combine that with the opportunity to live and work at the very base of the magnificent Colorado Rockies and to enjoy the summer and winter recreation these mountains provide, and you'll find yourself at STC. Currently we have openings for the following:

## ENGINEERS

- **Systems**
- **Test**
- **Quality**
- **Industrial**
- **Manufacturing**
- **Process** (PCB drilling, lamination, or semiconductor)
- **Development ELECTRICAL** (preferably with a background in I.C. design, read/write, semiconductor, thin film, tape or disk).
- **MECHANICAL** (servo, packaging, special tooling, tape or disk experience).

## TECHNICIANS

- **Engineering**
- **Manufacturing**
- **Quality**
- **SEM Equipment**
- **SC Process**
- **Electro/Mechanical**
- **HVAC**

## DESIGNERS/DRAFTSPERSONS

(Electro/Mechanical)

## PROGRAMMERS/

## SYSTEMS ANALYSTS

(Both business & engineering oriented)

If you are the type of person who likes to see your ideas impact the industry, we want to hear from you. We offer an excellent compensation package including health & insurance benefits, stock purchase plan and more. For consideration please submit your resume in confidence to Mr. Bob Williams, STORAGE TECHNOLOGY CORPORATION, MD#29, E6/19, 2270 South 88th Street, Louisville, Colorado 80027, or call TOLL FREE 800-525-2940, Ext. 3169. We are an equal opportunity employer.



**STORAGE  
TECHNOLOGY  
CORPORATION**

## SIEMENS

### Colorado Opportunities

You will like our suburban location just 15 miles north of Denver where you can enjoy plenty of excellent hunting, fishing and skiing locations.

We are the world's fifth largest producer of electronic equipment and components and the fastest growing power semiconductor manufacturer in North America. We have immediate openings for Senior Application Engineer, Process/Product Engineers and Development Engineer.

### POWER MOSFET PROGRAM SENIOR APPLICATIONS ENGINEER

Experienced in switch mode circuitry plus transistor applications with a BSEE or equivalent required. Key member of Siemens SIPMOS program with responsibility for North American customer support and applications coordination with Siemens in Munich, Germany.

### PROCESS/PRODUCT ENGINEERS

To sustain yields and make process improvements on high power diodes and SCR's during an aggressive plant expansion. The successful candidates will have experience in one or more of the following areas: Wafer fabrication, assembly soldering, brazing, welding, final test, diffusion, metalization, junction contouring and surface passivation. Requires a BS Degree in Engineering or a related physical science, or equivalent experience, and a thorough understanding of process variables and their influence upon final device characteristics.

### DEVELOPMENT ENGINEER

Position encompasses a wide variety of duties with emphasis in developing materials, methods and processes for the semiconductor market. Experience in diffusion, alloying, and soldering is required. Experience in processing for glass passivation, plasma etching, schottky diode processes and photolithography is desirable.

Due to our aggressive plant expansion program we anticipate the need to recruit management, engineering and technical support positions. We offer excellent salary and benefit program which includes life, medical, dental and retirement plan. If you would like to join a team of skilled professionals who enjoy the technical support of a parent company such as Siemens, send work experience and salary requirements to the Employment Manager.

## Sitronix

A member of the Siemens Group

800 Hoyt Street

Broomfield, CO 80020

Equal Opportunity/Affirmative Action Employer

**In sonics  
or phonics,  
why  
ELECTRONICS?**

Because in these and hundreds of other fields, electronics applications are taking over. If your firm is looking for smart new electronics engineering graduates, you'll find them—and all other technical disciplines—through McGraw-Hill's **Graduating Engineer**.

**Graduating Engineer** is specifically designed to put the recruitment stories of technically based firms before 70,000 newly graduating engineers in all disciplines, via request circulation to the college campuses of every major engineering school in the U.S. Call or write the Classified Representative at your nearest McGraw-Hill Regional Office for complete information. Or contact Arlene Anns, Publisher, at (212) 997-3306.

**GRADUATING  
ENGINEER** 

McGraw-Hill Publications Co.  
1221 Avenue of the Americas  
New York, N.Y. 10020

**ENGINEERS**

South & West Colorado

- ★ Mechanical
- ★ Electrical
- ★ Civil
- ★ Environmental

- Contracts • Design •
- Plant Operations •
- Forecasting & Rates • Planning •
- Construction • Analysis • Safety •

Colorado-Ute Electric Association is a rapidly growing generation and transmission utility serving Western and Southern halves of the State of Colorado. Currently two 400 megawatt units are being constructed and bids are being accepted on the third unit. At the present time we have 4 coal-fired stations, 2 hydros, over 50 substations and over 1,000 miles of transmission lines.

Degreed Engineers are being sought for transmission, substation and plant design, maintenance and planning.

We offer excellent benefits and promotional possibilities. Salaries commensurate with education and experience.

Send resume to:  
Dept. JVJ

**COLORADO-UTE  
ELECTRIC  
ASSN., INC.**  
P.O. Box 1149  
Montrose, CO 81401

*An Equal Opportunity Employer M/F*



**COLORADO OPPORTUNITIES  
FOR ENGINEERS**

Ball Aerospace Systems, a division of the Ball Corporation, is located in Boulder, Colorado - a community nestled in the foothills of the majestic Rocky Mountains. We are a leader in the development of space science instrumentation, electro-optics, antennas, military electronics, satellite systems and subsystems.

We are looking for top quality professionals who want to grow with a progressive aerospace organization:

- ELECTRICAL ENGINEERS
- MECHANICAL ENGINEERS
- QUALITY ENGINEERS
- ANTENNA ENGINEERS

We offer excellent salary and benefits, including medical, dental and life insurance, a stock purchase plan, and four (4) weeks vacation.

For more information about outstanding career opportunities, contact:

 **Aerospace Systems Division**

Employee Relations Department  
P.O. Box 1062  
Boulder, Colorado 80306  
(303) 441-4111

*An Equal Opportunity Employer M/F*

**Classified section** FOR ENGINEERING/TECHNICAL EMPLOYMENT OPPORTUNITIES

★ **ATTENTION  
ELECTRONIC ENGINEERS!!!** ★

<b>Electronic Design Engineers</b>	<b>24-36K</b>
<b>Design Engineers (Digital)</b>	<b>25-35K</b>
<b>Analog Design Engineers</b>	<b>-25-35K</b>
<b>Systems Design Engineers</b>	<b>-28-35K</b>
<b>Electrical Design Engineers</b>	<b>-24-40K</b>
<b>Instrumentation Design Engineers</b>	<b>-25-40K</b>
<b>Test/Design Engineers</b>	<b>-24-35K</b>

Our clients are aerospace and electronic firms who pay our fees for locating engineers. For more information, send note or resume to Al Madsen, C.E.C.

**CORPORATE PERSONNEL CONSULTANTS, INC.**  
5950 Fairview Road  
Two Fairview Plaza, Suite 608  
Charlotte, North Carolina 28210  
(704) 554-1800

 **An Opportunity  
to Be the  
Key Manager**



*in Starting a*  
**Custom LSI Design Capability at  
HAZELTINE CORPORATION**

Candidate Should Have at Least 10 Years Experience  
Emphasizing:

- PMOS, NMOS, and CMOS Circuit Design
- IC Design in Above Technologies
- Related Managerial Experience

Custom LSI Engineering, CAD, and Test will report to this manager. Please send resume indicating background, experience and salary requirements to:

**Employment Manager  
HAZELTINE CORPORATION  
Greenlawn, (Huntington) NY 11740**

*An Equal Opportunity Employer Committed to Affirmative Action.  
A HazelTine Corporate Policy!*

# Have questions about Allen-Bradley's opportunity for Engineers?

We have answers...  
Just call toll free  
**1-800-321-6980**  
(In Ohio Call 1-800-362-6120)

Talk to Tom O'Brien about your skills and background. Our continuing growth creates openings for many engineering disciplines including...

**Software Engineers** Capitalize on your Comp. Sci. or related degree and apply your software experience - assembly languages, PASCAL, FORTRAN. Utilize our VAX11/780, DEC11/34 or TEKTRONIX Development Systems to support your designs.

**Hardware/Firmware Design Engineers** Design NC and PC systems employing advanced digital techniques. Degree and 2+ years experience desired. Your involvement would include design verification using VAX11/780, DEC11/34 or TEKTRONIX Development Systems.

**Application Engineers**  
Define customer control system requirements, prepare proposals and assist new product planning.

**Product/Marketing Engineers** Research and identify product opportunities based on industry requirements utilizing your degree and 2+ years of electronics or industrial experience.

We are a dynamic part of an international corporation employing over 17,000 people. Our products apply "leading edge" computer and microprocessor technology that increases productivity for all types of industry.

**Our careers are challenging and rewarding...  
Let's Talk About It - Call Today!**

or if you prefer, send your resume to:



**ALLEN-BRADLEY**  
747 Alpha Drive, Highland Heights, Ohio 44143

An Equal Opportunity Employer M/F



## FACULTY POSITIONS VACANT

Faculty Positions in Electrical Engineering Technology Undergraduate teaching positions in electrical engineering technology available on August 16, 1980 in Tuscaloosa, Alabama at The University of Alabama. Teaching duties will be in the area of circuits and electronics and one or more of the following areas: power, controls, communications, digital electronics. Master's degree or equivalent and at least one degree in EE or EET desirable. Some recent relevant industrial experience required. Some teaching experience desirable. P.E. registration desirable. Although positions are tenure track, applications are desired from those wishing a temporary appointment for all or part of the 1980-81 academic year. Applicants should send a complete resume to: Dr. John D. Antrim, Director, Engineering Technology Programs, The University of Alabama, P.O. Box 1941, University, AL 35486. An EO/AA employer.

## POSITIONS VACANT

**Electrical Engineer/Instructor.** Qualifications: Electrical Engineer, Bachelor's Degree, Master's Degree preferred. Three years of applied experience in the design or application of engineering principles on electronic equipment or equal. Solid state and computer background as they relate to the communications field is desirable. Salary Range: depending upon training and experience. To apply send resume, transcripts and salary requirements in confidence to: Edward R. Maclosky, Director of Personnel, Springfield Technical Community College, One Armory Square, Springfield, MA 01105. An Equal Opportunity Employer.

**Computer Software Designers** needed immediately. Salaries to \$40,000. Computers and microprocessors. Fee paid. CAPA, 808 Downtowner Blvd., Suite G, Mobile, AL 33609.

## EMPLOYMENT SERVICES

Electronic engineering growth positions with clients located nationally. Our service is enhanced by the fact that I am an EE with 20 years in industry and over 10 years in placing professionals on an employer fee paid basis. Send your resume to Joe Torcassi, Director, J. Anthony & Associates, PO Drawer AD, Lynchburg, OH 45142. 513/364-2305.

## RESUMES

Resumes - Complete instructions and examples; \$4. Consultants, Box 567 - J. Bergenfield, N.J. 07621.



# TIRED OF BEING BOXED IN? FORD AEROSPACE AND COMMUNICATIONS CORPORATION HAS SPACE FOR YOU!

Ford Aerospace & Communications Corporation, a leader in space information systems, has room for talented people, like you, who want limitless challenges. Since 1963, Ford Aerospace has been instrumental in all phases of ground-based support systems that have helped man and machine share information across the far reaches of space. We were the principal company responsible for the development, design, manufacture of equipment, installation, and continued maintenance and operation of NASA's Johnson Space Center Mission Control Center.

Our challenges continue with exciting programs like the redesign of the Mission Control Center to support the Space Shuttle—the transportation system of tomorrow. We're developing the Payload Operations Control Center "POCC" to monitor the many experiments that will be performed on the Shuttle.

These programs are part of the career opportunities at Ford Aerospace. Currently we have openings for the following professionals:



**Digital Design Engineers**

**Systems Engineers**

**Engineering Designers**

**Mission Planning Analysts**

We offer competitive salaries, an outstanding benefits package, and the convenience of living in the Clear Lake area, just 25 miles southeast of downtown Houston. If you want the challenges of space, or just want more space to advance your career, CALL COLLECT, John Brown (713) 488-2119 or (713) 486-6228, or Ted Sarno, (713) 486-6219 or send resume in confidence to Ford Aerospace & Communications Corporation, P.O. Box 58487, Dept. AJH, Houston, Texas 77058. We are an equal opportunity employer, m/f.

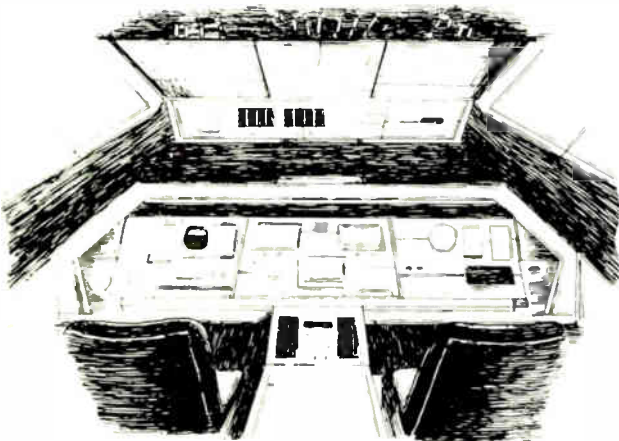

**Ford Aerospace &  
Communications Corporation**

Space Information Systems Operation

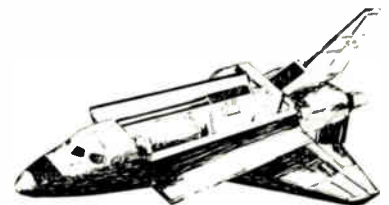



# JOIN THE SUPERGROUP

**The microwave team with 400 million miles of experience.** Imagine the growth potential when you join the world's #1 provider of GaAs FET power devices and the highly reliable silicon bipolar devices that gave man his first close-up look at Jupiter via Voyager 1. Especially when we're DOUBLING our microwave development facilities. Get the full story of our advancements in

## TELECOMMUNICATIONS, RADAR, AVIONICS and ECM

### PRODUCTION SUPERVISORS

Dynamic and self-motivated Production Supervisors who can "lead" Responsibilities include: developing and implementing production schedules; directing daily production operations; generating monthly production reports and supervising group leaders. College degree and at least five years experience preferred.

### MECHANICAL ENGINEER OR METALLURGIST

Provide engineering support for microwave device assembly activities. Specific areas of involvement are packaging, die mounting, wire bonding and sealing as they relate to device performance and yield as well as manufacturing efficiency. B.S.M.E. or B.S. in Met. Eng.

### PRODUCTION ENGINEER GaAs FET ASSEMBLY

Requires thorough knowledge of semiconductor manufacturing techniques, particularly in Gallium Arsenide Field Effect Transistor assembly. Specific emphasis will be on improving yields and assembly line trouble-shooting. College degree preferred.

### QUALITY ASSURANCE/CONTROL ENGINEERS

#### QA ENGINEER

Capability of reviewing customer documentation (including MIL SPECS) and preparing QA documentation from same. Will be involved in Qualification Test Report preparation, as well as heavy customer and internal disciplinary interfacing.

#### QC ENGINEER

Requires a minimum of two years of QA/QC experience or in the manufacture and testing of semiconductors. Working directly with manufacturing and engineering personnel, will assist in determining problem areas and instituting and verifying corrective action. Will prepare internal specs for QC Inspector use and training of same.

B.S. degree in E.E., M.E. or a Science.

Write to our Personnel Manager, W. Boyle detailing your background and salary history, or mail your resume to him at:

## MICROWAVE SEMICONDUCTOR CORP.

An Affiliate of Siemens

Dept. 2, 100 School House Road, Somerset, NJ 08873

An Equal Opportunity Employer M/F/H

**ELECTRONICS ENGINEERS, \$60,000.** Choice entry level to management positions immediately available in Pennsylvania & national locations. Reply in strict confidence to J. G. Weir, President, WEIR PERSONNEL SERVICES, 535 Court St., Reading, PA 19603 (215/376-8486).

**ELECTRONICS ENGINEERS, \$18,000-\$40,000.** Nationwide positions in digital, analog, microprocessor, microwave & instrumentation technology. For immediate confidential response, send resume w/ salary history to Glenn English, President, GLENN ENGLISH AGENCY, 7840 Mission Center Ct., San Diego, CA 92108 (714/291-9220).

**ELECTRONICS ENGINEERS, \$18,000-\$40,000.** Suburban New Jersey & nationwide. Numerous choice positions in co's utilizing the latest State-of-Art methods & equipment. Reply in confidence to James E. Mann, VP/Eng., ARTHUR PERSONNEL, Suite J6, 8 Forest Avenue, Caldwell, NJ 07006 (201/226-4555).

**DESIGN ENGINEERS to \$38K.** Central Penna. & nationwide. Design connectors/terminals, microprocessors & controls. Reply in confidence to Z. A. Gonglewski, MECK ASSOC. PERSONNEL, 1517 Cedar Cliff, Camp Hill, PA 17011 (717/761-4777).

all positions fee-paid



### ANALYTICAL INSTRUMENT SPECIALIST, CHEMISTRY:

Professional position for a well trained and experienced technician-specialist who can maintain, repair, and operate NMR and MASS SPECTROMETERS, and who is capable in low level digital electronics. A career opportunity with a first-rate private university located in upstate New York. Send resume in confidence to Virginia E. Lepore, Personnel Dept., University of Rochester, 260 Crittenden Blvd., Rochester, N.Y. 14624. An equal opportunity employer (M/F)

### SOUTH & SOUTHWEST POSITIONS

Engineering and Management positions throughout the South, Southwest and U.S. Employers pay all fees. Send resume in confidence to: Bob Hogue.

*personnel consultants*  
**SouthWest Technical**  
P.O. Box 33070,  
San Antonio, Texas 78233

## Engineers

- Design
- Development
- Project
- Software

**\$20,000-\$50,000**

Riddick Associates' Engineering Division specializes in placement of electrical and electronics engineers with top companies in the Southeast and throughout the U.S. We provide advice on careers, resumes and interviews for a position tailored to your skills. Client companies pay all fees. For details call or send resume in strict confidence to Phil Riddick, President

**Riddick Associates, Ltd.**  
9 Koger Executive Center  
Norfolk, VA 23502  
Area 804-461-3994

## TECHNICALLY ORIENTED...

**Sales/Marketing Professionals... \$20,000-\$60,000**

*If you have a science or engineering degree... we invite you to discuss your careers...*

*... with placement consultants who understand your particular qualifications & goals.*

*R.S.V.P. by calling or by sending your resume, in confidence, to:*

**r. m. ferren associates, inc.**  
(212) 986-5510  
505 Fifth Ave., NYC 10017  
CORPORATE INQUIRIES WELCOMED  
FEE PAID Agency

## ELECTRONICS ENGINEERS

If you are an engineer looking for upward career mobility, call us. We specialize in electronics/aerospace nationwide. All fees assumed by our clients. Submit resume in professional confidence to: Jim Crumpley/Gayle Smart



**Dorsey Love & Associates, Inc.**  
P.O. Box 4387 G.S.  
Springfield, Mo. 65804

### SOUTHWEST & SUNBELT

- Digital
- Hardware
- R&D
- Analog
- Software
- Design

\$20,000 to \$50,000

J. Robert Thompson Co., Inc.  
2200 W. Loop South, 8800, Houston, TX 77027 (713) 627-1940

Specialist for EE's - Co. Pays Fee Since 1967 - will provide resume service - or send resume, salary history, geographic preference.

# Communications Engineers.

# WE'LL SHOW YOU THE WAY HOME.

**The NAVSTAR Global Positioning System.** A unique navigation project consisting of 24 satellites, ground control stations and user systems. Designed to allow ships, ground troops and aircraft to determine their positions to an accuracy of within 10 meters anywhere on the globe.

It will make it easier to reach destinations—and get home again.

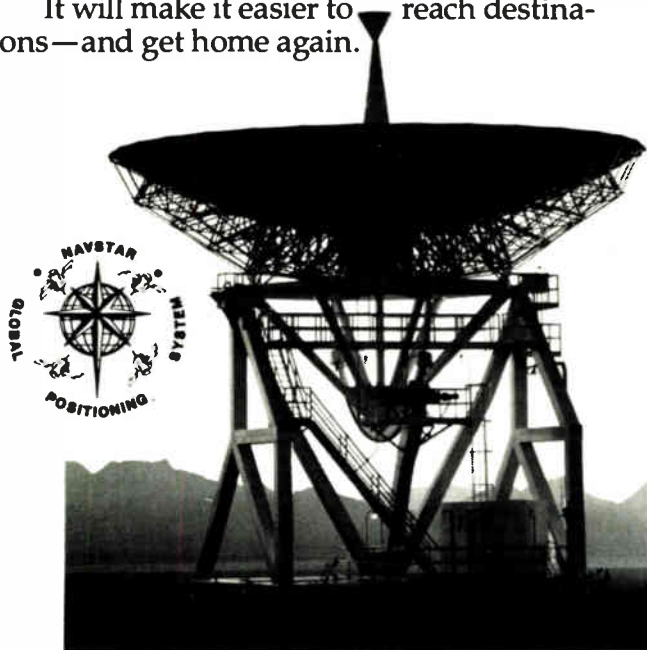

And Harris Government Communications Systems Division is helping make it happen.

Through our hands-on, state-of-the-art approach leading a constantly changing communications technology. Through a constant interchange of knowledge among all 10 Harris divisions. And an on-going program of growth and expansion that has made Harris the billion dollar leader.

**A family-oriented lifestyle.** A wide-open housing market where a good buy is still a reality. Parks, golf courses, tennis courts, and miles of white sand beaches.

It's a place to call home.

And Harris can make it happen for you. And your family. In Brevard County, Florida.

The Government Communications Systems Division currently has openings for state-of-the-art Engineers in a range of technologies relating to custom communications and information processing systems. Some of the many professional opportunities include ■ Program Managers ■ Microwave ■ Mechanical ■ Antenna ■ Phased Array.

We'd like to show you our success. We'd like to show you our lifestyle. We'd like to show you the Harris way home.



Send your resume and salary history to: **Steve Gilmore, Professional Staffing, Harris Corporation, Government Communications Systems Division, P.O. Box 37, Dept. E65, Melbourne, Florida 32901 or call collect (305) 727-4144.**



**HARRIS**  
COMMUNICATION AND  
INFORMATION PROCESSING

An Equal Opportunity Employer M/F

## If you currently earn between \$22,000 and \$48,000 we've got a better job for you...NOW!

Every day you spend in the wrong job is a waste of time, money and talent... YOURS! Your talents and experience are in great demand and you can choose among many rewarding opportunities available in your field. But how?

Talk to the experts at Wallach. We've been successfully recruiting professionals like yourself for over 15 years.

Nationwide opportunities include technical/management consulting, project management, R&D, test and systems evaluation in the fields of Communications, Satellites, Weapons, Intelligence, Computer, Energy, and Aerospace systems. Specific skill areas include:

- Minicomputers
- Microprocessors
- Software development
- Signal processing
- Digital systems
- Command & Control
- Radar Systems
- Communication Systems
- EW/SIGINT/ELINT
- Microwave Systems
- Electromagnetics
- Fire Control Systems

Don't waste another day in the wrong job! Call Robert Beach collect at (301) 762-1100 or send your resume in confidence. We can find you a better job. Let us prove it to you...NOW!

WALLACH...Your career connection

Equal Opportunity Employer Agcy

**WALLACH**  
associates, inc.

1010 Rockville Pike  
Box 6016  
Rockville, Maryland 20852  
(301) 762-1100

## Inventors

We are looking for individuals who will take creative risks with conductive polymer materials. Expand upon your educational background (BS, MS, or PhD) or Industrial experience as an Electrical Engineer or Physicist. You should be able to function in an environment which will professionally challenge your best efforts. If you feel confident about your ability to

- **Create New Products**
- **Develop Electronic Devices, or**
- **Research Unique Polymer Materials,**

**we can offer you an exciting future.**

Explore this opportunity to excel in a high-technology company with RAYCHEM... the International Leader in the field of irradiated polymers and specialty metals. Positions include Project Leaders, Staff, and Assistant Staff depending upon your motivation and capabilities. Write directly to me describing your abilities and preferences. Please include your resume and references.

**Dr. Steve Jacobs**  
**Raychem Corporation**  
**300 Constitution Drive**  
**Menlo Park, CA 94025**

We are proud to be an equal opportunity employer.

# Raychem

## NOTICE TO EMPLOYERS:

## Why we can recommend our readers for the top jobs

The subscribers to this magazine have qualified professionally to receive it. They are also paid subscribers—interested enough in the technological content to have paid a minimum of \$18 for a subscription.

As subscribers to ELECTRONICS, our readers have told you several things about themselves. They are ambitious. They are interested in expanding their knowledge in specific areas of the technology. And they are sophisticated in their need for and use of business and technology information.

Our readers are now in senior engineering or engineering management, or they are on the road toward those levels. In either case, they are prime applicants for the top jobs in almost any area.

If you are interested in recruiting the best people in electronics, these pages are open to you for your recruitment advertising.

Our readers are not "job-hoppers". To interest them you will have to combine present reward with challenge and opportunity for future career advancement.

The cost of recruitment advertising on these pages is \$71 per advertising inch. For information call or write:

## Electronics

Post Office Box 900, New York, NY 10020  
Phone 212/997-2556



# UNITED NATIONS

Invites Applications for the  
Following Positions at  
New York Headquarters

## 1. CHIEF, TECHNICAL SERVICES SECTION (P-5)

Supervises and specifies arrangements for the installation, operation and maintenance of equipment associated with the United Nations conference servicing and radio and television programming operations. This includes a wide range of broadcast standard audio and video equipment, simultaneous interpretation installations and electronic voting equipment.

Responsibilities include directing the work of some 100 personnel, design of and supervision of construction of equipment, advising other divisions on technical matters and preparation of budgets.

Should have advanced university degree in relevant engineering discipline, good electronic knowledge, computer experience and management skills particularly in the fields of budgeting projection and cost control, with 13 years professional experience.

Level P-5 carries net base salary per annum from US\$24,298 (single) and US\$26,298 (with dependents) plus post adjustment from US\$11,627 (single) and US\$12,584 (with dependents) per annum.

VA. 80-D-DAM-109-NY

## 2. CHIEF, TELEVISION AND FILM UNIT (P-4)

Controls the technical aspects of the United Nations television and film unit which works to full professional broadcast standards.

Is responsible for systems development and specifying operational and maintenance techniques and for assessing needs and making recommendations for purchase of equipment.

Supervises the operations in the technical areas and maintains contact with outside TV networks and operators.

Should have advanced university degree in electrical engineering with eight years' professional experience in the operation and maintenance of television and film equipment.

Level P-4 carries net base salary per annum from US\$20,209 (single) and US\$21,755 (with dependents) plus post adjustment from US\$9,779 (single) and US\$10,527 (with dependents) per annum.

VA. 80-D-DAM-108-NY

## 3. ENGINEER (TELECOMMUNICATIONS) (P-4)

Supervises the technical aspects of conference servicing operations with particular regard to simultaneous interpretation, audio distribution systems and electronic voting equipment.

Responsible for systems development and design and for the installation of these facilities both at Headquarters and for conferences away from headquarters.

Should have advanced university degree in an engineering discipline, with eight years' professional experience.

VA. 79-D-DAM-357-NY

**APPLICATIONS:** Please complete two copies of United Nations Personal History Form (P.11) or send detailed curriculum vitae to: Professional Recruitment Service, United Nations, New York, N.Y. 10017, USA. Mention the date of birth and nationality, and quote the Vacancy Announcement number.

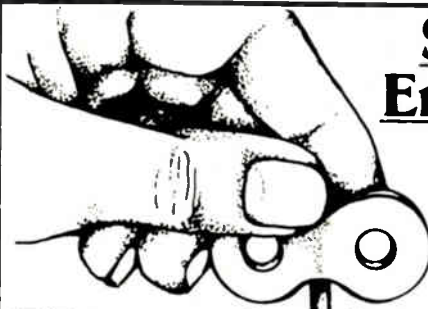

# Software Engineers.

## You wind you up. We turn you on.

Coulter Electronics is a world leader in medical electronics and instrumentation. An innovator in precision products related to health care and hematological functions.

The technology involved — and the diversified application problems — require constant upgrading in **software design and engineering.**

Obviously, we can't rely on yesterday's technology.

We need engineers with a grasp on tomorrow. Professionals who care about contributing to a project totally — from concept through implementation.

Which is why from day one at Coulter Electronics, **you're highly visible.** You're contributing. You're recognized.

We turn you loose. We turn you on. Expecting excellence because we have a tradition of engineering excellence.

Right now, **we need Software Engineers with micro-processor/mini-computer experience for our top-down design, structured programming environment.**

This is your chance to utilize your degree in Math, Computer Science, or Electrical Engineering — and your process control experience.

This is your chance to grow.

Send in your resume and salary history to: **Mr. Pete Chylko, Employment Manager, Dept. E, P.O. Box 5-2794, Miami, Florida 33152.**

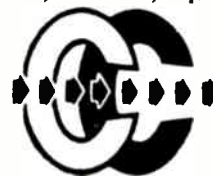

### COULTER ELECTRONICS, INC.

**INNOVATING A VITAL TECHNOLOGY.**

An Equal Opportunity Employer M/F

**ENGINEERS**  
SEND YOUR CREDENTIALS TODAY!  
TRANSITION to your new CAREER OBJECTIVES using TSC's nationwide employment search resources.  
TRANSITION SEARCH CONSULTANTS  
2697 International Parkway, Suite 203,  
Virginia Beach, Virginia 23452  
804-427-3700

### GREATER TEXAS POSITIONS

Engineering and related management openings throughout the Southwest. Top clients paying all fees and relocation expenses. Send resume in confidence to: Alan Myler.

**KEY SEARCH**  
P.O. Box 38271  
Dallas, TX 75238

### ENGINEERS

- Design
- Avionics
- Systems
- Test
- Communication
- Digital
- Analog
- Micro Processing

Our specialty is placing engineers with electronic and agricultural machinery companies. Engineering positions available anywhere in the United States. Companies pay for interview, relocation and fees.

Send resume to  
**ALPS PERSONNEL INC.**

235 S. Maitland Ave., Suite 113  
Maitland, Fla. 32751 Ph. (305) 628-2577

Abbott Transistors Labs	59	Cromemco	2nd cover	Fujitsu Limited	60
Advanced Micro Devices	10,11	‡ Cte Corporation	191,220	Garrett Corporation	128
■ AEG Telefunken	170	Cubit	230	General Instrument Microelectronics	205
American Microsystems Inc	72,73	‡ Curtiss Industries	9	■ Genrad Incorporated	133,227
American Telephone & Telegraph Co Long Lines	153	Data I/O Corporation	223	‡ Global Specialties Corporation	40
■ Amp Incorporated	173-175	■ Data Precision	199	■ Gould Inc., Instruments Division	211,213
■ Amphenol North America	221	Datum Incorporated	8	• Greenper	6E
Aramco Services Co.	208	Dialight	215	■ Hewlett Packard	17-26
■ Augat, Inc.	217	■ Digital Equipment Corporation TOEM	192,193	‡ Hitachi America Limited	168,169
‡ AVX Materials Division	163	Digital Equipment New Product Marketing	202,203	■ Houston Instrument	85
■ Bausch & Lomb Scientific Optical Products	220	Dit-MCO	58	Hybrid Systems	71
‡ Beckman Instrument Advanced Electro Products	200,201	DuPont Company Vaprel Solder Mask	219	Image Resource	114
Beckman Instruments, Inc.-Displays	188-189	• EG & G Wakefield Eng.	12E	Intel MPO	127,87-90
Belden Corporation	231	E-H International	136	Intel OMS	28,29
Berg Electronics	228	Electronic Arrays	37	• Interface Technology	201
■ Boonton Electronics	145	■ Electronic Navigation Industries	3rd cover	International Rectifier Semi. Div.	31
■ Bourns Inc	4th cover	Electronum	6	Iskra Commerce Marketing Advtg Dept	81
Burndy	74,75	Etifab	181	C. Itoh	106
■ Bussmann Mfg Div McGraw Edison Co	146	■ EMI Technology	56	■ ITT Cannon Electric	49
California Data Corporation	32	• Enertec Schlumberger (Velizy)	5E	• ITT Intermetall	11E
■ Cherry Electrical Products	1,13	EXAR	112,113	• Iwatsu Electric Co. Ltd.	8E
Compass Microsystems	230	Fairchild Test Systems	107	■ Jensen Tools & Alloys	182
Computer Automation, Inc. Industrial Prod. Div.	103	■ First Computer Corporation	15	Kodak Products Limited	224
		John Fluke Mfg Co	183, 8E A to F	Kontron Electronics Incorporated	57

Krohn-Hite Corporation	27	• Plessey Semiconductor	168	Texas Instruments Semiconductor	110, 111, 194, 195
Kyocera International	167	Plessey Semiconductor	99	• Thomson CSF Div. D.T.E.	163
Malloy Sonalert	166	RCA Solid State	164-166	■ TRW Electric Components	184, 185
Micro Devices Division of Emerson Electric	218	Robinson Nugent Incorporated	186-187	■ TRW LSI Products	105
■ Microswitch Division of Honeywell	178, 179	Rockwell Microelectronics Device Division	108, 109	TRW Dptron	14
Millennium Systems	138, 139	• Rohde & Schwarz	1E, 9E	Universal Instruments	209
• Mini-Circuits Laboratory	2	• SGS Ates	191	■ Vactec Inc.	172
Mitel Semiconductor Incorporated	94	‡ Sharp Corporation	67	■ Wabash Relay & Electronics	182
Monolithic Memories	38, 39	• Shell	9	Wiltron	225
Mostek Corporation	33	• Siemens AG	7E	• Zeltron	169
Motorola, Inc., Display Systems	7	Silicon Systems	159	Zendex Corporation	83
• Murata Mfg. Co Ltd	10E	Siliconix	16	Zilog	76, 77
■ National Semiconductor	51-54	Sprague Electric	63		
• NEDHM SPA	40	Strathclyde Industrial Development	226		
New Mexico Department of Commerce & Ind	86	Synertek	64, 65		
Nikkei Electronics	214	Systems Consultants Incorporated	78		
Ohio Scientific	34	TASA	224		
DKI Semiconductor	47	• TEAC Corporation	66		
Optec	12	Tektronix	207, 196, 197		
Optimetrix Corporation	93	Teledyne Philbrick	83		
Ovensaire (Division of Walter Kidde & Co)	220	Telpar	45		
Pertec Computer Corp./Peripherals Division	68	Teredyne Incorporated	176-177		
Phillips Industries (Gloeilampenfabrieken)	2E, 3E	TESLAcO Incorporated	230		
Plessey Company Ltd (Microsystems)	154	Texas Instruments, Inc. (Digital Systems Div.)	5		

#### Classified and employment advertising

F. J. Eberle, Manager 212-997-2557

Allen-Bredley Co	242
Alps Personnel Inc	247
Bell Aerospace	241
Colorado Life	241
Corporate Personnel Consultants	241
Coulter Electronics Inc	247
Digital Equipment Corp	237
Dorsey Love & Associates	244
R.M.Ferrea Inc	244
Ford Aerospace Comm. Corp	243
Gte Lenkurt	238
Harris Gov't Communication	245
Hazeltine Corp	241
Hewlett Packard	236
Key Search	247
Martin Marietta	235
Microwave Semiconductor Corp	244
Mostek	234
National Personnel Consultants	244
NCR Corp	236, 239
Raychem	246
Riddick Assoc. Ltd	244
Rochester University, The	244
Sitronix	240
Southwest Technical	244
Storage Technology Co	240
Thompson J. Robert	244
Transition Search Consultants	247
Tri-State	236
United Nations	247
Wallach Associates	246

■ For more information of complete product line see advertisement in the latest Electronics Buyers Guide

• Advertisers in Electronics International

‡ Advertisers in Electronics domestic edition

# Books of special interest to our readers



## Applying Microprocessors

Reprinted from *Electronics*, completes the EE's transition from the old methods of electronic design to microprocessor engineering. Pub. 1977, 191 pp. Order #R-701, \$9.95

## Basics of Data Communications

This compilation of essential articles from *Data Communications* magazine includes chapters on terminals, acoustic couplers and modems, communications processors, networking, channel performance, data link controls, network diagnostics, interfaces, and regulations and policy. Pub. 1976, 303 pp. Order #R-603, \$12.95

## Circuits for Electronics Engineers

Almost 350 circuits arranged by 51 of the most useful functions for designers. Taken from the popular "Designer's Casebook" of *Electronics*, these circuits have been designed by engineers for the achievement of specific engineering objectives. Pub. 1977, 396 pp. Order #R-711, \$15.95

## Design Techniques for Electronics Engineers

Expert guidance at every point in the development of an engineering project—making measurements, interpreting data, making calculations, choosing materials, controlling environment, laying out and purchasing components, and interconnecting them swiftly and accurately. Nearly 300 articles from *Electronics*' "Engineer's Notebook." Pub. 1977, 370 pp. Order #R-726, \$15.95

## Microelectronics Interconnection and Packaging

Up-to-date articles from *Electronics* include sections on lithography and processing for integrated circuits, thick- and thin-film hybrids, printed-circuit-board technology, automatic wiring technology, IC packages and connectors, environmental factors affecting interconnections and packages, computer-aided design, and automatic testing. Pub. 1980, 320 pp. Order #R-927, \$12.95

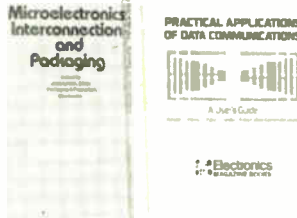

## Large Scale Integration

As published in *Electronics*, covers the entire range of design applications in sections on bipolar LSI, MOS LSI, new devices, system design, computer-aided design, testing, and applications. Pub. 1976, 208 pp. Order #R-602, \$9.95

## Memory Design: Microcomputers to Mainframes

The technology, devices, and applications that link memory components and system design. How to apply the new technology to meet specific design goals. Edited from the pages of *Electronics*. Pub. 1978, 180 pp. Order #R-732, \$12.95

## Microprocessors

The basic book on microprocessor technology for the design engineer. Published in 1975, articles are drawn from *Electronics*. 150 pp. Order #R-520, \$8.95

## Personal Computing: Hardware and Software Basics

More than 50 articles from leading publications give you up-to-date information on personal computing hardware, software, theory, and applications. Pub. 1979, 266 pp. Order #R-903, \$11.95

## Practical Applications of Data Communications: A User's Guide

Articles from *Data Communications* magazine cover architecture and protocols, data-link performance, distributed data processing, software, data security, testing and diagnostics, communications processors, and digitized-voice and data-plus-voice. Pub. 1980, 424 pp. Order #R-005, \$13.95

**FREE**  
Brochure describes *Electronics*' editorial reprints, services, books. For free copy, check the coupon in this ad or circle #275 on the reader service card.

## Advertising Sales Staff

**Advertising sales manager:** Norman Rosen  
3200 Wilshire Blvd., South Tower  
Los Angeles Calif. 90010 [213] 487-1160

## Market managers:

**Components:** William Boyle, Rochester, N.Y.  
**Computers & Peripherals:** Frank Mitchell, Boston  
**Test & Measurement:** Don Farris, San Francisco  
**Semiconductors:** Norman Rosen, Los Angeles

**Atlanta, Ga. 30309:** Peter Stien  
100 Colony Square, 1175 Peachtree St., N.E.  
[404] 892-2868

**Boston, Mass. 02118:** Frank Mitchell  
607 Boylston St., [617] 262-1160

**Cleveland, Ohio 44113:** William J. Boyle  
[716] 248-5620

**Fort Lauderdale, Fla. 33308:** Peter Stien  
3000 N.E. 30th Place, Suite #400  
[305] 563-9111

**New York, N.Y. 10020**  
1221 Avenue of the Americas  
John Gallie [212] 997-3616  
Matthew T. Reseska [212] 997-3617

**Philadelphia, Pa. 19102:** Matthew T. Reseska  
Three Parkway, [212] 997-3617

**Pittsburgh, Pa. 15222:** Matthew T. Reseska  
4 Gateway Center, [212] 997-3617

**Rochester, N.Y. 14534:** William J. Boyle  
Powder Mill Office Park, 1163 Pittsford-Victor Rd.,  
Pittsford, N.Y. 14534 [716] 248-5620

**Chicago, Ill. 60611**  
645 North Michigan Avenue  
Jack Anderson [312] 751-3739  
Robert M. Denmead [312] 751-3738

**Detroit, Michigan 48202:** Jack Anderson  
1400 Fisher Bldg., [313] 873-7410

**Costa Mesa, Calif. 92626:** Edward E. Callahan  
3001 Red Hill Ave. Bldg. #1 Suite 222  
[714] 557-6292

**Oakland, Texas 75201:** John J. Uphues  
2001 Bryan Tower, Suite 1070  
[214] 742-1747

**Denver, Colo. 80203:** Harry B. Doyle, Jr.  
655 Broadway, Suite 325  
[303] 825-6731

**Houston, Texas 77002:** John J. Uphues  
601 Jefferson Street, Dresser Tower  
[713] 659-8381

**Los Angeles, Calif. 90010:** Chuck Crowe  
3200 Wilshire Blvd., South Tower  
[213] 487-1160

**San Francisco, Calif. 94111:** Don Farris,  
Larry Goldstein, 425 Battery Street,  
[415] 362-4600

**Paris:** Michael Sales  
17 Rue-Georges Bizet, 75116 Paris, France  
Tel: 720-16-80

**United Kingdom:** Simon Smith  
34 Dover Street, London W1  
Tel: 01-493-1451

**Scandinavia:** Andrew Karnig and Assoc.  
and Simon Smith  
Kungsholmsgatan 10  
112 27 Stockholm, Sweden

Tel: 08 51 68 70 Telex: 179 51  
**Milan:** Ferruccio Silveira  
1 via Baracchini, Italy  
Phone 86-90-656

**Brussels:**  
23 Chaussee de Wavre  
Brussels 1040, Belgium  
Tel: 513-73-95

**Frankfurt/Main:** Fritz Krusebecker  
Liebigstrasse 27c, Germany  
Phone 72 01 81

**Tokyo:** Akio Saijo, McGraw-Hill  
Publications Overseas Corporation,  
Kasumigaseki Building 2-5, 3-chome,  
Kasumigaseki, Chiyoda-Ku, Tokyo, Japan  
[581] 9811

**Business Department**  
**Thomas M. Egan**  
Production Director  
[212] 997-3140  
**Carol Gallagher**  
Production Manager  
[212] 997-2045  
**Betty Preis**  
Production Manager Domestic  
[212] 997-2908  
**Thomas Kazich**  
Production Manager Related Products  
[212] 997-2044  
**Karen Walpole**  
Production Assistant  
[212] 997-2843  
**Frances Vallone**  
Reader Service Manager  
[212] 997-6057

## Electronics Buyers' Guide

**H.T. Howland**, General Manager  
[212] 997-6642  
**Regina Hera**, Directory Manager  
[212] 997-2544

## Classified and Employment Advertising

**Frank Eberle**, Manager  
[212] 997-2557

## Order today using this coupon!

**Electronics Magazine Books**  
P.O. Box 669  
Hightstown, NJ 08520  
Tel. (609) 448-1700, ext. 5494



Name \_\_\_\_\_

Title \_\_\_\_\_

Company \_\_\_\_\_

Street/P.O. address \_\_\_\_\_

City/state/zip \_\_\_\_\_

Payment enclosed (payment must accompany orders under \$25)

Bill my company (or attach company Purchase Order)

Bill me  Send a free copy of the *Electronics* Editorial Reprints brochure.

Ten-day money-back guarantee applies on all books.

Order #	Qty.	Price
R- _____	_____	\$ _____
R- _____	_____	\$ _____
R- _____	_____	\$ _____
R- _____	_____	\$ _____
R- _____	_____	\$ _____
Total		\$ _____

# Now... the only RF power amplifier you may ever need.

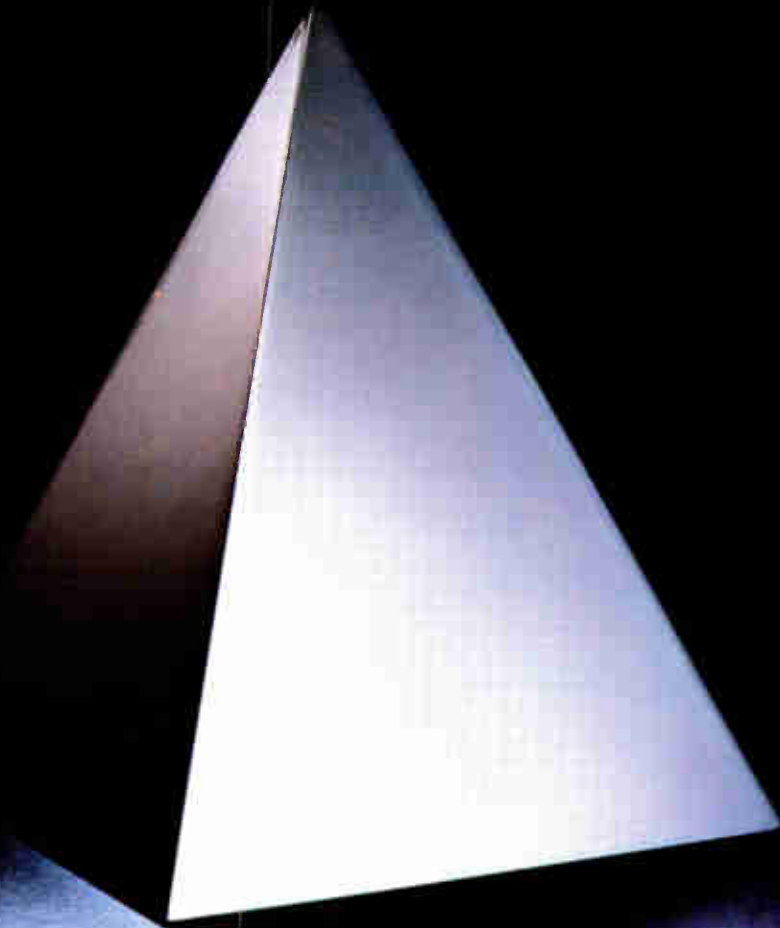

The new ENI 550L  
delivers 50W, 1.5-400 MHz.

This single unit is so incredibly versatile it can replace several you may be using now. And you may never need another. It's an extremely broadband high power, solid state, Class A linear amplifier. It's rated at 50W from 1.5-400 MHz. But it can provide 100 Watts from 1.5-220 MHz. All you need with the 550L is any standard signal or sweep generator and you've got the ultimate in linear power for such applications as RFI/EMI testing, NMR,



RF Transmission, ultrasonics and more.

And, like all ENI power amplifiers, the 550L features unconditional stability, instantaneous failsafe provisions, and absolute protection from overloads and transients.

The 550L represents the pinnacle in RF power versatility. There's nothing like it commercially available anywhere! And it may be the only RF power amplifier you ever need.

For more information, a demonstration, or a full line catalog, please contact us at ENI, 3000 Winton Road South, Rochester, NY 14623. Call 716/473-6900, or telex 97-8283 ENI ROC.

## ENI

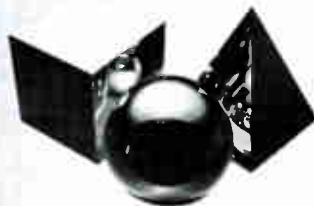

**The advanced design line of power amplifiers**

Circle 901 on reader service card

# Why Assemble, Mount and Calibrate a Pot and Dial...



## When you can simply insert a Knobpot<sup>®</sup> potentiometer into your panel?

No assembly, no calibration . . . saves you time and money with no hassle. Knobpot potentiometers are integrally designed 10-turn wirewound pot/dial components that are preassembled and prephased at the factory. Attractive, rugged and accurate, they're easy to install, require less front panel space than most dials alone, and are available with either digital or clockface readouts. A recent product upgrade provides improved reliability, positive lens retention and smoother rotational torque. Four different models to fit your front panel needs:

	Digital Readout		Clockface Readout	
	3610	3650	3600	3640
Diameter	1 1/4"	1 1/4"	1 1/4"	1 1/4"
Standard Resistance Range (Ohms)	100-100K	100-500K	100-100K	100-500K
Resistance Tolerance	+5%	+3%	+5%	+3%
Repeatability (Voltage Ratio)	0.1%	±0.05%	0.1%	±0.05%
Power Rating (25 °C)	1.5w	2.5w	1.5w	2.5w
Rotational Life (Revolutions)	50,000	100,000	100,000	100,000
Mounting Style	Snap-in	Recessed Cup	Bushing	Bushing

Save time . . . save money . . . save space. Specify Knobpot potentiometers – built only by Bourns. They're in stock now at your local Bourns distributor and available for immediate installation. Call your local Bourns representative or distributor for more information and for your new 52 page PP-1 Precision Potentiometer catalog.

PRECISIONS DIVISION, BOURNS, INC., 1200 Columbia Avenue, Riverside, CA 92507.  
Ph: 714 781-5122 TWX: 910 332-1252.

European Headquarters: Bourns AG, Zugerstrasse 74 6340 Baar, Switzerland. Ph: 042 33 33 33. Telex: 78722.



The last word in resistive components

# BOURNS<sup>®</sup>

For Immediate Application—Circle 120 For Future Application—Circle 220