

FEBRUARY 28, 1980

**DESIGNING A BIT-SLICE MAINFRAME/118**

Letter from Palo Alto: Silicon Valley is filling up/98

5-volt chip makes microprocessor output analog/125



FOUR DOLLARS A MCGRAW-HILL PUBLICATION

# Electronics®

ERASABLE PROM  
NEEDS  
NO LIGHT

# 5.

Circuit Board Testing Update/No. 5 in a series from Hewlett-Packard.

## JUSTIFYING THE PURCHASE OF AN AUTOMATIC BOARD TEST SYSTEM IN LIGHT OF TODAY'S HIGH COST OF CAPITAL.

Today, an automatic board test system can easily cost \$100,000 or more. Given the current high cost of money, can a purchase of this size be financially justified? If you choose the right kind of test system it can be. In fact, the right automatic test system will not only pay for itself — including interest costs — but will actually save your company additional money.

### The secret! Leveraging.

There are any number of testing alternatives now available. However, HP's 3060A Board Test System combines the latest in-circuit testing technology with board level functional testing. The addition of functional testing to in-

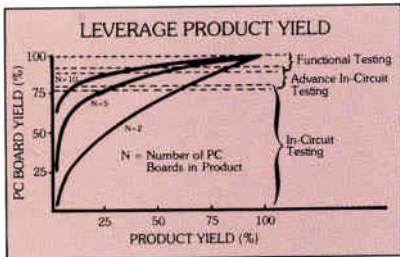

circuit testing provides a relatively small increase in board yield. But as you can see from the accompanying diagram,

this small increase can mean a large improvement in product yield. For example, in a 5 PC board product, an increase in board yield of only 8% (from 90% to 98%) will leverage product turn-on rate from about 59% to 90%.

### The impact of leveraging on production test costs.

As you may have already discovered, production testing costs increase exponentially. In other words, a fault that costs 18¢ to find during in-circuit testing can easily cost \$20 or more if not detected until final product test. Why? Because of the additional time — and increased labor costs — associated with fault diagnosis and repair at this level.

By helping leverage product yield through in-circuit plus functional testing, the HP 3060A can help decrease production test costs. For example, in a five PC board product, with a product volume of 12,000 per year, the 3060A can slash production test costs as much as \$19.94 per unit. And that's a total of nearly \$250,000 per year.

### Will it work for you?

As you can see from the graph, today's increasing cost of capital means the savings to be generated by an investment such as the HP 3060A must be substantial in order to produce a reasonable break-even point. How can you determine whether or not the 3060A would deliver a large enough reduction in production test costs — to justify its purchase?

To help you determine this for yourself, HP now offers a very helpful brochure titled "Financial Justifi-

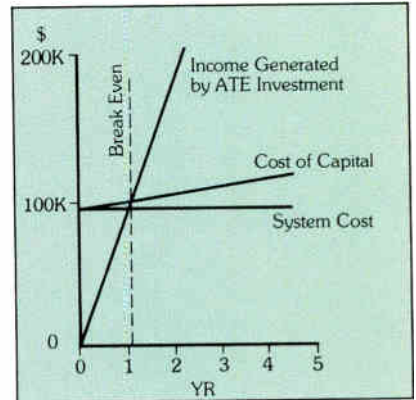

cation — Circuit Test Systems." It includes a production test model worksheet, and has guidelines for calculating the 3060A Automatic Board Test System's payback period, average return on investment and/or discounted cash flow. You can use this information to determine the rate of return offered by the HP 3060A in your facility, even in light of today's high-interest economy. For your free copy of "Financial Justification of Board Test Systems," or for more information on the HP 3060A, (Priced at \$82,000\* for standard operational system) write to Hewlett-Packard, 1607 Page Mill Road, Palo Alto, CA 94304. Or call the HP regional office nearest you: East (201) 265-5000, West (213) 970-7500, Midwest (302) 255-9800, South (404) 955-1500, Canada (416) 678-9430.

\*Domestic USA price only.

099-61

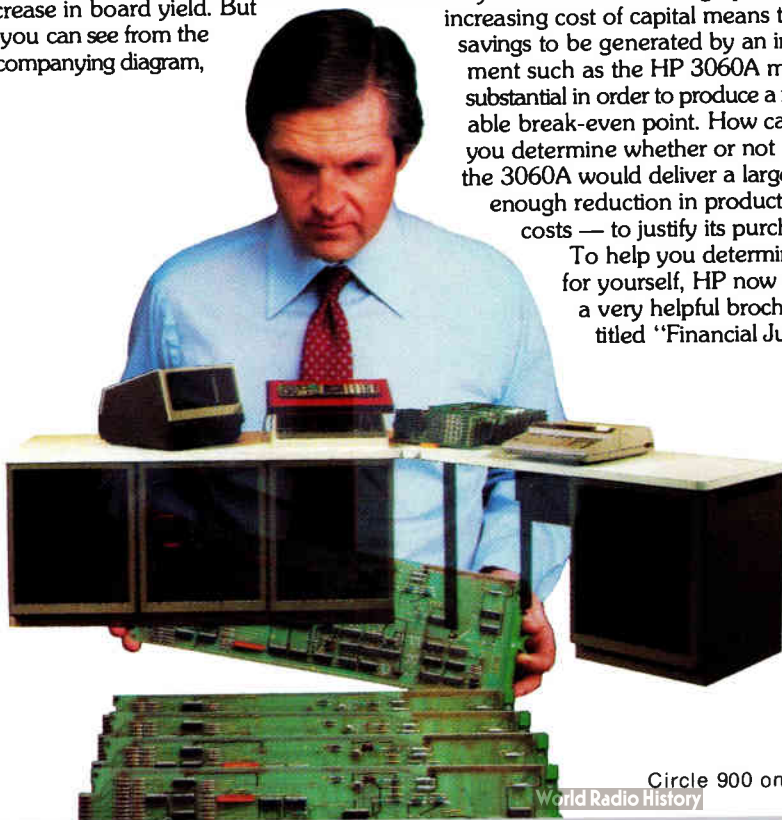

HP Circuit Testers —  
The Right Decision



Circle 900 on reader service card

World Radio History

# SURPRISE!

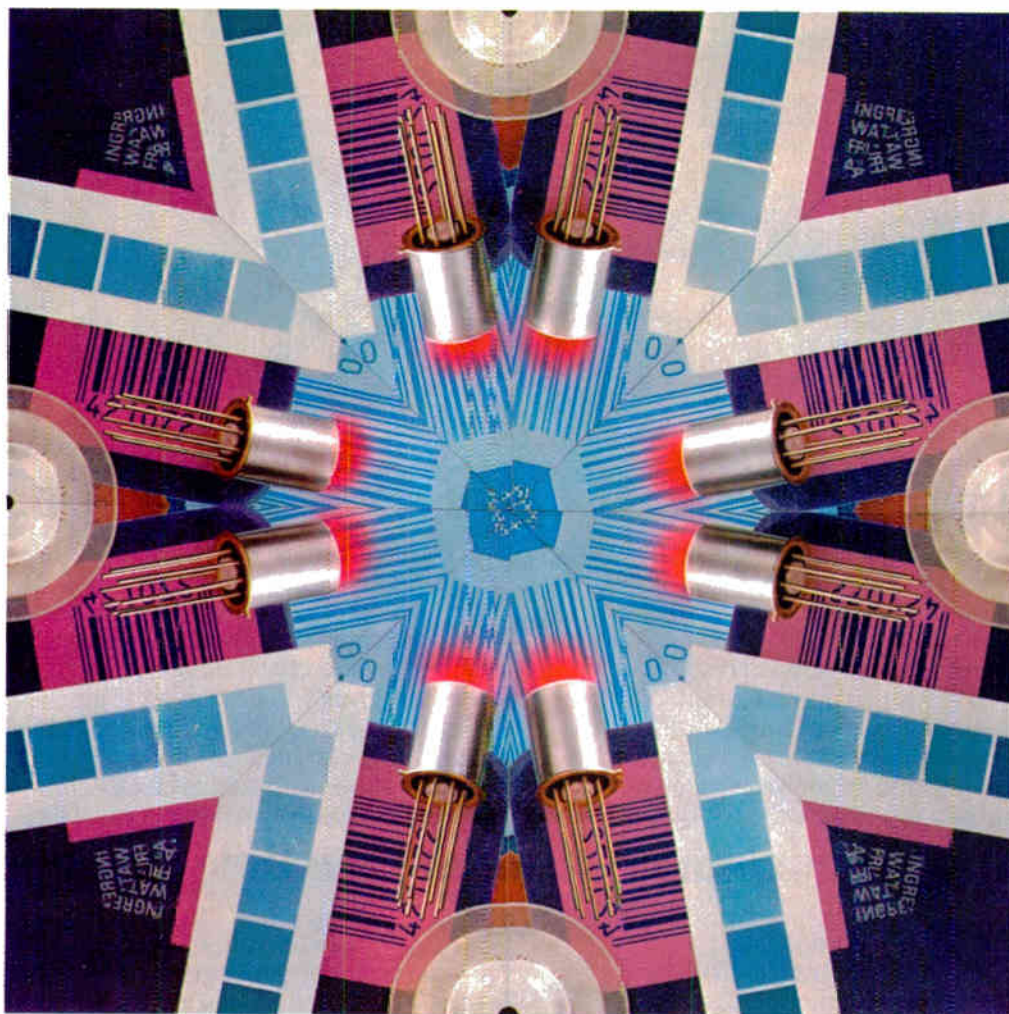

## HP's New Optical Sensor Solves a Kaleidoscope of Problems.

Here's a high-resolution, high-speed reflective sensor designed for facsimile sensing, pattern recognition and verification, edge sensing, pencil and pen mark detection, tachometry, and scanning color bar codes. Because it can sense most materials optically, you can use it to count, measure, sort, and detect flaws. Typical applications include monitoring production mechanisms, verifying printed bar codes, reading tickets, and encoding motors. The HP HEDS-1000 combines an LED emitter, photo IC detector, and precision optics. The sensor module is fully integrated, so that no precision alignment tools, optical test equipment or special training are required for its use. It operates from a single 3.5 to 20V power supply and is priced at \$18.50\* in quantities of 100.

For more information or immediate off-the-shelf delivery, call any franchised HP Components Distributor.

In the U. S. contact Hall-Mark, Hamilton/Avnet, Pioneer Standard, Schweber, Wilshire or the Wyle Distribution Group (Liberty/Elmar). In Canada, call Hamilton/Avnet or Zentronics, Ltd.

\*U.S. Domestic Price Only



# Once again HP makes your money count.



## A universal counter for \$375.

The smart money's on HP's new 5314A Universal Counter because it does so much for so little. Now, in one low-cost counter, you can measure frequency up to 100 MHz, period down to 400 nanoseconds with 100 picosecond resolution, and time interval with 100 ns resolution. Add frequency ratio, ratio averaging, totalizing and a full complement of time interval measurement controls and you've got a package you'd expect to find at almost twice the 5314A's

\$375 price. Options: internal battery and charger, \$95; TCXO time base, \$100.

Time interval measurement capabilities are truly outstanding at the 5314A's price. Instead of limited single channel controls, or none at all, the 5314A gives you both input trigger level and slope controls for two input channels. So now you can measure pulse widths or time between pulses with stop and start commands from either one or two input control lines.

## HP's frequency counters also save you time *and* money.

Using state-of-the-art components common to HP's most sophisticated counters, the HP5380 frequency counter series offers high accuracy, high input sensitivity, input attenuators and direct counting for rapid, convenient frequency measurement and adjustments.

5381A 80 MHz, \$295 • 5382A 225MHz, \$395 • 5383A 520 MHz, \$650.



To find out more about HP's low-cost laboratory grade counters and the entire family of sophisticated and versatile HP counters call your nearest HP field office. Or write for the 5314A and 5380 series data sheets and electronic counter brochure to Hewlett Packard, 1507 Page Mill Road, Palo Alto, CA 94304.

Prices domestic U.S.A. only

02902A



HP: MAKING EXPERIENCE COUNT

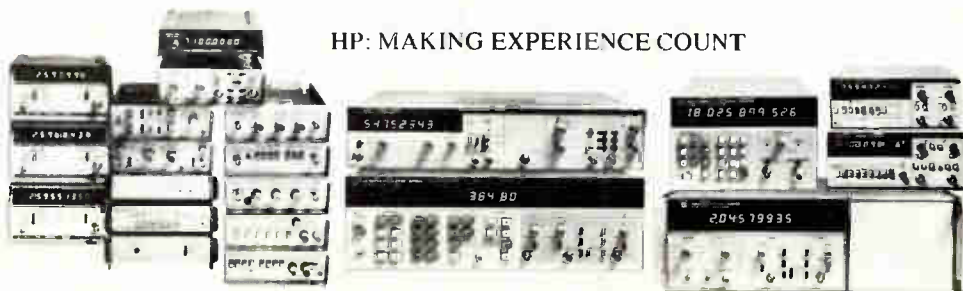

Circle 2 on reader service card

World Radio History

## 113 Technical Articles

### MEMORIES

**16-K EE-PROM uses tunneling for byte-erasable program storage, 113**

### SOLID STATE

**Bit-slice processors come to mainframe design, 118**

### DATA ACQUISITION

**Monolithic d-a converter operates on single supply, 125**

### PACKAGING & PRODUCTION

**Laser cold processing takes the heat off semiconductors, 137**

### VLSI DESIGN

**Development system lays basis for integrated VLSI design center, 143**

### CIRCUIT DESIGN

**LS<sup>2</sup> family squeezes more speed from existing TTL sockets, 149**

DESIGNER'S CASEBOOK: 132

ENGINEER'S NOTEBOOK: 156

## 39 Electronics Review

INSTRUMENTS: Scope can measure own waveforms, 39

PRODUCTION: E-beam unit goes below 1  $\mu\text{m}$ , 40

CONSUMER: Basic programs calculator, 40

COMPUTERS: Testing VLSI is Comcon topic, 41

INDUSTRIAL: 6800 microprocessor varies synchronous motor's speed, 42

AUTOMOTIVE: LCDs gear up for dashboard, 44

CONSUMER: Toys, games in electronics camp, 46

TELECOMMUNICATIONS: Data recorder for PBXs uses bubble memories, 46

Smarter products ease data transfer, 46

SATELLITES: Retrievable bird charts sun spots, 48

COMPONENTS: Motorola bows out of LCDs, 48

GOVERNMENT: Congress mulls competitive AT&T, 49

NEWS BRIEFS: 49

SATELLITES: Redundant time slots may conquer rain, 50

## 63 Electronics International

JAPAN: X-ray system prints six wafers at a time, 73

GREAT BRITAIN: Feedback a-d converter invades high-speed realm, 74

WEST GERMANY: Thin film enhances bolometer, 74

GREAT BRITAIN: Joint venture banks on SAW boom, 76

AROUND THE WORLD: 78

## 89 Inside the News

SEMICONDUCTORS: Intel takes aim at the '80s, 89

## 96 Probing the News

MEMORIES: Battle set for 32-K, 64-K E-PROMs, 96

LETTER FROM PALO ALTO: Silicon Valley is filling up, 98

ELECTRONICS ABROAD: Inflation clouds Spain, 102

## 171 New Products

ROUNDUP: Smart controllers take over, 171

IN THE SPOTLIGHT: V-MOS power FET sells for \$9.05 in 1,000-piece quantities, 186

COMMUNICATIONS: Chip assigns time slots, 195

SEMICONDUCTORS: Unit multiplies in 45 ns, 202

COMPONENTS: LED lamps get brighter, 208

COMPUTERS: Low-cost printer takes fast data, 214

INDUSTRIAL: Thin-film circuit senses moisture, 218

MICROCOMPUTERS & SYSTEMS: Winchester drive made for Intellects, 222

## Departments

Highlights, 4

Publisher's letter, 6

Readers' comments, 8

News update, 12

People, 14

Editorial, 24

Meetings, 26

Electronics newsletter, 33

Washington newsletter, 55

Washington commentary, 56

International newsletter, 63

Engineer's newsletter, 162

Products newsletter, 225

New literature, 226

## Services

Reprints available, 204

Employment opportunities, 228

Reader service card, 238

EDITOR-IN-CHIEF: Samuel Weber

MANAGING EDITORS

*Technical:* Raymond P. Capece,  
Alfred Rosenblatt  
*News:* Gerald M. Walker  
*International:* Arthur Erikson

ASSISTANT MANAGING EDITORS: Howard Wolff,  
Margaret Eastman

SENIOR EDITOR: Ray Connolly

ART DIRECTOR: Fred Sklenar

ASSOCIATE EDITORS: Benjamin A. Mason,  
Michael J. Riezenman

DEPARTMENT EDITORS

*Aerospace/Military:* Ray Connolly  
*Circuit Design:* Vincent Biancomano  
*Communications & Microwave:*  
Harvey J. Hindin  
*Components:* Roger Allan  
*Computers & Peripherals:* Anthony Durniak  
*Test, Measurement & Control:*  
Richard W. Comerford  
*New Products:* Michael J. Riezenman,  
Ana Bishop  
*Packaging & Production:* Jerry Lyman  
*Solid State:* John G. Posa

CHIEF COPY EDITOR: Margaret Eastman

COPY EDITORS: Mike Robinson,  
Charlotte Wiggers, Jeremy Young

ART: Charles D. Ciatto, *Associate Director*  
Paula Piazza, *Assistant Director*

EDITORIAL SECRETARIES: Maryann Tusa,  
Penny Reitman, Gail Walker

EDITORIAL ASSISTANT: Marilyn B. Steinberg

REGIONAL EDITORS

*New York:* Pamela Hamilton (212) 997-2306  
*Boston:* James B. Brinton,  
Linda Lowe (617) 262-1160  
*Chicago:* Larry Marion (312) 751-3805  
*Dallas:* Wesley R. Iversen (214) 742-1747  
*Los Angeles:* Larry Waller (213) 487-1160  
*Palo Alto:* Bruce Le Boss, *Manager*  
Martin Marshall, *Computers & Instruments*  
(415) 968-2712  
*Washington:* Ray Connolly (202) 624-7592  
*Frankfurt:* John Gosch 72-5566  
*London:* Kevin Smith 493-1451  
*Paris:* Arthur Erikson,  
Kenneth Dreyfack 720-20-70  
*Tokyo:* Charles Cohen 581-9816

McGRAW-HILL WORLD NEWS

*Editor:* Michael Johnson  
*Brussels:* James Smith  
*Milan:* Jeff Ryser  
*Moscow:* Peter Hann  
*Stockholm:* Robert Skole  
*Tokyo:* Robert Neff

PUBLISHER: Paul W. Reiss

GENERAL MANAGER, DIRECT MARKETING  
OPERATIONS: Horace T. Howland

CIRCULATION MANAGER: Herbert A. Hunter

RESEARCH MANAGER: Margery D. Sholes

MARKETING ADMINISTRATION MANAGER:  
Frances M. Vallone

BOOKS & SPECIAL PROJECTS MANAGER:  
Janet Eyster

## Cover: Process marks a new maturity for an EE-PROM, 113

Electrically erasable programmable read-only memory is vital to the approaching hordes of microprocessor-based systems: it makes program memory easy to modify when system requirements change and provides storage immune to power outages. Conquering a process for fabricating silicon oxide layers less than 200 angstroms thick (through which electrons tunnel in both directions) has allowed Intel Corp. to produce a 16-K byte-alterable EE-PROM pin compatible with the ultraviolet-erasable 2716.

Cover is by Art Director Fred Sklenar.

## Software crisis, or micromini, micromaxi, micromainframe, 89

Elsewhere on the microprocessing front, Intel is pushing the integration on silicon of operating systems and even translators for high-level languages. The company foresees software costs spiraling to dizzying heights in the next decade, and intends to attack the shortage of programmers through hardware that frees them from much assembly-language programming.

## Laser machine enters wafer-processing field, 137

A laser beam can perform many of the functions now taken care of by wafer furnaces, and with a selective precision previously impossible. A production laser machine has arrived on the scene that can heat the silicon at tightly defined locations while the rest of the chip stays cool, improving a number of device parameters. It also appears to be cost-competitive with furnaces.

## On the road to a fully integrated VLSI design center, 143

Development systems are trudging up a steep path towards the goal of coping with very large-scale integration, and here's another milestone: a development system that allows a team of designers to work together closely with a large and expandable shared file. The system's segmented bus makes it flexibly reconfigurable so it can meet changing design demands.

## When does a controller become a minicomputer? 171

At the high end of the programmable controller spectrum, the machines' sophistication makes them hard to distinguish from their data-processing brethren. A roundup of productivity-boosting products in this very healthy market tells of fiber optics, network configurations, and modular designs.

## . . . and in the next issue

A special report on displays . . . how Japan mass-produces highly reliable ICs . . . a chip that monitors, controls, and checks up on data all by itself in any data-communications system using a character-based protocol . . . a benchtop oscilloscope with a minicomputer's IQ.

February 28, 1980 Volume 53, Number 5 102,479 copies of this issue printed

Electronics (ISSN 0013-5070). Published every other Thursday by McGraw-Hill, Inc. Founder James H. McGraw 1860-1948. Publication office 1221 Avenue of the Americas, N.Y., N.Y. 10020; second class postage paid at New York, N.Y. and additional mailing offices.

Executive, editorial, circulation and advertising addresses: Electronics, McGraw-Hill Building, 1221 Avenue of the Americas, New York, N.Y. 10020. Telephone (212) 597-1221. Teletype 12-7960 TWX 710-581-4879. Cable address: MCGRAW HILL NEW YORK

Subscriptions limited to professional persons with active responsibility in electronics technology. No subscriptions accepted without complete identification of subscriber name, title or job function, company or organization, and product manufactured or services performed. Based on information supplied, the publisher reserves the right to reject non-qualified requests. Subscription rates: in the United States and possessions \$17 one year, \$29 two years, \$43 three years; company addressed and company libraries \$23 one year, \$41 two years, \$58 three years; APO/FPO addressed \$35 one year only; Canada and Mexico \$19 one year, \$32 two years, \$47 three years; Europe \$46 one year, \$78 two years, \$110 three years; Japan, Israel and Brazil \$70 one year, \$115 two years, \$165 three years; Australia and New Zealand \$95 one year, \$170 two years, \$240 three years, including air freight; all other countries \$50 one year, \$85 two years, \$125 three years. Limited quota of subscriptions available at higher-than-basic rate for persons allied to field served. Check with publisher for these rates. Single copies: \$4.00. Please allow four to eight weeks for shipment.

Officers of McGraw-Hill Publications Company: Paul F. McPherson, President; Executive Vice Presidents: James E. Boddorf, Gene W. Simpson; Group Vice President: Daniel A. McMillan; Senior Vice President: Editorial, Ralph R. Schurz; Vice Presidents: Kemp Anderson, Business Systems Development, Stephen C. Croft, Manufacturing; Robert B. Doll,

Circulation: James E. Hackett, Controller, William H. Hammond, Communications; Eric B. Herr, Planning and Ad Development, John W. Patten, Sales; Edward E. Schirmer, International

Officers of the Corporation: Harold W. McGraw, Jr., President, Chief Executive Officer, and Chairman of the Board; Robert N. Landes, Senior Vice President and Secretary; Ralph J. Webb, Treasurer

Title registered in U.S. Patent Office. Copyright © 1980 by McGraw-Hill, Inc. All rights reserved. The contents of this publication may not be reproduced in whole or in part without the consent of copyright owner.

Where necessary, permission is granted by the copyright owner for libraries and others registered with the Copyright Clearance Center (CCC), P.O. Box 8891, Boston, MA 02114, to photocopy any article herein for the base fee of \$0.50 per copy of the article plus \$0.25 per page. Payment should be sent directly to the CCC. Copying done for other than personal or internal reference use without the express permission of McGraw-Hill is prohibited. Requests for special permission or bulk orders should be addressed to the publisher. ISSN 0013-5070/80\$0.50+.25.

Subscribers: The publisher, upon written request to our New York office from any subscriber, agrees to refund that part of the subscription price applying to copies not yet mailed. Please send change-of-address notices or complaints to Fulfillment Manager; subscription orders to Circulation Manager, Electronics, at address below. Change-of-address notices should provide old as well as new address, including zip codes. Attach address label from recent issue. Allow one month for change to become effective. Subscriber Service: call (609) 448-8110, 9 a.m. to 4 p.m. EST.

Postmaster: Please send form 3579 to Fulfillment Manager, Electronics, P.O. Box 430, Hightstown, N.J. 08520.

# NEW DISTORTION ANALYZER SAVES TIME AND MONEY

In just a few seconds Krohn-Hite's Model 6800 Automatic Distortion Analyzer can make most distortion measurements. Simplicity of operation — plus the instrument's unique auto-ranging digital readout and its built-in accuracy — saves valuable production and personnel time.

Check what the Model 6800 offers, and compare with what you're using now.

- Frequency range 1Hz to 110kHz
- Automatic level set from 1 to 130V RMS
- Measures ultra-low distortion to 0.003%, typically, with a resolution of 0.001%
- Range selectors provide auto-nulling of frequency over a 10:1 range
- Auto-ranging digital readout
- Measures AC volts from 100mV to 130V RMS
- Priced at only \$1500 (domestic price). Model 6801, with automatic level set from 100mV to 13V, is also available. (Domestic price \$1600.)

Make value your standard of measure when you specify distortion instruments. Call Krohn-Hite today for further information and look up our complete product listings in EEM and Gold Book.

**KH KROHN-HITE CORPORATION**  
Avon Industrial Park, Avon, MA 02322 • (617) 580 1660 TWX 710 345 0831



© Krohn-Hite Corp. 1979

**Krohn-Hite . . . Benchmark of Value in Distortion Analyzers**

SALES OFFICES: AL., Huntsville (205)534-9771; AZ., Phoenix (602)279-1531; CA., Inglewood (213)674-6850, San Jose (408)292-3220; CO., Denver (303)773-1218; CT., Canton Center (203)693-0719; FL., Orlando (305)859-7450, Sunrise (305)742-2115; GA., Atlanta (404)455-1206; HI., Honolulu (808)941-1574; IL., Chicago (312)283-0713; IN., Carmel (317)844-0114; KS., Overland Park (913)649-6996; LA., Gretna (504)367-3975; MD., Towson (301)321-1411; MA., Wakefield (617)245-5940; MI., Detroit (313)961-3042; MN., Minneapolis (612) 835-4818; MO., St. Louis (314)569-1406; N.M., Albuquerque (505)255-2330; N.J., Cherry Hill (609)482-0059, Englewood (201)871-3916; N.Y., Rochester (716)473-5720, Syracuse (315)437-6666, Vestal (607)785-9947; N.C., Burlington (919)227-3639; OH., Chesterland (216)729-2222, Dayton (513)294-2476; OK., Jenks (918)299-2636; OR., Portland (503)297-2248; S.C., Greenville (803)271-8543; TX., Dallas (214)661-0400, Houston (713)688-1431; UT., Salt Lake City (801)466-8729; VA., Falls Church (703)573-8787; WA., Bellevue (206)454-3400; WI., Milwaukee (414)545-8400; CANADA, Montreal, Quebec (514)747-9747, Ottawa, Ontario (613)725-1931, Toronto, Ontario (416)625-0600, Calgary, Alberta (403)276-7567.

World Radio History

Circle 5 on reader service card

*The big european yearly electronic components show.*

**1383 exhibitors\***  
**from 31 countries**

**90962 visitors\***  
**from 93 countries**

\* 1979 salon official figures OJS controle office

salon international des  
**composants  
électroniques 80**

**PARIS**  
march 27 - april 2

further information  
and invitation card  
on request: S.D.S.A.

20, rue Hamelin, F 75116 Paris

In U.S.A.:

International trade shows in France  
1350 Avenue of the Americas

New York, N.Y. 10019

☎ (212) 582.4960

☎ Frshows 427 563



## Publisher's letter

**M**akers of industrial programmable controllers are accustomed to being on the front line in factories, where the enemies are heat, dirt, and electromagnetic interference. As it turns out, they are also on the front line of electronic technology.

"The interest in bubble memories and fiber optics is precisely because of what these technologies have to offer in providing reliability and ease of use," comments Linda Lowe of our Boston bureau. Linda gained considerable understanding of the problems posed by designing for industrial applications when she prepared the Product Roundup on programmable controllers (p. 171).

Aside from the environmental considerations, producers of programmable controllers have to be aware of the lack of knowledge of electronics on the part of the users. "When you tell a plant manager about the new complexity contained in microprocessor-based equipment, to him it only means a greater chance for breakdowns," Linda explains. "They are more impressed by equipment that is described as a good, hearty workhorse."

One example of the cautious acceptance of complex electronics in controllers is the half-joking remark from one manufacturer that his customers are uneasy because the machines make no noise. He thought of adding a device in the cabinet that would click once in a while just to reassure the user.

Nevertheless, there are signs of change in the industrial field. "Computer engineers are gaining a bigger role in the design and planning of plants and the use of information resulting from the data-collection capabilities that are now possible,"

Linda points out.

To meet these two needs, the controller industry is designing equipment that retains outward simplicity and familiarity to satisfy the plant operator but that increases the complexity of the inner workings to satisfy the plant designer.

**O**ur second letter observing trends in the major electronics areas is from Palo Alto (p. 98). Martin Marshall, who is a native Californian and an earthquake buff, as well as our West Coast computers and instrumentation editor, views the filling up of Silicon Valley with mixed feelings.

He points out in the letter that the growth of the semiconductor industry did not cause the traffic congestion, air pollution, and housing shortage in the Valley. But the people who have been attracted to the area to operate the facilities have contributed to the problem. "For communities to halt further industrial development must go against their grain," Martin observes. "I guess we have entered the 'age of limits' and these are some of the consequences."

So many people came to the Bay area for the good life it offered that everybody is now paying the price, he writes. Despite a trend toward setting up satellite facilities outside the Valley, company headquarters will remain in the area.

### Why not an editorial career?

*Electronics* has available challenging editorial positions for electronics engineers with a bent for journalism. Our editors keep abreast of and write or edit articles on the latest trends in electronic technology. Right now, we're looking for editors to cover microcomputer systems and software, as well as the consumer and industrial fields. A bachelor's degree and design experience are desirable. Salary and benefits are excellent. Write a letter telling us about yourself to the Managing Editor (Technical) at *Electronics*, 1221 Avenue of the Americas, New York, N. Y. 10020.



Where maximum reliability is a minimum requirement

## TELEREL quality diodes – quality which has taken the lead

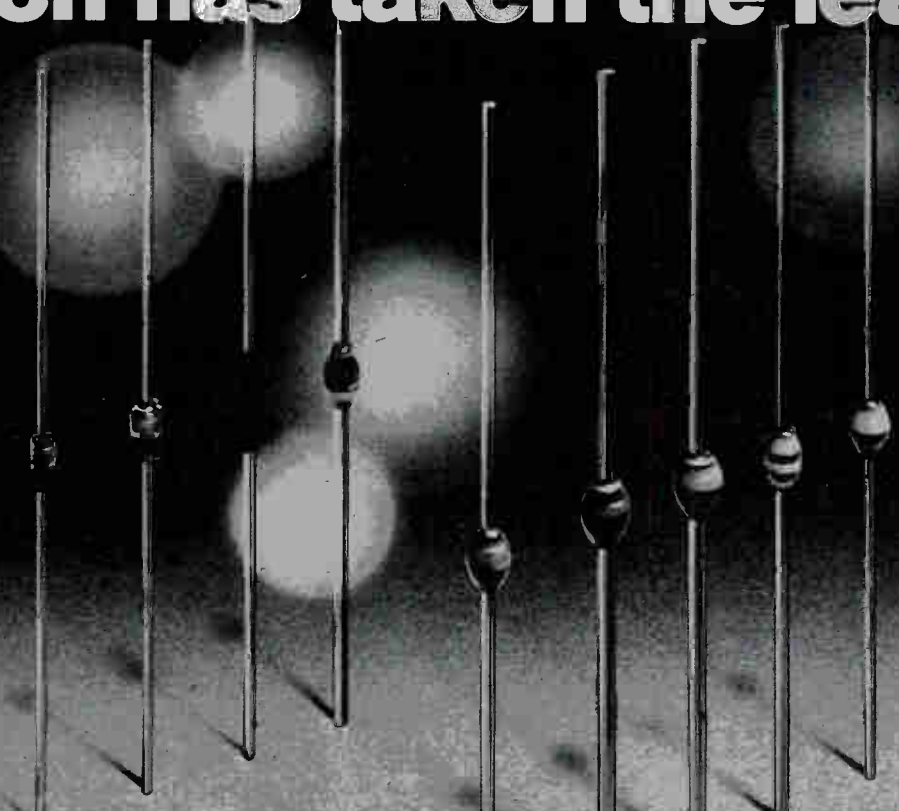

With our Z-diodes and with diodes in sinter glass cases, you get the quality you need for industrial applications. From our stock and for all voltages.

### Z-Diodes

Type	Reverse Voltage	Tolerance	Dissipation
BZX 55/...	2,4 V-75 V	1%, 2%, 5%	500 mW
BZX 85/...	2,7 V-75 V	2%, 5%	1,3 W
BZY 87/... <sup>1)</sup> 3)	0,7 V-3,4 V		250 mW

Naturally, all types are TELEREL tested. One at a time.

Whether you need **LOCEP Z-diodes** with special quality features such as, for example, very sharp reverse characteristic, very high stability, low noise and much more ... or **diodes in sintered glass cases** for the highest requirements.

### Mesa-Diodes in Sinter Glass Cases

Type	Reverse Voltage	Forward Current	Note
BYV 12-BYV 16	200 V-1000 V	1,5 A	
BYW 32-BYW 36	200 V- 600 V	2 A	
BYW 52-BYW 56 <sup>1)</sup> 2)	200 V-1000 V	2 A	≙ 1N 5059-1N 5062
BYW 72-BYW 76	200 V- 600 V	3 A	
BYW 82-BYW 86 <sup>1)</sup> 2)	200 V-1000 V	3 A	≙ 1N 5624-1N 5627
BYX 82-BYX 86 <sup>1)</sup>	200 V-1000 V	1,5 A	

<sup>1)</sup> Qualified Semiconductor Devices, <sup>2)</sup> Controlled Avalanche Characteristics, <sup>3)</sup> Stabilized Diodes

With controlled avalanche characteristics, hermetic glass passivation,

high surge current loading, reverse voltage from 200...1000 V...

Please ask for information material. A telephone call is sufficient.

Information is available from:

AEG-TELEFUNKEN  
Serienprodukte  
Semiconductor Division  
P.O.B. 1109  
D-7100 Heilbronn  
Tel. (0 71 31) 88 21  
or from your nearest agent  
for AEG-TELEFUNKEN  
components.



Semiconductor components  
from AEG-TELEFUNKEN  
Circle 7 on reader service card

# MPU Controlled Circuit Tester



#### Control Console:

1. Key Pad
2. Diskette Drive
3. Address Displays
4. Alphanumeric Printer

#### Switching Console:

5. 128-Termination Switching Modules
6. 4096-Termination Capacity Plugged for 2048T

#### CRT Operator Console:

7. Data Base Edit

### Price Performance Factors Of Model 1042 Bring Test/QA Cost Savings To Areas Where Costs-To-Test Previously Were Marginal Or Prohibitive.

Model 1042 is a fully automatic, micro-processor controlled, high speed, solid state, self-programmable circuit tester featuring...

- Test program printout in both analyzer and UUT language.
- Pluggable solid state switching expandable to over 16,000 T capacity.
- Diskette test program storage.
- Data base edit capability.
- Product error printout.
- Test program listing on printer.
- Self program and playback.
- Asynchronous communications link with host computer and port for download batch transfer of test program.

The Model 1042 price-performance factors result in a highly cost effective test system. Coupled with a DIT-MCO "PREMIER LINE" access fixture it provides a test package offering the speed, versatility, flexibility, and overall test

performance to sharply reduce throughput time and re-work costs.

Call or write now to see how your testing problems can be solved, economically, fast, and with a quick pay-back on equipment investment.



**DIT-MCO INTERNATIONAL  
CORPORATION**

**The Difference in Testing!**

5612 Brighton Terrace • Kansas City, Missouri 64130 • Telephone: (816) 444-9700  
Telex Number 42-6149

European Technical Representative, RADIX HOUSE, Central Trading Estate, Staines Middlesex, TW18-4-XA, England, Telephone: (0784) 51444

TEL Shinjuku Nomyra Bldg., 26-2, 1-Chome, Nishishinjuku, Shinjuku-ku, Tokyo 160, Japan, Tel: (03) 343-4411

## Readers' comments

### Non-contact scanner

To the Editor: With regard to "Scanner measures conductivity to find breast tumors" [Jan. 3, 1980, p. 68], I would like to call your attention to yet another means to locate abnormal cells at greater distances from the surface. Both systems detect the change in conductivity of the cancerous cells. In this system, currently under development by Col-Nic Industries, the conductivity of the tumor is detected by a change in the reluctance of a focused magnetic field, which can be up to 18 in. away from the transducer and can have a resolution as small as 0.1 in. in diameter. The heart of the system is the magnetic focus technique I invented several years ago for an unrelated task. This magnetic energy can also be used to promote more and rapid bone growth in internal areas of the body not available to the transducer arrangement described in the article. The field is created by a series of coils, each excited by a computer-timed pulse train of 1,500-Hz signals. The change in the nulling coil located in the same series indicates a change in the reluctance at the point of focus, causing a shift of frequency and upsetting the balance in a precision ac bridge whose legs are formed by the coil. The error signal so produced indicates the conductivity of the focused area. The magnetic field, when used as a conductivity measurement, is quite weak (0.061T\*), no stronger than that next to a small dc-powered fan.

Still other uses require increased magnetic energy (from 0.804T\* to 1.8T\*) focused at a small point with a more intense field. Research currently under way indicates that careful control of this field can stimulate tissue regeneration by creating a synthetic "current of injury" at discrete body locations by varying the duty cycle of the 1,500-Hz signals applied to the coil series.

This instrument can have a wide range of applications from the simple check for appendicitis to the stimulation of tooth development.

George S. Lehsten  
Englewood, Colo.

# Low Cost Mini-Disk Data Storage for EXORciser Bus Computers

- Compatible with EXORciser\* and other 6800/6809 computers based on EXORciser\* bus concept.
- 40- or 77-track drives in one-, two- and three-drive configurations add 102K bytes to 591K bytes of random access data on-line.
- 40-track LFD-400EX™ drives store data on both surfaces of mini-diskettes — almost 205K bytes per disk.
- EXORciser\* bus compatible controller includes 1K of RAM, provision for 3K of PROM. Mature design features explicit clock-data separator, drive motor inactivity time-out function, and more.
- Support software includes disk operating systems, a file manager, text editor, assembly language program development/debugging aids, an extended BASIC interpreter, an SPL/M compiler and business programs. Numerous programs available from other suppliers may be used with LFD-400/800EX mini-disk systems with little or no modification. Watch for FORTRAN & Pascal announcements.

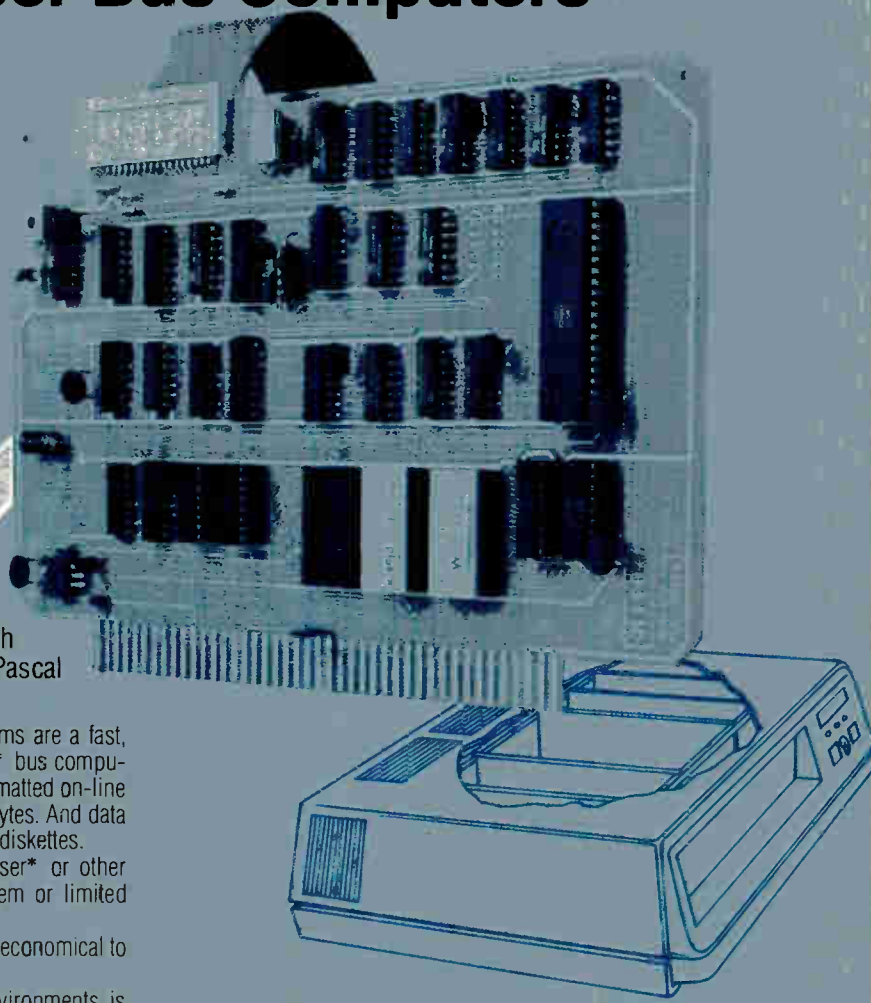

Low cost Percom LFD-400/800EX mini-disk data storage systems are a fast, dependable alternative to tape storage for 6800/6809 EXORciser\* bus computers. A single 40-track LFD-400EX™ drive adds 102K bytes of formatted on-line storage; a single 77-track LFD-800EX™ drive adds almost 200K bytes. And data may be stored and read from either surface of LFD-400EX™ minidiskettes.

Fast mini-disk data storage makes your Motorola EXORciser\* or other EXORciser\* bus computer more than just a development system or limited evaluation system.

For example, at the low LFD-400/800EX prices it becomes economical to use your development system as the final working system.

Data capture/retrieval in research, test and production environments is another application where versatile, random-access LFD-400/800EX storage can provide efficient operation.

Equipment control is yet another area where the speed and facility of mini-disk storage greatly expands application possibilities. Even if you use a mini-disk only to load and control programs you'll save simply by taking a lot less time than with slow, inconvenient tape storage. Moreover, by storing programs on fast-loading, low cost minidiskettes you eliminate the overhead of burning PROMs — an expense that quickly adds up to far more than the price of an inexpensive Percom mini-disk system.



The bottom line? An EXORciser\* or Micromodule\*, with percom LFD-400/800EX mini-disk data storage, is a remarkably adaptable microcomputer — a system that meets the quality and dependability demands of industry yet is competitively priced with personal computing systems.

## PRICES

Model	1-drive system	2-drive system	3-drive system
LFD-400EX™	\$649.95	\$1049.95	\$1449.95
LFD-800EX™	\$945.95	\$1599.95	\$2245.95

MPX Disk Operating System (2-chip ROM set)

Standard versions for most popular monitors . . . \$69.95

LFD-400/800EX Users Instruction Manual:

Includes driver utility listings, controller schematic \$15.00

The system prices are single-quantity prices. A system includes (1) the drives, power supplies and enclosure, (2) the EXORciser\* bus compatible controller PC card with 1K RAM and provision for three 2708 EPROMs, (3) an interconnecting cable, (4) an 80-page users instruction manual, and (5) a system minidiskette. The Percom Software Services Group will customize the MPX DOS for a nominal charge if one of the standard versions is not suitable for your monitor. LFD-400EX™ systems use 40-track drives; store 102K bytes of formatted data per minidiskette side. LFD-800EX™ systems use 77-track drives; store almost 200K bytes on one side of min. diskette.

Orders may be placed by dialing 1-800-527-1592 (outside of Texas) or (214) 272-3421 (in Texas). For additional technical information dial (214) 272-3421.

PERCOM DATA COMPANY, INC.  
2-1 N. KIRBY GARLAND, TEXAS 75042  
(214) 272-3421



Circle 9 on reader service card

Choosing a 16-bit MPU is no easy job. We know. We went through it ourselves back in '78.

We chose the Z8000 because we believed you'd choose the Z8000. Because it's better. Here's why:

## "The AmZ8000 has a better architecture."

It has 16 registers. All general. All for you. Use them for data or addresses. Use them to write more efficient software with less code and faster execution.

The AmZ8000 has gobs of address space: 8M bytes of direct addressing in each of four possible address spaces. It has memory management with sophisticated relocation and protection features. It has a rich instruction set that operates on data types from quad length words right down to single bits. You can even map the I/O into memory or keep it separate.

Sven Simonsen, Vice President and Technical Director, Advanced Micro Devices

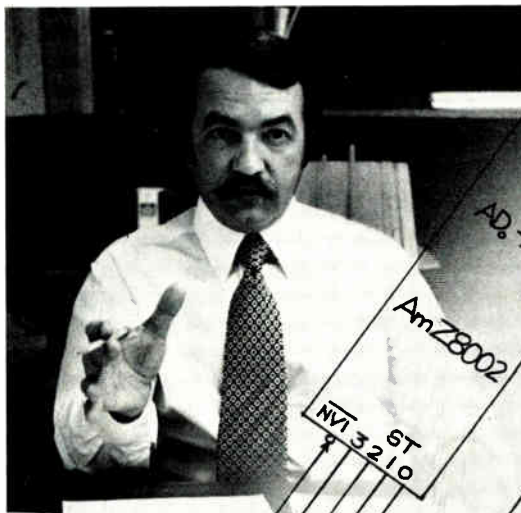

As if all that weren't enough, the AmZ8000 has a whole series of string-oriented instructions to move, translate or compare up to 64K bytes of data in a single instruction.

## "The AmZ8000 has a better future."

The AmZ8000's architecture and instructions fit perfectly with today's computation, communications and instrumentation markets. So do the peripherals. And all the popular existing parts for the 8080A/8085A, including the Am9511A and Am9512 floating-point processors and the Am9517A

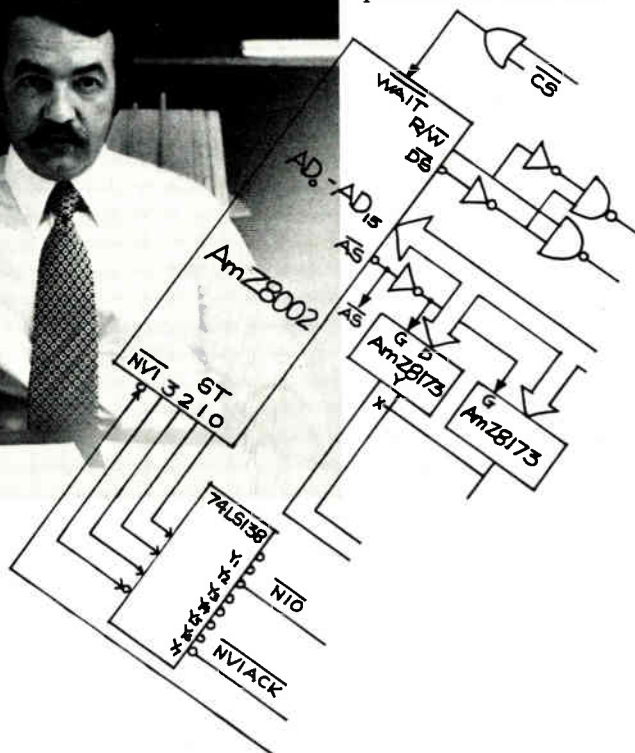

# "The AmZ8000 is better for your application."

DMA circuit, work great with the AmZ8000.

There's a CPU that's just right for you. For imbedded controllers, where 64K of memory is enough, there's a compact 40-pin CPU that uses less memory for programs. For addressing large memory spaces, there's a 48-pin CPU that's software compatible.

But best of all, we're getting ready to introduce a bunch of new bipolar and MOS peripherals. There's an I/O device with a built-in FIFO, a chained DMA controller, error correction circuits and an editing CRT controller, just to name a few.

As technology develops, newer and better software-compatible CPUs with higher throughput will be coming your way.

## **"The AmZ8000 has better support."**

We know you need supporting documentation. And we've got it. Ask us for our Data Book, our Processor Interface Manual and our Processor Instruction Manual.

We know you need software development tools. And we've got them, too. There's our macro assembler with powerful high-level constructs and a relocatable linking loader,

and a PASCAL compiler. Cross-software is available, too.

If you need a hardware development system, our AmSYS8/8 with in-circuit emulator was designed just for the AmZ8000. So was our Am96/4016 Evaluation Board. (To learn all about them, come to one of our field seminars or take one of the courses offered by our Education Department.)

And soon, you'll need parts. With the AmZ8000 you've got two major U.S. manufacturers with a mask-exchange agreement. We have international partners, also. When you need parts, we'll be there.

## **"The AmZ8000 is better because we're better."**

Advanced Micro Devices didn't become the nation's fastest growing IC company by accident. We did it by design. We only manufacture high-quality, high-volume parts. And from the day we opened for business, we've thrown in a freebie with every order: MIL-STD-883.

If you want your application to be better, get the MPU that's better. Get the AmZ8000. It's the best 16-bit family for you.

# **Advanced Micro Devices**

901 Thompson Place · Sunnyvale, CA 94086 · Telephone (408) 732-2400

Visit AMD at the Paris Salon International des Composants Electroniques,  
March 27 thru April 2, Hall 1, Aisle 8, Stand 41.

Circle 11 on reader service card



## FREEDOM OF CHOICE FROM TECNETICS

Until now, the field has been pretty limited in low power, high reliability 400Hz to DC single phase power supplies. Tecnetics changed all that with the introduction of its new 400 Series.

There are over 130 different power supplies in all: 3, 6, 10, 15 and 20 watt units with single, dual and triple outputs. Output range is from 5 to 28 volts. Military type components are standard and High-Rel components are available. All fully documented and ready to go.

And, look at some of the specs: MTBF on single output units ranging from 70,000 hrs. standard to a mighty 180,000 hrs. on the High-Rel models, high efficiency, overload protection, excellent

regulation, full encapsulation, and thermal design with baseplate cooling.

So, when you're designing complex military hardware, airborne instrumentation, or anyplace you have 400Hz to DC power conversion requirements, look to Tecnetics wide selection of power supplies. Send for our catalog now.

### 400 Series Prices (1-9)

	Single	Dual	Triple
3W	\$225	\$275	\$325
6W	235	285	340
10W	255	305	365
15W	270	315	375
20W	280	325	410

Contact factory for prices on hi-rel units

**tecnetics**  
INCORPORATED

The Power Conversion  
Specialists

P. O. Box 910 1625 Range Street,  
Boulder, Colorado 80306  
(303) 442-3837 TWX 910-940-3246

Circle 12 on reader service card

"The purpose of computing  
is insight not numbers"

—Hamming

Dr. DOBB'S JOURNAL (Software and systems for small computers)

P.O. Box E, Dept. G8, Menlo Park, CA 94025

\$15 for 10 issues • Remember to include your name, address and zip with your check.

12 Circle 144 on reader service card

## News update

■ By using a dual-element device that takes advantage of the relationship between the resistivity of a silicon device and its temperature, engineers at Texas Instruments Inc. have demonstrated a technique believed to be the first to employ solid-state sensors to monitor fluid flow. Prototype units have been delivered to auto makers, says sensor development manager Wayne Tarpley.

Potential applications include replacement of the paddle-wheel type of devices that supply the fuel flow inputs to microprocessor-controlled functions like trip computing and engine control. A TI paper presented at this week's conference of the Society of Automotive Engineers in Detroit describes the new sensor.

With its three-year-old family of TSP102 silicon temperature sensors now in volume production, TI is elevating its silicon sensor development group in Dallas to full branch status. In particular, it is eyeing the automotive market, where the firm hopes to capture large-volume contracts to supply lower-cost, more reliable solid-state replacements for the electromechanical sensing devices found in today's cars.

Fuel-flow sensing is only one of various automotive applications the company is pursuing with Detroit. The sensor branch has supplied more than 100,000 production units of an oil-level sensing device to Chrysler Corp. That system was said to be the first to use solid-state oil sensors [*Electronics*, July 5, 1979, p. 53].

Production is now under way on a solid-state temperature-sensing device designed for use in automotive exhaust-gas recirculation systems [*Electronics*, Nov. 9, 1978, p. 48]. Other applications also show promise, notes Hoyt Cowling, operations manager for the sensor branch.

Volume use of the TSP102 family in applications like medical instruments, thermostats, and appliances has enabled TI to make its first learning-curve price cuts on the parts, effective March 1. Price on one TSP device type will drop from 34¢ to 25¢ in 100,000-unit quantities, while another version will go from 25¢ to 18¢. —Wesley R. Iversen

Electronics / February 28, 1980

# There's a little tiger in every Cherry switch

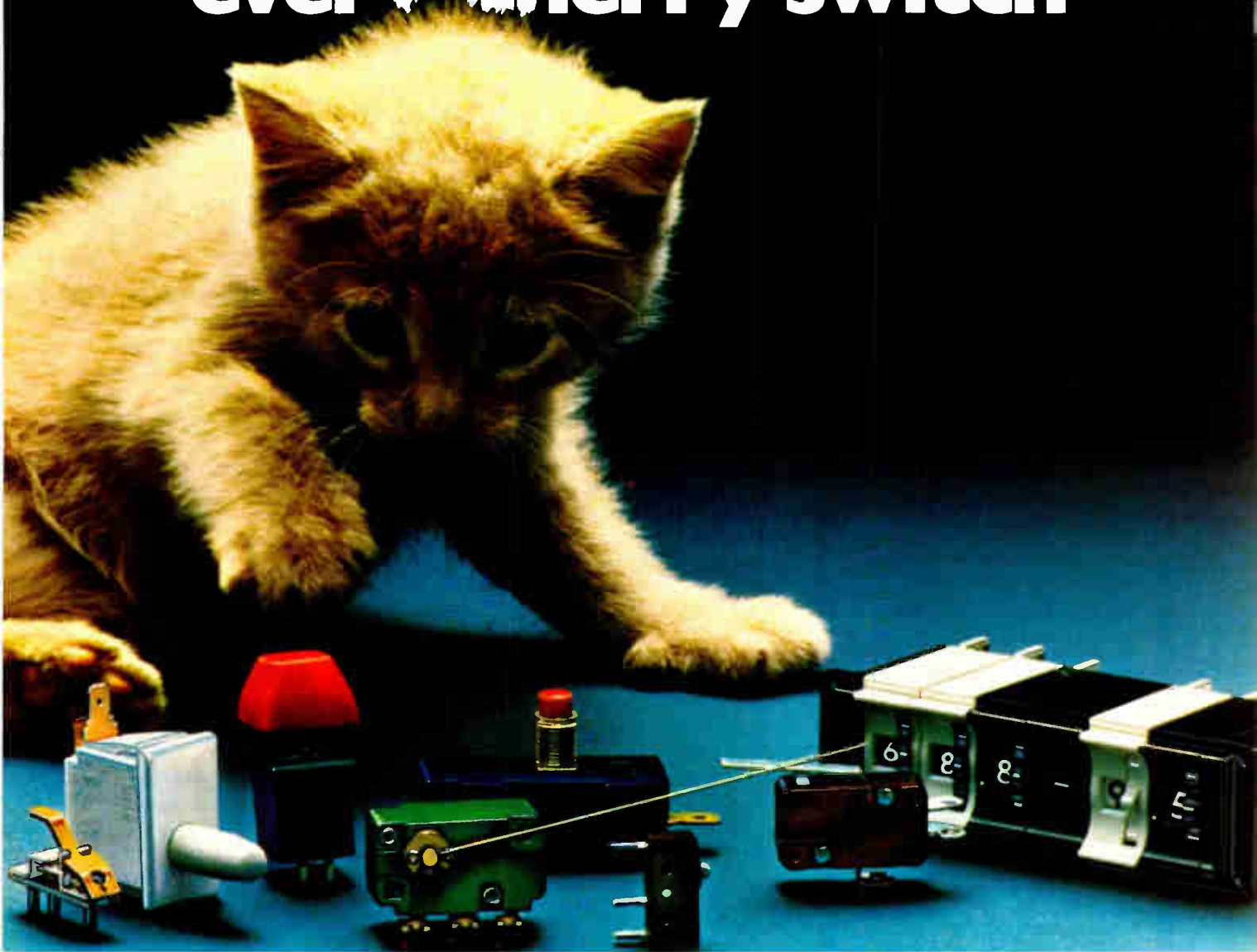

## ...but we're pussycats to do business with

Our products are tough, but our people aren't... and that's the beauty of dealing with Cherry.

You see, we can control the quality of our switches because we fabricate most of our own parts (moldings, stampings, springs, printed circuits, etc.) And we can keep the price down because we're loaded with automatic equipment to handle high volume.

But the real difference is in the *people* you work with at Cherry...from your first contact with a technically trained sales representative...through careful analysis and recommendations by engineers

who are really concerned about *your* problem... to production scheduling and customer service men who follow-up and expedite to make sure we keep our delivery promise to you.

Of course we're proud of our modern facilities and equipment...but what we're proudest of is our reputation for customer service. Try some.



Test a free sample "tiger" from the pussycats at Cherry.

Ask for our latest catalog which contains complete information on all our switches and keyboards, and we'll include a free sample switch. Just TWX 910-235-1572...or PHONE 312-689-7700... or circle the reader service number below.



CHERRY ELECTRICAL PRODUCTS CORP. • 3608 Sunset Avenue, Waukegan, Illinois 60085

SWITCHES and KEYBOARDS — Available locally from authorized distributors.

World Radio History

Circle 13 on reader service card

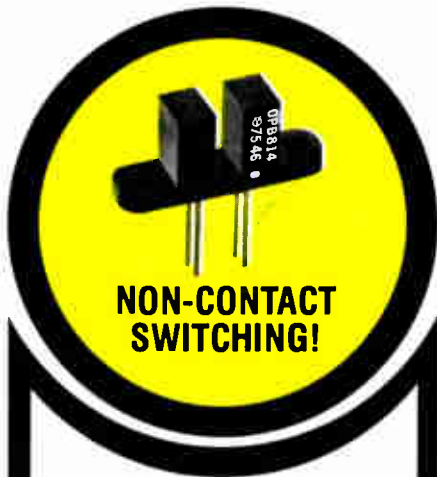

## OPTICALLY COUPLED INTERRUPTER MODULES

TRW Optron OFFERS IMMEDIATE DELIVERY OF NEW, LOW COST SERIES

TRW Optron's new, low cost optically coupled interrupter module series combines non-contact switching and solid state reliability for applications requiring sensing of position or motion of an opaque object such as motion limit, paper edge or shaft encoding.

The new OPB 813, OPB 814 and OPB 815 consist of a gallium arsenide infrared LED coupled with a silicon phototransistor in an economical molded plastic housing. With a LED input of 20 mA, the OPB 813 and OPB 815 have typical unblocked current outputs of 2.0 mA and 3.0 mA, respectively. Typical output of the OPB 814 is 3.0 mA with a 10 mA input. The entire series is available from stock.

Background illumination noise is reduced by a built-in infrared transmitting filter and dust cover in each device type. The OPB 813 also is available with a 0.010 inch aperture for high resolution applications.

New TRW Optron optically coupled interrupter modules are interchangeable with similar products as follows:

TRW Optron	GE
OPB 813	H13A1
OPB 813	H13A2
OPB 814	H13B1
OPB 814	H13B2

Detailed technical information on these and other TRW Optron standard interrupter and reflective modules, as well as versions for specific applications is available on request.

**TRW OPTRON**  
A DIVISION OF TRW INC.

1201 Tappan Circle  
Carrollton, Texas 75006, U.S.A.  
TWX-910-860-5958  
214/242-6571



## People

### McCoy aims CBS research toward a digital future

Donald S. McCoy, vice president and general manager of the CBS Technology Center, Stamford, Conn., should have little trouble getting to work on developing a video disk under an agreement recently announced with RCA Corp. Until September 1979, 49-year-old McCoy lead RCA's design efforts on the video disk system and had done so since the program's inception in the late 1960s.

McCoy, who was with RCA for 22 years, had previously worked on such projects as magnetic video tape recording, colorimetry of color television systems, psychoacoustical testing, seismic detection systems, and stereo disk recording and broadcasting systems. In 1957, he earned a Ph.D. in electrical engineering from Yale University; he also received his undergraduate degree from Yale. With his experience, he feels much in tune with the work he will be overseeing at the research center. "The breadth of work being undertaken here is an excellent match with my own background," he notes.

**Audio, too.** Actually the video disk program is closely connected with ongoing work at the center. "We have several active programs with Columbia Records to improve the quality of audio recordings. One of them is in PCM encoding of audio records, which is itself interrelated with video disk technology," he explains.

McCoy believes that one of the overwhelming trends facing the broadcast industry today is the conversion to digital format of the various broadcasting functions. These include program origination, editing, and transmission. Present work at the center accords with this view and covers direct satellite-to-home broadcasting techniques, most notably in program generation; the use of fiber-optic cable as a transmission medium from remote locations; and teletext formats. McCoy plans to initiate a substantial



**Disk man.** Donald S. McCoy is starting video disk development at CBS Tech Center.

amount of research into software development, too, particularly in identifying existing material that is suitable for data bases. "We're looking at which data bases within CBS make sense as a service to be sold to the public," he says. "It's work closely aligned with video data and teletext development."

### Product value key to Kennedy's market thrust

The big problem for J. Richard Kennedy in his new position as vice-president of marketing and field service at the Stromberg-Carlson subsidiary of General Dynamics Corp. in Tampa, Fla., is changing his company's position in the public and private switched network business from a sales-oriented to a market-driven organization. And the 45-year-old engineer thinks this challenge will take all the skills he has developed in his 21 years in the communications business—the last 14 of which were spent at TRW's Vidar division.

Though he agrees that Stromberg's problem in getting the right emphasis for the digital 1980s is not unique, he says that "it varies with the company, and Vidar probably did a better job of it—but only because it was a new entry." Stromberg, he remarks, is 85 years old and "has an unbroken record of always being there when the orders are placed for the previous technology."

For companies in the digital



# PDP11/03<sup>®</sup> PDP11/23<sup>®</sup> MICROCOMPUTER SYSTEMS



**FIRSTMICRO<sup>™</sup>**  
**PDP11<sup>®</sup>**

FIRST COMPUTER CORPORATION NOW OFFERS  
MICROCOMPUTER DEVELOPMENT SYSTEMS IN BOTH  
11/03 AND 11/23 CONFIGURATIONS.

The Basic PDP-11/03 systems offer the designer a low cost compatible alternative to the larger members of the PDP-11 family. The larger faster PDP-11/23 systems offer the power, expandability and operating systems of the larger members of the PDP-11 family while retaining the proven cost effective Q-Bus architecture. These systems save you money, improve programming efficiency and boost productivity.

	11T03-L		11V03-L		11T23-L		11V23-L	
PART #	SRVXLLB		SRVXSSB		SRWXLLA		SRWXSSA	
	KD11-HA CPU 11/03		KD11-HA CPU 11/03		KDF11 CPU 11/23		KDF11 CPU 11/23	
	MSV11-DD 32KW Memory		MSV11-DD 32KW Memory		MSV11-DD 32KW Memory		MSV11-DD 32KW Memory	
	RL01 Controller		RX02 Controller		MSV11-DD 32KW Memory		MSV11-DD 32KW Memory	
	RL01 Controller		DLV11-J Serial (4)		RL01 Controller		RX02 Controller	
	DLV11-J Serial (4)		OPEN		RL01 Controller		DLV11-J Serial (4)	
BACKPLANE	OPEN		OPEN		DLV11-J Serial (4)		OPEN	
	OPEN		OPEN		OPEN		OPEN	
	OPEN		OPEN		OPEN		OPEN	
	BOV11-AA Bootstrap		BOV11-AA Bootstrap		BOV11-AA Bootstrap		BOV11-AA Bootstrap	

Serving the world with cost effective computer systems.

**First<sup>™</sup>**  
computer corporation

corporate square/825 north cass avenue/westmont, illinois 60559/(312) 920-1050

TWX NUMBER 910-651-1916

<sup>™</sup>Trademark First Computer Corporation

Registered trademark of Digital Equipment Corporation

SS-3

World Radio History

Circle 15 on reader service card

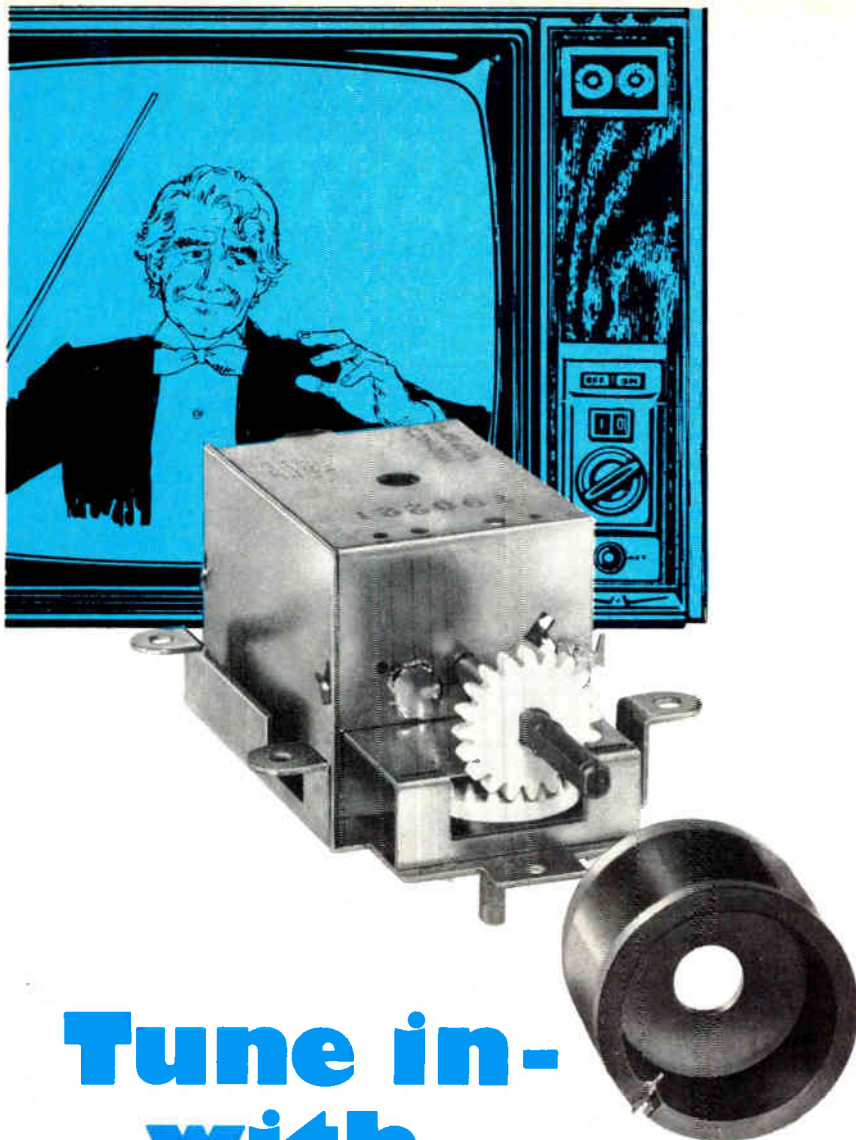

# Tune in- with Standard and Plenco

Among the key performance features offered by a number of major television manufacturers is the 20-Position Varactor Controller produced by Standard Components, Division Stancomp. Inc., Elk Grove Village, IL.

The TV tuner controller begins with a drum molded of a heat-resistant Plenco phenolic. Standard tells why:

"We chose your Plenco 485 compound," reports the company, "because of its dimensional stability, low shrinkage, surface hardness, and, of course, its ability to withstand heat.

"After processing the molded drum through our Thick Film Department for a coat of resistance ink it is then assembled with other components to produce the controller."

TV or not TV, for help on your own molding applications, tune in on Plenco. Just dial (414) 458-2121.

**PLENCO**  
THERMOSET PLASTICS

PLASTICS ENGINEERING COMPANY  
Sheboygan, WI 53081

Through Plenco research... a wide range of ready-made or custom-formulated phenolic, melamine-phenolic, alkyd and polyester thermoset molding compounds, and industrial resins.

## People

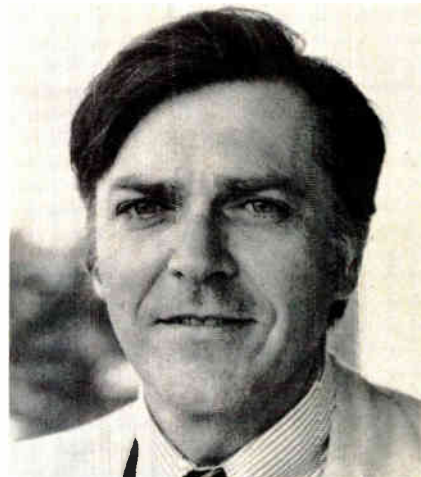

**Marketing man.** Stromberg-Carlson's Kennedy wants it to become market-driven.

communications field, the gut issue is the answer to the old question, what is the difference between sales and marketing? Kennedy's answer is direct: "Marketing is the process of having what you can get rid of, whereas sales is getting rid of what you have."

"Define the market requirements and product requirements," says Kennedy. "That may sound like a cliché, but the product is king and we will make it if we increase revenues for our customers through cost reduction, through better maintenance capability at their sites, or by adding improvements to our products so that, in turn, our customers can raise their prices."

**Changes.** Straight-talking Kennedy has gone through two traumas in the telecommunications industry. The first was the shift from an analog to a digital carrier for transmission. Now he is in the middle of the changeover from analog to digital switching.

One of the problems with this later brand of technology, he says, is that manufacturers are so sales-driven they have turned it into a commodity product before anyone knows what it is all about. "Customers buy on price because no manufacturer has done much to differentiate himself in his features, his capabilities, or his service activities," says the executive.

Clearly Kennedy does not intend that to be the case at Stromberg. □

# The new 8520A DMM: Fills your rack with math, memory and measurement capabilities.

Here's a new intelligent multimeter with the resolution, speed and accuracy that the most demanding system applications require - with powerful math and memory functions that you would expect to take up much more than a mere 3½ inches of rack space.

The 8520A is a precision system DMM, with dc, True RMS ac and ac + dc volts boasting a 50 ppm, 90 day, basic dc accuracy. Two and four wire ohms and conductance let you make resistance measurements to 10,000 Megohms. And because the 8520A was designed as a systems instrument, an IEEE-488 interface is standard. So are switchable front and rear inputs that

are fully protected from overloads.

The 8520A's speed and resolution run second to none. A 500 reading per second speed at 4½-digits resolution and 240 readings per second at 5½-digits with 60-Hz line operation (200 rps at 50 Hz) let you make fast, accurate, high-speed measurements.

With built-in intelligence this new DMM can run its own math programs - seven standard and seven optional - including limits testing, percent deviation, statistics, and dB. And a unique burst mode allows the 8520A to store up to 400 readings (Option

010) in a built-in memory instead of tying up the system controller.

To sum it up, the 8520A is a precise, powerful measurement computer. One that sets new standards of hard-working practicality. At a price that's hard to believe - \$2995 U.S.

Prove to yourself what this new intelligent multimeter will do for your system. Contact your Fluke Sales Engineer or Representative for a demonstration. For his name, call toll free 800-426-0361, or use the coupon below.



**IN THE U.S. AND NON-EUROPEAN COUNTRIES:**

John Fluke Mfg. Co., Inc.  
P.O. Box 43210 MS #2B  
Mountlake Terrace, WA 98043  
(206) 774-2481  
Telex: 32-0013

**IN EUROPE:**

Fluke (Holland) B. V.  
P.O. Box 5053, 5004 EB  
Tilburg, The Netherlands  
(013) 673 973  
Telex: 52237

- Please send me more information.
- I want to see the 8520A in action. Please have a Sales Engineer call.

Name		
Title	Mail Stop	
Company		
Address		
City	State	Zip
Telephone ( )	Ext.	

For literature circle no. 17

# INTEL SPECIAL REPORT



# LSI Breakthrough for Analog

## Intel announces the 2920 Signal Processor, first general purpose, real-time system on a chip.

Good news for analog designers. Intel breaks a new barrier in microelectronics: The first intelligent chip powerful enough to process analog signals in real time. Plus a computer-aided development package to help speed your systems to market faster than ever before.

Intel's 2920 is a complete, micro-sized signal processing system that packs the equivalent of over 18,000 transistors on a single chip. It operates hundreds of times faster than current digital processors. And best of all, the 2920 allows designers to *program* system values quickly, instead of having to match and tweak components.

### A revolution in analog design

From the beginning, LSI technology has helped designers achieve dramatic improvements in product size, design cycles and manufacturing economics. But until now, the speed and complexity of analog processing has stood in the way of general purpose, single chip solutions for real-time applications.

Today, Intel's 2920 Signal Processor brings the power and flexibility of LSI to the analog world. Because of its size, the 2920 can fit in spaces too compact for traditional analog solutions. Because the 2920 is programmable, product development and time-to-market are speeded significantly. Finally, because the 2920 is a solid state device produced with Intel's proven NMOS process, reliability and manufacturing repeatability are

assured to a degree not possible with previous methods.

### Micro-processing for the real world

Applications for the 2920 are as broad as your imagination. Since analog designers can program the 2920 processor to perform a large number of standard building block functions, the chip can be used as an entire subsystem. Implement such functions as complex filtering, waveform generation, modulation/demodulation, adaptive processing, and even non-linear functions. This broad capability makes the 2920 an ideal single chip solution for virtually any application in the DC to 10 kHz range.

And like the digital microprocessor, the 2920 is destined to create entirely new classes of applications: products that are smaller, simpler, and less costly to produce. It gives a competitive advantage to companies in such areas as process control, test

far less complex than the component matching it replaces. Most importantly, Intel provides the complete support tools and design workshops you need to start designing 2920 systems today.

Our SP20 Support Package and Intel's Intellec® Microcomputer Development System allow you to develop and debug by simulating your system in software. Just program functions according to your system schematic, then specify input and operating values. Together, Intel's development aids let you see how your system will work before you even build a prototype. Best of all, because you develop in digital code, your prototype system will be duplicated precisely in manufacturing.

### Start making news with your product

Everything you need to begin designing a new generation of real-time analog processing systems is here today: Intel's 2920 Signal Processor, SP20 Support Package, and the Intellec Development System. For detailed information, including our new 2920 brochure, plus a schedule of Intel's nationwide 2920 Design Workshops and Seminars, contact your local Intel sales office or distributor. Or write Intel Corporation,

Literature Department, 3065 Bowers Avenue, Santa Clara, CA 95051. Or call (408) 987-8080.

## intel® delivers.

Europe: Intel International, Brussels, Belgium. Japan: Intel Japan, Tokyo. United States and Canadian distributors: Arrow Electronics, Alliance, Almac/Stroum, Component Specialties, Cramer, Hamilton/Avnet, Harvey, Industrial Components, Pioneer, Wyle/Elmar, Wyle/Liberty, L.A. Varrah and Zentronics.

Circle 19 on reader service card

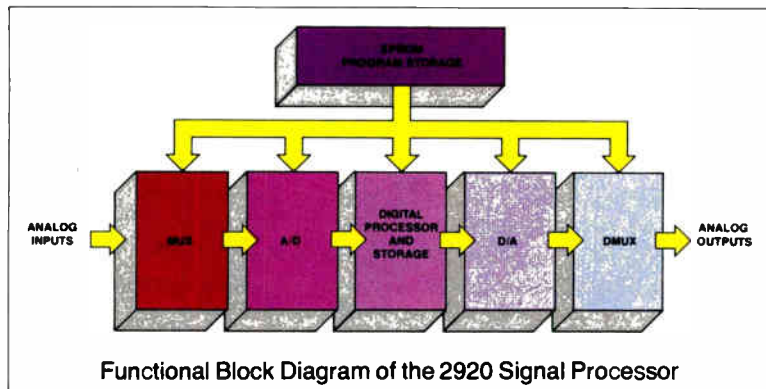

and instrumentation, guidance or control systems, telecommunications, speech processing, and seismic or sonar signal processing.

### How the 2920 simplifies system development

Programming Intel's 2920 Signal Processor is fast and easy to learn—

# Scientists and engineers find computer systems powerful tools and control.

## Why?

*Interfacing power.* Today's Hewlett-Packard desktop computer systems have such high performance interfacing features as direct memory access (DMA), vectored priority interrupt (up to 15 levels) and Enhanced BASIC and HPL programming languages. One model gives you up to 449K bytes of fully usable memory; another offers assembly language. Implementing your data acquisition and control system is as simple as choosing from one of four interface protocols on plug-in cards: HP-IB, Bit-Parallel, BCD or RS-232-C.

*Days, instead of weeks.* You can unpack a system and have it up and running on a production line, or in the lab in about one-third of the time you'd expect. Days, instead of weeks or even months.

*From lab to production line.* Once it's up, your test and control system can move with ease from one environment to another with no hardware or operating system changes. This kind of flexibility, coupled with the power and sophistication of today's models, makes an HP desktop computer the logical choice for your data acquisition and control needs.

*Friendly.* Together with the power to handle your big data acquisition and control problems, today's systems retain the reliability and ease of use that have always characterized HP desktop computers.



# today's desktop for data acquisition



## HP-IB: Not just a standard, but a decade of experience.

HP-IB is much more than just HP's implementation of IEEE Standard 488-78.

It reaches beyond IEEE-488-78 to cover the operational area as well as the mechanical, electrical and functional specifications. For example, HP-IB systems incorporate a built-in, high level I/O language that saves you the time and expense of writing instrument drivers and configuring operating systems. It means powerful interfacing through a system in which a lot of the work has been done for you.

## Expand your system through HP peripherals.

Many data acquisition and control applications require external mass storage for large volumes of data.

HP mass storage media include high speed flexible discs capable of handling data at burst rates and a selection of fixed discs offering storage up to 120M bytes. These and other input and output peripherals tailored for HP desktop computers allow you to configure the system that meets your needs today and accommodates future growth, as well.



## A wide selection.

We build a broad range of desktop computers, with one just right for your data acquisition and control application. From the low cost HP 9815 through the HP 9825, the standard for HP-IB controllers; the HP System 35 with BASIC and assembly language; and the HP System 45B with advanced graphics capability, every HP desktop computer has superior interfacing characteristics in terms of human engineering, ease of use and power.

## A growth path.

HP can meet expanding needs with communication links from desktop computers to HP 1000 series computers. For multi-user, multi tasking problems, HP 1000 systems offer a range of compatible RTE operating systems with software options for data base management, factory data collection and graphics.



**For more information.** Call 800-821-3777, extension 137, toll-free day or night (Alaska and Hawaii included). In Missouri, call 800-892-7655, extension 137. Or write 3404 E. Harmony Road, Fort Collins, Colorado 80525.

**For a demonstration.** Call the HP regional office nearest you: East 201/265-5000; West 213/970-7500; Midwest 312/255-9800; South 404/955-1500; Canada 416/678-9430.



# HEWLETT PACKARD

Circle 21 on reader service card

**MK3874**

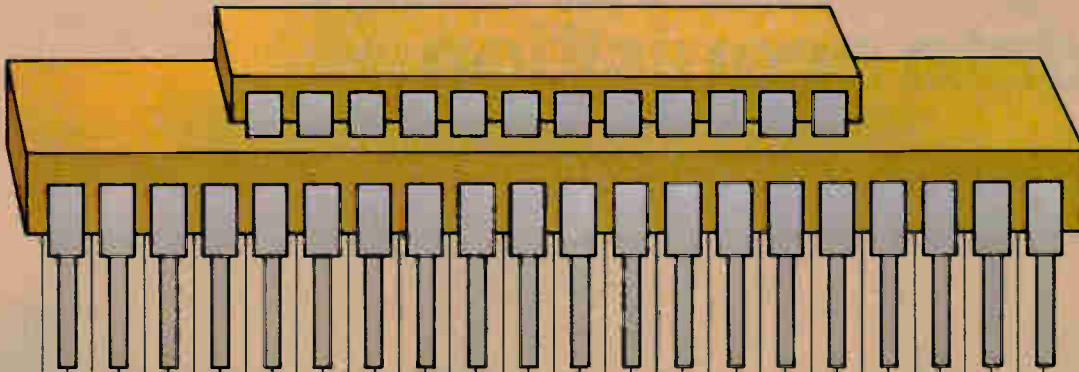

**MK3870**

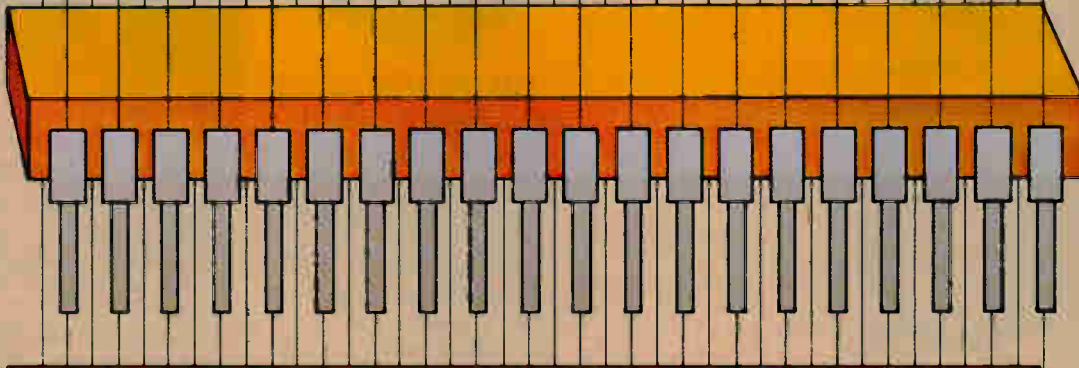

**MK3872**

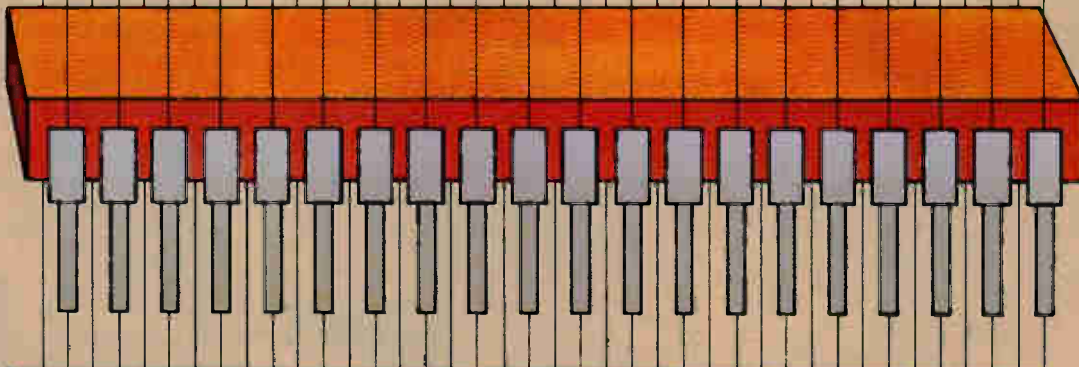

**MK3876**

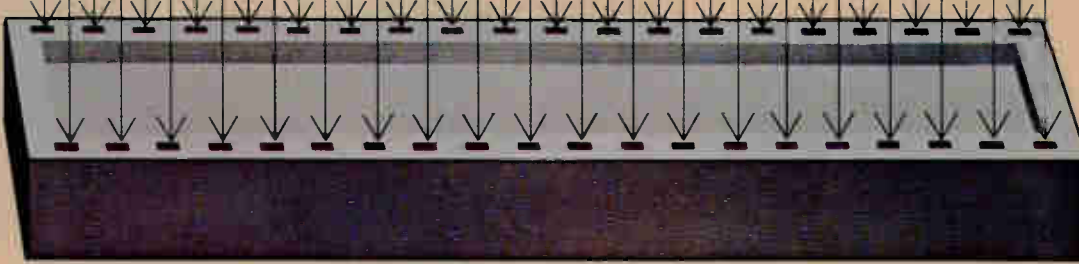
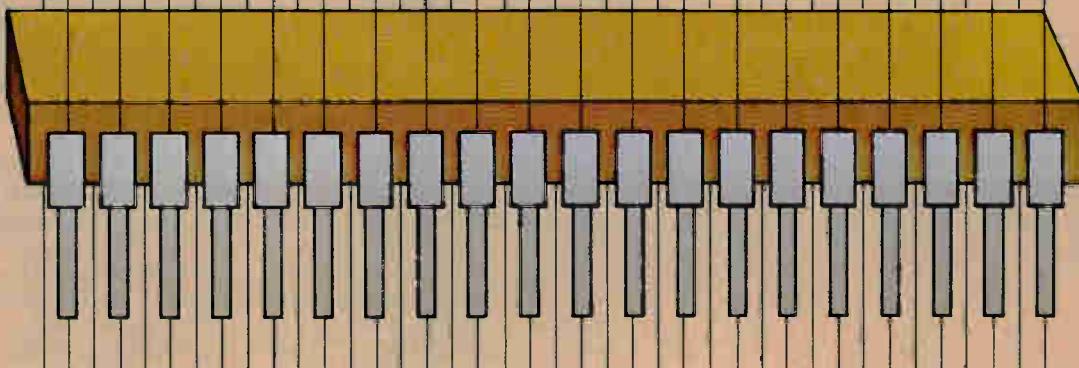



# Microcomputer Momentum.

## Capture it with Mostek's 3870 family of pin compatible microcomputers.

For single chip applications, no other microcomputer family can offer you more design momentum than Mostek's 3870. None.

Consider: When properly designed in, any 3870 family device may be replaced with any other 3870 family member in the same socket without hardware redesign. We call the concept in-socket expandability.

Let's say you start with the 2K bytes of ROM and the 64 bytes of RAM in the 3870. Need more RAM? Double it with the 3876. In the same socket. Need more ROM and RAM? Get 4032 bytes of ROM and 128 bytes of RAM with the 3872. In the same socket. Want to prototype and test your systems prior to ordering mask ROM programs? Plug in the 3874 with its piggyback EPROM and emulate all 3870 family members. In the same socket.

## The right idea for a fresh start.

As a new design path, the advantages are compelling, too. Not only does the 3870 offer you a variety of choices for the initial design, but it also simplifies planning for subsequent designs as well. In the same socket, expansion or upgrading can be accomplished as easily as exchanging one 3870 family device for another. There's no new architecture to learn. No retooling of artwork. No new software to buy. No concerns about debugging. No new vendors to qualify. Simply stated, there's no loss of momentum.



## Design it in with confidence.

Mostek's 3870 is the proven 8-bit single chip microcomputer industry standard. Over a million parts have already been shipped. For hundreds of applications. From microfilm recorders and electrocardiographs, to appliances, computer peripherals, and more. Supported by multiple second-sources, the 3870 has made a whole new technology affordable for scores of cost-sensitive applications.

## It's a powerful way to design.

All the pin-for-pin compatible 3870 family members operate on a single +5 Volt power supply. All standard members have 32 lines

Mostek 3870 Family				
Product	ROM	RAM	I/O	Power
MK3870	2048x8	64x8	32	+5V
MK3872	4032x8	128x8	32/30*	+5V
MK3874	2048x8 or 4032x8	64x8 or 128x8	32/30*	+5V
MK3876	2048x8	128x8	32/30*	+5V

\*with standby power mode option

(4 ports) of bidirectional I/O. Or you can order the standby power option to protect the extra 64 bytes of RAM in the 3872 or the 3876, and still have 30 I/O lines available. The versatile programmable binary timer can operate in three modes: internal timer, pulse width measurement, and event counter mode. And the compact instruction set has over 41 single byte instructions letting you do more in less memory.

All our 3870 family members are supported with complete development systems. Choose from the economical EVAL-70™ all the way up to our Matrix™ floppy disk development system with real time in-circuit emulation.

## An intelligent choice for the future.

To continue the momentum, more 3870 family members will be available soon. Including CMOS versions. And the 3873 serial I/O version which will interface to devices such as terminals, shift registers, and CCD memories.

If you want an intelligent design for the future, start with the microcomputer family that has expandable designs for the future: Mostek's 3870 family.

For more information, write Mostek, 1215 West Crosby Road, Carrollton, Texas 75006. Or phone (214) 323-6000. In Europe, contact Mostek Brussels, phone 660.69.24.

# MOSTEK®

Circle 23 on reader service card

## VLSI: the high-priced opportunity

We're seeing signs everywhere of the high cost of being in the very large-scale integration era. Texas Instruments goes to the outside money market for the first time in years by filing for a \$250 million debenture offering. Intel sounds an alarm heard around the world that there will not be enough software engineers to handle the programming tasks generated by VLSI unless the hardware designers intervene. Manufacturers are upset by the rising costs of semiconductor production equipment.

And for startup companies the prospects are also unsettling, implying that the big push to VLSI as witnessed at the recent International Solid State Circuits Conference in San Francisco is going to make the entry stakes prohibitive. Of course, the semiconductor industry has talked this way in the past; some years ago it was undisputed that the price was too high for new entries into the integrated-circuit business. But a number of new companies nevertheless succeeded.

This time the concern is real. The VLSI

business is not for everybody. It raises the question: have we seen the end of the startup companies that contribute so much vigor to the electronics industries? Though the picture seems bleak, we think not. As suggested in the Letter from Palo Alto (p. 98), even the established companies in the overcrowded Silicon Valley expect that this area will continue to be the jumping-off point for new companies excited about taking electronic technology into new applications.

That is the key. To a large extent the new companies in the VLSI era will be those that apply microcomputers in new ways and develop new markets. Examples of this trend are already around us. Look at the toy and game industry, which until a few years ago was basically a cardboard and plastics business. Today all the major concerns are up to their elbows in electronics.

Yes, the stakes are high in VLSI. But the outlook clearly is for a decade of expansion. The migration of engineers to new industries will continue.

## Fumbling with VHSIC

Delays in getting the three military services to cross the t's and dot the i's in the very high-speed integrated-circuit project sponsored by the Defense Department are beginning to disillusion contractors new to the defense market. The VHSIC program, which survived a flap with the House Armed Services Committee last year, is being frustrated by barracks lawyers more eager to defend their bureaucratic prerogatives than to get on with this defense project.

The delays have not been the fault of the Pentagon's VHSIC program managers, though they are getting the brunt of the results—contractors anxious to see the

program awards made are losing their early enthusiasm. This is especially true for the semiconductor companies that are more familiar with the industrial markets.

Underlying the situation is the age-old conflict between the lawyers worried about Congress and their service's rules and the engineers who want to get on with the job. The problem has been trying to coordinate the military in implementing applications of the new VHSIC devices. Almost by definition, every project is late. But delaying any longer in this case could have unfortunate repercussions, as contractors attempt to build up their manpower and equipment.

# Get meaningful signal analysis through complete annotation of accurate data. Introducing the Gould ES 1000.

The new Gould ES 1000 electrostatic analog recorder automatically makes the exact chart notations you require for determining the nature of your signals. Chart speeds, amplifier sensitivity settings, units of measurement, real time, and test identification are all printed exactly according to your preprogrammed instructions. Even when you make additional, immediate notations through the auxiliary keyboard, there's no need to touch the chart or stop the recorder.

You'll also find the rugged, dependable Gould ES 1000 is a versatile performer whatever your application. Plug-in signal conditioners provide accurate monitoring of a wide range of input functions. There's even an optional plug-in digital converter. You get a peak capture capability of 40 microseconds and flat frequency response from DC to at least 10 kHz across all 16 channels.

For accuracy, the fixed electrostatic linear array of the ES 1000 generates its own grid pattern at the same time it is producing the high resolution 100 dots per inch trace. Traces overlap allowing all channels to record full scale across the 10" wide writing area. The unique 1000 electrode head eliminates pens, ink, and other moving parts that might have the potential for trouble.

Find out more about how meaningful your signal analysis can be with the new Gould ES 1000. Write Gould Inc., Instruments Division, 3631 Perkins Avenue, Cleveland, Ohio 44114. Or Gould Instruments S.A.F., 57 rue St. Sauveur, 91160 Ballainvilliers, France.



An Electrical/Electronics Company  
Circle 25 on reader service card

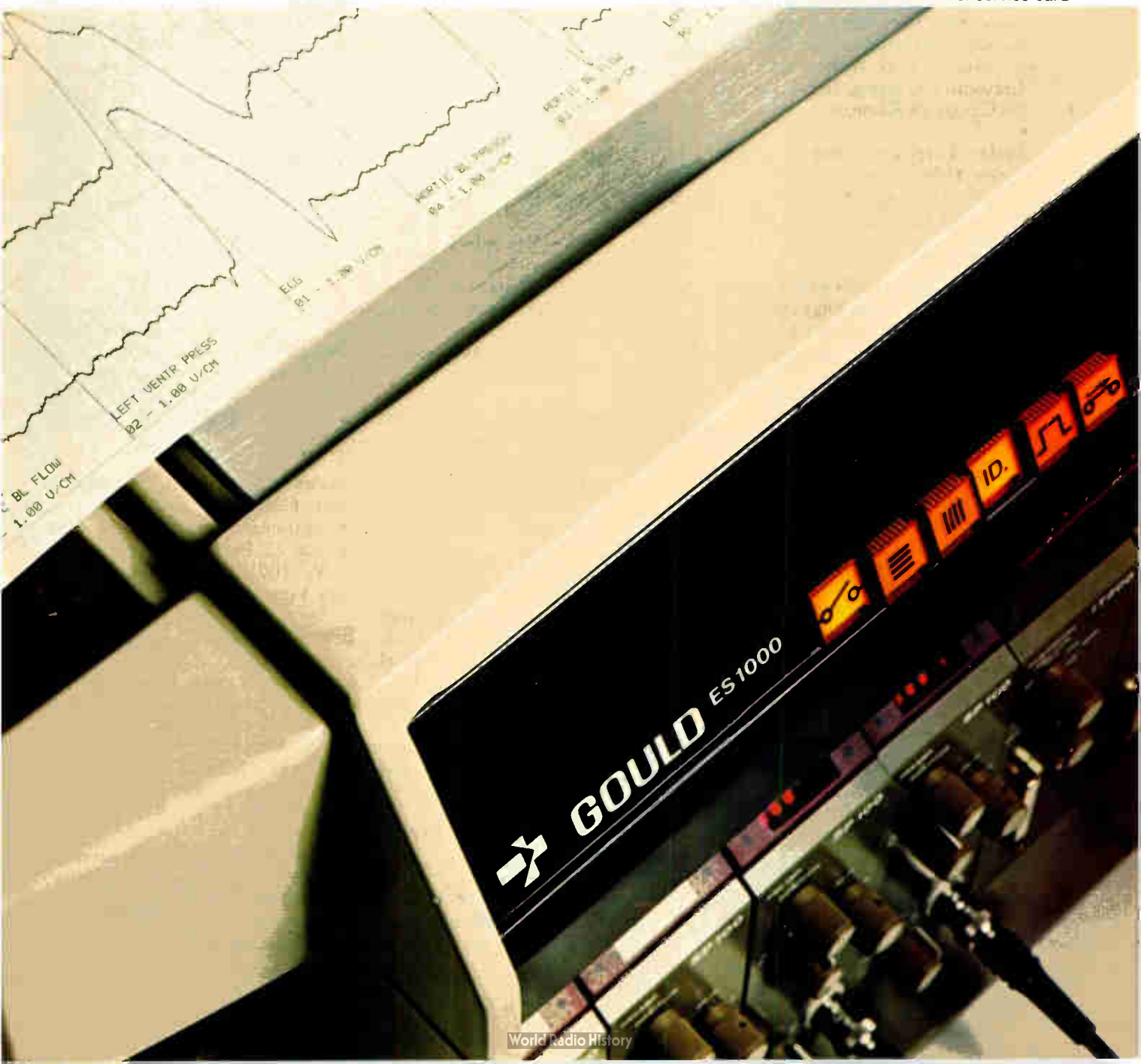

# Meetings

**1980 International Seminar on Digital Communications**, Secretariat, 1980 International Zurich Seminar (Department ENP, Brown, Boveri & Cie., CH-5401 Baden, Switzerland), Zurich, March 4-6.

**International Symposium on Industrial Robots and Conference on Industrial Robot Technology**, Centro Esposizioni Ucima (via Monte Rosa 21, 20149 Milan, Italy), Milan fairgrounds, March 5-7.

**22nd International Scientific Conference on Electronics and 20th International Scientific Meeting on Space**, Rassegna Internazionale Elettronica, Nucleare ed Aerospaziale (via Crescenzo 9, Rome, Italy), Palazzo dei Congressi, Rome, March 10-12.

**Spring Conference, Sperry Univac Series 1100 Users**, USE Inc. (Box 461, Bladensburg, Md. 20710), Hotel Utah, Salt Lake City, March 10-14.

**Second Annual Microelectronics Measurement Technology Seminar**, Benwill Publishing Corp. (1050 Commonwealth Ave., Boston, Mass. 02215), San Jose Hyatt House, San Jose, Calif., March 11-12.

**Semicon/Europa Show and First European Symposium on Semiconductor Materials and Processing**, Semiconductor Equipment and Materials Institute (625 Ellis St., Suite 212, Mountain View, Calif. 94043), Zurich, March 11-13.

**Fifth West Coast Computer Faire**, Computer Faire (333 Swett Rd., Woodside, Calif. 94062), Civic Auditorium and Brooks Hall, San Francisco, March 14-16.

**Sixth Annual Conference and Exhibit of Industrial, Control and Instrumentation Applications of Mini- and Microcomputers**, IEEE, Sheraton Hotel, Philadelphia, March 17-19.

**Fifth Annual Electronic Warfare Symposium**, Dixie Crow Club (Box 1331, Warner Robins, Ga. 31093), Warner Robins Air Force Base,

Warner Robins, Ga., March 17-20.

**Interface '80**, Interface Group (160 Speen St., Framingham, Mass. 01701), Convention Center, Miami Beach, Fla., March 17-20.

**1980 Western Metal and Tool Exposition and Conference**, American Society for Metals (Metals Park, Ohio 44073) and Society of Manufacturing Engineers, Los Angeles Convention Center, March 17-20.

**Computers in Manufacturing Conference**, American Institute of Industrial Engineers (P. O. Box 3727, Santa Monica, Calif. 90403), Ambassador West Hotel, Chicago, March 19-21, and New York Statler, New York, April 30-May 1.

**13th Annual Simulation Symposium**, IEEE Computer Society *et al.*, Holiday Inn, Tampa, Fla., March 19-21.

**Future Shock—Computers in the 1980s**, American Institute of Aeronautics and Astronautics *et al.* (Dept. Comp 80, Box 91295, Los Angeles, Calif. 90009), Hyatt House Hotel, Los Angeles International Airport, March 24-26.

**Seventh Energy Conference and Exposition**, Electric Power Research Institute *et al.* (Government Institutes, 4733 Bethesda Ave. N.W., Washington, D. C. 20014), Sheraton Washington Hotel, Washington, D. C., March 24-26.

**Seventh National Conference and Tutorial Exhibit, Powercon 7**, Power Concepts Inc. (P. O. Box 5226, Ventura, Calif. 93003), Town and Country Hotel and Convention Center, San Diego, Calif., March 24-27.

**Eurocon 80—Fourth European Conference on Electrotechnics**, Verband Deutscher Electrotechniker (D-7000 Stuttgart 1, Lautenschlagerstr. 21, West Germany), University of Stuttgart, March 24-28.

**1980 Communications Techniques Seminar**, Princeton University and IEEE, Princeton University, Prince-

ton, N. J., March 25.

**The IBM Evolving Network Strategy**, The Yankee Group (Box 43, Cambridge, Mass. 02138), Harvard Club, New York, March 25-26.

**Electro-Optics/Laser International Show**, Kiver Communications SA (171/185 Ewell Rd., Surbiton, Surrey KT6 6AX, England), Metropole Convention Centre, Brighton, England, March 25-27.

**First Southwest Semiconductor Exposition**, Cartlidge and Associates Inc. (491 Macara Ave., Suite 1014, Sunnyvale, Calif. 94086), Civic Plaza Convention Center, Phoenix, Ariz., March 25-27.

**International Electronic Components Exhibition**, International Trade Shows in France (1350 Avenue of the Americas, New York, N. Y. 10019), Parc des Expositions, Porte de Versailles, Paris, March 27-April 2.

**International Optical Computing Conference and Technical Symposium East**, Society of Photo-Optical Instrumentation Engineers (Box 10, Bellingham, Wash. 98255), April 7-11, Hyatt Regency Hotel, Washington, D. C.

**Second International Printed-Circuits Conference and Exhibition**, International Printed-Circuits Conference (2 Park Ave., New York, N. Y. 10016), Sheraton Centre, New York, April 8-10.

## Short courses

**Cryptography and Data Security**, Holiday Inn National, Arlington, Va., March 24-26 (and April 21-23 in Palo Alto, Calif., and May 19-21 in Woburn, Mass.). Write to Hellman Associates, 299 S. California Ave., Palo Alto, Calif. 94306.

**Integrated Circuit Engineering**, George Washington University, March 31-April 3. Write to Continuing Engineering Education, GWU, Washington, D. C. 20052.

# “What you'll need tomorrow is built into EIP's 18, 26.5 and 40 GHz counters today.”



“EIP has a revolutionary new family of CW microwave counters able to satisfy all my requirements today and tomorrow.

“EIP's Model 545 measures to 18 GHz. Their Model 548 goes to 26.5 GHz, with an option covering the range clear up to 40 GHz. And they built it to go even higher in frequency should my needs change a few years out.

“EIP's performance? No contest! All their counters deliver minus 30 dBm sensitivity plus excellent amplitude discrimination, frequency selection and offsets. Full 5-watt burnout protection gives me real peace of mind.

Circle 26 for literature

“EIP's new counters also have a power measurement option. For systems use they've got GPIB or BCD/remote programming.

“When I first saw these counters, I was afraid they'd be difficult to operate. But that wasn't the case at all. Their built-in microprocessor does most of the work. Front panel keyboard diagnostic test routines and signature analysis make servicing really simple.

“The most pleasant surprise came when I compared prices. An EIP 545 goes out the door for only \$4800.\* The Model 548 with 26.5 GHz frequency coverage costs only \$5700.\*

“For demonstration or literature on these new counters, phone or write EIP. Believe me, I shopped around, but I couldn't find a company or line of counters nearly as good. When it comes to microwave counters . . .

“I'm sold on EIP.”



EIP Microwave, Inc.  
2731 North First Street, San Jose, CA 95134  
Phone (408) 946-5700

In Europe:  
EIP International  
Brussels, Belgium  
Phone 2/660 48 70

\*U.S. List Price

Circle 27 for demonstration

# HP announces a way to accelerate microcomputer development...



HP—When you depend on logic

World Radio History

# and have a little fun while you're at it.

At last, there's a universal development system that frees you from mundane development tasks and lets you concentrate on challenging software and hardware problems . . . HP's 64000 Logic Development System. It brings minicomputer programming features to microcomputer development for faster, easier and more enjoyable software development, hardware emulation and system analysis. And because it's a universal system, you can use it with today's most popular microprocessors.

## ✓ MICROPROCESSORS NOW SUPPORTED BY HP's 64000

Microprocessor	Full Support*	Macro Assembler Support	Microprocessor	Full Support*	Macro Assembler Support
1802		✓	3085	✓	
6800	✓		9900,9940,9980		✓
6801 6802		✓	F8/3870		✓
6805		✓	Z80	✓	
6809		✓	8048		
8021		✓	8086		
8022		✓	68000		
8035,8039		✓	Z8000		
8041/8741		✓			
8048 8748		✓			
8049		✓			
8080	✓				

\*Includes macro assemblers, linkers, emulation and analysis.

## Put your fingers on a "soft key"

One of the system's key features is its ability to help you make decisions. At power up, for example, soft keys (keys whose functions are defined by CRT labels) give you a choice of 17 development functions, including edit, compile, assemble, link, emulate, PROM program and more. Pressing the edit key and typing in the name of a previously stored file result in a program listing and soft-key choices that simplify program editing, (shown above right). The CRT even flashes momentary directed-syntax messages to guide you in proper command entry.

The combination of minicomputer power and directed syntax using soft keys means you spend less time memorizing syntax, referring to instruction manuals, doing routine searching and entering line-by-line program changes. The 64000 handles most of those routine tasks



so you can concentrate on the real problems. And that's true in assembling, linking, emulating and other development modes as well.

## Work with a friend . . . or five

With HP's 64000, serial development is a thing of the past. Now, up to six team members can do software development and/or real-time emulation simultaneously. And each has immediate access to the latest version of software. That's because the 64000 has a hard disc that provides a common data base for all operators.

To assure accurate, real-time emulation, the 64000 has separate buses and memory for both the host and target processors. In addition, we use high-speed memory. As a result, there's no contention problem and your system runs at operating speed with no wait-states.

Of course there's much more to the 64000, including a wide choice of PROM programmers, up to 128K of emulation memory, an optional analyzer that gives you a real-time, transparent view of bus activity, and architecture powerful enough to adapt to future processor trends such as increased speed and bus width. Price for a minimum operating system is \$25,500.\*

Find out how much fun microcomputer development can be. For a copy of the HP 64000 brochure, write to Hewlett-Packard, 1507 Page Mill Road, Palo Alto, CA 94304. Or call the HP regional office nearest you: East (201) 265-5000, West (213) 970-7500, Midwest (312) 255-9800, South (404) 955-1500, Canada (416) 678-9430.

\*Domestic U.S.A. price only



**HEWLETT  
PACKARD**

World Radio History

039/9A

Circle 29 on reader service card

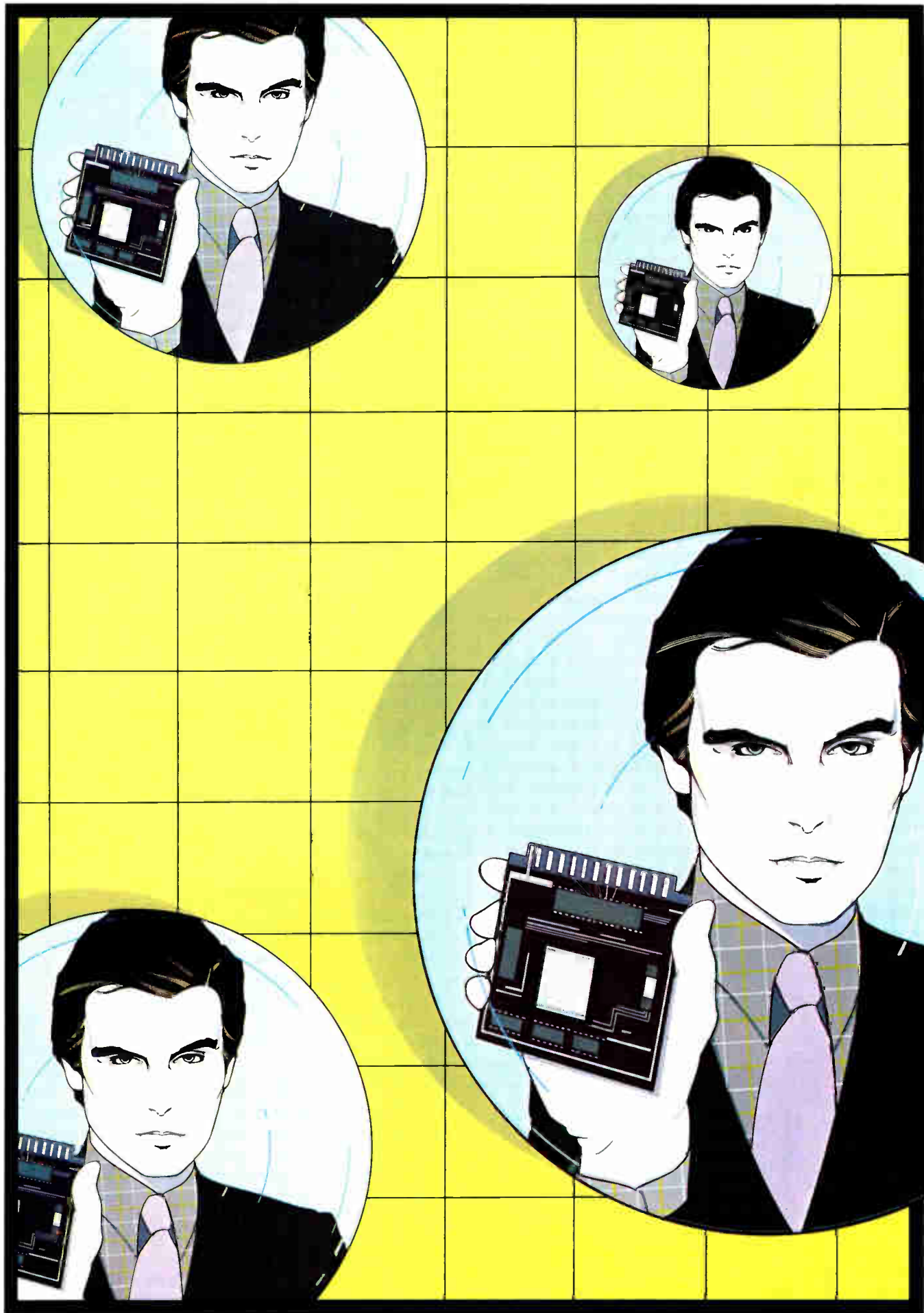



# Million Bit Memory Kit

## Intel delivers the first megabit bubble system and all the support you need to start designing today.

Step into the megabit bubble. You'll find an entirely new class of non-volatile storage—and vast new opportunities to exploit the microcomputer.

### Bubble memory for microcomputers

System designers have always been attracted to bubble memory for compact, low power, high reliability applications. Until now, though, bubble memories have been difficult to use and costly, since they require complex address, control and interface circuitry.

Today, Intel introduces a million bit bubble system perfectly matched in size and performance to the world of microcomputers. Intel's bubble memory gives you 128K bytes of low power read-write memory, plus all the system components you need for compatibility with advanced microcomputers like our 8-bit 8080, 8085 and 8088 and our 16-bit 8086.

### Our system makes it simple

To simplify designing and manufacturing, Intel's bubble memory system consists of only seven components. All of them fit easily on a pc board as small as 4"x4".

The heart of the system is our 7110 Magnetic Bubble Memory chip. It interfaces directly with our 7242 Formatter/Sense Amplifier, 7230 Current Pulse Generator, 7250 Coil Pre-Driver and two 7254 Quad Transistor Packs.

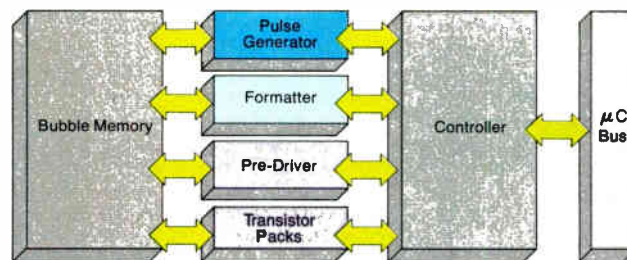

Intel® Bubble Memory System

The user interface, system timing and control functions are provided by our 7220 Controller, available Q1, 1980, or by our Controller Emulator Kit CPK-72, here today.

For systems exceeding a megabit, you can design with the same component family. Since one 7220 Controller will accommodate up to eight megabit chips and their support devices, larger system designs are simplified dramatically.

### Bubble you can believe in

Intel's bubble memory means unparalleled data integrity. It's a rugged, solid state device. And it's completely non-volatile, so your data remains when the power goes off. No battery backup is necessary.

But the bubble system goes even further to ensure reliability. Intel's megabit chip works with the 7242 Formatter to give your

system built-in error correction and detection. The 7110's ECC detects and corrects burst errors.

### Start designing today

Intel's megabit bubble memory system is an ideal solution for microcomputer-based instrumentation, terminals, process controls and telecommunication systems. Everything you need to start designing is here today. Build your own system with our bubble memory prototyping kit.

It gives you all the components for a one megabit system, plus complete documentation for easy designing. Or get a head start with our ready-to-use development board with complete system software. For a copy of our Bubble Memory Design Handbook, contact your local sales office or distributor. Or write Intel Corporation, Literature Department, 3065 Bowers Avenue, Santa Clara, CA 95051. Or call (408) 987-8080.

**intel® delivers.**

Europe: Intel International, Brussels, Belgium. Japan: Intel Japan, Tokyo. United States and Canadian distributors: Arrow Electronics, Alliance, Almac/Stroum, Component Specialties, Cramer, Hamilton/Avnet, Harvey, Industrial Components, Pioneer, Wyle/Elmar, Wyle/Liberty, L.A. Varah and Zentronics.



# HP introduces forms and graphics to desktop printing.

HP's new 7310A Graphics Printer mixes forms, text and graphics in any arrangement you need. And it prints text up to 500 lines per minute.

On demand from your terminal, the 7310A prints out your forms, and what goes on them at the same time. Work orders, assembly information, material lists, accounting reports, employee records, and all other forms with data, are printed and then

sized to your needs by an automatic paper cutter and page stacker.

Besides being fast and versatile, one of the printer's nicest qualities is just that. Printing quality. Readability can be enhanced with proportionally spaced type, reverse printing, and underlining. And programmable character height allows you to produce bold face headlines or titles in characters up to twice normal height.

In addition to supporting HP terminals and computers, four different interfaces let you adapt the 7310A to many other terminals and computers. For complete information, including OEM discounts, contact your local Hewlett-Packard sales office or write to Hewlett-Packard, Attn: Bill Fuhrer, 16399 West Bernardo Drive, San Diego, CA 92127; (714) 487-4100.

11001



**HEWLETT  
PACKARD**

Circle 32 on reader service card

## **Stanford plans research center to look into VLSI**

A \$16 million research center "designed to help keep the United States in the vanguard of the explosively expanding electronics revolution" is planned by a group of engineering professors at Stanford University. The facility, called the Center for Integrated Systems, to be built in Palo Alto, Calif., will investigate the technology of very large-scale integrated circuits and their applications, says a university spokesman. Although the university does not have funding for the center and does not know when it will open, dean of engineering William M. Kays says **the center and its laboratory will be the largest of their kind in the country.** Among the goals are turning out about 100 masters and 30 doctors annually, promotion of research into the automation of circuit manufacturing laboratories, and creation of training programs and conferences.

## **Bell's Unix gains popularity for small systems**

Taking advantage of Western Electric's recent slash in the price of a commercial license for Bell Laboratories' respected Unix operating system, **systems companies are rushing to fit the software pack into microcomputers.** And Unix's availability for small systems will also help sales of compilers for the C programming language used to write it.

First in line for Unix under the new deal is Onyx Systems Inc. The Zilog spin-off in Cupertino, Calif., will offer a Z8000-based machine this spring, complete with C and its version of Unix: Onix. Meanwhile, in the same city, Zilog itself is cooking up an April introduction of a cross-software package that allows PDP-11 users to develop Z8000 code.

Two others had previously been announced. Omnix, from Yourdon Software Products Group, New York, runs on the Z80, while Whitesmiths Ltd., a Yourdon offshoot also in New York, has Idris for microcomputers. Finally, it is reported that Thinker Toys of Berkeley, Calif., will come out with a version of Unix for the 8080.

## **TI's Speak & Spell spawning math, reading variations**

Later this year Texas Instruments Inc. is expected to add two products to its line of solid-state talking educational aids that will employ the same linear-predictive-coding speech synthesis used in the company's popular Speak & Spell. Mockups of the so-called Speak & Math and Speak & Read were shown to potential buyers at the Toy Fair this month in New York. Though TI refuses to discuss the planned products, both will probably use the same p-MOS chip set employed to make the Speak & Spell talk. **The new products may also reduce the amount of data required to be stored in read-only memory for synthesis of the analog waveforms necessary for intelligible speech.** As a result, the average 1,200-bit-per-second data rate could be 30% lower in the new products and still maintain or improve speech quality. However, they should cost more than the current \$75 retail tag on the Speak & Spell.

## **8048 to be made with Intel's HMOS process**

Look for the microcontroller operation of Intel Corp.'s Microcomputer Components division to change over from standard n-channel processing of its 8048 single-chip 8-bit microcomputer to the firm's HMOS process. That method is now used to make the 8086 16-bit one-chip microprocessor, among other devices. Yielding a smaller die size than the current 8048s, the new 8048H process will turn out **significantly faster devices and also allow the Phoenix, Ariz., operation to increase its production until it is more in line with increased demand for the device.**

# Electronics newsletter

---

## **Sears increases sales efforts of Atari computers**

Undaunted by a shortage of personal computers from Atari last fall, Sears, Roebuck and Co. of Chicago is expanding its effort to market the \$550 and \$1,000 machines. The new spring catalog will include the \$1,000 Atari CPU with a full-sized keyboard in addition to the \$550 touch panel version offered in the Christmas catalog. However, in-store displays are currently limited to the large urban markets. Atari says that it is now receiving the chips it needs to assemble the units, unlike last fall when a shortage prevented the company from meeting holiday targets. Atari now has lined up a broader software supply, printers, and other peripherals and has made a deal with Control Data Corp. for local servicing.

## **Bay State firm sees solar cell cost of 1¢/W**

Continuing development of ion-implantation and laser- or electron-beam-annealing techniques could cut the costs of terrestrial solar cells to about 1 cent/W, according to a recent design study by Spire Corp. The Bedford, Mass., firm used the same computer-modeling format as that developed by the Jet Propulsion Laboratory in Pasadena, Calif., to project cell costs of 56 to 69 cents/W in a 100-MW-per-year factory using conventional impurity-diffusion and furnace-annealing production methods [*Electronics*, July 19, 1979, p. 111].

## **Coast firm to introduce E-mail system**

Interactive Systems Corp of Santa Monica, Calif., plans a host-to-host electronic mail system for Digital Equipment Corp.'s PDP/11s and VAX systems. It will be introduced at the Office Automation Conference in Atlanta early next month. Using the firm's INmail facility, electronic messages can be sent and received between distant interactive installation, over existing data-communications networks. The host-to-host facility will be available immediately for use with the Western Union Telex/TWX network for intersite communications.

## **Addenda**

Last week, at the first meeting of the IEEE's board of directors, the race for next year's president and executive vice president began. The board selected Richard W. Damon, director of the Applied Physics Laboratory at the Sperry Research Center in Sudbury, Mass., as its presidential candidate, and Robert W. Lucky, director of the Electronics and Computer Systems Research Laboratory at Bell Laboratories in Holmdel, N. J., as his running mate. . . . Xicor Inc., the Sunnyvale, Calif., firm that expects to take on the semiconductor industry's giants with 1-K static random-access memories offering a nonvolatile "shadow" memory [*Electronics*, Sept. 13, p. 39], plans to begin shipping sample quantities of its devices by the end of this month. . . . Using a 3- $\mu$ m H-MOS process, Fairchild Camera and Instrument Corp. has designed a 100-ns 64-K random-access memory. . . . Another computer that runs on IBM software is about to make its debut. From Formation Inc. in Mount Laurel, N. J., the Formation 400 Information System will also include all the peripherals needed to compete with the IBM model 4300 line. . . . IBM is now the fifth largest minicomputer maker, according to market analysts speaking at International Data Corp.'s 15th annual computer industry briefing session earlier this month. They say that IBM sold \$200 million worth of Series 1 machines in 1979 out of total minicomputer industry revenues that reached \$4.7 billion.

---

## JELLYBEAN SALE!

### 4K RAMs IN 5 FLAVORFUL SPEEDS.

---

Our EA 2114L version of the industry-standard low power 1K × 4 static RAM has some important differences.

Such as 100% burn-in at 100°C for superior reliability. Or extra heavy lead frames to keep your chip extra cool. Or a guaranteed ± 10% power supply tolerance.

And more. You can pick from five different access times including one of the fastest on the market: 150 ns.

*Pick your favorite speed.*

Part Number	Access Time
EA 2114L	450 nsec
EA 2114L-30	300 nsec
EA 2114L-25	250 nsec
EA 2114L-20	200 nsec
EA 2114L-15	150 nsec

One more difference. They're available now—delivery within two weeks—at reasonable quantities in all speed versions.

From Electronic Arrays, 550 East Middlefield Rd., Mountain View, CA 94043. Call (415) 964-4321; Philadelphia (215) 643-1447; Chicago (312) 858-8508. Ask about our ROMs, too.

---

## QUALITY RAMs.

### AND THE ROMs TO GO WITH THEM.

---

---

## ELECTRONIC ARRAYS.

---



# Fast FIFOs from inventory.

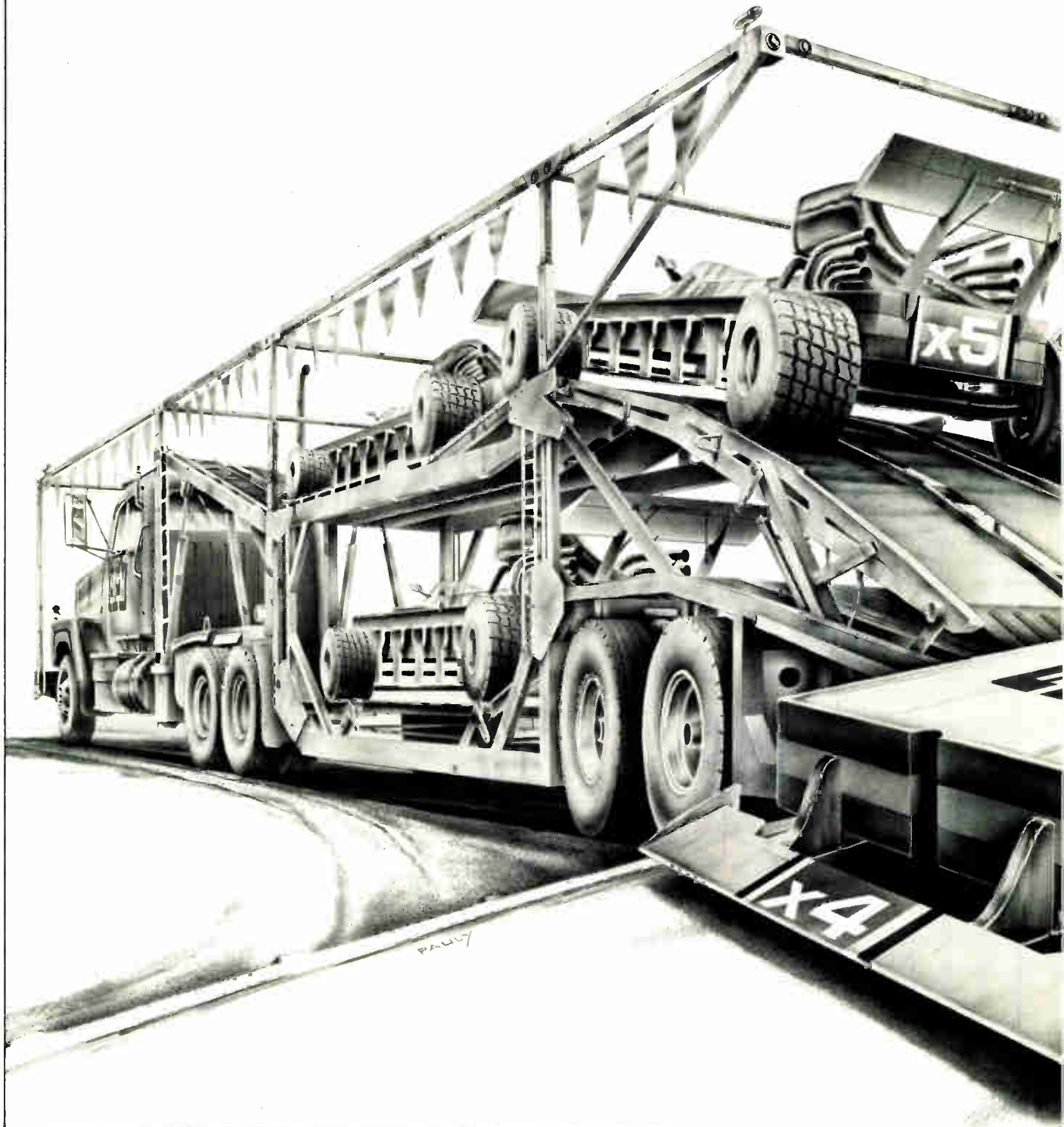

## For years MMI has made the world's fastest FIFOs. Now they're even faster, and come in four-bit and five-bit versions.

Our standard FIFO—the 64 x 4 bit 67401—comes with a guaranteed 10 MHz data rate ideal for disc controllers, communications, signal processing and more.

But *now* we're also offering the 67401A, with 15 MHz guaranteed, making it perfect for even more demanding applications such as digital video.

And we mean now! We have them in stock. Each in space-saving 300-mil-wide packages with industry standard pinouts.

### Also new. A 5-bit FIFO that reduces your parts count.

That's right. The 67402 and 67402A also guarantee 10 MHz and 15 MHz data rates. Combine these 64 x 5 FIFOs with our 4-bit devices and create a 9-bit organization using two packages instead of three.

### MIL-STD FIFOs from inventory.

The same devices come in mil-temp versions, and can be processed to MIL-STD 883B. Get up to one thousand off-the-shelf; up to five thousand in six weeks.

For details and information on MMI's whole line of FIFOs, write Applications Dept., Monolithic Memories, 1165 East Arques Ave., Sunnyvale, CA 94086. You can also get free samples by writing to us on your company letterhead and including a description of your application.

**Monolithic Memories** 

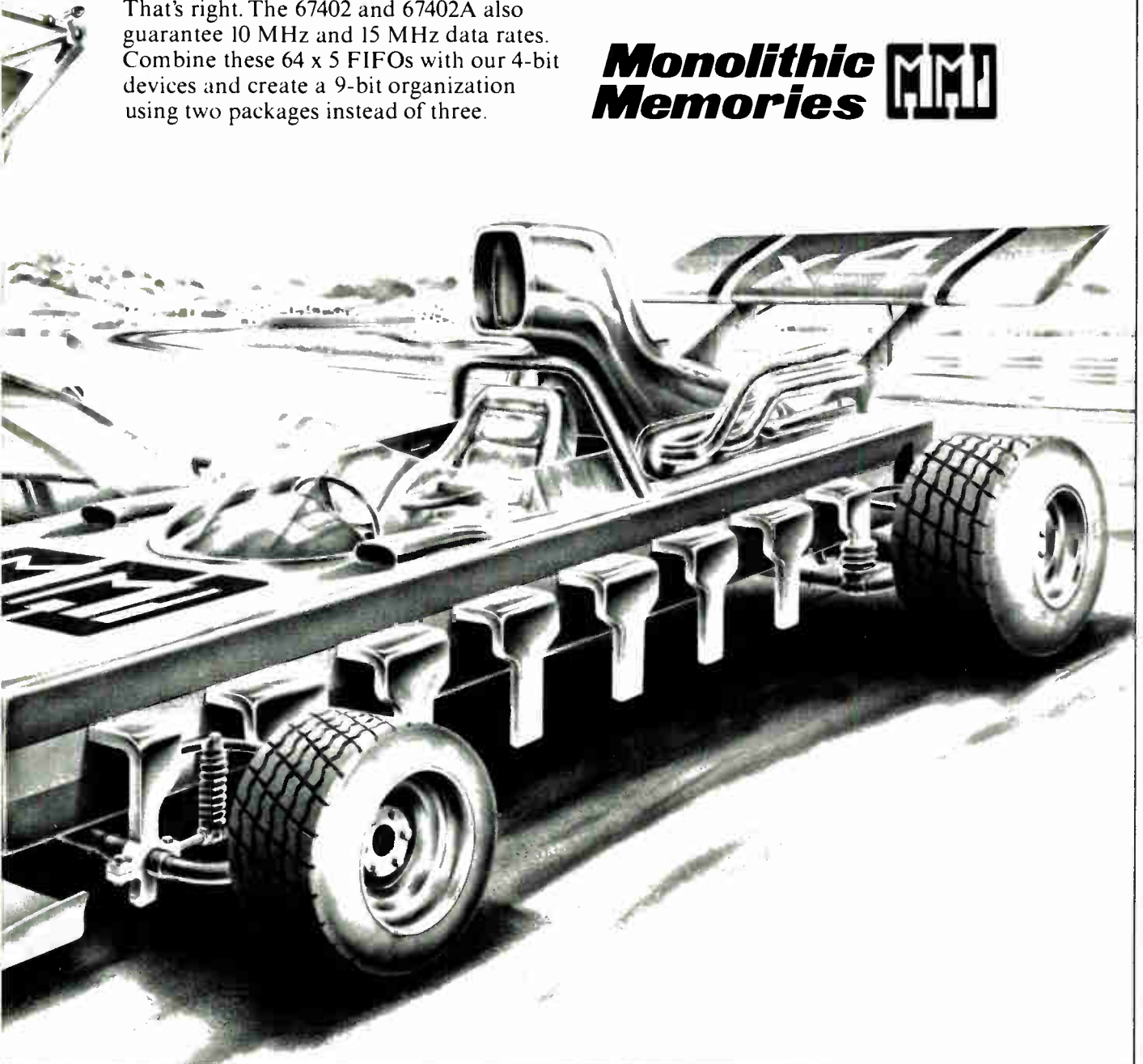



# BEFORE YOU'RE TOO DEEP IN MICROPROCESSORS . . . SEE US ABOUT MicroSupport™

Before you get too deep in the design, application and specification of microprocessors, think about the equipment you'll need.

Support is more than just PROM programmers . . . more than just emulators . . . more than just microprocessor development systems.

You're going to need total microprocessor support throughout your organization.

Advant introduces MicroSupport by E-H.

MicroSupport is a complete family of related support equipment that can be used in design, development, test and field service. It's the total approach to all of your needs . . . now and in the future.

MicroSupport is a highly efficient, fast, economical and comprehensive line of universal microprocessor support tools.

**First**, an improved line of universal PROM programmers that can quickly and easily program 4K-128K PROMs . . . using software, not personality boards. Units are available for use in the lab, for development work, production requirements and field service applications.

**Next** is a series of real-time, stand-alone emulators for microprocessor testing applications. The emulators can be used to debug your product without a microprocessor development system.

And the greatest news is the most

advanced microprocessor development system you can imagine now in final test. This system offers significant software and hardware advantages over any other microprocessor-based systems.

You get increased power and dramatically expanded capabilities in a cost-effective package.

Before you're up to your ears in microprocessor applications and problems, find out more about the microprocessor support equipment line that will help keep you in the chips.

Call or write us today and find out about MicroSupport.

**Advant for MicroSupport by E-H.**

**ADVANT**  
for  
**MicroSupport™**

By 

696 Trimble Road  
San Jose, CA 95131  
(408) 946-9300

MicroSupport is a Trademark of E-H International. MicroSupport products are marketed worldwide by Advant Corporation.

38 Circle 38 on reader service card

I'm up to my ears in microprocessors, please send me more information on:

Universal PROM  
Programmers

Real-Time Emulators

Economic, Universal micro-  
processor development  
systems

Call me today and save a  
drowning person.

Name \_\_\_\_\_ Title \_\_\_\_\_

Company \_\_\_\_\_

Address \_\_\_\_\_

City \_\_\_\_\_ State \_\_\_\_\_ Zip \_\_\_\_\_

Phone ( ) \_\_\_\_\_

Microprocessors Used \_\_\_\_\_

Applications \_\_\_\_\_



## Storage oscilloscope uses microprocessor to ease test chores

by Bruce LeBoss, San Francisco regional bureau manager

Using digitally stored waves, unit makes one-key readings, can run test programs from calculator-like keyboard

Combine a digital storage oscilloscope and a 16-bit microprocessor, and the result is the smart scope, Tektronix Inc.'s newest laboratory instrument. With a touch of a button the 7854 can make common waveform measurements extremely accurately, and the operator can program it for other waveform processing.

What's more, the new scope has a 400-megahertz bandwidth, 225 MHz wider than the minicomputer-dependent digitizing oscilloscope that the Beaverton, Ore., firm pioneered in 1973. Like its predecessor, the new unit will work with a 14-gigahertz sampling plug-in to measure super-high frequencies.

With some effort, other programmable scopes can be hooked up to minicomputers to perform much the same waveform processing as the 7854. But the new scope does it in one easy-to-use package, and with its TMS9900 processor, its \$10,500 price tag is a third or less than that of a minicomputer-based setup.

**Design time.** Although large-scale integration made the new design possible, it was more than a simple combining of instrument and microprocessor. The designers wanted 10-bit instead of 8-bit resolution for a truer representation of an analog signal of as much as 400 MHz.

With these requirements they had to build a very fast, accurate new digitizer and provide for the han-

dling of its output at a single word to keep the speed up. The cost-effective solution was the 16-bit processor, just being developed when design work began about four years ago.

The design effort was worth it, for it reaffirms Tektronix's preeminence in lab scopes, a product area in which it has successfully withstood the challenge of such competitors as Hewlett-Packard. However, the betting is that other makers of digital scopes—HP, Gould, and Philips, for instance—are working on similar smart scopes. Whether they will

have the performance of a conventional 400-MHz unit, as does the Tek tool, remains to be seen.

**Keyboard.** When the 7854 (see photograph) bows in June, lab engineers will find it comes with a separate keyboard, called a waveform calculator. "The scope can be programmed so that most common measurements, such as rise and fall times, pulse width, and complex waveform comparisons can be made with a single stroke on the keyboard," says Jim Cavoretto, business unit manager for lab scopes. For rise



**Combination.** Tektronix' new digital storage scope incorporates a 16-bit microprocessor to process waveforms and perform measurements and computations at the touch of a button.

time, for example, the user simply positions cursors at the base and amplitude of a pulse displayed from memory. He then touches the appropriate button and a digital readout of the rise time between the 10% and 90% points appears on the cathode-ray-tube screen. Because the measurement is performed digitally, the result is much more accurate than the typical method, which relies on the human eye.

**Programmability.** Tektronix also has programmed its new laboratory tool to perform single-key measurements of parameters like root-mean-square value and pulse energy that cannot be read off the scope but must be calculated. Also, users can program custom measurement sequences, much like programming any data processor.

The programmability means that the 7854 will undoubtedly find its way into the realm of automatic test equipment. The unit can perform measurement tasks on its own, automatically checking for errors. In fact, it can automate and organize a long series of measurements, Cavorretto says.

The scope digitizes the waveforms with 10-bit resolution, allowing the user to select the number of horizontal coordinates: 128, 256, 512, or 1,024. The basic 7854 with 8 kilobytes of random-access memory can store 16 waveforms, and a \$1,500 optional 16-kilobyte random-access memory stores 40 digitized waveforms. The unit also can function as a conventional analog dual-trace storage oscilloscope.

**External bus.** As well as controlling the digitizer, display, and keyboard, the 9900 supervises the workings of the IEEE-488 interface bus. This external interface lets users interconnect the scope with additional processors and data storage and permits coordination with other tests and measurement tools.

Along with the 7854, Tektronix will introduce a new signal-processing system: the WP 1310. It combines the smart scope with the firm's 4052 graphic computing system, suitably modified for waveform processing.

## Production

### Electron beam writes submicrometer features at better than mask-making throughputs

A sign that submicrometer electron-beam lithography is close to production-line use comes from Hughes Aircraft Co.'s research laboratories. Engineers at the Malibu, Calif., facility have devised a direct-write-on-wafer setup that routinely achieves 0.5-micrometer features, with wafer throughputs better than commercial machines with two to four times less resolution.

**Assemblage.** What's more, the EBS/4 comprises relatively standard electron-beam components: like earlier systems in the 2½-year-old program, its performance comes from the control subsystem devised at the labs. It has fabricated thousands of submicrometer chips and will soon move the company's Electron Dynamics division where it will turn out limited production quantities of integrated circuits.

Like such companies as IBM, Texas Instruments, and Bell Labs,

Hughes had to put together a high-resolution, direct-writing system in house. Commercial electron-beam lithography units are intended primarily for mask making, and they have neither the resolution nor the throughput desired.

The key to the submicrometer alignment accuracy is more precise control of the beam steps that trace the circuit pattern across the wafer. To get a machine capable of exposing 0.25- $\mu\text{m}$  device details, Hughes in effect redesigned the system, starting with existing components.

In addition to new control hardware, new software for machine control and support was written using a larger, more precise 16-bit address format. Thus the beam can be positioned in 0.05- $\mu\text{m}$  steps in the 2-millimeter scan field on 3-inch wafers. (In contrast, a typical commercial machine has a 13-bit format and about 0.15- $\mu\text{m}$  steps.)

### Basic programs hand-held calculator

The ubiquitous Basic programming language is a feature of what amounts to a pocket computer from Sharp Corp. With the language, programmable calculators will become easier to program and more flexible in their uses—more like computers, in fact.

The two new models from the Osaka, Japan, company will have a 24-character alphanumeric display and an optional interface for storing programs on an audio cassette tape recorder. Statements and library functions provide mathematical capabilities similar to most personal computer interpreters. Scientific notation consists of a 10-digit mantissa and a 2-digit exponent.

The PC-1210, with 400 program steps and 26 registers, will go on sale in Japan on March 1 for about \$123. The PC-1211, with an additional 1,024 program steps, will go

on sale a month later for \$178. The registers can be increased to 40 in the 1210 and 178 in the 1211 at the loss of eight program steps per additional register. The units will measure 6.9 by 2.8 by 0.6 inches and weigh 0.36 pound including the three button batteries that power them for 300 hours.

-Charles Cohen



The EBS/4 represents a major advance, says Ron Felker, vice president for marketing at Electron Beam Microfabrication Corp., San Diego. "It demonstrates that Hughes has proved to itself that direct-writing E-beam is here for submicrometer device production," he says. "What excites us is that Hughes is doing it for the military, joining IBM, which is using it for quick-turnaround, small-volume commercial memories, probably at  $2\mu\text{m}$ ."

Richard D. Fralick, head of the Hughes labs' electron-beam section, says the ICs fabricated include many large-scale integrated chips, working with both silicon and gallium arsenide. In silicon, technical staff member John Chen has used the system extensively and reports making charge-coupled devices with  $0.6\text{-}\mu\text{m}$  lines and 7,000 elements.

**More.** Other silicon ICs fabricated include a 4-K CCD array and various chips in complementary-MOS on sapphire. Gallium-arsenide field-effect transistors with  $0.5\text{-}\mu\text{m}$  gates are virtually routine for the EBS/4, and smaller GaAs FET geometries are becoming more common.

For device throughput, where electron-beam machines lag behind other exposure technologies, the Hughes unit is picking up the pace a bit. Fralick points out that throughput comparisons with other technologies are imprecise because electron-beam productivity depends so greatly on such variables as resist speed and line widths. Device expert Chen says the EBS/4 can handle from 2 to 10 3-in. wafers an hour with submicrometer resolutions.

**VHSIC?** Fralick says the machine could be restructured into high-throughput equipment. In fact, his group is contemplating a push to meet the performance requirements of the military's very high-speed IC program. A VHSIC requirement is  $0.7\text{-}\mu\text{m}$  chips from a 4-in. wafer exposed for only 15 minutes.

The present system with its "gaussian spot beam cannot meet VHSIC objectives as it stands today," says Fralick, because drawing a pattern with a single beam is too slow. But the group has experimented with a

shaped beam that exposes all or major parts of an entire circuit pattern at the same time with resolution as small as  $0.33\mu\text{m}$ .

Fralick declines to cite a cost for the EBS/4, built for the Electron Dynamics division under contract, but commercial equipment sells for between \$700,000 and \$2 million. Hughes has no plans to market machines, but is considering licensing its technology. **-Larry Waller**

## Computers

### Testing VLSI is major Compcon topic

With all the boons that computer designers can foresee from very large-scale integration, they are uncomfortably aware that testing VLSI parts may be a burden. "The ratio of testing costs to manufacturing costs is steadily increasing for LSI and VLSI systems," says P. G. Kovijanic of GenRad Inc., Concord, Mass.

In a paper for the IEEE Computer Society's Compcon Spring Conference in San Francisco this week,

Kovijanic argues that an objective measure of testability is needed to point the way towards design for testability. He proposes a software system called Testscreen, which examines how easily the condition of a node in a circuit can be controlled and observed.

Testscreen can provide the designer with a quantitative prediction of the success of an automatic test-generating or test program, he says. Also, it can aid the designer in detecting untestable areas. Sample runs on networks with about 1,000 nodes use about an order of magnitude less computer time than corresponding ATG and fault-simulation runs, he claims.

Another novel technique for testing VLSI (see figure) comes from Hisashige Ando, a senior engineer in the computer circuit engineering department of Fujitsu Ltd.'s plant in Kawasaki. In various scan-in, scan-out techniques previously proposed for testing VLSI circuits, the logic on a chip is partitioned by storage elements and all storage elements can be controlled by separate input and output pins. But most of these techniques are sequential, Ando

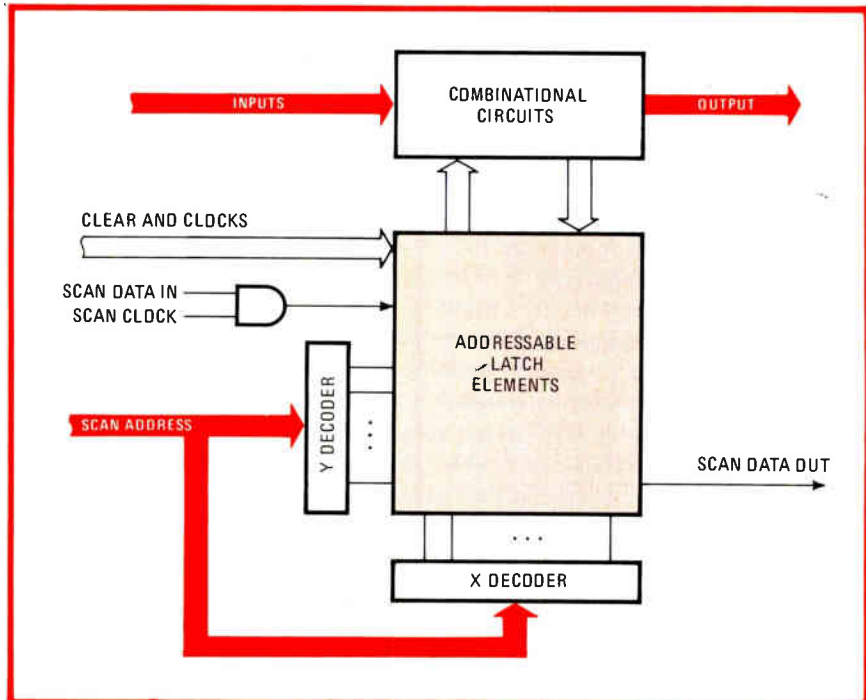

**Selectable.** Rather than sequentially scanning the latches separating the combinatorial logic into testable sections, Fujitsu proposes random access, much like addressing RAM elements.

points out in his presentation.

Instead, Fujitsu is developing a technique that addresses the storage elements in a random manner much the way the elements of a random-access memory chip are referenced. Although this random-access design puts more overhead circuits on the chip, Ando says it can test larger circuits faster than sequential methods can.

One feature of this year's Comcon is the concentration on hardware technology rather than the more traditional computer architecture and software topics. Program chairman Donald Senzig of Hewlett-Packard says, "We don't see architectures, operating systems, or programming languages being affected by VLSI very much. In fact, the emphasis is on maintaining the status quo in those areas because of the tremendous investment in applications software."

The few software papers concentrate on networking processors together and programming them for new applications. For example, Douglas Johnson discusses an experimental data-flow computer developed at Texas Instruments Inc.'s facility in Austin, Texas.

An unusual aspect of the system, according to Johnson, is that it "can accept a program written in a conventional programming language, compile it, link it, and then automatically partition it across any number of processors." This automatic partitioning saves programmers time and makes debugging the programs easier, he reports.

**Software problems.** John B. Munson of System Development Corp., Santa Monica, Calif., will examine future software technology with Jack Distaso of TRW Inc., John Manley of Johns Hopkins University, and Leon Stucki of Boeing Computer Services Co. As VLSI and other new technologies encourage the wider application of computing power and more complex systems, a problem will arise in software engineering, they say.

"Where the computer hardware developer has met the challenges [of the data-processing field] by shrinking the product and multiplying it,

the software people are still trying to learn how to effectively multiply its usage," they say. The solution, according to the authors, is increased research and development, but "the current sources for support of software engineering research are woefully inadequate." -Anthony Durniak

Industrial

6800 varies speed of synchronous motor

Aimed at making life on the assembly line simpler and more precise, a new ac servo drive uses a microprocessor to position machine tools for repetitive work and to provide variable speed control for a synchronous driving motor. Moreover, the microprocessor allows the servo loop to be programmed to cycle through an infinite number of highly precise

speed and position profiles.

When it goes into full production, the I-Drive from Ingersoll Milling Machine Co., Rockford, Ill., will replace electromechanical systems that use a complex transmission system to modify the output speed of two synchronous motors, one for rapid traverse and one for precise positioning of the machine tool. Until now the variable-speed alternative has been brush-type dc motors, but major users of machine tools, such as auto makers, have avoided such setups because of these motors' relatively poor reliability and high maintenance costs.

**Efficiency.** Ingersoll points to the  $\pm 0.0015$ -inch positioning repeatability of the I-Drive (see figure) as alone accounting for a 5%-to-10% efficiency increase on high-speed production lines. This highly accurate positioning all but eliminates the dead time of the old system, where a tool had to stop some 1/4 in.

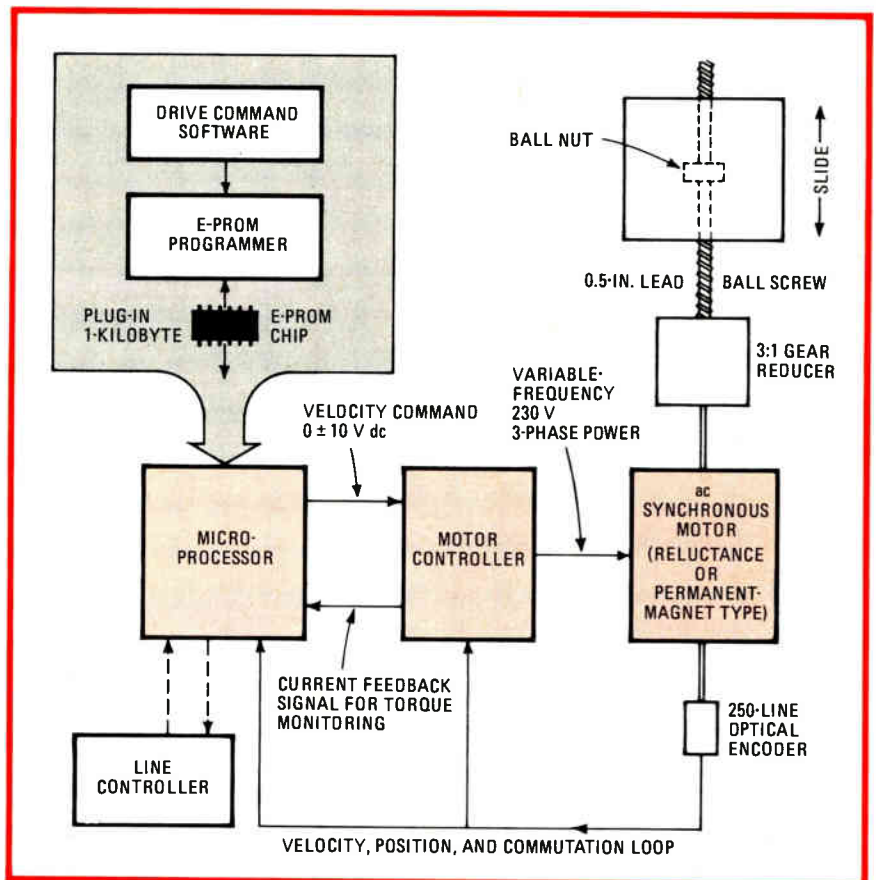

**Closing the loop.** Ingersoll's microprocessor-controlled ac servo for positioning machine tools maintains its torque over a wide speed range, unlike two-motor drives.

# 12 bit throughput at 500 KHz.

The 1410 sample and hold amplifier offers 12 bit accuracy with maximum acquisition time for a ten volt step of 200 nanoseconds to 0.1% and 350 nanoseconds to 0.01%.

In combination with a high performance con-

verter such as the 2850, it permits very accurate high speed operation.

Military versions of both are available.

Send for the data sheets, as well as APPLICATION TECHNIQUES bulletin AT-803.

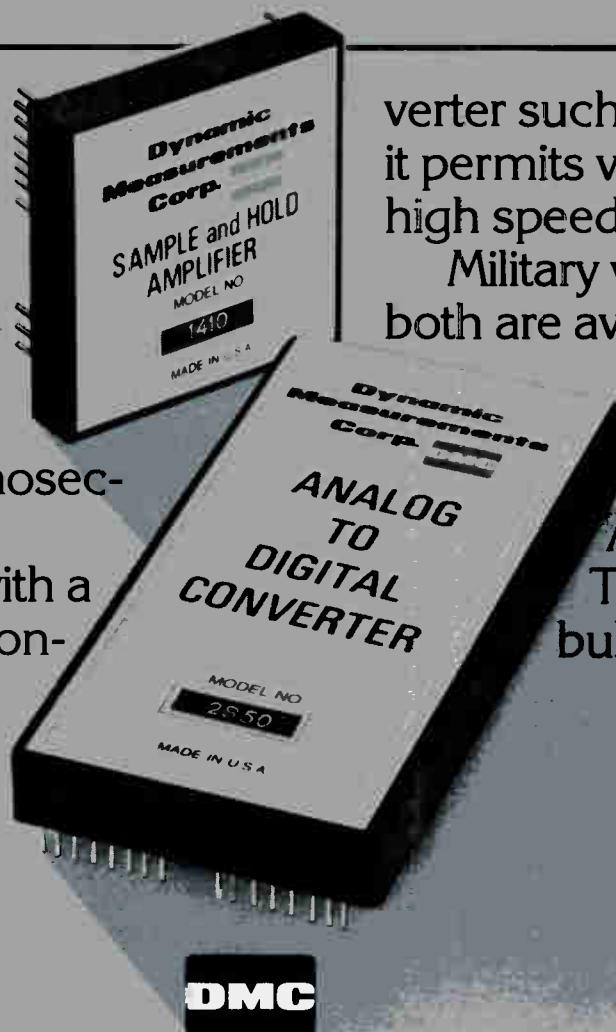

## **Dynamic Measurements Corp.**

6 Lowell Ave., Winchester, MA 01890. (617) 729-7870. TWX (710) 348-6596  
Call our toll free number 800-225-1151.

Circle 43 on reader service card

from the workpiece before being precisely positioned.

Most of the product development was concentrated on the micro-processor and the control loop for the motor. The Control Systems Research division of Contraves Goerz Corp., Pittsburgh, developed the synchronous motor drive and its control loop for Ingersoll, and the University of Wisconsin developed the basic software.

The I-Drive uses Motorola's 6800 industrial control module. Ingersoll adds an interface board that includes an easily removed erasable programmable read-only memory that contains all drive-function variables. Ingersoll says customers may opt to program the E-PROMS themselves because the software, which runs on any standard development system, uses machine-shop terminology in a question-and-answer format.

The 6800 instructs the servo motor to duplicate the drive motion defined by a velocity-and-position curve. It monitors the actual velocity and positioning signals from a feedback encoder, and it also can monitor the progress of the resulting machining operation by checking on such parameters as motor torque to warn of tool dullness and so on.

**Motor.** The Contraves' division designed a system for driving a three-phase synchronous motor at constant torque from 0 to 1,800 revolutions per minute and with constant horsepower from 1,900 to 3,600 rpm. The only practical way to vary the speed of a synchronous motor is to vary the input voltage's frequency, but the new drive makes it possible to do so easily over a wide speed range.

The control circuitry uses pulse-width modulation to produce a three-phase, sinusoidal variable-frequency motor-drive current. These three currents are electronically locked at the exact torque angles necessary for maximum torque and efficiency.

I-Drive technology should have a bright future in the automotive, agriculture, construction, and industrial fields. Field tests of the new drive begin this spring. **-Jerry Lyman**

## LCDs are gearing up for dashboard use as makers devise improved materials

Newly reported advances in liquid-crystal technology bring closer the day when LCDs will nudge aside light-emitting diodes and vacuum fluorescent units in automobile electronic displays. Auto makers may see that day as somewhat more distant than do the manufacturers of LCD materials, but they acknowledge the advances unveiled at this week's annual congress in Detroit of the Society of Automotive Engineers.

Prominent among the SAE papers is one from Japan's Mitsubishi Electric Corp. reporting a new blend of liquid-crystal materials that can extend the operating temperature to a range from 85°C to -40°C. Below -20°C, LCD materials usually have a response time of 1 second or more unless a relatively expensive conductive heater plate is included.

**Antifreeze.** The Mitsubishi researchers blended a phenylcyclohexane-biphenyl-ester mixture that extends the red and blue LCD's operating temperature much like ethylene glycol extends the range of the auto engine's coolant liquid. Response time at -20°C is less than a half second.

Other companies working on LCD improvements to sell to Detroit include Integrated Display Systems Inc. of Montgomeryville, Pa., and the Crystaloid division of Samuel

Moore and Co., Hudson, Ohio (see p. 48 for related story). IDSI will show a prototype dichroic panel using a nonpolarized technique [*Electronics*, Aug. 30, 1979 p. 252].

**Why LCDs?** The liquid-crystal innovations are sought because existing display technologies fall short of the ideal for car dashboards. LEDs are difficult to view in direct sunlight, and vacuum fluorescence has limited color possibilities, is power hungry, and requires substantial hand assembly. LCD advocates argue that the material can be configured into dichroic, mass-producible instruments with no glare problem.

However, vacuum-fluorescence defenders at Ford Motor Co. and elsewhere contend that its drawbacks are insignificant compared with its proven performance. Auto buyers also are swallowing the cost: more than 70% of 1980 Lincolns leave the factory with the \$700 fluorescent instrument panel [*Electronics*, Aug. 2, 1979, p. 43], and about a third of the 1980 Thunderbirds are equipped with a \$300 version.

Given the advances described at the SAE conference, optimists among the vendors are predicting that LCDs in autos are one or two model years away. However, engineers at one big Detroit assembler say it should take

### Electronics are prominent at SAE conference

With automobiles going in for electronics, Detroit's major engineering symposium, the annual Society of Automotive Engineers congress, includes sessions on microprocessors, sensors, and other digital hardware. In addition to the impact on car design, electronics' influence is spreading to the assembly line, as various papers on robotics and voice recognition testify.

Though several electronics firms like Texas Instruments Inc. and Fairchild Camera and Instrument Corp. are showing slides and discussing their sensors, actuators, microprocessors, and displays, National Semiconductor Corp. is going one step further with a liquid-crystal instrument panel featuring a voice-synthesizer warning system. In fact, many displays at the SAE's diamond jubilee congress point toward a future with voice-recognition and voice-response applications and electronic control of the auto. **-L.M.**

# IT'S THE RIGHT COMBINATION IN DISPLAY MONITORS... YOUR REQUIREMENTS AND OUR KNOW-HOW

In an industry dominated by a few large suppliers, your special needs are frequently ignored. So you have no recourse but to design your system around the same old CRT display.

But now you have a choice, because at TSD standard monitors are built to your exacting specifications.

12- and 15-Inch Models  
Available From Stock

## And we can supply...

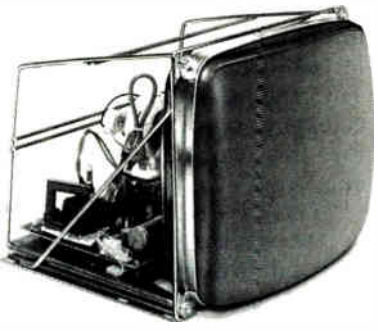
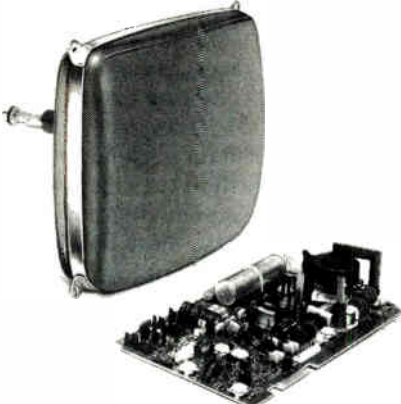
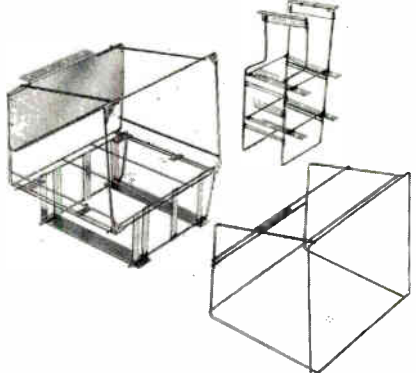
the entire monitor	the electronics (with and without the CRT)	or the welded wire frame (configured to your specifications)
		

### All TSD Display Monitors feature:

Wide Video Bandwidth • Extremely Good Linearity • Uniform Characteristics Across The Entire Screen • Brightness Limiting to Prevent Phosphor Burn • Very Fast Vertical Retrace Time • A Minimum MTBF of 10,000 Hours • A Skip Scan With a Settling Time of Less Than 20 Microseconds • Ease of Maintenance

And there are NO delays in delivery.

Let us tell you more about what is really new in CRT Display Monitors. Call or write today, and we shall give you the whole story.

# TSD

**TSD DISPLAY PRODUCTS, INC.**

35 Orville Drive • Bohemia, New York 11716/Tel. 516-589-6800 • Telex 14-4659

Circle 45 on reader service card

## Electronics review

from three to five model years.

In addition to testing LCD-equipped cars under desert and arctic conditions, one auto maker has built a few electroluminescent dashboards into test vehicles. Under consideration at another company is a cathode-ray-tube display, which would use a special short-necked, low-power CRT. **-Larry Marion.**

## Consumer

### Toys, games firmly in electronics' camp

The toy and game business is rapidly becoming an electronic playground. As the introductions at the annual Toy Fair indicate, electronic games are becoming more complex and expensive; the lucrative U. S. market is attracting foreign competitors; and electronic components are making their way into toys.

Within their total 1979 sales of \$4.2 billion, toy manufacturers saw a massive increase in the sales of electronic games—up over 300% to \$375 million in 1979 from \$112 million in 1978. That is nearly 10% of toy production, and the share will probably be much higher for 1980, despite shipping shortages.

**Up to \$100.** Most surprising for the 800-plus manufacturers who gathered earlier this month in New York for the annual show was that consumers are willing to pay much higher prices for electronic playthings. "The industry is not accustomed to selling as many high-priced toys—toys with \$50 or more tickets," Raymond P. Wagner, president of Mattel Inc., observes.

At this year's show, it was evident that those higher prices are opening up a new market for the toy industry. Many of the new games aim primarily at an adult audience.

Among those games is Milton Bradley Co.'s Omni Entertainment System, a multiple-choice quiz game that will retail for about \$100. Omni uses an eight-track tape system—four tracks for voice data and four for digital—to question players

### Phone data recorder uses bubble memories

Bubble memories are the heart of a call recorder and diagnostic system now available to operators of private branch exchanges. "We chose the bubble because of its superior reliability compared with other memory systems," says William R. Martin, president of the system's manufacturer, Telecommunications Service Bureau Inc. of Chicago.

The electronics for PBXs typically operates in a hallway closet, where the environment would be hardly sterile enough for floppy disks. The nonvolatility eliminates the need for the battery backup found in semiconductor storage, and the dearth of moving parts eliminates heat dissipation by fans.

The basic TSB-1 costs \$5,900 and uses six Texas Instruments 92-kilobit bubble memories, plus semiconductor program memory, and a TMS 900 microprocessor. For about \$15,000, users will obtain more bubble-memory cards, a cathode-ray-tube display, and other peripherals like a line printer. The CRT aids in the monitoring of PBX utilization. Users will be able to reprogram Northern Telecom SL-1 digital switching centers for such tasks as increasing traffic over underutilized lines.

Call record capacity is from 2,600 to more than 10,400 calls and can be expanded even more. Telecommunications Service Bureau is a subsidiary of an independent Chicago-based operating system, Central Telephone and Utilities Corp., but it will sell the TSB-1 to outside customers. **-Larry Marion**

about different types of trivia, with the players responding via four keyboards.

Another game aimed at adults is Mattel's Horse Race Analyzer. Also selling for about \$100, the pocket-sized aid for handicapping thoroughbred races has a liquid-crystal readout prompting users as they punch in 31 facts from the Daily Racing Form for each horse.

The growth in the electronic game market is also enticing new entrants into the arena, most notably Japanese toy and electronic manufacturers. Bambino Inc., a West Coast subsidiary of Japan's Emix Corp., was at the fair for the second time, but with a far larger offering.

To make its electronic games somewhat different from others on the market, Bambino is using a new display technology—what it calls a "vacuum-packed tube"—in which electrons are bounced off a phosphor-like coating on the face of the tube. The clarity of the image is similar to that of vacuum fluorescent displays. In 1981, Bambino plans to expand the technology by adding up to three colors to its displays.

Another company backing its American debut with technology is Bandai America Inc., a subsidiary of Japan's largest toy manufacturer, Bandai Co. With Hitachi, Bandai

has developed a 10-by-8-centimeter LCD. "The technology is expensive compared with light-emitting diodes, but it's more energy-saving," Makoto Yamashina, executive vice president, notes.

**Toys.** Another trend seems to be incorporating electronic technology in traditional toys. Tiger Electronic Toys Inc., a recently formed Illinois company, introduced five electronic toys this year, all aimed at the pre-adolescent market.

"There's a tremendous opportunity for electronic toys. Electronics adds a dimension to the toy, increasing its play value," William Pasco, senior vice president for marketing, says. Tiger expects to ship 4 million units in 1980. **-Pamela Hamilton**

## Communications

### Smarter products ease data transfer

The flowering of data communications is seeding a range of new products that will give impetus to the spread of networks and satellites by making them easier to use. Examples introduced at the recent Communication Networks '80 in Washington, D. C., include: a simulator-tester for



# The Ultimate "Brickwall" Filters

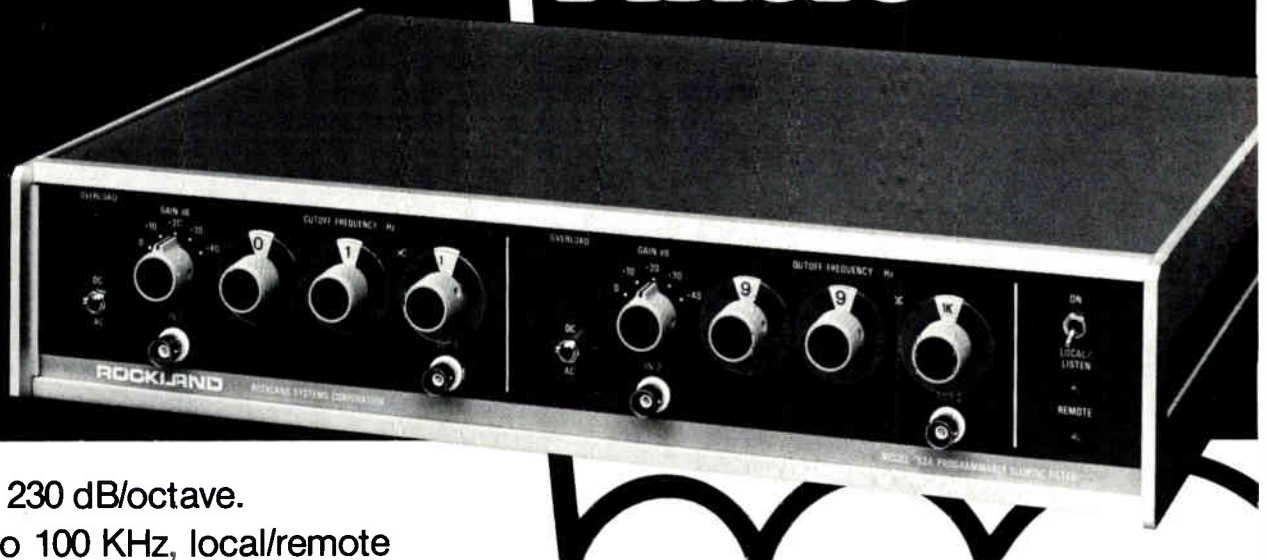

Up to 230 dB/octave.  
1 Hz to 100 KHz, local/remote  
programming, dual Low Pass or Band Pass, built-in gains, >80dB dynamic range.

IMPOSSIBLE? 230dB/octave attenuation in a moderately priced, wide-range programmable filter with superb passband and stopband characteristics? Not impossible, but it *did* take a decade of technological leadership in signal processing to develop these state-of-the-art elliptic filters.

**WHAT DO YOU NEED?** We offer two versions: Model 752A is dual-channel low-pass, tunable over 1Hz—100kHz, by remote digital or local manual means. Each channel provides passband flatness within 0.5dB p-p, 115dB/octave rolloff. Phase match between channels, typically, is 1° or better. Use them separately for two-channel anti-aliasing, cross-correlation, etc; *and cascade them to get 230dB/octave rolloff* . . . for the ultimate in alias rejection.

Or choose Model 751A, a tunable high-pass/low-pass (adjustable bandpass) elliptic. Independently programming Low and

High cutoffs allows you to set both center frequency and bandwidth anywhere in the 1Hz to 100kHz band; same rolloff rates, same programming. Speaking of programming, choose BCD or optional IEEE STD 488 . . . both built in.

**THERE'S MORE?** You bet. Too much for this space. More than 80dB dynamic range. Programmable gains (e.g., 0 dB to +60dB in 10dB steps in the Model 751A) . . . exceptional frequency-setting resolution and much more.

**GET THE FACTS ON THESE BRILLIANT NEW DESIGNS.** Call or write for the catalogs, engineering notes, and our 24-page "mini-textbook" on filter theory and applications.

Rockland Systems Corporation,  
Rockleigh Industrial Park,  
Rockleigh, NJ 07647  
(201) 767-7900



Model 751A.  
Bandpass.  
Brickwall.

# ROCKLAND

the development of packet-switching networks; a communications controller that automates many functions at satellite earth stations; and an antenna that can receive simultaneous signals from seven satellites.

**Simulate.** Already available in Europe, the \$12,000 simulator-tester from Applied Data Communications can simulate a network operating in the increasingly popular X.25 packet-switching protocol. Thus terminal interfaces may be developed more easily and cheaply, and front-end processors may also be debugged, since the unit can simulate terminal inputs.

Most packet networks are being developed with individually designed test systems or with the net on line, says Charles A. Morrissey, marketing vice president of the Tustin, Calif., firm. The 8080A-based tester can replace either at common baud rates up to 19,200, he says.

For its part, American Satellite Corp. is prepared to help its customers operate their earth stations more automatically. The Germantown, Md., company is making available a communications controller that uses a microprocessor to split satellite channels into the proper bandwidth segments for simultaneous transmission of computer data, voice, facsimile—in fact, of any data mix.

Without the unit, a human operator must do the mixing with a combination of hardware and software. The controller can handle 15 different inputs simultaneously and can provide satellite delay compensation and encryption.

The company designed the controller for its 250-kilobit-per-second earth stations. It will lease the unit for about \$500 a month, depending on the number of add-on features like encryption.

**Antenna.** Not to be outdone, Comsat Laboratories showed its multiple-beam torus antenna. It will be part of the parent operation's high-performance earth stations in West Virginia, Maine, and California serving as many as seven satellites in the 6-gigahertz up-link and 4-GHz down-link bands and grouped along arcs of the geostationary orbit about

20° wide.

The single, torus-shaped reflector can generate several beams because of the partial overlapping illumination of its surface by a number of small, moveable antenna feeds. Each beam is directed to a specific bird, and therefore an earth station is simultaneously linked to a number of satellites.

-Harvey J. Hindin

### Components

## Motorola bows out of LCD business

Economics, rather than technology hangups, appear to be behind Motorola Inc.'s dropout from the liquid-crystal business. The abrupt announcement on Feb. 14 that was part of the corporate 1979 earnings statement caught many by surprise, especially in light of the vigor with which the semiconductor group has pushed LCDs.

**Japanese role.** What evidently cooled Motorola's ardor for LCDs is the Japanese onslaught on the market and what it portends for profit margins. In watch-display modules alone, the price per unit has been cut

in half in the past year, to well below \$1 each.

The downward pricing impetus is coming from Japanese producers, principally Sharp Electronics, which put a new \$10 million automated manufacturing facility on stream. It is ironic that Motorola would suffer first, says a competitor, since several years ago it chopped prices in order to get market share.

One competitor not surprised by the move is Patrick L. Hoffpaur, director of National Semiconductor Corp.'s Salt Lake City LCD facility. He says fierce price and technology competition with Japanese companies was a factor, and Motorola was not generating enough volume to justify investment. Other firms will similarly drop out, he adds.

Motorola had a good product line, especially for automotive dashboard use, he says. He has been hiring its LCD engineers to beef up his operations, he adds.

Company sources say Motorola Semiconductor management came to the conclusion that LCD returns, even if things went well, could not match those from booming integrated circuits and decided to redeploy when business was strong, rather than waiting. The price tag for

## Retrievable satellite charting sun spots

Designed to study the sun, the first earth satellite slated to be retrieved by the space shuttle was launched on Feb. 14. Dubbed SMM for solar maximum mission, it will monitor the violent explosions on the sun known as solar flares. These flares are being generated by the sun as it enters an 11-year cycle of peak sun-spot activity. The amount of energy released is sufficient to cut off altogether the communications links in most forms of electronic communications [*Electronics*, July 19, 1979, p. 94].

The spacecraft instrumentation package will provide much needed information on the intensity and duration of the flares, says Harold L. Glaser, director of the project for the National Aeronautics and Space Administration. This, in turn, will help planners of radio communication systems to provide for alternative links should the usual ones go out of commission. The data, which is expected to be generated for about a two-year span, is particularly important to the military.

It is not clear at this point that the SMM satellite will need to be brought back to earth once it completes its mission, says Joseph Purcell of NASA's Goddard Space Flight Center. But refurbishing it for reuse would save millions of dollars, so for now it is number 15 on the shuttle mission list.

Given the delays in getting the shuttle ready for operation (for example its heat-resistant tile skin seems reluctant to stay on), it is not so clear that it will be ready for the low-priority retrieval, late in 1982 or early in 1983, when the bird will be ready to come down

-H. J. H.

# Phoenix...

where you can warm up your career!

If your goals include both a rewarding lifestyle and a stimulating career with an advanced-technology company, Sperry Flight Systems has good news for you.

Expanding business in the commercial, military and space avionics markets has created immediate opportunities for engineers at Sperry Flight Systems.

## Systems Design Engineers

Our Systems Engineers are heavily involved with:

**Navigation Systems** which include strapdown inertial techniques.

**Control Systems** which include digital as well as analog computations using state-of-the-art sensors.

**Multiplex Systems** which are used to integrate all aspects of an aircraft avionics suite.

**Display Systems** which include color CRT displays used for both commercial and military aircraft.

## Hardware Design Engineers

Our Hardware Engineers are involved with digital and analog circuit design, microprocessor applications and interface, state-of-the-art power supply design, advanced memory design, and fiber optic development.

## Software Design Engineers

Our Software Engineers are involved with:

**Airborne Operational Software** using assembly language and higher order languages, e.g. PASCAL.

**Support Software** dealing with compilers, assemblers, and emulators.

**Software Systems Analysis** to include coding, checkout, and validation.

**Because of recent expansion, we also need to hire experienced engineers to develop as Project Leaders.**

## Find out more!

To explore these positions further, send your resume and salary history, in complete confidence, to Jim Kenyon, or give him a call, toll-free, at (800) 528-0528.



P. O. Box 21111  
Phoenix, Arizona 85036

We're an Equal Opportunity Employer.





**Cambion Cage Jacks** are ideal for mounting components or for function switching. No soldering or unsoldering—just snap in and out. They're quick, easy, and economical. Here's why CAMBION's the best:

**contact**—3 beryllium copper spring surfaces in a unique "cage" insure superior contact redundancy.

**captivated cage**—insures proper insertion/extraction force.

**long life**—up to 50,000 cycles of use.

**selection**—almost any component lead size, from .014 to .080".

**fast delivery**—literally millions available from 54 distributors or directly from CAMBION.

For all the details, send for our FREE technical brochure. Cambridge Thermionic Corporation, 445 Concord Avenue, Cambridge, MA 02238. (617) 491-5400.

**CAMBION**  
The Right Connection.

## Electronics review

Motorola's dropout totaled \$7.9 million, in 1979 results, but the figure also includes writeoffs for watch modules and quartz crystals.

Although Motorola has offered LCD operation around to potential buyers, it is unlikely to find a taker, one source says, unless the package would be turnkey, with staff included. -Larry Waller and Larry Marion

## Government

### Congress leaning to competitive AT&T

Odds makers now favor passage of legislation that would permit American Telephone & Telegraph Co. to create arms-length subsidiaries to compete in unregulated data-processing and other markets. A late Justice Department protest and rising industry concern among AT&T competitors will not affect the odds, observers feel.

**No concern.** The Commerce Department's National Telecommunications and Information Administration, which supports the AT&T subsidiary proposal, says it is not concerned about the Justice Depart-

ment's opposition to legislation modifying the 1956 antitrust consent decree against Western Electric Co., AT&T's manufacturing arm, that limits the company to regulated markets.

**No choice.** "Justice really had no other choice," notes NTIA congressional and public affairs chief William Garrison, citing the ongoing Federal antitrust suit that calls for divestiture of any AT&T segments that would enter unregulated telecommunications markets. The suit is expected to come to trial this year.

Garrison's comments are in response to questions about a February letter by the Justice Department's new antitrust division chief Sanford M. Litvack to Rep. Harley D. Staggers (D., W. Va.). Staggers is chairman of the Interstate and Foreign Commerce Committee, which will begin consideration of its communications subcommittee's revision of the Communications Act of 1934 by the end of the month [*Electronics*, Feb. 14, p. 61].

Breaking a long silence by the department on the bill, the Litvack letter represents a clear split with the White House, which supported the legislation in the testimony of NTIA chief Henry Geller and economic

## News briefs

### Fiber-optic connectors to flourish

By the end of the decade, the market for fiber-optic connectors will surpass \$30 million a year, a tenfold increase from 1979, says a consulting firm. The primary market will be in computer networks linking the host machine with terminals, says International Resource Development Inc. Although telecommunications applications will use fiber optics, they will incorporate few connectors because of the long distance covered. In contrast, the automobile market should boom by the mid-1980s, says the firm's report. Early problems with the technology, including high attenuation and poor repeatability, have been solved, and connector prices have fallen to below \$1 in some instances, according to the Norwalk, Conn., firm.

### Memorex raises prices

Inflation may be reversing the longstanding downward price trend in the computer industry. Memorex Corp., a major maker of computer peripherals and communication equipment, is putting into effect a range of price hikes on the purchase, lease, and maintenance contracts for much of its equipment. The Santa Clara, Calif., company cites inflationary pressures in announcing its move. Other companies in the computer field are making similar pricing moves [*Electronics*, Jan. 31, p. 46]. Typical Memorex increases are about 7%, although the top hike is 38%. Maintenance prices typically went up 15%.

adviser Alfred Kahn earlier this year. The delayed Justice Department response suggests to some Staggers committee staff members that the agency may have been unsure of its position.

In a mid-February letter to Staggers, three groups—the Computer and Communications Industry Association, Independent Data-Communications Manufacturers Association, and the Ad Hoc Committee for Competitive Telecommunications—say the wholly deregulated AT&T subsidiary concept was presented to the communications subcommittee by the company last July, only after hearings had ended. The bill with that proposal would permit AT&T to “offer a multibillion dollar mixture of equipment and services” at its option, they say. —Ray Connolly

## Satellites

### Redundant time slots may conquer rain

When it rains in the plain, 12-gigahertz satellites will not have enough gain. This is because the amplification available in the new Ku-band satellite communications systems may not provide a signal-to-noise ratio adequate to maintain the designated bit-error rate in the received signals.

There is a cost-effective solution, says Anthony S. Acampora, a technical staff member of the satellite systems research group at Bell Laboratories' Holmdel facility. He proposes creating a reserve of time slots in each time-division multiple-access transmission frame (about 6% of each TDMA frame) to retransmit satellite signals beclouded by rain.

**Coding.** The key to Acampora's proposal is convolutional coding [*Electronics*, March 29, 1979, p. 91]. Also important are cost-effective large-scale integrated circuits, so that “the hardware complexity to enable TDMA operation with coded end-of-frame time slots during rain is quite modest,” he says.

The number of time slots set aside

for the rain margin, as it is called, would vary, depending upon such factors as the number of ground stations in each of the networks (still in planning). The net's central control computer would assign three additional time slots for each one already assigned to any ground station signaling rain interference. It also would reshuffle all the time-slot assignments so that the needy station would receive the signal packets in groups of four.

**Repeat.** Each of the four contiguous packets would contain the same data, but with different parity bits from the convolutional coding. Each ground station would be equipped with the necessary VLSI circuitry for the additional decoding, comparing, and reconstructing of a single relatively errorless signal packet.

The transmitting ground station would encode its outgoing data using what is called a rate  $1/3$  convolutional code. The receiving station would store the extended burst in a high-speed buffer.

The ground station has the time to decode and process the four signal packets because, for most of each TDMA duty cycle, the satellite is transmitting signal bursts to the other stations. Typically, a 600-megabit-per-second signal can be decoded at 10 Mb/s during the no-reception part of the duty cycle.

**Pickup.** If Acampora's proposal goes into effect, “we can pick up 5 dB of the rain margin because we are transmitting the information more often and 5 dB because of the coding gain,” he says. Thus the total improvement in the signal-to-noise ratio can be 10 dB.

The Bell Labs group is building a TDMA test setup to test the feasibility of the reserve-slot concept. The new satellite communication systems will be going to 14 GHz for their up links and 12 GHz for their down links because such transmissions are free from the interference plaguing the existing 6- and 4-GHz satellite nets. The cost-effective solution to the rain problem in the 14-GHz up link is something like more radiated power in the earth station, Acampora notes. —Harvey J. Hindin

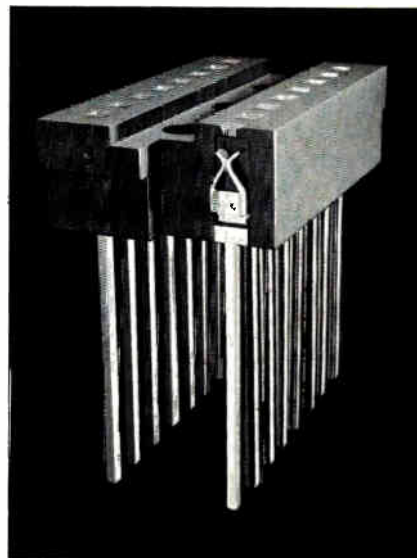

**Cambion Wire-Wrapable Sockets** are tops in quality, construction, and selection. Best of all—massive availability. Here are the facts:

- high temperature (160°C), flame retardant diallyl phthalate bodies.
- alignment within  $\pm .010$  of true position for fully automatic machine wrapping.
- choose replaceable or non-replaceable (phosphor bronze) pins.
- choose three-wrap or two-wrap.
- dual leaf spring for contact redundancy & increased reliability.
- all popular sizes in tin or gold plating: 6-pin, 8, 14, 16, 18, 20, 22, 24, 28, 36, and 40.
- immediate delivery from 54 distributors nationwide and from CAMBION.
- Send for our latest socket brochure and complete IC packaging catalog 121. Cambridge Thermionic Corporation, 445 Concord Avenue, Cambridge, MA 02238. (617) 491-5400.

**CAMBION®**  
The Right Connection.

# WHAT'S THE LOWEST PRICED MICROPROCESSOR DESIGN TOOL AVAILABLE TODAY?

With today's proliferation of MPU types and the often confusing array of specs, selecting the correct MPU for your application becomes more difficult and more time consuming. The decisions involving 16-bit vs 8-bit, microprocessor vs micro-computer, compound as the range of choices and complexity continues to grow. Is the single chip microcomputer too slow? Is the 16-bit microprocessor overkill? Do the manufacturer's specs provide sufficient answers?

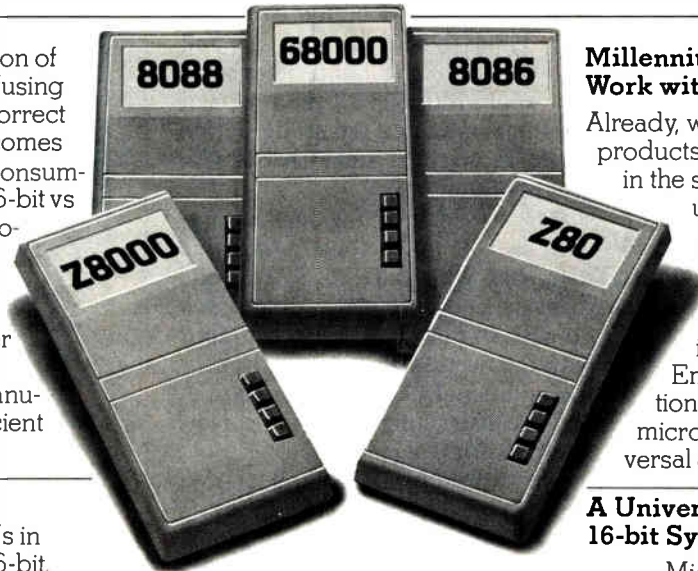

## There is a better way.

Evaluate the new MPUs in your applications, 8-bit and 16-bit 8086, Z8000, 68000, Z80, 8085. And at very low cost. And you don't need to buy expensive development systems or depend on spec sheets to really understand an MPU.

Millennium's new MicroSystem Designer—Series 1000 solves those problems, and a whole lot more.

## A design and debug aid that everyone can afford.

You can't afford not to keep up. The basic MicroSystem Designer is only \$990.\* Typical costs of the personality modules are \$550\* for the Z80, and \$960\* for the 8086 and 8088.

That buys you a system that will help you in such tasks as creating, executing and debugging programs, developing trial circuits; interfacing to I/O devices; debugging interrupt routines; building and debugging

hardware prototypes; and measuring code performance.

To do all this, the MicroSystem Designer includes features like hardware breakpoint, single-step, automatic step, manual interrupt control, user code timing function, and a real-time clock signal. An audio cassette interface lets you save programs on tape. And an RS232 serial link can tie you in with a host computer or development station.

## Become the MPU Expert Quickly.

Learning the ins and outs of new microprocessors and micro-computers can be difficult and time consuming. The MicroSystem Designer helps you make unbiased appraisals of the architectural resources of various MPUs. Or to compare software in two MPUs for proper benchmarking.

## Millennium Makes it Easy to Work with Microprocessors.

Already, we've introduced a series of products which makes us the leader in the support of microprocessor users in system development, testing, evaluation and repair. The MicroSystem Analyzer performs real-time board and system testing and the MicroSystem Emulator is an in-circuit emulation terminal for today's popular microprocessors. Both are universal and low cost.

## A Universal Tool for 8 and 16-bit System Design.

MicroSystem Designer will work with the most popular MPUs. Now and in the future. By simply changing low-cost personality modules, you can be right on top of the newest MPUs shown in the chart.

Here Today	More Tomorrow
8086	6809
8088	68000
Z8000	8048
Z80A	8085

## Get in Step—Get in Touch.

If you need more info on the MicroSystem Designer, or need solutions to MPU problems, write or call Chris Bailey, Millennium Systems, Inc. 19020 Pruneridge Avenue, Cupertino, California 95014. (408) 996-9109.

\*Domestic Price Only

# MILLENNIUM

a subsidiary of American Microsystems, Inc.

# MILLENNIUM'S MICROSYSTEM DESIGNER: \$1,540!

MicroSystem Designer, the first low-cost personal design tool for MPU users.

MicroCable and 40-pin connector let you plug right into your prototype system.

Solderless breadboard for prototyping

In back, real-time clock signal, RS232 serial port, audio cassette jacks, expansion connector

Personality Module.

User Port LEDs.

User Port Switches.

16 digit alpha-numeric display gives a clear readout.

Hex Input Pad.

Interrupt Keys.

Command Keyboard.

# Only TEAC makes both on-site and in-lab cassette data recording equipment.





Have you been going to one manufacturer for your portable data recorders, and to another for recorders for your lab? TEAC makes things easier for you by offering a complete line of data acquisition equipment including both portable and lab models. Complete compatibility allows you to collect data in the field with a convenient portable recorder and bring it back to the lab for analysis on a full-feature lab recorder.

Of all our models, you'll find that our cassette-format recorders are the most convenient. The R-60, R-61 and R-61D portable cassette data recorders have proven extremely popular because of their ruggedness, stability of operation and light weight. They can record four channels of data in a choice of DR or FM format.

Back in the lab, the R-80 and R-81 provide big-recorder performance and features without using up a big amount of space or budget. Both can be mounted in standard E.I.A rack panels if desired.

These five cassette data recorders are part of a complete line of data acquisition equipment. Only TEAC can handle *all* your data acquisition needs.

Feature Comparison Chart

Model	Feature	Channels	Record System*	Tape Speed	Freq. Response	Power	Weight
<b>R-81</b> 		7	FM (DR: option)	4 speeds (7 1/2, 3 3/4, 1 7/8, 1 5/8 ips)	FM: DC — 5k Hz at 7 1/2 ips	DC Car Battery (AC with AD-80)	12kg approx.
<b>R-80</b> 		4	FM (DR: option)	4 speeds (7 1/2, 3 3/4, 1 7/8, 1 5/8 ips)	FM: DC — 5k Hz at 7 1/2 ips	DC Car Battery (AC with AD-80)	12kg approx.
<b>R-61</b> 		4	Ch-1: FM/DR Ch-2: FM/DR Ch-3: FM Ch-4: FM	1 speed (1 7/8 ips)	DR: 50 — 8k Hz FM: DC — 625 Hz	DC Car Battery with CL-61 (AC with PA-2)	4.7kg approx.
<b>R-61D</b> 		4	Ch-1: DR/FM Ch-2: DR/FM Ch-3: DR Ch-4: DR	1 speed (1 7/8 ips)	DR: 50 — 8k Hz FM: DC — 625 Hz	DC Car Battery with CL-61 (AC with PA-2)	4.7kg approx.
<b>R-60</b> 		4	FM	1 speed (1 7/8 ips)	FM: DC — 625 Hz	AC	6.5kg approx.

TEAC CORPORATION: 3-7-3 Naka-cho, Musashino, Tokyo, Japan Tel: (0422) 53-1111

\* Noise Comp. & Memo capable

**TEAC**

• U.S.A. B.J. Wolfe Enterprise Inc., Tel: (213) 877-5518 • Canada R.H. Nichols Co., Ltd., Tel: (416) 661-3190 • Hongkong Dah Chong Hong Ltd., Tel: 5-261111, 5-226258  
 • Australia & New Zealand Jacoby Mitchell Ltd., Tel: 6307400 • South Africa Mayfair Sales (Pty) Ltd., Tel: 011-834-2131 • Belgium & Luxembourg Simac Electronics S.P.R.L., • Denmark Danbit, Tel: (03) 141515 • France Tekelec Airtronic S.A., Tel: (027) 7536 • Holland Simac Electronics B.V., Tel: 040-533725 • Italy A.E.S.S.E. S.R.L., Tel: 54.64.741-2-3 • Switzerland Wenger Datentechnik, Tel: 061-34 50 96 • Spain Ataio Ingenieros S.A., Tel: (215) 3543 • Sweden teleinstrument ab, Tel: 08-380 370  
 • United Kingdom International Recorders Ltd., Tel: 04427 5959 • West Germany & Austria nbn Elektronik Starnberg, Tel: (08151) 13036



## **Settlement limits AT&T access to U. S. IR&D files**

American Telephone & Telegraph Co. will get only a limited look at proprietary electronics industries data on independent research and development (IR&D) in Federal files as a result of two months of tough negotiations with the Government and three trade groups. AT&T lawyers had subpoenaed all cost and technical data in Government IR&D files as part of its defense against a Federal antitrust suit, in an effort to show that other companies have in fact pursued telecommunications R&D independently in areas that AT&T is being charged with monopolizing [*Electronics*, Oct. 25, 1979, p. 58].

Strong opposition from the American Electronics Association, the Electronic Industries Association, and the Aerospace Industries Association has produced a compromise **that will let AT&T see only general IR&D data stripped of identification of companies, funding, and specific projects.** Moreover, access to the files will be limited to attorneys working directly on the case.

## **Investigate FAA delays, boost R&D, EIA tells Congress**

Time-consuming and costly delays in the Federal Aviation Administration procurement cycle and a "grossly inadequate" research and development budget are reducing the number of companies bidding on air-traffic control programs. That is the judgment of Peter F. McCloskey, Electronic Industries Association president, who has urged Congress to investigate the FAA procurement process and increase the R&D budget for air-traffic control to encourage competition and accelerate long-stalled programs. McCloskey told the House subcommittee on transportation, aviation, and communication that EIA companies are **increasingly reluctant to assign resources to "very extensive and costly" R&D proposal paperwork** and then hold key employees on overhead, waiting for action by the FAA and its parent Department of Transportation. Citing the FAA's \$85 million R&D request for fiscal 1981—down from the \$90 million promised earlier by the Carter Administration—the EIA believes the agency should be spending at least 5% of its funds for R&D. Additionally, McCloskey says Congress should authorize another \$100 million specifically for the long-delayed computer replacement system to modernize the nation's air-traffic control network.

## **1985 power shortage halving EDP growth forecast by CBEMA**

A national electrical energy shortage in 1985—with regional outages as early as 1983—could produce "serious brownouts and actual curtailment of service" that would halve the growth rate of the U. S. data-processing and electrical business-equipment industries. Worse, asserts a new Computer and Business Equipment Manufacturers Association energy forecast, **recovery from the shortage would take 10 to 15 years because of the lead times for building new coal-fired or nuclear power plants.** The CBEMA prediction is based on the U. S.'s achieving only a 50% increase in coal production between 1981 and 1985, instead of doubling it, and of its adding no new nuclear plants. These factors would drop the average reserve margin of electrical capacity to 13% from the present level of 24%—well below the 20% minimum required to meet demand peaks. Especially hard hit, says CBEMA's energy committee, would be the New England, South Atlantic, East South Central, and West South Central areas—all heavily dependent on coal and nuclear power generation. CBEMA wants a presidential or industrial panel appointed to explore alternatives and recommend options before the power shortage develops.

## The challenge to U. S. satellite communications

The gap between American advances in tele-communications satellite technology and its application continues to widen while Europe and Japan mount increasingly strong challenges to U. S. leadership in the field that it pioneered.

The scenerio may produce a sense of *déjà vu* among domestic manufacturers of consumer electronics and semiconductors, but it is worth laying out nonetheless. For Federal support of advanced communications satellite research and development continues to bog down in the bureaucratic swamp created by the National Aeronautics and Space Administration and the Congress, supported by, among others, the three national broadcasting networks, whose interests are threatened.

### NASA's new 1977 program

It has been three years since NASA, acting on a National Academy of Engineering recommendation, moved to get back into communications satellite research and development after a four-year hiatus [*Electronics*, April 14, 1977, p. 57]. The academy was troubled that advanced satcom R&D in industry was dwindling and that military technology was too specialized for other uses. So NASA decided to concentrate its new effort at its Goddard Space Flight Center in Greenbelt, Md., exploring 12-to-14-gigahertz and ultrahigh-frequency direct-broadcast satellite technology for use with 5-foot-diameter rooftop antennas.

NASA's 1977 exploratory undertaking came in the same year that General Electric Co. was already building the 12-to-14-gigahertz direct-broadcast satellite known as BSE with which Japan planned to link its remote home islands and Okinawa with two color TV signals beamed to rooftop antennas of Japanese design. Their diameters were to be as small as 1 to 1.6 meters (3.3 to 5.2 feet) with prices as low as \$200. Drawing on the NASA technologies embodied in the ATS-6 applications technology satellite launched in 1974 and the joint U. S.-Canadian Communications Technology Satellite orbited two years later, Japan's receive-only BSE was launched successfully in 1978 [*Electronics*, March 30, 1978, p. 50]. Admittedly, the experimental BSE was not as sophisticated as proposed U. S. satcoms, but it was in orbit and it worked. The prospect of American TV-watchers having too many channel choices from a direct-broadcast system troubled U. S. broadcasters and their licensees, of course, and the NASA effort, coincidentally or not, quietly faded from view.

But now NASA has made a discovery, thanks

to two study contractors—ITT's U. S. Telephone & Telegraph Corp. and Western Union Corp.—and has inaugurated a new satcom R&D program. This one is based at its Lewis Research Center in Cleveland.

The discovery is that U. S. voice, data, and video communications traffic will grow fivefold by the year 2000, with satellites accounting for more than a quarter of all long-distance voice communications, as well as half the data and video traffic. The two \$650,000 year-long studies evaluated 31 service categories and premised their forecasts on annual growth rates of 10% for voice, 5% for video, and 17.6% for data, says NASA's John M. McElroy, communications division chief in the Office of Space and Terrestrial Applications.

By the early 1990s that growth will saturate existing U. S. domsat capacity in the 4-to-5-GHz (C) band and 11-to-14-GHz (Ku) band. Each of these bands has a 500-megahertz allocation, permitting the use of a dozen transponders of 12 Mhz each plus separating guardbands. Transponder capability can be doubled or quadrupled, "depending on how optimistic you are," McElroy explains, by adding overlying perpendicularly polarized signals in order to raise satellite capacity to 24 or 48 TV channels or up to 3,000 voice signals.

### The saturation solution at hand

Yet saturation will come in these bands, however engineered, so NASA's new Lewis program will place "primary emphasis on developing technology needed to open the 20-to-30-GHz band for commercial use during the next two decades in a cost-effective and spectrum-conserving manner." That Ka band of 2,500 MHz permits no overlays because atmospheric propagation of its signals is not as great, McElroy points out, yet this is more than offset by the five times greater allocation than at the C or Ku bands, permitting message capacities 50 to 100 times greater.

But whether the nation or NASA can afford to wait two more decades to perfect the Ka band technology and orbit the satellites using it is open to question. NASA's McElroy acknowledges that the European Space Agency shows strong interest in developing similar satellites, too. And what about Japan? Ford Aerospace Co. says that its predecessor, Philco Ford, built a satellite using a 31-GHz up link and a 21-GHz down link based on the American communications satellite program. Called Sakura, it went into orbit in 1977.

-Ray Connolly

# abbott

## POWER SUPPLIES

### Our standard products meet MIL specs

Why order "specials" and pay for "options" when you can get an Abbott militarized power module virtually off-the-shelf for fewer dollars per watt? Take our Model C's and W's, for example. They're hermetically sealed, feature superior tracking accuracy for *all* rated conditions, and come in package sizes as small as 2½" x 3¼" x 3¼". (The units we put on SKYLAB, except for some special components and testing, were "standard".)



**28 VDC to DC Power Modules (Model "C")** — feature smaller volume, lower weight, and higher performance. Low peak-to-peak ripple and close regulation meet even the most demanding specs. The standard Model "C" line converts 24-30 volts DC to any output between 5 and 100 volts DC.

**For Catalog Circle Card Number 100**

**400 Hz to DC Power Modules (Model "W")** — feature close line and load regulation, low output ripple, and are built to meet the EMI requirements of MIL-STD-461. The Model "W" family provides output voltages from 5 to 100 VDC with current levels from 0.3 to 20 amps. Why waste time and money designing a "special" power supply?

**For Catalog Circle Card Number 101**

**Dual Output Versions** — both the C and the W series are available in hermetically sealed, dual output models that feature 1% tracking accuracy, 0.2% regulation, low peak to peak ripple, +100°C operation . . . and we offer CC's and WW's as standards, not "specials."

**For Catalog Circle Card Number 102**

See Power Supply Section 4000, and Transformer Section 5600, Vol. 2, of your EEM catalog; or Power Supply Section 4500, and Transformer Section 0400, Vol. 2, of your GOLD BOOK for complete information on Abbott products.

**abbott transistor**

**LABORATORIES, INCORPORATED**

General Offices  
5200 W. Jefferson Blvd., Los Angeles 90016  
(213) 936-8185 Telex: 69-1398

Eastern Office  
1224 Anderson Ave., Fort Lee, N.J. 07024  
(201) 224-6900 Telex: 13-5332

# INTERSIL'S CAZ



**ICL7600 CAZ AMPS — ULTRA-STABLE OPERATIONAL AMPLIFIERS.**

**ICL7605 CAZ AMPS — FULLY DIFFERENTIAL INPUT INSTRUMENTATION AMPLIFIERS.**

- $2\mu\text{V}$  Initial Offset Voltage
- $0.005\mu\text{V}$  per  $^{\circ}\text{C}$  Offset Drift Tempco
- $0.2\mu\text{V}$  per Year Offset Stability
- Low Power CMOS: 20mW Max Power Dissipation at  $\pm 5\text{V}$

## CAZ AMPS?

Right. CAZ AMPS. Commutating Auto-Zeroing Amplifiers. The closest thing you can get to an ideal zero offset amplifier. It's a revolutionary product using a revolutionary idea from Intersil (patent pending). Two amplifiers are utilized instead of one... in a monolithic CMOS IC. While one amplifier is handling the signal, the other is zeroing itself. What you get is automatic cancelling of offset, offset drift with time and temperature and reduction of low frequency noise. It's a revolutionary product... at a revolutionary price: As low as \$6.50 in 100's.

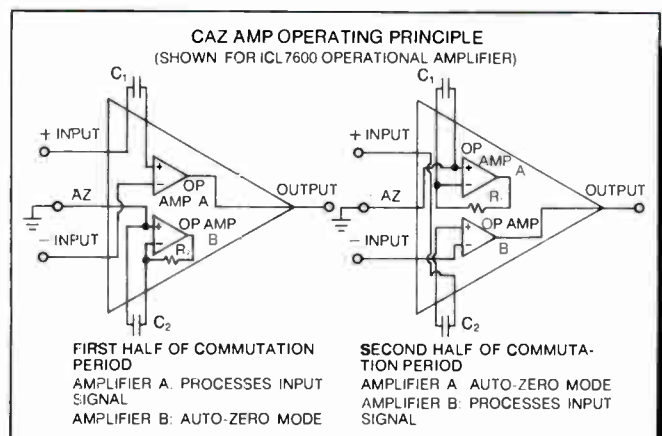

# AMPS: DYNAMITE!

## ONE PRINCIPLE. TWO CAZ AMPS.

Commutating Auto-Zeroing Operational Amplifiers. Commutating Auto-Zeroing Instrumentation Amplifiers. CAZ AMPS.

## GOODBYE EXPENSIVE MODULAR OP AMPS.

The CAZ AMP does it better. For less. In fact, the ICL7600 CAZ AMP operational amplifier is a perfect substitute for those other precision low drift Op Amps. With excellent DC stability characteristics that enable you to amplify very low level signals... stability that's virtually unaffected by time and temperature. All on a single chip. At one third the cost of those other precision Op Amps.

## HELLO INEXPENSIVE INSTRUMENTATION AMPLIFIERS.

If you're using Op Amps in instrumentation applications because you couldn't afford instrument amplifiers, the ICL7605 CAZ AMP instrumentation amplifier is good news. It's a precision low level amplifier that can extract small signals in the presence of high common mode voltages: Rail-to-Rail common mode range with 100 db common mode rejection. In fact, it's the best low drift instrument amplifier money couldn't buy. Until now. And, it only costs \$15.00 in lots of 100.

## IF THAT'S NOT ENOUGH DYNAMITE TO GET YOUR ATTENTION, CHECK THE COMPARISON BELOW.

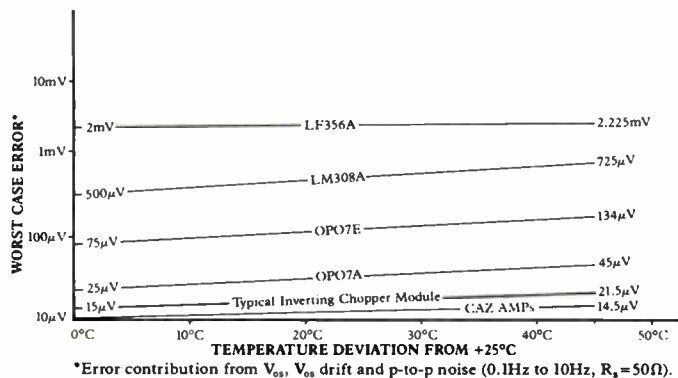

## A BROAD SPECTRUM OF APPLICATIONS.

You can use these CAZ AMPS as the front end of virtually any A/D converter in the demanding situations that surround medical, industrial or instrumentation applications. Accurately. In fact, super accurately. CAZ AMPS are the perfect answer to amplifying very small signals in applications such as digital voltmeters, thermocouples, strain gauge bridges, current shunts...you name it.

## AT AFFORDABLE PRICES:

CAZ AMP OP AMPS	Temp Range	100 Pc Price
ICL7600MDD	-55/+125°C	\$20.00
ICL7600IJD	-25/+85°C	\$10.00
ICL7600CPD	0/+70°C	\$ 6.50

## CAZ AMP

INSTRUMENT AMPS	Temp Range	100 Pc Price
ICL7605MDN	-55/+125°C	\$45.00
ICL7605IJN	-25/+85°C	\$22.50
ICL7605CPN	0/+70°C	\$15.00

## COMPARE THEM YOURSELF.

Compare performance. Compare cost. We think you'll agree. The CAZ AMPS are dynamite. For complete technical and applications data, call your nearest Intersil Sales Office or Franchised Distributor. Or, return the coupon below. We'll send you everything you need to know about the CAZ AMPS. And we think you'll get a bang out of it.

## INTERASIL SALES OFFICES:

CALIFORNIA: Sunnyvale (408) 744-0618, Long Beach (213) 436-9261 • COLORADO: Aurora (303) 750-7004 • FLORIDA: Fort Lauderdale (305) 772-4122 • ILLINOIS: Hinsdale (312) 986-5303 • MASSACHUSETTS: Lexington (617) 861-6220 • MINNESOTA: Minneapolis (612) 925-1844 • NEW JERSEY: Englewood Cliffs (201) 567-5585 • OHIO: Dayton (513) 866-7328 • TEXAS: Dallas (214) 387-0539 • CANADA: Brampton, Ontario (416) 457-1014

## INTERASIL FRANCHISED DISTRIBUTORS:

Advent (IND, IA) • Alliance • Arrow • Bell Industries • CESCO • Component Specialties • Components Plus • Diplomat (FLA, MD, NJ) • Harvey (upstate NY) • Intermark • Kierulff • LCOMP • Parrott • R.A.E. Ind. Elect. Ltd. • RESCO/Raleigh • Schweber • Summit • Wyle • Zentronics Ltd.

# INTERASIL

Analog Products — Data Acquisition  
10710 No. Tantau Ave., Cupertino, CA 95014  
Tel: (408) 996-5000 TWX: 910-338-0171  
(800) 538-7930 (Outside California)

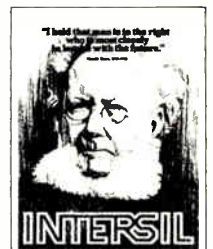

Gentlemen,

- Please send me complete product information on the ICL7600 CAZ AMP Operational Amplifier and the ICL7605 CAZ AMP Instrumentation Amplifier.
- Please include your Henrik Ibsen poster.

Name \_\_\_\_\_  
 Company \_\_\_\_\_  
 Address \_\_\_\_\_  
 City \_\_\_\_\_ State \_\_\_\_\_ Zip \_\_\_\_\_  
 Country \_\_\_\_\_

# The most important data communications purchase you'll ever make isn't a device or component!

It's a timely, easy-to-follow guide that spells out exactly what you need to know to get the best possible deals on all data communications equipment. To turn data communications procurement into a smoothly running, cost-effective operation. And to **save you thousands** in data communications costs while delivering top-performance service!

Just published, this immensely important resource comes packed with the most authoritative and current information you need to make all your data communications purchasing decisions.

Plus step-by-step guidelines on the procurement process that speeds communications with vendors and assures that you get exactly the equipment you're looking for.

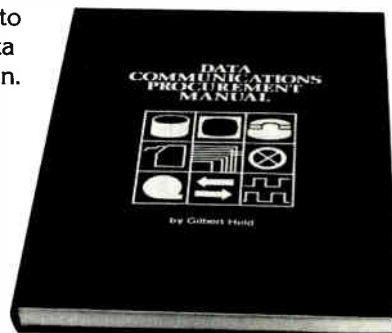

## A first-of-its-kind working reference that puts right into your hands...

- an alphabetical checklist of procurement document items to help you determine what's relevant to you and develop clauses or descriptions for the solicitation document
- sample solicitation format plus a compilation of solicitation clauses and forms most frequently used in procurement documents
- specifications for 38 devices, with a complete listing of both general and specific device specifications to consider when developing communications component requirements
- tabulation of Bell System data-set operating characteristics to help you develop a functional modem procurement
- vital facts to determine if special pin cross-connections are required to interface components with existing equipment
- tables of present value interest factors for yearly and monthly periods varying from 6 to 15%. Vital for evaluating proposals for future costs
- yearly energy costs of a continuously operating device in cents per Kilowatt hour
- checklist to develop a schedule of procurement activities
- plus invaluable guidance on the basic construction of a sample solicitation

Before you choose any data communications equipment, choose the **DATA COMMUNICATIONS PROCUREMENT MANUAL**. The before-you-buy buy for every data communications purchase!

## Data Communications Procurement Manual

by Gilbert Held

150 pages

### Contents

**PROCUREMENT DOCUMENT ITEMS. SAMPLE SOLICITATION CLAUSES AND FORMS.** Cover Sheet. Contact Form and Representations, Certifications, and Other Vendor Statements. Instructions, Conditions, and Notices to Vendors. Evaluation and Award Factors. Supplies/Services and Prices. Mandatory Specifications. Preservation/Packaging/Packing. Deliveries or Performance. Inspection and Acceptance. Special Provisions. Contract Administration Data. General Provisions. List of Documents and Attachments. **SPECIFICATIONS.** General Specifications. Specific Specifications (Acoustic Coupler, Analog Extension Unit, Analog Test Set, Automatic Calling Unit, Cable, Channel Service Unit, Code Converter, Concentrator, Controller, Data Access Arrangement, Data Compactor, Data Line Analyzer, Data Security Unit, Data Service Unit, Echo Suppressor, Facsimile Equipment, Frequency-Division Multiplexer, Front-End Processor, Interface Converter, Inverse Multiplexer, Limited-Distance Modem, Line Driver, MIL-STD-188C Adapter, Modem, Modem/Line-Sharing Unit, Multipoint Modem, Multiport Modem, Parallel Interface Extender, Port Selector, Port-Sharing Unit, Remote Batch Terminal, Speech/Data Unit, Speed Converter, Statistical Multiplexer, Switch, Time-Division Multiplexer, Transmission Test Set, Voice Adapter). **APPENDIXES.** Bell System Data Set Compatibility Guide. Modem Options. EIA Terminal/Modem Interface. Modem Interface Description. Present Value Interest Factors. Energy Consumption Cost. Communications Procurement Plan. Sample Modem Procurement.

### Order today using this coupon!

Return coupon to:

Data Communications Procurement Manual  
P.O. Box 669  
Hightstown, New Jersey 08520

Name \_\_\_\_\_

Send me \_\_\_\_\_ copy (copies) of the **DATA COMMUNICATIONS PROCUREMENT MANUAL** (606534-0) on a 10-day money-back guarantee. I understand that if I am not absolutely satisfied, I may return the book(s) within 10 days at no further obligation. Otherwise, McGraw-Hill will bill me \$24.50 for each copy, plus applicable sales tax, shipping and handling charges.

Title \_\_\_\_\_

Company \_\_\_\_\_

Address \_\_\_\_\_

City \_\_\_\_\_

State \_\_\_\_\_ Zip \_\_\_\_\_

**SAVE MONEY!** Enclose payment in full, plus local sales tax, and McGraw-Hill pays all regular postage and handling charges. Ten-day money-back guarantee still applies.

Check enclosed     Bill me     Bill my company

This offer subject to acceptance by McGraw-Hill and good only in U.S.



# Here are 5 good reasons to live and work in Greensboro, North Carolina:

## First, Climate:

In Greensboro, you get four moderate seasons. A long Indian Summer, with warm days and cool nights. A temperate winter—just enough snow to be pretty. And there's plenty of sunshine year-round.

## Second, Education:

We've got everything from well managed public schools to prominent colleges and universities. You'll also find a wide variety of schools specializing in exceptional children, college preparation, etc.

## Third, Recreation & The Arts:

Greensboro has noted art galleries, famous golf courses, and plenty of tennis courts. All surrounded by beautiful parks, covering more than 2600 acres. Or, enjoy the nearby Atlantic Coastline and the Blue Ridge Mountains.

## Fourth, Cost-of-living:

You'll find this as moderate as our climate.

## Fifth, (we saved the best till last), Gilbarco is here:

We're a dynamic subsidiary of Exxon, designing and producing precision fuel dispensing systems and monitoring instruments. And we're diversifying into many other areas. You'll find a unique blend of small company teamwork and big company resources.

### We're currently looking for:

**Principal Engineer Project leadership.** BSEE/MSEE & 5 years' hardware/software experience in microprocessor design. **Senior Engineer Affiliate Support** International responsibility for technology transfers. Limited international travel. You must be a technically current solution oriented generalist with 3+ years experience. **Test Engineer/Electronics Analysis** and design of hardware/software interface programs for automatic assembly test. BSEE or equivalent and 3+ years' experience in design, analysis and construction of electronic circuitry required. **Senior Electronic Engineer** Project responsibility. 3+ years' experience in designing microcomputers, using microprocessor chip sets (Hardware/Software). Also designing digital logic (TTL, MOS, etc.), analog circuits, power supplies and new technology (Displays, etc.).

We offer excellent salaries and benefits packages.

For consideration, please send your resume including salary history to Ms. Gail Payne, Employment Department EL-2, Gilbarco, P.O. Box 22087, Greensboro, N.C. 27420

**Gilbarco**

An exceptional way of working—and living.  
A wholly owned subsidiary of EXXON Enterprises Inc.  
We are an equal opportunity employer and invite  
response from minority and female applicants.

# A Programmable Cavity Oscillator?



## The Measure of Excellence Continues with the AILTECH 460 Signal Generator

If you're a believer in instrument versatility, you'll want to know more about the new AILTECH 460 Signal Generator.

Using the same instrument, now you can experience the low noise performance of a cavity generator in a programmable frequency synthesizer. The AILTECH 460 takes you from initial development through your production ATE operation, and it's no longer necessary to settle for a noisy synthesizer incapable of providing selectivity and spurious measurements at the expense of giving up programmability.

Not only is the 460 a low noise source, but check the AM performance—100% at levels to +13 dBm.

If that isn't enough, it has FM,  $\phi$ M, output power from +20 to -140 dBm, from 300 MHz to 650 MHz and an optional 1300 MHz range at +10 dBm to -140 dBm.

Complete with Spin-Wheel Tuning, the AILTECH 460 not only operates like a Signal Generator, but also delivers Synthesizer accuracy tied to its internal 10 MHz frequency standard.

Why not see the 460 in action in the convenience of your own laboratory. Simply call or write Eaton Corporation, Electronic Instrument Division, 2070 Fifth Avenue, Ronkonkoma, New York 11779, (516) 588-3600 today... and don't forget to ask about our new equipment leasing plan.

Circle 62 on reader service card

**EAT•N** Advanced  
Electronics

World Radio History



# International newsletter

---

## **MOS transistors switch up to 5 kW at low internal loss**

Researchers at Siemens AG have developed an MOS technology that allows the fabrication of power transistors with performance characteristics unattainable before. Called Sipmos, for Siemens power MOS, the new technology makes possible **drain-to-source voltage ratings of up to 200 v in devices now being offered as samples and of up to 1,000 v for units currently being developed.** The latter value is twice that of the highest-rated power transistors from other producers, the company says. Also of note is the low forward resistance. For samples of 50-v devices, it checks in at 0.03  $\Omega$ , in contrast to 0.1  $\Omega$  for competing MOS power transistors. The low resistance means that the devices now being offered can switch power levels of 5 kW and more at very low internal losses. Significant, too, is the low switch-on voltage range—from 2 to 5 v—which allows the transistors to be driven directly by microcomputers and other large-scale integrated circuits.

## **VLSI Co-Op Labs announces fast E-beam mask-making system**

A high-speed electron-beam pattern generator, a fast electron-beam pattern replicator, two new positive photoresists, and an electron-beam mask-inspection system have been unveiled by Japan's VLSI Cooperative Laboratories as it winds up its affairs and prepares to go out of business on March 31. **The pattern generator is about 10 times faster than the raster-scan units announced earlier by the labs and Toshiba Corp.** [*Electronics*, March 30, 1978, p. 44; March 31, 1977, p. 56 or 6E]. An augmented raster-scan system that incorporates a rectangular beam with a variable width up to 4  $\mu\text{m}$ , it allows features to be written with fewer scanning lines than previous such units. Contributing to the higher speed are **the two resists, which are more sensitive than the industry-standard polymethyl methacrylate (PMMA).** They are also more resistant to the heat in subsequent processes. (See also story on p. 73.)

## **United Kingdom shopping in U. S. for high technology**

Great Britain's semigovernmental National Research and Development Corp. has retained the Stanford Research Institute, Palo Alto, Calif., and Arthur D. Little Inc., Cambridge, Mass., to seek out high-technology firms that might license their techniques at least within the UK and, it is hoped, throughout Western Europe. **The effort will be short-term, ending in late May.** Until then, the two will be talking to firms with marketable technology in computer peripherals, electronic instrumentation, robotics, manufacturing technology, automatic test equipment, and other areas of electronics. Interested firms would be put in touch with the NRDC, which would negotiate for the technology.

## **Siemens to market Philips-Grundig's Video 2000**

The chances for the Philips-Grundig-developed Video 2000 video recorder system to grab shares of the European market from Japanese producers have improved significantly now that electronics giant Siemens AG has come out in favor of the Dutch-West German eight-hour reversible cassette system [*Electronics*, July 5, 1979, p. 72]. Although it will not produce the recorder itself, Siemens will sell it under its own label, beginning early this summer. With the Munich-based company's marketing clout and its big distribution network behind the Video 2000, industry observers say, **the system should tip the balance of market shares in favor of the two European producers—at least in West Germany, where Japanese firms' share of the market is currently better than 50%.**

## **Audio gear makers sign up for Telefunken's antinoise system**

The High Com noise-suppression system for audio applications developed by AEG-Telefunken's entertainment electronics arm, Telefunken GmbH [*Electronics*, Feb. 15, 1979, p. 70], is off to a good start. Since its first demonstration in 1978, **13 domestic and foreign audio equipment producers have signed licensing agreements** with the Hanover firm, and 21 others are expected to do so shortly. **An additional 150 or so companies are said to be interested in the system.** High Com, which Telefunken is convinced will eventually replace the ubiquitous Dolby system, provides for 20-dB noise suppression and for broadband companding from 20 Hz to 20 kHz.

## **EFCIS to expand and upgrade n-MOS products**

EFCIS, the MOS house owned jointly by Thomson-CSF and the French atomic energy agency, has charted a growth strategy aimed at tripling its sales during the next three years to reach \$75 million by 1982. The company, up to now best known for custom circuits, plans a major expansion of its line of standard n-MOS circuits—mainly 6800 and 68000 microprocessors, memories, and proprietary circuits for telecommunications and display drives. As its catalog builds up, **it will upgrade its technology through know-how bought by Thomson from Motorola Inc.** [*Electronics*, Nov. 23, 1978, p. 70]. From the 5-to-6- $\mu\text{m}$  technology it now uses for n-MOS, EFCIS is getting ready to go to 3 to 4  $\mu\text{m}$  next year and then down to 2 to 3  $\mu\text{m}$  in 1982.

## **Bell-Northern terminal records partial viewing of cable TV programs**

Bell-Northern Research Ltd., Ottawa, has introduced a terminal capable of pay TV billing by the month, by the program, or even by portions of a program. **The unit also has built-in protection for the viewer who goes to sleep while watching a cable TV program:** the user must activate it for each program. Designed to work with those pay TV service providers whose video signals are scrambled prior to transmission, the terminal has its own security against pirated reception of programs. Periodically, at night and when the telephone to which the terminal is connected is not in use, the viewing information stored in the unit's memory is extracted and recorded on magnetic tape in the telephone exchange; this data is delivered to the service provider for billing and statistical purposes.

## **Addenda**

Engineers at Hitachi Ltd.'s central research laboratories in Tokyo have developed a **64-K metal-nitride-oxide-semiconductor electrically erasable programmable read-only memory**. . . . Valvo, the Hamburg-based component-producing subsidiary of NV Philips Gloeilampenfabrieken, is **now gearing up for production of the 8048 microcomputer and other circuits in Intel Corp.'s MCS-48 family.** Production is expected to begin about the middle of this year. . . . The French telecommunications authority plans to install a 34-Mb/s fiber-optic link between two large Parisian telephone exchanges in September as the first act in an ambitious optic scenario. It will be followed in 1982 by an **experimental optic-fiber network with 2,000 individual subscribers in the city of Biarritz**. . . . Teleglobe Canada Ltd., Montreal, Canada's crown corporation that owns and operates the country's international cables and satellites, is **getting into international data services using high-speed packet- and circuit-switching technologies.** The first hookup in the Globedat service will connect data networks in Canada and England.

# ENLIGHTENMENT

ADVANCED OPTOELECTRONIC PRODUCTS

## How to add 55% more display to a 0.3" package

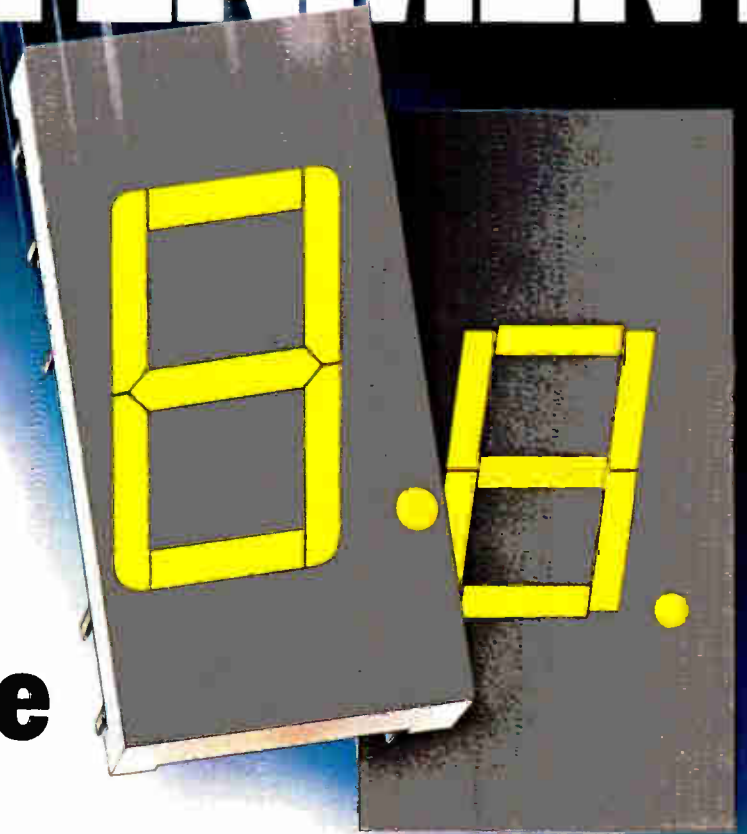

Now you can upgrade to our new 0.4" display without changing your 0.3" pin configurations.

Larger, brighter LED digits add sales appeal to any device or instrument using displays. That's exactly what General Instrument's 0.4" display can do for your product.



And the highly legible sculptured font improves aesthetics even further.

The Big 4 comes in 4 colors. These new seven segment displays are designed for high brightness, high contrast, and are available in:

- Green (MAN4500 Series)
- Orange (Hi-efficiency red, MAN4600 Series)
- Red (MAN4700 Series)
- Yellow (MAN4800 Series)

They're available in common anode or common cathode and overflow models.

And like all General Instrument displays, the new 0.4" digit offers low power consumption and solid state reliability for a longer operational life.

**Write or call today.**

For more technical data or pricing information, contact General Instrument, Optoelectronics Division (formerly Monsanto Optoelectronics), 3400 Hillview Avenue, Palo Alto, California 94304. Telephone: (415) 493-0400.

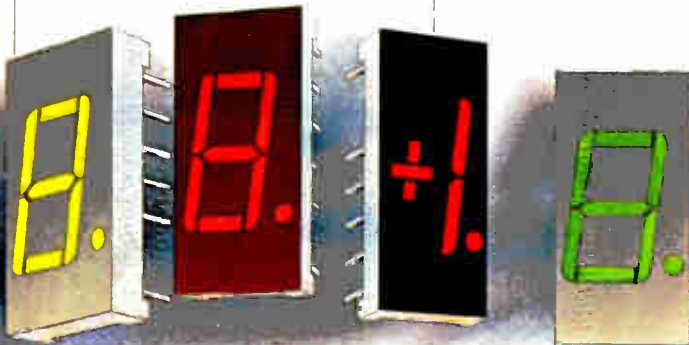

# GENERAL INSTRUMENT

# FAIRCHILD

## A lot of Fairchild thinking went into the world's most powerful computer.

A passion for building faster and faster computers led Cray Research into producing the Cray-1. This uniquely designed supercomputer is four times faster than anything built before it. And it's winning out against tough competition from some of the biggest names in the industry.

When Cray needed high-speed memories and logic for the Cray-1, they came to Fairchild. They knew we had everything it takes to help them build the highest-performance computers.

That's because Fairchild has grown up with the computer industry. We've been developing and delivering semiconductor components that have kept us on the leading edge of technology since its beginning. And we plan to stay there.

A quarter of a million chips of logic went into the Cray-1. Plus another seventy-three thousand memory devices. With the help of Fairchild logic and memories, the Cray-1 can process information much faster, while using much less power.

Thanks to Cray, the industry has a new supercomputer with a standard of performance that puts it in a class by itself. Thanks to us, the world's fastest computer has superior logic and great memories. We can do the same for you. And whatever else it takes to help you make a better computer.

Fairchild Camera and Instrument

Corporation, Box

880A, Mountain

View, CA 94042.

Tel: (415) 962-4451.

TWX: 910-379-6435.

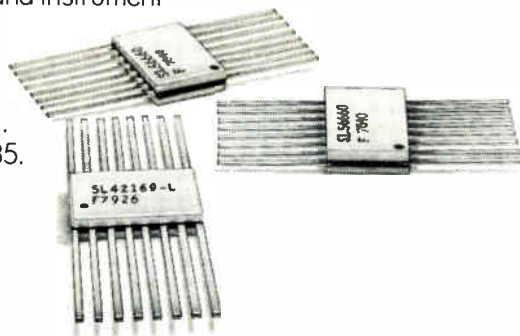

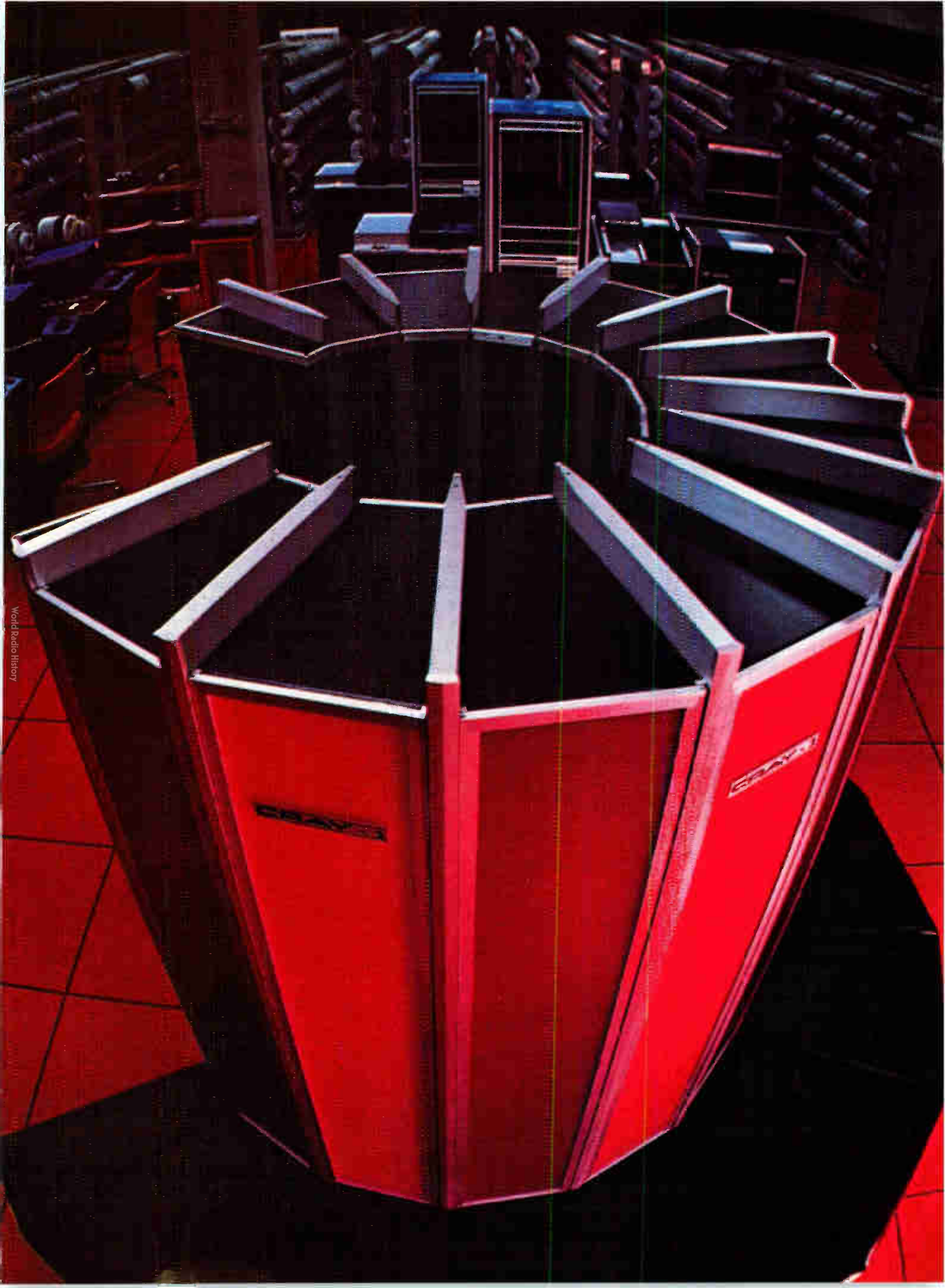

# MOTOROLA HELPED BRING

His name isn't important.

His story is.

He was simply walking back to his office when the pain hit him.

In less than three minutes, an ambulance with two paramedics arrived.

But as they began to work, arrhythmia—erratic, wildly uncontrolled heartbeat—set in.

Then his heart stopped altogether.

## **A MIRACLE OF ELECTRONICS.**

Fortunately, the ambulance was equipped with a Motorola APCOR Coronary Observation unit.

It put the paramedics in immediate touch with an emergency physician at the hospital miles away.

Not just by voice communication; that doesn't give a doctor all the information he needs.

But at the very same instant, by Motorola telemetry, an electrocardiogram of the activity of the man's heart was being transmitted.

A miracle of electronics—

microelectronics—was about to show what it could do.

## **TECHNOLOGY DOES THE TALKING.**

A lot of things were happening at once.

The medical assistants at the scene were talking to the emergency room at the hospital.

And the Motorola APCOR was also talking to the doctor in a language only a doctor could understand—by transmitting the patient's EKG.

The doctor could then treat the patient almost as if he were

on the spot.

In a few minutes, the man's heart began to beat. He was once again on his way to being alive, in every sense of the word.

## **MICROCIRCUITS MAKE IT HAPPEN.**

APCOR is made possible by Motorola microcircuits, tiny information processors that transmit both electronic

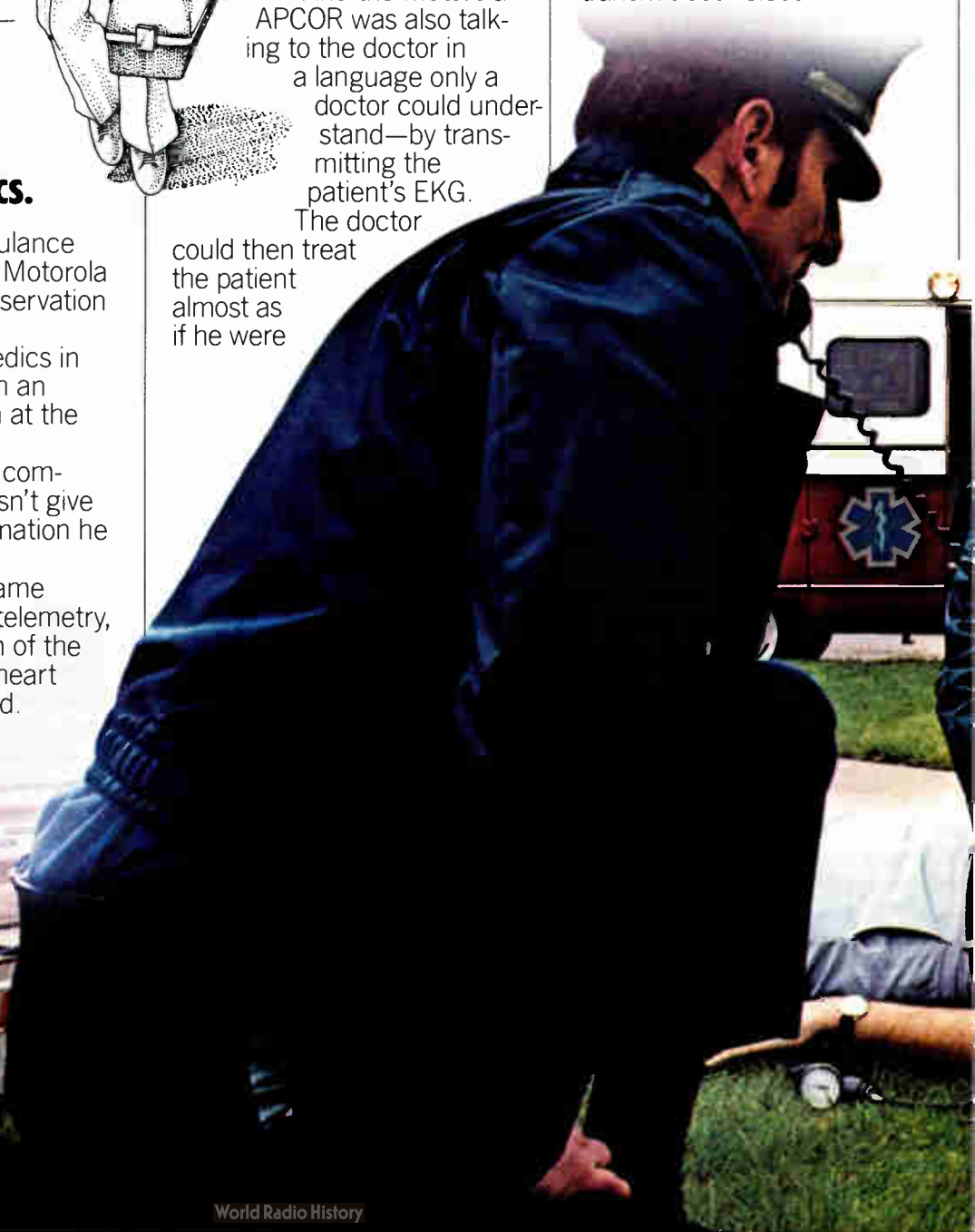

# THIS MAN BACK TO LIFE.

signals and the human voice.

Microcircuitry is also at the heart of the many other kinds of two-way communications equipment we make.

But communications equipment is only part of what contributes to our nearly two billion dollars a year in sales.

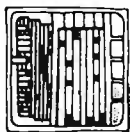

*A microcomputer, drawn larger than life.*

## MAKING ELECTRONICS HISTORY.

Thanks to Motorola microelectronics, we create all kinds of remarkable systems that would

have been inconceivable not long ago.

A system to help power companies handle peak loads without danger of blackouts.

An electronic car-engine management system that can save gasoline.

Even a communications system to help probe Mars.

But then, we've come a long way from the time we first made history by putting radios into cars (we went on to put alternators and electronic ignitions into them) and

later put popular-priced

TV sets into homes (they're a product we don't make here at all anymore).

Today, Motorola is one of the world's largest manufacturers dedicated exclusively to electronics, as well as one of its foremost designers of custom and standard semi-conductors.

Many of the things we make are changing people's lives.

Others are actually saving them.



## MOTOROLA

### Making electronics history since 1928.

Circle 69 on reader service card

APCOR, Motorola and  are registered trademarks of Motorola, Inc.

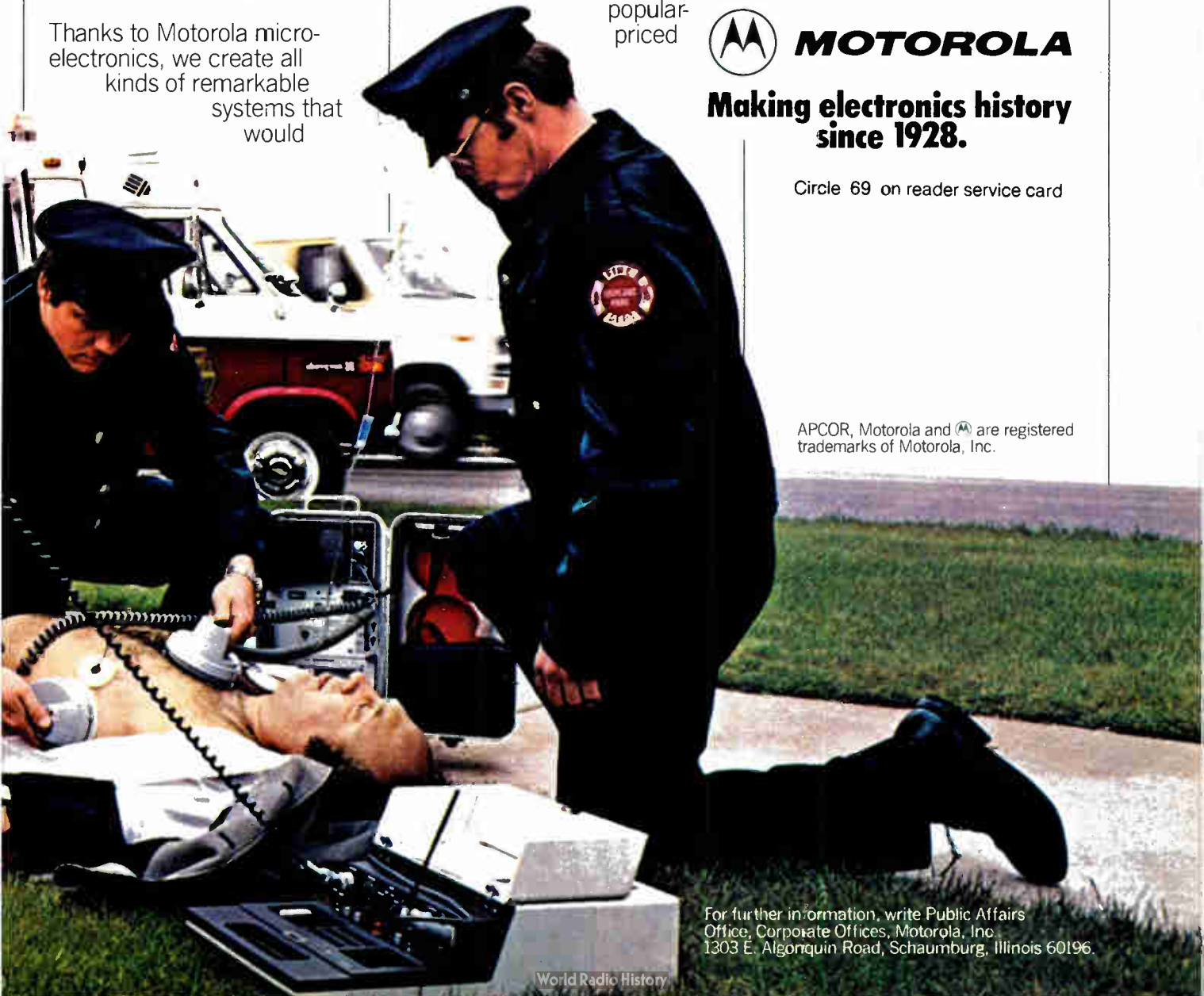

For further information, write Public Affairs Office, Corporate Offices, Motorola, Inc. 1303 E. Algonquin Road, Schaumburg, Illinois 60196.



TRW

TRW

TRW  
1971 1981  
75010

$$f(z) = A \prod_{k=1}^K \frac{1 + a_k z^1 + b_k z^2}{1 + c_k z^{-1} + d_k z^2}$$

$$= A z^r \sqrt{\dots}$$



# 16 to 32-bit products in only 45 to 100nsec

(With TRW monolithic multipliers.)

If you design digital filters or FFT processors... or if you want to increase the computational speed of a microprocessor... take a look at our "HJ" line of bipolar, monolithic multipliers.

These super-fast chips give you

added performance at greater speeds. And save circuitry, power and money in the process. One of our customers used 4 of our MPY-16HJ's and tossed out 98 multipliers he'd previously needed for the same function. That's real saving!

One of these "HJ's" ought to give you real savings, too...

Multiplier	Word Size (Bits)	Speed (Nsec)	Power (Watts)	Unit Price (in 100s)
MPY-16HJ	16x16	100	3.0	\$157
MPY-12HJ	12x12	80	2.0	\$103
MPY-8HJ	8x8	65	1.0	\$ 59
MPY-8HJ-1	8x8	45	1.0	\$ 71

Plus such important features as...

- Zero-nanosecond input register hold time.
- Two's complement or unsigned magnitude.
- Controllable transparent output registers (except MPY-8).
- TTL compatible.
- Pin-compatible with our "AJ" series multipliers.

**These super-multipliers are in stock at Hamilton / Avnet.**

**For immediate information, call us at 213/535-1831 or send us the coupon, or just attach your business card to this page and mail it back to us.**

**TRW LSI Products** E-2  
An Electronic Components Division of TRW Inc.  
P.O. Box 1125  
Redondo Beach, CA 90278

Please send data sheets on the **MPY/HJ** family of multipliers.

\_\_\_\_\_  
Name

\_\_\_\_\_  
Company

\_\_\_\_\_  
Div/Dept Mail Code

\_\_\_\_\_  
Address

\_\_\_\_\_  
City

\_\_\_\_\_  
State Zip

*TRW keeps you ahead in digital signal processing*

## **TRW** LSI PRODUCTS

ANOTHER PRODUCT OF A COMPANY CALLED TRW

Circle 71 on reader service card

# Expand with the MSC 8001

The MSC 8001 is a MULTIBUS compatible single board computer designed to provide new dimensions in function and versatility. Built around the powerful eight-bit Z80™ CPU, the MSC 8001 provides a flexible memory addressing scheme and extensive input/output capabilities at prices well below competing single board computer products. Using the MSC 8001 as a master module, you can select I/O and special feature modules to configure a system of virtually any complexity or refinement.

**Expand SBC 80 systems** Upgrade existing SBC 80 systems that are being slowed down by limited memory size or

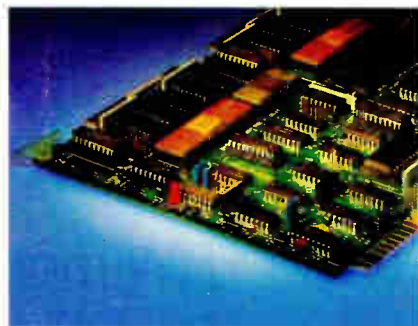

Monolithic  
Systems corp

restricted execution cycles. All existing I/O boards and memory expansion cards will operate with the MSC 8001.

**Expand to meet future needs** The MSC 8001 is designed to accommodate a wide range of versatile configurations. Almost any combination of memory, interface complement, and other options can be configured to meet your specific requirements without hardware modification. For additional information on the MSC 8001 and our other 41 Monolithic Systems Corp products and systems, please contact us at 14 Inverness Drive East, Englewood, Colorado 80112 (303) 770-7400. Telex: 45-4498. Z80A is a trademark of Zilog, Inc.

## Extending the limits of information.

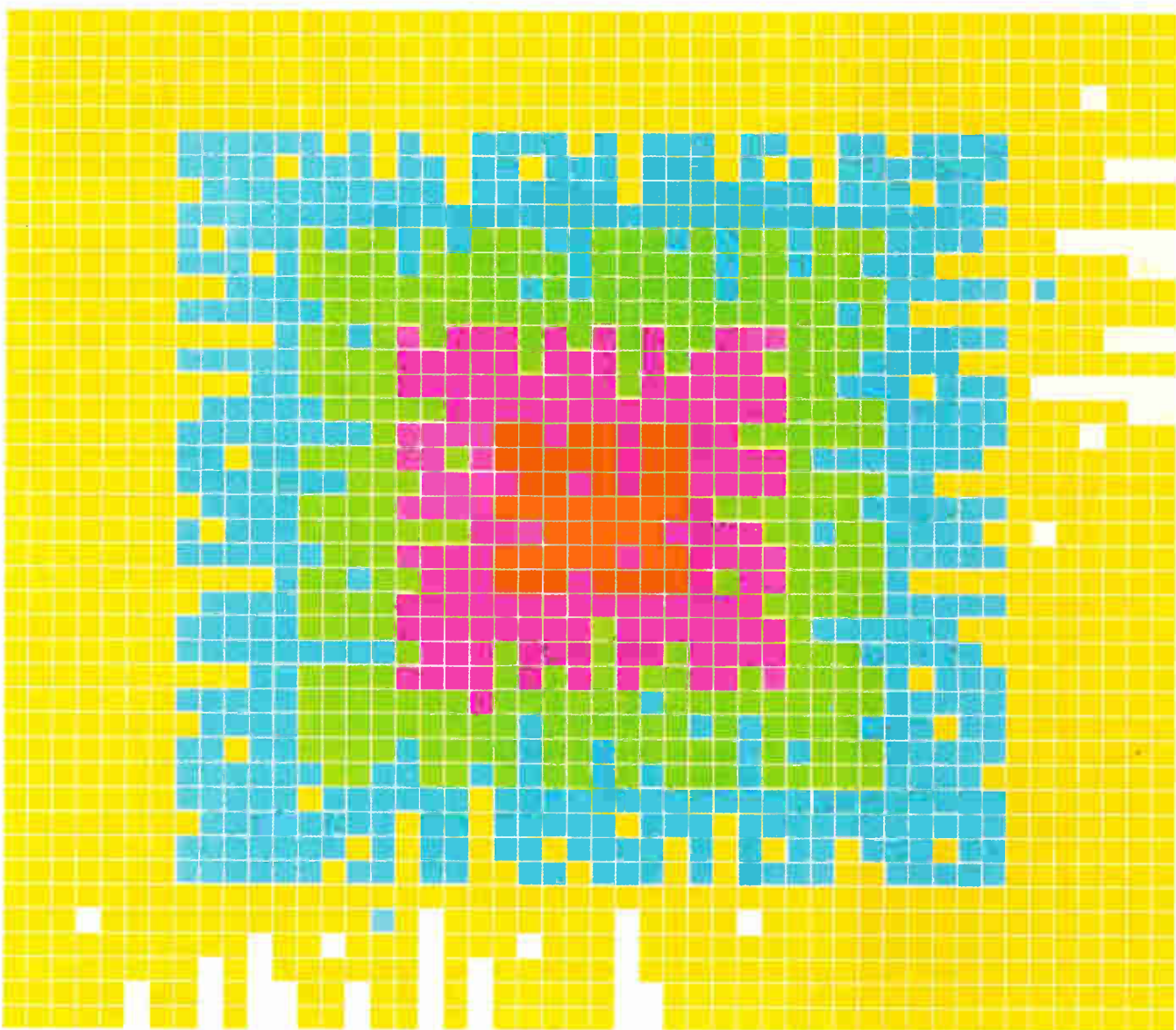

MSC Regional Sales Offices: Eastern Region 1101-B9 State Road, Princeton, NJ 08540, (609) 921-2240; Central Region 7200 East Dry Creek Road, Suite #B203, Englewood, CO 80112, (303) 773-1060; Western Region 49 South Birchway, Suite D, Sierra Madre, CA 91024, (213) 351-8717

Circle 72 on reader service card

## X-ray lithography unit gains speed by printing six wafers at a time

by Charles Cohen, Tokyo bureau manager

Experimental system from VLSI Co-op Labs processes 50 4-in. wafers an hour, exposes 1- $\mu\text{m}$  patterns

Japan's VLSI Cooperative Laboratories has taken an entirely new step to boost the throughput of an experimental X-ray lithography system. It has devised a machine that exposes six wafers simultaneously.

As a result, it is comparable in speed to step-and-repeat optical units. Furthermore, at 1-micrometer line widths, it prints finer patterns than those units.

Designed for the upcoming generation of very large-scale integrated circuits, it processes 50 4-in. wafers an hour when a negative resist (polyglycidyl methacrylate) is used and about 12 such wafers an hour when the resist is positive. Its alignment is accurate to  $\pm 0.25 \mu\text{m}$ .

**High resolution.** In contrast to optical methods, X-ray lithography has the inherent advantage that resolution is not degraded by diffraction, interference, and reflections; it is also relatively unaffected by dust. The labs' system has a minimum resolution of  $0.3 \mu\text{m}$  and can produce patterns with a large height-to-width aspect ratio.

Contributing to the speed is the fact that mask alignment is separated from the exposure unit and performed by a separate unit while the previously aligned wafers are being exposed. The disadvantage of this scheme is that more masks are required, but the proliferation of electron-beam exposure systems

should make that particular need less troublesome.

The X-ray source has a rotating water-cooled anode with a power input of 10 kilowatts from a 20-kilovolt electron beam. The power output is 535 milliwatts per sterad at 0.834 nanometer.

Radiation from the anode is radial, making it possible to arrange six wafers as the sides of a polygon so that they get essentially equal exposure. Spacing between the anode and the masks must be kept small, as the radiation density falls with the square of the distance. Contact rather than proximity printing then becomes imperative to prevent geometric distortion.

Six beryllium windows 64 milli-

meters from the anode allow the X rays to pass into six individual exposure boxes. These boxes have an X-ray shutter at their opposite end that is normally closed to prevent the helium in them from leaking out.

**Exposure.** Mask-wafer assemblies prepared in the alignment unit are attached to the exposure box directly from the atmospheric environment and the shutter is opened for exposure. A slight excess pressure prevents air, which attenuates X rays, from entering the box. The shutters can also be used to adjust the exposure of individual wafers if desired.

The fine resolution is obtained even with large wafers and despite the small spacing of 30 centimeters by using conformal masks in direct

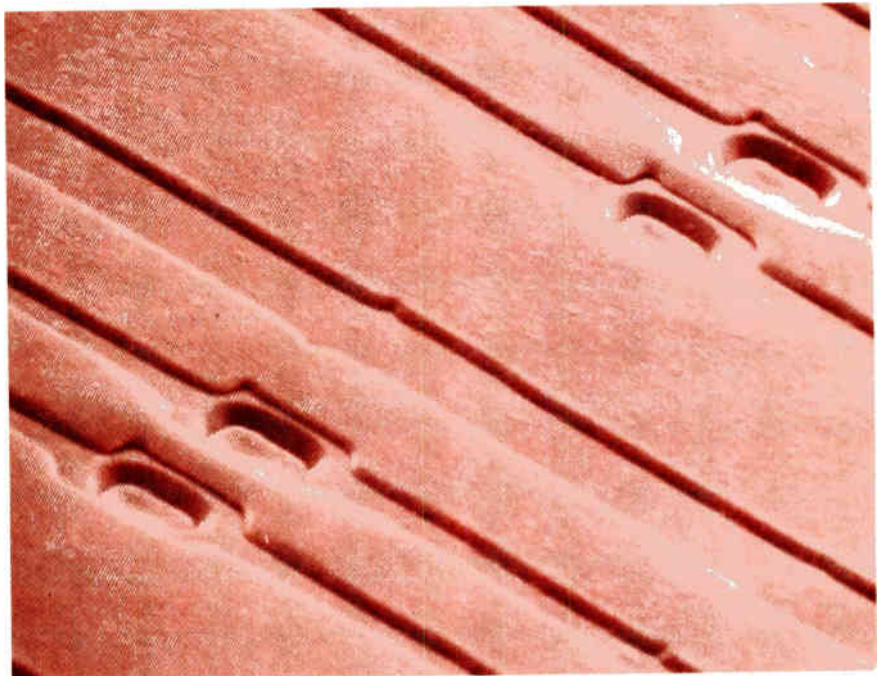

**Fine lines, more wafers.** This fine-line pattern was printed by a machine that combines the high resolution of X-ray lithography with the speed of fast step-and-repeat units.

contact with the wafer. Each mask consists of a gold pattern 0.5 to 0.7  $\mu\text{m}$  thick embedded in a polyimide film 3  $\mu\text{m}$  thick. This design protects both mask and wafer from scratches. Grooves 0.5  $\mu\text{m}$  deep in the mask enable it to be drawn against the wafer by vacuum—for minimum spacing and to prevent shifting—without bubbles forming. A silicon frame for the mask provides the same temperature coefficient of expansion as the wafer.

To speed the project, a commer-

cially available aligner was rebuilt rather than designing and building a new one. The exposure system of a Computervision Cobilt CA-2800H aligner was removed, and the drive system was replaced with a more accurate mechanism, a Burleigh Instruments Inchworm piezoelectric linear motor, which features the high resolution of 6 nm. Microcomputer control of the motors compensates for the shift in alignment that occurs when the vacuum is drawn to force the mask and wafer into contact.

---

### Great Britain

---

## Two-chip feedback a-d converter invades high-speed territory

Parallel-type analog-to-digital converters have dominated the high-speed realm, but an 8-bit successive-approximation unit may soon challenge their monopoly. Its developer, Plessey Co.'s Allen Clark Research Centre, in Caswell, Towcester, Northants., says that its fast two-chip set will be easier to operate and cheaper than existing monolithic devices using parallel conversion.

According to Albert J. Fryers, who heads the data-conversion products group, both chips will be in production this year. They are being developed under a Ministry of Defence contract and could have uses in video signal processing.

Samples of the primary component, an 8-bit monolithic digital-to-analog converter with a settling time of 4 nanoseconds to within  $\frac{1}{2}$  least significant bit of full scale have already been delivered, and the chip was described at the International Solid State Circuits Conference in San Francisco, Feb. 13-15 [*Electronics*, Feb. 14, p. 146]. The second chip, incorporating a fast successive-approximation register, is farther back in development.

**Departure.** The d-a chip differs from previous such parts by incorporating all the analog components needed for a feedback a-d converter, says Peter H. Saul, who developed the set. These are the converter

itself, a precision voltage reference, the reference amplifier, and a latched high-speed comparator with a 1.3-ns propagation delay.

The technique could be extended to 10- or even 12-bit devices with only a relatively small increase in chip area, Saul says. In fact a 10-bit set is already being developed. Its speed, he believes, could be much better than most hybrid designs.

**Rates.** As an a-d converter, the 8-bit two-chip set will have a sampling rate of 15 megahertz with an internal clock rate of 135 MHz, making it attractive for video applications. Further, since both chips are relatively small and yield well, they could be produced at low cost.

In contrast, the only monolithic 8-bit a-d converter now on the market is a very large chip that uses parallel conversion and consequently has an input capacitance of 300 picofarads. It is therefore hard to drive at video speeds, Saul says.

The high speed stems from a Plessey ion-implantation process plus a conversion technique that avoids current-switching transients. To attain the fine dimensional control needed for fast transistors, both base and emitter regions are implanted into a 2.6-micrometer-thick epitaxial layer, the former to a width of 0.15  $\mu\text{m}$  and the latter to a depth of 0.3  $\mu\text{m}$  typically. Autoregistered con-

tacts and photoresist masking of the implants contribute to both high speed and high yield. The chip itself is only 1.7 by 1.8 millimeters (67 by 71 mils).

**No ladder.** Rather than use resistor ladder networks to weight each digit according to its position in an 8-bit word, Plessey engineers use an array of transistors. These are grouped as current sources to give two, four, and eight times the current of the least significant bit. Each current source is steered from a "bit present" to a "bit absent" line by a transistor pair.

Such current steering eliminates abrupt switching transients that could cause glitches. Spikes are less than 80 picosecond-volts and anything less than 100 ps-v is generally considered glitchless, says Saul.

The military pedigree of the d-a chip also shows in its temperature performance, for its output varies by approximately  $\frac{1}{2}$  LSB at full scale between  $-55^{\circ}$  to  $+125^{\circ}\text{C}$ . The all-critical voltage reference is a modified bandgap arrangement, with particular attention paid to matching out the effects of the resistor temperature coefficients. The typical temperature coefficient is 25 parts per million/ $^{\circ}\text{C}$ . As for nonlinearity, it is  $\frac{1}{4}$  LSB for many of the devices made so far.

-Kevin Smith

---

### West Germany

---

## Thin film enhances bolometer's sensitivity

A bolometer no larger than the cross section of a human hair boasts a sensitivity approaching the theoretical limit for thermal radiant energy detection. It comes from the Battelle Institute in Frankfurt.

Developed for the German Aerospace Research Establishment, the device needs no cooling, in contrast to semiconductor infrared quantum detectors. Two more advantages, inherent in bolometers, are low noise and an absence of microphonics.

Unlike the more sensitive quantum detector, which responds to

# OUR WIDE CHOICE OF NEW DISCS WILL PUT OEMS IN FAT CITY.

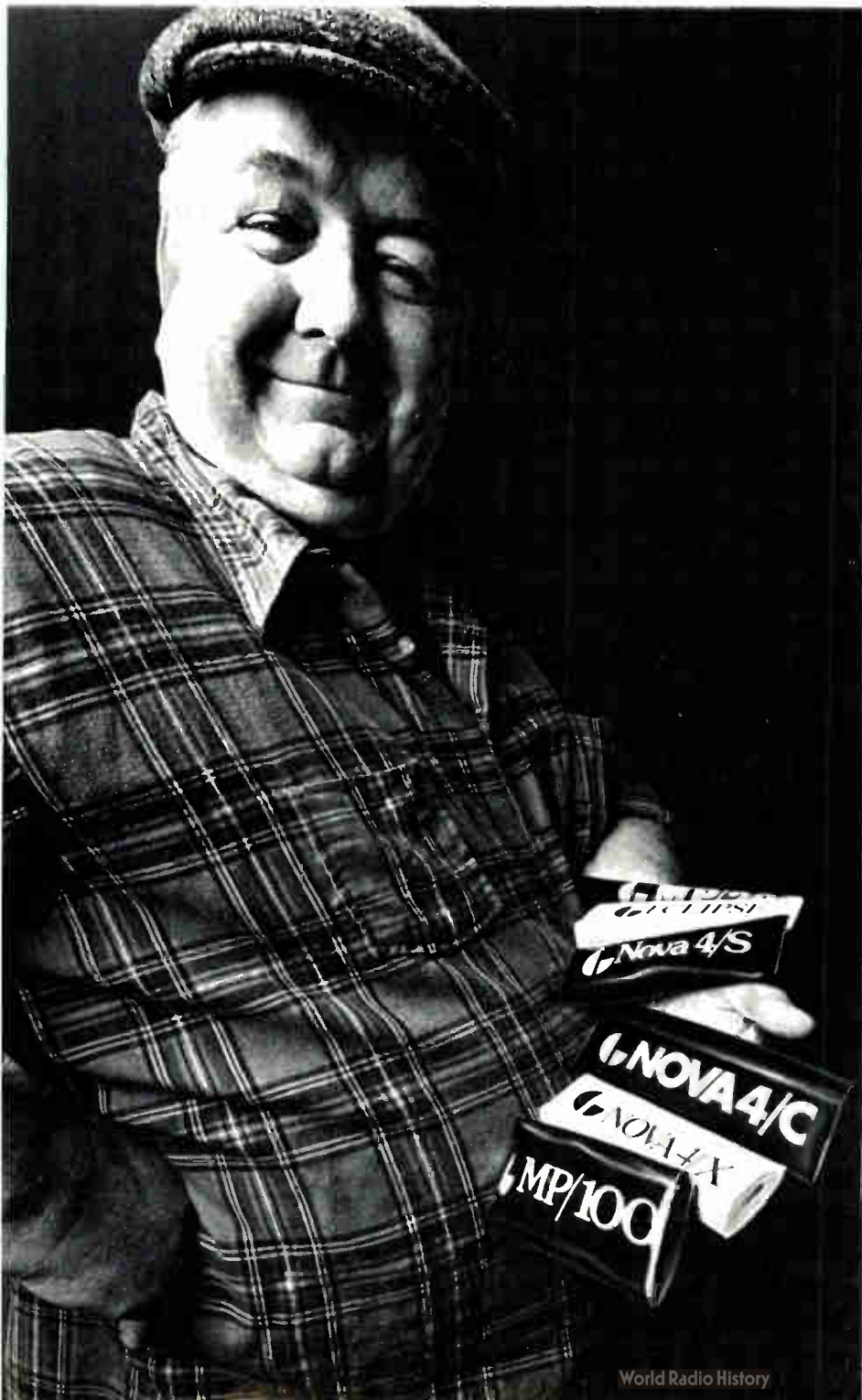

Data General announces a choice of new winchester discs in either 12.5 or 25 megabyte capacities (plus optional 1.26 megabyte diskette for backup and file exchange). This means our OEMs can now offer the widest range of compatible, low-cost disc-based systems available anywhere.

Dozens of new NOVA<sup>®</sup>, ECLIPSE<sup>®</sup> and microNOVA<sup>™</sup> configurations will help you fatten up sales with lower costs, higher reliability and easier maintenance.

Best of all the prices are lower than ever before. That means a change in your sales picture and change in your pocket. Let Data General fatten up your sales. Call, or write, or send in the coupon.

Data General Corporation, Westboro, MA 01580, (617) 366-8911. Data General (Canada) Ltd., Ontario, Canada. Data General Europe, 61 rue de Courcelles, Paris, France, 766 51 78. Data General Australia, (03) 89-0633. ECLIPSE and NOVA are registered trademarks and microNOVA is a trademark of Data General. ©Data General Corporation, 1980.

**Data General**

Mail to: Data General Corporation, Westboro, MA 01580  I'm hungry for more information. Send me full details on your new  ECLIPSE  NOVA  microNOVA systems for OEMs.  I'm starving. Send a salesman.

Name \_\_\_\_\_ Title \_\_\_\_\_ Company \_\_\_\_\_ Address \_\_\_\_\_ City \_\_\_\_\_ State \_\_\_\_\_ Zip \_\_\_\_\_ Tel. \_\_\_\_\_

The Computer of the U.S. Olympic Sports Medicine Committee

E228

Circle 75

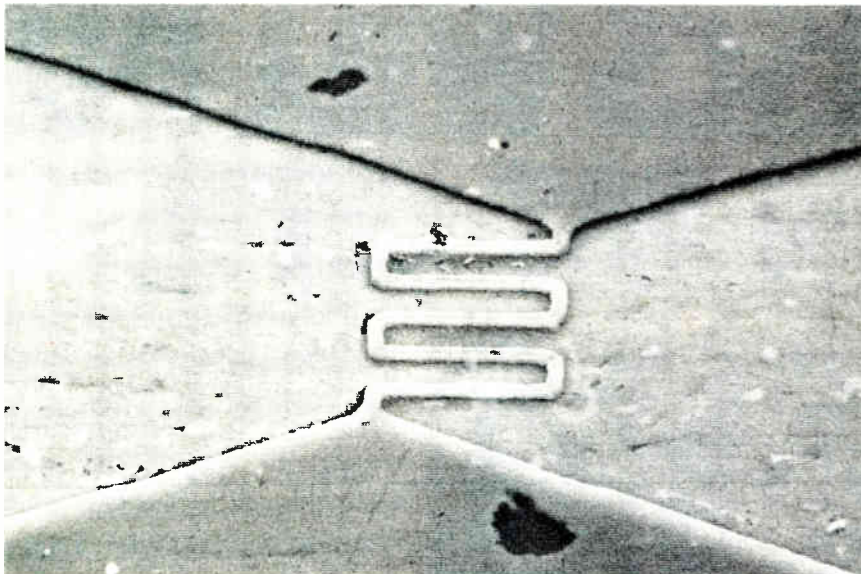

**Serpentine.** The heart of Battelle Institute's thin-film bolometer is a meandering gold resistive element 50 by 50  $\mu\text{m}$  (shown in scanning electron microphotograph).

photons, a bolometer reacts to heat. It is basically a fine resistive element that absorbs heat, which increases its temperature and hence its resistance. The changes in resistance can be measured using readily available instrumentation such as a microwave power meter to indicate the radiation sensed.

Significantly, since the radiation is absorbed evenly at all light wavelengths—from infrared through visible light and up into the ultraviolet region—a bolometer's sensitivity is largely independent of wavelength.

**Thin film.** Battelle's bolometer is a thin-film device with a meandering gold conductor about 5 micrometers wide (see photo). This structure, which constitutes the resistive element, is deposited on an aluminum oxide foil by photolithography.

Only 50 by 50  $\mu\text{m}$ , the element is so small "that it easily fits on the cross-sectional area of a human hair," says Rolf Hartmann, the developer of the device. The thickness of the bolometer is only 100 nanometers, of which the aluminum oxide foil takes up about 75 nm and the gold conductors roughly 25 nm.

Because of the small dimensions, the device has an extremely low heat capacity, corresponding to that of only  $1/40$  of a microgram of water. That low value makes for a high

radiation sensitivity and a short device response time, typically 5 milliseconds. The sensitivity, expressed in radiation detectivity, comes close to  $1.43 \times 10^9$  centimeter-hertz $^{1/2}$  per watt, the theoretical limit for thermal radiation detection. In contrast, conventional bolometers, which have millimeter dimensions, are much less sensitive.

Despite its fine dimensions, the new device can be fabricated easily, Hartmann says. What's more, just as with integrated circuits, a number of devices can be made simultaneously. Simple, fast fabrication promises low cost, he adds, pointing out that Battelle engages only in research work on a strict contract basis and not in production.

**Uses.** Although developed for infrared-based earth observations from space satellites, the thin-film bolometer could find plenty of other uses, Hartmann declares. Possible applications are in antitheft and intrusion-monitoring systems and in fire-alarm equipment for, say, forests, garbage dumps, or gasoline storage tanks. Still other uses are as carbon monoxide detectors in automobiles and as contactless temperature-measuring systems.

In addition, the use of several thin-film bolometers in infrared image converters, for example, could

lead to such widely differing applications as mammography, inspecting buildings for heat leaks, monitoring electric power lines, tracking infrared-radiating clouds emanating from industrial complexes, and determining leaks in steam pipes.

In many of these applications, infrared equipment built around semiconductor quantum detectors is now being used. Such detectors are more sensitive than Battelle's device, but they require relatively expensive and elaborate cooling apparatus. As the new bolometer does without such apparatus, infrared imagers using it can be made a lot smaller and cheaper, Hartmann says. **-John Gosch**

## Great Britain

### Joint venture banks on SAW boom

Small may be beautiful, but there are often advantages in size. To get the best of both, Plessey Co. is splitting off its surface-acoustic-wave operation into a new company with a like-minded U. S. partner.

The company, called Signal Technology Ltd. [*Electronics*, Feb. 14, p. 70], will be based in Swindon just a mile or two from Plessey Semiconductors Ltd.'s plant, where the SAW devices are now made. It will be jointly owned by Plessey and the Andersen Group Inc. of Bloomfield, Conn., which has 15 years' experience in SAW technology. The two will invest some \$500,000 each.

The firm will conduct research and develop and manufacture SAW devices covering the spectrum from 10 megahertz to 1 gigahertz. But as its name implies, its brief could widen to take in charge-coupled-device, magnetostatic, optical, and other techniques for processing signals. Significantly, there will be close links with Plessey's Allen Clark Research Centre, as its research director, John Bass, is a board member of Signal Technology.

By pooling technology and market outlets, Plessey and Andersen aim to establish a dominant position in the

# “BEEP! BEEP!”



## Data I/O's System 19 PROM programmer talks back to save you time and money.

It's a state of the art programmer that tells you when things are right, or if they're wrong, it tells you why.

Switch it on and the System 19 checks all its components: I/O port, microprocessor, RAM, bus, front panel and even its own software.

During the programming sequence, the System 19 conducts an illegal bit check, blank check, sum check on the newly programmed device and data verification at high, low and mid point voltages as required to make sure the device meets manufacturer's operating specifications.

The System 19 gently warns the operator when a simple procedural error is made and locks up before the operator can make a serious error and waste a device

If something goes wrong during operations, the System 19 flashes one of 27 error codes on the readout to lead you to the specific problem quickly.

With a System 19, you can program every type of programmable logic device including FPLA. And with its unique gang module, you can program up to eight MOS devices at once.

Best of all, Data I/O's System 19 is priced within just about everyone's budget.

You haven't shopped around until you've looked at Data I/O. Let us show you the difference. Circle the reader service number or contact Data I/O, P.O. Box 308, Issaquah, WA 98027. **For answers fast, call toll free: 800-426-9016.**

Good idea! **DATA I/O**

Programming systems for tomorrow...today

# HI-VOLTAGE CERAMIC CAPACITORS

to  
**30kV**

**in configurations  
to suit your  
application**

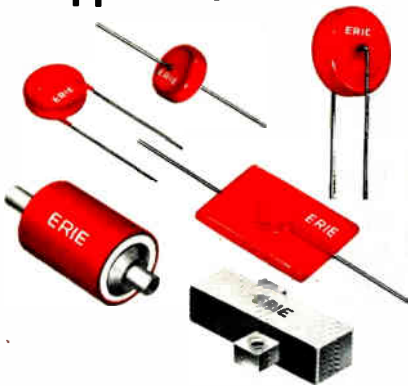

ERIE offers a broad range of high quality components with physical styles, leads, capacitance . . . and voltages to suit your needs. These popular capacitors are widely used in electric utility transformers, power supplies, voltage multipliers for CRT displays, image intensifiers for night vision apparatus, navigation equipment and electro-optic equipment . . . literally any application involving high voltage ceramic capacitors.

Write on your company letterhead for our new catalog 3900-R1 . . . or call 814-237-1431.

# ERIE

ERIE TECHNOLOGICAL PRODUCTS, INC.  
State College, Pa. 16801  
814-237-1431

## Electronics International

### Around the world

#### Racal wins Decca

After days of secret negotiations with large institutional investors, Racal Electronics Ltd. has won control of Decca Ltd. with a \$235 million bid. The new company will be called Racal Decca Ltd. General Electric Co. Ltd., which had fought fiercely for the radar and defense electronics group, has now conceded defeat. (See also the end of the story on p. 80.)

#### Israelis dope glass to amplify light hitting solar cells

By doping glass or plastic sheets with a combination of fluorescent ions and/or organic dye molecules, Renata Reisfeld of the inorganic chemistry department of Hebrew University, Jerusalem, has developed a method of energy enhancement that theoretically increases the photovoltaic effect a hundredfold, she claims, by increasing the quantity of light falling on the solar cells beneath the sheet. In this method, the diffuse light, which is normally unused by solar cell collectors, is absorbed by the molecules of the doped sheet and emitted at longer wavelengths. The sheet cannot reabsorb the emitted light, which is now internally reflected toward the solar cells at the sheet's edges. Similar work with doped surfaces is under way in the U. S. [*Electronics*, July 19, 1979, p. 119], but Reisfeld's method provides better theoretical results, she says.

#### Danes pioneer fiber-optic digital radio-TV system

What industry observers believe is the first—at least in Europe—glass-fiber system for digital transmission of television and radio programs is being installed in northern Denmark. The system, being built by Telefonverein Jütland in Aarhus, will make it possible for several thousand cable TV subscribers to receive up to eight TV channels, plus 6 stereo and 12 monaural radio channels, from a nearby central receiving station. Using optical transmitting and receiving units from AEG-Telefunken, it will handle digital signals initially at a rate of 140 megabits/second and later at 280 Mb/s. The heart of the optical transmitting unit is AEG-Telefunken's high-power CWL 2500 laser which can be used for rates of more than 1 gigabit/s.

European military and original-equipment-manufacturer markets for SAW devices, now emerging from a developmental phase. Comments M. W. Adams, formerly general manager of Plessey Semiconductors and now managing director of Signal Technology, the move will "create the critical mass" needed to make the SAW market catch fire.

**Fit.** The two firms' product portfolios and software skills—essential in a software-driven technology—mesh well. Plessey, for example, is up among the leaders in reflective-array-compressor technology for radar pulse compression and spectrum analysis, and Andersen's recent developments include bandpass filters and convolvers for spread-spectrum communications.

As for software, Plessey has advanced synthesis programs for SAW devices; Andersen's strengths are in simulating a part's performance in a

complete system. These skills will be useful in furthering the new firm's plans to offer complete subsystems to customers as well.

Though SAW technology has been developing for more than a decade, only one high-volume application has emerged. That's for color TV filters, and Plessey was one of the first out with these devices. Its filter design has been adopted by several UK and European manufacturers and has Mullard Ltd., a Philips subsidiary, as a second source.

But the new company thinks its business lies elsewhere. Most applications, says Ron D. Towns, marketing manager, are in the military sector, with first applications for OEMs now reaching production. Consequently, he believes, business will be split equally between custom and standard products.

The firm is therefore geared to provide a fast turnaround design



# Why satisfied users of Kerimid 601 Polyimide printed circuit boards won't let us brag about the low-cost improvements we made in their products.

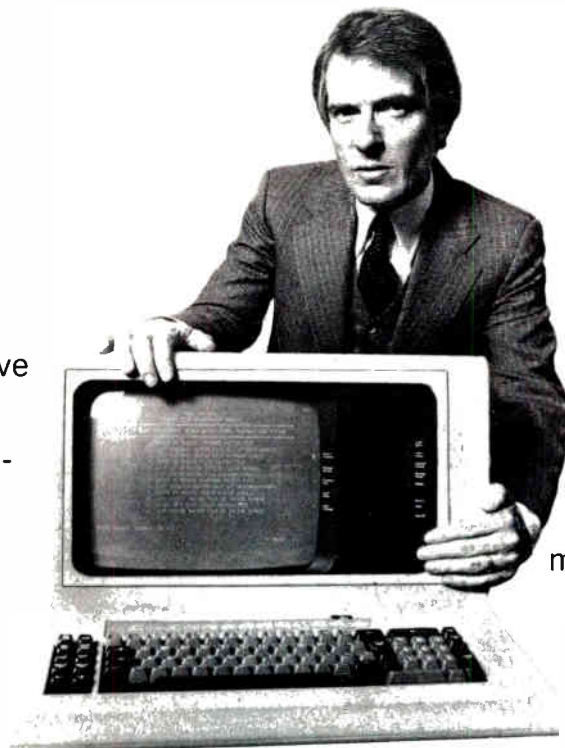

No company wants to give away their trade secrets.

And to a number of electronic equipment manufacturers, Kerimid 601 polyimide laminate offers advantages they'd rather not share.

The reason is economics.

You see, polyimide laminate may appear to cost more than epoxy. But informed companies know Kerimid 601 not only increases a product's reliability, it also increases a company's production yield. So in the long run, the higher price isn't really higher.

This is possible because Kerimid 601's lower co-efficient of thermal expansion dramatically reduces the rejects caused by smear and delamination you often get with epoxy and by allowing for the repair of boards that would otherwise be discarded.

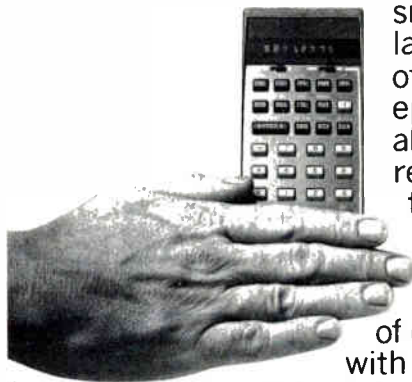

So instead of contending with rejected circuit boards, you'll be contending with increased productivity.

Kerimid 601 can be thermally compression bonded at temperatures of 350 degrees centigrade and higher. It also

has outstanding thermal and Z axis dimensional stability as well as a high degree of moisture resistance. For this reason, Kerimid 601 is approved for military use under military specifications, MIL-P-55617B, MIP-G-55636B and MIL-P-13949E. And in comparison to ceramic boards, Kerimid 601 not only costs less; it's

less brittle and makes finished products more durable. Circuit boards can also be multiple-punched instead of individually machined.

You can switch to Kerimid 601 for your watch, calculator, computer or other electronic package without adapting or adding to your present equipment. And once you do, you'll discover why users of Kerimid 601 are so satisfied. And so silent.



But we aren't. We're always ready to brag about Kerimid 601. Just give us a call.

## KERIMID® 601

Rhône-Poulenc Chemical Company, Chemicals Division  
P.O. Box 125, Monmouth Junction, N.J. 08852 • 201-297-0100  
Rhône-Poulenc Chimie Fine, Secteur Thermostables,  
21 rue Jean Goujon, F 75360 Paris Cedex 08 France



## Electronics international

service backed by small-batch production. Also, Andersen's U. S. production facilities will make the new company's products as needed. Any large orders may be subcontracted to Plessey Semiconductors, which will continue to make SAW filters for the television industry.

**Engineering.** "What we are sell-

ing," says Jim Heighway, engineering and operations manager, "is engineering." Engineering manpower of the new group will be rapidly built up to 30, he adds.

The company will be targeting applications in military weapons and radar systems, cable TV, terrestrial and satellite communications equip-



**Believer.** M. W. Adams, managing director of Signal Technology, believes the firm has the size and know-how to make the market for surface-acoustic-wave devices take off.

# EXPANDO

## Protect Your Investment With Expando™ Sleeving

Wire harnesses of any shape or size are safe with Expando from Bentley-Harris. Made from braided polyester this expandable sleeving resists abrasion and degradation in even the toughest environments. Expando's open-weave construction means added flexibility and freedom of movement for the products it protects. And it's UL recognized, too. Perfect for your reliability-conscious industry.

For a longer life for all your products, try Expando, the sleeving with a spring.

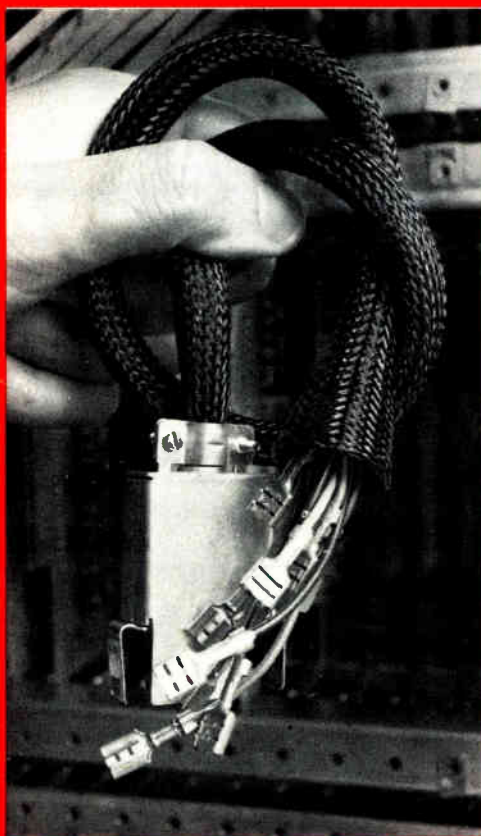

Bentley-Harris Mfg. Co.  
241 Welsh Pool Road  
Lionville, PA 19353  
(215) 363-2600

# BentleyHarris

ment, and land-mobile applications. It will serve the UK and European markets, and Andersen will handle the American and Japanese markets.

**Ready.** The firm will start operations with a catalog of over 200 products. This lineup includes filters for cable TV, narrowband filters for communications, pulse-compressor and -expander pairs and subsystems in radars, delay lines for radar and instrumentation, filters and dispersive delay lines for receivers for electronic warfare support or countermeasures, and phase-coded devices and correlators for spread-spectrum communications.

Though the total world market for SAW devices, excluding TV filters, is relatively small—between \$40 million and \$50 million, guesses Towns—the company says it expects semiconductorlike growth rates as companies start to run with the technology.

Also eyeing the market is Racal Electronics Ltd. It has recently acquired Microwave and Electronic Systems Ltd., New Bridge, Midlothian—now called Racal-MESL—which through its links with nearby Edinburgh University has developed a SAW technology. **-K. S.**

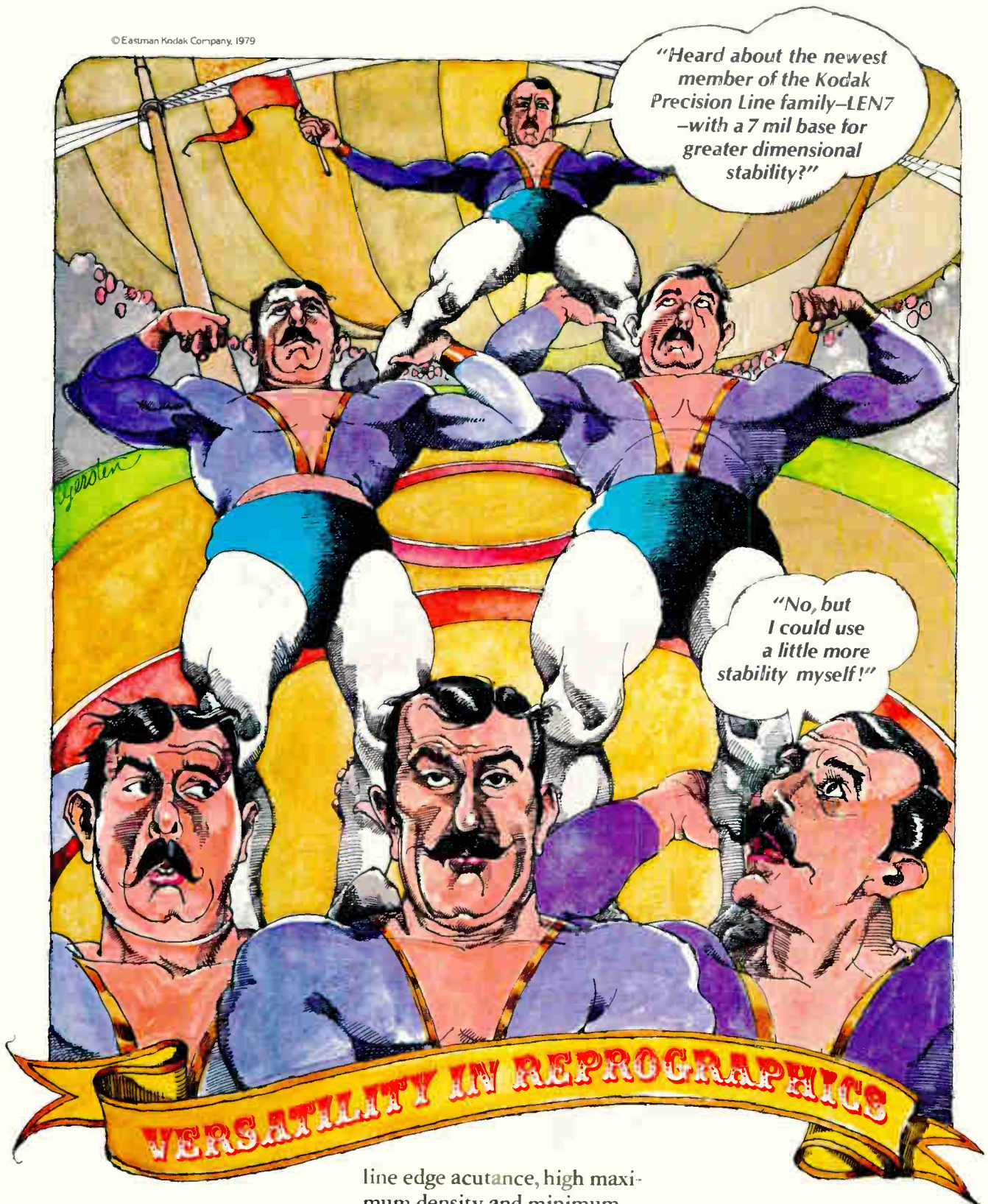

Kodak Precision Line film LEN7, is a pretty amazing act! Quality compares with the finest circuit negative films available at any cost...but LEN7 costs significantly less! LEN7 delivers excellent

line edge acutance, high maximum density and minimum pinholing...and the dimensional stability of a 7 mil Estar base.

LEN7. You've got to see it to believe it. It's an incredibly good film for circuit-making and other applications, at a remarkably low price.

For details, write for our information packet. Eastman Kodak Company, Dept. GA028, Rochester, N.Y. 14650.

1880  1980

**Last year, 200 American companies  
grossed \$4.5 billion  
in one electronically-minded country.**

**Read how they made it**

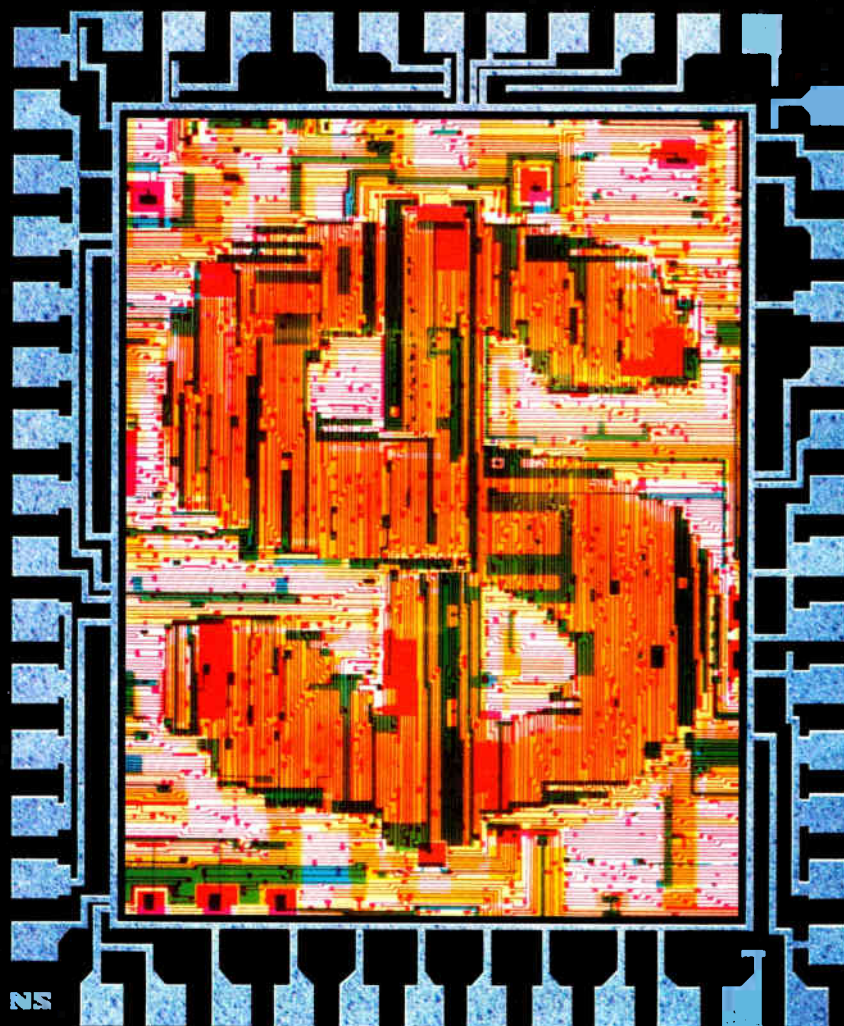

National Semiconductor, Digital Equipment, Honeywell, IBM, Burroughs and Beckman. These and others are making it right now—in Scotland. A true and highly profitable gathering of the clans.

More than 120 electronic companies, including many major U.S. multinationals have settled over the last 20 years in and around the spacious yet centrally located industrial belt of Scotland, their continuous current of steady growth has established the strong electronic pattern of our Dollar sign.

There are good reasons for the preponderance of electronic names on our list. Scotland is one of the major electronic manufacturing and research centers in Europe. More than 35,000 people go to work each day on computer systems, defense electronics, semiconductors and printed circuits, and into the highly developed support services that surround them.

There is a well established tradition of electronics manufacture and long-standing success for the companies that make them.



### A switched on skilled labor force

It's all down to people. There is quite simply no other reservoir of technical and engineering talent as economically available so near to the heart of the vital E.E.C. marketplace.

Scotland's eight Universities and fifty-five Polytechnics and Technical Colleges are responsible for a constantly refreshed skilled nucleus of people—producing proportionately more Graduates than other European countries; forty percent of them with Degrees or Diplomas in Science and Engineering.

Scotland's exceptionally high educational level is a contributing factor to Scotland's exceptionally low level of strike activity in U.S. Plants. In fact, in a survey conducted in late 1979 more than eighty percent have reported no strike activity whatsoever during their past eighteen months of operation and U.S.-owned electronic plants had been strike free for the last five years.

### Finance attractively packaged

Scotland's capital city of Edinburgh has an historic and well earned reputation as one of Europe's classic money centers. Right now its three major stock banks, together with strong Merchant Banking business thrive in healthy competition for short and medium term corporate funds with a wide variety of American and European banks. In addition, the high priority of "inward development" has resulted in some remarkable and attractive financial packages for American companies with an eye for the skills of the Scots.

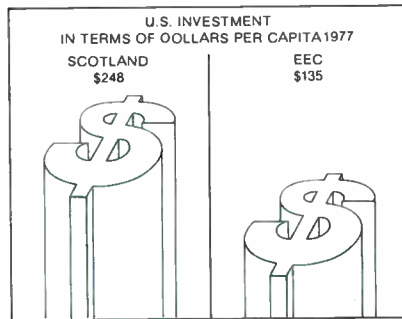

Finance from the Scottish Development Agency linked to Central Government Aid is tailored to encourage growth and development in the Electronics industry. Most of Scotland's industrial belt is eligible for a level of regional assistance either above or on a par with incentives available elsewhere in the E.E.C.

### New venture into electronics

The significant and growing presence of electronics in Scotland has led to new initiatives from the Scottish Development Agency. We recently announced plans to build a Scottish Micro Electronics Application Center in conjunction with Central Government and existing Scottish technical institutions.

Our New Ventures Unit is a recent development set up to stimulate the expansion of electronics in Scotland.

One of its significant objectives is to make things easy for electronics companies to locate here.

Our staff know the ins and outs of the electronics industry and have the experience of Scottish business life to provide marketing, technical and financial advice to clients.



Funding for the New Ventures Unit takes into account the high risks normally associated with advanced technology with an advantageously structured investment package.

All this, on top of expansion and further investment by existing and new companies, indicates that there's a lot going for us.

### Plus, the weather, the heather and political calm

The climate of Scotland—meteorologically and politically—is temperate and has a sunny disposition (who needs a stormy atmosphere when establishing a home base away from home?) due to the warming effect of the Gulf Stream. In fact, the average temperature for any month of the year never dips below the freezing point.

As for the heather, the world famous Highlands in which it flourishes, our lochs, fishing, ski-ing, sailing, golf (another Scottish development you may recall)—all are within a few hours drive of the bustling business and industrial region we have described. A unique leisure contribution to the necessary wellbeing of any efficient corporate staff.

As you can see, we also speak your language. In fact more than a quarter of all Americans actually have ancestral roots in Scotland—our final genial reason to "come home" and do business.

The Scottish Development Agency has the resources and financial muscle to help incoming industry. We can talk straight about your company's potential in Scotland, about land, finance, factories, labor, markets, energy and transport. Everything you need to make Scotland work for you.

Please send for our complete fully illustrated brochures on doing business in Scotland. Or call us in New York (212) 867-1066.

Make it in Scotland. Your best strategic market base in Europe.



### Scottish Development Agency

**US Offices:** 9 West 57th Street, New York, NY 10019. Tel: (212) 867-1066 and 11th Floor, 465 California Street, San Francisco, CA 94104. Tel: (415) 393-7703/4.

**Head Office:** 120 Bothwell Street, Glasgow G2 7JP, Scotland. Tel: 041-248 2700.

**London Office:** 17/19 Cockspur Street, London SW1Y 5BL. Tel: 01-839 2117/8.

# NEC gets serious about CMOS RAMs.

## Introducing the $\mu$ PD444/6514

Our new 1K x 4 CMOS RAM, the  $\mu$ PD 444/6514, offers pin for pin compatibility with our industry-standard NMOS  $\mu$ PD2114L. So whether your memory requirements call for low standby power down to  $0.065 \mu\text{W}$ , or high speed applications down to 150 ns, or a combination of both, NEC has exactly the part you need.

With our unique short channel length CMOS technology, we've designed the  $\mu$ PD444/6514 to provide access and cycle times as low as 200 ns in the industry standard 300 mil wide 18-pin package. Like the  $\mu$ PD2114L, it's manufactured on four-inch wafers—for low cost and high volume production. And the  $\mu$ PD444/6514 will operate in a fully static or asynchronous mode.

The  $\mu$ PD444/6514 is the latest

addition to our growing line of CMOS RAMs— a line that includes a 20-pin 4K RAM ( $\mu$ PD 445L), a 22-pin 1K RAM ( $\mu$ PD5101L), and an 18-pin 1K RAM ( $\mu$ PD443/6508). And besides

depth in products, we offer depth in support—including engineers available to help with specific application problems, plus complete documentation, testing, and special selection.

Our 1979 product catalog contains full details on our complete line of memories, plus our 8-bit and 4-bit microprocessors and peripherals.

If you are in North America, you may obtain a copy by attaching your business card or letterhead stationery to this page and sending it to:

NEC Microcomputers, Inc., 173 Worcester St., Wellesley MA 02181.

# Next time, think NEC.

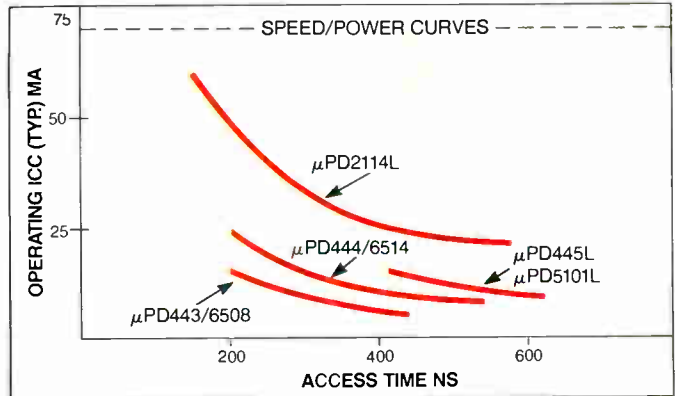

PART NUMBER	ACCESS TIME	OP POWER (TYP)	NO. PINS	STANDBY POWER (TYP)	LOW V <sub>cc</sub> POWER (TYP)
$\mu$ PD444/6514C	450 ns	45 mW	18	.065 $\mu$ W	.022 $\mu$ W
$\mu$ PD444/6514C-1	300 ns	60 mW	18	.065 $\mu$ W	.022 $\mu$ W
$\mu$ PD444/6514C-2	250 ns	75 mW	18	.065 $\mu$ W	.022 $\mu$ W
$\mu$ PD444/6514C-3	200 ns	95 mW	18	.065 $\mu$ W	.022 $\mu$ W
$\mu$ PD445LC	650 ns	45 mW	20	100 $\mu$ W	1 $\mu$ W
$\mu$ PD445LC-1	450 ns	75 mW	20	100 $\mu$ W	1 $\mu$ W
$\mu$ PD5101LC	650 ns	45 mW	22	1 $\mu$ W	.016 $\mu$ W
$\mu$ PD5101LC-1	450 ns	75 mW	22	1 $\mu$ W	.016 $\mu$ W
$\mu$ PD443/6508C/D	450 ns	25 mW	16	5 $\mu$ W	.3 $\mu$ W
$\mu$ PD443/6508C/D-1	300 ns	45 mW	16	5 $\mu$ W	.3 $\mu$ W

# NEC

## NEC Microcomputers, Inc.

WESTERN REGION OFFICE: Orange, CA at (714) 633-2980; EASTERN REGION OFFICE: Melville, NY at (516) 293-5660; MIDWESTERN REGION OFFICE: Des Plaines, IL at (312) 298-7081.

REPS: Action Unlimited, Arlington, TX, Spring, TX; Burton-Medley Associates, Grandview, MO; Cerco, San Diego, CA; Contact Sales, Inc., Burlington, MA; D/Z Associates, Inc., Denver, CO; Electronic Innovators, Inc., Minneapolis, MN; Eltron, Phoenix, AZ; HLM Assoc., Torrington, CT, Northport, NY, Parsippany, NJ; Imtech, Inc., Cleveland, OH, Dayton, OH; Kaytronics Limited, Ville St. Pierre, Quebec, Downsview, Ontario, Surrey, British Columbia; L & M Associates, Pikesville, MD, Montpelier, VA; Harry Nash Associates, Willow Grove, PA; R.C. Nordstrom & Company, Lathrup Village, MI; Nycorn, Inc., East Syracuse, NY; Perrott Associates, Inc., Fort Lauderdale, FL, Clearwater, FL, Orlando, FL; Santana Sales, Costa Mesa, CA; Stone Component Sales, Waltham, MA; Technology Sales, Inc., Palatine, IL; Trident Associates, Inc., Sunnyvale, CA; Tri-Tronix, Albuquerque, NM; Tri-Tronix, NW, Mercer Island, WA; 20th Century Marketing, Inc., Huntsville, AL, Knoxville, TN; Wolff's Sales Service Company, Raleigh, NC.

DISTRIBUTORS: Almo Electronics Corp., Philadelphia, PA, Baltimore, MD; Bell Industries, Bellevue, WA; Century Electronics, Albuquerque, NM, Wheatridge, CO, Salt Lake City, UT; Norman Davis Electronics, South Euclid, OH; Diplomat/Westland, Inc., Sunnyvale, CA; Diplomat/Southland, Inc., Clearwater, FL; Diplomat/Lakeland, Inc., Elk Grove Village, IL; Diplomat/IPC of Mass., Chicopee Falls, MA; Diplomat, Holliston, MA; Diplomat/Northland, Inc., Farmington, MI; Diplomat/Electro-Corn Corp., Minneapolis, MN; Diplomat/St. Louis, Inc., St. Louis, MO; Diplomat/IPC Corp., Totowa, NJ, MI, Laurel, NJ; Diplomat Electronics Corp., Woodbury, NY; Diplomat/Alta-Land, Inc., Salt Lake City, UT; Future Electronics Corp., Montreal, Quebec, Downsview, Ontario, Ottawa, Ontario, Natick, MA; Hughes-Peters, Inc., Cincinnati, OH, Columbus, OH; Intermark Electronics, Sunnyvale, CA, Santa Ana, CA, San Diego, CA; KA Electronics, Dallas, TX; Kent Electronics, Houston, TX; G.S. Marshall, Sunnyvale, CA, Canoga Park, CA, El Monte, CA, San Diego, CA, Phoenix, AZ; Milgray Electronics, Inc., Freeport, NY, Orange, CT; Repron Electronics, Inc., Livonia, MI, Columbus, OH; Resco/Raleigh, Raleigh, NC; Semiconductor Specialists, Inc., Chicago, IL, Burlington, MA, Farmington, MI, Minneapolis, MN, Hazelwood, MO, Pittsburgh, PA, Dallas, TX, Milwaukee, WI; Sterling Electronics, Phoenix, AZ, Santa Clara, CA, San Diego, CA, N. Hollywood, CA, Baton Rouge, LA, Waltham, MA, Albuquerque, NM, Dallas, TX, Houston, TX, Tukwila, WA; Summit Distributors, Inc., Buffalo, NY; Summit Elec. of Roch., Inc., Rochester, NY; Technico, Inc., Columbia, MD, Roanoke, VA; Western Microtechnology Sales, Cupertino, CA.

# STANDARD EQUIPMENT WITH EVERY FAIRCHILD TEST SYSTEM.

Half the reason anybody buys a Fairchild test system is the quality of the system itself.

The other half is customer support.

We pride ourselves on providing the very best customer support program in the test system business. We offer the world's most comprehensive training to get you started. Meaningful applications to get you running. And worldwide field service to keep your downtime to an absolute minimum.

Everything we do is designed to meet a common goal: Give you maximum use of your Fairchild system at the lowest possible cost.

That's the overview.

Here are the specifics:

## **TRAINING YOUR PLACE OR OURS.**

Fairchild operates training centers in San Jose, Munich and Tokyo. Courses can also be taught in your own plant by special arrangement.

In our training centers, your personnel are given hands-on experience with the exact kind of test equipment you buy. They start with 12 to 18 man-weeks of basic training, and then choose from a broad range of courses to fit your specific needs—from testing fundamentals to advanced LSI testing techniques.

We use the very latest teaching techniques, including videotape and programmed learning courses, in addition to live lectures and demonstrations. Our average instructor has a minimum of seven years of experience. We have trained over 8,000 customer

personnel in the past seven years.

## **APPLICATIONS. NOT JUST HOW, BUT WHY.**

The key to effective applications support is making sure your Fairchild system does everything it can to meet your specific testing requirements. We maintain a worldwide team of applications engineers to help you get your

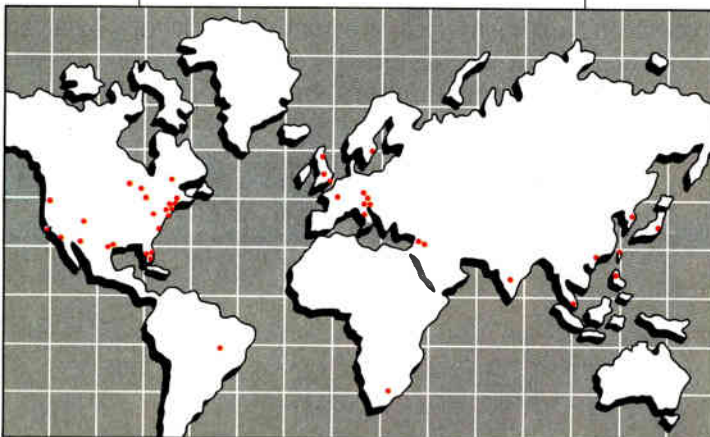

system up and running. We also have a software library containing hundreds of ready-to-run device test programs for standard ICs, almost every known microprocessor, I/O chips, bipolar RAMs, MOS RAMs and a number of support circuits. These programs would cost you tens of thousands of dollars if you had to develop them yourself from scratch.

It all adds up to an applications base that meets many of your testing needs before you begin.

## **SERVICE. ALWAYS THERE WHEN YOU NEED US.**

No matter where you are in the world, we have a field service engineer close by to keep your system uptime up. We have more than 25 major service centers throughout the U.S., Europe and the Far East.

We offer a variety of service contracts that can be tailored to your needs. They give you monthly servicing and calibration of your test systems, automatic field change notices, automatic software updates, replacement of defective parts, and a commitment to be there within a matter of hours (within 50 miles of a service center, average response time is four hours).

All in all, we guarantee never to forget you after the sale. That's why every Fairchild test system you buy comes with the personal commitment of trained professionals, applications engineers and service personnel as standard equipment.

For more information, contact your nearest Fairchild Test Systems sales office. Or

write Test Systems Group, Fairchild Camera and Instrument Corporation, 1725 Technology Drive, San Jose, California 95110. Tel: (408) 998-0123. TWX: 910-338-0558.

**FAIRCHILD**  
**TEST SYSTEMS GROUP**

**The  
first family  
of ATE.**







## BRAIN CELLS.

Employed by smart engineers for reliable, dependable, rechargeable power.

Now available in four, basic 2V cell sizes, ranging from 2.5 to 25Ah, for dozens of battery configurations and hundreds of applications.

With outstanding float and cyclical characteristics and superior storage life.

All invented, manufactured and refined by Gates Energy.

Be wise. Contact Gates Energy Products Inc.,  
1050 S. Broadway, P.O. Box 5887,  
Denver, CO 80217. Phone (303) 744-4806.

# GATES ENERGY

Circle our number on the reader service card for additional input.

Circle 88 on reader service card

# Intel takes aim at the '80s

Microcomputers will shift from hardware- to software-intensive to ward off otherwise inevitable 'programmer catastrophe'

by John G. Posa, Solid State Editor, and Bruce LeBoss, San Francisco regional bureau manager

The microcomputer's growing popularity has put the industry on a collision course with a major obstacle—a software crisis—that could seriously threaten the pervasiveness of electronics.

Unlike the past decade, when the microcomputer industry addressed itself to the problem of reducing the cost of electronic functions, "the problem of the 1980s is going to be reducing the cost of solutions," states Andrew S. Grove, president and chief operating officer of Intel Corp., Santa Clara, Calif. Grove, whose firm is in the vanguard of the proliferation of microcomputer applications. He believes electronics will shift into a new era "where pervasiveness will be limited" by what it costs the end customer to implement the complex functions that microcomputers and related devices now provide.

On the assumption that in the next decade the number of microcomputer designs will increase by 30% yearly and the implementation effort per design will double, Grove comes up with what he calls an absolutely mind-boggling requirement. "We will need in excess of 1 million software engineers by 1990," he states. Since the electrical engineering graduates in the U.S. are at present to be numbered in the tens of thousands, the picture Grove paints is one he describes as a "programmer catastrophe."

According to Grove, not only is the limited production capacity of the educational system a likely contributor to the potential "software crisis," but so is the cost of developing complex software. He estimates that a typical system of the

mid-1970s used about 3 kilobytes of memory at a hardware cost of just \$100. The software for such a system required about 1,000 lines of assembly language to be written. At a rate of 10 lines of debugged code per man-day and \$40,000 per man-year, that would require approximately one half a man-year and, with all the necessary overhead, \$20,000 to develop.

**Sky-rocketing software.** Today,



**Dire need.** Intel president Grove foresees need "for more than 1 million software engineers by 1990—a catastrophe."

what with memory costing much less, a typical system might use 40 to 45 kilobytes of memory, at a hardware cost of \$120 per system. Thus, though hardware costs have changed little, Grove points out that software costs have risen dramatically. Today's system typically requires either 13,000 lines of assembly language or 3,000 lines of a high-level language. At the same number of lines of working code per day and an inflated \$70,000-per-man-year outlay, the cost of developing the necessary software ranges from 1.5 man-years or \$100,000, using a high-level language, to 6.5 man-years or \$450,000 if developed with assembly language.

Typical customer application software costs are sky-rocketing, Grove points out. Whereas total implementation costs might have ranged from \$250,000 to \$300,000 in the mid-1970s, the system of the 1980s will see typical customer application costs balloon to \$1 million with manufacturer support and \$5 million without such support. This high cost of applications technology, coupled with the restricted availability of software engineers, he continues, "sets the limits to the utilization of VLSI."

"If we do not have a million software engineers, and do not change the way we do things, the growing pervasiveness of electronics will stop," Grove warns. However, he is optimistic that something will give, just as it did in the 1970s. "Our industry has always found ways to demolish whatever obstacle was in its way, and we are coming to terms with this problem."

**Complex silicon.** Intel's strategy, Grove says, has been and will contin-

# YOUR CHIPS COME IN



## MITEL'S 'CHIP + CHIP' TOUCH-TONE<sup>®</sup> RECEIVER.

At Mitel Semiconductor, we practice one-upmanship. The MT8860 DTMF Decoder and the MT8865 Band Split Filter are the lowest cost 100 per cent semiconductor solutions to a complete DTMF receiver available. Smaller than conventional receivers, this chip-set features separate filter and decoder components with applications ranging from switching systems to mobile radio.

### FEATURES

- 12 mW power dissipation.
- Single supply voltage from 4.5 to 13 volts.
- 14 dB signal to noise ratio.
- Exceptionally low talk-off rate (less than three hits on Mitel test tape).
- 30 dB dynamic range.
- 30 dB precise dial tone rejection.

Now available for immediate delivery.



LAUNCHING THE CHIPS OF TOMORROW.

## MITEL SEMICONDUCTOR

United States: 1735 Jefferson Davis Highway, Suite 1009, Arlington, Virginia, U.S.A. 22202. Telephone (703) 243-1600  
1223 Westchester Pike, Havertown, Pennsylvania, U.S.A. 19083. Telephone (215) 449-5556.  
2321 Morena Blvd., Suite M, San Diego, California, U.S.A. 92110. Telephone (714) 276-3421.

Canada: P.O. Box 13089, Kanata, Ottawa, Ontario, Canada K2K 1X3. Telephone (613) 592-2122,  
Telex: 053-4596, TWX: 610-562-8529.  
18 Airport Blvd., Bromont, Quebec, Canada J0E 1L0. Telephone (514) 534-2321, Telex: 05-267474.

Europe: Hamilton Road, Slough, Berkshire, England SL1 4QY. Telephone 0753-36137, 0753-36138, Telex: 847730  
Fredericiagade 16, Suite 309, 1310 Copenhagen K, Denmark. Telephone (01) 119302, Telex: 27246

Asia: Park-In Commercial Centre, Suite 1423, 56 Dundas Street, Mong Kok, Kowloon, Hong Kong.  
Telephone 3-318256, Telex: 64235.

Circle 92 on reader service card

Copyright 1979 Mitel Corporation  
\* Registered Trademark of AT&T

## Inside the news

provide "hardware protection and multiple levels of privilege," according to House. While Intel will not be the first to announce memory protection for a microprocessor, it may be the first to incorporate this mechanism on the same die as the processor. "If you go to a separate device, your performance is going to suffer," believes Hartmann.

Just as the microcomputer class exhibits 8- and 16-bit attributes, the micromaxi class has 16- and 32-bit attributes. "The 16/32 [class of processor] adds an enhanced bus structure over the 8086," says House. The 8087 math processor for the 8086 and 8088 will be changed for this new class of device, but only slightly. The basic 8087 design will be utilized; but there are some small pinout changes to produce the 8087A. "Because of the additional capability, you require certain extensions, but these are basically mask options," says House.

**The ultimate.** The micromainframe class represents the *pièce de résistance*. Whereas the micromini and micromaxi families have upgraded instruction sets compatible with the 8086, with the micromainframe there are no programmer-visible registers and there will be no assembly language for this machine, House reveals. "It's only programmed in a high-level language, and that language is ADA; in fact,

there will be some extensions to ADA, as I understand it." ADA is the Department of Defense's recently adopted standard programming language and is based upon Pascal, but modified in accordance with the DOD's requirements.

The micromainframe is a full-blown 32-bit processor on a chip. The table puts its typical memory size from between 256 thousand and 8 million locations, but this machine, with its adaptive virtual memory support, allows the user to refer to in excess of  $2^{30}$  bytes.

Program memory and physical memory are entirely severed in a logical sense, and the length of objects fetched can go to 64 bits. All scalar data types are symmetrically supported in the instruction set; multiple operands facilitate vector and record addressing modes; and multiprogramming and multiprocessing are supported in hardware with synchronization and concurrency logic.

The instruction set of the micromainframe will be a break with the past; it will not execute 8086 assembly-code programs. "Just as the 8085 to the 8086 was a new step in architecture, this is another," House observes. Although this new architecture will significantly affect software development, "the 32-bit-class machine utilizes the same set of concepts and the same set of interconnections and the same set of peripherals as the existing line," says House. "The 32-bit machine attacks

not only the problem of simplifying operating system software, but also the applications software, making a sizable reduction in software complexity by providing a more direct map of the structure of the problem." Indeed, House contends that at the 32-bit level the programming burden will be reduced tenfold. This should satisfy Grove, who hopes that the number of programmers required will be reduced from a million to 100,000.

The micromaxi and micromainframe machines will come in 64- and 68-pin packages and both will support networked architectures for advanced multiprocessing. This multiprocessing will be invisible to the user at the high end.

Beginning with the 8086 and the micromini class, these processors will take advantage of RMX/86, a modular real-time multitasking (and ultimately multiuser) operating system to be introduced late this year or early next. The concept of integrating the kernel of the operating system and other software components is already taken into account in RMX/86. "It's been designed from the ground up with a foreknowledge of the next generation of machines," states James P. Lally, general manager of development system operations. "We've designed it with expandability in mind so that as we add new features and capabilities we'll be able to automatically incorporate them into the operating system." RMX/86 is written in Intel's high-level system implementation language PL/M. "It's modular so the customer can pick what he wants and use the linking and locating features of all our languages," continues Lally.

**Saving steps.** Thus one idea behind RMX/86 is that, as programming tools move from the software world into the domain of hardware, this new environment is taken into account. For instance, the system will support memory protection even before this concept is imbedded into silicon at the micromaxi level. And when the micromaxi hits the streets, RMX/86 will already have the tools

---

**Action plan.** Systems general manager Davidow will help implement strategy of increasing degree of system integration.



## Inside the news

to exploit the protection hardware to full advantage. Although an operating system exists for the 8-bit class of processors, RMX/80, memory protection was unfortunately not considered.

"If you do not design an operating system with an architectural concept of what data protection is going to look like from a hardware standpoint, basically what you have to do is write another operating system," Lally admits.

A targetlike picture can be used to represent the operating system. The bull's eye is the nucleus, a collection of low-level functions comprising just slightly more than the basics of the kernel. The next layer adds I/O drivers; the next, a file system; and the next, a data-management system, a component not available with RMX/80. Surrounding this target is the ring of users with their applications programs.

Lally views the data-management functions as key inclusions in the RMX/86 operating system. "Data-

management functions allows for synchronous file I/O, asynchronous file I/O, and tree directory structures, so that when you're looking for a file, you can just specify the core of the file and it [RMX/86] goes out to the directory and picks up all the other files linked to it," he explains.

As Intel puts more and more software into silicon, "we will be providing standard building blocks at all these levels," forecasts Lally, "so customers can choose where they want to get started in solving their problem. I would maintain that the successful companies in the 1980s are going to start from data management out. The farther out they can get themselves from the center, the better off they are going to be in terms of breaking down generalized solutions logically. In 1985 you're going to want to put everything up to the application in the machine and interface with the computer at the outermost ring," Lally surmises.

Whereas the kernel will be built directly into the basic architecture of an upcoming Intel microprocessor, and though the remaining nucleus functions will probably be put into firmware in or very near the CPU, the next level out—the I/O drivers—may be integrated into support devices instead. "Where does an I/O driver belong?" asks Lally. "Wouldn't you like to put it on the peripheral controller? Why not have the I/O driver on the communications controller, for instance, so that the nucleus can talk directly to that chip? Maybe parameters will be sent back and forth in decimal," he adds.

With software components distributed throughout a microcomputer system, the concept of in-circuit emulation (ICE) becomes an even more interesting one. Lally feels that "at the component level, in-circuit emulators will always be required for hardware/software integration." But he is quick to add that with devices like the coprocessors, "ICE is tough. We have Multi-ICE now, which allows you to debug a system with an 8085 and an 8048. It's clear we're going to need the same kind of capa-

**The lineup.** Microprocessor general manager House says foundation of "microsystem architecture is five classes of processors."



**Looking away.** Software project manager Hartmann sees reorientation from data stored within processor itself to the data that is stored within other memory.

bilities for machines in the future that have coprocessors. We are certainly working on in-circuit emulators for the next generation of machines which will allow those people to debug their applications in a similar vein to Multi-ICE," says Lally. "There will be a plug for each [processor in the system]."

Intel's product plans will not be free, but the magnitude of the required investment gives it a security blanket. The company claims it has been getting ready for 1980's software crisis that others were late in anticipating. This leaves the competition with substantial expenditures to catch up with, according to Intel.

"In the technology game, sometimes you can really take off from where the state of the art is and go from there," states the company's chairman and chief executive officer Gordon E. Moore, "but in the computer business there is a cumulative investment that has to be duplicated. The more massive we can make it, the more difficult it is for anybody else to participate." Thus, Moore feels justified in predicting that the number of "full-service microcomputer solution suppliers will probably be limited to relatively few."

**Big spenders.** Intel expects to spend near \$150 million for capital equipment in 1980. Aiming his comments at one of its competing



firms, the general manager for Intel's microcomputer systems division, William Davidow, explains that "if a company is doing \$40 million and plans to invest \$10 million in capital equipment this year, that will drive them toward a 1% market share in the n-channel MOS business. That defines a specialty supplier. If you look at the economics, it is hard to believe that there are as many of us as there are in this business. When you get to the 16-bit microprocessor area, there're not going to be many names."

The high level of capitalization may signal maturity in the industry. "Success in this business is being determined more by the laws of economics than by the laws of technology," Davidow avers. "That is something that has traditionally happened as industries mature, which is what's happening in this business."

Moore defines two maturity indicators—"when we can no longer increase the amount of money coming into the industry, or when we've done everything," he says, adding, "We will reach the first limitation before we reach the other."

What Moore is saying, then, is that the pervasiveness will continue: "I think the opportunity exists to grow at 30% per year or more, on the average." Intel experienced a phenomenal 65% growth last year at a time when the industry was growing in excess of 30%, "and I would be disappointed if we grew any less

**Harvest.** RMX/86 Integrates operating-system kernel and other software, says development system general manager Lally.

## The going gets tough

Especially when the product is a microprocessor, an early announcement can spell the difference between a design-in and a put-down. Many of Intel Corp.'s product announcements have, fortunately, been early enough to minimize the impact of later introductions by the competition.

This picture has of course changed recently, especially with the advent of the latest generation of 16-bit microprocessors. Motorola Inc. has been aggressively marketing its MC68000 and Zilog has been doing the same with its Z8000. Both are now in production, with viable alternate sources.

Although Intel's 8086 was the first of these so-called high-performance machines, it is with much chagrin that Intel nonetheless has been losing market share. This situation became climactic last year when Olivetti of Ivrea, Italy, a long-time Intel customer, snubbed the Santa Clara, Calif., company in favor of Motorola's 68000.

Olivetti's "dear John" letter triggered the departure of a team to Italy to patch things up. Ironically, neither Intel nor Motorola won this buyer; Zilog did. Some say that the Italian government may have persuaded Olivetti to buy from a domestic supplier (SGS-Ates Componenti Electronici is a second source of the Z8000), but its system product group, which comprises more than half of the company's \$2 billion in worldwide sales, will be using neither 8086s nor 68000s after all.

Intel has been proud of its ability to retain a commanding position without having to resort to selling preannounced future products. Now the competition is fierce, and it exists not only at the device level. National Semiconductor Corp. has permitted a peek at its NSC16000, while others like Texas Instruments Inc., due to follow its 9900 with a new family, Signetics Inc., and American Microsystems Inc. are gearing up to enter the race.

Moreover, on the support side, universal development systems manufacturers continue to chip away. GenRad/Futuredata, and more recently Hewlett-Packard Co., have announced networked development systems architectures, beating Intel to the market with a product that it, too, plans.

than the industry average over the next decade," says Moore. At a 33% annual growth the company will top \$1 billion next fiscal year and reach \$15 billion by 1990.

Intel will not even have to go after the minicomputer and mainframe manufacturers to realize its expansion plans. "We're not interested in supplying general-purpose computers. If you manufactured one 8086 for every IBM 360 in the world, that would be what—a few days' produc-

tion?" Hartmann remarks. Similarly, with regard to minicomputers, Grove states that "in one month's time we ship more computers than DEC [Digital Equipment Corp.] has shipped in its entire existence. I don't think these gadgets will end up in what we know as mainframe applications today."

"We have to supply flexible building blocks and let the OEM provide the actual applications expertise because we can't master it—it's too broad. We are aiming to do so much of the common stuff that only the adaptation of those blocks is left, with 90% of it prefabricated, Grove adds.

"The application revolution of the '70s will look like a prewar skirmish compared to what's coming," warns House. "What happens when you can put free, unrestricted intelligence into any product?" He advises today's engineers to learn programming—to use modules of software.

"We're talking about 10 to 20 computers in the average home in the next decade and things of that nature," explains Hartmann. □

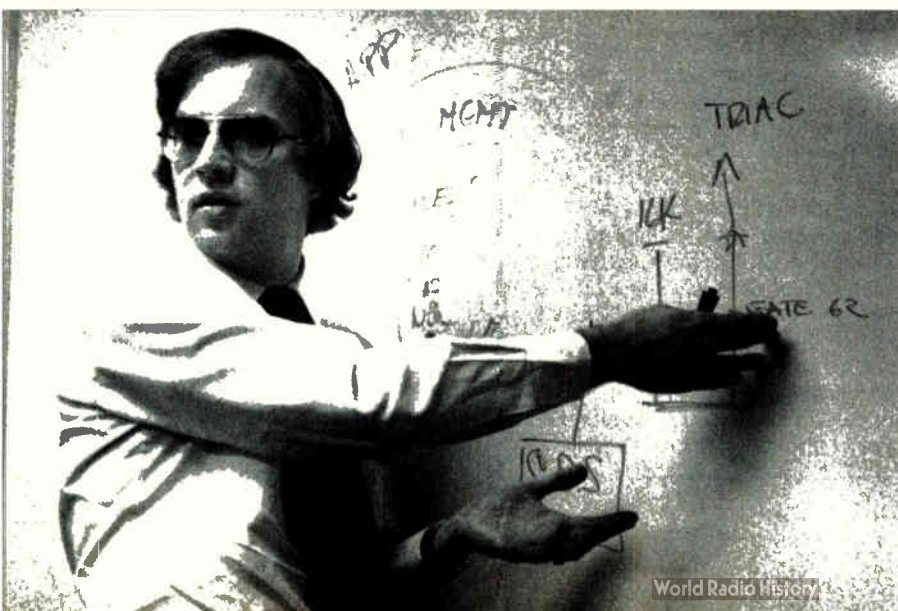

## Battle set for 32-K, 64-K E-PROMs

Intel, TI, Motorola, and Mostek have lined up faster and denser memories with new cell designs

by Wesley R. Iversen, Dallas bureau manager

As lead times shorten and prices begin showing signs of erosion on once hard-to-get standard 2716-type erasable programmable read-only memories, the focus of industry attention is shifting to the next generation of faster, denser parts.

In the near term, that means 32-K devices from the likes of E-PROM leader Intel Corp. in Santa Clara, Calif., and from Texas Instruments Inc., Dallas. According to Daniel Kleskin, vice president for the market research firm Dataquest Inc. in Menlo Park, Calif., Intel and TI led the industry in total E-PROM shipments last year, each pushing 3.7 million to 3.8 million parts out

the door compared with about 750,000 from the next nearest competitor. Two thirds of the TI total, however, consisted of older, three-supply parts, though the Dallas firm is currently thought to be running about even with Intel in 32-K E-PROM shipments of about 30,000 units monthly.

**The scraps.** In terms of E-PROM technology leadership and market strategy, Intel is perceived by many to be the one to catch. Now that a plethora of other suppliers have moved into the market for single-5-volt-supply, 16-K parts, Kleskin, for one, thinks Intel will de-emphasize that business and move on to

more profitable leading-edge E-PROM parts such as the 2732A—a new high-speed device fabricated in the company's latest H-MOS-E process. The 2732A employs minimum scaled 3-micrometer geometries in achieving premium access times of 200 nanoseconds [*Electronics*, Jan. 3, p. 189].

Indeed, at Motorola Inc.'s MOS division in Austin, Texas, strategic marketing manager David Ford expects as many as nine companies to be solid suppliers of 5-V-only, 16-K E-PROMS during 1980. He figures that this much competition could cause 2716 prices to drop by as much as 40% by year-end.

But if a dog-eat-dog battle for the 16-K "scraps" does develop, it appears as though there could be some scrapping at the top end as well. Intel has yet to bring out a 64-K E-PROM product, though a late third-quarter announcement is expected. Both Motorola and TI, however, have introduced 64-K E-PROM devices [*Electronics*, Sept. 27, 1979, pp. 40 and 176], and other 64-K product announcements are expected this year.

**Advances due.** Indications of what is in store came at the International Solid State Circuits Conference this month, where high-density advanced E-PROM devices were described by Intel, TI, Motorola, and Mostek Corp. of Carrollton, Texas.

Probably the most unusual was the Mostek device, a fully static, 8-K-by-8-bit chip employing 25% redundancy. The company plans to have samples of the MK2764 in the second quarter this year. Thanks to an X-shaped cell design that uses two levels of polysilicon and shared

### Pinout decision pins down TI

TI's attack plan on the high-density E-PROM market suffered a defeat in San Francisco this month when the Joint Electron Device Engineering Council's JC-42 committee failed to approve the TI 28-pin ROM, E-PROM, and static RAM packaging approach. TI had requested that its pinout be accepted as a second standard to coexist with a differing and already approved 28-pin package approach favored by Intel. But the JC-42 panel's vote apparently means that the Intel pinout will be the only one to get the nod as the industry settles on the 28-pin configuration that will be required for E-PROMs and other memory types beyond the 64-K densities.

Though TI moved from 24-pin packages used in previous-generation E-PROMS to a 28-pin carrier at the 64-K level (and Intel and Mostek are expected to do likewise), Motorola took a different tack with its 64-K E-PROM—the MCM68764. By multiplexing more than one function on a pin, Motorola designers were able to squeeze the 8-K-by-8-bit device into a 24-pin package.

Motorola memory officials in Austin concede that a 28-pin package will be necessary to move up the E-PROM density ladder, but expect to gain significant 64-K E-PROM market share by selling 68764 parts as plug-in replacements for industry-standard 24-pin ROMs of 64-K densities or less. The 68764 "is not a technology leadership product with bells and whistles. It's just a very nice, simple production part that we expect is going to be used by practically everyone," Motorola's MOS strategic marketing manager David Ford predicts. With access times specified at 450 ns, with a 350-ns version available as well, the 68764 is fabricated using Motorola's standard n-channel process, which produces a die size of about 60,000 square mils.



ground lines in achieving increased packing density, Mostek can hold the 2764 to 57,000 square mils—including the redundancy—using 5- $\mu$ m minimum geometries. That is how the part will be introduced, though later plans call for 3.5- $\mu$ m design rules, says Derrell Coker, manager of Mostek's memory products department. The X-shaped cell design employed in the 2764 has evolved from a cell described at ISSCC in 1978 and first used in Mostek's 64-K ROM, the MK 36000, Coker adds.

What Mostek gives up in extra real estate with its block-redundant approach on the 2764 it hopes to make up in increased yield. When a bad bit is found during testing of the device, a polysilicon fuse will automatically be blown, routing the input and output multiplexers away from the bad area and into one of two spare 2-K-by-4-bit matrixes.

**Denser devices.** If die size were the only measure of a device, the initial 57,000-mil<sup>2</sup> part from Mostek could have trouble competing against TI's high-density E-PROM components. TI's existing 32-K and 64-K E-PROM parts are housed on dice of 36,000 and 40,000 mil<sup>2</sup> respectively, using 4.5- $\mu$ m minimum design rules, and the Dallas firm is planning smaller, higher-performance pin-compatible replacements for those devices that could come late this year.

The basis for that move is what TI calls its X-Series cell, which is similar to the Mostek cell design. TI says it can cut array sizes by 40% using the X-Series approach without additional scaling down. The result will be a die size of 21,400 mil<sup>2</sup> on the 2532X, which will be built with the same equipment and will employ the same 4.5- $\mu$ m geometries used on the existing TMS2532, says Dick Gossen, TI's MOS memory marketing manager in Houston. A similar reduction will occur at the 64-K level, before TI moves on to 3.5- $\mu$ m geometries to be used in X-Series devices at the 128-K level and beyond, Gossen adds.

With the reductions in die size will come performance improvements as well. The 32-K X-Series product planned for introduction late this year will not match the 100-ns access time measured in one of two

devices described by TI at ISSCC. But the 2532X and later 2564X will improve on the 450-ns figure specified for the current 2532 and 2564, coming in between 200 and 300 ns, reports David J. McElroy, the firm's E-PROM branch manager in Houston. Likewise, the first two X-Series parts will typically dissipate between 200 and 300 milliwatts in an active mode with worst-case power specified around 500 mW. That compares to maximum operating power pegged at 840 mW on the existing 2532 and 2564, though TI also offers a low-power TMS25L32 that is specified at 500 mW maximum.

**High speed.** In the meantime, Motorola memory designers in Phoenix have not been sitting on their hands. In an ISSCC paper, Motorola engineers Stephen L. Smith and John R. Yeagain described an 8-K-by-8-bit E-PROM fabricated in double polysilicon HMOS that uses 4- $\mu$ m line widths, achieving a 42,500 mil<sup>2</sup> die size. Motorola could be in production on such a part with an access time specified around 200 ns in 9 to 12 months, if it chose to do so, says Peter Bagnall, marketing manager for MOS memories. But Motorola officials say they do not see a high-priority need for such speed in the near-term market.

Motorola is already selling a 32-K E-PROM device in the form of a 68764 partial [*Electronics*, Nov. 22, 1979, p. 168], but the company also has plans to bring out a straight-up 32-K E-PROM—the MCM-2532—during the second quarter this year. Systems designers can also look for low-power options to be offered on Motorola E-PROMs in the near term. The company's just-introduced 16-K E-PROM, for example (see p. 202), is available not only in a 250-ns access time version but also in iterations that offer a power dissipation of only 250 mW.

At Intel, the ISSCC device is fabricated with the same advanced HMOS-E process as that used for the 2732A. Since it is understood that the latter device was born out of a part originally fabricated at the 64-K level, it appears likely that the ISSCC-described 64-K device may be essentially the same as the 64-K device expected to be introduced by Intel later this year. □

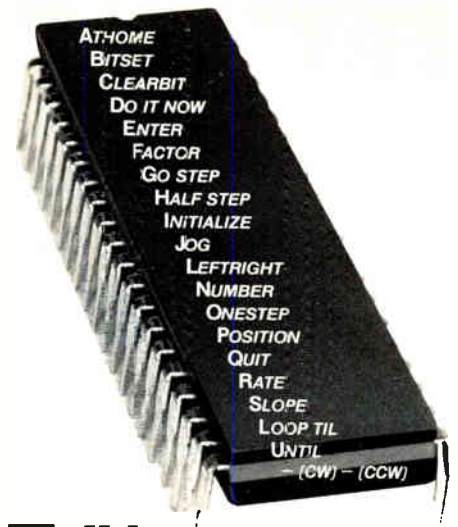

## Tell it and forget it...

... the new CY500 stored program stepper motor controller runs its own program, freeing your host computer for other jobs.

No more one-pulse, one-step operation requiring your host computer to tie itself down to a stepper motor. Now Cybernetic Micro Systems brings you a function-oriented stored program stepper motor controller that allows the user, or host computer, to program it and forget it...

The CY500 executes 22 hi-level instructions, either in command mode or as a sequence of internally-stored commands, using single byte code such as 'P' for position, 'R' for rate, and 'S' for slope. Parameter values can be expressed in ASCII-decimal for keyboard programming or binary code from the host computer. Parallel or serial communication.

The stored program capability allows the use of 'DO-WHILE' program looping and 'WAIT-UNTIL' operation. Ten different operational modes allow absolute or relative positioning, full- or half-step operation, hardware or software control of direction, start/stop, ... and many more.

Numerous input and output control lines allow synchronizing the CY500 with external events or devices and allow each step to be triggered. Stepping at rates up to 3500 steps/sec, the CY500 also provides ramp-up, slew, and ramp-down operation, all under software control. Two interrupt lines request the host's attention if needed.

This +5 volt N-MOS TTL-compatible controller is available from stock, today, for only \$95.00. Contact Cybernetic Micro Systems. We want to see you program your stepper motor and then ... forget it.



**Cybernetic Micro Systems**  
445-203 South San Antonio Road  
Los Altos, California 94022  
(415) 949-0666

(Use your MASTER CHARGE or VISA charge card)

Letter from Palo Alto

## Silicon Valley is filling up

Expansion has brought with it problems in housing, transportation, and energy; South Bay communities are calling a halt

by Martin Marshall, West Coast Computers and Instruments Editor

**Silicon Valley**—this world center of the semiconductor industry, this finger of land that stretches south along the San Francisco Bay, this phenomenal success story of the last two decades—must now pay the price of its own astonishing growth.

Part of that price is apparent in the orange-brown haze that hangs over what was once the magnificent South Bay landscape, with fruit orchards as far as the eye could see. The haze, like the area's problems, does not come directly from the electronics industries, but rather from

the people, cars, utilities, and attendant industries that electronics has brought to the area. This situation has in turn created more jobs and an influx of still more people—more than the area can or will be able to house. The cars of workers have seriously congested the Valley's highways, and it will get worse. Further—perhaps the ultimate irony—the combination of the area's growth and the state's energy policies may create brownouts by this summer.

The hard fact of the matter is that the area is bulging at its seams, and

executives are looking elsewhere to accommodate the growth of their companies. One example is Memorex Corp. of Santa Clara. "It is the broad policy of our company to expand outside of Silicon Valley," notes chairman Robert C. Wilson. He points out that the firm's opening of a floppy-disk-drive manufacturing facility in Mountain View last year was an exception to that policy and that the company's plans to build in Plano, Texas, are more indicative of the future.

Although the Memorex policy has been in effect for five years, findings of the Santa Clara County Manufacturing Group (SCCMG) of Sunnyvale, Calif., have quantified its rationale. The group is a nonprofit organization that was formed in 1978 by the principal officers of the Valley's major firms. Its existence indicates the importance that executives attach to growth problems.

The group's surveys reveal that, by the end of the decade, between 225,000 and 330,000 new jobs will have been created in the Valley, at least a 45% increase over 1975. Over the same period, however, housing will increase only 30%, or by 139,000 units. Since the building industry association figures that there are 32,000 too few housing units in the county right now, these projections conjure up visions of employed-but-homeless engineers.

The housing shortage has had a predictable impact on costs. In San Jose, the price of an average home has risen from \$33,000 in 1973 to over \$92,000 in 1979. In Palo Alto

**Stumped.** After 20 years of uprooting orchards to make room for electronics growth, Silicon Valley is running out of room and companies are planting their factories elsewhere.



This is the second in a continuing series of reports from Electronics bureaus relaying the talk of their regions.

# LAST NOVEMBER, DATA GENERAL AND DEC ANNOUNCED NEW COMPUTERS. THE SIMILARITY ENDS THERE.

<b>COMPARE:</b>	<b>SPEED</b>		<b>PRICE</b>
	Thousands Whetstone instructions/second		
	Single Precision	Double Precision	
DEC PDP 11/44 System	<b>314*</b>	<b>231*</b>	<b>\$41,900*</b> Includes PDP 11/44 with 256 ERCC memory, 20.8 MB dual RL02 disc subsystem, floating point processor and LA120 console printer
Data General ECLIPSE S/140 System	<b>450</b>	<b>380</b>	<b>\$37,450</b> System including S/140 with 256KB ERCC MOS memory, Model 6100 25MB non-removable moving head disc with integral 1.26 MB diskette floating point hardware and Dasher TP2 180 CPS console printer
<b>ECLIPSE S/140 is:</b>	<b>43% faster</b>	<b>65% faster</b>	<b>10% lower price</b>

What more can we say? Our new ECLIPSE® S/140 is not only a great deal faster than the 11/44, it's also a great deal, period. Read the chart. Then you'll understand why our ECLIPSE S/140 is your only choice. Break the speed limit without paying the price. Send in the coupon.

Data General Corporation, Westboro, MA 01580, (617) 366-8911. Data General (Canada) Ltd., Ontario, Canada. Data General Europe, 61 rue de Courcelles, Paris, France, 766.51.78. Data General Australia, (03) 89-0633. ECLIPSE is a registered trademark of Data General. ©Data General Corporation, 1980.

**Data General**

Mail to: Data General Corporation, Westboro, MA 01580 E228  
 I can read. Send me complete information immediately.  
 I can read but I can't wait. Send a salesman now.

Name \_\_\_\_\_ Title \_\_\_\_\_ Company \_\_\_\_\_  
 Address \_\_\_\_\_ City \_\_\_\_\_ State \_\_\_\_\_ Zip \_\_\_\_\_  
 Tel. \_\_\_\_\_

The Computer  
 of the  
 U.S. Olympic Sports  
 Medicine Committee

\*As reported in DATAQUEST Research Newsletter, Nov. 30, 1979; COMPUTER SYSTEMS NEWS, Dec. 3, 1979.

Hey! "Daisy" Wheel...

there's a

# NEW KIT IN TOWN!

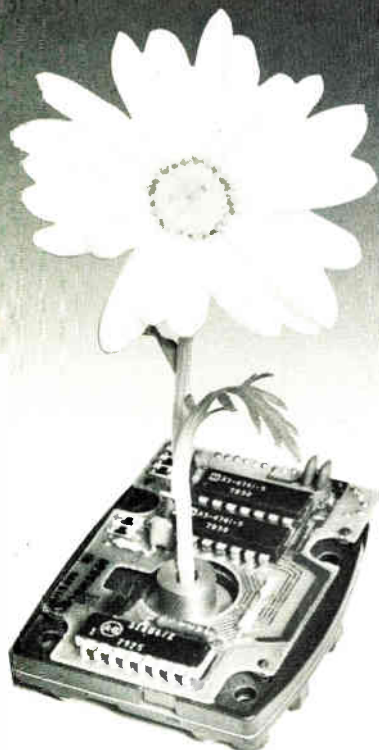

## SENSOR TECHNOLOGY

produces more OEM  
OPTICAL ENCODERS  
annually than anybody!

The UNDER \$20\*  
KIT ENCODER for Servo  
Applications featuring:

- Quadrature Push-Pull monolithic readout.
  - Sine and cosine output gives speed, direction, position and indexing information.
  - Single LED Light Source driven by a temperature compensated feedback loop.
  - Excellent Linearity. • Low, low offset.
- \*OEM Prices

WE MAKE LINEAR & ROTARY ENCODERS  
TO YOUR SPECIFICATIONS

**SENSOR TECHNOLOGY**  
A Subsidiary of Dynex Corporation

21200 LASSEN STREET, CHATSWORTH, CA 91311  
(213) 882-4100 TELEX: 910-494-4776

## Probing the news

the price of the average house has rocketed from \$56,000 to \$150,000 over a similar period.

**Powerless.** For managers of existing facilities, a pressing concern is likely to be electricity. Notes Hewlett-Packard Co.'s president, John Young, "If Governor Brown carries out his announced plan to keep the Diablo Canyon nuclear power plant from coming on line, the energy reserve could be as low as 2% by this summer. This is low enough to cause brownouts in some areas on a fairly routine basis."

In his testimony before the State Energy, Resources and Development Commission, Wilson pointed out that the need for electricity among Santa Clara County industries will increase by 6.1% per year in spite of the industry's efforts to conserve. "It is not realistic to rely on large cutbacks in energy use by our industry to offset decreasing power reserves," he concludes.

The implications of this future shock have not been lost upon either the county's officials or the Valley's executives. The City of Sunnyvale, for its part, has imposed a moratorium on new industrial development, and the City of Palo Alto is expected to follow suit in March. Meanwhile, the aggregate of Silicon Valley's firms are projecting that, in the next two years, half of their growth will be directed outside the area. This continues a trend, with new plants set up by Zilog Corp. in Idaho, by Intel Corp. in Oregon and Arizona, by National Semiconductor Corp. in Washington, by Advanced Micro Devices Inc. in Texas, and by Shugart Associates in Sacramento, Calif.

**Homebase.** These are all recent moves, but Hewlett-Packard has been expanding outside Silicon Valley for more than 20 years. "We first saw the handwriting on the wall in the late Fifties, before we built plants in Loveland, Colo., and Böblingen, West Germany," notes Young. "It was then that we decided to locate new plants according to such parameters as the available labor supply, the pleasantness of climate, and the availability of

schools and cultural facilities." Hewlett-Packard has recently built plants in Oregon, Washington, northern counties of California, and along the front range of the Rockies in Colorado, as well as in North Carolina and Puerto Rico. After its new headquarters are completed in Palo Alto this year, Hewlett-Packard will not build any new facilities in Silicon Valley.

All these factors do not toll a death knell for expansion in Silicon Valley. They may, however, contribute to the emergence of a "silicon mountain" in Colorado, a "silicon prairie" in Texas, a "silicon desert" in Arizona, and rapid expansion in the Portland-Vancouver region. The development of these areas shows that the industry has found the concept of distributed processing greatly to its advantage—not just in its computer systems, but in the actual allocation of their physical plant resources as well. Upon closer scrutiny of that advantage, the price of land emerges as the major factor, with the possibility of adding a local, assembly-level labor supply to the electronics community as a second factor.

Among the more skilled positions, the number of job opportunities within a locale becomes important. Before considering an opening in Portland, Denver, Phoenix, or Austin, for example, an engineer might well ask himself whether a similar job will be available within driving distance of the new house he expects to live in. With the recent developments in these areas, his question can now be answered in the affirmative.

Even so, as Young points out, "Silicon Valley is, and will remain, the startup capital of the United States." It will remain so because none of Silicon Valley's firms is talking about moving headquarters outside the Valley. As long as they remain, they will spin off former management and engineering personnel to small companies with hopes of becoming the next Intel. And as long as there are orchards and marshlands—even on earthquake fault lines—that can be converted into electronics facilities, some town is likely to accommodate them. □



Reliability in precision technology.

## Largest selection of Stepper, DC and Synchronous Motors

AIRPAX offers the largest selection of economical stepper and permanent magnet synchronous motors available anywhere. Whether you need a motor the size of a penny because of space limitations, or one powerful enough to drive an X-Y plotter . . . AIRPAX has it.

We have ironless rotor, brushless and permanent magnet DC motors for timing, drive and control applications. Plus shaded pole, reversible, lightweight synchronous AC motors for military or industrial applications. Also available are many instrument drive motors that can be provided with various gear trains. And a complete line of logic stepper motors from miniature to high torque types for use in computer peripherals and business machines.

In addition to this wide selection, all AIRPAX Motors are cool-running, reliable, low in cost and energy-efficient, too.

For a look at all of our motors and their specifications, write and ask for our free detailed literature.

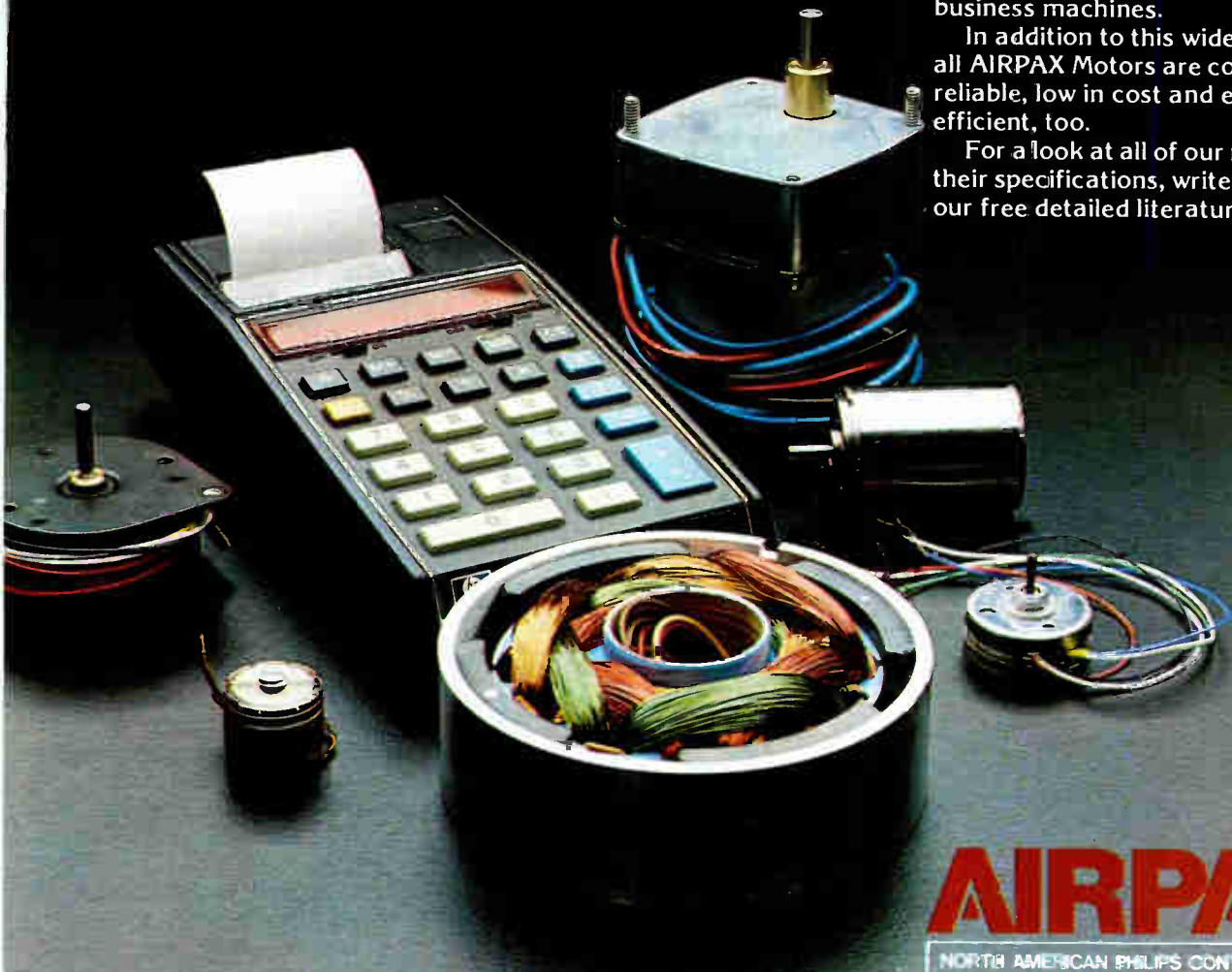

# AIRPAX

NORTH AMERICAN PHILIPS CONTROLS CORP.

Cheshire Division  
Cheshire Industrial Park  
Cheshire, CT 06410  
Telephone: (203) 272-0301

FOR IMMEDIATE NEED, CIRCLE 154  
FOR REFERENCE ONLY, CIRCLE 204  
See 2000

Electronics abroad

# Inflation clouds sunny Spain

Equipment sales, predicted to rise just 5.8%, are dulled by color TV and telephone markets; but computers shine

by Arthur Erikson, Managing Editor, International

Although millions of tourists presumably will flock to sunny Spain this year, the economic climate in the country will be anything but balmy. The output of goods and services, the government figures, will creep up only about 1.5%. Inflation is figured to run something like 16.5%. Capital investment, a sure gage of the confidence of businessmen, will edge up only 1% off the plateau on which it has been stuck for several years. And there are no signs yet that Spanish consumers might turn into heavy spenders in 1980.

This is the kind of mix that makes for leaden markets for electronics hardware—unless a color TV boom is under way or the government has earmarked funds for major communications projects. Nothing like that is in sight for 1980. So after its annual survey, *Electronics* forecasts

equipment sales of \$2.189 billion for the year ahead, a mere 5.8% over the estimated \$2.069 billion for 1979. In real terms, that translates into a slip backwards (throughout this report markets are evaluated at current prices at an exchange rate of \$1 equals 66 pesetas).

The experts attribute the backslide largely to color TV. Formerly a high-flyer that kept set makers winging upward with growth rates around 50% yearly, the color set market leveled off last year. Set production ran about 800,000 units and probably will get very little above that figure this year. Sales, according to the survey, will edge up to \$682 million.

That portends a shakeout. Of the dozen or so companies now operating color TV plants in Spain, estimates Carlos Alba Soto of the

Asociación Nacional de Industrias Electrónicas (ANIEL), a maximum of five will still be on the scene three or four years from now. What is more, all the survivors will be either multinational companies like the Netherlands-based Philips group or Japanese firms.

**Telephone lines down.** The communications sector, another former high-flyer, will lose altitude this year as well. The market figures here are forecast as \$338 million, up from an estimated \$320 million in 1979—again, a notch lower in real terms. Telecommunications gear suppliers were hard hit last year when the Spanish telephone system, Compañía Telefónica Nacional de España (CTNE), cut its investment plans by 20%. At the same time, CTNE stretched deliveries of hardware it had ordered earlier. As a result, about 15% of the work force was idled at the country's major telephone gear producer, Standard Electrica SA, an ITT company.

If they look very hard and beyond the year ahead, communications equipment manufacturers can find some solace. For one thing, the Defense Ministry has mounted a drive to procure more of its hardware at home and that should benefit military electronics companies in the long run. For another, CTNE has ordered a trial ITT system 12 electronic switching exchange with a capacity of 10,000 lines for installation in 1981.

Then, the Spanish radio-television network will take delivery for the studio, outside-broadcast, and relay equipment it needs to broadcast out to the world the World Cup soccer matches scheduled for Spain in

SPANISH ELECTRONICS MARKETS FORECAST  
(IN MILLIONS OF DOLLARS)

	1978	1979	1980
<b>Total assembled equipment</b>	<b>1,935</b>	<b>2,069</b>	<b>2,189</b>
Consumer electronics	917	978	1,032
Communications equipment	298	320	338
Computers and related hardware	481	520	556
Industrial electronics	96	107	118
Medical electronics	97	91	86
Test and measurement equipment	36	42	47
Power supplies	10	11	12
<b>Total components</b>	<b>352</b>	<b>373</b>	<b>389</b>
Passive and electromechanical	152	172	185
Discrete semiconductors	29	31	32
Integrated circuits	20	25	28
Tubes	151	145	144

(Exchange rate: 66 pesetas = \$1)

Note: Figures in this chart are consensus estimates of consumption of electronic equipment obtained from a survey made by *Electronics* magazine in September and October 1979. Domestic hardware is valued at factory sales price and imports at landed cost.

# Numbers You Can Count On!



## Five of the Most Popular Cermet Trimmers

These five cermet trimmer models are available at your local Spectrol distributor and versatile enough to cover almost every standard trimmer application! Each of these quality trimmers features

- brush wiper contact for low CRV • superior setability
- excellent stability • completely sealed construction. All are competitively priced. Give us a call or send for data sheets.

**Spectrol**

### SPECTROL ELECTRONICS GROUP

**UNITED STATES** Spectrol Electronics Corporation P.O. Box 1220, City of Industry, Calif. 91749, U.S.A. • (213) 964-6565 • TWX (910) 584-1314

**UNITED KINGDOM** Spectrol Reliance Ltd. Drakes Way, Swindon, Wiltshire, England • Swindon 21351 • TELEX: 44692

**ITALY** SP Elettronica SpA Via Carlo Pisacane 7, 20016 Pero (Milan) Italy • 35 30 241 • TELEX: 330091

**GERMANY** Spectrol Electronics GmbH Oberauerstrasse 15, 8000 Munich 70 West Germany • (089) 7145096 • TELEX: 52/3014

Circle 103 on reader service card

# GEOMETRY PROBLEMS?

**Pincushion distortion on CRT displays can be solved by the Syntronic problem solvers when electronic circuit correction is out of reach.**

**A Syntronic yoke with carefully calibrated and accurately positioned magnets will "push" in the corners and "pull" out the sides for near-perfect geometry. Any remaining distortion or defocusing is corrected with Syntronic's stator core design combined with special coil turns distribution.\***

**To see the difference 28 years experience makes, let Syntronic solve your geometry problem.**

*\*Write for Syntronic Instruments AP Note No. 1 "Pincushion Distortion, a Significant Factor in CRT Displays"*



**syntronic**

SYNTRONIC INSTRUMENTS, INC.  
100 Industrial Road  
Addison, IL 60101  
Phone (312) 543-6444

## Probing the news

1982. About \$200 million must be spent, the network estimates, to upgrade its technical infrastructure for the job. Whatever the final allocation there will be heavy pressure to buy in Spain whenever possible. Piher Electronica SA, a Madrid-based division of the components company of like name, should do nicely as a result. It produces color TV cameras.

**Olé for computers.** As elsewhere in Western Europe, computer suppliers in Spain can expect to do better than their brethren in consumer electronics and communications gear. The survey predicts computer sales (with rentals evaluated "as if sold") this year at \$556 million, 6.9% over the estimated \$520 million for 1979. The growth figures take on a different hue if you look at the lower end of the market. Sales of small-business machines should move up some 20% and intelligent terminals spurt more than 30%.

Sellers of big systems, in contrast, figure to confront balky buyers in the government administrations. "A lot of key jobs have changed hands as the old guard has been moved out of the government and no one will confirm a major procurement proposal approved by his predecessor," says a computer company executive who must remain anonymous. "We have to renegotiate for systems that we thought were sold and there is a 'no risk' attitude that is holding up orders." At big businesses, the poor economic outlook has quelled enthusiasm for new hardware.

As for components suppliers, they cannot expect to find much growth in a year when their major customers, the color TV set makers, will tread a plateau. *Electronics'* survey puts the 1980 markets for the bits and pieces of which electronics hardware is built at \$389 million. That works out to a modest 4.3% rise over the estimated \$373 million for 1979. The market profile is the classic one for a country with color TV in a stall—flat for tubes and discrete semiconductors, some increase for passives, and a goodly gain for integrated circuits. □

Last in a series examining European markets.



# With TM 500, the setup's up to you.

**Change it,  
rackmount it, bench  
it, roll it, carry it  
...whatever's right  
for you.**

Testing situations can change rapidly. Most test gear cannot. TM 500 gives you an answer to this long-standing problem. How? By letting you assemble your instrumentation in any combination and format that does the job best.

It's done through a series of nearly 40 interchangeable plug-in instruments that fit into any one of six mainframes. Including a sturdy rackmount. Or a hand-carried portable. Plus four different bench-top sizes. There's also a roll cart that lets you carry a scope along with two mainframes full of plug-ins.

Whatever way you want to go, TM 500 lets you do it. All mainframes accept all plug-ins. Everything from DMMs to scopes to generators. Up to six at a time.

For immediate action, dial our toll free customer answering service 1-800-543-1517.



With external rear connections in every mainframe to give you cable-free interfacing. There are even blank plug-in kits that let you construct your own special purpose instrumentation.

TM 500 also lets you change your setup along with your needs. Today's rackmount configuration can become tomorrow's portable testing outfit. It's all up to you. Simply switch your plug-ins around. No matter how you do it, you get the same dependable performance.

To find out more about TM 500, contact your local Tektronix Field Office, or write Tektronix, Inc.

**TM 500  
Designed for  
Configurability**

**Tektronix**  
COMMITTED TO EXCELLENCE

Tektronix, Inc.  
P.O. Box 5700  
Beaverton, Oregon 97005  
(503) 648-3151  
Toll-free 910-467-8700  
Cable: TEKTRONIX

Europe: Anco  
Middle East:  
Singapore: S. S. S. S.  
France: RST  
1160 Av. Armistice  
France: Boulogne



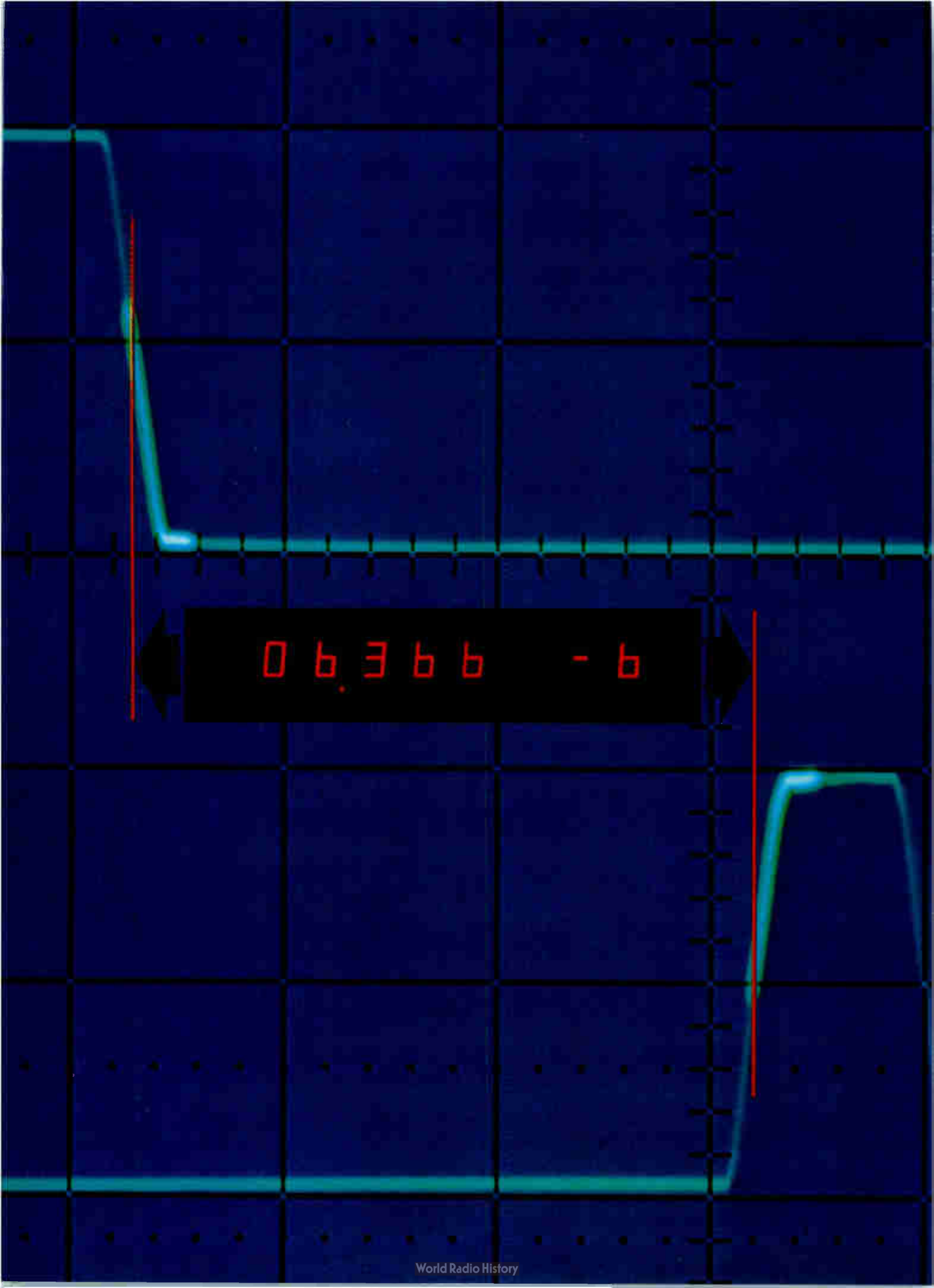

06.366 - 6

# For fast, accurate time interval measurements,

## HP's $\Delta$ -time scopes are the answer.

Ease, accuracy, expanded capability. These are the benefits a two-marker  $\Delta$ -time scope gives you for time interval measurements. Delta time is a feature you get on many HP 1700-series scopes as standard equipment. Here's how  $\Delta$ -time capability gives you added measurement flexibility and convenience:

**Ease of use.** A  $\Delta$ -time scope is an easy way to make time interval measurements such as periods, pulse widths and transition times. For example, to make a period measurement, just set the START marker at the beginning of one pulse and the STOP marker at the beginning of the next pulse. Then, simply read the time interval from the built-in DMM, the STOP control dial, or an external DMM. It's faster than aligning a pulse and counting graticule lines, and there's no mental arithmetic required.  $\Delta$ -time is not only fast and easy — it also greatly reduces the chance of error. A case in point is the crystal-referenced HP 1743A. In the lab, it provides high accuracy and fast, easy time interval measurement. In production, it lets you adjust circuit parameters to meet timing specs without touching scope controls. Even busy production personnel can make fast, accurate measurements with ease.

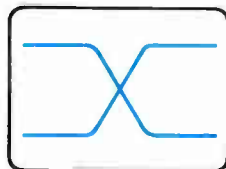

### More accurate measurements.

HP  $\Delta$ -time scopes are more accurate than conventional scopes. The

$\Delta$ -time measurement system is a nulling technique that reduces CRT and horizontal amplifier non-linearity errors. Direct digital readout eliminates errors inherent in interpolating numbers from a turn-

counting dial and multiplying by the main sweep time/division. As an example of HP  $\Delta$ -time accuracy, the HP 1743A makes precision measurements to 0.002%  $\pm 1$  count — up to 500 times more accurate than a conventional scope.

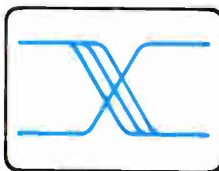

### Additional measurement capability.

Simultaneous two-channel magnification provided by HP

$\Delta$ -time scopes lets you directly compare pulses separated by time. You can easily compare input and output rise times, pulse shapes and ringing. Drift and jitter are easy to spot, letting you avoid measurement errors. And you can even measure the magnitude of jitter easily.

### A whole family to choose from.

HP offers five different  $\Delta$ -time scopes with bandwidths to 275 MHz. There's the 100 MHz 1742A (\$2650\*), with third-channel trigger view; the general-purpose 200 MHz 1715A (\$3300\*) or 275 MHz 1725A (3650\*), which have an optional DMM (\$325\*) available for direct digital readout; and the 275 MHz 1722B (\$5050\*), which calculates  $\Delta$ -time, frequency, DC voltage, instantaneous voltage and percent amplitude measurements. Or, if you're looking for a simple way to make precision measurements to counter accuracy, select the crystal-referenced 100 MHz 1743A (\$3300\*).

For data sheets and application notes, write to Hewlett-Packard, 1507 Page Mill Road, Palo Alto, CA 94304. Or call the HP regional office nearest you: East (201) 265-5000, West (213) 970-7500, Midwest (312) 255-9800, South (404) 955-1500, Canada (416) 678-9430.

\*Domestic U.S.A. price only.

089/12

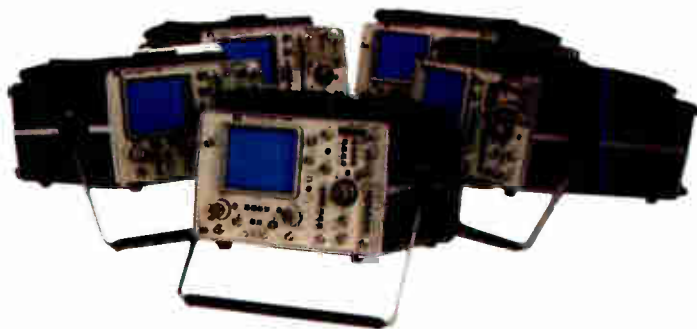

**HEWLETT  
PACKARD**

# THE BEST ADC80 YOU

## WE CAN FILL ALL YOUR ADC80 ORDERS IMMEDIATELY FROM STOCK.

Coming up with a vastly improved ADC80 is one thing; making sure that it's readily available in quantity is quite another. Analog Devices has done both.

Our ADC80 is a complete 12 bit successive approximation analog-to-digital converter that includes an internal clock, reference and comparator. It needs no external components to perform a 12 bit

accurate A/D conversion in only 25  $\mu$ s. To make it the best ADC80 you can get, we added lots of improvements. First, we only used half as many chips, so it's much more reliable. Then, we used a monolithic D/A chip so we can guarantee no missed codes over a wider temperature range. Ours also consumes less power, and the reference output can supply up to 1.5 mA of current to external circuitry. We even have a 40ns status delay that guarantees valid data at the end of a conversion. After we made a better ADC80, we made darn sure we put plenty into stock. So you can get as many as you need. Now.



## DESIGNED AND BUILT TO LAST FAR LONGER.

Our ADC80 is not only better, it's more reliable. Not only does it have half as many chips (17 versus 34), but we've reduced the number of bond wires by 63% from 177 to 73. We've even improved the packaging with a "SLAM" ceramic dual-in-line package that eliminates the substrate. The result in terms of calculated MTBF is that ours will far outlast theirs.

# CAN GET, YOU CAN GET.

## AD vs. BB

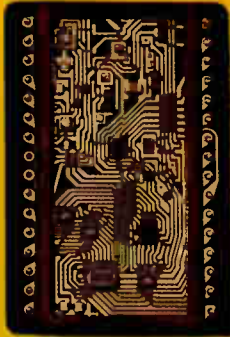
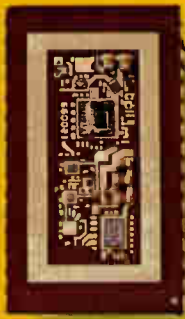

ACTUAL  
SIZE

### Number of Chips

17      34

### MTBF (failures/million hrs.)\*

15.1      24.8

### Temperature Range for No Missing Codes

-25°C to +85°C      0 to +70°C

### Power Dissipation

800mW      950mW

### Max. Reference Output Current

1.5mA      0.2mA

Chip count determined from actual devices. \*MTBF's calculated per MIL-HNBK-217C. Other BB data taken from published data sheet.

## PERFORMANCE SPECS THAT ARE SPECTACULAR.

Our ADC80 clearly beats the competition (see chart) in terms of chip count, calculated MTBF, temperature performance, power consump-

tion and reference output current. And our 40ns status delay allows you to latch output data directly into a data register without losing the 12th bit. This is a real cost saver, because it means you don't have to add external status delay circuitry.

## IF YOU LIKE OUR ADC80s, YOU'LL LOVE OUR DAC80s.

If you're looking for a pin-for-pin replacement for the industry standard DAC80 12 bit D/A converter, look no further. Our DAC80 features an internal output amplifier that settles to  $\pm 0.01\%$  in  $3 \mu\text{s}$  (voltage models), guaranteed monotonicity over the 0 to  $+70^\circ\text{C}$  temperature range, and a low profile ceramic dual in-line package. The same innovative design techniques used in our ADC80s are also incorporated in our DAC80s. So we also have the best DAC80, with fewer chips, high reliability, better temperature drift, and lower power consumption. You'll even love the price of our DAC80

(starting at \$18.50 in 100's).

And like our ADC80s they're in great supply (and demand).

For more information on our ADC80s and DAC80s, get in touch with Doug Grant or Don Travers at (617) 935-5565, or write Analog Devices, Inc., P.O. Box 280, Norwood, MA 02062.

### DAC 80

Number of Chips	3
MTBF (failures/million hrs.)*	9.3
Max. Total Bipolar Drift	$\pm 20 \text{ ppm}/^\circ\text{C}$
Max. Reference Output Current	2.5mA
Max. Power Dissipation	925mW



 **ANALOG  
DEVICES**

## WAY OUT IN FRONT.

Analog Devices, Inc., Box 280, Norwood, MA 02062; East Coast: (617) 329-4700; Midwest: (312) 894-3300; West Coast: (714) 842-1717; Texas: (214) 231-5094; Belgium: 031/37 48 03; Denmark: (02) 84 58 00; England: 01/94 10 46 6; France: 687-3411; Germany: 089/53 03 19; Japan: 03/26 36 82 6; Netherlands: 076/879 251; Switzerland: 022/315760; and representatives around the world.

# IDC-

## Socket Connectors— IDS Series

For pluggable termination of cable to header mounted on PCB. Single piece body for easy assembly, fewer parts to inventory. Cover latch and optional strain relief for operational reliability.

## Transition Connectors— IDT Series

Used to attach cable permanently to PCB, Has rugged single piece design for fast assembly and high reliability. Cover latch swivels for easy cable insertion.

## Cable Plugs—IDP Series

Offer fast, easy plugging of cable to PCB directly or into DIP sockets. Tapered pins assure quick, easy insertion into DIP sockets. One unit design speeds handling and assembly. Cover latch swivels for easy cable insertion.

## Headers— IDH Series

Mounts permanently to PCB and accepts socket connectors. In straight or right angle mounting—for solder or wrap/pin termination. Handy ejector/latch available—when closed it locks socket into place and serves as ejector when open.

## Laminated Flat Cable

RN offers both cable and connectors—your assurance of “single source” reliability. Available in white or color coded 100 foot rolls in 10 thru 50 conductor sizes.



has it now...a truly economical

# flat cable system

for high speed assembly  
using tooling you already have

**This RN IDC System delivers what engineers want ...**

- Advanced automated manufacturing facilities enable RN to cut costs — pass the savings on to you
- Fewer pieces for faster assembly, reduced inventory
- Can be assembled with IDC tooling already in place
- Each connector made more rugged, more resistant to shock, vibration and cable strain
- Assured reliability and compatibility of cable and connectors — RN supplies both

**Economical, easy to use — once properly adjusted, all RN IDC connectors can be assembled with a simple base plate change**



Hand Held crimp tool for assembling IDP series Cable Plugs and IDT series Transition Connectors

Bench mounted crimp tool for assembly of *all* RN IDC connectors.



**WRITE TODAY** For new Robinson-Nugent Insulation Displacement Connector catalog with complete specifications and dimensions on the entire IDC product line.

**FOR A SAMPLE** of any one of these RN IDC connectors please write on your company letterhead.



# **RN** ROBINSON NUGENT, INC.

800 East Eighth Street, New Albany, Indiana 47150 • Phone: (812) 945-0211 — TWX: 810-540-4082

# RESOLUTION



## When and where you need it.

There are times when a 3½ digit multimeter just can't cut it.

When you really need resolving power, you need a 4½ digit DMM. To illustrate: When measuring a 15VDC supply—a 4½ digit multimeter lets you see each millivolt of change while a 3½ digit instrument would not display a change less than 10 millivolts.

As the leader in 4½ digit multimeters, Data Precision gave you that resolving power 7 years ago with the first truly portable 4½ digit multimeter...our Model 245. Then as your applications became more varied and demanding, we designed other units to meet them. The result is a line of tough, full function 4½ digit DMMs that have given almost 200,000 world-wide users more sensitive measurements.

Circle 112 for demonstration

Circle 113 for additional information



### MODEL 245

The first of its kind, features high input impedance, 50kHz frequency response, 0.05% basic DC accuracy and a planar gas discharge display...\$345.

### MODEL 248

This high resolution instrument features 10µV and 10 nanoamp sensitivity, True RMS AC measurement, with a basic DC accuracy of 0.05% and an easy to read LED display...\$315.

### MODEL 258

Features True RMS AC measurement, 0.05% basic accuracy, 40 hour battery operation between charges and an LCD display ideal for outdoor as well as indoor applications...\$325.

If your needs are primarily for a bench instrument, Data Precision offers a truly versatile performer — the Model 2480R Bench/Portable with True RMS AC measurement and 0.03% basic DC accuracy. Wide measurement ranges on all functions and a benchtop case make it a logical choice for an in-house DMM...\$299 or the Model 2480 with AC average sensing...\$279. Both feature optional battery pack.

When you need more than a 3½ DMM can give, get a 4½ digit multimeter from Data Precision. We've made more 4½ digit multimeters than anyone else in the world.

For immediate delivery, demonstration, or further information, just contact your local Data Precision distributor or call:

(800) 343-8150

(800) 892-0528 in Massachusetts

Prices USA

 **DATA PRECISION**<sup>®</sup>  
A DIVISION OF ANALOGIC CORPORATION

Data Precision Corporation, A Division of Analogic Corporation, Electronics Avenue, Danvers, MA 01923, (617) 246-1600, TELEX (0650) 921819



**T**he electrically erasable programmable read-only memory, or EE-PROM, will one day be the standard form of program storage in microprocessor-based systems. It will follow in the steps of the ultraviolet-light-erasable PROM, for it, too, will become available in increasingly larger byte-wide arrays and will in time share silicon with single-chip microcomputers.

As with the E-PROM, the success of the EE-PROM described in this article hinges upon the mastery of a difficult process. The floating-gate avalanche cell, also pioneered by Intel, is a tricky construction that still eludes many a memory maker. Likewise, the widespread availability of large EE-PROMS is still years off.

The EE-PROM process will be perfected, though, because the rewards go beyond the elimination of the expensive quartz window on the E-PROM package. The electrically erasable memory will usher in systems

previously not practical. The microprocessor system whose programs can be altered remotely, as by phone, is one example. Another is the system that is immune to power outages, as it protects its contents in ROM. Perhaps most important, systems will be able to adjust their own program memory to environmental changes.

To be sure, there is more than one way to build an EE-PROM. The metal-nitride-oxide-semiconductor (MOS) structure has served for years in modest-sized arrays for TV tuning applications, for example. In fact, a year ago Hitachi Ltd. announced a 2-K-by-8-bit MNOS replacement for the 2716 E-PROM. Compatibility with the 2716 is the impetus behind the device described in the following article, but it uses only silicon and its derivatives, plus metal. Also, in place of avalanche injection, which can injure a cell, electrons tunnel to and from a floating gate.

-John G. Posa

# 16-K EE-PROM relies on tunneling for byte-erasable program storage

Thin oxide is key to floating-gate tunnel-oxide (Flotox) process used in 2,048-by-8-bit replacement for UV-light-erasable 2716 E-PROM

by W. S. Johnson, G. L. Kuhn, A. L. Renninger, and G. Perlegos, Intel Corp., Santa Clara, Calif.

□ The erasable programmable read-only memory, or E-PROM, is the workhorse program memory for microprocessor-based systems. It is able to retain data for years, and it can be reprogrammed, but to clear out its contents for new data, ultraviolet light must be made to stream through its quartz window. This works well for many applications, but the technique foregoes single-byte—in favor of bulk—erasure and in-circuit self-modification schemes.

Electrical erasability is clearly the next step for such memories, but like ultraviolet erasure a few years back, it is hard to achieve. In fact, the design of an electrically erasable read-only memory is paradoxical. In each cell, charge must somehow be injected into a storage node in a matter of milliseconds. Once trapped, however, this charge may have to stay put for years while still allowing the cell to be read millions of times. Although these criteria are easily met individually, the combination makes for a design with conflicting requirements.

These demands are more than met in a new EE-PROM, which is a fully static, 2-K-by-8-bit, byte- or

chip-erasable nonvolatile memory. At 16,384 bits, this new design not only meets the goal of high density, but also has long-term retention, high performance, and no refreshing requirement, in addition to functional simplicity unmatched by present nonvolatile memories. The device need not be removed from a board for alterations, and performance is consistent with the latest generation of 16-bit microprocessors such as the 8086.

This achievement required the development of a new nonvolatile process technology, HMOS-E, as well as a new cell structure, Flotox, for floating-gate tunnel oxide.

## Conflicting requirements

Nonvolatile semiconductor memories generally store information in the form of electron charge. At cell sizes achievable today, this charge is represented by a few million electrons. To store that many electrons in a 10-millisecond program cycle requires an average current on the order of  $10^{-10}$  amperes. On the other hand, if it is essential that less than 10% of this charge leaks away in 10 years, then a leakage current on the order of

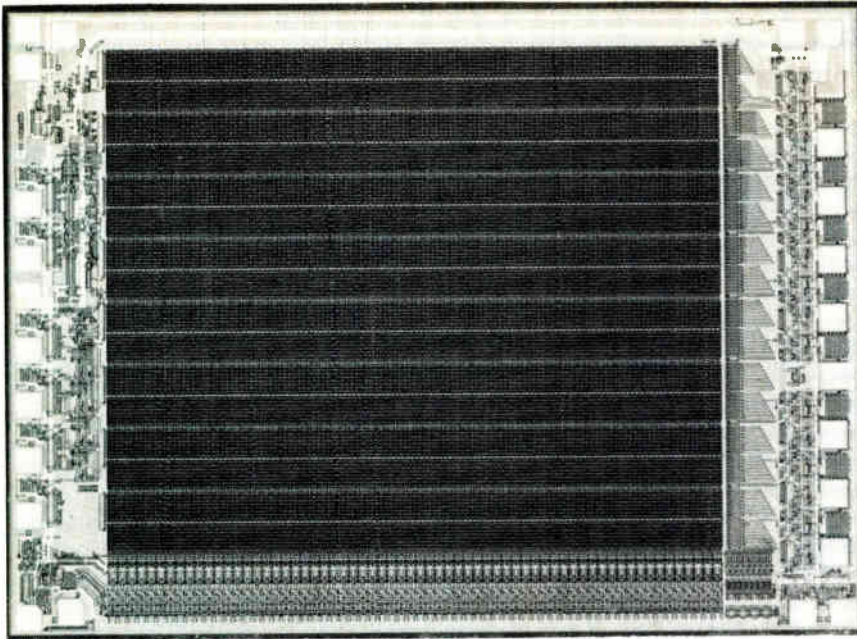

**The next memory.** The 16-K electrically erasable programmable read-only memory is eminently suitable for microprocessor program storage. Organized as 2,048 by 8 bits, the EE-PROM allows full-chip or individual-byte erasure using the same supply ( $V_{pp}$ ) as for programming.

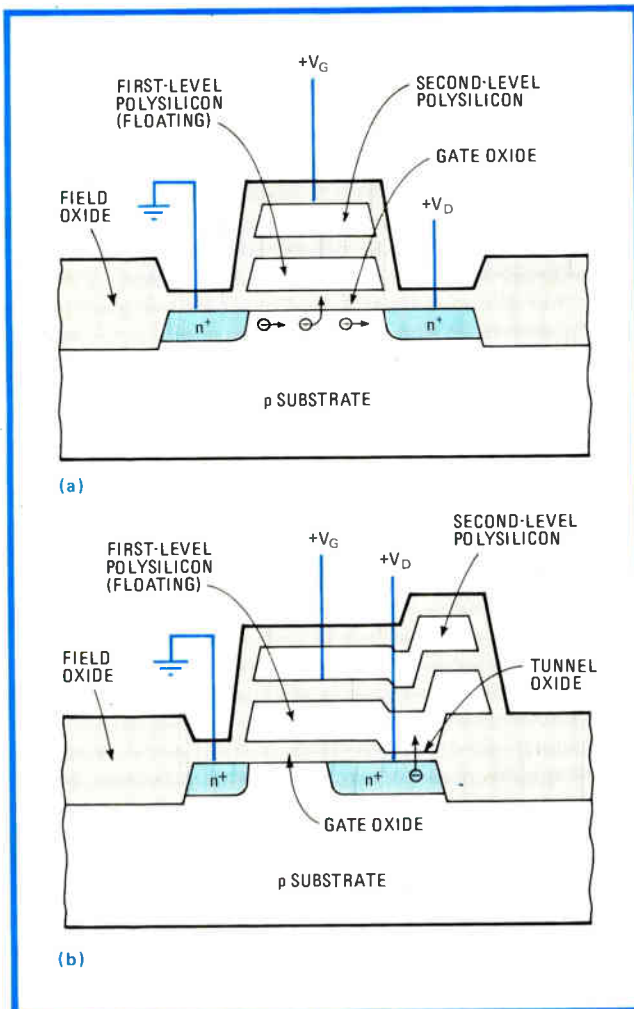

**1. First Famos, now Flotox.** The Famos cell (a) found in all E-PROMs stores charge on the floating gate by avalanche means. Flotox cell (b), the heart of the EE-PROM, relies on electron tunneling through thin oxide to charge and discharge the floating gate.

$10^{-21}$  A or less must be guaranteed during read or storage operations. The ratio of these currents,  $1:10^{11}$ , represents a difficult design problem. Few charge-injecting mechanisms are known that can be turned off reliably during nonprogram periods for such a ratio.

One structure that has proven capable of meeting such stringent reliability requirements has done so for many millions of devices over the last nine years. This is the floating-gate avalanche-injection MOS (Famos) device used in the 1702, 2708, 2716, and 2732 E-PROM families. In the Famos structure, shown in Fig. 1a, a polysilicon gate is completely surrounded by silicon dioxide, one of the best insulators around. This ensures the low leakage and long-term data retention.

To charge the floating gate, electrons in the underlying MOS device are excited by high electric fields in the channel, enabling them to jump the silicon/silicon-dioxide energy barrier between the substrate and the thin gate dielectric. Once they penetrate the gate oxide, the electrons flow easily toward the floating gate as it was previously capacitively coupled with a positive bias to attract them.

Because of Famos' proven reliability, the floating-gate approach was favored for the EE-PROM. The problem, of course, was to find a way to discharge the floating gate electrically. In an E-PROM, this discharge is effected by exposing the device to ultraviolet light. Electrons absorb photons from the UV radiation and gain enough energy to jump the silicon/silicon-dioxide energy barrier in the reverse direction as they return to the substrate. This suffices for off-board program rewriting, but the object of the EE-PROM is to satisfy new applications that demand numerous alterations of the stored data without removing the memory from its system environment. What evolved was the new cell structure called Flotox (Fig. 1b).

In the quest for electrical erasability, many methods were considered, and several potentially viable solutions were pursued experimentally. One initially attractive

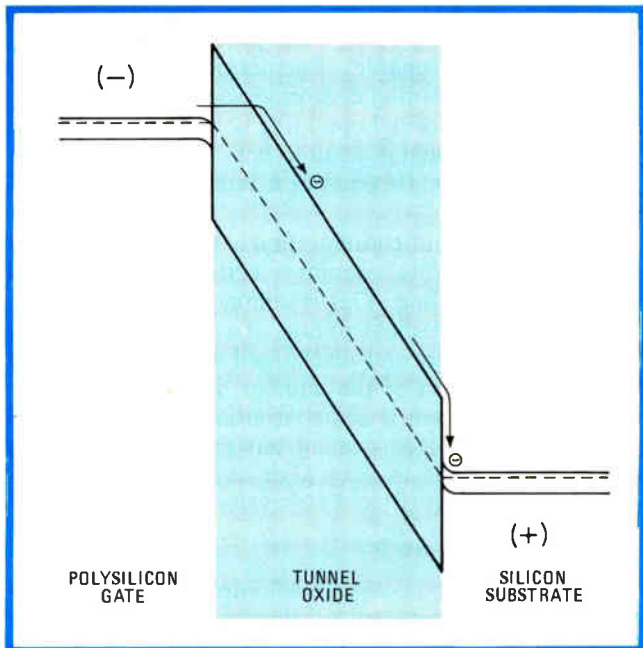

**2. Tunneling.** For a thin enough oxide, as shown here, under a field strength of  $10^7$  V/cm, Fowler-Nordheim tunneling predicts that a certain number of electrons will acquire enough energy to jump the forbidden gap and make it from the gate to the substrate.

approach attempts to harness a parasitic charge-loss mechanism discovered in the earliest E-PROMs. Referring again to Fig. 1a, the polysilicon grains on the top surface of the floating gate tend, under certain processing conditions, to form sharp points called asperities. The sharpness of the asperities creates a very high local electric field between the polysilicon layers, shoving electrons from the floating gate toward the second level of polysilicon. This effect is purposely subdued in today's E-PROMs by controlling oxide growth on top of the floating gate because this parasitic electron-injection mechanism would otherwise interfere with proper E-PROM programming.

It was first thought that asperity injection could be used to erase the chip. In fact, fully functional, electrically erasable test devices were produced; but the phenomenon proved unreproducible and the devices tended to wear out quickly after repeated program and erase cycling. After over a year's effort, that approach was abandoned.

### Tunneling solution

The solution turned out to be the one that initially seemed impossible. After investigating many methods of producing energetic electrons, it was decided to approach the problem from a different direction: to pass low-energy electrons through the oxide. This could be accomplished through Fowler-Nordheim tunneling, a well-known mechanism, depicted by the band diagram in Fig. 2. Basically, when the electric field applied across an insulator exceeds approximately  $10^7$  volts per centimeter, electrons from the negative electrode (the polysilicon in Fig. 2) can pass a short distance through the forbidden gap of the insulator and enter the conduction band. Upon their arrival there, the electrons

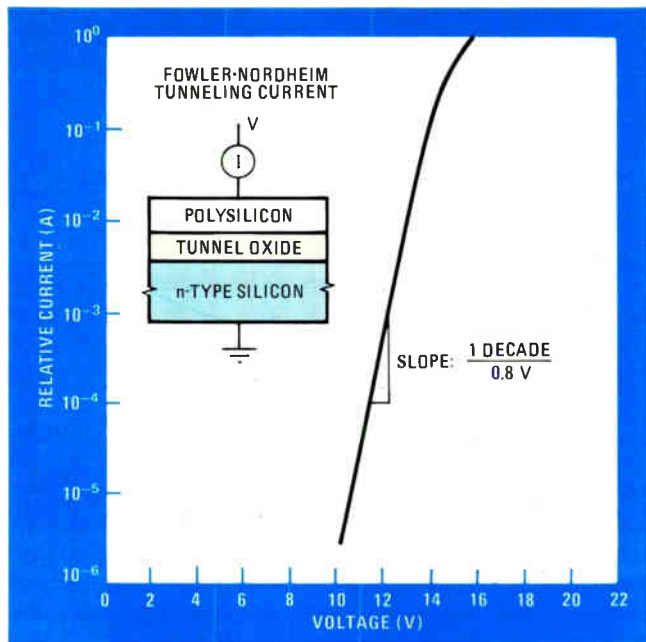

**3. Current characteristic.** In Fowler-Nordheim tunneling, current flow depends strongly on voltage across the oxide, rising an order of magnitude for every 0.8 V. Charge retention is adequate so long as the difference between programming and reading is at least 8.8 V.

flow freely toward the positive electrode.

This posed two fundamental problems. First, it was commonly believed that silicon dioxide breaks down catastrophically at about  $10^7$  V/cm, and MOS FETs are normally operated at field strengths 10 times below this. Second, to induce Fowler-Nordheim tunneling at reasonable voltages (20 V), the oxide must be less than 200 angstroms thick. Oxide thickness below about 500 Å had rarely even been attempted experimentally, and it was feared that defect densities might prove prohibitively high.

To be weighed against these risks, however, were several advantages. Tunneling in general is a low-energy, efficient process that eliminates power dissipation. Fowler-Nordheim tunneling in particular is bilateral and can be used for charging the gate as well as discharging it. Finally, the tunnel oxide area could be made very small, which is of course consistent with the needs of high-density processing.

With these motivating factors, development was initiated to grow reliable, low-defect oxides less than 200 Å thick. The success of this effort resulted in the realization of a working cell structure called Flotox.

The Flotox device cross section is pictured in Fig. 1b. It resembles the Famos structure except for the additional tunnel-oxide region over the drain. With a voltage  $V_g$  applied to the top gate and with the drain voltage  $V_d$  at 0 V, the floating gate is capacitively coupled to a positive potential. Electrons are attracted through the tunnel oxide to charge the floating gate. On the other hand, applying a positive potential to the drain and grounding the gate reverses the process to discharge the floating gate.

Flotox, then, provides a simple, reproducible means for both programming and erasing a memory cell. But

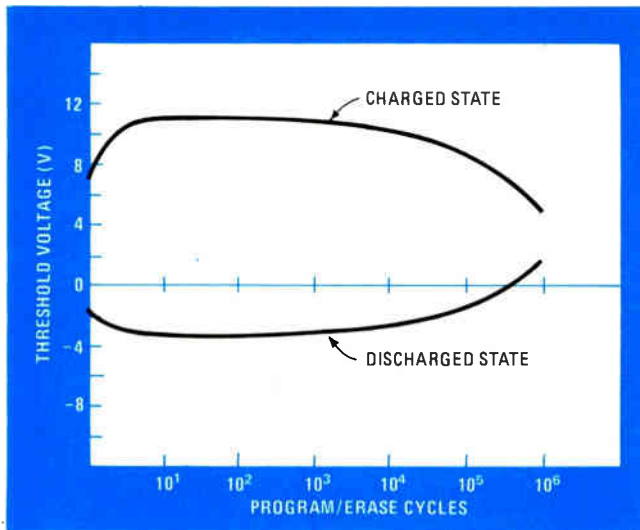

**4. Good endurance.** The endurance of the EE-PROM depends on the threshold-voltage difference between the charged and discharged states. Though repeated cycling degrades thresholds, the chip should stay within tolerable limits for 10<sup>4</sup> to 10<sup>6</sup> cycles.

what about charge retention and refresh considerations with such a thin oxide? The key to avoiding such problems is given in Fig. 3, which shows the exceedingly strong dependence of the tunnel current on the voltage across the oxide. This is characteristic of Fowler-Nordheim tunneling.

The current in Fig. 3 rises one order of magnitude for every 0.8-V change in applied voltage. If the 11 orders of magnitude requirement is recalled, it is apparent that the difference between the voltage across the tunnel oxide during programming and that during read or storage operations must be in excess of 8.8 V.

This value, including margins for processing variations, is reasonable. Furthermore, data is not disrupted during reading or storage so that no refreshing is required under normal operating or storage conditions. Extensive experimental testing has verified that data retention exceeding 10 years at a temperature of 125°C is possible.

Another important consideration is the behavior of the electrically erasable memory cell under repeated program erase cycling. This is commonly referred to as endurance. The threshold voltage of a typical Flotox cell, in both the charged and discharged states, is shown in Fig. 4 as a function of the number of programming or erasing cycles. There is some variation in the threshold voltages with repeated cycling but this remains within tolerable limits out to very high numbers of cycles—somewhere between 10<sup>4</sup> and 10<sup>6</sup> cycles.

### Putting Flotox to work

The Flotox cell is assembled into a memory array using two transistors per cell as shown in Fig. 5. The Flotox device is the actual storage device, whereas the upper device, called the select transistor, serves two purposes. First, when discharged, the Flotox device exhibits a negative threshold. Without the select transistor, this could result in sneak paths for current flow through nonselected memory cells. Secondly, the select transistor prevents Flotox devices on nonselected rows from discharging when a column is raised high.

The array must be cleared before information is entered. This returns all cells to a charged state as shown schematically in Fig. 5a. To clear the memory all the select lines and program lines are raised to 20 V while all the columns are grounded. This forces electrons through the tunnel oxide to charge the floating gates on all of the

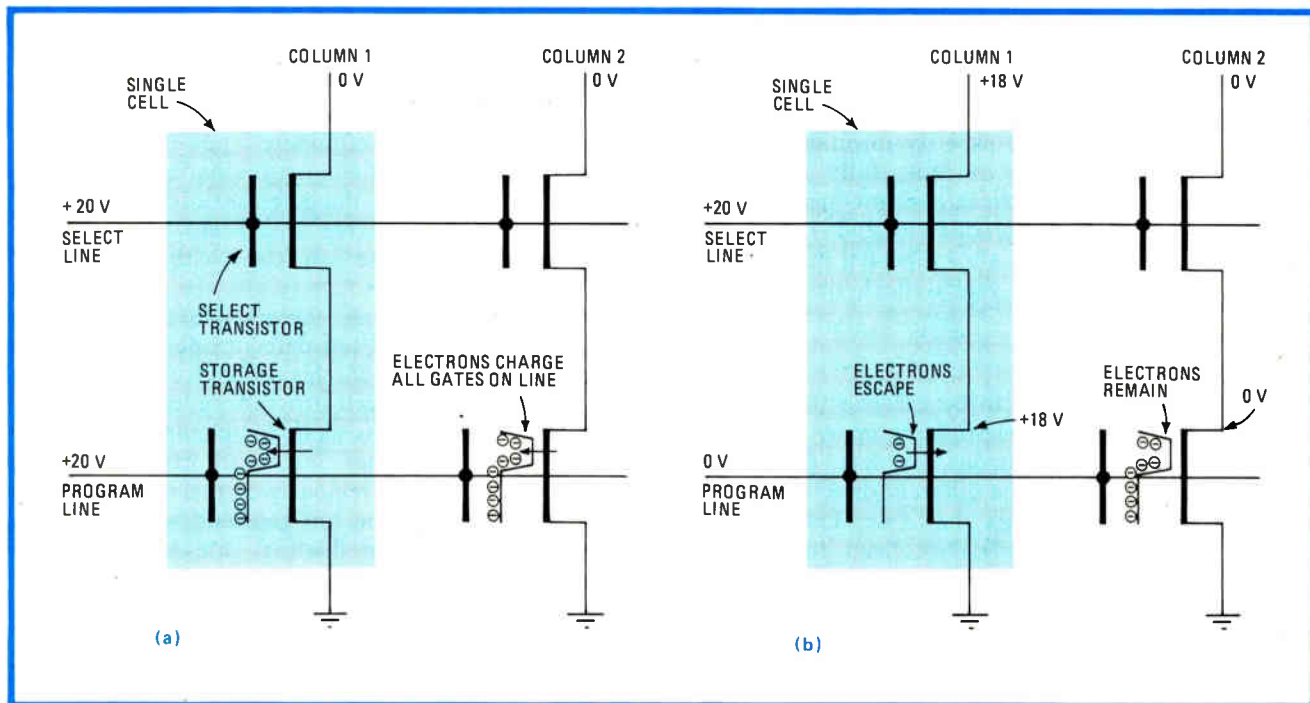

**5. Working.** To clear a Flotox cell, select and program lines are raised to 20 V and columns are grounded (a). To write a byte of data, the program line is grounded and the columns of the selected byte are raised or lowered according to the data pattern (b).

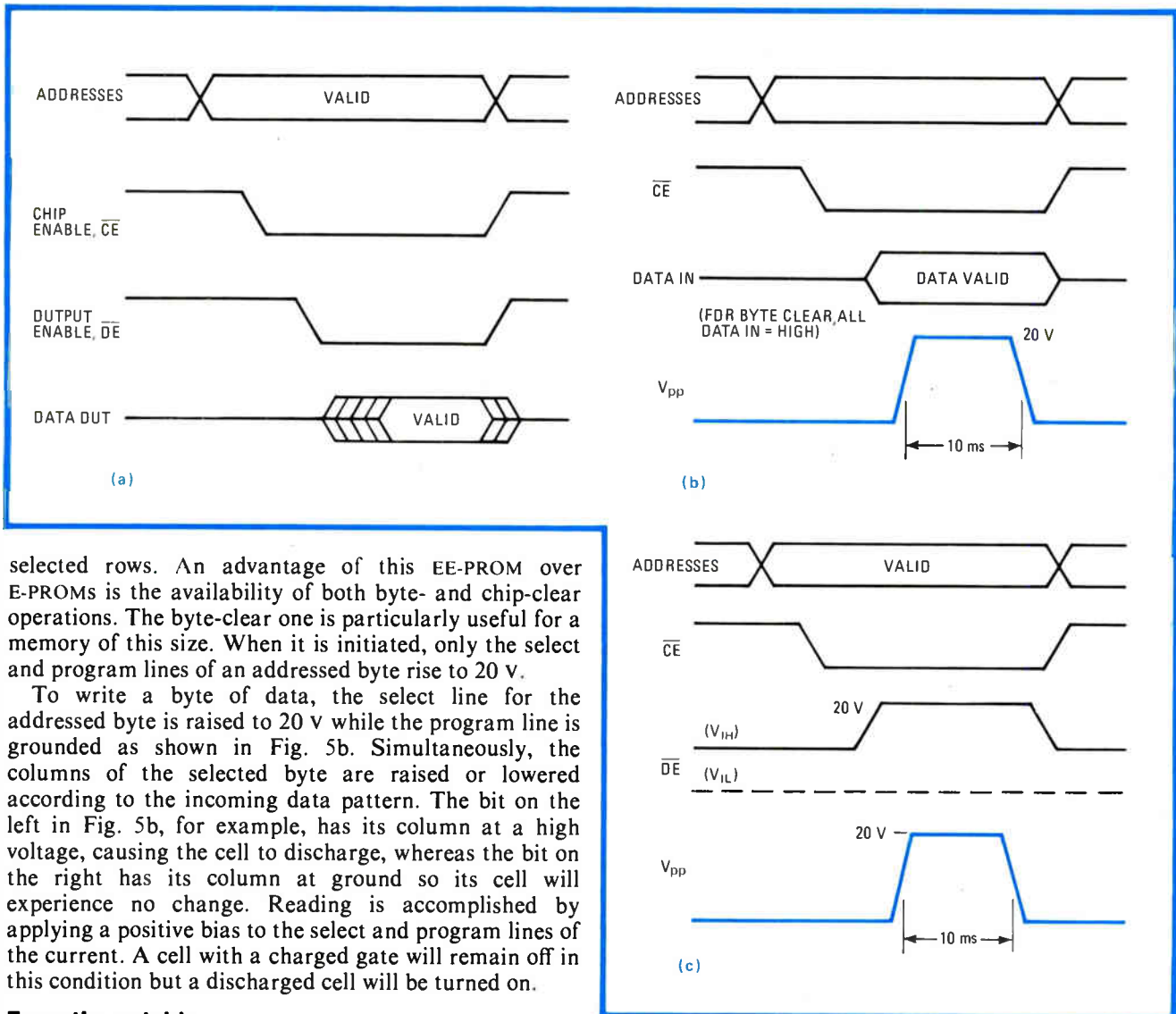

selected rows. An advantage of this EE-PROM over E-PROMs is the availability of both byte- and chip-clear operations. The byte-clear one is particularly useful for a memory of this size. When it is initiated, only the select and program lines of an addressed byte rise to 20 v.

To write a byte of data, the select line for the addressed byte is raised to 20 v while the program line is grounded as shown in Fig. 5b. Simultaneously, the columns of the selected byte are raised or lowered according to the incoming data pattern. The bit on the left in Fig. 5b, for example, has its column at a high voltage, causing the cell to discharge, whereas the bit on the right has its column at ground so its cell will experience no change. Reading is accomplished by applying a positive bias to the select and program lines of the current. A cell with a charged gate will remain off in this condition but a discharged cell will be turned on.

### From the outside

In terms of its pinout and control functions, the EE-PROM has evolved from the 2716 E-PROM. Both are housed in 24-pin dual in-line packages, for instance, and both offer a power-down standby mode. In addition, both utilize the same powerful two-line control architecture for optimal compatibility with high-performance microprocessor systems. Referring to Fig. 6a, it is seen that both control lines, chip enable ( $\overline{CE}$ ) and output enable ( $\overline{OE}$ ), are taken low to initiate a read operation. The purpose of chip enable is to bring the memory out of standby to prepare it for addressing and sensing. Until the output-enable pin is brought low, however, the outputs remain in the high-impedance state to avoid system bus contention. In its read mode, the EE-PROM is functionally identical to the 2716.

A single +5-v supply is all that is needed for carrying out a read. For the clear and write functions, an additional supply ( $V_{pp}$ ) of 20 v is necessary. The timing for writing a byte is shown in Fig. 6b. The chip is powered up by bringing  $\overline{CE}$  low. With address and data applied, the write operation is initiated with a single 10-ms, 20-v pulse applied to the  $V_{pp}$  pin. During the

**6. Timing.** The Flotx memory's operating modes are shown for reading (a), writing or clearing of bytes (b), and chip clearing (c). Both writing and erasing require a 10-ms program-voltage pulse. The read mode is functionally identical to that of a 2716 E-PROM.

write operation,  $\overline{OE}$  is not needed and is held high.

A byte clear is really no more than a write operation. As indicated in Fig. 6b, a byte is cleared merely by being written with all 1s (high). Thus altering a byte requires nothing more than two writes to the addressed byte, first with the data set to all 1s and then with the desired data. This alteration of a single byte takes only 20 ms. In other nonvolatile memories, changing a single byte requires that the entire contents be read out into an auxiliary memory. Then the entire memory is rewritten. This process not only requires auxiliary memory; for a 2-kilobyte device it takes about one thousand times as long (20 ms vs 20 seconds).

Chip clear timing is shown in Fig. 6c. The only difference between byte clear and chip clear is that  $\overline{OE}$  is raised to 20 v during chip clear. The entire 2 kilobytes are cleared with a single 10-ms pulse. Addresses and data are not all involved in a chip-clear operation. □

# Bit-slice processors come to mainframe design

But ensuring system performance places new emphasis on microcode; resulting two-level scheme directs parallel pipelined processors

by Charles F. Wolfe, *Sperry Univac division of Sperry Corp., Roseville, Minn.*

□ Putting the latest semiconductor technologies to work in computer hardware while maintaining the machine's software requirements is an ongoing challenge to computer engineers. Equally important, however, is the transformation of the design process itself by the use of the new parts.

The product of a five-year development effort, the hardware of Univac's model 1100/60 computer is a departure from previous designs. The most obvious difference is its use of bit-slice microprocessors in the central processing unit, one of the first applications of such parts to a general-purpose mainframe. The cost-effectiveness of these large-scale integrated circuits makes it practical to use parallel arithmetic and logic units in the CPU for speed and to include redundant ALUs for a new level of error detection and reliability.

But designing with these parts forces computer designers to place more emphasis on the microcode design than

ever before. The result is a novel two-level microprogramming mechanism that controls these bit-slice processors and the rest of the computer. The technique is designed to facilitate parallel processing in the ALUs and pipelining of both the micro-instructions and the user's application program instructions.

As the first customers receive their 1100/60s this month, however, they will find that these innovative hardware and microprogramming alterations have not affected what the programmers see and that the machine's outward appearance is fully compatible with their older machines. The 1100/60 uses the same 36-bit words and instruction set as previous 1100 series computers.

The 1100/60 is available in six models spanning a wide range of medium-sized to large price-performance ratios. The smallest unit, the model 1100/61 C1, is about comparable to IBM's latest model 4341 processor.

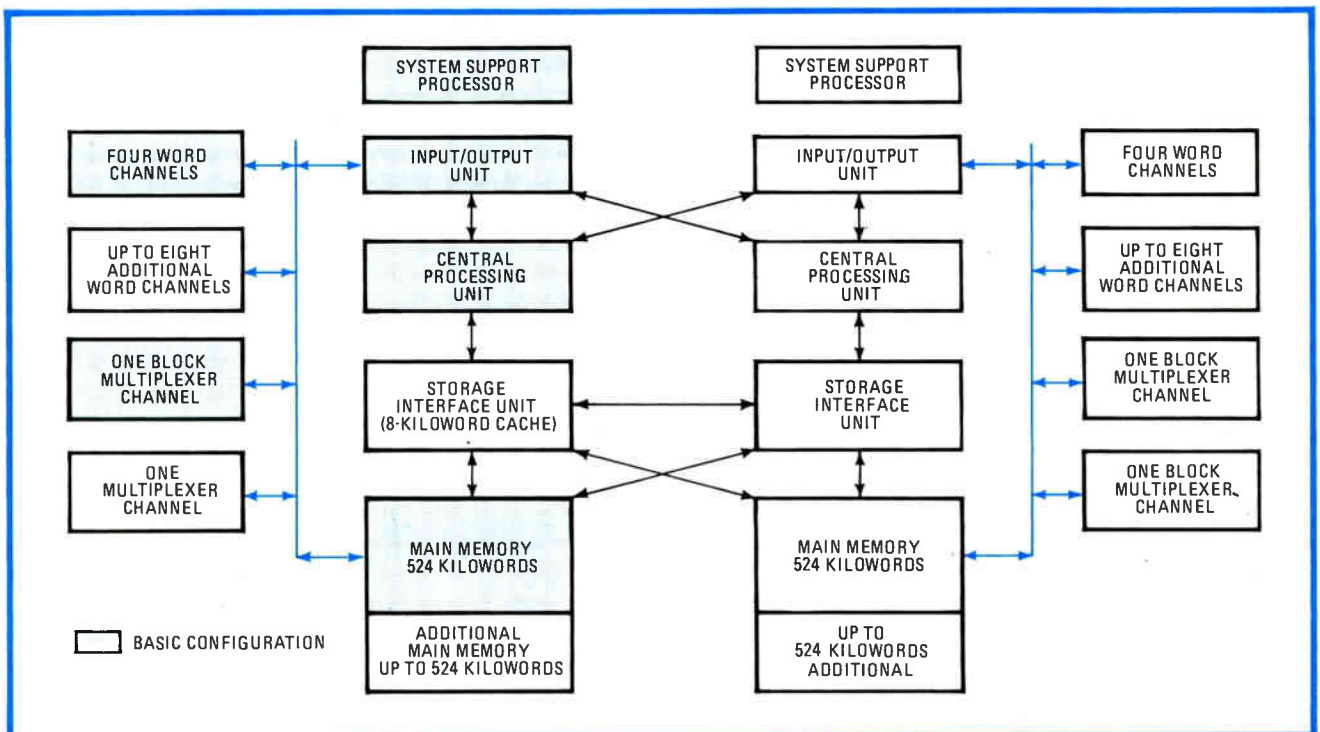

1. **Expandable configuration.** The basic 1100/60 configuration, indicated by the shaded boxes, can be expanded by adding memory, a cache storage interface unit, and more input/output channels. The dual processor version is five times more powerful than the basic unit.

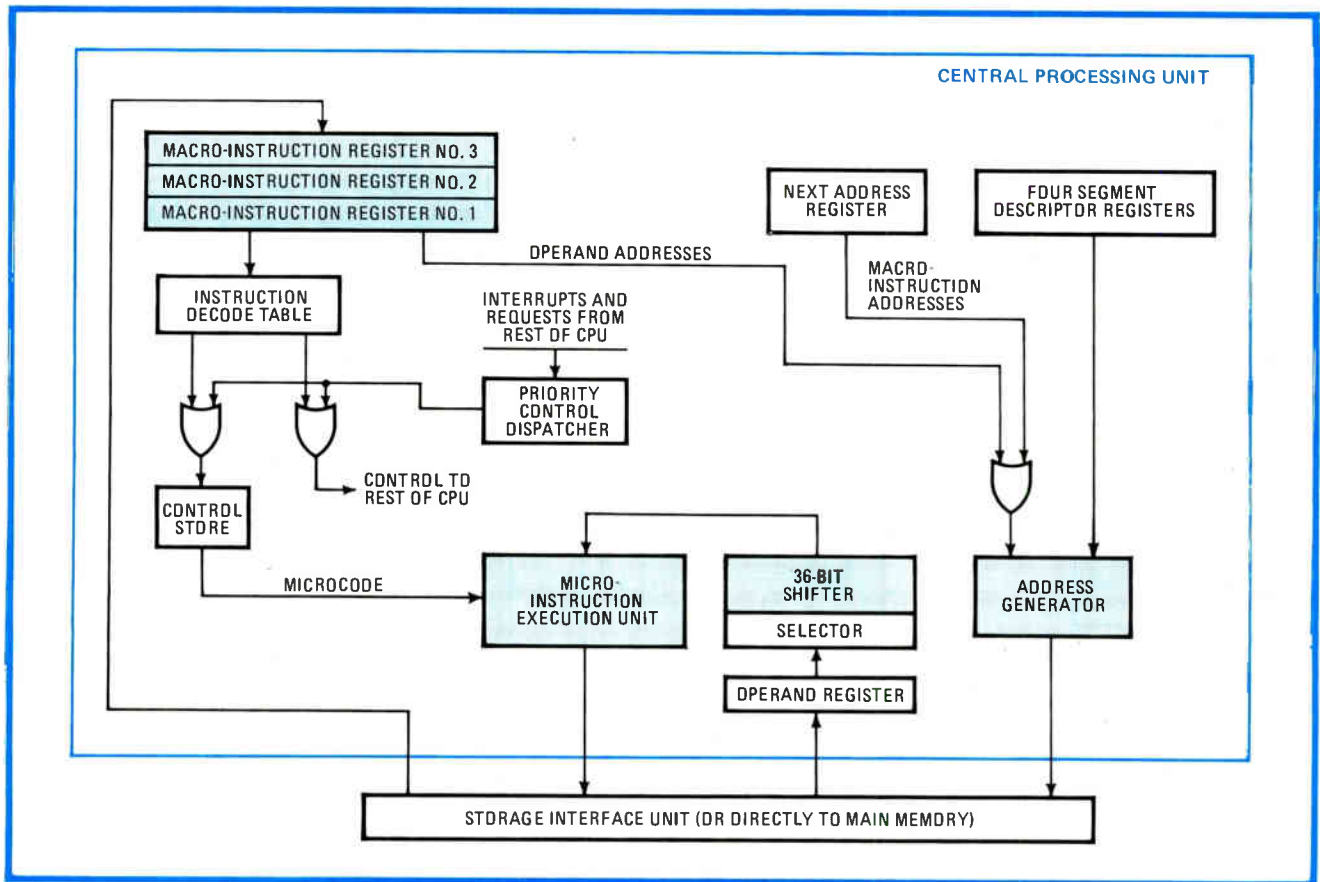

**2. Supportive.** The micro-instruction execution unit that is the heart of the central processing unit is supported by a 36-bit shifter, address generator, and three registers that pipeline macro-instructions. The priority control dispatcher is the first of two levels of control logic.

Univac's top-of-the-line dual processor model 1100/62 H2 has about a 10% advantage in price-performance ratio over IBM's second biggest model 3032.

As seen in Fig. 1, the basic configuration consists of a CPU, 524,288 words of memory, and an input/output unit with one block multiplexer channel and up to four word channels. A separate system support processor allows communication between the operator and the computer and handles error analysis and other maintenance operations.

### More storage

The power of this configuration can be expanded about 2.6 times by adding a storage interface unit containing an 8-kiloword cache memory previously available only on Univac's biggest machines. Up to 524,288 additional words of memory, another block multiplexer channel, and as many as eight more word channels can also be added. Another available option is an extended instruction set for business applications that speeds the execution of programs written in Cobol.

Coupling two of these computers further increases the machine's power. The biggest model, the 1100/62 H2, has five times the performance of the basic unit and as much power as Univac's larger model 1100/81.

In designing the basic central processing unit for the 1100/60, a primary objective was to reduce manufacturing costs by incorporating LSI circuits. Another was the capability to detect nearly 100% of the errors occurring

in the computer. Both of these were achieved through the use of the bit-slice microprocessors.

At the time the design began, certain forms of LSI, such as custom, hybrid, and gate-array circuits, were all considered too expensive. This narrowed the choice of LSI logic circuits to microprocessors. But most available microprocessors were too slow to be used in such a medium-scale mainframe, and also the instruction set of the 1100 series had never been parsed, or broken down, for emulation by a standard microprocessor. An alternative design that was researched and rejected used many low-cost, low-speed minicomputers operating in parallel to meet the overall system speed requirements. But that approach caused memory-design problems, since it required several application programs residing in main memory for each processor. In order to service the multiple processors rapidly enough to maintain system throughput, the main memory must be very large and fast, increasing costs enormously.

The final design choice was to build a single central processing unit from bit-slice processors. The Motorola 10800 4-bit-slice part, fabricated in emitter-coupled logic, solved the speed problem. Also, nine of the 4-bit-slice parts conveniently make an ALU that performs operations on the 36-bit words used by the 1100 series. Instead of multiple programs required by multiple minicomputers, the bit-slice parts are controlled by a single microprogram.

The bit-slice parts are used to build a unit called the

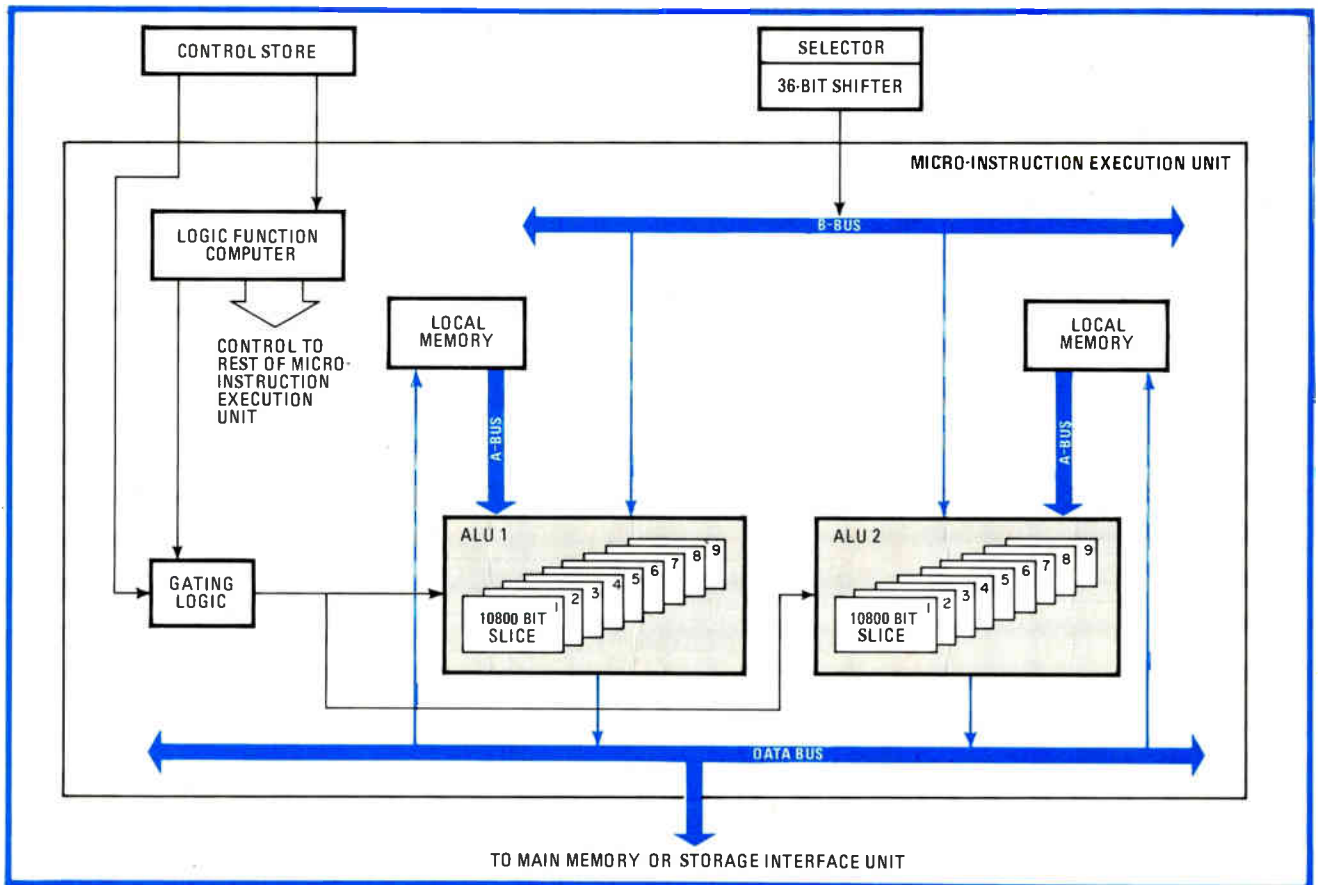

**3. Microprocessor-based.** The two ALUs in the micro-instruction execution unit are constructed from nine of the bit-slice microprocessors and controlled by the logic function computer. To increase throughput, they operate in parallel and their micro-instructions are pipelined.

micro-instruction execution unit (Fig. 2), which is the heart of the CPU and contains the ALUs. To improve the operational speed and efficiency of these parts, however, it was necessary to design custom control and support circuitry with conventional MECL 10-K parts rather than use any of the 10800's companion support parts. Along with this custom circuitry, a new two-level microprogramming scheme was designed to optimize performance. The most important parts of this control circuitry are the logic function computer and priority control dispatcher, which work with the unique two-level microcode to control the CPU.

### Chief executive

The priority control dispatcher is the chief of the micro-instruction execution unit. All requests for execution are routed there for scheduling. Control of the CPU is given to the priority control dispatcher at the completion of every macro-instruction. The priority control dispatcher then decides what the micro-instruction execution unit will do next and returns control to it.

Of the requests the dispatcher receives, process interrupts from the system support processor have the highest priority. These are followed by update clocks, process interrupts, and process macro-instructions. The wait-for-work function has the lowest priority.

The logic function computer, located in the micro-instruction execution unit, is built from Boolean logic with timing circuits that switch the data paths, or buses,

between logic in response to inputs.

Several features of the CPU hardware accelerate the performance of the micro-instruction execution units. The instructions coming from the user's program, called macro-instructions, are staged in three registers. This means that while the results from one macro-instruction are being stored, a second can be executed and a third decoded and the needed data fetched.

In addition, a special 36-bit shifter is included to allow faster shifts of multiple bits. Instead of having the micro-instruction execution unit divide its efforts between execution and address generation, a dedicated address generator is also included. Additional hard-wired logic is dedicated to other functions to speed the execution of those operations, but these are less exceptional. The remaining major portion of the CPU is the instruction decode table that, as will be described, decodes the macro-instructions and finds the appropriate two levels of microcode.

### Double pipelining

Instruction pipelining is a popular design technique, but Univac is unusual in that it uses it twice in the 1100/60. Pipelining of the macro-instructions helps speed up the operation of the CPU, and the parallel execution of similarly pipelined micro-instructions within the micro-instruction execution unit provides the basic high throughput needed by this class of machine.

Each micro-instruction execution unit contains two



ALUs, each constructed from nine of the bit-slice microprocessors (Fig. 3). Attached to each is a section of 256 words of local memory that stores their intermediate results. Each ALU can load either or both of the local stores by means of the data bus, and data in each local store is moved to the associated ALU through the A bus.

Two types of operands are used by the ALUs. Those of the first type are called macro-operands because they are supplied by the user's application program as the macro-instructions are. These are fetched from main memory and enter the micro-instruction execution unit through the shifter and the B bus.

Operands of the second type are called micro-operands because they are only seen by the ALUs in the micro-instruction execution unit. They can come to the execution unit from the control store or are able to represent intermediate results of the ALUs stored in the local store. The final result from the micro-instruction execution unit, however, is a macro-operand that leaves on the data bus.

Since the ALUs are built with LSI parts, it is now economically and physically possible to add redundancy to the CPU. This was done by adding redundant ALUs to the micro-instruction execution unit. For clarity these were left out of Fig. 3 but will later be shown to be primarily responsible for the error-detection capability.

To reduce costs enough to make the redundancy practical, the inputs and outputs of the ALUs in the micro-instruction execution unit were bused. Besides eliminating the need for gating logic to steer information in and out of the multiple ALUs, this lets them share the shifter. It also provides a convenient place to compare answers from redundant operations.

## Two levels

Though this hardware design takes advantage of the state of the integrated circuit art, controlling it required some innovations in microprogramming. First, the 1100/60's CPU is controlled by a two-level microprogramming scheme, which, unlike others, has the two types of microcode operating in parallel. In addition each micro-instruction offers a choice of operations essentially providing a conditional program branch without disrupting the microprogram's sequence.

The 1100/60's design is conceptually similar to that of most microprogrammed machines: the macro-instructions are decoded and a corresponding series of micro-instructions is located that actually steers the CPU performing the required function.

To avoid confusion, the user should remember that the programmer puts the macro-instructions into the main memory for the CPU. The micro-instructions, on the other hand, come from the instruction decode table and control store and are only used inside the CPU to control the operation of its various components, especially the micro-instruction execution unit.

Of the two levels of the 1100/60's micro-instructions, the horizontal microcode controls the various elements of the CPU with the exception of the micro-instruction execution unit. The other level, the vertical microcode, is dedicated to controlling the operations of the micro-instruction execution unit.

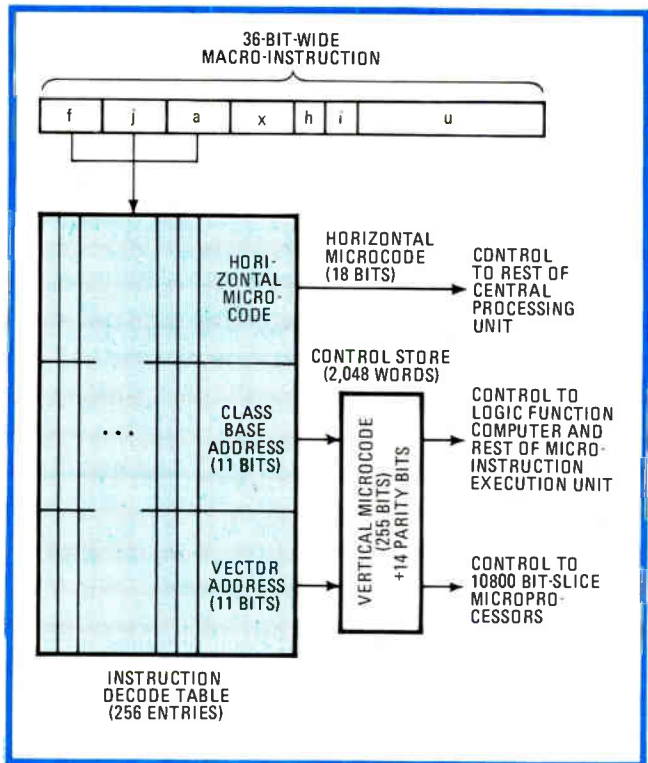

**4. Two levels.** Key to the 1100/60's operation is its two-level microcode. Each of 256 macro-instructions has an entry in the instruction decode table with 18 bits of horizontal microcode and two 11-bit fields pointing to vertical microcode in control store.

Micro-instructions are chosen by the decoding of a macro-instruction by the decode table. The table contains 256 entries, one for each macro-instruction in the 1100/60's repertoire. The F, J, and A fields of the macro-instruction, showing the operation to be performed and the registers involved, locate the appropriate entry on the table (Fig. 4). The other fields generate the addresses of the macro-operands in main storage.

The output of the instruction decode table is 40 bits wide and consists of three fields. One is the 18-bit horizontal micro-instruction and the other two are 11-bit fields that point to the location in the control store of the appropriate vertical micro-instructions.

Generally several vertical micro-instructions, called a vertical microprogram, are needed to implement the macro-instruction. But only one horizontal micro-instruction is needed per macro-instruction, since the condition of the rest of the CPU changes only once per macro-instruction. To minimize the number of vertical micro-instructions needed, the implementation of each macro-instruction is further subdivided into two microprograms—class-base and vector microprograms.

This scheme works because the various macro-instructions can be grouped by common characteristics. For instance, all add and subtract macro-instructions share the basic addition operation. The difference is that in subtraction the 1's complement of one operand must be taken before addition is performed.

Thus when these macro-instructions are decoded, they all produce the same class-base address, indicating the same class-base microprogram in the control store—in

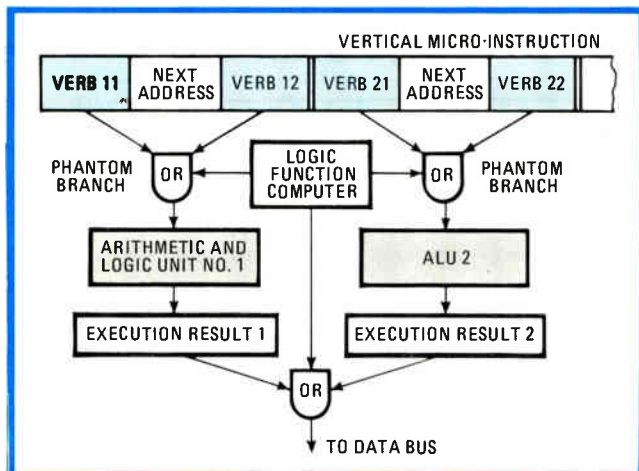

**5. Phantom choices.** Each vertical micro-instruction contains four function codes, or verbs, two for each ALU. The logic function computer chooses one for each, providing a conditional "phantom" branch without changing the microprogram sequence.

this case for the add operation. Each produces a different vector address, however, pointing to an additional microprogram unique to that macro-instruction.

The vertical micro-instructions coming out of the control store, which can hold up to 2,048 such words, are 255 bits long with 14 additional bits for parity. Of these bits, 64 hold the code for the 10800 bit-slice processors and the rest are control bits for other parts of the micro-instruction execution unit, primarily the logic function computer, as well as the A, B, and data buses, local store, and the next control store addresses.

In addition to these unique two levels of microcode, the vertical micro-instructions are constructed in a novel way that lets each ALU choose between two function codes without altering the vertical micro-instruction sequence. Most schemes offer the ALUs no such choice. Since this construction offers a conditional program branch during each cycle without altering the sequence of the microprogram, it is called a phantom branch.

### Choosing verbs

In each vertical micro-instruction there are four 16-bit operation codes, or verbs, two for each of the ALUs. The logic function computer, based on the condition of various test bits connected to it, decides which two of these verbs will be executed and which discarded (Fig. 5). The phantom branch is this decision process.

These four verbs in the current micro-instruction are accompanied by two control store addresses and by one address modifier from which four control store addresses are generated. As the logic function computer makes the phantom branch decision for the present micro-instruction, it also selects the one valid control-store address for the next microword.

One advantage of the phantom branch is that the execution unit can begin fetching the next micro-instruction before the current one is executed. Normally the address of the next micro-instruction is chosen by the execution of the current one. But this choice can be made a cycle earlier with the phantom branch than with a real branch. This produces shorter sequences of

micro-instructions and makes it possible to write extremely tight micro-instruction loops to perform long operations such as multiply or divide.

There are also several performance advantages with parallel ALU operation that are especially evident when extra time is needed to decide on the best procedure for carrying out an operation. Rather than wait for the decision, two alternative verbs, or operations, are performed in parallel. Later, when the decision is complete, only the valid result need be saved. An example is addition or subtraction using positive and negative numbers. The result can obviously be either the sum or difference of the operands. Therefore, the micro-instruction execution unit performs both—one in each of the parallel ALUs—but only the valid result is stored by the logic function computer.

In other micro-instructions both parallel tasks may produce valid results, so both are stored, one after the other, over the data bus. For instance, operations on floating-point exponents are executed by one ALU in parallel with operations on the mantissa number executed by the other, producing two valid outputs.

As was mentioned, in addition to overlapping up to three macro-instructions, the 1100/60 CPU overlaps four micro-instruction executions in the micro-instruction execution unit to increase throughput. That pipelining causes execution in four steps. First the control store address is generated, after which the micro-instruction is fetched and the data set up. The micro-instruction is then executed by the ALU and the results stored.

### Decision points

To handle this pipelined microcode effectively, the logic function computer has four types of decision points that allow control decisions for four different micro-instructions during each 116 ns major clock cycle. Each micro-instruction is in a different phase of completion and will need four cycles to finish. But because of this pipelining, the micro-instruction execution unit can produce a result once every 116 ns, which is a typical mainframe speed.

In addition to this first class of vertical micro-instruction that emulates macro-instruction, a second class, the hardware-control class, operates without decoding macro-instructions and is used for special 1100/60 tasks. Examples of such tasks are customer engineer and computer operator requests from the system support processor. The class base address for the first class always comes from the instruction decode store and the starting address for the second class from the priority control dispatcher.

Research projects have shown that redundancy improves reliability the most. But this approach is also the most costly. Up to now, only certain medical and military applications requiring virtually 100% up times could justify such high costs.

Many commercial computer applications, such as airline reservation and bank teller systems, also demand high reliability but at a more reasonable cost. The bit-slice LSI-based 1100/60 design brings redundancy features previously found only in military systems to these commercial applications, with redundant ALUs in

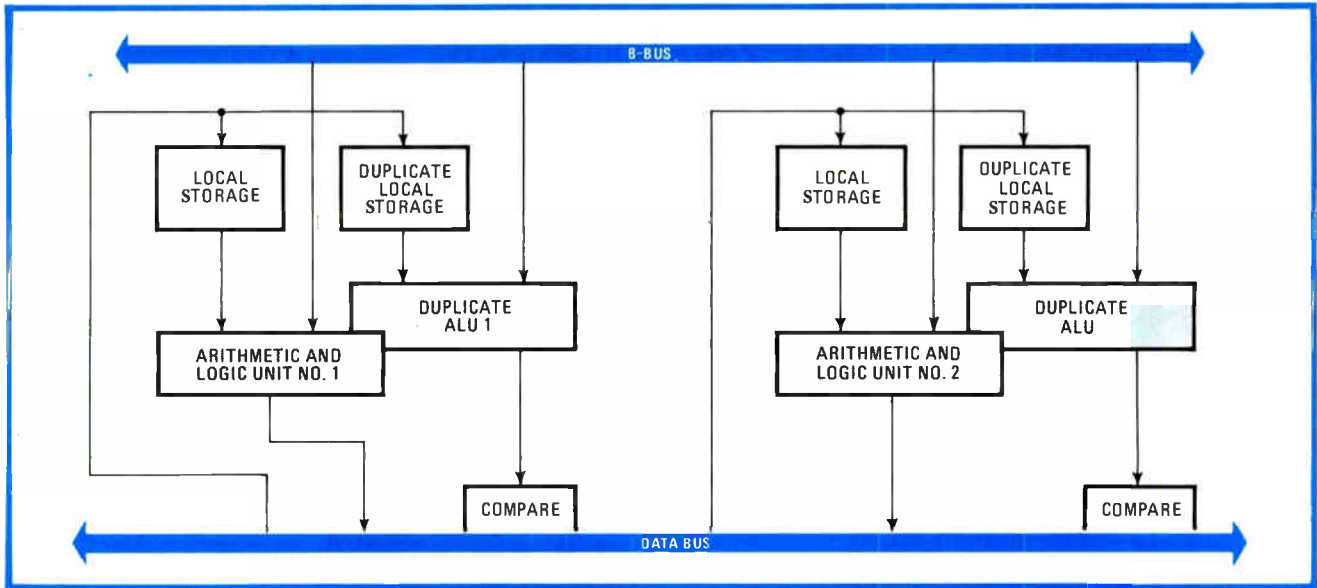

**6. Redundancy.** Substantially improving reliability are redundant arithmetic and logic units. Each performs the same operations as its twin, in lock step, comparing answers at the end. Disagreement triggers an instruction retry and, if that fails, an error message.

the CPU's micro-instruction execution unit.

As seen in Fig. 6, both of the ALUs and their associated local stores in the micro-instruction execution unit are duplicated with identical twins. The twin in each case duplicates every move of its related main ALU, in lock step. The main ALU and its twin share the same inputs from the B bus and use the data bus for comparing outputs. All four ALUs share the same 255-bit micro-instructions, but most of the control logic is duplicated to ensure complete error detection with the micro-instruction execution unit. The results of the twins are compared at several intermediate points at the end of each of the four phases of execution. Final results are also compared on the D bus before they leave the micro-instruction execution unit.

When the comparator finds a discrepancy, a special vertical microprogram is retrieved. This microprogram decodes the error, reports the status to the system support processor, restores the CPU to its previous state, and attempts to retry the macro-instruction. In this way the machine can proceed through most intermittent failures. If the retry fails, the system support processor is signaled to alert the operator to a hard machine failure.

Hardware faults are also detected by other more conventional means. LSI technology made it practical to apply these more than before. Error-correction codes, for example, are used widely in the storage hierarchy. All single-bit errors are corrected and double-bit errors detected in the main store, whereas in disk and tape units burst error-correction schemes are used on all data.

The cache store in the storage interface unit carries only parity because parity checking is faster than error-correction codes and the cache is primarily an acceleration device. But the cache has the exceptional ability to stop automatically using any four-word block that develops a parity error, including every block in any random order of single or multiple faults.

The microcode in the control store carries 14 parity bits per word, providing fast parity checking in parallel

with the micro-instruction processing. A special mechanism in the control store even allows it to operate with a single failed bit per chip. Since a failed binary bit is now in the opposite of its normal condition, or complemented, it is possible to correct a single-bit error by complementing the entire word and then reloading the control store. Each micro-instruction must once again be inverted as it is read out, but the computer can continue operations until a repair can be made.

Parity checking is also carried out on all data cables and data interfaces. The input/output unit is designed to ensure that the parity checker is itself checked before user data is written to peripheral storage.

### Fault isolation

Once an error is detected by such a technique, the CPU's scan-set mechanism aids in diagnosing the source of failure. This mechanism links all the registers in the CPU to the support processor through a separate and dedicated set of signal paths. Thus the condition of every register can be read, or scanned out, and displayed by the system support processor, and every register can be written into, or set, with a specific test value. Most errors occur in the logic located between registers.

Although this scan-set mechanism has been used in previous Univac computers, the 1100/60 is the first to tie every register into the mechanism. Because of this wide use of scan-set, the 1100/60 can even be remotely diagnosed, if the user attaches the support processor through a telecommunications line to a Univac center.

The operating system software and application software offer their own kinds of reliability design. These features are integrated with security, storage hierarchy management, and with interrupt queuing. For example, the address of every user and operating system worker is limit-checked to provide software security.

When a solid software fault occurs the support hardware will automatically reload the operating system from disk and then initiate user program recovery. □

AISLE 6  
PACKAGES

AISLE 7

SYSTEM COMPONENTS  
AND MODULES

CHASSIS      DIGITAL I/O

POWER SUPPLIES      ANALOG I/O

PROCESSORS      SERIAL COMM'S

AISLE 8  
SOFTWARE

**pcs** INDUSTRIAL  
COMPUTER  
MART



**Remember When We Had To Go To Different Stores  
for Math Processors, Industrial I/O and Sensor Conditioning.**

Your challenges are too complex to depend on modules that come from different sources — especially modules that were not designed for hostile plant environments. We now have a broad line of modules that covers virtually all industrial applications.

But modules are only part of our story. PCS offers a broad line of packages, modules and software designed specifically for industrial applications. We even have analog subsystems that interface directly to a broad range of primary sensors. Our growth in

the highly specialized industrial microcomputer field has caused us to be referred to as 'The Hardhat Computer People' — and with good reason. The trend today is to put the control or target computer out on the plant floor with the operator. To do so, you've got to have equipment that is designed, built and tested specially for the hostile plant environment. Simply adapting general purpose hardware isn't the answer.

So, to get the real answers call your local PCS office or call PCS World Headquarters — (313) 429-4970.



**The Hardhat Computer People®**

750 North Maple Road, Saline, Michigan 48176

# Monolithic d-a converter operates on single supply

Microprocessor-compatible chip runs on +5 volts, includes reference, latches, and amplifier

by Bruce Amazeen, Peter Holloway, and Doug Mercer, *Analog Devices Inc., Wilmington, Mass.*

□ The microprocessor's native tongue is not an analog one, but it often deals with devices that speak no digital, as in data-acquisition and control applications.

The hardware needed to extract an analog control voltage from a microprocessor-based system typically includes a digital-to-analog converter, a set of latches or a peripheral interface adapter, a precision voltage reference, and an output amplifier. Most d-a converters require a negative-voltage power supply; with the trend in microprocessor applications leaning heavily toward single +5-volt supplies, this requirement is costly.

The 8-bit AD558 DacPort reduces the parts count drastically in this type of system. Operating from a

+5-v supply, this monolithic d-a converter includes a voltage reference, latches, and an output amplifier on chip (Fig. 1). It needs no external trimming for full-scale or offset adjustments; the only external component needed is a power-supply decoupling capacitor.

## A combination of technologies

To implement so many functions on a single chip, unique circuit techniques, precision bipolar processing, laser trimming of thin-film components, and integrated injection logic are used. The 558's digital interface is an I<sup>2</sup>L octal data latch that also provides bit switching for the d-a converter. Control of the latch is accomplished

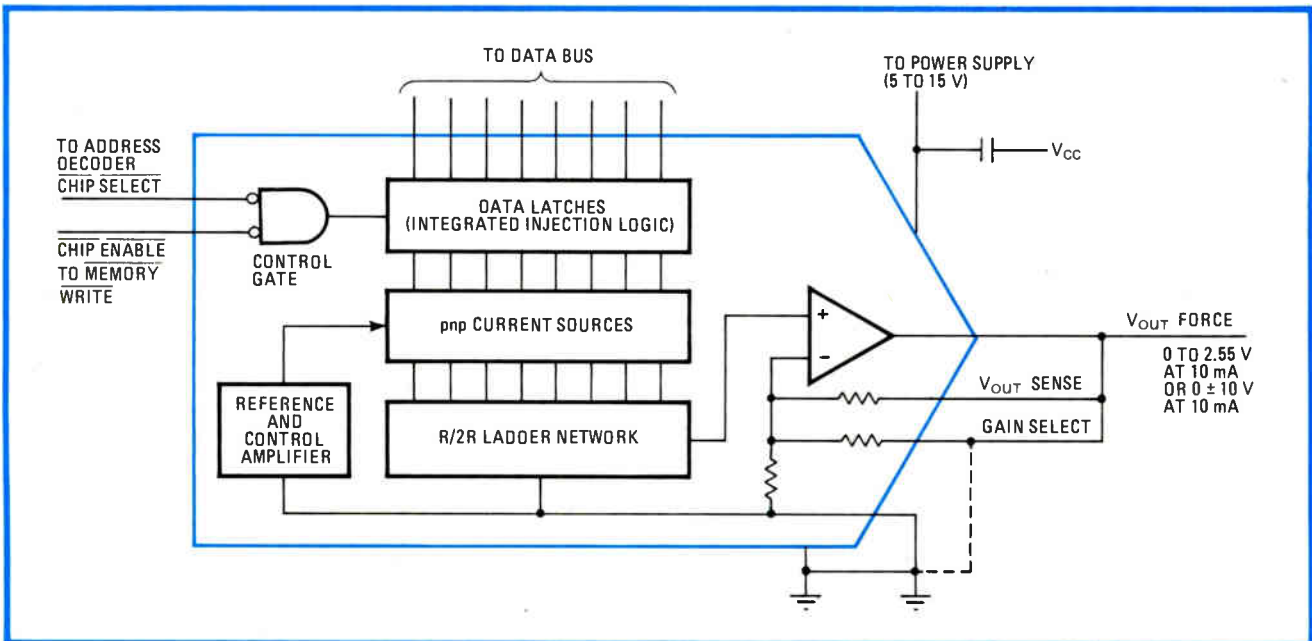

**1. Single supply.** A 5-volt power-supply line is all that is needed to operate the AD558, a complete monolithic 8-bit d-a converter. It includes reference, amplifier, and latches on the same chip. The only external component needed is a power-supply decoupling capacitor.

**2. I<sup>2</sup>L circuit.** Since I<sup>2</sup>L uses the same diffusion steps as a standard bipolar process, the addition of a deeply diffused n layer to isolate the gates makes possible analog and digital functions on the same chip. The 558's data latches are made with this extra step.

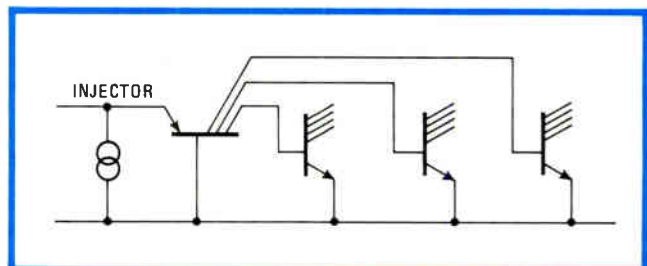

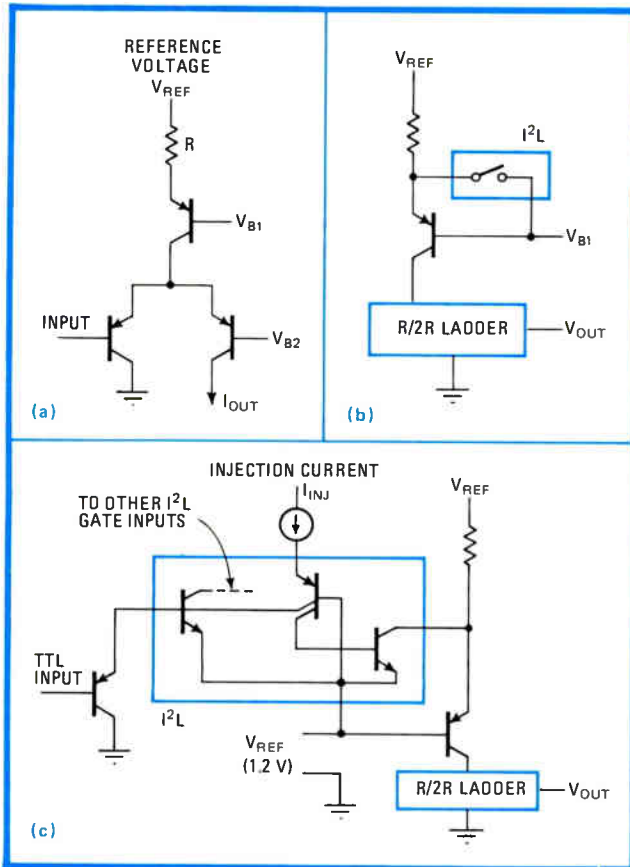

**3. Precision source.** A lateral pnp transistor version of a standard npn bipolar current source was chosen for the 558 (a). The circuit in (b) eliminates the alpha errors of (a) and can elevate the output of the 558's  $I^2L$  data latches to TTL-compatible voltage levels (c).

by a two-input NAND gate driven by two control signals, chip select ( $\overline{CS}$ ) and chip enable ( $\overline{CE}$ ). The latch is transparent to data when both  $\overline{CS}$  and  $\overline{CE}$  signals are at logic 0 and the chip's output then supplies the analog equivalent of the digital input word on the data bus. When either  $\overline{CE}$  or  $\overline{CS}$  goes to logic 1, digital data is held in the latch, preventing a change in analog output, and the microprocessor can use the data bus to communicate with other system peripherals without changing the d-a converter's output. Since the latch is level-triggered, non-microprocessor users can take advantage of the 558's other features by hardwiring the  $\overline{CE}$  and  $\overline{CS}$  lines to a logic 0.

A strobe pulse as short as 100 nanoseconds, applied to either the  $\overline{CE}$  or the  $\overline{CS}$  line, permits data to be transferred to the latch's output. This feature allows the 558 to interface directly with most of the faster microprocessors on the market. To minimize the pulse width and data-holding times for the latch, high-speed emitter-coupled logic is used in the control gate instead of  $I^2L$ .

The  $I^2L$  process employed to make the data latches is not new for data converters. It has been used successfully in the fabrication of the AD571 10-bit analog-to-digital converter [*Electronics*, April 13, 1978, p. 99] and more recently in the fabrication of the AD574 12-bit a-d converter. The process allows digital and analog functions to be combined on the same chip and has thoroughly demonstrated the capability for high-yield production.

An  $I^2L$  chip uses the same diffusion steps employed in a standard bipolar process (Fig. 2). The only extra step is a deeply diffused n layer to isolate the gates. Transistors in an  $I^2L$  gate are inverted-mode npn devices that provide extremely high functional densities. Current from the pnp transistor's collector drives the base of the multicol-

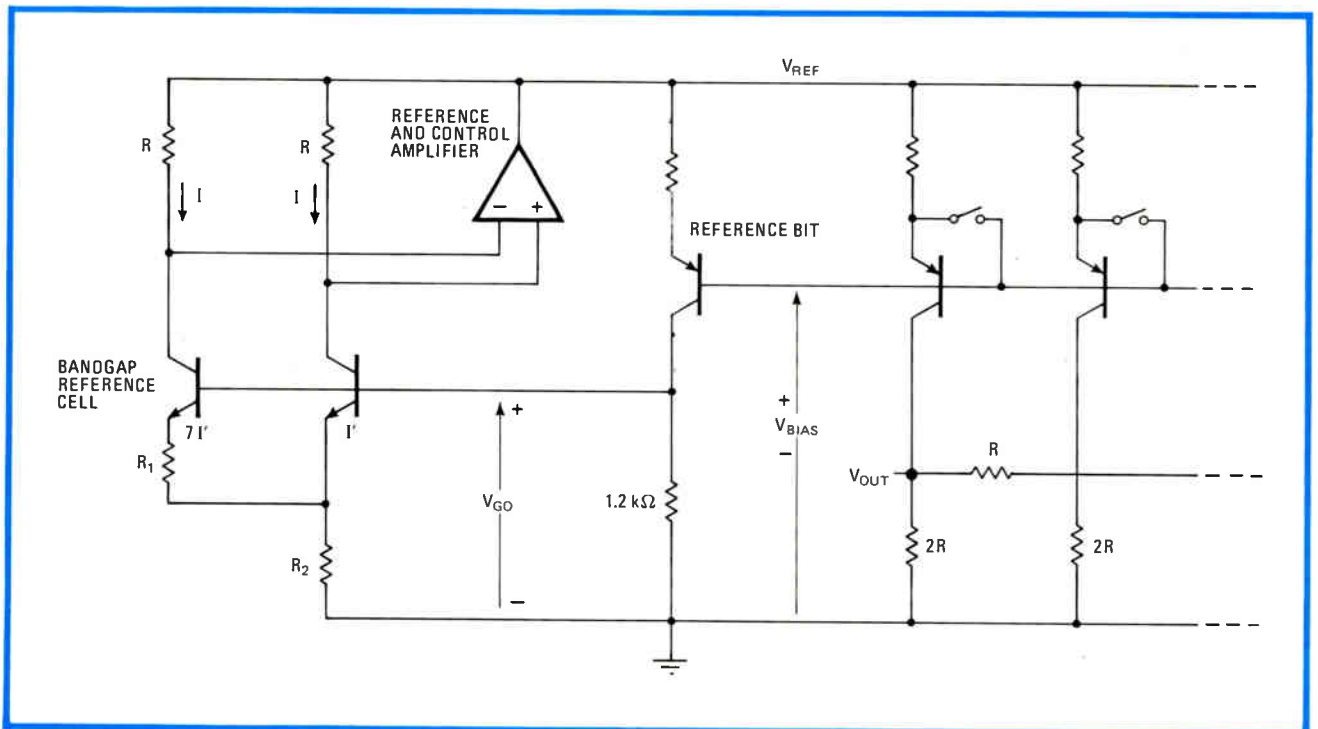

**4. Merging.** This newly devised circuit allows the merging of the 558's voltage reference and control amplifier. It offers improved dynamic-loop behavior and dc performance over conventional designs that incorporate separate voltage-reference and control-amplifier circuits.

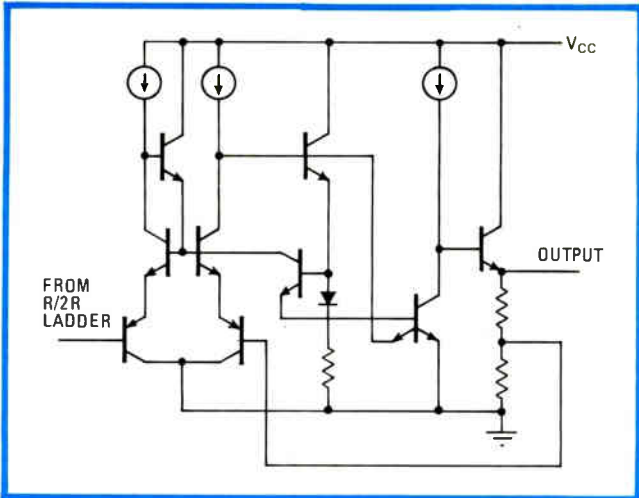

**5. Output amplifier.** The 558's noninverting output amplifier features pin-programmable gain. Kelvin drive and sense pins allow the output to be sent over long wires more accurately. A gain-select pin switches the feedback net and permits frequency compensation.

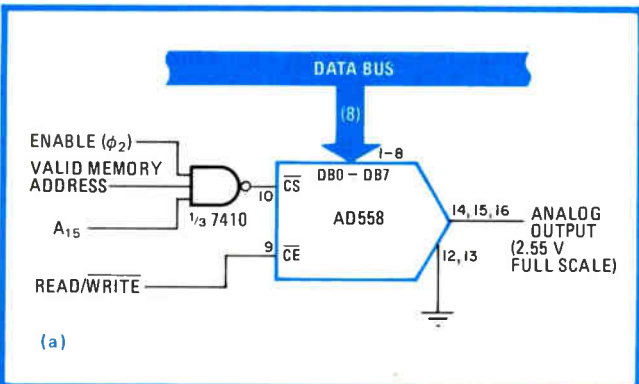

lector npn transistor, turning it on and pulling all the collectors down. Tying one of these collectors to the base of another I<sup>2</sup>L npn transistor diverts injector current away from the npn transistor's base and turns it off.

Since I<sup>2</sup>L is not compatible with TTL voltage levels, a level shifter is needed to use I<sup>2</sup>L circuits in a TTL driver switch cell. Level shifting is accomplished by elevating the I<sup>2</sup>L voltage levels by 1.2 v, thereby allowing direct TTL interfacing. The I<sup>2</sup>L outputs can then directly operate the npn transistor bit cells.

**Getting rid of lateral pnp shortcomings**

Most monolithic d-a converter designs rely on the high-quality npn transistors possible with a standard bipolar process to build the precision current-source and the current-steering stages. Unfortunately, chip architectures based on npn transistors are not useful for single-voltage designs such as the 558. The lateral pnp version of an npn transistor was therefore chosen as a possible alternative design approach (Fig.3a). This device, however, has its own shortcomings, namely, inherently poor current gain and mediocre speed. Since currents in successive lateral pnp transistors are binary-weighted, the cells suffer from alpha (common-base current-gain) errors in each stage, a condition that is difficult to compensate for. In addition, the cells yield relatively poor dynamic performance.

A reevaluation of the circuit in Fig. 3a produced the circuit in Fig. 3b, a cell structure that works around the

**6. Interface.** Circuit (a) can be used to interface the 558 with 6800-type microprocessors. For high-speed applications in which the 558's output glitches could cause a visible anomaly (as in display systems), a dual one-shot multivibrator can delay the  $\overline{CE}$  signal (b).

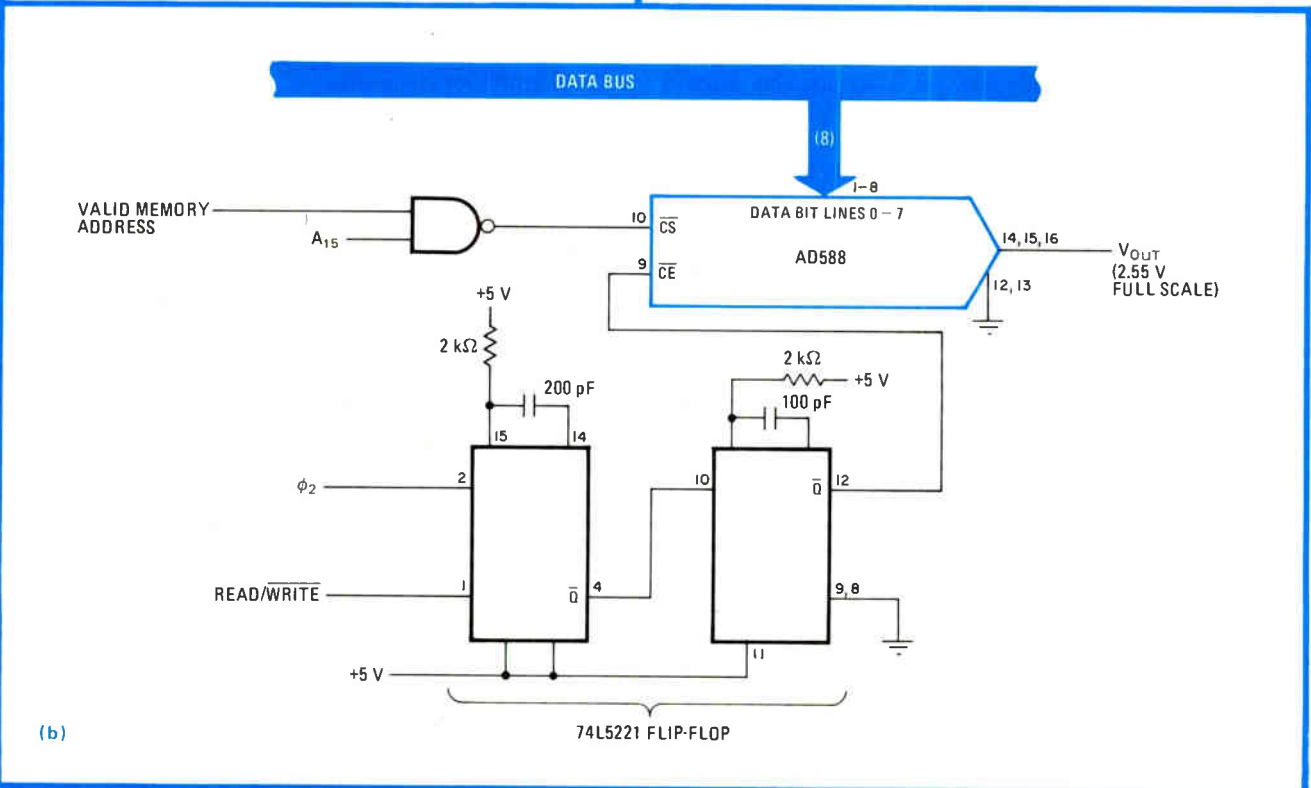

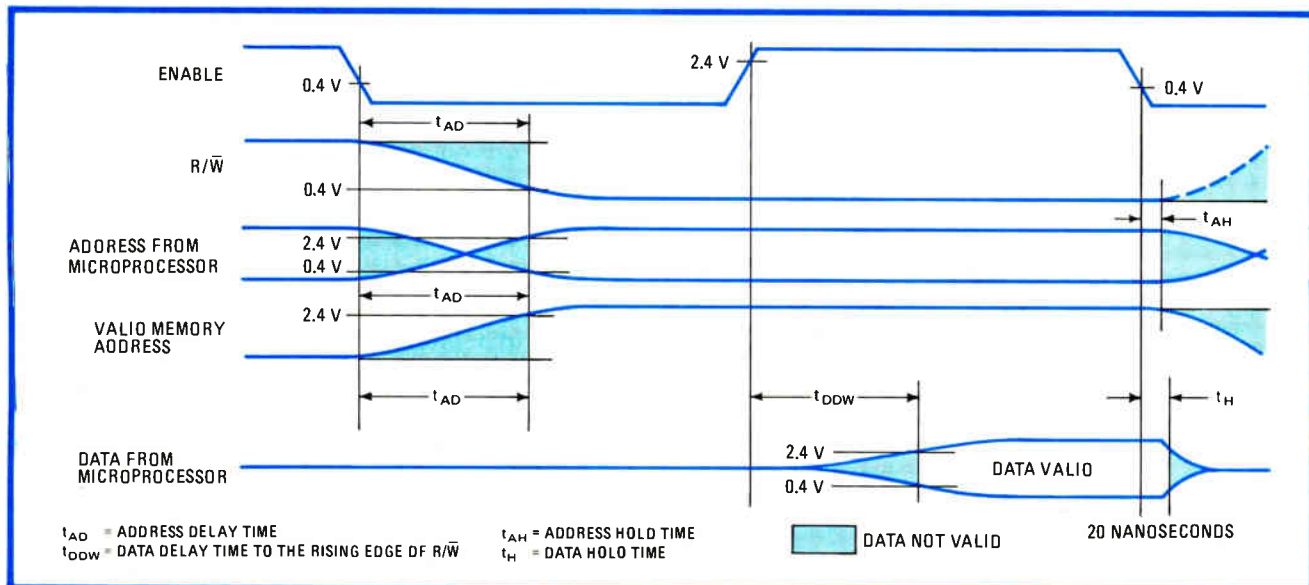

**7. Timing.** The 6802, like many microprocessor systems, will not respond to output glitches from the 558, since as can be seen from its write-cycle timing diagram  $t_{DDW}$  is a maximum of 225 ns. This fact makes possible the use of the simple interface in Fig. 6a.

shortcomings of lateral pnp transistors. Merging the current source and switch eliminates one alpha error. Stage currents are made identical, and the binary resistor ladder network in the transistors' collector provides binary weighting for the bits. These sidestep the need to match base-emitter voltages and current gains at different current levels. The current switch/source is thus reduced to a single common-base stage that exhibits low charge injection and rapid current settling.

The 1.2-v bias (shown as  $V_{B1}$  in Fig. 3b) of the lateral pnp structure can be used to elevate the output of the  $I^2L$  data latches to TTL-compatible voltage levels. As shown in Fig. 3c, the bias voltage is applied to the  $I^2L$  common potential. The  $I^2L$  latch output can operate the lateral pnp current sources directly, as long as the latches operate at a current level that is higher than  $(V_{ref} - V_{B1})/R$ , that is, the difference between the reference voltage and the bias voltage divided by the unit resistance value of the ladder network. This eliminates a second switch stage and enables the  $I^2L$  data latches to be super-integrated with the lateral pnp switch in the same isolation pocket on the chip. The 1.2-v bias allows a single vertical pnp transistor to serve as a high-impedance input stage compatible with both TTL and low-power Schottky TTL.

### Trimming the ladder network

The 558 includes eight identical pnp transistor current sources that feed an R/2R ladder network in a single-transistor-per-bit configuration. This configuration is made possible by the use of thin-film resistors connected in series with the pnp transistors' emitters. The resistors reduce bit interactions by increasing the output impedances of the current sources. The resistors are actively trimmed on the wafer by a laser, and the result is better than 8-bit linearity. The R/2R ladder network assigns a binary weight to each bit and produces a full-scale voltage output of 400 millivolts.

Current for each pnp transistor bit (and ultimately the

output voltage for each bit) is controlled by a reference and control amplifier. A bandgap reference cell is used, since it can operate within the desired 5-v supply range.

A new design allows the merging of the voltage reference and the control amplifier (Fig. 4). Merging these functions is necessary because conventional reference and control amplifier circuits for npn-based d-a converters are difficult to implement in a low-voltage design. In the merged circuit of Fig. 4, the collector voltage of the lateral pnp slave cell is sensed through a 1.2-v offset present at the amplifier input. The drive voltage to the top of the current sources is controlled accordingly. The results are improved dynamic-loop behavior and dc performance over conventional separate reference and control amplifier structures.

The merged amplifier-reference of Fig. 4 in effect does triple duty: it balances both sides of the bandgap reference cell, regulates its supply, and supplies a low-impedance voltage ( $V_{ref}$ ) to the d-a converter. The amplifier balances the currents in both sides of the bandgap cell by working through the reference current source to set the cell input voltage ( $V_{Go}$ , the bandgap voltage) at approximately 1.2 v. This voltage is set to a first-order approximation, is invariant with temperature, and fixes the current through the reference current source (and hence all the d-a converter bits) at a constant 100 microamperes. No trimming of the reference is necessary to produce a typical full-scale temperature coefficient of 10 parts per million per °C over the d-a converter's full operating-temperature range.

### Optimizing the output amplifier

The output amplifier for the 558 is a noninverting buffer with pin-programmable gain (Fig. 5). Kelvin drive and sense pins allow more accurate transmission of the output voltage over long wires. The gain-select pin is used to switch the feedback network and permit frequency compensation (not shown in Fig. 1).

When the 558 is operating from a 5-v supply line, the



gain-select pin is connected to the output-voltage sense pin ( $V_{out}$ ) and the full-scale output voltage is 2.56 v. If a 10-v full-scale output is needed, the 558 may be operated from a 15-v supply line with the gain-select pin connected to ground.

The output buffer is a source of up to 10 milliamperes and can settle to within  $\frac{1}{2}$  least significant bit of full-scale in less than 1 microsecond when operating in the 2.56-v output-voltage range. Settling time to within  $\frac{1}{2}$  LSB is less than 2.5  $\mu$ s in the 10-v output-voltage range.

The output amplifier is not a conventional design: circuit tricks were used to optimize the 558's performance. A look at the R/2R resistor ladder network's output shows a 400-millivolt output and a source impedance of several thousands of ohms. A conventional output amplifier cannot be used here, since the output stage for a single-voltage d-a converter like the 558 must have an amplifier whose input and output can operate down to ground potentials without saturating. In addition, the amplifier must have a gain-bandwidth product of approximately 25 megahertz to achieve closed-loop settling times of about 750 nanoseconds.

The output amplifier's input stage uses in an inverted structure similar to that of the 741 operational amplifier to provide input compliance to ground. Its differential input stage drives a floating current mirror that performs the conversion from differential- to single-ended signals that is necessary to drive the common-emitter, emitter-follower output stage.

### Swinging to ground

Enabling the output to swing to ground involves some unconventional circuitry. First, the output emitter-follower must have less than 200 mV at its base if the pull-down resistor is to have less than 1 mV across it over the d-a converter's full operating-temperature range. This is accomplished by having two collector contacts on the driver transistor to produce a Kelvin connection that senses the driver transistor's collector-emitter voltage more accurately. Increasing temperature raises the collector resistance, resulting in a higher apparent collector-emitter voltage. The Kelvin contact enables the true collector-emitter voltage to be sensed.

Another requirement is to prevent saturation of the

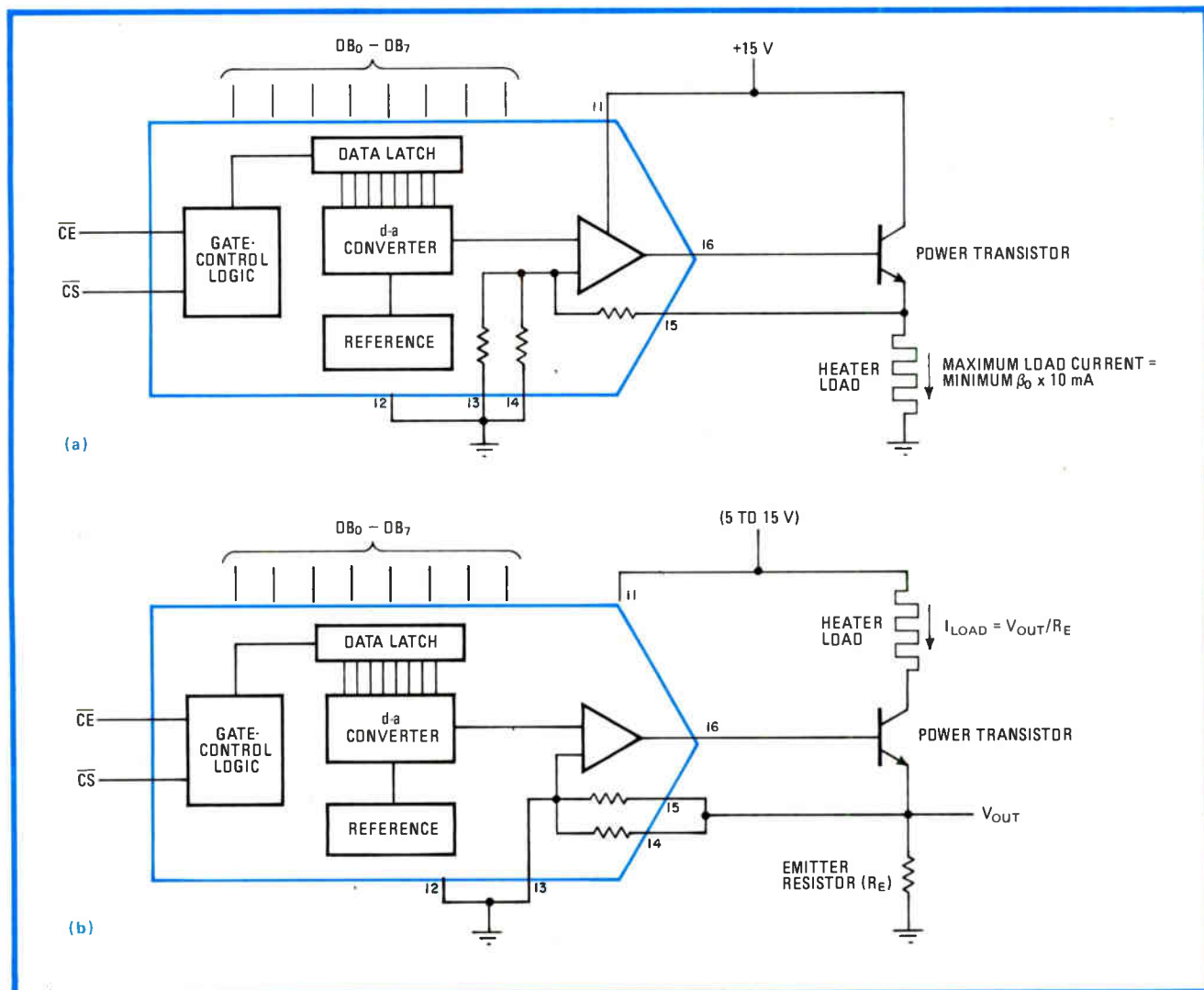

**8. High output current.** Industrial control systems often call for large a-d converter output currents. Adding a discrete high-current Darlington to the 558's output can satisfy this need (a). A second circuit makes this source output a high-current sink for high output voltage (b).

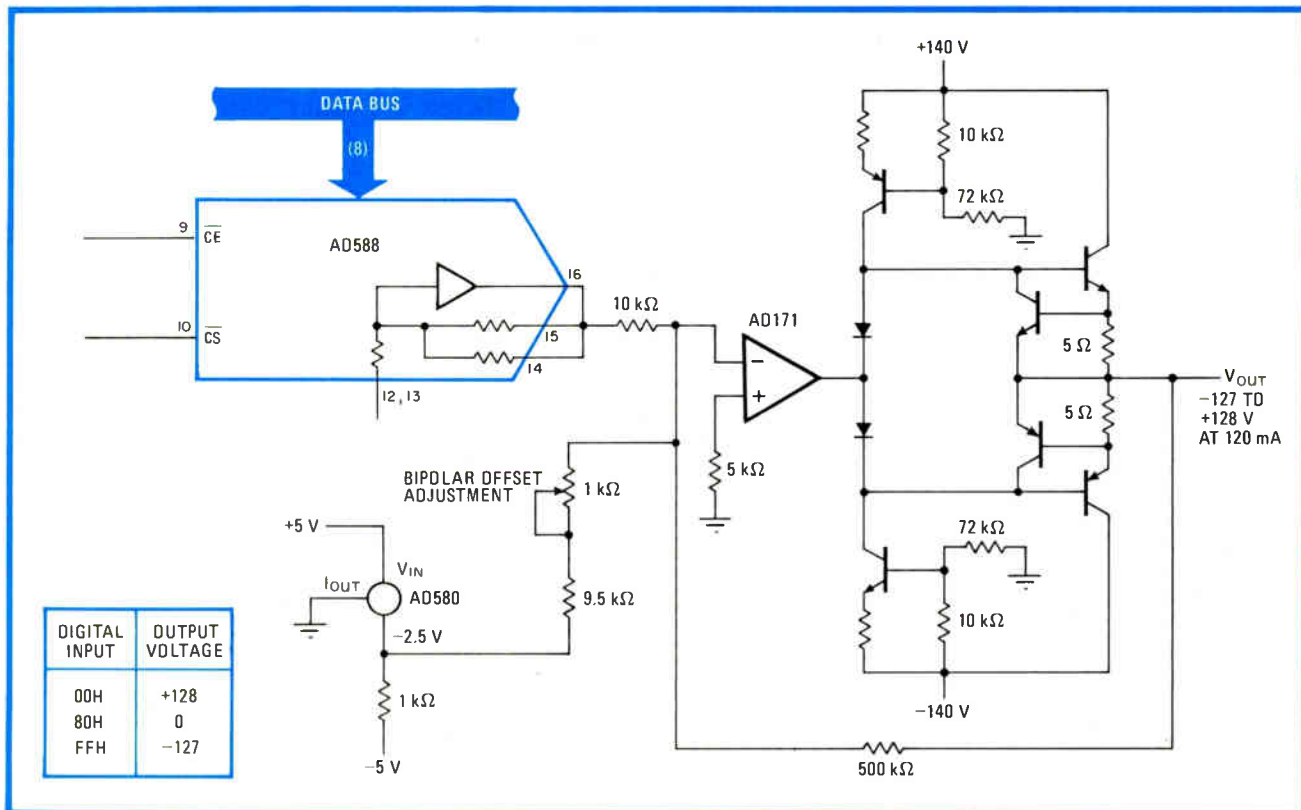

**9. High-power output.** For high-current as well as high-voltage output, a high-current circuit can be added to the AD171 operational amplifier in the 558's output stage. This circuit will produce an output swing of  $-127$  to  $+128$  V from a complementary-offset binary input code.

driver transistor. This is accomplished by adding an extra emitter (or P-L collector), which collects current when the transistor's normal collector-base junction becomes forward-biased. This current is then used in a local feedback loop to reduce the drive signal to the output transistor, thereby preventing saturation. Furthermore, this configuration provides an alternative feedback path when the output is close to ground potential. If such a path were not available, settling times would suffer as a result of the amplifier's open-loop operation at ground potential.

### The microprocessor connection

The 558's  $\overline{CS}$  and  $\overline{CE}$  inputs simplify connection to microprocessors. The converter can be either memory-mapped or treated as a separate input/output port in 8080, 8085 and Z80 microprocessor systems. For proper interface design, the timing diagrams of the 558 and the microprocessor in use must be compared.

In the case of memory-mapped I/O, the 558 can be visualized as a real-world read-only memory. Note that there is a subtle difference between writing into a random-access memory and writing into the 558. Data activity during the write cycle causes no ill effects in a RAM, as long as data is valid at the rising edge of the read/write ( $R/\overline{W}$ ) signal. Any bad input data, however, during a 558 write cycle temporarily causes an erroneous (and sometimes undesirable) analog output.

The  $R/\overline{W}$  timing scheme for the Z80 microprocessor is particularly convenient to use with the 558. Data is guaranteed valid and stable while the write line ( $\overline{WR}$ ) is

low. The minimum low time for  $\overline{WR}$  with the faster Z80A is 220 ns during memory write cycles (470 ns for I/O writing), easily meeting the timing requirements of the 558.  $\overline{CS}$  for the 558 can be derived from any convenient active-low address-decoding scheme. In simple systems, it may be possible to use a high-order address bit for  $\overline{CS}$ . The inverse of  $A_{15}$  is used in Fig. 6a, thus locating the 558 in the entire top half of the memory address space.

Interfacing methods used for the 558 with 6800-type microprocessors depend on the application. The 6802's timing diagram (Fig. 7) shows the period of time ( $t_{DDW}$ ) when all control signals are valid and data is not. Since  $t_{DDW}$  is 225 ns maximum (200 ns for 6500 microprocessors), many systems will be unable to respond to the glitch produced at the 558's output. For such systems, the interface circuit shown in Fig. 6a is adequate. For displays or other high-speed applications where this spurious output could cause a visible anomaly, a dual one-shot multivibrator can be used to provide an appropriately delayed  $\overline{CE}$  signal (Fig. 6b).

### A look at some applications

The 558's unique operating features allow it to perform novel functions. Its output of 100 milliwatts (10 V at 10 mA), for instance, makes it suitable for industrial applications.

Industrial control systems often call for large converter output voltages or currents, or both. The 558's output-current capability can be increased by adding a discrete high-current npn transistor in the form of a

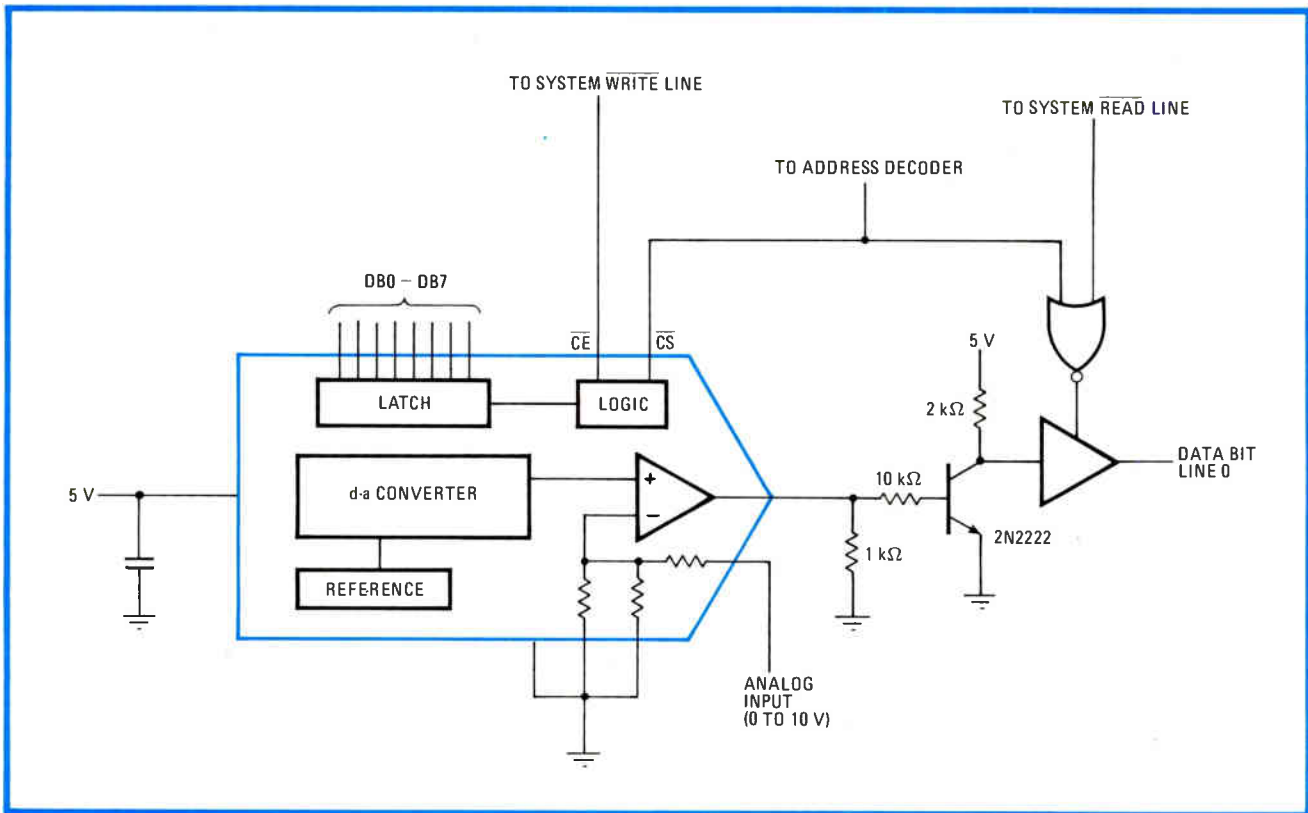

**10. Analog to digital.** The 558 can be used as an analog-to-digital converter under the control of a microprocessor. With the circuit shown above, limit testing can be performed directly, without the need for a full conversion step followed by a comparison step.

Darlington circuit to the converter's output stage (Fig. 8a). The maximum converter output current is limited by the current gain of the boost transistor (the discrete transistor) multiplied by the 10-mA maximum output of the d-a converter.

The d-a converter's Kelvin output is the key to this application. Connecting the output-voltage sense pin directly to the load preserves the output-voltage accuracy by making the drive pin absorb the additional base-emitter voltage of the boost transistor. Large capacitive loads should be avoided, since additional phase shifting may cause the output amplifier to oscillate.

The same circuit may be altered to make a high-current sink if the load is connected to the positive terminal of the power supply. This can be done by placing the load in series with the output power transistor's collector (Fig. 8b). The current level can be set by the emitter resistor and the output voltage of the d-a converter. The output-voltage compliance of this circuit may be increased by programming the 558 to the 2.56-v range (by tying pins 14 and 15 of the converter together). This allows the collector to be brought to within 3 v of ground potential before saturating the output transistor.

### High-voltage applications

For use with high-voltage circuits, the 558 may be connected to a high-voltage operational amplifier such as the Analog Devices 171 to produce swings in excess of 100 v. For high voltage as well as high current, a high-current output stage may be added to the opera-

tional amplifier, as shown in Fig. 9. This circuit will produce an output of  $-127$  to  $+128$  v from a complementary-offset binary input code.

The 558 may be used as the entire analog section of a single-supply 8-bit a-d converter. Many a-d converters contain a voltage reference, an analog comparator, and a d-a converter whose inputs are driven by either a counter or a successive-approximation function. The d-a converter's output is then compared with the a-d converter's analog input, and the d-a converter is subsequently adjusted for the closest possible match. Since such an analog comparator may be viewed as a high-speed open-loop operational amplifier, the output amplifier of the 558 may be used as just such a comparator.

### Microprocessor control

Figure 10 shows the 558 being used as an a-d converter under the control of a microprocessor. The first digital approximation is entered into the d-a converter in a conventional manner. The comparator state is next read back (after a delay for settling time) via the three-state buffer. The microprocessor can subsequently adjust the code sent back to the d-a converter according to some algorithm in its software. With this technique, limit testing can be performed directly, without the need for a full conversion followed by a comparison. The 558's laser-trimmed thin-film resistors allow calibrated analog-input scaling without any external trimming.

Should time or storage limitations make it impossible to implement a software conversion algorithm, the conversion routine can be implemented in hardware. □

## Frequency-marking controller indexes tape segments

by Joe Lyle and Jerry Titsworth  
Bendix Corp., Aircraft Brake and Strut Division, South Bend, Ind.

Tape recorders with footage counters are virtually useless for providing accurate tape markers, mainly because of the slippage created by the electromechanical counter-capstan arrangement generally employed. This controller, which indexes the tape with a frequency-labeling technique during record and stops the recorder at any preselected point during playback, offers the user an easy way to label and isolate any desired segment.

The unit is divided into two subcircuits, for frequency synthesis and for control. In the synthesis portion, thumbwheel switches  $TS_1$ – $TS_3$  are used to set the desired frequency that is to be placed on tape. The 14527 rate multipliers  $A_1$ – $A_3$  and their associated gates multiply the output of the K1116A oscillator by 0.001 to 0.999, thereby delivering frequencies in the range of 400 hertz to 399 kilohertz, in 400-Hz steps, to the input of the divide-by-four flip-flop. Thus, frequencies from 100 Hz to 99.9 kHz (100-Hz steps) are presented to the tape recorder. Because of the audio response of the typical recorder and the limits of the readout circuit used, frequencies of up to 9,900 Hz can be placed on tape. Thus the user may introduce a report number or test number with a frequency burst of selectable duration that directly corresponds to that test (that is, a frequency of 400 Hz will mark the start of test number 400).

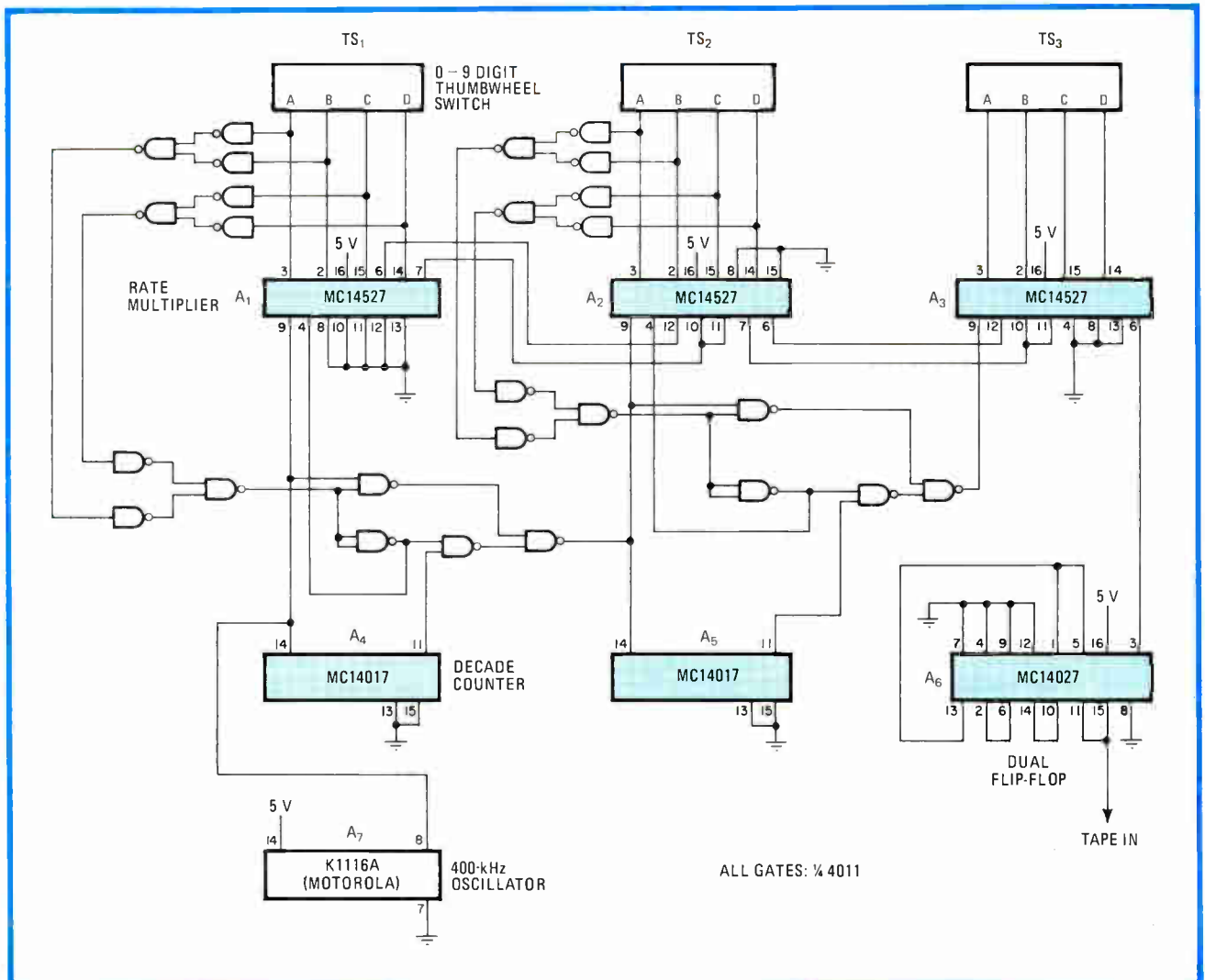

1. Search. Controller performs frequency labeling and searching functions to mark, isolate tape segments, respectively. Frequency synthesis portion injects tape markers over range of 100 Hz to 99.9 kHz, in 100-Hz steps.

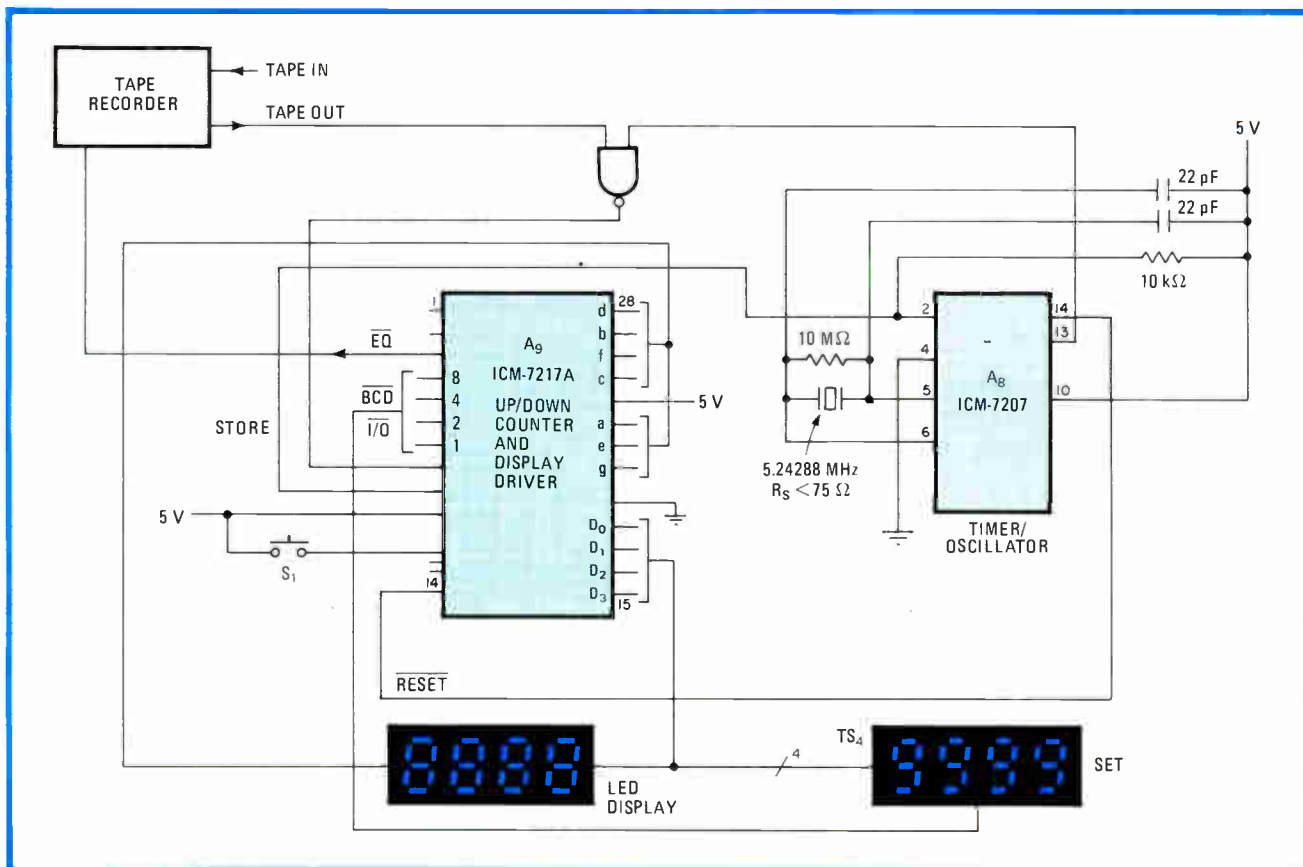

**2. Retrieve.** Control portion compares number corresponding to frequency selected to that generated by tape on playback, halts recorder when both are equal.  $TS_4$  sets the test number to be retrieved. LED display provides real-time readout of frequency measured.

The desired test is easily isolated on playback with the aid of the 7217A up-down counter/display driver, which is located in the control portion of the circuit. Thumb-wheel switch  $TS_4$  is used to set the test number at which the recorder is to be halted.

Pressing switch  $S_4$  loads the corresponding number into the device's on-board register. As the tape advances during playback, the 7217, which serves as a frequency

counter, compares the gated output of the recorder with the number that has been preset. The 7207A provides a 1-second gating time, after which it resets the 7217A's counter to zero. The LED display provides a real-time readout of the frequency measured.

Thus the equal (pin 3) output of the counter moves low if the tone matches the preset number. This signal is used (with appropriate logic) to halt the recorder. □

## High-frequency operation with the AM9513 controller

by Terence J. Andrews  
Vega Precision Laboratories, Vienna, Va.

The maximum source frequency of the Advanced Micro Devices' AM9513 system timing controller may be extended from 7 MHz to 20 MHz with this circuit. By

resolving timing intervals to 50 nanoseconds, the circuit significantly enhances the 9513's usefulness as a multiple programmable frequency divider. The improvement relies on the concept of swallow counting,<sup>1</sup> whereby the controller is made to operate synchronously with an external high-frequency clock. In particular, this circuit illustrates how the controller is configured to provide frequency division at 10 and 20 MHz as an example.

Here, the resolution obtained by either 10- or 20-MHz clocking can be selected as desired.  $A_2$ - $A_4$  achieve operation at 10 MHz. Register 1 of the 9513 is first loaded via its 16-bit data bus with  $01F5_{16}$ , which instructs the

# You are Invited!!!

to Examine the Prestigious,  
Portable Voltmeter Collection.

- Greatest selection.
- Smallest size.
- Low prices.
- Greatest portability.
- Excellent performance.
- Dependability.
- Reliable.

- VDC, VAC, Ohms, Low Ohms, DCmA & ACmA.
- Three & one-half digits.
- Automatic zero.
- Automatic polarity.
- Battery operation.\*



## LM-353

With LCD Readout

Circle 134 on reader service card & 100 Hr. Battery Life



## LM-4A

With LED Readout

Circle 138 on reader service card

- Measures VDC, VAC, Ohms, DCmA & ACmA.
- Full four digits.
- Automatic zero.
- Automatic polarity.
- Battery powered with charger unit included.

- VDC, DCmA, Ohms and RMS VAC & ACmA.
- Three & one-half digits.
- Automatic zero.
- Automatic polarity.
- Battery or AC line operation.\*



## RMS-350

Circle 139 on reader service card With LCD Readout

Size: 1.9"H x 2.7"W x 4.0"D/Weight: 9.2 oz

### SPECIFICATIONS

MODEL	RANGES	DC ACCURACY	RESOLUTION	DIGITS	PRICES
LM-3A	VDC, VAC, DCmA & ACmA	±1% Rdg	1 mV	3	\$134.00
LM-300	1, 10, 100 & 1000, *100% over-range - 1000 VDC or peak AC & 1A maximum.	±1% Rdg	1 mV	3	\$125.40
LM-3.5A*	RMS-350 displays true RMS in VAC and ACmA modes.	±0.5% Rdg	1 mV	3-1/2	\$165.85
LM-350*		±0.5% Rdg	1 mV	3-1/2	\$154.10
LM-353*		±0.5% Rdg	1 mV	3-1/2	\$155.05
RMS-350*	OHMS	±0.5% Rdg	1 mV	3-1/2	\$228.80
LM-40A	1 kΩ, 10 kΩ, 100 kΩ, 1 MΩ & 10 MΩ	±0.1% Rdg	100 μV	4	\$209.00
LM-4A	LM-353 also has 0.1 kΩ range.	±0.03% Rdg	100 μV	4	\$250.00

LM "A" Series display - LED's; LM-300, LM-350, LM-353 & RMS-350 - LCT's.

\*LED-display models—NiCad batteries and charger unit included.  
LCD-display models—batteries and charger unit not included.

NLS products are available from Nationwide Electronic Distributors. Send for our brochure today!



**Non-Linear Systems, Inc.**

Originator of the digital voltmeter.

Box N, Del Mar, California 92014 Telephone (714) 755-1134



## Semi-Finished Quartz Crystals

**Choose from the largest inventory in the U.S.**

P. R. Hoffman is one of the world's largest producers of semi-finished quartz crystal wafers. For nearly 40 years, we specialized in providing crystal blanks to finishers. Today we grow our own High-Q pure Z cultured quartz and process natural and cultured quartz to meet customer requirements for electronic and electro-optical applications. We supply crystal blanks lapped to the customers final frequency tolerances. We can also meet the most stringent specifications supplied with regards to dimensioning and orienting to precise angles. P. R. Hoffman maintains an inventory of over 2,000,000 crystals and can often ship from stock to meet your requirements. For information and prices, send your specifications to:

**P.R. Hoffman** A Norlin Technology Co.  
321 Cherry Street, Carlisle, PA 17013 Telephone: 717-243-2011

Circle 251 on reader service card

From... **ovenaire**  
...**OVENS FOR T05**  
CRYSTAL, TRANSISTOR, IC OR OTHER  
Temperature Sensitive Component in T05 Case

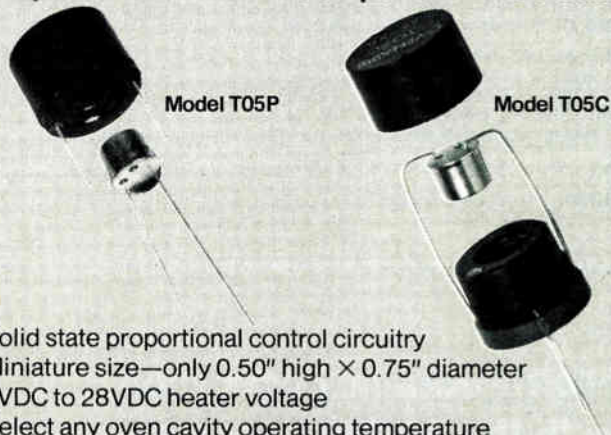

- Solid state proportional control circuitry
- Miniature size—only 0.50" high x 0.75" diameter
- 5VDC to 28VDC heater voltage
- Select any oven cavity operating temperature from 35°C to 95°C in 5° increments.
- Low power—0.5 to 0.9W nom. at stabilized +25°C ambient
- Temp. stability ±3°C typical for -30°C to +60°C
- Warm up from -30°C—3.0 minutes max.
- T05P—component cavity opening in bottom of oven
- T05C—component cavity access by removing top cover

**OVENAIRE-AUDIO-CARPENTER**

Division of Walter Kidde & Company, Inc.

706 Forrest Street

Charlottesville, Va. 22901

**KIDDE**

804-977-8050 • TWX 510-587-5461

Circle 135 on reader service card

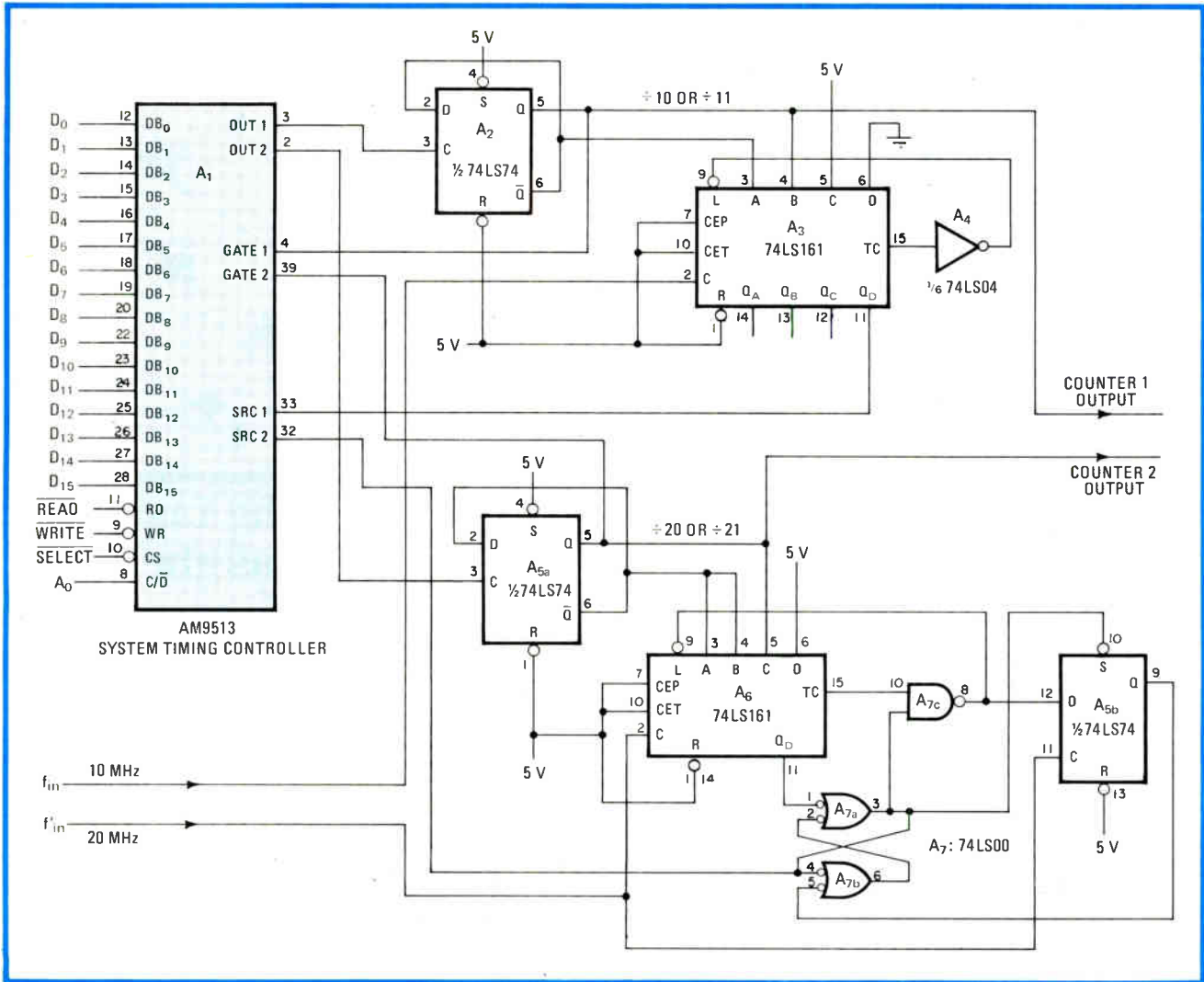

**Resolving divisors.** Swallow-counting improves resolution of AMD's 9513 system timing controller, thereby permitting pulse-train division at high frequency. Contents of the controller's load and hold registers set the divisor. Operation at 10 or 20 MHz can be chosen.

device to utilize incoming signals at pin 33 (SRC<sub>1</sub>) as its system clock and pin 4 (gate 1) to select either the device's hold or its load register for reloading each of the unit's five 16-bit counters upon receipt of a terminal count.<sup>2</sup> Counter 1 counts down in binary-coded-decimal fashion, with the contents of the load and hold registers determining the divisor.

In this application, only counters 1 and 2 of the device are used. Counter 1 begins to count down from a preset number on the rising edge of SRC<sub>1</sub>. SRC<sub>1</sub> in turn is driven by the 10-MHz clock through frequency divider A<sub>3</sub>. A<sub>3</sub> is programmed as a 10's complement counter and divides f<sub>in</sub> by either 10 or 11.

However, counter 1 is loaded with the contents of the load register if Q of toggled flip-flop A<sub>2</sub> (and thus gate 1) is low; otherwise, the contents of the hold register are loaded into counter 1. Thus when counter 1, which holds the contents of the load register, steps down to zero, A<sub>2</sub> orders A<sub>3</sub> to divide by 10; when the counter steps down from a value preset by the hold register, division is by 11. Because in this feedback arrangement there is a change of state at OUT 1 each time the counter reaches 0, it is

seen that the contents of both the load and hold registers determine when A<sub>2</sub> is toggled and thereby determine the divisor. Although the numbers loaded into the hold and load registers of the timing controller are in the BCD form, the AM9513 can be programmed to count binary numbers as well.

To determine the divisor, N, multiply the contents of the hold register by 11 and the load register by 10 and add the results. Because the loading of 0001 into either register will cause improper operation, 0011 must be used instead. For example, if division by 301 is desired, the hold register should be loaded with 0011 (not 0001) and the load register with 0018 (not 0029). If 0000 is loaded into either register, a divisor of 10,000 will be the result. □

#### References

1. The TTL Applications Handbook, "Swallow Counters," Fairchild Camera and Instrument, August 1973.
2. AM9513 Applications Sheet, Advanced Micro Devices, 1979.

Designer's casebook is a regular feature in *Electronics*. We invite readers to submit original and unpublished circuit ideas and solutions to design problems. Explain briefly but thoroughly the circuit's operating principle and purpose. We'll pay \$50 for each item published.

# How to compute if the dummy died?

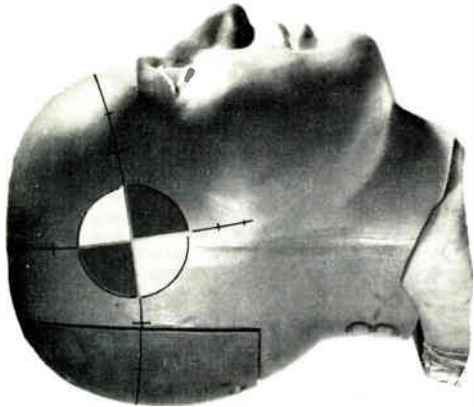

## A Problem for the Research Lab

Engineers working to make cars safer need to know what actually happens during car accidents. They need to know the extent of damage, the sequence of occurrences during collisions, the movements of passengers and how injuries occur. Researchers can duplicate accidents under controlled conditions. They can evaluate damage to auto structures, film the collisions and compile precise data. But when maniquins are substituted for human passengers, how can they tell if the dummies died? A tough problem for the research lab.

## The Solution

This research team found the solution at INTER-FACE. 1200 Series Low Profile Load Cells. By installing these highly accurate force measuring devices at strategic points they obtain instantaneous and precise measurements of the forces of impact. Computing this data with dummy positions and structural damage provides accurate information about the extent of injuries. Solving this testing problem has resulted in substantial improvements in auto safety. INTER-FACE Low Profile Load Cells high resistance to extraneous forces make them ideal for this type of testing application



INTERFACE Mini and Low Profile strain gage load cells are the modern answer to force measurement and weighing applications. Manufacturers, researchers, system designers recognize INTERFACE as the world leader in force measurement. A position that has been earned through pioneering research, proprietary advanced material technology in strain gage and flexure design, exacting standards, competitive pricing and on-the-shelf product availability. If you have a tough problem that requires measuring force or weighing to solve, contact INTERFACE for an easy answer.

# TOUGH PROBLEMS FIND EASY SOLUTIONS AT interface

ADVANCED FORCE MEASUREMENT

7401 E. Butherus, Scottsdale, Arizona 85260 USA (602) 948-5555  
Telex 668-394

Circle 136 on reader service card

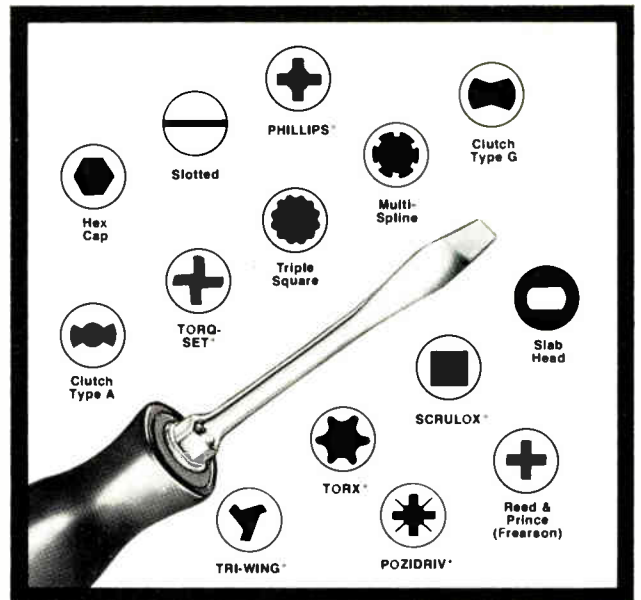

## If you have the fastener *Snap-on* has the tool

Snap-on offers screw drivers with bits in various sizes to fit all of the screw heads shown above. For complete details see your Snap-on representative or write us. Snap-on Tools Corporation, 8051-B 28th Avenue, Kenosha, Wisconsin 53140.

PHILLIPS®, POZIDRIV®, TRI-WING®, and TORQ-SET® are registered trademarks of the PHILLIPS SCREW COMPANY. SCRULOX® is a registered trademark of PAN AMERICAN SCREW. TORX® is a registered trademark of CAMCAR/TEXTRON.

**Snap-on Tools**

Circle 137 on reader service card

# Sound Performers.

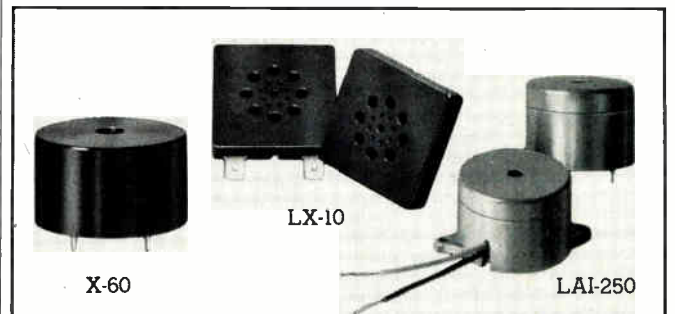

## New Low Frequency Piezo Audio Indicators.

54 to 84 dBA at super-low frequencies of 2.0 and 2.3 KHZ make Projects Unlimited's new LAI-250, LX-10, and X-60 piezo audio indicators standout performers. Along with compact size, get 1000 hour-plus design life... choice of wires or P.C. pins... and from 3.0 to 20 VDC operation. For specs, write: Projects Unlimited, Inc., 3680 Wyse Road, Dayton, Ohio 45414. Phone: (513) 890-1918. TWX: 810-450-2523.

 projects®  
unlimited

Circle 252 on reader service card



# Laser cold processing takes the heat off semiconductors

By heating wafers to the exact depths in the exact areas required, laser equipment avoids the inflexibility of thermal processing in furnaces

by R. A. Kaplan, M. G. Cohen, and K. C. Kiu, *Quantronix Corp., Smithtown, N. Y.*

□ A new and exciting technology has appeared in the last two years that could be of major importance in producing tomorrow's very large-scale integrated circuits as well as in raising the yields of today's LSI devices. It is the use of a laser as a heat source for some of the many high-temperature process steps in semiconductor manufacture—for instance, annealing a wafer to eliminate crystal damage due to ion implantation, diffusing a wafer with dopants, and growing crystalline material from amorphous or polycrystalline material.

In this new technique, an intense laser beam heats a semiconductor surface to a temperature at which some desirable physical or chemical change takes place in the material. The main practical advantage of this process is that the laser spot limits irradiation to specific areas and the short pulse limits heating to a small depth while the rest of the material stays near ambient temperatures. Hence the name of the technique—laser cold processing, or LCP.

Though the basic thermal and electrical behavior of laser-irradiated semiconductors is being widely studied, much less effort has been spent on actual device properties and even less on practical equipment designs. Quantronix therefore concentrated on building a production machine for LCP. The result, the Epitherm 610 system, is shown in Fig. 1. It uses a Q-switched neodymium-yttrium-aluminum-garnet laser that can be operated at either of two wavelengths, 1.06 or 0.53 micrometer.

## Excellent prospects

Experiments applying this type of equipment to IC annealing, diffusion, and epitaxial growth yielded devices with circuit and material parameters that were in many regards superior to those of devices that had been heated in a furnace. Moreover, an economic analysis indicates that laser heating can be cost-competitive with the use of a furnace.

The high-temperature steps in present-day semiconductor manufacture are all used to alter crystal structure or composition. The annealing of ion-implantation damage requires the use of heat to recreate the original

crystal structure after lattice ions have been displaced by collision with implanted ions; also involved is the migration of the implanted ions to substitute sites. In diffusion, heat is applied to a wafer in the presence of a dopant, so that the dopant ions may acquire just enough mobility to migrate to the right sites at the right depth. Finally, the heating of amorphous or polycrystalline layers grows crystalline materials directly on the substrate.

## Furnaces can be faulted

In all three processes, the entire wafer spends a long time in a high-temperature furnace, not without numerous deleterious consequences. For one thing, the lengthy heating times (typically major fractions of an hour) make the wafer vulnerable to defects introduced by contaminants from the furnace and to crystalline structure failures. For another, all high-temperature processing must precede all low-temperature processing, because the entire wafer, rather than specific small regions, has to be heated.

Dopant distribution and activation are also affected adversely by the process. For example, previous ion-implanted dopant profiles become distorted when a subsequent heating operation remobilizes and redis-

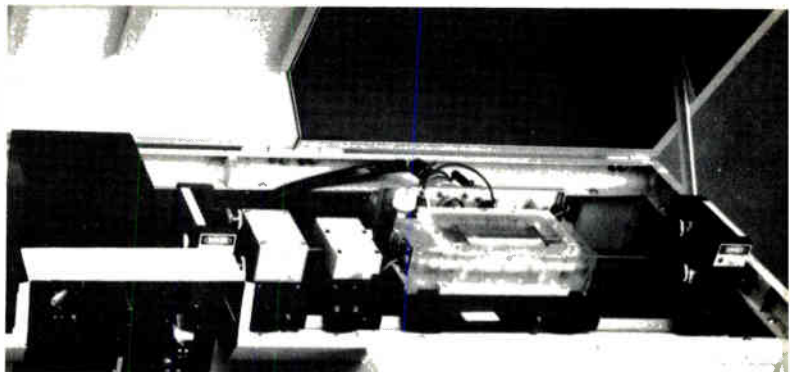

**1. Laser processor.** A laser thermal processing system built at Quantronix employs a Q-switched, cw-pumped YAG laser. The laser delivers 10 watts average power at a 1.07- $\mu\text{m}$  wavelength and 2 watts average power at a 0.53- $\mu\text{m}$  wavelength.

TABLE 1: COMPARISON OF HEATING COSTS-BASIC DATA

	Conventional furnace	Laser cold processing
Throughput (wafers/h)	100 (3 in.)	110 (3 in.)
Input power (kW)	15	7
Installed cost	\$20,000	\$100,000
Amortization period (shifts)	15	15
Operational duty cycle	0.5	0.95

TABLE 2: COMPARISON OF HEATING COST PER WAFER

	Conventional furnace	Laser cold processing
Amortization	1.3	3.2
Utilities at 6 c/kWh	1.8	0.4
Consumables	0.8	0.4
Maintenance	1.0	0.3
Total	4.9 c	4.3 c

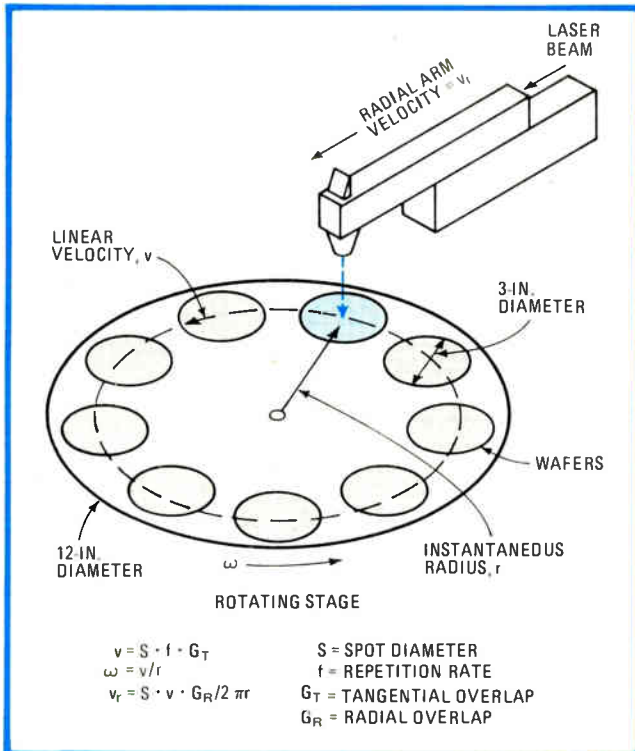

**2. Spot motion.** This is the high-speed motion system for the Quantronix laser cold processor. Nine 3-inch wafers are spirally scanned by a slow motion of the radial arm. In a production mode, throughput can be as high as 70 wafers per hour.

tributes the dopant ions. Again, the long-term heating of thermal annealing and diffusion results in structures representing equilibrium configurations (phases, stoichiometries, and so on), limiting the amount of dopant that may be introduced to form the active ions in a device.

Even bulk properties are often found to change. The carrier life-time of the basic wafer material is commonly shortened once the entire wafer has been raised to a uniform high temperature.

Finally, the large thermal mass of the furnace itself is a drawback since the resulting delay time makes it impossible to control short-cycle heating precisely—a limitation that contributes to all of the above defects. Moreover, furnaces warp and distort wafers, throwing the lithographic processes out of true so that IC layers are misaligned.

To a large extent the drawbacks of conventional furnaces are absent from laser cold processing. This technique heats and cools in microseconds rather than

hours. It can heat just the active surface layers of a wafer and no deeper. Most importantly, it can restrict this surface heating to only those areas requiring it. Thus the process sequence need no longer be as constrained as before by the need for high-temperature steps to precede lower-temperature steps.

The brevity of the heating period has several advantages. It reduces the risk of contamination greatly, alters dopant profiles less, and changes bulk properties not at all. The high-mobility state due to high temperature exists for only fractions of a microsecond, so that ions will be diffused over much shorter distances (except in the molten state). The rapid cooling of laser processing makes it possible to freeze in structures not otherwise available, while the localization of laser heating enables a user to produce new configurations by tailoring the processed regions. Laser processing could actually be a maskable operation. Finally, because the heating is localized, it cannot distort or warp the wafer.

**Heating costs**

Laser cold processing represents a major change in thermal processing of semiconductors and has yet to be fully evaluated. At least on paper, however, the new technique is economically competitive with furnace processing. Comparative data is given in Table 1. The two methods have comparable throughputs. The laser equipment costs more, however, but has a much higher duty cycle and uses less energy.

Translating these factors into the cost per wafer, Table 2 demonstrates that in both systems the figure is between 4 and 5 cents per wafer. Increasing energy costs should tilt the balance in favor of laser heating.

**Laser hardware**

A laser cold-processing system comprises two subsystems: a heating component consisting of laser and optics, and the wafer or beam scanning components consisting of motion mechanisms and control electronics.

The heating subsystem parameters a potential user should weigh are the wavelength, pulse width, average power, and stability of the laser, not to mention its cost.

Laser wavelength,  $\lambda$ , is critical since the temperature distribution of a wafer during and after irradiation is a function of its optical absorption coefficient, which in turn is strongly dependent on wavelength.

It is desirable to select wavelengths such that the material absorption,  $\alpha$ , will lie in the range of  $10^3$  to  $10^6$  centimeter<sup>-1</sup>, yielding an absorption length of 10 to 0.1  $\mu\text{m}$ . The lower value heats a thicker surface layer with a flatter temperature profile; the higher value

TABLE 3: COMPARISON OF LASER SOURCES

Parameter	Continuous-wave argon/krypton	Pulsed ruby	Pulsed YAG	Repetitively Q-switched YAG
Wavelength	visible	0.69 $\mu\text{m}$	1.06/0.53 $\mu\text{m}$	1.06/0.53 $\mu\text{m}$
Power	20 W	1 W	5/0.5 W	20/2 W
Spatial mode	TEM-00	multi	multi-/TEM-00	TEM-00
Pulse energy	—	1 – 2 J	2 J	5 mJ
Spot area	25 $\mu\text{m}$	local 1-mm areas in 10 mm	5 mm	0.2 mm
Typical operating flux	200 J/cm <sup>2</sup>	1 J/cm <sup>2</sup>	5/0.5 J/cm <sup>2</sup>	5/0.5 J/cm <sup>2</sup>
Overlap	1-axis, 75%	—	20 x 16 50%	2-axis, 50%
Throughput	0.1 cm <sup>2</sup> /s	0.01 cm <sup>2</sup> /s	0.5 cm <sup>2</sup> /s	1 cm <sup>2</sup> /s
Pulse duration	~1 ms	10 – 50 ns	10 – 50 ns	50 – 100 ns
Heated depth	~50 $\mu\text{m}$	0.1 – 0.5 $\mu\text{m}$	0.5 – 1 $\mu\text{m}$	0.2 – 1 $\mu\text{m}$
Stability	very good	poor	fair	very good
Controllability	very good	poor	fair	very good
Operating cost	\$3.00/h	\$1.50/h	\$4.00/h	\$1.50/h
Operating cost	0.8 $\phi$ /cm <sup>2</sup>	4 $\phi$ /cm <sup>2</sup>	0.2 $\phi$ /cm <sup>2</sup>	0.04 $\phi$ /cm <sup>2</sup>

results in surface heating with a sharper profile. For silicon a  $\lambda$  larger than 1  $\mu\text{m}$  yields an  $\alpha$  of approximately  $10^2$  to  $10^4$  cm<sup>-1</sup>; a  $\lambda$  smaller than 1.0  $\mu\text{m}$  yields an  $\alpha$  of approximately  $10^4$  to  $10^6$  cm<sup>-1</sup>.

Some applications require heat to penetrate relatively deeply—approximately 1  $\mu\text{m}$ —and for these long-wave radiation is desirable. Others need be heated to depths of the order of a few tenths of a micrometer, and for them short-wave (visible) radiation is desirable.

For shallow heating, the laser pulse must be narrow compared to a thermal diffusion time,  $t_D$ ;  $t_D = (\rho c/k)Z_D^2$ , where  $\rho$ ,  $c$ , and  $k$  are the density, specific heat, and thermal conductivity respectively and  $Z_D$  is depth of heating. For a  $Z_D$  on the order of 1  $\mu\text{m}$ ,  $t_D$  is approximately 100 nanoseconds for common semiconductor materials. Pulses of this duration ensure minimal heat flow into the bulk material and hence efficient heating and a sharp temperature profile.

Laser average power must be high enough to provide the necessary throughput. The area heating rate is given by average power,  $P_{av}$ , divided by threshold energy density,  $F_T$ . An  $F_T$  of 1 to 10 joules/cm<sup>2</sup> and a  $P_{av}$  of 2 to 20 watts yield heating rates of about 2 cm<sup>2</sup>/second. Thus a 3-inch wafer would be processed in less than 1 minute.

Stability is probably the laser's most important parameter because temperature distribution in the material must be carefully controlled. Too high an energy density and the surface may deform or evaporate; too low, and nothing or not enough may happen.

In weighing the scanning subsystem of a laser cold-processing machine, a user should consider its speed and positioning resolution. For instance, a motion system's

scanner must have a linear speed high enough for the wafer throughput to be limited not by the scanner but by the laser power. Depending on spot sizes, this may require speeds up to 50 in./s.

In some applications, it may be necessary to position each laser spot precisely for exact overlap of a total wafer surface. A motion system should be capable of control to within about 10% of the spot size. This requires positioning resolution on the order of 0.1 mil.

### Laser options

Choosing the right laser for the laser heating system is critically important. Experiments have employed continuous-wave argon and krypton, pulsed ruby, pulsed YAG, and cw-pumped YAG lasers. Now process engineers face the problem of selecting one of these electro-optical sources for production use in laser processing where wavelength flexibility, throughput, and cost are the governing factors.

After an extensive analysis, summarized in Table 3, Quantronix' engineers decided that the Q-switched, cw-pumped YAG laser was the most cost-effective type for production purposes.

The cw argon (or krypton) laser provides a continuous output at several wavelengths in the visible spectrum between 0.45  $\mu\text{m}$  and 0.51  $\mu\text{m}$ . The visible argon laser output is readily absorbed by a thin surface layer of most semiconductor materials. However, its low peak power necessitates rather prolonged heating (about 1 millisecond) to raise the surface temperature to a suitable level. As a consequence, the flux thresholds are high and processing rates rather low. On the other hand, the

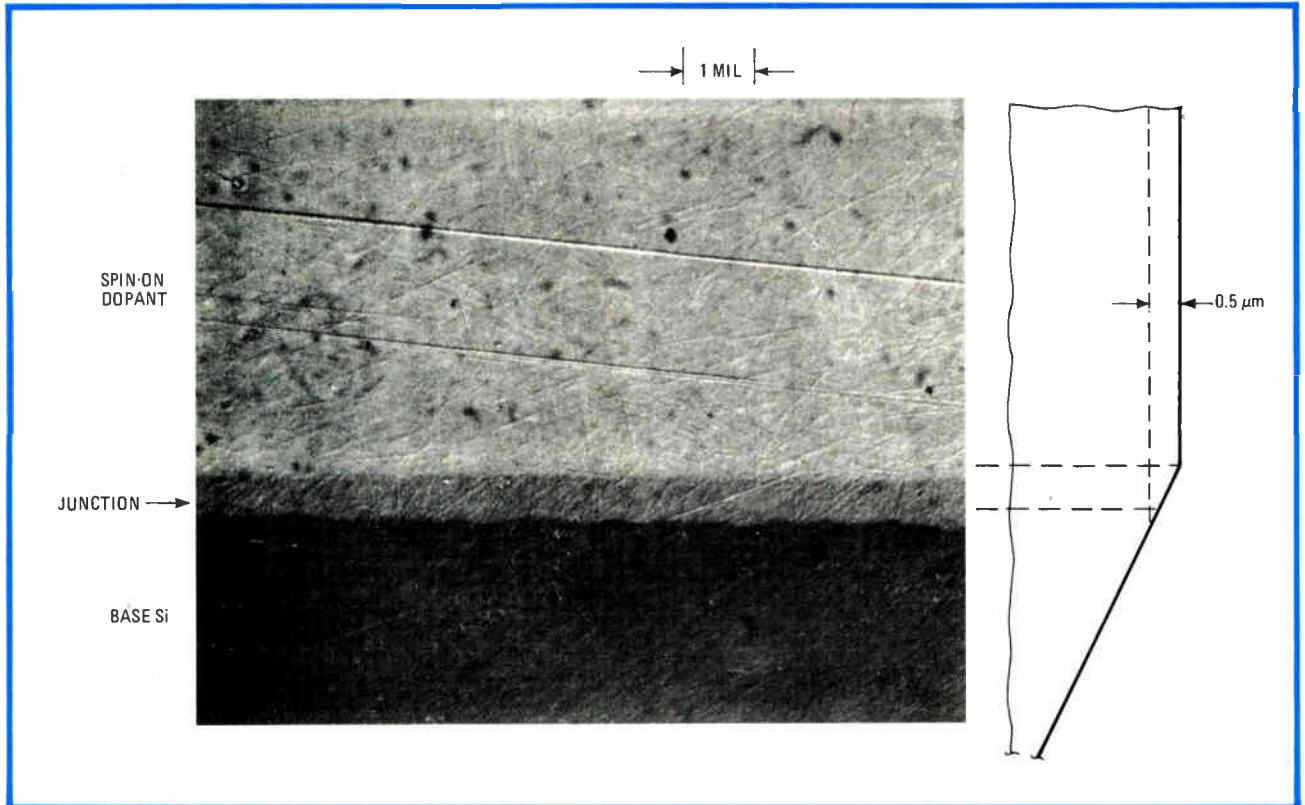

**3. Laser diffusion.** Both n-type and p-type junctions can be obtained by laser-assisted diffusion of dopants. Shown is a silicon wafer with spun-on arsenic, laser-irradiated at  $9.5 \text{ J/cm}^2$  at  $1.07 \mu\text{m}$ . The junction depth in this end view is approximately  $0.5 \mu\text{m}$ .

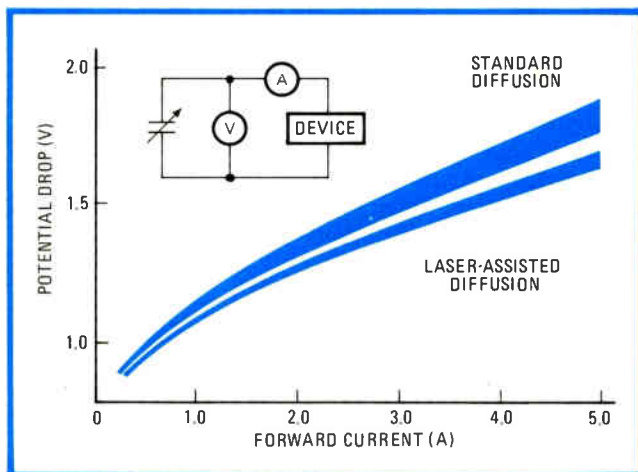

**4. Diffused contacts.** Laser-assisted diffusion has been shown to produce junctions with a 10% lower forward voltage drop than that of furnace-produced types. In addition, device-to-device variation is reduced by a factor of three with laser processing.

lengthy heating period makes solid-state regrowth possible, which has the advantage of leaving dopant profiles unaffected by the annealing process. Estimated laser operating cost is about  $0.8\text{¢/cm}^2$ ; capital cost is about  $\$125,000$  for a  $1\text{-cm}^2/\text{s}$  heating rate.

Pulsed ruby and YAG lasers both use a solid rod containing active ions (chromium and neodymium respectively) optically pumped with a xenon flashlamp. The ruby laser oscillates at  $0.69 \mu\text{m}$ , a wavelength that is fairly well absorbed by silicon and other semiconductors.

The YAG laser, on the other hand, oscillates at  $1.06 \mu\text{m}$  and thus couples well only to amorphous silicon or silicon at elevated temperatures. The YAG laser output may also be conveniently doubled in frequency (halved in wavelength) to provide pulses at  $0.53 \mu\text{m}$ .

Unit costs of these systems are in the area of  $\$30,000$  to  $\$50,000$ ; operating costs, primarily for replacement lamps, are about  $\$2.00$  to  $\$4.00$  per hour. The YAG laser provides the more economical processing cost of approximately  $0.2\text{¢/cm}^2$ .

The repetitively Q-switched, cw-pumped YAG laser provides a compromise between the laser types previously discussed. Optical pumping is supplied by a continuously operating arc lamp, whereas the output consists of a stream of short laser pulses at either  $1.06 \mu\text{m}$  or (with second harmonic generation)  $0.53 \mu\text{m}$ , produced by using an acousto-optic Q switch to periodically dump the energy stored in the excited Nd ions. The cw pumping and repetitive nature of the process leads to radiation with well-defined spatial and temporal properties. Typical pulse energy is small (on the order of millijoules) but average powers of 2 to 20 W are available.

Laser unit costs are of the order of  $\$20,000$ . Operating costs (once more, primarily for replacement lamps) are about  $\$2.00$  per hour.

Operation at both the  $1.06\text{-}$  and the  $0.53\text{-}\mu\text{m}$  wavelength offers the option of either moderate or high absorption with many materials and provides significant advantages in specific processing applications.

This type of laser's thermal time constant for heating depths of the order of  $1 \mu\text{m}$  is a few tenths of a microsec-

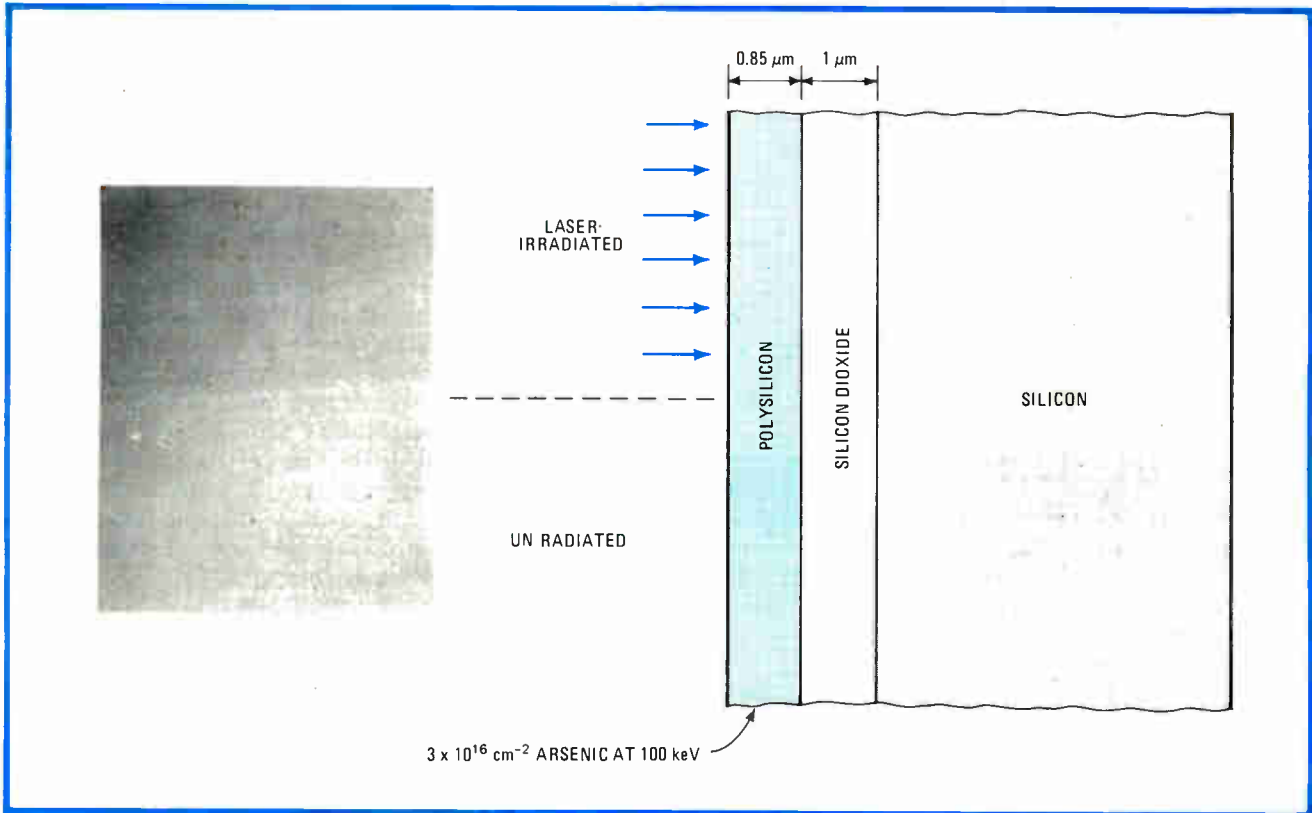

**5. Laser annealing.** Silicon sample has a 0.85- $\mu\text{m}$  polysilicon layer ion-implanted with arsenic on top of a 1- $\mu\text{m}$  layer of silicon dioxide. The polysilicon is laser-annealed at both 1.06 and 0.53  $\mu\text{m}$ . Note the difference in surface finish between the unradiated and irradiated regions.

and for typical semiconductor materials. Thus efficient heating is achieved with irradiation periods of this duration or less. Cw-output lasers, on the other hand, operate with effective irradiation durations of the order of a millisecond, thus heating a thick wafer layer and resulting in low area heating rates and throughputs.

The throughput of an LCP system,  $A$ , in  $\text{cm}^2/\text{s}$ , is directly proportional to the average power,  $P$ , and operating energy density  $F$ , so that:

$$A = PG/F$$

where  $G$  is the fractional overlap of laser spots. The Q-switched, second-harmonic YAG laser with a typical threshold energy density of 1  $\text{J}/\text{cm}^2$  yields rates of about 1  $\text{cm}^2/\text{s}$  with 2 W of average power.

The critical operating parameter used to characterize materials processed in scanning cw laser systems is the power divided by the spot size. A typical published value of 0.2  $\text{W}/\mu\text{m}$  can be connected to the more physically meaningful energy density,  $F$ , by dividing it by the scanning velocity. Since these rates range from about 2 to 12  $\text{cm}/\text{s}$ , the values of  $F$  for cw lasers range from 170 to 1,000  $\text{J}/\text{cm}^2$ . Thus for the cw argon (or krypton) laser with  $F$  on the order of 200  $\text{J}/\text{cm}^2$  or higher, very low throughputs (approximately 0.1  $\text{cm}^2/\text{s}$ ) result with even 20 W of average power.

Although the cw-pumped, Q-switched laser requires a scanning system for total wafer coverage, such a system can be extremely simple. The total cost of laser and scanning system is less than the cost of the laser required to produce single pulses of sufficient energy to irradiate

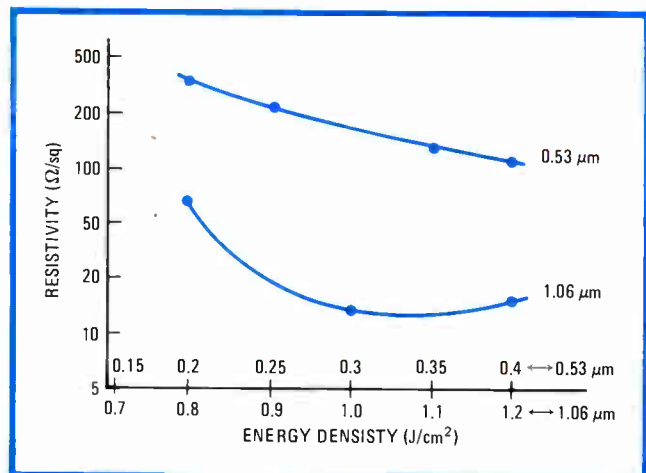

**6. Sheet resistivity.** In laser annealing, wavelength can be critical to this parameter. As the graph shows, a longer wavelength, 1.06  $\mu\text{m}$ , produces a lower resistivity (13 ohms per square) than the 100-ohm-per-square sheet resistivity at a 0.53- $\mu\text{m}$  laser wavelength.

large wafers in a single pulse.

For example, processing an entire 4-in. wafer would require pulse energies on the order of 100 J, necessitating large, expensive laser rods and pump-energy storage components, not now commercially available.

In addition, the repetitively Q-switched Nd:YAG laser is widely used in various kinds of industrial equipment and has a demonstrated high mean time between failures suitable for semiconductor manufacturing.

Laser cold processing techniques have been employed

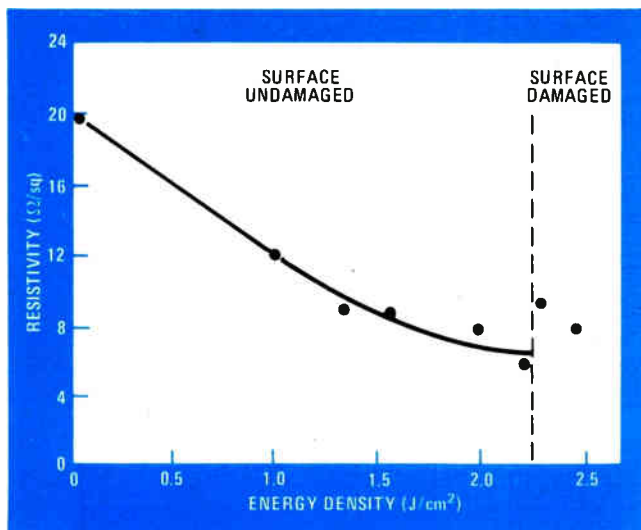

**7. Epitaxial growth.** These are the results of laser heating in order to epitaxially grow a chemically vapor-deposited phosphorus-doped layer on a silicon substrate. Resistivity of the layer can be reduced to 6 ohms per square without surface damage.

by Quantronix in conjunction with several semiconductor manufacturers in numerous experiments covering a wide range of materials, devices, and applications. The objective was to determine the advantages and disadvantages of various equipment designs as well as to study material and device properties. This work illustrates the three general applications previously mentioned: laser-assisted diffusion; laser annealing of ion-implantation damage; and laser growth and regrowth of single-crystal or large-grain polycrystalline films.

### The laser in action

The repetitively Q-switched cw-pumped YAG laser was used as the laser source for these experiments along with several configurations of high-speed motion systems. This laser delivered up to 10 W of average TEM-00 mode power at 1.06  $\mu\text{m}$  and 2 W at 0.53  $\mu\text{m}$ . A photograph of the laser used in the experimental system is shown in Fig. 1. The optical system consisted of a polarizing attenuator, to provide continuous adjustment of pulse energy, and a 76-mm objective, to provide a spot size of 50 to 150  $\mu\text{m}$ .

The motion system consisted of a two-axis X-Y table with 0.1-mil resolution for preliminary tests and sample work or a high-speed rotating, multiwafer stage for production-line qualification experiments (Fig. 2).

The wafer is scanned by means of a slow-speed radial motion of the arm that produces a spiral pattern. Rotational speed varies with radial position to maintain a constant linear velocity under microcomputer control.

Throughput of the system can be calculated by the formula  $A = PG/F$  relating average laser power (P), operational energy density (F), and overlap parameters (G). Typical values are 2 W of 0.53- $\mu\text{m}$  radiation, 1-J/cm<sup>2</sup> flux, and an overlap of 0.5, resulting in a processing rate of 1 cm<sup>2</sup>/s (approximately 70 3-inch wafers per hour). The individual spots are 200  $\mu\text{m}$  in diameter, and the linear velocity is 70 cm/s.

Quantronix' experiments with laser diffusion aimed at

statistically evaluating the application of this technique to the production of ohmic contacts. The typical laser-diffused sample shown in Fig. 3 is a silicon wafer with spun-on arsenic dopant, laser-irradiated at 9.5 J/cm<sup>2</sup> with 1.06- $\mu\text{m}$  radiation. Similar results were obtained with about 0.7 J/cm<sup>2</sup> at a 0.53- $\mu\text{m}$  wavelength, illustrating the sensitivity of the process to wavelength. Sectioning and staining of the wafer shows a fairly uniform junction at a depth of 0.5  $\mu\text{m}$ .

When ohmic contacts generated by this technique are compared with standard diffused contacts (Fig. 4), the forward voltage drop is seen to be reduced by about 10% and more. Significantly, the maximum variation from device to device is reduced by a factor of about 3.

Along with this application, another experiment evaluated the effect of oxide thickness on the laser's operating flux. It showed a minimum operating flux at the quarter-wave thickness, which agrees with theoretical calculations. These results indicate that optimum oxide thickness improves process efficiency by 30%.

### Crystal growing

Use of laser cold processing in the activation and growth of implanted polycrystalline films is depicted in Fig. 5. In this case, a 0.85- $\mu\text{m}$  polysilicon layer of 1- $\mu\text{m}$  silicon dioxide is implanted with  $10^{16}$  cm<sup>-2</sup> arsenic. Laser annealing and dopant activation was carried out at both 1.06- and 0.53- $\mu\text{m}$  wavelengths at various energy levels. At both wavelengths, it is possible to operate at a flux level that has no observable effect on the surface when viewed in an interference contrast microscope at 400 $\times$ .

The reduction in sheet resistivity of the polysilicon is shown in Fig. 6. For 0.53- $\mu\text{m}$  radiation, the resistivity is reduced to about 100 ohms per square at a flux of 0.5 J/cm<sup>2</sup>; increased flux results in observable surface damage. However, with 1.06- $\mu\text{m}$  radiation, the resistivity is reduced to 13 ohms per square at 1.1 J/cm<sup>2</sup> with no surface damage. The lowered sheet resistivity demonstrates the significance of wavelength selection.

Because of the thickness of the film, it appears that radiation with the longer wavelength results in a flatter distribution of temperature with depth and can therefore melt and regrow the entire thick film, while maintaining a lower peak temperature at the surface.

An ability to perform epitaxial growth of chemical-vapor-deposited layers with laser heating is indicated in Fig. 7. The resistivity of a phosphorus-doped layer is reduced to 6 ohms/sq without surface damage when scanned with a flux of 2.2 J/cm<sup>2</sup>.

Experiments on a p-i-n diode demonstrated the system's ability to anneal ion-implanted layers without affecting bulk properties. The device consists of an n-type silicon wafer with opposite surfaces implanted with  $2 \times 10^{15}$  cm<sup>-2</sup> boron and phosphorus, respectively. Carrier life-time of the bulk material was measured by irradiating it with pulses of long-wave radiation to minimize surface absorption effects.

The 400- $\mu\text{s}$  life-time after implantation but before annealing was reduced drastically to 45  $\mu\text{s}$  by 15 minutes at 900°C in a furnace. In contrast, laser annealing at 1 J/cm<sup>2</sup> with 0.53- $\mu\text{m}$  radiation leaves the bulk life-time essentially unchanged at 400  $\mu\text{s}$ . □

# Development system lays basis for fully integrated VLSI design center

Through a common file, all design and support engineers can share information on a product throughout its life cycle

by Charles H. House, Hewlett-Packard Co., Colorado Springs, Colo.

□ To realize the potential that very large-scale integration offers, new design aids are needed—tools that truly help the engineer in both the design and the analysis of such systems. Even a cursory examination of the capability and complexity of this densest of logics reveals that present-day design techniques are woefully inadequate to the VLSI challenge.

Because of the nature of its distinctive architecture, the HP 64000 logic development system paves the way to the creation of the fully integrated design center needed for VLSI. This is true despite the fact that many see it only as a relatively sophisticated microprocessor development system, and indeed it is intended to serve as such for the present.

To be sure, many VLSI designs will initially be accomplished with brute-force extensions of today's approaches. But the resultant designs will necessarily be limited to high-volume applications that are regular in the partitioning of their functions. Such applications include computational and communication uses and perhaps some consumer products, like automotive collision-avoidance systems. But because of their specialized nature, the truly exciting areas for VLSI—integrated real-time process control, for instance—will be virtually excluded without a new generation of tools that permits true synergism throughout the entire development process, from first silicon to field support.

## Needed

To fully actualize the power of VLSI for the myriad unique and complex applications that abound in today's society (primarily in areas not commonly considered logical applications for electronics), five major changes in the development process are needed:

- Hardware and software requirements must be described in a high-level language and optimized as a unit.
- Tools must be much more "friendly"—that is, they must inform people how to use them and be easier to operate.
- VLSI designs, complete with benchmarking performance criteria, must be simulated accurately and easily.
- Design and analytic techniques must be linked to each other and to files of accumulated data so that the many team members who will be involved with VLSI systems, in both professional design and functional support, can share developed information.

- There must be easy access to VLSI processing centers that can quickly turn around complex chip sets in low volume and at low cost.

Although all these changes cannot be made today, recognition of them as goals serves as a stimulus for changes in the definition of instrumentation that are needed for VLSI.

The changes in design methods that denser integration, currently represented by microprocessors and other LSI devices, are bringing about can be viewed in several ways. Of these, the engineering standpoint is most useful

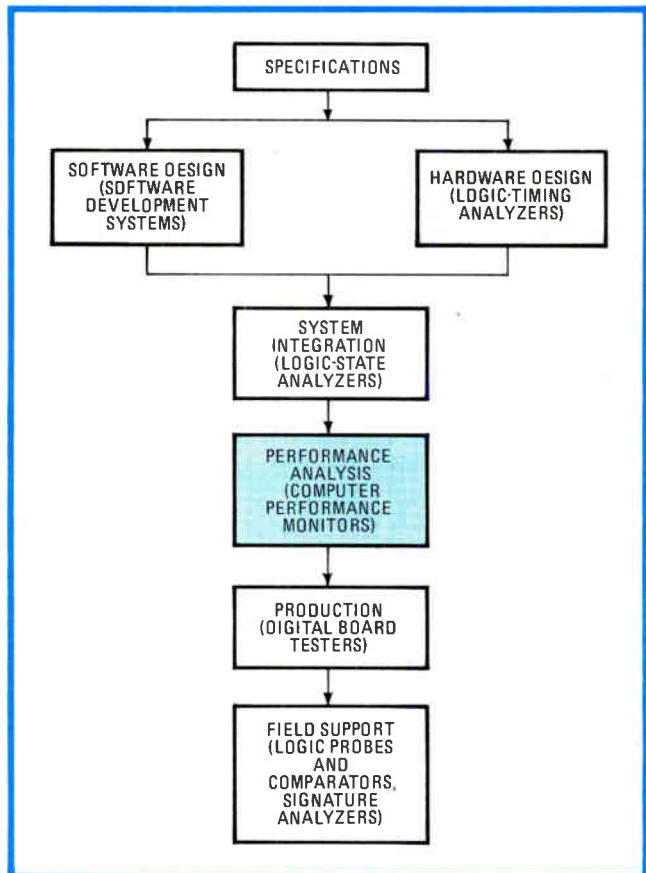

**1. Top-down design.** The growing use of microprocessors and LSI parts has changed the approach to product design. The design effort is now often driven by the overall specifications, which are determined first, rather than by the capabilities of an existing part.

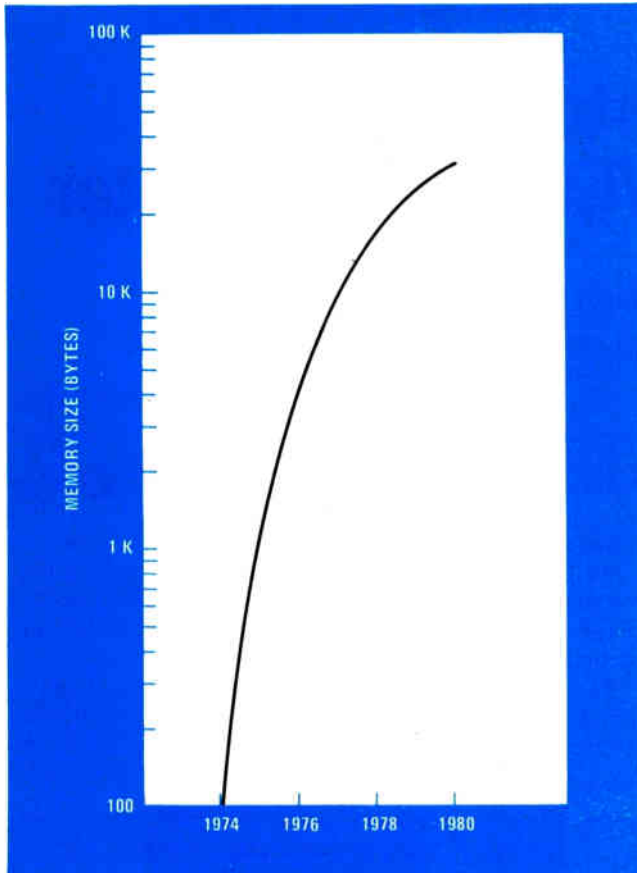

**2. More bits, more programs.** The rise in memory content of typical Hewlett-Packard products over the last few years shown here indicates the growing role that software is playing in them. It also accounts for the increased time spent writing programs.

here, since by considering the design and analysis of products based on these highly integrated components, the boundary conditions for taking advantage of current technology can be defined. Consequently, this point of view permits the requirements for further advances to be assessed and gives a glimpse of the potential and the pace at which that potential can be achieved.

Many of the latest engineering programs have been employing design approaches that are best described as top-down rather than bottom-up. In the top-down approach, the design is defined in terms of total system requirements, rather than of individual components or even a single product in a line.

The rationale for using this method is that the time required to minimize semiconductor real estate is not a wise economic investment. For example, the engineering investment required to optimize software code efficiency, and hence reduce the total amount of read-only memory, may equal or even exceed the savings in component costs over the product life. The total time required to develop a new product must similarly be balanced against the relative competitive value of actually having products out in the marketplace.

The application of this approach results in the refined design flow shown in Fig. 1. This diagram is similar to others that have been used to explain the role of microprocessor development systems and logic analyzers in

product design [*Electronics*, Sept. 13, 1979, p. 141]. The important block shown between system integration and production, frequently the most difficult and time-consuming aspect of system design, is often disregarded. Note that though there is some overlap between categories in the use of a particular instrument, there is really little sharing of information among those working in these different areas.

### Expanding software

Not so obvious is the fact that the emphasis in this design sequence is shifting to software. Examination of Hewlett-Packard's own history of software involvement, for example, shows a rapid expansion. Within a decade, the software effort for new-product development went from practically zero to a level that involved nearly 50% of the professional design staff. Today, some 70% of the professional staff at HP's Data Products group is involved. The relative time spent by such people appears to be approximately 40% on project creation, product definition, concept research, and preliminary test preparation; about 20% on editing; nearly 30% on system debugging; and the remainder on miscellaneous, nonfunctional activities.

Of equal interest is the growth in the amount of software, in terms of memory size for code, contained in new products (Fig. 2). These two trends indicate both that software must be written in a more efficient, higher-level language to keep any project within time constraints and that software designers must be able to work together to accomplish larger tasks than one or two could in a reasonable time.

The review of the breadboard version of the 64000 in 1977 highlighted one final system requirement—engineered integrity. HP research and development engineers, those most familiar with other instruments, noted that auxiliary features were essential to the tools needed. Such things as a truly helpful editor, error recovery, high mean time between failures, and thorough documentation of system capability all were emphasized because of the amount of time the system would be in use.

### Engineering the system

With a clear view of the basic architectural requirements imposed by VLSI, the overall system engineering of the 64000 could be addressed first, with feature sets to be readied later in a logical, phased manner after the essential structure had been realized. Thus the system could be augmented and enhanced with each advance in the technology, rather than having to revise or abandon the total system except at extremely long intervals of, say, 10 to 15 years.

The question of how the 64000 would actually function in developing VLSI systems can be discussed in terms of the cluster design-aids center for software design and system integration shown in Fig. 3. Consistent with the finding that most software designers spend their time there, each station is a very friendly but powerful terminal. It is a functionally self-contained station, on the level of a minicomputer, with 64 kilobytes of local file memory for text composition, editing, linking, and system control. Each station's keyboard contains "soft"



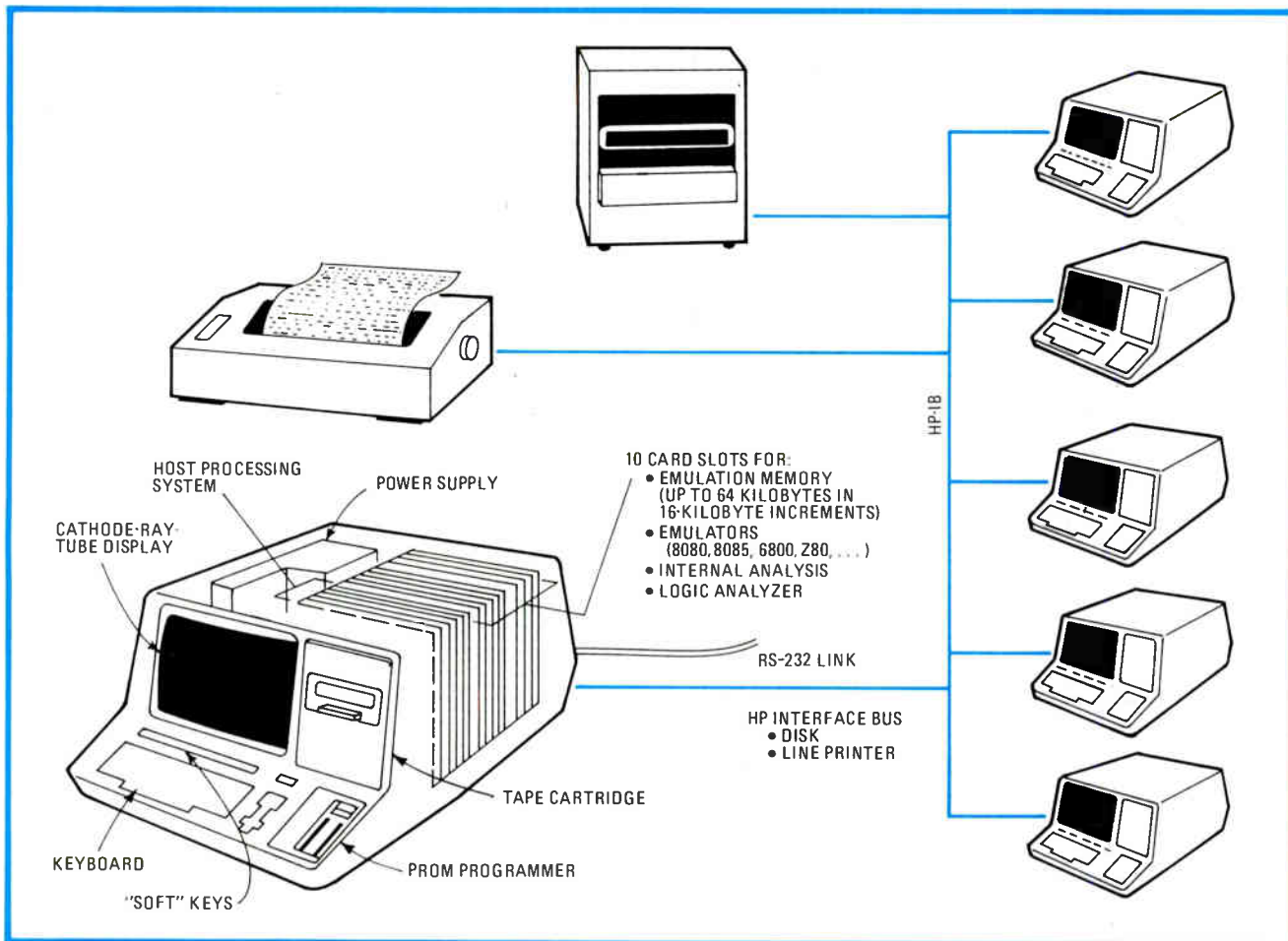

**3. Coming together.** The cluster arrangement of the 64000 permits the outputs of the various engineers involved to be shared more effectively through central documentation of the entire design process. The bus structure permits system expansion as needs change.

keys—keys that carry a software-determined label just above them on the station's cathode-ray-tube screen.

All stations are linked to a large central data file via a fast, dedicated version of the HP Interface Bus (150 kilobytes/second to 1 megabyte/second potentially). The central disk file can contain from 20 to 120 megabytes in a single cabinet and is expandable to a full support library of up to 960 megabytes.

This general system structure affords two major improvements in instrumentation imperative for VLSI. First, it promotes easy composition and editing and greater involvement in feature sets by means of both soft keys for continuous prompting of available capabilities and a powerful file management support system. Second, it ensures that teams of designers can proceed in a documented, traceable fashion toward a commonly understood system design by means of a large, shared central file. The space and access time of the file memory are compatible with the requirements of distributed LSI and VLSI designs.

### Synergism

An actual system operation illustrates the synergism of these improvements (Fig. 4). At each station, eight soft keys, available to the user at all times, provide a choice of the correct syntax for the particular operation

to be performed. In effect, the station tells the user what is expected, rather than simply providing an error message for an incorrect entry. In the event that more than eight choices exist, an "etc" label above the eight key allows the soft-key group to be scrolled.

Once an operator enters log information, like name and identification number, the station enters the monitor program, which provides three levels of soft-key scrolling. They form an extended menu of functional modes that includes such choices as edit, compile, link, emulate, PROM program, and command file.

If the operator wants to edit a previously composed program, he or she presses the edit key. That immediately causes the soft-key labels to change to allow the user to select the appropriate editing functions. At the same time, the editor program is loaded into the station's random-access memory from the central file in place of the monitor program. The ability to use the disk as a virtual memory for extended features of the operating system software is but one of the advantages obtained by using a large central disk file and an HP-IB data link.

The soft-key choices offered when the editor is called include such functions as: insert, revise, delete, find, replace, merge, copy, extract, retrieve, renumber, repeat, tab set, and list. If the delete function is selected, the soft keys are modified to include: thru, until, and all. If thru

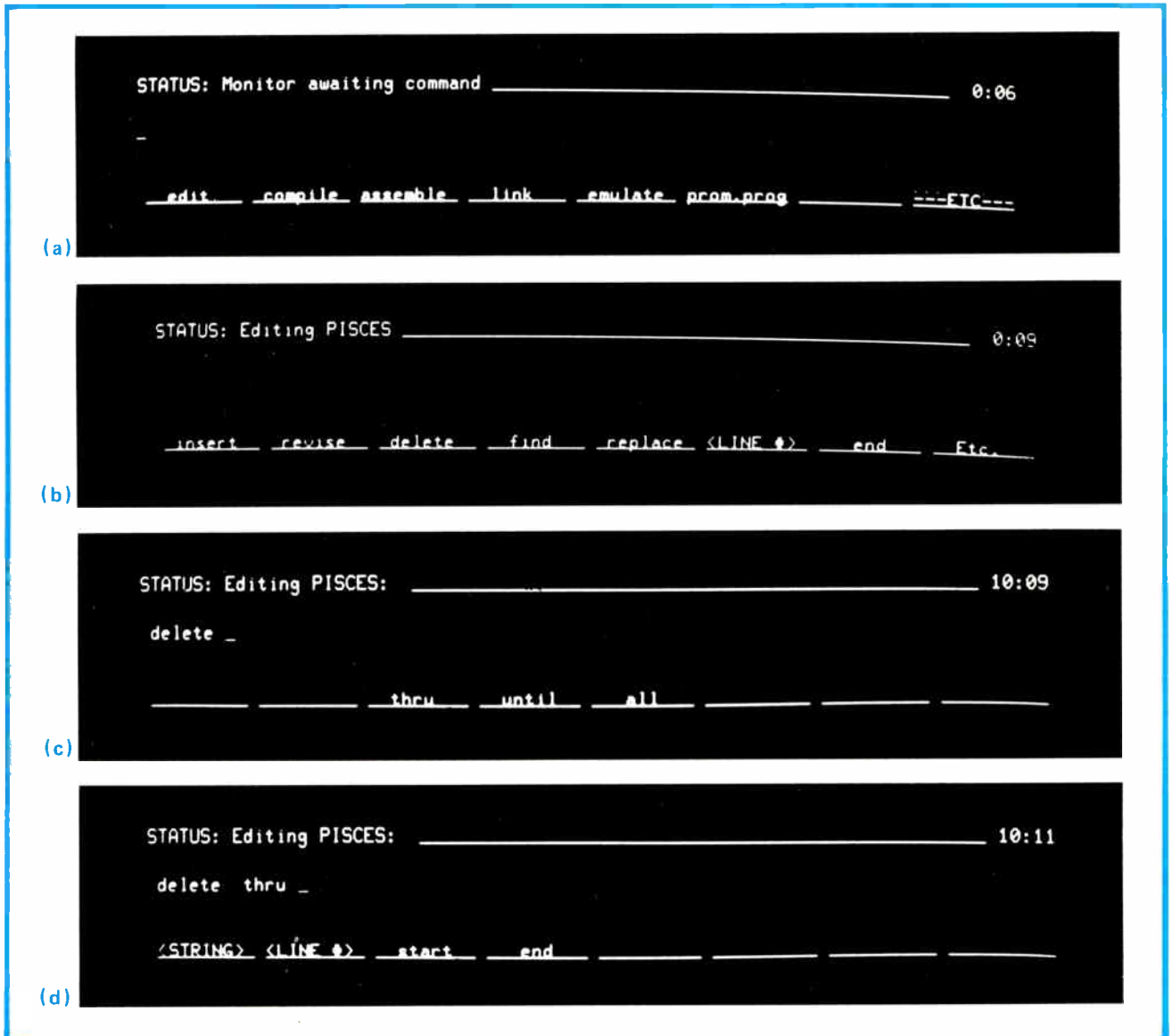

**4. Key feature.** Below each of the underlined words on the 64000's CRT screen is a key whose function is flexible, determined by software. Thus a user is easily guided through the editing process, shown in successive photographs, by changing the words to indicate his choices.

is then selected, the labels change to allow a choice of string, line #, start, or end.

The choices offered by selecting other functions are equally specific and prompt the user through sets of commands that are syntactically correct for the operating sequences, whether or not they are difficult. As a means of providing a simple and friendly interface between the user and the design aid, the syntax-driven key is hard to overvalue.

### The editor

The editor program, which is easily accessed by the soft keys, should be considered in its own light. It provides a flashing cursor that can be positioned in a truly random manner by means of dedicated cursor keys. With it, text can be modified by use of insert or delete keys or by typing over previous information. In addition, it controls the dedicated keys and virtual memory operation; consequently, it permits rolling up or down, left or

right, through an entire program and finding a character string anywhere in the program.

Pertinent code in several programs written by different programmers can be found simply by specifying the file name, the programmer's ID, and the editor's find mode. A new file can then be conveniently formed by using the editor's merge, revise, renumber, and end commands. Not only does this process result in a new, fully documented program, noted in the directory list and available to all team members, but furthermore, text preparation time can consequently be reduced significantly (see "Time saver").

Because of its architecture, the 64000 is also able to use its minicomputerlike power to provide more sophisticated emulation and analysis capabilities, thus synergistically combining aspects of both minicomputers and development systems to aid the design team. Several designers can be debugging code at various stations in a cluster, such as that shown previously in Fig. 3, while at

## Time saver

Many companies have been using the HP 64000 for several months and prototype systems have been operating at various Hewlett-Packard divisions for almost a year. Based on the experience with those systems, the 64000 can be compared with the other two kinds of commonly used systems: current-generation microprocessor development systems and time-shared terminals supported by a minicomputer. The latter have no built-in emulation or analysis capability, but since composition and editing take up some 60% of the software designer's time, only these functions were evaluated.

Three benchmarking tests were used to derive the results shown in the table below: text composition time, editing time, and interaction time for design teams.

Team interaction time is especially critical for today's designs and those of the future. If the interactions considered are limited to those between two people in the group, a best-case assumption, it can easily be calculated that a group of  $n$  people generates  $n(n-1)/2$  possible interactions. If only 2% of total work time is spent for communication in a two-person team, then for a four-person group the figure would be 12% of each person's time, and for an

eight-person group it would theoretically be a whopping 56%. Small wonder, then, that communication usually suffers, along with development time.

Based on the results of the tests, the 64000's file management structure and high-speed virtual sharing of files reduces communication overhead by 75% compared with microprocessor-based equipment and by 50% compared with minicomputers.

COMPARING THE 64000 DEVELOPMENT SYSTEM FOR PROGRAM COMPOSITION AND EDITING EFFICIENCY (AS A PERCENTAGE)

The 64000 vs:	Extra code generation per unit time	Time savings in text composition and editing		
		1 person	2 people	4 people
Microprocessor-based design systems	72	42	44	57
Minicomputer-based design systems	41	30	31	39

another station in the cluster another designer works on the breadboard of the real-time operating equipment. Moreover, two or more microprocessors running simultaneously in the breadboard can be independently monitored or emulated with equipment in the same cluster—again with shared files permitting simultaneous analysis and debugging by all designers involved.

### Real-time emulation

So that the debugging of early prototypes can be as close to "live action" as possible, the 64000 combines transparent logic analysis with full-speed emulation. The latter is achieved using 200-nanosecond RAM structures, and the 64-K RAM provided in each station can be enlarged to 128 K. By expanding the RAM for big projects, the system's shared file capability can be used to generate large amounts of code in less time.

To achieve this real-time emulation, the host processor in each station must be divorced from the emulating system. Separation of the host and emulation systems frees the emulator from any bus contention problems and interference with main memory requirements. It was accomplished by using an architecture based on four separate bus structures for each station: a host (or main-frame) bus, an input/output data bus, an emulation bus, and an emulator memory bus.

The I/O data bus is divided into two rails. One, an RS-232-C interface, can be used to tie the system to a variety of compatible equipment. The other is a dedicated version of the IEEE-488 bus, or the Hewlett-Packard Interface Bus, that has been optimized for fast data transfer, currently 150 kilobytes/s; it links the central disk, in which the bus controller resides, to the stations and if desired to a printer.

The divided bus structure of the 64000 offers exciting possibilities for configuring total systems in which product development categories are tied more closely, as in

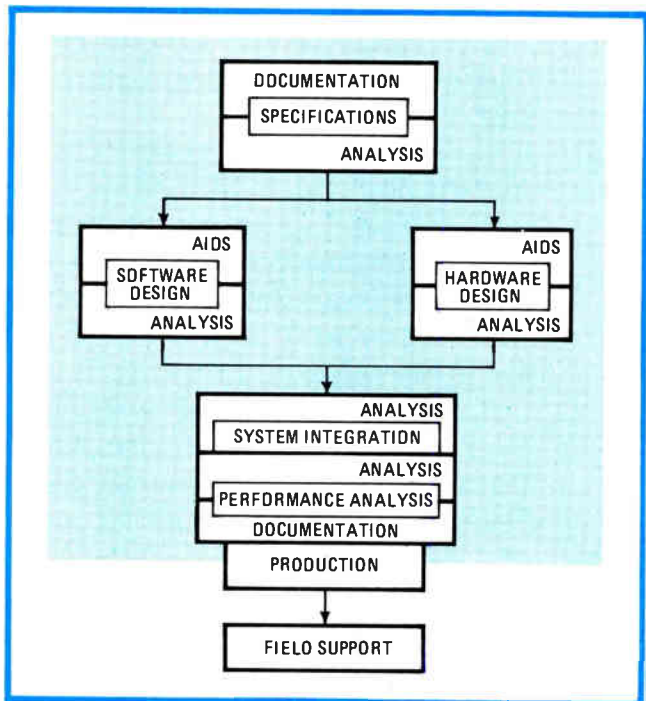

5. A closer fit. Development categories are more closely entwined by the 64000, as is mandatory for VLSI-based products. Though functionally very close, the design, development, and support of a product may take place at sites that are miles apart.

Fig. 5, because it enables remote sites to be linked to any station through the RS-232-C interface. Thus, for example, dispersed research and development laboratories or field support depots can have access to the latest software files. Conversely, each station can be downloaded with programs that may be available in other computers, such as equipment diagnostics, VLSI simulation programs, or production test records. □

# Glasgow's unique attraction for new-technology industries dates from 1451

There are many parts of the world which are superficially attractive for new industries – but where you would have to start from scratch.

Not so in Glasgow.

There is already a concentration of new-technology industries in and around the city. So there is an existing pool of experienced technicians, research engineers and experienced labour. There are electronics design consultants. And there are sub-contractors and marketing organisations.

But there is yet another attraction which Glasgow possesses. Glasgow is, and has been since 1451, a university city. And its two universities – Glasgow and Strathclyde – have been exceptionally responsive to the new industrial technologies. Both have large electronics departments. Both provide consultancy, and undertake projects for industry.

So, when Honeywell brought a new research unit to the Glasgow area, its Managing Director, James McGregor, could say:

"There already exists in Scotland a heavy concentration of micro-electronics industries.

"This, together with our excellent relationship with many Scottish academic institutions, was the principal factor in steering the Solid State Applications Centre to Scotland."

Maybe Glasgow could provide what your company needs for its development plans. It would be worth finding out.

Contact Stuart Logan, Industrial Development Officer, Estates Department, Glasgow District Council. He's at 116 West Regent Street, Glasgow G2 2RW.  
Telephone 041-332 9700.



**GLASGOW**  
city to build on

Circle 148 on reader service card

Glasgow University  
buildings date from  
the 1860's – The  
University itself was  
founded in 1451.

# LS<sup>2</sup> family squeezes more speed from existing TTL sockets

By raising switching thresholds and improving noise margins, new TTL family runs up to 20% faster than low-power Schottky TTL; the same propagation and transition times keep it compatible

by Patrick Hoffpauir, *National Semiconductor Corp., Santa Clara, Calif.*

□ With each succeeding family of 7400-series-type TTL devices, circuit designers have been forced to make increasingly complex tradeoffs in speed, power, and noise immunity and margins. More often than not, device manufacturers aim at the extremes of these parameters, leaving the broad middle range of users simply to make do—sacrificing power or noise immunity for high speed. Complicating the system designer's life has been the fact that devices from one manufacturer's family—nominally pin-for-pin-compatible with devices from another's—have minor but irritating variations that will not allow them to be swapped on a printed-circuit board. As if that were not enough, each succeeding generation—also nominally pin-compatible with its parent family—usually cannot be interchanged with the previous generation because of differences in noise immunity or input and output impedances or ultimately because of system timing problems.

For many device manufacturers, history appears to be repeating itself as low-power Schottky (LS) TTL is replaced by a number of so-called second-generation Schottky families. In fact, most of those cannot be used in their present configurations by the mainstream of system designers, who could use the speed improvement offered—often as much as two- to three-fold—but not at the cost of sacrificing the integrity of current designs.

But a second-generation family of 7400-type devices has been developed to resolve this problem. Called LS<sup>2</sup>, it has been designed for applications in today's systems rather than tomorrow's, since it offers significantly improved dynamic performance—plus better noise margins—without degradation of any other specified or nonspecified electrical parameters.

## Evolutionary improvements

Taking an evolutionary rather than a revolutionary approach to process and circuit design improvements, LS<sup>2</sup> not only offers as much as 10% to 20% improvement in speed over present standard LS devices, but has been designed in response to specific user complaints, such as noise sensitivity, inadequate input impedances, and insufficient drive capabilities.

Being used initially in about 110 different standard device types, the LS<sup>2</sup> process allows the fabrication of devices with delays in the 5-to-6-nanosecond range, equal in performance to the fastest standard LS parts available.

The noise immunity of the LS<sup>2</sup> family is significantly improved over standard LS, too. The typical switching level has been increased from 1 volt to 1.4 v, which is not only higher than standard TTL, but higher than standard Schottky (S), low-power TTL (L), and high-speed (H)

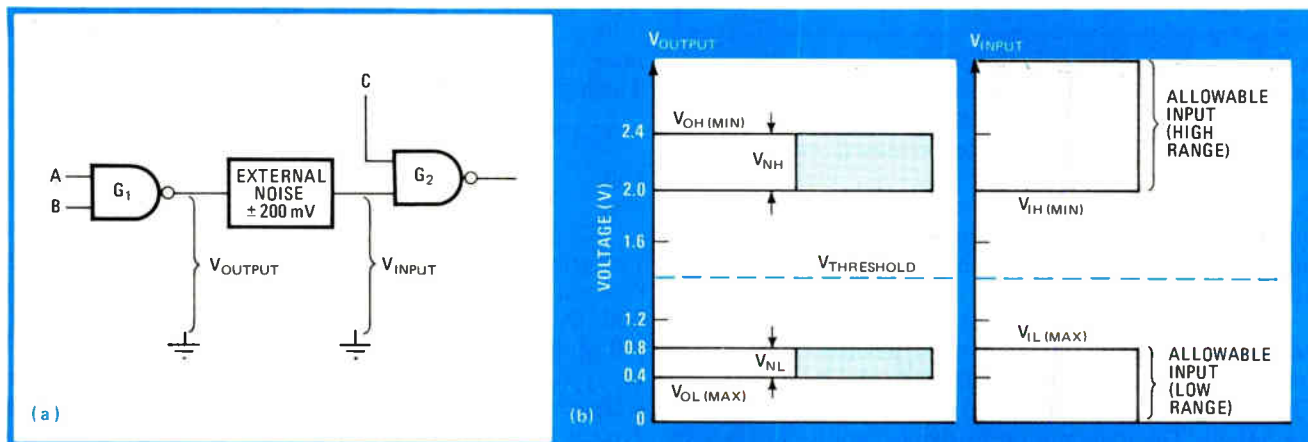

**1. Effects of noise.** The higher switching threshold of 1.4 V in the LS<sup>2</sup> TTL family improves noise immunity. Even a  $\pm 200$ -mV noise source (a) can be accommodated by the  $\pm 400$ -mV worst-case noise margin of gate 2 (b). The lower dc noise limit for LS<sup>2</sup> is typically 1,000 mV.

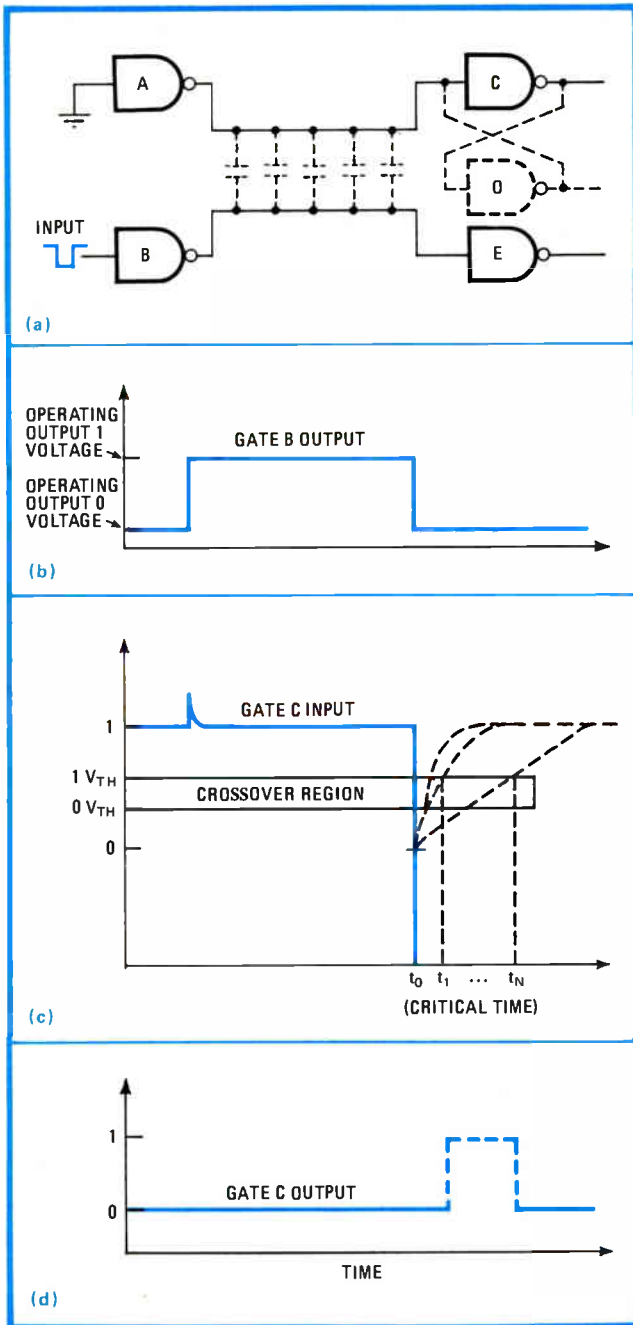

**2. Cross-coupling.** Noise can cross-couple through the stray capacitance between lines (a). As gate B output goes low (b), it pulls down gate C input (c). If its input is held down long enough, gate C's delayed output (d) incorrectly sets latch comprising gates C and D.

families. Moreover, the LS<sup>2</sup> family has removed all multiple-emitter transistor inputs, giving the product line higher impedance inputs with typical breakdowns of about 20 v.

Static and dynamic drive capabilities have also been enhanced. All three-state-output devices have been increased to triple the standard LS dc sinking capability (24 milliamperes at 0.5 v for 74LS and 12 mA at 0.4 v for 54LS). The dynamic (ac) drive capability of the LS<sup>2</sup> product line, which accommodates highly capacitive loads, is also significantly increased.

The search for the perfect logic family is hampered by two specific areas of concern. They are the static conditions (dc) and the dynamic (ac) or transient conditions. Under either condition an undesirable signal can propagate through a logic system.

### The question of noise immunity

All electronic circuits have trouble with noise, and although digital circuits are far more resistant to it than analog circuits, they are not immune. The difference between the operating voltage level of the input logic and the threshold voltage is called the noise margin of the circuit; it is the maximum amount of deviation from the nominal values of the logic-0 and the logic-1 voltage levels that the circuit can tolerate without changing states. The most stable operation for a given total logic voltage swing occurs with approximately equal logical-0 and logical-1 noise margins.

Although it is relatively straightforward to specify the dc noise margin of a circuit, the ac noise margin—or noise immunity, defined as the ability of a circuit to withstand short transient voltage pulses that appear at the input to a logic circuit—is considerably more difficult to specify. And, of course, the ability of the gate to operate reliably in a noisy environment is important in many applications.

### Accounting for noise

Consider a digital system consisting of two NAND gates as shown in Fig. 1a. Suppose noise from an external source (such as a switching relay) or internal noise (such as current spiking) produces a  $\pm 200$ -millivolt change in the output voltage level of gate G<sub>1</sub>. To determine how this noise voltage will affect the operation of the system, it is necessary to compare the high- and low-voltage ranges for the driving device, G<sub>1</sub>, and the driven device, G<sub>2</sub>.

Figure 1b shows the relations between the output and input voltage ranges. If the output of G<sub>1</sub> is low, a positive noise voltage will have to be at least 400 mV before the maximum input low voltage of G<sub>2</sub> is exceeded. Even if the output of G<sub>1</sub> were to exceed V<sub>IL</sub> (max), gate G<sub>2</sub> would not change state until its input voltage reached the threshold voltage of about 1.4 v for LS<sup>2</sup> circuits. Similarly, if the output of gate G<sub>1</sub> is high, a negative-going noise voltage would have to be at least -400 mV before the input voltage of G<sub>2</sub> falls below the minimum, V<sub>IH</sub> (min). The high and low dc noise margins are defined as:

$$V_{NH} = V_{OH(\min)} - V_{IH}(\min)$$

and:

$$V_{NL} = V_{IL}(\max) - V_{OL}(\max)$$

For standard TTL,  $V_{NH} = V_{NL} = 400$  mV. For LS devices,  $V_{NL}$  is 300 mV, while LS<sup>2</sup> devices have a  $V_{NL}$  of 400 mV.  $V_{NH}$  is 500 mV or higher for both LS and LS<sup>2</sup>. All of the values represent worst-case conditions; however, typical values are often of greater concern than the worst-case conditions. Thus, for standard TTL, with a typical threshold level of 1.2,  $V_{NL}$  is 800 mV; for LSI devices with threshold levels of 1 v,  $V_{NL} = 600$  mV; and for LS<sup>2</sup> with thresholds of 1.4 v,  $V_{NL} = 1,000$  mV.

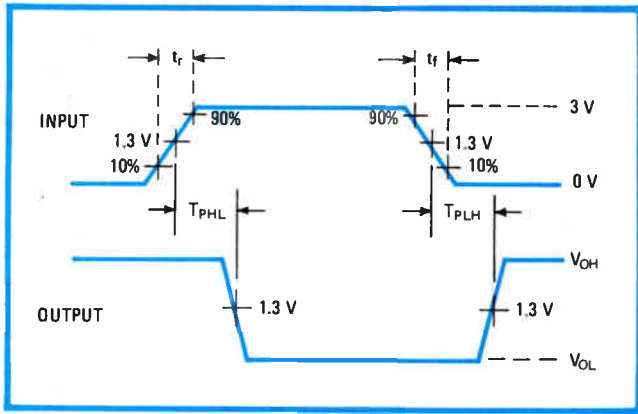

**3. Rise and fall.** To maintain compatibility with LS, LS<sup>2</sup> keeps the same propagation delays (for both low-to-high and high-to-low transitions  $t_{PDH}$  and  $t_{PDL}$ ) and rise and fall times  $t_r$  and  $t_f$ . Shorter transition times (less than 6 ns) would generate unwanted harmonics.

The calculation of ac noise margins is more complex, since the margin is a function of both amplitude and pulse width—that is, for a circuit's output to be affected, very narrow input noise pulses must be of much greater amplitude than wide pulses.

For wide pulses—those longer than 25 or 30 ns—the noise pulse amplitude approaches the dc noise margin. Since ac noise immunity is a measure of the ability of a circuit to reject noise from other signal lines, external noise sources, and transients on the power distribution lines to the circuits, an accurate measurement of it is not easily obtained.

### Cross-coupling conditions

Generally, the degree of cross-coupling of signals and susceptibility to external noise depends on the impedance of a circuit for a given logic state. Noise can cross-couple as shown in Fig. 2a. Any two signal lines that are close together will have a certain amount of stray capacitance between them; the waveforms in Figs. 2b to 2d show the effect of the capacitance.

With the output of gate A high and with B switching at some frequency, the stray capacitance will discharge each time the output of gate B is high, since both sides of

the capacitance are at the same level (Fig. 2b). When gate B switches low, the output of gate A (which is the input to gate C) will be pulled down (Fig. 2c), since the voltage across a capacitor cannot change instantaneously. The amount of change and duration of the disturbance at the input to gate C will be determined by the fall time of gate B, stray capacitance, and the output impedance of gate A in parallel with the input impedance of gate C. If the input to gate C is below threshold long enough, the output of gate C (Fig. 2d) will switch to the high state and depending on the speed of gate C and its cross-coupled partner gate D, the memory latch comprising C and D will be set to the incorrect state. Thus circuits with high-impedance inputs tend to be more susceptible to cross-coupling and to external noise sources than circuits with low impedance inputs.

Low-power Schottky families do tend to be more susceptible to this coupled-type noise than other logic families are. That is because of their relatively low output impedance and high input impedance, coupled with the rapid switching response of the Schottky-clamped transistor.

### Propagation delay is key

All these considerations are related to the speed of the logic families, which is in turn related to propagation time delay—the time required for a change from one logic level to another at the input of an element to cause a logic level change at the output. Two propagation time delays (or simply propagation times),  $t_{PHL}$  and  $t_{PLH}$ , are required to specify completely the response of a logical element. In the case of  $t_{PHL}$  the measurements are made for output changes from high to low logic levels, and  $t_{PLH}$  specifies the delay when the output changes from low to high. The corresponding voltage waveform for a typical element is shown in Fig. 3. Notice that the time reference for both the input and output is selected at the same voltage level. An average propagation time delay is also sometimes given. Denoted as  $t_{pd}$ , it equals  $t_{PHL} + t_{PLH}$ .

Another timing consideration that can become important in some logic applications is the time required for signal changes from one level to another: the rise time  $t_r$  and the fall time  $t_f$  as indicated in Fig. 3. Those times are

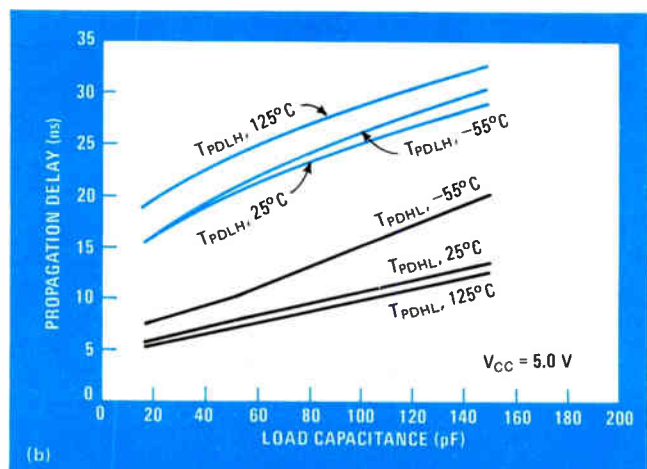
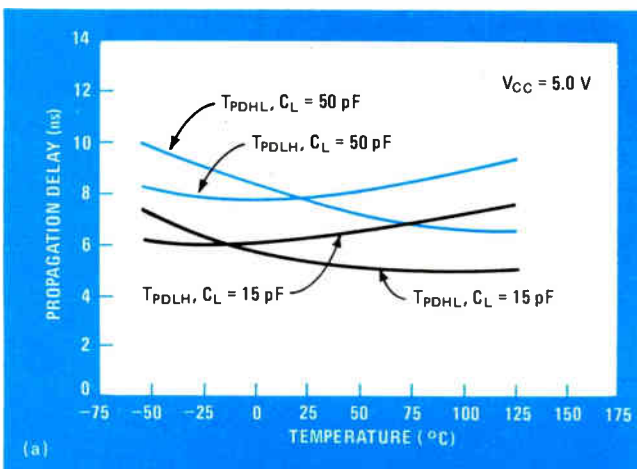

**4. Propagation characteristics.** Effects of temperature and capacitive loading on propagation delay are lessened with LS<sup>2</sup>. High-to-low transition time (a) is especially superior to that of competitive products. Delays for varying load capacitance (b) also improve.

measured between points that are 10% and 90% of the total level change. Output changes are always measured for input signals whose rise and fall times are precisely defined.

Selecting a logic family with a small  $t_r$ , though it might seem desirable, is not always practical. Signals that change levels extremely quickly generate high-frequency harmonics that can affect other circuits by the production of unwanted signals (noise) in the logic circuitry. As such, a system designed with low-power Schottky would not, in most cases, operate correctly if replaced with standard Schottky products. That is due to the noise generated by the switching transient of the parts, irrespective of power and race-condition problems that might exist in the system. The point is that the system designer must be aware of a logic family's noise-generation parameters to take advantage of the features of the family—and that knowledge typically involves a very difficult learning curve.

LS<sup>2</sup> offers the designer significantly improved specifications, yet with typical propagation delays and rise and fall times no faster than those encountered in existing LS families. This is accomplished through improved process control and circuit design that allow tightening the distribution of products being built, which, in turn, means the operating limits can be improved.

### LS<sup>2</sup> in today's systems

To solve some of the problems systems designers have with low-power Schottky parts while giving them some way of upgrading their product by a simple swapping of devices, second-generation LS<sup>2</sup> combines a fundamental process improvement with a new circuit-design technique. The result is a family of low-power Schottky functions that offer the user significantly improved dynamic specifications in addition to better noise margins—without any degradation of the existing data-

sheet and non-data-sheet specifications.

The first step was in the switching threshold. A major concern to system designers is the noise sensitivity exhibited by some LS products. That is alleviated with LS<sup>2</sup> by a significant increase in the dc threshold transfer characteristics.

The threshold voltage at 25°C is about 1.4 v, or 400 mV greater than existing low-power Schottky products. Noise immunity of up to 1,000 mV is achieved in the improved circuit also. As can be seen, the variation of  $V_{IL}$  with temperature has also increased from the previous 700 mV maximum to 800 mV.

### Better transitions

Switching characteristics for the product family have been improved significantly in both the low-to-high ( $t_{PDLH}$ ) and high-to-low ( $t_{PDHL}$ ) transitions. As can be seen in Fig. 4, propagation delay has been characterized from 15-to-150-picofarad capacitive loads over a wide temperature range. Under 15-pF loading conditions, delays are typically 6 ns in both directions.

Low-to-high transition time is relatively constant over temperature (Fig. 4b) and equivalent to the fastest competitive products over capacitive and supply extremes. The high-to-low transition time, however, is far superior to that of competitive products over the previously measured extremes. Moreover, the power dissipation remains unchanged over a wide range of input frequencies.

The input characteristics of the LS<sup>2</sup> family are the same as those for the standard low-power Schottky series. The circuits have diode inputs and will withstand high input voltage (10 v worst case) while maintaining low forward currents. One difference, however, is that the input threshold is now 400 mV higher than the typical low-power Schottky circuit and 200 mV higher than standard TTL. That is a significant improvement,

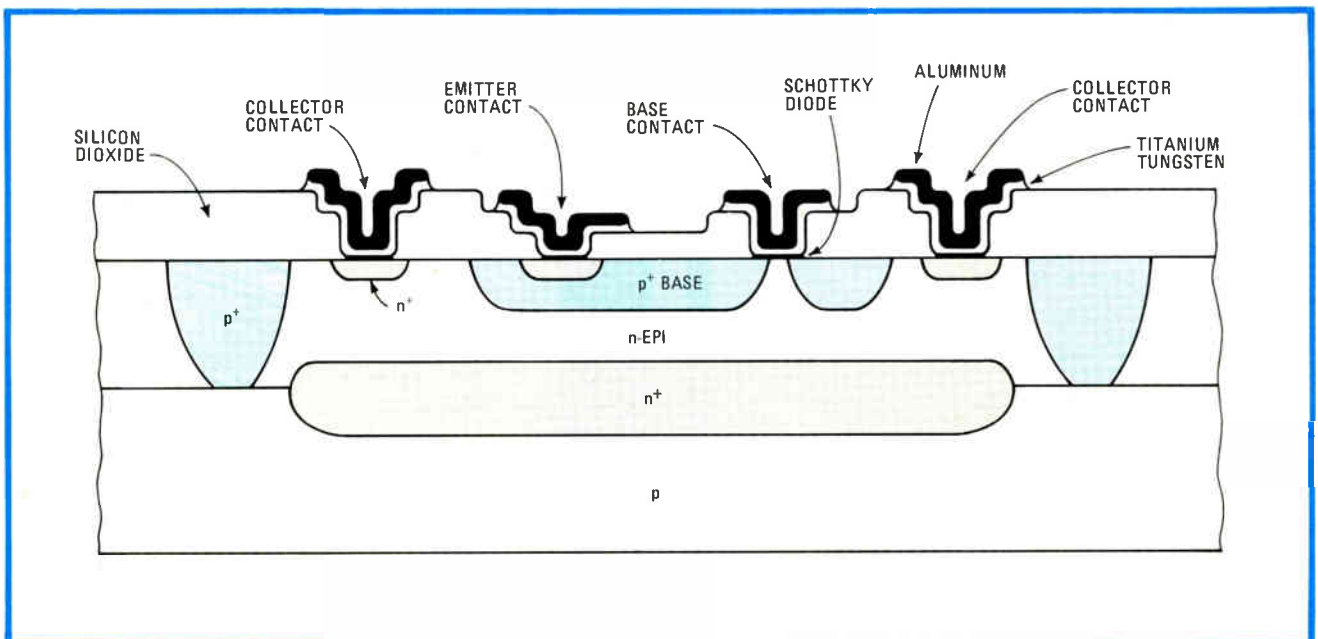

**5. Process improvements.** The bipolar process itself lends to the improvement in LS<sup>2</sup>. Though very similar to the basic LS process in production for the last five years, diffusion depths have been thinned in LS<sup>2</sup> to reduce inherent capacitances in the transistors.



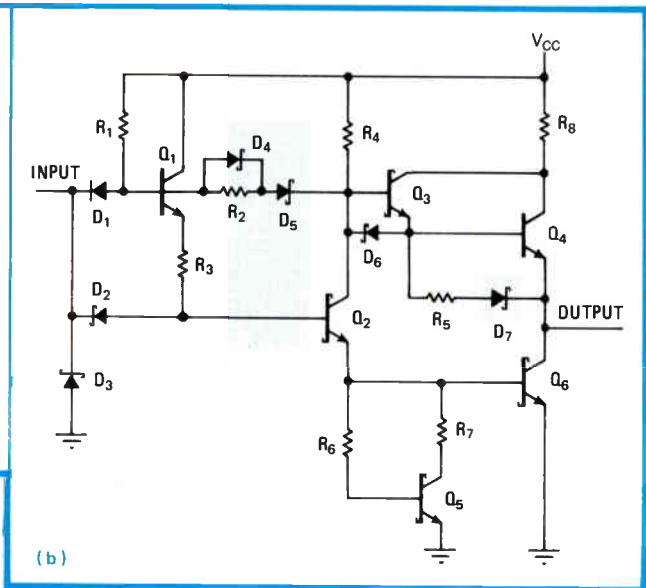
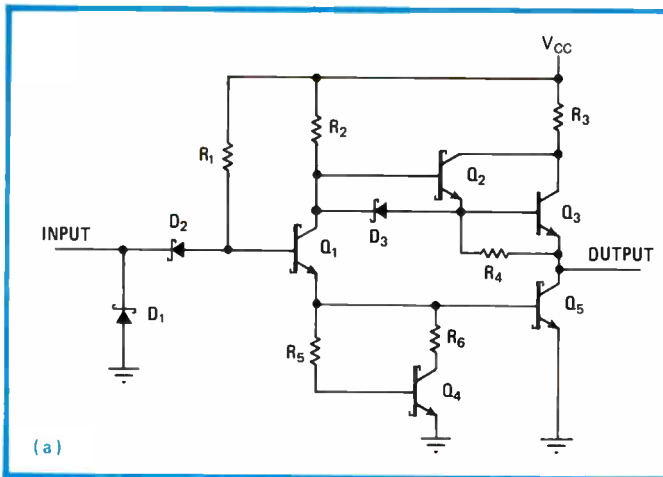

**6. Circuit changes.** The input and output circuits of LS and LS<sup>2</sup> are nearly identical. To the standard LS design (a), LS<sup>2</sup> adds diode D<sub>7</sub> to allow easier interfacing to complementary-MOS and devices Q<sub>1</sub>, D<sub>4</sub>, D<sub>5</sub>, R<sub>2</sub>, and R<sub>3</sub> to raise the switching threshold.

one that enables the user to maintain a more reliable system in terms of both static and dynamic noise level considerations.

The output configuration of LS<sup>2</sup> devices is the same as that of standard low-power Schottky devices with one exception: there is a Schottky diode in series with the Darlington-pulldown resistor to enable the outputs to be pulled high (about 10 v) while maintaining the logic-1 state. The modification makes it easy for LS<sup>2</sup> to interface with complementary-MOS logic.

The process that fabricates LS<sup>2</sup> is very similar to the basic LS process that has been in production for the past five years (Fig. 5). The difference is in the depths of the diffusion. Thinning the diffusions decreases transistor capacitances and allows dynamic performance improvements. Ion implantation is still utilized, as is Schottky barrier metal.

The process produces transistors with a typical gain (hfe) of 60 to 100 and typical collector-to-emitter breakdown voltages of 8 to 10 v for open base (BV<sub>ceo</sub>) and 15 to 25 v for the shorted base (BV<sub>ces</sub>).

### Circuit improvements

Although the input and output configurations of LS<sup>2</sup> are identical to those of standard LS, the internal circuitry has been modified to allow the improvement in noise immunity without a degradation of dynamic performance. The input of LS<sup>2</sup> involving diodes D<sub>1</sub>, D<sub>2</sub>, and D<sub>3</sub> and resistor R<sub>1</sub> is identical to that of LS (Fig. 6); also the output circuit from Q<sub>2</sub> to the output pin is the same as the standard LS circuit with one exception, D<sub>7</sub>—the diode has been added to allow easier interfacing to C-MOS and for bus-to-bus power interruption.

The circuit change enabling the improvement in threshold and dynamic performance involves components Q<sub>1</sub>, D<sub>4</sub>, D<sub>5</sub>, R<sub>2</sub>, and R<sub>3</sub>. As can be inferred from the schematic, the threshold voltage is established by:

$$V_{TH} = V_{BE(Q6)} + V_{BE(Q2)} + V_{BE(Q1)} - V_{D1}$$

which equals 1.4 v at 25°C for the LS<sup>2</sup> family, whereas for standard LS the threshold is:

$$V_{TH} = V_{BE(Q5)} + V_{BE(Q1)} - V_{S(D2)} = 1.0 \text{ V}$$

In the dynamic mode of operation, transistor Q<sub>1</sub> is the key to rapid high-to-low-level transition times and excellent high-capacitance drive capability. As the input rises to 1.4 v, Q<sub>1</sub> goes into the conductive mode and supplies a surge of current into the bases of transistors Q<sub>2</sub> and Q<sub>6</sub>. This surge of current rapidly changes the inherent capacitances of Q<sub>2</sub> and Q<sub>6</sub> and allows the output to switch from a logic one to a logic zero. But that current surge from Q<sub>1</sub> must be carefully controlled lest spiking—which does not occur in standard low-power Schottky devices—result. This control is accomplished by resistor R<sub>3</sub> and diodes D<sub>4</sub> and D<sub>5</sub>.

### Gain limiter

R<sub>3</sub> limits the gain of Q<sub>1</sub>, and D<sub>4</sub> and D<sub>5</sub> dynamically remove base drive from Q<sub>1</sub> the instant Q<sub>2</sub> begins to conduct. Therefore, Q<sub>1</sub> supplies a controlled current surge that is an order of magnitude larger than the base drive Q<sub>1</sub> would have in the standard LS circuit configuration. Once Q<sub>2</sub> is fully conducting, the circuit biases to a stable dc mode at the exact current drain of standard LS. The bias is controlled by R<sub>2</sub> and D<sub>5</sub> is referenced to the collector of Q<sub>2</sub>.

The low-to-high transition is also enhanced by the dc voltage at the collector of transistor Q<sub>2</sub>. Since this level is significantly higher than the equivalent voltage of standard LS, it reduces the Miller capacitance effect of Q<sub>2</sub> and allows a much earlier transition. Diodes D<sub>1</sub> and D<sub>2</sub> remove charge from transistors Q<sub>1</sub> and Q<sub>2</sub>, respectively, to speed switching.

Choosing the right logic family for a particular application is always a complex proposition since it requires that a number of factors be considered. LS<sup>2</sup> compares well in most key areas, including noise margin, noise generation, speed, power, and cost to implement.

For the designer, the additional benefit of LS<sup>2</sup> is that it can be used today in all designs now implemented with LS TTL. The system designer no longer has to wait until tomorrow to improve his product's performance. □

# Now, HP lets you make FDM carrier one programmable

0.1 Hz frequency resolution means precise frequency setability over the full 50 Hz to 32.5 MHz range.  $\pm 2$  dB level accuracy allows measurements with .01 dB resolution all the way down to -80 dBm.

Optional Transmission Impairments Measurements allow you to quickly troubleshoot voice channel problems using phase jitter, noise-with-tone, signal-to-noise-with-tone-ratio, and single level impulse noise, all with one instrument.

Level accuracy is  $\pm 0.05$  dB at full output at 10 kHz with  $\pm 0.1$  dB flatness to 20.9 MHz, and you can sweep the full band with  $\pm 15$  dB leveling.

Amplitude blanking allows testing of operational FDM systems without disturbing adjacent channels while the frequency is changed.

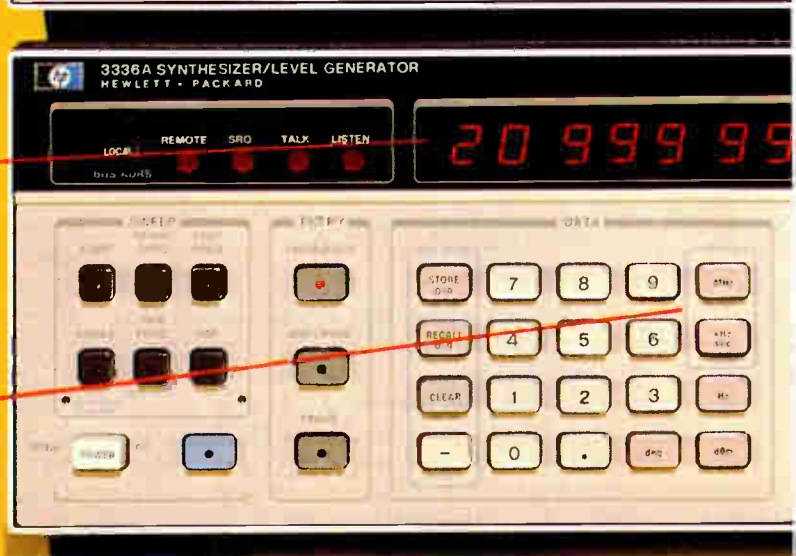

The new Hewlett-Packard Level Measuring Set brings outstanding measurement convenience, precision and automatic control to the design, manufacture, installation and maintenance of Frequency Division Multiplex systems. It consists of two new instruments: the HP 3586A/B Selective Level Meter, and the HP 3336A/B Synthesizer/Level Generator. The A versions are compatible with CCITT requirements, while the B versions are compatible with North American (Bell) standards. In addition, C versions are available for general purpose wave analysis and frequency synthesis applications.

Precise frequency and level measurements are provided by

the HP 3586A/B Selective Level Meter. In addition to delivering 0.1 Hz resolution over the full 50 Hz - 32.5 MHz range, the Selective Level Meter lets you make measurements at both FDM voice channel and carrier frequency with one instrument. And, when you select the optional Transmission Impairments Measurements feature, you enjoy a new versatility in FDM system troubleshooting.

The new HP 3336A/B Synthesizer/Level Generator offers extremely stable, accurate signals with harmonics more than 50 dB down, and phase noise 70 dB down in a 3 kHz band. As a precision companion source, the Synthesizer can be

# and voice frequency tests with Level Measuring Set.



Frequency Counter lets you measure a frequency precisely, then tune to it with one keystroke, eliminating the need for "rocking" the tuning control to peak the signal.

HP-IB control is standard on both instruments, allowing all functions to be remotely programmed for automated testing.

Use the 3586A/B as a "tunable channel bank filter" with shape factors up to 1.2 and 75 dB adjacent channel rejection.

Optional Noise Weighting Filter permits direct Psophometric or C-message weighted noise measurements. Or use the standard equivalent weighted noise filters supplied.

Manual tuning with selectable resolution lets you change frequency, amplitude and other functions in desired steps.

set to automatically track the frequency of the Selective Level Meter. Or you can use it for stand-alone frequency synthesis applications.

Through HP-IB, the Level Measuring Set is fully programmable. A computing controller such as one of HP's 9800 Series permits automatic operation to reduce manufacturing time and to lower maintenance costs through automated testing.

Prices are \$9,200\* for the 3586A/B (\$475\* for Transmission Impairments Measurements option) and \$4,100\* for the 3336A/B. For full information, write to Hewlett-Packard, 1507 Page Mill Road, Palo Alto, CA 94304. Or call the HP regional

office nearest you: East (201) 265-5000, West (213) 970-7500, Midwest (312) 255-9800, South (404) 955-1500, Canada (416) 678-9430.

\*Domestic U.S.A. price only.

099/54



**HEWLETT  
PACKARD**

## Removing residual voltage in dc generator

by C. W. Bray  
 Memphis State University, Memphis, Tenn.

The dc gain ( $E_g/E_f$ ) of a separately excited generator is an important parameter in its computer model or transfer function. However, direct measurement of this gain is often obscured by residual magnetism in the armature. The magnetism produces an unwanted dc voltage (several volts in a multikilowatt generator) that opposes the normal armature voltage induced by current in the field coil. With the circuitry shown, the output voltage due to residual magnetism can be reduced to a value less than 100 millivolts.

Assume the residual voltage to be canceled has a positive polarity. If the 5-volt square-wave source (shown in the lower right) is low, then gates 2 and 3 hold

transistor switch  $T_1$  off. The positive generator output is sensed by the comparator,  $A_1$ , which switches to its positive state. This output and its complement are used to set a J-K flip-flop.

When the square-wave voltage goes high, a positive pulse is applied to the clock input of the flip-flop. This drives the Q output of the flip-flop high, which, along with the positive square-wave voltage, turns  $T_1$  on, allowing current to pass through the field winding.

This current causes a voltage opposing the residual voltage to appear across the armature winding. The cycle repeats in synchronism with the square wave's period, until the output of the comparator goes negative (when the average residual voltage is close to zero or negative).

An increasing excitation voltage is provided by the integrator circuit  $A_2$ . The time constant selected for the integrator must be long enough so that each increment in field current will be small enough to prevent establishing residual voltage of the opposite polarity. Also, the frequency of the square wave should allow the field current to reach steady state during the time that the field is energized. □

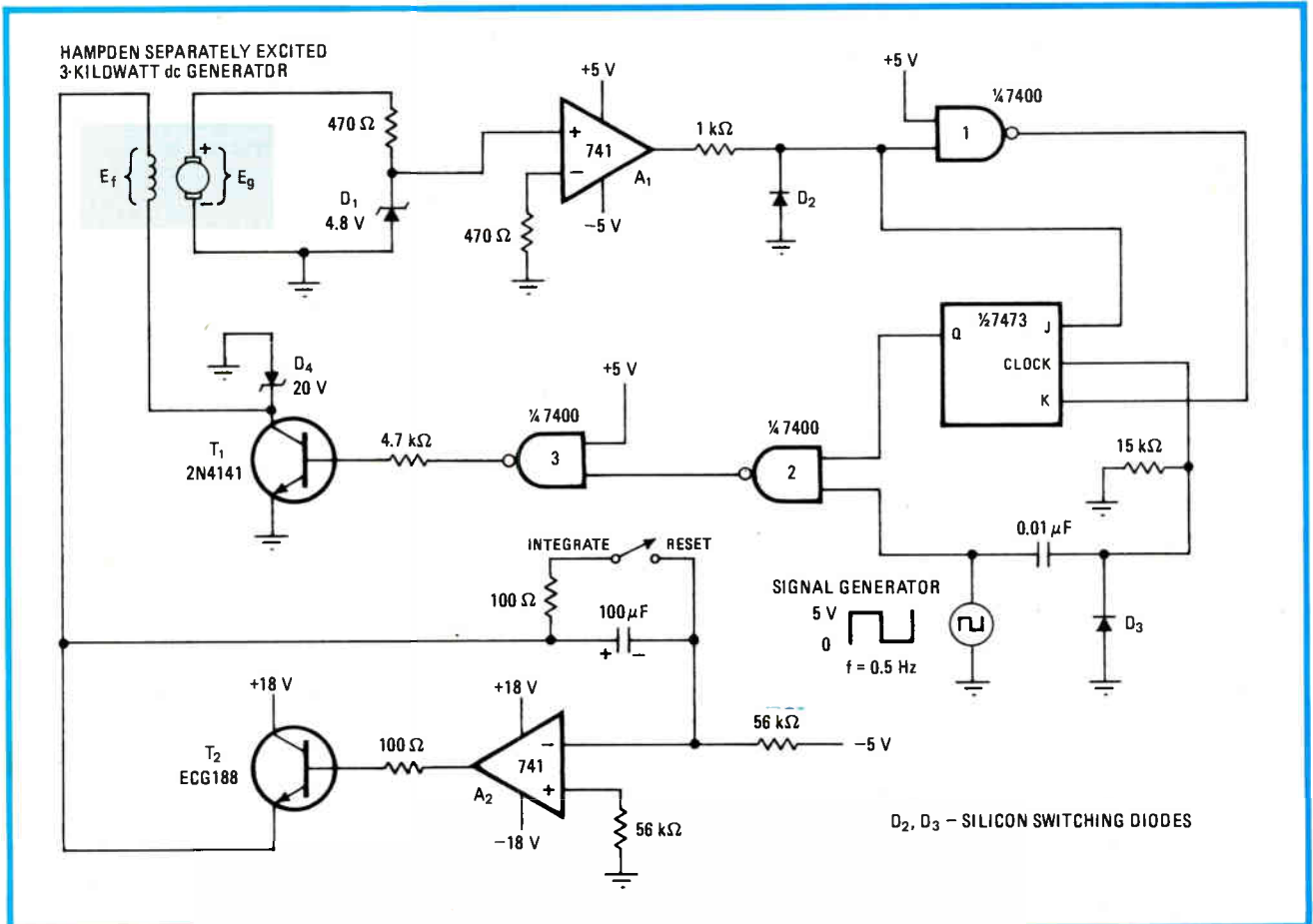

**Residual removal.** Synchronously switched current through the field coil of a dc generator will create a voltage opposing the machine's unwanted residual output. Transistor,  $T_1$ , is switched on by a positive-going square wave to cancel the undesired voltage.

Facts from Fluke on low-cost DMM's

# Is this any way to treat a \$129 multimeter?

In the rough world of industrial electronics, even a precision test instrument can get treated like dirt. You need all the ruggedness and dependability you can get in a DMM for field use.

You'll find these qualities and more in the Fluke line of low-cost DMM's. Our DMM's have been dropped from towers, stepped on, and run over by construction equipment. And they've survived because we never cut corners on quality, even on our lowest-priced, six-function Model 8022A Troubleshooter at \$129 U.S.

Take a close look at a low-cost DMM from Fluke and you'll notice tough, lightweight construction that stands up to the hard knocks of life.

Sturdy internal design and high-impact, flame-retardant shells make these units practically indestructible. Right off the shelf, they meet or exceed severe military shock/vibration tests.

Even our LCD's are protected by cast-tempered plastic shields. We use rugged CMOS LSI circuitry for integrity and endurance, and devote a large number of

components to protection against overloading, accidental inputs and operator errors.

We go to these lengths with all our low-cost DMM's to make sure they are genuine price/performance values. You can count on that. Because, that's what leadership is all about.

For more facts on DMM reliability and where to find it, call toll free 800-426-0361; use the coupon below; or contact your Fluke stocking distributor, sales office or representative.

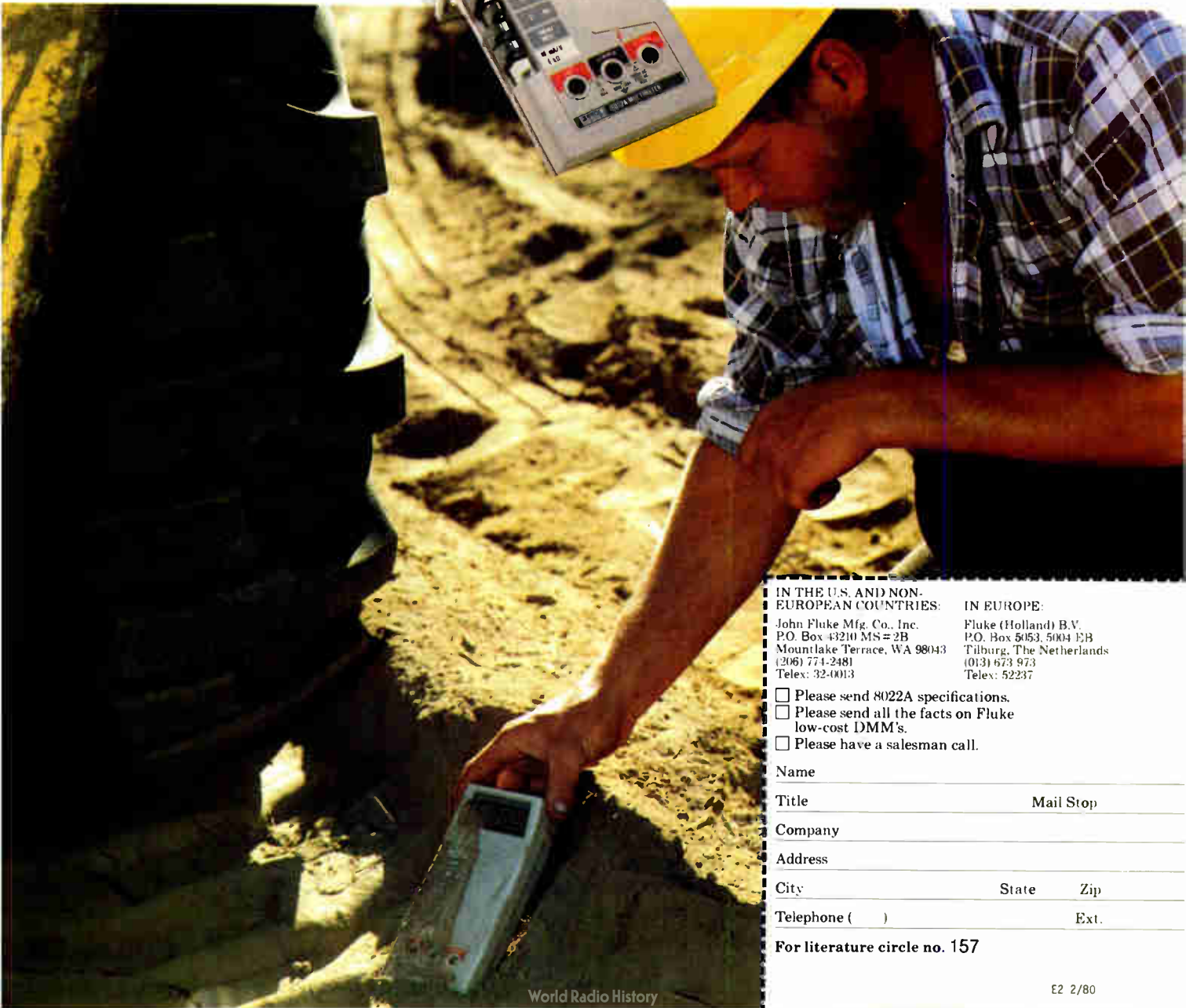

IN THE U.S. AND NON-EUROPEAN COUNTRIES:

John Fluke Mfg. Co., Inc.  
P.O. Box 43210 MS # 2B  
Mountlake Terrace, WA 98043  
(206) 774-2481  
Telex: 32-0013

IN EUROPE:

Fluke (Holland) B.V.  
P.O. Box 5053, 5004 EB  
Tilburg, The Netherlands  
(013) 673 973  
Telex: 52237

- Please send 8022A specifications.
- Please send all the facts on Fluke low-cost DMM's.
- Please have a salesman call.

Name \_\_\_\_\_

Title \_\_\_\_\_ Mail Stop \_\_\_\_\_

Company \_\_\_\_\_

Address \_\_\_\_\_

City \_\_\_\_\_ State \_\_\_\_\_ Zip \_\_\_\_\_

Telephone (    ) \_\_\_\_\_ Ext. \_\_\_\_\_

For literature circle no. 157

# TI-58 aids design of rf power amplifiers

by Fernando Lucio Tula  
Buenos Aires, Argentina

Simplifying the graphical analysis of a class C vacuum-tube power amplifier, this program finds, in a minimum of time, the power output and plate dissipation for a given set of operating conditions. Working with the power tube's constant-current curves, the program converts point-by-point information, which relates instantaneous current to instantaneous conduction angle (Wagener-type approximation), into the peak fundamental-component current,  $I_{pm}$ , and average plate current,  $I_{dc}$ . In this way the aforementioned variables,  $P_o$  and  $P_D$ , as well as the plate efficiency ( $\eta$ ), can be found.

As shown in the figure, the orientation of the load line on the constant-current curve is defined by the maximum plate voltage,  $E_{b\ max}$ , and the maximum dc current,  $I_{b\ max}$ . When this information, along with the dc grid-bias voltage,  $E_{cc}$ , the peak grid-driving voltage,  $e_{c\ max}$ , the minimum plate voltage,  $e_{b\ min}$ , the tube's operating angle,  $\theta_{opr}$ , the Wagener coefficient,  $N_1$ , and the point-to-point

current-vs-angle values at points A-F are supplied, the operating path is specified. Assuming a trial plate efficiency of 75% and a supply voltage,  $E_{bb}$ , that is 10% above the maximum potential applied to the plate of the tube,  $E_{b\ max}$ , the program then finds:

$$I_{dc} = 1/12(A/2 + B + C + D + E + F)$$

$$I_{pm} = 1/12(A + 1.93B + 3^{1/2}C + 2^{1/2}D + E + F/2)$$

and from this,  $P_o = e_p I_{pm}/2$  and  $P_D = E_{bb} I_{dc} - P_o$ , where  $e_p = E_{bb} - e_{b\ min} = x/\cos(\theta/2)$ . The values of the amplifier's tank (tuned circuit) components, which are not calculated by the program, may then be found in a straightforward manner.

An example illustrates the usefulness of the program. A low- $\mu$  triode is to be operated with  $E_{bb} = 3.5$  kV,  $I_{b\ max} = 1.2$  A,  $N_1 = 0.24$ ,  $e_{c\ max} = 0.24$  kV,  $e_{b\ min} = 0.35$  kV,  $\theta_{opr} = 130^\circ$ , and  $E_{cc} = -0.06$  kV. The operating line is partitioned in  $15^\circ$  segments, where  $I_{15} = 1,100$  mA,  $I_{30} = 950$ ,  $I_{45} = 600$ ,  $I_{60} = 110$ , and  $I_{75} = I_{90} = 0$ , and segments A-G through F-G correspond to that fraction of line segment A-G corresponding to the cosine of the points' representative angle. Entering the data as instructed yields  $I_{dc} = 280$  mA,  $I_{pm} = 493$  mA,  $P_o = 691$  W,  $P_D = 190$  W, and  $\eta = 78\%$ . □

Engineer's notebook is a regular feature in *Electronics*. We invite readers to submit original design shortcuts, calculation aids, measurement and test techniques, and other ideas for saving engineering time or cost. We'll pay \$50 for each item published.

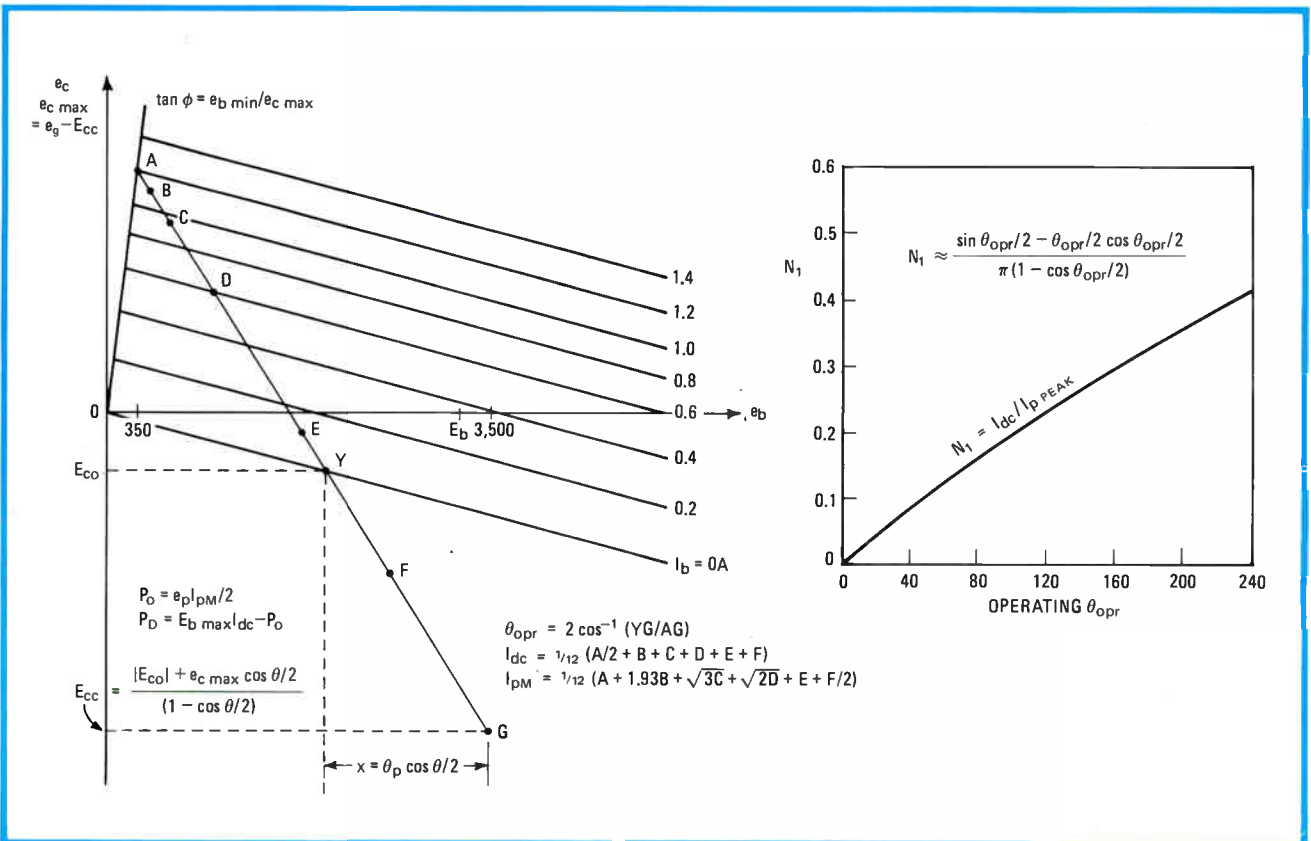

**Current line.** TI-58 simplifies design of Class C amplifiers with six-point approximation using power tube's constant-current curves. Wagener coefficient  $N_1$  defines tube's peak fundamental current,  $I_{pm}$ , for a given quiescent current,  $I_{dc}$ , enables calculation of  $P_o$ ,  $P_D$ , and  $\eta$ .

Locations	Codes	Keys	Locations	Codes	Keys
000 - 004	76 10 60 01 01	*LBL *E' *DEG 11	116 - 121	69 20 69 29 43 09	*OP 20 *OP 29 RCL 09
005 - 009	42 00 06 32 91	STO 00 6 x $\approx$ t R/S	122 - 125	22 77 25 91	INV x $\geq$ t CLR R/S
010 - 015	76 11 65 93 09 95	*LBL A x .9 =	126 - 132	76 17 43 11 55 02 85	*LBL *B' RCL 11 $\div$ 2 +
016 - 019	42 01 65 91	STO 01 x R/S	133 - 137	43 12 85 43 13	RCL 12 + RCL 13
020 - 025	42 02 65 93 07 05	STO 02 x .75	138 - 143	85 43 14 85 43 15	+ RCL 14 + RCL 15
026 - 031	95 91 55 03 95 91	= R/S $\div$ 3 = R/S	144 - 150	85 43 16 95 55 01 02	+ RCL 16 = $\div$ 12
032 - 037	76 12 35 65 43 02	*LBL B 1/x x RCL 02	151 - 156	95 42 17 91 76 18	= STO 17 R/S *LBL *C'
038 - 043	95 42 03 91 42 04	= STO 03 R/S STO 04	157 - 161	43 11 85 43 12	RCL 11 + RCL 12
044 - 048	91 42 05 94 85	R/S STO 05 +/- +	162 - 167	65 01 93 09 03 85	x 1.93 +
049 - 054	43 01 95 42 06 91	RCL 01 = STO 06 R/S	168 - 173	43 13 65 03 34 85	RCL 13 x 3 $\sqrt{x}$ +
055 - 060	55 02 95 39 42 07	$\div$ 2 = *COS STO 07	174 - 178	43 14 65 02 34	RCL 14 x 2 $\sqrt{x}$
061 - 066	65 43 06 95 91 85	x RCL 06 = R/S +	179 - 182	85 43 15 85	+ RCL 15 +
067 - 072	43 04 65 43 07 95	RCL 04 x RCL 07 =	183 - 186	43 16 55 02	RCL 16 $\div$ 2
073 - 078	55 53 01 75 43 07	$\div$ (1 - RCL 07	187 - 192	95 55 01 02 95 91	= $\div$ 12 = R/S
079 - 083	54 95 91 50 85	) = R/S * x  +	193 - 198	76 19 65 43 06 55	*LBL *D' x RCL 06 $\div$
084 - 089	43 04 95 42 08 91	RCL 04 = STO 08 R/S	199 - 202	02 95 42 18	2 = STO 18
090 - 095	76 14 42 10 55 91	*LBL D STO 10 $\div$ R/S	203 - 207	91 75 53 43 01	R/S - (RCL 01
096 - 099	95 35 22 39	= 1/x INV *COS	208 - 213	65 43 17 54 42 19	x RCL 17 ) STO 19
100 - 103	65 02 95 91	x 2 = R/S	214 - 217	95 91 43 18	= R/S RCL 18
104 - 110	76 15 39 65 43 10 95	*LBL E *COS x RCL 10 =	218 - 221	55 43 19 65	$\div$ RCL 19 x
111 - 115	76 25 91 72 00	*LBL CLR R/S STO *IND 00	222 - 226	01 00 00 95 91	100 = R/S

Instructions

- Key in program
- Initialize \*E'
- Enter supply voltage and maximum dc current desired ( $E_{bb}$ ), A, ( $I_{b\ max}$ ), R/S, R/S  
Displayed after each entry is  $E_{b\ max}$  (kV),  $P_{O\ max}$  (kW), and  $P_{d\ max}$  (kW) for tube.
- Enter operating parameters ( $N_1$ ), B, ( $e_{c\ max}$ ), R/S, ( $e_{b\ min}$ ), R/S, ( $\theta_{opr}$ ), R/S, ( $|E_{co}|$ ), R/S, R/S  
Displayed after each entry, in order, are  $I_{p\ peak}$  (A),  $e_{c\ max}$  (kV),  $e_p$  (kV), x (kV),  $E_{cc}$  (kV), and  $e_{grid}$  (kV).
- Check that the operating angle specified is within the amplifier's range for the set of operating parameters specified (AG), D, (YG), R/S  
Given the relative lengths of segments AG and YG, the program will calculate and display  $\theta_{opr}$ . If this angle is not near to  $\theta_{opr}$ , a different set of variables must be respecified to obtain the desired angle.
- Enter the angles that are used to partition the operating line ( $15^\circ$ ), E, ( $30^\circ$ ), E, ( $45^\circ$ ), E, ( $60^\circ$ ), E, ( $75^\circ$ ), E.  
The calculator displays the relative lengths of segments BG, CG, DG, EG, and FG and thus defines the locations of points A-F.
- Enter the values of current corresponding to the aforementioned points (A), R/S, (B), R/S, (C), R/S, (D), R/S, (E), R/S, (F), R/S  
The calculator will count through and display values 1 - 6 in succession after each entry.
- Find output variables \*B', ( $I_{dc}$ , mA), \*C', ( $I_{pm}$ , mA), \*D', ( $P_o$ , W), R/S, ( $P_o$ , W), R/S, ( $\eta$ , %)



# THE INSTRUMENTS IS SATISFYING THE NEED FOR FOR PEOPLE ALL



RECORDING  
INSTRUMENTS



OSCILLOSCOPES





# DIVISION OF GOULD INC. QUALITY INSTRUMENTATION OVER THE WORLD.



**LOGIC ANALYZERS**



**DIGITAL MULTIMETERS  
AND COUNTER TIMERS**

For more information on Gould recording, graphic display, signal analysis and measurement instruments and automatic test equipment, write Gould Inc., Instruments Division, 3631 Perkins Ave., Cleveland,

Ohio 44114. Or call toll-free:  
800-331-1000. In  
Oklahoma, call collect  
918-664-8300.

 **GOULD**

*An Electrical Electronics Company*

## **NBS develops electromagnetic probe with wide range . . .**

Instrumentation engineers will be interested in a new probe for measuring electromagnetic radiation. Developed by the National Bureau of Standards, the probe has a **unique combination of sensitivity and frequency range**—13 to 16  $\mu\text{V}$  per meter, a usable dynamic range of 125 to 144 dB, and a bandwidth extending from 10 MHz to 1 GHz. Designed for a continuous-wave environment, it will function independently of its position in the electromagnetic field.

The NBS will provide circuit details free to anyone who is interested and, according to spokesman Fred McGehen, is preparing a publication with all the data. Contact him at (303) 499-1000, extension 3244, for further information.

## **. . . and a calibration standard for a-m signals**

The NBS Center for Electronics and Electrical Engineering has developed a precision modulation meter and high-quality amplitude-modulation source that **will form the basis for a future calibration service** to ensure uniform and accurate performance of the Federal Aviation Administration's airborne and ground-based instrument landing systems. Although geared for commercial airlines, avionics instrument manufacturers, and the like, the standard will have applications for radio systems in general, including that of commercial broadcast stations. "A Standard for RF Modulation Factor," NBS Technical Note 1016, gives the details. Write the Superintendent of Documents, U. S. Government Printing Office, Washington, D. C. 20402, and request No. 003-003-02125-3. The cost is \$3.50.

## **VLSI courses bring IC engineers up to date**

With advances in very large-scale integration occurring almost monthly, it becomes increasingly difficult for chip engineers to keep up. In an effort to remedy the situation, the University of California at Los Angeles Extension, in cooperation with the University of Maryland, will host a five-day course in VLSI techniques, April 14–18, at the latter's University College in College Park, Md., and in Los Angeles, May 19–23 and Sept. 15–19. Design, fabrication and applications engineers, as well as device physicists and technical managers, should find the course useful. **Conducted by a group of experts in the field**, it will include a review of state-of-the-art technology and a discussion of physical limitations and scaling, new patterning and processing techniques, process analysis and modeling, computer aids to design, new device concepts, chip and system architecture, and testing and reliability. In addition, the new requirements that will be imposed on manufacturing facilities and the impact on consumer, industrial, and military electronics will be considered.

The fee is \$575. Further information may be obtained from the UCLA Extension, 10995 Le Conte Ave., Los Angeles, Calif. 90024.

## **AMD runs out of microcomputer design manuals**

Advanced Micro Devices Inc. has quickly exhausted the supply of its seven-booklet course, "Build a Microcomputer" [*Electronics*, Jan. 17, p. 144]. Although it does not plan a reprint, **the McGraw-Hill Book Co. will offer the series at \$18.50 starting in May**. To place an order, contact Ed Matthews, McGraw-Hill Book Co., 1221 Avenue of Americas, New York, N. Y. 10020.

**-Vince Biancomano**

# FACIT ANNOUNCES THE FOOLPROOF DATA- LOGGING CONCEPT.

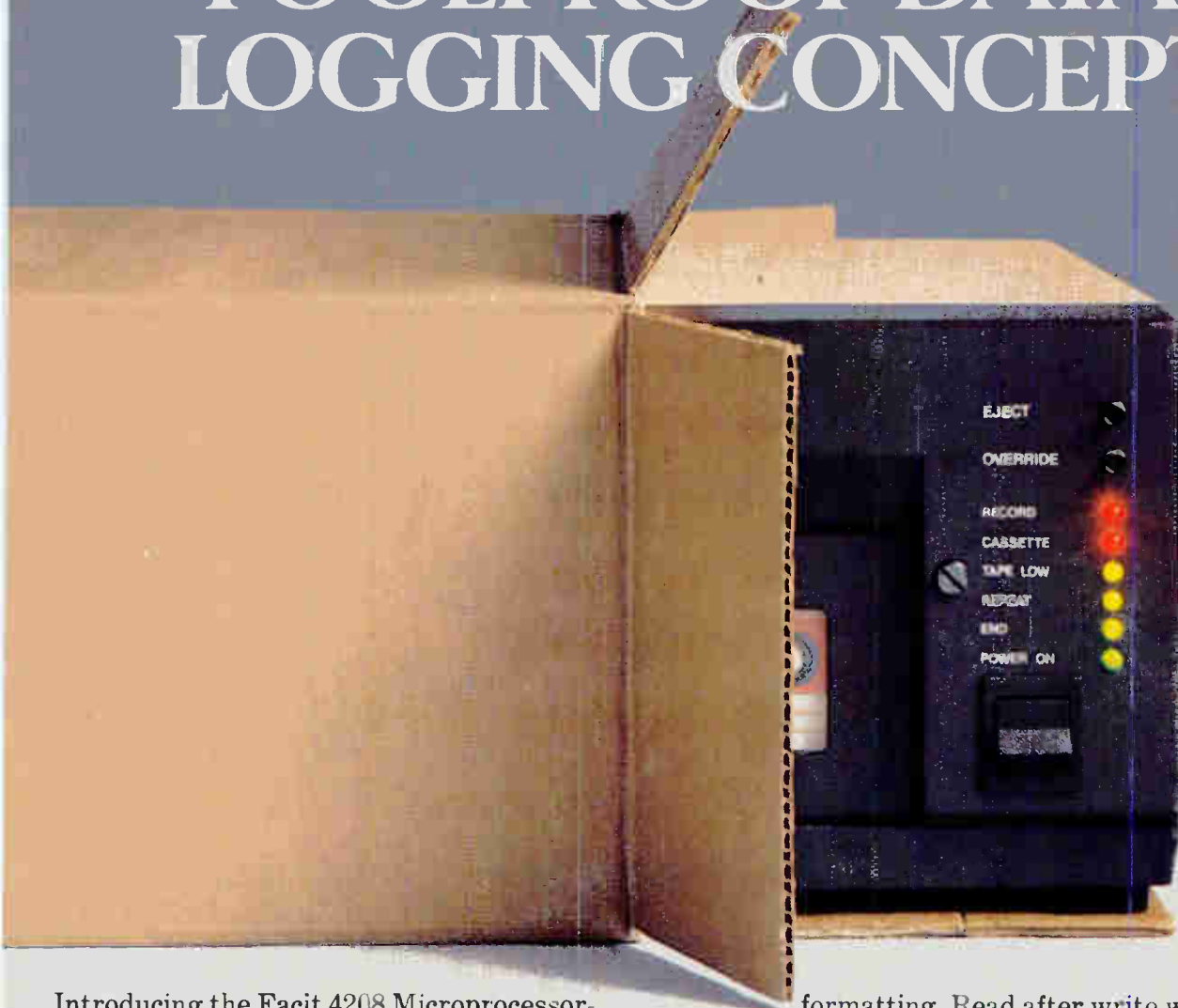

Introducing the Facit 4208 Microprocessor-controlled Cassette Tape Unit.

It's the most complete plug-in unit you can get. Combining absolute data security with truly brilliant system performance.

No restrictions on characters to be recorded. Dual 256 character buffer memory for continuous data transfer. Fully self-contained with battery back-up and extensive power-down programmes ensure 100% security of accepted data. Fully Facit 4070 compatible.

Read/write transfer rates 0-500 ch/s asynchronously with automatic tape handling and data

formatting. Read after write with bit by bit compare check and CRC check to ensure correct data on tape.

Storage capacity 230 000 ch/track. ECMA 34 and Silent 700® compatibility. Wide range of interfaces both serial and parallel.

All existing mains voltages and frequencies are covered. Noiseless 24-hour stand-by. No moving parts in stand-by mode.

The Facit 4208 foolproof Cassette Tape Unit concept comes from the company that gave you the Facit 4070 tape punch. And emphasizes the same ease of use and plug compatibility.



## ALWAYS SOMETHING MORE IN DATA PERIPHERALS.

*Facit Data Products. Head Office: S-105 45 Stockholm, Sweden. Phone: (8) 738 60 00.*

# Tektronix

1

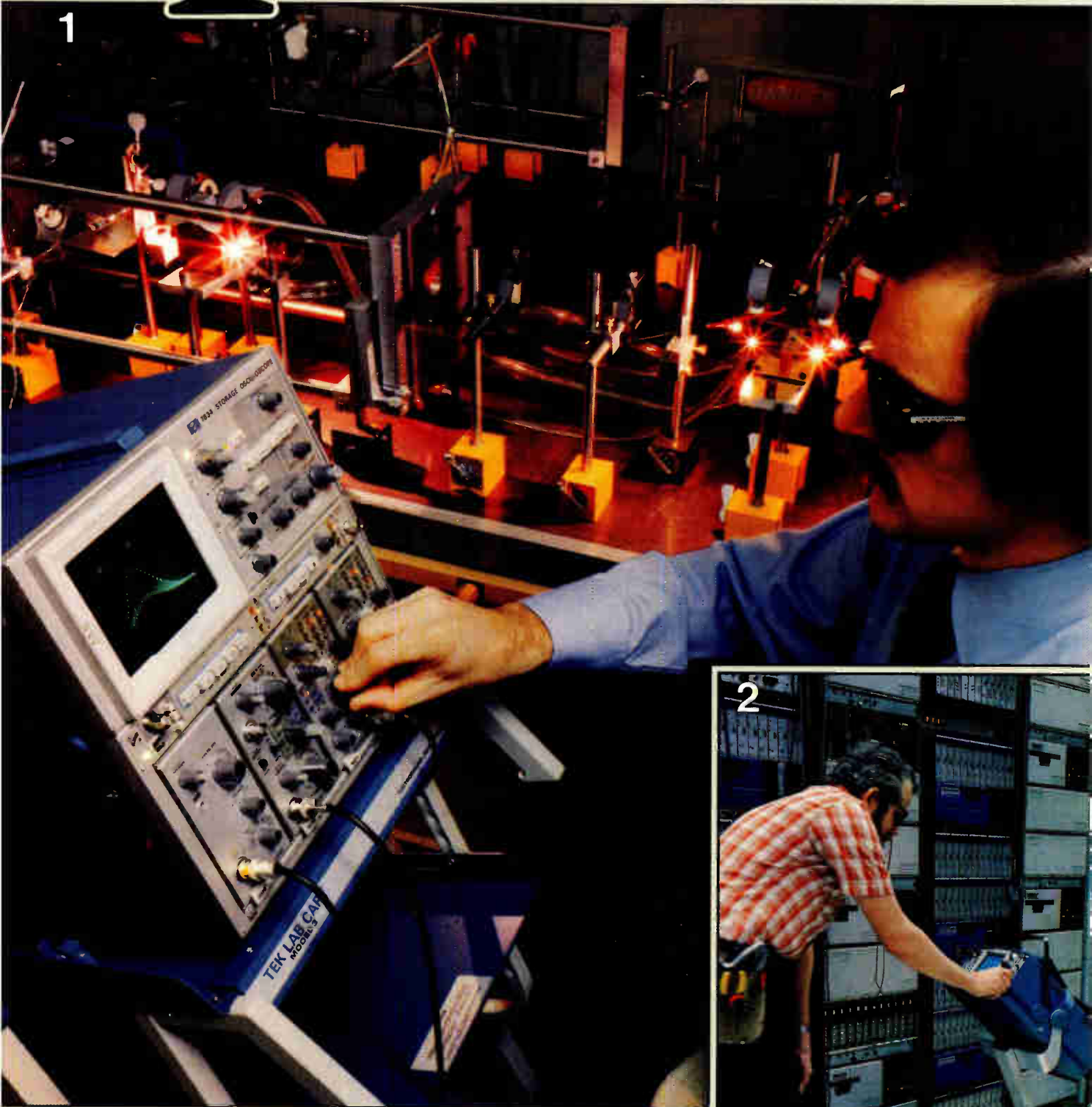

Tektronix offers 15 storage scopes and the widest selection of storage modes. Here is how just a few of those scopes are being used today.

**1** The FAST storage mode of the 7834 being used to capture high speed laser pulses.

**2** The extremely bright display provided by the 466 in variable persistence mode makes it easy to view low rep rate switching performance.

**3** The TM 500 with an SC 503 bistable storage plug-in being used for audio maintenance.

**4** The highly portable 214 at work in system troubleshooting.

**5** The long view time provided by bistable storage in the 5111 is useful for the study of pain threshold data.

World Radio History

2



# Storage Scopes.

Choose the one to match the job.

#### The industry's widest selection.

You'll find them throughout the world, in research and development labs, in service centers, and in the field. Each oscilloscope offers a unique combination of features ideally suited for a particular application. Choosing from the widest selection of storage speeds and modes to match the job is easy with the Tektronix Storage Scope Selection Guide.

**Performance.** The 7000 Series finds wide use in laser fusion labs in single shot analysis, glitch detection, and ECL logic design by offering the fastest storage available. Writing rates up to 2500 cm/ $\mu$ s, allow signals to be stored to speeds in excess of 250 MHz and with real-time bandwidths to 400 MHz.

**Flexibility.** Tektronix realizes that tools must be flexible. That's why both the 7000 and 5000 Series offer you a wide selection of storage mainframes... some that offer three different storage modes ... and a broad selection of

plug-ins that lets you custom tailor a package to meet your specific measurement need.

**Mobility.** If you need to perform tests in several locations with a scope that can capture and store slow, randomly timed events or very fast signals, our 400 Series meets the challenge.

**Portability.** For climbing ladders or traveling to remote locations where power is not available, we offer storage portables weighing from 1.6 kg (3.5 lbs), with a wide range of bandwidths and writing speeds.

**Configurability.** Our TM 500 Series offers a storage plug-in scope that you can combine with generators, multi-meters, counters, or other plug-ins to create a cost-effective, multitest capability in one package.

**Service and Support.** There are hundreds of Tektronix Service Engineers located throughout the world to calibrate and maintain your Tektronix Scope.

#### Send for your FREE Selection Guide.

Whatever your storage application, we've got the scope to match the job. So send for your free Selection Guide today. Descriptions of each storage mode and technical data on every model will help you select the one that's right for your application.

**Tektronix**  
COMMITTED TO EXCELLENCE

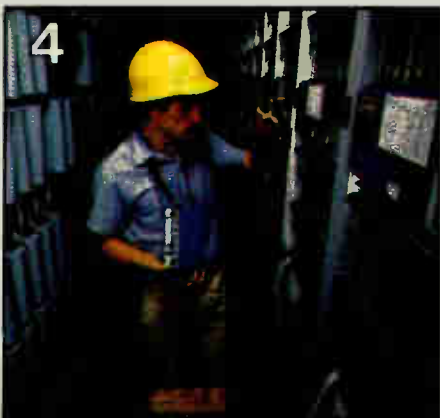

Send me the Tektronix Storage Scopes Selection Guide.

Name

Company

Address

City  State  Zip

**Mail to: Tektronix Storage Scopes**

Tektronix, Inc.  
P.O. Box 1700  
Beaverton, Oregon 97075



Everybody has his own idea of security. Like some people just can't feel safe about a DMM unless it's over-specified and over-priced. That's OK for them. But what about people like you, who know that buying more than what you need is a waste?

At Keithley, we think you should have a choice. We think you deserve the best possible DMM for your application at the lowest possible price. So that's how we design our DMMs—to match specific user need levels.

#### You pay for only what you need.

Of course, we'll be glad to sell you all the capabilities you want whether you need them or not. The important thing is that with Keithley the choice is all yours. We think a DMM on this page will show you exactly what we mean.

#### Our new, rough-and-ready 169.

The tough, battery-powered 169 is a 3½ digit DMM which delivers .25% DC accuracy. MTBF is 20,000 hours. Electrical parts are kept to a minimum for long life and fast, easy maintenance. It's the only low-powered DMM which displays both function and range along with the reading. You'll never settle for analog meters again.

# Buying too much DMM makes some people feel secure.

#### The 191 outclasses its class.

Our newly introduced 191 is a  $\mu$ computer-based, 5½-digit DMM. It offers 1 $\mu$ V sensitivity,  $\pm 200,000$  count resolution, 0.004% basic DC accuracy, 4 readings per second, non-linear digital filtering, pushbutton offset compensation and 2 or 4-terminal ohms measurement from 1m $\Omega$  to 20M $\Omega$  across 6 ranges.

It is a manual ranging bench DMM with DCV and ohms standard. ACV is optional. The  $\mu$ P design

**KEITHLEY**

makes possible a 12-month recalibration cycle—twice that of its nearest competitor.

#### The 179 is a full function DMM and a 4★ value.

The 4½-digit 179 expands 178 capabilities with true RMS, 10 $\mu$ V sensitivity, 1kV protection on  $\Omega$ , DC & AC current to 2A. It is also available in a 20A version.

Battery operation and BCD output are optional.

#### The 177 is total measurement capability.

The most sensitive DMM in its price range, the 177 offers outstanding specifications on all functions with 1 $\mu$ V, 1nA, and 1m $\Omega$  sensitivity.

True RMS, 5-functions, 0.03% basic accuracy, analog output, optional BCD output or battery pack—the 177 is a first rate bench DMM.

#### The 172A and 173A offer added features and performance.

Keithley's top-of-the line 4½'s offer 30,000 count display and auto or manual ranging on *all* functions including AC & DC current. Basic DC accuracy is 0.009%. Resistance capability spans seven ranges to 300M $\Omega$ . Both 2 or 4 terminal and Hi-Lo ohms are switch selectable. The 173A adds increased current capability to the 172A. Battery pack, BCD interface, and IEEE output are available on both models.

#### We sell satisfaction.

At Keithley we feel the best judge of what's best for your DMM application, is you. That's why we continue to expand our broad product line with a stream of first-quality, user-oriented DMMs.

When you look at all the price/performance options in the Keithley line of DMMs, we think you'll feel plenty secure.

To order the DMM of your choice or for information on any Keithley electronic measurement instrument, contact your Keithley representative or call us at (216) 248-0400. Telex: 98-5469.

**Keithley Instruments, Inc.**  
28775 Aurora Road  
Cleveland, Ohio 44139  
(216) 248-0400  
Telex: 98-5469

**Keithley Instruments Ltd.**  
1, Boulton Road  
GB-Reading, Berkshire RG2 0NL  
UNITED KINGDOM  
(0734) 86-12-87  
Telex: (851) 847047

**Keithley Instruments, GmbH**  
Heighofstrasse 5  
D-8000 München 70  
WEST GERMANY  
(089) 714-40-65  
Telex: (841) 5212160

**Keithley Instruments SARL**  
44, Rue Anatole France  
F-91121 Palaiseau Cedex  
FRANCE  
(01) 014-22-06  
Telex: (842) 204188

Circle 167 on reader service card



## TMS 2532 32K EPROM

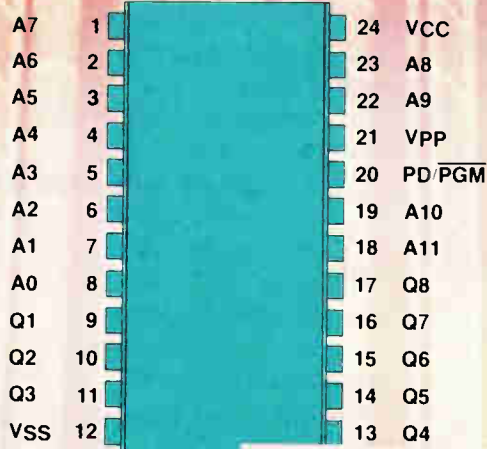

## TMS 2564 64K EPROM



MOVING AHEAD IN MEMORIES





8Ks, 16Ks, 32Ks, and now...

# The first 64K EPROM. From Texas Instruments. Naturally.

Introducing the TMS2564. The industry's first 64K EPROM. The densest yet. With all the high-performance features of TI's 5-V EPROM family. Features like 8-bit word configuration, fully static operation, automatic chip-select/power down, and low-power.

## Pin compatibility

TMS2564 is offered in a 600-mil, 28-pin dual-in-line package. But, it's compatible with industry standard 24-pin 64K ROMs, as well as less dense EPROMs.

This is because pins 3 through 26 of the TMS2564 are compatible with pins 1 through 24 of the 24-pin devices. Compatibility is enhanced by reserving both pins 26 and 28 for the 5-V supply. So,

with a supply trace to pin 26, both 24 and 28-pin devices can be used, with no jumpering.

## Fully static

Like all TI EPROMs, the TMS2564 maintains the fully static tradition that makes designing easier.

No timing signals. No clocks. No strobes. No refresh. No problems. Simply, cycle time equals access time.

## Lowest power ever

Operating at an access time of 450 ns with a power dissipation of only 840 mW maximum or less than 13  $\mu$ W per bit, it's the lowest power per bit ever achieved in EPROMs.

## Easy programming

The TMS2564 is designed to facilitate rapid program changes in high density, fixed memory applications.

All that's needed for simple, in-system programming, is a single TTL level pulse.

You can program in any order. Individually. In blocks. At random. So, programming time is reduced to a minimum. And, you can use existing 5-V PROM programmers.

Erasing? Simple ultraviolet. Just like any other EPROM.

## Widest choice

By adding the new TMS2564 to our fast-growing EPROM family, we offer the designer a product breadth unmatched by any other supplier.

All TI EPROMs are available in 600-mil packages with JEDEC compatible pin-outs.

And they all share the reliable N-channel process technology.

TI's growing EPROM family. For all your present and future memory requirements.

**For more information** about the first 64K EPROM, or any other family member, call your nearest field sales office or authorized distributor. Or write to Texas Instruments, P.O. Box 1443, M/S 6955, Houston, Texas 77001.



TI'S GROWING EPROM FAMILY

Device	Description	Power Supply	Max Power (0°C)		Access Time
			Operating	Standby	
TMS2564	64K	5 V	840 mW	131 mW	450 ns
TMS25L32	32K	5 V	500 mW	131 mW	450 ns
TMS2532	32K	5 V	840 mW	131 mW	450 ns
TMS2516-35	16K	5 V	525 mW	131 mW	350 ns
TMS2516	16K	5 V	525 mW	131 mW	450 ns
TMS2508-25	8K	5 V	446 mW	131 mW	250 ns
TMS2508-30	8K	5 V	446 mW	131 mW	300 ns
TMS2716	16K	+12, $\pm$ 5 V	720 mW	—	450 ns
TMS27L08	8K	+12, $\pm$ 5 V	580 mW	—	450 ns
TMS2708	8K	+12, $\pm$ 5 V	800 mW*	—	450 ns
TMS2708-35	8K	+12, $\pm$ 5 V	800 mW*	—	350 ns

\* $T_A = 70^\circ\text{C}$

TEXAS INSTRUMENTS  
INCORPORATED



# You Don't Have To Be A Super Sleuth To Find An Instrument Rental Shop. General Electric Has 48 Nationwide.

You'll find General Electric Rental Shops conveniently located in major cities across the country. We stock the most wanted equipment from leading manufacturers, including many unique and hard-to-find instruments. It's elementary that accuracy of equipment is never in question; each instrument is calibrated with standards traceable to the National Bureau of Standards before it leaves our door. Next time you need a test instrument, investigate a convenient weekly or

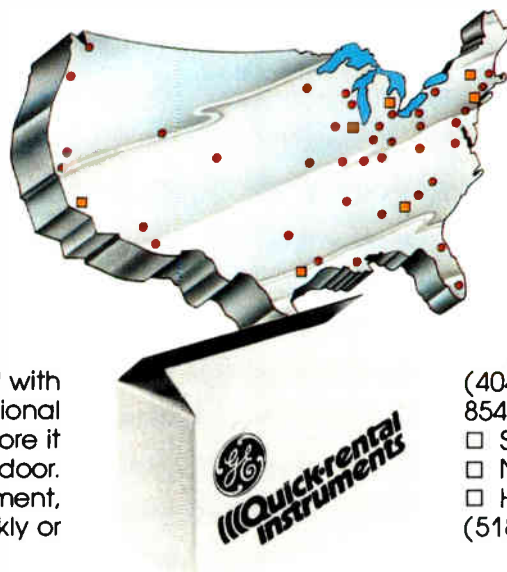

monthly program from General Electric. Delivery is fast—whether you rent a single recorder or a complete measurement system.

For your FREE RENTAL CATALOG call collect to the inventory center nearest you:

Los Angeles, CA (213) 642-5350  Atlanta, GA (404) 457-5563  Chicago, IL (312) 854-2994  Detroit, MI (313) 285-6700  Schenectady, NY (518) 385-2195  New York City (201) 227-7900  Houston, TX (713) 672-3570. Or call (518) 372-9900.

---

GENERAL ELECTRIC COMPANY  
Apparatus Service Division  
Building 4, Room 210, 1 River Road  
Schenectady, NY 12345

---

**GENERAL**  **ELECTRIC**  
World radio history

# Roundup: Smart controllers take over

Latest programmable industrial controllers use microprocessors and expanded input/output to handle more sophisticated jobs

by Linda Lowe, Boston bureau

Six programmable controllers that have entered the market since the fall reflect the changes such controllers of industrial processes have undergone since their birth in the early 1970s. And the variety of their configurations and their range of sophistication herald those they are likely to undergo in the future.

The programmable logic controller of the past decade, its name now shortened to programmable controller, has acquired many characteristics of the computer. This industry workhorse now has semiconductor memories and microprocessor-based central processing units; interfaces with peripherals such as intelligent cathode-ray-tube terminals and printers; increasingly sophisticated software schemes; and communication links (called data highways) to other controllers and control equipment. All this is changing the old concept of what a programmable controller is and what it can do.

The devices started out conforming to a fairly simple definition: they were solid-state logic boxes, programmable by a plant engineer using the traditional ladder diagrams inherited from relay days. Maintainable by an electrician and insensitive to the rigors of a factory environment, the programmable logic controllers accepted direct inputs from limit switches, push buttons, thumbwheels, and the like and made decisions based on a preset program to monitor and control machines by driving solenoids, motor starters, relays, lights, and so forth.

The term "programmable controller" now takes in a range of control devices from simple relay-replacement boxes to units much like mini-

computers. "I've been in this business for years, and even I am confused now about what distinguishes a programmable controller from a computer," says George MacDonald, marketing manager for Control Technology Corp., and he speaks for many. His Westboro, Mass., firm offers one of the small controllers—the 811 Promulator. The 811 has 32 programmable steps, monitors 11 conditional inputs, and drives 8 or 40 outputs. It does such chores as turning heat and light switches on and off at preset times.

At the high end of the scale, where the confusion sets in, are units like Eptak, from Eagle Signal Industrial Systems Inc. of Davenport, Iowa. It handles machine and process con-

trol, equipment testing, data acquisition, and energy management among its 50-odd applications. Another machine, Burr-Brown Research Corp.'s CS450 programmable data-acquisition and control system, functions in areas like production design and testing, product evaluation, and machine and process control.

Microprocessors began cutting the cost and volume of programmable controllers even as they made possible greater sophistication and wider capabilities. This has fueled the industry, whose sales, according to Gene J. Kucinkas, senior consultant at Arthur D. Little Inc. in Cambridge, Mass., are growing at over 50% annually and totaled about \$200 million in 1979. Auto makers,

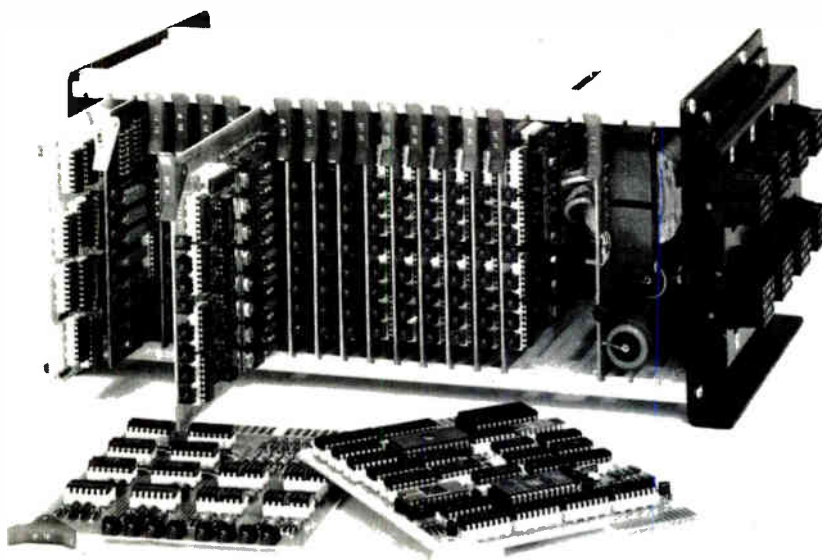

**Modules.** The IMP-3 programmable controller from Automation Systems is modular and uses an E-PROM to store up to 4,096 instructions.

### Controller market boom predicted in Europe.

Programmable controllers will be the fastest-growing segment of Europe's industrial temperature control industry during the 1980s, according to a 414-page report from Frost & Sullivan Inc. The New York market research firm predicts that programmable controllers—which had a market value of \$87.8 million in 1978—will enjoy a 20% annual growth rate and reach a market value of \$224 million by 1983. Beyond that, the report says, market gains are difficult to predict “because of the rapid rate of new developments and technological alternatives in the semiconductor industry.”

Microprocessor-based controllers with display and communications capabilities are already beginning to supersede more conventional discrete, general-purpose, recorder/controller, and mechanical-regulator forms of control. The industrial temperature control industry, which includes sensor equipment, will grow at a rate of about 7.6% annually over the coming decade, Frost & Sullivan predicts.

Increasing competition will be a major factor forcing growth. Currently, some 600 European-based firms command 75% to 80% of the industrial temperature control market. During the 1980s, however, other countries—Japan in particular—will challenge domestic suppliers more and more.

The study also notes that though the chemical-process sector currently is the biggest customer for temperature control equipment, it will be superseded by greater demand from the power-generation industry as energy-conservation concerns become more critical.

-L. L.

he notes, have accounted for some 60% of the market for the devices, but that relative percentage will decline as the controllers find new applications to match their growing talents.

Indeed, more production sectors are giving the controllers a try and are finding them flexible, time-saving answers to manufacturing needs. One automotive die-casting supplier recently switched from relays to programmable controllers to control automatic casting ladles and

**Fiber-optic link.** Struthers-Dunn's Director 4001 offers fiber optics as an optional way of linking the controller with remote input/output devices.

an automated, 800-ton aluminum-die-casting center. In 1979, the devices moved for the first time into the area of position control, which had formerly used cam-controlled switches in producing high-performance industrial components like switch assemblies for computers and test equipment. They are increasingly used to control centrifuges in chemical, pharmaceutical, food, and waste-treatment operations. They are also performing batching and logging functions in process control, and are being touted as an attractive energy-control method for homes, schools, and stores as well as factories (see “Controller market boom predicted in Europe”).

Despite the controllers' growing array of sophisticated accessories and high-technology features, plant engineers remain fairly uninterested in fancy hardware. “Their concern is with productivity,” comments one industry observer, “so the devices' big selling points are efficiency and reliability. Controller down-time cuts production, and every minute lost is money down the drain.”

**Other technologies.** So controller makers look to technological advances to address these concerns as well as to increase their products'

applications. They will be eager customers for nonvolatile magnetic bubbles to ensure memory security; they are moving into fiber optics for noise-free data links that will not spark and risk explosions; and they are developing ever more efficient diagnostic capabilities.

A major marketing concern is the peculiar psychology of the manufacturing community. “It's a tradition-bound area,” says Little's Kucinkas, and change is viewed warily. The old relay-ladder diagrams, many observers agree, are far from the most efficient *lingua franca* for operator and controller, but everyone is used to them. So ladder diagrams persist, even as makers gradually introduce auxiliary software languages to handle extra programmable-control functions. One manufacturer of the devices comments wryly, “We've had customers say they're uncomfortable with our machines because they don't make any noise while they work; we've thought of inserting a device that will click once in a while, just to reassure them.” Thus, a major task for the controller industry is that of retaining outward simplicity and familiarity as the inner workings of the devices become more complex.

**Distributed control.** Complexity can only increase with current trends toward the linking of controllers to distributed control networks along a communications system. Already showing up in factories [*Electronics*, May 24, 1979, p. 55], distributed control systems promise not only to expand the role of programmable controllers but also to alter the nature of the production environment. They could bring a whole manufacturing operation under the scrutiny of an operator working from an intelligent terminal monitoring many controllers. Whereas an engineer now must get information, modify programs, or troubleshoot problems by accessing a controller via a built-in display or a plug-in programming panel, those activities could more efficiently be handled at a central console.

Companies like Modicon and Allen-Bradley Co. are pushing the trend



Your Marketing department wants a new black box design. They want it to handle 37 bytes of information. It has to be solar energized. It has to fly. It has to speak. It has to reproduce. Naturally, it'll need special cable configurations. Call Belden.

We've developed workable wire, cable and cord answers for a lot of extraordinary new products. In fact, a lot of designers have found that working with Belden in the early stages of a design project usually pays dividends in compatibility, workability and lower overall costs.

And once your product is rolling, we're ready to dig in to wire processing, assembly and installation

problems to help insure that your idea makes it to market economically.

You see, Belden's capabilities in wire, cable and cord are comprehensive. Sure, we make thousands of standards, but we can also provide just about any custom that you can imagine. And our technical knowhow ranges from innovative packaging to in-depth value analysis.

Just imagine a wire, cable or cord—and we'll come through with it. Belden Corporation, Electronic Division, P.O. Box 1327, Richmond, IN 47374; 317-966-6661. Out West, contact our Regional Sales Office in Irvine, CA at 714-833-7700.

8-7-9B

# Your special designs need a special wire source



**Imagine  
what we  
can do  
for you**

## **BELDEN**

**Coming through...**

*with new ideas for moving electrical energy*

© 1979 Belden Corporation

World Radio History

Circle 173 on reader service card

## New products



**8-kiloword memory.** Allen-Bradley's 16-bit-microprocessor-based PLC-2/20 controller quadruples the earlier PLC-2 model's memory to 8,192 16-bit words.

with offerings like the Modicon Modbus Communications System, which can connect up to 32 controllers over telephone lines or a dedicated cable, and Allen-Bradley's data-highway interface package, which allows slave controllers to communicate among themselves. The increasing demand from users for standardized data highways that would let engineers build networks made up of programmable controllers and associated devices from many vendors reflects the industry's acceptance of distributed control as the way to go. "Lack of standardization limits not only customers' options, but the growth of the programmable-controller industry generally," thinks Gene Kucinkas at Little, "but you'll have a hard time convincing a controller manufacturer to open the door to a competitor's equipment that way."

Also behind the push to distributed control is the intelligent CRT console. With its ability to generate graphic representations of control information, it offers a greatly improved means of communication between operator and controller.

Eagle Signal is introducing a software package for its Eptak that will let the engineer turn a process drawing into a controller program by using a color CRT console.

Square D Co., in Milwaukee, Wis., has added graphics capabilities, too. Users of its Class 8881 controller can view animated, real-time schematics of such things as piping-system diagrams, machine tool systems, and materials flow. These new ways of presenting information, which programmable controllers have been showing as ladder diagrams of open and closed contacts and energized coils, will speed comprehension, notes William C. Hollopeter Jr., applications engineer at Modicon. They will make possible rapid monitoring of whole processes at a single terminal as they are reported by many controllers scattered throughout a factory.

**Fiber optics.** Yet another good omen for distributed control is the use of fiber-optic links for safe, isolated transmission of data between the programmable devices and other control equipment in the electrically noisy plant environment. Struthers-Dunn Inc. is the first controller maker to offer fiber optics as an optional means of connecting its Director 4001 with remote input/output devices up to a kilometer away. Industry observers have little doubt that other firms will follow suit.

Finally, the advent of intelligent I/O devices will take controls to the ultimate in distribution, placing them at the site of the machine or process being controlled. Performing analog-to-digital conversion for data transmission to the controller and converting the unit's commands back again on site, the I/O devices will speed communications. They will also increase reliability, since digital transmissions are more resistant than analog ones to electrical interference. Analog Devices and Data Translation are two of several firms already offering intelligent I/Os.

Manufacturers of programmable controllers are optimistic about the continuing strong growth of their

industry. Increasing capability and the move to distributed control mean widening areas of application as traditional markets continue their demand. The automotive industry, under pressure to comply with safety, pollution, and fuel-efficiency regulations while increasing productivity, should remain a big customer, according to Modicon marketing sources. Also, they say, in the next five years programmable controllers will be permeating the entire control spectrum—from the simplest relay-replacement function all the way up to large-scale process-control systems. Another marketing manager agrees, adding that "programmable controllers have always been modular in construction, making it easy for them to grow building-block style into new markets as they add hardware and software."

The programmable controllers will not in the near future be directly challenging such process-control-system giants as Honeywell and Foxboro, comments Little's Kucinkas, "but there is increasing overlap in markets now, and that should continue as long as the technology allows more capability."

The fast-growing programmable controller industry shows little signs of slowing down; the steady flow of new products confirms that. Among the devices announced in the past six months are:

- The IMP-3 from Automation Systems is modular in construction and uses an erasable-programmable read-only memory, organized as 16 or 32 K by 8 bits, for storage of up to 4,096 instructions, with each instruction corresponding to the status of a single contact in a relay ladder. The IMP-3 logic card's 8-bit microprocessor scans these instructions at about 5 ms each, a good deal faster than relays. Each IMP-3 logic unit can address, through I/O cards, any combination of up to 256 inputs and/or outputs. Adding slave logic cards gives more I/O. Each logic card contains a 256-bit MOS scratchpad memory with 128 locations. IMP-3 input cards are separate, each with eight photo-isolated inputs able to handle potentials that are

As a design engineer, you make or break a product on the drawing board. That's why it's crucial to specify top quality components right at the outset. Of course, this kind of quality doesn't come cheap. But it builds products that are attractive to your customers with long-range performance in mind.

That's where Cutler-Hammer electrical/electronic components really count. They're super tough to meet demanding applications — from aerospace vehicles to farm machinery to off-road equipment.

We make a diverse array of products that includes MIL-Spec switches, relays and remote control circuit breakers — as well

as control display systems that can monitor 1000 remote electrical functions in a single, space-saving location.

And if a stock item doesn't apply, we can modify existing products — or even design new ones to custom-fit your needs.

For more information, contact your Cutler-Hammer salesman. Or write for our complete catalog of control components and systems. Eaton Corporation, Aerospace Controls/Systems Division, 4201 N. 27th St., Milwaukee, Wisconsin 53216.



**EATON**  
Electrical/Electronic Control

Circle 175 on reader service card

**A quality end product starts here.  
Specify Cutler-Hammer components  
and systems.**

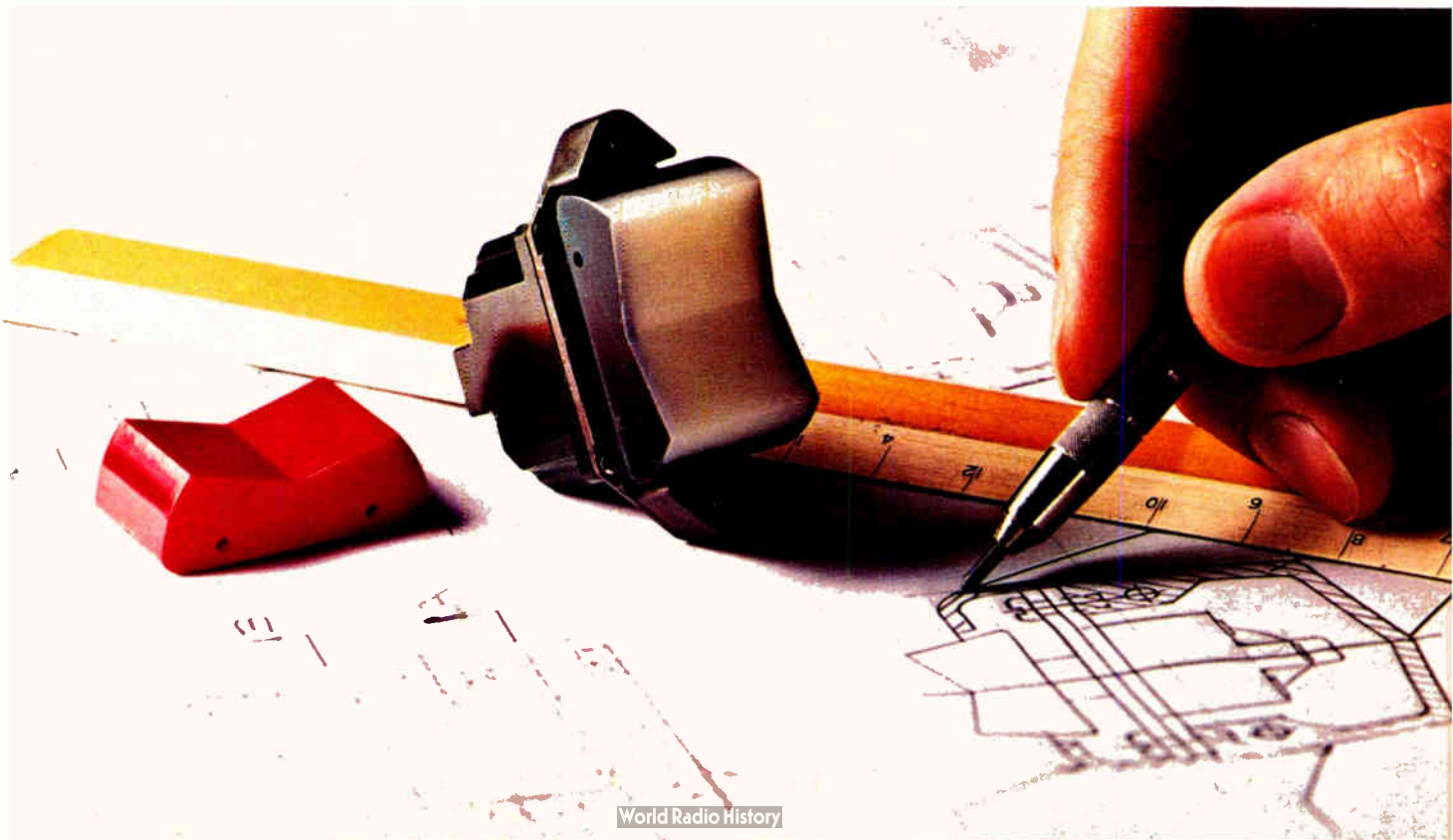

## New products

up to 220 v ac or dc.

IMP-3 output cards have eight transformer-coupled outputs capable of up to 3 A of current at up to 80 v dc, or 110 or 220 v ac. Other I/O modules include combination-I/O cards (four in, four out), analog communications interface cards, timer/counter cards, and special-purpose modules. The company offers a choice of E-PROM programmers—either a low-cost labor-intensive unit with data keyed in by thumbwheels or a much more expensive keyboard-based unit with a light-emitting-diode readout.

The IMP-3 costs \$432. Delivery is in 10 weeks.

■ Struthers-Dunn bills its Director 4001 as a medium-scale controller with growth potential and optional fiber-optic link. In some forms, the unit can handle data manipulation and math, in addition to the usual control and monitoring functions, and has data-conversion systems built in. The brain of the basic system consists of a 16-bit microprocessor and 240 discrete internal storage registers, in which information on processes under control and continual performance-monitoring data are stored—including fault diagnosis and isolation information. The Director 4001 can supervise up to 256 I/O channels, relying upon program data stored in C-MOS random-access memory, organized as 1, 2, or 4 k by 16 bits. Up to 64 timers or counters can be preset to 0.1 to 999.9 seconds, or 1 to 9,999 counts.

With a more capable optional microprocessor, the 4001 assumes "full data-handling capability." It supports up to 32 data I/O modules and comes with 512 additional 16-bit data-storage registers. Well on the way to distributed processing, this configuration also offers connectors for a data I/O bus and a program loader—a portable data-entry-panel and CRT-console subsystem that has some prompting ability, beeping if entry errors occur.

The Director 4001 costs \$870 to \$1,820. Delivery is in 16 weeks.

■ Allen-Bradley's new 16-bit-microprocessor-based PLC-2/20 is an

extension of the firm's PLC-2 line into the mid-range programmable-controller market. It offers four times the memory of the earlier PLC-2, at 8 k by 16 bits. It can address up to 512 I/O points. Memory expands in 512- and 2,048-word segments, and C-MOS memory is about four times faster than the firm has offered before; a "memory scan time" of 5 ms per kiloword is specified.

Using block data transfer, large blocks of data are shuttled from microprocessor-based I/O modules and the PLC-2/20 processor in a single memory scan. With microprocessors in its I/O, the PLC-2/20 is heading in the direction of distributed control. Also included are a built-in report-generation capability, RS-232 bus compatibility for communications, battery backup for MOS memory protection, diagnostics, and what is called a "floating data table." Using the floating-table system, users can select any reasonable number of timers and/or counters and preset them for a particular application.

The PLC-2/20 sells for \$1,650 and can be delivered in 90 to 120 days.

■ Modicon's model 584 [*Electronics*, Jan. 3, p. 33] is billed not only as a relay-replacement unit, but also, in its larger incarnations, as a stand-in for minicomputers. Like some other controllers, the 584 is programmed with a portable, plug-in panel, offers self-diagnostics, and is modular, so a 50-relay unit may be expanded to a 2,000-relay-equivalent machine. Based on a 16-bit, bit-slice microprocessor system, the 584 exhibits such additional capabilities as diagnostic monitoring, data storage and collection, and report generation. A core or C-MOS random-access memory can be expanded from 4 k to 32 k by 16 bits, with a ROM used for numerical and logic diagram storage. The unit also enables the user to reprogram in real-time, on-line fashion if the application allows.

Any 584 can support up to 256 input/output devices, placed as far as 15,000 ft from the unit's mainframe. The I/O channels are optical-

ly isolated. The 584 can communicate over about 50 ft with other controllers or with its programming panel through a variety of bus protocols, including Modicon's Modbus, when implemented with RS-232 interfaces. The 584 is also compatible with modems for communication over longer distances, presumably allowing remote programming and diagnostics.

The Modicon 584 costs \$5,500 to \$15,500 without I/O cards. Delivery takes 90 days.

■ The modular Macsym 20 programmable measurement and control system from Analog Devices is built around the concept of shared resources. For example, its analog input cards share a-d conversion systems, programmable gain amplifiers, and sample-and-hold systems, all in the Macsym 20 mainframe. The system also uses a stand-alone development system to work up programs and burn them into E-PROMs, thus allowing multi-Macsym users to store routines on floppy disks and then burn in several erasable PROMs consecutively in little more time than it takes to burn in a single one.

Built around an 8-bit microproces-

**Minifloppy disk.** The 8080-based CS450 data-acquisition and control systems from Burr-Brown has dual minifloppy disk storage and a CRT with keyboard.





# Easy to mount. Easy to connect. The RCA 25 amp triac comes in a rugged new package.



Our new QuikOn triac package is designed for high-speed assembly line installation.

Top side terminals let you do all your mounting from one side, with fast self-tapping sheet metal screws. The device can handle 300 amps surge current. 2500 volts isolation from any terminal to flange makes isolation hardware unnecessary.

Plus, we used quick-connect terminals that let you use solderless snap-on connectors.

All of which can add up to lower assembly costs than with conventional stud packages.

We've kept the price down too, by using a glass passivated chip in a molded plastic package. And there's no loss of reliability compared

to the standard stud package.

You can use the RCA QuikOn triac to control AC loads in large appliances and other types of high current equipment.

For more information, contact your local RCA Solid State Distributor.

Or RCA Solid State headquarters in Somerville, N.J. Brussels, Belgium. Tokyo, Japan.

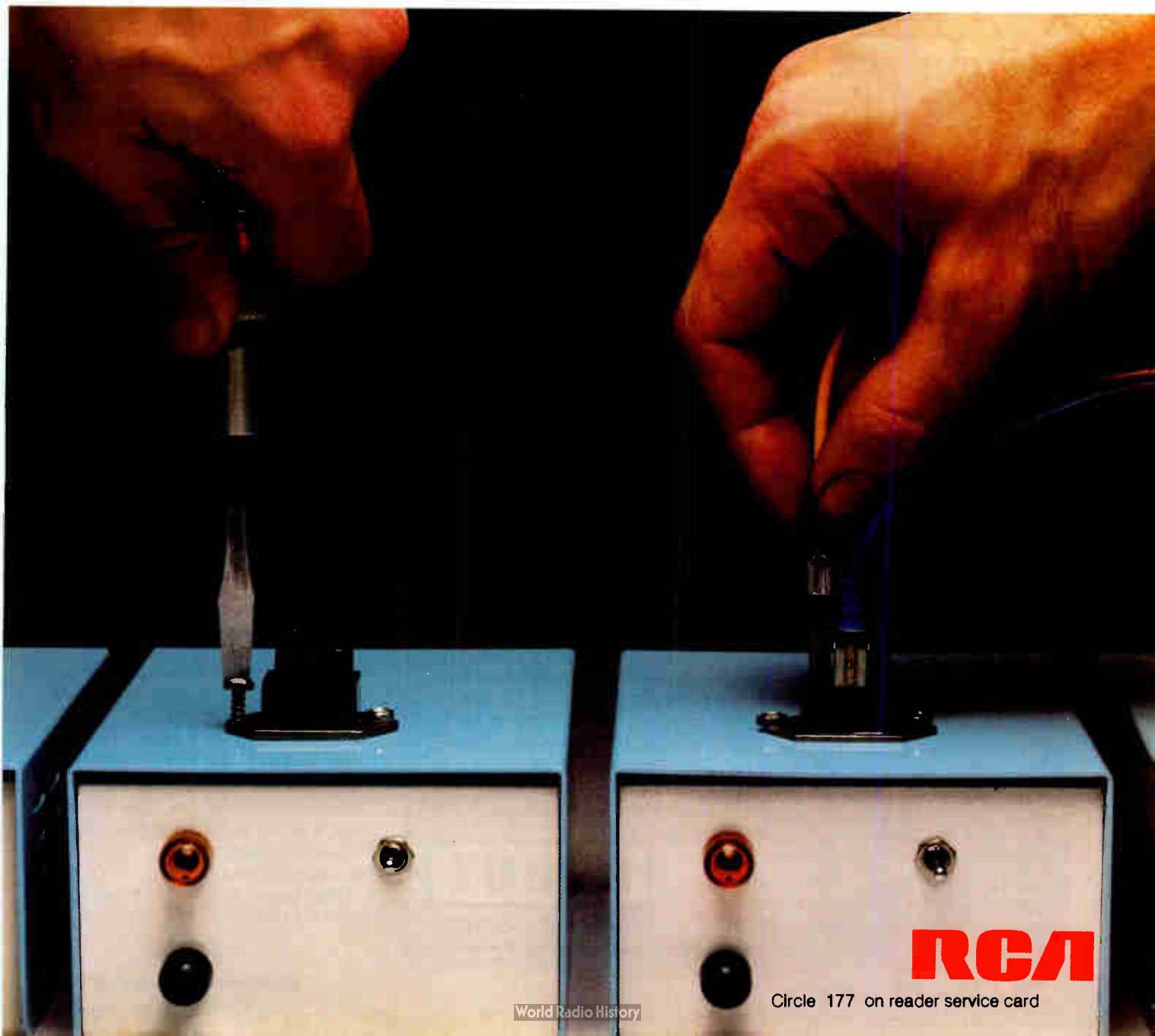

**RCA**

## New products

sor, the Macsym 20 includes 16 kilobytes of MOS RAM, room for up to 16 kilobytes of E-PROM, two optical RS-232 serial ports, a real-time clock, and the logic needed to support up to 16 signal-conditioning cards. The basic chassis will hold up to 16 cards, but an extension chassis can increase that to 240. Cards are available for such specialized inputs as

thermocouple, strain-gage, and frequency measurement.

A separately available development system uses Analog Devices' Pascal-like A<sup>PLAS</sup> [*Electronics*, Nov. 8, 1979, p. 41] to simplify software writing in industrial control.

The Macsym 20, because of its communications interfaces, is well equipped for distributed control, but

it also can act as a stand-alone controller without a display or keyboard. Base price for the unit is \$3,250, with delivery in 10 weeks.

■ Although aimed at control applications, the 8080-based CS450 programmable data-acquisition and -control system from Burr-Brown Research fringes on the minicomputer area. It has standard dual mini-floppy-disk storage, with optional minicassettes. It uses a 12-in. CRT-and-keyboard combination, with 28 specialized-function keys.

The CS450 uses Intel's Multibus protocol, allowing accessory equipment from other firms to be used within the system. Programming is in Basic rather than a language simulating a relay ladder diagram. There is an appropriately large inventory of I/O and specialized cards and a 40-column optional printer.

Half of the CS450's 64 kilobytes of RAM are used for the Basic language interpreter: 4 are for peripherals, and 28 are for user programs. Unlike most other controllers, the CS450 appears to have no read-only memory except that on the microprocessor for bootstrap-loader and maintenance routines—another area of similarity with minicomputers.

Burr-Brown is aiming the CS450 at production testing, process control, alarm monitoring, and computer-aided design applications.

The CS450 costs \$7,855, with delivery set for 60 days.

Automation Systems Inc., 208 North 12th Ave., Eldridge, Iowa 52748. Phone (319) 285-8171 [392]

Struthers-Dunn Inc., 4140 Utica Ridge Rd., Bettendorf, Iowa 52722. Phone (319) 359-7501 [393]

Allen-Bradley Co., PC Systems Division, 747 Alpha Dr., Highland Heights, Ohio 44143. Phone (216) 449-6700 [394]

Gould Inc., Modicon Division, P. O. Box S.V.S., Andover, Mass. 01810. Phone (617) 475-4700 [395]

Analog Devices Inc., Rte. One Industrial Park, P. O. Box 280, Norwood, Mass. 02062. Phone (617) 329-4700 [396]

Burr-Brown Research Corp., P. O. Box 11400, Tucson, Ariz. 85734. Phone (602) 746-1111 [397]

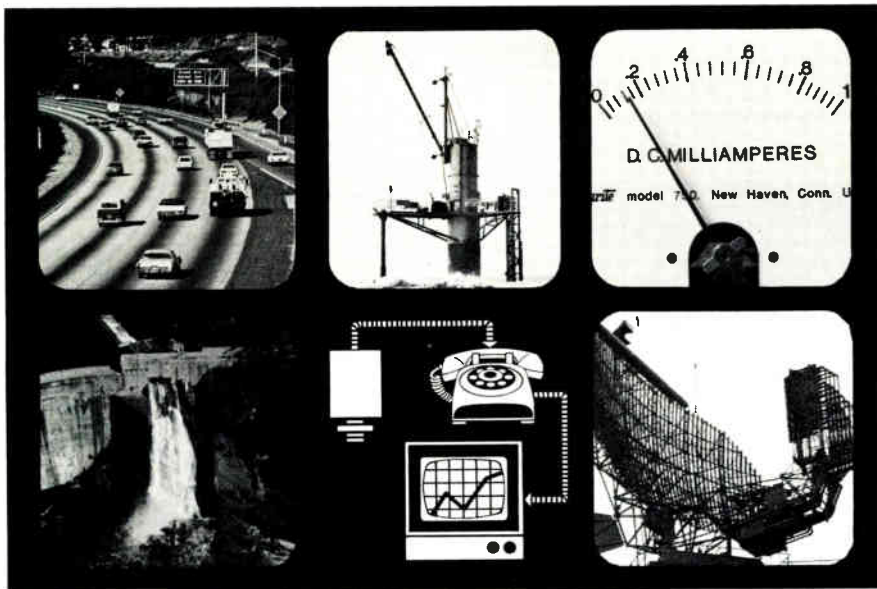

## Visual monitoring of anything, anywhere, by phone, in seconds, with Robot Phonline TV.

Robot's Phonline TV systems provide a low-cost, efficient solution to the problem of visually monitoring remote installations, meters, gauges, traffic, weather, water levels, or any subject, large or small. □ The Phonline TV equipment works well with standard CCTV equipment and converts the broadband video signal from the camera to narrow band audio tones for transmission via the dial telephone network or voice grade radio, then to a video signal again for display on a monitor at the receiving end. The entire process takes as little as 8.5 seconds and costs only the amount of the phone call. □ Since one or more cameras can be fed to one or more monitoring stations for viewing sequentially or simultaneously, and since the system can be fully automated, there is an almost infinite number of PLTV system configurations possible. □ Permanent storage is available by recording the transmissions on audio cassette tapes. □ For fast, uncomplicated, inexpensive visual monitoring of any subject anyplace, Robot Phonline TV is the answer. □ Write or call for more information and descriptive literature.

Robot Research Inc., 7591 Convoy Ct., San Diego, CA 92111 (714) 279-9430. Outside California: 800-854-2057

World Leaders in Phone Line Television and Image Processing Systems.

**ROBOT**  
ROBOT RESEARCH INC

# Everything You'd Expect of a Data Acquisition and Control System.

Probably More.

Our System 620 handles all types of I/O signals—high and low level transducer signals, discrete signals, contact closures, frequency, analog output—and it has many other features that you may not expect. **Remote operation**, for example.

Data acquisition and control processes frequently require a centrally located computer. Installation expenses mount as shielded cables, routed through cable trays or conduit, are stretched between the computer and remote sites.

That's why we included a Serial Controller in our System 620/ Series 500. It controls up to eight System 620s located up to 20,000 feet away and operating at full performance specifications. Two coax cables to each site provide the communication link that allows throughput rates to **50,000 data**

**words per second** and analog input capacity **expandable to 2048 channels at each site**—not limited, as you might expect, to a few channels.

Remote operation is only one feature of the versatile System 620. There are more, including some you may not expect and possibly just the one to solve your measurement or control problem. They're described in our new brochure—yours for the asking—or, for immediate answers, call us today.

**NEFF**  
INSTRUMENT CORPORATION

700 South Myrtle Ave., Monrovia, CA 91016  
(215) 357-2281 TWX 910-585-1833

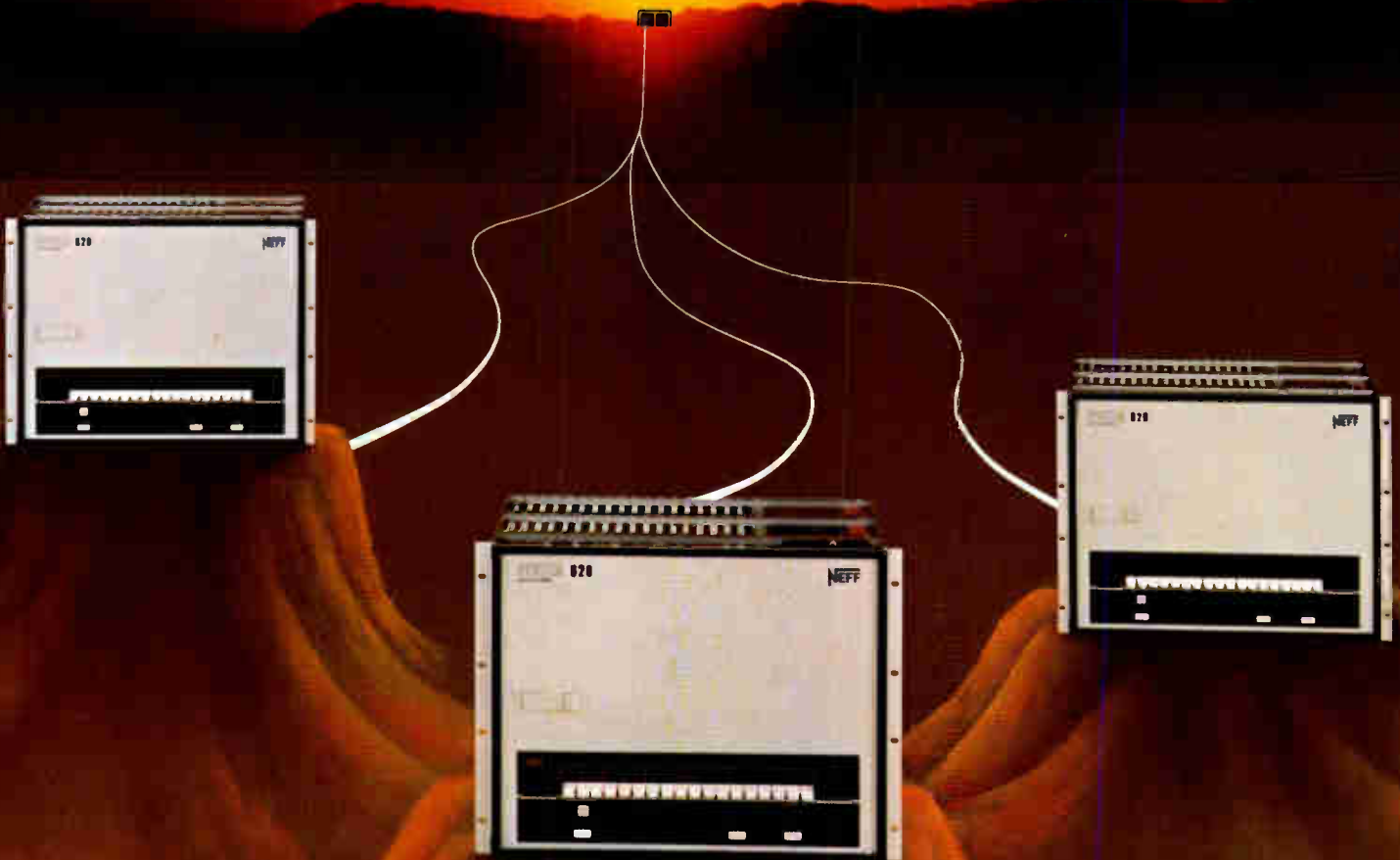

When you see how an Eaton  
you'll know why you'll never

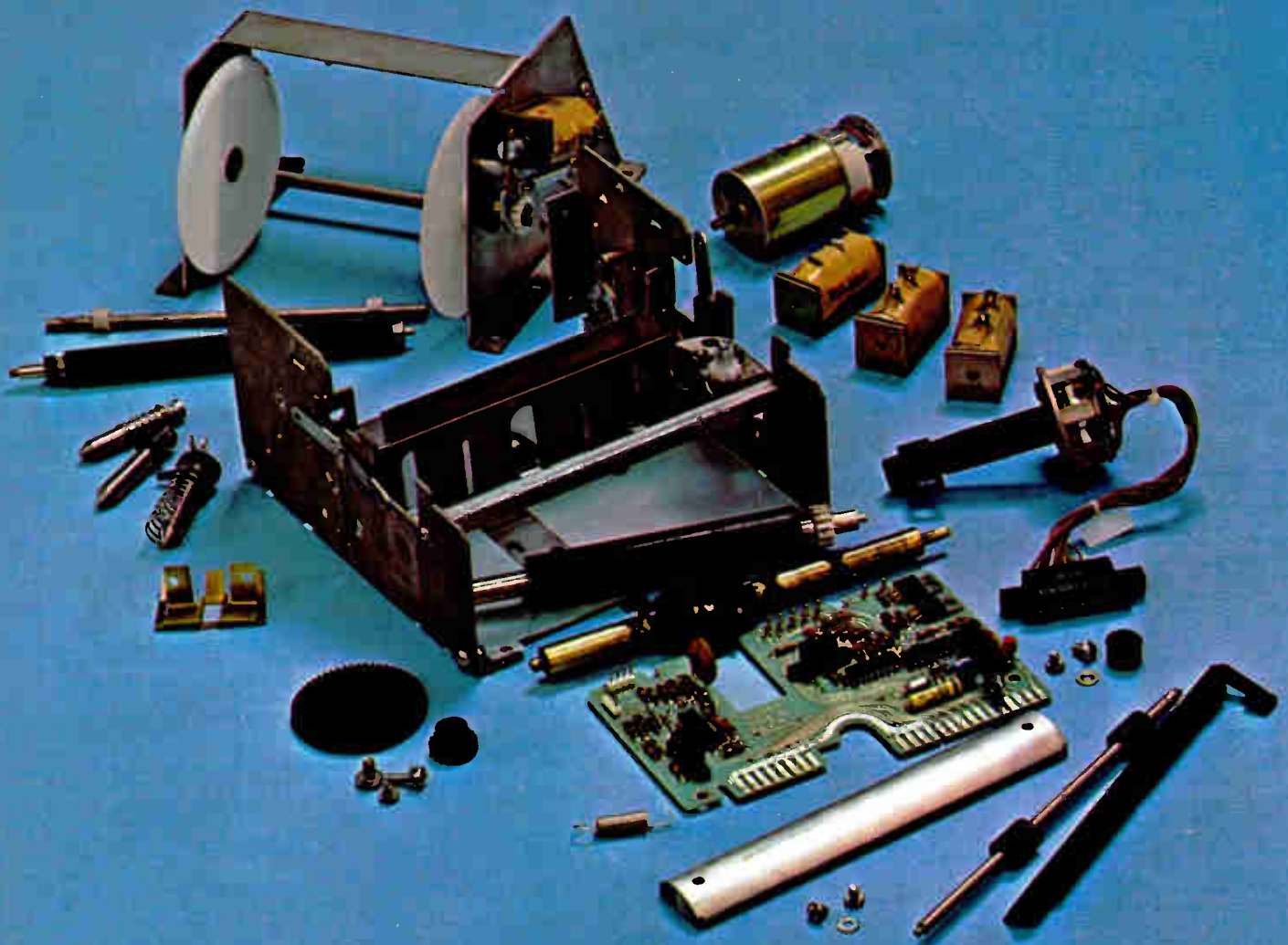

# LRC printer is put together, have to take one apart.

Introducing the new Eaton LRC M-410 high-speed, dot-matrix impact printer for only \$130.\*

At LRC, we worry about reliability when we design our printers, not after we've sold them to you. Take our new M-410 for example. It has fewer moving parts than any comparable printer on the market today. That means not only are there fewer parts to wear out, but also that routine maintenance is dramatically reduced. What little maintenance is required over the life of the printer is greatly simplified since the M-410 may be adjusted, or completely disassembled if necessary, using only the two simple hand tools shown in the illustration.

### All This Reliability Doesn't Come at the Expense of Performance

The M-410 features 3 lines per second bi-directional printing with a line feed of 10 lines per second. It accepts single or multi-ply paper rolls from 3/4 inch to 3-7/8 inches wide, and prints up to a 3-1/3 inch line. Capacity is 40 columns at 12 characters per inch,

and single-line validation is standard. Options available include multi-line validation up to 10 lines, built-in paper roll holder with low paper sensor, and a journal rewind mechanism for a second copy.

### The M-410 Printhead Boasts a Life of 100-Million Characters— Minimum

The M-410 comes equipped with LRC's newest 100-million (minimum) character printhead with a duty cycle of 120 characters per second. Character width and density can be varied, even within the same line, using the appropriate software.

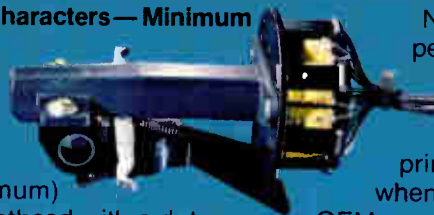

This improved long-life printhead allows the M-410 to print continuously without overheating.

### Simplified Interfacing

Interfacing with the M-410 is greatly simplified because the line feed is completely independent of the drive mechanism, thereby eliminating the need for timing line feed commands to correspond with particular printhead positions. Clock signals are unnecessary for energizing the printhead solenoid because the speed of the printhead is carefully controlled.

### Many Applications

The M-410's reliability, long-life, simplified interfacing and ease of packaging make it a natural for use in small business systems and home computers, as well as point-of-purchase terminals, electronic cash registers, banking terminals, medical instrumentation, data acquisition and test systems.

### The M-410 Is Available for Just \$130

No one can offer you the performance, reliability, and features of LRC's M-410 at anywhere near this low price. M-410 printers are available for \$130 when ordered in minimum OEM quantities of 1000.

### LRC's M-4 Series, a Complete Line of Reliable, High-Performance Printers

LRC's M-4 series of dot-matrix impact printers includes the M-400, a document printer designed to print on single or multiple tickets and forms; and the M-420, a split-paper feed printer that prints on two rolls of paper simultaneously. Both feature the simplified design, high-performance, and low cost of the M-410.

For more information, contact: LRC, an EATON company, River-ton, WY 82501, (307) 856-4821.

Or better yet, call your nearest LRC



### Regional Sales

Office: Northeastern office, One Lakeside Office Park, Wakefield, MA 01880, (617) 245-2730; South-central office, 29 Delmont Drive Northeast, Atlanta, GA 30305, (404) 231-4105; Western office, 1115 East Arques, Sunnyvale, CA 94086, (408) 245-1590.



an **EATON** company

Circle 181 on reader service card

\*1,000-pc qty



**“I need a cost-saving connector I can apply simply, anywhere in the world. And that’s a perfect description of the AMP Metrimate line.”**

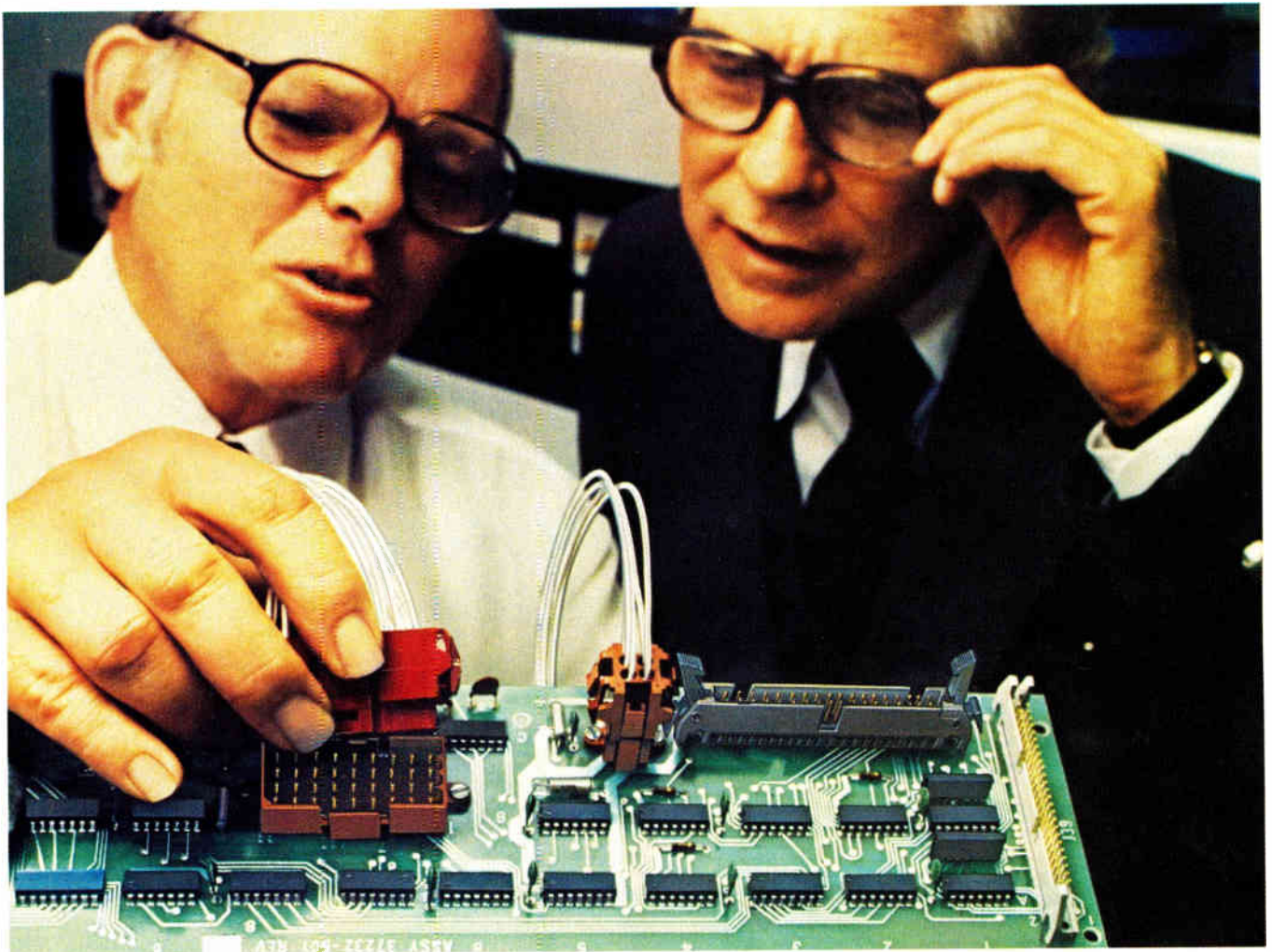

Metrimate is our internationally accepted rack and panel connector. Internationally accepted because no matter what standard of approvals you go by—UL, CSA, or VDE, Metrimate meets or exceeds them all.

Internationally accepted because Metrimate housings and contact spacings are designed to true metric dimensions.

And, because AMP can supply these connectors to you anywhere in the world, along with the technical service and support to back them up.

But the first description—"a cost-saving connector you can apply simply"—really tells the whole story. Because every time you use a Metrimate connector, it saves you money. With

features like low cost thermoplastic housings, shield accessories, strain reliefs, and the elimination of mounting hardware. And the incredible variety of automatic contact application equipment available to you. Now, with the addition of a new commoning power distribution header, Metrimate is cost effective in an even wider variety of applications.

Of course, descriptions only go so far. It's the application that counts. So to find out how you can start saving money with the connectors you can apply anywhere, call or write us for more information.

**AMP has a better way.**

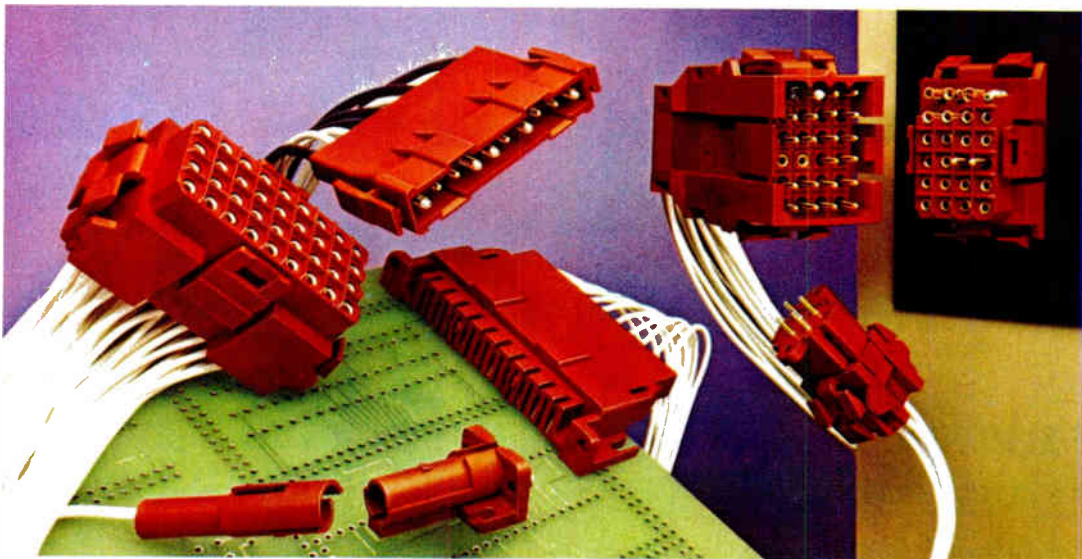

**Some facts worth knowing about AMP Metrimate Connectors**

**Description:** Part of AMP's exclusive Multimate Family that accommodates common contacts in a variety of connector housing styles and saves on both tooling and inventory costs.

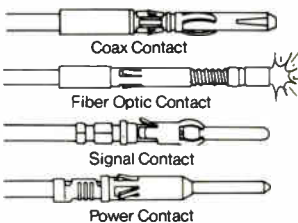

**Voltage rating:** 380 VAC, 450 VDC (VDE), 600 VAC (UL); 250 VAC (CSA).

**Dielectric strength:** 1500 volts rms at sea level.

**Temperature:** -55°C to +105°C.

**Current rating:** Signal and Power Contacts; 13A max. per contact (limited only by connector block working temperature).

**Insulation resistance:** 5000 megohms, min.

**Contact resistance:** 5.5 milliohms, max.

**Durability:** 250 cycles, tin-plated contacts, 550 cycles, gold-plated contacts.

**Where to telephone:** Call the Metrimate Information Desk (717) 780-8400.

**Where to write:** AMP Incorporated, Harrisburg, PA 17105.

AMP is a trademark of AMP Incorporated.

**AMP**

# Catch a dedicated or multiplexed bus...

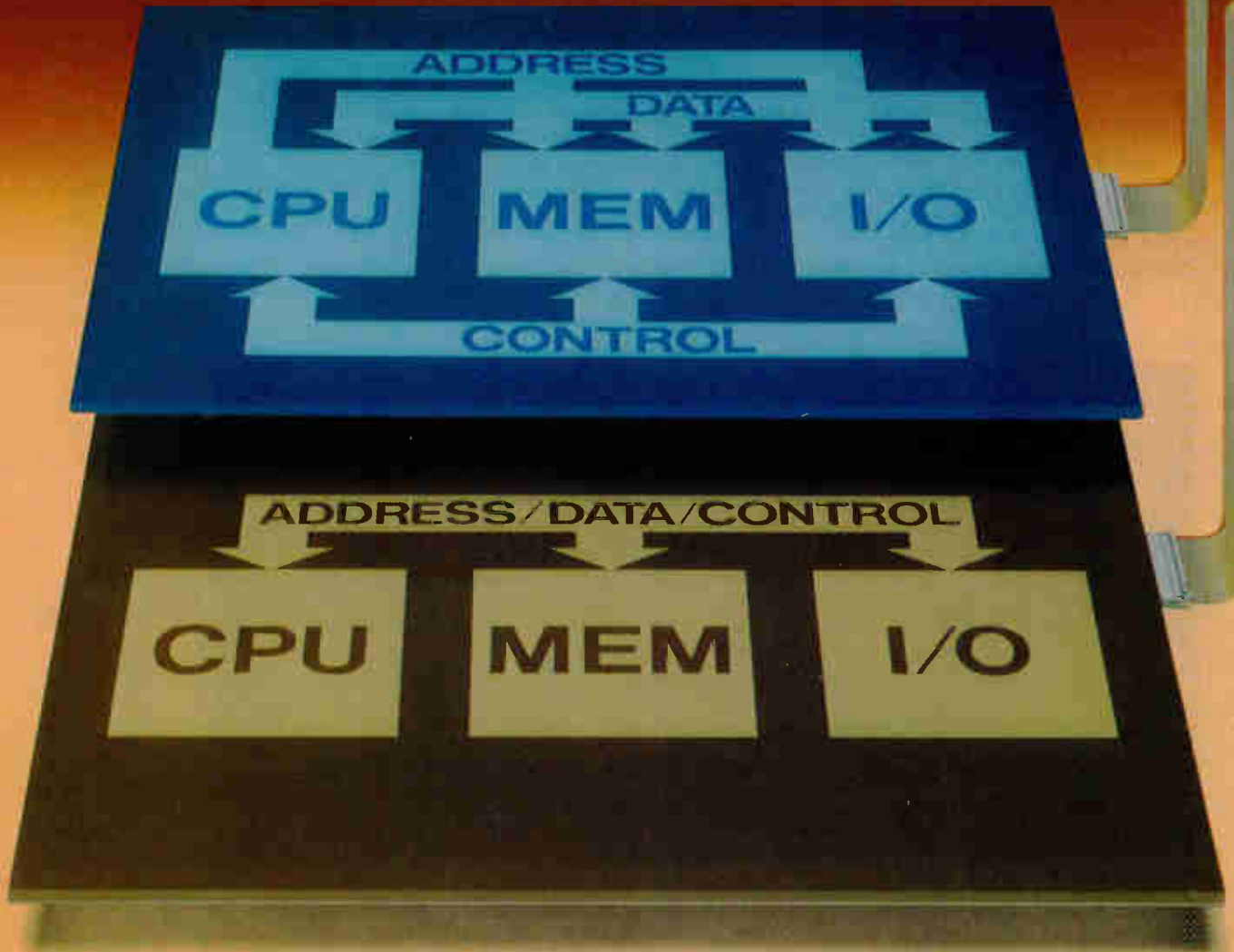

HP—When you depend on logic



# and leave the analyzing to HP's 1610B.



If you're working with mini- or micro-based systems, you'll find that HP's 1610B is a very efficient dedicated-bus logic state analyzer.

But unlike other analyzers, the HP 1610B can also handle multiplexed-bus analysis just as effectively. The reason? Because with multiplexed buses, addresses and data appear at different times on the same lines. And first-generation logic analyzers, with their single-clock design, simply cannot demultiplex these correctly.

One popular solution to this problem has been to build a two-clock sequential acquisition system into a single package. While this approach will separate out address and read/write functions, it is still inferior to the 1610B. Why? Because this is still not true demultiplexing, in that this technique cannot correct for the real-time differential between the capture of address information and the capture of read/write data.

This means address and data information can be interleaved in the display. It requires the operator to interpret read or write functions. And it means that triggering may occur on false address/data combinations. In other words, it complicates analysis and may lead to false conclusions.

In comparison, the HP 1610B incorporates not two — but three clocks — plus a buffered memory to deliver true demultiplexing. In short, the 1610B can independently monitor addresses, plus read and write data, to demultiplex in real time for efficient and accurate analysis.

So with the 1610B, addresses and corresponding data are displayed as a single line of information, for easy comparison with your original programs. And you're sure that if you trigger on an address-data combination, the data is present at that address at that specific point in the program.

#### **Other important capabilities.**

In addition, the HP 1610B delivers other capabilities required for efficient state flow analysis of both bus structures. It will store information on a qualified basis, to permit selective editing. Which means you don't have to sort through unnecessary data. And it makes functional measurements, such as time

interval analysis, on the state flow, which speeds analysis and troubleshooting.

#### **Flexibility for the future.**

Because the 1610B is a 32-bit analyzer with user-selected parameters, and a variety of options, you can use it with both mini and micro based systems, including 8-bit microprocessors such as the Motorola 6800 and the Intel 8085, as well as the newer 16-bit microprocessors such as the Z8000. And, of course, it includes HP's popular menu program format that speeds set-ups and analysis.

#### **An economical solution to microprocessor-based systems analysis.**

Another good answer to the problem of microprocessor demulti-

plexing is the 1611A Logic State Analyzer, with HP's general-purpose module. This module incorporates a seven-clock system that allows multiplexed information on common bus structures to be latched into 1611A inputs at the appropriate time for display. If you're already using an HP 1611A, you'll



find this module to be both an effective and cost-efficient solution.

#### **For complete details.**

The HP 1610B is priced at \$12,500,\* while the 1611A (including the general-purpose module) is \$6,000.\* For more information on these, and for an application note on state analysis of multiplexed microprocessors, write: Hewlett-Packard, 1507 Page Mill Road, Palo Alto, CA 94304. Or call the HP regional office nearest you: East (201) 265-5000, West (213) 970-7500, Midwest (312) 255-9800, South (404) 944-1500, Canada (416) 678-9430.

\*Domestic U.S.A. price only



**HEWLETT  
PACKARD**

# V-MOS power FET sells for \$9.05

In 1,000-piece quantities, 100-W n-channel enhancement-mode devices with 400-V breakdown rating will sell at bipolar prices

by Bruce LeBoss, San Francisco regional bureau manager

Although high-voltage vertical MOS power transistors now in development threaten to eliminate bipolar devices in many applications, the limited availability of such devices has users paying a premium. Now Siliconix Inc., a pioneer in the arena of V-groove MOS power field-effect transistors, has developed two new n-channel enhancement-mode devices whose cost, according to spokesmen at the Santa Clara, Calif., firm, means "the arrival of high-voltage V-MOS power FETs at bipolar prices."

Designated the VN4000A and VN4001A, the new devices have an on-resistance of 1.0 and 1.5  $\Omega$ , respectively, and are rated at 16-A maximum pulse drain current and 400-V breakdown, with a continuous current of 8 A. They are scheduled to be available in production quantities, by the end of this month, both from Siliconix distributors and—for large-

er quantities—directly from factory stock.

The VN4000A and VN4001A, priced at \$9.05 and \$8.60, respectively, in 1,000-piece quantities, "will be almost equivalent in price to the cream of existing bipolar devices," states Gary Hess, marketing and applications manager. What's more, he continues, "they will be an order of magnitude less expensive than prior vertical MOS power devices at introduction."

Such pricing is the result of a combination of improved production capabilities—offshore assembly and captive fabrication, for example—and a new high-density V-MOS process [*Electronics*, Feb. 14, p. 46], as well as marketing strategies, according to Hess. "We have been reluctant to come to the market with an expensive product and chose, instead, to come out with pricing that is comparable to that of existing

bipolar devices with similar characteristics," such as switching speed, safe operating area, and gain, among others, he says.

The new V-MOS power FETs "represent a real breakthrough in switching speed for power transistors," Hess claims. Typical bipolar devices have switching speeds in the 1- $\mu$ s area, although some switch as fast as 330 ns with a resultant loss of gain, he points out. The VN4000A and VN4001A have a maximum switching time of 100 ns with a 50- $\Omega$  driving impedance, but the switching speed is controllable. According to Hess, a 25- $\Omega$  driving impedance "cuts the switching time in half," and those who want to slow the switching need only increase the driving impedance.

Two primary areas of application at which Siliconix is targeting the new V-MOS power FETs are switched-mode power supplies and motor



speed control. "Manufacturers of switched-mode power supplies are sure to take advantage of these devices," Hess says, "since they [the devices] can be driven directly by C-MOS integrated circuits and require no interface stages, as do bipolar transistors." What's more, they require much less protective circuitry because the device, like all other V-MOS parts, does not experience the secondary breakdown mode that bipolars do.

The faster switching speed of the new devices will allow designers of switched-mode power supplies to increase considerably the operating frequency of their units. This increase, from 20 kHz to 200 kHz, for example, "isn't feasible with bipolars," Hess says. It also improves the regulation of switched-mode power supplies to a point where it challenges that of linear power supplies.

The switching speeds of the new V-MOS power FETs also make them good for motor speed-control applications, according to Hess, who points out that "control schemes have been demonstrated with up to 256 steps per cycle, a feat not possible with bipolars." An approximation this close to a sine wave, he says, "is much more efficient" than the usual 6- or 12-step approximation.

Another feature that makes the VN4000A and VN4001A useful in motor speed control is the ability to connect devices in parallel without concern for current sharing, Hess states. "Their positive temperature coefficient of resistance causes the devices to draw less current as they heat up. This, in turn, allows the designer to 'modularize' his design for higher horsepower ratings using the same circuitry," he notes.

Initially available in TO-3 packages, with TO-220 packages slated for mid-1980, the new V-MOS power FETs have an operating and storage temperature range of  $-55^{\circ}\text{C}$  to  $+175^{\circ}\text{C}$ . Maximum power dissipation, at  $25^{\circ}\text{C}$  case temperature, is 100 w.

Siliconix Inc., 2201 Laurelwood Rd., Santa Clara, Calif. 95054. Phone (408) 988-8000 [339]

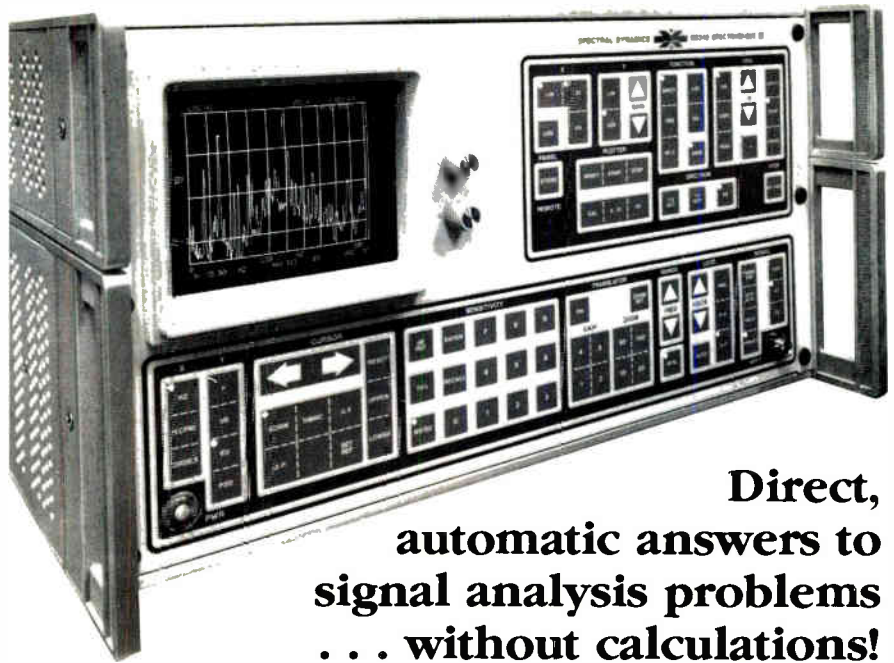

## Direct, automatic answers to signal analysis problems ... without calculations!

Confused by having to convert dB reference numbers to meaningful engineering unit (EU) values you can understand? The SD345 FFT Signal Analyzer does it automatically and displays the correct numbers instantly and directly on an exceptionally clear raster-scan display. Or you can record the answers by photography, digital or analog plotter, or video hard copy.

But getting instant, automatic solutions to your problems is only the first-order reason you should own the SD345. Our new 12-page brochure outlines its many other exclusive capabilities and applications. The SD345 is today's best buy... it's available right now... and we'll be glad to stage a live demonstration in your lab.

Call Leon Corcoran at  
(714) 268-7197 to schedule your demo.

*Actual photo of raster scan display — flicker-free, with full grids, complete annotation and engineering-unit readouts for total answers, understandable and usable at a glance. An incoming time waveform can be displayed simultaneously with a spectrum analysis of that waveform (on a real time or averaged basis) for direct comparison.*

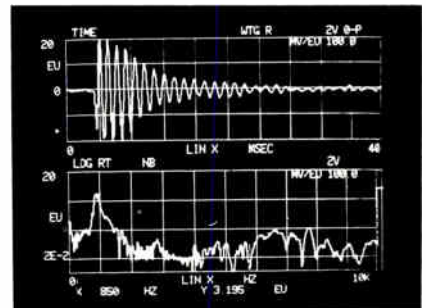

## Spectral Dynamics

Scientific-Atlanta

P.O. Box 671 • San Diego, CA 92112 • (714) 268-7100 • TWX 910-335-2022

Circle 187 on reader service card

## 1979 Electronics Buyers' Guide

The only book of its kind in the field. If you haven't got it, you're not in the market.

**To insure prompt delivery  
enclose your check with  
this coupon.**

Electronic Buyers Guide  
1221 Ave. of the Americas  
New York, N.Y. 10020

Yes, please send me \_\_\_\_\_ copy(ies) of 1979 EBG.  
 I've enclosed \$30 per copy delivered in the USA or Canada.  
 I've enclosed \$52 per copy for delivery elsewhere

Name \_\_\_\_\_  
Company \_\_\_\_\_  
Street \_\_\_\_\_  
City \_\_\_\_\_ State \_\_\_\_\_ Zip \_\_\_\_\_



**We developed the world's broadest line of  
OEM computers to meet a single application.  
Yours.**



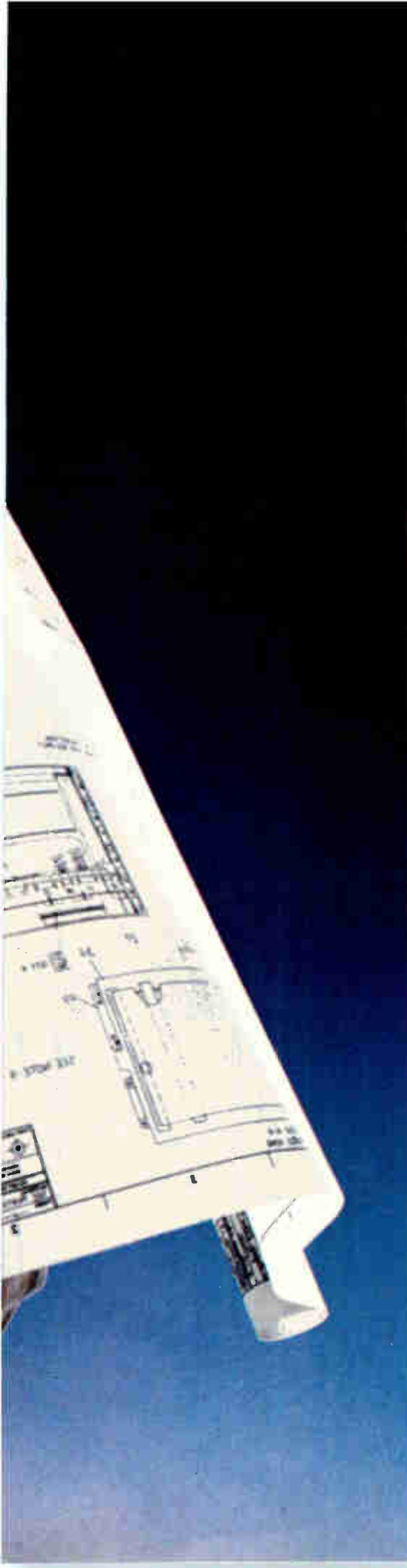

Sometimes, the hardest part about designing a computer-based product can be finding the right computer to go into it.

Too often, you're forced to make compromises.

You either have to buy more performance than you want. Or you settle for less than you need.

But at Digital, we don't think you should have to compromise. That's why we offer you a wider choice of OEM computer equipment than any other company. So you're always sure of finding the one combination of products that won't make you compromise on anything.

For example, we offer CPUs and systems that range from our 16-bit PDP-11 microcomputers all the way up to our 32-bit VAX family of super-minis. A wide choice of operating systems, software options, and sophisticated development tools. Mass storage devices from 512 kilobytes to 176 megabytes. State-of-the-art video and hardcopy terminals. And a set of communications options to tie our hardware and software products together.

In addition, we offer software compatibility across our whole line of products, so you can migrate up or down, and build distributed processing systems, with unequalled ease. Without having to scrap your original software investment.

At Digital, our approach has always been to give OEMs more than just great products. Just as important are the extra quality features, the extra testing that can make your design and marketing job easier. The worldwide service capability that can be tailored exactly to the way you run your business.

You probably already know a lot about Digital performance. To find out the rest, send for our brochure, "The Thinking Behind the Industry's Largest Selling Line of OEM Computers."

**Digital Equipment Corporation**, Technical OEM Group, 129 Parker St., (PK3/M-86), Maynard, MA 01754. (617) 493-5997.

In Europe: 12 av. Des Morgines, 1213 Petit-Lancy/Geneva. Tel. 93 33 11.

In Canada: Digital Equipment of Canada, Ltd.

**We build a lot more than performance into an OEM computer.**

N-2-28-0

**digital**

Circle 189 on reader service card

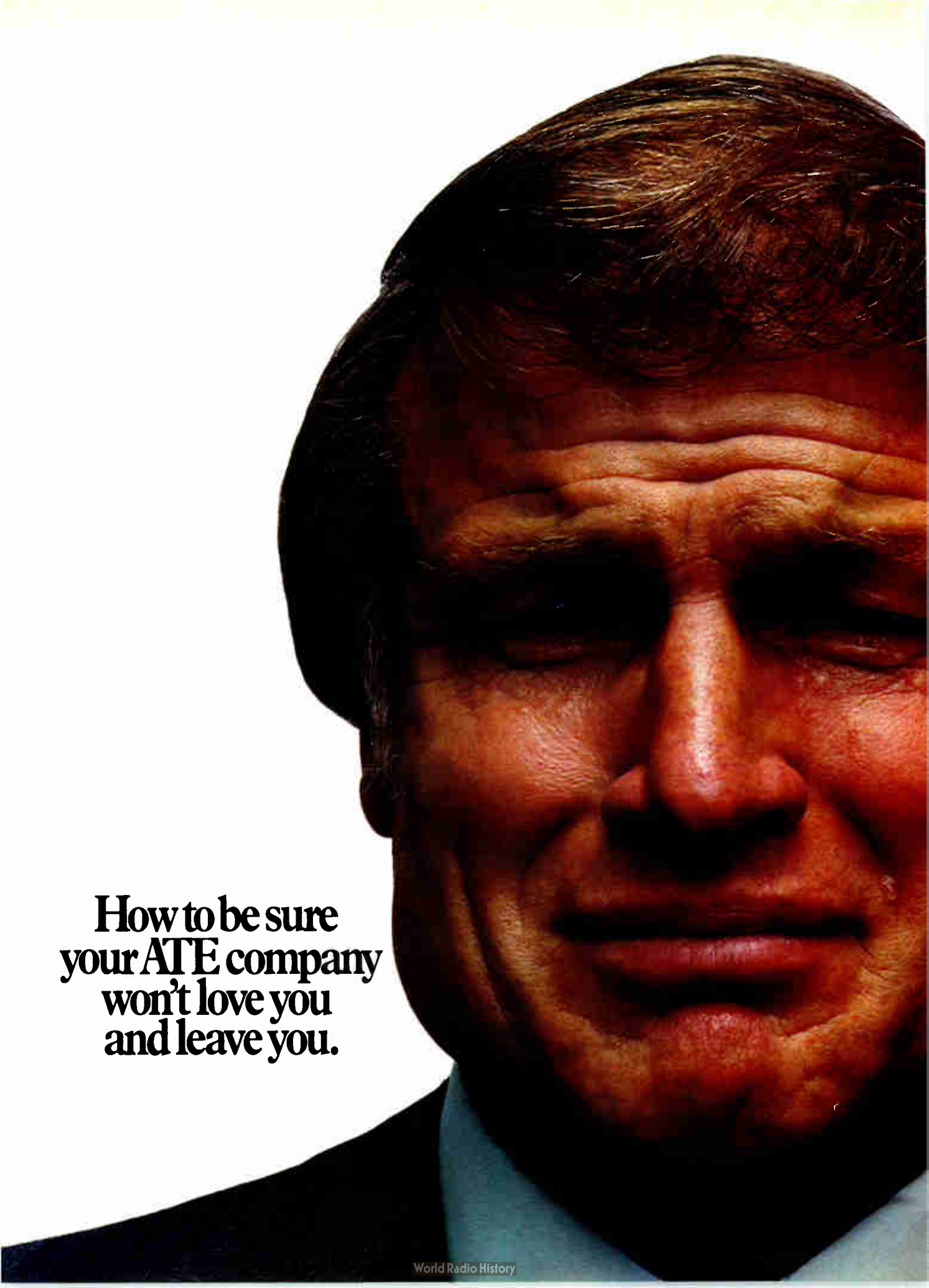

**How to be sure  
your ATE company  
won't love you  
and leave you.**

The last thing you want to do is fall for a sweet-talking ATE company, and find yourself left without any visible means of support.

That won't happen if your ATE company is GenRad. That's because no other company offers you as many different levels of support.

First, you'll meet our Product Specialist. He'll take a close look at your operation and analyze your needs.



GenRad Applications Engineers work closely with your test system engineers to develop the most effective solutions to your testing problems.

Then you'll meet our Applications and Software Engineers. Their job is to fine-tune both hardware and software to your specific application.

And as your needs change, our Software Support Group is always there to help. Generating software device models and application notes, and working with you on debugging and enhancements. Just give them a call whenever you need them.

GenRad also has a lot of other people you can call on. For instance, our Training Specialists will make sure every one of your programmers understands their new system inside and out.

And our Programming Services Group, made up of full-time applications specialists, can off-load your programmers whenever you need help.

If a problem does occur, we can have a Field Service Specialist right there and solving any problem within hours of your call.

We even help you solve problems *before* they develop by putting you in touch with one of our User Groups.



GenRad User Groups meet often to discuss common concerns and share ideas. One user may already have an answer to a testing problem you're working on.

People like you who own and use GenRad equipment. In many cases, you'll be able to benefit from the experience of someone who's had a testing problem similar to yours.

Altogether, GenRad offers you eight different levels of support. No other ATE company even comes close.

That's something to think about before you let an ATE company get close to you.

For details on our complete ATE line—from product development to field testing—write GenRad, Concord, MA 01742.



GenRad's Programming Services Group is always ready to off-load your programmers whenever you need help.



# GenRad

Put our leadership to the test.

# 100% tax exemption for American Business for up to 10 years

**That's just one reason why Sri Lanka is the best place in Asia for you to put up a factory.**

**Another reason: additional concessionary tax breaks for up to 15 years.**

Sri Lanka, formerly Ceylon, is a sunny island 25,000 square miles in size, 21 miles from the southern tip of India. Its Free Trade Zone is an ideal place for a factory.

In an effort to strengthen the economy, the government is offering American manufacturers unprecedented incentives and profit opportunities, including total tax exemptions for up to 10 years.

## Just how does the tax deal work?

The tax holiday is administered by Sri Lanka's Greater Colombo Economic Commission (GCEC).

During the tax holiday period, foreign investors will have no tax on salaries of foreign personnel, no tax on royalties and no tax on shareholders' dividends. The length of the tax holiday will depend on the number of Sri Lankans employed, net foreign exchange earned on your export sales, magnitude of your capital investments, and infusion of new technology. And this period can vary from a minimum of 2 years to a maximum of 10 years.

A further concessionary tax period of up to 15 years will follow the tax holiday. During this period, a tax of only 2%-5% per annum, based on

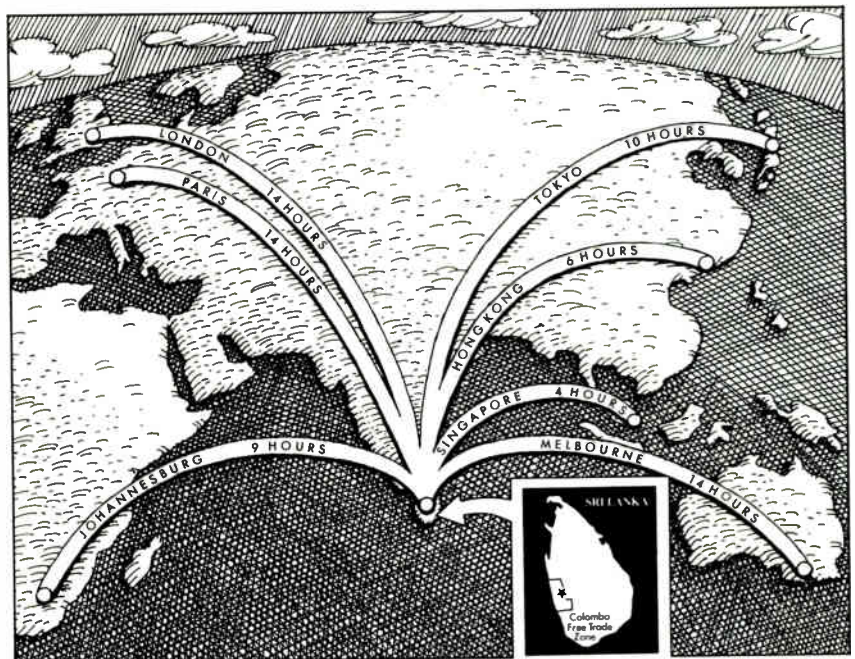

## WHERE IN THE WORLD IS SRI LANKA?

**This pleasant island republic, a member of the British Commonwealth, is just 21 miles from the southern tip of India. Its central Indian Ocean location places it on all major shipping routes. And it's served by 13 major international airlines.**

turnover, will operate in place of income and corporate taxes.

## Is there a qualified labor force?

Sri Lanka's labor reserve numbers over 600,000 people.

They are educated, intelligent and highly trainable. A great many people in Sri Lanka speak English. Many are professionally qualified. The literacy rate is a high 88%. Education in Sri Lanka, including university educa-

tion, is free. And educational training facilities are excellent. Sri Lanka has six universities and two university colleges augmented by an extensive network of professional, technical and vocational institutes.

In addition, the Department of Labor trains electricians, welders, fitters, auto mechanics and machinists. And the National Apprenticeship Board has a training program for school-leavers, teaching them basic manufacturing skills. This board also reim-



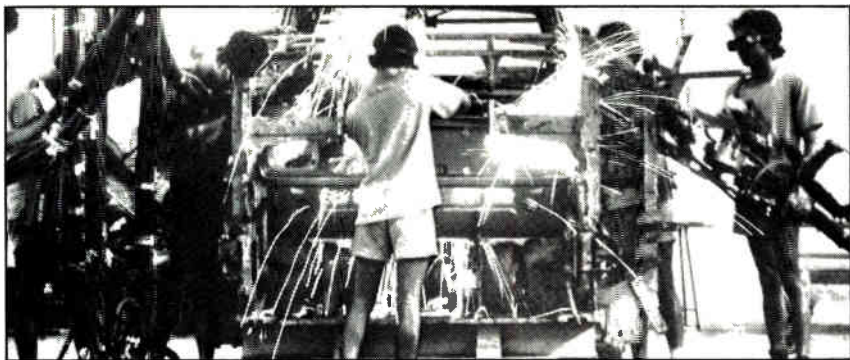

**Sri Lankan workers in an automobile factory. Part of a labor force that totals over 600,000 educated, highly trainable workers with a relative productivity ranked number 2 in Asia.**

burses employers for money paid to employees during in-service training.

### What's the average wage?

By your standards, it's low—\$1 to \$2 per day, depending on whether the labor is unskilled, semi-skilled or skilled. That makes Sri Lanka's labor among the least expensive in Asia. We intend to make a better life for our

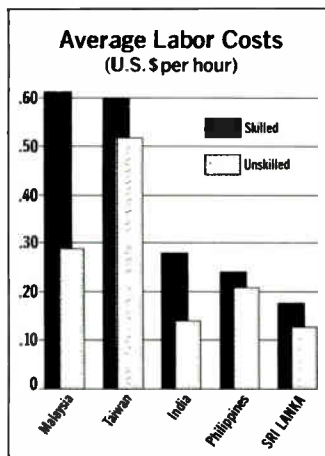

people, which is why we're running this advertisement.

### Do the wages imply low productivity?

Quite the opposite is true. According to a Business Asia study, the Sri Lankan worker ranks second in Asia in terms of relative productivity.

### How would I get my raw materials?

More easily than you might expect. Raw materials are imported free of duty. The Free Trade Zone is located next to Colombo's Katunayake International Airport, which is serviced by many international airlines and cargo carriers.

You will also be just 18 miles from the port of Colombo, which is on all

major shipping routes and has regular callings to all major international shipping centers. The port of Colombo has modern container-handling facilities. What's more, rail and road connections throughout the entire country are excellent.

### Can I use American management personnel?

Yes, especially top management. However, we would hope that you would also train Sri Lankan personnel to fill middle management positions in your company.

### What language is spoken?

In addition to the local languages, English is spoken and understood widely.

### How safe is my investment?

Sri Lanka's democratic form of government consists of an elected president and an elected House of Representatives. In the last election, the present government secured 140 of the 168 seats in Parliament.

As this ad sets out to detail, the government is dedicated to the encour-

agement of foreign investment.

That's why Sri Lanka has a special clause in its constitution which guarantees foreign investment. Sri Lanka has also signed specific investment guarantees with the United States.

### Can I make useful business contacts?

Certainly. There are 91 approved GCEC projects today.

They represent investments from 25 countries around the world, as well as several multinationals established in the last decade.

A wide variety of businesses are represented. Major firms in the building materials, children's clothing, electronics, footwear, gloves, textiles, tea and yacht building industries have established themselves in Sri Lanka.

### How many government agencies will I deal with?

One. The Greater Colombo Economic Commission has been empowered by the government to handle *all* activities connected with investment proposals in the Free Trade Zone and their subsequent implementation. This way you'll be able to take advantage of the maximum benefits that Sri Lanka has to offer you with an absolute minimum of red tape.

### Should I or shouldn't I?

You should. No red tape, no taxes up to 10 years. That is just part of our effort to attract American business. We think it makes Sri Lanka the best place in Asia for *your* business. Only by getting all the facts can you decide if we're right. As a smart businessman, we expect you to fill in the coupon below and do just that.

## SRI LANKA

E228

Greater Colombo Economic Commission  
% UNIDO Investment Promotion Service, 6th Floor  
821 U.N. Plaza, New York, NY 10017

Please send me your free brochure outlining opportunities for building a successful manufacturing facility in Sri Lanka (Ceylon).

NAME \_\_\_\_\_

TITLE \_\_\_\_\_

COMPANY \_\_\_\_\_

COMPANY ADDRESS \_\_\_\_\_

CITY \_\_\_\_\_ STATE \_\_\_\_\_ ZIP \_\_\_\_\_

TYPE OF BUSINESS \_\_\_\_\_

BUSINESS PHONE \_\_\_\_\_

*The foremost solution  
to monolithic capacitor performance with disc economy...*

# Ultra-Kap<sup>®</sup> Ceramic Disc Capacitors

*from*

## CENTRALAB

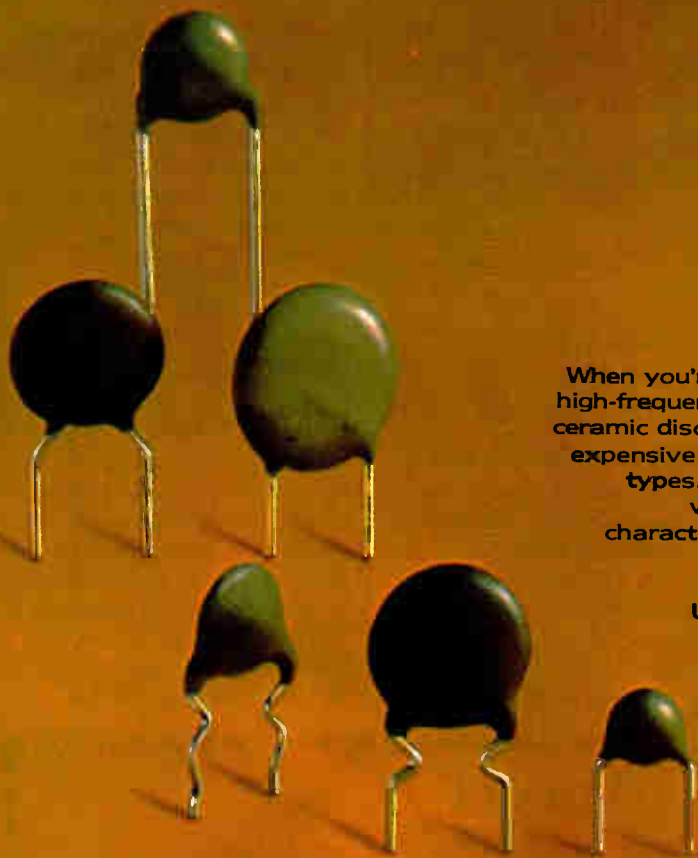

When you're selecting capacitors for low-voltage, high-frequency applications, Centralab's Ultra-Kap ceramic disc is the economical alternative to more expensive film, tantalum and multi-layer ceramic types. Look at the specs and you'll find that when you can't afford the performance characteristics of an X7R monolithic, but your circuit demands better stability than a hi-K dielectric ceramic disc, the Ultra-Kap is the answer. It will provide the stability and ceramic reliability you need at a reasonable price.

With Ultra-Kap, you get a non-polarized, temperature-stable capacitor with excellent high frequency characteristics and a small package size. You get the kind of ceramic reliability that's been proven in many types of severe environmental and other demanding applications.

They're available in a wide variety of lead configurations and are offered with your choice of tape and reel packaging for automatic insertion.

Discover the foremost source for your ceramic capacitor requirements. Call your Centralab Representative or write Centralab Electronics, Division Globe-Union Inc., 5757 North Green Bay Avenue, P.O. Box 591, Milwaukee, Wisconsin 53201.

# CENTRALAB REPRESENTATIVES

- L** Huntsville  
CARTWRIGHT & BEAN  
☎ (205) 533-3509
- Z** Phoenix  
CLEMICK-NEENAN  
☎ (602) 279-7649
- A** Palo Alto  
BROOKS TECH. GROUP  
☎ (415) 328-3232  
San Diego  
CLEMICK-NEENAN  
☎ (714) 268-8540  
Sherman Oaks  
CLEMICK-NEENAN  
☎ (213) 990-3150  
Tustin  
CLEMICK-NEENAN  
☎ (714) 547-0966
- O** Denver  
ELECTRO-REP. INC.  
☎ (303) 744-2821
- T** Meriden  
CENTRALAB  
☎ (203) 235-0766
- L** Ft. Lauderdale  
CARTWRIGHT & BEAN  
☎ (305) 735-4900  
Orlando  
CARTWRIGHT & BEAN  
☎ (305) 422-4531
- A** Atlanta  
CARTWRIGHT & BEAN  
☎ (404) 255-5262
- I** Honolulu  
DOUGHERTY ENT.  
☎ (808) 847-4144
- I** Cedar Rapids  
JERRY VRBIK CO.  
☎ (319) 366-8733
- S** Des Plaines  
CENTRALAB  
☎ (312) 827-4487
- I** Indianapolis  
LES M. DEVOE CO.  
☎ (317) 842-3245
- S** Shawnee Mission  
LOWELL-KANGAS  
☎ (913) 631-3515
- A** Metairie  
CARTWRIGHT & BEAN  
☎ (504) 835-6220
- IA** Needham  
CENTRALAB  
☎ (617) 444-4781
- ID** Columbia  
BRESSON ASSOC.  
☎ (215) 664-6460
- II** Lathrup Village  
CENTRALAB  
☎ (313) 559-9095  
St. Joseph  
CENTRALAB  
☎ (616) 983-0233
- IN** Minneapolis  
CENTRALAB  
☎ (612) 831-5212
- IO** St. Louis  
LOWELL-KANGAS  
☎ (314) 821-4050
- IS** Jackson  
CARTWRIGHT & BEAN  
☎ (601) 981-1368
- NY** Albany  
REAGAN/COMPAR  
☎ (518) 489-7408  
Endwell  
REAGAN/COMPAR  
☎ (607) 723-8743  
Fairport  
REAGAN/COMPAR  
☎ (716) 271-2230  
Great Neck  
CENTRALAB  
☎ (516) 466-6570  
New Hartford  
REAGAN/COMPAR  
☎ (315) 732-3775
- NC** Charlotte  
CARTWRIGHT & BEAN  
☎ (704) 377-5673  
Raleigh  
CARTWRIGHT & BEAN  
☎ (919) 781-6560
- OH** Brecksville  
CENTRALAB  
☎ (216) 526-1205  
Worthington  
CENTRALAB  
☎ (614) 888-2150
- OR** Beaverton  
CENTRALAB  
☎ (503) 643-5516
- PA** Narberth  
BRESSON ASSOC.  
☎ (215) 664-6460
- TN** Knoxville  
CARTWRIGHT & BEAN  
☎ (615) 693-7450  
Memphis  
CARTWRIGHT & BEAN  
☎ (901) 276-4442
- TX** Austin  
CENTRALAB  
☎ (512) 454-9529  
El Paso  
CENTRALAB  
☎ (915) 779-3961  
Farmers Branch  
CENTRALAB  
☎ (214) 243-8791
- VA** Lynchburg  
BRESSON ASSOC.  
☎ (215) 664-6460
- WA** Bellevue  
CENTRALAB  
☎ (206) 454-7754
- WI** Milwaukee  
CENTRALAB  
☎ (414) 278-2122
- PUERTO RICO**  
Hato-Rey  
M. ANDERSON CO.  
☎ (809) 751-2026
- CANADA**  
B.C. North Vancouver  
ARWIN TECH SALES  
☎ (604) 980-4346
- ONT** Ajax  
McHUGH ELEC.  
☎ (416) 683-1540
- QUE** Ste. Oorothee Laval  
HARNETT ENT.  
☎ (514) 689-4184

## New products

Communications

# Chip assigns time slots

Designed to work with  
codecs, C-MOS circuit  
helps keep parts counts low

With its eye on the market for central-office and private-branch-exchange digital switching, Motorola is adding a new circuit to its bag of complementary-MOS telecommunication devices. The MC14418, which will be available in sample quantities this month, is a programmable time-slot assigner circuit (TSAC) that incorporates a variety of features aimed at reducing per-channel component counts and simplifying hardware design.

Like Motorola's C-MOS codecs and filters, the 14418 TSAC is potentially a high-volume part, since one TSAC is required for each subscriber channel. To be fabricated using Motorola's standard metal-gate C-MOS process, the 14418 is among the devices covered by a recently announced agreement [*Electronics*, Jan. 3, 1980, p. 50] under which RCA Corp.'s Solid State division will second-source Motorola telecommunication parts.

**Supervisor.** The TSAC's basic function is to supervise the multiplexing of digitized voice signals onto a digital bus. In the Motorola scheme, one time-slot assigner is associated with each codec. Based on a time-slot assignment generated by a call-processing microcomputer that controls a bank of channels, the 14418 pulses its codec to tell it when to transmit or receive data.

The time-slot assignment function may be implemented using currently available digital multiplexing circuitry; in fact, at least one manufacturer has integrated the TSA function onto a codec chip. However, Motorola says that by supplying a separate microprocessor-programmable TSAC device, it can provide additional

features that will greatly simplify digital switch design while lowering costs and component counts, and, hence, increasing reliability.

**Easy addressing.** The 14418 is housed in a 22-pin dual in-line package with a pinout that allows it to be inserted into a bus backplane with a separate hardwired address for each of the 32 TSACs in the bank. This makes it very easy for the channel-bank controller to specify which channel is being addressed, says Bob Karasch, Motorola product manager for standard telecommunication devices, in Austin, Texas.

Unlike competing approaches, which usually require individual control lines for each TSAC, the Motorola approach has the controlling microprocessor send out address information with each transmission of a time-slot assignment. The time-slot data is then accepted only by the TSAC whose hardwired identity matches the address.

The 14418 is equipped with a serial port for interfacing with the controller. Time-slot assignment and address data are transmitted as 8-bit words. Since only 5 bits are required for the address, 3 are left for other functions. In typical applications, Karasch says, the user will choose to use these bits for power-down control, tone and data control, and ring enabling, thereby reducing the required amount of external circuitry.

The 14418 TSAC is intended for use at rates between 1.536 and 2.56 MHz. When active, it needs a maximum of 60 mW; when powered down, it pulls only about 1 mW. Packaged in a standard ceramic DIP, the MC14418 sells for \$8.80 each in quantities of 100 or more pieces. For the same volume, a plastic-packaged version goes for \$7.50. Both versions will be available in production quantities in April.

The MC14416, to be offered concurrently with the 14418, is a 16-pin version of the part that provides the basic time-slot assignment function but that does not incorporate the hard-wired address capability nor the associated control options. In lots of 100 and up, it will sell for \$6.40 each in a cerdip and

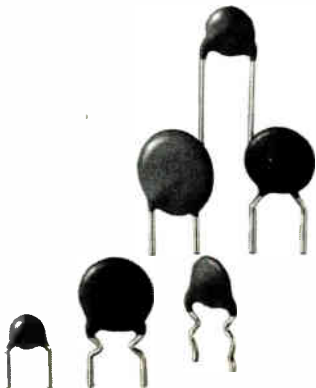

# Fail-Proof Miniature BITE Indicators

BUILT-IN TEST  
EQUIPMENT

- Complete selection from one source!
- Mil-spec or commercial quality
- Ball or Flag Indicators and Annunciators
- Magnetic Latching, Self-Restoring and Manual-Reset models
- Micro-miniature sizes
- Positive indication
- Excellent visibility
- Fast reliable response
- Negligible power drain
- Standard voltages 1.5, 3, 6, 12, 24, 28 VDC
- Off-shelf delivery
- Write or phone for catalog



**Sudden  
Service  
on Small  
Quantities!**

## PROTOTYPES

available on phone or letterhead request

**MINELCO** **Talley**  
Industries

135 South Main Street  
Thomaston, Conn. 06787 203-283-8261

## New products

for \$5.75 apiece in a plastic package. Motorola Inc., 3501 Ed Bluestein Blvd., Austin, Texas 78721 [401]

### Flexible satellite receivers

sell for under \$3,200

Two satellite receivers offering increased flexibility for configuring cable TV networks are priced under \$3,200. The receivers have built-in threshold extension, yielding pictures with a carrier-to-noise ratio of 7 dB. A 4.5-MHz subcarrier composite that consists of video plus program audio signals is suited for direct feeding into microwave transmitters such as the MA-12X or 12G.

The model VR-4X has 24-channel frequency agility via a frequency-calibrated selector switch on the front panel. Automatic frequency controls lock the receiver to the signal of the selected channel. The unit also has a remote control plug on the back panel. It sells for \$3,150.

The VR-3X is designed for assigned-frequency operation, but can be tuned with a screwdriver through a tuning aperture in the front panel. It is priced at \$2,150.

Options available at extra cost include as many as four audio demodulators and a built-in cable modulator for direct feeding into a cable system.

Microwave Associates Communications Co., 63 Third Ave., Burlington, Mass. 01803. Phone J. Brown at (617) 272-3000 [404]

### 54-channel set-top terminal is microprocessor-based

The series 6700 set-top terminal is a microprocessor-based 54-channel converter for cable television systems. The device may be modularly upgraded. The basic converter, which sells for \$59, has a digital, touch-sensitive keypad and 10-channel programmability.

The terminal uses a programmable read-only memory to authorize selection of any combination of up to 40 channels. Changing the

PROMs inserted in the terminal changes the channel authorization. The basic 6700, with a PROM programmed to convert only a set of specified channels, sells for \$67. With the addition of scrambling at the head end and unscrambling in the terminal for channels 15 through 54, it is priced at \$80. A two-step security measure requires that the terminal equipped with the appropriate circuitry unscramble the signal and that the PROM authorize the channel selected. Only then can the terminal generate a clear picture on a customer's television set.

Terminal addressability from the head end allows changes in channel authorization to be made without a service visit by simply transmitting a signal down the cable. With this additional feature, the terminal sells for \$110. All prices are for 5,000 units or more. Deliveries will start by August.

Scientific-Atlanta Inc., 3845 Pleasantdale Rd., Atlanta, Ga. 30340. Phone John Messerschmitt at (404) 449-2000 [403]

### Portable test set stores, recalls 4,096 characters

The Hawk 4010 Datatrap is a portable, diagnostic data-communications test set. A cathode-ray tube displays data traffic and menu pages. The microprocessor-based unit simultaneously displays both transmitted and received data. It can be programmed to trap, store, and recall 4,096 characters.

The Hawk 4010 operates with synchronous data rates of up to 19,200 b/s in both half- and full-duplex modes. Sixteen internally generated clock speeds ranging from 50 to 19,200 b/s provide asynchronous operation. Data characters can contain 5, 6, 7, or 8 bits, with one or two sync characters, plus parity. Compatible with virtually any data-communications system, the unit is priced at \$7,500. Delivery takes 60 days.

International Data Sciences Inc., 7 Wellington Rd., Lincoln, R. I. 02865. Phone (401) 333-6200 [407]

# MORE POWER TO YOU.



## THE IT200™ TEST SYSTEM FROM MCT.

Power. Capability. Accuracy. That's what you'll get from the MCT IT200™ digital IC test system. In fact, the IT200 has the power to test more kinds of ICs more accurately than any other "bench-top" tester.

If you test a variety of IC types...TTL, CMOS, ECL, and others...the IT200 is right for you. 48-pin testing capability plus total programming flexibility allows the IT200 to keep pace with your growth.

The IT200 has the accuracy you need for complete testing and thorough failure analysis. That translates to fewer component failures and higher quality levels

in your end product.

When you specify the MCT IT200 you can be assured you're specifying equipment that's been proven by performance over many years. And you can be assured of the most comprehensive support in the industry.

Before you specify any other IC test system, you owe it to yourself to find out more about the IT200. Write MCT or call us collect at (612) 482-5170.

We'll send a brochure that'll show you how to get more testing capability for your money.

# MCT

Micro Component Technology, Inc.

P.O. Box 43013, St. Paul, Minn. 55164

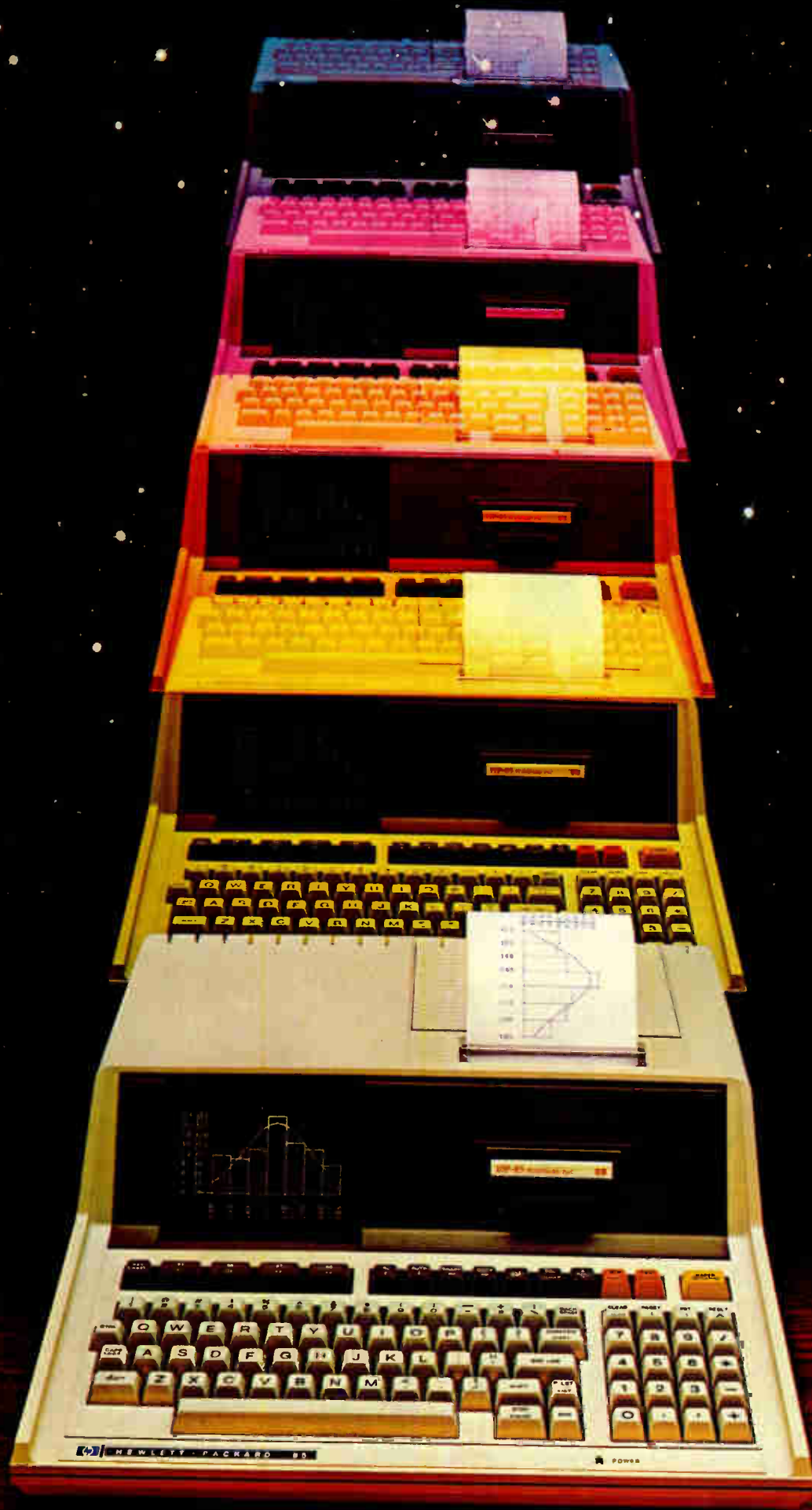

# INTRODUCING HP-85.

## A NEW WORLD OF PERSONAL-PROFESSIONAL COMPUTATION.

Imagine the new world that would unfold before you if you had a powerful, portable, completely integrated computer system at your personal disposal. And at an affordable price. That's exactly what Hewlett-Packard has just created.

### THE HP-85: A PERSONAL COMPUTER FOR PROFESSIONALS.

At the lab, on your desk or in your study this 20-pound, self-contained system provides professional computing power when and where you need it. That means no more waiting for data to be remotely processed and returned.

### A COMPLETE COMPUTER SYSTEM IN ONE SMALL PACKAGE.

You get all this in the HP-85: Interactive graphics under keyboard control.

**16K RAM Memory** standard. Standard typewriter keyboard with separate numeric key pad and eight user-definable special function keys. **High resolution CRT display** with powerful editing capability. **Built-in thermal printer** produces a hard copy of the display on command.

**Built-in tape cartridge drive.** Each cartridge provides 217K bytes of storage capacity.

**Operating system and BASIC language,** permanently stored in ROM. **A SOPHISTICATED COMPUTER AT YOUR FINGERTIPS.**

Hewlett-Packard has combined these sophisticated capabilities with advanced design to give you a system that is easy to use yet uncompromised in its power.

A key to this achievement is Hewlett-Packard's choice of BASIC

for the HP-85's language. BASIC is easy to learn and lets you solve complex problems in an English-like, conversational style.

Sixteen graphic commands have been added to the HP-85's extended BASIC to give you easy control of its amazingly versatile graphic capabilities. You can draw graphs, label axes, set the scale of the X and Y axes independently, plot data and control the graphics display either from the keyboard or in programs.

Other advanced capabilities include software security, flexible string commands, an internal clock, programmable beeps—more than 150 commands and statements to give you the power you need to solve your problems swiftly and easily.

### DESIGNED FOR TODAY AND TOMORROW.

Whether you're in science, engineering, industry or business, the HP-85 you need today can easily be expanded or customized to meet your needs tomorrow.

You can double RAM capacity to 32K or expand ROM firmware to 80K with optional modules that plug right into the HP-85.

It's easy to enhance the system's capability by adding powerful HP peripherals like a high-speed, full-width line printer, full-size plotter, or flexible disc drives.

You can also streamline your problem solving with HP Application Pacs which offer preprogrammed solutions in a wide variety of disciplines on prerecorded magnetic tape cartridges.

The HP-85's versatility, expandability and sophisticated simplicity all grew out of Hewlett-Packard's underlying principle of excellence

by design. Excellence by design means rigorous quality control and testing as well as a worldwide maintenance support network.

When you buy the HP-85, you're not just buying a computer system, you're buying the confidence that the Hewlett-Packard name brings and the knowledge that the HP-85 can expand with your changing needs.

For the address of your nearest HP dealer, CALL TOLL-FREE 800-648-4711 except from Alaska or Hawaii. In Nevada, 800-992-5710. For details on the HP-85, send the attached coupon, or write: Hewlett-Packard, 1000 N.E. Circle Blvd., Corvallis, OR 97330, Dept. 214B.



619/20

HEWLETT-PACKARD  
Dept. 214B  
1000 N.E. Circle Blvd.  
Corvallis, OR 97330

Please send details on HP-85.

NAME \_\_\_\_\_

TITLE \_\_\_\_\_

COMPANY \_\_\_\_\_

ADDRESS \_\_\_\_\_

CITY \_\_\_\_\_

STATE \_\_\_\_\_ ZIP \_\_\_\_\_

Circle 199 on reader service card

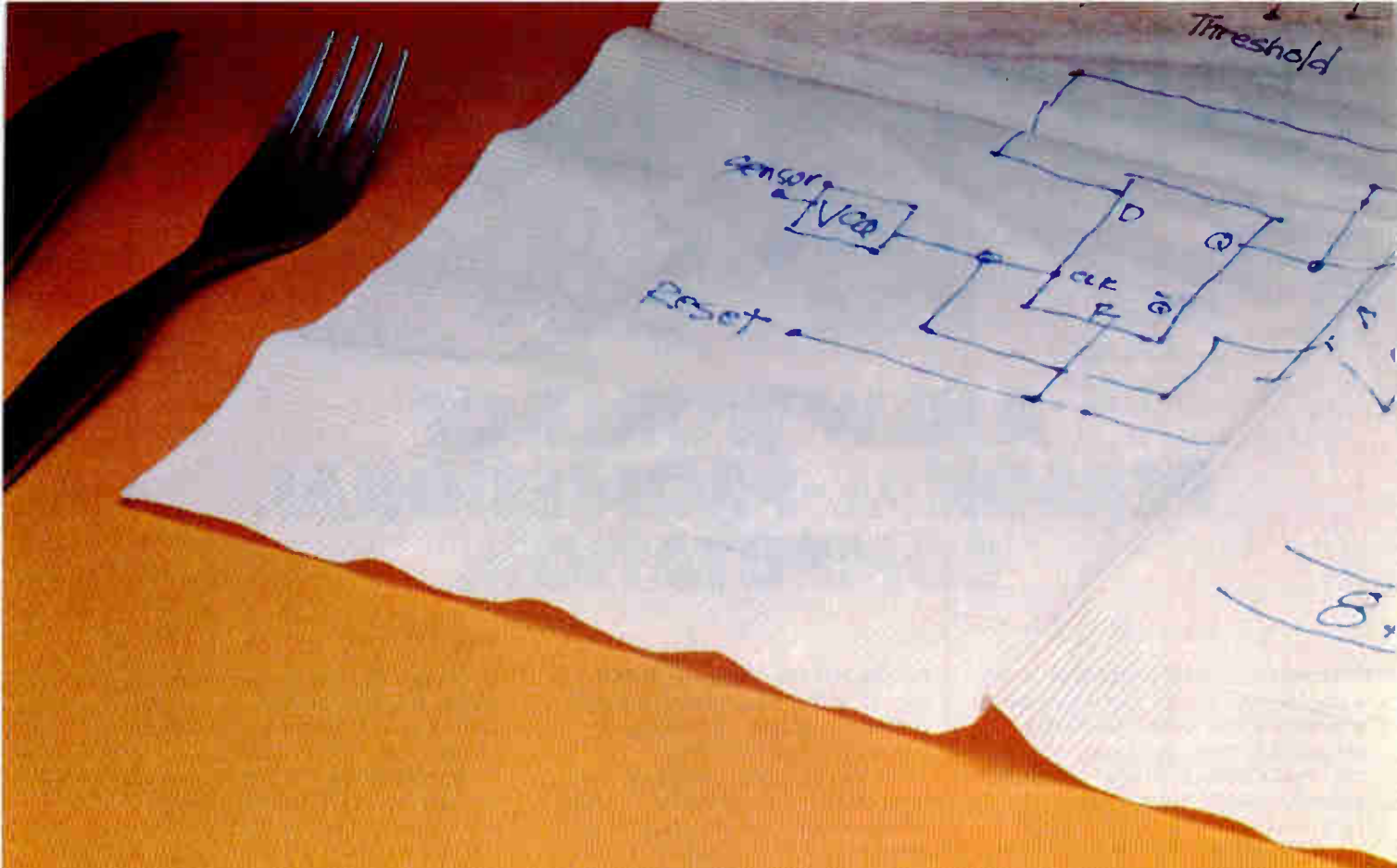

# In a few short weeks Exar can into an I<sup>2</sup>L custom

**S**emi-custom—a fast, easy, reliable and inexpensive way to transform your digital or combined linear/digital designs into reality.

Exar's standardized semi-custom digital circuits combine high density I<sup>2</sup>L logic arrays and bipolar transistors on the same partially fabricated chip. You interconnect the gates and bipolar I/O interfaces. The end result: a customized digital circuit produced at a fraction of the cost of a full custom circuit, and in far less time.

These semi-custom I<sup>2</sup>L circuits perform exactly

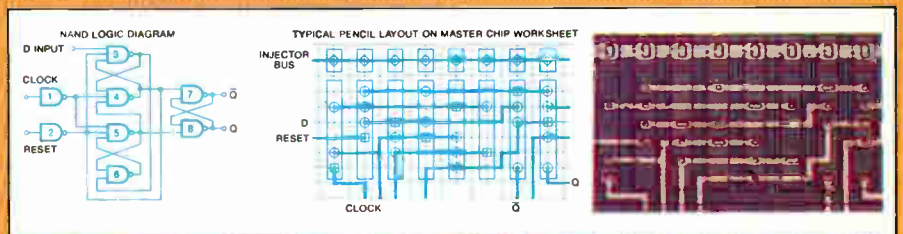

**Easy 3-stage design.** Logic diagram to worksheet layout to finished chip.

the same as bipolar LSI chips. Plus, I<sup>2</sup>L technology gives you high functional density and easy interconnection. Bipolar compatibility lets you interface with existing TTL and MOS logic families or retrofit into existing systems. A computer-generated three mask customizing technique eliminates mask

errors. And it packs more circuitry onto each chip.

Exar's alternative source agreements with other IC manufacturers let you specify and order custom circuits with confidence.

**Go to full custom later.**

As your product matures and your need for



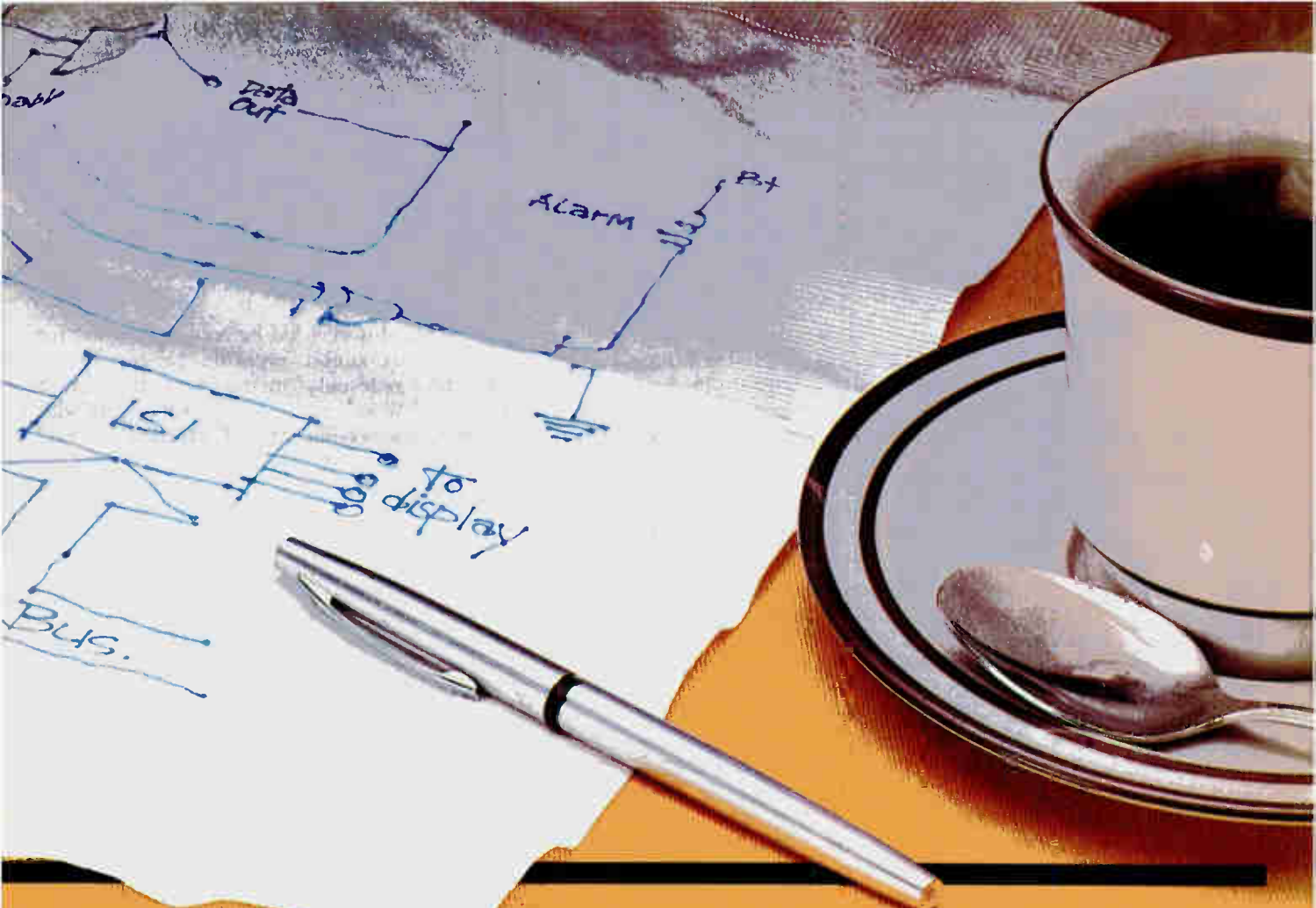

# transform your inspirations digital circuit.

circuits increases, Exar can convert your semi-custom chip to a full-custom IC, reducing chip size, saving money, and often providing added performance benefits.

## Design kits make it easy to get started.

Exar's digital kits include circuit components

for breadboarding, comprehensive design manual and layout worksheets corresponding to Exar's master chips.

## Exar also has six bipolar semi-custom linear chips.

All provide a wide variety of NPN and PNP transistors, Schottky diodes, various resistors and ample bonding pads. These chips are direct replacements for other master chips.

CHIP TYPE	I <sup>2</sup> L GATES	SCHOTTKY BIPOLAR I/O INTERFACES	AVAILABLE BONDING PADS	LINEAR COMPONENTS
XR-200	192	24	30	NO
XR-300	288	28	34	NO
XR-400	256	18	40	YES
XR-500	520	40	42	NO

Choose from four chips.



## Learn the economics and advantages of semi-custom.

For a copy of our 40-page data book, "Semi-Custom IC Design Programs," and our product guide, write on company letterhead to Exar, 750 Palomar Ave., Sunnyvale, CA 94086 or phone (408) 732-7970.



## New products

Semiconductors

# Unit multiplies in 45 ns

TTL chip accepts 8-bit inputs and provides a 16-bit double-precision product

Just as the makers of video signal-processing equipment are forever searching for faster subsystem components, so TRW LSI Products seems always to be producing such devices. The company's latest high-speed monolithic component is an unsigned-magnitude multiplier that takes two 8-bit inputs and provides a 16-bit double-precision product as its output. Typically, at 25°C, the multiplication takes only 45 ns.

Actually, two versions of the multiplier are being offered: the MPY-8HUIJ and the MPY-8HUIJ-1. Both have a typical multiply time of 45 ns at 25°C, but the MPY-8HUIJ-1 is also guaranteed to have a maximum multiply time of 65 ns across its operating range of 0° to 70°C.

To help the designer translate the high speed of the multiplier into high system speed, the multipliers have

on-chip input and output registers that both reduce system overhead and simplify interfacing with 8-bit microprocessors. The combined speed and flexibility of the new devices makes them well suited for digital filtering as well as video signal processing and other applications in which operation in unsigned-magnitude notation is an advantage.

Like other TTL circuits, the multipliers require only a single 5-v power supply. Typically, at 25°C, they draw 240 mA.

As may be seen in the diagram, the product generated by the asynchronous multiplier array is stored in two 8-bit registers—one for the least significant product (LSP) and another for the most significant product (MSP). A single product-output clock and two separate three-state controls for the MSP and LSP make interfacing with 8-bit microprocessor systems particularly easy. An additional advantage of this architecture is that it allows several multipliers to be combined in a pipelined system.

In quantities of 100 or more units, the MPY-8HUIJ sells for \$48. The MPY-8HUIJ-1 goes for \$56 in similar quantities. The units are available off the shelf.

TRW LSI Products, 2525 E. El Segundo Blvd., El Segundo, Calif. 90245. Phone (213) 535-1831 [411]

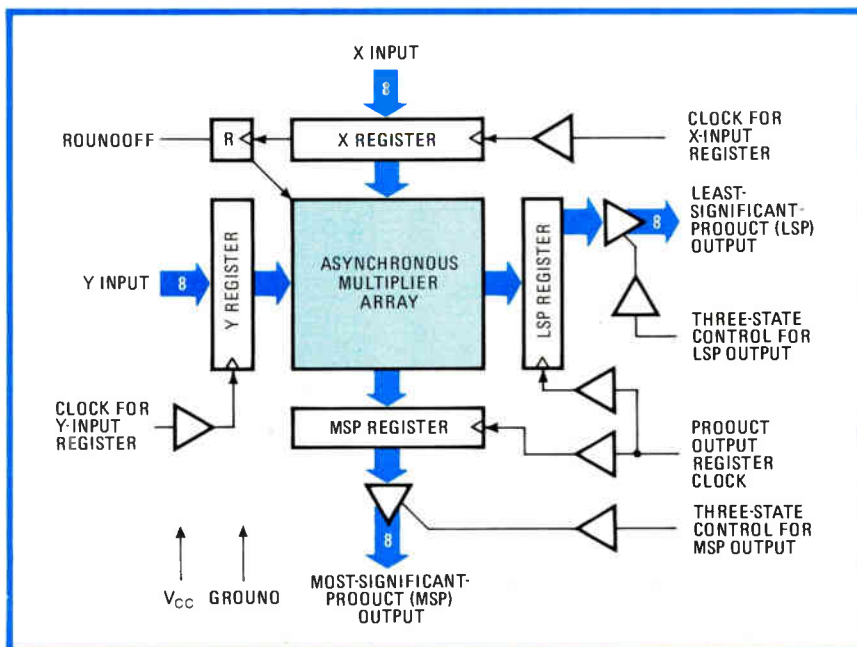

## 16-kilobit E-PROM comes in six speed-power combinations

Motorola has entered the market for 16-kilobit erasable programmable read-only memories that operate from a single 5-v power supply with a 24-pin device offering several speed and power options.

The MCM2716 is available now in large quantities in versions that offer access times of 450, 350, or 250 ns, says David Ford, Motorola's MOS memory strategic marketing manager in Austin, Texas. The standard 450-ns version is offered at \$33.90 each in 100-unit quantities. The faster 2716-35 (350 ns) and -25 (250 ns) will be sold at \$47.55 and \$59 in the same quantities.

Low-power versions of the part at each of the three speed ratings are also being offered. According to Ford, the 27L16 and 27L16-35 pull only 50 mA of current at a nominal 5 v in the active mode, resulting in a power dissipation of 250 mW. The faster 27L16-25 pulls 70 mA active, thus dissipating 350 mW at 5 v. The standard-power 2716 and -35 versions pull 100 mA active (500 mW), and the standard-power -25 device is specified at 120 mA active (600 mW). In the automatic power-down mode, each of these parts is specified at 25 mA and the low-power versions at 10 mA.

In 100-unit quantities the 27L16, 27L16-35, and 27L16-25 are priced at \$40.68, \$57.06, and \$70.80, respectively.

The MCM2716 is organized as

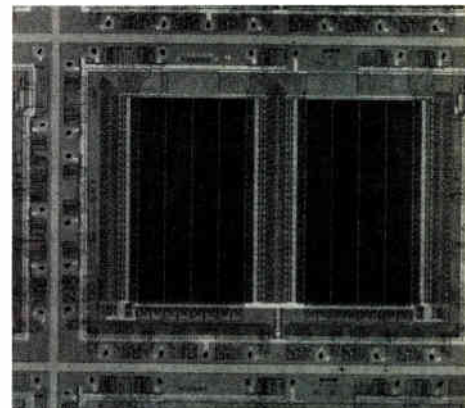



## **HONEYWELL'S 5600E. ITS MONITOR METERS ASSURE THAT YOU WON'T COME BACK EMPTY-HANDED.**

When you take the versatile 5600E to the field you have the best possible chance of getting the data you need. Because built-in meters let you monitor your record and reproduce signals right on the spot. In fact, you can view two inputs or outputs or simultaneously monitor the input and output of any channel.

Conventional recorders require that you set up, calibrate and then carry along a reproduce amplifier for every channel to be monitored. But with the 5600E, a single reproduce amplifier can be used to monitor all channels.

So if you need up to 32 channels of laboratory-quality record or reproduce capability in a single compact unit, call Darrell Petersen at (303) 771-4700. He can help you choose the wideband or intermediateband configuration that best meets your requirements.

Or write for technical data sheets on the 5600E and a free illustrated brochure that describes all of Honeywell's magnetic tape systems, oscillographic recorders and signal conditioning modules.

Honeywell Test Instruments Division, Box 5227, Denver, CO 80217.

**WE'LL SHOW YOU A BETTER WAY.**

# **Honeywell**

World Radio History

Circle 203 on reader service card

# NEED A MICRO EXPERT?

The microcomputer experts listed below specialize in custom applications of microcomputers. Find the one nearest you or the one that fits your needs best.

**Orange Digital Electronics**  
23011 Moulton Pkwy. # G-6  
Laguna Hills, CA 92653  
Tel: (714) 581-3212  
Codes: B H L P S W

**KASK LABS**  
1207 E. Secretariat Dr.  
Tempe, Arizona 85284  
Tel: (602) 831-1420  
Codes: B C D E H L P S

**A C C**  
Box 747  
Mountain View, CA 94042  
Tel: (415) 969-4969  
Codes: B C H L W

**Detrek Engineering Co. Inc.**  
8246 Nieman Road  
Lenexa, Kansas 66214  
Tel: (913) 686-3575  
Codes: B C P S

**Micro Logic Corp.**  
P.O. Box 174  
Hackensack, N.J. 07602  
Tel: (201) 342-6518  
Codes: C H L P S W

**Critical Point Consulting**  
3435 Hillock Lane  
Wilmington, Del. 19808  
Tel: (302) 731-7766  
Codes: B C D E P S W

## Specialization Codes:

B=Business C=Scientific D=Data Processing E=Education  
H=Hardware L=Electronics P=Process Control S=Software  
W=Word Processing

To Participate in next ad write to:

MLC, P.O. Box 174, Hackensack, N.J. 07602

## New products

2,048 8-bit words and is housed in an industry-standard ROM-compatible 24-pin package. The 16-K part is fabricated using the same standard n-channel process employed in Motorola's 64-K E-PROM [*Electronics*, Sept. 27, 1979, p. 176].

Motorola Inc., 3501 Ed Bluestein Blvd., Austin, Texas 78721. Phone (512) 928-6000 [412]

## 3.2-kV hockey puck diodes rated at 3.5 and 4 kA rms

Available in voltage ranges of 2,000 to 3,200 v, the D1400 series hockey puck diodes are rated at 3,500 A rms and 2,250 A average at a 45°C case temperature. The D1800 series units are rated at 4,000 A rms and 1,800 A average at a case temperature of 100°C. Both series extend the peak one-cycle nonrepetitive surge current ratings of the company's line to 34,000 A. The thermal resistance of the two devices is less than 0.212°C/w and 0.016°C/w, respectively. Each sells for \$25 in small quantities.

AEG-Telefunken Corp., Rte. 22-Orr Dr., P. O. Box 3800, Somerville, N. J. 08876. Phone (201) 722-9800 [415]

## Fast Darlingtons handle 60 A at 200 and 250 V

The MJ10020 and MJ10021 npn power Darlington transistors handle continuous currents of 60 A and peak currents of 90 A. The monolithic devices have sustaining voltage ratings of 200 and 250 v, respectively. The units have a minimum gain of 75 at 15 A and 15 at 60 A. The maximum storage time is 3.5 μs, and the fall time at 30 A is 0.5 μs. They come in TO-3 metal packages, with copper construction and heavy-duty pins. The units are available from stock for \$8.25 each for the MJ10020 and \$9.75 apiece for the MJ10021 in quantities of 100 to 999. Motorola Semiconductor Products Inc., P. O. Box 20912, Phoenix, Ariz. 85036. Phone (602) 244-6900 [416]

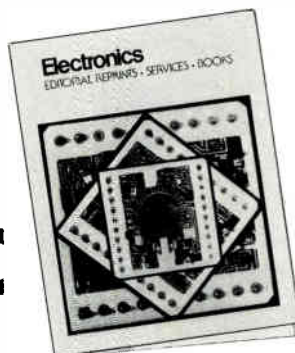

# FREE

## Brochure describes Electronics editorial reprints, services, books...

- More than 70 article reprints in 15 subject categories
- Handy wall charts
- Custom-made reprint services
- Books especially for **Electronics'** readers
- Convenient postage-paid order cards

For your free copy, circle #275 on the reader service card.

For faster response, write directly to **Electronics Reprints**, P.O. Box 669, Hightstown, NJ 08520, or call (609) 448-1700, ext. 5494.

# THE FIVE BEST WAYS TO ISOLATE A PROBLEM.

We've developed the industry's broadest line of 6 and 8-pin optoisolators because you can't solve all electrical noise problems with one product.

For instance, we took care of data rate problems with our 1 Mbit 6N series, which also offers 400% CTR at a .5mA input current.

Or if you need to switch SCRs or TRIACs, our SCR is rated at 300V (peak), and features up to 5000 VDC isolation.

Our SPX 7000 series provides 1, 5, or 10mA controlled gain at percentages ranging from 10-50% (1mA), 30-200% (5mA) and 10-250% (10mA).

And for TTL interface, our SPX 74A1 offers guaranteed logic level compatibility and 4000V RMS isolation over the full 0°C to 70°C operating range.

Finally, we supply industry standard 4N optoisolators including transistors and darlington off the shelf.

The choice is yours for replacing pulse transformers, twisted wires and coaxial cables in computer peripherals, data terminals, home appliances and telephone systems. And for providing protective isolation between microprocessor and 120-240V power lines.

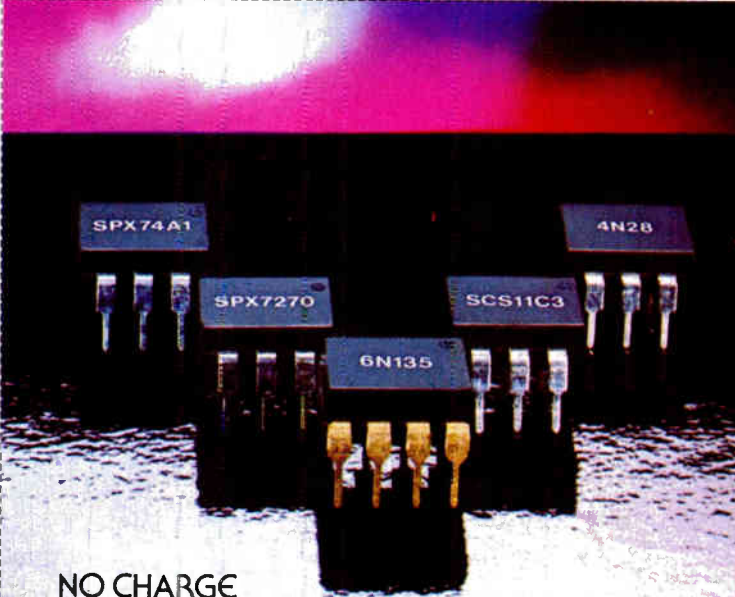

**NO CHARGE**  
Please send me free samples of your optoisolators so I can design the noisy electrical charge out of my next application.

SPX74A1    SPX7270    6N135    SCS11C3    4N28

Name \_\_\_\_\_ Street \_\_\_\_\_  
Company \_\_\_\_\_  
City \_\_\_\_\_ State \_\_\_\_\_ Zip \_\_\_\_\_  
Application \_\_\_\_\_ Annual Usage \_\_\_\_\_  
 New Design    Current Design   E

The point is, no two electrical noise problems are exactly alike. That's why we offer more ways to isolate them than anybody else.

For more information on our optoisolators and other optoelectronic products, call us at 214/234-4271. Or write to 830 East Arapaho Road, Richardson, Texas 75081.

***Spectronics***  
A Division of Honeywell

Here's 600,000 lines of micro software  
you won't have to write yourself.

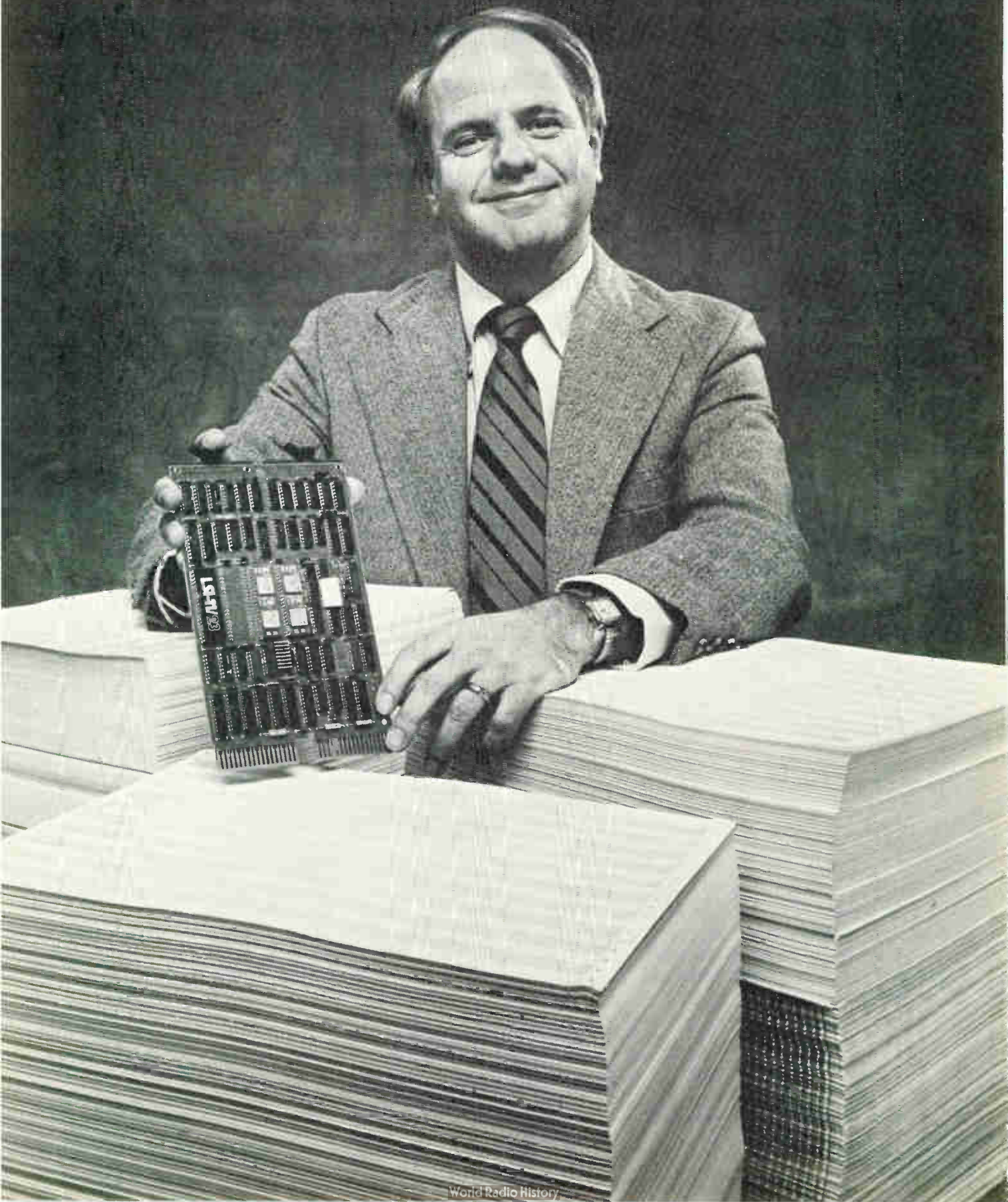

Most micro companies are new to 16-bit architecture. Which means they leave you to your own devices when it comes to software.

But with Digital's LSI-11/23 micros, you start off with 600,000 lines of the best real-time software in the micro industry: RSX-11M.

It's the multitasking operating system that's already been proven and refined in five years of use with our PDP-11 minicomputers.

And that's a headstart you won't get from any other micro company.

### **State-of-the-art programming.**

RSX-11M can make your most complex application manageable.

For example, it lets you break your programs into simpler segments. So several programmers can work on the same application at one time, using one of our multiuser development systems.

Then you can link and integrate your application either on your target system, or on the development system. And you won't have to worry about timing problems showing up, because our development systems are based on the same processors as our micros.

You get to work with advanced development tools, too.

Like an optimized FORTRAN IV-PLUS compiler. Line-by-line assembly. And interactive debugging through every stage of development, with English diagnostics that make it easy to pinpoint bugs before you ever run your programs.

### **Smaller applications are easier, too.**

If you don't need all the resources of RSX-11M, you can use RT-11 — the real-time operating system we designed for smaller applications.

With a FORTRAN package that automatically segments your programs into read-only and read-write sections. And it's a full implementation of the language, complete with I/O statements, data formatting and data conversion facilities.

### **Program one, and you've programmed them all.**

Best of all, Digital's micros are software-compatible. So what you learn on one, you can apply to the others.

In fact, our micros are even software-compatible with the world's broadest family of minicomputers — the PDP-11s.

So your migration will always be easy, no matter how far you or your customers may go.

### **The total approach to micros.**

Advanced programming is only one way we make microcomputers easy to work with.

We also offer hundreds of hardware tools — micros in boards, boxes and systems. Memory and interface boards. Terminals and printers.

And we back it all with over 13,000 support people worldwide.

It's the total approach to micros, only from Digital.

For more information, contact **Digital Equipment Corporation**, MR2-2/M70, One Iron Way, Marlboro, MA 01752. Or call toll-free 800-225-9220. (In MA, HI, AK, and Canada, call 617-481-7400, ext. 5144.) Or contact your local Hamilton/Avnet distributor. In Europe: 12 av. des Morgines, 1213 Petit-Lancy/Geneva. In Canada: Digital Equipment of Canada, Ltd.

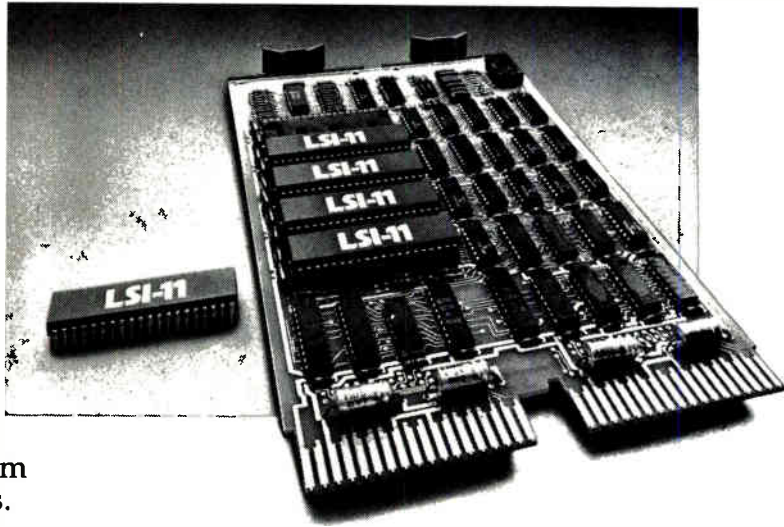

**It took the minicomputer company to make micros this easy.**

**digital**

Circle 207 on reader service card

Components

## LED lamps get brighter

Two chips wired in series provide 100 millicandelas and a 140° viewing angle

The picture is getting brighter in the light-emitting-diode lamp field, at least from the perspective of General Instrument Corp.'s Optoelectronics division. With a new chip and package design, engineers at the firm have developed a series of LED lamps that increase output by more than an order of magnitude over that of conventional high-efficiency devices [*Electronics*, Feb. 14, p. 235].

Designated the Illuminator series,

the new devices use high-efficiency gallium phosphide semiconductor technology to provide "the same illumination levels and the same uniformity of illumination as incandescent lamps," claims Michael Bottini, marketing manager.

Initially available in orange (which can be filtered to red) and yellow, with green to follow, the new monochromatic lamps can operate on up to 0.5 W of input power, a level where they can easily backlight panel areas up to 1 in.<sup>2</sup> What's more, Bottini adds, their light output is 100 millicandelas, equal to that of subminiature incandescents using the same input power. Therefore, he adds, the lamps will offer a "true alternative design approach to the use of subminiature LED lamps" in copying machines, control panels, vehicle dashboards, and instrumentation, for example.

The Illuminators achieve their

high output, Bottini explains, by means of two LED chips wired internally in series and mounted in an injection-molded T-1 1/4 package with its own built-in lens and molded light reflector. Each chip is made with a new process in which an epitaxial layer of nitrogen-doped gallium arsenide phosphide is grown on a GaP substrate. Unlike the opaque gallium arsenide, the GaP is transparent to the emitted light so each LED chip becomes a full emitter that produces light in all directions.

To make use of the extra light, GI engineers designed the package with a molded plastic (nylon) reflector to direct light through the lamp's plastic lens for a 140° field of view. The two LED chips are mounted on a dual-lead frame that also serves as a heat sink to dissipate a maximum of 650 mW of excess power equally among the two leads.

The MK9150 (orange) and MK9350 (yellow) LED lamps, available next month, will initially be priced at about 50 to 60 cents in large quantities and at about \$1 in small quantities from distributors. Incandescents cost about 20 cents per lamp and require sockets for installation, but the shock-resistant Illuminators can be mounted either directly on a printed-circuit board or in a socket. Moreover, they experience no surge current and have a typical rise time of 550 ns. Whereas incandescents may last only up to 50,000 h, says Bottini, the Illuminator series has an effective life of up to 1 million h.

General Instrument Optoelectronics Division, 3400 Hillview Ave., Palo Alto, Calif. 94304. Phone (415) 493-0400 [341]



### Hermetic resistor has 0.05% load-life drift

At 0.3 w and 125°C, the hermetic HS555 bulk-metal resistor has a load-life drift of a 0.01% typical (0.05% maximum) change in resistance in 2,000 h. It has the same instability at 0.6 W and 70°C. Long-term drift is a maximum of 0.0005% after one year and 0.001% after



three years. The resistors are designed for industrial and aerospace applications.

The resistance range is 1 to 100 kΩ with tolerances from ±0.005% to ±1.0%. The nominal temperature coefficient of resistance is +2.2 ppm/°C from -55° to +25°C and -1.8 ppm/°C from +25° to +125°C. Standard spread from the nominal is ±2.0 ppm/°C. The resistors employ a wrap-around paddle-lead construction; consequently, each lead has only a single weld connection located away from the lead's point of entry to the case. In 100-piece lots, an HS555 resistor with 0.05% tolerance and a 20-to-20-kΩ resistance range is typically priced at \$12.09.

Vishay Resistive Systems Group of Vishay Intertechnology Inc., 63 Lincoln Highway, Malvern, Pa. 19355. Phone (215) 644-1300 [343]

## Bi-FET op amps operate over military temperature range

For use in high-speed integrators, fast digital-to-analog converters and sample-and-hold circuits, three operational amplifiers that function over the military temperature range and are made with bipolar and field-effect transistors sell for \$3.25 to \$6 each in 100-lot quantities. The LF151A, 151, and 153 devices are op amps with junction-FET inputs and internally trimmed input offset voltages.

The LF151A has a maximum offset voltage of 2 mV at 25°C and 4 mV over the full military range. Input bias current is 50 pA, noise voltage is 20 nV/√Hz, and noise current is 0.01 pA/√Hz. The device has a minimum slew rate of 10 V/μs ± 0.02%, a 1/f noise corner of 50 Hz, and a settling time to 0.01% or 2 μs. The 151A and 151 single op amps are pin-compatible with the standard LM741; the 153 dual is pin-compatible with the LM1558. All three devices are available now.

National Semiconductor, 2900 Semiconductor Dr., Santa Clara, Calif. 95051. Phone Jim Martin at (408) 737-5880 [345]

# The Pascal Software Tool

## OMSI PASCAL V1.2™

The value of Pascal in computer software design is becoming widely recognized. And our new V1.2 version contains significant enhancements in ease of operation and reliability. Consider the V1.2 Symbolic Debugger.

**Pascal debugging** should be performed in Pascal, not with assembler listings and memory maps. Our Debugger knows your data names and structures. Values are accepted and displayed in Pascal notation, including scalars, sets, arrays, records, and pointers.

**Complete interactive control** displays your original source lines, including embedded comments. Breakpoints give statement numbers and procedure names, rather than octal addresses. The Debugger can show the program execution history, including all stacked procedure calls. Should fatal errors occur, they are intercepted by the Debugger instead of ending your testing.

For more information on our approach, ask for the complete OMSI Pascal V1.2 Product Description.

## Oregon Software

2340 S.W. Canyon Road • Portland, Oregon 97201 • (503) 226-7760 • TWX 910-464-4779

### INTERNATIONAL DISTRIBUTORS

Australia: Sydney;  
Network Computer Services  
390-3677

Canada: Vancouver;  
Valley Software  
(604) 524-9741

England: Stafford;  
Hours Computing Ltd.  
0785-44221

Japan: Tokyo;  
Rikei Corporation  
03-345-1411

Circle 209 on reader service card

# Sprague-Goodman. The first and last name for trimmer capacitors.

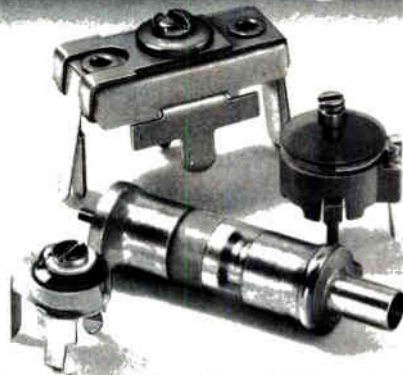

## PISTONCAP®/CERAMIC/FILMTRIM™/MICA

At Sprague-Goodman we specialize in trimmer capacitors. They're our only business. So we offer prompt service and off-the-shelf delivery of our full line of catalog parts. From multi-turn tubular Pistoncaps® in glass or quartz, thru ceramic single turn and Filmtrim™ plastic single turn, to our new Mica compression line.

Our comprehensive line of trimmer capacitors deliver reliability at competitive prices, and our staff is always available for custom designing to your needs.

So the next time trimmer capacitors are called for, call us or your distributor and ask for them by name... Sprague-Goodman.



**Sprague-Goodman Electronics, Inc.**  
(An Affiliate of the Sprague Electric Company)

134 FULTON AVE., GARDEN CITY PARK, N.Y. 11040 • 516-746-1385 • TLX: 14-4533

Circle 212 on reader service card 209

# How Nicolet fits into this box than

Fitting more oscilloscope into a cubic foot took one big first step—the use of modern digital methods. Plus a lot of little steps such as recognizing what's "oscilloscope," what's not, and keeping the "not" outside where it belongs. Here are some of the great things the digital method has made possible.

## Resolution and Accuracy

Scientists and engineers (thousands of them)



are delighted with the Explorers' 4000-line resolution, and accuracy literally an order of magnitude better than that of analog scopes and other digital scopes.

## Super Storage

Users appreciate the Explorer's waveform

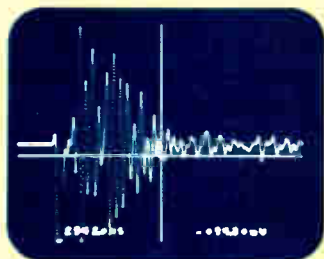

storage. At equivalent writing rates of up to 50 cm/ $\mu$ sec an Explorer can clearly remember, every time, without fade or bloom, literally hundreds of times as much about signals as the finest analog

## 64X Zoom Display

Explorer users enjoy the convenient display that allows them to *zoom in* on details of interest. They also can superimpose "old" signals and

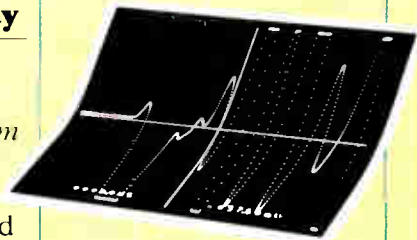

live, "fresh" signals for extremely sensitive observation of differences or changes. They can

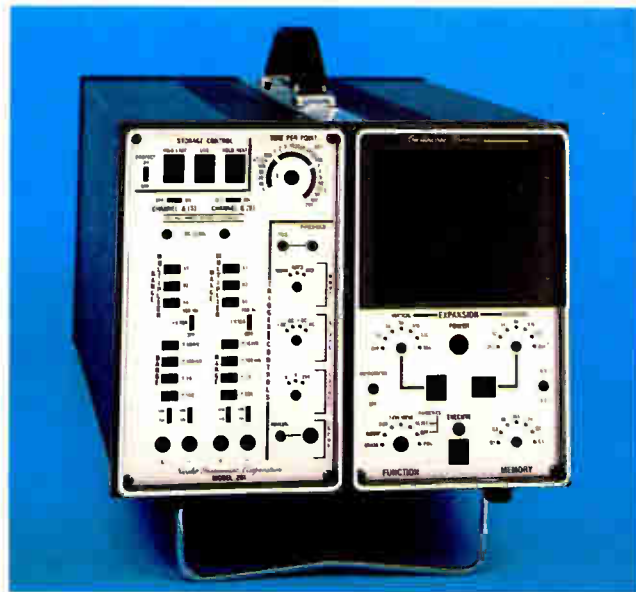

storage scopes. Best of all, Explorers store waveforms with no hassle.

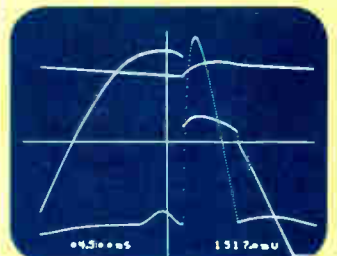
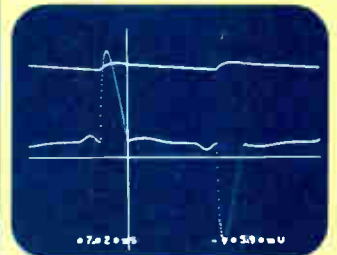
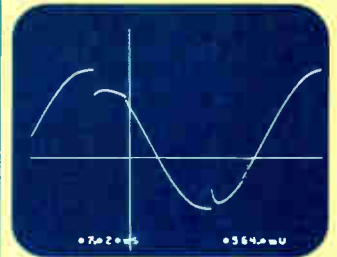
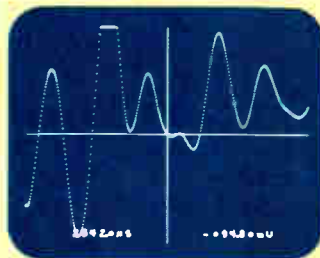
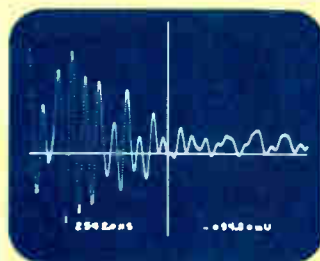
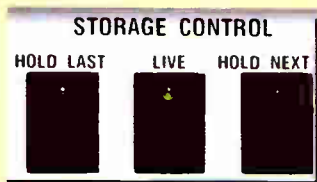

superimpose two (or four) old waveforms, or two live waveforms. And zoom in on details with up to 64X digital display scale magnification.

# more oscilloscope anyone else.

## They're Pure Oscilloscopes

The digital method results in other welcome improvements. Sweep speeds that range down to days in length to allow you to precisely measure very slow phenomena. Pre-trigger sweep start



allows you to see what precedes an event as well as what follows. XY operation provides even greater precision

than servo-driven XY recorders, but at speeds a million times greater. Speeds as high as most analog XY oscilloscopes.

All of these are oscilloscope function improvements. The

## Disk Memory Option

The optional, built-in disk memory can remember signals for years, storing as much data per disk as you could capture



improvements include greater ease of use, for a dozen reasons. The Explorers are "pure oscilloscope." They interface between the signal source and the most intelligent and powerful computer in the world. You.

on thousands of photos. Disks are inexpensive and reusable, don't need developing, and store data at the touch of a button.

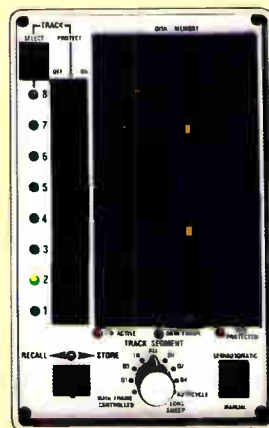

## Matching Your Needs

You can choose the Explorer model that fits your measurement needs from a family of instruments, plug-ins and IEEE-488 or RS-232 options.



## For More Details

To get complete information quickly, call free 1-800-835-2246 (in Kansas, 1-800-362-2421) anytime and request our new brochure.

To discuss your application or to arrange a demonstration, call (608) 271-3333.

**NTE** NICOLET INSTRUMENT CORPORATION  
OSCILLOSCOPE DIVISION

5225 Verona Road  
Madison, WI 53711  
Telephone: (608) 271-3333  
TWX: 910-286-2737  
Sales and Service Offices Worldwide

Circle 211 on reader service card

# Order your copy of the 1979 Electronics Buyers' Guide. There won't be another like it until June, 1980.

**The 1979 EBG is only a postage stamp away!** Completely new listings of catalogs, new phone numbers, new addresses, new manufacturers, sales reps, and distributors! The total market in a book—four directories in one!

## 1.

Directory of products. Over 4,000 products, over 5,000 manufacturers.

## 2.

Directory of catalogs. Includes six post-paid catalog inquiry cards for 10-second ordering.



## 3.

Directory of manufacturers. Local sales offices, reps, and distributors, with phone numbers. Number of employees and engineers, dollar volume, name of company contact.

## 4.

Directory of trade names of products and their manufacturers. You can trace a product by its trade name only.

**The only book of its  
kind in the field.**

**If you haven't got it,  
you're not in the market.**

**To insure prompt delivery  
enclose your check with the  
coupon now.**

Yes, please send me \_\_\_\_\_ copies of 1979 EBG.

I've enclosed \$30 per copy delivered in USA or Canada. Address: EBG, 1221 Avenue of the Americas, New York, N.Y. 10020.

I've enclosed \$52 for air delivery elsewhere. Address: EBG, Shoppenhangers Road, Maidenhead, Berkshire S16, 2Q1 England.

Name \_\_\_\_\_

Company \_\_\_\_\_

Street \_\_\_\_\_

City \_\_\_\_\_

State \_\_\_\_\_ Zip \_\_\_\_\_ Country \_\_\_\_\_

# We cover the world of electronics technology with the only international edition in the field

You are reading the international edition of Electronics. The worldwide news and information is gathered for you by thirty-one editors stationed around the globe.

Every other week, the magazine is sent to subscribers in 123 countries outside of North America. Each issue is packed with important current information on industrial, scientific and military applications, electronics manufacturing, new products, new research, new designs.

Marketing information and statistics keep subscribers up to date with latest economic intelligence and new market developments, with interpretation of their meanings to the electronics industries.

Electronics magazine's international edition is the only way electronics engineers can keep up with worldwide developments in the field wherever they occur. If you are not now a subscriber, you are invited to become one. Simply mail in the subscription card which is bound into this magazine.

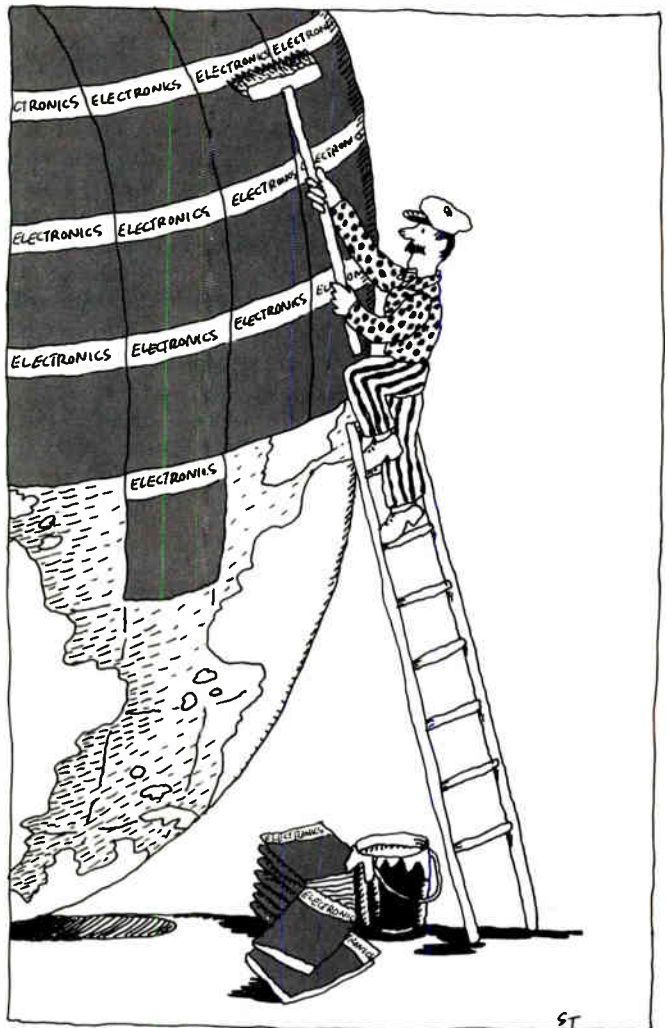

## Electronics Magazine The one worth paying for.

---

## New products

---

Computers & peripherals

### Low-cost printer takes fast data

---

Dot-matrix unit for small computer systems sells for less than \$1,000 in quantity

---

Moving into a new market, North Atlantic Industries' Qantex division is now offering a dot-matrix printer with a price tag of under \$1,000 in production quantities and \$1,325 for single units. Featuring microcomputer control, the model 6000 is aimed at low-cost electronic data-processing applications, including small-business computer systems and home computer installations. Until this introduction, Qantex offered only data storage devices [*Electronics*, Oct. 25, 1979, p. 337].

With both current-loop and RS-232 interfacing capabilities, the printer may be used in a variety of environments. "By putting in the current-loop interface, we're compatible with Teletype protocol," Carl I. Wassermann, manager for printer products, notes. "Most printers offer an X-on/X-off protocol, but with ours the signal is coded busy or not busy—exactly as it is with a Teletype signal." The 6000 is also compatible with the parallel inter-

face used on Centronics' printers.

The bidirectional printer accepts incoming data at rates ranging from 110 to 19,200 bauds, Wassermann says. This feature enables the unit to handle high-speed computer data, he adds. The 6000 has a 240-character buffer as a standard feature.

The unit has a 136-column capacity, with a printing speed of 150 characters/s. Weighing about 40 lb, the printer is small enough to fit on a desktop, as well as accommodate paper of various widths—from about 3 up to 14 7/8 in.—and printing multipart forms with up to six parts. There is also an out-of-paper sensor to alert the operator when the paper has run out. The unit uses a cartridge-type ribbon that is easily replaced.

The microcomputer controlling the printer is Mostek's single-chip, 8-bit 3870. All software for control of fonts resides in programmable read-only memory; the 6000 comes with a set of 96 ASCII characters as the standard font.

A print head with a nine-by-nine-dot matrix can print underlines and descenders on characters such as "y" and "g". "Eight needles are used for the ASCII font, with the ninth used mainly for the underlining," Wassermann points out.

Delivery time is approximately 90 days after receipt of order.

North Atlantic Industries Inc., Qantex Division, 60 Plant Ave., Hauppauge, N. Y. 11787. Phone (516) 582-6500 [361]

---

### Fixed disk drives interface with 6-megabyte floppy

The FD 210 series of 14-in. Winchester technology fixed disk drives for original-equipment manufacturers are interface-compatible with Burrough's MD 122 6-megabyte dual floppy drive. Like the floppy drive, the FD 210 series has an integral microprocessor controller that performs tasks normally required of a host system such as asynchronous file search, diagnostic tests, cyclic redundancy checking, error detection and correction, and sector relocation. The drives have a simple parallel interface and are RS-422 compatible. They have a transfer rate of 7.1 Mb/s. The FD 211 has a 20-megabyte capacity, and the FD 214 has an 80-megabyte capacity. They handle one and four disks, respectively. Average access time is 45 ms. The recording density for both drives is 300 tracks/in. or 5,500 bits/in. In quantities of 100 to 250, the FD 211 is priced at \$3,130, and the FD 214 is priced at \$4,060. For more than 250 units, prices are under \$3,000 and \$4,000, respectively. Sample units are available now, and volume production is scheduled for the third quarter of 1980.

Burroughs OEM Marketing Corp., Burroughs Place, Detroit, Mich. 48232. Phone (313) 972-8031 [364]

---

### Tape transport for Winchester disk drives sells for \$2,500

A microprocessor-controlled half-inch reel-to-reel tape transport for multiplatter 8-in. and 14-in. Winchester disk drives sells for \$2,500 in large quantities to original-equipment manufacturers. The price includes a formatter with all the logic necessary for reading, writing, and controlling a 1,600-character/in. nine-track tape that is ANSI- and IBM-compatible. The transport—called the Data Streamer—operates at 100 in./s. In the streaming mode, it stores or restores 12 megabytes of

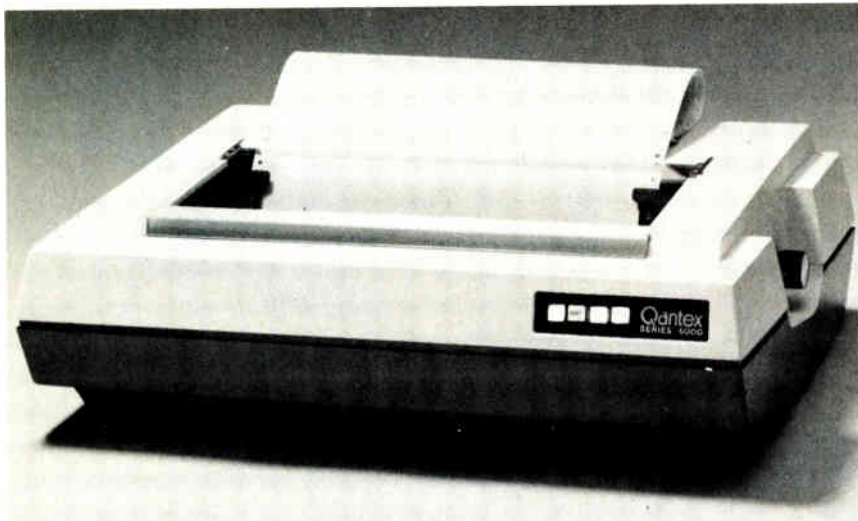

# What makes the HI-LINE™ power module different from all the rest?

# General Electric packaging technology.

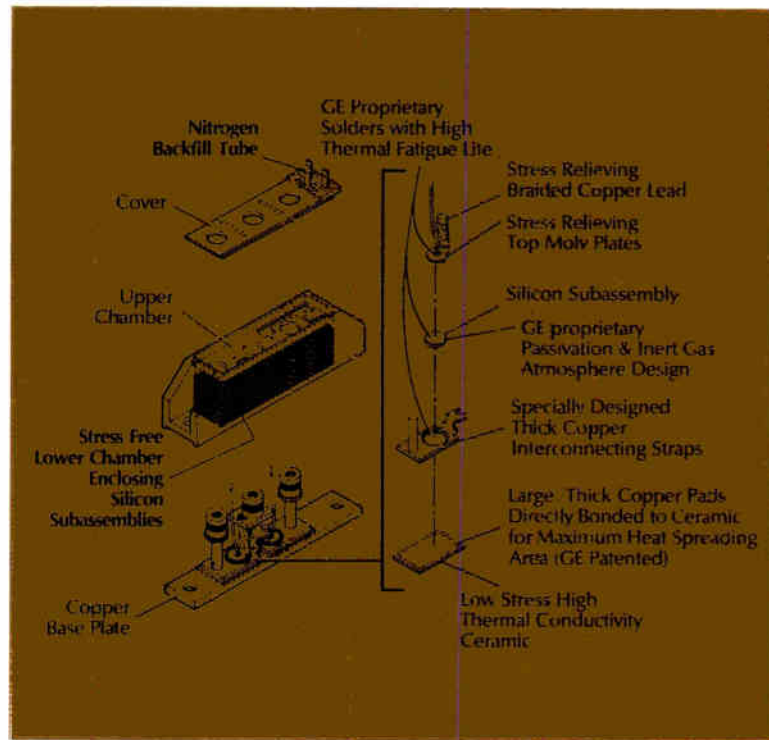
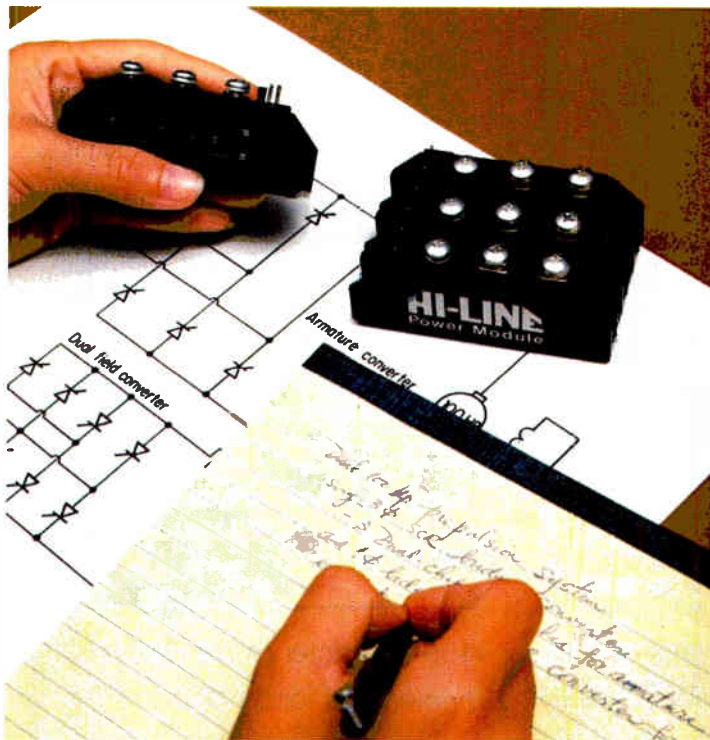

Most power modules look alike. To tell the difference you have to look inside. See how it's designed and put together. See the inside difference.

Only the HI-LINE™ power module has General Electric packaging technology. And only the HI-LINE™ power module can offer these three design features:

- **Low thermal resistance:** Obtained by placing the semiconductor elements closer to base plate and heat sink. Large, thick copper pads directly bonded to ceramic for maximum heat spreading. Cooler running increases device reliability.
- **Low mechanical stress:** Achieved by using a cavity-type package and unique dual chamber design. Epoxy-filled upper chamber seals housing. Controlled gas chamber encloses silicon subassemblies and is free from stress forming encapsulants and degrading gases. The advantage is better blocking life and thermal cycling capability.
- **Extended blocking life:** The device is vacuum baked and internal atmosphere is extracted through an evacuation tube. The cavity is then backfilled with dry nitrogen resulting in a tightly controlled inert atmosphere. The evacuation tube is then sealed. A GE proprietary passivant is applied to the element to extend blocking life for greater reliability.

HI-LINE™ model W4DC55 contains two isolated phase control SCR's in a center tap configuration for motor controls, power conversion and lighting controls.

### HI-LINE Power Module—Model W4DC55 Specifications

Voltage—300-1200 Volts

$I_T$  (Avg)—55 Amps } Baseplate temp. of 85°C  
 $I_T$  (RMS)—90 Amps }

$I_{TSM}$ —1000 Amps (60 Hz half-sine at 125°C)

Fusing current—4,150 A<sup>2</sup>S (8.3-ms surge, half cycle)

Isolation blocking voltage—2500 V RMS

Discover the inside difference for yourself. Contact your nearest GE electronic sales office, authorized distributor or write General Electric Co., West Genesee St., Box 14, Auburn, N.Y., 13021. For specific questions or consultation call (315) 253-7321, ext. 375 or 458.

In Europe, contact the International General Electric Company of New York, Dundalk, Ireland (042) 32371, telex 33816.

222-18

TM: Trademark of General Electric Company

GENERAL  ELECTRIC

# FREE

## TEN-TEC ENCLOSURE CATALOG

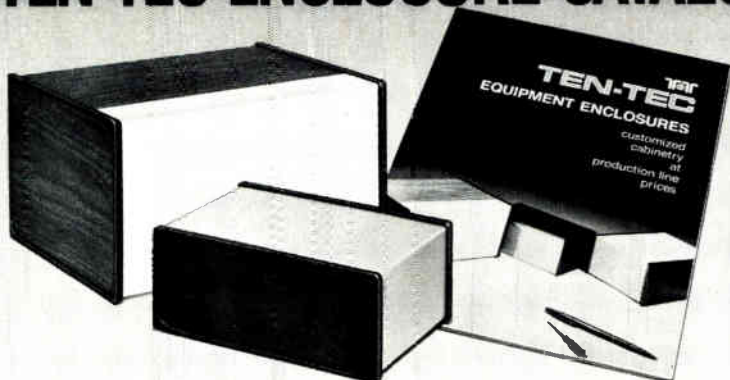

### CUSTOMIZED CABINETRY AT PRODUCTION LINE PRICES

TEN-TEC's OEM cabinet line gives you *affordable* customizing freedom. 51 different sizes. Two construction styles: all-aluminum or aluminum and molded Cycloc. Two color styles: beige with walnut-grain end panels or gray with black pebble-grain (or choose your own). Custom chassis punching. Custom silk-screening. Your cabinets arrive ready for your product. For less than you think. Ask for a quotation.

Write or call:



**TEN-TEC, INC.**  
Hiway 411 E., Sevierville, TN 37862  
(615) 453-7172

Circle 216 on reader service card

### New products

data in 75 s and 40 megabytes in 250 s. Total unformatted capacity is 46 megabytes on a 10.5-in. reel. The model 6809 employs digital micro-processor control to eliminate costly mechanical or vacuum-column tape-tensing elements, drive capstan, and analog circuit elements associated with servomechanisms.

The integral formatter generates preamble, post-amble, file marks, and identification bursts. All timing is referenced to a quartz-crystal-controlled oscillator. In the 100-in./s streaming mode, the transport's access time is 295 ms for both read and write; in a 12.5-in./s start/stop mode that accommodates conventionally recorded tapes, read access time is 44 ms and write access is 40 ms. The unit rewinds at 200 in./s. The Data Streamer can be delivered in 60 to 90 days.

Kennedy Co., 1600 South Shamrock Ave., Monrovia, Calif. 91016. Phone (213) 357-8831 [363]

### comptique comptique comptique



#### TEXAS INSTRUMENTS electronic calculators

TI-35 NEW	\$24.95	TI-5100	\$39.95
TI-50	33.50	Programmer	48.95
TI-55	34.95	MBA	59.95
TI-58C NEW	109.95	Business Analyst II	21.95
TI 59	209.95	Business Analyst II	39.95
TI-56/59 Libraries	28.95	Business Card NEW	39.95
TI-30SP	17.95	Language Translator NEW	279.95
PC-100E	146.95	Digital Thermostat NEW	104.95
TI-1750	19.95	Speak & Spell	65.00
TI 5015	64.95	Chrono Alarm 806-31	39.95
TI 5040	94.95		

World Time Alarm Chrono 807-3 . . . 89.95



#### HEWLETT PACKARD INTRODUCING THE HP-85!

HP 67	\$299.95
HP 92	399.95
HP 97	584.95
HP-33C NEW	109.95
HP-34C NEW	124.95
HP-38C NEW	124.95
HP 31E	41.95
HP 32E	54.95
HP-33E	73.95
HP-37E	59.95
HP-38E	94.95
HP-41C NEW	CALL
HP-85 . NEW	3250.00



The HP-85 is a powerful BASIC language computer complete with keyboard, CRT display, printer, and tape drive - all in one compact unit.

180-character/s dot-matrix printer sells for \$1,350

Original-equipment manufacturer prices for a seven-by-seven-dot-matrix impact printer with a 180-character/s print speed can go as low as \$1,350. The unit operates in a bidirectional, logic-seeking mode. Average throughput time is 120 lines/m, with 75 lines/m for 132-character lines and 200 lines/m for 40-character lines. The model M-120 has a single-column, seven-wire print head that is replaceable by the user, and the ribbons come in easily loaded cassettes. The life of the head is rated by the manufacturer at more than 200 million characters, and the ribbons are good for 5 million characters. It has a built-in self-test feature and an optional light-emitting-diode diagnostic display to show which cycle the printer was in at the time it went off line. The printer has a standard 8-bit parallel and optional RS-232-C serial interfaces.

Dataproducts Corp. 6200 Canoga Ave., Woodland Hills, Calif. 91365. Phone (213) 887-8451 [365]



TI HOME COMPUTER 99/4 . . . \$1150.00



IMAGINATION MACHINE . . . 495.00



16K MEMORY . . . 999.95



6200 NEW EXECUTIVE	99.95
5813 NEW PROGRAMMABLE	34.95
5100 NEW LCD Alphanumeric	89.95



COMMAND . . . 39.95  
Each Module . . . 14.95

WE WILL BEAT OR MEET ANY COMPETITOR'S PRICE ON MOST ITEMS IF HE HAS MERCHANDISE ON HAND. All units shipped in original factory cartons with accessories according to manufacturer's specification. CALL TOLL FREE (800) 854-0523 (outside CA) or (714) 549-7373 (within CA). Visa and MasterCard; money order; Pers. Ck. (2 Wks. to clear); COD accepted. Min. \$4.95 for shipping in USA. We ship AIR on request. CA residents add 6% sales tax. All merchandise subject to availability. Prices good only with this ad for limited time only. Send orders to Dept. E-F28

WRITE OR CALL FOR FREE CATALOG



3211 SOUTH HARBOR BOULEVARD, SANTA ANA, CA 92704 • 6 Stores in California

CALL TOLL FREE (800) 854-0523 (outside CA) • (714) 549-7373 (within CA)

PERSONAL ELECTRONICS AT PROFESSIONAL DISCOUNTS

216 Circle 254 on reader service card



# INTEL did it with Rogers' Q/PAC.<sup>™</sup> Now you can too.

World Radio History

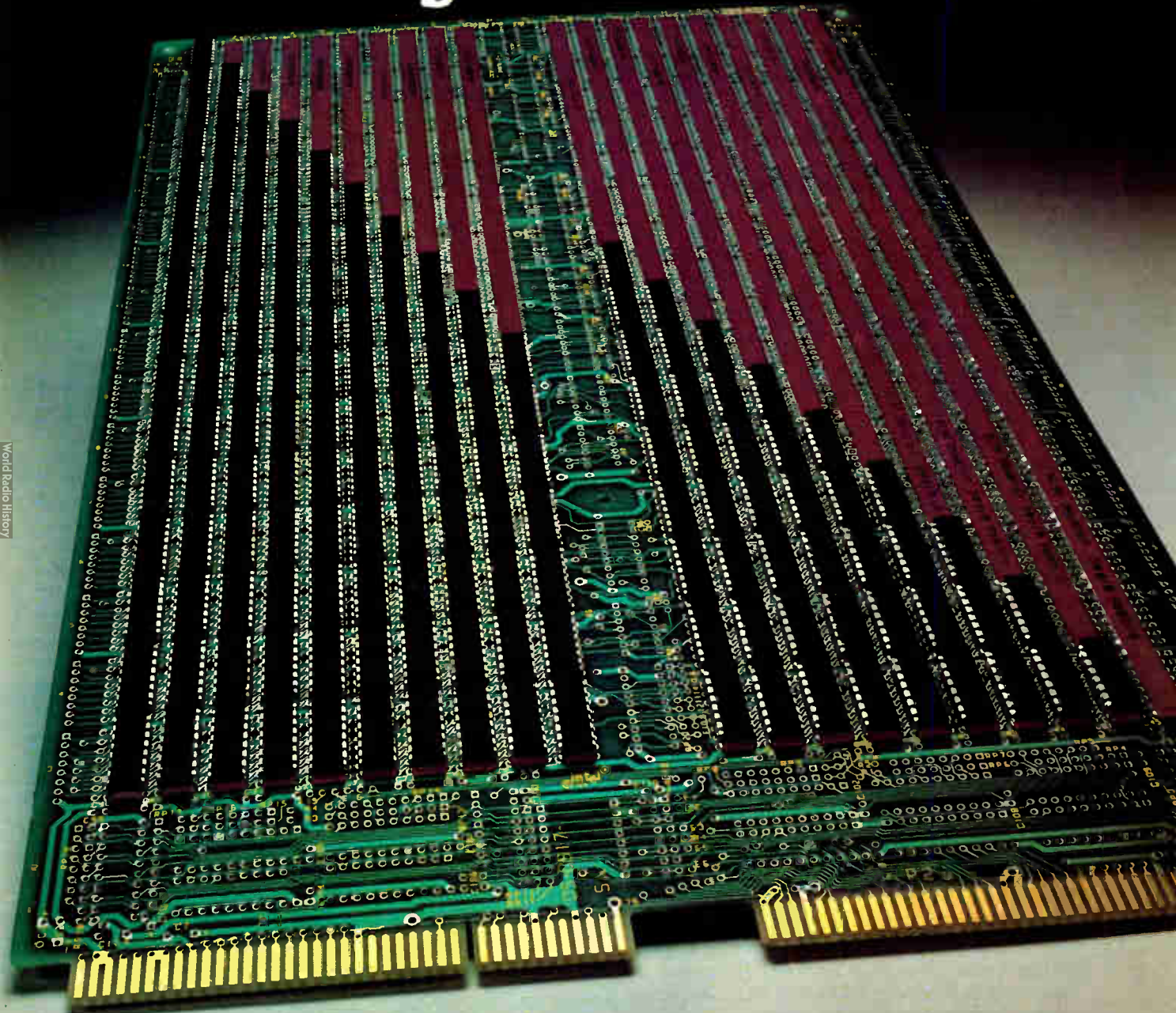

## Q/PAC<sup>™</sup>

Intel's new Series 90 half-megabyte memory replaced 352 decoupling capacitors with 20 Rogers' Q/PAC power distribution elements.

Result: a quiet memory with exceptional density for a two-layer PC board. In fact, density is as high or higher than multi-layer boards with discrete capacitors.

Q/PAC elements also heighten board reliability through reduced part count; minimize on-board power traces; and they have low inductance, low impedance and a low dissipation factor.

Capacitance values up to 0.05  $\mu\text{f}$  per inch of length, in lengths up to 16 inches. Available for either vertical mounting or horizontal installation under IC's.

This partially populated Intel memory board shows the space-saving advantages of Q/PAC over discrete capacitors and on-board power distribution.

For detailed information, contact the Q/PAC Product Specialist at (602) 963-4584.



Rogers Corporation  
Chandler, Arizona 85224  
EUROPE: Mektron NV, Gent, Belgium  
JAPAN: Nippon Mektron, Tokyo

Industrial

## Thin-film circuit senses moisture

---

Built-in heater lets sensor operate over wide temperature range

---

Many industrial processes require continual monitoring of the amount of water or water vapor in gases or liquids, a process that can be complex and often requires some computation. Now the Aquamax II simplifies both the process and the calculation.

The Aquamax is a thin-film integrated circuit that determines moisture variations by measuring the impedance changes they cause. The unit is formed by two roughly circular electrodes that are laid down on a silicon substrate with a porous dielectric between them. As the dielectric absorbs or gives up moisture, the capacitive reactance of the sensor changes. According to the makers of the Aquamax II, Panametrics Inc., there is a neat correlation between impedance and moisture.

So far, so good. But relative humidity is a function of temperature in gases, and the water-vapor pressure of most organic liquids varies with temperature, too. Panametrics' solution to this problem is to embed a heavily doped p-type heating element in the Aquamax substrate. Drawing about 200 mW, the element keeps the sensor at a constant 50°C. The Aquamax is thus able to operate over a fairly broad temperature range like a constant-temperature liquid-sampling system. Its integrated heater maintains the sensor temperature constant to within 0.1°C at process temperatures of down to 20°C and at flow rates of up to 5 cm/s.

The Aquamax can make dew- or frost-point measurements from -110° to +60°C with a maximum error of 2°C. That is equivalent to a range of 0.001 to 200,000 ppm at

1 atm. The device will operate at relative humidities up to 100% at 40°C without saturating. Further, it can withstand pressures as high as 5,000 lb/in.<sup>2</sup>

**Fast.** The Aquamax is fast, too. It has a large-signal time constant of about 2 s—that is, its impedance will change 63% in 2 s in response to a step change in moisture. For small signals, in the neighborhood of 0.1 to 1.0 ppm, the response time is approximately a minute.

Supplied complete with a stainless steel mount to which are attached the unit's TO-5 header and a protective shield, the Aquamax II sells for \$595. It is delivered with documents showing the results of three months of burn-in testing and calibration. Panametrics keeps track of the performance of each unit in the field and, at delivery, guarantees the performance of each sensor for the next six months. Delivery time is about 45 days.

Panametrics Inc., 221 Crescent St., Waltham, Mass. 02154. Phone Lloyd Searle at (617) 899-2719 [371]

---

## Solid-state multiplexers replace flying-capacitor units

Two solid-state four-channel signal conditioners are designed to serve as alternatives to flying-capacitor multiplexers in industrial data-acquisition systems. The devices are intended for use with thermocouples and other low-level transducers. They have normal-mode input protection of 130 v rms, and each of the input channels is galvanically isolated to  $\pm 1,000$  v dc from the other input channels and from output ground.



The model 2B54 is intended to condition signals from  $\pm 5$  mV to  $\pm 100$  mV in the presence of high common-mode voltages. The model 2B55 is for conditioning voltage spans of  $\pm 50$  mV to  $\pm 5$  v or 4-to-20-mA current-loop signals. The 2-by-4-by-0.4-in. units scan at a rate of 400 channels/s. They have a minimum common-mode rejection of 156 dB at 60 Hz.

The devices use amplifier-per-channel architecture to obtain an input drift of  $\pm 1$   $\mu$ V/°C maximum and a gain drift of  $\pm 25$  ppm/°C maximum. They also have an input noise level of 0.6  $\mu$ V, peak to peak, and a maximum nonlinearity of  $\pm 0.02\%$  of full scale. The model 2B54 provides open-thermocouple detection.

Gain can be optimized by installing a single resistor per channel. A direct output provides  $\pm 5$  v with low source resistance, which permits error-free operation with relatively heavy loads, says the manufacturer. A separate series-switched output is provided so that multiple modules may be mixed without external analog multiplexers.

The operating temperature range of the devices is -25°C to +85°C. In 100s, prices start at \$144 apiece.

When cold-junction compensation is required for compensating thermocouples, the 2B54 may be used directly with another new device, the model 2B56 compensator. The unit sells for \$49 in 100-unit quantities and features a compensation accuracy of  $\pm 0.8$ °C, maximum, over a +5° to +45°C ambient range. It allows digital selection of four of seven thermocouple types.

The 2B56 has a signal input span of 0 to  $\pm 10$  v, with 100-k $\Omega$  input impedance. The output voltage is 0 to  $\pm 10$  v at  $\pm 5$  mA, with 0.1- $\Omega$  output impedance. The output is protected against a continuous short to either the supply or ground. The digital thermocouple-selection inputs are TTL and complementary-MOS-compatible. The module is guaranteed over the 0° to +70°C range. Like the 2B54 and 2B55, the 2B56 is available for delivery from stock.

# Now... You, the small systems user can enjoy the advantages of HI-performance *low cost* computer graphics

## HI PLOT™ Digital Plotters



### The perfect small system output device

- Displays data in easy to read graphical format
- Both serial and parallel inputs built-in.
- Used standard 8½" x 11" paper (DIN A4)
- Plotting speed up to 2.4 ips (60 mm per sec)
- Resolution of both 0.01 and 0.005 in. (0.1 mm and 0.2 mm)
- Baud rate and step size easily changed
- Completely assembled and ready to use
- Priced at \$795\*

## HI PAD™ Digitizers



### The perfect small system input device

- Resolution and repeatability of 0.005 in. (0.1 mm)
- Origin is completely relocatable
- RS232C and 8 bit parallel interface selectable at the connector
- Accuracies of ±0.015 in. (0.4 mm)
- Optional LC display shows actual values being inputted
- Digitizing surface 11" x 11" (28 mm x 28 mm)
- Priced at \$795\*

Circle 216 on reader service card

For complete information contact Houston Instrument, One Houston Square, Austin, Texas 78753. (512)837-2820. For rush literature requests persons outside Texas call toll free 1-800-531-5205. In Europe contact Houston Instrument, Rochesterlaan 6, 8240 Gistel Belgium. Phone 059/27 74 45.

**HOUSTON  
INSTRUMENT**

DIVISION OF BAUSCH & LOMB

"the graphics · recorder company"

TM Trademark of Houston Instrument  
\*U.S. Domestic Price Only

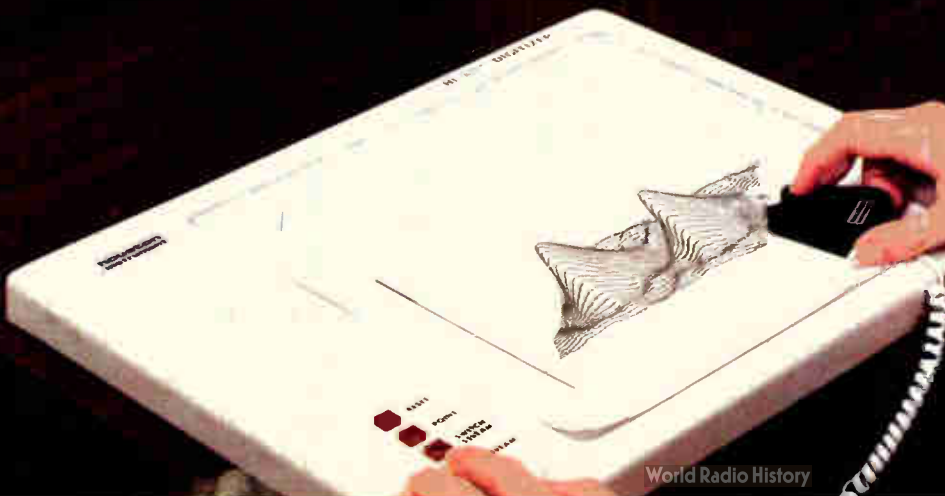

# FIRST,

**Bud developed this System because no two people think alike.**

Create an electronic package your way with the Bud System.

Use PC boards; use varied-size modules to house power supplies, relays, transformers, other components. Design, redesign, adapt your package. Exercise your options!

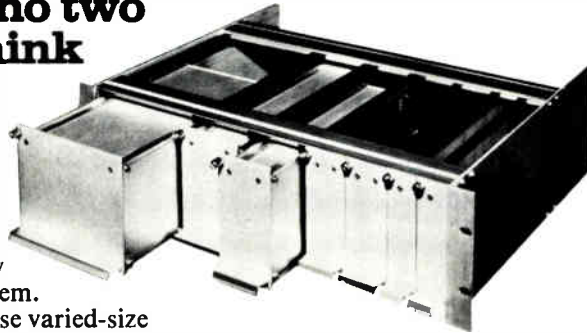

# SECOND,

**for an equally adaptable card frame, order the System's sub-rack.**

Snap-in guides, made of fire-retardant plastic, are movable, adjust to a 0.2" pitch. You can use up to 42 PC boards which slip directly into edge

connectors attached at rear of guides. This assures perfect alignment.

Write for 8-page brochure. Bud Industries, Inc., 4605 E. 355 St., Willoughby, Ohio 44094. Bud West, Inc., 3838 N. 36 Ave., Phoenix, Ariz. 85019.

In Cleveland: 216/946-3200

In Phoenix: 602/269-3151

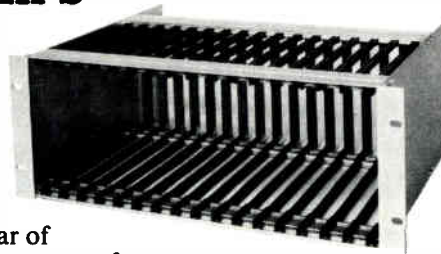

**BUY  
BUD**

First...of all.

Circle 255 on reader service card

## New products

Analog Devices Inc., P. O. Box 280, Rte. 1 Industrial Park, Norwood, Mass. 02062. Phone Janusz Kobel at (617) 329-4700 [372]

### Dynamics analyzer

produces animated display

A structural dynamics analyzer, the model 5423A analyzes frequency-response data from a mechanical structure to determine its frequency, damping, and shape and presents the results in the form of animated displays of the structure's deformation for each mode of vibration. By means of a stereoscope, the structure may be viewed in three dimensions. The results are also displayed numerically, completely annotated.

Users may set up special sequences of keystrokes for specific measurements and analyses that can then be executed without the intervention of the operator. The operator may also add custom annotation to the data for display or plotting. All data can be stored on a built-in digital magnetic-tape cartridge. Each track of the dual-track cartridge has a capacity of up to 70 records. Data may be sent to any of several compatible digital plotters.

The 5423A includes a waveform calculator that operates on measured functions of frequency and time, with real and complex constants entered by the operator.

The 5423A analyzer sells for \$36,000. Delivery time is 15 weeks.

Hewlett-Packard Co., 1507 Page Mill Rd., Palo Alto, Calif. 94304 [374]

## FREE

**Brochure describes Electronics editorial reprints, services, books...**

- More than 70 article reprints in 15 subject categories
- Handy wall charts
- Custom-made reprint services
- Books especially for **Electronics'** readers
- Convenient postage-paid order cards



For your free copy, circle #275 on the reader service card.



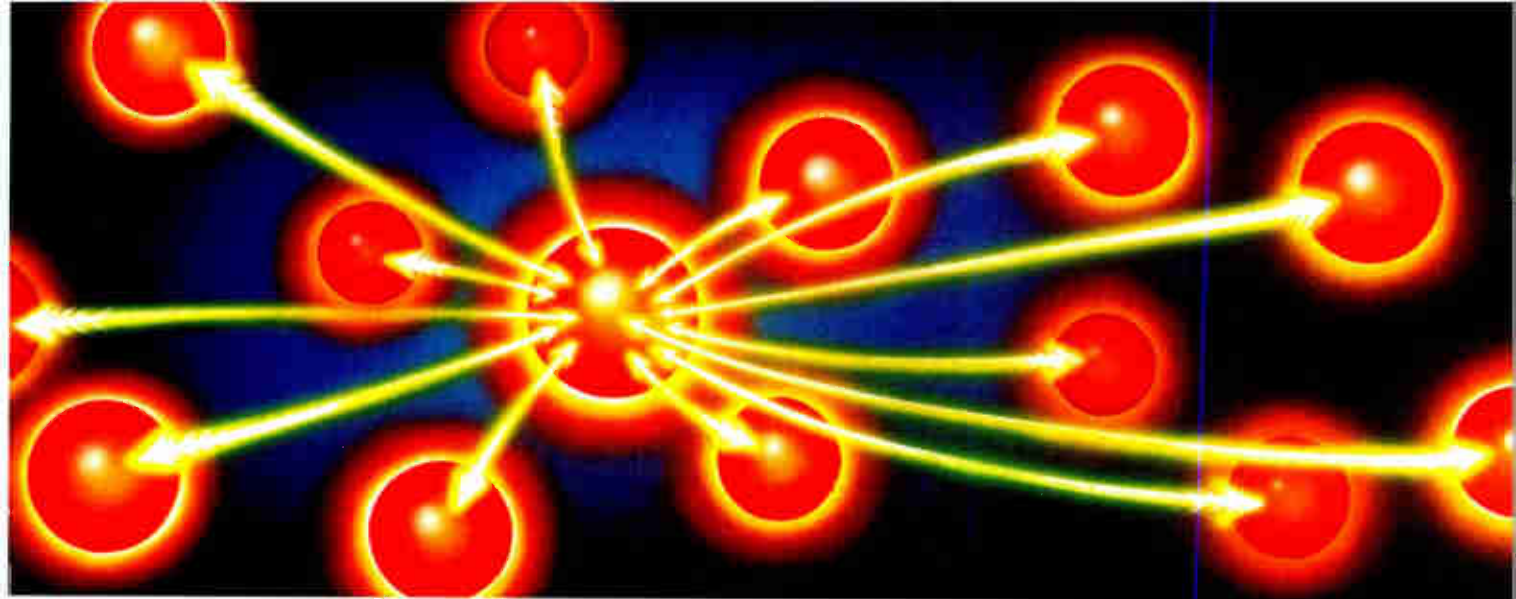

# Managing to cover all bases.

Expansion. Diversification. Acquisition. Growth. As a business becomes more complex, its information management needs expand exponentially. The more locations involved, for example, the greater the need for centralized control of intercity communications.

Many corporations seeking ways to increase productivity, while controlling communications costs at all locations, are converting to Bell's Dimension<sup>®</sup> PBX.

With Electronic Tandem Switching, it provides an integrated system with over 150 customized management and control capabilities. Its stored programs bring cost-saving features to the network, add time-saving functions to existing telephones. Long distance calls automatically take the least expensive routes. Calls that encounter busy signals are redialed electronically. Detailed calling records facilitate the allocation of charges. And each company as well as each of its locations can modify its own system without calling in Bell installers.

We have applied such advances for some of America's leading businesses, integrating many divisions, plants, warehouses and service centers into one total system.

That's our business—applying a knowledge of networks and advanced communications to the specialized information management needs of your business.

It's a process that starts with a call to your Bell System Account Executive.

## The knowledge business



Microcomputers &amp; systems

## Winchester drive made for Intellects

---

8-inch hard-disk unit stores  
10 megabytes, comes  
with floppy-disk backup

---

As designers make the transition from Intel Corp.'s 8-bit microprocessors to the firm's 16-bit machines, they often need much more mass storage on their Intellect development systems. Intel first addressed this problem by making the Intellects capable of addressing as many as 10 floppy-disk drives. Then the company introduced a 14-in. platter with a capacity of 7.3 megabytes. Now Advant Inc. is taking Intel's logic a step further by introducing a 10-megabyte 8-in. Winchester disk system for all Intellect systems using versions 2.0 or higher of the system's ISIS-II operating software.

Advant's Microsupport model 105 is the first 8-in. Winchester mass-storage system to be offered for a development system. Its price of \$13,500 includes an 8-in. 500-kilobyte floppy-disk drive for backup

and removable storage, as well as a controller, a power supply, a host interface, an adapter board, and interface cables. It is installed simply by plugging the adapter board into a slot in the Intellect and attaching the interface cables.

The 105's advantage over Intel's 14-in. platter is not so much its slightly lower price (Intel's MDS 740 sells for \$13,990 plus a \$2,400 yearly service contract) as the inherent advantages of a Winchester disk over a cartridge disk. "The Shugart SA 1004 we use in the model 105 is so reliable it makes the service contract unnecessary," asserts Advant president Grant Record.

Record maintains that his system's Winchester disk is 50 times more reliable than the Control Data Corp. Hawk cartridge disk that is used in the Intel MDS 740. Its track-to-track access time of 19 ms, however, is somewhat longer than the Hawk's 13 ms.

The huge differences in estimated reliability between the Intel and Advant units come from the fact that Winchester drives are hermetically sealed and are, therefore, much less susceptible to contamination than are the removable-cartridge drives. The principal advantage of the Hawk drive is that 3.65 megabytes of its memory are removable.

A microprocessor-based controller on Advant's model 105 is used to control both the hard- and floppy-disk sections. It also provides an on-board data separator for both drives. The model 105 will be ready for delivery next month.

Advant Inc., 696 Trimble Rd., San Jose, Calif. 95131. Phone (408) 946-9300 [351]

---

## Pascal compilers run on PDP-11, LSI-11, 8080, Z80

A Pascal software-development system builds upon Whitesmiths Ltd.'s C compiler and libraries to provide a portable software environment for Pascal programming on PDP-11, LSI-11, 8080, and Z80 computers. The system comes in three packages: a PDP-11 native Pascal compiler package that produces assembly language under Idris, UNIX, or various Digital Equipment Corp. operating systems; a PDP-11 Pascal cross-compiler that runs on the PDP-11 or LSI-11 but produces 8080 or Z80 modules that run under CP/M, CDOS, or ISIS-II or that stand alone; and an 8080/Z80 native Pascal compiler that runs under CP/M or CDOS and, like the cross-compiler, produces modules for use under CP/M, CDOS, or ISIS-II or that stand alone. All three versions can generate programable read-only memory code.

Included as part of the standard package are an A-Natural assembler, an 8080 linking loader, and a librarian. Users also get full use of the C programming language. Appropriate manuals for use with these packages are included with each development system, but they may be purchased separately for \$15 each. Both the 8080/Z80 and PDP-11 native Pascal compilers are priced at \$750 per single central processing unit binary license; the PDP-11 cross-development system is priced at \$1,100. All packages are covered by a 90-day warranty and will be available in March for a two-week delivery.

Whitesmiths Ltd., P. O. Box 1132, Ansonia Station, New York, N. Y. 10023. Phone (212) 799-1200 [353]

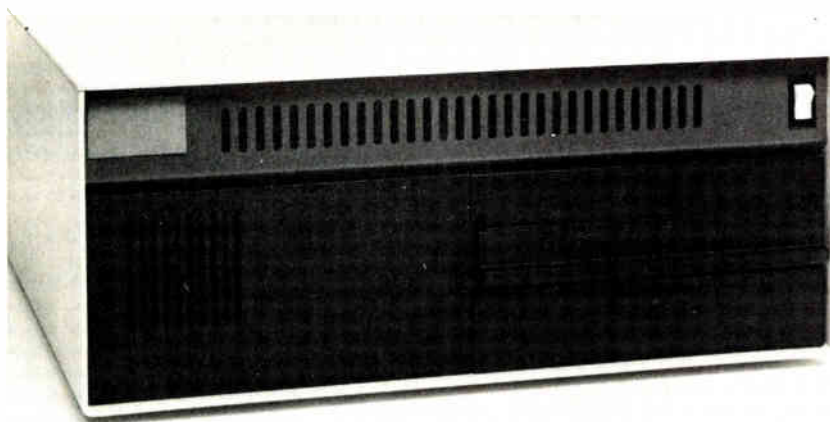

# When you need rockers & toggles or more than rockers & toggles...



Come to the people who've always been specialists in having more good ways to solve problems: Dialight. What we've done in indicator lights, illuminated switches, readouts and LEDs, we're doing now in miniature rockers and toggles.

This new Dialight family of switches, which comes in a full range of sizes is, we're proud to point out, all-American made.

When you consider all the configurations of styles, sizes, life and safety ratings, colors and mountings, you'll find there are literally hundreds of thousands of design combinations. Such a number of possibilities

can in itself be a problem, except that the new Dialight catalog is specifically designed to prevent confusion and help you quickly and easily find the most advantageous combination of features for your applications.

If you'd like to see what Dialight quality rockers and toggles can do for the looks, durability and economics of your products, contact us today for the Dialight "Meets Your Need" Book. Your free copy will include a list of stocking distributors in the U.S. and Canada.

**DIALIGHT**

A North American Philips Company

Made in the U.S.A. by DIALIGHT

## Dialight meets your needs.

Dialight, 203 Harrison Place, Brooklyn, N.Y. 11237 (212) 497-7600

World Radio History

Circle 223 on reader service card

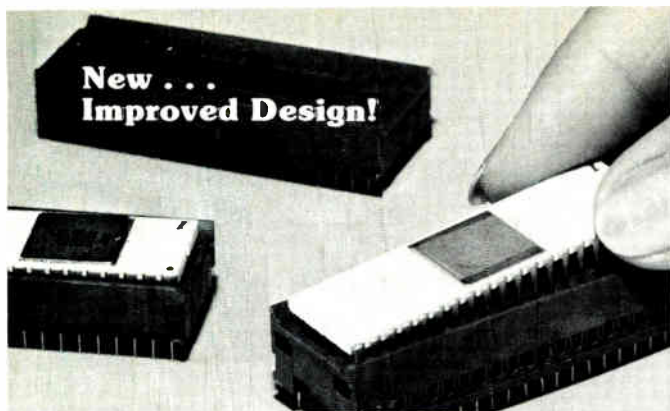

## Costly I/Cs Need Our "Zero-Insertion-Force" Production Sockets!

- Improved socket opens easily, retains device with 50% greater force than original design!
- No tools — or screwdrivers — necessary for opening or closing socket.
- I/Cs literally "drop" into open socket — no lead damage!
- Positive-wiping, dual-leaf contacts provide true reliability when socket is closed.
- New design now available for 24- and 40-lead production applications.

# Welcon™

See our full line at  
NEPCON/WEST  
Booth 314

WELLS ELECTRONICS, INC., 1701 S. Main, So. Bend, IN, USA

Circle 224 on reader service card

# "When are you going to get yours?"

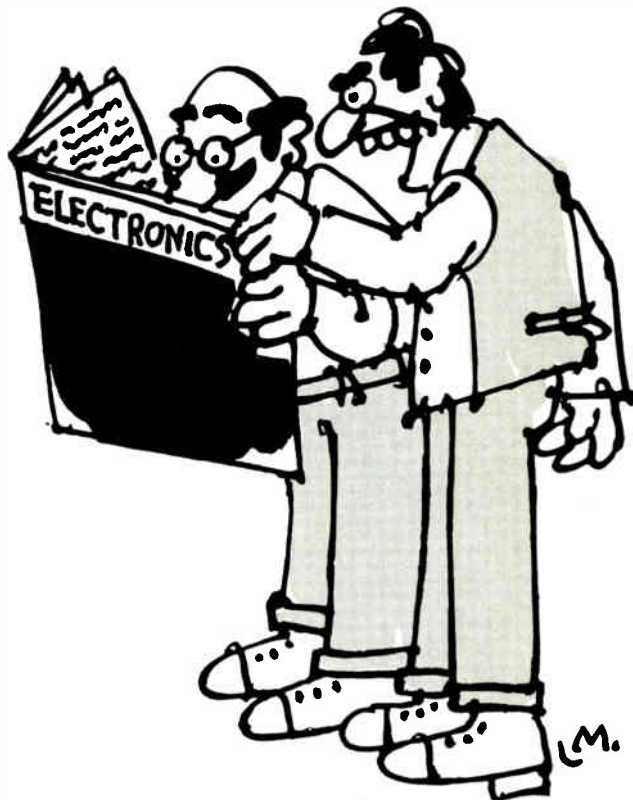

When are you going to get your very own, personal subscription to Electronics?

It could be very important to you. And we're not just referring to your status in the office hierarchy.

You (and we) are in a quick-moving business. News breaks frequently. Change is the name of the game. Awareness is the way to win.

You've got to follow what's going on beyond your specialty. Your career may have to last longer than your specialty.

If change is the game, obsolescence is the penalty for losing. Obsolescence of products, of technology and, unfortunately, of people. We can't change this fact. But we can help you cope with it.

Give us one hour of reading time every two weeks and we will keep you aware of what's going on around you and around the changing world of electronics technology.

Move up. Fill out one of the subscription postcards in this issue.

## Electronics Magazine. The one worth paying for.



## Required Reading for Electronic Design Engineers: Cambion Catalog 800

When it comes down to selecting the definitive design reference source in the electronic components field, get Cambion's Catalog 800 listing over 23,000 different components—connectors, terminals, inductive products, handles, and much more associated hardware. Cambion's reputation for high quality, reliability, and worldwide off-the-shelf availability, plus our special attention to custom-designs have made us a near-legend in our own time. The Catalog 800—designed to make your design concept a design reality. Get your copy today! Cambridge Thermionic Corporation, 445 Concord Avenue, Cambridge, Massachusetts 02238. (617) 491-5400.

**CAMBION**  
The Right Connection.

Circle 225 on reader service card



## **Mostek expands 3870 single-chip family of microcomputers**

Mostek Corp. is taking orders with 14-week lead times for its MK3876 single-chip microcomputer now in volume production in Carrollton, Texas. **With  $\pm 5\%$  supply tolerance, the device is priced at \$10.50 in 10,000-unit quantities.** The fourth member of the 3870 single-chip family to be introduced, the 3876, like the earlier MK3872, contains scratch-pad and executable random-access memories with 64 bytes apiece. Unlike the 3872, which contains 4 kilobytes of read-only memory, it houses only 2 kilobytes of ROM for users with smaller code requirements. The next 3870 family product expected is the MK3873, which has a serial input/output port and is scheduled for introduction at Electro in May.

## **Prices keep going up**

Citing increases in the prices of labor and materials, especially gold, manufacturers of electronic components and equipment are entering yet another round of price increases. For example, **Memorex Corp.'s Business Systems division has increased its prices an average of 10% for new leases and renewals.** The Santa Clara, Calif.-based company blamed inflation in general and the increasing cost of field service in particular.

Following suit are Ampex Corp., Redwood City, Calif., which is **raising prices on its professional audio and video equipment from 8% to 10%**, and Varian Associates' Electron Device group, Palo Alto, Calif., which was "forced to institute price adjustments" because of the last surge in precious metal prices. The group's Communications Transistor Corp. has already added such surcharges, and other divisions are considering a similar move.

## **Emulex enhances disk controllers for PDP-11/70**

Emulex Corp., of Santa Ana, Calif., has enhanced its family of SC70 large-disk controllers for PDP-11/70 computers so that they **can handle disk drives with capacities of up to 600 megabytes.** The model SC70/B1, which emulates DEC's RH70/RMO3 subsystem, accommodated just 80- and 300-megabyte drives, but it can now control 160- and 600-megabyte units as well. The SC70/B2, which emulates the RH70/RP06, handled only 200-megabyte drives, but now also runs 300-megabyte units. The controllers, which handle both fixed- and removable-media drives, sell for \$5,150 apiece in quantities of 50 units.

## **Trying out this Pascal compiler costs only \$50**

For a \$50 service charge, Rational Data Systems will supply customers with a test copy of a Pascal compiler and a run-time system, as well as a programmer's manual. The fee includes a license to use the materials for 60 days. **Full prices for the software packages are: \$3,500 for a version that works with Data General's AOS operating system and \$2,500 for a variation for use with the same firm's RDOS and DOS operating systems.** A purchasing packet containing ordering instructions and appropriate agreements may be obtained by writing to the company at 245 West 55th St., New York, N. Y. 10019.

## **Memory power supply capacity doubles**

Stevens-Arnold Inc., South Boston, Mass., has announced the introduction of its UPS-2708B uninterruptible power supply for volatile memories. **The unit has twice the capacity of the earlier UPS-2708A, delivering 3 A at 5 V dc and 1 A at 12 V dc for a full hour.** Supplied complete with battery, the regulated supply has a small-quantity price of \$445.



**compass**  
microsystems

*There is nothing like a*  
**DAIM**

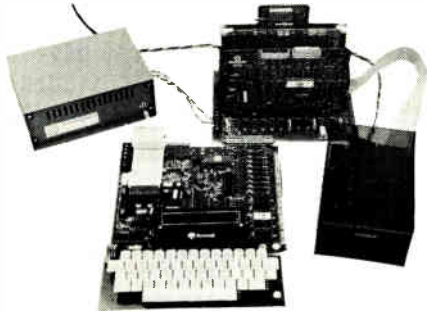

A complete disk system for the Rockwell Aim 65. Uses the Rockwell Expansion Motherboard. Base price of \$850 (U.S.) includes controller with software in Eprom, disk power supply and one packaged Shugart SA400 Drive.

224 SE 16th St.  
P.O. BOX 687

AMES, IA 50010  
(515) 232-8187

Circle 226 on reader service card

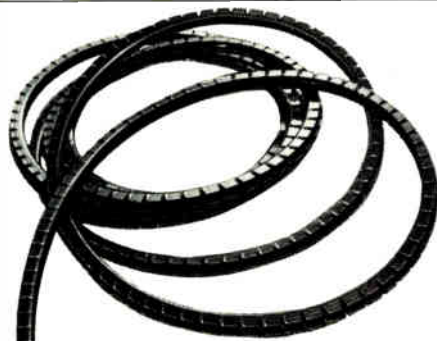

## NYLON GROMMETING

Make your own grommets to fit any size or shape opening with Weckesser Type 6/6 Nylon Grommeting. Extruded grommeting available in 25 and 50 foot lengths, five standard sizes to fit panel thicknesses from .052" to .250".

Also available in molded flexible strips, 12-3/4" long. All available in black or natural.

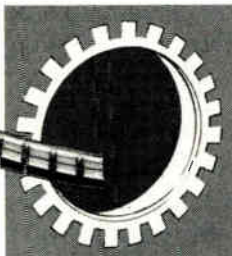

**Weckesser COMPANY, Inc.**

4444 West Irving Park Road • Chicago, Illinois 60641 • 312/282-8626

226 Circle 257 on reader service card

## New literature

**Bubble memory devices.** A 16-page booklet, "Bubble Memory Devices" gives the reader insight into these memories. It explains what they are, what magnetic bubbles are, and how to use them. It also details loop organization and peripheral circuitry. Fujitsu America Inc., Component Sales Div., 910 Sherwood Dr. - 23, Lake Bluff, Ill. 60044. Circle reader service number 421.

**Improving performance.** The 1980 edition of the "Engineering Guide" suggests ways to increase mean time between failures through better thermal management and proper power-source specification. The discussion of thermal management in the 64-page guide includes the necessary formulas for predicting temperature rise and explores methods of both reducing and dealing with temperature effects. Semiconductor Circuits Inc., 218 River St., Haverhill, Mass. 08130 [422]

**Foil capacitors.** Two technical notes on foil capacitors are available from CSI Capacitors. Technical article #113, "The Non-Inductive Myth," dispels the misconception that extended-foil capacitors are noninductive. It provides formulas and graphs for calculation of the inductance of all common capacitor geometries. Along with this, article #14, "How to Tell a Nanohenry from a Microfarad," provides techniques for the measurement of small inductance values that are inherent in the structure of foil capacitors. CSI Capacitors, A Division of CSI Technologies Inc., P. O. Box 2052, Escondido, Calif. 92025 [423]

**Transistors.** A 44-page catalog contains detailed data on monolithic dual npn, monolithic dual npn, and monolithic dual n-channel junction field-effect transistors. Specifications, performance, and key parameters identified include: matching characteristics, gain values, power dissipation, output capacitance, log conformance, drift, noise, and transconductance. Micro Power Systems Inc., 3100 Alfred St., Santa Clara, Calif. 95050 [424]

Electronics/February 28, 1980

# 7 Major Routes to Reliability, Provided by the RAC

- System Reliability and Maintainability Consulting Services
- Customized Data Searches
- Semiconductor Device Reliability Databooks
  - Digital Data
  - Linear/Interface Data
  - Memory/LSI Data
  - Hybrid Circuit Data
  - Transistor/Diode Data
- Reliable Equipment Design Guidelines
  - Design Reliability Handbook
  - Microcircuit Reliability Bibliography
- Tutorial Reliability Courses
- Annual Reliability Workshop
- Periodic Reliability Seminars

**RAC**  
 **Reliability Analysis Center**  
 RADC/RBRAC, Griffiss AFB, NY 13441

Phone 315-330-4151, Autovon 587-4151

RAC is a DoD Information Analysis Center Operated by IIT Research Institute

Circle 256 on reader service card

## Ciarcia's Circuit Cellar

by Steve Ciarcia

The marvelous computer projects that Steve Ciarcia has constructed in his cellar are explained in detail in Ciarcia's Circuit Cellar so that you can make your microcomputer perform the same useful functions.

This easy-to-read book contains a collection of more than a year's worth of the popular series Steve writes for BYTE magazine. Included are six winners of BYTE's On-going Monitor Box (BOMB) award voted by the readers as the best articles of the month: *Control the World* (a four channel digital to analog converter for controlling appliances and other devices); *Memory Mapped IO*; *Program Your Next EROM in BASIC*; *Tune In and Turn On* (a computerized wireless AC control system); *Talk To Me* (add a voice to your computer); and *Let Your Fingers Do the Talking* (a touch panel for your video display).

Each article is a complete tutorial, presented in such an easy-going style that even beginners can understand and enjoy.

Buy this book at your favorite computer book store or direct from BYTE \$8.00 ISBN 0-931718-07-4



Please send  \_\_\_\_\_ copies of Ciarcia's Circuit Cellar

Name \_\_\_\_\_ Title \_\_\_\_\_ Company \_\_\_\_\_

Street \_\_\_\_\_ City \_\_\_\_\_ State/Province \_\_\_\_\_ Code \_\_\_\_\_

- Check enclosed in the amount of \$ \_\_\_\_\_  
 Bill Visa  Bill Master Charge  
 Card No. \_\_\_\_\_ Exp. Date \_\_\_\_\_  
 Add 60¢ per book to cover postage and handling.

• 70 Main Street Peterborough, NH 03458

E20

Circle 258 on reader service card

# Order the professional's choice.

## UCSD Pascal.™

The Pascal everyone is talking about is UCSD Pascal... with over 10,000 users and growing. The fully developed Pascal is available with support from a professional software company. Implemented on most major microprocessors.

Not just another compiler, but complete development software — from operating system to screen-oriented editor. Language extensions for systems development and commercial applications programming.

Program portability that allows programs written on one microcomputer to run without recompilation on different microcomputers. This protects your software investment... without restricting your hardware options.

If you have CP/M®, visit your local computer store or order below. System supplied on single-density, soft-sectored, 8" floppy disks and requires 48K of contiguous RAM. For other systems call us or write for more information. Telephone orders accepted with Master Charge or VISA.

**SOFTTECH**  
**MICROSYSTEMS**  
 A SUBSIDIARY OF SOFTECH

9494 Black Mountain Road • San Diego • CA • 92126  
 TEL: (714) 578-6105 • TWX: 910-335-1594

CP/M is a registered trademark of Digital Research Corporation. LSI-11 is a trademark of Digital Equipment Corporation. UCSD Pascal is a trademark of the Regents of the University of California.

- Yes! Rush me a complete UCSD Pascal system for my CP/M® based microcomputer. A check or money order for \$300.00 is enclosed. I have a \_\_\_\_\_ computer.
- Send me more information about UCSD Pascal. Versions are available for systems using the following microprocessors: LSI-11™ 6502, 6800, 6809, 9900, Z80 and 8080/8085.
- Send me only the complete set of documentation for UCSD Pascal. A check or money order for \$37.00 is enclosed.
- Send distributor information.

Name \_\_\_\_\_

Company \_\_\_\_\_

Address \_\_\_\_\_

City \_\_\_\_\_

State/Zip \_\_\_\_\_

M/C or VISA # \_\_\_\_\_ Exp. Date \_\_\_\_\_

Mass. and Calif. residents enclose applicable sales tax.

E 228

Circle 227 on reader service card

227

# Classified section FOR ENGINEERING/TECHNICAL EMPLOYMENT OPPORTUNITIES

## CLASSIFIED SALES REPRESENTATIVES

Atlanta .Maggie McClelland 404/692-2666	Chicago . . . . . Linda Nocella 312/751-3770	Detroit . . . . . Mac Huestis 313/673-7410	Philadelphia . Dan Ferro . . . 215/568-6181
Boston . Jim McClure . . . . . 617/262-1160	Cleveland . . . . . Mac Huestis. 216/781-7000	Houston . . . . . Mike Taylor 713/659-6381	Pittsburgh . . . Jack Gardner 412/227-3856
Chicago . Bill Higgins . . . . . 312/751-3733	Dallas . . . . . Mike Taylor . 214/742-1747	Los Angeles . Ana Galaz . 213/487-1180	San Francisco . Peter McGraw 415/362-4600
	Denver . . . . . Shirley Klotz 303/637-1010	New York . . . . . Larry Kelly . 212/997-3594	Stamford . . . . . William Eydtt . 203/359-2860

Sales Manager—Mary Ellen Kearns—212/997-3306

# GRADUATE ENGINEERS

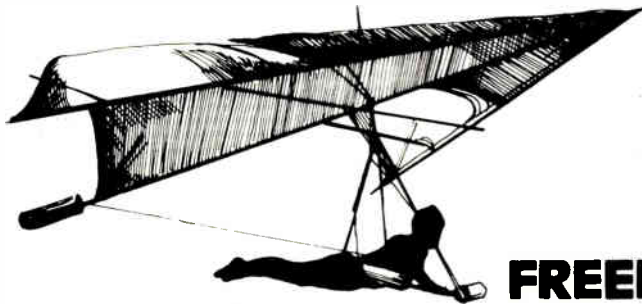

**FREEDOM,  
ADVENTURE,  
CHALLENGE**

### YOU DON'T WORK IN AN OFFICE!

That's right and you don't have to work in an office to get a great start in pursuing career objectives! Many success stories have NOT started with soft desk jobs, but in the field with people willing to be their own boss and meeting the exciting technical challenges it takes to become one of the best.

Schlumberger has the responsibility, as world leader in Electronic Well Logging, of the search for tomorrow's energy. To assist us in this search, we need career minded individuals with a 4 year degree in Electrical or Mechanical Engineering or Physics, 0-3 years work experience and outstanding scholastic record. Must be U.S. citizen. Candidates will be faced with the challenges of: decision making, long hours, taking charge, working outdoors, operation of sophisticated electronic equipment and the recording and interpretation of oil and gas well information.

In addition to our excellent company benefits, the experience you gain from this unique opportunity will provide invaluable rewards.

### IMMEDIATE POSITIONS AVAILABLE NOW

In the "Sunbelt" states throughout Texas and Louisiana

(additional openings in 24 other states)

Please Call Collect  
(713) 658-9223 Ext. 34

**4-YEAR DEGREE REQUIRED!**

**Schlumberger**

**SCHLUMBERGER WELL SERVICES**

Two Allen Center, Suite 2900  
1200 Smith St., Houston, Texas 77002

We Are An Equal Opportunity Employer M/F

# Electronic Design

**£6000-£10,300**

**London**

Multitone lead the world in the design and manufacture of sophisticated radio paging systems. Continued success in this advanced technology industry, has led to expansion in all sectors of our operation.

This overall growth creates the need to expand our development potential by appointing more Electronic Design Engineers.

If you're one of the experienced men and women we're looking for, you'll have a sound background in Physics, Electronics or Mathematics.

You should also have some experience in one or more of the following areas: RF theory and practice; large scale logic design; thin/thick film technology; microprocessor systems.

When you join Multitone, you'll be given early project responsibility and enjoy a stimulating working environment where individual achievement is a basic objective.

We'll offer you an excellent initial salary in the range of £6,000 – £10,300, according to qualifications and experience.

Fringe benefits include pension and life assurance plans, flexible working hours, assistance with relocation expenses where appropriate and in some cases local housing may be available.

If you're fluent in English and are looking for a fresh challenge, come to Multitone in London.

Please write, giving full personal and career details to Brian Young, Personnel Department,

**Multitone Electric Co. Ltd.,**  
6-28, Underwood Street, London, N1 7JT, England.

## multitone



## COMPONENT QUALIFICATION AND TESTING ENGINEERS (UDINE)

We are looking for top-notch electronic engineers having an advanced degree and more than 4 year's experience in one or more of the following areas:

- Test and Diagnostics of digital IC's (MSI, LSI).
- Qualification and Characterization of LSI IC's.
- Failure Analysis of digital IC's.
- Manufacturing of IC's.
- Test and Diagnostics of linear IC's.

Successful candidates will join dynamic teams operating in the following areas:

- LSI Reliability
- Test and Qualification
- Failure Analysis

Our laboratory is equipped with the most sophisticated equipment and works very closely with many European companies.

## GROUP LEADER— CUSTOM INTEGRATED CIRCUITS (UDINE)

To satisfy our needs for specialized integrated circuits ZELTRON is creating an in-house design centre. The centre will be responsible for the specification, design and layout of integrated circuits to be produced by third parties.

As manager of this centre the successful candidate will have the following responsibilities:

- Co-operate with the Director of Microprocessor Applications in setting up the centre and in selection of appropriate capital equipment.
- Technical control of all operations within the centre.
- Negotiation with suppliers and product managers.

Suitable applicants will have several years experience in the design of integrated circuits (preferably both analogue and digital) and will have a good working knowledge of mainstream semiconductor technologies. Preference will be given to candidates having both experience on computer aided graphics systems and well established contacts within the semiconductor industry.

We also require senior design engineers for this area of activity.

## SENIOR SOFTWARE DESIGNER (MILAN)

We require an advanced degree in Computer Sciences or equivalent and at least 4 year's experience in compiler design and implementation, preferably for microprocessor-based systems.

The successful candidate will lead a design team involved in implementation of high-level languages for state-of-the-art microprocessor systems. The software development group is based in Milan.

For the above positions we offer either renewable, fixed length (2-3 year), contracts or permanent positions.

English is spoken at ZELTRON and therefore knowledge of the Italian language is not a prerequisite. Salary is open and a function solely of qualifications and experience.

Our company is a totally owned subsidiary of INDUSTRIE ZANUSSI, a leading European manufacturer of appliances and electronic consumer goods (1979 sales: 1.2 billion US\$). The ZANUSSI Corp. employs 33,000 people and has 41 plants in Italy and Spain and divisions in 12 countries.

Udine is a lovely, small (population of 100,000) city in Northern Italy. Your week-ends and holidays (4 weeks per year) will be far from boring as Udine is only 80 miles from Venice and very close to Austria and Yugoslavia and beach and mountain resorts are within an hour's drive.

Give it all a thought and contact us at:

# ZELTRON

Istituto Zanussi per l'Elettronica SpA  
Via Principe Di Udine 66  
33030—CAMPOFORMIDO—Udine—Italy

## Research & Development Microprocessor Applications

Opportunities exist for Hardware and Software Engineers to work with new and advanced microprocessor architecture and applications for data communications products. You'll be developing operating systems and applications software in a multiprocessor real time environment. A BS or MS in Electronic Engineering-Computer Science is required. Opportunities to advance to senior level positions are excellent.

Located 35 miles south of Boston and with easy access to Cape Cod and Buzzard's Bay, Codex Corporation continues to enjoy a phenomenal 35% growth rate and leadership in the high speed data communications industry. We produce equipment and systems linking large mainframe computers with geographically remote users. Typically, we sell to Fortune 1000 businesses with world wide communications networks.

Send us your resume including salary history to: Jerry Dombrowski, CODEX CORPORATION, 20 Cabot Boulevard, Mansfield, MA 02048.

codex

A Subsidiary of  MOTOROLA INC.

An Equal Opportunity/Affirmative Action Employer

# FREE Your dream job.

We hope you're happy in your current position, but there's always that ideal job you'd prefer if you knew about it.

That's why it makes sense to have your resume on file in the Electronics Manpower Register, a computerized data bank containing the qualifications of career-conscious ELECTRONICS readers just like yourself.

You'll benefit from nation-wide exposure to industry firms privileged to search the system, and since the computer never forgets, if you match up with their job requirements you'll be brought together in confidence.

To take advantage of this free service, mail your resume to the address below.

ELECTRONICS MANPOWER REGISTER  
Post Office Box 900/New York, N.Y. 10020

all positions fee-paid

## ENGINEERS

**ELECTRONICS ENGINEERS, \$18,000-\$50,000.** Choice entry level to management positions immediately available in Pennsylvania & national locations. Reply in strict confidence to J. G. Weir, President, WEIR PERSONNEL SERVICES, 535 Court St., Reading, PA 19603 (215/376-8486).

**BSEE / ELECTRONIC DESIGN ENGINEERS, \$18,000-\$40,000 +.** Immediate, desirable up-state New York & nationwide. Jr. to Sr. project management. Engineering placement specialists since 1946. In confidence send resume or call James F. Corby, Pres., NOR-MILE PERSONNEL ASSOC., 5 Leroy St., Box 110 Westview Station, Binghamton, NY 13905 (607/723-5377).

**ELECTRONICS ENGINEERS, \$18,000-\$40,000.** Suburban New Jersey & nationwide. Numerous choice positions in co's utilizing the latest State-of-Art methods & equipment. Reply in confidence to James E. Mann, VP/Eng., ARTHUR PERSONNEL, SUITE M6, 8 Forest Avenue, Caldwell NJ 07006 (201/226-4555).

**ELECTRONICS ENGINEERS, \$18,000-\$40,000.** Nationwide positions in digital, analog, microprocessor, microwave & instrumentation technology. For immediate confidential response, send resume w/ salary history to Glenn English, President, GLENN ENGLISH AGENCY, 7840 Mission Center Ct., San Diego, CA 92108 (714/291-9220).

**ENGINEERS to \$40K.** Get results from the oldest private employment service (est. 1946) in the heart of New England with the best clients in the industry. Contact LANE EMPLOYMENT SERVICE, 405 Main Street, Worcester, MA 01608 (617/757-5678).

**DESIGN ENGINEERS to \$38K.** Central Penna & nationwide. Design connectors/terminals, microprocessors, controls. Reply in confidence to Z. A. Goglewski, MECK ASSOC. PERSONNEL, 1517 Cedar Cliff, Camp Hill, PA 17011 (717/761-4777).

**npc** NATIONAL PERSONNEL CONSULTANTS

### POSITIONS VACANT

**Electronics And Engineering Professionals**—Explore employment opportunities in various disciplines. For a complete and confidential investigation at no cost to you, send resume to Gerald E. Bell, Independent Recruiters, 550 Pinetown Rd., Ft. Washington, PA 19034.

**Engineer—EE/ME \$28K +** Microprocessors, 605 E. 9 Mile Rd., Highland Springs, Va 23075.

**South? Technical/Professional Placement Network**—fee paid. Murkett Associates, Box 527, Montgomery, AL 36101.



The Telecommunications Division of Canadian Marconi Company is continuing to expand its design and development capability in high technology radio and cable communication systems. There are immediate openings for talented individuals to work in a stimulating environment involving state-of-the-art techniques and to pursue an active and challenging career with excellent opportunities for advancement to senior positions.

## ELECTRONIC DESIGN ENGINEERS

2 to 3 years' design experience in one or more of the following:

- Digital circuit design
- Analog circuit design
- Micro processor hardware/software design

## POWER SUPPLY DESIGNERS

Minimum of 5 years' experience in power supply design covering the following areas:

- DC to DC converters
- Low noise switching regulators
- DC to AC inverters

## SYSTEM ENGINEERS

Experienced communications system engineers with a background in equipment design using PCM and TDM techniques in both radio and multiplex systems.

## TECHNICAL WRITERS

Required for the production of technical manuals including all levels of maintenance, operation and modification instructions; will support major programs of several projects.

Candidates must have a knowledge of specialized fields of electronics, and technical publication productions, maintenance and repair methods. Previous experience in writing, illustrating and publishing techniques.

Good salary and prospects for advancement in an expanding publications operation.

All positions offer excellent salaries and generous fringe benefits including flexible working hours, tuition assistance, group insurance, pension plan and Employees' Credit Union.

Personnel Administrator



# CANADIAN MARCONI COMPANY

380 Aberdare Road • Town of Mount Royal, Quebec, Canada, H3P 1Y9

### SOUTH & SOUTHWEST POSITIONS

Engineering and Management positions throughout the South, Southwest and U.S. Employers pay all fees. Send resume in confidence to: Bob Hogue, personnel consultants

**SouthWest Technical**  
P.O. Box 33070,  
San Antonio, Texas 78233

### SENIOR DESIGN ENGINEER

Excellent career opportunity in Electrical Instruments! Total Project Responsibility! Analog and Digital background helpful. Salary to \$40,000. Contact E. Freeland, Management Recruiters, 2421 Willowbrook Pkwy., Indianapolis, Indiana 46205 (317) 257-4261

### RESUMES

Resumes—Complete instructions and examples; \$4, Consultants, Box 567—J. Bergenfield, N.J. 07621.

## RELIABILITY ENGINEERS

The Nation's Number One Avionics Team is looking for junior and senior Reliability Engineers, to help advance the state of the art.

Your one to three years experience in reliability analysis of designs (parts application review, failure mode and effects, prediction) and analysis of hardware failures for cause and corrective action is desired for project support responsibility.

Your four to eight years experience in all phases of reliability is desired to lead the definition of reliability programs and provide work direction to accomplish those programs.

Honeywell Avionics is a leading subsystem supplier of diversified avionics products with some 80 current subcontracts and millions more in R&D business. Recent key program assignments and continuing aggressive marketing have increased opportunities for challenging career assignments with Honeywell-in-Florida.

For immediate attention, please send us your resume (in strictest confidence).

Mail to: Walt N. McMillen  
Avionics Division,  
Honeywell-in-Florida  
13350 U.S. Highway 19  
St. Petersburg, Florida 33733



Avionics Division  
**Honeywell**  
in Florida "A Place In The Sun For You."  
Honeywell is an equal opportunity employer

### *Electronic Engineers...*

### *We Invite You To Discuss Your Careers...*

*...with consultants who understand your particular qualifications and goals. Since F-O-R-T-U-N-E is staffed with specialists in every aspect of the electronics industry, this is an opportunity to take advantage of.*

*R.S.V.P. by calling or by sending your resume, in confidence, to:  
Manager, Electronics Division*

Personnel Agency, Inc.  
**F-F-F-O-R-T-U-N-E**  
A Nationwide Service

(212) 557-1000 - 505 Fifth Ave., NYC 10017  
"CORPORATE INQUIRIES WELCOME"

## NOTICE TO EMPLOYERS:

## Why we can recommend our readers for the top jobs

The subscribers to this magazine have qualified professionally to receive it. They are also paid subscribers—interested enough in the technological content to have paid a minimum of \$15 for a subscription.

As subscribers to ELECTRONICS, our readers have told you several things about themselves. They are ambitious. They are interested in expanding their knowledge in specific areas of the technology. And they are sophisticated in their need for and use of business and technology information.

Our readers are now in senior engineering or engineering management, or they are on the road toward those levels. In either case, they are prime applicants for the top jobs in almost any area.

If you are interested in recruiting the best people in electronics, these pages are open to you for your recruitment advertising.

Our readers are not "job-hoppers". To interest them you will have to combine present reward with challenge and opportunity for future career advancement.

The cost of recruitment advertising on these pages is \$65 per advertising inch. For information call or write:

## Electronics

Post Office Box 900, New York, NY 10020  
Phone 212/997-2556



Abbott Transistors Labs	57	Data General Corporation	75 99	John Fluke Mfg Co.	17 157
Advanced Micro Devices	10 11	Data I/O Corporation	77	‡ Gates Energy Products, Inc.	88
Advant	38	* Data Laboratories	49	* Gec M-O Valve	84
■ AEG Telefunken	7	■ Data Precision	112	‡ General Electric Instrument Rental Div.	170
■ Alltech	62	■ Dialight	223	■ General Electric Company Semiconductor Dept.	215
■ Airpax Cheshire Division	101	Digital Equipment Corp. Microcomputer	206, 207	‡ General Instrument Opto Electronics Division	65
*■ Allen Bradley Electronics Ltd	69	Digital Equipment Corporation TOEM	188 189	■ Genrad Incorporated	190 191
American Telephone & Telegraph	221	DII-MCO	8	‡ Gilbarco	61
■ Amp Incorporated	182 183	Dynamic Measurements Corporation	43	Glasgow District Council, City of	148
Ampex DpD	236	‡ Eastman Kodak Co. Graphics Markets Div.	81	■ Gould Inc./Instrument Systems Div/T&M	161
Analog Devices	108 109	Eaton Corporation	175	* Harting Elektronik GmbH	88
Belden Corporation	173	Eaton LRC	180, 181	■ Hewlett Peckard 2c 1, 2, 20, 21, 32, 36, 37, 106, 107 154, 155, 184, 185, 198, 199	
Bentley Harris	80	EIP	27	* ITT Standard AG	5E
■ Bourns Inc. Precision Division	4c	Electronic Arrays	35	* Iwatsu Electric Co. Ltd.	10E
‡ Bud Industries	220	■ Electronic Navigation Industries	3c	P. R. Hoffman	134
*■ Burr Brown Research Corporation	85	Elographics Inc.	236	■ Honeywell TID	203
Byte Books	227	* EMI Technology Data Recording Div.	2E 3E	■ Houston Instrument	219
Cambion	50, 51 224	■ Erie Technological Products	78	Intel TCO	18 19
Centralab Electronics Division	194 195	EXAR	200 201	Intel-Magnetics	30, 31
■ Cherry Electrical Products	13	Fecit AB	163	Interface Incorporated	136
Compas Microsystems	226	Fairchild (Semiconductor Operations Div.)	66 67	Intersil	58 59
Computique	216	Fairchild Test Systems	86 & 87	Keithley Instruments	166 167
Cybernetic Micro Systems	97	■ First Computer Corporation	15	■ Krohn-Hite Corporation	5

•	Matsushita Electric Trading Company	81	■	Projects Unlimited	136	TEAC Corporation	54
■	Micro Component Technology	205		RAC Reliability Analysis Center	227	Techanabexport	236
	Micro Logic Corporation	204		RCA Solid State	177	Tecnetics	12
■	Microtran Company	235		Rhone Poulenc	79	Tektronix	105, 164, 165
	Millenium Systems Incorporated	52 53		Robinson Nugent Incorporated	110 111	‡ Ten-Tec Inc.	216
■	Mineico	196		Robot Research	178	Texas Instruments Semiconductor	168 169
	Mitel Semiconductor Incorporated	92		Rockland Systems Corporation	47	• Thomson CSF Div. D.T.E.	9E
	Monolithic Memories	36 37		Rogers Corporation	217	■ TRW LSI Products	70 71
	Monolithic Systems	72	•	Rohde & Schwarz	65, 7E	■ TRW Optron Incorporated	14
	Mostek Corporation	22, 23	•	SEPA S.P.A.	68	TSD Incorporated (Megadata)	45
‡	Motorola Corporate	68 69	‡	Scottish Development Agency	82 83	Weckesser Company Incorporated	226
•	Murata Mfg. Co Ltd	125		S. D. S. A.	6	Wella Electronics	224
‡	NEC Microcomputers	84 85		Sensor Technology	100	• Zeltron	83
	Neff Instrument Corporation	179	•	Siemens	11E		
	Nicolet Cad Corporation	210 211	•	Siemens AG	60		
■	Non-Liner Systems Inc.	134		Snap-on Tools Corporation	136		
	Oregon Software	209		Softech	227		
	Ovensaire (Division of Walter Kidde & Co.)	134		Spectral Dynamics Corporation	187		
	PCS Communications	124	■	Spectrol Electronics	103		
	People's Computer Company	14		Spectronics	197		
	Percom	9	‡	Sperry Flight Systems	49		
•	Philips T & M	1E	■	Sprague-Goodman Electronics	209		
	Plastics Engineering Company	16		SRI Lanka	192, 193		
•	Plessey Semiconductor	82		Syntronic Instruments Incorporated	104		

#### **Classified and employment advertising**

F. J. Eberle, Manager 212-997-2557

Canadian Marconi Co.	231
Codex Corp.	230
Fortune Personnel Agency Inc.	232
Honeywell-In-Florida	232
Management Recruiters of Indiana	231
Multitone	229
National Personnel Consultants	231
Schlumberger Well Services	228
Southwest Technical	231
Zeltron	230

■ For more information of complete product line see advertisement in the latest Electronics Buyers Guide  
 • Advertisers in Electronics International  
 ‡ Advertisers in Electronics domestic edition

# The 1979 EBG!

## Nothing like it until June, 1980.

Completely new listings of catalogs, new phone numbers, new addresses, new manufacturers, sales reps, and distributors! The total market in a book—four directories in one!

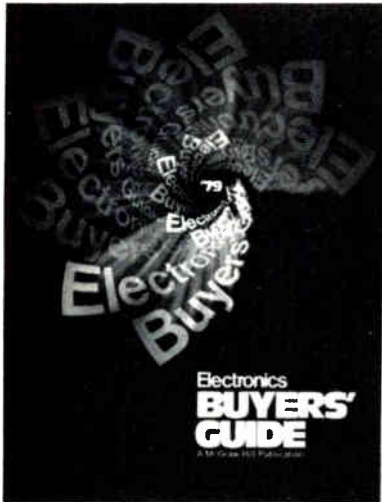

The only book of its kind in the field.

If you haven't got it, you're not in the market.

To insure prompt delivery enclose your check with the coupon now.

Yes, please send me \_\_\_\_\_ copies of 1979 EBG.

I've enclosed \$30 per copy delivered in USA or Canada. Address: EBG, 1221 Avenue of the Americas, New York, N.Y. 10020.

I've enclosed \$52 for air delivery elsewhere. Address: EBG, Shoppenhangers Road, Maidenhead, Berkshire S16, 2Q1 England.

Name \_\_\_\_\_

Company \_\_\_\_\_

Street \_\_\_\_\_

City \_\_\_\_\_

State \_\_\_\_\_ Zip \_\_\_\_\_ Country \_\_\_\_\_

### Advertising Sales Staff

**Advertising sales manager:** Paul W. Reiss  
1221 Avenue of the Americas, New York, N.Y. 10020  
[212] 997-3468

**Atlanta, Ga. 30309:** Peter Stien  
100 Colony Square, 1175 Peachtree St., N.E.  
[404] 892-2868

**Boston, Mass. 02118:** Frank Mitchell  
607 Boylston St., [617] 262-1160

**Cleveland, Ohio 44113:** William J. Boyle  
[716] 248-5620

**Detroit, Michigan 48202:** Jack Anderson  
1400 Fisher Bldg., [313] 873-7410

**Fort Lauderdale, Fla. 33306:** Peter Stien  
3000 N.E. 30th Place, Suite #400  
[305] 563-9111

**New York, N.Y. 10020**  
1221 Avenue of the Americas  
John Gallie [212] 997-3616  
Matthew T. Reseska [212] 997-3617

**Philadelphia, Pa. 19102:** Matthew T. Reseska  
Three Parkway, [212] 997-3617

**Pittsburgh, Pa. 15222:** Matthew T. Reseska  
4 Gateway Center, [212] 997-3617

**Rochester, N.Y. 14534:** William J. Boyle  
Powder Mill Office Park, 1163 Pittsford-Mendon Rd.,  
Pittsford, N.Y. 14534  
[716] 248-5620

**Advertising sales manager, Western:** Norm Rosen  
3200 Wilshire Blvd., South Tower  
Los Angeles, Calif. 90010 [213] 487-1160

### Chicago, Ill. 60611

645 North Michigan Avenue  
Jack Anderson [312] 751-3739  
Robert M. Denmead [312] 751-3738

### Costa Mesa, Calif. 92626:

3001 Red Hill Ave. Bldg. #1 Suite 222  
[714] 557-6292

**Dallas, Texas 75201:** John J. Uphues  
2001 Bryan Tower, Suite 1070  
[214] 742-1747

**Denver, Colo. 80203:** Harry B. Doyle, Jr.  
123 Speer Blvd. #400  
[303] 837-1010

**Houston, Texas 77002:** John J. Uphues  
601 Jefferson Street, Dresser Tower  
[713] 659-8381

**Los Angeles, Calif. 90010:** Chuck Crowe  
3200 Wilshire Blvd., South Tower  
[213] 487-1160

**San Francisco, Calif. 94111:** Don Farris,  
Larry Goldstein, 425 Battery Street,  
[415] 362-4600

**Paris:** Patrick Mouillard  
17 Rue-Georges Bizet, 75116 Paris, France  
Tel: 720-16-80

**United Kingdom:** Simon Smith  
34 Dover Street, London W1  
Tel: 01-493-1451

**Scandinavia:** Andrew Karnig and Assoc.  
and Simon Smith  
Kungsholmsgatan 10  
112 27 Stockholm, Sweden  
Tel: 08 51 68 70 Telex: 179 51

**Milan:** Ferruccio Silvera  
1 via Baracchini, Italy  
Phone 86-90-656

**Brussels:**  
23 Chaussee de Wavre  
Brussels 1040, Belgium  
Tel: 513-73-95

**Frankfurt/Main:** Fritz Krusebecker  
Liebigstrasse 27c, Germany  
Phone 72 01 81

**Tokyo:** Akio Saijo, McGraw-Hill  
Publications Overseas Corporation,  
Kasumigaseki Building 2-5, 3-chome,  
Kasumigaseki, Chiyoda-Ku, Tokyo, Japan  
[581] 9811

### Business Department

#### Thomas M. Egan

Production Director  
[212] 997-3140

#### Carol Gallagher

Production Manager  
[212] 997-2045

#### Betty Preis

Production Manager Domestic  
[212] 997-2908

#### Thomas Kazich

Production Manager Related Products  
[212] 997-2044

#### Frances Vallone

Reader Service Manager  
[212] 997-6057

#### Electronics Buyers' Guide

H.T. Howland, General Manager

[212] 997-6642

Regina Hera, Directory Manager

[212] 997-2544

Thomas Kazich, Production Manager

[212] 997-2044

Marianne Meisner, Production Assistant

[212] 997-2843

Frances Vallone, Reader Service Manager

[212] 997-6057

#### Classified and Employment Advertising

Frank Eberle, Manager

[212] 997-2557

## NEW TELEPHONE COUPLING TRANSFORMERS

NOW AVAILABLE TO COMPLY WITH NEW FCC PART 68



Low Profile  
PC  
Construction

DESIGNED FOR VOICE/DATA TELECOMMUNICATIONS

Request Engineering Bulletin F232 and Complete Catalog on your Letterhead

Complete line of AUDIO · POWER COMMERCIAL · MIL Transformers



IMMEDIATE DELIVERY FROM DISTRIBUTORS

**MICROTRAN**  
COMPANY INC  
145 E Minerva Ave. Valley Stream N.Y. 11582

Circle 235 on reader service card

# MOVING?

Please give us 4 weeks advance notice. Attach the label for your old address, write in your new address below, and send to Fulfillment Manager, Electronics, P.O. Box 430, Hightstown, N.J. 08520.

OLD ADDRESS LABEL

### NEW ADDRESS

Name \_\_\_\_\_

Address \_\_\_\_\_

City \_\_\_\_\_

State/Province \_\_\_\_\_

Zip/Postcode \_\_\_\_\_

Country \_\_\_\_\_

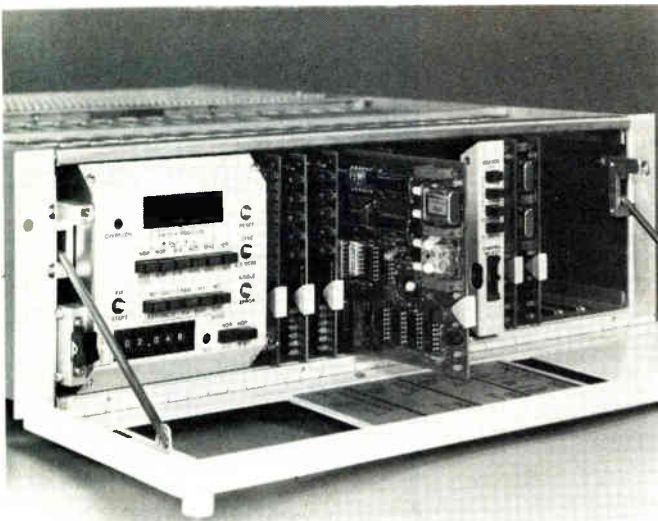

# NEW LIFE FOR ANALOG RECORDERS IN A DIGITAL ENVIRONMENT

Ampex calls it the *M<sup>2</sup> Digital Encode/Decode Unit*. You'll call it the most cost-effective modem you've ever seen for high density digital multi-channel transmission applications.

Used in conjunction with an analog instrumentation recorder, the Ampex M<sup>2</sup> Encode/Decode Unit gives you a digital capability of 5 megabits/second at 120 ips, working in Biphase-L, Miller or M<sup>2</sup> codes. And you can get as many as 10 channels of record/playback in a package only 5 1/4 inches high by 19 inches wide.

The built-in test option functions as an error counter with a digital readout to diagnose input rates, and it also serves as both a tape and a total system certification system, displaying number of errors in either 10<sup>6</sup> or 10<sup>8</sup> bits. It can also be used as a frequency counter.

Use this unique unit as a digital recording front end, as a self-standing modem on wideband telephone and a signal circuits, or as a multichannel diagnostic adjunct. Power supply is 115/220V, 47 to 400 Hz, and price ranges from about \$6,000 to \$12,000 depending upon channel count and installed options.

Rene Chikhani can provide complete technical and performance specifications, and he'll work with you on custom system applications. Call Rene at 415-367-2758, or write to him at Ampex Data Systems, 401 Broadway, Redwood City, California 94063.

## AMPEX

## RADIATION COUNTERS

for registration of

- alpha-radiation
- beta-radiation
- gamma-radiation
- X-rays
- cosmic-rays
- neutrons

Exporter:  **Techsnabexport**  
32/34, Smolenskaya-Sennaya  
121200, Moscow, USSR  
Tel. 244-32-85 · Telex 7628

**AMTORG TRADING CORP.**  
750 Third Avenue,  
New York, N. Y. 10017,  
Tel. (212) 682-7404

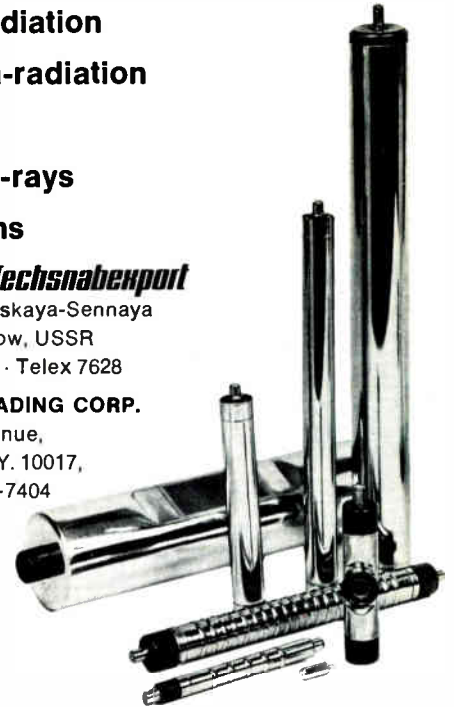

Circle 237 on reader service card

## LET YOUR FINGERS DO THE TALKING . . . .

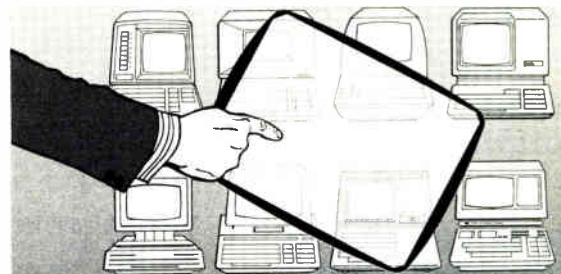

With the touch of a finger on the Elographics E270 Position Sensor, the coordinates of the point touched are transmitted to a terminal or computer for limitless menu and graphic applications. Replaces light pens, joy sticks and opens new applications where finger touch simplicity is a must.

The E270 is a transparent formfitting sensor mounting directly on CRT's. Utilizing modern continuous thin film coatings, the E270 gives high resolution coordinates. A variety of controller electronics is available to enable the OEM or system builder to interface easily to most micros and minis.

- |                     |                       |
|---------------------|-----------------------|
| ● POINT MODE        | ● LOW COST            |
| ● STREAM MODE       | ● RESOLUTION TO .003" |
| ● MODELS TO FORMFIT | ● HIGH RELIABILITY    |
| VARIETY OF CRT's    | ● EASY TO INSTALL     |

The E270 offers a uniquely simple and flexible way to communicate with computer systems. Let Elographics solve your man-machine interface problems.

 **ELOGRAPHICS, inc.**

1976 OAK RIDGE TURNPIKE OAK RIDGE, TENNESSEE 37830 (615) 482-4038

# Now... the only RF power amplifier you may ever need.

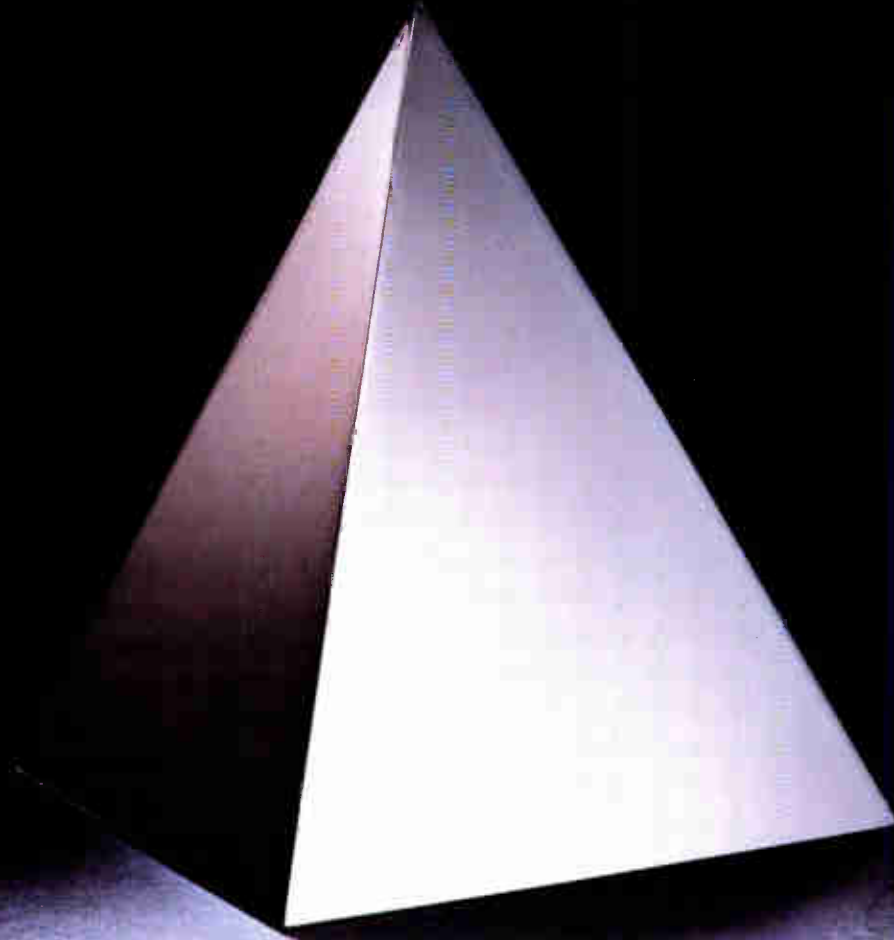

The new ENI 550L  
delivers 50W, 1.5-400 MHz.

This single unit is so incredibly versatile it can replace several you may be using now. And you may never need another. It's an extremely broadband high power, solid state, Class A linear amplifier. It's rated at 50W from 1.5-400 MHz. But it can provide 100 Watts from 1.5-220 MHz. All you need with the 550L is any standard signal or sweep generator and you've got the ultimate in linear power for such applications as RFI/EMI testing, NMR,



RF Transmission, ultrasonics and more.

And, like all ENI power amplifiers, the 550L features unconditional stability, instantaneous failsafe provisions, and absolute protection from overloads and transients.

The 550L represents the pinnacle in RF power versatility. There's nothing like it commercially available anywhere! And it may be the only RF power amplifier you ever need.

For more information, a demonstration, or a full line catalog, please contact us at ENI, 3000 Winton Road South, Rochester, NY 14623. Call 716/473-6900, or telex 97-8283 ENI ROC.

## ENI



### The advanced design line of power amplifiers

Circle 901 on reader service card

World Radio History

# Wirewound or Hybrid Pots...



## Bourns gives you the choice.

Your choice of either wirewound or hybrid conductive plastic/wirewound elements: If your precision pot application requires a low tempco, tight linearity and excellent resistance stability, choose the Model 3540 wirewound potentiometer. If you **also** need extremely long operational life, infinite resolution and excellent output smoothness, choose the Model 3541 Hybritron<sup>®</sup> potentiometer. Both models are field-proven, 10-turn, 7/8" diameter precision potentiometers, with a range of resistance values to satisfy the most demanding applications.

**Wirewound** — The Model 3540 pot offers very good stability of total resistance with time and temperature changes. Tempco is 50 ppm/°C maximum. Design concentricity permits linearities from our standard 0.25% down to 0.1% for special orders.

**Hybrid** — The Model 3541 pot features our exclusive Hybritron resistance element, combining the best features of both wirewound and conductive plastic.

The Hybritron element — conductive plastic material on a wirewound mandrel — extends rotational life to 5 million shaft revolutions, provides essentially infinite resolution and output smoothness of 0.015% maximum. It's priced just slightly higher than the wirewound version.

Both the Model 3540 and 3541 pots are available with a variety of special electrical and mechanical options for additional design flexibility. Whether your choice is wirewound or hybrid, Bourns provides worldwide availability and fast delivery through your local distributor. For your specific requirement, call our design-experienced applications engineers today. Or, see us in EEM, Volume 2, pages 3775 and 3776.

PRECISIONS DIVISION, BOURNS, INC.,  
1200 Columbia Avenue, Riverside, CA 92507.  
Phone: 714 781-5122. TWX: 910 332-1252.

European Headquarters: Bourns AG, Zugerstrasse 74 6340 Baar, Switzerland. Phone: 042 33 33 33. Telex: 78722.



# BOURNS

For Immediate Application—Circle 120 For Future Application—Circle 220

World Radio History