

APRIL 26, 1979

SPECIAL REPORT: HERE COME THE FAST STATIC RAMS/125

Hybrids, materials dominate components conference/112

Single chip interfaces IEEE-488 bus in measurement systems/145



FOUR DOLLARS A MCGRAW-HILL PUBLICATION

Electronics®

MEGABIT BUBBLE MEMORY CHIP GETS SUPPORT FROM LSI FAMILY

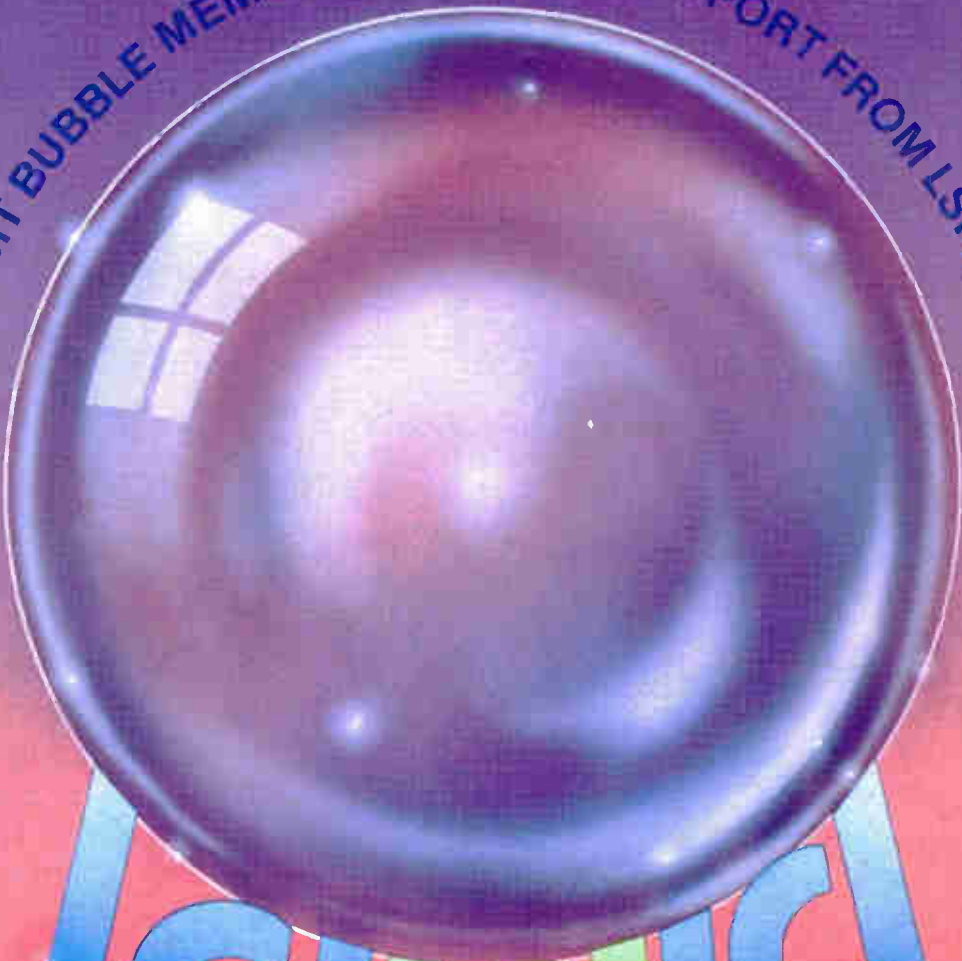

LSI

1470 SW1105 CASAO DEC80
SE SAMICKI
DATA ACQUISITION SYSTEMS
105 N CHAPEL ST
TORRINGTON CT 061

ELECTRICAL ENGINEERS

Hewlett-Packard in Loveland, Colorado, has challenging opportunities for electrical engineers who are experienced in circuit design, manufacturing and marketing. Join creative teams involved in analog and digital electronic instrumentation including voltmeters, circuit test systems, signal sources and analyzers and distance measurement devices.

CAREERS IN COLORADO

Imagine living and working near the magnificent Colorado Rockies. You will be only a few miles from towering, snow-capped mountains, offering a wide array of recreational activities. Located north of Denver, Loveland is a short distance from cultural, sports and educational opportunities of a large metro area. Please send your resume today in confidence to Hewlett-Packard Company, P.O. Box 301, Department E, Loveland, Colorado 80537

HEWLETT  PACKARD

We are an equal opportunity employer dedicated to affirmative action.

For Further Information Circle 900 On Reader Service Card.

SURPRISE!

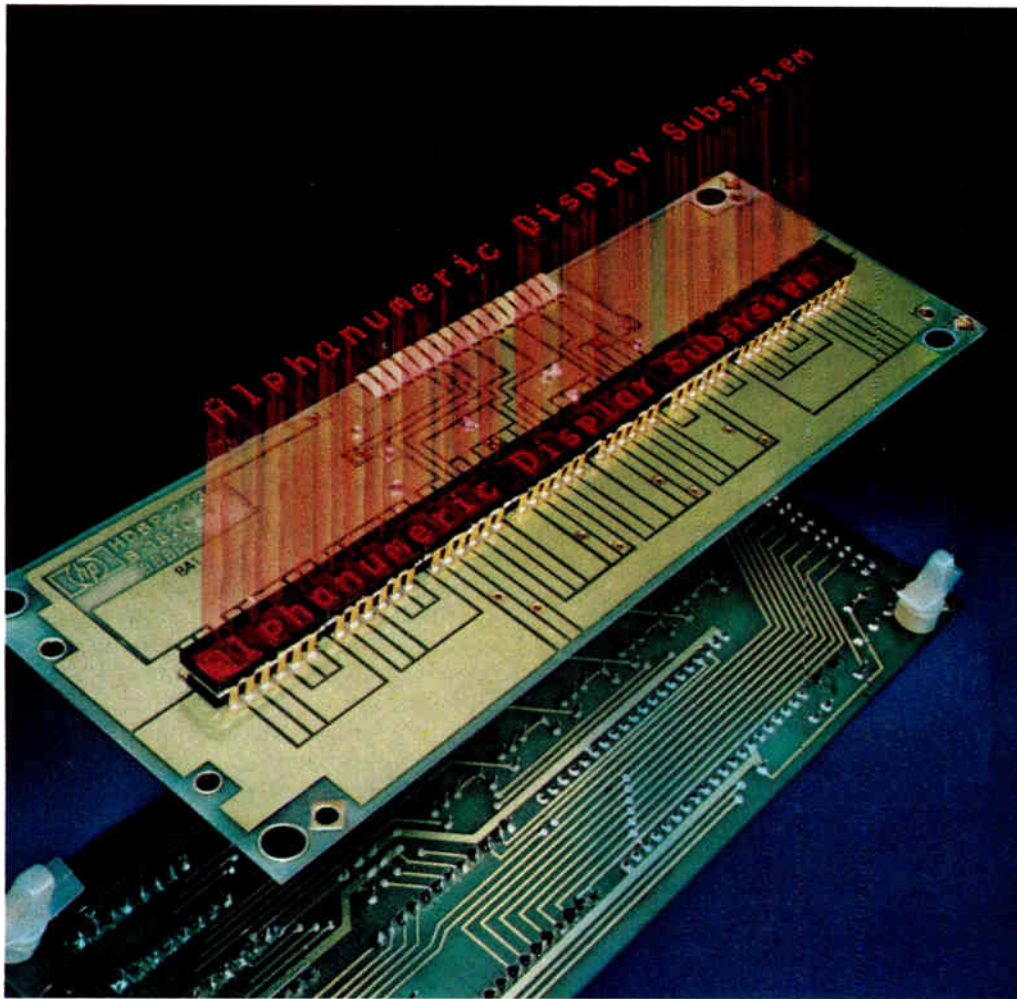

The first stand-alone LED alphanumeric display system is here.

Here's a completely supported alphanumeric display system that frees you from costly display maintenance, requires very low operating power, and minimizes the interaction normally required for alphanumeric displays. You get a choice of 64 or 128 ASCII characters and a choice of a 16-, 24-, 32-, or 40-element display panel. Each 5 x 7 dot matrix is bright, clear and easy to read. In addition, you get editing features that include cursor, backspace, forward, insert, delete and clear. The display system is TTL compatible, requires a single 5V supply, and easily interfaces to a keyboard or microprocessor. It is ideally suited for word processing equipment, instrumentation, desktop calculators, and automatic banking terminals applications. Prices for a complete system start at \$290* for the HDSP-2416 (16 character) display board and HDSP-2470 (64 character ASCII subset) controller board.

For more information on the HDSP-24XX alphanumeric system or immediate off-the-shelf delivery, call any franchised HP distributor.

In the U.S. contact Hall-Mark, Hamilton/Avnet, Pioneer Standard, Schweber, Wilshire or the Wyle Distribution Group (Liberty/Elmar). In Canada, call Hamilton/Avnet or Zentronics, Ltd.

*U.S. Domestic Price Only.

01902

HEWLETT  PACKARD

1507 Page Mill Road, Palo Alto, California 94304

For assistance call: Washington (301) 258-2000, Chicago (312) 255-9800, Atlanta (404) 955-1500, Los Angeles (213) 877-1282

Circle 1 on reader service card

Once again HP makes your money count.



A universal counter for \$375.

The smart money's on HP's new 5314A Universal Counter because it does so much for so little. Now, in one low-cost counter, you can measure frequency up to 100 MHz, period down to 400 nanoseconds with 100 picosecond resolution, and time interval with 100 ns resolution. Add frequency ratio, ratio averaging, totaling and a full complement of time interval measurement controls and you've got a package you'd expect to find at almost twice the 5314A's

\$375 price. Options: internal battery and charger, \$95; TCXO time base, \$100.

Time interval measurement capabilities are truly outstanding at the 5314A's price. Instead of limited single channel controls, or none at all, the 5314A gives you both input trigger level and slope controls for two input channels. So now you can measure pulse widths or time between pulses with stop and start commands from either one or two input control lines.

HP's frequency counters also save you time *and* money.

Using state-of-the-art components common to HP's most sophisticated counters, the HP5380 frequency counter series offers high accuracy, high input sensitivity, input attenuators and direct counting for rapid, convenient frequency measurement and adjustments.



5381A 80 MHz, \$295 • 5382A 225 MHz, \$395 • 5383A 520 MHz, \$650.

To find out more about HP's low-cost laboratory grade counters and the entire family of sophisticated and versatile HP counters call your nearest HP field office. Or write for the 5314A and 5380 series data sheets and electronic counter brochure.

Prices domestic U.S.A. only
02902



1507 Page Mill Road, Palo Alto, California 94304

For assistance call: Washington (301) 258-2000, Chicago (312) 255-9800, Atlanta (404) 955-1500, Los Angeles (213) 877-1282

HP: MAKING EXPERIENCE COUNT



39 Electronics Review

CONSUMER: Japanese boost area, number of LEDs of flat-screen TV, 39
MICROPROCESSORS: Development station runs eight emulators, 40
COMPUTERS: Business systems doing double duty, 41
BUSINESS: U.S., Israel broaden electronic ties, 42
AUDIO: Apple computer checks out speakers, 42
NAVIGATION: Filtering improves Loran-C position fix, 44
MEDICAL: Microwaves affect action of Librium, 46
MICROWAVES: NBS builds simple near-field measuring instrument, 46
NEWS BRIEFS: 48
WEATHER: \$10,000 station sends data to satellite, 50

61 Electronics International

GREAT BRITAIN: Hybrids on heat sinks cut weight, volume, 67
BELGIUM: Personal computer aims at households, 68
FRANCE: Projection LCD exploits three molecular states, 70
JAPAN: UV projection unit goes deep for fine lines, 72
NEW PRODUCTS INTERNATIONAL: 7E

81 Probing the News

COMMUNICATIONS: Tunnel diodes flying high, 81
MICROSYSTEMS: STD bus leaves gate fast, 86
MEDICAL: Microwaves heat up tumor therapy, 88
COMPUTERS: New architecture goes with the flow, 92
OPTOELECTRONICS: Display meeting looks to computers, 96

105 Technical Articles

BUBBLE MEMORIES: Megabit chip gets support from LSI family, 105
COMPONENTS CONFERENCE: Hybrids, materials rule at ECC, 112
DESIGNER'S CASEBOOK: Counter handles data over one channel, 118
Annunciator control uses only passive components, 119
LEDs track signal level in visual data monitor, 121
SOLID STATE: The race heats up in fast static RAMs, 125
COMMUNICATIONS: C-MOS codec uses bipolar interface, 138
INSTRUMENTS: LSI streamlines interface with IEEE-488 bus, 145
ENGINEER'S NOTEBOOK: Checker gauges pulse-width range, 154
CALCULATOR NOTES: HP-97 finds microwave coupler response, 155

167 New Products

IN THE SPOTLIGHT: Tester for bubble memories first in field, 167
Op amps give more for less, 172
Hybrid d-a converter resolves 18 bits, 180
COMPUTERS & PERIPHERALS: Terminal shows full page, 188
DATA ACQUISITION: System acquires data, not space, 196
COMMUNICATIONS: Optic modules are affordable, 200
INSTRUMENTS: Smart counters cost little, 204
PACKAGING & PRODUCTION: Modular printer marks parts fast, 208
MICROPROCESSORS & SYSTEMS: Pascal resides in PROM, 212
SEMICONDUCTORS: Generator drives bar-graph displays, 216
MATERIALS: 222

Departments

Publisher's letter, 4
Readers' comments, 6
News update, 8
People, 14
Editorial, 24
Meetings, 26
Electronics newsletter, 33
Washington newsletter, 55
Washington commentary, 56
International newsletter, 63
Engineer's newsletter, 158
Products newsletter, 221
New literature, 249

Services

Reprints available, 216
Employment opportunities, 250
Reader service card, 273

Highlights

Cover: LSI aids bubble memory design, 105

Ease of use could determine which bubble memories succeed best with designers. So a new megabit bubble memory comes complete with a group of circuits that will interface it to many different systems.

Cover is by Sean Daly.

Look, no central processing unit, 92

A radically different computer architecture from the Massachusetts Institute of Technology has hundreds of arithmetic and logic units processing parts of a problem simultaneously and using packet-switching to route the results through similarly decentralized memory units.

Hybrids inherit ECC, 112

In a marked shift of emphasis, this year's Electronic Components Conference is focussing on materials, manufacturing methods, and packaging, particularly hybrid packaging of very large-scale integration, says this ECC preview. Also worth noting are some novel hybrid circuits and work on gallium-arsenide field-effect transistors.

Static RAMs pick up speed, 125

Led by Fairchild and Intel, makers of 4-K static random-access memories are pushing access times below 55 nanoseconds. This special report describes these rapidly expanding options for fast cache and buffer memories.

... and in the next issue

A special report on data converters . . . a magnetic-bubble memory tester . . . replacing backplanes with zero-insertion-force connectors.

EDITOR-IN-CHIEF: Kemp Anderson

EXECUTIVE EDITOR: Samuel Weber

MANAGING EDITORS: Arthur Erikson,
Gerald M. Walker

ASSISTANT MANAGING EDITORS: Howard Wolf,
Alfred Rosenblatt

SENIOR EDITORS: William F. Arnold,
Ray Connolly

ART DIRECTOR: Fred Sklenar

DEPARTMENT EDITORS

Aerospace/Military: Ray Connolly
Circuit Design: Vincent Biancomano
Communications & Microwave:
Harvey J. Hindin
Components: Nicolas Mokhoff
Computers: Anthony Durniak
Consumer & Industrial: John Javetski
Instrumentation: Albert F. Shackil
Microsystems & Software: John G. Posa
New Products: Michael J. Riezenman,
Richard W. Comerford
Packaging & Production: Jerry Lyman
Solid State: Raymond P. Capece

CHIEF COPY EDITOR: Margaret Eastman

COPY EDITORS: Mike Robinson,
Charlotte Wiggers, Jeremy Young

ART: Charles D. Ciatto, *Associate Director*
Paula Piazza, *Assistant Director*

EDITORIAL SECRETARIES: Janet Noto,
Penny Reitman, Maryann Tusa

EDITORIAL ASSISTANT: Marilyn B. Steinberg

REGIONAL EDITORS

New York: Benjamin A. Mason (212) 997-2245
Boston: James B. Brinton,
Pamela Hamilton (617) 262-1160
Chicago: Larry Marion (312) 751-3805
Dallas: Wesley R. Iversen (214) 742-1747
Los Angeles: Larry Waller (213) 487-1160
Palo Alto: William F. Arnold,
Robert Brownstein (415) 968-2712
Washington: Ray Connolly (202) 624-7592
Frankfurt: John Gosch 72-5566
London: Kevin Smith 493-1451
Paris: Arthur Erikson,
Kenneth Dreyfack 720-20-70
Tokyo: Charles Cohen 581-9816

McGRAW-HILL WORLD NEWS

Editor: Michael Johnson
Brussels: James Smith
Milan: Jeff Ryser
Moscow: Peter Hann
Stockholm: Robert Skole
Tokyo: Robert E. Lee

PUBLISHER: Paul W. Reiss

GENERAL MANAGER, DIRECT MARKETING
OPERATIONS: Horace T. Howland

CIRCULATION MANAGER: Herbert A. Hunter

RESEARCH MANAGER: Margery D. Sholes

READER SERVICE MANAGER:
Frances M. Vallone



It is always exciting to print a story that can shake up the industry—for instance, the cover article in this issue (p. 105), on the development of the 1-megabit magnetic-bubble memory and support chips at Intel Corp.'s subsidiary, Intel Magnetics Inc., Santa Clara, Calif.

Written by vice president of engineering Dick Clover, product engineer Dave Lee, and bubble memory marketing manager Don Bryson, the technical article is the first general disclosure of this group of products. In fact, when arranging for the piece, solid state editor Ray Capece and San Francisco regional bureau manager Bill Arnold were the first editors ever to have been allowed to tour the closely guarded Intel Magnetics facility.

To ready the memory and support chips for market took the combined efforts of the magnetics subsidiary and two Intel divisions. The Special Products division worked on the bipolar Schottky current-pulse generator and the complementary metal-oxide-semiconductor coil pre-drivers. The Microcomputer Components division was responsible for the n-channel formatter/sense amplifier and the HMOS bubble memory controller.

Without these integrated control and driver circuits, there wouldn't be much of a product. As Bryson points out, "Give somebody a bubble memory and not a heck of a lot can be done with it without support chips to make it run."

Now that bubble memories have been made easy for users to apply, products using them should be on the market within a year, Intel esti-

mates. "Ahead we can see a path similar to that of dynamic random-access memories—a quadrupled capacity in three years, to 4 megabits and then 8 megabits," Bryson states.

If someone were to ask you what components are operating as front-end amplifiers for communications satellites and you were aware of the latest technology, you might answer gallium-arsenide field-effect transistors. Right? Wrong.

On a recent visit to the ComSat Laboratory in Bethesda, Md., communications editor Harvey Hindin was dumbfounded to discover that the birds are flying around up there with tunnel diodes aboard, though the devices were originally developed some 20 years ago.

"I had to find out why," says Harvey, and he was intrigued enough with the answer to produce the Probing the News on page 81.

The reason turned out not to be nostalgia, but the reliability ensured by new preflight screening procedures. So far, over 100 tunnel-diode amplifiers have gone into orbit without a single flight failure.

Nevertheless, these old dependables will probably not be around too much longer, according to Harvey. Eventually the new GaAs FETs will pass tunnel diodes in reliability and offer better noise figures into the bargain, signaling the end for the old timers in this application.

April 26, 1979 Volume 52, Number 9

101,906 copies of this issue printed

Electronics (ISSN 0013-5070). Published every other Thursday by McGraw-Hill, Inc. Founder: James H. McGraw 1860-1948. Publication office 1221 Avenue of the Americas, N.Y., N.Y. 10020; second class postage paid at New York, N.Y., and additional mailing offices. Executive, editorial, circulation and advertising addresses: Electronics, McGraw-Hill Building, 1221 Avenue of the Americas, New York, N.Y. 10020. Telephone (212) 512-2000. Teletype 12-7960 TWX 710-581-4879. Cable address: MCGRAW HILL N Y N Y R K. Subscriptions limited to professional persons with active responsibility in electronics technology. No subscriptions accepted without complete identification of subscriber name, title or job function, company or organization, and product manufactured or services performed. Based on information supplied, the publisher reserves the right to reject non-qualified requests. Subscription rates: in the United States and possessions \$17 one year, \$29 two years, \$43 three years; company addressed and company libraries \$23 one year, \$41 two years, \$58 three years; APD/FPO addressed \$35 one year only; Canada and Mexico \$19 one year, \$32 two years, \$47 three years; Europe \$46 one year, \$78 two years, \$110 three years; Japan, Israel and Brazil \$70 one year, \$115 two years, \$165 three years; Australia and New Zealand \$95 one year, \$170 two years, \$240 three years, including air freight; all other countries \$50 one year, \$85 two years, \$125 three years. Limited quota of subscriptions available at higher-than-basic rate for persons allied to field served. Check with publisher for these rates. Single copies: \$4.00. Please allow four to eight weeks for shipment. Officers of McGraw-Hill Publications Company: Gordon L. Jones, President; Group Vice-President: Daniel A. McMillan, Senior Vice-President; Russell F. Anderson; Ralph R. Schulz, Editorial; Vice-Presi-

dents: James E. Hackett, Controller; Thomas H. King, Manufacturing; Robert L. Leyburn, Circulation; John W. Patten, Sales; Edward E. Schirmer, International. Officers of the Corporation: Harold W. McGraw, Jr., President, Chief Executive Officer, and Chairman of the Board; Robert N. Landes, Senior Vice President and Secretary; Ralph J. Webb, Treasurer. Title registered in U.S. Patent Office; Copyright © 1979 by McGraw-Hill, Inc. All rights reserved. The contents of this publication may not be reproduced in whole or in part without the consent of copyright owner. Where necessary, permission is granted by the copyright owner for libraries and others registered with the Copyright Clearance Center (CCC) to photocopy any article herein for the base fee of \$0.50 per copy of the article plus \$0.25 per page. Payment should be sent directly to the CCC. Copying done for other than personal or internal reference use without the express permission of McGraw-Hill is prohibited. Requests for special permission or bulk orders should be addressed to the publisher. ISSN 0013-5070/79\$0.50+.25. Subscribers: The publisher, upon written request to our New York office from any subscriber, agrees to refund that part of the subscription price applying to copies not yet mailed. Please send change-of-address notices or complaints to Fulfillment Manager; subscription orders to Circulation Manager, Electronics, at address below. Change-of-address notices should provide old as well as new address, including zip codes. Attach address label from recent issue. Allow one month for change to become effective. Subscriber Service: call (609) 448-8110, 9 a.m. to 4 p.m. EST. Postmaster: Please send form 3579 to Fulfillment Manager, Electronics, P.O. Box 430, Hightstown, N.J. 08520.

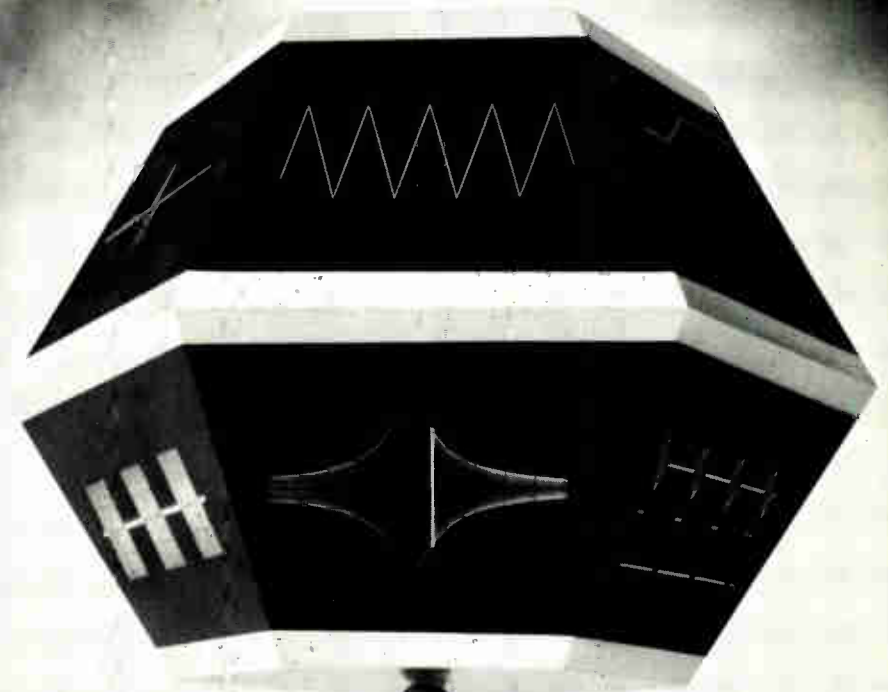

**14 functions at your fingertips
plus frequency marker for ... \$695**



Krohn-Hite's new Model 1600 lin-log sweep generator provides sine, square and triangle waveforms from 0.2 Hz to 3 MHz. Choose among these frequently needed functions:

- Continuous ● Gate ● Trigger ● Pulse ● Continuous sweep ● Triggered sweep ● Gated sweep ● Hold-sweep-hold ● Tone burst ● Triggered burst ● Gated swept burst ● Triggered swept burst ● Sweep-hold-burst ● External VC

Model 1600 also gives you a handy frequency marker useful for frequency response tests. Calibrated start/stop controls provide choice of up or down sweep. Other helpful features include an output attenuator calibrated in dB; variable DC offset $\pm 10V$; TTL output for gating, blanking, etc.; variable start phase and trigger level; and more.

If you would like all these features at your fingertips, circle reader service number or call us.

KH KROHN-HITE CORPORATION

Avon Industrial Park, Avon, MA 02322 • (617) 580-1660 TWX 710 345 0831

AL, Huntsville (205) 534-9771; AZ, Phoenix (602) 279-1531; CA, Inglewood (213) 674-6850, San Jose (408) 292-3220; CO, Denver (303) 773-1218; CT, Canton Center (203) 693-0719; FL, Orlando (305) 894-4401; GA, Atlanta (404) 455-1206; HI, Honolulu (808) 941-1574; IL, Chicago (312) 283-0713; IN, Carmel (317) 844-0114; KS, Overland Park (913) 649-6996; LA, Gretna (504) 367-3975; MO, Towson (301) 321-1411; MA, Wakefield (617) 245-5940; MI, Detroit (313) 961-3042; MN, Minneapolis (612) 835-4818; MO, St. Louis (314) 569-1406; NM, Albuquerque (505) 255-2330; NJ, Cherry Hill (609) 482-0059, Englewood (201) 871-3916; NY, Rochester (716) 473-5720, Syracuse (315) 437-6666, Vestal (607) 785-9947; NC, Burlington (919) 227-3639; OH, Chesterland (216) 729-2222, Dayton (513) 294-2476; OK, Jenks (918) 299-2636; OR, Portland (503) 297-2248; TX, Dallas (214) 661-0400, Houston, (713) 688-1431; UT, Salt Lake City (801) 466-8729; VA, Falls Church (703) 573-8787; WA, Bellevue (206) 454-3400; WI, Milwaukee (414) 545-8400; CANADA, Montreal, Quebec (514) 341-7630, Ottawa, Ontario (613) 235-5121, Toronto, Ontario (416) 445-9900, Vancouver, British Columbia (604) 253-5555, Halifax, Nova Scotia (902) 454-8321, St. John's Newfoundland (709) 726-2422.

Choose a
TELEQUIPMENT
Oscilloscope
for:

Performance.
Reliability.
Economy.

A hard to find combination in most low-priced oscilloscopes. But Telequipment, a Tektronix Company, has over 20 years of experience in designing and building high-quality, competitively-priced instruments. Instruments that will meet your measurement needs today and for years to come.

Twelve oscilloscopes, including nine benchtop models and three battery-powered portables, a curve tracer and a family of accessories are now available in the United States. Bandwidths range from 5 MHz to 25 MHz. Various models feature dual trace, delayed sweep, and storage modes.

And TELEQUIPMENT Instruments are now sold through stocking-distributors offering local availability, service, warranty repairs and models previously not sold in the U.S.

For specifications and the name of the Telequipment Distributor nearest you, write: Telequipment U.S. Sales, P.O. Box 500, Beaverton, OR 97077 or call: (503) 644-0143.

TELEQUIPMENT 
A division of Tektronix U.K. Ltd., a subsidiary of Tektronix, Inc.

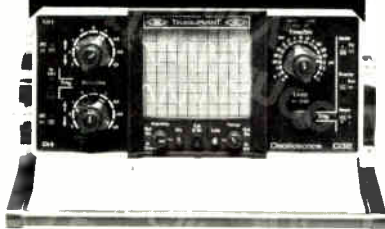

Readers' comments

Already ready

To the Editor: I would like to point out a significant omission in your March 15 review of bus-compatible converters ["IC makers ready converters for 8-bit processors," p. 39]. While others talk of introducing such products, AMD has already done so. In fact, last year we introduced a pair of bus-compatible digital-to-analog converters, the Am6080 and Am6081 (see *Electronics*, Oct. 12, p. 180). These Busdac products contain the data-bus input latches and the address and decoding circuitry that allow them to interface with any 8-bit microprocessor.

Robert M. Grossman
Advanced Micro Devices Inc.
Sunnyvale, Calif.

Waste as savings?

To the Editor: The News Update column on March 1 [p. 8] quotes a Federal Aviation Administration lead engineer proudly claiming "great" power savings by revamping plan-view displays at 20 en-route air terminals, for a purchase price of \$1 million. If this is an example of the quality of technical decision-making in a government bureau, it is no wonder our energy policy can't get off the ground.

Based on an estimated 20 PVDs in each of the terminals operating continuously, and saving 450 watts each, at an electric utility rate of 5¢ per kilowatt-hour, this "savings" will require more than 12 years to pay out. Since the quoted price probably does not include freight, installation, or the myriad of Government contract overhead costs, I imagine the payout is more likely about 20 years.

Your reporter missed the real story—another example of waste, foisted on the taxpayer and masquerading as Government savings!

J. W. Pehoushek
Cincinnati, Ohio

Correction

That new line of Regent terminals, Regent 300 terminal cluster system and System 75 (April 12, p. 42) is, of course, from Applied, not Advanced, Digital Data Systems Inc.

Check

- Transistors
- Capacitors
- Diodes
- IC's

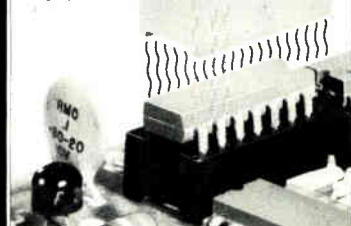

CONTROLLED HEATING
... where it counts

THERMO-PROBE

Heat any integrated circuit or electronic component to its rated temperature with a heat probe. Accuracy $\pm 3^\circ\text{C}$ or better. Or check the component's temperature with a thermo-couple probe. Model 810 Thermo-Probe does both. Reads out directly in $^\circ\text{C}$ and $^\circ\text{F}$ on a large $4\frac{1}{2}$ -inch meter.

MTI MICRO-TECHNICAL INDUSTRIES

P.O. Box 287 South Laguna, CA 92677

TELEPHONE (714) 545-3734

TWX 910 596-1325 MICROTECH LBEN

Circle 225 on reader service card

bel delay lines

- Digital
- Programmable
- DIP

TTL DTL Compatible

BEL FUSE INC.

203E Van Vorst St. Jersey City N.J.

07302 (201) 432-0463

TWX 710-730-5301

Circle 226 on reader service card

Mail us this ad

and we'll help you discover simple, effective solutions to difficult troubleshooting problems.

FAULT	STIMULUS	RESPONSE	TEST METHOD
Shorted Node	546A Pulser ¹	547A Current Tracer	<ul style="list-style-type: none"> • Pulse shorted node • Follow current pulses to short
Stuck Data Bus	546A Pulser ¹	547A Current Tracer	<ul style="list-style-type: none"> • Pulse bus line(s) • Trace current to device holding the bus in a stuck condition
Signal Line Short to Vcc or Ground	546A Pulser	545A Probe Current Tracer	<ul style="list-style-type: none"> • Pulse and probe test point simultaneously (short to Vcc or Ground cannot be overridden by pulsing) • Pulse test point, and follow current pulses to the short
Vcc to Ground Short	546A Pulser	547A Current Tracer	<ul style="list-style-type: none"> • Remove power from test circuit • Disconnect electrolytic bypass capacitors • Pulse across Vcc and ground using accessory connectors provided • Trace current to fault
Internally Open IC	546A Pulser ¹	545A Probe	<ul style="list-style-type: none"> • Pulse device input(s) • Probe output for response
Solder Bridge	546A Pulser ¹	547A Current Tracer	<ul style="list-style-type: none"> • Pulse suspect line(s) • Trace current pulses to the fault • Light goes out when solder bridge passed
Sequential Logic Fault in Counter or Shift Register	546A Pulser	548A Clip	<ul style="list-style-type: none"> • Circuit clock de-activated • Use Pulser to enter desired number of pulses • Clip onto counter or shift register and verify devices truth table

1. Use the Pulser to provide stimulus, or use normal circuit signals, whichever is most convenient.



HP's IC Troubleshooters make troubleshooting digital circuits fast and less frustrating. Take a look at the chart and see why more than 50,000 people use these simple, rugged, low-cost Hewlett-Packard instruments.

LOGIC PULSER stimulates IC's in-circuit for testing. Automatically drives the circuit to its opposite state. No unsoldering components or trace cutting. \$115-\$175*

LOGIC PROBE shows pulse activity: high, low or bad level, single pulse or pulse trains. High input impedance. Overload protected. Automatic. More convenient than a scope. \$90-\$150*

LOGIC CLIP with 16 LED's displays state of up to 16 IC pins at once. High input impedance. Overload protected. Automatic. \$90-\$125*

CURRENT TRACER inductively senses and displays logic current pulses. Finds shorts and stuck nodes with no unsoldering or trace cutting. Uses in-circuit current or pulses from Logic Pulser. \$350*
*Domestic US prices only.

Order now or call your nearby HP field sales office for complete information.

I want to discover easy solutions to difficult troubleshooting problems. Please rush me a free copy of HP's 20-page Troubleshooting Catalog.

NAME _____
 COMPANY _____
 ADDRESS _____
 CITY _____
 STATE _____ ZIP _____



1507 Page Mill Road, Palo Alto, California 94304

For assistance call Washington (301) 258-2000, Chicago (312) 255-9800, Atlanta (404) 955-1500, Los Angeles (213) 877-1282

02904

You can have our Type 105 metallized polyester capacitors taped and reeled, in special values or tolerances, with higher voltage ratings or special leads — or standard, off the shelf.



We're nothing if not accommodating.

Our Type 105 metallized polyester capacitors are inexpensive and very very good. Little tubular jobs with axial tinned copperweld or tinned copper leads. In standard values from 0.01 to 10 mfd $\pm 20\%$, 10%, 5%. WVDC 100, 250, 400, 630. Self-healing, extended foil construction, non-inductive. Etc.

Our Type 105 manufacturing process is so flexible that "specials" are easily produced to your specs without either long delivery or breathtaking prices.

Standard Type 105 capacitors are at least as good as the very best on the market (we secretly think they're a little better) and "specials" are normally no problem at all.

Need a quote? We'd be delighted. Samples? Please ask.

SEACOR INC., 123 Woodland Ave., Westwood, N.J. 07675
Tel. (201) 666-5600 ■ Telex 135354

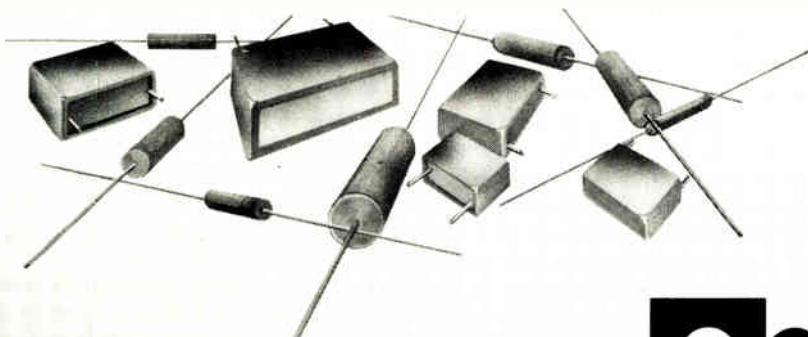

Everything in Film Capacitors

Circle 8 on reader service card



News update

■ No one can accuse the military of moving with unseemly haste to purchase electronic systems. A case in point is the Navy's two-year old plan to equip its vessels and aircraft with standard militarized computers, peripherals, and software [*Electronics*, Dec. 23, 1976, p. 54].

Called the Tactical Digital Standardization Program, the exercise is supervised by the Naval Electronics Systems Command in Washington, D. C., as a means of saving money in training, documentation, maintenance, and parts inventory, among other things. It attracted the attention of such heavyweights as the Sperry Univac division of Sperry Rand Corp., whose AN/UYK-20 minicomputer was the first machine to win approval under the program, and Control Data Corp.

But to a small company in Plainview, N. Y., the Qantex division of North Atlantic Industries Inc., the program represented a potential boon. Qantex supplies the \$20,000 magnetic-tape cartridge unit for the UYK-20 as well as all other present and proposed mini types. The contract for its standardized parts, called by the Navy the AN/USH-26 data-storage peripheral, could be worth \$50 million to Qantex over five years.

Now, after two years of tests, the Qantex part has been approved by the Navy for fleet-wide deployment. Orders have been piling up during that period, although 462 have been shipped, mostly to Navy contractors for use in their system development.

The Qantex unit is based on the 3M data cartridge. Its modular form makes for easy matching to widely different systems and to a number of computers of differing design. It has four cartridge transports per unit, for a capacity of 10 million characters. Access time is faster than that of reel-to-reel tape drives, since the USH-26 has four tracks on each cartridge in contrast to serial processing for the reel versions.

Joel Kramer, president of Qantex, says the Navy has 50 programs under development that will require tape-storage systems like the model 26.

-Howard Wolff



Presents the NEW digital[®] 11/03-L Systems



FLOPPY 11V03-L

Standard 11/03-L systems are available as 1 Megabyte Double Density Floppy Disk based or



VT100

10 Megabyte Hard Disk Cartridge based RT-11 systems.



HARD DISK 11T03-L

These systems are available with choice of LA36, VT52 or VT100 as consoles.

DON'T WAIT! With FIRST Computer's "EXCLUSIVE" BUYER PROTECTION PROGRAM You can buy tomorrow's computer system—TODAY!

BUYER PROTECTION PROGRAM

This Certificate entitles _____ located at _____ to priority allocation for the purchase of one (1) of the following LSI-11/23 upgrade Processor/Memory options:

- | | | |
|-------------|---------------------|--------|
| 1. KDF11-HH | LSI-11/23 with 96KW | \$5250 |
| 2. KDF11-HF | LSI-11/23 with 64KW | \$3850 |
| 3. KDF11-HD | LSI-11/23 with 32KW | \$2450 |

This option must be exercised by submission of written Purchase Order within thirty (30) days of receiving written notification by Certified Mail at the above address of the availability of product by First Computer Corporation.

Priority allocation of the new LSI-11/23 Processor/Memory option will be assigned solely on the sequence of the receipt of valid Purchase Orders as evidenced by the numeric sequence of the above Certificate Number. Ex-

pired options will be voided thirty-one (31) days after written notification is tendered by Certified Mail. The cost of this option is non-refundable and in no case will expired options be reinstated.

by First Computer Corporation
VOID
First computer corporation

CERTIFICATE NO. _____
SYSTEM MODEL _____
SERIAL NO. _____
DATE PURCHASED _____
SALES ORDER NO. _____

This option is applicable to all purchases of PDP-11/03 (SRVxxx-xx) packaged systems purchased from First Computer Corporation between the period April 1, 1979 and December 31, 1979 inclusive. This option must be ordered on the same Purchase Order as the packaged system by specifying the following:

1. KDF11-XX LSI-11/23 Upgrade Option \$300.00

® Registered trademark of Digital Equipment Corporation, Maynard, Mass.

™ Registered trademark of First Computer Corporation



TWX NUMBER 910-651-1916

computer corporation

corporate square/825 north cass avenue/westmont, illinois 60559/(312) 920-1050

Circle 9 on reader service card

"I HAVE SEEN THE FUTURE AND IT'S 8086!"



There's a lot of noise out there about the 8086. A lot of noise. And all of it's coming from Intel.

But even with all the pages of advertising, all the claims, all the chest-beating, there's one little fact Intel forgot to mention.

The 8086 isn't the best 16-bit CPU.

The AmZ8000 is.

The AmZ8000 is the beginning of a product line. The 8086 is the end. It's nothing but a souped-up version of the 8080 and 8085.

The AmZ8000 has a more powerful, more

advanced, much more flexible architecture than the 8086. It also has more addressing modes, more general-purpose registers, larger addressing spaces, better I/O capability and more powerful instructions. It can even accommodate more data types. And the AmZ8000 has a lot higher throughput using standard NMOS than the 8086 using HMOS.

Worried about software? Don't be.

The AmZ8000 is cheaper and easier to program than the 8086.

But it won't just save you money; it'll save you time. You'll be able to develop new

**"The AmZ8000
is better."**

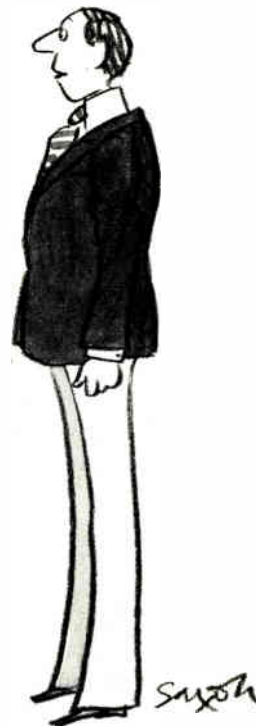

programs faster than ever before. That means you'll be able to get new products to market faster than ever before.

And to speed things up even more, we designed a software development system especially for the AmZ8000. It combines versatile hardware with powerful software. And it's got a real catchy name: the System 8/8.

One last thing: we know it hurts to drop Intel for somebody else. We've just been through it ourselves. But it's going to hurt a

lot more next year and the year after that. By then your competitors could be so far ahead of you, you might never catch up.

Call Advanced Micro Devices and we'll send you all the facts on the AmZ8000.

Then quietly and calmly, in the privacy of your own office, compare the AmZ8000 with the 8086.

We think you'll agree with us: Intel may make a lot of noise. But the AmZ8000 makes a lot of sense.

Advanced Micro Devices 

901 Thompson Place, Sunnyvale, CA 94086 • Telephone: (408) 732-2400

Circle 11 on reader service card

Technical for impatient

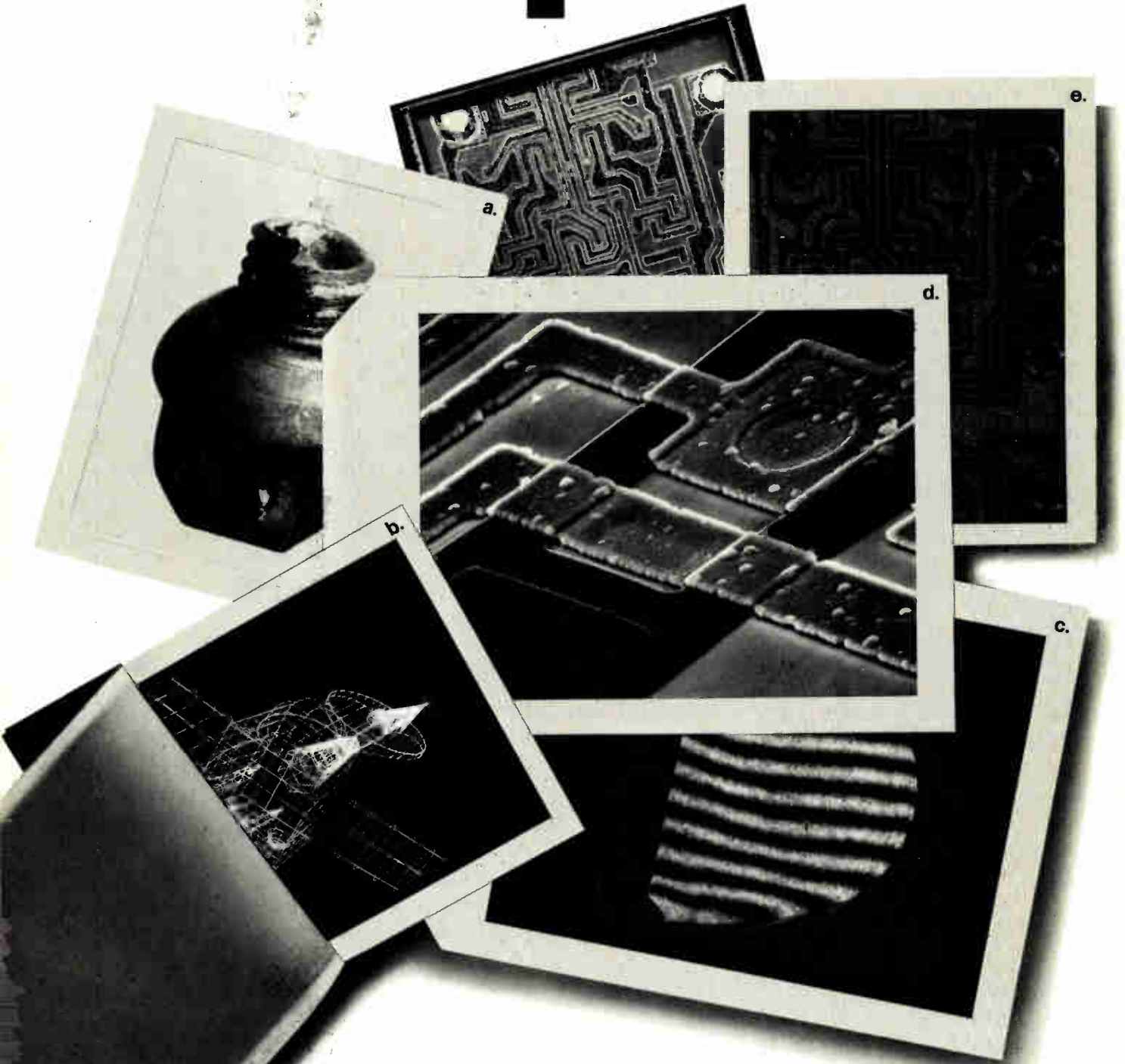

a. Torque test, axle bolt. Type 667 Coaterless film.

b. CRT graphic display. Type 084 film.

c. Interferometric evaluation of flat mirror with laser light. Type 57 High Speed 4 x 5 film.

d. Converter circuit inspection 700x, scanning electron microscope. Type 52 Fine Grain 4 x 5 film.

e. Memory circuit, 100x. Type 665 Positive / Negative film.

photography people.

If you need photographs of your work, why sit around waiting for them? With Polaroid instant photographic equipment you get immediate results.

Our wide range of equipment lets you record everything from microbes to metal stress tests. With Polaroid self-developing films you can have professional quality results in color in 1 minute, or in black and white (with or without a usable negative) in seconds. And our equipment is simple to use. So you can take the photographs you need without needing to know a lot about photography.

The MP-4 Multipurpose camera (1) is a versatile, self-contained photo studio anyone can operate. It uses 14 different Polaroid instant films to keep you out of the dark-room. And it copies, delivers close-ups, reductions, macro-photographs and photo-micrographs, to bring your answers to light.

Our CU-5 Close-up camera (2) is a lightweight, hand-held system you can take almost anywhere and get instant photos from 1/4 to 3 times life size. Exposure is easy to set,

lighting is built in and framing is automatic. So all you have to think about is the picture. You can even use the CU-5 to capture a transient image on a cathode ray tube.

Many cameras and instruments can be adapted quickly and easily for instant photography with Polaroid film holders (3). They come in 3 models to handle 3 different sizes of Polaroid Land film (3 1/4 x 4 1/4, 4 x 5, and 8 x 10 in.), so you can get instant results in almost any format.

Many other manufacturers of cameras and instruments also supply Polaroid Land camera backs that adapt their equipment to instant photography. These backs use 9 different convenient Polaroid pack films, so you can see your project in a new light.

To find out how you can get instant results, mail the coupon below. Or if you're a very impatient person, call us toll-free from the continental U.S. at 800-225-1618 (from Massachusetts, call collect 617-547-5177).

And stop tapping your foot while you wait for your photos to come back from the lab.

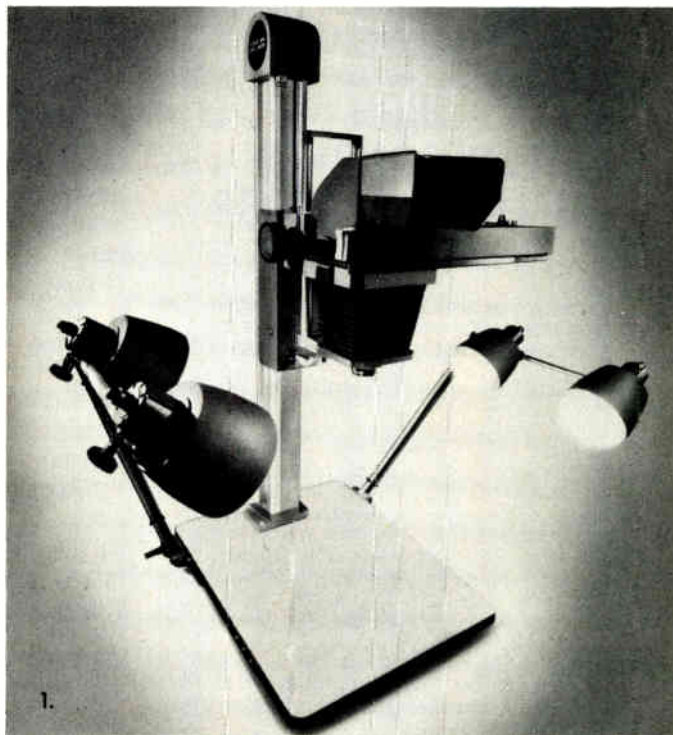

Polaroid Instant Laboratory Pictures

Polaroid Corporation
Industrial Marketing, Dept. A435
575 Technology Square
Cambridge, Mass. 02139

I'm impatient. Please send me more information on how I can use Polaroid instant photography in my work.

Name _____

Title _____

Company _____

Address _____

City _____ State _____ Zip _____

Current camera or instrument _____

Application or need _____



HIGH PERFORMANCE GALLIUM ARSENIDE LIGHT EMITTERS

New, low cost OPTRON LED's offer exceptional light output characteristics in a choice of wide or narrow beam spreads.

OPTRON's new OP 190 and OP 195 plastic encapsulated light emitting diodes give high performance with light output characteristics exceeding the specifications of currently available hermetic packaged LED's.

These highly reliable devices allow the choice of either a wide or narrow beam angle and are optimized for pulsed applications including smoke detectors, TV remote control systems, security alarms, and garage door openers.

The new OP 190 and OP 195 feature a typical power output of 10 mW at 100 mA and are capable of pulsed operation to 3 amps.

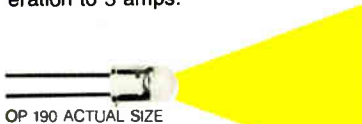

The OP 190 has a beam spread of 40° (total angle between half intensity points) and a typical radiant intensity at 100 mA of 15 mW/sr.



For applications requiring a concentrated beam over longer distance, the OP 195 is designed with a beam spread of only 15° and radiant intensity of 50 mW/sr.

Detailed technical information on these new high reliability, low cost plastic LED's and other OPTRON optoelectronic products is available from your nearest OPTRON sales representative or the factory direct.



OPTRON, INC.

1201 Tappan Circle
Carrollton, Texas 75006, U.S.A.
TWX-910-860-5958
214/242-6571

People

Biomation's Blecki revels in high-end logic analyzers

Price sensitivity is being thrown to the winds when it comes to buying logic analyzers, says David J. Blecki, 39, recently named president of Gould Inc.'s Biomation division. "Anything you can do to make an engineer's job more efficient in view of the manpower shortage is worth it," he says.

High-end logic analyzers, selling for around \$10,000, are indispensable to the development of bus-oriented computer systems, he believes. It is the product to which Biomation, a 10-year-old Santa Clara, Calif., maker of waveform recorders and logic analyzers, will devote most of its research and development dollars. Low-end analyzers will come later, he says, after designers develop specific needs.

Strength. Blecki, with a master's degree in electrical engineering and eight years under his belt as Biomation's marketing vice president, takes over a company in a strong position. Running third in the logic analyzer market—total sales were \$50 million in 1978—behind leader Hewlett-Packard, for whom he once worked, and runner-up Tektronix until last September, Biomation moved to a "solid No. 2," Blecki says, mostly because of the success of its model K100-D, which was introduced then.

The 20-input, 100-megahertz analyzer, with a variety of display formats, has taken the market by storm, he maintains. "We've had a step-function increase in market share because of that product." Moreover, it pulled Biomation, which had grossed \$9 million before being acquired in 1977 by Gould, out of a slump.

Of the field-service market, Blecki says the logic analyzer may be a bit of overkill there. "A logic analyzer reveals a lot of information about a system that requires a highly skilled technician to interpret."

In theory, smarter instruments that relieve the need for technician interpretation have merit, he says, but they require too much software



Worthwhile. A price of \$10,000 is little enough to pay to make an engineer more efficient, says David Blecki.

support. "Right now, the only widely accepted field service technique continues to be board exchange."

Now that he is at the helm, Blecki regrets he has to delegate all the "fun stuff" and take on the problems "with no solution." One of the first he must grapple with, he says, is President Carter's voluntary 7% wage ceiling. "How do you stay within 7% when in this area 20% isn't enough to keep a technician in your employ?" asks Blecki.

Schineller moves MAI toward the electronic office

Sights focused sharply on the office of the future, Richard J. Schineller is moving his company, Management Assistance Inc., smartly in that direction. Word processing is a key, says the 44-year-old executive vice president for domestic operations.

At the Interface 79 data communications show in Chicago earlier this month, MAI unveiled part of what he has in mind: word-processing capabilities in a data-processing network, a new feature of the Data-Word system introduced a few months ago by subsidiary Basic Four Corp. With 1978 sales of \$119 million out of MAI's \$200 million, Basic Four has catered to the small-business computer user.

Now Schineller wants to provide word processing for this same mar-



Here's how you can be fully computerized for so much less than you thought

BUSINESS — EDUCATION — ENGINEERING — MANUFACTURING

We are pleased to announce the first professional time-sharing system in the microcomputer field.

Naturally, it's from Cromemco.

This new multi-user system will do all of the tasks you usually associate with much more expensive time-sharing computers. Yet it's priced at an almost unbelievably low figure.

Look at these features:

- You can have up to 7 terminals plus a fast, 132-column line printer
- You can have a large system RAM memory that's expandable to 1/2 megabyte using the Bank Select feature
- Each user has an independent bank of RAM
- You can have floppy disk storage of up to 1 megabyte
- You have confidentiality between most stations
- And, make no mistake, the system is fast and powerful. You'll want to try its fast execution time yourself.



PROGRAMMERS LOVE OUR BASIC

This new system is based on Cromemco's well-known System Three Computer and our new Multi-User BASIC software package.

Programmers tell us that Cromemco Multi-User BASIC is the best in the field. Here are some of its attractions:

- You can use long variable names and labels up to 31 characters long — names like "material on order" or "calculate speed reduction."
- You get many unusual and helpful commands that simplify programs and execution — commands such as PROTECT, LIST VARIABLES, NOLIST, and many more.

- No round-off error in financial work (because our BASIC uses binary-coded decimal rather than binary operation). And we've still been able to make it FAST.
- Terminals and printer are interrupt-driven — no additional overhead until key is pressed.
- The conveniences in this Multi-User BASIC make it much easier to write your own application software.
- A line editor simplifies changes.

BENCHMARK IT — NOW

In the final analysis, the thing to do is see this beautiful new system at your dealer. See its rugged professional quality. Evaluate it. Benchmark it for speed with your own routine (you'll be agreeably surprised, we guarantee you).

Find out, too, about Cromemco's reputation for quality and engineering.

Look into it now because you can have the capabilities of a fully computerized operation much quicker and for much less than you ever thought.

 **Cromemco**
i n c o r p o r a t e d
Microcomputer Systems

280 BERNARDO AVE., MOUNTAIN VIEW, CA 94040 • (415) 964-7400

Circle 15 on reader service card

Yes! There is a Stator Yoke for 110° CRT's!

The Syntronic Datamaster™ 110° stator core yoke will produce clean, clear dot/matrix or stroke-written characters anywhere on a 110° CRT . . . over 6000 of them on a 15" diag. screen.

This is achieved using a precision-tooled ferrite stator core, built-in geometry correction, complementary coil turns distribution, and interlocking components for repeatability in volume production.

If a saddle yoke doesn't do the job . . . evaluate the Datamaster 110° yoke. Ask for Bulletin # 033.



Datamaster 110° Stator Yoke

Booth No. 330 at the SID Show.

**syntronic**

Syntronic Instruments, Inc.
100 Industrial Road
Addison, IL 60101
Phone: (312) 543-6444

People

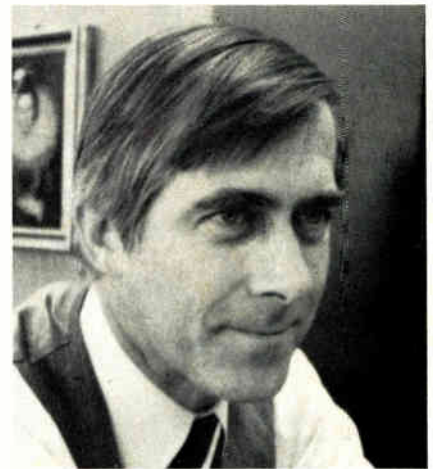

New fields. Richard Schineller might even consider computerized branch exchanges.

ket. "What we introduced [in Chicago] was improved distributed data-processing capacity with implications for electronic mail," he says.

He has plans for all three MAI subsidiaries. The others are Wordstream Corp., with word-processing systems for larger companies than those Basic Four serves, and Sorbus Inc., a computer-service company, where he plans expansion in the area of word-processing equipment.

Schineller has been watching the development of the electronic office since his 1956-65 stint with IBM. From there he went to MAI, headquartered in New York, for three and a half years in its days as a purchase and lease-back company. After brief stays at two other firms, he returned to MAI when it started Basic Four and Sorbus in 1971—first as vice president for business planning and development and then in his present position.

Plans. Basic Four will continue to add capabilities to its office systems, as the Interface 79 introduction suggests, he says. And plans are even more ambitious at Wordstream. Look for an electronic alternative to the file cabinet, Schineller says, as well as electronic mail handling.

Another important role could be integration of the entire communications management function. Management of communications could become as important a factor in MAI's product lines as management of data and text, he says. □

Silent Partners.

Signetics' new dual op amps. Team them with your design for the industry's lowest noise.

Now the instrument OEM can specify op amps that deliver precision performance *and* low noise operation.

Our new duals combine the industry's lowest spectral voltage with a 600Ω output drive capability. The Signetics 5532 really shines at $6nV/\sqrt{Hz}$. And our 5533 brings it all home at $4.5nV/\sqrt{Hz}$.

Compare our monolithic pair to other "low-noise" op amps, and see what you've been missing. Like wide power bandwidths at exceptional slew rates.

Use them in your new design. Or specify them as superior replacements for not-so-low-noise op amps you may be using now.

Both devices give you a small-signal bandwidth of 10MHz, and high output drive capability.

By "high," we mean 10V rms into 600Ω at $V_s = \pm 18V$. Great for a wide range of applications. And either is the perfect choice for active filters or low-signal transducers.

Specs like these are going to let every instrument, telecom and wideband servo control systems designer upgrade his op amp requirements.

If you don't need two op amps on a single chip, check out our 5534. Same super features as our 5533. And this one's already become an industry standard. Whichever you choose, you're going to be dollars ahead and decibels lower.

Join the silent revolution today with the op amps that let every OEM get the low noise performance that qual-

ity systems call for.

Send us the coupon for full details. Or phone your nearest Signetics sales office or authorized distributor.

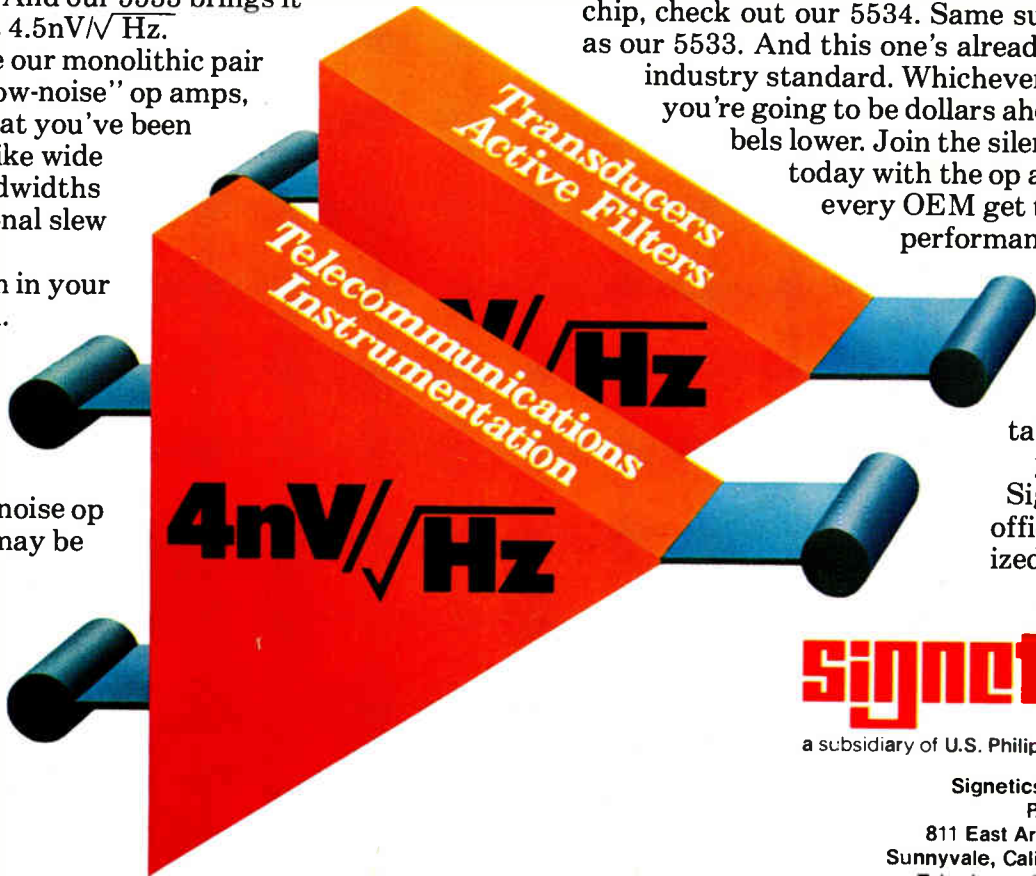

signetics

a subsidiary of U.S. Philips Corporation

Signetics Corporation
P.O. Box 9052
811 East Arques Avenue
Sunnyvale, California 94086
Telephone 408/739-7700

Signetics Dual Op Amps	
Part Number	Key Specifications
NE5532*	Low Noise: $6nV/\sqrt{Hz}$ (max.); internally compensated; 140kHz power BW @ 9V/μsec slew.
NE5533	Low Noise: $4.5nV/\sqrt{Hz}$ (max.); 200kHz power BW @ 13V/μsec slew.
NE/SE5530*	High Slew: 35V/μsec; internally compensated; 500kHz power BW; 3MHz small-signal BW.
NE/SE5535*	High Slew: 15V/μsec; internally compensated; 200kHz power BW; 1MHz small-signal BW.
NE/SE5538*	High Slew: 60V/μsec; compensated to gains of +5/-4; 700kHz power BW; 6MHz small-signal BW.

*industry standard pinouts

Electronics / April 26, 1979

To: Signetics Information Services, 811 East Arques Avenue
P.O. Box 9052, MS27, Sunnyvale, CA 94086

- Rush details on Signetics NE5532/33 dual op amps.
 Tell me about Signetics industry standard NE5534 op amp.
 I want to get the noise out right now.

Please have an applications specialist phone me at:

() _____ ext. _____ E426

Name _____ Title _____

Company _____ Division _____

Address _____ MS _____

City _____ State _____ Zip _____

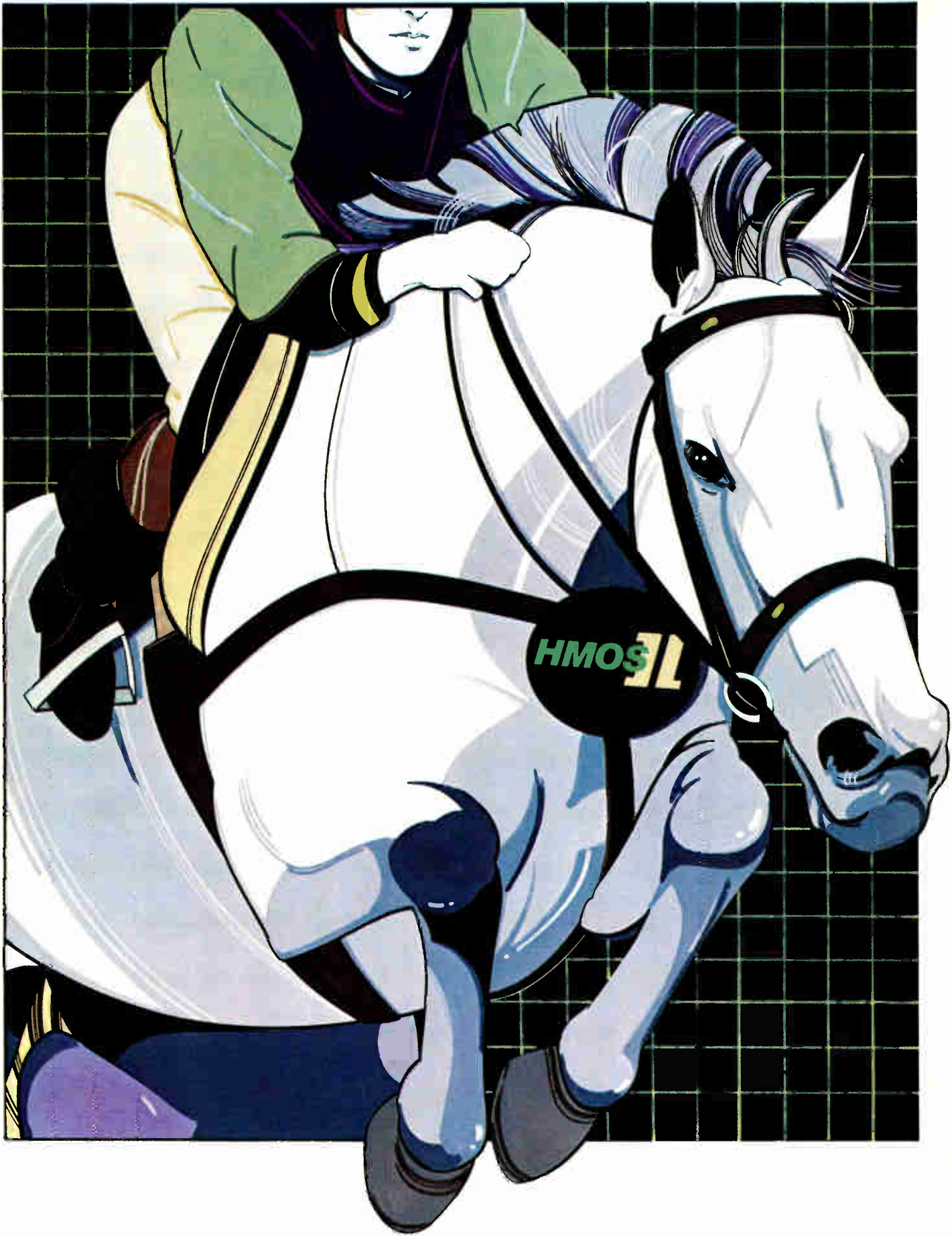

New Breed of MOS.

Intel introduces HMOS II*—and a new family of static RAMs that cross the finish line in 20 ns.

Intel just set a new pace for high performance memory with HMOS II. It's our patented next generation MOS technology so advanced it delivers speeds faster than bipolar and even our own first generation HMOS process. HMOS II gives designers the fastest, lowest power static RAMs ever—plus traditional MOS economy and reliability. Our new

History of MOS speed

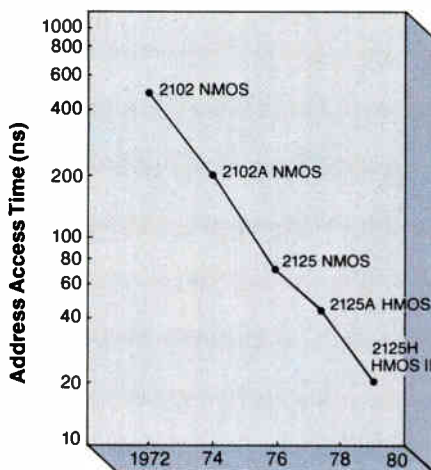

Intel's continued process and scaling improvements have doubled MOS speeds every two years. The above graph demonstrates this trend with Intel's 1K x 1 static RAMs.

1K and 4K RAMs are fully compatible, higher speed upgrades of Intel's time-tested 2115A/2125A and 2147 devices.

1K fast statics that leave bipolars behind

Designers building cache, writeable control store or buffer memories will find our 16-pin

2115H/2125H 1K RAMs ideal. For new designs, two versions deliver record access speeds of 20 ns and 25 ns, with a speed/power product twice as good as slower bipolar RAMs.

Our 35 ns and low power 30 ns models can be used as direct plug-in replacements for 93415A and 93425A bipolar RAMs. They'll cut power dissipation up to 36%. And, best of all, they're available now.

New, faster 4K with no power increase

Intel's new 2147H gives you all the advantages of our 18-pin 4K x 1 industry standard 2147, with twice the speed and no increase in power. With access times as fast as most 1K RAMs, it's important news for anyone designing buffer, cache, control store and main memory systems. If you're presently working with 1K RAMs, you can increase density or reduce board space by a factor of four. In a 4K format, the 2147H makes possible a new dimension of higher performance systems.

The 2147H's low active power dissipation and automatic power down on deselection also mean dramatically reduced power consumption compared to constant current static RAMs. In fact, because most devices are deselected at any given time, the larger your system, the lower your power dissipation per bit. It all adds up to simplified designs and major

HMOS II fast static RAMs

Part No.	Maximum Access Time (ns)*	Power Consumption (mA)*	
		Active	Standby
4096x1			
2147H-1	35	180	30
2147H-2	45	180	30
1024x1**			
2125H-1	20		125
2115H-2	25		125
2125H-2			
2115H-3	30		100
2125H-3			
2115H-4	35		125
2125H-4			

*Over full 0° to 75°C operating temperature range.

**All 2115H versions have open-collector outputs, all 2125H versions have tri-state outputs.

savings in cooling and power supplies.

All HMOS II components are fully static and can be used in clocked and unlocked systems. They are directly TTL compatible in all respects: inputs, outputs and operation from a single +5V supply.

Order 2115H/2125H and 2147H RAMs from your Intel distributor. Or, for more information, contact your local Intel sales office or write: Intel Corporation, 3065 Bowers Avenue, Santa Clara, CA 95051.

intel® delivers.

Europe: Intel International, Brussels, Belgium. Japan: Intel Japan, Tokyo. United States and Canadian distributors: Arrow Electronics, Alliance, Almac/Stroom, Component Specialties, Cramer, Hamilton/Avnet, Harvey, Industrial Components, Pioneer, Sheridan, Wyle/Elmar, Wyle/Liberty, L.A. Varah and Zenronics.

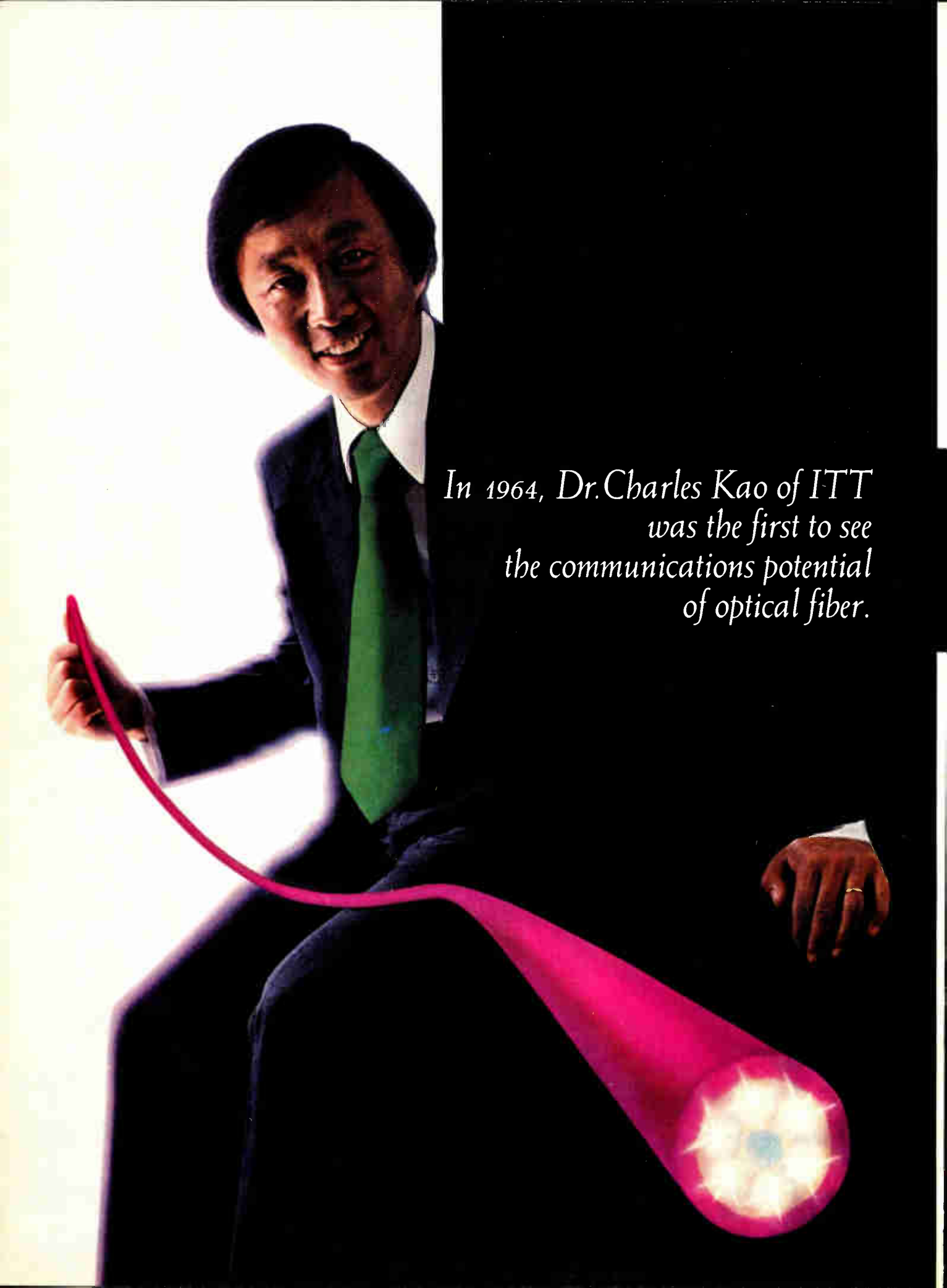
A photograph of Dr. Charles Kao, an Asian man in a dark suit and green tie, smiling and holding a glowing red optical fiber. The fiber starts as a thin line in his hand and widens into a large, bright, glowing circular shape at the bottom right. The background is split: white on the left and black on the right.

*In 1964, Dr. Charles Kao of ITT
was the first to see
the communications potential
of optical fiber.*

*Today, ITT is the first
to be able to offer you
total optical fiber communications
systems capability.*

Many commercial ITT designed and installed fiber optic systems ranging to 45 Mb/s are already in use. All are delivering the interference-free communications expected. Additional systems are currently in production.

A unique record. A record only made possible by our early recognition of the potential of fiber optics, and the willingness to concentrate the scientific, technical, and production resources required to turn feasibility into practical reality.

Today, the Electro-Optical Products Division of ITT can offer design and application engineers either complete systems or any components their work requires.

- Optical fiber cable.
- Light source and detector packages.
- Electro-

optical transmitter and receiver modules (digital or analog). • Star, tee, directional and bidirectional couplers. • Connectors. • Connector and splice installation equipment. All provide interference-free information handling capacity not achievable in conventional wire systems. All are compatible. All are field proven.

If you envision use of fiber optics in your computer system, telecommunications, industrial applications, or for any other purpose, write us on your letterhead. Because we may already have

gone over the same ground. And because we both know the optical fiber communications age has begun.

Imagine what we can do together.

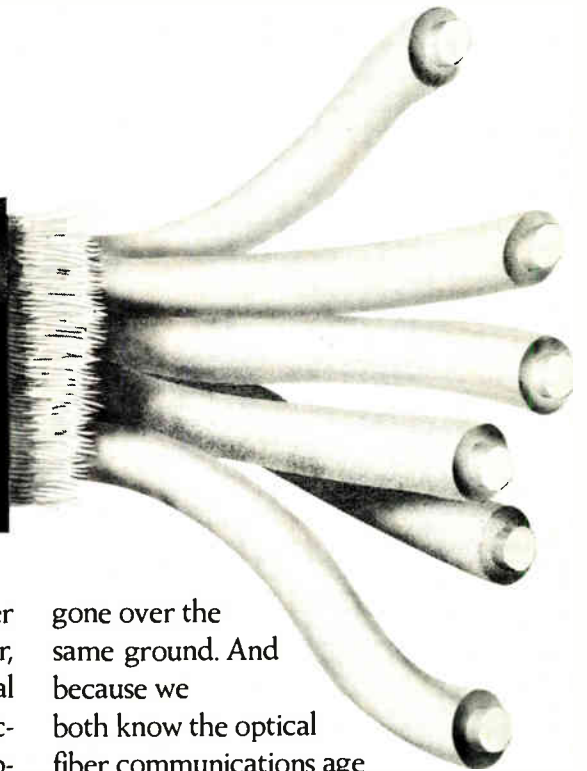

ELECTRO-OPTICAL PRODUCTS DIVISION

7635 Plantation Road, Roanoke, VA 24019

ITT

PROJECTION MASK ALIGNER

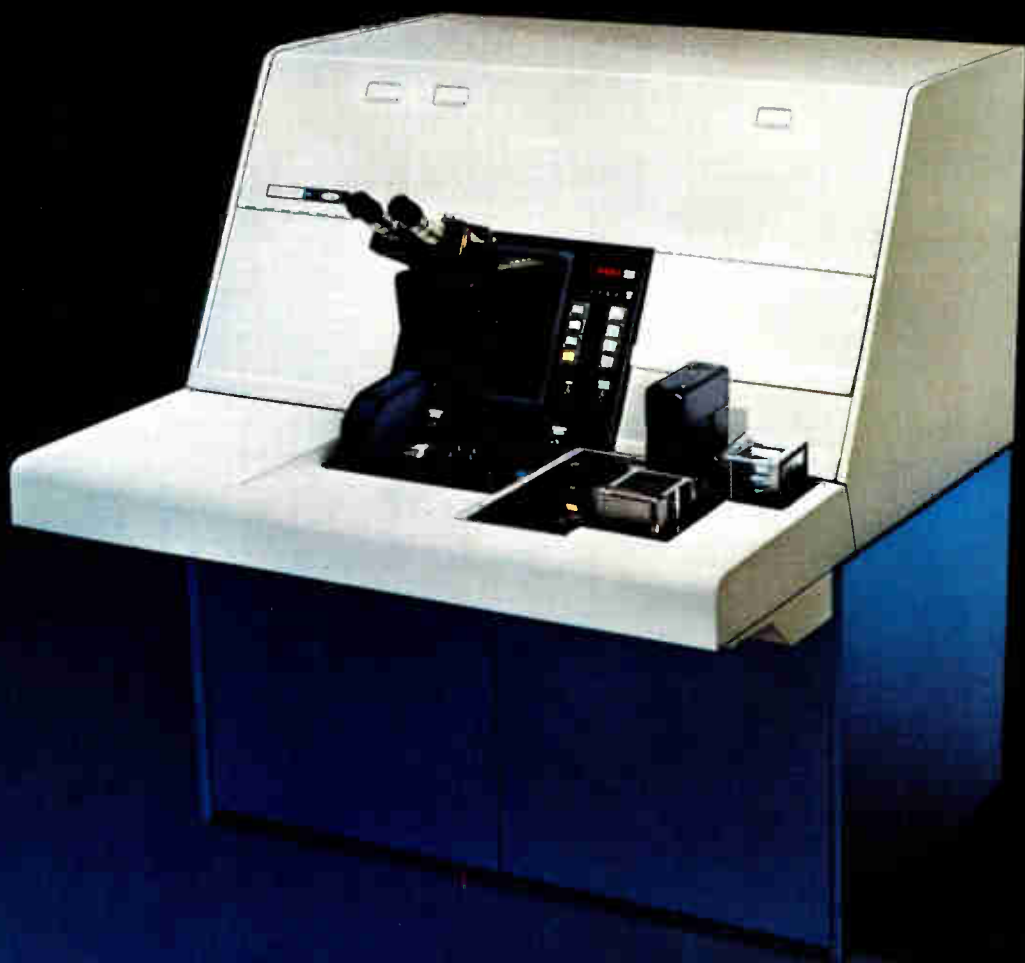

Introducing the **Micralign™ 200 Series.** Higher throughput than step-and-repeat at a much lower price.

Perkin-Elmer designed the new Micralign Model 200 to be the most cost-effective projection mask aligner available. In performance, it achieves 2-micron geometries or better in production, distortion/magnification tolerance of 0.25 micron, and 4 percent uniformity of illumination. Options available include automatic wafer loading and automatic alignment to 0.25 micron. Soon to be available: deep UV optical coatings for still smaller geometries.

Compared to the leading step-and-repeat aligner, the Micralign Model 200 delivers outstanding performance for not much more than half the cost. It takes about a quarter of the floor space. It provides consistently higher throughput regardless of die size.

The Model 200's remarkable performance is the result of a number of major innovations.

Improved optical design and fabrication

We improved the optical design to provide increased resolution

and depth of focus. Optical manufacturing tolerances are five times tighter to ensure precise overlay from aligner to aligner.

Near-zero vibration

We minimized vibration. We constructed the Model 200 with two frames—one inside the other. The inner frame, which carries the projection optics and carriage drive, is completely isolated from the outer frame.

We incorporated a superb linear motor carriage drive with air bearing slide. This drive does more than eliminate vibration. With the air bearing feature there's no contact and no wear. And no limit to carriage drive durability.

Built-in environmental control

We provided the Model 200 with a built-in environmental chamber. External air, supplied by you or from our optional air conditioning system, is blown through a HEPA filter and heating elements built into the Model 200 top cover. A positive-pressure, class 100 environment is carefully controlled to better than 1°F.

We included a separate thermal control for the mask, to compensate for mask run-out.

No mask contamination

We designed a sealed mask carrier for the Model 200. You put the mask in the special carrier right in the mask department. Seal it. When you load the sealed carrier in the Model 200, the cover plates are automatically removed. After use, the cover plates are automatically replaced.

Proven production capabilities

Perkin-Elmer, the leader in projection mask alignment systems, offers six years of proven production capability, with an excellent training and service record.

Get all the facts

These are just a few of the features that make the Micralign Model 200 Series a completely new concept in projection mask aligners. Get more details on how these and other improvements in design can translate into improvements in your production. For literature, write Perkin-Elmer Corporation, Electro-Optical Division, 50 Danbury Road, Wilton, CT 06897. Or phone (203) 762-6057.

PERKIN-ELMER

Circle 23 on reader service card

Does NTT's chief have his hand on the doorknob?

Representatives of the industrial nations of the world have consummated five years of hard bargaining with an agreement to liberalize world trade. Although individual governments must still ratify the accord reached at Geneva, the pact brings into sharper relief the battle by the United States Government, allied with American telecommunications suppliers, to liberalize an extremely attractive market closed to them until now: Japan's giant Nippon Telegraph and Telephone Public Corp.

What started as a cloud on the horizon has developed into a major diplomatic storm. Sitting at its center is Tokuji Akikusa, president of NTT, who is still firmly resisting the pressure and arm-twisting of the Americans. However, in a recent interview with a Japanese newspaper, Akikusa intimates NTT may eventually back down; his thinking is that his company will have to agree to some concessions—beyond those already offered in the way of open procurement of such items as telephone poles—because it simply cannot expect to have its way in all areas.

Akikusa makes the point that even if his utility were to buy \$3 billion worth of equipment from overseas suppliers, "it will take 10 years to carry this out. . . . It will be impossible to completely revise the present procurement method." The company president also addresses the broader problem of virtual subsidization by NTT of a supplier network, a so-called inner circle, and its responsibility to ensure solvency of the members of that circle.

"Once an enterprise enters that inner circle," he says, "NTT must look after the enterprise on a permanent basis. There will be a loss from a national economic point of

view if the NTT tells an enterprise that has built big plants and trained technicians that its services are no longer required."

Asked if it were something of an exaggeration to say that opening NTT's procurement to foreign suppliers would cause a chain reaction of Japanese bankruptcies and unemployment, Akikusa replies, "If a competitive bidding system is introduced, there are fears that know-how developed by experts after much [effort] will be released outside. The technicians will lose their [incentive] to work if know-how developed not only by the NTT but also by [its suppliers] is made available. Enterprises connected with the corporation will not go bankrupt one after the other. But Nippon Electric Co. [for example], relies on the NTT for around 20% of its orders, and Fujitsu Ltd. 22% to 23%. There are also firms engaged only in producing equipment for the NTT. Such firms will suffer most."

Does Akikusa think that behind the open-door demand of the U. S. is a plan by IBM and other American computer makers to "cultivate" the Japanese market? "There appears to be such a rumor," Akikusa replies, "but there is no definite proof. . . . The communications business does not merely involve telephones and telegraph. It probably will nurture all sorts of industries in the future. Therefore I believe the American side is also aware that the communications business has big future possibilities in respect to industrial strategy."

But Akikusa's closing words, which reflect the long decision-making process in Japan, could be the most prophetic. "I would like," he said, "to open doors gradually."

The Microcomputers you should take seriously.

The C3 Series is the microcomputer family with the hardware features, high level software and application programs that serious users in business and industry demand from a computer system, no matter what its size.

Since its introduction in August, 1977, the C3 has become one of the most successful microcomputer systems in small business, educational and industrial development applications. Thousands of C3's have been delivered and today hundreds of demonstrator units are set up at systems dealers around the country.

Now the C3 systems offer features which make their performance comparable with today's most powerful mini-based systems. Some of these features are:

Three processors today, more tomorrow.

The C3 Series is the only computer system with the three most popular processors—the 6502A, 68B00 and Z-80. This allows you to take maximum advantage of the Ohio Scientific software library and the tremendous number of programs offered by independent suppliers and publishers. And all C3's have provisions for the next generation of 16 bit micros via their 16 bit data BUS, 20 address bits, and unused processor select codes. This means you'll be able to plug a CPU expander card with two or more 16 bit micros right in to your existing C3 computer.

Systems Software for three processors.

Five DOS options including development, end user, and virtual data file single user systems, real time, time share, and networkable multi-user systems.

The three most popular computer languages including three types of BASIC

Circle 25 on reader service card

plus FORTRAN and COBOL with more languages on the way. And, of course, complete assembler, editor, debugger and run time packages for each of the system's microprocessors.

Applications Software for Small Business Users.

Ready made factory supported small business software including Accounts Receivable, Payables, Cash Receipts, Disbursements, General Ledger, Balance Sheet, P & L Statements, Payroll, Personnel files, Inventory and Order Entry as stand alone packages or integrated systems. A complete word processor system with full editing and output formatting including justification, proportional spacing and hyphenation that can compete directly with dedicated word processor systems.

There are specialized applications packages for specific businesses, plus the vast general library of standard BASIC, FORTRAN and COBOL software.

OS-DMS, the new software star.

Ohio Scientific has developed a remarkable new Information Management system which provides end user

intelligence far beyond what you would expect from even the most powerful mini-systems. Basically, it allows end users to store any collection of information under a Data Base Manager and then instantly obtain information, lists, reports, statistical analysis and even answers to conventional "English" questions pertinent to information in the Data Base. OS-DMS allows many applications to be computerized without any programming!

The new "GT" option heralds the new era of sub-microsecond microcomputers.

Ohio Scientific now offers the 6502C microprocessor with 150 nanosecond main memory as the GT option on all C3 Series products. This system performs a memory to register ADD in 600 nanoseconds and a JUMP (65K byte range) in 900 nanoseconds. The system performs an average of 1.5 million instructions per second executing typical end user applications software (and that's a mix of 8, 16 and 24 bit instructions!).

Mini-system Expansion Ability.

C3 systems offer the greatest expansion capability in the microcomputer industry, including a full line of over 40 expansion accessories. The maximum configuration is 768K bytes RAM, four 80 million byte Winchester hard disks, 16 communications ports, real time clock, line printer, word processing printer and numerous control interfaces.

Prices you have to take seriously.

The C3 systems have phenomenal performance-to-cost ratios. The C3-S1 with 32K static RAM, dual 8" floppies, RS-232 port, BASIC and DOS has a suggested retail price of under \$3600. 80 megabyte disk based systems start at under \$12,000. Our OS-CP/M software package with BASIC, FORTRAN and COBOL is only \$600. The OS-DMS nucleus package has a suggested retail price of only \$300, and other options are comparably priced.

To get the full story on the C3 systems and what they can do for you, contact your local Ohio Scientific dealer or call the factory at (216) 562-3101.

C3-B wins Award of Merit at WESCON '78 as the outstanding microcomputer application for Small Business

The C3 Series from Ohio Scientific.

C3-B

C3-S1

C3-OEM

OHIO SCIENTIFIC
1330 S. Chillicothe Road, Aurora, Ohio 44202

F. W. Bell PX series industrial watt transducers to measure and control single and 3-phase power

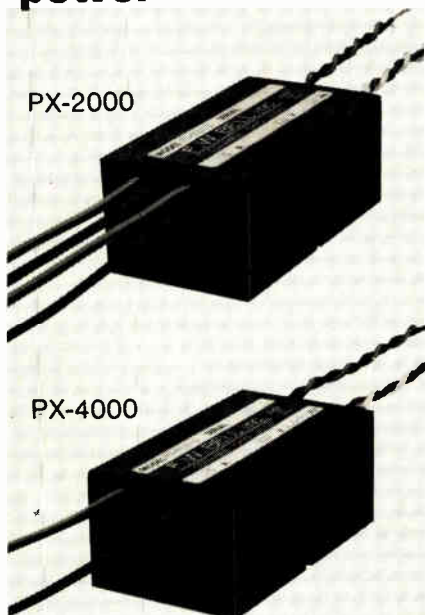

Bell PX-2000 and PX-4000 series transducers are compact, reliable modules that convert power into dc voltage to indicate, control or alarm to let you protect or monitor practically any operation.

A single PX-2000 unit can monitor 3-phase power through its dual coils. Units within the two series are available for working with frequencies ranging from 50 Hz to 10 kHz.

Write for complete technical data.

If power levels are important to you, F. W. Bell transducers are just what you need.



Subsidiary,
Magnetics & Electronics, Inc.

6120 Hanging Moss Road
Orlando, Florida 32807
Phone 305/678-0900

Meetings

25th International Instrumentation Symposium, Instrument Society of America, Sheraton Hotel, Anaheim, Calif., May 7-10.

ISS '79—International Switching Symposium, Colloque International de Commutation (Paris), PLM St. Jacques Hotel, Paris, May 7-11. For information in the U.S., contact A. E. Joel Jr., Bell Laboratories, Holmdel, N. J.

1979 SID International Symposium, Society for Information Display (Los Angeles), Chicago Marriott Hotel, Chicago, May 7-11.

29th Electronic Components Conference, EIA and IEEE, Hyatt House, Cherry Hill, N. J., May 14-16.

Electrical and Electronic Measurement and Test Instrument Conference, IEEE, Skyline Hotel, Ottawa, May 15-17.

Naecon—National Aerospace and Electronics Conference, IEEE and Naecon (Dayton, Ohio), Dayton Convention Center, May 15-17.

Advances in Systems Technology: Trends and Applications, 1979, IEEE and NBS, National Bureau of Standards, Gaithersburg, Md., May 17.

Huntsville Electro-Optical Technical Symposium and Workshop, Society of Photo-Optical Instrumentation Engineers (Bellingham, Wash.), Huntsville Hilton, Huntsville, Ala., May 22-25.

Failure Avoidance Seminar, Integrated Circuit Engineering Corp. (Scottsdale, Ariz.), Hilton Inn, Jamaica, N. Y., May 23-24.

Conference on Laser Engineering and Applications, IEEE and Optical Society of America, Washington Hilton Hotel, Washington, D. C., May 30-June 1.

Computers in Communications Conference, American Institute of Aeronautics and Astronautics (Los Angeles), International Inn, Washing-

ton, D. C., May 31-June 1. Program will be repeated at the Hyatt L. A. International Hotel, Los Angeles, June 25-26.

1979 International Summer Consumer Electronics Show, EIA, McCormick Place, Chicago, June 3-6.

NCC '79—1979 National Computer Conference, IEEE, American Federation of Information Processing Societies, New York Hilton and Americana Hotels, New York, June 4-7.

Automated Testing for Electronics Manufacturing, Benwill Publishing Co. (Boston), Radisson Ferncroft Hotel, Danvers, Mass., June 4-7.

ICC '79—International Conference on Communications, IEEE, Sheraton Boston Hotel, Boston, June 11-14.

Machine Vision, Automatic Assembly, and Productivity Technology, summer session, Massachusetts Institute of Technology, Department of Electrical Engineering and Computer Science, MIT, Cambridge, Mass., June 11-15.

33rd Annual Convention of the Armed Forces Communications and Electronics Association, AFCEA (Falls Church, Va.), Sheraton Park Hotel, Washington, D. C., June 19-21.

Device Research Conference, IEEE, at the University of Colorado, Boulder, Colo., June 25-27.

Second Joint Intermag—Magnetism and Magnetic Materials Conference, IEEE and American Institute of Physics, Statler Hilton Hotel, New York, July 17-20.

Comcon Fall '79—18th IEEE Computer Society International Conference, IEEE, Capital Hilton Hotel, Washington, D. C., Sept. 4-7.

Second International Fiber Optics and Communications Exposition, Information Gatekeepers Inc. (Brookline, Mass.), Hyatt Regency O'Hare Hotel, Chicago, Sept. 5-7.

TEKTRONIX thinks your logic analyzer should be as versatile as you are

So ours let you sample *synchronously* and *asynchronously*.

Use the 7D01F
for hardware
and software
applications.

As a digital designer you must be versatile enough to do the *entire* design job. Logic and *timing*. Software and hardware analysis. Activity on *and* off the bus.

And so you need a logic analyzer that lets you *synchronously* verify logic and trace program flow on the bus; then *asynchronously* verify timing sequences and examine chip to chip transactions off the bus. A logic analyzer, in short, as versatile as you are.

Tektronix Logic Analyzers are versatile. In the synchronous mode, examine software flow using the clock of the system under test—up to 20 ns sampling rate. Switch to asynchronous and sample with the Logic Analyzer's own clock—up to 10 ns sampling rate. Pulse anomalies and timing problems are out in the open, where you can see them. With *one* logic analyzer.

Synchronous and asynchronous sampling: it helps

make our Logic Analyzers versatile. So you can do today's job and tomorrow's. So you can change applications without changing your logic analyzer.

Contact Tektronix Inc., P.O. Box 500, Beaverton, OR 97077. In Europe, Tektronix, Ltd. P.O. Box 36, St. Peter Port Guernsey, Channel Islands.

Tektronix
COMMITTED TO EXCELLENCE

TEKTRONIX LOGIC ANALYZERS THE VERSATILE ONES

For Technical Data circle #27 on Reader Service Card
For Demonstration circle #227 on Reader Service Card
For immediate action, dial our toll free automatic
answering service, 1-800-547-1512



FAIRCHILD TEST SYSTEMS.

WE NEVER FORGET THAT YOUR REPUTATION IS ON OUR LINE.

We've become the first family of Automatic Test Equipment by remembering one thing: Our reputation for testers is only as good as your reputation for reliability.

We started on a small scale testing discrete components. Then, when you needed more sophisticated testers for MSI, we designed and built them. Today it's LSI, and our systems are still state-of-the-art. And we're not through. We've already introduced the only 120-pin tester commercially available for tomorrow's technology, VLSI.

And we're now extending our expertise into subassembly testing in a big way. Today, no discussion of ATE is complete without us.

WE'RE FIRST IN FIRSTS.

Our technical leadership is second to none. We developed the first programmable automatic transistor tester. We were first with an IC tester. First with an LSI logic tester. And first with a VLSI logic tester.

First again with a microprocessor program generator for software.

First with an in-circuit tester. And first to hook up a host computer to multiple testers to perform centralized processing of test data.

WE PROTECT YOUR SOFTWARE INVESTMENT.

Ten years ago we made a major commitment to our customers:

Your software will always be compatible with our test systems. If your needs change, we will change to meet those needs — without obsoleting your program investment. This is a big economy when you consider that nearly 75% of your total testing cost is software-related.

IF YOU CAN MAKE IT, WE CAN TEST IT.

No one can offer you more kinds of testers than we can. For almost any application you name. Whether

it's engineering characterization, production testing, incoming inspection, shorts and continuity testing, depot repair or field troubleshooting, if you've got a semiconductor device or subassembly that needs testing, there's probably a Fairchild test system designed to do the job.

THE RIGHT ANSWERS TO THE COMPONENT TEST.

For general-purpose LSI testing, we have Sentry[®], the most widely used family of test systems in the world. You can do production testing and incoming inspection on Sentry V. Engineering characterization on the industry workhorse, Sentry VII. And VLSI testing on Sentry VIII, the world's most powerful tester.

For low-cost production testing of LSI, there's our new Sentinel. It's software-compatible with Sentry at half the cost. You can design on Sentry and test on Sentinel with minimal investment in software.

WE HAVEN'T FORGOTTEN MEMORIES.

Our Xicom III series of dedicated memory testers features distributed architecture, which ties a host computer and test satellites together in a system to test ROMs,



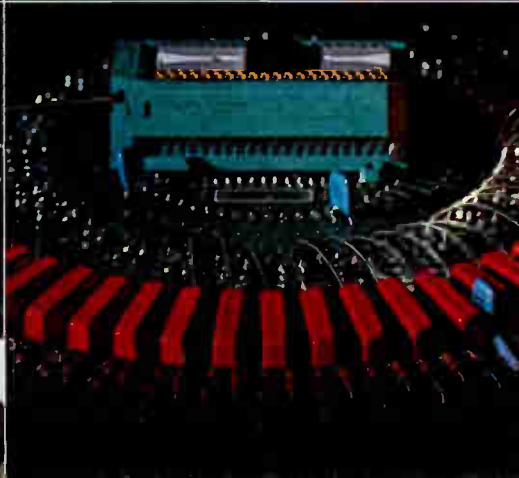
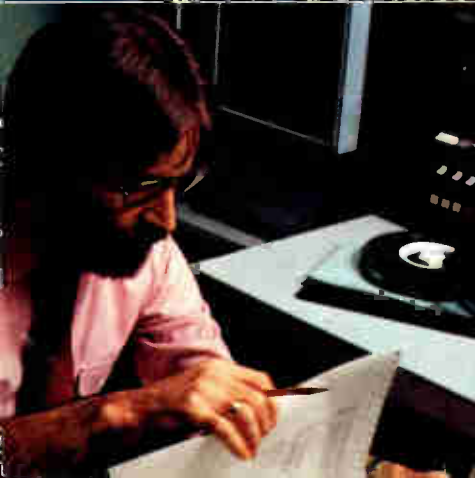
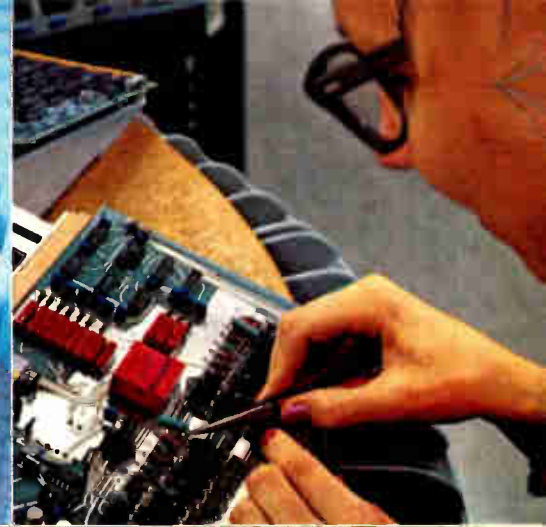
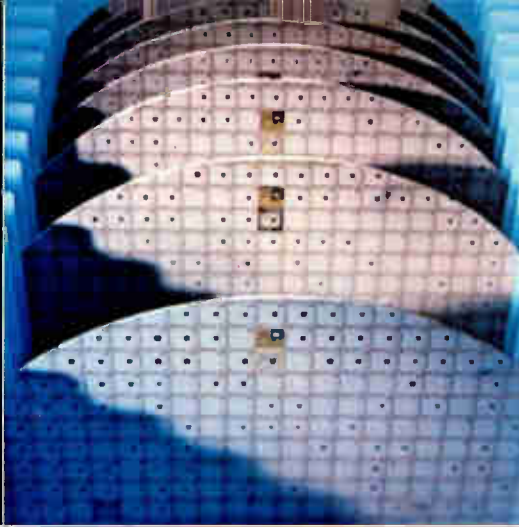

EPROMs, dynamic and static MOS, bipolar and CCD devices.

The Xincor 5580 test satellite can accommodate up to two test heads and can test two different devices which are under the control of separate programs.

The Xincor 5581 parallel operation satellite can test up to four 4K, 16K or 65K multiplexed address RAMs in parallel.

The Xincor 5582 25MHz satellite can test the same devices in parallel as well as handle the new HMOS high-speed static MOS devices. And if you're getting into bubble memories, so are we with our soon-to-be-introduced Xincor 5585.

THE BEST TEST FACILITY MANAGER YOU CAN HIRE.

If you already own our component test systems and you're wondering what to do with all the data you're getting, help is here. It's called Integrator® II. Our powerful new host computer which lets you communicate with your testers, whether they're around the corner or around the world. While your Fairchild systems are busy testing, Integrator can write, edit and store your programs. It can synthesize and simplify your test data. And give you a broad range of reports that can help you manage your test facility more efficiently.

WE CAN TEST A WIDE ASSEMBLAGE OF SUBASSEMBLIES.

Fairchild's Testline family of in-circuit test systems provides fast, thorough and economical Automatic Fault Isolation Testing (AFIT) of digital PC boards. The Testline AFIT 4000 is a production-oriented system

that features fully automated testing of boards with up to 400 ICs. Each

AFIT 4000 comes with a disk library containing programs for TTL, DTL, ECL, CMOS and other popular logic families.

Our Testline AFIT 3000A System is designed

for repair operations. It's so simple to use that an unskilled operator can test at a rate of 15 ICs per minute.

For QC and troubleshooting, there's our semi-portable Testline AFIT 1500, with 40-pin capability. We also make a strong case for field service. It's our Testline AFIT 1000 suitcase tester, weighing in at 23 pounds.

If your need is high-volume testing of complex analog or hybrid PCBs, Fairchild's Faultfinder FF 303 computer-based, in-circuit test system achieves high yields at low cost. With automatic test program generation. Foreground/background programming. Solid-state switching. And built-in functional capabilities of the IEEE 488 Interface Bus.

When you're testing less complex hybrid boards, or boards with a higher ratio of analog components, our Faultfinder FF 101 system features up to 2,400 points to locate and identify errors such as shorts, opens and components that are reversed, missing or not up to spec. And for inspection testing of bare or loaded boards, there's our self-programming Faultfinder FF 202, with up to 2,000-point capacity.

And to make our subassembly test system complete, we offer a broad selection of vacuum fixturing systems. Called Thinline®, these fixtures provide fast, positive interface between the testers and the board under test.

THREE HUNDRED EXPERTS COME WITH EVERY SYSTEM.

There are more than three hundred ATE specialists backing up the Fairchild Test Systems Group. It starts with training. Anywhere from

4-20 man-weeks spent however you wish on over a dozen intensive courses that include hands-on experience using over \$2 million in test equipment.

Send your operations personnel, programmers and technicians to our centers in San Jose, Munich and Tokyo, or arrange to have our training team come to you.

After training, our applications group gets you running. They'll help you develop your own special programs or work with the hundreds of ready-to-run programs in our library.

To keep you going, we have the industry's largest field service organization, with over 20 major service centers throughout the U.S., Europe and the Far East.

No other ATE manufacturer can offer support as thorough as ours. But then, no one else has such a good reputation to maintain.

For more information on the first family of ATE, just contact your nearest Fairchild sales office today. Or write Test Systems Group, Fairchild Camera and Instrument Corporation, 1725 Technology

Drive,
San Jose,
California
95110.
Telephone:
(408)998-0123.
TWX:
910-338-0558.

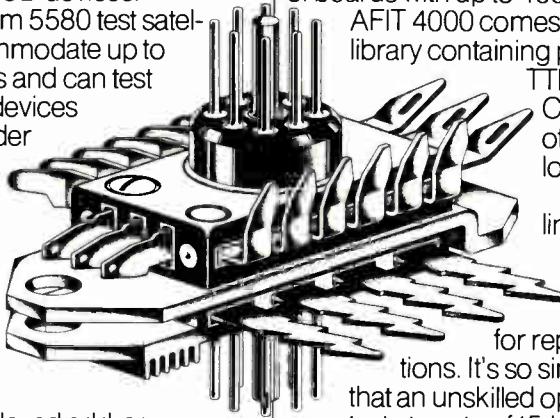

FAIRCHILD
TEST SYSTEMS GROUP
The first family of ATE.

Interested in network variety? Select from a spectrum of 542 standards.

Allen-Bradley has the popular configurations you need. Pull-ups, Pull-downs. Line Terminators. Networks to complement Core Memory Sense Amplifiers. TTL to ECL Translators. O-Pad Attenuators. R/2R Ladders. Interconnect Networks. All styles available from your Allen-Bradley *Electronic Distributor*. Call for specs or check your EEM Catalog. If you need specials, contact your local Allen-Bradley district office for fast turn-around. Ask for Publication 5840. A-B is an experienced twin-film manufacturer, i.e. precision thin film and thick film.

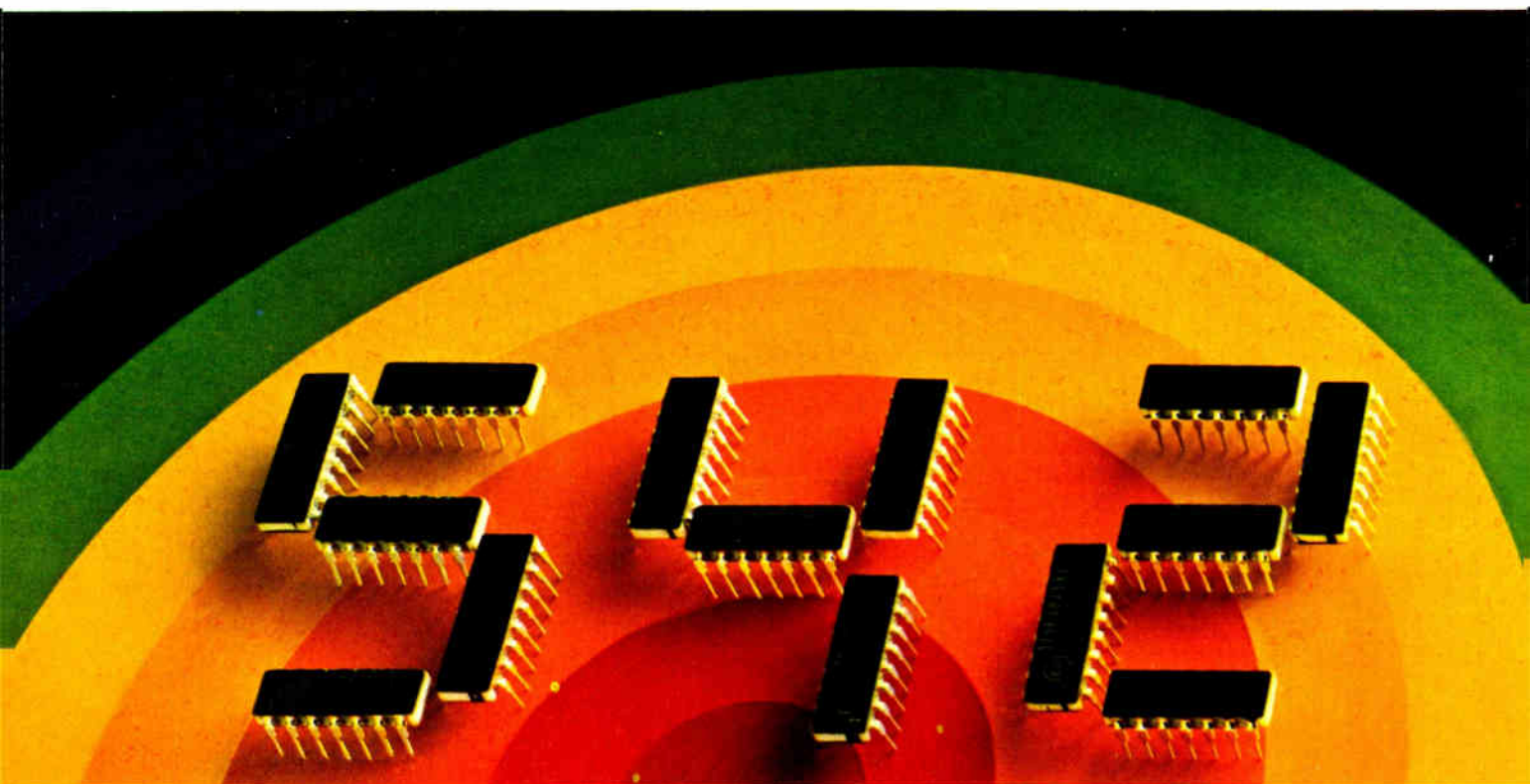
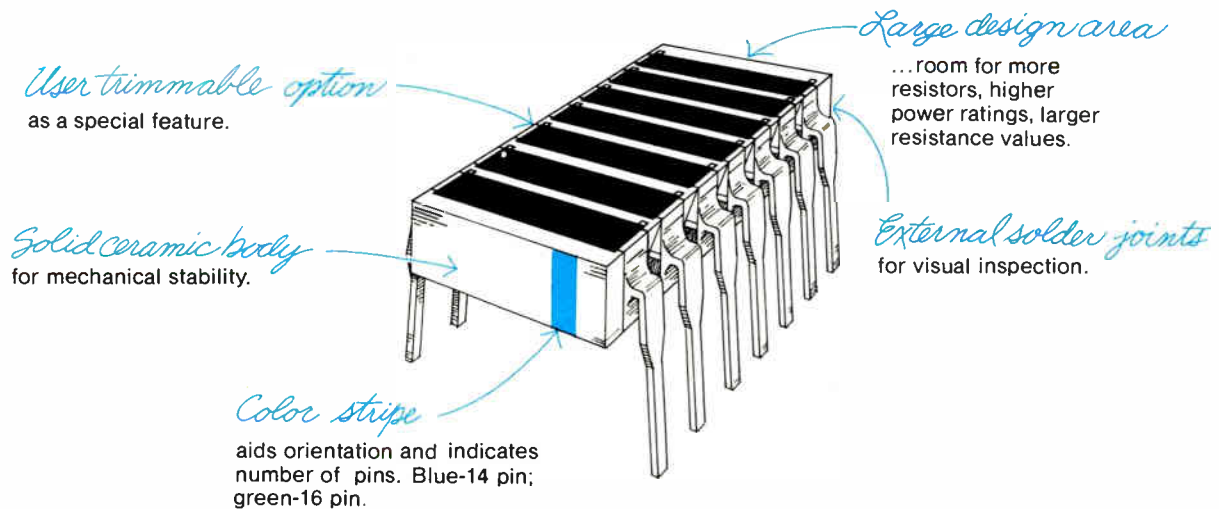

Quality in the best tradition.



ALLEN-BRADLEY
Milwaukee, Wisconsin 53204

Pinout of unreleased pseudostatic RAM from Mostek changed

Despite a formal announcement and release of price information last January, Mostek Corp. of Carrollton, Texas, has not yet shipped samples of its MK4816 dynamic random-access memory and has revised the pinout for the device. With preliminary specifications released last summer [*Electronics*, Aug. 7, 1978, p. 33], the 2,048-by-8-bit single-supply part was **the first of what are called pseudostatic devices—containing on-chip refreshing circuitry—to be discussed.** (Zilog Corp. described plans for a 32-K pseudostatic device earlier this year.) Samples of Mostek's 4816 were expected last November, and then in the first quarter of this year. But because of design revisions to maximize yield, samples will not be available until June, says Sam Young, a Mostek marketing official.

TI sees 17% rise in world markets

Texas Instruments Inc. expects worldwide semiconductor sales in 1979 to reach \$9.6 billion, some 17% more than the figure for 1978. TI president J. Fred Bucy also told the company's annual meeting last week that the market for calculators and learning aids should have relatively little growth: from last year's \$1.8 billion and 82 million units to \$1.9 billion and 84 million units. **The Dallas-based firm also announced that its first-quarter sales netted \$720.8 million, up 29% from last year.**

National, Zilog to alternate-source byte-wide pseudos

National Semiconductor Corp. and Zilog Corp. have signed a letter of intent to alternate-source each other with a family of 8-bit-wide pseudostatic random-access-memory chips. **The move is seen as a way for both companies to beat Mostek Corp. to the market for byte-wide pseudostatic memories.** National, in Santa Clara, Calif., will receive tooling and technical information from Zilog, in nearby Cupertino, for the Z6132, a 4-K-by-8-bit RAM. They will also coproduce and identically specify a 2-K-by-8 and an 8-K-by-8 RAM.

Math processor may be next in 8086 family

The power of Intel Corp.'s 16-bit microcomputer family obviously is not going to come from the 8086 central processing unit alone: the Santa Clara, Calif., company plans a wide range of high-performance support chips to relieve the CPU of its computing burdens. So far, Intel has announced an input/output channel processor called the 8089, and its next may be a high-speed floating-point arithmetic processor called the 8087. **This also may be the first IC to meet the IEEE Computer Society's proposed standard for floating-point math.** The standard is nearing a detailed specification, and Intel has recently played an important role in refining its definition. Since the 8087 is being designed to work closely with the 8086, it is called a coprocessor.

Specialized terminals share industrial processing chores

Specialized terminals and software are key features of a pair of plant-management systems from Honeywell Inc.'s United States Information Systems Group in Waltham, Mass. Both offer some distributed data-processing capability. The larger of the two builds on the firm's Level 6 minicomputer; the smaller uses a Honeywell/Incoterm SPD terminal processing unit as a front-end processor for a remote host computer. Three microprocessor-based terminals are common to both systems, as are ruggedized keypad and plasma-display devices.

They would accept data on employee time and attendance, inspection

reports, inventory, work status, material flow, and work in process. Most of the new software was developed for the Level 6 mini. It includes packages for production scheduling, inventory management, and materials requirement planning. **The SPD processor is programmed in an extended Basic language aimed at transaction processing.** The price of a typical Level 6 system is \$116,660; for an SPD-based system it's \$22,390.

Data General unveils small-business systems at Hanover Fair

Data General Corp. announced its CS/30 microprocessor-based small-business computer systems at West Germany's Hanover Fair last week. Priced from \$22,000 to \$49,000, **the CS/30s are aimed at companies with as few as four employees,** or operation as distributed processors for larger companies, according to spokesmen for the Maynard, Mass., company. The CS/30 model C1 includes 65,536 bits of MOS main memory, a cathode-ray-tube console and interface, a 10-megabyte disk store, and a receive-only printer. Price is \$21,090. The larger of two CS/30 Model C3 systems has 96 kilobits of MOS main memory, a master CRT console and two displays, two 10-megabyte disks, a 300-line-per-minute printer, synchronous communications capability, and IBM 2780/3780-compatible communications software. It sells for \$49,820. Both systems are programmed in interactive Cobol.

Dataram moves into semiconductor sector with RAM

Long a proponent of bulk magnetic core storage for disk emulation and main memory, Dataram Corp. is introducing its first Bulk Semi memory, offering up to 8 megabytes of semiconductor dynamic random-access memory in a standard rack 15¾ inches high. The Cranberry, N. J., firm says it is moving into solid state for bulk storage **to get more capacity into a box and to take advantage of the RAM's better cost per bit for large-capacity systems.** Also, main memory cycle time will drop sharply: for 36-bit operation, from 1.5 μ s to 600 ns. A 1-megabyte system complete with controller board, power supply, and other peripherals will cost \$17,000 in single quantities and will be electrically compatible with the firm's Bulk Core modules, which continue in production. The new line will use 16-K 4116 RAMs, as will the new 128-kiloword DR-113S, a single-board add-on memory for the LSI-11/23. In single quantities, the 16-bit version costs \$31.50, and the 18-bit parity version \$33.50.

TI eschews single-supply 16-K RAM market

Though Texas Instruments Inc. and Motorola Inc. are currently squaring off as the first two firms to supply samples of 64-K dynamic random-access memories requiring only a single 5-v power supply, don't look for a rematch at the 16-K level. TI officials say they don't plan to build a single-supply 16-K RAM soon. The scaled single-supply process developed for TI's 64-K part is just now starting down the learning curve, explains George Robillard, MOS memory marketing manager at TI's Houston operation. **"We've a hard time seeing the need for a single 5-v 16-K part at the price we believe it would have to sell to be profitable,"** he says.

Motorola, on the other hand, is planning to jump into the ring soon with other firms—including Intel, National Semiconductor, and Mostek—that have single-supply 16-K RAMs planned or announced. Peter Bagnall, Robillard's counterpart at Motorola's Austin, Texas, plant, says Motorola expects to have samples of a single-supply 16-K RAM in the third quarter.

ADVANCE WITH TECHNOLOGY



through cost-effective, Intensive Short Courses from
INTEGRATED COMPUTER SYSTEMS, INC.

Computer Graphics State of the Art Techniques and Applications

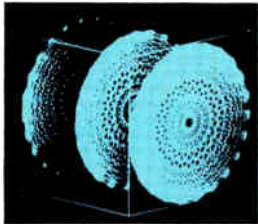

ST. LOUIS June 5-8
TORONTO June 12-15
SAN DIEGO July 10-13
WASHINGTON D.C. July 17-20
MINNEAPOLIS July 31-August 3

Course 365 – Four days

Hardware elements of computer graphics systems are presented at the level required for detailed system specification, selection and acquisition. Software techniques for computer graphic systems are developed from the elementary level of line generation and continue through advanced approaches to animated three-dimensional color displays with hidden surface removal. Off-the-shelf, commercially available software packages are analyzed and evaluated. Emphasis is placed on hardware/software tradeoffs, cost effectiveness and the advantages and limitations of alternative approaches.

Digital Signal Processing

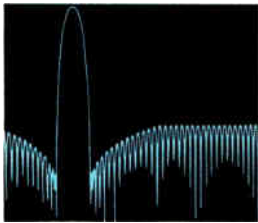

SAN DIEGO May 7-11
SAN FRANCISCO June 11-15
TORONTO June 18-22
MINNEAPOLIS July 9-13
OTTAWA July 16-20

Course 412 – Five days

The objective of this course is to present the necessary fundamentals of digital signal processing in a clear and comprehensive manner, to develop an understanding of new processing techniques, to survey the state of the art of hardware and software available, and to apply this information to a range of concrete design examples. The course is of benefit both for those who wish to achieve a basic understanding of this exciting area, and for those whose interest is in advanced techniques and the implementation of practical systems.

Distributed Processing and Computer Networks

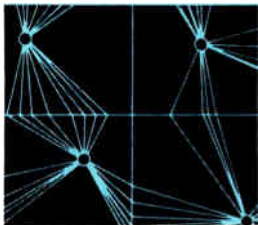

TORONTO June 5-8
HARTFORD June 12-15
WASHINGTON D.C. June 19-22
SAN DIEGO July 10-13
OTTAWA July 17-20
MINNEAPOLIS July 24-27

Course 350 – Four days

This course provides a comprehensive introduction to distributed processing and computer network design techniques. It covers the individual elements of a distributed processing system and how these elements are synthesized for form a system which best meets application specific objectives. Throughout the course, application examples provide concrete examples of the concepts presented, with emphasis on the factors affecting key planning, design and implementation decisions.

Database Management Systems

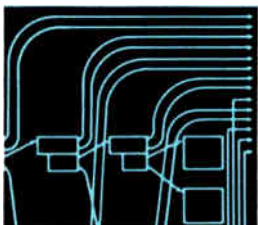

WASHINGTON, D.C. May 8-11
LOS ANGELES May 15-18
TORONTO July 10-13
SAN FRANCISCO July 31-August 3
MINNEAPOLIS August 7-10

Course 380 – Four days

This course is designed for programmers, analysts, data base administrators and managers who are responsible for the selection, implementation and operation of a DBMS in their organization, either on mainframes or minicomputer systems. Commercially available DBMS packages are evaluated in terms of data definitions, data structure, data language facilities, storage and access efficiency, state-of-the-art currency, and the types of application for which they are best suited. Application Case Studies covering requirements analysis, database design and system utilization, provide concrete examples of how DBMS concepts are implemented in different types of data environments.

ABOUT INTEGRATED COMPUTER SYSTEMS . . .

- These courses have been attended by over 15,000 engineers and managers worldwide
- Course Materials: 1000-1500 pages, including copies of all overhead transparencies as well as extensive reference materials
- Students praise the intense learning experience provided by expert instructors using an efficient multi-media audio/visual presentation
- CLASS SIZES ARE STRICTLY LIMITED – ENROLL NOW

For **FREE BROCHURES** and detailed information, contact:

ENROLLMENT MANAGER

Integrated Computer Systems, Inc.
3304 Pico Blvd., P.O. Box 5339
Santa Monica, CA 90405

(213) 450-2060
LOS ANGELES

OR:

Integrated Computer Systems, Inc.
300 N. Washington St., Suite 103
Alexandria, VA 22314

OR
(703) 548-1333
WASHINGTON, D.C.

Another What- from Widlar.

cha-ma-call-amp

Just for convenience purposes we'll call renowned designer Bob Widlar's new brainstorm an Op Amp. But in actuality, this device, tabbed the LM10, is much, much more.

It's two designs in one, maybe more.

The LM10 is an adjustable buffered reference as well as a high quality, general purpose op amp. This double duty makes the design very flexible. Total supply voltage can be as low as 1.1 volts or as high as 40 volts, with the same performance results.

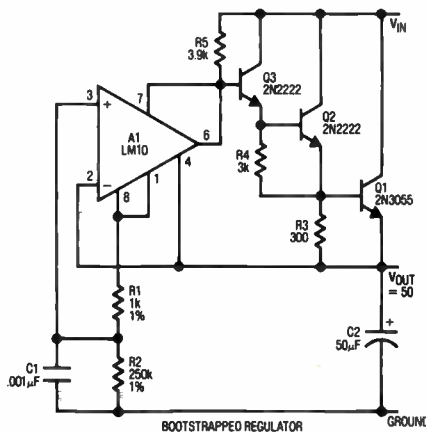
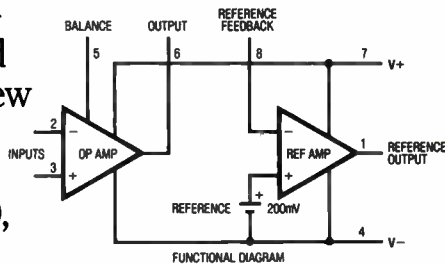

It draws only 270 micro amps. Regulates 500 volts or more with external components. Functions remotely. Includes thermal limiting. Fits existing op amp sockets. And prices start at only \$3.30.

Bob has written a detailed reference book outlining various application ideas for his brainchild.

Contact us and we'll send it to you along with more information about the LM10. Then you figure out what to call it.

National Semiconductor
2900 Semiconductor Drive
Santa Clara, CA 95051

Gentlemen:

Call it what you will, the LM10 interests me. Please, send me all the information concerning it.

Name _____

Title _____

Company Name _____

Address _____

City _____ State _____ Zip _____

E 4/26-9-10

 National Semiconductor

New from
Heinicke...

the tunnel washer of the 80's is here!

This is the most important advancement in high volume industrial washing in a generation.

The new Heinicke tunnel washer has feature after feature to eliminate the problems that afflict traditional tunnel washers. Say goodbye to washers that cost a fortune to ship, and can't be installed or moved without breaking down walls. So long to washers that are a constant source of burnouts and repairs. Nevermore to noisy washers that waste heat and water and run up utility bills.

Heat exchanger.

No more electric or steam heated coils that can't be cleaned, or burn out from detergent residue.



Heinicke Instruments Company

3000 Taft Street, Hollywood, Florida 33021
Phone 800-327-9783 or (305) 987-6101

Please send the Buyers Guide to tunnel washers.

Name _____

Title _____ Phone _____

Institution _____

Address _____

City _____ State _____ Zip _____

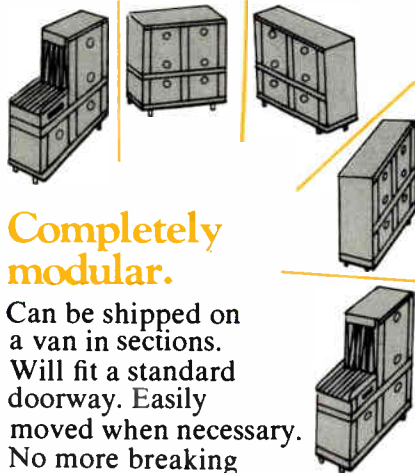

Completely modular.

Can be shipped on a van in sections. Will fit a standard doorway. Easily moved when necessary. No more breaking down walls. No more expensive flat car shipping costs.

Engineered for economy and efficiency.

Uses less water energy and detergent than any volume washer on the market due to new techniques in washing and water handling.

Reduces noise and heat loss.

Heavily insulated with high density urethane.

Best of all, the Heinicke name and expertise in washers means you have the famous Heinicke jet spray nozzle and the engineering that made Heinicke the premier name in the industrial and laboratory washer field.

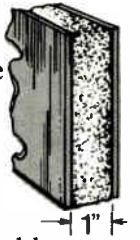

Truly a new generation of washers engineered for the volume user. Yet the cost is very competitive.

Send for the Buyers Guide

to tunnel washers, and read all the details.

If you should ever have an equipment breakdown...

a Heinicke Minute Man will be on his way to you in 48 hours!

You'll seldom need the Minute Man service, because Heinicke and Napco instruments are built to work. But if you do, just dial toll-free 800-327-9783.

Circle 38 on reader service card

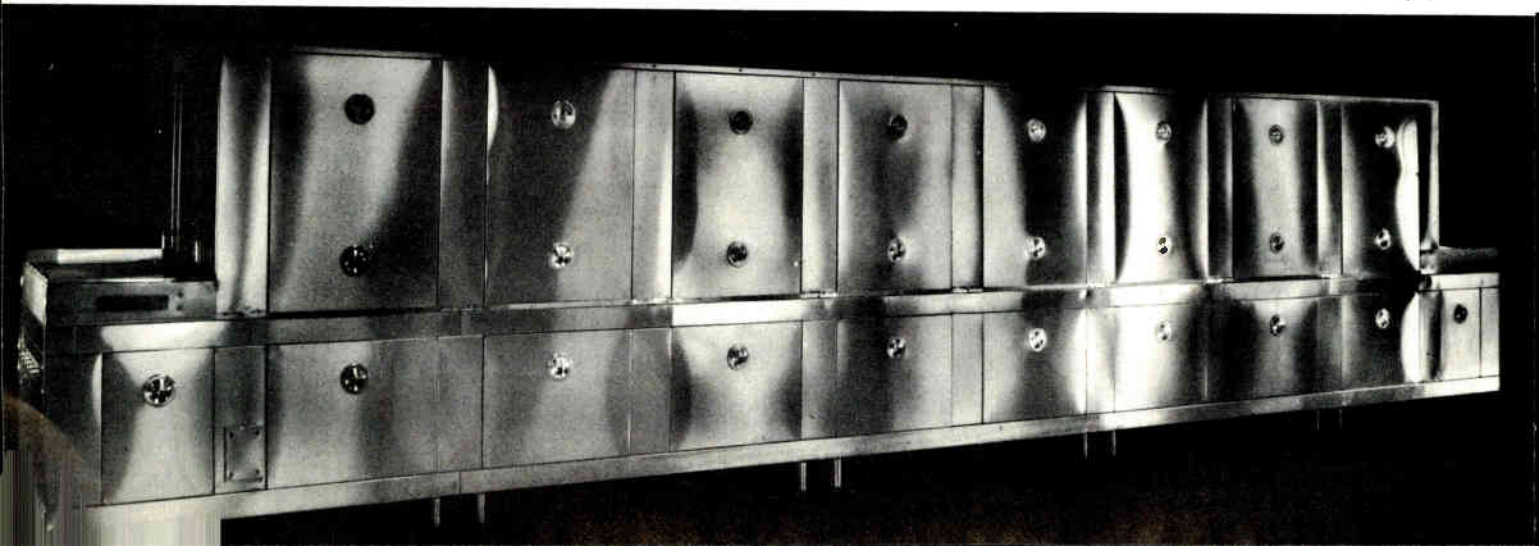

Japanese boost area, number of LEDs of flat-screen TV

by John Javetski, Consumer & Industrial Editor

Automatic die bonding
gives Sanyo a display
160 mm wide, 120 mm high,
with 38,400 GaP LEDs

There's no disagreement that the direction TV receivers will take is a flat set that hangs on the wall like a picture. The problem is to find an alternative to the bulky cathode-ray tube. A key firm in that effort, Japan's Sanyo Electric Co., is working with light-emitting diodes, and its latest experimental development is a monochrome receiver that uses no less than 38,400 LEDs in a 160-by-120-millimeter display.

There are a number of possibilities under investigation for the CRT-less set (see "Researching a flat world"). However all prototypes have been plagued by low brightness and resolution and complex manufacturing procedures—problems that Sanyo's research center in Osaka claims to have solved with relatively efficient green gallium-phosphide LEDs and an automated fabrication technique.

Manufacture. In making gallium-phosphide wafers, Sanyo uses a liquid-phase epitaxial process to grow the n- and p-type wafers on an n-type substrate. This process is the key to the 0.23% efficient LEDs, which measure 0.3 mm square and yield 7,000 to 10,000 per wafer.

To double the brightness of the display, the assembly on which the LEDs are mounted has a reflective glass sheet. In the sheet are holes to accommodate the 38,400 diodes, and to maximize reflection of light the walls of each of the holes are covered

with a film of thin gold.

To mate wafers and assembly, Sanyo uses automated die bonding. The assembly is mounted on a table with precisely controllable X and Y motions, and the wafer is placed in a cylinder or collet.

The collet descends toward the table, tests each LED, and a needle in its middle punches out good ones and secures them to the holes in the assembly. The table moves, and the procedure repeats until all the LEDs are installed in a zigzag matrix, with

Thin is in. Flat TV screen, measuring 6.4 by 4.8 inches and 80 mils thick, has fairly good resolution. Green-hued LEDs making up the screen are wire-bonded to an aluminum substrate in a zigzag fashion, top. Screen dissipates 12 watts.

160 diodes per row. The final step wire bonds the top electrodes, using 40-micrometer gold wire.

The TV set has two basic units: the display, housed in a box 460 mm wide by 320 mm high by 80 mm

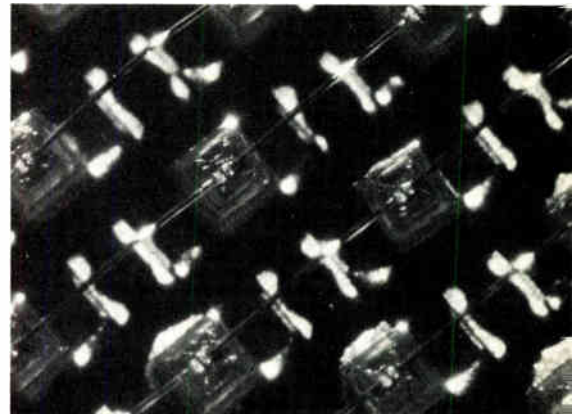

Researching a flat world

Sanyo's flat-panel TV set with 38,400 light-emitting diodes is not the company's first. Previous versions were a 6,144-LED set [*Electronics*, May 11, 1978, p. 72] and a 17,920-element set described at last October's Biennial Display Research Conference in Cherry Hill, N. J.

Nor will work stop here, says designer Tatsuhiko Niina. He hopes to improve picture quality by adding red, orange, and yellow LEDs; to reduce size and power consumption with custom integrated circuits; and to cut costs by improving the fabrication technique even more. Moreover, LEDs are but one class of devices vying for a share of the flat-TV future. Liquid crystals are under investigation by Hitachi Ltd. [*Electronics*, May 26, 1977, p. 41] and PanelVision Inc. of the U. S. [*Electronics*, Nov. 9, 1978, p. 34]. Japan's public service broadcasting system, NHK, is examining plasma displays [*Electronics*, June 22, 1978, p. 63], and the Hirst Research Laboratories of General Electric Co. Ltd. is studying dc electroluminescents [*Electronics*, Sept. 14, 1978, p. 63]. Moreover, a Swiss lab has demonstrated the feasibility of a flat CRT [*Electronics*, July 20, 1978, p. 68].

thick; and the power supply and signal-processing circuitry, which is made up of general-purpose bipolar and complementary metal oxide semiconductors.

The circuits convert incoming analog signals to digital signals that are held in a memory for two horizontal scanning periods. To improve resolution, each line of the signal is duplicated, so that it appears on two different LED rows.

The display has a brightness of 40 foot lamberts at a drive current of 0.5 milliamperes per diode and consumes only 12 watts, less than a CRT of comparable size. It can be hung on a wall separate from the power supply and processing circuitry.

Microprocessors

Development station runs eight emulators

Last year, Futuredata Computer Corp., Los Angeles, made news when it lowered the per-station cost of its microprocessor development system by allowing eight designers to share a floppy-disk memory and printer. Carrying the sharing idea further, Futuredata hopes to introduce in July a system that lets each development station handle multiple prototypes—perhaps as many as eight—via slaved in-circuit emula-

tors. A full-blown system, then, could have as many as 8 master development stations with 8 slaves apiece. Price with 64 prototyping stations: as low as \$6,000 per station.

Inside out. Futuredata can join so many emulators because it brings them outside the development station. Instead of having an emulator dedicated to a station, it loops several of them together via a high-speed serial loop. Thus, one station can control many prototypes. And the microprocessors being emulated can be 8- or 16-bit types from a variety of manufacturers.

According to Futuredata, the prototypes will run at top speed without having to halt, as other systems do, during debug operations while test information is displayed on a cathode-ray tube. "There are other master-slave systems but their processors share a common memory," explains David Ulmer, Futuredata's director of engineering. "When the master is running, the slave can't, and vice versa. We don't do it that way. We can have both executing simultaneously so that we don't have to halt for debug."

In the new Futuredata system, each slave-emulator box has a random-access memory containing software personalized for the processor under test. At power-up, debug routines are downloaded into the slave's memory. In its earlier design [*Electronics*, August 17, 1978, p. 89], the memory and "personality" board for the device to be emulated were both in the master station.

Futuredata is still ironing out the final design particulars, one of which is how many slaves to put in the high-speed loop. "The hardware doesn't dictate the maximum," says Ulmer. "We daisy-chain the slaves: the serial line goes into one emulator, then comes out to go to the next. Since you can do this indefinitely, it's really up to the software. My

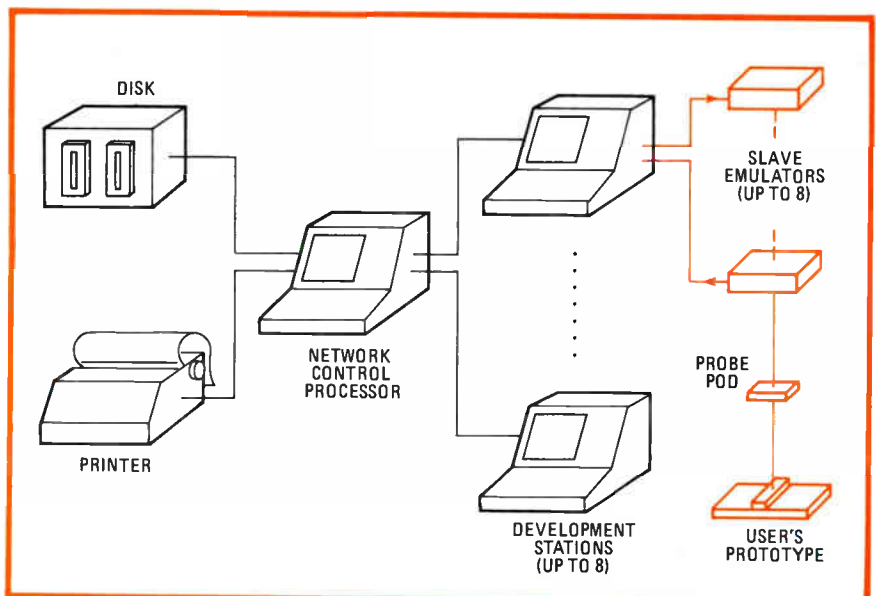

Multiple stations. As many as eight master development stations can have up to eight emulators apiece in new system from Futuredata that could be out as early as July.

guess is that we'll limit the number to around eight."

Ulmer expects the emulator's memory to be more than capable of handling an 8-megahertz 8086, one of the fastest microprocessors. "That requires a 185-nanosecond device, and we'll probably use 100-ns RAMs," he says. The size of a slave's address space will be 16 megabytes (the amount Motorola's 68000 will access directly). Yet Ulmer predicts Futuredata won't install more than one megabyte because "even that requires 64-K RAMs and we really don't have any yet," he says. "You would need 256-K parts to really do it right." Futuredata has not decided on the exact order of the devices it will emulate, but the 8086 will probably be the first.

—John G. Posa

Computers

Business systems doing double duty

It's no longer a matter of either/or, say manufacturers of microprocessor-based small business systems. Rather than specializing in either word or data processing, they must offer both in a package.

Sophisticated and cost-conscious users now balk at buying separate terminals for word and data processing, said marketers showing their wares at Interface 79, the data communications show held earlier this month in Chicago. So they must offer two functions for the price of one piece of hardware to maintain the 35% or better annual sales growth they have been experiencing.

Additions. Manufacturers are adding new software to upgrade existing equipment into combined distributed data- and word-processing centers and to prevent competitors—especially larger equipment suppliers like IBM, Xerox, and Burroughs—from siphoning new business from their old customers. Thus they hope to be on top of the explosive growth expected in the market for small business systems: 1982 sales are



Added capability. Basic Four Corp., Tustin, Calif., shows off its model 730 small-business computer system, to which it has added distributed data- and word-processing modes.

pegged at \$3.55 billion, up from an anticipated \$885 million this year.

Several makers showed their re-packaged combination systems at Interface. Others are expected to unveil their offerings later this year.

Basic Four Corp., Tustin, Calif., a subsidiary of Management Assistance Inc., showed its existing 410, 200, and 730 systems in a distributed data- and word-processing mode. The 730, the largest unit with 256 kilobytes of memory and 300 megabytes of disk storage, acts as a message center and periodically polls other network nodes to distribute interoffice mail, orders, and bills. "We're the only vendor offering this kind of thing," claims David Seigle, vice president and general manager of the Distributed Data Processing division.

"With the recent introduction of the DataWord word-processing system, we achieved simultaneous data processing and word processing on the same system," he says, adding that the combination has now been integrated with a distributed network capability. A full-capability system in minimum configuration probably will cost about \$150,000.

Mohawk Data Sciences Corp., Parsippany, N. J., says its combination offering is a less expensive alter-

native to new competing products. It added word-processing software to its Series 21 models designed for distributed data processing and sells it for \$17,000 per node, including a printer. Comparable competitive systems would cost triple that amount, claims Douglas Davidson, senior vice president for marketing. However, the system is restricted to four keyboards per processor, 64 to 96 kilobytes of main memory, and 1 megabyte of disk storage.

Davidson says the new sophistication of buyers unwilling to duplicate hardware is leading vendors to integrate communications links into the word-plus-data-processing packages. "The key element is now communications. Some customers are already asking for electronic mail."

Others. Although Megadata Corp., Bohemia, N. Y., scheduled a press conference to introduce its series 2001 distributed word-processing system, last-minute delays with software forced cancellation. A model on the exhibit floor had 64 kilobytes of random-access memory and dual disk drives storing 500,000 bytes. Company sources say a distributed data-processing package will be demonstrated this year.

To keep up with the competition, Datapoint Corp., Dallas, will soon

announce a software upgrading of certain distributed data-processing products so they can perform word processing, sources say. Demonstration systems at Citibank and Texaco already are on line.

The next innovation will be down-line loading. Instead of isolating the new systems, Basic Four will soon offer a program linking large main-frame processors with its dedicated networks, much like a present feature of Mohawk's systems.

Such announcements make real the concept of merging word and data processing. But as Frederick Wang, director of market planning and development at Wang Laboratories, Lowell, Mass., notes, [*Electronics*, March 1, p. 14] a lot of user education will be necessary in order to make effective use of the new systems. **-Larry Marion.**

Business

U. S., Israel broaden electronic ties

Israel's expanding electronics industry hopes to benefit substantially from the peace treaty with Egypt. The treaty has led to an American decision to allow Israeli firms to compete with American firms for Pentagon contracts. A memorandum of agreement on the subject was completed on March 26 between Secretary of Defense Harold Brown and Israel's Defense Minister Ezer Weizmann and could mean millions of dollars to Israel's defense-related electronics industry.

In the past, very few Israeli electronics firms were able to sell to the Pentagon because of "Buy American" rules, which require foreign bidders to be 50% below American firms in order to be considered. Under the new agreement the American market will be opened up to what one Israeli defense official terms competition on an equal footing with American firms for the whole gamut of sophisticated military electronics gear. He points out Israel's advantage of a large techni-

cally skilled and well-educated labor force working at wages only half those in Europe and the U. S. Electronics production, most of it for export, is valued by the Israelis at over a billion dollars last year.

Israel military electronics and aerospace manufacturers should get before summer's end a list of U. S. military hardware for which they may compete with their American counterparts. The lists will begin to be drawn up during a meeting of U. S. and Israeli defense representatives scheduled to start within 60 to 90 days, according to a Pentagon spokesman.

The agreement also calls for more mutual cooperation between the two countries in research and development, including exchanges of engineers and scientists, and increased procurement and logistics support. The rationale for the agreement, the Pentagon says, is to help offset Israel's negative military trade balance with the U. S. resulting from large purchases of American weapons. However, the memorandum sets no specific dollar value on U. S. military hardware that Israel, may supply.

Joint ventures. Director of the Israel Investment Authority, Rafael Benvenisti says he expects the agreement to lead to the establishment of many new joint ventures between American and Israeli electronics firms. In the past, the Pentagon forbade a number of American electronics firms to open plants in Israel because of the sophisticated nature of their technology, he says. "We are now in the process of renewing contacts with three American electronics firms affected by this ban," Benvenisti says, although he declines to name them.

The Aerospace Industries Association of America sees no significant problems with the agreement, according to one official, since many of its airframe and avionics manufacturers already have working agreements with counterparts in Israel. But the Electronic Industries Association says its Government division is still studying the agreement. **-Neal Sandler, Jerusalem**

Audio

Apple computer checks speakers

Loudspeaker tests are normally done in anechoic chambers so that reflected sound cannot skew measurements of amplitude versus frequency. However, listeners use their speakers not in anechoic chambers, but in living rooms. Since the environments are very different, speaker performance may seem to suffer.

Robert A. Berkovitz, 52, research director of Teledyne-Acoustic Research Inc., Norwood, Mass., one of the country's largest makers of speakers, and consultant David McIntosh, 35, have come up with a portable, microprocessor-based system that can be used to test speakers almost anywhere.

Based on the Apple II microcomputer (from Apple Microcomputer Co., Cupertino, Calif.) with a custom software package and input/output, the system makes possible measurements that are about as accurate as those using anechoic chambers—but without the cost of the chamber, and at a lower hardware cost than competing testers. According to Berkovitz, spectrum analyzers that could do the job cost at least \$10,000 versus the approximately \$1,600 price of the Apple II

Responding. Nine-inch monitor of Apple II computer displays frequency response of speaker determined with FFT program.



Electronic Film Materials:

Engelhard produces more kinds of film materials than anyone else in the world... and we've been doing it for a long time.

Precious Metal Powders — Gold, Platinum, Palladium and Silver. Available in pure form, or as alloys and sub-micron mixtures with wide ranging capabilities in selection and control of surface area. Average particle size in the one to five micron range.

Electronic Inks — Used in Hybrid Microelectronics and stacked ceramic capacitors. They

include gold platinum, silver platinum, silver palladium, palladium, platinum and gold conductors; zero-flow multi-layer and overglaze inks; rely-ohm high stability resistor inks and organic coatings.

Metallo-Organics — This remarkable *thin film* is obtained by using thick film processing suitable for the screen printing, spraying, or brushing of all precious metals and their alloys. Flat surfaces, porous internal surfaces or even gauze can be coated.

Industrial Silver Inks — Used in products as diversified as *bronze baby shoes* and *automobiles!* Available in very large or very small volumes for room temperature curing or high temperature sintering.

Next time *you're* involved in electronic film application, make the one call that gets results. Call (201) 589-5000.

ENGELHARD

We're the only one!



ENGELHARD

HANOVIA THICK FILM
ENGELHARD INDUSTRIES DIVISION
ENGELHARD MINERALS & CHEMICALS CORPORATION
1 WEST CENTRAL AVENUE, EAST NEWARK, N. J. 07029

An Equal Opportunity Employer

Circle 43 on reader service card

system with its peripheral attachments for the job.

In action. The system uses a series of 10-microsecond pulses that contain energy of all frequencies, like white noise. These pulses are fed into the speaker terminals, converted to acoustic energy, and received by a calibrated microphone. In effect, the microphone output is an electrical analog of the acoustic output of the speaker augmented by reflections from the speaker cabinet and the walls of the listening room.

The Apple system actually pumps about 16 pulses at a time into the speaker. The Apple's I/O system opens gates, or time windows, so as to catch only the desired part of the acoustic output from the speaker. By electronically controlling the opening of the windows and their duration, it is possible to look at the direct sound coming from the speaker or to include cabinet or listening-room wall reflections.

The 16 acoustic bursts are digitized and summed; this culls out random noise in the test area. The data then is treated to a software-based 256-point fast-Fourier analysis which takes about 3 seconds. Afterward, the spectral response of the speaker is displayed on a video terminal driven by the Apple.

With its sample rate of 46.5 kilohertz, the system can display speaker performance across a band from 200 hertz to 23 kilohertz with a dynamic (amplitude) range of 32 decibels. By shifting the data into a memory and filtering and analyzing it again, the low end of the spectrum can be displayed down to about 25 Hz with 2.2 Hz resolution. The processing takes about 25 seconds for the small computer, but that's plenty fast enough, according to Berkovitz.

Differences. By moving the time window around, engineers can spot differences in a speaker's pulse response at different frequencies. They can also spot the presence of cabinet reflections that might reinforce some frequencies or cancel others. And the system can show how the speaker and room interact.

Acoustic Research engineers are using the setup to help them design

speakers by taking test speakers to actual living rooms and getting a cross section of speaker responses in different environments. The company is also using three other systems it has built as marketing tools. Salesmen use them to demonstrate the basics of a speaker system.

The system has also spawned interest among makers of audio test gear. Although no product developments have yet been agreed upon, it seems fairly certain that low-cost, microprocessor-based spectrum analyzers are on the way, according to Berkovitz. **-James B. Brinton**

Navigation

Time-domain filtering gives Lonars better position fix than Loran-C systems

Adding new technology to tried-and-true principles sometimes advances the state of the art with a relatively small investment. Johns Hopkins University's Applied Physics Laboratory has demonstrated that maximum by using time-domain filtering techniques implemented with a Hewlett-Packard minicomputer to eliminate the noise limitations of the Loran-C long range navigation system.

With a Navy investment of approximately \$1 million and two years of engineering effort, the Laurel, Md., lab has come up with a new Loran navigation receiving system called Lonars that can generate a position-fix to within less than 100 feet in real time, five times better than Loran-C [*Electronics*, March 29, p. 57]. Lonars' developers believe it has potential for navigation accuracies of within 30 feet.

Classified. The Navy, whose Strategic Systems Project office is sponsoring Lonars, already has three prototypes operational, says APL's project supervisor William J. Peters III. Neither Peters nor the Navy will discuss the classified applications, but other sources suspect one of the program's goals is to deploy Lonars aboard the underwater missile-launching submarine fleet to enhance the accuracy of the Polaris, Poseidon, and upcoming Trident intercontinental nuclear missiles. "Before you can figure out where you want to go, you must know where you are," explains one source. "The more precisely you know your position at launch time, the better your aim."

"Time-domain filtering is the guts of the system," says Peters, since the software technique used in Lonars' HP 2109 mini tracks and edits the pulsed, 100-kilohertz Loran-C station signals to eliminate and compensate for noise. Noise has long plagued users of signals from Loran-C transmitters, whose positions are known to the navigators that use signals from three stations to compute their own position. Whether the superimposed noise originates in lightning or other atmospheric sources or in cross-rate interference generated by a second transmitter's pulse, the result is the same: inaccuracy in measuring the signal's arrival time that produces a corresponding inaccuracy in computing the user's location.

Lonars not only is unaffected by atmospheric noise, says APL project engineer Leo F. Fehlner, but it also can track signals from up to eight Loran-C transmitters simultaneously. Although Lonars uses only three stations for a fix, the ability to track and use additional stations permits the system "to coast through periods of cross-rate interference" from other Loran signals, Peters explains.

Costs. Precision navigation with Lonars could be important for future civilian uses, Peters believes, citing its potential for accuracies of 50 or perhaps 30 feet as useful for piloting in harbors, narrow channels, and other restricted areas, as well as for offshore oil- and mineral-exploration vessels and research ships. But the APL supervisor is quick to add that costs will have to come down

BIFET OP AMPS

We expanded our line so you can tighten your specs.

We've just added four new VOS relatives to our industry-standard family of BIFET Op Amps. So now you can tailor your applications in the most cost-effective way possible.

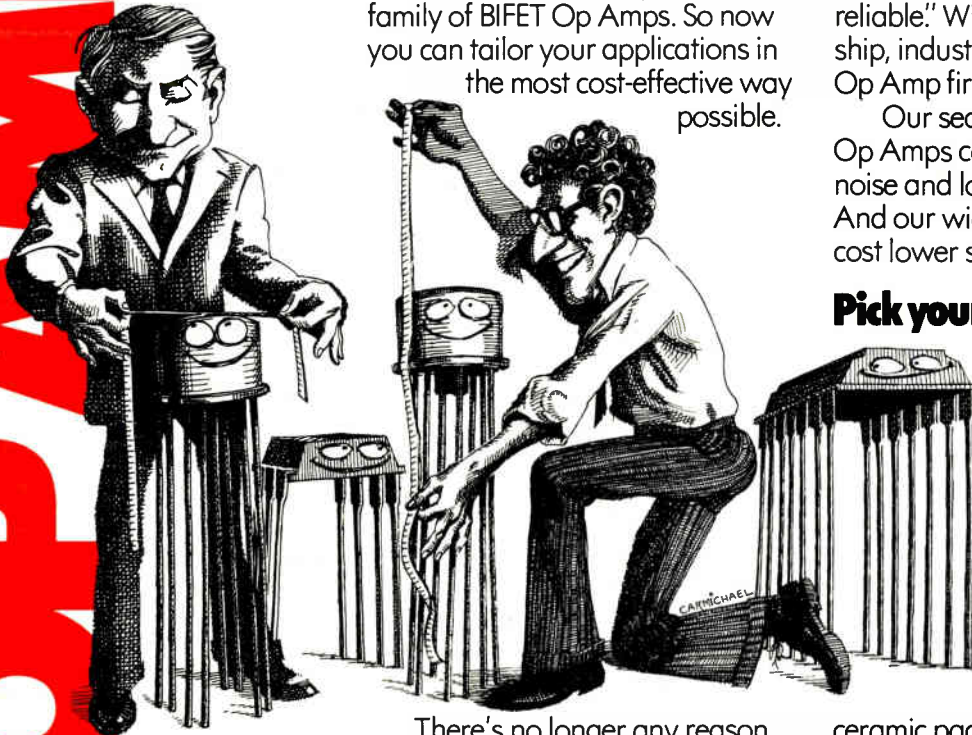

When it comes to Op Amps, we're already the industry's "old reliable." With 14 years of leadership, industry standards and Op Amp firsts.

Our second-generation BIFET Op Amps combine the lowest noise and lowest cost available. And our wider selection cuts the cost lower still.

Pick your size for the perfect fit.

Our monolithic BIFET operational amplifiers come in single μ AF771, dual μ AF772 and quad μ AF774. In commercial and military temperature ranges. And in plastic, cans and

ceramic packaging.

If you'd like to find out all the ways to tighten your specs, contact your Fairchild distributor or representative today. Or use the direct line at the bottom of this ad to reach our Linear Division direct. Fairchild Camera and Instrument Corporation, Box 880A, Mountain View, California 94042. Telephone: (415) 962-4903. TWX: 910-379-6435.

There's no longer any reason to buy more specs than you need. Or less. By buying the BIFET that's closest to your requirements you eliminate waste in performance and cost.

Our BIFETs really measure up.

MAX. RATINGS @ 25°C			
VOS mV	I _{OS} pA	I _B pA	ORDER CODE
2	50	100	μ AF77XA
5	50	100	μ AF77XB
10	100	200	μ AF77X
15	100	200	μ AF77XL

X = 1 single amplifier
 = 2 dual amplifiers
 = 4 quad amplifiers

FAIRCHILD

Call us on it.
(415) 962-4903

substantially from the estimated \$80,000-per-system price of the Navy prototypes. Nevertheless, Peters says that the laboratory has already received inquiries from several manufacturers.

As for the HP 2109, Peters says its high speed and 32,000 words of core memory are more than adequate for the application, but the printed-circuit boards are being retrofitted with connectors of military standard. "Its speed is perfect, since it takes only 75 nanoseconds for add or subtract functions and something like 225 nanoseconds to multiply or divide," he says. "The memory is more than adequate. Lonars only requires about 18 to 20 thousand words—about 60% of what is available to us." **-Ray Connolly**

Medical

Microwaves affect action of Librium

It's close quarters aboard naval vessels and their innards are filled with all kinds of low-level microwave radiation from the ships' electronic systems. There is little or no evidence that the microwave levels affect human biology, so, the reasoning goes, if exposure standards are followed there is no cause for concern.

Or is there? A team of researchers at the Naval Medical Research Institute in Bethesda, Md., has found that low-level microwaves change the way laboratory rats respond to the tranquilizing drug Librium. The radiation has no other apparent effects.

Now a lot of work must still be done before it can be shown that human beings taking Librium would also be affected. But Librium is commonly prescribed to relieve the tensions of shipboard duty, hence the Navy's interest.

The rats worked harder when exposed to as little as 1 milliwatt per square centimeter of pulsed power, according to John R. Thomas, who worked on the project with Linda S.

Burch and Stephen S. Yeandle. This power level, at 2.45 gigahertz, is typical of what is found near radar equipment aboard ships.

In the tests, the researchers first trained the rats to do certain tasks after giving them Librium. The animals were, for example, taught to push a certain button to reward themselves with a food pellet. This learned, the researchers turned on the microwaves. They observed, simply, that the rats went about obtaining the pellets at a faster rate.

Testing. The microwaves came from a standard-gain horn antenna oriented so the electric field was vertically polarized at the animal's location. Near-field conditions applied since the animals were kept 3.75 wavelengths from the antenna. The average power density was measured with a conventional broadband radiation monitor.

The researchers structured the tests so that the behavior of the rats depended only on whether the microwave radiation was turned on. Extreme care was taken to ensure that behavioral changes were not caused by other variables.

Why the microwaves and the Librium interact is unknown. The researchers have measured rat temperatures and are fairly certain the change in behavior was not due to any heating effects.

In the future, they plan to work with other major drugs that affect the central nervous system to see if their action is also affected by microwaves, according to Thomas, an experimental psychologist. The overall objective, he notes, is to "de-

termine safe [radiation] exposure guidelines." Thomas believes it cannot be emphasized enough that the results of his experiments cannot yet be applied to human beings.

He also points out the big difference between exposing a biological system and the amount of radiation the system actually absorbs. Also important is where the absorption takes place. "Until all research uses the absorbed dose as a common measure, it is very difficult to talk about low-level microwave effects in a general way." **-Harvey J. Hindin**

Microwaves

NBS builds simple near-field instrument

The electromagnetic radiation emitted by industrial machinery is causing concern among Government health organizations, industries, and also Congress, which is considering legislation to set maximum standards for these emissions. If such limits are imposed, compliance with them will require easy-to-build instruments capable of quick and accurate readings within one wavelength from the source. The National Bureau of Standards, Boulder, Colo., has come up with a prototype of such a near-field device.

"A small, efficient, and accurate near-field instrument would be very welcome," says Mays Swicord, chief of the electromagnetics branch at the Bureau of Radiological Health, Rockville, Md. His branch has been testing industrial machinery—mainly radio-frequency "sealers" used to join plastic sheets together—but to do so is using sophisticated instruments that require considerable skill to set up and interpret.

Lack of tools. "Sixty per cent of the radiation problems are in the near field yet there is a lack of tools for really getting a handle on measurements in that region," says Charles K. S. Miller, chief of the electromagnetic-interference radiation hazards metrology program responsible for the prototype. Com-



MICRO POWER

Microcomputer with printer—\$375. That's Rockwell Micropower.

For learning, designing, work or just fun, Rockwell's AIM 65 microcomputer gives you an easy, inexpensive head start.



- 20-Column Printer and Display
- Dual Cassette, TTY and General-Purpose I/Os
- R6502 NMOS Microprocessor
- System Expansion Bus
- Read/Write RAM Memory
- PROM/ROM Expansion Sockets
- Advanced Interactive Monitor Firmware
- Big Terminal-Style Keyboard

For more on AIM 65 and how you can develop programs in assembly language or BASIC, write Microelectronic Devices, Rockwell International, D-727-F 4, P.O. Box 3669, Anaheim, CA 92803 or phone (714) 632-3729, or contact your local Hamilton-Avnet office.



Rockwell International

...where science gets down to business

News briefs

Chips cut Dataspeed's lease costs

Microprocessors make for lowered prices in the American Telephone and Telegraph Co.'s new Dataspeed 4540 clustered-terminal system. The system adds a new cluster controller and individual display controllers to the Dataspeed 40/4 line. The cluster controller uses a Z-80 8-bit microprocessor to interconnect as many as 24 displays and eight printers. Underneath each display is a controller with its own Z80 and a video controller chip developed by subsidiary Teletype Corp. A typical system with three displays and an 80-column printer should lease for \$600 to \$700, depending on options. A similar system from IBM leases for slightly over \$900.

PAVE PAWS radar in final tests

The U.S. Air Force's Sixth Missile Squadron is putting the controversial PAVE PAWS missile-warning radar through its final tests, following USAF acceptance earlier this month of the Cape Cod, Mass., phased-array system from prime contractor Raytheon Corp. A final environmental impact statement on the massive radar [*Electronics*, Dec. 7, 1978, p. 8] will be published in May, and the Air Force hopes to declare it operational in June.

Apple to bite into educational market

Apple Computer Inc., Cupertino, Calif., will take its personal computers into the educational market in a contract with Bell & Howell Co., Chicago. The move gives Bell a new medium for its educational materials libraries and offers Apple ready resources for software packages, as well as access to an education-oriented distribution and repair network through Bell's 100 audio-visual equipment centers.

National to produce PAL chips

National Semiconductor Corp. has signed a world-wide, nonexclusive agreement to produce all 15 of Monolithic Memory Inc.'s programmable array logic chips. MMI, in Sunnyvale, Calif., will supply the Santa Clara firm with all the PAL mask sets, circuit diagrams, and technical information needed to produce the bipolar fusible-link devices. These bipolar replacements for random logic are popular with makers of small computers. A year ago, MMI signed a similar agreement with Raytheon Co.

Hitachi to second-source 68000

With first chips of its MC68000 microprocessor expected in mid-May, Motorola's Integrated Circuit operation in Austin, Texas, has confirmed reports that Hitachi Ltd. will second-source the 16-bit machine [*Electronics*, March 29, p. 36]. Sources say the deal calls for Motorola to provide the Japanese firm with tooling for production of a mask-compatible alternative. Already a second source on the 8-bit MC6800, Hitachi will also be given rights to, and help develop, 68000 peripherals. There is still no word on a U.S. second source for the 68000, which will compete with the emerging 16-bit processors from other makers, all of whom have signed second sources.

mercial probes are available, such as Narda's model 8600, but Miller says none offers the same combination of frequency range, sensitivity range, and isotropic characteristics (independence of position in the field) as the NBS prototype, or emi probe, as it is called.

Wide range. The prototype is designed to operate over the broad frequency range of 500 kilohertz to 1 gigahertz, according to Miller's de-

puty, Francis X. Ries. Its wide dynamic range of 1 volt per meter to 1,000 v/m, or 30 decibels, covers the spectrum of field strengths likely to be emitted by high- or low-level sources, he says.

The probe is in two sections—a box containing the electronics and a hand-held antenna designed to be isotropic. Instead of one dipole, there are three for detecting simultaneously three orthogonal electric-field

- ALABAMA**
Huntsville—Powell Electronics
- ARIZONA**
Phoenix—Kachina Electronic Distr.
Tucson—Inland Electronic Supply
- ARKANSAS**
Little Rock—Carlton-Bates Company
- CALIFORNIA**
Los Angeles—Electric Switches
Fisher/Brownell
Riverside—Electronic Supply
San Diego—Fisher/Brownell
Richey Electronics
Santa Clara—Fisher/Brownell
Sunnyvale—Powell Electronics
Sun Valley—Richey Electronics
- COLORADO**
Denver—Electronic Parts Co.
Newark Electronics
- CONNECTICUT**
Greenwich—Wise Components
Wallingford—Midan Electronics
- FLORIDA**
Miami Springs—Powell Electronics
Oakland Park—Peerless Radio Corp.
Orlando—Hammond Electronics
- ILLINOIS**
Addison—LCOMP-Chicago
Chicago—Newark Electronics
Elgin—Allied Electronics
Elk Grove Village—Pioneer/Chicago
Northbrook—Classic Components Supply
Peoria—Klaus Radio
- INDIANA**
Evansville—Hutch & Son
Ft. Wayne—Ft. Wayne Electronics Supply
Indianapolis—Graham Electronics
Ra-Dis-Co.
South Bend—Radio Distributing Co.
- IOWA**
Cedar Rapids—Deeco
- KANSAS**
Wichita—Radio Supply Company
- MARYLAND**
Beltsville—Powell Electronics
Gaithersburg—Pioneer/Washington
Rockville—Capitol Radio Wholesalers
- MASSACHUSETTS**
Dedham—Gerber Electronics
Hingham—Sager Electric Supply Co.
North Adams—Electronic Supply Center
Worcester—R.M. Electronics
- MICHIGAN**
Livonia—Pioneer/Michigan
R.S. Electronics
Oak Park—Newark Detroit Electronics
- MINNESOTA**
Minneapolis—Newark Electronics
St. Paul—Gopher Electronics Company
- MISSISSIPPI**
Jackson—Ellington Electronic Supply
- MISSOURI**
Kansas City—LCOMP-Kansas City
Maryland Heights—LCOMP-St. Louis
St. Louis—Olive Indust. Electronics
- NEBRASKA**
Lincoln—Scott Electronic Supply Corp.
- NEW HAMPSHIRE**
Hudson—Heiland Electronics
- NEW JERSEY**
East Hanover—State Electronics Parts Corp.
Springfield—Federated Purchaser
- NEW MEXICO**
Albuquerque—International Electronics
Walker Radio Company
- NEW YORK**
Binghamton—ASI Electronics
Bohemia—Car-Lac Electronic Industrial Sales
Buffalo—Summit Distributors
Farmingdale—Arrow Electronics
Lynbrook—Peerless Radio Corporation
Rochester—Simcona Electronics Corp.
Vestal—Harvey/Federal Electronics
- NORTH CAROLINA**
Greensboro—Hammond Electronics
Pioneer Carolina
Raleigh—Southeastern Radio Supply
- OHIO**
Dayton—ESCO Electronics
Pioneer/Dayton
Cincinnati—Hughes-Peters
Cleveland—Pioneer/Cleveland
Columbus—Hughes-Peters
- OKLAHOMA**
Oklahoma City—Electro Enterprises
Tulsa—Oil Capitol Electronics
- OREGON**
Portland—United Radio Supply
- PENNSYLVANIA**
Erie—Mace Electronics
Harrisburg—Cumberland Electronics
Philadelphia—Almo Electronics Corp.
Herbach & Rademan
Powell Electronics
Pittsburgh—Cam/RPC
Pioneer/Pittsburgh
Reading—George D. Barbey Company
- RHODE ISLAND**
Warwick—W.H. Edwards
- SOUTH CAROLINA**
Columbia—Dixie Electronics
Greenville—Hammond Electronics
- TENNESSEE**
Nashville—Electra Distributing Company
- TEXAS**
Dallas—Solid State Electronics
Ti Supply
El Paso—International Electronics
Fort Worth—Allied Electronics
Houston—Harrison Equipment Co.
Kent Electronics
Stafford—Southwest Electronics
- UTAH**
Salt Lake City—Standard Supply Company
- VIRGINIA**
Richmond—Sterling Electronics
- WASHINGTON**
Seattle—Interface Electronics Corp.
- WISCONSIN**
Milwaukee—Marsh Electronics

Instant Custom Keyboards! Create Any Keyboard Array Your Way With Grayhill's System 87



1. Do-It-Yourself Prototypes.

Choose the building block modules you need; the System 87 includes 1, 2, 3, 4, 5, or 6 button strip switches, plus 3x4 and 4x4 keyboard pads. Stack them as you want them; they maintain 1/2" button centers in any configuration. Single pole/common bus circuitry and matrix coding. We provide snap-on caps and self-stick legend sheet. You get a professional looking keyboard, laid out exactly the way you want it.

2. Short Run Production.

We supply modules electrically and mechanically identical to your prototypes, except the legending is now hot-stamped. Mount them on your boards, and you're in business.

3. Complete Boards for High Volume Production.

GRAYHILL delivers your complete custom keyboard—button legends hot-stamped or molded-in to your order, arranged, mounted and terminated to your specification.

Easy to use and easy to buy
GRAYHILL Series 87 Dome-Contact Keyboards
are available off-the-shelf
from GRAYHILL or its distributor network.

It's all one product...

...but the sophistication grows right along with your program. Sophisticated low-profile snap-dome contact system, too... provides tactile and audible feedback to the operator and a 3,000,000 cycle life.

Write for free literature.

Grayhill
INC

...the Difference Between Excellent and Adequate

561 Hillgrove Avenue • LaGrange, IL 60525 • (312) 354-1040

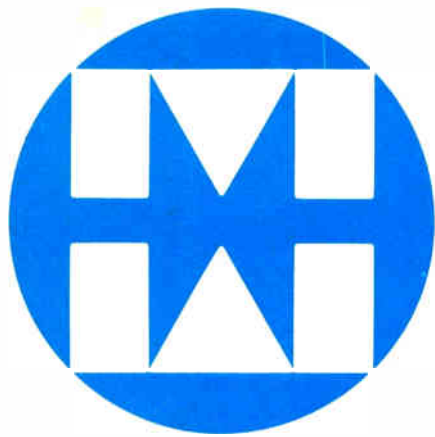

MITEL

CMOS/LSI DIGITAL TONE RECEIVER CIRCUIT MT8820



Featuring:

- CMOS Low Power Consumption
- Wide Operating Ranges:
 - Supply Voltage: 5 to 15 volts.
 - Temp. Ranges: -55 to 125°C & -40 to 85°C
- Decodes all 16 DTMF Digits.
- Has 3 Selectable Output Codes.
- Latched 3-State Buffered Outputs.
- Uses Std. 3.58 MHz TV Crystal.
- Detect Times: 10 to 30 MS.
- Adjustable Detect & Release Times.
- Std. 24-Pin Plastic & Ceramic DIP.
- Immediate Delivery
- **LOW PRICE:**
\$15.00 ea. in Qty's of 100-up.

Contact the leader in tone receivers and CMOS technology for more information:



1745 JEFFERSON DAVIS HWY
SUITE 611
ARLINGTON, VA. 22202
TEL 703-243-1600

MITEL

Semiconductor

Electronics review

components. The dipoles are electrically short and each has a beam-lead diode ultrasonically bonded to its junction. Short dipoles, however, are high Q circuits and therefore have a narrow frequency response.

To broaden the response, the circuit's equivalent resistance must be made higher. The designers do this by using highly resistive leads (80 kilohms per centimeter) made from Teflon impregnated with carbon and extending the full length from the dipoles to the opposite end of the 1-meter-long handle that supports them. Low-resistance cables carry the signals from this end of the hand-held wand to the boxed electronics where they are converted into individual readings or a vector-summation reading of all three.

Easy to build. Sensitive to criticism that NBS designs are often extremely expensive to build, Ries says the designers took special pains to make the probe easy to manufacture. Off-the-shelf parts are used wherever possible, he says.

Also, the prototype is not meant to be an exact model. "There's plenty of room for shrinking the size of the box—now 17 cm high, 21 cm wide, and 20 cm deep—and the boards," Ries continues. NBS plans to make several prototypes that it will give to selected manufacturers for examination to determine their interest. Ries estimates that a mass-produced version could be made to sell for roughly \$3,000. **-Robert Brownstein**

Weather

\$10,000 station sends to satellite

Anyone unfamiliar with satellite earth stations priced in the \$10,000 range that can be put together in three hours probably has not heard of Electronic Techniques Inc. Yet the little Fort Collins, Colo., company has made itself known to the Department of the Interior, which has awarded it a \$1.5 million contract to build 150 portable, solar-powered earth stations over the

period of the next 20 months.

Interior's Bureau of Reclamation says it plans to use the stations in a meteorological surface observation network, called Mesonet, to relay data hourly via NASA's geostationary operational environmental satellite (GOES) to ground stations. From there the data is to be relayed to a computer complex at Reclamation's Engineering and Research Center at Denver.

Using lead-calcium batteries from Delco Electronics and drawing power from Arco Solar silicon photovoltaic solar cells, each Mesonet station's sensors will measure the usual remote weather station parameters—wind speed and direction, temperature, humidity, barometric pressure, precipitation, and battery status. This will be done at 5-minute intervals for hourly digital radio transmission to the satellite. Signals are sent via a Yagi antenna in the 402-megahertz region assigned to the GOES satellite.

What is remarkable about the Mesonet stations, according to Interior officials, is their high reliability and relatively low cost. Even in the unlikely event the solar panels receive no sun for 30 days, for example, the batteries can still continue station operation. The stations, aluminum rods shaped into triangles and standing 20 feet tall, are designed to withstand winds in excess of 100 miles per hour. The weather sensors and electronic equipment will all be off the shelf.

Big money. The \$1.5 million competitive award represents big money for four-year-old Electronic Techniques, says vice president Vincent Scheetz. The privately held company's annual volume last year was about \$1 million.

Interior says the Mesonet stations will be used to advance the agency's investigations of cloud seeding and natural irrigation created by runoff from mountain snowpacks. The initial 25 stations will be deployed in an area with a radius of 150 kilometers near Big Springs, Texas, Scheetz says, while others will be used later at research sites in Montana and elsewhere. **-Ray Connolly**

THINK BAUSCH & LOMB QUALITY

When your quality control depends on precision, convenience, or reliability—think StereoZoom® microscope quality.

Since BAUSCH & LOMB introduced the first zooming microscopes in 1959, more people all over the world have put StereoZoom® microscopes to work for them than any other instruments of their kind.

The reasons all relate to BAUSCH & LOMB quality. Optimum balance of resolution and depth of field, precision optics, highly reliable mechanical components, precise photomicrographic exposure capabilities and a wide variety of illuminators, stands, and accessories are just a few of those reasons.

From industrial research to routine failure analyses and wafer inspections, there is a BAUSCH & LOMB StereoZoom microscope precisely right for your application. Write or call for a detailed catalog or demonstration. THINK BAUSCH & LOMB ... Quality since 1874.



BAUSCH & LOMB
Scientific Optical Products Division

Rochester, New York 14602 USA
716-338-6000, TWX 510-253-6189
TELEX 97-8231, CABLE: Bausch & Lomb

In CANADA: Bausch & Lomb Canada Ltd. 2001 Leslie Street Don Mills, M3B2M3, Ontario, Canada (416) 447-9101

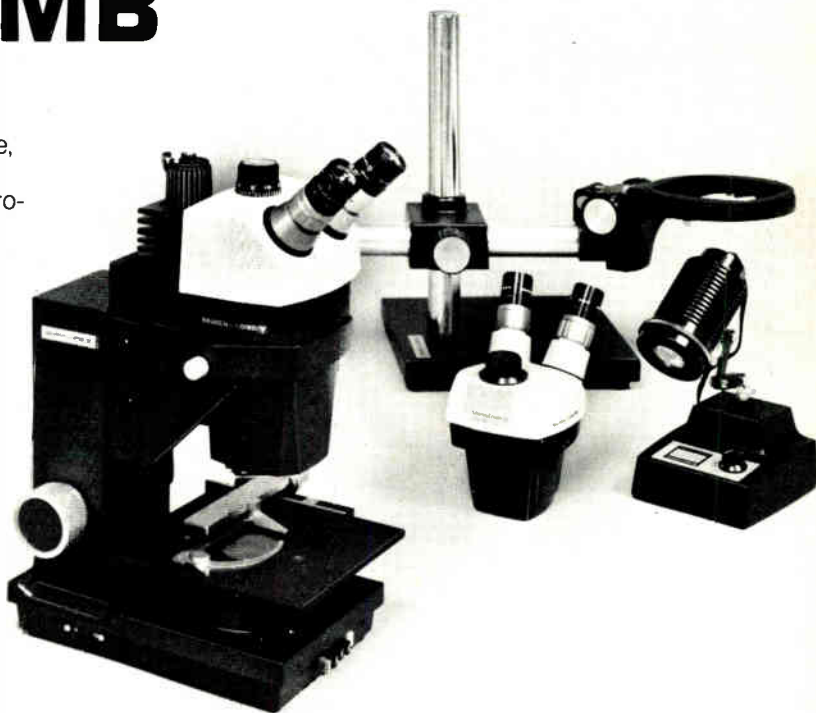

Consult Yellow Pages under "Microscopes"

Circle 257 on reader service card

Electronics Magazine Books.

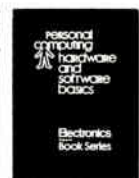
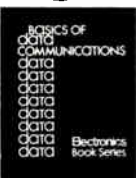
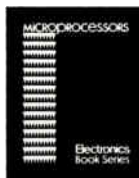

- 1. Microprocessors** What you must know about available microprocessor technology, devices, information, 4th printing. \$8.95
- 2. Applying Microprocessors** 2nd and 3rd generation technology. 26 detailed applications from data networks to video games. \$9.95
- 3. Large Scale Integration** Covers the basic technology, new LSI devices, LSI testing procedures, plus system design and applications. \$9.95
- 4. Basics of Data Communications** Includes 47 articles from Data Communications magazine covering more than 11 key areas. \$12.95

- 5. Circuits for Electronics Engineers** Contains 306 circuits arranged by 51 functions from Amplifiers to Voltage Regulating Circuits. Saves design drudgery. \$15.95
- 6. Design Techniques for Electronics Engineers** Nearly 300 articles drawn from "Engineer's Notebook." A storehouse of design problem solutions. \$15.95
- 7. Memory Design: Microcomputers to Mainframes** The technology, devices, and applications that link memory components and system design. \$12.95
- 8. Personal Computing: Hardware and Software Basics** More than 50 articles from leading publications in the field. \$11.95

Electronics Magazine Books
P.O. Box 669, Hightstown, NJ 08520

I must be fully satisfied or you will refund full payment if the book is returned after ten-day trial examination. Send me:

- _____ copies of 1. *Microprocessors* @ \$8.95
- _____ copies of 2. *Applying Microprocessors* @ \$9.95
- _____ copies of 3. *Large Scale Integration* @ \$9.95
- _____ copies of 4. *Basics of Data Communications* @ \$12.95
- _____ copies of 5. *Circuits for Electronics Engineers* @ \$15.95
- _____ copies of 6. *Design Techniques for Electronics Engineers* @ \$15.95
- _____ copies of 7. *Memory Design: Microcomputers to Mainframes* @ \$12.95
- _____ copies of 8. *Personal Computing: Hardware and Software Basics* @ \$11.95

Discounts of 40% on orders of 10 or more of each book.

Payment enclosed Bill firm Bill me

Charge to my credit card:

American Express Diners Club
 Visa Master Charge

Acct. No. _____ Date Exp. _____

On Master Charge only, first numbers above name _____

Name _____ Title _____

Company _____

Street _____

City _____ State _____ Zip _____

Signature _____



ICM7218: THE FIRST 8-

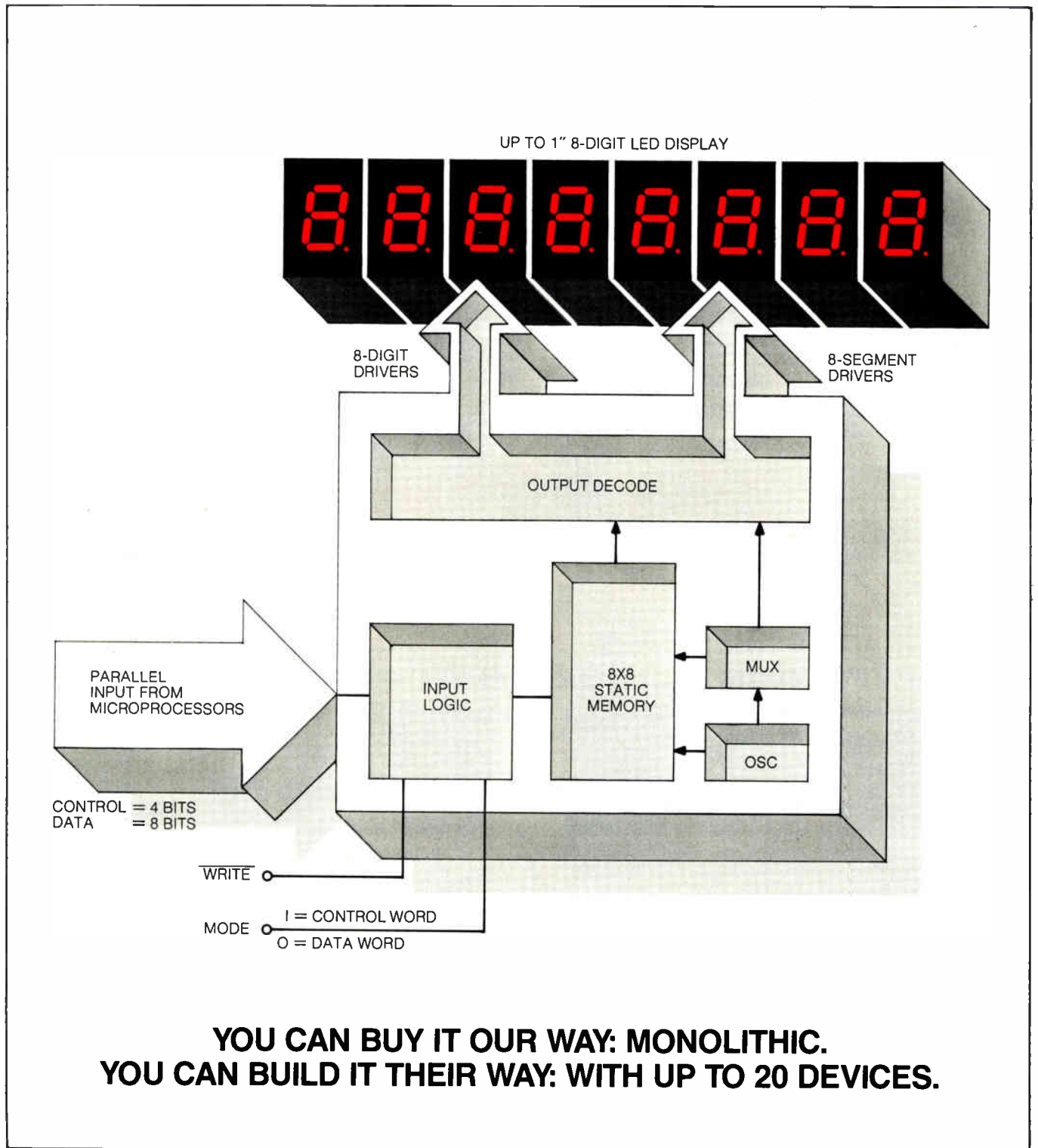

**YOU CAN BUY IT OUR WAY: MONOLITHIC.
YOU CAN BUILD IT THEIR WAY: WITH UP TO 20 DEVICES.**

MONOLITHIC. FROM INTERSIL.

The ICM7218 is the first 8-digit, 7-segment LED driver on a single chip. In fact, a whole series of display drivers driving up to 1" LED's. Common anode or common cathode. In low power CMOS for μ P or hardwired applications.

TEAR UP YOUR SHOPPING LIST.

Until now, when you wanted to interface an 8-digit display to a system, you made up a shopping list...15 to 20 TTL packages. 15 to 20 opportunities for the system to go down. Not now. The ICM7218 series gives you the complete system. On a single chip. With all the power you need to drive up to 1" LED's.

DIGIT DISPLAY DRIVER ON A SINGLE CHIP

BELLS.

A full 8 x 8 of static memory is included on-chip for storage of displayed information. And that too is a first. Even for Intersil.

AND WHISTLES.

On a single chip: Digit and segment drivers. All multiplex scan circuitry. Hexadecimal or Code B Decoding. Pin selectable choice of 7-segment decode or no-decode. A shutdown feature that turns off the display and puts the chip in a very low power mode while continuing to retain data. And, since they're manufactured in Intersil's MAXCMOS™ process, the ICM7218's operate on a single 5V supply.

MICROPROCESSOR READOUTS.

The ICM7218 A & B are intended for use with μ P-based systems and drive up to 1", 8-digit, 7-segment LED displays. Or, in the no-decode mode, you can drive 64 individually addressable "ON-OFF" LED's. Common anode or common cathode.

HARDWIRED SYSTEMS.

The ICM7218 C & D are intended for hardwired systems. Again, common anode or cathode. Both μ P-based and hardwired versions are available in 28-pin DIP's. The ICM7218E is a common anode, 40-pin version for hardwired applications. The "E" provides 4 separate lines for control information, 8 lines for data input and 3 lines for BCD digit address.

MAXCMOS™ PERFORMANCE. YOUR KIND OF PRICE.

	PINS	PLASTIC PKG	CERDIP PKG	CERAMIC PKG	COMMON CATHODE	COMMON ANODE	MICROPROCESSOR READOUTS	UNDECODED	PRICE
ICM7218AIJI	28	x			x	x			1-24 25-99 100-999
ICM7218BIPI	28	x		x		x			9.45 7.55 6.30
ICM7218CIJI	28	x			x		x		9.00 7.20 6.00
ICM7218DIPI	28	x		x			x		9.45 7.55 6.30
ICM7218EIDL	40		x		x		x		9.00 7.20 6.00
									12.75 10.20 8.50

THE UNEXPECTED IN MAXCMOS™ FROM INTERSIL.

The ICM7218 Series is just the latest in Intersil's

growing family of LED and LCD drivers-on-a-chip. CMOS systems that cost less, require less design-in time, less power, and, replace dozens of discrete devices. Monolithically. Because at Intersil, your way is our way.

AVAILABLE NOW.

Call your nearest Intersil Sales Office or Franchised Distributor for our 10 page applications booklet. Or, return the coupon below.

INTERISIL SALES OFFICES:

CALIFORNIA: Sunnyvale (408) 744-0618, Long Beach (213) 436-9261 • COLORADO: Aurora (303) 750-7004 • FLORIDA: Fort Lauderdale (305) 772-4122 • ILLINOIS: Hinsdale (312) 986-5303 • MASSACHUSETTS: Lexington (617) 861-6220 • MINNESOTA: Minneapolis (612) 925-1844 • NEW JERSEY: Englewood Cliffs (201) 567-5585 • OHIO: Dayton (513) 866-7328 • TEXAS: Dallas (214) 387-0539 • CANADA: Brampton, Ontario (416) 457-1014

INTERISIL FRANCHISED DISTRIBUTORS:

Advent/Indiana • Alliance Electronics • Arrow Electronics • Bell Industries/Century Electronic Division • CESCO • Component Specialties Inc. • Components Plus • Diplomat Electronics Inc., (FLA) • Diplomat Electronics Inc., (NJ) • Harvey Federal Electronics • Intermark Electronics • Kierulff Electronics • LCOMP • Parrott Electronics • R.A.E. Ind. Elect. Ltd. • RESCO/Raleigh • Schweber Electronics • Sheridan Associates • Summit Distributors Inc. • Wyle Distribution Group • Zentronics Ltd.

INTERISIL

Analog Products — Low Power
10710 No. Tantau Ave., Cupertino, CA 95014
Tel: (408) 996-5000 TWX: 910-338-0171
(800) 538-7930 (outside California)



Gentlemen,
_____ If you're willing to send me your 10 page applications booklet, I'm willing to tear up my shopping list.
_____ And please include your 18 x 24" Mark Twain poster.

Name _____

Company _____

Address _____

City _____ State _____ Zip _____

Country _____

E42679

Give Yourself a Generous Choice. Choose TEAC.

Whatever your data storage needs, large or small, there's a TEAC that's right for the job.

In the fast-growing mini market, two TEAC units are standout choices.

The MT-2 is a cassette data pack that's packed with value. Its compact, lightweight design and free-angle installation mean it can be used virtually anywhere, and durability is outstanding. It's highly accurate, too: soft error rate is better than 1×10^{-9} bits. In addition to being compatible with ISO, ANSI, EMCA and JIS phase encoding standards, the MT-2 is available in four versions, two of which incorporate an interface for connection to the bus lines of 8080, 6800, Z-80 or equivalent series microprocessors for greatly expanded flexibility.

If you've decided to go with mini disk, you'll be interested in the FD-50A. This Mini Disk Driver utilizes a direct seek system for faster access time than other units this size. Data integrity is ensured by accurate head positioning and write protection circuitry. Additional features include extended track and daisy chain capabilities. And the FD-50A is fully compatible (plug-to-plug and mechanical size) with the Shugart SA-400.

The MT-2 and FD-50A. Two more good reasons to choose TEAC.

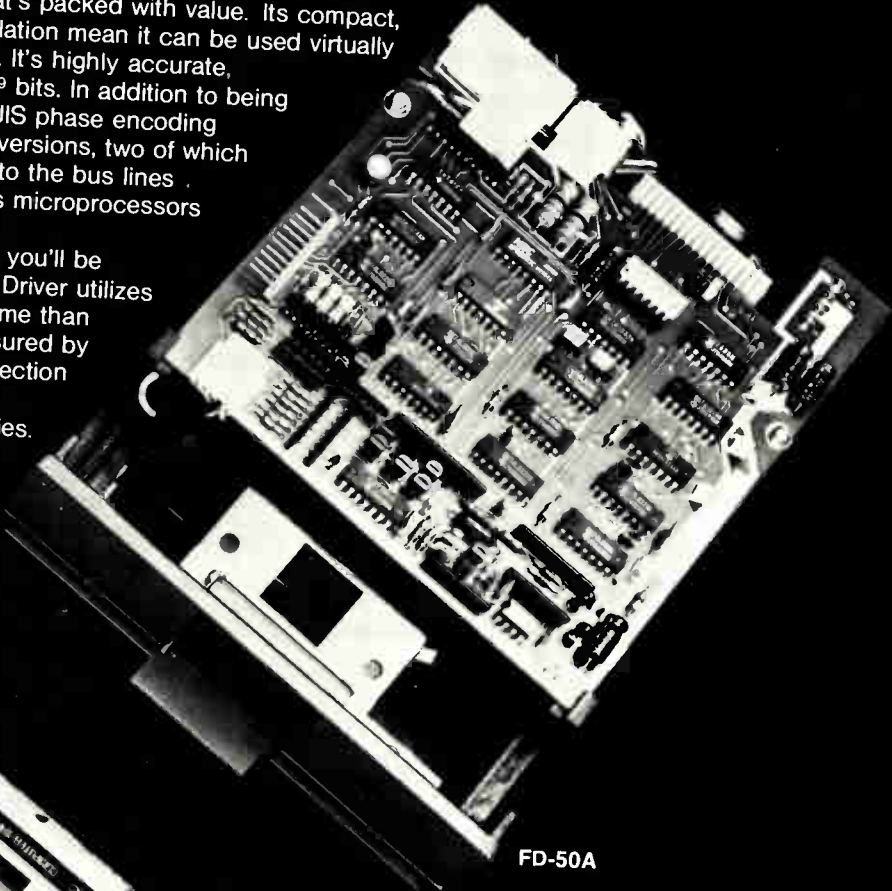

FD-50A

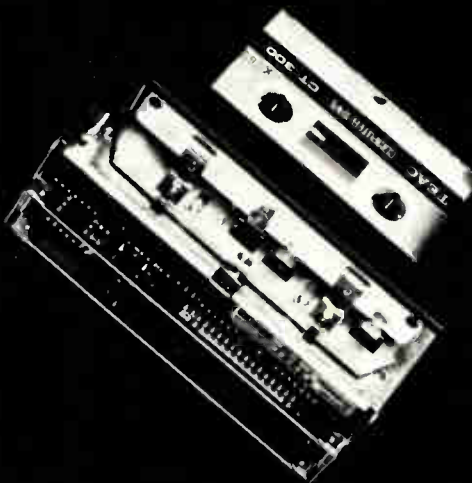

MT-2

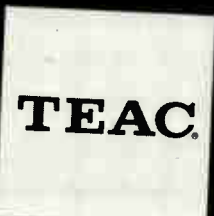

See the line of fine TEAC products at the NCC Show, Booth 441 at New York Hilton.

TEAC CORPORATION: 3-7-3 Naka-cho, Musashino, Tokyo, Japan Tel: (0422) 53-1111

U.S.A. Triple I, 4605 N. Stiles, P.O. Box 18209, Oklahoma City, Oklahoma 73118 Tel: (405) 521-9000 Canada R.H. Nichols Co., Ltd., 214 Dolomite Dr., Downsview, Ont. M3J2P8 Tel: (416) 661-3190
 Hongkong Dah Chong Hong Ltd., Hang Seng Bank Bldg., 77 Des Voeux Road, Central Tel: 5-261111, 5-226258 Australia & New Zealand Jacoby Mitchell Ltd., P.O. Box 70, Kingsgrove N.S.W. 2208, Australia
 Tel: 6307400 South Africa Mayfair Sales (Pty) Ltd., Marshalltown 2107, Transvaal Tel: 011-834-2131 Belgium & Luxembourg Simac Electronics S.P.R.L., Tromfiiaan 148 1160 Brussel Denmark Danbit
 Plantagevej 23 DK-2680 Solrod, Strand Tel: (03) 141515 France Tekelec Airtronic S.A., Cite des Bruyeres, Rue Carle-Vernet 92 Sevres Tel: (027) 7536 Holland Simac Electronics B.V., Veenstraat 20,
 Veldhoven Tel: 040-533725 Italy A.E.S.S.E. S.R.L., Corso Lodi, 47 20139 Milano Tel: 54.64.741-2-3 Switzerland Wenger Datentechnik, Güterstrasse 253, CH-4053 Basel Tel: 061-34 50 96 Spain Atalo
 Ingenieros S.A., Madrid-16, Enrique Larreta 12 Tel: (215) 3543 Sweden Scantel AB, Tengdahlsgatan 24, 116 41 Stockholm Tel: 08-24 58 25 United Kingdom International Instruments Ltd., 92 High Street,
 Berkshosted, Herts HP4 2BL Tel: 044275959 West Germany & Austria nbn Elektronik Starnberg, 813 Starnberg, Max-Emanuel-Str. 8, West Germany Tel: (08151) 13036

Circle 54 on reader service card

FCC urged to act on opening Japan's data market

Pressure is being put on the Federal Communications Commission to deny applications of three American-based international record carriers to provide their data services between Japan and the U. S. **until their Japanese counterpart, Kokusai Denshin Denwa Co., opens its domestic data-distribution system to competition.** Petitions to deny the applications of ITT World Communications, RCA Global Communications, and Western Union International to work with KDD were filed in mid-April by the Association of Data Processing Service Organizations (Adapso), the Computer and Business Equipment Manufacturers Association (CBEMA), and Control Data Corp., whose Japanese data-processing subsidiary is limited to communicating with a single U. S. computer center via a leased line. KDD controls and restricts the use of private-line circuits in Japan.

The three opponents of the application contend that the restrictions are inconsistent with the recommendations of the CCITT, the international record-carrier organization. If the FCC does not issue a denial aimed at opening the Japanese market, Adapso says, the commission should investigate "KDD's actions in restricting private-line service and requiring the use" of its specialized data services in Japan by U. S. carriers.

China wants Westar for domsat, U. S. confirms . . .

China has decided what it wants in a domestic satellite system. It would have 12 C-band transponders with time-division multiple access like the Hughes Aircraft Co.'s Westar built for Western Union, say State Department officials, confirming an initial report last year [*Electronics*, Oct. 26, 1978, p. 57]. **However, the Chinese are still undecided on selection of ground stations,** despite reports that Hughes is offering them a complete package of ground stations to use with satellites that would be launched by the National Aeronautics and Space Administration.

. . . as Westar extends Mailgram coverage to Southeast

Western Union Telegraph Co., meanwhile, is touting its operating Westar satellite and ground stations equipped with time-division multiple access as its "electronic mail system of the future," using a 16-foot antenna prototype at its Miami, Fla., offices to demonstrate Mailgram message transmissions from its earth station outside Atlanta. **Western Union says the earth station will be permanently connected to the Miami post office late this summer,** with other earth stations to be added later this year at Tampa and Orlando, Fla.; Memphis, Tenn.; and Charlotte, N. C.

U. S. suppliers told to work harder for NATO business

American military electronics contractors must be better represented and more competitive at North Atlantic Treaty Organization headquarters in Brussels if they expect to get some of the **\$1.2 billion worth of command, control, and communications hardware business the alliance expects to do** during the next five years. According to T. Joseph Loveland, director of the U. S. NATO mission's infrastructure division, approximately \$400 million will be spent for tactical point-to-point and mobile communications systems, with an equal amount available to enhance the NATO air defense ground environment, known as Nadge. Another \$300 million to \$400 million will go for outlays on such basic electronics as radars and fixed communications systems.

Solar-power satellites in a time of timidity

Whatever became of the Flippo bill? H. R. 2335, last year's proposal by Alabama Democrat Ronnie Flippo to spend \$25 million on the evaluation and demonstration of a solar-power satellite (SPS) is still resting in a House subcommittee [*Electronics*, April 27, 1978, p. 60]. On the Senate side, no counterpart to it even exists for examining space-based systems that would convert the sun's energy into electricity and transmit it as microwave power to antennas located on the earth.

The Solar Power Satellite Research, Development, and Evaluation Program Act of 1979 has been modified to eliminate a single, large-scale demonstration program and confine expenditures largely to earthbound tests and paper studies of the SPS system's technology and its societal impact. This has gained it more sponsors. Yet diminished opposition hardly guarantees success. Even with passage in both the House and Senate, the effort is likely to produce no more than several stacks of interesting and sometimes conflicting studies that will never come to the attention of the one person who could bring them to life, the President.

Commitment from Carter

Jimmy Carter might consider adapting a page from John F. Kennedy's special second State of the Union message in 1961. This year marks the 10th anniversary of America's successful manned lunar landing, a program to which President Kennedy committed himself in May 1961. Its cost was enormous, and so was the controversy that surrounded it—yet what Kennedy called "this great new American enterprise" served to restore a declining American world image, spark the national imagination and the economy, significantly advance technology, and make space a place "not filled with weapons of mass destruction, but with instruments of knowledge and understanding for the progress of all people."

Two other aspects of SPS are equally important. A national commitment to such satellites by the President would serve notice on the cartel of oil-exporting nations known as OPEC that the Western world can tolerate no longer the economic blackmail their price-fixing represents. Moreover, by making participants of other nations, some of which have already expressed interest in the concept, the President could take a long step toward improving America's strained relations with these allies.

The technological and societal challenges of

SPS are admittedly enormous. Solar power has a soothing sound in contemporary jargon, but microwaves rate as high as nuclear radiation in any lexicon of scary sounds. As one reader put it a year ago, solar-power satellite stories should be headlined "How to fry New York in 2½ hours." The comment is still more evidence of a national malaise that Arthur Kantrowitz labels the time of timidity.

"The time of timidity is best defined by contrast with the idea of progress," explains Kantrowitz, who directs the Avco-Everett Research Laboratory. "Progress, to my mind, is best described by the distinguished philosopher of science, Sir Karl Popper's description of the scientific method; namely, it is trial and elimination of error. By contrast, in the time of timidity, we eliminate errors first. Before we act, we will insist on a certainty human beings can never attain."

Action or reaction?

For America's timid leaders in the White House and the Congress, where reaction to potential disasters has taken precedence over positive, imaginative action, Kantrowitz has two caveats: "First, that perhaps the time of timidity might not be all-inclusive. Unless the idea of progress can be stamped out everywhere, we must expect that technological surprise might still intrude from those barbarian domains where the idea still survives.

"The second caveat is that, in the nearly stagnant society, any residual action may result in irreversible side effects—whereas in a time of technological progress, unanticipated side effects, which do not appear until years later, can be more readily dealt with by a technology which will have greatly advanced in the meanwhile. Thus, there are important forces that drive the nearly stagnant society toward complete stagnation, or more hopefully toward a renewal of vigorous technological progress."

Much of the technology for making a vigorous start on SPS is already in place. Still, much research and development remains to be done, and it must be done carefully, particularly in such areas as the impact of microwave transmissions on the ionosphere. But those efforts deserve to be accelerated far beyond anything that can be accomplished by Ronnie Flippo's proposed outlay of \$25 million—an amount that today will barely pay for one new fighter plane, let alone the jet fuel and lubricants required to fly it.

Ray Connolly

On a single new Burroughs
SELF-SCAN® panel
you can vividly display
graphics
foreign languages
large and small characters
upper and lower case letters
single or multiple lines
blinking lines and characters

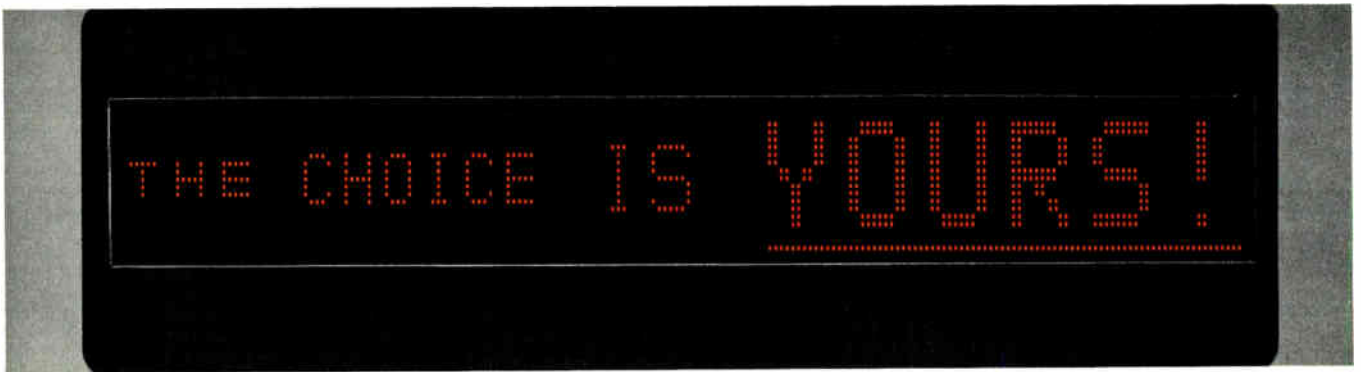

or anything else you want.
That's versatility.

The SELF-SCAN "One-for-All" gas plasma display offers maximum display capability on a *single* panel. This includes alphanumeric, symbols, charts, etc., for word processing, typesetting systems, signature verification, plotting trends and many other applications.

With 17 horizontal rows and 192 vertical columns of addressable dots (3294 programmable dots in all), you can display single or multiple character lines on 5x5, 5x7, 6x12, 7x12, 8x12, etc. dot matrices (max. 17 vertical dots).

You've never seen a display this bright, crisp or easy to read. It's rugged and reliable. Get all this, including drive electronics, for only \$262 per display in lots of 100. And, you get 90-day delivery.

Nothing . . . but nothing beats this Burroughs SELF-SCAN panel display. We'll prove it! Write Burroughs Corporation, OEM Division, P.O. Box 1226, Plainfield, N.J. 07061 or call (201) 757-5000. In Europe, contact Burroughs OEM Division, Langwood House, High Street, Rickmansworth Hertfordshire, England. Telephone Rickmansworth - 70545.

**The first name in displays
the last word in displays**

Burroughs



ND-10 Large-Capacity ESS Lauded By Tennessee Firm

Telephone and Data System, Inc. (TDS) in Concord, Tennessee reports its NEC-built, large-capacity electronic switching system is performing beautifully.

The system, an ND-10 stored program controlled ESS, was officially cutover at Concord last October. It provides 8,000 lines to serve the people of Concord, a community that is growing rapidly in population. It is the first building-type ND-10 system ever commissioned in the United States.

The Concord system offers such custom call features as call forwarding, call waiting and abbreviated dialing. In addition, it is equipped with the LAMA (Local Automatic Message Accounting) feature, which allows the company to ticket its own direct distance dialing traffic.

Mr. LeRoy T. Carlson, Jr., TDS's Executive Vice President, said that his company has received many calls from customers who are very pleased with the services provided by the ND-10 system. Mr. Carlson, Jr. also said, "It is a truly outstanding switching machine and we believe the best in the world."

The system is interfaced with NEC's Technical Assistance Service Center in



Mr. Fred T. McPhee (left), President, and Mr. R.C. Eldridge, General Manager, Concord Exchange, Inc., look over ND-10 ESS.

Dallas, Texas, so that it can benefit from remote maintenance services.

The ND-10 is one of the most advanced fully stored program controlled ESSs manufactured by NEC.

Designed for medium to large line capacity of up to 160,000 and equipped for nearly 30 standard service features, it can also have about 30 useful optional service features.

In addition to the Concord system, twelve ND-series electronic switching systems are now in service in the U.S. providing a total of more than 35,000 lines, and another is currently being built.

New FET To Replace TWT

NEC recently announced the successful development of a series of new GaAs power FETs which can replace conventional traveling-wave tubes used in microwave systems.

The new GaAs FETs can deliver an output power of 15W at 6 GHz, 10W at 8 GHz, 2.5W at 11 GHz or 1.1W at 14 GHz.

To obtain high output power with a GaAs FET, it is necessary to optimize the device structure so that the device has a high breakdown voltage, high gain, good matching and reproducible fabrication process. NEC has developed a new FET structure called the "graded recess structure" which meets all of these conditions.

The new FET, no bigger than 1 cm square as against a traveling-wave tube measuring about 30 cm in length, will reduce the size of microwave equipment remarkably. It will also greatly reduce power consumption and increase the reliability of microwave systems.

NEC has also completed an amplifier capable of producing 22W in the 6 GHz band, by coupling two new FETs.

Nigeria's Direct Dialing Network Ready This Year

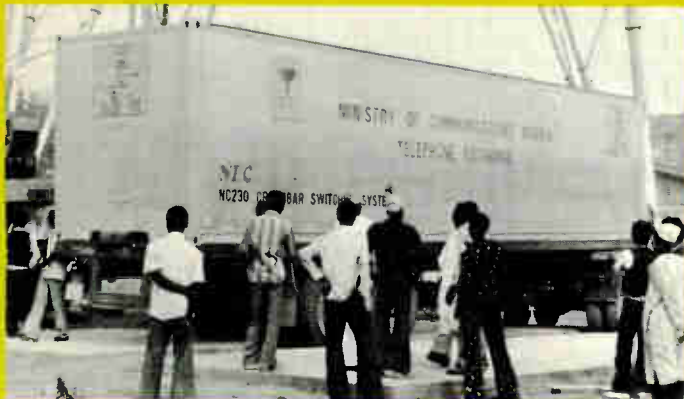

One van-type switching system arrives at installation site.

Nigeria will have its nationwide subscriber direct dialing telephone network completed toward the end of this year.

The Posts and Telecommunications, Nigerian Ministry of Communications is carrying out the project.

NEC has shipped twenty-nine NC230 van-type crossbar switching systems.

Of the 29 systems for the project, six were airlifted from Japan with three hav-

ing already been commissioned and the other seven now undergoing acceptance tests. Installation of the remaining 19 systems will be completed toward the end of this year at important cities throughout the country.

These van-type crossbar switching systems will provide a total of 23,400 high-grade telephone lines.

The NC230 is a small-capacity, high-mobility crossbar switching system designed by NEC. It offers a choice between the 500-line and the 2,000-line van or building types. Its capacity can be expanded up to a maximum of 10,000 lines by multi-unit installation. It is flexible enough for use as a local exchange, trunk exchange or can be interconnected with existing switching systems. Simple connection of external cables is practically all that is required for installation, and maintenance is very simple.

ANTARA Has Installed ESS For National Telex/Data Link

The National News Agency Institute of Indonesia, known as ANTARA News Agency, has installed an advanced electronic telex/data switching system, to link its branch offices throughout the country.

The system, NEC's NEDIX-510AS stored program controlled time division electronic telex/data switching system, links 11 branch offices in such important cities as Medan, Bandung, Jogjakarta and Surabaya. It will be expanded to cover 26 branch offices in future.

The system is provided with a special multi-address call service feature so that a telex message can be simultaneously transmitted to all branch offices.

The NEDIX-510AS, capable of accommodating up to 1,920 lines, is a small capacity version of the NEDIX-510A stored program controlled time division telex/data switching system with a capacity of up to 30,720 lines. It can be expanded up to the full capacity of the



large model, the NEDIX-510A system, as needs arise.

Since the latest, most sophisticated electronic components are used throughout, the NEDIX-510AS system is extre-

NEDIX-510AS stored program controlled time division electronic telex/data switching system

mely compact, highly reliable and economical to operate.

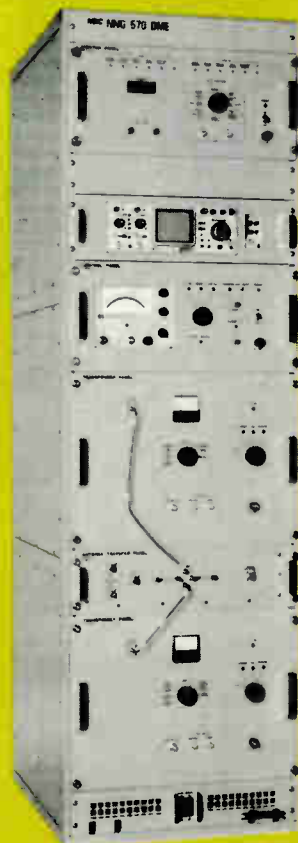

New DME Navigational Aid Already Becoming Popular

NEC-developed all solid-state DME (Distance Measuring Equipment) is becoming popular around the world.

The equipment, the first all solid-state unit ever developed, is offered in two models depending on output power - 100 W and 1 kW - in the NNG-500 series line.

The new DME uses a newly-developed 1.6 kW transistor power amplifier which allows the equipment to cover its working frequency range from 962 MHz to 1,213 MHz with no need for adjustments.

In addition, the new DME incorporates a digital monitoring system and a remote control system using a micro-processor to provide multiplex control

by a single telephone channel, as well as easy maintenance.

NEC has already shipped a 1 kW all solid-state DME to El Salvador for its Cuscatlan International Airport and seven VOR/DME systems using the new DME are now being manufactured for Sudan.

The NNG-570 all solid-state DME measures 1,960 mm (h), 570 (w) and 450 (d) and weighs 260 kg. Each panelled unit is easily accessible for maintenance.

NEC
Nippon Electric Co., Ltd.
Tokyo, Japan.

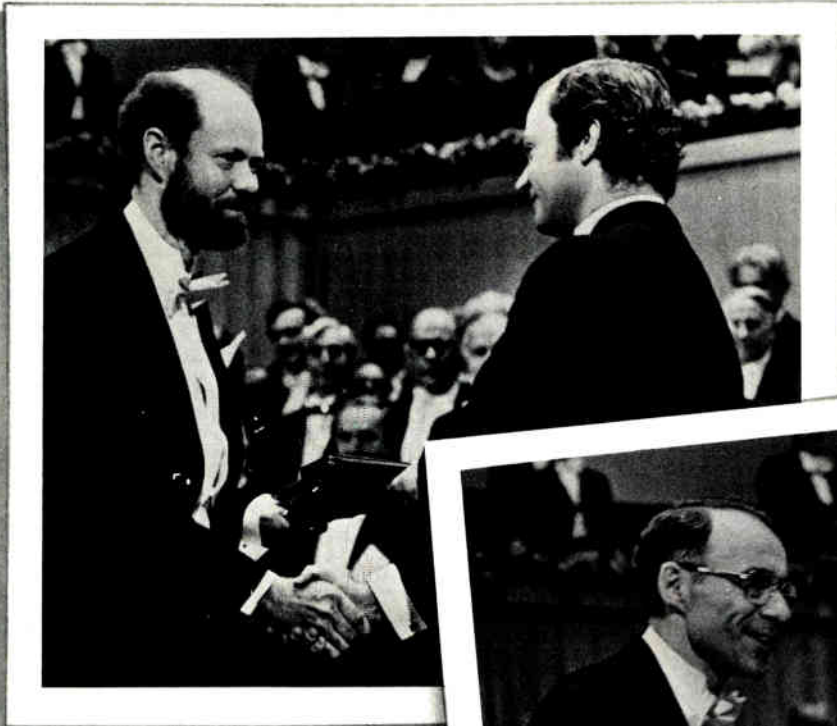

King Carl XVI Gustav of Sweden—on the right in these photos—presents the 1978 Nobel Prize in Physics to Bell Laboratories scientists Robert Wilson (top photo) and Arno Penzias.

What does the Nobel Prize have to do with your telephone?

The two scientists on the opposite page are receiving the highest honor a scientist can earn—the Nobel Prize. They are the sixth and seventh laureates who did their prize-winning research at Bell Telephone Laboratories. These scientists shared a common goal—the search for new knowledge to further advance the art of telecommunications.

Clinton Davisson shared the Nobel Prize in 1937 for demonstrating the wave nature of matter. In 1956, John Bardeen, Walter Brattain and William Shockley were honored for their invention of the transistor. Philip Anderson's theoretical work on amorphous materials (such as glass) and on magnetism led to a Nobel Prize in 1977. And in 1978, Arno Penzias and Robert Wilson received the Prize for detecting the faint radiation from the "big bang" explosion that gave birth to the universe some 18 billion years ago.

The search for knowledge

These scientists and their colleagues at Bell Labs, given the freedom to explore, have proved

time and again the value of investment in research—not only for telecommunications but for society in general. The transistor, for example, revolutionized communications and brought into being entire new industries—indeed, a new industrial society—based on solid-state electronics.

Other Bell Labs advances—products of this same research environment—have included high-fidelity recording, sound motion pictures, long-distance television transmission in the United States, the electrical digital computer, information theory, the silicon solar cell, and the laser. The impact of this work—on almost every field of commerce, industry, education and even medicine—has been incalculable.

The innovation process

Research done at Bell Labs in the past is the basis for the products and services the Bell System offers its customers today, just as the research going on now is the foundation for tomorrow's telecommunications.

Bell Labs scientists—specialists in physics, chemistry,

mathematics and many other disciplines—team their efforts with those of our systems, development and design engineers. They, in turn, work closely with Western Electric manufacturing engineers and with the people of the Bell System operating telephone companies.

This technical integration is the foundation for true innovation. One idea feeds another. A basic scientific discovery can make possible entire new technologies and products for telecommunications, and a concept for a new product or system can stimulate the research to find even more new knowledge. That interaction, that teamwork, has been extremely productive: Bell Labs people have received 18,645 patents between our founding in 1925 and the end of 1978.

Sometimes, the search for knowledge may lead to a Nobel Prize. Often, it benefits all of society. And always, its ultimate aim is better service for Bell System customers.

Bell Laboratories
600 Mountain Avenue
Murray Hill, N.J. 07974



Bell Laboratories

Keeping your communications system the best in the world.

Now available from RCA: The 5101 RAM in plastic and at plastic prices.

Just look at the table. The prices speak for themselves.

And this 5101 is the fastest you can get. 250 ns access at 10 μ A leakage, plus a range of other speed/leakage

values. And they're available fast, from stock. At any participating RCA Solid State Distributor.

In-use simplicity.

These RAMs have separate data

inputs and outputs. The outputs are TTL compatible. And there are two Chip-Select inputs for easy system expansion.

For immediate delivery contact your RCA distributor.

For more information, contact your local RCA Solid State Distributor.

Or contact RCA Solid State headquarters in Somerville, New Jersey. Brussels, Belgium. Tokyo, Japan.

Type	Leakage μ A	Access time, ns	Voltage V	Temperature range, °C	Price 1000+
MWS5101EL-1	10	250	5	0 to +70	5.19
MWS5101EL-2	50	250	5	0 to +70	3.88
MWS5101EL-3	200	350	5	0 to +70	2.94
MWS5101EL-8	500	450	5	0 to +70	2.84



International newsletter

Manchester U. develops bit-slice multiplier for super-mini

For its projected MU6-G super-performance minicomputer, Manchester University's computer science department is developing a multiplier unit that gives the product of two 64-bit numbers in 290 ns yet fits onto a single printed-circuit board roughly 16 by 8 in. To meet the twin objectives of high performance and low cost, the group uses a 2-bit-slice multiplier chip with an uncommitted emitter-coupled logic array (ULA) from Plessey Ltd.'s Allen Clark Research Centre in Caswell, Northants. The projected unit comprises 71 ICs—one tenth the number obtained with standard logic—but further process refinements from Plessey will cut the chip count to 56 and the multiplication time to 115 ns. The group has already proved its bit-slice multiplier in a 16-bit version, which uses nine 28-pin ULAs and has a multiplication time of 115 ns.

Sorting system listens to operator to route packages

West Germany's post office research lab in Darmstadt is trying out a computerized package-sorting system that responds to spoken words instead of to the keyboard signals formerly used. The operator pronounces the digits of the postal code on the package into a headset microphone, controlling the system so that the package is routed into its appropriate destination bin. With trained, even-voiced operators, the post office says, **the level at which the digits are correctly understood is nearly 100%**. The system, which will go into regular service soon, according to officials, can recognize up to 32 words. It features a plausibility check whereby a nonexistent postal code is recognized as such and indicated on a display. British EMI-Threshold Ltd. makes the voice-recognition equipment.

Japanese shrink processor's channel length to 1.5 μ m

As part of Japan's very large-scale integration project, NEC-Toshiba Information Systems Inc. has reduced the linear dimensions of an 8-bit microprocessor 30% to give an area half that of the original chip. Although the work is essentially a straight shrinkage from 4- to 2.8- μ m design rules, MOS transistor channel lengths are only 1.5 μ m in finished devices. Overall chip size is only 3.8 by 3.8 mm, with **approximately 7,000 gates, or about 480 gates/mm²**. The devices were fabricated at NEC-Toshiba's Horikawa-cho laboratory, which is in Toshiba Corp.'s works in Kawasaki. Toshiba project engineers say the device uses the instruction set of a common microprocessor—they refused to say which, but a good guess is the 8080A, which Toshiba produces commercially. Toshiba does say that yield on its pilot line has been good, but commercial production is at least a year away.

Pye reads SSB system to cut bandwidth

Prototype 5-kHz vhf single-sideband mobile-radio equipment, **capable of doubling and theoretically even quintupling spectrum utilization**, is receiving its first public airing in London this week. The system, developed by Pye Telecommunications Ltd. in Cambridge in collaboration with the Philips Research Laboratories, Redhill, uses a pilot carrier at power levels one fourth to one tenth that of speech to provide an automatic gain-control signal needed to overcome vhf fading and to provide a local frequency reference. As a result, claim Pye engineers, fading is eliminated even at speeds up to 70 mph and sensitivity to mistuning is ± 150 Hz. This is within the capability of high-stability crystal techniques [*Electronics*, Sept. 14, 1978, p. 67], one of which can generate all required channel frequencies with a two-chip frequency synthesizer set also developed at the Philips labs [*Electronics*, Aug. 31, 1978, p. 74].

Fujitsu uses high-density logic to counter IBM

Firing another salvo in answer to IBM's 4300 mainframes, Fujitsu Ltd., Japan's largest computer manufacturer, has started selling four new computers using high-density logic and memory. The M-130F, -140F, -150F, and -160F span the range from somewhat smaller than the IBM 4331 to about 10% larger than the 4341 [*Electronics*, Feb. 15, p. 85]. The central processing unit of the three smallest models **employ newly developed 600-gate master-slice arrays** using low-power Schottky technology. All feature 64-K memory chips (for computers delivered after Dec. 1), 1,500-gate n-MOS logic chips in the service processor, and a 6,000-gate complementary-MOS logic chip in the display controller. Minimum rental prices range from about \$5,000 to \$22,500 a month. Fujitsu has also started sales of the Facom V-830, a small computer competitive with IBM's System/34 but incompatible with the M series mainframes. The V-830 contains a 10,000-gate C-MOS processor. Memory is up to 512 kilobytes, and purchase prices start at some \$79,500.

West German firms divide up Awacs contract for NATO

Only a few months after getting the go-ahead from the Bonn government, the major West German companies to work on the Boeing Co.'s E-3A Airborne Warning and Control System, or Awacs [*Electronics*, Nov. 9, 1978, p. 50], are already lined up for the job of equipping the Boeing 707-320B aircraft with electronics gear. **Dornier GmbH has overall responsibility** for system integration and installation of the avionics hardware. Other firms participating in the project are AEG-Telefunken, Siemens AG, and Elektronik System Gesellschaft, which will implement the Awacs data-communications system. The first aircraft is scheduled for delivery to North Atlantic Treaty Organization forces by 1982.

France completes Initial VLSI phase

The government's drive to make sure France will have a strong IC industry in the era of very large-scale integration is now through its first stage—signing up suitable American partners for the French companies that will share nearly \$150 million in aid over the next five years. The last pairing became official this month when National Semiconductor Corp. and Saint-Gobain Pont à Mousson, a major industrial group, set up Eurotechnique SA. **The new company plans to start producing MOS memories and microprocessors by 1981.** There are two other MOS makers in the government's scheme: Efcis, a joint venture between Thomson-CSF and Commissariat à l'Énergie Atomique (CEA), which is getting its technology from Motorola Semiconductor; and Matra-Harris Semiconductors, which will concentrate on complementary-MOS devices. The bipolar effort is split between the Sescosem division of Thomson-CSF and RTC—La Radiotechnique Compélec, the lead house for emitter-coupled logic in the Philips Gloeilampenfabrieken group.

Addenda The Canadian government will **spend approximately \$161 million (U. S.) over the next three years** to help develop products and technologies in the electronics and telecommunications industries. . . . **Production of bipolar ICs will begin in July at a pilot plant** of Taiwan's Electronics Industry Research Center under a technology-transfer arrangement with RCA Corp. The necessary equipment has been installed, and a group of technicians sent to the U. S. for training last year will be returning shortly.

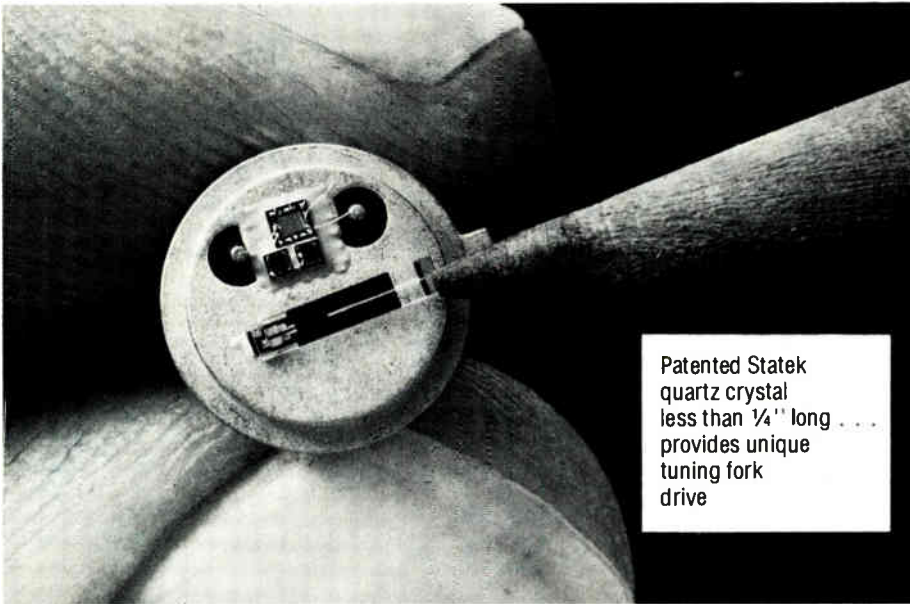

Patented Statek quartz crystal less than 1/4" long . . . provides unique tuning fork drive

Is this the Ultimate Low-Frequency Oscillator?

Introducing the world's smallest, toughest, most accurate low-frequency quartz crystal oscillator.

Now available at modest prices IN ANY CUSTOM FREQUENCY from 350 kHz all the way down to 10kHz in a tiny TO-5 can.

If you need compact, low-frequency oscillators, our new SQ oscillators can save you money and headaches—no matter whether you need 5,000,000 pieces or just 50. They offer all the superb performance features associated with quartz crystal drive such as extreme accuracy, high temperature stability, low aging and very low power consumption. In addition, they offer Statek's patented quartz tuning fork which allows greater miniaturization, lower power drain and much higher shock resistance compared to any other low-frequency crystal on the market.

LONG LIFE

The typical no-load current drain of the SQ oscillator is only 500 uA, meaning extremely long life when powered by battery. Calibration accuracy is $\pm 0.01\%$ and remains

within specification for enormous periods of time because of the microscopic aging properties of quartz.

REMARKABLE FOR \$10

It is built to withstand a shock of 1000g (half sine wave) for one millisecond—the equivalent of a hammer blow. That's why the world's largest manufacturer of police radios uses our SQ oscillator for hand-held radios that take a tough beating every day. The temperature capability of the SQ oscillator is also exceptional. Thousands have been used at extremely high temperatures in torturous down-hole, oil-well logging operations. These are remarkable features for a \$10 (1000-piece price) oscillator tuned to your custom frequency anywhere in the range 10 to 350kHz.

THE SECRET

How did we get such a lot of capability into such a tiny space—at such tiny prices? The secret is a unique quartz crystal design in the shape of a tuning fork plus patented production processes and nine years' experience in producing 20 million crystals. We manufacture crystals in the millions by semi-conductor manufacturing techniques and tune them to your special frequency with automatic high-speed laser systems that burn off deposited gold until each unit resonates at the correct natural frequency.



Custom frequencies in a TO-5 can

PRICES: SQ SERIES

Prices are for custom frequencies. Minimum order is five pieces.

5-24	\$49.00
25-49	38.00
50-99	28.00
100-249	21.50
250-499	15.50
500-999	12.50
1,000	10.00

Stock frequencies of 10.0, 12.8, 15.36, 16.0, 16.384, 19.2, 32.768 & 100.0 kHz available at even better prices.

NOTE: Extremely low custom frequencies—as low as 1 Hz per day—are also available in a divided output version of the SQ oscillator known as the DQ series.

Call Mal Kaufman now at (714) 639-7810 to discuss your application

STATEK Innovators in Frequency Control

Statek Corporation, 512 N. Main, Orange California 92668, phone (714) 639-7810
TELEX: 67-8394

NOW YOU CAN HAVE THE DISPLAY CIRCUITRY FOR A CRT TERMINAL YOUR WAY.

REGULAR...



CRT 7004 \$14.00*

FEATURES

On chip character generator (mask programmable).
128 Characters • 7 x 11 Dot matrix block.
On chip video shift register.
Maximum shift register frequency.
CRT 7004A 20MHz • CRT 7004B 15MHz
CRT 7004C 10MHz • Access time 400ns
No descender circuitry required.
On chip cursor.
On chip character address buffer.
On chip line address buffer.
On chip horizontal and vertical retrace video blanking.
Single +5 volt power supply.
TTL compatible.
MOS N-channel silicon-gate COPLAMOS® process.
CLASP® technology.
Compatible with CRT 5027 VTAC®
Enhanced version of CG5004L-1.

OR WITH THE WORKS.



CRT 8002 \$24.00*

FEATURES

On chip character generator (mask programmable).
128 Characters • 7 x 11 Dot matrix block.
On chip video shift register.
Maximum shift register frequency.
CRT 8002A 20MHz • CRT 8002B 15MHz
CRT 8002C 10MHz • Access time 400ns
No descender circuitry required.
On chip cursor.
On chip address buffer.
On chip attribute buffer.
On chip horizontal and vertical retrace video blanking.
Single +5 volt power supply.
TTL compatible.
MOS N-channel silicon-gate COPLAMOS® process.
CLASP® technology—ROM and options.
Compatible with CRT 5027 VTAC®
Four modes of operation (intermixable).
Internal character generator (ROM).
Wide graphics • Thin graphics •
External inputs (fonts/dot graphics).
On chip attribute logic—character, field
Reversible video • Character blank
Character blink • Underline • Strike-thru
Four on chip cursor modes.
Underline • Blinking underline
Reverse video • Blinking reverse video
Programmable character blink rate.
Programmable cursor blink rate.
Expandable character set.
External fonts • Alphanumeric and graphic
RAM, ROM, and PROM.

*price for 100 unit quantity, "B" version in ceramic package.



STANDARD MICROSYSTEMS CORPORATION

35 Marcus Boulevard, Hauppauge, New York 11787 (516)273-3100 TWX: 510-227-8898

We keep ahead of our competition so you can keep ahead of yours.

Circle 66 on reader service card

Bonding hybrids to heat sinks cuts weight, volume

by Kevin Smith, London bureau manager

Ferranti technique forgoes printed-circuit boards, reduces cooling requirements by cutting thermal resistance

In the shrinking world of microelectronics, the packaging frequently dwarfs the hybrid or integrated circuitry it contains. But substituting metal heat sinks for printed-circuit cards may offer a way to cut the volume and weight of the package and improve the thermal management of the resulting system.

This technique is under development at the Electronics Systems department of Ferranti Ltd. for high-performance radar systems and other avionics payloads. It could cut the weight of a 300-pound radar by one third, says John Morrison, head of the hybrid microelectronics group at Edinburgh. Such a savings in the avionics payload could lop 200 lb off airframe weight, he notes.

In Ferranti's HELP (hybrid electronic light-weight packaging), as many as four 3/8-inch-square flat packs, each containing a hybrid circuit, are bonded directly to a standard 3-by-2-in. heat sink. Each of these modules is equivalent to a 7-by-4-in. pc board. The technique is compatible with thick- and thin-film hybrids and discrete components.

Savings. As many as 25 HELP modules plus motherboard will fit in a metal case, together with a potted power supply from Power Cube Inc. (see figure). The resulting weight is 4.7 lb, compared with 26 lb for a multiple-board version, and the volume is 124 in.³, versus 926 in.³

Adhesive bonding of the thin-film hybrid packages directly to the heat sink ensures an extremely low thermal resistance relative to the standard method of mounting flat packs on pc boards. Heat sinking cuts the requirement for cooling air flow, allowing a far higher board density to be achieved for the same device junction temperature.

Plug-in. The base of the HELP container holds a multilayer pc motherboard, into which each module plugs by way of an 80-pin edge connector. The leads of the flat packs are inserted directly into the edge connector.

The container fits into a cooling tray with two full-length slots in its

base to permit air to enter. Drilled holes in the container let the air flow across each module. This approach ensures a parallel air flow; the usual approach is to let the air in one end of the unit, which means the cards at the other end might receive a heated air flow.

Cooling can be tailored to the dissipation of each module by blocking the flow across the heat sink's cooling fins. The air flow requirement for identical device temperatures drops from 35 to 15 cubic feet per minute, Morrison says.

The company says the modular approach makes fast turnaround one of the advantages of HELP. A prototype printed-circuit board can be

Shrinking the package. Mounting flat packs containing circuitry onto a heat sink instead of onto printed-circuit boards gives a module with significant size and weight savings, as well as less need for cooling air flow. As many as 25 modules fit into a container.

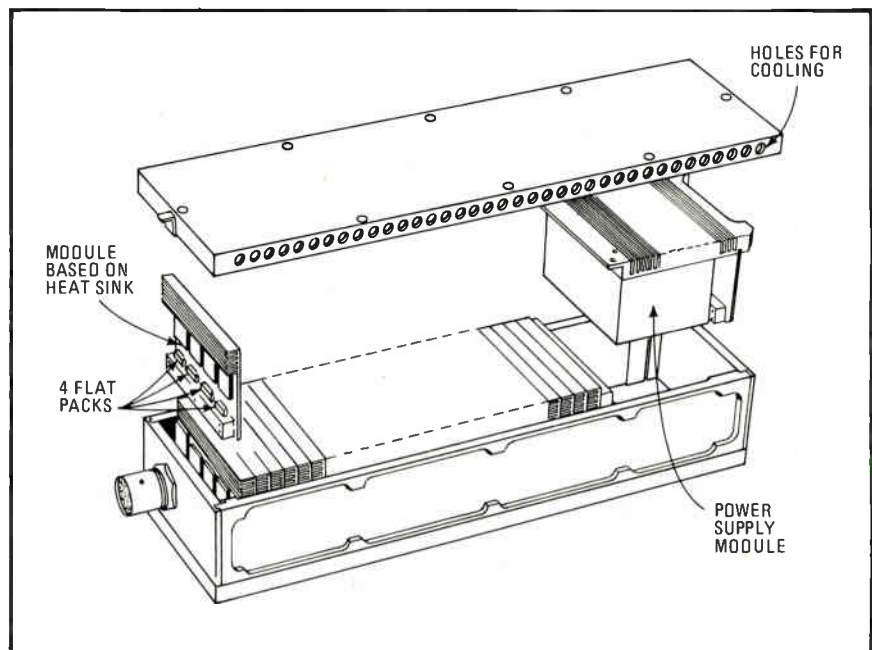

turned into a thin-film hybrid module in days, Morrison says.

At the moment, the microelectronics group is moving from its first prototype to a radar-scan-converter

test unit that will fly in a Harrier jet fighter. After these trials, Ferranti plans to build future-generation radar systems with HELP and to introduce the technology commercially.

Belgium

Personal computer aims at households with extensive hardware, software choices

Europeans shopping for personal computers will get one more choice: Data Applications International (DAI), a small Belgian microcomputer systems house, launches its personal computer at the May 8-10 Compec '79 minicomputer show in Brussels, the firm's home town.

It will join such well-known American brands as Apple Computer Co.'s Apple II, Commodore International Ltd.'s PET, Tandy Corp.'s TRS 80, and MITS Inc.'s Altair—as well as some European machines on the market. But Claude Simpson, managing director, insists the new DAI personal computer will not compound consumers' confusion.

For the home. "This is a second-generation personal computer that will sell for under \$1,000," he says.

"It is not oriented toward data processing but toward recapturing resources available in households."

One thing is sure: DAI's personal computer will become a familiar object in literally thousands of Dutch households starting this fall. In October, Teleac NV, a nonprofit foundation in Utrecht, will start airing a 20-week-long course on microcomputer programming over the Dutch educational TV network and has settled on DAI's new machine as the hardware.

It has ordered 1,000 of them to resell to its students, who will pay some \$45 for course materials and quiz corrections. The personal computer, an option, costs \$900.

Enrollment. "We had 13,000 students for our first series on hard-

ware, and we expect at least 10,000 for the series on software," reports Chriet Tellulier, Teleac's project director for the microcomputer courses. Since a lot of the learners work in groups for their employers, he figures most of the computer buyers at the outset will be companies rather than individuals.

Simpson, of course, is aiming for a much wider market. "Most first-generation personal computers were aimed at professional applications," he explains, "although the Apple II added educational applications. We see other household uses as well—home bookkeeping, health monitoring, and building and garden management. Clubs are another promising outlet." To cover this applications spectrum, DAI designed the microcomputer with a lot of memory, a panoply of input/output possibilities, powerful graphics, and what Simpson calls "graphical sound."

Choices. Thus the 8080A microprocessor around which the machine is built can have anywhere from 4 to 48 kilobytes of random-access memory to work with for program memories. There are sockets for 24 kilobytes of read-only memory, but the system actually uses only up to 22, enough for extensive software like a Basic pseudocode compiler, integral and floating-point math, debugging monitor, and standard 8080 software library packages. There is also a socket for an Advanced Micro Devices 9511 math chip.

As for I/O, the microcomputer has an ASCII keyboard, for starters. Then there are interfaces for a pair of audio cassettes (for low-cost memory storage), game paddles, and serial I/O peripherals meeting the RS-232 standard, plus a modulator that feeds both video and sound into a TV set through its antenna.

Looking outward. As if this were not enough, it is possible to hook into the system bus and through it interface with almost every common electrical control signal through the "real world" cards that DAI makes for automated systems.

In the least expensive versions, the personal computer will have black-and-white graphics that can put



Homeward bound. DAI's personal computer has up to 22 kilobytes of ROM and up to 48 kilobytes of program RAM, together with a range of input/output devices.

Memorex OEM Drives

We deliver product, not promises.



In the past 24 months we have delivered more Winchester-type OEM drives than all of our competitors put together. Here's why:

SUPERIOR DESIGN—The 601 is based on an investment of over \$25 million in Winchester technology.

HIGH RELIABILITY—The sealed environment of the 601 is expected to yield MTBFs in excess of 8,000 hours. Using an 801 tester, the MTTR is only one hour.

REDUCED INFANT MORTALITY—A special quality control program at Memorex is set up to screen out early failures that are expensive and embarrassing to OEMs.

LOW COST—Other manufacturers may quote lower initial prices, but when it comes to cost of ownership over the life of the product, the Memorex® 601 disc drive is clearly the best value.

OEM SUPPORT—An extensive, worldwide service and support network assures you that help will be there when you need it.

IMMEDIATE AVAILABILITY—The 601 is in volume production and evaluation units are readily available.

Call or write:

MEMOREX

GENERAL SYSTEMS GROUP (OEM DIVISION), SAN TOMAS AT CENTRAL EXPRESSWAY, SANTA CLARA, CA 95052. BOSTON (617) 890-0700
NEW YORK (201) 325-0164; DETROIT (313) 354-4511; LOS ANGELES (714) 891-2541; DALLAS (214) 258-3510; SAN FRANCISCO (408) 987-1373

© 1979 MEMOREX CORPORATION. Memorex is a registered trademark of Memorex Corporation.

Circle 69 on reader service card

See us at NCC '79, New York
Booth #2129

diagrams or 24 lines of 64 characters (or a combination of graphics and text) on a television set. It was designed, though, with color in mind—it can handle up to 16 colors selected through software, with up to 260 lines of picture elements, 352 elements per line. Furthermore, the displays can be moved around easily by programming, through a scheme

developed by DAI that mixes control words and display words.

The new machine also produces audio through a TV or a hi-fi set by means of three oscillators and a white-noise generator. Frequency and amplitude can be programmed over the whole audio range in order to make simple music and guttural vocal sounds. **-Arthur Erikson**

France

LCD uses three molecular states to produce experimental TV picture

The fuzzy gray images on the tiny screen seem incapable of ever rivaling the brightly colored, crystal-sharp pictures on television screens just a few steps away. But scientists at Thomson-CSF's central research labs, Courbeville, believe the projection liquid-crystal display they showed for the first time at the Paris electronic components show in early April could one day replace cathode-ray tubes in all sorts of applications.

Three, not one. Their new LCD, they say, has that promise because it exploits the smectic, nematic, and isotropic states of liquid crystals. Previous LCDs have stuck to the nematic state and, though adequate for slow-changing watch and instrument displays, have not been fast enough for video displays.

Thomson's LCD is still very much in the development phase. The device measures just 4 by 5 millimeters and projects an image onto a viewing screen not much bigger than an index card. The resulting projection (see photograph) is decipherable, but not sharp. The display, based on a matrix of 100 by 100 points, can produce only five shades of gray plus black and white.

Key to the LCD's operation is the fact that liquid crystal molecules are in different conditions in each of their three states—and, what is more, the positions taken on by the molecules in the nematic phase remain "frozen" into place in the smectic. In both states, the crystal molecules are parallel. The differ-

ence is that in the smectic phase, the centers of gravity of the molecules line up in parallel, equidistant planes; in the nematic phase, though, the centers of gravity are randomly distributed. In the isotropic state, however, the crystal molecules themselves are randomly distributed.

Sensitivities. Nematic liquid crystals are sensitive to electrical fields, whereas such fields have no effect on crystal in the smectic phase. On the other hand, smectic crystals are sensitive to temperature.

In designing the new LCD, the researchers took advantage of the particular sensitivities of both the nematic and smectic states. The horizontal rows on the display consist of a network of tiny resistances, and the vertical columns are controlled by a network of electrodes. Between the two grids is a thin layer of liquid crystal in the smectic state.

The resistances heat the crystal to the point where it passes from the smectic through the nematic into the isotropic phase. As the heat is cut off and the temperature drops, the crystals move back through the nematic into the smectic state. As they change, the molecules do not line up again and the result is a crystal that diffuses light.

Lined up. However, if an electrical field is applied to the vertically arranged electrodes during the cooling process, the molecules do line themselves up and the result, in the smectic state, is a single transparent crystal. Although the ambient temperature is significant, Thomson says its experimental screen operates at between 15° and 30°C.

To display an image on the screen,



TV or not TV. Experimental LCD from Thomson-CSF produces a projected TV picture by exploiting the properties of the smectic, nematic, and isotropic states of liquid crystals.

Adac System 1000 handles a ton of I/O functions.

In its simplest form, the System 1000 functions as a low cost peripheral expander to minicomputers. When incorporating a DEC LSI-11 microcomputer, it acts as a stand-alone data acquisition and control system or as a remote intelligent terminal.

No other data acquisition system comes close to offering so many analog and digital input and output modules. Functional analog cards communicate directly with thermocouples, load cells, strain gauges, isolation amplifiers, transmitters and strip chart recorders to name a few. Discrete cards communicate with switch contacts, relays, thumb wheel switches, pumps, motors and many other devices.

A single System 1000 provides up to 700 high level analog input channels, or 128 analog low level input channels, or 700 digital I/O functions. For even greater capacity, a bus repeater card allows additional System 1000s to accommodate as many modules as desired.

System 1000 in the stand-alone configuration can be supplied with up to 32K of memory and DEC RT-11 software.

If you are interested in an extraordinary data acquisition system, you must check out the System 1000. Nothing compares with it.



CORPORATION

70 Tower Office Park • Woburn, MA 01801
617-935-6668

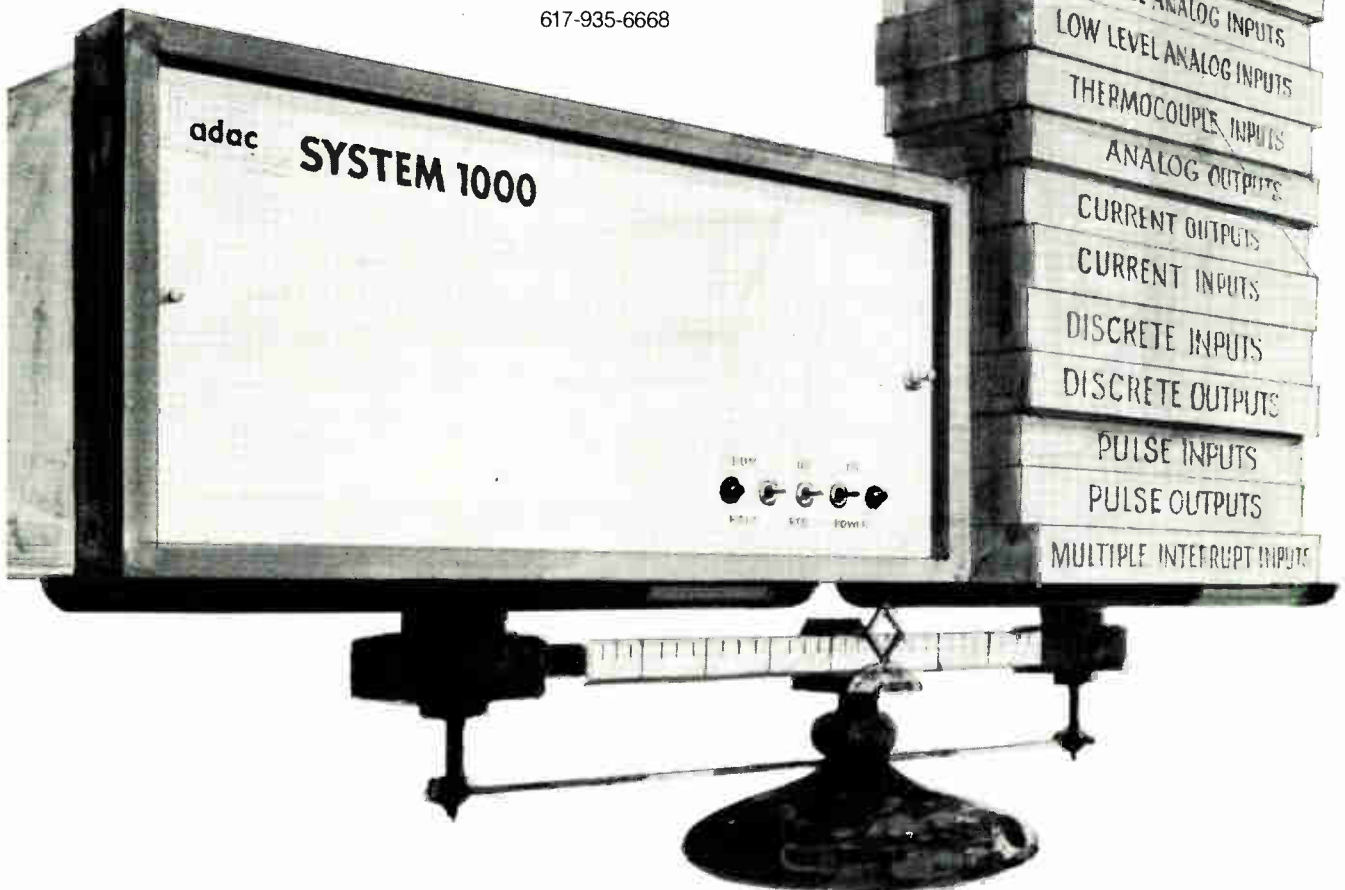

signals corresponding to each point along a row are fed in parallel to the columns as the rows cool in sequence. The drive signals range between 15 and 20 volts, way below the kilovolts needed for a CRT.

The process happens so fast, the researchers claim, that rows can be changed in less than 60 microseconds (compared with 64 μ s for a TV line). There is no flickering at low speeds because liquid crystal in the smectic state has, in effect, a built-in memory; that is, the molecular positions do not change until the row is heated again.

In the experimental screen exhibited at the Paris show, an analog-to-digital converter is used to feed a video image onto the screen. As the LCD is developed, says Michel Hareng, director of the visualization lab within the Thomson research labs, a fully analog device will replace the converter and do away with the concomitant logic problems.

First, though, Hareng says, Thomson will concentrate on increasing the number of rows and columns to achieve a much more sharply defined image. He says work is already under way on a larger matrix, although he refuses to say just how much larger. Eventually, with the larger matrix and the all-analog device, he envisions a smectic LCD that will be virtually an integrated circuit. **-Kenneth Dreyfack**

Japan

Deep UV unit projects fine lines

Japan's VLSI Cooperative Laboratory has developed a deep-ultraviolet-light unity-magnification reflex projection unit that can print line widths as small as 1 micrometer with alignment accurate to within 0.3 μ m. The lab did the basic design and set the system's specifications, with the detailed design and fabrication carried out by Canon Inc.

Key to the new aligner is a 2-kilowatt deep UV point source. This xenon-mercury lamp is very stable

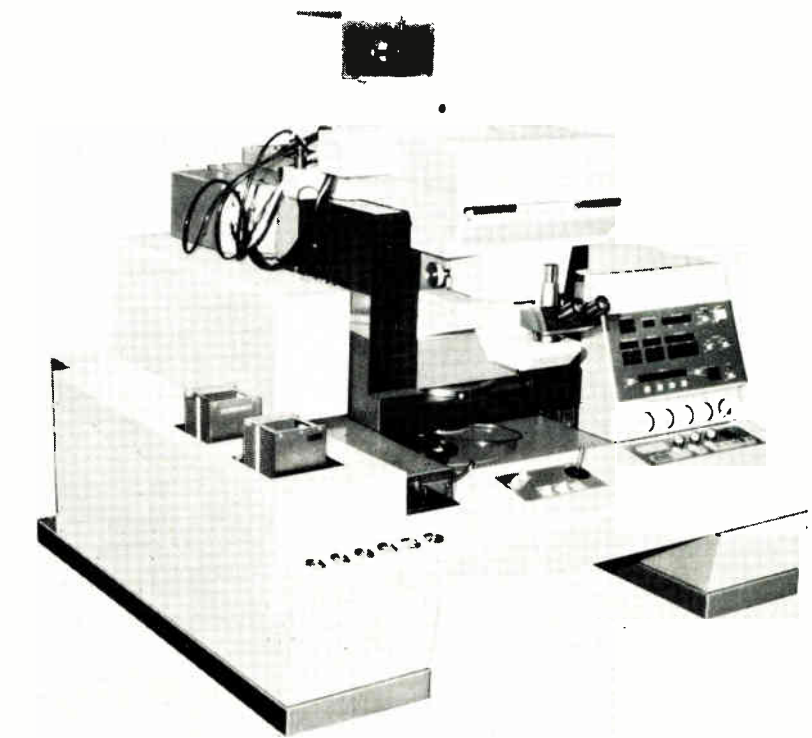

Going deep. Unity-projection machine developed by Japan's VLSI Cooperative Laboratory and Canon magnifies deep UV light into an arc-shaped beam to print lines as narrow as 1 μ m.

and efficient. Three concave mirrors preceding the photo mask magnify the light into an arc-shaped beam having a uniformity of better than 97%. This shape is used because it minimizes the aberrations of the projection mirror system between the mask and the wafer.

In general, the optical projection system is similar to that used by Perkin-Elmer Corp. [*Electronics*, July 21, 1977, p. 81], but it is different in detail.

Exposure of an entire wafer of up to 5 inches in diameter is performed in a single process. The mask and wafer are aligned on a frame. The frame, mounted on air bearings for smooth operation, then moves past the 1.5-millimeter-wide beam at a constant speed. This causes the beam to sweep across the mask and wafer, thereby exposing the wafer.

Alignment. Before exposure, a filter shutter is placed between the light source and the photo mask. The filter stops deep ultraviolet rays, preventing exposure of the resist on the wafer, but passes visible light and thus permits alignment of the

mask and wafer through the system's microscope. After alignment, the filter shutter is removed.

The mask is fabricated on a fused-quartz substrate, which is transparent to deep UV light. In contrast, the glass usually used for masks is completely opaque at the 200-to-260-nanometer wavelengths employed for exposure. Fused quartz is more expensive, but since the masks never touch the wafers, they should last indefinitely. The resist used is polymethyl methacrylate (PMMA), and the metal is chrome.

An automatic parts feeder and an automatic laser alignment system permit processing of 60 5-in. wafers an hour. Although designed for operation at deep UV wavelengths for lines widths of 1 μ m, the aligner can also be operated at ordinary UV wavelengths of about 360 nm for printing 2- μ m line widths. Masato Nebashi, executive director of the VLSI Technology Research Association, which is the parent of the cooperative lab, says he expects Canon to start taking orders for commercial systems this fall. **-Charles Cohen**

Gain huge savings—in dollars and inches—by replacing bulky conventional oscillators with tiny IC circuits.

WHILE CONVENTIONAL OSCILLATORS (FUNCTION GENERATORS, WAVEFORM GENERATORS, VCO'S, ETC.) COST UP TO SEVERAL HUNDRED DOLLARS, A SINGLE-CHIP IC OSCILLATOR CAN LITERALLY DO THE SAME JOB...AND FOR AS LITTLE AS \$1.72. All you give up for this tremendous reduction in cost and size is a certain degree of regulation in the output, and a variety of knobs and controls. But let's be realistic—for most applications, the IC oscillator is perfectly adequate. Its small size and low price makes the alternate approach quite impractical.

Nothing left out in the process.

Despite its small size, an IC chip really does contain every operating section of a traditional function generator. Consider a typical semiconductor oscillator, the XR-2206. On-chip you find the oscillator circuit (to generate the basic periodic waveform); the wave shaper to give you a clean sinewave; the modulator section (for AM capability); and an output drive amplifier. Basically the selfsame circuitry you'd receive if you bought a standard oscillator or benchtop function generator hundreds, even thousands of times as big as the IC.

But the real payoff comes in the outputs of these oscillators, and here too you lose nothing by going solid-state. The IC

oscillator will generate a combination of eight different types of output waveforms: triangle, ramp, sawtooth, squarewave, sinewave, pulse and FSK (frequency-shift keying) outputs, each with its own appropriate range of applications.

Just the item for sweep generators and sweep modulators.

The sweep generator, with its output hodgepodge of frequencies, can be a complex device. Yet it's a circuit easily built with ICs. A triangle-, ramp- or sawtooth-wave generator (XR-2207) modulates another oscillator (XR-2206) set up for voltage-to-frequency conversions. And presto! You have a functioning pocket-size sweeper.

Digital test equipment and stable phase-locked loop design.

Where space is at a premium, the solid-state precision voltage-controlled oscillator (XR-2209) comes to the rescue with banners flying. It more than meets the functional accuracies required, saves pounds and inches, and shaves dollars too.

Audio test equipment too.

Low cost is the prime requisite here, and once again the IC oscillator comes through for the design engineer. Solid-state sinewave generators (XR-2206 or XR-8038) are ideal, low-cost, simple solutions that often can offer a size and power advantage perfect for the test or hobby market.

Digital communications, including data-interface or acoustical-coupled MODEMS.

The FSK oscillator is tailor made to solve this design dilemma. Modern designers, particularly those dealing with computer and data-processing systems, are continually put upon to squeeze more capability into ever decreasing amounts of space. Where board space is tight, the IC FSK oscillator (XR-2206 or XR-2207) is magnificently effective in compressing a complex function into a nutshell. You wind up with inches of real estate for really important things such as more memory.

Digital testers, logic circuits, on/off gating.

Naturally, there's an IC oscillator for the purpose. This time one with a pulse output (XR-2206 or XR-2207). All the same advantages you find in other applications—size, cost, low power requirements—apply here as well. In short, regardless of where you need to use an oscillator or function generator, there's an outstanding chance you can find a solid-state device to do the job and make you a hero in the bargain.

Beware. Only one company produces a complete line of IC oscillators.

With a stable of five different circuits, Exar boasts by far the industry's broadest choice of IC oscillators. From low cost, easy-to-use devices to high performance function generators, the line is summarized in Table 1. Check them out, find the one best suited for your use, then make the shrewd move to solid state.

Exar's Function Generator Data Book contains technical articles and application notes. To request your copy, write on your company letterhead to your nearest Exar representative or to Exar, 750 Palomar Avenue, Sunnyvale, California 94086.

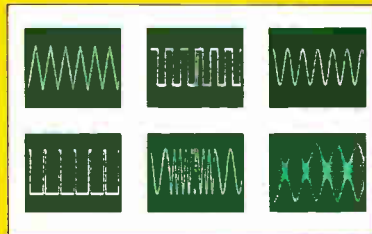

Electrical Characteristics	EXAR Device Type				
	205	8038	2206	2207	2209
Output Waveforms	Triangle, Square, Sine			Triangle, Square	
Upper freq. limit (MHz)	4	1	1	1	1
Operating range	7-1	1000-1	2000-1	2000-1	2000-1
Typ. temp. drift (ppm/°C)	300	50	50	20	20
Typ. sinewave distortion	2.5	0.5	0.5	—	—

Table 1. Exar's line of IC Oscillators.



FOR THE EXAR DISTRIBUTOR OR REP NEAREST YOU, CALL EXAR AT (408) 732-7970.

The friendly desktop computer system...

They're solving big problems.

They've learned what computer power is all about. HP's System 45 desktop computer provides the simplest, most direct way to a solution—from the problem in your mind to a final report or plot, quickly and easily. That's why more and more problems thought to need a big computer are now being solved by System 45.

This powerful graphic, computational tool operates with a wide range of input, mass storage and output peripherals. As for software, we don't think you should have to write all the programs you need to solve your problems. That's why we have a wide array of practical, user-tested software to help you handle statistical analysis, engineering design, management science, business administration and much, much more.

In the graphics system shown, the input device is the HP digitizer (9874A), the mass storage is the internal dual tape drives, and the output is the HP 4-color plotter (9872A). You can interface System 45 with virtually any instrument found in the scientific



But not on a big computer.

or engineering environment. All interface cards, cables and I/O slots are designed for quick "plug in and run" operation.

In addition, the System 45 Enhanced BASIC language allows you to upgrade any peripheral—internal printer to line printer, CRT graphics to 4-color plotter, tape drive to floppy disk—by simply changing one statement with no other software modification.

If you'd like to solve big problems on your own terms, at your own pace, and in your own work environment, you need the power and flexibility of the friendly HP System 45. Power in terms of fast, simple solutions, and the flexibility to solve more big problems than you probably thought possible.

For brochures describing System 45 and the HP programs of interest to you, call the HP Literature Center toll-free day or night.

The number is 1-800-821-7700, Extension 400. (In Missouri, call 1-800-892-7655, Extension 400.) Or, call your nearest HP sales office for a demonstration.

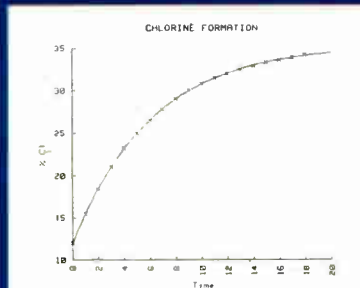

Hard copy record from CRT display of non-linear regression curve.

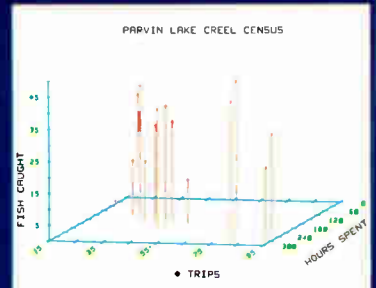

4-color plot of three-variable data in a scattergram.



CRT graphic display of input to Fast Fourier Transform.

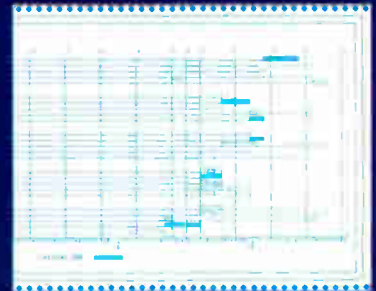

Printer/Plotter output of project schedule (GANTT chart).

409-3A

HEWLETT  PACKARD

3404 E. Harmony Road, Fort Collins, Colorado 80525

For assistance call: Washington (301) 948-6370, Chicago (312) 255-9800, Atlanta (404) 955-1500, Los Angeles (213) 877-1282
Ask for an HP Desktop Computer representative.

Circle 75 on reader service card

Design Flexibility in

**Introducing the LSI Logic Sequencer.
Now your complete state diagram can
become hardware with a single chip.**

Our new Field Programmable Logic Sequencer (FPLS) is simply the most sophisticated device in programmable logic you can put your hands on.

And here's why: it has LSI arrays of AND gates and OR gates—all with nichrome-link programmable interconnects. This, plus an on-chip state register with an internal feedback loop, provides everything you need to implement any synchronous state machine.

We stretch your design freedom even further with a complement array for generating NAND functions. Which means you can often incorporate large algorithms—and still have many gates to spare. Moreover, we've included an independent output register which lets you send output commands to downstream logic—regardless of state transitions.

The Logic Sequencer's uses are limited only by your imagination. In control sequencing, waveform generation, handshake protocols, data formatting . . . the new Signetics Logic Sequencer meets the challenge.

And if you're not already using them, you should meet the other members of the programmable logic family: the FPLA, the Field Programmable Gate Array, and our award-winning ROM Patch. Within this family, you'll find features like multi-level programming and editing to maximize your design freedom. All Signetics devices can be customized with widely available PROM programming equipment.

With greater design flexibility as close as the coupon, don't wait. Send it today. We'll rush you complete information on the new Logic Sequencer as well as the rest of the family. You may also contact your local Signetics sales office or franchised distributor.

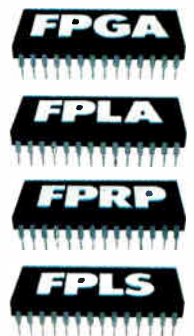
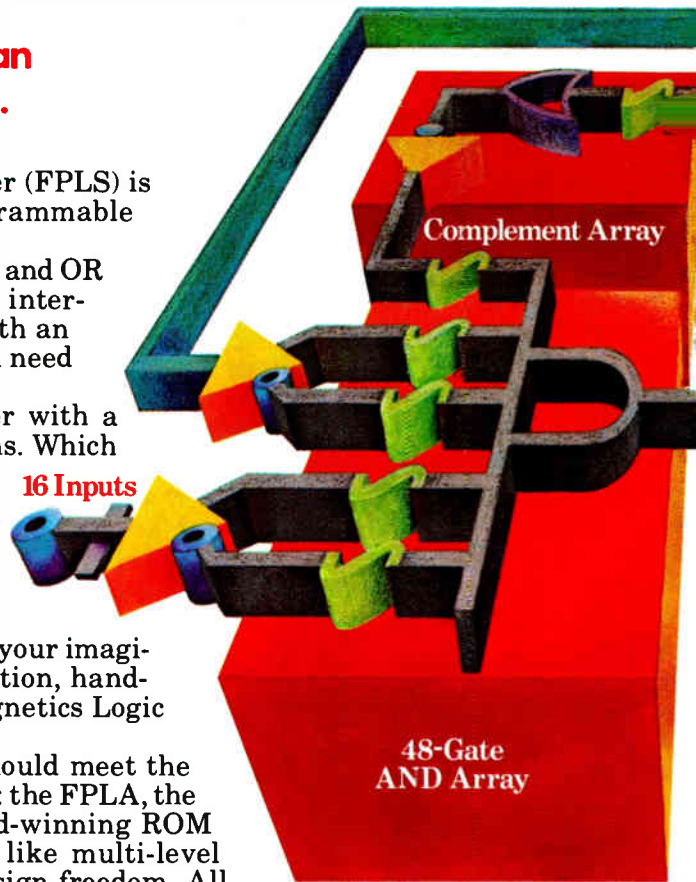

Programmable Logic.

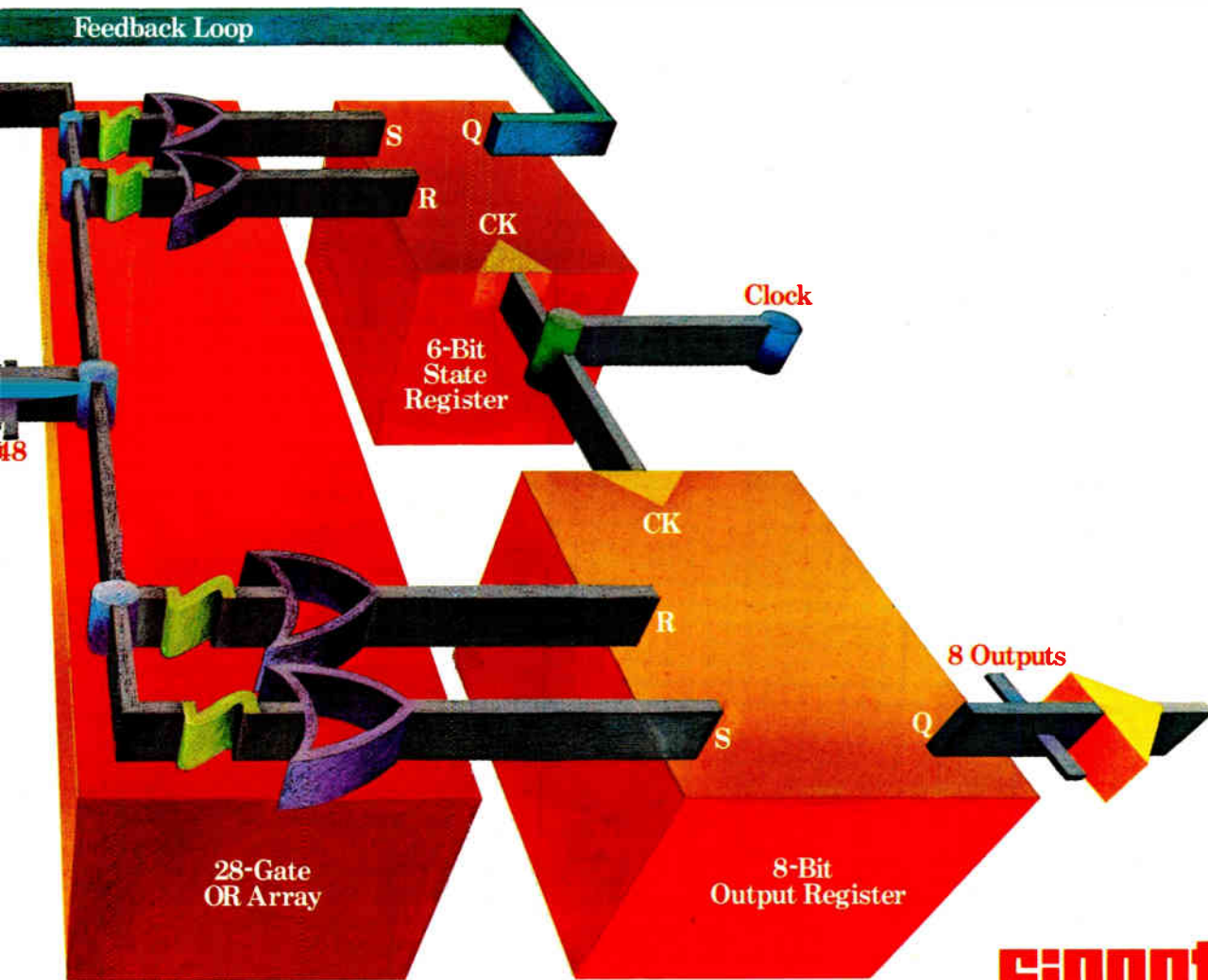

Signetics

a subsidiary of U.S. Philips Corporation

Signetics Corporation
 P.O. Box 9052
 811 East Arques Avenue
 Sunnyvale, California 94086
 Telephone 408/739-7700

The 82S104/105 is available now in sample quantity directly from Signetics. For production quantity, contact your local distributor in third quarter, 1979.

FIELD PROGRAMMABLE LOGIC FAMILY

Device	Inputs	Outputs	Speed (ns max)	Power (mW typ)	Mil-Spec Versions	Organization
Gate Array (82S102/103)*	16	9	35	600	Now	9 AND/NAND gates; programmable output polarity.
Logic Array (82S100/101)*	16	8	50	600	Now	48 AND terms; programmable OR array; programmable output polarity.
ROM Patch (82S106/107)*	16	9	70	600	mid-79	48 patch words; self-enable output flag.
Logic Sequencer (82S104/105)*	16	8	90	600	4th Qtr.	48 transition terms; 6-bit R/S FF state register; 8-bit R/S FF output register; complement array.

*Two models available for each device: Open collector or three-state.

To: Signetics Information Services, 811 E. Arques Ave.,
 P.O. Box 9052, MS 27, Sunnyvale, CA 94086

E426

Please send me more details on your:

FPGA FPRP FPLA FPLS

My need is urgent; have an applications specialist

phone me at once: () _____

Name _____ Title _____

Company _____ Division _____

Address _____ MS _____

City _____ State _____ ZIP _____

THINGS TO CONSIDER BEFORE YOU MAKE A DECISION

Is automatic testing a panacea? With today's PC volume and complexity, it's not so much a panacea as it is a necessity. But to implement a test solution requires a thorough understanding of the available test systems and your production environment.

When to test?

That's as important as how. The cost of fault identification increases dramatically with each production step. Thus, you want to catch faults as early in the production process as possible, but it doesn't necessarily follow that extensive incoming parts inspection is the answer. Your real goal is high turn-on rates in final test. That demands high-yield PC boards. And as the diagram below shows, several factors including good parts go into high-yield PC boards.

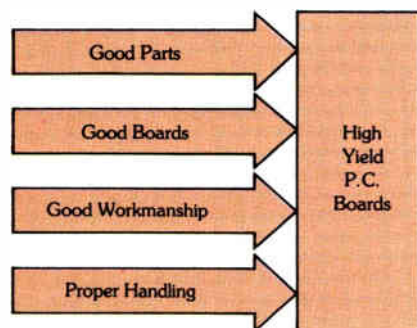

A PC board assembly process will produce anywhere from 20% to 80% good boards. A typical number is 60%. Of the faulty boards, a fault spectrum might look like this:

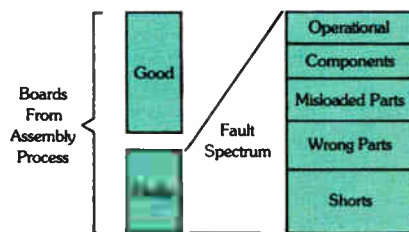

With a good board yield of 60% and no PC board testing, even a simple product with five boards would overload final test. Nine out of ten units would fail. This makes board level a good place for thorough testing. For this is the first opportunity to locate faults across the entire fault spectrum. But which tester is for you?

Choosing a circuit board tester.

There are no simple answers to selecting an automatic circuit test system. But, from our experience, we know that these are some of the factors involved: Production yield, test yield, fault spectrum, PC volume, board type, and anticipated new products.

Will the system test for the spectrum of faults that you will encounter? Will it generate component level diagnostic information? Will it test present and future board types and do it fast? Is it easy to expand and adapt to changing requirements?

What are the true costs? How much time and effort is involved in programming, debugging, fixturing and training? And will you get prompt, competent service if you need it? HP can help you answer these key questions.

Over two million boards worth of experience.

HP's new Automatic Circuit Test Systems are the result of our extensive in-house experience with automatic circuit testing.

In fact, we were spending such large sums on dedicated equipment and manual test stations that back in 1970 we developed an automatic circuit test system called Optest I. This system, along with its more recent companion Optest II, is still in operation today. Optest I and Optest II are now testing over 100,000 printed circuit boards annually. Our new circuit test system is, in reality, a third-generation product, which originated from over eight years' experience in actual in-use operation. Today, HP is using 46 of these new automatic test systems within our own plants.

The case for in-circuit plus functional testing.

The marketplace has many potential test solutions. You can choose from simple shorts testers to completely automated systems. From testers that measure components in-circuit to functional test systems that verify dynamic performance of complete circuits.

HP's new 3060A Board Test System (\$74,000* for standard operational system) is an advanced system that combines the latest in-circuit technology with functional testing. It includes a comprehensive software package for fast program development. It is a proven package, which combines ease of use with flexibility to handle tough test problems. The addition of functional testing to in-circuit testing may provide a relatively small increase in board yield. But that small increase can



3060A



ON AUTOMATIC TEST EQUIPMENT.

result in large improvements in product yield, as shown below. For example, in a ten PC board product, increasing board yield by only 8% (from 90% to 98%) will leverage product turn-on rate from about 35% to 80%. That's a large payoff, and an excellent reason to consider HP's 3060A.

PRODUCT YIELD VS. PRODUCT COMPLEXITY

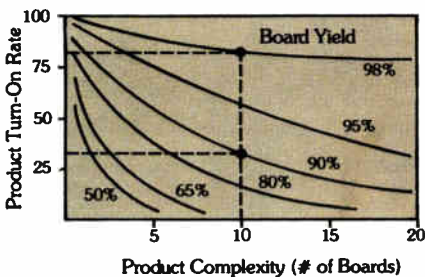

The standard 3060A has a full set of analog and digital functional testing tools for testing most analog, digital or combined boards including at-speed testing of microprocessor-based boards using signature analysis techniques.

Some boards, such as large complex logic boards, will benefit from the use of HP's DTS-70 Digital PC Board Test System (\$90,350* for standard operational system). This simulator-based tester tells you how effective your test programs are and identifies the portion of the circuit not completely tested. This is important feed-back permitting better program development. A useful tool in R&D, the DTS-70 can model your designs and help you produce better products. Your test engineer will appreciate its ability to

model feed-back loops, find open traces and identify intermittent faults.

Just as important, the DTS-70's power and flexibility comes from its controller, the HP 1000 Computer System. Using a Real-Time Executive operating system, you can simultaneously test PC boards and develop new programs. As your testing needs expand, two more test stations and several programming terminals can be added without the expense of additional computer power. The operating system is compatible with data-base management software to keep track of your test data and help you better manage your production. The DTS-70 will easily fit into your long range computer network plans providing distributed processing and communication to your data processing center.

The bottom line.

Can automated PC board test equipment save you money? Again, there are no simple answers. But it has saved us money and chances are it will save you money, too, if any of these conditions exist in your plant: high PC volume, complex boards, production testing backlog, low turn-on rates of complete systems, high in-process inventory costs and high warranty costs.

Your production operation is unique, but we can help you characterize it by comparing the cost of testing, or not testing, at each level to arrive at your best test resource allocation. Let us help you answer these key test questions. Call your HP field engineer today.

* Domestic U.S.A. price only.

DTS-70



**HP Circuit Testers—
The Right Decision**

HEWLETT  PACKARD

P.O. Box 60001, Loveland, Colorado 80537

For assistance call: Washington (301) 944-5400, Chicago (312) 255-9800, Atlanta (404) 955-1500, Los Angeles (213) 877-1282.

Circle 79 on reader service card

Expanding the parameters of press-fit technology

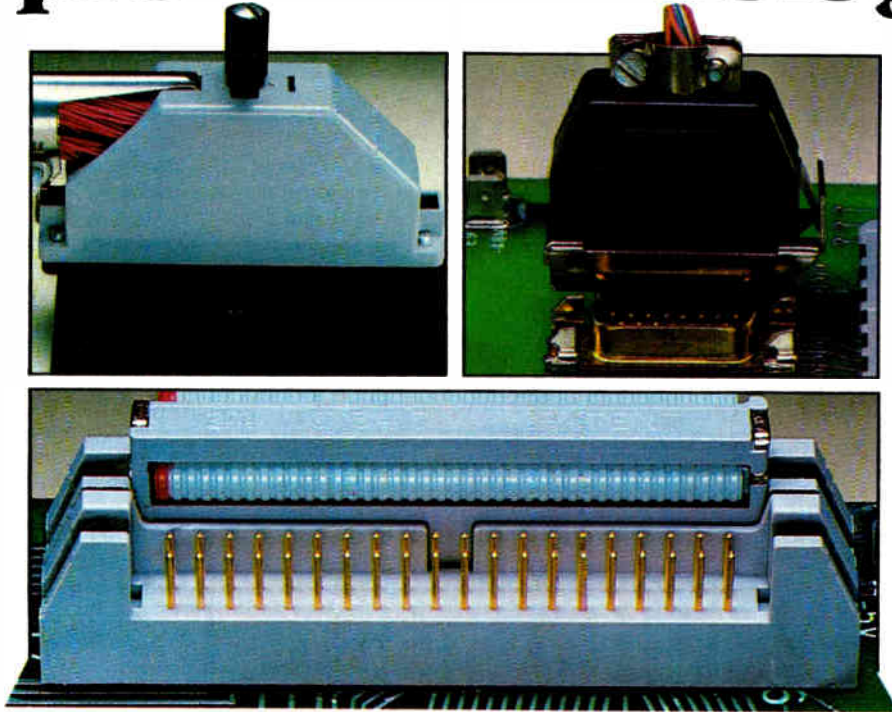

Three new I/O connector styles from ELFAB now available on our press-fit backpanels.

Now you have additional flexibility with press-fit backpanels. You can include three popular connector styles — zero insertion force series, subminiature "D" and a popular ribbon cable header — and still utilize the economy of press-fit.

With press-fit, your contacts are removeable and replaceable on the board.

No soldering is required.

You can get up to eight planes or circuitry through the use of Multi-Pac®... with no external wiring.

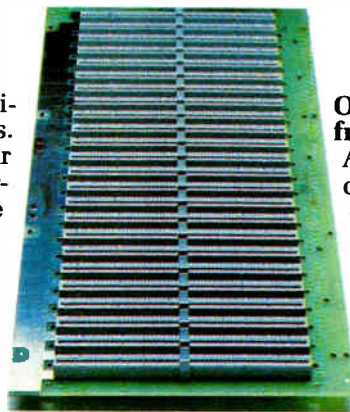

Other new press-fit products from Elfab

A new I.C. socket with oriented contact pins — replaces traditional plastic body sockets and other pin-in-board techniques — all of which require soldering.

A new bellows-type contact — now with all the benefits of press-fit.

We opened the door to industry application of press-fit — and we're making it more usable all the time. Write or call for additional information.



The Leader in Press-fit Technology

P. O. Box 34555 • Dallas, Texas 75234 • 214-233-3033

Tunnel diodes flying high

Reliability and simplicity of supposedly forgotten technology make it ideal for satellite communications

by Harvey J. Hindin, Communications & Microwave Editor

Although the research money and hoopla for microwave amplifiers center around gallium-arsenide field-effect transistors, most of the wave amplifiers in communications satellites use germanium tunnel diodes, which were supposedly obsolete years ago. It appears that even the new birds—in the 14-gigahertz band—will be served by tunnel diodes.

It's all due to their simplicity, low power drain, and linearity. These, combined with a reliability so great that none of the 102 diodes used in Intelsat satellites has failed in 2 million device-hours of operation, makes for an almost irresistible combination. Contrary to popular opinion, the tunnel-diode amplifier is adequate both for the present 6-GHz family of satellites (noise figure of 5 decibels) and for the forthcoming 14-GHz generation (6-dB noise figure), even though the noise figure of FETs is 1 dB or so better.

This success is due to an understanding of the tunnel diode's unique failure mode and the establishment of a screening technique that differs markedly from the conventional burn-in process. The work was done by Akos G. Revesz, senior staff scientist, and Paul L. Fleming, device physics department manager, at Comsat Laboratories in Clarksburg, Md.

Under stress. "Germanium tunnel diodes are subject to an internal mechanical stress that depends on subtle variations in the fabrication process, which may significantly vary from one device to another," says Fleming. "This stress may start a plastic deformation—known as creep—in the germanium, which

results in eventual deterioration of the diode characteristics."

Creep is intimately related to the way the diode is made, the Comsat researchers found (See "The neglected tunnel diode"). In a typical tunnel diode, the arsenic in the

arsenic-doped tin ball forms the n-doped region on the surface of the p-doped germanium chip. The tin ball is attached to a wire mesh and separated from the chip by two insulating supports. The chip must be etched so that the diameter of the

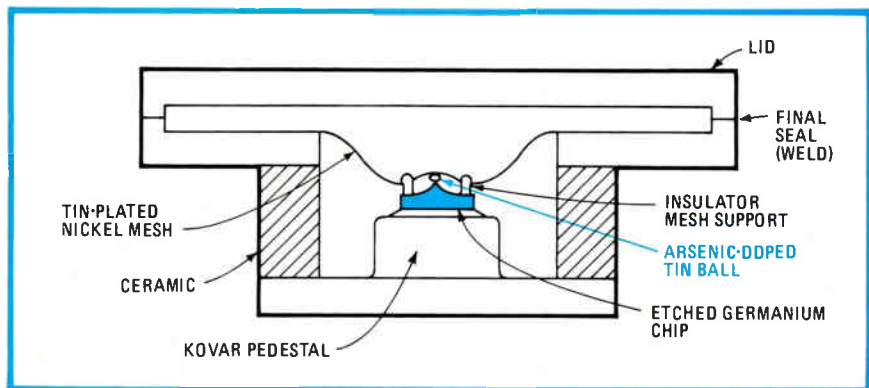

Construction. The typical germanium tunnel diode has a mechanically delicate germanium chip, tin ball, and nickel mesh junction. Internal stresses in this region cause partial or total amplifier failure, but a screening process culls out the susceptible diodes.

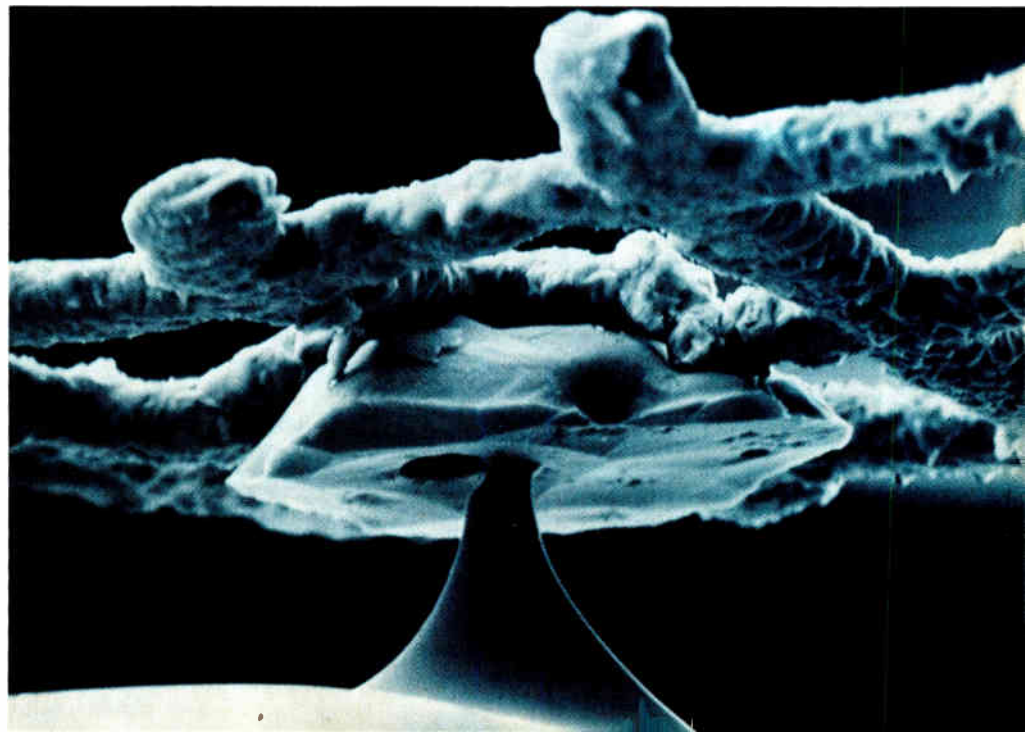

Probing the news

resulting pinnacle is only about 2.5 micrometers for a 6-GHz device and even less for higher-frequency diodes.

It turns out that there are large variations in the shape of the pinnacle and the position of the tin ball. The soldering of the mesh electrode to the tin ball also varies. Analysis of the mechanical stresses showed that even minor deviations from the mechanically ideal symmetrical mesh cause substantial mechanical stresses, since the junction area is very small. Comsat concluded that the diodes have an inherent built-in stress with a magnitude that varies in some unknown way.

Going bad. The diodes go bad by showing an increase in valley current. This is the current that flows in the diode when the applied bias voltage increases to the point where the negative resistance region is about to end, returning the diode to the normal forward diffusion current mode. As the valley current increases, the diode negative resistance decreases. In extreme cases, the negative resistance region may disappear altogether and the diode dies,

says Comsat's Fleming.

It was found experimentally that the valley current of a faulty tunnel diode increases with applied heat. "Apparently," says Fleming, "mechanical defects are generated" by the heat.

These defects are caused by plastic deformation of material that is time-dependent as well as thermally activated. In fact, there is an incubation time above which the defect density greatly increases.

Acorns. A theoretical study of this phenomenon led the Comsat researchers to conclude that a relatively small change in mechanical stress on the junction results in a change of up to five orders of magnitude in the creep incubation time. In the typically small junction of a microwave tunnel diode at the 25°C operating temperature of a satellite, the creep incubation time shrinks from decades to a fraction of a year. This occurs with only a small change in force on the junction.

Problems increase with the operating frequency. Since the junction area is smaller, a force that causes a given stress at 6 GHz produces much more stress at 14 GHz, reducing the creep incubation time. Therefore the demand for mechanical perfection of

the tunnel diode understandably increases greatly.

Explaining how much depends on a given tunnel diode's internal mechanical structure, Fleming says, "Since the internal diode construction at the junction can vary greatly, the internal stresses can also be very different. Their different sensitivities to creep reflect the variation in built-in stress."

Although annealing may allow substandard diodes to recover by relieving internal mechanical stresses, it is inconvenient. What was needed was a test or prescreening procedure to cull out bad or potentially bad diodes before they were used.

Timing. Simple burn-in of the diodes was insufficient to ensure adequate satellite lifetime because the valley current change was not detected. So Revesz proposed a more elaborate procedure using the temperature sensitivity of the incubation time to isolate high-stress diodes by measuring changes in the valley current.

This is done by subjecting the diodes to a carefully calculated temperature for a period that is equivalent to a specific mechanical stress over the seven-year projected satellite lifetime. Any diode with a change in valley current greater than 10% is rejected.

The results could not have been better. In one test, says Fleming, no failures were experienced in a screened group, whereas 10% failed in an unscreened group.

Not only have tunnel diodes been used in 15 Intelsat birds, but they are in at least 20 others, including Comstar, Anik, and Westar. They are scheduled to appear in Intelsat 5, at 14 GHz, where, according to Richard C. Mott of the Comsat Laboratories microwave laboratory, they will provide oscillation-free gain and noise figures of about 14.30 ± 0.10 dB and 5.60 ± 0.05 dB, respectively, performing across the 14.00-to-14.50-GHz band.

This state-of-the-art performance, Mott says, was achieved with the help of computer-aided design and is typical of what the diodes can do. The devices come from Aertech Industries Inc., Sunnyvale, Calif., at present the only supplier. □

The neglected tunnel diode

Tunnel diodes—Leo Esaki's brainchild of the 1950s—never lived up to expectations because semiconductor device technology quickly bypassed them. Germanium-based and made by an alloying technique, they could not compete with silicon planar technology, which is suitable for inexpensive mass processing of devices. Silicon planar became the process of choice after the development of successful surface passivation of silicon by silicon-dioxide films. These films could also be used as a mask during the dopant diffusion process. Though tunnel planar diodes have been made, electrical noise problems have limited their use.

Since the production volume has been small, research and development have been at a minimum and the device technology—except for reliability considerations—has not changed much since the early days. Yet the simplicity of the tunnel diode has made it useful. Requiring only a direct current bias for operation as a negative-resistance amplifier, it consists of a narrow junction between heavily doped p and n regions. Electrons can easily penetrate the potential barrier across this junction by the so-called tunneling process.

When the forward bias on the diode is increased, the current increases, and then decreases, with voltage. With still further increases in the forward voltage, the normal diffusion current—as in the case of a standard p-n diode—takes over and the current increases again.

The region of interest, where the current decreases with increasing voltage, provides the negative resistance useful for amplification. Since the tunnel diode is a single radio-frequency terminal device, a circulator is required to separate the incoming signal from the amplified output signal.

The ubiquitous Spectrol dials and the universal Spectrol pot



Models 15 & 16 Dials/Model 534 Pot

Two of the industry's most popular turns-counting dials are Spectrol's Model 15 digital and Model 16 concentric. And you will often find these "ubiquitous" dials backed-up behind the panel by Spectrol's Model 534 "universal" pot. It's a winning combination worth looking into—easy reading dials that look good on everybody's panel, plus a versatile, wirewound, precision potentiometer available in so many standard and special variations it will fit almost everybody's application. Call or send for data sheets.



SPECTROL ELECTRONICS GROUP

UNITED STATES Spectrol Electronics Corporation P.O. Box 1220, City of Industry, Calif. 91745, U.S.A. • (213) 686-1280 • TWX (910) 584-1314

UNITED KINGDOM Spectrol Reliance Ltd. Drakes Way, Swindon, Wiltshire, England • Swindon 21351 • TELEX: 44692

ITALY SP Elettronica SpA Via Carlo Pisacane 7, 20016 Pero (Milan) Italy • 35 30 241 • TELEX: 330091

GERMANY Spectrol Electronics GmbH Oberauerstrasse 15, 8000 Munich 70 West Germany • (089) 7145096 • TELEX: 05-213014

Circle 83 on reader service card

Digital signal processing is here.

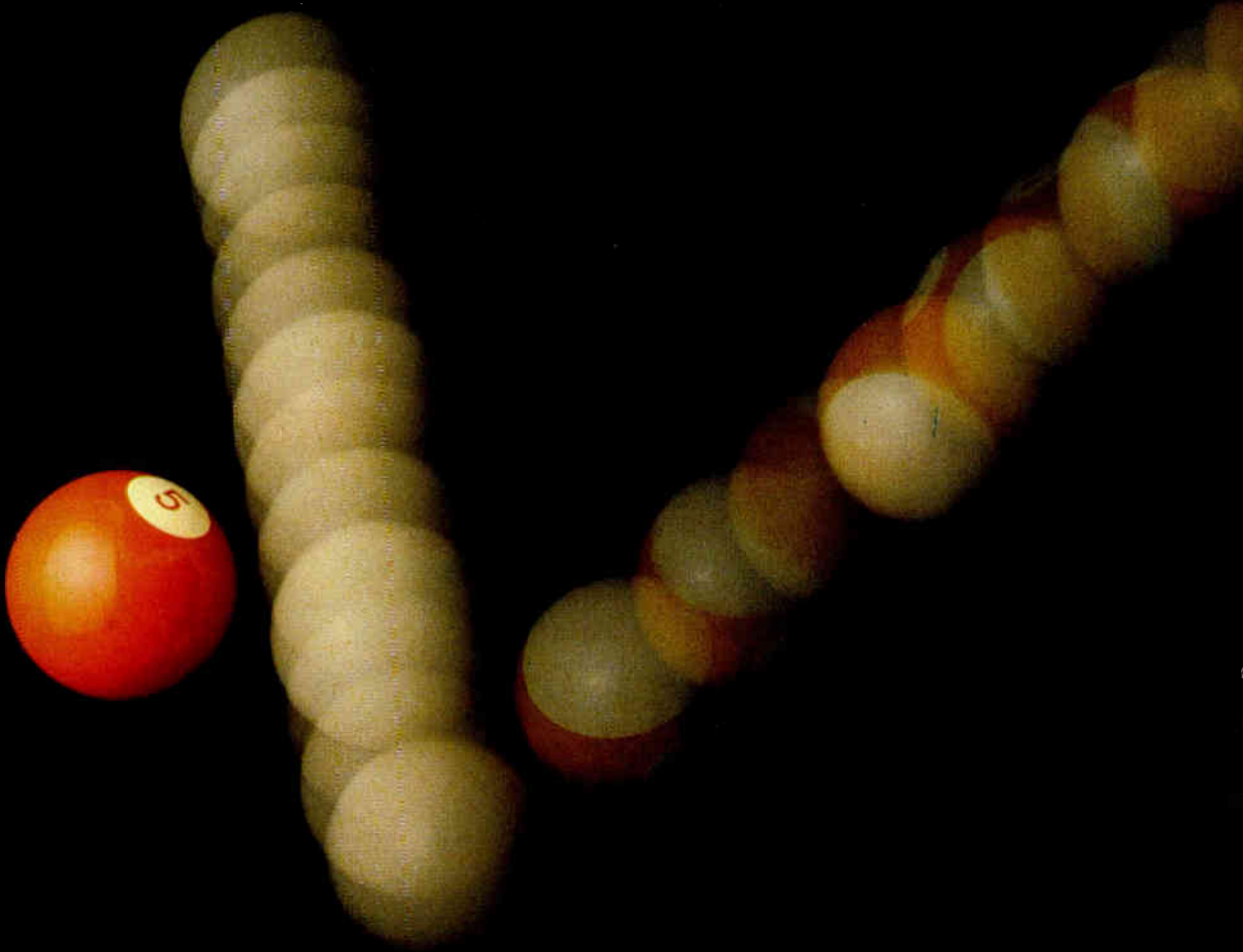

Monolithic 6 & 8-bit video A/D converters you can afford to design in

We've developed a family of single chip, 30MHz A/D converters with VLSI technology. They're TTL devices that bring all the advantages of digital signal processing to high-speed, wide-bandwidth signals like those used in radar, broadcast video and closed-circuit TV systems. We've designated the 8-bit converter TDC-1007J and the 6-bit device, TDC-1014J.

With digital processing of video signals, you can use simple algorithms to control video images of all kinds. You can freeze, store, and replay the action; compress and expand time; fade in, fade out, wipe, and superimpose—all under non-critical digital control.

Our inexpensive A/D converters make the connection to all this flexibility.

Because we invented TTL and refined it to the level of VLSI, our converters enjoy the luxury of operating as *flash converters*, rather than depending on tedious, successive-approximation techniques.

Our TDC-1007J features full

eight-bit resolution. It is a single chip with 255 comparators and a resistive voltage divider. Activating a single device pin strobes the comparators, encodes all their binary outputs into an eight-bit word, and stores the word in an output latch. All this can happen 30 million times a second—now *that's* video-speed data conversion!

The TDC-1007J provides four output data formats and does not require a sample-and-hold circuit at the front end; it is unsurpassed for both NTSC and PAL color video systems.

Our six-bit converter chip, the TDC-1014J, is no falloff from the larger device—it is made with its own 63-comparator mask set and features all the speed, linearity, and utility of its big brother. Use it for applications that call for reduced resolution and cost—like ultrasound, X-ray, radar, and CCTV.

Both the eight-bit A/D and the six-bit A/D are packaged in industry standard DIPs. The larger -1007J has 64 pins; the smaller -1014J has 24. They are both powered by +5V and -6V supplies; the -1007J uses 2W and the

-1014J needs only 750mW. Both are radiation hard.

The TDC-1007J (in 100s) is priced at \$485. The TDC-1014J (in 100s) is priced at \$186. (And these are only our introductory prices—they will go lower like all monolithic devices.)

These products are now in stock at Hamilton/Avnet.

For immediate information call 213/535-1831 or send in coupon. If you can wait several weeks, use reader service card.

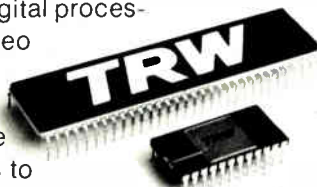

TRW LSI Products
An Electronic Components Division of TRW Inc.
P. O. Box 1125
Redondo Beach, CA 90278

Please send data sheets on the new **TDC-1007J**, 8-bit and **TDC-1014J**, 6-bit A/D converters.

Name _____

Company _____

Div/Dept _____ Mail Code _____

Address _____

City _____

State _____ Zip _____

TRW LSI PRODUCTS
...for Digital Signal Processing

Microsystems

STD bus leaves gate fast

Smaller, less costly solution from Mostek and Pro-Log has found a ready market as well as quick peripheral support

by John G. Posa, *Microsystems & Software Editor*

What amounted to a calculated risk about eight months ago by Mostek Corp. and Pro-Log Corp. has turned into a good-sized market with other companies moving in quickly to help exploit it.

The risk involved a decision to design and build a new bus for microcomputers despite the fact that the Multibus, the S-100, the LSI-11, and a slew of support products for them already existed. But Mostek of Carrollton, Texas, and Pro-Log of Monterey, Calif., moved ahead with their joint design on the theory that big modules clogged with large-scale integrated devices often spelled overkill. Thus was born the STD bus [*Electronics*, Aug. 31, 1978, p. 41].

STD boards are small, almost tiny, measuring only 4.5 by 6.5 inches, and they interface via an inexpensive 56-line edge connector cleanly segmented for 8-bit data, a 16-bit address, power, and control. What's more, because the idea and the first boards came from two sources simultaneously, the developers reasoned that potential supporters would be less afraid to get started.

It turns out that they were right. There is a market, especially in industrial and process control. Sixteen bits are still 8 too many for some applications, and the users like the small size and price of the modules as well as the ability to pick and choose only the functions they need. Although Mostek and Pro-Log remain the primary sources for central-processing-unit and memory modules, several companies have elected to bring out peripheral support, and others are following.

Analog Devices Inc. in Norwood, Mass., and Data Translation Inc. in

Natick, Mass., are helping to interface the STD bus with the real world. Data Translation just announced four data-acquisition cards [*Electronics*, April 12, p. 255], and Analog Devices is putting the finishing touches on a board that has 16 analog inputs and 2 analog outputs. It was challenged to stuff all it wanted into the confines of an STD module, so a new analog-to-digital converter was designed, and the board will use only monolithic integrated circuits. "Future boards will be more processor-independent and intelligent for remote operation," predicts Barry Glasgow, marketing manager for microcomputer peripherals at Analog Devices.

Specialists. Smaller companies, lacking ready access to leading-edge analog and digital processing, are putting together more specialized interfaces. Industrial Dynamics Inc., Parma Heights, Ohio, has built a stepper-motor controller that gives an STD CPU software control over the pulse rate and start and stop ramping. Don Davenport, the firm's president, says future products will include a temperature controller for heating and curing, a dc motor controller, and a 4-kilobyte electrically erasable programmable read-only memory (EE-PROM) module.

Another company with plans for an EE-PROM board is Microcomputer Applications Inc. of Woburn, Mass. It already has a dual asynchronous receiver-transmitter module and a clock-timer that "emulates the Intel 8253-5 programmable interval timer chip," according to Ernest Frohring, the firm's president. "We will concentrate on specialized ac-line interfaces in the future," he says. The

first, due next quarter, will connect to solid-state relays from Motorola Inc.'s Semiconductor Group and Opto 22, Huntington Beach, Calif.

Ziatech Corp. of San Luis Obispo, Calif., has also decided on a marketing strategy. "I'd like to put together a poor man's HP2240A," says Bert Forbes, president of the company (Hewlett-Packard's 2240A is a 128-channel measurement and control processor). So Ziatech's first STD module interfaces the bus with the IEEE-488 instrument bus (HP calls it the HP-IB and the 2240A connects to it). The next board will have eight dry-reed relays.

"Most of our boards will look like memory, with jumpers for mapping," says Ron Daubenspeck, an applications engineer at Micro-Link Inc., Carmel, Ind. Orders are now being taken for a four-channel asynchronous-synchronous receiver-transmitter with on-board interrupt control.

A keyboard and display controller will be its next STD board. It will really be two boards in one: the controller will mate with the STD bus, and the 16-digit alphanumeric display and 64-key keyboard will be on a separate card to facilitate connection to a front panel. Still more future support will include an a-d converter using the 7109 chip from Intersil and a printer driver to control a dot-matrix mechanism.

In one interesting application, Kris Brown and Jerry Jeffress in San Raphael, Calif., are using STD boards to control the animation for the sequel to the motion picture "Star Wars." Jeffress, who received an Academy Award for his work on the film "Close Encounters of the

MAKERS OF STD-COMPATIBLE BOARDS

Board type	Functions	Analog Devices	Data Translation	Industrial Dynamics	Matrox Electronic Systems	Micro-Link	Microcomputer Applications	Mostek (MD series)	Pro-Log (7000 series)	Ziatech	
Single-board computer	CPU with RAM, ROM, and I/O						●	●			
Memory	Dynamic RAM						●				
	Static RAM							●			
	RAM/ROM						●				
	ROM only							●			
	Nonvolatile (EE-PROM)			●		●					
Memory and I/O	E-PROM/UART						●				
Digital input/output	Serial I/O				●	●	●	●			
	TTL input							●			
	TTL output							●			
	TTL I/O						●	●			
	IEEE-488 interface						●		●		
	Transmission-line							●			
Analog I/O	A-d converter		●		●		●				
	D-a converter						●				
	A-d and d-a	●									
	Analog expander		●								
	Ac-line monitor								●		
Controllers	CRT display			●			●				
	Floppy disk						●				
	Cassette						●				
	Printer				●						
	Direct memory access						●				
	Keyboard and display				●			●			
	Stepper motor			●							
	Modem						●				
	Ac line					●		●	●		
	Temperature			●							
	Hardware enhancement	Single step						●			
		Floating-point math						●			
		Real-time clock and timer					●				
Calendar clock					●						

SOURCE: ELECTRONICS

● = in production

● = samples or planned

Third Kind," is handling the hardware and Brown is doing the software. "We're using STD modules from outside suppliers and we are building some of our own," says Brown. "We were probably one of the first to get Data Translation's converters."

To interface with a Hewlett-Packard cartridge tape deck, they designed their own IEEE-488 interface using Intel's 8291 and 8292 chips. They put Advanced Micro Devices' Am9511 high-speed math processor to work on another card for "the scaling of the axes," and they built

their own stepper-motor driver to position the cameras. "We have to control the cameras and keep track of the movements," says Brown.

Growing. Both Pro-Log and Mostek are stepping up production and rounding out their families. "We have one to two cards a month under development," comments Ken Marks, marketing technical support manager at Pro-Log. "About the only support product not yet provided is a bubble-memory module," says Ron Baldrige, a Mostek marketing manager.

If the STD concept has a limita-

tion, it would have to be that the bus itself could never be upgraded to accept 16-bit data or a direct addressing range larger than 64 kilobytes. All 56 of the signal lines are currently dedicated, so expansion means rethinking definitions.

So far, Z80 CPUs have been put on the STD bus by both Pro-Log and Mostek. Pro-Log also offers cards employing the 8085 CPU and, just recently, the 6800. But there is no reason hybrid chips—16-bit processors with 8-bit buses like the 6809 and the 8088—cannot be put on the STD bus later. □

Medical electronics

Rf used to fight cancer

Experimental fever therapy in which body is heated to as much as 50°C shows encouraging results

by James B. Brinton, Boston bureau manager

Medicine is attacking cancer with electromagnetic radiation, from a few megahertz to microwave frequencies, and the results are encouraging. The heating produced by radio-frequency radiation often weakens and sometimes kills cancer cells. In addition, it also seems to enhance other cancer therapies.

Such heating is part of a larger thrust in cancer treatment called hyperthermia, or fever therapy. It is based on the simple technique of heating either a tumor or a whole body to a temperature that normal cells can withstand but cancer cells cannot. The use of hot baths and other "direct" heat treatments is not new, and interest in rf heating has been growing steadily in recent years because it offers good temperature control and because its effect can be as localized as the physician desires.

Pluses. There are other advantages, too. According to Dr. Howard M. Shapiro, chief of cytokinetics at Boston's Sidney Farber Cancer Institute, hyperthermia "doesn't 'depress' the bone marrow [impairing the body's response to disease], and it won't lead to nausea, vomiting, or hair loss, as will ionizing-radiation therapy. Nor is there any interference with surgical wound healing."

What's more, he continues, "it is suitable for use with high-risk or feeble patients. Its side effects are few and modest, and those that exist are different from those of other cancer therapies [making it possible

to combine other therapies with hyperthermia]. Finally, rf heating sometimes can be used on inoperable tumors. It's interesting stuff."

It becomes even more interesting in the light of research results like those of Dr. J. Y. Kim and his associates at New York's Memorial Sloan Kettering Cancer Center. Kim combined rf heating at 27.12 MHz with ionizing-radiation therapy in the treatment of malignant melanoma, a tumor type known for its resistance to ionizing radiation. He

treated two groups: one with the combined therapies, and another with ionizing radiation alone, with the latter group acting as an experimental control.

Kim heated the tumorous tissue to a minimum of 42.2°C, holding the temperature for 30 minutes just prior to radiation therapy. Six months after this combined therapy, 16 of 18 tumors in nine patients had "completely responded," but only 1 of 8 tumors treated with radiation alone had responded.

A tailored system

"We hope the BSD-1000 will give researchers the kind of experimental control they need to generate convincing results," says Ted V. Jensen, director of marketing for the manufacturer, BSD Corp. Introduced in late February by the Salt Lake City, Utah, firm, the BSD-1000 may be the first system especially developed for radio-frequency hyperthermia research. It combines a microprocessor-controlled rf system with cathode-ray-tube displays and hard-copy printout of experimental parameters.

Its rf system covers a range from 10 to 2,500 megahertz, making it possible for the researcher to control the depth of rf penetration, and thus the depth of heating. Lower frequencies penetrate more deeply; higher ones are restricted to areas near the surface of the body.

Temperature is measured in the tumor with nonmetallic thermistors. Their output is fed to a Z80 microprocessor, which in turn controls rf output. The result is temperature control to within $\pm 0.1^\circ\text{C}$.

To avoid confusion with ambient fields or rf reflections, the BSD-1000 comes with a walk-in screened room lined with rf-absorbing material. Large enough for studies on large animals or humans, its rf-tight construction also allows experimentation at all frequencies without interfering with other uses of bands not reserved for medical use.

BSD is selling the system for about \$117,000. That's not much above cost, but the company is philanthropically supported, making profit less of a concern. "We want to keep price down," says Jensen, "and make hyperthermia available to as many researchers as possible." He expects to sell or lease about 20 systems this year, with early units going to the Loma Linda (Calif.) University School of Medicine and the University of Utah.

What about clinicians? "Of course, some of these systems are going to make their way into clinical use; we can't stop that. But we are selling a research tool, not a treatment," he says, making a distinction that may be more important to the regulators of such devices at the Food and Drug Administration than to cancer victims.

A report by Harvey J. Hindin in the April 12 issue (p. 85) explored research on microwave detection of tumors. This article discusses experimental treatment of tumors.

Kim's results could mean two things for future cancer patients. First, some radiation-resistant tumors could be treated more successfully using the combined approach. Second, with hyperthermia, smaller doses of radiation might be required than are needed now.

The research of Drs. J. A. Dickson and S. A. Shah is typical of animal studies done using rf hyperthermia. Working in England at the cancer research unit of the Royal Victoria Infirmary, Newcastle-upon-Tyne, the experimenters implanted tumors in rabbits and let them grow until some had become as large as 22 millimeters. Others spread throughout the animals' bodies. Using a 13.56-megahertz rf heater from Critical Systems Inc., Palo Alto, Calif., they heated the tumors to 50°C for 30 minutes. In the following six to eight weeks, 10 of 15 tumors regressed, and metastasis, or cancer-spread sites, disappeared as well.

Dickson and Shah prefer rf hyperthermia over other forms, most of which they find slow, cumbersome, and ineffectual. The pair also tried electrocoagulation hyperthermia and found it rapid, but temperature was hard to control and the coagulator left a slow-healing, easily infected wound. There was only one regression in 18 rabbits treated with electrocoagulation.

Explanations. There are several theories that try to explain the effect of hyperthermia. Shapiro offers another. Many tumors have concentric layers of tissue. "The center is often dead, he notes, "and is usually surrounded by a layer of so-called dormant cells with little circulation. Around this is a fast-growing surface layer. If you raise tissue temperature, the heat will be carried away from normal tissue far more efficiently than it will be removed from the tumor. Where you have heat, you have changes in cell pH and other factors which can kill cancer cells. That's the important thing."

If the news is all good, why isn't medicine rushing to use hyperthermia? There are several reasons, but most critical is the chicken-and-egg problem with available equipment: there is so little rf hyperthermia equipment available that researchers

FLEX CIRCUITS MEAN SECURITY

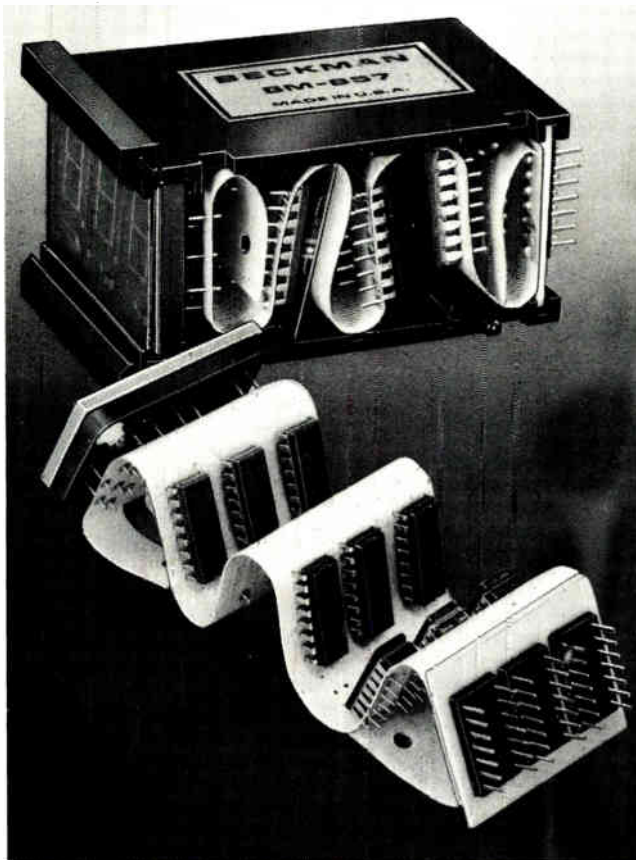

Add security to your design and do several jobs at once with R/flex circuits.

Heightened reliability and lowered costs are assured by elimination of multiple circuit boards and jumpers.

Labor savings, too, with components mounted directly on the circuit—manually or automatically inserted. Stiffeners can be added where needed.

R/flex circuits can be made in one or more layers in a variety of shapes and sizes, with or without plated-through holes.

ROGERS

Rogers Corporation
Chandler, Arizona 85224
(602) 963-4584

EUROPE: Mektron NV, Gent, Belgium JAPAN: Nippon Mektron, Tokyo

For Information Only 88
For Immediate Need 89

WHAT KIND OF FAILURES CAN YOU EXPECT IN YOUR DIGITAL DEVICES?

What are the failure modes; what are the mechanisms? What are their distributions? What screens or tests are used to weed-out deficient devices?

Learn to identify causes and cures by reading:

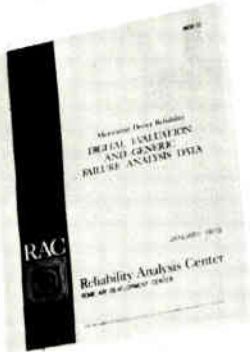

DIGITAL EVALUATION AND GENERIC FAILURE ANALYSIS DATA

- Burn-in and environmental/screening test results • SSI and MSI digital devices; TTL, CMOS, PMOS, ECL, STTL technologies; hermetic DIP, plastic, hermetic flatpack encapsulation • Failure modes and mechanisms distributions • Constituent

failure modes • Recommended screens/tests for die-related and package-related failure modes • Over 300 pages

• Ordering No. MDR-10. \$50 per copy, \$60 non-U. S., prepaid

RAC



Reliability Analysis Center

RADC/RBRAC • Griffiss AFB, NY 13441 • Tel. (315) 330-4151; Autovon: 587-4151

RAC is a DoD Information Analysis Center Operated by IIT Research Institute

Circle 90 on reader service card

PCB Problems?

Try Kalmus Reliability..

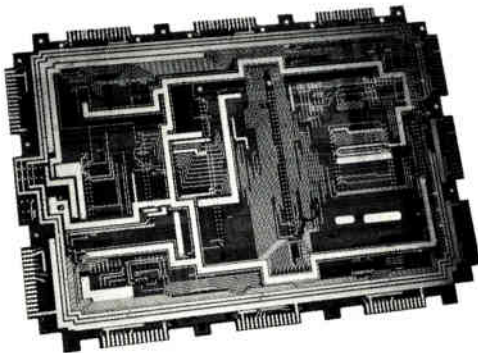

If you're a printed circuit board user, you know what poor quality boards can do to production schedules and profits. As rejections go up, schedules get longer and profits get shorter.

If you want quality you can rely on from a supplier you can depend on—give Kalmus a try. We stand ready to meet your most demanding requirements for single and double sided boards or boards with plated thru holes.



Send for our free facilities brochure.

KALMUS & ASSOCIATES, INC.
2424 South 25th Avenue, Broadview, Illinois 60153
Phone: 312-343-7004

90 Circle 229 on reader service card

Probing the news

have used jury-rigged microwave ovens, ancient diathermy machines, and costly custom systems. And although the experimental results have been exciting to many, the variety of equipment used makes it hard to generalize from published reports and thus difficult to design effective hyperthermic treatment. This holds back clinical use of hyperthermia, and the lack of a market holds back equipment producers. (See "A tailored system").

There are also questions of technique. For example, should the tumor alone or the whole body be heated? Some research indicates that whole-body hyperthermia may be less effective, and thus one group favors localized heating. Another group figures that there is always a risk of cancer having spread by the time it is discovered and that whole-body hyperthermia is better, as it would treat unknown cancer sites.

Finally, some fear that rf heating may help spread a cancer even as it kills it. Because circulation in the normal tissue surrounding a tumor increases with temperature, doctors are afraid that cells might slough off a tumor and be carried in the blood to another part of the body. This is an obvious area for future research.

In use. Meanwhile, a few physicians are trying to use rf hyperthermia. For now, it is a treatment of last resort, used largely on terminal patients when other therapies have failed, or on individuals with otherwise untreatable cancers—say, large tumors involving the head that cannot be removed surgically.

That seems to be about all that can be done until there is either more experimental data available or more rf-hyperthermic equipment on the market. "What's needed are firm research results based on well-controlled experiments," says Shapiro. "Hyperthermia looks good, but it still has a lot of people to convince. Blue Cross/Blue Shield won't pay for rf hyperthermia treatments and the Food and Drug Administration will have to pass on the effectiveness of any hyperthermia equipment sold for clinical use." Until then patients may just have to wait. □

Electronics / April 26, 1979

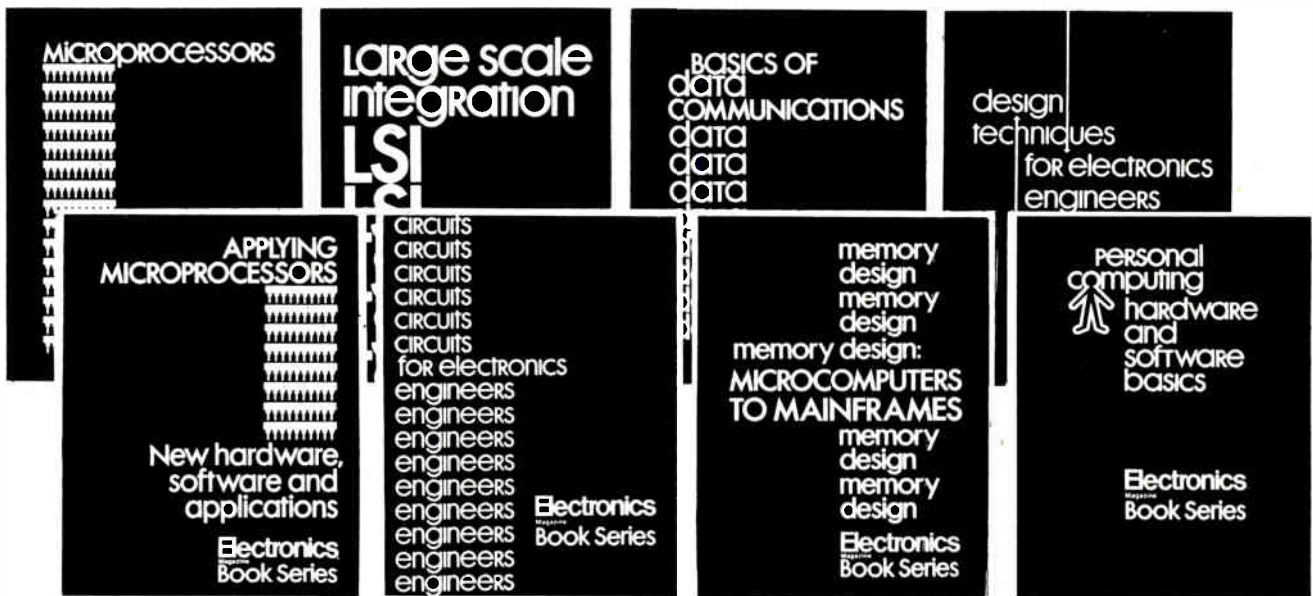

Electronics Magazine Books

1. Microprocessors

What you must know about available microprocessor technology, devices, information, 4th printing. \$8.95

2. Applying Microprocessors

2nd and 3rd generation technology. 26 detailed applications from data networks to video games. \$9.95

3. Large Scale Integration

Covers the basic technology, new LSI devices, LSI testing procedures, plus system design and applications. \$9.95

4. Basics of Data Communications

Includes 47 articles from Data Communications magazine covering more than 11 key areas. \$12.95

5. Circuits for Electronics Engineers

Contains 306 circuits arranged by 51 functions from Amplifiers to Voltage Regulating Circuits. Saves design drudgery. \$15.95

6. Design Techniques for Electronics Engineers

Nearly 300 articles drawn from "Engineer's Notebook." A storehouse of design problem solutions. \$15.95

7. Memory Design: Microcomputers to Mainframes

The technology, devices, and applications that link memory components and system design. \$12.95

8. Personal Computing: Hardware and Software Basics

More than 50 articles from leading publications, including specifications, helpful hints, subject index. \$11.95

Electronics Magazine Books
P.O. Box 669, Hightstown, NJ 08520
(609) 448-1700, ext. 5494



If after my 10-day free-trial examination I am not fully satisfied I understand that my payment will be refunded.

Payment enclosed Bill firm Bill me

Charge to my credit card:

American Express Diners Club
 Visa Master Charge*

Acct. No. _____ Date Exp. _____

*On Master Charge only, first numbers above name _____

Name _____ Title _____

Company _____

Street _____

City _____ State _____ Zip _____

Signature _____

No. of Copies	Title	Price
_____	1. Microprocessors	\$ 8.95
_____	2. Applying Microprocessors	\$ 9.95
_____	3. Large Scale Integration	\$ 9.95
_____	4. Basics of Data Communications	\$12.95
_____	5. Circuits for Electronics Engineers	\$15.95
_____	6. Design Techniques for Electronics Engineers	\$15.95
_____	7. Memory Design: Microcomputers to Mainframes	\$12.95
_____	8. Personal Computing: Hardware and Software Basics	\$11.95

Discounts of 40% on orders of 10 or more copies of each book.

Computers

New architecture goes with flow

Data-flow concept developed at MIT uses parallelism to do away with RAM, program counter, CPU

by James B. Brinton, Boston bureau manager

After 12 years of study, researchers at the Massachusetts Institute of Technology are getting ready to build a different kind of computer. The data-flow computer exists only on paper, but by late summer, an engineering prototype might be operating and pointing the way to future machines that could be smaller, cheaper, and 50 to 100 times faster than traditional designs.

Almost all currently available computers use a random-access memory, a program counter, and a central processing unit (CPU). Instructions and data are fetched from

the memory in a sequence monitored by the program counter; successive operations like add, compare, and multiply are performed in the CPU until the program has run its course. But most problems have a lot of parallelism; their solution involves many operations that could be done simultaneously. And that's where the data-flow concept comes in.

Old and new. A data-flow machine has no central processor. Instead, it has a processing section with tens, hundreds, or thousands of processing units—each perhaps equivalent to a simple arithmetic and logic unit or

an input/output processor. There is no RAM, either. Instead, there is a memory section with a potentially large number of cells, each holding operating code, operand, and destination address. The usual synchronous clock, program counter, and storage registers are absent, too. Instead, a packet-switching system called an arbitration network directs the output of a memory-section cell to an appropriate processor unit of the system.

Each processor unit crunches its part of the problem and sends a "result packet" consisting of a cell address and an operand to a distribution network, which routes it to a cell for storage.

The leader of the group that has developed MIT's data-flow concept is Jack B. Dennis, a 47-year-old professor of computer science and engineering and head of the computation structures group of the Cambridge, Mass., institute's Laboratory for Computer Science. Dennis once sketched a data-flow machine 100 times more powerful than a \$10 million IBM 360/91. The paper machine would have been about as compact as a large mini—"I could have installed it in my office," says Dennis—and would have a 200-megahertz instruction rate, although Dennis points out that the figure is a little misleading. Not only are many instructions being executed almost simultaneously, but also data-flow instructions do more than instructions used in typical computers.

The hardware. Dennis's group is finishing the hardware design for a data-flow machine, and so far it seems as if data flow and large-scale integration were made for each

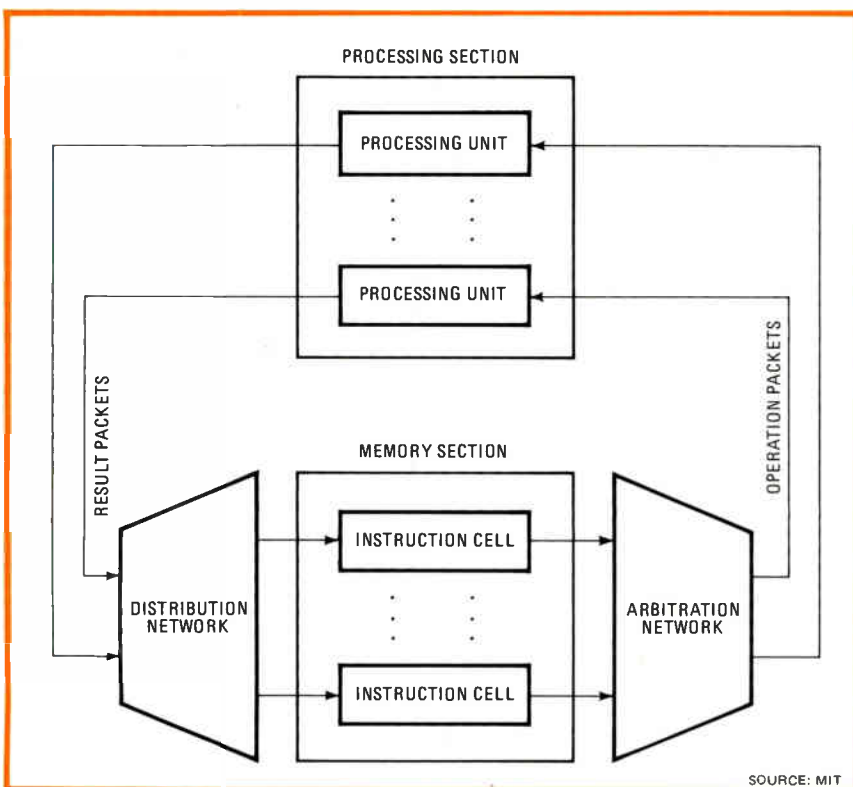

Moving information. Data-flow computer architecture developed at MIT could lead to a computer that is smaller, less expensive, and 50 to 100 times faster than present systems.

YOU DON'T HAVE TO SEE THE LIGHT TO KNOW THE WAY.

Maybe you can't see the light from our infra-red LED components, but we'll show the way to successful opto design.

To start with, our SEP and SDP 8000 series comes in a low cost plastic package and offers a reliable replacement for the TIL 31, TIL 81, LED 55 series and L14G series.

And our photodiodes, phototransistors, photodarlington and GaAs diodes make up the broadest line of opto components in the industry.

Already, they've been highly successful in applications like automobile cruise controls, business machine paper detectors, vending machine and telephone coin detectors, smoke detectors, industrial controls, even fiber optics.

Or if you'd rather buy pre-assembled products, we offer industry standards in slotted interrupter



modules, optically coupled isolators and fiber optic modules. You can even get assemblies custom designed for your application.

So if you've got an idea for an optoelectronic design, let us know. We'll show you how to make it shine.

Give us a call at 214/234-4271.

Or write us at 830 East Arapaho Road, Richardson, Texas 75081.

Spectronics
A Division of Honeywell

Still the best L-C-R test

solution for under \$1000

fast digital accuracy
for L,R,C,G and D



You can order ESI's Model 252 Digital Impedance Meter on a 2-week Free Trial basis, because we know the first several hundred buyers agree it's the most cost-effective tester on the market for reactance (L,C) and loss (D,R,G). Its performance rivals machines costing three to four times as much and its reliability is second to none.

It's simple, fast and accurate and comes with four-terminal Kelvin Klips®. Options include an autorange version (Model 253), a low frequency Model 254 (120 Hz), special sorting fixture and front panel dust cover. Check these other features:

- Lightweight; tiltstand handle.
- 0.25% basic accuracy.
- Wide ranges (especially on autorange option).
- 1 kHz test frequency (120 Hz optional).
- Four measurements/sec.
- External bias.
- 4-terminal connection.
- Analog outputs.
- Low power design.
- Large 3½ digit display—no manual balance to fuss with.
- Input protection.
- Convenient calibration.

2-WEEK FREE TRIAL

Order Now or Send for New Full Color 8-page brochure!



esi.
ELECTRO
SCIENTIFIC

Electro Scientific Industries
13900 N.W. Science Park Dr.
Portland, Oregon 97229
(503) 641-4141

Circle 94 on reader service card

Probing the news

other. "In our early machines, we might use only one or two types of processing unit, perhaps a maximum of four if we need the specialization," he says.

He goes on to project as many as 512 processing sections, each with several processing units, for a possible total of 2,048. There would be a similar number of cell blocks, composed of 16-byte-deep cells and logic. To switch and steer the operation and result packets, there would be networks of two-by-two-port routers, each consisting of a pair of multiplexers, 8 to 16 bytes of buffer memory, and control logic. A data-flow computer could contain thousands of routers in its arbitration and distribution networks. These relatively simple circuits are good candidates for LSI.

When the hardware is assembled, the group will use its VAL language to program the machine. VAL, for value-oriented algorithmic language, "is complete enough now to allow coding of large scientific programs," Dennis says, adding that he expects VAL to develop into a general language with wide applications.

Industry response. Meanwhile, industry is keeping a low profile, according to Dennis. "Only Texas Instruments has an in-house data-flow program, to my knowledge," he says, noting that TI also has an in-house application for a fast computer in its seismic data-processing business. And Burroughs Corp. is supporting a form of data-flow work at the University of Utah.

If data flow is not only potentially cheap because of its LSI implementation, but lightning fast as well, why isn't there more industry interest? It is not because data flow is unsuited to general-purpose work. Dennis points out that "IBM and others have a large investment in existing software, and for data flow to be most useful, programs now written in Fortran, PL-1, and Cobol would have to be rewritten in something like VAL." The alternative would be to develop a translation system to convert standard programs into something that would take advantage of data flow's parallelism. □

If this magazine is worth your time, it's worth 65¢.

Drop off the routing list. Avoid the Perils of Passalong. Get your own fresh, unclipped copy mailed to your home or office. \$17 (65¢ per issue) for a one-year U.S. subscription. (\$19 in Canada.) Turn to the subscription card in the back of the magazine. If somebody beat you to it, write: Electronics, P.O. Box 430, Hightstown, N.J. 08520.

Neff Series 500 Measurement & Control I/O. One System. Versatile.

Most computer-based measurement and control applications have one problem in common — a variety of diverse signals. Each with its own interface and control problems, and any one capable of generating bad data and destroying system performance.

The Solution?

Neff Series 500. It's a complete measurement and control subsystem with a plug-in standard interface to your computer. The Series 500 is compatible with virtually any process or measurement I/O signal. The system is supplied with complete software and uses only one of the computer's I/O ports.

Solving Your Problem

Many standard features assure a Series 500 configuration to match *your* requirements.

Versatile Input Structure Plug-in function cards accommodate a variety of input signals including analog, TTL, contact closures and frequency.

Control Signals Computer controlled signals are generated in the Series 500 for driving elements requiring analog levels, TTL signals, contact closures and frequency.

On-Board RAM The Series 500 contains a 4096-word RAM in which the computer stores scan lists and instructions to control the peripheral devices.

Remote Operation A Serial Controller permits the operation of systems located at eight or more separate remote sites — up to 20,000 feet from the computer.

Expandability All systems are expandable at both local and remote sites.

Analog Input The Series 500 supports operation of the Neff high-performance analog input subsystems - the most powerful and versatile in the world.

These are just a few of the reasons for Series 500's success. The rest are described in our new full-line catalog. Send for it today.



1088 E. Hamilton Rd., Duarte, Calif. 91010
Tel. (213) 357-2281 TWX 910-585-1833

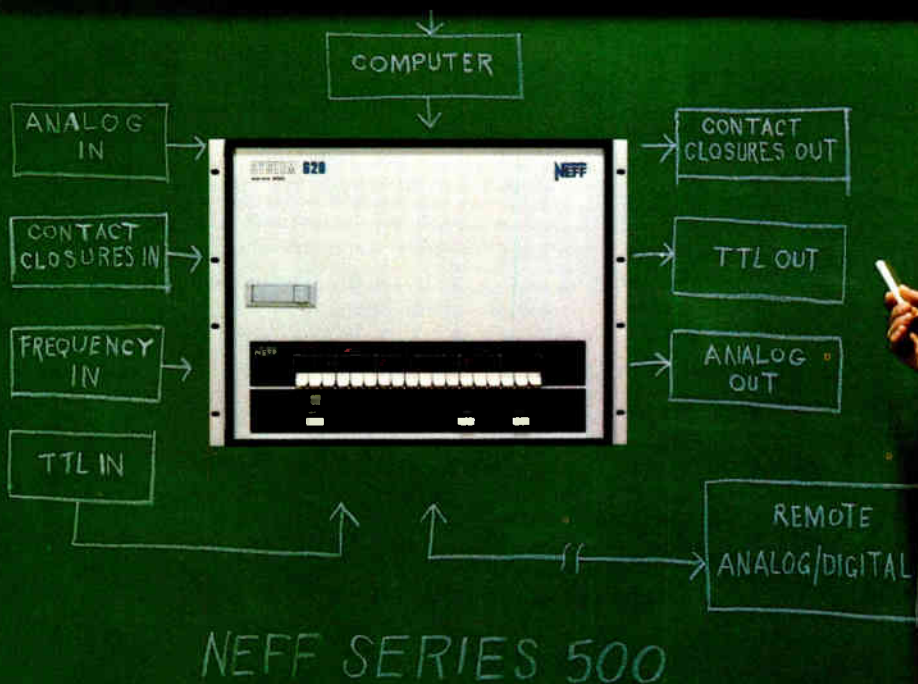

Optoelectronics

Display meeting looks at computers

Half of papers to be presented at SID conclave are related to that area; show also is heavy with papers from overseas

by Howard Wolff, Assistant Managing Editor

Trend watchers will have a field day in Chicago early next month at the annual meeting of the Society for Information Display. For the meeting—officially it is the International Seminar/Symposium and Exhibition, to take place May 7-11 at the Chicago Marriott—will put the spotlight on two important tendencies in display technology in particular and in technology in general.

In the first, the movement is toward computers. "About 50% of this year's papers are tied up with computers in one way or another," says program chairman Philip M. Heyman of RCA Corp.'s David M. Sarnoff Laboratories in Princeton, N. J.

The second trend, a more ominous one, has to do with the direction of research and development in the United States. "Several years ago," says Heyman, "about 20% of the papers were from foreign countries. Last year it was 35%, and this year the figure has jumped to 50%. Where is American R&D going?"

Syllabus. All told, the conference will be packed with nine technical sessions, two panel discussions, and four tutorial seminars. Though the subjects of most of the nine sessions are predictable—flat panels, cathode-ray tubes, projection systems, and the like—one will deal with nonimpact printing and another with high-density information storage.

In the session on nonimpact printing, three out of five papers are from Japan, two by a team from Oki Electric Industry Co. Those engineers,

led by S. Nakaya, will discuss their use of low-cost paper with flat-bed scanning for a gray-scale recording system for picture facsimile or TV hard copy; they will then describe a system of high-speed thermal recording in which parallel drivers heat the head elements instead of multiplexing them.

In the session on high-density storage, Hsu Chang of the IBM Research Center in Yorktown Heights, N. Y., will review the potential of bubble and charge-coupled devices; K. K. Bulthuis of Philips Research Laboratories in Eindhoven, the Netherlands, will describe an optical disk system based on a gallium-arsenide diode laser; R. A. Bartolini and A. E. Bell of RCA's Sarnoff labs will review playback media for available optical-disk recording systems; and a method of photographic replication of full-bandwidth NTSC video signals that have been laser-recorded on thin metal films will be described by D. G. Howe, H. T. Thomas, and J. J. Wrobel of Eastman Kodak Co., Rochester, N. Y.

LCDs. The busiest technical session is the one on liquid-crystal displays, with eight papers. Two Britons, I. A. Shanks and P. A.

Holland of the Royal Signals and Radar Establishment in Malvern, Worcs., will describe an addressing method to drive LCDs in single-value displays [*Electronics*, March 29, p. 70], and two Americans, A. L. Berman and G. Kramer of Beckman Instruments Inc. in Fullerton, Calif., will outline a method for constructing light-field pleochroic LCDs.

Five papers are from Japan: from Nippon Electric Co.'s team, led by T. Ueno, will come a description of a cholesteric dye display with dark characters on an electrically driven background; and a group from Hitachi Ltd. led by K. Odawara will discuss an 80-character alphanumeric system for computer terminals. A twisted nematic layer device will be described by T. Uchida, Y. Ishii, and M. Wada of Tohoku University in Sendai, and two-frequency addressing of a 56-line twisted nematic display using an improved material will be the subject of a group from Suwa Seikosa Co. of Nagano-ken led by M. Hosokawa. Finally, C. Tani heads a Nippon Electric team that, working with O. Kogure of Nippon Telegraph and Telephone Public Corp., produced low-power storage matrix LCDs. □

Slim picture. Flat-panel vacuum fluorescent display from Ise Electronics Corp. of Japan will be described at SID annual meeting.

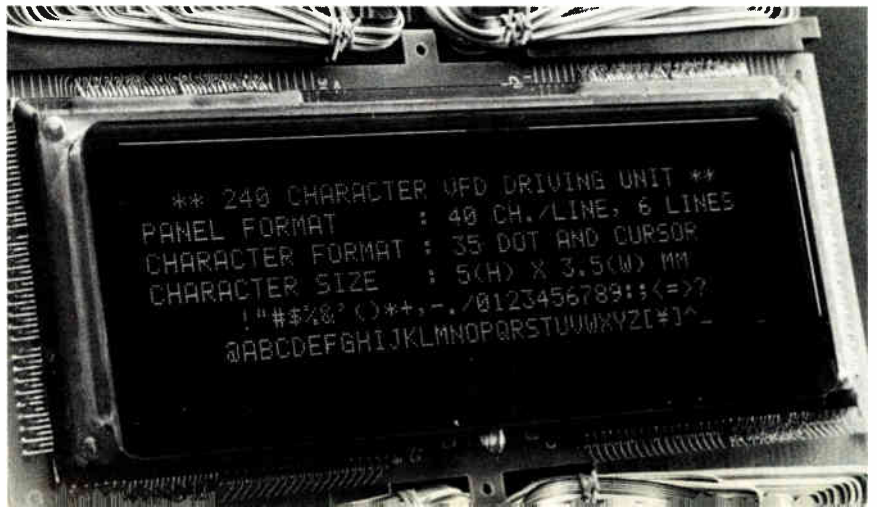

THE BEST-KEPT SECRET IN OPTO-ISOLATORS.

70% of all industry standard opto-isolator types can be found at Litronix.

Not too many folks know Litronix has one of the broadest lines of opto-isolators around. We've told you about our LED displays and

lamps, photodetectors, IR diodes, et al. But we haven't said much about our opto-isolators. Until now.

We have almost two dozen single channel couplers. Two dual couplers. And our exclusive quad coupler. Listed below are the more popular types.

Our pricing is aggressive. And there's

our tech support. We'll duplicate exotic test conditions, do parameter guarantees, and even help you trouble shoot.

So say the secret word (Litronix), and cash in on the best opto-couplers around. Litronix, 19000 Homestead Road, Cupertino, CA 95014. (408) 257-7910.

Part Number	Current Transfer Ratio %	Voltage	Description	No. of Channels
1L-1	20	2500	Photo Transistor	1
1L-5	50	2500	"	1
1L-15	6	1500	"	1
1L-74	12.5	1500	"	1
4N25	20	2500	"	1
4N26	20	1500	"	1
4N27	10	1500	"	1
4N28	10	500	"	1

Part Number	Current Transfer Ratio %	Voltage	Description	No. of Channels
4N32	500	2500	Photo Darlington	1
4N32A	500	2500	"	1
4N33	500	1500	"	1
1L-100	1000	2500	High Speed 75 nS	1
1L-101	1000	1500	High Speed 200 nS	1
1LCT6	20	1500	Photo Transistor	2
1LD74	12.5	1500	"	2
1LQ74	12.5	1500	"	4

litronix
AN AFFILIATE OF SIEMENS

THE LIGHTS FANTASTIC

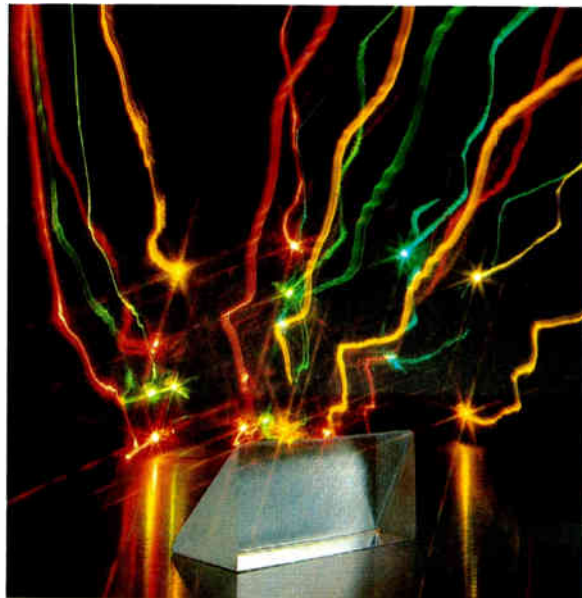

The Great Micro Power Op Amp Race: *It's easier to win when no one else begins.*



© PMI 1978

Lewis Carroll loved competition. In *Alice in Wonderland* the action frequently unfolds as some form of game or race.

The most nonsensical of all is the Caucus Race. As Alice discovered, it's a race where everyone wins, which is the same thing as saying that no one wins. In the I.C. business, there's a lot of that going around.

As the Dodo explained to Alice, for a Caucus Race you simply mark off a racecourse in a circle, and then everyone lines up around the course. The competitors begin running when they like and they stop when they like, so that it isn't easy to tell when the race is over.

In Carroll's Wonderland, the race lasted until the Dodo cried, "The race is over!", following which the

runners stood panting around the circle asking, "But who has won?"

"Everyone has won," said the Dodo, "and all must have prizes."

In Linear Wonderland, there has been kind of a Caucus Race going on for some time in the development of micropower operational amplifiers. A lot of people have jumped into the circle, run for a while and then stopped, so that the industry lost track of who was running or when the race would end.

But now it's official. PMI has declared, "The race is over!", as it announces the *OP-20*, the first *precision* op amp that runs on just microamperes and can be powered from either dual or single voltage supplies!

Of course, as Alice herself says, it's much easier to win a race when no one else begins. No one else *really* began in this race, either. A few thought they had and even thought they had won when they offered micropower op amps, without precision performance. That's about as absurd as calling the Mad Hatter's watch a watch, when it tells you the day of the month, but not what o'clock it is.

The Winner!

Look at these specifications and you'll see why we've declared the *OP-20* the winner in a race no one else has even begun.

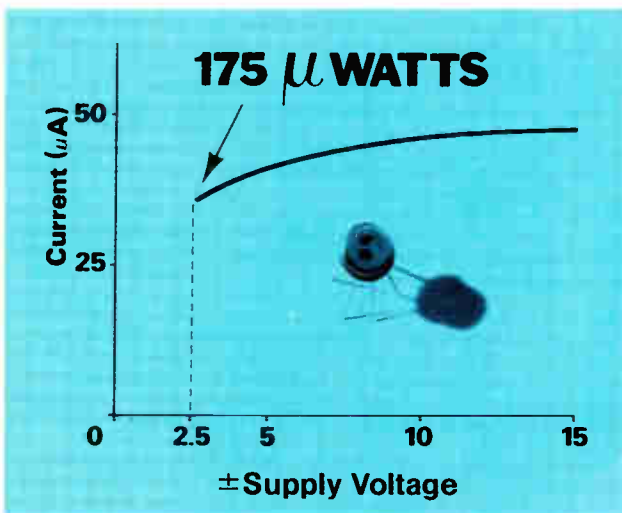

Only 175 Microwatts are needed to supply the *OP-20*—that's 35 microamperes from a ± 2.5 volt supply. And the supply current stays below 50 microamperes when powered by dual supplies to ± 15 volts.

In Linear Wonderland, everyone thinks you've got to trade off a lot of performance in order to get down to micropower supply levels. But PMI knows you don't win races that way. That's why with the *OP-20*, offset voltage is typically 100 microvolts and input offset voltage temperature coefficient is extraordinarily low at 1 microvolt/ $^{\circ}$ C. At 15 nanoamperes, input bias current is low, too.

Sound like a winner? We're not even done yet.

Open loop gain is over 1 million; common mode and power supply rejection ratios both exceed 110 dB.

So who is the real winner in this race?

Everyone out there in Linear Wonderland who wants a precision micropower op amp with single supply voltage. And beware the Jubjub Bird and the frumious Bandersnatch who try to mislead you by saying their Op Amps achieve the same results by being programmable. In the language of Linear Wonderland, which is not far removed from Carroll's "Jabberwocky," that means that *they* couldn't give you what you want, but if you play around with it long enough maybe you can do it yourself. The next time they come whiffing through the tulgey wood, smite them with your vorpal sword!

Versatility is a key to the *OP-20*'s success with designers. It can be powered with either a single 3 to

30-volt or a dual ± 1.5 to ± 15 -voltage source and the common mode input voltage swing is wide, from V^- to within 1.5 volts of V^+ .

There are a trillion sockets in Linear Wonderland and the *OP-20* will fit in many of them. It's at home in 4132, 741, and 4250 op amp sockets and it comes in TO-99 cans or minidips. It can also be bought as a 42 x 68 mil chip for hybrid applications.

Explore all the things you can do with the *OP-20*. After all, you can get them right now from your distributor's stock.

The *OP-20* is PMI's newest winner in Linear Wonderland.

As the White Knight said to Alice after the Red Knight rode away from the battle, "it was a glorious victory, wasn't it?" He knew that victory is still sweet even when no one else puts up a fight.

If someone beat you to the coupon, write to us for your sample. Or circle #200 for literature.

PART NO.	TEMP. RANGE	PACKAGE	Vos μ V TYP @25 $^{\circ}$ C	100+ U.S. OEM
OP-20BJ	-55/+125 $^{\circ}$ C	TO-99	80	\$14.00
OP-20CJ	-55/+125 $^{\circ}$ C	TO-99	150	9.00
OP-20FJ	-25/+85 $^{\circ}$ C	TO-99	80	6.50
OP-20GJ	-25/+85 $^{\circ}$ C	TO-99	150	4.00
OP-20HJ	0 $^{\circ}$ /+70 $^{\circ}$ C	TO-99	300	3.00
OP-20GP	0 $^{\circ}$ /+70 $^{\circ}$ C	Mini-Dip	150	3.50
OP-20HP	0 $^{\circ}$ /+70 $^{\circ}$ C	Mini-Dip	300	2.20



Precision Monolithics, Incorporated

1500 Space Park Drive

Santa Clara, California 95050

(408) 246-9222 TWX: 910-338-0528 Cable MONO

PMI'S "MAD AS A HATTER" OFFER:

*Of course we know it's madness to offer free samples but don't remind us. Just take advantage of us and order your complete *OP-20* package now.*

Check which type:

- OP-20GJ, OP-20GP
 I don't need samples, just send a data sheet.

Mail to:

PRECISION MONOLITHICS, INC., 1500 Space Park Drive
 Santa Clara, CA 95050

My name _____

Title _____

Company _____

Dept. _____

Address _____

City _____ State _____ Zip _____

Phone () _____

4E5005

VAX Software. Ask any user.

"VAX puts us on the leading edge — with tremendous power and a full-blown operating system."



*Dr. Herb Schwetman,
Assoc. Professor
Dept. of Computer Science
Purdue University
West Lafayette, Indiana*

Purdue's Department of Computer Science is involved in researching operating system performance, programming languages, and computer system security.

Because their experimentation requires heavy interactive use, they needed an alternative system to augment time-sharing on a CDC 6500.

Dr. Herb Schwetman, Associate Professor, explains what made Digital's VAX-11/780 so attractive. "We were intrigued because VAX provided a lot of the features and performance of a central facility — but for a lot less money."

Since Purdue's research involves state-of-the-art technology, VAX's advanced architecture and software were especially

appealing. "The operating system is set up very cleanly," says Dr. Schwetman, "Processes can operate independently. And that's a very good way to do it."

Also, VAX's 32-bit address space and large main memory give the Purdue researchers more flexibility. Dr. Schwetman says, "With VAX, we'll be able to double the size of the problems we can look at. In fact, VAX offers user programs more memory than is available on the big CDC 6500 downstairs."

"It's amazing," Dr. Schwetman concludes, "All this power — in a machine in this price range."

"We needed virtual memory software and fast real-time performance. VAX gives us both."

*Gary Willis, Program Specialist
Advanced Technologies Engineering
Laboratory
Ground Systems Department
General Electric Company
Daytona Beach, Florida*

At the Advanced Technologies Engineering Laboratory of its Ground System Department, General Electric designs color visual systems for flight simulators, primarily for the military.



The application demanded operating system software that could handle static simulation; but real-time performance was important, too. After a number of tests and benchmarks, General Electric decided on VAX.

Gary Willis, Program Specialist, tells us, "If you can imagine emulating a roomful of simulation hardware, you can see why we needed a virtual memory operating system. But since we have to compute a new image every 30th of a second in our real-time application, we also needed a lot of number crunching. VAX gives us both."

The VAX/VMS operating system and real-time dynamic performance are only part of what impressed General Electric. Says Willis: "Most military contracts require FORTRAN, and we're very pleased with what VAX gives us—very fast, very efficient FORTRAN, with super execution times."

According to Willis, VAX software is also getting high marks on ease-of-use.

"Our people are very pleased with how easy it is to translate FORTRAN programs from the PDP-11 series to VAX. Also, our programmers like the HELP command—especially those who are just getting used to Digital equipment."



"We were very impressed with the maturity of the VAX operating system. Everything that's supposed to work, works."

*Harry Hill, Program Manager
Ford Aerospace &
Communications Corp.
Western Development Laboratories
(WDL) Div.
Palo Alto, California*

Ford Aerospace performs large double precision floating point scientific computing for a variety of government projects.

When it was time to move to a larger computer, WDL's Harry Hill, Program Manager,

admits they were apprehensive about committing to a product as new as Digital's VAX-11/780.

"We were originally very leery of the new machine," says Hill, "Because it traditionally takes years to develop maturity. But the price was so good that we went ahead, and it's been very successful."

One feature that made VAX particularly attractive for Hill's application was the powerful virtual memory. He tells us: "By going to VAX, we were able to eliminate memory mapping and let the machine just sit there and crunch numbers. It saves time and cuts down on the chances of messing something up."

Hill is also impressed with VAX's interactive and batch capabilities. "The multi-stream, multi-queue batch is one of the best systems we've ever seen."

The programmers' reaction? Says Hill, "Everybody is amazed."

Digital's VAX-11/780 represents the first truly integrated approach to hardware and software architecture. The result is one of the most advanced systems on the market. Extremely powerful, yet extremely easy to use.

But don't just listen to us. Send for our new brochure. And listen to our customers.

- Please send me the new "VAX—Ask Any User" brochure and detailed Technical Summary.
 Please contact me.

Name _____ Title _____

Company _____

Address _____

City _____ State _____ Zip _____

Phone _____

My application is: Education Medical Laboratory
 Engineering Government Resale Other

Send to: Digital Equipment Corporation, 146 Main Street,
Maynard, MA 01754, Attn: Communication Services,
NR-2/2, Tel. 617-481-9511, ext. 6885.

Digital Equipment Corporation International, 12 av. des
Morgines, 1213 Petit-Lancy, Geneva, Switzerland

In Canada: Digital Equipment of Canada, Ltd.

N-4-26-9

digital



“You get what you pay for.’
I’m tired of hearing that
lame excuse when an edge
connector can’t cut the mustard.
I need a reliable product
that’s backed up by
the people who make it”

Now you have it.

Switching to AMP's New Standard Edge Connector could be the most cost-effective move you make this year.

Because here at last in this new black beauty is the kind of reliability you need at a price you can live with.

The New Standard has been carefully designed and quality controlled to meet the specs we claim for it. No if's.

No and's. No but's. When it comes to specs, the buck stops at AMP.

At the heart of this unique edge connector is AMP's computer-designed bifurcated leaf spring contact. With its forgiving contacts and lower insertion force, The New Standard will accept commercial grade boards with the greatest of ease. Compensation for warped boards is no problem. You get excellent electrical connections.

Try AMP's New Standard. Priced the way you like it. Delivered the way you need it. You can also order them with our exclusive graphite impregnated contacts for longer wear life. It's available as an option on both The New Standard as well as on the complete line of AMP Low Profile Edge Connectors.

For the complete story call
(717) 564-0100, Ext. 8400.

AMP has a better way.

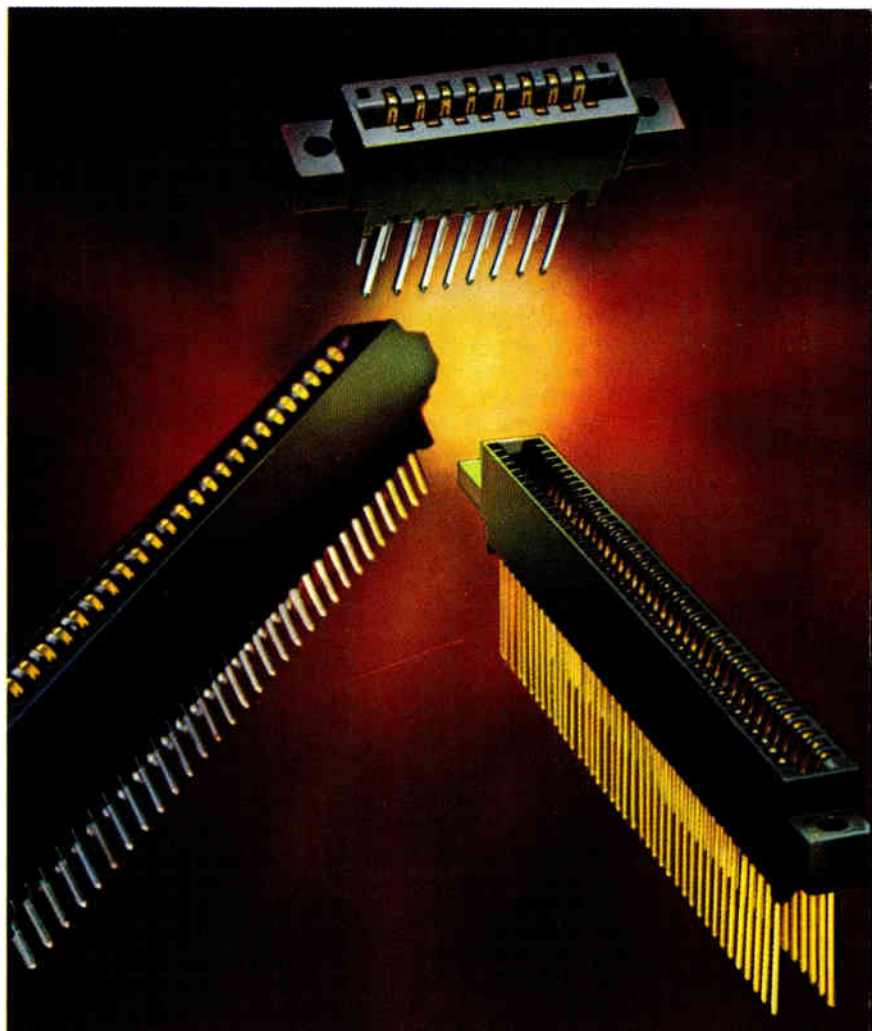

AMP announces "The New Standard."

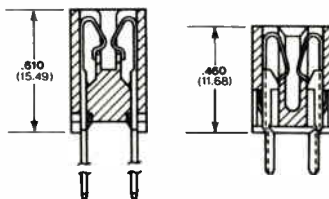
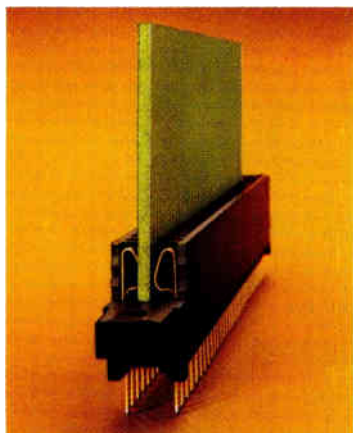

Low Profile versions are also available.

Some facts worth knowing about AMP Standard Edge Connectors.

Contact Rating: 3 Amp. (5 AMP low profile)

Contact Resistance: 12 Milliohms
(10 Milliohms low profile)

Operating Temperature: -55°C to +105°C

Voltage Rating (Sea Level): 1000 VAC

Insulation Resistance: 5,000 Megohms (min.
after humidity test)

Vibration Test: 10 to 500 cycles per second
(10 G's peak)

Engaged Forces: 6.5 oz. typical (.062" board)

Humidity Test: 90-95% (for 96 hours)

Where to telephone: Call AMP Standard Edge
Connector Information Desk
at (717) 564-0100, Ext. 8400.

Where to write: AMP Incorporated,
Harrisburg, PA 17105.

AMP is a trademark of AMP Incorporated.

Ask for our price and delivery on these
popular sizes. We'll surprise you.
Standard Edge Connector—Gold Plate

0.100 Centerline Conn.

4-530396-1	25 Pos.	3 Hi Wrap Type Post
4-530396-3	30 Pos.	3 Hi Wrap Type Post
4-530396-4	36 Pos.	3 Hi Wrap Type Post
4-530396-6	40 Pos.	3 Hi Wrap Type Post
4-530396-7	43 Pos.	3 Hi Wrap Type Post
4-530396-8	50 Pos.	3 Hi Wrap Type Post
1-530841-6	25 Pos.	0.187 Solder Tail
1-530841-8	30 Pos.	0.187 Solder Tail
1-530841-9	36 Pos.	0.187 Solder Tail
2-530841-0	40 Pos.	0.187 Solder Tail
2-530841-1	43 Pos.	0.187 Solder Tail
2-530851-2	50 Pos.	0.187 Solder Tail

0.125" Centerline

4-530825-6	28 Pos.	3 Hi Wrap Type Post
4-530825-7	30 Pos.	3 Hi Wrap Type Post
5-530825-0	36 Pos.	3 Hi Wrap Type Post
4-530825-0	40 Pos.	3 Hi Wrap Type Post
5-530825-2	50 Pos.	3 Hi Wrap Type Post
1-530842-7	28 Pos.	0.187 Solder Tail
1-530842-8	30 Pos.	0.187 Solder Tail
1-530842-9	36 Pos.	0.187 Solder Tail
2-530842-0	40 Pos.	0.187 Solder Tail
2-530842-2	50 Pos.	0.187 Solder Tail

AMP

Circle 103 on reader service card

When you've got it, flaunt it

High performance, high volume.

The high current switching device designers have been waiting for has arrived. Thanks to the efficiencies of second generation VMOS processing, Siliconix' 60 volt, 12.5 amp VN64GA is now in volume production, selling at volume prices and on distributor shelves today.

It's good news for anyone presently having to use bipolars in switching regulators, motor controllers and other high speed, high reliability power control applications. VN64GA switches 12.5 amps in 45 ns. Since VN64GA is a simple one-stage power driver, it's ideal for boosting the low current output of logic devices to higher voltages and currents. VGS threshold is only 2.4 volts.

VN64GA Specifications

 TO-3	BV_{DSS}	60 volts
	$I_{D(on)}$	12.5 amps
	$R_{DS(on)}$	0.4 ohms
	P_D	80 watts
	$t_{(on)}, t_{(off)}$	45 ns.

But enough. Our new 80-page VMOS Design catalog has all the details on VN64GA and the largest family of VMOS power FETs available — including new additions soon to come. For your free copy, call us today on our VMOS Hot Line: (408) 988-4110. Or write Siliconix, 2201 Laurelwood Road, Santa Clara, CA 95054.

To order VN64GA, contact our franchised distributors:

Alliance, Bell/Century, Cadence, Components Plus, Future, Hamilton/Avnet, Industrial Components, Pioneer, Quality Components, R.A.E., Wilshire, Wyle/Elmar and Wyle/Liberty.

 **Siliconix**



Our new 12.5 amp VMOS power FET is here

Megabit bubble-memory chip gets support from LSI family

Dedicated control and addressing chips, sensors, and driver waveform generators ease system interface problems

by Don Bryson, Dick Clover, and Dave Lee, *Intel Magnetics Inc., Santa Clara, Calif.*

□ Because of their potentially high density and nonvolatility, magnetic-bubble memory devices are destined to find diverse applications in areas ranging from low-performance terminals to high-performance mass-storage systems. However, to utilize the attractive capabilities of bubbles, the system designer must deal with an interface problem more challenging than that posed by semiconductor memories.

The designer, for example, must not only provide addressing and control logic for the memory device, but also precise current-pulse generation, low-level analog voltage sensing, and relatively high-current waveforms in a set of drive coils. For bubble memories to gain wide acceptance in the marketplace, therefore, their manufacturers must provide more than a memory device. An entire family of parts is needed to ease the designer's complex interface problem.

Now Intel Magnetics, a wholly owned subsidiary of

Intel Corp., has fulfilled these requirements with the introduction of a 1-megabit magnetic-bubble memory chip accompanied by a supporting family of large-scale integrated (LSI) circuits that not only provides an easy-to-use interface, but also retains the flexibility the user needs to configure a system according to his own requirements. Figure 1 is a block diagram of the generalized system concept developed by Intel Magnetics. Key ingredients are compatibility with the 8080/8085/8088 bus system, use of advanced LSI technologies, partitioning of control and data paths, and a degree of user programmability. Transparent handling of redundancy, automatic error correction, and power failure reset are built-in features.

Heading the family is the Intel Magnetics 7110, a nonvolatile, solid-state memory with a normal data capacity of 1,048,576 bits. The device includes additional memory that is normally devoted partly to error

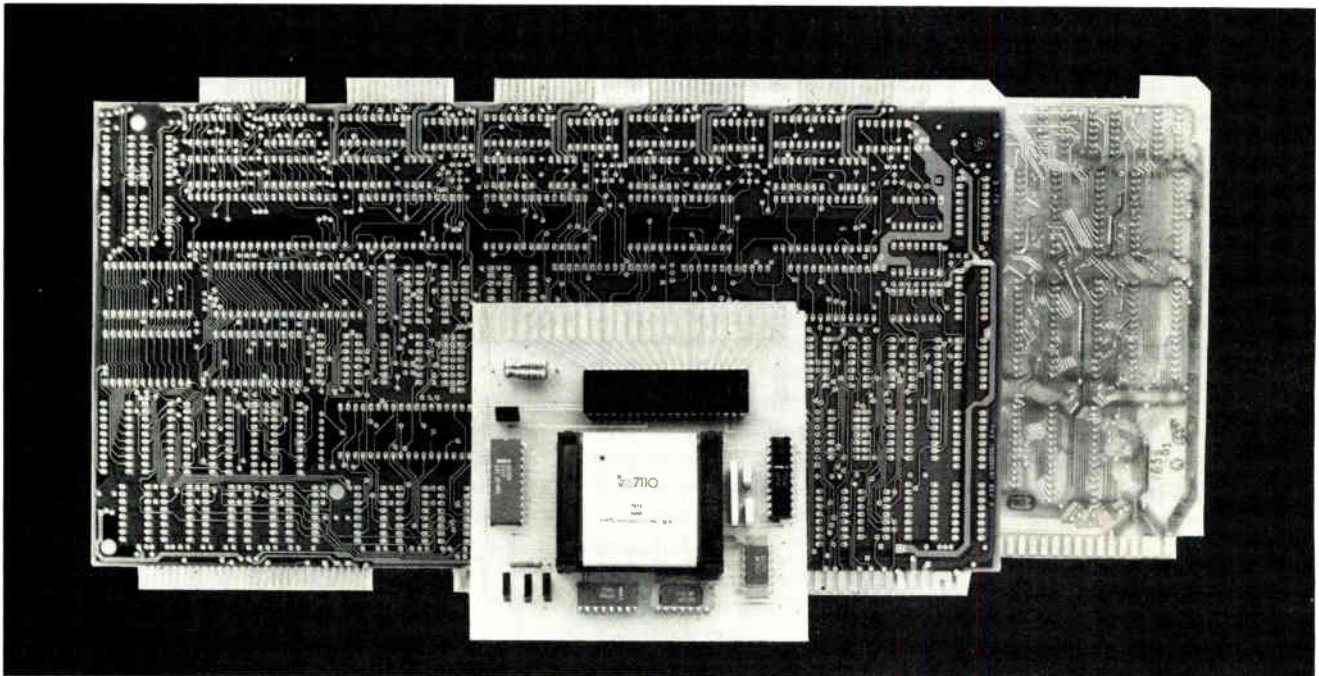

Space saver. Availability of Intel Magnetics bubble memory and supporting LSI family of control and driver circuits reduce space, component count for 1-megabit bubble system by order of magnitude, replacing two printed-circuit boards, four 256-K modules, and about 85 ICs.

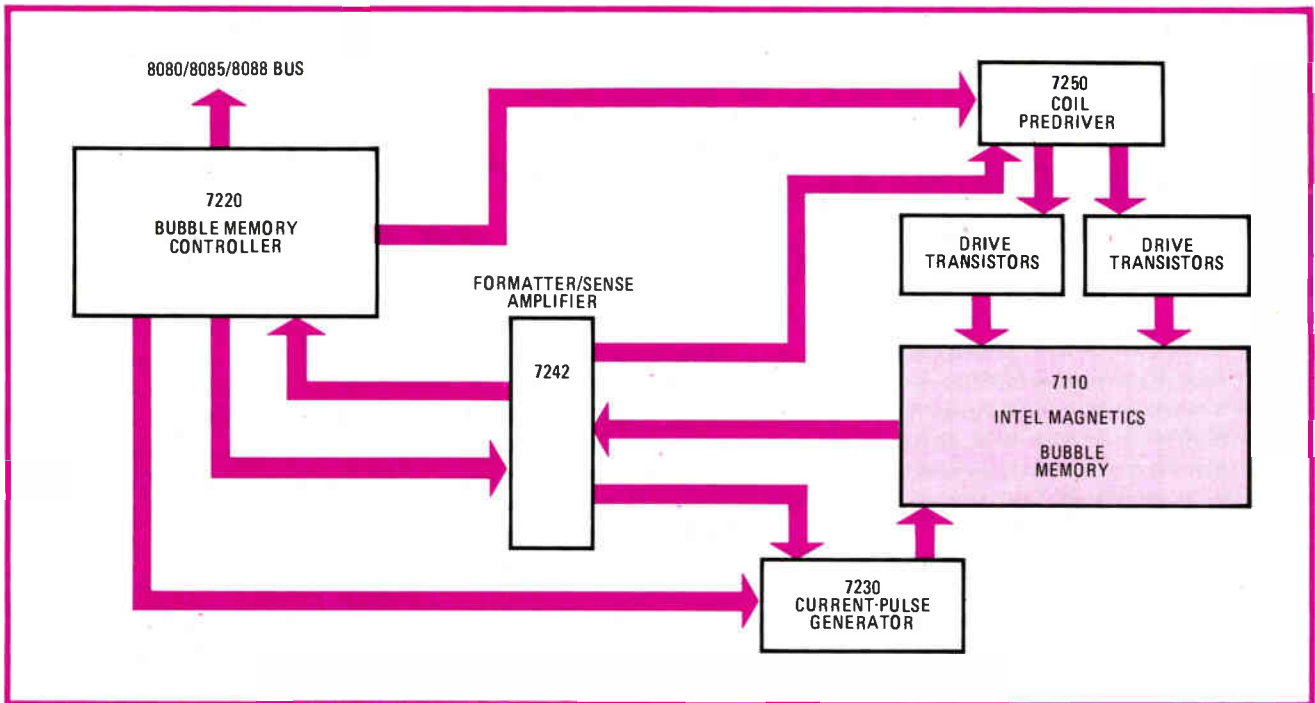

1. Minimum system. A complete bubble memory system with a storage capacity of 128 kilobytes can be implemented with only one 7110 bubble memory package plus four LSI devices along with two quad transistor packs. The entire system can fit on a 16-square-inch board.

correction and partly to extra storage in the form of redundant loops, to increase the yield of good devices. The accompanying interface circuits are the 7220 bubble memory controller, 7242 formatter/sense amplifier, 7250 coil predriver, and 7230 current-pulse generator. With these, designers can now begin product development using the memory, without concern for drive and interface details. They can treat memory and support electronics as a unique new mass-storage element.

The memory is expected to be used initially in microprocessor applications requiring 128 kilobytes to 2 megabytes of storage. These include terminals, word-processing systems, telecommunications, and process-control wherever nonvolatile storage is required.

The basic components of Fig. 1 can be used to build a minimum system of 128 kilobytes in a 16-square-inch board space. For larger systems, up to eight magnetic-bubble memories (MBMs) can be interfaced with one controller for a megabyte of storage. Through the 7220 bubble memory controller the system interfaces directly with the Intel microprocessor bus systems, so the memory can be treated as a slave to 8080, 8085, 8086, or 8088 host systems. Key functions of the system include binary data organization, standard +12- and +5-volt power supply operation, flexible multiple MBM organizations, single-page (512 bits, or 64 bytes) or multiple-page data transfers, and built-in error correction.

A 1-megabit MBM

The 7110 is a serial-parallel-serial shift-register storage device with a binary page organization. Its storage elements are cylindrical bubble domains, 2.7 micrometers in diameter, occurring in a thin film of magnetic garnet material grown by liquid-phase epitaxy on a gadolinium-gallium-garnet wafer. After the film is

grown, wafer-processing is similar to that used with silicon. Standard photolithography creates conductive and magnetic nickel-iron patterns on the chip. The permalloy patterns form storage loops, input/output tracks, and control elements. The permalloy elements are the usual asymmetrical chevron patterns.

The resulting 2-square-centimeter chip stores 2,048 pages, each holding 512 bits in turn divided into two channels of 256 bits, or 64 bytes. Figure 2 shows one channel of the 7110's basic organization and illustrates the separate block-replicate, block-swap organization. There are 128 data-storage loops per channel divided into two sections of 64 data loops each. A page address is selected and the page is shifted to the starting location for a read or a write operation.

The first part of the read operation nondestructively replicates the bits of the page in parallel on an output track to feed a detector bridge. The bits are shifted serially through the bridge so that the maximum data rate is twice the shift rate. In the write operation, the bits for a new page are first written serially on an input track. Again the maximum data rate is twice the shift rate. The bits shift until they coincide with the bits of the page in storage to be replaced. A swap operation then exchanges the new page for the old at the address location selected.

The performance of the device is readily estimated from the shift rate. The initial product, the Intel Magnetics 7110, will have a shift rate of 50 kilohertz and a storage loop 4,096 bits long. Therefore, the average random access time of a page is about 40 milliseconds. The maximum data rate is twice the shift rate, or 100 kHz. Page read and write times for the 7110 each require a minimum of 327 shift cycles, or 6.5 ms.

From this, the average data rate is 78 kHz (512 bits

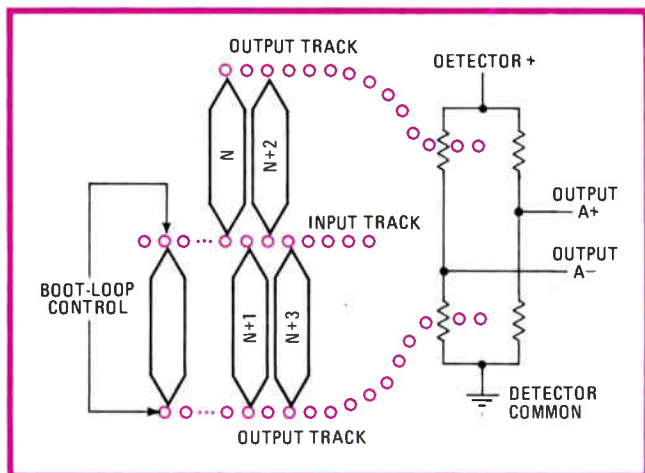

2. Organization. Basic bubble memory architecture has a serial-parallel-serial organization. Shown here in simplified form is one of two channels of the 1-megabit MBM. There are altogether 128 loops in each channel, plus a so-called boot loop whose function is to identify and keep track of the guaranteed-good loops.

per page divided by 6.5 ms). Most of the reduction from the maximum data rate is associated with the spare storage-loop overhead on the chip. Along with the 256 guaranteed data-storage loops holding the 512-bit pages, there are 64 additional loops. Sixteen of these are guaranteed good so an error-correction code of up to 32 bits can be appended to each 512-bit page. Up to 48 loops can be defective, so that in fabrication a few processing defects do not mean rejection of the chip. Defective loops can be isolated during testing so that they do not interfere with memory operation. Provisions are made in the support electronics to compensate for them. These spare loops, therefore, increase chip yield and hold down costs.

The boot loop

At the system level, the good storage loops and the spare loops must be identified so data is never entered into the spares. To handle this, the bubble memory chip has an additional loop, called the boot loop, that holds a loop-map code for that particular chip along with an index address code. When the system is turned on, the boot code is replicated at the detector. First the index address is located and sets up the address counter in the controller. Then the loop map is read and stored in the Intel 7242 formatter/sense amplifier (FSA). After this, page read or write can begin.

In operation, one page or a burst of pages can be read or written for a given system request. Upon completion, the bubble device itself can be stopped until the next request. This start/stop feature can reduce the average page access time in systems where successive page accesses are not random. Least recently used (LRU) and look-ahead algorithms can be used to put expected future pages at the locations corresponding to the start of the page read or write cycles.

Also at the system level the data rate can be increased by operating bubble devices in parallel. The Intel 7220 controller allows up to eight in parallel. With the 50-kHz 7110, the average bit rate then becomes 625 kHz. With two controllers and 16 7110s, the bit rate is 1.25 MHz.

TABLE 1: BUBBLE MEMORY SYSTEM PERFORMANCE

	One magnetic-bubble memory cell (MBM)	Four MBMs	Eight MBMs operated in parallel	Eight MBMs multiplexed one at a time
Capacity	128 kilobytes	512 kilobytes	1 megabyte	1 megabyte
Average data rate	62.5 kHz to 125 kHz	250 kHz to 500 kHz	500 kHz to 1 MHz	62.5 kHz to 125 kHz
Average access time	50 to 25 ms	50 to 25 ms	50 to 25 ms	50 to 25 ms
Power dissipation (100% duty factor)	6 W	20 W	40 W	11 W
Standby power	1.3 W	3.7 W	7.0 W	7.0 W
Board area	16 in. ²	45 in. ²	90 in. ²	90 in. ²

Sometime in the future a 100-kHz MBM, the 7112, will be offered with twice the data rate. Table 1 shows the range of expected performance characteristics encompassed by the 7110 and 7112.

Support components

The user interface is provided by the Intel 7220 bubble memory controller (BMC). The controller is a 40-pin LSI device implemented in Intel's HMOS technology. Figure 3 is a block diagram of the 7220 BMC. Major functions of the controller are to provide the bus interface, to generate all memory system timing and control functions, to maintain memory address information, and to interpret and execute user requests for data transfers.

The heart of the bubble system is the 7242 formatter/sense amplifier diagrammed in Fig. 4. The FSA is a dual-channel device that can interface directly with both channels of the memory. Three key functions of the 7242 are sensing the low-level bubble signals, handling the redundant loops, and buffering data. In addition, the user may choose a circuit for detecting and correcting burst errors. The 7242 FSA communicates with the 7220 BMC via a serial bus, so that a 20-pin DIP may be utilized. The operation of the FSA is discussed in more detail later. An advanced n-MOS technology was chosen to incorporate sensing and data-handling functions.

A Schottky bipolar process was chosen to implement the Intel 7230 current pulse-generator (CPG) because of the relatively high peak currents required. The 7230 CPG interfaces directly with the 7220 BMC and the bubble memory device and provides the fast, high-current pulses required by the latter. It consists of a reference-current generator, a power-failure-sensing circuit, and 12 current sinks switched on or off by the 7220 controller. The chip contains a power-down circuit that shuts off the current sources whenever the chip is disabled. The 22-pin device's logic diagram is shown in Fig. 5.

Finally, the support electronics makes it possible to drive the coils of the bubble memory. The peak currents required in the coil are beyond the capacity of standard IC devices, so a coil predriver (CPD) that interfaces the 7220 controller and discrete transistors has been developed. The Intel 7250 CPD is a C-MOS device in a 16-pin DIP that translates the TTL outputs of the 7220 controller into high-voltage, high-current signals that can be used

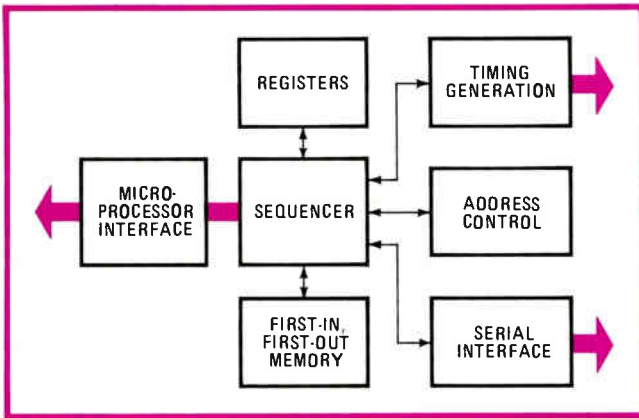

3. User interface. The 7220 controller is a complex LSI 40-pin device that provides the interface to the system bus, generates all memory system timing and control functions, and supervises the execution of data transfer requests.

to drive transistors. The logic diagram of the 7250 is shown in Fig. 6. Quad transistor packs are used to drive each coil. V-channel MOS field-effect transistors are preferred for the drivers, since they are fast, require no bias currents, and have a built-in diode to commutate the coil current when the transistor is turned off. However, the 7250 CPD has the ability to provide up to 200 milliamperes of base current for bipolar drivers.

System features

Since the system designer is given a complete set of LSI parts, he can concentrate on higher-level system objectives, instead of having to learn the intimate details of bubble memory interfacing. He saves still more time by working with a standard bus already familiar to him, rather than designing counter circuits and trying to convert millivolt signals into TTL voltage levels. The system operates from +12 V and +5 V only, with circuitry to monitor these voltages. Should the voltages drop below acceptable levels, it will shut itself down in an orderly manner, so that integrity is preserved.

Even though the details of interfacing to the bubble device are hidden, the support electronics are flexible enough to accommodate widely different system designs. Figure 1 shows the minimum system—that is, it contains only one bubble device (128 kilobytes) and the required support electronics. Figure 7 is a block diagram of a larger system containing eight bubble memory cells. Each contains a bubble device, a 7230 CPG, a 7250 CPD, and two quad transistor packages. A single 7220 BMC can directly control from one to eight bubble memories.

Expansion to larger systems can be accomplished in two ways. In the first approach, provisions are made in the BMCs for paralleling controllers. This provides greater word width at the bus, and each controller can still accommodate from one to eight bubble memory devices. In the second, each support device has a chip-select pin so that banks of devices can be switched into or out of the circuit under external control. The maximum number of devices in each bank remains eight. In addition to these two expansion modes, the 7220 BMC also has a chip-select input so that entire subsystems may be multiplexed (or, more typically, located at different I/O

addresses). This form of expansion involves the decoding of I/O or memory-address lines to create the chip-select input for the 7220 BMC. The amount of expansion is limited only to the number, usually quite large, of I/O or memory addresses available.

Although eight devices are included in the system in Fig. 7, the user retains the option of accessing data from only one. The controller transfers data and commands to the FSA over a serial bus. The controller addresses the 7242 FSAs by means of a time-division multiplexing scheme that allows individual addressing.

The role of the FSA

To communicate with the FSAs, the controller puts out a sync pulse that is passed in shift-register fashion along their daisy-chain configuration. Simultaneously, a data stream is put out on the serial bus. As each FSA receives its sync pulse, it examines the serial bus to determine whether it is being addressed. Note that each channel of the dual FSA can be individually addressed since the sync is passed internally from channel A to channel B. Commands are distinguished from data by a C/D pin controlled by 7220 BMC. The direction of data on the bus is determined by the mode the FSA has been set to by the controller. However, FSAs are forced to "listen" to the serial bus when a logic C/D line occurs.

Any FSA that is not addressed during a command automatically disables and removes itself from the bus. This action provides an added benefit, in that each FSA channel also has an enable output active only when selected. It is connected to the chip-select pins of the other support circuits, so each bubble memory device that is not needed for the present access remains powered down. The only restriction on the selection of devices to be accessed is that the number of channels to be accessed be binary (i.e., 1, 2, 4, 8, or 16) and that each multiple group be contiguous in the FSA daisy chain. For example, if the user's data rate requires that two bubble devices be accessed simultaneously, the two must be either devices 1 and 2 or 3 and 4, etc.

In any configuration, data is transferred in serial form and reassembled into an 8-bit byte by the 7220 controller. The serial bus operates at a minimum rate equal to 20 times the rotating field rate so that a bit of data can be transferred to or from each FSA channel during each field rotation. Thus a system containing a megabyte of bubble memory can be useful in low-data-rate, low-power systems as well as in high-performance systems. The partitioning of most of the data handling into the FSAs makes this flexibility possible.

It now becomes readily apparent why the FSA is considered the heart of the system: it enables the system to parallel as well as multiplex memory devices easily—something not possible previously with bubbles. All this is accomplished with minimum parts since the sense amplifier and redundancy handling are in the same package. Redundancy handling involves deleting bits read from defective loops on the bubble chip and inserting zeros into the data stream when writing to the bubble chip. This function is ideally performed by the FSA as the defective loops are different in each bubble device.

A map of defective loops is contained in the boot loop

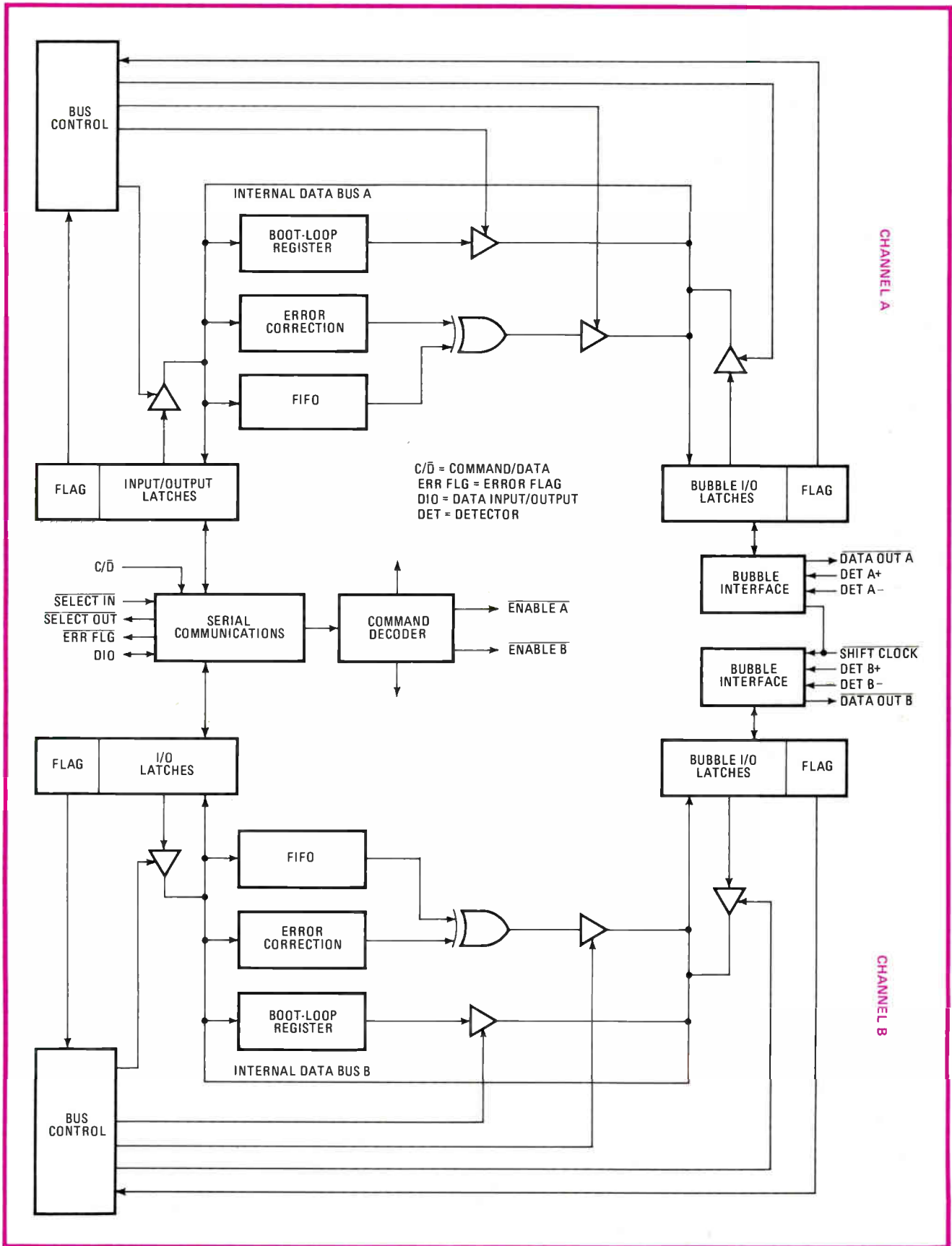

4. Heart of the matter. The 7242 dual formatter/sense amplifier (FSA), implemented with an advanced n-MOS process, makes available many system functions that are required by the user, but handles them transparently. Besides permitting optional error correction and detection, the FSA makes it possible for the memory devices to be paralleled and multiplexed with minimum parts count.

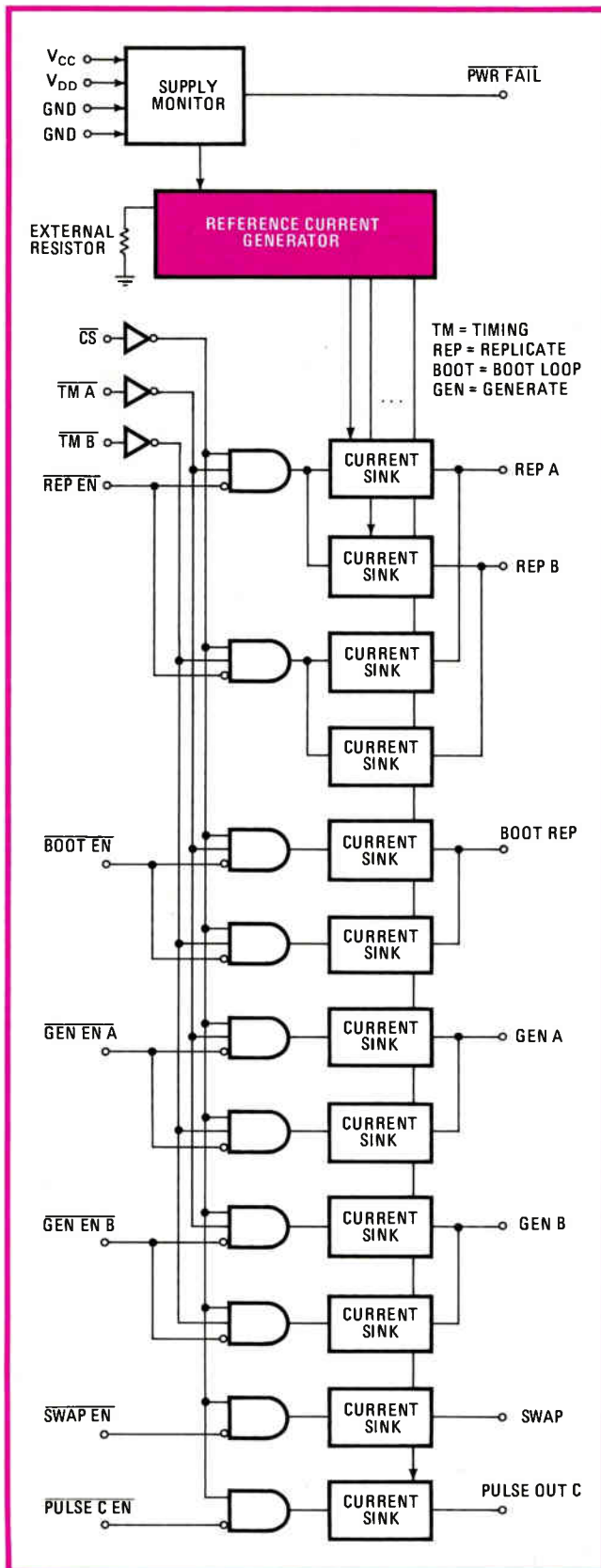

5. Reaching the peak. Implemented with a Schottky bipolar process, the 7230 current-pulse generator produces the high peak currents required to power the 7110 MBM. It incorporates a power-failure-sensing circuit and a power-down circuit that shuts off the current sources when the chip is disabled.

on the bubble memory chip. It is normally read out and stored in the FSA during system initialization. Therefore, the 7220 controller sees only good data bits and need not be concerned with maintaining a map of bad loops for each bubble memory chip. Redundancy therefore becomes transparent to the user.

Error detection and correction

An additional function performed by the FSA is error detection and correction. Each channel of the 7242 FSA contains a 14-bit Fire code, which detects and corrects burst errors up to 5 bits long. The FSA can generate and attach the code to the end of each 256-bit data block when writing into the bubble cell. It can then check the code when the block is read and, if errors are present, correct the data—within the capabilities of the code—before it is transferred to the host.

Since most errors are likely to be in detection (soft) rather than in bubble loss (hard), repeating a read operation can generally be avoided. In addition, the error rate can be improved by several orders of magnitude, transparent to the user, if desired. The overhead loops required for storage of the code do not subtract from storage area (that is, each chip has a binary 1 megabit of usable storage). Should the user decide to forego the error detection and correction feature, or to implement his own, an extra 16 loops (32 bits) become available for data, error code, or page-address header and storage.

Not only does the user have flexibility in organizing his system, he can also choose his methods of transferring data across the system bus. The 7220 controller supports three: (1) polled I/O, (2) interrupt-driven I/O, and (3) direct memory access (DMA). The first two methods of transfer require that the host central processing unit be involved, i.e., data is transferred to a register in the CPU before being stored in memory. In the DMA mode, data is passed directly to host memory without host intervention.

High-performance systems with parallel bubble devices must use DMA since the data rate can exceed the I/O capabilities of most microprocessors. A bubble memory system with eight bubble devices running in parallel at a field rate of 80-kHz can achieve a maximum data-transfer rate of 160 kilobytes/s (6.25 μ s/byte). A typical microprocessor instruction execution requires 2 μ s. Since a transfer execution under CPU control would require several instructions, it is obvious that DMA operation is a necessity for higher-performance systems. The 7220 controller is designed to interface directly to an Intel 8257 DMA controller chip. For systems with moderate data rate where DMA is not desired, the DMA request pin can signal the host that data is available. In this mode (selected by the user by programming the controller properly), the DMA request pin is set whenever the controller first-in, first-out (FIFO) memory is half full (during a read operation) or half empty (during write). This pin can be used as a data, or second level of interrupt, that guarantees the host can read or write a minimum number of bytes (20) to the controller.

The last, and lowest, performance mode is provided by a status bit in the controller that indicates presence of data in the FIFO. The host could continually poll status

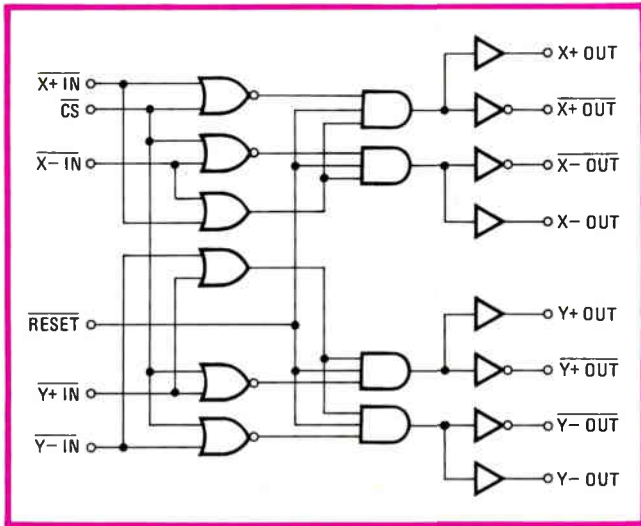

6. Predriver. The 7250 converts TTL outputs of the 7220 controller into the high-voltage, high-current waveforms used to energize the transistors that drive the coils of the MBM through quad transistor packs. The coil predriver can interface with either V-MOS FET drivers or can provide up to 200 mA of base current for bipolar types.

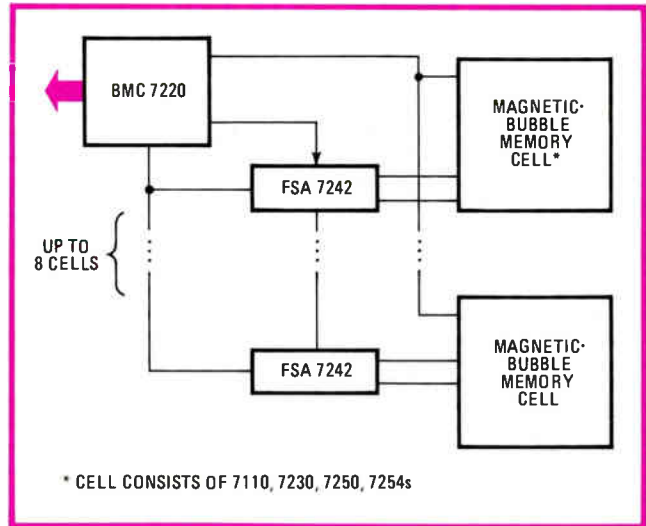

7. Big system. This system diagram shows how the 7220 bubble-memory controller can be used to control up to eight bubble memory cells for a total capacity of 1 megabyte. Even more capacity can be attained by paralleling extra controllers. Additionally, the 7220's chip select input permits multiplexing entire subsystems.

and output data when the FIFO is available, but this mode is useful only in the lowest performance system.

After power-up, the host must initialize the system. Communication with the controller is accomplished via a set of addressable registers contained within the controller. These registers are addressed by the host and written with information relating to the desired operating modes (for example, DMA is enabled, the number of data blocks is specified, etc.). The host must then issue a command to initialize. The controller proceeds to read the bootstrap loop of each bubble device (which is redundantly coded) and write the bad loop information into the bootstrap loop register contained in the corresponding FSA. The controller begins with the first FSA in the chain and continues down the chain in order until all devices have been initialized. Each bubble device is left in the home position (page 0 is ready to be read).

Sequence of events

After initialization, the controller, if enabled, interrupts the host and is ready for data transfers. The host writes an address into the controller registers, issuing a read or write command. The controller then takes over and accesses the desired page or pages of information. An interrupt is normally issued upon completion, but it may be inhibited by the user. An address is maintained and updated for each bubble device in the system, regardless of organization, within the controller. If a block transfer overflows the address boundary of a bubble device or devices, the controller will automatically switch to the next in the chain. A maximum of 2,048 pages of data can be transferred with a single-command sequence. Should a power-down occur during a transfer, the controller will automatically shut down the coil drivers in the proper sequence, if power remains at acceptable levels for about 100 microseconds.

The user requests data transfers by addressing a command/status register in the 7220 BMC. A large

number of commands are available to the user, including several that are useful for system diagnostics.

The most commonly used commands are:

- Initialize—performed after power-up in order to reset the system.
- Read—causes the selected pages of bubble memory to be accessed.
- Write—writes user data into selected pages of the bubble memory.

Read and write can be specified for 1 to 2,048 pages. In addition, a seek command lets the user predict his next read address, avoiding additional latency. However, in multiple-page read or write operations, consecutive page addresses are physically located so the next page is available immediately upon completion of the preceding operations. Additional commands include reading and writing of the bootstrap loop registers in the FSAs, or the bootstrap on the bubble chip, a software reset, and an abort command. Status bits provided to the user include a busy signal, an operation complete flag, a FIFO ready flag, and several error flags, including timing and correctable and uncorrectable error. Status of each FSA can be determined by the host processor with a special command. Interrupt masking lets the user decide whether he is interrupted by errors or by normal operation-complete interrupts. The combination of error-correction capability, a versatile command set, and appropriate status flags also lets him perform on-line maintenance checks to enhance reliability.

The key design features incorporated in the Intel Magnetics MBM systems approach were chosen after a strong effort to define the appropriate markets for bubbles. Ideas from more than 200 potential customers were gathered and greatly influenced the choices of size, speed, and organization. Thus, two years after inception, the program will yield bubble memory products including development boards so customers can begin evaluating the 1-megabit bubble memory product line. □

Hybrids, materials rule at Electronic Components Conference

The requirements of very large-scale circuits set tone of many sessions; porcelain-on-steel substrates also star

by Jerry Lyman, *Packaging & Production Editor*, and Nicolas Mokhoff, *Components Editor*

□ The "components" in "Electronics Components Conference" is a distinct misnomer this year. The annual conference, jointly sponsored by the Institute of Electrical and Electronics Engineers and by the Electronics Industries Association at the Cherry Hill Hyatt House, N. J., on May 14-16, is fast switching its emphasis from the discrete, passive components of years past to materials, manufacturing methods, and packaging, above all in relation to hybrid circuits.

In fact, thick- and thin-film hybrids are emerging as the best way to package very large-scale integrated (VLSI) circuits. For this reason, ECC has even seen fit to bestow an entire session on that supremely VLSI problem—what to do about the alpha particles that cause soft (transient) errors in the functioning of VLSI devices [*Electronics*, March 15, 1979, p. 85]. As it happens, the alpha particles that do the damage are generated within the very packages designed to protect the chips.

Still other ECC papers describe such ingenious new hybrid devices as a nonvolatile solid-state relay, a transformer equivalent, and high-voltage yet mass-producible silicon controlled rectifiers. The microwave potential of porcelainized-steel substrates is analyzed, and gallium-arsenide MES FETs also come in for attention.

As integration pushes chip densities to ever new highs, the packaging engineer must find the most cost-effective way of interconnecting these VLSI circuits. According to C. T. Goddard, head of the hybrid circuits department at Bell Telephone Laboratories, Allentown, Pa., thick- and thin-film hybrid circuits on ceramic substrates are the answer. He finds that 1 square inch of ceramic circuit costs about the same as, yet has 10 times the interconnection density of, 1 square inch of multilayer board containing two signal layers plus buried power and ground planes.

Hybrids rescue VLSI . . .

Figure 1 compares double-sided and multilayer printed-circuit boards, hybrids, and silicon chips in terms of their cost per interconnection. (This cost has been normalized by assigning 100 units of cost to the four-plane multilayer board already described.) Densest and least costly packaging occurs within the silicon chip, of course. But when the micrometer-wide lines of the chips must link up with the mil widths of the packaging world, the most effective solution is a hybrid with 5-mil lines and spaces of the type shown in Fig. 2, since its high interconnection density more than compensates for its intermediate cost. In fact, with 2-mil features, the per-interconnection cost of a hybrid falls to about 1/30 that of a multilayer board.

Goddard enlarges on his thesis by comparing the use of 68-pin chip-carriers with 200-pin hybrids in a design in which 25,000 gates must be interconnected on a 13-by-8-inch board. The chip-carriers hold 220 gates each, so that their board requires eight signal layers and the carriers barely fit in the allotted space. The hybrids can hold 2,000 gates apiece and fit easily on a board requiring only two signal layers—obviously a much simpler structure.

. . . despite soft errors

Though hybrid circuits may be the best way of packaging VLSI devices in terms of overall cost and density, they pose a problem in terms of reliability. Radioactive traces in their ceramic substrates generate most of the alpha particles that induce soft errors in the functioning of the dense chips. ECC therefore devotes an entire session to ways of measuring and compensating for the activity of alpha particles, a single one of which gener-

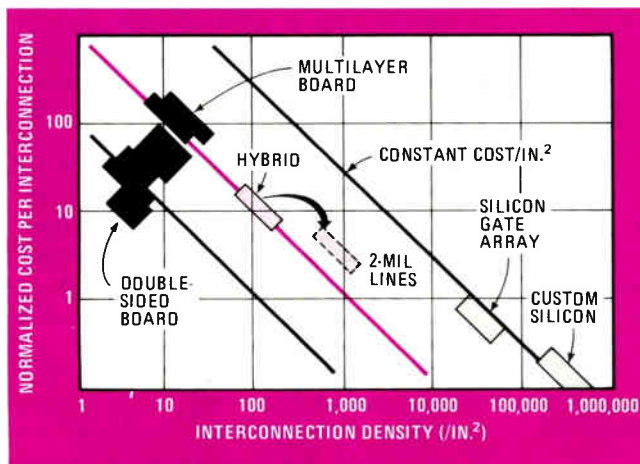

1. The cost of density. These graphs compare the cost and interconnection density of five packaging methods. The normalized cost per interconnection of multilayer boards and hybrids (5-mil lines and spaces) is the same. Hybrids, however, have 10 times the interconnection density of the multilayer boards.

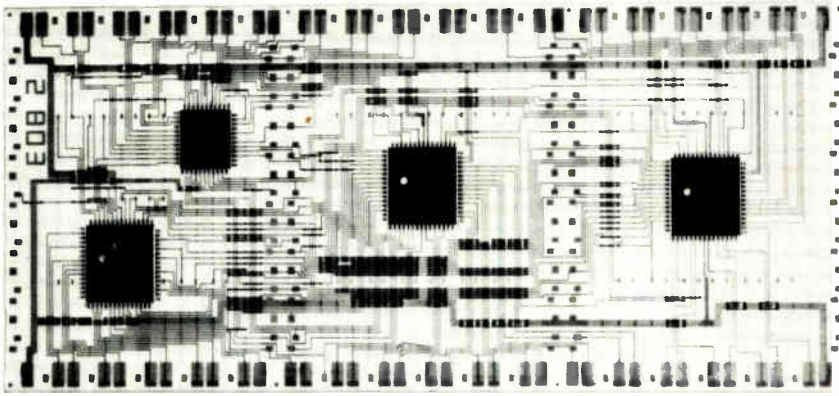

2. The superior hybrid. The four LSI chips on this two-layer substrate replaced 31 DIPs on a six-layer pc board, illustrating the cost-effectiveness of hybrid technology. There are about 500 gates on the 1.7-square-inch hybrid, and its interconnection density is about 100 gates/in.².

ates 1.4 million electron-hole pairs on a path 25 μm long through silicon at right angles to the chip surface.

Of all the semiconductor technologies, n-channel metal-oxide-semiconductor is the farthest along the VLSI road. Its micrometer features and the minimal electrical difference between its binary 1s and 0s therefore make it the most vulnerable to alpha upset, points out Timothy C. May of Intel Corp., Santa Clara, Calif., in the session's first paper. The solution to this problem may lie in the chip, the package, or both, he says. Through the LSI level of complexity, the chip costs less than the package and a change in its design should be made to provide the solution. At the VLSI level, the package costs less than the chip and becomes worth improving also.

Table 1 summarizes the flux levels of the main packaging materials used in the semiconductor industry, including a rough estimate of the levels probable by the early 1980s. Having the largest area in parallel with the chip, alumina should be given priority for purification to the lowest possible flux level, though of course all materials next to the semiconductor chip must be guaranteed to a desired flux level.

However, there is a practical limit to the purification of any package material. As May says, it is the point beyond which the measurement of the flux level is impossible. Today's most sophisticated method—gamma spectroscopy—detects at best a flux of 0.001 to 0.01 alpha particle per square centimeter per hour, which is

only 10 to 100 times below the figure for the coldest (least radioactive) packaging ceramic now in use.

As for the effects of alpha bombardment on different VLSI circuit designs, May says the most vulnerable appear to be dynamic random-access n-MOS memories, some static RAMs, and in general any VLSI devices with low speed-power products and the ability to accumulate carriers. Possible remedies include: raising charge storage by decreasing front-end gate oxide thickness, reducing the duration of charge collection, and improving charge transfer, all with the goal of either dodging an alpha hit or minimizing its impact.

How to test

To evaluate the effectiveness of these different remedies, accelerated testing of the supposedly improved VLSI packages devices will be needed. (The alternative—large error-logging systems—is prohibitively expensive, according to May). Such testing would involve bombarding the packaged devices with intense alpha sources, producing 10^5 $\alpha/\text{cm}^2\text{-hr}$ and up, in order to cause soft errors running around 0.1%/1,000 hr in a $0.1\text{-}\alpha/\text{cm}^2\text{-hr}$ package. Some other test method, though, would have to be found for packages whose device cavities are lined with alpha-barrier coatings.

In another paper, H. P. Gibbons and J. D. Pittman from Coors Porcelain Co. in Golden, Colo., agree with May's conclusions on packaging materials. They found

TABLE 1: MATERIALS AND PROJECTED ALPHA ACTIVITY

Material	Significance to device	Flux range ($\alpha/\text{cm}^2\text{-hr}$)	1980s' range ($\alpha/\text{cm}^2\text{-hr}$)	Comments
Alumina	<ul style="list-style-type: none"> above die, in CerDIP low angle, in side-brazed ceramic 	0.1–0.6	0.01–0.05	<ul style="list-style-type: none"> screening of natural sources of alumina likely
Glass	<ul style="list-style-type: none"> low angle in CerDIP especially serious with full-glazed ceramic lids 	1–60	0.01+	<ul style="list-style-type: none"> zirconia can be eliminated may be "don't care" in some geometries, except for radon
Metal lids	<ul style="list-style-type: none"> above die in side-brazed ceramic 	≤ 0.01 –0.5	< 0.01 –0.05	<ul style="list-style-type: none"> sources of Kovar, Alloy 42 must be watched for uranium and thorium gold-plating controlled
Plastic packages	<ul style="list-style-type: none"> above die 	0.05–2.0	< 0.01 –0.05	<ul style="list-style-type: none"> mainly due to silicon-dioxide filler; other fillers can be used
Coatings	<ul style="list-style-type: none"> in contact with die 	≤ 0.01	< 0.005	<ul style="list-style-type: none"> only useful if colder than package sources

TABLE 2: COMPARISON OF SUBSTRATES

Substrate type	Attenuation constant at 1 GHz (dB/in.)	Propagation velocity (% of free space)	50-ohm line width (in.)
No. 1 porcelain on iron	0.9	48.0	0.010
No. 2 porcelain on iron	0.75	44.0	0.010
No. 3 porcelain on iron	0.68	45.5	0.012
No. 1 porcelain on copper and iron	0.34	46.0	0.010
No. 2 porcelain on copper and iron	0.32	45.0	0.010
Alumina thin-film	0.28	35.0	0.007

that ceramics, sealing glasses, and metalizing materials were all alpha emitters, but that ceramic has the worst effect on the chip, being in parallel with it and thus permitting line-of-sight alpha bombardment. Changing package geometry is not an effective cure. But coating the chip cavity walls with a material that blocks alpha particles and emits very few itself would virtually eliminate soft errors due to the particles. The package would be costlier but in some applications might be worth it in terms of improved reliability.

Further evidence

The lower limit of ceramic package alpha emission and how to reach it is the subject of a paper by J. A. Woolley and colleagues from three divisions of the 3M Co., St. Paul, Minn. They, too, found that only those packaging materials opposite and adjacent to the active surface of a die affected it with their alpha emissions. Those parallel with it had the biggest effect.

As in the Coors Ceramic paper, they concluded that with careful selection of raw materials, it should be possible to formulate conventional 90–95% alumina ceramic semiconductor packaging components with alpha fluxes of about $0.1 \alpha/\text{cm}^2/\text{hour}$ and glass package sealants with alpha fluxes of about $0.5 \alpha/\text{cm}^2/\text{hour}$. Also 99.9% alumina ceramic semiconductor packaging components with alpha fluxes in the range of 0.01 to $0.03 \alpha/\text{cm}^2/\text{hour}$ are possible, while anything lower than $0.01\text{-}\alpha/\text{cm}^2/\text{hour}$ radiation will require raw materials with uranium and thorium contents lower than are currently available. To go below the 0.01 level, analytical techniques for separating and concentrating uranium and thorium will have to be combined with direct alpha flux measurement.

An alpha count actually at the 0.01 level is obtained by the author of a fourth paper from Semi-Alloys Inc. of Mount Vernon, N. Y. Samuel Levine did it by going to gold-plated metal lids that are used for hermetic sealing and gold-tin eutectic solder. He put a gold-plating salt, formulated from extremely high-purity gold, in an elec-

trolytic bath containing a proprietary chelating agent. This agent prevented the thorium and uranium ions from plating out with the gold.

Porcelain-coated steel is one of the more exciting substrates to have come along in years, being relatively low-priced, strong yet bendable, a natural heat sink, and suitable for both printed-circuit and thick-film techniques [*Electronics*, March 15, 1979, p. 125]. Now it seems likely to add good performance at microwave frequencies to all its other virtues.

Porcelainized steel for high frequencies

In one of the key papers on substrate development, A. Schwarzmann of RCA's Government Systems division in Moorestown, N. J., shows that this type of substrate is a potential low-cost alternative to alumina substrates for high-frequency applications. RCA's investigation compared alumina with both commercial electronic-grade porcelain-coated steel and a special substrate, porcelain-coated copper and steel.

In one experiment, a thick-film copper conductor was screened onto each metal substrate to form a microstrip transmission line with a 50-ohm characteristic impedance. On the commercial steel version, it had an attenuation of 0.9 decibel per inch normalized to 1 gigahertz; on the copper and steel, attenuation was 0.34 dB/in. A thin-film chrome-gold equivalent on an alumina substrate yielded an attenuation of 0.28 dB/in. (see Table 2).

In the second experiment, a low-noise amplifier and a high-power transistor amplifier were constructed on a porcelainized metal and an alumina substrate. The low-noise amplifier was designed to operate from 800 to 1,300 MHz. On metal, it has a gain of 20 dB and a noise figure of 3 dB, only 0.2 dB higher than on alumina; all other parameters were about the same. The power amplifier on the metal substrate performed as well as the one on the ceramic substrate, with only 0.5-dB less gain but with the advantage of a lower junction temperature.

Fine lines for thick films

The screened-on circuit patterns of thick-film hybrids seldom achieve high yields for line widths much below 4 mils. But Yutaka Watanabe and his coauthors at Fujitsu Ltd. in Japan have obtained line widths down to 2 mils with a new method: they substitute photolithography with a water-soluble negative photoresist for the normal screening of thick-film materials through a steel mesh.

In the new technique, a thick-film paste is first printed over the entire substrate surface. Then the resist is coated over the dried thick film, exposed through a photomask, and its unexposed areas washed away with water. Next, an organic solvent is sprayed over the newly exposed thick film to dissolve it, leaving the desired circuit pattern. Finally, with the resist still in place, the substrate is heated to a predetermined temperature, firing the thick film and evaporating the resist. With this technology, a large hybrid has been built having 25 IC chips on a 30-millimeter-square (1.2-in.²) substrate. In addition, this process creates resistors with a range of 10 ohms to 100 megohms, in contrast to the 10Ω to $10 \text{M}\Omega$ of conventional thick-film hybrid resistors.

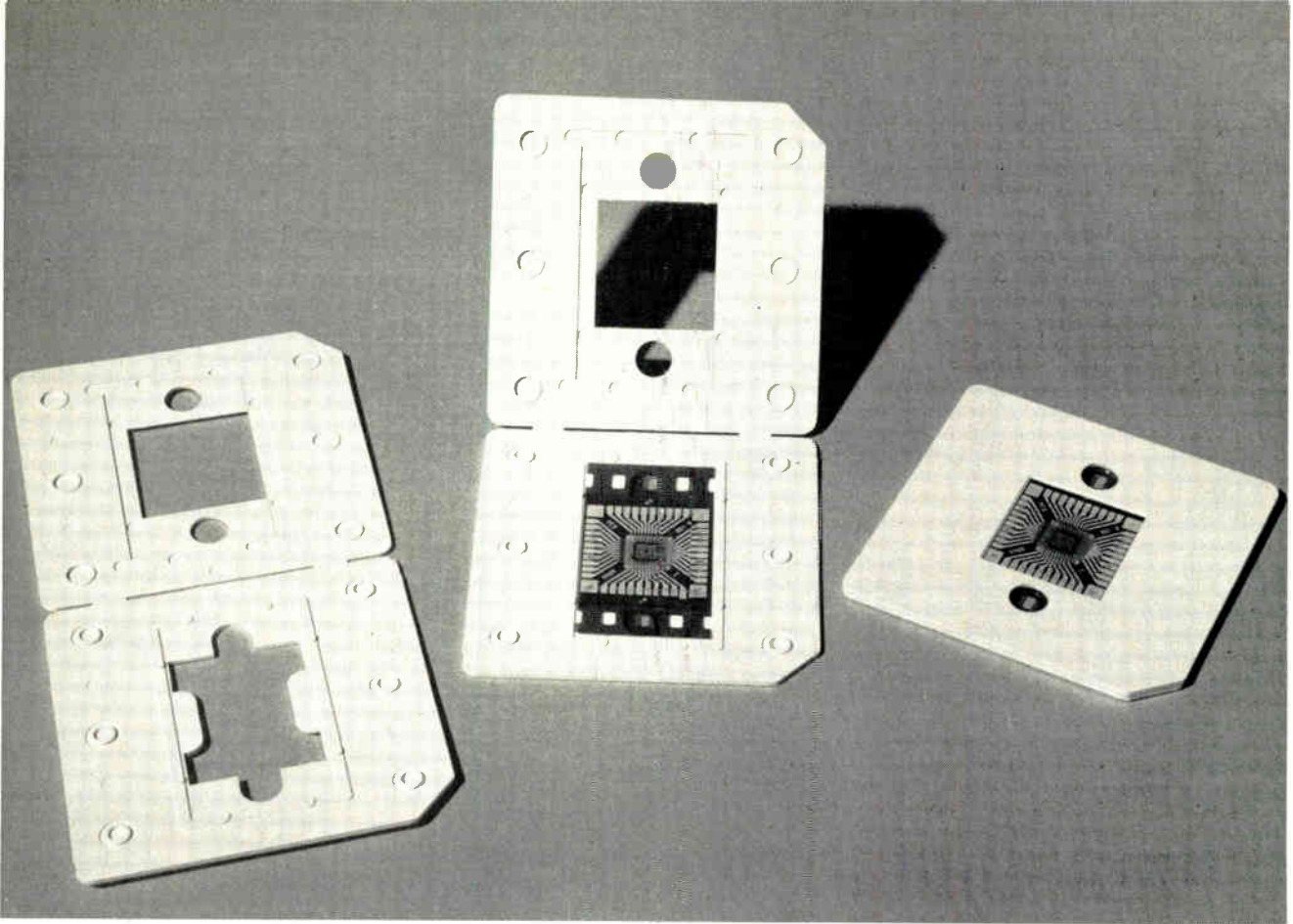

3. Individual tape-automated bonding. Honeywell Information Systems has developed individual carriers for tape-automated bonding of chips to hybrid substrates. Shown here is a 35-mm expendable TAB carrier in open, partially folded, and closed positions.

Tape-automated bonding (TAB) is a means of mass-producing interconnections between chips and their packages; it uses IC interconnects (spiders) etched into a copper surface of a sprocketed nonconductive film. Usually, reel-to-reel handling moves the tape first through an automated bonder, where specially bumped chips are mass-bonded to the inner leads of the interconnects, then through a machine that bonds their outer leads to lead frames, which are then molded into plastic dual in-line packages. An equivalent system for hybrid manufacture must perform be more complicated since a single hybrid substrate must often hold as many as 50 different device types.

Automating hybrid assembly

John Kowalski, manager of advanced equipment engineering at Honeywell Information Systems, Phoenix, Ariz., describes one solution in his ECC paper (for other solutions, see *Electronics*, Sept. 28, 1978, p. 120). Kowalski's procedure is to cut up a reel of tape after the chips have been bonded to it, store each piece in a carrier in an interim magazine, test them, and then unload carriers from assorted interim magazines into a final magazine, which thus contains the assortment of chips needed for a given hybrid.

At Honeywell, a framer cuts up the film and loads the frames into the carriers (Fig. 3). A sequencer stores these carriers and loads their contents upon demand into the final magazine. A placement unit accepts the final magazine, excises chip-plus-interconnect from its piece of film, forms the leads, and places it in the hybrid

assembly. A reflow unit then reflow-solders the two together. Since it is expensive to stock reels of different devices, Honeywell is looking into extending the carrier concept to the inner-lead bonding of each chip to individual frames of tape.

Some hybrid attractions

Among the more interesting hybrids discussed at ECC this year are a nonvolatile solid-state relay, an inductor, a substitute transformer, a high-voltage yet mass-producible SCR, and two GaAs MES FET developments.

The relay uses a p-channel metal-nitride oxide semiconductor (MNOS) transistor to remember its on or off state during power outages. Described by John A. Skok of Lockheed Missiles and Space Co., Sunnyvale, Calif., it is the functional (and more reliable) equivalent of a latching electromechanical relay. Besides the MNOS device, the hybrid package consists of a custom reset-set IC driven by a dual voltage-controlled current source through two optically coupled isolators.

Japan is the source of the solid-state inductor—or more precisely, a hybrid IC gyrator functioning as one. According to M. Nakamura of the Hiroshima Institute of Technology and his two coauthors from Tokyo and Hyogo, the phase delay inherent in conventional gyrators creates a problem in this application, for it causes instability in high values of Q at high frequencies. They therefore connect a phase-compensating capacitor to their IC gyrator, which has a maximum obtainable Q of about 100. Moreover, the temperature coefficient of the equivalent inductance was observed around 200 ppm/°C

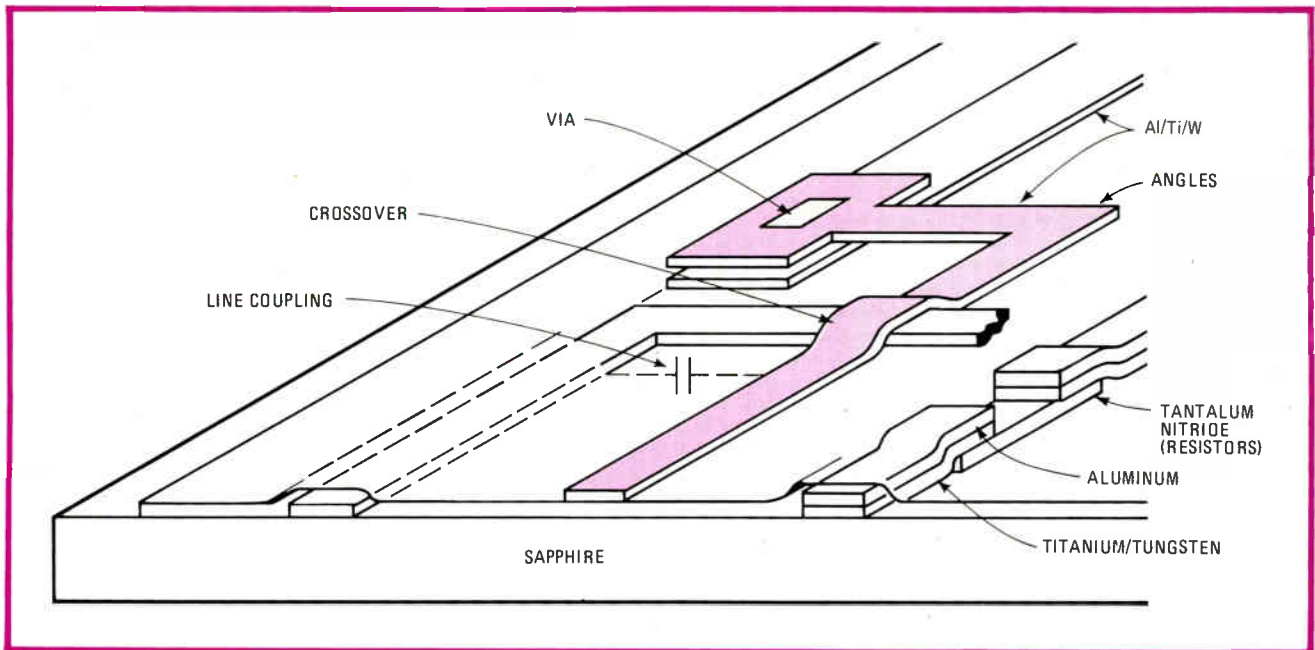

4. Sapphire substrate. High-density, high-impedance transmission lines can be designed on a supporting structure of sapphire. The drawing shows a two-level signal interconnect with thin-film resistors for impedance matching. Line widths are 5 to 10 micrometers.

at 2 MHz and below. In its hybrid IC form, the gyrator circuit has mini-mold transistors and chip resistors reflow-soldered on both sides of a ceramic substrate.

Another optoisolator circuit from Japan replaces the transformer in transmission systems and indeed is superior to it, say Y. Fukui and S. Yoneda of Tottori and Osaka Prefecture Universities. Their optoelectronic transmission device is very simple, being composed of two optoisolators in a positive feedback arrangement that yields a loop gain of less than unity. The experimental circuit can exhibit not only transmission gain or attenuation like that of a step-up or step-down transformer but also (under certain conditions) bilateral transmission.

Additionally, the device's input impedance is nearly independent of the external load impedance, making it ideal for suppressing impedance variation in a two-wire line. When optoisolators with a cutoff frequency of several kilohertz are employed, the device works at frequencies up to a few hundred kilohertz.

Making it better

Noteworthy for their efficiency at switching voltages of 1,400 and 2,500 volts are a pair of asymmetrical silicon controlled rectifiers (ASCs) described by J. Y. Fichot and two colleagues from General Electric Co. in Syracuse, N. Y. The secret is a low-concentration diffusion process that should be far better than epitaxial deposition at producing large-area devices like these ASCs on a volume basis, for it forms an n^+ layer with fewer defects, less difficulty, and at lower cost. This n^+ layer is inserted between the n^- bulk base and p^+ anode of a conventional SCR to supply the $p-i-n$ punch-through function. The resulting ASCR requires a much narrower n base width than an SCR for the same blocking capability—hence its switching efficiency.

Another processing breakthrough is described in a

paper on gallium-arsenide metal-semiconductor field-effect transistors. Lynn Kuller of the Rochester Institute of Technology of Rochester, N. Y., and James J. Whalen of State University of New York at Buffalo, recommend processing GaAs MES FETs as individual dice, typically 2.5 mm square, rather than by the wafer, when limited quantities are needed. Material cost per project is reduced because photomask requirements are relaxed: the entire set of masks for one die can be shrunk 400 times onto a plate little more than 4 inches square.

The procedures developed were used to put four different GaAs MES FETs on a single die. All had 6- μm gate lengths and each had a different pinchoff voltage for possible application in multivalued logic gates. Variable pinchoffs would not be possible if full wafers were fabricated and subsequently diced up.

High-impedance hybrid for gigahertz logic

Integrated arrays of GaAs MES FETs switch much faster than currently available emitter-coupled logic—in 50 to 100 picoseconds, rather than 200 to 400 ps. But the output impedance of large integrated GaAs arrays is inherently high, so that the characteristic impedance of supporting transmission structure must be high to minimize signal attenuation between chips. (In general, a high-impedance transmission structure is advantageous for any high-speed circuit family because it reduces the amount of power required for signal transmission between devices.)

Edward Lewis of Raytheon Co.'s Missile Systems division in Bedford, Mass., describes a fine-line, hybrid technology that meets these goals. It centers on a two-level structure of 5- μm -wide lines on a sapphire substrate. Using projection lithography, thin films of resistive material and aluminum were evaporated onto the sapphire. A characteristic impedance of 100 to 300 ohms can theoretically be achieved (Fig. 4). □

In Data Display...

TTL means high performance

If you build high-performance intelligent terminals,
don't settle for less than **BALL TTL**
Series displays

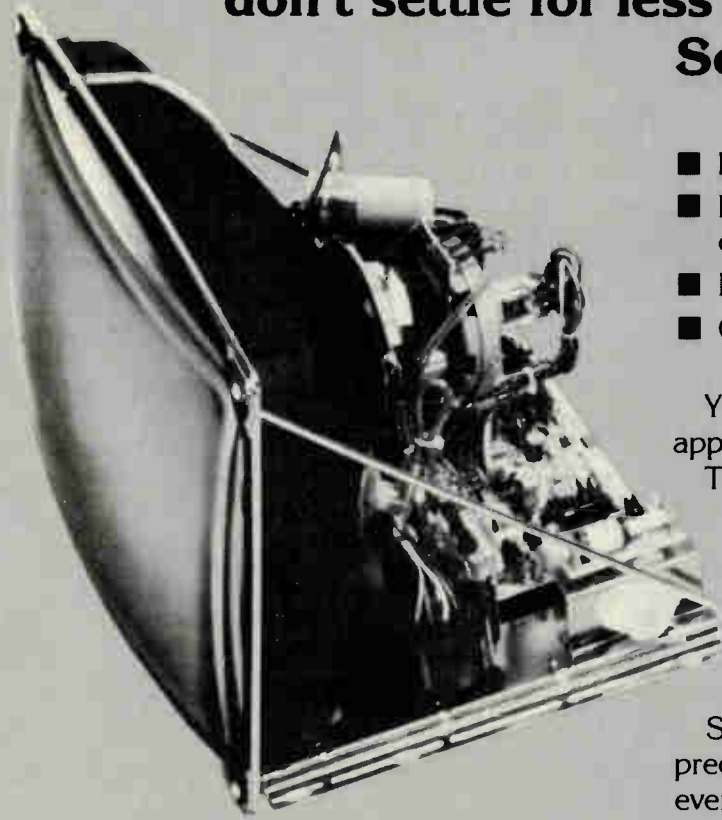

BALL TTL Series
High Performance
Data Display

- Electronic horizontal video centering
- Electronic horizontal and vertical linearity control
- Horizontal line rates up to 24 KHz
- Optional dynamic focus and skip scan

Your high-performance intelligent terminal application calls for BALL TTL Series quality.

These rugged 12 and 15-inch units offer the industry's best combination of performance and reliability, and Ball engineers will modify TTL display design to meet your requirements so you don't have to settle for fixed electrical or mechanical specifications.

Specify TTL display, and you can be sure of precise adjustment and alignment. If service is ever required, you'll find BALL regional technical support to be fast and efficient.

If you want the best buy in high-performance data displays, remember that it pays to spend just a little more up front. Life cycle costs tell the real story, so specify TTL Series displays from BALL. It's a decision you can live with.

In data display,
BALL means
experience, quality
and service.

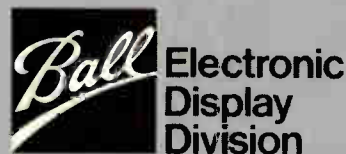

P.O. Box 43376 St. Paul, MN 55164 (612) 786-8900 TWX: 910-563-3552

Sales Offices:

Downers Grove, IL (312) 960-4434

Santa Clara, CA (408) 244-1474

Ocean, NJ (201) 922-2300

Upland, CA (714) 985-7110

Lewisville, Texas (214) 436-2383

Burlington, MA (617) 273-0608

Circle 117 on reader service card

Up/down counter processes data over single channel

by N. Bhaskara Rao
U. V. C. E., Department of Electrical Engineering, Bangalore, India

Two inputs are normally required for incrementing and decrementing an up/down counter—a count-up command line and a count-down line. But commands can be sent and received over a single channel if they are first multiplexed. Shown here is a transmitter-receiver pair for the one-channel system, which is particularly cost-effective over long distances.

At the sending end, it can be seen that $\bar{x} = QU + \bar{Q}D$, where x represents the transmitted signal, U is the count-up variable, and D is the count-down variable. It is assumed that the width of the U and D pulses is not more than a few hundred nanoseconds, and that the frequencies of U and D are relatively low.

When negative-going count-up pulses appear on the U

line, the 7470 flip-flop is preset to $Q = 1$ and so $x = \bar{U}$ thereafter. Thus x moves from logic 1 to logic 0 on the trailing edge of the count-up command.

Similarly, a count-down command clears the 7470 and so $x = D$. Thus x moves from logic 0 to logic 1 on the trailing edge of the down command. The timing diagram details transmitter operation.

The receiver determines if variations in x are due to changes in U or D by using an indirect and inexpensive phase-locking scheme. Transitions in x are introduced at the input of the 7486 exclusive-OR gate. Feedback loop A_1, A_2 , and A_4 acts to bring point L high, regardless of whether the transition is positive- or negative-going. One-shot A_1 , having a set delay time, τ , slightly greater than the width of the U and D command pulses at the transmitter, then triggers one-shot A_2 . By this time, x has stabilized, so that a logic 0 (U pulse) or a logic 1 (D pulse) is clocked into A_4 , thus bringing point L low τ nanoseconds after it goes high.

Meanwhile, one-shot A_3 is fired, and the active contents of A_4 are transferred to either the clock-up or the clock-down port of the 74193. The receiver's timing diagram should be inspected to clarify operation. □

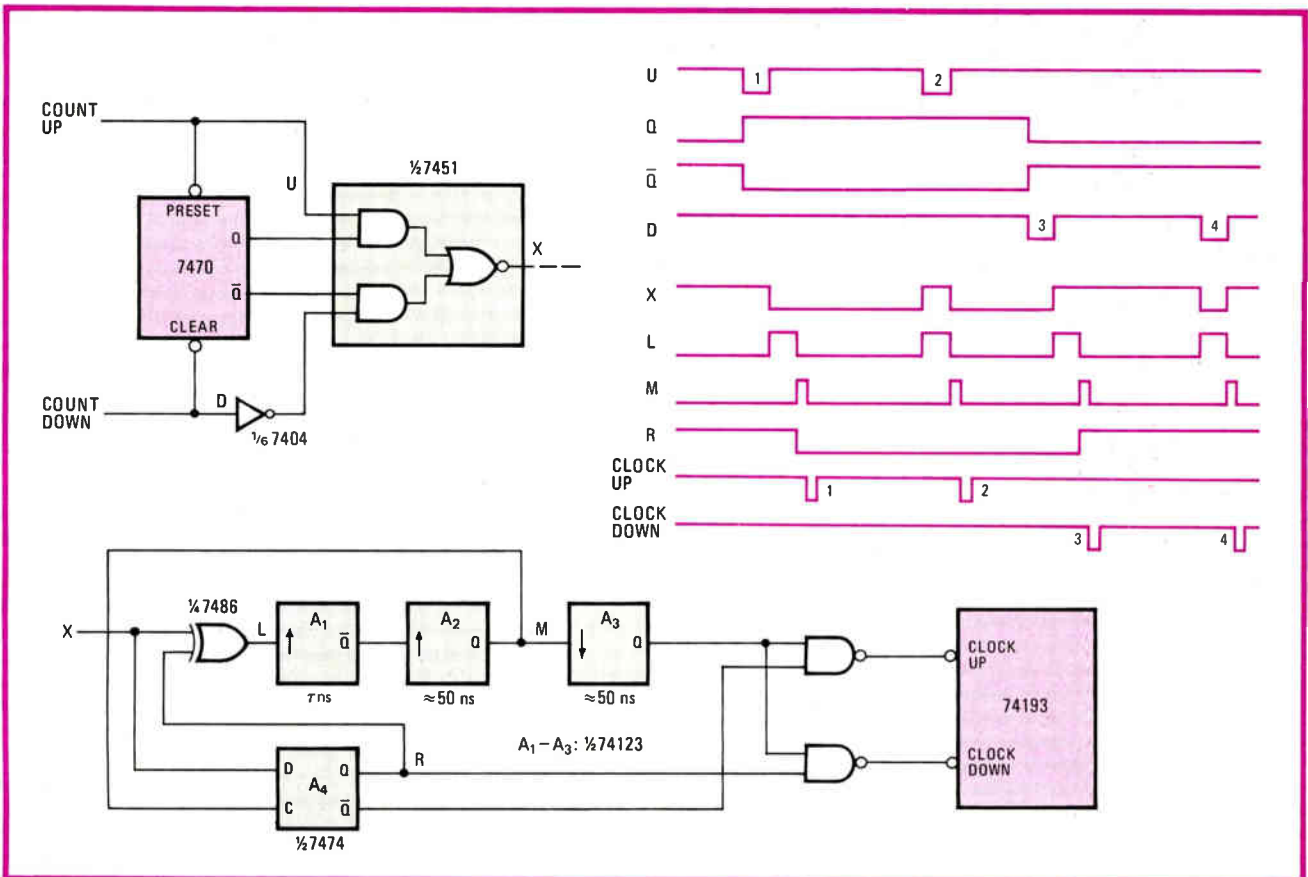

Self-synchronous. Flip-flop and gates pack count-up and count-down commands on a single data line for transmission over long distances (top). Receiver (bottom) senses polarity of pulses, without using complicated synchronous detectors, to increment or decrement up/down counter. Three one-shots provide superior operation as compared to detection schemes employing sequential logic.

Annunciator control uses only passive components

by John A. Haase
Fort Collins, Colo.

Combining relays with other passive components, this circuit provides time delays of anywhere from milliseconds to minutes without the need for the polarizing potentials normally required by monostable multivibrators. Such an electromechanical arrangement is ideally suited to the implementation of a practical call controller, or annunciator.

Delays are produced by first generating a staircase voltage. Pushing button PB₁ momentarily latches relay K₁ and energizes its bell circuit. The bridge circuit used with each relay permits the use of an inexpensive dc relay.

Call-indicator lamp L₁ then lights, and supply voltage is applied to C₁, C₂, D₁, and D₂, which make up the staircase generator. The step interval of the rising output voltage, V, at the junction of D₂ and C₂ becomes $\Delta V_o = C_1 E(10^3)/C_2$ millivolts per cycle, where E = 12.6(1.414) = 18 volts. Note that the diodes are consid-

ered passive elements in this application, as their characteristic curve, per se, is not utilized in the generation of the staircase waveform.

Circuit constants are selected so that D₃, which serves as a comparator, breaks down after 155 cycles (2 seconds), when output voltage V reaches 28 v. Relay K₂ is then energized, enabling K₃ to close and lamp L₂ to light, because the alternating voltage is applied to a second delay circuit through one of the normally open contacts of K₂. At the same time, voltage to relay K₁ is removed, since the normally closed relay contact of K₃ (in K₁'s energizing path) opens. Simultaneously, C₂ is discharged by K₃'s closed relay contact (in series with the 1-kilohm resistor).

Relay K₃ remains closed for 80 seconds to prevent repeated (and most times annoying) calls. At that time, the output voltage across C₄, generated by the second staircase waveform, steps to 28, whereupon D₆ breaks down and relay K₄ is energized. Relay K₃ then opens and the path of relay K₁ is reactivated to accommodate call requests, while C₄ discharges.

Call requests may be extended to 4 seconds by placing switch S₁ in the hold position. In this mode, relay K₄ does not come into play, so the user must wait an infinite inhibiting time before initiating a second call request. Under this condition, push button PB₂ must be depressed to clear the circuit so that it can respond to calls. □

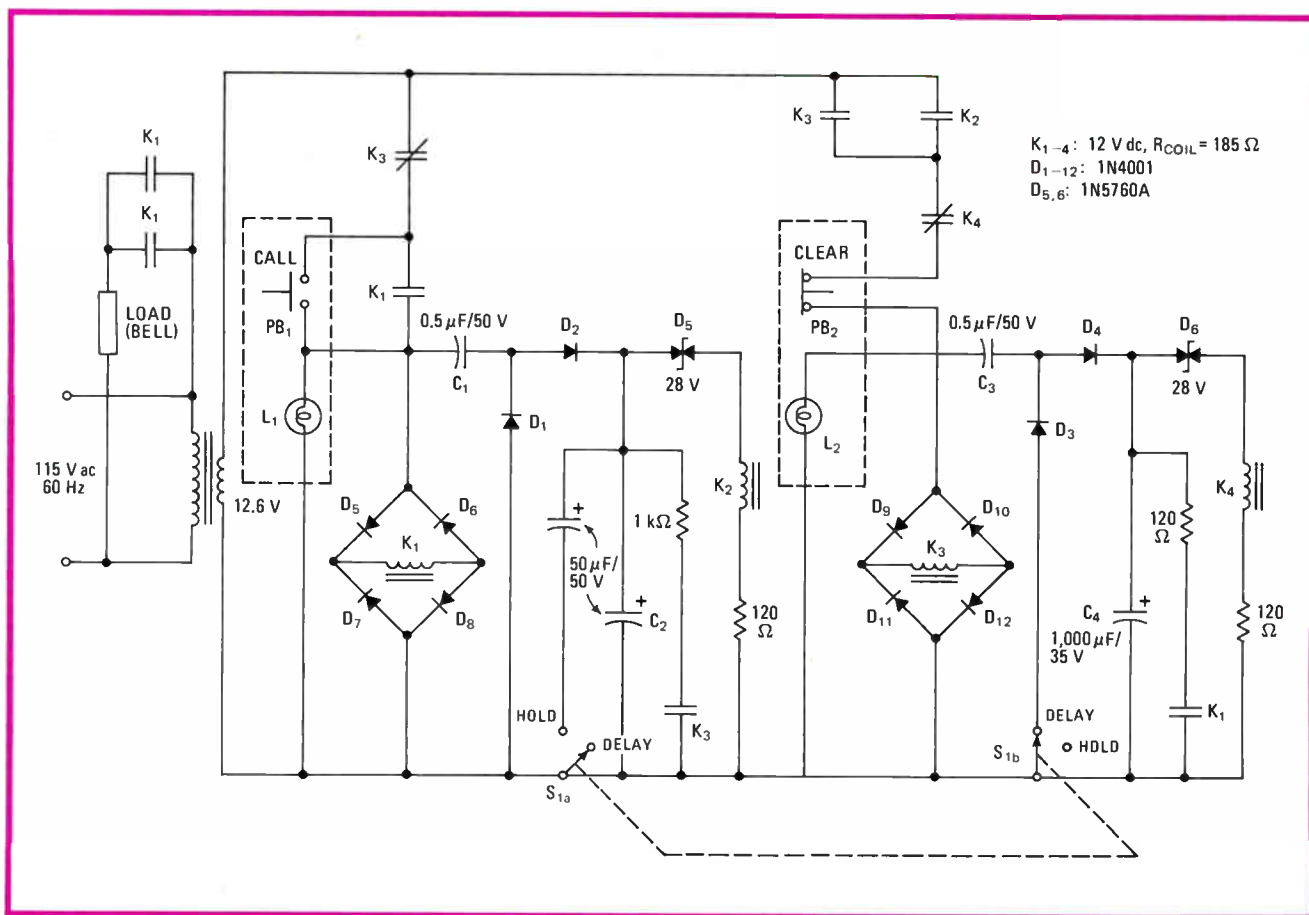

Charged delay. Electromechanical relays and other passive components form charge pump that generates a time-dependent staircase voltage, V, for call controller. By suitably selecting diodes D₅ and D₆ so that their breakdown voltages conform to some preset value of V, the circuit provides delay. Depressing PB₁ rings bell for 2 seconds, inhibits circuit for 80 seconds to prevent quick second requests.

SOMETHING YOU CAN COUNT ON

Work seems more worthwhile, knowing that we're helping to build financial security for ourselves and our families. And there's no easier way to save for the future than U.S. Savings Bonds.

With painless, automatic payroll deductions, the Savings Bond Program is a practical method of creating a financial reserve that reflects the stable, responsible outlook of savings bond holders. It's something you can really count on.

More than that, it's an expression of confidence in ourselves and in this country.

You can help by encouraging maximum participation among employees.

Robert T. Campion, chairman and president of Lear Siegler, Inc., and chairman for the second year of the program for the electronics industry, urges you to

Support U.S. Savings Bonds



LEAR SIEGLER, INC.

3171 South Bundy Drive, Santa Monica, California 90406



LEDs track signal level in visual data monitor

by Michael O. Paiva
Teledyne Semiconductor, Mountain View, Calif.

In this circuit, a matrix of light-emitting diodes is combined with an analog-to-digital converter and multiplexing logic to form a dual-setpoint meter. The LEDs are used to track changes in the input data and display the setpoints. The unit may be considered a variation of the analog panel meter; it will find many uses in industrial control applications where it is necessary to observe quick changes while determining whether data is within a preset range. By adding a dual comparator to the circuit, an alarm can be sounded when the input level goes outside the range.

The signal to be tracked, V_{in} , and the upper and lower setpoint voltages are applied to an eight-channel multiplexer, A_1 . The a-d converter, A_2 , samples channel 1 first. After the conversion, pin 23 of A_2 goes high and

advances the binary counter, A_3 . A_3 then addresses the second channel of the multiplexer, and so on, until each channel is scanned in sequence.

Bits 2 through 8 of the a-d converter, representing the binary equivalent of the voltage sampled, drive A_4 – A_7 , which are wired as two one-of-eight decoders. Thus each voltage is converted into a control signal that drives one diode in the eight-by-eight-diode matrix.

The setpoint voltages are sampled twice during each scan cycle (each is connected to two input channels), while the input signal, V_{in} , is connected to four channels and so is scanned four times per cycle. Thus the brightness of the LED corresponding to V_{in} is twice that of the setpoint LEDs, making it easy to differentiate between the three signals.





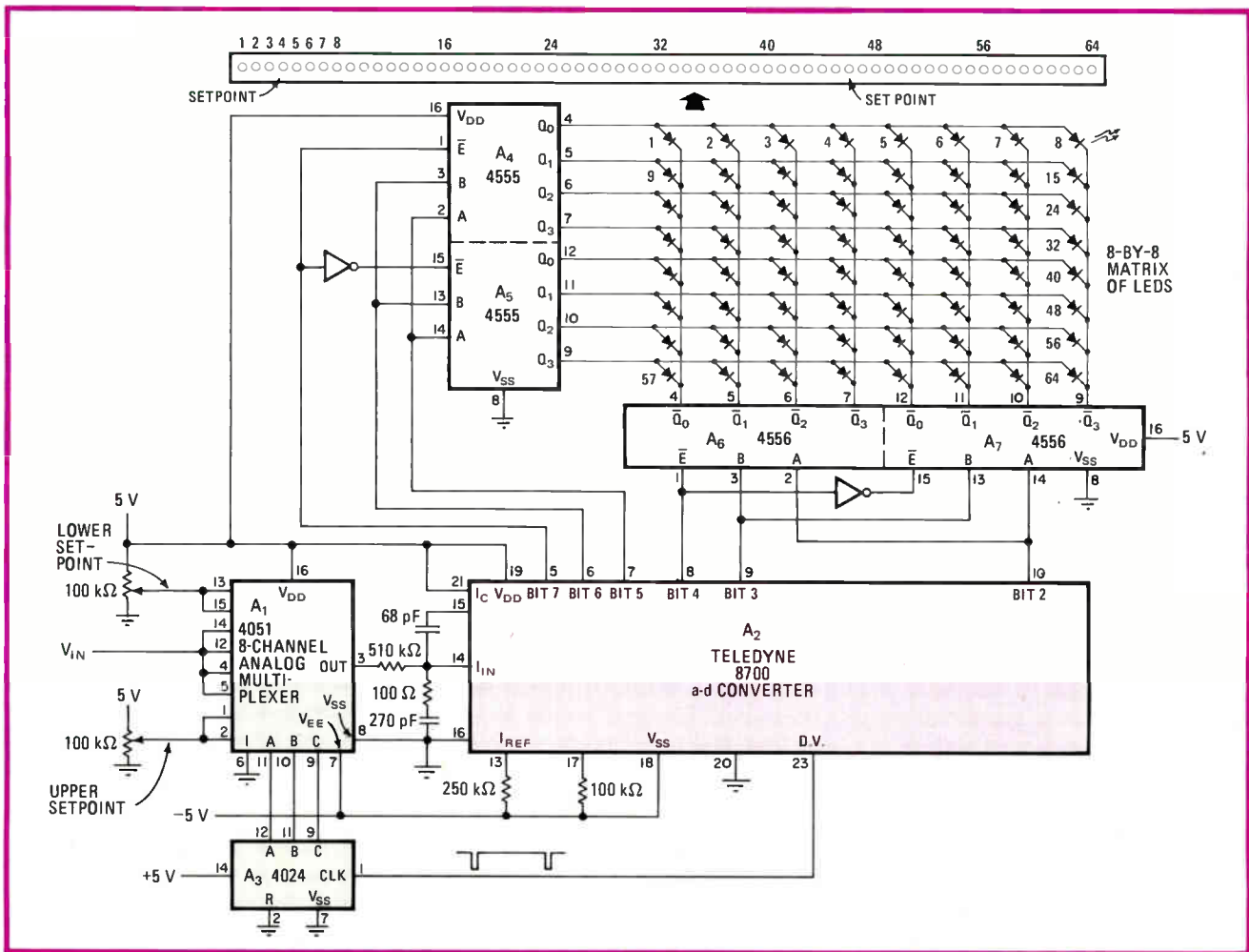





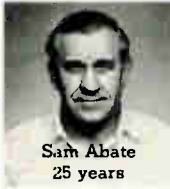
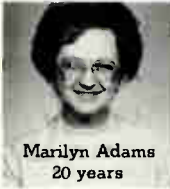
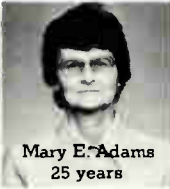
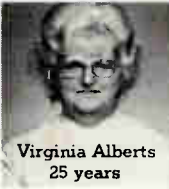
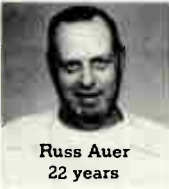
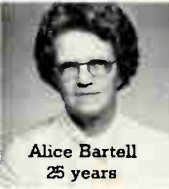
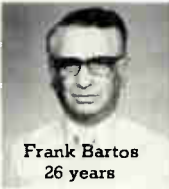
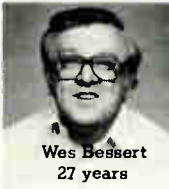

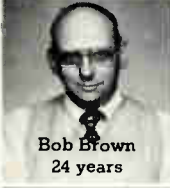
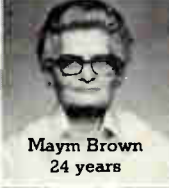
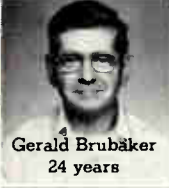



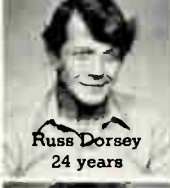
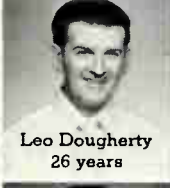

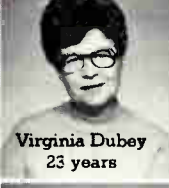







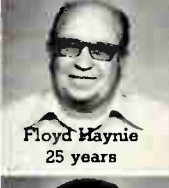
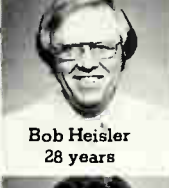





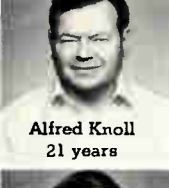







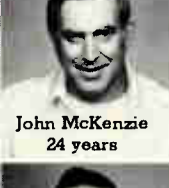

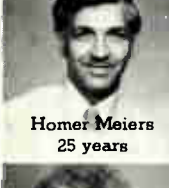
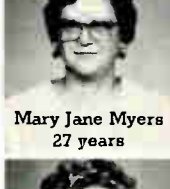

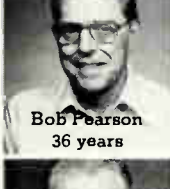

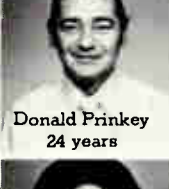
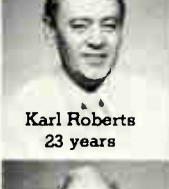

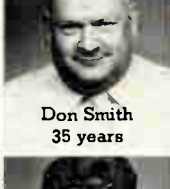
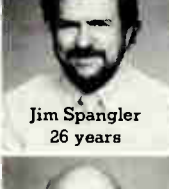

The circuit's worst-case response time is two scan cycles. A_2 has a conversion time of 1 millisecond, so that the display will require 2 ms to follow a change in V_{in} and 4 ms to follow any change in the setpoint potentials. Because of this high refresh rate, no flicker will be observed on the LED display. □

Designer's casebook is a regular feature in *Electronics*. We invite readers to submit original and unpublished circuit ideas and solutions to design problems. Explain briefly but thoroughly the circuit's operating principle and purpose. We'll pay \$50 for each item published.

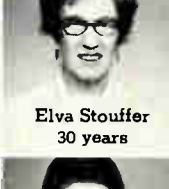
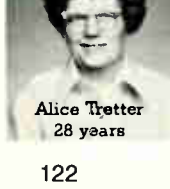

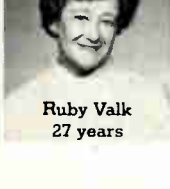
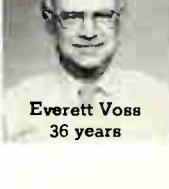
Visualizing voltage. Eight-by-eight-LED matrix and C-MOS logic form analog dual-setpoint meter. Setpoint potentials and data voltage V_{in} are each introduced into multiplexer and scanned in sequence, then converted into control signals that light the appropriate LEDs in the matrix. Setpoint LEDs are half the brightness of the LED representing V_{in} because they are sampled at half the rate.

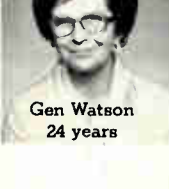
When it comes to quality control

 Sam Abate 25 years	 Marilyn Adams 20 years	 Mary E. Adams 25 years	 Virginia Alberts 25 years	 Russ Auer 22 years	 Alice Bartell 25 years	 Frank Bartos 26 years	 Wes Bessert 27 years
 Irene Brinkmeier 24 years	 Bernice Brown 22 years	 Bob Brown 24 years	 Maym Brown 24 years	 Gerald Brubaker 24 years	 Leon Burgener 37 years	 Carlo Christensen 36 years	 Becky Coomes 22 years
 Betty Donmeyer 26 years	 Russ Dorsey 24 years	 Leo Dougherty 26 years	 Flora Downing 24 years	 Ruth Dreibelbis 26 years	 Virginia Dubey 23 years	 Ruth Eisenbise 25 years	 Don Epping 26 years
 Ellen Greene 22 years	 Irene Hadju 23 years	 Bob Hamon 39 years	 John Harris 24 years	 Catherine Hartman 23 years	 Floyd Haynie 25 years	 Bob Heisler 28 years	 Dawn Henke 22 years
 Gemny Johnson 24 years	 Bob Johnston 24 years	 Gene Kumpmeier 24 years	 Marie Kirchberg 28 years	 Mary Kirkpatrick 23 years	 Alfred Knoll 21 years	 Violet Knowles 27 years	 Karl Koch 24 years
 Caryl Lorenz 24 years	 Charlene Magee 23 years	 Carole Mani 22 years	 Joyce Mater 23 years	 Eleanor McKenzie 28 years	 John McKenzie 24 years	 Phyllis McLain 26 years	 Homer Meiers 25 years
 Mary Jane Myers 27 years	 Gerald Osborne 27 years	 Bob Pearson 36 years	 Marie Piper 22 years	 Genevieve Potter 22 years	 Donald Prinkey 24 years	 Karl Roberts 23 years	 Millie Roenneburg 25 years
 Virginia Schlamp 22 years	 Milly Seefeldt 22 years	 Don Smith 35 years	 Jim Spangler 26 years	 Vi Springer 27 years	 Mary Stamm 23 years	 Ernie Stanley 24 years	 Elva Stouffer 30 years
 Alice Tretter 28 years	 Irene Undieme 22 years	 Ruby Valk 27 years	 Everett Voss 36 years	 Vernenna Wachlin 27 years	 Gen Watson 24 years	 Ruth Weckerly 22 years	 Helene Wegner 22 years

we're years ahead of the competition.

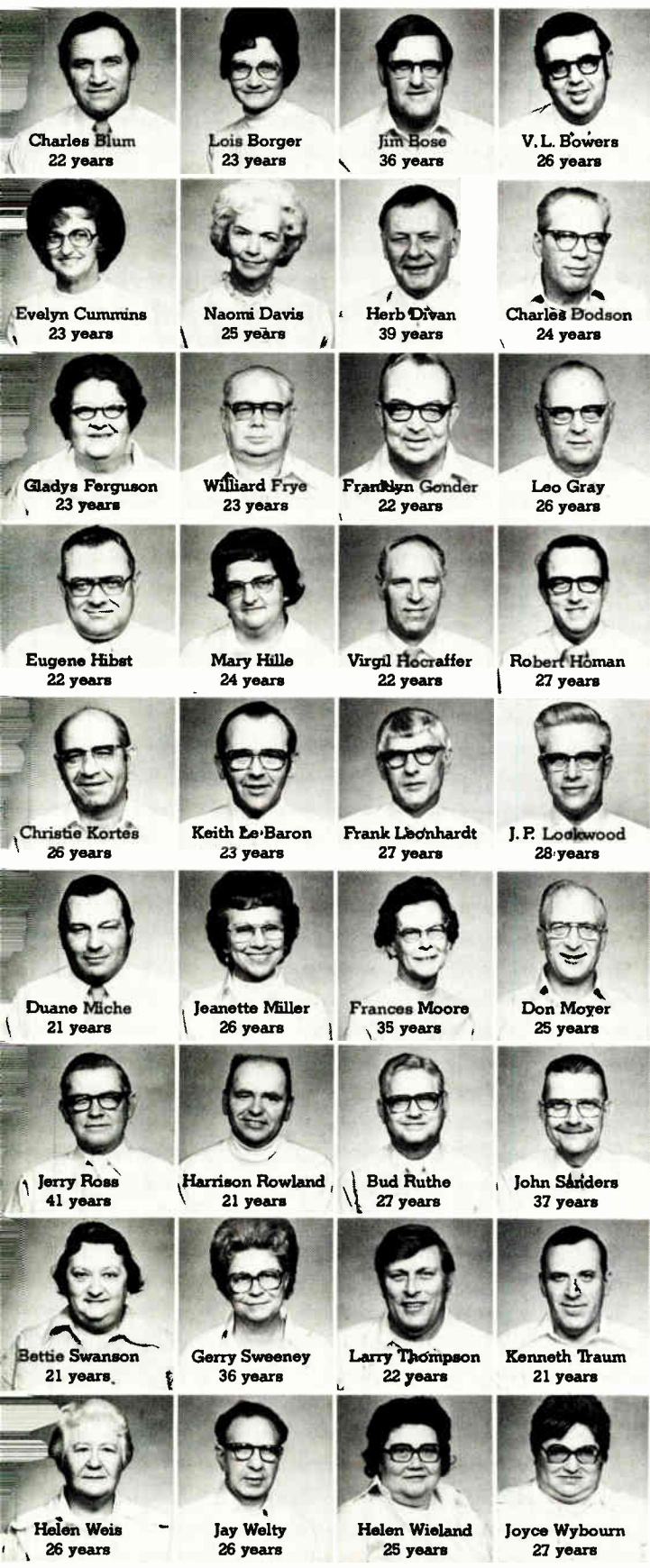

2775.

That's the total number of years these Quality Assurance employees have been on the job. And it's a figure that speaks for itself.

Because they use that experience to help make sure every MICRO SWITCH product meets the toughest performance standards in the business. Ours.

That's the MICRO SWITCH commitment to quality. A commitment made by every department. Every day. It adds up to the kind of products your money can't buy anywhere else.

We team our fine people with the very latest equipment. They use everything from simple, hand-held ring gauges to ultra-sophisticated electronic devices. Plus an evaluation lab that duplicates almost any environmental condition.

And it's all used with the same thought in mind. To see to it every MICRO SWITCH product is exactly what our designers intended it to be.

You see, when you buy a MICRO SWITCH product, whether it's a keyboard, a position sensor or a manual control, you're buying more than just a component. You're buying a company.

A company with capabilities to help solve your problems. Whether through research and development. Innovation. Availability. Reliability. Or Quality Assurance.

MICRO SWITCH. Consider what it would cost to have anything less.

For more information, write for our Quality Assurance booklet. MICRO SWITCH, Freeport, Illinois 61032. Or call 815/235-6600.

MICRO SWITCH products are available worldwide through Honeywell International.

MICRO SWITCH
Can you afford anything less?

Up-front backup.

Now Bussmann brings products and technical backup right to your front door.

If you've been going to an electronics distributor for Bussmann products, here's great news.

The Bussmann representative who brings new product information and application help to your distributor will now do the same for you.

He is likely to be the same sales representative who's kept you stocked with a variety of other electronics products. But now that he'll be bringing you Bussmann too, you

stand to gain a lot more than just single-source convenience.

For one thing, you'll get dependable technical help whenever you need it. As an experienced electronics professional, your Bussmann representative is a prime source of application advice. And he has the full backup of Bussmann in-plant application specialists.

Your Bussmann representative will also give you faster, more direct access to Bussmann products. Product literature. Tech-

nical bulletins. And more.

Working with your distributor, your Bussmann representative puts our total capability at your disposal. This new service team is just one more way we've strengthened and reaffirmed our commitment to you.

After all, when you specify the best electrical protection devices money can buy, you expect equally good service.

And now Bussmann gives you both.

Bussmann Manufacturing Division
McGraw-Edison Company
P.O. Box 14460
St. Louis, Missouri 63178

McGRAW-EDISON

**Bussmann.
The Protection
Experts.**

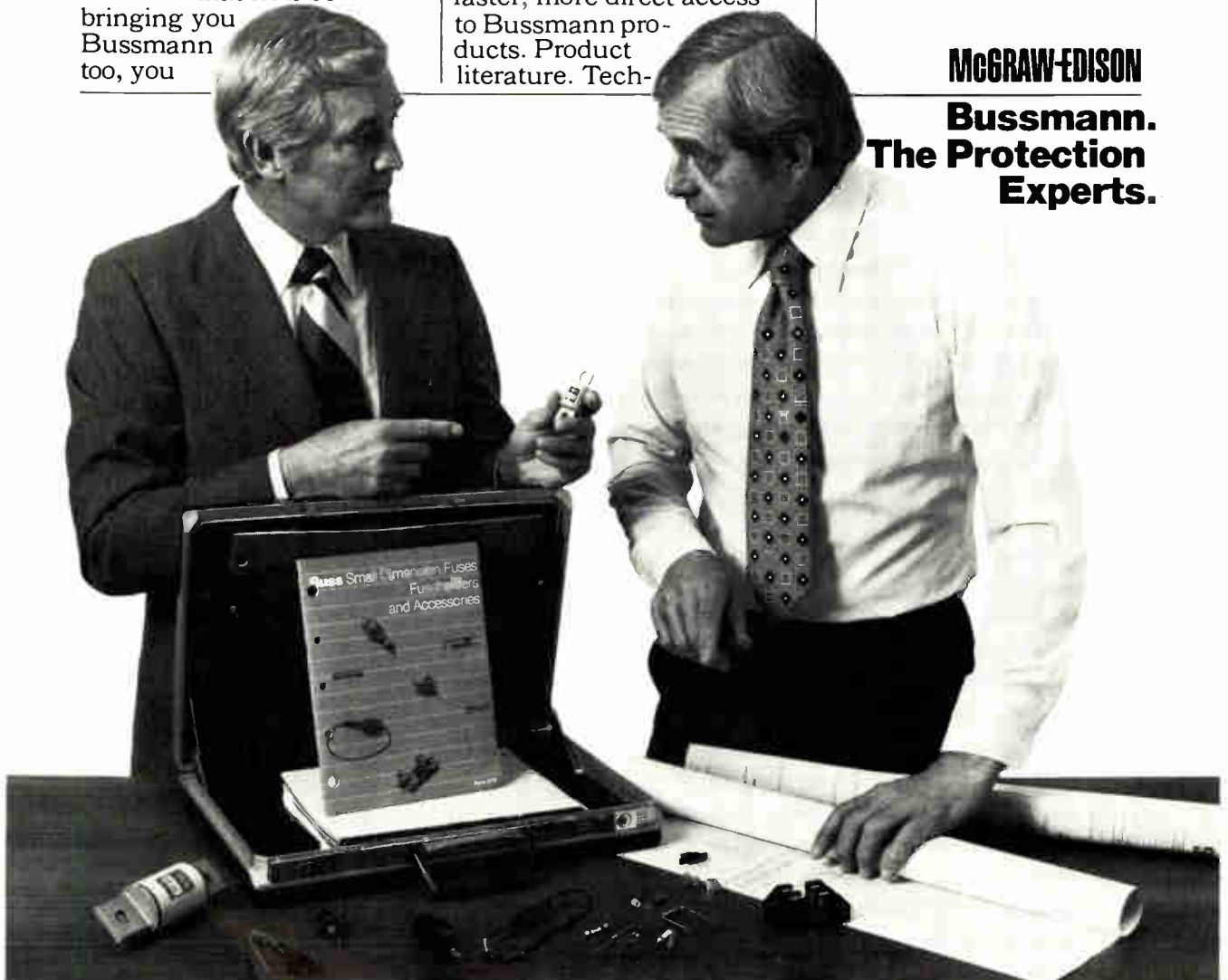

The race heats up in fast static RAMs

While Fairchild's bipolar parts and Intel's MOS chips slug it out in the sub-55-ns arena for random-access memories, other manufacturers are gearing up their processes too

by Raymond P. Capece, *Solid State Editor*

Memory system designers have a lot to look forward to in very high-speed semiconductor random-access memories. Over the next 12 months, static RAMs with access times of 55 nanoseconds or less will proliferate, as chip manufacturers scramble for secure positions in the sockets of their biggest customers, the builders of mini-computers and mainframes. For customers, that is good news: it means a price war that will drive down the cost of fast static memory.

Serving as high-speed buffers and cache memories, this portion of the RAM spectrum will see bipolar designs fighting against the encroaching metal-oxide-semiconductor chips. At the moment, there are two chief contenders: Fairchild on the bipolar side and Intel on the MOS side. Both companies are poised and ready to strike

with new processes (Fig. 1); but not far behind are such companies as Motorola, Advanced Micro Devices, Signetics, National, Mostek, EMM Semi, American Microsystems, and Texas Instruments.

It is prophesied that the world of memory systems will inevitably be all MOS, because these parts ultimately will be cheaper to build and they consume less power. However, that prophecy may not hold, for the commitment to a device type, as always, will take into account considerations other than technology. Delivery schedules and the availability of a second source will often take priority over price and even performance. Of course, designers must keep track of what is on the market and what is coming. (The table on p. 132 will serve as a handy reference for the present and future parts.) The

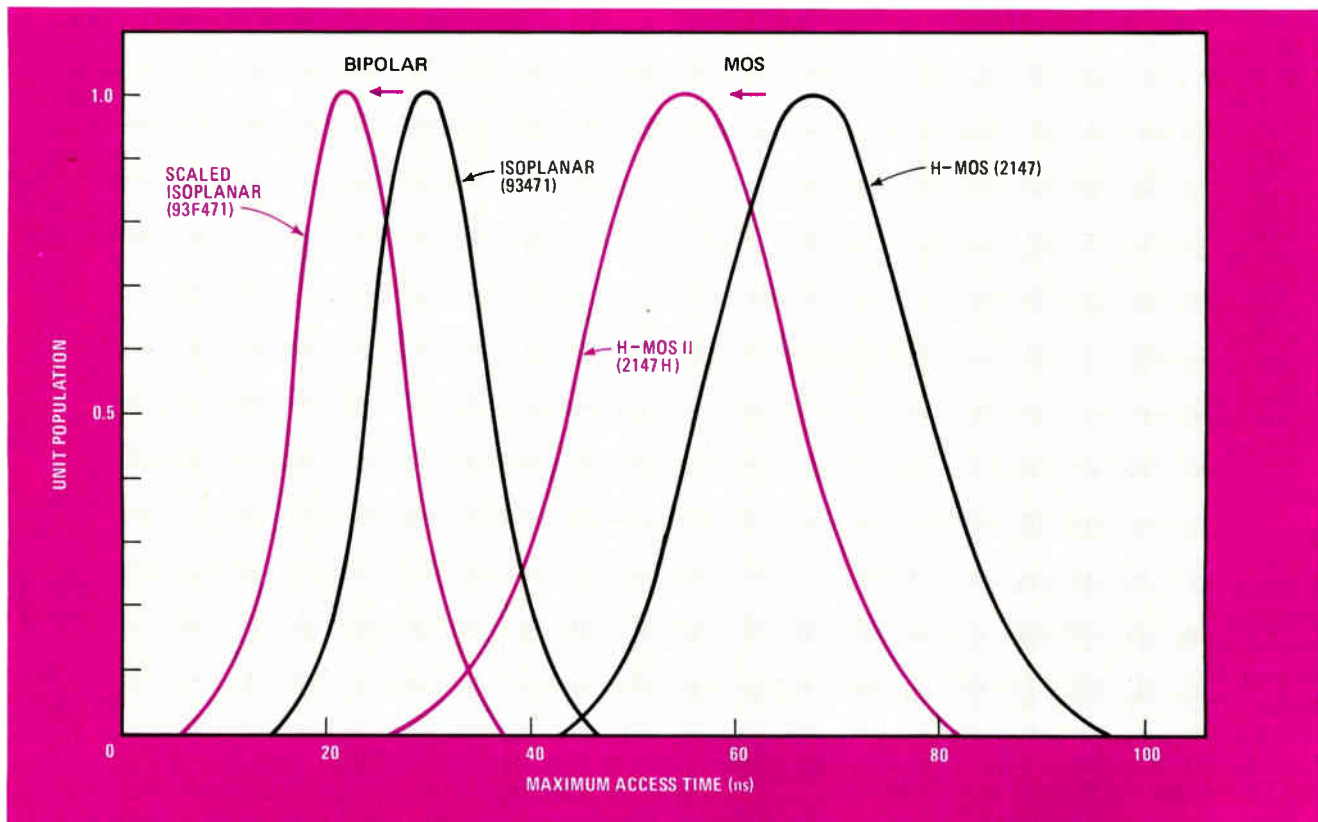

1. Downward bound. Curves for access-time distributions of the leading bipolar and MOS 4-K static RAMs tell the story: both are getting faster. Intel and Fairchild have begun production using processes (color) that will pare access times by 10 to 20 nanoseconds.

Watch out for Super C-MOS

Static random-access memories made with complementary-metal-oxide-semiconductor processes tempt memory system designers with their attraction of one tenth the power dissipation of n-channel MOS parts—although traditionally they lag a generation behind n-MOS static RAMs in speed and only somewhat less in density. Still, C-MOS adds low, low power consumption to the list of price, performance, and availability tradeoffs between bipolar and n-channel MOS chips.

C-MOS static memories are, at the very least, displacing n-MOS in moderate-speed applications where power is a strong consideration. Moreover, the development over the past few years of high-performance processes is starting to pay off in the high-speed arena as well.

First production. The magic access time of 55 nanoseconds has been reached by several manufacturers working with advanced self-aligned and oxide-isolated C-MOS processes. But the first to get there with a production part is Japan's Hitachi Ltd., which is surrounding an n-channel memory array with C-MOS peripheral chips to get high speed and low power. It has dubbed its 4,096-by-1-bit RAM the 6147, and its goal is clear: the part is a plug-in replacement for Intel's industry-standard 2147.

The 6147, shown to the right, is an impressive part. Built with a 3-micrometer process the Tokyo-based firm calls Hi-C-MOS, it employs several design twists, such as the use of both p- and n-type wells and the incorporation of bipolar transistors as output drivers. One U. S. C-MOS manufacturer who got a peek inside found "extremely innovative processing and design."

At 17,000 mil², its die is significantly smaller than Intel's 25,000-mil² 2147. Moreover, the part carries a 55-ns maximum address-access time and an absolute maximum chip-select access time of 55 ns—it pays no penalty for a short deselection period as the Intel part does. Most impressive are its worst-case standby power dissipations: 4.2 milliwatts in the standard version and only 520 microwatts in a selected low-power version.

However, operating power is another matter: the 6147 exhibits the typical C-MOS dependency of dissipation on operating frequency. The maximum power dissipation of the device cannot be clearly inferred from the data-sheet specifications. Average operating current is given as 14 milliamperes typically, which translates into a dissipation of 73.5 mW, but that spec is at a cycle time of 150 ns. The absolute worst-case dissipation is likely to climb to more than half a watt and could be as high as the 2174's 900 mW. Still, the main attraction of C-MOS lies in its low dissipation during standby.

To get such low power out of its n-channel array, however, Hitachi is using extremely high-value polysilicon

loads—the phosphorus-doped resistors are on the astronomical order of 40 gigohms. Since static RAMs with polysilicon load resistors of even far lower resistance have fallen prey to soft errors caused by alpha-particle radiation [*Electronics*, March 15, 1979, p. 85], the 6147 should be besieged by soft errors.

Not so, says Hitachi, claiming no soft errors until the supply voltage is reduced to about 1½ volts. It offers as an explanation the unique construction of the chip: the n-type transistors of the memory array sit in a grounded p well sunk into an n-type substrate tied to the positive supply. That electric field sweeps away the memory-disturbing charge carriers that alpha particles generate. So confident is Hitachi that it will begin offering third-quarter samples of its 16,384-by-1-bit static, a scaled-down extension of the 6147 design.

The alpha-particle invasion of standard n-channel static RAMs may swing more attention to C-MOS statics than anything else. C-MOS may offer low power dissipation without any increased susceptibility to alpha particles, whereas n-channel devices become more susceptible as their power is reduced. Look at the differing approaches to power reduction, says James A. Ford, manager of very large-scale integrated design for Control Data Corp.'s Digital Image Systems division, Minneapolis.

Susceptible. "Power is reduced in n-channel devices by using very low GM [transconductance] load devices or by using extremely high-value load resistors," he says. "In either case, the memory cell is inherently susceptible to flipping when an alpha-induced current is injected into the off side of the cell.

"In the case of C-MOS technology, power is reduced by an off transistor in series with an on transistor. The on transistor's effective resistance is in the range of 2 to 5 kilohms, three to six orders of magnitude less than the load devices used in n-MOS memories. When an alpha particle hits a C-MOS memory cell, the current induced is readily sourced or sunk by the device in the low-resistance state, without upsetting the state of the cell."

Perhaps that is why the major C-MOS manufacturers in the U. S. have begun to apply the tricks used by n-channel MOS makers. For example, Harris Corp., Melbourne, Fla., currently makes 1,024-bit and 4-K C-MOS RAMs that, with access times of several hundred nanoseconds, are sold primarily into applications needing extremely low power.

However, as long as two years ago the company identified a need for combined low power and high speed—both its military and mainframe customers want this combination of attributes in a RAM—and it will definitely make a play for that market. According to James F. Townsend, advanced product planner, Harris's C-MOS

name of the game is technological advance, and there is plenty of it going on in both bipolar and MOS designs. Moreover, there is a whole new host of chips on the horizon, thanks to the advances in complementary-MOS design. They add super-low dissipation to the list of design tradeoffs, and recent intense development of these processes is starting to pay off in terms of higher speeds (see "Watch out for Super C-MOS," above).

Focal point of the high-speed RAM industry is Intel Corp's 2147, announced in July 1977. It is no secret that every manufacturer aiming at high-speed MOS memories

covets this 4,096-by-1-bit chip. Although half a dozen of them are working on their versions, only Intel is shipping substantial volume of premium-speed, 55-ns parts.

With a six-transistor cell design (two of them are depletion-mode loads), the 2147 is an industry standard—the pin configuration received approval from the Joint Electron Device Engineering Council more than three years ago—and is in great demand. Other manufacturers undoubtedly began planning their parts as long ago as did Intel. But they are finding it a tough one, chiefly in the processing but also in design and layout

process is in its fifth generation, each having added a process variation that offered some improvement in speed or density. "We're closing the gap on n-MOS manufacturers in speed just as they are on bipolar makers," Townsend says.

He would not detail the process enhancements, but it is a good bet they are like those that other C-MOS manufacturers are beginning to use. Aside from shrinking the layout rules from the conservative 4 to 4½ micrometers, companies like American Microsystems Inc. and Intersil Inc., both in Cupertino, Calif.; Motorola Inc.'s Semiconductor Group; Solid State Systems Inc., Montgomeryville, Pa.; and others are using self-aligned processes and local-oxidation techniques to reduce the capacitance that hinders speed in C-MOS.

Faster. Harris has reportedly offered samples of 1-K RAMs with maximum access times of 50 ns without fully exploring design-rule shrinkage—at about 3½ μm, the process is comparable to Intel's H-MOS. Indeed, it is likely that in 1980 sub-100-ns C-MOS RAMs will be readily available from several manufacturers.

Yet another C-MOS approach comes from RCA Corp.'s Solid State division in Somerville, N. J., and Rockwell International Corp.'s Electronic Devices division in Anaheim, Calif. They are developing memories using silicon on sapphire. Although RCA's parts are showing density advantages—its 4-K RAM is 24,000 mil², as against Harris's 30,000-plus—the parts are not yet yielding the speed that SOS promises. However, the company will make the most of the density advantage, having already unveiled designs for its 16-K static RAM at conferences earlier this year.

Toshiba Corp., with increasingly strong sales of 1-K and 4-K C-MOS RAMs in the U. S., is readying a 2-K-by-8-bit part for midyear samples that will use a 3-μm process. Moreover, the Tokyo firm has its eye on the high-speed business with its C-MOS-on-sapphire process. A 4-K chip in the laboratories is running at a remarkable 40-ns access time, and it could be a predecessor of SOS parts for buffer and cache memories sometime next year.

C-MOS manufacturers expect that their parts will always cost more, though a premium of 20% to 30% is one they would accept comfortably. To be truly competitive with n-channel MOS, they will have to pare down die sizes more. Harris and RCA feel that the 2-μm geometries available in 1981-82 would give C-MOS substantially the same size as n-MOS—in parts such as static RAMs and random-logic devices, which can take advantage of C-MOS's inherently smaller implementations of functions like transmission and exclusive-OR gates. "We mainly have to tighten up our layouts," says Harris's Townsend.

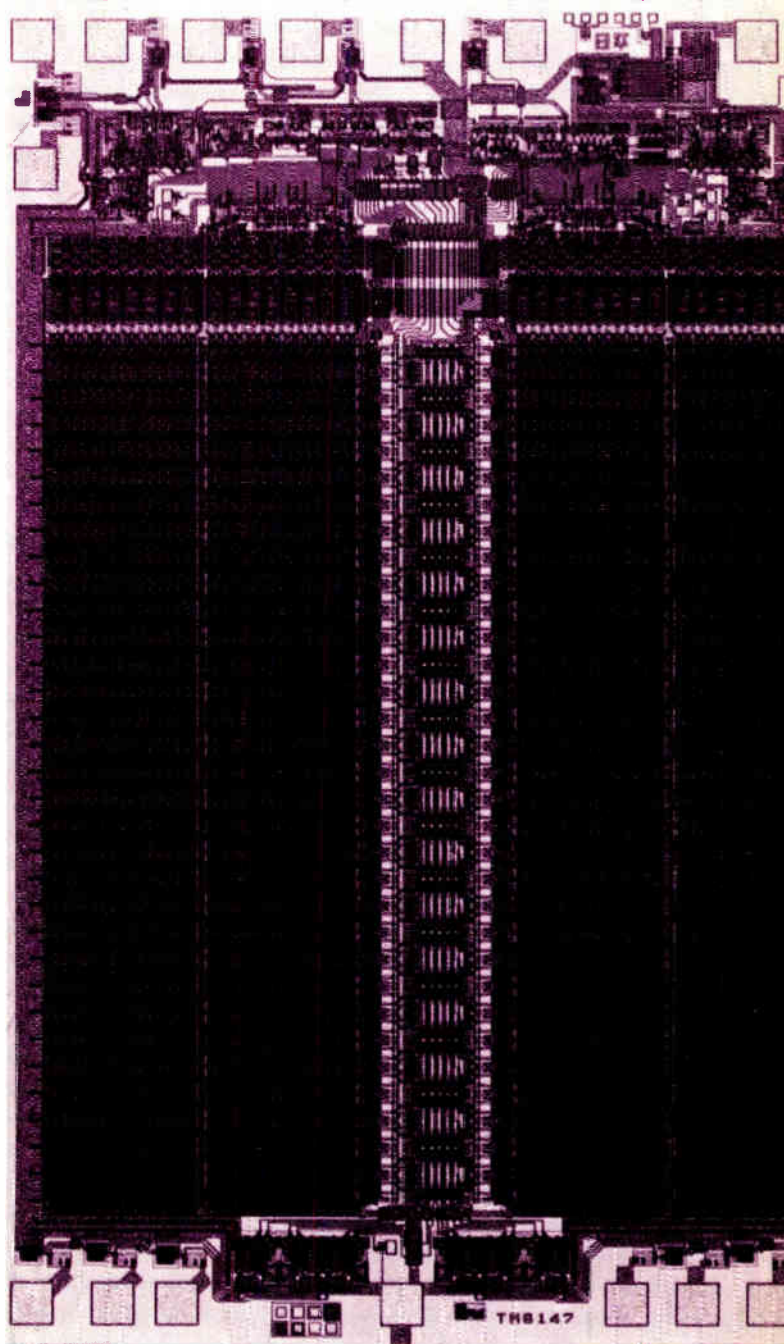

(see "MOS: not so simple now," p. 129).

Now Intel has announced the 2147H, with worst-case access times of 35 and 45 ns [*Electronics*, March 1, 1979 p. 156]. Could the Santa Clara, Calif., manufacturer really be that far ahead of so many other respected static RAM builders who have not yet achieved 55-ns devices?

Deliveries alone will tell. To build the 2147H, Intel has parlayed its high-performance H-MOS n-channel process into H-MOS II by thinning gate oxides to 400 angstroms, scaling channel lengths from 3½ to 2 micrometers, and tightening up its process. The company is

counting on direct step-on-wafer projection lithography equipment just coming on line, for the DSW units are the only machines capable of 2-μm resolution in production.

Of course, Intel is a double threat in the computer memory market, as it is the originator of the 1,024-by-4-bit 2114, which offers access times ranging from 100 to 400 ns. Widely imitated by other chip makers, the 2114 has almost reached the status of a jelly-bean part.

But, it is the fine lines claimed for the 2147H that concern Fairchild Camera and Instrument Corp., the bipolar RAM pioneer on whose toes Intel is stepping. "If

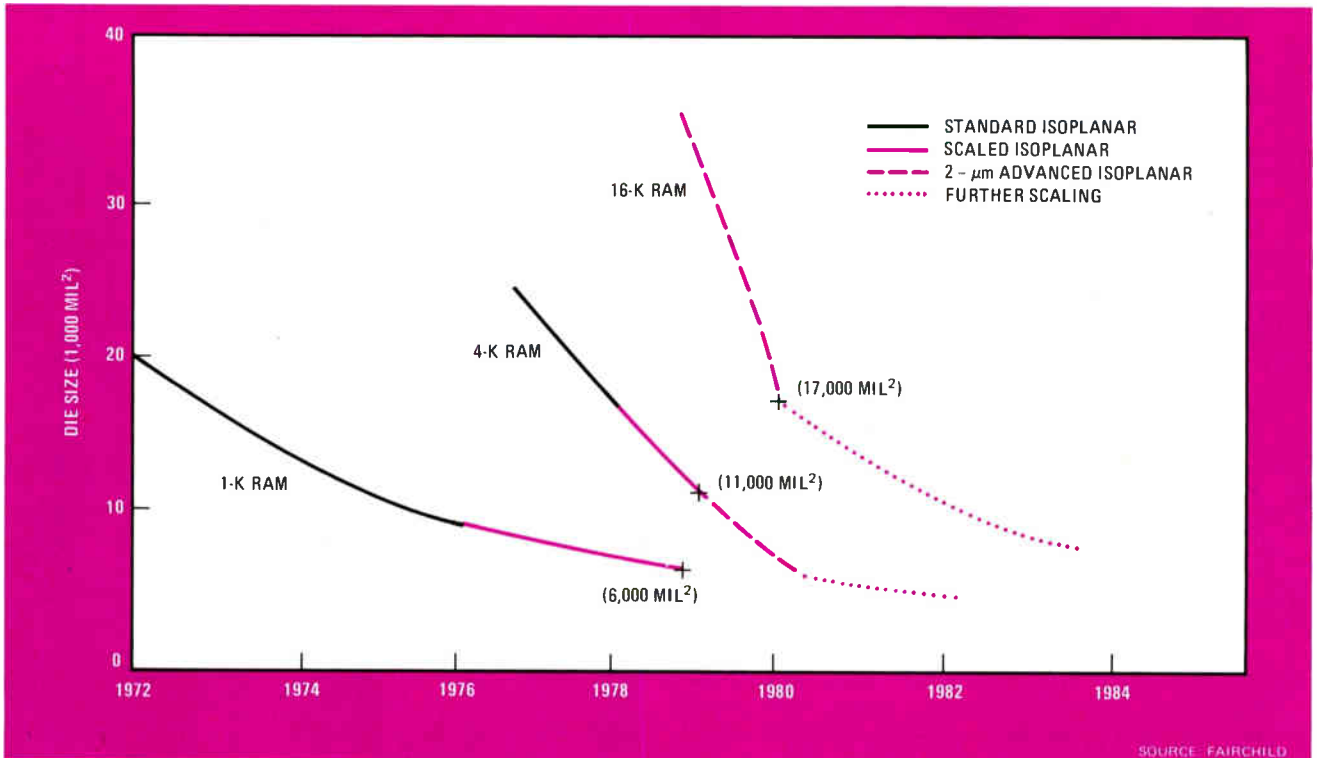

2. Evolving. Fairchild is reducing die sizes of bipolar memories with its Scaled Isoplanar process, which puts 3-to-3½- μm lines in place of 4½- μm lines. The first redesign will bring the 1-K RAM down to 6,000 mil² from 9,000 mil² and the 4-K RAM from 17,000 mil² to 11,000 mil².

they are really at 2 μm , that puts them several years ahead of everyone else," says Stephen Jasper, group marketing manager for bipolar large-scale integrated circuits at the Mountain View, Calif., Company.

Jasper's job is to chart a course for Fairchild's transistor-transistor-logic RAM products, which include the industry-standard 1-K-by-1-bit 93415 introduced in 1973 (and the popular three-state-output version, the 93425) and the 4-K-by-1-bit 93471 rival to the 2147 but with a different pinout. "I've got to plan on H-MOS II being a production reality within 12 months," he says.

In fact, he had better expect the worst, according to Kirk McKenzie, director of memory marketing at Intel's Aloha, Ore., division. "We're offering samples of the 2147H now and will be in volume production by the third quarter," he says. The part has a premium access time of 35 ns (compared with the 93471's 45 ns), as well as offering a power-down mode that retains data while cutting power dissipation by 80%.

Moreover, H-MOS II is making possible the recent 1-K 2115H, whose worst-case access time of 20 ns upstages the 30-ns 93415A from Fairchild, with which it is plug-compatible. Next to arrive, adds McKenzie, will be a high-speed, 16,384-by-1-bit static RAM, probably some time in 1980.

However, Fairchild is ready to counter with a taste of the medicine that MOS makers use: the shrink (Fig. 2). "The 93415A out today is built with conservative, 4- μm lines," Jasper says, "and we've already shrunk that to a geometry comparable to MOS." Using the company's new Scaled Isoplanar process for 3- μm lines, the 93F415 reduces the 9,000-square-mil die of the 93415A to only 6,000 square mils. A general introduction should come

late in the second quarter of this year, offering a part with a worst-case access time of 20 ns.

Fairchild also has plans on the 4-K-by-1 front. There will be a 93F471 that will drop the 17,000-mil² die of the 93471 down to 13,000 mil². "We expect the shrinks to pare down access time to well below 20 ns in a year or so," Jasper says.

The firm has other parts up its sleeve, involving its coming DSW lithography equipment. This is the same half-million-dollar system from GCA Corp. that is giving Intel its 2- μm parts. So Jasper offers the 1980 possibility of a 4-K RAM the size of present 1-K parts and a 35-ns 16-K-by-1 chip with a die size less than 20,000 mil².

Process differences

One point in favor of bipolar parts, as Fig. 1 shows, is that processing yields parts of uniform speed, unlike the wide range of speed distribution exhibited by MOS processing. The speed of bipolar circuits depends on relatively easily controlled diffusion steps, whereas MOS speed is extremely dependent on lithographic registration. "When a bipolar part is specified at 30 ns, all dice on the wafer are 30 ns," Jasper says.

Of course, power dissipation can be bipolar's Achilles heel. For example, one major computer firm has all but pronounced Fairchild's 1-K 93415 dead because Intel's MOS 2115 does the same job at less power. However, Jasper argues that in many cases pushing MOS to high speeds kills its power advantage: at the 4-K level, Intel's 2147H dissipates 945 milliwatts, compared with the Fairchild 93471's 892.5 mw.

Moreover, Fairchild is in volume production of the 93L415, which drops dissipation from 814 to 182.5 mw,

MOS—not so simple now

Lest MOS manufacturers continue to sell their high-speed random-access memories against bipolar RAMs with the old pitch, "The process is simpler, the part will eventually cost less," let the buyer beware. High-speed metal-oxide-semiconductor RAMs are built with processes that could easily take as many steps as bipolar chips, and the yield of good chips and the speed distribution of the dice on each wafer depend directly on the ability of the manufacturer to keep each of those mask steps aligned.

Moreover, the 2-micrometer channel lengths in Intel's latest H-MOS II methods and to come next year from other MOS makers put a strain on the process. All but extinct will be any advantage over bipolar processing, considered more complex because of the two semiconductor types, the epitaxial construction, and the oxide isolation.

"People still think MOS is cheap from the old four-mask p-channel days," says Frank Barone, National's director of bipolar memories. "Even our emitter-coupled-logic process is simpler, and we're betting that one day the costs for all high-speed memories will be equal."

Though he acknowledges that the scene is changing, Steve Jasper, group marketing manager for bipolar LSI at Fairchild, still puts bipolar at a 2:1 speed advantage, while giving MOS memories a cost edge. "It's the distribution game they're playing," he says, referring to the wide range of speeds that any MOS run yields. "The center of their distribution curve is what you have to look at."

More steps. The basic n-channel polysilicon MOS process requires five masking steps: field oxide, polysilicon, contacts, metalization, and pads. Moving to a higher density adds another mask step for buried contacts, and to get the threshold for a depletion-mode load transistor, another mask is needed.

Moreover, each time a device with a different threshold is added, that is another mask step. For example, a high-performance memory chip might use two types of depletion-mode transistors: those in the memory array would be lower-power devices with a threshold of -1 volt, whereas output transistors would get a -3 -V threshold for

more current drive. Similarly, enhancement-mode transistors with several thresholds can be advantageous in high-speed designs. Before long, the simple MOS process is using 10 masks—as many as bipolar.

Also, scaling down to $2\frac{1}{2}$ μm or less cuts into yields. Arsenic dopants must be used, and that means ion implantation with a very high-energy beam that will heat up the wafers and could even crack them; thus special cooling precautions must be taken.

Resistance. Finally, there are circuit-design considerations. The resistance of polysilicon becomes a problem, because the RC time constant of the circuit can hold back the speed of a memory part. Designing around that resistivity is tricky and requires juggling chip layout.

Since the number of good dice per wafer is still the best measure of cost, keeping die size as small as possible remains the name of the game. There, bipolar parts are showing an advantage.

In the latest version of Fairchild's 1-K static bipolar RAM, the geometries have been reduced from conservative $4\frac{1}{2}$ - μm lines to the resolution of present-day high-performance MOS—about $3\frac{1}{2}$ μm . That makes the 93F415 a 6,000-square-mil die. By comparison, even Intel's equivalent MOS 2115H, which uses 2- μm channel lengths, will yield a die greater than 10,000 mil². Moreover, in 1980, Fairchild will apply 2- μm geometries that will reduce its 4-K RAM to less than 10,000 mil².

A feeling throughout the semiconductor industry has long been that fast bipolar memories and dense MOS memories would clash when both processes were tried for a fast 4-K static RAM. Because only Fairchild and Intel are shipping the parts and neither has a dependable second source, there are not enough players yet to tell.

Meanwhile, Fairchild's Jasper is looking to jump back to the 1-K level and set a precedent with the shrunken 93F415: true cost competition for the first time between bipolar and MOS. "With a 6,000-mil² die, we ought to be able to attack the 2115 and get back some of that business we've lost," he says.

and the 93L471, which has a dissipation of 472.4 mW, Jasper says—but they are offered only with slower access times. Although the L parts are selected from standard production runs, the company is working hard on reducing power dissipation, as are other firms.

Fairchild acknowledges that a low-power standby feature is an advantage for MOS chips and a problem for bipolar parts. "The applications we see, however, are speed-oriented, and the users don't care," Jasper says. Still, others think the inherent power-down capability of MOS will be a boon, especially in applications with large arrays of statics (see "On powering down," p. 131).

Perhaps the greatest 4-K problem for Fairchild is the lack of a second source for the 93471. Jasper cites as a potential source Motorola, the only other manufacturer shipping the 93415A in volume. However, Motorola is not tipping its hand yet.

Yet Motorola will make Fairchild's emitter-coupled-logic 4-K memory, the 10470. Interestingly, all of Fairchild's transistor-transistor-logic memories start out as ECL parts; that is how the 93471 ended up with a nonstandard pinout, the company says. In fact, the levels

used within the memory arrays of the firm's bipolar chips are the same for both species. The input- and output-level translating circuits determine whether the parts are ECL- or TTL-compatible—and the ECL versions hit the street first. The firm thus offers a full complement of ECL parts, mask-programmable for compatibility with either the 10K or 100K families.

Of course, ECL's speed isolates it from MOS competition, and that feature may make many bipolar makers more interested in second-sourcing Fairchild's ECL parts than its TTL parts. As is Motorola, Signetics, National, and others are aiming at a strong ECL capability.

Another factor are Japanese firms, hungry for U.S. market niches, especially with parts they find useful for their own mainframe computers. So these firms are building—and exporting—more and more ECL and TTL parts that are in short supply from the U.S. makers. The key Japanese companies are Hitachi Corp., Fujitsu Ltd., and Nippon Electric Corp., all three offering plug-in replacements for the 93415.

Like Motorola, AMD, and Signetics, Fairchild is in the somewhat awkward position of interleaving strategies for

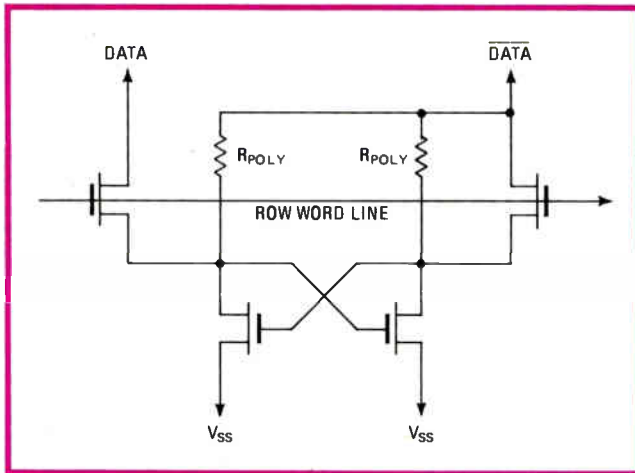

3. Different cell. Mostek Corp.'s 4801 1-K-by-8-bit RAM boasts a die size of less than 20,000-mil². One reason: Mostek hooks the loads to the data line, rather than to the positive supply. Eliminating the need for V_{cc} to run through each cell permits smaller dimensions.

bipolar and MOS statics. It is developing its high-performance MOS process and has seen the first passes of a 2147-type part. There still is much tightening of the process to be done, says George Urbani, manager of MOS marketing, and samples probably will not be available until early 1980.

Urbani acknowledges that Fairchild's 2147 part will be competing with its own 93471. "But everyone with an MOS process will be doing that part," he says. "There's a lot of money to be made on it." The company's next move in MOS statics will be to boost density to the 16-K level, but the part will be slow and organized as 2,048 by 8 bits for microprocessors. "Then we'll proceed with a fast 16-K-by-1 part," Urbani says.

Motorola in both races

Already making moderate-speed static RAMs (the popular 4-K 2114 in standard and low-power versions and its own 4-K-by-1 6641), the Austin, Texas, MOS memories operation of Motorola Inc.'s Semiconductor Group is working on a 2147 type. Dual designs were developed, one with polysilicon load resistors, the other with depletion-mode transistor loads. Motorola found the latter to show slightly better speed, so it will likely end up in the first production parts, which will come in at just under 20,000 mil². Samples should start appearing around midyear.

Once the high-speed process is nailed down, the unit will look at other chip sizes and organizations. The 2115 looks interesting, and building it would not be a backward step, says David Ford, marketing manager for MOS memories. "Many customers we talk to are using cache memories 1,000 words deep, and that means either a 2115 or a part with a by-4 or by-8 organization. We even get some calls for by-9 parts, since many computer people carry along the parity bit."

Ford says a 1-K-by-4 part is too small. A better possibility for his company, so heavily into the microprocessor business, is the 1-K-by-8 organization, since slower runs of a byte-wide part can be sold for microcomputer applications.

Perhaps somewhat further out is the 16-K-by-1 RAM that Intel has in the works. "It's just too hard to tell right now if caches will actually go to 16,000 words deep," Ford says. "There are a lot of advantages, since you can do much less pushing and pulling of data with a big cache. We'll be keeping an eye on the Intel part."

Motorola's bipolar memory operation in Mesa, Ariz., has long concentrated on emitter-coupled logic because the company's 10K family is a major commitment to this technology for high-speed logic. It offers a half dozen ECL statics, ranging from 16-bit to 1-K sizes with speeds between 15 and 30 ns.

With its recently introduced version of the bipolar 93415, the firm is seeing that there is money to be made in the TTL arena. Since Signetics suffered a production hiccup, Fairchild and Motorola are the only U.S. suppliers of the 1-K 93415.

But the 4-K TTL part is another matter. "We're not yet committing on the 93471," says Ron Lipinski, manager of bipolar marketing. It is likely that the plans of the MOS memory unit for the 2147 have something to do with the bipolar outfit's indecision. At any rate, Lipinski says, a 4-K TTL part would follow 4-K ECL design, "and we won't have that until 1980." Motorola will be calling that part the 10470, a variant on its own numbering system to accord with Fairchild's for the first time.

AMD looks to both

Like Motorola and Fairchild, Advanced Micro Devices Inc. has a foot in both MOS and bipolar camps. It has just seen first passes of its 2147-type part, which it is calling the 9147. Samples should be available within the next couple of months. The part, built with fairly conservative geometries to achieve its size of less than 17,000 mils², uses polysilicon-load cells, says Lowell Turriff, marketing manager for MOS RAMs.

The Sunnyvale, Calif., firm now makes a 2114 version (its 9114); the 4-K-by-1 9044, its version of Texas Instruments' 4044; and the 9244, a 4044 version without power-down. Not unlike its competition, AMD's game plan for static RAMs calls for a relatively slow 2-K-by-8 part aimed at microprocessors.

Next could be another 50-ns part. "If you're going after speed, the part to do is the 1-K-by-8," says Turriff, who is looking for these byte-wide fast parts to be a factor in control stores for computers. "We see the market clearly segmented: either 100-to-150-ns access times or 50 ns and below." The forthcoming high-speed 16-K-by-1 static memory could be the next workhorse after the 2147, "but Intel will have to prove its capability," he adds.

On the bipolar side, AMD does plan to second-source Fairchild's 1-K RAM. Samples of three parts will be ready by midyear, says Ralph Cognac, marketing manager for bipolar memories: the 93415 and the three-state 93425, both at the standard 45 ns; and the 93415A, running at 30 ns. Also in the works for end-of-the-year samples is a low-power version, the 93LS415.

The company has used a standard diffused Schottky TTL process to build smaller memories, but for the 93415 it is introducing a high-density, high-performance, oxide-isolated process it calls IMOX, for implanted oxide.

On powering down

With its 2147 random-access memory, Intel Corp. introduced automatic power-down, a feature that will be a major issue in the struggle between metal-oxide-semiconductor and bipolar RAMs. In less than one memory cycle after access ends, the 2147 reduces its 900-milliwatt power dissipation 80%, to 158 mW—while retaining data, of course. The reduction in overall power consumption could approach 85% in large memory arrays, says Intel.

Bipolar memories offer no such mode, although several manufacturers are working on the basic cell design. Their inherent low impedance and poor thermal noise immunity dim prospects of future power-down designs with much better than a one-third savings in power.

Though the scales may seem tipped in MOS's favor, the situation is not so simple. A memory that goes to sleep when not needed can cost in system speed. Moreover, it can even prove to be a disadvantage in certain situations and can be troublesome when designing systems.

For one, powering up a chip that is powered down takes more time than if it were not in standby. Therefore, the designer must look beyond the RAM's address-access time (t_{AA} in part a of the figure), which only specifies the time required for valid data to appear at the output once the signals on the address lines are stable. He must consider the chip-select access time (t_{ACS}), the time required for valid data to appear after the chip is selected.

Critical window. In many memory systems, the chip-select signal is part of the address information; an access time longer than the address-access time will hinder throughput. The data sheet's fine print tells the story: chip-select access time can be as much as 75 ns on a 55-ns 2147 if the part is activated within 55 ns of being deselected. That critical timing window (between deselect and select) must be greater than 55 ns, lest access time be extended. It is, in fact, a highly vulnerable feature of the 2147. A glitch on the chip-select line, for example, can stretch the access time and thus slow a computer cache, while being very difficult to detect.

Mostek Corp.'s 1,024-by-8-bit 4801 uses a different

power-down scheme, and it is likely that others will appear as well. Mostek calls its technique address activation: within a memory cycle after the signals on the address line have settled, the part powers down. However, the 4801's standby power is only about 50% of the active power—not a tremendous reduction. On the other hand, the part's chip-select access time is that much better for it: 25 ns for the 55-ns version of the 4801.

Another argument against memory parts is that power-down involves the noise generated by the switching transients as the many RAMs on a circuit board cycle through active and standby modes. As shown below in part b, the current through bipolar RAMs fluctuates by at most 10%, whereas MOS memories generate many transients as they switch through 10-to-1 current extremes.

Boards. Such signal behavior makes the job of laying out the memory boards for a high-speed cache difficult. Closer attention must be paid to board layout, conductor length and pattern, power-supply decoupling, and transient suppression. One mainframe designer likened the difficulties with power-down statics to those encountered when designing with hard-to-use dynamic RAMs.

The rule is that computer makers will always take the lower-power part—if it does not cost too much. Therefore, power-down may be here to stay if "memory system designers will go through the learning process for using power-down memories," as one component evaluator for a major computer firm puts it.

Still, critical cache memories must squeeze the most speed out of parts, and if they contribute little to a computer's total power dissipation, speed will easily take priority over power. As caches grow and as fast statics make their way into main memory, power dissipation will increase in importance. Even on its fast 6147P memory, Hitachi is offering power-down. The 6147P drops from a typical operating power of 75 mW (cycling at 150 ns) to a maximum standby of 4.2 mW. The Hitachi part, incidentally, suffers no extension in chip-select access time even with short chip-select intervals.

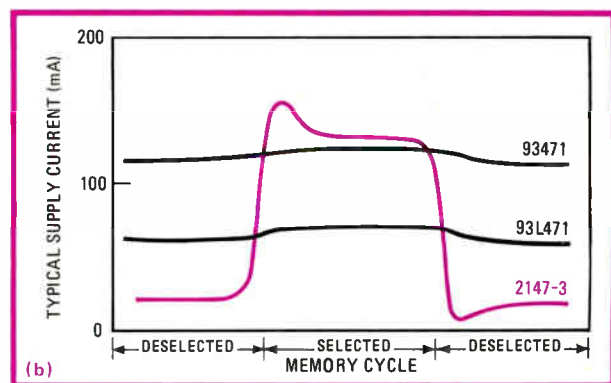
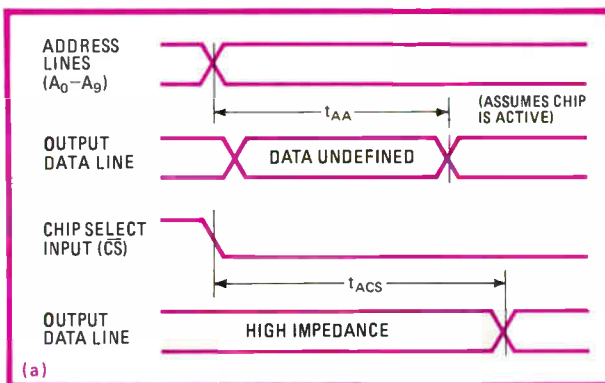

Cognac says the new process reduces transistor dimensions for faster, smaller chips.

AMD could use IMOX to build a 4-K bipolar device, but it is still in the throes of decision. "We're not committing beyond the 1-K density," Cognac says. Apparently, the MOS people at the firm are confident that they will be building a version of the competing 2147.

However, Cognac says there is plenty of life left in

bipolar RAMs. Not only can they be designed with better power-down features, but process improvements may lead to smaller chips and cost reductions. "Besides," he adds, "some markets, like the military, prefer to stick with the bipolar devices they have more confidence in."

Having built its MOS business on read-only memories, Signetics Corp. admits being a late starter on the RAM side of the technology. But the Sunnyvale, Calif, subsid-

THE STATIC RAM LINEUP

Part	Organization	Process type	Maximum access time (ns)		Maximum power dissipation		Package
			Address access, t_{AA}	Chip-select access, t_{ACS}	Active (mW)	Standby (mW)	
2115A/2125A	1 K by 1 bit	n-MOS	45 70	45 70	656	—	16-pin
2115AL/2125AL	1 K by 1 bit	n-MOS	45 70	45 70	394	—	16-pin
2115H/2125H	1 K by 1 bit	n-MOS	20 25 30	15 15 20	656 656 525	—	16-pin
93415A/93425A	1 K by 1 bit	bipolar (TTL)	45 60	35 45	814 814	—	16-pin
93L415/93L425	1 K by 1 bit	bipolar (TTL)	45 60	35 45	341 341	—	16-pin
93F415/93F425	1 K by 1 bit	bipolar (TTL)	20 35	15 20	656 656	—	16-pin
10415	1 K by 1 bit	bipolar (ECL)	20	7	780	—	16-pin
10422	256 by 4 bits	bipolar (ECL)	10	7	1,000	—	22-pin
10470	4 K by 1 bit	bipolar (ECL)	35	15	1,000	—	18-pin
93471A	4 K by 1 bit	bipolar (TTL)	45 60	35 45	893 893	—	18-pin nonstandard
93L471	4 K by 1 bit	bipolar (TTL)	45 60	35 45	472 472	—	18-pin nonstandard
93F471	4 K by 1 bit	bipolar (TTL)	30	20	893	—	18-pin nonstandard
2147	4 K by 1 bit	n-MOS	55 70	55* 70	900 800	158 105	18-pin standard
2147H	4 K by 1 bit	n-MOS	35 45	35* 45	945 945	158 158	18-pin standard
HM6147P	4 K by 1 bit	C-MOS	55 70	55 70	75**	4.2	18-pin standard
HM6147LP	4 K by 1 bit	C-MOS	55 70	55 70	75**	0.53	18-pin standard
MK4801	1 K by 8 bits	n-MOS	55 70 90	25 35 45	656 656 656	325 325 325	24-pin standard
μ PD421D	1 K by 8 bits	n-MOS	85	85**	788	105	22-pin standard

*chip-select access time may increase 10 to 15 ns if device is selected within a time equivalent to t_{AA} after deselection.
 **typical power dissipation at 150-ns memory cycle rate, 50% duty cycle. t_{2Q} = second quarter.

Manufacturer and availability	Comments
Intel, now	<ul style="list-style-type: none"> no second source plug-compatible with 93415/93425 2115 has open-collector outputs 2125 has three-state outputs
Intel, now	
Intel, 2Q† '79	<ul style="list-style-type: none"> built with HMOS II
Fairchild, now Motorola, now Hitachi, now Fujitsu, now NEC, now Signetics, 2Q '79 AMD, 2Q '79	<ul style="list-style-type: none"> 93415 has open-collector outputs 93425 has three-state outputs 93415 equivalents: Fujitsu: MB7061 NEC: μPB2205D Hitachi: HM2510
Fairchild, now Signetics, 3Q '79	<ul style="list-style-type: none"> low-power selection
Fairchild, 2Q '79	<ul style="list-style-type: none"> high-speed version built with Scaled Isoplanar Process
Fairchild, now Motorola, now Signetics, 2Q '79	
Fujitsu, now Fairchild, now Motorola, 4Q '79 National, now	<ul style="list-style-type: none"> 100K logic family compatibility is available Fujitsu equivalent is MB7072
Fairchild, now Motorola, 1Q '80 Fujitsu, 2Q '79	
Fairchild, now	<ul style="list-style-type: none"> no second source
Fairchild, now	<ul style="list-style-type: none"> low-power version
Fairchild, samples 3Q '79	<ul style="list-style-type: none"> high-speed version built with Scaled Isoplanar Process
Intel, now AMI National TI AMD Motorola NEC Signetics Mostek	<ul style="list-style-type: none"> some manufacturers, preliminary data sheets quote lower power dissipation device powers down after chip-select goes high
Intel, samples 2Q '79	<ul style="list-style-type: none"> high-speed version built HMOS II
Hitachi, samples now	<ul style="list-style-type: none"> equivalent to 2147 at much lower power
Hitachi, samples now	<ul style="list-style-type: none"> low-power version of 6147P
Mostek, samples now	<ul style="list-style-type: none"> no second source pinout is ROM or PROM compatible device powers down after address information stabilizes
NEC, samples 2Q '79	<ul style="list-style-type: none"> pin-compatible with EMM Semi Inc's 8108

SOURCE: ELECTRONICS

itary of U. S. Philips Corp. intends to be in the ball game. Already shipping 16-K dynamic RAMs, it expects to see working 2147 parts by summer's end, with production volumes by the new year.

Signetics adds MOS to bipolar

Statics seekers get a bipolar choice at Signetics: both TTL and ECL parts. Unfortunately the company has suffered a production setback because it has gone into redesign of its bipolar process. However, production should resume in the coming months. Napoleone Cavlan, marketing manager for bipolar memories, says demand is great enough for versions of the Fairchild 1-K 93415 that Signetics plans to go ahead with its model, the 82S10. He foresees demand in other sizes, so the firm will be making 256-by-8-bit and -by-9-bit parts.

Cavlan expects his firm to forge ahead for a 1980 introduction of a 4-K bipolar part to be competitive with the 2147. The pressure from MOS chips will not come down to speed, but will stay on density, he says. "Still, it's not unlikely that we will have a bipolar 16-K-by-1 part by the end of 1980."

Also in his jurisdiction are the ECL static parts. Offering a 256-bit chip compatible with the 100K family of logic parts, Signetics will bring out a 1-K-by-1 RAM later this year. It will have a maximum access time of 15 ns.

National sees squeeze on TTL

At National Semiconductor Corp., the opinion is that fast ECL and thrifty MOS are squeezing out TTL. As early as August 1977, the firm scrapped plans to build the bipolar 4-K 93415, says Frank J. Barone, director of the bipolar memory division. "We just decided there was no window for it."

The Santa Clara, Calif., firm's guns are fully trained on ECL. "We're not after very high density—that's for MOS, and treading on MOS is dangerous," Barone says.

The 10422, a 256-by-1-bit ECL part, can be mask-programmed for compatibility with either the 10K or 100K ECL families. Its access time is still a conservative 25 ns. "However, we've only begun to apply the tricks of TTL, like oxide isolation, to ECL," Barone says. "Our goal will be well below 10 ns." As well as boosting speed, these improvements will cut power, reduce die size (and hence price), and make possible the 4-K RAM National expects to bring out in 1980.

The impetus for National's ECL program comes from the changing face of computer technology, says Pierre Lamond, vice president and technical director. "The powerful, mainframe-replacing minicomputers, like those in our own computer group, have revitalized the computer industry in general," he explains. "And they're starting to use ECL."

Another reason for the company's shunning of TTL memories is because it is getting its MOS act together. Moving on from a host of slower statics, including a 2114 with polysilicon loads, it is very close to offering samples of its 2147. Like Motorola, National carried out dual development, settling on depletion loads rather than polysilicon resistors for initial production offerings.

"We're committed to the 2147," says Andrew G. Varadi, director of memory components. "We're looking

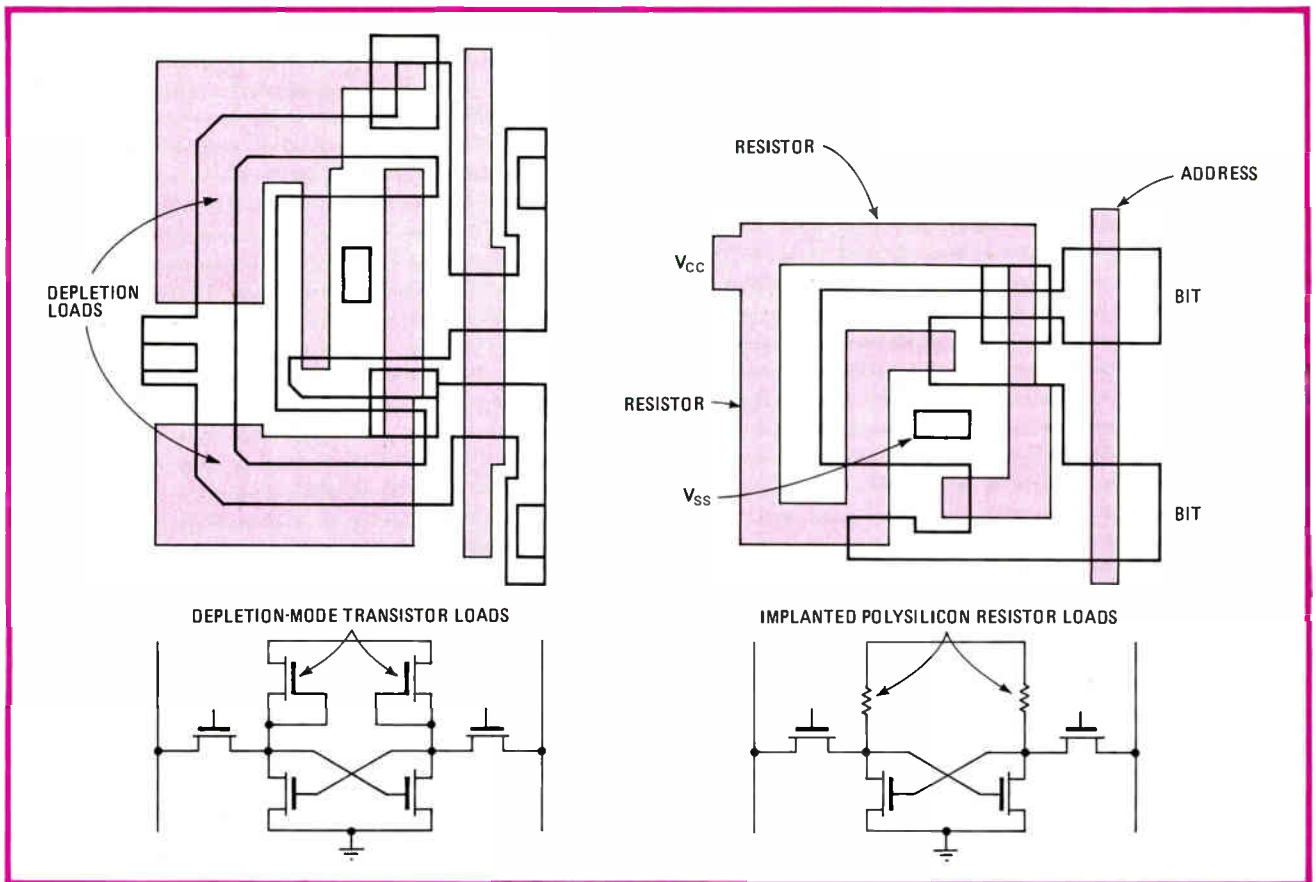

4. Watch the loads. The smaller die size of polysilicon load resistors (right) in comparison to depletion-mode transistor loads (left) is an advantage in the design of an MOS static RAM memory cell. Polysilicon expertise will be essential for the next generation of statics: the 16-K.

at various configurations of 16-K parts after that." A year will go by before any part with a spec below 55 ns appears, he adds.

The 2147 will be the first memory to use X-MOS, the name National is giving to its high-performance n-channel process. Starting point is a channel length of about $3\frac{1}{2}$ μm , but that eventually will be scaled down to 2 μm as the company brings up its DSW equipment.

The future does not hold a version of Intel's 2115 1-K static RAM, even though the bipolar group will not make a version of Fairchild's 93415. Fast RAM plans at National, though, do include larger memories with by-1 and by-4 organizations.

Mostek goes its own way

While Mostek Corp. is pursuing a 2147 part, the Carrollton, Texas, company is also taking a unique route to the high-speed RAM arena. It is promoting a 1-K-by-8 organization for its statics, the 4118 and 4801. The two products are functionally identical, but are cast with different processes and are aimed at different markets.

The 4118 carries access-time ratings that range from 120 to 250 ns, so it is a memory for minicomputers or slower mainframes—or one that is more than adequate for microprocessors. It is built with Mostek's Poly R process, using polysilicon load resistors.

The 4801 will be the first memory to use Scaled Poly 5, which is Mostek's high-performance process that ultimately will be shifted to DSW equipment for scaling of

channel lengths down to 2 μm . The 4801 will carry 55-, 70-, and 90-ns specs, with samples of the 55-ns version available in a few months.

Both RAMs are fully static parts, relying on what Mostek calls an address-activated system to reduce dissipation when the device is inactive. The parts go into a standby mode, reducing power about two thirds, soon after the signals on the address lines have settled.

The die size of the 4801 is just under 20,000 mil², making it smaller than Intel's 4-K 2147. The polysilicon load resistors help the density, as does the Poly 5 process, which fixes channel lengths at around 3 μm . Also, Mostek made some changes in the basic static cell circuit (Fig. 3): the load resistors in the flip-flop are connected to a data line, rather than to the positive power-supply line as is the convention. This circuit twist adds significantly to density, since the cell can be smaller if the V_{cc} line does not run through it.

Meanwhile, another group at Mostek is working on a version of the 2147: the 4147, samples of which will be available this summer. Richard Lee, product line manager for statics, explains that his company wants to be in both camps: "Designers of caches and buffer memories have different preferences. Those designing larger arrays will use the 4-K-by-1; but if the depth is less than 4 kilowords, then a 1-K-by-8, like the 4801, or a 2-K-by-8, or even a 4-K-by-8 part is preferred. We want to supply parts for both designs."

As can be inferred, Mostek's plan beyond the 4801

will be a 4802 2-K-by-8 RAM sometime in 1980 and a 4-K-by-8 part after that. Over in the 4147 group, Lee adds, the plans are as straightforward. A 16-K-by-1 part, the 4167, will materialize next year.

Mostek will be looking for finer lines with scaled Poly 5 on both the 4801 and 4147. Eventually, the 4147 will be just larger than 10,000 mil² (that will put the 16-K part in the high-20,000-mil² range) and the 4801 will descend to 14,000 mil².

Semi was early entry

A good deal ahead of the industry, in February 1976, EMM Semi Inc., Phoenix, Ariz., began shipping a sub-100-ns 4-K-by-1 clocked static RAM. Although Semi produces more static RAMs than any other manufacturer and thus has more experience, it has not pushed the speed of its parts.

The problem has been chiefly limited fabrication facilities committed to an extraordinary amount of static RAMs with nonstandard pinouts. Armed now with a new wafer-fabrication plant that will more than double capacity, plus the confidence of a strong, seasoned design team, the well-respected RAM producer will begin to address the high-speed market where most of the MOS action is still talk.

The subsidiary of Electronic Memories and Magnetics Corp. is indeed aiming at the high-speed target, says Fran L. Krch, director of marketing. "Right now, we have the modeling and process work going on to take us down to the 50-ns range." He intimates that the new parts may tend toward the standard-product lineup. "We have [Intel's] 2115 under consideration, and we're also looking at a 2147-type part," he says.

V-MOS still in the groove

V-groove MOS offers higher density than standard n-channel MOS, and those systems designers whom American Microsystems Inc. has convinced of the theoretical advantages are waiting anxiously for proof of the pudding. Well, AMI has spread around enough 1-K 2114Hs to prove they exist; they carry a 70-ns access time and have a memory-cell size of a scant 1.95 mil².

The clincher is that the Santa Clara, Calif., company is among the very few to have provided customers with samples of a 4-K 2147 design. Also using the 1.95-mil² cell, it is a tiny 14,000 mil², as against Intel's 25,000 mil².

The speed distributions on the production line are just starting to throw enough 2147s into the 55-ns bin for volume offering, says T. J. Rodgers, manager of development in the memory division. As well as V-MOS, the polysilicon load resistors contribute to the small size, Rodgers says—AMI and Intel use the same relative lithographic resolution of 4.5 μm.

AMI intends to offer a mixed bag of differing power dissipations and speeds at the 4-K level, as well as a 2147 version with no power-down feature. Meanwhile, it will be perfecting the 1.95-mil² memory cell, then spin it off into all statics, including slower, byte-wide memories for microprocessors and high-speed 1-K and 4-K memories.

A good part of the cell development concentrated on the polysilicon load resistors, which Rodgers maintains

must be used in future generations of static memories (Fig. 4). In due course, reduction of geometries from the conservative 4.5 μm, together with tweaking of the basic cell design, will drive the company's static RAMs down into the 20-to-30-ns territory.

Another trick up AMI's sleeve: the company has developed a 150-ns 2-K-by-8 static, using a double polysilicon process. The part boasts a 1.3-mil² cell, and it should spin off into a next-generation, high-speed 16-K-by-1 static.

If any move could put teeth into the market viability of V-MOS, it will come from Texas Instruments Inc. Admittedly behind in the development of high-speed RAMs, TI has spent the last 18 months playing catch-up ball on two fields: V-MOS and the company's own high-performance n-channel process it calls S-MOS.

Both development tracks have yielded buildable versions of the elusive 2147 that meet the Intel 55-ns spec. However, the Texans find themselves on the horns of a dilemma: they must settle on one design, says Richard Gossen, manager of the MOS memory division in Houston. "We were hoping that one of the approaches would show a clear margin above the other, but the economic data have been too close," he says. "It's hard to weigh the smaller size of V-MOS against its epitaxy and anisotropic etch—a more complicated process than with S-MOS."

TI faces a decision

TI can support only one such long-term commitment to its customers, according to Gossen. That decision will come in the next few months, and it is not to be taken lightly. The process technology chosen will eventually be the mold from which TI will cast all its static RAMs.

Like others, the Dallas firm is looking for very high performance from MOS devices. "But we can't wait to get there by going through the continuum of development," Gossen maintains. "We'll build the 2147, of course, because it's in high demand. But really it's just the means to an end for us. We have to make a very deliberate shot at the 20-to-30-ns market." Like others, he sees a clearly segmented static RAM business: below 55 ns and then up at the slower end of the range where TI has been supplying 150-ns 4-K parts for some time.

Of course, the high-speed end is requiring a huge effort, but development in the two speed extremes is not entirely unrelated. As have other manufacturers, TI used the slow end as a training ground. Its 150-ns 2-K-by-8 TMS 4016 static memory [*Electronics*, July 20, 1978, p. 39] was a combined salvo aimed at boosting density and lowering cost.

This extremely ambitious part only recently began showing respectable yields, but its 1.6-mil² cell size strongly undercuts that of the 4.3-mil² 4-K TMS 4045. Yet the new part uses the same 4.5-μm line widths as the 4045 which is TI's version of Intel's 2114. The small cell size, the result of a redesign that folded the load resistor back onto the transistors, will be fanned out through existing moderate-speed parts and is the seed for TI's sub-50-ns efforts. □

Reprints of this special report cost \$3 each. Write to *Electronics* reprint department, P.O. Box 669, Hightstown, N. J. 08520. Copyright 1979, *Electronics*, a McGraw-Hill publication.



Visicorder Model 1858



Visicorder Model 1508B



Visicorder Model 1508C

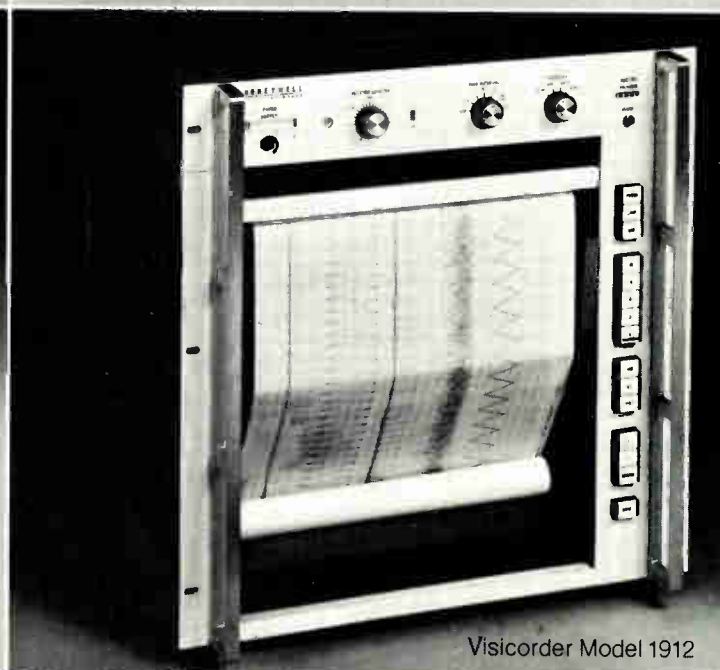

Visicorder Model 1912



Visicorder Model 1856A



Visicorder Model 1806A

MEET SIX TOP RECORD MAKERS.

Perhaps the data you need can best be obtained by a high-performance oscillographic recorder with excellent trace resolution. Or you may require a linescan image recorder having very fast scan rates and a broad gray scale. Whatever it takes to get your data, chances are you will get it faster and easier with one of the recorders shown here.

These Visicorder oscillographs set the standard for high-performance graphic recording.

Visicorder Model 1858 is a completely self-contained system with up to 18 channels, yet it stands less than nine inches high. This unexcelled portability, enhanced by a wide selection of miniature, plug-in signal conditioners, makes the Model 1858 ideal for field or mobile use. And its dc to 5 kHz response, wide chart speed range, 100 μ V-300V input sensitivity, and the ease with which it expands to 32 channels also make it a favorite in the lab. A fiber-optic CRT assures sharp traces of high resolution across the entire 8-inch record.

Visicorder Models 1508B and 1508C offer dc to 25 kHz response, wide chart speed range and writing speeds greater than 50,000 inch/sec. Both combine

high-linearity optical systems with sensitive galvanometers to produce extremely accurate 8-inch-wide recordings. The Model 1508B has 24 data channels plus 4 for event recording; Model 1508C has 12 data channels plus 2 for event recording.

Visicorder Model 1912 offers the most data channels, widest recording paper, and widest transport speed range of all Honeywell galvanometer-type oscillographs. This versatile recorder can handle up to 36 channels of data, in addition to 6 channels of event recording. It accommodates 12-inch-wide paper at speeds from .005 to 200 inch/sec.

Do you need 4-axis recording capability? Our linescan image recorders give you the kind of record quality you can only get with a direct writing fiber-optic CRT.

Visicorder Model 1856A produces 6-inch-wide records that have exceptionally high resolution and wide gray scale. This makes the recorder particularly suited for such applications as facsimile, spectrum analyzer readouts, IR mapping and echocardiography. Z-axis response is dc to 8 MHz, Y-axis is dc to 75 kHz, and the X-axis is capable of scan rates to 18,000/sec. Accessories are available for film records.

Visicorder Model 1806A can record, on 6-inch-wide paper,

high-frequency signals that would otherwise require magnetic tape or oscilloscope camera techniques. It offers Y-axis response from dc to 1 MHz, Z-axis to 10 MHz, X-axis to 1 MHz and writing speeds greater than 1,000,000 inch/sec. The Model 1806A also accommodates accessories for film records.

Honeywell's Accudata signal conditioning modules speed most recording and measurement tasks.

Whether you need to control and amplify strain-gage signals, drive oscillograph galvanometers or magnetic tape recorders, or amplify low-level signals where relatively high common mode voltages are encountered, we have the modules to do the job easily and economically. Just give us your requirements and we'll show you an Accudata signal conditioner than can meet them.

For detailed information on any of these recorders or Accudata modules, call Lloyd Moyer at (303) 771-4700. Or write for our technical data sheets and a free brochure that describes all of Honeywell's Visicorders, magnetic tape systems and Accudata modules. Honeywell Test Instruments Division, Box 5227, Denver, CO 80217.

WE'LL SHOW YOU A BETTER WAY.

Honeywell

C-MOS codec solves phone line problems with bipolar interface

Three-chip low-power channel unit handles high-voltage transients

by Steve Kelley

Motorola Inc., Semiconductor Group, Phoenix, Ariz.

□ The typical codec does not slip unaided into existing telephone networks, being unable by itself to provide the benefits of full-duplex voice digitization in a time-division multiplexed switching system. The lonely codec needs some help with two major circuit functions that must be handled in the standard telephone interface. Frequency-limiting filters are needed to allow the codec to sample the analog voice signal without spurious response generation. In addition, a two-to-four-wire converter and line feed circuit are needed in order to eliminate a bulky transformer connection in the line leading to the telephone.

Unified approach

If digital telephone equipment is to take its place in the industry, it is necessary to address the problem of the complete subscriber channel unit needed in a modern digital switching office. Motorola Inc.'s Semiconductor

This is the sixth part of a series on the new integrated-circuit codecs. The other articles have appeared in the issues of Sept. 14, 1978, p. 108 and 111, Sept. 28, p. 141, Oct. 12, p. 130, and Feb. 1, 1979, p. 126.

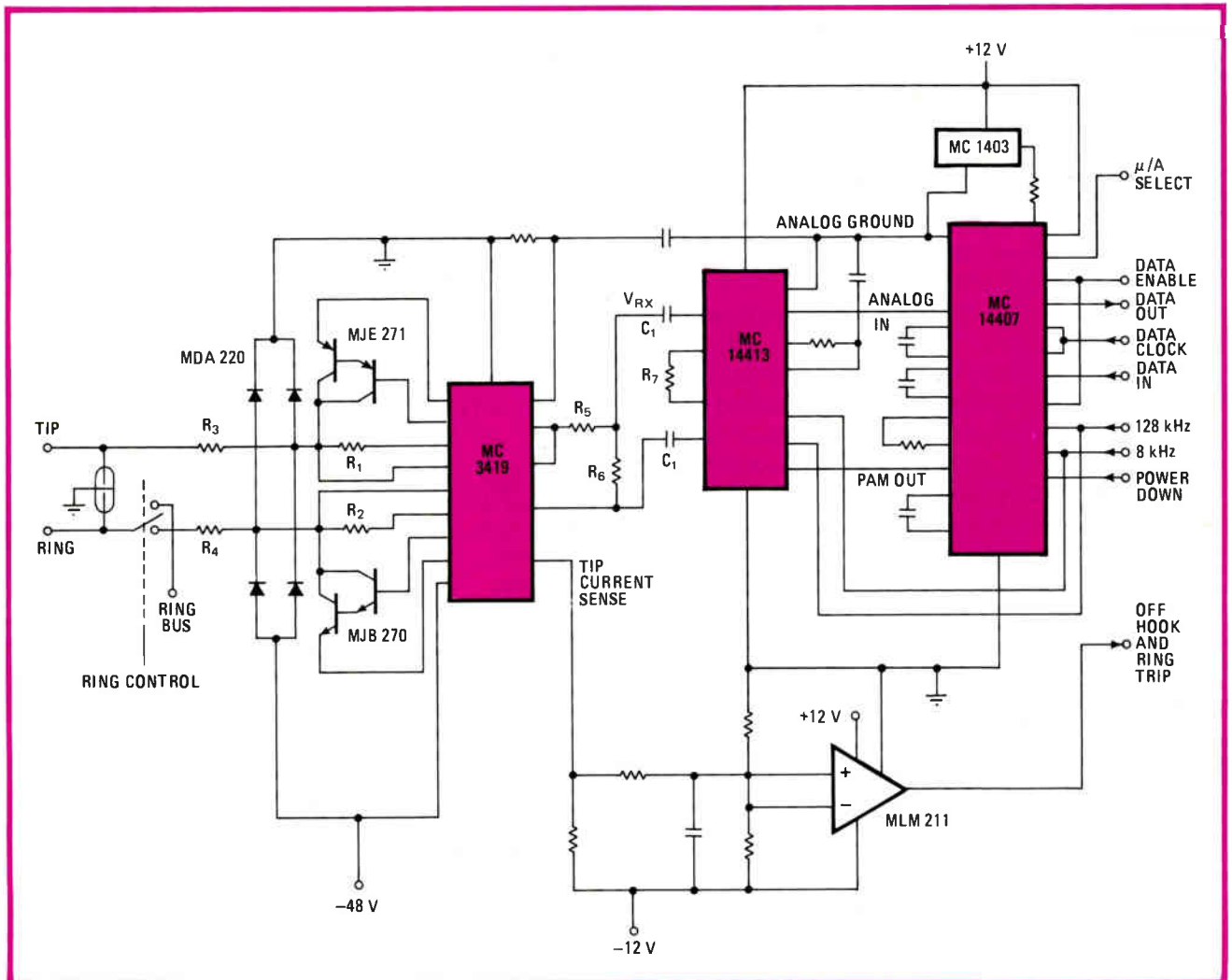

1. Subscriber channel unit. Up to 1,900 ohms of resistance can accumulate in the wire pair leading from the tip and ring connections in an individual subscriber telephone to the codec circuitry in the local telephone office. This long connection is a chief source of telephone troubles.

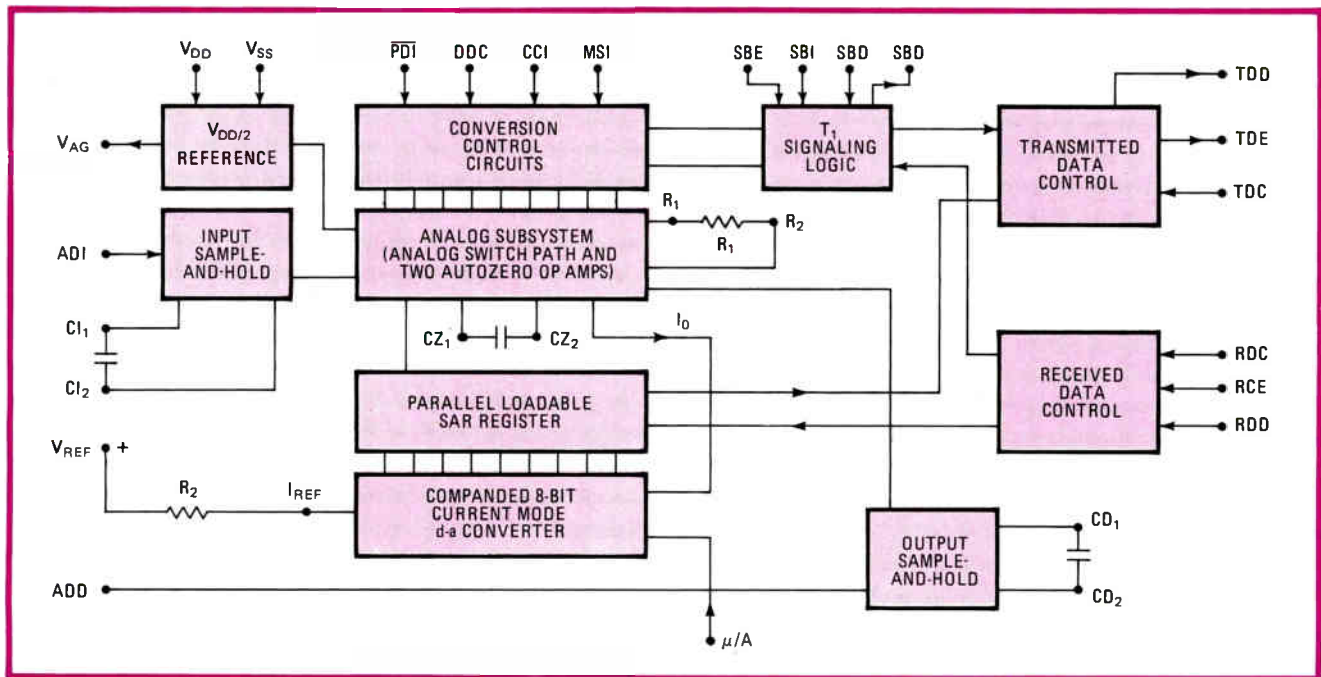

2. What's inside. The various companding functions of the MC14406/7 codecs are implemented with metal-gate C-MOS because they are most reliable and easy to design in this technology. The analog voltage V_{AG} provides a ground reference signal for the other two chips.

Group has developed a three-chip approach to complete channel unit design, using a combination of bipolar and complementary-metal-oxide-semiconductor technology.

The MC14407 codec is a single-chip full-duplex C-MOS device that offers pin-selectable A- or μ -law companding in a 24-pin package. The MC14406— μ -law only—has additional signaling capability required by μ -law specifications and needs a 28-pin package. Each codec operates from a single supply voltage with an on-chip voltage regulator for analog ground. Normal operating power is less than 90 milliwatts; the codecs use less than 1 mW in the standby mode. The other members of Motorola's codec trio are the C-MOS MC14413 switched-capacitor filter and the bipolar MC3419 subscriber loop interface circuit (SLIC).

The C-MOS process was chosen for the companding chip because all the necessary digital-to-analog converters, operational amplifiers, voltage regulators, and comparators are available in this technology, satisfying the codec's need for precision analog circuitry. The complementary nature of C-MOS switches, amplifiers, and logic allows the low-power operation that is necessary for efficient use of many codecs in large telephone switching systems.

C-MOS reliability

Motorola's metal-gate C-MOS process has been in production for more than eight years. It has a proven history of high reliability behind it and readily meets the stringent reliability requirements of the telecommunications industry.

In the usual telephone subscriber hookup (Fig. 1), the standard L_1 and L_2 telephone terminals are connected through wire with up to 1,900 ohms resistance to the tip and ring terminals of the subscriber channel unit. Two-way voice transmission, signaling, and power are all

supplied to the subscriber's telephone through this single pair of wires.

At the digital end of the channel unit, the codec is connected to a high-speed digital highway with separate data buses for transmitting and receiving. An enable signal from the switch controller tells the codec to transmit a serial 8-bit word on the transmit bus and to receive one from the receive bus. These 8-bit words are coded representations of the voice signals on the two-wire pair.

Digital control

There is also a low-speed digital highway between the channel unit and the office control system for supervisory and control signals. Dialing pulses, ringing control, requests for service, and various test modes all appear as binary numbers on the digital office side of the channel unit circuitry.

In the codec itself (Fig. 2), the transmitted-data and received-data control lines (TDE and RCE) handle the digital input/output interface. They use independent data clocks—one for transmitting, the other for receiving—that run at rates up to 3 MHz. The rest of the circuit is controlled by a 128-kHz conversion clock (CCI).

An analog subsystem provides autozeroing and signal-path control to and from the 8-bit companding digital-to-analog converter. An 8-bit parallel-loadable successive-approximation register manipulates data in the d-a converter for both transmitting and receiving functions. Additional logic is provided for signaling data, power-down, and other telephone functions.

The compandor's d-a converter is built with stacked 8-bit and 6-bit matched-device arrays. This structure provides direct, inherently monotonic companding. The d-a converter is fully static and its output is a precision current similar to that of bipolar d-a units.

The advantage of this current-steering d-a converter is

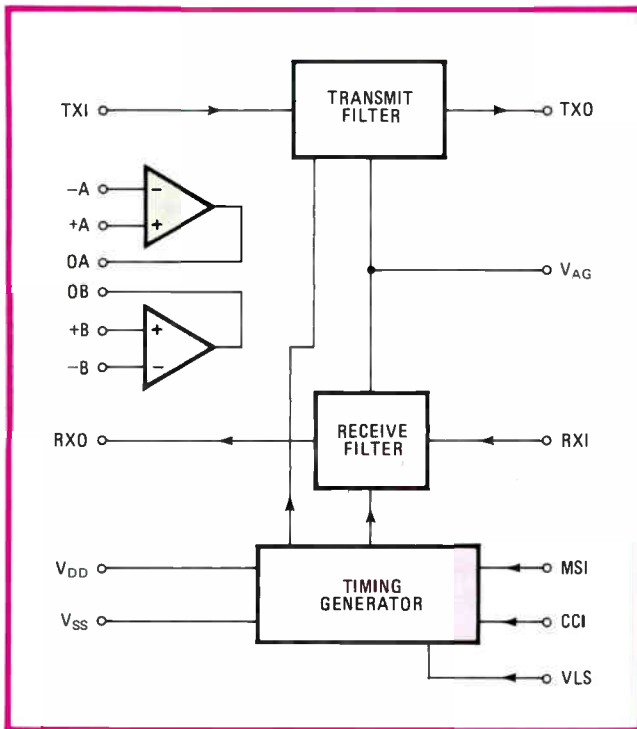

3. No spurious responses. The two antialiasing filters employ switched-capacitor technology, which offers more attractive characteristics than the charge-coupled-device approach. Each chip has two extra operational amplifiers that are used in the channel unit.

that it may be statically tested with 8-bit words applied through the data-receiving logic of the codec. The current output of the d-a converter is available at the codec's R_2 pin. Its static accuracy is testable after product assembly; in fact, an external current-to-voltage converter at R_2 bypasses the zeroing circuitry, allowing a fully static test. Capacitive-array d-a converters must be tested dynamically—no existing resistor-string approach allows static testing external to the packaged part.

Considerable margin over the performance requirements is achieved in the μ -law device's measured signal-to-noise ratio performance. The A-law characteristic yields similar results. Idle-channel noise with zero input signal is typically 0 dBm for both μ and A laws, thanks to the autozeroing method chosen. Gain tracking performance for both μ - and A-law devices is also well within specifications.

Independent analog ground

The codec uses its on-chip voltage regulator to produce a $(V_{DD}-V_{SS})/2$ analog ground output. All of the analog circuitry operates with reference to this internally generated supply; external filters and hybrids may use this output as a ground reference. The on-chip regulator allows the codec to operate from a single 10- to 16-volt supply. A channel unit consisting of codec, filter, SLIC, and reference voltage can be assembled using the codec's V_{AG} output as the channel unit's own independent analog ground. This avoids ground loop connections among the system's channel units that might cause crosstalk.

The rationale behind the use of C-MOS technology for the codec compandor is even more convincing for the

required antialiasing solid-state filters. The MC14413 C-MOS switched-capacitor filter is an analog integrated circuit that uses the advantages of complementary active loads in the C-MOS gain stages to great advantage. The lower power needed per stage results in a design that dissipates only 30 mW overall when active.

The transmit filter section of the 16-pin package (Fig. 3) is composed of a five-pole elliptic low-pass filter and a three-pole Chebyshev high-pass section. It samples the applied signal at 128 kHz and thus requires only a single-pole prefilter for antialiasing.

The receive filter is a five-pole elliptic low-pass section that resamples the codec signal; it includes all necessary frequency compensation. The 128-kHz full-duty-cycle signal from this filter requires no postfiltering to be compatible with system specifications. The design incorporates 16 C-MOS operational amplifiers, two of them uncommitted units available for interface with the SLIC.

Filter compatibility

The filter is designed to be compatible with various features on the MC14407 codec. Operating synchronously with the codec, proper filter operation requires both the 8-kHz sync and 128-kHz conversion clock. It can operate with a dual supply of ± 5 to ± 8 v, but uses the V_{AG} output of the codec as a ground so that only the single codec supply of 10 to 16 v is needed. A codec power-down also brings the filter down to a 1 mW consumption level through the V_{AG} input.

The filter's switched-capacitor techniques offer certain inherent advantages for codecs in pulse-code modulation systems. They allow high sampling rates without the antialiasing front ends required in charge-coupled-device designs. Furthermore, the phase response of a switched-capacitor filter is naturally near the desired minimum phase design: the large group delay of linear-phase CCDs need not be overcome.

Subscriber line interface

The subscriber channel unit must ultimately interface the standard telephone wire pair. Unfortunately, the equipment environment changes drastically on the telephone side of the filter. Telephone pairs with a typical 1,900-ohm resistance depend on a 48-v battery to inject sufficient current into the telephone to make it function.

The 18-pin MC3419 and its associated circuitry are designed to operate from that 48-v battery and to withstand lightning and faults, as specified for the outside-plant interface. These voltage and transient requirements mean that bipolar technology must be used instead of C-MOS.

Decoded and filtered signals from the digital highway arrive at the receiving terminal (RX) of the SLIC as an analog voltage (Fig. 4). The RX pin has a low impedance, so the signal current injected into the SLIC is determined by R_5 .

Two power transistors drive the parallel combination of loop and SLIC termination with signal current. The current flowing in the SLIC termination causes signal current at TX_2 which is out of phase with the current at RX. Resistor R_6 is selected to cancel that signal to achieve transhybrid rejection. Signals from the telephone

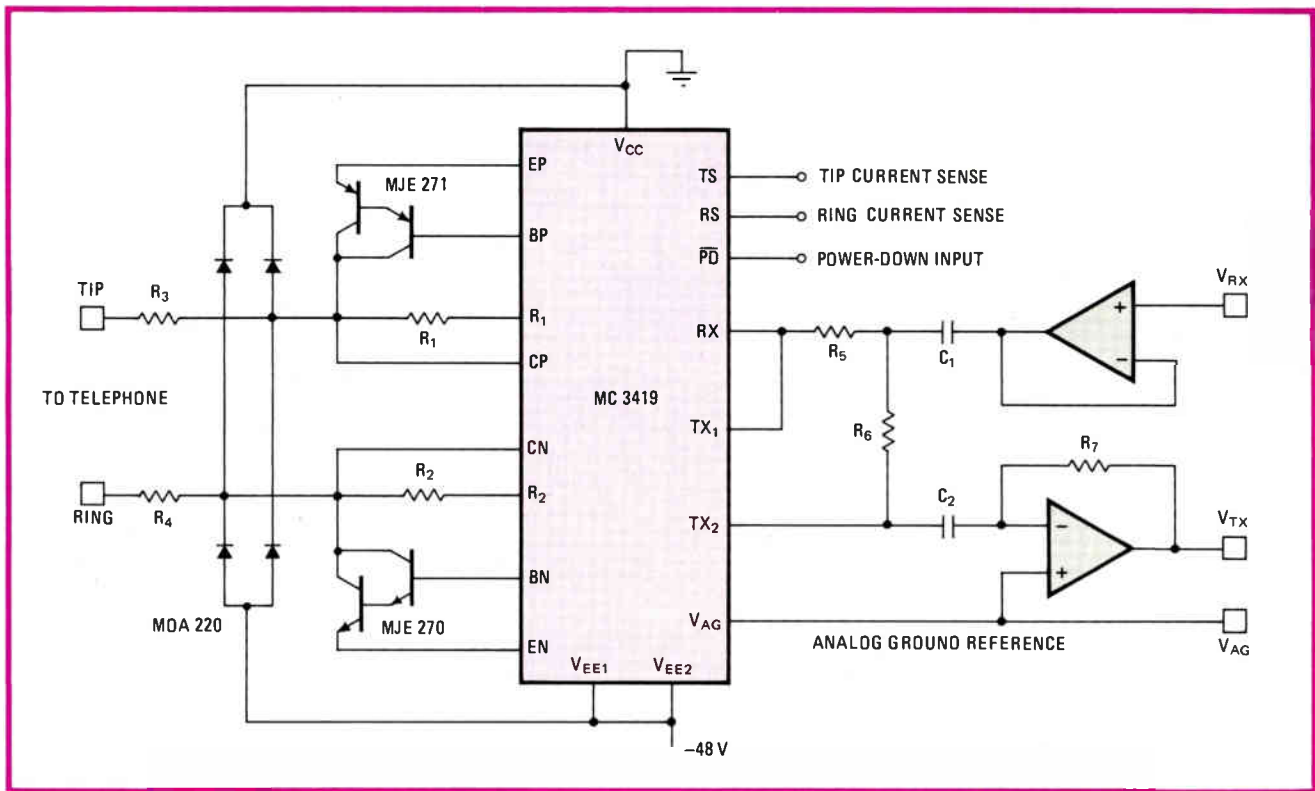

4. Two becomes four. The subscriber line interface circuit provides the impedance conversion from the two-wire hookup in the individual telephone to the four-wire system in the codec and telephone office. It is made with bipolar technology because it has to handle 48 volts.

cause current in R_1 and R_2 and consequently signal current at the TX_2 pin.

This uncanceled component is converted to a voltage in R_7 , providing the signal to be transmitted via the filter and codec. The two uncommitted op amps on the MC14413 can be used as the op amps shown in Fig. 4. Selection of R_5 , R_6 , and R_7 adjusts the channel unit's gain for both transmitting and receiving.

On the two-wire side of the SLIC, both the feed resistance and termination resistance must be synthesized with R_1 through R_4 . For a 400-ohm feed and 900-ohm terminations, for example, R_3 and R_4 are set at 30 ohms and R_1 and R_2 at 16.4 kilohms. A short loop connection will draw 120 milliamperes from the battery with 118 mA supplied through the MJE270/271 transistor pair. Only 2 mA will flow in R_1 and R_2 , so they can be quarter-watt devices. In the short-circuit state, the transistors dissipate 2.5 watts each while the MC3419 uses only 0.5 w. The SLIC thus has resistive feed and can be designed for any feed resistance value by proper selection of resistors R_1 through R_4 .

The MDA 220 diode bridge and feed resistors R_3 and R_4 provide various forms of hazard protection for the channel unit. The diodes are rated to take the 50-ampere surges of 1,500-v lightning transients. Intermittent power line contact will generate similar surges and 4 A of continuous current; this is also within the diodes' rating. Extended power line contact will destroy the resistors without damaging the diode bridge or other portions of the channel unit. In the normal operating mode the diodes are back-biased and the resistors contribute the feed and termination impedances for the SLIC.

Another common external hazard is a short circuit to ground of either the tip or ring lead. When the MC3419 SLIC is used, a ring or tip lead faulted to ground in any combination will draw only 10 mA. The worst-case unprotected fault condition is a short circuit between the ring and tip lines, which draws only 120 mA.

Requests for service, dialing pulses, and ring trip signals can all be handled by the SLIC's loop sensing outputs. The TS and RS leads provide switch hook status information to the central office. Only a 20-Hz, 120-v rms ringing signal must be provided externally. A single-pole double-throw relay in series with the ring lead is required to accomplish this.

Putting it together

A complete telephone-to-digital-highway channel unit with unique features is possible using the MC14407, MC14413 and MC3419 trio as a package. The MC3419 circuit uses no power with the phone on the hook; the codec and filter may also be powered down with a logical input when they are not in use. If the codec and filter are powered up while the phone is on the hook, a unity-gain loop-back is created at the SLIC interface. This allows for automatic diagnostic testing by the operating telephone company.

An idle channel unit will consume less than 10 mW when powered down. The design of an economical digital telephone office is not dominated by codec selection alone: the cost of the entire subscriber channel unit's function must be considered. This can be easily done with this three-chip set's unified approach to the telephone-to-digital-highway interface. □

"The trouble with it costs you an

A natural assumption. Name anything that's tailor-made for you, and you expect it to cost more than the off-the-shelf model.

Except when it comes to microcircuitry. Because in this field, you're not talking about a one-for-one replacement. With custom LSI, you usually pack one or two circuits with all the functions you need—and nothing more. (At last count, we'd put 19,000 transistors onto a single random logic custom chip). But when you're building a system with off-the-shelf components, you generally use multiple circuits that do a lot more than your product requires.

So, to get right down to the bottom line, you have to weigh all the hidden expenses. Not simply the number of parts involved. But also board space, assembly time and testing, which can run you as much as 50% of the cost of the circuits themselves. Then throw in warranty, service, spares and, for microprocessor systems, software development, and you may well discover that custom turns out to be the most cost-effective way to go.

"How do I know what's best?"

Sometimes it's hard to find out. Take your problem to half a dozen LSI companies, and you'll probably get six different solutions. That's because a few specialize only in custom. Many others only in standard. And naturally they all push their specialty.

The situation is different at AMI. Besides being the leading custom LSI company we have a full range of standard microprocessor families—the 4-bit S2000, 8-bit S6800 and 16-bit S9900.

So we'll make a careful study of your application. Then recommend the best solution for you—not us. As we cover standard and custom so thoroughly, and use 25 variations of four basic MOS processes, we're not biased by any design or production limitations. We may

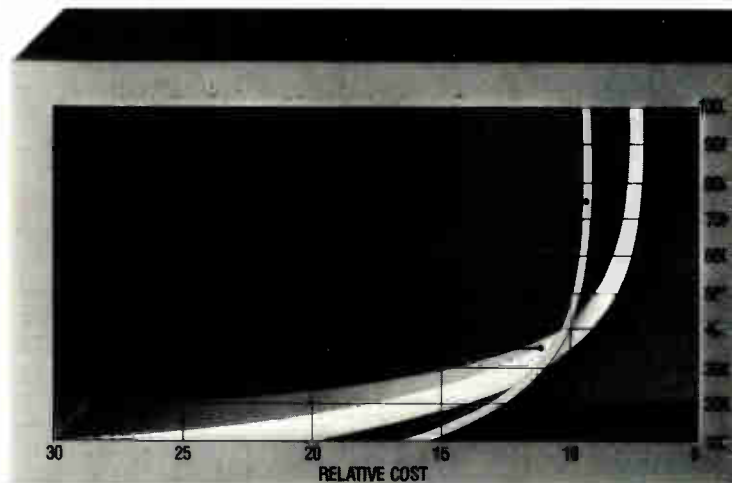

In the right volume, custom circuits can be more cost-effective than standard.



What makes more sense: a unique, dedicated custom system (left) or a whole family of standard parts?

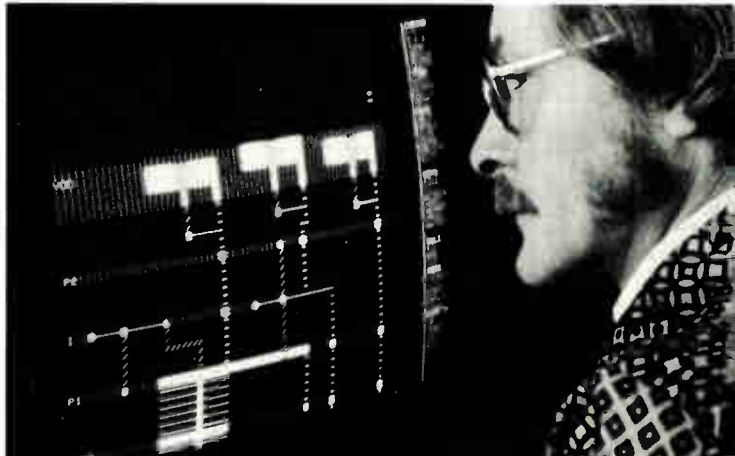

Interactive graphics lets us check and alter circuits directly on a computer.

Custom LSI is that arm and a leg."

advise a pure custom design. Or a standard approach. Or a mixture of the two. In some cases, we even customize standard microprocessors.

Our only criterion is what will do the job best for the least.

"Suppose we want to design it ourselves?"

That's fine, too. Since this "customer tooling" approach is becoming more popular, we've set up a special department for it. In many ways, it gives you the most flexible solution. It makes sense if you have your own MOS design staff or a working relationship with an independent design house. (If you don't we can recommend some good ones to you.) Or when you need a second source for an existing circuit.

We then become your manufacturing facility, offering so many options that we can customize a program just for you. And with plants in California, Idaho and Korea, we have plenty of production lines to handle your orders. (Some of our customers use more than a million custom circuits a year.) We even have a design center in England to help service our European clients.

Another possibility is a joint venture. We're involved with several major companies in this way, where teams from AMI and the customer work together to develop a family of products.

Whatever way you choose, you can be sure of getting the best solution in the shortest possible time. By using the very latest computer technology, we've managed to shrink the production cycle significantly. Our SLIC method (Symbolic Layout of Integrated Circuits) has reduced design time by a third. And, with interactive graphics, we can design circuits directly on a computer, eliminating the time and expense of digitizing. The result of all this is the fastest turnaround in the industry, an average of seven months from firm specification to fully tested circuit.

Want to know more? Ask for our books.

The experience of 13 years in this business (longer than anyone else) is condensed into our new brochures called "Six Steps to Success with Custom LSI" and "MOS Systems Solutions: A Dozen Case Histories Using Custom Circuits and Microprocessors"

They take you through such subjects as alternative solutions, a dozen types of processes, fabrication steps and device testing. And throw in some thought-provoking case histories to show how much ground custom LSI has covered. Your imagination will tell you how much further it can go.

So take the first step towards the success of your next product by getting hold of our books. Just write or call AMI Custom Marketing III, 3800 Homestead Road, Santa Clara CA 95051. Phone (408) 246-0330. Or contact one of these regional sales offices: California, (213) 595-4768; Florida, (305) 830-8889; Illinois, (312) 437-6496; Indiana, (317) 773-6330; Massachusetts, (617) 762-0726; Michigan, (313) 478-9339; New York, (914) 352-5333; Pennsylvania, (215) 643-0217; Texas, (214) 231-5721; Washington, (206) 687-3101.

And if you'd like a more personal look at AMI, we'll give you a presentation right in your office. It'll only take half an hour. But we don't have to talk your ear off to prove that custom LSI doesn't cost an arm and a leg. And that it can give you a priceless advantage over your competition.

AMI
AMERICAN MICROSYSTEMS, INC.



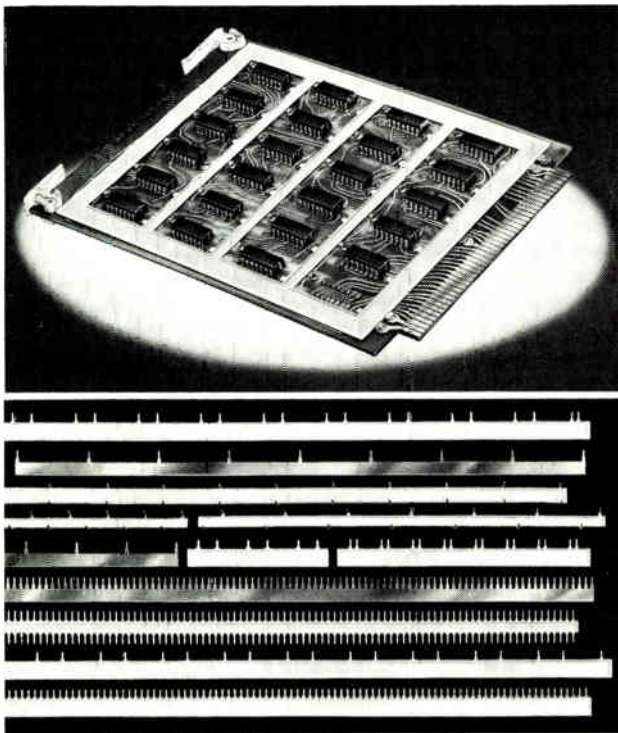

MINI BUS[®]

Printed Circuit Board Bus Bars Obsolete most Multi-Layer Boards

MINI/BUS PCB bus bars are the cost-lowering alternative to adding layers to printed circuit boards.

Move power distribution off the board with MINI/BUS PCB bus bars. That means higher packaging density and more room for signal interconnections.

LOW-COST MINI/BUS

PCB BUS BARS ALSO AFFORD:

Greater latitude in board layout.

Low impedance, low inductance power distribution network.

Lower capacitor count through inherent distributed capacitance.

Noise Reduction. (Write for application notes.)

MINI/BUS PCB bus bars are reliable!

Prototype kits are in stock; dozens of standard MINI/BUS PCB bus bar configurations are in stock — for mounting either vertically on the board or horizontally under DIPs.

You can't go wrong with MINI/BUS PCB bus bars. For fast action, call MINI/BUS PCB bus bar Product Specialist at (602) 963-4584.

ROGERS

Rogers Corporation
Chandler, AZ 85224
(602) 963-4584

EUROPE: Mektron NV, Gent, Belgium
JAPAN: Nippon Mektron, Tokyo

For Information Only circle #144
For Immediate Need circle #237

**Get your
1978 EBG
while
they last.
1979 edition
not available
until June.**



**The only book of its
kind in the field.**

**If you haven't got it,
you're not in the market.**

**To insure prompt delivery
enclose your check with
the coupon now.**

Electronics Buyers' Guide
1221 Ave. of the Americas
New York, N.Y. 10020

Yes, please send me _____ copy(ies) of
1978 EBG.

I've enclosed \$25 per copy delivered in the
USA or Canada.

I've enclosed \$35 per copy for delivery
elsewhere (\$47 if shipped by Air). Full money-
back guarantee if returned in 10 days.

Name _____

Company _____

Street _____

City _____ State _____ Zip _____

LSI streamlines instrument interface with standard IEEE-488 bus

Highly flexible design enables large-scale integrated circuit to link most microprocessor-based instruments to popular bus

by John Pieper, *NV Philips Gloeilampenfabrieken, Almelo, the Netherlands*
and Robert J. Grossi, *Philips Test & Measuring Instruments Inc., Mahwah, N. J.*

□ With the acceptance of the IEEE-488 bus for automatic measurement systems, the demand for instruments incorporating this standard is almost universal. However, the growing use of microprocessors in recent instruments makes implementation of the interfacing tricky. In particular, matching an instrument's internal buses to the external IEEE-488 bus is difficult when the buses differ in the number of their lines and operating speed.

Until recently, instruments capable of this interface needed as many as 45 additional transistor-transistor-logic circuits, making the overall design very complex and expensive. Philips has therefore developed a single large-scale integrated circuit that provides all the required coding, decoding, and interface functions. The designer is thus free to concentrate on the performance of the instrument itself.

The chip, designated the HEF 4738, comes in a 40-pin dual in-line package. It is made using Philips' LOCMOS (for local-oxidation complementary-metal-oxide-semiconductor) technology, which is as fast as transistor-transistor logic but with lower power consumption, as well as higher circuit density.

The HEF 4738 gives the designer a great deal of flexibility, since it can both drive and be driven by C-MOS, TTL, or low-power TTL devices. It operates from

supply voltages between 4.5 and 15 volts. The outputs to the bus drivers can drive one standard TTL load; all others can drive two low-power Schottky TTL loads. Quiescent power dissipation for the entire package is 1 milliwatt; typical dissipation is 30 to 50 mW. Transmission rate of the DIO lines is 200 kilobytes per second.

The device may be operated in ambient temperatures of between -40° and $+85^{\circ}\text{C}$. It comes in a plastic or a metal-ceramic package [*Electronics*, Feb. 15, p.181].

To design an instrument for compatibility with the IEEE-488 bus, be it counter, multimeter, or waveform generator, a clear understanding of how the bus operates and how the HEF 4738 can implement the required interfacing is needed.

The bus

Figure 1 shows the basic structure of the IEEE-488 interface bus system. Its 16 lines permit a maximum system configuration of 15 devices. The bus lines break down into three sections, consisting of eight data lines; three data-byte transfer control lines, also known as the handshake bus; and five lines for general interface management, designated the management bus.

Four types of device can be connected to the bus. Those which only transmit bus data (done upon demand)

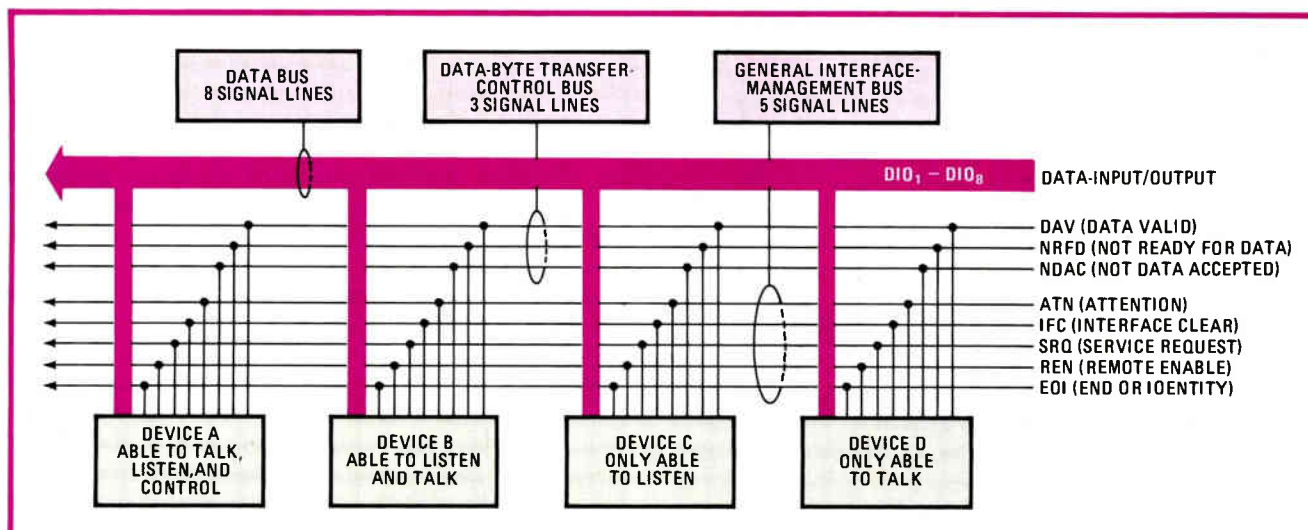

1. Bus basics. The 16 lines of the IEEE-488 interface bus are divided into three segments to control up to 15 devices. The four basic device categories are represented at the bottom of the diagram. Each bus line is named after the function performed by the signal it carries.

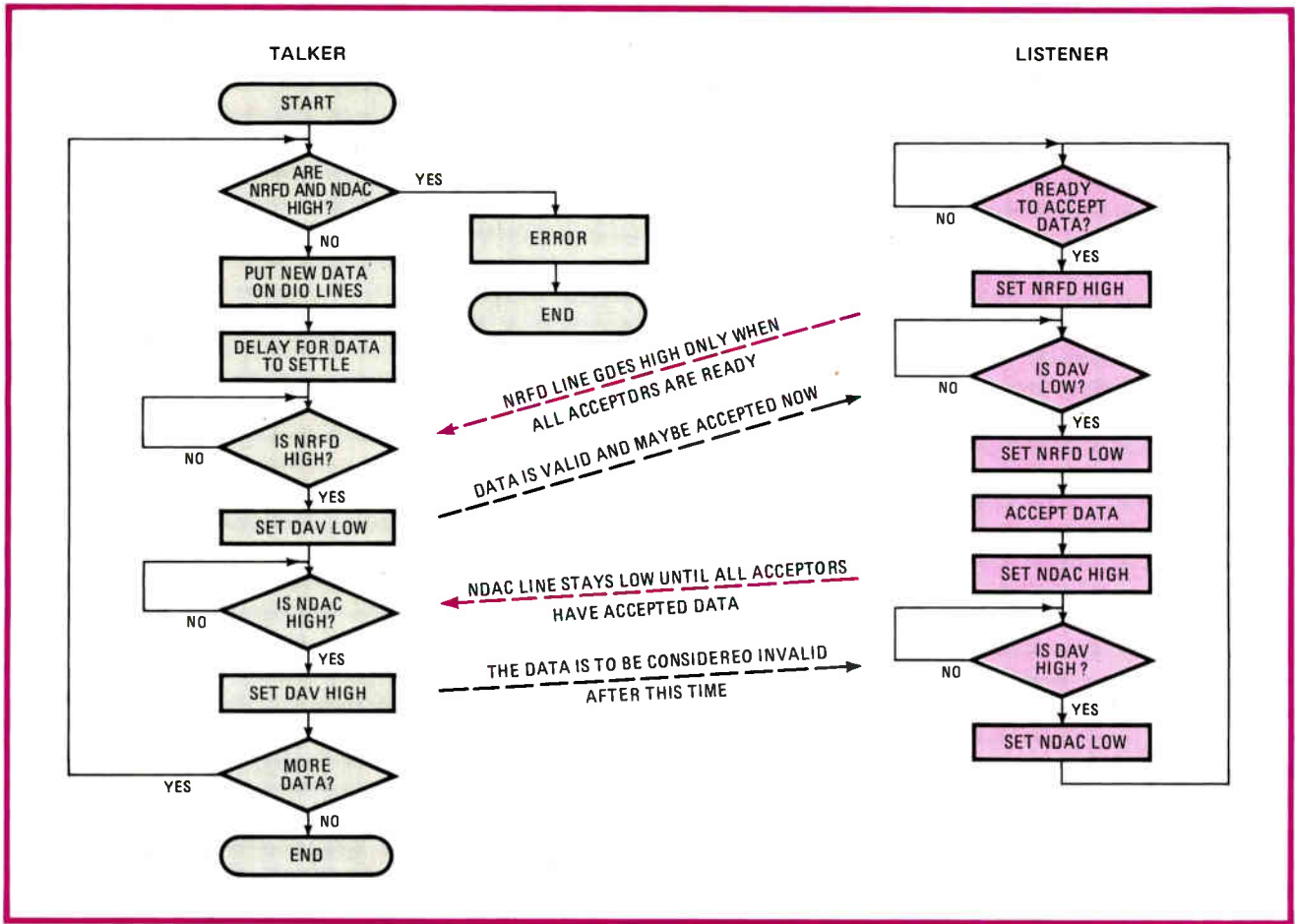

4. Bus conversations. The flow chart describes the sequence of events between a listener and a talker during the handshake operation. The data-valid, not-ready-for-data and not-data-accepted lines of the data-byte transfer-control bus ensure information-transfer integrity.

byte-serial form in both directions. The data bus lines are used for carrying all interface and device-dependent messages.

Figure 2 is a functional block diagram of the HEF 4738. Note that the chip's interface signals are positive logic, whereas the 488 bus signals all are negative logic. The signals in the chip must therefore be inverted by inverting transceivers (not shown here). They are prefixed by I or O, designating input or output signal flows, respectively. Capital letters indicate chip-to-bus (external) signals, and lowercase letters represent chip-to-device (internal) signals.

Only seven data lines are needed for all messages to the interface. The data-input/output bus lines (DIO₁-DIO₇) connect to the chip's respective inverted-data inputs (IDI₁-IDI₇) at the locations shown,

Controlling the data flow between devices is a handshake process operating over the three lines of the data-byte transfer-control bus. These lines effect the transfer of each byte of data on the data lines from a controller or a talker to one or more listeners.

Each of the handshake bus's three lines is named for the signal it carries. The data-valid (DAV) line indicates the availability or validity of the information on the data bus lines. The not-ready-for-data (NRFD) line indicates the readiness of the device or devices to accept data. The remaining line signals that one or more devices has not

accepted data and is called the not-data-accepted (NDAC) line.

Figure 3 shows the timing diagram of the handshake operation. Based on an interlocking relationship between source (talker) and one or more acceptor (listener) devices, it ensures that information is put on the data lines properly and then removed correctly for decoding.

The source starts the process by setting the DAV line false, denoting the absence of any valid data. Simultaneously, the acceptor that is addressed sets the NRFD and NDAC lines true, indicating that the acceptors are not ready and will not accept any data.

The source then places a new data byte on the data-I/O lines, allowing it to settle for at least 2 microseconds. The NRFD line goes false when all the acceptors are ready to accept the data byte. This causes the source to put DAV true, signaling that the data is settled and valid. The acceptors indicate that they are taking data by setting NRFD true, which also blocks the acceptance of data from another source.

Once all the acceptors have taken the information, the NDAC line goes false. The source then sets DAV false, telling the acceptors that the data is no longer valid. The data may then be changed and the process restarted. The flow charts in Fig. 4 show the sequence of events for handshake process between a talker and a listener.

To accomplish talker and listener interfacing, the

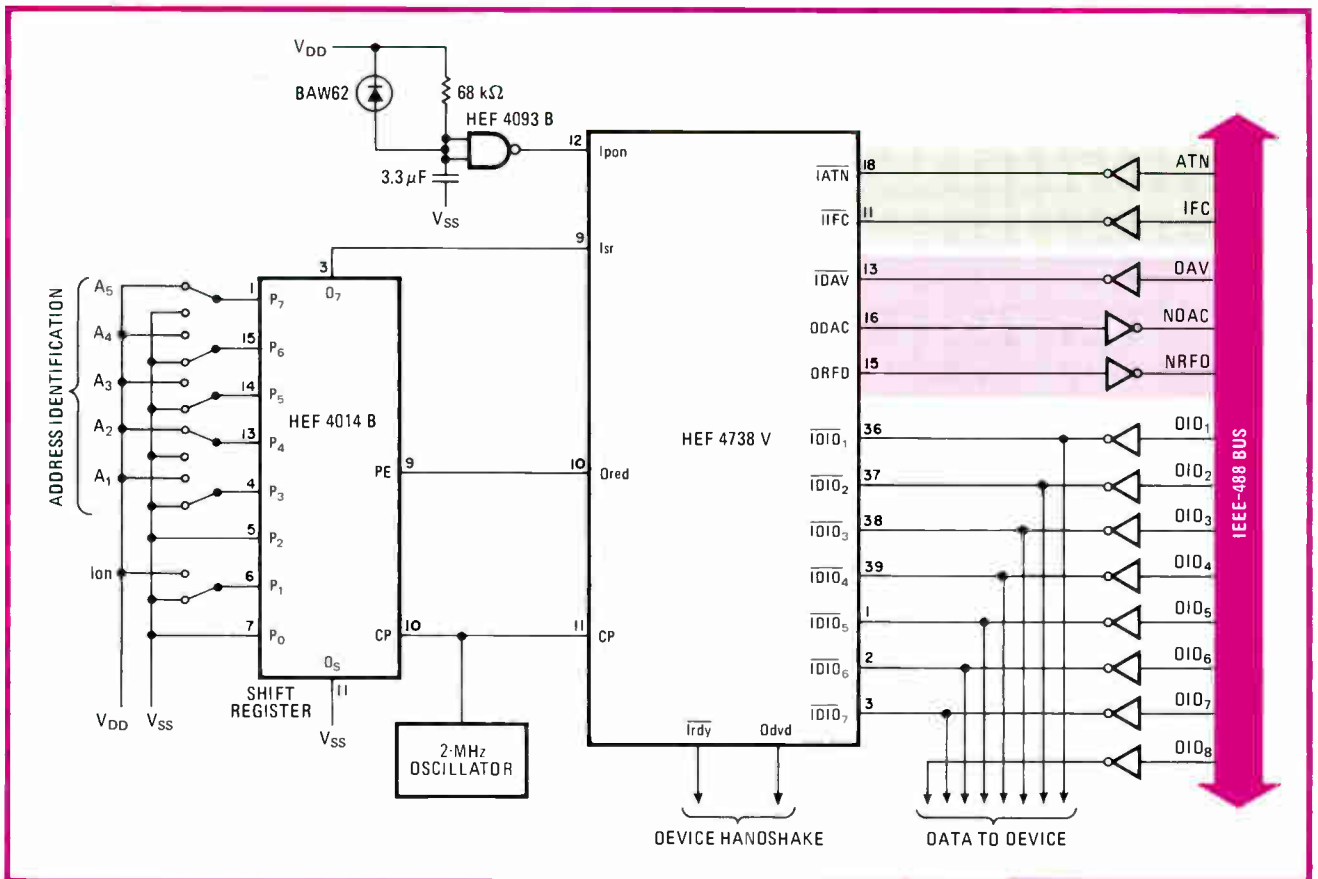

5. Basic listener. The diagram shows the interface for a basic listener device with the IEEE-488 bus using the HEF 4738 interface chip, the HEF 4014B shift register, and the necessary inverting transceivers. The shift register handles the device's internal addressing.

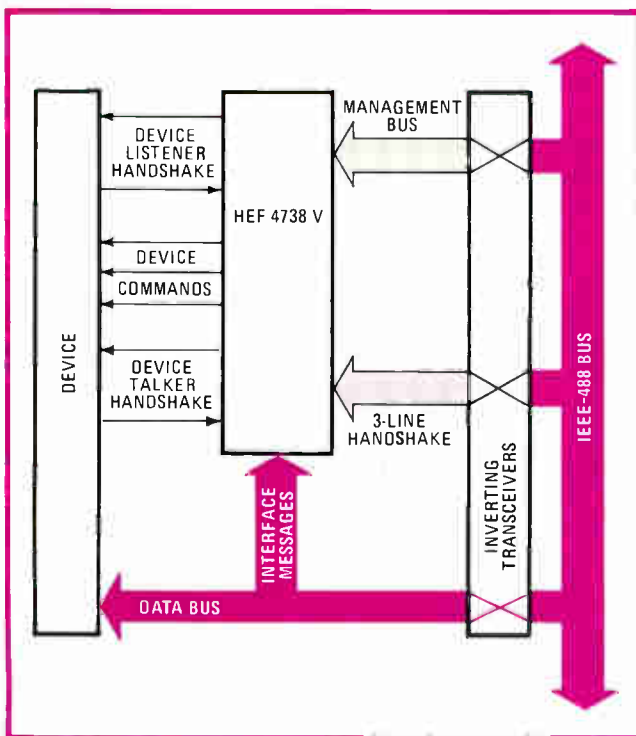

6. Double shake. The block diagram illustrates the HEF 4738's role in interfacing the device with the 488 bus. Two handshake operations take place: one between the measurement device and the interface chip, the other between the chip and the external bus.

handshake bus's signals are each split into input and output subsets. These subsets interface a source device with an acceptor device over the 488 bus. The source subset comprises IRFD, IDAC, and \overline{ODAV} signals; ORFD, ODAC, and \overline{IDAV} signals make up the acceptor subset. Figure 5 shows the configuration for devices able only to listen using the HEF 4738 and a HEF 4014B shift register.

Another handshake process occurs between the device and the interface chip, as shown in Fig. 6. However, if the device is able to send or receive data within one clock period, these device handshake control signals are not needed and each I/O set can simply be shorted together for the interface to work properly.

If not, the handshaking for the talker setup uses the don't-change-data output (Odcd) signal and the new-byte-available input (Inba) signal. With these signals, the device may change the data only when Odcd is low and set Inba low to indicate that new data is available. The Odcd line can go low only when Inba is high.

The corresponding listener device handshake signals use the data-to-device-valid output (Odvd) signal and the ready-for-next-byte (\overline{Irdy}) signal to indicate device readiness.

The management bus is a set of five lines used to manage an orderly flow of information across the interface. As with the other lines, the management lines are named for their tasks. The attention (ATN) line is managed only by a controller, to specify if information

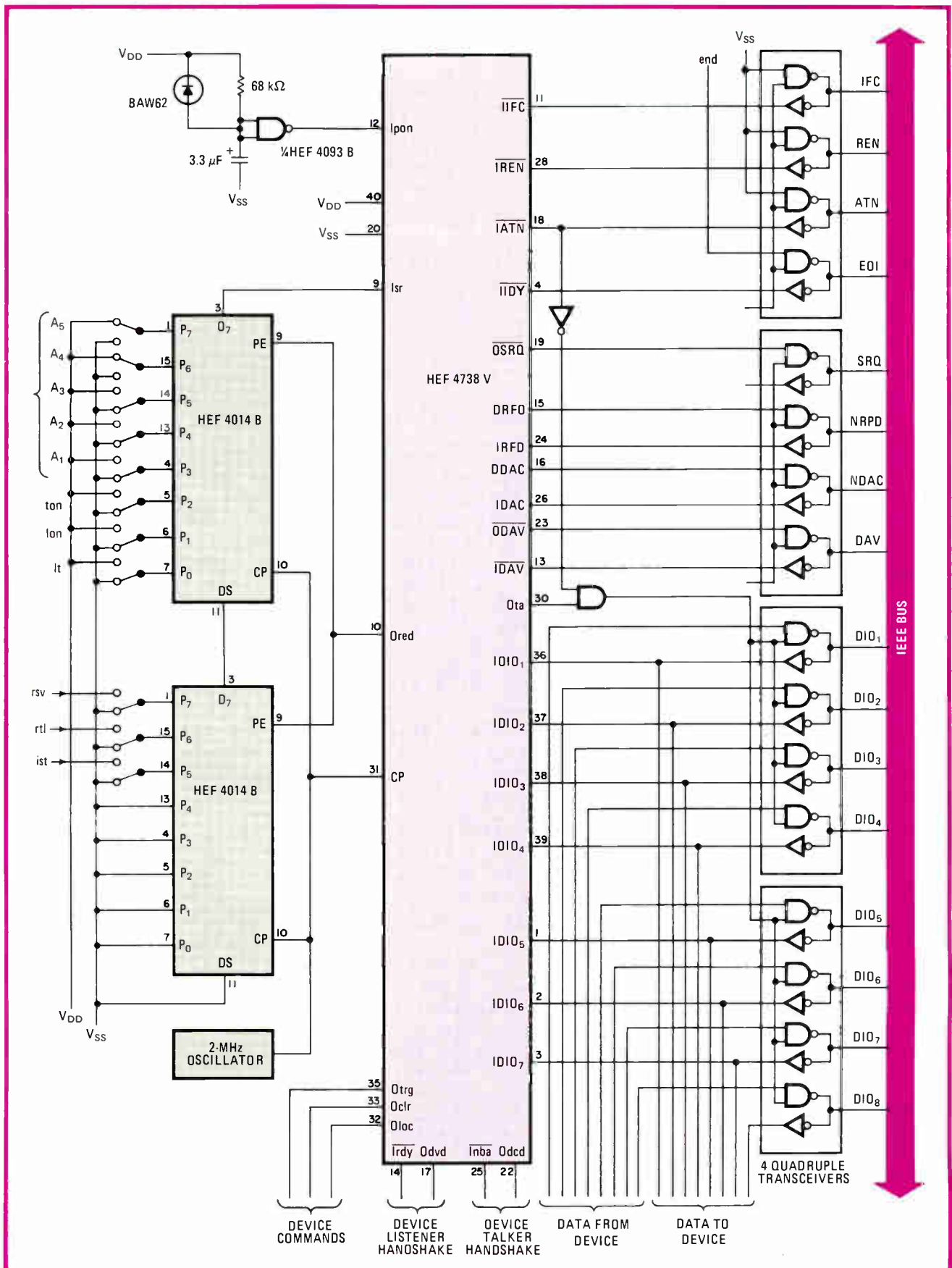

7. Talker-listener. Shown is the circuit diagram for a basic talker and listener interface realized with the HEF 4738 interface chip, two HEF 4014 B shift registers, and four quadruple inverting transceivers. The transceivers make the positive (chip) to negative (bus) logic transitions.

IEEE-488 Interface functions

Acceptor handshake (AH) enables a device to guarantee correct reception of remote multiline messages.

Controller (C) lets the controlling device send device addresses, universal commands, and addressed commands to other devices over the interface. A controller can only exercise its capabilities when it is sending the attention (ATN) message.

Device clear (DC) allows a device to be reset to an initial state by a remote message. The device may be addressed individually or as part of a group.

Device trigger (DT) allows the controller to command the device to start its basic or programmed operation.

Listener or extend listener (L or LE) enables a device to receive device-dependent data over the interface. This capability exists only when the listen interface function is addressed to listen by a controller or by the local listener-only (lon) input.

Parallel poll (PP) allows the device to present a parallel

poll response (PPR) message to the controller without being previously addressed to talk. Before performing a parallel poll sequence, a device must be assigned (enabled) to respond on a particular data-input/output (DIO) line either locally or by a remote message.

Remote/local (RL) lets the device select between programming information from device front-panel controls (local) and from the interface (remote).

Service request (SR) lets the device request service actions from the controller (for example, polling).

Source handshake (SH) enables a device to guarantee the correct transfer of multiline messages to one or more acceptor handshake interface functions.

Talker or extended talker (T or TE) lets a device send device-dependent data over the interface to other devices. This capability exists only when the talker interface function is addressed to talk by a controller or the local talk-only (ton) input.

on the data bus lines is to be interpreted as an interface message or as a device-dependent message. If this line is in the logic 1 state, the information appearing on the data-I/O lines is interpreted as an interface control message; if it is in the 0 state, the information is data.

Interface-control messages

The interface-control messages provide remote control through four classes of messages available with the HEF 4738. These are:

- **Addresses:** my listen address (MLA), my talk address (MTA), other talk address (OTA), and unlisten (UNL).
- **Addressed commands:** go to local (GTL) group execute trigger (GET), selected device clear (SDC), take control (TCT), and parallel poll configure (PPC).
- **Universal commands:** local lockout (LLO), serial poll enable (SPE), serial poll disable (SPL), device clear (DCL), and parallel poll unconfigure (PPL).
- **Secondary:** parallel poll enable (PPE) and parallel poll disable (PPD).

Another line used only by the controller is the interface-clear (IFC) line, for resetting the complete interface system into its quiescent state. The service-request (SRQ) line is used by a device to indicate to the controller that the device requires attention, an interruption of the current sequence of events, or both.

The last two are the remote-enable (REN) and the end-or-identify (EOI) lines. The former is used only by a controller to select between the two alternative sources of device programming data (interface and device front-panel controls). The latter is used by a talker to indicate the end of a multiple-byte transfer sequence or by a controller to execute a parallel polling sequence in conjunction with an ATN signal.

As noted, these five signals are connected to the HEF 4738 by means of the chip's inverting transceivers and are prefixed with I/O notation. Thus the chip's corresponding management bus signals appear as $\overline{\text{IATN}}$, $\overline{\text{IIFC}}$, $\overline{\text{OSRQ}}$, and $\overline{\text{IREN}}$. The EOI signal, however, changes to $\overline{\text{IDY}}$, or identify, since the end signal originates from the device itself after it completes the last task.

System operation is generally initiated by the controller, which programs a particular instrument to make measurements and then passes them to the bus by addressing it as a talker. The controller also addresses the listeners that receive the measurements.

To inhibit all instruments from listening, the controller issues an unlisten (UNL) command on the bus before addressing one or more instruments and listeners. Having sent the address, the controller then transmits the program information in a sequence of data bytes—for example, to perform a measurement.

Once the measurement starts, the instrument may be programmed as a talker, sending its information on the bus when the measurement ends. The controller also addresses new listeners to receive the measurement information. Figure shows a basic listener-talker interfacing setup.

Serial and parallel polling

Ten IEEE-488 bus interface functions provide comprehensive and flexible control of the measurement system (see panel). Linking the instrument's internal operation to the external protocol of the IEEE-488 bus, they enable each individual instrument to receive, process, and send messages. The designer chooses which interface function subsets are required for the particular instrument's operation, since an instrument that is basically only a talker has different requirements from one that is basically only a listener or that both talks and listens.

The HEF 4738 provides these basic IEEE-488 bus interface functions with the addition of a shift register. Special features like local programming and serial polling can also be implemented. Parallel polling, though, requires a decoder.

The only 488 interface function the HEF 4738 does not provide is that of the controller, although it does provide three controller function signals for use with a controller: input-controller-active-or-transfer-state (ICATS), output-talker-active (Ota), and output-take-control (Otct). □



GET THE BIG ONES

The latest in computer books that people waited in line to buy!
Now available by mail for the first time.

Computer Dictionary and Handbook (2nd Ed.)

By C.J. & C.P. Sippl

Comprehensive, 778-page reference on computers & their applications. Over 22,000 definitions, acronyms & abbreviations re: data processing. 13 appendices on computer-related topics. Hardbound. #20850... \$21.50

Computers & Programming Guide for Engineers

By D. Spencer

Discusses various types of digital computers, input/output devices, storage devices, etc. Details FORTRAN & BASIC programming. 288 pgs., 8½x11. #20950... \$12.95

Using the 6800 Microprocessor

By E. Poe

A basic guide to hardware & software of the 6800 "fun" machine, & how to run a variety of practical programs. 176 pgs. #21512... \$6.95

Interfacing and Scientific Data Communications Experiments

By D. Larsen & P. Rony

How to use UART & USAR/T "chips" for serial data communications between instruments & computers. 160 pgs. #21546... \$5.95

IC Converter Cookbook

By W. Jung

How to understand & use IC A/D & D/A converters. Details circuits, with part numbers & component values. Appendix of catalog sheets & part number cross references. 576 pgs. #21527... \$13.95

Active-Filter Cookbook

By D. Lancaster

Covers theory, use, design, analysis, synthesis & applications—in brainwave research, electronic music, quadrature art, psychedelic lighting, etc. 240 pgs. #21168... \$14.95

Logic and Memory Experiments Using TTL Integrated Circuits

By D. Larsen & P. Rony

A hands-on intro to using 7400-series devices, memories, display & arithmetic elements. 352-pgs. Book 1: #21542... \$9.95. 384 pgs. Book 2: #21543... \$9.95. Both books: #21544... \$17.95

Microcomputer—Analog Converter Software and Hardware Interfacing

By C. Titus, P. Rony & D. Larsen

Covers microcomputer hardware & software needed to interface A/D & D/A converters to 8080-based microcomputers. With experiments. 228 pgs. #21540... \$9.50

CMOS Cookbook

By D. Lancaster

What CMOS is, how it works, & how to power, use, test & interface it, etc. With minicatalog of 100 devices. 416 pgs. #21398... \$10.50

IC Timer Cookbook

By W. Jung

Gives basic information, over 100 circuits for a variety of uses, & reprints of manufacturers' data sheets—plus more. 288 pgs. #21416... \$9.95

IC Op-Amp Cookbook

By W. Jung

Details basic theory of the IC op-amp, & offers over 250 circuit applications, well illustrated. Appendices of manufacturers' reference material. 592 pgs. #20969... \$12.95

TTL Cookbook

By D. Lancaster

Explains what transistor-transistor logic is, how it works & how to use it—for a digital counter & display system, electronic stopwatch, digital tachometer, etc. 336 pgs. #21035... \$9.50

SAVE 10% when you order 3 or more!

Examine any book(s) at NO RISK for 15 Days!

313

Clip Out—Mail Today!

YES—Please send me the book(s) indicated below. If I'm not completely satisfied, I may return any or all within 15 days of receipt for full credit or refund. Add sales tax where applicable.

- | | | |
|--------------------------------|--------------------------------|--------------------------------|
| <input type="checkbox"/> 20850 | <input type="checkbox"/> 21527 | <input type="checkbox"/> 21540 |
| <input type="checkbox"/> 20950 | <input type="checkbox"/> 21168 | <input type="checkbox"/> 21398 |
| <input type="checkbox"/> 21512 | <input type="checkbox"/> 21542 | <input type="checkbox"/> 21416 |
| <input type="checkbox"/> 21546 | <input type="checkbox"/> 21543 | <input type="checkbox"/> 20969 |
| | <input type="checkbox"/> 21544 | <input type="checkbox"/> 21035 |

I have checked 3 or more titles and deducted my 10% savings.

Name _____ (Please Print)

Address _____

City _____

State _____ Zip Code _____ Total: \$_____

Check Money Order Master Charge

Visa/BankAmericard

Exp. Date _____

Account No.: _____

Interbank No.: _____ (Master Charge only)

Signature: _____

Minimum credit card purchase: \$10.00 MH51

MAIL TO:

Howard W. Sams & Co., Inc.

4300 W. 62nd St.

Indianapolis, IN 46206

Prices subject to change 6 months after issue date.

**What's the leader in
functional board testing
doing in the
in-circuit race?**



Just what you'd expect: We're improving the state of the art. And leaving the competition way behind.

GenRad has taken the technological know-how that's made us number one in the functional board test field and put it to work on in-circuit problems.

As a result, our first in-circuit test system, the GR 2270, has capabilities other in-circuit test equipment companies are still dreaming about:

Automatic test generation software that's so accurate and reliable you don't have to start out with a known good board. It allows analysis of test settling time, parallel networks, and measurement accuracy.

Architecture based on the powerful PDP-11—the most popular minicomputer in the industry.

A new level of accuracy for analog testing, including a unique 4-line scanning method.

A 10 megabyte disk system—for high speed program preparation with less data manipulation.

Plus the kind of human engineering that makes GenRad equipment as popular with operators as it is with management. Everything from high-level interactive software to an adjustable test bed.

And, like our functional systems, the 2270 is structured for future growth. Because you upgrade with software—and never lose your hardware investment.

GenRad.

We may be new to in-circuit testing. But we're used to leading the way. For details, write GenRad, Concord, MA 01742 or call the office nearest you. Atlanta (404)394-5380; Boston (617)646-0550; Chicago (312)884-6900; Dallas (214)234-3357; Cincinnati (513)831-9210; Los Angeles (714)540-9830; New York (NY) (212) 964-2722, (NJ) (201)791-8990; San Francisco (408)985-0662; Washington, DC (301)948-7071; Toronto (416)252-3395; Bourne End (UK) (06285) 2 66 11.

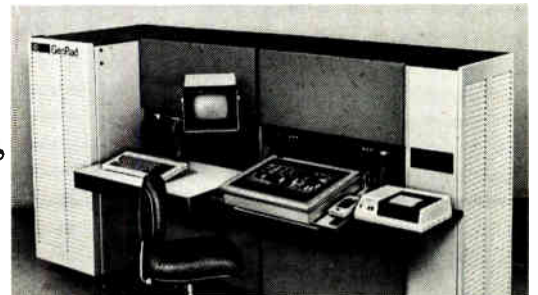

The GR 2270 in-circuit test system, designed for large printed circuit boards. It has the most flexible emulation and diagnostic software on the market. We also offer a powerful benchtop tester, the GR 2230 I, for smaller boards.

 **GenRad**

Put our leadership to the test.

Dynamic go/no-go checker gauges pulse-width range

by R. E. S. Abdel-Aal
Sunderland Polytechnic, Sunderland, England

Because it can determine if the width of a pulse falls between two specified limits, this circuit is useful in tasks like testing the dynamic performance of circuit cards. Using three integrated circuits—one dual monostable, one dual flip-flop, and a quad NAND gate—the circuit can be built for \$5. Three light-emitting diodes indicate instantly whether the pulse width is less than, within, or greater than the specified width, making the circuit ideal for the production line.

The positive edge of the pulse to be measured triggers one-shots A_1 and A_2 , whose resistor-capacitor time constants are set to provide a pulse equal to τ_{min} and τ_{max} , respectively. The input pulse, having width τ , is also

applied to the data (D) input of flip-flop A_3 .

A_3 's clock input is driven by the \bar{Q} output of A_1 . Thus if $\tau < \tau_{min}$, there will be a logic 0 at the D input of A_3 at the time the rising edge of the \bar{Q} output of A_1 clocks A_3 . LED L_1 will then light, indicating the input pulse width is below the minimum value set, τ_{min} .

Similarly, the D input of flip-flop A_4 is driven by the Q output of one-shot A_2 , while the inverted pulse input serves to clock A_4 's C input. If $\tau > \tau_{max}$, LED L_3 will light, indicating the input pulse width is greater than the maximum value set, τ_{max} .

If τ lies between τ_{min} and τ_{max} , the Q outputs of both A_3 and A_4 will move high, activating the NAND gate connected to LED L_2 . This LED will then light. Note that it is not possible for more than one LED to be on at any given instant.

The circuit is self-resetting and can accept the next input pulse to be measured as soon as the one-shots time out. □

Engineer's notebook is a regular feature in *Electronics*. We invite readers to submit original design shortcuts, calculation aids, measurement and test techniques, and other ideas for saving engineering time or cost. We'll pay \$50 for each item published.

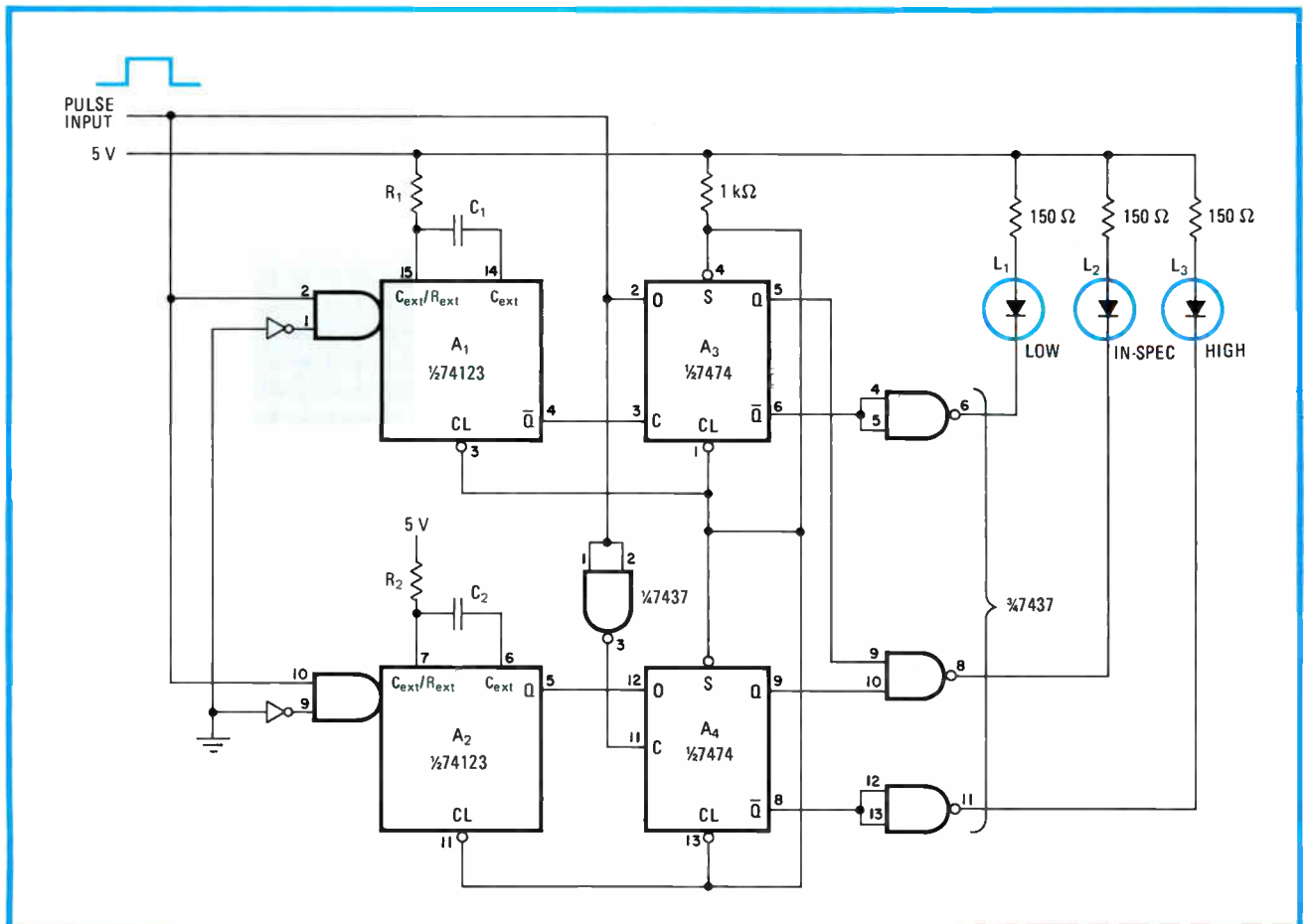

Within limits. Circuit checks if width of test pulse is less than, within, or greater than two specified values, τ_{min} and τ_{max} . RC elements of one-shot A_1 set τ_{min} ; corresponding components of A_2 set τ_{max} . Three LED's provide instant and direct indication of pulse width range.

HP-97 finds response of microwave couplers

by J. Saillard, Université de Rennes
Rennes-Cedex, France

Finding the amplitude and phase of microwave energy at the output ports of rat-race and other symmetrical couplers is fast with this program. Given the coupler's matrix elements, the program generates the required data for any normalized frequency. It has been designed to accommodate the entry of a series of frequencies so that curves for the coupler can be plotted.

A four-port network is defined by the two equations

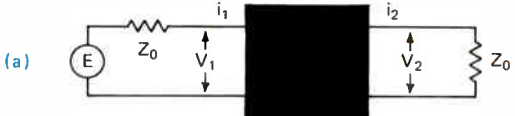
(a) 

$$V_1 = AV_2 + B(-i_2)$$

$$i_1 = CV_2 + D(-i_2)$$

(b)

	$\begin{bmatrix} 1 & 0 \\ (j \tanh a_1 \theta)/z_1 & 1 \end{bmatrix}$	$\begin{bmatrix} \cos a_2 \theta & j z_2 \sin a_2 \theta \\ (j \sin a_2 \theta)/z_2 & \cos a_2 \theta \end{bmatrix}$	$\begin{bmatrix} 1 & 0 \\ (j \tanh a_3 \theta)/z_3 & 1 \end{bmatrix}$	=	$\begin{bmatrix} A_1 & A_2 \\ A_3 & A_4 \end{bmatrix}$	EVEN MODE
	$\begin{bmatrix} 1 & 0 \\ -j/z_1 \tanh a_1 & 1 \end{bmatrix}$	$\begin{bmatrix} \cos a_2 \theta & j z_2 \sin a_2 \theta \\ (j \sin a_2 \theta)/z_2 & \cos a_2 \theta \end{bmatrix}$	$\begin{bmatrix} 1 & 0 \\ -j/z_3 \tanh a_3 \theta & 1 \end{bmatrix}$	=	$\begin{bmatrix} A_1 & A_2 \\ A_3 & A_4 \end{bmatrix}$	ODD MODE

Matrix manipulation. Equation set for general four-port network (a) is converted to equivalent matrix equation for considering circuit behavior at high frequencies, where all matrix parameters are defined in text. When a symmetrical coupler is considered, matrix expression becomes (b), the equation solved by the HP-97. Plotted response of a popular coupler is shown in illustration below.

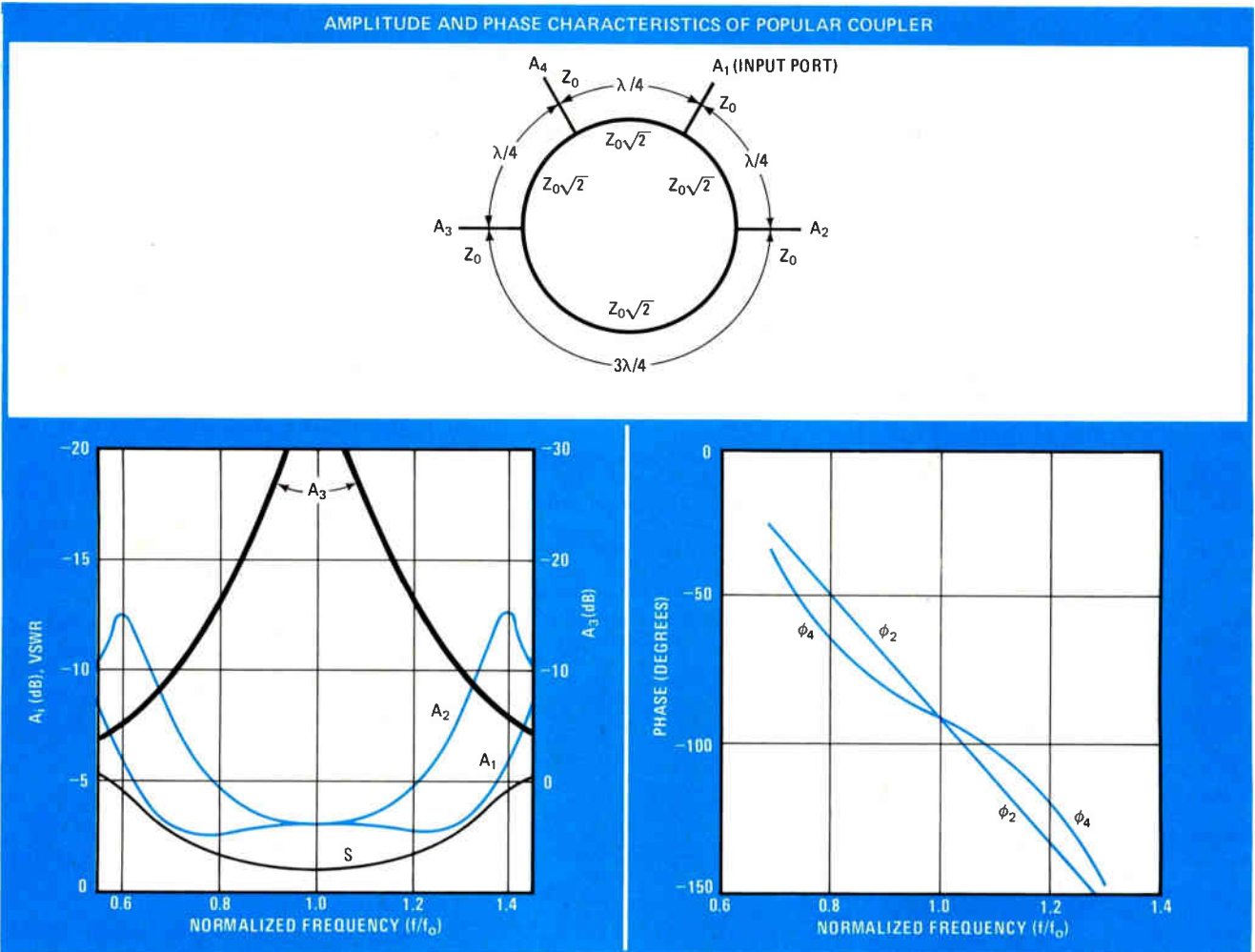

GROWTH SPURS HIRING

Rockwell Plans For Continued Avionics Growth In 1979.

CEDAR RAPIDS — Rockwell International is anticipating another year of growth and new developments for its avionics and telecommunications businesses, according to sources in Cedar Rapids where Rockwell's Avionics and Missiles Group is headquartered. Rockwell's Collins Divisions have helped place the company among the largest electronic firms in the world. The company is now gearing up for development of the next generation of electronics products. Among the systems produced in Cedar Rapids are the Rockwell-Collins Pro Line and Micro Line avionics for general aviation aircraft, and a complete line of air transport avionics. Government avionics products and systems include the U.S. Air Force standard tactical air navigation system, and the complete avionics system for the new U.S. Coast Guard Medium Range Search Aircraft.

Rockwell-Collins digital flight control systems to guide new generation of commercial aircraft through the turn of the century.

CEDAR RAPIDS — A new multimillion-dollar contract awarded to Rockwell International's Collins Air Transport Division is expected to provide a baseline business for the Division through the turn of the century. The contract is for digital flight control systems to guide a new generation of commercial aircraft. It's the firm's largest single avionics project ever, surpassing even their work on the U.S. space program. The Division has immediate openings for additional engineers to help handle the increased work load.

General Aviations' new product introductions help provide continued market leadership.

CEDAR RAPIDS — The availability of exciting new technology, combined with healthy sales projections for general aviation aircraft, has helped stimulate a wave of new product introductions by Rockwell International's Collins General Aviation Division. Typical of the energetic product development efforts of the Division was the introduction this year of six new general avionics products. Among them: the first Rockwell-Collins Pro Line color weather radar and a Pro Line navigation processor which displays checklist and map information of the radar indicator; and the new Micro Line DCE-400 distance computing equipment which uses the bearing information

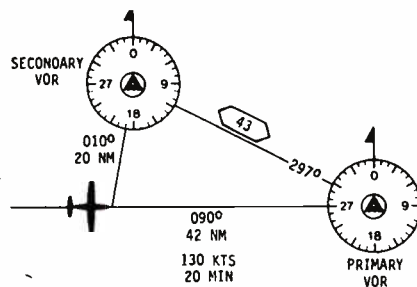

from two VOR stations to compute distance and groundspeed. (The engineer who developed the latter product was named Engineer of the Year for the Division.) The thrust of the new product development work for both product lines will be to further increase the momentum that has propelled the Division to market leadership.

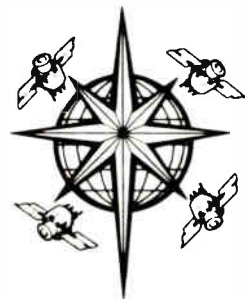

New products and systems under intensive development at Rockwell's Collins Government Avionics Division.

CEDAR RAPIDS — The GPS generalized development model user equipment being developed by Rockwell's Collins Government Avionics Division continues to perform well beyond expectations in USAF Avionics Lab tests. Meanwhile, the Division continues work on the USAF standard TACAN, standard AM/FM comm transceiver, the avionics system for the USCG HU-25A and an entire new family of cockpit control and display systems. The Division is also engaged in a series of major new product and system development programs for the government avionics market, creating a requirement for engineering and technical personnel to help the Division expand its share of this growing market.

Professional Rockwell employees enjoy a wide range of benefits, including life, medical, dental and accident insurance; paid vacations/holidays; reimbursement for relocation; and excellent savings and retirement plans.

For full details, write Loren Wells, Mgr., Professional Employment, Avionics and Missiles Group, 400 Collins Road NE, M/S 120-145, Cedar Rapids, IA 52406. Attention: Dept. (E-2).



Rockwell International

Equal Opportunity Employer M/F



001	*LBLA	039	P = S	077	RCL E	115	STO5	153	+	191	X = Y
002	RCL0	040	RCLB	078	+	116	X = Y	154	-P	192	LOG
003	SPC	041	RCLC	079	STOA	117	RCL6	155	X = Y	193	2
004	PRTX	042	+	080	RCL E	118	X	156	PRTX	194	0
005	9	043	RCLA	081	RCLB	119	STO4	157	X = Y	195	X
006	0	044	RCLD	082	RCL2	120	RCL1	158	PRTX	196	PRTX
007	X	045	+	083	÷	121	RCL0	159	STO9	197	RCL1
008	STO7	046	-P	084	RCL1	122	2	160	1	198	RCL5
009	RCL3	047	X = Y	085	RCL7	123	÷	161	+	199	-
010	X	048	CHS	086	X	124	-R	162	1	200	RCL0
011	ENT1	049	STO3	087	TAN	125	STO0	163	RCL9	201	RCL4
012	COS	050	X = Y	088	÷	126	X = Y	164	-	202	-
013	STOE	051	1/X	089	+	127	STO1	165	÷	203	-P
014	X = Y	052	STO2	090	GSBB	128	RCL3	166	PRTX	204	X = Y
015	SIN	053	RCLB	091	P = S	129	RCL2	167	RCL3	205	PRTX
016	RCL4	054	RCLC	092	RCLB	130	-R	168	RCL7	206	X = Y
017	X	055	-	093	RCLC	131	STO2	169	+	207	LOG
018	STOB	056	RCLA	094	+	132	X = Y	170	RCL2	208	2
019	RCL6	057	RCLD	095	RCLA	133	STO3	171	RCL6	209	0
020	÷	058	-	096	RCLD	134	RCL5	172	+	210	X
021	RCL7	059	-P	097	+	135	RCL4	173	-P	211	PRTX
022	RCL5	060	X = Y	098	-P	136	2	174	X = Y	212	P = S
023	X	061	RCL3	099	X = Y	137	÷	175	PRTX	213	RTN
024	TAN	062	+	100	CHS	138	-R	176	X = Y	214	*LBLB
025	X	063	STO1	101	STO7	139	STO4	177	LOG	215	STOD
026	-	064	X = Y	102	X = Y	140	X = Y	178	2	216	RCLA
027	STOA	065	RCL2	103	1/X	141	STO5	179	0	217	X
028	RCL E	066	X	104	STO6	142	RCL7	180	X	218	CHS
029	RCLB	067	STO0	105	RCLB	143	RCL6	181	PRTX	219	1
030	RCL2	068	P = S	106	RCLC	144	-R	182	RCL3	220	+
031	÷	069	RCLB	107	-	145	STO6	183	RCL7	221	RCLB
032	RCL1	070	RCL6	108	RCLA	146	X = Y	184	-	222	÷
033	RCL7	071	÷	109	RCLD	147	STO7	185	RCL2	223	STOC
034	X	072	RCL7	110	-	148	RCL1	186	RCL6	224	RTN
035	TAN	073	RCL5	111	-P	149	RCL5	187	-		
036	X	074	X	112	X = Y	150	+	188	-P		
037	-	075	TAN	113	RCL7	151	RCL0	189	X = Y		
038	GSBB	076	÷	114	+	152	RCL4	190	PRTX		

Instructions

- Key in program
- Enter normalized frequency and coupler's parameters
(f/f_0), STO 0, (a_1), STO 1, (z_1), STO 2, (a_2), STO 3, (z_2), STO 4, (a_3), STO 5, (z_3), STO 6
- Press R/S
Normalized frequency (f/f_0), phase and amplitude of reflection coefficient at input (ϕ_1 , $|r_1|$), VSWR at input (S), phase and amplitude of wave at second, third, and fourth arms of coupler (ϕ_2 , A_2 , ϕ_3 , A_3 , ϕ_4 , A_4) are displayed
- Enter new normalized frequency to generate corresponding phase and amplitude information
(f/f_0), R/S

seen in (a). Here A, B, C, and D are proportionality factors corresponding to the particular network analyzed. Further, it can be shown that when networks in the microwave region are considered, values A through D are specified by analyzing the black box as a transmission line flanked by two stubs at each end, where z_1 and l_1 , and z_3 and l_3 , are the normalized impedance and length of the two stubs. Impedance z_2 and length l_2 correspond to the transmission-line parameters. Each section has a matrix, and when they are multiplied together, they equal the matrix of the proportionality factors A-D.

If a symmetrical coupler is analyzed and assumed to be lossless, then the matrix equation can be written as shown in (b), where $a_i = 4l_i/\lambda$, $\theta = 90f/f_0$, $\gamma = j\beta$, and $\beta l_i = a_i\phi$. The HP-97 will solve these matrices for any symmetrical coupler.

The illustration shows the results of a plot carried out for one of the most popular coupler configurations now available, where $a_1 = 0.5$, $a_2 = 1.0$, $a_3 = 1.5$, and normalized impedance values are $z_1 = 2^{1/2}$, $z_2 = 2^{1/2}$, and $z_3 = 2^{1/2}$. Entering these values into the calculator as instructed will generate information in tabular form for each normalized frequency desired. □

New to laser trimming? Try contracting it out

Thinking of buying a \$250,000 to \$500,000 laser trimmer? Perhaps you should look into an alternative—contract laser trimming. Laser Trim Inc. has the equipment to trim thick- or thin-film resistor networks to a ratio accuracy of 0.002% at rates of up to 50,000 units per hour.

Contract trimming also provides an easy transition for those about to buy a laser system. Laser Trim can work out all the trimming problems, tooling, and programs before a user purchases his own trimmer and pass all this material along to him when his machine arrives—a **procedure that is bound to make life easier for a first-time user**. More information is available from the company at 4009 North Nashville, Chicago, Ill. 60634.

Another use for a microprocessor's restart command

Included in the repertoire of several microprocessors are one or more software interrupt instructions. The chief function of this kind of instruction is to transfer control to an interrupt routine when the appropriate op code is forced onto the data bus by an internal device's request for service. Because it carries an implied vector, the software interrupt minimizes the code that must be directed into the processor.

The eight restart instructions common to the 8080, 8085, and Z80 are good examples. Bernard Verreau of Intel's Microcomputer Systems division points out that these "RST 0, . . . 7" instructions can also be used as unconditional subroutines to call in an assembly language program. They offer the dual advantage of faster execution and fewer bytes than the standard call instruction. In fact, **if the most frequently referenced subroutines are accessed through restarts, a substantial memory saving may result.**

It pays to pay more on packaging optical devices

Shipping optical laser components is not a simple procedure, as a Government laboratory that uses many of these delicate and costly elements found, to its expense. It came to Zero Corp., in Burbank, Calif., for help with its problem—the marring and staining of the optical surfaces of laser components, mainly lenses, which it had been shipping all over the world in plastic or wooden boxes containing polyurethane packing.

Zero's solution was an aluminum carrying case fitted with a custom-designed polyethylene insert. The case protects its contents against shock and vibration, while the tongue-and-groove design of the shell plus a neoprene gasket excludes outside elements like rain, snow, or excessive humidity. Also, **unlike the boxes, the aluminum case is reusable.**

Chip monitors power supply

Most power supplies require additional circuitry for monitoring their performance and protecting them in the event of a fault. An application note from Silicon General Inc. describes an interesting new monolithic integrated circuit that contains all the functions necessary to monitor and control the output of any power supply system. Called "The Output Supervisory Circuit," the note also suggests **applications for the new chip, including limiting linear foldback, sensing multiple supply voltages, and overcurrent, undervoltage, and overtemperature shutdown.** To receive a copy, write to the company at 11651 Monarch Street, Garden Grove, Calif.

—Jerry Lyman

Let us bring out your creative genius

...to make your product more saleable...more profitable
with **CHERRY CUSTOM ICs.**

Cherry engineers are ready and willing to work with you on your IC requirements. In fact, the only way we work is as a team; with you as the leader. This way—working together—we can be sure from the beginning that the final system will meet your needs. And, it doesn't matter what your requirement is, whether digital or linear...call us. Want both digital and linear functions on the same IC? We've done it with I²L...successfully.

The same engineers who are ready to help solve your custom IC problems have already helped solve a lot of

standard problems. You'll find several examples of this problem-solving capability in our just-published catalog of standard digital and linear bipolar integrated circuits.

Here's a quick rundown of the contents of our 36 page, free-for-the-asking catalog: Low level amplifiers—differential amplifiers—level detectors—DC to DC converters—timing circuits—motor speed controls—optical detector systems—camera controls—plus, flip chips.



CHERRY **SEMICONDUCTOR**

CHERRY SEMICONDUCTOR CORPORATION 99 Bald Hill Road, Cranston, Rhode Island 02920/(401) 463-6000/TWX 710-381-1757

Circle 159 on reader service card

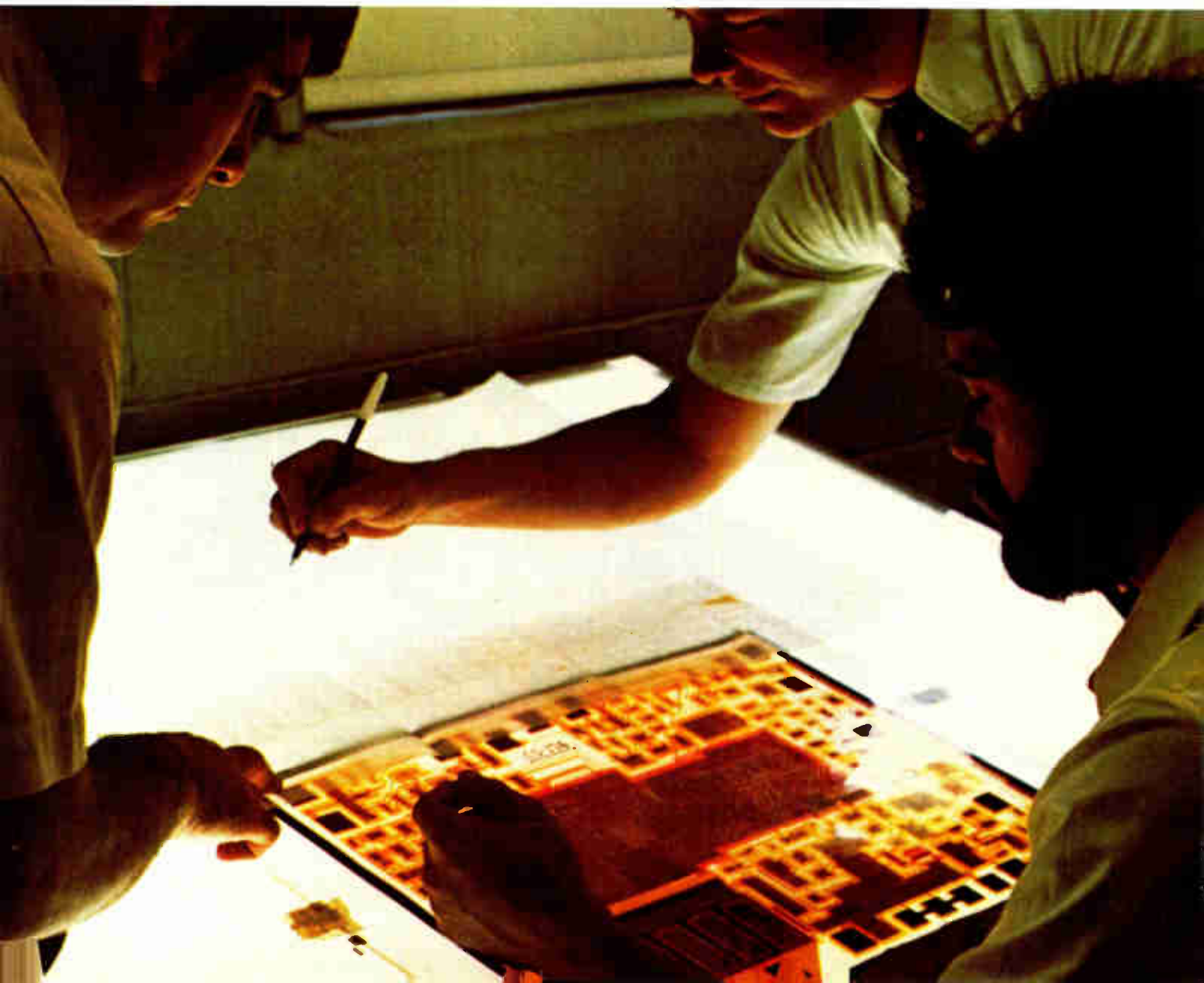



WANTED



**"DEADWOOD"
CHIP.**

~ FOR CONSIDERENT PRIZE UNDER ~
~ MOUNTAIN TESTS ~

WANTED



**LUKE (SHORT)
CAPACITOR.**

~ DEED OR AUVIS ~
SILVER COUNTY - CALIFORNIA

**The real
reward is
long-term
savings in
PCB
testing.**

Fairchild component test systems have paid big rewards in the world of LSI testing. Now Fairchild gives you the same rewards in production testing and field testing of printed circuit boards.

You'll be rewarded with a broad range of flexible, compatible hardware and software to help meet your present test needs and anticipate future requirements. You'll get higher yield of good boards. And you'll get fast, precise fault isolation to help reduce board repair costs.

Our Faultfinder FF202 is a low-cost, self-programming automatic tester that's faster and more versatile than visual/manual probe testing for isolating shorts and opens on bare boards and loaded PCBs. It uses in-circuit test techniques for PCB prescreening. The same techniques are used in our computer-controlled Faultfinder FF101C and FF303, and in our Testline AFIT 4000 production test systems to give you maximum software and hardware compatibility. And each system is designed to give you 90% plus yields in testing the most complex analog, hybrid and digital boards.

Software compatibility in the Testline AFIT systems extends to the repair depot, with the AFIT 3000A, and into field service with the portable AFIT 1000 and 1500.

You're rewarded with cost savings in fixturing, too, with Fairchild's Thinline® Vacuum Fixture System. It's transformed the bed-of-nails into a multi-option test interface that lets you build inexpensive do-it-yourself fixtures on site, or utilize universal fixture components that can save you more than 40% on conventional fixturing costs.

At Fairchild, we've learned the importance of making flexible test systems to meet your present needs and adapt readily to future requirements. And we've learned the importance of fast, dependable service and support for every customer everywhere in the world. These are the things we do to reward you with long-term savings in production testing.

Find out how big your reward will be. Give us a call, or write:
Fairchild Test Systems Group,
Subassembly Test Systems Division,
15 Avis Drive, Latham,
New York 12110
(518) 783-3600



FAIRCHILD

Test Systems Group

**The
First Family
of ATE**

HP's OEM-compatible the start of s

However big the system you're planning, make sure you start with a computer and disc combination from Hewlett-Packard. HP 1000 processors and disc memories were designed to work together. So whatever combination you choose, you're assured of complete compatibility. Then you can add off-the-shelf peripherals and instruments, as well as the equipment you build yourself, to

create extremely reliable, cost-effective OEM systems.

This compatibility extends to our RTE family of real time operating systems, data base management and networking software, too.

By offering computers in a range of speeds and main memory sizes, and discs from 5 to 50MB, we make it easy for you to find the performance you need at the price you can afford. And you have a choice of packaging in standard or low-profile racks, or as separate modules.

Three ways to mix and match

You can put together all kinds of disc and computer combinations. These three examples cover a range of prices and performance.

1. Our HP 1000 F-Series computer and 7920 top-loading disc give you a lot of speed and power for \$24,310. The computer has 128K bytes of 350 ns memory (expandable to 2MB), a Scientific Instruction Set, 14 I/O channels (expandable to 46), hardware floating point, and fast Fortran processor. The 50MB disc has a 25 ms seek time and a transfer rate of 937.5K bytes per second. You can also add storage to 400MB.

2. At \$17,428, our HP 1000 E-Series computer and 7906 disc is a great combination. The 64K byte memory (expandable to 2MB) has a 595 ns cycle time (350 ns optional). It has nine I/O channels, expandable to 46. The 7906 disc has half of its 20MB storage on removable cartridges and the other half on fixed platter. Seek time is 25 ms and the transfer rate is 937.5K bytes per second.

3. For economy, you can pair our HP 1000 M-Series computer with this same 7906 disc. You get the same ability to expand the 650 ns memory from 64K to 2MB, and similar I/O options. And the price starts at just \$16,187.

Quantity 50—U.S. domestic OEM prices with cabinetry as shown.



e computers and discs: something big.

Another reassuring point: buying from one supplier means good service and support. Especially when that supplier is Hewlett-Packard.

We've been solving problems in the lab and factory for the past forty years, making thousands of instruments, computers and peripherals in that time. So we know exactly what an OEM needs

to make them all work smoothly together.

That's why so many successful OEMs start their systems with one of ours. So check out the full range of HP performance at your nearest HP sales office. You'll find it listed in the White Pages. Or write for complete information to Hewlett-Packard, Attn: Roger Ueltzen, Dept. 649, 11000 Wolfe Road, Cupertino CA 95014.



I'd like to know more about HP 1000 computers and discs for use in systems for my company for re-sale to others.

My application is (system function)

For (type of company/industry)

Name

Title

Company

Address

City/State/Zip

Phone

22806HPDS18

Circle 163 on reader service card

On the long road Tektronix

As a result of the meeting, events never before seen by the naked eye came to light on Tektronix' new 7104—the world's fastest general purpose oscilloscope. Events such as a pulse with the incredibly short rise time of 350 picoseconds. To follow such fleeting

excursions, the beam energy had to be low enough to be steerable—so low, in fact, that the phosphor couldn't light up. All of Tektronix' innovations in high speed circuitry might have come up against laws of physics: Too few electrons to produce visible photons.

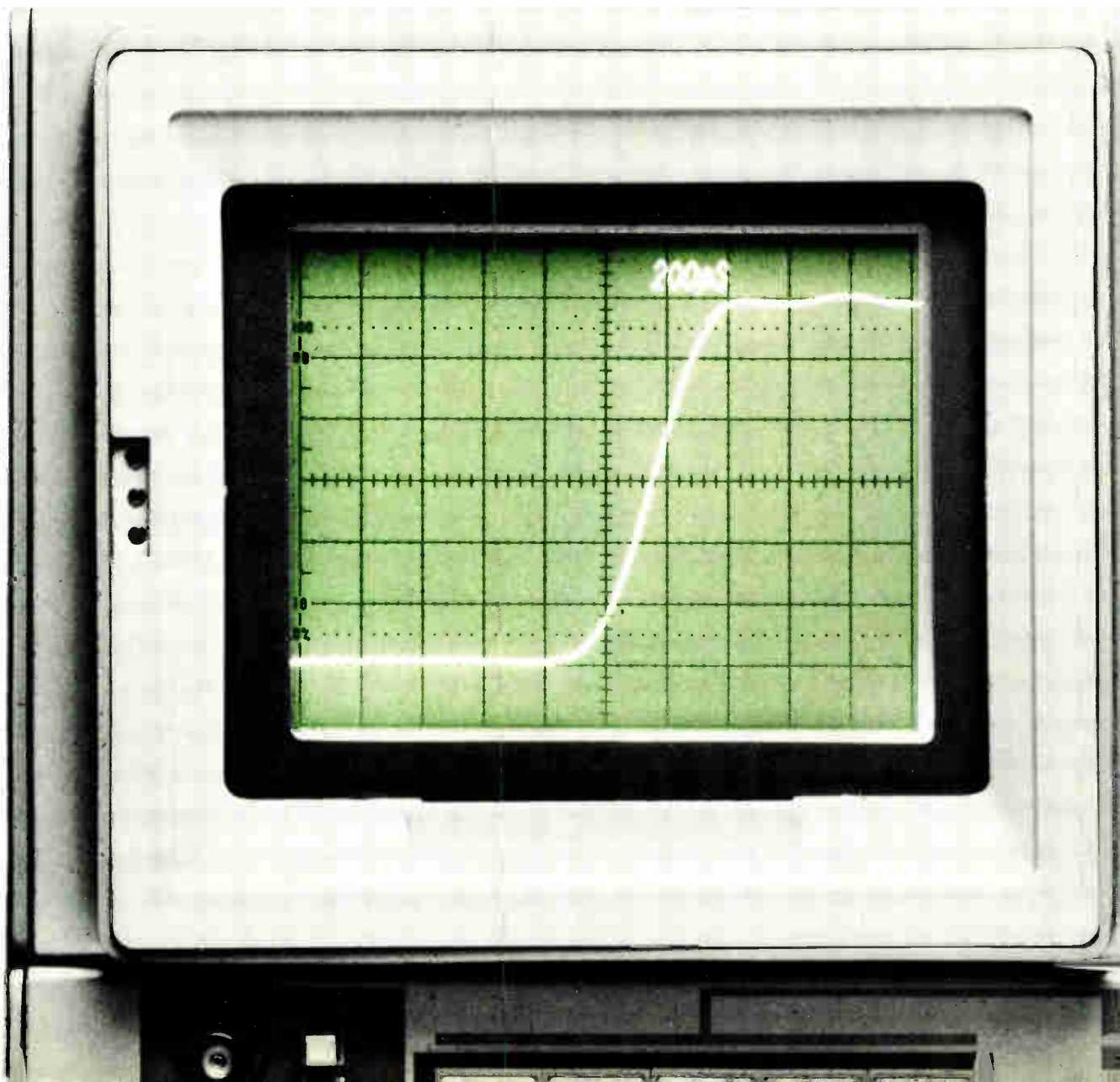

to 1 GHz, met Galileo.

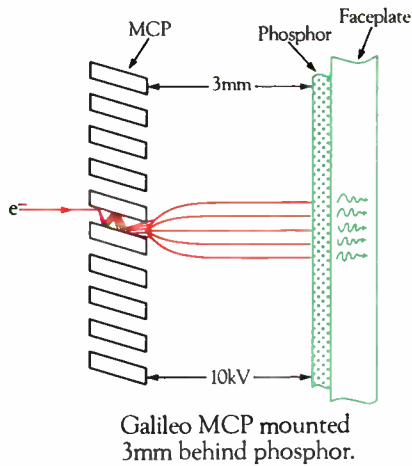

So Tektronix talked with Galileo, because we pioneered the development of electron multiplier arrays called Micro-Channel Plates. Positioned just behind the phosphor surface in the CRT, our MCP delivers 20,000

times more electrons to the phosphor surface than it receives from the weak beam. The resulting trace is almost 1000 times brighter—enough to be seen easily and recorded with conventional photographic techniques and film.

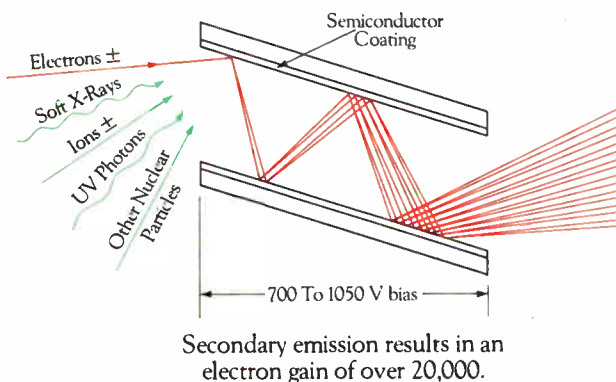

As you can see, Tektronix' solution was based not on brute-force engineering but on imaginative use of advanced technology. At Galileo this technology arises from a unique blend of applied physics and glass making. The MCP has found applications in mass and vacuum UV spectrometers, fusion and other energy-related detection systems, elec-

tron and ion microscopes, electron beam lithography, and in nuclear and medical research. MCP's are available in various sizes, shapes and geometries to meet your requirements.

In addition, Galileo is the world's largest manufacturer of single-channel electron multipliers for use in a wide variety of atomic particle and photon detectors.

Tektronix' application involved electrons. It could just as easily have been a success story about ions, protons, soft X-rays, beta particles, vacuum UV photons, or metastable particles. The application might be in counting, mapping, or imaging. The possibilities for dramatically improving the performance of an industrial product with Galileo technology are wide open to any imaginative designer, including you.

We're listening and ready to work with you, as we did with Tektronix. Call 617-347-9191 and explore your ideas with one of our technical staff.

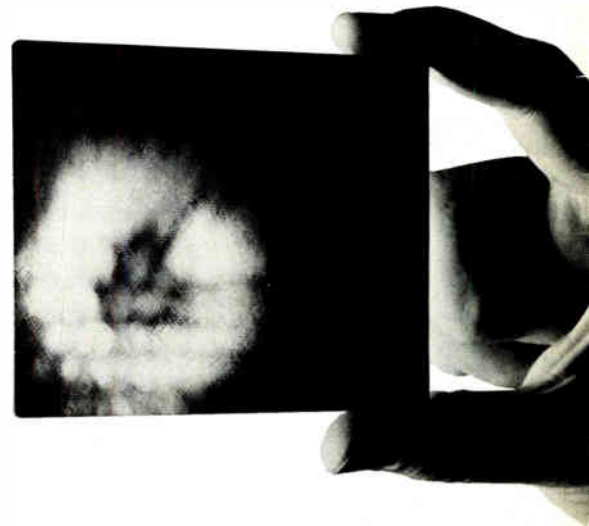

Galileo Electro-Optics Corp.

Galileo Park, Sturbridge, Massachusetts 01518

NEW DIGITAL MULTIMETERS THAT WORK THE WAY YOU DO.

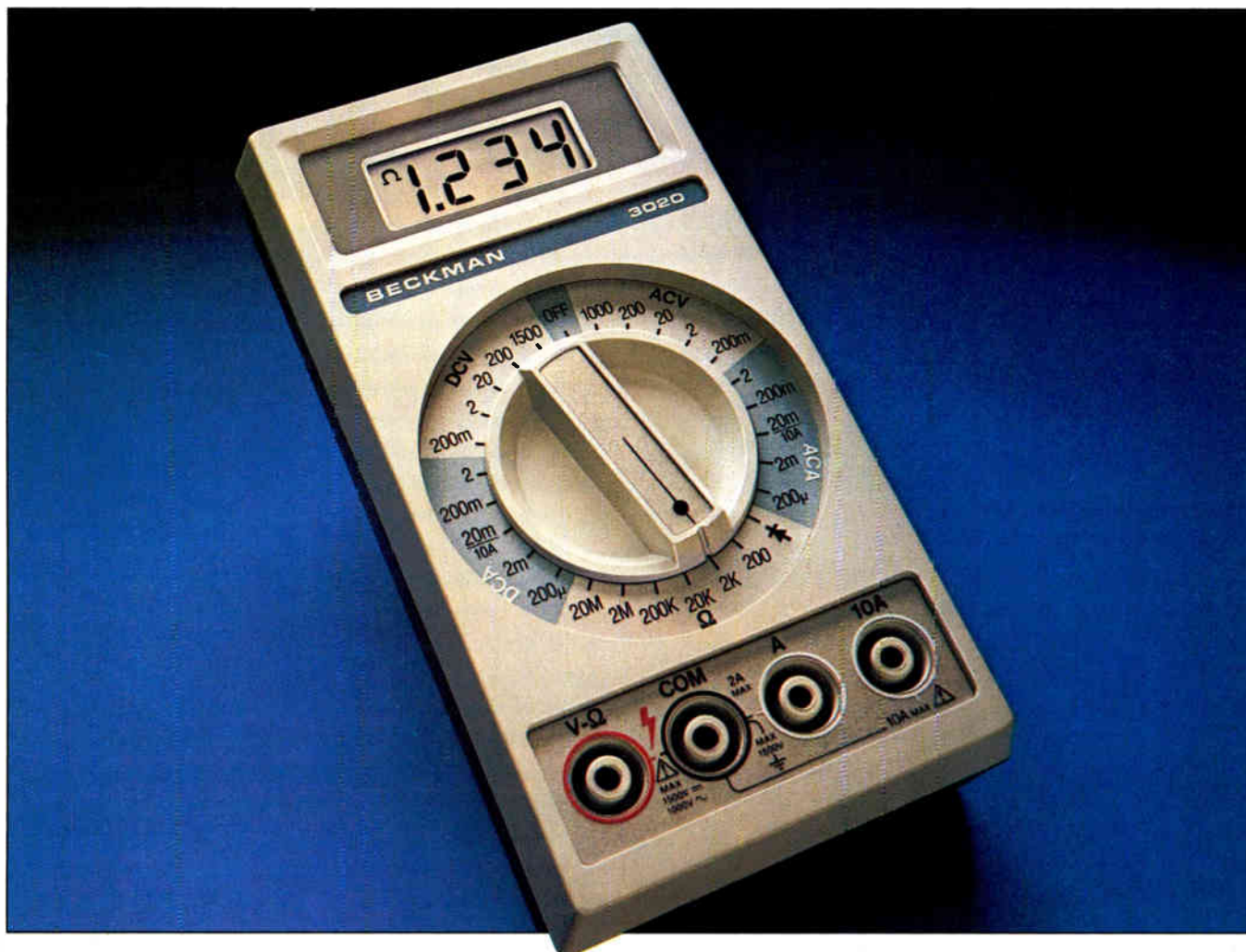

Featuring new continuity function.

You do your job as well as it can be done. Now there's a line of digital multimeters from Beckman that does the same. A new generation of 3½-digit multimeters a step above all other digital and analog multimeters. We've combined the best of both to give you useful and easy-to-use features found in no other multimeter.

Features like a unique continuity test function. With Beckman's new Insta-Ohms™ quick continuity indicator, you no longer need an analog VOM for fast, convenient continuity checks.

There's also 10-amp current ranges, in-circuit measurement capability in all six-ohm ranges, a dedicated diode test function, and up to two years normal operation from a common 9V battery.

The Model 3020 with all these features, 7 functions, 29 ranges, and 0.1% Vdc accuracy, is only \$170.

These features are also available in the Model 3010 with a 0.25% Vdc accuracy for just \$130.

Then the Model RMS 3030 features true RMS ac current and voltage measurement capability, and 0.1% Vdc accuracy, for only \$190.

Whichever model you choose, you get long-term accuracy and reliability, assured through the use of band-gap reference elements, thin-film resistor networks, custom-designed CMOS LSI chips and more.

So get the Beckman digital multimeter that does its job as well as you do yours. For information on the complete line and accessories, write or call your local distributor or the Advanced Electro-Products Division, Beckman Instruments, Inc., 2500 Harbor Boulevard, Fullerton, CA 92634, (714) 871-4848, ext. 3651.

BECKMAN

Tester for bubble memories first in field

System is designed for engineering and production and can handle variety of devices in package or wafer

by Robert Brownstein, San Francisco regional bureau

The ten-year trek from laboratory to production line is now a part of bubble-memory history. Commercial reproducibility is spurring manufacturers to develop and employ such products, so test-equipment makers are racing to gain an early lead in what could become a sizeable market [*Electronics*, March 29, 1979, p. 35].

The winner of the first lap appears to be Megatest Corp., which is not, as might be expected, one of the test industry giants, but a small Santa Clara company. Its product, succinctly named the bubble-memory test system, addresses both the engineering shop and the production line.

This duality of purpose is not a "value-added ploy" but a marketing necessity, claims Steve Bisset, president of Megatest. The operational characteristics of bubble memories make testing a long process. Furthermore, Bisset points out, "Bubbles are new, so testing is going to involve a lot of analysis." Megatest's designers feel they have covered all bases by providing a proprietary pattern processor and offering the option of testing up to eight devices in parallel.

To accommodate a great variety of test conditions, the memory's bubble-propagating drive field, its gating loops, and its bias field must be independently controlled. To note the presence of a magnetic bubble, the system must be able to measure a flea-sized magnetoresistive distortion in its permalloy detector. What is therefore required in such a tester is hardware that provides programmable currents up to tens of amps, is fast, and can sense extremely low-level signals.

To be versatile, the hardware must have a controller that directs it, collects and stores the data it provides, and is easy to program. The Megatest system incorporates all these hardware and controller features. In addition, it can even be tied to a host computer for large-scale distributed processing.

The system is divided into three parts: a PDP 11/V03 central processing unit with dual floppy-disk drives, a tall rack containing analog and digital hardware, and a test head to accept either packaged devices or wafers.

Programmers at the PDP 11 terminal will work in an extended version of Pascal. It includes structures to ease parameter specification plus simple commands for displaying test results, mapping bad loops, and logging results on disk. Software breakpoints are provided for debugging and utilities are included for constructing shmoo plots and histograms.

Most bubble devices available now (and those that will be shortly) use block-replicate or major-minor loop architecture. From type to type, the organization of magnetic bubbles to represent a given block of data varies. The relative position of these bubbles from one loop to the next, referred to as the device's topology, can affect the memory's operation.

Megatest's engineers decided that letting a pattern processor handle device topology would make writing programs for more than one vendor's devices considerably easier. A by-product, Bisset claims, is that it helps push throughput way up.

The pattern processor contains a sequence controller, an image con-

troller, and an error-map memory. Both the image controller and the error map are organized topologically. At the behest of the sequence controller, the image controller will write or read a block of data arranged in accordance with the architecture of the chip under test. The sequence controller is arranged in terms of events and oversees the order of read, write, transfer, and block move operations.

Both controllers orchestrate the timing generator, which uses emitter-coupled logic for speed. The generator, in turn, controls the timing of signals emanating from the current pulsers and the drivers for the drive-field and the bias-field coils.

Various parameters of the drivers and pulsers—such as magnitude, phase, and pulse width—are digitally controlled by the PDP 11's CPU



Big deal



Miniature switches with large toggles from C & K. They really give you a handle on design problems where ease of operation is a key consideration. Start thinking big.

Available in two lengths, both in 1, 2, 3 & 4 pole models. With contact ratings up to 5 amps, including dry circuit applications. UL listing available.

The Primary Source Worldwide
C & K Components, Inc.
15 Riverdale Avenue, Newton, MA 02158
Tel: (617) 964-6400, TELEX: 92-2546, TWX: 710-335-1163



Circle 238 on reader service card

The right angle is the right idea.



C&K's right angle miniature toggle switch mounts directly on P.C. boards with a low profile that makes a good design look even better. An integral switch support bracket reduces stress on the terminals. Right on.

C&K makes it with a wide range of actuator, and bushing options in 1, 2, 3 and 4-pole versions, with contact ratings of 0.4 VA max. UL listing available.

The Primary Source Worldwide
C & K Components, Inc.
15 Riverdale Avenue, Newton, MA 02158
Tel: (617) 964-6400, TELEX: 92-2546, TWX: 710-335-1163



Circle 168 on reader service card

Electro/79 Booths 2725-2727

New products

via the data bus. The CPU presets various parameter values digitally, but it is the pattern processor which synchronizes and controls the changes on the drivers' outputs.

Programmable X and Y voltages of the tester's drive-field coil driver determine the peak current supplied to that coil of the memory. For packaged devices, they can be specified in 10-mV steps over a 0-to-30-v range to an accuracy within 50 mV. The resultant output current peak can be a maximum of 3 A with a 1-A average at the upper frequency limit of 500 kHz.

For probing wafers, the tester has circuitry to drive field coils in the wafer fixture. This requires more power than a package's coils use and, therefore, it can drive ± 16 A, peak, with 75-v compliance at a maximum frequency of 300 kHz.

To detect the presence of a bubble, a sampling of voltage is taken at two intervals during which a bubble could be passing under a permalloy chevron detector. A constant current is fed into the actual detector and a second, dummy detector. The voltage drop produced is sampled differentially to eliminate variations due to rotating field effects.

Nucleating (forming) a bubble, transferring it, replicating it, or annihilating it is done by controlling the phase, width, and magnitude of gating pulses. Six drivers are provided; each has a 0.5-mA resolution over a 0-to-250-mA range with accuracy to within 2% ± 5 mA. Rise and fall times are 25 ns and voltage compliance is variable between 0 and 30 v. All pulsers are short-circuit protected and up to 20 can be accommodated by the system.

Megatest's system ranges in cost from \$90,000 up to \$125,000 with available options like a printer, second test head, rigid disk drive, extra pulsers, and others. Delivery will begin by the end of May, Bisset says, and first systems are slated to go to Rockwell's Electronic Devices division in Anaheim, Calif.

Megatest Corp., 2900 Patrick Henry Dr., Santa Clara, Calif. 95050. Phone (408) 988-1700 [338]

IEEE 488 BUS (GPIB)

8-line
data
bus

8-line
management
bus

SN75160

SN75161

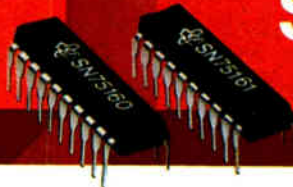

Reduce power and board space 40%. TI's new octal transceivers.

Introducing two new octal, bidirectional bus transceivers that meet the IEEE 488 General Purpose Interface Bus (GPIB) Standard.

The SN75160 data bus transceiver and SN75161 management bus transceiver contain all the circuitry required, yet consume only 95 mW per channel. That's 40% less power than conventional quad circuits.

And you can reduce pc board space required for IEEE 488 applications by replacing 4 quads and associated external logic with 2 octals.

But that's not all. Bus terminating network as specified by IEEE 488 is provided on all driver outputs. It also provides a high impedance even with power off.

In addition, the output structure of the SN75160 data bus transceiver makes it a versatile device suitable for many other octal transceiver applications.

Transceiver features

The SN75160 and SN75161 feature:

- Built-in bus terminating resistors on driver outputs
- High impedance to bus during power down
- Enable control selects 3-state or open-collector driver output (SN75160 only)
- 3-state outputs on receiver
- Hysteresis on receiver inputs
- High impedance PNP inputs
- 20-pin dual-in-line package

The management bus transceiver SN75161 has several additional features:

- Internal logic for proper direction of control signals on management bus
- Properly assigned output structures (active or passive) eliminates necessity for external control
- No external logic required

Powerful combination

The SN75160 and SN75161 combine to yield a complete IEEE Standard 488 16-line bus interface system. A system that allows asynchronous communication between satellite equipment on a bi-directional 8-line data bus. The 8-line management bus provides handshake protocol to assure interlocked communication between talker and listener.

In 100 pieces, the cost for SN75160 is \$3.90. The 100 piece price for SN75161, \$4.32.

Send for data sheets

For fast delivery call your nearest authorized TI distributor. For data sheet information write: Texas Instruments Incorporated, P.O. Box 225012, M/S 308, Dallas, Texas 75265.



TEXAS INSTRUMENTS
INCORPORATED

MOTOROLA HELPS STRETCH GAS MILEAGE

Automotive manufacturers are caught between a rock and a hard place. They are obliged not only to reduce fuel consumption, but also, at the same

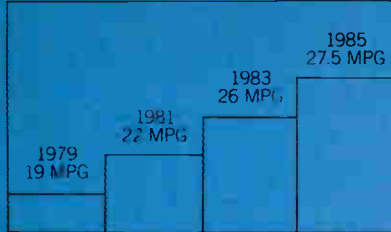

Government mandated Corporate Average Fuel Economy (CAFE) standards. Source: NHTSA

time, to reduce harmful exhaust gas emissions. And these objectives seem to be mutually exclusive.

An engine whose carburetor and spark timing are

adjusted to give high mileage tends to produce unacceptable levels of pollution. The same engine, adjusted for low pollution levels, uses more gas and gives disappointing performance.

The trick is to burn exactly the right amount of fuel at exactly the right moment. But what is "right" depends on a whole complex of constantly changing factors, including terrain, engine and air temperature, barometric pressure, and the load and speed of the car.

It would take a genius to juggle all those factors. Fortunately, Motorola has been working on the problem for some time, and has in fact

produced just such a genius.

ELECTRONIC ENGINE MANAGER.

It's an electronic engine-management system, controlled by a microcomputer that thinks like a first-rate automobile mechanic. It lives inside the car, and because it can make a million calculations each second, it can automatically regulate carburetion, spark timing, and the recirculation of exhaust gases through the engine. It makes all these adjustments continuously, so you get as much performance with as little pollution as possible, whatever the driving conditions are at that particular moment.

It's a real computer in

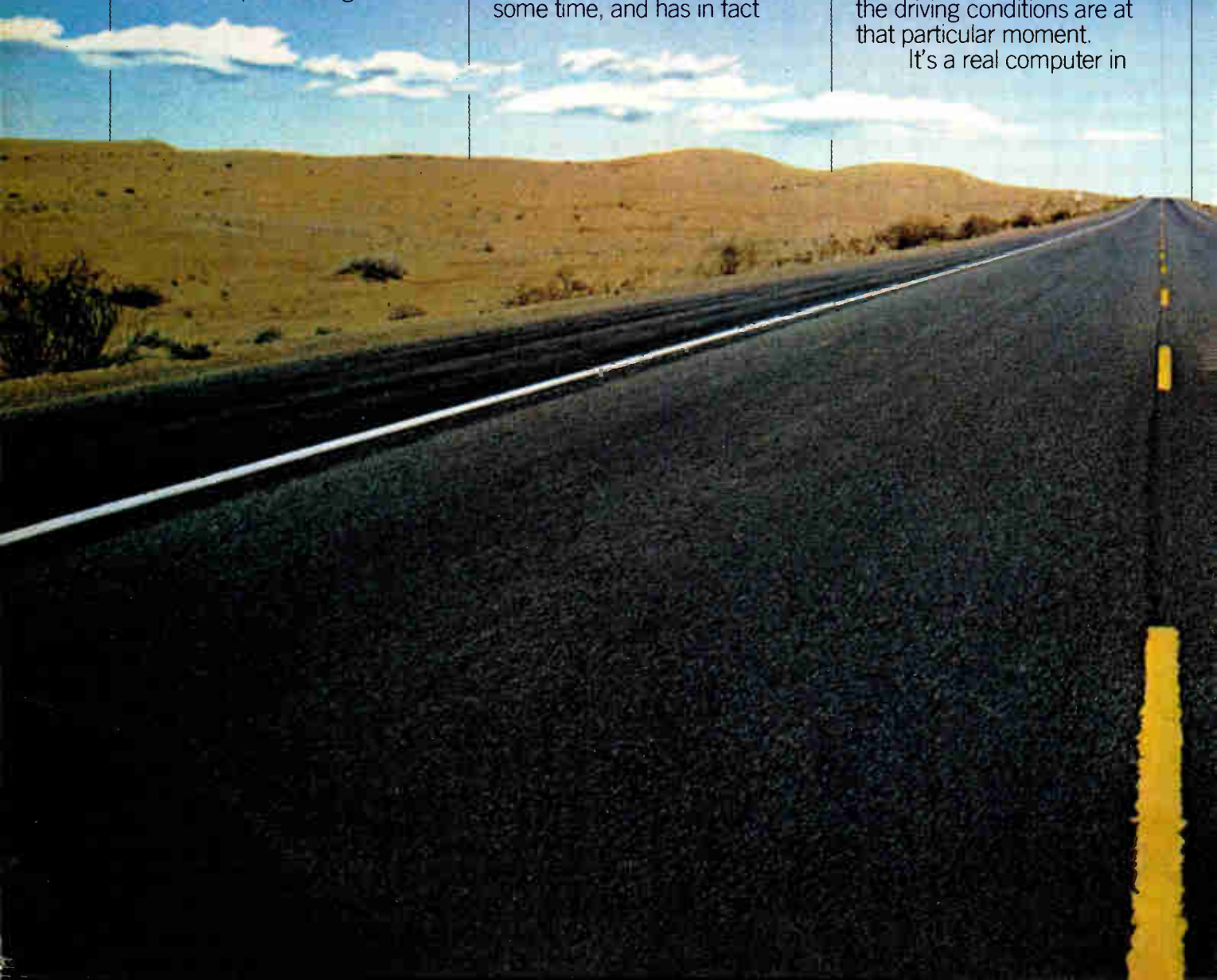

BY MAKING ENGINES THINK.

miniature, with a memory and the ability to manipulate what it learns in terms of what it already knows. It works so well that car and heavy-duty-equipment manufacturers in America and Europe plan to use it, some as early as the 1980 model year.

IMPOSSIBLE WITHOUT ELECTRONICS.

Such precise, continuous engine management would be impossible without the integrated circuit, an electronic microcosm that contains the equivalent of twelve thousand transistors and measures about 5mm square. These small miracles are the central nervous system of Motorola's electronic engine-management system,

and they're a remarkable but not unique demonstration of the kinds of things Motorola is doing with microelectronics today.



A microcomputer, drawn larger than life

IMAGINATIVE ELECTRONICS.

Motorola is not only one of the world's largest manufacturers dedicated exclusively to electronics, but also one of its foremost designers of custom and standard semiconductors.

We've come a long way from the time when we put radios into cars fifty years ago, and TV sets into America's living rooms. Now we make hundreds of

models of two-way radios, and we no longer make home TV sets here at all.

We make microelectronics carry telephone services to places where there are no phone lines. Transmit electrocardiograms and voice messages simultaneously from the scene of an accident to a nearby hospital. Help the energy industries develop the resources of the earth, the sea and the sun.

And we help make automobile engines think about how they use precious fuel.



MOTOROLA

Making electronics history since 1928.

Circle 171 on reader service card



For further information, write Public Affairs Office, Corporate Offices, Motorola, Inc., 1303 E. Algonquin Road, Schaumburg, Illinois 60196.

Motorola and  are registered trademarks of Motorola, Inc.

Op amps give more for less

Dual devices for audio and for video applications demonstrate the op amp's ability to perennially challenge engineering creativity

by William F. Arnold, San Francisco regional bureau manager, and Nicolas Mokhoff, Components Editor

Of all the circuits an engineer encounters, the one that never seems to lose its appeal is the operational amplifier. Simple and easy to use, it nonetheless challenges his inventiveness. These observations are borne out by the LM13600 and the LM359. Created from earlier models, the two low-cost devices extend the applicability of op amps.

The LM3080 operational amplifier, a transconductance type that puts out current for a voltage input, is well suited for use in electronic organs and music synthesizers because it easily modulates wave-shapes. Then National Semiconductor Corp. began wondering how it could improve things.

First, it found that it could put two amplifiers on one chip, which would improve circuit density and not use up all the pins in a 16-pin package, recalls Tim D. Isbell, director of consumer linear integrated

circuit design. "Okay, what can I do with the rest of those pins?" he then mused. What he found he could do was add on-chip Darlingtons, so users could buffer the outputs, and linearizing (or Gilbert) diodes on the inputs, so they could accept higher-level signals while reducing distortion (a 10-dB signal-to-noise ratio improvement referred to 0.5% total harmonic distortion).

The result is the LM13600 dual operational transconductance amplifier, which National believes has wide applications, not only in audio equipment, but in a variety of industrial and process-control systems. These applications include current-controlled amplifiers, filters, and oscillators as well as multiplexers, timers, and even sample-and-hold circuits. In some cases, the LM13600 could replace mechanical potentiometers and act under the control of a microcomputer in indus-

trial process-control systems.

In the LM13600, the two transconductance amplifiers share common supplies but otherwise act independently, with individual differential inputs and push-pull outputs. National also says that the device has excellent matching between the amplifiers. The supply range is wide: ± 2 to ± 20 v.

Interesting. For the designer, the LM13600 has these interesting specifications. The common-mode rejection ratio over the common-mode input range of ± 12 v is 80 dB minimum, with 110 dB typical. Input offset voltage is typically 0.4 mV, input offset current is typically 0.1 mA, and input bias current is typically 0.4 mA.

Transconductance is 5,400 micro-mhos, or rather microsiemens (abbreviated μS) minimum for the part with a 0-to-70°C range and 4,000 μS minimum for the device with a range of -55° to +125°C. Both parts show a typical transconductance tracking figure of 0.3 dB. Maximum leakage current is 100 nA and only 5 nA, respectively.

For applications, Isbell points to various circuit configurations. For example, as a voltage-controlled oscillator, the LM13600 can be implemented in function generators, organs, and process-control systems. It also can be designed into a battery powered sensing instrument so that it would turn on periodically to detect any presence of gas but remain off in between. In all, National lists 31 applications for the LM13600. Both versions cost \$1 each in high volume.

Take the popular LM3900 quad op amp, slice it in half, and increase

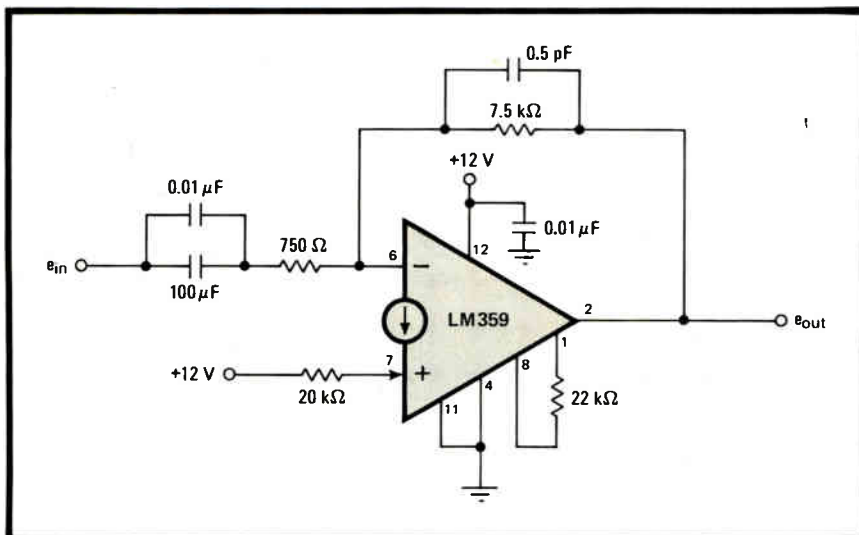

Color me fast. Built with the high-speed LM359, this video amplifier is optimized for the color subcarrier frequency, 3.58 MHz. Its differential phase error is under 1°.

PTK lights CRT's

COMMERCIAL
2 to 30kV, 3 to 30 watts,
high voltage power supplies.
Custom flyback transformers.

MILITARY
Mil grade units for ground,
ship and aircraft.

L.V. / H.V. COMBO'S
High voltage power supplies
combined with a multiple
output low voltage switcher.

SPECIALS
Miniature and sub-miniature
high voltage power supplies
to 20kV. Ultra stable or ultra
low ripple designs.

*Send for Data Package on
standard product lines, or
call Factory for technical
assistance.*

PTK Corporation
1173 Los Olivos Avenue
Los Osos, CA 93402
(805) 528-5858

HIGH VOLTAGE FOR CRT APPLICATIONS

M-200 Series

MAJOR FEATURES:

- Extremely Compact ($\cong 16 - 24 \text{ in}^3$) designed to spec units for use in Military Aircraft.
- Fixed Anode Voltages to 22kV (@ 1mA)
- Adjustable Focus Voltages to 6kV (@ $500\mu\text{A}$)
- Adjustable G1 Voltages to 1kV (@ $100\mu\text{A}$)
- Operating Temperature -55°C to $+95^\circ\text{C}$
- Enclosures are custom designed for maximum use of available space and N.C. milled from solid aluminum stock.

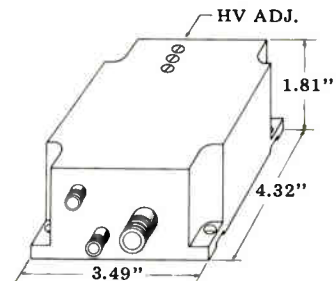

Typical M-200 enclosure.

Circle 173 on reader service card

The biggest problem with your IEEE bus...

So your new equipment conforms to IEEE standards. Great. But your system doesn't work. Not so great. Either your interface or your software isn't compatible. But which one?

Look no further. This is Model 488. The IEEE Bus Monitor/Analyzer from Interface Technology.

It records, analyzes, and controls. It stimulates, calibrates, tests, and verifies. In short, it does the thinking – and the searching – for you.

Call today for a demonstration of this remarkable time saver. Now that you're on the bus, you don't want to miss the boat.

...is finding why your bus has a problem.

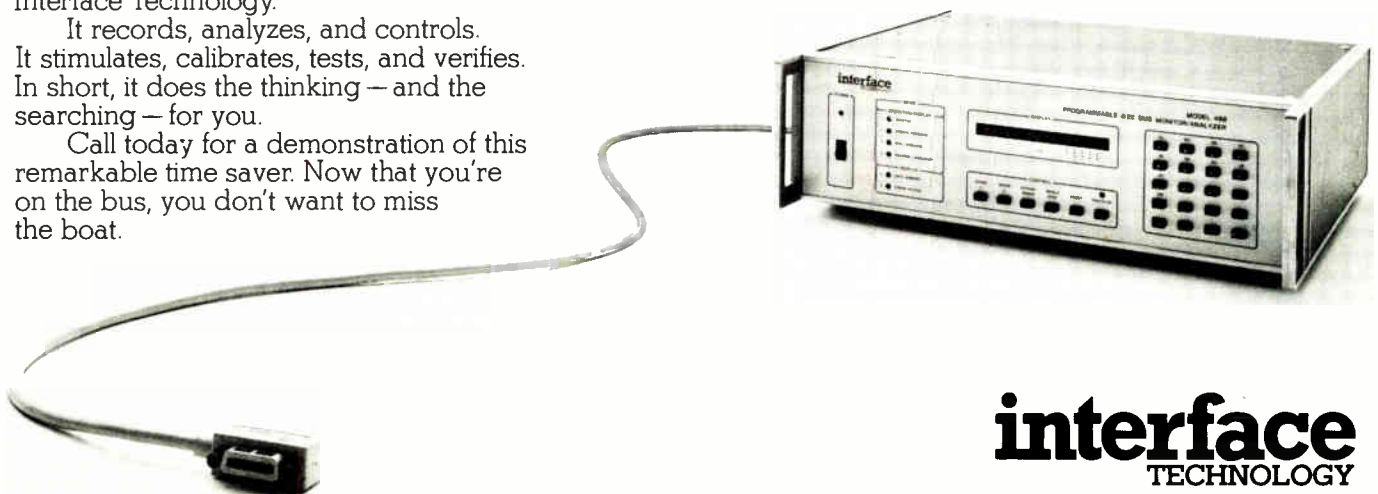

interface
TECHNOLOGY

852 North Cummings Road • Covina, California 91724 U.S.A. • (213) 966-1718

France MB Electronique • Switzerland/Spain Instrumatic AG • W. Germany Kontron Elektronik GmbH • UK Wavetek Electronics Ltd. • Japan Tokyo Electronics Trading Co., Ltd.

Circle 235 on reader service card

Dialight LEDs

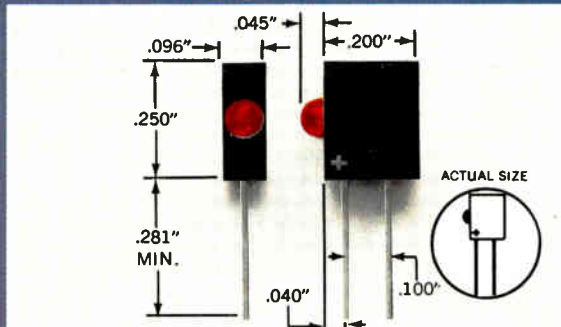

555 SERIES LED logic state indicators available in 14 models with voltage ratings from 1.7 to 14. Suitable for dense packaging on printed circuit boards—up to 10 units to the inch—IC compatible. Polarity identified. Low power consumption. With pricing as low as .57¢ (1000 lot quantity).

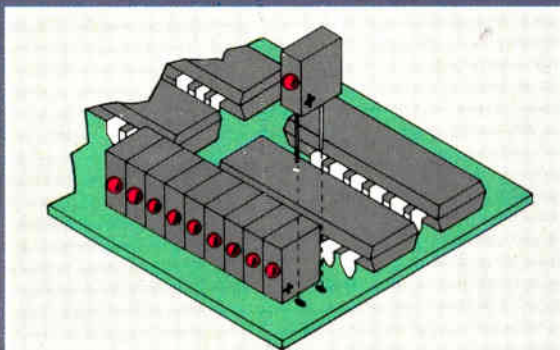

These low cost LED logic state indicators are extremely versatile devices and lend themselves to a wide range of applications. Digital status indicators and circuit fault indicators are typical applications.

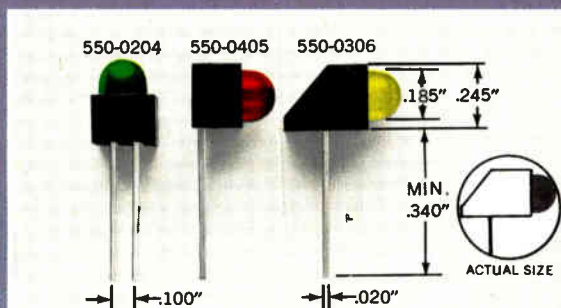

550 SERIES Mix 'em or match 'em. LED logic state indicators are available in red, yellow and green, in a variety of shapes, some with a built-in resistor. Can be driven from DTL and TTL logic. Designed for easy alignment on PC boards. Also available with high brightness LEDs. With pricing as low as .32¢ (1000 lot quantity).

Dialight meets your needs. So talk to the specialists at Dialight, first. Send for your free copy of Dialight's current catalog today.

DIALIGHT

Dialight, A North American Philips Company
203 Harrison Place, Brooklyn, N. Y. 11237
(212) 497-7500

Circle 174 on readerservice card

New products

the unity-gain bandwidth from 2.5 to 30 MHz. The result is a dual video amplifier called the LM359.

Projecting its original concept into the video arena, National hopes to give a totally different perspective to users who need broadband amplification, fast slew rate, and stable operation with a closed-loop gain of 10 or better. At gains from 10 to 100, the gain-bandwidth product is 400 MHz and slew rate is 60 V/μs (at unity gain, the slew rate is 30 V/μs).

"The significant improvement in frequency response is the result of using a common-emitter/common-base, or cascode, gain stage," explains Nello Sevastopoulos, standard linear IC applications section head.

Another important feature is the current-mirror configuration, he adds. To work as it does from a single supply, the output must have a dc bias. "The current-mirror feature facilitates this task by always having both the ac and dc currents that flow into the noninverting input force an equal amount of current to flow into the inverting input," he says. Placing a reference dc current on the positive input and making the output drive the negative input forces the output dc level to the value needed.

The product can be externally programmed to suit a wide variety of applications. Besides general-purpose color video amplification, these include such uses as high-frequency, high-Q active filters, photodiode amplifiers, and waveform generation circuits with a video frequency range. The amplifiers, like the LM13600, work from a wide power range, in this instance +5 to +22 V. They can accommodate input common-mode voltages greater than the supply voltage.

The open-loop voltage gain of the device is 72 dB at a supply voltage of +12 V and a 1-kΩ load at a frequency of 100 Hz. Maximum power dissipation is a hefty 1 W. The LM359, a 0°-to-70° device, costs \$1.50 in 100s and is available from stock.

National Semiconductor Corp., 2900 Semiconductor Dr., Santa Clara, Calif. 95051. Circle reader service number 339 for the LM13600, 341 for the LM359.

Special wide band amplifier offer!

The Demonstrator

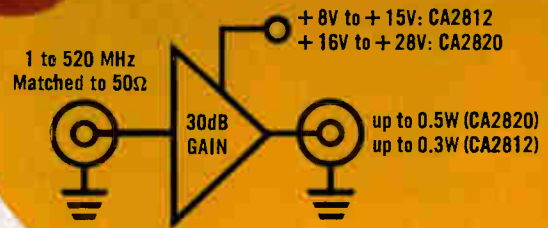
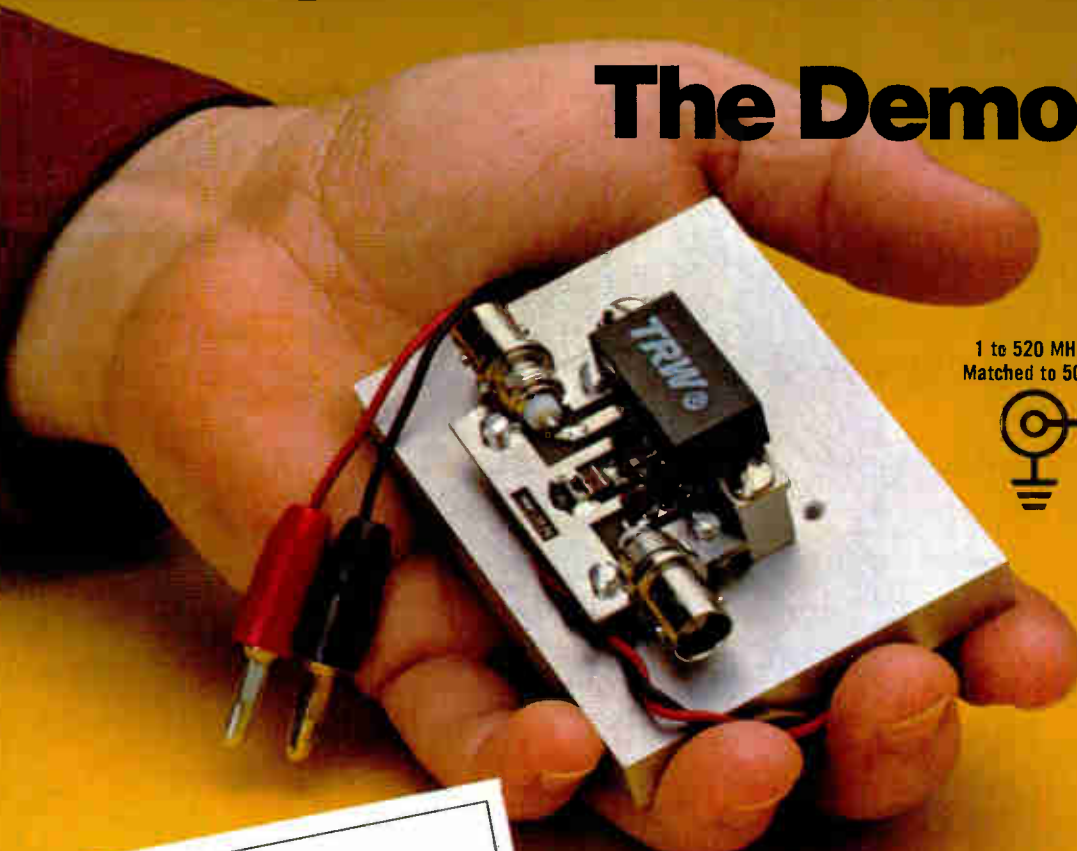

Evaluation Test Fixture and Wide Band Amplifier. A \$126.25 value, ONLY \$39 COMPLETE.*

We want to show you that TRW's wide band hybrid amplifiers are ideal for all sorts of analog and digital applications. *The Demonstrator* will prove it to you. Instantly.

Whatever type of instrument or system you're working on, chances are you'll have to boost an RF signal somewhere—and with minimum distortion. Before you spend hours or days designing and debugging a discrete component amplifier, spend \$39 and send for *The Demonstrator*. It's a special

evaluation test fixture (worth \$100) with a TRW CA2820 or CA2812 RF Linear Wide Band Hybrid Amplifier priced at \$26.25, (25-99). Both are yours for only \$39.00. Just plug in *The Demonstrator* and you'll see how well a TRW hybrid will perform in your application.

The hybrids feature linear phase response, 50dB reverse isolation and are available in a hermetic package. They're unconditionally stable into all load impedances. You can simplify your design and save PCB space. And our low, low OEM prices will slash costs.

What's more, if our wide band hybrid amplifier isn't demonstrably superior for your application, return *The Demonstrator* for a full refund,

no questions asked. Send us your \$39 or send for complete data sheets now. Or contact your local TRW Distributor. You can't lose.

*U. S. Price

TRW RF Semiconductors

An Electronic Components Division of TRW Inc.
14520 Aviation Boulevard, Lawndale, CA 90260

Enclosed is my purchase order or check for \$39.00 for *The Demonstrator*. Send me the model checked: CA2812 CA2820

Please send data information on TRW's complete line of thin film RF hybrid amplifiers.

NAME _____

MAIL STOP _____

COMPANY NAME _____

ADDRESS _____

CITY _____ STATE _____ ZIP _____

TRW RF SEMICONDUCTORS

ANOTHER PRODUCT OF A COMPANY CALLED TRW

Circle 175 on reader service card

Our teamwork saves you work.

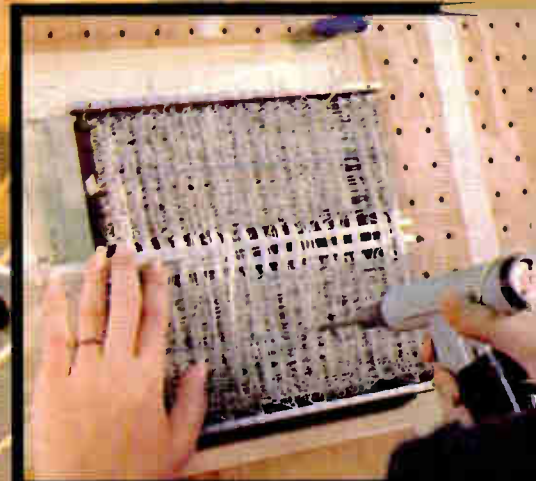

Manual solderless wire-wrapping. Fast, economical computer-controlled semi-automatic wire-wrapping also available.

Planetary strander applies up to 88 conductors in a single pass.

**Our Production Plus™ team
can cut your costs.
And deliver quality connector system
design, production, testing—and more!**

Amphenol North America will work hard with you and for you in all these areas:

- | | |
|----------------------|--------------------------------|
| Engineering Design | Harness Assembly |
| Cable Assembly | System Testing |
| Custom Molding | Printed Circuit Board Stuffing |
| Wire Wrapping | Electromechanical Assembly |
| Fiber Optic Assembly | Microscopic or Wave Soldering |

We're a single source that has the proven design, production, and testing experience you need. And when you use any or all of our Production Plus services, you will:

- Solve your connector system problems faster, more efficiently, and more economically than you could by doing it in-house or by using several different vendors.
- Ease your production overloads. You won't have to buy or lease new equipment, train new workers, or find new space.
- Reduce start-up costs, simplify inventory, eliminate scrap, and ease your internal work load.
- Cut your purchasing, expediting, and warehouse costs.
- Enjoy the benefits of single-source total responsibility for quality. *Tested* quality that meets the most stringent industrial and military requirements.



Custom-molding (from injection and compression to pot molding) using thermoset, thermoplastic and resilient materials.

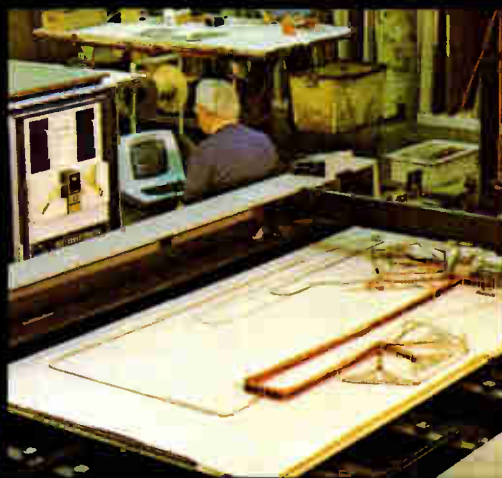

Computer-controlled wire harness and cable forming system cuts production time, test and rework costs up to 90%.



Fiber optic capability includes design development and fabrication of connectors and interconnection systems.

Get the full story of how our Production Plus team can serve you. Call the nearest sales office listed below or write for the illustrated brochure: Amphenol North America, Bunker Ramo Corporation, 2122 York Road, Oak Brook, Illinois 60521.



AMPHENOL NORTH AMERICA

General Offices: Oak Brook, Illinois 60521

Sales Offices: Atlanta (404) 394-6298 • Boston (617) 475-7055 • Chicago (312) 449-1880 • Dallas (214) 235-8318 • Dayton (513) 294-0461
 Denver (303) 758-8033 • Detroit (313) 722-1431 • Greensboro (919) 275-8644 • Houston (713) 444-4096 • Indianapolis (317) 842-3245
 Kansas City (913) 764-1541 • Knoxville (615) 690-6765 • Los Angeles (213) 649-5015 • Minneapolis (612) 835-4595 • New York (516) 364-227
 Orlando (305) 647-5504 • Philadelphia (215) 657-5170 • Phoenix (602) 265-3227 • St Louis (314) 569-2277 • San Diego (714) 272-5451
 San Francisco (408) 732-8990 • Seattle (206) 455-2525 • Syracuse (315) 455-5786 • Washington, DC (703) 524-8700
 Canada: Montreal (514) 482-5520 • Toronto (416) 291-4401 • Vancouver (604) 278-7636 • International: Oak Brook, Illinois TELEX 206-054

Circle 177 on reader service card



This year's OEM hardware shouldn't cost you last year's OEM software.



At Digital we believe you shouldn't have to trade in your software every time you want to trade up or down in hardware. Because brand-new software costs you far more than the price of a license and programmer's fees.

It also costs you valuable time in getting your product or service to market.

So at Digital we offer OEMs software compatibility over the broadest range of products in the industry. Everything from 16-bit micros to 32-bit large-scale machines. And we preserve this compatibility from one generation of technology to the next.

You get compatibility in operating systems, languages, basic instruction sets, data types, file structures, protocols, and software interfaces. Even the mechanical interfaces are the same.

At Digital, our approach has always been to give OEMs more than just great products. Just as important are the extra quality features, the extra testing that can make your design and marketing job easier. The worldwide service capability that can be tailored exactly to the way you run your business. It's an approach designed to help you meet a wide range of computer strategies.

You probably already know a lot about Digital performance. To find out the rest, send for our new brochure, "The Thinking Behind the Industry's Largest Selling Line of OEM Computers."

Digital Equipment Corporation,
(PK3/M-86), Maynard, MA 01754. (617)
493-6253. In Europe: 12 av. des Morgines,
1213 Petit-Lancy/Geneva. Tel. 93 33 11. In
Canada: Digital Equipment of Canada, Ltd.

**We build a lot more than performance
into an OEM computer.**

digital

Hybrid d-a converter resolves 18 bits

Housed in a 32-pin DIP that measures 1.77 by 1.15 by 0.22 in., high-accuracy device keeps nonlinearity down to 0.0008%

by James B. Brinton, Boston bureau manager

Eighteen-bit digital-to-analog converters of any size are tough enough to find, but a hybrid unit is rare indeed. Just such a device, however, has just been introduced by Hybrid Systems Corp. Called the DAC 374-18, the unit packs 18-bit resolution, 0.0008% nonlinearity, as well as mil-spec performance into a 32-pin dual in-line package with dimensions of 1.77 by 1.15 by 0.22 in. Exactly how the feat was achieved, the world won't learn for a while because much of the design is secret, pending the filing of patent applications.

Samual Wilensky, vice president of the company, will go so far as to say that the new approach makes the converter almost totally insensitive to the characteristics of its internal switching network. "This DAC's accuracy is almost totally a function of its resistor network," he says, "and we are using thin-film laser-trimmed resistors. They are trimmed to extreme accuracy to begin with, and because they are all on a common glazed-silicon substrate, their ther-

mal tracking is quite tight." Guaranteed worst-case linearity drift is ± 2 parts per million per $^{\circ}\text{C}$, with ± 1 ppm/ $^{\circ}\text{C}$ typical.

The converter is not only small, it also dissipates little power—important because compact packages are often used in tight layouts where minimizing the overall temperature rise can be a problem. Its power requirement is about 500 mW, compared with the 1 to 2 W needed by competing modules. Supply voltage is ± 15 V; no 5-V supply is required.

Also not required is an external voltage reference; a -10 -V reference is built in. The unit will accept external references if necessary though, and in some ultra-close-tolerance applications this probably will be necessary since the performance of the built-in reference limits the performance of the converter. Its drift is about ± 5 ppm/ $^{\circ}\text{C}$ maximum, ± 3 ppm typical.

The converter accepts unipolar-binary and bipolar-offset-binary inputs from transistor-transistor,

diode-transistor, and 5-V complementary metal-oxide-semiconductor logic. Its output is 0 to +10 V, ± 5 V, or ± 10 V. The unit has an output impedance of less than 1 Ω and can deliver 2 mA. Settling time to within 0.05% of final value, for a full-scale 10-V output change, is 50 μs —faster than some 16-bit units.

Wilensky expects the 374-18 to find its way into many "insurance" applications—situations in which the user really needs 16-bit performance but doesn't trust a 16-bit converter—as well as into high-resolution displays and references.

Hybrid Systems is a qualified MIL-M-38510 supplier that routinely builds products to MIL-STD-883. All of its DAC 374-18s, whether intended for military use or not, will be made on the same production lines up through the visual-inspection step. According to marketing manager G. James Estep, the principal factor that then makes the military units more expensive than the commercial ones is documentation. In small quantities, the commercial version goes for \$350, whereas a similar converter qualified to MIL-STD-883, Class B goes for about \$725. At the 100-unit level, these prices drop to \$260 and \$520, respectively. MIL-M-38510 parts will also be offered, but at a somewhat higher price.

Interestingly, these prices also are highly competitive. Similar devices housed in modules typically sell from about \$640 to more than \$1,100. Delivery time for the DAC 374-18 is 10 to 12 weeks.

Hybrid Systems Corp., Crosby Drive, Bedford, Mass. 01730. Phone (617) 275-1570 [340]

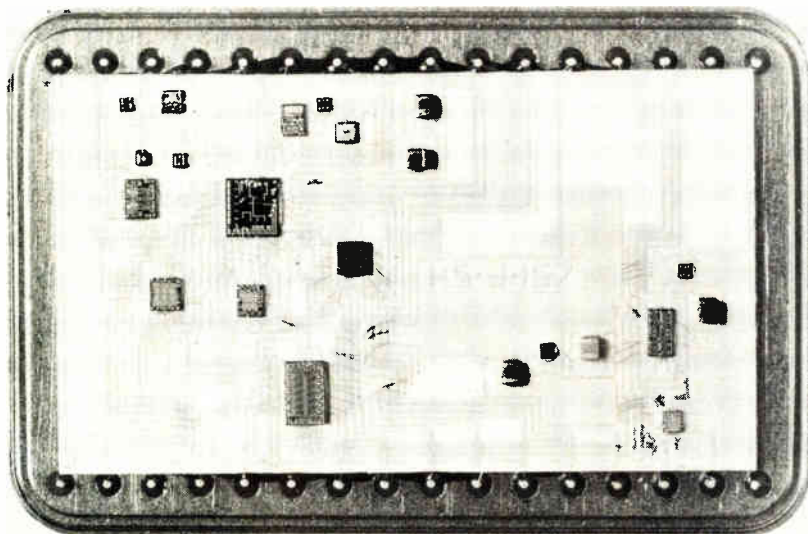

abbott

POWER SUPPLIES

2,685 answers to power supply questions.

Answers to better power and thermal efficiency. Answers to size and weight reductions. Answers to available off-the-shelf covered/open frame power supplies and transformers. And price and delivery answers.

These and many more answers can be found in our three product catalogs. And they're yours. Free. Just circle reader card number. Better yet, write or call Abbott. The Power Supply Specialist.



Power Supply Catalog — Comprehensive 60-pager describes our full line of 1,573 hi-efficiency, hermetically sealed, single and dual output power supplies and switcher modules. Inputs of 60 and 400Hz and DC are available with outputs from 3VDC to 740VDC, 1 to 250 Watts. Prices start as low as \$174 for 2-4 units.

Circle Card Number 100

Industrial Power Supply Catalog — Some 279 of our low cost, high quality OEM power modules are detailed in this 16-pager. Includes covered/open frame, AC to DC single, dual and triple output versions, with outputs from 5 to 36VDC, 0.5 to 320 Watts. Plus DC to AC converters with 50 and 60Hz outputs. Priced as low as \$35 for up to 24 units.

Circle Card Number 101

Transformer Catalog — We specialize in custom transformers, and this 20-pager gives you detailed information on how to specify for your exact requirements. It also covers over 800 standard military, industrial and miniature pcb transformers, including 60 and 400Hz, single phase input units. Prices for standards start as low as \$5.10 for up to 9 pieces.

Circle Card Number 102

See Power Supply Section 4000, and Transformer Section 5600, Vol. 2, of your EEM catalog; or Power Supply Section 4500, and Transformer Section 0400, Vol. 2, of your GOLD BOOK for complete information on Abbott products.

abbott transistor

LABORATORIES, INCORPORATED

General Offices
5200 W. Jefferson Blvd., Los Angeles 90016
(213) 936-8185 Telex: 69-1398

Eastern Office
1224 Anderson Ave., Fort Lee, N.J. 07024
(201) 224-6900 Telex: 13-5332



Store Recorders have made



Flick a single switch on a dual standard recorder in the new Racal Store DS range, and you've changed instantly from Intermediate Band to Wideband operation on FM. A single switch that selects either recording standard – without the need to interchange plug-in modules. A single switch changes all the signal channels (four to fourteen) on all seven speeds.

FM Capability

The Store range of instrumentation recorders, well-renowned for research in the scientific, automobile, aerospace and medical fields, now offers an FM capability over the entire band DC to 40 kHz, and up to 300 kHz on Direct Recording.

Greater Flexibility

And even greater flexibility. Switch any channel to unipolar, and the full dynamic range becomes available to either positive or negative going signals. Switch any channel to offset, and you can record a 100 mV peak-to-peak signal on a 20 V step—without losing any dynamic range.

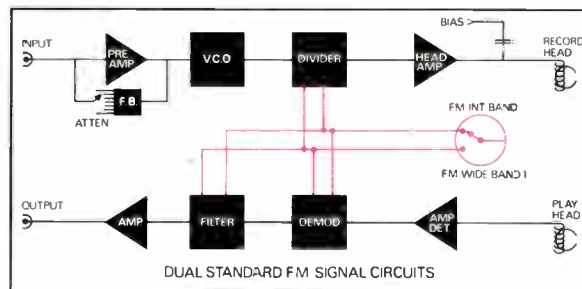



a quick switch to wideband.

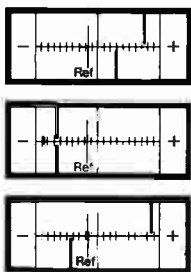

Proven Success

All these outstanding new advantages have been added to the host of features which have made the existing range such a success—like single switch seven-speed selection, full servo operation, dual peak-indicating meters, full remote control of all functions, portability, and operation

from AC or battery power sources.

That's why, by switching to the Racal Recorders' new Store DS range, you can make a quick switch to a whole new wideband world.

Racal Recorders Limited Hardley Industrial Estate,
Hythe Southampton Hampshire SO4 6ZH England
Telephone: 0703-843265 Telex: 47600.

Racal Recorders Inc 5 Research Place,
Rockville Maryland 20850,
Telephone: (301) 948 3085.

Racal Recorders Inc. 1109 West San Bernardino Road,
Suite 110 Covina California 91722
Telephone: (213) 967 2869.



Racal Recorders Always on the right track

RACAL



CAN YOU FIND THE 14 WAYS ONE PRODUCT IMPROVED THIS PICTURE?

The items you're looking for all had one thing in common: at some point in their manufacture an organic polymer had to be combined with an inorganic filler.

In every case, the product that brought them together was a silane coupling agent.

These remarkable agents improved processability through reduced viscosity, faster wetting and better dispersion. And helped improve moisture resistance, barrier properties and everything from better physicals to better dielectrics.

Our key will give you some idea of our coupling agents' application versatility. They

improve a wide range of plastic, rubber and fiberglass products as well as foundry sands, electrical and electronic components and circuitry.

To learn about hundreds more, please write to us at Dept. JSW, 270 Park Avenue, New York, N.Y. 10017. Just describe your system and the properties you want. We'll be glad to recommend the correct silane coupling agent as well

as practical formulations.

Get the picture?

PEOPLE PLANNING THE FUTURE.

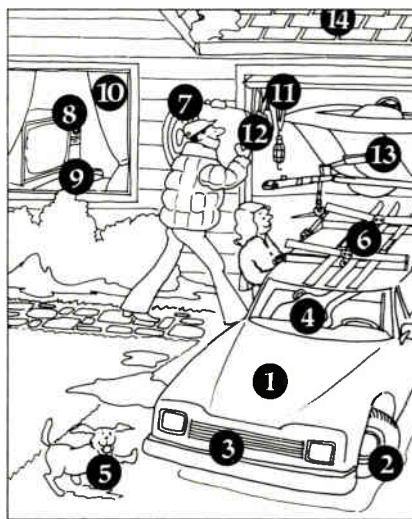

1. Foundry-cast engine block. 2. Tires. 3. Grill-opening, header panels. 4. Electric guitar case. 5. Golf-ball core. 6. Fiberglass skis. 7. Home insulation. 8. TV circuit board. 9. Telephone circuit board. 10. Fiberglass curtains. 11. Trouble-light EPDM insulation. 12. Hand-drill housing. 13. Fiberglass boat. 14. Roof shingles.



Silicones

Can BETTER

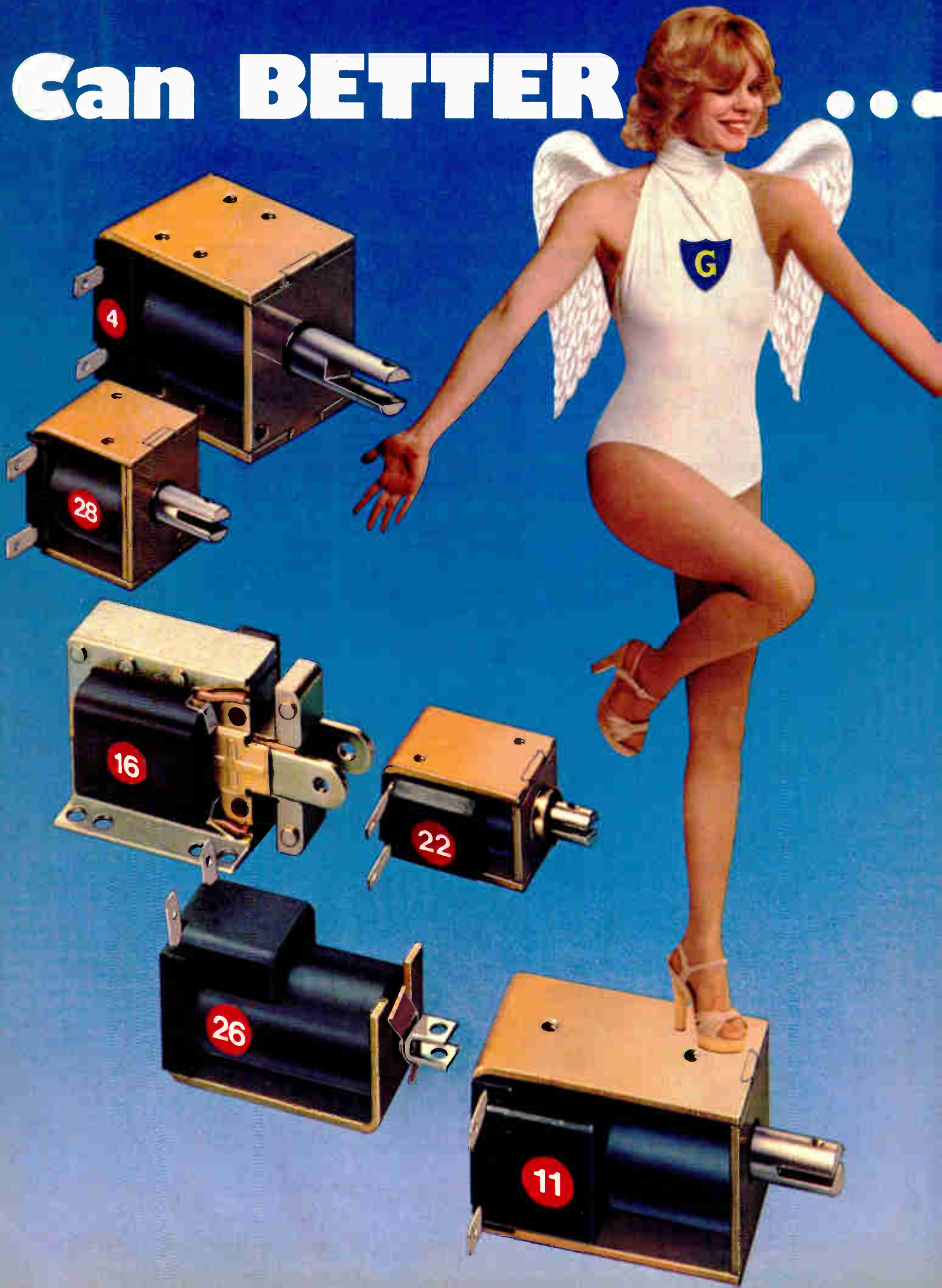

...be CHEAPER?

If you specify one of these
six best-selling solenoids
in quantity

you bet it can!



Your Guardian Angel has a solenoid bargain for you.

Solenoids that are ready for immediate delivery at important savings. The six solenoids used most in applications like yours. The ones we stock in depth for instant shipment. The ones that save you so much it actually pays you to design them into your product. Or, to modify your mounting arrangement or other minor design elements to fit these stock solenoids. Because, when you order any of these solenoids, you save 12 to 15%!

All six of the Guardian best-sellers feature either Uni-Guard® II molded bobbin and coil covers or molded coils that give longer life—up to 5 million operations for most . . . 250,000 operations for the No. 16. All are pull type. All meet or surpass u/L and CSA component recognition requirements. All have .187" QC lug termination.

Guardian Number	Overall Dimensions	Coil Voltage	Duty	Power Ratings @ 25°C.	
				Minimum Stroke	Maximum Stroke
4 No. 4 Box Frame	2 1/16" x 1 1/16" x 1 3/8"	120 AC	Inter.	36 oz. at 1/8"	26 oz. at 1"
		120 AC	Cont.	8 oz. at 1/8"	7 oz. at 1"
		24 DC	Inter.	115 oz. at 1/8"	16 oz. at 1"
		24 DC	Cont.	63 oz. at 1/8"	6 oz. at 1/8"
11 No. 11 Box Frame	1 1/8" x 1 3/16" x 1 3/16"	120 AC	Inter.	21 oz. at 1/8"	11 oz. at 3/4"
		120 AC	Cont.	12 oz. at 1/8"	6 oz. at 3/4"
		24 DC	Inter.	40 oz. at 1/8"	6 oz. at 3/4"
		24 DC	Cont.	24 oz. at 1/8"	3 oz. at 3/4"
16 No. 16 Laminated	1 5/8" x 1 1/4" x 1 1/2"	120 AC	Inter.	110 oz. at 1/8"	28 oz. at 3/4"
		120 AC	Cont.	63 oz. at 1/8"	15 oz. at 3/4"
22 No. 22 Box Frame	1 5/32" x 3/4" x 3/4"	120 AC	Inter.	20 oz. at 1/16"	2 oz. at 3/8"
		120 AC	Cont.	12 oz. at 1/16"	1.7 oz. at 3/8"
		24 DC	Inter.	20 oz. at 1/16"	2 oz. at 3/8"
		24 DC	Cont.	12 oz. at 1/16"	1.7 oz. at 3/8"
26 No. 26 U-Frame	1 3/4" x 2 3/32" x 1 3/16"	120 AC	Inter.	32 oz. at 1/16"	4 oz. at 1/2"
		120 AC	Cont.	17 oz. at 1/16"	6 oz. at 5/8"
		24 DC	Inter.	46 oz. at 1/16"	4 oz. at 1/4"
		24 DC	Cont.	26 oz. at 1/16"	3 oz. at 1/2"
28 No. 28 Box Frame	1 1/8" x 1 1/32" x 1 3/16"	120 AC	Inter.	40 oz. at 1/16"	7 oz. at 1/2"
		120 AC	Cont.	24 oz. at 1/16"	5 oz. at 1/2"
		24 DC	Inter.	40 oz. at 1/16"	3 oz. at 1/2"
		24 DC	Cont.	25 oz. at 1/16"	2 oz. at 1/2"

And remember: All are available from Guardian immediately. From stock. Ready and waiting to save you a bundle. Just call Guardian. Or, better yet, call your nearby Guardian Representative.



GUARDIAN®

GUARDIAN ELECTRIC MANUFACTURING CO.

1550 W. Carroll Avenue, Chicago, IL 60607
312/243-1100

Circle 187 on reader service card

See Us At Booths #1310
Design Engineering Show

New products

Computers & peripherals

Terminal shows full page

Based on a Z80 processor, terminal displays 60 lines of 80 characters

In word- and data-processing applications, the typical 80-character-by-24-line format can lead too frequently to scrolling. So Ann Arbor Terminals devised the 6080-Compat.

A Z80-based cathode-ray-tube terminal, it displays a full typewritten page of data: 60 lines of 80 characters. The terminal includes a 15-inch non-glare screen using the P39 green phosphor for greater readability and minimal reader fatigue. The 72-key detachable keyboard generates the full 128-character ASCII set.

Also standard are a numeric pad and cursor control keys. All keys

have automatic repeat, and up to 36 special-function keys may be installed at the buyer's option.

Upper- and lower-case characters are formed in a 7-by-7-dot matrix on a 10-by-10-dot field. Three character accents—blink, dim, and reverse-video—are also provided for highlighting. The cursor is displayed as a blinking field.

All commands and controls are entered through the keyboard. Commands include erase memory; cursor home, return, up, down, right, and left; set cursor position; and set character accent. Control functions are communications rate (110 to 19,200 b/s), input/output mode (local, full, or half-duplex), keyboard mode (teletypewriter or full ASCII), and display mode (roll or page).

Measuring only 15 in. wide by 14 in. high by 13.6 in. deep, the terminal is packaged in Ann Arbor's compact E-Case, which weighs only 33 lb. Since all connections are made inside the unit, no connectors protrude from the case, making the 6080-Compat suitable for desktop

installations. A switching-regulator power supply allows a wide range of operating-voltage levels, including overseas conventions.

Options include 50-Hz refreshing, bell, various combinations of carriage return and line feed, and current-loop interface. Prices begin at \$1,895. Delivery typically takes 12 weeks.

Ann Arbor Terminals Inc., 6107 Jackson Rd. Ann Arbor, Mich. 48103. Phone Sarah Freeman at (313) 769-0926.

Controller colors communications conditions

The CC-8 is a communications processor that can serve as a plug-compatible front end to one or more 360-, 370-, or 303X-type computers. It has more features and is less expensive than the 3705 controller that it emulates, according to its manufacturer, Computer Communications Inc.

The system comes with a cathode-ray-tube terminal that displays read-outs of system line status, alarms, and statistical data in four colors when the CC-8 is used as a system monitor. In this mode, users can adjust over 60 types of errors.

The CC-8 also operates as a

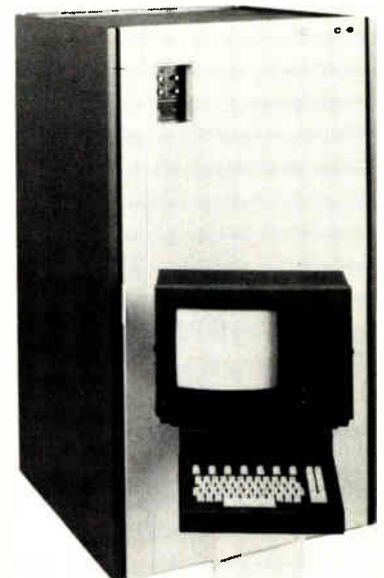
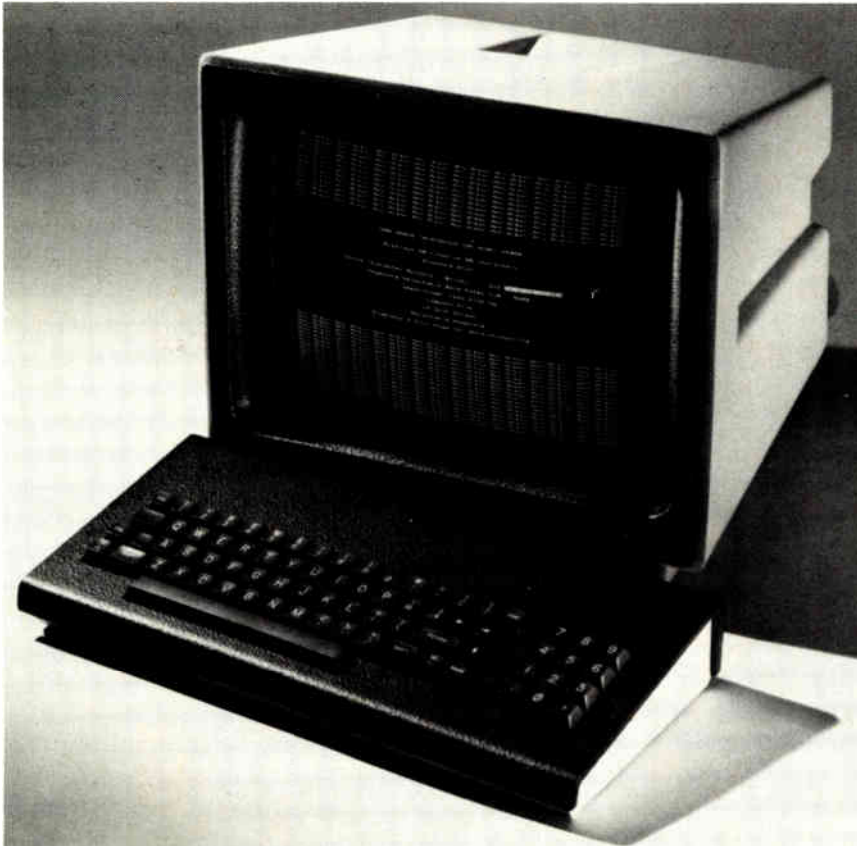

FLEXIBILITY

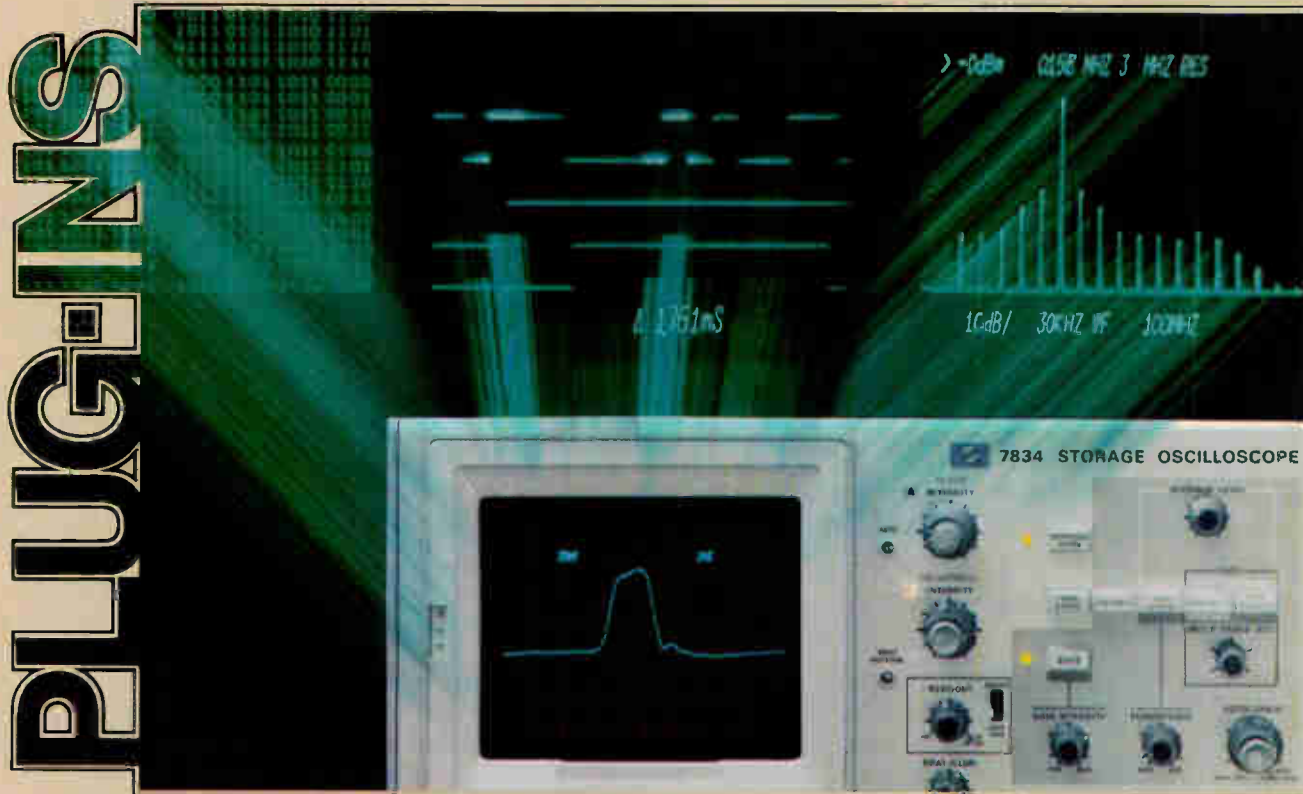

One instrument. Multiple measurements.

Tektronix Plug-In oscilloscopes combine a number of diverse measurement functions in the same instrument. And in combinations you require. One instrument takes the place of many. You get maximum measuring power with a minimum of instruments.

How? By choosing from the continually evolving 5000 and 7000 families of Plug-Ins. Already there are 14 mainframes and 21 plug-ins in the 5000-Series; 19 mainframes and 35 plug-ins in the 7000-Series. (With them, you can also use compatible logic and spectrum analyzers plus other special purpose plug-ins.) Choose from a family providing up to 8 input display channels. Analog and digital delayed sweeps. Sampling displays. Digital interconnections. And differential inputs. Just to name a few.

No matter what your test and measurement situation, we offer a Plug-In oscilloscope that fits. From circuit design to plasma physics research. From balancing rotating machinery to measuring the accuracy of D to A converters. With every scope representing the same superior research and engineering you expect from Tektronix.

What about your own particular situation? Are your measurement capabilities confined by monolithics? Contact the Tektronix Field Office near you and get your hands on the kind of flexibility that only a Plug-In scope can deliver.

Tektronix
COMMITTED TO EXCELLENCE

For literature, call (800) 547-1512 toll free.

For Technical Data circle 188 on Reader Service Card
For Demonstration circle 189 on Reader Service Card

NEW PRODUCT

CHARGE SENSITIVE PREAMPLIFIERS

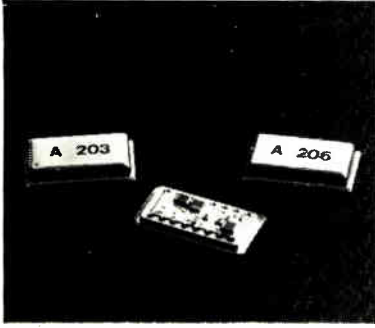

Models A-203 and A-206 are a Charge Sensitive Pre-amplifier/Pulse Shaper and a matching Voltage Amplifier/Discriminator developed especially for instrumentation employing solid state detectors, proportional counters, photomultipliers, channel electron multipliers or any charge producing detectors in the pulse height analysis or pulse counting mode of operation.

These hybrid integrated circuits feature single supply voltage, low power dissipation (16mW), low noise, pole zero cancellation, unipolar and bipolar outputs and adjustable discrimination level.

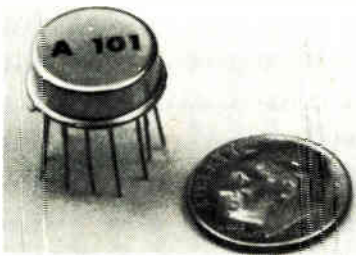

Model A-101 is a Charge Sensitive Pre-amplifier-Discriminator and Pulse Shaper developed especially for instrumentation employing photomultipliers, channel electron multipliers and other charge producing detectors in the pulse counting mode. Its small size (TO-8 package) allows mounting close to the collector of the multiplier. Power is typically 15 milliwatts and output interfaces directly with C-MOS and TTL logic. Input threshold and output pulse width are externally adjustable.

All Amptek, Inc., products have a one year warranty.

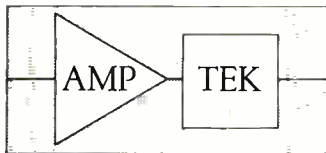

AMPTEK INC.

6 DeAngelo Drive, Bedford, Mass 01730
Tel: (617) 275-2242

New products

system supervisor, permitting dynamic system reconfiguration and extensive control, including real-time assignment of lines and terminals within the network.

Designed for heavy communications traffic, it can handle a sustained synchronous throughput of over 200,000 characters/s and peak loads approaching 400,000 c/s. Furthermore, it supports most popular line disciplines and remote terminals, works with any mixture of line types and communications rates, and can control up to 240 lines.

Computer Communications Inc., 2610 Columbia St., Torrance, Calif. 90503. Phone (213) 320-9101 [366]

Space-saving printer saves capital too

In building desk-top computer systems, how much space and money does a designer want to devote to a printer? Integral Data Systems figures that the answer to both questions is: as little as possible. So it put together a tractor-fed impact printer called the Paper Tiger that has a paw-print of just 1.37 ft² and a single-quantity price of \$995.

The 12¼-in.-high printer doesn't skimp on features to realize its price. On fanfold or roll paper 1.75 to 9.5 in. wide, the unidirectional unit prints a 96-character ASCII set using a seven-by-seven-dot matrix. Character width is software-adjustable, so users can combine pitches of 8.3, 10, 12, and 16.5 characters/in. on a single line. With a single pitch, lines can be 73, 80, 96, or 134 characters long. Depending on pitch, they are printed at rates of 100, 120, 144, or 198 characters per second.

Switches set the line spacing at six or eight lines/in. and the form length from 3 to 14 in. An automatic 1-in. skip between pages is also selectable. For generating forms and other graphics, users can choose an optional package that provides both full dot-pattern control and a 2-kilobyte buffer that will store an entire 80-by-24-character page, the typical display capability of most low-cost

cathode-ray terminals.

Integral Data Systems, 14 Tech Circle, Natick, Mass. 01760. Phone (617) 237-7610 [365]

Midi mainframes distribute processing

To extend its so-called Distributed Systems environment into medium-scale mainframe computers, Honeywell Information Systems has introduced four new models. By so doing, the company is joining Burroughs and NCR [*Electronics*, March 15, p. 46] in responding to IBM's new low-end mainframe, the 4300 [*Electronics*, Feb. 15, p. 85].

There are two Level 64/Distributed Processing Systems, or DPSs for short. The DPS-320 can have from 512 kilobytes to 1 megabyte of main memory, five times the main memory capacity of the bottom-line Level 64 computers, and offers 50% more performance than those machines. The DPS-350, which can have up to 2 megabytes of memory, has 2.6 times the internal performance of the basic Level 64 and also 5 times the memory capacity. The DPS-320 is priced at \$81,360, 12% below the previous Level 64 computers, while the DPS-350, is priced at \$155,232, about 60% more than the current models. The former is scheduled for delivery in this quarter, the latter for the third quarter. Honeywell positions these units against IBM's 4331 processor.

Two other models add to the Level 66 offerings and compete with the IBM 4341. The DPS-440 offers twice the performance of the previous entry-level model 66/05 computer and sells for \$198,338 with 1 megabyte of memory or for \$265,397 with 2 megabytes. The even more powerful DPS-520 sells for \$371,316 with 1 megabyte of main memory, \$416,066 with 2 megabytes, and \$466,831 with 4. Deliveries of these two models are scheduled for early 1980.

Honeywell Inc., United States Information Systems Group, 200 Smith Street, Waltham, Mass. 02154. Phone (617) 890-8400 [363]

Illuminated single-pole rockers come in red, green, amber, white or clear. Hot-stamped legends available.

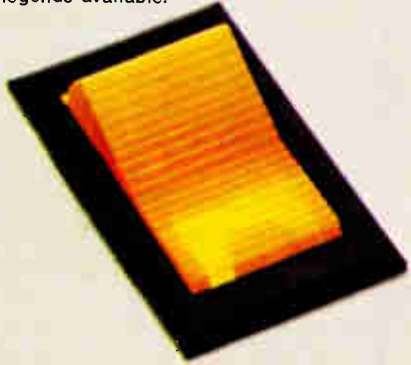

Flush-mounted switches snap in and stay in. Available in a wide range of designer colors and styles. Choose from bright nickel-plated metal or all-plastic bezel. 1 or 2 pole.



Locking rocker switches. Supplied with a unique removable "key" to prevent inadvertent or unauthorized operation.



We've added a new look to our rocker line—"see thru"

One of the industry's biggest selections of reliable snap-ins just got bigger. We've added new mechanical indicator switches to our already broad Rockette® line. Look over our full lineup. It includes sub-panel mounting, as well as a wide variety of termination types and circuit configurations. Then look up your Cutler-Hammer Sales Office or Switch Distributor.

NEW rockers with mechanical indicators show functions thru a "window" on the actuator. Available non-illuminated or illuminated and can be customized with words or colors. Choose from bright nickel-plated metal or all-plastic bezel.



CUTLER-HAMMER
SPECIALTY PRODUCTS GROUP, Milwaukee, WI 53201



Circle 191 on reader service card

When you're searching for

- Ceramic Capacitors
- EMI/RFI Filters
- Thick Film Circuits
- Switches
- Potentiometers
- Trimmer Resistors

Centralab offers solutions.

When you're searching for just the right electronic component, which manufacturer has the total capability to appreciate your problem and interact to help? In the maze of electronic component suppliers there are precious few who have the technical expertise to serve all electronic markets with both standard and custom designs on a worldwide basis – with high volume capability for production quantities or immediate delivery through a network of industrial distributors.

But Centralab is that kind of supplier.

We're an *electronics* company. We offer you more than *just* switches, or *just* capacitors, or *just* any other single type of component. Our application experience – for whatever the function – from circuit board to front panel – has created an ideal customer/supplier interface to help you when you're searching for solutions to electronic component problems.

Write for our catalog of solutions to your component problems.

Products you need from people who care.



CENTRALAB

ELECTRONICS DIVISION
GLOBE-UNION INC.

5757 North Green Bay Avenue
Milwaukee, Wisconsin 53201



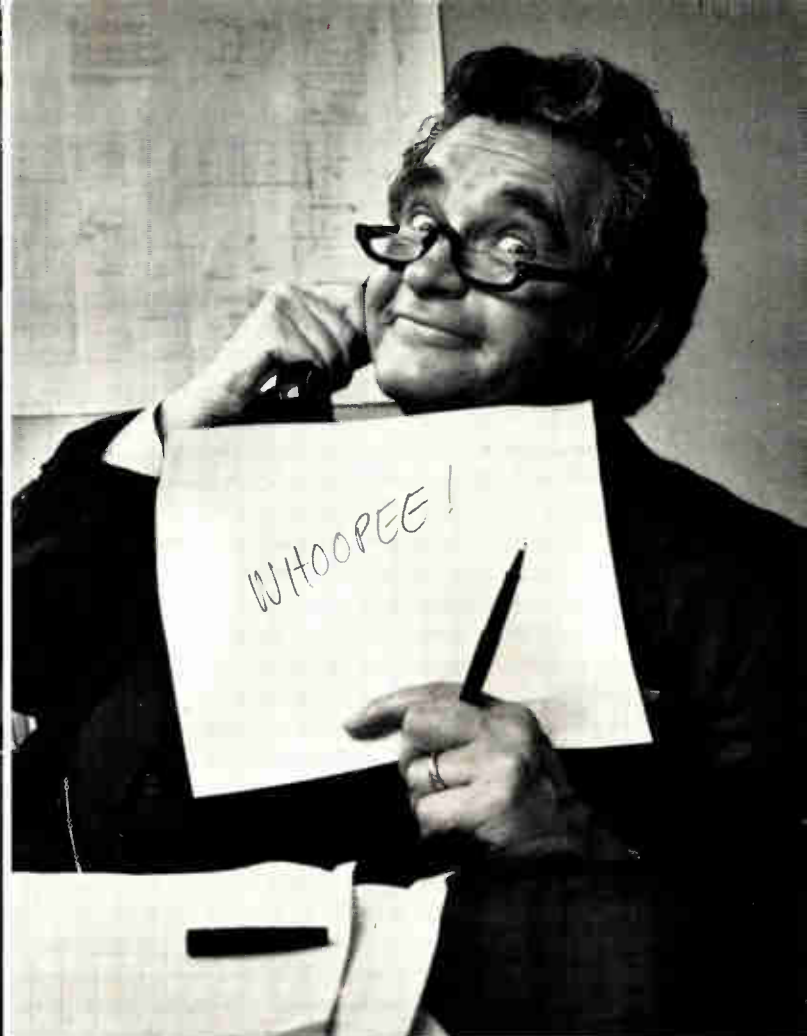

OUR CUSTOMERS' REACTION TO THE NEW NOVA 4 DIDN'T SURPRISE US.

After the success we've had with the Data General NOVA computer line (in the 10 years since its introduction, over 60,000 have been shipped), who could blame them? But what really counts is your reaction to our latest NOVA—NOVA 4.

The new NOVA 4 gives you three ways to sell. It's the one computer system that's really a family of three. It's the one computer that will give you so wide a range of capability and options it will meet the price and capability needs of all your customers.

NOVA 4/C. The component OEM's dream.

The speed and performance you get in the NOVA 4/C, for \$3500* (complete), is the best deal ever offered a customer needing a basic computer to integrate in his terminals, test instruments or business applications. And it includes a unique self-diagnostic capability that lets the computer trouble-shoot itself to cut service time and cost.

NOVA 4/S. An important part of your process.

Whatever data your customers process now—from blood analysis to pipeline flow—the new NOVA 4/S can cut processing time in half. Outstanding processing throughput comes from its new high speed floating point and character manipulation capabilities. Plus, it includes NOVA 4 self-diagnostic features.

NOVA 4/X. The business end of the line.

For the business computer customer, or the technical one, the 4/X will do the job. All the capabilities of the 4/S with memory up to 256K bytes, with self-diagnostic capability.

NOVA 4. The multi-customer mini.

4/C, 4/S, 4/X—all three are fully compatible with the NOVA 3 computers now in use. And there's one that's right for your customer's application.

And they match the 10 year NOVA tradition of increasingly high performance (NOVA 4 achieves up to twice the speed of competitive systems as well as the NOVA 3), newsworthy price (lower than competitive units; 43% lower than NOVA 3) and reliability and maintainability features unheard of in competitive systems.

The all new NOVA 4. It's the brand new computer with 10 years of proven performance that will leave your customers smiling. Mail the coupon for full information.



*NOVA 4/C with 64K bytes of MOS Memory, asynchronous interface, automatic program load, power fail/auto restart, and 5-slot chassis with power supply. Domestic U.S. price, quantity one. OEM and quantity discounts available.

Mail to: Data General Corporation Westboro, MA 01581

Send me full information on the NOVA 4.

Name _____

Title _____

Company _____

Address _____ Tel. _____

City _____ State _____ Zip _____

E426

Data General

We make computers that make sense.

Data General Corporation, Westboro, MA 01581. (617) 366-8911. Data General (Canada) Ltd., Ontario, Canada. Data General Europe, 61 rue de Courcelles, Paris, France, 766.51.78. Data General Australia, (03) 89-0633. Data General Ltda., Costa Rica, Latin America, 22-79-42. Data General Middle East, Athens, Greece, 952-0557. (c) Data General Corporation, 1979.

Circle 195 on reader service card

Data acquisition

System acquires data, not space

Designed for the LSI-11/23 data-acquisition system can stand alone or work in net

Sometimes it is not the uniqueness of what you put in a package but the package itself that will make people sit up and take note. ADAC Corp.'s newest data-acquisition and control system, the System 2000, measures only 7 by 8⁷/₁₆ by 21¹/₂ in.

Designed with Digital Equipment Corp.'s latest microcomputer in mind—the LSI-11/23 [*Electronics*, March 1, p. 34]—the System 2000 will house up to 13 half-quad (8.5-by-5-in.) boards. With them, it can act as a stand-alone control system or as a remote data station in a distributed processing network (with either an LSI-11/2 or LSI-11/23 on board). All LSI-11/2-compatible

analog and digital input/output systems from ADAC can also be used with the system.

"A lot of people don't need a large backplane; look at the size of the LSI-11/23 and its memory management chip," observes A. L. Grant, vice president of marketing and sales, "and the power supply in our System 2000 can support 128 kilobytes of memory." According to Grant, many earlier systems based on the LSI-11 and 11/2 could not begin to support that much memory with a single power supply.

The System 2000 has a transformer, which allows the system to be used anywhere in the world, and a dual power supply built into the back of the unit. The power supply operates at +5 v at 15 A, and +12 v at 3 A. The ±15 v needed for analog I/O boards is supplied by on-board dc-dc converters or a plug-in power supply board.

The front panel of the unit pulls off—it is secured by four spring clip fasteners—to allow easy access for any one of 13 cards; they slide in on two vertical tracks from the front. Inside the unit is a half-rack enclou-

sure, a 13-slot backplane and card cage, and the power supply. All I/O cables are routed to the right side of the card cage and through a slot in the back panel. There is a fan in the back panel to cool both the card cage and power supply.

If the user needs more than one unit for additional I/O boards, a second System 2000—minus the front panel switches—with its own power supply can be purchased. Putting a bus-repeater card from ADAC in the first unit and cabling it to the second will complete the expansion.

A System 2000 with CPU and 32 kilobytes of memory, a CRT, serial port, and a double-density floppy-disk drive and controller, added to DEC software, will cost under \$10,000, according to Grant. "The hardware is also there for a development system for the LSI-11/23," he notes, although that's not being pushed until the LSI-11/23 is readily available in June.

Grant expects the System 2000 to complement and expand on ADAC's earlier System 1000. "It's also going to be used in process-control applica-

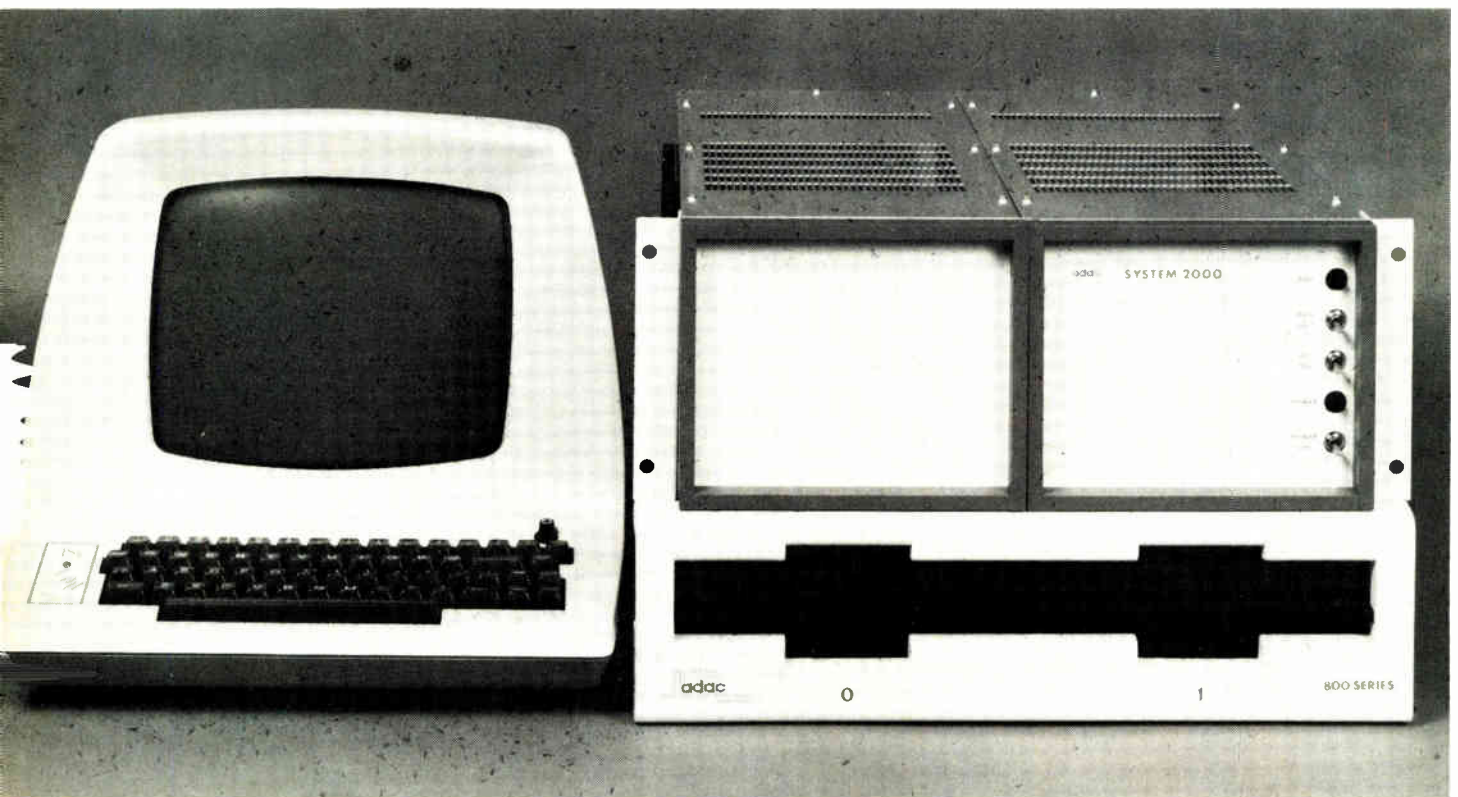



Metal film with muscle. Plus.

Our Metal Glaze™ resistors are rated 2 to 4 times mil spec power, yet retain precision resistor characteristics.

This means you can often standardize, particularly on the RN55 size, and save space, inventory, and paperwork.

Plus, we now have the highest reliability level for film resistors in the toughest spec — MIL-R-55182S level. That's $\leq .001\%/1000$ hours.

Plus, a new RLR05 subminiature 1/8 watt unit in the same reliable construction.

Plus, the application of high speed lasers to target

resistance. Now you can get standard RN types as high as 5 megohm $\pm 1\%$ with a resistance layer 100 times thicker than evaporated thin film types.

And the biggest plus. Metal Glaze resistors are both cost effective for a wide range of industrial applications, and readily available.

TRW metal films with muscle are offered in popular RL05 to 32, RN55 to 65, and industrial equivalents. For standards in all types of resistors, contact your local TRW distributor. Or TRW/IRC Resistors, an Electronic Components Division of TRW, Inc., Greenway Road, Boone, N.C. 28607. Dept. G (704) 264-8861.

TRW IRC RESISTORS
ANOTHER PRODUCT OF A COMPANY CALLED TRW

™ Metal Glaze is TRW's trademark for its proprietary thick metal film resistors.

Circle 197 on reader service card

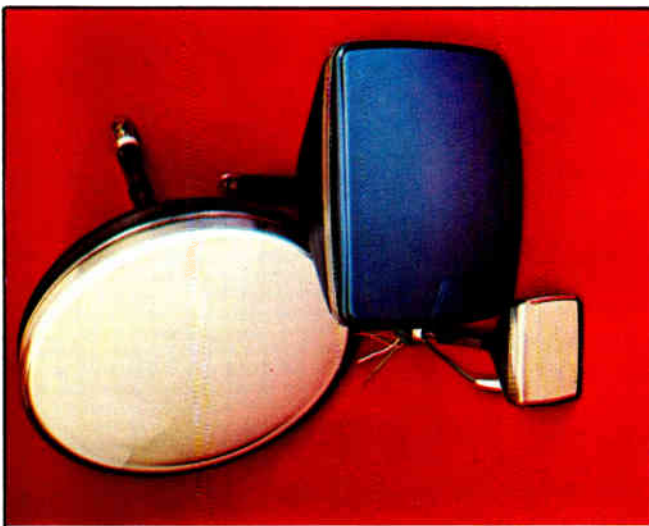

ELMITRONS

you want now for your multi-colour displays

- luminous intensity up to 2,000 cd/sq.m
- trace width up to 0.15 mm
- writing speed up to 2 mm/μs
- easy reading even in bright sunlight due to excellent distinction of spectrum colours – from red through discrete hues to green
- spherical, flat, round and 6- through 20-inch rectangular screens with angles of deflection from 50° to 100° and a post-glow time of 0.001 through 10 s.

The ELMITRONS are available in the following modifications:

- single-beam or dual-beam models (the latter come in single- or double necked makes), rear-wall-screen and on-screen-grid models. Vibro-shock-explosion-proof ELMITRONS can be safely used at high altitudes.



32/34 Smolenskaya-Sennaya
121200 Moscow
USSR
Telephone 251-39-46, Telex 7586

New products

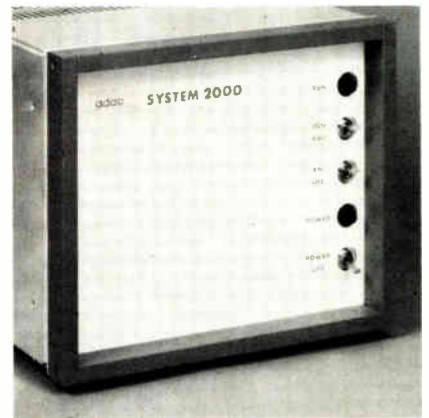

tions, as well as other industrial and scientific environments," he notes. "It can be put into dust-free enclosures—the size of the unit lends itself to those types of applications."

The system weighs about 25 lbs. The unit with power supply and card cage sells for \$995 in quantities of one to four. Shipments will begin in May, with deliveries 30 to 45 days after receipt of order.

ADAC Corp., 70 Tower Office Park, Woburn, Mass., 01801. Phone Al Grant at (617) 935-6668 [381]

Board expands microNOVA analog input capacity

The ST-MNOVA-ADX series of peripheral slave expander boards for Data General's microNOVA microcomputers allows system expansion, in increments of 64 single-ended or 32 differential channels, up to 256 channels, when used with Datel's ST-MNOVA analog input/output master boards. The slave expander cards slide into and interface directly with the microNOVA bus.

Two ST-MNOVA-ADX boards are available: the 64-channel, single-ended ADX64S; and the 32-channel, differential ADX32D. Both feature a multiplexer crosstalk specification of 0.01% from dc to 1 kHz, both are powered by the master board, and both operate from 0° to 70°C.

Use of the differential-input board requires that the master board be fitted with an amplifier.

Datel Systems Inc., 11 Cabot Blvd., Mansfield, Mass. 02048 [383]

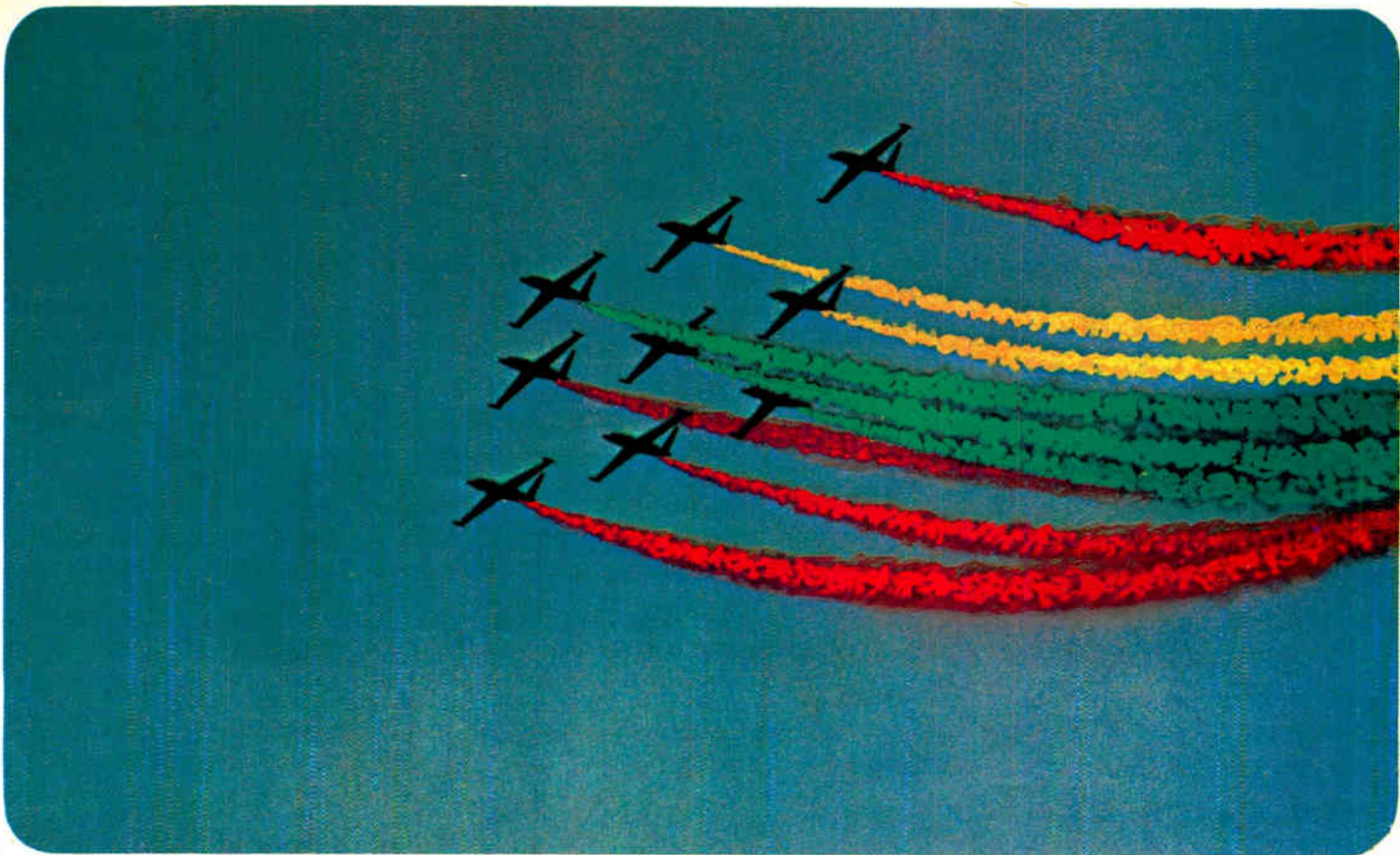

Fly by color!

The Electron Tube Division is now readying a range of specially ruggedized, extremely high brightness, high-resolution, multicolor CRT's, destined for the head-down display (HDD) systems of the new generations of civilian and military aircraft that are being developed for the 1980's. The use of these tubes in HDD's permits displaying several different parameters simultaneously on a single screen, by using different combinations of scanning standard (TV or stroke-writing) and color. This reduces total display area, simplifies data assimilation, and reduces recognition errors. All of these new tubes will use the penetration screen principle, pioneered by THOMSON-CSF. Typical of

these new tubes is a 5" x 5", 3-color, high-resolution tube with a contrast-enhancing directional filter. Primarily destined for the MIRAGE 2000, the new French combat aircraft, this tube, or a derivative thereof, is suitable for any military aircraft in which high readability is required under the intense lighting commonly found in cockpits. Similar tubes have been developed for civilian aircraft where environmental conditions are slightly less severe. In addition, because the copilot must have access to the same information as the pilot, these tubes use wide-viewing-angle, neutral-density filters for contrast enhancement, instead of directional filters.



See us on our stand n° 430
SID Show - Chicago: 8-10/5/79



THOMSON-CSF

DUMONT ELECTRON TUBES

750 BLOOMFIELD AVENUE / CLIFTON NJ 07015 / TEL. : (201) 773.20.00

FRANCE - THOMSON-CSF DIVISION TUBES ELECTRONIQUES
38, RUE VAUTHIER / 92100 BOULOGNE-BILLANCOURT
TEL. : (1) 804.81.75

GERMANY - THOMSON-CSF ELEKTRONENRÖHREN GMBH
LEERBACHSTR. 58/ 6000 FRANKFURT AM MAIN. 1
TEL. : (0611) 71.72.81

ITALY - THOMSON-CSF TUBI ELETTRONICI SRL
VIALE DEGLI AMMIRAGLI 71 / I - 00136 ROMA / TEL. : (6) 638.14.58

JAPAN - THOMSON-CSF JAPAN K.K. / TBR BUILDING
KOJIMACHI 5-7 / CHIYODA-KU / TOKYO / T 102 / TEL. : (03) 264.63.41

SPAIN - THOMSON-CSF TUBOS ELECTRONICOS S.A.
CALLE DEL SEGRE, 17 MADRID 2 / TEL. : (1) 250.84.07

SWEDEN - THOMSON-CSF ELEKTRONRÖR AB
BOX 27080 / S 10251 STOCKHOLM 27 / TEL. : (08) 225.815

UNITED KINGDOM - THOMSON-CSF COMPONENTS AND MATERIALS LTD.
RINGWAY HOUSE / BELL ROAD / BASINGSTOKE RG24 0QG
TEL. : (0256) 29155 / TELEX : 858865

Between \$18,000 to \$45,000

Simply input ideas
with Joystick or
Graphic tablet



Computer does work,
you do the thinking



Instant Recall: Add or delete
entire blocks of drawings with
one command

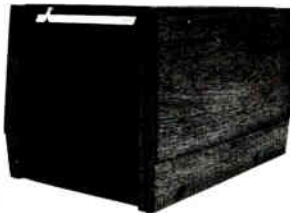

Plotter gives camera ready
art in minutes

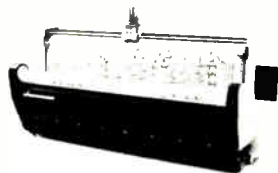

Only at I Corporation
Order yours today!

- * PC Layout
- * Schematic
- * Mechanical
- * Hybrid

(415) 848-6600

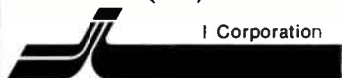

835 Addison Street
Berkeley, CA 94710

New products

Communications

Optic modules are affordable

Transmitter and receiver
link TTL-level devices
for as little as \$49.95 each

Like any new technology, communication through fiber optics will gain public acceptance when functionally complete and affordable units are available. Fitting that bill are a compact transmitter and receiver from Spectronics Inc., a Honeywell subsidiary.

The company, long known in the military market for highly reliable optical products, is launching a full fiber-optic family of parts for commercial applications. The SPX 4140 transmitter and SPX 4141 receiver optically couple transistor-transistor-logic-level signals through a variety

of single-fiber cables, including plastic or glass strands from Siecior, Galite, and Dupont. The modules incorporate integrated-circuit chips in leadless carriers to control interfacing functions. Either one sells for \$49.95 in quantities of 1,000.

The transmitter IC (SPX 3619) has a high-speed current driver that works in conjunction with an 820-nm light-emitting diode. The companion IC (SPX 3620) for the receiver transforms low-level signals from a p-i-n or avalanche photodiode into a TTL output. The link will transfer Manchester-encoded data at rates up to 10 megabits/s over distances up to 2 km with no need for external fine-tuning. It will operate in the 0°-to-70°C range.

Transition and propagation times of the transmitter's LED are 7 and 5 ns, respectively. It exhibits peak output at a current of 150 mA.

The photodiode, a transimpedance preamplifier with automatic gain control, and a post-amplifier comparator and buffer comprise the receiver. Its sensitivity for Manches-



BUILD STRONG SIGNALS 5 WAYS.

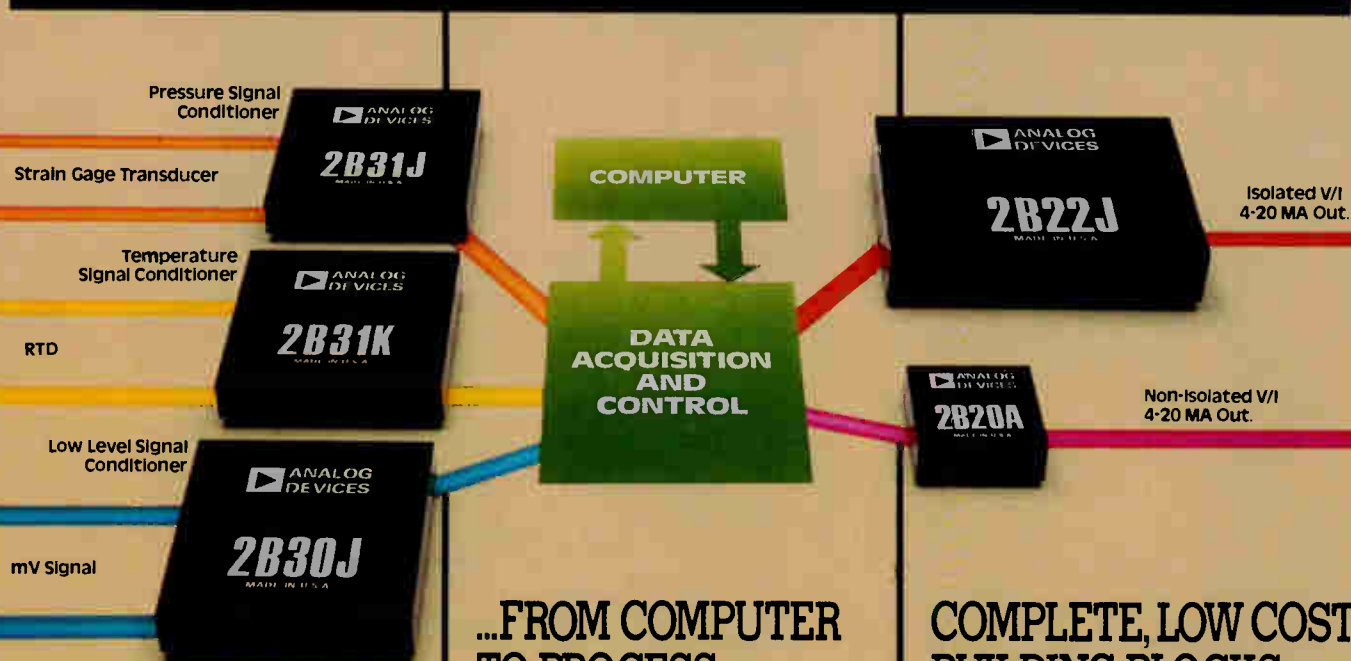

FROM TRANSDUCER TO COMPUTER...

Where strain gages, RTDs or low level signals measure pressure, temperature, strain, torque and force, our 2B30 and 2B31 high performance, economy Signal conditioners amplify low level signals, filter noise and excite transducer bridges. \$45 – 100's (2B31J).

The 2B31 directly interfaces to transducers providing adjustable voltage or current excitation, programmable gain, low offset drift, 0.5uV/°C max., high CMR, 140dB @ 60Hz, and a low pass filter with 60dB/decade rolloff to eliminate line noise and aliasing errors. The 2B30 has no excitation capability. \$34 – 100's (2B30J).

...FROM COMPUTER TO PROCESS.

Our new high performance Voltage-to-Current converters produce a standard 4 to 20mA current proportional to the voltage input. The 2B20 provides non-isolated V/I conversion with low span drift, 0.005%/°C max., over the -25°C to 85°C temperature range. It operates from a single +10V to +32V supply and provides 4 to 20mA output from a 0 to +10V input into a grounded load without any additional external components. \$25 in 100's (2B20A).

The 2B22 offers 4 to 20mA output with $\pm 1500V$ dc input to output isolation to eliminate ground loops and to protect against high voltage transients. It meets IEEE Std 472 for transient protection (SWC). \$59 in 100's (2B22J).

COMPLETE, LOW COST BUILDING BLOCKS.

In harsh industrial environments, our new signal conditioners feature high noise rejection, filtering, input protection, and excellent temperature stability to assure measurement integrity. Economical, easy to use, they provide a pre-packaged, cost-effective analog signal handling and interface capability for a wide variety of transducers or process signals.

For complete information, call Janusz Kobel at 617/329-4700. Or, write Analog Devices, Inc., P.O. Box 280, Norwood, MA 02062.



WAY OUT IN FRONT.

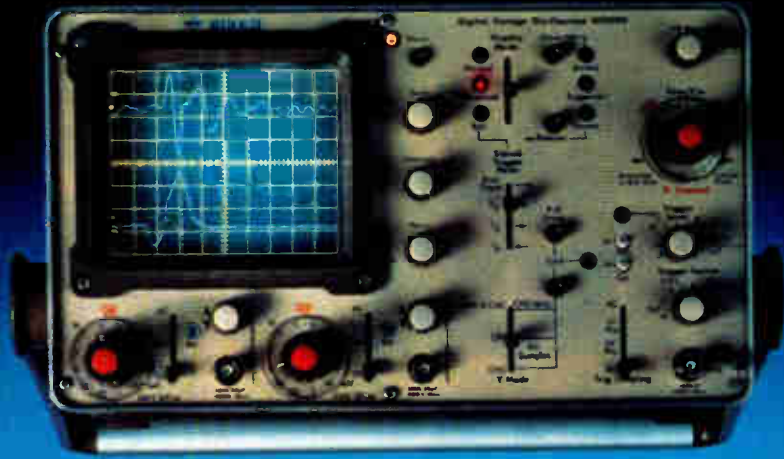

Now Gould offers a range of digital storage oscilloscopes that offer a world of advantages over conventional tube storage technology, beginning with being able to capture transient or "one-time" events and store them indefinitely for display or hardcopy printout. This makes them ideal for electronic, electromechanical, educational, and biophysical applications.

Both the OS4000 and the new OS4100 combine the capabilities of semi-conductor memory with a bright, stable, flicker-free display. This technique allows analysis of signal build-up and decay characteristics through pre- and post-trigger viewing. Expansion of the display after storage permits detailed study of specific areas of the trace.

The new model—OS4100—also offers you stored X-Y displays, channel sum or

difference and a maximum of $100\mu\text{V}$ per cm sensitivity with noise suppression. A unique trigger window circuit assures capture of transients of unknown polarity.

Other outstanding features include automatic operation, display of stored and real time traces simultaneously and hard copy memory output in digital or analog form. And IEEE488 is available for compatible interfacing.

If features like these aren't enough to lure you away from less sophisticated instruments, remember that Gould scopes are backed by a two-year warranty of parts and labor, exclusive of fuses, minor maintenance and calibration. And application assistance, customer training and worldwide service centers are part of Gould's customer support program.

Extend your storage capabilities beyond the conventional.

 **GOULD**

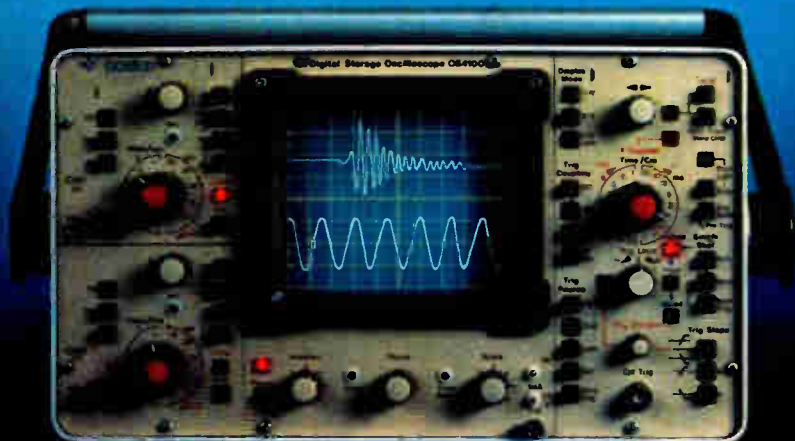

Gould manufactures 60% of the world's digital storage oscilloscopes.

Our full line of portable, general purpose oscilloscopes is used with confidence around the world. And since we're committed to research and development, you can be assured that we will keep offering you new and improved products.

For detailed information or an on-site demonstration of any oscilloscope in the Gould line, contact Gould Inc., Instruments Division, 3631 Perkins Avenue, Cleveland, OH 44114. In Europe contact Gould Instruments, Roebuck Road, Hainault, Essex England IG6 3UE.

For brochure or demonstration call toll free (800) 325-6400, Ext. 77. In Missouri (800) 342-6600, Ext. 77.



New products

ter-encoded data is 200 nA at 10 Mb/s, with a 10^{-8} bit error rate.

Both modules work off a single +5-v supply and they can be easily connected to optical SMA-style connectors. Standard versions are equipped with Amphenol fiber-optic connectors but other connectors can also be provided.

The exit aperture of the LED is guaranteed to be 300 μm and typical output power is 0.7 mW. This is achieved by using a reflective cone that in effect places the emitter chip directly in contact with the flat window of the LED package while enlarging the target area. The approach permits high-volume production and also yields a low price.

Spectronics Inc., 830 East Arapaho Rd., Richardson, Texas 75081. Phone (214) 234-4271 [401]

Lightweight TWTA delivers 5.5 W

Originally developed for the Tracking and Data Relay Satellite (TDRS) system, the model 1264H is a traveling-wave-tube amplifier that delivers 5.5 w in the 3.7-to-4.2-GHz range.

The unit is based on the model 230H TWT and was designed for high efficiency, ruggedness, and light weight. It has a saturated gain of 55 dB, an expected operating life of 10 years, and weighs 3 lb.

Hughes Electron Dynamics Division, 3100 West Lomita Blvd., Torrance, Calif. 90509. Phone (213) 534-2121 [403]

Receiver meets changing needs by changing modules

The model SR-2093 is a vhf-uhf surveillance receiving system that uses a synthesized local oscillator. Designed to accept a variety of modules, it can be changed to fulfill different tracking requirements.

The system can be tuned from 20 to 500 MHz and provides a choice of three intermediate frequencies: 20 kHz, 300 kHz, and 4 MHz. The range can be expanded to 1,200 MHz

and additional intermediate frequencies can be selected. Memory, single-sideband detectors, and other options may also be specified.

The receiver may be operated locally or remotely and features a liquid-crystal display of all tuning information.

Norlin Communications Inc., 9125 Gaither Rd., Gaithersburg, Md. 20760. Phone Don Biscoe at (301) 948-5210 [408]

Chip set filters DTMF signals

Designers digitizing telephones can now turn to two 24-pin devices to do their dual-tone-multifrequency (DTMF) filtering. One, the AF121, separates the 697-to-941-Hz frequencies while the other, the AF122, tackles the 1,209-to-1,633-Hz zone.

Used together, the sixth-order elliptic filters provide 40 dB group separation as well as 40-dB separation from the dial-tone frequency. They can be purchased with a maximum peak-to-peak ripple of 2 or 4 dB in the passband and are priced

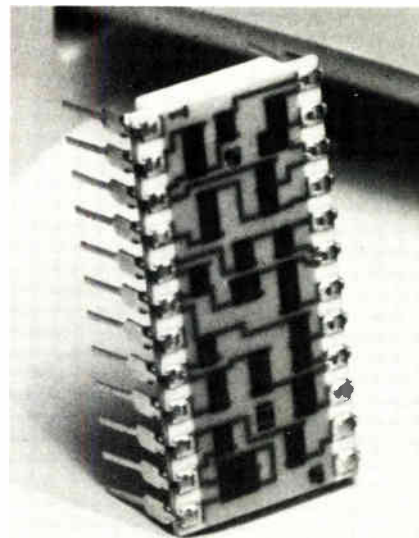

accordingly at \$27.50 and \$24.50 in small quantities. Delivery time is three weeks.

National Semiconductor Corp., 2900 Semiconductor Dr., Santa Clara, Calif. 95051. Phone Dennis Dauenhauer at (408) 737-5848 [409]

Instruments**Smart counters cost little**

120-MHz and 1-GHz units make measurements quickly and automatically

One measure of the "intelligence" of a so-called "smart" instrument is the complexity of its front panel. A really smart machine should have a fairly simple set of controls, since it requires little user intervention. By this criterion, two new microprocessor-based frequency counters from Philips belong near the top of the class. Aside from their seven-digit displays and input connectors, all these counters have on their front panels are an on/off switch, a sensitivity control, and a two-position measurement-rate switch.

A patented automatic trigger level circuit gives the 120-MHz PM 6667 and the 1-GHz PM 6668 the capability of triggering reliably on a wide variety of waveforms, including pulse trains with low duty cycles.

The counters make high-resolution measurements of low frequencies by taking multiple period measurements and computing the reciprocal value. The microprocessor eliminates the need for long gate times, gets rid of the usual ± 1 -Hz error, and overcomes the limitations of phase-locked frequency multipliers. This means that a tone frequency of, say, 988.1183 Hz or a line frequency of 60.81253 Hz can be measured to seven places in only one second. Furthermore, range setting, decimal-point positioning, and indication of units (kHz, MHz, etc.) are all done automatically.

Cutting costs. In addition to providing brain power, the microprocessor helps to cut costs by eliminating many components. The designers of the counters really concentrated on this area by using monolithic front-end circuits and by making extensive use of large-scale integration in the logic circuitry. The result is that the 120-MHz counter sells for only \$425 and the 1-GHz instrument goes for \$545. Included in the higher-frequency counter is an automatic p-i-n diode attenuator that provides protection against signal levels that might do damage to the sensitive input circuitry.

The measurement-rate switch gives users a choice of two measurement times: 1 s and 200 ms. The normal (1-s) time yields the full frequency resolution of seven digits. The fast speed makes it easier to track changing frequencies—when making adjustments, for example—but trades off resolution, reducing it to six digits.

The six-step attenuator, which allows the sensitivity to be adjusted from 5 V rms down to 15 mV rms, is claimed to provide up to 10 dB more noise immunity than conventional $\times 10$ attenuators. When it is in its most sensitive position, the input sensitivity of the high-impedance input is 15 mV rms for sine waves from 10 Hz to 75 MHz and 25 mV rms for sine waves from 75 MHz to 120 MHz. For pulses with a duration of 7 ns or more, the sensitivity is specified at 45 mV peak to peak.

In addition to the high-impedance (1 M Ω shunted by 25 pF) input, the PM 6668 has a 50- Ω input, which is not affected by the sensitivity control. This rf input has a sine wave sensitivity of 15 mV rms from 70 MHz to 500 MHz and 25 mV rms from 500 MHz to 1 GHz.

Both meters can be supplied with an optional battery pack that provides up to five hours of uninterrupted operation. The use of a liquid-crystal display allows a large readout (11.5-mm digit height) with little effect on battery life.

Built around crystal oscillators that drift less than one part in 10^7 per month, the new counters are given a comprehensive check-out every time they are turned on. If they fail the test, a diagnostic code appears on the display.

Philips Test and Measuring Instruments Inc., 85 McKee Dr., Mahwah, N. J. 07430. Phone (201) 529-3800 [35 1]



4 $\frac{1}{2}$ -digit true-rms multimeter sells for \$345

The model 4020 digital multimeter is a 4 $\frac{1}{2}$ -digit instrument that can resolve voltage to 10 μ V, current to 10 nA, and resistance to 10 m Ω . Its

The Liberator



Opto 22 Z Series gives you freedom from hybrid relays.

Revolutionary All-Solid State "Z" series relay. Opto 22 offers uncompromised performance at unprecedented prices. Whether you're engineering systems for discotheques or dairy farms you need top efficiency. For what you invested in a less reliable hybrid relay, you can now get the best in a photo-isolated SSR; zero voltage turn on, built-in snubber, 4000 volt photo-isolation. If you're looking for top performance in solid state switching from decibels to dairy products, look to the liberator.

Opto 22, 5842 Research Drive, Huntington Beach, CA 92649
(714) 892-3313/Telex 692386

Circle 205 on reader service card

New products

Packaging & production

Modular printer marks parts fast

Components of all types are handled by versatile print-and-cure system

"Increased efficiency and flexibility are the two main thrusts of the manufacturing environment of the 1980s," says Bill Lynch, product manager for electronics and electrical industries of Markem Corp., Keene, N. H. To meet these trends, Markem has produced a fully automated modular component printing system called the series 3000. Components in lead frames or unattached parts can be handled by the new printer. In addition, depending on the type of part, one operator using the new printing system can churn out printed parts at rates varying from 5,400 to 21,600 units per hour.

Flexibility of the series 3000 is obtained by breaking the system down into a series of functional modules. These are composed of a single print module, two parts-conveying modules, three parts-handling modules, and three curing modules. The modules are assembled to suit the type of component to be marked.

Key modules of the series 3000 are the two parts-conveying mod-

ules: one for attached parts such as dual or single in-line packages in lead frames and capacitors in strips, the other for separate parts such as switches, relay housings, cases, TO-3s, or DIPs in sticks.

The conveyor in the photo is for attached parts. It is a microprocessor-controlled unit that features low-cost, quick-change belts and product guides, which assure that parts are properly presented to the print station for accurate registration. Each belt is "programmed" with eyeholes that activate photocell controls in the print module. Changing the belt and guide for one product to those for another requires no more than five minutes.

Cycle rate for attached parts ranges from 7,800 to 21,600 per hour, depending on operator skill and parts configuration. This is five times as fast as older Markem print-line systems.

The unattached-parts conveyor offers a variable cycle rate up to 5,400 components per hour, depending on size, parts configuration, and operator skill.

Parts-handling modules are available to help increase throughput for several major applications. For instance, products in strips may be hand-fed more smoothly and efficiently with a specially designed feed assist. Alternately, lead-frame magazine loaders and unloaders, engineered at the factory to the user's specifications, allow a cycle rate of 13,000 parts per hour with real throughput up to 80%; and stick

unloading and reloading mechanisms for 300-, 400-, 600-, and 900-mil DIPs provide a cycle rate of up to 11,000 per hour, also with high real throughput.

A refined design of Markem's highly reliable rotary offset print module does the actual printing on the series 3000. The offset wheel is retractable, providing registration capability for products in strips on close centers.

The dual tangicam typeholder accepts all commonly used printing elements, including rubber plates, Markem type, and plates made in the user's plant with the Markem model 452 Platemaker System.

Integral curing modules of three types—ultraviolet, serpentine, and infrared—will be offered to help component manufacturers increase the productivity of their mark-and-pack operations. In-line print curing reduces the amount of product handling required and frees floor space that would otherwise be needed for a batch curing oven.

Ultraviolet curing, available immediately, provides a quick cure with low heat to substrate and low energy consumption. Infrared and serpentine curing modules for the series 3000 are under development.

Price for a print-cure system with the attached-parts conveyor is between \$40,000 and \$45,000, whereas the cost of a system built around the unattached-parts module is in the region of \$25,000.

Approximate dimensions of the series 3000 are 4 feet high by 10 feet wide by 2 feet deep. Approximate weight is 1,400 lb.

Markem Corp., 150 Congress St., Keene, N. H. 03431. Phone (603) 352-1130 [391]

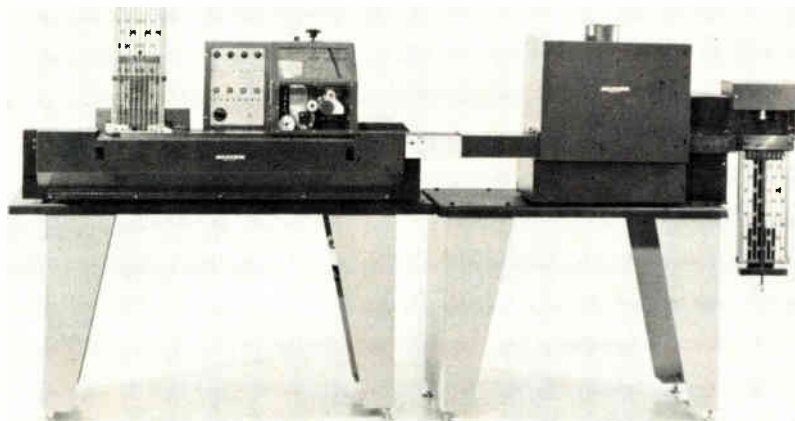

E-beam system exposes mask in as little as 14 minutes

An electron-beam lithography system can etch circuit patterns with lines and spacings as fine as 1 μm , so that as many as 15,000 circuits can be fabricated on a 4-inch silicon wafer. Using a 0.5- μm address structure, the Ec-BES 40 can expose an

Make your readouts outstanding with the latest Itron innovations.

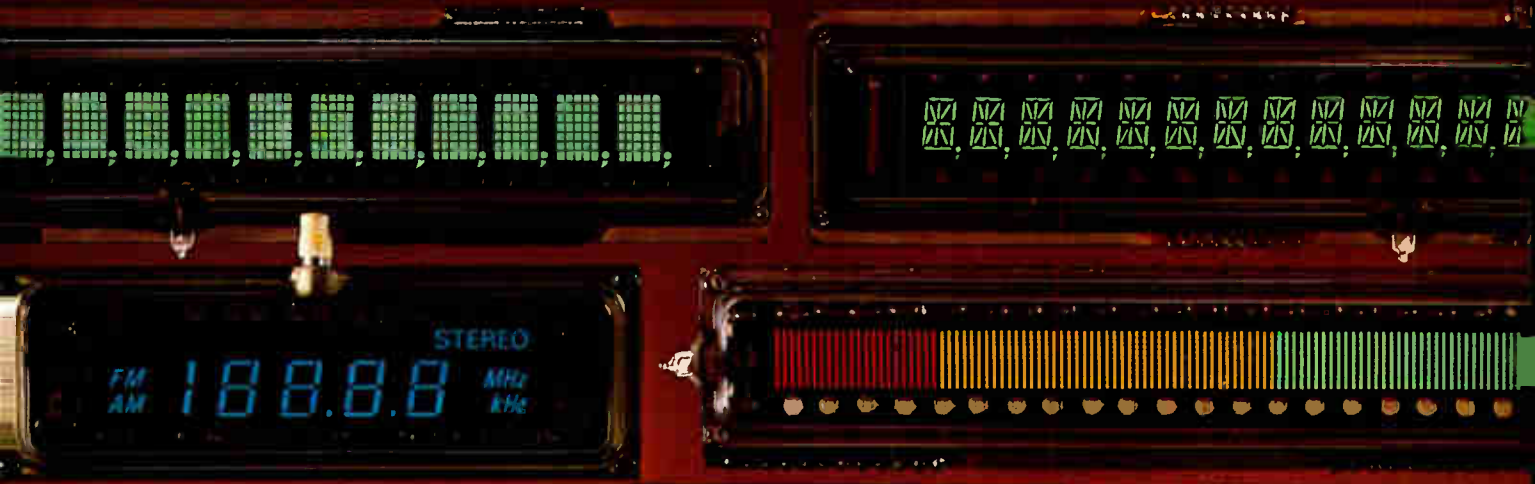

Multi-color configurations. Red, blue, yellow and blue-green arrays. 5 x 12 dot matrices for upper/lower case alphanumeric and 5 x 7 dot matrix displays. High density dot and bar graphic panels. 14-segment alphanumeric units. These latest, and all the other Noritake Itron advancements, are sure to open up new readout innovation opportunities for you.

And you'll realize all the advantages offered by Itron Fluorescent units over ordinary digital displays. Their cost-effective pricing and simple, fast installation will save you time and trouble, as well as a great deal of money. Interfacing with peripheral circuits is easy too; further reducing costs. They operate at low voltage and consume little power. Their bright fluorescent output and flat-glass packages make for easy readability, at a distance and at wide viewing angles, even under high ambient light conditions.

What's more, Itron displays have a proven long-life track record for reliable performance under stringent conditions. And we can quickly and economically fabricate custom configurations. Since there's much more you should know to make an optimum display selection, contact us for all the particulars.

itron®

FLUORESCENT
DISPLAYS

Patented and manufactured by
ISE ELECTRONICS CORP.

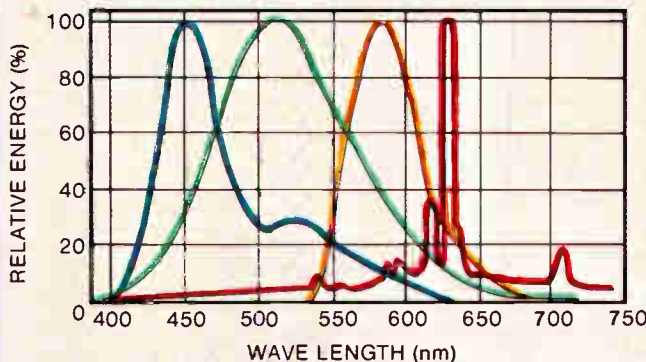

INTERNATIONAL REPRESENTATIVES

WEST GERMANY: Neumuller GmbH, Eschanstr. 2, 8021, Taufkirchen, Munich Phone: 089/6118-245 Telex: 522106

FRANCE: Europavia, France, 5 Avenue Leon Harmel 92167 Antony Cedex Phone: 666-21-10 Telex: 42204381

UNITED KINGDOM: ITI Meridian, West Road, Harlow, Essex CM20 2BP Phone: 0279-35351 Telex: 817202

SWEDEN: AB Nordqvist & Berg, Box 9145 S-10272, Stockholm Phone: 08-690400 Telex: 10407

HONG KONG: Phone: 5-232420 TAIPEI: Phone: 351-0293

NORITAKE ELECTRONICS, INC.

L.A. OFFICE: 22410 Hawthorne Boulevard, Torrance, CA 90505, (213) 373-6704, Telex: 67-4910
N.Y. OFFICE: 41 Madison Avenue, New York, NY 10010, (212) 481-3440, Telex: 12-5469

NORITAKE COMPANY LIMITED

JAPAN: 1 - 1 Noritake Shinmachi, Nishiku, Nagoya-Shi, (052) 561-7111, Telex: J59738
EUROPE: Burotel Belgium SA, Rue de la Presse 3-5, 1000 Bruxelles, (02) 217-83-60, Telex: 4626962

Circle 208 for Demonstration
Circle 209 for Literature only

**Now you can sound off
right from your
printed circuit boards.**

The Mallory Sonalert® Signal.

This new Sonalert design gives you a choice of three medium loud sounds — continuous, fast pulse, or slow pulse at 2900 Hz. It will even give you pulsing or continuous sound in the same package. You can spec it into just about anything in which you need sound. And its pin mounting makes it easy to insert and solder into printed circuit boards. Units may be hand or wave soldered.

Mallory Sonalert Electronic Signals are available direct, or through authorized Mallory distributors in U.S., Canada and overseas. Give us a hearing. Write or call. P. R. Mallory & Co. Inc., Box 1284, Indianapolis, Indiana 46206. (317) 856-3731.



MALLORY

New products

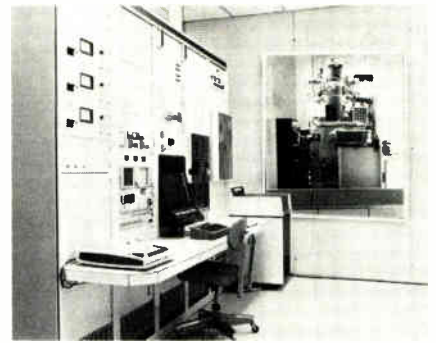

area of 5 cm² per minute so that a mask for a 4-in. wafer can be exposed in as little as 14 minutes.

The mask cassette handling system of the unit operates without interruption for 8 hours. To start production, a magazine is manually loaded with up to 10 cassettes that each hold the parameters of a single mask. The magazine is then loaded into the vacuum system by a four-position elevator. The magazine remains under high vacuum in an antechamber while the handling system automatically transfers cassettes to and from the writing chamber.

The machine has a throughput rate of 40 MHz, which is twice as fast as other mask-making machines, according to the company. The work chamber accommodates 6-in. masks. The Ee-BES 40 sells for about \$1.7 million and delivery is scheduled for the fall of 1979.

Varian/Extrion Division, Blackburn Industrial Park, Gloucester, Mass. 09130. Phone (617) 281-2000 [394]

Machine terminates

2- to 24-wire assemblies

The CT-1347 harness-fabrication machine can simultaneously terminate discrete wire assemblies having from 2 to 24 wires at a rate of 500 per hour. The wires may vary in length from 8 to 50 in. Lead lengths may be changed in the machine, and the wires can be terminated by stripping them or with a Jaguar connector. The machine sells for \$25,000. Delivery takes 10 to 12 weeks.

Methode Electronics Inc., Interconnect Products Division, 170 Hicks Rd., Rolling Meadows, Ill. 60008. Phone (312) 392-3500 [396]

Semiconductor Lasers



The Light of the Future Available Today From

General purpose lasers for specialized optical systems and fiber optic products with integral fiber cable connectors or pigtailed, offer selectable power levels, wavelengths and modal properties, electronic plug compatibility with standard printed circuit technology and electronic feedback.

Improve your system performance, reliability and cost by buying those, and only those features you need from 56 standard, easy to use products, available in quantity with 100% quality control.

See us... ELECTRO '79, N.Y. Coliseum, Booth 1106. CLEA, Washington Hilton, Booth 1020.

EXXON

OPTICAL
INFORMATION
SYSTEMS

EXXON ENTERPRISES INC.

OIS

350 Executive Boulevard
Elmsford, N.Y. 10523
(914) 345-5850

Circle 211 on reader service card

Multi-terminal software for a \$645 computer?

Yes. And it's a powerful software development capability for computers in this price class. A multi-terminal editor that runs on, and produces code for, any NAKED MINI 4 family computer.

Including our \$645 NAKED MINI 4/10.

And there are no licensing agreements or copying charges.

Our multi-terminal editor enables as many as four users to interactively create and edit high-level and assembly language programs. While concurrently executing background batch jobs such as FORTRAN.

System requirements are any NAKED MINI 4 processor, 128K bytes of memory, floppy and hard disk subsystems, up to four CRTs, and an OS-4 operating system.

If you are a volume OEM and want to reduce your software development costs as well as your total product costs, contact any ComputerAutomation sales office or write us at 18651 Von Karman, Irvine, CA 92713.

 **ComputerAutomation**
NAKED MINI® Division

WHERE OEM'S COME FIRST.

Circle 214 on reader service card



New products

cide, indicating transfer completion. Texas Instruments Inc., Inquiry Answering Service, P. O. Box 1443, MS-6404 (Attn: TMS9911), Houston, Texas 77001 [374]

Package paves way for forthcoming MC6805

An MC6805 simulator module, a floppy disk with a linking loader, a demonstration program, a cross assembler for macrocode, and an instruction manual comprise the MEX6805SIM. With this package, system designers and programmers can familiarize themselves with the MC6805 single-chip computer that will very shortly become available from Motorola.

The package simulates the computer's entire instruction set and interrupt-driven routines, with provision for user reset and timer interrupt signals. It features full trace capability and traps all invalid instructions, effective addresses, stack pointer overflows and underflows, and program counter over-

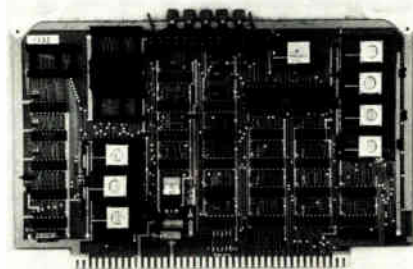

flows. Nonmicroprocessor features of the MC6805 can be emulated using an MEX68USM universal support module configured in accordance with instructions in the supplied manual.

The simulator module plugs into an EXORciser 1 or 1A or an EXORterm 200. Minimum system requirements also include an EXORDisk II, an editor, and 24 kilobytes of memory, as well as a terminal. The MEX6805SIM package is priced at \$2,500.

Motorola Microsystems, P. O. Box 20912, Phoenix, Ariz. 85036. Phone (602) 962-2223 [378]

LF Cram Course

In a nutshell, Plessey IC's are a simpler, less expensive, more flexible alternative to whatever you're using now for an IF strip up to 240 MHz. Whether you're working with radar and ECM, communications, weapons control or navigation and guidance systems.

The log IF strip shown, for example, uses only five devices and a single interstage filter to achieve a logging range of 90 dB, ± 1 dB accuracy, -90 dBm tangential sensitivity and a video rise time of 20 ns or less.

The devices shown are all based on the Plessey SL1521, the simplest, easiest-to-use and least expensive wide-band amplifier you can buy. It has a 12 dB gain and upper cut-off frequency of 300 MHz. The SL1522 is two 1521's in parallel with a resistive divider for increasing the IF strip's dynamic range, while the SL1523 is two 1521's in series.

The SL541 lets you vary video sensitivity, and has the high slew rate (175 V/ μ sec), fast settling time (1% in 50 ns) and high gain stability you need, with on-chip compensation so it's not tricky to use.

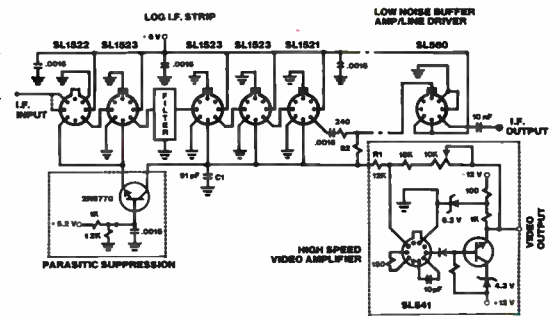

The SL560 on the IF output is a "gain block" that replaces your hybrid and discrete amplifiers, usually with no external compensation. Noise figure is under 2 dB, gain up to 40 dB, and the bandwidth is in excess of 320 MHz.

So send for all the details today. At our prices, never has so little done so much.

PLESSEY SEMICONDUCTORS
1641 Kaiser Avenue, Irvine, CA 92714. (714) 540-9979.

All things to some people.

Circle 215 on reader service card

WHERE ELSE BUT DAVIS?



100% quality, 50% saving:

500 MHz and 1 GHz Counters with built-in preamp

Series CTR-2A Frequency Counters exceed the highest quality standards demanded by electronics industries, communications, ham radio, research labs, technicians, and service. Yet cost only half the price of other commercial counters. How does Davis do it? Advanced design and production techniques. That's the Davis difference. One year warranty on assembled units, 90-day on kit components.

2 RANGES: 500 MHz Kit \$249.95 Assembled \$349.95 1 GHz Kit \$399.95 Assembled \$549.95

- Preamp 10 mv @ 150 MHz
- 8 Digit .3" LED Display
- High Stability TCXO ± 1 ppm
- Oven Controlled Crystal ± 5 ppm (Opt. @ \$49.95)
- Period Measurement (Opt. @ \$15.00)
- Input Diode Protected
- Selectable Gate Times, .1 & 1 sec.

OPTIONS: 43" LED \$10.00 10 sec. Time Base \$ 5.00
12 V/DC 10.00 Handle 10.00

Order direct from factory. Add \$3.00 for shipping, \$1.00 extra for C.O.D., and 7% sales tax in N. Y. State. Payment by check (certified for C.O.D.), money order, Master Charge, VISA. Credit-rated company P.O. accepted. Money back guarantee if returned in good condition in 10 days. Kits returnable only unassembled.

For more information, request FREE DESCRIPTIVE LITERATURE, or for in-depth preview, send \$5.00 for 32-page INSTRUCTION MANUAL. Detailed, illustrated. Credited against purchase of either unit.

DAVIS

DISTRIBUTOR INQUIRIES INVITED

Affordable quality is the Davis difference.

DAVIS ELECTRONICS

636 Sheridan Drive, Tonawanda, N.Y. 14150 • 716/874-5848

ELECTRONICS REPRINTS

No. of copies wanted

Articles

- R-901 1979 world market survey and forecast 24 pp \$4.00
- R-829 Special report: New networks tie down distributed processing concepts 16 pp \$3.00
- R-827 Tackling the very large-scale problems of VLSI: a special report 15 pp \$3.00
- R-825 1978 technology update special issue \$4.00
- R-821 Codexes answer the call 18 pp \$4.00
- R-817 How bit-slice families compare 18 pp \$3.00
- R-816 Packaging technology responds to the demand for higher densities 9 pp \$3.00
- R-815 Higher power ratings extend V-MOS FETs' dominion 8 pp \$2.00
- R-813 Data-link control chips: bringing order to data protocols 10 pp \$3.00
- R-811 Multiplexing liquid-crystal displays 10 pp \$3.00
- R-809 New methods and materials stir up printed wiring 10 pp \$3.00
- R-807 Here come the big, new 64-K ROMs 14 pp \$3.00
- R-805 Why and how users test microprocessors 8 pp \$3.00
- R-801 World market report 1978 24 pp \$4.00
- R-734 Microcomputer families expand 20 pp \$4.00
- R-730 Special report—Automotive electronics gets the green light 10 pp \$3.00
- R-728 Flexible circuits bend to designers' will 10 pp \$3.00
- R-724 Special report—Technologies squeeze more performance from LSI 22 pp \$3.00

Charts

- R-823 Communications satellites \$3.00
- R-516 Electronic symbols \$2.00
- R-213 Electromagnetic spectrum (updated 1976) \$3.00
- R-326 Optical spectrum (6-page report and chart) \$3.00

Payment must accompany your order

Make check or money order payable to Electronics Reprints. All orders are shipped prepaid by parcel post. Allow two to three weeks for delivery. For additional information call (609) 448-1700 ext. 5494.

Mail your order to:
Janice Austin
ELECTRONICS REPRINTS
P.O. Box 669
Hightstown, N.J. 08520

New products

Semiconductors

Generator drives bar-graph displays

Aimed at audio applications, IC works with both LED and vacuum-fluorescent displays

There is a growing trend in the design of audio equipment, both professional and consumer, to replace conventional volume-level (VU) meters with bar-graph displays, which respond better to instantaneous peaks. Designers are looking for easy ways to make the swap, and Exar Integrated Systems Inc. feels it has an answer in its XR-2276 bar-graph generator circuit.

Similar in design to National Semiconductor Corp.'s LM3914 [*Electronics*, July 20, 1978, p. 161], the monolithic device is distinguished by several characteristics that reflect particular requirements and preferences in the audio market, according to Exar's vice president of engineering and marketing, Alan B. Grebene. "Instead of 10 bar-graph elements, the 2276 drives up to 12 and will drive vacuum-fluorescent displays, too," he points out, referring to the fact that the LM3914

drives light-emitting-diodes only.

Audiophiles prefer a 12-point bar graph to the 10-point type and find fluorescent displays more pleasing to look at, Grebene claims on the basis of information he has gathered from makers of audio equipment. He estimates the market for this \$2 chip (in quantities of 100 and more) to be greater than 200,000 devices, not counting what the Japanese may see fit to buy. "Japan," he acknowledges, "is where the big volume is, but we have a few key U.S. manufacturers who make high-priced audio systems, and they are looking for 50,000 to 100,000 parts each for the first year."

The 2276 is a relatively simple bipolar device, consisting of 12 voltage comparators whose inverting inputs are connected to taps along a resistive voltage-divider string, an input buffer amplifier whose output feeds the noninverting input of all of the comparators, and a 0-dB reference supply that may be programmed by means of a single external resistor. The reference supply provides the excitation voltage for the multitapped voltage divider; it therefore sets the 0-dB point for the meter-replacing display.

The chip's operation is straightforward. With no input signal, the comparators are all in a low-output state. As the input increases, it sequentially reaches each compara-

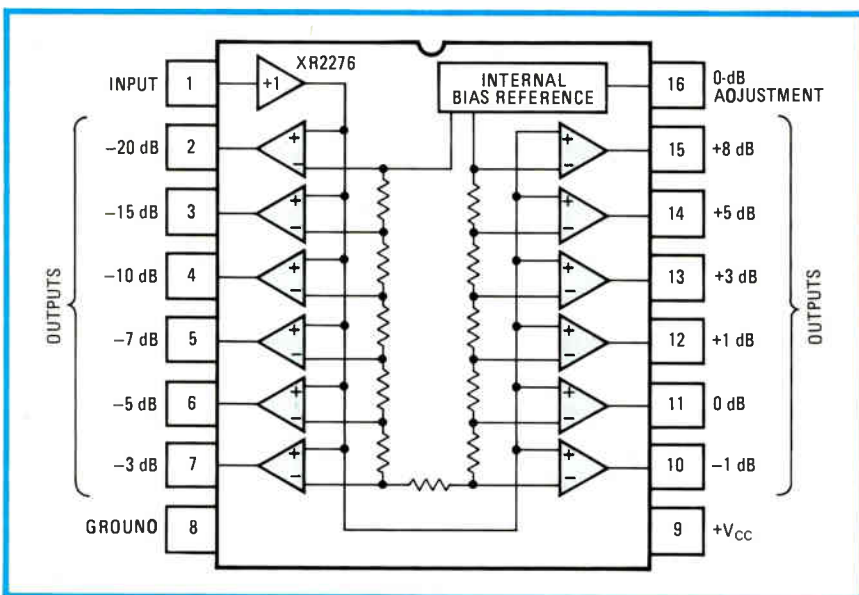

Power Play

tor's inverting-input voltage, causing the comparator to turn on and drive the next bar-graph element. Best resolution is obtained around the 0-dB point, decreasing as the reference-voltage increments get larger toward the high (+8-dB) and low (-20-dB) ends.

With a supply voltage of 18 v dc and an ambient temperature of 25°C the 2276 will draw no more than 20 mA of current. The maximum current at the signal-input pin is 300 nA and the maximum input offset voltage is 1.6 v, both also at 25°C. The device will operate from 0° to 75°C.

Exar Integrated Systems Inc., 750 Palomar Ave., Sunnyvale, Calif. 94088. Phone (408) 732-7970 [411]

1-K static RAM is a power miser

Designers who must be stingy with power, such as those who make smart portable instruments, will want to investigate a 1-K static read-write memory dubbed the MN5101. Fabricated using complementary-metal-oxide-semiconductor technology, the 256-by-4-bit random-access device consumes only 1 mW on standby.

The unit's chip is only 18 mm² in area—about 15% smaller than conventional C-MOS memories. It operates from a single +5-v power source and can access stored data in only 800 ns. The 22-pin RAM works with transistor-transistor-logic-level signals and has three output states for easy connection to microcomputer buses.

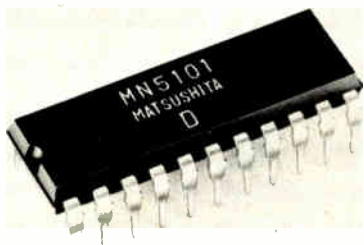

A.C. power control is almost child's play with any one of a series of zero-voltage switches from Plessey.

They all provide better, more economical control for your hair-dryers and heaters, freezers and furnaces, pools and percolators, or whatever else you may be working on.

Plessey zero-voltage switches include spike filters to prevent false triggering. Low voltage sensors to protect your triacs. Provide symmetrical control to prevent the addition of D.C. to your circuits.

And three of them (the SL441A, 443A and 445A) include an integral ramp generator and a patented pulse integration technique that allows you to get long, long time constants—repeatably—with fewer and much less expensive components and without the inherent problems of using electrolytic capacitors.



If you need a clincher, just call and ask about our prices and deliveries.

We're not playing games.

 **PLESSEY SEMICONDUCTORS**
1641 Kaiser Avenue, Irvine, CA 92714. (714) 540-9979.

All things to some people.

Circle 217 on reader service card

SUPER MINIATURE Neon Glow Lamps

Circuit Volts..... AC 105-125
Series Resistance..... 150KΩ
Nominal Current..... 0.3mA
Total Flux..... 20mIm MIN.
Average Life Hours... 30,000

Dimension:mm

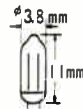

NL-8S

CLEAR-GREEN Fluorescent Glow Lamps

Circuit Volts..... AC or DC 105-125
Series Resistance..... 33KΩ
Nominal Current..... 1.6mA
Total Flux(MIN.)..... AC:120mIm, DC:130mIm
Avg. Life Hours..... AC:30,000 DC:40,000



NL-35/G

Circuit Volts..... AC 105-125
Series Resistance..... 27KΩ
Nominal Current..... 1.5mA
Total Flux..... 90mIm MIN.
Avg. Life Hours..... 20,000

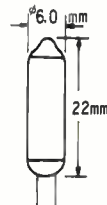

NL-21/G

● MAIN PRODUCT

NEON GLOW LAMP, XENON FLASH LAMP,
RARE GAS, DISCHARGE LAMP.
MINIATURE : BLACK-LIGHT, UV-LIGHT,
FLUORESCENT COLOR-LIGHT.

ELEVAM ELECTRONIC TUBE CO., LTD.

EXPORT DIVISION

NO. 17-8CHUO 2-CHOME OTA-KU, TOKYO JAPAN.
TELEPHONE : 03(774)1231-5 TELEX : 246-8855 ELEVAM

WHATEVER TEST SYSTEM YOU'VE GOT . . . WE'VE GOT THE "Perfect Mate"

You've got the test system and the products to be tested. We've got the perfect way to mate them to assure a highly reliable test. The Series 33 Test fixturing system accepts a variety of product sizes by simply changing the test

head on the interface adaptor. No other interface adaptor needed to access boards of up to 10" x 14", 16" x 18" or 20" x 24".

**BY ATEC
AN EVERETT/CHARLES COMPANY**



ATEC

**ASSEMBLY AND TEST
EQUIPMENT CORPORATION**

2806 METROPOLITAN PLACE
POMONA, CALIFORNIA 91767
714 593-2541
TWX 910-581-3838

EC EVERETT/CHARLES, INC.

**THE EVERETT/CHARLES COMPANIES:
The names are new the service and quality traditional.**

New products

the M5101 at \$7.50 and deliveries are from stock to eight weeks.

Panasonic Corp., One Panasonic Way, Secaucus, N. J. 07094. Phone Bill Bottari at (201) 348-7276 [413]

Dual JFETs for scope input come as chips or in cans

Consisting of two junction field-effect transistors on a single chip, the SSD3578 and SLD3579 are intended for use as high-frequency front ends on oscilloscopes. In 100-piece lots, the TO-77-can version is priced at \$3.75 and the chip version at \$1.50.

The dual JFETs have a small-signal common-source forward transfer admittance of 7.5 millimhos. Their gate-to-source leakage is less than 50 pA. Gate-to-gate leakage and parasitic capacitance are a low 50 pA and 3 pF, respectively. The noise figure is 3 dB.

The chip is constructed using V-groove technology to achieve junction isolation and has expanded contacts traversing the isolation moat, to increase reliability.

Texas Instruments Inc., Inquiry Answering Service, P. O. Box 225012, MS/34 (Att: SSD3578/SLD3579), Dallas, Texas 75265 [415]

Transceiver handles eight IEEE-488 bus lines

The MC3447 is a transceiver that conforms to the IEEE-488-1975 bus standard. Unlike other transceivers, which can handle only four of the bus's 16 lines, the MC3447 can work with eight.

The unit's low, 95-mA power consumption is achieved by allowing the seven noncritical channels to have a worst-case propagation delay of 50 ns. The eight, critical line has a worst-case propagation delay of 30 ns low to high or 22 ns high to low. In hundreds, the MC3447 costs \$3 in a plastic package, \$3.75 in ceramic.

Motorola Semiconductor Products Inc., P.O. Box 20912, Phoenix, Ariz. 85036 [416]

And now, powerless memory

The addition of non-volatile memory to standard logic functions in Plessey's NOVOL series may be the most exciting news since the abacus.

Because you can now include memory that won't give out when the power does—in your counters, security code storage systems, machine tools, and other applications where memory requirements are small but critical.

The first two products in the Plessey NOVOL family are our MN9102 Quad Latch and MN9105 Quad Decade Up/Down Counter. Both monolithic IC's include MNOS memories that store the data in them when power is removed, and hold it for at least one year at temperatures up to 70°C. Guaranteed.

And unlike other MNOS devices, ours require only standard MOS supply voltages of +5V and -12V and are fully TTL/CMOS-



compatible with no external drivers or special interfaces.

If you like our story, you'll love our prices and deliveries, because that's what really makes us Number 1 in state-of-the-art IC's.

And we're not likely to forget it.



**PLESSEY
SEMICONDUCTORS**

1641 Kaiser Avenue, Irvine,
CA 92714. (714) 540-9979.

All things to some people.

Circle 219 on reader service card

Who stole page 39?

This whodunit happens all the time. By the time the office copy of Electronics Magazine gets to your name on the routing slip, a page is missing. Or maybe the reader service cards. Or an entire article has been clipped. Sometimes you never get the magazine at all.

Other times the magazine is (glory be!) intact. But dogeared. Or otherwise abused. Or at the very least, you get it late.

O.K., we'll grant that a second-hand, third-hand, or maybe seventh-hand copy of Electronics is better than none. But it's no substitute for the copy that comes directly to you—to your home if you wish—with up-to-the-minute news and information of the technology in this fast-moving field.

To get your very own subscription to Electronics send in a subscription card from this magazine. And if they are missing, write to subscription department, Electronics, McGraw-Hill, 1221 Avenue of the Americas, New York, N.Y. 10020.

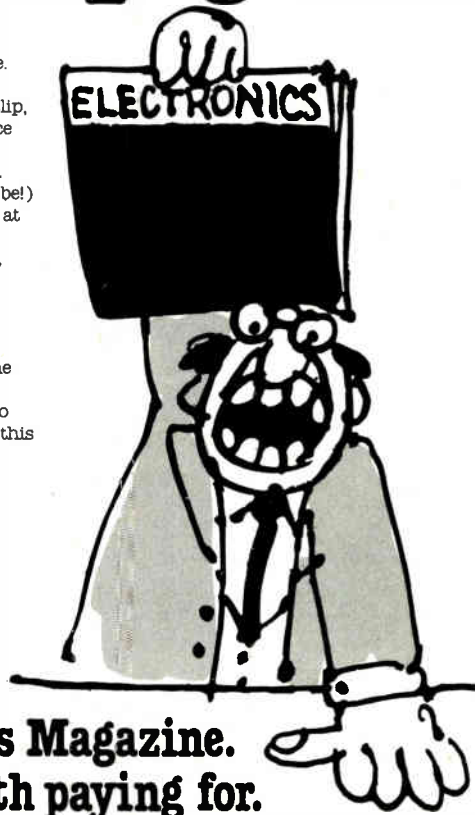

**Electronics Magazine.
The one worth paying for.**

NEW WAYS TO MEASURE TEMPERATURE AND SAVE MONEY

MULTI-POINT SCANNING WITH THERMOCOUPLE OR I.C. SENSOR.

For remote data acquisition or data logging where easy interfacing to computers and printers is the key, we offer a choice of two 6-channel scanning digital thermometers. Each offers automatic scan, external BCD or manual selection of 6 channels.

The AD2036 monitors 6 thermocouples, J, K, or T, with 1.0 or 0.1 degree resolution, in °C or °F. It costs only \$349.

The AD2038 monitors 6 channels with our AD590 or AC2626 solid state two-terminal sensors. It features high accuracy over a range of -55° to +150°C. It costs only \$349.

I.C. TEMPERATURE PROBE.

Costly linearization and cold junction compensation are eliminated with the AC2626. It's a solid-state, stainless steel, immersion type temperature probe available in lengths of 4" and 6", 3/16" O.D. The AC2626 produces a current which is linearly proportional to absolute temperature. It is especially useful in remote temperature sensing because its high impedance current output makes it insensitive to voltage drops over very long lines. Its unit price is \$22. The solid-state sensor is available as an I.C. at a unit price as low as \$3.

COMPLETE, LOW-COST SINGLE CHANNEL SYSTEM.

The AD2040 is designed to be used in conjunction with the AC2626 solid state temperature probe. It reads out directly in °C, °F, °R, or K.

It is complete and self-contained with all the circuitry needed to display the various temperature scales. User selectable readout, as well as other connections such as power supply and AC2626 interface are made at the terminal

block on the rear. Designed to measure and display temperatures from -55°C to 150°C with an accuracy to $\pm 1.0^\circ \pm 1$ digit. Its price is \$55 in 100's.

VERSATILE SCANNING DVM.

The AD2037 is a low-cost 3 1/2 digit, ac line powered, 6-channel, digital scanning voltmeter designed to interface easily to a variety of sensors and transducers for display, control, logging or transmission of multi-point analog data. Its unit cost is \$319.

For complete technical information call Steve Castelli at (617) 329-4700 or write Analog Devices, P.O. Box 280, Norwood, MA 02062.

 **ANALOG DEVICES**

WAY OUT IN FRONT.

Safe lithium cells available in volume

A line of lithium cells that will not explode or release toxic gases even if short-circuited is available in the U. S. for immediate delivery from Plainview Electronics Corp., Plainview, N. Y. Made by Tadiran Israel Electronics Industries Ltd., the cells use lithium thionyl chloride as both electrolyte and cathode. They are available in four standard sizes: 1/2AA, AA, C, and D. The cells are offered plain, with spot-welded solder tabs, and with spot-welded printed-circuit pins. In sample quantities, they are priced at \$9.80, \$10.75, \$14, and \$18 each, in increasing order of size. For quantities between 1,000 and 5,000, these prices drop to \$4.50, \$5.15, \$6.15, and \$8.35, respectively.

DEC cuts cost of LSI-11/2 . . .

Digital Equipment Corp., Maynard, Mass., has lowered the price of its LSI-11/2 microcomputers by as much as 24%. Introduced in November 1977 [*Electronics*, Nov. 24, 1977, p. 50], the original LSI-11/2 with 64 kilobytes of working memory sold for \$2,490; it is now priced at \$1,900. For a unit with 32 kilobytes of memory, the price has been dropped from \$1,690 to \$1,490.

. . . and triples memory capacity of DECsystem 20

Three new DECsystem 20 mainframe computers use metal-oxide-semiconductor devices in their main memories to provide three times the capacity of earlier systems, which had magnetic cores. In the new configurations, the DECsystem 2040 and 2060 each support a maximum of 6 megabytes, whereas the 2020 supports 2 megabytes. Basic 2020, 2040, and 2060 packages, including 1 megabyte of solid-state memory, begin at \$161,000, \$359,600, and \$485,100, respectively. Kits for upgrading computers already in the field are also available.

Custom keyboards cost little, even in small quantity

Unicorn Engineering Co., Berkeley, Calif., is shifting from its first year's research and development mode into the manufacturing of small lots of custom keyboards for users who need only small quantities, according to founder Steve Gensler. The custom boards will be similar to an 11-by-21-in., 128-key product Unicorn developed for systems made for the physically handicapped. They use membrane switch technology, are environmentally sealed, and have adjustable sensitivity. Custom legends are easily inserted beneath the clear upper membrane. The large keyboards sell for \$75 each and the smaller ones will be proportionately less expensive. Prototype charges will vary from a minimum of \$200 to as high as \$900, according to Gensler.

Motorola packages triacs for consumer applications

Motorola Semiconductor Products Inc., Phoenix, Ariz., has put its 15-A to 40-A triacs, the MAC20/25/50, into a new package that makes them well suited for both consumer and industrial applications. The hermetic package, which has a base like that of a TO-3 can, has just received UL recognition. Its solderless terminals are expected to help cut costs in both appliance assembly and repair.



Get the FACTS on CMOS MEMORIES from

SOLID STATE SCIENTIFIC

The MOSSOURCE.

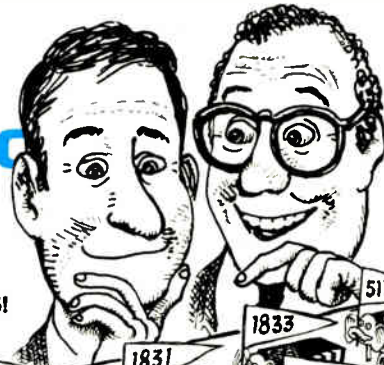

Seeing is Believing, Henshaw.
SOLID STATE SCIENTIFIC
DOES have MORE in CMOS MEMORIES!
Better write them for the facts, now!

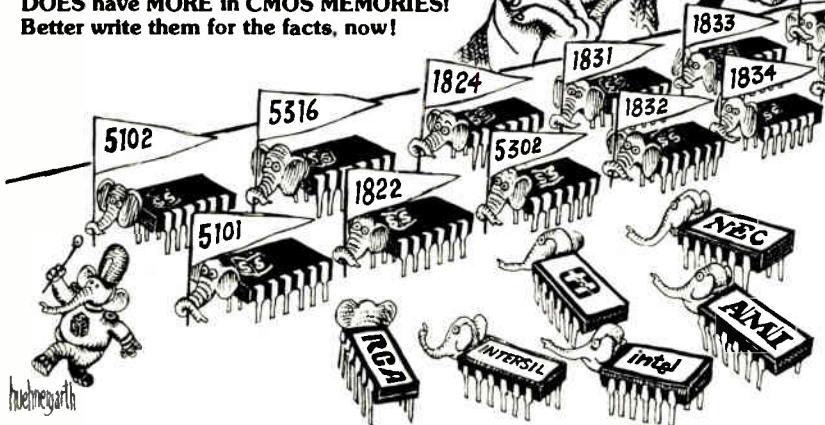

ANOTHER of the MANY SIDES of SOLID STATE SCIENTIFIC

Copy or clip coupon below and
attach to your letterhead. Mail to:
or Call:

SOLID STATE SCIENTIFIC
Montgomeryville, Pa. USA 18936
215-855-8400

Send me Facts about your CMOS RAM's, ROM's.

Name _____
Position _____
Company _____
Street _____
City _____ State _____
Zip _____
Phone _____



SOLID STATE SCIENTIFIC

Also send information about
THE OTHER SIDES OF
SOLID STATE SCIENTIFIC:

- μ MOS 1800 Microprocessors
- DT/ μ MOS Systems
- Custom MOS ICs
- HI Rel MOS
- Data Communications
- Display Drivers
- Security ICs
- 4000 Series
- Timekeeping

Circle 222 on reader service card

From Electronics Magazine Book Series. Zero-risk trial offer.



New Product Trends in Electronics, Number One
From "New Products," state-of-the-art materials and equipment, arranged according to function. \$14.95

Electronics Book Series
P.O. Box 669, Hightstown, N.J. 08520
Send me _____ copies of "New Product Trends in Electronics, Number One" at \$14.95 per copy

Discounts of 40% on orders of 10 or more copies.
I must be fully satisfied or you will refund full payment if the book is returned after ten-day trial examination.

- Payment enclosed Bill firm Bill me
- Charge to my credit card:
- American Express Diners Club
- Visa Master Charge

Acc't No. _____ Date exp. _____
On Master Charge only,
first numbers above name

Name _____ Title _____
Company _____
Street _____
City _____ State _____ Zip _____
Signature _____

New products/materials

A single-component fritless paste, suitable for screening conductors on printed-circuit boards, can be cured in one hour at temperatures as low as 90°C. Aremco-Coat 560 can be screened on in lines as narrow as 0.002 in., producing a conductive pattern only 0.00025 in. thick. The silver material has a viscosity of

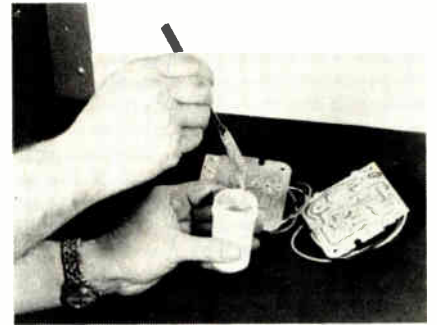

70,000 to 80,000 centipoises, a sheet resistivity of less than 0.04 ohm/square/mil, and a bulk resistivity of 2×10^{-5} ohm-cm. In lots of 50 grams, the material sells for \$1.25 per gram and in quantities of 1,000 g, 23 cents per gram. Delivery time is two to three weeks.

Aremco Products Inc., P. O. Box 429, Ossining, N. Y. 10562 [476]

A conductive resin coating, Eccocoat CC-30, is a one-component material that can be air-dried at room temperature in 15 to 30 min. It can be brushed or sprayed on, or the material to be coated can be dipped into it. Eccocoat CC-30 has a surface resistivity of 1 Ω /sq and will not be affected when bent over a 0.25-in. (0.635-cm) mandrel. It will operate over the temperature range of -65 to +350°F (-54 to +177°C). It has a shelf life of at least six months when stored in a sealed container at temperatures below 25°C.

Emerson & Cuming Inc., Dielectric Materials Division, Canton, Mass. 02021 [478]

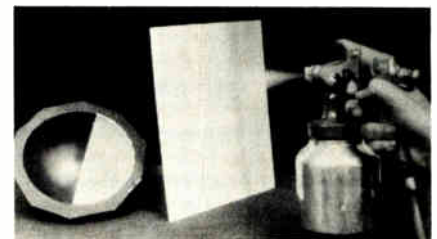



RELAX...it's amazing how an easy mind puts you in touch.

We're the easy mind people, TRW Capacitors. Our new X659F can solve your packaging problems. We call it "the new dimension capacitor". It's the smallest possible size—at the smallest possible price. The advanced design of the new TRW X659F utilizes very thin gauges of metallized polyester with design highlights such as capacitance values to 20.0 MFD, dissipation factors less than 1.0%. Electrically, the new X659F is interchangeable with our X663F. Same rugged durability and long stable life.

Oval shape allows either vertical or flat, horizontal

board-hugging mounting. It's ideally suited to small portable equipment for commercial and instrument grade products.

So if you have a packaging problem, relax and send for complete specifications and applications information on the new X659F Capacitor. Call or write: TRW Capacitors, An Electronic Components Division of TRW Inc., 301 W. "O" St., Ogallala, Nebraska 69153. Tel: (308) 284-3611.



Actual size .022 MFD, 400VDC

TRW CAPACITORS
ANOTHER PRODUCT OF A COMPANY CALLED TRW

Circle 223 on reader service card

Just published!

Your guide into the fascinating world of...

PERSONAL COMPUTING Hardware and Software Basics

A reliable, easy-to-use resource that tells you...

What's available in hardware and software, including costs.

Who's using it, and what they've experienced.

How it all works.

Why it's caught on so fast, including practical applications to use now.

Some of the most exciting advances in computing are taking place, not in research labs and commercial facilities, but in homes across the country. All sorts of people with a basic background in mathematics and electronics are taking the computer revolution into their own hands—experimenting with new equipment and technology, and devising their own *personal* applications.

If you've considered joining them, if you've thought about building or buying your own computer—this is a fast, up-to-date guide that answers all your questions precisely and reliably.

At your fingertips, all the most needed information on...

- what's available in personal computers
- the most popular microprocessor chips
- programming at microprocessor level and in high-level languages
- design hitches and how to prevent them
- where to buy
- plus a glossary of the most current terms in home computing

Drawn from major publications throughout the industry...

To get all the up-to-the-minute information and guidelines presented here, you'd have to read through numerous issues of...

- Electronics • Datamation • Mini-Micro Systems • BYTE
- Interface Age • IEEE Spectrum • Kilobaud • People's Computers

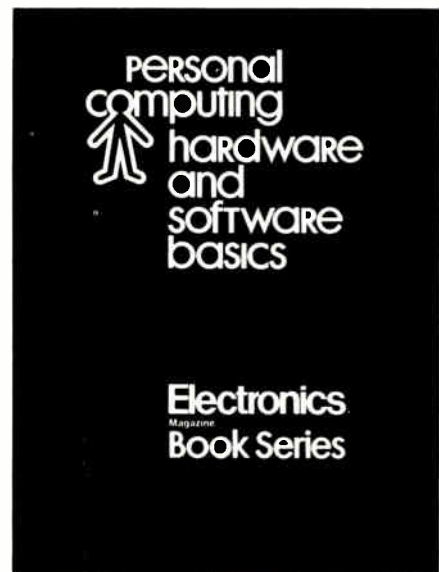

edited by

Raymond P. Capece, Solid State Editor,
Electronics Magazine
266 pages, \$11.95

Table of Contents

Part 1: Introduction to Personal Computing.
The term defined, equipment and components, costs, applications.

Part 2: Basic Computer Theory.
Microcomputer architecture with the emphasis on memory.

Part 3: Advanced Microcomputer Theory.
Board-level computers using the most popular microprocessor chips.

Part 4: Reviews of Personal Computers.
Features and capabilities of the most widely used microcomputers.

Part 5: Software for Microcomputers and Microprocessors.
Description and uses of both machine-level and high-level programming languages.

Part 6: Specifications and Other Useful Information.
Glossaries, microprocessor specs, electronics symbols, buying used equipment.

Electronics Magazine Books
P.O. Box 669, Hightstown, NJ 08520
(609) 448-1700, ext. 5494

No. of Copies	Title	Price
_____	Microprocessors	\$ 8.95
_____	Applying Microprocessors	\$ 9.95
_____	Large Scale Integration	\$ 9.95
_____	Basics of Data Communications	\$12.95
_____	Circuits for Electronics Engineers	\$15.95
_____	Design Techniques for Electronics Engineers	\$15.95
_____	Memory Design: Microcomputers to Mainframes	\$12.95
_____	Personal Computing: Hardware and Software Basics	\$11.95
_____	New Product Trends in Electronics	\$14.95



If after my 10-day free-trial examination I am not fully satisfied I understand that my payment will be refunded.

Payment enclosed Bill firm Bill me

Charge to my credit card:

American Express

Diners Club

Visa

Master Charge*

Acct. No. _____

Date Exp. _____

*On Master Charge only, first numbers above name _____

Name _____

Title _____

Company _____

Street _____

City _____

State _____

Zip _____

Signature _____

Discounts of 40% on orders of 10 or more copies of each book.

A complete line of laboratory, systems and test equipment power supplies.

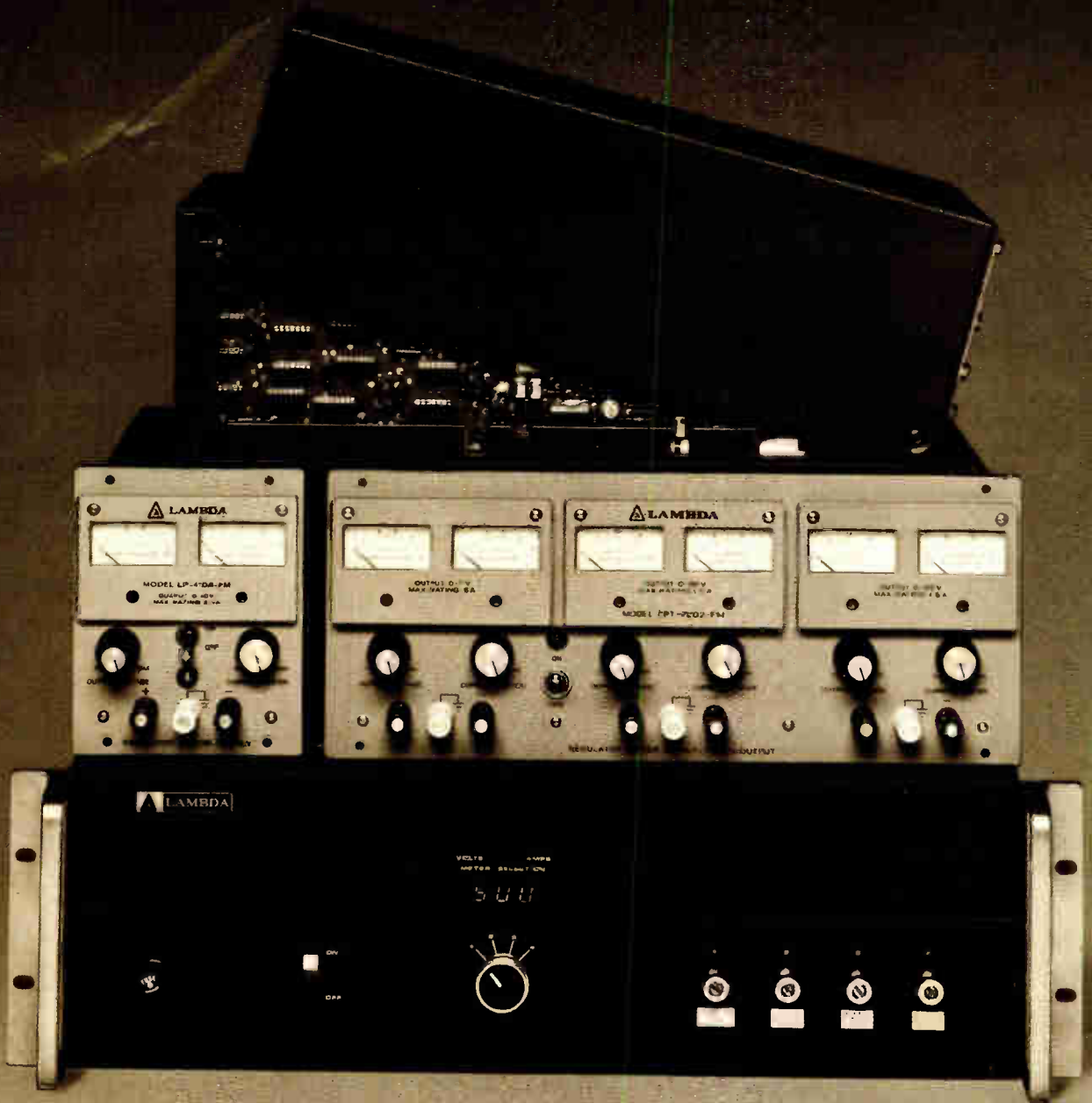

Standard and custom, bench and rack mountable,
DC supplies with single and multiple outputs.



LAMBDA

CUSTOM POWER SUPPLIES

LAMBDA MAKES IT EASY FOR YOU TO ORDER

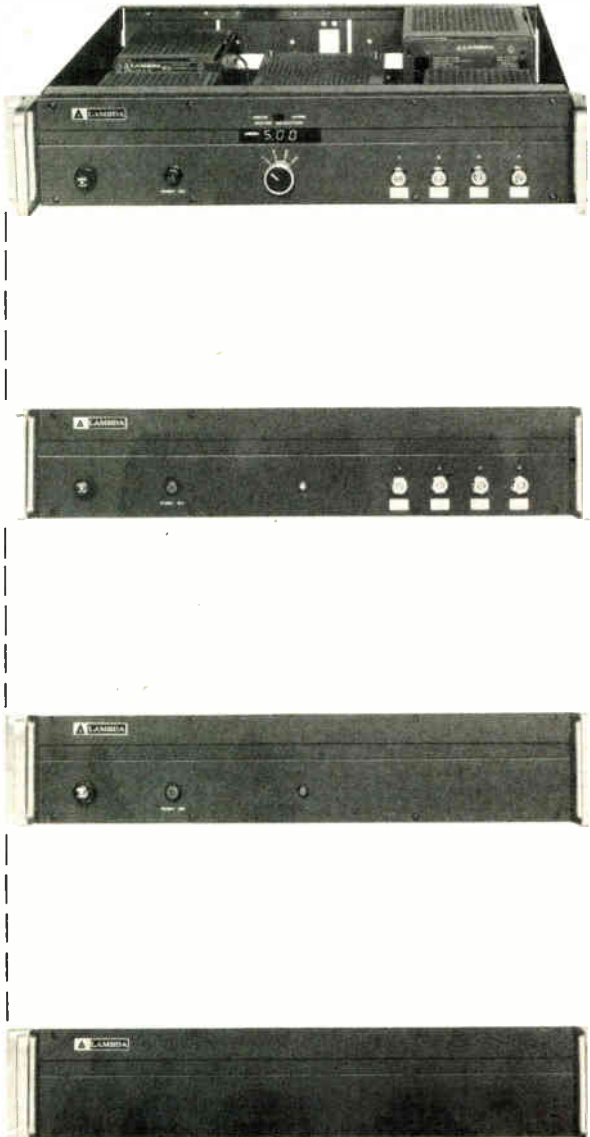

Built to your requirements

Lambda custom power supplies are designed to your requirements, and we have made it very simple for you to specify within our 16 standard configurations. By calling your nearest Lambda office you can tell us what we need to know:

1. To give you a firm price quotation on the number and type of custom units you require.
2. To design and build these supplies to the parameters you select.

No engineering charge

There is no engineering or set-up charge for designing your custom power supply. This is one more reason why Lambda can offer you a custom product at a lower cost than if you built it yourself.

Wide range of options

Lambda offers you a custom power supply with up to 4 outputs, in 4 package sizes and 4 front panel configurations for each package size. (Call your nearest Lambda office for your system requirements.) Choose one of the group of 5 regulation, ripple and temperature coefficient specifications for each output and we will determine which package size you need. From the descriptions on the following pages, also enter on the Request for Quotation Form the front panel configuration which best meets your monitoring and control requirements.

Six week delivery

Your custom power supply, assembled, wired and ready to operate will be shipped within 6 weeks after receipt of your order.

5 year guarantee

Every custom power supply is covered by Lambda's comprehensive 5 year guarantee (when five year guaranteed power supplies are used) which includes labor as well as parts. Guarantee applies to operation at full published specifications at end of 5 years.

PACKAGE SIZE J

3 1/2" x 19" x 14" • up to 8 outputs • and for any single output up to 150V, up to 90A

PACKAGE SIZE L

3 1/2" x 19" x 21" • up to 8 outputs • and for any single output up to 150V, up to 140A



CONFIGURATION 1

Blank panel. Economical when power supply will be remotely controlled. Maximum of 8 outputs (up to 4 power supplies) with AC input wiring provided through barrier strip on rear of rack adapter. Customer to provide necessary wiring for dc outputs available at rear of rack.

CONFIGURATION 2

Panel with on/off switch for AC input, pilot light and fuse. Maximum of 8 outputs (up to 4 power supplies) with AC input wiring provided through barrier strip on rear of rack adapter. Customer to provide necessary wiring for dc outputs available at rear of rack.



CONFIGURATION 3

Panel with on/off switch for AC input, pilot light and fuse plus voltage controls (up to 4 potentiometers provided). Maximum of 4 outputs with AC input wiring provided through barrier strip on rear of rack adapter and DC output wiring provided through barrier strip on rear of rack adapter. Power supply nameplates at output barrier strips and at front panel potentiometers.

CONFIGURATION 4

Panel with on/off switch for AC input, and fuse, plus voltage controls (up to 4 potentiometers provided) and metering panel (up to 4 supplies monitored, monitoring up to 70A up to 99.9V per supply). Maximum of 4 outputs with AC input wiring provided through barrier strip on rear of rack adapter and DC output wiring provided through barrier strip on rear of rack adapter. Power supply nameplates at output barrier strips and at front panel potentiometers.



Example

Package L, Configuration 3 provides a completely wired, assembled, ready-to-use, custom power supply consisting of:

Two LGS-6-12-OV-R (12V @ 37.5A with built-in OV)	\$642 ea.
One LRA-16 rack adapter	95
Panel, AC on/off, indicator light, fuse, cables, voltage potentiometers and assembly labor	170
	<hr/>
Total Price	\$1549

Call your nearest Lambda office for your custom system requirements.

PACKAGE SIZE K

5³/₁₆ x 19" x 14" • up to 8 outputs • and for any single output up to 150V, up to 135A

PACKAGE SIZE M

5³/₁₆" x 19" x 21" • up to 8 outputs • and for any single output up to 150V, up to 220A



CONFIGURATION 1

Blank panel. Economical when power supply will be remotely controlled. Maximum of 8 outputs (up to 4 power supplies) with AC input wiring provided through barrier strip on rear of rack adapter. Customer to provide necessary wiring for dc outputs available at rear of rack.

CONFIGURATION 2

Panel with on/off switch for AC input, pilot light and fuse. Maximum of 8 outputs (up to 4 power supplies) with AC input wiring provided through barrier strip on rear of rack adapter. Customer to provide necessary wiring for dc outputs available at rear of rack.



CONFIGURATION 3

Panel with on/off switch for AC input, pilot light and fuse plus voltage controls (up to 4 potentiometers provided). Maximum of 4 outputs with AC input wiring provided through barrier strip on rear of rack adapter and DC output wiring provided through barrier strip on rear of rack adapter. Power supply nameplates at output barrier strips and at front panel potentiometers.

CONFIGURATION 4

Panel with on/off switch for AC input, and fuse, plus voltage controls (up to 4 potentiometers provided) and metering panel (up to 4 supplies monitored, monitoring up to 110A up to 99.9V per supply). Maximum of 4 outputs with AC input wiring provided through barrier strip on rear of rack adapter and DC output wiring provided through barrier strip on rear of rack adapter. Power supply nameplates at output barrier strips and at front panel potentiometers.



Example

Package M, Configuration 4 provides a completely wired, assembled ready-to-use, custom power supply consisting of:

Two LGS-5-5-OV-R (5V @ 45A with built-in OV)	\$476 ea.
Two LGS-5-12-OV-R (12V @ 24A with built-in OV)	476 ea.
One LRA-17 rack adapter	95
Digital Meter, panel, AC on/off, indicator light fuse, voltage potentiometer, cables, and assembly labor	430
	<hr/>
Total Price	\$2429

Call your nearest Lambda office for your custom system requirements.

LL SERIES I-C REGULATED BENCH POWER SUPPLIES

for general purpose laboratory use

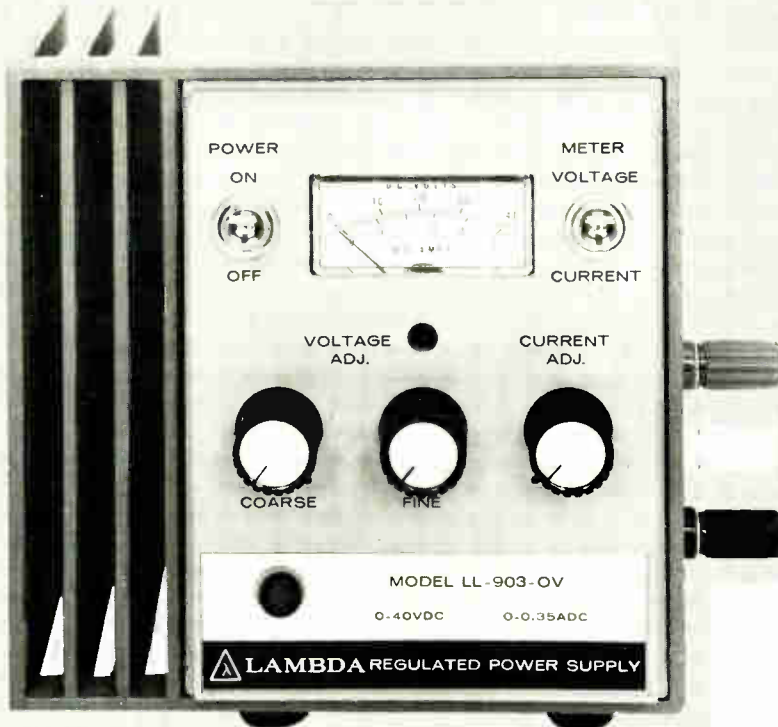

LL Series I-C Regulated Power Supply



Multi-position lies flat or stands erect

LL SERIES BENCH TYPE SUPPLY 5⁵/₈" x 5¹/₂" x 3⁷/₈"

MODEL	ADJ. VOLT. RANGE VDC	CURRENT RANGE (1)	PRICE(2)
3 models with built-in tracking overvoltage protection			
LL-901-OV	0-10	0-1 amp	\$163
LL-902-OV	0-20	0-0.65 amp	163
LL-903-OV	0-40	0-0.35 amp	163
LL-905	0-120	0-65 ma	163

REGULATION: Line: 0.01% + 1 mV Load: 4 mV

RIPPLE: 250 μ V RMS

NOTES:

- (1) Consult factory for operation at 400 Hz or temperatures above 50°C. Ratings apply 0-50°C.
- (2) All prices and specifications subject to change without notice.

Outstanding Features

All-silicon DC power supply using integrated circuit to provide regulation system

except for input and output capacitors, rectifiers, and series regulation transistors

Regulation

line: 0.01% + 1 mV

load: 4mV

Ripple

250 μ V RMS, 1 mV pk-pk

Convection cooled

Multi-position operation

lies flat or stands erect

Die-cast aluminum construction

Weight

less than 6 lbs.

No overshoot

on turn-on, turn-off or power failure

Adjustable current limiting

0 to 110 % of rating

Controls

course voltage adjust, fine voltage adjust, current adjust, ON/OFF switch, meter function switch

Built-in tracking overvoltage protection models available

LP SERIES SINGLE-OUTPUT POWER SUPPLIES LPD SERIES DUAL-OUTPUT POWER SUPPLY LPT SERIES TRIPLE-OUTPUT POWER SUPPLY

for general purpose laboratory and test equipment use.

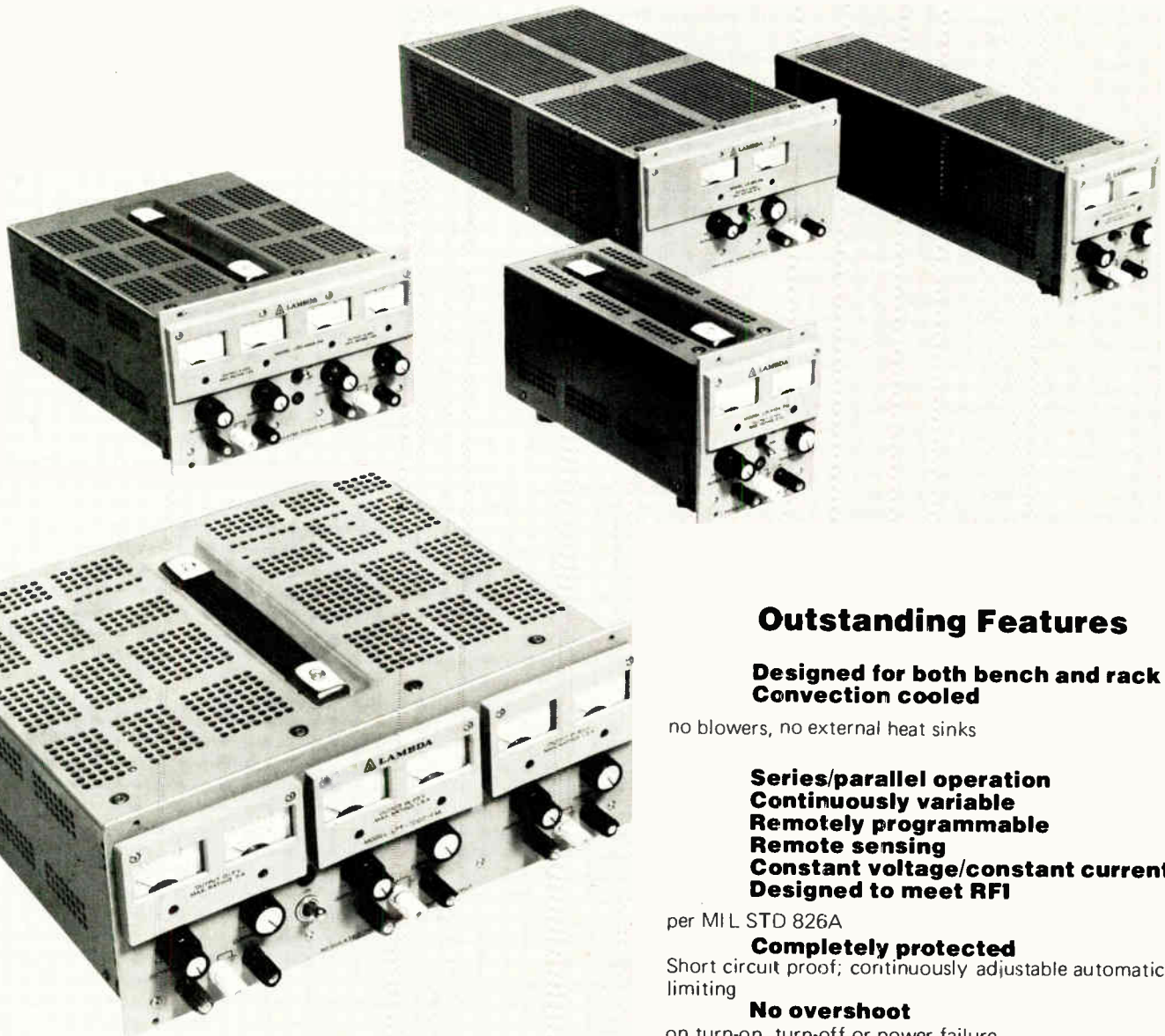

Widest selection of laboratory supplies with big-system features and capabilities for bench or rack use.

Outstanding Features

**Designed for both bench and rack use.
Convection cooled**

no blowers, no external heat sinks

**Series/parallel operation
Continuously variable
Remotely programmable
Remote sensing
Constant voltage/constant current
Designed to meet RFI**

per MIL STD 826A

Completely protected

Short circuit proof; continuously adjustable automatic current limiting

No overshoot

on turn-on, turn-off or power failure

Features of dual and triple output models

**6 models with independent DC
outputs offer widest choice**

up to ± 250 VDC, up to 5 Amps. Either output may be plus or minus, or both outputs may be plus or minus.

Series/parallel operation

of outputs yields two times the voltage or two times the current — up to 500 Volts or up to 3.4 Amps.

Auto series/auto parallel (master-slave)

permits tracking to a common reference

Separate meters

provide simultaneous monitoring of both voltage and current.

LPT SERIES TRIPLE OUTPUT MODEL

MODEL	REGULATION ^(s)	RIPPLE (RMS)	VOLTAGE RANGE (VDC) ⁽⁴⁾	MAX CURRENT, AMPS AT AMBIENT OF: ⁽¹⁾				DIMENSIONS	Price ⁽²⁾
				30°C	40°C	50°C	60°C		
LPT-7202-FM	0.01% + 1 mV	500 μ V	0-7	5.0	4.5	4.0	3.5	5 3/16" x 12 1/2" x 11"	\$706
			0-20	1.5	1.35	1.2	1.0		
			0-20	1.5	1.35	1.2	1.0		

LPD SERIES DUAL OUTPUT MODELS

MODEL	REGULATION ⁽⁴⁾	RIPPLE (RMS)	VOLTAGE RANGE ⁽³⁾ Per Output/ Outputs in Series VDC	MAX CURRENT, AMPS AT AMBIENT OF: ⁽¹⁾				DIMENSIONS	Price ^{(2),(3)}
				30°C	40°C	50°C	60°C		
*LPD-421A-FM	0.01% + 1 mV	500 μ V	0- \pm 20/0-40	1.7/3.4	1.5/3.0	1.3/2.6	0.9/1.8	5 3/16" x 8 3/8" x 10 3/32"	\$480
*LPD-422A-FM	0.01% + 1 mV	500 μ V	0- \pm 40/0-80	1.0/2.0	0.85/1.7	0.7/1.4	0.55/1.1	5 3/16" x 8 3/8" x 10 3/32"	480
*LPD-423A-FM	0.01% + 1 mV	500 μ V	0- \pm 60/0-120	0.7/1.4	0.6/1.2	0.5/1.0	0.4/0.8	5 3/16" x 8 3/8" x 10 3/32"	480
LPD-424A-FM	0.01% + 1 mV	500 μ V	0- \pm 120/0-240	0.38/0.76	0.32/0.64	0.26/0.52	0.20/0.40	5 3/16" x 8 3/8" x 10 3/32"	480
LPD-425A-FM	0.01% + 1 mV	1 mV	0- \pm 250/0-500	0.13/0.26	0.12/0.24	0.11/0.22	0.10/0.20	5 3/16" x 8 3/8" x 10 3/32"	572

LP SERIES SINGLE OUTPUT MODELS

0-10 VOLTS

MODEL	REGULATION ^(s)	RIPPLE (RMS)	MAX CURRENT AMPS AT AMBIENT OF: ⁽¹⁾				DIMENSIONS	Price ^{(2),(3)}
			30°C	40°C	50°C	60°C		
*LP-410A-FM	0.01% + 1 mV	500 μ V	2.0	1.8	1.6	1.4	5 3/16" x 4 3/16" x 10"	\$269
*LP-520-FM	0.01% + 1 mV	500 μ V	5.0	4.7	4.3	3.7	5 3/16" x 4 3/16" x 15 1/2"	332
*LP-530-FM	0.01% + 1 mV	500 μ V	10.0	9.0	8.0	7.0	5 3/16" x 8 3/8" x 15 5/8"	480

0-20 VOLTS

*LP-411A-FM	0.01% + 1 mV	500 μ V	1.2	1.1	1.0	0.8	5 3/16" x 4 3/16" x 10"	\$269
*LP-521-FM	0.01% + 1 mV	500 μ V	3.3	3.0	2.6	2.3	5 3/16" x 4 3/16" x 15 1/2"	332
*LP-531-FM	0.01% + 1 mV	500 μ V	5.7	5.3	4.7	4.0	5 3/16" x 8 3/8" x 15 5/8"	463

0-40 VOLTS

*LP-412A-FM	0.01% + 1 mV	500 μ V	1.0	0.90	0.80	0.60	5 3/16" x 4 3/16" x 10"	\$269
*LP-522-FM	0.01% + 1 mV	500 μ V	1.8	1.6	1.4	1.2	5 3/16" x 4 3/16" x 15 1/2"	332
*LP-532-FM	0.01% + 1 mV	500 μ V	3.0	2.9	2.7	2.3	5 3/16" x 8 3/8" x 15 5/8"	463

0-60 VOLTS

*LP-413A-FM	0.01% + 1 mV	500 μ V	0.45	0.41	0.37	0.33	5 3/16" x 4 3/16" x 10"	\$269
*LP-523-FM	0.01% + 1 mV	500 μ V	0.9	0.8	0.7	0.6	5 3/16" x 4 3/16" x 15 1/2"	338
*LP-533-FM	0.01% + 1 mV	500 μ V	2.4	2.2	2.1	1.8	5 3/16" x 8 3/8" x 15 5/8"	516

0-120 VOLTS

LP-414A-FM	0.01% + 1 mV	500 μ V	0.20	0.18	0.16	0.12	5 3/16" x 4 3/16" x 10"	\$297
LP-524-FM	0.01% + 1 mV	500 μ V	0.5	0.45	0.4	0.35	5 3/16" x 4 3/16" x 15 1/2"	378
LP-534-FM	0.01% + 1 mV	500 μ V	1.2	1.0	0.9	0.8	5 3/16" x 8 3/8" x 15 5/8"	572

0-250 VOLTS

LP-415A-FM	0.01% + 1 mV	500 μ V	80 mA	72 mA	65 mA	60 mA	5 3/16" x 4 3/16" x 10"	\$332
------------	--------------	-------------	-------	-------	-------	-------	-------------------------	-------

NOTES:

* Overvoltage protection available as an accessory. Each output requires separate OV accessory — add \$35.00 for each output. See Catalog

(1) Current rating applies over entire voltage range. Ratings based on 57-63 Hz operation.

(2) All prices subject to change without notice.

(3) LPD, LPT Series models require one LH-OV for each output.

(4) See next page for full specifications

SPECIFICATIONS OF LP, LPD & LPT SERIES

DC output

voltage ranges shown in tables.

Regulated voltage

regulation (line or load)	0.01% + 1mV for line variations from 105-132 VAC or for load changes from no load to full load.
current range	as shown in table
remote programming	200 ohms/volt nominal resistance
remote programming	volt per volt
voltage	
ripple and noise.	500uV RMS, 1.5mV pk-pk (either plus or minus terminal grounded.) LPD-425-A-FM model only 1mV RMS, 3mV, pk-pk.
Temperature.	(0.015% + 0.3mV)/°C
coefficient	C-LP, LPT models (0.015% + 0.5mV)/°C-LPD models

Constant current

(current regulated line and load)

Automatic crossover

voltage range	as shown in tables
current range	min: 45mA or 1% whichever is greater (LP-530-FM - LP-534-FM, LPT models only) all other LP models and LPD models 5mA or 1% whichever is greater.
	max: as shown in tables.
regulation (line	less than 0.2% or 5mA whichever is greater.
or load)	

AC input

105-132 VAC; 47-440 Hz. Ratings based on 57-63 Hz.
187-242 VAC; 205-265 VAC. See "AC Input Option."

Ambient operating temperature range

continuous duty from 0° to +60°C

Storage temperature range

-55°C to +85°C

Overload protection

Thermal

Thermostat, automatic reset.

Electrical

external overload.	adjustable, automatic electronic current limiting, settable to 105% of rated current.
internal failure	provided by fuse protection

Input and output connections

covered terminal block on rear of chassis; five-way binding posts on front panel. On LPD, LPT Models one set of five-way posts is provided for each output.

Meters

voltmeter and ammeter. For LPD, LPT Models, each output has a separate voltmeter and ammeter.

Controls

DC output controls

coarse and fine voltage and coarse and fine current adjust provided on front panel of all LPD, LPT models for each output. On all other LP models coarse and fine voltage adjust and single current adjust controls are provided.

Power

on-off switch, front panel.

Remote sensing

provision is made for remote sensing to eliminate effect of power output lead resistance on DC regulation.

Physical data

Series	Weight		Size (Inches)
	Lbs net	Lbs ship	
LP410A	7	10	5 3/16 x 4 3/16 x 10
LP520	14	18	5 3/16 x 4 3/16 x 15 1/2
LP530	25	30	5 3/16 x 8 3/8 x 15 5/8
LPD	13	16	5 3/16 x 8 3/8 x 10 3/32
LPT	24	29	5 3/16 x 12 1/2 x 11

Panel finish

tan glass-filled, flame-retardant nylon panels.

Accessories

rack adapters, overvoltage protectors, pot covers, blank panels. See catalog.

Options

Add suffix	for operation at:	Price Qty 1-14	Price Single Model Qty 15 & up	Price Mixed Model Qty 15 & up
-V	187-242 VAC 47-440 Hz	12% or \$30*	10%	12% or \$30*
-V1	205-265 VAC 47-440 Hz	12% or \$30*	10%	12% or \$30*

*Whichever is greater

For 50 Hz operation derate current 10% on all models

Fungus proofing

add suffix "-R" to model number and add 10% or \$25.00 to the price (whichever is greater).

Guaranteed for 5 years

5-year guarantee includes labor as well as parts. Guarantee applies, to operation at full published specifications at end of 5 years.

LE SERIES 20KHz WIDE RANGE SWITCHING POWER SUPPLIES

For use in laboratory, systems and test equipment

New



45% smaller by volume and 46% more amps per dollar than an equivalent SCR switching power supply.

Guaranteed 5 Years

Outstanding Features

Designed to meet military environment MIL-STD-810C

Digital Meter Readout

Convection cooled, no fans or blowers

Constant voltage/constant current

Oversvoltage protection — built in on all models

OUTPUT RATINGS FOR LES-F SERIES

MODEL	REGULATED OUTPUT VOLTAGE	MAX. OUTPUT CURRENT AT				PRICE
		40°C	50°C	60°C	71°C	
LES-F-01-0V	0 - 7.5V	100A	83A	66A	47.5A	\$1200
LES-F-02-0V	0 - 18V	47.5A	41A	32.5A	23.5A	1100
LES-F-03-0V	0 - 36V	24A	20.4A	16.5A	12A	1000
LES-F-04-0V	0 - 60V	15A	12.8A	10.3A	7.5A	1200

Note: Maximum output current applies over entire output voltage range.

SPECIFICATIONS OF LE SERIES

DC output and rating

Refer to the table.

Regulated voltage

regulation line	0.02% + 2 mv for line variations from 105 to 132 vac (or 187 to 242 vac on 'V' options, 205 to 265 vac on 'VI' options).
regulation load	0.02% + 2 mv (LES-F-01, 02) 0.02% + 4 mv (LES-F-03, 04) for load variations from 0 to full load.
remote programming resistance	200 Ω/volt nominal
remote programming voltage	volt/volt
ripple and noise	10 mv-rms; 50 mv pp for LES-F-01 15 mv-rms; 100 mv pp for LES-F-02,03,04
temperature coefficient	(0.02% + 50 μv)/°C

Constant current

(current regulated line and load)

automatic crossover.	
voltage range	As shown in table.
current range	5% to full load current.
regulation line	0.5% + 50 mA (LES-F-01, 02) 0.5% + 20 mA (LES-F-03, 04) line variations from 105 to 132 vac (or 187 to 242 vac on 'V' opts, 205 to 265 vac on 'VI' opts).
regulation load	0.5% of $I_{(max)}$ for load changes from 5% to rated DC voltage.

AC input

line	105-132 vac (47-63 Hz) standard input (derate output current by 5% at 50 Hz)
power	1250 watts max at 0.6 P.F. at maximum output voltage, nominal line.
efficiency	Minimum 60% at maximum output voltage.
soft start circuit	Limits inrush current at turn on to 200% of full load peak current.
input current	25A rms max.

Ambient operating temperature

Continuous duty from 0°C to 71°C with appropriate deratings (40°C to 71°C—see table).

Storage temperature range

-55°C to +85°C

Overload protection

Thermal

By self resetting thermostat

Electrical

External overload protection—adjustable, automatic, electronic current limiting circuit limits output current to preset value. Current limiting settability to 105% of rated current via front panel adjust.

Overvoltage protection

Built in, adjustable overvoltage protection standard on all sets. When preset voltage is exceeded, the overvoltage protector crowbars the output and removes the inverter drive. See table for OV range on each unit.

OVERVOLTAGE PROTECTION ADJUSTABLE RANGES - LES-F SERIES.

MODEL	V _{OUT}	ADJUSTABLE OVERVOLTAGE PROTECTOR RANGE	
		V _{OV(min)}	V _{OV(max)}
LES-F-01-0V	0 - 7.5VDC	3V	10V
LES-F-02-0V	0 - 18VDC	6V	24V
LES-F-03-0V	0 - 36VDC	9V	47V
LES-F-04-0V	0 - 60VDC	12V	70V

EMI

Conducted EMI conforms to MIL-I-6181D.

Cooling

Convection cooled—no fans or blowers.

Input and output connections

Heavy duty barrier strip and output studs on rear of chassis.

Meters

Digital panel meter standard on all sets monitors output voltage/current by means of a volt/amp selector switch.

Controls

DC output controls

coarse and fine voltage adjust and coarse current adjust on front panel.

Overvoltage protection

overvoltage trip point set by screwdriver adjust on front panel.

Power

on-off switch on front panel.

Remote sensing

Provision is made for remote sensing to eliminate effect of power output lead resistance on DC regulation.

Fungus proofing

All units are rendered fungi inert.

Options

AC Input	Add Suffix	For Operation at:	Price Qty. 1-14	Price Mixed Models Qty. 15 and up	Price Single Model Qty. 15 and up
	-V	187-242 VAC (47-63 Hz*) (derate current 10%)	12%	12%	10%
	-V1	205-265 VAC (47-63 Hz*)	12%	12%	10%

*derate 5% at 50 Hz operation

Accessories

Chassis slides (KHT-34-012).

Weight

net: 40 lbs
ship: 50 lbs

Size

3 1/2" x 19 x 16 1/2" (H x W x D)

Guaranteed for 5 years

5 year guarantee includes labor as well as parts. Guarantee applies to operation at full published specifications at end of 5 years.

LK SERIES HIGH CURRENT POWER SUPPLIES

for automatic test equipment, systems, and general
purpose laboratory use.

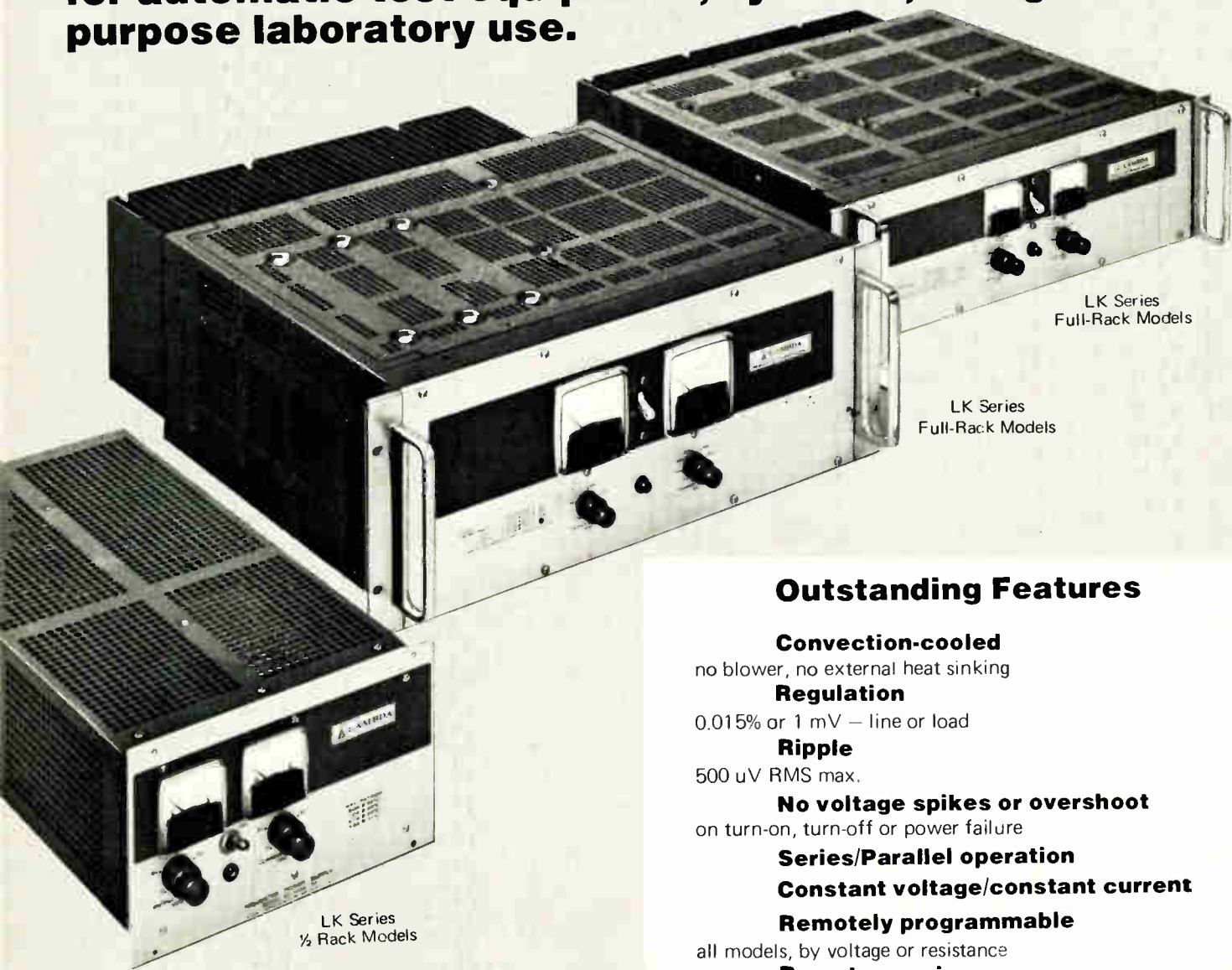

LK Series
Full-Rack Models

LK Series
Full-Rack Models

LK Series
1/2 Rack Models

All silicon convection-cooled power supplies
for bench or rack use

Outstanding Features

Convection-cooled

no blower, no external heat sinking

Regulation

0.015% or 1 mV — line or load

Ripple

500 μ V RMS max.

No voltage spikes or overshoot

on turn-on, turn-off or power failure

Series/Parallel operation

Constant voltage/constant current

Remotely programmable

all models, by voltage or resistance

Remote sensing

eliminates effect of power output lead resistance on
DC regulation

Meet mil, environment specs.

vibration: MIL-T-4807A

shock: MIL-E-4970A Proc. 1 & 2

humidity: MIL-STD-819 Meth. 507

temp. shock: MIL-E-5272C (ASG) Proc. 1

Altitude: MIL-E-4970A (ASG) Proc. 1

marking: MIL-STD-130

quality: MIL-Q-9858

LK SERIES

Three high current, all convection-cooled power packages

0-20, 0-36, 0-60 VDC and up to 66 Amps.

0-20 VOLTS

MODEL	REGULATION	RIPPLE (RMS)	MAX. CURRENT, AMPS AT AMBIENT OF:(1)				DIMENSIONS	PRICE (2)
			40°C	50°C	60°C	71°C		
LK-340-A-FM	0.015% or 1 mV	500 μ V	8.0	7.0	6.1	4.9	5 3/16" x 8 3/8" x 16"	\$ 601
LK-341-A-FM	0.015% or 1 mV	500 μ V	13.5	11.0	10.0	7.7	5 3/16" x 8 3/8" x 16"	779
LK-350-FM	0.015% or 1 mV	500 μ V	35.0	31.0	26.0	20.0	5 3/16" x 19" x 16 1/2"	1082
LK-360-FM*	0.015% or 1 mV	500 μ V	66.0	59.0	50.0	40.0	7" x 19" x 18 1/2"	1683

0-36 VOLTS

LK-342-A-FM	0.015% or 1 mV	500 μ V	5.2	5.0	4.5	3.7	5 3/16" x 8 3/8" x 16"	\$ 601
LK-343-A-FM	0.015% or 1 mV	500 μ V	9.0	8.5	7.6	6.1	5 3/16" x 8 3/8" x 16"	779
LK-351-FM	0.015% or 1 mV	500 μ V	25.0	23.0	20.0	15.0	5 3/16" x 19" x 16 1/2"	1082
LK-361-FM*	0.015% or 1 mV	500 μ V	48.0	43.0	36.0	30.0	7" x 19" x 18 1/2"	1683

0-60 VOLTS

LK-344-A-FM	0.015% or 1 mV	500 μ V	4.0	3.5	3.0	2.5	5 3/16" x 8 3/8" x 16"	\$ 653
LK-345-A-FM	0.015% or 1 mV	500 μ V	6.0	5.2	4.5	4.0	5 3/16" x 8 3/8" x 16"	779
LK-352-FM	0.015% or 1 mV	500 μ V	15.0	14.0	12.5	10.0	5 3/16" x 19" x 16 1/2"	1167
LK-362-FM*	0.015% or 1 mV	500 μ V	25.0	24.0	22.0	19.0	7" x 19" x 18 1/2"	1683

*AC INPUT 188-238 VAC STANDARD

OVERVOLTAGE PROTECTOR ACCESSORIES

ADJ. VOLT. RANGE VDC	MODEL	FOR USE WITH	PRICE
3-24	LH-OV-4	LK-340-A-FM, 341-A-FM	\$35
3-47	LH-OV-5	LK-342-A-FM, 343-A-FM	35
3-70	LH-OV-6	LK-344-A-FM, 345-A-FM	35
3-70	Add "-OV" to	LK-350-FM to 352-FM	100
3-70	Model No	LK-360-FM to 362-FM	135

NOTES:

- (1) Current rating applies over entire voltage range.
- (2) Overvoltage protection up to 70 VDC as a built-in option for full-rack models. To order, add suffix "-OV" and add \$100.00 to price of models LK-350-FM, 351-FM, 352-FM. For models LK-360-FM, 361-FM, 362-FM, add \$135.00 and order by adding -OV to model number.
- (3) Chassis slides for full rack models: add suffix "-CS" to model number and add \$70.00 to the price, except for models LK-360-FM, LK-361-FM and LK-362-FM, for which add \$120.00.

SPECIFICATIONS OF LK SERIES

DC output

voltage ranges shown in tables.

Regulated voltage

regulation line	0.015% or 1 mV whichever is greater for line variations from 105-132 VAC, (or 188-238 VAC LK-360-FM series); or for load changes from no load to full load.
remote programming	200 ohms/volt resistance
remote programming	volt per volt voltage
ripple and noise	500 μ V RMS; with either pos. or neg. terminal grounded.
temperature coefficient	0.015%/°C

Constant current

(current regulated line and load)

Automatic crossover

voltage range as shown in tables.

current range minimum—5% of 40°C rating, maximum — as shown in tables.

regulation, line less than 10 mA or 0.1% whichever is greater for Input Variations of 105-132 VAC (188-238 VAC LK-360-FM series).

regulation, load less than 10 mA or 0.1% whichever is great — from 0 to rated VDC load voltage change.

AC input

105-132 VAC, 47-63 Hz. (188-238 Vac, 47-63 Hz LK-360-FM Series only). For operation at 50 Hz derate output current by 10%. 187-242 VAC, see AC option.

Ambient operating temperature range

continuous duty from 0°C to +71°C with load current ratings shown in tables.

Storage temperature range

-55°C to +85°C

Overload protection

Thermal

thermostat; automatic reset when over-temp. condition is removed.

Electrical

external overload protection: adjustable, automatic electronic current limiting circuit limits the output current to the preset value, thereby providing protection for load as well as power supply. Current limiting settability to 105% of rated current. internal failure protection: provided by fuse.

Input and output connections

terminal block on rear of chassis

Meters

voltmeter and ammeter on all models.

Controls

DC output controls

coarse and fine voltage adjust and coarse and fine current adjust on front panel.

Power

on-off switch, front panel, — ½ rack models; circuit breakers, front panel — full-rack models.

Remote Sensing

provision is made for remote sensing to eliminate effect of power output lead resistance on DC regulation.

Physical data

Series	Weight		Size (Inches)
	Lbs net	Lbs ship	
LK-340-AFM	35	41	5 3/16 x 8 3/8 x 16
LK-350-AFM	95	125	5 3/16 x 19 x 16 1/2
LK-360-AFM	135	170	7 x 19 x 18 1/2

Panel finish

brushed aluminum clear anodized panels with grey inlay (standard).

Accessories

rack adapters LRA-1, LRA-2 (LK-340 series only) chassis slides, over-voltage protectors, pot covers, blank panels. See catalog.

Options

AC input

For LK-340, LK-350 Series Only

Add suffix	for operation at:	Price Qty 1-14	Price	Price
			Single Model Qty 15 & up	Mixed Model Qty 15 & up
-V	187-242 VAC 47-63 Hz	12% or \$30*	10%	12% or \$30*
-V1	205-265 VAC 47-63 Hz	12% or \$30*	10%	12% or \$30

For LK-360 Series Only

-V1	205-265 VAC 47-63 Hz	12% or \$30*	10%	12% or \$30*
-----	-------------------------	--------------	-----	--------------

*Whichever is greater

For 50 Hz operation derate current 10% for all models

Fungus proofing

add suffix "R" to model number and add 10% to price.

Guaranteed for 5 years

5-year guarantee includes labor as well as parts. Guarantee applies to operation at full published specifications at end of 5 years.

LB SERIES HIGH CURRENT, HIGH-EFFICIENCY POWER SUPPLIES

for use in main frame computers, component life tests
aging racks and test equipment

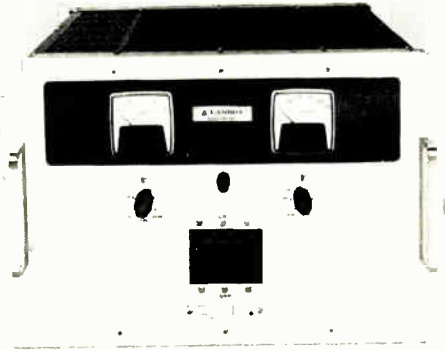

LB-720 Series High-Efficiency
Power Supplies

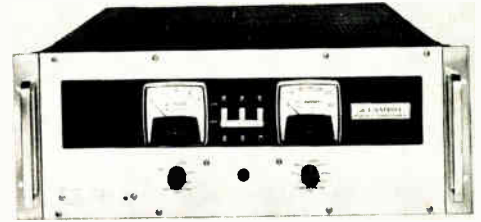

LB-700 Series High-Efficiency
Power Supplies

Convection-cooled – no internal fans

0-7.5 VOLTS

MAX AMPS AT
AMBIENT OF: (1)

MODEL	40°C	50°C	60°C	71°C	DIMENSIONS	PRICE
LB-701-FM-OV	300	270	235	200	7" x 19" x 20 1/16"	\$2728
LB-721-FM-OV	500	450	400	350	12 3/16" x 19" x 22 1/16"	4333

0-15 VOLTS

LB-702-FM-OV	180	170	160	150	7" x 19" x 20 1/16"	\$2728
LB-722-FM-OV	300	265	225	180	12 3/16" x 19" x 22 1/16"	4333

0-36 VOLTS

LB-703-FM-OV	80	75	70	65	7" x 19" x 20 1/16"	\$2728
LB-723-FM-OV	135	130	125	120	12 3/16" x 19" x 22 1/16"	4333

0-60 VOLTS

LB-704-FM-OV	50	47	44	40	7" x 19" x 20 1/16"	\$2728
LB-724-FM-OV	80	75	70	65	12 3/16" x 19" x 22 1/16"	4333

0-120 VOLTS

LB-705-FM	25	22	19	16	7" x 19" x 20 1/16"	\$2568
LB-725-FM	40	36	32	28	12 3/16" x 19" x 22 1/16"	4173

0-300 VOLTS

LB-706-FM	10	9.5	9.0	8.0	7" x 19" x 20 1/16"	\$2568
LB-726-FM	16	15	14	13	12 3/16" x 19" x 22 1/16"	4173

NOTES:

- (1) Current rating applies over entire voltage range.
- (2) Prices include meters. LB Series models are not available without meters. Prices for all models up to and including 60 VDC include built-in over-voltage protection.
- (3) Chassis slides are available with LB-701 thru LB-706-FM models only. Add suffix "CS" to the model number and add \$250.00 to the prices.

Outstanding Features

**Up to 87% efficiency
Regulation**

line 0.05% + 6 mV
load 0.1% + 10 mV

Ripple

10 mV RMS max. by use of electronic ripple reducer

Convection-cooled

no blowers or internal fans, no external heat sinking

Overvoltage protection

standard on all models up to 60 VDC rating

No overshoot

on turn-on, turn-off or power failure

Remotely programmable

Remotely sensing

Magnetics

designed to MIL-T-27C, grade 6

Completely protected

short circuit proof – continuously adjustable
automatic current limiting

Constant I /Constant V

by automatic crossover

Series operation

Multi-current-rated

for 40°C, 50°C, 60°C, 71°C

SPECIFICATIONS OF LB SERIES

DC output

voltage ranges as shown in tables

Constant voltage

regulation, line	0.05% + 6 mV for line variations from 187-229 VAC or from 229-187 VAC
regulation, load.	0.1% + 10 mV for load variations from 0 to full load
remote programming, resistance	200 ohms/volt nominal
remote programming, voltage	volt per volt
ripple and noise.	10 mV RMS max; 100 mV RMS max for LB-706-FM; 150 mV RMS max for LB-726-FM. With "V" option: 15 mV RMS for LB-701 thru LB-705; 150 mV RMS for LB-706
temperature coefficient	(0.03% + 0.5 mV/°C)

Constant current

(current regulated line and load)

Automatic crossover current range	zero to max. current as shown in tables
regulation (line and load, combined)	less than 1% + 10 mA for 721-725; less than 1% for 701-706 (1% + 50 mA for LB-726-FM) for input variations from 187-229 VAC or from 229-187 VAC and from 0 to 95% output voltage change
ripple and noise.	for LB-701-LB-705-FM and LB-721-FM-OV-LB-725-FM less than (1/Vout*)% RMS of load current either positive or negative terminal grounded for LB-706-FM, less than (10/Vout*)% of load current for LB-726-FM, less than (15/Vout*)% of load current. With "V" option (1.5/Vout*)% of I DC for LB-701-705; (15/Vout)% of I dc for LB-706

*Vout equals I out R_L measured at output terminals of power supplies.

AC input

208 ± 10% VAC; 57-63 Hz, 3 phase ± 10% max. phase unbalance, 4 wire. For operation at other than 57-63 Hz, see AC input option.

Efficiency

up to 87% efficiency.

Response time

for a 20% load change between 20% and 100% load, the voltage will recover to within 0.5 volt in 150 milliseconds.

Ambient operating temperature range

continuous duty from 0° to 71°C with load current rating shown in tables.

Storage temperature

-55° to +85°C.

Overload protection

Thermal

thermostat required resetting of circuit breaker to re-energize.

Electrical

external overload protection: adjustable, automatic electronic current limiting circuit limits the output current to the preset value, thereby providing protection for load as well as power supply. Current limiting settability to 110% of rated current.

internal failure protection: provided by primary circuit breaker.

Overvoltage protection

built-in overvoltage protection on all models up to 60 VDC ratings.

Input connections

terminal block on rear of chassis.

Output connections

LB-700 series: 2 heavy duty studs 1/2"-20 on LB-701-FM-OV and LB-702-FM-OV models; all other models: 5/16"-24 studs on rear of chassis. LB-720 series: 4 heavy duty studs 5/16"-24 on LB-721-FM-OV and LB-722-FM-OV models; all other models: 2 studs, 5/16"-24.

Meters

independent voltmeter and ammeter with ±2% accuracy.

Controls

DC output and control

coarse and fine voltage adjust and coarse and fine current adjust on front panel.

Power

circuit breaker to protect against internal failure and to provide an on-off control on front panel. Pilot lamp on front panel energizes when circuit breaker is "on"

Remote sensing

provision is made for remote sensing to eliminate effect of power output lead resistance on DC regulation up to 5 Volts in each leg..

Physical data

Series	Weight		Size (Inches)
	Lbs net	Lbs ship	
LB 700	230	240	7 x 19 x 20 1/16
LB 720	360	410	12 3/16 x 19 x 22 1/16

Panel finish

brushed aluminum clear anodized panels with grey inlay.

Chassis finish

grey, FED. STD. 595 No. 26081

Options

AC input

For LB 700 Series Only

Add suffix	for operation at:	Price Qty 1-14	Price	Price
			Single Model Qty 15 & up	Mixed Model Qty 15 & up
-V	208 ± 10% VAC 47-53 Hz 3 phase	12%	10%	12%

For 50 Hz operation derate current 10%.

-V1	230 ± 10% VAC 57-63 Hz 3 phase	12%	10%	12%
-----	-----------------------------------	-----	-----	-----

For LB-720 Series Only

-V1	230 ± 10% VAC 57-63 Hz 3 Phase	12%	10%	12%
-----	-----------------------------------	-----	-----	-----

Accessories

chassis slides (LB-701-FM-OV thru LB-706-FM models only) and pot covers. See Catalog

Guaranteed for 5 years

5-year guarantee includes labor as well as parts. Guarantee applies to operation at full published specifications at end of 5 years.

LR SERIES HIGH PERFORMANCE POWER SUPPLIES

for automatic test equipment in systems where high accuracy is required.

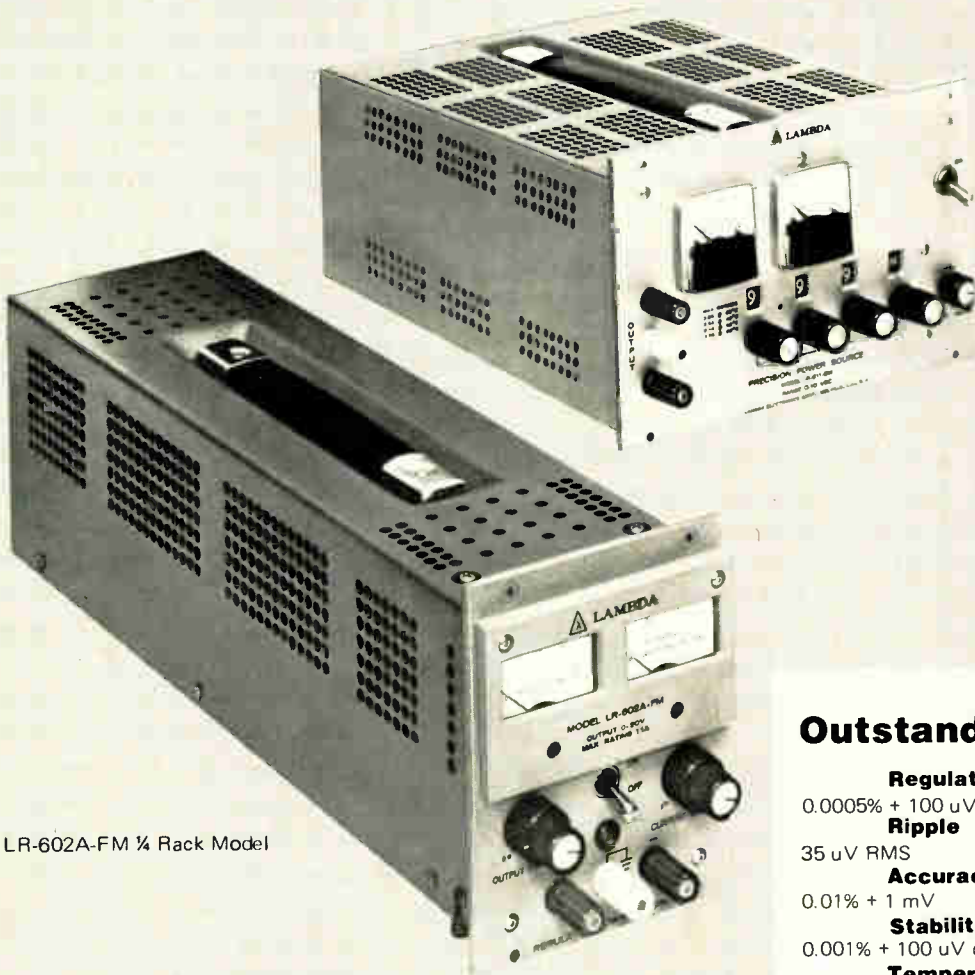

LR-602A-FM 1/4 Rack Model

LR-613-DM 1/2 Rack Model
with DIGITAL READOUT

MAX. CURRENT
AMPS AT AMBIENT OF: (1)

MODELS	MAX. CURRENT AMPS AT AMBIENT OF: (1)				DIMENSIONS	PRICE
	30°C	40°C	50°C	60°C		
0-20 VOLTS						
LR-602A-FM	1.1	0.95	0.80	0.64	5 3/16" x 4 3/16" x 15 1/4"	\$589
0-40 VOLTS						
LR-613-DM*	1.0	0.9	0.75	0.6	5 3/16" x 8 3/8" x 10 3/32"	\$1059

*Provided with digital readout.

NOTES:

(1) Current rating applies over entire voltage range. Ratings based on 55-65 Hz operation. Derate current 10% for 50 Hz input.

Outstanding Features

Regulation

0.0005% + 100 uV line or load

Ripple

35 uV RMS

Accuracy

0.01% + 1 mV

Stability

0.001% + 100 uV over 8 hr. period

Temperature coefficient

(0.001% + 10 uV)/°C

Constant I/Constant V

by automatic crossover

2 meters

monitor both voltage and current simultaneously and continuously.

Digital readout

for voltage output on all LR-DM models.

Convection-cooled

for convenience and reliability . . . no blowers or external heat sinks

Remote sensing

Remote programming

by external voltage or resistance for convenience in systems, test equipment and automatic equipment applications.

Auto series/auto parallel

with Master-Slave tracking

Completely protected

short-circuit proof; continuously adjustable automatic current limiting.

Overvoltage protection

available as low cost add-on accessory.

SPECIFICATIONS OF LR SERIES

DC output

voltage ranges shown in tables.

Regulated Voltage

regulation, line0.0005% plus 100uV for line variations from 105-132 VAC.
 regulation, load.0.0005% plus 100uV for load variations from 0 to full load.
 remote programming1000 ohms/volt. nominal resistance
 remote programmingvolt per volt voltage
 ripple and noise.35uV RMS, 100uV pk-pk with either positive or negative terminal grounded, with 60 Hz input.
 temperature coefficient(0.001% plus 10uV)/°C

Constant current

(current regulated line or load)

Automatic crossover

voltage rangeas shown in tables.
 current rangecontinuously adjustable from 1% to 100% of 30°C rating.
 regulationless than 2.0mA for input variations of 105-132 VAC and from 0 to rated VDC load voltage change.
 ripple and noiseless than 500uA with either pos. or neg. terminal grounded.

AC input

105-132 VAC, 47-440 Hz (derate DC output current 10% at 50 Hz). 187-242 VAC or 205-265 VAC, 47-440 Hz, see AC input option.

Accuracy *

0.01% plus 1 mV at 25°C.

Stability *

0.001% plus 100 uV over any 8-hour period after 30 minute warmup.

*Remote programming mode only on FM models.

Ambient operating temperature range

continuous duty from 0° to +60°C with load current ratings shown in table

Storage temperature range

-55°C to +85°C.

Overload protection

Thermal

thermostat; automatic reset when overtemperature condition is removed.

Electrical

limiting circuit limits the output current to the preset value, thereby providing protection for load as well as power supply. Current limiting settability to 105% of rated current.

internal failure protection: provided by fuse.

Input and output connections

covered DC output and AC input terminal blocks on rear of chassis.

Controls

DC output controls

coarse and fine voltage adjust on FM models; 5 digits voltage readout system including a continuous vernier on DM models.

Current limiter

coarse and fine front panel concentric controls on FM models; single front panel control on DM models.

Power

on-off switch, front panel.

Remote sensing

provision is made for remote sensing to eliminate effect of power output lead resistance on DC regulation, rear panel.

Physical data

Series	Weight		Size (Inches)
	Lbs net	Lbs ship	
LR-602A-FM	11	14	5 3/16 x 4 3/16 x 15 1/4
LR-613-DM	14	17	5 3/16 x 8 3/8 x 10 3/32

Retractable Bench Rest included for LR-FM Series

Finish

DM Models onlyBrushed aluminum clear anodized panels (standard).

FM Models onlyTan glass-filled, flame-retardant nylon panels.

Accessories

rack adapters LRA-1, LRA-2, overvoltage protectors, pot covers, blank panels. See Catalog

Options

AC input

Add suffix	for operation at-	Price Qty 1-14	Price Single Model Qty 15 & up	Price Mixed Model Qty 15 & up
-V	187-242 VAC 47-440 Hz	12% or \$30*	10%	12% or \$30*
-V1	205-265 VAC 47-440 Hz	12% or \$30*	10%	12% or \$30*

*Whichever is greater

For 50 Hz operation derate current 10%.

Fungus proofing

add suffix "R" to model number and add 10% to price except LR-DM models, for which fungus proofing option doesn't apply.

Guaranteed for 5 years

5-year guarantee includes labor as well as parts. Guarantee applies to operation at full published specifications at end-of-5 years.

LF-9-04 POWER SUPPLY

LF-9-04-GPIB POWER SUPPLY

The most advanced automatic test equipment power supplies on the market today

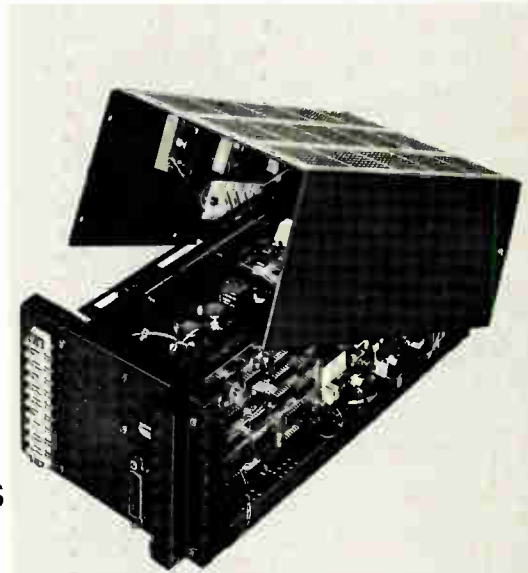

Now  Lambda offers two power supplies for your automatic test equipment power supply requirement. It provides plus or minus 0-50 volts at 2 amperes DC with the following features:

Features

LF-9-04		LF-9-04-GPIB	
8, 12, or 24 bit BCD programming or ASCII programming	current limit flag	IEEE Standard 488-75 interconnector bus ASCII programming	ripple—20 mV pk-pk on 50 Volt range
0.01% regulation, line or load	busy ready flag	0.01% regulation, line or load	optical isolation
A 2 msec programming time for full voltage compliance	Current limit programming	A 2 msec programming time for full voltage compliance	Current limit programming
15 mV accuracy for 50 V BCD programming	current over-ride	30 mV accuracy for 50V of ASCII programming	zero adjust
30 mV accuracy for 50V of ASCII programming	zero over-ride	Resolution 100 mV at 50 V	worst-case overshoot—1 volt
Resolution 50 mV (BCD) at 50 V; 100 mV for ASCII	inverted/noninverted input	100% sinking capability	transient response—1.2 msec
100% sinking capability	zero adjust	ripple—10mV pk-pk (BCD) on 50 Volt range; 20 mV for ASCII	unique digital circuitry designed with CMOS
optical isolation	worst-case overshoot—1 volt		
	transient response—1.2 msec		
	unique digital circuitry designed with CMOS		

Ordering Information

Model LF-9-04	Price \$1070	Model LF-9-04-GPIB	Price \$1284
------------------	-----------------	-----------------------	-----------------

SPECIFICATIONS OF LF-9-04

DC output

Volt (VDC)	MAX AMPS AT AMBIENT OF:		
	40°C	50°C	60°C
0 to ± 49.95	1.98	1.8	1.6

Output range

X1 range:	± 9.99V in 10 mV steps
*X5 range:	±49.95V in 50 mV steps
X10 range:	ASCII only – selected automatically(0– to ±49.9 V in 100 mV steps

Source or sink

1.98 amps continuous

Regulated voltage

regulation line.....	0.01% – for line variations 105-132VAC (see AC input option)
regulation load	0.01% – for load variation of (all ranges) 0 to full load.
ripple and noise.....	X1 range: 2.0 mV pk-pk max *X5 range: 10 mV pk-pk max X10 (ASCII): 20 mV pk-pk max
temperature coefficient	Voltage X1 range: .005%/°C+35 μV/°C *X5 range: .005%/°C + 0.115 mV/°C X10 range: (ASCII only) .005%/°C + .215 mV/°C Current All ranges: 500 μA/°C

Constant current operation

Current Range:	1% to 99% of full scale
Regulation line	1 mA max
load	20 mA max

AC input

105-132VAC, 47-440Hz. For 187-242 or 205-265 VAC see AC input option.

Ambient operating temperature range

continuous duty from 0° to 60°C with load current ratings shown in table.

Storage temperature range

–55°C to +85°C

Basic accuracy

(at 25°C, 115VAC input and no load).....	<u>Voltage</u> X1 range: 3 mV *X5 range: 15 mV X10 range: 30 mV (ASCII only) <u>Current</u> All ranges: 10 mA
--	--

Resolution

<u>Voltage</u> X1 range: 10 mV *X5 range: 50 mV X10 range: 100 mV (ASCII)	<u>Current</u> All ranges: 20 mA
--	-------------------------------------

Transient response

1.2 msec to within .05% of full scale for 90% load change
*BCD only

Overshoot

Worst case overshoot 1 volt under any conditions

Input data word:

A 24 Bit data word is used comprising of 12 bits BCD voltage programming, 8 bits BCD current and one bit each for gain, polarity and current limit override. Data word may be accepted in 3, 2, or 1 sequential segments of 8, 12, 24 bits, or ASCII to make up the 24 bits. Current is programmed as a percentage of full scale.

Programming time:

see graphs on page 113.

Data validity

10 μsec

Data loading

Logic Levels—all 0 to +5V. One CMOS load per line. Compatible with TTL or DTL

Interface requirements:

CMOS – direct

DTL – direct

TTL – direct, with a 10K pull up resistor on each data line to +5V bus.

Control lines

One TTL or DTL buffer per line

Data Flag – CMOS input

Zero Override – requires sinking of 15mA, compatible with DTL or TTL buffers

Final Transfer Pulse – CMOS input

Output flags

1. Current Limit Flag – optical coupler, conducting when in current limit.
2. Busy Ready Flag – open collector, logic zero when ready to accept new data.

Cooling

Convection-cooled, no heatsinks or blower necessary

Mounting positions

one mounting position on horizontal plane

Input/output connections through heavy duty barrier strip and connector

Physical data

Model (Package 9)	Size (inches)	Weight	
		lbs net	lbs ship
LF-9-04	4 15/16 x 7 1/2 x 14	20	22

Options

AC input

Add Suffix	for operation at:	Add to Price
–V	187-242 VAC, 47-440 Hz	12%
–V ₁	205-265 VAC, 47-440 Hz	12%

Accessories:

rack adapters LRA-15, LRA-17. Overvoltage protectors, chassis slides, blank panels. See catalog.

Guaranteed for 5 years.

5-year guarantee includes labor as well as parts. Guarantee applies to operation at full published specifications at end of 5 years.

SPECIFICATIONS OF LF-9-04-GPIB

DC output

Volt (VDC)	MAX AMPS AT AMBIENT OF:		
	40°C	50°C	60°C
0 to ± 49.95	1.98	1.8	1.6

Output range

X1 range:	± 9.99V in 10 mV steps
X10 range:	selected automatically (0- to ±49.9 V in 100 mV steps)

Source or sink

1.98 amps continuous

Regulated voltage

regulation line.....	0.01% — for line variations 105-132VAC (see AC input option)
regulation load.....	0.01% — for load variation of 0 to full load.
ripple and noise.....	X1 range 2.0 mV pk pk max X10 range 20 mV pk pk max
temperature coefficient.....	Voltage X1 range .005%/°C + 35 μV/°C X10 range .005%/°C + .215 mV/°C Current All ranges 500 μA/°C

Constant current operation

Current Range:	1% to 99% of full scale
Regulation line.....	1 mA max
load.....	20 mA max

AC input

105-132VAC, 47-440Hz. For 187-242 or 205-265 VAC see AC input option.

Ambient operating temperature range

continuous duty from 0° to 60°C with load current ratings shown in table.

Storage temperature range

-55°C to +85°C

Basic accuracy

(at 25°C, 115VAC input and no load).....	<u>Voltage</u>
	X1 range 3 mV X10 range 30 mV
	<u>Current</u>
	All ranges 10 mA

Resolution

<u>Voltage</u>	X1 range 10 mV
	X10 range 100 mV
<u>Current</u>	All ranges 20 mA

Transient response

1.2 msec to within .05% of full scale for 90% load change

Overshoot

Worst case overshoot 1 volt under any conditions

Input Data Format:

Data is entered in bit-parallel, byte-serial format as specified by IEEE Std. #488. The 24 programming bits contain 12 bits BCD voltage programming, 8 bits BCD current programming and one bit each for gain, polarity and mode. The valid data format is ASCII.

Programming time:

see graphs on page 113.

Data Loading:

Logic levels ("0" ≥ + 2.0V; "1" ≤ + 0.8V) and interface requirements are as specified in IEEE Std. #488.

Data Input Lines:

DIO-1 thru 8 as specified in IEEE Std. #488.

Control Lines:

ATN, EOI, IFC, NRFD, NDAC, DAV, SRQ, REN* as specified in IEEE Std. #488. All control and data input lines are accessed through 24-pin GPIB connector on back panel. The SRQ line is activated by a current overload condition while in constant voltage mode or overvoltage limit condition while in constant current mode. Mode of operation programmed with mode bit.

*REN is not a usable function for the LF-GPIB and is terminated in a logical "0".

Cooling

Convection-cooled, no heatsinks or blower necessary

Mounting positions

one mounting position on horizontal plane
Input/output connections through heavy duty barrier strip and connector

Physical data

Model (Package 9)	Size (inches)	Weight	
		lbs net	lbs ship
LF-9-04-GPIB	4 15/16 x 7 1/2 x 14 5/8	20	22

Options

AC input		
Add Suffix	for operation at:	Add to Price
-V	187-242 VAC, 47-440 Hz	12%
-V ₁	205-265 VAC, 47-440 Hz	12%

Accessories:

rack adapters LRA-15, LRA-17 Overvoltage protectors, chassis slides, blank panels. See catalog.

Guaranteed for 5 years.

5 year guarantee includes labor as well as parts. Guarantee applies to operation at full published specifications at end of 5 years.

SPECIFICATIONS OF LF-9-04, LF-9-04-GPIB

Programming Time mSec Vs Programmed Voltage Step (Constant Current Load)

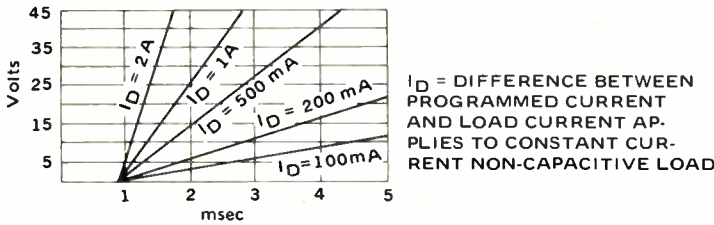

Programming Time mSec Vs Programmed Voltage Step (Resistive Load)

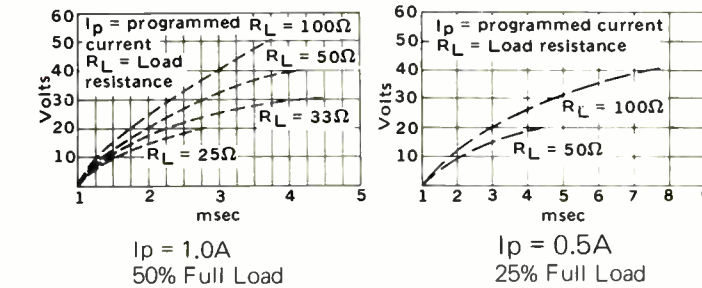
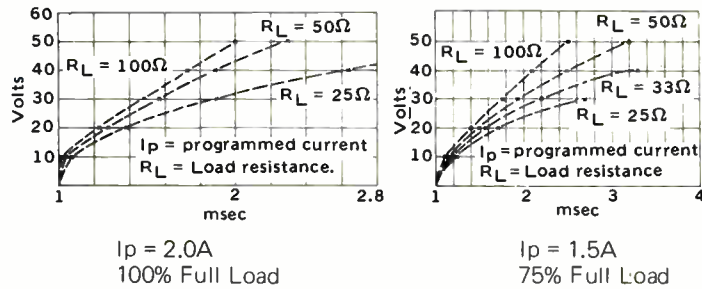

Programming Time mSec Vs Programmed Voltage Step (Capacitive Load)

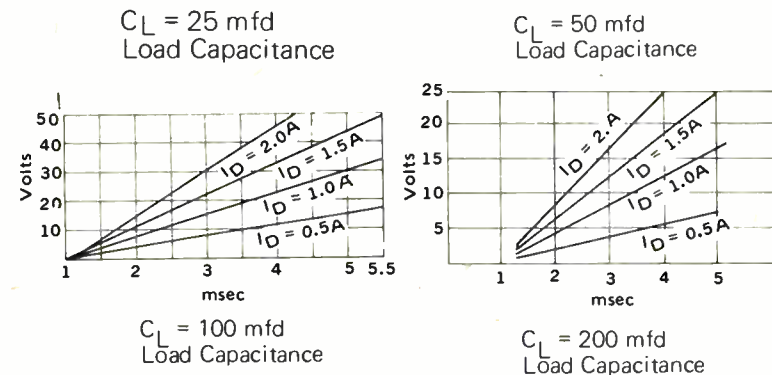
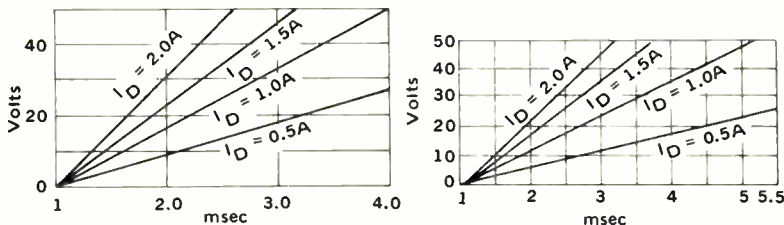

I_D = Difference between programmed current and constant load current.

DEFINITION OF TERMS:

Resolution:

Minimum programmable change

Basic Accuracy:

Maximum deviation from programmed value at 25°C constant temperature, 115 VAC and no load.

Programming Time:

Time, after data entry, required for the supply to settle within 0.05% full scale.

Data Flag: (Not Applicable to GPIB)

Customer generated 3.3 μsec minimum pulse, beginning at least 2 μsec after date is presented, to signal that data is available and ready for processing.

Final Transfer Pulse: (Not Applicable to GPIB)

Customer generated 2 μsec minimum pulse beginning at least 300 μsec after first data flag, to transfer data from input shift register into storage and the DAC's. This pulse is internally generated by the system for ASCII.

Data Validity: (Not Applicable to GPIB)

Minimum time for which data must remain present after data flag.

Transient Response:

Time required for supply to return to within 0.05% full scale of programmed value, for 90% change of load.

Overshoot:

Magnitude of voltage by which output may exceed programmed value or fall below zero volts during turn-on, turn-off, voltage to current limit crossover or current limit to voltage crossover and programming.

Zero Override: (Not Applicable to GPIB)

Input signal pulse programs output of power supply to zero volts. This signal is also activated when input data plug is pulled out. Zero override is a system feature that may be utilized in an emergency by forcing the output to zero volts from any previous state. When in that mode the output will be kept at zero ±50 mV max. While the output ripple will be limited to 15 mV pk-pk max.

Output Flags:

System generated signal, available to the user through the input data connector.

SUMMARY OF THE IEEE STD. #488

See Specifications of LF-9-04-GPIB

IEEE Standard #488 specifies a system for the interconnection of as many as 14 pieces of test equipment on a single 24-wire bus controlled by a central processing unit. The bus consists of 8 bidirectional data lines, 8 command lines and 8 ground lines. Data is transferred along the bus via a specific 3-wire "handshake" process. This process greatly reduces the possibility of lost data since any one operation must be confirmed by all addressed units before the following operation may commence.

The address system allows the controller to identify the units which are to transmit or receive data while allowing the other units on the bus to function uninterrupted. The service request (SRQ) line provides each module on the bus with the ability to inform the controller if a particular condition in that module warrants attention or service.

Listed below are the designations of the 8 command lines and a brief function description for each:

1. **ATN (ATTENTION)** - This line is used to call the attention of all units on the bus (i.e., all units are listening). All command instructions must be given under this signal.
2. **IFC (INTERFACE CLEAR)** - This line is used to set the interface—parts of which are contained in all units on the bus—at a known quiescent state.
3. **SRO (SERVICE REQUEST)** - This line provides a means for each unit on the bus to indicate to the controller that a condition exists which may require attention or service.

4. **EOI (END OR IDENTIFY)** - This line is used to indicate the end of a particular multiple-byte transfer sequence.
5. **REN (REMOTE ENABLE)** - This line is used to select between two alternate sources of device programming data (i.e., computer control or local control).

The remaining three commands comprise the three-wire "handshake" process. This process utilizes interlocking command sequences to transfer each data byte across the interface. These sequences can only proceed at the rate of the slowest addressed unit on the bus, thus assuring that all units on the bus can completely assimilate the data.

6. **DAV (DATA VALID)** - This command is used by the "talker" to indicate that the data on the DIO signal lines is valid and ready to be processed.
7. **NRFD (NOT READY FOR DATA)** - This line is used by the "listeners" on the bus to indicate whether or not they are ready to process the next byte of data.
8. **NDAC (NOT DATA ACCEPTED)** - This line is used by the "listeners" on the bus to indicate that the data on the line has been processed and can now be removed.

Consult Factory For:

- A. Application information using BCD as input format.
- B. Application information using IFC as an emergency shutdown.

ACCESSORIES

Overvoltage Protectors Accessories



Adj. Volt. Range VDC	Model	For Use With	Price
3-24	LH-OV-4	LP-530-FM, LP-531-FM, LK-340A-FM, LK-341A-FM, LP-410A-FM, LP-411A-FM, LPD-421A-FM, LR-602A-FM, LP-520-FM, LP-521-FM	\$ 35
3-47	LH-OV-5	LP-532-FM, LK-342A-FM, LK-343A-FM, LP-412A-FM, LPD-422A-FM, LP-522-FM	35
3-70	LH-OV-6	LP-533-FM, LK-344A-FM, LK-345A-FM, LP-413A-FM, LPD-423A-FM, LP-523-FM, LP-413A-FM, LR-613-DM, LK-350-FM, LK-351-FM, LK-352-FM	35 100
		LK-360-FM, LK-361-FM, LK-362-FM	135

Add "-OV" to power supply model number

Adjustable Crow bar type (Mounting provisions provided 2 terminal connections.)

RACK ADAPTERS



LRA-1 Rack Adapter
5 3/16" H x 19" W x 16 1/2" D
For use with LP, LPD, LK, LR, series \$85

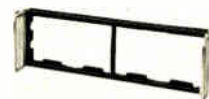

LRA-2 Rack Adapter
5 3/16" Heights
For use with LP, LPD, LK LR series \$50

A complete line of laboratory, systems and test equipment power supplies.



WORLD'S LARGEST MANUFACTURER OF STANDARD POWER SUPPLIES.

▲ Lambda staffed sales and service offices

1

ATLANTIC REGION

Melville, New York 11747
515 Broad Hollow Road
Tel. 516-694-4200
TWX: 510-224-6484

Long Island, N.Y.; New York, N.Y.;
Northern New Jersey
Tel. 516-694-4200

Poughkeepsie, New York
Tel. 914-297-4800

Southern New Jersey
Tel. 609-965-5299

Eastern Pennsylvania; Delaware;
Tel. 215-279-5644

Maryland; Dist. of Columbia;
Northern Virginia
Tel. 301-951-0968

Southern Virginia;
North & South Carolina;
Tel. 919-373-0339

Alabama; Georgia;
Tennessee; Mississippi
Tel. 404-581-0593

Orlando, Florida
305-422-0288

Ft. Lauderdale, Florida
Tel. 305-564-6330

2

NORTH-EASTERN REGION

Lexington, Massachusetts 02173
2 Millis Drive
Tel. 617-861-8585
TWX: 710-325-7558

Rochester, New York
Tel. 716-454-8770

3

SOUTH-WESTERN REGION

Dallas, Texas 75231
6950 Winchester
Tel. 214-341-5130
TWX: 910-861-2048

Houston, Texas
Tel. 713-464-6554
Oklahoma
Tel. Enterprise 2-143

4

MID-WESTERN REGION

Arlington Heights, Ill. 60005
2420 East Oakton St., Unit Q
Tel. 312-593-2550
TWX: 910-222-2856

St. Louis, Missouri
Tel. 314-822-8944

Dayton, Ohio
Tel. 312-593-2550

Minneapolis, Minnesota
Tel. 612-373-0997

Detroit, Michigan
Tel. 313-961-9611

Cleveland, Ohio;
Western Pennsylvania
Tel. 216-431-9806

5

FAR-WESTERN REGION

Cerritos, Ca 90701
12607 Hidden Creek Way Suite J
Tel. 213-926-0562
TWX: 910-346-7649

6

NORTH-WESTERN REGION

Sunnyvale, Ca 94086
599 N. Mathilda Ave.
Tel. 408-738-2514
TWX: 910-339-9243

CANADA

Veeco Lambda Ltd.
100C Hymus Blvd
Pointe-Clair, Quebec-H9R 1E4
Tel. 514-697-6520
TWX: 510-422-3929
Veeco Lambda Ltd.
P.O. Box 501, Postal Station K
Toronto, Ont., M4P 2G9
Tel. 416-486-0744
TWX: 610-422-3029

▲ LAMBDA
ELECTRONICS
DIVISION OF **Veeco** INSTRUMENTS INC.

New literature

Tape-drive troubles. Crosstalk, dropouts, and interchannel time-displacement errors are scrutinized in three papers. Each paper includes graphic representations of the tape-drive troubles discussed, such as curves showing typical crosstalk for adjacent and nonadjacent tracks and diagrams showing how head-tape separation causes dropouts. The papers are numbered 5952-2844 (crosstalk), 5952-2841 (dropouts), and 5952-2848 (interchannel time-displacement errors). Write the Inquiries Manager, Hewlett-Packard Co., 1507 Page Mill Rd., Palo Alto, Calif. 94304 or circle reader service number 423.

Maskmaking. A four-page brochure delineates the mask-making capabilities of Electromask Inc. and lists the specifications that the company can meet. Electromask Inc., E-Mask Division, a subsidiary of TRE Corp., 6109 De Soto Ave., Woodland Hills, Calif. 91367 [430]

Semiconductor equipment. Specifications and illustrations for more than 800 semiconductor processing and handling products are contained in Fluoroware's 1979 products catalog. Among these items are: injection-molded processing carriers, tanks, trays, tweezers, tongs, beakers, chip trays, and storage and shipping boxes. For a copy of the catalog, write to Fluoroware Inc., Jonathan Industrial Center, Chaska, Minn. 55318 [426]

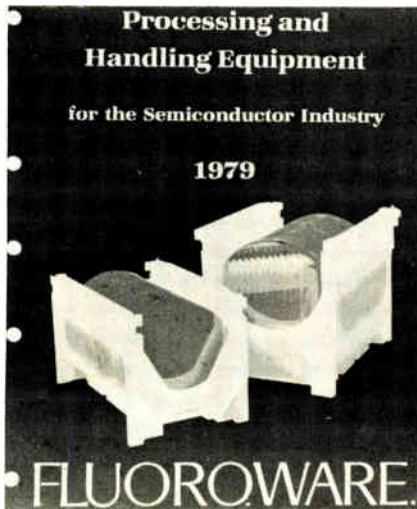

"When are you going to get yours?"

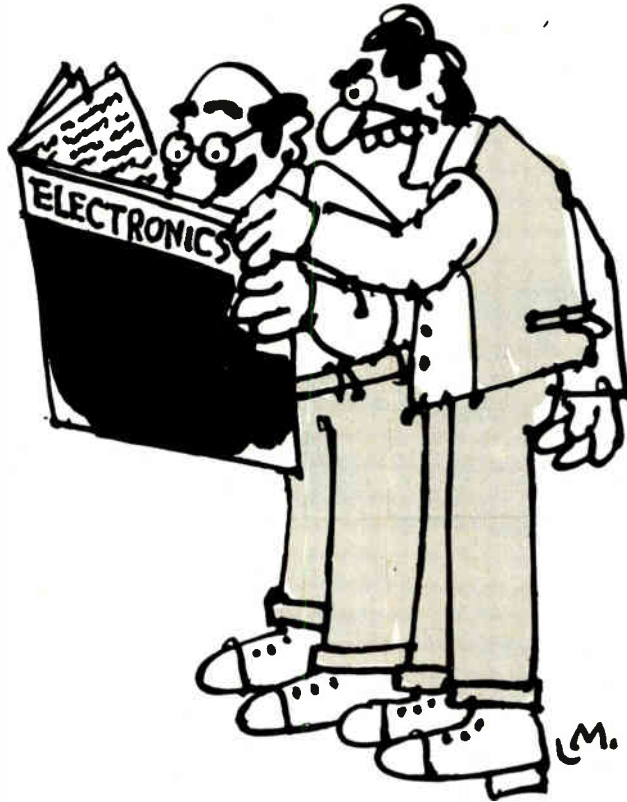

When are you going to get your very own, personal subscription to *Electronics*?

It could be very important to you. And we're not just referring to your status in the office hierarchy.

You (and we) are in a quick-moving business. News breaks frequently. Change is the name of the game. Awareness is the way to win.

You've got to follow what's going on beyond your specialty. Your career may have to last longer than your specialty.

If change is the game, obsolescence is the penalty for losing. Obsolescence of products, of technology and, unfortunately, of people. We can't change this fact. But we can help you cope with it.

Give us one hour of reading time every two weeks and we will keep you aware of what's going on around you and around the changing world of electronics technology.

Move up. Fill out one of the subscription postcards in this issue.

Electronics Magazine. The one worth paying for.

Classified section FOR ENGINEERING/TECHNICAL EMPLOYMENT OPPORTUNITIES

CLASSIFIED SALES REPRESENTATIVES

Atlanta	404/892-2868	Cleveland	Mac Huestis	216/781-7000	Houston	Mike Taylor	713/659-8381	Philadelphia	Dan Ferro	215/568-6161
Boston	Jim McClure	Dallas	Mike Taylor	214/742-1747	Los Angeles	Ana Galaz	213/487-1160	Pittsburgh	Dan Ferro	412/391-1314
Chicago	Bill Higgins	Denver	Shirley Klotz	303/837-1010	New York	Larry Kelly	212/997-3594	San Francisco	Peter McGraw	415/362-4600
	312/751-3733	Detroit	Mac Huestis	313/873-7410				Stamford	William Eyd	203/359-2860

Sales Manager—Mary Ellen Kearns—212/997-3306

FACULTY POSITIONS VACANT

Applicants are invited for a faculty position in The Electrical Engineering Dept. at South Dakota State University, Brookings, SD to begin Aug. 16, 1979. Rank and salary are commensurate with background and ability. Acceptance of applications until position is filled. Contact Dr. V. Ellerbruch Head, or call 605-688-4526. An equal opportunity/affirmative action employer.

Physics/Earth Sciences Anticipated Position—Assistant Professor, Full-time, 10 month position, Salary: \$14,850, Fall 1979. Responsibilities: Teach Electronics for Physics and Pre-Engineering Students; Computer Electronics including integrated circuits, microprocessors, and interfacing techniques. To develop computer assisted instructions in Physics courses and develop courses in computer hardware to enhance computer science program. Qualifications: Ph.D. strongly preferred, will consider M.S. with appropriate experience or Engineering background. Resumes forwarded to: Dr. James A. DellaValle, Chairperson, Physics/Earth Sciences Dept., Central Conn. State College, New Britain, Connecticut 06050. Please include three(3) letters of recommendation. Deadline for application: June 1, 1979. EOE/Minorities, Females. Handicapped persons encouraged to apply.

Anticipated faculty position in Bachelor of Technology Program Fall 1979. Teach courses in areas of digital electronics micro-processors, and computer interfacing. Ph.D. required for assistant professor appointment; industrial and teaching experience desired. Send resumes to: Dr. George DePuy, Director of Technology Programs, School of General Studies, SUNY-Binghamton, Binghamton, New York 13901. An equal opportunity employer.

3 Tenured Track Faculty positions available in the Department of Electronics and Computer Technology. Fall 1979. Send resumes to: Richard Lyons, Department of Electronics and Computer Technology, School of Technology, Indiana State University, Terre Haute, IN 47809. Applications received after June 1, 1979 cannot be assured consideration. Equal Opportunity/Affirmative Action Employer.

POSITIONS VACANT

Engineers and Designers—Florida positions urgently need electronic experience. PCB, Analog, Electronic Packaging, and logic design experience desired. Permanent or long term contract positions. All fees paid. Salaries 15K to 30K. Rush confidential resume and earnings history to: J. C. Dayvault, President, R. P. Rita Inc., 1211 N. Westshore Blvd #107, Tampa, Florida 33607.

ENGINEERS:

AMECOM Challenges You!

Put Your Ideas Up Against Our Best in EW/ECM Systems.

We work on the leading edge of EW and ECM systems, and our success is measured by the major programs in house with production follow-on to provide systems operating capability through the year 2000. If you are an innovative Microprocessor or EW Software Engineer we challenge you to work in the development of multifunction distributed microprocessors.

These positions range from Member of the Technical Staff to Senior Scientist with salaries to \$35,000.

Find out more about the challenges waiting for you at AMECOM. Please send your resume including salary history, or better yet, call COLLECT to:

Philip T. Foster
(301) 864-5600

AMECOM also has openings for Telecommunications and RF Engineers at our College Park headquarters. We are located in a pleasant Maryland suburb close to the Nation's capital with your choice of city, suburban, waterfront or country living.

 **AmeCom Division**
LITTON
SYSTEMS, INC.

5115 Calvert Rd., College Park, Md. 20740
An Equal Opportunity Employer M/F/H

Build a career.

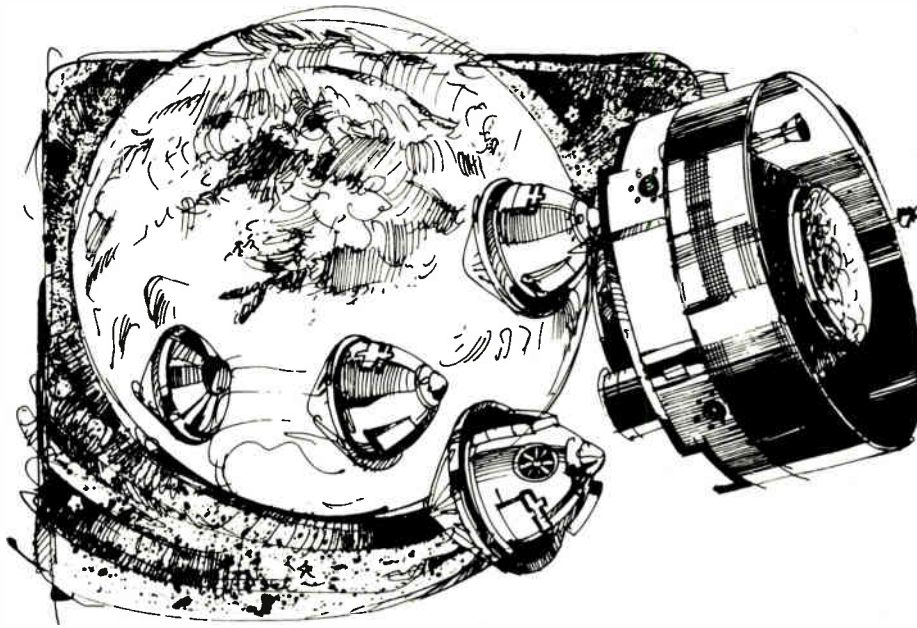

With the people who built Pioneer Venus.

In February, 1974, Hughes Space & Communications was assigned one of the most epochal missions in space exploration. It was to build two different kinds of spacecraft. To take two different flight paths to Venus. And send back to Earth streams of invaluable new information.

In May, 1978, the first phase of Pioneer Venus was launched. And today, NASA officials are still marveling at the mission's success. In 90 minutes, Pioneer Venus told scientists more about Venus than mankind had learned since the days of Galileo.

At Hughes Space & Communications, the success of Pioneer Venus is already gearing us up for new programs now underway.

That's why, when you build a career at Hughes Space & Communications, you join much more than our stellar accomplishments. You join our future.

And if you take a college course after hours, we pay for 100% of it.

If building a career in this kind of environment appeals to you, join top-notch engineers and computer scientists working on top-priority programs.

Other communications and scientific spacecraft by Hughes: Syncom; ATS; Tacsat; Intelsat I, II, IV and IV-A; OSO-8; GMS-1; Marisat; Anik; Westar; Comstar; Palapa I.

Applications Software Development.

- Software Development (Fortran, Compass, Macro 11).
- Top-Down, Structured Software Design and Programming.

DP Systems Engineering and Analysis.

- Software Requirements Engineering.
- Resource Requirements Analysis.
- Software Design.

DP Systems Integration, Test and Evaluation.

- Test/Evaluation across DP life-cycle.
- Programming/Checkout of Test Driver Software.
- DP Software and Hardware Testing.

Communications Systems and Components.

- R.F. Circuit Design and Development.
- Solid State Transmitter and Receiver Design.
- Power Supply Design, Lo and Hi Voltage.
- R.F. Packaging and Product Design.

Microwave Systems, Antennas and Components.

- Antenna Design and Fabrication.
- Microwave Circuits, Filters, Solid State Design and Development.
- Spacecraft Communications Receiver Engineering.

Digital Communications and Control Systems.

- Telemetry and Command Analog/Digital Circuit Design.
- Advanced LSI Custom SOS/CMOS Design.
- Test Equipment and Packaging Design.

Please send your resumé to T. W. Royston, Space & Communications Group, Department EL, Building 373, Mail Station 170, P.O. Box 92919, Los Angeles, CA 90009.

HUGHES

HUGHES AIRCRAFT COMPANY

**SPACE &
COMMUNICATIONS
GROUP**

U.S. Citizenship required.
Equal Opportunity M/F/HC employer.

Microcomputer Applications Engineers

At Intel, we don't wait for technological change to happen—we make it happen—almost everyday! So, once again, our fast-growing, highly respected Microcomputer Components Division is breaking new ground. If you want to work with the people who brought you the 8080, the 8085, and the new 8086 in the continuing development of state-of-the-art microcomputer components, consider this opportunity as a Microcomputer Applications Engineer.

You will be responsible for developing hardware and software applications for existing and newly designed microcomputers to support OEM manufacturers' needs. You will interface extensively with customers, participate in technical conferences and prepare articles for trade publications. To qualify for this highly visible position, you must have a BSEE or equivalent combination of education and experience and at least 3 years' experience in microcomputer hardware and software development. Some experience in automotive control applications is desirable.

For immediate consideration, please send your resume to Joyce Cordi, Intel Corporation, Dept. 17BD, P.O. Box 3078, Santa Clara, CA 95051. An equal opportunity employer m/f/h.



ELECTRICAL ENGINEERS

Immediate Openings Nationwide positions. All fees and relocation paid by our client companies. Call collect or send resume to K. Schargus or S. Nemser.

Electronic schematics, semi-conductors, PC boards, circuit design, terminal systems, microwave, modems, multiplexers, instrumentation, DTL, TTL, HTL, MOS logic, peripherals, kinematics, electro-optical, computer systems, acoustics and sonar.

American Personnel Service
240 State Street
New London, Conn. 06320
203-442-0395

ENGINEERS

We currently have numerous positions available for engineers throughout the Northeast. If you are in the salary range of 18-35K and have a desire to explore our career opportunities, please call or send resume to Mike Haburay at:

New England Recruiters
900 Chapel Street
New Haven, CT 06510
203/624-0161

ENGINEERS

Take advantage of the most individualized job search in the Engineering field today. You pay absolutely NO FEE for our local or nationwide service. Forward your resume in confidence to:

ENGINEERING SEARCH
3152 Linwood Ave. Cinti. Oh 45208
all replies answered

DESIGN ENGINEER—(3) career opportunities and professional challenges in Houston, Texas with our high-growth medical equipment division. BS, EE and experience in design of analog circuits in medical devices, radar systems, microwave, DC to DC converter, power supply, etc: UL experienced. Send resume and salary history, in confidence, to E. France, **NARCO SCIENTIFIC, INC.**, Commerce Drive, Ft. Washington, Pa., 19034. Equal Opportunity Employer, M/F.

FLIGHT TEST DATA SYSTEMS

McDonnell Aircraft Company has immediate openings in Flight Test Data Systems associated with the collection processing and presentation of Flight Test Data.

- **Technical Specialist**— To direct the software development of minicomputer systems. M.S. in computer science with E.E. basis. Familiarity with minicomputer operating systems, assemblers, and source file management, and the ability to deal with system hardware as well as software are required.
- **Senior Programmer and Programmer**— To write or direct the writing of minicomputer applications for Raytheon RDS-500, Data General Nova and H.P. Scientific Minicomputers. Experience with aforementioned systems is desirable but not required. M.S. or B.S. in E.E., Computer Science major. 3-5 years experience in minicomputer programming preferred.

Please send your resume in confidence to:

W. B. Kellenberger
Section Manager,
Professional Employment
(62-2A)
Department E-04
P.O. Box 516
St. Louis, Missouri 63166



NATIONWIDE ELECTRONICS PLACEMENT

Digital Ckt Dsgn * Hardware Sys Dsgn
Analog Ckt Dsgn * Software Sys Dsgn
Quality Reliability * Test Equipment Mtnce
Entry Level through Management
All Fees are Exclusively Employer Paid
Resume Format Guide
Available Upon Request

E. J. STEPHEN ASSOCIATES
1601 Concord Pike, Suite 86, Wilmington, DE 19803
(302) 654-5350

ENGINEERS

ENGINEERS - EXECUTIVES to \$100K+. No challenge? No satisfaction? Underpaid? Maybe we can help you. Over 400 clients. Call me collect. John Ruck, CAREER ASSOC., 583 State Rd., N. Dartmouth, MA 02747 (617/997-3311).

ELECTRONIC ENGINEERS, \$18,000-\$45,000. For the electronics engineer, New England offers the widest diversity of positions available anywhere. As one of the largest, long established (15 years) technical placement organizations in the area, we can represent you with a wide variety of clients, large and small, for positions ranging from entry level to senior management. Nationwide representation is also part of our service. Contact Bob McNamara, E. P. REARDON ASSOCIATES, 888 Washington St., Dedham, MA 02026 (617/329-2660).

DESIGN ENGINEERS to \$38K. Central Penna. Design connectors/terminals, micro-processors. Outstanding relocation packages. Prompt confidential reply. MECK ASSOC. PERSONNEL, 1517 Cedar Cliff, Camp Hill, PA 17011 (717/761-4777).

BSEE / ELECTRONIC DESIGN ENGINEERS, \$15,000-\$35,000. Immediate, desirable upstate New York & nationwide. Junior to senior project management. In confidence send resume or call James F. Corby, President, NORMILE PERSONNEL ASSOC., INC., 5 Leroy St., Box 110 Westview Station, Binghamton, NY 13905 (607/723-5377).

all positions fee-paid

npc NATIONAL PERSONNEL CONSULTANTS

The Engineers Index

**Systems Engrs.
Data Processing
Electronics**

Salaries to \$46,000
Manufacturing Engrs.
ECM Engrs.
Tool Design Engrs.
Air Traffic Contrl. Syst. Engrs.
Rotating Devices Engrs.
Thermometric Engrs.
Digital CKT Design Engrs.
Power Systems Engrs.
Sr. Military Systems Engrs.
Field Engrs. (Electronic Equip.)
Digital Systems Engrs.
Production Control
Programmers/Mgrs.
QA and/or QC Engrs.
Technicians

Companies Assume Our Fees.
Submit Resume, Call or Visit:
THE ENGINEER'S INDEX
133 Federal Street, Suite 701
Boston, Massachusetts 02110
Telephone (617)482-2800



High technology excitement in top locations

SAN FRANCISCO BAY AREA
★ Sunnyvale

WASHINGTON, D.C. AREA
Beltsville, Md. ★
Arlington, Va. ★

FLORIDA
Daytona Beach ★

The professional who practices commitment and is spurred by the need to excel will find no more compelling environment than that offered by GE Space.

The above locations are involved in substantial advanced state-of-the-art assignments demanding innovative approaches:

COMPUTER IMAGE GENERATION (Daytona Beach, FLA)

We're now enhancing a simulation system that provides an unlimited range of flight conditions and ground maneuvers as well as new levels of realism.

Hardware Systems Design & Systems Engineers — BS/MS EE, experienced in design of large scale, real time digital systems including computer image generation systems and digital radar land mass simulators.

Digital Design Engineers — BS/MS EE or Computer Science with experience in microprocessor systems and/or special purpose digital control systems. Must be experienced in design of digital control systems such as ship controls and visual/radar simulation systems.

Visual Display Design Engineers — MS EE or Physics, experienced in design of display systems and related equipment involving CRTs, light valve projectors, dome screens, virtual optics and associated electronics.

CALL COLLECT OR WRITE: E. H. Mollinger, P.O. Box 2500, Daytona Beach, FL 32015 (904) 258-2115

LANDSAT D (Beltsville, MD)

This next step of a long-term Earth Resources Survey Program offers the chance to be at the very heart of advanced work in digital image processing.

Data Systems Engineers — BS/MS EE, experienced in design, implementation and testing of minicomputer-based systems. Translate mission requirements into hardware and software specifications.

Digital Design Engineers — BS/MS EE, experienced in digital logic design with emphasis on high speed (50 MB/S and above) ECL design; and microprocessor application and firmware development.

CALL COLLECT OR WRITE: C. Gayle, 5030 Herzel Place, Beltsville, MD 20705 (301) 937-3500

LARGE-SCALE SYSTEMS (Arlington, VA)

We're now involved in developing a wide variety of state-of-the-art applications for both commercial and government customers.

Computer Programmers — BS CS/Math, or EE, experienced in scientific applications.

System Analysts — experienced in technical leadership of scientific programming applications.

CALL COLLECT OR WRITE: C. Mudge, 1755 Jefferson Davis Highway, Arlington, VA 22202 (703) 979-6000

COMMAND & CONTROL SYSTEMS (Sunnyvale, CA)

We're designing and developing C & C Systems for satellites. Work involves command assemblies, data base management and orbital analysis and prediction.

Software Validation and Test Engineers — BS CS or Math, experienced in scientific applications.

Math Analysts — Computer Applications — OR/Math/CS, experienced in operations research and simulation modeling.

Information System Analysis — BS/MS CE, Math, EE, experienced in design of computer programs for application to control of complex systems.

CALL COLLECT OR WRITE: C. Walker, 450 Persian Drive, Sunnyvale, CA 94086 (408) 734-4980

We offer excellent compensation, noted GE benefits, and the opportunity to work with the top people in the field.



GE takes pride in being an equal opportunity employer, m/f



1



2



3



4



5



6



7



8



9



10



11



12

From Beef on 'weck... to Isaac Stern on violin

If you come to work at Calspan it'll be in a familiar discipline. Our expertise includes Full Scale Flight Research, Systems Analysis, Avionics Research, Environmental Engineering and much more.

But we're located in Western New York which might not be so familiar.

Here's a little orientation on the area:

1. It's the only place in the world where prime roast beef is served on a taste delight called kummelweck.
2. We have exciting NFL Football/NHL Hockey Teams.
3. Teddy Roosevelt became president here, two other presidents were born here and Mark Twain once wrote for one of our major papers.
4. Admiral Perry drove the British off Lake Erie here (and they haven't been back).
5. We have over 15,000 square miles of fresh water for recreation and easy access to the unspoiled Canadian vacationland.
6. And one of the world's Seven Wonders.
7. Our Real Estate Market is favorably priced for home ownership.
8. Excellent skiing is within half an hour (unfortunately the season is only from mid December to mid March).
9. The largest University in the New York State system is here, with schools in Science, Fine Arts, Medicine and (of course) Engineering.
10. Our night life includes Broadway theatre, ballet, cool jazz, hot rock and disco. And, just across the Canadian border are Shaw and Shakespeare Festivals.
11. And in addition to beef on 'weck, we have over a hundred restaurants (many of which Mobil would gladly give stars to).
12. We have one of the finest music halls in the world, a philharmonic orchestra to go

with it, and visiting virtuosi like Isaac Stern. (Incidentally, our art gallery has one of the finest collections of moderns in the nation — plus permanent exhibitions of originals by older masters such as Picasso, Renoir and Degas.)

And you won't have time to read Shapiro's "Compressible Flow Theory" on the way home from work because work and home are usually less than a half hour apart.

Now that we've piqued your interest about living in Western New York, check the facing page about working here. You'll be working with some of the finest engineering and scientific talent anywhere and facing some of the nation's foremost technical challenges — the kind that Calspan and its predecessor, Cornell Aeronautical Laboratory, have so successfully addressed for over 32 years.

Calspan CORPORATION
AN ARVIN COMPANY

ADVANCED TECHNOLOGY CENTER

4455 Genesee Street, Buffalo, New York 14225
An Equal Opportunity Employer

CAREER OPPORTUNITIES WITH CALSPAN CORPORATION

Career opportunities exist in these general areas:

• Electronic Design • Electronics Warfare • Avionics • Tactical Mission Analysis • Programming • Manufacturing Analysis/Quality Assurance • Operations Research • Systems Analysis

ELECTRONIC DESIGN

• Radar/Communications Equipment • Microwave and Signal Processing Circuitry • Display Equipment

ELECTRONICS WARFARE

• Survivability/Vulnerability: Nuclear (EMP, TREES, Hardness Criteria); Non-nuclear • Strategic Systems/Sub-systems Analysis

DEFENSIVE/OFFENSIVE AVIONICS

• System Effectiveness Simulation • ECM/ECCM • Receive/Transmit Requirements • Processing/Control Functions • Expendable Countermeasures • Thrust Definition • Tail Warning Systems • Thrust Simulation • Navigation/Guidance Sub-systems • Weapons Delivery Sub-systems • Terrain Following/Avoidance • Sensitivity Analysis • Performance Requirement Decisions

TACTICAL MISSION ANALYSIS

• Tactical Battlefield Systems • Air to Air/Ground Operations • Red/Blue Gaming

PROGRAMMING

• Simulation: Campaign, Weapons Effectiveness; ECM/ECCM System • CDC-6600 Series: NOS/BE • IBM 360/370: OS/MVT, MVS

MANUFACTURING ANALYSIS/QUALITY ASSURANCE

• Reliability/Maintainability • Military Specifications • Life Cycle Costing • System Safety • Avionics Systems • Mechanical/Aerodynamic Systems

OPERATIONS RESEARCH

• Performance Requirements Decisions • Systems Effectiveness Evaluation • Statistical Analysis

We also have openings for Economists, Materials Engineers, Chemists, Environmental Engineers, Psychologists, Statisticians and many others. Think of us this way. The "SPAN" in CALSPAN labels our wide range of high technology effort—and the spectrum of disciplines involved.

While most of our projects are conducted at our Advanced Technology Center in Buffalo, we also have openings at our Technical Centers in White Sands, N.M.; Dayton, Ohio; Washington, D.C.; San Diego, Los Angeles and Honolulu.

If your background and interests match ours, we'd like to hear from you.

Please send me your resume and you'll receive full consideration—in strict confidence.

E.B. RICKARD

Calspan
CORPORATION
AN ARVIN COMPANY

**ADVANCED
TECHNOLOGY
CENTER**

4455 Genesee Street
Buffalo, N.Y. 14225

An Equal Opportunity Employer



Attractive living and challenging work . . .

This is what Hewlett-Packard offers engineers in Santa Rosa, California...

HP's Santa Rosa Division develops, manufactures, and markets state-of-the-art RF and microwave measurement instrumentation: spectrum analyzers, network analyzers, and sweep oscillators. The HP Microwave Technology Center in Santa Rosa develops devices, circuits and processes that result in the unmatched performance of these HP instruments.

Hewlett-Packard has career opportunities for engineers and scientists with 1-3 years of experience in the following areas:

- Analog/digital circuit design
- Semiconductor processing/device design
- Instrument application/product marketing
- Component applications
- Reliability engineering
- Manufacturing engineering

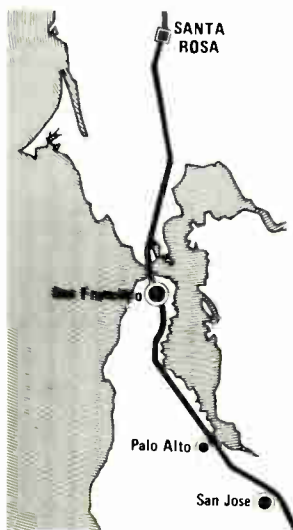

Santa Rosa — "The City Designed for Living," gateway to the Redwood Empire and the North Coast wine country, is a smog-free, modern city of 75,000 people. It offers excellent schools, affordable housing, recreational and cultural activities, and a superb climate year round. There's plenty of active living in the Santa Rosa area; it's a fun place to relax or play. It's a great place to work and a comfortable place to raise a family. And yet it's only an hour away from cosmopolitan San Francisco.

If this sounds like your kind of place, send your resume today to Hilary Hollister.

HEWLETT  PACKARD

1400-8 Fountain Grove Parkway, Santa Rosa, CA 95404

An equal opportunity employer dedicated to affirmative action



DALMO VICTOR

Engineer

Dalmo Victor Technology

provides the world's most advanced Digital Radar Warning Systems.

Lock in Your Career Path to Dalmo Victor
on the beautiful San Francisco Peninsula

Call Our TOLL-FREE, 24-Hour Number
(800) 821-3777, ext. 710
(Missouri residents, 800-892-7655, ext. 710)

Dalmo Victor continues to excel as the leader in the design and manufacture of state-of-the-art Digital Radar Warning Systems. If you've been anxious to expand your career with a company on the move, perhaps now is the perfect time to investigate the exciting opportunities available with us. We invite talented professionals to join us in the most advanced aircraft defense system available in the free world today. Immediate opportunities exist in the following disciplines.

Component Engineers

This position requires experience in selecting and analyzing MIL-SPEC semiconductor, IC and hybrid modules. You will prepare specifications, analyze data groups (A, B, & C), assist in failure analysis and coordinate with Engineering, Procurement, and Manufacturing.

Reliability Engineers

Successful candidates must be capable of performing and/or supervising preparation of reports on circuit stress analysis, reliability predictions, program plans, proposals, design review and failure analysis. Our expanding programs in our Integrated Logistics Support Department offer key opportunities for individuals with BS/MSEE and minimum 4 years' experience on aerospace programs.

Benefits

Lock in your career path to Dalmo Victor now and enjoy an excellent salary and benefits package that includes RELOCATION ASSISTANCE, company-paid medical/dental (for you and your dependents); company-paid retirement program; stock purchase plans; 13 paid holidays; and educational reimbursement. You'll enjoy western living at its best with fine schools, pleasant year 'round weather, beaches and mountains nearby, plus easy access to San Francisco and San Jose.

Come enter Dalmo Victor's World of Innovation now. For immediate consideration, please call our TOLL-FREE number (800) 821-3777 ext. 710, (Missouri residents please call 800-892-7655 ext. 710). If unable to call, please submit your resume (or letter of interest) to the Director of Product Assurance, Dept. 862, Dalmo Victor, 1515 Industrial Way, Belmont, CA 94002. U.S. citizenship required. An equal opportunity employer, M/F.

People & Products Dedicated to Leadership

DALMO VICTOR OPERATIONS
Bell Aerospace **TEXTRON**

ENGINEERS

KAISER ELECTRONICS
on the
SAN FRANCISCO
PENINSULA ...

continues to expand
its capability to pro-
duce the finest Air-
borne Display Systems
in the world:

Our continuing commitment to the advancement of airborne CRT display systems' technology has created rare career opportunities for additional talented Engineers to blend their skills with ours. We require BSEE, BSME or higher and experience in any of the following areas:

- MECHANICAL ENGINEERING
- ANALOG DESIGN
- DIGITAL DESIGN
- RELIABILITY ENGINEERING
- SOFTWARE ENGINEERING
- PROJECT ENGINEERING
- ENVIRONMENTAL TEST DESIGN
- OPTICS ENGINEERING
- SYSTEM ENGINEERING
- TEST EQUIPMENT DESIGN

KAISER ELECTRONICS offers exceptional salary and benefits including Company-paid Medical (+ Major Medical)/Dental/Life/Disability Insurance, Profit Sharing, Retirement Plan, Educational Assistance & Credit Union ... AND the opportunity to live and work on the beautiful San Francisco Peninsula in the heart of the electronics industry. We will move into brand new ultra modern facilities in San Jose in June 1979.

To arrange interview, call COLLECT to Michelle Gross, 415/494-8411, Ext. 269 or send resume including salary history & requirements to Staffing Manager, KAISER ELECTRONICS, 1681 Page Mill Road, P.O. Box 11275, Plant 3, Palo Alto, CA 94306. U.S. citizenship required. Equal Opportunity Employer M/F/H.

**KAISER
ELECTRONICS**
A KAISER AEROSPACE &
ELECTRONICS COMPANY

Plug Into Our Electronics Opportunities.

When you plug into General Dynamics' Electronics Division, you get more than a challenging job, good pay and fringe benefits for you and your family. You get San Diego, one of the country's most beautiful cities. With miles of clean beaches, year-around golfing, sailing and tennis, and an average temperature of 68°, San Diego is one of America's most desired living areas.

As a Design Engineer you will find a broad selection of opportunities in a variety of technical areas: Automatic test equipment for the F-16. High-resolution, helicopter-borne radar systems. Satellite-based, world-wide navigational aids. Plus other projects for military and space programs.

If your career needs challenge, stimulation or just a change of scenery, contact us immediately.

AUTOMATIC TEST EQUIPMENT

Automatic test equipment design including analog measurement, analog stimulus and digital subsystems. Requires BSEE/MSEE and 2-5 years design experience. Analog design background preferred.

DISPLAY SYSTEMS DESIGN

Responsible for the configuration of display systems to meet customer requirements. Requires experience in areas of customer interface and proposal preparation, as well as display logic design or display analog circuit design.

ELECTROMAGNETIC COMPATIBILITY ENGINEER

Provide EMC support in development of electronic equipment and tracking navigation systems. Minimum of 2 years experience in system EMC analysis, EMC design, and equipment/system EMC testing is required; EMP and/or TEMPEST experience is desirable. Minimum BS degree with background in electromagnetic bonding.

RF DESIGN

Engineering specialist to head new airborne radar design group. Requires strong technical/proposal experience and analytical background. MSEE required.

Principal engineer for radar section requires technical/proposal and "hands on" experience. MSEE required.

HARDWARE/ SOFTWARE DEVELOPMENT

Work in field of digital image processing and display. Background in systems analysis such as error budget calculation helpful. Requires microprocessor familiarity and BSEE, Physics or Math degree.

DIGITAL DESIGN

Responsible for the design and special computer and transponder interfaces, display logic and microprocessor multifunction transponders used in sophisticated tracking systems.

All positions require at least a technical BS degree and 2-5 years experience.

Excellent benefit program includes life insurance and medical program, dental and prescription drug plans, savings/stock investment and retirement plans.

Qualified applicants, submit your resume, including recent salary history, to: GENERAL DYNAMICS Electronics Division, Drawer KE, P.O. Box 81127, San Diego, CA 92138.

GENERAL DYNAMICS *Electronics Division*

An Equal Opportunity Employer M/F/H

SPARTON ELECTRONICS

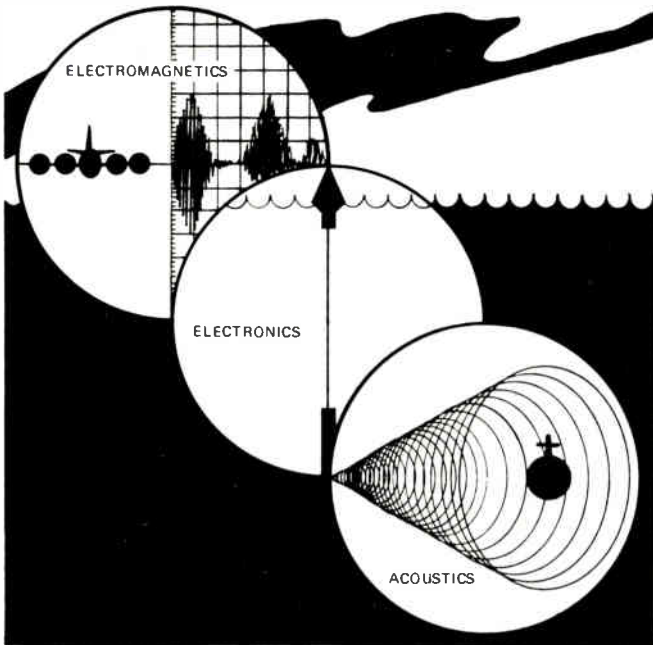

Sparton Electronics -- Our approach has always been a little different. It's our nature to experiment and innovate -- you see it in everything we do. But it's not just the innovation, it's the testing and research behind it. That's why we place such importance on you -- the engineer -- and that's why we have so much to offer. If you are an experienced EE or ME looking for more challenge and responsibility or maybe you just enjoy a small town atmosphere with easy access to almost any kind of recreation, check out Sparton Electronics.

IMMEDIATE OPENINGS:

Electronic Design Engineers - Responsible for the design of VHF-UHF receivers and transmitters, sonar receivers and transmitters, and various analog and digital circuits. Experience applicable to one or more of these areas required.

Mechanical Design Engineers - Responsible for the mechanical design of low-cost, high-quantity electromechanical and electronic equipment. Experience should include the design of injection moldings and die castings. Responsibilities consist of conceptual design, prototype build and qualification, and production support.

Call, or send resume and salary requirements to: Paul Cook, Employee Relations Manager



sparton electronics

2400 E. Ganson St
Jackson, Michigan 49202
Phone (517) 787-8600

AN EQUAL OPPORTUNITY EMPLOYER M/F

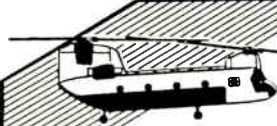

BOEING VERTOL TECHNOLOGY KEEPS THINGS MOVING

Our reputation as one of the industry's most innovative and efficient transportation manufacturers is borne out by our recent acquisition of long term projects. In order to meet and surpass our production goals, BOEING VERTOL has immediate openings for engineers at all levels of experience for the following positions:

ENGINEER LIAISON

BS or equivalent and electrical background. Minimum 4 years experience in Engineering Liaison, general design or both. Will prepare documentation of problems; analyze and write corrective action relating to documents or ENGINEERING ORDERS. Provide detail investigation and technical data or analysis on routine problems. Provide engineering assistance in various areas of manufacturing. Provide engineering interpretation for drawings and mock-up engineering guidance in fit and functional problems.

ELECTRICAL ELECTRONIC DESIGN

BS, MS, or equivalent, preferably in Electrical/Avionics design field. Minimum of 3-5 years of experience in aircraft electrical/avionics sub-system or component design. Perform specialized layouts and feasibility studies on highly complex installations and assemblies. Preparation of electrical lode analysis and responsible to review and check production documentation. These positions offer a salary commensurate with experience, an excellent benefits package, and the opportunity to work in one of Philadelphia's very attractive suburbs.

For more information send your resume with salary history to:

C. Murray
BOEING VERTOL
P. O. Box 16858, M/S P50-40
Philadelphia, Pa. 19142

Equal Opportunity Employer M/F

Job-seekers... be the first to know with McGraw-Hill's Advance Job Listings

By having our weekly ADVANCE JOB LISTINGS sent to your home every Monday you can be the first to know about openings both in and out of your field. AJL will enable you to contact anxious recruitment managers BEFORE their ads appear in upcoming issues of 21 McGraw-Hill publications. To receive a free sample copy, plus information about our low subscription rates, fill out and return the coupon below.

ADVANCE JOB LISTINGS / P.O. BOX 900 / NY 10020

PLEASE SEND A SAMPLE COPY
OF ADVANCE JOB LISTINGS TO

NAME _____ ADDRESS _____
CITY _____ STATE ZIP _____

BRAZIL RESEARCH AND DEVELOPMENT MANAGER TELECOMMUNICATIONS

The company is part of a highly respected and successful multi-national corporation. Telecommunications is one of our main areas of involvement and we believe it to have considerable potential particularly in South America. We intend to expand our activities in this continent in close cooperation with the official authorities and with full regard for national interests.

An integral part of this plan is to develop and expand a Telecommunications R & D department. This activity will correspond closely with the worldwide R & D strength of the corporation and will be located and affiliated with our existing manufacturing organization in Brazil which has some thousand employees.

We are looking for the expert who will direct this department. Brazilian citizenship or a similar background is desirable. In addition we expect fluency in English or French.

The department head will report directly to the regional Telecommunications Division manager and within a few years will be responsible for about 100 employees. A qualified college degree and at least 5 years broad experience in Telecommunication or equivalent fields, such as digital techniques or composition, are considered essential for this assignment.

Remuneration including company car and pension plan will satisfy the most demanding requirements. For a first contact please call our consultants— Mr. Apostel in Sao Paulo (for applications in South America)—Dr. Bartels in Munich (for applications from Europe and other countries) or send them your complete resume.

ROLAND BERGER ASSOCIADOS (Consultoria Internacional Ltda.)
Rua Marechal Deodoro, 543 • 047388 Sao Paulo— Alto Da Boa Vista 10'
(Caixa Postal 21370) • Tel. (011) 347 3657

ROLAND BERGER U. PARTNER GMBH (BDU) International Management Consultants
Truderinger StraBe 13 • D-8000 Munchen 80 • Telefon 089/47 10 73
Geschäftsbereich Personalberatung

BRUSSEL • LONDON • MAILAND • MUNCHEN •
NEW YORK • PARIS • SAO PAULO • UTRECHT • ZURICH



Product Development & Design Engineers BSME/EE

General Electric specializes in producing high quality appliances for the home. We offer engineers the opportunity to make original contributions . . . while working within a top professional team.

ELECTRONIC PRODUCT DEVELOPMENT ENGINEERS: BSEE

3-5 years product development experience. Background must include applying the latest circuit design and microelectronic design techniques.

DESIGN ENGINEERS:

BSME/EE 3-5 or more years of experience with mass produced products —preferably consumer—and knowledge of heat transfer, strength and cost of materials, UL Standard, design experience should include die casting, thermoplastics, thermostats, heaters, motors, and related devices.

Join us, and we'll provide you with a fully commensurate salary. Famous General Electric benefits, and an environment where individual success is seen and recognized.

Please send resume with salary requirements, identifying area of interest, to Ms. C. C. Ref. 78-D, St. Mark, General Electric Housewares & Audio Business Division, 1285 Boston Ave., Bridgeport, Ct. 06602.

GENERAL  ELECTRIC

an equal opportunity employer m/f

PROJECT ENGINEER

Design new research instrumentation.

Here's an opportunity to become deeply involved in developing new advanced equipment at Merck & Co. Inc . . . one of the largest and fastest growing companies in the pharmaceuticals and specialty chemicals industry. Concept-to-design-to-implementation responsibilities require an EE with 2-5 years experience in designing and assembling scientific instruments. Thorough familiarity with sophisticated research instrumentation—theory and methodology is required. Experience in adapting such instrumentation for use in solving specific bioelectronic problems is a plus.

Please send resume and salary history to Mr. Robert O'Connor,



MERCK & CO., INC.

P.O. Box 2000, Rahway, NJ 07065.

An equal opportunity employer, m/f.

Job-seekers... be the first to know with McGraw-Hill's Advance Job Listings

By having our weekly ADVANCE JOB LISTINGS sent to your home every Monday you can be the first to know about openings both in and out of your field. AJL will enable you to contact anxious recruitment managers BEFORE their ads appear in upcoming issues of 21 McGraw-Hill publications. To receive a free sample copy, plus information about our low subscription rates, fill out and return the coupon below.

ADVANCE JOB LISTINGS / P.O. BOX 900 / NY 10020

PLEASE SEND A SAMPLE COPY
OF ADVANCE JOB LISTINGS TO

NAME _____ ADDRESS _____

CITY _____ STATE ZIP _____

HARRIS Corporation—PRD Electronics Division

CALL IT "THE HORNET"... **CALL IT THE F-18...**



Call It An Extra Reason to Come With PRD on Long Island—World Leader in ATE—Now!

It's a magnificent aircraft, with a key role to play for years ahead. To keep Hornets ready to fly, Automatic Test Equipment is essential. For years PRD Electronics has set the pace in this intricate, fascinating field. Our equipment in stations around the globe and at sea has an outstanding performance record—not only for the F-18 but for approximately 80% of all new military aircraft, including F-14, E2C, S3A, CP-140 and A7E.

Be In On the Ground Floor of A New Generation of ATE

The system we are developing right now will be the backbone of PRD's activities in this field for the next five years and beyond... giving you even more opportunity to prosper and advance in your professional specialty. You'll also find the stimulating environment, the superb facilities, and the working atmosphere hard to top. Salaries and benefits are excellent.

PRD Electronics is a division of Harris, a corporation, diversified across the whole spectrum of advanced electronics, that has enjoyed strong, steady growth to over \$850-million in sales. **Please send resume, indicating salary record and areas of interest, to: Mr. Tony Pfarrer, Manager, Employment, Harris Corporation, PRD Electronics Division, 6801 Jericho Turnpike, Syosset, New York 11791.**

**PRD INTERVIEWS DURING
ELECTRO '79
April 24th to the 26th**
Please stop by and talk to our
Professional Recruitment Staff
At the
NEW YORK HILTON
6th Ave. Bet. 53rd & 54th St., NYC

SOFTWARE

PROJECT ENGINEERS Lead technical teams to define and develop control software and compiler software in support of advanced ATE systems. As such should be fully familiar with the disciplines of software development starting with language standardization, compiler design operating on a real time mini-based operating system with multi-tasking. BS Engr/Physics/Computer Science. Advanced degree desirable.

SENIOR ENGINEERS Responsible for detail design of programs and subsequent systems integration and validation. Should be capable of working from overall software specifications into systems analysis and subsequent coding conversions. Experience with mini-base systems as well as micro-processor designs and applications. BS Engr. Comp. Sci., Advanced Degree desirable.

ENGINEERS Working from detailed specifications capable of developing FORTRAN IV software modules. Executing under a mini-based real time operating system. Knowledge of Backus-Naur form of language definition a plus. BS Computer Science required.

SENIOR PROGRAMMER/ANALYSTS Using your familiarity with DBMS, be involved in design of application packages (TOTAL DBMS), research and design utilizing the DBMS theory, compiler, and language development and access methods. At least 2 years experience on a major DBMS system and overall experience not less than 4 years is needed, including scientific languages—FORTRAN, assembler, etc. BS in engineering, Math, Physics or CS of equivalent is essential, with higher degree preferred. Other disciplines will be considered if practical DP background is impressive.

PROGRAMMER/ANALYST Data communications person familiar with hardware software. Capable of implementing network protocols.

HARDWARE DESIGN

PROJECT ENGINEERS • SENIOR ENGINEERS BSEE, 3-10 years experience with strong R&D background, hands-on experience current LSI and microprocessor technology, and leadership capability. Key positions in advanced development department, participation in state-of-the-art design activities.

TEST PROGRAMS

PROJECT ENGINEERS • SENIOR ENGINEERS • ENGINEERS Responsibilities in these positions will be for engineering design and analysis of digital and analog circuitry, audio through microwave frequencies, with objective of translating circuit operation in computer programs for automatic fault detection and isolation. Background is essential in programming, ATE operation and circuit analysis, with at least 1-3 years experience in circuit design, analysis, development, 3-5 years in design and utilization of ATE and associated software. EE or Physics degree/equivalent is required.

PUBLICATIONS

TECHNICAL WRITERS & PROPOSAL WRITERS Several openings are available requiring 3 to 5 years experience in electronics technical writing. Degree preferred.

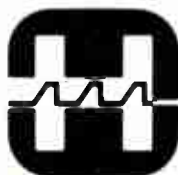

HARRIS
COMMUNICATION AND
INFORMATION PROCESSING

An Equal Opportunity Employer—Male and Female

**We're looking for
people to make our
advanced technology
obsolete.**

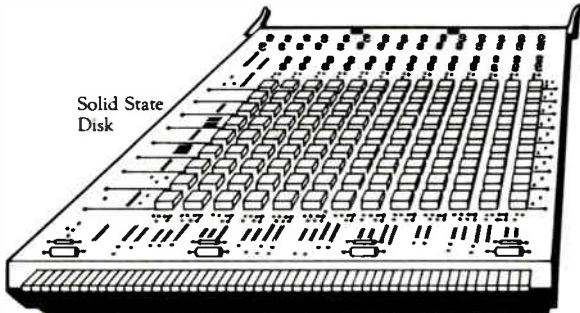

Storage Technology Corporation is no ordinary company. We've built our reputation on innovation and advanced technology with a commitment to developing better products. We constantly strive to improve our technology. That's one reason why we are the world's largest manufacturer of high density tape data storage products and a major manufacturer of disk subsystems.

If you are an engineer who wants a creative, challenging career, one of the following openings may be just the opportunity you've been looking for.

MANUFACTURING ENGINEERS
INDUSTRIAL ENGINEERS
ELECTRICAL ENGINEERS
MANUFACTURING TEST ENGINEERS
QUALITY ENGINEERS
PRODUCT PERFORMANCE ENGINEERS
QUALITY TEST ENGINEERS
RELIABILITY ENGINEERS
LOGIC DESIGN ENGINEERS
MEMORY DESIGN ENGINEERS
POWER SYSTEMS DESIGN ENGINEERS
BLOCK MULTIPLEX I/O DESIGN ENGINEERS
MICROCODE DIAGNOSTICS ENGINEERS
ARCHITECTURAL DESIGN (ADVISORY) ENGINEERS
TELECOMMUNICATIONS FIELD ENGINEERING SPECIALISTS
TELECOMMUNICATIONS ENGINEERS
TELECOMMUNICATIONS SOFTWARE ENGINEERS
MECHANICAL DESIGN ENGINEERS (TELECOMMUNICATIONS)
SYSTEMS ENGINEERS/DATA COMMUNICATIONS

Living in the Denver-Boulder area is just the beginning of the outstanding benefits of a career at Storage Technology Corporation. We offer an excellent salary and benefits package that includes health and insurance benefits, stock purchase plan and retirement.

Write or send your resume in complete confidence to the Professional Employment Department at the address listed below. Your correspondence will be answered promptly and courteously and we'll tell you what it's like to be part of our company, and why we can say with pride at STC, people count and technology truly is our middle name.

Dept. E/4-12
MD-13



STORAGE TECHNOLOGY CORPORATION

2270 South 88th Street
Louisville, Colorado 80027

An equal opportunity employer.

IMAGING PHYSICIST

Advancing technology and growth have created an opening in our Tek Labs group for a Research Project Leader specializing in ink jet technology. Ideally we are looking for three to five years experience in the design and development of ink jet technology or related processes, and a PhD (or equivalent experience) in the physical sciences or engineering.

Tektronix develops and markets internationally recognized electronic measurement instruments as well as other related products. Located near Portland, Oregon, we are within a two-hour drive of the Cascade Mountains or Ocean Beaches. Salary is open and benefits include educational support, multiple insurance plans, and profit sharing.

For this opening, please call toll free (800) 547-1164 and ask for Gary Hecht or send your resume to Gary Hecht, Tektronix, Inc., Box 500, L79, Beaverton, Oregon 97077.

An Equal Opportunity Employer M/F/H.

Tektronix®
COMMITTED TO EXCELLENCE

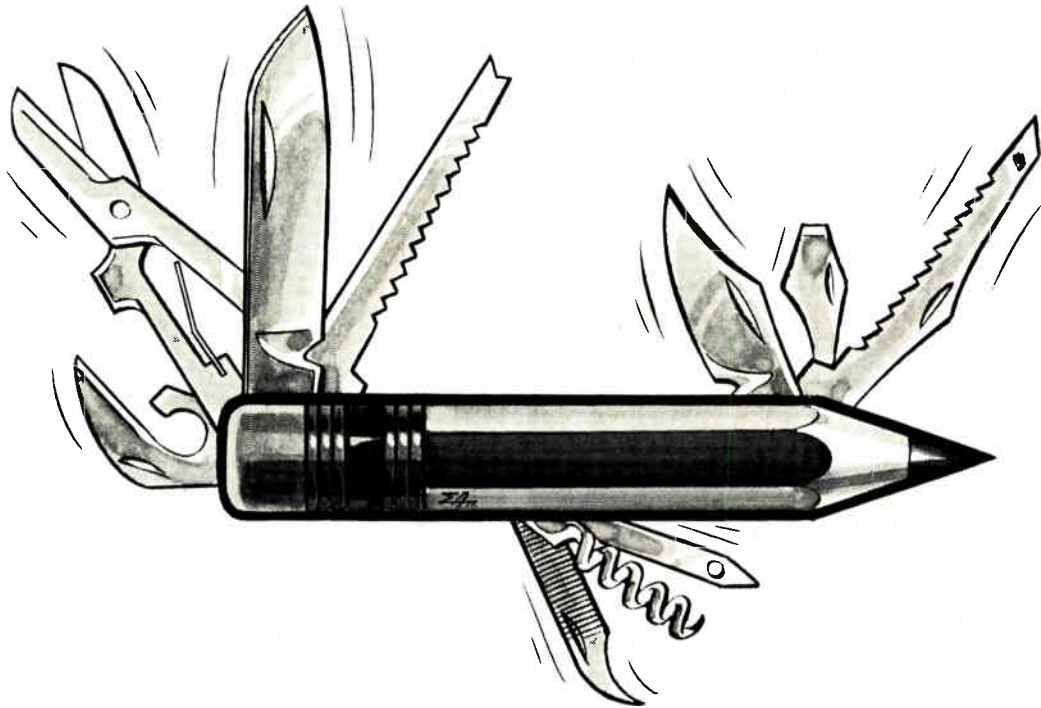

Versatility

The ability to work on several aspects of a tough problem — that's versatility. And at the ITT LSI Systems Support Center, it's the name of the game.

In fact, every member of our small, high-caliber staff has the opportunity to play every position on the design and development team.

The atmosphere is informal and stimulating. Ideas are freely exchanged. Head-to-head sessions can happen anytime.

And while the work we're doing is so proprietary we can't give specifics, we can tell you that we're handling the more complex large scale integrated circuit design assignments for telecommunications, space, defense, commercial, industrial, and automotive product areas throughout International Telephone and Telegraph Corporation.

This spring we'll be moving into new quarters near Milford, Connecticut, where we'll have 20,000 square feet all to ourselves and the latest resources at our command — including digital and linear test systems, SEM for failure analysis, environmental test equipment, computer and graphic systems . . . and wafer fabrication facilities at ITT's nearby Corporate Technology Center.

Our new location also offers the best in Connecticut living, near Long Island Sound and New Haven — and almost midway between New York and Boston.

So, if you're looking for hands-on, end-to-end involvement and the opportunity to work closely with some of the most versatile minds in the LSI field, get in touch with us.

We have opportunities at various levels for:

- **Process & Device Specialists**
- **LSI and VLSI Design Engineers**
- **Linear IC Designers**
- **LSI Layout Designers**
- **LSI Applications Engineers**
- **Digital & Linear IC Test Engineers**
- **Reliability & Quality Engineers**

**Call collect to arrange interview:
(203) 348-8855, Monroe Weiant,
Assistant Director — Operations.**

Or send resume including salary history in confidence to Mr. Eugene Edwards, Caller Service 1-14, Milford, Connecticut 06460

**ITT LSI SYSTEMS
SUPPORT CENTER**

An Equal Opportunity Employer, M/F

Marketing Representatives (Avionics Systems Commercial Airline Sales/ Military Sales

At Lear Siegler, you won't find yourself tangled in a lot of red tape and corporate structure. On the contrary, you'll enjoy freedom - high visibility - and uncommon growth opportunities with a clear path to success. Right now we're looking for innovative individuals to join our rapidly growing group of sales professionals and market our quality avionics product to both commercial airline and military markets.

The successful candidates will be talented, aggressive and thoroughly knowledgeable in either the commercial airline or military markets. If you are seeking diversity, immediate recognition and top rewards, these opportunities are unmatched.

We offer a superior salary/benefits package, plus unlimited potential to grow with a leader. So bring your expertise to us. Forward your resume to: Bill Notteimann, Manager, Professional and Technical Employment.



**LEAR SIEGLER, INC.
INSTRUMENT DIVISION**

4141 Eastern Avenue
Grand Rapids, Michigan 49508
*We encourage minorities and
females to apply.*

FREE Your dream job.

We hope you're happy in your current position, but there's always that ideal job you'd prefer if you knew about it.

That's why it makes sense to have your resume on file in the Electronics Manpower Register, a computerized data bank containing the qualifications of career-conscious ELECTRONICS readers just like yourself.

You'll benefit from nation-wide exposure to industry firms privileged to search the system, and since the computer never forgets, if you match up with their job requirements you'll be brought together in confidence.

To take advantage of this free service, mail your resume to the address below.

ELECTRONICS MANPOWER REGISTER
Post Office Box 900/New York, N.Y. 10020

ELECTRONIC ENGINEERS

State-Of-The-Art Digital Systems Applications

This is your chance to help form a new, vital Development/Design Team for GENERAL ELECTRIC's Power Systems Management Department located in Philadelphia. You will work on the latest concepts in digital systems for control and protection of power generation and transmission equipment, to maintain and expand GE's worldwide leadership in the Electrical Power field, through the 80's and into the 90's.

To qualify, you must possess a BSEE, (ME a plus) and a proven thorough knowledge of analog and digital circuitry. Background in systems design, programming and applied mathematics is highly desirable. Power Systems experience a plus.

GENERAL ELECTRIC offers an excellent salary structure, geared to your experience and potential, a full range of corporate benefits, exciting technical challenges and high visibility opportunities for advancement. Interested applicants should send their resume, in confidence or call COLLECT: PROFESSIONAL RELATIONS OFFICE, Dept. 10B04

GENERAL  ELECTRIC

Switchgear Division
6901 Elmwood Ave., Dept. D
Philadelphia, Pa. 19142
215-726-3582

An Equal Opportunity Employer M/F

ENGINEER-DEVELOPMENT ENGINEER—Outstanding career opportunity with our high-growth medical equipment division located in Houston, Texas. Requires background in product design and development with experience in analog circuit design, RF, UHF, telemetry modulation, etc. Advanced EE degree, first class FCC license. Send resume and salary history in confidence, to E. France, **NARCO SCIENTIFIC INC.**, Commerce Drive, Ft. Washington, Pa. 19034. Equal Opportunity Employer, M/F.

ENGINEERS

ELECTRONICS ENGINEERS, \$15,000-\$45,000. Choice entry-level to management positions immediately available in Pennsylvania & national locations. We have been placing electronics engineers for more than 14 years, and have established contacts with many of the leading companies in the nation. Reply in strict confidence to J. G. Weir, President, WEIR PERSONNEL SERVICES, 535 Court St., Reading, PA 19603 (215/376-8486).

ELECTRONIC ENGINEERS, \$21,000-\$42,000. Minneapolis, the electronic capital of the World. Immediate openings in engineering and mfg. Reply in confidence to B. G. Gray, ABC EMPLOYMENT SERVICE, 401 Second Ave., Minneapolis, MN 55401 (612/339-1453).

ENGINEERS, \$18,000-\$34,000. Sunbelt. Nationwide. Leading companies. Analog, digital, microprocessor, instrumentation, application. Entry & management. Reply in confidence to J. F. Halloran, President, NATIONAL SEARCH, P.O. Box 73006, Houston, TX 77090 (713/376-9383).

ENGINEERS, \$15K-\$40K. West Coast & nationwide positions entry level thru mgmt. Design, Inst., Application, Test, etc. Reply in confidence. Call or send resume to GLENN ENGLISH AGENCY, 7840 Mission Center Ct., San Diego, CA 92108 (714/291-9220).

ENGINEERS. WHY not LIVE, WORK and PLAY in tax-free New Hampshire? Numerous career opportunities at all levels with salaries form \$15,000 to \$30,000+. Contact AVAILABILITY PERSONNEL CONSULTANTS, 160 South River Rd., Bedford, NH 03102 (603/669-4440).

all positions fee-paid

inpc NATIONAL PERSONNEL CONSULTANTS

ENGINEERS ELECTRONICS & ELECTRICAL

Let our ENGINEERING professionals work with you in strict confidence
Free NATIONWIDE service-140 offices

RPM RPM-Technical Div (agency)
div. of RPM Affiliates Ltd
6 E 45 St NYC 212-692-6150

Engineers - SE Locations, Process, Powerlight, Software, Hardware, Systems, Instrumentation, Facilities. Fee Paid, No Contracts, 12 yrs. experience. Send resume to Ted McCulloch.

Beall Associates
P.O. Box 5042
Spartanburg, S.C. 29304

**ELECTRONIC ENGINEERS
IMMEDIATE
CAREER OPPORTUNITIES**
Contact in Confidence:

ff (212) 557-1000
O-R-T-U-N-E
Personnel Agency
505 Fifth Avenue
New York, N.Y. 10017

MS/PhD Engineers & Computer Scientists

Bell Laboratories offers important professional challenges to:

INTEGRATED CIRCUIT DESIGNERS AND TEST ENGINEERS

Openings for both MOS and Bipolar Design in:

- LSI Digital Circuits
- LSI Linear Circuits
- Static and Dynamic Memories
- Microprocessors

Above openings are available at Reading and Allentown, PA; Murray Hill, N.J.

COMPUTER SCIENTISTS & ELECTRICAL ENGINEERS

- Operating Systems
- Compiler Design
- System Architecture
- Computer Networks
- Communications Processing
- Software and Firmware Design
- Distributed Computer Networks
- Analog and Digital Data Systems
- Electronic Switching Systems
- Transmission Systems

Above openings available in: New Jersey, Illinois, Pennsylvania, Reading and Allentown, PA; Georgia, Colorado, Ohio, Indiana, Massachusetts.

OUR PROFESSIONAL COMMUNITY

As the Research and Development Unit of the Bell System, our work spans the widest range of science and technology. At Bell Labs we employ 18,000 people in eight states. We've put together a staff of professionals with a worldwide reputation for excellence. Out of their efforts have come developments such as the information theory, electronic switching and other contributions in computer science and computer controlled real time systems. Such developments have helped make America's communications network the finest in the world.

THE TECHNICAL CHALLENGE

To keep it that way we are advancing the state-of-the-art on a variety of fronts. We are applying advanced electronics and computer techniques to virtually all phases of telecommunications. With such new technologies, we're developing new products and services, as well as sophisticated tools for operating the nationwide network efficiently and economically.

We offer salaries and benefits that rank among the best in industry; the latest and best laboratory equipment; excellent libraries and technical support; strong continuing education programs; and, most important, work that will keep you thinking in creative and productive ways.

If your background matches our needs, and you have a Master's or a PhD degree, we can use your expertise immediately. If you're interested, please write, stating your geographic preference and including resume and transcripts, to: Director of Technical Employment, Center 831-EL, Bell Laboratories, Murray Hill, N.J. 07974.



Bell Laboratories

An equal opportunity employer, m/f.

Get A View From The Top. Join Wang.

If you're a computer professional who wants to be on top, open your eyes to Wang. And set your sights on a company that's far above the rest.

At Wang, you'll see things happen. You'll also be encouraged to express your own ideas, and get the organizational support you need to have them realized.

Come make things happen, with the #2 company in the area of small business computers. Join Wang. We'll take your career to new heights.

In our Diagnostics Development group:

Supervisor - Manufacturing Test Development

As part of the department that has corporate responsibilities for diagnostic development, you will be instrumental in building a group that has diagnostic test development responsibilities for our manufacturing facilities. You will analyze manufacturing's software testing requirements and design and implement appropriate solutions. You will also interface with manufacturing engineering groups to develop hardware/software test systems.

This is a ground-floor opportunity in a rapidly growing department and a dynamic company. The ideal candidate will have a thorough understanding of computer architecture, 5 or more years of direct diagnostic experience, project and/or supervisory experience, and an understanding of manufacturing processes and testing requirements. A BSEE or equivalent experience and excellent written and verbal communications skills are required.

Diagnostic Programmer Analyst

Wang's growing diagnostic Software Development Department is looking for highly motivated individuals with a minimum of 3 years hardware/software experience to fill intermediate through senior level openings to design, code, debug, evaluate and release diagnostic programs for hardware systems and subsystems, ranging from a microprocessor-based subsystem to a medium sized general purpose virtual memory system.

The applicant should be versed in assembly language programming, knowledgeable of diagnostic testing strategy for subsystems, including CPUs, memories, and peripheral devices, acquainted with hardware/software compromises to obtain levels of hardware visibility that will ensure a product that we can test, diagnose and maintain.

We offer excellent salaries and benefits. Please send your resume, including salary history, to Merle Halverson, Wang Laboratories, Inc., One Industrial Avenue, Lowell, MA 01851.

We are an affirmative action employer

Computers

WANG

Word Processing

SENIOR SCIENTIST

Position available for Supervisor of U of M Chemistry Dept. Electronics Shop (Sr. Scientist). Stimulating opportunities to interact w/research personnel in applying state-of-the-art electronics to chemical instrumentation. Supervisor responsible for analog & digital design, interfacing w/computers, overseeing maintenance of wide variety of instrumentation. Excellent fringe benefits, incl. 18 days vac. + 9 U holidays. Educ. opportunities. Salary: 22K-29.6K. If you have min. 8 yrs. relevant post-EE degree exp. & study, write: U of M Personnel Dept., 2651 University Ave., St. Paul, MN 55114, or call J.E. Wertz, 612-373-2368.

UNIVERSITY
OF
MINNESOTA

*An Equal Opportunity Employer
and Educator*

EMPLOYMENT SERVICES

Electronic engineering growth positions with clients located nationally. Our service is enhanced by the fact that I am an EE with 20 years in industry and over 10 years in placing professionals on an employer fee paid basis. Send your resume to Joe Torcassi, Director, J. Anthony & Associates, PO Drawer AD, Lynchburg, OH 45142. 513/364-2305.

M.E.s, I.E.s, E.E.s, Ch.E.s—Let our search firm represent you to our clients nationally and overseas. If you are seeking a more prestigious position with increased responsibilities and a better future, send a resume or request a position profile and at no charge we will provide you with interview opportunities. Register in our exclusive Executive Search Program. All replies strictly confidential. All fees employer paid at Management Recruiters, 1900 Point West Way, Suite 281, Sacramento, CA 95815. (916) 920-0441.

SCHOOLS

World Open University—A Non-Resident Graduate School—Division of Electrical, Electronics & Computer Engineering offers full graduate courses in areas: Applied Mathematics & Physics; Electronics Engineering; Electrical Circuits; Computers & Advanced Programming; Communications Systems; Control Systems; Energy-Power Systems; Nondestructive Testing—leading to M.S., Ph.D., Sc.D., Eng.D., Tech. D.—guided by full professors having a series of original contributions to international learned societies. Request complete information to WOU, PO Box 5505, Orange, CA 92667, USA, enclosing \$5 in US, or US \$7 outside of US, for airmailing. Self-authored original paper reprints from national learned societies may get proper credits. WOU is racially nondiscriminatory. To mention Electronics in request.



ELECTRONIC ENGINEERS

There are many reasons why you should explore the world of electronics at

**ROCKWELL INTERNATIONAL'S
AUTONETICS DIVISIONS
IN ANAHEIM, CALIF.**

But the best reason is simply that our engineers will tell you it's a great place to work.

We are growing in a majority of the future electronic areas. We are located convenient to reasonably priced housing. We are involved in a broad variety of electronic projects, as shown below:

ACOUSTIC SIGNAL PROCESSING AIRBORNE GUIDANCE SYSTEMS AIRBORNE RADARS ANTISUBMARINE SYSTEMS AUTOMATIC TEST EQUIPMENT BUBBLE-DOMAIN MEMORIES CHARGE-TRANSFER DEVICES COMMAND AND CONTROL COMPUTERS CONTROL SYSTEMS COUNTERMEASURES DEVICE DEVELOPMENT DIGITAL ELECTRONICS DISPLAYS ELECTROMAGNETIC SYSTEMS ELECTROMECHANICS ELECTRONIC INTELLIGENCE ELECTRO-OPTICS ELECTRO-SENSOR SYSTEMS FIELD ENGINEERING AND LOGISTICS INERTIAL INSTRUMENTS INFRARED INSTRUMENTATION INTEGRATED MICROCIRCUITRY LASER TECHNOLOGY MAGNETICS MICROCIRCUITRY MANUFACTURING ENGINEERING MARINE ELECTRONICS MARINE NAVIGATION MATERIALS AND PROCESSES MICROMAGNETIC PHYSICS MICROWAVE PHYSICS MILITARY AVIONICS MISSILE SYSTEMS MOS/SOS/LSI MULTIPLEXING PATTERN RECOGNITION RADIATION HARDENING SEMICONDUCTOR DEVICES SHIP DYNAMICS AND CONTROL SOFTWARE SOLID-STATE PHYSICS SONAR SYSTEMS SPACE ELECTRONICS SURFACE ACOUSTIC WAVE DEVICES TACTICAL/STRATEGIC ELECTRONICS

If you would like us to explore career opportunities for you, mail us your resume. We'll take it from there. (U.S. citizenship required)



**Rockwell
International**

Equal Opportunity Employer M/F

AUTONETICS DIVISIONS
Rockwell International
3370 Miraloma Avenue
Anaheim, CA 92803
ATTN: E41226 BA39

CAREER OPPORTUNITIES AT GOULD

Join The Search For The Technology of Tomorrow

Gould Ocean Systems is the world's leading pioneer in the field of oceanic technology, and is continually striving to stay #1. Significant growth coupled with forecasted expansion and a solid commitment to new product development has created exciting professional opportunities for imaginative engineering talent with Gould's fast-moving Ocean Systems Division. Immediate openings are now available for professionals with U.S. Citizenship in the following areas:

ELECTRICAL ENGINEER

To qualify, candidates must have at least 5 years experience in the design of test circuits for use in complex digital and analog systems. Primary responsibility will involve the design and development of test circuits and specifications for performance testing. A BS in Electrical Engineering is required.

SENIOR ENGINEER

Prior work experience should include at least 7-10 years of power control engineering demonstrating strong leadership abilities as well as solid experience in Fortran IV and other computer aided analysis. Areas of responsibilities will include analyzing power systems used for undersea propulsion, generating system requirements and overseeing design integration and evaluation processes. A BSEE, MS or PhD in Electrical Engineering is required.

ELECTRICAL ENGINEER

For consideration, candidate must have experience in either hardware design or test program development, plus a background in automatic test equipment. Primary responsibilities will involve the analysis and synthesis of circuits for prototype development, the development of software and hardware test programs, as well as the generation of engineering documentation. A BS in Electrical Engineering is required.

ELECTRICAL ENGINEER

For consideration, candidates must have 0-3 years electronic experience in either hardware design or test program development, plus a solid background in automatic test equipment. Primary responsibilities will involve the analysis and synthesis of circuits for prototype development and the development of software and hardware test programs, as well as providing liaison with other departments to expedite realization of hardware and software products. A BS in Electrical Engineering is required.

If you're up to the large scale challenges and the exhilarating growth pace that have established Gould as an integrated technology company... you'll be rewarded with an exceptional salary, a full benefits package and highly-visible advancement opportunities. Submit letter or resume in confidence with earnings history and salary requirements to:

GOULD OCEAN SYSTEMS DIVISION

18901 Euclid Avenue
Cleveland, Ohio 44117



An Equal Opportunity Employer, M/F/H.

FLIGHT TEST ENGINEERS

McDonnell Aircraft Company has immediate openings for engineers experienced in Flight Test data systems applications. Career opportunities include development, operation and support of Flight Test data systems on F-15, F-18, AV-8 and advanced aircraft projects in one or more of the following applications.

- Mini-Computer Technology
- Computer Programming
- Flight Test Data Assessment
- System Design
- Airborne Instrumentation
- Installation Design — Electrical & Mechanical
- Electronic Circuit Design
- Micro-Processor Technology

Please send your resume in confidence to:

W. B. Kellenberger, Section Manager
Professional Employment
Department E-04 • P. O. Box 516
St. Louis, Missouri 63166

MCDONNELL DOUGLAS

An Equal Opportunity Employer

CORPORATION

**If you currently
earn between
\$15,000 - \$36,000
we've got a better
job for you ... NOW!**

Several new contract awards have created numerous, immediate, long term career opportunities for degreed, technical professionals. We are only interested in top caliber, creative individuals with proven records of success in engineering, management & consulting. Locations are nationwide.

Opportunities include technical/management consulting, project management, R&D, test and systems evaluation. Major contract areas include Communications, Satellites, Weapons, Intelligence, Computer, Energy and Aerospace systems. All positions require U.S. CITIZENSHIP, MINIMUM OF A BS degree (MS/Ph.D. preferred), and a minimum of one year experience in one or more of the specific areas listed below.

- Minicomputers
- Microprocessors
- Software development
- Signal processing
- Digital systems
- Command & Control
- Radar Systems
- Communication Systems
- EW/SIGINT/ELINT
- Microwave Systems
- Electromagnetics
- Fire Control Systems

If you want to join one of the fastest growing firms in the country, call Robert Beach, Vice President, collect at (301) 762-1100 or, if you prefer, send your detailed resume, in confidence. We'll make you an offer you can't refuse.

WALLACH... Your career connection
Equal Opportunity Employer Agcy.

WALLACH
associates, inc.

1010 Rockville Pike
Box 6016
Rockville, Maryland 20852
(301) 762-1100

You'll make the
right connections
at **GTE LENKURT**



San Francisco Peninsula

ENGINEERS, DESIGNERS

Join a people-oriented TELECOMMUNICATIONS Company that is not only stable, but also growing rapidly to meet the expanding demand for a variety of communications systems.

Our customers depend on us for excellence in design, manufacture, and service of sophisticated video, voice and data communication systems. We offer a rewarding career, excellent advancement potential, interface with knowledgeable professionals.

DEVELOPMENT ENGINEERS

Electrical Engineers at all levels for projects in subscriber carriers, signaling and VF equipment design, PCM carrier and switching as well as digital microwave radio. Experience in either linear, digital or microprocessor control circuit design.

PCM DEVELOPMENT ENGINEER

As a key member of a product development team, you will have significant responsibilities for system and circuit design of high bit rate PCM equipment. This equipment will utilize State-of-the-Art techniques including high speed digital circuits and microprocessors, and will be used with fiber optic and microwave radio systems. Applicants should have a minimum of 4 years digital design experience, preferably including ECL and a BSEE degree. A background in PCM telecommunication's equipment design is desirable.

PCM TERMINALS ENGINEERS

Responsible for circuit design of PCM voice/data channel bank equipment from concept to factory production. Position requires BSEE degree and experience in analog design. Prefer some digital experience or desire to learn digital design. Openings at all skill levels.

GTE Lenkurt offers excellent salaries and a comprehensive benefits package including Paid Vacations and 11 Paid Holidays; Medical/Dental/Life/Disability Insurance; Stock Purchase; Savings & Investment Program; 100% Tuition Refund; Pension Plan; Employee Store and Credit Union, and Relocation Assistance. We are an Equal Opportunity/Affirmative Action Employer.

Please send your resume or a brief letter outlining your qualifications to DICK NELSON, Employment Manager, GTE Lenkurt, 1105 County Road, San Carlos, CA 94070. (415) 595-3000.

MICROPROCESSOR SOFTWARE ENGINEERING

For a Stored Program Digital Telecommunications Switching System. Should have a BS or MS degree in one or more of the following areas: Telephone Call Processing, Structured Software Design, Real Time Systems Design, Systems Diagnostics, PL/M.

TEST EQUIPMENT DESIGN ENGINEER

Position requires experience in digital and analog circuit design, preferably in the area of test equipment. Some programming background/TTL and ECL experience desirable. Ability to convert engineering test requirements into finished production test equipment.

Projects involve the design of test equipment for digital and analog carrier systems, microwave and digital radio systems, as well as microprocessor based products. Work includes design of calculator controlled and microprocessor based automatic and semi-automatic test systems as well as dedicated hardware test sets. BSEE or equivalent experience required. (Reply specifically to Job #JC1)

POWER ELECTRONICS ENGINEER

Position requires a BSEE with 2-5 years experience in power electronics and power processing. Knowledge of solid state components, power electronic circuits and power magnetics is required.

CUSTOM IC DEVELOPMENT ENGINEERS & DESIGNERS

BS/MS or PhD in Electrical Engineering to develop custom integrated circuits in Bipolar and N-Mos technologies. Analog and/or digital design and computer simulation desirable. Willing to train Engineer with solid experience in discrete circuit design. You will have full responsibility for the development of your telecommunication circuit. Need Electrical Engineer to generate IC modeling test pattern and to develop automatic programs for high speed test systems. Solid background in linear or digital circuit analysis and aptitude in programming required. Programmer or IC Designer to develop and maintain IC layout design rules and to generate software programs for digitizing and mask design.

EQUIPMENT MECHANICAL/PC DESIGNERS

Must have knowledge of electro-mechanical packaging and/or printed circuit board layout for proprietary products. No degree necessary.

GTE LENKURT

A Part of General Telephone & Electronics Corporation

ENGINEERS

Career Opportunities have never been better!

A broad spectrum of high-technology job categories at all levels. Immediate positions are available; an extraordinary diversity of product lines to choose from.



Research Laboratories!

Engineering Positions

Available to personnel with the following interests or backgrounds:

• **ELECTRONIC DESIGN**

Analog, Digital, RF Circuits, Microprocessors

• **SYSTEMS ENGINEERING/ANALYSIS**

IFF, Communications, ECCM, Microwave Landing Systems

• **RESEARCH AND DEVELOPMENT**

SAW Devices, Microwave Systems and Antennas Systems Analysis and Simulation

• **RELIABILITY/MAINTAINABILITY**

• **FIELD ENGINEERING — DIGITAL**

• **TEST ENGINEERING**

• **QUALITY CONTROL**

• **INDUSTRIAL ENGINEERING**

• **ENGINEERING PROGRAMMERS**

CONSIDER THE CHALLENGE...CONSIDER THE OPPORTUNITY...
CONSIDER THE MANY BENEFITS OF WORKING FOR
HAZELTINE, A WORLD LEADER IN INFORMATION
ELECTRONICS FOR MORE THAN A HALF CENTURY.

Send your resume, indicating your salary requirements to : Employment Manager, Hazeltine Corporation, Greenlawn, New York 11740.

An Equal Opportunity Employer Committed to Affirmative Action—

HAZELTINE



**Would
you hire
an engineer
who
couldn't
understand
this
magazine?**

Of course not. ELECTRONICS is the technical publication for technical people. If they can't understand it, they can't receive it. That's why, when you're looking for qualified engineers, you should consider our Classified Section.

For only \$46.00 per inch your recruitment advertising will reach 46,000 pre-screened engineers—that's just \$1 per thousand!—as they're reading to combat job obsolescence, while they're thinking about their future and bettering themselves.

There's no charge for type-setting and free layout service is provided.

For more information call or write:

ELECTRONICS

Post Office Box 900
New York, N.Y. 10020
Phone: 212/997-2556

■ Abbott Transistor Labs	181	Data General Corporation	194, 195	Interface Technology	173
ADAC	51	Davis Electronics, Div. of Digital Instruments	215	Intersil	52, 53
Advanced Micro Devices	10, 11	■ Dialight	174	ITT Electro-Optical Products	20, 21
* AEG Telefunken	9E	Digital Equip. Accessories & Supplies Group	100, 101	‡ Kalmus & Associates	90
■ Allen-Bradley	32	Digital Equip. Corp. OEM 11 Group	178, 179	■ Keithley Instruments	207
* Allen Bradley Electronics Ltd.	166	Electro Scientific Industries	94	■ Krohn-Hite Corporation	5
American Microsystems Inc.	142, 143	■ Electronic Navigation Industries	3rd Cover	■ Lambda Electronics Corporation	225-228
■ American Optical Scientific Instr. Div.	206	Elfab	80	■ Lear Siegler	120
■ Amp Inc.	102, 103	Elevam Electronic Tube Co. Ltd.	217	Litronix	97
Amphenol North America Bunker Ramo Corp.	176, 177	Elorg Electronorgtechica	198	Mallory Capacitor Co.	210
Amptek Incorporated	190	■ Englehard/Thick Film	43	■ McGraw Edison Co. Bussmann Mfg. Div.	124
Analog Devices	201, 220	EXAR	73	Memorex	69
Assembly and Test Equipment Corp.	218	Fairchild Faultfinders	160, 161	* Micro Devices Div. of Emerson Electric Co.	170
Ball Display Division	117	Fairchild Semiconductor Operations Division	45	* Micro Networks Corporation	151
Bausch and Lomb Scientific Optical Products	71	Fairchild Test Systems	28-31	Microswitch Division of Honeywell	122, 123
* Bayer AG	15E	‡ First Computer Corporation	9	■ Microtechnical Industries	6
‡ Beckman Instruments, Hellpot	166	Galileo Electro Optics	164, 165	Mitel Semiconductor Inc.	50
Bel Fuse Inc.	6	General Semiconductor Industries Inc.	171	‡ Motorola Corporate	170, 171
‡ Bell Laboratories	60, 61	■ GenRad Inc.	152, 153	* Munchner Messe	91
■ F. W. Bell, Inc.	26	* Gould	9	* Murata Mfg. Co. Ltd.	170
■ Bourns, Inc.	4th Cover	Gould Inc./Instruments Oscilloscopes	202, 203	National Semiconductor Corp.	36, 37
* Burr Brown Research Corporation	4E	■ Grayhill, Inc.	48, 49	Neff Instrument Corporation	95
Burroughs	57	Guardian Electric Mfg. Co.	186, 187	■ Nippon Electric Co. Ltd.	58, 59
Centralab Electronics Division	192, 193	‡ Heinicke Instruments Corporation	38	Noritake Electronics, Inc.	209
■ Cherry Electrical Products	159	■ Hewlett-Packard	1, 2, 7, 74, 75, 78, 79, 162, 163	Ohio Scientific	25
C & K Components	168	■ Honeywell TID	136, 137	Optical Information Systems Exxon Enterprises Inc.	211
Computer Automation, Inc. Industrial Prod. Div.	214	I Corporation	200	■ Opto 22	205
Cromemco	15	Integrated Computer Systems	35	Optron, Inc.	14
Cutler Hammer Incorporated	191	Intel Memory Systems	18, 19	Perkin-Elmer Corp.	22, 23

• Phillips ELA	12E	■ Tektronix	27, 189
• Phillips Elcoma	16E	• Tektronix Datatek NV	5E
• Phillips Elcoma Market Promotion	2E, 3E	‡ Telequipment	6
■ Phillips TMI	6E	Texas Instrument Components	169
Plessey Peripheral Systems	213, 215, 217, 219	Thomson CSF	199
Polaroid Corporation	12, 13	• Thomson Sescosem	10E, 11E
Precision Monolithics	98, 99	■ TRW Capacitors	223
■ Projects Unlimited	213	■ TRW Globe Motor Division, TRW Inc.	6
PTK Corporation	173	■ TRW/IRC Resistors	197
RAC Reliability Analysis Center	90	■ TRW LSI Products	84, 85
Racal Recorders Ltd.	182, 183	■ TRW Power Semiconductors	175
RCA Solid State	62	■ Union Carbide	184, 185
Rockwell Microelectronic Device Division	47	• V/O Technasexport	91
Rogers Corporation	89, 144	• Wavetek San Diego Inc.	156
• Rohde & Schwarz	1E		
‡ Howard Sams	151		
■ Seacor Inc.	8		
• Sternica	14E		
• Siemens AG Munich	60, 13E		
Signetica Corporation	17, 76, 77		
Siliconix	104		
Solid State Scientific	222		
Spectronics	93		
■ Spectrol Electronics	83		
• SSC Division of Thomson Group	38		
Standard Microsystems	66		
Statek Corporation	65		
■ Syntronic Instruments Inc.	16		
TEAC Corporation	54		

Classified and employment advertising
F. J. Eberle, Manager 212-997-2557

Advanced Technology Center	254, 255
American Personnel Service	252
Beall Assoc.	265
Bell Laboratories	265
Boeing Vertol	258
Daimo Victor	256
Engineers Index., The	252
Engineering Search	252
Fortune Personnel Agency	265
General Dynamics	257
General Electric	253, 260, 264
Gould Ocean Systems Div.	268
GTE Lenkurt	269
Harris Co.	261
Hazeltine	270
Hewlett-Packard Co.	255
Hughes Aircraft	251
Intel	252
Int	263
Kaiser Electronics	256
Lear Siegler Inc.	264
Litton Systems, Inc.	250
McDonnell Douglas	252, 268
Merck & Co., Inc.	260
Minnesota University of	266
Narco Scientific Inc.	252, 264
National Personnel	252, 265
New England Recruiters	252
Rockwell International	267
Roland Berger & Partner	259
RPM	265
Sparton Electronics	258
Stephen, E.J.	252
Storage Technology Corp.	262
Textronix	262
Wallach Associates Inc.	268
Wang	266

■ For more information of complete product line see advertisement in the latest Electronics Buyers Guide
• Advertisers in Electronics International
‡ Advertisers in Electronics domestic edition

Advertising Sales Staff

Advertising sales manager: Paul W. Reiss
1221 Avenue of the Americas, New York, N.Y. 10020
[212] 997-4371

Atlanta, Ga. 30309: Michael Charlton
100 Colony Square, 1175 Peachtree St., N.E.
[404] 892-2868

Boston, Mass. 02116: Frank Mitchell
607 Boylston St.
[617] 262-1160

Chicago, Ill. 60611
645 North Michigan Avenue
Jack Anderson [312] 751-3739
Robert M. Denmead [312] 751-3738

Cleveland, Ohio 44113: William J. Boyle
[716] 586-5040

Costa Mesa, Calif. 92626: Robert E. Boedicker
3001 Red Hill Ave. Bldg. #4 Suite 242
[714] 557-6292

Dallas, Texas 75201: John J. Uphues
2001 Bryant Tower, Suite 1070
[214] 742-1747

Denver, Colo. 80203: Harry B. Doyle, Jr.
123 Speer Blvd. #400
[303] 837-1010

Detroit, Michigan 48202: Jack Anderson
1400 Fisher Bldg.
[313] 873-7410

Fort Lauderdale, Fla. 33306: Michael Charlton
3000 N.E. 30th Place
[305] 563-9111

Houston, Texas 77002: John J. Uphues
601 Jefferson Street, Dresser Tower
[713] 659-8361

Los Angeles, Calif. 90010: Robert J. Rielly
Robert E. Boedicker, 3200 Wilshire Blvd., South Tower
[213] 487-1160

Minneapolis, Minn. 55435: Robert M. Denmead
4015 W. 65th St.
[312] 751-3738

New York, N.Y. 10020
1221 Avenue of the Americas
John Gallie [212] 997-3616
Matthew T. Reseska [212] 997-3617

Philadelphia, Pa. 19102: Matthew T. Reseska
Three Parkway
[212] 997-3617

Pittsburgh, Pa. 15222: Matthew T. Reseska
4 Gateway Center
[212] 997-3617

Rochester, N.Y. 14534: William J. Boyle
Power Mill Office Park, 1163 Pittsford-Victor Rd.,
Pittsford, N.Y. 14534
[716] 248-5620

San Francisco, Calif. 94111: Don Farris
Dean Genge, 425 Battery Street,
[415] 362-4600

Paris: Patrick Mouillard
17 Rue-Georges Bizet, 75116 Paris, France
Tel: 720-73-01

United Kingdom & Scandinavia: Robert Ghey
34 Dover Street, London W1
Tel: 01-493-1451

Scandinavia: Andrew Karnig and Assoc.
Kungsholmsgatan 10
112 27 Stockholm, Sweden
Tel: 08 51 68 70 Telex: 179 51

Milan: Ferruccio Silvera
1 via Baracchini, Italy
Phone 86-90-656

Brussels:
23 Chaussee de Wavre
Brussels 1040, Belgium
Tel: 13-73-95

Frankfurt / Main: Fritz Krusebecker
Liebigstrasse 27c, Germany
Phone 72 01 81

Tokyo: Akio Saijo, McGraw-Hill
Publications Overseas Corporation,
Kasumigaseki Building 2-5, 3-chome,
Kasumigaseki, Chiyoda-Ku, Tokyo, Japan
[581] 9811

Business Department
Thomas M. Egan
Production Director
[212] 997-3140
Carol Gallagher
Production Manager International
[212] 997-2045
Betty Preis
Production Manager Domestic
[212] 997-2908
Thomas Kazich
Production Manager Related Products
[212] 997-2044
Marianne Meissner, Production Assistant
(212) 997-2843
Frances Vallone
Reader Service Manager
[212] 997-6057

Electronics Buyers' Guide
H.T. Howland, General Manager
[212] 997-6642
Regina Hera, Directory Manager
[212] 997-2544
Thomas Kazich, Production Manager
[212] 997-2044
Marianne Meissner, Production Assistant
[212] 997-2843
Frances Vallone, Reader Service Manager
[212] 997-6057

Classified and Employment Advertising
Frank Eberle, Manager
[212] 997-2557

Electronics

Reader Service

For additional information on products advertised, new products or new literature, use these business reply cards.

Complete entire card. Please print or type.

Circle the number on the Reader Service postcard that corresponds to the number at the bottom of the advertisement, new product item, or new literature in which you are interested.

To aid the manufacturer in filling your request, please answer the three questions.

All inquiries from outside the U.S. that cannot reach Electronics before the expiration date noted on the Reader Service postcard must be mailed directly to the manufacturer. The manufacturer assumes all responsibilities for responding to inquiries.

Subscriptions & Renewals

Fill in the subscription card adjoining this card. Electronics will bill you at the address indicated on the card.

Electronics April 26, 1979 This reader service card expires July 26, 1979

NAME _____ TITLE _____

PHONE (_____) _____ COMPANY _____

STREET ADDRESS (Company or home check one) _____

CITY _____ STATE _____ ZIP _____

Was This Magazine Personally Addressed to You? Yes No

Industry classification (check one):

- | | | |
|--|--|--|
| <input type="checkbox"/> a Computer & Related Equipment | <input type="checkbox"/> e Test & Measuring Equipment | <input type="checkbox"/> j Independent R&D Organizations |
| <input type="checkbox"/> b Communications Equipment & Systems | <input type="checkbox"/> f Consumer Products | <input type="checkbox"/> k Government |
| <input type="checkbox"/> c Navigation, Guidance or Control Systems | <input type="checkbox"/> g Industrial Controls & Equipment | |
| <input type="checkbox"/> d Aerospace, Underseas Ground Support | <input type="checkbox"/> h Components & Subassemblies | |

Your design function (check each letter that applies):

- x I do electronic design or development engineering work.
 y I supervise electronic design or development engineering work.
 z I set standards for, or evaluate electronic components, systems and materials.

Your principal job responsibility (check one)

- t Management
 v Engineering

Estimate number of employees (at this location): 1. under 20 2. 20-99 3. 100-999 4. over 1000

1 16 31 46	61 76 91 106	121 136 151 166	181 196 211 226	241 256 271 348	363 378 393 408	423 438 453 468	483 498 703 718
2 17 32 47	62 77 92 107	122 137 152 167	182 197 212 227	242 257 272 349	364 379 394 409	424 439 454 469	484 499 704 719
3 18 33 48	63 78 93 108	123 138 153 168	183 198 213 228	243 258 273 350	365 380 395 410	425 440 455 470	485 500 705 720
4 19 34 49	64 79 94 109	124 139 154 169	184 199 214 229	244 259 274 351	366 381 396 411	426 441 456 471	486 501 706 900
5 20 35 50	65 80 95 110	125 140 155 170	185 200 215 230	245 260 275 352	367 382 397 412	427 442 457 472	487 502 707 901
6 21 36 51	66 81 96 111	126 141 156 171	186 201 216 231	246 261 338 353	368 383 398 413	428 443 458 473	488 503 708 902
7 22 37 52	67 82 97 112	127 142 157 172	187 202 217 232	247 262 339 354	369 384 399 414	429 444 459 474	489 504 709 951
8 23 38 53	68 83 98 113	128 143 158 173	188 203 218 233	248 263 340 355	370 385 400 415	430 445 460 475	490 505 710 952
9 24 39 54	69 84 99 114	129 144 159 174	189 204 219 234	249 264 341 356	371 386 401 416	431 446 461 476	491 506 711 953
10 25 40 55	70 85 100 115	130 145 160 175	190 205 220 235	250 265 342 357	372 387 402 417	432 447 462 477	492 507 712 954
11 26 41 56	71 86 101 116	131 146 161 176	191 206 221 236	251 266 343 358	373 388 403 418	433 448 463 478	493 508 713 956
12 27 42 57	72 87 102 117	132 147 162 177	192 207 222 237	252 267 344 359	374 389 404 419	434 449 464 479	494 509 714 957
13 28 43 58	73 88 103 118	133 148 163 178	193 208 223 238	253 268 345 360	375 390 405 420	435 450 465 480	495 510 715 958
14 29 44 59	74 89 104 119	134 149 164 179	194 209 224 239	254 269 346 361	376 391 406 421	436 451 466 481	496 701 716 959
15 30 45 60	75 90 105 120	135 150 165 180	195 210 225 240	255 270 347 362	377 392 407 422	437 452 467 482	497 702 717 960

Electronics April 26, 1979 This reader service card expires July 26, 1979

NAME _____ TITLE _____

PHONE (_____) _____ COMPANY _____

STREET ADDRESS (Company or home check one) _____

CITY _____ STATE _____ ZIP _____

Was This Magazine Personally Addressed to You? Yes No

Industry classification (check one):

- | | | |
|--|--|--|
| <input type="checkbox"/> a Computer & Related Equipment | <input type="checkbox"/> e Test & Measuring Equipment | <input type="checkbox"/> j Independent R&D Organizations |
| <input type="checkbox"/> b Communications Equipment & Systems | <input type="checkbox"/> f Consumer Products | <input type="checkbox"/> k Government |
| <input type="checkbox"/> c Navigation, Guidance or Control Systems | <input type="checkbox"/> g Industrial Controls & Equipment | |
| <input type="checkbox"/> d Aerospace, Underseas Ground Support | <input type="checkbox"/> h Components & Subassemblies | |

Your design function (check each letter that applies):

- x I do electronic design or development engineering work.
 y I supervise electronic design or development engineering work.
 z I set standards for, or evaluate electronic components, systems and materials.

Your principal job responsibility (check one)

- t Management
 v Engineering

Estimate number of employees (at this location): 1. under 20 2. 20-99 3. 100-999 4. over 1000

1 16 31 46	61 76 91 106	121 136 151 166	181 196 211 226	241 256 271 348	363 378 393 408	423 438 453 468	483 498 703 718
2 17 32 47	62 77 92 107	122 137 152 167	182 197 212 227	242 257 272 349	364 379 394 409	424 439 454 469	484 499 704 719
3 18 33 48	63 78 93 108	123 138 153 168	183 198 213 228	243 258 273 350	365 380 395 410	425 440 455 470	485 500 705 720
4 19 34 49	64 79 94 109	124 139 154 169	184 199 214 229	244 259 274 351	366 381 396 411	426 441 456 471	486 501 706 900
5 20 35 50	65 80 95 110	125 140 155 170	185 200 215 230	245 260 275 352	367 382 397 412	427 442 457 472	487 502 707 901
6 21 36 51	66 81 96 111	126 141 156 171	186 201 216 231	246 261 338 353	368 383 398 413	428 443 458 473	488 503 708 902
7 22 37 52	67 82 97 112	127 142 157 172	187 202 217 232	247 262 339 354	369 384 399 414	429 444 459 474	489 504 709 951
8 23 38 53	68 83 98 113	128 143 158 173	188 203 218 233	248 263 340 355	370 385 400 415	430 445 460 475	490 505 710 952
9 24 39 54	69 84 99 114	129 144 159 174	189 204 219 234	249 264 341 356	371 386 401 416	431 446 461 476	491 506 711 953
10 25 40 55	70 85 100 115	130 145 160 175	190 205 220 235	250 265 342 357	372 387 402 417	432 447 462 477	492 507 712 954
11 26 41 56	71 86 101 116	131 146 161 176	191 206 221 236	251 266 343 358	373 388 403 418	433 448 463 478	493 508 713 956
12 27 42 57	72 87 102 117	132 147 162 177	192 207 222 237	252 267 344 359	374 389 404 419	434 449 464 479	494 509 714 957
13 28 43 58	73 88 103 118	133 148 163 178	193 208 223 238	253 268 345 360	375 390 405 420	435 450 465 480	495 510 715 958
14 29 44 59	74 89 104 119	134 149 164 179	194 209 224 239	254 269 346 361	376 391 406 421	436 451 466 481	496 701 716 959
15 30 45 60	75 90 105 120	135 150 165 180	195 210 225 240	255 270 347 362	377 392 407 422	437 452 467 482	497 702 717 960

Electronics Reader Service

If the cards below have already been used,
you may obtain the needed information
by writing directly to the manufacturer,
or by sending your name and address,
plus the Reader Service number and issue date,
to Electronics Reader Service Department,
P.O. Box No. 2530, Clinton, Iowa 52734.

Affix
Postage
Here

Electronics

P.O. Box No. 2530
Clinton, Iowa 52735

Affix
Postage
Here

Electronics

P.O. Box No. 2530
Clinton, Iowa 52735

The Power Elite



ENI truly is the Power Elite. In fact, when you want the ultimate in power flexibility, there's simply nothing finer in all the world. And our instrumentation can meet all your application needs, for RF signal generator amplification, RFI/EMI testing, signal distribution, RF or data transmission, NMR/ENIXOR, ultrasonics and more.

ENI's selection of Class A power amplifiers is unsurpassed, combining a frequency spectrum

of 10 kHz to 1 GHz with power outputs that range from 300 milliwatts to over 4,000 watts. Rugged, compact and versatile, these power amplifiers can be driven by virtually any signal source. They're completely broadband and untuned, amplifying inputs of AM, FM, TV, SSB and pulse modulations with minimum distortion. The unconditional stability and failsafe design make them impervious to severe load conditions (open or

short circuit), delivering their rated power to any load, regardless of match.

Clearly, when it comes to meeting your power amplification needs, ENI is in a class by itself.

For detailed technical specifications, a demonstration or our latest full-line catalog, write: ENI, 3000 Winton Road South, Rochester, New York 14623. Call (716) 473-6900, or Telex 97-8283 ENI ROC.

ENI

The World's Leader in Power Amplifiers

Circle 901 on reader service card

Tested for Quality Time and Again...

Bourns Resistor Networks.

Put to the Test — From incoming inspection of the raw materials through final inspection prior to shipment, Bourns DIP and SIP resistor networks are stringently tested to assure the highest quality possible.

First article inspection is performed at every key manufacturing step. All parts are laser-trimmed to their correct value and then 100% inspected. Rejects are sorted out, eliminating many latent defects. Only parts passing inspection are assembled and then subjected to an additional 100% parametric test. This electrical test is followed by another QC inspection prior to shipment.

Designed In Quality — Inside and out, Bourns resistor networks are designed to deliver superior performance and trouble-free operation. Inside, the Bourns exclusive KRIMP-JOINT™ lead frame termination design provides both a mechanical and electrical bond that assures reliability. Outside, a proprietary molding technique eliminates the mold gate, resulting in a dimensionally stable, thermoset plastic package.

Auto-Insertion — Inserting molded Bourns DIP and SIP resistor networks is the same as inserting ICs. No changing of adjustments is necessary on the automatic insertion equipment.

Superior Performance — Bourns resistor networks offer superior load life, better thermal shock performance and lower, more uniform tempco.

Verified quality, competitive pricing, distributor availability, a broad line of both DIPs and SIPs, and excellent delivery. Put Bourns Resistor Networks to the test. Call or write today for your new catalog. Or, see the EEM directory (Volume 2, pages 3639 - 3645).

TRIMPOT PRODUCTS DIVISION, BOURNS, INC., 12155 Magnolia Avenue,
Riverside, CA 92503. Phone: 714 781-5415. TWX: 910 332-1252

European Headquarters: Bourns AG, Zugerstrasse 74 6340 Baar, Switzerland.
Phone: 042 33 33 33. Telex: 78722.



BOURNS®