

APRIL 27, 1978

**DESIGNERS TURN TO GATE ARRAYS FOR HIGH-SPEED CUSTOM LOGIC/83**

Special report: the new technologies behind printed wiring/ 114

Single-chip system cuts cost of data acquisition/ 131

FOUR DOLLARS A McGRAW-HILL PUBLICATION

International

# Electronics®



45667

SPECTRUM  
ANALYSIS  
WITH  
FRACTIONAL-N  
SYNTHESIS

# Speed total harmonic distortion measurements.



## With HP's newest distortion analyzer.

Automatic frequency nulling and auto set level features of the 339A Distortion Measurement Set speed your total harmonic distortion measurements (THD). And true-rms detection means accurate measurements as low as 0.0018% (-95 dB) from 10 Hz to 110 kHz. Whether you're testing signal sources or amplifiers, here's how the 339A, priced at \$1,900\*, can help you make quick and precise measurements.

**Speed your set-up.** Just select the frequency of the built-in oscillator and the 339A's "turn signal" indicators show you how to make the proper input range setting. This means you have a low-distortion source for testing high-performance amplifiers and

you tune one instrument instead of two. If you're using an external source, "turn signal" indicators show you which direction to turn frequency controls for quick manual nulling.

**Save test time.** The 339A's auto set level feature automatically sets the 100% reference level, within a 10 dB capture range, every time you change frequency or level. Again, visual indicators show you which way to turn the input range switch if your signal is outside of the capture range. You not only save time, you also minimize operator errors.

Standard features even make the 339A suitable for checking broadcast equipment for FCC compliance. And for measuring frequency response, you can quickly read relative measurements in either percentage or dB.

Contact your local HP field engineer for further details.

\* Domestic U.S.A. price only.

HEWLETT  PACKARD

1507 Page Mill Road, Palo Alto, California 94304

For assistance call: Washington (301) 948-6370, Chicago (312) 255-9800, Atlanta (404) 955-1500, Los Angeles (213) 877-1282

096/41

World Radio History  
Circle 900 on reader service card

## 39 Electronics Review

SOLID STATE: IBM, Intel swap bubble memory, microprocessors, 39  
MEMORIES: Hard disk drive shrinks nearly to floppy size, 40  
AUTOMOTIVE: Ford readies electronic distributor replacement, 40  
MICROPROCESSORS: Z8000 design packs minicomputer punch, 41  
PRODUCTION: Components solder directly to boards, 42  
TRADE: U. S. imports of ICs show sharp rise, 44  
UNDERWATER: Microprocessor directs unmanned craft, 46  
MICROWAVES: Suit against Air Force attacks U. S. standards, 48  
TELECOMMUNICATIONS: Signetics develops I<sup>2</sup>L codec, 51  
NEWS BRIEFS: 51  
SPACE: NASA seeks ideas for space shuttle work, 52

## 63 Electronics International

GREAT BRITAIN: Mainframe hits 100 million operations a second, 69  
FRANCE: Flat YIG resonator is simple to handle and orient, 70  
ITALY: International phone fight attracts new competitor, 72  
EAST GERMANY: Quiet teletypewriter uses mostly ICs, 72  
Color TV industry is booming, 74  
NEW PRODUCTS INTERNATIONAL: 3E

## 83 Probing the News

SEMICONDUCTORS: Makers look to huge market for gate arrays, 83  
COMPANIES: Exxon seeks big strike in electronics, 88  
SEMI beats out big guys on the block, 90  
SEMICONDUCTORS: SOS pact has 'em guessing, 94  
SPACE ELECTRONICS: Should U. S. get its power from space? 96

## 107 Technical Articles

INSTRUMENTS: Frequency domain yields to PLL synthesizer, 107  
SPECIAL REPORT: Methods, materials stir up printed wiring, 114  
DESIGNER'S CASEBOOK: Unity-gain buffer amplifier is ultrafast, 124  
Dual charge-flow paths extend pulse repetition rate, 126  
PROM adds bootstrap loader to Intellec-8 development system, 126  
DATA ACQUISITION: One-chip system cuts cost, 131  
CONSUMER: Linear IC automatically focuses camera lens, 139  
ENGINEER'S NOTEBOOK: Light detector checks optical cables fast, 148  
Pilot-lamp controller stabilizes crystal oven, 150  
Tester determines solar cell's sunlight-gathering efficiency, 152

## 163 New Products

IN THE SPOTLIGHT: Are power transistors beating out SCRs? 163  
Small switchers pack in the power, 164  
INSTRUMENTS: Spectrum analyzer measures signal coherence, 170  
MICROPROCESSORS: Module adapts MDS 800 to Z80, 183  
SUBASSEMBLIES: 'Compromise' a-d converter enters, 196  
DATA HANDLING: Emulator board thinks small, 216  
SEMICONDUCTORS: Here's Mostek's IC tone decoder, 234  
INDUSTRIAL: Data-acquisition unit ignores high voltages, 242  
MATERIALS: 252

## Departments

Publisher's letter, 4  
Readers' comments, 6  
News update, 8  
People, 14  
Editorial, 25  
Meetings, 26  
Electronics newsletter, 33  
Washington newsletter, 59  
Washington commentary, 60  
International newsletter, 65  
Engineer's newsletter, 154  
New literature, 254

## Services

Reader service card, 9E  
Reprints available, 246  
Employment opportunities, 262

## Highlights

### Cover: A calculating spectrum analyzer, 107

A new spectrum analyzer can measure the waveforms that it displays by a low-cost method of frequency synthesis using a phase-locked loop. Microprocessor control enhances the accuracy and even automates some spectrum-analysis operations.

Cover is by Art Director Fred Sklenar.

### The big name in 4-K static RAMs is SEMI, 90

Nearly half the sales of 4-K static MOS random-access memories are made by one firm: EMM SEMI Inc. Yet not too many years ago the firm was bankrupt, and its comeback is a tale of targeting a market.

### Pc makers update technology, 114

The technology of printed-circuit boards is stirring once again. This special report covers a host of new developments in both methods and materials, notably the adaptation of thick-film techniques and new dry-film resists.

### Data acquisition gets cheaper, 131

A single-chip system promises to cut the cost of many data-acquisition and -processing systems. Though not as fast as hybrid versions, the \$20 chip gives a cost-performance tradeoff suitable for many applications.

### And in the next issue . . .

A preview of Electro/78 . . . a single-chip computer gets more memory . . . a field tester cuts system maintenance costs.

EDITOR-IN-CHIEF: Kemp Anderson

EXECUTIVE EDITOR: Samuel Weber

MANAGING EDITOR: Arthur Erikson,  
*International*

SENIOR EDITORS: William F. Arnold, Ray Connolly,  
Lawrence Curran, Gerald M. Walker

ART DIRECTOR: Fred Sklenar

ASSOCIATE EDITORS: Howard Wolff,  
Alfred Rosenblatt

DEPARTMENT EDITORS

*Aerospace/Military*: Ray Connolly  
*Circuit Design*: Vincent Biancomano  
*Communications & Microwave*:

Richard Gundlach

*Components*: Lucinda Matterna

*Computers*: Raymond P. Capece

*Consumer*: Gerald M. Walker

*Instrumentation*: Albert F. Shackil

*New Products*: Michael J. Riezenman

*Packaging & Production*: Jerry Lyman

*Solid State*: Raymond P. Capece

CHIEF COPY EDITOR: Margaret Eastman

COPY EDITORS: Ben Mason, Mike Robinson

ART: Charles D. Ciatto, *Associate Director*  
Paula Piazza, *Assistant Director*

EDITORIAL SECRETARIES: Janet Noto,  
Penny Kaplan

EDITORIAL ASSISTANT: Marilyn B. Rosoff

FIELD EDITORS

*Boston*: Lawrence Curran (Mgr.)

Pamela Hamilton

*Los Angeles*: Larry Waller (Mgr.)

*Midwest*: Larry Armstrong (Mgr.)

*New York*: Bruce LeBoss (Mgr.)

*San Francisco*: William F. Arnold (Mgr.)

Robert Brownstein

*Washington*: Ray Connolly (Mgr.)

*Frankfurt*: John Gosch

*London*: Kevin Smith

*Paris*: Arthur Erikson

*Tokyo*: Charles Cohen

McGraw-Hill WORLD NEWS

*Editor*: Michael Johnson

*Brussels*: James Smith

*Milan*: Andrew Heath

*Moscow*: Peter Hann

*Paris*: Andrew Lloyd

*Stockholm*: Robert Skole

*Tokyo*: Robert E. Lee

PUBLISHER: Dan McMillan

ADVERTISING SALES MANAGER:

Paul W. Reiss

MARKETING ADMINISTRATION MANAGER:

Wallis Clarke

CIRCULATION MANAGER: Karl Peterson

MARKETING SERVICES MANAGER:

Tomlinson Howland

RESEARCH MANAGER: Margery D. Sholes

Wherever there's a microprocessor in use, there's a printed-circuit board on which to mount it. Therefore, tracking printed-circuit technology is as much in the mainstream as following microprocessor developments. Which is why packaging and production editor Jerry Lyman has written the special report that starts on page 114.

As in other technologies, rapid changes over the last few years have caused some interesting new trends in pc boards. There's even a little controversy, Jerry points out.

For example, line resolution of printed-circuit boards is rapidly approaching the line resolution of thick-film hybrids. Also, special thick-film conductive and resistive materials are now showing up on pc substrates. Thus there's a blurring of distinctions between printed-circuit and hybrid technologies.

Holding up a sample board picked up during the course of preparing the article, Jerry observes, "What do you call a product that has etched copper connectors, on top of which are screened-on thick film resistors, on top of which is an insulator, and then on top of that are screened-on conductors? Is it a hybrid or a pc board or what?"

Pointing to another board sample, he adds, "What if you have a board-

sized piece of vitreous enamel steel with screened-on conductors and resistors and IC chips bonded on as well? Is it a steel pc board or a large hybrid on steel in a size that couldn't be made in ceramic?"

Essentially, Jerry concludes, the industry is probably due for a round of new classifications to cover these changes. Some manufacturers are considering the problem, but it's still too early to tell how the newest pc boards (or are they pc hybrids?) will be labeled.

Another trend Jerry noted is the upgrading of the pc-board specs when linked with microprocessors. Two important examples have been in automotive and TV game applications. Users started with the idea of mounting the microprocessors on low-cost laminates but ended up by putting them on aerospace-quality boards.

"You can't put a microprocessor on a cheap board," Jerry states. "If you want results, you have to put it on a quality, two-sided board."



### Wanted: engineers who want to be editors

We have challenging positions available for electronics engineers who can combine writing ability and technical know-how into a rewarding career as an editor on *Electronics* magazine in New York. Candidates should have a BSEE and design experience in computers or communications. We offer excellent salary and fringe benefits. Send your résumé to the Executive Editor, *Electronics*, 1221 Avenue of the Americas, New York, N. Y. 10020.

April 27, 1978 Volume 51, Number 9 99,764 copies of this issue printed

Published every other Thursday by McGraw-Hill, Inc. Founder: James H. McGraw 1860-1948. Publication office 1221 Avenue of the Americas, N.Y., N.Y. 10020; second class postage paid at New York, N.Y. and additional mailing offices ID # 172400.

Executive, editorial, circulation and advertising addresses: *Electronics*, McGraw-Hill Building, 1221 Avenue of the Americas, New York, N.Y. 10020. Telephone (212) 997-1221. Teletype 12-7960 TWX 710-581-4879. Cable address: MCGRAW HILL NEW YORK.

Subscriptions limited to professional persons with active responsibility in electronics technology. No subscriptions accepted without complete identification of subscriber name, title or job function, company or organization, and product manufactured or services performed. Based on information supplied, the publisher reserves the right to reject non-qualified requests. Subscription rates in the United States and possessions: \$15 one year, \$26 two years, \$38 three years; company addressed and company libraries \$20 one year, \$36 two years, \$50 three years; APO/FPO addressed \$35 one year only; Canada and Mexico \$17 one year, \$29 two years, \$43 three years; Europe \$42 one year, \$71 two years, \$100 three years; Japan, Israel and Brazil \$70 one year, \$115 two years, \$165 three years; Australia and New Zealand \$95 one year, \$170 two years, \$240 three years, including air freight; all other countries \$45 one year, \$80 two years, \$112 three years. Limited quota of subscriptions available at higher-than-basic rate for persons allied to field served. Check with publisher for these rates. Single copies: \$4.00. Please allow four to eight weeks for shipment.

Officers of McGraw-Hill Publications Company: Gordon L. Jones, President; Paul F. McPherson, Executive Vice-President; Group Vice-President: Gene W. Simpson; Senior Vice-Presidents: Russell F. Anderson; James E. Bodoor, Planning & Development; David G. Jensen, Manufacturing; Ralph R. Schulz, Editorial; Vice-Presidents: Denis C. Beran, European Operations; David P. Forsyth, Research; Douglas Greenwald, Economics; James E. Hackett, Controller; Robert L. Leyburn, Circulation; Edward E. Schirmer, Sales.

Officers of the Corporation: Harold W. McGraw, Jr., President, Chief Executive Officer, and Chairman of the Board; Robert N. Landes, Senior Vice President and Secretary; Ralph J. Webb, Treasurer.

Title registered in U.S. Patent Office; Copyright © 1978 by McGraw-Hill, Inc. All rights reserved. The contents of this publication may not be reproduced in whole or in part without the consent of copyright owner.

Subscribers: The publisher, upon written request to our New York office from any subscriber, agrees to refund that part of the subscription price applying to copies not yet mailed. Please send change-of-address notices or complaints to Fulfillment Manager; subscription orders to Circulation Manager, *Electronics*, at address below. Change-of-address notices should provide old as well as new address, including postal zip code number. If possible, attach address label from recent issue. Allow one month for change to become effective.

Postmaster: Please send form 3579 to Fulfillment Manager, *Electronics*, P.O. Box 430, Hightstown, N.J. 08520.

From DC to 1 megahertz, the Model 7500 direct coupled amplifier puts up to 75 watts and 125 VRMS at your fingertips. This all solid state unit offers typical frequency response of  $\pm .05\text{db}$  and harmonic distortion of  $.05\%$ . Output circuit is both current and voltage protected. Voltage gain is 0 to X100, fixed or variable. Both AC and DC input coupling are provided. Ideal for precision meter calibration and transducer driving. Stick with the WAVEMAKERS.™ Contact any of the reps listed.

**KH KROHN-HITE CORPORATION**

Avon Industrial Park, Avon, MA 02322 • (617) 580-1660 TWX 710 345 0831

OVERSEAS SALES OFFICES ARGENTINA: Coasin S/A AUSTRIA: Universal Elektronik Import.  
AUSTRALIA: Warburton Frankl. Limited BELGIUM: C. N. Rood, s.a. CANADA: Canadian Marconi  
Company DENMARK: SC Metric A/S ENGLAND: Keithley Instruments, Ltd. FINLAND: Into/OY.  
FRANCE: MB Electronique GERMANY: Keithley Instruments, GMBH. HOLLAND: C. N. Rood, b.v.  
ISRAEL: R. D. T. Electronics Engineering Ltd. ITALY: Vianello S.P.A. JAPAN: Chisho Corporation.  
NEW ZEALAND: Warburton Frankl. Ltd. NORWAY: Telemet AB PORTUGAL: Magnetrom.  
SINGAPORE: O Connors (PTE) Ltd. SOUTH AFRICA: Protea Physical and Nuclear Inst. (Pty) Ltd.  
SPAIN: Rema Leo Haag, S.A. SWEDEN: Telemet AB SWITZERLAND: Megex Electronic AG

# the 7500 amplifier... WIDEBAND-AID for system designers

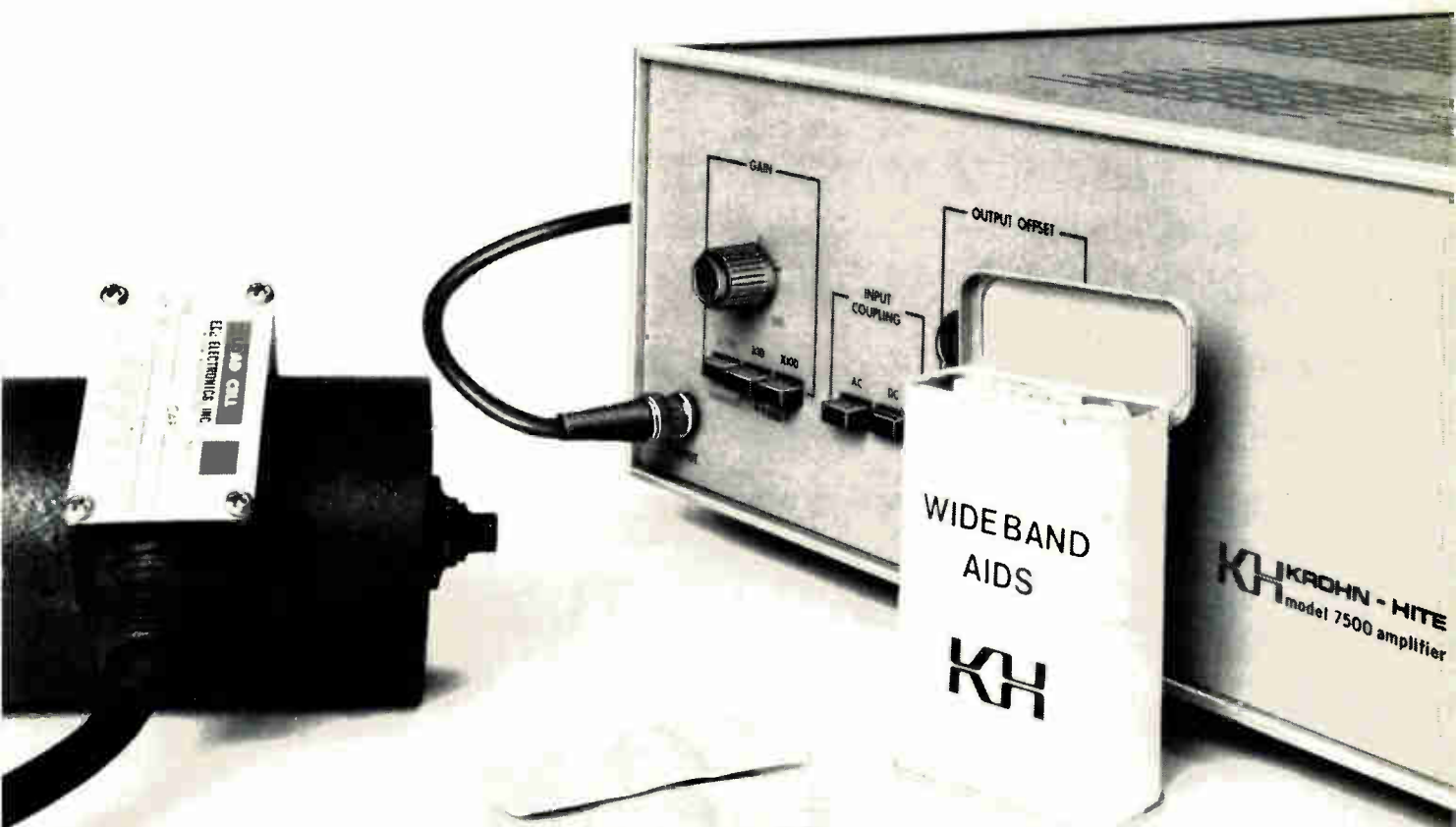

# FIRST,

**Bud developed this System because no two people think alike.**

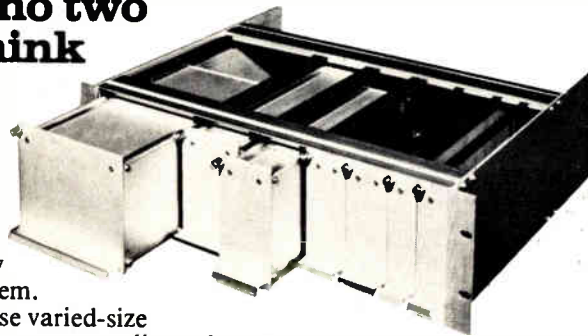

Create an electronic package your way with the Bud System.

Use PC boards; use varied-size modules to house power supplies, relays, transformers, other components. Design, redesign, adapt your package. Exercise your options!

# SECOND,

**for an equally adaptable card frame, order the System's sub-rack.**

Snap-in guides, made of fire-retardant plastic, are movable, adjust to a 0.2" pitch. You can use up to 42 PC boards which slip directly into edge

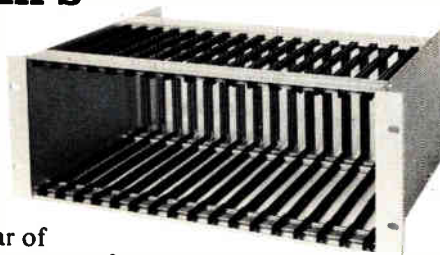

connectors attached at rear of guides. This assures perfect alignment.

**BUY  
BUD**

First...of all.

Write for 8-page brochure. Bud Industries, Inc., 4605 E. 355 St., Willoughby, Ohio 44094. Bud West, Inc., 3838 N. 36 Ave., Phoenix, Ariz. 85019.

Or phone toll free: (800) 321-1764; in Ohio, (800) 362-2265.

Circle 6 for full details  
Circle 142 to have salesman call

**The magazine you're reading now, could be your own.**

Drop off the routing list. Get your own fresh, unclipped copy mailed to your home or office. Turn to the subscription card in the back of the magazine. If somebody has beat you to it, write: Electronics, P.O. Box 430, Hightstown, N.J. 08520.

## Readers' comments

### Hydrogen here on earth

**To the Editor:** After reading the Feb. 16 Washington Commentary [p. 60], I felt that someone must be pulling our collective leg. We can all agree that our energy problem needs a solution, and quickly. And surely photovoltaics can play a big part. But why take them into space at unbelievable expense when they can do the same job right here on earth? [For more on the pros and cons of solar-power satellites, see p. 96.]

The power from photovoltaic farms could be used to produce hydrogen by electrolysis. The hydrogen could then be liquefied for inexpensive transportation by pipeline, truck, or train, or it could be used at the site. Most of our existing fossil-fuel electric-power-generating plants could use hydrogen as a fuel with little or no modification. Even our cars could be converted to hydride or liquid-hydrogen fuel.

Certainly, there are problems. We would have to train industrial workers and consumers to handle liquid hydrogen safely. But a similar problem exists with most fuels, and a hydrogen-based economy could be built on existing economic systems, rather than overturn the world economic balance as we are now doing by buying oil from other countries. Even they will someday run out of oil and need solar power.

H. L. Anderson  
Arlington, Va.

### Too simple

**To the Editor:** Dennis Snyder's solution for connecting an older trailer's lights (one lamp, two filaments, for all functions) to a modern automobile having three separate lamps is oversimplified [Readers' Comments, March 2, p. 6].

His wired-OR gate using two power diodes will permit *either* the turn *or* the brake source to light the trailer lamp. However, use of the turn signal usually is soon accompanied by the brake signal; but being continuously lit by the brake indicator, the trailer's lamps can hardly flash the turn signal.

R. O. Deck  
Palo Alto, Calif.

# The Fujitsu Edge: ICs with a MTTF of 2,500 years.



**Built and tested to exceed Mil std. 883A.** Every Fujitsu IC meets Mil std. 883A because our own company standards—for commercial products—meet or exceed that specification. That's how important quality is to us.

#### Life Test Data MB8116HC

Test	MIL-STD 883A	Number Tested	Number Failed	70°C Equiv. Device-Hrs
150°C Storage	1008.1 C	200	0	6.2x10 <sup>6</sup>
200°C Storage	1008.1 D	200	0	22x10 <sup>6</sup>
250°C Storage	1008.1 E	100	1*	34x10 <sup>6</sup>
150°C S.S.	1005.1 C	200	0	5.9x10 <sup>6</sup>
125°C Dynamic	1005.1 D	400	1**	1.2x10 <sup>6</sup>
-10°C Dynamic	1005.1 D	50	0	—
<b>Total</b>		<b>1150</b>	<b>2</b>	<b>69.3x10<sup>6</sup></b>

\*: Metalization Scratch \*\*: Oxidation Defect

**Beginning with basics.** At Fujitsu, nothing is overlooked in our efforts to bring you the most reliable ICs available anywhere in the world. Every one of our devices takes full advantage of our time-tested proprietary processing techniques. Our facilities are housed in modern, scrupulously clean buildings that were designed with the same care that we take with our circuits. Our dedicated and disciplined employees work with the most modern production and test equipment available.

**Constant vigilance at every step.** Beginning with our inspections of incoming material and continuing through to the shipment of the finished product, every Fujitsu IC is tested 18 separate times. In addition, 10 different sample tests are performed on each production lot.

**Nine million device hours without a single failure.** In recent testing by a major U.S. computer manufacturer Fujitsu RAMs delivered well over nine million device hours without a single failure. If your products could benefit from that kind of reliability, we are your kind of company.

**No extra charge for Fujitsu quality.** How can we do it? Simple. Fujitsu yields are well above the industry average. In addition, our automated assembly techniques substantially reduce overhead costs. So, even though we spend more on quality assurance and testing, we can still meet the toughest competition.

**Get the complete story.** For more information, write or call. We've got data to back up everything we say.

## FUJITSU AMERICA, INC.

1208A East Arques Avenue  
Sunnyvale, CA 94086  
(408) 739-3200  
Telex: 346393 • TWX: 910-338-0047

- Please send me data on your 4K, and 16K MOS dynamic RAMs
- Please send me the Fujitsu reliability story
- Please send me Fujitsu's short-form Product Selector
- Please send me the Fujitsu Product Catalog
- Please call me about an immediate application

Name \_\_\_\_\_ Title \_\_\_\_\_

Organization \_\_\_\_\_

Address \_\_\_\_\_

City \_\_\_\_\_ State \_\_\_\_\_

Zip \_\_\_\_\_ Telephone: (\_\_\_\_) \_\_\_\_\_

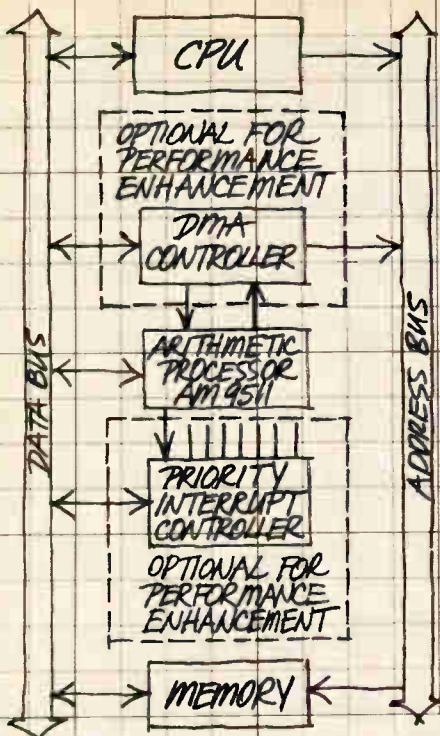

COMMAND IS ENTERED.  
 OPERATES INDEPENDENTLY UNDER  
 INTERNAL MICROPROGRAM CONTROL.  
 REQUIRES NO CPU INTERVENTION.  
 INTERNAL ARCHITECTURE HAS  
 MANY FEATURES THAT EN-  
 HANCE THE COMPUTA-  
 TIONAL SPEED!

- ✓ DATA & STACK MANIPULATION COMMANDS.
- ✓ 16-BIT INTERNAL BUS
- ✓ VALL & STACK STRUCTURE
- ✓ HARDWARE ARITHMETIC SEQUENCING
- ✓ TWO-PORT STACK ORGANIZATION
- ✓ WORKING REGISTER SPACE.

J.B.-  
 Saves a whole board  
 of TTL! MIL-STD-883  
 for free too.  
 This one's a  
WINNER!

The weakest link in your micro-processor-based system has always been software development. It's always taken weeks and dollars and headaches. But that's going to be different now.

# MICROPROCESSING: THE WEAK LINK REMOVED.



Advanced Micro Devices announces the Am9511 Arithmetic Processor.

It implements the following functions in high speed hardware, two orders of magnitude faster than the standard MPU software approach.

Simple: addition, subtraction, multiplication and division.

Complex: logarithms, square roots, powers, exponentiation, trigonometry and inverse trigonometry.

(The basic functions can be performed in 16-bit or 32-bit fixed point and 32-bit floating point format.)

As if that weren't enough, you pick the microprocessor. That's right. Not only is our Am9511 amazing, it's also compatible with all of the most com-

monly used microprocessors on the market—including the industry standard 8080/8085.

Increase your system throughput. Save weeks and months of software development. Reduce your chip count.

Remove the weak link. Call Advanced Micro Devices and ask for the data sheet and application note on the Am9511 Arithmetic Processor.

# Advanced Micro Devices



Multiple technologies. One product: excellence.  
901 Thompson Place, Sunnyvale, California 94086  
Telephone (408) 732-2400

Advanced Micro Devices, Inc. • France: Silic 314-Immeuble Essen, 20 Rue Saarinen, 94588 Rungis Cedex, France. Tel: (1) 686-91-86;  
Germany: 8000 Munchen 2, Herzog-Heinrich-Strasse 3, West Germany, Tel: (089) 539588; United Kingdom: 16 Grosvenor Place, London,  
SW1, England, Tel: (01) 235-6380; Belgium: 412, Avenue de Tervuren, B P 9, 1150 Brussels, Belgium, Tel: 32-2-771.99.93.

Circle 10 on reader service card

# The HP8750A Storage-Normalizer: It brings additional accuracy and simplicity to swept frequency measurements.

Here's an extremely useful and versatile accessory for most HP Network and Spectrum Analyzers. The 8750A Storage-Normalizer employs memory techniques to "normalize" — that is, remove system response from measured data. And its digital storage, constantly updated, provides a continuous flicker-free display regardless of sweep speed.

Here are some examples of the improvements it can bring to your swept frequency measurements:

## High Accuracy Measurements.

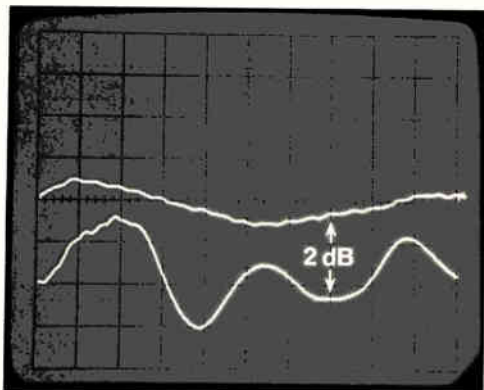

Before Normalization

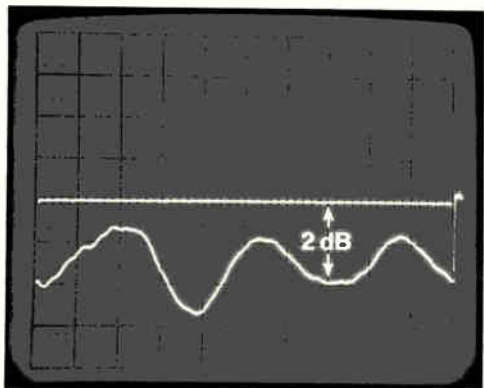

Normalized

Frequency response or tracking errors in transmission or reflection measurements are eliminated with normalization. You can calibrate the test system's response and store it, then subtract it from the measured data. The resultant difference represents the corrected measurement that's displayed directly in dB.

## Comparison Measurements.

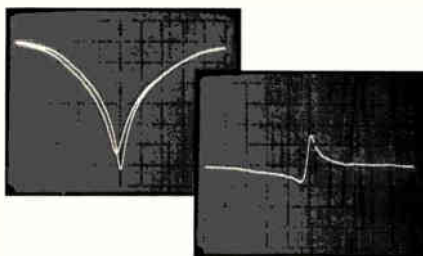

No longer is it necessary to visually scale deviations between two traces. With the HP 8750A, you can now display the *difference* between the two. Deviation between test devices is displayed directly in dB with a single trace.

## Slow Sweep Measurements.

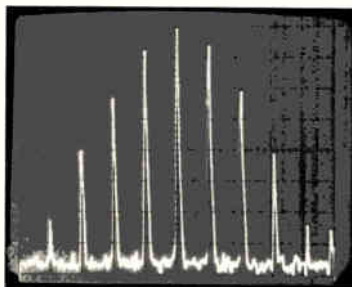

Use it for high resolution measurements when slow scan times are needed and get a bright, flicker-free display. Measurement data are displayed from memory with continuous refresh, independent of scan time and scope adjustments.

## Spectral Comparisons.

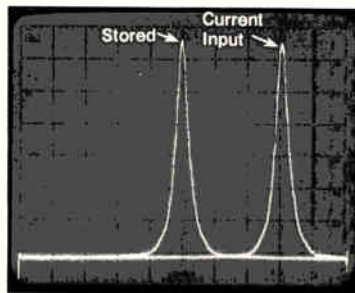

Using the 8750A in spectrum analysis applications, a signal spectrum can be frozen on the CRT and then compared directly with the current input signal.

Because the HP 8750A can "freeze" the display, photography is simplified and hard copies such as X-Y recordings can automatically be plotted, even while new measurements are being made.

Domestic U.S. price of the Storage-Normalizer is \$1450.

Call your HP field engineer for more information on how the 8750A enhances measurements made with HP 8755, 8410, 8407 and 8505 Network Analyzers, HP 8557, 8558 and 8565 Spectrum Analyzers, plus other instruments. Or write.

HEWLETT  PACKARD

1507 Page Mill Road, Palo Alto, California 94304

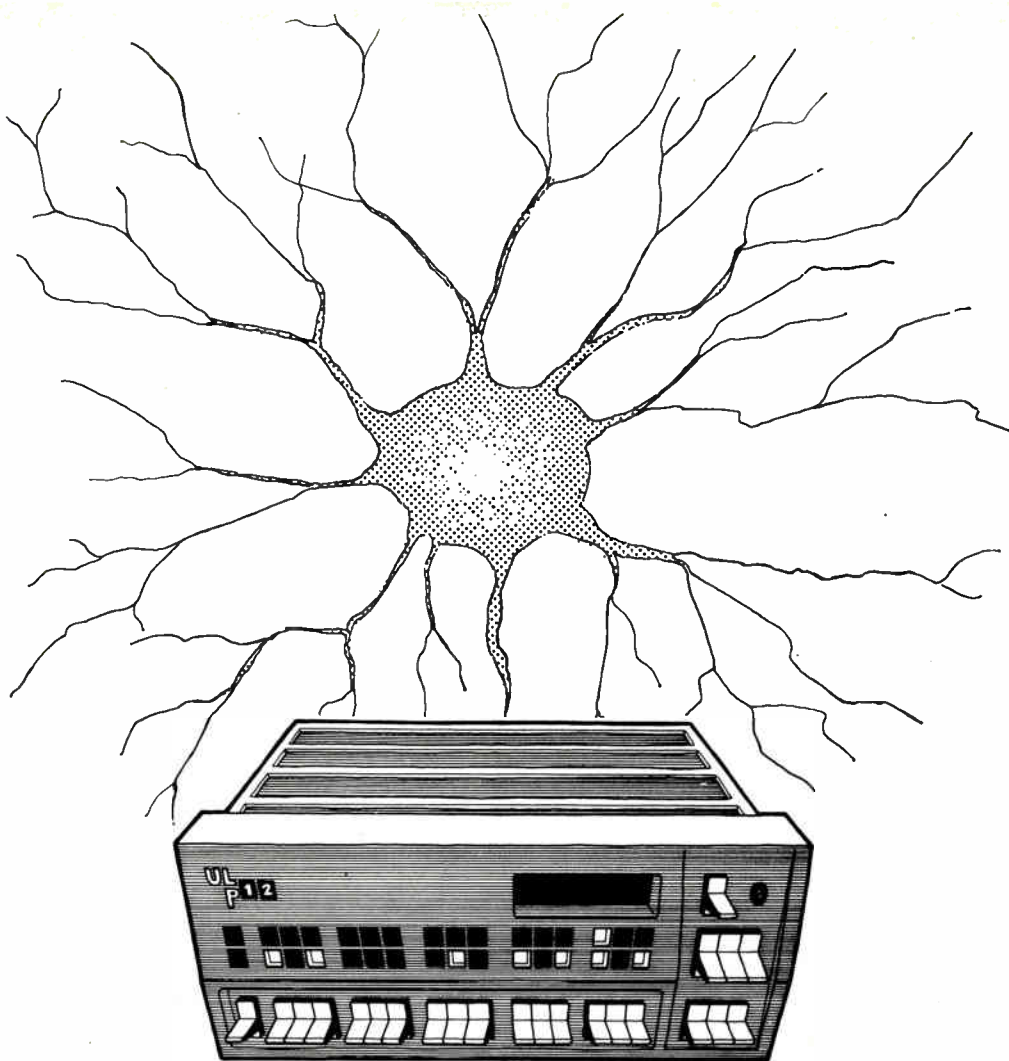

# ULP 12

## The "intelligent" system cell.

Basic unit of automation systems SEPA design and manufacture, the ULP 12 minicomputer is being used in a wide range of applications such as:

- industrial, marine and military system automation
- data acquisition, processing and transmission
- scientific calculus
- data base management in industrial, business and community environment.

SEPA manufactures the ULP 12 minicomputer in a professional as well as a military version: both are compatible with the same software packages and interface to a wide range of conventional and special peripherals.

The available standard software packages are heavily user oriented to provide maximum ease

and promptness of use. In addition to various utility and service programs they include mono/multiprogramming operating systems as well as compilers and interpreters for high level languages (RTL/2, BASIC).

**Società di Elettronica per l'Automazione S.p.A.**  
**Lungo Stura Lazio 45 - 10156 Torino (Italy)**  
**Tel. (011) 262.3333 (5 linee r.a.) Telex: 23527 Sepa**



**User size electronics**

# “Until now, we’d been mistaking access to processing for access to answers.”

**Problem: It takes more than a desktop processor to organize output into its simplest, most usable form.**

A personal computer can shave timeshare expenses, but do nothing about trimming the fat off alphanumeric answers. You can give up the power of a mainframe without the promise of more intelligent, instantly visible data.

**Solution: Tektronix’ 4051. The one desktop unit that shapes information into usable graphics.**



From interfaces and firmware to hard copy units, data storage devices, printers, plotters, graphic tablets and proven software, Tektronix provides plug-in capability to customize the 4051 to your special needs.

A graphics answer is the most concise of all possible solutions. The 4051 can eliminate the hand-plotting and mental gymnastics that users of alphanumeric-only systems take for granted. It lets you instantly unscramble data and interactively experiment with graphs, charts, maps and models. With exceptional simplicity. With almost the speed of thought.

**You command up to 32K of off-line processing power.** With a graphically beefed-up BASIC language. With complete editing and versatile graphic-oriented software.

You can tackle big programs on-line in any language,

store data on built-in mag tape, and generate graphic reports—all at your own pace.

**The 4051: Its Graphics keep working when other systems quit.** Yet it can pay for itself in less than a year in timeshare savings alone. Call your local Tektronix Sales Engineer, or write:

**Tektronix, Inc.**  
 Information Display Group  
 P.O. Box 500  
 Beaverton, OR 97077  
**Tektronix Datatek N.V.**  
 P.O. Box 159  
 Badhoevedorp, The Netherlands

## Get the picture. Get straight to the point.

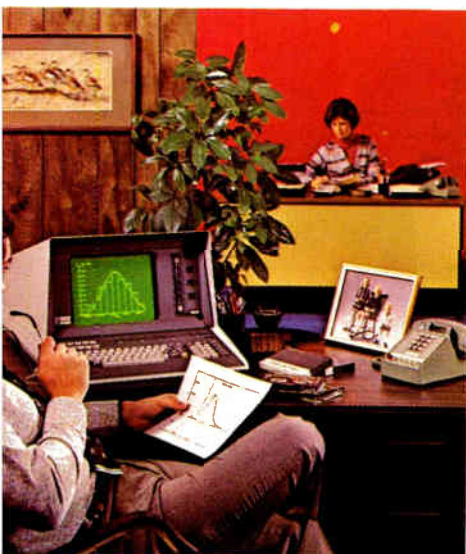

**Tektronix**  
 COMMITTED TO EXCELLENCE

OEM information available  
 Copyright © 1977, Tektronix  
 All rights reserved

# Intel delivers the 8-bit microcomputer,

Our newest 8085A selection is, quite simply, the world's fastest 8-bit microcomputer. It's the 8085A-2, with a 5 MHz clock rate—66% faster than a standard 3 MHz 8085A. Now you can achieve a new level of system performance using the world's best selling and best supported microcomputer family.

# 5MHz

There's a surprising measure of economy that goes along with the 8085A-2's startling performance. Its superior bus architecture enables you to use relatively slow, low cost standard memories.

You don't need the costly, high speed memories that other high performance microcomputers demand. In fact, at any clock rate, MCS-85™ CPUs operate with 25% slower memories than even the most efficient competitive microcomputers.

The 8085A-2's faster clock rate sets a performance trend all MCS-85 components will follow. That gives you the design option of 5 MHz or 3 MHz operation within the same family. Of course the 8085A is fully compatible with the 8085, and offers the same growing selection of memories, programmable peripheral interfaces and support circuitry.

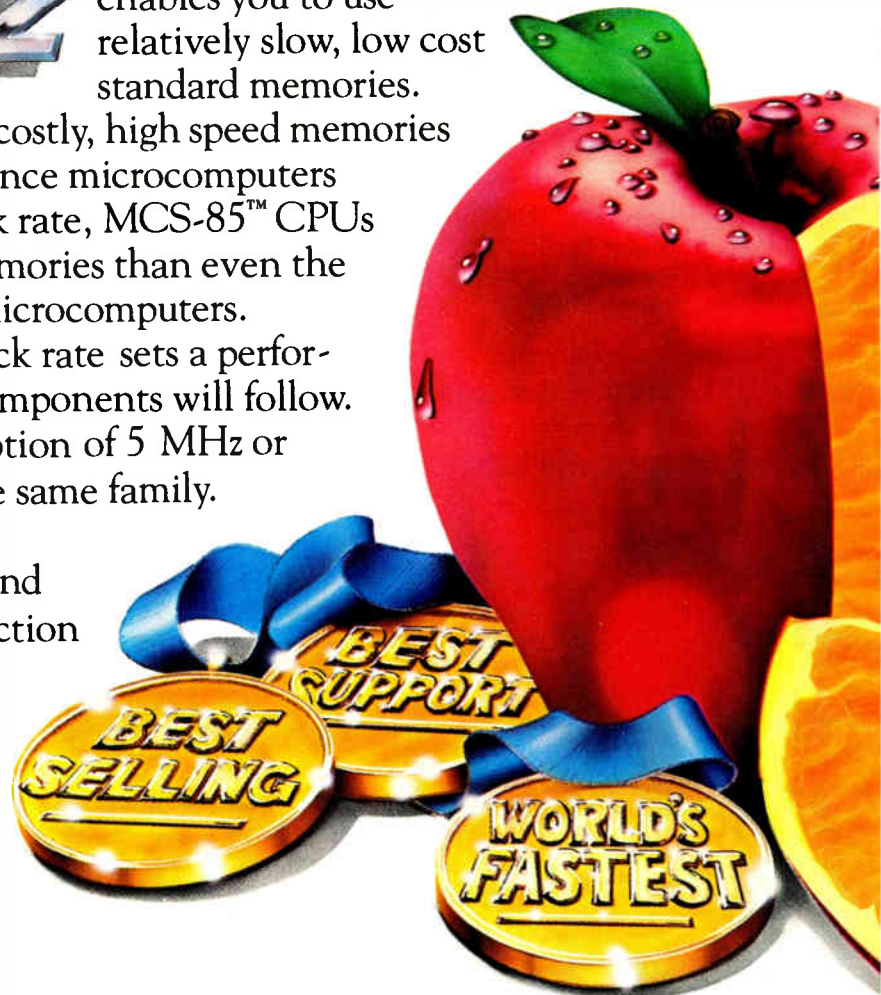

# world's fastest the newest 8085A.

**Join the Majority.** Since its introduction, more major companies have chosen the 8085A than all other microcomputers combined. Almost overnight, the 8085A became the new industry standard.

Full software and bus compatibility with the familiar 8080 is one reason why. Designers have found they have a head start in implementing new MCS-85-based designs. And, the 8085A is your bridge to compatibility with upcoming Intel microcomputer advances.

**#1 in Support.** Choosing the right microcomputer means more than evaluating CPU performance. When you choose MCS-85, you get the highest performance CPU, plus a full family of compatible memories and peripherals, and access to our fast growing software library. Making Intel your microcomputer supplier unlocks the door to the industry's most comprehensive development support, too.

Our Intellec<sup>®</sup> and new Intellec<sup>®</sup> Series II, Microcomputer Development System speeds your product to market. It's the only development system with two high level languages, PL/M and FORTRAN. It's the only development system that gives you symbolic debugging, using ICE-85<sup>™</sup> in-circuit emulation. And it's the only development system you'll need for today's leading microcomputers, and tomorrow's, too.

Intel further supports our microcomputers worldwide with on-site FAE applications assistance, training classes and design seminars.

The quickest way to get started is to order MCS-85 components from your nearest Intel distributor. Or, for a new 8085A-2 data sheet, contact your local Intel sales office or write: Intel Corporation, 3065 Bowers Avenue, Santa Clara, CA 95051.

Telephone: (408) 987-8080.

## intel<sup>®</sup> delivers.

Europe: Intel International, Rue du Moulin a Papier, 51-Boite 1, B-1160, Brussels, Belgium. Telex 24814.  
Japan: Intel Japan, K.K., Flower Hill-Shinmachi East Bldg. 1-23-9, Shinmachi, Setagaya-ku, Tokyo 154.  
Telex 781-28426.

Distributors: Almac/Stroum, Component Specialties, Cramer, Hamilton/Avnet, Harvey, Industrial Components, Pioneer, Sheridan, Wyle/Elmar, Wyle/Liberty, L.A. Varah or Zentronics.

# SPACE on your PC board?

What are downright miserly about space  
but generous about saving you money.

For 250 mils to 5 amp loads.



**SPDT, 250 mils to 1 amp subminiature relays.** The smallest, newest relays of them all. Subminiature in size to make them perfect for high density packaging, yet low in cost. Terminals mount directly to PC board. Series 1505, DC only.

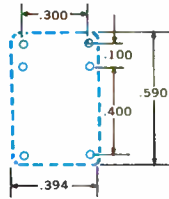

**4PDT, 5 amp miniature relays.** Solder right on your PC board... or use special PC socket for wave soldering. Also available with solder lug type terminals and a choice of mating sockets. Series 1310 AC and 1315 DC.

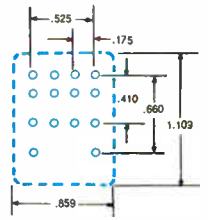

**SPDT, SPST-NO or SPST-NC, 3 amp subminiature relays.** Size is ideal for high density packaging. Enclosure keeps contacts free from dust, dirt, grime. Terminals mount directly to your PC board. Series 1565, DC only.

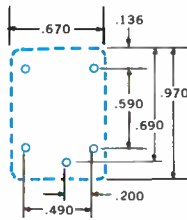

**DPDT, 5 amp miniature relays.** Like the 1310/1315 above, provide large control capacity in a smaller package. Same choice of mountings and sockets. Mechanical life, 100 million operations DC, 50 million AC. Series 1330 AC and 1335 DC.

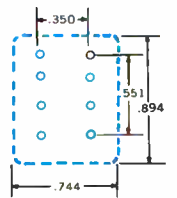

**SPST-NO, SPST-NC or SPDT, 3.5 to 5 amp miniature relays.** Just over a cubic inch small to save you valuable space. Similar to Series 1565 DC above... only a little larger to handle more current. Series 1345, DC only.

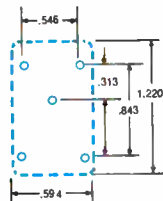

Ask your Guardian Angel for this 48 page handbook and guide that gives details, specs and data for all the relays on this page... plus scores of others.



# GUARDIAN®

**GUARDIAN ELECTRIC MANUFACTURING CO.**

1550 W. Carroll Avenue, Chicago, IL 60607  
312/243-1100

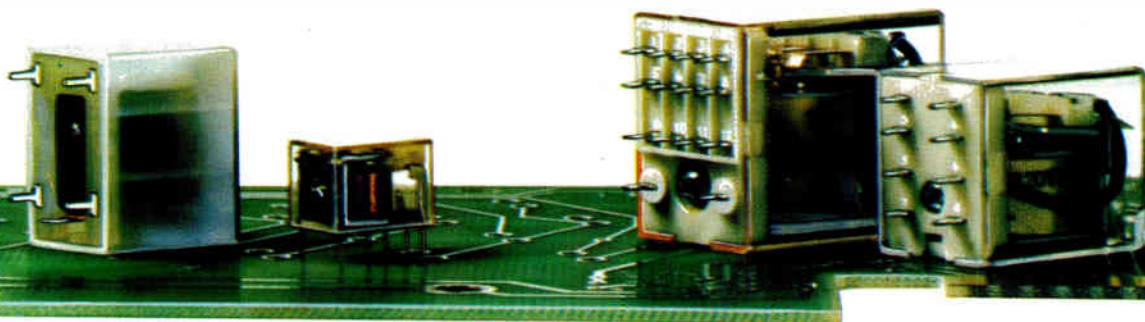

## Bankrolling electronics with petrodollars

The need for venture capital by the electronics industries has become a growing problem. We have commented in the past that some means of filling this need, particularly through Government policies that would encourage investment, is vital to the future health of this country's technology.

Very quietly, though, a huge source of funding, in the form of oil company investments, has become an important factor in electronics. As the article on Exxon Corp.'s subsidiary, Exxon Enterprises Inc., points out on page 88, financial support of small undertakings is made on the premise that future growth appears assured. Even now, the results of this infusion of petrodollars from companies like Sun Co., Standard Oil of Indiana, and Wilshire Oil Co. are impressive.

The question, then, may well be—is it a healthy situation? Obviously the oil companies' investment organizations have identified electronics as an important growth area full of profit potential. On this score—siphoning petrodollars into an industry in bad need of green fuel—the signs are positive.

Another positive sign is that, at least in Exxon's case, the investments are going for new technologies in young or even fledgling electronics businesses such as word processing, computer voice recognition, and data communications. Oil money is being risked on advancing technology. There are even some long shots on the future.

One of the hazards of these ventures, however, is the mammoth size of the petroleum companies and their potential long-range influence over the directions research may take. The big tend to get bigger.

Fortunately, Exxon, for one, seems aware of this pitfall and is content, first, to let smaller outfits pursue their own directions and, second, to give them enough time to make their marks. It appears that, as a hedge for the future, these oil companies will continue to be patrons of electronics technology.

## And now it's Taiwan TVs

Putting a quota on the import of color television receivers from Japan has had the predicted results. The Japanese share of market has declined, and a few Japanese producers have set up production outposts in the United States.

But hold on, the problem is not solved, for it was also predicted that the vacuum for low-priced sets would have to be filled. So coming on the market, just as the Japanese have been sidelined, are television sets from Taiwan.

According to import data from the Department of Commerce, in February Taiwan emerged as the leading supplier of color TV sets to the U. S. Admittedly, a large share of the goods were from American- and Japanese-owned facilities on the island. But even so, it is an impressive performance, since few TV producers here expected Taiwan to become a major factor until the end of this year.

What have we learned from this rapid turn of events? Essentially, we have seen what one observer calls “the futility of any realistic hope that unilateral quotas on Japan's exports would help domestic factories.” More than likely, imports this year will increase over 1977 and come very near to the record set in pre-quota 1976. So much for quotas.



# managers should know computers profitably.

RMX-80™ Real-time Multitasking Executive gives you a head start in software development, without the need to reinvent system software for every application. Intellec®, our microcomputer development system, speeds application software development. It puts PL/M and FORTRAN-80 (ANS FORTRAN 77) high-level programming languages and a macro-assembler at your command. And supports full text editing, relocation and linkage capability. In-Circuit Emulation, with symbolic debugging, provides a diagnostic window



into your prototype to speed and simplify system development.

Our growing selection of iSBC™ products gives you the flexibility to tailor a system to your specific application, without compromise. Choose one of our five single board computers, starting at \$99.\* There's a full selection of memory expansion boards, communication interface boards, digital and analog I/O boards, mass storage systems and a high speed math processor. Or you can start with one of our packaged System 80's.

You're assured of the highest reliability when you build your system around an Intel single board computer. For example, MTBF for our iSBC 80/10 is 91,739 hours at 25°C. Ask for your copy of our iSBC Reliability Report.

There's also the security of Multibus™, the multi-processing bus architecture we developed for single board computers. Multibus has become such a widely accepted industry standard that today there are over a hundred Multibus-compatible products available from 42 independent companies. And Multibus is your guarantee of compatibility with future Intel iSBC products.

Get started with our comprehensive iSBC System Configuration Kit. It's a catalog of Intel single board computer products, with detailed configuration instructions and worksheets to help you define the optimum iSBC solution for your needs.

For your kit, or for on-site assistance in configuring and pricing your iSBC system, contact your Intel representative or distributor. Or write: Intel Corporation, 3065 Bowers Avenue, Santa Clara, California 95051. Telephone: (408) 987-8080. In Europe contact: Intel International, Rue du Moulin a Papier, 51-Boite 1, B-1160, Brussels, Belgium. Telex 24814. In Japan contact: Intel Japan, K.K., Flower Hill-Shinmachi East Bldg. 1-23-9, Shinmachi, Setagaya-ku, Tokyo 154. Telex 781-28426.

## intel® delivers.

Visit us at the Hanover Fair '78  
April 19 through 27, 1978. Cebit-West,  
Hall 18. Booth 1503.

Circle 28 for iSBC Configuration Planning Kit  
Circle 29 for pricing and configuration assistance

29

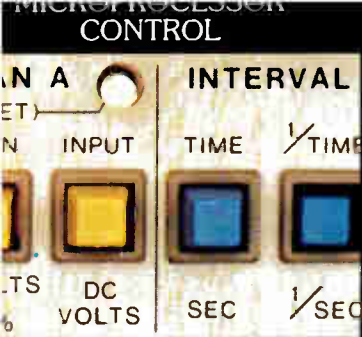

# When you want top scope performance plus speed and accuracy in time-interval measurements...

## HP's $\Delta$ -time family is the Answer.

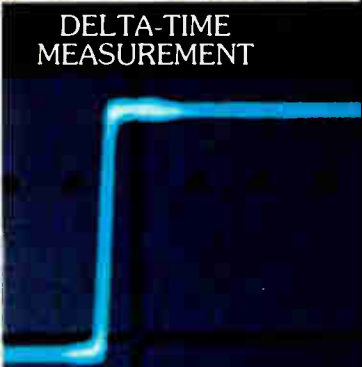

And a solution to your unique set of measurement problems. With bandwidths up to 275 MHz, crisp dual-trace displays and large screen viewing. Plus advanced  $\Delta$ -time capability for unparalleled speed and accuracy in time-interval measurements. You'll be able to evaluate transition times, propagation delays, clock phasing and more with greater ease than was previously possible.

**Simplified, more accurate measurements.** Pulse-period, pulse-width jitter and all digital timing measurements are simplified with the Analog Ramp  $\Delta$ -time group. By setting the two marker display of start and stop points, signal drift errors are virtually eliminated. And for convenient trace expansion, you can still easily switch to conventional delayed sweep. Choose from the new 100 MHz 1742A with third-channel trigger view (\$2650\*); the general purpose 200 MHz 1715A (\$3100\*) and 275 MHz 1725A (\$3450\*); or the microprocessor-controlled 275 MHz 1722B (\$4900\*) which electronically calculates  $\Delta$ -time, frequency, dc voltage, instantaneous voltage and percent amplitude measurements.

**Crystal-controlled accuracy.** For precision measurements (to 0.002%  $\pm 1$  count at 15° to 35°C) in lab and field applications, consider the crystal-referenced 100 MHz 1743A (\$3300\*). It simplifies your tasks by making time measurements automatically, even dynamic timing measurements. Our exclusive triggered  $\Delta$ -time mode eliminates the need for scope control adjustments.

Just select your start and stop points, then read the time interval directly from the five digit LED display. You'll find it a real plus in

set-up and production service. And for that augmented insight into digital systems, the third-channel trigger view shows clock/data line activity in relation to the trigger signal.

**Pushbutton troubleshooting.** You can enhance the operation of any family member with HP's Logic State Switch option. This gives you pushbutton selection of either a time domain or data domain display when used with HP's 1607A Logic State Analyzer. It's a sanity saver when designing or trouble-shooting logic circuitry.

Rounding out HP's  $\Delta$ -time family are the features you expect from a high-performance oscilloscope. Like a human engineered front panel and switch selectable 50 ohm/1 megohm input impedance.

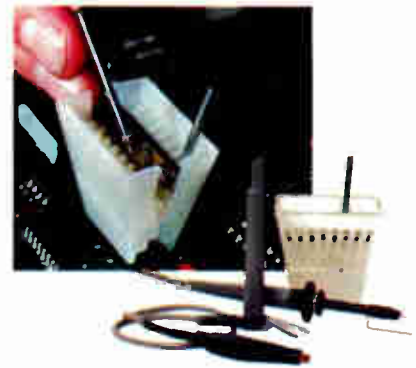

Plus HP's **Easy IC Probes** which help you avoid shorting hazards and improve closely spaced probe connections.

User benefits and convenience are what the  $\Delta$ -time scope family is all about. Call your local HP field engineer today for more details.

\* Domestic U.S.A. price only.

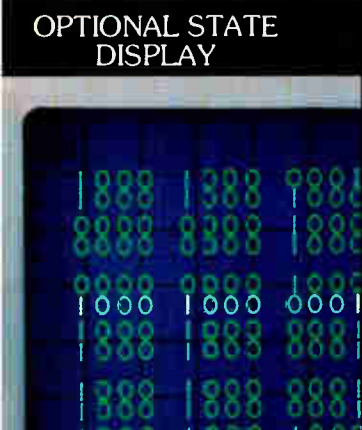

HEWLETT  PACKARD

1507 Page Mill Road, Palo Alto, California 94304

For assistance call: Washington (301) 948-6370, Chicago (312) 255-9800, Atlanta (404) 955-1500, Los Angeles (213) 877-1282

Circle 31 on reader service card

# MOD-POT offers still more. New switch. New conductive plastic element.

Allen-Bradley introduces a new rotary switch for the MOD-POT series. Designed for signal level circuits. Tested for current levels as low as 15 milliamps, with 5-volt open circuit. Plus new conductive plastic resistance elements with low turning torque for velvet-smooth rotation. And CRV of typically less than 0.2%. Linear and modified log tapers (CW and CCW) available from 100 ohms to 1 megohm. All feature smooth characteristics, particularly at resistance roll-on and roll-off positions. Come to the original source for MOD-POTS. We have what you need; our distributors have them when your need is now. Ask for Publication 5217.

*Low detent torque*  
and low contact  
resistance.

*Variety of switch  
options:* rotary  
(CW or CCW actuation),  
push-pull or momentary  
push. Gang switching  
capability.

*Vernier drives*  
and concentric shafts  
also available.

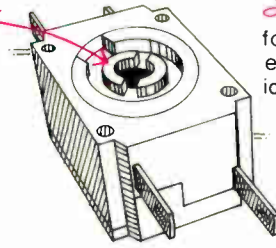

*Smooth surface*  
for low turning torque,  
excellent linearity and  
ideal roll on/roll off.

*Conductive plastic*  
resistance track  
is embedded into  
substrate.

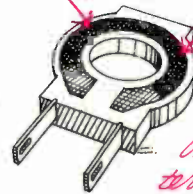

*Insert molded  
terminals.* Choice of  
solder lug or PCB pins.



## Quality in the best tradition.



**ALLEN-BRADLEY**  
Milwaukee, Wisconsin 53204

## **Harris to build 32-mi fiber-optic phone system**

Harris Corp.'s Fiber Optic Systems division is going to build the longest and highest-capacity fiber-optic telephone line in the world to date. The six-pair, half-inch-diameter cable will run underground for 32 miles from Calgary to Cheadle in Alberta, Canada, and at full capacity will carry 20,160 conversations simultaneously. **The data rate will be 274 megabits per second—the highest ever for an operational telephone link.** Work on the system will start later this year, to be completed in fall 1979. The contract for the system comes to a whopping \$6.6 million, whereas Harris estimates sales of all fiber-optic systems in 1977 at only \$10 million.

## **IBM reported ready to buy 16-K RAMs**

International Business Machines Corp. spokesmen will not confirm or deny industry reports that it is about to place major orders with Intel Corp. and Texas Instruments Inc. for 16,384-bit random-access memories. The move would be a departure from IBM's practice of producing its own key components. **Potential business for memory makers selling to the computer titan is enormous.** At the same time, reports are circulating that IBM will buy microprocessors from Motorola Semiconductor.

One industry observer, Kent A. Logan, research vice president at Goldman, Sachs & Co. in New York, believes IBM will not be buying 16-K RAMs in any volume from outside suppliers in 1978 or 1979. However, he expects the firm to award small development contracts to both Intel and TI to develop prototypes of a 32,768-bit RAM module (two 16-K RAMs in a package). He does not expect volume shipments to begin until 1980.

## **T-Bar prepares to take a giant step**

Now that the wraps are off its model 3917 microcomputer-controlled switching system for interconnecting computers and peripherals, T-Bar Inc. is ready for the next step in integrating data processing with data communications. That, says the Wilton, Conn., firm, is pulling the switching information out of the digital data stream, and it could be taken by the end of this year.

The delay is not in the technology, says John Tobey, the company's product manager, "but in the standardization of the protocol. **No manufacturer is willing to sacrifice the investment he's made in his own protocol.**" Meetings involving the largest computer manufacturers, like IBM, Burroughs, Honeywell, and Univac, as well as some European manufacturers, have been dragging on in Washington, and the synchronous data-link control (SDLC) protocol looks popular—but each manufacturer has its own way of implementing that one, too.

## **RAM prices drop, so do those of systems**

Down, down, down plunge the prices of MOS random-access memories, and the bargains are beginning to show up in all types of computer-based equipment. **Last week Intel Corp. cut prices 35%** on its 2115A/2125A family of 1,024-bit static RAMs to \$3.95 each for 100 or more. Those chips have a fast 30-ns access time that is comparable to bipolars. Meanwhile, Hewlett-Packard Co.'s Data Systems division is **taking advantage of the learning curve for 16,384-bit RAMs**, packing 128 kilobytes per board in its HP 1000 computer systems and cutting the board prices from \$6,400 to \$4,000. That comes to a reduction from a nickel a byte to just over 3 cents.

## **In-circuit tester from CA sells for \$29,500**

A lower-cost entry into the \$20 million in-circuit test equipment market is being prepared for June by Computer Automation Inc.'s Industrial Products division. The Mica 5000, priced at \$29,500, is some 40% to 50% cheaper than existing competitive testers, claims Doug Cutsworth, manager of marketing and business development at the Irvine, Calif., division. **The basic tester, expandable to 1408 pins in 64-pin increments as options**, has a 16-bit processor, 32 kilobytes of memory, a cathode-ray-tube display, keyboard, console, printer, 256-kilobyte floppy disk, and full software. Completely new, it is intended to supplement the company's general-purpose functional board tester brought out in 1974 when the division was formed.

## **Tek, Millenium swap emulator technology**

Giant instrument maker Tektronix Inc. and tiny Millenium Systems Inc. are joining forces to increase the number of microprocessor types emulated by their development systems. Millenium, Cupertino, Calif., will develop four microprocessor-emulator boards for the Tektronix 8002 microprocessor development system. In return, Millenium will receive the Beaverton, Ore., company's technology for the Z80, 8085, 3870, and F8 emulators that have already been developed. **Each company will thereby expand the capabilities of its own system:** Tektronix will add four processors to the 8002 list, and Millenium will expand the universality of its micro-system analyzer, which now supports the 8080 and 6800 microprocessors.

## **Video chip displays up to eight colors**

American Microsystems Inc. of Santa Clara, Calif., is trying to jump ahead of its competitors in the low-cost terminal and home-computer market by producing samples of a **video-display chip that can show up to eight colors plus a border color**. Called the S68047 video-display generator, the n-channel MOS device features an on-chip character generator, a read-only memory, and an analog-to-digital converter. It can display 14 different modes, including alphanumeric, semigraphic, and full graphic. The plastic-packaged device, which is compatible with almost any 8-bit microprocessor, sells for \$11 in lots of 100 and up.

## **GenRad to sell Omnicom's field tester**

GenRad Inc., a leading supplier of automatic test equipment for manufacturers and users of circuit boards, integrated circuits, and discrete devices, is making its first move into the fast-growing field-service test market. The Concord, Mass., company will market and later manufacture the portable service processor developed by Omnicomp Inc. in Phoenix [*Electronics*, Feb. 16, p. 41]. "GenRad will initially market this product to all parties except for those companies with which Omnicomp has supply agreements," says C. J. Lahanas, GenRad's vice president of corporate development. **Omnicom sells the processor in quantity for \$20,000 and GenRad plans to be near that price.** GenRad officials regard the field tester as a natural companion for their own and competitors' manufacturing test systems. It will accept translated test programs from GenRad, Teradyne, Computer Automation, Mirco, and Instrumentation Engineering systems.

# SSI to Glue ... and Memories, too

## All you need for TTL microprogrammable processors

Motorola is unique when it comes to providing what it takes to design and build your high-speed TTL microprogrammable processor. We're the only ones who has it all\*, and it's all off the same Schottky process for uniformity, reliability, and lower over-all component cost.

\*The MC2901A 4-bit slice and our other M2900 Family industry-standard LSI functions, for sequencing, number crunching, and interface.

\*Memories, for microprogram storage, with your option of 2K, 4K, or 8K PROMs, or even RAMs.

\*LSTTL "glue," a whole family of over 100 SSI and MSI functions for logic and interface, to bind your system together for your specific application.

The MC2901A is the familiar plug-in replacement that shows greatly improved performance over the 2901 4-bit slice in higher speed, reduced power supply current, increased noise immunity, and increased low-level output current. A new M2900 Family 4-bit slice, the MC2903, with easy register file expansion and no loss of speed or reliability is scheduled for third quarter availability.

Additional M2900 Family LSI for your processor system includes the MC2909 and MC2911 microprogram sequencers, I/O

sequencer functions MC2905-7, MC2915A-17A, and the MC2918 register file. The MC2910, planned for mid-year, is a new 12-bit wide microprogram controller that can address up to 4096 words of microcode.

Among the memories, the MCM93415 and MCM93425 1K RAMs, and the 4K MCM7641 and MCM7643 three-state PROMs are available now, and due to be joined by a large group of additional industry-standard PROMs: 2K MCM7620, 21—MCM7640 and 42 4K (open-collector output)—and 8K MCM7680, 81. All are planned for availability by July.

These Motorola PROMs are pin-compatible replacements for industry-standard PROMs and ROMs. All have common dc performance and programming.

As for LS, let it suffice to suggest that among the more than 106 SSI and MSI parts available now, and the more than 150 parts to be available by year's end, we have what your processor system requires. The 74LS240 series, bus-oriented octal line drivers and quad receivers, and the 74LS365A hex buffers are typical examples.

We can save you money when you buy it all here, by packaging your orders to get lower, large-quantity prices in play. Come to Motorola, where we've got it all. **N**

## Diode guide reflects 20 years of knowhow

The right device for nearly every application is listed and cross-referenced in the new Motorola Rectifier/Zener Diode Selection Guide & Cross-Reference.

Included are rectifiers, bridges, Schottky and fast recovery units, high voltage diodes/stacks and high current devices. Also zener, TC and precision reference diodes, amplifying and current regulator diodes, low-voltage regulators, transient suppressors and optional variations. Without a doubt the most complete publication of its kind and it's yours on company letterhead request.

## Motorola opens op amp/comparator game with 2 pair

The MC3405/3505 offer an economical quad function with a twist. Two of the four devices are op amps and the other two voltage comparators. An industry first.

The op amps are internally compensated, have true differential inputs and are equivalent in performance to MC3403/3503. The comparators provide low offset voltages with low power consumption and are similar to LM339/139. The circuit offers 3-36 V single supply and +1.5-+18 V split supply operation plus low current drain. Both are capable of common-mode inputs down to the negative supply.

It's a useful, versatile building block in automotive, consumer and industrial designs including PWM, window comparator, squelch circuit for AM or FM, LS to CMOS interface with hysteresis, high/low limit alarm and zero crossing detector with temperature sensor.

The MC3405/3505 is available in two temperature ranges in plastic (P) or ceramic (L) 14-pin packages. The '3405 has a specified operating ambient range of 0° to 70°C and the '3505 is spec'd from -55° to +125°C.

Input offset voltage is typically 2 mV and power supply current is typically 2.5 mA.

100-up pricing is MC3405P, \$1.15; MC3405L, \$1.50; and MC3505L, \$7.50. **Q**

## Plastic Triac saves 30% over old metal TO-5

Here's a low-cost, drop-in replacement for those old, TO-5 2.5 A (RMS), 3 mA sensitive-gate RCA T2300 Series Triacs that have been around since year 1.

It's tested and spec'd for the same electricals and available in TO-5 pin circle.

There's an actual 30% price saving over CA, too—the Motorola T2300PB is just 70¢ and the T2300PD is only 87¢, both 100-up.

Time-tested design and materials add up to reliability documentation that's really impressive for plastic units like these. Power

cycling at extreme  $\Delta T$  operation shows over 43 million cycles resulting in an estimated MTTF of over 3 million cycles. Blocking life tests are equally impressive and a variety of other tortures proves glass-passivated thyristor die and greatly improved molding compound afford a reliability level that easily meets industrial and consumer requirements.

Other series, the T2301P and the T2302P, are available with IGT spec'd at 4 mA and 10 mA, respectively. **P**

## MOTOROLA OMNIBUS Looking ahead in all technologies.

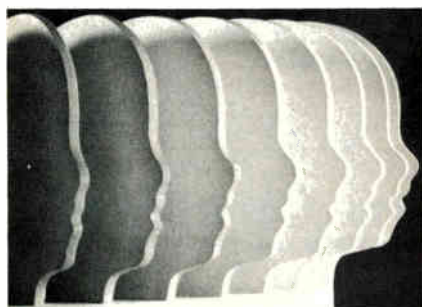

(Coupon Missing?) Send inquiries to: Department LDC, Motorola Semiconductor Products Inc., P.O. Box 20912 Phoenix, AZ 85036

(Please Check Only The Items You're Interested In:)

- |   |   |  |
|---|---|--|
| <input type="checkbox"/> A <b>MDA2500</b>       | <input type="checkbox"/> F <b>MC3448AL/AP</b>         | <input type="checkbox"/> L <b>MC3410C/3510</b>     |
| <input type="checkbox"/> B <b>MC14469</b>       | <input type="checkbox"/> G <b>MHW1171/1172</b>        | <input type="checkbox"/> M <b>MC66700/6670</b>     |
| <input type="checkbox"/> C <b>MC14443/47</b>    | <input type="checkbox"/> H <b>MRF844/846, 641/648</b> | <input type="checkbox"/> N <b>TTL, LSI to Glue</b> |
| <input type="checkbox"/> D <b>MC14495</b>       | <input type="checkbox"/> J <b>MWA110/120</b>          | <input type="checkbox"/> P <b>T2300PB</b>          |
| <input type="checkbox"/> E <b>LM148/248/348</b> | <input type="checkbox"/> K <b>Microwave</b>           | <input type="checkbox"/> Q <b>MC3405/3505</b>      |

For complete product itineraries, fill in and send to: Motorola Semiconductor Products Inc., P.O. Box 20912, Phoenix, Arizona 85036

Please have salesman call ( ) \_\_\_\_\_

Name \_\_\_\_\_ Title \_\_\_\_\_

Company \_\_\_\_\_ Address \_\_\_\_\_

City \_\_\_\_\_ State \_\_\_\_\_ Zip \_\_\_\_\_

## IBM and Intel exchange licenses on bubbles and ICs

IBM receives license for MCS-48, UPI-41 architectures and software; Intel gets IBM's bubble-memory know-how

In a surprising move that brings together the giants of the computer and microcomputer marketplaces, International Business Machines Corp. and Intel Corp. have agreed to exchange royalty-free licenses covering microcomputer architecture and magnetic-bubble memory technology.

Under the nonexclusive agreements announced last week, the Armonk, N. Y.-based firm receives the right to use Intel architecture for the MCS-48 and UPI-41 families of microcomputers and peripheral products, plus related software for devices like the single-chip 8048 and high-performance 8085, and other microcomputers, including the 8049 and 8021.

In return, Intel gets a license to use all of IBM's patents on magnetic-bubble components and systems. The pacts are not complete technology exchanges; they allow each company to use only the other's published information unfettered by royalty payments or potential lawsuits about alleged patent infringement.

**Little comment.** Neither IBM nor Intel would be specific about the five-year pact's significance, with IBM, following its standard policy in declining any comment at all. Leslie L. Vadasz, vice president and general manager of Intel's Microcomputer Components division, Santa Clara, Calif. says his company is "delighted



**Pleased.** A favorable rating for its microcomputers from IBM can't be anything but pleasing to Intel's Leslie Vadasz.

that the Intel line is continuing to be perceived as [a] well-conceived, total product line."

The accord does not commit either side to actually using the other's technology, he says, but "we're hopeful that IBM will be a user of our products. IBM machines provide plenty of room for the use of Intel devices." For example, the 8084 would be ideal as a loop controller, he points out. Intel will not furnish masks under the agreement, but IBM could make the microcomputers if it wanted to.

Vadasz acknowledges that magnetic-bubble technology has "an important potential" but says that it's mainly "an R&D activity, as there's a lot of work to be done." His firm organized a subsidiary last year, Intel Magnetics Inc., also located in Santa Clara, to do its bubble work.

Other members of the semiconductor industry focused their com-

ments on the pacts' advantages.

"My first reaction is that it's going to make Intel a very formidable contender in the magnetic-bubble market," declares Jerry Sanders, president of Advanced Micro Devices Inc., Sunnyvale, Calif., which makes Intel microcomputers under a second-source agreement.

Secondly, if IBM adopts the 8048, "it proves the validity of the Intel approach" to microcomputers, he says. And thirdly, besides being a big boost for Intel "it has got to result in IBM using [Intel] products in the field."

In addition, Richard Petritz, IBM watcher and president of New Business Resources Co., a venture capital and management consultant firm in Dallas, terms the accord "another example of how companies, even ones as big as IBM, can't master the technology that will be needed to build computers in the future." "I expect to see a lot more of these types of exchanges," he adds.

Sanders notes that it is significant that "IBM feels that it has to get a license for an architecture," and he believes that there will be other licensing pacts for protection against unauthorized copying. Intel has sought even more protection in a suit it brought recently against the U. S. Copyright Office [*Electronics*, Jan. 19, p. 40]. However, some semiconductor industry executives downplay the new agreements, saying they sounded like standard cross-licensing arrangements.

The pacts follow closely on the heels of a technology-exchange accord under which RCA Corp. gets the right to make Intel's 8080A and 8048 microprocessors and two mem-

ory chips in complementary-metal-oxide-semiconductor-on-sapphire in exchange for giving Intel silicon-on-sapphire know-how (see "SOS pact has 'em guessing," p. 94). □

---

**Memories**

---

## Hard disks shrink to 8-inch diameter

How do you make a hard disk drive, usually selling for \$5,000, fit into a much smaller budget? But cutting the drive down practically to the size of a floppy-disk drive and the disk itself to 8 inches—exactly the size of a floppy disk.

That is the approach being taken by a company founded only last year to develop disk technology, International Memories Inc. in Sunnyvale, Calif. "We will offer twice the capacity at half the cost of conventional disk-drive systems," says its president, David L. Britton. "Our price to original-equipment manufacturers will be about \$1,500." Moreover, the 7710 will offer the speed and reliability of top-notch Winchester technology and 11 megabytes of storage in a package measuring 5¼ by 8½ by 19 in., not much larger than most floppy drives, he says. The disk itself is of conventional oxide-coated aluminum.

**Big difference.** IMI's approach differs significantly from that of Shugart Associates Inc., the leading floppy manufacturer. Shugart an-

nounced a low-cost hard-disk drive earlier this month that uses full-sized (14-in.) platters [*Electronics*, April 13, p. 43]. But size is not the only difference. IMI has built its drive around the fast voice-coil actuator used in the bigger and more expensive hard-disk drives. Shugart, on the other hand, went to a slower floppy-type actuator to cut its costs. (Shugart's model 4004 offers 14.5 megabytes for \$1,450 in quantity).

The access speed of the IMI unit is nearly twice that of the Shugart drive. This is likely to send the two comparably priced systems into different markets: IMI heading for on-line, multiple-user systems, Shugart for off-line, mass-storage systems.

Voice-coil actuators are able to move around the disk much faster than stepper-driven ones and are almost a necessity in multiuser time-shared systems, which require fast access to data. Says Britton, "Companies trying to expand their small-business or word-processing systems, for example, frequently encounter a time-sharing problem because the string of terminals needing access to data has to wait for the slow floppies." But until the 7710, for fast access, a \$5,000 hard-disk drive was the only solution.

**Standard parts.** In building their system, the IMI designers steered clear of custom parts, using standard Winchester heads and assemblies as well as standard electronics to make servicing easy. The only part that had to be built to specification is the drive motor, a special brushless dc

type that enables the drive to be used internationally because it does not depend on the frequency of the ac power lines.

The 7710 retains the Winchester-media track density of 300 tracks per inch. Disks rotate at 3600 revolutions per minute, and the data transfer rate of the drive is 648 kilobytes per second. The low-mass head and slider are key to a 50-millisecond average access time (vs 80 ms in the 4004), 8.3-ms latency, and 10-ms track-to-track speed. The disks, heads, and actuator assembly are in the sealed, filtered environment that is characteristic of Winchester technology.

The electronics fits on three printed-circuit boards in the drive's base. There is also room for an optional controller board, which is designed around a Signetics 8X300 bipolar microprocessor.

Due out later this year is a 23-megabyte version, the 7720, but the first products, to be in volume production this July, will be the 11-megabyte type. Britton is confident he will eventually be able to get 75 megabytes, an unheard-of capacity on just a pair of oxide-coated disks. He says he will do it with plated disks, a technology still in development at several organizations that electrochemically deposits a ferrous metal on the disk. □

---

**Automotive**

---

## Ford readies electronic distributor

The distributor in a car may soon disappear entirely. It has already given up spark timing, and now electronics also looks like it is taking over its other job of channeling the energy from the ignition coil to the right spark plug.

Ford Motor Co., for one, is developing an electronic system for the channeling task. The two controls together will completely replace the distributor and its need for periodic maintenance. They will also free up space under the hood and rid the car

**Small stuff.** Eight-inch-diameter disk fits into new \$1,500 disk drive from International Memories. Disk is made of same material as the conventional 14-in. platter beside it.

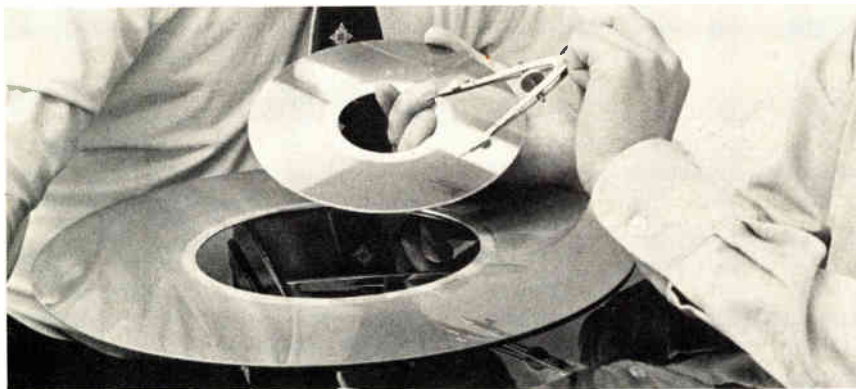



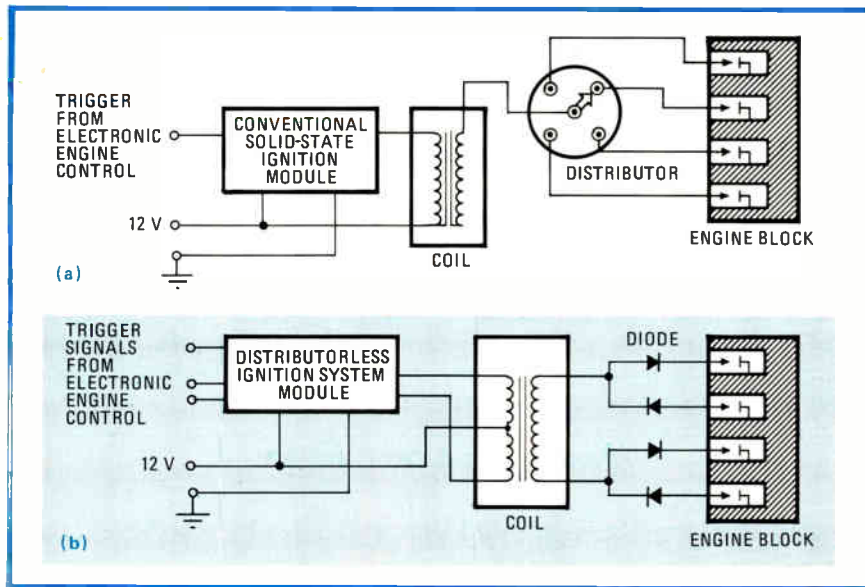

**Replacement.** Rotating distributor of conventional ignition system (a) is being replaced by new Ford system (b). Diodes and special coil route energy to the spark plugs.

of a significant source of radio-frequency interference.

Electronic engine controls such as Ford's existing unit supply the spark-advance signal, traditionally done by a spinning assembly of springs and weights in the distributor base. That signal shifts the time that the spark plugs fire as engine speed and manifold vacuum varies—a technique that boosts the car's performance and fuel economy while staying within federally mandated emission levels.

**Experimental.** Ford's new module, still in the experimental stage at its Dearborn, Mich., laboratories, directs the ignition energy to the proper spark plug and cylinder. That is now done by the spinning rotor as it hits contacts in the distributor cap.

The firm will not discuss projected costs or production plans for its distributorless ignition system, as it is called. But it is being designed for four-cylinder engines, and, since it relies on an engine computer for its timing signals, it probably will first show up when the company starts using electronic engine control on its smaller cars.

Since the unit does away with the distributor rotor, it should lead to a more reliable ignition system. "Assuming the electronic components don't fail, the customer is left with

just an occasional spark-plug change," says David F. Moyer, who is director of Ford's Systems Research Laboratory.

Ford is also concerned about the rfi generated as the spark jumps from the distributor rotor to a terminal on its stator—the primary rfi source in a car. "We feel that such legislation is almost a certainty in the U. S.," Moyer says. With the new system, sparking occurs only inside the cylinders.

**More.** But as cars acquire more electronics, rfi becomes more of a problem: "The electronic engine control has seven sensors connected by long wires to the processor," he says. "Those leads act as antennas, and there can be significant coupling of ignition energy into the onboard computer."

Cars currently use a solid-state module to excite the primary winding of an electromagnetic ignition coil. The high voltage output of the coil's secondary winding is distributed by the rotor to the engine's spark plugs. With a four-cylinder engine in mind, Ford uses two independent, parallel ignition circuits and a coil with two primary winding and two opposite-polarity, high-voltage terminals in the single secondary. Each of these terminals is connected to two spark plugs

through a pair of high-voltage diodes arranged in back-to-back polarity.

The new module alternately energizes each primary winding. When the current in the first primary winding switches off, opposite polarity voltages are generated at the secondary's two terminals, firing two spark plugs. The polarity of the rectifiers determines which plugs are fired. When the second primary switches off, the polarity of the terminals reverses, and the other two plugs fire.

The cylinders are paired so that when fired, one cylinder is in its compression stroke, the other in its exhaust stroke. This is a peculiarity of the system, required by the way it is designed. "Firing a spark plug during the exhaust stroke does not affect engine performance or emissions," Moyer says.

Ford is also working to further simplify its distributorless ignition. By adding a double-pole double-throw switch, it will be able to alternate the direction of the current in the coil. That way, the ignition coil could be built with a single primary winding instead of two. □

## Microprocessors

### Z8000 design packs minicomputer punch

The first microprocessor that adapts elements of minicomputer and mainframe architecture—that is what Zilog Corp. says it will have in August when it starts offering samples of its Z8000 16-bit microcomputer. The result should be a highly flexible general-purpose central processor, one that can tackle a market stretching from the high end of the Cupertino, Calif., manufacturer's own Z80 8-bit microprocessor into the minicomputer area.

In claiming that the Z8000 employs the first full high-end 16-bit architecture, Zilog pits its new chip against Digital Equipment Corp.'s PDP 11/45 minicomputer, which it claims the Z8000 outperforms.

Basically, the Zilog designers

ly to conventional kinds of circuit boards. Usually, the military prefers to attach the devices first to ceramic mother boards bearing relatively heavy but flexible leads that prevent fracturing by absorbing expansions during thermal cycling [*Electronics*, Nov. 24, 1977, p. 86].

**Tests.** The Martin Marietta engineers tested glass-epoxy and polyimide boards loaded with ceramic LIDs and chip carriers. They ran through the military range of thermal shock and cycling with no failures, according to John E. Fennimore, a member of the professional staff in the division's mechanical microelectronic design section.

They also did a theoretical analysis of what should happen to the solder joints under temperature stress. They assumed a linear temperature coefficient of expansion for the circuit boards of  $10 \times 10^{-6}$  inch/inch/ $^{\circ}$ F, a figure well above the  $6$  to  $8 \times 10^{-6}$  in./in./ $^{\circ}$ F coefficient they actually measured in the X and Y planes on samples from eight circuit-board vendors.

Even with such a worst-case temperature coefficient, the loaded boards still passed the analysis. Apparently, the critical Z- or vertical-axis expansion of the components is minimized because there are no conventional leads to expand.

The LIDs, which resemble tiny inverted stools or tables, can carry a variety of discrete or integrated-circuit parts. The company soldered the LID legs and the bumps on the bottom of the chip carriers directly to the boards. Both types of carriers are mounted by silk-screening a solder cream onto the board, attaching the carriers, and reflow-soldering them in place.

"There's a place for this [packaging] technology in military hardware," says Fennimore. "It can be used for quick-turnaround prototyping, and I don't see any reason why it couldn't be used in production units for selected programs."

Martin Marietta is already using the simplified package. One example is in a preamplifier for the Copperhead cannon-launched guided projectile the company builds for the

Army. In the LID—discrete-component version, the preamp weighs just 2 grams. An earlier hybrid design weighed 6.5 grams.

For prototypes, the approach is especially suitable because it is faster than designing a board to carry multichip hybrids or a combination of hybrids and discretely. In a Martin Marietta camera for an airborne laser target identification and tracking system, for example, the vidicon tube's power supply was designed in only one sixth to one third the time it would have taken to design a hybrid or discrete version, the company estimates. The three-board supply uses several LIDs.

Fennimore also says his group put reflow-soldered discrete capacitor chips directly onto 12 printed-circuit boards, instead of first using protective ceramic carriers. The boards were loaded with the capacitors and stressed up to 100 cycles over the military temperature range of  $-55^{\circ}$ C to  $+125^{\circ}$ C. There were no bond failures, he says. □

### Trade

## U. S. imports of ICs show sharp rise

American imports of integrated circuits topped the \$1 billion mark for the first time last year, climbing 26% from the 1976 level of \$809 million. ICs accounted for more than half of the \$2 billion-plus worth of component imports, a 21% increase and another record, says the Department of Commerce.

While U. S. components exports continue to exceed imports, the U. S. advantage is declining steadily. Last year's \$665 million surplus, for example, dropped 23% from the 1976 level and was the lowest in five years, reports Commerce Department trade specialist Norman McLennan.

Within the components category, semiconductor exports of \$1.5 billion reflected a 7% gain on 1976 figures and continued to surpass the \$1.35 billion in imports. But the 22% rise

in imports cut the semiconductor trade surplus to \$151 million, a little more than half the 1976 total.

Of the changes, two are noteworthy. Malaysia replaced Singapore as the largest shipper of ICs to the U. S., with exports up nearly 4% last year to \$247 million. Also, Japan made a strong move upward last year, becoming the largest supplier of components of all types to the U. S., as well as greatly increasing shipments of ICs.

Component imports from Japan jumped 44% to \$371 million, while American exports there dropped 6% to \$133 million. Of the imports from Japan integrated circuits accounted for approximately \$40 million, more than double the \$19 million recorded in 1976, according to the Commerce Department figures.

**Tariffs.** In the intensely price-competitive IC market, more American producers are developing offshore assembly operations to take advantage of U. S. Tariff Code. Sections 806-807 of the code permit imports of products assembled abroad from U. S. materials, with the payment of tariffs only on the value added. "Probably 99% of the ICs coming in from places like Malaysia, Singapore, and South Korea fall in this category," McLennan estimates. Such value-added integrated circuit imports have been "steadily increasing at a rate of about 1% a year for the past seven or eight years," he adds.

For example, contributing to Malaysia's rise to the top last year as the leading IC shipper, the Commerce Department indicates, were operations there by companies like Harris, RCA, Intel, and Motorola Semiconductor. U. S. components companies are also dominant in Singapore, which fell behind Malaysia even though its shipments rose 8% to \$230 million from the 1976 level of \$212 million.

South Korea ranked third in IC shipments to the U. S. last year with \$170 million worth, a 38% increase from 1976. Overall, it shipped more than \$235 million worth of components to America for the year.

IC shipments from Taiwan last

# Our dedicated MOS processing line can make our ROMs into your ROMs a lot faster than you might think.

When we give you a promise on ROM delivery, you can consider it a commitment.

Ordering ROMs is easy. Getting your ROM order when you need it is not so easy. ROM production is a custom business filled with variables. Your program mask is unique. ROM quantities vary widely. Your parts must be handled separately—and completely—through all stages of fabrication, assembly, test and, lastly, shipment. These factors can snowball to cause problems.

*Except at Signetics.*

**Dedicated Processing Means Predictable Delivery.** At Signetics, we maintain a completely separate production line for MOS ROMs. This dedicated processing means efficiency, process uniformity, and predictability. It also means faster turnaround from mask design to finished product. And it enables us to deliver you—in advance—when your order will be shipped. Dedicated processing is our guarantee to you that your custom mask ROM order won't be bumped by someone else's requirement for a standard memory product.

**All Signetics MOS ROMs Have Standard Pin-Outs.** When you design with our ROMs, regardless of the initial density specified, memory expansion is automatically built in. All Signetics ROMs are socket-compatible, and are designed to the industry-standard 24-lead pin configuration. They're also compatible with the 2708 and 2716 EPROMs.

You can design future systems now, upgrading density as required in the same socket.

**A Fully Static ROM Family—Single +5V Power Supply Optimizes Design.** Ordering your ROMs from Signetics can produce a lot of other benefits. We can offer you everything you need in fully static MOS ROMs from 8K to 32K.\* They're TTL-compatible, require a single +5V power supply, and feature state-of-the-art access time.

Our recent history as a ROM supplier will tell you something, too. In 1977 our ROM sales tripled. This year, we expect to triple again.

Call your local distributor today or use the coupon below to order your technical data on Signetics' growing family of high-performance MOS ROMs and EPROMs.

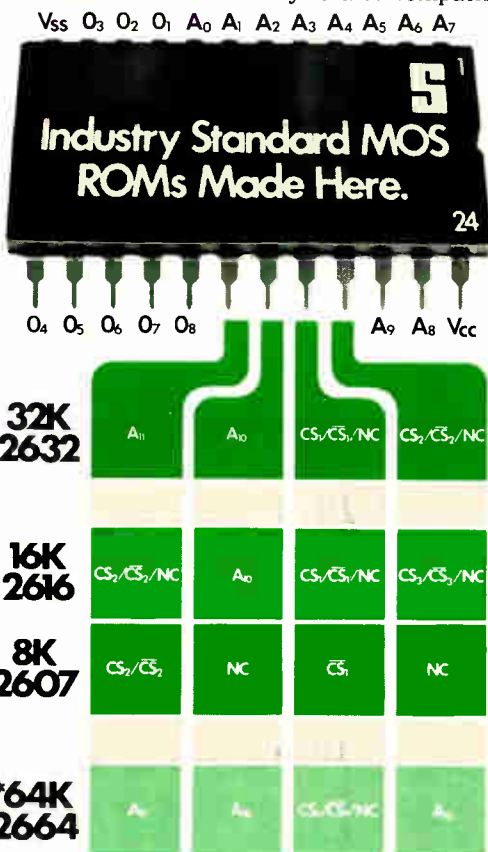

## Signetics

a subsidiary of U.S. Philips Corporation

Signetics Corporation  
811 East Arques Avenue  
Sunnyvale, California 94086  
Telephone 408/739-7700

You're writing the book on semiconductor memories. Our book has over 300 pages. And \$3.50 for your copy.

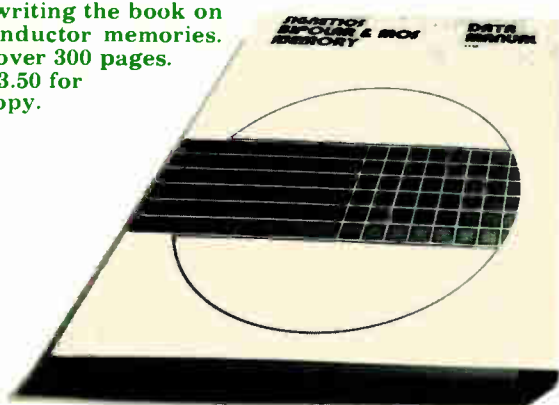

You can expect an industry-standard 64K ROM from Signetics in the third quarter.

To: Signetics Information Services, 811 East Arques Avenue  
P.O. Box 9052, MS 27, Sunnyvale, CA 94086

Please send me technical data on the following products:

- 8K ROMs    16K ROMs    32K ROMs    Denser ROMs  
 8K EPROMs    16K EPROMs    32K EPROMs    Denser EPROMs

I have an urgent requirement. Please have a ROM specialist phone me at once: (\_\_\_\_\_) \_\_\_\_\_, Ext. \_\_\_\_\_

Name \_\_\_\_\_ Title \_\_\_\_\_

Company \_\_\_\_\_ Division \_\_\_\_\_

Address \_\_\_\_\_ MS \_\_\_\_\_

City \_\_\_\_\_ State \_\_\_\_\_ Zip \_\_\_\_\_

- Enclosed is my check for \$3.50. Please send me your Memory Data book.

EM427

# THE ADRET 6000 SERIES

## FREQUENCY SYNTHESIZER FREQUENCY GENERATOR

### from 300 Hz to 1.2 GHz



**NOW!**  
**IEEE Bus compatible**  
**with 414 interface**

Frequency generator  
400 kHz/1.2 GHz

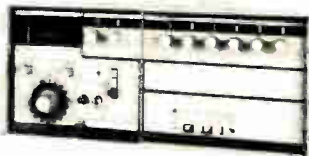

Frequency synthesizer 300 Hz/110 MHz



Frequency generator 400 Hz/600 MHz

The modular design of the Adret Series 6000 instruments allows you to assemble programmable frequency signal generators suited to your particular application.

The series features three output plug-in units capable of frequency coverage from 300 Hz to 110 MHz, 400 kHz to 600 MHz and 400 kHz to 1.2 GHz respectively. These plug-in units are inserted in either a 6100 A or 6101 A mainframe for maximum versatility.

Inserted in the 6100 A mainframe, the plug-in will provide a true stable and accurate frequency generator synthesizer with AM, FM and PM capability, 0.01 Hz resolution, frequency comparison and sweep mode with markers.

For applications requiring an accurate frequency source with AM capabilities, the 6101 A mainframe associated with either plug-in will satisfy your needs. Both mainframes and plug-ins are remotely programmable, either in parallel BCD code or through the IEEE bus with the Interface 414.



**ADRET ELECTRONIQUE FRANCE**  
12, avenue Vladimir Komarov • BP 33 78192 Trappes Cedex • France • Tél. 051.29.72 •  
Télex ADREL 697821 F • Siret 679805077 - 00014 • CCP Paris 21 797 04 •

**adret**  
**ae**  
electronique

display signals, as it would normally do for a calculator.

A separate seven-segment-to-binary-coded-decimal chip converts this output into a BCD format compatible with the microcomputer bus. The

microcomputer uses the data to drive the craft's 1/8-horsepower binary-controlled motors. They are either on or off, and controlling them at various frequencies alters the vehicle's speed and direction. □

## Microwaves

### U.S. microwave standards under attack in Cape Cod suit against Air Force radar

U.S. microwave ambient radiation standards are heading into court with a civil suit seeking to prevent the Air Force from completing or testing its Pave Paws missile-warning radar at Otis Air Force Base. A hearing on the action is expected next month, says Anne M. Vohl, a Lexington, Mass., attorney representing the Cape Cod Environmental Coalition Inc.

Low-power tests of portions of the Pave Paws phased-array antenna [*Electronics*, Aug. 7, 1975, p.42] began early this month at Otis. The coalition's suit, however, could postpone the operational target date of April 1979. The building housing the radar stands some 100 feet high, with phased arrays occupying most of that height on two sides. Peak

power output is specified at 700 kilowatts in pencil-thin beams, with average power at 140 kw, at a frequency of 425 to 450 megahertz.

**Impact statement.** The Air Force has already agreed to produce an environmental impact statement covering the environmental effects of the Otis radar, which is one of the objectives of the coalition's civil action. Besides seeking the statement, the suit filed in the U.S. District Court for Massachusetts would enjoin the Air Force from completing, activating, operating, or modifying Pave Paws "because significant damage to the human environment is likely to occur" if the radar is operated as planned. "The most significant hazard inherent in the project involves the danger of

microwave radiation," the complaint continues.

The Pave Paws program is managed for the Air Force Systems Command by the Electronic Systems division at Hanscom Air Force Base, Bedford, Mass., with Raytheon Co. as prime contractor. The system, along with a companion site at Beale Air Force Base, Marysville, Calif., would provide early warning of sea-launched missile attacks against the U.S. Raytheon has contracts totaling more than \$80 million for the two systems, and both are well along in construction.

**Established guideline.** Program officials at Hanscom are not available for comment because of the litigation, but a spokesman there says the Air Force felt comfortable in proceeding with the Otis system on the basis of conclusions reached in a March 1976 Air Force environmental assessment. That assessment uses an Air Force regulation adopting an exposure level for humans of 10 milliwatts per square centimeter for 6 minutes or longer as its safety criterion—a guideline established by the USAF School of Aerospace Medicine at Brooks Air Force Base, San Antonio, Texas.

For her part, attorney Vohl says this level is too high and regards the Air Force environmental assessment a botch, "put together by a number of people who didn't talk to each other sufficiently." Nor is she convinced by a subsequent environmental impact analysis completed in December 1977 by the Electromagnetic Radiation Analysis branch of the U.S. Environmental Protection Agency. It concludes, in part, that calculated power densities at the site's nearest boundary and at the nearest housing area "are well below those for which any acute or somatic health effects have been found in any research efforts."

"We're waiting to hear from the Air Force what the power output will be in the next few months," she says. "I think we've got to have

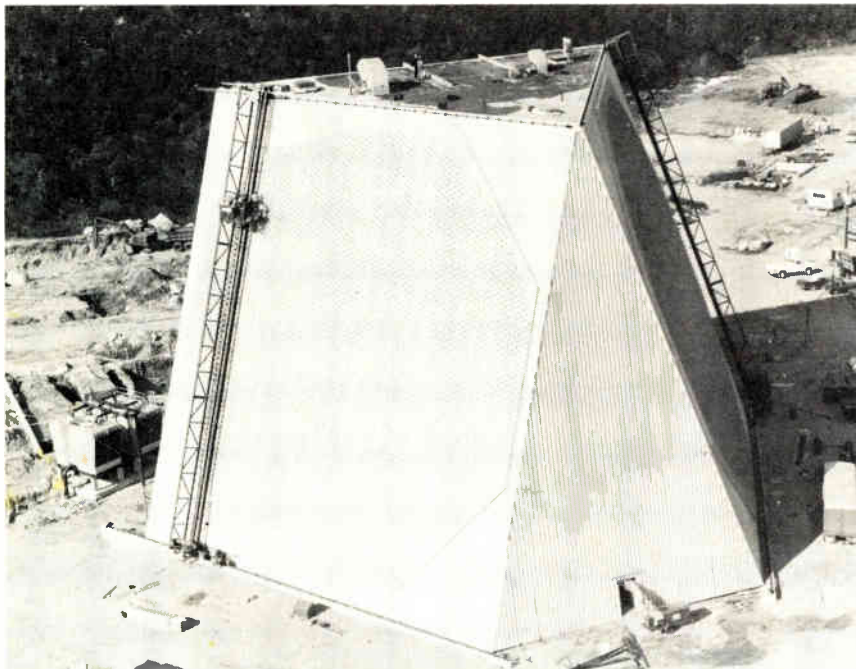

**Big array.** Pave Paws phased-array radar under construction at Otis will produce a peak output of 700 kilowatts.

# PROMs

## MOS PROM

Organization	Part Number	Access Time (ns max)	No. of Power Supplies <sup>1</sup>	No. of Pins
1024 x 8	MCM2708P	450	3	24

## ECL PROMs

Organization	Part Number	Access Time (ns max)	Output	No. of Pins
32 x 8	MCM10139†	25	ECL output	16
256 x 4	MCM10149†	30	ECL output	16

## TTL PROMs

Organization	Part Number	Access Time (ns max)	Output	No. of Pins
64 x 8	MCM5003/5303†	125	Open collector	24
64 x 8	MCM5004/5304†	125	2K pull-up	24
512 x 4	MCM7620*†	50	Open collector	16
512 x 4	MCM7621*†	50	3-state	16
512 x 8	MCM7640†	70	Open collector	24
512 x 8	MCM7641†	70	3-state	24
1024 x 4	MCM7642†	70	Open collector	18
1024 x 4	MCM7643†	70	3-state	18
1024 x 8	MCM7680*†	70	Open collector	24
1024 x 8	MCM7681*†	70	3-state	24
2048 x 4	MCM7684*†	80	Open collector	18
2048 x 4	MCM7685*†	80	3-state	18
1024 x 8	MCM82707*†	70	Open collector	24
1024 x 8	MCM82708*†	70	3-state	24

# EPROMs

## MOS EPROMs

Organization	Part Number	Access Time (ns max)	No. of Power Supplies <sup>1</sup>	No. of Pins
1024 x 8	MCM2708L†	450	3	24
1024 x 8	MCM27A08L†	300	3	24
1024 x 8	MCM68708L†	450	3	24
1024 x 8	MCM68A708L	300	3	24
2048 x 8	MCM2716L†	450	3	24
2048 x 8	MCM2717L	450	3	24
2048 x 8	MCM2716AL*†	450	1	24

# Motorola Memories

Motorola has developed a very broad range of MOS and bipolar memories for virtually any digital data processing system application. And for those whose requirements go beyond individual components, Motorola also supplies Memory Systems and Micromodules.

New Motorola memories are being introduced continually. **This selector guide lists all those available as of April 1978.** For later releases, additional technical information or pricing, contact your nearest authorized Motorola distributor or Motorola sales office.

Data sheets may be obtained from your in-plant VSMF Data Center, distributors, Motorola sales offices or by writing to:

Literature Distribution Center  
 Motorola Semiconductor Products Inc.  
 P.O. Box 20912  
 Phoenix, AZ 85036.



**MOTOROLA INC.**

# MOTOROLA MEMORIES

## Selector Guide

# RAMs ROMs PROMs EPROMs



**MOTOROLA INC.**



MOTOROLA INC.

# RAMs

## MOS DYNAMIC RAMs

Organization	Part Number	Access Time (ns max)	No. of Power Supplies <sup>1</sup>	No. of Pins
4096 x 1	MCM4096C-6†	250	3	16
4096 x 1	MCM4096C-16†	300	3	16
4096 x 1	MCM4096C-11†	350	3	16
4096 x 1	MCM4027C-2†	150	3	16
4096 x 1	MCM4027C-3†	200	3	16
4096 x 1	MCM4027C-4†	250	3	16
4096 x 1	MCM6604AC	350	3	16
4096 x 1	MCM6604AC-2	250	3	16
4096 x 1	MCM6604AC-4	300	3	16
4096 x 1	MCM6605AL	300	3	22
4096 x 1	MCM6605AL-2	200	3	22
8192 x 1	MCM4108C-20*†	200	3	16
8192 x 1	MCM4108C-30*†	300	3	16
16,384 x 1	MCM4116C-15*†	150	3	16
16,384 x 1	MCM4116C-20†	200	3	16
16,384 x 1	MCM4116C-25†	250	3	16
16,384 x 1	MCM4116C-30†	300	3	16
16,384 x 1	MCM6616C-20†	200	3	16
16,384 x 1	MCM6616C-25†	250	3	16
16,384 x 1	MCM6616C-30†	300	3	16

## CCDs

65,536 x 1	MCM0464L-50*†	50	3	16
65,536 x 1	MCM0464L-60*†	60	3	16
65,536 x 1	MCM0464L-70*†	70	3	16

\*To be introduced.

†Second source.

Heavy black type denotes industry standard part numbers.

Operating temperature ranges

MOS 0° to 70°C

CMOS -40°C to +85°C and -55°C to +125°C

ECL Consult individual data sheets.

TTL -55°C to +125°C

<sup>1</sup>MOS power supplies:

3 +12, +5 V  
1 ±5 V

All MOS outputs are 3-state except the 6570 and 6580 Series which are open-drain.

<sup>2</sup>Character generators include shifted and unshifted characters, ASCII, alphanumeric control, math, Japanese, British, German, European and French symbols.

## MOS STATIC RAMs

Organization	Part Number	Access Time (ns max)	No. of Power Supplies <sup>1</sup>	No. of Pins
1024 x 4	MCM2114P-20†	200	1	18
1024 x 4	MCM2114P-25†	250	1	18
1024 x 4	MCM2114P-30†	300	1	18
1024 x 4	MCM2114P-45†	450	1	18
1024 x 4	MCM21L14P-20†	200	1	18
1024 x 4	MCM21L14P-25†	250	1	18
1024 x 4	MCM21L14P-30†	300	1	18
1024 x 4	MCM21L14P-45†	450	1	18
4096 x 1	MCM6641P-20†	200	1	18
4096 x 1	MCM6641P-25†	250	1	18
4096 x 1	MCM6641P-30†	300	1	18
4096 x 1	MCM6641P-45†	450	1	18
4096 x 1	MCM66L41P-20†	200	1	18
4096 x 1	MCM66L41P-25†	250	1	18
4096 x 1	MCM66L41P-30†	300	1	18
4096 x 1	MCM66L41P-45†	450	1	18
4096 x 1	MCM2147C-55*†	55	1	18
4096 x 1	MCM2147C-70*†	70	1	18

## CMOS STATIC RAMs

Organization	Part Number	Access Time (ns max)	No. of Power Supplies	No. of Pins
64 x 1	MCM14505	300	1	14
256 x 1	MCM14537	1500	1	16
64 x 4	MCM14552	1600	1	24
256 x 4	MCM145101†	650	1	22
256 x 4	MCM145101-1†	450	1	22
256 x 4	MCM145101-3†	650	1	22
256 x 4	MCM145101-8†	800	1	22
1024 x 1	MCM146508*†	460	1	16
1024 x 1	MCM146508-1*†	300	1	16
1024 x 1	MCM146518*†	460	1	18
1024 x 1	MCM146518-1*†	300	1	18

## ECL BIPOLAR RAMs

Organization	Part Number	Access Time (ns max)	Output	No. of Pins
8 x 2	MCM10143	15	ECL output	24
256 x 1	MCM10144†	26	ECL output	16
16 x 4	MCM10145†	15	ECL output	16
1024 x 1	MCM10146†	29	ECL output	16
128 x 1	MCM10147†	15	ECL output	16
256 x 1	MCM10152†	15	ECL output	16

## TTL BIPOLAR RAMs

Organization	Part Number	Access Time (ns max)	Output	No. of Pins
1024 x 1	MCM93415†	45	Open collector	16
1024 x 1	MCM93425†	45	3-state	16

# ROMs

## MOS STATIC ROMs

### Code Converters

Organization	Part Number	Access Time (ns max)	No. of Power Supplies <sup>1</sup>	No. of Pins
1024 x 8 or 2048 x 4	MCM6560P†	350	3	24
1024 x 8	MCM6561P†	350	3	24
1024 x 8	MCM6562P†	350	3	24
2048 x 8	MCM6590P†	800	3	24
2048 x 8	MCM6591P†	800	3	24

### Character Generators<sup>2</sup>

128 x (9 x 7)	MCM6570P†	500	3	24
128 x (9 x 7)	MCM6571P†	500	3	24
128 x (9 x 7)	MCM6571AP	500	3	24
128 x (9 x 7)	MCM6572P†	500	3	24
128 x (9 x 7)	MCM6573P†	500	3	24
128 x (9 x 7)	MCM6573AP	500	3	24
128 x (9 x 7)	MCM6574P†	500	3	24
128 x (9 x 7)	MCM6575P†	500	3	24
128 x (9 x 7)	MCM6576P†	500	3	24
128 x (9 x 7)	MCM6577P	500	3	24
128 x (9 x 7)	MCM6578P	500	3	24
128 x (9 x 7)	MCM6579P	500	3	24
128 x (7 x 9)	MCM6580P†	400	3	24
128 x (7 x 9)	MCM6581P†	400	3	24
128 x (7 x 9)	MCM6583P†	400	3	24
128 x (7 x 5)	MCM6670P	350	1	18
128 x (7 x 5)	MCM6674P	350	1	18
128 x (9 x 7)	MCM66700P†	350	1	24
128 x (9 x 7)	MCM66710P†	350	1	24
128 x (9 x 7)	MCM66714P†	350	1	24
128 x (9 x 7)	MCM66720P†	350	1	24
128 x (9 x 7)	MCM66730P†	350	1	24
128 x (9 x 7)	MCM66734P†	350	1	24
128 x (9 x 7)	MCM66740P†	350	1	24
128 x (9 x 7)	MCM66750P†	350	1	24
128 x (9 x 7)	MCM66760P†	350	1	24
128 x (9 x 7)	MCM66770P†	350	1	24
128 x (9 x 7)	MCM66780P†	350	1	24
128 x (9 x 7)	MCM66790P†	350	1	24

### Binary ROMs

1024 x 8	MCM68A30P8	350	1	24
1024 x 8	MCM68A308P7	350	1	24
2048 x 8	MCM68A316P91	350	1	24
1024 x 8	MCM68B30AP†	250	1	24
1024 x 8	MCM68A30AP†	350	1	24
1024 x 8	MCM68B308P†	250	1	24
1024 x 8	MCM68A308P†	350	1	24
2048 x 8	MCM68A316EP†	350	1	24
2048 x 8	MCM68A316AP†	350	1	24
2048 x 8	MCM6832P†	550	3	24
2048 x 8	MCM6832P91	550	3	24
4096 x 8	MCM68A332P†	350	1	24
8192 x 8	MCM68A364P*†	350	1	24

## CMOS ROM

Organization	Part Number	Access Time (ns max)	No. of Power Supplies	No. of Pins
256 x 4	MCM14524	1200	1	16

## Electronics review

direct commitment from them about those levels," she adds, citing the fact that in the Soviet Union, for example, human exposure to microwaves in residential areas is limited to 1 microwatt/cm<sup>2</sup>. □

## Telecommunications

### Signetics develops an I<sup>2</sup>L codec

A different tack in codecs is coming from Signetics Inc., which has opted for a coder-decoder with a complete bipolar approach using the integrated injection logic it has applied in custom designs for telecommunications and other markets.

Most semiconductor firms are turning to metal-oxide-semiconductor technology or combining it with

bipolar approaches to enter the emerging codec market. Key is the MOS process, which provides a low-cost, low-power design.

For Signetics, I<sup>2</sup>L clearly is superior to MOS for several reasons, according to Ronald R. Ruebusch, product marketing manager for analog telecommunications circuits in Sunnyvale, Calif. "Telecommunications people are extremely interested in noise," and bipolar "is inherently quieter than an MOS process," he says. In fact, the codec's idle channel noise performance measured for the worst case is typically a very competitive 10 dBnCo, he says. (A dBnCo is a unit of relative noise measurement taken through a C-message filter, which simulates the frequency response of a telephone.) For example, at a -15-dBm nominal signal point, a 10-dBnCo measurement means that the noise

## News briefs

### GE develops high-power Darlington transistor

A power transistor able to switch 400 volts and 350 amperes, or about three times the current-handling capability of other high-power Darlington transistors, has been developed at General Electric Co.'s Research and Development Center in Schenectady, N. Y. The transistor requires about 0.1 A to open or close the switch in less than 1 microsecond. The heart of the device, a 0.375-by-0.625-inch silicon chip, is mounted in a copper package about the size of a quarter and cooled from the top through direct contact with a proprietary copper heat-removal system. One of the first applications will be in a pair of experimental electric vehicles that the GE center is developing under contract to the U. S. Department of Energy.

### Gehring named Sperry Univac president

Richard L. Gehring, previously a Sperry Rand Corp. executive vice president responsible for the firm's defense and aerospace operations, is the new president of the computer-making Sperry Univac division. He succeeds Gerald G. Probst, appointed to the new position of group executive vice president for computers, business equipment, and defense and aerospace operations. Probst has overall responsibility for three of Sperry's six divisions—Sperry Univac, Sperry (formerly Sperry Gyroscope), and Sperry Flight Systems—and the corporate research center in Sudbury, Mass.

### IBM cites cost, material savings in magnetic-bubble production

Researchers at IBM Corp.'s General Products division development laboratory in San Jose, Calif., have been issued a U. S. patent for a precision alignment method that, says IBM, can save as much as 50% of the garnet material usually lost during the preparation of magnetic-bubble storage devices. The process first shapes the garnet crystal so that its geometric axis is aligned with its crystallographic axis. Heretofore, the crystal remained stationary, but now it is rotated perpendicular to a thin rotating diamond blade. As wafers are sliced, two extremely flat, parallel surfaces are produced. The wafers are perpendicular to the crystallographic axis to within 0.06° to 0.07°, or about two to three times more precise than before.

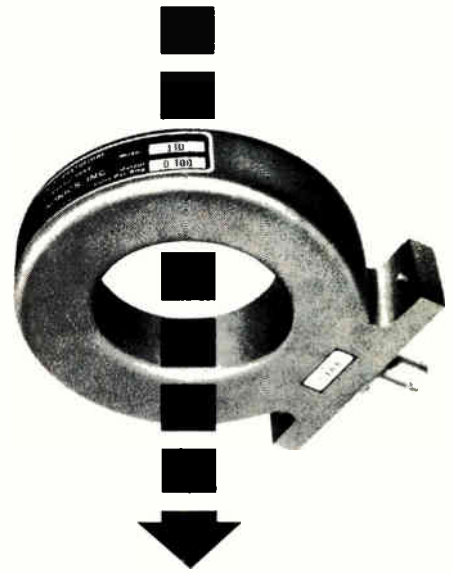

## Wide Band, Precision CURRENT MONITOR

With a Pearson current monitor and an oscilloscope, you can measure pulse or ac currents from milliamperes to kiloamperes, in any conductor or beam of charged particles, at any voltage level up to a million volts, at frequencies up to 35 MHz or down to 1 Hz.

The monitor is physically isolated from the circuit. It is a current transformer capable of highly precise measurement of pulse amplitude and waveshape. The one shown above, for example, offers pulse-amplitude accuracy of +1%, -0% (typical of all Pearson current monitors), 20 nanosecond rise time, and droop of only 0.5% per millisecond. Three db bandwidth is 1 Hz to 35 MHz.

Whether you wish to measure current in a conductor, a klystron, or a particle accelerator, it's likely that one of our off-the-shelf models (ranging from 1/2" to 10 3/4" ID) will do the job. Contact us and we will send you engineering data.

### PEARSON ELECTRONICS, INC.

4007 Transport St., Palo Alto, CA 94303, U.S.A.

Telephone (415) 494-6444





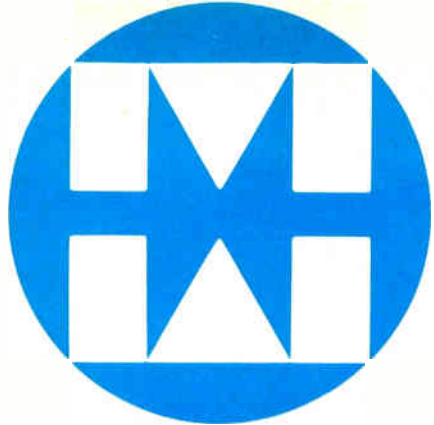

# MITEL

## CMOS/LSI LIQUID-CRYSTAL- DISPLAY DRIVER/LATCHES

MD4330 • MD4331 • MD4332  
30 & 32-BIT REGISTER DRIVERS

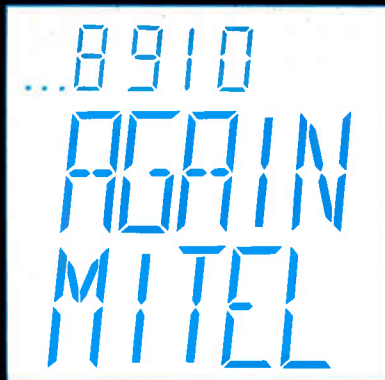

DRIVES UP TO FOUR 7-SEGMENT OR TWO 16-SEGMENT LCD READOUTS DIRECTLY. THE LATCHED DATA CAN BE CHANGED BY SERIALY SHIFTING NEW DATA INTO THE REGISTER AT SPEEDS OVER 3MHz.

Low-Power (1 $\mu$ A) Consumption with High-Power Performance.

### FEATURING:

- 3 to 18 VOLT OPERATION
- SYNCHRONOUS OR ASYNCHRONOUS RESET
- INPUTS WAVE-SHAPED ON-CHIP
- FULL PARALLEL TRUE/COMPLEMENT OUTPUTS
- STD. 40-PIN DUAL-IN-LINE PACKAGES

For more information write or phone:

18 AIRPORT BLVD.  
BROMONT, QUEBEC, CANADA  
JOE 110  
(514) 534-2321  
TLX: 05-267474



# MITEL

Semiconductor

## Electronics review

power level there is -95 dbm.

A second reason for the bipolar approach is found in the codec's performance. "I<sup>2</sup>L is superior to MOS" for the long-term drift and aging that are important to telecommunications users, Ruebusch says. And Signetics' custom work on a circuit of a similar size meant that "it didn't take massive development to bring the chip into existence."

Moreover, though other companies shy away from I<sup>2</sup>L because it is reputed to be a power eater, the new ST100 codec dissipates only 300 milliwatts maximum, a figure comparable to competing designs. And, because I<sup>2</sup>L is bipolar, it is easy to interface to it, he says.

The new ST100 codec is designed to work in pulse-code-modulated telephone systems, where it will sample voice signals and convert them into 8-bit words for multiplexed transmission at one end and reconversion to voice at the other. It is aimed at all of the four main equipment segments of the market: PCM channel banks, electronic private-branch exchanges, digital switching units, and digital subscriber carrier equipment in rural areas.

**Special features.** To meet those markets, the ST100 has two especially significant features, Ruebusch says. One is dual-channel signaling, required by Bell's D3 specification for channel banks but not found on other new codecs. This allows four states of control signaling and reduces the number of line termination circuits, he says. The other is zero code suppression, which automatically inserts a 1 in a stream of 0s so the clock frequency can be regenerated more readily.

The 24-pin device features clock rates up to 2.048 megahertz and asynchronous operation. It requires power supply voltages of -15, +8, and +5 volts and an external reference of 2.5 v  $\pm$  1%, which Signetics also plans to supply. With working parts in house, Signetics says it will have samples in May and production devices in the third quarter. Ruebusch says prices will be competitive—\$10 in 100-and-up quantities and down to \$7 in large volume. □

## Space

### NASA seeks ideas for shuttle work

Companies with ideas for using the space shuttle's next-to-zero gravity and high vacuum to process new commercial products are being sought by a new National Aeronautics and Space Administration task force. The team, headed by NASA's Richard L. Brown at Marshall Space Flight Center, Huntsville, Ala., wants to "develop simplified working arrangements and make it as easy as possible for commercial firms to try out new ideas" for materials processing in space, Brown says. Flight opportunities for experiments will be available on a limited basis by 1980, with openings to be "routinely available within five years," he adds.

Technologies involving electronics, metals, and medicines, for example, may be able to develop new families of materials in the shuttle's micro-gravity—one millionth of that on earth—"where forces of buoyancy, sedimentation, and movement in fluids caused by heat are virtually eliminated," Brown says. This condition could permit uniform mixing and separation of such substances as semiconductor materials that cannot be otherwise achieved.

NASA offers three avenues for commercial ventures: (1) joint endeavors with cost sharing between NASA and a company with no exchange of funds; (2) industry-funded ventures in which a company pays for development of the experiment package plus a pro-rata share of its integration, operation, and flight costs; or (3) Government-funded ventures resulting from competitive NASA solicitations.

NASA will consider waiving invention rights in joint ventures when it is in the public interest, Brown says. The address of his Commercial Space Processing Development Office at Marshall is Mail Code PF12, Huntsville, Ala. 35812. □

# The SBA programmable controller.

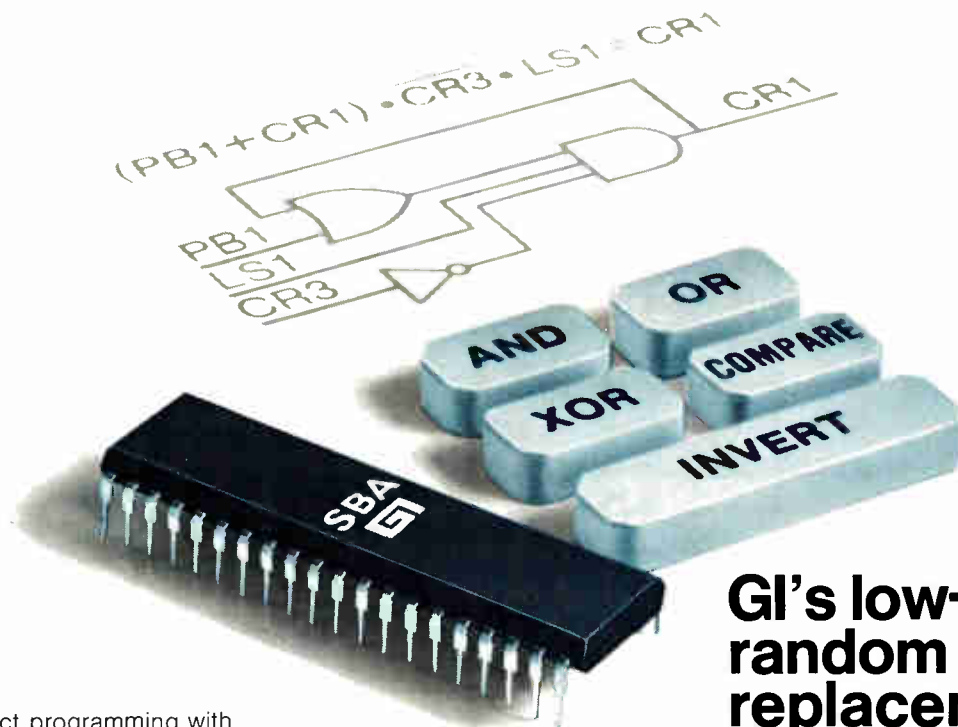

## GI's low-cost random logic replacement

Simple direct programming with logic statements, and a low price tag are leading features of GI's new SBA. Sequences are written using familiar Boolean logic equations as a "programming language." Now you can program timing and control functions in a range of products.

The single-chip, one-bit SBA microcomputer has 30 TTL compatible pins that can be assigned as inputs, outputs, or multiplexed input/outputs. And a 1023-word memory stores your program. A logic unit teamed with a 16-element stack interacts with a 120-element read/write memory to produce programmed outputs a term at a time.

A cost-effective alternative to 4-bit and 8-bit microprocessors, the SBA performs decision-oriented tasks efficiently at millisecond speeds.

As for applications, consider using the SBA in process timers and monitors, machine controllers, security or telecommunication systems. The SBA will do wonders for electronic games and household appliances. What's more, you can put the SBA to work converting and processing routine data in microprocessor-based systems.

This versatile NMOS processor in a 40-pin DIP requires only +5 and +12 volt supplies and an RC network for its internal clock. You can depend on GI Microelectronics to give you a hand with simulator and software program aids to get you started. Write or call today, General Instrument Microelectronics Ltd., 1-4 Regency House, Warwick Street, London W1R 5WB, England, Telephone: 01-439-1891.

**We help you compete.**

**GENERAL INSTRUMENT CORPORATION  
MICROELECTRONICS**



# The single chip analog computer.

A versatile, new  
computational IC that's  
accurate and easy  
to use,

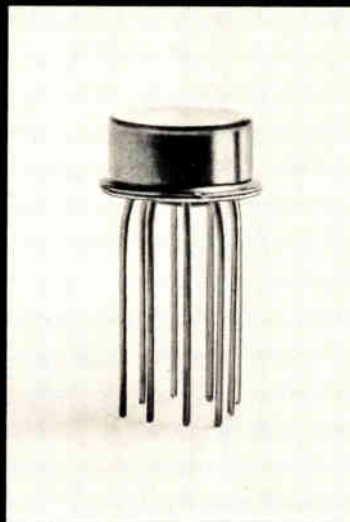

The AD534 Analog Multiplier,  
from \$16 in 100s.

The Analog Devices' AD534 Analog Multiplier. A new, monolithic, laser-trimmed, four-quadrant analog multiplier destined to smash the myth that analog multipliers are more complex than the computing function they solve.

The AD534 has a guaranteed maximum multiplication error of  $\pm 0.25\%$  without external trims of any kind. This level of accuracy you'd normally expect to find only in expensive hybrids or bulky discrete modules. Excellent supply rejection, low temperature coefficients and long-term stability of the on-chip thin film resistors and buried zener reference preserve the AD534's accuracy even under the most adverse conditions.

The AD534 is the first general purpose, high performance analog multiplier to offer fully differential high impedance operation on all inputs. And that's what gives the AD534 its amazing flexibility and ease of use.

The AD534 is a completely self-contained, self-sufficient multiplier which can generate complex transfer functions very close to theoretical. Our active laser trimming of thin film resistors on the chip to adjust scale factor, feedthrough and offset allow you to plug in the AD534 and run it virtually without adjustment.

In addition to straightforward implementation of standard MDSSR functions (multiplication, division, squaring and square rooting), the AD534 simplifies analog computation (ratio determination, vector addition, RMS conversion); signal processing (amplitude modulation, frequency multiplication, voltage controlled filters); complex measurements (wattmeters, phasemeters, flowmeters) and function linearization (transducers, bridge outputs, etc.) You can set up the AD534 to perform complex calculations by using various feedback arrangements to manipulate the AD534 transfer function of  $(X_1 - X_2)(Y_1 - Y_2) = 10(Z_1 - Z_2)$ .

## and use,

### In Frequency Multiplication.

Nonlinear circuits which accept sinusoidal inputs and generate sinusoidal outputs at two, three, four, five or more times the input frequency make use of trigonometric identities which can be implemented quite easily with the AD534 as shown. For this frequency doubling circuit the output should be AC-coupled to remove the DC offset resulting from the trigonometric manipulation.

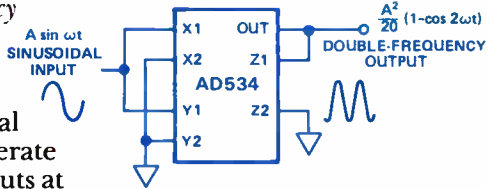

*In Ratio Computing.* The percentage deviation function is of practical value for many applications in measurement, testing and control. The AD534 is shown in a circuit that computes the percentage deviation between its two inputs. The scale factor in this arrangement is 1% per volt although other scale factors are obtainable by altering the resistor ratios.

## and use,

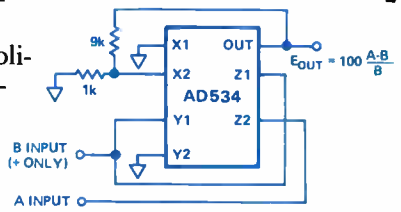

The AD534 is shown in a circuit that computes the percentage deviation between its two inputs. The scale factor in this arrangement is 1% per volt although other scale factors are obtainable by altering the resistor ratios.

## and use,

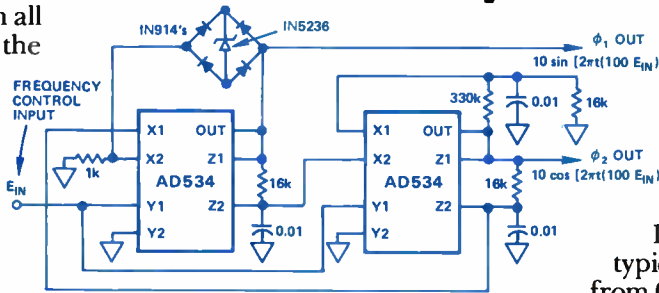

### *In Sine Wave Function Generation.*

The voltage controlled 2-phase oscillator uses two AD534's for integration with controllable time constants in a feedback loop. The frequency control input,  $E_{IN}$ , varies the integrator gains, with a sensitivity of 100Hz/V and frequency error typically less than 0.1% of full scale from 0.1V to 10V.

### *In a Voltage Controlled Filter.*

The output voltage, which should be unloaded by a follower, responds as though  $E_s$  were applied directly to the RC filter but with the filter break frequency proportional to the input control voltage (i.e.  $f_0 = \frac{E_c}{20\pi RC}$ ). The frequency response has a break at  $f_0$  and a 6dB/octave rolloff.

## and use.

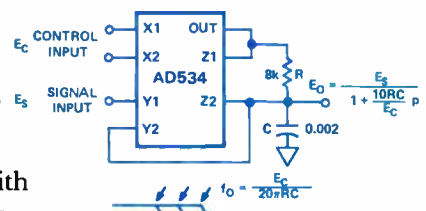

These uses of our new Single Chip Analog Computer, the AD534, are only the beginning. For the big picture call Doug Grant at (617) 935-5565. Or write for a copy of our new Multiplier Application Guide and the data sheet on the AD534.



The real company in analog computation.

See us at Electro '78 in Boston, Booths 1235 and 1237.

Circle 54 on reader service card

# How 36 trigger points can simplify analysis of your microprocessor-based systems.

## 5ns Glitch Capture.

Latch mode for glitch detection, or sample mode, can be independently selected for channels 1-8 and 9-16. Wide bandwidth BNC input allows capture of pulses as narrow as 5ns.

## Mixed Logic Thresholds.

Select one threshold voltage for channels 1-8, another for 9-16. Dial in ECL, TTL, MST, any of three user-preset values or continuously variable level.

**Display Control.** Select timing diagram, data domain logic state display or map mode using the accessory 116 Display Control. Memory feature permits comparison of current and stored system characteristics.

## Precise Memory Control.

Pretrigger recording enables you to split the 512-word memory to capture data on both sides of the trigger event. Or, with Delay Mode, start of recording can be delayed as long as 9999 clock intervals after the trigger.

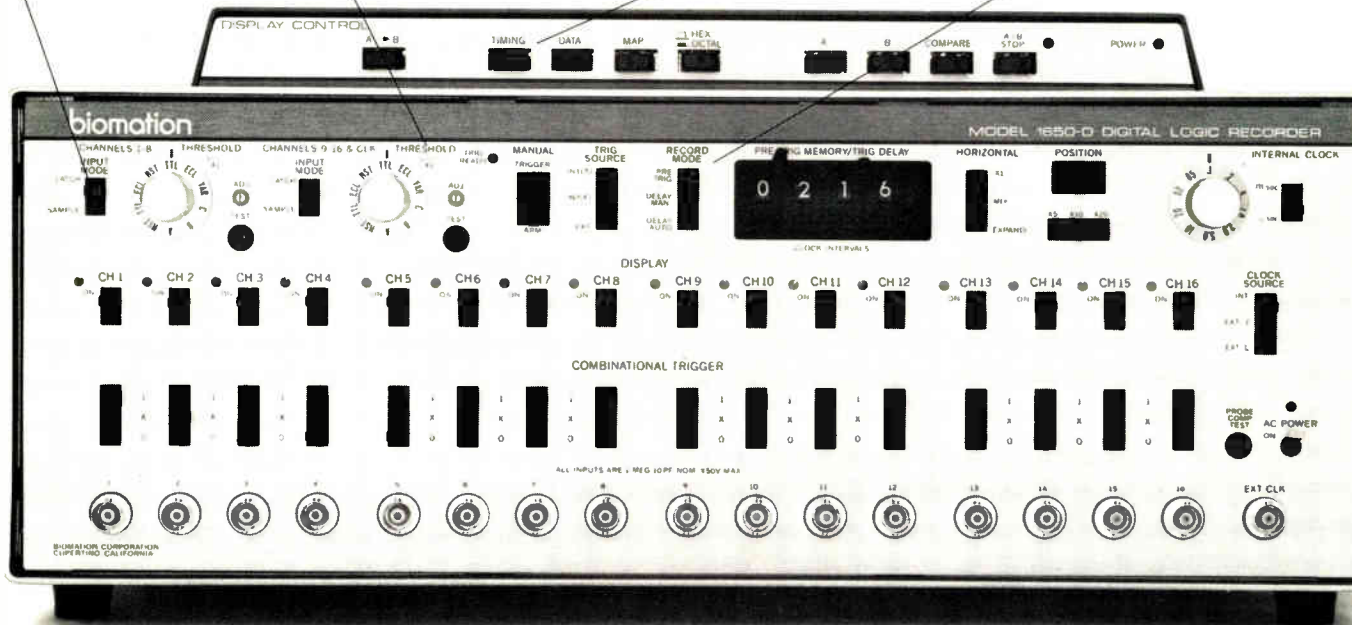

designing a microprocessor-based system? There's no better way to get a precise, detailed look at both 8-bit and 16-bit microprocessor system operation than our 16-channel, 50 MHz logic analyzer. Plug in two of our 10-TC active probe pods and the 1650-D's combinational trigger capability is expanded to trigger on words up to 36 bits long. That gives you the power to record and analyze up to 36 digital signals triggering on any word up to 36 bits long. Additional applications. Now, with the 1650-D, you can trigger on word lengths that you just couldn't detect before.

Versatility is the key to the 1650-D's popularity with designers working on microprocessor system development, instrumentation interfacing or analysis of real-time digital circuits. With the 116 Display Control, the 1650-D gives you the capability to analyze both timing and logic state displays. That's the key to simplified hardware/software debugging and integration. A Latch Mode on the input signal

enables the 1650-D to detect and record glitches or pulses as narrow as 5ns — vital information when troubleshooting the operation of digital circuits. Or, for data analysis, Sample Mode ignores synchronous glitches not coincident with the data clock.

There's not space here to give you all the details on how our 1650-D, with 10-TC probe pods and 36-bit trigger, can simplify your task. But we'll gladly send you detailed information on the 1650-D and our entire line of

logic analyzers, from the budget-priced 920-D to the ultra-fast, 200 MHz 8200. And, at your convenience, we'll arrange a demonstration of Biomation's logic analyzers in your lab, capturing and displaying the data you work with.

Write, call or use the reader service card. Biomation, 4600 Old Ironsides Drive, Santa Clara, CA 95050. (408) 988-6800. TWX: 910-338-0226.

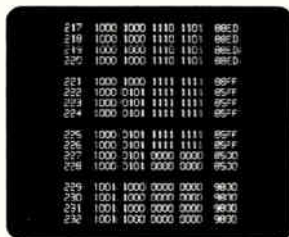

**Data Domain.** Display logic states (1's and 0's) with hex or octal translation. That's essential information for troubleshooting software and firmware.



**Map Mode.** Each digital word can be translated into a singularly positioned dot in this graphic representation of recorded data. Especially useful for spotting illogical or illegal memory addresses.



**Time Domain.** Timing diagram you see the sequential and simultaneous relationship between digital signals, to simplify hardware troubleshooting.

# biomation

## **FAA to speed domestic MLS after international OK**

The Federal Aviation Administration expects to move fast on adoption of a new domestic microwave landing system standard using time-reference scanning-beam technology. TRSB, an American-Australian technology, was adopted as the future international standard in Montreal last week by member nations of the International Civil Aviation Organization over Britain's doppler system by a vote of 39 to 24 with 8 abstentions. **A key beneficiary is the Hazeltine Corp. system known as Compact**, for smaller airports [*Electronics*, March 2, p. 78]. Also expected to gain from TRSB domestic and international business—estimated at \$1.5 billion over several decades—are developers like Bendix Corp. and Texas Instruments Inc. The ICAO recommendation, to be formally adopted later this year, calls for retention of the existing instrument-landing-system standard at international airports through 1995—subject to review in 1985—before switching to TRSB worldwide.

## **Army names Collins to develop faster Singcars radio**

Rockwell International's Collins Radio has won a \$7.1 million Army contract to design, develop, and test a fast frequency-hopping version of its next generation of portable combat radios known as Securable Singcars V. **Collins won the 40-month program in competition against a team of Cincinnati Electronics Corp. and Britain's Marconi Space and Defence Systems Ltd.** Earlier in April, Cincinnati and ITT Corp. won parallel development awards for a slower frequency-hopping version of Singcars V [*Electronics*, April 13, p. 59]. The earlier award gives Marconi, a member of the Cincinnati team, its first entrée into the military manpack market.

## **Drive to cut capital gains tax is nip and tuck**

The fight for legislation to spur investment in electronics and other money-starved U. S. industries by halving capital gains taxes is "still nip and tuck," admits one House tax specialist, as congressional and White House opposition is countered by heavy industry support. Lobbyists are concentrating on H. R. 11773, a bill by Rep. William Steiger (R., Wis.). It seeks to cut capital gains taxes back to the pre-1969 level of 25% and bring investors back into the market [*Electronics*, Feb. 16, p. 42]. **Should the bill survive an initial House Ways and Means Committee test scheduled for May 3**, it must make it through the Rules Committee before a floor vote in the face of strong Treasury Department and White House opposition. A set of similar hurdles waits in the Senate.

## **Changes sought in \$1.5 billion solar measure**

While the Department of Energy tries to formulate a solar-energy policy, Congress is getting its principal input largely from industry on a bill by Rep. Mike McCormack (D., Wash.) to fund a \$1.5 billion photovoltaic development effort over the next decade. The Solar Energy Industries Association's photovoltaics chairman, Anthony Adler, says the McCormack bill's **1987 goals for installed U. S. production and cost per watt are unrealistic.** Production goals should be halved to 1 million peak kilowatts, Adler says, while installed costs of \$2 per peak watt—double McCormack's estimate—are more likely. Adler also says that the SEIA believes the program should have an inflation hedge built in to achieve its goals. Industry estimates that this would lead to actual spending levels of closer to \$3 billion over the program's lifetime.

## The solar power controversy begins in Congress

The Department of Energy's under secretary, Dale Myers, is an accomplished engineer and manager of large-scale programs, but he is still learning the art of politics. While directing the National Aeronautical and Space Administration's manned space flight programs between 1970 and 1974 and Rockwell International's contracts earlier for the space shuttle and Apollo spacecraft, Myers had relatively little need for political skills. But he needs them now as a harried Department of Energy tries to pull itself together and establish priorities while badgered by competing interests.

During NASA's formative years, there were no competitive interests, no environmentalists challenging its every judgment. Who needed a piece of the moon? When Congress occasionally questioned NASA spending in those early years, the agency sent Administrator James Webb up to Capitol Hill to respond. Webb, a master political craftsman, had difficulty telling one end of a transistor from another. Nevertheless, he did have a firm mandate from the White House establishing a lunar landing as a national goal. The President had said so.

Neither Dale Myers nor his boss, Energy Secretary James Schlesinger, has a similar strong and clear mandate from Jimmy Carter. Moreover, they work against powerful and competing interests in the energy industries. Myers can readily distinguish one end of a transistor from another, but that has not helped him justify DOE's priorities on Capitol Hill.

An increasing number of congressional members want more research and development on solar-power satellites (see p. 96) to determine if they are a viable energy alternative for America in years to come. Spurred on by aerospace and electronics industry advocates like the recently formed Sunsat Energy Council, some House and Senate members want to give DOE another \$25 million in fiscal 1979 to accelerate SPS R&D. "That's not much at all, just about the cost of one new fighter plane," says one puzzled congressional staffer. "Most agencies would take the money and run, but not Myers. I don't get it."

### Carter's changing position

What constrains Dale Myers in this case is the existing White House emphasis on increasing the availability over the short term of domestic ground-based resources like coal as an alternative on imported oil. That program is not working well, and the White House is already having second thoughts about its feasibility

after the recent prolonged strike by coal miners.

Indeed, Jimmy Carter is expected to alter his Administration's uninterested position on solar power in May by forming a new Solar Policy Coordinating Committee headed by Schlesinger to lead an interagency effort promoting solar-power source development. While this is expected to focus on ground-based programs, satellites may be included in another Carter policy revision reportedly due next year. For the moment, all Myers can say about SPS is that "it is an attractive and interesting concept but we must be very careful in entering into it. We may look like we're tiptoeing but we must be very, very careful because of the enormous costs."

### Making political points

While Myers argues SPS dollars-and-cents, industry advocates are making points with Congress by going beyond costs and technology and citing the political advantages as well. Arthur D. Little Inc.'s Peter Glaser is one. He heads the nonprofit Sunsat Energy Council and holds a patent on the SPS concept after first advancing it in 1968. Glaser sees one political advantage to the U.S. in an SPS program when it comes to dealing with OPEC, the cartel of oil-exporting nations. "SPS is an alternative energy source that OPEC would have to weigh carefully when it considered raising oil prices," he says.

When opponents swoon at the system's estimated \$500 billion cost, advocates cite the public power industry's own \$476 billion estimate to replace less than two thirds the capacity of 50 SPS systems. They make other points, too. "Given our national economic commitment to support technology," one proponent contends, "wouldn't it be better to have companies building peaceful systems for society's benefit, instead of weapons?"

Definitive answers to that and a host of other questions about SPS are still to come. The SPS controversy is only beginning to come to public attention—a requirement for congressional action. Getting SPS its first \$25 million through passage of the proposed legislation "may be very hard" in view of DOE and NASA opposition, concedes Boeing's Ralph Nansen, a Sunsat director. But industry has an effective lever in the program's increasing congressional support. The concept is more than an energy alternative; it is an option for creating jobs at home using American technology for something other than weapons exports. The arguments have strong political appeal, and Dale Myers cannot easily put them aside.

**Ray Connolly**



# 5 REASONS WHY... TODAY, TOMORROW WE LEAD THE PACK IN IC INTERFACE

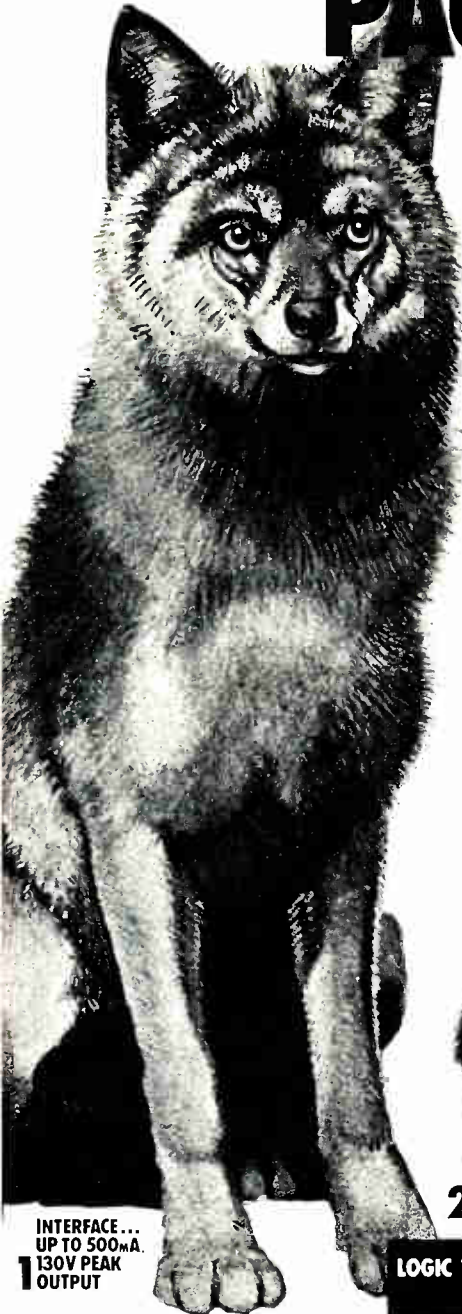

In short, SPRAGUE claims to leadership have teeth in them: we offer an ever widening IC INTERFACE programme – providing both unsurpassed logic compatibility and driving versatility. Additionally, construction is exclusively monolithic and features DIL encapsulation.

For full information, just fill-in the address patch and INTERFACE squares which correspond to your design requirements – returning the completed coupon to Sprague World Trade Corporation.



**2** 8 STAGE DARLINGTON

**3** PNP DARLINGTON

**4** 95V DARLINGTON

**5** LOW POWER SCHOTTKY TTL COMPATIBILITY

**1** INTERFACE...  
UP TO 500mA.  
130V PEAK  
OUTPUT

LOGIC TYPES	INDUCTIVE LOADS					POWER					DISPLAYS								
											LED		GAS DISCHARGE						
DTL/TTL LOW POWER SCHOTTKY TTL	1	2	3	4	5	1	2	3	4	5	1	2	3	4	5	1			
CMOS (5V)	1	2	3	4		1	2	3	4		1	2	3	4		1			
CMOS (12-15V)	1	2	3	4		1	2	3	4		1	2	3	4		1			
PMOS	1	2	3	4		1	2	3	4		1	2	3	4		1			

177

NAME \_\_\_\_\_

POSITION \_\_\_\_\_

FIRM \_\_\_\_\_

ADDRESS \_\_\_\_\_

SPRAGUE WORLD TRADE CORP  
P. O. B. 195, CH-1215 GENEVA  
AIRPORT 15, SWITZERLAND



# Electronics

April 27, 1978

## International<sup>®</sup>

Flat YIG resonator is a snap  
to handle and orient: page 70

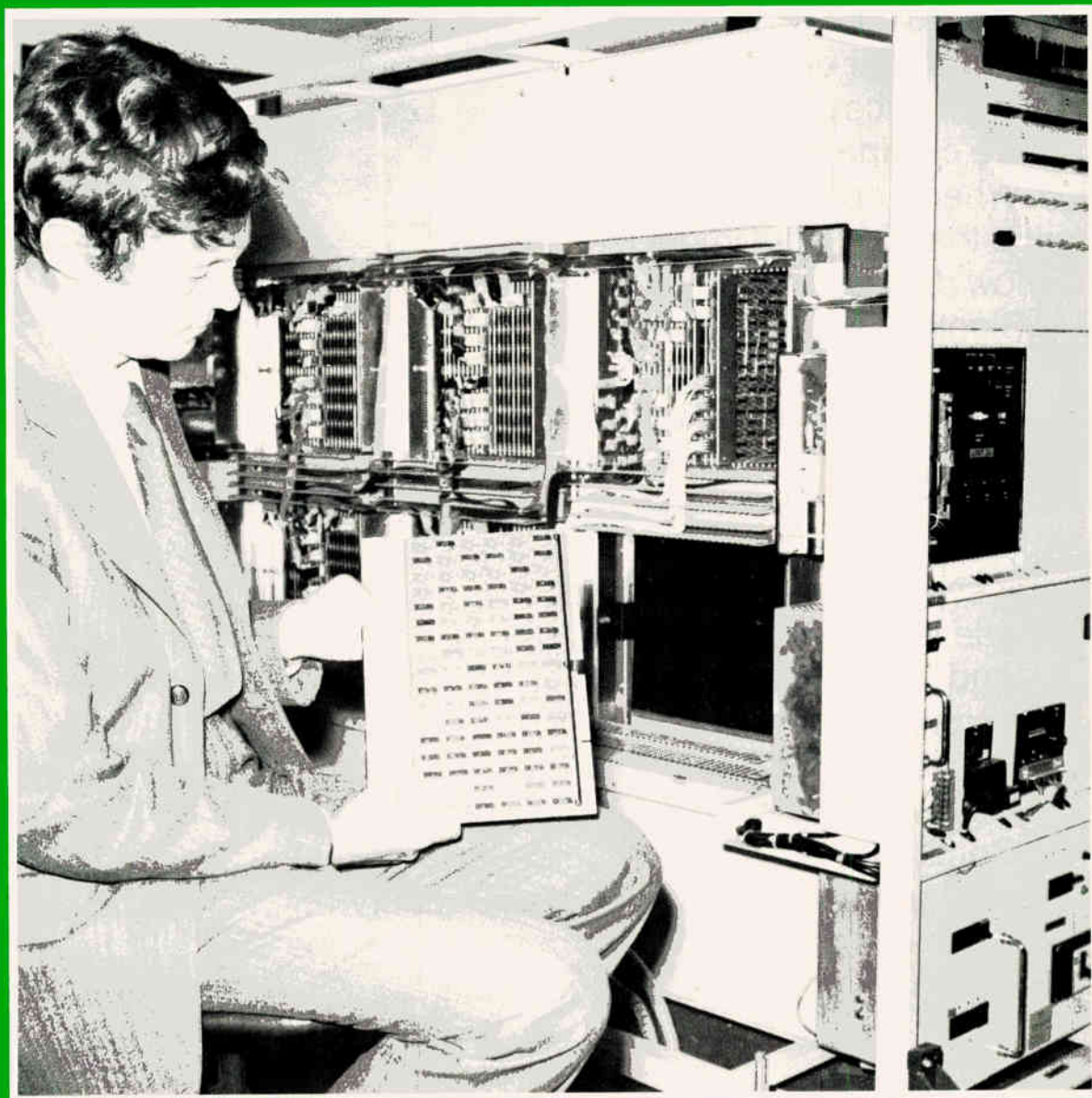

ICL's Stewart Reddaway has devised a distributed-array processor that will do 100 million calculations a second. Pilot model is shown: page 69

# RCA. Newsmaker in Linear

## New BiMOS CA 3290. Low-cost single-supply dual comparator.

BiMOS does it again—creates new performance at cost-effective prices. The new RCA CA3290 dual comparator LIC beats Bipolar on performance and Bifet on prices.

### Compare comparators.

When it comes to accuracy, compare the high input impedance/low current of BiMOS with that of Bipolar: 50 picoamps input vs. at least 25,000. This means the CA3290 can be coupled directly to high-impedance sensors.

### Check prices.

Then compare the prices of our new CA3290 voltage comparator in any quantity you need. At a fraction of Bifet costs, the BiMOS comparator is better at sensing small signals close to ground potential. Because its common mode input voltage includes ground.

And you have the added convenience and flexibility of two single-supply comparators in one package with operation up to 44 volts.

Let us give you the details as well as information on how you can make your own first-hand evaluation of the 3290.

Contact your local RCA Solid State distributor. Or contact RCA Solid State headquarters in Somerville, NJ; Sunbury-on-Thames, Middlesex, England; Quickborn 2085, W. Germany; Ste.-Anne-de-Bellevue, Quebec, Canada; São Paulo, Brazil; Tokyo, Japan.

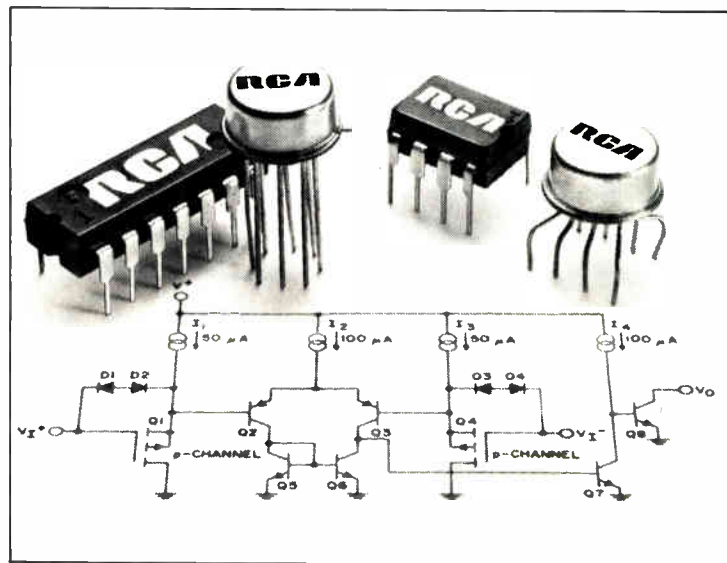

**RCA Linear IC experience is working for you.**

Circle 64 on reader service card

World Radio History

# RCA

## **8085 featured on modules for industrial control**

Data Applications International, a small Brussels-based microcomputer company, will introduce a line of industrial-control modules priced at just \$300. Built around 8085 one-chip microprocessors, **the one-board micro-computer systems carry both analog and digital output ports**, include space for user-defined circuits, and run off a standard 24-v industrial power supply. The firm will offer a development module for \$300, plus the cost of resident software. The line will be first shown at the late June International Minicomputers, Microcomputers, and Microprocessors Show in Geneva.

## **ICL may sell new number cruncher to other OEMs**

Britain's ICL is mulling marketing its advanced distributed-array processor DAP (p. 69) and its disk-based computer-assisted file-search system CAFS to other manufacturers. The number-crunching DAP could be dropped into other host mainframes as a 2-megabyte self-processing memory. CAFS, a stand-alone associative store, is undergoing acceptance trials at the British Post Office to speed telephone enquiries [*Electronics*, Jan. 19, p. 63]. **Thrust for the move comes from marketing men, who argue that both systems should be sold like minis to OEM customers.** These manufacturers would develop their own applications software, thus allowing ICL to maximize worldwide sales before competitive products appear.

## **Siemens is expanding SAW filter line for TV applications**

With surface-acoustic-wave filters for TV applications in full production, Siemens AG is getting set to mass-produce units for Great Britain and is developing versions for the U. S. and French video standards. Starting from scratch last year, **the firm has cranked up production of its single-crystal SAW filters for TV sets to some 100,000 units a month.** It plans to turn out roughly 6 million of them next year, a volume that would make the German company the leading producer of SAW filters on the Continent. The new versions also will be single-crystal types, in standard 19-by-16-by-5-mm packages with five terminals brought out on one side.

## **Saab and Bofors join forces on missiles**

At the prompting of the Swedish government, Saab-Scania and Bofors are establishing a joint company to develop, manufacture, and market missiles. **The Saab-Bofors Missile Corp. is intended to rationalize the Swedish effort in international arms sales.** Saab's missiles have been primarily air-to-ground and ground-to-air models, while Bofors, best known for its 40-mm anti-aircraft guns, has a ground-to-air laser-guided manpack missile system developed for the Swedish and Swiss armies. The new missile company will not make any major changes in the present production facilities of the privately owned parent firms.

## **Pay phone has 6800 to adapt it to worldwide use**

Now in prototype at Standard Elektrik Lorenz AG is a microcomputer-equipped version of the company's NT2000 public telephone. The Motorola-supplied 6800 microcomputer adapts the export version of the direct-dial set to the operating requirements of different countries. What prompted the West German ITT affiliate to turn to a microcomputer is the difficulty of adapting the domestic model's LSI circuitry [*Electronics*, June

21, 1973, p. 78] to the different rate pulses, coin designs, and operating parameters around the world. The microcomputer's programmability greatly simplifies the adaptation. A decisive factor in choosing the Motorola processor was its ability to withstand ambient temperatures from  $-25^{\circ}\text{C}$  to  $+75^{\circ}\text{C}$ , the Stuttgart firm says.

## **Solartron pushing new technique for a-d conversion**

Solartron-Schlumberger, originator of the widely used dual-ramp analog-to-digital conversion technique is pushing its successor, a precision pulse-width conversion process, in the 7045  $4\frac{1}{2}$ -digit multimeter. The Farnborough, Hants., company says **the technique offers greater accuracy and reading stability, better freedom from drift, and better noise reduction.** It first applied the technique in their laboratory standard full-seven-digit Maestro introduced in 1975, but has come up with a cost-reduced version built around a single p-MOS chip designed in house and manufactured by Plessey Semiconductors. With a price tag under \$600, the 7045 has automatic ranging on all scales.

## **Sony VCR to bow in West Europe; Philips also active**

Watch for a May introduction of Sony's Betamax video cassette recorder designed for West European countries using the PAL color-TV transmission system. In West Germany, Sony's PAL recorder is slated to retail for about \$1,400. It will be competing against the Philips format VCRs made by the Dutch firm and Grundig.

In a bid to stimulate the still small VCR market in Europe, Philips will start selling a black-and-white TV camera for just under \$1,000 early in May. **The V 100 comes with an electronic viewfinder, a zoom lens, and a built-in microphone.** It works in subdued light, down to 25 lux, and corrects automatically for changes in illumination. A color version priced under \$1,500 will follow in 1979, Philips says.

## **Addenda**

Bidding for a leading position in Spain's still developing color-TV market, **West Germany's Grundig AG has acquired the majority holding in Inter,** Barcelona's \$100 million entertainment electronics producer. . . . The Italian office-machine and computer maker, **Olivetti, is likely to get a major new infusion of capital** from Turin businessman Carlo De Benedetti. An ambitious entrepreneur with ties to the New York banking community, he is known to be interested in committing more than the present 3% of the firm's revenues to research. . . . A universal coin-vending machine from England is using a single-bit ROM-controlled micro-processor. **With the p-MOS ion-implanted chip, the Mars Money System vendor can be programmed for any combination of 63 prices,** based on the coinage of any country. . . . Chinese officials are supposed to start negotiations next month with an unidentified Japanese TV manufacturer **about construction of a plant to mass-produce PAL-system color-TV sets.** In the works for several years, the Chinese project has been discussed with various set makers around the world. . . . Great Britain's ICL is introducing an enhanced version of its 1500 small computer system inherited from Singer. **For the first time, it will have an interactive capability,** offered with the Cobol language.

# Standard frequency made to measure

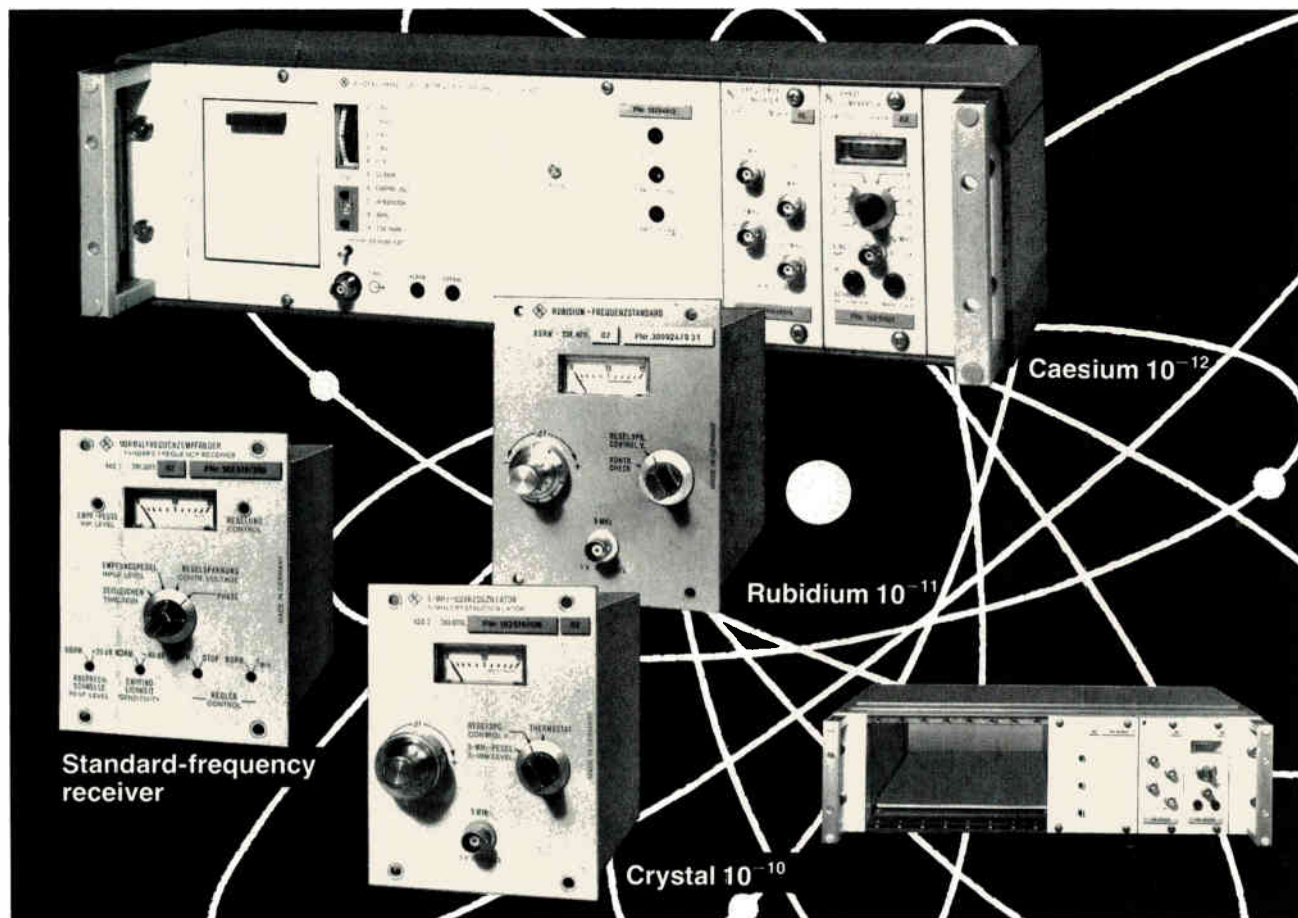

Rohde & Schwarz's modular system for standard frequency offers the ideal solution for every application.

## Caesium frequency standard XSC

Primary standard of the highest quality. Accuracy  $\pm 5 \cdot 10^{-11}$ , longterm stability  $\pm 5 \cdot 10^{-12}$ , shortterm stability  $3 \cdot 10^{-11}$  (1 s). Mains- and battery-powered thus optimal for standard-frequency and -time systems of extreme accuracy, for flying-clock applications, radio location, data networks and self-sufficient frequency systems.

## Rubidium frequency standard XSRM

High-quality secondary standard with longterm stability  $\pm 2 \cdot 10^{-11}$ /month, shortterm stability  $5 \cdot 10^{-12}$  (1 s). For calibration labs, mobile and stationary navigation and location, TV transmitters with precision offset. It also comes as OEM unit XSRB.

## Crystal oscillator XSD 2

Economic standard-frequency source. Longterm stability  $2 \cdot 10^{-10}$ /day, short-term stability  $1 \cdot 10^{-11}$  (1 s). Acts as accurate reference for frequency-synthesis and -analysis systems and for calibration needs.

## Standard-frequency receiver XKE 2

Greatly improves the longterm stability of crystal and rubidium standards through electronic frequency regulation. High sensitivity and freedom from interference in the receiving range 10 to 200 kHz. Digital storage of control signal if reception is interrupted.

Other modules: **frequency converter** from 5 MHz to 0.1/1/10 MHz; **phase comparator** for 1, 2, 3 etc. to 10 MHz; **standby power supply**.

Rohde & Schwarz  
Postfach 80 14 69  
D-8000 München 80  
Fed. Rep. of Germany

Electronic Measurements and Radio Communications. Development, manufacture, sales and service. Known for "electronic precision". Independent concern (establ. 1933), represented in 80 countries.



**ROHDE & SCHWARZ**

## Mainframe computer reaches 100 million operations a second

Self-processing memory has a processor for each RAM; such an array of power will come at bargain prices

The magic figure in scientific number crunching is 100 million floating-point calculations per second, and International Computers Ltd. is readying a machine it says will get to that goal at significantly lower prices than the competition. What the English firm has devised is a self-processing memory that gives a conventional mainframe a 2-mega-byte store that performs operations on its own elements.

By distributing processing power within the store and splitting it into many small elements each with its own processor, ICL reckons to overcome the communications bottleneck between memory and processor that bogs conventional computers down, particularly in three-dimensional modeling problems like forecasting weather patterns.

The firm has a prototype of its 32-by-32-element DAP (for distributed-array processor) with a capability of 25 million 32-bit calculations a second. It has an order for a 64-by-64-element computer with four times the number of elements and hence four times the capability [*Electronics*, March 30, 1978, p. 56].

**Fast.** Researchers of the Putney-based firm have simulated many performance comparisons with other giant computers. They say the 64-by-64 model will be three times faster than the Cray 1 in table look-up problems, 10 times faster than a

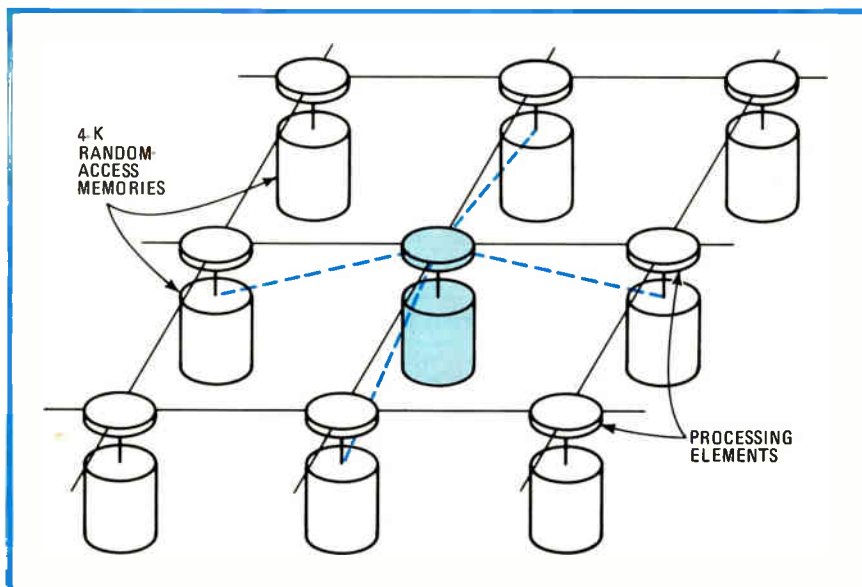

**Fast work.** Self-processing memory has 4,096 RAMs and associated processors, each of which is connected to its immediate neighbors and to the rest of the 64-by-64 matrix.

CDC 7600 in a galactic body simulation, 13 times faster than an IBM 360/195 on meteorological tasks, and 14 times faster than a 360/91 in magneto-hydrodynamic uses.

Yet another feature that will make the opposition sit up and take notice is a bargain-basement price tag only 20% to 50% more than that of other mainframes in the company's range. Typical costs of an ICL 2900 computer with a DAP will range from \$2.5 million to \$5 million. Other number crunchers cost \$8 million up and perform between 50 million and 80 million floating-point operations per second with data word sizes to 64 bits.

The DAP is the brainchild of Stewart Reddaway, who originated the design concept back in 1972. Work was funded by the United Kingdom Department of Industry

through its advanced computer-technology project. In 1975, ICL decided to build a pilot machine—also with government support—using standard medium-scale integrated circuits, and this has been working for the past two years.

Like the pilot machine, the larger 64-by-64-element array will be engineered initially in standard MSI logic. It will have a 64-by-64-element matrix of 4,096-bit random-access memories. Associated with each RAM chip is a rudimentary single-bit processing element comprising three 1-bit registers, a 1-bit full adder, and multiplexing circuitry connecting each processor to its immediate neighbors, to its associated store, and to the matrix row-and-column highways (see figure).

Because each bit processor is so simple, it lends itself to integration,

and ICL's West Gorton design and diffusion unit is developing an appropriate bipolar large-scale integrated circuit. There will be four on a chip initially, eight later on.

In operation, all 4,096 processors in the array execute the same instruction simultaneously in about 200 nanoseconds. Direction is by a master control unit, analogous to the instruction sequencing and control section of a minicomputer.

**Overseer.** The host computer is responsible for the administrative chores of putting the problem into the DAP and getting the answers out. Only minor changes are required to the host operating system to achieve this, and thus no expensive new operating system need be developed.

Both data and instructions are loaded from the host into the array

memory via the master control unit. Once it is loaded, transfer between host and DAP ceases until the next block of data and instructions is called up. All the processing elements obey a common program, but each can be instructed, or instruct itself, to ignore any command in order to provide sufficient flexibility to enable the matrix to be adapted to the parameters of a real problem.

Since the facilities provided by each processing element are quite elementary, all operations—even those for floating-point arithmetic, for instance—usually built into hardware are carried out by program subroutines. A new dialect of Fortran—DAP Fortran—is being developed by ICL to give users access to the array through a familiar high-level language. □

**France**

**Flat, simple-to-handle YIG resonator is a snap to orient in an oscillator**

The yttrium-iron-garnet spheres used as resonators in microwave systems are pesky little devils to work with, just because they are spheres. But a flat YIG replacement would overcome the handling difficulties during the production of oscillators and filters, reason engineers at Thomson CSF's Laboratoire Centrale de Recherches.

Moreover, it would avoid the considerable problems of orienting the crystalline resonator within the external magnetic field that produces the required frequency. "It is very difficult to put the spherical YIG onto a flat circuit and to make sure it is aligned in the right plane, with no external evidence of its crystalline structure to guide you," says one engineer at the lab in Orsay, southwest of Paris. Yet another advantage: "With a planar structure, it will be possible to use 2-inch-diameter YIGs and chop them up into a number of separate resonators."

A usable flat resonator would indeed be a breakthrough, says Larry Miller, vice president of engi-

neering at EIP Inc., a Santa Clara, Calif., manufacturer of microwave-frequency counters. While there has been considerable research into the configuration over the past 10 years, "nobody has successfully built commercial YIGs in other than spherical configurations." In fact, there are three major problems for Thomson to overcome: temperature sensitivity, spurious modes, and the tracking of multiple resonators.

The Thomson lab started its development program six months ago, and the first examples are undergoing tests. The configuration could bring significant, though undetermined, cost savings in production.

**Periodic gratings.** The approach used by the researchers is to generate the resonance using the reflection of surface magnetostatic waves between periodic gratings made up of microgrooves engraved in a thin YIG layer. The lab is currently working with a 10-micrometer layer deposited by liquid-phase epitaxy on a substrate of gadolinium gallium garnet. The waves are transmitted into and out of the grooves by aluminum microstrips deposited on the YIG layer. The grooves themselves are engraved using standard semiconductor techniques.

The researchers have managed to achieve frequencies of 1 to 2 gigahertz. However, they think the technique should produce frequency ranges of from 2 to 10 GHz—and maybe even up to 18 GHz. A good example of a spherical YIG resonator is one that covers a range of 800 megahertz to 18 GHz.

These frequencies will be obtainable with acceptable insertion losses, which the engineers anticipate will be around 10 decibels at 3 GHz. Other performance characteristics already achieved are a tuning range of 1 octave, varied by a magnetic field, and a Q-value coefficient of around 500.

These early efforts demonstrate the feasibility of the approach, say

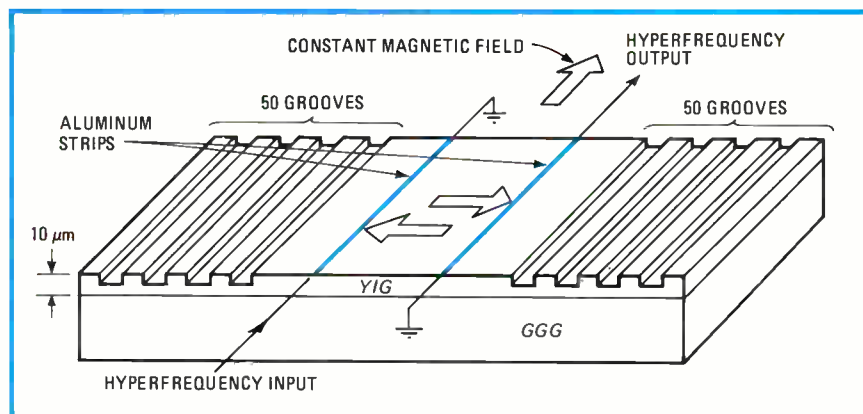

**In the groove.** In Thomson's flat YIG resonator, aluminum microstrips transmit surface magnetostatic waves into and out of a periodic grating made up of microgrooves.



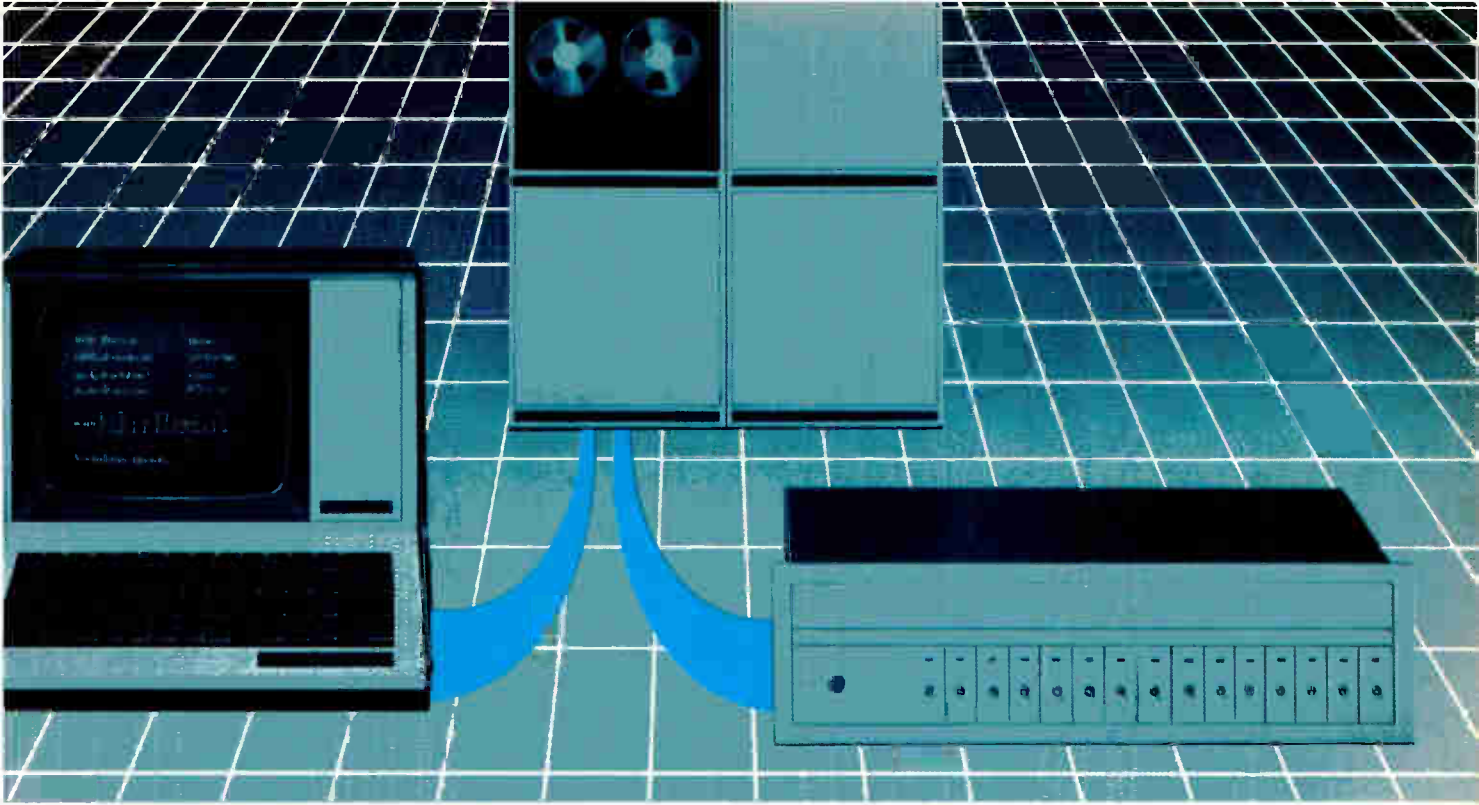

# Four more new line circuits. Meet EIA Standard RS-422. From the leader. Texas Instruments.

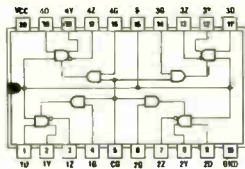

**SN75151 Quad differential line driver with 3-state outputs.**

- 40mA sink and source capability.
- Common strobe and enable.
- Individual enable control for each driver.
- Very low power dissipation in disabled state.
- Low output skew.

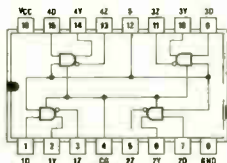

**SN75153 Quad differential line driver with 3-state outputs.**

- 40mA sink and source capability.
- Common strobe and enable.
- Very low power dissipation in disabled state.
- Low input current to minimize loading.
- Low output skew.

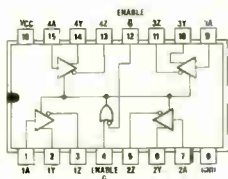

**AM26LS31 Quad differential line driver with 3-state outputs.**

- High output impedance in power-off conditions.
- Complementary enable inputs.
- TTL/DTL compatible.
- Low output skew.

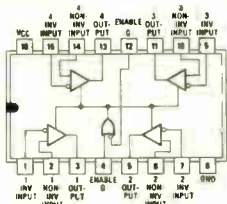

**AM26LS32 Quad differential line receiver with 3-state outputs.**

- Complementary enable inputs.
- Built-in input threshold hysteresis.
- Meets EIA Std. 422 and 423, Fed. Standards 1020 and 1030 for balanced and unbalanced digital data transmission.

Two innovative quad differential line drivers. Two second source circuits, one quad differential line driver and one quad line receiver.

All are designed to meet EIA and federal interface standards to ensure balanced voltage for the interchange of serial binary signals between data terminal and data communications equipment. Or any interface of binary signals between voice and data equipment.

Each offers 3-state outputs and low power Schottky circuitry to reduce power consumption without sacrificing speed. They all operate from a 5 V power supply.

In addition to these new line circuits, TI offers the SN55/75158 and SN75159 dual differential line drivers that meet EIA RS-422.

For more information on your most complete source of linear and interface circuits, write Texas Instruments, P.O. Box 5012, M/S 308, Dallas, Tx. 75222.



**TEXAS INSTRUMENTS**  
INCORPORATED

the researchers. However, they are working on improving the quality of the planar YIG resonator. The microgrooves are currently 75  $\mu\text{m}$  across, giving a wavelength of 300  $\mu\text{m}$ , and the width must be reduced to achieve 10 to 18 GHz. "But this should present no problem—5- $\mu\text{m}$  grooves are obtainable without too much difficulty," says Pierre Hartemann, who is one of the project engineers.

What will be problems are what other researchers have faced, says EIP's Miller. To begin with, flat YIG resonators have proved highly temperature-sensitive. Unlike spherical units, they have no temperature-compensated orientation.

A second problem is that nonuniform coupling of the resonator tends to excite spurious modes, degrading off-resonance-rejection performance. The third problem comes when the flat resonators are coupled together for filters. Getting the individual units all to track at the same resonant frequency has been exceedingly difficult, Miller says.

The Thomson lab is known to be concerned about temperature stability. Hartemann thinks the planar structure may mean including a thermostat to stabilize temperature in the final circuit. The figure on p. 70 shows a prototype.  $\square$

---

### Italy

---

## Phone fight attracts another competitor

It's a fierce race for the makers of electronic telephone equipment, selling their wares to countries with long-established telephone infrastructures, as well as winning over the countries that are modernizing their primitive phone nets. Although it is off to a late start, Italtel, the major hardware producer in the Italian telecommunications establishment, figures markets like Latin America and Africa will still be open in 1980.

That is when it plans to start selling its Proteo time-division electronic switching equipment abroad.

Already the company is negotiating with the Brazilian telephone company for joint development of electronic switching hardware.

To get the experience it needs to win export orders, Italtel is putting Proteo equipment into service in the Italian phone system as fast as it can. Both the phone operating company and Italtel (known in Italy as SIT-Siemens) are units of the government telecommunications holding company, STET.

To begin, there will be a batch of stand-alone 2,048-line time-division exchanges, which Italtel terms CTAs (Centrali Terminali Autonomi). The first CTA was cut over in a Rome exchange early this year (after field trials of Proteo equipment in Milan). "It's like an electronic island in a step-by-step network," says Paul Rupesh, senior systems engineer for electronic switching at the firm.

Four other such islands—one more in Rome and one each in Venice, Florence, and Messina—will go into service by the end of the year. They will make available such optional services as automatic transfer of calls, outgoing number limitations, and tracing of calls.

**Installations.** By the end of 1979, Rupesh expects, there should be some 20 CTAs at work in the country's phone system. More important, there should be four or five big Proteo systems in the works by then, if all goes well.

Actually, the stand-alone CTAs are special versions of Proteo peripheral exchanges (CT), and as many as 32 of them can be tied to a transit network and a common computer for urban exchanges of 30,000 lines with a capacity of up to 150,000 calls in a busy hour. The network links the CTs together through pulse-code-modulation lines and also ties the Proteo system to other exchanges, electronic or otherwise.

The control computer usually sends its commands to the CTs by a separate transmission, although the signaling, always in the form of a digital message, may be routed through PCM channels. The system, then, can have a Protean variety of configurations—hence its name.

For stand-alone CTAs, a pair of minicomputers do the job instead of the special-purpose computer that Italtel developed for full-fledged Proteo systems. They are Hewlett-Packard 21MX machines, each with a memory capacity of 48,000 words of 32 bits. The minis, one a hot standby for the other, control duplicate line-control units (UCL). A third 21MX, operating off line, is used for maintenance and ancillary services.

The UCLs themselves are hard-wired processors with eight cyclic memories. They interface with the local network, which includes the time-division-multiplexing circuits with 80 time slots and uses pulse-amplitude modulation for internal transmission.

**Special CPU.** In full-fledged Proteo networks, the system controlled is a fully duplicated, modular, special-purpose computer, designed for a maximum down time of not more than 2.5 hours in 40 years. The central processing unit, built mainly around transistor-transistor logic, is microprogrammed with some 800 instructions of 100 different types; a representative microcycle is 180 nanoseconds.

Paired with this CPU is a core memory with a maximum capacity of 256 kilowords of 32 bits. Eventually, it will be replaced with metal-nitride-oxide-semiconductor packages—a 64-K MNOS module has the same size as a 16-K block in cores.  $\square$

---

### East Germany

---

## Quiet teletypewriter uses mostly ICs

Just as their counterparts in the West have done, East German teletypewriter designers are championing microelectronics to replace the array of levers, rods, and other mechanical parts in such machines. The result of their efforts is the world's latest electronic teleprinter, in which only the print mechanism is a moving mechanical part.

Unveiled at East Germany's Leipzig fair last month, the receive-only

# The New Infrared Remote Control System from ITT Semiconductors

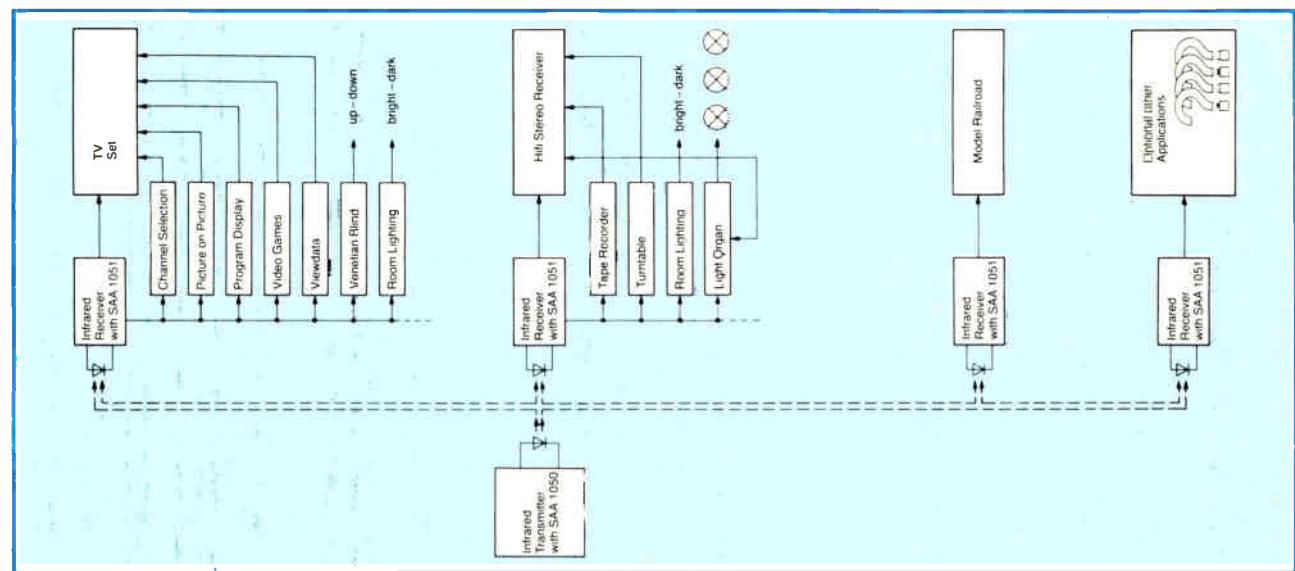

In the early seventies even the experts doubted we would succeed in replacing those expensive and delicate remote control devices – some using switches and cables – with a digitally operating ultrasound system built around highly integrated MOS circuits. But we did it... with the right technology and the right partners in the industry. Now, in Germany alone, more than half of all remotely operated color TV sets are equipped with our ultrasound control system.

video and tape recorders... and even variable control of room lighting and Venetian blinds. No doubt there are many other applications that we, together with our established partners and new customers, can work out.

## A New Control System Generation, one that's Based on a Long-Lived Concept

### SAA 1050 Transmitter Circuit in CMOS Technology

### SAA 1051 Receiver Circuit in Silicon-Gate Technology

This feat has spurred us to even greater efforts. We have applied our know-how to an entirely new, flexible, and long-lived system... an infrared control system that can transmit as many as 64 instructions to each of 16 different pieces of equipment. That's a total of 1024 instructions – a big jump over the 30 or so instructions common for the TV remote controls now in use.

#### Technical Features:

- large set of instructions (16 x 64, or 1024, instructions)
- extremely low transmitter current consumption
- several units controllable from the same transmitter

- minimum need for external circuitry, no quartz crystal
- high noise immunity and operating reliability
- control of four analog parameters, for example volume, brightness, color saturation, and contrast
- receiver requires no shielding
- only one transmitter for 16 units

Now that our new infrared remote control system is available, designers can consider features for their equipment that are still in the early stages of development... for example intelligent TV games, teletext, viewdata, home data terminal, etc. Also feasible is remote operation of record players,

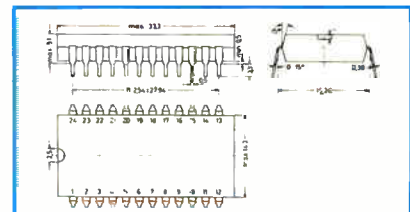

SAA 1050, SAA 1051 in Plastic Package.  
Weight approx. 3.5 g, Dimensions in mm

We will gladly give you more details. Ask for our data sheet 6251-110 and for the application consultants in your country.

**USA:** ITT Semiconductors, 500, Broadway, Lawrence, Mass. 01841, Tel. 617-688-1881, Telex 7103420764,  
**UK:** ITT Semiconductors, Footscray, Sidcup, Kent, Tel. 3003333, Telex 21836,  
**W. Germany:** INTERMETALL GmbH, P.O. Box 840, D-7800 Freiburg, Tel. (761) 5171, Telex 07-72716,  
**Japan:** ITT Semiconductors, P.O. Box 21, Shinjuku-ku, Tokyo 160-91, Tel. 3478881-5, Telex 22858.

semiconductors **ITT**

# Calculator controls measuring of radio signals and interference



Automated VHF-UHF measuring setup for 25 through 1000 MHz controlled over IEC interface bus from Tektronix desktop calculator 4051. Interactive programs for essential applications plus basic software for producing user programs. Numeric and graphic display of results on storage screen.

The VHF-UHF selective test equipment MSU with test receiver ESU 2, frequency controller and panoramic adapter meets the needs of automated and manual measurement of radio signals and interference, of lab assignments and monitoring tasks.

The calculator 4051 governs the operating, measuring and checking routines, makes computations and produces test readouts and diagrams on its screen.

**Interactive programs** for primary applications:

- radiomonitoring with level measurement and – for the first time – remote frequency measurement

(using a frequency counter) acc. to CCIR Report 272-3

- search program for detecting signals
- measuring signal and interfering field strength with results allowing for antenna factors
- measuring interference to MIL specs and VG standards
- measuring radio-interference in line with CISPR and VDE (calculator-controlled for the first time)
- lab chores: measuring two-port attenuation and gain, harmonics and intermodulation

For more information quote **ESU 2 calculator-controlled**

**Rohde & Schwarz**  
Postfach 80 14 69  
D-8000 München 80  
Fed. Rep. of Germany

Electronic Measurements and Radio Communications. Development, manufacture, sales and service. Known for "electronic precision". Independent concern (establ. 1933), represented in 80 countries.



**ROHDE & SCHWARZ**

# ENERTEC

measurement  
is our vocation



## function generator 4415

**2 generators in 1 instrument**

Frequency range: 0.1 Hz to 2 MHz

Waveforms:  $\sim$ ,  $\wedge$ ,  $\sqcap$ , DC, TTL,  $\sphericalangle$

Vobulation: internal, external ratio 1000:1

Output level: 20 V peak to peak

Distortion factor: 0.15 %



Oscilloscopes



Voltmeters



DC powers



Counters



HF generators

A. T. E.

Selective levels

LF generators

ENERTEC  
Schlumberger

ENERTEC  
DEPARTEMENT INSTRUMENTS  
5. RUE DAGUERRE 42030 SAINT ETIENNE  
CEDEX FRANCE TEL (77) 25 22 64  
TELEX 330696 CIRCE STETN

# T93

9,5 mm x 9,5 mm x 4,5 mm,  
it is a big space saver  
on PC boards

Five versions are available.  
They differ in :

- the relative position  
of the adjusting screw  
to the PC board

- the terminal spacing  
Cermet 0,5 W at 70°C  
0,75 W at 40°C

10 Ω to 2,2 MΩ

± 10 % or ± 20 %

Actual electrical travel :

19 ± 2 turns.

The cermet element provides  
excellent stability in use.

Sealed against dust and PC  
board cleaning.

Environmental conditions :  
-40°C/+ 125°C/56 days damp  
heat.

# TAKE THE SIZE ADVANTAGE OF A COMPACT MULTITURN

HAECHLER 126

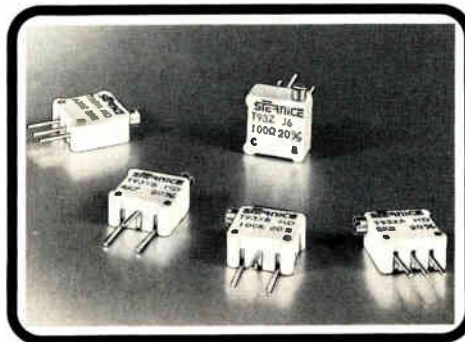

## STERNICE

SOCIETE FRANÇAISE DE L'ELECTRO RESISTANCE

115-121, bd de la Madeleine  
B.P. 17 - F 06021 NICE CEDEX  
Phone (93) 87.58.90 - Telex 470261

Circle 136 on reader service card

## From Electronics Magazine Book Series. Zero-risk trial offer.



### Memory Design: Microcomputers to Mainframes

The technology, devices,  
and applications that  
link memory components  
and system design. As  
published in *Electronics*.  
\$12.95

#### Electronics Book Series

P.O. Box 669, Hightstown, N.J. 08520

Send me \_\_\_\_\_ copies of "Memory Design:  
Microcomputers to Mainframes" at \$12.95  
per copy

Discounts of 40% on orders of 10 or more copies.

I must be fully satisfied or you will refund  
full payment if the book is returned after ten-  
day trial examination.

Payment enclosed  Bill firm  Bill me

Charge to my credit card:

American Express  Diners Club  
 Visa  Master Charge

Acc't No. \_\_\_\_\_ Date exp. \_\_\_\_\_

On Master Charge only,  
first numbers above name \_\_\_\_\_

Name \_\_\_\_\_ Title \_\_\_\_\_

Company \_\_\_\_\_

Street \_\_\_\_\_

City \_\_\_\_\_ State \_\_\_\_\_ Zip \_\_\_\_\_

Signature \_\_\_\_\_

## New products international

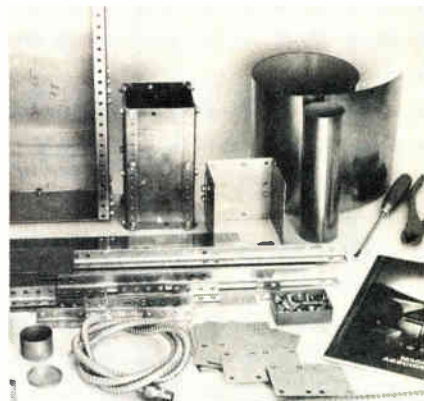

A set of shielding devices contains sheets,  
tubes, and foils of high-permeability Mumetal  
to protect equipment and components  
against stray magnetic fields. The shielding  
effect is also given in the low-frequency  
range. Vacuumschmelze GmbH, 6450 Ha-  
nau, P. O. Box 109, West Germany[448]



The Rampenpot is a 360° conductive-plastic  
potentiometer for industrial applications. Lin-  
earity is ±0.075%, and resolution is 0.007°.  
Operating life is 100 million revolutions.  
Nominal resistance is 5 kilohms. Novotech-  
nik, 7302 Ostfildern, P. O. Box 4220, West  
Germany[449]

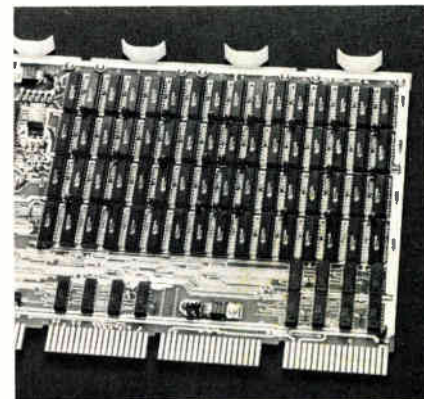

The 501 range of semiconductor add-on  
memories for the PDP-11 range of comput-  
ers fit in either a quad- or a hex-height slot  
for a small peripheral controller and have a  
memory extension of up to 28 kilowords.  
Sension Ltd., Denton Drive, Northwich,  
Cheshire, England, CW9 7LU[450]

# ELECTRONICS REPRINTS

No. of  
copies  
wanted

## New reprints

- \_\_\_ R-801 World market report 1978 24 pp \$4.00
- \_\_\_ R-734 Microcomputer families expand 20 pp. \$4.00
- \_\_\_ R-730 Special Report—Automotive electronics gets the green light 10 pp \$3.00
- \_\_\_ R-728 Flexible circuits bend to designers' will 10 pp \$3.00
- \_\_\_ R-724 Special Report—Technologies squeeze more performance from LSI 22 pp. \$3.00
- \_\_\_ R-722 Demands of LSI are turning chip makers towards automation 12 pp \$3.00
- \_\_\_ R-720 How EEs Feel About Engineering—3-part series 26 pp \$5.00
- \_\_\_ R-718 Display makers strive to refine their technologies 8 pp \$3.00

## Books

- \_\_\_ R-803 New product trends in electronics—Electronics Book Series 333 pp \$14.95
- \_\_\_ R-732 Memory Design—Microcomputers to Mainframes—Electronics Book Series 180 pp \$12.95
- \_\_\_ R-726 Design Techniques for Electronics Engineers—Electronics Book Series 370 pp \$15.95
- \_\_\_ R-711 Circuits for electronics engineers: 306 circuits in 51 functional groups—Electronics Book Series 396 pp \$15.95
- \_\_\_ R-704 Thermal design in electronics \$5.00
- \_\_\_ R-701 Applying microprocessors—Electronics Book Series 191 pp \$9.95
- \_\_\_ R-608 Basics of Data Communications—Electronics Book Series \$12.50
- \_\_\_ R-602 Large Scale Integration—Electronics Book Series 208 pp \$9.95
- \_\_\_ R-520 Microprocessors—Electronics Book Series 154 pp \$8.95

## Payment must accompany your order

Make check or money order payable to Electronics Reprints. All orders are shipped prepaid by parcel post. Allow two to three weeks for delivery. For additional information call (609) 448-1700 ext. 5494.

Mail your order to:

Janice Austin  
ELECTRONICS REPRINTS  
P.O. Box 669  
Hightstown, N.J. 08520

# HOT PANTS<sup>®</sup> CAPACITORS



## HOW TO AVOID 43% FAULTY SOLDERING

HOT PANTS<sup>®</sup> CAPACITORS avoid cold solder joints as the leads have special upsettings.

These guarantee:

1. Faultless soldering
2. Insertion into printed circuit boards with double faced contacts (through connections)
3. Constant slight inductivity at high frequencies
4. Standard price despite improved quality
5. Rational application with automatic insertion

We are looking forward to receive your request for additional information and samples.

 **STETTNER  
INTERNATIONAL**

Hersbrucker Straße 22  
D-8560 Lauf a. d. Pegnitz  
Telefon: 09123/3021  
Telex: 0626084

World Radio History

Circle 139 on reader service card

# No One Else Does This In Hybrid Form

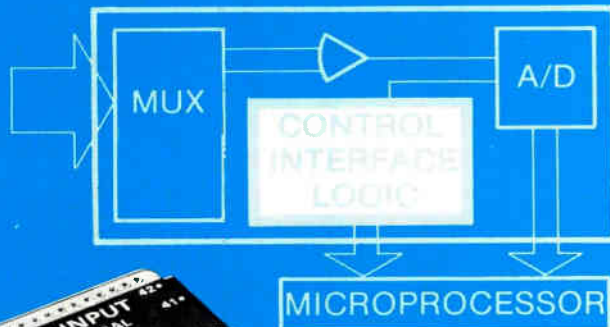

**A COMPLETE 12-BIT  
ANALOG INPUT SYSTEM  
THAT INTERFACES TO  $\mu$ P'S WITH  
NO ADDITIONAL ACTIVE COMPONENTS**

MP22 is a memory-mapped hybrid data acquisition system. Address it directly as though it were memory; one instruction acquires data and internal logic provides a choice of halt, interrupt or DMA operating modes.

MP22 contains address decoder, timing and control logic, 16 channel multiplexer, instrumentation amp and CMOS A/D converter! It's a stand-alone 12-bit device that accepts high or low level inputs and channel expansion is unlimited. Even with all these features, MP22 is contained in an 80-pin quad in-line package that measures only 54.6mm x 43.2mm x 5.6mm high. Contact the Burr-Brown sales office in your area.



**Putting Technology  
To Work For You**

FRANCE - Le Chesnay, 954-3558 - GERMANY - Leinfelden, 0711/75 3021; Bremen, 0421/61 2273; Neuss, 02101/30738; München, 089/61 7737 - HOLLAND - Schiphol Oost, (020) 470590 - JAPAN - Tokyo, (03) 686-8141 - SWITZERLAND - Rüschlikon, 01/724 0928 - UNITED KINGDOM - Watford, (0923) 33837 (Other areas contact) Burr-Brown, P.O. Box 11400, TUCSON, ARIZONA 85734 USA - Tel. (602) 746-1111 - TWX: 910-952-1111 - Telex: 66-6491 - Cable: BBRCORP

## New products international



The T233 pulse-echo cable-fault locator has crystal-controlled digital timing. Fault distances, in meters, appear on a five-digit LED display that eliminates zero or scale setting. Faults are located from 1 m to 24 km. Biccotest Ltd., Delamare Road, Cheshunt, Herts., England, EN8 9TG[451]

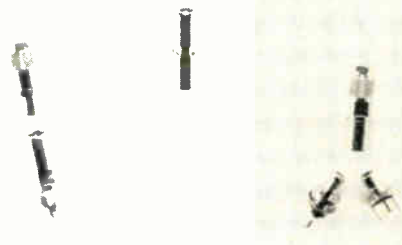

Subminiature connectors for RG 174/U and RG 178/U coaxial cables can be used at frequencies up to 10 GHz. The impedance is 50  $\Omega$  and the VSWR is 1.15 to 1.45. The connectors are snap-on types, and the cables are crimped on. UMD-Amphenol, B. P. 349, 39105 Dole, Cedex, France[452]

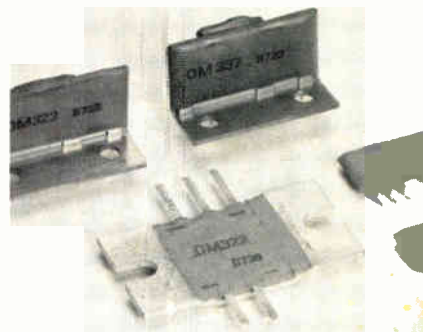

A series of hybrid wideband amplifiers, designated OM320 to OM377, cover the full range of 40 to 860 MHz and provide a choice of gain and output voltages. Philips Gloeilampenfabrieken, Elcoma Division, P.O. Box 523, 5600 AM, Eindhoven, the Netherlands[453]



# Electronics Reader Service

If the cards below have already been used,  
you may obtain the needed information  
by writing directly to the manufacturer,  
or by sending your name and address,  
plus the Reader Service number and issue date,  
to Electronics Reader Service Department,  
P.O. Box No. 2530, Clinton, Iowa 52734, U.S.A.

Place correct airmail  
postage here ... for  
faster service.

## Electronics

P.O. Box No. 2530  
Clinton, Iowa 52734  
U.S.A.

Place correct airmail  
postage here ... for  
faster service.

## Electronics

P.O. Box No. 2530  
Clinton, Iowa 52734  
U.S.A.

## Timing Analysis—The hardware approach

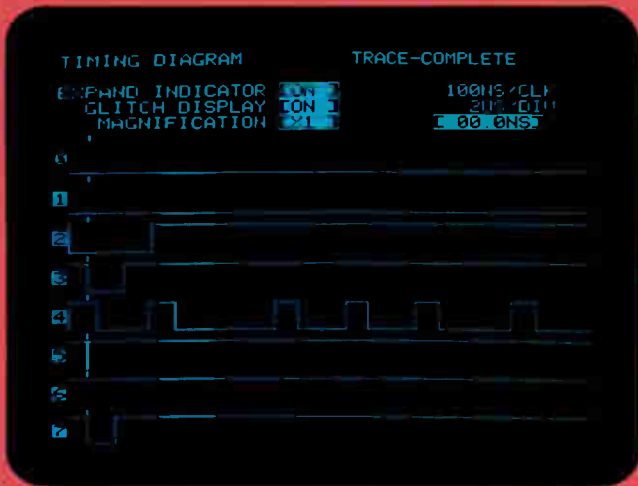

**Trigger on glitches.** A glitch on an input to a one shot (channel 5) is causing a false interrupt (channel 7). This glitch (which is intensified to distinguish it from data) can be used to trigger state as well as time displays.

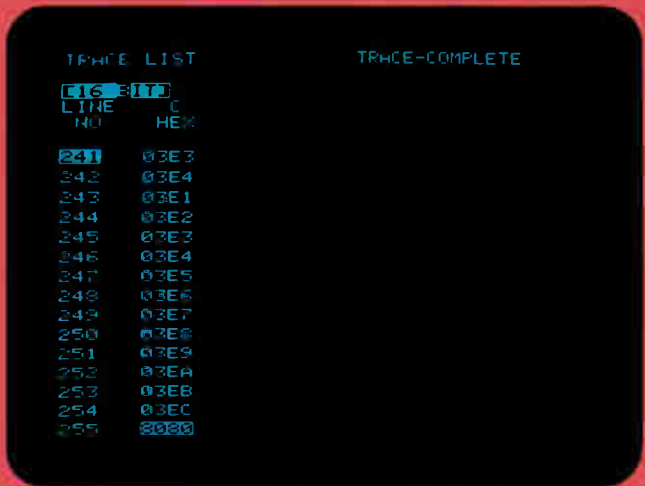

**Observing state display** shows address flow at the moment the glitch occurs and reveals that the I/O port address 8080 always occurs at the same time. This would lead you to observe I/O related signals for transitions occurring simultaneously with the glitch.

## State Analysis—The "Software" approach

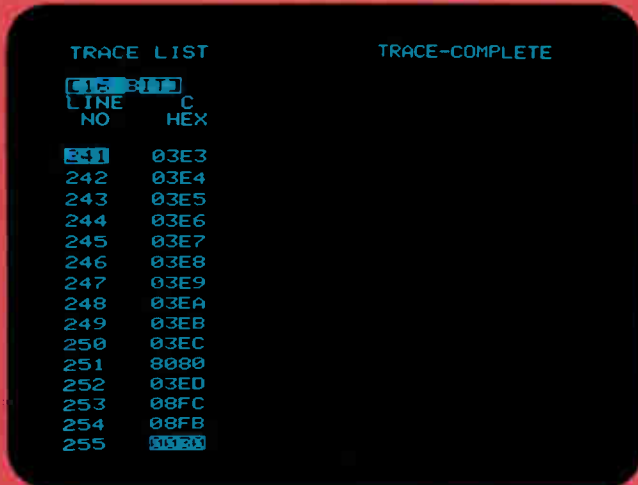

**Trigger on state.** The interrupt vector (0030) can be used as the trigger point to observe address flow prior to the false interrupt. Evaluation shows that the I/O port address 8080 always appears four machine cycles prior to the interrupt vector.



**Observing timing display** of signals on I/O and one-shot shows that the glitch on the input to the one shot (channel 5) occurs four machine cycles before the trigger point and is coincident with the transition on I/O read (line 3) indicating possible capacitive coupling.

HEWLETT  PACKARD

1507 Page Mill Road, Palo Alto, California 94304

For assistance call: Washington (301) 948-6370, Chicago (312) 255-9600, Atlanta (404) 955-1500, Los Angeles (213) 877-1282

Circle 267 on reader service card

# We have. So our microprocessor system offers real time trace. To spot problems as they happen.

Tektronix microprocessor labs can cut your time to market by letting engineers and software designers work together throughout development.

## WE'VE GOT DEBUGGING DOWN TO A SYSTEM.

Everyone offers some kind of in-prototype testing. But our unique array of features can cut debugging time by 50 percent or more.

Most significant is our lab's Real Time Prototype Analysis option: with two fully independent 48-bit breakpoint registers that let you get software timing down to prototype clock cycle resolution. Plus pre-, post-, and center triggering. Our engineers say it saves them time in all stages of integration.

## MORE OF THE BEST

When you see all the debugging features available to you, you understand why our labs have been so enthusiastically adopted by engineers and software designers.

## DISC BASED SYSTEM

Text editor, macro relocatable assembler, file management utilities and powerful debugging software keep you moving through test and integration.

## DUAL ARCHITECTURE

Separate system and application memories, and processors, allow more



program workspace and realistic emulation, while making the system virtually uncrashable. And you get versatile testing with 128-byte block mapping.

## DISASSEMBLY

When the lab displays instruction data in debug mode, you receive it in easy-to-read assembler mnemonics. You never get bogged down translating machine code.

## MULTIPLE MICROPROCESSOR EMULATION

Our design aids are the first to actually emulate, not just simulate, a variety of major chips: The 8085 and 8080, The Z80, The 6800, The TMS 9900. And others to come.

Let us show you the kind of development system you'd probably engineer for yourself. Contact Tektronix Inc., P.O. Box 500, Beaverton, OR, (503) 644-0161. In Europe, Tektronix Ltd., P.O. Box 36, St. Peter Port, Guernsey, Channel Islands.

**Tektronix**  
COMMITTED TO EXCELLENCE

**Tektronix  
microprocessor  
development labs.**

**Designed by  
people on your side  
of the bench.**

Circle 81 on reader service card



Actual size front view. Shown with optional antenna.

# Portable 250 MHz Frequency Counter \$345. ...Goes Anywhere You Need It

The 585 is rechargeable battery and line operated with .1 Hz resolution, 3 gate times and 10 millivolt sensitivity. It comes complete with battery module, line cord charger and vinyl carrying case.

For complete information on the Model 585 and other Data Precision instruments or a demonstration, contact your local Data Precision representative or Data Precision Corporation, Audubon Road, Wakefield, MA 01880 USA (617) 246-1600. TELEX (0650) 949341.

 **DATA PRECISION**<sup>®</sup>  
...years ahead

Circle 84 for demonstration  
Circle 85 for additional information

Visit us during Electro '78 in  
Boston in Booths 2224-26-28

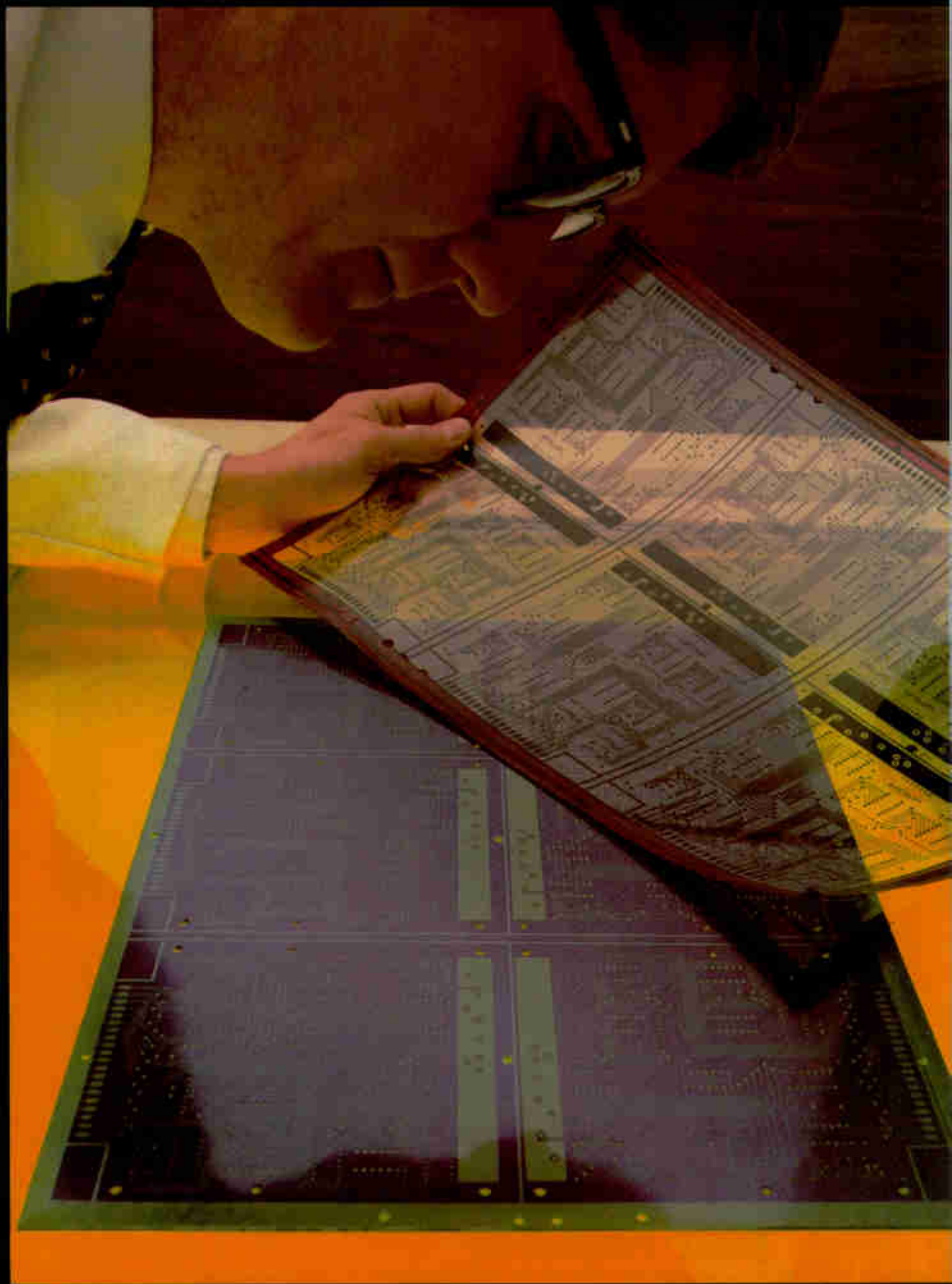

# Our new high-contrast **RISTON** "Thousand Series" films help assure quality control, speed inspection and cut costs.

## Here's proof.

Everything about the new RISTON Thousand Series films is designed to give you the high-quality printed circuit board you want at the lowest possible cost in time, labor and materials. The Thousand Series are high-contrast, high-performance solvent and aqueous films with a lot of cost savings built in.

**New color.** The Thousand Series' light green color makes registration and setup remarkably fast. After exposure, the vivid blue print-out image makes inspection easy.

**High productivity.** This starts with rapid registration and inspection. Then, fast photospeed, developing and stripping provide more processing benefits.

**Quality boards.** The films' superior artwork reproduction gives you straight sidewalls and fine line resolution.

**High yields.** Easy inspection and excellent processing performance reduce rework and rejects:

**DuPont films have never saved you more,** in process and materials costs. Take a look at the new Series 1000, 1200 solvent and 3000, 3300 aqueous films. Call your DuPont RISTON Technical Representative, or write DuPont Company, Room 36358, Wilmington, DE 19898.

\*Registered U.S. Pat. & Tm. Off. for DuPont's photopolymer film, chemicals & processors.

# RISTON



Circle 87 on reader service card

Companies

# Exxon seeks big strike in electronics

Giant oil company provides venture capital for more than a dozen electronics firms that it hopes can top \$100 million a year each

by Bruce LeBoss, New York bureau manager



Exxon Corp. did not become the world's largest industrial corporation by doing things in a small way. That is why it is surprising at first glance to see the giant oil company investing in more than a dozen small or start-up electronic ventures. But Exxon is not thinking small.

"Each venture has the potential to grow to about \$100 million to \$1 billion on its own," says H. Benjamin Sykes. Sykes is the senior vice president in charge of the Information Systems and Advanced Materials group of Exxon Enterprises Inc., a wholly owned subsidiary of Exxon Corp. in New York. It was organized in 1965 to create new business and pursue new ventures outside the company in three areas—information systems, advanced materials, and energy systems.

New businesses are formed totally from resources within Exxon or through venture-capital investments of about \$500,000 in return for a minority position in a fledgling company. Should Exxon continue to invest in a venture, Sykes says, it may be with other investors or alone. If the investment capital is all Exxon's, he adds, "we often gain controlling interest."

Exxon is looking to invest not in "me, too" situations, says Sykes, but in what it perceives as unique tech-

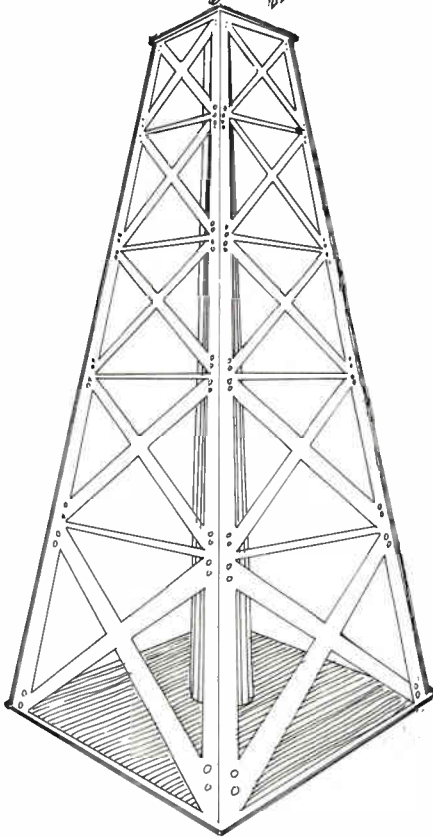

nologies and market concepts. Also, the venture must have the potential to hit that \$100 million to \$1 billion mark. The third objective, and just as important, is profits. "We aren't a nonprofit organization," he says jokingly, "so the sooner the earnings

come, the better. But we don't take a short-term view and look for a quick cash turnover. We won't sacrifice the future size of a company for a limited objective."

At present, there are 14 ventures in Sykes' group, 9 of which began as venture-capital investments and 5 as projects originated at Exxon. Of the 14, all but 4 are majority-owned and all but 3, which Sykes will not identify, are out of research and development and into sales.

**Growth.** The group accounted for about \$50 million in sales last year, up from \$30 million in 1976, and the outlook is to roughly double in 1978, Sykes says. "We have investments in market areas that are growing rapidly. Most of our companies are targeted to grow at least 50% per year while under \$100 million, and 20% to 30% annually when over that mark." A shining example is micro-computer maker Zilog Inc. of Cupertino, Calif., whose sales of about \$8 million in 1977 are expected to nearly triple in 1978.

As for information systems, Sykes sees new product opportunities emerging from a convergence of three industries: data processing, communications, and storage and copying. He is particularly optimistic about the future of office systems and equipment that Exxon ventures have spawned to meet the needs of

what has been called the office of the future. Already, three majority-owned Exxon ventures serve this market: Vydec Corp. manufactures and sells a word machine with a video display; the Qwip division produces and markets a low-cost telephone facsimile machine; and the Qyx division recently introduced a line of modular electronic typewriters that is based on Zilog's Z80 8-bit microprocessor [*Electronics*, March 2, p. 46]. Still another Exxon affiliate, minority-owned Qume, makes and markets character-impact printers for the office equipment field.

Vydec, in Florham Park, N. J., is a good example of the way Exxon can make a strike with a venture-capital investment. The firm was started by several engineers from Hewlett-Packard Co., which had been working on a very intelligent terminal with alphanumeric capability. When HP chose not to put the unit into production, a group of engineers obtained permission to use the technology to develop a word-processing terminal. They left HP, set up shop in a basement in New Jersey, and built a prototype. They then went to Exxon for financing, and Exxon invested \$500,000 in 1973 for a 40% interest. HP received 20% of Vydec's equity in return for releasing the technology, and the founders kept the rest.

**Gambling.** Over and above its use of the HP technology for producing a high-resolution display, Sykes continues, "Vydec took a gamble on two additional technologies. It was the first to use both the floppy-disk drive and daisy-wheel printer for word processing." Although the industry was skeptical when the product was introduced in late 1973, "in time the impact of full-screen display on word processing began to be felt, and the terminal began denting the market." Today, he notes, most word-processor manufacturers, IBM included, offer a display option in their product line. As for Vydec, it had sales last year of about \$24 million and Exxon has increased its ownership to over 80%.

On its way to being equally successful, if not more so, is Qwip, the producer of a convenience facsimile system that sends or receives letters over the telephone in

## Mixing oil and electronics

Exxon Corp. is not the only oil company that is using its dollars to invest in the electronics industries as a means of diversification. Here is what three other oil companies are doing:

- The Sun Co. (formerly the Sun Oil Co.) recently purchased Audio Magnetics Corp. in Gardena, Calif., a producer of blank audio tapes and cassettes, and also bought Pentagon Industries Inc. in Chicago, a manufacturer of professional audio tape duplicating equipment. What's more, Sun Information Services has been formed to offer computer services.
- Standard Oil Co. (Indiana) last May invested \$5 million in Analog Devices Inc. of Norwood, Mass., a producer of measurement and control components. The oil concern also has first rights to invest up to \$10 million more.
- Wilshire Oil Co. of Texas has an industrial electronics distribution business, the Wilshire Electronics Group.

4 to 6 minutes. Started internally in 1972 by a staff member with a better idea, Qwip got funding to develop prototype systems and placed its first 200 machines in 1973. It subsequently received additional cash to get into large-volume production, build a sales force, and provide working capital, and was set up as an independent division.

**A leader.** By the end of 1977, Qwip was in first place in the market, in terms of annual placement rate, although it is not the leader in terms of installed base," Sykes says. Revenues last year were about \$6 million and are forecast to more than double this year. However, Qwip is not yet profitable, because manufacturing and marketing costs of placing the machines exceed the first year's rental income.

Exxon has other interests in the office systems area and one of its undisclosed ventures still in the R&D phase falls into that category. However, Sykes notes, "more than one of our R&D ventures will affect technology in office systems as well as in total information systems," which includes communications equipment and services. "We have an embryo venture in that area that is exciting," he says. Though he will not name it, it is believed to be the Optical Information Systems division in Elmsford, N. Y., formed to develop advanced emitters and detectors for modern communications systems.

Meanwhile, Exxon already has several ventures active in communications equipment. For example, Dialog Systems Inc. has developed and brought to market a unique computer that recognizes the spoken

word. A counterpart in this area is Periphonics Corp., a producer of a voice-response computer.

In addition to several other companies in the information systems field, Sykes's group also includes two ventures in advanced electronic materials. One of these is Emdex, in Milford, Conn., which makes silicon photodiodes. The other, still in the R&D stage, is understood to be the recently formed DataScreen Corp. of Mountain View, Calif., which is developing multiplexed liquid-crystal displays.

Exxon also has two commercial ventures in the solar energy field that are part of an Advanced Energy Systems group. One, Solar Power Corp., makes and sells solar photovoltaic electric cells using technology developed for space applications. The other, Daystar Corp., produces solar heating systems.

**No blend.** Because most of Exxon's ventures are concentrated in the information systems field, with particular emphasis on office systems, some Exxon watchers believe the company will eventually consolidate most, if not all, of these ventures into one large office products company. Not so, says Sykes. "Our approach is to develop entrepreneurial, independently managed ventures, because that's the most effective way to develop new products and bring them to market."

More specifically, he says of the office systems ventures, "each has the potential to become a major enterprise on its own. Therefore, as long as they're doing well, we have no plans to merge them." It sounds as if Exxon has struck oil again. □



It will process your wafers, supply production control information, help you establish a management data base, and grow as your needs change.

Uniplane System 4000. Suddenly all other wafer processing systems are obsolete.

Because System 4000 is more than a processing system. It is a total information and management control system for wafer processing.

Now, for the first time, you can have both local and remote supervision and programming.

Now, for the first time, you can have reports on system operation whenever you want them—displayed or printed.

Now, for the first time, you can truly manage your wafer fabrication.

No other system available can match it.

System 4000 includes new microprocessor-controlled scrubbers, spinners, developers, ovens, and complete handling/interface facilities. Plus a unique optional Supervisory Terminal System (STS) for remote programming and monitoring.

It's so completely modular that each station can operate independently of the others, under the control of its own on-board microprocessor. Or as part of a totally integrated system with full station-to-station communications upstream and downstream.

You can even integrate mask aligners and inspection stations into the system.

It's so completely flexible that you can expand at any time. Now, or in the years to come.

Uniplane System 4000. It has so many other features to improve your wafer fabrication you simply cannot afford to be without it—because you cannot afford to be obsolete.

Get in touch with your local Kasper office right away. They have an 8-page color brochure for you. Or write Kasper Instruments, 749 N. Mary, Sunnyvale, California 94086, (408) 733-9800.



**The dawn  
of a new era  
in wafer processing.**

**Introducing  
Uniplane  
System 4000.**

Circle 91 on reader service card

compare to n-MOS, he says.

The entry point for SOS is the single-chip low-power market in such applications as telecommunications instruments, and the industrial market, says Roger Badertscher, Zilog's components department director. "That's how we would start it," he says, adding that his firm will be looking at sapphire within a year. However, the company sees "a lot left in silicon-gate technology."

For Hewlett-Packard, on the other hand, the future is now. In production with C-MOS-on-sapphire devices for a year, the company now makes from 30,000 to 50,000 dice a month for in-house consumption, according to Larry J. Lopp, integrated circuits manager, Data Systems Development division, Cupertino, Calif. "There may not be any product introduced by the computer division that doesn't have SOS," he says.

**Working.** His firm's five-year development effort has paid off, with the sapphire devices working as intended, Lopp says. There are 18 major LSI designs under development, concentrated in logic, with some work in control memory and nothing in main memory. Within the next three months, HP expects to top its 16-bit, 165-nanosecond microprocessor with a new model featuring a 10-to-11-megahertz clock.

In terms of such specifications as propagation delays and circuit complexity, SOS is on the same development curves as competing technologies: 5,000 to 8,000 gates per chip now, rising to 30,000 in the future, Lopp says. Because it has such low active and standby power requirements, he predicts that a 120,000-gate chip would dissipate as little as today's circuits, or between 25 milliwatts and 0.5 watt per chip. "There's no technology on the horizon that has better performance," he says.

Silicon on sapphire's only marginal area is density, which is not as good as for dynamic technologies such as n-MOS, Lopp concedes. However, current devices are being made with 6-micrometer geometries, new ones will have 4- $\mu$ m, and HP is working on even smaller ones, he says. And SOS's pesky problem with leakage currents "is acceptable at 4  $\mu$ m and looks like it will be okay at 2  $\mu$ m," he says. □

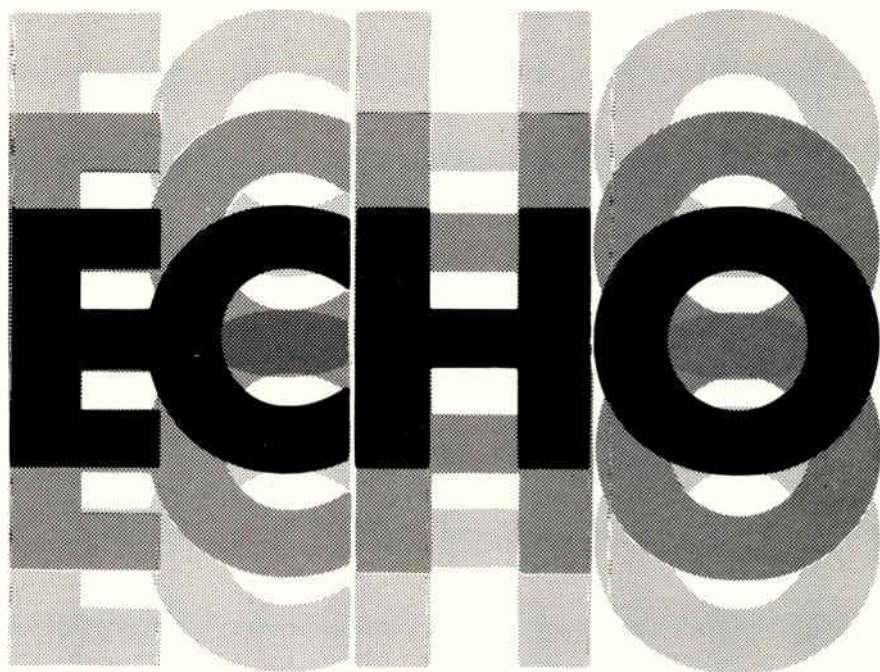

## FOUR TIMES THE ECHO FROM OUR CHIP.

We brought you the SAD-1024, the SAD-512D, and now we are introducing the next generation audio delay line, the R5101. This CCD unit holds 2000 samples of the signal, almost four times as many as the SAD-1024. It's easier to use, because it has an on-chip clock driver so you only need a single phase clock to control it. Its performance is significantly better than anything you have ever used. Now you can achieve longer delays, better echos, reverberation and significant amounts of data buffering.

The delay provided by the device can be continuously varied by the clock rate from one millisecond to more than one second. Our R5101 will give you 10dB better S/N than four SAD-1024's, at half the price. Also available is a complete circuit card to help you evaluate this incredible device so you can be up and running immediately. So if you want the longest delays with the best performance, get the Reticon R5101.

This is another I.C. in our growing family of signal processing devices. We have a worldwide network of over 20 distributors and more than 70 salesmen to help serve you.



# RETICON®

AN  EG&G COMPANY

910 Benicia Ave • Sunnyvale, California 94086  
(408) 738-4266 • TWX: 910-339-9343

Space electronics

# Should the U. S. switch to solar power?

That's the question that is being debated in Congressional committees by advocates and foes of solar-power satellites

by Ray Connolly, Washington bureau manager

**Congressional support** is growing for a new solar-power satellite research and demonstration program. But also growing are two controversies. One concerns the impact on the environment of microwaves beaming the electricity from the satellite's massive photovoltaic arrays back to earth. The other is over the enormous investment required for an operational system of 25 to 50 satellites needed to provide all of America's electric power—the estimated cost is \$500 billion in 1975 dollars to be spent over the next 50 to 100 years.

SPS proponents contend the figure is not large relative to the forecast cost of new ground-based systems for generating equivalent power from fossil or nuclear fuels. According to Klaus P. Heiss, who heads the New Jersey-based economic analysis

group called Econ Inc., the Edison Electric Institute and American Gas Association estimate that it would cost \$476 billion to add 10 quads of energy to existing conventional power supplies (1 quad equals  $10^{18}$  British thermal units). For \$500 billion, he claims, the U. S. could get 17 quads from the first 50 solar-power satellites, each capable of delivering 5 usable gigawatts. After research and development, Heiss estimates that the cost of the first such satellite will come to \$15 billion.

Thus do SPS advocates in Congress want the Department of Energy, working with the National Aeronautics and Space Administration, to accelerate their research efforts. Those advocates are promoting legislation to give the two agencies an additional \$25 million in fiscal 1979

to do it [*Electronics*, Feb. 16, p. 60]. Since the introduction of H. R. 10601 by Alabama Democrat Ronnie G. Flippo, the bill has gained more than 50 cosponsors. On the Senate side a similar bill was introduced in mid-April by Montana Democrat John Melcher, where it has 30 days to pick up additional sponsors.

The biggest support for the bills comes from the new Sunsat Energy Council, a lobby whose rolls include more than 25 of the largest aerospace and electronics companies, plus representation from Massachusetts Institute of Technology. Sunsat's Washington counsel is retired Sen. Frank Moss, former chairman of the Aeronautics and Space Sciences Committee, while the chairman is Peter Glaser of Arthur D. Little Inc., who conceived of the SPS in 1968 and patented the concept in 1973.

**Foe wary of cost.** One announced congressional opponent is Rep. Anthony Ottinger (D., N. Y.). He not only suspects that the economic and environment challenges are insurmountable, but sees the program as an attempt by the aerospace and electronics industries to capitalize on the popular appeal of solar power and "line their pockets" at public expense.

The most potent opposition to the Flippo-Melcher bills, however, is developing within the Department of Energy and NASA as they hew to the White House goal of holding down long-term R&D in favor of expanding near-term energy sources like coal and natural gas. Energy under secretary Dale D. Myers surprised House subcommittee hearings on the Flippo

## Wars and laws

The American public's concern with microwaves and their potential for damaging living things has been on a steady upswing ever since the large-scale marketing of microwave ovens. The level jumped last year with stories about the Soviet Union's microwave bombardment of the U. S. embassy in Moscow as well as unexpectedly large sales of the book titled "The Zapping of America" by Paul Brodeur. Concern over the possible deliberate or inadvertent use of solar-power satellites to "burn up" a major city or small nation by misdirection of its microwave beam was raised in mid-April hearings before a joint session of two House subcommittees.

Witnesses not only were asked for assurances that an SPS microwave beam transmitting between 5 and 10 gigawatts from space "could not be focused and used as a weapons system," but they were also queried about the prospect that a future enemy might deprive an SPS-dependent America of electricity by destroying its satellites. SPS advocates had no guarantees that either event might not somehow come to pass, as opponents were at pains to point out. Other international issues such as space usage, microwave standards, rf interference, and possible environmental damage also need further detailed examination, committee officials and witnesses pro and con agreed. And public acceptance of the concept—particularly massive ground antennas—is also considered a major hurdle.

## Tools Let You Change Applications . . . Without Changing Your Logic Analyzer

Logic analyzer . . . it's been the essential measurement tool for digital designers for years. But just a logic analyzer isn't enough. Because a logic analyzer should be as versatile as you are. The dictionary calls versatile the ability of turning with ease from one to another of various uses. And versatile is exactly what you have to be in your day-to-day digital design work. Versatile in the tasks you perform, versatile in your role as part of a design team. So you need a logic analyzer every bit as versatile as you are. One that lets you switch with ease. From hardware to software analysis. Or from microprocessor to non-microprocessor design.

### TEKTRONIX LOGIC ANALYZERS: THE VERSATILE ONES

**VERSATILE APPLICATIONS:** Concentrate on new applications — not on learning a new logic analyzer. Modules that let you do any Tektronix 7000

Series oscilloscope let you "build" the logic analyzer you need.

#### VERSATILE FEATURES:

You — not the logic analyzer — decide how you'll look at logic. Go from state tables to mapping to timing — without going to another logic analyzer. Touch a button and select binary, hex, octal, mapping, timing, GPIB, or ASCII.

You need confidence in your measurements. So you want the best possible resolution. And that means you need to sample faster than the system under test — the faster the better. So Tek Logic Analyzers let you sample asynchronously up to 100 MHz at a resolution of 15 ns.

You're looking at a lot of information in digital systems — yet you want to find your problem in one pass. Our large, formattable 4K memory can deliver up to 1024 bits per channel.

You need to see what's on — and off — the bus. Synchronous and asynchronous operation in the same logic analyzer lets you perform software and

hardware analysis. Your design has to work right every time. Automatic Data Comparison will verify it for you. Or identify any fault. While you're busy elsewhere.

#### VERSATILE APPLICATIONS:

Tektronix Logic Analyzers stay with you. For design; debugging; and troubleshooting. For hardware and software analysis. For timing and state applications. For *whatever* job is at hand.

**Versatile — so you can do today's job and tomorrow's. So you can change applications without changing your logic analyzer.**

Contact Tektronix Inc., P.O. Box 500, Beaverton, OR 97077. In Europe, Tektronix Ltd., P.O. Box 36, St. Peter Port, Guernsey, Channel Islands.

**Tektronix**  
COMMITTED TO EXCELLENCE



Look at logic in your language: choose binary, hex, octal, mapping, timing, GPIB, or ASCII



The faster your measurements, the better the resolution. Sample up to 100 MHz at 15 ns resolution



See all the information you need to see with our large 4K formattable memory



Get the whole picture: verify logic on the bus synchronously; verify timing sequences asynchronously



Concentrate on other work while Automatic Data Comparison verifies operation — or identifies faults

# Get your design into production faster, at lower cost.

*With a modern information system* that puts needed specifications, standards, regulations and product data right at your fingertips.

The system is compact, modular, and highly cost-effective. It's a comprehensive source of virtually all the data you're likely to need to design efficiently and competitively in the fast-changing electronics field.

*You'll get quick access* to Mil Specs, Industry Standards such as ASTM, ANSI, EIA and ten others, the Code of Federal Regulations, electronic component parameter comparison data, product information and more. Because it's modular, the system can be expanded or divided into sub-systems according to the needs of personnel in various locations.

*Unique computer-generated indexing* lets you find the information you need in minutes. It lets you access standards by subject or number. When you look up a product or material, you're automatically directed to the applicable code, standard, specification or regulation. We can also apply our indexing and retrieval expertise to your proprietary information such as company standards, parts inventories, engineering drawings, maintenance data and other internal records.

*The benefits of the system are many.* You'll increase the productivity of your department—many users claim it's like adding an engineer. You'll be able to keep costs down by taking advantage of alternate sources. You'll be current on specifications, codes and regulations. And you'll be up-to-date on the latest products and materials and their availability.

To learn more about how this system will make your operation more productive, call our toll-free number today, or write to Information Handling Services, 15 Inverness Way East, Englewood, Colorado 80150.

**For information, call toll-free day or night, 7 days a week:**

**1-800-821-3424, ext. 242**

(In Missouri: 1-800-892-7655, ext. 242)



**Information Handling Services**

An Indian Head Company

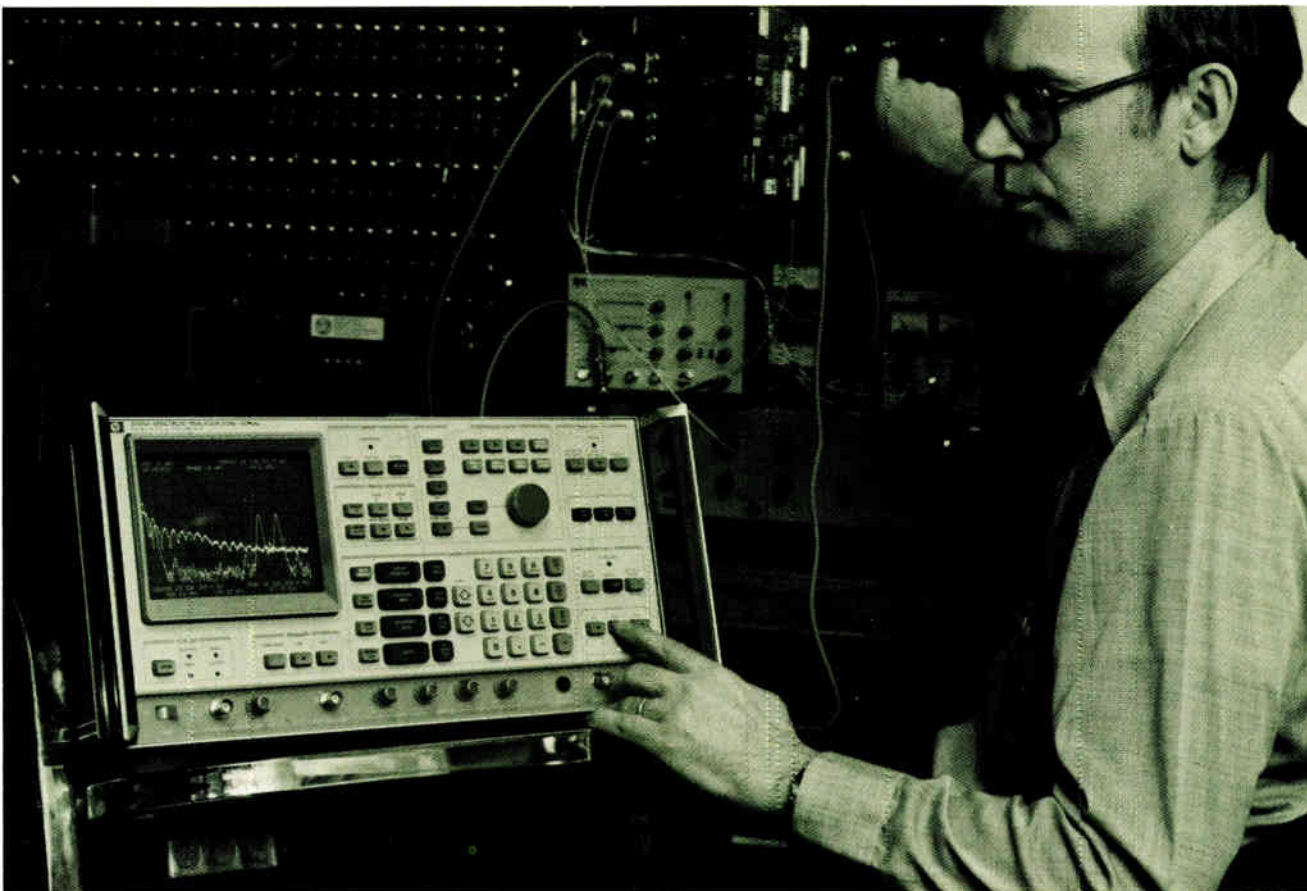

**1. Microprocessor plus.** The HP 3585A spectrum analyzer combines microprocessor technology with a synthesizer based on a new phase-locked loop to improve the accuracy of amplitude measurements. The instrument also features improvements in data display and ease of use.

# Frequency domain yields its data to phase-locked synthesizer

Fractional-N synthesis and microprocessor technology combine to give a spectrum analyzer the capability of measuring amplitude accurately and sometimes automatically

by John Gibbs and Robert Temple, *Hewlett-Packard Co., Loveland Instrument Division, Loveland, Colo.*

□ Spectrum analyzers put on a good show for design and production engineers working with radio-frequency equipment, and the incorporation of a low-cost method of frequency synthesis, plus microprocessor control, packs even more utility into a new analyzer. The addition of the two technologies both enhances performance and simplifies operation.

By portraying a signal's properties in the frequency

domain, the standard spectrum analyzer can help measure linear and nonlinear circuit performance, distortion, modulation, frequency response, and many other properties. Its spectral plots offer excellent qualitative information; however, the amplitude measurements derived from these plots generally are of poor accuracy, even when obtained by experienced operators. Nor is there any easy way in the operation of a standard

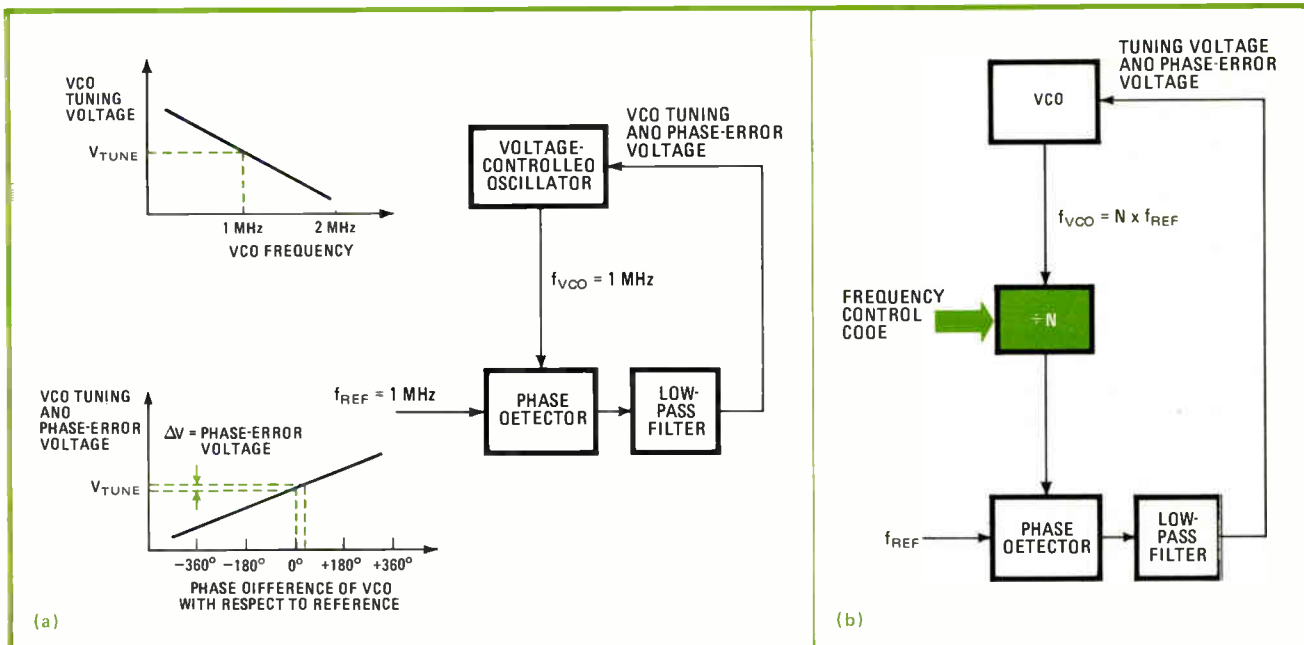

**2. Changing output frequency.** The basic phase-locked loop (a) consists of a phase detector, a low-pass filter, and a voltage-controlled oscillator. To change output frequency without changing reference frequency, a divide-by-N counter is in the loop (b).

analyzer to automate these difficult measurement procedures without employing a microprocessor.

The HP 3585A spectrum analyzer (Fig. 1), covering 20 hertz to 40.1 megahertz, combines synthesizer and microprocessor technologies to overcome these limitations. With a synthesizer based on a new type of phase-locked loop, center frequency and span settings can be entered with a resolution of 0.1 Hz over the entire frequency range. This frequency precision makes it possible to use the narrowest resolution bandwidth, 3 Hz, for close-in analysis, even at 40 MHz.

The primary tasks of the microprocessor are to control the frequency synthesizer and to enhance the accuracy of amplitude measurement. An automatic internal calibration routine provides  $\pm 0.5$ -decibel accuracy over most of the measurement range of +30 to -135 dBm, with a dynamic range of 80 dBm over the entire frequency span.

The improvements in measurement techniques are accompanied by an improved method of display. This has been accomplished by digitizing the detected video signal and refreshing the analyzer's cathode-ray tube from digital data stored in a memory of 1,001 horizontal-sweep points by 1,024 vertical-level points. The frequency and amplitude of each of the data points can be alphanumerically displayed on the cathode-ray tube by moving a marker (an intensified dot) along the trace to the desired data point.

### Ease of use

The power of the microprocessor provides a bonus by making the instrument easy to use, in spite of its complexity and versatility. Several of the usually tedious spectrum-analysis operations, such as centering a signal, raising it to the reference level, and modifying span and resolution, are now simplified with dedicated key-operated routines working in conjunction with the marker. In addition, new functions have been added,

such as internal frequency counting, noise-level measurement normalized to a 1-Hz bandwidth, and offset capability for both frequency and amplitude.

The voltage-tuned oscillator, commonly used in spectrum analyzers, has been replaced with a PLL synthesizer for several reasons. First and most important, a synthesizer can be designed with less residual frequency modulation than can a VTO. When narrow bandwidths are used to resolve such close-in signals as 60-Hz power-line sidebands, the residual fm can smear the signal across the filter's narrow bandwidth, burying the sidebands and rendering the bandwidth useless. This is the primary reason that the narrowest bandwidth of these gigahertz-range analyzers is several times greater than the narrowest bandwidth of low-frequency analyzers where the fm on the local oscillator is just too great to effectively use narrower bandwidths.

The synthesizer also makes long, slow sweeps practical. Its inherent linearity and stability ensure that a multihour sweep will truly reflect changes in the input signal, rather than the drift of the local oscillator. Also, the programmability offered by a synthesizer-based spectrum analyzer allows remote control of the instrument over the IEEE-488 standard interface bus. Lastly, the synthesizer is crucial for microprocessor-controlled calibration routines.

However, the advantages of a synthesized local oscillator do not come without their price. It is more expensive than a voltage-tuned oscillator, and it consumes more power and dissipates more heat.

In addition, for spectrum-analyzer use it must possess several properties seldom found in synthesizers. For instance, it must have phase-continuous sweeps, or else the display would show a glitch at each phase discontinuity. It must also have extremely low generation of spurious outputs and phase noise, because these will appear directly on the analyzer display and cannot be

distinguished from input signals. Lastly, it must use very small frequency steps so that it appears to sweep in a continuous fashion.

These requirements can be satisfied with a technique called fractional-N synthesis. With only one phase-locked loop, the fractional-N technique produces a signal with a frequency resolution limited only by the length of the digital registers. It can easily be made to sweep in a phase-continuous manner with zero frequency error. Its simple design eliminates the seven or eight loops of a conventional synthesizer, which leads to power and dollar savings, and its spectral purity (lack of spurious outputs and phase noise) is excellent far from the carrier.

### Phase-locked loops

A basic phase-locked loop (Fig. 2a) consists of a phase detector, a low-pass filter, and a voltage-controlled oscillator. The phase detector compares the VCO output to the reference signal, and a frequency-tuning voltage is applied to the oscillator. In addition, the phase detector generates a voltage proportional to the phase difference (the phase-error voltage). These tuning voltages are passed through the low-pass filter to suppress noise and high-frequency components. The polarity of the phase-error voltage is such that it will pull the VCO frequency in a direction to phase-track the reference frequency. However, in this basic phase-locked loop, the frequency change is limited by that of the reference source: to change the output frequency, the reference signal's frequency must be changed.

A divide-by-N phase-locked loop allows the VCO to be locked to integral multiples of the reference frequency (Fig. 2b). The operation of this circuit is similar to that of a conventional PLL, but the VCO frequency is now proportional to the number N in the divide-by-N counter. The oscillator thus operates at N times the reference frequency ( $f_{ref}$ ). The output frequency of the counter locks and tracks the phase of the reference signal.

The new fractional-N phase-locked loop (N.F PLL) in the HP 3585A is similar to a divide-by-N loop except that its VCO is not restricted to operating only at integral multiples of the reference signal. It also can operate at fractional multiples of the reference signal.

In the following discussion, the N in N.F represents this integral multiple, the divide-by-N number, while the F represents the fractional part of the VCO's offset frequency with respect to the integral frequency. With a fixed reference frequency, the integral part can be changed by changing the divide-by-N number. The integral part of the VCO frequency may be referred to as  $N_{vco}$ . ( $N_{vco}$  equals the divide-by-N number times the reference frequency). Thus, in a typical open-loop condition with a reference frequency of 1 MHz,  $N = 10$ , and  $.F = 0.1$  (Fig. 3), the VCO operates at a fractional multiple (10.1) of the reference signal ( $10.1 \times 1 \text{ MHz} = 10.1 \text{ MHz}$ ).

During each reference period of an open-loop N.F PLL, the reference signal goes through one cycle, while the VCO, which is operating, say, 10.1 times as fast, goes through 10.1 cycles. When the oscillator operates with a fractional offset, it is continually advancing phase on  $N_{vco}$  each reference period. Here, it advances  $1/10$  of a cycle on the integral part  $N_{vco}$  in one reference period. In

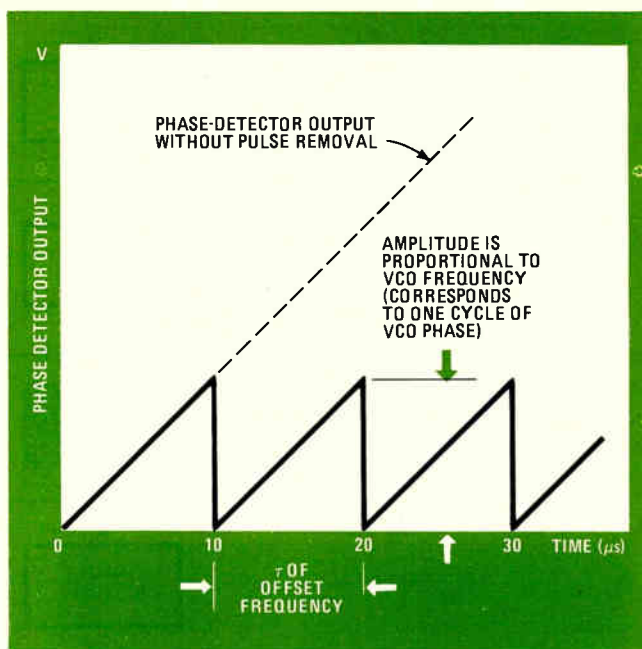

**3. Phase detector output.** The phase of the VCO pulse train advances, causing a linear increase in the output waveform until one cycle,  $N_{vco}$ , is complete. The output then drops to zero, forming a sawtooth waveform that cancels the previous phase advancement.

10 reference periods, it will have gone 101 cycles and will have advanced one full cycle ( $360^\circ$  of phase) on  $N_{vco}$ .

Just as the oscillator signal advances phase on  $N_{vco}$ , the divide-by-N VCO signal applied to the phase detector advances on the reference frequency,  $f_{ref}$ . If the phase-detector output were not limited by its finite dynamic range, this continual advancement of phase by the divided VCO signal would cause the output to increase without bound. However, it is possible to design in compensation for this condition.

With a voltage-controlled oscillator operating at 10.1 MHz, a reference of 1 MHz, and  $N = 10$ , the oscillator advances one cycle ( $360^\circ$ ) on  $N_{vco}$  every 10 reference periods. If a VCO cycle is removed when the oscillator advances the one full cycle of phase, the problem can be solved. The average frequency then applied to the divide-by-N counter is set back to  $N_{vco}$ . This cycle removal must repeat, as the VCO frequency N.F constantly advances phase on  $N_{vco}$ , because of the offset F.

The continual removal of a VCO cycle whenever the oscillator advances one cycle on  $N_{vco}$  means that the phase-detector output is a sawtooth waveform (Fig. 3). The waveform increases linearly because of the advancing phase of the VCO pulse train. Then it drops to zero, canceling the previous advancement of a cycle. The phase detector responds to this sudden one-cycle ( $360^\circ$ ) loss by returning to its  $0^\circ$  phase output.

Since one cycle must be removed from the voltage-controlled-oscillator output each time the output advances one cycle on  $N_{vco}$ , a pulse remover must be added in the divide-by-N phase-locked loop (Fig. 4a). If a VCO pulse is removed each time the oscillator advances one cycle of phase, the average frequency applied to the divide-by-N block is  $N_{vco}$  and the average frequency



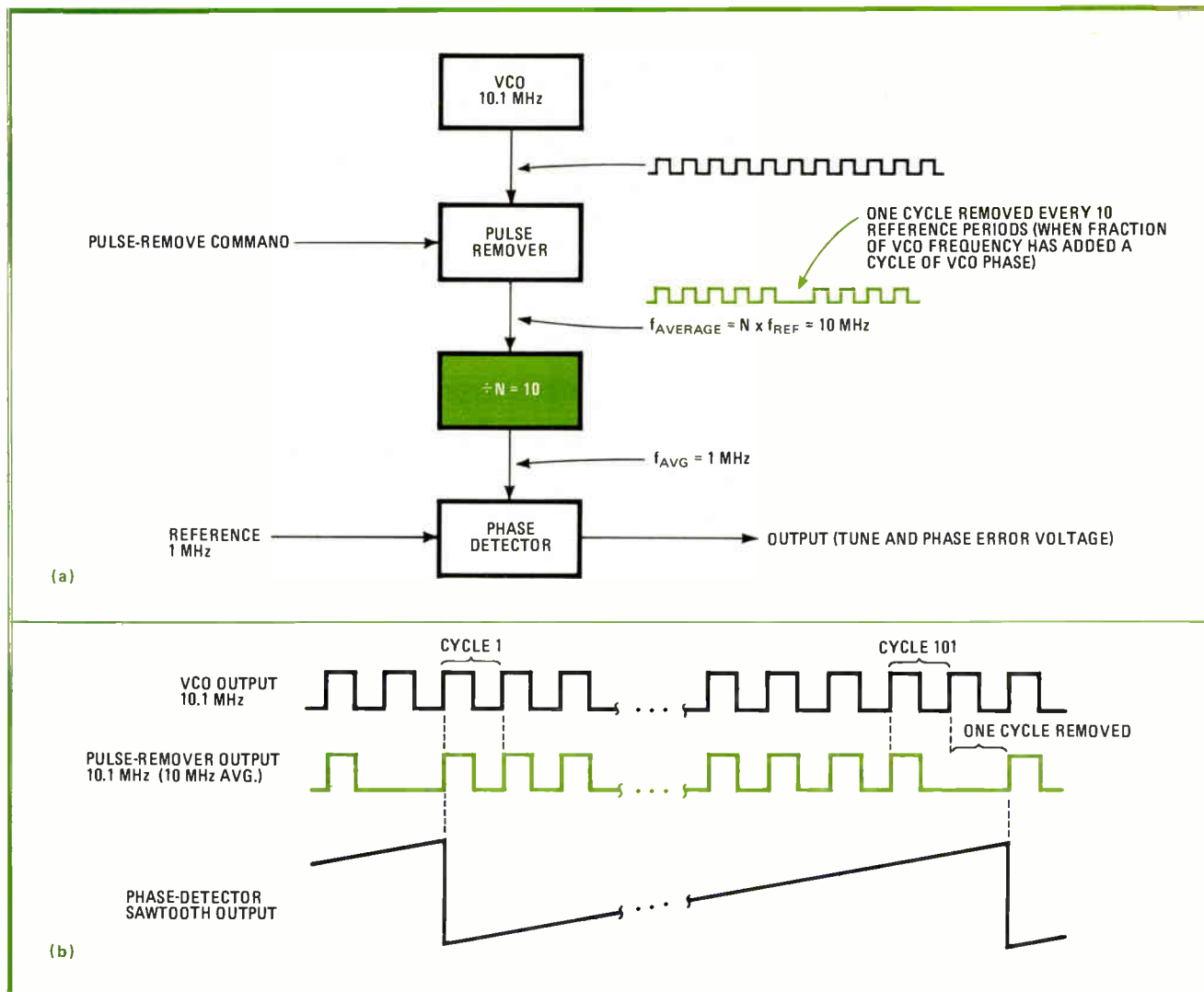

**4. Pulse remover.** The addition of a pulse-remover stage to the divide-by-N PLL (a) will remove one VCO cycle from the oscillator's output when triggered. The phase-detector output waveform indicates each completion of a cycle, which is used to trigger pulse removal (b).

applied to the phase detector is  $f_{ref}$  (Fig. 4b).

A method of determining when the VCO has advanced one cycle of phase is required. Such information can then be used to trigger the pulse remover. Fortunately, it is not difficult to come by. The fractional part of the VCO frequency determines the time required for the oscillator to advance one cycle of phase on  $N_{vco}$ . The time required is the period of  $f_{ref}$  and corresponds to a certain number of reference periods.

The fractional part of the frequency can be stored in a register and then added to a second register each reference period. The second register thus contains a running total of the VCO cycle advancement at any point in time. For this reason, the second register is called the phase register (Fig. 5).

During the reference period that the VCO advances one full cycle of phase, the phase register reaches unity. For example, the oscillator has gone 10.1 cycles in one reference period, 20.2 cycles in two reference periods, and so on. The phase register thus contains 0.1 after one reference period, 0.2 after the second reference period, etc. When unity is reached, the register overflows and trans-

mits an overflow signal corresponding to the point in time that the VCO has advanced one cycle of phase on  $N_{vco}$ . The overflow signal can now be applied to the pulse remover as a pulse-remove signal.

If the VCO operates with an offset frequency not evenly divisible into 1 (such as 0.3), a fractional overflow can result when the phase register reaches unity. For example, if it operates at 10.3 MHz, it has gone 10.3 cycles after one reference period, 20.6 after two, and 30.9 after three. When the fourth reference period's offset of 0.3 is added to the 0.9 already in the phase register, the resulting 1.2 causes an overflow as the pulse-remove signal. The fractional overflow of 0.2 is then loaded into the phase register and the next sequence begins to accumulate from 0.2 instead of 0.

Figure 5 shows that the open-loop phase-detector output is a sawtooth waveform superimposed on a dc voltage. The sawtooth must be removed, since a voltage-controlled oscillator requires a dc tuning voltage to maintain a stable output signal. A sawtooth ac signal superimposed on the dc VCO tuning voltage would cause frequency modulation of the oscillator signal.

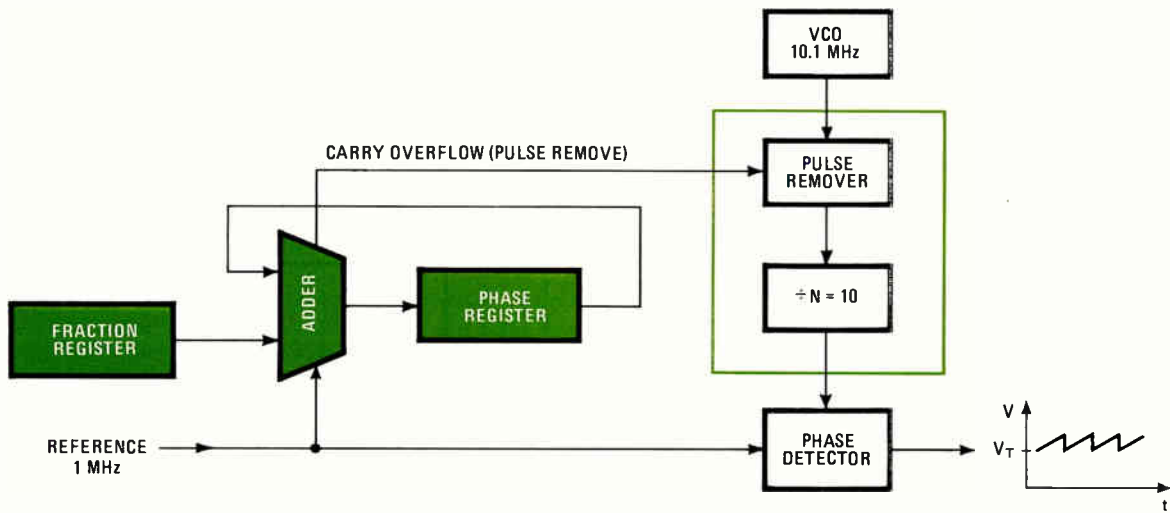

**Registers added.** The contents of the fraction register and phase register are added at each reference period until unity is reached, indicating that the VCO has advanced one cycle of phase on  $N_{\text{vco}}$ . The phase register overflows at unity, triggering the pulse-removal stage.

However, the contents of the phase register, viewed with respect to time, is a staircase resetting to zero once unity is reached (Fig. 6). If the content of the summing register is applied to a digital-to-analog converter, the converter output will follow the steps of this register and approximate a sawtooth output. Applying the converter output through an inverter and summing it with the phase-detector output essentially cancels the ac component (sawtooth) of the phase detector output. This leaves the dc component required as a VCO control signal.

A simplified block diagram of an N.F. PLL is shown in Fig. 7. The phase register, in accumulating phase, transmits serial data back to the adder to add the content of the fraction register to its contents each reference period. This method accumulates the instantaneous phase advancement and generates the pulse-remove signal at the appropriate time.

#### Fractional-N limitations

The fractional-N technique of frequency synthesis does have some limitations. Discrete phase-modulation sidebands exist at a frequency separation from the carrier equal to the difference between the carrier frequency and the nearest harmonic of the reference frequency. These are typically 50 to 70 dB below the carrier. There are also phase-noise sidebands approximately  $-95$  dB/Hz below the carrier, extending out on both sides to the synthesizer loop bandwidth. In resolution bandwidths below 10 kHz, these signal imperfections appear on the analyzer screen within the desired performance range.

For bandwidths of 10 kHz and 30 kHz, the sweep is done with the N.F. system only. In these bandwidths, the 0-to-70-dB close-in spurious noise and the 95-dB/Hz close-in phase noise do not show up. Since fractional-N spurious and phase noise far from the carrier is low enough to meet the design goals, such a PLL can be used directly as the local oscillator.

However, it is not practical to obtain the desired

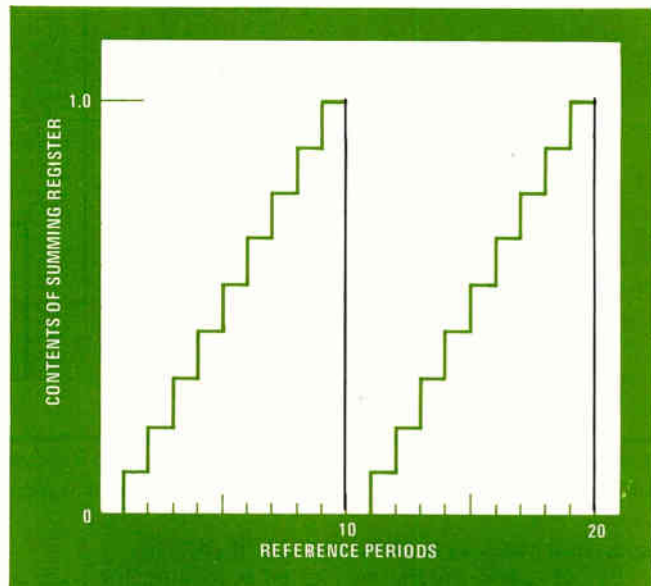

**6. Summing register.** The phase registers' contents are a staircase waveform approaching unity in steps occurring each reference period. The waveform resets to zero once unity is reached, indicating overflow, pulse removal, and VCO advancement of cycle.

performance of the local oscillator directly from the N.F. loop in all bandwidths. Thus, in the narrower bandwidths, the spurious and phase noise of the loop is reduced by dividing the frequency and then summing it with a divide-by-N loop. In effect, the limited performance of the fractional-N loop is accepted in return for its sweep advantages and high resolution.

#### Microprocessor control

To truly capitalize on the addition of a synthesizer to a spectrum analyzer, a microprocessor should be added to make it easy for the operator to use. With processor control, the operator can specify frequency entry in any form. Also, many useful functions not usually found on

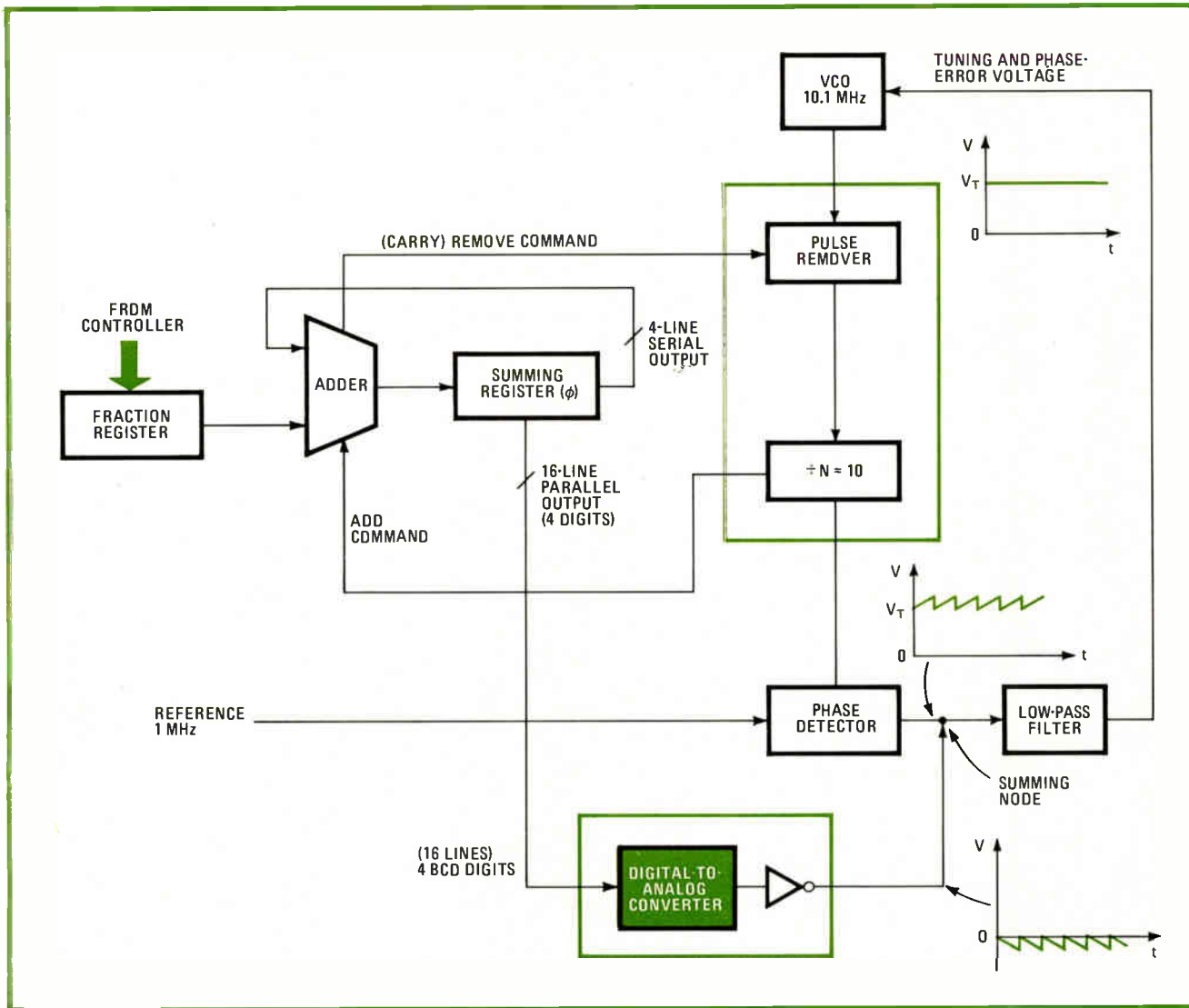

**7. VCO control.** Applying a d-a converter and inverter to the staircase phase-register output yields an approximate sawtooth waveform that is summed with the phase detector's sawtooth, canceling the ac component and leaving the dc component required for a VCO control signal.

spectrum analyzers can be added (Fig. 8).

For instance, an engineer often is looking for signals without knowing their exact frequency. The processor allows the addition of a counter function to find such a frequency. It is a period-measuring counter, which calculates and displays on the CRT the exact frequency of the signal in the final intermediate-frequency stage, when the local oscillator is tuned to the marker frequency. This means that if the user sets the marker anywhere on a signal, the counter will measure the exact frequency of that signal.

### Centered signal

In addition, pushing another button will put the measured signal exactly in the center of the screen. The operator can then reduce the frequency span (and bandwidth) to resolve the details of the signal. The center frequency will not have to be readjusted, as with a traditional spectrum analyzer, because it was set to the measured signal frequency.

Unlike a standard wideband electronic counter, this

function can count the frequency of a small-amplitude signal in the presence of a much stronger signal. This stems from the fact that the spectrum analyzer's filters can be used to process the signals and eliminate the bigger one, simply by using a narrow enough bandwidth to resolve the smaller signal. Thus, for instance, the exact frequency of the oscillator's spurious signals can be measured easily.

The microprocessor also makes it easy to implement such features as automatic input ranging, reference-level tracking, and coupling the functions of the resolution bandwidth and sweep time to the frequency span that has been selected.

The spectrum analyzer has its best accuracy at the top center of the screen. The calibration time required to correct the frequency response and linearity errors all across the screen is excessive. However, the added controls make it easy for the operator to top-center the signal, so this tradeoff was considered acceptable. The operator simply places the marker at the peak of the signal he desires to measure and pushes two buttons, and

TABLE 1: COMPARING THE SUBTRACTIVE, ULTRATHIN-FOIL, AND SEMIADDITIVE PROCESSES FOR FINE-LINE PATTERNS

	Subtractive 1-oz/ft <sup>2</sup> foil	Subtractive ultrathin foil	Semiadditive CC-4 Unclad
Fine lines	difficult to achieve: slivers, undercuts	easier to achieve: no slivering or undercutting	easier to achieve: no slivering or undercutting
Processing	difficult, costly	easy: no tin-lead needed	easy: no tin-lead needed
Substrates	all NEMA grades	only FR-4 at present	all NEMA grades
Reworking	no	no	yes
MIL spec approval	yes	pending	under study
Special steps	none	removal of carrier for some laminates	oxidation
Cost (1-oz/ft <sup>2</sup> foil = 100)	100	103	93
Burrs produced by drilling	yes	some	no

SOURCE: PHOTOCIRCUITS DIVISION, KOLLMORGEN CORP.

carbon-based PTF ink can be used. Secondly, it is easier to wire-bond or wave-solder to this substrate than to those used in the PTF method. If necessary, copper thick-film inks, easily solderable, can be screened onto the coated steel and fired, as shown in Fig. 3.

So far, production examples of boards made of enameled steel are few. (Two are used in Sylvania and General Electric flashbulb arrays.) Erie Ceramic Arts, however, has samples out to over 100 potential users, of which three are close to going into production.

Both the PTF and enameled-steel techniques will likely coexist and be applied mainly in automotive and consumer applications. The thermal and mechanical properties of the coated-steel substrate make it ideal for high-temperature-high-shock environments. On the other hand, the high dielectric constant of enamel (6.5) may rule it out for applications covered by high-frequency boards easily made with PTF.

**Shrinking conductor widths**

At the present time, the majority of the pc boards made for computer, telecommunications, and instrument equipment are made subtractively by etching plastic substrates clad with 1-ounce-per-square-foot copper foil. These boards typically carry 10- to 20-mil-wide copper conductors etched from the 35-micrometer-thick foil.

Over the last two to three years, however, there has been a constant demand from pc users, particularly in the computer field, for higher circuit density. The result is three different processes, each with the same aim—to produce pc boards with fine lines of 5 to 10 mils. The most widely used is a slightly modified form of etching of epoxy-glass laminates clad with ultrathin copper foils. The other contenders for fine-line production are the semiadditive and resistless additive processes.

The success of ultrathin foils (UTF) in fine-line etching is due to the fact that they undergo a minimum of undercutting. Undercutting occurs because the etchant penetrates at about the same rate laterally as vertically. The amount of undercutting is therefore proportional to the thickness of the copper foil. Excessive undercutting

limits line widths to about 10 mils on 35- $\mu$ m-thick (1-oz/ft<sup>2</sup>) copper-foil-clad boards.

Ultrathin-foil laminates, on the other hand, are clad with copper foil approximately 9  $\mu$ m (1/4-oz/ft<sup>2</sup>) or 5  $\mu$ m (1/8-oz/ft<sup>2</sup>) thick. These foils etch proportionally quicker than the 35- $\mu$ m types, drastically reducing the amount of undercutting and allowing for finer lines. They are supplied either with a peelable-copper or etchable-aluminum protective carrier foil or with no carrier at all.

The application of ultrathin copper foils was originally held back by material shortages and developmental troubles. Today, the material and development problems have all but been eliminated, and perhaps 4% to 10% of all printed circuits produced in the U. S. use such foils.

Conventional etching of a 1-oz/ft<sup>2</sup>-clad board and the fairly similar process for etching a UTF-clad board are compared in Fig. 4. As can be seen, fewer steps are needed with ultrathin foils, and conversion from the former to the latter is relatively simple because of the similarities of the two processes.

In addition to its capability for producing fine lines, the UTF process has other advantages over conventional etching. First, etching times and chemical costs are less. For a 1/4-oz/ft<sup>2</sup> foil, times and costs are approximately 25% those incurred with 1-oz/ft<sup>2</sup> foil. Also, since the amount of etchant is reduced, waste treatment of the etchant is obviously less of a problem.

Despite the higher cost of UTF laminates compared with 1-oz/ft<sup>2</sup>-clad types, processing UTF-clad boards can still cost less. For example, according to information furnished by Fortin Laminating Corp., San Fernando, Calif., processing costs for a 1/4-oz/ft<sup>2</sup>-clad, carrierless pc board are 54¢/ft<sup>2</sup> less than for a comparable one clad with 1-oz/ft<sup>2</sup> foil. In fact, this savings suggests that ultrathin copper foil could be economical for boards with 10- to 20-mil lines.

UTF fine-line processing does have two disadvantages, however: the clad substrates are expensive, and they require an added process step to remove the carrier. The trend, though, is now to bare foils.

With the increasing demand for fine-line circuits, the

advantages of the 20-year-old semiadditive process are being reevaluated by at least two major independent U. S. printed-circuit houses. This process, heavily used in Europe and Japan but not in the U. S., is based on electroless plating of a 0.10-mil-thick layer of copper on a bare substrate. This layer is even thinner than  $\frac{1}{8}$ -oz/ft<sup>2</sup> copper foil, the actual thickness of which is 0.17 mil. The flashed electroless copper will therefore etch faster than the thinnest available UTF, with less undercutting, making possible even finer lines.

### Semiadditive processing

The semiadditive technique has three additional advantages over the subtractive UTF method. With it, any type of plastic substrate can be used. UTF has been limited to clad FR-4 as a substrate (see below) simply because until recently only FR-4 was supplied with  $\frac{1}{4}$ - and  $\frac{1}{8}$ -oz/ft<sup>2</sup> foil. However, Atlantic Laminates is now just starting to supply its CEM-3 material, AL-910, with  $\frac{1}{4}$ -oz/ft<sup>2</sup> foil.

The second advantage of the semiadditive process is that copper patterns can be erased (that is, the copper can be chemically removed), which is not possible with an all-subtractive method. Furthermore, since drilling in the semiadditive process is done on a copperless substrate, deburring is eliminated. A comparison of conventional subtractive, UTF subtractive, and semiadditive methods is shown in Table 1.

The semiadditive process starts with bare substrate on which conductor patterns are built up by electroplating copper over a thin film of electroless copper. The production flow of a typical semiadditive process (that of the Photocircuits division of Kollmorgen Corp. for making its CC-4 Unclad) is shown in Fig. 5. Note that after the electroless-copper flashing, all succeeding steps resemble those for etching UTF.

Litton Industries Inc.'s Advanced Circuitry division, Springfield, Mo., has recently developed its own semiadditive process, called Semi Plus, which was shown a couple of months ago at Nepcon West in Anaheim, Calif. According to Robert Schutz, vice president of marketing at Advanced Circuitry, "In mass production, our process gets lines down to the state of the graphic arts, which is in the 5-to-6-mil range."

Although semiadditive processing has undeniable advantages over the subtractive UTF technique, it does have one serious drawback: to convert a subtractive production line to a semiadditive one requires new equipment and new chemical processing. In contrast, the conversion of a standard subtractive production line to handle carrier-protected ultrathin foils is simple. In fact, if the UTF is carrierless, no conversion is needed.

### Fine lines without resists

The ideal method for producing fine-line circuitry would be a fully additive plating process that requires no resist, masking, or etching. Two such processes do exist. N V Philips Gloeilampenfabrieken has one it calls physical development by reduction, or PD-R, which it introduced in early 1977 and is now using at its Elcoma division in Eindhoven, the Netherlands, for prototype telecommunications boards. In the U. S., Photocircuits

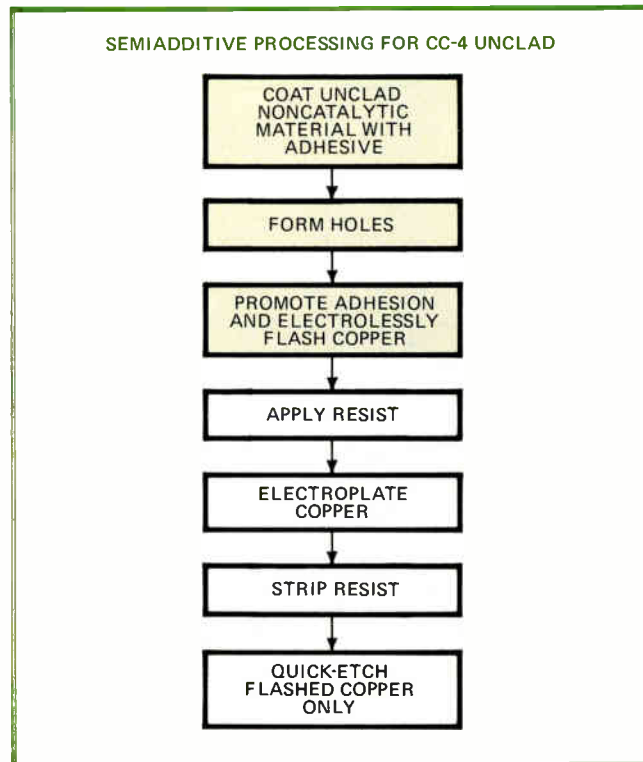

**5. Semiadditive.** In the semiadditive process, extremely thin copper is electrolessly plated on a bare pc substrate. The resulting layer of copper, even thinner than ultrathin foil, allows quick etching of fine conductor widths comparable to those of UTF.

has been working on its Photoforming process since 1975. It expects to have a line for prototype production applying Photoforming by late 1978.

Philips' process starts by coating an FR-4 substrate with a layer of titanium oxide. Holes are drilled in the board, which then goes through a swell-and-etch step to ensure a firm surface for conductor patterns. Next, the roughened laminate is prepared for photoexposure by a dilute solution of palladium chloride, which provides a source of palladium ions to react with the titanium oxide. Conductor patterns are then contact-printed onto the substrate with ultraviolet light. After exposure, the remaining palladium chloride is washed off, leaving a pattern image of metallic palladium.

A special electroless process deposits a thin layer of copper over the palladium image. At this point, flawed patterns can be "erased" and the laminate reused. A second electroless plating brings the copper up to its final thickness of about 25  $\mu$ m. The final step is to clean the board of process chemicals.

Photoforming resembles PD-R but with some important differences. It can start with any adhesive-coated substrate, unlike PD-R, which can only be plated onto FR-4. Also, it uses a recently developed noncatalytic film adhesive, rather than the titanium-oxide coating of the newer method, and a rolled-on activator based on copper salts instead of the noble-metal palladium solution used in Philips' system.

Both processes look promising for fine-line boards. Philips has found PD-R to be 30% cheaper than a straight subtractive approach, while Photocircuits says that with

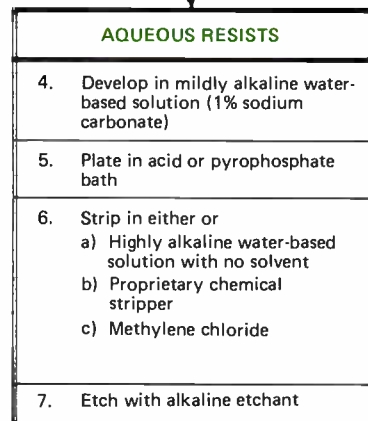
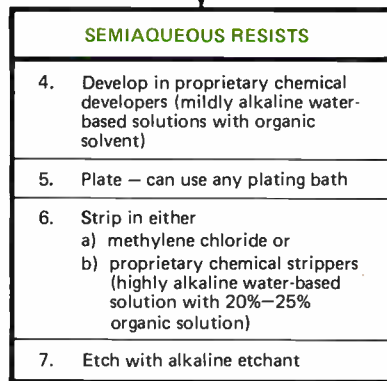
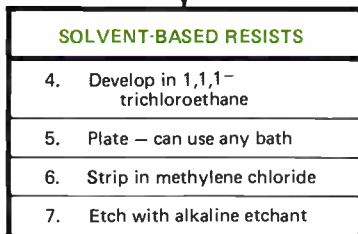
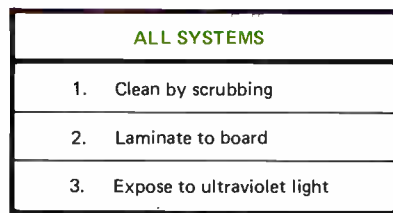

SOURCE: DU PONT CO.

**6. Film resists.** Normally, dry-film resists are both developed and stripped in organic solvents. But semiaqueous and aqueous films are now available to cut solvent costs and disposal. Aqueous dry films use no solvent, while semiaqueous films require only a small amount.

photoforming it can produce photoprinting-quality boards at screen-printing costs. Because there is no etching, neither process will undercut or sliver conductors, and therefore conductor resolution is limited only by the quality of the photographic master used in contact printing of the treated substrate. Furthermore, disposal problems are greatly reduced.

Both processes bear watching. David Frisch, manager of development engineering at Photocircuits' Technology group, says: "Formerly, Photoforming was tied to a resin-rich FR-4, which limited potential users to one source of laminate. Now, we have developed a low-cost dry-film adhesive that can go on any standard pc substrate, and this should help make Photoforming price-competitive with other fine-line methods."

### New directions in film resists

All the well-established pc processes—subtractive, semiadditive, additive—have a step in which a photosensitive polymer is placed either on a copper-clad or -plated board (subtractive and semiadditive) or on a bare board (additive). The image of the printed wiring is then exposed on the resist and developed. Next, the sensitized image is either selectively plated or etched.

Today, there are two main types of resist, screenable and dry-film. Seventy-five percent of all resists used are screenable. However, the properties of this type are not consistent enough to produce fine lines. In fact, without dry-film resists, high-resolution pc boards (from 13-mil conductors down) would be impossible. To achieve high optical resolution and high product yield, the optical and

photochemical characteristics of dry film are needed.

The first dry films were introduced by Du Pont in 1958. Films of this type require processing with organic solvents. They are developed in 1,1,1-trichloroethane and stripped with methylene chloride. However, chemical costs are high, stainless-steel tanks are needed to handle the fluorocarbons that the films contain, and effluent-disposal problems have appeared as a result of the recent concern over environmental pollution.

During 1971–72, the pc industry grew tremendously. At that time, there were as many as 600 to 800 firms involved. Many were small and could not afford the investment needed for processing solvent-based films. To meet this need, Du Pont's Riston Products division, Wilmington, Del., and Thiokol/Dynachem Corp., Santa Ana, Calif., introduced semiaqueous dry-film resists. These films require solvent only for stripping. The procedure for processing these resists is given in Fig. 6.

Semiaqueous resists represents a considerable improvement over solvent-based dry-film resists. They use proprietary chemical developers with a mildly alkaline water-based solution plus some organic solvent, and they can be stripped either with methylene chloride or with a highly alkaline water-based solution.

The new resists lowered the cost of dry-film processing. For example, a typical solvent-based resist processor costs about \$25,000, whereas a comparable unit for a semiaqueous film costs \$12,000 or less, and stripping could be done in plastic tanks. In addition, the chemical-disposal problem is much smaller. For large installations (greater than 100,000 ft<sup>2</sup>), though, the cost of a good

TABLE 2: LAMINATE COMPOSITION, APPLICATIONS, AND COST

	Composition	Applications	Cost (\$/ft <sup>2</sup> )
XXXXP	paper-based, impregnated and bonded with a phenolic resin	consumer, automotive	1.00
FR-2	paper-based, impregnated with a flame-retardant phenolic resin	consumer, automotive	NA
FR-3	paper-based, impregnated and bonded with an epoxy resin and incorporating a flame-retardant additive	consumer, automotive	NA
FR-4	woven glass-cloth impregnated and bonded with an epoxy resin and incorporating a flame-retardant additive	computer, military, telecommunications, instruments	2.10
CEM-1	a composite incorporating an epoxy resin and a flame-retardant additive. The core is a nonwoven cellulosic felt similar to FR-3 sandwiched between cover sheets of woven glass similar to FR-4	consumer, automotive	1.40
CEM-3	a composite incorporating an epoxy resin and a flame-retardant additive. The core is a nonwoven glass felt sandwiched between cover sheets of woven glass similar to FR-4	computer, telecommunications, instruments	1.85
Polyester-random-glass	random-glass matte combined with a polyester resin with or without a flame-retardant additive	consumer, automotive	1.28

SOURCE: PHOTOCIRCUITS DIVISION, KOLLMORGEN CORP.

closed-loop solvent-recovery system is not much more than the cost of a semiaqueous system, and conversion is therefore not profitable.

Semiaqueous resists caught on particularly in the Northeast, where both Digital Equipment Corp., Maynard, Mass., and Data General Corp., Westboro, Mass., adopted them for their large in-house facilities. However, it was still desirable to have a family of film resists that required no organic solvent at all in processing. The first fully aqueous resists were put on the market by Du Pont in 1975. The processing steps with this type of resist are also given in Fig. 6. Here, developing is in a low-cost solution of 1% sodium carbonate in water at 100°F to 110°F. Stripping may be done by a highly alkaline water-based solution with no organics, by a proprietary chemical, or by methylene chloride.

This first family of fully aqueous resists was successfully applied to simple printing and etching operations on the inner layers of multilayer boards. On the over-plated lines of double-sided boards, though, stripping was difficult with nonorganic compounds. Many firms using these resists simply went to organics for stripping—really a semiaqueous procedure. Still, overall chemical costs were cut compared with a production line for a solvent-based dry-film resist.

The 1975 generation of resists is now being superseded by newer aqueous dry films from Du Pont called Riston 3000 and 3300, which were introduced recently at Nepcon West. Also, later this year, Dynachem will offer improved versions of their aqueous resists.

Du Pont claims that the new Ristons will have more processing latitude and will eliminate the acid dip after developing required with older aqueous film. In addition, the newer material will strip better in an all-aqueous solution. Brian O'Conner, product marketing manager for the Riston Products division, says: "The primary application for Riston 3000 is the inner layers of multilayer boards. Since this is a straightforward print-and-etch operation, it is easy to match its chemical processing to an aqueous resist. We're working with many pc firms to apply aqueous resists to all forms of pc fabrication. Eventually, we hope to make the processing costs of these resists competitive with those of screened types." But although they are fine for subtractive and semiadditive processes, O'Connor points out that aqueous films will not work for fully additive pc plating because the pH of the additive solutions is too high.

At present, aqueous processing of dry-film resists is mostly being done by new or small firms, since, as was mentioned, it is not worthwhile for big companies with heavy investments in large closed-loop solvent-recovery systems to change over to the newer system. But for a firm about to start a pc facility or add a new production line to an existing facility, aqueous film resists can result in great savings.

For instance, Mike Busby, president of Cirtel Inc., in Anaheim, Calif., began using fully aqueous processing at the start-up of his pc company 5½ years ago—about the time fully aqueous dry films came out. At first, Cirtel's engineers had trouble with the new Du Pont and Dyna-

TABLE 3: MECHANICAL AND ELECTRICAL PROPERTIES OF LAMINATES

	Flexural strength (lb/in <sup>2</sup> )		Impact resistance (IZOD) (ft-lb/in)		Water absorption (% of maximum value)	Insulation resistance (MΩ)
	X direction	Y direction	Lengthwise	Crosswise		
XXX P	12,000	10,500	0.45	0.40	0.75	2 x 10 <sup>4</sup>
FR-2	12,000	10,500	0.45	0.40	0.75	2 x 10 <sup>4</sup>
FR-3	20,000	16,000	0.55	0.50	0.65	1 x 10 <sup>5</sup>
CEM-1	40,000	30,000	2.5	1.5	0.35	5 x 10 <sup>5</sup>
CEM-2	40,000	30,000	2.5	1.5	0.35	5 x 10 <sup>5</sup>
FR-4	50,000	40,000	7.0	5.5	0.40	5 x 10 <sup>5</sup>
Polyester-random-glass	18,000	18,000	3.0	3.0	0.40	2 x 10 <sup>4</sup>

SOURCE: PHOTOCIRCUITS DIVISION, KOLLMORGEN CORP.

chem resists, particularly with brittleness. The troubles were solved by the vendors, and Cirtel's production line has run smoothly ever since, turning out etched fine-line and multilayer printed-circuit boards.

As predicted, Cirtel has had lower equipment and solvent costs. In addition, its disposal problems have been simplified. Cirtel is now adding another production line for prototyping, and it, too, will be fully aqueous.

**Above board**

The keystone of any printed-circuit process is the substrate itself. It must have adequate flexural strength and impact resistance, a small amount of water absorption, and good electrical properties like low dielectric constant and dissipation factor. Table 2 gives the composition, applications, and costs of the most popular laminates currently used, and Table 3 lists their mechanical and electrical properties.

Until fairly recently, XXXP, FR-2, and FR-4 were the most heavily used, with paper-phenolic boards filling consumer slots and epoxy-glass boards dominating the computer and military markets. As Table 3 shows, the mechanical and electrical properties of FR-4 are far superior to those of the less expensive XXXP and FR-2. What was needed were materials with properties approaching those of FR-4 but at a lower cost. Two new types of substrates, one made of random-glass matte and polyester resin and the other of composite epoxy materials, have now appeared to fill the gap.

The polyester-based material has excellent impact resistance (about half that of FR-4), but its flexural strength is only about as good as that of paper-phenolic materials. Because of its high impact resistance, it is displacing XXXP and FR-2 substrates in automotive and consumer applications where more complex circuitry requires a laminate with better electrical properties than paper-phenolic types. But because of its low flexural strength, it is pretty much ruled out for applications that use FR-4. However, Cincinnati Milacron Co.'s Molded Plastic division, Blanchester, Ohio, which produces a polyester-random-glass laminate called Cimclad, now

has a newer version called Milclad with double the flexural strength of the older material. Milclad could conceivably be applied as a substitute for epoxy-glass.

The composite epoxy materials, which were developed a little later, come in two basic types: CEM-1 is composed of an internal core of cellulose paper encapsulated between two layers of woven glass, and CEM-3 has an internal core of a nonwoven glass.

CEM-1 (General Electric's PC-75 is an example) is superior to paper-phenolics and polyester and is proving popular in automotive electronics, video games, and smoke detectors. As Table 2 shows, it is price-competitive with XXXP and Cimclad. But according to J. E. White composites project manager of GE's Laminated and Insulating Materials Business department, Coshoc-ton, Ohio, "polyester-random-glass material is competitive with CEM-1 in price only. PC-75, for instance, has a longer die life and higher yields." However, the cellulose-paper construction of CEM-1, with its attendant high water absorption, prevents it from replacing epoxy-glass boards in demanding applications.

Of the new materials, CEM-3 is the one that could have a large impact on the pc field, since on the whole it has the same specifications as FR-4 at a lower cost. In addition, it can be used in any pc process that employs FR-4, and it can be drilled or punched more easily than its epoxy-glass counterpart or other competitive plastic substrates. Moreover, there is no difficulty in making plated-through holes, as there is with CEM-1 and polyester-random-glass.

Atlantic Laminates, Franklin, N. H., a division of Oak Industries, was the first to come out with a successful CEM-3, called AL-910. Derek Russel, product manager for punchable substrates for the company, sees CEM-3 replacing FR-4 in 85% to 95% of the boards in the near future. He points out that CEM-3 meets or exceeds FR-4 in every specification except flexural strength. For instance, 1/16-inch-thick AL-910 has a flexural strength of 61,000 pounds per in.<sup>2</sup>, whereas an FR-4 laminate of the same thickness has a 79,400-lb/in.<sup>2</sup> flexural strength.

Russel believes that very few applications need the



TABLE 4: HIGH-FREQUENCY PROPERTIES OF PC LAMINATES

Material	Copper clad	Dielectric constant (at 10 <sup>6</sup> Hz)	Dissipation factor (at 10 <sup>6</sup> Hz)	Continuous-use temperature °F	
Low-cost materials	ABS	no	2.4 – 3.8	0.007 – 0.015	180
	Epoxy-paper	yes	4.0	0.018	250
	Polyester-random-glass	yes	4.5	0.020	290
	Noryl	no	2.7 (at 60 Hz)	7 x 10 <sup>-4</sup> (at 60 Hz)	220
	Epoxy-glass	yes	4.5	0.020	290
	Polysulfone	no	3.1	3.4 x 10 <sup>-3</sup>	345
	TPX	no	2.1	2.5 x 10 <sup>-5</sup>	320
	Polycarbonate	no	2.9	0.010	250
Medium-cost materials	PPS-glass	no	3.9	4.1 x 10 <sup>-3</sup>	400 – 500
	PPS	no	3.2	4 x 10 <sup>-4</sup>	400 – 500
	Epoxy-polyimide-glass	yes	5.1	0.017	425
	PPO	no	2.6	7 x 10 <sup>-4</sup>	220
	Tefzel	no	2.6	5 x 10 <sup>-3</sup>	300
High-cost materials	PPO	yes	2.6	7 x 10 <sup>-4</sup>	220
	Teflon-glass	yes	2.5	8 x 10 <sup>-4</sup>	500
	Teflon	yes	< 2.1	< 2 x 10 <sup>-4</sup>	500
	X-linked polystyrene-glass	yes	2.6	4 x 10 <sup>-4</sup>	190

SOURCE: TEKTRONIX INC.

flexural strength of a glass-epoxy board and that most boards are oversized and could use a CEM-3 material. Only military or aerospace boards really need the structural and impact strength of FR-4, he says.

As the operating frequency of a circuit board moves up, dielectric constant and dissipation factor suddenly become more important. Table 4 lists the properties of plastics suitable for circuit boards. The materials are arranged roughly according to cost. For example, 1/16-in.-thick ABS is less than \$1.00/ft<sup>2</sup>, whereas the materials at the bottom of the third group—clad Teflon and X-linked polystyrene—cost \$30 to \$50 a square foot. Note that the general-purpose materials previously discussed—epoxy-paper, polyester-random-glass, and epoxy-glass—all have relatively high dielectric constants and dissipation factors that exclude them from high-frequency applications for all practical purposes.

**High-frequency boards**

Tektronix Inc., Beaverton, Ore., has a large in-house pc facility and makes many high-frequency boards. Its engineers considered polysulfone, ABS, and TPX as hf substrates, but the last two were discarded because they softened under soldering. Bare polysulfone, though, did have the electrical and thermal properties required.

Tektronix now makes high-frequency boards from relatively low-cost unclad polysulfone using its own semiadditive process. These boards are fulfilling all their requirements, says Jerry Jacky, senior chemical engineer at the company. In addition, the use of polysulfone has cut raw-board costs by about \$10,000 a month.

The next development in this area will be copper-clad polysulfone. With clad polysulfone, straight etching could be done, thus cutting the price of processing by utilizing available etching equipment. Steve Nelson, marketing manager for Union Carbide Corp. in New York, says, "We are working with several laminators to develop sources." One of the companies is the Norple division of Universal Oil Products, La Crosse, Wis., which is now supplying such samples.

Union Carbide, a larger supplier of polysulfone, sees two markets for this material. One is for high-frequency boards, either bare or clad. The other is for general-purpose boards with premolded features like holes and connector housings. Premolding makes it possible to combine structural and circuit-board functions, and the printed wiring can be plated or screened on with conductive inks. The resulting boards would most likely be employed in consumer items.

In general, all the developments discussed above are in their formative stage. Polymer thick-film inks and enameled-steel boards have a good chance of moving from consumer to industrial applications.

Practically every independent pc supplier is now either developing or using ultrathin copper foils. In fact, in the future, standard etching may shift to 1/2- rather than 1 oz/ft<sup>2</sup> foil as a result of the influence of fine-line boards. Also, copper foil suppliers are now experimenting with even thinner foils, and boards with 1- to 3-mil-wide conductors may appear in a few years.

A reprint of this special report is available for \$3.00. Write to Electronics Reprint Dept., P. O. Box 669, Hightstown, N.J. 08520. Copyright 1978, Electronics, a McGraw-Hill publication.



Model 178

# Now... the next generation of bench DMMs!

**Two New Keithley Models offer uncompromising performance and outstanding value!**

- Accuracy 3 1/2's can't match: 0.04% + 1 digit on dc volts and ohms.
- Large, bright, 20,000-count LED display that's quick and easy to read.
- Convenient bench size that won't get "lost" yet doesn't crowd.
- Exceptional reliability.

Model 178 offers functions and ranges for most measurement needs: 100µV to 1200V dc, 100µV to 1000V ac, 0.1Ω to 20MΩ. At \$199\* it is a remarkable value!

Model 179 is a full-function, multi-feature model offering the same advantages as the 178. Plus TRMS AC; 10µV Sensitivity; Hi and Lo Ohms; AC and DC Current. Yet it's still half the price you'd expect. Only \$289\*!

**Both models feature designed-in reliability.**

Rugged circuits use a minimum of parts—high quality, off-the-shelf parts—carefully assembled and tested by Keithley (we've been making sensitive

laboratory instrumentation for more than 30 years.)

Outstanding overload protection and rugged mechanical design keep both units going even after severe abuse. One-year accuracy specifications minimize recalibration costs. Local assistance keeps downtime to a minimum should service ever be needed.



Model 179

A battery option, user installable, gets you off "line" for critical measurements or for field use. Nine other accessories add versatility.

For complete specifications and immediate delivery on the 178 and 179, call your local Keithley representative. Or, call or write: Keithley Instruments, Inc., 28775 Aurora Road, Cleveland, Ohio 44139, (216) 248-0400. In Europe: D-800 München 70, Heighhofstrasse 5, West Germany. (089) 7144065.

## To order your Keithley DMM:

- ALABAMA:** Huntsville, (205) 883-8660
- ARIZONA:** Phoenix, (602) 944-9185
- ARKANSAS:** (214) 231-9489 (Dallas, TX)
- CALIFORNIA:** Los Angeles, (213) 836-6170  
San Diego, (714) 226-0305  
San Francisco (408) 257-8333
- COLORADO:** Denver, (303) 795-0250
- CONNECTICUT:** (800) 225-3409, Toll Free
- DELAWARE:** (609) 871-9341 (Philadelphia, PA)
- DISTRICT OF COLUMBIA:**  
(703) 573-8787 (Arlington, VA)
- FLORIDA:** Ft. Lauderdale, (305) 776-4800  
Melbourne, (305) 723-0766  
Orlando, (305) 425-5505  
Pensacola, (904) 243-6424
- GEORGIA:** Atlanta, (404) 939-1674
- IDAHO:** (303) 795-0250 (Denver, CO)
- ILLINOIS:** Chicago, (312) 585-5485
- INDIANA:** Indianapolis, (317) 293-0696
- IOWA:** Cedar Rapids, (319) 365-8071
- KANSAS:** Kansas City, (913) 492-7020  
Wichita, (316) 788-0621
- KENTUCKY:** Lexington, (317) 293-0696  
(Indianapolis, IN)  
Louisville, (216) 729-2222 (Cleveland, OH)
- LOUISIANA:** Baton Rouge, (504) 626-9701
- MAINE:** (617) 944-6660 (Boston, MA)
- MARYLAND:** Baltimore, (301) 321-1411  
South, (703) 573-8787 (Arlington, VA)
- MASSACHUSETTS:** Boston, (617) 944-6660
- MICHIGAN:** Detroit, (313) 569-4497
- MINNESOTA:** Minneapolis, (612) 559-1976
- MISSISSIPPI:** (504) 626-9701 (Baton Rouge, LA)
- MISSOURI:** St. Louis, (314) 426-7055
- MONTANA:** (303) 795-0250 (Denver, CO)
- NEBRASKA:** (913) 492-7020 (Kansas City, KS)
- NEVADA:** (213) 836-6170 (Los Angeles, CA)
- NEW HAMPSHIRE:** (617) 944-6660 (Boston, MA)
- NEW JERSEY:** North, (201) 368-0123  
South, (609) 871-9341 (Philadelphia, PA)
- NEW MEXICO:** Albuquerque, (505) 255-2440
- NEW YORK:** Metro New York, (201) 368-0123  
Syracuse, (315) 454-9314 (Paramus, NJ)
- NORTH CAROLINA:** Durham, (919) 682-2383
- NORTH DAKOTA:** (612) 559-1976 (Minneapolis, MN)
- OHIO:** Cleveland, (216) 729-2222  
Dayton, (513) 434-8993
- OKLAHOMA:** (214) 231-9489 (Dallas, TX)
- OREGON:** Portland, (503) 297-2248
- PENNSYLVANIA:** Philadelphia, (609) 871-9341  
Pittsburgh, (216) 729-2222 (Cleveland, OH)
- RHODE ISLAND:** (617) 944-6660 (Boston, MA)
- SOUTH CAROLINA:** Columbia, (803) 798-3297
- SOUTH DAKOTA:** (612) 559-1976 (Minneapolis, MN)
- TENNESSEE:** Oak Ridge, (615) 482-5761
- TEXAS:** Austin, (512) 451-7463  
Dallas, (214) 231-9489 Houston, (713) 783-1492
- UTAH:** (303) 795-0250 (Denver, CO)
- VERMONT:** (617) 944-6660 (Boston, MA)
- VIRGINIA:** Arlington, (703) 573-8787
- WASHINGTON:** Bellevue, (206) 454-3400
- WEST VIRGINIA:** (216) 729-2222 (Cleveland, OH)
- WISCONSIN:** Milwaukee, (414) 464-5555
- WYOMING:** (303) 795-0250 (Denver, CO)

## CANADA

- BRITISH COLUMBIA:** Vancouver, (604) 732-7317
- MANITOBA:** Winnipeg, (204) 475-1732
- ONTARIO:** Toronto, (416) 638-0218  
Ottawa, (613) 521-8251
- QUEBEC:** Montreal, (514) 735-4565

## EUROPE

- FRANCE:** Palaiseau, (01) 928-00-48
- UNITED KINGDOM:**  
Reading, Berks., (0734) 861287/88
- WEST GERMANY:** München, (089) 7144065

**Or call Keithley's Toll Free DMM Hot Line (800) 321-0560**

# KEITHLEY

The measurement engineers.

\*U.S. domestic price only.

## Unity-gain buffer amplifier is ultrafast

by James B. Knitter and Eugene L. Zuch  
*Datel Systems Inc., Canton, Mass.*

Applications where transmission-line drivers, active voltage probes, or buffers for ultrahigh-speed analog-to-digital converters are needed can use a stable buffer amplifier capable of driving a relatively low-resistance, moderate-capacitance load over a wide range of frequencies. The circuit shown in (a) fulfills these requirements. With a bandwidth of 300 megahertz, it exhibits no peaking of its response curve, having a gain of virtually 1 (0.995) under no-load conditions and 0.9 under a maximum load of 90 ohms.

The circuit is a variation on a basic emitter-follower network, which is inherently capable of wideband performance. However, no feedback loops are needed anywhere within the circuit to boost the gain at the high frequencies, and dispensing with them contributes to the

stability of the circuit. Also, using two matched npn-pnp transistor pairs ensures close tracking between input and output voltages (a task normally addressed by suitable feedback circuitry) as well as low offset-voltage drift (20 microvolts/°C).

The complementary-transistor pairs are 2N4854s wired for active current sourcing and sinking so that bipolar input signals can be processed. Each transistor has a typical  $\beta$  of 100. With the npn and pnp input-bias currents tending to cancel each other, the resultant input-bias current of the amplifier is  $\pm 5$  microamperes.

Layout is critical to the stability of the circuit. The buffer should be constructed as shown in (b). The two transistor pairs are mounted close together, in holes drilled in a copper-clad circuit board as shown. The flanges on the TO-99 cases encapsulating the 2N4854s should be soldered to the copper, which serves as a ground plane. The collector of each transistor must be bypassed by a 0.1-microfarad ceramic-chip capacitor mounted close to the transistor. This is done by standing the capacitors on end, with the bottom contact lead soldered to the ground plane and the top contact lead soldered to the collector.

All leads must be less than 1/2 inch in length and be as

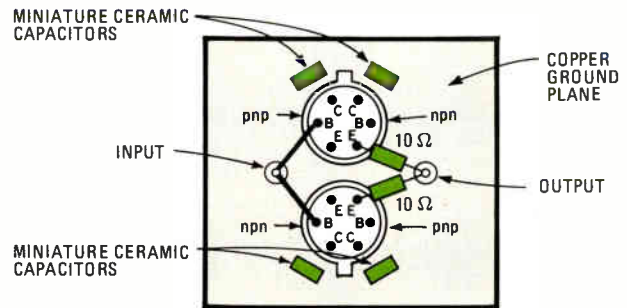
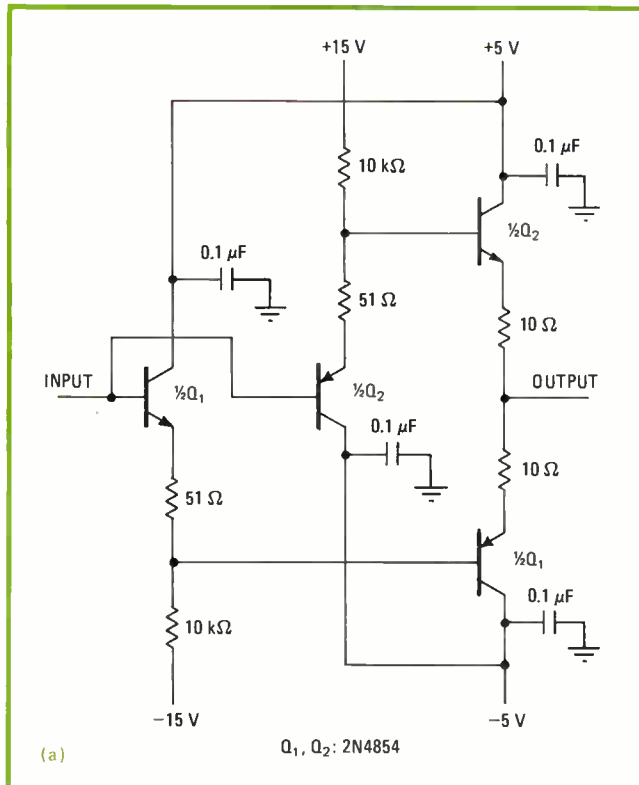

(b)

### CHARACTERISTICS OF UNITY-GAIN BUFFER

Input impedance	500 kilohms (dc)
Input bias current	$\pm 5 \mu\text{A}$
Input capacitance	16 pF max
Input/output voltage range	$\pm 3 \text{ V}$
Output offset-voltage drift	$\pm 20 \mu\text{V}/^\circ\text{C}$
Output impedance	10 ohms
Load resistance	90 ohms max
Gain, no load	+0.995
Bandwidth, -3 dB	300 MHz
Power supply, quiescent	$\pm 15 \text{ V dc at } 1.5 \text{ mA}$ $\pm 5 \text{ V dc at } 4.5 \text{ mA}$
Power consumption	90 mW

**Wideband buffer.** Emitter-follower configuration yields unity gain from dc to 300 megahertz. Absence of feedback in circuit contributes to buffer stability. Use of matched npn-pnp transistor pairs ensures almost perfect input/output signal tracking (a). Component layout is critical for circuit stability (b).

# The big switch

**...is to energy saving switchers.**



300 watt, quad output MGQ 300: 75% energy efficient.

Switching power supplies are more efficient than linears.

To produce a 200 watt output, a linear supply needs 400 watts coming in. A Gould switcher needs only 270. The switcher saves the 130 watts that the linear throws off in the form of heat.

Since the switcher dissipates less heat, your system operates at a lower temperature. This improves overall reliability and can reduce the need for external cooling.

But energy efficiency isn't the only advantage switchers offer. They're 1/3 the size and 1/4 the weight of linears. And they offer far better holdup and brownout protection.

Gould offers single and multiple output switchers with power levels from 8 to 2,250 watts. And custom designs can be provided to meet your exact specifications. You'll be backed by a high volume production capability and worldwide service network that only a \$1.5 billion company like Gould could offer.

For more information contact Gould Inc., Electronic Components Division, 4601 North Arden Dr., El Monte, CA 91731. Phone (213) 442-7755.

**Gould.**  
**The power in switching power supplies.**



directly wired as possible. One-eighth-watt resistors are used throughout and are soldered to the transistor leads as close as possible to the case. For clarity, not all components are shown. For coupling to or from the

amplifier, subminiature radio-frequency connectors can be mounted at the input and output ports of the buffer.

Typical characteristics of the unity-gain buffer circuit are listed in the table. □

## Dual charge-flow paths extend pulse repetition rate

by J. Klimek  
Pretoria, South Africa

Although the basic, one-gate pulse generator shown in part (a) of the figure cannot be beaten for convenience in general test applications, it has a relatively narrow repetition-rate range, typically only a few tens of kilohertz. But with a few modifications (b), the repetition rate for a narrow-width pulse train can be extended from dc to 1 megahertz or so.

The range of the pulse generator is increased because the timing capacitor is charged and discharged through separate paths. This operation decreases circuit-switching times and enables the circuit to oscillate over a wide band of frequencies. Gate  $T_1$  is one sixth of the 4007 chip, which contains three n-channel and three

p-channel enhancement-mode transistors; it charges capacitor  $C$  for as long as pin 1 is high. For the circuit configuration shown, the charging period is a fraction of a microsecond.

When  $T_1$  is switched low by pin 4 of the 4093,  $C$  discharges through  $T_2$ , the current source-sink whose value is controlled by  $R$ . Once  $C$  is discharged,  $T_1$  switches high again and the process repeats.

In this instance, when  $0.7 \text{ volt} \leq V_{in} \leq 3.4 \text{ volts}$ , the corresponding repetition rate varies from dc to 1 MHz. The pulse width, which is about 0.5 microsecond, may vary by as much as a factor of 2, depending on the particular 4007 used. But whatever the value, it will be constant throughout the 0-to-1-MHz range.

To minimize the phase jitter that may occur at low frequencies because of the small charge current involved, the circuit should be placed inside a metal enclosure. In line with the low-frequency consideration, a low-leakage capacitor is also recommended. □

Designer's casebook is a regular feature in *Electronics*. We invite readers to submit original and unpublished circuit ideas and solutions to design problems. Explain briefly but thoroughly the circuit's operating principle and purpose. We'll pay \$50 for each item published.

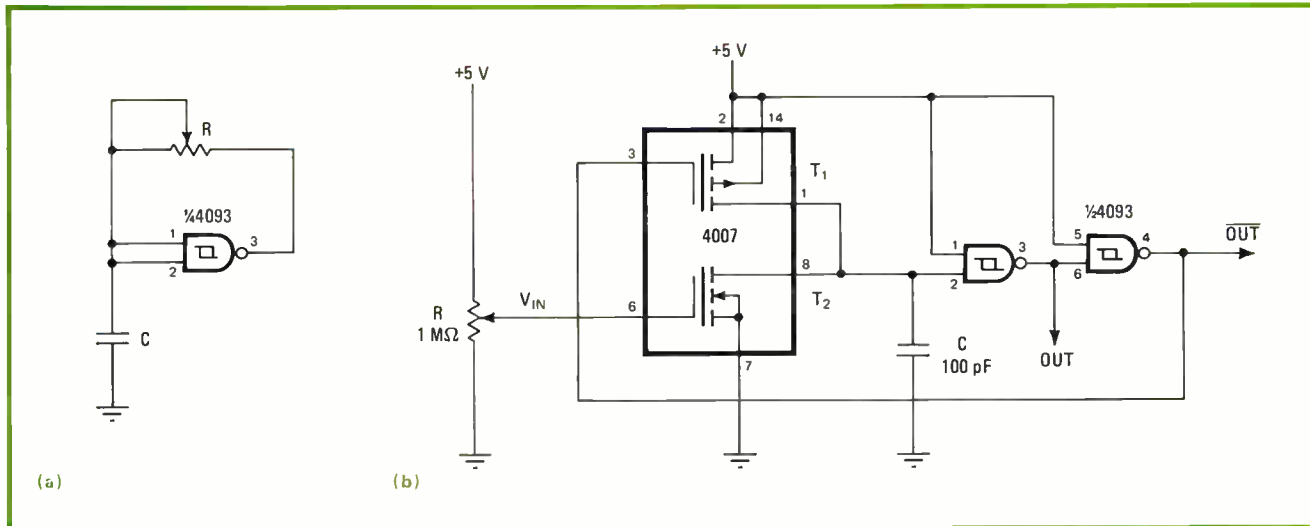

**Simple improvement.** The range of a standard Schmitt-trigger pulse generator (a) can be easily extended by adding one 4007 gate array to circuit (b). New circuit charges and discharges timing capacitor  $C$  through separate paths, enabling the circuit to generate a narrow-width pulse train (0.5 microsecond) over 0 to 1 MHz for an input voltage ranging from 0.7 to 3.4 V.

## PROM adds bootstrap loader to Intellec-8 development system

by Bernard Boulé and Simon Gagné,  
Laval University, Department of Electrical Engineering, Quebec, Canada

This three-byte bootstrap loader program will enable users of Intel's popular microcomputer-development package, Intellec-8, to immediately and automatically access the system's monitor, or executive-control routines, on power-up. The bootstrap is stored in a programmable read-only memory external to the system.

In normal operation, the Intellec's 8080 microprocessor is reset on starting up, thus clearing the system's

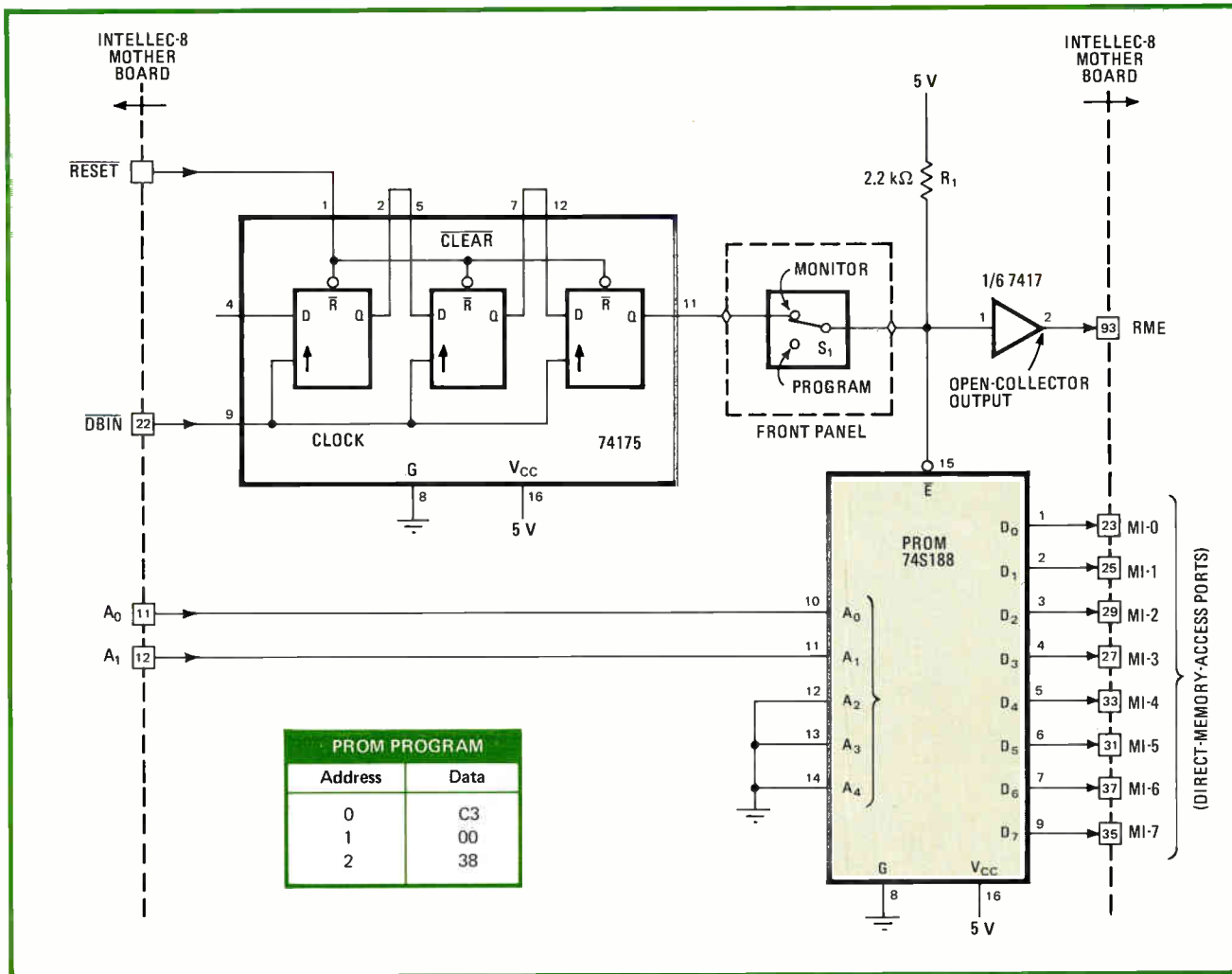

**Quick access.** Intellec-8 bootstrap loader is programmed into a programmable read-only memory, enabling the user to automatically enter a system monitor at location 3800H on power-up. The PROM's contents are dumped into the system's direct-memory-access ports on three successive data clocks (DBIN). The PROM operation in no way affects the system's random-access memories (not shown).

program counter. Program execution then proceeds from memory location 0, but the monitor is located at starting address 3800H. Therefore, to enter the monitor, a jump instruction (programmed as C3 00 98) must be written into the first three locations of the system's random-access memories starting at location 0 after each power-up. Manual programming is a bothersome task, requiring that the memory-access port be activated and that each address be entered, loaded, and then incremented as the contents of each (C3, 00, 98) are set and loaded into memory.

An easier way to enter the monitor is to program the jump instruction into a 742188 PROM and dump its contents directly into memory during power-up, as shown in the figure. Although only 3 of the 32-word-by-8-bit device's locations are used, the low cost of the PROM and the convenience afforded by the modifications overshadow the waste of the 29 unused locations. The only other consideration with this circuit is to ensure that the system's RAMs will not be disturbed in any way by the PROM.

The PROM is programmed with the data shown in the table. With  $S_1$  in the program position, the PROM's

output lines ( $D_0$ - $D_7$ ) are disabled and the PROM can be loaded. Pull-up resistor  $R_1$  ensures that the RAM memory enable (RME) line is active, so that any program loaded into RAM at address 0 can be run without interference stemming from programming the PROM.

The actual programming of the 742188 is simple and is done only once.  $A_0$  and  $A_1$  address the desired location, and after the normal supply voltage on pin 16 is brought to 10 volts, a 10-v, 65-milliampere current emanating from a constant-current source is applied to the output lines that are to be programmed to logic 1. The procedure is repeated for all locations.

$S_1$  is then placed in the monitor position. Immediately after a system reset, the three flip-flops in the three-stage 74S175 shift register and the RME line are reset. At the same time, the output of the PROM is enabled. Upon the arrival of the first three normally occurring system, or data-byte, clock pulses (DBIN), lines  $A_0$ - $A_1$  are incremented and the contents of the PROM are read into system memory. On the third pulse, the output of the shift register goes high, releasing the RME line and disabling the PROM, which remains inactive until a new reset cycle occurs.

# Analog Multiplydivide-squaresquarerootrms-to-dc-conversionagcmmodulate-demodulate function with .1% maximum nonlinearity for only \$3.75

Raytheon now has the first analog multiplier to have complete compensation for nonlinearity, the primary source of error and distortion.

The Raytheon 4200 is the first analog multiplier to have three on-board operational amplifier designed specifically for use in multiplier logging circuits. This means superior AC response in comparison to other analog multipliers.

The Raytheon 4200 is ideally suited for use in low-distortion audio modulation circuits, voltage-controlled active filters, and precision oscillators.

The 4200 is designed to multiply two input currents ( $I_1$  and  $I_2$ ) and to divide by a third input current ( $I_4$ ) yielding an output current ( $I_3$ ).

Think of the advantages to you the circuit designer. Multiple function capability, high-accuracy (0.1% maximum nonlinearity) a temperature coefficient of 0.005%/°C and a wide bandwidth of 4 MHz.

For the complete details about Raytheons' new 4200 Analog Multiplier, fill in the coupon or call Raytheon Company, Semiconductor Division, 350 Ellis Street, Mountain View, CA 94042. (415) 968-9211.

**Another first from Raytheon.**

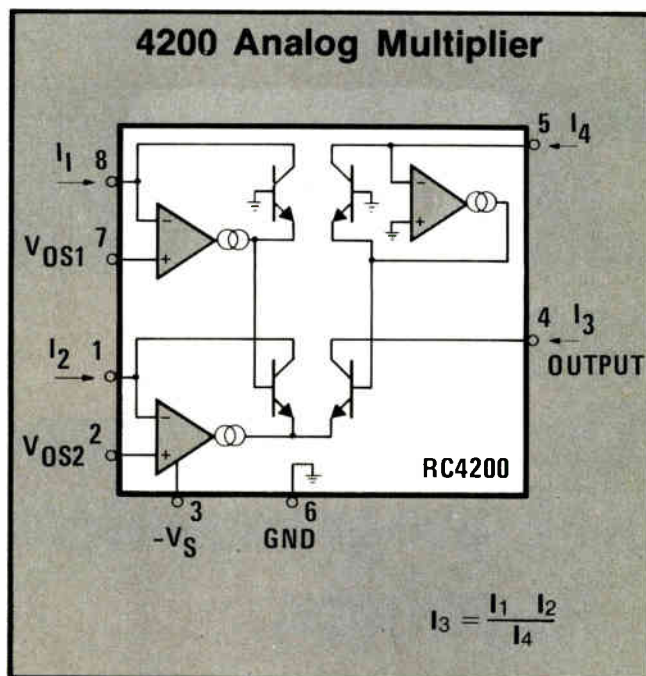

## Tell me more...

- Send me your complete 4200 data sheet.
- Send me your full product Selection Guide.

Name \_\_\_\_\_

Title \_\_\_\_\_

Company \_\_\_\_\_

Address \_\_\_\_\_

City, State, Zip Code \_\_\_\_\_

Have a salesman call, I need help ASAP! My phone number is \_\_\_\_\_

# One-chip system cuts cost of data acquisition

by Jake Buurma, National Semiconductor Inc., Santa Clara, Calif.

□ There was a time, perhaps only five years ago, when a designer needing a data-acquisition system had to settle for a bulky, multimodule one costing upwards of \$1,000. Then three years ago the first of the single-module hybrid systems brought the price crashing down to \$300 or \$400. But with the advent of the \$20 microprocessor, it was only a matter of time before large-scale integration put a data-acquisition system on a chip, too. Such a chip would slash the costs of many data-acquisition-and processing systems, especially those used in industrial instrumentation, and medical applications.

The introduction of a complete data-acquisition system on a complementary-metal-oxide-semiconductor chip, the National Semiconductor ADC0816, brings designers much closer to that still-elusive low-cost, high-performance data system. Complete with on-chip multiplexer and address decoder, the \$20 device replaces available hybrid or discrete-component data-acquisition systems costing 5 to 10 times as much.

On the 147-by-197-mil chip are most of the elements

desired in a standard data-acquisition system. Besides an expandable 16-channel analog multiplexer, there is an 8-bit successive-approximation analog-to-digital converter complete with the three-state output ports and logic control circuitry needed to interface to all standard microprocessors. True, there are no instrumentation amplifiers to boost analog multiplexer signals, and available hybrid units are twice as fast. But the cost-performance tradeoff of the ADC0186 should be seriously considered on a case-by-case basis.

## Overview

As Fig. 1 shows, the new chip duplicates the classical structure of a data-acquisition system, while relieving

**1. All on one.** Data-acquisition chip includes 8-bit d-a converter, expandable 16-channel analog multiplexer, latched address decoders, and monotonic resistor network for high-accuracy encoding of analog samples. Use of transistor-transistor-logic, three-state output latches/buffers ensures versatile driving capability.

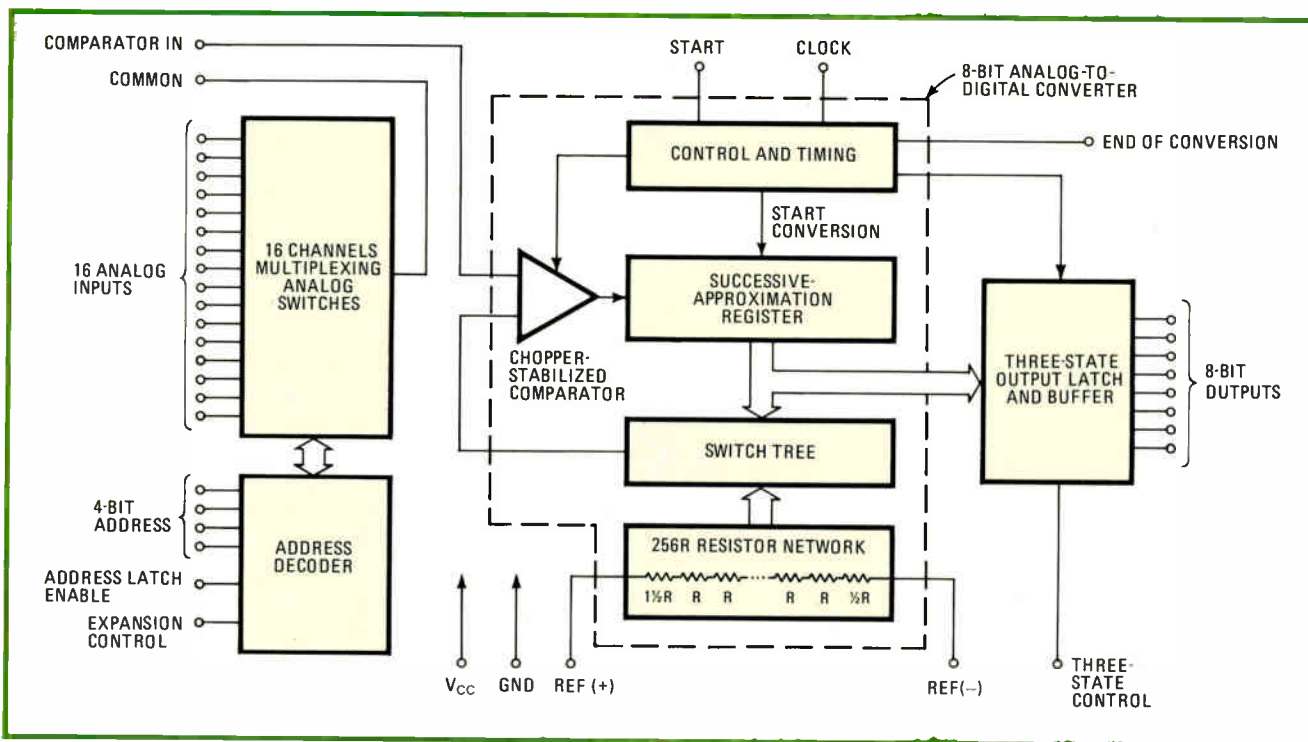



the user of a myriad of interface and device-compatibility considerations. The 40-pin device operates from a single 5-volt supply and consumes only 15 milliwatts. It owes this and other advantages as well to the C-MOS design process (see "Why C-MOS for a data-acquisition chip," p. 133). The ADC0816 performs an a-d conversion in a minimum of 50 microseconds and typically 100 microseconds for each channel. The a-d conversion

process is guaranteed to generate a monotonically increasing 8-bit code for a corresponding incremental increase in the analog-input sample. In cases where this device is used in a feedback system, the use of a monotonic output code will ensure that any potentially catastrophic oscillations that would be generated by a nonmonotonic system are reduced or entirely eliminated.

Long-term and temperature-drift errors in the ADC0816 are minimal. There is no need for zero- or full-scale adjustment. The device has an absolute accuracy (including quantizing error) of 1 least significant bit. Total unadjusted error is less than  $\frac{1}{2}$  LSB, as are the linearity, zero-scale, and full-scale errors.

### Acquiring the data

Many desirable and useful features have been incorporated into the design. The 16-channel analog multiplexer directly accesses any of 16 single-ended input signals and then either presents the signal to the comparator by way of the comparator-input port for direct conversion or else first brings the signal for additional conditioning to an external device such as a prescaler or a sample-and-hold module. Alternatively, by disabling all the multiplexer inputs, an external analog signal can be introduced into the a-d converter directly through the comparator-input port. The address-decoder latches and the three-state output latches simplify the interface between the device and the microprocessor.

A resistor-ladder network, a switch tree, a successive-approximation register, and the comparator form the analog-to-digital converter that transforms the analog-input signal into an 8-bit digital equivalent. The successive-approximation register selects several voltages from the tapped, biased-resistor network to be introduced to the input of the comparator for comparison with the analog-input signal (Fig. 2a).

The control and timing subsystem directs the operation of the register, which performs eight iterations each sampling cycle to determine if a selected ladder voltage equals that of the analog input voltage. If it does, the register's contents are frozen and transferred to the output latch either when or just before the next sample is coded. Essentially, a logic 0 is stored in the appropriate bit of the register if after a given iteration the voltage from the output of the ladder is below that of the analog voltage. A logic 1 is stored when the voltage from the ladder exceeds that of the analog voltage.

The successive-approximation register is reset on the positive edge of the start-conversion pulse. Continuous conversion may be accomplished by tying the end-of-conversion output to this pulse.

Although the conventional R2R ladder network occupies less chip space, a 256R network was selected, since otherwise the output code might not be monotonic. In addition, the 256R network does not impose a varying load on the reference voltage. Actually, of the 256 resistors existing in the network, 254 have the same value (R), while the end-point resistors are equal to  $1\frac{1}{2}R$  and  $\frac{1}{2}R$ , to ensure that the system's output characteristic is symmetrical with the zero and full-scale points of its input-to-output, or transfer, curve.

Figure 2b and 2c illustrates the advantages of using

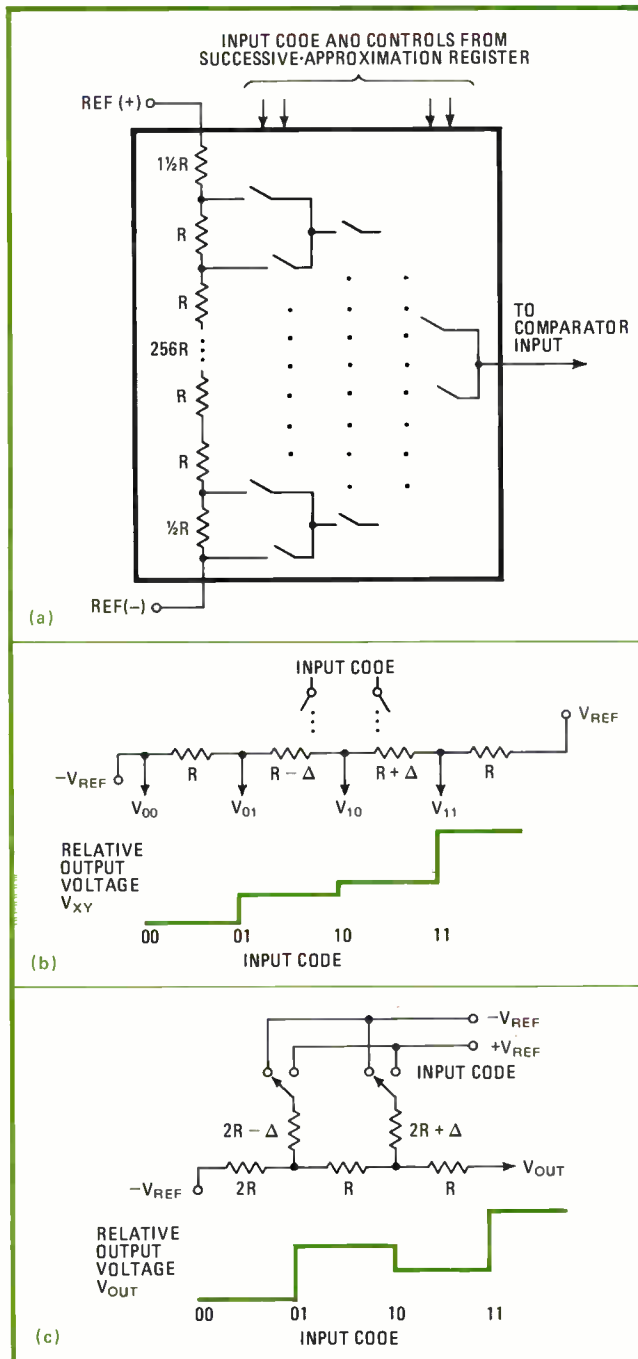

**2. Monotonic ladder.** Use of 256R network with successive-approximation switch tree (a) ensures stable, high data-coding accuracy in a-d converter. Advancing input code generates increasing voltage from taps (b), a requirement if oscillations are to be avoided in many closed-loop system applications. However, monotonicity of output voltage is not guaranteed when an R2R network is used (c).

## Why C-MOS for a data-acquisition chip

To achieve both its low price and much of its versatility, the ADC0816 data-acquisition chip makes unusual use of C-MOS technology. For one thing, it uses a butted-guard, metal-gate version of the standard process to improve chip density. For another, it turns the parasitic structures inherent in C-MOS circuits to advantage. It also exploits the ease with which C-MOS yields high-quality capacitors.

The butted-guard process pulls the guard bands—the regions separating adjacent structures on the chip—closer together so as to squeeze more elements into a given area. As usual, there is a tradeoff. The increase in chip density reduces the breakdown voltage between neighboring elements, so that the operating voltage has to be reduced and, along with it, overall device speed. To compensate, the gates in the digital portion of the data-acquisition system have been designed for a lower threshold voltage than standard C-MOS gates—0.6 volt as against 1.2 V—so that reasonably high a-d conversion

times of 50 to 100 microseconds can be attained with a low-voltage power source.

The parasitic structures also, as it happens, help the system run fast and accurately off a supply of just 5 V. One turns up as a bipolar npn transistor in a charge pump for the converter's resistor ladder, which at a crucial point in the circuit's operation boosts the internal voltage to 8 V for good linearity and performance. (The entire chip system, being C-MOS, consumes only 15 milliwatts.)

Monolithic a-d converters frequently make use of external capacitors. But the two capacitors needed by the ADC0816 are on chip. One is in the charge pump, and the other is in the chopper-stabilized comparator.

Finally, diffused resistive elements for the ladder network eliminate the need for depositing thin film and laser-trimming it. Although such elements are not unique to C-MOS technology, they do help keep the processing costs of this converter low.

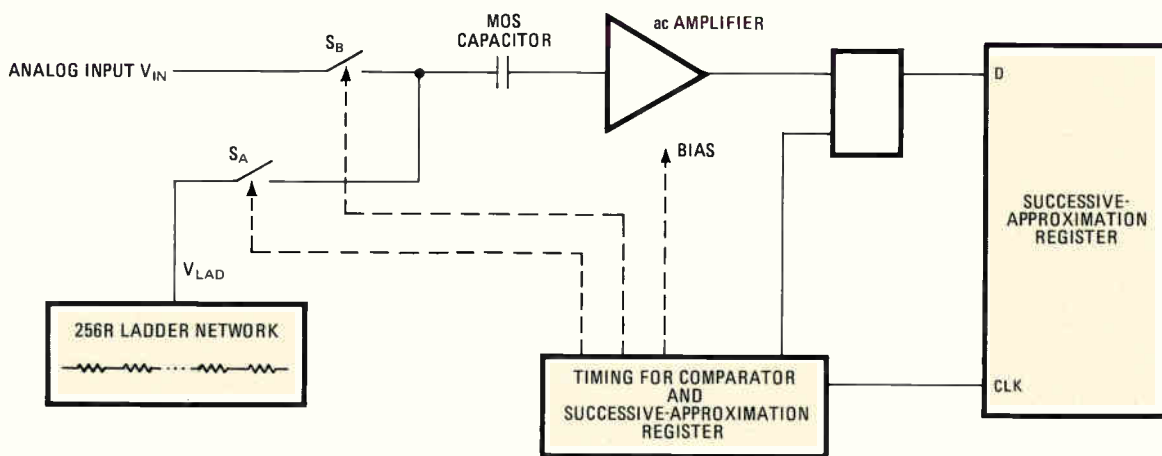

such a network. For simplicity, a two-variable ( $N = 2$ ) network is shown for both the  $2^N R$  and the  $R2R$  ladders. With a  $2^N R$  (monotonic) ladder, it is seen that an increase in the input code number (expressed in binary form) ensures an increase in the output voltage, because the reference voltages are applied across the entire ladder. In the worst case, any small variations in the value of each  $R$  will cause a nonuniform voltage-step increase in the transfer curve. In the  $R2R$  network, however, the unequal resistance values may cause a sign change in the transfer curve, causing a nonmonotonic response, because of the way in which the input code and supply voltages are applied.

### Chopper-stabilized comparator

The most important section of the a-d converter is the comparator, since it is the comparator's offset voltage and stability that determine the converter's ultimate accuracy and the comparator's drift that has a first-order influence on its precision. The low-voltage-offset, chopper-stabilized comparator of this converter op-

**3. Stability.** Low-offset, chopper-stabilized comparator reduces drift and minimizes temperature-dependent errors. Internal oscillator and counters switch in elements of  $2^N R$  ladder and provide timing for comparator circuit, enabling successive-approximation register to store 8-bit equivalent of  $V_{in}$  with minimum error.

timizes performance by minimizing temperature-dependent and input-offset errors as well as drift.

Chopper-stabilized comparator operation may be visualized with the aid of Fig. 3. At the beginning of a comparison cycle, switch A is closed, and the alternating-current amplifier is biased in its linear region. A voltage from the ladder network passes via the switch tree (not shown) through the switch to the input of the amplifier. As switch A is opened and switch B is closed, the bias signal is removed, and  $V_{in}$  is introduced to the high-gain amplifier. The dc voltage at the input to the amplifier becomes  $V_{in} - V_{lad}$ , and the small voltage change produced saturates the amplifier to the positive supply rail for a positive voltage difference or the negative rail for a negative difference.

The output of the amplifier, in essence a 0 or 1, is then

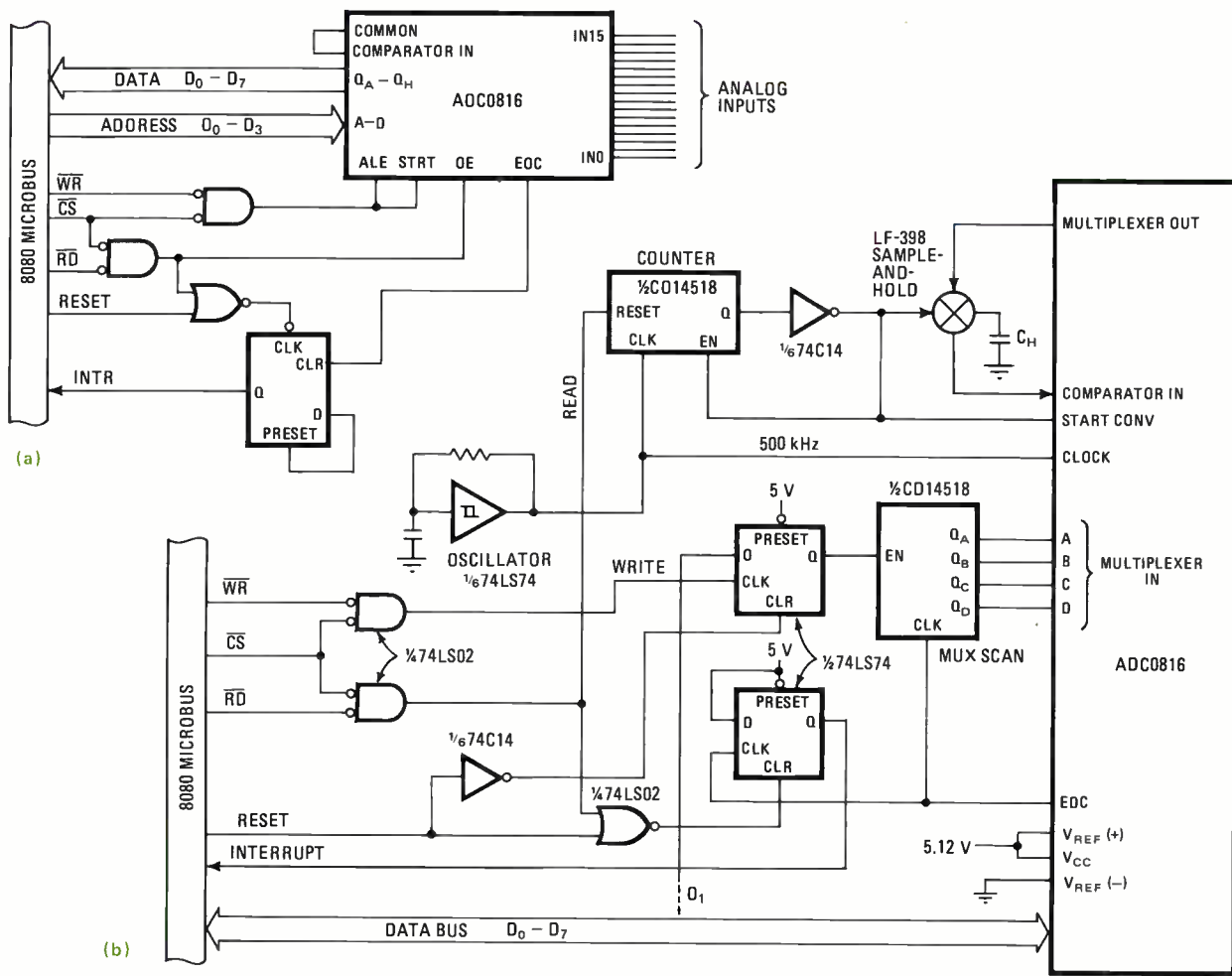

**5. Applications.** Basic interface for coding a single channel requires three gates and a flip-flop (a). For sequential sampling of all 16 channels (i.e., multiplexing), more gating is needed, but the interface is still relatively simple and inexpensive (b).

plexer scans all 16 channels. The sample-and-hold module is controlled by half of a 4-bit up counter. A clock frequency of 500 kilohertz samples each channel for 16 μs and stores the analog voltage on the hold capacitor, C<sub>H</sub>, during the conversion. The interrupt flip-flop is set when the conversion is completed. The multiplexer's scan counter is then incremented with a single read instruction so that the next analog channel can be processed. The same instruction simultaneously services the interrupt and starts the next conversion.

The ADC0816 can also be used in ratiometric-conversion applications (Fig. 6) with ratio-type transducers like potentiometers. Here, this converter's big advantage is that its input voltage can be made equal to its supply voltage. As a result, a transducer powered by the same voltage can be linked directly to the multiplexer input.

In ratiometric measurement, the input data is represented as a proportion of the full-scale value, so that it is unnecessary to maintain a precision reference voltage in order to measure output voltage accurately. But many other types of measurement must be referred to an absolute standard of voltage or current. In these cases, a standard voltage reference must be provided. With one of 5.12 v made equal to the supply voltage, an error of a 1 least significant bit amounts to an analog coding error of 5.12/256 = 20 millivolts. □

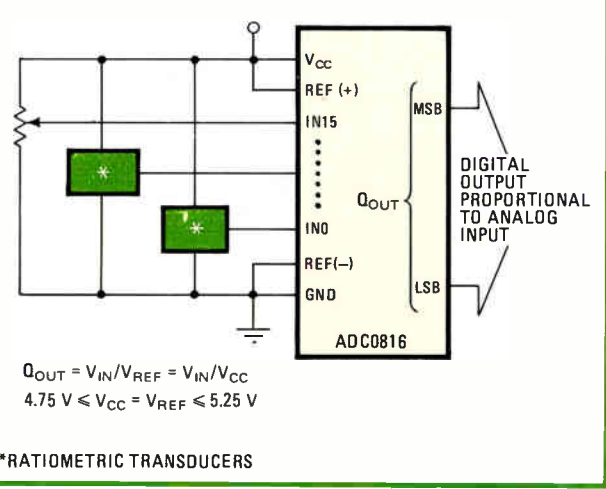

**6. Ratiometric conversion.** ADC0816 can perform ratiometric measurements easily. Potentiometers, strain and pressure gauges, and thermistor bridges are suitable for use as ratiometric transducers. A major advantage of this data-acquisition system is that the input voltage maximum can be made equal to the supply voltage.

**MAKE YOUR DECWRITER CUT DOWN ON ITS PHONE BILLS.**

There's a new electronic send/receive buffer for DECwriter II's and III's. Easier than magnetic or paper tape, it's perfectly suited to your off-line editing needs. And best of all it's a real money saver, often paying for itself in as little as four months on reduced phone line charges alone. Available for all DECwriter II's and III's, old or new. Check the coupon.



**DESIGN YOUR OWN INTERFACE WITH A DIGITAL CHIPKIT.**

Take some LSI chips, package them with a wire wrappable board and an interface cable and you've got a "Digital Chipkit" for the do-it-yourself interfacer. Two types available — one called *Program Control Bus Interface*, and the other titled *Direct Memory Access Bus Interface*. For complete information, check the box.

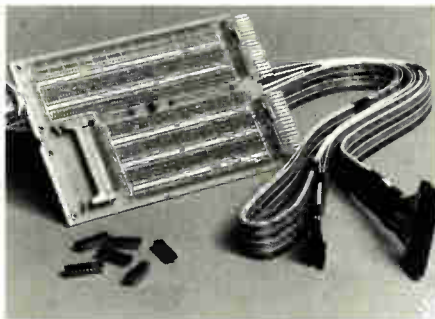

**NEED SUPPLIES? CALL US COLLECT. AND CHARGE IT!**

Here's a better way to order your disk packs, cartridges, floppies, ribbons, paper, ink, cleaning fluid, tapes, canisters, filters, and all your Digital supplies. It's the new SOS HOTLINE. A supply line with a phone number you can call and place an order up to \$2,000. You can



even use your American Express or Master Charge. Delivery in 48 hours. Check the coupon and find out more. Or give it a try. Dial (800) 258-1710. In New Hampshire 884-5718.

**SPRING SALE ON MEMORIES.**

Digital memory, with Digital quality, Digital reliability, and Digital compatibility, is ready for immediate delivery now! And at lower prices than ever before. But hurry. Sale ends May 26, 1978. Check the box.



Digital Equipment Corporation, Maynard, MA 01754. European headquarters: 12, av. des Morgines, 1213 Petit-Lancy/Geneva. In Canada, Digital Equipment of Canada, Ltd.

**digital**

(PRICES APPLY IN U.S. ONLY.)

Tell me more about:  Direct Sales Catalog and Supplement E4-278  
 Digital Memory Sale  Digital Supplies  Writable Control Store Option  
 Spares Sale  DECwriter Buffer  Chipkit

Name \_\_\_\_\_ Title \_\_\_\_\_

Address \_\_\_\_\_

Company \_\_\_\_\_

City \_\_\_\_\_ State \_\_\_\_\_ Zip \_\_\_\_\_

Mail to: Digital Equipment Corporation, 129 Parker St. (PK3-2/M18), Maynard, MA 01754.

# Linear IC automatically focuses camera lens

By comparing a fixed and a moving image on two photodetectors, focusing system based on an optolinear chip recognizes best match and produces a signal that is used to set a range-finder camera lens

by Lavon K. Cooper, David E. Fulkerson, and Norman L. Stauffer, *Honeywell Inc., Minneapolis, Minn.*

□ Electronics has become well established in cameras for shutter operation. Focusing has presented more of a problem, though. Not only is the camera expected to function at dim light, but in addition, the electronic controls operating the lens setting must work with very small photocurrents even in bright light.

In fact, the automatic-focusing system developed by

Honeywell Inc. for range-finder cameras took more than a decade to perfect. In large part, the eventual availability of sophisticated linear components was the key to making this autofocus module, called Visitronic, practical.

Visitronic views a subject optically under the control of a rather large linear integrated circuit. The output of the IC is connected to a control device that mechanically focuses the camera lens, either in the moment before the shutter opens in a still camera or continuously in a motion-picture or television camera.

In a conventional range-finder camera, the optical system produces two images of the subject, slightly displaced. Adjusting the lens over a range from a near distance to infinity involves moving a mirror so that when the two images are exactly superimposed, the subject or scene is in focus. This basic triangulation concept is common to all passive range-finding systems

**1. In the picture.** To focus a conventional range-finder camera, an optical-beam splitter (a) splits the image and a movable mirror linked to the lens is adjusted until the images coincide. The autofocus system (b) uses two mirrors to reflect two images onto two photo-sensor arrays. An IC establishes when the two images are matched and creates a correlation signal to control focusing.

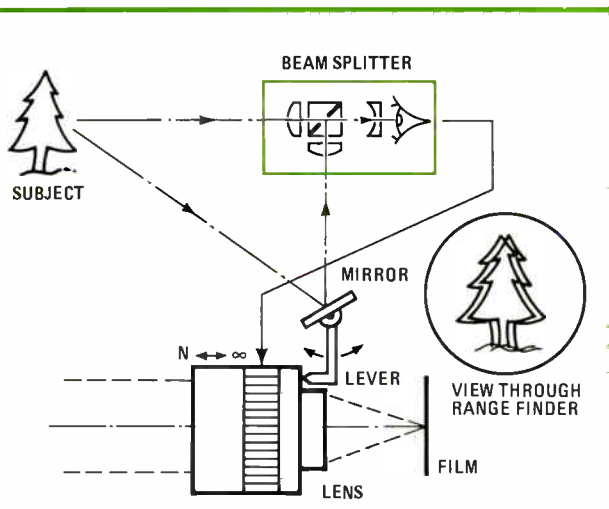

(a)

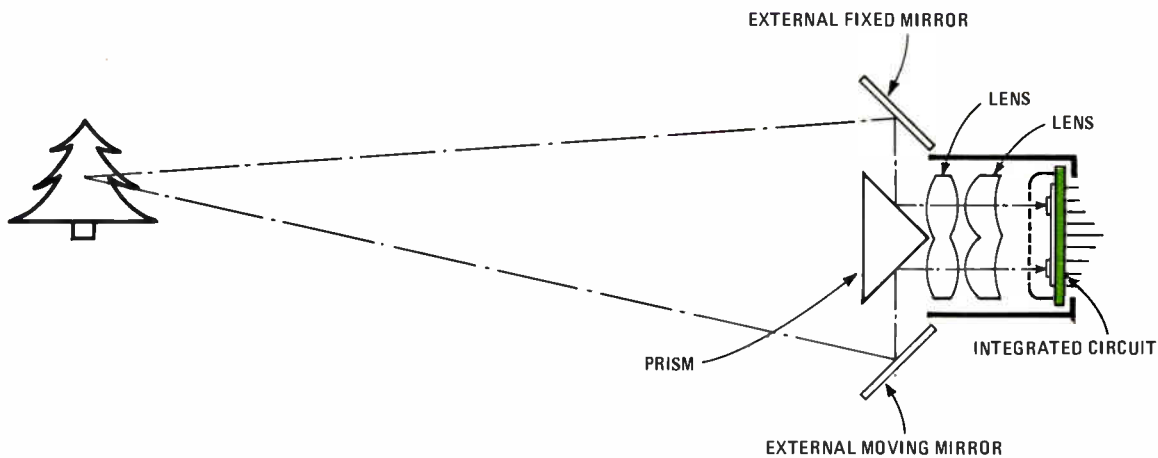

(b)

necessary to avoid algebraic cancellation during summing when different segment pairs have a mismatch in opposite directions.

The images are broken into segments by using four smaller photosensors in each detector array instead of one large one. A pair of corresponding photosensors, one from each array, and their associated comparison circuitry make up a "photo channel," and since each detector has four sensors, there are a total of four photo channels in all.

The comparison circuits are placed at the center of the chip. Other circuits—sum amplifier, reference voltage, voltage regulator, output, and peak detector—are located along the edge (Fig. 2). The two critical requirements that dominated this arrangement were enhancement of component matching and minimization of crosstalk between circuits.

The Visitronic integrated circuit is packaged in a module that includes two sophisticated plastic lenses to produce the images on the photodetectors. In addition, a prism above the lenses reflects the images entering on opposite sides of the module, as indicated in Fig. 1b.

A TO-8 can with a glass window on top, the module (Fig. 3) has a field of view of approximately 10° vertically by 10° horizontally, which is significantly less than the field of view of most camera lenses. Therefore, the Visitronic's detectors see a central area of the complete scene to be photographed. Whatever portion of the subject is inside that area will be in sharpest focus, and the photographer can center within the area the object he wants to have in focus.

External mirrors are needed to complete the optical system. These mirrors may be placed at different distances from the module in order to produce the required accuracy for a particular camera. Proportionately greater accuracy is achieved as this optical base is made larger. For example, a system with a 60-millimeter base would give 50% greater accuracy than an otherwise identical system with a 40-mm base.

The Visitronic unit has been designed for optimum performance with typical photographic subjects—which are not necessarily the professional photographer's subjects—and to operate under a wide range of lighting conditions that a typical camera user is likely to encounter. Further, the system response was selected at a relatively low spatial frequency so that it can react to even poorly defined subjects, like clouds and shadows, which would be difficult to focus on manually.

**Highest peak**

Often, as the scanning mirror moves through the focusing range, the module will see several peaks in the correlation signal caused by brightness patterns similar to the subject. The system, however, is set up to respond only to the highest peak.

As can be seen in Fig. 4, an output signal occurs at the first peak, and additional signals occur at each subsequent peak that is larger than the previous one (in this case, there is only one larger one). Thus, the control system takes the last signal, which represents the mirror angle corresponding to the maximum peak, to set the camera lens accurately.

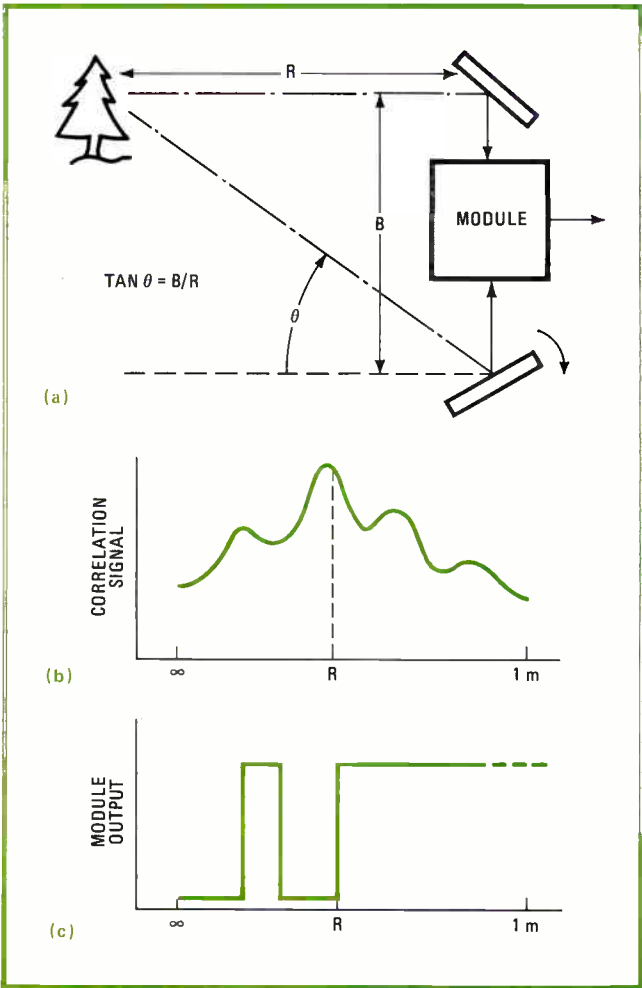

**4. Module in action.** As the scanning mirror moves through the range from infinity to a near distance (a), similar brightness patterns may produce peaks in the correlation signal. The IC will produce a positive transition for all increasingly higher peaks until it reaches the highest peak correlation, which is the best focus (b, c).

Figure 5a shows how the Visitronic unit could be designed into a still camera, complete with mirrors, control electronics, and lens driver. Also shown is a typical output transition curve (Fig. 5b) with one minor peak having occurred in the correlation signal before the maximum peak (as in Fig. 4).

Note that the control electronics takes the module's output and samples an increasing ramp voltage so as to produce a signal that bears a reciprocal relationship to subject distance, as shown in the second graph (Fig. 5c). Because of this relationship, it is important that the scanning mirror move at a uniform angular velocity to ensure a correct proportional relationship between the ramp voltage and the mirror.

The output voltage from the control circuitry determines the lens position. One way to effect control is to apply the output voltage to a solenoid (as in Fig. 5) to extend the lens from its infinity focus position by an amount proportional to the control voltage. This type of arrangement, however, would be applicable only to a camera demanding moderate accuracy and cost.

Focusing accuracy also depends on how accurately the

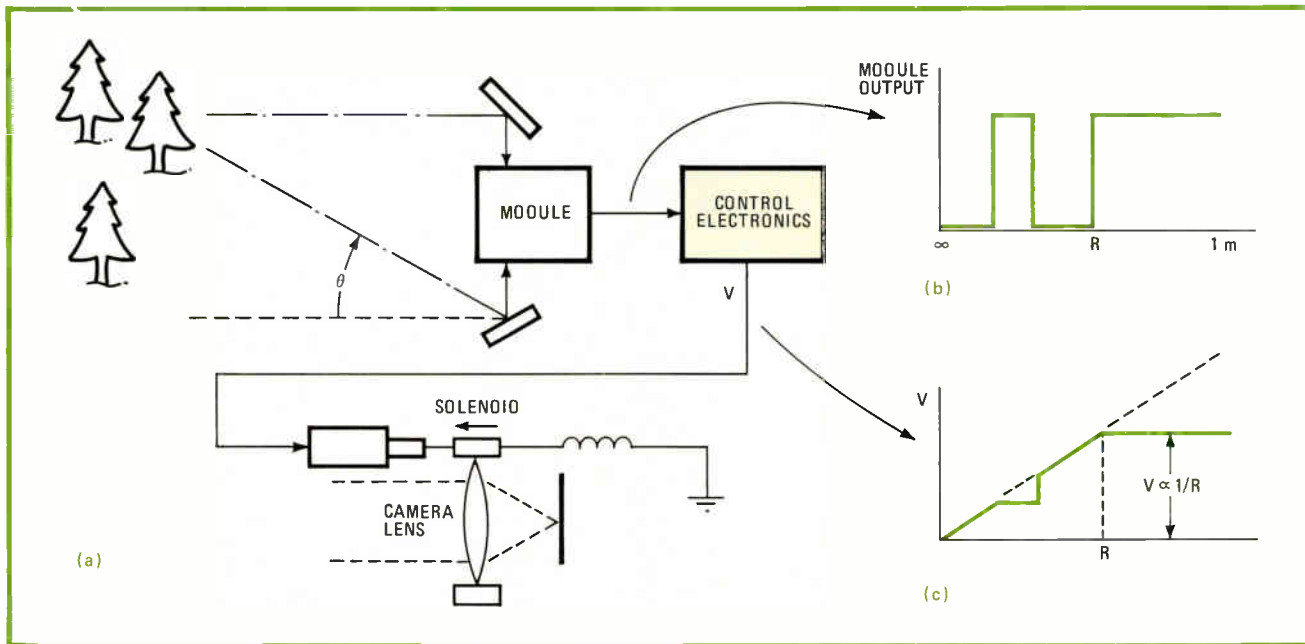

**5. Camera setup.** Top graph (b) shows the correlation signal that goes to the control electronics in one possible application of autofocus system. The controller takes the module's output signal and samples an increasing ramp voltage (c) so that an output voltage is produced that bears a reciprocal relationship to target distance. This voltage is applied to a solenoid to drive the lens (a).

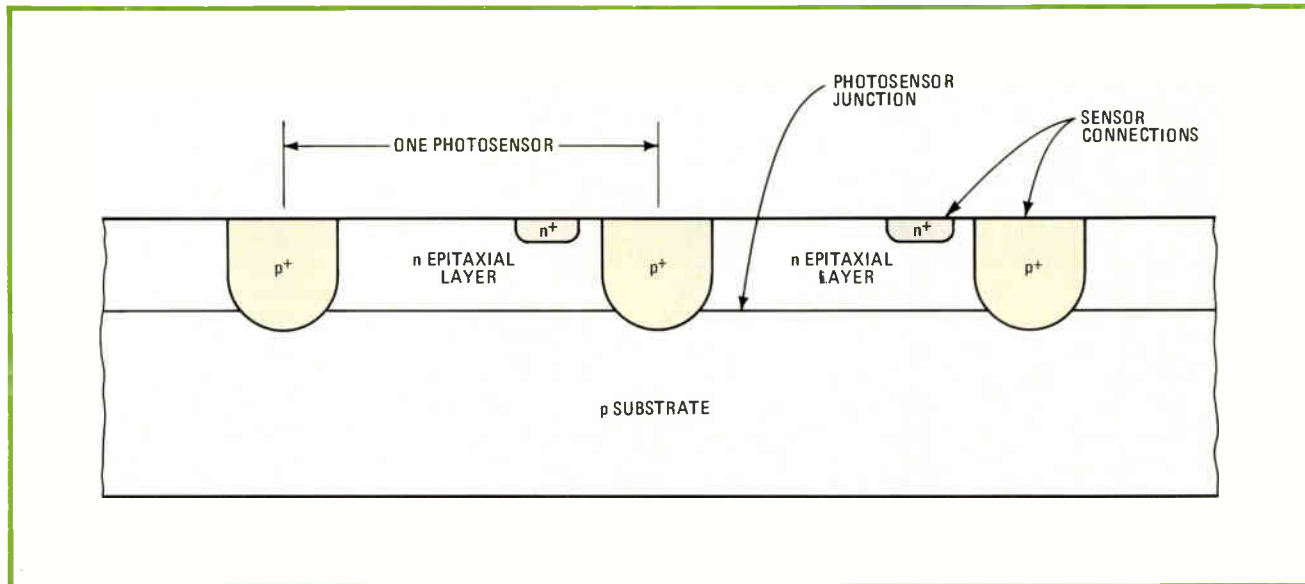

**6. Sensor makeup.** The photosensors, operated in the current mode with a slight back bias, are integrated photodiode structures, each an isolated epitaxial-layer-to-substrate junction area. This arrangement requires only the isolation ring to define the detector area. Connections are made to the cathode through a small  $n^+$  diffused area and to the anode through the isolation diffusion.

circuitry in the IC makes the comparison of incoming light. The comparison circuitry in each of the four photo channels includes bias voltage regulation for the photosensors, logarithmic photocurrent-to-voltage converters, a differential amplifier, and an absolute-value function.

For accurate focusing under normal conditions, the component characteristics must be matched over a light input range of several decades, a temperature range of  $60^\circ\text{C}$ , and a supply voltage range of several volts. (Match enhancement helped determine the IC layout, as mentioned earlier.) Further, power consumption must be low enough for the unit to operate off battery supplies.

The photosensors are junction photodiodes operated in the current mode with a slight back bias, as described below. They are integrated structures, each being an isolated epitaxial-layer-to-substrate junction area (Fig. 6). This arrangement requires only the isolation ring to define the detector area, and connections are made to the cathode through a small  $n^+$  diffused area and to the anode through the isolation diffusion.

Because the photocurrent is only a few nanoamperes at the lowest light level, the sensors and comparison circuitry had to meet many extreme requirements besides tight matching. The detectors must have low

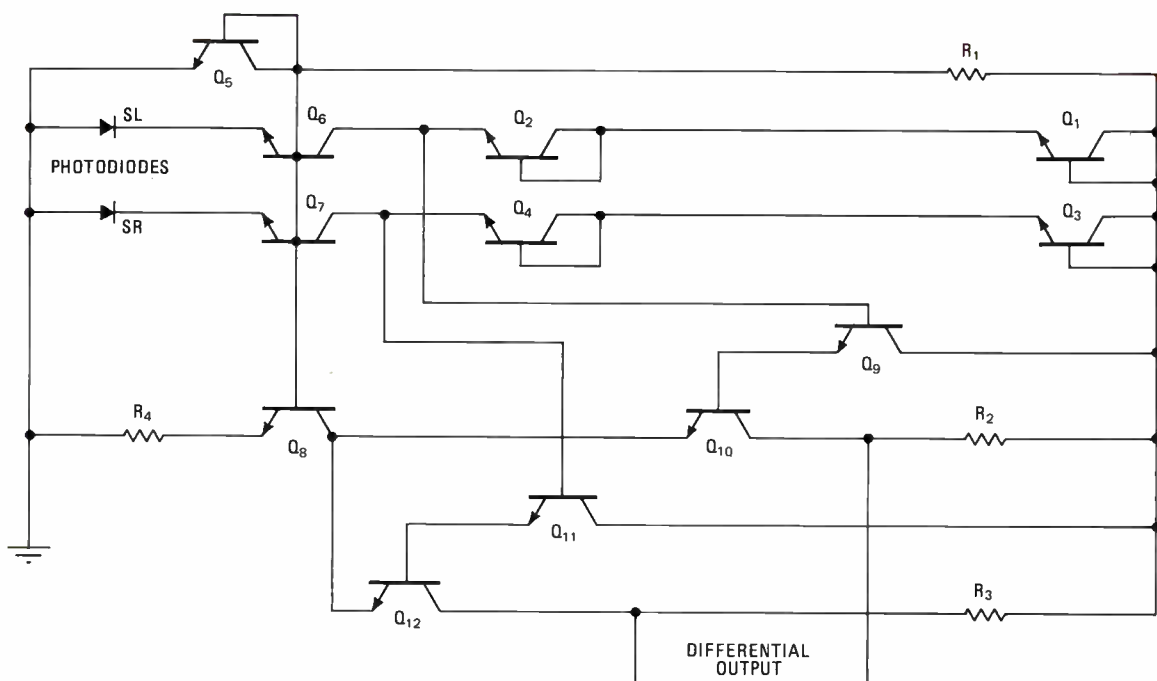

**7. Stopping leakage.** Since leakage would attenuate the comparison signals, it is important to design the photo channel's front-end circuit so as to protect the sensors. A slight back bias is maintained across the detectors established by transistors  $Q_6$  and  $Q_7$ , which are biased by  $Q_5$ .

leakage currents, because leakage would attenuate the comparison signals and would not necessarily be balanced, especially at high temperatures. Also, the input impedance of the comparison circuits must be several gigohms to avoid loading the detectors.

These requirements have been met by the front-end circuit (Fig. 7) that is part of each photo channel. As stated earlier, the channel includes two photosensors, that is, photodiodes (labeled SL and SR), one from each array. The slight back bias, which is maintained across the detectors in order to minimize leakage current, is established by transistors  $Q_6$  and  $Q_7$ , which are in turn biased by transistor  $Q_5$  wired as a diode. The emitter currents of  $Q_6$  and  $Q_7$  consist of photocurrents and sensor leakage that are one to four decades down from the  $Q_5$  diode current, depending on the input light level, causing a reverse bias of 60 to 240 millivolts across the sensors. As a result, the bias regulation arrangement puts a tight alpha-matching requirement on  $Q_6$  and  $Q_7$ , which operate with collector currents at the nanoampere level.

The collector currents of  $Q_6$  and  $Q_7$  (approximately equal to the photocurrents) are converted to voltage signals proportional to the log of the photocurrents by passing each through a string of diodes. Only single diodes are necessary to get the log conversion, but multiple diodes provide a voltage gain as well. The log conversion gives the necessary signal compression to enable operation over several decades of light intensity.

Additional voltage gain is then obtained in differential amplifier  $Q_9$ - $Q_{12}$ . The low emitter bias current, controlled by the current source formed by  $Q_8$  and  $Q_5$ , along with the large current gain of the Darlington pairs,

results in an input bias current much less than 1 nA. The four transistors used in the Darlington pairs have tight beta- and  $V_{BE}$ -matching requirements, and the collector resistors must also be closely matched.

The differential-amplifier outputs are passed through individual emitter followers for impedance conversion before going into the absolute-value circuits. The absolute value is created in a dual emitter follower in which the two emitter-follower transistors share a common emitter resistor. The channel output voltage is maximum at balanced light conditions.

Next, the individual channel outputs are summed in a standard noninverting operational amplifier to get the correlation, or overall scene-match, signal. As stated before, the correlation signal rises as overall scene matching improves and falls as scene matching decays.

The problem here is to respond to the maximum peak, or best focus. The peak detector is another op amp that makes a continuous comparison between the present level of the correlation signal and its previous highest value, which is stored on a capacitor. The peak detector's output then is high except when the correlation signal falls below the stored voltage.

The Visitronic system can be used with a single scan from some near distance to infinity (or the reverse) or with a double scan from a near distance to infinity and back (or the reverse). In single-scan systems, the last peak detected is the best focus. In double-scan systems, the first scan causes the amplitude of the highest peak to be stored on the capacitor and the best focusing point is where the first peak is found during the return scan. A scan-direction switch gives a logic signal that allows usage of the IC output only during the return scan. □



# A new high in temperature handling capability that removes traditional design restrictions . . . adds a 25°C reliability factor . . . minimizes the possibility of thermal runaway.

Until now, only the temperature limited Schottky has kept switching power supplies from operating at high ambients, and gaining a big increase in power ratings.

Now, International Rectifier's "830 Process" removes the heat related design restrictions of yesterday. You can add a 25°C reliability "guard band" to existing designs now using 150°C rated devices. In new designs, heat sinks can be smaller or current ratings can be higher. Take your choice.

## Industry's highest junction temperature rating

New 175°C junction temperature Schottkys are the product of IR's new "830 Process", which produces a junction temperature capability 25°C higher than any other devices available (Figure A). At a given case temperature, you'll get more current and full rated voltage, or conversely, more reliability.

## A five-fold decrease in reverse current leakage

As plotted in comparison to other available types in Figure B at left, IR "830" Schottkys exhibit a five-fold improvement in reverse leakage at given junction temperatures. Note the maximum leakage of 50ma versus 250ma for competitive devices at 45V and 125°C. With lower leakage you can design for higher

temperature operation . . . with a significant reduction in the possibility of thermal runaway.

## No voltage derating vs. case temperature

Because of high leakage, it has been necessary in the past to derate voltage as case temperature increased. Not now. The "830 Process" junction carries rated voltage out to 175°C. The design advantages are obvious. See Figure C.

## 20% guaranteed transient voltage capability

Most manufacturers do not publish transient voltage ratings let alone guarantee them. The new "830 Process" 45V devices are guaranteed to withstand 20% repetitive transients, or 54V, without failure.

Contact your local IR Field Sales Office or Distributor, or contact us directly for complete data and test samples. "830 Process" Schottkys are a major development that you have probably been waiting for. They're here!

# International Rectifier

. . . the innovative semiconductor people



The rumors are true.

**TERADYNE  
HAS A NEW  
LSI BOARD  
TEST  
SYSTEM.**

# AND IT'S LOADED.

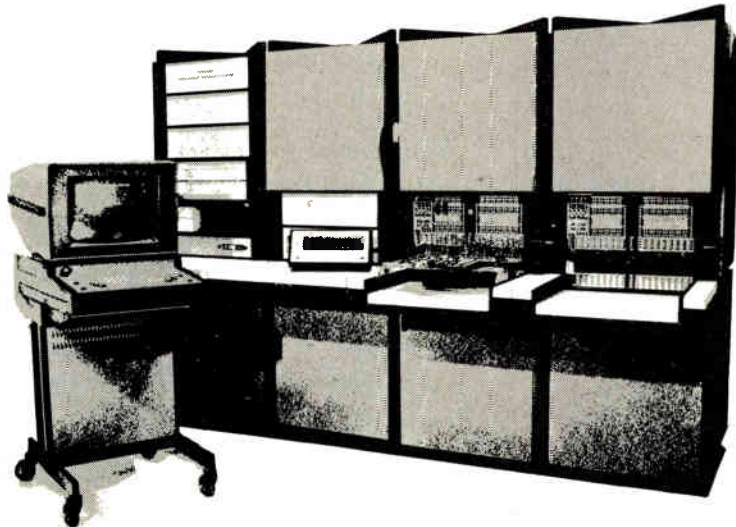

Maybe you've heard whisperings about a new LSI Board Test System from Teradyne. One with all the capability that today's circuit boards demand. One with the speed and capacity to handle virtually any board, no matter how complex.

If that's what you heard, you heard right.

The system is called the L135. How does it meet the challenge of LSI board testing? Head-on, with sheer power.

The power of 5-MHz test rates to run fast LSI boards at their normal operating speeds.

The power of 444 channels to handle the most complex circuits without compromise.

The power of an "electronic knife" to diagnose bus-line faults right to the bad device — for *all* IC logic families.

The power of automatic programming, with computer models of many popular LSI devices for use with the P400 Automatic Programming System.

The power of integrated analog capability to cope with the growing challenge of hybrid LSI boards.

The power of automatic probing, to maximize throughput in high-volume applications.

All this comes in a system that is Teradyne to the core. That means it is designed and built for hard, industrial use. It means Teradyne's standard 10-year warranty, locked-in no-calibration performance, telephone trouble-shooting assistance, programming and maintenance training, world-wide spare-parts stocking, and much, much more.

The L135. The most powerful LSI Board Test System you can buy. From Teradyne. Pass it along.

## TERADYNE

183 Essex Street, Boston, Mass. 02111

## Low-level-light detector checks optical cables fast

by Edward W. Rummel  
A. B. Dick Co., Chicago, Ill.

A standard phototransistor and a quad operational amplifier can be used as a total-energy detector of pulsed-light signals that propagate through fiber-optic communications systems. Such a circuit is especially useful for checking and comparing the condition of long fibers when the light intensity at the source is kept constant. Alternatively, it may detect changes in light intensity or pulse widths with a given fiber.

Current from the Fairchild FPT130B phototransistor drives  $A_1$ , a bipolar-field-effect-transistor op amp that serves as a current-to-voltage converter with an extremely high input impedance (see figure). The phototransistor has high sensitivity and a low dark current—only 10 nanoamperes flows for zero radiant-input flux. It has been given a flat lens to facilitate the addition of

fiber-optic couplers, spectral band-pass filters, and so on.

This input configuration enables the circuit to give a linear response to light levels ranging from 100 to 10,000 ergs per square centimeter, provided each pulse in a given train has a width of no less than 10 microseconds. The phototransistor's low parasitic capacitances contribute to the high response speed of the circuit. The low input bias current (0.4 nanoampere) and high slew rate (3.5 volts per microsecond) of  $A_1$  and subsequent bi-FET amplifiers also contribute to the speed and accuracy. The 100-kilohm trimming resistor at the output of  $A_1$  is provided to eliminate the variations in sensitivity caused by the 2:1 gain spread of the combination of the phototransistor and the optical components.

$A_2$  is a standard RC integrator that produces a voltage directly proportional to the total light energy received. As both  $A_1$  and  $A_2$  operate in the inverting mode and are on the same bi-FET chip, offset voltages appearing at the output of  $A_1$  are virtually canceled by the input offset voltage of  $A_2$ . The cascade connection of  $A_1$  and  $A_2$  shown also allows a high degree of freedom in the choice of source voltages for the circuit.

The low input-bias current of the bi-FET amplifiers makes it feasible to use low-value, and hence low-cost,

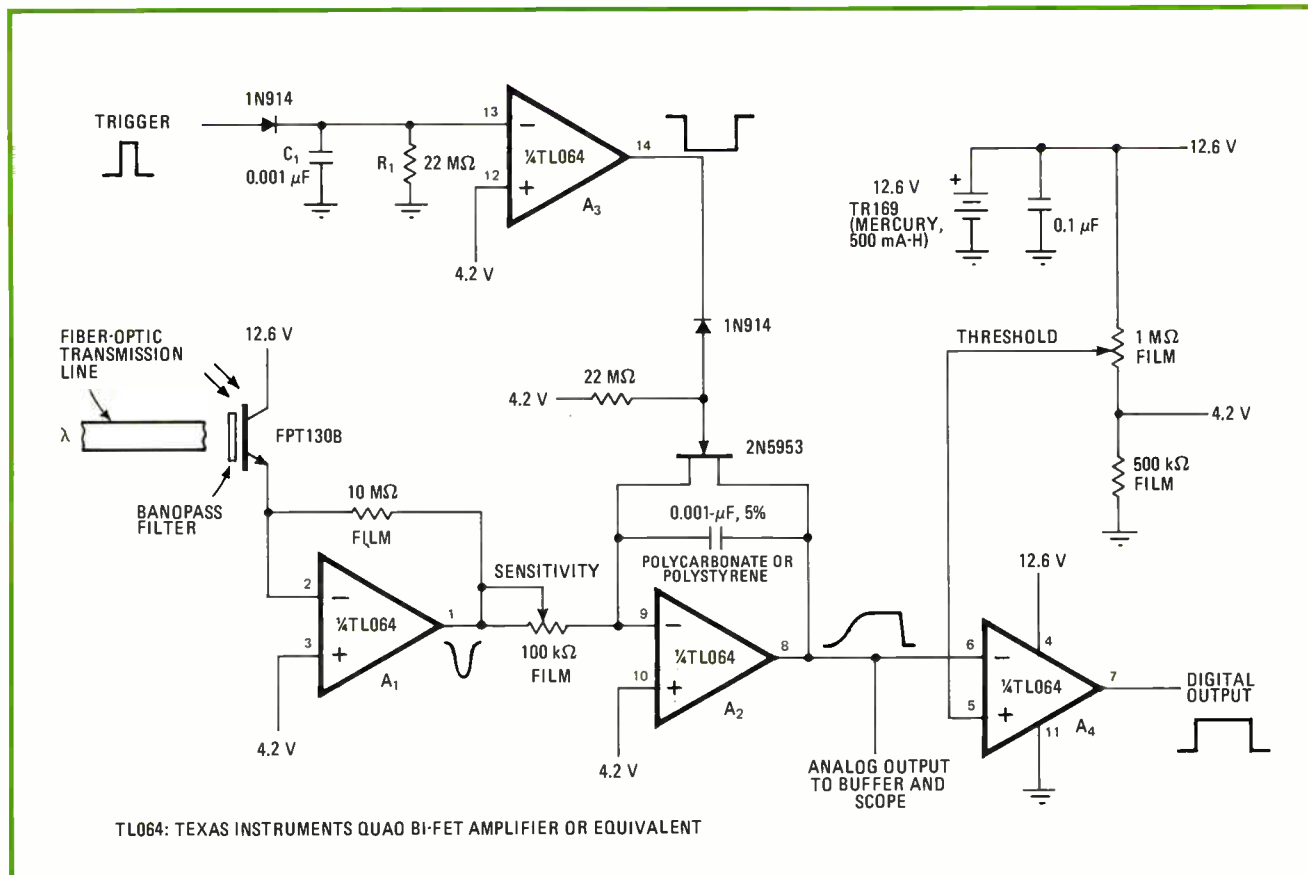

**Light monitor.** Phototransistor and bi-FET op amps form \$5 light detector useful for checking optical communications systems. Circuit responds linearly to light levels in the range of 100 to 10,000 erg/cm<sup>2</sup>. Circuit runs for 500 hours from a 12.6-V mercury battery.

# OUR SCHOTTKY RECTIFIERS WOULD STILL BE THE BEST BUY EVEN IF THEY WEREN'T THE BEST PRICED.

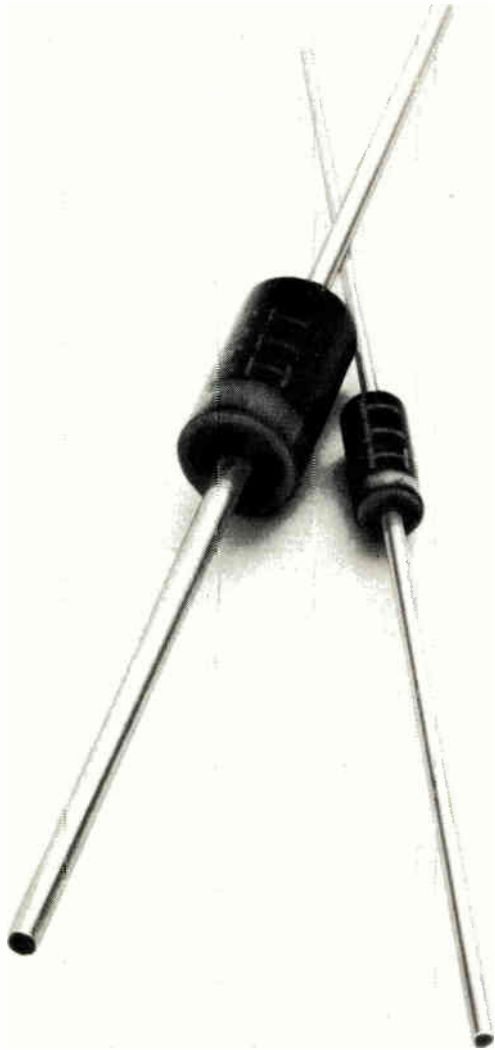

But they are. In fact, our Axial Leaded Schottky Rectifiers are priced as low as 92¢ in hundreds (Model ITS 5818). And when you combine the price with ITT's superior technology, they clearly become the best buy on the market.

You get epitaxial construction for higher operating efficiency. Oxide passivation. Metal overlap contact system for improved reverse characteristics. A guard ring protected barrier for superior reverse power surge capability. Lower high temperature leakage. An inherently low forward voltage drop. Small size. And lots more. And they're all made right here.

Sure, other manufacturers can offer you some of these features. But it took ITT to put them all together in the Axial Leaded Schottky Rectifiers that are destined to become the new state of the art. And ITT to offer them at a price that makes them practical.

Get detailed technical information on our Axial Leaded Schottky Rectifiers. Write ITT Semiconductors, 500 Broadway, Lawrence, MA 01841. Tel. (617) 688-1881.

semiconductors **ITT**

Call the ITT Semiconductors Representative nearest you • Reseda, California: (213) 345-5270 • Palo Alto, California: (415) 961-5265 • Canada: (416) 630-7971 • Illinois: (312) 991-7100 • Ohio: (513) 435-3750 • Texas: (214) 243-7851 • New York (315) 451-5980 • Pennsylvania: (215) 688-6990/1/2/3 • Georgia: (404) 939-6715 • Lexington, Massachusetts: (617) 861-0880



# SEMS-16: AYK-14 memory for those tight spots.

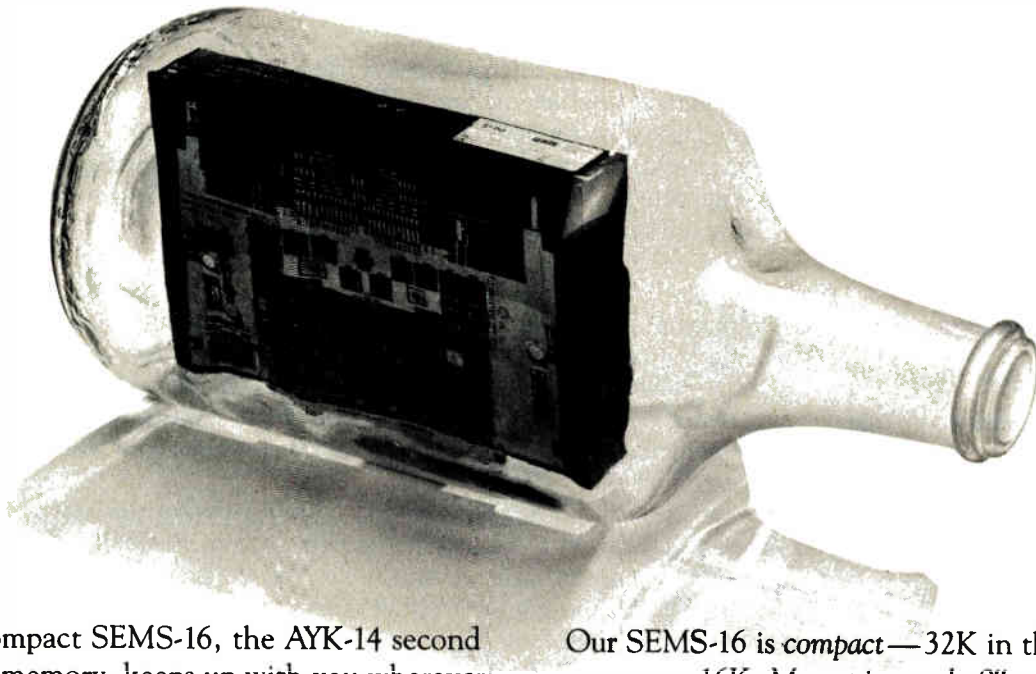

Our compact SEMS-16, the AYK-14 second source memory, keeps up with you wherever and whenever you need it. Even in the tightest spots. Such as the cockpit of a fighter plane or inside a tank. Aboard a supertanker, in a nuclear sub, or for fire control, navigation, stores management and data handling. Wherever rugged, large capacity, high performance memory is needed. SEMS-16 is a non-volatile 32K x 18 bit core memory. So, even during power fluctuations, our Data Guard option allows EMM memories to keep the correct data intact. Among its other features is a *read/modify/write option*.

Our SEMS-16 is *compact*—32K in the same space as a 16K. Measuring only 9" x 6" x 1.4" It's a high speed unit. With an access time of 350 nanoseconds and a cycle time of 900 nanoseconds. And, it's *rugged*. SEMS-16 meets the toughest shock and vibration specs. Operating in temperatures from  $-55^{\circ}\text{C}$  to  $+105^{\circ}\text{C}$ . It has a standard TTL interface and meets applicable MIL SPECS.

SEMS-16 is memory that can take it. So, when you've got a severe environment application, call on EMM. We've been building severe environment memories longer than anyone else.

## The difference in severe environment systems

**EMM**

SEVERE ENVIRONMENT PRODUCTS

A Division of Electronic Memories & Magnetics Corporation  
20630 Plummer Street, Chatsworth, CA 91311  
(213) 998-9090

See our new products at NAECON, Dayton, Ohio, May 16-18.

## **Seal for use at nuclear facilities tells of tampering**

A fiber-optic bundle and a liquid-crystal display are combined in an unusual self-monitoring seal for revealing whether instrumentation or storage containers at nuclear facilities have been tampered with. It was developed by Sandia Laboratories, Albuquerque, N. M., for use by the International Atomic Energy Agency. The device permits an inspector to tell at a glance whether the seal has been cut and rejoined or replaced. An electronic detector module continuously monitors the integrity of a fiber-optic loop and displays the status on an LCD that is an integral part of the seal. The detector module is programmed to display codes that indicate both if and when any violation has occurred.

## **Why not a cascode optocoupler? Here's why not**

On this page on March 2, 1978, S. Ashok suggested that the cascode connection of phototransistors has been overlooked. Not so, replies John Carroll of Dynamics Measurement Corp. in Winchester, Mass.—it has been tried and found wanting. "I couldn't make it work well enough to be worth bothering with, and I suspect others have run into the same roadblock," he says.

The problem, according to Carroll, is that a phototransistor acts like a conventional transistor with a photodiode across the collector junction. Even though the cascode circuit holds the collector-to-emitter voltage constant, the base-to-emitter voltage must change to switch the transistor on and off. The photodiode charges the junction capacitances until the transistor turns on, and then the base current must discharge the same capacitances to turn the transistor off again. With rather poor photon collection and a very high beta transistor, **response times in the circuit tend to be in the range of tens of microseconds to milliseconds.** There just isn't very much current available to charge and discharge these capacitances. Carroll suspects that a cascode scheme might work better with a photodiode instead of a phototransistor—but then there would be a problem building up the extremely small output current into a logic swing with good speed.

## **Silver mends damaged pc boards**

A damaged copper conductor is usually enough to consign a printed-circuit board to the scrap heap. But new screen-printable resin-based silver-conductor materials can easily be applied to save it. For instance, a material like ESL's 1109-S conductive coating **can be screened or painted onto the area of the broken conductor**, allowed to dry (at up to 100°C), and then cured. The drying temperature is determined by the types of components on the board. For further information, contact Electro-Science Laboratories Inc., 1601 Sherman Ave., Pennsauken N. J. 08110.

## **How to coddle the solid-state multiplier**

Even the most carefully designed multiplier is at the mercy of its circuit surroundings. **Power supply output impedance, grounding technique, strategic use of bypass capacitors, wire lengths, and passive component characteristics all can affect the operation of this sensitive circuit.** For a thorough discussion of the care and feeding of the solid-state multiplier, and for many interesting applications of it, send for the Multiplier Application Guide, available free from Analog Devices Inc., P. O. Box 280, Norwood, Mass. 02062.

**Jerry Lyman**





**AMP has a better way  
...Fiber Optics**

A photograph of a white plastic tray containing various fiber optic components and tools. The tray is divided into compartments, some of which are filled with small black and gold connectors, lenses, and cables. A pair of pliers and a magnifying glass are also visible on the tray. The background is a dark, textured surface.

**To help you innovate, two OPTIMATE Kits are available:** just connectors, cable and tooling, or complete with active devices and predrilled circuit boards for construction of optical links with TTL or CMOS input/output.

For information on other fiber optic contacts for intermixing in standard connectors, please call Customer Service at (717) 564-0100.

AMP is a trademark of AMP Incorporated

**AMP**  
INCORPORATED

Circle 159 on reader service card

# Power transistors beating out SCRs?

New line in TO-83 packages can handle up to 100-120 A at 100-120 V; higher-rating devices to come are headed for electric vehicles

by Larry Waller, Los Angeles bureau manager

Today, switching regulated power supplies is the fastest-growing market for power semiconductors. But a potentially important market still over the horizon is electric vehicles, which require a combination of low price and high power levels not yet attainable. In the meantime, however, power semiconductor firms are positioning themselves with new lines of more powerful transistors.

The latest of them is International Rectifier Corp.'s Semiconductor division, which has three new components able to handle from 100 A to 120 A at 100 v or 120 v. Housed in a stud-mounted TO-83 package, these are the first of a contemplated even higher-powered line intended to replace bulkier, slower silicon controlled rectifiers or paralleled power transistors with lower ratings.

"High-power transistors have advantages over both SCRs and paralleled devices," says Robert P. Del Vecchio, product line marketing manager. "And since the electric vehicle market is not quite open yet, we think we can crack it."

Transistors have the edge over SCRs because they do not need commutation circuits to turn them off which makes them more compact and simplifies their design. Also, transistors can operate at higher frequencies, 5 to 10 kHz, compared with 2 to 3 kHz for SCRs, Del Vecchio points out. And, while paralleling lower-rated transistors can be a cheaper power solution, hooking up 10 or 15 devices can badly clutter circuit boards.

All three International Rectifier devices, designated the HPT1012, the HPT1210 and the HPT1212, have fall time of 2.5  $\mu$ s and a

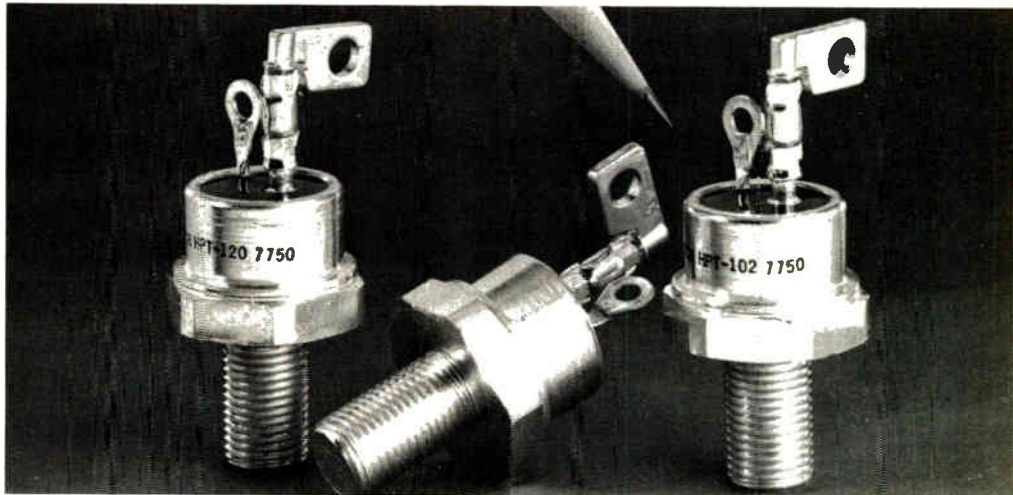

maximum power dissipation of 350 w. Model 1012 has collector-emitter sustaining voltage of 120 v, continuous collector current of 100 A, and peak at 120 A. Comparably, the 1210 has ratings of 100 v, 120 and 150 A; and the 1212, 120 v and 120 and 150 A. Maximum junction operating temperature ranges from  $-65^{\circ}\text{C}$  to  $+200^{\circ}\text{C}$ . Saturation voltage is listed at 2.5 v maximum.

To produce the new devices, International Rectifier drew on its extensive SCR background "and took a shortcut, using the same TO-83 package," Del Vecchio points out. Like the SCRs, the power transistors are manufactured by epitaxially based processing techniques. This process provides devices with faster switching times than do single-diffused techniques, according to the company. The chip is 472 mils on a side, about four times larger than the biggest (250-mil<sup>2</sup>) transistors now fabricated by the company. Del Vecchio estimates that having the SCR experience saves "six months to

a year in developing them."

International Rectifier is already turning out the transistors for an unnamed customer. "It's typical of the power device business for each customer to have special requirements. There is little off the shelf," he says.

For future electric vehicles, power transistors will have to range up to the 600-A level and cost less than \$100 to compete against SCRs, the marketing executive estimates. The company plans to have even higher-powered devices ready by the end of the year. Del Vecchio expects that the company will have transistors rated at 350-400 v and 80 A available in three or four months, followed by 600-v, 40-50-A units somewhat later.

In 100-quantities, prices are \$85 for the 100-A 1012, \$90 for the 120-A 1210, and \$95 for the 120-A 1212. They are available now.

International Rectifier Corp., Semiconductor division, 233 Kansas St., El Segundo, Calif. 90245. Phone (213) 322-3331 [338]

# Small switchers pack in the power

Family of encapsulated 25-W supplies occupies as little as 11 cubic inches, has only 20 mV of peak-to-peak noise and ripple

by Lawrence Curran, Boston bureau manager

Thanks to advances in semiconductors and magnetic circuits, switching power supplies are providing economic competition to linear supplies down at the 25-watt level. Last month, Boschert Inc., in Sunnyvale, Calif., introduced multioutput open-frame 25-w switchers in a 2.5-by-4-by-6-inch package [*Electronics*, March 2, p. 159]. Now, adding increased power density to the attractiveness of small switchers, comes Computer Products Inc., Fort Lauderdale, Fla., with a series of 25-w switchers in an even smaller package [*Electronics*, April 13, p. 36]. And these latest units are not only small, they're encapsulated for reliable service under demanding conditions—particularly high vibration and humidity.

There are two series in the Computer Products 25-w switcher line: the HE300 chassis-mount models, and the HE500 printed-circuit-

board-mounting models. Four 115-v ac input models are in each series, all delivering 80% efficiency at full load. Each series has a 5-v; 5-A model providing  $\pm 0.05\%$  line regulation maximum;  $\pm 0.1\%$  load regulation, maximum; and a ripple and noise rating of 20 mV peak to peak.

The other three models in each series, all with those same ratings, have outputs of 9 v at 2.8 A, 12 v at 2.2 A, and 15 v at 1.8 A, respectively. The only difference in the two series is the mounting configuration. The HE300 chassis-mount case is 4 in. long, 2.7 in. wide and 1.44 in. high; the HE500 pc-board-insertion case measures 3.5 by 2.5 by 1.25 in. All are shielded on six sides to prevent electromagnetic and radio-frequency interference.

David Yoder, president, says that while power-supply manufacturers don't specify system noise, "we've paid a lot of attention to making sure

these don't create noise in a system." He believes these units offer the most power per cubic inch in a switcher today. Thomas Pantelakis, project engineer for power supplies, and designer of the new devices, adds that with the move to ever-smaller packages in digital logic, "these designs should be a major step in power-supply technology in matching that trend."

Moreover, Pantelakis stresses that "no shortcuts have been taken to put these in a small package. We still provide things like EMI/RFI filtering, crowbar over-voltage protection, and input filtering for low noise." Input voltage can range from 90 to 130 v, and short-circuit protection is provided indefinitely. The over-voltage protection is provided with a silicon controlled rectifier shorting the output at 120% of the rated voltage output, he says.

Both series have a switching frequency of 20 kilohertz, minimum, transient response to within 0.5% of final value of 500  $\mu$ s, and output-voltage error of 1% maximum. The chassis-mount models offer remote sensing to compensate for a drop of up to 0.3 v in dc distribution lines, regulated at the load end.

Pantelakis expects the supplies to be used in a wide variety of logic applications. Prices for the chassis-mount models are \$105 (115-v models) to \$110 (230-v), with a discount to \$84.25 and \$89.25, respectively, in hundreds. Evaluation quantities will be available in mid-May, with production quantity deliveries beginning in July.

Computer Products Inc., 1400 NW 70th St., Fort Lauderdale, Fla. 33309. Phone (305) 974-5500 [339]



# Introducing the GMR-37 modular display system

## Low cost, high performance graphics

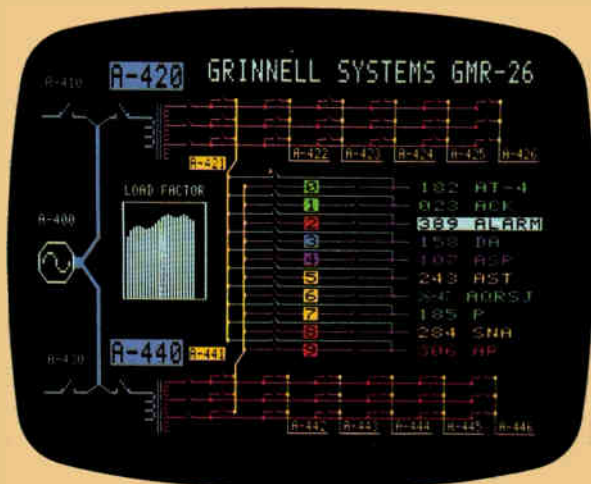

**\$5100** 256 x 512 resolution  
4 memory planes  
7 colors plus blink

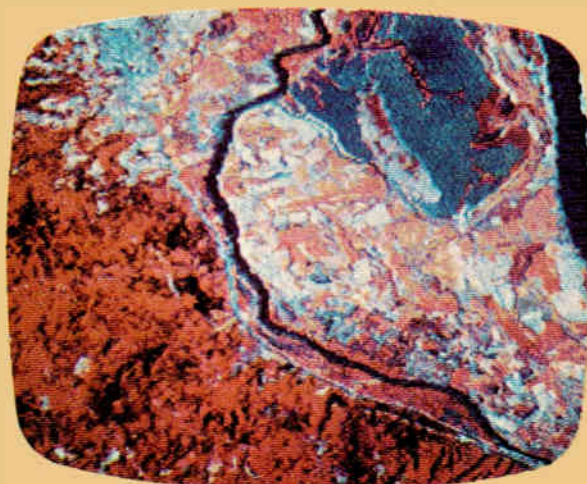

**\$5900** 256 x 256 resolution  
12 memory planes  
4096 colors

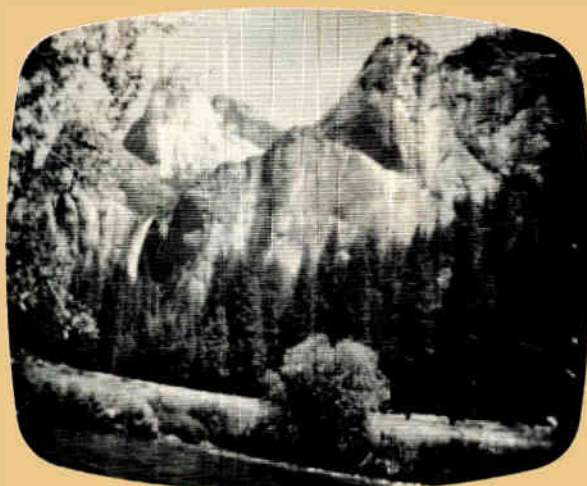

**\$5400** 256 x 256 resolution  
8 memory planes  
256 grey levels

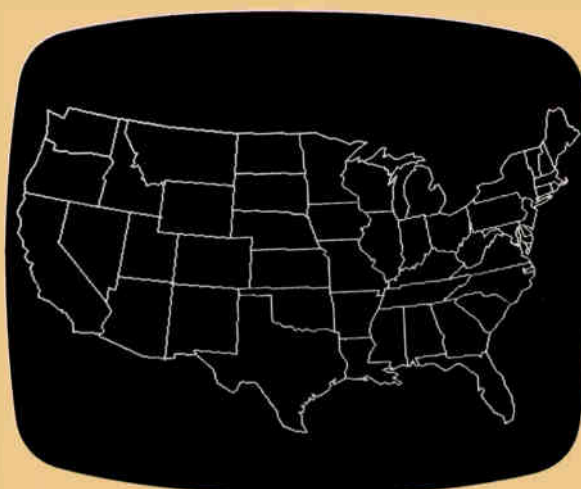

**\$4300** 512 x 512 resolution  
1 memory plane  
Black & white video

These are just a few of the ways you can tailor the all solid state GMR-37 to fit your needs.

You don't give up performance either. Every GMR-37 has, as standard, the generation of vectors, characters, plots, graphic data and high speed images. Plus 4K MOS random access memories, memory readback, full alphanumerics and a standard RS-232 computer interface.

In addition, a powerful instruction set minimizes software overhead and simplifies programming. You don't need complex macro instructions and high order programming languages.

Available options include video lookup tables, independent cursors, trackball or joystick control units and many more. Plug-compatible parallel interfaces are available for most minis.

Further, if you ever want to move up, Grinnell has a complete line of larger systems—all software compatible with the GMR-37—to do things like animation, image processing and real-time frame grabbing.

GMR-37 systems start at **\$3900**, and quantity discounts are available. (Domestic U.S.A. prices.)

For a quotation on your specific needs, call or write.

# GRINNELL SYSTEMS

2986 Scott Boulevard, Santa Clara, California 95050 (408) 988-2100

# DIP SOCKETS **for the price you're paying for junk!**

**Robinson Nugent "side-wipe" DIP sockets make 100% greater contact than any edge-bearing socket on the market.**

This 100% greater contact with the wide, flat surface of your IC leads is your guarantee of unmatched reliability. This RN "side-wipe" contact provides constant low contact resistance. No edge-bearing contact can possibly deliver this long term dependability. This designed-in reliability of RN DIP sockets is your assurance of trouble-free IC interconnects—yet they cost no more than ordinary sockets.

**Put an end to troublesome junk sockets!** Write today for catalog and informative book "What to Look for in IC Interconnects." It's free from RN—the people who make more kinds of high reliability IC sockets than anyone.

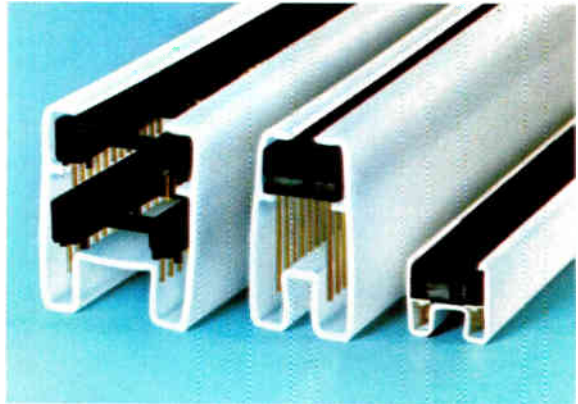

**They're even packaged for high reliability.**

"Protecto-pak"<sup>®</sup> packaging delivers consistently perfect RN sockets to your production line—for automated or manual assembly.



# **RN EUROPE, S.A.**

ROBINSON-NUGENT EUROPE, S.A. / Rue Victor Allard 191 / 1180 Bruxelles, Belgium / Phone: (02) 377-27-44

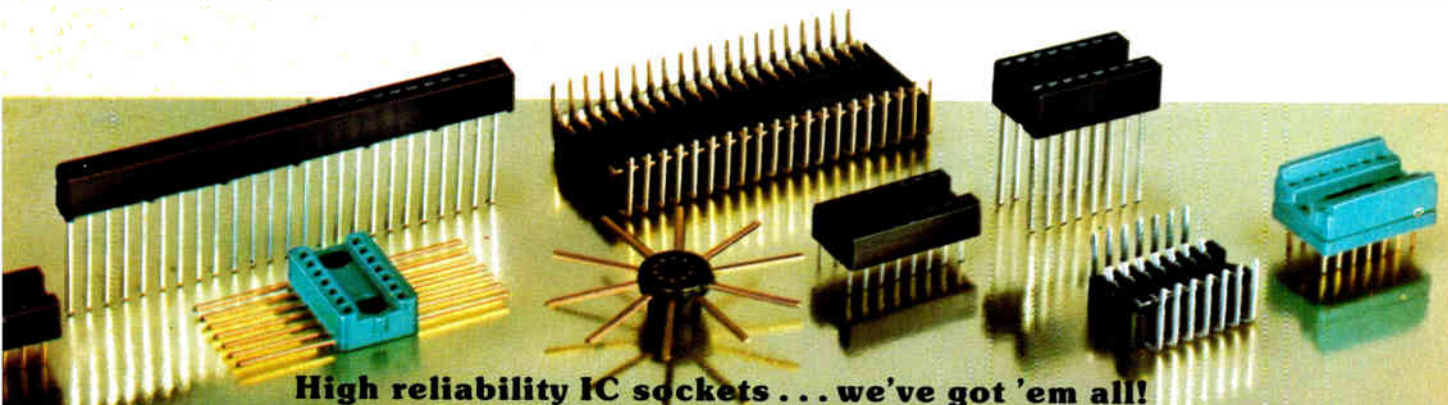

**High reliability IC sockets... we've got 'em all!**

# Data Acquisition System?

It happens constantly. You buy a DAS, install it and then spend a lot of time, energy and money de-bugging the hardware, creating some specialized software, burdening the host computer and finding that you bought a 12-bit A/D system that doesn't stay a 12-bit A/D system very long.

## Why Are We Any Different?

We're an ultra engineering-oriented company with a strong commitment to product reliability, integral accuracy, stability over time and temperature and innovative solutions to customer problems. And we know, that to really solve your problem it takes more than block diagrams. It takes experience; it takes what you might call a "green-thumb" in data acquisition systems.

Superior Data Acquisition Systems must provide solutions to customer problems, measurement techniques and specific microcomputer requirements and purposes. And that is what Analogic does, provides solutions qualitatively and innovatively over a broad line of products. Maybe that's why Analogic is, by far, the world's largest designer and manufacturer of microcomputer Data Acquisition Systems.

A call to our Data Acquisition Technical Support Team is the shortest route to years of accumulated experience and solutions to any of your data acquisition problems.

## Another Innovation from Analogic - A DAS for the TI TM990/100M Microcomputer with "Program-Transparent I/O"

Our ANDS Series of 12-bit input/output DAS boards was specifically designed for the Texas Instruments TM990/100M. Whether you must accommodate either hi-level or low-level signals, you will find this DAS clearly accommodates and enhances the unique capabilities of the TM990/100M.

Analogic's innovative "PROGRAM-TRANSPARENT I/O" allows the user, in one instruction to (a) initiate the conversion (b) collect the data (c) operate on that data and (d) store the resultant data. To you, the user, this adds up to sharply reduced software costs and rapid system implementation.

In addition, our low-level DAS provides for Thermocouple Cold Junction Compensation and direct Linearization, thereby unburdening the host computer from the overhead and program code required to perform such linearization.

... AND TO AVOID BEING AM-BUSHED, Analogic exercises the most stringent quality control procedures in the industry. All components are 100% inspected — modules undergo extensive testing — systems are burnt-in and power cycled for 48 hours in a special environmental chamber — and all systems undergo final dynamic tests in a TI microcomputer. All this, and we're competitive, too.

For complete data on our ANDS Series of I/O boards please contact your closest distributor or call or write Analogic's Marketing Department (617) 246-0300. Analogic Corporation, Audubon Road, Wakefield, Massachusetts 01880.

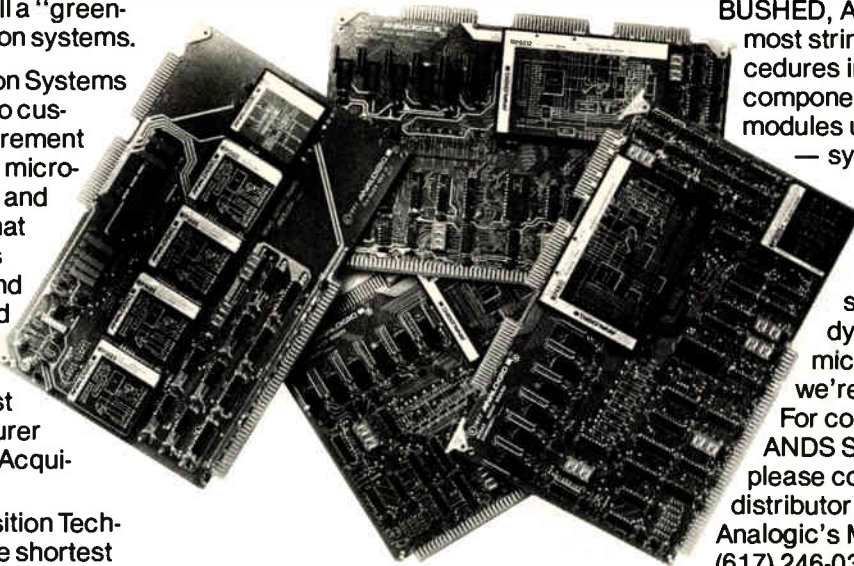

ANDS Series I/O Boards for the TI TM990/100M Microcomputer.

# ANALOGIC

AUSTRIA  
Kontron GmbH & Co. KG  
Arneisgasse 49  
1140 Vienna  
Tel: (222) 94 56 46

BELGIUM  
Betea Automation  
Avenue Geo Bernier 15  
1050 Brussels  
Tel: (02) 649-9900

DENMARK  
Tage Olsen A/S  
Teglværksgade 37  
2100 Copenhagen O  
Tel: (01) 29 48 00

ENGLAND  
Analogic Limited  
68 High Street  
Weybridge, Surrey KT13 8BN  
Tel: (44) 932-41251/41215

FINLAND  
Into Oy  
P.O. Box 222  
SF-00661 Helsinki 66  
Tel: 90-742133

FRANCE  
Kontron Electronique  
BP 99  
6, Rue Des Freres Caudron  
78140 Velizy Villacoublay  
Tel: 946 97 22

ISRAEL  
Landseas (Israel) Ltd.  
38 King George St.  
P.O. Box 23011  
Tel Aviv  
Tel: 247291-4

GERMANY (WEST)  
Kontron Elektronik GmbH  
8051 Eching/Munich  
Industriegebiet 1  
Tel: 49-8165-771

ITALY  
Elcam s.r.l.  
Via Bazzini 14  
20131 Milano  
Tel: (02) 23 65 255

NETHERLANDS  
Koning en Hartman  
P.O. Box 8220  
The Hague 2040  
Tel: 070-67-83-80

NORWAY  
A/S Kjell Bakke  
Tekniske Agenturer  
Box 143  
2011 Stroeimmen  
Tel: (47) 2 711-872  
715-350

SPAIN  
Hispano Electronica, s.a.  
Poligono Industrial Urtinsa  
Alcorcon Madrid  
Tel: 619 41 08

SWEDEN  
Johan Lagercrantz KB  
Kanelvagen 5  
Box 78  
S-134  
Upplands Vasby  
Tel: 0760-861 20

SWITZERLAND  
Kontron Electronic Ltd.  
Bernstrasse-SUD 169  
8048 Zurich  
Tel: 01-62-82-82

TURKEY  
Ehelsan Endustriyel Elektronik  
Sanayii A.S.  
Ayazaga, Masiak Ucyol Mevki  
No. 110 4 Levent  
Istanbul  
Tel: 64 34 38

EASTERN BLOC COUNTRIES  
Tettex A.G.  
Rotbuchstrasse 45  
8042 Zurich, Switzerland  
Tel: 01-26-46-80

JAPAN  
Yamada Corporation  
Yamada Bldg. No. 9-1  
2-Chome  
Shinbashi Minato-ku  
Tokyo  
Tel: 03591-7211

Circle 168 on reader service card

# Switchmode power can move you years ahead of your competition.

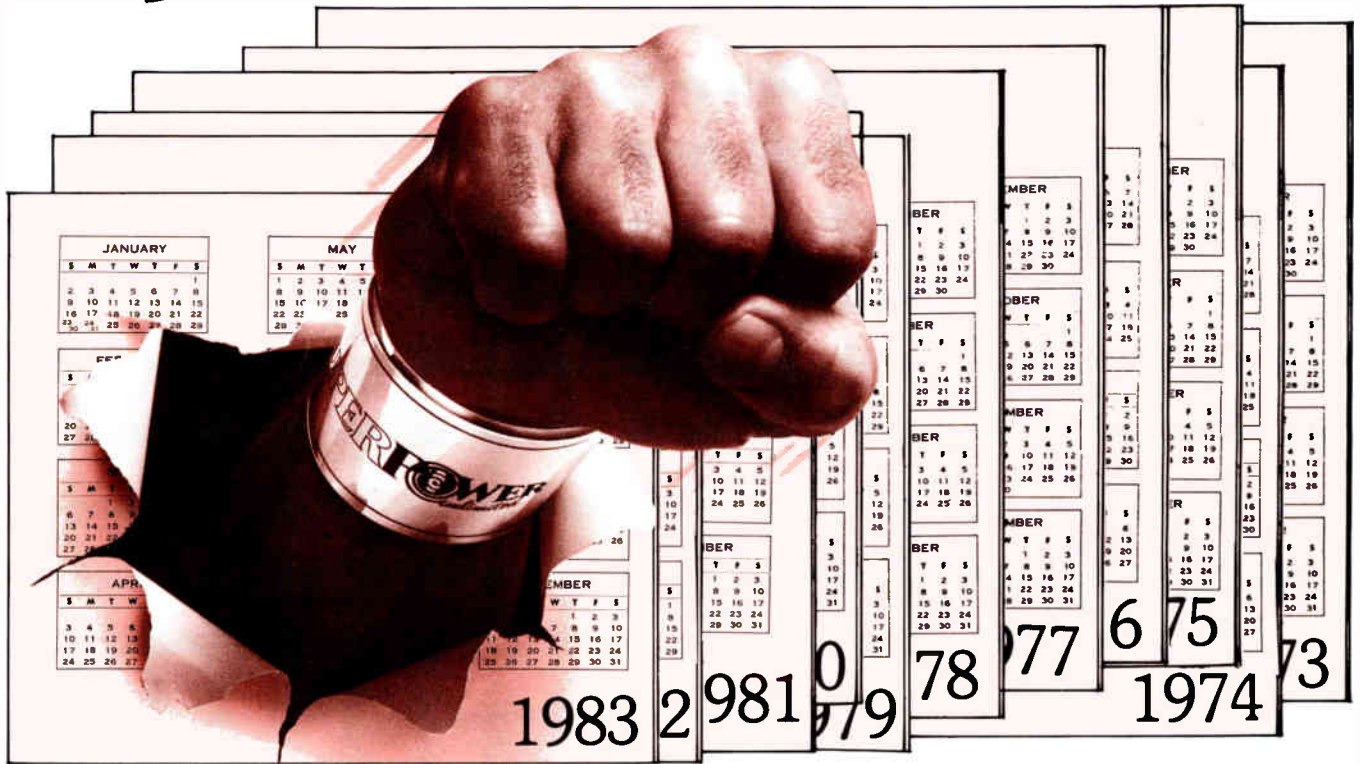

## Just like it's done for us.

State-of-the-art in silicon power transistors has long been one of Motorola's strengths. Our introduction of the Switchmode\* concept three years ago with the 2N6542 through 2N6547 proved it to be the overwhelming choice of designers everywhere for switching power supplies and similar high voltage applications.

Because each and every Switchmode device is specifically *designed and characterized* for those applications.

Nobody else goes to the lengths we do to completely define all necessary performance data of this state-of-the-power art. No unknowns, no empiricals, no vague or non-existent specs but solid, practical data from a pragmatic source . . . the Designers\* Data Sheet. You're way ahead from the start.

There are imitators, but nobody offers anywhere near the broad

selection of unique device-tools we do to make your design job even easier—nearly 70 individual Switchmode discrete and Darlington parts for applications from 0.5 to 50 A, 200 to 750 V. We cover all the bases—and at the right price, naturally.

There are now 16 economical Darlington devices available from 8 to 50 A, 450 to 750 V. The new MJ10008/9 Darlington's offer 20 A, 500 V capability with max hot inductive crossover time of 1.6  $\mu$ s and min gain of 30 at 10 A. 100-ups are just \$6.25 and \$7.65. And our MJ10004-5, 20 A, 450 V series offering 1.5  $\mu$ s max crossover and min gain of 40 at 10 A is value-priced at \$6.25 and \$7.65. The MJ13014/15 10 A, 400 V discrete units provide 1.5  $\mu$ s max crossover time and min gain of 8 at 5 A. Prices are only \$3.45 and \$4.05. And the new high current MJ10015/16 50 A,

500 V Darlington's provide 1.0  $\mu$ s time and gain of 25 at 20 A with price tags of \$13.80 and \$16.85. Plus we've got TO-220s including the new discrete MJE13006/7 with 8 A, 400 V performance and low cost of \$1.95 and \$2.60.

These or any of the industry-leading Switchmode units on the next page are available now from factory or your authorized distributor for your years-ahead designs.

Stay with us. There's a lot more from a SuperPower.

\*Trademark Motorola Inc.



**MOTOROLA**  
Semiconductor Group

# Motorola Switchmode\* Power Transistors

V <sub>CEO</sub> (sus) Volts Min	I <sub>C</sub> Cont Amps Max	V <sub>CEX</sub> Volts Min	Device Type NPN unless otherwise noted	h <sub>FE</sub> @ I <sub>C</sub> Min/Max Amp		Resistive Switching			f <sub>T</sub> MHz Min	Case JEDEC/Motorola	
						t <sub>s</sub> μs Max	t <sub>f</sub> μs Max	@ I <sub>C</sub> Amp			
750	8	1500	MJ12005	5 min	5		1	5	4 typ	TO-3/11	
	5	1500	<b>MJ12004</b>	2.5 min	4.5		1	4.5	4 typ	TO-3/11	
	2.5	1500	<b>MJ12002</b>	1.11	2		1	2	4 typ	TO-3/11	
700	8	1400	MJ10011#	20 min	4		1	4		TO-3/11	
600	15	700	● MJ10014##	10/70	10	2.5	0.8	10		TO-3/11	
550	15	650	● MJ10013##	10/70	10	2.5	0.8	10		TO-3/11	
500	50	750	● MJ10016##	10 min	40	2.5	0.5	20		TO-3 Mod/197	
	20	750	● MJ10009##	30/300	10	2	0.6	10	8**	TO-3/11	
		600	● MJ13335	10/60	5	4	0.7	10		TO-3/11	
450	20	650	● MJ10008##	30/300	10	2	0.6	10	8**	TO-3/11	
	20	550	● MJ13334	10/60	5	4	0.7	10		TO-3/11	
	50	600	● MJ10015##	10 min	40	2.5	0.5	20		TO-3 Mod/197	
400	20	500	<b>MJ10001#</b>	40/400	10	3	1.8	10	10**	TO-3/11	
			<b>MJ10005##</b>	40/400	10	1.5	0.5	10	10**	TO-3/11	
			● MJ13333	10/60	5	4	0.7	10		TO-3/11	
	15	850	<b>2N6547</b>	6/30	10	4	0.7	10	6	TO-3/11	
	12	700	<b>MJE13009</b>	6/30	8	3	0.7	8	4**	TO-220/221A	
	10	550	MJ10012#	100/2K	6	15	15	6		TO-3/11	
		500	<b>MJ10003#</b>	30/300	5	2.5	1	5	10**	TO-3/11	
			<b>MJ10007##</b>	30/300	5	1.1	0.25	5	10**	TO-3/11	
	10	450	● MJ13015	8/20	5	2	0.5	5		TO-3/11	
	8	850	<b>2N6545</b>	7/35	5	4	1	5	6	TO-3/11	
		700	<b>MJE13007</b>	6/30	5	3	0.7	5	4	TO-220/221A	
	5	850	<b>2N6543</b>	7/35	3	4	0.8	3	6	TO-3/11	
	4	700	● <b>MJE13005</b>	6/30	3	3	0.7	3	4	TO-220/221A	
	1.5	700	<b>MJE13003</b>	5/25	1	4	0.7	1	5	TO-126/77R	
	0.5	400	<b>MJ4647</b>	20 min	0.5	0.72†		0.05	40	TO-39/79	
	350	20	450	<b>MJ10000#</b>	40/400	10	3	1.8	10	10**	TO-3/11
				<b>MJ10004##</b>	40/400	10	1.5	0.5	10	10**	TO-3/11
			450	● MJ13332	10/60	5	4	0.7	10		TO-3/11
		15	375	2N6251	6/50	10	3.5	1	10	2.5	TO-3/11
		10	400	● MJ13014	8/20	5	2	0.5	5		TO-3/11
8		700	2N6308	12/60	3	1.6	0.4	5	5	TO-3/11	
		450	<b>MJ10002#</b>	30/300	5	2.5	1	5	10**	TO-3/11	
			● MJ10006##	30/300	5	1.1	0.25	5	10**	TO-3/11	
5		450	2N6499	10/75	2.5	1.8	0.8	2.5	5	TO-220/221A	
2		400	2N6213-PNP	10/100	1	2.5	0.6	1	4	TO-66/80	
325		8	700	MJ9000	3.75 min	6		1.1	6		TO-3/11
		5	700	MJ3030	3.75 min	3		1	3		TO-3/11
300		350	2N6235	25/125	1	3.5	0.5	1	20	TO-66/80	
	15	650	<b>2N6546</b>	6/30	10	4	0.7	10	6 to 24	TO-3/11	
	12	600	<b>MJE13008</b>	6/30	8	3	0.7	8	4**	TO-220/221A	
	8	650	<b>2N6544</b>	7/35	5	4	1	5	6	TO-3/11	
			2N6307	15/75	3	1.6	0.4	3	5	TO-3/11	
			<b>MJE13006</b>	6/30	5	3	0.7	5	4	TO-220/221A	
	5	650	<b>2N6542</b>	7/35	3	4	0.8	3	6	TO-3/11	
		400	2N6498	10/75	2.5	1.8	0.8	2.5	5	TO-220/221A	
	4	600	● <b>MJE13004</b>	6/30	3	3	0.7	3	4	TO-220/221A	
	2	500	2N3585	25/100	1	4	3	1	10	TO-66/80	
			2N6422-PNP	25/100	1	4	3	1	10	TO-66/80	
		350	2N6212-PNP	10/100	1	2.5	0.6	1	4	TO-66/80	
	1.5	600	<b>MJE13002</b>	5/25	1	4	0.7	1	5	TO-126/77R	
	1	300	2N5345	25/100	0.5	0.6	0.1	0.5	60	TO-66/80	
	275	15	300	MJ4646	20 min	0.5	0.72†		0.05	40	TO-39/79
	8	500	2N6250	8/50	10	3.5	1	10	2.5	TO-3/11	
	7	300	2N6306	15/75	3	1.6	0.4	3	5	TO-3/11	
	5	500	2N6077	12/70	1.2	2.8	0.3	1.2	7	TO-66/80	
	2	375	MJE3029	30 min	0.4		1	3		TO-3/11	
		275	2N6234	25/125	1	3.5	0.5	1	20	TO-66/80	
		275	2N3584	25/100	1	4	3	1	10	TO-66/80	
		275	2N6421-PNP	25/100	1	4	3	1	10	TO-66/80	
250	1	250	2N5344	25/100	0.5	0.6	0.1	0.5	60	TO-66/80	
	20	350	● MJ13331	8/40	10	3.5	0.7	10	5	TO-3/11	
	7	275	2N6078	12/70	1.2	2.8	0.3	1.2	7	TO-66/80	
	5	350	2N6497	10/75	2.5	1.8	0.8	2.5	5	TO-220/221A	
225	5	250	2N6233	25/125	1	3.5	0.5	1	20	TO-66/80	
	2	275	2N6211-PNP	10/100	1	2.5	0.6	0.1	4	TO-66/80	
200	20	300	● MJ13330	8/40	10	3.5	0.7	10	5	TO-3/11	
	15	225	2N6249	10/50	10	3.5	1	10	2.5	TO-3/11	
	2	200	2N5052	25/100	0.75	3.5	1.2	0.75	10	TO-66/80	
	0.5	200	MJ4645	20 min	0.5	0.72†		0.05	40	TO-39/79	

● New Device #Darlington ##Darlington with speed-up diode. †t<sub>off</sub> \*\* h<sub>fe</sub> @ 1 MHz. Heavy black type denotes Designers Data Sheet characterization.  
\*Trademark Motorola Inc.



## New products

drastically while the measurement is being made.

The 3582A, on the other hand, avoids these problems by sampling the time-domain data in real time and then calculating the spectrum digitally. Each of the 1,024 samples is converted to a 12-bit digital word. The microcomputer operates on these samples and transforms them into 256 frequency-domain equivalents, which it then displays.

In the FFT process, not only the magnitude but also the phase of each of the 256 components is determined. The user gains complete characterization for each of the input signal's measured components.

For better resolution, the band-select feature lets the operator shrink the frequency span down to as low as 5 Hz. At that spectrum limit, the 256 components occur at separations of only 20 mHz. Compared to a fixed-span instrument with the HP-3582A's upper limit of 25.5 kHz, this resolution is 5,000 times better.

The band-select feature, a potentially costly one requiring 48 high quality filters to implement, is economically achieved using four large-scale integrated digital filters.

It would be difficult to argue against HP-3582A's worth if the list of features stopped here. Add to it the following: storage of one or two traces for later recall; selectable flat-top, uniform, and Hanning filters; successive averaging for eliminating random effects on analyzed signals; IEEE-488 interface capability; 70-dB dynamic range and 1- $\mu$ V-to-30-V input range.

Hewlett-Packard Co., 1507 Page Mill Rd., Palo Alto, Calif. 94304 [351]

Compact 4½-digit meter  
sells for \$59 in hundreds

The DM-4100N digital panel meter displays analog input voltages with up to 4½-digit resolution and will resolve 100  $\mu$ V in its last digit. A run/hold input momentarily freezes the last reading so that an operator can copy down a reading.

Decimal points may be illumi-



## NEED RELIABLE CIRCUITRY? ELORG RESISTORS WILL DO THEIR BIT!

With their specifications that meet IEC standards for dimensions, ratings and tolerances.

Some 50 types of fixed, variable, wirewound and non-wire resistors include

- S2-33i miniature metal film resistors for 0.25 W and 0.5 W power dissipation ratings; maximum temperature coefficient  $500 \times 10^{-6}/^{\circ}\text{C}$ ; packed in adhesive tape or placed on tape reels; color code markings;
- S1-4M carbon resistors for 0.25 W power dissipation ratings; average temperature coefficient  $800 \times 10^{-6}/^{\circ}\text{C}$ ; packed in adhesive tape or placed on tape reels; color code markings;
- precision non-wire fixed resistors S2-29 for 0.125 W, 0.25 W, 0.5 W, 1.0 W and 2.0 W power dissipation ratings, temperature coefficient  $\pm 25 \div \pm 300 \times 10^{-6}/^{\circ}\text{C}$ ; resistance tolerance  $\pm 0.1\%$ ;  $\pm 0.25\%$ ;  $\pm 0.5\%$  and  $\pm 1.0\%$ ;
- thermal resistors
- photoresistors;
- varistors.

## Sole exporter -



32/34 Smolenskaya-Sennaya  
121200 Moscow  
USSR

Telephone 251-39-46, Telex 7586

# Suddenly your last year's Electronics Buyers' Guide is as outdated as last year's phone book

**Just published; 1978 Electronics Buyers' Guide.** Completely new listings of catalogs, new phone numbers, new addresses, new manufacturers, sales reps, and distributors! The total market in a book—four directories in one!

**1.**

Directory of products. Over 4,000 products, over 5,000 manufacturers.

**2.**

Directory of catalogs. Includes six post-paid catalog inquiry cards for 10-second ordering.



**3.**

Directory of manufacturers. Local sales offices, reps, and distributors, with phone numbers. Number of employees and engineers, dollar volume, name of company contact.

**4.**

Directory of trade names of products and their manufacturers. You can trace a product by its trade name only.

**The only book of its kind in the field.**

**If you haven't got it, you're not in the market.**

**To insure prompt delivery enclose your check with the coupon now.**

Electronics Buyers' Guide  
1221 Ave. of the Americas  
New York, N.Y. 10020

Yes, please send me \_\_\_\_\_ copy(ies) of 1978 EBG.

I've enclosed  \$35 per copy for surface mail

\$47 per copy for air mail

Full money-back guarantee if returned in 10 days.

Name \_\_\_\_\_

Company \_\_\_\_\_

Street \_\_\_\_\_

City \_\_\_\_\_ Country \_\_\_\_\_

# Dialight

## INDICATOR LIGHTS

The widest choice for your every application.

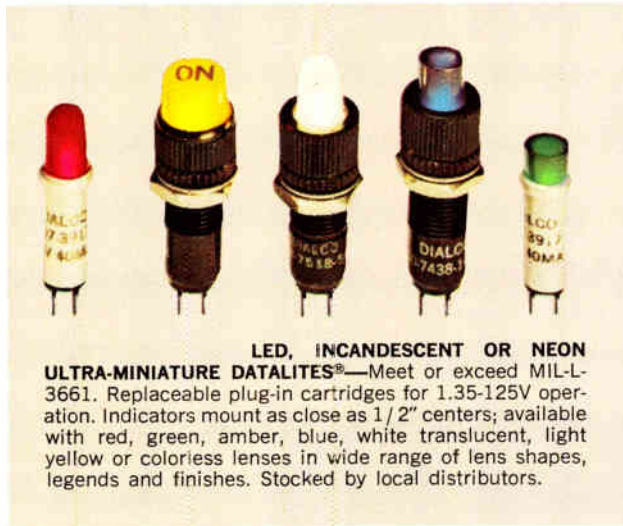

**LED, INCANDESCENT OR NEON ULTRA-MINIATURE DATALITES®**—Meet or exceed MIL-L-3661. Replaceable plug-in cartridges for 1.35-125V operation. Indicators mount as close as 1/2" centers; available with red, green, amber, blue, white translucent, light yellow or colorless lenses in wide range of lens shapes, legends and finishes. Stocked by local distributors.



**INCANDESCENT OR NEON SUB-MINIATURE INDICATORS**—Meet or exceed MIL-L-3661. Mounts in 15/32", 1/2" or 17/32" clearance holes. Incandescent for 1.35-28V; neon has patented built-in current limiting resistor. Choice of cylindrical, faceted, convex, flat, square and round lens shapes, finishes, legends. Stocked by local distributors.



Dialight, the company with the widest choice in switches, LEDs, indicator lights and readouts, looks for needs . . . your needs . . . and then they develop solutions for your every application. No other company offers you one-stop shopping in all these product areas. And no other company has more experience in the visual display field. Dialight helps you do more with these products than any other company in the business, because we are specialists that have done more with them. Talk to the specialists at Dialight first. You won't have to talk to anyone else. Send for your free new copy of Dialight's current catalog.

### DIALIGHT

Dialight, A North American Philips Company  
203 Harrison Place, Brooklyn, N. Y. 11237  
(212) 497-7600

# See Dialight.

## New products

line with a known fundamental resonant frequency and Q factor is perturbed with a test component connected either in series at the short-circuited end of the line or in shunt at the open-circuited end of the line.

The connection of the component alters the resonant frequency of the system, and the combined Q factor of the test component and that of the line is measured using the  $\Delta f$  technique at the newly established resonant frequency. These Q factors, applied in the proper equation, allow the computation of the Q factor of the test element.

Price of the Model 34A is \$1,450, and delivery time is 10 weeks.

Boonton Electronics Corp., Parsippany, N. J. 07054 [355]

## Oscillator spans 1 MHz with less than 0.02% distortion

The model 4100A sine-and-square-wave oscillator is an ultralow distortion instrument with a range of 0.01 Hz to 1 MHz and a frequency response better than 0.05 dB. Distortion is typically 0.005% (through the audio range), with an overall maximum of 0.02%.

Push-button frequency controls provide three-digit resolution and 0.05% frequency accuracy, suitable for use in audio laboratories or in production testing. A calibrated amplitude control for the sine-wave output provides 10 v rms at 0.5 w from its 50- $\Omega$  source. The square-wave output is variable over a 0-to-5-v peak-to-peak range. The oscillator sells for \$795.

Krohn-Hite Corp., Avon Industrial Park, Bodwell Street, Avon, Mass. 02322 [353]

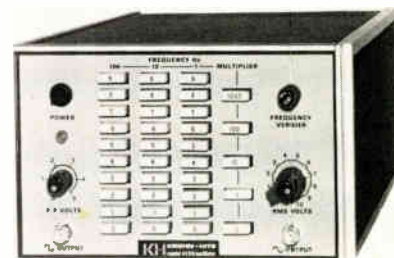

# That new product... where is it now that you need it?

**New Product Trends in Electronics**  
by the editors of *Electronics Magazine*  
333 pages, \$14.95



How often do you have to go back through magazines and journals, searching for the specific development that's needed on one of your design projects? You *noticed* it then, but you *need* it now. State-of-the-art products, *arranged by application*, are easy to find in this newest addition to the *Electronics Books Series*.

Compiled from recent issues of *Electronics Magazine*, this reliable reference presents up-to-date, usable information on important materials and equipment. It's more convenient than going back through periodicals... more current than textbooks.

### From the simple to the complex

Covered here is a wide range of products from simple resistors to sophisticated automatic testing machinery. More than 500 manufacturers are represented from throughout the world—all cross-referenced in an easy-to-use company index.

### Functional... dependable

The emphasis is on listing products according to function, making this a true problem-solving guide. And all product information was researched by the editors of *Electronics* through direct contact with the people responsible for the product's development.

### Find out all about the latest

- amplifiers
- industrial equipment
- semiconductors
- power supplies
- displays
- memory products
- communications equipment
- computers
- components
- instruments
- packaging and production equipment
- data converters

### Among the hundreds of manufacturers included...

- |                           |                         |
|---------------------------|-------------------------|
| Allen-Bradley             | Intel                   |
| American Microsystems Inc | International Rectifier |
| Analog Devices            | Motorola                |
| Analogic                  | National Semiconductor  |
| Bourns                    | Philips                 |
| Burr-Brown                | Systron Donner          |
| Dana Laboratories         | Tektronix               |
| Datel Systems             | Teledyne                |
| John Fluke                | Texas Instruments       |
| Hewlett-Packard           | TRW                     |

Order today, and don't forget the other valuable books in the Electronics Books Series listed in the coupon below.

**Electronics Book Series**  
P.O. Box 669, Hightstown, NJ 08520

If after my 10-day free-trial examination I am not fully satisfied I understand that my payment will be refunded.

Payment enclosed     Bill firm     Bill me

Charge to my credit card:

American Express     Diners Club

BankAmericard/Visa     Master Charge\*

Acct No. \_\_\_\_\_ Date Exp. \_\_\_\_\_

\*On Master Charge only, first numbers above name \_\_\_\_\_

Name \_\_\_\_\_ Title \_\_\_\_\_

Company \_\_\_\_\_

Street \_\_\_\_\_

City \_\_\_\_\_ State \_\_\_\_\_ Zip \_\_\_\_\_

Signature \_\_\_\_\_

**1. Microprocessors**  
Send me \_\_\_\_\_ copies at \$8.95 per copy.

**2. Applying Microprocessors**  
Send me \_\_\_\_\_ copies at \$9.95 per copy.

**3. Large Scale Integration**  
Send me \_\_\_\_\_ copies at \$9.95 per copy.

**4. Basics of Data Communications**  
Send me \_\_\_\_\_ copies at \$12.95 per copy.

**5. Circuits for Electronics Engineers**  
Send me \_\_\_\_\_ copies at \$15.95 per copy.

**6. Design Techniques for Electronics Engineers**  
Send me \_\_\_\_\_ copies at \$15.95 per copy.

**7. Memory Design: Microcomputers to Mainframes**  
Send me \_\_\_\_\_ copies at \$12.95 per copy.

**8. New Product Trends in Electronics**  
Send me \_\_\_\_\_ copies at \$14.95 per copy.

Discounts of 10% on orders of 10 or more copies of each book.

# Are you rushing into microprocessor-based development with old friends?

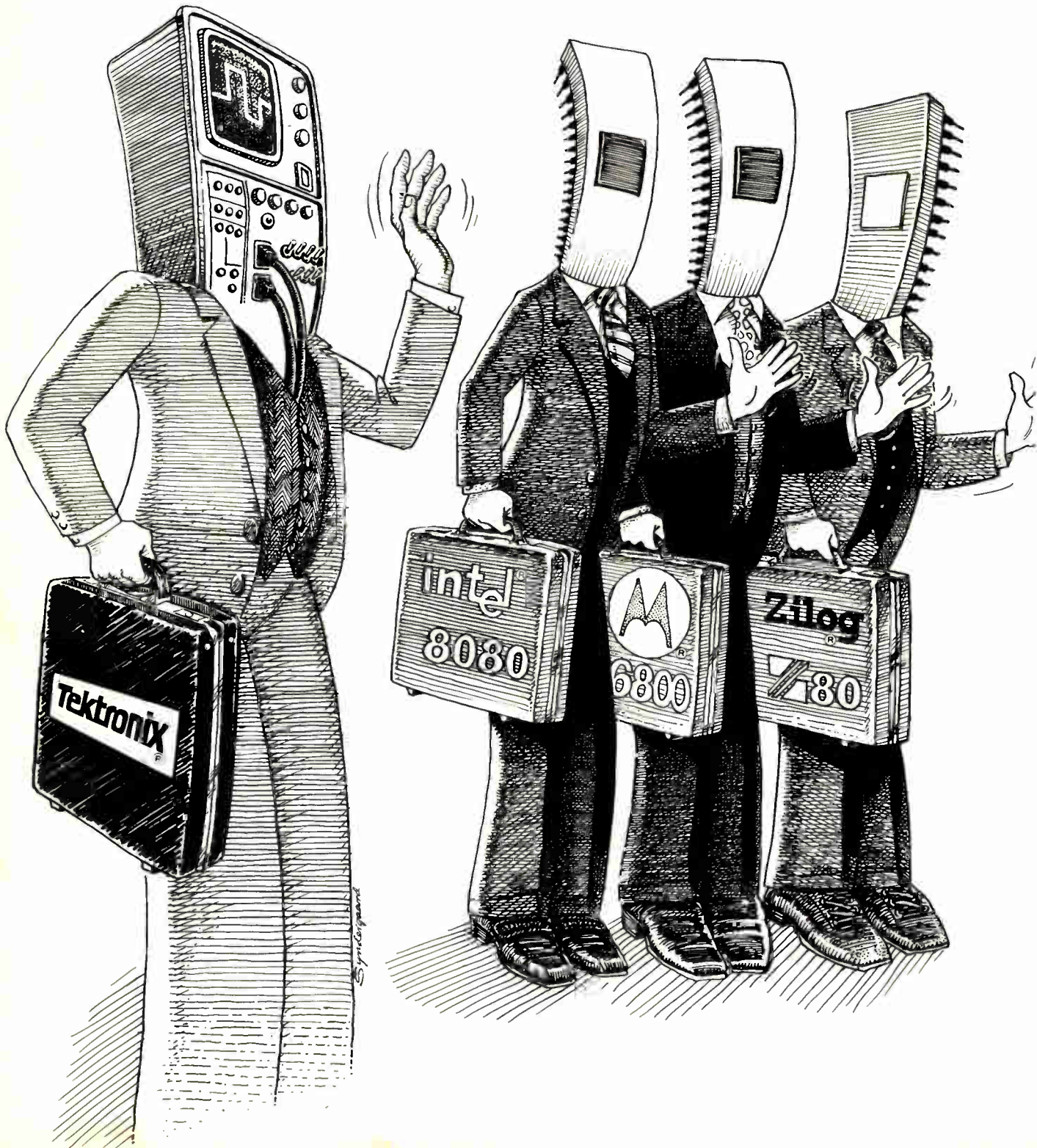

# You have a new friend.

don't have to pay a big name price for a universal product development lab. And, don't let your fondness for a certain chip lead you to a convenient but confining marriage. The inevitable divorce will be costly and time consuming. If you want to develop products happily hereafter, move in with Futuredata.

## Futuredata systems are universal.

can move you into multiple-processor-based product development at half the cost. With the largest selection of powerful hardware, software and economical peripherals around. With high speed disk or low cost tape operating systems. With in-circuit emulators for 8080, 6800, and Z-80. With the universal microcomputer that tackles every



## Why Futuredata move you in for \$3850.\*

no other microcomputer can match the cost/performance standards set by our MICROSYSTEM/20 & 30 disk-based systems and our MICROSYSTEM/10 & 15 tape-based systems. Each of these are complete development systems with up to 64K memory, 960 character CRT, full keyboard, two RS-232 serial ports, 8-bit parallel I/O, real-time clock, bootstrap in PROM, 8-level vectored interrupts and complete disk and tape operating systems with monitor, debugger, editor, assembler and utility.

\*Suggested U.S.A. prices

Circle 179 on reader service card



## The most complete spectrum of economical systems.

Move in with our Dual 5" Mini Floppy Disk System, our Dual 8" Standard Floppy Disk System, our unique QUICKRUN™ 32K Tape Operating System or our new Universal Dual Development System. No matter which you choose, the savings will be significant.

## Only Futuredata has QUICKRUN™

MICROSYSTEM/15 has the only co-resident assembly and interactive debugging system in the industry. With editor, assembler and debugger/monitor all in memory, things happen fast. Assembly of a 1000 statement program takes a mere 15 seconds. At \$5275,\* it's the most cost-effective development tool around.

## Now the first Universal Dual Development System.

Futuredata has combined two separate memory/processor sys-

tems in one host computer. Mix or match processors, disk or tape operating systems in each half. Put two development engineers to work at full speed, simultaneously. You get two complete systems in one and save nearly \$2000.



## In-circuit emulation and higher-level language.

We have in-circuit MICROEMULATORS™ for 8080, 6800, Z-80, Extended BASIC, line printers, EPROM programmers, hardware, software, documentation and a rock-solid record for reliability. So, let's be friends!



## 30-day "Get Acquainted" offer.

Try one of our development systems for 30 days at no risk. For more information, write or call Futuredata today.

## Move into product development with a new friend...

# futuredata

FUTUREDATA COMPUTER CORPORATION • 11205 S. LA CIENEGA BLVD. • LOS ANGELES, CA 90045 • (213) 641-7700 • TWX 910-328-7202

SEE US AT MIDCON, BOOTH #333.

World Radio History

SEE US AT ELECTRO '78, Booth Nos. 2543/2544; and at NCC, Booth Nos. 1235/1237

easily tailored to your needs—efficient—they'll provide 50 to 100 percent greater throughput than competing systems.

### **Sentry V for economical LSI testing.**

It's the most advanced LSI test system in its price class. Sentry 5 delivers high throughput, exceptional accuracy and the flexibility to handle all modern technologies.

### **Sentry VII for LSI engineering and characterization.**

It's the industry standard.

Sentry 7's multi-tasking software and distributed processing cuts device charac-

terization to a fraction of the time required by other systems.

**Sentry VIII for VLSI.** When it comes to testing VLSI, Sentry 8 is the only game in town. It's the only commercial 120-pin test system with data pattern handling, multiple clocking, real-time error analysis and high speed memory on every pin. Its test programs are also software-compatible with Sentry 5 and 7.

**Xincom III for efficient memory testing.** Xincom 3 is Fairchild's computer controlled memory test system for production testing, circuit characterization and incoming inspection. It has a host computer and up to four test satellites, each with two heads for testing RAMs, ROMs or PROMs in wafer form or packages. Its distributed architecture lets you test several devices simultaneously in real time with true foreground/background processing. Without slowing the

testing function in the foreground, the background allows program development, data analysis and logging, printer/CRT interaction and more.

### **World-wide service for every system.**

Our products made us number one. Our service keeps us there. Training centers in the U.S., Europe and Asia have taught over 5000 engineers and technicians the latest in LSI testing techniques and equipment. Our world-wide applications staff will help you develop test programs to suit your requirements, so your Fairchild system is productive from the moment it's installed. And our field service group will be close by to keep your system running. Whether you're in Singapore or San Francisco.

**Watch us roar.** With the lion's share of the market, you have made Fairchild king of the testing jungle. We're constantly improving our technology to keep pace with yours. We intend to stay on top.

Find out more about Fairchild's LSI test systems. Mail the coupon today, or contact: **Fairchild Systems Technology**, 1725 Technology Drive, San Jose, California 95110 (408) 998-0123.

## **Fairchild: First in LSI testing**

Please send data on the following: Sentry V  VII  VIII   
Xincom III  I'd like to talk with a Fairchild engineer.

My testing needs include: \_\_\_\_\_

\_\_\_\_\_

\_\_\_\_\_

\_\_\_\_\_

Name \_\_\_\_\_

Title \_\_\_\_\_

Company \_\_\_\_\_

Address \_\_\_\_\_

City \_\_\_\_\_ State \_\_\_\_\_ Zip \_\_\_\_\_

Area Code \_\_\_\_\_ Phone \_\_\_\_\_



**FAIRCHILD**

Circle 181 on reader service card

# wear out.

The solid state keyboard, AML, lighted push-buttons and sensors you see here will probably never wear out. Because they're all solid state.

Each is based on a Hall-effect integrated circuit. A circuit that's been tested through billions of operations without failing. And proven by performance in thousands of applications.

The precision electro-mechanical components you see here come close. Simply because of the careful way they're designed and put together.

Like the long-life versions of our snap-action B, SM and SX precision switches. Available in a wide variety of sizes, electrical ratings, terminals, actuators, contact forms and operating characteristics—some tested to a mechanical life of over 10,000,000 operations.

MICRO SWITCH will provide you with field engineers for application assistance and a network of authorized distributors for local availability. Write us for details or call 815/235-6600.

And find out how you can get a component that wears on forever. Or at least comes very, very close.

## MICRO SWITCH

FREEPORT, ILLINOIS 61032  
DIVISION OF HONEYWELL

MICRO SWITCH products are available worldwide through Honeywell International.

## New products

### Microprocessors

## Module adapts MDS 800 to Z80

A combination of adapter and emulator makes both 8080 and Z80 use possible

Users of Intel MDS 800 microprocessor development systems who also want to design with Zilog Z80 microprocessors can now use the first to do the second. Relational Memory Systems Inc.'s Z80 SAM (for Systems Adapter Module) and a recently announced Z80 ICE (In-Circuit Emulator) between them enable a designer to employ the MDS 800 for the Zilog device also.

"The combination working in concert with an Intel MDS-800 offers Z80 users a development capability they could not get from Z80 vendors or universal microprocessor development equipment," claims president James Kelley. The SAM aids the user to develop his software, and the ICE helps debug the hardware.

When using the Z80 SAM, which features a relocatable macroassembler, a designer can do his assembly using Z80 mnemonics. Because the 8080 code is a subset of the Z80 code, users with existing 8080 software can simply convert up to the Z80. "The key," Kelley points out, "is they use the same link and locate functions, because of the abundance of existing 8080 software."

The Z80 ICE not only debugs but also helps integrate the hardware with the software. Its expansion of the breakpoint concept is unique to it. Instead of having first to determine and indicate a specific address of generating a break, the user specifies a region of memory or input/output address space. Entering or quitting the region will set off a break, which permits the engineer in effect, to zero in on a problem by narrowing the limits of the region until he locates the desired point.

The Z80 ICE's programmable clock rate, with 32 different frequencies, can be used to test a user system's clock rate sensitivity. A too-narrow clock rate dependence can be widened, avoiding trouble in the field caused by frequency drift. Up to six Z80 ICE subsystems may be connected to a single MDS 800 for production test purposes. A combination of Z80 ICE and SAM costs \$3,595. Either one of these subsystems may be purchased separately. The ICE for \$2,100 and the SAM for \$1,495.

Relational Memory Systems Inc., P. O. Box 6719, San Jose, Calif. 95150. Phone (408) 248-6357 [401]

### Development system supports Zilog processors

The ZDS-1/40 Development System is a stand-alone hardware and software design tool for supporting development of Z80- and Z80A-based microprocessor systems. The system is also designed to support Zilog's upcoming Z8 and Z8000 products.

The ZDS-1/40 achieves real-time emulation by using two microprocessor circuits—a Z80A central processing unit inserted into a prototype system, and a second Z80 CPU inside the development system. This feature reduces the problems inherent in connecting the user's system to a development system and allows precise emulation of the Z80A's 4-MHz clock frequencies.

The 4-MHz emulator may be acquired together with the ZDS-1/40 for \$11,690 or as a factory-installed option (Zilog Real-Time Emulator) for \$2,750 by users who want to upgrade an existing ZDS/U development system to accommodate 4-MHz components.

A standard ZDS-1/40 Development System includes 32 kilobytes of main memory, with capacity of up to 65 kilobytes on a single board, allowing more room for additional I/O options. It also offers an RIO operating system with relocating



# SEMICON 78 EUROPA

Sie sollen jetzt schon einen Besuch auf West-Europas *einzig*er Industriemesse planen, die *ausschließlich* auf Halbleiterherstellung spezialisiert ist. Außer einem dreitägigen technischen Symposium erwarten Sie über 200 Einzelaussteller mit den neuesten Produktionsausrüstungen und dem neuesten Material zur Herstellung von Halbleitern.

Don't miss your *one* opportunity to come to Zurich for Western Europe's *only* tradeshow devoted *entirely* to semiconductor production equipment and materials. Now in its third year, SEMICON Europa will feature an informative three-day Technical Symposium, and more than 200 exhibits demonstrating the industry's latest products. Plan now to be one of the 4,000 engineers, managers and decision-makers in attendance.

Pensez dès maintenant à aller voir la *seule* exposition commerciale d'Europe Occidentale consacrée *entièrement* à la fabrication des semi-conducteurs; un Symposium Technique d'une durée de trois jours et qui devrait s'avérer très instructif figure au programme, et plus de 200 exposants présenteront les nouveautés les plus récentes en matière d'appareils et de matériaux pour la fabrication des semi-conducteurs.

**Sept. 12-14**  
**ZÜRICH**  
**Züspa Convention Center**

Sponsored By

**SEMI**

Semiconductor Equipment and  
Materials Institute, Incorporated

**IN WESTERN EUROPE CONTACT**

SEMICON Europa '78 Secretariat, Oberdorfstr. 28,  
8001 Zurich, SWITZERLAND  
Telephone: 01/47 44 45 Telex: 56 170

**IN THE U.S.A. CONTACT**

Golden Gate Enterprises, Inc. 1307 South Mary Ave.  
Suite 210, Sunnyvale, CA 94087 U.S.A.  
Telephone: (408) 737-1100 TWX: 910 338 0564

THE VERY ATTRACTIVE SOVIET-MADE  
MINI-COMPUTERS NEWS  
**SM-1 SYSTEM**



- \* Ideal for real-time single-level automated process control systems
- \* Also readily fits as a low-level component into large sophisticated hierarchies, with the ASVT-M and ES
- \* A valuable tool in engineering calculations, too

with

— appreciable speed of up to 400,000 addition-type ops per second

— a comprehensive system of checks and diagnostics, automatic self-recovery after failures, automated initial program-loading and starting

and also

full software and input/output interface compatibility with M-6000/M-7000 ASVT-M Processors.

plus the Instruction List readily expandable with both standard additional instruction sets and User's special instructions

 **TECHMASHEXPORT**

35 Mosfilmovskaya  
117330 Moscow, USSR  
Telephone 147-15-62  
Telex 7568

**New products**

learning tool to acquaint designers with a 1-bit microprocessor and, thereafter, as a dedicated functional control system. In use, the I/O Simulator is replaced by the actual I/O devices in the working system.

The boards have 15 inputs and 16 outputs and incorporate a random-access memory capable of holding 128 MC14500B program instruc-

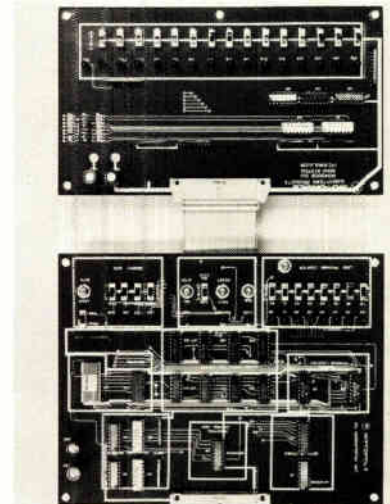

tions. The user is able to examine or change the contents of any memory location and has the option of single-stepping or running the program. Alternatively, a programmed programmable read-only memory may be installed in an available socket to run the program.

The \$295 price includes the processor board, the I/O simulator board, and an appropriate 40-conductor ribbon cable. For end-use application where an I/O simulator is not required, the processor board is available separately, under part number DS 14500B, for \$197.00.

Motorola Semiconductor Products Inc., P. O. Box 20912, Phoenix, Ariz. 85036. Phone (602) 244-6900 [406]

**Digital input board  
accepts 24 channels**

A single-board microcomputer peripheral accepts 24 digital inputs. Each group of eight having an isolation of up to 600 v dc from other



# THE MEMORY BOOK



## YOUR KEY TO SUCCESSFUL MEMORY DESIGN.

This newest book in the highly respected *Electronics Books Series* provides you with the most up-to-date and authoritative information compiled from the pages of *Electronics Magazine*. You'll learn exactly how to apply the new technology and components to meet specific design goals. And you'll be fully prepared to work with everything from small microcomputer-based systems to large memory-rich mainframes.

### You'll have instant access to the NEW industry-standard memory devices.

- the 16-k RAM that offers high start-up reliability
- the 4-k static RAM that saves costs on power
- the speedy RAM that runs cool with power-down circuitry
- the dynamic injection logic random-access memory that competes with MOS designs
- the biggest erasable PROM that puts 16,384 bits on a chip
- the electrically alterable ROM that doesn't use nitride
- *and much, much more*

### You'll learn all about the latest memory technology.

- the cheaper RAMs, reprogrammable ROMs, CCDs, and bubble memories that are being developed *now*
- five technologies that squeeze more performance from memory chips
- grooves to add new dimension to V-MOS structure and performance
- cutting costs and boosting performance with injection logic
- *and much, much more*

### You'll discover specific applications to use NOW.

- flag potential problems with 4,096-bit RAMS
- ease memory design for mainframes and microcomputers with the 16-k RAM
- Expand a microcomputer's memory
- predict the real costs of semiconductor-memory systems
- check on the reliability of 4-k RAMS
- *and much, much more*

Solidly packed with usable, up-to-date, reliable data and guidelines, this is your key to successful memory design on any scale.

Order today, and don't forget the other valuable books in the **Electronics Books Series** listed on the coupon below.

#### Electronics Book Series

P.O. Box 669, Hightstown, N.J. 08520

#### 1. Microprocessors

Send me \_\_\_\_\_ copies at \$8.95 per copy.

#### 2. Applying Microprocessors

Send me \_\_\_\_\_ copies at \$9.95 per copy.

#### 3. Large Scale Integration

Send me \_\_\_\_\_ copies at \$9.95 per copy.

#### 4. Basics of Data Communications

Send me \_\_\_\_\_ copies at \$12.95 per copy.

#### 5. Circuits for Electronics Engineers

Send me \_\_\_\_\_ copies at \$15.95 per copy.

#### 6. Design Techniques for Electronics Engineers

Send me \_\_\_\_\_ copies at \$15.95 per copy.

#### 7. Memory Design: Microcomputers to Mainframes

Send me \_\_\_\_\_ copies at \$12.95 per copy.

Discounts of 40% on orders of 10 or more copies of each book.

If after my 10-day free-trial examination I am not fully satisfied, I understand that my payment will be refunded.

Payment enclosed     Bill firm     Bill me

Charge to my credit card:

American Express     Diners Club  
 Bank Americard     Master Charge\*

Acc't No. \_\_\_\_\_

Date Exp. \_\_\_\_\_

\*on Master Charge only, first numbers above name \_\_\_\_\_

Name \_\_\_\_\_ Title \_\_\_\_\_

Company \_\_\_\_\_

Street \_\_\_\_\_

City \_\_\_\_\_ State \_\_\_\_\_ Zip \_\_\_\_\_

Signature \_\_\_\_\_



## New products

groups and from the computer bus up to 600 v dc in the MP710, 300 v dc in the MP710-NS. The MP710, with an on-board power supply, operates with dry relay contacts and MP710-NS uses wet relay contacts.

Both peripheral models are compatible with Micromodule and EXORciser microcomputers. They are programmed as memory locations and, with each input using 1 memory

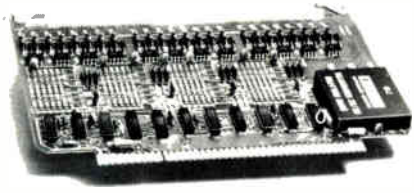

bit, any read command may be used.

Input impedance is 15 k $\Omega$  and input delay time is a maximum of 25  $\mu$ s open to closed, 100  $\mu$ s closed to open. Price in 1 to 9 quantities is \$355 for the MP710 and \$295 for the MP710-NS. Delivery is from stock.

Burr-Brown, International Airport Industrial Park, Tucson, Ariz. 85734. Phone (602) 294-1431 [407]

### Programmer for EPROMs covers five processors

An erasable-PROM programmer for the Intel 8080, Motorola 6800, MOS Technology 6502 (KIM-1), Fairchild F-8, and RCA 1802 microprocessors has provisions for programming both the 2708 and 2716 eras-

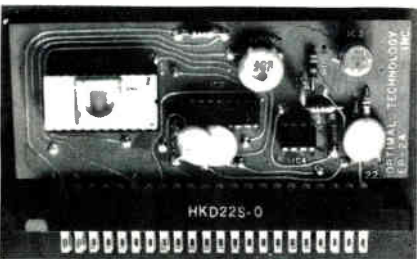

able programmable read-only memories. By using the microcomputer monitor, any random-access-memory starting address within the address space of the programmable

ROM may be specified along with the number of bytes to be programmed. The programmer has a verify mode to confirm that all bits have been programmed correctly. One and one-half input/output ports are required to interface the processors to the programmer. Price is \$59.95, and delivery is from stock.

Optimal Technology Inc., Blue Wood 127, Earlsville, Va. 22936. Phone (804) 973-5482 [408]

### Microassembler can handle bit-slice microprocessors

The Signetics Micro Assembler is a software package that can be used for the complete microprogramming cycle, including defining microinstructions, writing and assembling programs, and generating paper-tape output for programming the read-only memory of bipolar, bit-slice microprocessors. It is written in ANSI Fortran IV and may be run on any 16- or 32-bit computer that has Fortran capability. The assembler can also be accessed via Tymeshare, GE, or NCSS timesharing services. This program eliminates the need for the binary coding process of assembly languages often required in developing bipolar systems.

In its present form, the microprocessor assembly language provides direct support for the 3002 and 2901-1 bipolar microprocessors and the 8X02 Control Store Sequencer. With the inclusion of explicit definitions, similar support can be obtained for the 3001 Microprogram Control Unit, as well as other bipolar processing elements and sequences.

The assembler consists of two independent programs. The first reads the microprogram and the appropriate configuration and format descriptions written in the microprocessor assembly language. The second punches paper tapes that can be used to program programmable ROMs. Price is \$775.

Signetics Corp., P. O. Box 9052, 811 E. Arques Ave., Sunnyvale, Calif. 94086. Phone (408) 739-7700 [409]

# NEVER AGAIN?

If it can happen in New York it can happen anywhere.



## POWERLESS!!

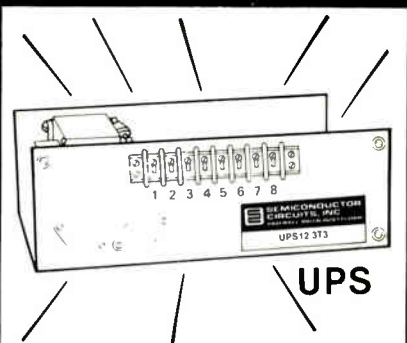

Protect your Memory and Systems against Blackout with one of S.C.I.'s UNINTERRUPTIBLE POWER SUPPLY SYSTEMS . . . or design your own system using S.C.I. modules.

UPS SERIES priced from: \$155.00 to \$225.00 (unit price)

### PERFORMANCE!

- Reliable Float Charge Battery Backup Systems
- Regulated Single & Multi Outputs
- 36 Standard High Performance, High Efficiency Models

The Memory Savers from the No. 1 Source. Want the Facts Fast? Call Frank Frontiero



**SEMICONDUCTOR CIRCUITS, INC.**

POWER SOURCES DIVISION

306 RIVER ST., HAVERHILL, MA 01830  
TEL. (617) 373 9104, TWX. 710 347 0269

# THE GO-EVERYWHERE MICROPROCESSOR NOW HAS A DO-EVERYTHING DESIGN AID.



# New RCA Micromonitor helps you debug designs and software, production-test and field-test RCA 1800 microprocessor systems.

Now you can quickly and economically prove out the RCA 1800...our cost-effective, environmentally rugged, CMOS microprocessor.



Our new COSMAC Micromonitor CDP18S030 is a complete portable  $\mu$ P system diagnostic tool. The best tool, in fact, to perform breadboard debugging and factory checkouts and field tests without additional diagnostic equipment. The Micromonitor can take instructions electronically, supply hard-

copy or CRT display through your terminal, and become more powerful via our COSMAC Development system with floppy disk—all useful features in automated testing.

## Prototype debugging

Simply plug the CPU of your system under test into the Micromonitor. You now have control of both hardware interfaces and program execution. Using the keyboard and display, you can start/stop, examine any portion of the system, and make changes. An optional RAM or ROM card lets you evaluate your system before building memory and finalizing ROM.



## Unique automated testing

The Micromonitor can be

used with any of its configurations to provide the factory test system you require.

## Field service

Its self-contained package is designed to be carried easily to any place RCA 1800 microprocessor systems are in operation.

## Operation software

An optional Micromonitor Operating System (MOPS) CDP18S831 gives you an extended set of commands. You can execute command programs from files on a floppy disk. During debugging you can dump a status report at any time. So you don't have to keep starting over. MOPS, on the COSMAC Development System with floppy disk option, helps the Micromonitor do everything from simple terminal-Micromonitor dialog to fully automated system testing.



RCA Solid State, c/o KLM Publications Handling Dept.  
Schiphol Airport, The Netherlands

Tell me more about why the Micromonitor is one more reason to go RCA 1800. My microprocessor application is:

\_\_\_\_\_

Name \_\_\_\_\_

Title \_\_\_\_\_

Company \_\_\_\_\_

Address \_\_\_\_\_

\_\_\_\_\_

E-1

**RCA 1800. Our systems are go.**

# RCA

# PLUS EVERYTHING THEY WANT IT IN.

## **The new RL01 5Mb disk.**

Introducing a top-load, rack mountable, low priced 5.2Mb disk with state-of-the-art performance and solid OEM reliability.

The RL01 features 512Kb per second transfer rate.

Plus an incredibly simple design. There's no back plane. And just 5 electronic modules. So it's super reliable and easy to spare.

The RL01 is simple to service, too. All maintenance is done from the top of the unit. The heads can be changed in minutes, not hours. There's even a universal power supply with a frequency range of 47.5-63 Hz that can be quickly (but not accidentally) switched between 100-127V and 200-254V. And it can be replaced with just four screws without disturbing heads or logic.

The RL01 is also easy to configure. Our one board controller can power four drives for up to 20.8Mb.

Our RL01 is so good, you probably won't want a system without one. So we're offering those, too.

## **Incredibly priced new packaged systems, starting at just \$18,000.**

Here's what you get: a PDP-11 CPU with 64 Kb of main memory, clock, serial line interface, cabinet, 10Mb of RL01 capacity with controller, an LA-36 terminal, and our RT-11 operating system.

You can get a PDP-11/03 based system for just \$18,000, PDP-11/04 based for just \$21,000, and the PDP-11/34 based one in the picture for just \$25,500. And prices go even lower with our OEM discounts.

The new RL01 disk and new PDP-11/RL01 packaged systems.

They're the systems you've always wanted.

Which is just what you'd expect from the OEM Group at Digital.

Call or write: Digital Equipment Corporation, PK3/M-86, Maynard, MA 01754. (617) 493-4237. In Europe: 12 av. des Morgines, 1213 Petit-Lancy/Geneva. Tel. 93 33 11. In Canada: Digital Equipment of Canada, Ltd.



**digital**  
OEM PRODUCTS  
GROUP

Circle 193 on reader service card



# ELECTRONICS REPRINTS

No. of  
copies  
wanted

## New reprints

- \_\_\_ R-801 World market report 1978 24 pp \$4.00
- \_\_\_ R-734 Microcomputer families expand 20 pp. \$4.00
- \_\_\_ R-730 Special Report—Automotive electronics gets the green light 10 pp \$3.00
- \_\_\_ R-728 Flexible circuits bend to designers' will 10 pp \$3.00
- \_\_\_ R-724 Special Report—Technologies squeeze more performance from LSI 22 pp. \$3.00
- \_\_\_ R-722 Demands of LSI are turning chip makers towards automation 12 pp \$3.00
- \_\_\_ R-720 How EEs Feel About Engineering—3-part series 26 pp \$5.00
- \_\_\_ R-718 Display makers strive to refine their technologies 8 pp \$3.00

## Books

- \_\_\_ R-803 New product trends in electronics—Electronics Book Series 333 pp \$14.95
- \_\_\_ R-732 Memory Design—Microcomputers to Mainframes—Electronics Book Series 180 pp \$12.95
- \_\_\_ R-726 Design Techniques for Electronics Engineers—Electronics Book Series 370 pp \$15.95
- \_\_\_ R-711 Circuits for electronics engineers: 306 circuits in 51 functional groups—Electronics Book Series 396 pp \$15.95
- \_\_\_ R-704 Thermal design in electronics \$5.00
- \_\_\_ R-701 Applying microprocessors—Electronics Book Series 191 pp \$9.95
- \_\_\_ R-608 Basics of Data Communications—Electronics Book Series \$12.50
- \_\_\_ R-602 Large Scale Integration—Electronics Book Series 208 pp \$9.95
- \_\_\_ R-520 Microprocessors—Electronics Book Series 154 pp \$8.95

## Payment must accompany your order

Make check or money order payable to Electronics Reprints. All orders are shipped prepaid by parcel post. Allow two to three weeks for delivery. For additional information call (609) 448-1700 ext. 5494.

Mail your order to:

Janice Austin  
ELECTRONICS REPRINTS  
P.O. Box 669  
Hightstown, N.J. 08520

## New products

### Subassemblies

## 'Compromise' a-d converter enters

Designed to tradeoff speed and price, 12-bit model has 5- $\mu$ s conversion

There are faster 12-bit hybrid analog-to-digital converters on the market, but with a maximum conversion time of 5 microseconds, the MN5240 from Micro Networks Corp. is no slouch. John Munn, manager of market development, believes the unit represents a good compromise—compared with the few announced 2- $\mu$ s products—between high speed, versatility, and moderate price.

The 5240 is a thin-film hybrid in a hermetically sealed, 32-pin dual in-line package. It has five user-selectable analog-voltage input ranges, an optional input buffer amplifier, and a choice of internal or external clock. The input ranges are:  $\pm 2.5$ ,  $\pm 5$ , and  $\pm 10$  v, and 0 to +5 and 0 to

+10 v. Robert Calkins, manager of circuit development, says the converter is an optimization of existing designs, including the company's own ADC80 a-d converter, "without a lot of circuitry that runs the price up and yields down."

Calkins says the high speed is achieved by optimizing the speed of the digital-to-analog converter and input to the comparator and by selecting good quad switches. He looks for the 5240 to be used in high-speed military and industrial applications and says it is especially suitable for high-speed acquisition and digitizing of analog data in microprocessor-based data-acquisition systems. In fact, when the 5240 is combined with Micro Networks' MN7130 multiplexed sample-and-hold amplifier, the user gets a 16-channel data-acquisition system in just two DIPs, Calkins points out.

Some of the other key features, he notes, are the absence of missing codes over the operating temperature range and the option of external offset and gain adjustments using potentiometers. And while input impedance is a maximum of 10 k $\Omega$  at  $\pm 10$  v, the optional internal buffer amplifier can boost that to 100 M $\Omega$ ,

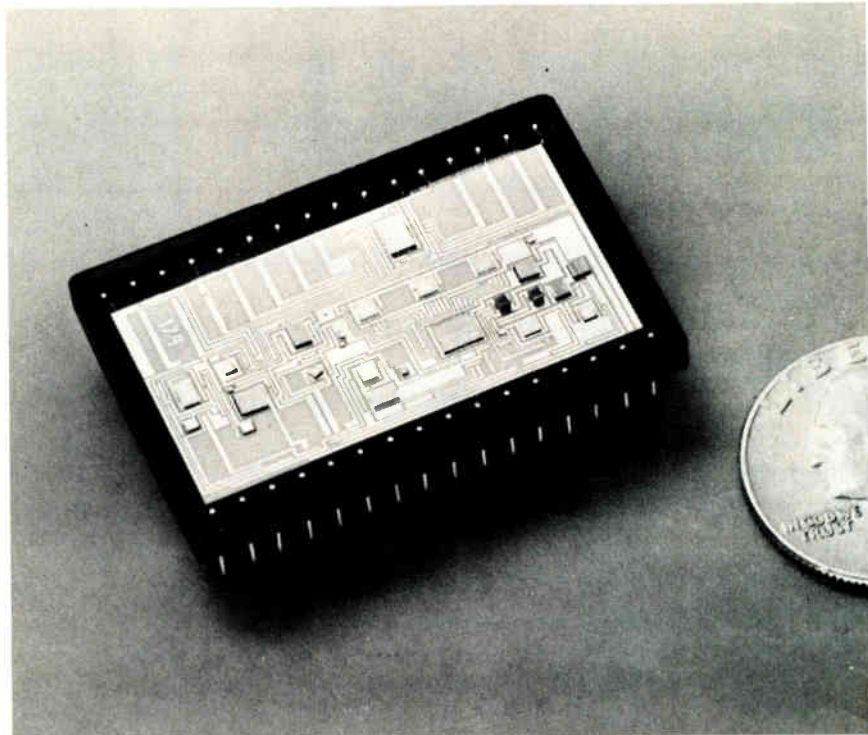

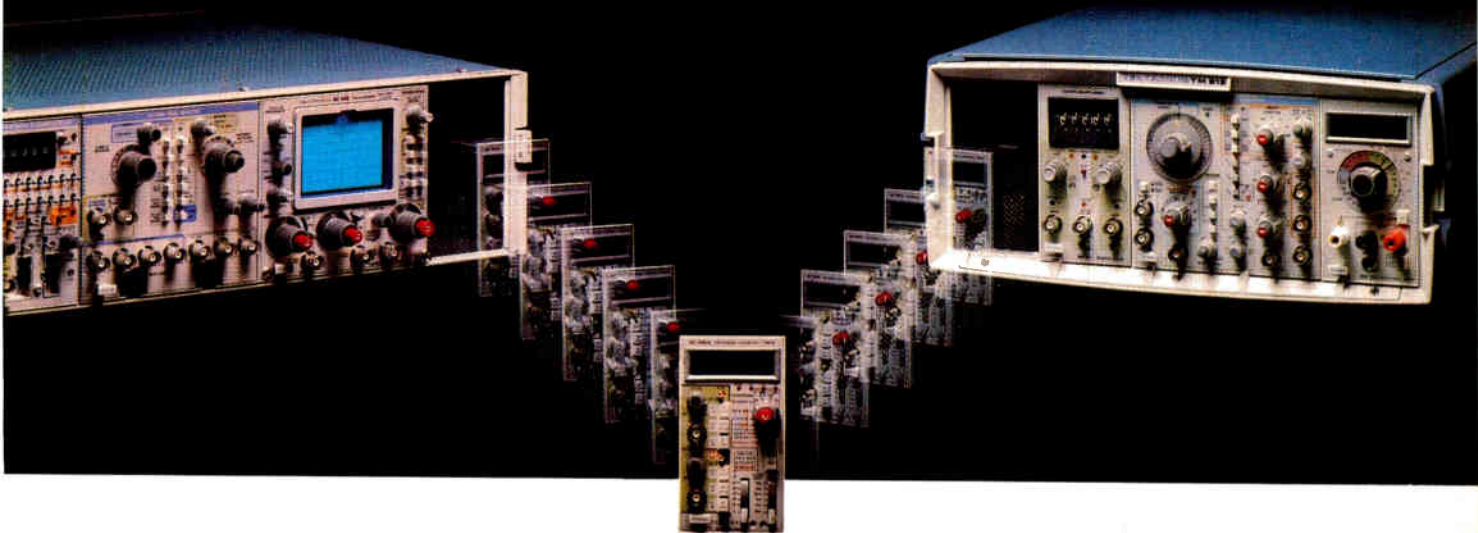

# Stock Exchange.

If you want the highest return for your instrument dollar, take a look at the unmatched value of an electrically configurable TM 500 test and measurement system from Tektronix.

Not only do you get Tektronix' bluechip performance and reliability, but also the convenience and versatility of plug-in instrumentation, at a very reasonable cost.

If your applications are diversified, TM 500 gives you the power to configure literally thousands of plug-in combinations, all mechanically compatible in your choice of TM 500 mainframes.

There are nearly 40 different plug-ins to choose from, in eight major categories:

DMMs	Oscilloscopes
Counters	Logic Analyzers
Generators	Word Recognizers
Amplifiers	Power Supplies

A single mainframe accommodates up to six plug-ins. Switching your system around from one application to another is just a matter of a simple stock exchange. Slip one plug-in out, slide another one in.

If your applications are growing, a TM 500 system is a wise investment. You can update your system or add on new performance capabilities to your initial TM 500 system without buying another mainframe. Since all plug-ins are powered through the mainframe, you won't be paying for an unnecessary power supply component with every new instrument you buy.

TM 500 go-anywhere mainframes come in six different versions for benchtop, rackmount, rollcart or on-the-road engineering.

Another long-term advantage is, as new standards are set in electronics, new instruments will be added to the TM 500 family — like our 40 MHz function generator with log sweep, phase lock, AM and FM capabilities and a long list of added dividends.

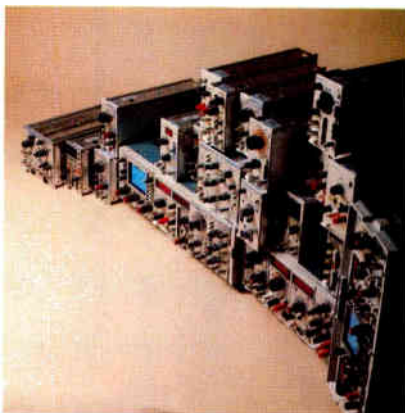

Your investment is further protected by Tektronix Long-term Product Support Program and worldwide over-the-counter service.

So, if you're in the market for accurate, reliable instrumentation, take stock of what TM 500 has to offer. In convenience, versatility and economical performance, TM 500 pays big dividends.

## TM 500 Designed for Configurability

Ask your Tektronix Field Engineer to assemble a portfolio of TM 500 instrumentation for you, or write for a copy of our TM 500 concepts brochure. Tektronix, Inc., P.O. Box 500, Beaverton, Oregon 97077. (503) 644-0161, Ext. 5283. In Europe: Tektronix Limited, P.O. Box 36, St. Peter Port, Guernsey, Channel Islands.

**Tektronix**  
COMMITTED TO EXCELLENCE

For Technical Data circle 49 on Reader Service Card  
For Demonstration circle 197 on Reader Service Card

# VICTORY SELECTIVITY

## THERMISTORS

Selectivity, not just a word but a reality at VECO. SensiChips® thick films, beads and probes in a wide variety of sizes and resistances. Try us, you'll like VECO quality and prices.

**VECO VICTORY ENGINEERING CORP.**  
Victory Rd., Springfield, N. J. 07081  
TWX: 710-983-4430 Tel: 201-379-5900

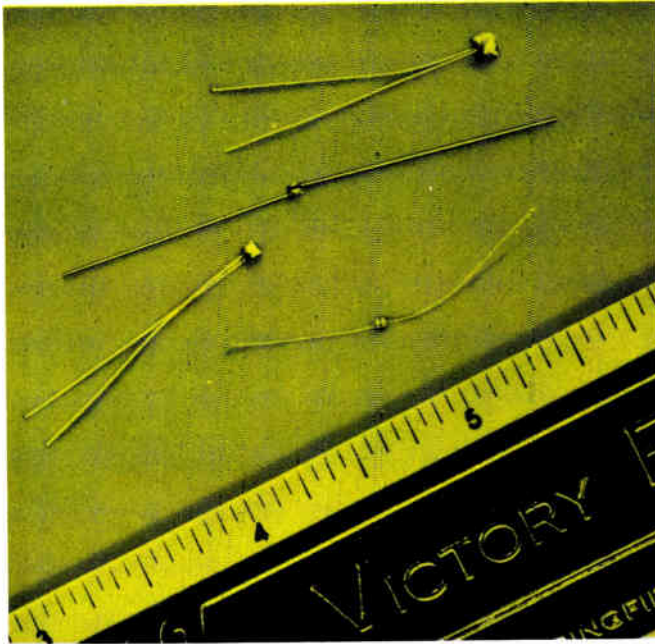

Circle 198 on reader service card

## SALE · EASTON, PA.

Valuable, Fully Air Conditioned  
Industrial Building  
**85,000 S.F.**  
Forks Township Industrial Park

(Now used as a printing plant)

- At the New Jersey border, and 1 hour from New York City and Philadelphia
- 4 years old, excellent condition
- fully airconditioned
- 13,000 s.f. finished offices
- rail available
- 40 x 40' bays
- excellent network of highways nearby serving PA, NY and NJ
- 12-acre site.

For information contact

**CUSHMAN &  
WAKEFIELD**

2000 MARKET STREET  
PHILADELPHIA, PA 19103  
215-564-2400



## New products

allowing the converter to be driven from high-impedance sources or directly from an analog multiplexer.

Prices for the 5240 range from \$193 in quantities of 1 to 24, to \$151 in lots of 100 to 249 for the version designed to operate between 0°C and 70°C. Delivery is from stock to 4 weeks.

Micro Networks Corp., 324 Clark St., Worcester, Mass. 01606. Phone John Munn at (617) 852-5400 [381]

## Synchro-digital converters track up to 300 rpm

Two low-profile, low-cost synchro-to-digital converters use a true Type II servo loop to eliminate velocity lag up to their maximum tracking rate of 300 revolutions per minute. Both the 12-bit SDC-632 and the 14-bit SDC-634 employ a novel transformer algorithm for high accuracy and jitter-free output. Although they stand only 0.42 inch high, they

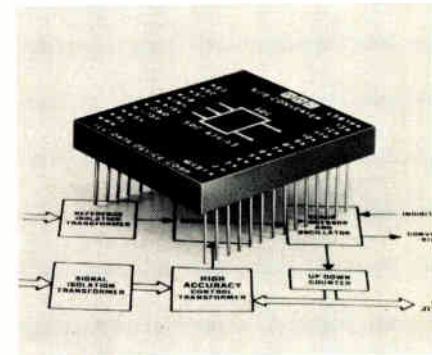

feature internal transformer isolation for all standard 60-Hz and 400-Hz inputs.

The 12-bit converter has a maximum error of 8.5 minutes. The 14-bit module is offered in two accuracy versions: one has a maximum error of 2.6 minutes; the other is rated at 4 min + 0.9 least significant bit. There are two standard temperature ranges: 0°C to 70°C and -55°C to +105°C. They measure 3.125 by 2.625 in., are 0.42 in. high, and weigh 4 oz.

The SDC-632 sells for \$345, and the lower-accuracy version of the SDC-634 is priced at \$395. Both are

# National and Lambda prove Fairchild regulators give you more for your money.

Compare our high current voltage regulators to the leading competitors.

You'll see we come out on top across the board.

Our unique Hybrid technology allows us to overcome the limitations

3 AMP, 5 VOLT REGULATORS				
PARAMETER	CONDITIONS*	FAIRCHILD SH323SC	LAMBDA** LAS1405	NATIONAL** LM323K
Available Peak Current (typ)	$V_{IN}-V_{OUT}=10V$ $V_{IN}-V_{OUT}=20V$	6 A 6 A	4.2 A 2.3 A	4.2 A 3.2 A
Available Average Output Current (typ)	$V_{IN}-V_{OUT}=10V$ $V_{IN}-V_{OUT}=20V$	5 A 2.5 A	3 A 1.5 A	3 A 1.5 A
Minimum Input Voltage (typ)	$I_{OUT}=3A$	$V_{OUT}+1.8V$	$V_{OUT}+2.2V$	$V_{OUT}+1.9V$
Max Power Dissipation	—	50 W	30 W	30W
Price	100 pieces	\$5.00	\$6.75	\$5.35

\* $T_C=25^\circ C$   
\*\*Based upon published data sheet specifications

# HIGH-CURRENT REGULATORS

5 AMP, 5 VOLT REGULATORS				
PARAMETER	CONDITIONS*	FAIRCHILD $\mu A78HO5ASC$	LAMBDA** LAS1905	NATIONAL
Available Peak Current (typ)	$V_{IN}-V_{OUT}=10V$ $V_{IN}-V_{OUT}=20V$	7 A 7 A	5 A 1.5 A	N O A V A I L A B L E P A R T
Available Average Output Current (typ)	$V_{IN}-V_{OUT}=10V$ $V_{IN}-V_{OUT}=20V$	5 A 2.5 A	5 A 1.5 A	
Dropout Voltage (typ)	$I_{OUT}=5A$	2 V	2.4 V	
Price	100 pieces	\$5.50	\$11.25	

\* $T_C=25^\circ C$   
\*\*Based upon published data sheet specifications

see by this chart, one leading competitor doesn't even offer the part. And the one that does isn't much competition.

For more details on our voltage regulators, just contact your Fairchild distributor or representative. Or, for more immediate results, call your nearest Fairchild sales office.

France: Fairchild Camera & Instrument S.A., 121 Ave. d'Italie, 750013-Paris. Tel: 00331 584 55 66. Telex: 0042 200614.  
Italy: Fairchild Semiconductor S.P.A., Via Roseolini, 12, 20124 Milano. Tel: 02 6887451. Telex: 36522.  
Germany: Fairchild Camera & Instrument (Deutschland) GmbH, 8046 Garching Hockbruck, Daimlerstr. 15, Mun-chen. Tel: 089 320031.  
Telex: 52 4831 fair d  
England: Fairchild Camera & Instrument (UK) Ltd., 230 High St., Potters Bar, Hertfordshire EN6 5BU. Tel: 0707 51111. Telex: 0051 262835.  
Sweden: Fairchild Semiconductor AB, Svarthensgatan 6, S-11620 Stockholm. Tel: 8-449255 Telex: 17759.

of monolithic designs. Which means you get better specs at a lower cost.

## How our 3 Amp regulators stack up.

Our SH323SC 3 Amp, 5 Volt regulator is a perfect example of the value of applying Hybrid know-how to regulator designs

This side-by-side comparison based on published data sheets should leave no doubt.

## How our 5 Amp regulators stack up.

Our  $\mu A78HO5ASC$  is a new, enhanced 5 Amp, 5 Volt regulator that's pretty much in a class by itself. As you can

**FAIRCHILD**

# INTERDATA interface . . . from MDB

General Purpose Logic Modules

Peripheral Device Controllers ■ Communications Interfaces

Systems Modules ■ Accessory Hardware

When it comes to Interdata interface, MDB has it:

- General Purpose Interfaces

GP Interface Board, full wirewrap board with 197 socket positions

Universal Logic Module provides handshake plus 92 wirewrap positions for any DIP configuration; handles two independent device controllers with I/O register options

- Device Controllers for most major manufacturer's

Printers

Card equipment

- Communications/Terminal Modules

Programmable Asynchronous Single Line Adapter (PASLA) Crystal controlled baud rate; all addressing and speeds DIP switch selectable.

Current Loop/RS232 Interface for TTY device, multiple

baud rate selection from 50 to 19.2K baud

- Systems Modules

IEEE/488 Instrumentation Bus Controller

Universal Clock Module, includes line frequency clock

Line Frequency Clock only

MDB interface products always equal or exceed the host manufacturer's specifications and performance for a similar interface. MDB interfaces are completely software transparent to the host computer. MDB products are competitively priced, delivery is 14 days ARO or sooner.

MDB places an unconditional one year warranty on its controllers and tested products. Replacement boards are shipped by air within twenty-four hours of notification. Our service policy is exchange and return.

MDB also supplies interface modules for PDP\*-11, LSI-11, and Data General computers. Product literature kits are complete with pricing.

**MDB** 1995 N. Batavia Street  
Orange, California 92665  
714-998-6900  
SYSTEMS INC. TWX: 910-593-1339

\* TM Digital Equipment Corp.

Circle for Interdata; 76 for PDP-11; 77 for LSI-11; 78 for Data General 202

"See us at Mini Micro Show"

## New products



average temperature coefficient of 0.01%/°C. Typical output noise voltage is 20 mv peak-to-peak.

The dc-to-dc converter keeps its conducted and radiated noise down by combining a pi-type input filter with multiple transformer shielding and a six-sided continuous-case shield. The switching frequency is greater than 20 kHz both to make any acoustic noise inaudible and to enhance the effectiveness of the shielding.

Typically, the UB has an efficiency of 55%. It will recover from a load transient to within a 0.1% error band in less than 50  $\mu$ s. The converter can be operated in free air from -25°C to +71°C with no derating. In quantities of one to nine, it sells for \$99. Delivery is from stock to six weeks.

Stevens-Arnold Inc., 7 Elkins St., South Boston, Mass. 02127. Phone (617) 268-1170 [385]

## Synchro-to-dc converter

tracks up to 240 rpm

Capable of maintaining zero tracking error up to 240 revolutions per minute, the model 426 synchro-to-dc converter has a conversion uncertainty of 6 arc-minutes and a choice of four outputs: 0 to 5 v, 0 to 10 v,  $\pm 5$  v, and  $\pm 10$  v. The unipolar outputs are for 0° to 360° rotation, the bipolar outputs for  $\pm 180$ °.

Although it is packed into a module with dimensions of only 2.6 by 3.1 by 0.82 inches, the model 426 contains a tracking synchro-to-digital converter with isolating transformers on both inputs and a digital-

# 32K ROM

**It's fully-static NMOS.  
It's fast (300 ns max. cycle time).  
It's available in volume now.**

If you're ready for a 32K ROM, make the move up to a Rockwell R2332 fully-static N-Channel ROM, (4096 x 8-bits).

The R2332 is universally compatible with N-Channel microprocessors, and supports Rockwell's growing R6500 microprocessor family.

The fast R2332-3 features maximum access and cycle time of 300 ns. Both the R2332-3 and the standard 450 ns R2332 use 400 mW power and one 5V power supply.

R2332 and R2332-3 inputs are TTL compatible with a 400 mV minimum noise immunity on both the HIGH and LOW inputs. All eight outputs are tri-state drivers capable of driving 100 pf and a TTL gate.

The R2332 from Rockwell operates totally asynchronously and requires no clock input, so it's compatible with both static and clocked-static versions. Two mask-programmable chip select

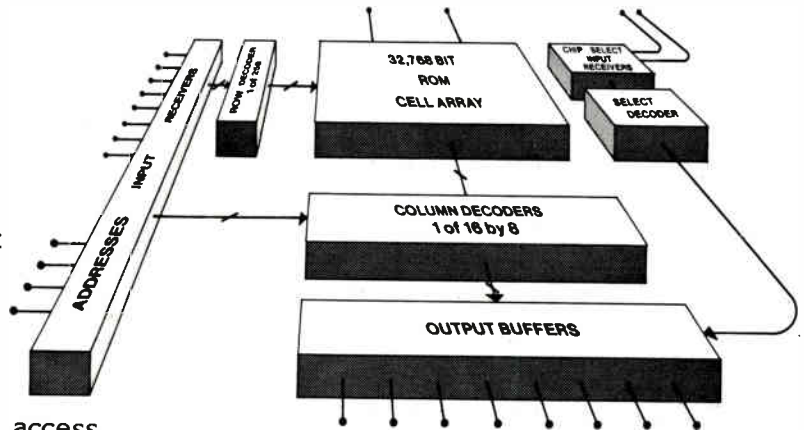

inputs allow four 32K ROMs to be OR-tied without external decoding. Programming allows selection when the input is HIGH or LOW or in a don't care mode. Both chip select and chip deselect delays are 100 ns.

Get started today by getting more information on R2332 and the R6500 family. Contact a local Hamilton/Avnet distributor or write: D-727-F, Microelectronic Devices, Rockwell International; P.O. Box 3669, Anaheim, CA. 92803 or phone (714) 632-3729. Telex (via TWX) 910-591-1698.



**Rockwell International**

...where science gets down to business

# Network testing worries? See our analyst.



High accuracy and resolution keep the Anritsu Network Analyzer ME527A/B ahead of the pack. All the way from 100 kHz to 500 MHz, the specially designed microprocessor helps deliver 0.01 resolution over the entire dynamic range of 100 dB, and 0.1 degree resolution from  $-180^\circ$  to  $+180^\circ$  in phase.

What's behind this kind of superior performance? Anritsu technology applied to digital signal processing. Digital techniques permit memory, conversion, and transmission of all measured results without reducing the signal-to-noise ratio. It's Anritsu technology that puts high precision, high speed, versatility, and low cost into an efficient compact package.

Today's complex communications, broadcasting, and acoustic equipment requires precision network analysis, and the Anritsu ME527A/B comes through with unsurpassed accuracy complemented by CRT visual confirmation to keep your network in top condition.

- Measures amplitude, phase, and impedance
- Automatic compensation of frequency response of the measuring system
- Display limits specified and GO/NO-GO determination
- Data processing

For comprehensive literature on Anritsu's Precision Network Analyzer Series, Contact—

## Anritsu

**ANRITSU ELECTRIC CO., LTD**  
MEASURING INSTRUMENTS DIVISION

SALES DEPARTMENT:

12-20, Minamiazabu 4-chome, Minato-ku, Tokyo 106, Japan  
Phone (03) 446 1111/Telex: 0 242-2353  
Cable: ANRITDENKI TOKYO

U.S.A. Tau-Tron Inc. Tel: (617) 667-3874 • West Germany Knott Elektronik GmbH Tel: (08178) 4085  
• U.K. Dymar Electronics Limited Tel: Watford 37521 • France Tekelec Airtronic Tel: (1) 946-96-48  
• Italy Vianello S.p.A. Tel: (02) 54 40 41 • Spain Unjtronics, S.A. Tel: 242 52 04 • Holland C.N. Rood B.V. Tel: 070-99 63 60 • Sweden Teleinstrument AB Tel: 08-38 03 70 • Singapore O'Connor's (Pte.) Ltd. Tel: 637944 • Australia NEC Australia Pty. Ltd. Tel: Melbourne 560-5233 • Malaysia O'Connor's (Malaysia) SDN.BHD. Tel: 51563/5 • Brazil Anritsu Eletrônica Comércio Ltda. Tel: Rio 221-6086

## New products



to-analog converter. It operates from  $0^\circ\text{C}$  to  $70^\circ\text{C}$  and sells for \$445 in quantities of one to nine. Delivery is from stock to six weeks.

Units that operate from  $-55^\circ\text{C}$  to  $+105^\circ\text{C}$  are available, as are models that meet MIL-STD 883 levels B and C.

Natel Engineering Co., 8954 Mason Ave., Canoga Park, Calif. 91306. Phone (213) 882-9620 [386]

## Voltage reference drifts only 3 ppm per year

A series of six three-cell solid-state voltage references includes two units with long-term drift rates of only 3 parts per million per year. The model VTS/3-1003-1AT is a portable standard with rechargeable batteries that permit operation for as long as 60 hours between charges. It sells for \$4,300. The VRS/3-1003-1AT is a line-operated version with a price of \$4,100. Both units have temperature coefficients of better than  $0.1 \text{ ppm}/^\circ\text{C}$  and contain three independent reference cells. Each cell puts out both 1.01850 v and 10.0000 v, but outputs other than 1.01850 v are available.

Battery-operated and line-operated versions with long-term drifts of 6 and 9 ppm per year are also available. These range in price from \$3,400 down to \$2,750. All units have a delivery time of 12 to 14 weeks.

Standard Reference Labs Inc., Pollitt Drive South, Fair Lawn, N. J. 07410. Phone John Halgren at (201) 797-3907 [387]

# NOW YOU CAN AFFORD TRUE OVERVOLTAGE PROTECTION

**FOR ANY POWER SUPPLY YOU BUY OR BUILD**



**MONOLITHIC  
OVERVOLTAGE  
PROTECTOR**

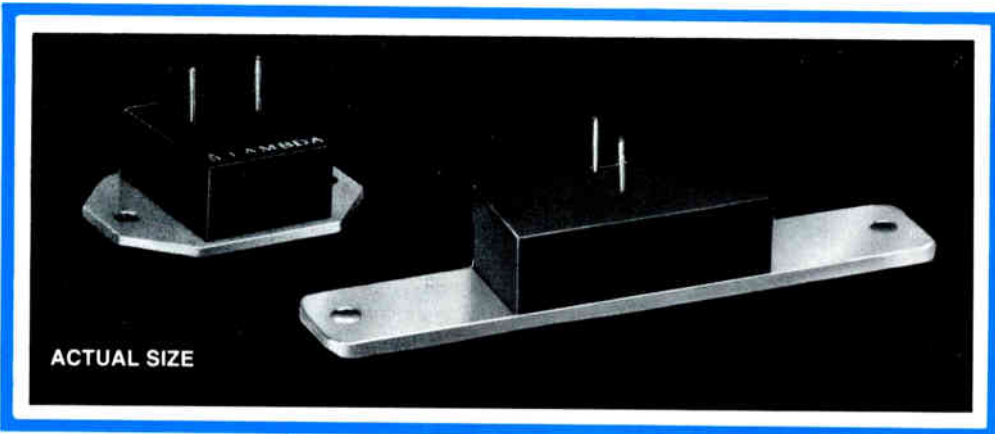

**HYBRID  
OVERVOLTAGE  
PROTECTOR**

**Replace your entire overvoltage protection  
circuit with a single Lambda Semiconductor.**

 **LAMBDA  
ELECTRONICS**  
DIVISION of  **INSTRUMENTS INC.**

See inside for complete details on  
2A, 6A, 12A, 20A, and 35A Monolithic  
and Hybrid Voltage Regulators



# NOW YOU CAN AFFORD TRUE FOR ANY POWER SUPPLY LAMBDA SEMICONDUCTOR OVERVOLTAGE PROTECTION

## BUY:

Whether you're building or buying power supplies use the same semiconductor overvoltage protector we use in Lambda's 5-year guaranteed power supplies. A single device provides complete protection with no external components needed.

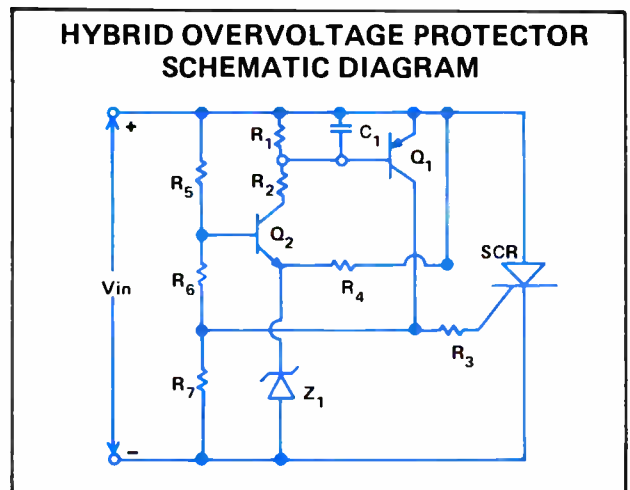
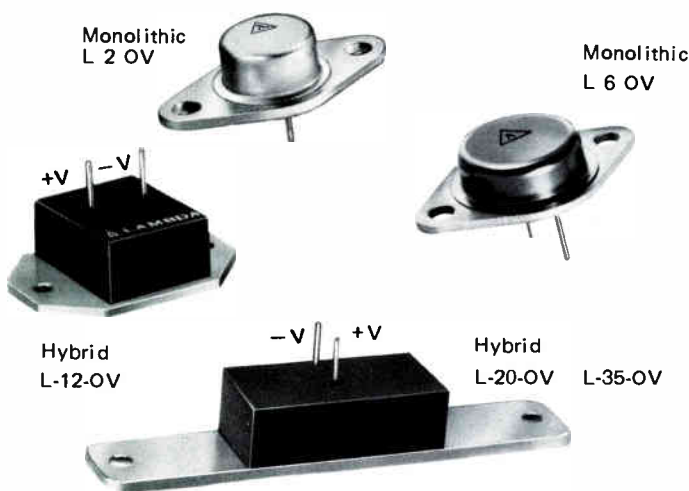

## BUILD:

Simplify and improve your overvoltage protection at no extra cost by using Lambda's Monolithic L2 OV semiconductor overvoltage protector as the control device. Only \$1.70 in quantities of 1000.

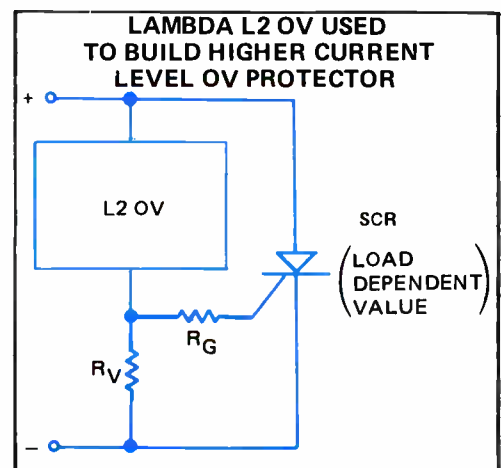

$R_V$  Value dependent on voltage  $\frac{V_{GT}}{Z_A} = R_V$

$R_G$  Value defined by maximum gate current of SCR

## 38 MODELS—UP TO 28 VOLTS DC—UP TO

# OVERVOLTAGE PROTECTION YOU BUY OR BUILD. WITH A FIXED TOLERANCE OVER 0-71°C

## GENERAL DESCRIPTION

The Lambda overvoltage protector prevents damage to the load caused by excessive power supply output voltage due to improper adjustment, improper connection, a disconnected sense lead, or failure of the power supply. Load protection is accomplished by effectively short circuiting

the output terminals of the power supply when a preset limit voltage has been exceeded. The trip-point limit voltage cannot be adjusted. To reset overvoltage protector, remove AC input to power supply, allow overvoltage protector to cool, and reapply power.

## OVERVOLTAGE PROTECTOR ABSOLUTE MAXIMUM RATING

PARAMETER	SYMBOL	L2 OV SERIES		L6 OV SERIES		L-12-OV SERIES		L-20-OV SERIES		L-35-OV SERIES	
		MIN	MAX	MIN	MAX	MIN	MAX	MIN	MAX	MIN	MAX
On State Current	$I_{DC}$	2A	—	6A	—	12A	—	20A	—	35A	—
On State Voltage	$V_{DC}$	2.6V	—	2.6V	—	1.3V	—	1.4V	—	1.6V	—
Non-Repetitive Peak Surge Current*	$I_p$	20A	—	70A	—	200A	—	260A	—	350A	—
Standby Current	$I_s$	35mA	—	25mA	—	30mA	—	30mA	—	30mA	—
Operating Temperature (Blocking)**	$T_{CB}$	-40°C	+100°C	-40°C	+100°C	-40°C	+100°C	-40°C	+100°C	-40°C	+100°C
Operating Temperature (Conducting)***	$T_{CC}$	-40°C	+150°C	-40°C	+150°C	-40°C	+140°C	-40°C	+140°C	-40°C	+140°C
Storage Temperature	$T_s$	-40°C	+150°C	-40°C	+150°C	-40°C	+125°C	-40°C	+125°C	-40°C	+125°C
Power Dissipation @ $T_c = 25^\circ\text{C}$ Derate @ $1.5W/^\circ\text{C}$ above $50^\circ\text{C}$	$P_D$	30	150	30	150	30	150	30	150	30	150
		Watts		Watts		Watts		Watts		Watts	
Thermal Resistance	$R_{\theta JC}$	5.0°C/W		1.0°C/W		1.0°C/W		1.0°C/W		1.0°C/W	

\*For sinusoidal current duration of 8.3 milliseconds max.

\*\*Case temperature for overvoltage protector in non-conducting or "OFF" state.

\*\*\*Case temperature for overvoltage protector in conducting or "ON" state. Power must be removed and case temperature allowed to drop to 100°C before application of output voltage.

The overvoltage protector requires an external heat sink to maintain case temperature below rated limit. When the overvoltage protector is used with a Lambda power supply, the power supply chassis acts as the heat sink. The L-12-OV, L-20-OV, L-35-OV, overvoltage protector is supplied with mating connectors for pins on overvoltage protector (+V and -V engraved on unit).

## OUTLINE DRAWING

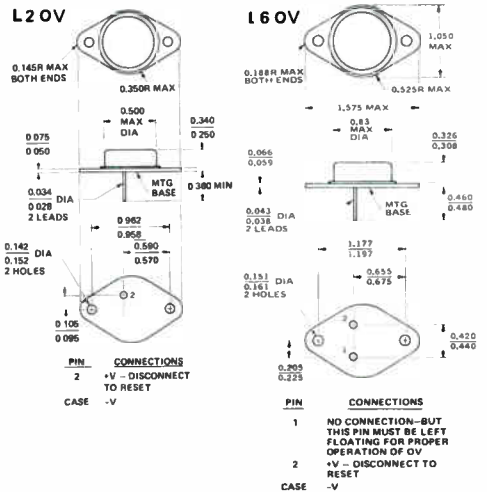

## ORDERING INFORMATION

NOM SUPPLY VOLTAGE (VOLTS)	TRIP POINT VOLTAGE <sup>A</sup> (VOLTS)	2 AMP MODELS	QTY 1	PRICE			6 AMP MODELS	QTY 1	PRICE		
				QTY 100	QTY 250	QTY 1000			QTY 100	QTY 250	QTY 1000
5	6.6 ± 2	L2 OV 5	2.50	\$2.00	\$1.90	\$1.70	L 6 OV 5	5	\$4	\$3.75	\$3.40
6	7.3 ± 2	L2 OV 6	2.50	2.00	1.90	1.70	L 6 OV 6	5	4	3.75	3.40
9	10.5 ± 4	L2 OV 9	2.50	2.00	1.90	1.70	L 6 OV 9	5	4	3.75	3.40
10	11.0 ± 5						L 6 OV 10	5	4	3.75	3.40
12	13.7 ± 4	L2 OV 12	2.50	2.00	1.90	1.70	L 6 OV 12	5	4	3.75	3.40
15	17.0 ± 5	L2 OV 15	2.50	2.00	1.90	1.70	L 6 OV 15	5	4	3.75	3.40
18	20.5 ± 1.0						L 6 OV 18	5	4	3.75	3.40
20	22.8 ± 7	L2 OV 20	2.50	2.00	1.90	1.70	L 6 OV 20	5	4	3.75	3.40
24	27.3 ± 8	L2 OV 24	2.50	2.00	1.90	1.70	L 6 OV 24	5	4	3.75	3.40
28	31.9 ± 1.0	L2 OV 28	2.50	2.00	1.90	1.70	L 6 OV 28	5	4	3.75	3.40
30	33.5 ± 1.0						L 6 OV 30	5	4	3.75	3.40

NOM SUPPLY VOLTAGE (VOLTS)	TRIP POINT VOLTAGE <sup>A</sup> (VOLTS)	12 AMP MODELS	QTY 1	PRICE			20 AMP MODELS	QTY 1	PRICE			35 AMP MODELS	QTY 1	PRICE		
				QTY 100	QTY 250	QTY 1000			QTY 100	QTY 250	QTY 1000			QTY 100	QTY 250	QTY 1000
5	6.6 ± 2	L-12-OV-5	11	\$11	\$8	\$7.50	L-20-OV-5	16	\$11.20	\$10.50	\$9.50	L-35-OV-5	20	\$14.40	\$13.60	\$12.30
6	7.3 ± 2	L-12-OV-6	11	8	7.50	6.80	L-20-OV-6	16	11.20	10.50	9.50	L-35-OV-6	20	14.40	13.60	12.30
9	10.5 ± 4	L-12-OV-9	11	8	7.50	6.80										
10	11.0 ± 5															
12	13.7 ± 4	L-12-OV-12	11	8	7.50	6.80	L-20-OV-12	16	11.20	10.50	9.50	L-35-OV-12	20	14.40	13.60	12.30
15	17.0 ± 5	L-12-OV-15	11	8	7.50	6.80	L-20-OV-15	16	11.20	10.50	9.50					
18	20.5 ± 1.0															
20	22.8 ± 7	L-12-OV-20	11	8	7.50	6.80	L-20-OV-20	16	11.20	10.50	9.50					
24	27.3 ± 8	L-12-OV-24	11	8	7.50	6.80	L-20-OV-24	16	11.20	10.50	9.50					
28	31.9 ± 1.0	L-12-OV-28	11	8	7.50	6.80	L-20-OV-28	16	11.20	10.50	9.50					
30	33.5 ± 1.0	L-12-OV-30	11	8	7.50	6.80	L-20-OV-30	16	11.20	10.50	9.50					

<sup>A</sup> VOLTAGE TOLERANCE MAINTAINED OVER 0-71°C DUE TO POWER DESIGN

# 5 AMPS—STARTING AT \$1.70 (QTY. 1000)

# NEW 30 AMP MONOLITHIC FULL-WAVE CENTER-TAP RECTIFIERS



## REPLACES TWO STUD RECTIFIERS

Up to 200V PIV: 30 amps.

Available in common-cathode and common anode arrays in a TO 3 package.  
Designed for and used in Lambda's 5-year guaranteed power supplies.

## BETTER THAN MOTOROLA!

Parameter	Compare these specifications		Units
	Lambda PMR35K200	Motorola 1N1186	
$V_{RRM}$	200	200	Volts
$I_o$ (Avg)	30	35	Amps
$I^2T$	600	—	$A_{rms}^2S$
$I_{RM}$	400	400	Amps
$V_F @ I_o$	1.4	1.3	Volts
$T_{J-STG}$	-65° to +200°	-65° to +175°	°C
Quantity required for full-wave center-tap bridge	1	2	—
Price quantity 100 for full wave center tap bridge	3.15 ea.	2.24 ea. (2 needed)	—

## CONTACT YOUR NEAREST LAMBDA SALES OFFICE

1

**MID-ATLANTIC REGION**  
Melville, New York 11746  
515 Broad Hollow Road  
Tel. 516-694-4200  
TWX: 510-224-6484

2

**NORTH-EASTERN REGION**  
Lexington, Massachusetts 02173  
2 Militia Drive  
Tel. 617-861-8585  
TWX: 710-326-7558

3

**SOUTH-WESTERN REGION**  
Dallas, Texas 75231  
6950 Winchester  
Tel. 214-341-5130  
TWX: 910-861-9048

4

**MID-WESTERN REGION**  
Arlington Heights, Ill. 60005  
2420 East Oakton St., Unit O  
Tel. 312-593-2550  
TWX: 910-222-2856

5

**FAR-WESTERN REGION**  
Carson, Calif. 90746  
20601 S. Annalee Ave.  
Tel. 213-537-8341  
TWX: 910-346-7649

6

**NORTH-WESTERN REGION**  
Sunnyvale, California 94086  
599 N. Mathilda Ave., Suite 210  
Tel. 408-738-2541  
TWX: 910-339-9243

### ENGLAND

Lambda Electronics  
Abbey Barn Road, Wycombe Marsh  
High Wycombe, Bucks HP 11 1RW  
Tel. High Wycombe 36386/7/8  
TWX: 837153  
Cable: VEELAM HIWYC

### CANADA

Veeco Lambda Ltd.  
100C Hymus Blvd.  
Pointe Claire, Quebec H9R 1E4  
Tel. 514-697-6520  
TWX: 610-422-3029

Veeco Lambda Ltd.  
P.O. Box 501, Postal Station K  
Toronto, Ont., M4P 2G9  
Tel. 416-486-0794

### INTERNATIONAL

Lambda Electronics Corp. Export Dept  
515 Broad Hollow Road  
Melville, N.Y. 11746  
Tel. 516-694-4200  
TWX: 510-224-6484  
Cable: Lambdatron, Melville, N.Y.

### FRANCE

Lambda Electronique S.A.  
Route de Grivry  
91 Gometz le Chatel  
Address Postale BP 77 91403 Orsay  
Tel. 012 1487

### GERMANY

Lambda Netzgerate GmbH  
Lindenstrasse 93  
D 7590 Achern 15  
Tel. 078-41 5527  
Telex 752209 Lake D

### ISRAEL

IsLAMBDA ELECTRONICS LTD.  
85 King Solomon St.  
Tel Aviv, Israel  
Tel. 240-672  
Telex 341667 RMYM IsLAMBDA

### LAMBDA MANUFACTURING PLANTS

**Melville, N.Y.**  
Plant 1: 515 Broad Hollow Rd.  
Plant II: 1770 Walt Whitman Rd.  
**Reynosa, Mexico**  
Corpus Christi, Texas 78410  
121 International Dr.

POWER SEMICONDUCTORS  
DESIGNED, DEVELOPED  
AND MANUFACTURED BY



**LAMBDA**  
ELECTRONICS

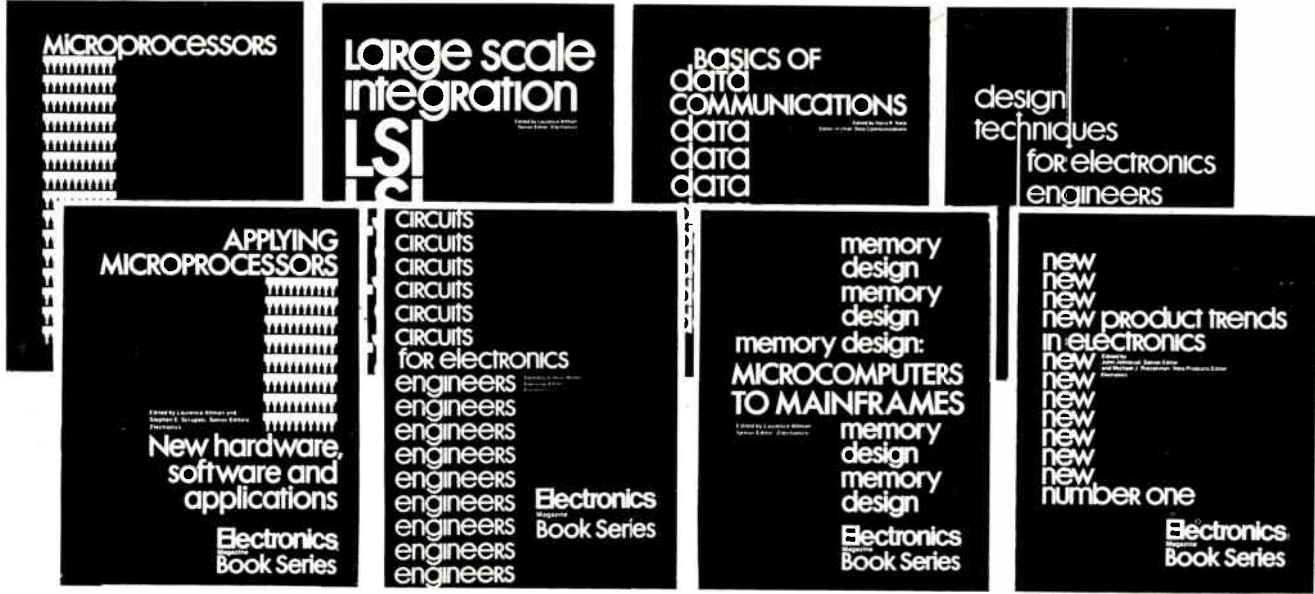

# Electronics Magazine Book Series

## 1. Microprocessors

What you must know about available microprocessor technology, devices, information, 4th printing. \$8.95

## 2. Applying Microprocessors

2nd and 3rd generation technology. 26 detailed applications from data networks to video games. \$9.95

## 3. Large Scale Integration

Covers the basic technology, new LSI devices, LSI testing procedures, plus system design and applications. \$9.95

## 4. Basics of Data Communications

Includes 47 articles from Data Communications magazine covering more than 11 key areas. \$12.95

## 5. Circuits for Electronics Engineers

Contains 306 circuits arranged by 51 functions from Amplifiers to Voltage Regulating Circuits. Saves design drudgery. \$15.95

## 6. Design Techniques for Electronics Engineers

Nearly 300 articles drawn from "Engineer's Notebook." A storehouse of design problem solutions. \$15.95

## 7. Memory Design: Microcomputers to Mainframes

The technology, devices, and applications that link memory components and system design. \$12.95

## 8. New Product Trends in Electronics, Number One

From "New Products," state-of-the-art materials and equipment, arranged according to function. \$14.95

Electronics Book Series  
P.O. Box 669, Hightstown, NJ 08520

### 1. Microprocessors

Send me \_\_\_\_\_ copies at \$8.95 per copy.

### 2. Applying Microprocessors

Send me \_\_\_\_\_ copies at \$9.95 per copy.

### 3. Large Scale Integration

Send me \_\_\_\_\_ copies at \$9.95 per copy.

### 4. Basics of Data Communications

Send me \_\_\_\_\_ copies at \$12.95 per copy.

### 5. Circuits for Electronics Engineers

Send me \_\_\_\_\_ copies at \$15.95 per copy.

### 6. Design Techniques for Electronics Engineers

Send me \_\_\_\_\_ copies at \$15.95 per copy.

### 7. Memory Design: Microcomputers to Mainframes

Send me \_\_\_\_\_ copies at \$12.95 per copy.

### 8. New Product Trends in Electronics

Send me \_\_\_\_\_ copies at \$14.95 per copy.

Discounts of 10% on orders of 10 or more copies of each book.



If after my 10-day free-trial examination I am not fully satisfied I understand that my payment will be refunded.

Payment enclosed  Bill firm  Bill me

Charge to my credit card:

American Express  Diners Club  
 BankAmericard/Visa  Master Charge\*

Acct No. \_\_\_\_\_ Date Exp. \_\_\_\_\_

\*On Master Charge only, first numbers above name \_\_\_\_\_

Name \_\_\_\_\_ Title \_\_\_\_\_

Company \_\_\_\_\_

Street \_\_\_\_\_

City \_\_\_\_\_ State \_\_\_\_\_ Zip \_\_\_\_\_

Signature \_\_\_\_\_

# PMI announces the first, fast precision bi-FET op amps

## pin-for-pin replacements for the 155, 156, and 157.

No question about it, the bi-FET op amp was quite an achievement. Speed combined with acceptable input performance for the first time. The Miracle of Silicon Gulch was a great step forward.

But there was room for improvement. In several areas. So we went to work on it.

### First, we second sourced it. And made it better.

We set about to improve idling current control, reduce second-stage  $TCV_{os}$  and improve the first stage balance. The results were PMI's PM155A, 156A, and 157A, with specs, yields, and delivery far superior to the Miracle's maker. But we didn't stop there.

We were convinced that the basic design could be improved. It could be made faster. And more precise. So we designed a completely new proprietary series of op amps that would perform the way bi-FET op amps should.

### And now, meet the Miracle of Miracles!

PMI's OP-15, OP-16, and OP-17 are the first precision pin-compatible versions of the 155A, 156A, and 157A, respectively. They give you three major improvements in performance:

1. Higher speed—by a factor of two.
2. Reduced offset voltage, thanks to our production-proven zener zap trimming technique.  $TCV_{os}$  is well-behaved.
3. High-temperature bias current drastically reduced—by an order of magnitude—by means of a FET leakage current cancellation circuit (patent pending).

Let's look at that last point for just a moment. Although FET input current is picoamperes at room temperature, it doubles with every ten-degree rise. It can be several nanoamperes at 70°C ambient and **hundreds** of nanoamps at 125°C—worse than many bipolar op amps. The fact that the chip temperature is 20° to 30° higher than the ambient doesn't help. FET bias current is important. We think it's misleading to specify it at junction

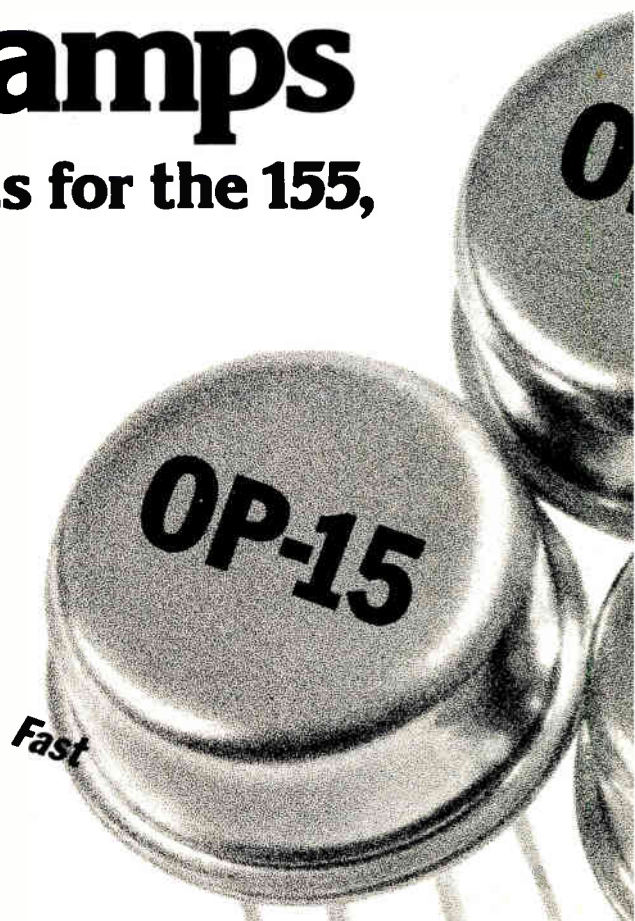

temperature, so we specify it warmed up—the way you'll use it.

Consider the specs:

**OP-15/LF155, OP-16/LF156 and OP-17/LF157 Comparison Chart**

Parameter*	LF155A LF355A	OP-15A OP-15E	LF156A LF356A	OP-16A OP-16E	LF157A LF357A	OP-17A OP-17E	Units
Offset Voltage, Max.	2.0	0.5	2.0	0.5	2.0	0.5	mV
Bias Current, Max. (warmed-up) 0 to 70°C	8.0	0.75	9.0	0.9	9.0	0.9	nA
—55 to 125°C	100	9	180	11	180	11	nA
Slew Rate, Min.	3	10	10	18	40	45	V/μsec.
Gain-Bandwidth Product Typ.	2.5	6.0	4.5	8.0	20	30	MHz
Supply Current, Max.	4	4	7 156A 10 356A	7	7 157A 10 357A	7	mA
Voltage Gain, Min.	50	100	50	100	50	100	V/mV

\*All other parameters are more or less equivalent; in the case of  $TCV_{os}$ , however, the OP-15/16/17's **really do** meet the spec—and our typicals are typical of what you get.

A quick look tells us that the OP-15 has the speed of the 356A, but not the **power dissipation**, which is the same as the 355A. The OP-16 is twice as fast as the 356A.

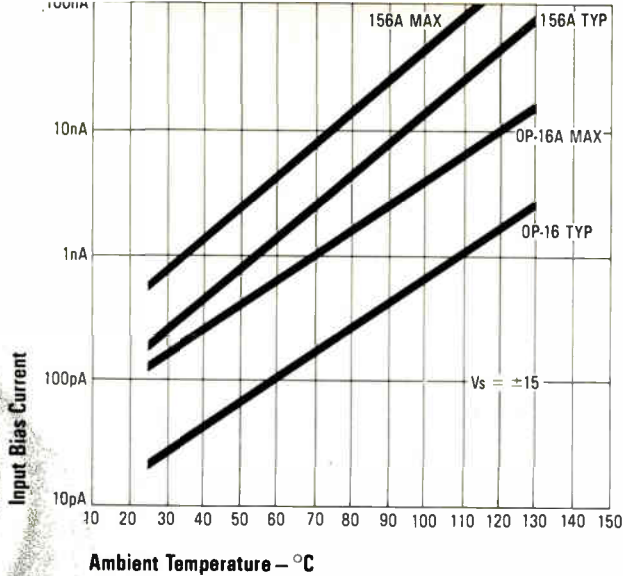

Ambient Temperature — °C

**Input Bias Current vs. Ambient Temperature**  
(Units are warmed-up in free air)

## So what's the bottom line?

Offset voltage improved four-fold. Circuit balanced for low  $TCV_{OS}$ . Bias current over temperature reduced ten times. And the OP-15/16/17 fits all 155/156/157 sockets. Plus:

The OP-15's supply current is low like the 155s, yet it gives you the speed of the 156.

The OP-16 gives you the best power/speed compromise you can find—twice as fast as the 156, but with the same moderate power dissipation.

The OP-17 gives you ultra-high speed ( $70v/\mu\text{sec}$ . typical in a gain of five)—high enough to challenge costly dielectrically-isolated devices.

## And cost. What about cost?

There's no basis for comparisons, since nobody else is delivering "A" grade bi-FETs anyway. For sure nobody is delivering anything that comes close to the OP-15/16/17 specifications. But we would like to make something clear:

We do not consider a bi-FET op amp to be a substitute for a 741. With its larger chip area and extra ion-implant step, the bi-FET will always cost more; and the OP-15, 16, and 17 are **precision**, high-speed, low-bias-current op amps designed to give you high performance and high speed over the full operating temperature range. They cost more than 741's.

On the other hand, they cost **less** than LF-155/6/7A's—even though they outperform them.

Model	Temp. Range	Price (100-999)
OP-15/16/17A	-55°C/+125°C	\$18.00
OP-15/16/17B	-55°C/+125°C	\$ 9.00
OP-15/16/17C	-55°C/+125°C	\$ 6.00
OP-15/16/17E	0°C/+70°C	\$10.00
OP-15/16/17F	0°C/+70°C	\$ 3.50
OP-15/16/17G	0°C/+70°C	\$ 2.50

Lower price. Better performance. And we actually deliver them.

When you get right down to it, our miracle is a lot more dazzling than their miracle.



**PMI's OP-15, OP-16, and OP-17.**  
The next industry standard.



**Precision Monolithics Incorporated**  
c/o BOURNS AG  
Baarerstrasse 8, 6301 Zug, Schweiz  
Phone: 042-23 22 42 Telex: 787-22

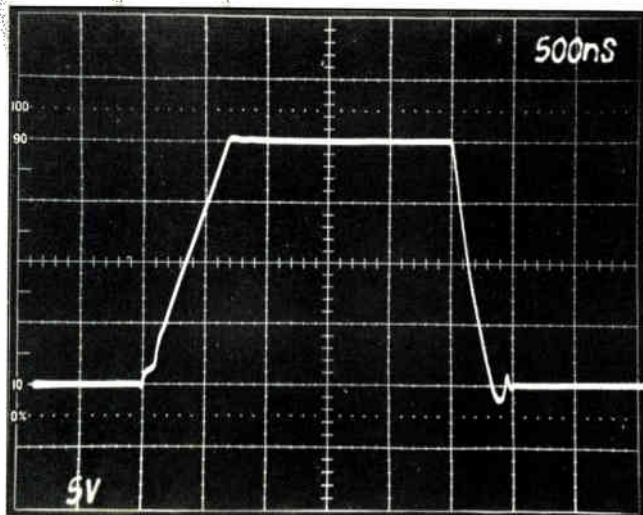

OP-16 Typical Slew Rate

# Introducing a new and a new low in

Fairchild has a brand new family of 3-terminal positive voltage regulators that offers you several advantages:

A new low-cost, easy-mounting package.

## Lowest cost half-amp on the market.

We've built a low-cost version of our popular  $\mu$ A78M regulator: The  $\mu$ A78C. It's designed for applications with less critical parameters and tight cost restrictions. It would be ideal for many consumer electronics products.

The  $\mu$ A78C comes in both the

# VOLTAGE REGULATORS

A new low-cost regulator.  
An old, reliable regulator in a new package.

## The small bend that saves big bucks.

Our new U1C package has a small bend at the mounting end. It allows you to mount the regulator anywhere you like. With fewer thermal junctions, better heat dissipation and increased performance.

It costs less than the TO-220. It fits in the same mounting holes. And it's a lot more convenient to work with than the TO-202.

Of course, we have much more to offer you than a new package. We also have some new products to put into it.

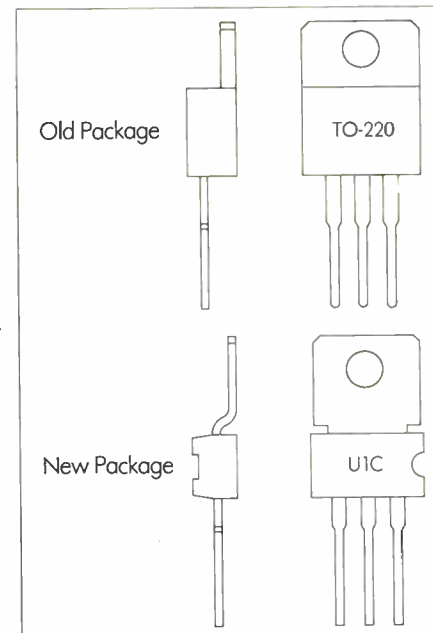

# high in packaging pricing.

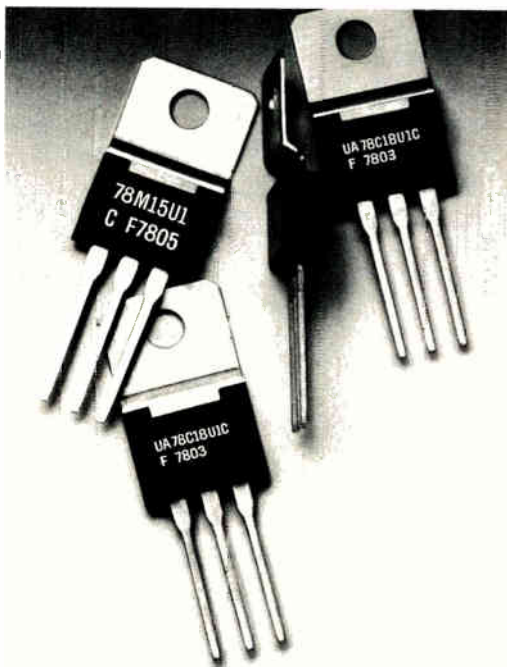

bent tab and straight tab TO-202 configuration. Either way, it only costs you forty-five cents in quantities of 100. That makes it the lowest priced 1/2-amp positive voltage regulator on the market.

The  $\mu$ A78C series is available in nine voltage options (8, 10, 12, 15, 17, 18, 20, 22 and 24 volts).

## New shape for an old friend.

We've also put the  $\mu$ A78M in these new low-cost packages. It comes in seven versions, ranging from 5 V to 24 V. Like the  $\mu$ A78C, it features internal current limiting, thermal shutdown and safe area compensation, making these devices practically indestructible.

The  $\mu$ A78M is designed primarily for industrial applications. The 100-piece price is fifty cents.

## New ideas from a proven source.

The UIC package and  $\mu$ A78C series are just a small sample of the regulator technology available to you from Fairchild.

We invented the first IC voltage regulator in 1966. We invented the first 3-terminal regulator in 1972. We invented the  $\mu$ A78M series 1/2-amp regulator in 1973. And the  $\mu$ A78L

series 100 mA regulator in 1974.

Today, we are the world's leading supplier of voltage regulators.

If you have special requirements in this specialized area, please give us a call. There's a very good chance we have just what you need.

## We're here to help.

For complete information on any of our voltage regulators, contact your Fairchild sales office or representative today. Or use the direct line at the bottom of this ad.

France: Fairchild Camera & Instrument S.A., 121 Ave. d'Inde, 750013-Paris. Tel: 00331 584 55 46. Telex: 0042 200614.  
Italy: Fairchild Semiconduttori S.P.A., Via Rosellini, 12, 20124 Milano. Tel: 02 6887451. Telex: 36522.  
Germany: Fairchild Camera & Instrument (Deutschland) GmbH, 8046 Garching Hockbruck, Daimlerstr. 15, Munchen. Tel: 089 320031. Telex: 52 4831 fair d.  
England: Fairchild Camera & Instrument (UK) Ltd., 230 High St., Potters Bar, Hertfordshire EN6 5BU. Tel: 0707 51111. Telex: 0051 262835.  
Sweden: Fairchild Semiconductor AB, Svartengsgatan 6, S-11620 Stockholm. Tel: 8-449255. Telex: 17759.

**FAIRCHILD**



# A quick memory test.

Feature	Our HP 1000 and 21MX Computers	Your old favorite
Memory	High density 128K byte modules use new 16K bit RAMs—just 5¢ per byte for 595 ns speed. Capacity to 1.8 million bytes with 22-bit Hamming fault control. Cache-speed 350 ns MOS/RAMs available for all memory.	
CPU	Mapped memory addressing for large memories. Standard instruction set includes floating point, integer arithmetic and data communications. Fast FORTRAN processor optional. User microprogramming. Direct memory access rates up to 2M bytes/sec; microprogrammed burst rates to 11.4M bytes/sec. Standardized interfaces for parallel TTL, process I/O. RS232 and IEEE-488 (HP-IB).	
Reliability	Memory parity standard; fault control also available. Automatic microcoded diagnostics. High resistance to shock, vibration and temperature variations. Brown-out proof power supply. Battery backup.	
Cost	16K byte 595 ns memory : \$ 488* 128K byte 595 ns memory : \$4,160* 32K byte 350 ns memory : \$1,365* 21MX M-Series computer with 256K bytes of fault control memory : \$13,910* HP 1000 System with 21MX E-Series computer and 512K bytes of fault control memory, 15M bytes of disc storage, CRT console with dual mini-cartridges, and RTE operating system : \$62,300	
Delivery	3 to 12 weeks ARO.	

*\*Prices shown include 35% OEM quantity discount.  
All other prices U.S. domestic list.*

It's hard to beat that kind of performance at those prices. Especially when you have one of our compatible RTE operating systems to make it all work smoothly. So if your old favorite didn't score very well in this test, maybe you should call your nearest HP sales office listed in the White Pages. Or write to Robert Puette, Hewlett-Packard, 11000 Wolfe Road, Dept. 1209 Cupertino CA 95014. The quicker, the better.

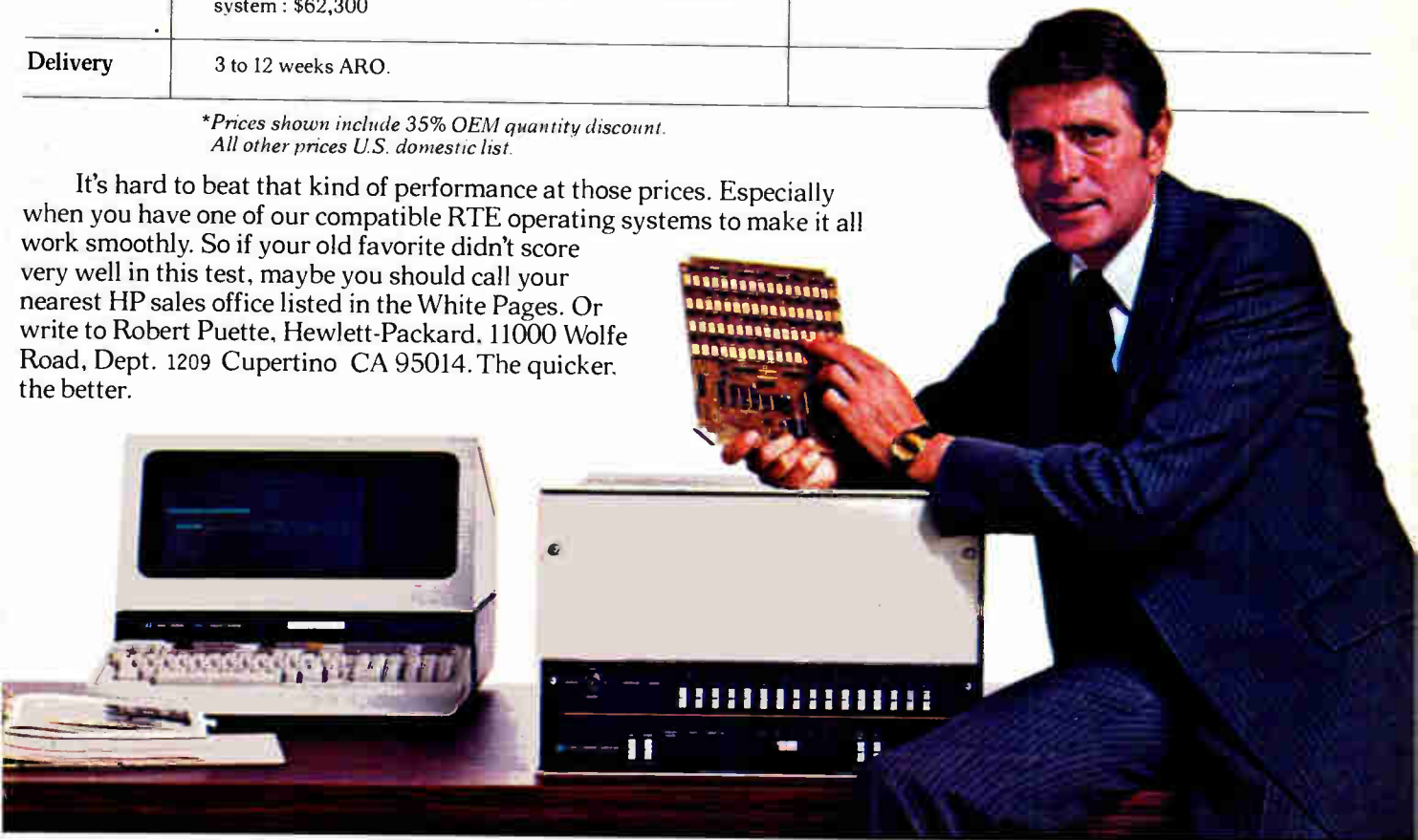

HEWLETT  PACKARD

227021 HP10S4

Circle 217 on reader service card

# Another Rogers circuit—for **PRONTO!**

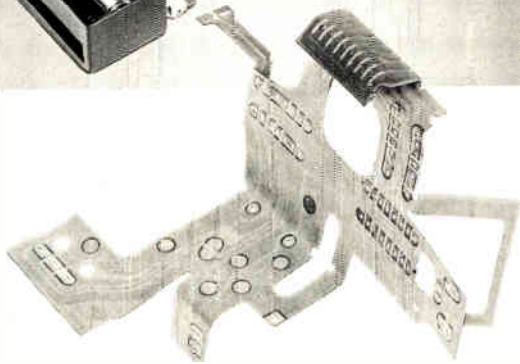
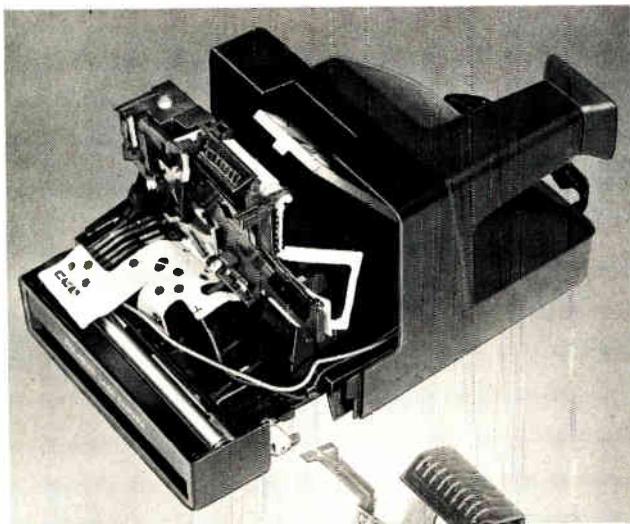

Fast, dependable flexible circuit production by Rogers fits Polaroid's requirements for its Pronto! camera—connecting IC's and other components with shutter, flash firing assembly, battery, and drive mechanism — all in one flexible unit readied for assembly, pronto!

For prompt, comprehensive design expertise—followed up with economical mass production of reliable flexible circuits, contact Rogers—pronto!

## **ROGERS**

**ROGERS CORPORATION**  
P.O. Box 700 Chandler, AZ 85224  
(602) 963-4584

EUROPE: Mektron NV, Gent, Belgium. JAPAN: Nippon Mektron, Tokyo.

*Pronto! is a trademark of Polaroid Corp.*

See us at **NEPCON**  
East Booth 5008

## **New products**

the board with discrete transistor-transistor logic, Kanter reports, rather than large-scale integrated metal-oxide-semiconductor circuits in order to avoid being locked into dedicated architecture and lose general-purpose appeal. The central processing unit alone is made up of 118 TTL circuits.

Versions of the T-1000 can be provided for difficult environmental requirements or military specifications. In 100-or-more quantities, the general-purpose emulator sells for about \$1,000.

Dynamic Sciences Inc., 7660 Gloria Ave., Van Nuys, Calif. 91406. Phone (213) 782-0820 [361]

## Mini floppy disk's recording technique gets high density

A dual-drive, single-unit floppy disk can store nearly 500,000 bytes of formatted data on one surface, instead of the 300,000 or so formatted bytes for otherwise similar models. This increased density is due to the use of group code recording, a technique previously employed by IBM on high-density magnetic tape. GCR translates data into specially chosen binary codes before it is written onto the diskette surface.

The model 1055, which is priced at \$1,132 in quantities of 500, offers four soft-sectored formats for each of 77 tracks. This arrangement makes it possible to select 6 sectors of 1,024 bytes each, 11 sectors of 512 bytes each, 20 sectors of 256 bytes each, or 31 sectors of 128 bytes each.

As an option, the selected data field may be extended by 12 bytes to accommodate either file or link-



# Instrumentation Interfacing: how does your real-time computer measure up?

Feature	Our HP 1000 and 21MX Computers	Your old favorite
Standard Interfaces (IEEE-488, NSI MC 1.1)	HP-Interface Bus (HP-IB) simplifies connections to over 200 bus-compatible instruments for stimulus, measurement and display, and reduces installation costs. High-level READ and WRITE calls in FORTRAN and BASIC simplify programming.	
Intelligent Analog and Digital Subsystem	HP's 2240A microprocessor-based analog and digital subsystem off-loads CPU and simplifies programming. Handles complete real-time tasks such as time-scheduled data acquisition, scan synchronization with external events, interrupt waits, waveform sample pacing, temperature drift corrections for high accuracy.	
Real Time Software	Compatible family of memory and disc-based Real Time Executive (RTE) operating systems. Interrupt handling at 100 $\mu$ s. Real-time BASIC, ISA FORTRAN with bit-manipulation and real-time extensions.	
Computer Costs*	HP 1000 Model 20 memory-based system from \$21,000. HP 1000 Model 30 disc-based system from \$31,500. (Both include 21MX E-series CPU, 64K bytes memory, 2645A CRT with dual mini-cartridges, RTE software.)	
Interface Costs*	Plug-in measurement and control cards: 32 analog inputs, 32 digital inputs and outputs, \$2,625. 96 channels of analog and digital I/O in $\mu$ P-controlled 2240A. \$5,110. HP-IB card, \$600.	
Delivery	8 weeks ARO.	

*\*All prices shown are U.S. domestic list.*

When you consider the number of instruments we make, it's not surprising that we know how to get the best out of them with our computers. If you'd like to see how well our real-time computers measure up, call you local HP office listed in the White Pages. Or write to Robert Puette, Hewlett-Packard, 11000 Wolfe Road, Dept. 1213 Cupertino CA 95014. And save a lot of interface.



HEWLETT  PACKARD

22706HPDS8

World Radio History

Circle 219 on reader service card

# Processor growth: can your small computer make the upgrade?

Product	Our HP 1000 and 21MX Computers	Your old favorite
Computers	<p>21MX computers, with memory capacity of 1.8 million bytes, speeds up to 350 ns, and user microprogramming. All have compatible architecture, instruction sets, I/O and memory.</p> <p><i>K-Series</i> computer on a board: \$974*</p> <p><i>M-Series</i> low-cost computer: \$2,698*</p> <p><i>E-Series</i> high-performance computer: \$3,803*</p> <p>Instructions 70-100% faster than M-Series.</p>	
Systems	<p>HP 1000 includes 21MX-E computer, CRT console with soft keys and dual cartridges, RTE operating system. Fault control memory available to 1.8 million bytes. Easy to upgrade as your needs expand, with full selection of HP manufactured and supported peripherals.</p> <p><i>Model 20.</i> 64K-byte memory-based systems: \$21,000. 500K-byte flexible discs optional.</p> <p><i>Model 30.</i> 64K-byte disc-based system. 15M-byte disc storage: \$36,500. 5M and 50M-byte discs available.</p> <p><i>Model 80.</i> 128K-byte data base management system with 15M-byte disc storage. HP-developed IMAGE DBM software, mag tape and line printer: \$61,700. 50M-byte discs available.</p>	
Software	<p><i>One upward-compatible family of Real Time Executives:</i> RTE manages 1.8 million bytes of main memory. BASIC, FORTRAN, Assembly and Microprogramming languages. Distributed Systems Networks. Measurement and control support.</p>	

*\*OEM quantity 100. All other prices U.S. domestic list.*

If you've been having trouble making the upgrade with your old favorite, it's probably time you got a new one. So call your local HP sales office listed in the White Pages. Or write to Robert Puette, Hewlett-Packard, 11000 Wolfe Road, Dept. 612, Cupertino CA 95014. We don't think anyone should have to live with an incompatible family.



HEWLETT  PACKARD

# ASSOCIATED ENVIRONMENTAL SYSTEMS

Quality Controlled Environmental Rooms

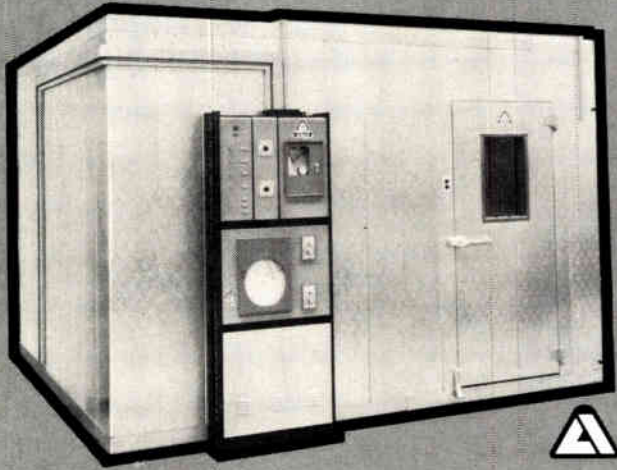

Constant Temp. and Temp./Humidity Cycling,  
Bio-Cold, Burn-in, and Metrology Rooms  
Working Cold Labs • Deep Freeze  
Variable Temp. • Humidity Simulation Shelf Life Testing  
Contamination Controlled, Incubation, Stability  
Testing and Drug Mfg. Rooms

Standard sizes, low cost, quality Walk-In Rooms. Standard temperature ranges from  $-40^{\circ}\text{C}$ ,  $-20^{\circ}\text{C}$ ,  $0^{\circ}\text{C}$ , all with high temperature capability of  $+93^{\circ}\text{C}$ . Control stabilities of  $\pm 0.15^{\circ}\text{C}$ . Standard sizes from 4' x 4' to 12' x 16'. Constructed of interlocking modular type panels of sandwich construction, superior insulation for peak efficiency. Several choices of surface finishes. Options include controlled humidity between 10% to 98%  $\pm 2\%$  RH, recorders and automatic programming with cams, step timers, microprocessors. Rooms can also be adapted to various degrees of cleanliness according to Federal Standard 209.

Associated also offers a complete line of packaged environmental chambers from  $\frac{1}{2}$  ft.<sup>3</sup> to 64 ft.<sup>3</sup> working volumes. Ovens, liquid CO<sub>2</sub> or LN<sub>2</sub> cooled, mechanical cascade refrigeration systems to  $-73^{\circ}\text{C}$ , humidity chambers, thermal shock, and A.G.R.E.E. From Bench Top to Walk-In, talk to Associated, the leader for over 25 years.

## ASSOCIATED ENVIRONMENTAL SYSTEMS

Subsidiary of Walter Kidde & Company, Inc.

**KIDDE**

360 MERRIMACK ST., LAWRENCE, MA. 01842  
(617) 683-9501 • TWX 710-342-0765

## New products

computers and with all PDP-11 and PDP-8 minicomputers. The RK07 is designed for use with the PDP-11/04, the -11/34 through the -11/70 and also with the VAX-11/780 systems. The RM02 is applicable to the PDP-11/70, VAX-11/780, and Decsystem-2020.

Digital Equipment Corp., 146 Main St., Maynard, Mass., 01754. Phone (612) 897-5111 [364]

## Image-processing computer gets into TV picture

An image-processing computer has the arithmetical ability to manipulate television picture elements (pixels) at high speed. The model 70 can perform these arithmetic operations at a rate of 10 million per second. Processing speeds of 100 ns per pixel are achieved on arrays of 512 by 512 lines.

The unit includes a display terminal for applications in industry, space imagery, biomedicine, radiography, forward-looking radar, and document storage and retrieval. Other features include a hardware histogram generator, display of graphic overlays and cursors in up to 32 colors, up to 12 channels of image-refresh memory, 10-bit digital-to-analog converters, and multiple independent cathode-ray-tube monitors. It also has internal character, vector, and conics generators, as well as hardware scroll.

Stanford Technology Corp., 650 N. Mary Ave., Sunnyvale, Calif. 94086. Phone (408) 737-0200 [366]

## 64-bit mainframe has very fast I/O throughput

A 64-bit mainframe computer—F6400—can have up to 2 billion bytes of disk storage, and multiple units may be interconnected in a network. It has an input/output throughput rate of up to 40 million bytes per second, two to four times faster than similar computers.

As a result, each central process-

# Another Industry Breakthrough!



## Introducing... The Harris HI-562 D/A Converter.

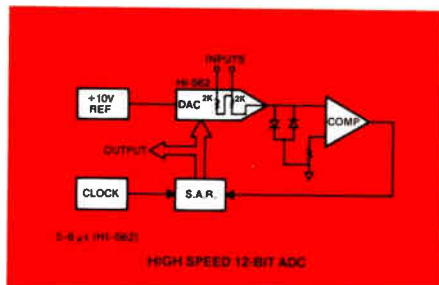
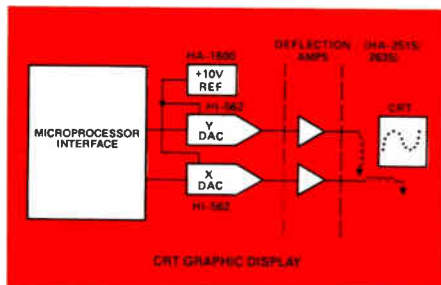
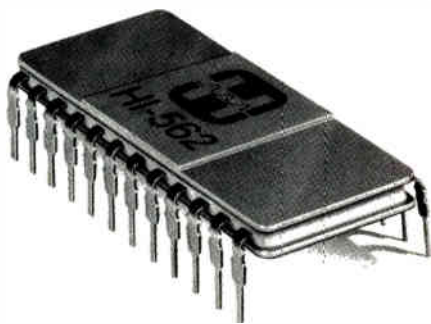

If you've been looking for the right D/A converter to match your brightest design ideas, you can stop looking... it's here... the new Harris HI-562.

The HI-562 is the first monolithic D/A to combine high speed performance and true 12-bit accuracy on the same chip—attained through the utilization of the most advanced laser resistor trimming techniques in the industry. Consider these features:

- Fast Settling: 200 ns to  $\pm 1/2$  LSB
  - Excellent Linearity:  $\pm 1/4$  LSB
  - Low Gain Drift:  $\pm 2$  ppm/ $^{\circ}$ C
  - Fully monotonic over temperature
- The Harris HI-562 is the cost-effective answer to your most demanding data

conversion design problems. So if you are into A/D converters, CRT graphic displays, process control systems, precision instruments, data acquisition systems, communication terminals... to mention a few... the Harris HI-562 can provide you with the performance, economy, accuracy and design versatility you won't find in any other D/A converter.

Available in a 24-pin DIP, the 562 operates on +5V and -15V supply voltages and a +10V reference.

Check out this new dimension in data conversion. Contact your nearby Harris Semiconductor distributor sales office for evaluation devices. For full details, write: **Harris Semiconductor Products Division, P.O. Box 883, Melbourne, Florida 32901.**

### International OEM Sales Offices:

Slough, England, Tel. 34666  
Brussels, Belgium, Tel. 511 08 24  
Tokyo, Japan, Tel. (03) 279-1691

*Harris Technology  
...Your Competitive Edge*



**HARRIS**  
SEMICONDUCTOR  
PRODUCTS DIVISION  
A DIVISION OF HARRIS CORPORATION

# MODPAK™

## The Totally Modular Electronics Packaging System

Provides everything you need... from CASES, COVERS, CONNECTORS and MOUNTING CLIPS to RF GASKETS. Even BLANK CIRCUIT

BOARDS to speed your prototype designs of RF and other circuits. All at a fraction of the cost of in-house fabrication. Shipped in less than 24 hours.

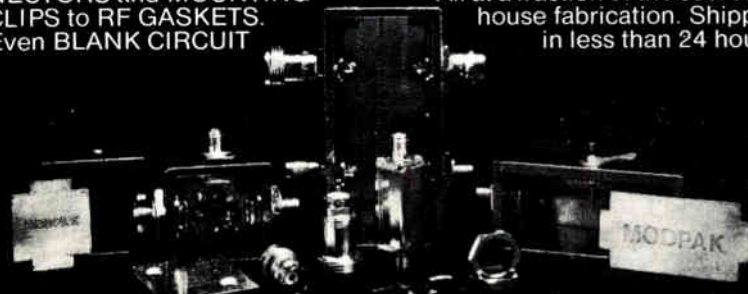

- Nickel-Plated Aluminum Cases
- 26 Standard Models — Custom Models — Fabricated Packages to Exact Specifications

- BNC, TNC, Type N or SMA Connectors & DC Feedthrus
- Unique Mounting Clips let you install PC Boards in Minutes

Catalog complete with Order Forms by return mail.  
Call (617) 891-7048 for Prototype or Production Volumes

**MODPAK™** an Adams-Russell Company

31 Green Street, Waltham, Massachusetts 02154

Circle 224 on reader service card

### New products

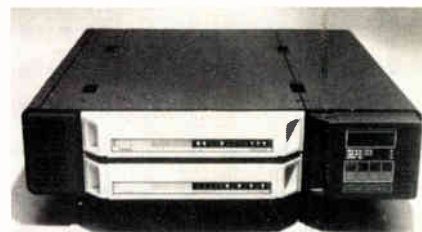

ing unit may have up to 60 micro-processor-controlled terminal ports in operation simultaneously. Designed for scientific and industrial applications, the 7.5-megabyte F6400 allows the user to place all working data and program information in memory, rather than segmenting the data onto disks.

The computer is designed to compile and execute PL/1 and Fortran IV+ software. The price is a low \$110,000.

Functional Automation, 118 Northeastern Blvd., Nashua, N. H., 03060. Phone (603) 882-1580 [365]

### Display terminal designed for military use

A plasma-display computer terminal is available for airborne and shipboard environments meeting military specifications. The model PD 3000 can operate at 20,000 ft and can tolerate altitudes up to 70,000 ft. It offers high-resolution graphics even when more than 4,000 characters are displayed. Operating temperature range is  $-32^{\circ}\text{C}$  to  $+55^{\circ}\text{C}$ .

Weighing 53 lb and occupying slightly more than 1 ft<sup>3</sup> of space (13 by 14 by 12 in.), the PD 3000 has a flicker- and distortion-free flat panel display measuring 8.5 by 8.5 in. Mean time between failures is in excess of 10,000 hr. An rfi-emi enclosure to meet MIL-E-5400R, MIL-STD-901C, and MIL-STD-461 is standard.

The PD 3000's software includes a real-time, high-level macroinstruction set that provides subroutines for display control, alphanumeric display, and incremental and vector graphics. Custom software and engineering are also available. Other



## ETCHED CIRCUIT PRODUCTS

THE ONE STOP SOURCE FOR:

- ★ EQUIPMENT ★ COPPER CLAD LAMINATES ★ CHEMICALS
- ★ P.C. KITS ★ ART & GRAPHIC SUPPLIES ★ NAMEPLATE MATERIALS

**PRINT-ETCH**  
facility for  
**Circuit Boards**  
in MINUTES

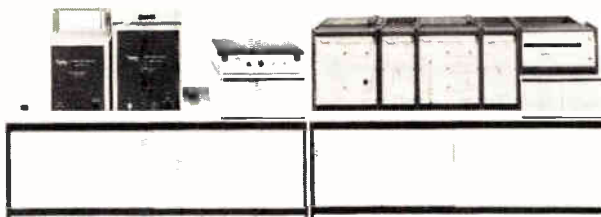

Kepro Printed Circuit Copper Clads, Chemicals and Equipment are designed to provide a fast "in house" prototype and short run P.C. Board capability. Equipment is available as single pieces, which may be combined into the systems pictured. Chemicals and Copper Clads are also available in small and medium quantities. Write for NEW 1978 KEPRO CATALOG No. D-7803.

**PLATE-THRU**  
facility for  
**SAME DAY**  
**Plate-Thru Holes**

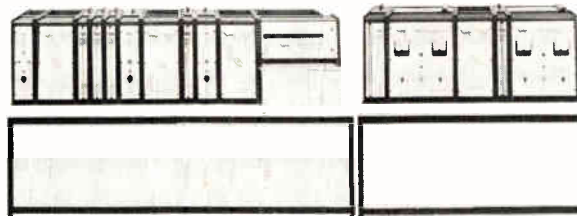

**KEPRO CIRCUIT SYSTEMS, INC.**  
3630 Scarlet Oak Blvd.  
St. Louis, Missouri 63122 U.S.A.

Out of State 1-800-325-3878  
In Missouri 1-314-225-5166  
Export Telex 442326 EBEX STL

224 Circle 110 on reader service card

Electronics / April 27, 1978

# Give your next great design idea the quality connector it deserves.

For example:

**Miniature Circular Connectors** — high quality at commercial prices in polycarbonate, quick disconnect, high-contact-density



connectors that go just about anywhere. From computers and medical instrumentation where the compactness and reliability are essential — to marine and automotive use, especially where ruggedness, corrosion resistance and low cost are desired.

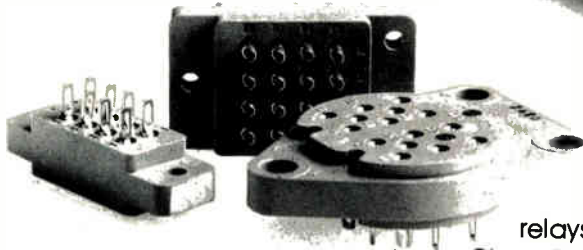

**Relay Sockets** — for just about every crystal can relay made.

Viking sockets are used for relays with Babcock, C.P. Clare, Deutsch, Electronic Specialty, Hi-G, Leach, Struthers-Dunn, Wabco and more. It's first quality at competitive prices.

**Printed Circuit Board Connectors** — one of the

broadest quality lines available. Contact centers range from 0.50 through .156, from 6 to 210 contacts, all contact designs including low insertion force, economical selective gold plating, and miniatures, to name a few.



**Special products for special applications.**

We've been designing and manufacturing connectors for over 25 years. One result is our broad, deep connector line — a line we can only begin to suggest here. Another important result is our custom design and production capabilities with special experience in underwater, geophysical exploration and marine applications.

For full details, call our nearest representative.



Viking Industries, Inc., 9324 Topanga Canyon Blvd., Chatsworth, Ca. 91311, U.S.A. — Telephone: (213) 882-6275 — TWX 910-494-4912

**New Zealand:**  
Terminal Distributors Ltd.  
23 Edinburgh Street  
Auckland, New Zealand

**Switzerland:**  
Egli, Fischer & Co., Ltd.  
Gotthardstrasse 6, Claridenhof  
8022 Zurich, Switzerland

**West Germany:**  
Selectron GmbH  
Pappenheimstrasse 7/111  
8 Munich 2, West Germany

**Benelux:**  
Bodamer International BV  
Havensstraat 8A  
Zaandam, The Netherlands

**South Africa:**  
Tecnetics (Pty) Ltd.  
P.O. Box 56412  
Pinegowrie 2123  
South Africa

**United Kingdom:**  
Viking Industries (U.K.) Ltd.  
Barton Industrial Estate  
Faldo Road, Barton-le-Clay  
Bedfordshire, England  
MK 45-4RS

**Korea:**  
The Yeu-Da Ltd.  
CPA Box 332  
Seoul, Korea

**Spain:**  
Oilitronic S.A.  
Provenza, 214, 5<sup>a</sup>, 2<sup>a</sup>  
Barcelona 11, Spain

**Sweden/Norway/Finland:**  
Gylling Teledata AB  
Pepparvagan 27  
S-123 05 Stockholm-Fersta,  
Sweden

**Italy:**  
Auriema Italia, SRL  
Via Domenichino 19  
20149 Milano, Italy

**Israel:**  
Ira Curtis Ltd.  
67 Brandeis Street  
Tel-Aviv, Israel

**Japan:**  
Daito Shoji Co., Ltd.  
1-6 Kojimachi  
Chiyoda-Ku, Tokyo 102,  
Japan

**Denmark:**  
Lars Vallentin Elektronik ApS  
Stenlose Center 30A  
3660 Stenlose, Denmark



# Thermocouple Simulator / Calibrator plus...

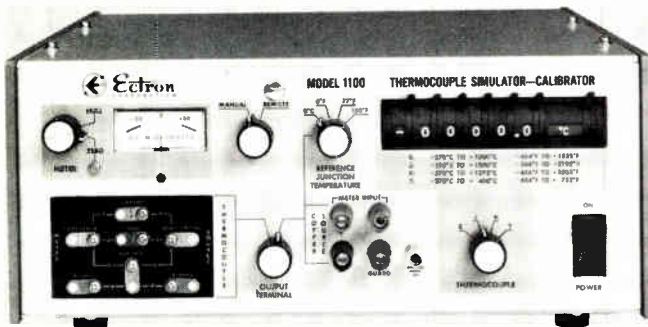

Model 1100—  
Dial  
Temperature  
directly  
in degrees  
C or F.

**This new standard is 4 instruments in 1.** It's a thermocouple simulator, thermocouple calibrator, linear DC voltage standard and DC linear differential voltmeter. Simplifies precise calibration of thermocouple measuring instruments. Includes production and lab applications.

#### FEATURES

Simulates 4 TC types  
Dial Temperature in Degrees  
Digital Conformity to NBS 0.1°  
Self-Contained Ref. Junction  
Dial Millivolts Directly  
0.01% of Reading Accuracy  
Optional Remote Programming

#### THERMOCOUPLE APPLICATIONS

Calibration of:  
Temperature Indicators  
Data Systems  
Temperature Transmitters  
Amplifiers & Linearizers  
Temperature Controllers  
Thermocouples  
(requires bath)

#### LINEAR APPLICATIONS

Calibration of:  
DC Digital Voltmeters  
Panel Meters  
Strip Chart Recorders  
Millivoltmeters  
VCO's & Amplifiers  
DC Power Supplies

8159 Engineer Road, San Diego, CA 92111  
Phone (714) 278-0600 / TWX 910-335-1259



Circle 226 on reader service card

## New products

features include standard alphanumeric and graphics capability, inherent panel memory (requiring no refresh), single-point write and erase, constant spot size, operating voltage of less than 150 v, and a continuous image (no flicker). The terminal has standard ASCII keyboard commands for the operator, dual EIA RS-232-C-compatible interface ports, and an optional high-speed parallel input/output facility.

The basic price is \$12,000 for one unit, and delivery is in 90 days.

Interstate Electronics Corp., 707 E. Vermont Ave., Anaheim, Calif. 92803. Phone (714) 772-2811 [367]

## Dot-matrix impact printer has many applications

The Terminet 200 dot-matrix impact printer may be configured as a teleprinter, a receive-only printer, or a bidirectional line printer. The print rate is 200 characters per second, and a 20-in./s paper-slew rate and 60-in./s skip rate give the 200 family a high data throughput with just a 1,024-character buffer memory.

Microprocessor control means the seven-by-nine-dot character sets reside in read-only memory and can be changed from the ASCII standard. Nearly all changeable features, such as line and character spacing and head offsetting (which exposes the previously printed characters), are selectable by means of dual in-line package switches. Prices for the printer without the keyboard start at \$3,100.

General Electric Co., Data Communication Products Business Department, Waynesboro, Va. 22980. Phone (703) 942-8161 [368]



## Our 50-watt switch. The low-cost alternative.



Switch up to 7 times the power of a similar-size reed switch with our new axial-travel switch. Handle inductive loads without arc suppression. Just like triacs.

Buy the 50-watt version with tungsten contacts for only 33¢ in quantities of 25,000. Or the 25-watt model with standard contacts for even less.

Call or write for details on the ATS.

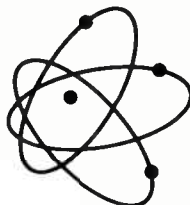

# EAC

**Electronic Applications Company**

4918 Santa Anita Avenue,  
El Monte, California 91734  
213/442-3212 TWX 910/587-3351

**ANOTHER LAMBDA EXCLUSIVE**

# **VARIABLE MONOLITHIC VOLTAGE REGULATOR**

**5 AMP 50W 4 TO 30 VOLTS**



MODEL 19U 4 PIN DEVICE

QTY	PRICE
1-25	\$21.00
2500-4999	\$10.25

**A SINGLE DEVICE  
REPLACES UP TO 40  
CIRCUIT COMPONENTS**



THIS. . .



INSTEAD OF THIS

**LAMBDA  
ELECTRONICS**  
DIVISION of **Veeco** INSTRUMENTS INC

**Lambda has a complete line of fixed and  
now variable 5 amp 50W voltage regulators.**

# λ LAMBDA LAS 1900 5 AMP, 50 WATT MONOLITHIC VOLTAGE REGULATOR TO 3 PACKAGE

## FEATURES

- Guaranteed input-output differential — 2.6V @ 5A
- Lowest thermal resistance — 0.9°C/watt (more usable output power)
- Internal current limit and thermal shutdown
- Guaranteed load regulation at 5.0 Amp — 0.6%  $V_o$
- 100% burn-in under load
- Guaranteed temperature coefficient 0.03%  $V_o/°C$
- Guaranteed ripple attenuation 60dB for LAS 1905
- Safe area protection

## FUNCTIONAL BLOCK DIAGRAM

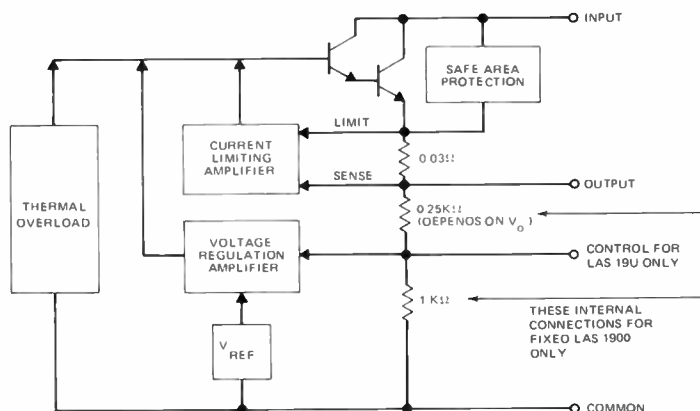

## PACKAGE OUTLINE DRAWING AND PIN CONNECTIONS

LAS 19U

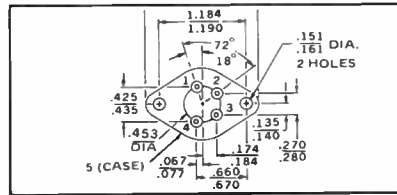
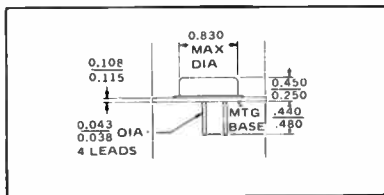
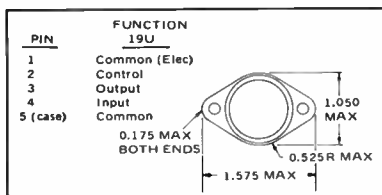

LAS 1905-1915

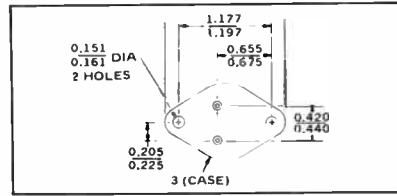
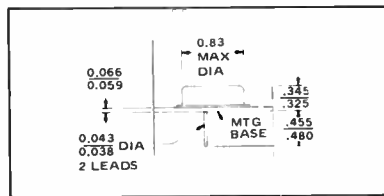
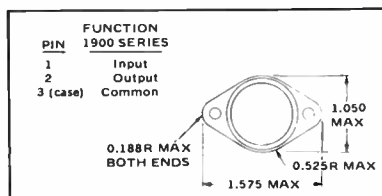

## PRICE LIST

$V_o$ VOLTS	MODEL	QTY 1-24	QTY 25-49	QTY 50-99	QTY 100-249	QTY 250-499	QTY 500-999	QTY 1000-2499	QTY 2500-4999
5	LAS 1905	\$14.00	\$12.50	\$11.75	\$11.25	\$9.50	\$8.40	\$7.40	\$6.85
6	LAS 1906	14.00	12.50	11.75	11.25	9.50	8.40	7.40	6.85
8	LAS 1908	14.00	12.50	11.75	11.25	9.50	8.40	7.40	6.85
10	LAS 1910	14.00	12.50	11.75	11.25	9.50	8.40	7.40	6.85
12	LAS 1912	14.00	12.50	11.75	11.25	9.50	8.40	7.40	6.85
13.8	LAS 19CB	14.00	12.50	11.75	11.25	9.50	8.40	7.40	6.85
15	LAS 1915	14.00	12.50	11.75	11.25	9.50	8.40	7.40	6.85
4.0-30.0	LAS 19U	21.00	18.75	17.65	16.88	14.25	12.60	11.10	10.25

# Performance Specifications

## 5 amp positive regulator

The LAS 1900 series three-terminal positive voltage regulators are designed for applications requiring a well regulated output voltage for load currents up to 5 amperes. The monolithic construction of the integrated circuit permits the incorporation of current-limiting, thermal shutdown, and a safe-area protection on the chip providing protection for the series pass Darlington under most operating conditions. A low-noise temperature-stable diode reference circuit is the key to the excellent temperature regulation of the circuit. A very low output impedance ensures excellent load regulation. A hermetically sealed copper TO 3 package is used for high reliability and low thermal resistance. The pin connections of the devices are the same as the LAS 1500, LAS 1400,  $\mu$ A78H00 and LM 323K series thus allowing existing designs to be up-graded to 5 amperes without layout or wiring changes.

The LAS 19U, a four terminal positive voltage regulator, is designed for applications requiring a well regulated output voltage for load currents up to 5 amperes. Output voltage can be adjusted over a 4.0 to 30 volt range by the use of a single potentiometer. The monolithic construction of the integrated circuit permits the incorporation of current limiting, thermal shutdown, and safe area protection on the chip providing protection for the series pass Darlington under most operating conditions. A low-noise temperature-stable diode reference circuit is the key to the excellent temperature regulation of the circuit. A very low output impedance insures excellent load regulation. A hermetically sealed copper 4-pin TO 3 package is used for high reliability and low thermal resistance.

PARAMETER	SYMBOL	TEST CONDITIONS			LAS 1905 - 1915 TEST LIMITS		LAS 19U TEST LIMITS		UNITS
		$V_{IN}$	$I_o$	$T_J$	MIN	MAX	MIN	MAX	
Input Voltage	$V_{IN}$	10mA	0-125°C	$V_o + 2.6V$	.30(35) <sup>(7)</sup>	$V_o + 2.6V$	.30(35) <sup>(7,9)</sup>	Volts	
Output Voltage <sup>(1)</sup>	$V_o$	$V_1$ to $V_2$	10mA to 5.0A	25°C	$0.95 V_o$ <sup>(2)</sup>	$1.05 V_o$	$4.0$ <sup>(10)</sup>	3.0	Volts
Input Output Differential	$V_{IN} - V_o$	5.0A	0-125°C	2.6	— <sup>(8)</sup>	2.6	— <sup>(8)</sup>	Volts	
Input Output Differential	$V_{IN} - V_o$	0.5A	0-125°C	—	.25	—	.25	Volts	
Output Current	$I_o$	10mA to 5.0A	25°C	5.0	—	5.0	—	Amps	
Standby Current	$I_Q$	$V_1$	25°C	6.5	20	6.5	25	mA	
Standby Current Change with Input	$\Delta I_Q$	$V_1$ to $V_2$	10mA	25°C	5.0	—	5.0	mA	
Standby Current Change with Load	$\Delta I_Q$	$V_1$	10mA to 5.0A	25°C	5.0	—	5.0	mA	
Maximum Current Limit	$I_{LIM}$	$V_o + 5V$	25°C	6.5	—	6.5	—	Amps	
Short-Circuit Current	$I_S$	25V	25°C	2.0	—	2.0	—	Amps	
Power Dissipation <sup>(4)</sup>	$P_D$			50	—	50	—	Watts	
Thermal Resistance Junction-to-case	$R_{\theta JC}$			0.9	—	0.9	—	°C per Watt	
Storage Temperature	$T_S$			65	+150	65	+150	°C	
Maximum Operating Junction Temperature	$T_J$			-55	+135	-55	+135	°C	
Regulation-Load <sup>(3)</sup>	(REG) $_L$	$V_o + 5V$	10mA to 5.0A	25°C	0.6	—	0.6	% $V_o$	
Regulation-Line <sup>(3)</sup>	(REG) $_L$	$V_1$ to $V_3$	3.0A	25°C	2.0	—	1.0	% $V_o$	
Temperature Coefficient	$T_C$	$V_1$	0.1A	0-125°C	—	0.03	—	% $V_o$ /°C	
Output Noise Voltage <sup>(5)</sup>	$V_N$	$V_1$	0.1A	0-125°C	—	10	—	$\mu$ Vrms/V	
Ripple Attenuation	$R_A$	$V_1$	2.0A	0-125°C	60 <sup>(6)</sup>	—	60 <sup>(6)</sup>	dB	
Control Voltage	$V_C$	$V_1$ to $V_2$	.5mA	25°C	—	3.625	—	Volts	

- $V_1 = V_o + 3V$ ,  $V_2 = V_o + 10V$ ,  $V_3 = V_o + 12V$  or the maximum total input voltage or differential, whichever is less.
- Nominal output voltages are specified under ordering information.
- Instantaneous regulation, average chip temperature changes must be accounted for separately.
- Derate above  $T_C = 90^\circ C @ 1.111W \text{ per } ^\circ C$
- Specified in  $\mu V_{rms}/volts$  output BW = 10 Hz - 100K Hz
- Ripple attenuation is specified for a 1Vrms, 120 Hz input ripple. Ripple attenuation is a minimum of 60 dB at 5V output (for LAS 1900 Series), 62 dB at 3.75V output (for LAS 19U).
- Value of 30V applies to  $V_o$  of +5 to +12V. Value of 35V applies to  $V_o$  of 15V.

- Maximum input-output differential is constrained by 25V, current limit-SOA, and maximum power specifications, whichever is less. Care should be taken to avoid differential voltages greater than the maximum specified. However, the devices employ a power limiting circuit to protect the series pass Darlington from overvoltage stress conditions such as an inadvertent short on the output. If the overstress exceeds 25 Volts, power must be interrupted to restore operation.
- Minimum input voltage is 6.525V
- $V_o = V_c \left( 1 + \frac{R_1}{R_2} \right)$   $R_1$  = resistance from output to control  $R_2$  = resistance from control to common
- Instantaneous regulation, average chip temperature changes must be accounted for separately.

## Operational Data

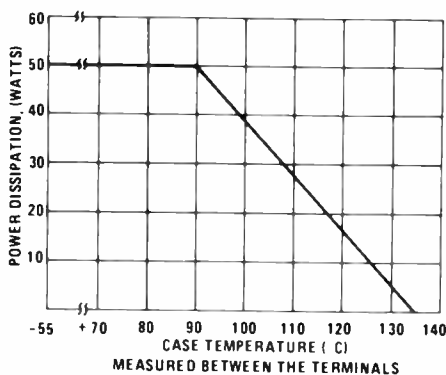

POWER DERATING

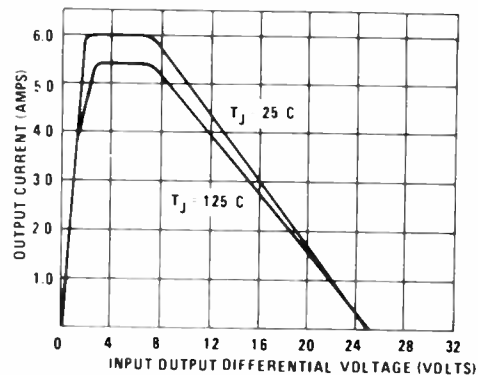

TYPICAL CURRENT LIMIT VS INPUT-OUTPUT VOLTAGE DIFFERENTIAL

# Operational Data

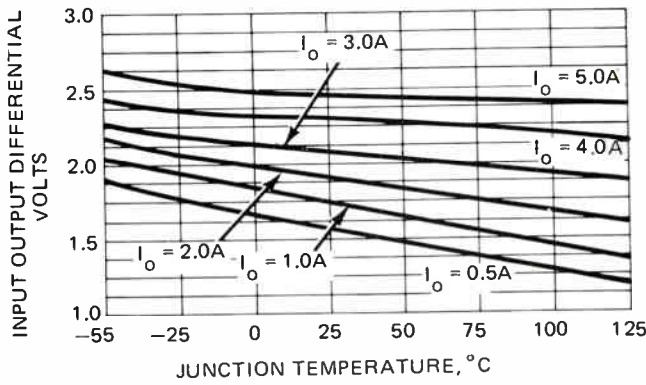

TYPICAL INPUT-OUTPUT DIFFERENTIAL VOLTAGE VS JUNCTION TEMPERATURE

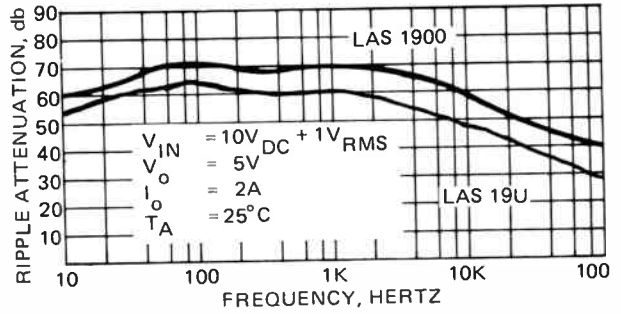

RIPPLE ATTENUATION VS FREQUENCY

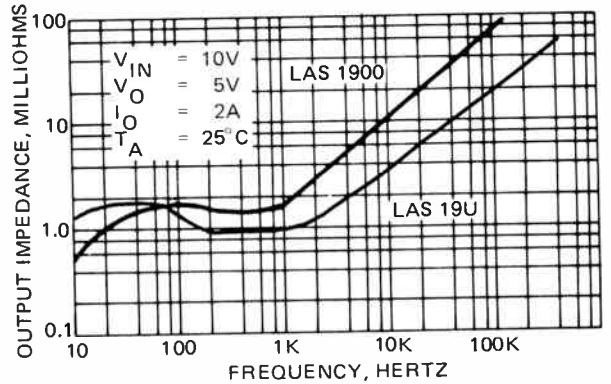

TYPICAL OUTPUT IMPEDANCE VS FREQUENCY

## Connection Diagrams

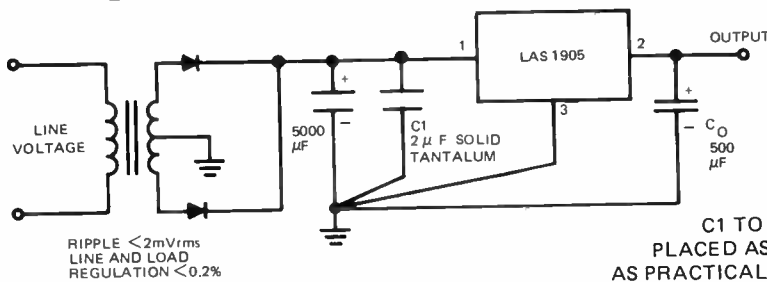
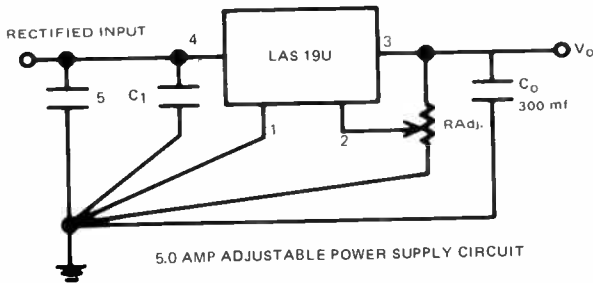

5.0 AMP POWER SUPPLY CIRCUIT

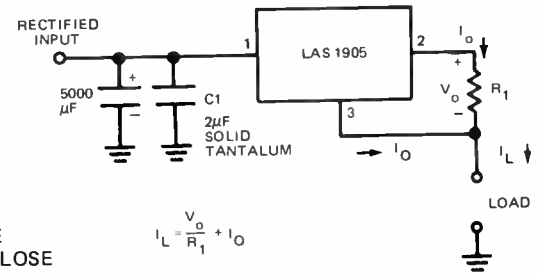

CURRENT REGULATOR CIRCUIT

## ▲ Lambda staffed sales and service offices

1

**MID-ATLANTIC REGION**  
Melville, New York 11746  
515 Broad Hollow Road  
Tel. 516 694 4200  
TWX: 510 224 6484

2

**NORTH-EASTERN REGION**  
Lexington, Massachusetts 02173  
2 Militia Drive  
Tel. 617 861 8585  
TWX: 710 326 7558

3

**SOUTH-WESTERN REGION**  
Dallas, Texas 75231  
6950 Winchester  
Tel. 214-341-5130  
TWX: 910-861-9048

4

**MID-WESTERN REGION**  
Arlington Heights, Ill. 60005  
2420 East Oakton St., Unit Q  
Tel. 312-593-2550  
TWX: 910-222 2856

5

**FAR-WESTERN REGION**  
Carson, Calif. 90746  
20601 S. Annalee Ave  
Tel. 213-537-8341  
TWX: 910-346-7649

6

**NORTH-WESTERN REGION**  
Sunnyvale, California 94086  
599 N. Mathilda Ave., Suite 210  
Tel. 408-738 2541  
TWX: 910 339 9243

### INTERNATIONAL

Lambda Electronics Corp. Export Dept.  
515 Broad Hollow Road  
Melville, N.Y. 11746  
Tel. 516 694 4200  
TWX: 510 224-6484  
Cable: Lambdatron, Melville, N.Y.

### ENGLAND

Lambda Electronics  
Abbey Barn Road, Wycombe Marsh  
High Wycombe, Bucks HP 11 1RW  
Tel. High Wycombe 36386 7 8  
TWX: 837153  
Cable: VEELAM HIWYC

### CANADA

Veeco Lambda Ltd.  
100C Hymus Blvd  
Pointe Claire, Quebec H9R 1E4  
Tel. 514 697 6520  
TWX: 610 422 3029

### FRANCE

Lambda Electronique S.A.  
Route de Grivery  
91 Gomez le Chatel  
Address Postale: BP 77 91403 Orsay  
Tel. 012 1487

### GERMANY

Lambda Netzgerate GmbH  
Lindenstrasse 93  
D 7590 Achern 15  
Tel. 078 41 5527  
Telex 752209 Lake D

Veeco Lambda Ltd.  
P.O. Box 501, Postal Station K  
Toronto, Ont., M4P 2G9  
Tel. 416 486 0794

### ISRAEL

IsLAMBDA ELECTRONICS LTD.  
B5 King Solomon St.  
Tel Aviv, Israel  
Tel. 240-672  
Telex 341667 RMYM IsLAMBDA

### LAMBDA MANUFACTURING PLANTS

Melville, N.Y.  
Plant I: 515 Broad Hollow Rd.  
Plant II: 1770 Walt Whitman Rd.  
Reynosa, Mexico  
Corpus Christi, Texas 78410  
121 International Dr.

POWER SEMICONDUCTOR:  
DESIGNED, DEVELOPED  
AND MANUFACTURED BY



**LAMBDA**  
ELECTRONICS

# Speed and THRUPUT . . . That's CSPI'S Idea of Array Processing



The Model A was faster than a horse and buggy, and it got you where you wanted to go.

A first generation array processor will compute and spit out data. It is faster than a minicomputer, but will it get you where you want to go **on time**? CSPI recognized that speed and thruput are the whole point of array processing. Therefore MAP™. The best fully-programmable, floating point array processor in the business. If you haven't seen MAP, you're only one step beyond the horse and buggy.

**MAP is independent of its host for fast continuous data flow.** MAP's internal controller and resident Snap II Executive frees the host to give 75 to 95% of its time to other tasks. Intelligent programmable interfaces and independent asynchronous multi-bus structure permit simultaneous input, processing, and output of data

streams. There are no traffic jams with the MAP/host/periphera! union.

**Flexibility and economy are designed in.** You can mix and match 500, 300, and 125 nsec memory without interleaving or cycle stealing; you can address MAP directly in bytes, halfwords, or 32-bit words for memory efficiency. Modular architecture, devoid of synchronous clocks, lets you buy additional plug-in power when you need it: arithmetic processors, memories, multi/MAP configurations, and additional I/O processors transferring data up to 40 megabytes per second.

**A total signal processing task can be programmed directly in FORTRAN.** Any special array function can be programmed in 16-bit Assembly Language (not 64-bit microcode) and added to the MAP resident Snap II Executive.

Why not talk to someone who is getting fast thruput with MAP? Write CSPI for references as well as for technical specifications, price lists, and a configuration work sheet that helps you specify your own system.

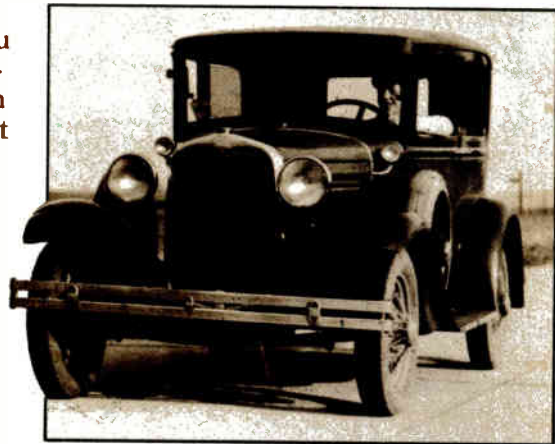

**The MAP™ Product Line of Modern Array Processors Offers Fast Continuous Data Flow — Not Just Fast Arithmetic.**



**CSP Inc.** 209 Middlesex Turnpike, Burlington, MA 01803•617-272-6020

The leader in digital signal processing since 1968.

TWX: 710-332-0835

# 7 Major Routes to Reliability, Provided by the RAC

- System Reliability and Maintainability Consulting Services
- Customized Data Searches
- Semiconductor Device Reliability Databooks
  - Digital Data
  - Linear/Interface Data
  - Memory/LSI Data
  - Hybrid Circuit Data
  - Transistor/Diode Data
- Reliable Equipment Design Guidelines
  - Design Reliability Handbook
  - Microcircuit Reliability Bibliography
- Tutorial Reliability Courses
- Annual Reliability Workshop
- Periodic Reliability Seminars



**Reliability Analysis Center**  
RADCR/RBRAC, Griffiss AFB, NY 13441

Phone 315-330-4151, Autovon 587-4151

*RAC is a DoD Information Analysis Center Operated by IIT Research Institute*

Circle 236 on reader service card

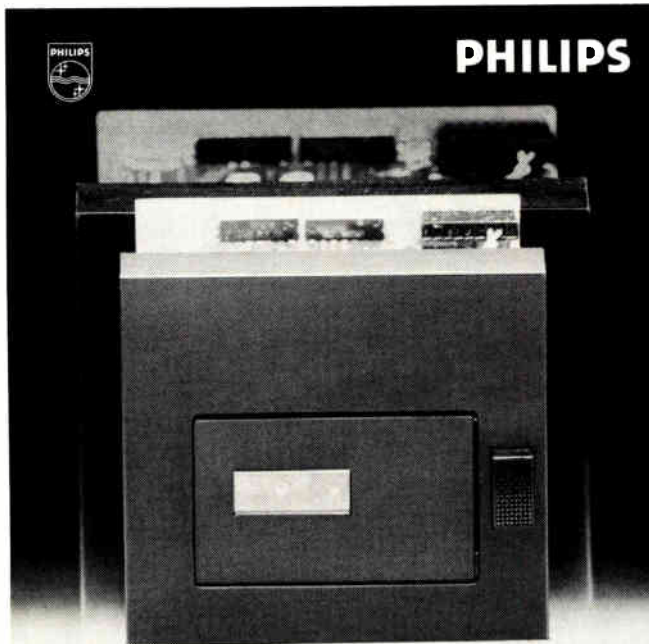

**30% reduction?...**

236 Circle 115 on reader service card

## New products

applications that the monolithic tone receiver is designed for, the firm figures that the IC will open new markets. "We see a lot of business in telephone data-transmission applications," Callahan says, "including credit-verification terminals, or order entry and delivery information systems for salesmen. And it also could be included in home computer systems so that the system could be accessed from a push-button phone."

By changing the circuit's metal mask, Mostek plans to tailor versions that detect different frequencies. "Those could be used in garage door openers or security locks, for example," he says. "Such a system couldn't be tricked by signaling it with a telephone." And since Mostek's tone dialers work from the same crystal reference as its receiver, the tones that are generated and received can be changed simply by changing the crystal.

Mostek Corp., 1215 W. Crosby Rd., Carrollton, Texas 75006 [411]

## 8-bit monolithic a-d converter runs at 30 MHz

The monolithic video analog-to-digital converter has arrived. It is a parallel converter that resolves 8 bits, performs 30 million conversions per second, and sells for a relatively low \$485 in quantities of 100 or more. Housed in an enormous 64-pin dual in-line package with dimensions of 3.25 by 1.00 by 0.5 inches, the model TDC1007J nevertheless occupies much less volume than its closest hybrid competitors. The unit's power consumption is lower too. It requires 2.5 w in addition to the approximately 1 w needed by its peripheral circuitry.

For evaluating the converter, the

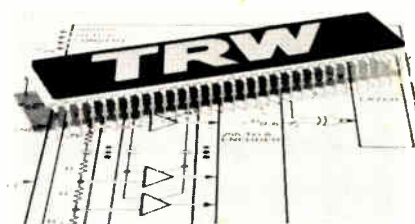

Electronics / April 27, 1978

When nobody's got  
just what you need in  
Magnetic Materials

# PERMAG'S Got It!

In stock. Off-the-shelf. 24-hour delivery. Grinding to your prints. Engineering assistance. Fabricating facilities. In addition, PERMAG has exotic, exclusive hard-to-get items. Complete facilities for measuring, testing, and producing special materials. 8 modern plants stocked, staffed, and equipped to meet your every requirement.

**Write for new catalog.**

**IN THE MAGNETIC FIELD  
PERMAG IS NO. 1.**

YOUR NO. 1 SOURCE  
FOR ALL MAGNETIC MATERIALS



ALL ACROSS THE COUNTRY

Consult your Yellow Pages for  
address and telephone number  
of PermMag near you

Circle 240 on reader service card

**PHILIPS**

**...80% reduction**  
In size and price of digital cassette recording  
Philips new 128k byte  
Mini-Digital Cassette Recorder

**NEW PRODUCT!**  
NCC Anaheim, Ca.  
South Hall  
June 5-8

240 Circle 117 on reader service card

## New products

trouble in high-performance micro-processor systems.

Intel Corp., 3065 Bowers Ave., Santa Clara, Calif. 95051. Phone Rob Walker at (408) 249-8027 [413]

### 1,024-stage bucket-brigade device delays up to 51.2 ms

The latest addition to Panasonic's line of bucket-brigade devices is a 1,024-stage unit that offers a variable delay time of 5.12 to 51.2 ms. Designated the BBD3007, the device has a 0-dB insertion loss, a signal-to-noise ratio of 82 dB, a frequency response that extends up to 40 kHz, and a maximum clock frequency of 100 kHz. Harmonic distortion is a maximum of 0.5%. The unit is intended for use in electronic musical instruments, analog signal processing, telephone time compression, and voice scrambling. It has a six-week delivery time; prices to original-equipment manufacturers are available on request.

Panasonic, 1 Panasonic Way, Secaucus, N. J. 07094. Phone Bill Bottari at (201) 348-7276 [414]

### Fast rectifiers are aimed at switching power supplies

Two series of high-speed rectifiers are intended especially for use in high-efficiency switch-mode power supplies. The rectifiers, which are second sources for Unitorde products, are the 1N5802-5806 series and the 1N5807-5811 series. The former has an average-rectified-current rating of 2.5 A and a switching time of 25 ns. The latter is rated at 6 A and 30 ns. One-cycle (8.3-ms) surge-current limits for the two series are 35 A and 125 A, respectively. Both series are offered with peak-inverse-voltage ratings from 50 v to 150 v. Prices, for quantities of 100 to 999, range from \$1.90 to \$6.50.

Microsemiconductor Corp., 2830 Fairview St., Santa Ana, Calif. 92704. Phone (714) 979-8220 [416]

Electronics/April 27, 1978



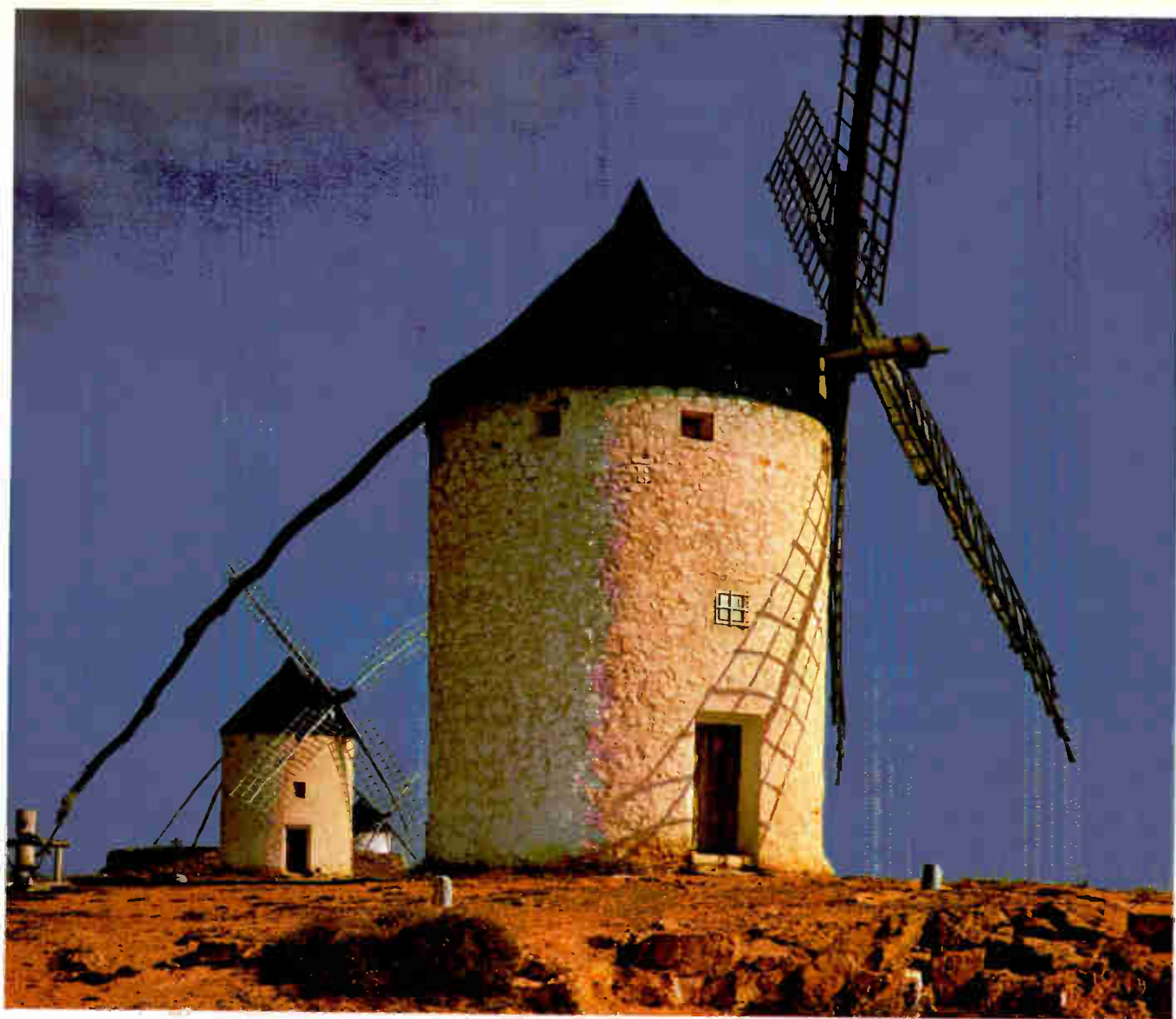

# What have the La Mancha windmills got to do with electronic components?

For one thing, they're in Spain. Even Don Quixote knew that. Which today means that these beautiful structures now have a few advanced products tucked away inside – radios, TV's and the like – which use the components from Spain's largest electronics company, Piher.

Piher. A name you'll find on the world's finest electronic components. And on the finest professional TV equipment, weighing machines, mini-computers – and much, much more.

You'll find Piher products at work in almost 50 countries, supporting industry, enhancing leisure.

Believe it, you don't have to live in a windmill to know about Piher – although it's a nice thought.

Have a tilt at finding out more about us from our technical data sheets and product brochures. We're always glad to help.



 **PIHER**

Spain · Germany · Great Britain · France · USA · Italy · Austria · Holland

PIHER INTERNATIONAL CORPORATION, 505 WEST GOLF ROAD, ARLINGTON HEIGHTS, CHICAGO, ILLINOIS 60005, U.S.A. TELEPHONE (312) 640 8300

Electronics / April 27, 1978

Circle 243 on reader service card 243

# abbott

## POWER SUPPLIES

### 2,685 answers to power supply questions.

Answers to better power and thermal efficiency. Answers to size and weight reductions. Answers to available off-the-shelf covered/open frame power supplies and transformers. And price and delivery answers.

These and many more answers can be found in our three product catalogs. And they're yours. Free. Just circle reader card number. Better yet, write or call Abbott. The Power Supply Specialist.

**Power Supply Catalog** — Comprehensive 60-pager describes our full line of 1,573 hi-efficiency, hermetically sealed, single and dual output power supplies and switcher modules. Inputs of 60 and 400Hz and DC are available with outputs from 3VDC to 740VDC, 1 to 250 Watts. Prices start as low as \$174 for 2-4 units.

**Circle Card Number 100**

**Industrial Power Supply Catalog** — Some 279 of our low cost, high quality OEM power modules are detailed in this 16-pager. Includes covered/open frame, AC to DC single, dual and triple output versions, with outputs from 5 to 36VDC, 0.5 to 320 Watts. Plus DC to AC converters with 50 and 60Hz outputs. Priced as low as \$35 for up to 24 units.

**Circle Card Number 101**

**Transformer Catalog** — A 20-pager for the do-it-yourself power supply designer with instructions on how to specify for your custom units. Also covers 833 of our standard military, industrial and miniature pcb power transformers. Included are 60 and 400Hz, single phase input units, with prices starting as low as \$5.10 for up to 9 pieces.

**Circle Card Number 102**

See Power Supply Section 4000, and Transformer Section 5600, Vol. 2, of your EEM catalog; or Power Supply Section 4500, and Transformer Section 0400, Vol. 2, of your GOLD BOOK for complete information on Abbott products.

**abbott transistor**

**LABORATORIES, INCORPORATED**

General Offices  
5200 W. Jefferson Blvd., Los Angeles 90016  
(213) 936-8185 Telex: 69-1398

Eastern Office  
1224 Anderson Ave., Fort Lee, N.J. 07024  
(201) 224-6900 Telex: 13-5332

World Radio History

# ARTICLES FROM *ELECTRONICS* AVAILABLE IN REPRINT FORM

No. of  
copies  
wanted

## New reprints

- \_\_\_ R-801 World market report 1978 24 pp \$4.00
- \_\_\_ R-734 Microcomputer families expand 20 pp. \$4.00
- \_\_\_ R-730 Special Report—Automotive electronics gets the green light 10 pp \$3.00
- \_\_\_ R-728 Flexible circuits bend to designers' will 10 pp \$3.00
- \_\_\_ R-724 Special Report—Technologies squeeze more performance from LSI 22 pp. \$3.00
- \_\_\_ R-722 Demands of LSI are turning chip makers towards automation 12 pp \$3.00
- \_\_\_ R-720 How EEs Feel About Engineering—3-part series 26 pp \$5.00
- \_\_\_ R-718 Display makers strive to refine their technologies 8 pp \$3.00
- \_\_\_ R-716 Special report—Japanese wave in semiconductor technology 24 pp \$3.00
- \_\_\_ R-714 Special report—active filter technology 6 pp \$3.00
- \_\_\_ R-713 Electron-beam lithography
- \_\_\_ R-712 Special report—large-scale integration 16 pp \$3.00
- \_\_\_ R-710 Personal computers mean business 8 pp \$2.00
- \_\_\_ R-708 So you want to be a consultant 6 pp \$2.00
- \_\_\_ R-706 Low-cost dual delayed sweep method 6 pp \$2.00
- \_\_\_ R-705 Powering up with linear ICs 12 pp \$3.00

## Charts

- \_\_\_ R-516 Electronic symbols \$2.00
- \_\_\_ R-213 Electromagnetic spectrum (updated 1976) \$3.00
- \_\_\_ R-326 Optical spectrum (6-page report and chart) \$3.00

## Books

- \_\_\_ R-803 New product trends in electronics—Electronics Book Series 333 pp \$14.95
- \_\_\_ R-732 Memory Design—Microcomputers to Mainframes—Electronics Book Series 180 pp \$12.95
- \_\_\_ R-726 Design Techniques for Electronics Engineers—Electronics Book Series 370 pp \$15.95
- \_\_\_ R-711 Circuits for electronics engineers: 306 circuits in 51 functional groups—Electronics Book Series 396 pp \$15.95
- \_\_\_ R-704 Thermal design in electronics \$5.00
- \_\_\_ R-701 Applying microprocessors—Electronics Book Series 191 pp \$9.95
- \_\_\_ R-608 Basics of Data Communications—Electronics Book Series \$12.95
- \_\_\_ R-602 Large Scale Integration—Electronics Book Series 208 pp \$9.95
- \_\_\_ R-520 Microprocessors—Electronics Book Series 154 pp \$8.95
- \_\_\_ R-011 Computer-aided Design 135 pp \$4.00
- \_\_\_ R-032 Active Filters 88 pp \$4.00

## Payment must accompany your order

Make check or money order payable to Electronics Reprints. All orders are shipped prepaid by parcel post. Allow two to three weeks for delivery. For additional information call (609) 448-1700 ext. 5494.

Back issues now available:  
1960 to 1969, \$5.00 each  
1970 to 1973, \$3.00 each  
1974 to 1976, \$4.00 each

## USE THIS PAGE AS YOUR ORDER FORM

Cost of orders \$ \_\_\_\_\_  
Plus 10% handling charge \$ \_\_\_\_\_  
TOTAL AMOUNT ENCLOSED \$ \_\_\_\_\_

Mail your order to:  
Janice Austin  
ELECTRONICS REPRINTS  
P.O. Box 669  
Hightstown, N.J. 08520

## SEND REPRINTS TO

Name \_\_\_\_\_  
Company \_\_\_\_\_ Dept. \_\_\_\_\_  
Street \_\_\_\_\_  
City \_\_\_\_\_ State \_\_\_\_\_ Zip \_\_\_\_\_

## New products

itive sensor whose electrodes are isolated from the environment in an evacuated reference cavity. A thin pressure-sensitive diaphragm separates the reference cavity from a sensing cavity. Displacement of the diaphragm causes capacitance changes that are converted to the analog output voltage. The 422 is accurate to within 2% of reading and has a response time of 40 ms for a step input from 10% to 90% of full scale.

MKS Instruments Inc., 22 Third Ave., Burlington, Mass. 01803. Phone (617) 272-9255 [374]

## Pressure transducers are accurate to within 1%

Two series of differential pressure transducers, the LX17XXDD and the LX17XXDDF, are designed to make measurements on flowing fluids with errors of no more than 1%. Both units employ a construction method that isolates the sensing element from stresses such as those that can be generated when mounting the transducer. In addition, the LX17XXDDF series provides chemical isolation by means of a fluid-filled feature. Both bipolar and unipolar differential pressure ranges are available. The bipolar ranges are  $\pm 5$  and  $\pm 15$  lb/in.<sup>2</sup> Five unipolar ranges go from 0 to 15 lb/in.<sup>2</sup> to 0 to 300 lb/in.<sup>2</sup>, with common-mode-pressure ratings of 30 to 300 lb/in.<sup>2</sup> In quantities of 1 to 24, the LX17XXDD series units sell for \$105 each and the others are priced at \$125. The devices are available from distributors' stock.

National Semiconductor Corp., 2900 Semiconductor Dr., Santa Clara, Calif. 95051. Phone Dennis Dauenhauer at (408) 737-5393 [375]

## Unit controls speed of 1/40- to 1/5-hp dc motors

The model MSC motor speed controller is a solid-state assembly that can be used with dc and universal

# Minimax<sup>TM</sup>

## Lowers Life Cycle Costs

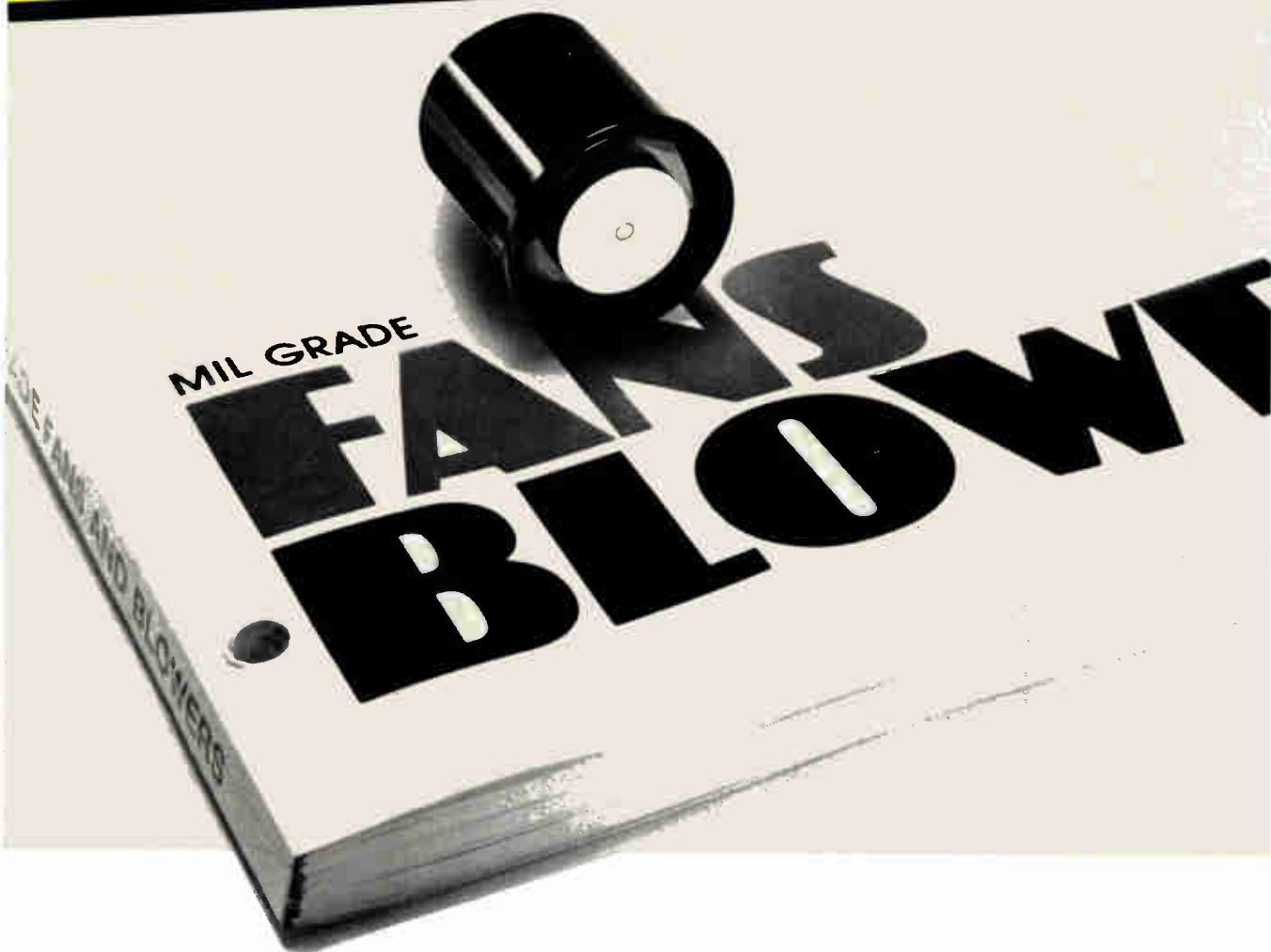

All Rotron precision airmovers prolong the life of electronic equipment. They live longer themselves. And, there is...or can be...a Rotron airmover for your needs.

Take our new MINIMAX fan, one of the smallest fans ever made. It delivers up to 12 cfm of air to

provide electronics temperature stability and instrument defogging. And it takes up little more space than a watchmaker's loupe.

Learn more about the MINIMAX and get your free 196-page, 625-product catalog by contacting Rotron's Custom Products Division.

*Rotron has a way with air*

**ROTRON INC.**

AN EG&G COMPANY



Woodstock, N.Y. 12498 □ 914•679-2401 □ TWX 510-247-9033

Garden Grove, Cal. 92641 • 714•898-5649 • Rotron B.V., Oosterhout, Netherlands, Tel: 01620-32920, Telex: NL 74174

Circle 247 on reader service card

499\*

# Introductory offer to new members of the **ELECTRONICS AND CONTROL ENGINEERS' BOOK CLUB**

**any one  
of these great  
professional books  
for only \$1.89  
values up  
to \$60.00**

**Special \$1.89 bonus book comes to you  
with your first club selection**

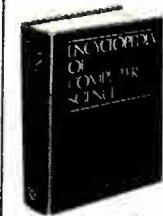

769/01X  
**ENCYCLOPEDIA  
OF COMPUTER  
SCIENCE**  
by A. Ralston  
and C. L. Meek  
Pub. price, \$60.00  
Club price, \$39.95



286/051  
**OPTOELEC-  
TRONIC APPLI-  
CATIONS  
MANUAL**  
by Hewlett-  
Packard  
Pub. price, \$19.25  
Club price, \$14.50

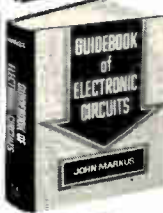

404/453  
**GUIDEBOOK OF  
ELECTRONIC  
CIRCUITS**  
by J. Markus  
Pub. price, \$29.50  
Club price, \$21.50



772/622  
**SEMI-  
CONDUCTOR  
ELECTRONICS  
DESIGN**  
by F. K.  
Manasse  
Pub. price, \$21.95  
Club price, \$18.25

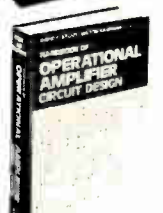

617/97X  
**HANDBOOK OF  
OPERATIONAL  
AMPLIFIER CIR-  
CUIT DESIGN**  
by D. E. Stout  
and M. Kaufman  
Pub. price, \$29.65  
Club price, \$17.50



491/380  
**MICROCOM-  
PUTER-BASED  
DESIGN**  
by J. Peatman  
Pub. price, \$23.00  
Club price, \$17.50



162/468  
**INTEGRATED  
CIRCUITS AND  
SEMICONDUCTOR  
DEVICES:  
Theory and  
Application, 2/e**  
by G. J. Deboo  
and C. N. Burrous  
Pub. price, \$17.95  
Club price, \$13.95



353/670  
**MICROPROCES-  
SORS AND SMALL  
DIGITAL COM-  
PUTER SYSTEMS  
FOR ENGINEERS  
AND SCIENTISTS**  
by G. A. Korn  
Pub. price, \$24.50  
Club price, \$18.95



629/218  
**DIGITAL  
INTEGRATED  
ELECTRONICS**  
by H. Taub and  
D. Schilling  
Pub. price, \$23.50  
Club price, \$16.95



231/494  
**ELECTRONICS  
DESIGNERS'  
HANDBOOK, 2/e**  
by L. J.  
Giacoletto  
Pub. price, \$47.50  
Club price, \$37.50



255/342  
**MANAGEMENT OF  
ENGINEERING  
PROJECTS, 2/e**  
by V. G. Hajek  
Pub. price, \$15.95  
Club price, \$12.50



209/804  
**ELECTRONICS  
ENGINEERS'  
HANDBOOK**  
by D. G. Fink  
Pub. price, \$45.50  
Club price, \$33.50



571/384  
**ELECTRONIC  
COMMUNICA-  
TION, 3/e**  
by R. L. Shrader  
Pub. price, \$16.95  
Club price, \$12.50



637/539  
**DIGITAL INTE-  
GRATED CIR-  
CUITS AND  
OPERATIONAL  
AMPLIFIER, AND  
OPTOELEC-  
TRONIC CIR-  
CUIT DESIGN**  
by Texas  
Instruments  
Pub. price, \$16.50  
Club price, \$12.50

## save time and money by joining the **ELECTRONICS AND CONTROL ENGINEERS' BOOK CLUB**



Here is a professional book club designed to meet your on-the-job engineering needs by providing practical books in your field on a regular basis at below publisher prices. If you're missing out on important technical literature—if today's high cost of reading curbs the growth of your library—here's the solution to your problem.

The *Electronics and Control Engineers' Book Club* was organized for you, to provide an economical reading program that cannot fail to be of value. Administered by the McGraw-Hill Book Company, all books are chosen by qualified editors and consultants. Their understanding of the standards and values of the literature in your field guarantees the appropriateness of the selections.

How the club operates: Every month you receive free of charge *The Electronics and Control Engineers' Book Club Bulletin*. This announces and describes the Club's featured book of the month as well as alternate selections available at special members' prices. If you want to examine the Club's feature of the month, you do nothing. If you prefer one of the alternate selections—or if you want no book at all—you notify the Club by returning the card enclosed with each Bulletin.

As a Club member, you agree only to the purchase of four books (including your first selection) over a two-year period. Considering the many books published annually, there will surely be at least four you would want to own anyway. By joining the Club, you save both money and the trouble of searching for the best books.

## MAIL THIS COUPON TODAY

**ELECTRONICS AND CONTROL ENGINEERS' BOOK CLUB**  
P.O. Box 582, Princeton Road, Hightstown, New Jersey 08520

Please enroll me as a member and send me the two books indicated. I am to receive the bonus book at the introductory price of \$1.89 plus my first selection, plus tax, postage and handling. If not completely satisfied, I may return the books within 10 days and request that my membership be cancelled. If I keep the books, I agree to take a minimum of three additional books during the next two years at special Club prices (guaranteed 15% discount, often more). I will receive the Club Bulletin 13 times a year. If I want to examine the featured selection, I need take no action. It will be shipped automatically. If, however, I want an alternate selection—or no book at all—I simply notify the Club by returning the convenient card always enclosed. I will always have a minimum of ten days in which to return the card and you will credit my account fully, including postage, if this is not the case. Membership in the Club is continuous but cancellable by me at any time after the four-book purchase requirement has been filled. This order subject to acceptance by McGraw-Hill. Orders from outside the continental U.S. must be prepaid. All prices subject to change without notice. Offer good for new members only.

Write Code # of \$1.89 bonus  
book selection here

Write Code # of  
first selection here



NAME \_\_\_\_\_

ADDRESS \_\_\_\_\_

CITY \_\_\_\_\_

STATE \_\_\_\_\_ ZIP \_\_\_\_\_

**EXTRA SAVINGS:** Remit in full with your order, plus any local and state tax, and McGraw-Hill will pay all postage and handling charges. **E33336**

# **PROGRAMMABILITY!**

## **Exclusive with SABRE X**

### **IRIG tape recorder/reproducer**

**What puts SABRE X IRIG Tape Recorder/Reproducer above and beyond all others? . . . Programmability.**

With SABRE X you get keyboard-programmable (and re-programmable) microprocessor control of tape speeds, operating modes, end-of-tape, shuttle and search functions, even monitor/alarm and other diagnostic testing functions. It lets you set up your entire protocol in a fraction of the time needed for manual controls. A standard peripheral keyboard does all that's required. The SABRE X is also programmable from a complete computer system with peripherals such as mag tape, disc, etc. . . . a standard feature to other IRIG tape recorder/reproducer provides. And that's just the start.

Another SABRE X exclusive is a tape transport with ten speeds electrically switchable from 240 through 15/32 ips for both record and reproduce, High Density Digital (HDR) Direct, or FM. As the only 4.0 MHz/track direct record and reproduce system available, SABRE X offers the most extended frequency range . . . plus the industry's longest record time of 88.8 hours per tape reel . . . plus the engineering capable of housing a full system's 32 record and reproduce channels in a single cabinet. We could go on . . . but you get the idea: SABRE X is the state-of-the-art. For more information, call or write: Sangamo Weston, Inc., Sangamo Data Recorder Division, P.O. Box 3041, Sarasota, FL 33578 TEL: (813) 371-0811

**SANGAMO WESTON**

**Schlumberger**

# **SABRE X**

Circle 253 on reader service card



**The Intecolor 8080 Development System Gives You Total In-House Control.** You probably already realize that an in-house development system would give you a lot more control, flexibility and efficiency.

You may not realize that now you can afford one. Our new low-cost 8080 development system features a 19-inch, 8-color data entry terminal with an Intel 8080 micro computer. A 110 CPS bi-directional desk top printer. A dual mini disk drive and our 2708/2716 PROM programmer. It also includes a sophisticated ROM-based Text Editor and Assembler. And as an option, a FORTRAN compiler with double precision by Microsoft®

Call today 800/241-9888 toll-free for a demonstration.

Color Communicates Better

**Intelligent Systems Corp.**



5965 Peachtree Corners East/Norcross, Georgia 30071  
Telephone 800/241-9888 TWX: 810-766-1581

Circle 254 on reader service card

## SUPER MINIATURE

### Neon Glow Lamps

Circuits Volts.....AC 105-125  
Series Resistance.....150KΩ  
Nominal Current.....0.3mA  
Total Flux.....20mlm MIN.  
Average Life Hours...30,000

Dimension:mm

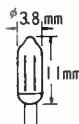

NL-8S

## CLEAR-GREEN

### Fluorescent Glow Lamps

Circuit Volts.....AC or DC 105-125  
Series Resistance.....33KΩ  
Nominal Current.....1.6mA  
Total Flux(MIN.).....AC:120mlm,DC:130mlm  
Avg. Life Hours.....AC:30,000 DC:40,000

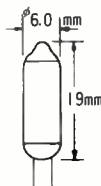

NL-35/G

Circuit Volts.....AC 105-125  
Series Resistance.....27KΩ  
Nominal Current.....1.5mA  
Total Flux.....90mlm MIN.  
Avg. Life Hours.....20,000

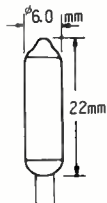

NL-21/G

## ● MAIN PRODUCT

NEON GLOW LAMP, XENON FLASH LAMP,  
RARE GAS, DISCHARGE LAMP.  
MINIATURE : BLACK-LIGHT, UV-LIGHT,  
FLUORESCENT COLOR-LIGHT.

**ELEVAM ELECTRONIC TUBE CO., LTD.**

NO. 17-B CHUO 2-CHOME OTA-KU, TOKYO JAPAN  
TELEPHONE : 03(774) 1231~5

EXPORT DIVISION : JAPAN NANOTRONIX CO., LTD.  
OTA-KU TOKYO, TELEPHONE. (03)775-4811 TELEX 246-6583 JNANOX

## New literature

**Battery charger.** "Current-Limited and Voltage-Regulated Battery Charger," a nine-page applications report, explains how to recharge a 44-ampere-hour lead-acid battery from fully discharged to fully charged in three hours by using a programmable shunt regulator and dual common-cathode rectifier. CA-194 discusses how the TL430 programmable shunt regulator is used in current-limiting and voltage-regulating circuits to protect the battery and how the TIR101 dual rectifier provides an economical power supply. Texas Instruments Inc., Box 5012, M/S 308, Dallas, Texas 75222. Circle reader service number 421.

**Switchers.** Features of five series of single- and multiple-output switchers are summarized in a catalog, along with the major specifications of each series. Options briefly described include power-failure detection, remote on-off control, master-slave paralleling, straight paralleling, added brownout protection and dc inputs. LH Research Inc. 1821 Langley Ave., Irvine, Calif 92714 [422]

**Electromechanical equipment.** A 116-page catalog presents thousands of electromechanical components and support equipment selected to meet the needs of the engineer, designer, or scientist. Among the units are accelerometers, amplifiers, digital displays, potentiometers, power modules and supplies, switches, and test and measuring equipment. American Design Components, 39 Lispenard St., New York, N. Y. 10013 [423]

**Fiber optics.** "Microbend Losses in Multimode Optical Fibers," a 51-page report, will permit designers of fiber-optic equipment to calculate the transmission loss in an optical waveguide caused by minute bends. The calculation is made by assuming that there is a certain density of microbends per unit length of waveguide. Then by using a sequence of equations, it is possible to predict the rate of loss attributable to the

# If you're looking for high capacitance

You'll be interested in AVX Ceraseal®. It's a unique ceramic-epoxy encased radial capacitor designed specifically to put the maximum amount of capacitance in the minimum size package.

To get capacitance of 1 mfd and above in a standard CKR06/CK06, .290 inch-square case size, most manufacturers use a smaller, thinner chip. The result is thinner dielectric layers with greater chances for failure. Instead, AVX uses a

thinner case, the Ceraseal ceramic-epoxy coating. It provides excellent physical protection for the chip. And it allows us to put more plate area and thicker dielectric layers into the standard CK06 package size.

AVX offers Ceraseal construction, in standard off-the-shelf products, up to the

MIL-designated CKR08 2.0 mfd capacitance rating, all available at

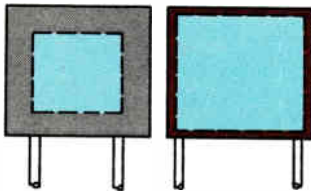

the highest military reliability levels. And we can build Ceraseal radials to even higher

reliability levels, tight tolerances, with capacitance values up to 50 mfd.

If you need high capacitance, with the reliability that only a ceramic multilayer can provide, contact your local AVX representative or distributor. He's the only one who can offer you Ceraseal components. And Ceraseal is the answer.

## ...look to AVX.

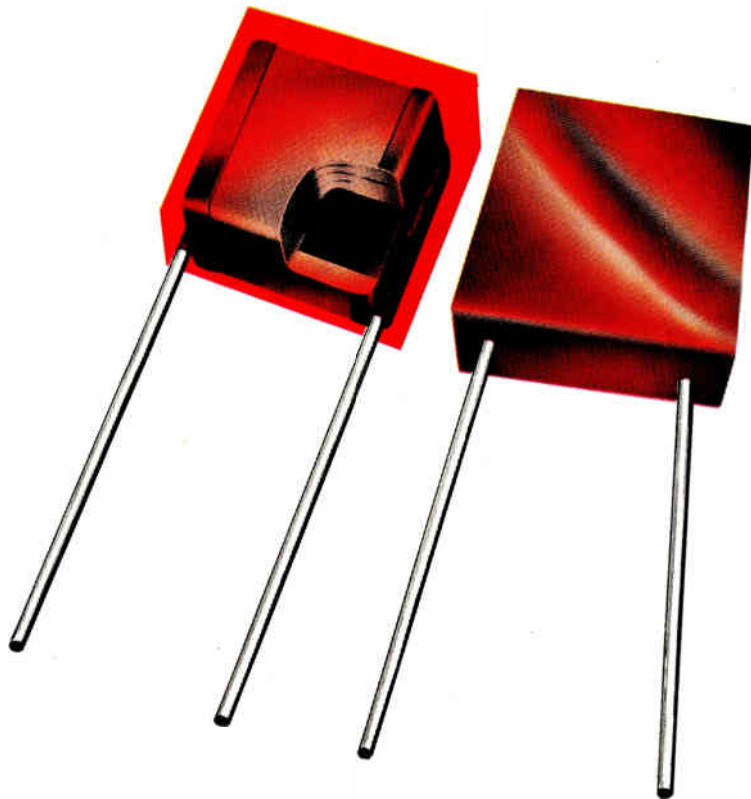

### AVX CERAMICS

AVX Ceramics, P.O. Box 867, Myrtle Beach, SC 29577 (803) 448-3191  
TWX: 810-661-2252; Olean, NY 14760 (716) 372-6611 TWX: 510-245-2815  
AVX Limited, Aldershot, Hampshire, GU12 4RG England, Tel: Aldershot (0252) 312131 Telex: 858473



**WE'LL SEND YOU A SAMPLE  
TO PROVE OUR POINT.**

*Replaceable electrical  
contacts for  
reliable circuit  
testing*

The sample will demonstrate how easily the probe tip is replaced without disturbing the wiring. We'll also send complete specifications illustrating the variety of standard sizes and tip styles available from stock. Let us prove our point. Contact

**EVERETT/CHARLES, INC.**

2806 Metropolitan Place, Pomona, CA 91767  
(714) 593-2541.

Circle 256 on reader service card

**SMALLER  
SIZE**

**WIDE  
RANGE**

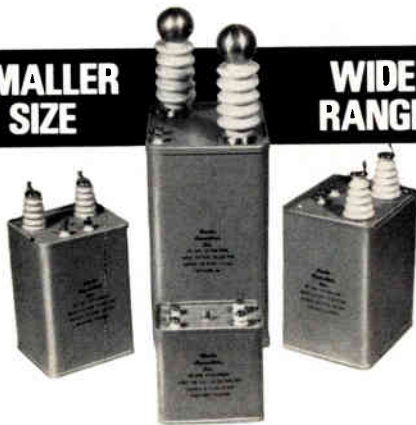

## POWER PACKS

**TYPE HV-M** Small size, hermetically sealed. Promise long life, low ripple, withstand vibration and shock. AC input, DC output. Wide variety of electrostatic and solid state applications. Standard and custom designs available. Off the shelf delivery up to 75 KVDC. Just send your specs. TYPE HV-MW export series in stock for foreign voltages. Write for Technical Data.



**Plastic Capacitors, Inc.**

2623 N. PULASKI ROAD, CHICAGO, ILL. 60639 (312) 489-2229

"Serving industry for over a quarter century"

### New literature

microbends. Report OT 77-136 sells for \$5.25 each. National Technical Information Service, 5285 Port Royal Rd., Springfield, Va. 22161.

**Power supplies.** A revised and enlarged 1978 power-supply catalog lists four new families of dual- and triple-output power supplies, in both screw-terminal and plug-in types, as well as single- and dual-output rack-mounting supplies. A selection guide lists detailed electrical and mechanical specifications, including outline drawings. Acopian Corp., Easton, Pa. 18042 [425]

**Assembly technology.** A bibliography of free source material about the advantages of numerically controlled printed-circuit-board assembly technology is available from Ragen Industries Inc., 9 Porete Ave., North Arlington, N. J. 07032 [426]

**Temperature measurement.** More than 8,000 temperature-measurement instruments and accessories are described in the "1978 Temperature Measuring Handbook." This document includes 44 more products than last year's edition. Some of the



products include digital readout meters, thermocouple wells, pyrometers, controllers, and amplifiers. It is a good source of basic temperature-measurement data, including information on temperature vs millivolt conversion and response time



# Chemicals for a bold new world.

Optical waveguides. Thin film memory. Liquid crystal displays. Wherever today's breakthroughs are shaping tomorrow's world, you'll find EM Laboratories as a source for fine chemicals.

We manufacture chemicals for vacuum deposition, liquid crystal displays, fiber optics, crystal growth... dopants for electronics... that's just the start. And the R&D for tomorrow is bubbling in our labs.

Pure consistency in fine chemicals from EM Laboratories. Whatever you need to frame your future, we produce it. For a better world.



**EM Laboratories, Inc.**

associate of

**E. Merck, Darmstadt, Germany**

500 Executive Boulevard

Elmsford, N.Y. 10523

(914) 592-4660

Pure Consistency...

◆ Chemicals for electro optics ◆ Suprapur<sup>®</sup> ◆ Patinal<sup>®</sup>  
◆ Aneron<sup>®</sup> ◆ Licristal<sup>®</sup> ◆ Selectipur<sup>®</sup>

Circle 257 on reader service card

If we don't have the —  
**Broadband Linear High Power Amplifier**  
 you're looking for . . .

- **ALL SOLID STATE** — 10 KHz to 1 Ghz
- **BUILT IN WATTMETER** — reads true forward and reflected power.
- **ALC SIGNAL** — DC voltage available to feed back to the driving source.
- **CONSTANT FORWARD POWER** — with ALC the forward power is held constant into any load.
- **POSITIVE PROTECTION** — no damage when operated into any load.

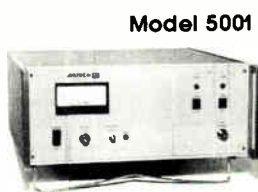

- Model 5001**
- High Power 50 watts minimum (70 watts available).
  - 10 KHz — 10 MHz frequency range.
  - Ideal for medical ultrasound research applications.

- 20512 minimum 20 watts output (30 watts available).
- 35512 minimum 35 watts output (50 watts available).
- 150 MHz — 512 MHz frequency range.
- Covers two important Mobile bands plus the Military communications band.

**Model 20512 & 35512**



- Model 15100**
- High Power (15 watts minimum).
  - 500-1000 MHz frequency range.
  - Modular design.

**Models 1020, 2020 & 5020**



- 10, 25 & 50 watts (Up to 75 watts available).
- 1 MHz to 200 MHz frequency range.
- Can deliver 100 watt narrow band.



For OEM applications modules tailored to the customers system requirements are available. They are packaged in an RFI proof module and operate from a standard 28V supply.

**. . . you really have a problem.**  
 and if you let us know —  
 we could solve that problem too.



**AILTECH**  
 A CUTLER-HAMMER COMPANY

WEST COAST • CITY OF INDUSTRY, CA 91748 • (213) 965-4911  
 EAST COAST • RONKONKOMA, NEW YORK, NY 11779 • (516) 588-3600  
 FRANCE • TELEPHONE 780-7373  
 UNITED KINGDOM • TELEPHONE 5777  
 GERMANY • TELEPHONE (089) 5233023  
 JAPAN • TELEPHONE (404) 8701 (NIPPON AUTOMATIC)

**New literature**

for thermocouples. Omega Engineering Inc., P. O. Box 4047, Stamford, Conn. 06907 [427]

**LED displays.** A 72-page catalog covers digital, alphanumeric, and integrated-logic light-emitting-diode displays, ranging in size from 0.27 up to 1.02 inches high. There is also a section on display-mounting hardware and clock displays and modules. Detailed dimensional drawings and technical data accompany the more than 133 different LED models,

CATALOG HE

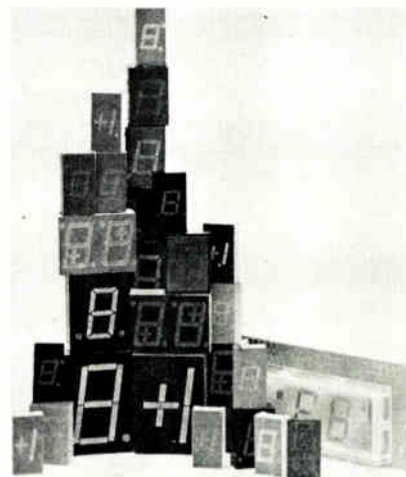

**IEE** -MERCEDES  
 LED DIGITAL DISPLAYS

which are designed for use in the telecommunications and test-equipment industries. Industrial Electronic Engineers Inc., 7740 Lemona Ave., Van Nuys, Calif. 91405 [428]

**Lead wire.** Publication L-77, a 16-page booklet on lead wire for internal wiring of appliances and equipment, emphasizes Underwriters Laboratories-listed and Canadian Standards Association-certified designs used for motors, transformers, mercury switches, switch boards, control panels, instruments, and electronic circuits. Insulation constructions described include silicone rubber and Nomex. Charts detail the general properties of the constructions including temperature and voltage rating. Marketing Communications Manager, Belden Corp., 2000 S. Batavia Ave., Geneva, Ill. 60134 [429]

# New from Electronics... when you can't afford to reinvent the wheel.

Here's just a sampling of the vast range of useful information you'll have at your fingertips...

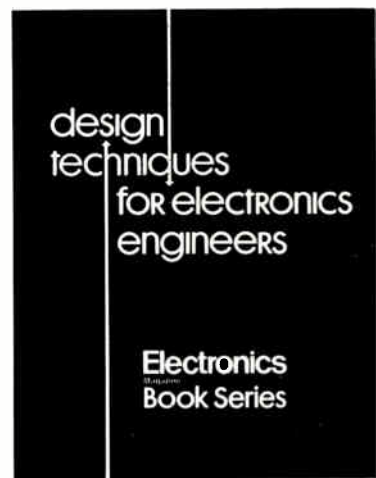

- How to use soluble masks to protect pc boards from solder.
- How to evaluate power dissipation in microcircuit design.
- How to hand-solder DIP circuits to save testing dollars.
- How to compare the power of C-MOS with TTL.
- How to really look at low-drift IC op amps.
- How to accurately trim closed resistor loops.
- How to drive LEDs directly from C-MOS logic outputs.
- How to convert coordinates and find SWRs graphically.
- How to compare coaxial-cable shielding effectiveness.
- How to calculate resistance for sum and difference networks.
- How to use a programmable calculator to analyze filter designs.
- How to compute response of RLC networks with a short program.
- How to eliminate stray signals in remotely gain-switched op amps.
- How to chart power losses for hybrid-combined amplifiers.
- How to reduce IC FET op-amp input bias currents.
- How to build timing circuits for noisy environments.
- How to approximate waveforms with exponential functions.
- How to increase an instruction set without increasing word length.
- How to extend the life of digital recording heads.
- How to add numeric readout to logic probe displays.
- How to pick the right film for better oscilloscope pictures.
- How to use a frequency counter to measure capacitance.
- How to evaluate high-energy pulse effects on materials.
- How to operate a logic gate as a flip-flop.
- How to choose the right detector for rf power measurements.
- How to measure the access time of bipolar read-only memories.
- How to test power supplies quickly and cheaply.
- How to get the most out of a digital multimeter.
- *And much, much more.*

Order today, and don't forget the other valuable books in the Electronics Books Series listed on the coupon below.

**Electronics Book Series**  
P.O. Box 669, Hightstown, N.J. 08520

- 1. Microprocessors**  
Send me \_\_\_\_\_ copies at \$8.95 per copy.
- 2. Applying Microprocessors**  
Send me \_\_\_\_\_ copies at \$9.95 per copy.
- 3. Large Scale Integration**  
Send me \_\_\_\_\_ copies at \$9.95 per copy.
- 4. Basics of Data Communications**  
Send me \_\_\_\_\_ copies at \$12.95 per copy.
- 5. Circuits for Electronics Engineers**  
Send me \_\_\_\_\_ copies at \$15.95 per copy.
- 6. Design Techniques for Electronics Engineers**  
Send me \_\_\_\_\_ copies at \$15.95 per copy.

Discounts of 40% on orders of 10 or more copies of each book.

If after my 10-day free-trial examination I am not fully satisfied, I understand that my full payment will be refunded.



- Payment enclosed     Bill firm     Bill me  
Charge to my credit card:  
 American Express     Diners Club  
 BankAmericard     Master Charge

Acc't No. \_\_\_\_\_ Date exp. \_\_\_\_\_

On Master Charge only, first numbers above name \_\_\_\_\_

Name \_\_\_\_\_ Title \_\_\_\_\_

Company \_\_\_\_\_

City \_\_\_\_\_ State \_\_\_\_\_ Zip \_\_\_\_\_

Signature \_\_\_\_\_

# Now you can save money and get the counter you want— immediately

A frequency counter should deliver all the performance you expected when you placed the order. If the counter is a B&K-PRECISION you'll be getting that plus some equally important benefits—a price that you can easily afford and off-the-shelf delivery.

B&K-PRECISION has engineered a line of full-feature frequency counters to suit most

applications. All have been conceived as cost-effective answers to frequency measurement needs in communications, lab, field and plant applications. Every B&K-PRECISION counter features: autoranging, liberal input overload protection, a minimum of 1Hz resolution, conservative specifications, and easy-to-read LED displays.

#### MODEL 1850

- 520MHz guaranteed; 600MHz typical
- Period measurement capability

#### MODEL 1801

- 40MHz guaranteed; 60MHz typical
- Reliable discrete TTL logic

#### MODEL 1827

- 30MHz guaranteed; 50MHz typical
- Compact size; portable
- 8 digit accuracy with 6 digit readout

#### MODEL 1820

- 80MHz guaranteed; 100MHz typical
- Period, event and time measurements

At the top end of our line is the new Model 1850, very conservatively rated at 520MHz. Features include: TCXO time base...Period measurements from 5Hz to 1MHz...Leading zero suppression...Bright .43" LED display...Gate times from 10 ms to 10 seconds...\$450.

The 1820 Universal Counter is one of the most versatile counters available at any price. Frequency measurement typically extends beyond 100MHz...Period measurements from 5Hz to 1MHz...Period average, auto and manual positions...Elapsed time measurements to 9999.99 seconds (plus overflow)...Totalizes event counts to 999999 (plus overflow)...\$260.

At only \$120, the 1827 portable frequency counter is slightly larger than a pocket calculator. 30MHz guaranteed; 50MHz typical...Battery saver for all-day field use...Full range of optional accessories available.

The 1801 is a rugged frequency counter designed for production line and maintenance applications. Readings to 40MHz guaranteed; 60MHz typical...Easy to use and read...Wide range input eliminates the need for level adjustments...\$200.

Isn't it time you stopped sacrificing features and performance for price? See your local distributor for immediate delivery.

**B&K PRECISION** **DYNASCAN CORPORATION**

6460 W. Cortland Avenue, Chicago, IL 60635 312/889-9087

In Canada: Atlas Electronics, Ontario

International Sales: Empire Exporters, Inc., 270 Newtown Road, Plainview, L.I., NY 11803

Circle 261 on reader service card

# memo to: ENGINEERING

from:

Kazim Ali, Employment Manager  
GTE Lenkurt  
1105 County Road, San Carlos, CA 94070  
(415) 595-3000

Changing jobs; selecting the field in which to employ your talents; and choosing the Company best suited to your potential are critical decisions. I hope you are looking for more than a job . . . and want a career that will bring you personal gratification as well as an opportunity to develop and advance.

GTE Lenkurt, Inc., a part of General Telephone & Electronics Corporation (GTE) and a major manufacturer of video, voice and data communications systems, is a Company with a Future, a future that has never looked better and that gives promise for a growth and expansion unsurpassed by any other segment of industry. The outstanding feature in most of the positions offered at GTE Lenkurt is the advancement opportunity that accompanies the job.

GTE Lenkurt also is a Company with a Challenge, a challenge to meet the requirements of the ever-growing communications industry, a challenge to meet the expanding requirements of the World's largest industrial community that is only beginning to realize the value of communications in business; and a challenge to supply our customers with the World's finest communications network.

## DEVELOPMENT

Electrical Engineers at all levels for projects in subscriber carrier analog and digital microwave radio and PCM carrier and switching. Experience in either linear, or digital circuit, microprocessor control circuit design.

## ELECTRICAL

### Microcircuit Development

1. Development of Custom Integrated Circuits, Analog and/or Digital Design and computer simulation desirable. Willing to train if solid experience in discrete circuit design. Will work with Bipolar and N-MOS technologies.
2. Development of Automatic programs for high speed laser trim and test of hybrid circuits. Solid background in linear or digital circuit analysis and aptitude in minicomputer programming required.

In a generation, GTE Lenkurt has created a tradition normally reserved for Century-old organizations. The tradition is Excellence, and the cornerstones that support it . . . quality workmanship, thorough service and intelligent research.

While we are proud of our locations, our plants, our facilities and hardware, we believe GTE Lenkurt is a dynamic, successful and stable organization today because of its greatest resource — People. These are people who have devoted a good part of their lives and many millions of hours to building and upholding the Company's tradition of excellence and quality. These are people who represent some of the best minds in the Communications Industry. We need more such people, people who are imaginative, creative and intelligent, and want to grow and expand with a Company that has continuously progressed in the leadership of its industry. GTE Lenkurt is a Leader whose reputation is firmly established both in the world of electronics and also as an equal opportunity employer.

If you have the capacity to accept the challenge, and the ability to answer it, consider the opportunities with our Team in the following areas:

## DIGITAL DESIGN

### PCM Transmission & Terminals

For design of PCM digital multiplexers and terminal equipment. 2-7 years experience. Background in high speed digital design utilizing TTL and ECL. Logic, some knowledge of microprocessors desirable, but not required.

## FIBER OPTICS

We seek an experienced Engineer knowledgeable in the design and circuit applications of fiber optics components such as laser diodes, light emitting diodes, avalanche photodiode receivers, single fiber connectors and cable-to-cable splicing.

# GTE LENKURT

# Classified section FOR ENGINEERING/TECHNICAL EMPLOYMENT OPPORTUNITIES

## CLASSIFIED SALES REPRESENTATIVES

Atlanta . . . . . Jane Core . . . . . 404/892-2868  
 Boston . . . . . Jim McClure . . . . . 617/262-1160  
 Chicago . . . . . Bill Higgins . . . . . 312/751-3733

Cleveland . . . . . Mac Huestis . . . . . 216/781-7000  
 Dallas . . . . . Mike Taylor . . . . . 214/742-1747  
 Denver . . . . . Shirley Klotz . . . . . 303/837-1010  
 Detroit . . . . . Mac Huestis . . . . . 313/873-7410

Houston . . . . . Mike Taylor . . . . . 713/659-8381  
 Los Angeles . . . . . Stan Kassir . . . . . 213/487-1160  
 New York . . . . . Larry Kelly . . . . . 212/997-3594  
 Philadelphia . . . . . Dan Ferro . . . . . 215/568-6161

Pittsburgh . . . . . Dean Genge . . . . . 412/391-1314  
 San Francisco . . . . . M.E. Kenny . . . . . 415/362-4600  
 Stamford . . . . . Jim McClure . . . . . 203/359-2860  
 XEROX 400 TELECOPIER . . . . . 212/997-6800

## .. ENGINEERS ..



The Raymond Corporation is actively seeking highly competent communications engineers; engineers seeking more responsibility and more professional challenge; engineers qualified to contribute to our justified reputation as the innovative leader in the narrow aisle, electric powered, material handling equipment field.

The excellent salaries and full range of benefits are complemented by our commitment to a participative management philosophy, which translates into an unparalleled opportunity for professional growth and advancement.

If you have a BSME or BSEE with four to ten years of communications experience, preferably in Digital Mobile Communications and have the kind of demonstrated ability which this kind of opportunity, demands, send resume and salary history, in confidence, to:

Ms Margaret Gallagher, Personnel Manager  
Phone (607) 646-2408

**THE RAYMOND CORPORATION**  
**GREENE, N. Y. 13778**  
"AN EQUAL OPPORTUNITY EMPLOYER, M/F"

## SENIOR TEST ENGINEER

The individual we seek will have designed in a high technology engineering group working in a small team environment.

*Background should include:*

- Design of test fixtures for digital and analog equipment
- Some microprocessor design experience
- Some automatic test set design experience
- Emphasis on hardware design
- Experience reviewing and improving basic product circuit and logic design
- B.S.E.E. Degree with 5-7 years' related test experience.

We offer an excellent salary and generous benefits. If you are interested and qualified, please send your resume with salary history/requirement in complete confidence to:

**J. R. Walter, Personnel Manager**

## Databit

INCORPORATED

50 Davids Drive  
Hauppauge, New York 11787  
Equal Opportunity Employer M/F

# SYSTEMS ENGINEERS

**ESL provides...  
TEAMWORK + ATMOSPHERE**

**as key ingredients of our continuing growth on the San Francisco Peninsula:**

ESL has openings for Engineers with 3-10 yrs. exp. in Systems Engineering. Candidates must be familiar with state-of-the-art in antenna systems, receivers and processing hardware for signal acquisition systems. Responsibilities include:

- ★ Requirements studies
- ★ Generating System Specifications
- ★ End-to-End System Evaluation

BS/MSEE or Physics required. Both JUNIOR AND SENIOR-LEVEL POSITIONS AVAILABLE.

Identify with a progressive, employee-oriented Company offering excellent salaries, advancement opportunities and a benefits package including 11 PAID HOLIDAYS (including a full week at Christmas), BONUS PLAN, COMPANY PAID MEDICAL/DENTAL/LIFE INSURANCE . . . and a whole lot more.

Please send resume to Kay Cooper, Professional Employment, ESL Inc., 495 Java Drive, Sunnyvale, CA 94086. An equal opportunity employer. U.S. Citizenship required. (408) 734-2244.





# ENGINEERS

## Why are FLORIDIANS moving to Kansas?

**OPPORTUNITY...CHALLENGE...ENGINEERING** career openings exist NOW at Boeing Wichita Company on a number of long range programs involving advanced aircraft systems. Staffing is underway for the early phases of a range of projects relating to Air Force bombers and tankers.

Air Launched Cruise Missiles Integration ... Offensive and Defensive Avionics Systems ... Countermeasures Systems ... Electronic Agile Radar Systems ... Electronic Steerable Antenna Systems ... Weapon System Trainers ... Aircraft Winglets ... and Automated Test Equipment. Join these high technology programs now while program assign-

ments are growing. Ask us today just how your experience and background match our many requirements. We think you'll be pleasantly surprised at what we have to talk about.

**AND MIDWEST LIVING**, the kind of friendly neighbor environment you won't find elsewhere, in a Metropolitan area without big city problems is waiting ... for families and families-to-be. Wichita, with an area population of 383,312, has close-to-work living, excellent schools including three universities, smog-free four-season climate and recreational activities, informal atmosphere with ample opportunity for personal expression and growth.

**IMMEDIATE REQUIREMENTS** include the following which call for a BS or higher degree in Engineering, Physics, Computer Science or Math.

- AVIONICS SYSTEMS DESIGN
- AVIONICS SYSTEM TESTING
- ELECTROMAGNETIC COMPATIBILITY
- ELECTROMAGNETIC WARFARE/ COUNTERMEASURES
- ELECTROMAGNETIC PULSE ANALYSIS
- ELECTRONIC ANALYSIS
- ELECTRONIC CIRCUIT DESIGN
- HARDWARE/SOFTWARE TESTING
- INSTRUMENTATION TESTING
- NAVIGATION/GUIDANCE/WEAPON DELIVERY
- SOFTWARE SYSTEMS DESIGN/ANALYSIS
- TECHNICAL PUBLICATIONS — ELECTRICAL/ELECTRONIC SYSTEMS

Send resume to: Wes Penner, Boeing Wichita Company  
4300 E. MacArthur Road, Wichita, KS 67210  
or Call Collect (316) 687-3057

**BOEING**  
**WICHITA COMPANY**  
An Equal Opportunity Employer M/F



# memo to: **ENGINEERING**

**from:**

Kazim Ali, Employment Manager  
GTE Lenkurt  
1105 County Road, San Carlos, CA 94070  
(415) 595-3000

Changing jobs; selecting the field in which to employ your talents; and choosing the Company best suited to your potential are critical decisions. I hope you are looking for more than a job . . . and want a career that will bring you personal gratification as well as an opportunity to develop and advance.

GTE Lenkurt, Inc., a part of General Telephone & Electronics Corporation (GTE) and a major manufacturer of video, voice and data communications systems, is a Company with a *Future*, a future that has never looked better and that gives promise for a growth and expansion unsurpassed by any other segment of industry. The outstanding feature in most of the positions offered at GTE Lenkurt is the advancement opportunity that accompanies the job.

GTE Lenkurt also is a Company with a *Challenge*, a challenge to meet the requirements of the ever-growing communications industry, a challenge to meet the expanding requirements of the World's largest industrial community that is only beginning to realize the value of communications in business; and a challenge to supply our customers with the World's finest communications network.

## **DEVELOPMENT**

Electrical Engineers at all levels for projects in subscriber carrier analog and digital microwave radio and PCM carrier and switching. Experience in either linear, or digital circuit, microprocessor control circuit design.

## **ELECTRICAL**

### **Microcircuit Development**

1. Development of Custom Integrated Circuits, Analog and/or Digital Design and computer simulation desirable. Willing to train if solid experience in discrete circuit design. Will work with Bipolar and N-MOS technologies.
2. Development of Automatic programs for high speed laser trim and test of hybrid circuits. Solid background in linear or digital circuit analysis and aptitude in minicomputer programming required.

In a generation, GTE Lenkurt has created a tradition normally reserved for Century-old organizations. The tradition is *Excellence*, and the cornerstones that support it . . . quality workmanship, thorough service and intelligent research.

While we are proud of our locations, our plants, our facilities and hardware, we believe GTE Lenkurt is a dynamic, successful and stable organization today because of its greatest resource — *People*. These are people who have devoted a good part of their lives and many millions of hours to building and upholding the Company's tradition of excellence and quality. These are people who represent some of the best minds in the Communications Industry. We need more such people, people who are imaginative, creative and intelligent, and want to grow and expand with a Company that has continuously progressed in the leadership of its industry. GTE Lenkurt is a Leader whose reputation is firmly established both in the world of electronics and also as an equal opportunity employer.

If you have the capacity to accept the challenge, and the ability to answer it, consider the opportunities with our Team in the following areas:

## **DIGITAL DESIGN**

### **PCM Transmission & Terminals**

For design of PCM digital multiplexers and terminal equipment. 2-7 years experience. Background in high speed digital design utilizing TTL and ECL. Logic, some knowledge of microprocessors desirable, but not required.

## **FIBER OPTICS**

We seek an experienced Engineer knowledgeable in the design and circuit applications of fiber optics components such as laser diodes, light emitting diodes, avalanche photodiode receivers, single fiber connectors and cable-to-cable splicing.

# **GTE LENKURT**

# PROFESSIONALS

subject:

# YOU and YOUR CAREER!

## POWER SUPPLY DESIGN

Experienced Engineer in power electronics and power processing is required. Basic knowledge of solid state components and power magnetics is desirable.

## DESIGN SUPPORT

Electrical Engineers at various levels to maintain, modify and assist the current production of electrical designs in various product lines.

## MICROWAVE SYSTEMS

Responsible for defining radio performance specifications and product arrangements including baseband, IF, RF and protection switching. Must have experience in 2-13 gigahertz analog and digital radio development.

## MICROPROCESSOR PROGRAMMERS

Openings at all levels. Knowledge of structured programming concepts, telephone circuits and terminology, and basic electrical engineering of particular interest. BS/MSEE desired.

## MICROPROCESSOR HARDWARE DESIGN & TESTING

Position requires a BS/MSEE with interest in design and testing of microprocessor system hardware.

*GTE Lenkurt benefits are an outgrowth of a feeling of responsibility toward the Employee that has always prevailed. Some benefits are entirely at the option of the Employee — as they should be. Others are automatic. Taken as a whole, they represent a comprehensive, competitive package that can offer a distinct advantage to the user. Consider the following:*

**Excellent salaries; paid vacations and Holidays; Medical, Life and Disability insurance; stock purchase; savings and investment program; 100% tuition refund; pension plan; Employee Store, Credit Union and Recreation Center privileges.**

For a change, if you wish to join a Company that wants to *work for you*, send your resume, with salary history and requirements, to Professional Employment, GTE Lenkurt, 1105 County Road, San Carlos, CA 94070, or phone our Employment Office Collect 415/595-3000 and request an application. We are an equal opportunity employer.

## DIGITAL SYSTEMS

Responsible for defining characteristics, evaluating new applications and developing customer documentation on evolving multi line PCM subscriber pair gain systems, channel banks, multiplexers and repeated lines. Should have electrical engineering background and be familiar with Telephone Operating Company switching and digital transmission plant.

## INDUSTRIAL

### Methods Improvement

Responsibilities include methods improvement, equipment selection, facilities layout and work flow, materials handling and packaging, computer applications to manufacturing problems and solution of production problems during new product introduction. Electronic assembly experience desirable. Minimum BSIE or equivalent with 1-2 years experience desired.

*for ENGINEERING POSITIONS, a BS or MS (or equivalent experience) is required.*

## SYSTEMS ANALYST

Bachelor's degree plus 1-5 years experience in analysis and design of computerized business information systems. Experience in data base/data communications-oriented applications for a manufacturing company desired. Must have sound knowledge of business functions and have strong verbal and written communications skills.

## EQUIPMENT DESIGNERS

Equipment Designers must have knowledge of electro-mechanical packaging and/or printed circuit board layout. No degree necessary.

# GTE LENKURT

*A Part of General Telephone & Electronics Corporation  
on the beautiful SAN FRANCISCO PENINSULA*

In support of our development and manufacturing of computer peripherals and instrumentation, Tektronix, Inc., has for ten years designed and produced custom, in-house state-of-the-art MOS, bipolar and hybrid linear and digital IC's.

## Assembly Operations Manager

You will have management responsibility for production and engineering support functions for our integrated circuit assembly operations and will be accountable for assembly capacity and production capacity need, including personnel, technical support, and in-line manufacturing requirements.

Your experience should include at least five years experience in semiconductor manufacturing and a thorough knowledge of IC/hybrid assembly processes, packaging techniques, microwave component manufacturing and equipment capabilities and proven managerial competence in directing production and assembly/packaging engineering groups.

## Wafer Fabrication Manager

You will manage production and engineering support functions for bipolar Wafer Fab operations and accountability will include bipolar and thin film substrate capacity and production capacity needs; including personnel.

Your experience will include at least five years in Wafer Fab and thin film substrate processing and a thorough understanding of the processes, manufacturing techniques and equipment/facility capabilities. A proven managerial background is also necessary.

Salary is open. Benefits include educational support, insurance and profit sharing programs.

Send detailed resume and salary history to Roy Epperson, TEKTRONIX, INC., P.O. Box 500, C31, Beaverton, Oregon 97077.

An Equal Opportunity Employer  
M/F/H/C.

**Tektronix**<sup>®</sup>  
COMMITTED TO EXCELLENCE

## POWER SUPPLY DESIGN ENGINEERS

Engineered Magnetics, a leader in the field of Solid State Power Conversion and Conditioning Systems, is expanding due to new long term contracts which naturally create permanent engineering career opportunities ranging from Junior Engineers to Sr. Product Design Specialist.

- Electrical Engineer
- Project Engineer
- Sr. Electrical Engineer-Product Specialist

In general, efforts will include specific designs of special high reliability power supplies and conditioners up to 50KW. Your meaningful accomplishments will be readily recognized and rewarded.

We can also offer you outstanding benefits of a large company plus the comfortable working atmosphere of a small Southern California Company. Our salary and benefit compensation are the best in the industry.

For immediate consideration, send your resume today in confidence to or phone the Personnel Department:

Gulton Industries, Inc.

### ENGINEERED MAGNETICS DIVISION

13041 Cerise Avenue  
Hawthorne, California 90250  
(213) 679-0111

*An Affirmative Action/Equal Opportunity Employer*

## Job-seekers... be the first to know with McGraw-Hill's Advance Job Listings

By having our weekly ADVANCE JOB LISTINGS sent to your home every Monday you can be the first to know about openings both in and out of your field. AJL will enable you to contact anxious recruitment managers BEFORE their ads appear in upcoming issues of 21 McGraw-Hill publications. To receive a free sample copy, plus information about our low subscription rates, fill out and return the coupon below.

ADVANCE JOB LISTINGS / P.O. BOX 900 / NY 10020

PLEASE SEND A SAMPLE COPY  
OF ADVANCE JOB LISTINGS TO

NAME \_\_\_\_\_

ADDRESS \_\_\_\_\_

CITY \_\_\_\_\_

STATE/ZIP \_\_\_\_\_

# Advanced computers need advanced semiconductors.



That's why we're at the leading edge of MOS and bipolar technology.

Burroughs is one of the world's leading computer manufacturers. So we don't entrust our semiconductor requirements to just anyone.

That's why in 1971 we established our Micro-Components Organization (MCO) in San Diego. Today, MCO consists of three main groups: MOS, bipolar and R&D. Together, these groups provide Burroughs with its own advanced IC design, process development and manufacturing.

If you join MCO in San Diego, you'll become involved in state-of-the-art programs including:

- Product engineering
- Manufacturing engineering

- IC packaging development (plastic, ceramic, multi-chip).
- Advanced device technology (high performance MOS, VLSI, high-performance bipolar devices).
- Advanced interconnect structures (including unique dielectric materials and multi-layer structures).
- Amorphous semiconductor process development.

And your environment will be different. There will be much more engineering and scientific emphasis than at a semiconductor house. You will have a broader, more visible role to play as a generalist rather than a specialist.

Of course you'll have more responsibility, with the accompanying rewards.

And as part of a \$2 billion company whose profits are ranked in the top 50 nationally, you'll have a feeling of security that you may never have felt before.

So if you have a technical degree, a record of accomplishment in your field and a desire to get into creative semiconductor engineering, processing and research, send your resume to Professional Staffing, Burroughs Corporation, 16701 W. Bernardo Drive, San Diego, CA 92127. Or call toll free 1-800-821-2280 ext. 906. We are an equal opportunity employer m/f.

Come work with us in San Diego.

## Burroughs



**You are just 16 reading hours away from a new and extended proficiency in today's (and tomorrow's) major electronics advances, concepts, and techniques....**

**The McGraw-Hill  
OPERATION UPDATE  
Series in  
INTEGRATED CIRCUIT  
TECHNOLOGY  
AND APPLICATIONS**

**A series of eight professional quality manuals  
—prepared by a panel of top electronics experts  
—tested on the job by thousands of electronics engineers**



**The Manuals**

- Integrated Circuit Processes
- Integrated Circuit Devices and Components
- Operational Amplifiers
- Active Filters Using Operational Amplifiers
- Combinational Logic Design
- Logic Design with TTL
- Semiconductor Memories
- Display Devices

**ALL THIS FIRST-RATE MATERIAL—AND**

- ✓ No enrollment in any kind of course—no classes to attend or lessons to sweat over.
- ✓ No schedules to meet.
- ✓ No time away from your job.
- ✓ And no long-range commitment on your part. Just let the *Introductory Manual* and *Master Outline and Guide* convince you that the Series is just what you need right now to get your electronics know-how together!

**Special Offer!  
Only \$1.00 for  
Introductory Manual  
and  
Master Outline—  
But examine them  
first—FREE—for  
15 Days.**

**Who Designed the OPERATION UPDATE Series in Integrated Electronics?**

Acknowledged electronics experts researched and planned the Series, and prepared the Master Outline and Guide...

**Advisory Board  
Chairman**

Ronald Jay Gutmann, Associate Professor, Electrical Engineering and Systems Engineering Department, Rensselaer Polytechnic Institute.

**Members**

- William D. Becher, Chairman and Professor, Department of Electrical Engineering, University of Michigan—Dearborn.
- Gerald W. Neudeck, Associate Professor of Electrical Engineering, Purdue University School of Electrical Engineering.

**How Does the OPERATION UPDATE Series in Integrated Electronics Work?**

Simply return the Free-Examination Coupon and we'll send you for 15 days on approval *Integrated Circuit Processes* (your Introductory Manual) plus the *Master Outline and Guide* for the entire Series. Take up to 15 days to examine them. Put them to the test any way you wish. Then either send the special Series price of only \$1.00 for this first package, or return the material without further obligation.

If you are convinced this is the right way to update your electronics know-how, we'll begin shipping you the other seven manuals at six-week intervals. We bill you for only one manual—\$6.50—at a time as it's shipped. You risk nothing, because any manual that does not meet your needs may be returned within the 15-day examination period.

**15-DAY FREE EXAMINATION!**

**McGraw-Hill Book Company**  
1221 Avenue of the Americas  
New York, N.Y. 10020



Send me the Introductory Manual plus the Master Outline and Guide for the McGraw-Hill OPERATION UPDATE Series: Integrated Circuit Technology and Applications (079212-7) for 15 days' free examination. At the end of that time, I will either remit \$1.00, plus local tax, postage, and handling charges, or return the material without further obligation. If I decide to keep the material, I will receive the remaining seven Manuals at six-week intervals. I will be billed \$6.50 for each Manual as it is sent, plus local tax, postage, and handling charges.

Name \_\_\_\_\_

Address \_\_\_\_\_

City \_\_\_\_\_

State \_\_\_\_\_ Zip \_\_\_\_\_

Order subject to acceptance by McGraw-Hill.

**41-19401**

■ Abbott Transistor Labs	245	EH International	93	■ Kepro Circuit Systems Inc	224
* Adret Electronique	47	■ Electronic Applications Co	226	‡ Kollmorgen Corp. Photocircuits Division	168-169
Advanced Micro Devices	10-11	■ Electronic Development Corp	274	■ Krohn-Hite Corporation	5
■ Ailtech	258	■ Electronic Measurements	26	■ Lambda Electronics Corporation	205-210, 227-232
■ Alco Electronic Products (Sub. of Augat)	92	Electronic Memories & Magnetics (Sep Div)	153	MDB Systems	202
■ Allen-Bradley	32	■ Electronic Navigation Industries	3rd c.	■ MFE Corp	160-161
■ Amp., Inc.	158-159	Elevam Electronic Tube Co Ltd	254	■ Microswitch, Div. of Honeywell	182-183
Analog Devices	54-55	Elorg Electronorgtechica	173	Millenium Systems Inc	7
Analog Devices	4E	EM Laboratories, Inc.	257	■ Miller-Stephenson Chemical Co., Inc.	200
* Analogic Corp.	168-169	EMR Telemetry	271	■ Mini-Circuits Laboratory	38
* Anritsu Electric Co., Ltd.	204	* Enertec Schlumberger	5E	Mitel Semiconductor Inc	52
Analey (Thomas & Betts)	241	■ Everett/Charles, Inc.	256	Modpak Div Adams-Russell Company	224
Associated Environmental Systems	222	Fairchild (Semiconductor Operations Div)	201, 214, 215	■ Motorola Semiconductor Products	49-50, 35-37, 171-172
Astro-Med	97	Fairchild Systems Technology	180-181	‡ Murata Corporation of America	188
Atlanta Chamber of Commerce Ind Devl	248	Figaro Engineering Inc	8	Electronics & Control Engineers Book Club	249-251
■ Augat, Inc.	239	■ John Fluke Mfg Co Inc	27	Mc-Graw Hill Operation Update Series	269
AVX Corporation	255	Fujitsu America Inc.	9	Optron, Inc.	14
‡ Beckman Instruments, Helipot	67	Futuredata Computer Corporation	178-179	■ Pearson Electronics	51
Biomation	56-57	‡ Galileo Electro Optics Corporation	177	■ Permag Corporation	240
■ B & K Precision, Div. Dynascan Corp	261	GE Plastics	99	■ Philips ELA	236, 238, 240
Bourns, Inc.	4th c.	‡ General Electric Instr Rental Div	162	Philips Elcoma	2E
■ Bud Industries, Inc.	6	■ General Instrument Microelectronics	53	‡ Philips TMI	155
* Burr Brown Research Corp	8E	* Golden Gate Enterprises	187	Piher	243
■ C & K Components	223	■ Gould Electronics Components Div	125	Plastics Capacitors Inc	256
‡ Comstron/Adret	63	Grinnell Systems	165	Practical Automation	274
■ Conap Inc	16	Guardian Electric Mfg. Co.	20-21	Precision Monolithics	212-213
Conrac Div/Conrec Corporation	237	‡ Guildline Instruments, Inc.	187	RAC-Reliability Analysis Center	236
‡ Continental Resources Inc.	47	Harris Semiconductor	273	* Recal Thermionic Ltd.	156-157
Control Electronics	8	■ Hewlett-Packard	22, 23, 24, 217, 219, 221, 2, 149, 12-13, 76-77, 30-31, 2nd c., 1	■ Radio Research Instruments	248
CSPI	235	■ Hughes Aircraft	138	Raytheon Company	12E
‡ Cts Corporation	186, 233	■ ILC Data Device Corporation	68	RCA Solid State	64, 190-191
Cushman & Wakefield	198	Information Handling Services	104-105	Reliability Inc	43
Data General Corp.	100-101	Intel-Microcomputer Components	18-19 28-29	‡ Rental Electronics Inc	156-157
Data I/O Corporation	194-195	Intelligent Systems Corporation	254	Reticon Corporation	9E
■ Data Precision	85	Intermetall Halbleiterwerk	73	Robinson Nugent Inc	166-167
■ Dialight	176	International Rectifier Corp. Semi. Div.	144-145	■ Rockland Systems Corporation	27E
Digi-Data Corp.	244	Interstate Electronics	130	Rockwell Microelectronic Device Division	203
Digital Equipment Components	136-137	ITT Semiconductor	151	Rogers Corporation	21E
Digital Equip Corp OEM 11 Group	192-193	Iwatsu Electric Company, Ltd.	98	* Rohde & Schwarz	1E, 6E
E.I. Dupont De Nemours & Co. Inc.	86-87	■ Johanson Manufacturing Corp.	8	Rotek Instrument Corp.	22C
‡ Eastman Kodak Co., Graphic Markets Division	15	Kasper Instruments	91	Rotron, Inc. (Commercial Prod. Div.)	247
■ Ectron	226	■ Keithley Instruments	123	Sangamo Data Recorder Div Schlumberger	25E

# ELECTRONICS STATEMENT of OWNERSHIP

## LEGAL NOTICE

### U.S. POSTAL SERVICE STATEMENT OF OWNERSHIP, MANAGEMENT AND CIRCULATION

(Act of August 12, 1970: Section 3685, Title 39,  
United States Code)

- Title of publication: Electronics.
- Date of filing: October 11, 1977.
- Frequency of Issue: 26 issues.
- Annual Subscription Price: \$14.00.
- Location of known office of publication: 1221 Avenue of the Americas, City, County and State of New York—10020.
- Location of headquarters or general business offices of the publishers: 1221 Avenue of the Americas, City, County and State of New York—10020.
- Names and addresses of publisher, editor, and managing editor: Publisher, Daniel A. McMillan—1221 Avenue of the Americas, New York, N. Y.—10020; Editor, Kemp Anderson—1221 Avenue of the Americas, New York, N. Y.—10020. Managing Editor, Samuel Weber—1221 Avenue of the Americas, New York, N. Y.—10020.
- The owner is McGraw-Hill, Inc., 1221 Avenue of the Americas, New York, NY 10020. Stockholders holding 1% or more of stock are: Donald C. McGraw, Jr.; Harold W. McGraw, Jr.; John L. McGraw; William H. McGraw; June McGraw McBroom; Elizabeth McGraw Webster; all of 1221 Avenue of the Americas, New York, NY 10020; Eye & Co., c/o State Street Bank & Trust Co., P. O. Box 5006, Boston, MA 02101; Sabat & Co. c/o Savings Banks Trust Co., 200 Park Avenue, New York, NY 10017; Ronis & Co., c/o Bankers Trust Co., P. O. Box 704, Church Street Station, New York, NY 10008; Sior & Co., c/o Bankers Trust Co., 16 Wall Street, New York, NY 10015; Myers & Co., c/o State Street Bank & Trust Co., P. O. Box 5006, Boston, MA 02101; Douglas & Co., c/o Morgan Guaranty Trust Company of New York, P. O. Box 2010, Church Street Station, New York, NY 10008.
- Known bondholders, mortgagees, and other security holders owning or holding 1 percent or more of total amount of bonds, mortgages or other securities: None.
- Permission requested.
- Not applicable.
- Extent and nature of circulation:

	Average No. Copies Each Issue During Preceding 12 Months	Actual No. Copies Of Single Issue Published Nearest to Filing Date
A. Total No. Copies Printed.....	96,273	98,021
B. Paid Circulation		
1. Sales through dealers and carriers, street vendors and counter sales.....	-	-
2. Mail Subscriptions.....	90,452	89,247
C. Total Paid Circulation.....	90,452	89,247
D. Free distribution by mail, carrier or other means samples, complimentary, and other free copies.....	4,345	4,417
E. Total Distribution.....	94,797	93,664
F. Copies Not Distributed		
1. Office use, left over, unaccounted, spoiled after printing.....	1,476	4,357
2. Returns from news agents	-	-
G. Total.....	96,273	98,021

I certify that the statements made by me above are correct  
and complete.

McGRAW-HILL, INC.  
Daniel A. McMillan, Publisher

• Schlumberger	155
Scientific Atlanta, Optima Div.	174
■ Semiconductor Circuits	189
• SEPA S.P.A.	15
• Sfernice	6E
• Siemens AG Munich	62
Signetics Corporation	45
Slaughter Company	238
Spectrol Electronics	82
Sprague Electric	61
■ Stackpole Components Company	78-79
• Stettner & Company	7E
• TEAC Corporation	58
■ Tektronix	102-103, 197
■ Tektronix-IDP	17
■ Tektronix-MDA	80-81
Teradyne, Inc.	146-147
‡ Texas Instruments, Calculator	175
Texas Instruments Components	71
Thermotron Corp.	233
T-K Enterprises	92
• Trio Kenwood Corporation Test Inst. Division	163
Trio-Tech Int'l	127
TRW Capacitors	199
‡ TRW/IRC Resistors	185
TRW Div. Cinch Connectors	75
■ Vactec Inc	259
■ Victory Engineering	198
Viking Industries	225
• V/O Techmashexport	186
Wall Industries	184
Wavetek San Diego	106
‡ XEBEC Systems Inc.	204

### Classified and employment advertising

F. J. Eberle, Manager 212-997-2557

Atomic Personnel, Inc.	268
Boeing Wichita Co.	263
Burroughs	267
Databit, Inc.	262
ESL	262
East Translation	268
Fortune Personnel	268
GTE Lenkurt	264, 265
Gulton Industries, Inc.	266
Public Service of New Mexico	268
Raymond Corp.	262
Myers H. Wm. & Assoc	268
Tektronix, Inc.	266
Wallach Assoc.	268

■ For more information of complete product line see  
advertisement in the latest Electronics Buyers Guide

‡ Advertisers in Electronics International

‡ Advertisers in Electronics domestic edition

## Advertising Sales Staff

**Advertising sales manager:** Paul W. Reiss

1221 Avenue of the Americas, New York, N.Y. 10020  
[212] 997-4371

**Atlanta, Ga. 30309:** Michael Charlton  
100 Colony Square, 1175 Peachtree St., N.E.  
[404] 892-2868

**Boston, Mass. 02116:** Frank Mitchell  
607 Boylston St.  
[617] 262-1160

**Chicago, Ill. 60611**  
645 North Michigan Avenue  
Jack Anderson [312] 751-3739  
Robert M. Denmead [312] 751-3738  
**Cleveland, Ohio 44113:** William J. Boyle  
[716] 586-5040

**Dallas, Texas 75201:** John J. Uphues  
2001 Bryant Tower, Suite 1070  
[214] 742-1747

**Denver, Colo. 80203:** Harry B. Doyle, Jr.  
123 Speer Blvd. #400  
[303] 837-1010

**Detroit, Michigan 48202:** Jack Anderson  
1400 Fisher Bldg.  
[313] 873-7100

**Fort Lauderdale, Fla. 33306:** Michael Charlton  
3000 N.E. 30th Place  
[305] 563-9111

**Houston, Texas 77002:** John J. Uphues  
601 Jefferson Street, Dresser Tower  
[713] 659-8381

**Los Angeles, Calif. 90010:** Robert J. Rielly  
Robert E. Boedicker, 3200 Wilshire Blvd., South Tower  
[213] 487-1160

**Minneapolis, Minn. 55435:** Robert M. Denmead  
4015 W. 65th St.  
[312] 751-3738

**New York, N.Y. 10020**  
1221 Avenue of the Americas  
Michael J. Stoller [212] 997-3616  
Matthew T. Reseska [212] 997-3617

**Philadelphia, Pa. 19102:** Matthew T. Reseska  
Three Parkway  
[212] 997-3617

**Pittsburgh, Pa. 15222:** Matthew T. Reseska  
4 Gateway Center  
[212] 997-3617

**Rochester, N.Y. 14534:** William J. Boyle  
1175 Pittsford-Victor Rd., Pittsford, N.Y.  
[716] 248-5620

**San Francisco, Calif. 94111:** Don Farris  
Dean Genge, 425 Battery Street,  
[415] 362-4600

**Paris:** Patrick Mouillard  
17 Rue-Georges Bizet, 75116 Paris, France  
Tel: 720-73-01

**United Kingdom & Scandinavia:** Robert Ghey  
34 Dover Street, London W1  
Tel: 01-493-1451

**Scandinavia:** Andrew Karnig and Assoc.  
Kungsholmsgatan 10  
112 27 Stockholm, Sweden  
Tel: 08 51 68 70 Telex: 179 51

**Milan:** Luigi Rancati  
1 via Baracchini, Italy  
Phone 86-90-656

**Brussels:**  
23 Chaussee de Wavre  
Brussels 1040, Belgium  
Tel: 13-73-95

**Frankfurt/Main:** Fritz Krusebecker  
Liebigstrasse 27c, Germany  
Phone 72 01 81

**Tokyo:** Tatsumi Katagiri, McGraw-Hill  
Publications Overseas Corporation,  
Kasumigaseki Building 2-5, 3-chome,  
Kasumigaseki, Chiyoda-Ku, Tokyo, Japan  
[581] 9811

**Business Department**

**Thomas M. Egan**  
Production Manager [212] 997-3140

**Carol Gallagher**  
Production Manager International  
[212] 997-2045

**Betty Preis**  
Production Manager Domestic  
[212] 997-2908

**Roberta Cummings**  
Production Assistant [212] 997-2044

**Frances Vallone**  
Reader Service Manager  
[212] 997-6057

**Electronics Buyers' Guide**

**H.T. Howland**, General Manager  
[212] 997-6642

**Regina Hera**, Directory Manager  
[212] 997-2544

**Roberta Cummings** Production Manager  
[212] 997-2044

**Frances Vallone**, Reader Service Manager  
[212] 997-6057

### Classified and Employment Advertising

**Frank Eberle**, Manager

[212] 997-2557

# An 8½ inch Microprocessor Controlled Impact Printer for just \$345\*

Now that's what we call  
Practical!

Laugh all the way to the bank, OEM's. With both matrix impact print head and built-in microprocessor controller, our DMTP-6uP is a budget printer in price only. In practice, it's one of the greats.

You can print 80-96 columns of both data and text at a fast 110 cps. Turn out up to four copies at once on regular 8½ inch roll paper, even on fan-fold forms and labels. Not only are all needle drivers and diagnostic routines included with the microprocessor, but you can choose the interface function you want — parallel ASCII, RS-232C/I-Loop, or switch-selectable baud rates from 110 to 1200. You even get the economy of easily-replaceable ink rollers and a self-reversing 10-million character life ribbon.

\* \$345 in 100 qts.; single units \$472

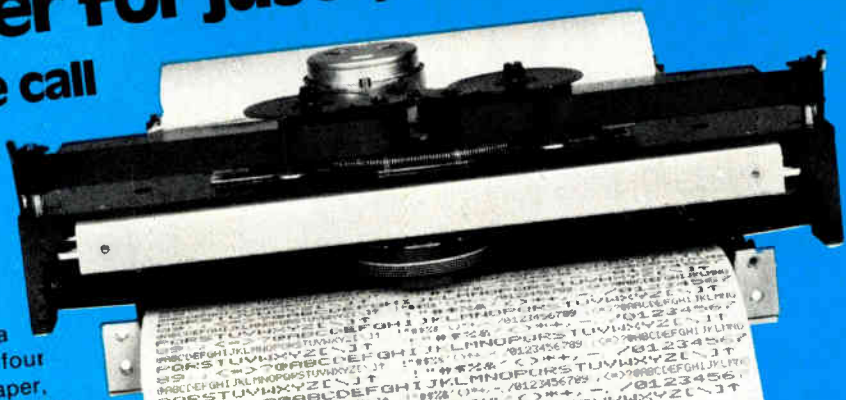

All that for \$345\*? It's phenomenal...  
and it's also very Practical.



**PRACTICAL AUTOMATION, INC.**  
Trap Falls Road, Shelton, CT. 06484  
Tel: (203) 929-5381

Circle 274 on reader service card.

# The ultimate spec: \$1675.

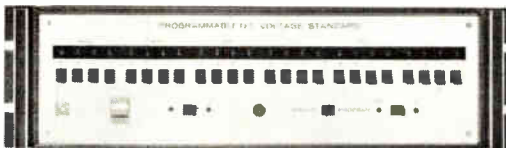

MODEL 501J

Compare the specifications and features of the Model 501J high speed Programmable DC Voltage Calibrator with any competitive model, and you'll see it meets or beats everything else on the market spec for spec. Then look at the bottom line. You'll see why we call our \$1675. price\* *the ultimate spec!* Call Bob Ross at (617) 268-9696 while supplies last at these prices.

**Specifications** (depending on options)  
*High Speed:* 50µS switching and setting time  
*High Accuracy:* ± 0.005%  
*Current:* from 10nA to 10 Amps DC  
*Outputs:* ± 0.1µV to ± 1000 VDC  
TTL Logic. BCD Code. Serial or Parallel.  
*Options:* Binary, ASCII Code, IEEE 488 Buss Interface.



**ELECTRONIC  
DEVELOPMENT  
CORPORATION**

11 Hamlin St., Boston, MA 02127, Tel: (617) 268-9696

\*USA price only.



# Electronics

## Reader Service

For additional information on products advertised, new products or new literature, use these business reply cards.

Complete entire card. Please print or type.

Circle the number on the Reader Service postcard that corresponds to the number at the bottom of the advertisement, new product item, or new literature in which you are interested.

To aid the manufacturer in filling your request, please answer the three questions.

All inquiries from outside the U.S. that cannot reach Electronics before the expiration date noted on the Reader Service postcard must be mailed directly to the manufacturer. The manufacturer assumes all responsibilities for responding to inquiries.

### Subscriptions & Renewals

Fill in the subscription card adjoining this card. Electronics will bill you at the address indicated on the card.

# Electronics

April 27, 1978

This reader service card expires July 27, 1978

NAME \_\_\_\_\_ TITLE \_\_\_\_\_

PHONE ( \_\_\_\_\_ ) \_\_\_\_\_ COMPANY \_\_\_\_\_

STREET ADDRESS (Company  or home  check one) \_\_\_\_\_

CITY \_\_\_\_\_ COUNTRY \_\_\_\_\_

Was This Magazine Personally Addressed to You?  Yes  No

### Industry classification (check one):

- a  Computer & Related Equipment
- b  Communications Equipment & Systems
- c  Navigation, Guidance or Control Systems
- d  Aerospace, Underseas Ground Support
- e  Test & Measuring Equipment
- f  Consumer Products
- g  Industrial Controls & Equipment
- h  Components & Subassemblies
- j  Independent R&D Organizations
- k  Government

### Your design function (check each letter that applies):

- x  I do electronic design or development engineering work.
- y  I supervise electronic design or development engineering work.
- z  I set standards for, or evaluate electronic components, systems and materials.

### Your principal job responsibility (check one)

- t  Management
- v  Engineering

Estimate number of employees (at this location): 1.  under 20 2.  20-99 3.  100-999 4.  over 1000

1	16	31	46	61	76	91	106	121	136	151	166	181	196	211	226	241	256	271	348	363	378	393	408	423	438	453	468	483	498	703	718
2	17	32	47	62	77	92	107	122	137	152	167	182	197	212	227	242	257	272	349	364	379	394	409	424	439	454	469	484	499	704	719
3	18	33	48	63	78	93	108	123	138	153	168	183	198	213	228	243	258	273	350	365	380	395	410	425	440	455	470	485	500	705	720
4	19	34	49	64	79	94	109	124	139	154	169	184	199	214	229	244	259	274	351	366	381	396	411	426	441	456	471	486	501	706	900
5	20	35	50	65	80	95	110	125	140	155	170	185	200	215	230	245	260	275	352	367	382	397	412	427	442	457	472	487	502	707	901
6	21	36	51	66	81	96	111	126	141	156	171	186	201	216	231	246	261	338	353	368	383	398	413	428	443	458	473	488	503	708	902
7	22	37	52	67	82	97	112	127	142	157	172	187	202	217	232	247	262	339	354	369	384	399	414	429	444	459	474	489	504	709	951
8	23	38	53	68	83	98	113	128	143	158	173	188	203	218	233	248	263	340	355	370	385	400	415	430	445	460	475	490	505	710	952
9	24	39	54	69	84	99	114	129	144	159	174	189	204	219	234	249	264	341	356	371	386	401	416	431	446	461	476	491	506	711	953
10	25	40	55	70	85	100	115	130	145	160	175	190	205	220	235	250	265	342	357	372	387	402	417	432	447	462	477	492	507	712	954
11	26	41	56	71	86	101	116	131	146	161	176	191	206	221	236	251	266	343	358	373	388	403	418	433	448	463	478	493	508	713	956
12	27	42	57	72	87	102	117	132	147	162	177	192	207	222	237	252	267	344	359	374	389	404	419	434	449	464	479	494	509	714	957
13	28	43	58	73	88	103	118	133	148	163	178	193	208	223	238	253	268	345	360	375	390	405	420	435	450	465	480	495	510	715	958
14	29	44	59	74	89	104	119	134	149	164	179	194	209	224	239	254	269	346	361	376	391	406	421	436	451	466	481	496	701	716	959
15	30	45	60	75	90	105	120	135	150	165	180	195	210	225	240	255	270	347	362	377	392	407	422	437	452	467	482	497	702	717	960

# Electronics

April 27, 1978

This reader service card expires July 27, 1978

NAME \_\_\_\_\_ TITLE \_\_\_\_\_

PHONE ( \_\_\_\_\_ ) \_\_\_\_\_ COMPANY \_\_\_\_\_

STREET ADDRESS (Company  or home  check one) \_\_\_\_\_

CITY \_\_\_\_\_ COUNTRY \_\_\_\_\_

Was This Magazine Personally Addressed to You?  Yes  No

### Industry classification (check one):

- a  Computer & Related Equipment
- b  Communications Equipment & Systems
- c  Navigation, Guidance or Control Systems
- d  Aerospace, Underseas Ground Support
- e  Test & Measuring Equipment
- f  Consumer Products
- g  Industrial Controls & Equipment
- h  Components & Subassemblies
- j  Independent R&D Organizations
- k  Government

### Your design function (check each letter that applies):

- x  I do electronic design or development engineering work.
- y  I supervise electronic design or development engineering work.
- z  I set standards for, or evaluate electronic components, systems and materials.

### Your principal job responsibility (check one)

- t  Management
- v  Engineering

Estimate number of employees (at this location): 1.  under 20 2.  20-99 3.  100-999 4.  over 1000

1	16	31	46	61	76	91	106	121	136	151	166	181	196	211	226	241	256	271	348	363	378	393	408	423	438	453	468	483	498	703	718
2	17	32	47	62	77	92	107	122	137	152	167	182	197	212	227	242	257	272	349	364	379	394	409	424	439	454	469	484	499	704	719
3	18	33	48	63	78	93	108	123	138	153	168	183	198	213	228	243	258	273	350	365	380	395	410	425	440	455	470	485	500	705	720
4	19	34	49	64	79	94	109	124	139	154	169	184	199	214	229	244	259	274	351	366	381	396	411	426	441	456	471	486	501	706	900
5	20	35	50	65	80	95	110	125	140	155	170	185	200	215	230	245	260	275	352	367	382	397	412	427	442	457	472	487	502	707	901
6	21	36	51	66	81	96	111	126	141	156	171	186	201	216	231	246	261	338	353	368	383	398	413	428	443	458	473	488	503	708	902
7	22	37	52	67	82	97	112	127	142	157	172	187	202	217	232	247	262	339	354	369	384	399	414	429	444	459	474	489	504	709	951
8	23	38	53	68	83	98	113	128	143	158	173	188	203	218	233	248	263	340	355	370	385	400	415	430	445	460	475	490	505	710	952
9	24	39	54	69	84	99	114	129	144	159	174	189	204	219	234	249	264	341	356	371	386	401	416	431	446	461	476	491	506	711	953
10	25	40	55	70	85	100	115	130	145	160	175	190	205	220	235	250	265	342	357	372	387	402	417	432	447	462	477	492	507	712	954
11	26	41	56	71	86	101	116	131	146	161	176	191	206	221	236	251	266	343	358	373	388	403	418	433	448	463	478	493	508	713	956
12	27	42	57	72	87	102	117	132	147	162	177	192	207	222	237	252	267	344	359	374	389	404	419	434	449	464	479	494	509	714	957
13	28	43	58	73	88	103	118	133	148	163	178	193	208	223	238	253	268	345	360	375	390	405	420	435	450	465	480	495	510	715	958
14	29	44	59	74	89	104	119	134	149	164	179	194	209	224	239	254	269	346	361	376	391	406	421	436	451	466	481	496	701	716	959
15	30	45	60	75	90	105	120	135	150	165	180	195	210	225	240	255	270	347	362	377	392	407	422	437	452	467	482	497	702	717	960

# Electronics Reader Service

If the cards below have already been used,  
you may obtain the needed information  
by writing directly to the manufacturer,  
or by sending your name and address,  
plus the Reader Service number and issue date,  
to Electronics Reader Service Department,  
P.O. Box No. 2530, Clinton, Iowa 52734, U.S.A.

Place correct airmail  
postage here ... for  
faster service.

## Electronics

P.O. Box No. 2530  
Clinton, Iowa 52734  
U.S.A.

Place correct airmail  
postage here ... for  
faster service.

## Electronics

P.O. Box No. 2530  
Clinton, Iowa 52734  
U.S.A.