

JULY 7, 1977

SPECIAL REPORT: WHAT'S NEW IN DIGITAL DISPLAYS/96

Universal peripheral chip eases microprocessor's burden/ 109

Technology in Eastern Europe/first of a series/68

97232

FOUR DOLLARS A MCGRAW-HILL PUBLICATION

Electronics®

1420 NILL251 CAMA6 NOV77
MATT NEILL
2516 NE CLACKAMAS
PORTLAND OR



Our career survey reveals
**HOW EEs
FEEL ABOUT
ENGINEERING**



**First
of a
three-part
series**



**84% find
their careers
satisfying**



**Few favor
a quota
for new
engineers**



**Almost
half feel
under-
utilized**



**Management
policies
frustrate
many**





Bourns resistor networks

... for the "discreet"
design engineer.

Sure, you've already made a smart decision, choosing networks over discrete resistors. After all, the cost per resistor in a network package can be 40% less; they require only 10-15% of the P.C. board space needed by discretes; and component count is reduced as much as 95% with resistor networks.

But, when choosing a network supplier, you should also consider these points:

1. Bourns has the broadest network product line in the industry — over 1000 part numbers in all. And our standard DIP circuits range from simple pull-up configurations to Thevinin-equivalent ECL terminators and memory interface circuits.
2. Bourns Krimp-Joint™ offers both a mechanical and electrical bond that lap or butt joint construction doesn't provide. The lead is crimped onto the network element and a high-temp. reflow-resistant solder is used to prevent failure during wave soldering and in circuit thermal cycling and vibration.
3. Bourns was the first manufacturer to offer a complete line of off-the-shelf, super low profile SIPs with demonstrated automatic insertion capability.

These are the facts. So, now you can be even more "discreet". We're sure you'll specify Bourns Resistor Networks — direct or through your local distributor.

Send today for our new 1977 Resistor Networks Catalog.

TRIMPOT PRODUCTS DIVISION, BOURNS, INC., 1200 Columbia Avenue,
Riverside, CA 92507, Telephone 714 781-5415 — TWX 910 332-1252.



International Marketing Offices: European Headquarters — Switzerland 042/23 22 42 • Belgium 02/218 2005 • France 01/2039633 • Germany 0711/24 29 36 • Italy 02/32 56 88 • Netherlands 70/87 44 00 • United Kingdom 01/572 6531 • Norway 2/71 18 72 • Sweden 764/20 110 • Japan 075/921 9111 • Australia 02/55-0411 03/95-9566 • Israel 77 71 15/6/7



For Immediate Application — Circle 120
For Future Application — Circle 220

Introducing

HP's first general-purpose Logic State Analyzer designed for both controllable production testing and field service...and it's low cost.

Until now, production line testing of digital equipment has meant complex test gear, large sums for computerized equipment or time-consuming manual checks...perhaps all three. In the field, it's been traditional test gear without the measurement capabilities of logic state analyzers.

Now, with the low-cost 1602A, HP offers a general-purpose, Logic State Analyzer that's easy to use in a number of plant or field applications. Manufacturing can use it in automatic functional test systems or in board-level and incoming inspection testing. And its ease of use, light weight and portability makes it a natural for field service applications, too.

For manual production line testing and for field service troubleshooting, the 1602A keyboard lets you define testing and display parameters with just a few keystrokes. The LED display then lets you compare line or bus activity with test specifications.

For automatic systems, an HP IB** option lets you do setup and evaluation using a computing controller. When used with HP's 9830A or 9825A controllers, programming is simple. An operator just presses a few special function keys, and the HP IB's "Learn Mode" does the rest.

Edge connector probes speed setup. When test points are built into your system's boards or board extenders, the probes are simply plugged in. Time-consuming and error-prone probe connections can be eliminated.

This instrument minimizes chances of error two ways. Extensive messages tell the operator that the 1602A is being used properly. And internal diagnostics verify proper operation.



© Hewlett-Packard Company, 1982
HP and the HP logo are registered trademarks of HP.

HEWLETT  PACKARD

1527 Page Mill Road, Palo Alto, California 94304

For sales and service, call your nearest HP office: Chicago (312) 235-9400; Austin (512) 835-7000; Los Angeles (213) 877-1300

Circle 1 on reader service card

Troubleshoot microprocessor products fast—

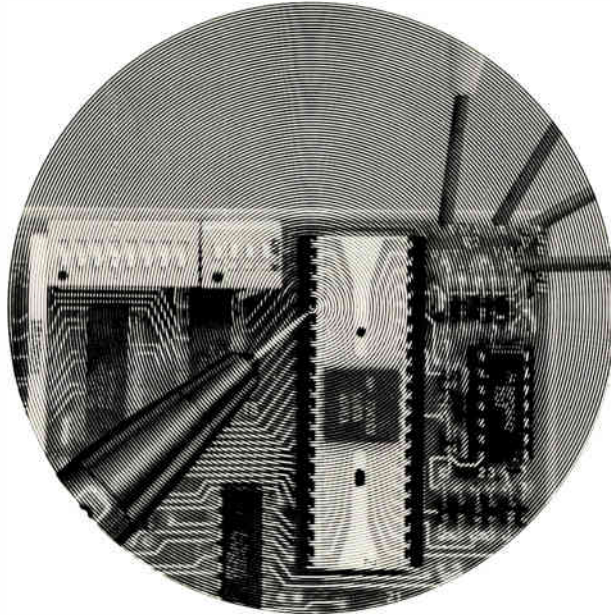

right down to the component level.

Here's HP's new Signature Analyzer. It makes it economical to find the faulty component in a microprocessor-based product both in production and in the field. No longer is it necessary to make a large investment in expensive modules or boards for service. And no longer do you have to troubleshoot by conventional and costly hit-and-miss methods. It could even eliminate the need to partition your product for modular service.

The concept is simple. The 5004A Signature Analyzer converts lengthy bit streams at any node in a circuit into short, four-digit, hexadecimal

"signatures." Just activate a digital exercise routine in the circuit under test, and compare the bit stream "signature" at each data node with the known good signatures previously written into your manual. This information lets you backtrace right down to the faulty component. Quickly and confidently.

The price is low. Only \$990*. To help you design your product with all the advantages of digital signature analysis, we've prepared Application Note 222—"A Designers Guide to Signature Analysis."

It's yours for the asking, just contact your nearest HP field sales office, or write. *Domestic U.S. price only.

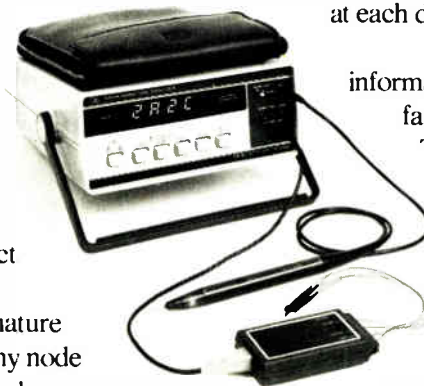

HEWLETT  PACKARD

1507 Page Mill Road, Palo Alto, California 94304

For assistance call: Washington (301) 948-6370, Chicago (312) 255-9800, Atlanta (404) 955-1500, Los Angeles (213) 877-1282

2 Circle 2 on reader service card

World Radio History

31 Electronics Review

MILITARY: Congress hits management of DOD telecommunications, 31
SOLID STATE: Intel stretches n-MOS by scaling it down, 32
Technology exchange pacts show even leaders cannot go it alone, 33
COMMUNICATIONS: Bell System adding SSB to microwave links, 34
NAVIGATION: Loran-C transmitter does without tubes, 34
DISPLAYS: Electroluminescence looks good to British, 36
NEWS BRIEFS: 38
DATA SECURITY: Encryption boards to lure more users, 40
PACKAGING & PRODUCTION: Subassembly shaves calculator costs, 42

53 Electronics International

GREAT BRITAIN: Microprocessor calls door-chime tune, 55
POLAND: German firm buys marine-radar system, 55
WEST GERMANY: Plastic foil allows optical-fiber tapping, 56

65 Probing the News

ELECTRONICS ABROAD: East Germans press components work, 65
INDUSTRIAL: Energy-control system makers watch utilities, 68
COMPUTERS: Europeans discover the old kit bag, 70
COMMUNICATIONS: Lasercom gliding toward 1980s, 74
SPACE: New day dawning for environment snoops, 76

87 Technical Articles

SPECIAL REPORT: Part 1, Career attitudes are mostly upbeat, 87
INSTRUMENTS: Display makers strive to refine their technologies, 96
DESIGNER'S CASEBOOK: One-shot has programmable pulse width, 104
Resistor-controlled LC network drives tunable discriminator, 105
MICROPROCESSORS: Slave processor eases main system load, 109
MOS processor picks up speed with bipolar multipliers, 113
ENGINEER'S NOTEBOOK: Fail-safe circuit initializes processor, 116
CALCULATOR NOTES: HP-25 program optimizes system noise, 117

127 New Products

IN THE SPOTLIGHT: CAD system aims at smaller users, 127
Control processor uses C-MOS-on-sapphire ICs, 128
INSTRUMENTS: Digital meter measures power, 132
DATA HANDLING: Graphics terminal has raster scan, 139
PACKAGING & PRODUCTION: Connectors do a quick change, 144
SEMICONDUCTORS: Gate array cuts interconnect delay, 152
SUBASSEMBLIES: A-d converter handles 16 bits, 160

Departments

Publisher's letter, 4
Readers' comments, 6
News update, 8
Editorial, 12
People, 14
Meetings, 20
Electronics newsletter, 25
Washington newsletter, 49
Washington commentary, 50
International newsletter, 53
New literature, 170

Services

Employment opportunities, 174
Reprints available, 180
Reader service card, 183

Highlights

Cover: EE career is worth it, but . . . , 87

Work for electronics engineers is generally satisfying, but there are a few thorns among the roses. So say a group of EEs in a special McGraw-Hill survey. This is the first part in a series on engineers and their careers. The other two parts in the next issues will focus on changing technology and the future, while including personal statements.

Cover illustrated by Art Director Fred Sklenar.

Export! is the cry in East Germany, 65

Self-sufficiency through development of advanced components and a strong export drive characterize the East German electronics industries. This look at the No. 2 Communist electronics producer will be followed in subsequent issues by reports on other Eastern Bloc countries.

Digital-display technology advances, 96

More colors, better performance, reduced power, and lower cost are showing up in digital displays. As well reviewing current technology, this special report details developments just over the horizon as the market for 0.5-to-1-inch displays grows.

Peripheral controllers go the 'smart' route, 109

To ease the loads on the memory and processing time of central processing units is the function of new universal peripheral interface chips that are themselves microcomputers. In essence, the devices act as slave processors to the CPU.

And in the next issue . . .

Automation comes to semiconductor production lines: a special report . . . part 2 of the EE career survey . . . a product update on optically isolated solid-state relays.

EDITOR-IN-CHIEF: Kemp Anderson

EXECUTIVE EDITOR: Samuel Weber

MANAGING EDITOR: Arthur Erikson,
International

SENIOR EDITORS: Laurence Altman,
Ray Connolly, Lawrence Curran,
John Johnsrud, H. Thomas Maguire,
Stephen E. Scrupski, Gerald M. Walker

ART DIRECTOR: Fred Sklenar

ASSOCIATE EDITORS: Howard Wolff,
Alfred Rosenblatt

DEPARTMENT EDITORS

Aerospace/Military: Ray Connolly
Circuit Design: Vincent Biancomano
Communications & Microwave:
Richard Gundlach

Components: Lucinda Mattera
Computers: Raymond P. Capece
Consumer: Gerald M. Walker
Instrumentation: Stephen E. Scrupski
New Products: H. Thomas Maguire,
Michael J. Riezenman

Packaging & Production: Jerry Lyman
Solid State: Laurence Altman

CHIEF COPY EDITOR: Margaret Eastman

COPY EDITORS: Ben Mason, Mike Robinson

ART: Charles D. Ciatto, *Associate Director*
Paula Piazza, *Assistant Director*

EDITORIAL SECRETARIES: Janet Noto,
Penny Rothman

EDITORIAL ASSISTANT: Marilyn B. Rosoff

FIELD EDITORS

Boston: Lawrence Curran (Mgr.), Pamela Leven

Los Angeles: Larry Waller (Mgr.)

Midwest: Larry Armstrong (Mgr.)

New York: Bruce LeBoss (Mgr.)

San Francisco: Bernard Cole (Mgr.)

Judith Curtis

Washington: Ray Connolly (Mgr.)

Frankfurt: John Gosch

London: William F. Arnold

Paris: Arthur Erikson

Tokyo: Charles Cohen

McGraw-Hill WORLD NEWS

Editor: Michael Johnson

Brussels: James Smith

Milan: Andrew Heath

Moscow: Peter Hann

Paris: Andrew Lloyd

Stockholm: Robert Skole

Tokyo: Robert E. Lee

PUBLISHER: Dan McMillan

ADVERTISING SALES MANAGER:

Paul W. Reiss

MARKETING ADMINISTRATION MANAGER:

Wallis Clarke

CIRCULATION MANAGER: Karl Peterson

MARKETING SERVICES MANAGER:

Tomlinson Howland

RESEARCH MANAGER: Margery D. Sholes

Eastern Europe has something of the air of mystery about it—at least it has since it moved into the Soviet sphere after the Second World War. While one can assume that something as pervasive as electronics technology is having an impact on the industries of Eastern European countries, it is often difficult to find how just what is happening there in the sensitive electronics area.

Over the years, though, we have published stories about interesting developments from Eastern Europe, ranging from reports gathered at annual trade shows to news filed by McGraw-Hill correspondents in Moscow. Indeed, just five years ago, we published a major country-by-country report detailing where electronics stood in East Europe.

Now, by way of updating that report and seeing what progress there has been in the past five years, we are kicking off a new series of articles. Starting on p. 65, you'll find the first part of that series—a profile of the growing electronics effort in East Germany. Written by our Bonn bureau manager, John Gosch, it, like the rest of the series, is based on on-the-spot interviewing and reporting. In upcoming issues, we'll be having reports on such countries as Poland, Bulgaria, Czechoslovakia, Hungary, and Russia.

Displays are one of those always seen but seldom noticed elements that are crucial to information transfer at the interface between man and machine. Starting on p. 96, you'll find a comprehensive review of display technology, put together by our instrumentation editor Steve Scrupski, with reporting from our

network of correspondents who are out in the field.

As you read it, you'll appreciate what a fast-paced area is display technology. For example, although display makers are hard at work improving present seven-segment numeric displays, this improved technology will spawn still more complex displays. Says Steve: "Although microprocessors are often used simply to handle numerical data and thus only require a numeric display, they also can process status data, which will require text displays. Messages to the operator will become as important as are the numeric results of computations that are performed by the microprocessor."

Beyond new alphanumerics will come area displays and flat-screen replacements for CRTs made with liquid-crystal technology. This new generation will not be limited to segmented alphanumerics, but will be formed to have any shape or complete message that will fit on the glass. "Forming messages in liquid-crystal displays is basically as simple as making the mask to etch the conductive film on the glass," Steve says. "It's basically a printed-circuit-board process."

The key to making a multimesage display practical will be the application of multiplexing. "With many different message areas on the glass, there will be a great number of leads coming out and it will be impractical to devote individual drivers to each area," he says.



July 7, 1977 Volume 50, Number 14 95,350 copies of this issue printed

Published every other Thursday by McGraw-Hill, Inc. Founder James H. McGraw 1860-1948 Publication office 1221 Avenue of the Americas, N.Y., N.Y. 10020, second class postage paid at New York, N.Y., and additional mailing offices.

Executive, editorial, circulation and advertising addresses. Electronics, McGraw-Hill Building, 1221 Avenue of the Americas, New York, N.Y. 10020. Telephone (212) 997-1221. Teletype 12-7960 TWX 710-581-4879. Cable address: MCGRAW HILL NEW YORK.

Subscriptions limited to professional persons with active responsibility in electronics technology. No subscriptions accepted without complete identification of subscriber name, title or job function, company or organization, and product manufactured or services performed. Based on information supplied, the publisher reserves the right to reject non-qualified requests. Subscription rates: in the United States and possessions \$14.00 one year, \$35.00 three years; company addressed and company libraries \$20.00 one year, \$50.00 three years; APO/FPO addressed \$35.00 one year only; Canada and Mexico \$16.00 one year, \$40.00 three years; Europe \$40.00 one year, \$100.00 three years; Japan, Israel and Brazil \$65.00 one year, \$165 three years; Australia and New Zealand \$90.00 one year, \$240 three years, including air freight; all other countries \$45.00 one year, \$112.00 three years.

Limited quota of subscriptions available at higher-than-basic rate for persons allied to field served. Check with publisher for these rates. Single copies \$4.00. Please allow four to eight weeks for shipment.

Officers of McGraw-Hill Publications Company: Gordon L. Jones, President; Paul F. McPherson, Executive Vice-President; Group Vice-President Gene W. Simpson; Senior Vice-Presidents: Russell F. Anderson; David G. Jensen, Manufacturing; Ralph R. Schulz, Editorial; Vice-Presidents: Denis C. Beran, European Operations; James E. Boddort, Planning & Development; David P. Forsyth, Research; Douglas Greenwald, Economics; James E. Hackett, Controller; Robert L. Leyburn, Circulation; Edward E. Schirmer, Sales.

Officers of the Corporation: Harold W. McGraw, Jr., President, Chief Executive Officer, and Chairman of the Board; Robert N. Landes, Senior Vice President and Secretary; Ralph J. Webb, Treasurer. Title registered in U.S. Patent Office. Copyright © 1977 by McGraw-Hill, Inc. All rights reserved. The contents of this publication may not be reproduced in whole or in part without the consent of copyright owner.

Subscribers: The publisher, upon written request to our New York office from any subscriber, agrees to refund that part of the subscription price applying to copies not yet mailed. Please send change-of-address notices or complaints to Fulfillment Manager; subscription orders to Circulation Manager, Electronics, at address below. Change-of-address notices should provide old as well as new address, including postal zip code number. If possible, attach address label from recent issue. Allow one month for change to become effective.

Postmaster: Please send form 3579 to Fulfillment Manager, Electronics, P.O. Box 430, Hightstown, N.J. 08520

INTERESTED IN HIGH EFFICIENCY POWER SUPPLIES?

ABBOTT HAS THE ANSWER

Abbott Transistor Laboratories manufactures three complete lines of hermetically sealed, switching regulated power supplies. These rugged and dependable power modules have already found wide use in many military, aerospace and industrial applications. All units are designed to meet the EMI requirements of MIL-STD-461 and the environmental requirements of MIL-STD-810.

77%
EFFICIENT



**60 Hz to DC
model VN**

Abbott's Model VN series converts 47 to 440 Hz AC lines to any DC voltage between 4.7 and 50 VDC at output powers of 25, 50 and 100 watts. Line and load regulation are controlled to 0.4% with a peak-to-peak ripple of 100 mV. Efficiencies of 77% are achieved with power densities of greater than 1 watt per cubic inch.

70%
EFFICIENT



**400 Hz to DC
model UN**

Designed to operate from 380 to 420 Hz AC lines, Abbott's Model UN series offers output powers of 25, 50 and 100 watts at all popular voltages between 5 and 50 VDC, including ± 12 and ± 15 . The full load operating temperature range is -55°C to $+100^{\circ}\text{C}$. Peak-to-peak ripple of 100 mV and load regulation of 0.5% are just a few of the standard features of this line of 70% efficient power modules.

70%
EFFICIENT



**DC to DC
model BN**

Wide range DC inputs of 20 to 32 VDC can be accommodated by Abbott's BN line of high efficiency DC to DC converters. All popular output voltages between 5 and 50 VDC, including ± 12 and ± 15 , are available at output power levels of 25, 50 and 100 watts. 0.5% line and load regulation, 100 mV peak-to-peak ripple and -55°C to $+100^{\circ}\text{C}$ operating temperature range are a few of the standard features of the BN line.

Complete electrical specifications, size charts and prices for these units are listed in our new 60 page free catalog. Also listed are 12 additional line of power modules, including —

60 A to DC
400 A to DC
DC to DC
DC to 60 A
DC to 400 A

For immediate information on Abbott Modules, see pages 1836-1848 of your 1976-77 EEM Catalog or pages 676-682 Vol. 2 of your 1976-77 GOLD BOOK.

abbott transistor

LABORATORIES, INCORPORATED

Send for our
new 60 page
FREE catalog —

GENERAL OFFICES
5200 W. Jefferson Blvd.
Los Angeles, CA. 90016
(213) 936-8185
Telex 69-1398

EASTERN OFFICE
1224 Anderson Ave.
Fort Lee, N.J. 07024
(201) 224-6900
Telex 13-5332

6 Circle 6 on reader service card

Readers' comments

Change that equation

To the Editor: In my Designer's Casebook on forming a differentiator circuit from a sample-and-hold module and an operational amplifier [April 28, p.110], the equation and accompanying description should read: $E_r = \Delta e/\Delta t$, where E_r is the final output voltage at the time immediately before the next sample and $\Delta e/\Delta t$ is the change in input voltage between sampling intervals, or an approximation of the derivative of the input signal with respect to time.

John Nolte
U. of Colo. Medical Center
Boulder, Colo.

Tubes do grace X-band radars

To the Editor: In your article on gallium-arsenide field-effect transistors for solid-state phased-array radar systems operating at X band [June 23, p. 30], I am quoted as saying "the only way to get a phased-array radar at X band was with vacuum tubes—but these are much narrower-band systems." Under no circumstances did I mean to imply that microwave tubes cannot achieve broadband performance. This, of course, is not true.

What is correct is that earlier attempts to develop solid-state phased-array radar systems at X band resulted in bandwidths too narrow to meet requirements of the current U.S. Navy program. It is also correct that present-day X-band radar systems (phased-array or not) all use microwave tubes.

Eliot D. Cohen
Naval Research Laboratory
Washington, D. C.

Add some asterisks

To the Editor: There is a pair of minor typos in the Calculator Note on the SR-52 program that simplifies universal-base number conversion [June 9, p. 152]. At location 065, "PROD" should be "*PROD." At location 176, "LBL" should be "*LBL." The codes given in the preceding column are OK.

Norman C. Peterson
Rapifax Corp.
Santa Monica, Calif.

Electronics/July 7, 1977

PMI's CMP-01/02 precision comparators:

Need a 100 nsec., low-cost precision comparator with instant DELIVERY? Our CMP-01 is it, in stock at all our distributors. Need even BETTER input performance than the CMP-01? Choose the CMP-02! That includes MIL-STD-883A CLASS B parts, too. On the shelf.

If you use LM111 or LM311-type comparators, you can usually use one of our CMP-01's as a pin-for-pin replacement. Of course, you will have to settle for improved performance, such as higher slew rate, faster settling time, higher open loop gain, higher

CMMR, and lower offset voltage, offset current, bias current, and tempco's . . . AND A LOWER PRICE!

To get these high performance precision comparators all you have to do now is call in your order to your local PMI distributor. If you want a data sheet, circle the bingo number or give us a call.

in stock.

Circle 7 on reader service card



Precision Monolithics, Inc.
1500 Space Park Drive
Santa Clara, CA 95050
☎(408) 246-9222. TWX: 910-338-0528

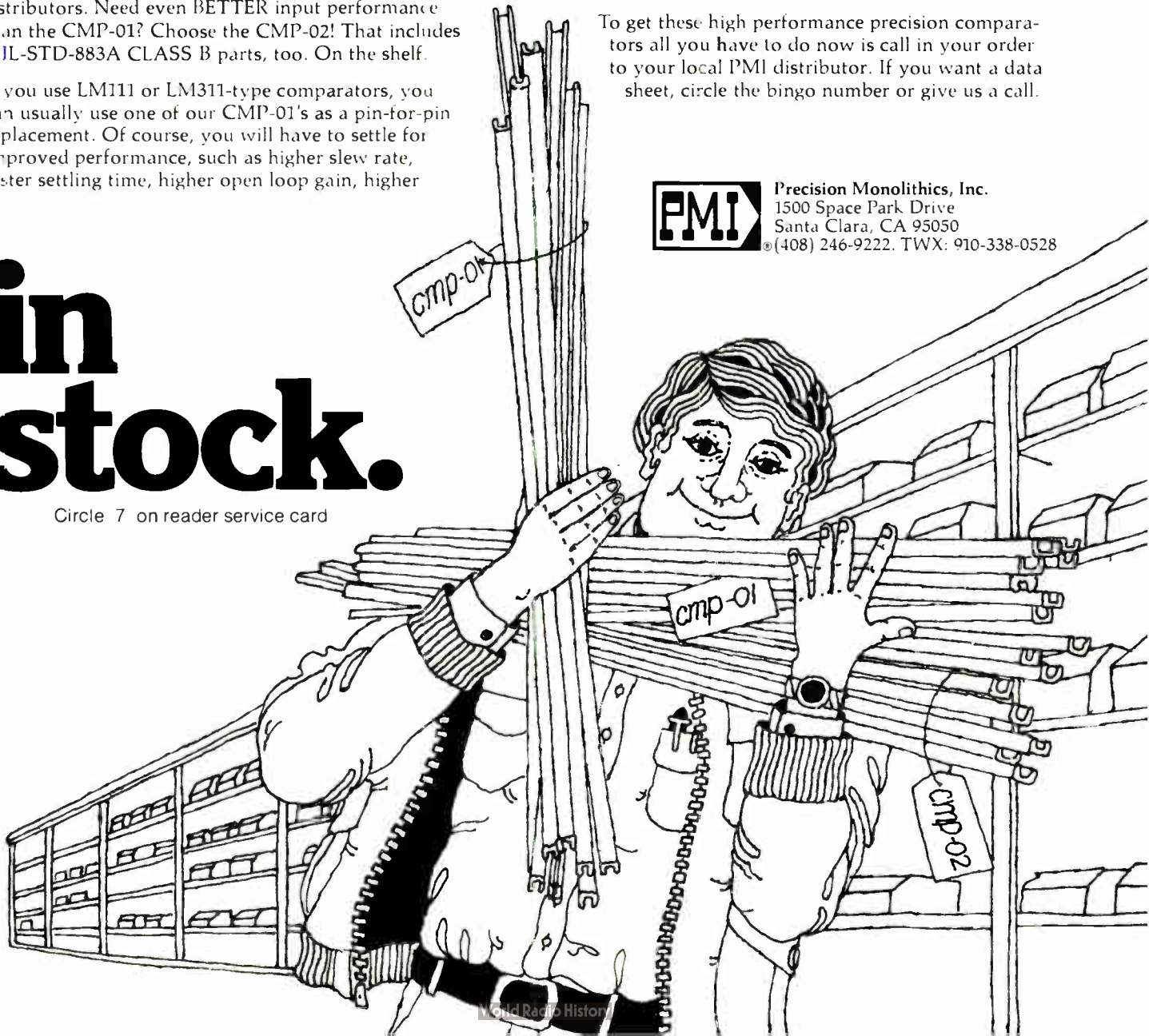

Want 90 DVM's for 90 days?



At 90 different places? For short-term, peak DVM needs, call the "Instrument Professionals". They can put the models you need, when and where you want them. Rental is the economic answer to training, field retro-fit or other short-term DVM needs.

Write or call for data on our other specialties: Instrument Leasing • Computer Peripherals • Equipment Sales • Instrument Service.

Circle 8 on reader service card

Call FREE Catalog Continental Rentals

Div. Continental Resources, Inc.
175 Middlesex Turnpike, Bedford,
MA 01730 (617) 275-0850

FOR IMMEDIATE RESPONSE CALL:
N.E. (617) 275-0850; L.I. (516) 752-1622;
NY, NJ (201) 654-6900;
Gtr. Phila. (609) 234-5100;
Wash., D.C. area (301) 948-4310;
Mid West (312) 439-4700;
So. Central (214) 690-1706;
Costa Mesa, CA (714) 540-6566;
L.A., CA (213) 638-0454;
Santa Clara, CA (408) 735-8300.

News update

■ What has happened to semiconductor maker Intersil Inc. of Santa Clara, Calif., in the year since it agreed to a marriage with Advanced Memory Systems Inc. of neighboring Sunnyvale [*Electronics*, July 8, 1976, p. 36]?

Then, it was struggling to recover from a \$2.5 million loss in fiscal 1975. Now, after a wrenching series of top-management resignations, cutbacks in operations and products, and 50% turnover in its sales organization, it is in far better shape. In fact, by the time the merger with AMS was completed in November, Intersil was earning \$300,000 a month versus a loss of \$650,000 per month a year earlier.

Recently, too, Northern Telecom Inc., the U.S. subsidiary of Canada's Northern Telecom Ltd., bought RCA Corp.'s 7 1/2% interest in Intersil. It has since increased its holdings to about 13% via open market purchases and plans to increase them to 20% to 25%.

Intersil now is "very profitable" and "running at the rate of \$85 million, in sales" for the current fiscal year ending in September, says Fred Adler, a director. Sales for the first half of fiscal 1977 topped \$40 million, and earnings for the same period were \$1.8 million before an extraordinary tax credit.

Adler, a partner in New York law firm Reavis and McGrath, is the former Intersil chairman who played the matchmaker's role in the merger. He also brokered the share purchase by Northern Telecom.

"The Northern Telecom deal is the most critical deal in Intersil's history," says Adler, because Intersil "picked up the industrial partner that gives it the greatest advantage that any industrial partner can give." Northern, he adds, is the "world's leader in the digital telecommunications field."

Further, Northern Telecom's affiliation with Canada's Bell-Northern Research gives Intersil both ready access to, and greater insight into, the needs of the telecommunications market. That sector, says Adler, "is the next major growth market for semiconductors." **Bruce LeBoss**

Gas Sensing Semiconductor

FIGARO TGS GAS SENSOR

quickly senses
even small
amount
of gas.

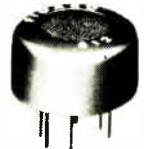

Applications

1. Natural Gas-Leak Alarm
2. Propane Gas-Leak Alarm
3. Carbon Monoxide Detector
4. Automatic Fan Control
5. Fire Alarm Detecting
6. combustible gases contained in smoke
7. Alcohol Detector
8. Detector for drunken driver
9. Air Pollution Monitor

Please contact any of the addresses below direct for catalogs and prices. Tel. (714) 751-4103.

FIGARO ENGINEERING INC.

● Head Office 3-7-3 Higashi-Tonaka, Tononaka
City, Osaka 560 JAPAN, TELEX 05286155
FIGARO J. CABLE FIGARO TOYONAKA
TEL. (06) 849-2156

● North America 3303 Harbor Boulevard, Suite
D 8, Costa Mesa, California 92626, U.S.A.
TELEX 678396 CABLE FIGARENGIN
COSTAMESA 1FL (714) 751-4103
Circle 183 on reader service card

TEST NTI'S DIGITAL UNI-PATTERN

- Pattern is generated electrically. No tube is used.
- DRC Digital Rise time Controller is employed to produce an image having the same feeling as that of a pick-up camera tube.
- Plug-in unit system by function makes maintenance easy and another resolution can be made.
- Any desired pattern can be produced. Send us your pattern diagram and we will send you an estimate.

MODEL 525 DIGITAL MONOSCOPE SIGNAL GENERATOR

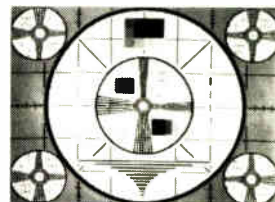

Basic pattern of conventional television signal

MODEL 535 COLOR MONOSCOPE SIGNAL GENERATOR

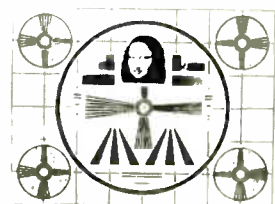

Simple pattern. But perfect color test signal generated. Flying spot face project on is unnecessary.

NTI America, Inc.
10800 Wilshire Blvd., Suite 1000, Beverly Hills, CA 90210
Tel. (213) 462-8442

Circle 184 on reader service card

Intel delivers 8085 experience with five day workshops in your area.



Intel announces 8085 designer workshops.

Bring your lunch and be prepared for five days of hard work in the world of microprocessors. Intel's five day 8085 workshop will teach you how to design and develop a system using the Intel[®] 8080 and new 8085 microcomputers. Why spend months training yourself when Intel does it in five days? Enroll now for the workshop in your area.

Get all the facts on the 8080 and new 8085.

In five days Intel experts immerse you in systems, configurations, sample programs and support hardware. You'll learn system timing, interface, I/O and all other design considerations for the 8080/8085 family of microcomputers and system components. And how to write, assemble and execute programs. When you've got the facts, take them home. Intel provides you with a library of ten valuable reference publications including the 8080 and 8085 Microcomputer Systems User's Manuals.

Grab some hands-on experience.

Learn by doing at the Intel Workshop. So you can test your

know-how, Intel brings four individual micro-computer development systems with full in-circuit emula-

tion same workshops are available at any one of the three national Intel training centers.

Want more information? Just check the coupon request for a complete schedule and description of all Intel workshops.

The workshop coming to your area is limited to 16 persons. So sign up now. We guarantee you'll work hard, and we will too. That's how you become an experienced 8085 system designer in five days.

capability. You'll actually program your own system.

How and how much.

To reserve your space send in the completed coupon below with a check/money order for \$450. Or, simply let Intel bill you.

If the Intel workshop schedule doesn't coincide with yours, the

Workshop Schedule

Cincinnati, OH	6/27-7/1
Detroit, MI	7/18-22
Cleveland, OH	7/25-29
Pittsburgh, PA	8/1-5
Toronto, ONT	8/8-12
Ottawa, ONT	8/15-19
Montreal, QUE	8/22-26
Bridgeport, CT	8/29-9/2
Plainview, NY	9/12-16
Edison, NJ	9/19-23
Philadelphia, PA	9/26-30
Baltimore, MD	10/3-7
Washington, DC	10/10-14

For an immediate reservation in the 8085 workshop in your area, phone Intel MCD Training. (408) 246-7501 ext. 2086.



Enroll me in the Intel 8085 Workshop. Workshop Location and Date _____

I can't make it at this time, but I'm interested in future workshops. Please send course descriptions and schedules for the MCS-85™ System Workshop, the PL/M-80 Language Workshop, the MCS-48™ System Workshop, The Series 3000 Workshop and the Programmable Peripheral Circuits Workshop. EL

Name _____

Company _____ Title _____

Address _____

City _____ State _____ Zip _____

Signature _____

Enclosed is a check/money order for \$ _____ for _____ enrollment/s.

Bill me \$ _____ for _____ enrollment/s.

MAIL TO: Intel Corp.
2880 Northwestern Pkwy., Santa Clara,
CA 95051 Attention: MCD Training

intel delivers.

The 2900 Family: Two years later.

1975. Advanced Micro Devices introduces the world's best 4-bit microprocessor slice, the Am2901, along with a few support circuits.

1977. It's a whole new family. Now there's an Am2901A just like the Am2901, only better. Now there are 18 support circuits, two or three second sources and all the software you'd ever want. The 2900 family has become the family of the future. Here's why:

The first family.

The Am2900 family is the first group of products designed specifically for microprogrammed machines. Microprogramming is rapidly becoming the most popular way to design medium- and high-performance systems, to reduce development time, make changes easily, and conveniently add new features.

Less weight, less size.

With the Am2900 family, it's not uncommon for entire boards to be eliminated. You'll shrink system size and weight, increase

overall reliability and reduce manufacturing costs.

Time goes by, price goes down.

In July 1975, we told you we'd reduce the cost of the Am2901 by 30% per year. We've done it twice. Once in April 1976 and once in March 1977. The Am2900 family gets less and less expensive all the time.

We're so popular, we're the industry standard.

The Am2900 family is the most widely used Bipolar LSI family in:

- **Minicomputers:** For emulators, high-performance CPU's and add-ons by eight out of the top ten U.S. manufacturers.
- **High-performance controllers:** For discs, tapes, floppy discs and universal controllers.
- **Communications:** For PBX systems, central exchanges, multiplexers and modems.
- **Military:** For radar processors, display systems and the Navy's new standard avionic computer, the AN/AYK-14.

The Family:

CPU Slice (ALU and general registers)	Am2901A, 2902, 2903* 2904*
Microprogram Control Units	Am2909, 2910* 2911
Branch and Instruction Control for Microprogram Sequencers	Am29803, 29811
LSI Bus Interface Devices	Am2905, 2906, 2907, 2915A, 2916A, 2917A
Priority Interrupt Control	Am2913, 2914
Main Program Control	Am2930* 2931* 2932*
New More Powerful MSI functions	Am2918, 2919, 2920, 2921, 2922

*In Development

Plus:

Schottky and low-power Schottky MSI, MOS static and dynamic RAM's and all the devices you need to build your high-performance microcomputer.

We don't sell and run.

Advanced Micro Devices offers learning aids to help speed up designs and keep your engineers up-to-date on the very latest microprogramming techniques. Learning aids and application materials like these perennial favorites:

- A 16-Bit Microprogrammed Computer
- The Am2900K1 Learning and Evaluation Kit
- The Microprogramming Handbook

- A High Performance Microprogrammed Disc Controller
- In development:
- Vertically Microprogrammed State Machines
 - An emulation of the Am9080A/8224/8228 using the Am2900 family

And two terrific design aids:

AMDASM

Our powerful, easy-to-use microprogram assembler offering software support through the worldwide INFONET time-sharing division of Computer Science Corporation. (It supports user-defined mnemonics for producing microinstructions up to 128 bits wide, and includes formatting and default features as well as tape generation for PROM programmers. If you've got the other guy's MDS system, ask for AMDASM/80. It comes on a floppy disk and runs under their operating system.)

AMDS

Beginning this fall, we'll be offering hardware support with the Advanced Microprogram Development System. (It's the first prototyping system especially designed for microprogramming systems.) It'll help speed up construction of prototype systems and generation and de-bug of microcode. Resident AMDASM, of course!

The Am2900 family.

It's today's product family for tomorrow's high-performance machines. Am2900. Remember that number. You're going to be hearing it a lot.

Advanced Micro Devices

Bipolar LSI. N-channel, silicon gate MOS. Low-power Schottky. Multiple technologies. One product: excellence.



Behind the career statistics

Attitudes expressed by our readers toward a career in engineering appear on the surface to be laced with contradictions. Take, for example, the difference between the upbeat opinions expressed on career satisfaction and the evidence of frustration about recognition of contributions.

Though a large majority of EES say they are satisfied with their career and almost two thirds would do it over again, not quite 50% say they are underused in their present position. Even among the very and moderately satisfied majority, a large number feels a lack of adequate recognition by employers.

What is to be made of these reactions? Once again, as they did during the crunch of the recession in the early 1970s, EES appear to support their choice of career despite the problems. The reason? A major factor is still the creative challenge of electronics design. In response to a survey question, most EES say that their main satisfaction comes from solving a problem or seeing a design solution emerge as a piece of hardware. Conversely, their major frustrations appear to be inept management, bureaucracy, paper work — anything that gets in the way of what they deem is their proper function, technical creativity.

Their overall success is evident in what electronics is delivering to society today — from powerful computers, to communications links, to entertainment products — let alone to the profits of the electronics industries.

The track record, however, of companies that employ EES is a spotty one. There are certainly employers who are known for their recognition of EES whether in the form of promotions or increased salaries or, less directly, in the form of career support. Yet there are still many companies that take unfair advantage of the proven high motivation of engineers. For instance, most EES say that they want career support from their employers, yet well under half think that their companies have workable dual-ladder promotion systems for those who want to stay in engineering.

So if EES are challenged by design problems posed by a changing technology and receive their greatest satisfactions from meeting these challenges — in other words, are highly motivated — wouldn't it make sense to strengthen rewards accordingly? Recognizing technical achievement and rewarding continuing technical contributions, after all, is what makes both EES and the industry go. If companies are going to exploit their EES, let it be in the best sense of the word, not the worst.

Dynamic-Logic Testing Has Arrived

Via GenRad's new 1796 Digital/Analog Test System

Complex digital boards using LSI chips such as microprocessors, RAMS, ROMS, UARTS, etc. are no longer beyond the reach of PC board testers. To diagnose boards containing such devices, GenRad designed a completely new system from the ground up.

A sophisticated high-speed controller with dedicated memory for each driver/sensor pin provides the MHz rates required to test dynamic logic. Other unique operating features include bi-directional bus testing at high speed and flexible synchronization, new digital I/O electronics that can switch from drive to sense at high speed while synchronizing itself with the Unit Under Test (UUT). It synchronizes itself either by waiting

for selected phases of the UUT clock or by providing the clock signal itself.

The digital I/O operates through a universal scanner that allows both digital and analog, source and measure capability at each I/O pin. This means the system analog modules (including a new precision 16-bit multimeter, pulse generator, function generator, and the frequency/time measurement unit) plus any IEEE-bus-controlled instrumentation can all use the same UUT

interface as do the driver/sensors. In addition, these modules also operate through a dedicated wide-band analog scanner for precision analog measurements.

With the 1796 you can take full advantage of the CAPS VIII software, including its latest enhancements: the Diagnostic Resolution Module, Analog Diagnostics, and Diagnosis Logging.

To learn more about how this state-of-the-art test system can match your needs, request a copy of our new brochure. Or, if you have an immediate need, call one of the numbers listed below.

**The difference in
software is the
difference in
testers.**



Circle 13 on reader service card



GenRad

300 BAKER AVENUE, CONCORD, MASSACHUSETTS 01742 • ATLANTA 404 394 5380 • BOSTON 617 646 0550
CHICAGO 312 884 6900 • DALLAS 214 234 3357 • DAYTON 513 294 1500 • LOS ANGELES 714 540 9830 • NEW YORK (N.Y.) 212 964 2727
PHILADELPHIA 215 381 8890 • SAN FRANCISCO 415 985 0662 • WASHINGTON, DC 301 948 7071 • TORONTO 416 252-3395 • ZURICH (01) 55 24 20

World Radio History

Racal and Elsbury look to grow in the American market

"Our objective is to get ourselves well-known," said David C. Elsbury of Racal-Tacticom Ltd., Britain's leading supplier of tactical-communications equipment. The managing director (equivalent to president) of the Reading, Berkshire, firm was speaking at a press reception he hosted at last month's meeting of the Armed Forces Communications and Electronics Association in Washington. With one of the largest exhibits at the show and the presence of a large array of top executives, the friendly, broad-shouldered Elsbury was serving notice that "we are making a multipronged attack on the U. S. market."

The "we" he is referring to are the companies belonging to Racal Electronics Ltd., Bracknell, Berkshire. Elsbury is also one of three deputy managing directors of the parent company and regarded as the second in command to the chairman, Ernest T. Harrison.

Active in more than a dozen fields, including defense communications, electronic instrumentation, avionics, and computer-aided design, Racal Electronics had sales of \$210.3 million for the fiscal year ended March 31, 1977. Five years ago, in 1972, it grossed just \$36.2 million. Elsbury's goal is to maintain that growth rate of 30% per year.

The firm has already made an astounding beginning, Elsbury points out. In March, following a hotly contested stock market battle, it bought Milgo Electronics Co. (renamed Racal Milgo Inc.), Miami, one of the leading U. S. modem makers, for \$60 million. That same month, it announced it was bidding, assisted by RCA Corp., for the Sincgars-V program, the U. S. Army's post-1985 family of combat radios, which could amount to 200,000 units. And another one of its five U. S. subsidiaries, Racal Communications Co., Rockville, Md., won a \$1 million contract for digitally controlled hf radio receivers.

The 41-year-old Elsbury, who



The key. David Elsbury counts on "sensible acquisitions" to expand Racal in the U. S.

began at Racal in 1956 as a junior tester of military radios, is counting heavily on the Milgo acquisition. Racal was missing data communications in its technological bag of tricks. "That's why it made sense to acquire Milgo, which, in addition to its modems, has strong systems expertise."

As for Sincgars, Elsbury realizes the chances against a foreign company becoming a major electronics supplier to the U. S. military. He agrees he would have to manufacture much of the radios in the U. S., and "we're optimistic, but we're not going to live or die on Sincgars," he says. Racal already exports communications equipment to 140 countries and will apply its Sincgars approach—involving lower per-unit costs more than technological innovation—to those markets as well.

With Elsbury's eye on growth, Milgo may be just the beginning. "The only way to maintain growth is by a sensible acquisitions policy," he says, declining to hint at where those acquisitions may lie.

Hollenkamp and Dutch invade U. S. audio market

Can a 77-year-old international trading company from Holland establish itself in the rough and tumble American audio market? Yes, says

Monsanto

Products Are Available from These Distributors:

AVNET ELECTRONICS
CESCO ELECTRONICS
DIPLOMAT/ALTALAND
ELMAR ELECTRONICS
HAMILTON/AVNET
HAMMOND ELECTRONICS, INC.
HARRISON EQUIPMENT CO.
KIERULFF ELECTRONICS
LIBERTY ELECTRONICS
R.A.E. ELECTRONICS
SCHWEBER ELECTRONICS
SEMICONDUCTOR SPECIALISTS
SHERIDAN SALES

For technical assistance contact our representative in your area:

- A.P.J. Associates, Inc.**
 Plymouth, MI. (313) 459-1200
- Beacon Electronic Associates**
 Huntsville, AL. (205) 881-5031
 Ft. Lauderdale, FL. (305) 971-7320
 Maitland, FL. (305) 647-3498
 Atlanta, GA. (404) 351-3654
 Charlotte, NC. (704) 525-7412
 Oak Ridge, TN. (615) 482-2409
 Falls Church, VA. (703) 534-7200
- Bob Dean, Inc.**
 Ithaca, NY. (607) 272-2187
- CMS Marketing**
 Oreland, PA. (215) 885-5106
- Cantronics**
 Downsview, Ont. Canada. (416) 661-2494
 Montreal, Que. Canada. (514) 341-5207
- Comtronic Associates**
 Melville, L.I., N.Y. (516) 249-0505
- CPS, Inc.**
 Orange, CT. (203) 795-3515
- Datcom**
 Waltham, MA. (617) 891-4600
- Harvey King, Inc.**
 San Diego, CA. (714) 566-5252
- Ed Landa Company**
 Los Angeles, CA. (213) 879-0770
- Lorenz Sales Inc.**
 Cedar Rapids, IA. (319) 393-6912
- Midwest Marketing Associates**
 Chagrin Falls, OH. (216) 247-6655
 Dayton, OH. (513) 433-2511
- Microsystems Marketing**
 Dallas, TX. (214) 238-7157
 Houston, TX. (713) 783-2900
- Wm. J. Purdy Company**
 Burlingame, CA. (415) 347-7701
 Albuquerque, N.M. (505) 266-7959
- Spectrum Associates**
 Phoenix, AZ. (602) 997-6324
- Straube Associates**
 Denver, CO. (303) 426-0890
 Salt Lake City, UT. (801) 943-5650
- Sumer, Inc.**
 Rolling Meadows, IL. (312) 394-4900
 Milwaukee, WI. (414) 259-9066
- Technical Associates, Inc.**
 Eden Prairie, MN. (612) 944-3034
- Technical Representatives, Inc.**
 Olathe, KS. (913) 782-1177
 Hazelwood, MO. (314) 731-5200
- Valentine-Schillinger**
 Greenwood, IN. (317) 888-2260
 South Bend, IN. (219) 291-6258
- Waggoner-Ver Hill Associates**
 Pittsburgh, PA. (412) 241-5202
- Western Technical Sales**
 Portland, OR. (503) 297-1711
 Bellevue, WA. (206) 641-3900

Big. Bright. Flexible. Low voltage. Low power. Low cost. What more can we say?

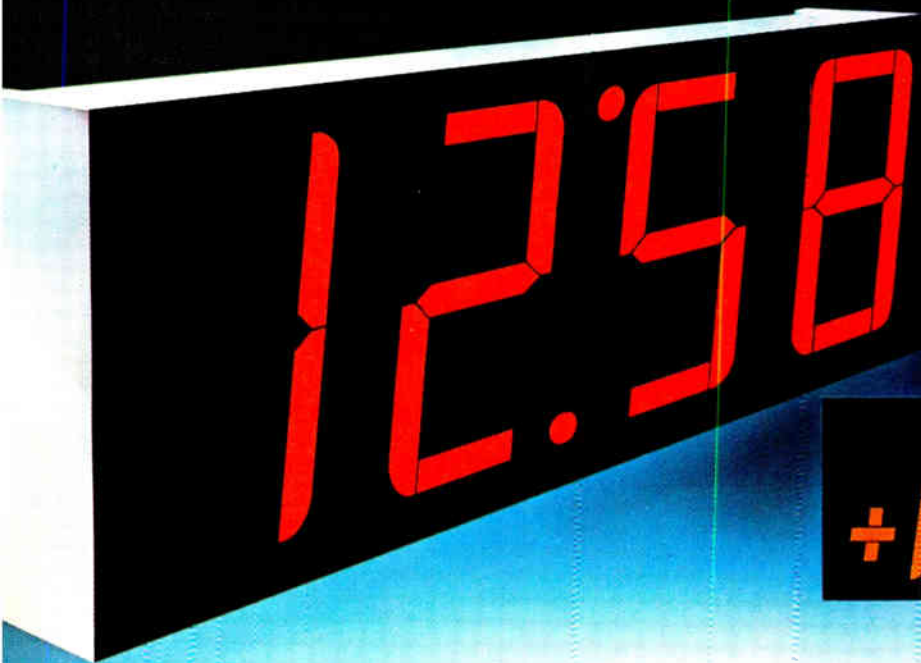

8453.27

500382.400

+1594

Plenty.

DESIGN IS SIMPLE — DIRECT DRIVE FROM IC LEVELS.

Higher brightness output means you don't need as much current. You can drive directly from MOS circuitry with as little as 3-5 mA.

BUILD A BETTER STICK.

Get the cost advantages of a stick with the high reliability, quality, and flexibility of Monsanto displays. They come in single- or double-digits, with or without overflow (± 1) readouts. So, you can build your own display — whether it's 3½ digits or 12 digits.

You can eliminate costly stick connectors by mounting our 0.6" displays directly to your PC board. And Monsanto categorizes its displays by output, so you don't have to sort for brightness.

UPGRADE YOUR PRESENT 0.4" READOUT.

The package size of our 0.6" digit is no larger than most 0.4" displays, so you can use our larger, easier to read,

sculptured font design to give a new bright face to your product. They're available in high-efficiency orange or red through our stocking distributor in your area. Appearance, high brightness, large digit, design simplicity. Everything comes together in our 0.6" LED displays. Put 'em together yourself!

WRITE OR CALL TODAY.

For more information or a demonstration, contact Monsanto Commercial Products Co., Electronics Division, 3400 Hillview Ave., Palo Alto, CA 94304.

Telephone: (415) 493-3300.

Monsanto:
the science
company.

World Radio History

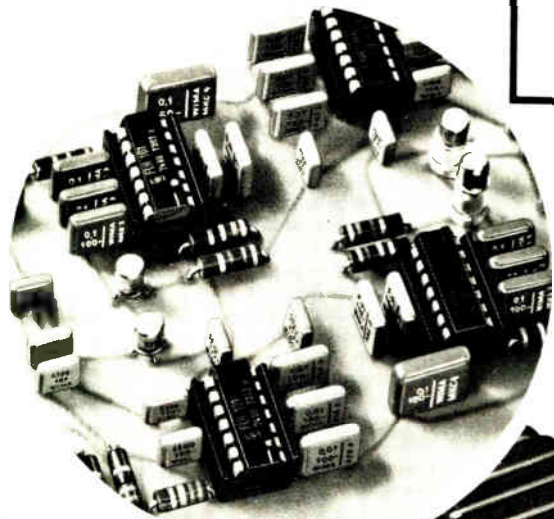

IC's
require
small
C's

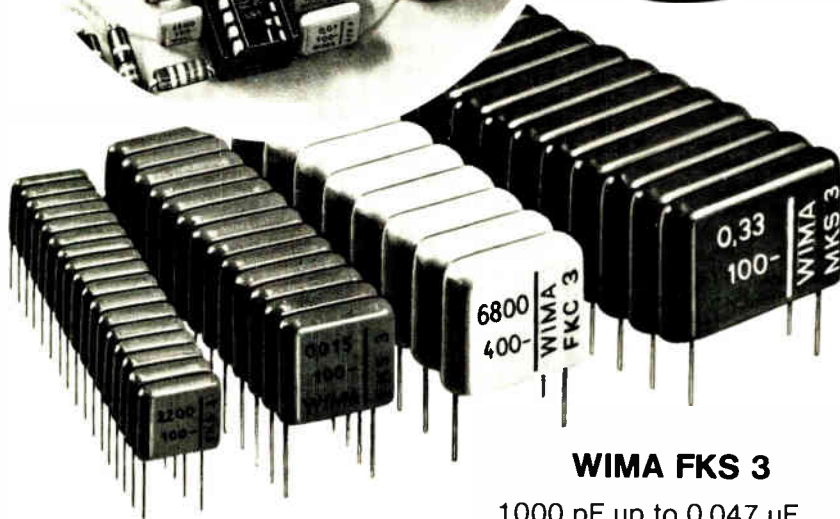

WIMA FKS 3

1000 pF up to 0.047 μ F

WIMA FKC 3

100 pF and up

WIMA MKS 3

Up to 0.47 μ F

WIMA FKS 2 min

P.C.M. 5 mm
1000 pF to 0.047 μ F

Cast-moulded capacitors

are an excellent aid in designing your IC-equipped printed boards. Use the new plug-in WIMA[®] capacitors which are smaller and have regular dimensions.

Write for our new catalogue.



WILHELM WESTERMANN

Spezialvertrieb Elektronischer Bauelemente
D-68 Mannheim 1
Fed. Rep. of Germany
Augusta-Anlage 56
P. O. Box 2345
Tel.: (0621) 40 80 12

John J. Hollenkamp, 50-year-old executive director of the country's largest independent trading company, Hagermeyer NV in Naarden.

Within three years, Hollenkamp, who spent 30 years in Asia starting with the Dutch Indonesian army in 1945, expects to capture 5% of the U.S. market in the middle-priced audio field that includes modular stereo sets, tape cassettes, radios, clock radios, and record players. By then, this market is estimated to be worth almost a billion dollars. It is a market Hollenkamp could not ignore. Helping him compete here is the fact that consumers, faced with so many new names on imported equipment, no longer buy on brand name alone, he points out. Instead, they buy on price and performance, which he feels will allow his company to do well. He expects to boost his business in America from its present 6% annual sales (in commodities trading) to 15%. Last year, the total sales were \$600 million, a 33% increase over 1975.

Good line. He emphasizes that his company knows its way in the audio business. For example, it represents Matsushita's popular line of audio equipment (known as the Panasonic line in the U.S.) throughout Europe and in Asia, outside Japan. It sells its own units as well.

To enter the U.S. market, Hagermeyer recently acquired control of fledgling audio-equipment producer, Yorx Electronics Corp., Totowa, N. J., and began to line up American retail sales outlets. And by calling on its worldwide organization of 75 operating companies in 37 countries, Hollenkamp expects to tap U.S., European, and Asian sources for design and low-cost production of lines to be assembled and distributed by Yorx.

At present, Hagermeyer has engineering offices in Holland, Japan, the U.S., Hong Kong, and Canada. Yorx will specialize in middle-priced products such as a recently introduced \$300 stereo-tape deck, tuner-amplifier combination, Hollenkamp says. But he expects to gradually expand the size of the line to include even video-tape recorders.

TO-5 RELAY UPDATE

The Relay of Tomorrow is here today: the Centigrid.

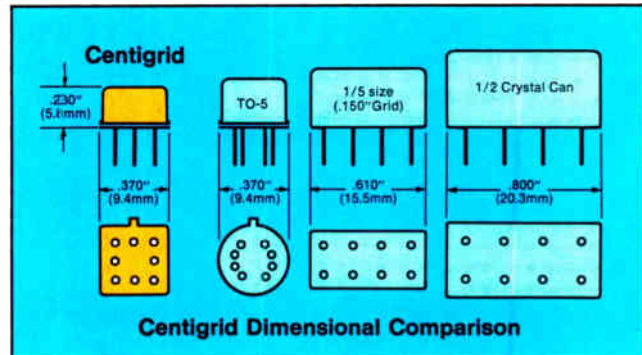

Out of Teledyne's TO-5 relay technology has evolved the Centigrid® — the ultimate subminiature relay. It combines the proven TO-5 relay design concept and internal construction into an even more compact package. Low profile height — just .230" (5.84mm) — with terminals spaced on a .100" (2.54mm) grid permitting direct pc board mounting without the need for lead spreading.

Add to this the same low coil power consumption as the TO-5 relay, with obvious thermal and power

supply advantages. And for RF switching, the Centigrid's low inter-contact capacitance and contact circuit losses provide high isolation and low insertion loss up through UHF frequencies.

To top it all off, the Centigrid is qualified to levels "L" and "M" of MIL-R-39016, including the internal diode suppressed versions.

For complete specification data on the Relay of Tomorrow, contact Teledyne Relays, the technology leader in the relay industry.

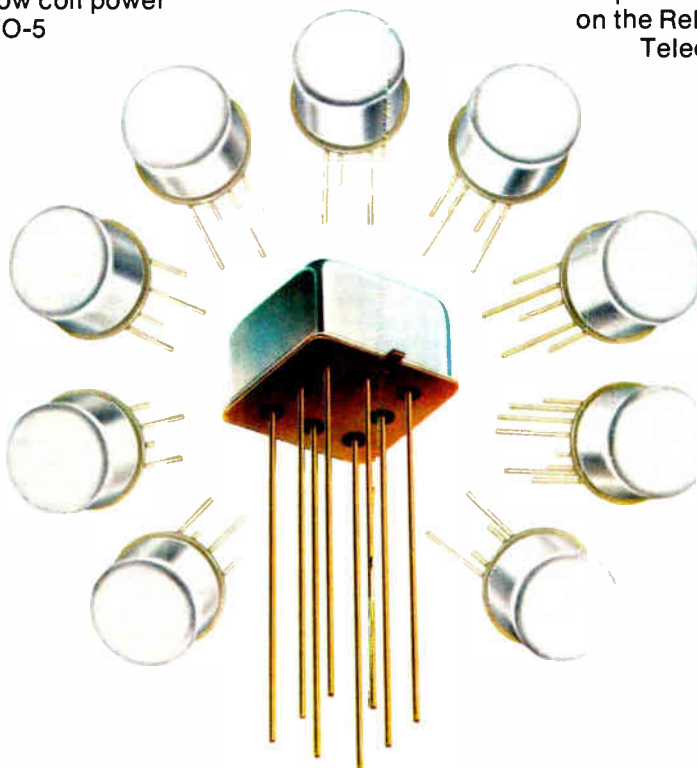

 **TELEDYNE RELAYS**

3155 West El Segundo Boulevard, Hawthorne, California 90250, Telephone (213) 973-4545

**A lot of people depend on our
Circular Plastic Connectors.
In the air and on the ground.**





We build CPC's out of tough, durable high-grade thermoplastic. They're 50 percent lighter than comparable metal connectors. And recognized under the component program of the Underwriter's Laboratories for 250-volt service. They are also CSA certified and FAA accepted.

And in case you're not familiar with AMP technical support, you will be, because it comes with every AMP product. It's based on AMP's long-held conviction that professional engineers are entitled to expert technical support, both before and after the sale.

CPC connectors accommodate a variety of pins and socket contacts, including coax. They are part of the AMP Multimate concept. Their contacts are interchangeable with those in several other AMP connector families. And they all can be assembled with the same application tooling. For you, that means substantial production and inventory savings.

Why not try AMP CPC's in your next avionic, industrial or commercial application. For more information, just call AMP Customer Service at (717) 564-0100. Or write AMP Incorporated, Harrisburg, PA 17105.

AMP has a better way.



AMP
INCORPORATED

Meetings

Summer Computer Simulation Conference, ISA, IEEE, *et al.*, Hyatt Regency O'Hare Hotel, Chicago, July 18-20.

1977 International Conference on Crime Countermeasure Science and Engineering, IEEE *et al.*, Oxford University, England, July 26-29.

ACM-Pacific 77—Exploring the Small Computer, ACM, LeBaron Hotel, San Jose, Calif., July 28-29.

Electromagnetic Compatibility Symposium, IEEE, Olympic Hotel, Seattle, Wash., Aug. 2-4.

IFIP Congress 77, International Fed-

eration for Information Processing (Toronto, Ont., Canada), Royal York Hotel, Toronto, Aug. 8-12.

Medinfo 77—World Conference on Medical Informatics, International Federation for Information Processing, Harbour Castle Hotel, Toronto, Ont., Aug. 8-12.

Conference on Active Microwave Semiconductor Devices and Circuits, Cornell University, Ithaca, N. Y., Aug. 16-18.

NBS Seminar on Time and Frequency: Standards, Measurements, and Usage, National Bureau of Standards, Boulder, Colo., Aug. 22-26.

21st International SPIE Symposium, Society of Photo-Optical Instrumentation Engineers (Bellingham, Wash.), Town and Country Hotel, San Diego, Aug. 22-26.

Product Liability Prevention Conference, IEEE, New Jersey Institute of Technology, Newark, N. J., Aug. 24-26.

Intrasociety Energy Conversion Engineering Conference, IEEE, Sheraton Park Hotel, Washington, D. C., Aug. 28-Sept. 3.

7th European Microwave Conference, Microwave Exhibitions & Publishers Ltd. (Sevenoaks, Kent, England), Bella Center, Copenhagen, Denmark, Sept. 5-8.

7th International Congress on Instrumentation in Aerospace Simulation Facilities, IEEE, Royal Military College of Science, Shrivenham, Wilts., England, Sept. 6-8.

Ineltec 77: Exhibition of Industrial Electronics and Electrical Engineering, Ineltec Exhibition Secretariat (Basle, Switzerland), Basle, Sept. 6-10.

Fall meeting of Electronics Division of American Ceramic Society, ACS (Columbus, Ohio), Queen Elizabeth Hotel, Montreal, Canada, Sept. 18-21.



CABINETS WITH FLAIR

Elegant Designs for marketing power...
Rugged Construction for practical packaging...
Many Models and Sizes for space requirements...
Accessories for completion of enclosure needs...
 (panels, fans, blowers, slides, outlet strips, shelves, drawers, chassis, hardware, etc.)

You can rely on Premier for quality, good delivery, and surprisingly low prices.

write for complete catalog and prices

PREMIER METAL PRODUCTS CO.
 381 CANAL PLACE, BRONX, N.Y. 10451 (212) 993-9200

*What would you get if you crossed
a rotary switch with a coded thumbwheel switch?*

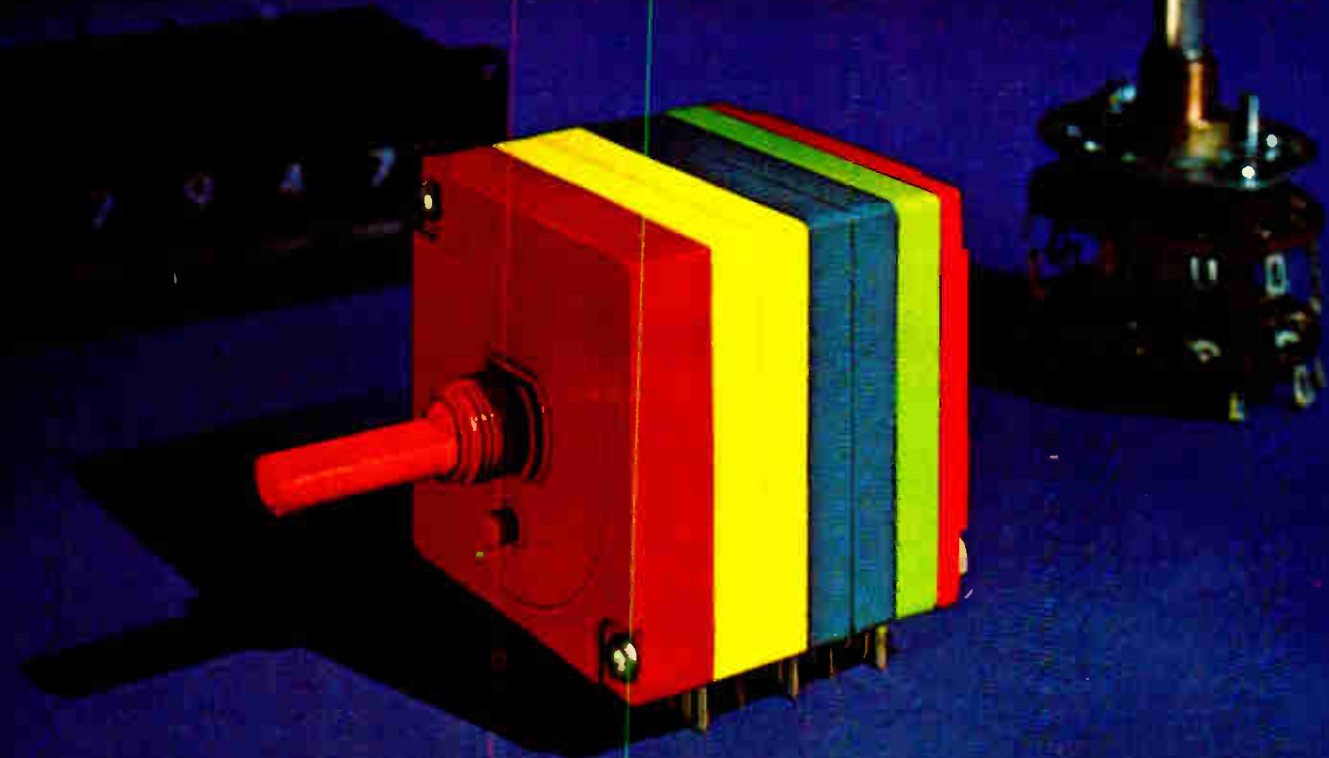

ROTOCODE ® A NEW KIND OF ANIMAL ALTOGETHER!

The shaft actuation of a **rotary switch** . . . with the coded electrical output of a **thumbwheel switch**. We call it Rotocode. You'll call it revolutionary! Ideal as a channel selector in CB, aircraft or marine radios and TV's. **Perfect** for item and price changing in vending machines. **Great** for quantity control in photocopier machines. **Versatile** enough to be modified and expanded to precisely the number of positions required . . . whether 1 or 23 or 40 or **more**. **Modular** design permits assembly of as many decks as needed for specific function. **Superb** for programming virtually any electronic instrumentation or equipment in place of conventional thumbwheel switches or multi-deck rotary switches.

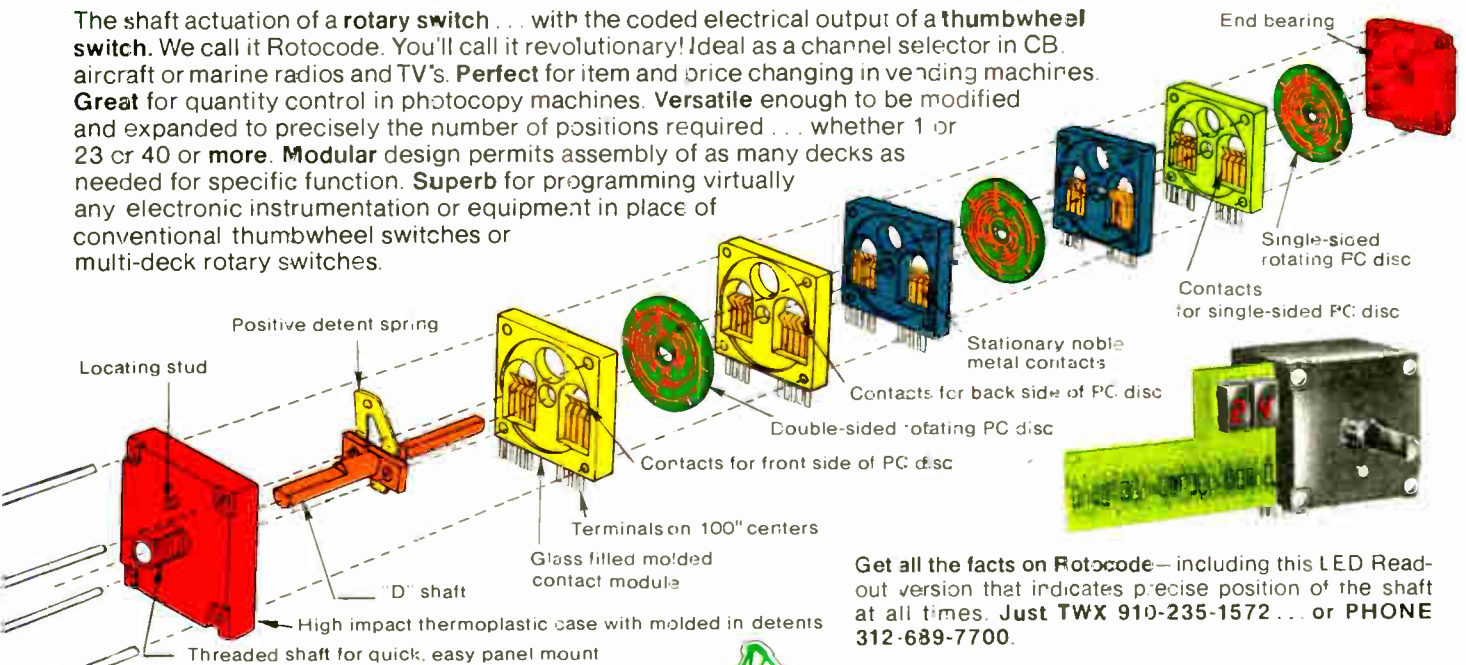

Get all the facts on Rotocode—including this LED Read-out version that indicates precise position of the shaft at all times. Just TWX 910-235-1572 . . . or PHONE 312-689-7700.



CHERRY ELECTRICAL PRODUCTS CORP.
3608 Sunset Avenue, Waukegan, Illinois 60085

SWITCHES and KEYBOARDS — Available locally from authorized distributors. 21

World Radio History

Circle 21 on reader service card

**Mostek
takes you forward
to a new era
in low power systems.**



Introducing the Edge-Activated Series.TM

Higher density, lower power and simplified system design. That's the idea behind Mostek's Edge-Activated Series. The series includes a complete family of high-density static RAMs and ROMs, with a wide selection of organizations. All devices are implemented with the same edge-activated circuit design concept which allows you to design a +5V only system without compromising speed or power. It's the best of both worlds.

Proven design techniques for maximum performance.

Mostek's approach integrates a static MOS storage cell with dynamic MOS periphery so that the full advantages of the technology can be realized. Now your applications can be implemented with a minimum number of devices. Also, edge-activated devices operate at faster speeds than traditional static circuits but with much lower power dissipation. Other system benefits include . . .

- totally static operation—no refresh required
- single +5V power supply— $\pm 10\%$ tolerance
- on-chip address latches
- active and standby power—lowest in the industry
- reduced V_{CC} for battery back-up applications
- direct TTL compatibility and common I/O operation

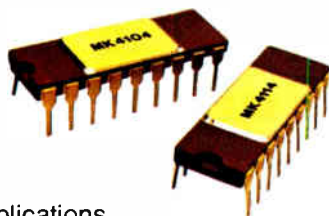

Let's put a dollar value on lower power.

One common timing signal, provided in almost every memory application, activates the entire family of devices. However, if the clock signal must be provided externally, the system benefits of lower power far outweigh design complexity. An example is a 16K \times 9-bit storage matrix. Designed with edge-activated MK 4104's, this system would

dissipate less than 1 watt in the memory array, while the same system with static-interface RAMs would dissipate approximately 18 watts. Since typical power sub-system designs cost from \$1.00 to \$1.50 per watt, both design and cooling costs are reduced significantly.

Data Sheets, Application Notes, price and delivery are available from Mostek field sales representatives.

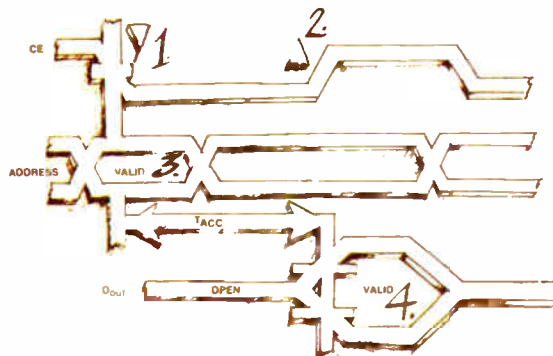

A simple high to low transition at the Chip Enable input (1) activates the entire family of memory devices. Returning the CE input to a high level (2) achieves a 75% reduction in device operating power for an automatic standby power mode. Address information is strobed and latched (3) into a set of on-chip registers, thereby eliminating "set up" time requirements and minimizing "hold" time. While data is valid (4) you have full control of the Data Output.

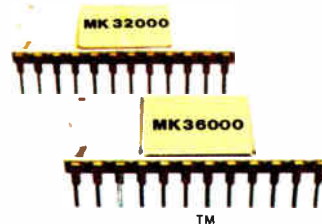

The Edge-Activated Series

	Access Time (max)	Active Power (max)	Standby Power	Industry Standard Pin Configuration
MK4104 (4K \times 1 RAM)	200 ns	120 mW	30 mW	18 pin
MK4114 (1K \times 4 RAM)	200 ns	120 mW	30 mW	18 pin
MK32000 (4K \times 8 ROM)	300 ns	200 mW	25 mW	24 pin
MK36000 (8K \times 8 ROM)	300 ns	200 mW	25 mW	24 pin

MOSTEK

1215 West Crosby Road • Carrollton, Texas
75006 • (214) 242-0444 • MOSTEK GmbH • West
Germany • Telephone: (0711) 701096 • MOSTEK
ASIA • Hong Kong • Telex: 85148MKA HX

Your Problem Solvers!

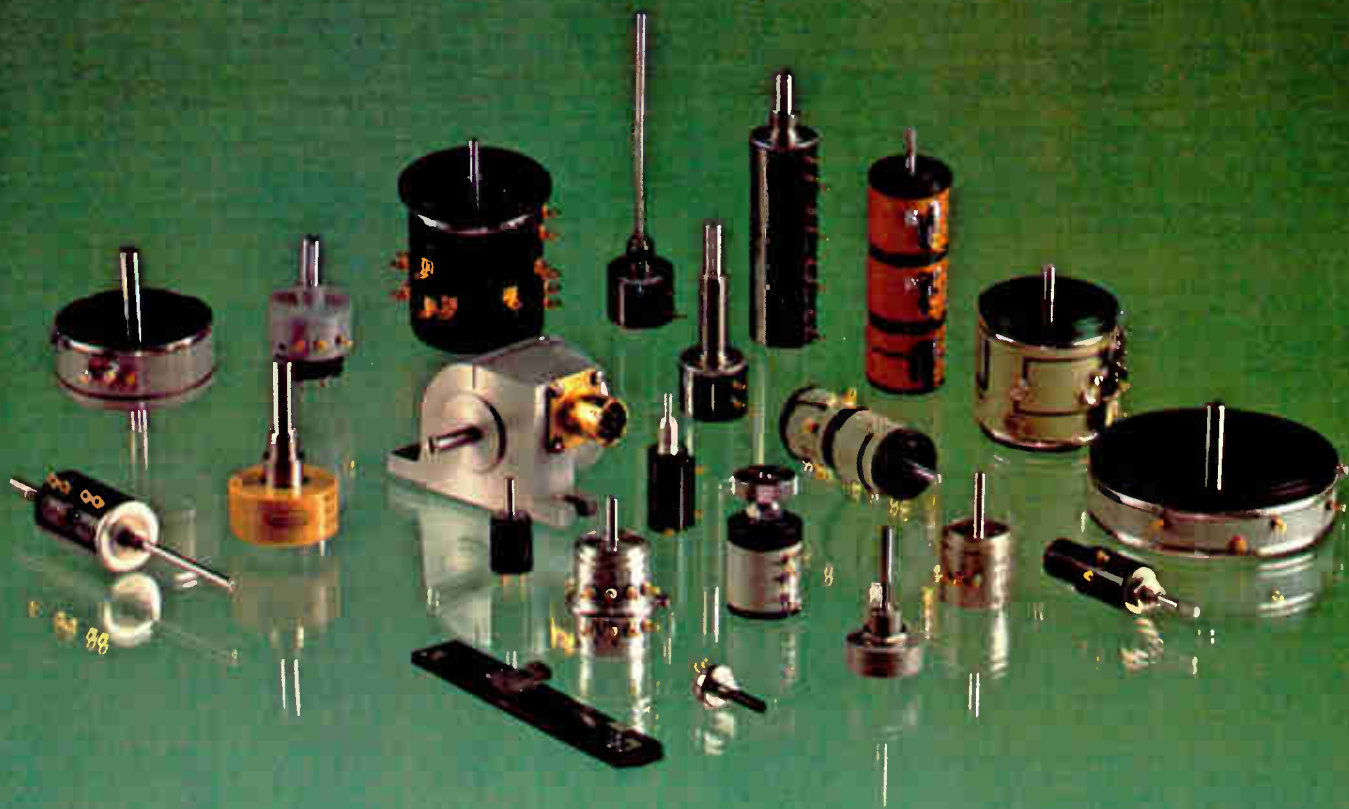

Special Pots from Spectrol

For more than 20 years, designers with application problems have turned to Spectrol for special pot solutions. They have come to us for • cermet, conductive plastic, and wirewound pots • linears and non-linears • special torque devices • concentric shafts • spring returns • linear motions • pot/switch combinations • element sectors • 1000°F pots • Moon pots and Mars pots.

So for help with your tough applications, come to Spectrol. Let us design a "Problem Solver" for you.



SPECTROL ELECTRONICS GROUP

UNITED STATES Spectrol Electronics Corporation 17070 E. Gale Avenue, City of Industry, Calif. 91745, U.S.A. • (213) 964-6565 • TWX (910) 584-1314

UNITED KINGDOM Spectrol Reliance Ltd. Drakes Way, Swindon, Wiltshire, England • Swindon 21351 • TELEX: 44692

ITALY SP Elettronica SpA Via Carlo Pisacane 7, 20016 Pero (Milan) Italy • 35 30 241 • TELEX: 36091

Circle 24 on reader service card

World Radio History

TI's 4-k static RAM, made with I²L process, ready for market

Texas Instruments' answer to the new high-speed MOS 4,096-bit static random-access memories now entering the market will be available as preproduction samples next month. It is scheduled for full high-volume production in October. Called the S400 [*Electronics*, May 13, 1976, p. 25], the fully static 4-k RAM is built with integrated-injection-logic technology **and sports specifications at least as good as Intel Corp.'s newly announced 2147 device.**

Read and write cycle times of the S400 are the same, and TI expects to characterize them at a maximum of 70 nanoseconds. The part will operate like a 4-k register array, which keeps active power dissipation to 500 milliwatts. The RAM will feature a standby mode that further cuts power to 25 mw, and it will retain data with V_{CC} as low as 2 volts.

Analog Devices chip combines I²L and linear bipolar elements

Analog Devices Inc., a leading innovator in data-conversion products, will soon announce the first commercially available monolithic analog-to-digital converter to be made with a combination of integrated injection logic and linear bipolar processing. As a result, the chip, to be called the AD571, is also **the first 10-bit successive-approximation a-d converter to be completely self-contained** and include all the trimmings like a voltage reference, a clock, a comparator, and even three-state buffers for micro-processor interfacing. The clock and successive-approximation register are I²L, so conversion time is fairly fast, taking less than 20 microseconds. Made with a buried zener, the voltage reference provides good long-term stability of 50 ppm/°C year for full-scale accuracy. The device, to be available in September, will be in an 18-pin dual in-line package and will sell for under \$25 in hundreds for the commercial-grade unit.

Zilog entering memory business with two designs

Zilog Corp., the Exxon-backed microcomputer maker, has entered the memory business and will begin shipping samples of two memory products this summer, with production to follow in the fall. Zilog's 16,384-by-1-bit dynamic random-access memory, a 16-pin device, **will be the Cupertino, Calif., company's first in-house design.** It will feature 20 milliwatts of maximum standby power and come in three combinations of speeds, with access and cycle times of 150 nanoseconds and 375 ns, 200 ns and 375 ns, and 200 ns and 410 ns, respectively.

Zilog's 4,096-by-1-bit static RAM will have a single 5-volt supply. The static memory will also come in three versions, with access and cycle times of 100 ns and 175 ns, 150 ns and 250 ns, and 200 ns and 340 ns.

AMI targets telecommunications and auto markets

With its V-groove-MOS agreement with Texas Instruments under its belt (see p. 33), American Microsystems Inc. is planning major thrusts in the automotive and telecommunications markets. Its first microprocessor development project to use V-MOS **will be a communications processor family** consisting of a programmable communications controller and a signal processing peripheral.

The firm also is planning to introduce in the next 12 months three new MOS circuits designed to be retrofitted into the telephone set, as well as a first-quarter-1978 introduction of a circuit that "will allow you to display on your home TV set the same kind of information now displayed on any video-display computer terminal," says president Glenn E. Penisten. Also, by virtue of its recent agreement to sell 25% of its common stock to West

Germany's Robert A. Bosch Co. for some \$14 million, AMI-designed circuits for electronic fuel injection and antiskid braking systems are close to production by Bosch.

Datel adds facility to turn out its own monolithic devices

Datel Systems Inc. is the latest hybrid microcircuit house to invest in its own monolithic semiconductor facility. Jack Gallagher, marketing vice president of the Canton, Mass., company, believes it needs to provide itself with specialized monolithic devices required in precision data-conversion and acquisition products. He says the investment is small—less than \$500,000—but he expects that, as the company grows to \$35 million in sales by 1980, semiconductors sold separately from hybrid products **will account for \$3 million to \$5 million of that.**

The firm has 16 diffusion tubes, although it will use only about six to start with in its linear bipolar process. Having designed the initial test devices, Datel expects to have the first wafers out this summer.

Bell Labs predicts lasers with lives of 10⁶ hours

Bell Laboratories scientists have reported solid-state lasers with projected lifetimes of 1 million hours—100 years of operation. These predictions are based on long-term accelerated aging tests on the same type of gallium-aluminum-arsenide lasers being used in Bell's fiber-optic systems now undergoing field trials in Chicago. By operating groups of lasers at 50°C, 70°C and 90°C, the scientists **were able to cause them to fail in measurable times.** According to Barney DeLoach, head of the light wave sources department, which fabricated and tested the lasers, some tests exceeded two years. "By extrapolating these high-temperature results to lower temperatures we can project room temperature (22°C) lifetimes of about 10⁶ hours," says DeLoach.

Chrysler prepares trip computer for 1979 vehicles

Chrysler Corp. is readying an optional trip computer for some of its 1979 model vehicles; it is now building prototypes with Mostek Corp.'s MK3870 and Intel Corp.'s 8048 single-chip microcomputers. One will be selected to supply parts for the estimated 120,000 units Chrysler needs for the 1979 model year.

The dashboard-mounted information system will be offered early next year on one of the firm's British cars and the French-built Simca, and in the U. S. next fall on trucks and recreational vehicles. Chrysler is not divulging features, though **the option—to cost around \$100—may be similar to the General Motors version** that's scheduled for 1978 Cadillacs. GM's Tripmaster, using Motorola's 6800 microprocessor, reportedly allows drivers to call up engine parameters and other data.

Addenda

Predictions that sales of bubble domain memories will reach as high as \$100 million by 1979 may have been too optimistic, says Venture Development Corp. of Wellesley, Mass. The consulting firm doubts the impact of bubbles as replacements for present recording methods. **Venture's estimate: sales of \$40 million in 1980.** . . . Ford plans to offer an optional "miles-to-empty" indicator on its 1978 Continental Mark V. The digital gas-discharge display will be controlled by **a custom chip from American Microsystems, Inc., Santa Clara, Calif.**



Introducing the hungry ECLIPSE.

Data General's new ECLIPSE S/130 computer has a bigger appetite for work than any other mid-range mini. And enough speed and versatility to wolf down any kind of data you have to dish out.

The hungry ECLIPSE computer is built around the same powerful architecture as our super high-speed ECLIPSE S/230. Added to that is a host of special features that make the hungry ECLIPSE unique. Like our fast micro-coded floating point and efficient character string instruction sets. And our second-generation WCS general-purpose user microprogramming ability that results in unmatched throughput in demanding applications. To top it off it also includes AOS, our amazing new heuristic multi-programming advanced operating system, and of course the full range of Data General's economi-

cal big-computer peripherals, software and worldwide support.

Now, you don't have to skimp along with an undernourished mini that's too limited for your work. Or splurge on one that's too fat just to get the performance you need. Just order an ECLIPSE S/130 computer. It will make your work load a lot leaner. Want more food for thought? Send for our brochure.

- Send your S/130 brochure.
 Send your S/130 brochure and have your sales representative call.

Mail to: Data General, Westboro, MA 01581

Name _____

Title _____

Company _____

Address _____ Tel. _____

City _____ State _____ Zip _____

ECLIPSE is a registered trademark of Data General Corporation.

© Data General Corporation, 1977

EM

Data General
 It's smart business.

Circle 27 on reader service card

Data General, Westboro, MA 01581, (617) 366-8911. Data General (Canada) Ltd., Ontario.
 Data General Europe, 15 Rue Le Sueur, Paris 75116, France. Data General Australia, Melbourne (03) 82-1361.

HP's Terminals: smart, but simple.

With 10,000 sold in just two years, Hewlett-Packard's CRT line has made a considerable impact on the terminal market. The secret? Human engineering.

By designing our smart terminals around a microprocessor, we've managed to uncomplicate difficult jobs and make simple tasks a piece of cake.

But that was just the beginning. We wanted to make our terminals easy to maintain and expand. And we wanted to make them easy on the eyes, both from the operator's point of view and as pieces of office furniture.

We did it all. Our terminals won design awards for their appearance. And our exceptionally clear, high-resolution displays have won the hearts

(and eyes) of everyone who has to spend long hours in front of a CRT.

Reducing operator fatigue.

For our screens, we use a 9x15 character cell, with dot shifting to provide exceptionally clear definition. You don't have to peer at tall, skinny letters. Ours look like the best typewriter printing, with the right spacing and descenders below the line.

By using white characters rather than green, we've made the display brighter and easier to read. (Have you ever tried

watching black and green television?)

Several other screen features simplify an operator's life. Inverse video, optional half-brightness, underline or blinking characters can be used to stress important information, and reduce mistakes in transmission.

Plug-in modules for quick changes.

That's the simplest way of adapting a terminal to your job. So we offer a variety of components that pop in and out.

All our terminals have plug-in character sets to cover a wide range of computer languages. And a plug-in Forms Drawing option lets you generate almost any form your company uses.

Our smartest terminals let you plug in fully integrated mass storage. This takes the form of twin cartridges, each able to store up to 110,000 bytes of data or programs.

You can use this information locally (the terminal's "soft keys" save a lot of time and effort on off-line jobs) or transmit it to your central computer.

Another new terminal, the ultimate "have-it-your-way" design, should be extremely popular with OEMs. You can pick and choose from a variety of hardware modules, and write your own firmware. Everything plugs together for a virtually custom display station.

Some intelligent ideas for smart terminals:

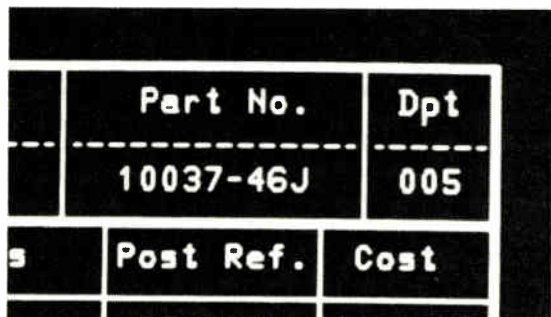

An exceptionally clear display eases long sessions at the CRT. A Forms Mode aids accurate data entry.



Plug-in mass storage: you can get up to 110,000 bytes per cartridge.



The "soft keys" on our smartest terminals let you execute complex operations with a single keystroke and eliminate many repetitive jobs.



Problems? The self-test key helps pinpoint them for you.

Maintenance is a snap.

Unsnap a couple of catches and our terminal is wide open. The plug-in PC boards are right there. What could be easier for changing options or speeding up repairs by our servicemen?

Not that downtime is a problem. Our terminals have such a good MTBF that we've lowered our maintenance price twice in the past 18 months.

And when you do need service, you've come to the right company. We have more than 700 Customer Engineers ready to



give you support, documentation and training.

So when you're choosing a terminal, think of your people first. Then think of the terminals that are smart enough to be almost human. Your local Hewlett-Packard sales office can give you complete information. Or mail us the coupon and we'll send you the facts.



Smart doesn't have to mean complicated: eight HP terminals that prove the point.

The HP 2640B Interactive Display Terminal. Even our simplest terminal has many intelligent features, including an enhanced high-resolution display, plug-in character sets, dynamically allocated memory, microprocessor control, full editing, self-test, forms mode and more. It's a lot of terminal for the money.

The HP 2640C Cyrillic Display Terminal. This has everything you like about the B version, but it speaks Russian too.



Cyrillic



Swedish



Arabic

The HP 2640N is fluent in Danish or Norwegian.

The HP 2645S completes our Scandinavian coverage with Swedish or Finnish.

The HP 2645R. Designed for an application in Iraq, this model enters Arabic characters from

right to left. It also works from left to right for standard computer languages.

The HP 2645A Display Station. Our smartest terminal, it can transmit at rates up to 9600 baud, has a forms mode, user definable "soft keys," and optional fully integrated mass storage. A very intelligent choice.

The HP 2641A APL Display Station. This is modeled after the 2645A, but also includes a full 128 character APL set, plus an APL 64 character overstrike set.

The HP 2649A Mainframe Terminal. This data station is ideal for OEMs. It lets you design custom firmware for your special application and pick the hardware modules your system demands. Available with all of the 2645A's advanced features.



I want to know more about HP's terminals.

- Contact me to arrange a demonstration in my office.
- Let me know dates of the HP Terminals Seminar to be held in my area.
- Send me complete information about the following terminals:

Name _____ Company _____

Address _____

City/State/Zip _____ Phone _____

Mail to: Ed Hayes, Hewlett-Packard, 11000 Wolfe Road, Dept. 603, Cupertino, CA 95014

42702HPT3

Pro-Log taught the PROM programmer to think so you can relax.

Way back in 1973, Pro-Log revolutionized PROM programming with a microprocessor-based programmer that simplifies programming and lets you relax.



Because it analyzes PROMs as they're being programmed, it minimizes dropped data and mis-programming, and maximizes PROM yield.

It leads you step by step through each programming operation to lessen the chance of mistakes.

Our microprocessor-based control unit is so reliable we back it with the industry's longest warranty, 2 full years parts and labor.

Using our field proven plug-in PROM Personality Modules, each with its own full-year parts and labor warranty, the stand-alone Series 90 PROM Programmer programs, lists, duplicates and verifies every major MOS and bipolar PROM. Its master control unit costs only \$1,800.

The single-button Series 92 Peripheral PROM Programmer/Duplicator control unit, including a TTY interface, is \$995.

PROM Personality Modules cost from \$360 to \$450 and plug into either control unit.

Pro-Log routinely submits PROM Programmers and PROM Personality Modules to PROM manufacturers for evaluation and approval. Contact us for approval status on the PROM Personality Module you want.

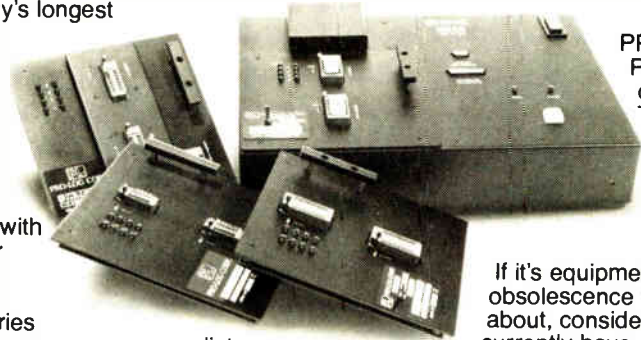

PROM Programmer options include TTY, paper tape reader, parallel I/O, RS232 and CMOS RAM buffer.

If it's equipment obsolescence you're worried about, consider this. We currently have about 2,000 Series 90 PROM Programmers in use worldwide. And every one, oldest and newest alike, accommodates every one of our field-proven PROM Personality Modules including our new Generic PROM Personality Modules.

Try programming your next PROM the relaxing way. For a demonstration or for the latest version of our 48-page PROM User's Guide, contact Pro-Log Corporation, 2411 Garden Road, Monterey, CA 93940. Phone (408) 372-4593.

Circle 30 on reader service card

PRO-LOG
CORPORATION

Microprocessors at your fingertips.



Congress hits at management of DOD telecommunications

House panel strikes at 'cost overruns, frustration and failure,' asks for delay in deployment of GE's DSCS-3

After a nine-month-long examination of military telecommunications, a House subcommittee has delivered a blistering 32-page critique that comes down hard on program management by the Department of Defense. Defense satellite communications, for example, "have been characterized by cost overruns, frustration, and failure," says the report of the command, control, and communications panel of the House Armed Services Committee's investigations subcommittee.

Chaired by Rep. Robert H. Mollohan (D., W. Va.), who has served on it since its inception seven years ago, the panel describes the military's efforts as having produced "a concern that borders on dismay at [DOD's] inability to deploy such a system after 16 years of effort." TRW Inc.'s second phase of the Defense Satellite Communications System (DCSC-2) has yielded only one operational satellite, despite six launch attempts in as many years. The program, the report points out, has been plagued both with launch failures and with poor satellite performance.

Moreover, Mollohan wants DOD to defer deployment, set for the 1980s, of General Electric Co.'s larger DSCS-3 system until phase 2 "is established as a working network" of four satellites and two orbiting spares. He adds that DOD would do

well to learn from the successful operating experience and technical expertise of commercial satellite communications companies.

Assistant secretary of defense Gerald P. Dinneen, who has just taken over as head of communications, command, control and intelligence, calls Mollohan's report "an excellent review and critique" by "a well-informed and most competent critic" that is getting a thorough study. Dinneen, former director of MIT's Lincoln Laboratory, is treading lightly, of course. For him there is good news in Mollohan's support for the creation of his new post by Secretary of Defense Harold Brown and his call for giving Dinneen full



Critic. Communications specialists promoted to the top ranks might help DOD, says House panel chairman Robert H. Mollohan.

responsibility for "tactical as well as strategic communications programs" at every level, including those associated with weapons systems.

New lever. However, DOD's new civilian managers see Mollohan's report as "a useful lever," to quote one of them, for their own efforts to review and restructure telecommunications. The issue of military programs' management, as well as their technology, was the subject of intense discussion at the Armed Forces Communications and Electronics Association's annual meeting in Washington late in June, with a number of contractors privately acknowledging agreement with Mollohan. Among the criticisms:

- The Army-managed Tri-Service Tactical Communications System (Tri-Tac) "continues to flounder," contends Mollohan's panel, and should be critically examined to see if "problems are primarily technical . . . or whether they result from mismanagement." Neither Dinneen nor Tri-Tac manager, Maj. Gen. John Hoover, said they knew of any new review of the program.

- The Navy's controversial Project Seafarer cable grid for extremely-low-frequency transmissions to submarines—formerly Sanguine—is not only unable to survive a nuclear attack as now modified, but may be too slow to handle routine data transmissions. Thus the Navy should examine "all possible alternatives" to the program.

- The military has been slow to buy equipment for secure voice communications. Citing an earlier DOD promise to buy secure voice digital hardware on "an urgent and expedited basis," the Mollohan panel

Jamming tests inhibited by TV, radio priorities

The U. S. and its NATO allies cannot fully simulate Soviet wartime communications jamming or test their own countermeasures in military field tests because jamming "power levels are severely restricted to avoid interference" with commercial television and radio broadcasting near training sites. These jammer power levels "are far below those which the Soviets are known to employ," says the House Armed Services investigations subcommittee panel on command, control and communications. For U. S. and allied forces to conduct exercises in a realistic electronic warfare environment, the House watchdog group wants U. S. and European communications regulatory agencies to allocate brief periods—perhaps a day or two at most—during which unrestricted jamming could be employed in field exercises so its impact could be assessed and countermeasures tested.

Moreover, the panel wants intensified research and development in electronic countermeasures and counter-countermeasures, as well as "more timely deployment" of the products of ECM and ECCM technology. The report notes that the U. S. has "developed technology far superior to anything possessed by the Soviets" in these classified areas, but staffers stopped short of specifying examples. Yet panel chairman Robert H. Mollohan reminded the Pentagon's new leadership that "the objective of development is to put equipment into the hands of the troops, not to build a perfect item which is available only on a laboratory shelf."

calls for DOD to speed up and, if necessary, redirect funds from lower-priority programs for secure voice procurement.

The JTIDS program—for Joint Tactical Information Distribution System—for all services overseen by the Directorate of Defense Research and Engineering was one of the few to get the Mollohan panel's blessing. With three classes of terminals, ranging from small manpacks to larger units for fighter aircraft plus a third for base stations, ships, and large planes like the E-3A Airborne Warning and Control System, JTIDS addresses the pressing requirements of signal security, survivability, interoperability, compatibility, and anti-jamming, according to the report (see "Jamming tests inhibited by TV, radio priorities").

The panel attributes JTIDS' ability to make interservice combat communications "play together"—including those between foot soldiers and fighter planes—to DDR&E's management coordination, and the Army and Marine Corps are urged to make greater use of the terminals, rather than locking themselves into planned Tri-Tac hardware.

One criticism common to defense telecommunications programs throughout the Mollohan panel re-

port was what the West Virginia Congressman calls "the military pre-occupation with developing engineering specifications." Afcea contractors indicated widespread agreement with his call for military users to limit themselves to performance specifications and allow industry to develop engineering details competitively. Mollohan says he is convinced that if the military were to limit itself to performance specs and improve its own internal management, the 12-to-14-year cycle between system development and deployment could be halved. □

Solid state

Intel stretches n-MOS by scaling it down

While some semiconductor manufacturers are gambling on V grooves and other new metal-oxide-semiconductor structures for achieving next-generation circuit density and performance, the leader in MOS technology is taking an evolutionary approach. Intel Corp. has moved into production with an advanced process that is a straight scaling down of standard silicon-gate n-

channel processing. Yet the new process, called H-MOS for high-performance MOS, will result in large-scale-integrated circuits that are as fast and dense as those produced by more exotic processes [*Electronics*, June 23, p. 29].

H-MOS will be applied across Intel's entire product line. Being shipped this month is a new family of 4,096-bit static random-access memories that use a single 5-volt supply. With a typical access time of 45 nanoseconds and 500 milliwatts of power dissipation, the family has the best speed-power performance of any 4-k part now available. Indeed, it is two to three times faster than any other 4-k, and it is at least as fast as most 1,024-bit MOS static RAMs.

Designated the 2147 series [*Electronics*, March 3, p. 32], the parts will be priced from \$37.50, depending on access time. The company has also introduced an H-MOS version of the 2115/2125 1-k RAM, which has an equally good speed-power performance rating.

Intel also is known to be working on H-MOS versions of microprocessors, complex peripherals, dynamic 16,384- and 65,536-bit RAMs, read-only memories, and erasable programmable ROMs. Intel's high-density 827X series of peripherals averaging 15,000 to 25,000 devices per chip [*Electronics*, May 26, p. 132] may also be fabricated using some version of H-MOS.

What it is. H-MOS is an under-4-micrometer, silicon-gate process that combines very small devices with on-chip substrate-bias generation. By reducing the dimensions of the MOS devices by a fixed scaling factor, circuit density and performance increase while active circuit power drops. Gate oxide thickness is less than 1,000 angstroms. Shallow junctions (less than 1 μm) are obtained by using arsenic as the source drain diffusant. In addition, oxide isolation and depletion-load processing improve performance and density further.

Substrate biasing reduces device body effects and parasitic junction capacitances, again improving speed

and lowering power. Speed-power product for the H-MOS devices is about 1 picojoule, compared to 4 pJ for conventional 6- μ m chips.

For systems designers, one of the significant things about the 2147 is a new power-down mode, says Bill Regitz, strategic marketing manager at Intel. It reduces average device consumption to 40 mW, a fraction of the active power.

During power down, the memory array is completely deselected and the column bus and input/output bus are reset to a threshold below supply voltage. This results in the low standby power. Moreover, the user need not pay a penalty in access

time for this low-power mode. By balancing the internal circuitry during power down, Intel overcomes the additional power-up delay and obtains access time equal to the address access time.

Regitz emphasizes that the 2147 is easier to use than other recently introduced 4-k statics. "Operation is fully static," he says, "and the inputs and outputs are unlatched to insure simple static timing. No address setup and hold timings are needed." Other 4-k MOS RAMs require timing strobes or clocks. Also, they have cycle times longer than access times, which can reduce system throughput by as much as 50%. □

gives TI an equal footing with Intel, its fiercest memory competitor, in trying to drive an MOS wedge into the \$60 million bipolar buffer-memory business now dominated by Fairchild's transistor-transistor-logic RAMs. (Intel has already announced 1-k and 4-k static RAMs for this purpose, using an advanced silicon-gate process, p. 32). On the other hand, the V-MOS technology applied to dynamic RAMs gives TI a club against Mostek and Intel in the big mainframe memory business, promising as it does 16-kilobit and 65,536-bit devices on smaller chips with speeds of less than 100 nanoseconds. This is not to mention the advantage V-MOS gives to erasable ROMs and microprocessors.

All at once TI has acquired a powerful tool for use against its toughest competitors without spending the \$10 million to \$20 million required in a crash program for developing a comparable process. (It already is deeply into the D-MOS process anyway.) Furthermore the Dallas-based company acquires a 9900-family alternate source, much needed leverage against the new higher-performing 8-bit microprocessors, such as the 8085 and Z-80, in the general-purpose microprocessor markets.

As for AMI, it gets instant credibility for its V-MOS process, which

Technology pacts of TI, Intel show even big guns can't go it alone

Although the ink is hardly dry on the agreement between Texas Instruments and American Microsystems, its long-term implications are evident. Coming on the heels of the Intel-Advanced Micro Devices [*Electronics*, June 23, p. 25], it demonstrates that the executives of even the leading semiconductor manufacturers feel that they cannot go it alone in the complex business of developing the technology and the marketing support required to participate in today's memory and microprocessor markets.

The arrangements mark the first time that TI and Intel Corp. have entered into major technology and product exchanges. Such deals were usually the concern of second-level participants in a market. But now every major memory and microprocessor supplier has entered into some form of partnership with another supplier (see "Who is pairing up with whom?").

While it is tempting to call these agreements simply second-source arrangements, in reality they are aggressive business transactions that reflect shifting market strategies. Take the TI-AMI deal. TI gets the Santa Clara, Calif., company's V-groove metal-oxide-semiconductor process for supplying AMI's 1,024-bit

and 4,096-bit static random-access memories and 16,384-bit and 32,768-bit read-only memories. In exchange, AMI gets the masks and software program tapes for supplying TI's 9900 16-bit microcomputer family. Thus, both firms can point to *bona fide* second sources for these complex LSI products early in the product entry cycles.

Up close. But look closer. In memory alone, the V-MOS technology applied to high-speed static RAMS

Who is pairing up with whom

The technology and product exchange agreements springing up everywhere between manufacturers of integrated circuits underline a fact of life in today's semiconductor industry: you cannot do everything yourself. The financial and personnel burden of developing all the complex circuits and software for memory and microprocessor families, let alone the semiconductor technology required to implement them, is becoming too heavy for the individual manufacturer, especially since the life cycles of these products are a short three to four years. Hence, the new pairings.

Here is a scorecard on the lineups. Besides the TI-AMI 9900/V-MOS swap and the Intel-AMD 8085 deal, there is the agreement of Intel and Siemens on the 8085; the Fairchild-Motorola 6800 and transistor-transistor-logic exchange; Rockwell and MOS Technology on the 6500 microprocessor; National and Signetics on microprocessor peripherals and other LSI chips; Mostek and Fairchild on the F 8 microcomputer; Mostek and Zilog on the Z-80; and RCA, Hughes, and Solid State Scientific on the 1802 microcomputer. This is not to mention last year's Intersil/Advanced Memory Systems merger. Not all deals work out; the National-Rockwell agreement of two years ago, swapping p-channel microcomputer families, never got off the ground, although it is still formally in effect.

with its vertical etching and nonplanar oxide levels was being dismissed by other manufacturers of integrated circuits as too chancy for guaranteeing high-volume production.

The other camp. A hard look at the Intel/AMD deal reveals the same mixture of technology and marketing strategy. When Intel established the 8080 as the dominant general-purpose 8-bit processor family in late 1975, it had only one real competitor—Motorola's 6800. Today, however, the Intel 8085 faces stiffer competition from the Z-80, the 9900, and the enhanced 6800. Worse, no 8080 supplier was willing to follow Intel up the notch and spend the funds necessary to copy the new parts. In fact, Intel was faced with the prospect of having a united camp of 8080 suppliers who could compete with the 8085 by adding chip enhancers to the family.

The AMD deal changed all that. With a strong partner in the 8085 camp, Intel puts increasing pressure on the remaining 8080 suppliers such as National Semiconductor, TI, and others to either come along with the 8085 or take their chances on selling the older 8080 into new designs. □

Communications

Bell adding SSB to microwave links

Even though the single-sideband technique for transmitting radio signals was invented by an AT&T engineer in 1915, telephone systems have not needed more than the bandwidth available from frequency modulation equipment, which transmits information using carrier and sidebands. Now, however, the Bell System has decided that the SSB scheme is the least costly path—in terms of both spectrum use and capital investment—to expand its microwave radio relay network, which handles about 70% of this country's interstate telephone calls.

Next month, Bell Telephone Laboratories Inc. will begin testing a

new microwave radio over a 6-gigahertz, 26-mile hop in Massachusetts. Late next year, production equipment will be installed on a six-hop test route between St. Louis and Kansas City that will be phased into commercial telephone service in mid-1980. "From then on, we expect a fairly heavy build-up," says Raymond E. Markle, head of the SSB Microwave Radio department at Bell's Merrimack Valley Laboratories, North Andover, Mass.

More circuits. "We went to SSB in the 6-GHz common-carrier band because it gives us 6,000 voice circuits per radio channel," Markle says. That is more than triple the 1,800 now available in Bell's highest-capacity microwave link. "To get the expansion with conventional fm radio, we would need additional routes," he says. "But the economics strongly favor SSB, with its lower capital investment and shorter reaction [installation] time."

Bell selects the lower sideband—and suppresses the carrier and upper sideband—at one frequency to occupy the lower half of a radio channel; the upper half of the same channel holds the lower sideband of a second, higher-frequency carrier. "This doubles the capacity of any theoretical fm system," Markle points out, "but it effectively triples the bandwidth of our existing fm systems. Since SSB involves a simple translation of baseband [voice] frequencies up to the channel frequency, all the information is contained in one sideband that can be sharply defined and filtered. This allows us to pack more voice circuits into existing channel space and put them closer to the channel's edge. On the other hand, fm signals require more space at the edge of the channel for the filter's roll-off to preserve the secondary and tertiary sideband information that is needed to prevent distortion."

Obstacle. "The stumbling block with SSB has been the transmitter, where it's very difficult to get highly linear transmission at microwave frequencies," he notes. To solve the linearity problem, Bell starts with an improved traveling-wave-tube amplifier in the transmitter, but also



Tripler. Sharply filtered SSB effectively triples the bandwidth of existing fm systems, says Bell's Raymond E. Markle.

predistorts the signal so that distortion generated by the TWT is cancelled. In the Massachusetts test, this transmitter will be coupled with a receiver that corrects for multipath fading of the microwave signals.

The 1978 tests in Missouri will include not only the radio, but all other parts of the system, Markle says, including terminal multiplex equipment to combine the 6,000 voice circuits, a special microwave preamplifier that can handle both amplitude-modulated SSB channels and conventional fm channels in a single radio station, and space-diversity antennas to counter fading. □

Navigation

Loran-C transmitter does without tubes

The first Loran-C transmitters to do away with vacuum tubes are being built for the U. S. Coast Guard by Megapulse Inc., Bedford, Mass. Four of the high-powered systems have been ordered, the first all-solid-state designs of their kind.

Three of the four will cover the Gulf of Mexico, which has only minimal Loran-C coverage now, and



MOS RAMS

First JAN-qualified LSI ICs: 4K RAMs from Texas Instruments.

Now. The benefits of LSI technology come to many military/aerospace applications. With the first LSI integrated circuits ever qualified to JAN MIL M-38510, TI's types TMS 4050 and TMS 4060 industry standard MOS 4K dynamic RAMs.

Listed in QPL 38510/28, these 4K LSI RAMs offer an accepted standardized specification. Extended operating temperature range. And extra-stringent military-approved manufacture.

Standardized Specification

Military Specification MIL-M-38510/235 provides a single comprehensive document to solve your standardization problems. It cov-

ers electrical characteristics, product assurance provisions, package dimensions, test circuits, algorithms and waveforms.

Industry Standard

And the devices are standard too. The popular TMS 4050 (18 pin) and TMS 4060 (22 pin) are organized as 1096 words of 1-bit length. With simple non-multiplexed, fully decoded addressing utilizing a single clock that simplifies system design.

All inputs and outputs except the clock, are fully TTL compatible. With 200 mV minimum guaranteed dc noise immunity when interfacing with Series 54, 54S, and 54LS TTL.

JAN versions of the TMS 4050JR

and TMS 4060JR in dual-in-line packages are designated JM 38510/23502BVC and JM 38510/23501BVC. They are manufactured in TI's dedicated production line—fully certified by the Defense Electronics Supply Center. Guaranteed from -55 C to +85 C, they are \$65.00 each in 100-piece quantities.

Military Hotline

For more details on this and other planned MOS/LSI mil devices, call MOS Military Marketing collect at (713) 494-5115, Extension 2094. Or write Texas Instruments Incorporated, JAN 4K, P.O. Box 1443, M/S 662, Houston, Texas 77001.



TEXAS INSTRUMENTS
INCORPORATED

Solid-state Loran C pleases Coast Guard

The Coast Guard reports satisfactory test results thus far on the solid-state preproduction transmitter delivered to its engineering center in Wildwood, N. J., by Megapulse Inc. When seeking bids on future Loran-C transmitters, the Coast Guard will for the first time specify solid-state for the six units it may yet eventually buy for new and replacement installations, says Capt. James F. Culbertson, the service's electronic engineering chief. The system in test since December is a prototype of four production units ordered from Megapulse for about \$5 million.

"The benefits in going from vacuum-tube to solid-state technology are in efficiency and the controllability of the signal, which provides the possibility of running the transmitters remotely," says the engineering center's commander, Capt. William Roland. Vacuum-tube system efficiency is particularly poor because a standby unit must be kept powered up in reserve.

He also likes the fact that "instead of the gross failures that occur with vacuum-tube technology, there's a graceful degradation with the solid-state system." With the multiple half-cycle generators, "you don't face loss of total power, as is true with vacuum-tube systems." Each group of four generators is housed in a cabinet so the power shuts down in only that cabinet, if there is a fire there, Roland explains. "The remaining seven cabinets maintain the shape of the transmitter pulse, with the pulse timing taken care of via control circuitry."

the fourth will be installed near Seneca Lake, N. Y. to help cover the East Coast. All are scheduled to be operational by mid-1978.

Even the latest Loran-C transmitters recently installed on the West Coast [*Electronics*, June 9, p. 80] use multiple vacuum-tube amplifiers to achieve the high power required—400 kilowatts to a megawatt. The final stage of these designs incorporates a triode some 10 inches in diameter and 3 feet high that must be water-cooled.

Synthesis. In contrast, instead of generating a low-level pulse of the desired shape and amplifying it, the Megapulse transmitters synthesize the output waveform at full power, says Stephen Bigelow, vice president for operations at seven-year-old Megapulse. The synthesis is done with a series of saturable-reactor-and-transformer combinations, called megatrons. Each produces a half cycle of a 100-kilohertz signal.

A dc power supply charges at 350 volts a "substantial" capacitor bank, which then resonantly charges a second bank in a shorter time. Across this second bank sits the saturable reactor in series with the primary of the output transformer. While the bank is charging, the saturable reactor is in a nonsatu-

rated state and appears as a large impedance.

However, a small charging current does flow, and after a time, the inductor core saturates and the impedance of the reactor suddenly changes to basically a short circuit. This happens at about the time the capacitors reach full charge, discharging them through the transformer to produce the half cycle of the 100-kHz wave. Pulse amplitude and timing circuitry adjust the triggering of each megatron to control the power level and shape of the output waveshape. A saturable reactor is used instead of a silicon controlled rectifier because it can more easily handle the fast rise of the 100-kHz signal, says Bigelow.

Also part of the system is a pair of rotary switches. One switches the megatron outputs to one of two (redundant) coupling networks, the other chooses between one of two output networks to the antenna.

Lower wattage. Bigelow says that the Megapulse design requires about 90 kilowatts to generate a 300-pulse/second 400-kw Loran-C signal. This compares with a prime power requirement of some 300 kw for tube transmitters generating similar signals—one unit is always powered up and standing by. The

megatron element itself is an oil-filled container that measures 12 in. in diameter and 9 in. high. Some 6 to 7 joules are stored in the megatron before it fires, according to Bigelow, and 3 to 4 J are actually transferred to the coupling network. About 100 J are needed for a 400-kw output.

Of the four transmitters being built, three have 56 half-cycle generators (700-kw output) and the other, 400-kw unit has 32. The Coast Guard furnishes the timing signals.

Multiple megatrons are used to develop a single half-cycle, which is why the system will not fail catastrophically; if one megatron fails, others may have their outputs increased to compensate. Moreover, extensive fault-detection is built into the system. For example, detection of a failure on the coupling or output network causes automatic switch-over to the backup.

The megatron groups are staggered 5 microseconds apart over 20 μ s by the pulse and timing controller. Peak amplitude is reached in 65 μ s, after which the decay is carefully controlled to maintain the signal envelope. Ships or aircraft with Loran-C receivers then take the time differences in signals received from three transmitting stations to develop the intersecting hyperbolic curves that show them their position. The ground-wave Loran-C signals can pinpoint position to within 200 feet at a range of 1,200 miles, Bigelow points out. □

Displays

EL displays look good to British

The bright promise electroluminescent-display technology showed 20 years ago dimmed fairly quickly as users lost faith in its reliability. But 10 years of research and development may help an English company stage the technology's comeback in alphanumeric displays, despite all the competition from light-emitting-diode and other display approaches.

Using direct-current electrolumi-

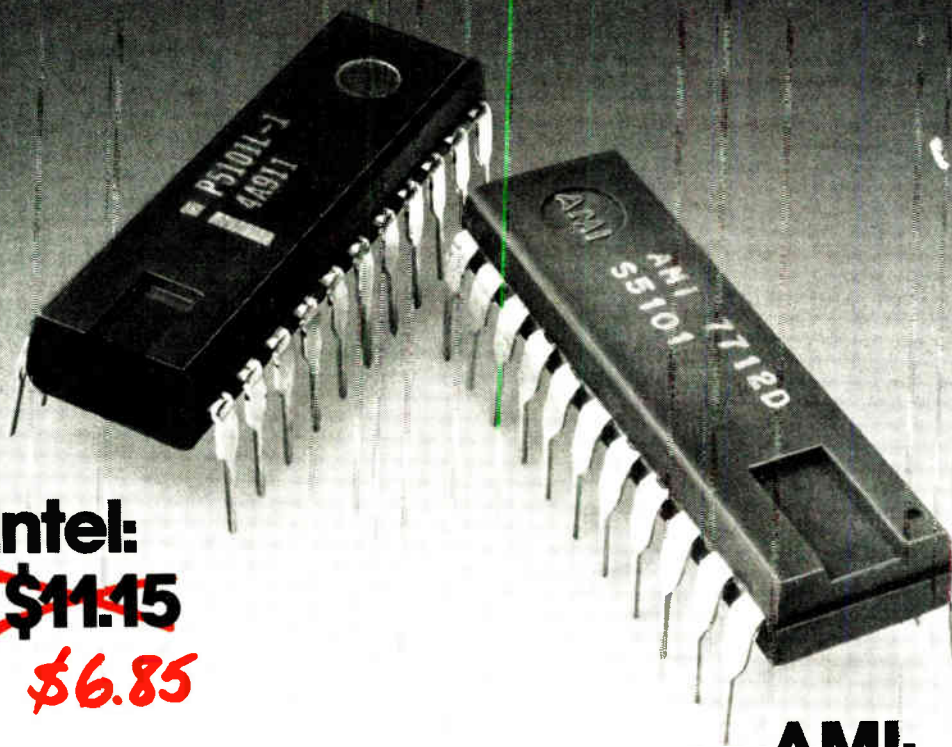

Intel:
~~\$11.15~~
\$6.85

AMI:
~~\$9.35~~
\$5.50

Our CMOS RAM ^{still} has a lot less going for it.

You can see that our 1K RAM costs less. What you can't see is that it uses less power, too.

Our 55101 takes only 10 milliamps of operating current to give you 650 nanosecond access time. The competition uses almost three times as much. Our standby power is just 10 microamps. And our L version retains data down to 2.0 volts.

With our part, you also have

far less waiting around. Call up an AMI distributor right now, and he'll supply you right off the shelf.

But we can't promise you less of everything. For instance, we have more packages to choose from—plastic, ceramic and cerdip. We have more RAMs, too, with speeds ranging from 450 ns to 800 ns. They all have the L option in case power retention is critical to your

product, and all of them operate over the full military temperature range.

Want to know more? Check with your nearest AMI distributor or sales office. Or contact us at AMI, 3800 Homestead Road, Santa Clara, California 95051. Phone (408) 246-0330. We'll prove that less is really more.

AMI
AMERICAN MICROSYSTEMS, INC.

Prices effective 6, 20, 77.

World Radio History

Circle 37 on reader service card

nescent techniques, a group at Phosphor Products Co. in Poole, Dorset, is building preproduction 256-character displays and supplying the British Post Office with trial 64-character units. Measuring 3 by 4 inches, they will go into the automatic call-recording equipment that presents routing instructions and call charges to telephone operators. The small firm also has built a 200-by-300-line, 1,250-character display under a Ministry of Defence contract and is working with Smiths Industries on car dashboard displays [*Electronics*, March 3, p. 55].

Life. Units now appear to have operating lifetimes of 10,000 hours and indefinite shelf life, says sales director Peter Smith. This achievement depends on the ability to control fabrication precisely, produce purer materials, and improve hermetic seals—the results of the research done first at Thames Polytechnic College near London and then for the last four years at Phosphor Products itself.

To produce the displays, conductively coated glass substrates are photolithographically etched with a dot pattern and matrix-address electrical leads. Phosphors of polycrystalline copper and manganese-doped zinc sulphide deposited by spreading with a blade, spraying, or silk screening, rest between the substrate and an aluminum layer that is connected to the cathode of the conductive coating. Completing the flat package are a dry atmosphere and an encapsulating resin. Dc (90 to 130 volts) instead of ac voltages are used because dc makes addressing and switching much easier.

The dc electroluminescent displays are strong on density and compactness, points out Norman Werring, technical director. Character packing densities are as good as in liquid-crystal displays and better than in light-emitting-diode and gas discharge units, he says. His 256-character panel has only 30% of the area of Burroughs's 156-character gas discharge display, even allowing for three unused lines between rows, he continues. His electroluminescent approach typi-

News briefs

Heath introduces pair of hobby computers

Electronic-kit manufacturer Heath Co. of Benton Harbor, Mich., has started a line of personal computing products for hobby, educational, and small-business applications. As expected, the line includes an advanced computer, the H11, based on Digital Equipment Corp.'s LSI-11 16-bit microcomputer technology [*Electronics*, March 3, p. 25] under a 3-year licensing agreement that gives Heath access to Digital Equipment's PDP-11 software. However, Heath is also introducing a low-end computer, the H8, based on the 8-bit 8080A microprocessor. The \$375 H8 features an intelligent front panel with octal data entry and display and a resident monitor with built-in bootstrap for one-button program loading or storing. The \$1,295 H11 has a fully wired and tested central processing unit with 4,096 bits of dynamic random-access memory, expandable to 20,480 bits. System-compatible peripherals include a 12-inch cathode-ray-tube terminal with a 12-line-by-80-character format (\$530), a paper-tape reader and punch (\$350), serial and parallel interfaces, a hard-copy printing terminal, and a cassette player-recorder.

Mailgram gets a competitor

TDX Telecommunications Inc. of Houston, Texas, is introducing a less expensive alternative to Western Union's Mailgram. The subsidiary of TDX Systems is offering subscribers Datapost, an electronic-message service that accepts typewritten messages or graphic material over a facsimile machine. Messages received by TDX's facsimile center in Chicago by 3 p.m. are delivered the next day by the U. S. Postal Service's Express Mail.

Initially, Datapost will serve 25 major cities, expanding eventually to 200 points. The cost for sending Datapost messages ranges from \$0.60 to \$1.05 per message, depending on monthly volume. A minimum of 200 messages of 200 words costs \$1.05 per message, compared with Mailgram's cost of \$1.80 per message for the same number of 100-word messages.

Honeywell to supply airborne B-1 test equipment

Honeywell Inc.'s Avionics division has won a \$19 million contract to supply test equipment for electronic systems on the B-1 strategic bomber—the first major weapons system that uses software-compatible test equipment from the manufacturing level to depot repairs. The prime contractor, Rockwell International Corp.'s B-1 division, will also sign contracts for identical equipment with the Boeing Co. and Cutler-Hammer Inc.'s AIL division, both B-1 avionics contractors.

Honeywell will supply a manually sequenced test station for communications and navigation equipment, but stations for servo, digital, microwave, display, and electronic-warfare systems will be controlled by Honeywell Level 6 minicomputers. About 90% of the hardware was developed under earlier contracts and reconfigured to meet Rockwell's specifications.

Solar panels coming from Motorola

Motorola Semiconductor is entering the solar-cell business with arrays of 48 and 36 cells, made from 3-inch wafers, from its Discrete division in Phoenix. With each cell producing slightly more than 1/2 watt of peak power, the 48-cell array is rated at a nominal 26-W output. It covers a 4-foot-square area and is intended as a power source for remote equipment. Cost for a typical medium-sized radio repeater station is estimated at about \$3,000, including voltage regulator, storage batteries, and mounting hardware.

Fairchild, Time Computer reach digital-watch settlement

Fairchild Camera and Instrument Corp., Mountain View, Calif., and digital-watch manufacturer Time Computer Inc., a subsidiary of HMW Industries Inc. of Lancaster, Pa., have reached a settlement of Time Computer's patent infringement suit against Fairchild. The maker of the Pulsar line of digital watches filed suit in December 1975, alleging Fairchild infringed on patents relating to the manufacture of solid-state light-emitting-diode modules and watches. The settlement includes a cross-license agreement.



PUSH to initiate automatic in-circuit testing of all of your analog, hybrid and digital boards.

Test *all* of your printed circuit boards, and, in many cases, completely eliminate costly functional testing. Faultfinders FF101C and FF303 in-circuit test systems give you the flexibility you need with a broad range of CPU/peripheral compatibility. And you can get full time utilization of the system computer with foreground/background programming to execute automatic program generation, text editing, data analysis or file maintenance *even while you're testing boards.*

You'll be testing more boards, bigger boards and more complex boards, so now is a good time to start checking on what Faultfinder in-circuit test systems can do to make the job more cost-efficient. Call your Faultfinder

representative:

Latham, Tom Coleman, (518) 783-7786;
Irvine, Chuck Hults, (714) 549-4901;
Chicago, Al Roraus, (312) 696-0335;
San Francisco, Bruce Douglas, (408) 432-9020;
Waltham, Thomas McLaughlin, (617) 890-4717
Europe, Marty Liebman, (49) 6196-44008;
England, Mike Cook, (44) 4204-3443.

Or start with the coupon.

FF **FAULTFINDERS Inc.**
15 AVIS DRIVE, LATHAM, NY 12110



O.K., Start.

Show me how Faultfinder in-circuit test systems can improve our production testing

NAME _____ TITLE _____
 COMPANY _____
 ADDRESS _____
 CITY _____ ZIP _____
 PHONE _____

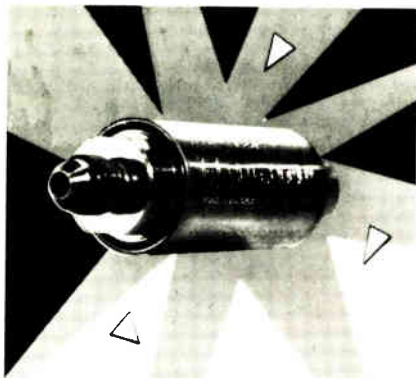

A Breakthrough in Pressure Transducer Design

The highest performance requirements of a transducer can be met economically and efficiently with the use of the CEC® 1000 Sputtered Gage Pressure Transducer, the most consistently accurate, stable and reliable thin film transducer available. Obtainable in full scale pressure ranges from 15 to 10,000 psi, the CEC® 1000 also features an innovative double case isolation which insures against externally induced mounting stresses.

Manufactured in accordance with the program quality requirements of MIL-Q-9858A, the CEC® 1000 provides combined linearity, hysteresis and non-repeatability of $\pm 0.25\%$ of the full scale output. Advanced techniques in sputtered film deposition have created sensing elements which deliver performance stability of $\pm 0.1\%$, or better, for extended operation under the most severe environmental conditions.

The CEC® 1000 is capable of Total Error-Band Performance and long-term stability — far exceeding the performance of "average" transducers. Tell us your operational parameters of your application. You may be surprised to hear of the Total Error-Band Performance attainable with the CEC® 1000.

 **BELL & HOWELL**

CEC DIVISION

360 SIERRA MADRE VILLA PASADENA CA 91109

In Canada: 125 Norfinch Drive, Downsview,
Ontario M3M 3B5

CEC is a registered trademark of Bell & Howell
© Bell & Howell 1975

40 Circle 40 on reader service card

Electronics review

cally yields 40 lines per inch but can get up to 100 on a small display.

Flexible. Another advantage is "the flexibility of design," Werring says. "You can change the display by changing the photographic artwork," unlike gas discharge where "each dot is a specifically defined gas-filled cavity" or LEDs where in a large display "you must match the different LED chips," he says.

Temperature appears not to be a problem either. Preproduction displays operate to -12°C , and laboratory models have reached -40°C , while the high end peaks to $+70^{\circ}\text{C}$. This is better than gas discharge at the low end, equals LCDs and is not quite as good as LEDs at the high end, he says. Switching speeds are relatively fast, averaging 2 microseconds per dot for about a 2.5-millisecond refresh rate in the 256-character display.

Though the devices are still in the prototype stage, Werring estimates that "we can beat most on cost." In production, the post office's 64-character display should cost about \$65. Potential applications are in word-processing terminals and small data-entry and -display terminals. In consumer products, too, they should find uses as monitoring panels for programmable appliances. □

Data security

Encryption boards may lure more users

Existing equipment for scrambling digital data so thieves, spies and worse cannot make head or tails of it has limited appeal, being expensive and added on after a data system is installed. To popularize data encryption, the Government Electronics division of Motorola Inc. has introduced under-\$500 boards that plug into a microcomputer to perform the data-encryption standard algorithm recently adopted by the National Bureau of Standards [*Electronics*, March 3, p. 74].

Motorola is hoping to interest manufacturers of terminals and

communications equipment — "an audience that is very unaware of what's going on in data security," concedes Durrell Hillis, program manager of secure communications at Motorola's Scottsdale, Ariz., division. "Our boards are designed to help people learn about encryption and get comfortable with it." Then, he hopes, they will move to 36-pin hybrid encryption circuits Motorola will be producing late this year.

The hybrids will cost about \$150 each in lots of 1,000 and will be able to protect data for just a few hundred dollars. This contrasts with, for example, the \$7,000 add-on on-line data scrambler built by Datotek Inc., an eight-year-old manufacturer of communications-security equipment in Dallas, Texas.

Two types of boards are at present available: one designed for Motorola's M6800 Exorciser microprocessor development system and Micro-module single-board computer, and another for Intel Corp.'s MDS development system and SBC microcomputer. The boards are priced at \$475 and \$495, respectively. An encryption board for Digital Equipment Corp.'s LSI-11 microcomputer will be ready later this year.

Complex. The heart of the data-security boards and hybrids is a depletion-load n-channel metal-oxide-semiconductor integrated circuit designed by Motorola, which calls it a data-security device. The large-scale-integrated chip — 200 mils on a side — executes the NBS algorithm in hardware and with over 5,000 devices has nearly the complexity of the 6800 microprocessor chip, according to Hillis.

The NBS algorithm is a complicated expression known as a recirculating block product cipher that uses a 64-bit key, essentially a password, to operate on and encrypt data. (The key itself is actually 56 bits, with 8 bits for parity error checking.) The algorithm operates on eight 8-bit bytes of data, combining the key with the data in a complex fashion that involves matrix inversions and many iterations. Eight bytes are loaded into shift registers on the data-security device one byte at a

Introducing the intelligent LED display.

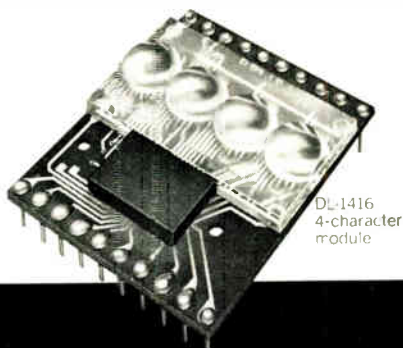

I I N T E R F A C E J U S T L I K E A R A M

Photograph of display actual size

Alphanumeric at the lowest cost ever.

This newest Litronix Alphanumeric display has built-in ASCII decoder, multiplexer, memory and LED drivers. That means it needs only the inputs you'd feed a RAM. Operates directly off a microprocessor bus. Creates all 64 ASCII characters 0.16" high — shown in actual size above.

No alphanumeric display has ever been so simple to use. Actuated entirely by TTL logic levels. Needs only a +5v supply.

And it's by far the most economical way to create alphanumeric displays as long as 80 characters. Because you don't need to supply all that built-in circuitry externally.

The DL-1416 4-character modules can be butted end-to-end to make displays of any length with equal spacing between all characters.

Now available at stocking distributors.

**I'm in favor of intelligence.
Tell me more.**

For DL-1416 data phone (408) 257-7910 or send coupon.

NAME

TITLE

ORGANIZATION

ADDRESS

ZIP

PHONE

Mail to Litronix, Dept. E, 19000 Homestead Road,
Cupertino, CA 95014. Phone (408) 257-7910.

litronix

MONOLITHIC CRYSTAL FILTERS



THANK YOU, MA BELL

For years, mobile radios operating in urban areas have been plagued with interference problems. One of the biggest is intermodulation. This is where Ma Bell comes in. Mobile telephone channels assigned to her can cause IM products to be generated at nearby frequencies allocated to local taxi-cab companies.

The solution — a monolithic front-end filter in each cab radio to protect the first stage. We make these filters as custom jobs for end users with interference problems. We also make them in low-cost OEM quantities for improving the performance of VHF single-channel receivers — paging receivers for instance. Interested? Ask about our Model 2133F.

SPEAKING OF INTERMODULATION ...

It should be noted that crystal filters — even ours — can generate IM products. Happily, this non-linear proclivity can be controlled. If your application involves IM requirements for either out-of-band or in-band signals, we may be able to help where others have failed.

Whether it's a tough IM spec, a VHF application or a plain vanilla 10.7 MHz IF filter, we've got the monolithic filter know-how to help you. Just drop us a line or, if you're in a hurry, call us via Ma Bell at (305) 298-2000.

Pi

Piezo Technology Inc.

2525 Shader Road, Orlando, FL 32804
(305) 298-2000

**The standard in
monolithic crystal filters.**

Electronics review

time, and in 160 microseconds, eight new bytes—the ciphered text—appear in the registers ready for serial output.

The hybrid encryption circuit will consist of the data-security chip, buffers and control logic, and a complementary-MOS random-access memory for storing four keys. The RAM will have battery backup to prevent loss of the key information.

The boards have everything the hybrids will have, plus devices like bus buffers that ensure compatibility with the microcomputer bus architecture for which it is designed. They appear as memory to the microcomputer, fitting into a slot in its back-

plane. Keys can be stored in an on-board RAM or in an optional 1,024-by-8-bit erasable read-only memory. The ROM holds as many as 128 keys and can store instructions as well as data.

Other manufacturers have built chips that execute the NBS algorithm, though none has plans to market them as microcomputer add-ins. By the end of the year, Fairchild Camera and Instrument Corp. will have available its 9414 four-chip, which uses a bit-slice approach and will cost about \$30 per set. The Collins Radio division of Rockwell International plans to use a p-MOS LSI chip. □

Packaging & production

Subassembly with parts, interconnects shaves cost of hand-held calculators

The cost of hand-held calculators has been squeezed till there is little left to squeeze—or is there? By developing an integrated but flexible subassembly, officials at Chomerics Inc., Woburn, Mass., say they have cut another 75 to 80 cents from the component and labor costs of makers of liquid-crystal-display calculators.

The flexible Mylar assembly con-

tains a cavity for the large-scale-integrated circuit and carries bubble-shaped contacts for the keyboard, plus contacts to the liquid-crystal display. Except for the chip cavity, which is pressed into the Mylar in a separate step, all the elements are screened onto the flexible circuit using Chomerics' proprietary silver-based inks. So are the

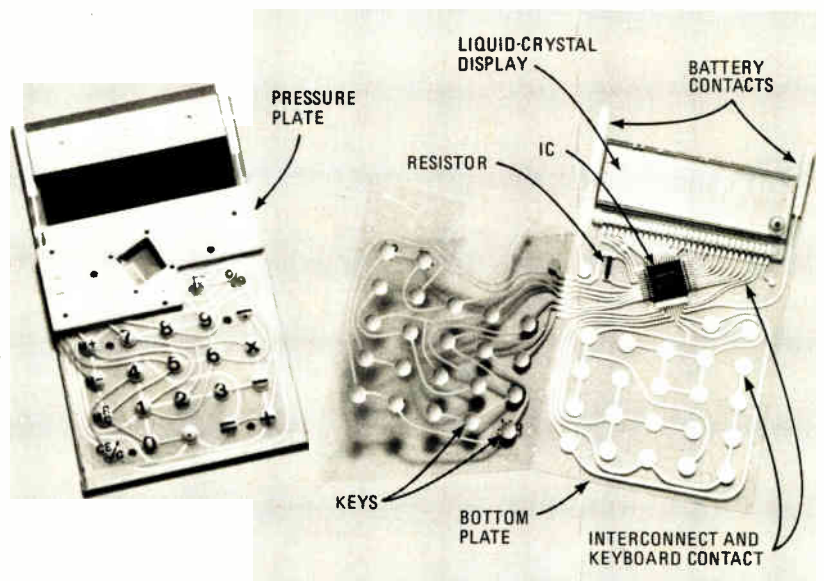

All on one. Flexible Mylar includes bubble-shaped keyboard contacts, flat-pack cavity, and screened-on resistor. Partially assembled calculator is at left.

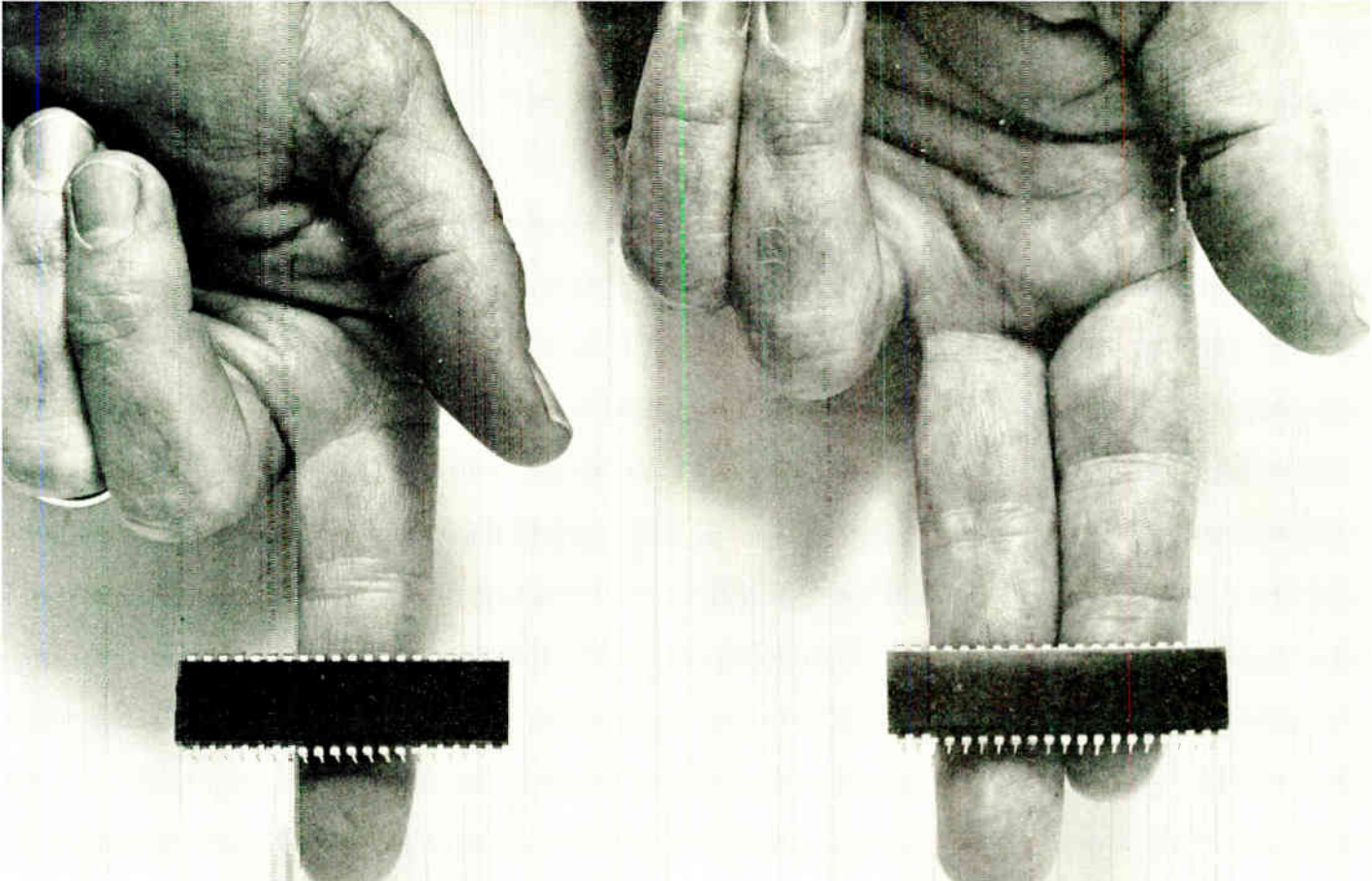

Announcing the 1800 CMOS microprocessor.

Again.

Hughes now has, off the shelf, second-source availability of RCA's 1802 CPU, 1824 RAM and 1852 I/O devices. And very soon, for the entire standard 1800 microprocessor family.

The advantages of CMOS microprocessors? Low-power dissipation, single wide-range power supply; high noise immunity; single-phase clock; full operating temperature range, -55°C to 125°C and dc-to-6.4 MHz operation.

And this is only the beginning. You'll soon be able to get the 1800 series ROMs from us.

Why Hughes? It makes sense. We were one of the pioneers in CMOS technology. We are the largest producer of digital watch modules. We have the experience, the production capability, and the necessary resources to turn out high-quality devices in large volume.

For full information, contact Hughes Solid State Products Division, 500 Superior Avenue, Newport Beach, California 92663 (714) 548-0671.

Availability Schedule

HCMP 1802 CPU	Now
HCMP 1824 RAM	Now
HCMP 1852 I/O Port	Now
HCMP 1831 4k ROM	3rd Qtr.
HCMP 1854 UART	3rd Qtr.
HCMP 1833 8k ROM	4th Qtr.
HCMP 1853 N Bit Decoder	4th Qtr.
HCMP 1856/57 Buffer	4th Qtr.
HCMP 1858/59 Add. Latch Decoder	4th Qtr.

HUGHES

HUGHES AIRCRAFT COMPANY
SOLID STATE PRODUCTS DIVISION

MOS/LSI comes to Dual-Tone detection.

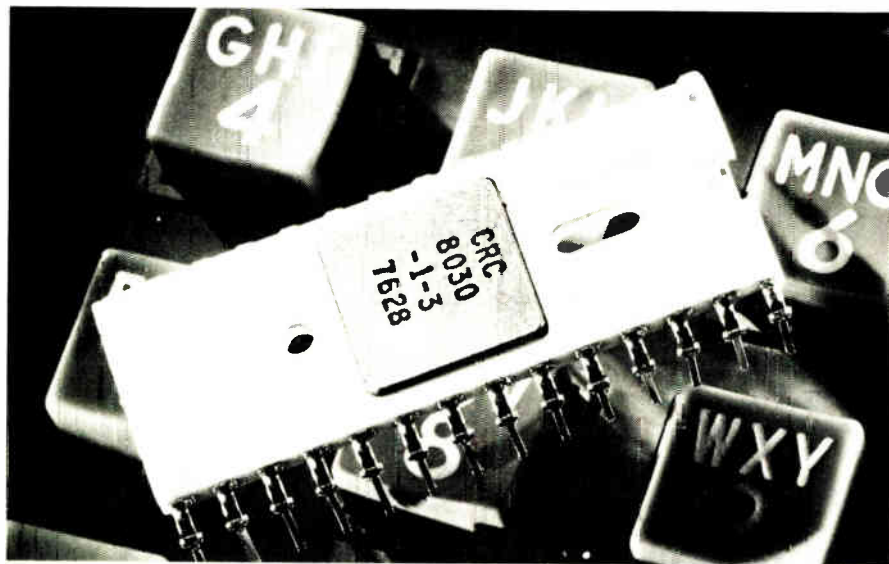

The Collins MOS/LSI digital Touch-Tone* detector is now in production. High quantity production.

It's the Collins CRC-8030.

For a low cost, high performance solution to dual-tone multi-frequency (DTMF) detection, you can't beat it. You get the economics of MOS/LSI — plus central office quality.

Here are the CRC-8030's features: Digital range filter detects all 16 Touch-Tone signal combinations. Detection in 22 to 39 MS. On-chip-oscillator operating at 3.579545-MHz color burst crystal frequency. Binary or 2-of-8 coded outputs. Operation with single or dual power supply. Many parameters can be mask programmed for custom applications.

A product of Collins high technology MOS/LSI experience, the CRC-8030 performs the key critical functions of a DTMF receiver. When used in conjunction with a front-end band-split filter/limiter, it implements a complete DTMF receiver.

Also, if you need DTMF-to-dial pulse conversion, use the CRC-8030 in conjunction with our CRC-8000 (a MOS/LSI Binary-to-Dial Pulse Dialer).

For more information on our telephony or custom MOS/LSI products and services, call your local Collins MOS/LSI Product Sales Representative. Or use the coupon below.

*Touch-Tone is a registered trademark of AT&T.

I want Collins to come to me.

MOS/LSI Marketing
Collins Hybrid Microelectronics
Rockwell International
Newport Beach, California 92663
(714) 833-4638

I want information on CRC-8030 CRC-8000 Custom MOS/LSI
 Send it by mail Call me

Name _____ Title _____
Company _____
Address _____ City _____
State _____ Zip Code _____ Telephone _____



Rockwell International

...where science gets down to business

Electronics review

subassembly's interconnect paths.

Richard Seeger, vice president for operations at the company, which makes conductive elastomers and calculator keyboards as well, says, further, that thick-film resistors are being screened onto the subsystem. This completely eliminates the usual kind of printed-circuit board that would carry components, the axial-lead resistors themselves, and the connector required to tie into the display. Also eliminated from assembly is the need for soldering, a prime source of bad contacts or troublesome solder splashes.

Sandwich. With the technique, the calculator looks internally a bit like a club sandwich. An injection-molded plastic bottom plate (at the right in the photo, p. 42) carries locating pins for the layers above it. Next comes the bottom of the Mylar subsystem, bearing the chip cavity and holes for the locating pins, as well as a cutout for the LCD. This layer also carries "ears" extending to each side of the display to make electrical contact with the calculator's batteries. An insulating layer, not visible in the photo, goes down next, and then the calculator maker folds the left or top part of the flexible subsystem over the insulator. This top also has holes for the locating pins, plus a cutout for the LSI package.

The calculator manufacturer positions the display and LSI chip in place and pressure-clamps or screws the entire sandwich together by means of a top contact plate made of injection-molded plastic. This plate also has holes for the locating pins and a cutout to allow the LSI chip to protrude through it. When tightened down, it provides the pressure for making the electrical connection between the screened interconnects on the Mylar and the LSI package leads and the display.

Seeger is aware that flexible circuitry is widely used in small calculators, but maintains that no one else offers as much integration of internal elements in one piece as Chomerics. The company has provided samples to calculator manufacturers for evaluation, he says. □

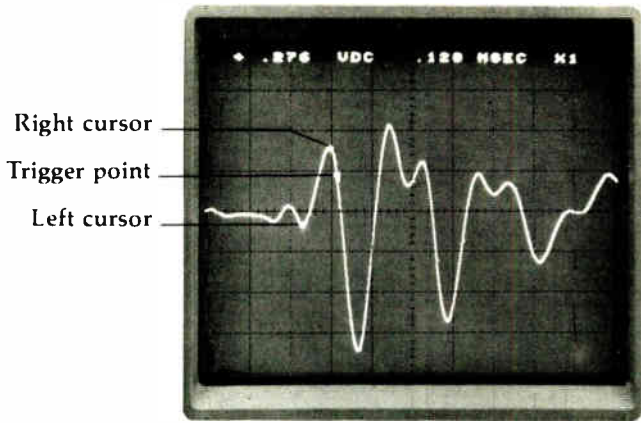

Right cursor
Trigger point
Left cursor

Biomation's new 820 Digital Storage Oscilloscope captures one-shot analog events, converts them to digital form, then holds them in memory. Exclusive pre-trigger recording lets you keep as much of the signal prior to the trigger point as you want. You can set the trigger level high enough to avoid false triggers. The delayed trigger stops the recording process trapping information before and after the event.

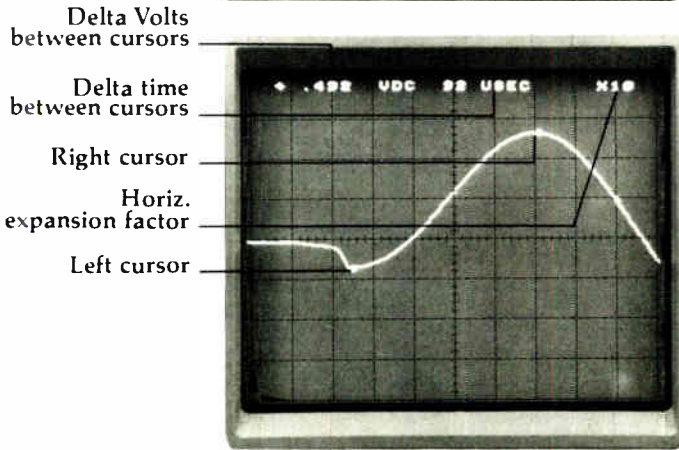

Delta Volts between cursors
Delta time between cursors
Right cursor
Horiz. expansion factor
Left cursor

Biomation's new 820 Digital Storage Oscilloscope offers you 4 MHz input bandwidth and 20 MHz A/D conversion rate to capture a broad spectrum of analog signals. Move the cursors to measure time and voltage and read them out on the CRT along with a display expansion factor. You have up to a X50 digital expansion of the display for close examination of your analog data.

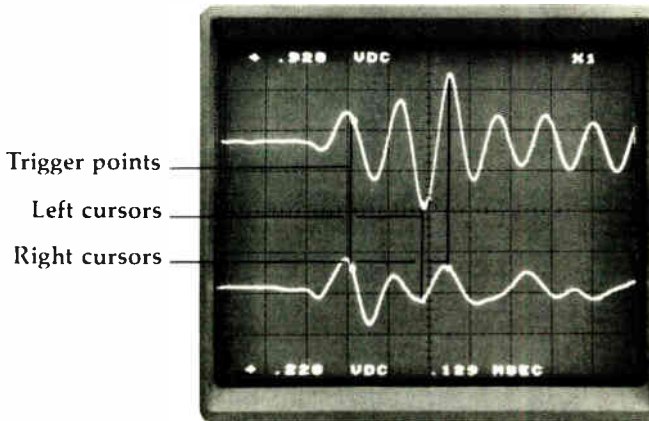

Trigger points
Left cursors
Right cursors

Biomation's new 820 Digital Storage Oscilloscope has a 2048 word memory which can be split in half to record separate analog events. Record one test signal, change a test parameter, and test again. Then you can compare the before and after signals and their voltage and time measurements right on the display.

We've just changed the way you look at things.

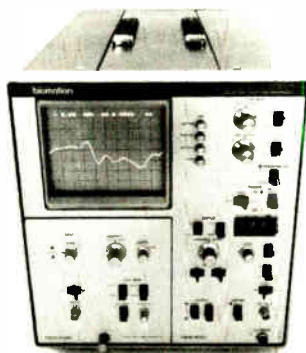

Our new 820 Digital Storage Oscilloscope offers you high performance analog capture capabilities that let you trap events you've never seen before and built-in display features that let you see that information in a whole new way. To start to put our 820 to work on your problem, call now and arrange for a demonstration. Ask for Roy Tottingham, Product Manager, (408) 255-9500. Or write Biomation, 10411 Bubb Road, Cupertino, CA 95014.

biomation

BIPOLAR MEMORIES



THE WORLD'S FIRST 4K STATIC BIPOLAR RAM IS READY FOR ACTIVE DUTY.

You can stop gluing your 1K RAMs together.

Fairchild proudly introduces the very first, fully static, 4K Bipolar TTL RAM.

It also happens to be the fastest 4K RAM ever made.

To make matters better, it's available today at good prices from your Fairchild distributor.

What else would you expect from the world's largest supplier of Bipolar Memories?

FASTER THAN A ROLLING MOS.

If you think that MOS memories roll along at a pretty fast clip, wait till you

see our new static Bipolar RAM perform. The new Fairchild 93471 has an incredible T_{AA} of 50ns max, and 25-30ns typical. On top of all that speed, you get Bipolar reliability backed by Fairchild's Walled Emitter Isoplanar™ process.

Also, because our new device is fully static, no special clocking or refresh circuits are required.

AN INDUSTRY STANDARD IS BORN.

The new 93471 is organized 4096 by one bit.

It's a 3-state device in an 18-pin package.

It offers full decoding on the chip, separate data input and data output lines, and active LOW chip select lines.

The power supply is 5 volts with power dissipation 0.12 mW/bit typical. You also get operation over full military and commercial temperature ranges.

The 93471 also comes in a version with an open

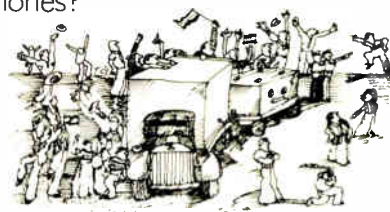

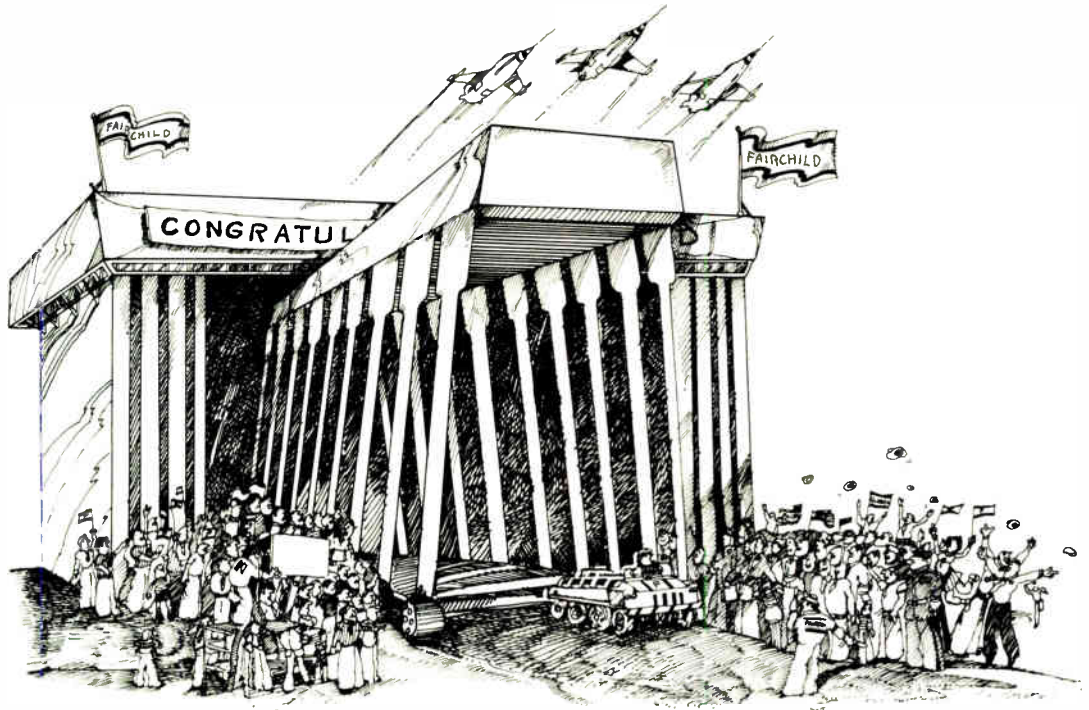

collector. We call that one the 93470. All other specs are the same.

RAM OF MANY TALENTS.

The new Fairchild 4K RAM is ideal for mainframe memories, controllers, minicomputers, CRT terminals, peripherals, add-on memories and a great number of military applications. Circuitry uses include cache, buffer and scratch pad memories.

GET THEM WHILE THEY'RE HOT.

Your Fairchild distributor, sales office or representative can get you all the parts and specs you need to completely fall in love with our new 4K RAMs. For more immediate results, call the direct line at the bottom of this ad. Fairchild Camera and Instrument Corporation, 464 Ellis Street, Mountain View, California 94042. Telephone: (415) 962-3951. TWX: 910-373-1227.

FAIRCHILD

**CALL US ON IT.
(415) 962-3951**

The Chronograph Computer.

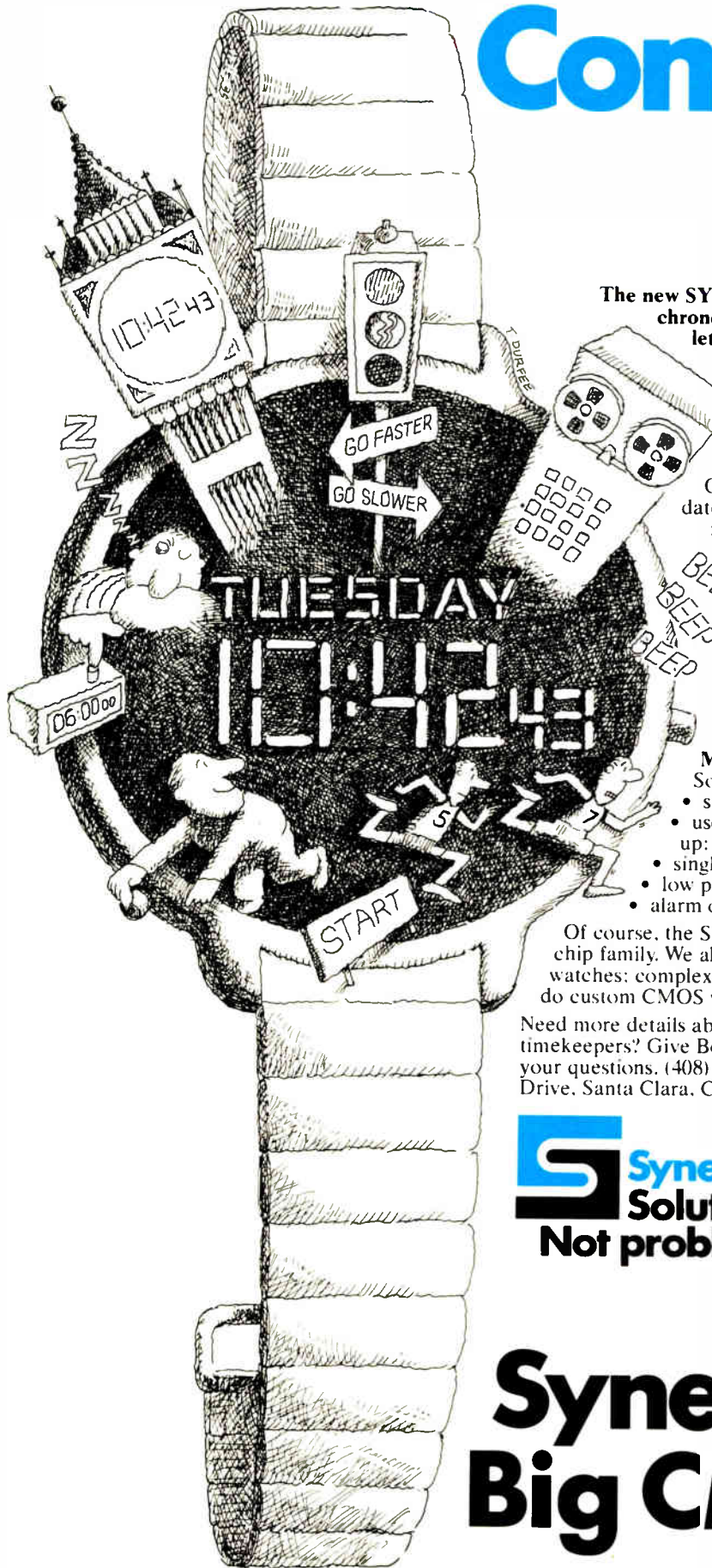

The new SY5009A delivers everything you want in a chronograph circuit. And its on-board computer lets you program it to run faster or slower.

When we designed our new chronograph chip, we threw away the rule book. We decided to build one chip that you could use in any conceivable time-keeping system.

Our SY5009A chip gives you accurate time and dates, but the fun doesn't end there. It maintains a 100 year calendar with automatic Leap Year update. Complete stopwatch functions, too. Start/stop time accumulation. Standard split. Even Taylor Split. Hundredths-of-second accuracy for those at-the-wire decisions.

How about an event counter? It's here. Alarms? Sure, plus a pre-alarm warning signal. For dozers, there's a seven-minute "snooze control," too.

More! More!

Some other features include:

- six digit LCD display (2 alphanumerics)
- user-adjustable frequency correction (speed it up: slow it down)
- single step and fast roll in set modes
- low power (one 1.5V battery) operation
- alarm output for either coil or ceramic resonators

Of course, the SY5009A is only one of our time-keeping chip family. We also make chips for LED and analog display watches: complex and wonderful. And, as you know, we also do custom CMOS work. *Big CMOS.* Try us.

Need more details about the SY5009A or the rest of our CMOS timekeepers? Give Bob Cushman a call. He'll be happy to answer your questions. (408) 984-8900. Or, write us at 3050 Coronado Drive, Santa Clara, CA 95051. TWX 910-338-0135.

Synertek.
Solutions.
Not problems.

Synertek Big CMOS.

Trade balance cut 60% by import gains in 1976

The favorable U. S. trade balance in electronics gear plummeted 60% to an \$876 million surplus in 1976 from nearly \$2.2 billion the year before. Total electronics imports approached the \$7.2 billion mark, a 57% rise. **Leading were consumer products—largely television and citizens' band radios**—which accounted for \$3.8 billion, an 86% jump. Citizens' band imports alone totaled \$577 million. Exports, on the other hand, rose only 19%, topping \$8 billion for the first time, according to the Commerce Department. Computers and components dominated the export market, with each category passing the \$2.5 billion mark, reflecting increases of 16% and 27% respectively. However, component imports climbed 40% to \$1.65 billion, while computer imports jumped 82% to \$235 million.

Other Commerce Department figures showed telecommunications exports of \$227 million, up 14.7%; against imports of \$100 million, up 7.5%; commercial, military, and industrial products exports of \$1.28 billion, up 26.3%, and imports of \$653 million, up 43.2%. Test and measuring instrument exports were down 0.6% to \$492 million against a 20% imports rise to \$180 million, while electromedical apparatus exports rose 13.8% to \$223 million against imports of \$199 million, a 15% gain.

FCC Inquiries set for a-m stereo, 4-channel fm

Two new radio broadcast inquiries have been started by the Federal Communications Commission—one on whether to adopt standards for quadrasonic fm transmissions (Docket 21310) and the other to determine the interest in a-m stereo (Docket 21313). The four-channel fm inquiry—initiated after petitions from CBS Inc., General Electric Co., and Pacific FM Inc.—has a Sept. 15 deadline for comments from radio equipment makers, broadcasters, and the public. While there is some quadrasonic broadcasting, most equipment makers believe it is a less viable market than a-m stereo. Explains one broadcast equipment specialist, "Fm quadrasonic is very complex and very expensive to develop. The limited market potential doesn't seem worth the investment." A-m stereo, on the other hand, has been described as having an annual wholesale receiver potential of \$250 million, much of it in car radios, and broadcast tests already are in progress [*Electronics*, April 14, p. 82].

The B-1 decision: some good news, but some bad

President Carter's decision to deploy cruise missiles from existing aircraft instead of producing Rockwell International's B-1 bomber is good news for two aerospace companies: **Boeing Co.**, which makes the AGM-86 cruise missile, and **General Dynamics Corp.'s Convair division** which makes the Navy Tomahawk version. The bad news: loss of many of the 9,000 jobs in California alone depending on the B-1, which will continue in R&D only.

Addenda

Projections of CB radio user **satisfaction and demand for services** are expected to be ready for the Federal Communications Commission this fall after completion of a \$100,000 contract survey of users made by the Advance Research Resources Organization, Silver Spring, Md. . . . Watch for the FCC later this year to **ban production and sale of linear amplifiers used to boost** CB station power above the 4-watt level resulting in interference to TV and other CB receivers and other electronics. The Electronic Industries Association's Citizen Radio section, comprised of 40 CB makers, says it supports the ban.

DOD draws a moral from CB radios

There is a lesson for military communications program managers in the citizens' band radio revolution. That is the judgment of Everett Greinke, assistant director of defense research and engineering for combat support, who believes future "tactical data links must follow the same route as the CB radio if we are to significantly improve performance while achieving cost goals."

Just three years ago, Greinke recalls, CB radios were characterized "by multiple-crystal-mixing schemes for 23-channel operation, discrete-device intermediate-frequency sections, and only modest requirements for harmonic and spurious suppression." In CB radios today, "we routinely find the latest in large-scale integrated-circuit technology, monolithic filters, and compliance with more stringent FCC requirements at a lower cost with extended warranties."

Will it work in DOD?

Greinke's question: "If vastly improved CB radio components can move from laboratory benches and semiconductor processing furnaces to production lines in three years or less, why can't we—or rather—how will we do so in our data link program?" It is not a simple question, particularly in view of the need for tactical data links to cope with enemy countermeasures—a problem outside the jurisdiction of the Federal Communications Commission.

Nevertheless, it is a question Greinke believes DOD's managers must address quickly, and he said so when he first raised it last month as a panelist at the Armed Forces Communications and Electronics Association's annual meeting. Greinke's call for an urgent answer will surely warm the coldest congressional hearts—even that of Rep. Robert Mollohan (D., W. Va.), whose latest critique (see p. 31) of military telecommunications includes a blast at DOD's "obsession with R&D" instead of adapting commercially available products.

Everett Greinke's solution for speeding up production of tactical data links is one that should appeal to most contractors as well. It calls for creating a larger market by consolidating the many diverse programs into fewer systems that would permit buys of larger quantities that should cut unit costs. Not only should this intensify competition within industry, but it should also increase contractor profits through longer production runs. For military users the

most obvious benefits include greater interoperability of equipment and smaller spare-parts inventories.

If DOD can stop writing specifications for complete systems and limit itself instead to form-fit-function requirements for contractors to meet, Greinke believes data links can move more quickly from development to deployment, much like CB radios.

A reorganization proposal

This is a goal long sought after by several generations of civilian leaders in the Pentagon, of course. But if Secretary of Defense Harold Brown picks up on the initiative of his predecessor, that could result in a restructuring of DOD's management of electronics programs by categories of technology, rather than individual service needs. If well organized, it could simplify many of the electronics industries' existing problems in dealing with a variety of commands for similar programs.

"There is hope," says Greinke, "that after the technical smoke starts to clear we may see the data link program managed by an executive agent under the aegis of a forthcoming DOD directive." That proposed directive—tentatively titled "Executive Agents for the Management of Categories of Electronic Equipment"—is moving toward a final draft, along with another on reliability and maintainability.

There have been reorganizations within DOD before, of course, going back to those much publicized declarations of Robert S. McNamara in the 1960s that promised to introduce hard-headed business management tactics as a means of controlling military cost overruns, duplication of effort, and equipment deficiencies. But many of those problems still plague DOD—and on an even grander scale.

Yet Everett Greinke and his colleagues have not stopped searching. With Congress increasingly on their backs as it learns more about how the system works, they cannot. After a discussion of the data link program's goals for performance, reliability, and modularity that will permit crossing service and weapons platform lines, Greinke asks: "Can the DOD bring these thrusts together on the data link program? Will our rate of technological evolution be comparable to that of the CB radio?" Right now he can only answer that "we are determined to give it a good run for the money."

Ray Connolly



HOW DOES DATA I/O KEEP YOU ON TOP OF PROM PROGRAMMING TECHNOLOGY?

We allow you complete design flexibility.

Data I/O programmers are capable of programming all of the more than 200 PROMs currently available.

You'll always be programming to PROM manufacturers' approved specifications.

Data I/O Program Card Sets are tested and certified by the PROM manufacturers themselves before we approve them for manufacturing and distribution to our customers.

If manufacturers change specifications, we

keep our customers updated on how to make proper adjustments to the card sets.

To help you reduce programming costs and reach maximum yields and reliability, we also offer a universal calibrator so that you can conduct your own periodic calibration tests.

We're there when you need us. Data I/O is a worldwide organization. Our field sales and service offices are staffed by Data I/O personnel. Our customers have direct access to us through people who understand the products.



Programmers from \$1095.00.

HOW TO SELECT THE RIGHT PROM PROGRAMMER FOR YOUR NEEDS.

We'd like to tell you more.

This fact filled tabloid gives you valuable information about PROM programming technology. To get your copy, circle reader service number or contact Data I/O Corporation, PO. Box 308, Issaquah, WA 98027. Phone 206/455-3990.

DATA I/O

THE PROM PROGRAMMER PEOPLE.

Need power-switching inductors for switching regulators?

TRW/UTC has a stock answer.

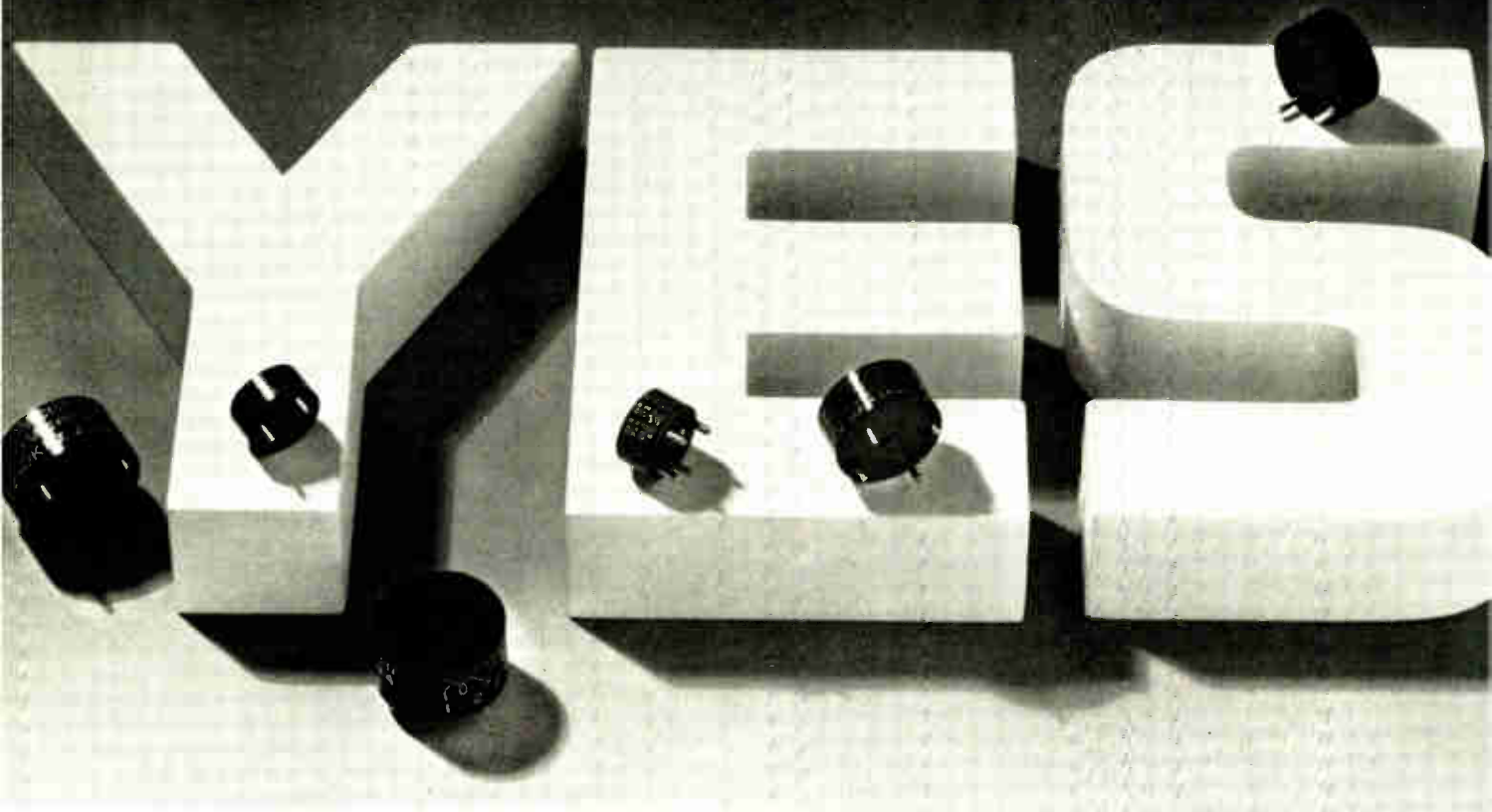

Introducing the SR series, a family of miniature high-performance, power-switching inductors.

Our SR Inductors reduce size and weight. Now you have off-the-shelf power-switching inductors with performance advantages over your in-house capabilities.

Low temperature rise and low loss characteristics combine to give the SR series high performance with maximum reliability. With an inductance range of 8 to 10,000 μ H, a DC current range from .8 amps to 15 amps, SR Inductors have low losses in the 3 to 100 KHz frequency range, making them ideal for use in switching regulators and AC filter-choke applications.

Compact and easy to install, the SR family has pin

terminals for mounting on PC boards. Available with double windings, which when brought out to four terminals permit series, parallel, center-tapped or transformer connections.

Available from stock in three sizes. Type SRA measures 7/8-in. OD by 7/16-in. height; SRB measures 1-3/16-in. OD by 9/16-in. height; and SRC measures 1-3/8-in. OD by 3/4-in. height.

Check your authorized TRW/UTC local distributor for immediate off-the-shelf delivery or contact TRW/UTC Transformers, an Operation of TRW Electronic Components, 150 Varick Street, New York, N.Y. 10013. Area Code: 212 255-3500.

TRW UTC TRANSFORMERS

ANOTHER PRODUCT OF A COMPANY CALLED TRW

Britain's STC eyes 565-Mb/s, 1-Gb/s optical links

Now that Britain's Standard Telephones and Cables is successfully sending test traffic on its recently-installed 9-kilometer, 140-megabit-per-second fiber-optic link, it has even bigger plans for the technology [*Electronics*, April 28, p. 80]. **The ITR subsidiary expects to receive soon a British Post Office research contract to establish the technology for transmitting 565 Mb/s, the equivalent of 7,000 telephone channels, over coaxial or fiber-optic cables.** This would be performed by research affiliate Standard Telecommunication Laboratories, which already has sent 1-gigabit-per-second signals over 1 km of monomode optical fiber. STC says that the 140-Mb/s trial link, which was installed through normal telephone ducts in less than 50 working days, is among the world's most advanced because it uses two repeaters that are powered through the cables from the end terminals. **Having transmitted the 140-Mb/s signals along 6 km of unrepeated optical cable, STC says that current commercial systems would need repeaters only 8 km apart—which would be a big savings in systems costs.**

Japan's TV output stumbles

Japan's TV business slumped in May as both domestic shipments and exports showed downturns from the previous month. Total production was 854,000 sets, down 5% from April but up 5.7% from May 1976. Total factory shipments, though, were only 825,000 sets, down 4.2% from April and down 8% from last May. **Exports were 412,000 sets, down 2.4% from April, and exports to the U. S. were 239,000 sets, up 1.5% from last May but far below the 299% growth of last May over the previous year.**

Optical system to handle many communication services

West Germany's Heinrich-Hertz-Institute is currently working on an optical-fiber broadband communications system that stands out because of its complexity and multitude of services it is being designed to handle. The system, now in the preliminary design phase at the West Berlin institute, **will eventually integrate all communication services such as telephone, video-phone, telex, data transmission, audio programs, and television.** One major aim of the government-supported project is compatibility with existing telephone networks. The system consists of two different wideband network levels: a digital level with decentralized switching that uses time-division multiplexing and an analog level with centralized switching and using space- and frequency-division multiplexing. The digital signals will be transmitted at bit rates of 140, 280 and 560 megabits per second, and analog signals at a bandwidth of up to 120 megahertz.

French IR detector is key to inexpensive thermal scanner

France's Arga Infrared Systems has cut the cost of infrared detectors with a device that combines the detector and preamplifier in a unit about the size of a thumb. The firm is offering the units at \$120 apiece or for less \$70 for quantity orders. **The temperature range of the new detector is -60°C to +100°C, and it is capable of detecting variations of 0.02°.** The same device, linked to a mechanical scanner, will print a thermogram on a Polaroid film pack in less than a minute. The firm claims that a thermal imaging scanner of this sort would cost around \$3,500 instead of the \$38,000 to \$55,000 for more conventional scanners.

Why fool around?

Our Snap-Lock makes your tough little connector decisions easy. It's the rugged, make-sure miniature circular connector to call for when you just don't want to fool around.

It has the right quality features: metal housing, high contact density, moisture-proof, can be pressure resistant and/or hermetically sealed.

And you can choose from enough sizes and options to make designing-in Snap-Lock as easy as it is dependable: 2 to 19 contacts, reversible, and crimp removable or soldered —

plus a variety of mounting styles, back shells and potting boots.

Positive, vibration-proof locking.

You can hear it snap into place. It won't shake loose. But release is easy with a squeeze of the metal ring.

Need a quick, pull-the-cable disconnect?

We have it: Pull-Lock. Friction holds the connector together, but a firm yank on the cable pulls it apart.

Details.

We have those, too, summed-up in our latest Snap-Lock catalog. Get your free copy.



O.K. Send me your latest Viking Snap-Lock miniature circular connector catalog.

MY APPLICATION: _____

NAME: _____

TITLE: _____

COMPANY: _____

ADDRESS: _____

CITY: _____ STATE: _____ ZIP: _____



Viking Industries, Inc., 21001 Nordhoff Street, Chatsworth, CA, U.S.A./ (213) 341-4330

Microprocessor calls tune in battery-operated door chime

Pretty soon, visitors ringing the doorbells at some homes will be greeted by their national anthem or Bach instead of the typical ding-dong. Their hosts will have bought the latest in microprocessor-controlled home gadgets—a door chime its owner can direct to play any one of 24 preprogrammed tunes.

Due to become available to British buyers this month, the approximately \$43 Chroma-Chime should be on sale to U. S. and Continental shoppers in a few months, according to its 29-year-old designer, Robin Palmer. Videomaster Ltd., a TV-game maker, for which Palmer is technical director, will be one manufacturer and distributor, he says.

Grab bag. The repertoire of the Chroma-Chime, which is built around a Texas Instruments TMS1000 4-bit microprocessor, has an international flavor. The electronic door chime will play the national anthems of Britain, France, U. S. and West Germany, as well as a tune known as "Maryland, My Maryland" in the U. S., "The Red Flag" in Britain, and "Tannenbaum" in West Germany, according to Palmer. Classical and traditional folk songs also are included in the fixed suite of melodies.

Palmer chose the TMS1000 because it had "the right track record. TI can provide an extremely competent backup service for it, so economics played a vital factor." On chip, the design also includes the oscillator, input and output circuitry, a 256-bit random-access memory to store the selection, and a mask-programmed 1,024-byte read-only memory that holds the instructions needed to digitally encode the tunes. Thus, Palmer only has to add to the printed-circuit board 5 transistors, 3 capacitors, 11 resistors, 4 diodes, 3 potentiometers, and the selector switch contacts to provide the power amplification, tone control, and tim-

ing functions. Also, because the TMS1000 is low-current p-channel metal-oxide-semiconductor, two flashlight batteries should power the door chime for a year.

When a door button is pushed, the TMS1000 starts up by recalling the desired tune from the ROM and decoding it. As each note command is encountered, the processor executes a subroutine that generates the correct frequency for the required note. Generating notes is done by counting machine cycles derived from a 400-kilohertz master clock. Palmer says the system cannot play out of tune because all notes are generated by a precise mathematical process of counting.

Each of the notes in the program is derived by counting up to a different memory-located base. In all, the program has nearly two octaves of pitch, ranging from G

below middle C to upper E. The intervals are both semitones and tones selected so that scaling in different keys is possible. Palmer says that the door chime "can play anything that is written down on a score, including rests and all the timing subtleties you can do."

On the audio side, an envelope-shaping network modifies the audio-frequency square-wave output from the microprocessor. This is fed to an amplifier via a volume control to a loudspeaker, which is driven by a direct-coupled transistor amplifier. The homeowner not only selects a particular tune with an 8- and a 3-position switch but also can choose tempo and timbre. The latter control can simulate sounds ranging from a bell to a plucked stringed instrument. The Chroma-Chime weighs 400 grams and measures 1½ by 5¼ by 7¼ inches. □

Poland

German firm signs deal to market Polish small-craft marine-radar system

Though generally trailing their Western counterparts in technology, Polish electronics producers frequently come out with devices and equipment that are highly regarded and sought by customers in the West. Examples are peripheral data-processing equipment for West European users, navigational systems for customers in Scandinavia, and piezoelectric crystals for a large computer maker in the U. S. [*Electronics*, July 10, 1975, p. 68].

Now comes word of a five-year contract involving the delivery of several hundred Polish-designed marine-radar systems to a West German firm. Partners in the deal are Bremen-based Krupp Atlas-Elektronik, itself a shipboard-radar pro-

ducer, and Rawar, a 2,000-person enterprise in Warsaw belonging to Poland's big state-owned Unitra electronics combine. The radar is a small X-band system designated the SRN207 and especially designed for motorboats, yachts, coastal fishing vessels, and other small craft, says Zbigniew Ostaszewski, Rawar's marketing manager.

"We shopped around for quite some time for a small, inexpensive system to round out our radar program at the low end," says Peter H. Adank, a sales manager at Atlas-Elektronik. "We found what we wanted in Poland." The radar system was slightly modified to the German company's specifications and will go on sale in the West as the

Atlas 2100 with a price tag of about \$3,820.

Introduced at Poland's big industrial fair held in Poznan, June 12 to 21, the equipment consists of two main parts: the display unit, with a 6½-inch-diameter cathode-ray tube, and the scanner unit, comprising the transceiver and the antenna with its drive system. This division into just two main parts, Ostaszewski says, reduces the installation costs and facilitates maintenance.

The entire equipment uses only three tubes—the magnetron, the transmit-receive cell, and the CRT. All other subassemblies are built around integrated circuits and discrete semiconductor devices. The pulse modulator, a linear type, employs a silicon-controlled rectifier for switching, and the heterodyne uses a Gunn diode with a varactor. The components are mounted on plug-in printed-circuit cards, making access to them very easy.

Electroluminescent diodes are used as tuning indicators. Mounted along the bearing scale and in the transceiver, they enable precision tuning under operating conditions and in preventive-maintenance procedures. The receiver has linear-logarithmic characteristics.

Of note are the display's high bril-

Tapping in. Offset of optical-fiber ends splits light in multiple-coupling method.

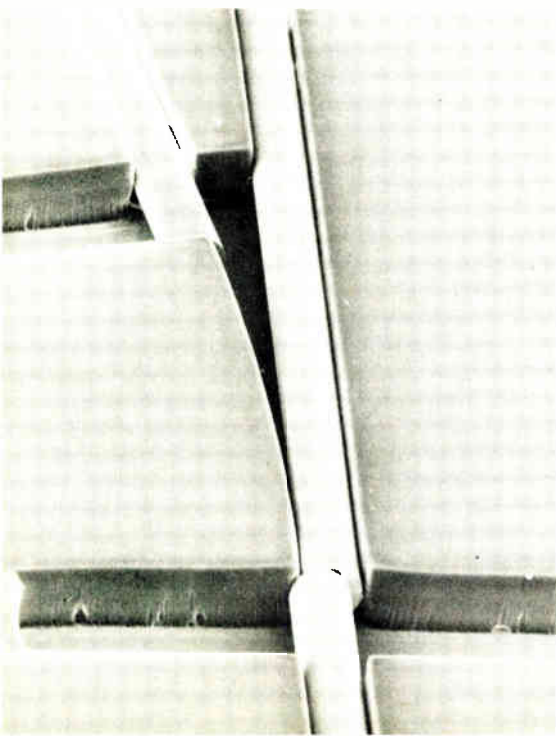

liance and good resolution and range discrimination. When set to the 0.5-nautical-mile range, the display can discriminate between distances as small as 20 meters. There is a total of six range scales extending from 0.5 to 32 nautical miles. The calibration accuracy is 1.5% of the range scale in use or 54 m, whichever is the greater of the two. The bearing accuracy is 1.5%.

Operating at frequencies from 9,320 to 9,500 megahertz, the transmitter develops 3 kilowatts of peak

power. The pulse lengths are 0.08 microsecond for the two smallest ranges and 0.3 microsecond for the four larger ones.

The antenna, a slotted-waveguide version, rotates at 30 revolutions per minute. It produces a beam with a vertical width of 20° and a horizontal width of 2.6°. All radar assemblies, Ostaszewski points out, are resistant to tropical marine environments, and the outside transceiver-scanner unit stands up to wind velocities as high as 100 knots. □

West Germany

Plastic foil with molded-in curve allows multiple optical-fiber tapping

Despite all the recent advances in optical-communications systems, it is still hard to couple a defined amount of light from one glass fiber to another without appreciable loss. Such light coupling may be required in a network that must distribute data to many receivers.

Two research engineers at Siemens AG may have a simple solution to the problem of tapping into fibers. Using planar thick-film technology, H. H. Witte and Franz Auracher at the company's Munich laboratories have produced tapping elements in which the fibers are run along tiny channels in a foil. The trunk fiber from which light is to be tapped is cut and the two ends butted, with one end slightly displaced laterally.

The light that leaves the fiber through the joint is fed along a curved boundary in the foil into the other fiber. Instead of dispersing into the foil, the light follows the curved boundary as a result of total reflection occurring at its interface with air. Just how much light is coupled into the other fiber depends on the lateral displacement of the two fiber ends at the butt joint.

Use of thick-film technology in device fabrication has several advantages, Auracher says. Simple to apply, this technique, together with photolithographic methods, allows both the curved boundary and the

channels in the foil to be made in just one production step.

What's more, the fabrication technique fulfills the requirements imposed on fiber alignment accuracy. The fiber ends at the joint can be made to line up with a ± 3 -micrometer accuracy.

Finally, a high coupling efficiency is also obtained. With laboratory-type tapping elements in which two 100- μm -diameter fiber ends are laterally displaced by 25 μm , a coupling efficiency of 74% is obtained. This means that the losses in the butt joint are only 26% or 1.3 decibels.

Fabrication. Although Witte reported on the tapping structure about a year ago, it was only recently that the two researchers produced miniature devices of optimized design and high reproducibility. The fabrication technique starts out with a light-sensitive plastic foil as thick—about 100 μm —as the fiber diameter.

Laminated to a fused-quartz substrate, the foil is exposed through a mask in conventional photolithographic methods. A single process produces both the fiber channels and the curved boundary in the foil. To complete the element, the fibers are pressed into the channels, which are just a bit narrower than the fibers for a tight fit. □

FROM  LAMBDA
THE INDUSTRY'S BROADEST LINE
OF VOLTAGE REGULATORS

THE WORLD'S FIRST
MONOLITHIC 5A, 5V, 50W
VOLTAGE REGULATOR



LAS 1905



Actual size

Compare these specifications of Lambda's new 5 amp monolithic voltage regulator

PARAMETER	 LAMBDA LAS 1905		NATIONAL		UNITS
	MIN	MAX	MIN	MAX	
Regulation-Load		30			mV
Ripple Attenuation	60				dB
Temperature Coefficient		0.03			%V _o /°C
Output Noise Voltage (BW 10 Hz - 100 KHz)		10			μV rms/V
Thermal Resistance junction to case		0.9			°C per watt
Current Limit Protection	Yes				—
Thermal Overload Protection	Yes				—
Safe Area Protection	Yes				—
100% burn-in under-load	Yes				—

△ **LAMBDA LAS 1905** **5 VOLT, 5 AMP, 50 WATT** **MONOLITHIC VOLTAGE REGULATOR** **TO 3 PACKAGE**



OUTSTANDING FEATURES

- Guaranteed input-output differential – 2.5V@ 5A
- 100% Burn-in under load
- Lowest thermal resistance – 0.9°C/watt (more usable output power)
- Guaranteed temperature coefficient 0.03% $V_o/^\circ\text{C}$
- Internal current limit and thermal shutdown
- Guaranteed ripple attenuation 60dB
- Guaranteed load regulation at 5.0 Amp – 30mV
- Safe area protection

FUNCTIONAL BLOCK DIAGRAM

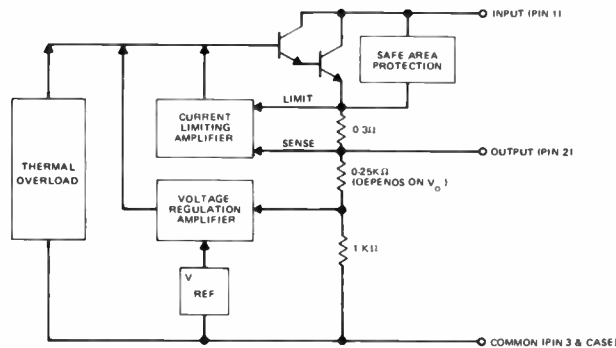

PACKAGE OUTLINE DRAWING AND PIN CONNECTIONS

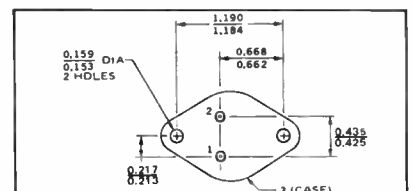
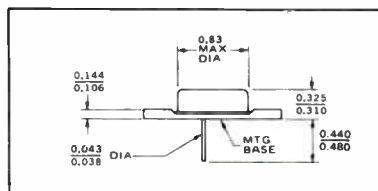
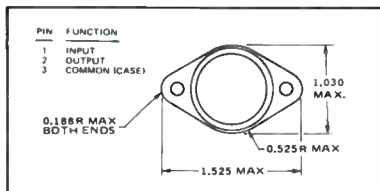

PRICE LIST

MODEL	QTY 1-24	QTY 25-49	QTY 50-99	QTY 100-249	QTY 250-499	QTY 500-999	QTY 1000-2499	QTY 2500-4999
LAS 1905	\$14.00	\$12.50	\$11.75	\$11.25	\$9.50	\$8.40	\$7.40	\$6.85

Performance Specifications

5 amp positive regulator

The LAS 1905, a three-terminal positive voltage regulator, is designed for applications requiring a well regulated output voltage for load currents up to 5 amperes. The monolithic construction of the integrated circuit permits the incorporation of current-limiting, thermal shutdown, and safe-area protection on the chip providing protection for the series pass transistor under most operating conditions. A low-noise temperature-stable diode reference circuit is the key to the excellent temperature regulation of the circuit. A very low output impedance ensures excellent load regulation. A hermetically sealed copper TO 3 package is used for high reliability and low thermal resistance. The pin connections of the devices are the same as the LAS 1500, LAS 1400 and LM 323K series thus allowing existing designs to be up-graded to 5 amperes without layout or wiring changes.

PARAMETER	SYMBOL	V _{IN}	TEST CONDITIONS I _o	T _J	LAS 1905 TEST LIMITS		UNITS
					MIN	MAX	
Input Voltage	V _{IN}	-	10mA	0-125°C	V _o + 2.5V	30	.Volts
Output Voltage ⁽¹⁾	V _o	V ₁ to V ₂	10mA to 5.0A	25°C	0.95 V _o ⁽²⁾	1.05 V _o	.Volts
Input Output Differential	V _{IN} -V _o		5.0A	0-125°C	2.5	25	.Volts
Output Current	I _o			25°C		5.0	.Amps
Standby Current	I _Q	V ₁		25°C	6.5	20	.mA
Standby Current Change with Input	ΔI _Q	V ₁ to V ₂	10mA	25°C		1.3	.mA
Standby Current Change with Load	ΔI _Q	V ₁	10mA to 5.0A	25°C		1.5	.mA
Maximum Current Limit	I _{LIM}	V _o + 5V		25°C		6.5	.Amps
Short-Circuit Current	I _S	25V		25°C		2.0	.Amps
Power Dissipation ⁽⁴⁾	P _D					50	.Watts
Thermal Resistance Junction-to-case	R _{θJC}					0.9	°C per Watt
Storage Temperature	T _S				-65	+150	°C
Maximum Operating Junction Temperature	T _J				-55	+135	°C
Regulation-Load ⁽³⁾	(REG) _L	V _o + 5V	10mA to 5.0A	25°C		0.6	%.V _o
Regulation-Line ⁽³⁾	(REG) _{IN}	V ₁ to V ₃	3.0A	25°C		2.0	%.V _o
Temperature Coefficient	T _C	V ₁	0.1A	0-125°C		0.03	%.V _o /°C
Output Noise Voltage ⁽⁵⁾	V _N	V ₁	0.1A	0-125°C		10	.μVrms/V
Ripple Attenuation	R _A	V ₁	2.0A	0-125°C	60 ⁽⁶⁾		.dB

- (1) V₁ = V_o + 3V, V₂ = V_o + 10V, V₃ = V_o + 12V
- (2) Nominal output voltages are specified under ordering information
- (3) Instantaneous regulation, average chip temperature changes must be accounted for separately

- (4) Derate above T_C = 90°C @ 900mW per °C
- (5) Specified in μVrms/volts output BW = 10 Hz - 100K Hz
- (6) Ripple attenuation is specified for a 1 Vrms, 120 Hz input ripple.

Operational Data

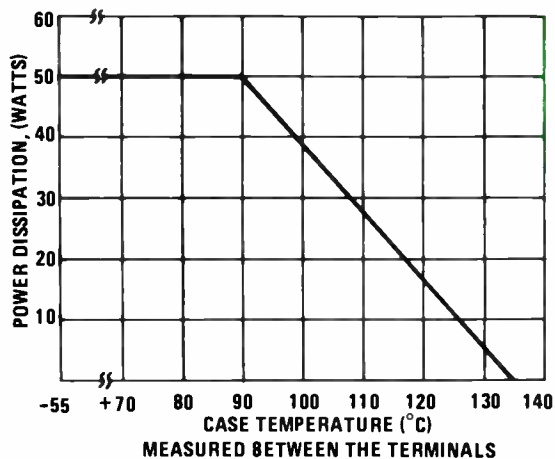

LAS 1905 POWER DERATING

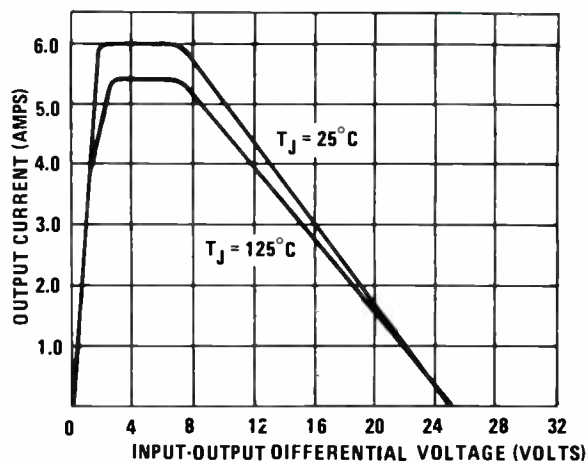

TYPICAL CURRENT LIMIT VS INPUT-OUTPUT VOLTAGE DIFFERENTIAL

Operational Data

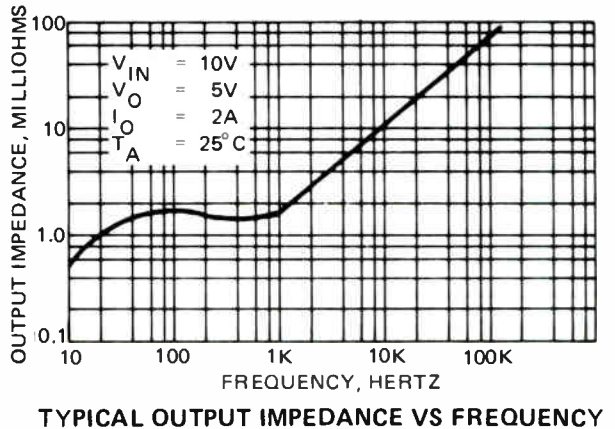
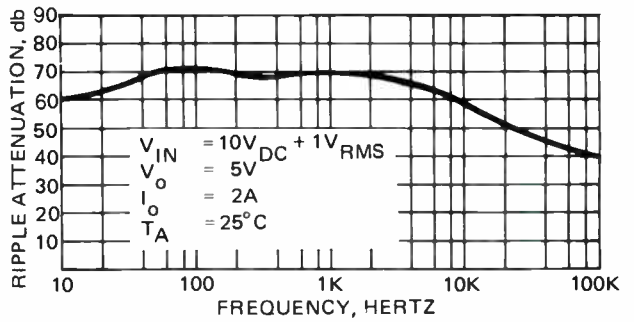
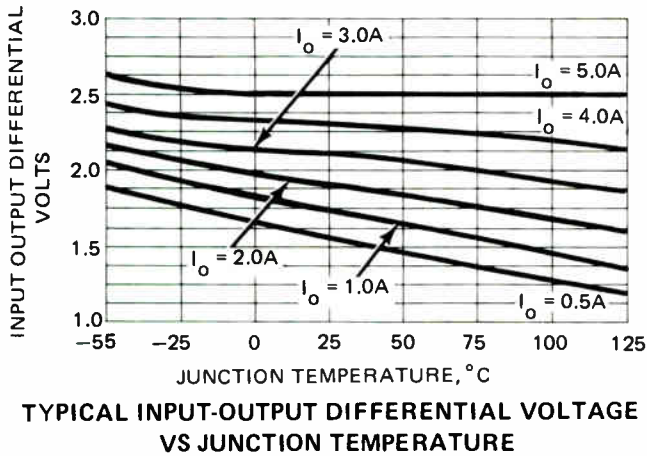

Connection Diagrams

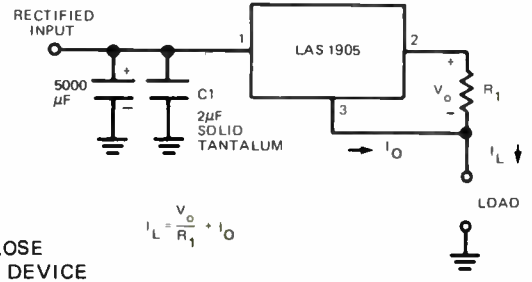
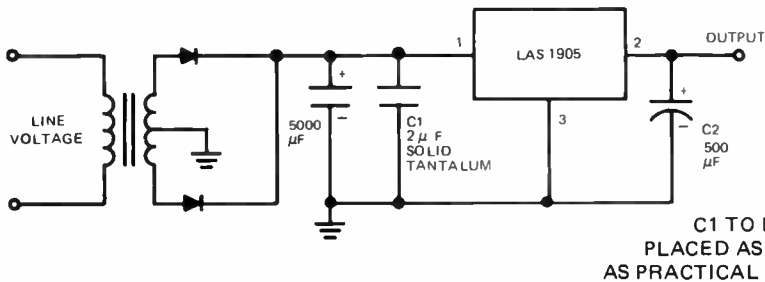

▲ Lambda staffed sales and service offices

1
MID-ATLANTIC REGION
 Melville, New York 11746
 515 Broad Hollow Road
 Tel. 516-694 4200
 TWX: 510-224-6484

Long Island, N.Y.; New York, N.Y.;
 Northern New Jersey
 Tel. 516-694-4200

Delaware; Eastern Pennsylvania;
 Southern New Jersey
 Tel. 215-279-5644

Maryland; Dist. of Columbia;
 Northern Virginia
 Tel. 703-451-9340

Southern Virginia;
 North & South Carolina;
 Alabama; Georgia;
 Tennessee; Mississippi
 Tel. 704-542-1991

2
NORTH-EASTERN REGION
 Lexington, Massachusetts 02173
 2 Militia Drive
 Tel. 617 861-8585
 TWX: 710-326-7558

Rochester, New York
 Tel. 716-454 6770

Poughkeepsie, New York
 Tel. 914-297 4800

3
SOUTH-WESTERN REGION
 Dallas, Texas 75231
 6950 Winchester
 Tel. 214 341 5130
 TWX 910-861 9048

Houston, Texas
 Tel. 713 464 6554

Oklahoma
 Tel. Enterprise 2 183

Largo, Florida
 Tel. 813 596 5151

4
MID-WESTERN REGION
 Arlington Heights, Ill. 60005
 2420 East Oakton St., Unit Q
 Tel. 312 593 2550
 TWX -310 222 2856

Minneapolis, Minnesota
 Tel. 612 935 6194

Cleveland, Ohio;
 Western Pennsylvania
 Tel. 216-585 7808

5
FAR-WESTERN REGION
 Carson, Calif. 90746
 20601 S. Annalee Ave
 Tel. 213-537-8341
 TWX 910-346-7649

Phoenix, Arizona
 Tel. 602 996 1010

6
NORTH-WESTERN REGION
 Sunnyvale, California 94086
 599 N. Mathilda Ave., Suite 210
 Tel. 408 738 2541
 TWX 910 339 9243

INTERNATIONAL
 Lambda Electronics Corp. Export Dept
 515 Broad Hollow Road
 Melville, N.Y. 11746
 Tel. 516 694 4200
 TWX 510 224 6484
 Cable: Lambdatron, Melville, N.Y.

ENGLAND
 Lambda Electronics
 Abbey Barn Road Wycombe Marsh
 High Wycombe, Bucks HP 11 1RW
 Tel. High Wycombe 36386 7 8
 TWX 837153
 Cable: VEELAM HIWYC

CANADA
 Veeco Lambda Ltd
 100C Hymus Blvd
 Pointe Claire, Quebec H9R 1E4
 Tel. 514 697 6520
 TWX 610 422 3025

Veeco Lambda Ltd
 P.O. Box 901, Postal Station K
 Toronto, Ont. M4P 2G9
 Tel. 416 486 0794

FRANCE
 Lambda Electronique S A
 Route de Grivery
 91 Gometz le Chatel
 Address Postale: BP 77 91403 Orsay
 Tel. 012 1487

GERMANY
 Lambda Netzgeräte GmbH
 Lindenstrasse 93
 D 7590 Achern 15
 Tel. 078 41 5527
 Telex 752209 Lake D

ISRAEL
 IS LAMBDA ELECTRONICS LTD.
 85 King Solomon St
 Tel. Aviv, Israel
 Tel. 240 672
 TWX 03 2470 COIN (IL) LAMBDA

JAPAN
 Pan Electron Inc
 1 Higashikata Machi, Midori Ku
 Yokohama, Japan
 Tel. 045 471 8811

LAMBDA MANUFACTURING PLANTS
 Melville, N.Y.
 Plant I 515 Broad Hollow Rd.
 Plant II 1770 Walt Whitman Rd.
Reynosa, Mexico
Corpus Christi, Texas
 121 International Dr.

DESIGNED, DEVELOPED
 AND MANUFACTURED BY



▲ LAMBDA



Downtown is now uptown.

Reports of the death of Main Street U.S.A. are greatly exaggerated. All across the country, bold and imaginative programs spearheaded by architects are rescuing our hometowns' downtowns from decay.

Blighted structures are being reborn as sound and often innovative housing and business places. Entire districts are being restored and protected. Our architectural heritage is being saved.

Best of all, people are going downtown again, bringing with them a revitalization of commerce and industry, a resurgence of social contact.

Recently *Architectural Record* reported on the revitalization programs of eight representative small towns and medium-sized cities. Spelling out how community leaders, architects and urban planners brought new life and hope back to their hometowns, this comprehensive report became a blueprint for other localities. All of these efforts are creating new options for people, creating new ways of living that people feel comfortable with.

Tangible social benefits such as this clarify the role that McGraw-Hill magazines have played for many years. That of reporter, fact-finder, educator, and sometimes, conscience.

McGraw-Hill Publications Company, 1221 Avenue of the Americas, New York, N.Y. 10020.

McGraw-Hill Magazines



We help the doers get things done.

The P400 makes excuses obsolete.

A new product comes on line and the circuit boards start piling up. This is when the excuses begin:

"I can't get near the computer."

"I need more programmers."

"I just got schematics last week."

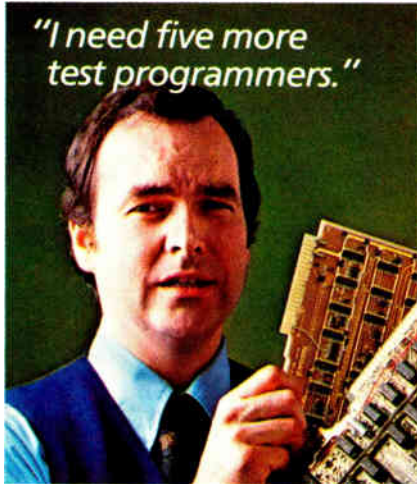

It's a difficult time for a test engineer because the success of an important product can hang in the balance.

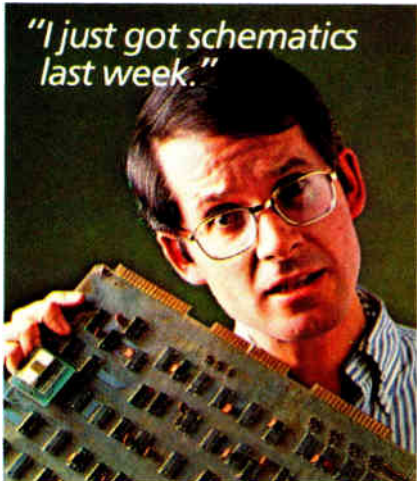

But Teradyne's P400 Automatic Programming System has changed all that. Used with L100 series test systems, the P400 creates the entire test program

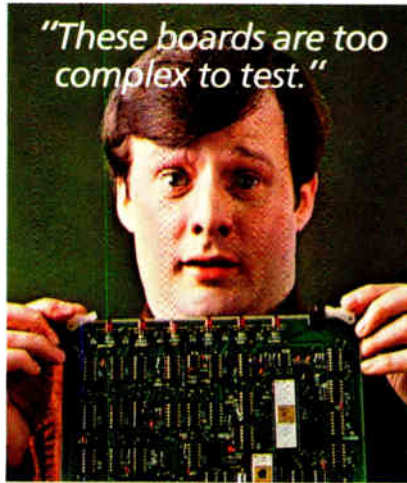

automatically. It gives you all input patterns, provides all diagnostic data, and resolves all races. It cuts programming time from weeks to days. And it does it all without tying up the computer on your production tester or increasing your programming staff.

Suddenly, new programs can be ready on time, even in the face of the tightest schedules. And even for the most complex boards.

Just as important, the P400 spares you all the boring work it usually takes to deliver new programs. You get typically better than 95% fault coverage simply by using the telephone to access a large computer containing the P400 software.



The P400 Automatic Programming System.

Now there's no reason for being late.

And we think that's the way you want it.

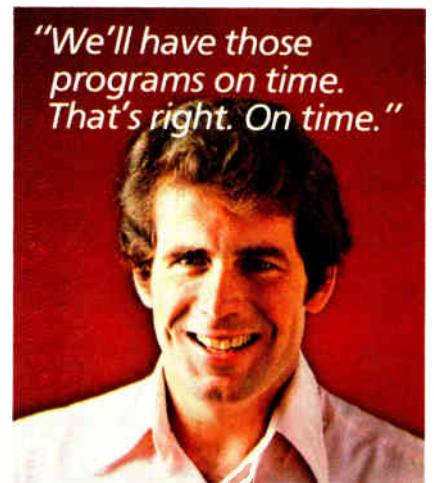

East Germans press components work

Emphasize technological self-reliance in sophisticated electronics while exporting 60% of their production

by John Gosch, Frankfurt bureau manager

Ask East German electronics officials what characterizes their industry and they will most likely cite the large volume of exports and their various efforts to be self-reliant in technology.

Self-sufficiency is demonstrated by development of microprocessors and other advanced components, as well as by a strong native computer industry. Official figures bear out the significance of exports. Of the total production in communications and related equipment, about 60% goes abroad. The figure for office machines is well over 50%; for automation and control equipment, about 55%.

With East Germany firmly in the Soviet economic sphere, the bulk of shipments goes to the other members of Comecon: the Soviet Union, Poland, Czechoslovakia, Hungary, and some other Eastern Bloc countries. The Soviet Union, by far the biggest electronics consumer in the East, takes the bear's share of East German foreign deliveries.

All this has helped East Germany become the No. 2 electronics producer in the Socialist world, trailing only the Soviet Union. And the East Germans expect to keep that position at least through the end of this decade—when, according to some knowledgeable West German observers, Poland will start overtaking East Germany both as an electronics user and as a manufacturer.

To value East Germany's electronics output in dollars is difficult. (Complicating matters are the different exchange rates used at home and abroad.) But most sources agree



Checking it out. At VEB Robotron-Elektronik in Dresden, EC2640 central processing units undergo tests. East Germany's computers mesh with those of others in Comecon.

that production by the country's combined electrical and electronics industries in 1974, the latest year for which they have figures, was worth about \$8 billion. According to estimates from a large West German firm, domestic consumption by electrical and electronic products in 1975 was close to \$5 billion.

As do other Eastern Bloc countries, East Germany works according to five-year economic plans. The current plan, which runs through 1980, again gives top priority to the electrical-electronics industries. Output is scheduled to increase 42% during the 1976-to-1980 period. The growth rate for communications and electronic components is to be even higher. Rising still steeper will be production of data-measuring and -control equipment, which will jump between 60% and 90%.

"Progress in the electrical and

electronics industries depends on developments in the components sector, particularly on developing and putting into production highly integrated solid-state circuits." These words, from Otfried Steger, head of East Germany's Ministry for Electrotechnology and Electronics, give an inkling of the key role.

Pointing up the efforts East Germany is making in this sector is the development of a large-scale-integrated microcomputer. This "makes the GDR the Socialist bloc's second country, after the Soviet Union, to have such device," says one East German engineer.

Built on 8-bit CPU. Developed at VEB Funkwerk Erfurt, the system is built around an 8-bit parallel central processing unit, a device fabricated in p-channel metal-oxide-semiconductor silicon-gate technology. External to the CPU are a static 2,048-

This article is the first in a series that will examine the electronics industries of the nations of the Eastern European Bloc, or Comecon.

Probing the news

bit read-only memory based on metal-nitride-oxide-silicon techniques and a dynamic 1,024-bit random-access memory also using p-MOS silicon-gate technology.

Illustrating East Germany's strength in electronic components quantitatively is a 1975 production level of nearly \$946 million—almost 13% higher than the previous year's output. As expected, the increase for semiconductors was even steeper—a hike of about 19%.

One sector in which the East Germans are considered Bloc pacesetters is communications. Exemplifying their expertise are automatic telephone switching centers; capacity frequency-multiplex systems with low- and high-channel capacities; microwave gear for telephone, television, and radio transmissions; and pulse-code-modulation systems.

Some 18 facilities, backed by the efforts of the Institute for Communications Technology in East Berlin and several technical universities, turned out an estimated \$750 million worth of equipment last year. Annual growth of communications equipment production has been between 8% and 10% in recent years.

The current economic plan calls

On the tube. This Robotron PBT4000 CRT display terminal utilizes a microcomputer. It is made by VEB Kombinat Robotron.



for a considerable expansion and modernization of its services. By 1980, about 200,000 telephone subscriber lines are to be added, and the degree of automation in long-distance dialing is to be raised to 93%. More frequency-multiplex systems, mobile- and stationary-radio communications services, and data-transmission links are to be installed.

But the bulk of the business will once again come from abroad. Direct exports account for about 60% of production, says Manfred Tietze, director general of the 36,000-worker communications and related measuring-equipment industry. On top of that come indirect exports, as defined by sales of hardware to domestic systems makers who ship their products abroad.

Comprehensive. One reason for the communications industry's success abroad is that "we can offer customers comprehensive system solutions—from project planning and design to equipment installation and commissioning, including maintenance," Tietze says. This turnkey approach has won the East Germans a number of substantial contracts abroad. For example, there are the installation of some 140 large and small phone exchange systems in Cuba, the construction of local and trunk exchanges for more than 3 million subscribers in the Soviet Union, and similar projects in Egypt, Iraq, Vietnam, and elsewhere.

The export refrain continues with the electronic-office-equipment and small-computer makers. Well over half of last year's \$800 million output last year wound up on foreign markets, says Gunther Weber, who heads East Germany's efforts in the field. Earlier this year, the Russians ordered about \$180 million worth of small data-processing and office equipment—the largest order they ever placed for such gear in East Germany.

The task of building office equipment belongs to VEB Kombinat Zentronik, a 40,000-employee combine with eight member firms. Among Zentronik's chief products are invoicing and accounting machines, data-collection systems, input and output peripherals, word processors, and drafting equipment.

A recurring goal of the economic plans is raising productivity—this year, the goal is a 6.3% hike over the 1976 level. And because it has a labor shortage, East Germany must rely on computer technology and automated production in as many industries as possible.

Computer activities are closely meshed with those of other Comecon members, and intra-Bloc cooperation has resulted in a unified series of central processors characterized by standard interfaces permitting the use of common peripherals. In this series, called ESER, all computer models built by the Soviet Union, Poland, Hungary, Bulgaria, Czechoslovakia, and East Germany are upwardly compatible.

Under the ESER program, East Germany builds the EC1040, a third-generation 1,024-kilobyte multipurpose system that is capable of handling 380,000 operations per second. Using transistor-transistor logic, the system has a cycle time of 0.9 microsecond and an access time of 0.45 μ s.

In consumer electronics, the industry has its job cut out for itself: satisfying the population's craving for television sets, stereo equipment, and other entertainment products. Demand for certain items is enormous. There are plans to more than double the output of color TV sets this year to close to 200,000.

As for black-and-white receivers, the industry faces pretty much the same problems as do producers in the West—declining sales as more and more people become set owners. For a population of about 17 million, the saturation for black-and-white models has reached more than 90%, industry officials say. However, with only 10% to 15% of East German households having color TVs, the slack in monochrome receiver production will be more than taken up in the coming years by color sets.

In technology, the country's set designers are not doing badly at all. Following the practice of their West German counterparts, they have turned to modular design techniques, are incorporating ultrasound remote control, and are making abundant use of integrated circuits—all to streamline receiver production and ease viewer control. □

LOOK:

1. Characterize phase lock loops.
2. Generate digital phase modulation.
3. Program signals 10kHz to 2600MHz.

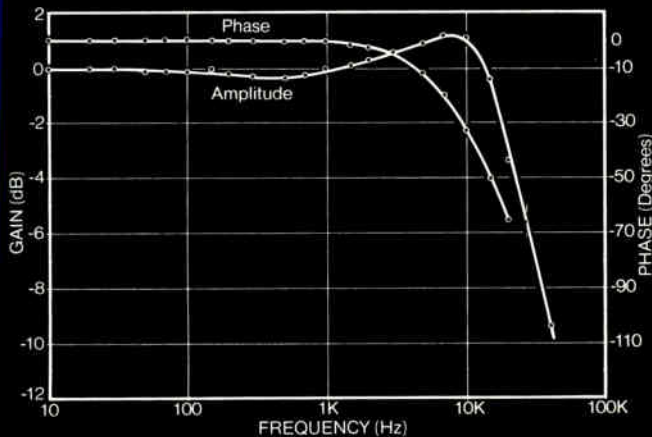

1. A complete Bode Plot of a phase lock loop can be generated with 8660C phase modulation capability.

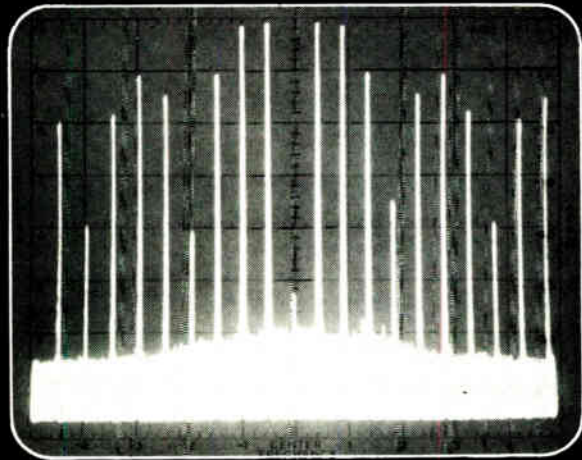

2. A QPSK phase modulation signal is shown with 1 MHz clock rate and 50 dB carrier null.



3. 8660C Synthesized Signal Generator under 9825A Desk Top Computer Control provides fully programmed signals from 10 kHz to 2600 MHz with AM, FM, phase or pulse modulation.

Look how the HP 8660 Synthesized Signal Generator makes a lot of things easy. Its phase modulated signals allow you to test a wide variety of phase lock loops in their closed loop operating condition. And low frequency drift gives good results even with narrow band PLL's. We've discussed it in detail in our Application Note 164-3.

You can use the HP-86634-35 Modulation Sections with their analog phase capability to generate discrete phase states for binary and quadra-phase shift keyed (BPSK & QPSK) signals. Such signals will prove valuable for applications such as communications receiver testing, military secure links and time domain multiple access satellites. Our Application Note 164-4 tells how to build the simple interface circuit.

You can also use it as a programmable signal simulator. Application Notes 164-1 and

164-2 show how to program the 8660A/C for automatic test systems or signal simulation.

The versatile 8660A/C Synthesized Signal Generator and its family of three RF output plug-ins (10 kHz to 2600 MHz) and 5 modulation plug-ins (AM, FM, ϕ M, and pulse modulation) are made even more valuable with the information in these application notes:

- AN 164-1 BCD Programming
- AN 164-2 Calculator Programming
- AN 164-3 Phase Lock Loop Testing
- AN 164-4 Digital Phase Modulation

Circle the appropriate bingo number, or contact your nearby HP field sales office.

HEWLETT  PACKARD

1507 Page Mill Road, Palo Alto, California 94304

Industrial electronics

Energy-control systems makers watch utilities

by Raymond P. Capece, Computers Editor

If anyone should be viewing the future with unalloyed optimism, it is the maker of systems that control energy use in buildings. "The beauty of the whole energy-management market is that everyone benefits," says Roy V. Gavert, marketing vice president of Westinghouse Electric Corp.'s Industry Products division. "It opens up a whole new selling opportunity for the manufacturers, it offers a customer significant savings on his fuel bill, and from a world-wide aspect, it conserves precious fuels."

For manufacturers selling into this \$50 million-a-year market, impending changes in utility billing methods may prove to be still another plus. The reason is that energy-management systems base savings to users not only on reduced fuel consumption, but also on using the billing schemes of utilities to their own advantage—in some cases meaning savings in fuel bills ranging from 12% to 20%.

There are two basic billing schemes, though they may be combined. One is peak-demand billing, the other time-of-day billing.

Highs and lows. Peak-demand billing bases the charge per kilowatt on a peak power level the user has reached at some time in a particular period. Such billing is often subject to a "ratchet" effect: the customer may be paying peak-level rates for six months or more, even though he uses far less average power.

One municipally owned utility in southern California ratchets the cost for as long as 11 months—which is why the Anheuser-Busch Inc. breweries in Anaheim, Calif., installed a management system. Based on an

IBM System 7 computer, it lowered the brewer's peak demand level by 700 kw and lopped \$1,400 off the top of the monthly bill. Says Marvin Port, assistant plant engineer at Anheuser-Busch: "The system saves us about \$3,000 each month overall, and so our savings on demand charges is about equal to our savings on consumption."

Less with more. The premise is that a firm can actually save money while still using the same amount of electricity—but at different times and by watching those peaks. But here is where that worrisome change comes in. Port says the utility company will soon switch to a time-of-day billing system that will have only two rates—daytime and nighttime—and this means the elimination of demand charges along with the savings on them yielded by management systems. In the case of Anheuser-Busch, that means half of its overall savings. But throughout the rest of the country, the move is to time-of-day billing with demand charges still included.

Particularly hurt by higher daytime rates are retail businesses, which cannot shift operations to night hours. That is why such systems makers as Westinghouse are looking to stores and small businesses, particularly supermarkets, which they see as a potential half-billion-dollar market.

Makers of the large systems—those selling for at least \$100,000—see a bull market. They expect it will be easier to sell their equipment as utility rates increase and billing schemes change, since installations would pay for themselves in two years or less where it once might



Control center. Pilot-light module of Delta 1000 from Honeywell provides plant managers with means of controlling energy use right in the equipment room.

have taken five or more to build up enough savings.

But though billing changes come and go, prospective users of energy-management systems still may select from a wide range of options. Large management systems like Anheuser-Busch's are suited to centralized control systems, where one computer is managing up to a dozen or so buildings. Federated Department Stores Inc., which encompasses 20 divisions including Bloomingdale's, Abraham & Straus, Filene's and others, is managing 50 stores on four IBM System 7 computers.

Stores separated by a few miles are tied in over phone lines, though

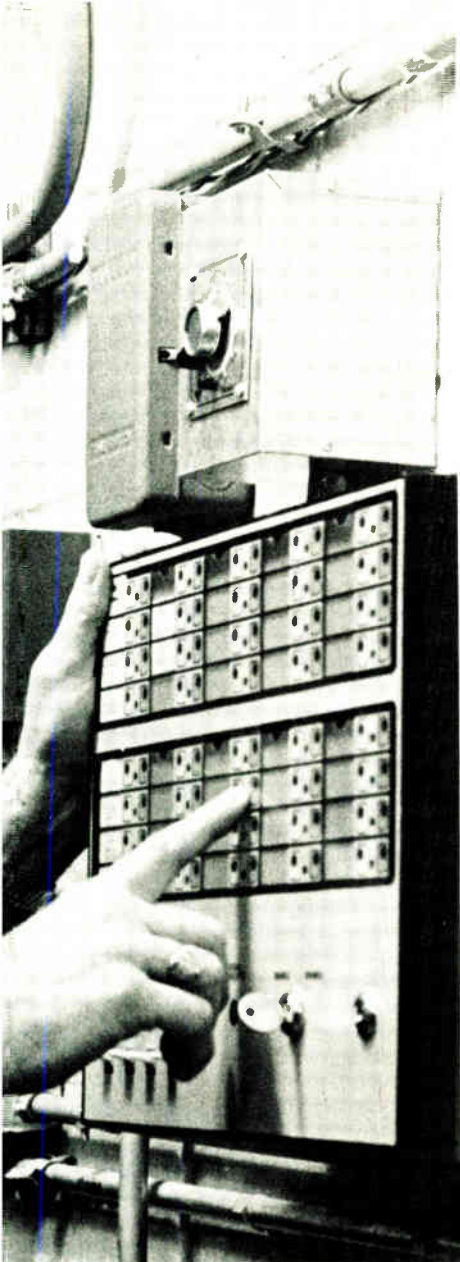

they are powered individually so that no loads are shared by any of the separate buildings. At the other end of the scale, Federated has installed smaller stand-alone systems in stores that are too spread out for central management. In stores in New York City, including Bloomingdale's and Abraham & Straus, Federated has installed microprocessor-based systems from CSL Industries, a privately owned company in Rock Island, Ill.

CSL, with a few thousand installations, has the greatest number of management systems in the field, claims its executive vice president, Jerry Montrose. Among its customers are J. C. Penney, Montgomery Ward, Times Square Stores, and Phillips-Van Heusen. The Monitrol line of management systems from

CSL uses an 8080 microprocessor and reduces both consumption costs and demand charges—the first by automatic startup, shutdown, and load cycling, and the second by anticipating peaks and shedding loads until the threat is over.

Not all makers of management systems believe microprocessors are flexible enough to handle an ever-increasing number of parameters. One is Joseph Ackerman, director of engineering at Energy Control Systems Inc., a privately owned company in Atlanta, Ga. Using a Hewlett-Packard 9815 desk-top computer, ECS programs its systems to adjust the air-conditioning as the sun moves and monitor temperatures, as well as to watch peak usage.

Sharing. Large computer systems can have advantages. Honeywell Inc.'s commercial division in Minneapolis, Minn., which makes the large Delta 1000 and 2000 systems, has incorporated fire alarms, inventory control, and security—including closed-circuit television—into one centrally located processing unit. And Honeywell's time-shared management system, called BOSS, can be used without a large capital investment for as little as \$1 an hour.

Westinghouse Electric Corp. is involved in three areas of management, spanning a range from simple controllers on the low end to industrial energy management, which is more a utility type of control.

But aside from supplying control gear to original-equipment manufacturers, Westinghouse, unlike Honeywell, has steered clear of building management, which includes air-conditioning, ventilation, and so on. Rather, its Industry Systems division is involved in the utility end of management, an area that requires quarter-million-dollar control systems and that proves highly profitable for the Pittsburgh, Pa., division. And Hewlett-Packard Co. has adapted systems used in its own plants for sale to others.

Meanwhile, according to Roger Feulner, marketing manager at Honeywell, the present \$250 million now invested in energy-management systems for buildings is just the tip of the iceberg. "For this market," he says, "it's blue sky all the way." □

CAPABILITIES DETAILED IN NEW FOLDER



Updated folder describes Emerson & Cuming, Inc. Research, Engineering, Manufacturing, Customer Services and Publications. Standard products and sales office listings included. Send for complimentary copy.

Circle 68 on reader service card STRUCTURAL-ELECTRICAL SYNTACTIC FOAM



ECCOSTOCK GT-22

Density, lbs./cf (g/cc)	23(0.37)
Flex. Strength, psi (kg/sq. cm)	6,000(420)
Water Absorp.	Nil
Dielectric Const.	1.46
Loss Tangent	0.006

Circle 69 on reader service card

NEW LITERATURE ON ONE-PART EPOXY SYSTEMS



ECCOPRIME one-part products provide most of the properties of standard E&C resins, adhesives, and coatings, and they can be used directly from the container, without weighing, measuring, or mixing. A new four-page illustrated folder lets you select from up to sixteen systems. Each offers improved convenience, accuracy, and speed when you use epoxies for casting, potting, bonding, sealing, or coating. Send for a free copy.

Circle 191 on reader service card



EMERSON & CUMING, INC.

CANTON, MASSACHUSETTS 02021 U.S.A.

Manufacturing at Canton, MA, Northbrook, IL, Gardena, CA, U.S.A.
Scunthorpe, ENGLAND, Oevel, BELGIUM, and Kuriyama, JAPAN

Sales Offices in Principal Cities

Computers

Europeans discover the old kit bag

Despite high prices, personal-computer shops are opening in hopes of big sales to small companies

by Arthur Erikson, Managing Editor, *International*

For a variety of reasons, including much higher prices, Western Europe has fewer builders of electronics kits than the United States. All the same, a few hardy entrepreneurs in Great Britain and on the Continent have started marketing personal computers, which is about as far as you can go with electronics-oriented kits.

While the U.S. market includes a great number of hobbyists [*Electronics*, March 31, p. 89], these European retailers of mainly U.S.-made personal computers believe they can focus on small businesses and organizations that cannot afford a conventional computer. Though no one has any real fix yet on the size of the market, a safe guess is that it has already reached several million dollars a year.

So big is the potential, in fact, that the American suppliers see Europe as a major potential outlet. "Our long-term goal is to have between 35% and 40% of sales outside the United States," affirms William Millard, president of Imsai Manufacturing Corp., San Leandro, Calif., one of the first into the field. J. David Callan, vice president and general manager of Pertec Computer Corp. of Los Angeles, estimates that Europe eventually will account for 25% of the sales of its Altair machines. (Pertec recently acquired MITS Inc. of Albuquerque, N. M.,

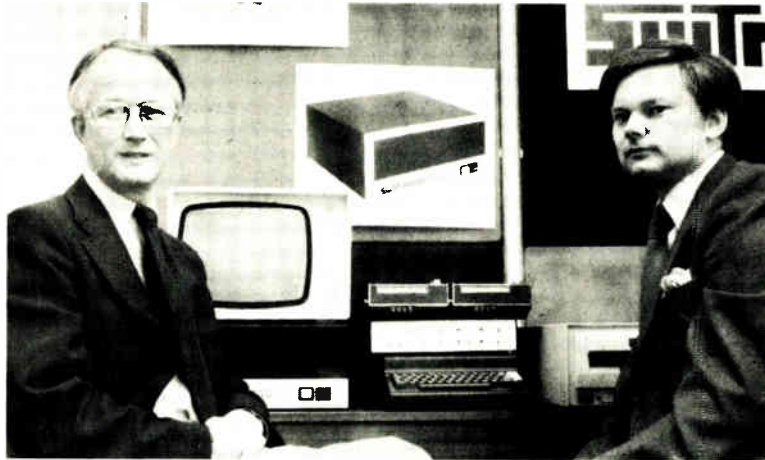

Entrepreneurs. Gordon Ashbee, left, and John Burnett direct Computer Workshop in London. Opened last summer, it is Europe's first hobby computer shop.

which builds and markets them and is changing the name of the operation to Altair.) Southwest Technical Products of San Antonio, Texas, and Ohio Scientific Instruments of Hiram, Ohio, plan to score strongly in Europe.

Britain. One thing seems sure: the market in Europe will differ considerably from that in the U.S. "Your European hobbyist is not a 14-year-old, but a 45-year-old business manager," says Gordon Ashbee, who opened Western Europe's first retail outlet, the Computer Workshop, in London last summer. Typically, he finds, the business manager takes a personal computer home to play with and winds up taking it into his business. Ashbee likens the invasion of businesses by microcomputers in Europe to that mounted by minicomputers in the U.S. just a few years ago.

West Germany. Relatively high prices are the main reason behind a "very hesitant" mood in the still-

mention middlemen—make list prices for microcomputer systems much higher than in the U.S. A lesser drawback, in Weckler's opinion, is the lack of assembly instructions in German. Many Germans speak English, so that lack is not as crucial as it is in some other countries.

Despite the drawbacks, the West German personal-computer market is "around 5% to 6% of the present U.S. market," Weckler guesses. Though it has got off to a slow start, the market could gather enough momentum in the next two years or so to reach the kind of growth rates that now prevail in the U.S., he feels. There are grounds for this belief. Altair, for example, is talking to possible European partners about setting up jointly owned retail stores. Imsai, taking a measured approach, set up a bonded warehouse in Frankfurt last fall and followed up by opening a sales office this spring. "We will start producing parts of

small market in personal computers in West Germany. Anyway, that is the judgment of Wolfgang Weckler, who heads Data Logic Computer GmbH, an eight-person outfit operating out of a two-story house in a suburb of Frankfurt. Nonetheless, it is the largest personal-computer retailer in the country at the moment. Freight costs, import duties, and taxes—not to

We're now an analog for Analog.

Analog Devices has named us the second source for these linear CMOS circuits:

The broadest selection of linear CMOS switches, multiplexers and converters used to be available from only one company—Analog Devices. Now you can get identical CMOS components from us.

We've become the second source for Analog Devices for a lot of good reasons. Like specs, functions and package options you can't find anywhere else. And CMOS—our brand of High-Density CMOS—which insures the lowest power dissipation available in linear ICs.

Multiplexers

- 7501 8 channels
- 7502 4 channels (differential)
- 7503 8 channels (inverted Enable)
- 7506 16 channels (DG506 replacement)
- 7507 8 channels (DG507 replacement)

So let's begin a dialogue about Analog today. Simply circle the R.S. number, and we'll send you more information about the circuits listed here. We'll also give you an opportunity to request detailed data sheets for the specific devices which interest you.

If your need is urgent, contact Linear Marketing at (408) 247-5350.



3100 Alfred Street, Santa Clara CA 95050

Switches

- 7510DI Quad SPST (protected)
- 7511DI Quad SPST (protected)
- 7512DI Dual SPDT (protected)
- 7513 Dual SPST (DG200 replacement)
- 7516 Quad SPST (CD4016A replacement)
- 7519 Quad SPDT (current steering)

If you've used Analog CMOS in the past, you'll find

it easy to order pin-for-pin replacements from us. Our numerical model numbers are identical, and our OEM prices are comparable. And of course, we offer the same reliability and product performance you've come to expect from Analog.

Check the tables for the linear CMOS you can get from us today. Soon, more unique circuits will join the roster. Whether you're a veteran user of linear CMOS, or just now contemplating its merits, you should know more about our responsive second-source capability.

Converters

Digital-to-Analog

- 7520 10-bit, Multiplying
- 7521 12-bit, Multiplying
- 7522 10-bit, Multiplying (buffered)

Analog-to-Digital

- 7550 13-bit (2's complement)
- 7570 10-bit (successive approximation)

WE'RE WARNING YOU...™

New sounds from an old case...

We've broadened our Series AI-300 line of panel mounted audio indicators to include some exciting new sounds. In addition to continuous and pulsing tones, you can now order these 5-15 vdc units in hi-lo siren, whooper siren and electronic chime tones. Nine models... with .250" (6.4mm) quick disconnect tabs... 85 dbA... 5 to 50 vdc. Fits 1.125" (28.58mm) diameter opening; adapter ring optional for larger openings. For catalog and a demonstration, give us a buzz.

Where to buy an audio indicator for every need:



**projects®
unlimited**

3680 Wyse Road, Dayton, Ohio 45414
Tel. (513) 890-1918, TWX 810-450-2523

Distributors throughout the world.

CALIFORNIA, COSTA MESA
MarVac Electronics

CALIFORNIA, SUNNYVALE
Pyramid Electronics

COLORADO, DENVER
Waco Electronics Inc.

MASSACHUSETTS, SHARON
Adcour

MICHIGAN, FARMINGTON
CMP Distributor Co.

MISSOURI, ST. LOUIS
Olive Industrial Elec.

NEW JERSEY, WAYNE
Gordon/Horne, Inc.

NEW YORK, ROCHESTER
Ossmann Component Sales

OHIO, CINCINNATI
Hughes Peters Inc.

OHIO, CLEVELAND
CMP Distributor Co.

OHIO, COLUMBUS
Hughes Peters Inc.

OHIO, DAYTON
NASCO

TEXAS, DALLAS
GARLAND

K. A. Electronics

WASHINGTON, SEATTLE
Frank Jackson & Associates

WISCONSIN, MILWAUKEE
Taylor Electric Co.

B. C., VANCOUVER
Deskint Sales Corp.

ONTARIO, TORONTO
Deskint Sales Corp.

ONTARIO, WILLOWDALE
Electro Sonic, Inc.

QUEBEC, MONTREAL
Deskint Sales Corp.



Series AI-300
Actual size

Optional No. 06301
Adapter Ring

Circle 72 on reader service card

Record with Hewlett-Packard

Hewlett-Packard XY's— when you need performance and reliability.

Hewlett-Packard builds precisely the right XY recorder for virtually every kind of data collection... with performance and reliability that lets you capture data just about wherever and whenever you want.

HP PERFORMANCE: Includes the optimum combination of pen acceleration and pen speed. Accelerations up to almost 10 Gs provide the big advantage that lets you record small rapid changes in data.

HP RELIABILITY: Rugged design provides long life under tough environmental conditions. Single mainframe castings in many models help assure positive, permanent alignment. Autogrip electrostatic hold-down puts a solid grip on the chart. And every recorder is supported by HP's worldwide sales and service network.

Performance and reliability are recognized HP traditions—25 years for XY's. And that's experience to draw from.

HEWLETT  PACKARD

1507 Page Mill Road, Palo Alto, California 94304

For assistance call: Washington (301) 948-6370, Chicago (312) 255-9800, Atlanta (404) 955-1500, Los Angeles (213) 877-1282

Circle 187 on reader service card



Probing the news

systems in Europe by the end of the year," maintains Imsai's Millard.

Still another computer retailer in West Germany that sees a spurt ahead is Jack Davies, who runs Pan Atlantic Computer Systems GmbH of Darmstadt. He took on the exclusive European distributorship for Ohio Scientific just a year ago. Davies figures he will have sold 1,000 systems by the end of 1977 and expects to double that in 1978. Pan Atlantic sells assembled computers, building them mainly with parts from the U.S. but with printed-circuit cards made in Germany.

"The major market is schools," says Davies, who is also a computer consultant to the school system that the U.S. Department of Defense runs in Europe for 105,000 students. Because prices are a shade too high for European hobbyists, he is promoting computer clubs in Germany, France, Switzerland, and Austria. In a further bid to hype the market—and his own turnover as well—Davies air-freights from the U.S. most of the leading personal-computer magazines and peddles them to European subscribers.

France and Switzerland. As the market grows, so does the list of personal-computer retailers. In June, an Englishman named John Varley started selling Southwest's products in France and Switzerland under the name COI Systems. His outfit is loosely associated with a West German group called Computer Organization International, which centralizes purchasing for outlets in Germany, France, and elsewhere.

The latest group to set up shop in France is a small company called Sigmatronics. Company president Oliver Puyplat insists the Computer Boutique he is to open early this month in Paris is just the first store in what will one day be a chain. Puyplat joined forces for the venture with Andrew Seligman, a 22-year-old American business-school student who has lived much of his life in France, and expects to do some \$400,000 of business during the first year selling Southwest, Imsai, and Digital Group hardware and that of two French firms, MCB and Serel. □

Fujitsu
Plasma
Display Units

Now! AC-drive character plasma displays with inherent memory from Fujitsu.

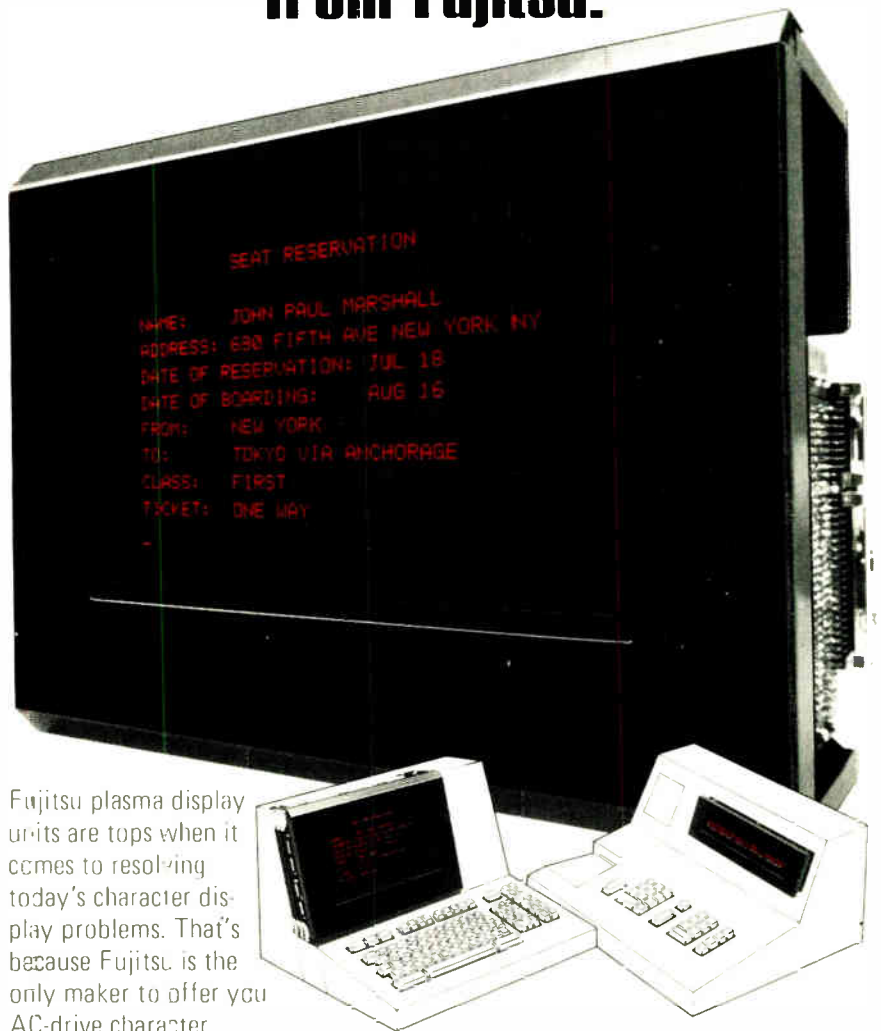

Fujitsu plasma display units are tops when it comes to resolving today's character display problems. That's because Fujitsu is the only maker to offer you AC-drive character

plasma display units with inherent memory—and in both regular and self-shift models to meet virtually every need. What does this mean for you? Well, with their AC-drive and inherent memory functions, Fujitsu plasma displays can retain displayed information **without the need for a buffer memory** and refresh cycle; thus, our units are more compact and easier to operate. Also, with inherent memory, Fujitsu character displays are **flicker-free** and **brighter** for improved visualization that eliminates operator eyestrain. Remember, Fujitsu plasma display units are the answer to your character display needs. Call or write for more information today.

Fujitsu Character Plasma Display Lineup

Model	Display capacity (char. x line)	Character format	Character size	Display
PDUS1601R	16 x 1	5 x 7	0.31" x 0.44"	Self-shift type
PDUS1602R	16 x 2	5 x 7	0.31" x 0.44"	
PDUA2004R	20 x 4	5 x 7	0.16" x 0.22"	Regular type
PDUB3208R	32 x 8	7 x 9	0.14" x 0.18"	
PDUB4012R	40 x 12	7 x 9	0.14" x 0.18"	

Fujitsu, in addition to this table, has graphic display unit (PDUG0909R) using AC type full matrix panel of 512 x 512 dots, each of 0.016" pitch for graphic application.

FUJITSU LIMITED
Communications and Electronics

Head Office: 6-1, Maunouchi 2-chome, Chiyoda-Ku, Tokyo 100, Japan Phone: 03-216-3211 Telex: J22833
New York Office: 680 Fifth Avenue, New York, N.Y. 10019, U.S.A. Phone: 212-265-5360 Telex: 23 234969

World Radio History

Circle 73 on reader service card

Communications

Lasercom gliding toward 1980s test

by Larry Waller, Los Angeles bureau manager

With minimum fanfare, Air Force scientists are clearing a path to doubtless the most advanced laser communications system yet conceived. Working first at Wright-Patterson Air Force Base's Avionics Laboratory and now at headquarters in El Segundo, Calif., a team from the Air Force Space and Missile Systems Organization is pushing toward a late 1980 satellite flight test of Lasercom, a space laser communications system.

"In every sense it's a trail-blazing kind of program," observes Samso's program director, Maj. Paul M. Freedman, who has lived with Lasercom from its beginning in 1971. Objectives of the 405B program are ambitious: a two-satellite system in which laser beams will handle data at the unprecedented rate of 1,000 megabits, or 1 billion bits, per

second. That is more than four times the speed of present satellite systems, which use radio frequencies.

Here is the way Lasercom works: a surveillance satellite 500 miles above the earth beams its information to a synchronous satellite standing 20,000 miles out. From that synchronous satellite, the information is beamed to an earth station at Cloudcroft, N. M. Each satellite houses a transmitting laser plus a beacon laser, which lines up incoming beams with high data-rate receivers. Not only can Lasercom carry vast amounts of data, points out Freedman, but it is "highly secure, immune to conventional jamming techniques, and can be seen only in a ground area 520 feet across."

However, "in 1971 not a single

Lasercom component was available to meet specifications," Freedman recalls. The data rate alone was a formidable goal, and the then state of the art in laser technology, detectors, and modulators could not come close to the requirements, even in bulky ground-based equipment. Also, the system had to fit into a satellite, operate reliably over thousands of hours, and draw minimum power. "Two hundred pounds and 250 watts was the goal," he says.

Initially, what his team did was to take existing equipment and systematically set out to improve its performance and lifetime. The effort took place first in Air Force labs, then, as feasibility improved, through development contracts awarded to companies. In 1975, McDonnell Douglas Astronautics East, St. Louis, was named prime contractor. Others include Motorola Government Electronics for electronics, Varian Associates for detectors, and GTE Sylvania for the lasers.

Not surprisingly, some of the most important improvements occurred in the performance and life of the lasers themselves. After an evaluation showed the neodymium-doped yttrium-aluminum-garnet type of laser was the most likely to produce the 1,000-mb/s rate, Samso researchers zeroed in on it.

In addition to reduced weight, volume, and power, other considerations were the delicate nature of lasers and maintaining optical characteristics and mechanical tolerances to 0.001 inch. So the Samso group came up with a new laser design and new methods for fabrication and assembly.

Two ways. Because of contrasting operating environments of the two satellites, different ways of optical pumping had to be used for the best control of power consumption. On the 20,000-mile-high synchronous satellite, never in shadow, sunlight itself pumps the laser.

To power the laser aboard the low-orbit satellite, researchers have improved a potassium-rubidium arc lamp. The laser itself now performs in the lab five times better than anyone has done anywhere, according to project scientists. This translates into a 250-watt input yielding a 330-milliwatt green mode-locked



Light touch. James D. Barry, left, and Maj. Paul M. Freedman with the laser they developed for use aboard Lasercom, the Air Force space laser communication system due in the 1980s.

beam in 420-picosecond pulses. On a constant-wave basis, output is 550 mw, and the lamp has lasted 4,500 hours. Also, the sun-pumped laser is about twice as efficient as present devices, producing a beam of 400 to 450 mw.

In testing over a simulated 25-mile range, Samsco achieved a signal loss of 9 decibels on the lamp-pumped laser and 12 db on the sun-powered version. "This is well within specifications," Freedman says. The Nd-YAG laser weighs only 12 to 14 pounds; the goal is 10 to 12 lb.

What would seem a major complication is space-to-space laser acquisition and tracking of two widely separated satellites. While the short laser wavelength, 1.06 micrometers, makes it possible to transmit large volumes of data and focus into a 5-microradian beam, the accuracies required to line up two space satellites and then retransmit to a ground station are measured in 1 microradian. That is akin to throwing a strike at Busch Stadium in St. Louis from the pitcher's mound at Wrigley Field in Chicago. However, laboratory simulation with laser beams showed consistent acquisition in from 3.5 to 20 seconds.

Flight test. As presently planned, the Lasercom flight test system is configured with each type of laser, two modulators, diagnostic telemetry, and an 8-in. antenna. It will be flown on one satellite, and the laser beacon transmitters will communicate with the ground terminal.

Lasercom technological fallout is already starting. One is a dual-function laser that combines in a single device the two lasers normally needed on any single satellite—one the beacon and the other the high data-rate unit. Designers Freedman and James D. Barry, senior scientist on the program, estimate that it could save about \$500,000 per satellite by eliminating one entire laser and its associated thermal, electrical, and mechanical support. Based on the two-wavelength emission capability of the Nd-YAG laser with intracavity frequency doubling, this development came along too late for the flight test package. But it will be incorporated later and could have applications in future ground Lasercom systems. □

the Chip makes the difference in...

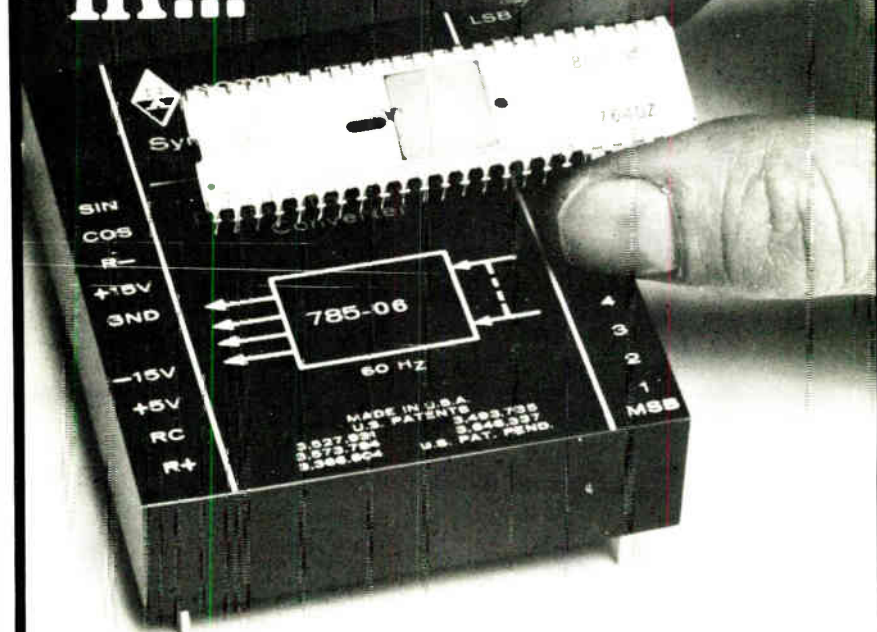

NORTH ATLANTIC SYNCHRO CONVERTERS with LSI's and 100 hour burn-in

- high reliability • best dependability
- low rate of return.

LSI/85 SYNCHRO TO DIGITAL
10, 12 or 14 bits
4-minute accuracy at
3600°/second
All standard Synchros and
Resolvers
Type II Tracking —
no velocity lag

785 DIGITAL TO SYNCHRO
Full 1.25 VA output at 60
and 400Hz
10, 12 or 14 bits
Slew speed 4000°/second
4-minute accuracy under
full load
All standard Synchros and
Resolvers

CALL OR WRITE FOR
COMPLETE SPECIFICATIONS.



NORTH ATLANTIC
industries, inc.

200 TERMINAL DRIVE, PLAINVIEW, NEW YORK 11803
cable: noatlantic / twx: 510-221-1879 / phone: (516) 681-8600

Space electronics

A new day dawns for environment snoops

by Bruce LeBoss, New York bureau manager

With another Tiros-N-related contract in hand, RCA Corp. is closer to launching this new generation of environmental spacecraft. Late last month, the National Oceanographic and Atmospheric Administration awarded to RCA American Communications Inc. a one-year \$768,000 contract for satellite communications support, with options for seven additional years that could bring the total to \$3.1 million. The RCA satellite communications system will be designed to accommodate the increased data flow expected when the first Tiros-N vehicles are launched next summer.

Designed and built by RCA Astro Electronics division in Princeton, N. J., for \$83.4 million, the satellites will carry more sophisticated sensors than any other operational meteorological spacecraft. They will replace NOAA-5 satellites of the ITOS series, also built by RCA. Their developers claim the new satellites will greatly improve the data used for weather forecasting, among other services.

"The Tiros-N series satellites will provide a greater amount of information, more accurately, and at a faster rate than does our present satellite system," says David S.

Johnson, director of NOAA's National Environmental Satellite Service.

The satellites, which the National Space and Aeronautics Administration manages for NOAA, will achieve their high performance with an instrument payload weighing over 500 pounds.

The first two Tiros-N spacecraft, now going through ground tests before systems integration, carry six data-gathering instruments. Besides providing visible and infrared weather imagery data of the earth and its atmosphere, the instruments will take atmospheric and sea temperatures and water vapor soundings. They also will measure proton, electron, and alpha activity surrounding the earth. In addition, they will gather data from balloon-borne and ocean- and land-based weather-sensing platforms that are at remote locations.

One Tiros-N instrument, a four-channel very-high-resolution radiometer built by International Telephone & Telegraph Corp.'s Aerospace/Optical division in Fort Wayne, Ind., "replaces two two-channel scanning radiometers on ITOS," says George Barna, RCA's program manager.

Three other Tiros-N instruments improve vertical sounding of the atmosphere. One, a high-resolution infrared sounder built by the ITT division, provides 20 channels of spectral coverage to produce tropospheric temperature and moisture

profiles—as compared with eight-channel coverage from its ITOS counterpart. A stratospheric sounding unit, a three-channel instrument made by Marconi Ltd. in England, makes similar profiles, as does a microwave sounding unit from Jet Propulsion Laboratories in Pasadena, Calif.

Also flying will be a solar environmental monitor from Ford Aerospace and Communications Corp. in Palo Alto, Calif., and a data collection system from Dassault in France. The data system measures proton, electron, and alpha particle densities in six bands and replaces the two-band solar proton monitor on ITOS.

Complex processor. But perhaps the most complex equipment to fly on Tiros-N, says Barna, is the manipulated information rate processor, which receives, processes, and formats radiometer data into four separate outputs for simultaneous transmission to the ground. In addition to high-resolution picture-taking data, the processor produces data for limited and global area coverage, and automatic picture taking.

The RCA-developed processor weighs 11 pounds and consumes less than 11 watts. Its 150-kilobit main memory consists mostly of Texas Instruments' TMS 4060J 4,096-bit n-channel metal-oxide-semiconductor dynamic random-access memories, and some 256-bit static RAMs. Programs are stored in bipolar, programmable read-only memories, Intersil's HM7630 devices.

Tiros-N also will use complementary-MOS technology for the logic circuitry and main memory of another on-board computer, the SCP-234, that serves as "the nerve center for the attitude control system and general command of the spacecraft, eliminating the need for a separate guidance computer," Barna says. Weighing 11.8 lb and consuming 5 w, the RCA SCP-234 has a memory of 18,000 16-bit words.

To telemeter the weather and environmental data gathered by the sensors and processed or stored on board the satellites back to earth, RCA Americom in Piscataway, N. J., will build an earth station at Wallops Island, Va., and a microwave link between Suitland, Md., and an earth station at Goddard. □

Cornerstone. RCA's SCP-234 processor is nerve center of Tiros-N's attitude control system and commands the craft.

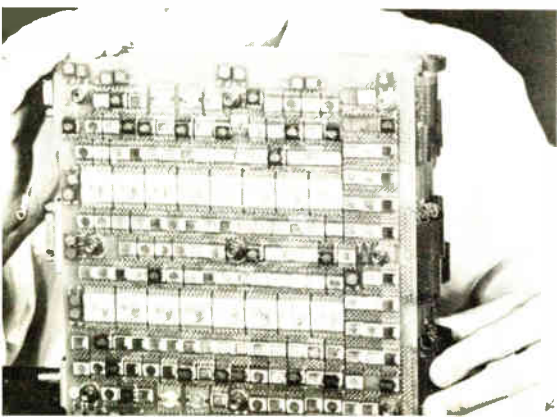

Ready for automatic insertion?

Our Radial Capacitors are

That's right. Our radial leaded ceramic capacitors — both disc and monolithic — are now available in reel packaging for your automatic insertion equipment. That means whichever type you need, you can now use the most efficient production method for lowest installed cost. For price, delivery, and technical information, contact Centralab, El Paso about the discs, and Centralab, Los Angeles about the MonoKaps™.

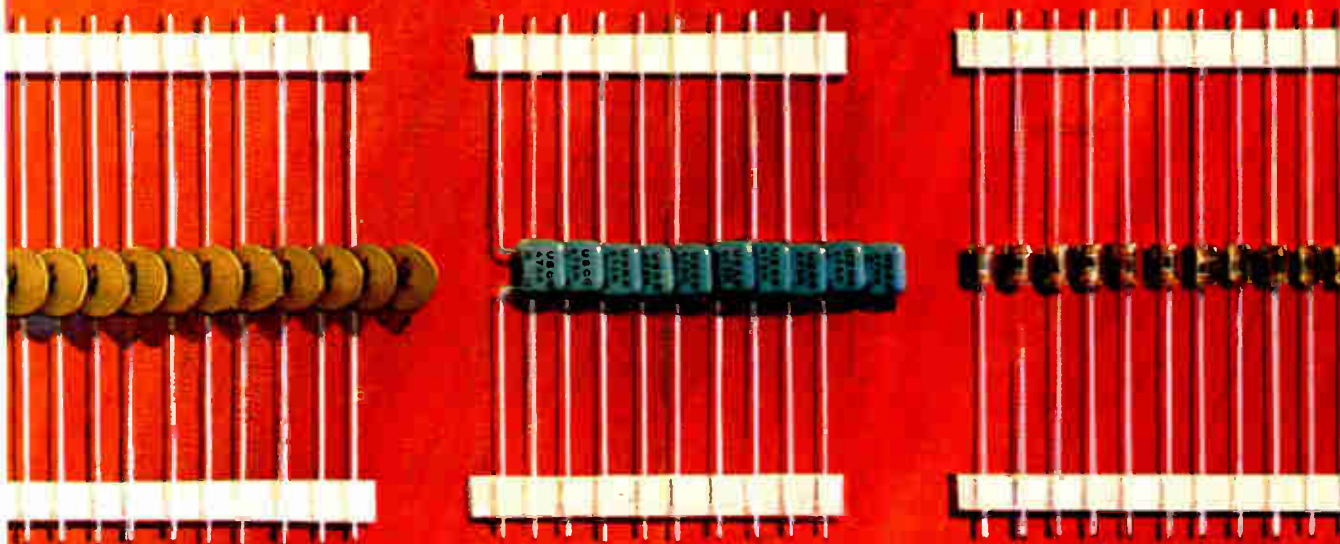

So are our Axial Capacitors

If board space and weight are your critical concerns, consider our miniature Mono-Glass ceramic capacitors. Also reel packaged for automatic insertion, they feature glass encapsulated construction in an axial leaded configuration, and a variety of dielectrics, in both precious and base metal electrodes. Contact Centralab, Los Angeles for complete price and delivery information.



CENTRALAB
Electronics • GLOBE-WACON INC.

4561 Colorado Blvd., Los Angeles, CA 90038 (213) 240-4860
7158 Merchant Ave., El Paso, TX 79915 (915) 778-3951

CERAMIC CAPACITORS • FILTERS • POTENTIOMETERS • SWITCHES
THICK FILM CIRCUITS • TRIMMER RESISTORS



SAY HELLO TO OUR MODEL 101. AND

Meet a new kind of instrumentation portable, one so self-contained that all the calibration equipment you'll ever need is built right in. Just press AUTO TEST and

Honeywell's new Model 101 checks itself and tells you what, if anything, needs adjustment. You can do a complete calibration in about half the usual time, and do it with only a screwdriver or simple tweaking tool.

But don't think of the 101 as just a more portable portable. Because it's also a more advanced lab system.





GOODBYE TO CALIBRATION HASSLES.

One that comes with up to 32 data channels - wideband or intermediateband, speeds from 15/16 to 120 ips, programmable selective track sequencing, and large reels for up to 32 hours of recording time.

Compare the Model 101 with your present tape system and see what a difference a microprocessor makes. For complete details, or for a demonstration of the Model 101, contact: Darrell Petersen, Honeywell Test Instruments Division, Box 5227, Denver, CO 80217. (303) 771-4700.

WE'LL SHOW YOU A BETTER WAY.

Honeywell

World Radio History

Circle 79 on reader service card

A new direction in microprocessor design aids.

Introducing a software development system that supports a variety of microprocessors: first the 8080 and 6800, then the Z-80*, with a wide selection to follow. Assembler software for two microprocessors is provided from those available at the time of purchase, and software for each additional microprocessor may be purchased as an option with a minimum of added expense.

This feature alone means that you can *change* direction without having to make a major investment in a new design aid. Choose a component on the basis of its suitability for a particular project, then, if it seems desirable, switch to another for the next project.

*Available late summer 1977.

It also means that you don't have to relearn your software development system each time you use a different microprocessor chip. And that can save valuable time.

The 8002 offers several other time-saving features to ease the task of program creation: a text editor that simplifies software entry and revisions, an assembler with macro capability, and dynamic trace for software debugging.

Since microprocessor-based program creation and prototype design typically go hand in hand, the 8002 also offers three progressive option levels for program emulation and debugging, prototype emulation and debugging, and real-time prototype analysis.

The 8002 Program Emulation and Debugging System, which adds an emulator processor and software for a selected microprocessor, enables the developmental software to be run, tested, changed, traced, and debugged on the desired microprocessor. The

THE TEKTRONIX 8002 MICROPROCESSOR LAB



emulator microprocessor is identical to the microprocessor in the designer's prototype; if the software is to be executed on an 8080 in the prototype, for example, an 8080 microprocessor chip is used in the emulator processor.

The 8002 Interactive Prototype Emulation and Debugging System adds a Prototype Control Probe for a selected microprocessor. With the probe inserted into the prototype, developmental software and hardware may be tested, traced, and debugged together.

The 8002 Real-Time Prototype Analyzer System adds real-time trace and an 8-channel Analyzer Probe. At this level bus transactions and events external to the microprocessor may both be monitored.

One final advantage: the Tektronix name. Tektronix has always been responsive to the instrumentation needs of the design engineer . . . and the 8002 Microprocessor Lab is no exception. Its ability to deal with a

number of different microprocessors, its many convenience features for software development, and its capabilities for software/hardware debugging, make it a unique design tool.

As a leading electronics instrument company, Tektronix offers you a full line of options and peripherals, from the three 8002 option levels . . . to PROM programming facilities for the 1702 or the 2704/2708 MOS PROMs . . . to a line printer and choice of system terminals.

Backed by years of experience, Tektronix also offers you a rare commodity in the field of microprocessor development tools: local Field Engineers and local service. A nation-wide network of Field Offices and Service Centers is ready to help you realize the full benefits of the 8002.

For more information or a demonstration of this new software development tool, write Tektronix, Inc., P.O. Box 500, Beaverton, Oregon 97077.

For availability outside the U.S., please contact the nearest Tektronix Field Office, Distributor, or Representative.

The 8002... with multiple microprocessor support.



Tektronix[®]
COMMITTED TO EXCELLENCE

World Radio History

For Technical Data circle 80 on reader service card
For Demonstration circle 81 on reader service card

Reduce your vulnerability. Specify Amphenol® connector systems.

You'll get just the right connector.
Plus quality that makes you look good.

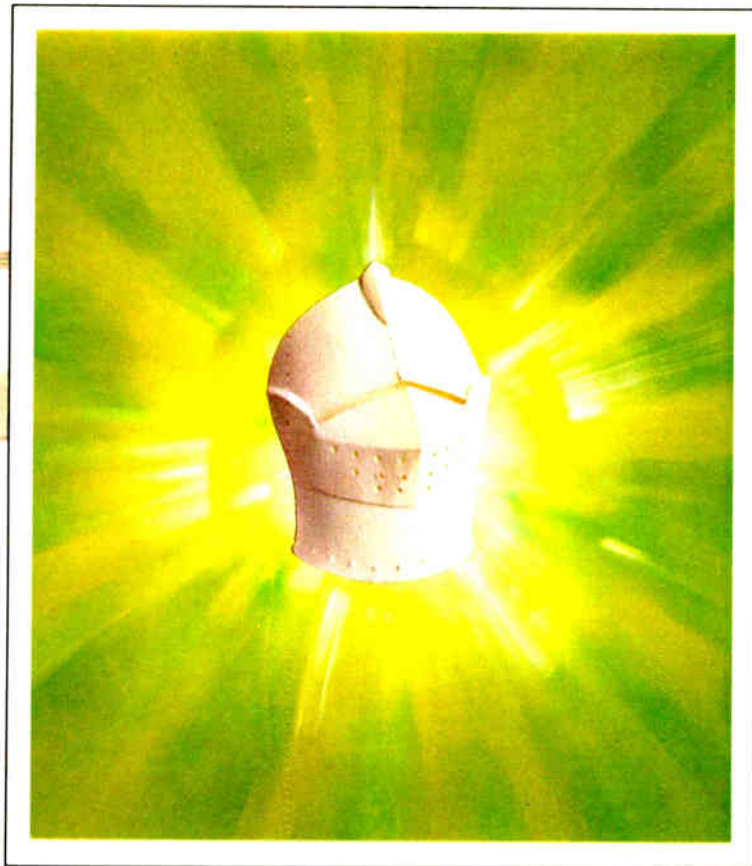

Waiting for the missing link in your product —the connectors—can be more than frustrating. A delay can leave you wide open to the perils of lost business and lost profits. So can less than top-notch quality.

Relax. There are thousands and thousands of famous Amphenol quality connector products. Many are available for prompt delivery from a close-to-you distributor. And even if you order a highly specialized connector, you won't have to wait long. Just long enough for us to give it quality worth waiting for.

You get that kind of prompt availability in quality connectors like those shown here. And a host of others for consumer and business products, data and word processing equipment, aerospace and military applications, nuclear power, telephony, and more.

We make much more available to you, of course. From the constant stream of connector ideas we originate to the methods of termination. So bring your connector problems to us. Just call us at (312) 986-2320 or write to: Amphenol North America Division, Bunker Ramo Corporation, Dept.A77B, 900 Commerce Drive, Oak Brook, Illinois 60521.

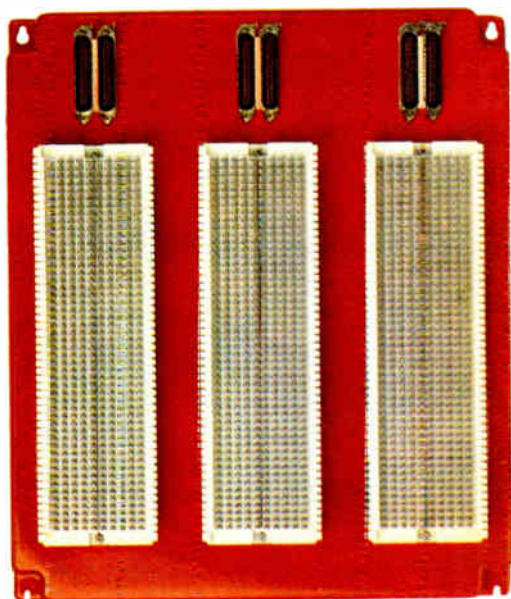

Cut telephone key-set installation costs in half. With System 66 connectorized red-fied back panels. They're factory pre-wired.



Microphone connectors that are quick to disconnect. Our QWIK-91 Series are efficient, easy to operate and an attractive complement to quality audio equipment.

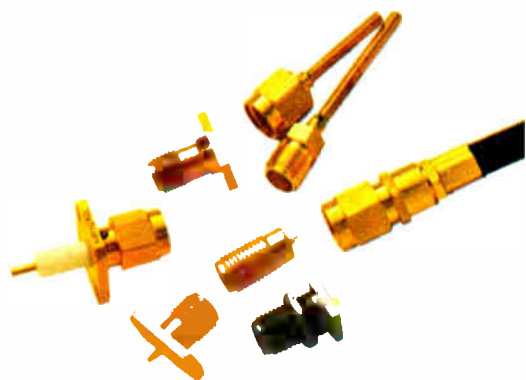

The big name is SMA's. Amphenol, of course. Stainless steel or beryllium copper. Built-in quality ensures performance to your toughest design demands.



Missile launcher connector-and-cable assembly is important to the military. Used on an infantry anti-tank weapon, this assembly is typical of our total design capability.



Radiation-resistant connectors for the nuclear power industry. Our 206 Series for containment rooms. Features stainless steel shells and crimp Poke-Home® contacts.

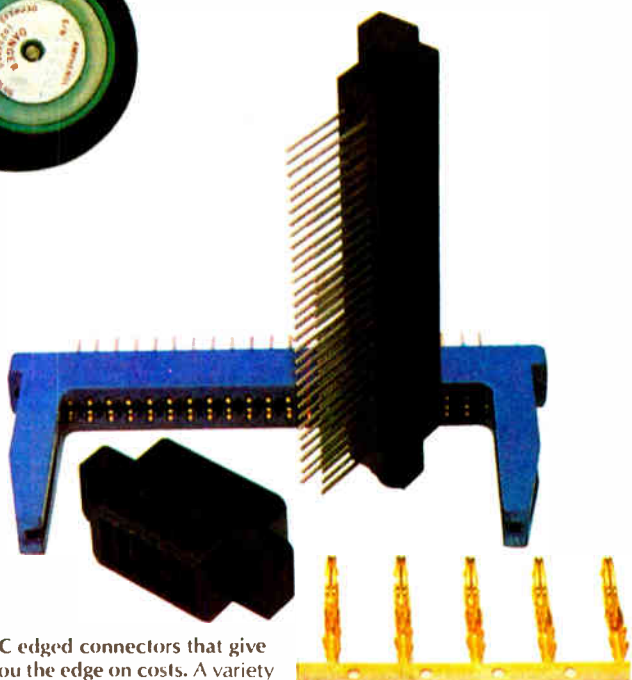

PC edged connectors that give you the edge on costs. A variety from 143, 225, and 261 Series. For solder, wire-wrap, and crimp snap applications.

The right idea
at the
right time.

AMPHENOL **BUNKER RAMO**®



Digital introduces DECstation. A big computer system that's small enough for anyone.

Digital put an amazing LSI version of the PDP-8 inside a DECscope, added some ingenious interconnecting devices and created something new. The DECstation. A complete computer system big enough to do all kinds of work and small, simple and inexpensive enough to do it for almost anyone.

DECstation. A complete computer system in disguise. It looks like a terminal, but look again. The DECstation has a powerful general purpose computer, a video terminal, a dual diskette drive, and its own special operating system. What's more, you can hook up two different printers and a second dual diskette drive. Then put the whole thing in a mini-desk, and when you're done you'll have the smallest big computer you've ever seen.

The Video Data Processor. It's the big reason the DECstation's so small. The VT78 Video Data Processor is a computer wrapped in a terminal. Inside the familiar DECscope you'll find an LSI version of the PDP-8 with 16K words (32K characters) of MOS memory and built-in interfaces. Two serial asynchronous ports feature speeds from 50 baud to 19.2 kilo-

baud. A disk port interfaces with up to 4 diskette drives. A parallel I/O port for printers and custom interfacing provides data transfer rates up to 180 kilobits/sec. All standard.

You can go from carton to computer in less than an hour. If you can push a button, you can run a DECstation. Because one button is all it takes to start things up. The bootstrap and self-test routines are built in.

Put it together, plug it in, and immediately you can begin to run anything from the PDP-8 software library. Which means you start with one of the most comprehensive sets of software tools available in a small system. Including two proven operating systems: OS/78 for stand alone applications and RTS/8 for real-time. OS/78, an extension of

OS/8, supports a number of languages, including FORTRAN IV and BASIC. So all you have to do is load the operating system and start programming your application.

Whatever that application, if you're looking for a sophisticated little system, at the right price, and a remarkable OEM tool, consider DECstation. \$7995 each. \$5436 OEM quantity 50.

For our free brochure, write Digital Equipment Corporation, Parker Street, Maynard, MA 01754. European headquarters: 81 route de l'Aire, 1211 Geneva 26. Tel: 42 79 50. In Canada: Digital Equipment of Canada, Ltd.

digital

PDP-8 Marketing Communications
Digital Equipment Corporation, Parker Street, PK3-1, M34
Maynard, MA 01754.

E77

Send me the free DECstation brochure. (please print)

Name _____

Company _____

Address _____

City _____ State _____ Zip _____

Phone _____ OEM _____ End-user _____

Application _____

_____ Please send additional information about the PDP-8 family.

The Choice In Laboratory & Systems Measurement

Data Precision provides for precision laboratory or Automatic Test Equipment and Data Acquisition requirements by offering a selection of multimeters encompassing a wide range of specifications, features, and options . . . a selection that will meet almost all precision laboratory and monitoring control needs.

MODEL 7500

Model 7500 is a 5½ digit multi-speed instrument that will perform a full conversion 1000 times per second! It is completely programmable in function, range, mode, timing, and conversion speeds. DCV accuracy is $\pm 0.007\%$ of input $\pm 0.001\%$ range ± 1 l.s.d. for 6 months; sensitivity is $1\mu\text{V}$ DC and AC and $1\text{m}\Omega$; DCV and ACV measurement from $1\mu\text{V}$ to 1000V . As a true universal ratiometer, the 7500 also enables the user to choose both the numerator and denominator independently, and every measurement – DC Volts, AC Volts, and Resistance – can be made on a ratio basis to any other if desired.

Model 7500 provides for full incorporation into any computer-based, high-speed, multi-channel automatic test or data acquisition

system. In addition, a broad range of standard options are available, including built-in micro-processor-controlled IEEE 488 BUS or RS232/TTY Output. Base price is \$2995.00.*

MODEL 3500

Model 3500 is a full-function, autoranging, 5½-digit instrument with 6 months basic accuracy of $\pm 0.007\%$ of reading $\pm 0.001\%$ of range ± 1 l.s.d. All important control and state signals are brought to rear panel connectors for use in automated control, test, and computing systems. Voltage ratio is included.

Time-buffered isolated BCD Output, brought out through Standard DTL/TTL interface circuits, permit asynchronous printing, recording, and/or display. In addition, Model 3500 features measurement of DC volts, AC volts, Resistance, Ratio and local/remote Ranging and Triggering plus excellent common-mode and normal-mode rejection. Base price is \$995.00.*



MODEL 3400

Model 3400 is the world's most accurate systems/lab 4½ digit multimeter. It is a fully programmable system multimeter and a highly versatile stand-alone, autoranging laboratory multimeter.

Full 100% overranging, basic DCV accuracy of $\pm 0.007\%$ of input ± 1 l.s.d. for 6 months, measures from ± 10 microvolts to $\pm 1,000$ VDC, ACV from 10 microvolts to 750V, resistance from 10 milliohms to 20 Megohms, AC/DC, DC/DC voltage ratio and full remote control up to 12 conversions per second. It has complete capacity, and its BCD output is fully printer-compatible. IEEE Standard 488 BUS is optional. Base price is \$795.00.* With true RMS AC Volts-\$895.00.*

Data Precision Corporation
Audubon Road
Wakefield, MA 01880 USA
(617) 246-1600, TELEX (0650) 949341.

*Price USA.

 DATA PRECISION[®]
...years ahead



For Additional Information circle 86 on Reader Service Card
For Demonstration circle 87 on Reader Service Card

World Radio History

Part 1: EE survey discloses

Career attitudes mostly UPBEAT

Most EEs satisfied, would do it over despite some feeling of underutilization, lack of recognition, age discrimination

by Gerald M. Walker, *Senior Editor*

□ If you were to put together a composite of an engineer in the electronics industries today, you would probably come up with a person satisfied with an engineering career, intent on staying in engineering, and likely to remain with his or her present employer. Yet, alongside this complacent figure there is a person who feels underused on the job, expects more career support from employers, and furthermore believes that electronics companies practice age discrimination in hiring and assigning tasks.

These are, in fact, some of the conclusions from a survey of 3,000 randomly selected engineers who subscribe to *Electronics*. Prepared by McGraw-Hill's Research department especially for this magazine, the results are based on returns of 1,304 questionnaires, a 43% response (see "Who took part," p. 94).

The poll presents a view of EEs that reflects the more conservative, quieter mood of most Americans in the late 1970s. As with the general national climate, gone is the malaise that seemed so apparent a few years ago. The survey provides insights into engineers' career expectations for the 1980s in the face of such technological developments as the microprocessor, and it presents a good breakdown of job experience, salary, and personal activities, providing a reference against which EEs can measure themselves.

Apparently, what engineers believe about their personal career varies slightly from what they think about an engineering career in general. For example,

A large majority of engineers are satisfied with their careers



asked, "How satisfied are you with your engineering career?" a sizable majority responded affirmatively—32.6% "very satisfied" and 51.5% "moderately satisfied," for a total of 84.1% (Table 1). By contrast, in a mail-in sampling of readers' opinions conducted in the summer of 1972 [*Electronics*, Aug. 28, 1972, p. 89], 61% were satisfied or moderately satisfied. So it may be that the morale of EEs has improved in the last five years.

Significantly, the group expressing the highest percentage of satisfaction was the 30-to-39-year-olds, while the most dissatisfaction was in the 40-to-49-year-old group. EEs with only a bachelor's degree tended to be as favorable toward their career as those with an advanced degree—82.9% and 84.8%, respectively, reported they are "very" and "moderately" satisfied. Also, career satisfaction is pretty much the same, no matter what the job title or type of company (Table 2).

Will EEs match MDs?

What about the status of engineers generally? In response to the question "Do you think that EEs can attain professional status similar to physicians and lawyers in the next decade?" 74.2% said no, only 15.9% said yes, 9.2% had no opinion, and the remaining 0.7% did not answer (Table 3). But although most engineers do not expect their profession to reach the status of doctors and lawyers, 61.4% feel that gaining such professional status would be beneficial. By degree of career satisfaction, the figures are 70.3% for those who are dissatisfied, 62.9% for those moderately satisfied, and 55.1% for those very satisfied.

On another question dealing with the overall view of engineering, 55.4% of the respondents reported that

	Total	Highest degree		Age			
		BS	Advanced degree	Under 30	30-39	40-49	50 & over
Very satisfied	32.6	30.8	31.0	34.3	30.6	30.0	39.1
Moderately satisfied	51.5	52.1	53.8	49.0	54.0	50.9	49.7
Moderately dissatisfied	12.6	14.9	10.7	12.8	12.8	14.8	8.4
Very dissatisfied	2.4	1.6	3.8	3.2	1.5	3.6	1.7
No response	1.0	0.6	0.6	0.6	1.1	0.7	1.1

employers practice age discrimination against EEs in hiring and job assignments, 16.6% think not, and 27.1% do not know (Tables 4 and 5). In the fall of 1975, a mail-in sampling of readers resulted in 90% reporting age discrimination in hiring and firing [*Electronics*, Jan. 8, 1976, p. 112]. Although the two surveys cannot be reliably compared, this swing in opinion may reflect a real change in company behavior caused by the increased attention paid by the Federal Government, engineers' organizations, and the press to engineering employment practices in the last two years. On the other hand, the large percentage of "don't know" responses to this question in the current poll may indicate that individual EEs are not in a position to know their company's employment practices.

Also interesting is the contrast between the desire to remain in engineering and the perceived existence of opportunities for advancement. Asked their ambitions, almost 70% said they want to advance in engineering or in engineering management, and only 6.8% indicated they would leave a technical career entirely. Yet fewer than two in five stated that their companies have workable dual-ladder promotion and salary increases for engineers who prefer to remain in technical assignments rather than transfer to management positions (Table 6). Over 45%, in fact, feel that their companies do not have adequate dual-ladder systems, and most of the remainder do not know.

Breaking down this question by type of company indicates that navigation and guidance systems firms do a better job of dual-ladder promotion than all of the others. Fifty percent of EEs in this category responded affirmatively, whereas at the other extreme only 31.7% of engineers for medical-electronics equipment producers say they can advance equally well in engineering or in management. The best score by company among the subassemblies and components group went to hardware and materials firms, where 48% said yes.

Considering the high percentage of respondents who are satisfied with their engineering careers, a rather small majority believe that it is possible to make engineering a lifelong career without shifting to management positions.

Series examines EE career

Beginning with this issue, *Electronics* presents a three-part series of articles about electronics engineering as a career. Part 1 covers the results of an exclusive survey of readers conducted for this magazine by the McGraw-Hill Research department. The main topics include EEs' attitudes toward their career, satisfactions and frustrations, salary and promotions, and outside interests.

Part 2, appearing in the next issue, will cover another vital section of our survey: the impact of changing technology on the way EEs do their jobs. It will also reveal results of questions concerning engineering education. Included will be comments culled from personal interviews with engineers around the country.

Part 3, to be published in the Aug. 4 issue, will conclude the series with a group of personal statements from a cross section of EEs. The opinions may be controversial, but they come to grips with the career today and its possible directions for the future.



Career satisfaction runs the same for EEs in all types of companies

TABLE 2: HOW SATISFIED ARE YOU WITH YOUR ENGINEERING CAREER? (PERCENTAGES)

	Electronic systems / equipment							Subassemblies / components				Other manufacturers					
	Survey total	Computer processing	Communications	Navigation and guidance	Aircraft, space and undersea	Test and measurement	Consumer products	Medical electronics	Subassemblies	Components	Hardware and materials	Industrial equipment	Miscellaneous				
Very satisfied	32.6	32.0	37.5	31.0	37.3	24.9	32.9	38.3	41.7	46.0	39.2	39.4	41.1	33.3	35.1	38.9	30.7
Moderately satisfied	51.5	51.5	46.0	54.1	49.2	54.1	47.9	47.9	48.3	41.3	50.0	51.5	48.2	51.9	49.4	52.8	47.7
Moderately dissatisfied	12.6	13.1	13.4	11.4	9.3	16.7	15.0	11.7	9.9	7.9	10.2	7.6	10.7	14.8	11.7	6.9	15.9
Very dissatisfied	2.4	2.6	1.9	3.1	2.5	3.4	4.3	1.1	—	3.2	—	—	—	—	2.6	1.4	3.4
No response	1.0	0.9	1.1	0.4	1.7	0.9	—	1.1	—	1.6	0.6	1.5	—	—	1.3	—	2.3

Sixty-one percent say they will remain in engineering; however, the difference between the very satisfied and dissatisfied is striking—70.8% of the very satisfied expect to make engineering a lifelong career, compared with only 46.2% of the dissatisfied.

Another striking response: less than half (45.3%) said that employers usually recognize their engineering contribution appropriately. Over 38% said they sometimes receive recognition, and almost 13% claimed they are rarely recognized for their contribution.

One form of recognition is a promotion. Of those responding, 28.5% were promoted in the last year, 19.5% in the last two years, and 24.6% in the last five years (Table 7). A high 27.4% did not answer, possibly indicating a desire to avoid the question. Those 29 years old and under and those in their thirties had the highest percentages for promotions in the last year, as might be expected.

Another form of recognition is a raise in salary. The mean salary increase for all respondents over the last five years was 45.96%; the median was 43.26% (Table 8). For those 30 to 39 years old, the mean increase was 53.99%, but for those 40 to 49 it was just 33.61%—an indication of how an EE's earning power slows with age. Salaries for most of those in their forties fell in the \$20,000-to-\$40,000 bracket, and most of those in their thirties were in the \$15,000-to-\$30,000 annual income range (see "Measuring pay and fringes," p. 93).

A third form of recognition is job assignment. On this score, EEs as a group are split almost evenly. Just under half the respondents, 49.4%, feel underutilized in their present positions versus 48% who claim to be properly assigned, with the remainder not answering. Predictably, there is a direct relationship here with job satisfaction. Over 74% of those very satisfied with their career feel they are properly placed, while 87.2% of those who are dissatisfied believe

that they are underused on the job. There was very little difference, no more than a few percentage points, separating age groups on this question.

There were differences, however, by type of company. More EEs for subassembly and components makers feel properly used than do engineers for electronic-systems and -equipment producers and for industrial and other users of electronic products. Of the subgroups, the electronic-components companies appear to do the best job of properly placing engineers, with 38.4% reporting feeling underused. On the other hand, aircraft and space systems firms appear to do the worst—59.2% reported being underused.

Perhaps the acid test of career satisfaction is whether one considers it worth doing over again. Despite what appears to be, for professionals, just so-so compensation in pay, promotions, job assignments, and status, a clear majority would become engineers if they had it to do over. Almost 65% said yes; 16%, no; 17.6%, don't know; and the rest did not respond.

A resounding 90.6% of those very satisfied with their careers would do it again, whereas only 29.2% of those dissatisfied with their careers would do so. Of the moderately satisfied, 58.7% would opt for an engineering career a second time. Surprisingly, more engineers with only a BS degree would choose to be EEs again than would those with advanced degrees—66.2% and 59.8%, respectively. Enthusiasm for doing it over varies inversely with age up to age 50. For those 29 and under, it was 71.2%; for those in their thirties, 62.5%; and for those in their forties, 58.2%. But among those 50 and over, there was a jump to 68.2% who would become EEs if they had it to do over.

Would EEs advise their children to enter engineering? A majority, 58.1%, would not advise either way, compared with just 23.4% who would recommend it and 17.1% who would discourage a son or daughter from following in their

A majority believes that employers are guilty of age discrimination



TABLE 3: DO YOU THINK THAT EEs CAN ATTAIN PROFESSIONAL STATUS SIMILAR TO PHYSICIANS AND LAWYERS IN THE NEXT DECADE? (PERCENTAGES)				
	Total	Satisfaction with engineering career		
		Very satisfied	Moderately satisfied	Dis-satisfied
Yes	15.9	18.4	14.5	15.9
No	74.2	69.2	76.3	77.4
No opinion	9.2	11.5	8.6	6.2
No response	0.8	0.9	0.6	0.5

DO YOU BELIEVE THIS TYPE OF PROFESSIONAL STATUS IS BENEFICIAL? (PERCENTAGES)				
	Total	Very satisfied	Moderately satisfied	Dis-satisfied
Yes	61.4	55.1	62.9	70.3
No	19.6	24.9	17.9	14.9
No opinion	15.8	16.5	16.5	11.3
No response	3.1	3.5	2.7	3.6

TABLE 4: DO YOU BELIEVE THAT EMPLOYERS PRACTICE AGE DISCRIMINATION AGAINST EEs IN HIRING AND JOB ASSIGNMENTS? (PERCENTAGES, BY CAREER SATISFACTION AND AGE)								
	Total	Satisfaction with engineering career			Age			
		Very satisfied	Moderately satisfied	Dis-satisfied	Under 29	30 - 39	40 - 49	50 and over
Yes	55.4	44.2	58.0	72.3	49.0	56.6	58.8	58.1
No	16.6	22.1	14.9	8.7	17.3	15.8	15.9	18.4
Don't know	27.1	32.7	26.1	19.0	33.3	26.6	24.2	21.8
No response	0.9	0.9	1.0	—	0.3	0.9	1.1	1.7

footsteps—a sign of the growing tendency of parents to let their children follow their own course.

Results of these two questions are in marked contrast to a sampling done in the spring of 1971 [*Electronics*, June 21, 1971, p. 60]. At that time, 52% said they would do it over again, and 48% said they would not advise their children to enter the field. (A third had no opinion.) Reflecting the depth of feeling about the last question, one EE stated at the time, "If my son becomes an engineer, I will have failed as a parent."

Satisfactions plus frustrations

The greatest satisfactions to EEs, reported uniformly by age group and level of education, are solving technical problems and putting a new product into manufacturing and onto the market. Similarly, another important satisfaction is introducing a new technology. Creativity, which embraces all three, is also high on the list.

Chief among the frustrations reported by EEs is some form of discontent over company management—either lack of recognition or rewards, unfair treatment, or difficulty in selling design ideas. "Incompetent upper management," "company politics," and "bureaucracy" were oft-repeated complaints, as well as the familiar engineer's lament of "paper work not related to the job."

Some 70.3% of respondents agreed that companies have an obligation to plan and support the professional growth of EEs. Less than a third, however, feel that the Federal Government should improve the job security of EEs by sponsoring engineering training programs. This attitude is consistent with previous opinion samples. In 1971, at the height of the defense and aerospace layoffs and severe Government spending cutbacks, EEs felt they could not depend on the Government to create jobs and were also skeptical of Federal activity to retrain displaced engineers.

The ultimate failure of various retrain training and placement programs and the continued de-emphasis of Government spending for research and development since 1971 have borne out the validity of these beliefs.

Oddly enough, EEs do not seem inclined to strong fraternal feelings, at least as far as Government intervention on behalf of engineers involved in Federal service contracts is concerned. Asked, "Should the Federal Government assist EEs in job security by changing contracting requirements to prevent wage busting?" only 49.2% said yes. Even among engineers working on aircraft and space systems and those working on navigation and guidance systems, the vote was barely a majority—54.5% and 51.7%, respectively.

Fraternal attitudes do not seem to increase with age either. Just 46.9% of EEs 50 years old and over see the need to stop wage busting among government contractors. On the other hand, a majority of those in their thirties supported changing contracting requirements.

Possibly, the effort in Washington to amend the Service Contracts Act of 1965 to eliminate wage busting of engineers is simply not well enough understood by most EEs. Almost 20% had no opinion, and many of those against preventing wage busting may have reacted negatively to the phrase implying Government assistance.

Stable job conditions prevail

Ten years ago, EEs, primarily from defense and space contractors, had established a reputation as technical nomads jumping from job to job. But the *Electronics* survey seems to refute the notion that EEs were ever job hopping to any great extent. Perhaps the job hoppers of the 1960s have hopped right out of engineering to stay, while those who remained have tended to be stable. And the economic crunch of the 1970s appears to have put an end to any job hopping that did exist.

For example, asked how many different companies they have worked for since receiving their bachelor's degree, over



Less than half think their companies have workable dual-ladder promotion systems

TABLE 5: DO YOU BELIEVE THAT EMPLOYERS PRACTICE AGE DISCRIMINATION AGAINST EEs IN HIRING AND JOB ASSIGNMENTS? (PERCENTAGES, BY TYPE OF COMPANY)

	Electronic systems / equipment									Subassemblies / components			Other manufacturers				
	Survey total	Total	Computer processing	Communications	Navigation and guidance	Aircraft, space and undersea	Test and measurement	Consumer products	Industrial controls	Medical electronics	Total	Subassemblies	Components	Hardware and materials	Total	Industrial equipment	Miscellaneous
Yes	55.4	56.6	46.0	57.2	60.2	66.1	61.4	55.3	57.0	61.9	56.3	51.5	62.5	55.6	44.8	48.6	42.0
No	16.6	16.3	20.3	15.3	16.9	10.7	15.0	18.1	15.9	7.9	17.0	18.2	16.1	18.5	26.0	26.4	25.0
Don't know	27.1	26.3	33.0	27.1	22.9	22.3	23.6	24.5	27.2	28.6	26.7	30.3	21.4	25.0	29.2	25.0	33.0
No response	0.9	0.8	0.8	0.4	—	0.9	—	2.1	—	1.6	—	—	—	—	—	—	—

TABLE 6: DOES YOUR COMPANY HAVE A WORKABLE DUAL LADDER OF PROMOTION AND SALARY INCREASES FOR ENGINEERS WHO PREFER TO REMAIN IN TECHNICAL ASSIGNMENTS AND ENGINEERS WHO TRANSFER TO MANAGEMENT POSITIONS? (PERCENTAGES)

	Electronic systems / equipment									Subassemblies / components			Other manufacturers				
	Survey total	Total	Computer processing	Communications	Navigation and guidance	Aircraft, space and undersea	Test and measurement	Consumer products	Industrial controls	Medical electronics	Total	Subassemblies	Components	Hardware and materials	Total	Industrial equipment	Miscellaneous
Yes	37.5	39.1	47.9	41.5	50.8	40.3	35.7	31.9	34.4	31.7	33.0	31.8	33.0	48.1	37.0	30.6	42.0
No	45.3	43.9	38.7	42.8	35.6	42.1	50.0	44.7	41.7	44.4	44.3	40.9	47.3	25.9	49.4	52.8	45.5
Don't know	13.9	13.7	11.1	12.7	12.7	14.2	10.7	17.0	18.5	20.6	19.3	19.7	17.0	22.2	11.7	15.3	10.2
No response	3.3	3.2	2.3	3.1	0.8	3.4	3.6	6.4	5.3	3.2	3.4	7.6	2.7	3.7	1.9	1.4	2.3

60% of those aged 40 to 49 reported working for only three companies, that is, having made two job switches in 15 to 20 years of working. Almost 75% of those aged 30 to 39 have had just three employers since graduation. Somewhat surprisingly, changing jobs does not seem to be a function of career satisfaction. Of those very satisfied with their careers, 32.9% have had one employer since graduation; of those moderately satisfied, 35.3% have had one employer; and of the dissatisfied, 34.9% have had just one employer.

Perhaps, then, it has been only the aerospace-defense sector that has witnessed job switching tied to shifts in Government contracts. Not necessarily, according to the results of the survey. Of the engineers from aircraft and space companies, 39.9% have had just one employer since graduation, the highest percentage among the electronic-systems and -equipment manufacturers and the second highest percentage of any subgroup. Moreover, this sector is not ahead of the other 12 subgroups in the percentage of

those having worked for four or more companies. As a group, EEs for subassembly and components producers have switched jobs more often than those in either the systems and equipment group or the industrial- and miscellaneous-electronics users group. Overall, the mean for EEs was 2.54 companies worked for since graduation.

In addition, a majority of the engineers responding intend to remain with their present employer. Fifty-seven percent plan to stay, 15.9% want to move, and the rest are not sure. As expected, the older the EE, the more likely he or she is to remain with his or her present employer. For those under 30, 48.4% plan to stay, 20.5% want to move, and 30.4% are not sure; for those in their thirties, the figures are 51.7%, 18.7%, and 29.1%, respectively; for those in their forties, 65.3%, 9.7%, and 24.2%, respectively; and for those 50 and over, 74.9%, 9.5%, and 10.6%, respectively.

There is a marked contrast on this subject between those who are satisfied with their career and those who are

On average, salary increases are highest for those in their twenties, decline steadily with age



TABLE 7: HAVE YOU BEEN PROMOTED? (PERCENTAGES)

	Total	Satisfaction with engineering career			Highest degree		Age			
		Very satisfied	Moderately satisfied	Dissatisfied	BS	Advanced degree	Under 30	30 – 39	40 – 49	50 and over
In the last year?	28.5	36.7	26.2	20.0	31.8	23.5	45.2	31.1	16.2	10.1
In the last two years?	19.5	18.8	20.9	15.9	20.9	18.2	16.3	26.4	14.8	11.7
In the last five years?	24.6	16.9	28.3	29.2	23.1	26.7	7.1	27.2	34.7	31.8
No response	27.4	27.5	24.6	34.9	24.2	31.6	31.4	15.3	34.3	46.4

TABLE 8: BY WHAT PERCENT HAS YOUR SALARY INCREASED COMPARED WITH FIVE YEARS AGO? (PERCENTAGES)

	Total	Satisfaction with engineering career			Highest degree		Age			
		Very satisfied	Moderately satisfied	Dissatisfied	BS	Advanced degree	Under 30	30 – 39	40 – 49	50 and over
None	2.6	2.6	1.9	5.1	2.9	2.4	3.2	1.1	2.5	6.1
1% – 9%	2.1	1.6	1.9	3.6	2.6	1.7	1.0	2.1	1.1	5.6
10% – 19%	7.4	6.1	7.5	10.8	8.2	6.2	5.1	4.5	9.7	16.8
20% – 29%	14.9	13.4	14.9	17.9	14.0	14.5	8.3	10.4	26.0	22.3
30% – 39%	12.9	12.5	14.0	10.3	13.0	12.2	5.8	10.2	22.7	16.4
40% – 49%	10.6	10.1	11.0	10.8	9.6	13.2	5.8	13.4	11.9	8.9
50% – 59%	11.0	9.6	11.3	12.8	11.2	10.7	10.6	15.3	7.6	5.0
60% – 69%	6.1	5.9	6.7	5.1	5.7	7.3	5.1	9.2	4.3	1.7
70% – 79%	3.8	2.8	4.3	3.6	3.4	4.7	4.5	5.5	1.4	0.6
80% – 89%	3.9	4.7	3.6	3.6	3.7	4.1	5.1	5.3	1.4	0.6
90% – 99%	1.2	1.4	1.3	0.5	1.4	1.1	2.6	1.5	–	–
100% and over	10.4	15.5	9.1	3.1	9.3	10.9	13.1	15.5	2.5	2.2
No response	13.0	13.6	12.4	12.8	14.9	11.1	29.8	6.0	8.7	11.7
Mean	45.96	50.24	45.64	36.97	44.71	47.71	54.58	53.99	33.61	27.27
Standard deviation	28.557	30.757	27.470	24.692	28.473	28.072	31.550	28.282	19.716	19.504
Standard error of the mean	0.848	1.605	1.133	1.894	1.168	1.376	2.132	1.267	1.240	1.552
Median	43.26	46.74	43.24	36.00	41.94	45.64	55.45	53.45	42.69	27.00

dissatisfied, as is to be expected. Almost 80% of those very satisfied said they plan to stay with their present employer, while only 26.2% of those dissatisfied intend to remain. Further, the percentage of EEs dissatisfied with their careers who said they will leave their present employer is over six times greater than the percentage of those satisfied with their career.

What direction will electronics engineering take?

The professional aspects of an engineering career have become complex and controversial. In fact, professional issues have considerably altered the EEs' own organization, the once-staid Institute of Electrical and Electronics Engineers, with the formation of a well-funded professional activities board. Professional activities have in fact split the

IEEE into hostile camps, caused its first contested elections, and created conflicts among members. Unions, limits on the number of engineers, portable pensions, lobbying, employer black lists—topics rarely if ever discussed 10 years ago—are now important subjects for many EEs. At the same time, underscoring the basically conservative nature of engineers, the survey indicates that EEs are not calling for radical departures from the status quo.

Two of the hottest subjects these days are controlling the quality and limiting the number of engineers entering the field. But whereas almost 69% favored the former, only 26.5% favored the latter (Table 9). Of those in favor of either, 37.6% said that the IEEE is best able to administer the task. A little over a quarter listed the Engineers Council for Professional Development. The remainder suggested



Most want to control the quality of engineers, but not the number

TABLE 9: DO YOU FAVOR THE CONTROL OF THE QUALITY OF EEs ENTERING THE FIELD? (PERCENTAGES)

	Total	Satisfaction with engineering career		
		Very satisfied	Moderately satisfied	Dis-satisfied
In favor	68.9	63.3	70.8	74.4
Against	20.6	25.6	18.8	16.4
No opinion	9.7	10.6	9.1	8.7
No response	0.9	0.5	1.3	0.5

DO YOU FAVOR THE CONTROL OF THE QUANTITY OF EEs ENTERING THE FIELD? (PERCENTAGES)

In favor	26.5	19.3	27.0	40.0
Against	56.3	63.1	55.7	44.1
No opinion	15.7	16.9	14.9	15.4
No response	1.5	0.7	2.4	0.5

using the educational institutions or forming a new independent organization.

Formation of a trade union for engineers is no more popular today than it was six years ago, when *Electronics* asked for opinions on the subject [*Electronics*, Aug. 2, 1971, p. 50, and Sept. 27, 1971, p. 72]. In 1971, 22% favored a union and 56% favored formation of a professional association to supersede the IEEE in promoting the status of EEs. Not quite 20% favored a union in the present survey. Among the reasons given for rejecting an engineers' union were: unions are not professional; they serve no useful function, and they restrict individual initiative or freedom.

The series of questions regarding attitudes toward the IEEE resulted in anything but encouraging responses for the institute. For instance, less than half of the respondents,

Measuring pay and fringes

How does your salary match up with the incomes reported by survey respondents? The highest percentage, 28.2%, fell into the \$15,000-to-\$19,999 bracket. However, a rough calculation of the median salary (based on the midpoint of each salary bracket) comes out somewhat higher—approximately \$22,000. The mean income works out a bit higher—around \$23,000. Within the following income brackets, the percentages were:

- \$15,000 to \$24,999—54.4%
- \$25,000 to \$34,999—24.8%
- \$35,000 to \$44,999—6.7%

Worth noting is the fact that there was no significant variation among types of companies.

Predictably, incomes tended to follow age patterns, with those under 30 earning the lowest pay and a steady increase for those in their thirties and forties. Advanced degrees boost salaries, but only somewhat.

EEs reported receiving the standard package of fringe benefits—hospital, medical, major medical, and disability—but not much else. Stock programs, profit sharing, and salary bonus programs are practically nonexistent. Pensions, however, are common—69% reported belonging to plans—but a sizable minority lacks them. The mean number of vacation weeks is 2.86, although most reported receiving two weeks.

41.7%, are members of the IEEE (Table 10). Breaking down the results by education and age results in two interesting findings: first, 53.8% of those with advanced degrees are members, compared with 37.7% with BS degrees; and second, only 39% of those under 30 have joined.

Of those who are members of the institute, just 22.4%

TABLE 10: DO YOU BELONG TO THE INSTITUTE OF ELECTRICAL AND ELECTRONICS ENGINEERS? (PERCENTAGES)

	Total	Satisfaction with engineering career			Highest degree		Age			
		Very satisfied	Moderately satisfied	Dissatisfied	BS	Advanced degree	Under 30	30 – 39	40 – 49	50 and over
Total respondents	100.0	100.0	100.0	100.0	100.0	100.0	100.0	100.0	100.0	100.0
Yes	41.7	43.5	42.6	35.9	37.7	53.8	39.7	38.3	45.1	51.4
No	57.1	55.1	56.0	63.6	61.6	45.3	58.7	60.9	53.1	48.0
No response	1.2	1.4	1.3	0.5	0.7	0.9	1.6	0.8	1.8	0.6

DO YOU SUPPORT THE IEEE'S EFFORTS TO PROVIDE PROGRAMS CONCERNING THE PROFESSIONAL STATUS OF EEs? (PERCENTAGES)

Belong to IEEE	100.0	100.0	100.0	100.0	100.0	100.0	100.0	100.0	100.0	100.0
Yes	72.4	67.6	74.1	81.4	74.9	72.2	74.2	72.4	72.0	70.7
No	11.9	16.8	9.1	10.0	11.4	10.7	9.7	12.8	10.4	15.2
No opinion	13.1	14.1	14.3	5.7	11.4	14.7	16.1	11.8	12.8	12.0
No response	2.6	1.6	2.4	2.9	2.3	2.4	—	3.0	4.8	2.2

Most still join the IEEE for technical information



Who took part

Of the 1,304 readers who responded to the *Electronics* survey, 81.7% listed their major job responsibility as engineering, the remainder as primarily management. Job titles, which usually do not carry the same significance from one company to another, were spread over a wide range, from vice president to technician, so that no single position dominated the results.

Over 70% of the respondents listed themselves in design and development engineering and 22% in engineering services. The remainder was divided into basic research, manufacturing, and other functions. There were no respondents from engineering school faculties.

Categorized by education, 53.5% have only a bachelor's degree, 30.1% have a master's, and 5.8% have a Ph.D., with 10.6% not answering. Just over 70% of the respondents took their degrees in electrical engineering; the rest are scattered among other fields.

The largest age group represented was in the 30-to-39-year-old bracket, with 40.6% of the returns. The next largest number came from those 29 and under—23.9%. Twenty-one percent were 40 to 49 years old, and the remainder were 50 and over.

Respondents were also grouped by company products

into three main categories: electronic systems and equipment, accounting for 80.4% of returns; subassemblies, components, and materials, with 13.5%; and other manufacturers using electronics, 11.8%. (Some checked more than one category.) The groups were subdivided into product segments—eight in the first group, three in the second, and two in the third. See Table 2 for a complete listing of the 13 product types.

Within the systems and equipment group, most responses came from EEs working for computer, data-processing, and peripherals firms. Responses from communications firms were next, followed by returns from aircraft, missiles, and space systems engineers.

In the subassembly and components group, most replies came from engineers working for active-components companies. In the third group, there were more responses from miscellaneous equipment producers using OEM electronics than from industrial OEM users.

Geographically, all of the electronics industries centers were well represented. Most responses came from firms in California, followed by those in the New England, Middle Atlantic, Southwest, Southeast, and Midwest states. (The survey was limited to U. S. EEs.)

consider themselves active in IEEE affairs. Even members with advanced degrees are no more active than those without. The most active, by age group, are those 50 years old and over. Nevertheless, by voting, members do express an interest in who leads the organization. Over two thirds said they voted in the last IEEE presidential election. (This figure does not jibe with the results announced by the institute: according to the IEEE just 36% of those eligible voted.) The most apathetic voters in the poll were those under 30—58.9% of those said they voted, compared with over 79% of those over 49.

By far the strongest reason chosen for joining the IEEE was for technical information—86.6% listed it as the main attraction. Yet, when asked if they support the IEEE's efforts to provide programs concerning the professional status of EEs, 72.4% said yes (Table 10). By career satisfaction, 67.6% of those very satisfied supported professional activities, 74.1% of those moderately satisfied said yes, and 81.4% of those dissatisfied with their careers favored professional programs.

EEs inactive in public affairs

EEs are also inactive in community affairs, the survey reveals. Only about 27% reported taking part in community service organizations. Fewer are active in religious organizations—26%. And a mere 7.7% said they participated in politics. However, over 83% voted in the last general election, and if they had their way, Gerald Ford would still be

in the White House—58.1% voted for Ford-Dole, 35.8% for Carter-Mondale, and the rest for other candidates (3.7% did not respond to this question).

As for hobbies and pastimes, puttering with electronics gadgets is still a favorite, but not as popular with EEs as are various outdoor sports and other outdoor activities. Do-it-yourself electronics, including home computers, is much more popular with young engineers and with those very satisfied with their careers. Fishing, hiking, camping, and hunting got the most responses from those in their forties and from those dissatisfied with their careers. Also popular among respondents are playing musical instruments and listening to recorded music.

Looking ahead

A vital aspect of an engineering career today and in the 1980s is the effect of changes in technology on how the EE functions. To what extent has the microprocessor altered the way engineering is performed? How do EEs keep up with changing technology? Are engineering schools in step with the times? Are EEs using the specialties they studied at school in their current assignments?

Responses to these and similar questions in the *Electronics* survey will be the basis of the next part of this series, appearing in the July 21 issue. Also included will be comments gathered from direct interviews held around the country with a variety of engineers. Part 2, then, will focus on the demands that technology has put on the EE. □

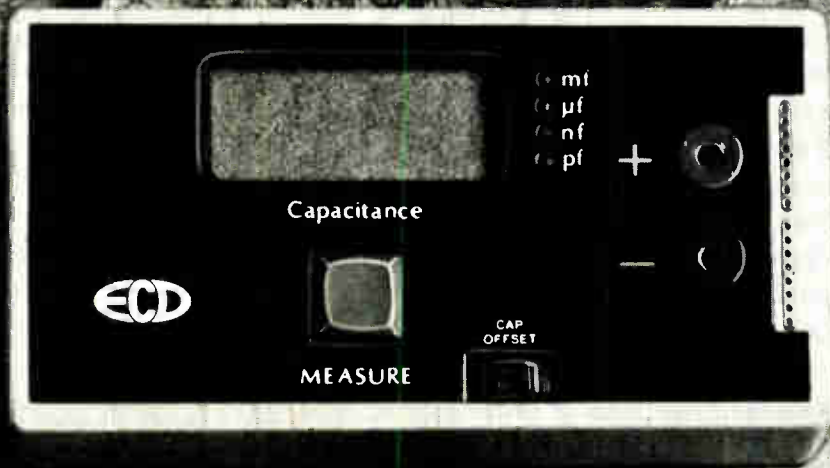

My shirt, yes...my C-Meter, no.

Test the kind of guy who'll give you the shirt off his back: ask him for his C-Meter.®

He knows that his C-Meter gives him a definite edge. It exposes an obvious efficiency: capacitors are easier to measure than resistors.

No more twiddling and nulling. No need for expensive, tight-tolerance capacitors or tweak pots. With its pushbutton speed, high accuracy (0.1%), small size

and versatility (0.1 pf to 0.2 farads), the C-Meter makes you a more productive engineer.

You owe it to yourself to try one on. It'll cost no more than a fine suit: stocked locally at only **\$289.00.**

ECD CORP.
196 Broadway, Cambridge
Mass. 02139 (617) 661-4400



SALES OFFICES: AL, Huntsville (205) 533-5896; AZ, Scottsdale (602) 947-7841; CA, Costa Mesa (714) 540-7160; CA, Sunnyvale (408) 733-8690; CO, Denver (303) 750-1222; FL, Winter Haven (813) 294-5815; GA, Chamblee (404) 457-7117; IL, Elk Grove Vill (312) 593-0282; IN, Indianapolis (317) 293-9827; MD, Silver Spring (301) 622-4200; MA, Burlington (617) 273-0198; MN, Minneapolis (612) 781-1611; MO, Kansas City (816) 358-7272; NJ, Camden (215) 925-8711; NM, Albuquerque (505) 299-7658; NY, Great Neck (516) 482-3500; (212) 895-7177; Syracuse (315) 446-0220; NC, Raleigh (919) 787-5818; OH, Centerville (513) 433-8171; TX, Houston (713) 688-9571; TX, Richardson (214) 231-2573.



Digital-display manufacturers strive to refine their technologies

Efforts center on more colors and performance, less power use and cost

by Stephen E. Scrupski,

Instrumentation Editor

□ A surge of activity in the laboratories of digital-display manufacturers is producing a deluge of product improvements such as reduced power consumption, stable performance across wider ranges of temperature and humidity, and lower prices through lower-cost packaging methods. The most action probably is taking place with liquid-crystal displays, using developments in watch LCDs as a springboard into the larger sizes needed for new digital equipment.

The technological advances also are aimed at larger displays—for instruments, point-of-sale terminals, electronic clocks, and the like—which represent a burgeoning market for display makers. In fact, it is this market for 0.5-to-1-inch digits that is driving the manufacturers to improve their products. While light-emitting-diode displays and LCDs are the most popular, other types of displays have well-established uses, because each type of equipment sets its own major parameters for display selection. For example, portable equipment requires rugged displays that consume little power, while outdoor equipment requires displays that are readable in sunlight and are insensitive to extremes of temperature and humidity. In every application, input requirements should be compatible with economical driver circuits, which can restrict the display's speed of response.

Although displays must be evaluated on the basis of their costs and electrical and optical characteristics, human response and preference in colors are sometimes important factors. The possibility of the red LEDs causing eyestrain has prompted a major test-equipment maker, Dana Laboratories Inc., Irvine, Calif., to switch to yellow LEDs, according to Arch Conway, engineering manager. The neutral black and gray colors of the LCD are generally accepted without question by those users who want extremely low power dissipation. But new developments may give such users a far wider choice of LCDs in color.

The pleasing soft-orange glow of the gas-discharge display has attracted many users for applications where electrical power is readily available and thus high-voltage drives do not offer extra problems. The blue-green vacuum fluorescent displays have been widely used in portable calculators and are just becoming available in larger sizes. Incandescent displays can generate any color with proper filtering, as can electromechanical types, which need only a different color of paint.

LED colors

The red glow from a light-emitting-diode display can now be seen in nearly every type of digital instrument. Compared with other display types, these solid-state devices are reliable and fast and are compatible with many commercially available integrated drive circuits. Most important, of course, LEDs are an active source of light, so they can be used in darkened surroundings.

However, they are not without their problems. They require significant drive current—about 10 milliamperes per segment—which can drain a battery in portable equipment. They also suffer from washout in direct sunlight. The past few years have seen the launching of high-efficiency diodes, the introduction of the lower-cost air-reflector cavities in place of the epoxy-filled construction of the segments, and the growing use of “sticks”—sets of digits assembled on one printed-circuit board—which reduce per-digit costs (Fig. 1).

Because red is the color involved, washout is unlikely to be completely solved. Higher drive currents can help, as can the proper filter, but future improvements will be “systems gains unless someone stumbles across something wonderful,” says Thomas Brandt, general manager and division vice president of Fairchild Camera and Instrument Corp.’s Optoelectronics division.

There is growing use of colors other than the red, with yellow and orange displays readily available from most producers. Such diodes generally cost about 30% more and require about 50% more current than present red diodes. Green diodes have yet to make an impact as digital displays, although automotive applications still are a possibility.

Higher efficiencies

Higher-efficiency diodes built with gallium-phosphide substrates rather than gallium-arsenide-phosphide ones are cutting drive currents by about 50%. Gallium phosphide is a transparent material, so light emitted downward from the diode’s junction can be reflected back up to double the brightness perceived by the viewer. Gallium arsenide is an opaque substrate, so it absorbs such light.

The trick in building the segmented LED display necessary to produce digits is to convert the diode’s point source of light into a long segment, without the point source being evident to the viewer. There are two methods: use a scattering material such as an epoxy light pipe above the diode to smooth out the light and bring it to the surface, or use an air cavity and coat its wall with scattering material.

The light pipe is the older of the two methods, but it is about 25% more costly. It does offer a wider angle of

view because it presents a flat surface of light emission. And some air-reflector displays are not sealed as well as the light-pipe devices, so that any dust or other contamination landing on the reflecting walls will cut down on emitted light. Also, the last step in many assembly operations is to dip the completed board into a cleansing solution, which also can contaminate the walls. However, some manufacturers argue that brightness does increase with the air-reflection approach.

The increasingly popular sticks, which use the air-reflector technique for their preassembled sets of digits, can cut the cost per digit about 20%. Other savings accrue from less handling during instrument assembly and from lower inventories. The LED manufacturers take on the task of matching the digit colors in the stick, so that the users need not maintain different bins of compatible colors.

The only drawback, of course, is that if one digit fails, the whole stick must be replaced. But manufacturers point out that the savings in basic price, assembly, and inventory could outweigh the cost of infrequent field failures.

Diode placement

One manufacturing problem with the sticks is maintaining the placement tolerances for the individual diodes. To be most effective, the diodes must be placed fully within the input port of the reflector cavity. With a diode measuring about 15 mils square, this means that the placement must typically be within about 2 mils. Flexing of the pc board, thermal expansion, and other mechanical effects could move diodes. When the reflector unit is attached, it could find a diode off center and partially under one of the edges of the reflector

1. LED stick. The costs of light-emitting-diode displays drop with the packaging of several digits on one printed-circuit board, mounting the diodes directly on the board. This display from Texas Instruments Inc., Dallas, holds 12 seven-segment LED digits each 0.27 inch high.

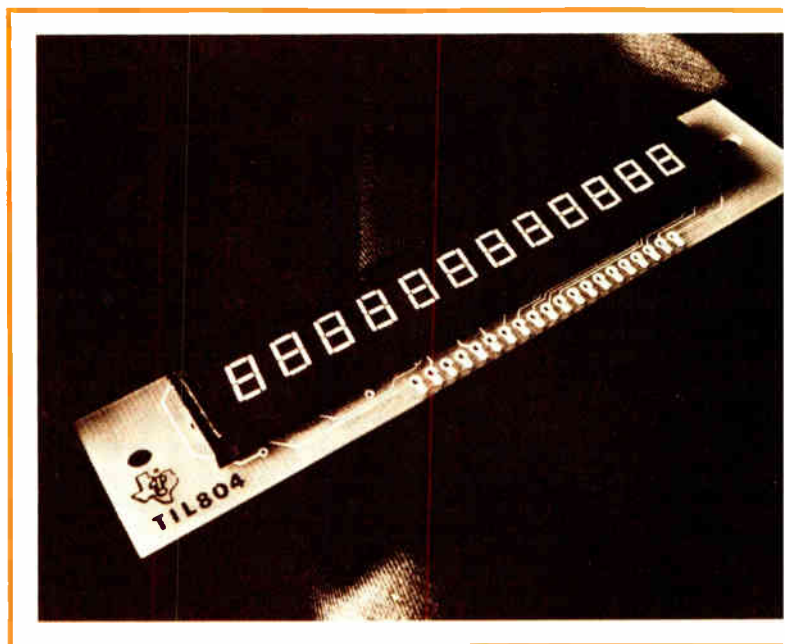

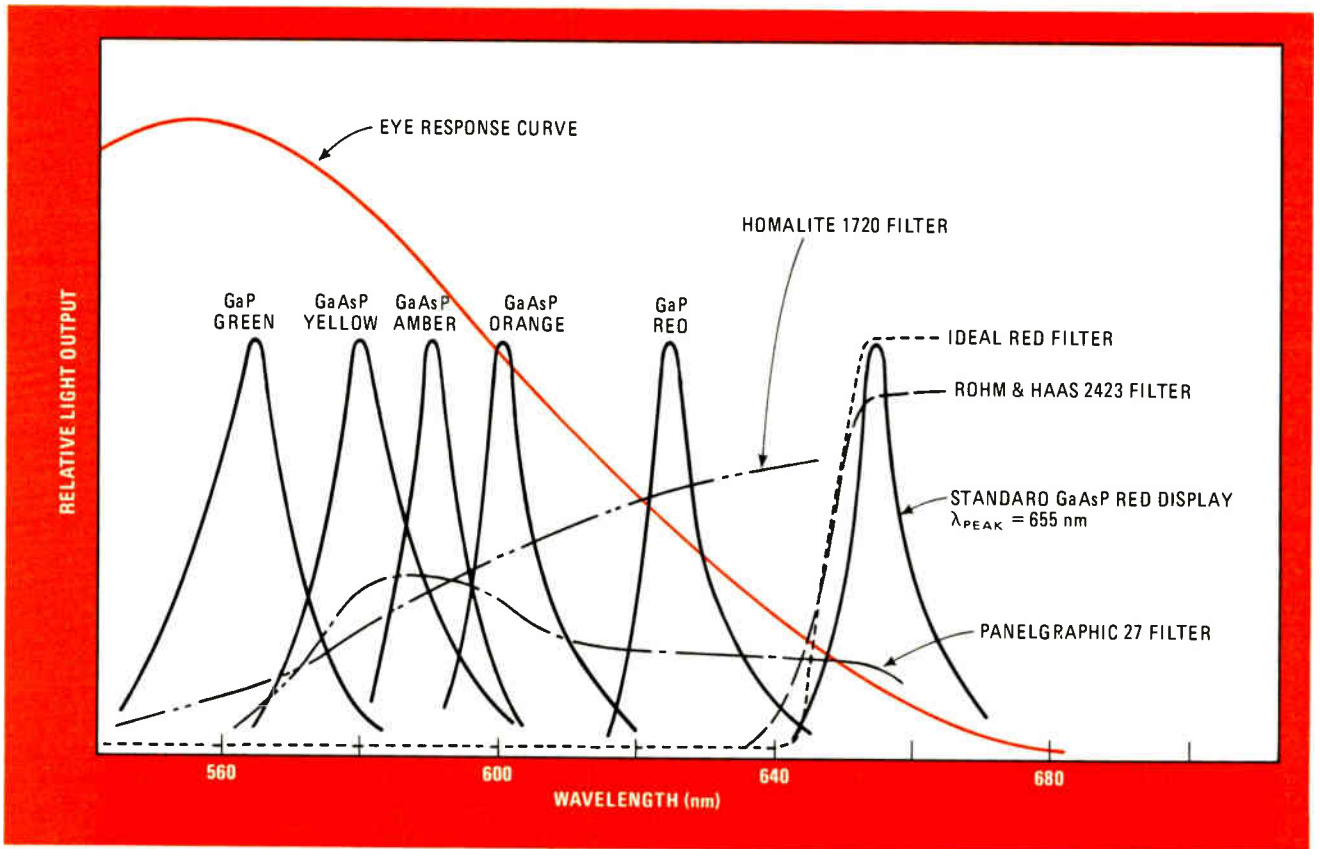

2. Filter selections. Light-emitting-diode displays require the proper filter to assure maximum brightness. This chart developed by Texas Instruments shows peak wavelengths generated by various diodes and the characteristics of commercial filters that could serve each type.

walls. So assembly could actually damage the diode.

One factor that is easy to overlook is specifying the proper filter for readability and cosmetics for the LEDs. "Many customers are reducing the effectiveness of their product by as much as 30% to 50% because of the use of the wrong filter," says Mike Bender, optoelectronics marketing manager at Texas Instruments Inc., Dallas. There have been cases, he says, where a particular filter has been used in a product for a couple of years, and the designer apparently has not realized that the diodes have changed over that period of time.

LED wavelengths

Today's diodes, in fact, have much tighter tolerances on wavelength. What lies behind these changes is the manufacturer's effort to improve the uniformity of yellow diodes' output. Subtle differences in shades of yellow are much easier to discern than are differences in red. Thus, the manufacturers have been forced to improve their technology. Once they have done this, they have applied the same techniques to the red diodes.

A couple of years ago, the wavelength of red diodes may have been anywhere within a 50-to-75-angstrom band, but today it is more typically between 25 and 30 angstroms, and a filter that sufficed by catching one of the wider band's edges may not have enough transmission under the new situation. Thus, more manufacturers of displays are specifying the particular filter to be used with each one (Fig. 2).

Liquid-crystal displays, of course, are passive displays

requiring an external source of light. They use very little power—in the microampere range for each segment—and they generally can be enlarged more easily than others, although sizes larger than about 0.6 in. are not a significant factor yet. Because of their low power consumption, they are beginning to dominate displays for portable instruments.

Two LCD types

There are two types of LCDs. The older uses dynamic scattering, in which an applied voltage causes turbulence in the liquid-crystal material, making it reflective. The other is the field-effect or twisted-nematic type, in which an applied voltage changes the way the material rotates light polarization. Then, with polarizers on front and back, light can be absorbed and thus digits can be formed on the display panel.

The field-effect type is the more widely used today, since it is faster and requires lower voltage and power. However, it does need a polarizer, which represents a major problem of reliability. The polarizer material is susceptible to degradation under high humidity.

All polarizers for field-effect LCDs use an iodine suspension in a thin sheet less than 1 mil thick, which is laminated to a 5-mil cellulone-acetate-butyrates support film. The sandwich is laminated to the top of the LCD.

Moisture absorption is the cause of polarizer failure. For watches, where relative humidity usually ranges from 50% to 60%, the iodine polarizer is adequate. For the industrial use of LCDs, an extra laminated protective

layer has been found to help protect the iodine polarizer from moisture and is being used in many devices.

However, Polaroid Corp., Cambridge, Mass., has reintroduced a material called the K polarizer, which replaces iodine with a more complex chemical to remove short molecules that can diffuse under humid conditions. Various LCD makers have tested it and shown interest, according to Polaroid.

"It's an elegant polarizer, but it's a pain in the neck to make," says a Polaroid researcher. It is more costly, since it involves chemical conversion of the polymer. (The material had been in production until about three years ago, when a lack of demand caused the company to shelve it.)

Polarizers restrict the viewing angle of field-effect LCDs to about 45° each side of the vertical. However, the angle can be widened by using a thinner backglass, according to Jim Yamasaki, product marketing manager at Beckman Instruments, Fullerton, Calif. The thinner the glass, the better the superimposition of shadow and image. To obtain this backglass of 0.010-to-0.012-in. thickness, Beckman employs grinding techniques developed for potentiometer production, Yamasaki notes.

Work on improvements

Nearly every manufacturer of both types of LCDs is trying to improve the switching speed and the temperature range over which the devices work. Speed and temperature are closely related—the liquid crystal slows down as temperature decreases (Fig. 3).

There is also a limited temperature range over which

3. Temperature and LCDs. Liquid-crystal displays have varying response times depending on the temperature. The dynamic-scattering-material data is from Itek Corp.'s Applied Technology division, and curves for field-effect materials are from Liquid Xtal Displays.

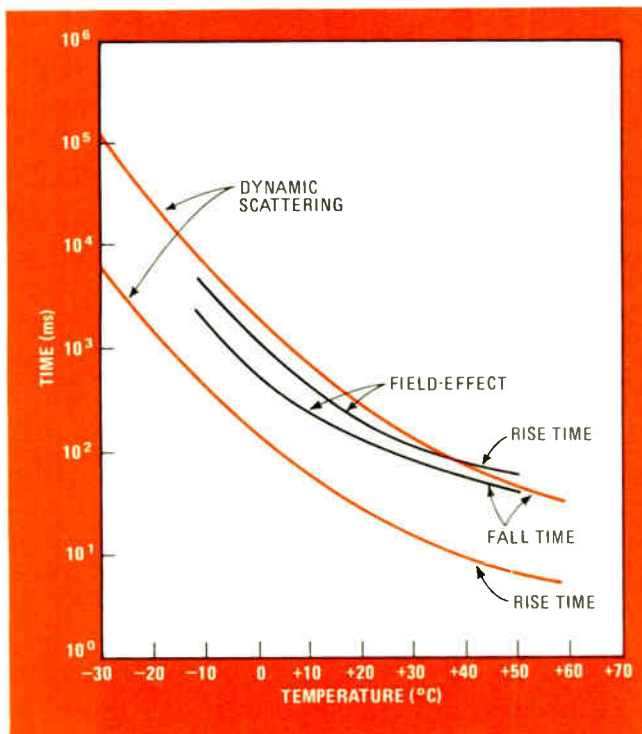

the materials actually work as liquid crystals. Most field-effect materials work from a melting point of about -10°C to a clearing point of +65°C. Only recently have some manufacturers announced materials that will operate after freezing solid.

However, there is a new family of field-effect liquid crystals that may improve temperature performance. EM Laboratories Inc. of Elmsford, N. Y., an associate of E. Merck, Darmstadt, West Germany, is readying the material, called phenylcyclohexane. The firm says PCH will be at least twice as fast as previous materials at low temperatures—at 0°C, a typical display has had turn-on delay and rise time of 380 milliseconds and a turnoff time of 270 ms. The material also has better oxidation resistance and ultraviolet stability, as well as a wider viewing angle, the company says. Melting point is -6°C, which is not as low as that of other materials, but the advantage in low-temperature speed is important. Clearing point is 70°C, slightly higher than the others.

Dynamic scattering materials have been developed to work over much wider ranges, although they are very slow at the low temperatures. Itek Corp.'s Applied Technology division, Sunnyvale, Calif. for example, has a dynamic-scattering material that exhibits liquid-crystal properties from -55°C to +80°C. At the low end, its rise time is on the order of hundreds of seconds, but it does operate as a liquid crystal there.

Although much work is under way to improve LCD performance near 0°C, a simpler approach might be to heat up the display. At least two manufacturers of film-type electric heaters are working with LCD manufac-

4. LCD heaters. Film-type heaters are being developed to be applied to the back of a liquid-crystal display to raise the temperature to a point where switching speeds up. These are typical heaters developed by Process Technology Inc., Londonderry, N.H.

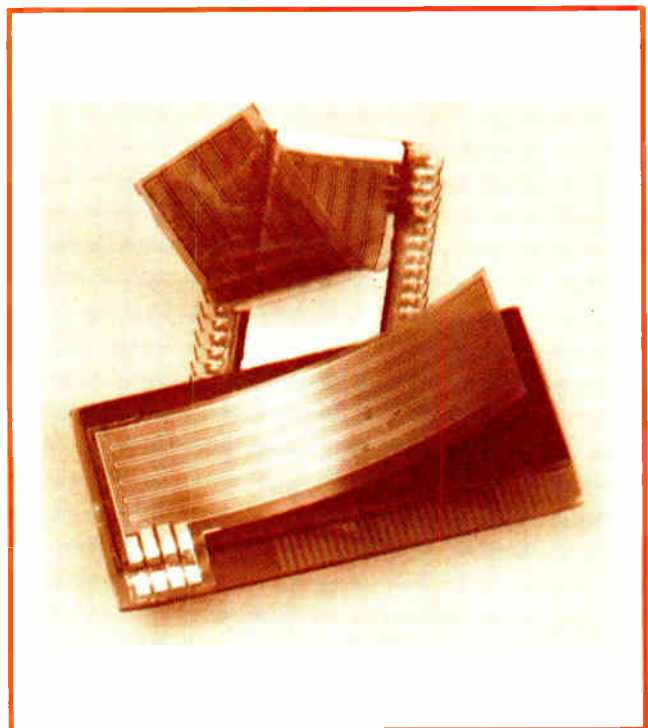

turers to develop heaters that would be attached to the back of a display. One problem still to be worked out is the rate at which heat is pumped into the display (the glass is susceptible to thermal shocks that could ruin the seal). Others are electrical connections to the temperature-control circuitry, and setting optimum power for the heater if it is to be used in, say, a portable instrument.

LCD heaters

Photofabrication Technology Inc., Londonderry, N. H., and Minco Products Inc., Minneapolis, Minn., say they can convert their standard Kapton-based heaters, developed to maintain integrated-circuit packages at constant temperatures, to a format that will work with liquid crystals. General manager Russ Howe says that Photofabrication's heater is made by etching two resistive patterns in a nickel-alloy foil that has been bonded to a thin Kapton base (Fig. 4). One of the patterns is the heater; the other serves as a resistive temperature detector. The nickel alloy has a positive temperature coefficient of resistance of about 0.5%/°C and thus can be used to sense temperature.

A simple RCA Corp. CA3094 operational amplifier can sense the temperature change from the detector circuit and drive the heater. Howe says that tests show that the heaters allow readings on a portable digital multimeter to be made within 15 seconds after a cold soak at -40°C. Without the heater, it would take about half an hour until the display warms up enough for readings to be taken.

Nearly all LCD makers have major efforts under way to develop liquid crystals that can be multiplexed. The reasons are simple. If each digit has seven segments, then a five-digit array with five decimal points requires 40 leads without multiplexing. This is a costly package. If corresponding segments of each digit were connected together internally and only briefly pulsed on, then the

5. LCD mounting. Zebra-strip, developed by Tecknit Inc., Cranford, N. J., can make connections to edge pads on a liquid-crystal display. Strip is made up of alternating layers of conductive and insulating materials, which provide the alignment of connector and edge pads.

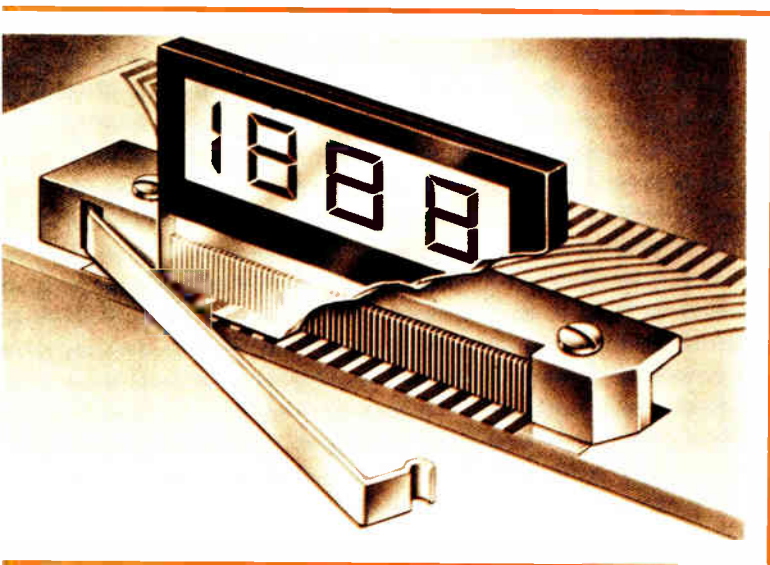

total would be only eight leads plus digit-enable lines for each digit.

More importantly, "multiplexing saves several pins on the driver circuitry, where the number of pins equates directly to the cost of the packaged chip," says Jerry Gross, LCD sales manager at Hamlin Inc., Lake Mills, Wis. He points out that it is usually cheaper for the user to parallel the digits externally, rather than try to save pins in the display. "We can run into limits on digit and segment size and spacing if we have to make the multiplex connections in the display to save pins."

One problem in multiplexing LCDs is that the circuitry must handle ac signals. If a significant amount of direct current is present in the drive signal, the display will react electrochemically and fail in short order. The ac drive signal must be as symmetrical as possible with as little dc as possible (Weston Instruments, Newark, N. J., for example, allows only 25 millivolts of dc to be present in the direct drive to the display used in its model 1900 portable digital multimeter).

A more basic problem in multiplexing lies in the threshold voltage curve of the liquid-crystal material. It does not exhibit a sharp knee, but instead gives a somewhat smooth transition from no transmission to full transmission. It thus is difficult to prevent digits that should be off from being partially switched on.

Also, the material's switching speed has to be increased, since the digits turn on and off at a faster rate with multiplexing. Present 100-ms rise times must be improved to about 30 ms, according to most display manufacturers.

Gross says that Hamlin has solved the threshold and speed problems in an LCD material. It has developed a fluid with which it can multiplex four digits over a temperature range from 0°C to 40°C. (The same fluid can be used for four directly driven digits over a wider temperature range—between -10°C and 60°C.) The company has seen no production volume orders for its multiplexed displays, though it has shipped a sizeable number of prototypes, Gross says.

There are many LCD producers, large and small, and there is very little standardization among their products. In packaging, for example, Zebra-strip (Fig. 5), made by Tecknit Inc., Cranford, N. J., is almost universally used in LCD watches and is gaining some adherents for larger LCDs—but dual in-line packages also are becoming popular. In an attempt to introduce some order, the Joint Electronics Device Council has formed a committee under the chairmanship of John Dunn of Applied Materials Inc., Santa Clara, Calif. The committee has set up five subcommittees on test methods, terms and definitions, sizes and configurations, polarizers, adhesives, transfectors and reflectors, and environmental and reliability test methods.

Pleochroic dyes

An example of the intensive work to make LCDs more competitive with LEDs is the development efforts by many manufacturers on a display that will show white numerals on a colored background. Generally called pleochroic-dye displays, they use a field-effect liquid-crystal "host" material to reorient "guest" molecules of

Everything from A to Z

Just as numeric displays are on the rise with the growth of digital large-scale integration, so alphanumeric displays also will be more widely used. They will be showing the control information generated by microprocessors, as well as numerical results.

Most display technologies can be adapted to alphanumeric displays, either with a 5-by-7-dot matrix or a segmented approach. Burroughs Corp.'s gas-discharge Self-Scan dot matrix display, for example, is in use in many computer terminals. Manufacturers of light-emitting diodes have long offered dot-matrix displays, and segmented LED alphanumeric displays are coming. Liquid-crystal displays are available with both dot-matrix and multisegment formats, and even the vacuum-fluorescent display will soon be available from NEC America Inc., Plainfield, N. J. in a dot-matrix format. And electroluminescent alphanumeric displays are being developed.

In LEDs, Hewlett-Packard recently introduced the HDSP-2000 four-character dot-matrix alphanumeric display with characters 0.15 inch high. On-board electronics drives the LED array and perform decoding, cutting the number of package pins and reducing external circuitry. Earlier LED arrays required both X and Y connections with a substantial number of pins, says Michael Shannon, product marketing engineer in optoelectronics.

Another set of LED alphanumeric displays is the DL-1416 series from Litronix Inc., Cupertino, Calif. Still in development, these devices will be 16-segment alphanu-

meric displays with characters 0.16 in. high. There will be four characters per package, which will also include a complementary-metal-oxide-semiconductor memory and a decoder driver.

Applied Technology division of Itek Corp., Sunnyvale, Calif., recently delivered a 480-character LCD panel to Computing Devices Co., Ottawa, Canada, for a computerized field-artillery control system. The display (below) uses dynamic scattering liquid-crystal material to form the 0.3-in.-high, 14-segment characters. Characters are packed four to the inch. Each segment is addressed independently through connection pins that extend from the back of the panel. A C-MOS static serial-to-parallel shift-register drives the panel and handles data up to a 5-megahertz rate.

Phosphor Products Ltd. Poole, Dorset, England, is building preproduction 256-character electroluminescent displays and 64-character units for trial by the British Post Office. The firm has built a 200-by-300-line (1,250 character) display for the Ministry of Defense and is working with Smiths Industries on car dashboard displays.

The company's direct-current electroluminescent displays are based on polycrystalline copper and manganese doped zinc-sulphide powder phosphors. The basic color is orange, but the firm is working on green and blue. Preproduction displays can operate to -12°C , and laboratory models have been down to -40°C and up to about 70°C . Switching averages about two microseconds per dot or about a $2\frac{1}{2}$ -ms refresh rate for the 256-character display.

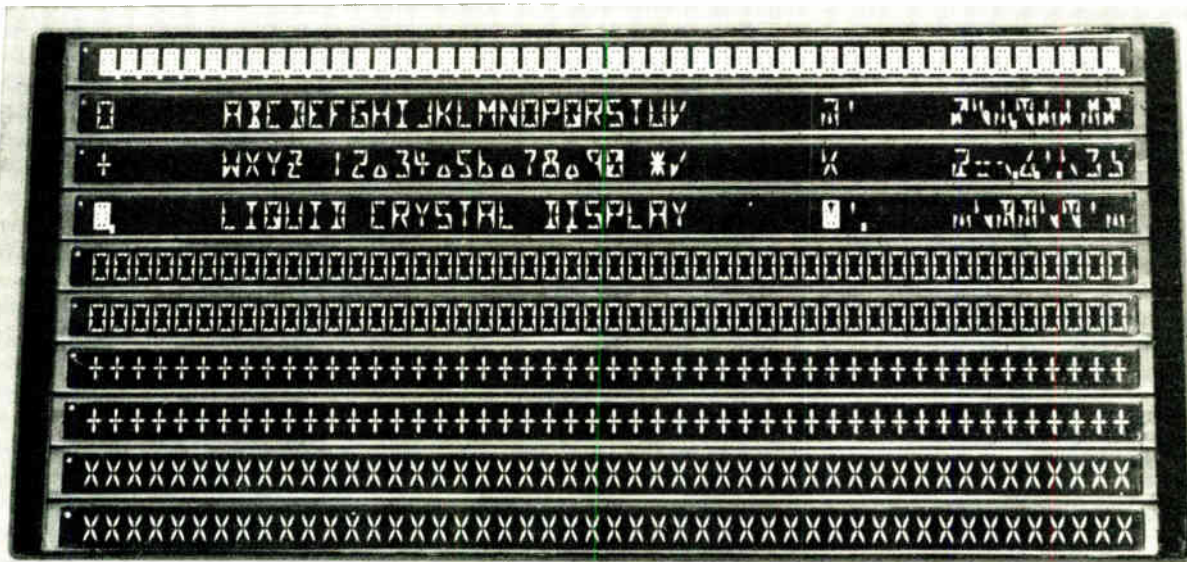

a colored dye to change reflection characteristics. An applied voltage in the pattern of a numeral causes the dye molecules in that pattern to become colorless, and thus the number is formed.

These displays do not require polarizers and thus have a 180° viewing angle vs about 90° for the twisted-nematic displays, says Tom Saldi, president of Integrated Display Systems Inc., Montgomeryville, Pa. Other disadvantages of the polarizers, he notes, are low brightness when viewed by reflective light as a result of absorption by

polarizers and destruction of the devices by high temperature and humidity caused by bleaching of the polarizers. Also, the pleochroic displays are potentially lower in cost because of the lack of polarizers and because of a simpler manufacturing process.

The displays do require higher drive voltages—8 volts vs about 3 v for field-effect devices, but they are fast. Saldi's firm is achieving typical switching speeds of 120-ns rise time and 150-ns decay, which is typical of other LCDs. The three most common color combinations the

firm is making are white-on-purple (wine), white-on-black, and white-on-blue.

Optel Corp., Princeton, N. J., is concentrating on improving lifetimes of its pleochroics, since the dyes tend to break down after long exposure to light. And Beckman Instruments also has built color units using pleochroic dyes, but Yamasaki says life "has not been good to date, and we can't get perfectly white digits."

The FLAD

A noteworthy recent development out of a West German laboratory is the FLAD, the fluorescent-activated display. Invented at the Institute for Applied Solid State Physics in Freiburg, it has the same low power dissipation as an LCD but a light intensity that is much stronger than that of a LED display, especially at high ambient light levels. What's more, the device can produce digits of any color in the spectrum between green and red.

Basically, the new display is an LCD. It consists of a thin plexiglass panel doped with organic fluorescent molecules (Fig. 6). In front of the panel is a liquid-crystal cell. Ambient light entering the plexiglass excites the molecules, and the resulting fluorescent light is emitted from the segments of which the display's digits consist. The segments pass the fluorescent light when a voltage is applied to them.

The FLAD is now in the prototype phase at Siemens, AG, and in the U. S., Optel Corp. is working on it. Production at the Munich firm will begin during the fourth quarter, initially for timepieces like battery-

operated alarm clocks.

The gas-discharge display has taken on new life since the most popular days of Nixie tubes (which are still being produced by National Electronics, a division of Varian in Geneva, Ill.). There are at least three major manufacturers: Burroughs Corp., Electronic Components division, Plainfield, N. J.; Beckman Instruments Inc's Information Display Operations division, Scottsdale, Ariz., and Pantek Corp., Lewistown, Pa.

The major hurdle in using these devices is, of course, the high voltage needed to initiate the discharge and cause the segments to glow with their characteristic orange color. "The drive-voltage question is the most misunderstood attribute of gas-discharge displays," says Bob Kuntz, marketing manager at Beckman Instrument's Information Display operations. Although 170 v is required to turn on the devices, there are methods of biasing the tubes so that the actual voltage switched is much lower. Depending on the application, 28 to 30 v works nicely, and one model could even work with 12-to-14 v switching, he says.

Gas glow

Despite the high-voltage problem, many users prefer gas-discharge displays because of their appearance. In the Beckman displays, for example, the raised cathodes allow the glow to wrap around the segments, giving a fuller character and helping to close the intersegment gaps. Horst Seperant, marketing manager at Analogic Inc., a maker of digital panel meters, estimates that

DISPLAY TYPES		
Type	Typical drive requirements	Comments
Light-emitting diodes	5 V, 10 mA dc	<ul style="list-style-type: none"> ○ red, orange, yellow, green colors ○ up to about 0.6-in.-high characters
Field-effect liquid crystal	10 V p p, 1 μA	<ul style="list-style-type: none"> ○ switching slows down at low temperature (typically 150 ms at 25°C) ○ requires illumination ○ limited viewing angle ○ polarizer lifetime sensitive to humidity ○ up to about 2-in.-high characters
Gas-discharge	180 V, 2 mA per segment	<ul style="list-style-type: none"> ○ limited temperature range (about 0 to 65°C) ○ orange color widely accepted ○ up to about 0.8-in.-high characters
Vacuum-fluorescent	18 V, 1.3 mA per digit (filament and grid supplies also required)	<ul style="list-style-type: none"> ○ pleasant blue-green glow ○ other colors available with filters ○ up to 1.0-in.-high characters
Incandescent	4.5 V, 24 mA per segment	<ul style="list-style-type: none"> ○ any color with filter ○ excellent brightness ○ up to 1-in.-high characters
Electromechanical	28 V, 400 mA per segment	<ul style="list-style-type: none"> ○ inherent memory — no continuous power drain ○ reflective display — requires illumination ○ up to 1-in.-high characters

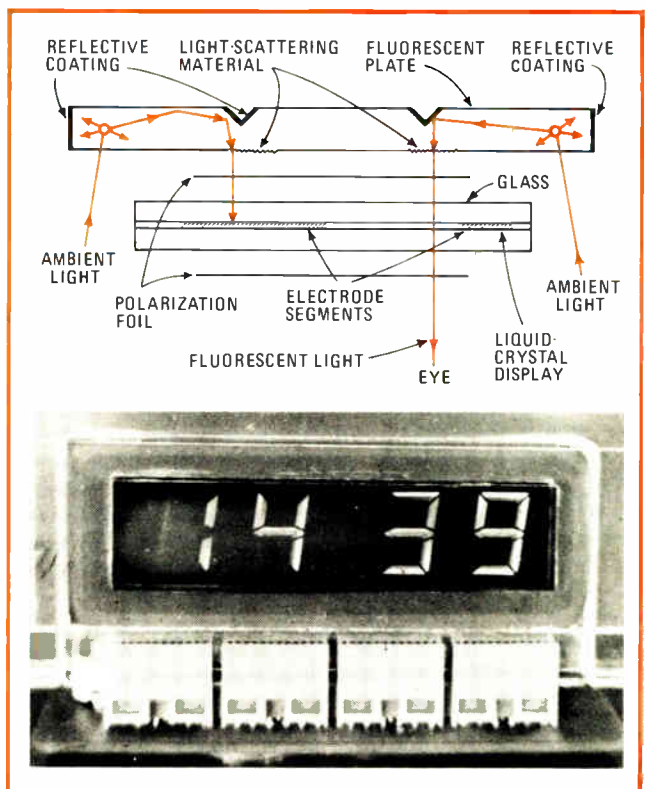

6. FLAD. The fluorescence-activated displays in development at Siemens AG, Munich, Germany and also at Optel Corp., Princeton, N. J., use liquid-crystal material to control the light striking a fluorescent material, which in turn provides a bright display.

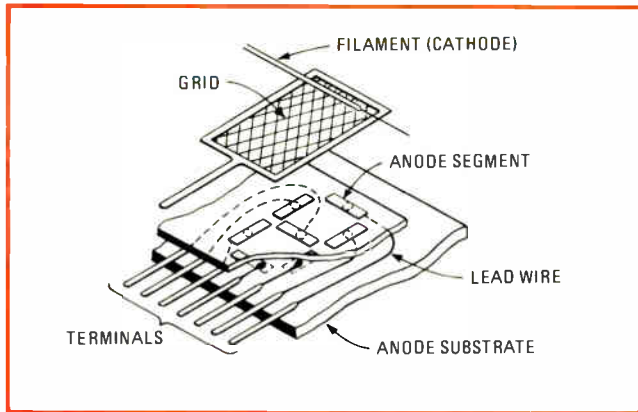

7. Vacuum-fluorescent display. The basic vacuum-fluorescent digit has a cathode as a source of electrons, a control grid, and anode segments coated with a fluorescent material. Electrons striking biased anode segments cause a blue-green glow.

about half his production uses gas-discharge displays, primarily because the customers want them.

There had been no integrated drive circuits for the displays, but now Dionics Inc., Westbury, N. Y. is producing an IC driver. However, some users are staying with discrete high-voltage transistors as drivers, because they have yet to be convinced of IC reliability at such high voltages.

The Japanese-made vacuum fluorescent displays, the familiar blue-green digits in many calculators, have recently been enlarged by the two major sources in the U.S., NEC America Inc., Santa Clara, Calif., and Futaba Industries of America, Compton, Calif. The bigger digits will make the displays more attractive for automotive, instrument, and point-of-sale applications.

Fluorescent construction

The device is basically a glass-envelope triode vacuum tube—with cathode, grid, and anode—in which the anode is segmented and coated with zinc-oxide fluorescent material to form the display (Fig. 7). Heating the filament creates electrons that strike those anode segments biased positively, causing them to glow.

A positive voltage also must be applied to the grid of the selected digit (which allows multiplexing of the digits, since a negative voltage will turn off a digit even if the anode segments are energized). Thus, like the gas-discharge tube, the devices require more than one voltage. But in the case of the vacuum fluorescent, the voltages and currents are much lower. A typical 0.6-in. character would require a cathode drive of 3 v at 75 mA, grid at 18 v at 8.5 mA, and a plate drive of 18 v at 15 mA. (Recently, Dionics introduced a series of dielectrically isolated integrated circuits to drive vacuum fluorescent displays.)

As with other devices, manufacturers are attempting to make the fluorescents more efficient—with better phosphors—in order to reduce the drive requirements and to improve their lifetime.

The construction of incandescent displays, such as the RCA Numitron, has steadily improved. Since these displays use a glass envelope with filaments to form numeric segments, they are not intended for demanding

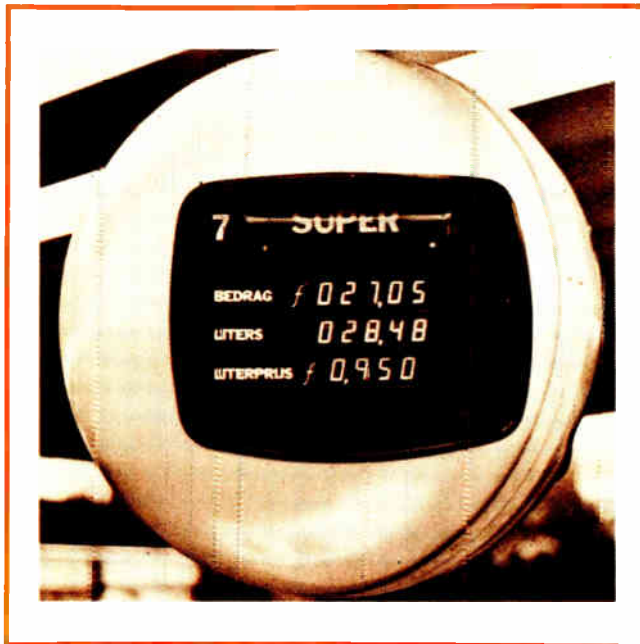

8. Electromechanical display. This seven-segment electromechanical display from Ferranti-Packard is in gasoline pumps in Europe. Individual segments are controlled by electromagnets. Once switched, they hold the display in position without applied power.

environments. But RCA says it has been working on designs for a rounded dome that would increase envelope strength, as well as on improvements in the segment support structure.

The devices generally require about 4.5 v per segment and about 24 mA. However, RCA says that the lower-voltage DR2200 series, which was discontinued about a year ago, has been redesigned and is in life test. The devices use 2.5 v and about 14 mA per segment.

The incandescent display's major advantages are its high brightness (which also can be easily controlled) and its practically unlimited selection of color filters. Its planar construction allows wide-angle viewing. It operates over a broad range of ambient temperatures—from -50°C to 125°C —since it is its own source of heat.

Using DIPs

Segmented incandescent displays also are available in 14- and 16-pin dual-in-line packages, such as the 0.47-in. character units from Industrial Electronic Engineers Inc., Van Nuys, Calif. (The firm probably offers the broadest line of displays in the industry, including LEDs, LCDs, gas-discharge, rear-projection incandescents, and the segmented incandescents.)

Finally, there are the electromechanical displays, in which segments flipped by electromagnetic action to display either a colored side or painted side. These are similar to the large outdoor displays which use, say, yellow disks in a 5-by-7 matrix.

Ferranti-Packard, Toronto, Canada, for example, supplies 1-in. seven-segment displays that require a 28-v drive pulse with 400 mA to write and -400 mA to erase (Fig. 8). No sustaining power is required, however, since the segments are held in place by permanent magnets until flipped again. □

One-shot multivibrator has programmable pulse width

by Stephen C. Armfield
MCI Inc., Fort Lauderdale, Fla.

The pulse width of a monostable multivibrator can be varied by digital control of its timing network. Using diode-modified gate circuits solves the interface problems inherent in driving the RC port with unipolar devices, while permitting the selection of resistors that shunt the timing capacitor to control its charging time.

As shown in the timing diagram in Fig. 1, a negative voltage is generated at pin 11 of a standard 74121 transistor-transistor-logic multivibrator although positive supply voltages are applied to the device. As a

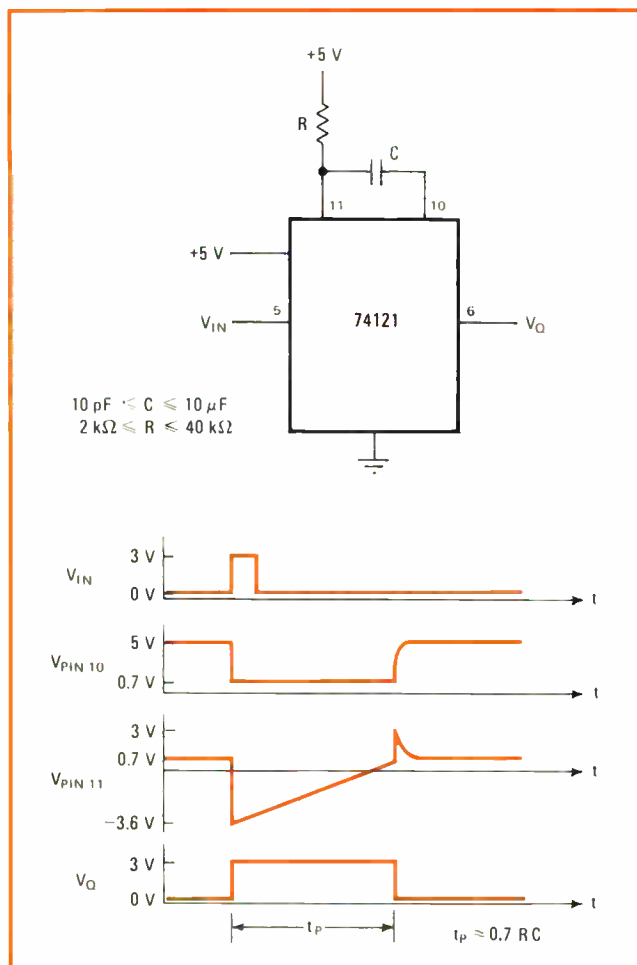

1. Standard configuration. TTL circuits alone cannot control the duty cycle of a one-shot directly because negative voltage is generated at timing port during normal operation. Reduction of this voltage to low level permits adjustment of pulse width.

consequence of a triggering signal, the voltage at pin 10, which started at 5 volts, drops to 0.7 v. The voltage at pin 11 also drops by the same amount; since its initial voltage was only 0.7 v, however, its final voltage is -3.6 v. Thus, the timing (RC) network cannot be directly driven by standard TTL configurations.

With the use of diodes D_a and D_b , pin 10 can be clamped to about 1.6 volts without disturbing circuit operation, and the negative excursions at pin 11 will be restricted to a few tenths of a volt, as shown in Fig. 2. The 7405 open-collector gates can then be used in conjunction with isolating diodes D_1 through D_n to alter the charging rate of C. The alteration is accomplished by

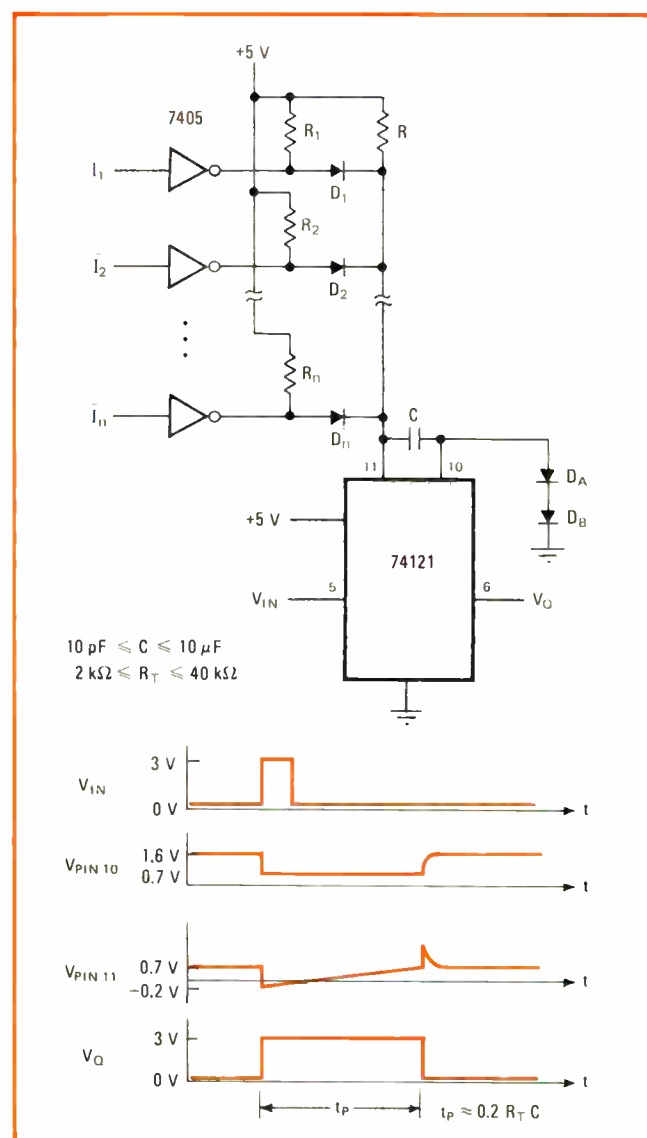

2. Pulse width variation. The use of diodes D_a and D_b clamps pin 10 of one-shot, permits TTL to drive and control the duty cycle. Actuating isolation diodes D_1 to D_n alters the charging rate of C, providing a choice of duty-cycle times.

activating the desired digital inputs I_1 through I_n , which permit conduction through the isolating diodes, and consequently, shunting of resistance by resistors R_1 through R_n . The equivalent resistance is:

$$\frac{1}{R_T} = \frac{1}{R_1} + I_1\left(\frac{1}{R_1}\right) + I_2\left(\frac{1}{R_2}\right) + \dots + I_n\left(\frac{1}{R_n}\right)$$

where I_1 through I_n is equal to 1 or 0, corresponding to logic 1 or logic 0.

The current required by the clamping diodes D_a and D_b is 20 milliamperes or so and is supplied by a transistor internal to the multivibrator. If the increased power consumption can be tolerated, this programmable one-shot can be useful in many digital applications. □

Resistor-controlled LC network drives tunable discriminator

by John W. Newman

U. S. Army Electronics Materiel Readiness Activity, Warrenton, Va.

A single potentiometer can adjust the fixed-tuned circuits that determine the mark-and-space frequencies in an audio-frequency-shift-keyed discriminator. This can be accomplished if the potentiometer controls the feedback current that passes through the inductor of each LC combination. Such calibrated single-control tuning is an advantage when reception of any one pair of several widely used shifts is necessary, because the mark-and-space filters do not have to be individually and repeatedly set by a frequency counter or by some other instrument.

A LaPlace analysis of a current-driven tuned circuit will show the dependence of the resonant frequency on the amount of feedback. The tuned circuit in Fig. 1 has a transfer function that is:

$$A(s) = \frac{s + R_L}{s^2 + R_L s + 1}$$

Feedback provided by the second amplifier is:

$$B(s) = \frac{K}{s^2 + R_L s + 1}$$

where K is the amplifier gain, a function of the potentiometer setting, and may be positive or negative in value. The complete transfer function becomes:

$$H(s) = \frac{s + R_L}{s^2 + R_L s + 1 - K}$$

The denominator of this equation, which is of major importance in this analysis, is of the form:

$$s^2 + (AQ)s + \omega^2$$

where A is a constant, Q is the circuit's selectivity or quality factor, and ω is the radian frequency of the circuit. Thus it is observed that $\omega = (1-K)^{1/2}$. This assumes that bandwidth and gain of the circuit are independent variables.

Analysis of the feedback loop containing a tuned circuit that is driven from a voltage source is somewhat more complicated, but the results are similar. For the actual voltage-driver circuit in Fig. 2, the transfer function is approximately:

$$H(s) = \frac{(s + R_L)}{R_4[s^2 + s(R_L + 1/R_4 + 1/R_5) + 1 \pm K]}$$

where the radian frequency term is the same, but the value of Q depends largely on resistors R_1 and R_2 , and the value of K is dependent on R_3 .

Determination of R_1 , R_2 , and R_3 is most important for circuit optimization of Q and transient response. After limiting of the 2-to-3-kilohertz input signal by the first operational amplifier, the 14-volt output signal must be reduced by one half by the voltage divider consisting of R_1 and R_2 . This will prevent overdrive of subsequent stages containing two identical tuned circuits with equivalent impedance Z_x . In addition, the dc output of the circuit is a function of the relationship of the mark-and-space frequency to the frequency of each tuned circuit (and thus Z_x , R_1 , and R_2).

An unloaded (no-feedback) Q of about 100 is to be expected at 2,500 Hz from each resonant circuit, providing a Z_x of 138,200 ohms. It is reasonable to set a loaded Q of 25, providing a bandwidth of 100 Hz. Resistor R_2 is selected for a Q of 50 so that the parallel equivalent of Z_x , R_1 , and R_2 reduces the Q to 25 and

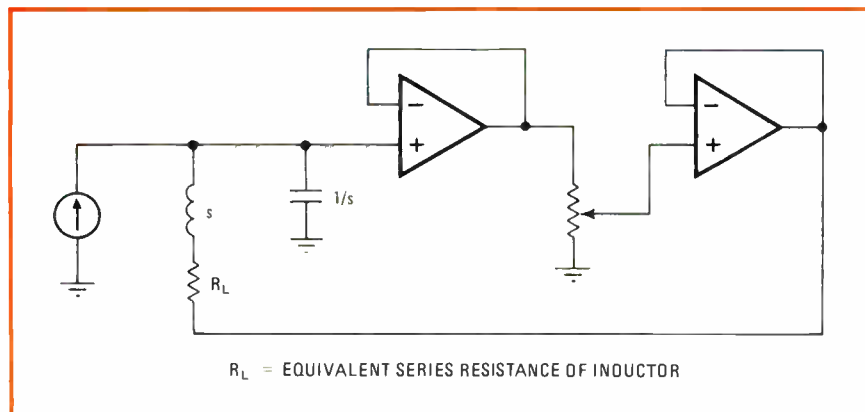

1. Current analysis. Resonant frequency of tuned circuit is affected not only by L and C values but also by magnitude of feedback current through inductor. Potentiometer may control gain of amplifier and thus resonant frequency. Circuit is simpler to analyze but yields results similar to voltage-driven discriminator network described in text.

and do it with standard modules

Powercube's MIL-Standard "gold line" Cirkitblock® modules enable you to bread-board custom power supply systems in minutes with AC or DC input switching preregulators, EMI terminal modules, high-frequency generators and transformer isolated output modules - all encapsulated in tiny, lightweight packages and most available right off the shelf. (Powercube can also assemble your power supply systems for you.)

You will find many of our military and space programs rely on the "gold line"

Cirkitblock modules. The reason: these MIL-Standard power modules meet the most demanding specs for sophistication, weight, environment, ruggedness, reliability and performance (i.e., MIL-STD-704A, MIL-STD-461 and environmental conditions of MIL-E-5400). What's more, all "gold line" Cirkitblock modules are MIL-qualified*.

If you have problems because your power supply vendor let you down, or you are involved in a new system and want to test your power supply quickly, read our "gold line" Selection Guide. Just circle the reader response number or phone 617-891-1830 to get your copy.

It will give you a whole new set of standards.

*Supporting documentation available upon request.

Custom design your power supply system...

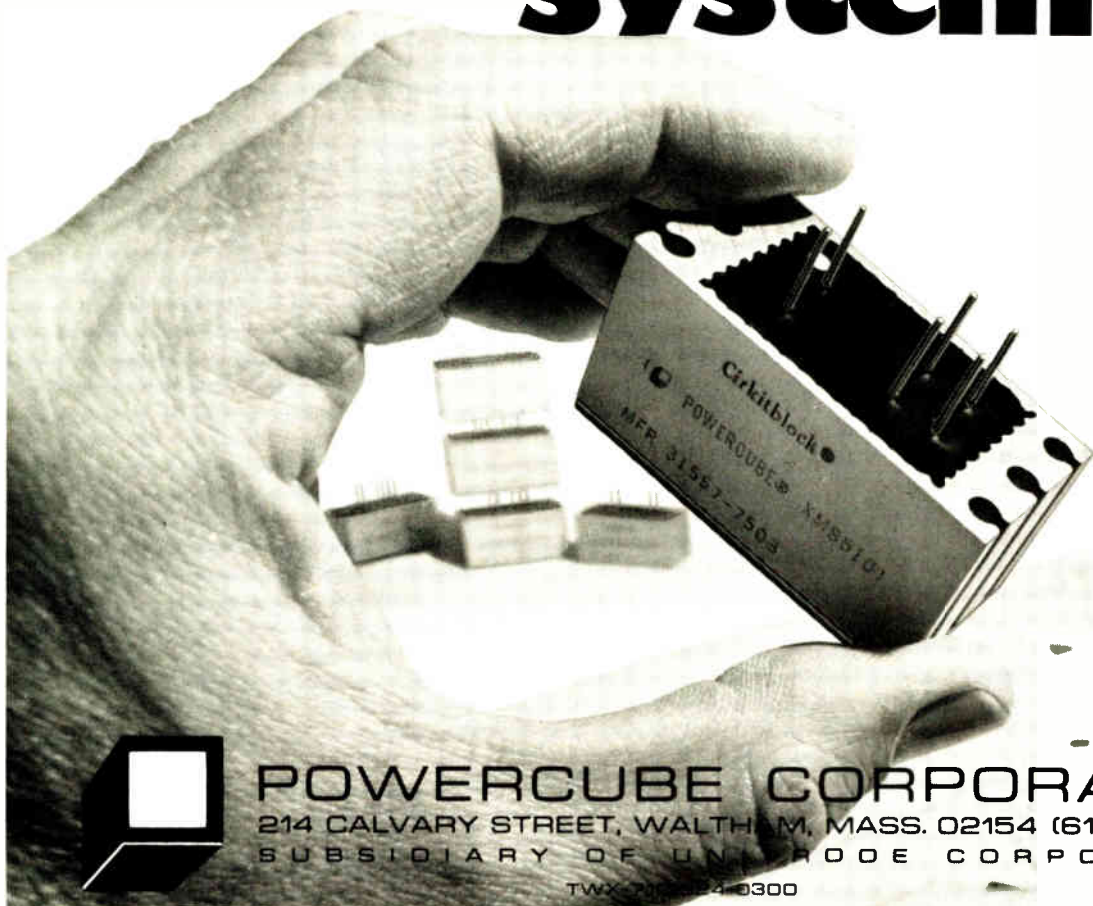

POWERCUBE CORPORATION

214 CALVARY STREET, WALTHAM, MASS. 02154 (617) 891-1830

SUBSIDIARY OF UNITED ROPE CORPORATION

TWX 714 24 0300

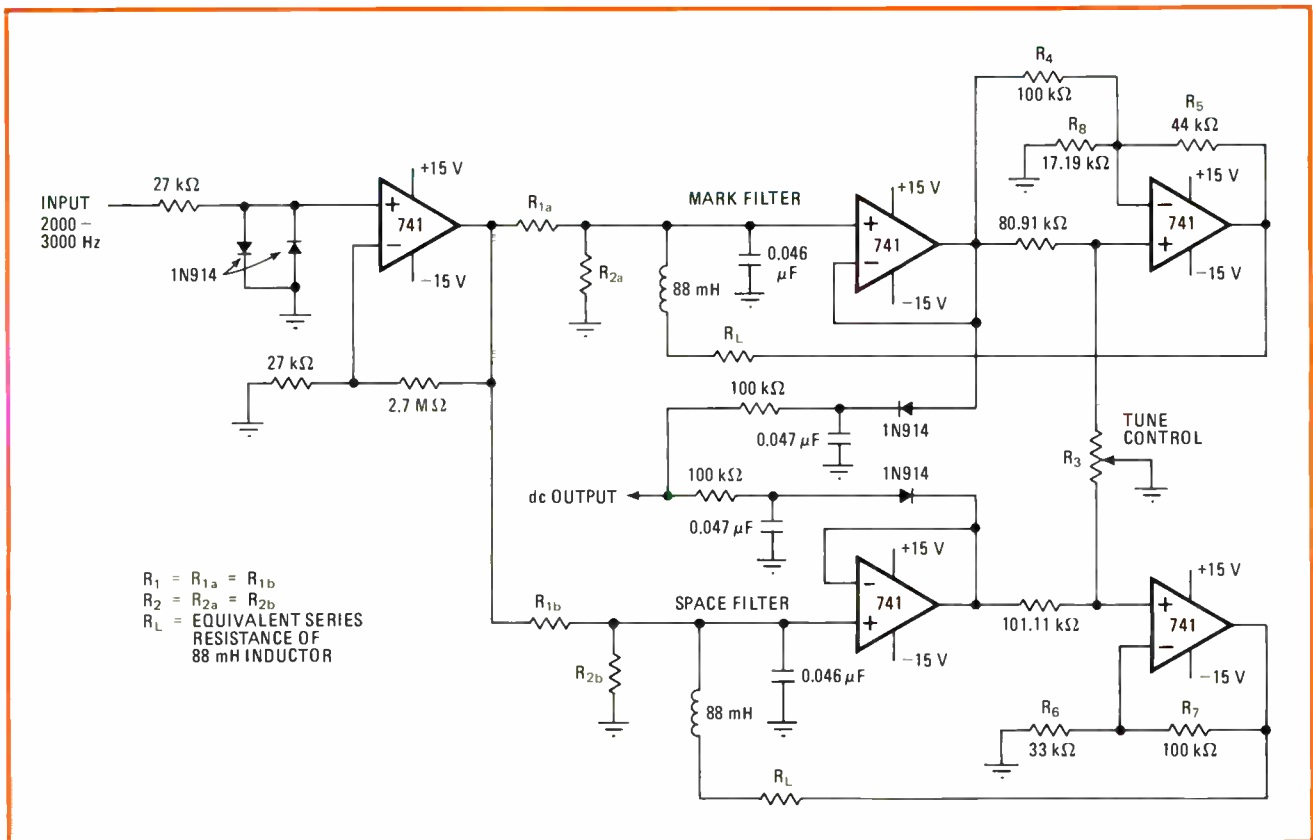

2. A discriminating network. Resistor-tuned filters provide one-control adjustment of mark-and-space frequencies. Shifts are continuously adjustable from zero to 1 kilohertz at a center frequency of 2,500 hertz and are linearly proportional to potentiometer setting.

RESISTOR-TUNED DISCRIMINATOR		
POT ROTATION (%)	FREQUENCY (Hz)	
	MARK	SPACE
0	2,500	2,500
10	2,549	2,451
20	2,598	2,401
30	2,647	2,352
40	2,697	2,302
50	2,747	2,252
60	2,797	2,202
70	2,847	2,152
80	2,897	2,102
90	2,949	2,051
100	3,000	2,000

yields the desired voltage division. Thus, R_2 is equal to 138,200 Ω , and R_1 is equal to the parallel combination of Z_x and R_2 , or 69,100 Ω .

The resonant frequency of the mark-and-space filters is directly determined by R_3 . With the potentiometer's resistance at a minimum as measured from the junction of the 101-kilohm resistor and the noninverting input of the 741 op amp, the noninverting gain for the mark filter is 0.44, which nullifies the inverting gain of 0.44 from the following amplifier stage. Thus the mark resonant

frequency remains at 2,500 Hz. Feedback through the space resonant circuit is zero, and it is also resonant at 2,500 Hz. When R_3 increases, the inverting gain for the mark filter becomes greater than the noninverting gain and the mark resonant frequency increases. The feedback signal through the space resonant circuit decreases the space resonant frequency. The maximum input signal available across R_3 is 0.09 times the output signal; at this setting the op amp gain is 4. The lowest resonant frequency is thus $(1 - 0.36)^{1/2} (2,500) = 2,000$ Hz. Conversely, the mark filter has a maximum frequency of $(1 + 0.44)^{1/2} (2,500) = 3,000$ Hz.

The table shows the relationship of the potentiometer setting to the mark-and-set frequency pairs. The resonant frequency of the mark filters should be trimmed to a center frequency of 2,500 Hz by R_8 . The space filter's lower limit should be trimmed by R_6 or R_7 ; the mark filter's upper limit should be set by R_4 or R_5 .

The dc output is derived from intermediate op amps in conjunction with half-wave rectifier networks. The output voltage will always be positive for received mark frequencies and negative for space frequencies, permitting a suitable source for transistors that will drive radio teleprinter relays and similar equipment. Rejection of off-frequency mark-or-space signals is excellent. Mark-and-space frequency pairs can be within 100 Hz of each other while still providing good circuit performance. □

Designer's casebook is a regular feature in *Electronics*. We invite readers to submit original and unpublished circuit ideas and solutions to design problems. Explain briefly but thoroughly the circuit's operating principle and purpose. We'll pay \$50 for each item published.

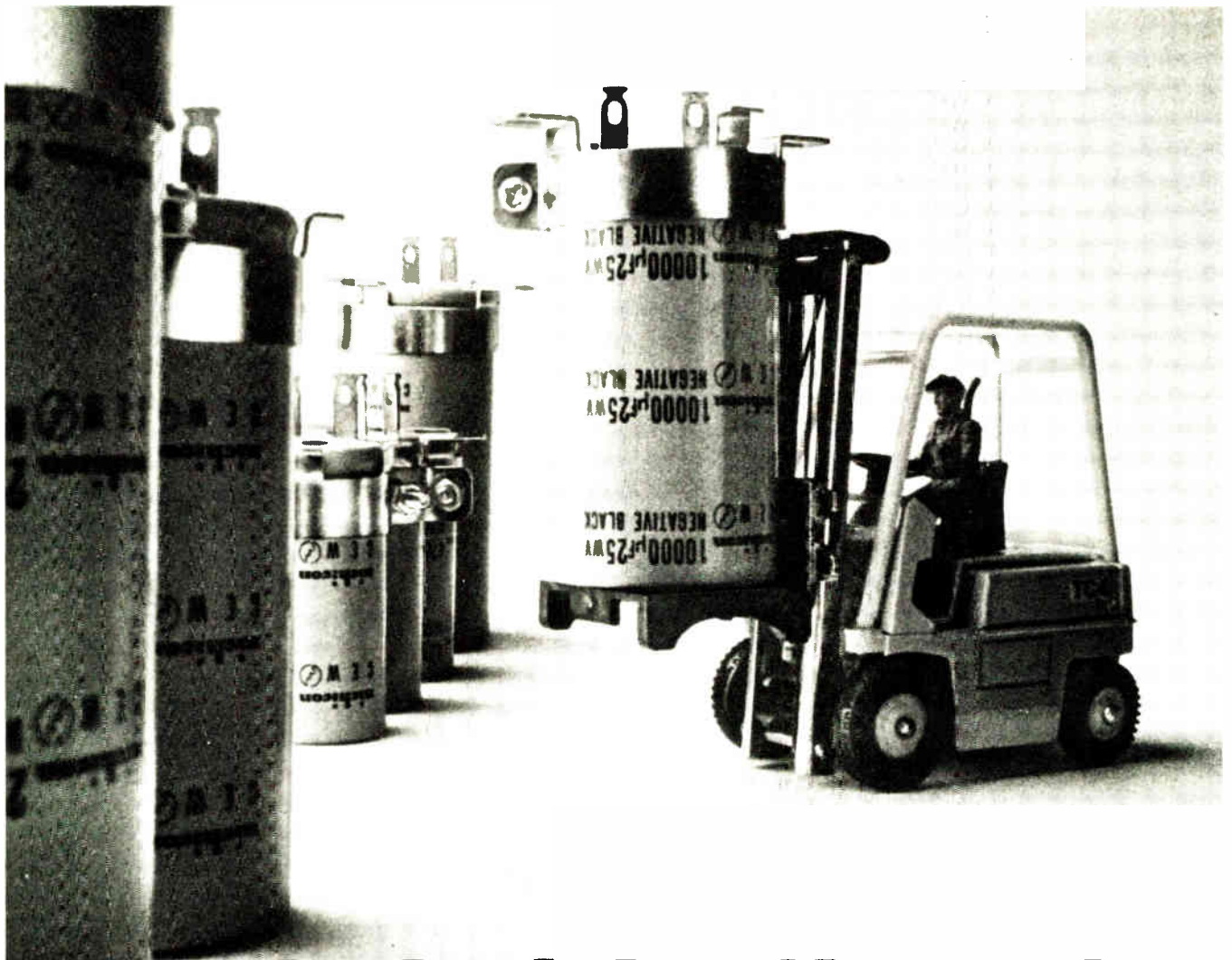

Industrial-Strength Capacitors.

Both our high- and low-voltage Industrial Grade Aluminum Electrolytics offer you operating accuracy over a long, hard-working life span. **The Nichicon High-Voltage Can Series** with lug-type terminals operates dependably from -25°C through $+85^{\circ}\text{C}$ with a voltage range from 100 V. DC through 500 V. DC.

Our Low-Voltage Can Series offers an even wider temperature range, -40°C through $+85^{\circ}\text{C}$,

with a voltage range from 16 V. DC through 80 V. DC.

The values marked on the outside of our capacitors tell you exactly what you're getting on the inside. From Nichicon, you get exactly what you've paid for.

Our Industrial Grade Aluminum Electrolytics are just one more example of our continuing

emphasis on reliability as the dominant design criterion.

We manufacture every type of capacitor including other types of aluminum electrolytics, ceramic discs, film, oil filled—without PCB's, metallized paper and wax paper capacitors for standard or specialized applications.

Send for your free catalog and engineering samples today. Simply write to us on your letterhead. You'll hear from us soon.



The pulse of the industry.

nichicon

NICHICON (AMERICA) CORPORATION • 6435 N. Proesel Ave. • Chicago, IL 60645 • (312) 679-6530
Division of NICHICON CAPACITOR, LTD., Kyoto, Japan

Slave microcomputer lightens main microprocessor load

by Don Phillips and Allen Goodman, *Intel Corp., Santa Clara, Calif.*

Peripheral devices for microprocessors are growing in number and complexity to the point where they are taxing the processor's time and memory. Nor do simple interface adapters that contain no intelligence of their own lighten the burden of managing such peripheral equipment as floppy disks, cathode-ray-tube displays, and keyboards. What can save the day for the central processing unit is a new class of peripheral controllers: intelligent microcomputer-based universal peripheral interface chips.

In essence, what the UPI microcomputer does is act as a slave processor to the main-system CPU. With a built-in processor and memory, it greatly eases the handling of real-time tasks such as controlling printers, encoding keyboards, and multiplexing displays. In fact, entire control algorithms can be programmed locally in the slave processor, instead of taxing the limited memory

space and execution time of the main system. Moreover, the device substantially increases the overall efficiency of a system, since two processors—the central CPU and the slave UPI device—are working in parallel.

A peripheral controller

In operation, the UPI microcomputer acts as a peripheral controller rather than just an interface adapter. Its architecture, detailed in Fig. 1, is similar to the recently introduced 8048 one-chip microcomputer: it has an 8-bit CPU, 64 bytes of random-access memory, 1,024 bytes of read-only memory, a timer/counter, and 18 input/output lines. In fact, the device executes the same basic set of instructions as does the 8048, except for special tailoring of data-bus operations to better suit control applications. The difference is that the new peripheral-controlling microcomputer is designed to function as a

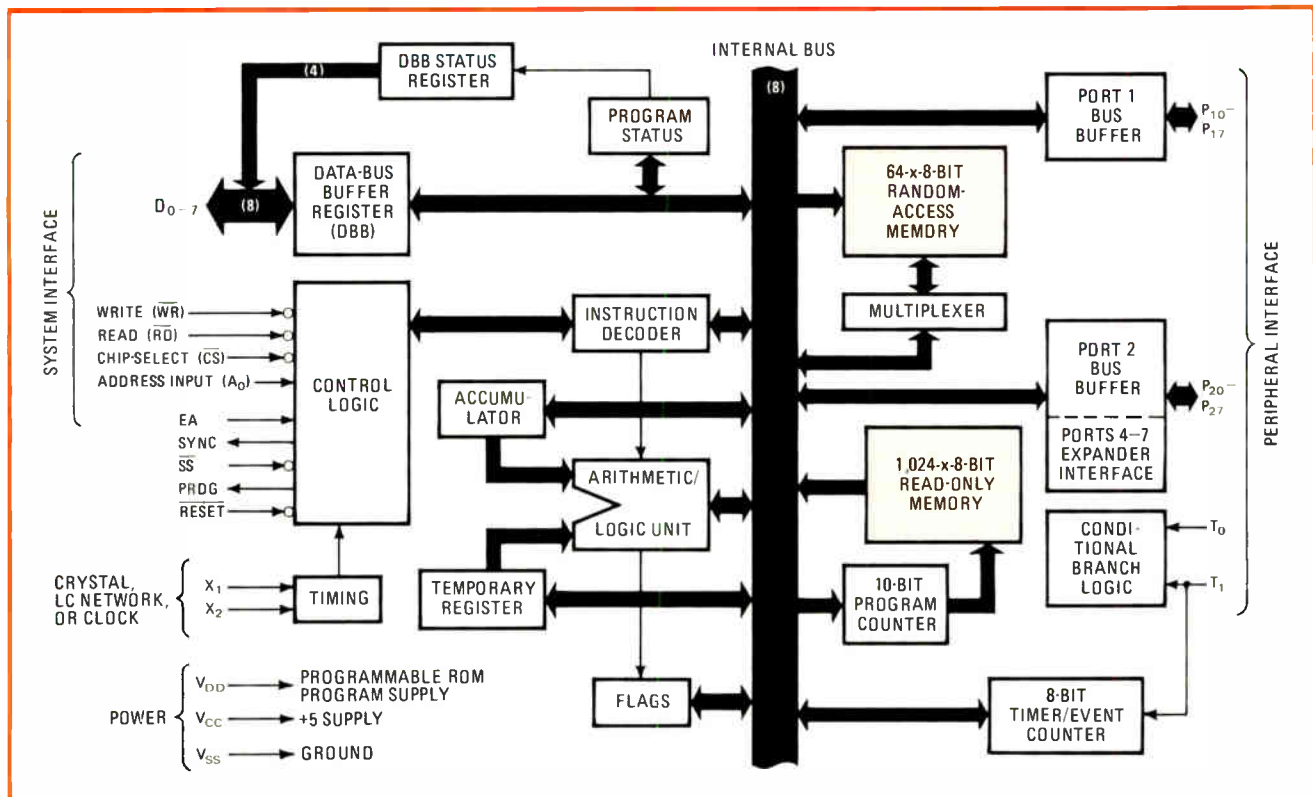

1. Smart interface. With an 8-bit CPU, 64 bytes of RAM, and 1,024 words of ROM or erasable PROM, the universal peripheral interface chip is an intelligent peripheral controller rather than a simple interface adapter. The architecture of the chip is similar to that of the 8048 microcomputer. It uses nearly the same instruction set, save for slight variations that improve data-bus operations.

2. Slaves. The microcomputer-based universal peripheral interface chips—the 8741 with erasable PROM and the 8041 with mask-programmed ROM—are connected as slave processors to a main processor (here an 8080 CPU) to take over its I/O chores.

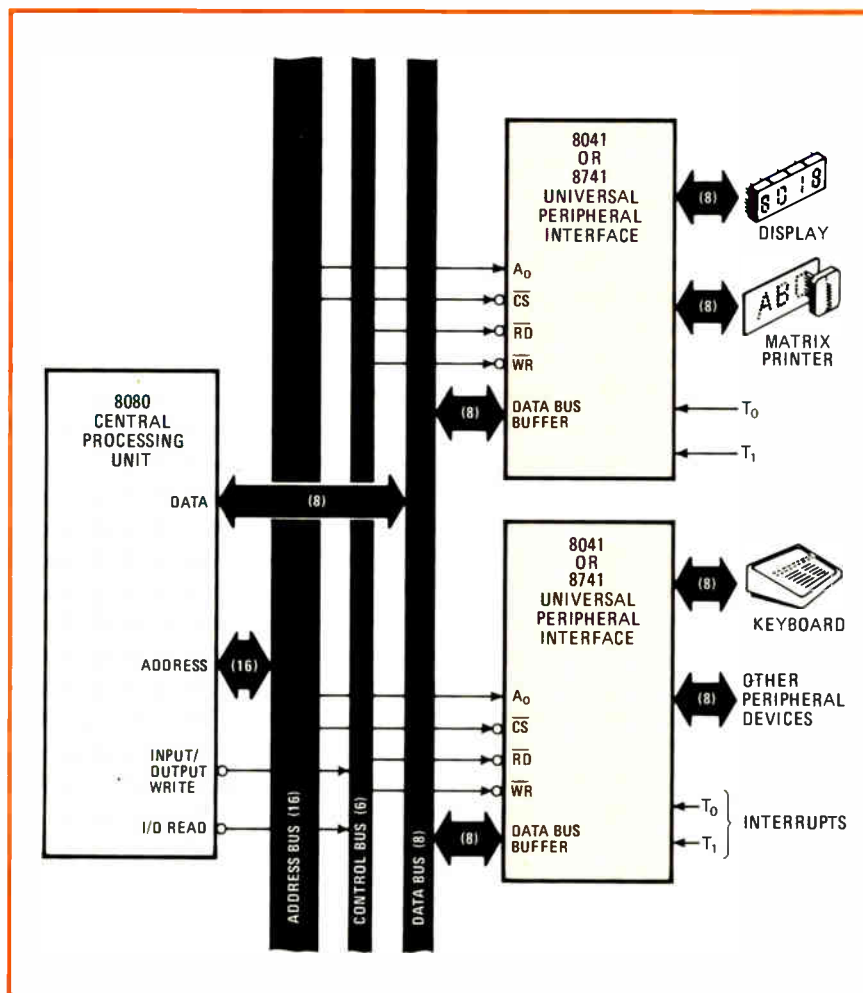

slave processor to the main-system processor.

The chip is the first microcomputer made specifically for a multiprocessor environment in which a master processor sends information to one or more slave processors that in turn control peripheral devices. To accommodate a variety of master processor types, including the 8080, the enhanced 8085, and other 8-bit processors, the chip has bus interface registers that work directly with the central processor's data bus.

Two peripheral controllers are available: the 8741 and the 8041, identical except in one respect. The 8741 has an ultraviolet-erasable, electrically programmable ROM plus the special capability of running through a program a single step at a time. It is designed for low-volume applications requiring program development, as in prototype testing and custom interfacing. The 8041 has a conventional mask-programmable ROM and features a low-power standby mode. It is intended to replace the 8741 once a system design has been set. The 8741/8041 connections for a master-slave arrangement are shown in the block diagram of Fig. 2.

The master processor and the peripheral controller communicate through an asynchronous data-bus buffer register on the UPI. Data and commands are received from the master processor through the DBB, and status and data information are returned through it to the master. The controller sends status information to the

main processor from a 4-bit status register that uses four of the buffer register's eight lines.

The configuration of the DBB and status registers is shown in Fig. 3. The master processor controls data transfer to the UPI by four input lines: the address-input signal specifies whether a command or a data word is being sent; the chip-select line is an enable input that permits communication with the interface, and the read and write lines are used to strobe output and input data, respectively. The master processor uses these signals to direct the exchange of information through the DBB register, which serves as temporary storage for commands and data flowing between master and slave processors.

The four flags

The status register comprises four flags that direct the handshaking between the master and slave processors. The first is a general-purpose flag, which is set by programming in the 8041/8741 and used to prevent contention over the DBB register between master and slave processors. Another is the command/data flag that, when set, indicates that command information is being transferred. The input-buffer-full flag is set whenever the DBB register is loaded with a word from the main processor, and the output-buffer-full flag is set when the UPI loads its DBB register.

Protocol for the interface begins with the master processor writing an 8-bit character into the buffer register. This sets the IBF flag, signaling the peripheral controller with an internal interrupt. The UPI can then transfer the 8-bit data byte to its accumulator at any time under software control, which clears the IBF flag.

In transferring data in the other direction—from slave to master—the peripheral chip loads the DBB register while automatically setting the OBF flag. The master processor can then read the status register to determine that the OBF flag is set and can proceed to take in data from the buffer register, at the same time clearing the flag in preparation for the arrival of more data.

Transfer of data within the peripheral controller is asynchronous to external processor timing. The chip can thus effectively control peripheral devices while data transfers go on unhindered. Moreover, the DBB register isolates peripheral control tasks from the main processor. Task isolation is desirable in that it eases software development and debugging within a given system (by modularizing functions). In addition, it is certain to enhance data throughput, since two microprocessors are running concurrently.

Optimized for control

The CPU and instruction set of the 8041/8741 are designed to efficiently handle the single-bit operations required in most control applications, including I/O operations and data-bit manipulation. Two 8-bit-wide ports, compatible with transistor-transistor logic, are provided on the chip. (Sixteen additional lines may be had with the addition of an 8243 I/O expander chip, which takes up half the lines of I/O port 2.) Two inputs to the peripheral controller are provided that may be tested with conditional branch instructions in UPI software. Any port line can be set or cleared individually under software control, and any line can function as either input or output, irrespective of remaining lines.

The timer/event-counter included on the peripheral controller can be preset, read, started, or stopped under software control. In the timing mode, an internal oscillator can be set by a crystal or an LC network. In the event-counter mode, the T₁ input may be used to count switch closures or tachometer pulses, directing program flow accordingly. If the counter has been preset, a flag is available that indicates overflow, and it can signal the master processor.

The 1,024 bytes of on-chip ROM are sufficient for most dedicated programming applications. Typically, keyboard encoding or printer control requires 500 to 700 8-bit bytes, and therefore ample program space is available for additional functions.

Of the 64 locations in the on-chip RAM, there are two 8-byte register banks, an eight-level program-counter stack, and 32 bytes of user RAM. The dual 8-byte register banks allow fast response to interrupts such as the IBF flag or time overflow. The stack also provides convenient handling of subroutine cells and storage of other data.

The thrust of the peripheral-controller chip is in its isolation of peripheral tasks from the main processor. Since its job is specifically for control, the main

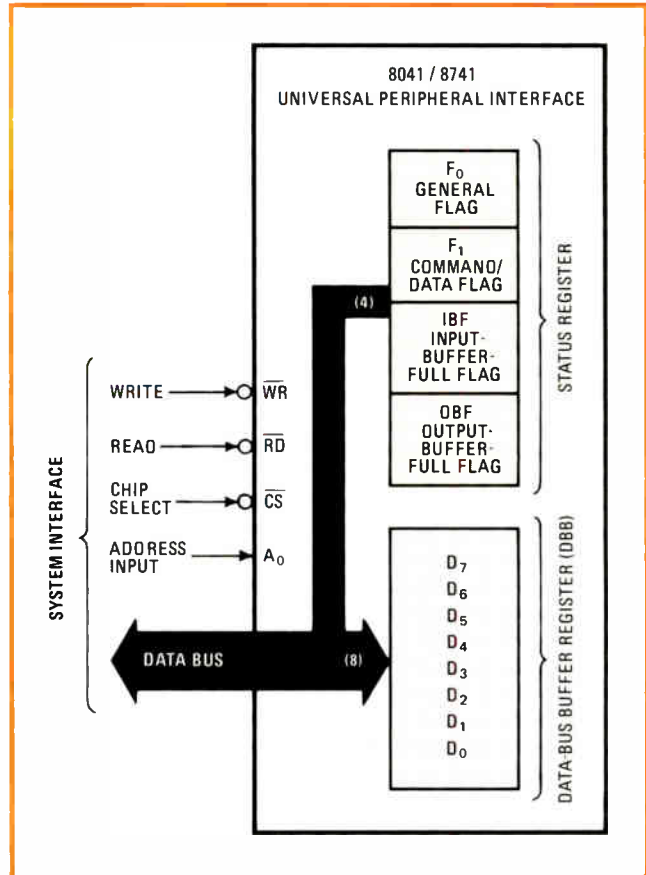

3. Buffer to the bus. The data-bus buffer register (DBB) provides temporary storage for commands and data flowing between the UPI and a main-system processor. The status register puts four signals on the data bus that between them inform the main processor of the status of the DBB and also establish a handshaking protocol.

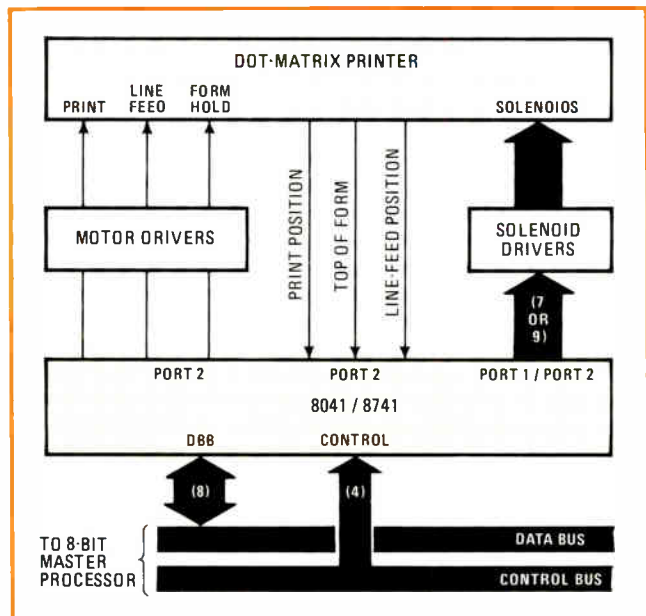

4. Printer control. Memory in the 8741/8041 allows the device to buffer as many as 40 characters to be printed. The main-system processor can transfer a block of data at this speed and then continue with other tasks while the UPI's bidirectional I/O ports monitor and control sequential character printing.

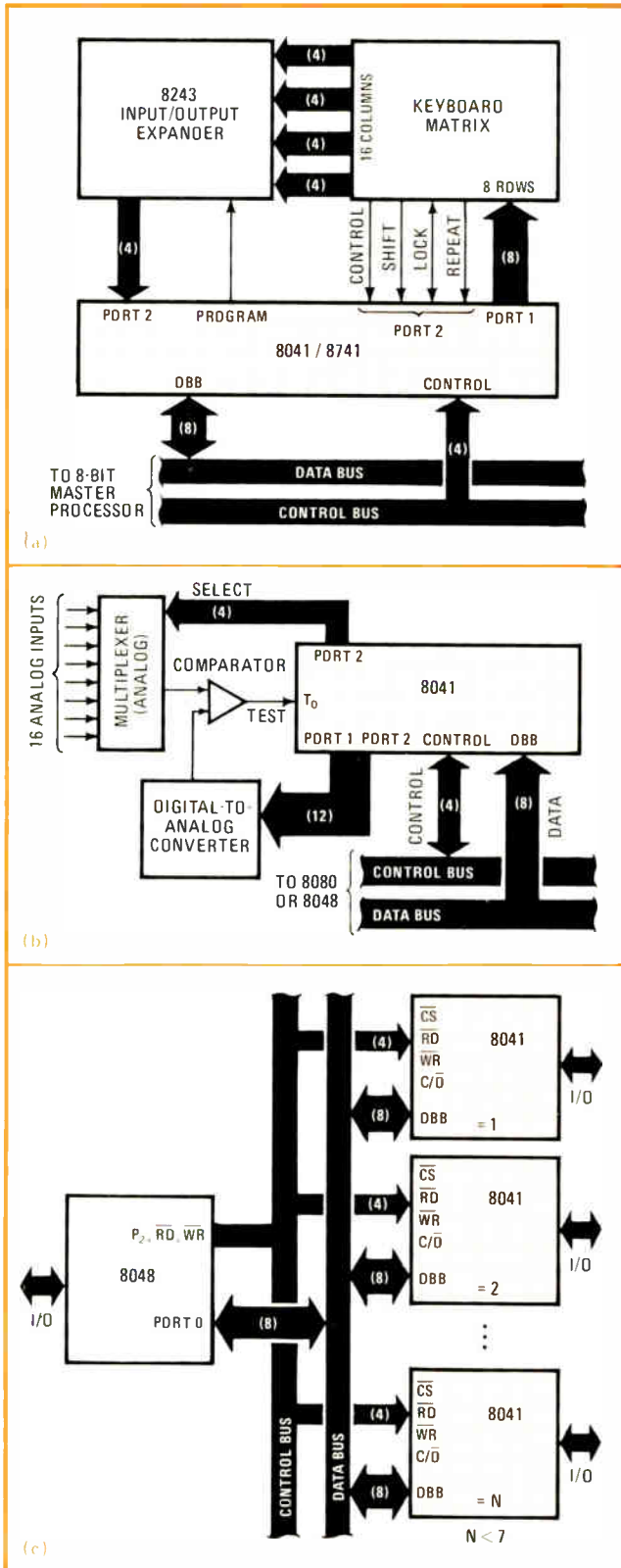

5. Using the UPI. Typical applications of the 8741/8041 include (a) a keyboard scanner in which an 8243 input/output expander is added to permit the encoding of as many as 128 keys, (b) a process-control subsystem implemented with an analog multiplexer and a digital-to-analog converter, and (c) a generalized distributed processing system that employs up to seven of the devices as slave processors, connecting them to a single 8048 microcomputer.

processor can therefore be left to download commands and transfer data, while the UPI works in real time.

One application might be the controlling of a printer peripheral to an 8080 system, as shown in Fig. 4. The entire real-time control portion of the task can be handled by the peripheral controller. With its built-in timer, it easily handles timing functions like character spacing, print position, and line feed. The UPI has ample I/O ports for a 40-column dot-matrix printer.

In this printer application, the DBB register allows for standardization of data transfer to and from the 8080-based main processing system. To do this, one typical format might be for the main processor to send a start command followed by a full line of 40 ASCII characters. The peripheral controller would then store the characters under program control in a portion of the RAM and begin execution of the printing as soon as the print head and line feed were in the proper position. In the meantime, the main processor returns to other tasks. The ROM in the 8041/8741 can be used to convert the ASCII code to dot-matrix or other formats.

In printer applications, standardization is the key feature offered by the slave peripheral controller. Without any changes in the 8080-based main processing system, the UPI can be programmed to handle any printer mechanisms—dot matrix, drum, spherical head, and so on. In this way, a designer can easily upgrade the peripherals in his system with a minimum of change in the master-processor software.

A keyboard application

Figure 5a illustrates an application in which the new chip plus an 8243 I/O expander provide a compact system for scanning and encoding as many as 128 keys from a terminal keyboard. N-key rollover and debounce are implemented by using the on-chip RAM to keep a copy of the key status after each scan. When a key closure is detected, the 8041 uses a ROM look-up table to generate the appropriate ASCII code for transfer to the master processor. As many as 16 characters can be stored and transferred in a block to the master processor.

The analog process-control subsystem illustrated in Fig. 5b can be implemented using an analog multiplexer and digital-to-analog converter along with the 8041. In this configuration, the peripheral controller can monitor and digitize eight analog inputs, perform linearization (using equations or ROM look-up tables), check for limits and zero offsets, and receive control information that could determine new limits.

Figure 5c illustrates a generalized distributed-processing system using as many as seven 8041s as slave processors connected to a single 8048 master processor. Port 2 of the 8048 provides seven chip-select lines to the peripheral controllers plus the command/data control function. This low-cost, low-speed multiprocessor configuration has many advantages over a single high-speed processor. The peripheral controllers are designed especially for control or interface applications, and each can be programmed to handle a single isolated task. This modular approach allows easy development and debugging of the system. □

MOS processor picks up speed with bipolar multipliers

Taking over from software, the bipolar additions let the metal-oxide-semiconductor chip do real-time processing

by Douglas J. Geist, *Motorola Inc., Government Electronics Division, Scottsdale, Ariz.*

□ Adding a teammate can boost a metal-oxide-semiconductor microprocessor into the big leagues of specialized signal processing. Such chores have been the province of the higher-speed bipolar microprocessors, but adding a parallel multiplier to an MOS microprocessor will provide the fast computational capability that is necessary for such jobs as real-time data acquisition, signal processing, and digital filtering.

The slower MOS processors are generally less expensive than their bipolar counterparts, and they are relatively easy to program for most tasks. However, performing the multiplications inherent in real-time signal processing by software can be time-consuming. But the addition of multiplier hardware will solve the problem—with fast parallel multipliers preferred because they do not require the additional support circuitry that combinatorial-array or serial-parallel multipliers do.

Interfacing a microprocessor with an 8-by-8-bit or

1. Matrix organization. In the MPY-8 and MPY-16 multipliers, the product is formed by matrix interconnections of the X and Y input operands. At the intersection of each bit in X and Y, the 1-bit product is summed with previous sums and carries from other positions.

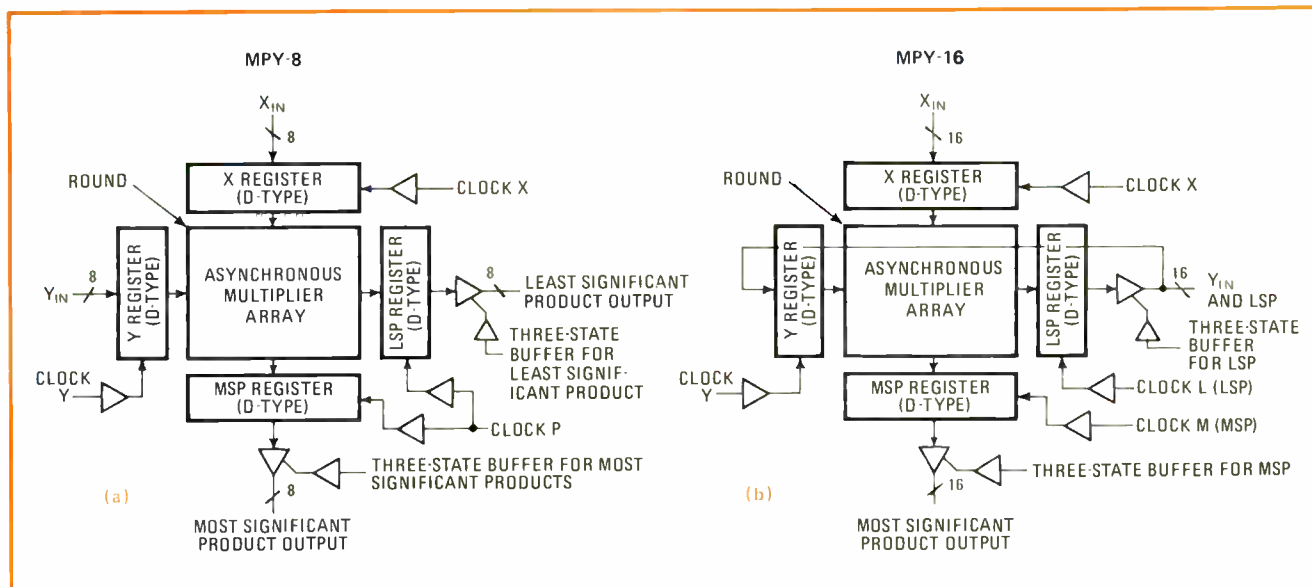
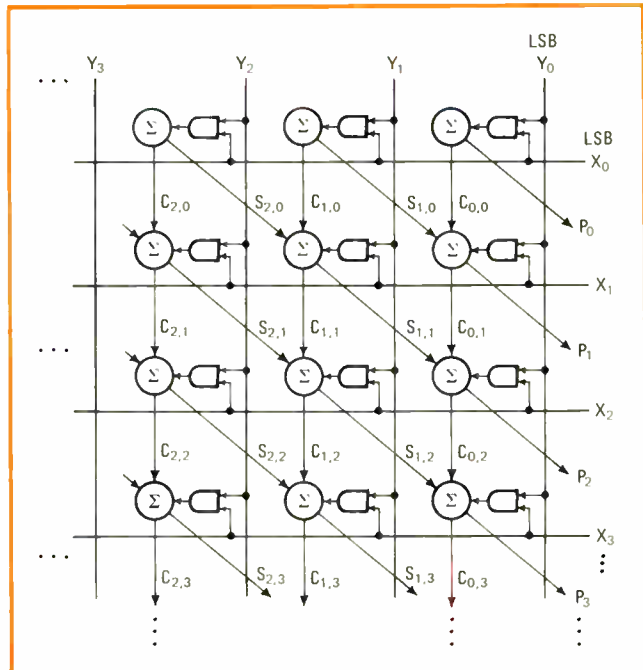

2. Producing a product. Input X and Y operands and the output product are on separate data lines on the MPY-8 (a), whereas on the MPY-16 (b) the Y operand and the least significant product share a common data line. Once the operands are latched, computation begins.

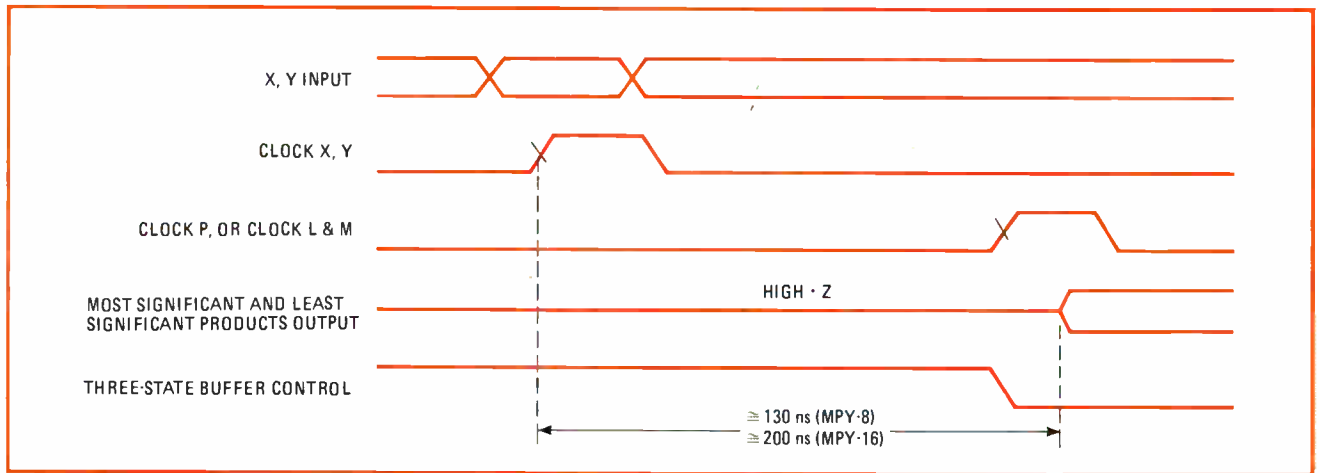

3. Timing. Data is latched into the operand registers on the positive edge of the clock-X and clock-Y pulses. After about 130 ns (MPY-8) or 200 ns (MPY-16), the product may be read by clocking the output-latch clock and turning off the three-state buffer control.

with a 16-by-16-bit multiplier expands the processor's capabilities. The software of the MC6800 microprocessor takes about 300 microseconds to perform an 8-bit multiplication algorithm. When an 8-by-8 multiplier is harnessed, the operation takes only 18 μ s. It also is more cost-effective to improve the 6800's multiplication speed in this way than to pursue a bit-slice approach. Moreover, the 6800's bus concept, with addressable memory and input/output, keeps interface problems to a minimum and programming relatively simple.

Two fast-multiply integrated circuits especially suited for 8-bit microprocessors are the MPY-8 and MPY-16 multipliers. These chips, for 8-by-8-bit and 16-by-16-bit operations respectively, are available from TRW Electronic Systems division, Redondo Beach, Calif. They are made with the relatively simple, low-cost triple-diffusion bipolar process in an emitter-follower-logic configuration [*Electronics*, Aug. 7, 1975, p. 101]. The process allows about 17,000 EFL devices on a single die measuring 84,000 square mils, with gate delays of 6 to 12 nanoseconds and a power dissipation of 1 milliwatt per gate. These multipliers can provide multiplications as much as 3,000 times faster than do typical MOS processors.

A useful number system

With most numerical algorithms, it is necessary to deal with signed numbers when implementing multiplication. Four methods are commonly used to represent fixed-point negative numbers in binary number systems: sign and magnitude, offset binary, 1's complement, and 2's complement. The choice of one of these methods is determined primarily by the choice of hardware or software implementation of arithmetic operations.

The MPY-8 and -16 operate with the 2's-complement number system, which uses addition rather than subtraction when performing a multiplication with a negative number. This approach makes it easier to implement the algorithm used. A binary code represents positive magnitudes (sign bit equals zero). Negative magnitudes are formed arithmetically by complementing the positive number and then adding 1 least significant bit. When subtracting binary numbers, the bit beyond the original

most significant bit is always ignored in the result.

An advantage of the 2's-complement system is that it forgives minor, temporary scaling problems. If the magnitude of the binary-word overflows because of an arithmetic operation, the true magnitude is recovered easily by proper scaling.

Hardware multiplexer

The multipliers accept X and Y input operands in the 2's-complement form and supply the double-precision products in the same form. They have a matrix organization that forms the product of X and Y input operands. The sequential-add algorithm that is used in the multiplication provides all partial products in the matrix simultaneously.

In the matrix shown in Fig. 1, each cell has circuitry to form a 1-bit product and a full-adder circuit to add this product to the sums and carries from the other parts of the matrix. The bit lines of the multiplier register (X) and the multiplicand register (Y) run through the matrix perpendicular to each other. The 1-bit products are formed at each intersection in the matrix. A full adder sums the product of an intersection with the previous sums and carries from a less significant position of the matrix.

The carry from this addition is fed to a matrix position of greater significance, while the sum appears at a position of less significance. This process is similar to the way one performs longhand multiplication, except each carry of the individual binary additions is passed immediately to the next column of the matrix, rather than after adding the whole column.

Although either multiplier accomplishes the same job, there is less interface circuitry needed with the MPY-8. Both X and Y operand inputs and product outputs are on separate lines on the MPY-8 chip (Fig. 2a); the Y input operand and the least-significant-product output share common 16-bit data lines on the MPY-16 (Fig. 2b).

Both chips contain data registers for the input operands and output products. Input operands are loaded into D-type registers by the positive transition of the clock X and clock Y signals. The most significant bits of the X and Y input operands (8-bit or 16-bit words)

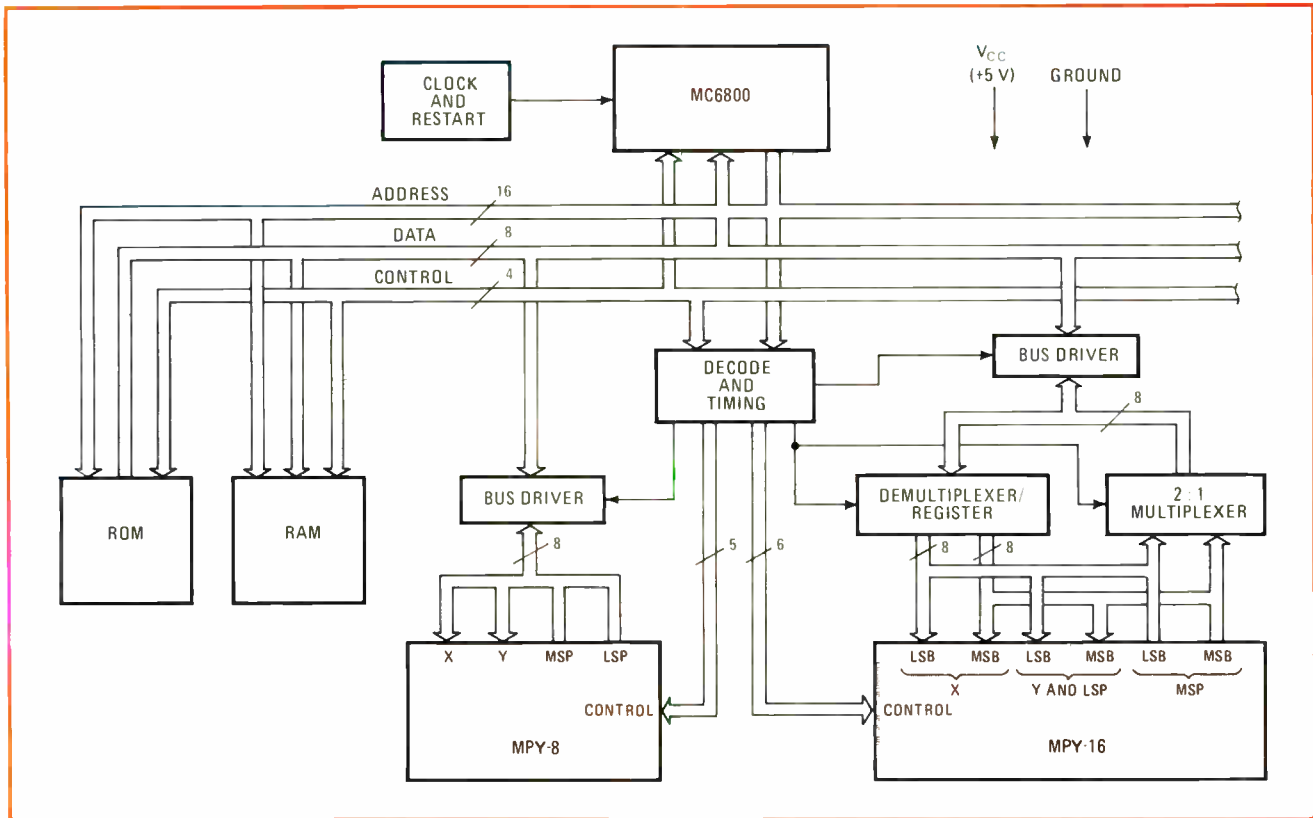

4. Combination. Both multipliers interface easily to the MC6800 data bus. The MPY-8 connects through a bus driver, while the MPY-16 input/output must be multiplexed. Clock-X, -Y, and -P, and three-state control signals are generated using the signals from the MC6800.

represent the sign; the other bits in each word represent the magnitude. The product sign bit is supplied with the most significant and the least significant product.

As soon as the X and Y operands are stored in the registers, computation of the product begins. After the multiplication is complete, the product is latched into the output registers by the MPY-8's clock P signal and the MPY-16's clock L and clock M signals.

Figure 3 shows the timing sequence used. Multiplication time is approximately 130 nanoseconds for the MPY-8 and 200 ns for the MPY-16.

Bus interface

Because of the three-state output buffers, either multiplier can interface with a microprocessor through a single data bus. Figure 4 diagrams the interfaces with the MC6800's 8-bit data bus. In these setups, the X and Y operand registers are treated as memory locations. Four such locations are required for the MPY-16 and two for the MPY-8. This keeps programming simple, since only two store-and-load accumulator instructions are required for the MPY-8, and four for the MPY-16.

An excerpt from an application program (Fig. 5) illustrates the simplicity of programming. This subroutine uses the accumulators in the 6800 to store and load the X and Y operands into and out of the MPY-16. The clock and control signals for the multiplier's three-state output buffers are easily generated from the address, read/write, and clock signals from the microprocessor.

The much slower speed of the MC6800 means the multiplier can complete a multiplication long before the

```

SUBROUTINE MPY
LDA A 0, X      • LOAD X OPERAND
LDA B 1, X
STA A MPYXL    • STORE X OPERAND
STA B MPYXM
LDA A 2, X      • LOAD Y OPERAND
LDA B 3, X
STA A MPYYL    • STORE Y OPERAND
STA B MPYYM
LDA A MPYYL    • LOAD PRODUCT (LSP)
LDA B MPYYM
STA A PRODLL   • STORE PRODUCT (LSP)
STA B PRODLM
LDA A MPYXL    • LOAD PRODUCT (MSP)
LDA B MPYXM
RTS            • RETURN FROM SUBROUTINE
  
```

5. Simple routine. A relatively small subroutine that makes use of several memory reference instructions is all that is required to transfer data into and out of the MPY-16 multiplier.

processor can return to get the result. The actual multiply time is 18 μs for an 8-by-8-bit multiplication and 54 μs for a 16-by-16-bit multiplication. Software execution takes 300 μs and 1.2 milliseconds, respectively.

This great increase in the computational power extends the range of applications for the 6800 into the signal-processing domain. The new military model of the processor (-55°C-to-125°C operating range) is in use at Motorola's Government Electronics division for application to missile guidance systems. Presently, fast multiply hardware is teaming with the MC6800 in an autopilot/guidance computer feasibility model and in radome calibration/compensation studies. □

Fail-safe reset circuit initializes processor

by C. Gyles
Canadian Marconi Co., Montreal, Canada

No matter how unreliable the power source or troublesome the switch-on transients may be, this circuit will successfully initialize any circuit either during normal power-up conditions or after a power failure or glitch. This virtually fail-safe circuit was designed for a microprocessor with multiple power-source requirements (12, 5, and -5 volts), where transients could occur on one or more supplies, thus causing loss of data or other disasters in stringent control applications.

The most common reset circuit used to initialize microprocessors, one that is suggested by many manu-

facturers, is shown in the lower right-hand corner of the figure. When power is switched on, all microprocessor circuits are energized, but capacitor C charges slowly, meanwhile maintaining a reset condition (logic 1) at the output until all circuits stabilize. At stabilization, the capacitor is nearly charged and the reset signal is removed.

This circuit will not function satisfactorily if a momentary glitch should occur, because the capacitor voltage will not go below the 1 threshold before it again charges to the value of the supply voltage. Thus the circuits in the microprocessor may fail to function, but the circuits will not be reinitialized. Placing a diode permanently across the resistor to quickly discharge the capacitor is not always satisfactory, as the voltage could fall sufficiently to destroy processor operation but not enough to discharge the capacitor below the logic threshold. There is a cure—fully discharge the capacitor before the voltage has fallen below the component's threshold, thus assuring a reset signal if there is a power failure.

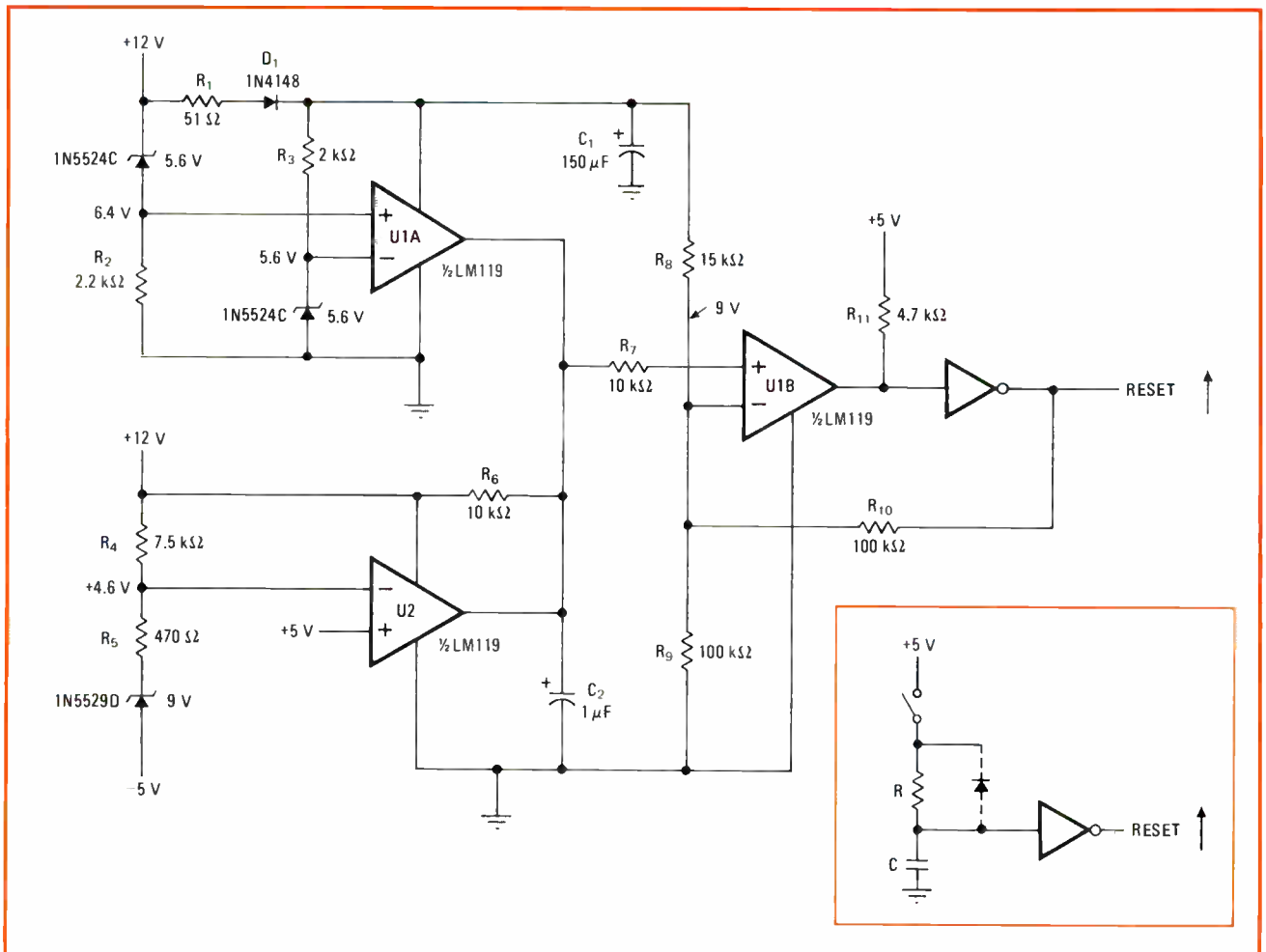

Fail-safe and foolproof. Simple RC circuit to the right cannot reliably initialize microprocessors under power-up or power-glitch conditions, even with addition of diode. Circuit using threshold detectors is more expensive but dependable.

Three threshold detectors using LM119 open-collector operational amplifiers overcome the inherent faults of the usual reset circuit. Comparator U_{1A} and its associated components form the 12-v detector, and U_2 is the ± 5 -v detector. Comparator U_{1B} monitors the voltage across a capacitor, C_2 , in order to determine the state of the reset signal.

During power-up conditions, the inverting input of the op amp rises almost immediately to 9 v through a resistor divider consisting of R_1 , D_1 , R_8 , and R_9 . The noninverting input rises slowly to 12 v through R_6 and C_2 . Thus U_{1B} is turned on and a reset signal is generated until the voltage on the noninverting input, which is the voltage across C_2 , exceeds 9 v. The period of the reset signal is about 15 milliseconds, enough time for the microprocessor circuits to settle and be successfully initialized. During the switch-on transient, the internal operation U_{1B} is not defined; R_7 is therefore added to prevent premature charging of C_2 by current supplied from the noninverting input of the op amp.

In the steady state, voltages on the input ports to U_{1A}

are within 0.8 v of one another, as shown. The voltage differences at the inputs to U_2 differ by only 0.4 v. These differences are arbitrarily set, and any value may be selected by the appropriate choice of zener diodes and divider resistors. A glitch on the 12-v line that causes a 0.8-v drop will cause U_{1A} to turn on, discharging C_2 and generating a reset signal. C_1 maintains voltage to the comparator's supply line to assure that the comparator fully discharges C_2 under conditions where the 12-v line voltage drops rapidly. D_1 prevents discharge into the collapsing 12-v line. In the event of a failure in either 5-v supply and not in the 12-v line, the 0.4-v threshold is exceeded, and comparator U_2 turns on, again discharging C_2 and producing a reset signal. R_{10} provides hysteresis to ensure a clean transition into the reset state. R_1 reduces the initial current surge through C_1 .

The required length of the reset signal in any system depends on the settling time of the microprocessor circuits. Combinational logic will settle very fast, whereas divider chains or circuits that use large capacitors (one-shots) need a sufficiently long reset signal. \square

Calculator notes

HP-25 program optimizes system noise figure

by Peter T. Rowe and D. Clifford Smith
Barry Research, Sunnyvale, Calif.

With this easy-to-use program, an HP-25 calculator can quickly obtain the noise figure for a communications system. The program shown in the table promptly produces the intermediate and overall noise figure from the noise figure and gain of the individual stages. It will allow the system designer to easily evaluate the gain-to-noise tradeoff when choosing the components for the different stages.

A system with low intermodulation distortion and a wide dynamic range requires that the noise figure be minimized, because maximum sensitivity must be attained at the minimum gains of the individual stages. The total gain of the system, expressed in decibels, may be found by simple addition of the individual stage gains. But the overall noise figure cannot be determined in this manner, because the noise figure at the output of each stage is affected by the net gain before the stage. Determination of these individual noise figures is usually time-consuming and repetitious, because the calculation uses a logarithmic equation to analyze each stage.

The noise figure is conventionally expressed in decibels and is given by:

$$NF = 10 \log \left[\log^{-1} (NF_i/10) + \frac{\log^{-1} (NF_{i+1}/10) - 1}{\log (g_i/10)} \right]$$

where NF is the noise figure at the output of the $i + 1$ stage (as counted from the input to the system), NF_{i+1} is the noise figure of the $i + 1$ stage, and NF_i , g_i are the noise figure and gain, respectively, at the input to the

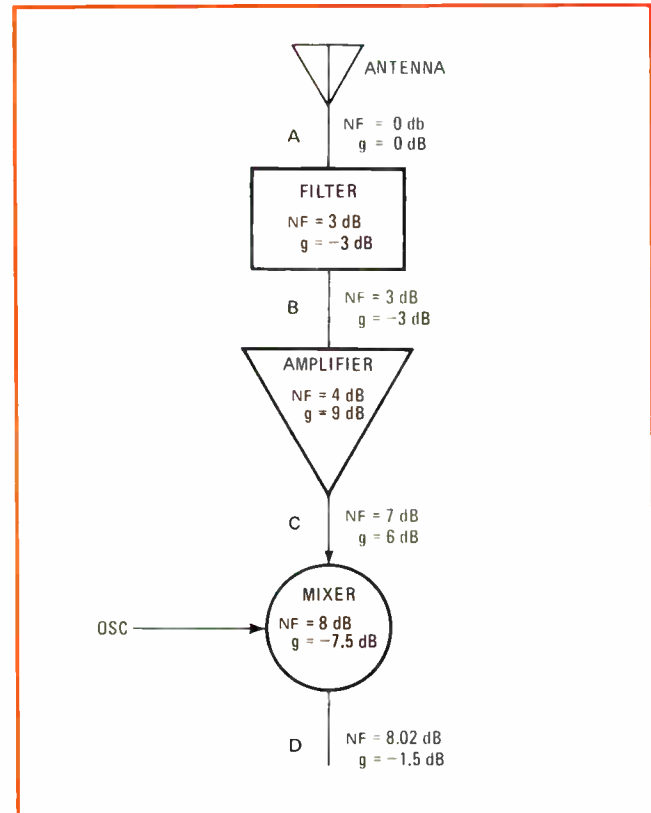

Determining system noise figure. Once the noise figure and gain of the individual building blocks in this simple receiver are known, the system noise figure and gain can be easily determined by the program. Noise figures of individual stages cannot be added directly.

$i + 1$ stage. If the noise figure and gain for each stage are known, the calculator will determine the overall noise figure when the stages are cascaded, through repeated use of the equation.

The value of the program is best illustrated by an

example (see figure) of the input (wideband) section of a simple receiver. The noise figure and gain for various points help determine the location of any sources producing excessive noise.

To find the noise figure and gain at the output point D, analysis must begin at point A, the input stage. After the program has been entered into the calculator, the noise figure and gain at point A (both assumed to be zero) are entered into registers R_2 and R_3 . This is followed by entry of the filter's parameters into R_0 and R_1 . The NF at point B will be calculated and stored in R_2 ; the gain at point B will be stored in R_3 . The amplifier data is then entered into R_0 and R_1 . The values

for NF and gain at the output of the amplifier stage are determined and once again stored in R_2 and R_3 .

This process is repeated for n stages. The noise figure is over 8 dB at the output, with -1.5 -dB gain. It can readily be seen that the net gain before the mixer stage is too low, and that the mixer's internal noise figure adds significantly to the system's noise figure. Consequently, an amplifier with slightly higher gain should be used in place of the present amplifier to improve the performance of the receiver. □

Engineer's notebook is a regular feature in *Electronics*. We invite readers to submit original design shortcuts, calculation aids, measurement and test techniques, and other ideas for saving engineering time or cost. We'll pay \$50 for each item published.

HP-25 NOISE FIGURE PROGRAM

LINE	CODE	KEY
01	24 00	RCL 0
02	01	1
03	00	0
04	71	÷
05	15 08	$g 10^X$
06	01	1
07	41	-
08	24 03	RCL 3
09	01	1
10	00	0
11	71	÷
12	15 08	$g 10^X$
13	71	÷
14	24 02	RCL 2
15	01	1
16	00	0
17	71	÷
18	15 08	$g 10^X$
19	51	+
20	14 08	$f LOG$
21	01	1
22	00	0
23	61	x
24	23 02	STO 2
25	24 03	RCL 3
26	24 01	RCL 1
27	51	+
28	23 03	STO 3
29	24 02	RCL 2

REGISTERS	
R_0	Noise figure [NF] (dB) - new
R_1	Gain [g] (dB) - new
R_2	NF (dB) - old
R_3	g (dB) - old

INSTRUCTIONS	
•	Key in program
•	Enter RUN mode
•	Input i values: <i>(NF), STO 2, (g), STO 3</i>
•	Input $i + 1$ values: <i>(NF), STO 0, (g), STO 1</i>
•	Press f PRGM, R/S New noise figure displayed <i>Press x ↵ y to display gain</i>
•	Input new values: <i>(NF), STO 0, (g), STO 1</i>
•	Press f PRGM, R/S, etc.

AUGAT MAKES IT EASY TO BUY THE BEST.

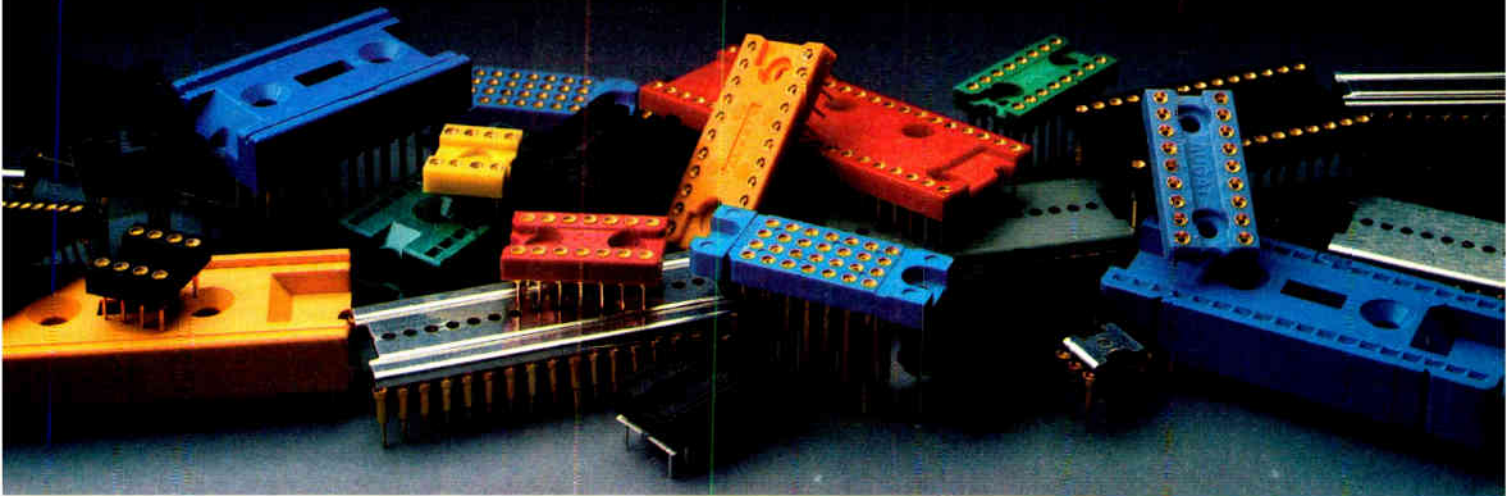

One of the biggest reasons Augat sockets outsell all others is that we make Augat sockets the easiest to buy. Augat offers IC sockets for off-the-shelf delivery from hundreds of worldwide distributor locations. So you have it easy when you buy the best. And here are some of the best you can buy.

Our Series 300 low-profile sockets excel over competitive types with their superior beryllium copper side wipe contacts that handle all com-



300 Series low-profile

ponent lead sizes with better retention and longer contact life. They are available in all sizes from 8 to 40 contacts.

Our 300 Series wire wrap sockets are the best buy in the industry today. Their special pin taper locks them in place without bonding or soldering, and

they're very attractively priced.

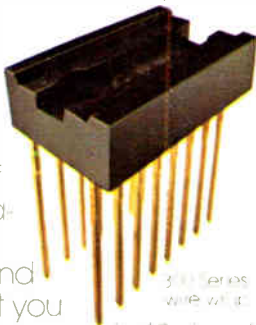

300 Series wire wrap

in 12 sizes between 8 and 40 contacts.

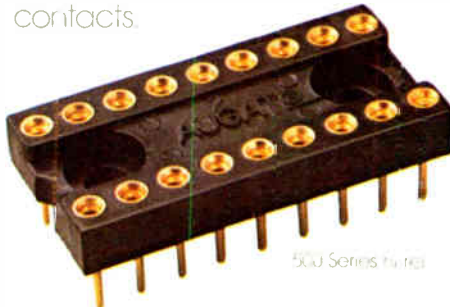

500 Series carrier

Our 700 Series lead socket carrier is a new concept of growing popularity. The metal carrier holds the individual contacts in place through assembly and soldering, and is then removed. Advantages: improved airflow and complete topside accessibility for inspection and solder rework. Available in 14 sizes.

Beyond that, of course, is our

broad selection of standard profile and test sockets, LED sockets and numerous accessories.

So the next sockets you buy, make them Augat. They're not only the best you can get, but getting them is a breeze... just about anywhere. Write us for a condensed socket selection guide with prices and a list of our distributors.

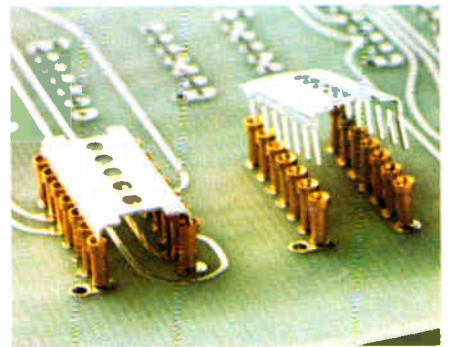

700 Series lead socket carrier

Augat Inc., 33 Perry Avenue, P.O. Box 779, Attleboro, Mass. 02703 Tel. (617) 222-2202

AUGAT[®]

Augat interconnection products: Isoltronics microcircuit packaging and Alco subminiature switches.

Superior performance here...

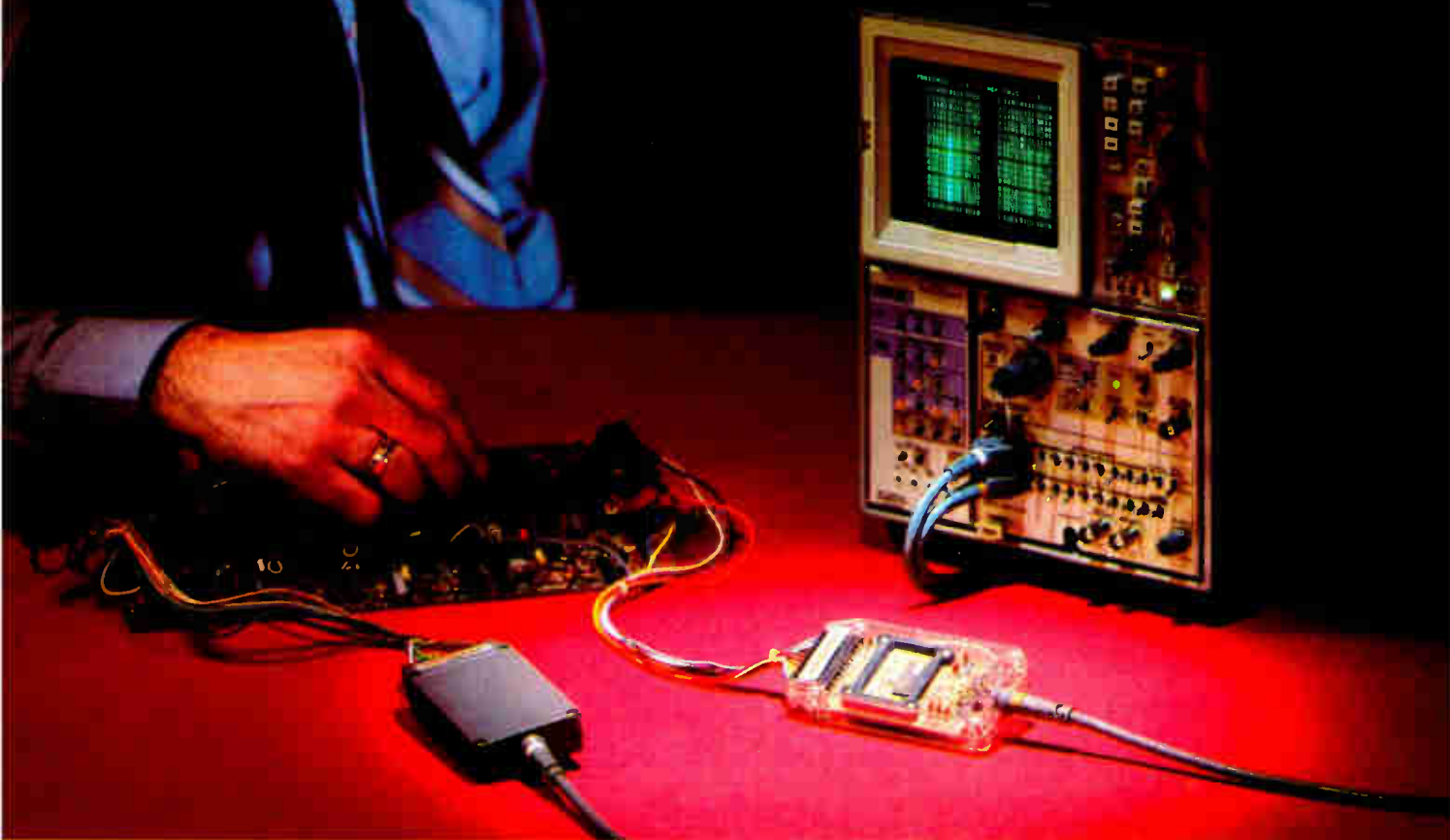

...starts here.

Look inside today's innovative electronic products. You'll find more and more circuitry on hybrids. Take, for example, the TEKTRONIX P6451 Data Acquisition Probe shown above. Thanks to hybrid circuitry, the P6451 is the most versatile data acquisition probe on the market. (In fact, almost all its circuitry resides on two thick-film hybrids.) That's why more resources are being dedicated to hybrid design, fabrication, and testing than ever before.

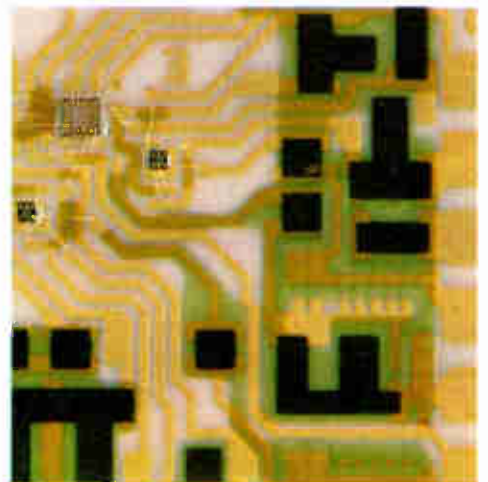

However, it takes more than innovative hybrid design to be successful in the fast-paced electronics marketplace. Successful designs must be repeatable and manufacturable. How does a circuit designer know when the design *is* repeatable and manufacturable? By testing.

At Tektronix, hybrid prototypes are evaluated using a TEKTRONIX S-3260 Automated IC Test System. The evaluation team—the hybrid designer and test engineer—begins by investigating whether or not the prototype functions as designed. This sometimes leads to a complete device characterization, a process that requires exhaustive testing.

When a hybrid is characterized, every measurable parameter and function is tested, actual limits of performance are determined, and then its behavior is documented for all the various sets of input conditions in all their combinations and permutations. That's a lot of testing and it can quickly build mountains of test data. A system that merely performs accurate and repeatable tests is not enough. The evaluation team must also have the tools to reduce the data mass into a useable form. The S-3260 is a combination general-purpose IC test system and a data processing system—a totally integrated package that both acquires and processes test and measurement data.

You'll find TEKTRONIX S-3260's used for device characterization, process evaluation, production testing, and field failure analysis. Tektronix IC test systems are used by the world's leading communications companies, aerospace contractors, computer manufacturers, semiconductor manufacturers, and by the military.

Serious about performance? Then you should know about Tektronix IC test systems. Write Tektronix, Inc., P.O. Box 500, Beaverton, OR 97077. In Europe write Tektronix Limited, P.O. Box 36, St. Peter Port, Guernsey, Channel Islands.



"It works, but . . ." Test engineer and device designer evaluating the prototype. Information gathered here guides the circuit designer as he adjusts his design for volume production.

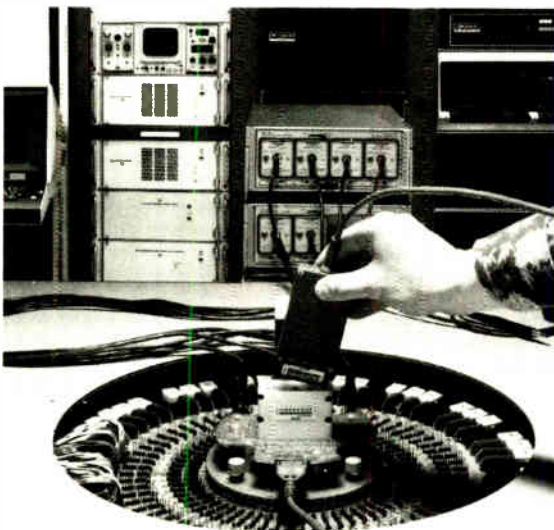
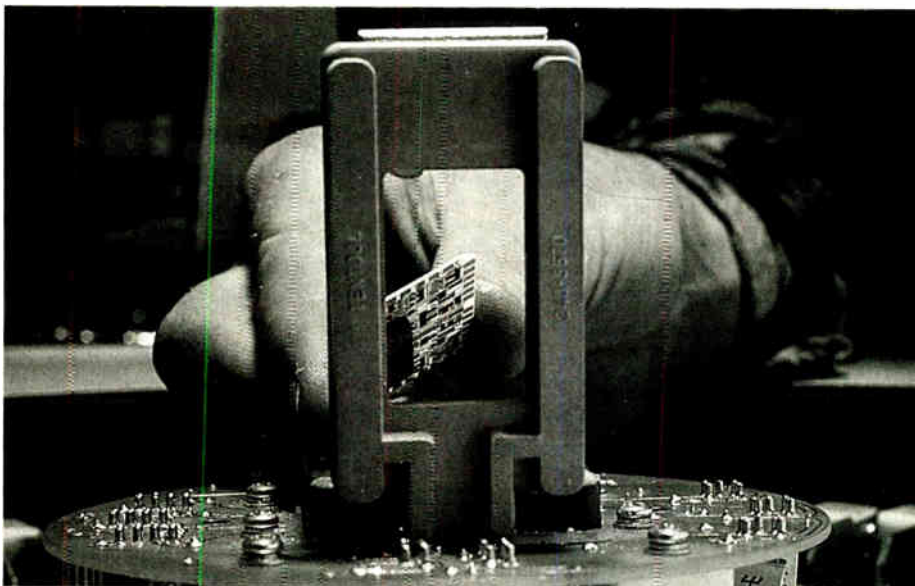

Hybrid circuits are tested throughout the manufacturing process. Information gathered here alerts production engineers to manufacturing and process problems.

Final test of the completed data acquisition probe. Information gathered here dramatically reduces the labor involved in calibration and troubleshooting.

**Serious about performance?
Then you need to know about
Tektronix IC Test Systems.**

Tektronix®

COMMITTED TO EXCELLENCE

For Technical Data circle 188 on Reader Service Card

For Demonstration circle 121 on Reader Service Card

World Radio History

Intel delivers Intellec® There's no shorter route

Intellec® is Intel's Microcomputer Development System that delivers in-depth support. And, in-depth support gets your microcomputer based products to market faster and easier.

Intellec is the only system that supports the entire line of Intel microcomputers. It's the only system with ICE In-Circuit

Emulation for the 8080, 8085, 8048 and Series 3000 microcomputers. And Intellec is the only development system with a resident high level language for microcomputer system programming.

We call that language PL/M. It has become the most widely used language for microcomputer programming and can cut months off your software devel-



in-depth support. from design to production.

opment cycle. And, because PL/M is resident in the Intellec system, you put an end to timeshare computer charges. You just can't get that kind of power and efficiency from any other system.



We've made Intellec easy to use. You communicate with the system in simple English-like statements. You can write application programs in small, manageable modules and link them together with other programs from the diskette library for loading into your microcomputer's PROM or EPROM memory.

To simplify hardware/software integration and system debugging, Intel's unique ICE modules give you a "diagnostic window" into the operation of your system. The ICE software system is the only one that lets you control, monitor and analyze all microcomputer functions using symbolic references for addresses

and data. And the new ICE-85™ provides expanded in-system emulation capability, extending the window to your entire microcomputer system.

You can count on Intel for in-depth support in other areas, too. Like user application assistance, complete documentation, training programs and design seminars worldwide, and a users' software library with over 275 programs and growing.

That kind of in-depth support is the reason more designers are using more Intel microcomputers and Intellec development systems than all others combined.

To find out how Intellec can get you on the road to faster and easier microcomputer development, contact your nearest Intel distributor or sales representative. For a local demonstration or a copy of the Intellec brochure, use the reader service card or contact us directly. Intel Corporation, 3065 Bowers Avenue, Santa Clara, California 95051. Telephone (408) 246-7501.

intel® delivers.

Circle 122 for technical information

Circle 123 for technical information and a demonstration

Incredible performance... at unbelievable prices!



TRW hybrids shatter the price/performance barrier for RF output power, linearity and dynamic range!

You'll have to see it to believe it! And we're ready to show you proof. Take a look at some of our typical applications. Look at the gain quoted for each.

Then take a look at the price. Now, in your production units, you can get the performance you'd only expect from precision laboratory gear.

TRANSMITTER DRIVERS:

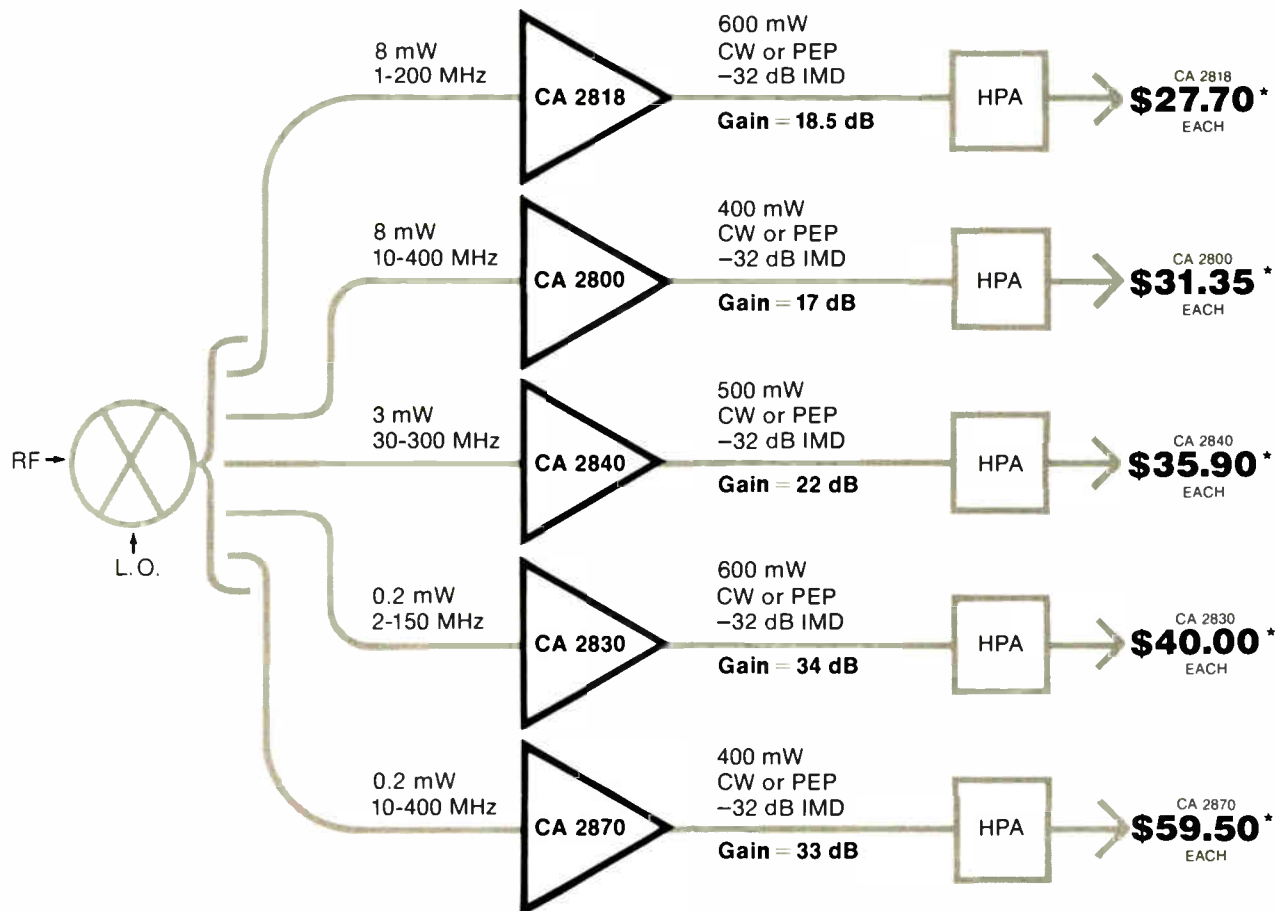

RECEIVER APPLICATIONS:

40 MHz to 100 MHz IF amplifier.

STANDARD IF

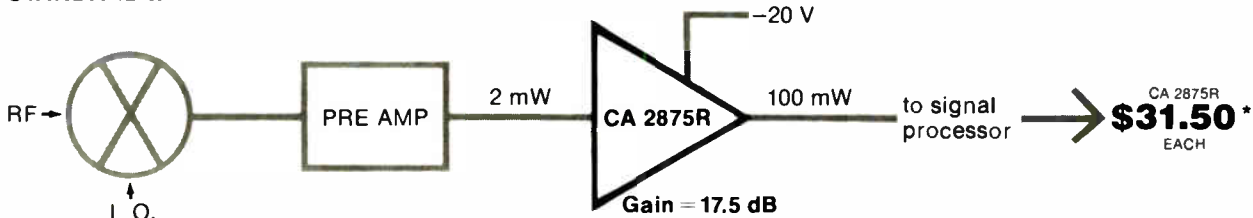

HIGH PERFORMANCE IF

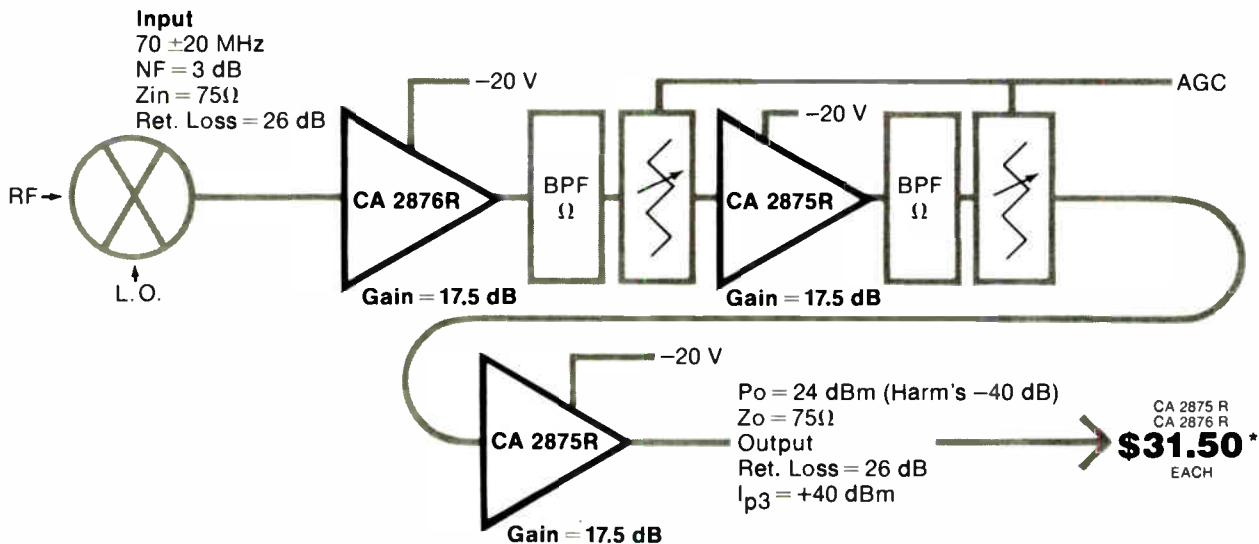

INSTRUMENTATION APPLICATIONS:

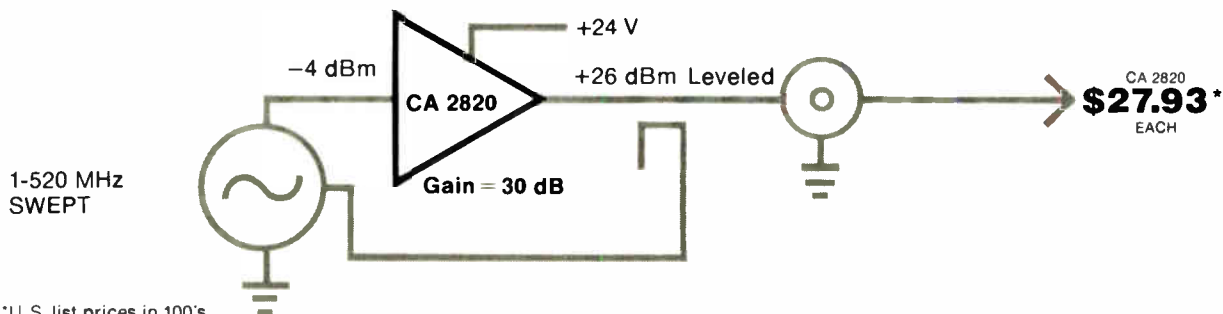

*U. S. list prices in 100's

These applications are only the beginning. TRW RF linear hybrids can revolutionize design after design...with incredible performance at unbelievable prices. Let us prove it. To get complete data sheets, send us the coupon. **To find out how you can get a free sample and test fixture, call Dan Brayton at (213) 679-4561.**

TRW RF Semiconductors

An Electronic Components Division of TRW, Inc.
14520 Aviation Boulevard, Lawndale, California 90260

- Please send me your new RF linear catalog.
- Please have an applications engineer contact me.

(Phone) _____

Name _____

Position _____

Company Name _____

Address _____

City _____

State _____

Zip _____

TRW RF SEMICONDUCTORS

ANOTHER PRODUCT OF A COMPANY CALLED TRW

You Don't Have To Beg, Borrow Or Buy...



Rent'em From GE

Short or long-term instrument rentals give you flexibility and economy.

GE has over 9,000 instruments available for immediate shipment: □ Tek Scopes □ Biddle Megger Insulation Testers □ H-P Signal Generators □ Honeywell Oscillographs □ Complete Data Systems □ Esterline Angus Recorders □ GE Chart Recorders □ Modems □ Communication Terminals . . . all calibrated to the manufacturer's specs.

We have over 100 Sales/Service Centers,

and one of them is near you. In addition to maintaining our Rental Inventory, they can also repair and calibrate your own equipment.

Don't borrow someone else's GE Rental Catalog. **Call collect (518) 372-9900** or your nearest Sales/Service Center.

**Quick-rental[®]
instruments**

GENERAL  **ELECTRIC**

ALA. BIRMINGHAM (215) 925-3104 • ARIZ. PHOENIX (602) 278-8515 or 8516, TUCSON (602) 294-3139 • CAL. LOS ANGELES (213) 642-5350, SAN FRANCISCO (415) 436-9260 • COL. DENVER (303) 371-1260 • CONN. SOUTHINGTON (203) 621-4059 • FLA. JACKSONVILLE (904) 751-0610 • GA. ATLANTA (404) 457-5563 • ILL. CHICAGO (219) 933-4500 • IND. INDIANAPOLIS (317) 639-1565 • KY. LOUISVILLE (502) 452-3311 • LA. NEW ORLEANS (504) 367-6528 • MD. BALTIMORE (301) 332-4700 • MASS. BOSTON (617) 396-9600 Ext. 160, SPRINGFIELD (413) 781-1111 • MICH. DETROIT (313) 285-6700 Ext. 208 • MINN. MINNEAPOLIS (612) 522-4396 • MO. KANSAS CITY (816) 231-4377, ST. LOUIS (314) 965-7115 • N.J. CLIFTON (201) 471-6556 • N.Y. BUFFALO (716) 876-1200, SCHENECTADY (518) 385-2195 • N.Y.C. CLIFTON, N.J. (201) 471-6556 • N.C. CHARLOTTE (704) 525-0311 • OH. CINCINNATI (513) 874-8512, CLEVELAND (216) 523-6382, TOLEDO (419) 691-3501 • OR. PORTLAND (503) 221-5101 • PA. PHILADELPHIA (609) 424-4450, PITTSBURGH (412) 462-7400 • TEX. DALLAS (214) 357-7341, HOUSTON (713) 672-3570 • VA. RICHMOND (804) 232-6733 • WASH. SEATTLE (206) 854-0211 • W.V. CHARLESTON (304) 345-0920 • WISC. MILWAUKEE (414) 744-0110 • PUERTO RICO PONCE (809) 843-4225.

CAD system aims at smaller users

Featuring a wide variety of graphics editing, repeating, and manipulating capabilities, \$16,000 package lays out circuit boards

by Bernard Cole, San Francisco bureau manager

Small to medium-sized electronics companies soon will be able to build up a computerized layout and development system for printed-circuit boards for less than \$16,000, thanks to a new software package—the PC50—by Second Source Industries of Berkeley, Calif. The PC50 is an interactive software package designed to run on the Tektronix 4051 graphics system and produce a variety of camera-ready artwork and documentation.

To take advantage of the PC50 package, designers may first generate a library of user-defined objects ranging in complexity from simple patterns for dual in-line packages to more sophisticated structures like frequently used circuits. Data-base size is limited solely by the availability of magnetic tapes or flexible disks, says Michael Smith, general manager of Second Source Industries. The PC50 also provides an assortment of standard components such as 90° radius corners, doglegs, and integrated-circuit pad sets featuring square or hexagonal pads.

When the data base is established, pc-board design may be initiated, Smith says. Predefined objects are called from memory, oriented, and displayed on the 4051's cathode-ray tube. Repetitively used objects may be automatically duplicated.

Designers can specify the size of the pads and the width of the buses, doglegs, and round corners used to connect various components and circuit elements. Throughout the initial and revision stages of the layout cycle, the system's zoom capability can be used or the drawing scales changed at any time. Data may be stored in memory and output dis-

played later on the Tektronix 4662 plotter, at any user-defined scale.

Extensive editing facilities enable designers to revise pc-board layouts quickly and accurately. Objects may be selectively erased, redrawn, or overlaid. A special feature enables users to draw a line around any portion of the layout, permitting the enclosed structures to be manipulated as a single object.

By placing copperclad pc-board stock in the plotter and employing a pen carrying etch-resist ink, designers can use the plotter to prepare the board for etching and drilling. After the prototype is tested, the layout may require some changes. With the PC50 system and some simple etching equipment, check boards are available the day the layout is completed. Negatives are not made until the design is proven correct. Typical project development time with a PC50-based system is reduced to 3½ days compared with 30 to 40 days for the manual approach, according to Smith.

The software of the PC50 runs on the 4051 graphics system configured with 32 kilobytes of operating memory, a joystick, and the plotter. Both hardware and software can be implemented for less than \$16,000 by acquiring the 4051 graphics computer (\$7,500) and 4662 plotter (\$4,495), plus Second Source Industries' 8-to-32-kilobyte add-in memory (\$2,500) and model 2005 joystick (\$380). The PC50 software package is priced at \$750.

Second Source Industries is already beginning to increase the power of the software. The company will soon announce its model 3200, a dual-floppy-disk system that will sell for \$4,950 and will double layout speed. In addition, a Schematic 50 software package priced at \$750 will be available in August. It will use the same system hardware to provide additional documentation including block diagrams, flow charts, PERT charts, and similar documents.

Second Source Industries, 735 Addison St., Berkeley, Calif. 94710 [338]



another first
from
Grayhill

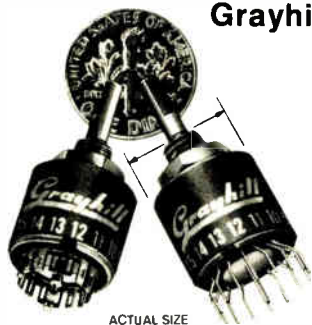

ACTUAL SIZE

16 positions in a dime-sized switch!

Now available with
PC or solder lug
terminals

- 1/4 amp, 1/2 inch switch
single or double-pole
with 16 positions in a single deck
- occupies only 1.1 cubic inch
behind panel
- contamination-free enclosed
construction, molded-in terminals

This new addition to the popular Grayhill Series 51 Rotary Switch family meets the growing number of applications calling for the maximum number of positions in the minimum amount of space. (Previously available 16 position switches had diameters of 1-1/3 inches instead of 1/2 inch!) And you'll be pleased with the performance and price of these switches too...rated for 25,000 cycles of operation, priced about \$6.00 in 100 quantities.

New Product Bulletin #257 contains complete specs and price information...free on request from the leaders in switch miniaturization, Grayhill, Inc. 561 Hillgrove Avenue, La Grange, IL 60525 (312) 354-1040.



New products

Control processor uses C-MOS on sapphire

Hewlett-Packard markets microprocessor-based instrument that replaces computer or calculator in automated testing

by Stephen E. Scrupski, Instrumentation Editor

The first product to use complementary-MOS integrated circuits built with Hewlett-Packard's silicon-on-sapphire process [*Electronics*, May 26, p. 99] is the firm's model 2240A measurement and control processor. The microprocessor-based instrument can take over many tasks previously assigned to the computer or calculator in an automated test setup. Working through the IEEE-488 standard interface bus, the 2240A handles both digital and analog measurement data and can control digital and analog outputs with simple computer commands.

The instrument uses a 16-bit central-processing-unit chip (which HP calls the MCC), an IEEE-488 interface chip, 12 8,192-bit read-only-memory chips for control and self-testing, and 8 2,048-bit random-access-memory chips for buffer storage—all built with the SOS process—plus other complementary-metal-oxide-semiconductor circuits. C-MOS technology results in low power dissipation—about 130 watts—whereas the SOS process results in

devices with speeds approaching those of bipolar devices.

The 2240A can be used with the HP 1000 and 2100 series computers or the 9800 series desk-top computers to acquire and process data and to intelligently control physical and electrical processes through the IEEE-488 bus. With couplers, it will operate remotely.

Basically, the 2240A multiplexes and converts analog input signals to digital form, monitors and counts digital signal events, does frequency counting, and delivers digital and analog signal outputs and stepper-motor control outputs. The MCC also automatically corrects analog input signals for temperature offset and drift, using a temperature sensor mounted on the analog-to-digital converter. Whenever the temperature drift exceeds 10°C, an interrupt signal is generated and the MCC adjusts the zero and full-scale points. This allows the instrument to be accurate to within 0.05% across the full ± 10 -volt range of analog input.

The MCC interprets simple ASCII



Need custom LSI? That's easy. Call NITRON: (408) 255-7550.

When you need custom LSI, you need Nitron. For years, we've been meeting hard-nosed designers' demands for industrial, commercial and military LSI applications with just what they need: definition, design assists, and unequalled manufacturing capabilities for MNOS, n and p channel MOS, CMOS, and ion-implant custom products that are the best in the business.

Stability: it's an advantage

Sized right to give you the flexibility and attention of a high-quality custom house, Nitron has the added advantage of the resources and stability of McDonnell Douglas behind it. And the production versatility of a standard products supplier.

Your one-stop source

Services? Everything from design assistance through manufacturing to packaging. Response? Design cycle times of 20 weeks are not uncommon with us. Special capabilities? A few of immediate

interest to you might be our own in-house mask making facility (utilizing chrome masking, by the way), application of ADS computer aided design to generate masks, and a new cell technology which brings the densities of Nitron's ADS circuits to within 13% of that of expensive, handcrafted layouts.

Custom or off-the-shelf

Name your needs: non-volatile memories (NVMs); mask-programmable ROMs; frequency synthesizers; communications circuits; or something that's never been done before. Tell us. We can work with you on the design if you wish, translate it into a manufactured and packaged product, or you may even discover that it's already on our shelf. Whatever the problem, we're here to help you solve it. Quickly, efficiently, happily. If you want more information, fill out the coupon below and send it to us, or call Nitron Custom Marketing at (408) 255-7550.

NITRON

A DIVISION OF MCDONNELL DOUGLAS



E-7

MAIL TO: Nitron Custom Marketing
10420 Bubb Road, Cupertino, CA 95014

SEND ME THE FACTS!

I'm interested in (check boxes):

- | | |
|--|-------------------------------|
| <input type="checkbox"/> Capabilities Brochure | <input type="checkbox"/> MNOS |
| <input type="checkbox"/> NMOS | <input type="checkbox"/> CMOS |
| <input type="checkbox"/> PMOS | |

DATA SHEETS

- | | |
|---|---|
| <input type="checkbox"/> Non volatile memories (NVMs) | <input type="checkbox"/> Frequency synthesizers |
| <input type="checkbox"/> Data Communications | <input type="checkbox"/> ROMs |
| <input type="checkbox"/> Telecommunications | |

SEND TO:

name & title

company

address

city

state

zip

EQUAL OPPORTUNITY IN PROFESSIONAL CAREERS SEND RESUME BOX 14526 ST LOUIS MO 63178

New products

message strings from the computer and translates them into tasks for execution. A task could include synchronizing the operation with an external event, periodically gathering a group of measurements, starting a control sequence at a specified time, and repeating an entire series of commands. The commands for complete tasks are generated by simple read or write statements that

are coming from the calculator or computer in Basic, Fortran, HPL, or assembly language.

Product manager Peter Palm says that an effort was made to simplify the command structure to make it easy to learn. He says that anyone who understands simple Fortran or Basic commands can easily learn to use the 2240A. Its specifications include accurate estimates of the

time required to perform most commands, he notes, so a user can quickly judge whether the 2240A can perform a job.

According to Palm, the instrument complements HP's 6940B multiprogrammer, which handles only digital signals, and the 2313B, which handles only analog signals. However, the programmable 2240A will not handle high-speed digital data as

We're
showing
off for
Bendix.

well as the 6940, which is a hard-wired system; nor will it handle millivolt-level signals, as does the 2313. For such signals, which might be produced by thermocouples and strain gages, to be handled, the 2240A requires extra cards.

The mainframe can accommodate four function cards, for a total of as many as 128 channels. An extender card provides an additional 128

channels. Each analog input card has 32 single-ended input or 16 differential-input channels. Each digital input card provides for 32 channels. Other function cards include a 4-channel d-a output card, a 32-channel digital output card, a 4-channel counter-stepper card, and a common interrupt (event-sense) card with 16 input channels. Digital inputs and outputs are 32 bits at

transistor-transistor-logic or C-MOS voltage levels. Analog inputs are at ± 10 v full scale with a sample rate of 20 kilohertz. The analog output can be either 0 to 10.24 v or -10.24 to $+10.22$ v.

Price of the 2240A, with a typical mix of analog and digital I/O cards, is about \$6,000.

Hewlett-Packard Co., 1501 Page Mill Road, Palo Alto, Calif. 94304 [339]



This display shows the Quinault Indian Reservation in Washington state. 16 separate colors have been assigned for such categories as Burn Areas, Forest, Brush and Bare Land.

Bendix Aerospace Systems Division uses a Ramtek display generator to really show its colors. The Bendix Multispectral Data Analysis System (M-DAS) provides a clear, color-coded display for analysis of data from NASA's LANDSAT. And by using Ramtek's moving window display—or scroll—they're able to look at more data at one time than can be displayed on the still screen. Images of the same areas may also be correlated so that changes between past and present can be referenced.

Bendix is but one of a growing number of customers who are finding that Ramtek's modular graphics and imagery systems are giving them the expandability, flexibility and increased productivity they need. Besides the basic alphanumeric and imaging capability, Ramtek offers a wide variety of other functions including graphics—vectors, conics, plots, bar charts—pseudo color and grey scale translation.

Because the Ramtek RM 9000 family is totally controlled by a standard 8080 micro-processor, it is easy to develop and download your own control software.

To find out more about how Ramtek can show off for you, call or write: Ramtek Corporation, 585 North Mary Avenue, Sunnyvale, California 94086; (408) 735-8400.

ramtek
Our Experience Shows

New products

Instruments

Digital meter measures power

Hand-held communications instrument measures levels from -50 to $+10$ dBm

A pocket-sized precision level meter designed for operational service on telephone transmission equipment reads levels from -50 to $+10$ dBm on its three-digit liquid-crystal display. The battery-powered instrument, which operates over the band from 200 hertz to 4 kilohertz, also includes a signal generator with a send frequency of 1,020 Hz and switch-selectable levels of -10 and -27 dBm into 600 ohms.

Called the model PM-10, the

rugged meter covers its 60-dB dynamic range without switching scales. Its input has an impedance that can be switched from 600 ohms to approximately 100 kilohms and is protected against high-level dc and signaling voltages.

The PM-10 can be supplied with either a rechargeable nickel-cadmium battery or a dry battery. Operating time is approximately 20 hours with the former and 100 hours with the latter. A warning signal appears when the battery has about two hours of life remaining. Should the battery become too weak to provide reliable measurements, the meter will shut itself off and may be switched on again only after the battery has been replaced or recharged.

Because of its built-in signal generator, the PM-10 digital level meter can make measurements on end-to-end paths that are not carrying traffic; it can also make loop-

back measurements. The -27 -dBm send level can be changed at the factory to any value between -10 dBm and -30 dBm. The send frequency can be varied by 10% around its rated value.

Housed in a compact case that measures 90 by 42 by 160 millimeters, the PM-10 weighs only 500 grams complete with battery. It sells for \$295.

W & G Instruments Inc., 119 Naylor Ave., Livingston, N.J. 07039. Phone (201) 994-0854 [351]

250-MHz counter/timer sells for only \$495

Selling at about the same price as simple frequency counters that cover the same range, the model 1911A universal counter/timer is a flexible instrument that performs frequency measurements, event counting, period measurements, and period averaging for frequencies from 5 hertz to 250 megahertz. In its period-average mode, the instrument can average up to 10^4 periods to obtain a resolution of 10 picoseconds.

Although it sells for only \$495, the 1911A includes several features normally associated with more expensive instruments. Among them are a trigger-level control and an input attenuator, autoranging, autoreset, and automatic clean dropout. The autoreset feature is activated every time the user selects a new range or function, assuring that the first measurement made after the controls have been activated will be correct. Automatic clean dropout prevents errors caused by input signals that fall below the sensitivity threshold of the trigger circuit. When that happens, the 1911A gives a zero readout to warn the user of



THE BEST VOLTMETER YOU CAN BUY ISN'T A VOLTMETER.

The Fluke 8500A is an advanced measurement system, but most people buy it because it's the finest high speed 10 ppm voltmeter built.

So why make a distinction?

Simply because all other digital voltmeters have been nothing more than that, voltmeters. As quickly as technology advanced or needs changed, the unit became obsolete. Not so with the 8500A.

The 8500A employs a unique analog/digital bus in conjunction with an internal micro-processor to control measurement and interface modules. The function modules, such as resistance, current, IEEE-488 interface, etc., can be plugged into any available slot in the bus by the user.

The controller then senses the module and measures the new parameter or performs the new function.

So as technology or your needs change, so does the 8500A. You won't be stuck with a dead-ended instrument.

All for a basic system price of \$2,695*.

Obviously, there's a lot more to tell. For data out today, dial our toll-free hotline, 800-426-0361.

**U.S. price only.*

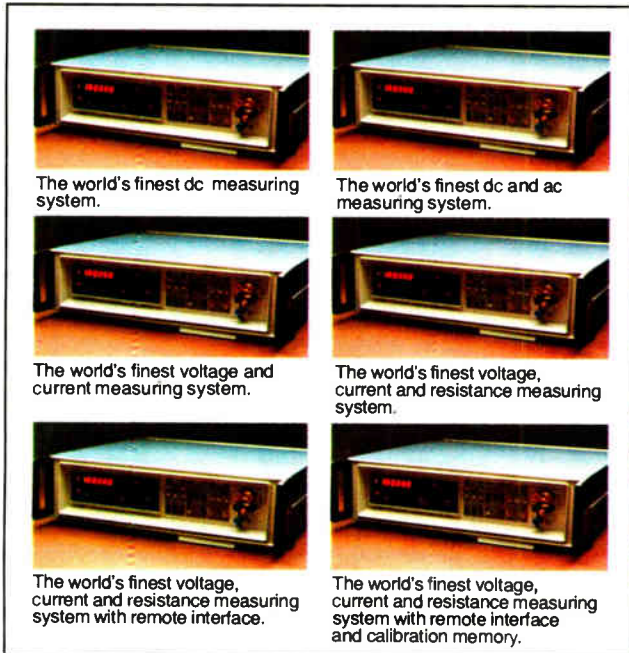

The 8500A can be whatever you want it to be, so it's never obsolete.

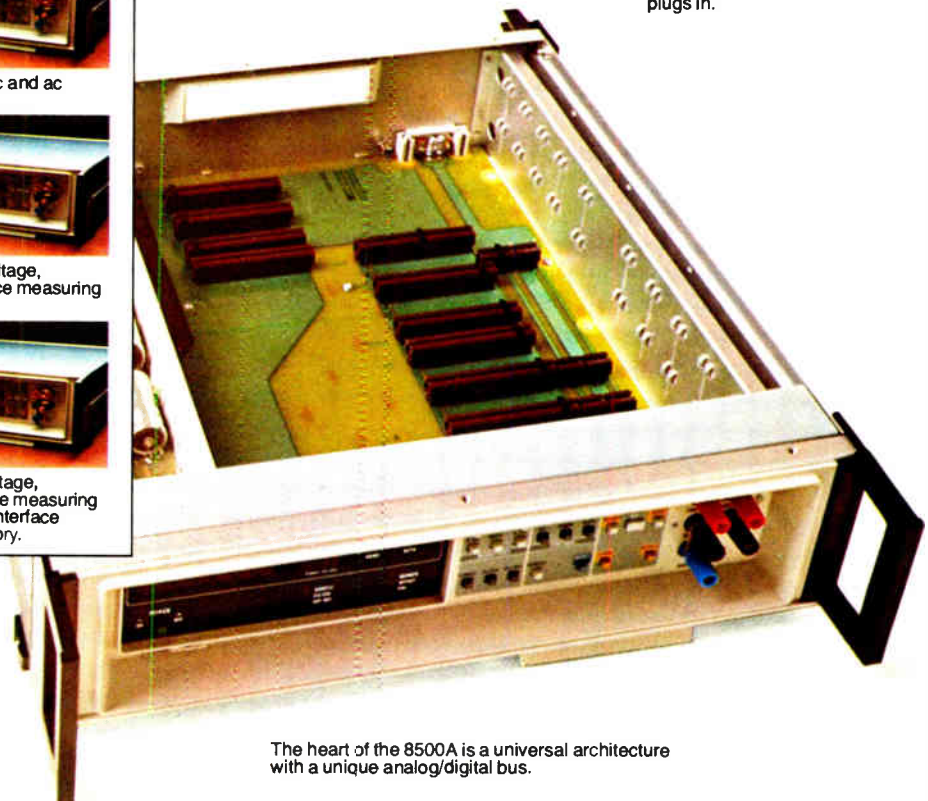
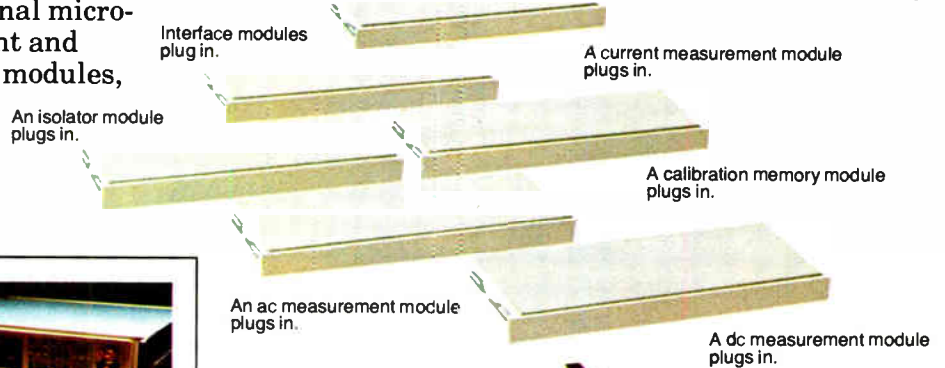

The heart of the 8500A is a universal architecture with a unique analog/digital bus.

The computer you can call your own.



The System 8813 from PolyMorphic Systems is a complete, powerful problem solver in a walnut cabinet. This microcomputer allows you to quickly formulate and solve sophisticated financial, scientific, and engineering models from the convenience of your office or den.

The English language commands of our disc BASIC programming language permits easy use of our video graphics and disc files. Complete systems are available as low as \$3250. See it at your local PolyMorphic Systems dealer.

**PolyMorphic
Systems**

460 Ward Dr., Santa Barbara, CA 93111 (805) 967-0468

Circle 134 on reader service card

Yes

we make all of these ...



Crystals, ovenized oscillators, TCXO's, VCXO's, and a hybrid crystal oscillator only .200" high in a frequency range of 2.5 KHz to 30 MHz.

No

We don't want to brag about our capabilities, people, facilities, price or delivery ...

Not Much

Call (913) 631-6700 or write P.O. Box 913,
Shawnee Mission, Kansas 66201.

Electronic Research Operations
Speidel Division of Textron Inc.

Speidel **TEXTRON**

Circle 192 on reader service card

World Radio History

New products

the instrument's low-input condition.

The 1911A has two input channels. Channel A has a sensitivity of 15 millivolts root mean square from 5 Hz to 100 MHz and a sensitivity of 25 mv rms from 100 MHz to 125 MHz. Channel B's sensitivity is 15 mv rms from 50 MHz to 175 MHz and 30 mv rms from 175 MHz to 250 MHz.

A similar counter, the model 1910A, is almost identical to the 1911A except that it has only the Channel A input. It sells for \$395. Both counters have a delivery time of 30 days.

John Fluke Manufacturing Co., P. O. Box 43210, Mountlake Terrace, Wash. 98043. Phone (206) 774-2211 [353]

Generator sweeps from 1 MHz to 2.5 GHz

The model 2002 sweep-signal generator is a versatile instrument with a frequency range of 1 megahertz to 2.5 gigahertz and a maximum power output of 13 dbm. The unit is internally leveled to within 0.5 decibel and has a maximum sweep nonlinearity of 1%. The maximum residual frequency modulation is 5 kilohertz peak, and the nonharmonic content is said to be nondetectable over most of the frequency range.

Several options add to the flexibility of the 2002. Option B-3 allows the unit to cover the entire 1-to-2,500-MHz range in one sweep; option B-1 gives the user front-panel control of the slope, allowing him to compensate for frequency-dependent losses in the test setup. Crystal-controlled harmonic markers at frequencies of 1, 10, 50, and 100 MHz are also available.

The basic generator sells for \$2,700 and has a delivery time of six

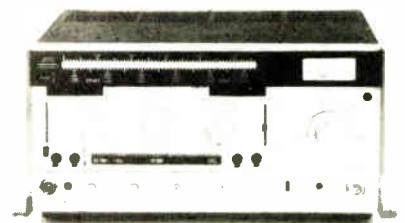

FOR RENT...

the most advanced new products from Intel's Intellec[®] Microcomputer Development System family, including the exciting new 888...

You can take delivery now at low monthly rental rates on these ready-to-use products from 10 fully-stocked U.S. and Canadian instant inventory centers.

The Intellec System 888 is the new development package which provides all the resources necessary to develop microcomputer system software in assembly language or in Intel's high level programming language, PL/M-80. Included in the system are the MDS-800 with 64k bytes of RAM and resident PL/M-80 high-level language compiler, the new MDS-DDS 1-million byte capacity Dual Drive Double Density Diskette Operating System, and the MDS-CRT. It's available now.

The Intellec MDS-800 supports the development and implementation of Intel 8080, 8085, 8748, 8048, 8035 and Series 3000 microcomputers. It includes an 8080A CPU, a universal bus with multiprocessor and DMA capability, an 8-level maskable priority interrupt structure, a real-time clock, 256-byte bootstrap loader, 2k bytes of ROM memory, 16k bytes of RAM, and interfaces to a teletypewriter, CRT, high-speed paper tape reader, high-speed tape punch, line printer and Universal PROM programmer. Standard software includes a ROM-resident system monitor, a RAM-resident 8080/8085 assembler and a text editor. It's available now.

The Intellec MDS-016 is a 16k RAM option, consisting of a model 2107 N-Channel dynamic RAM. It's available now.

The Intellec MDS-PTR is a High-Speed Paper Tape Reader peripheral, including a cable assembly and featuring a transfer rate of 200 cps. It's available now.

The Intellec MDS-PRN is a High-Speed Printer peripheral. The 5 x 7 matrix line buffered printer operates at a maximum of 165 cps. Line width is switch-selectable from 80 columns at 10 characters/inch to 132 columns at 16.5 characters/inch. The printer produces an original plus four copies and includes a tabletop cabinet, power supply, interface cable, operator lights, automatic on-off motor control and a 2-channel VFU control. It's available now.

The Intellec MDS-DDS is a Dual Drive Double Density Diskette Operating System for MDS-800 direct access bulk storage. It includes an intelligent controller and two Diskette Drive Units (each with 500,000 byte capacity), a cabinet, power supplies, cable assemblies and two ISIS-II system software Diskettes. ISIS-II includes a Relocating Macro-Assembler, Linker, Object Locator, Text Editor and Library Manager. The DDS is expandable to 2-million bytes. It's available now.

The Intellec MDS-CRT is a Keyboard Display Unit providing total user communication with all Intellec Diskette software and peripherals. The keyboard is detachable, and the RS232C-compatible CRT provides asynchronous data transfer rates of up to 9600 baud and features cursor positioning and cursor homing capability. It's available now.

The Intellec MDS-80-ICE is the famous In-Circuit Emulator which allows the design, development and debugging of a product in its own real-time operating environment. The ICE module consists of an 8080 CPU In-Circuit Emulator and includes a cable assembly and interactive software. It's available now.

The Intellec UPP-101 is a Universal PROM Programmer, including a cabinet, software, power supplies, cable and one 16/24-pin zero insertion force PROM programming socket pair. At least one "personality card" is required. It's available now.

The Intellec UPP-816 is a Personality Card for the 2716 2k x 8 EPROM, which features a 450 nanosecond access. It's available now.

The Intellec UPP-848 is a Personality Card for the new 8748 single-chip LSI microcomputer. The card includes an adaptor socket. It's available now.

The Intellec UPP-855 is a Personality Card for the new 8755 PROM (a pin-for-pin equivalent of the 8355 ROM) which contains 2k bytes of program memory, an address latch and two 8-bit general purpose I/O ports (one of which may be used to address external memory). It's available now.

The Intellec MDS-PLM is a Resident Compiler for Intel's High Level Programming Language, PL/M. It translates a source program written in PL/M into machine code for the 8080A and 8085 microcomputers. An MDS-DDS and 64k bytes of RAM are required. It's available now.

The Intellec MDS-D48 is a Support Package for assembling 8748, 8048 and 8035 single chip microcomputer programs on the MDS-800. It's available now.

The Intellec PROMPT-48™ is a Personal Programming Tool for the 8748 and 8048. It runs programs in real-time, with multiple breakpoints, or with single-stepping. PROMPT-48 includes both 8748 and 8035 CPUs, an EPROM Programmer, an integral keyboard, displays and system monitor in ROM. The system provides 64 bytes of RAM register memory, 1k bytes of EPROM program memory, 256 bytes of RAM data memory and 1k bytes of RAM program memory. System I/O, bus and memory can be expanded or directly interfaced to a user prototype. It can be used as a stand-alone system, or it can work with any terminal. It may be connected to the MDS-800 for direct program downloading and includes I/O ports, a bus cable and comprehensive documentation. It's available now.

The Intellec PROMPT-SER is a serial cable for connecting PROMPT-48 to a TTY or CRT. It's available now.

The Intellec PROMPT-SPP is a Specialized EPROM Programmer Kit which allows PROMPT-48 to be connected to the MDS-800 as a specialized EPROM programmer peripheral or debugging station. It's available now.

You can rent any of these products—from stock, immediately—by contacting

Rental Electronics, Inc.

Another of the **AMERICAL** companies

Anaheim, Calif. (714) 879-0561
Mountain View, Calif. (415) 968-8845
Northridge, Calif. (213) 993-RENT (7366)
Fort Lauderdale, Fla. (305) 771-3500

Des Plaines, Ill. (312) 827-6670
Burlington, Mass. (617) 273-2770
Gaithersburg, Md. (301) 948-0620
Dallas, Texas (214) 661-8082
Oakland, N.J. (201) 337-3757
Rexdale, Ontario, Canada (416) 667-7513



From REI... off-the-shelf,
throughout North America.

Circle 135 on reader service card

When are 100 Million Programmable Factors Not Enough?



Most of the time our front panel switch or rear connector programs are perfect to convert the output of any pulse producing transducer into engineering units... **but...**

when only a few pulses

per event (revolution, gallon, feet, etc.) are available, or high resolution and accuracy are required, **you need something more...**

our internal input multipliers...

they multiply the input up to a 1000 times to provide high resolution and accuracy with fast measurement time.

One of these panel mount instruments will satisfy your measurement/display requirements, no matter how difficult.

An optional parallel BCD output readily interfaces into your system.

8150 Series Factoring Counter/Timers

- Connector Programming\$375
- Thumbwheel Programming\$450



RATE

Accepts any input regardless of rate and displays directly in rpm, rps, fpm, Hz, or any other unit.

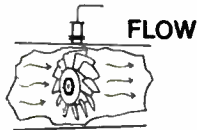

FLOW

Displays directly in bbls/hr, Gals/Min, or any other flow units. TOTAL FLOW directly in bbls, gals, liters or other volume units.



RATIO

Accepts any two pulse inputs and displays in any designated unit, or directly in % of draw or ratio.

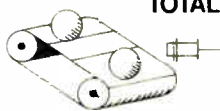

TOTAL

Automatic division of input count by any number gives direct readout in cases, gross, dozens, ft. or yds.

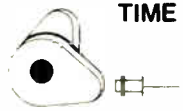

TIME

Measure elapsed time by days, hours, minutes, seconds, milliseconds, microseconds or express time as a percentage of total (i.e. 14 seconds = 100.0%).

New products

to eight weeks after receipt of order. Wavetek Indiana Inc., 66 N. First Ave., Beech Grove, Ind. 46107. Phone (317) 783-3221 [355]

Pulse generator spans

10 Hz to 60 MHz

The latest addition to the E-H line of pulse generators is a 60-megahertz unit that can put out ± 20 volts into 50 ohms. Actually, the output circuit is a back-matched 50- Ω source providing up to 10 v into 50 Ω ; when the back-match is switched out, the model 136A will deliver 20 v into 50 Ω from a high-impedance current source.

Key specifications include a frequency range of 10 hertz to 60 MHz, a delay and pulse-width range of 10 nanoseconds to 50 milliseconds, rise and fall times from 3 ns to 8 ms, and an offset of ± 5 v. Among its other features are external drive, external gating, triggering, double- and single-pulse operation, and normal and complement modes. The 136A sells for \$1,885 and has a delivery time of 90 days.

E-H Research Laboratories Inc., Box 1289, Oakland, Calif. 94604. Phone (415) 834-3030 [354]

Miniature chart recorder

consumes only 7 watts

A compact thermal-writing chart recorder, the model M1-40 DCM writes across a 40-millimeter channel while drawing only 7 watts from a 10-to-14-volt dc supply. The recorder has a 3-decibel bandwidth of 40 hertz, but it can operate up to 110 Hz if the deflection is limited to 10 mm peak to peak.

The recorder provides up to four chart speeds between 1 mm/second and 50 mm/s; however, the ratio of the fastest speed to the slowest must not exceed 10:1. The unit's amplifier has an input impedance of 100 kilohms.

MFE Corp., Keewaydin Drive, Salem, N. H. 03079 [356]

Digitec. **UNITED SYSTEMS CORPORATION**

518 Woodley Road, Dayton, Ohio 45403
 (513) 254-6251, TWX (810) 459-1728

United Systems Corp.: Precision measurements to count on

State of the art leadership in mass terminations ...that's what the BLUE MACS™ System is all about!

LEADERSHIP IN MASS TERMINATION DESIGN FLEXIBILITY begins with a complete package of BLUE MACS connector styles and sizes to meet your varied interconnect requirements. An expanded standard cable package that includes round conductor cable for intra-cabinet wiring, flat conductor cable for high flex life applications, and U.L. listed jacketed cable for external interconnect requirements. A tool package that includes hand and bench versions, cable cutters and separators, discrete wire fixtures and accessories.

LEADERSHIP IN MASS TERMINATION CONTACT RELIABILITY starts with our exclusive patented TULIP™ contact that provides 4 points of electrical contact per conductor for gas-tight, corrosion-free ter-

minations. Comprehensive test information is available upon request.

LEADERSHIP IN LOWER INSTALLED COSTS begins with a one piece connector design that eliminates unnecessary handling to reduce installation time by as much as 65%. This one piece design incorporates mating grooves which assures positive cable to connector alignment, and it eliminates the operator variable when assembling the cable to the connector. Insulation displacing TULIP contacts let you simultaneously mass terminate up to 60 conductors in seconds—without wire stripping or soldering.

A colorful reference guide tells the full reliability story about our complete systems package. Ask your local Ansley distributor for a free copy of the BLUE MACS Wall Chart. Or write us, direct.

T&B / Ansley

The mass termination company.

T&B/Ansley Corporation
Subsidiary of Thomas & Betts Corporation
3208 Humboldt St., Los Angeles, CA 90031
Tel. (213) 223-2331 • TWX 910-321-3938



Stocked and sold through authorized Ansley distributors.

International Offices: AUSTRALIA, Brookvale, (02) 938-1713 • CANADA, Iberville, Quebec, (514) 658-6611 • SOUTH AFRICA, Benrose, 24-8134 • ENGLAND, Luton, (0582) 597-271 • WEST GERMANY, Dreieichenhain bei Frankfurt, 06103-8 20 21 • FRANCE, Rungis, 687-23-85 • JAPAN, Tokyo, 03-354-9661 • SWEDEN, Upplands Vasby, 0760-86140 ITALY, Milano, 02-431216.

Circle 137 on reader service card



COMMANDER

MODULAR WORK STATIONS BY BUD

Put efficiency on your side -- better yet, at your side -- with the new, modular, contemporary-styled Commander.

One, two and three-bay units, each with a rear compartment, plus a selection of cabinets, three-drawer pedestals, and shelves, give you the options to choose what you require for storage, or housing electronic equipment; the options to develop a self-contained, independent data/terminal station.

The new Commander comes in a choice of 19 colors. Walnut wood-grained Formica[®] top has a smooth, comfortably beveled front edge.

The new Concorde Series was designed as a companion piece for the Commander work station; designed to provide a contemporary-styled installation, a complete and effective system. Yet, the Concorde, a definite break with traditional racks, will harmonize with and enhance any installation, simple or sophisticated.

Contact Bud for further facts on the Commander and Concorde. Phone Bud toll free: (800) 321-1764; in Ohio, (800) 362-2265.



Front and rear view of one-bay unit with vertical sliding drawer.

Ask us for our 4-color brochure on Bud's new Commander and Concorde Series.

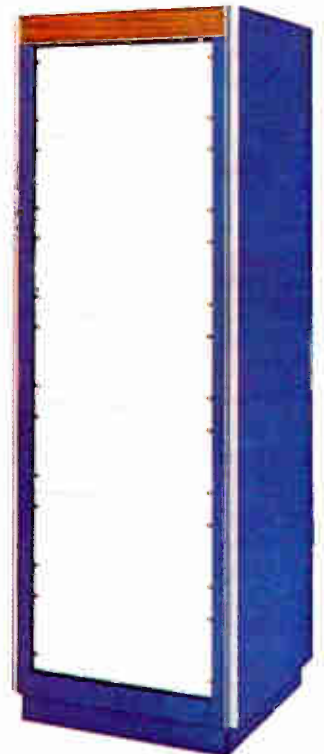

BUD

Bud Industries, Inc.
4605 East 355th St.
Willoughby, Ohio 44094

Bud West, Inc.
3833 North 36th Ave.
Phoenix, Arizona 85019

CONCORDE

New products

Data handling

Graphics terminal has raster scan

Hewlett-Packard uses method to keep costs of high-performance unit down

Who wouldn't want a terminal with high-performance graphics, in addition to the usual alphanumeric capabilities, if the package cost as little as a simple data-entry unit? At \$5,500, Hewlett-Packard Co.'s 2648A graphics terminal may not be there yet, but the raster-scan approach seems likely to make it happen soon.

"With the cost of memory and hardware going down, all terminal manufacturers will soon start to add graphics," says Tom Anderson, product manager of HP's data terminals division in Cupertino, Calif. The key is in the raster-scanning of the cathode-ray tube which paints images by scanning the entire screen as in television, as opposed to storage

and refresh technologies, in which lines are drawn point to point.

Described by Anderson as a "better way, rather than an alternative" to storage/refresh graphics terminals, the 2648A has many advantages. Brightness is probably the main one, he says, closely followed by the fact that "the raster-scan terminal needs no erase-and-refresh of images to delete items, as in storage CRTs." The selective erasing capability—wiping just a single line or portion of an image off the screen—makes the 2648A useful in highly interactive applications.

The argument against raster-scan graphics has been that the definition and separation of the raster lines limit image resolution. However, HP scans 360 lines across the 5-by-10-inch screen, and there are 720 dot locations on each line. The images formed have well defined edges, and only upon close inspection is the jaggedness of a discretely stepped diagonal line noticeable.

A champion of the scanning approach is William B. Huber, marketing vice president at the computers division of Genisco Technology Corp., makers of raster-scan graphics products for original-equip-



MONITOR LINE VOLTAGE

Plug-in our \$320.00, M12DLVM and get an unattended record of line voltage variations from 95 to 135V for up to 2 months without reloading. Circle Bingo 156

OR ANY TREND

With this compact, rugged, single channel thermal recorder offering DC to 5 Hz frequency response, plus 2% FS accuracy at any one of 18 fixed speeds from 1/2"/hr to 12"/min. M12D prices start at \$275. Circle Bingo 139

Call (603) 893-1921 for specs, prices and delivery.



M12DLVM

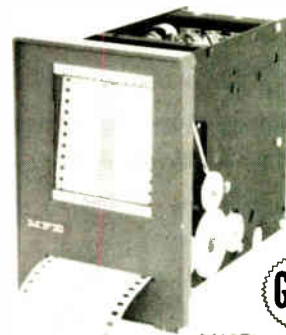

M12D



Keewaydin Drive, Salem, N.H. 03079

ME434A/B/C

Meets INTELSAT and other international standards

Extensive IF coverage, 35-105MHz

0.1dB/cm sensitivity for amplitude measurements

0.3ns/cm sensitivity for group delay measurements

0.1°/cm sensitivity

for differential phase measurements

Comprehensive BB frequency range,

83.333kHz-12.39MHz

Wideband sweep for simultaneous measurement
of inside and outside bands

Loopback and end-to-end measurements

Wide 20dB dynamic range

Easy readout of comb marker (1, 5 and 10MHz)

Simple measurement
of AM-PM conversion coefficient

Lightweight and compact for space-saving installation

Also available:

140MHz-band ME515A/B/C and 70/140MHz dual-band ME525A/B/C

**Everything you expect
from
a microwave system analyzer.**

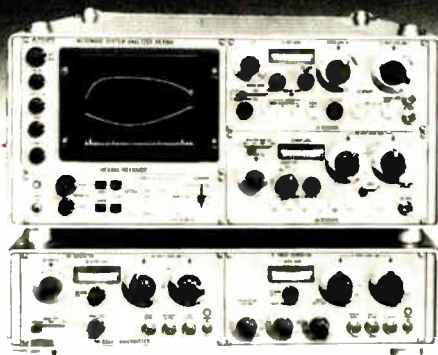

ME434A

Anritsu

ANRITSU ELECTRIC CO., LTD.

MEASURING INSTRUMENTS DIVISION

SALES DEPARTMENT:

12-20, Minamiazabu 4-chome, Minato-ku, Tokyo 106, JAPAN
Phone (03)446-1111/Telex 0-242-2353

U.S.A. Tau-Tron Inc. Tel: (617) 667-3874 • West Germany Knott Elektronik GmbH Tel: (08178) 4085 • England Dymar Electronics Limited Tel: Watford 37321 • France Tekelec Airtronic Tel: (1) 946-96-48 • Italy Vianello S.p.A. Tel: 544041 • Sweden Teleinstrument AB Tel: 08-38 03 70 • Singapore O'Connor's (Pte.) Ltd. Tel: 637944 • Malaysia O'Connor's SDN. BHD. Tel: 51563/5 • Australia NEC Australia Pty Ltd. Tel: Melbourne 560-5233

New products

48 tracks per inch. Options include activity lights, DIP-switch drive select for daisy-chaining, write fault reset, separated data, and separated clock. The single-unit price is \$725. Deliveries will begin in August.

MFE Corp., Keewaydin Drive, Salem, N.H. 03079 Phone James Bartley at (603) 893-1921 [362]

Drive stores 11.5 megabytes
in a 300-foot tape cartridge

The DEI series CMTD-3400S2 is a compact drive for quarter-inch-tape cartridges. Using 6,400-bit-per-inch MFM or other high-density codes, it can store 11.5 megabytes of data in a 300-foot cartridge. Its data transfer rate of 192 kilobits per second makes it well suited for loading and unloading fixed-disk systems. Four units provide more than 46 megabytes of on-line storage on a 7-inch panel.

Data Electronics Inc., 370 North Halstead St., Pasadena, Calif. 91107. Phone (213) 351-8991 [364]

Remote diagnostic system
checks communications lines

Designed to bring diagnostics to the data-communications center and eliminate the need for personnel and test equipment to travel to remote modem, controller, or terminal locations, a new line monitor selection system can check digital communications circuits while they are carrying traffic. The system monitors circuits several hundred feet from the data center and selects up to 999 circuits of any type for monitoring.

The system consists of a monitor select station, line monitor units, and line select modules. The monitor select station sells for \$650. The line monitor units, each of which contains up to 16 line select modules, sell for \$640. And each line select module costs \$110. Delivery time is four weeks.

Spectron Corp., Church Road and Roland Ave., Mount Laurel, N.J. 08057. Phone Boyce M. Adams at (609) 234-5700 [366]

A GOOD FUSE CAN'T HOLD ON WITHOUT A GOOD GRIP.



GET BOTH FROM BUSSMANN.

Don't put a good fuse in the grip of a poor fuse holder. If the holder can't hold on right, the best fuse in the world can't, either.

Some clips just don't have the muscle to hold tight. The fuse gets loose. The heat builds up. You know what happens.

There's an easy way to put a stop to it: Put good Buss fuses in good Buss fuse holders. Our holders are made with the muscle it takes to keep a good tight grip on trouble-free electronics protection.

They'll pay off for you a thousand times over in reliability that's for sure, not for maybe.

Your equipment deserves the best. Bussmann has it for you. A great fuse. And a great grip. Get them together now.

Ask for Buss Bulletin SFB.

SUPPLIED THE ECONOMICAL WAY
THRU DISTRIBUTORS
BUSS FUSES
THE QUALITY LINE



BUSSMANN MANUFACTURING
a McGraw-Edison Company Division
Earth City, Missouri 63045

Packaging & Production

Connectors do a quick change

Handling up to 50 conductors, solderless unit can be modified with special tool

A connector designed for equipment that must be serviced in the field also handles on-the-spot wiring changes. Manufactured by Viking Industries Inc., Chatsworth, Calif., the Vitel-F can be attached, or mass-terminated, with up to 25 wire pairs or 50 conductors by using a special portable tool. The solderless connector can accommodate 24 and 26 AWG copper telephone conductors and also is available in 26 or 27 AWG stranded conductors.

Mass termination is accomplished by lacing the conductors into the carrier strips provided with each connector. With the self-contained tool, the conductors are attached and

the carrier strips fastened to the connector body, where they serve as strain reliefs for individual wires and as protection for the contact area. The resulting mechanical coupling has four contact-to-conductor junctions with an area of up to 1,000 circular mils per coupling.

If a termination error occurs or if wiring changes are needed, the connector may be reterminated by removing the carrier strips, repositioning them, and pressing them back into place. Individual Vitel-F contacts may be reused a minimum of five times without degradation.

Each connector is packaged in a polyethylene bag containing an insulator body with installed dust cover, two carrier strips, right-angle cable hood, cable clamp, and locking screw. Packaged this way, it can be mated with miniature ribbon connectors, including those of other manufacturers.

Typical applications for the Vitel-F are input/output for backplanes, cabling between mainframe computers and peripherals, and data-bus connections for industrial process-control systems. The company says

that its rugged case and strain-relief system make the connector suitable for severe environments, and its design reduces the chance of short-circuiting from washing detergents and wet mops.

Price of the Vitel-F is \$2.52 in quantities of 50 to 249, with delivery from stock.

Telecom Division, Viking Industries Inc., 21001 Nordoff St., Chatsworth, Calif. 91311. Phone (213) 882-5020 [391]

High-throughput tester detects short circuits

Working on the premise that between 50% and 75% of the faults on digital printed-circuit boards are short circuits, Teradyne Inc. has introduced the L429 shorts-detection system, which tests only for shorts. Jeff Hotchkiss, product manager in the In-Process Test Equipment group, says the machine is intended to augment far more expensive and sophisticated systems, such as Teradyne's L100 series, which tests many more parameters and does fault diagnosis.

The L429 includes a board handler, which uses bed-of-nails test plates that the customer can build himself from the company's fixturing kit. Up to 760 points of test electronics can be provided, and the testing is done in less than 1 second.

Continuity tests are performed at a 200-millivolt level to a 10-milliamperere current limit, with a 3-ohm short point and a 15-ohm open point. This makes essentially all active and passive board components appear as opens during testing. Hotchkiss ex-

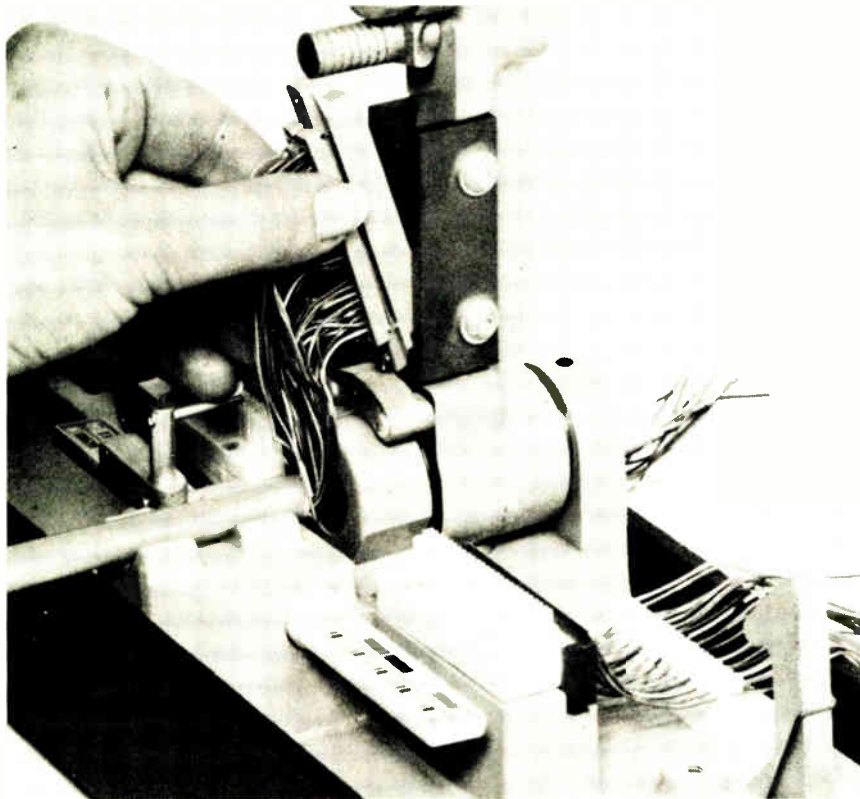

7 trimmers handle 95% of your applications.

Single-turn

With these industry standard cermet trimmers, you're assured design versatility, high quality, and fast delivery.

Just decide what you need regarding: (1) single- or multiturn; (2) sealed or not; (3) size; (4) resistance; (5) pin spacing; and (6) price.

Then call your local Beckman Helipot distributor for *free* evaluation samples. To get his number, or immediate technical literature, call (714) 871-4848, ext. 1776. See how fast and easily you can solve trimmer problems.



Model 91

- High quality — low price
- Unique brush contact
- Excellent setability
- Protective dust cover
- Top or side adjust
- Standoffs prevent rotor binding, permits board washing
- Small 3/8" dia. size



Model 72

- 3/8" square
- Sealed for board washing
- Available in flame-retardant SEO housing
- Top or side adjust
- Brush contact
- Excellent setability
- 2 ohms of end resistance



Model 82

- 1/4" dia. by 0.150" max. height
- Sealed for board washing
- Flame-retardant SEO materials
- 82P — top adjust; 82PA — side adjust
- Brush contact for excellent setability
- Resistance range: 10 Ω to 1 meg Ω

Multiturn

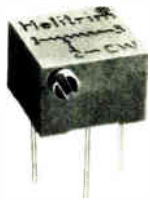

Model 64

- Miniature, sealed
- 22 turns of adjustment
- 0.25 watt at 85°C
- Resistance range: 10 Ω to 1 meg Ω
- 1/4" square for tight P.C. board packaging
- Unique brush contact
- Adjustability — voltage ratio within 0.01%

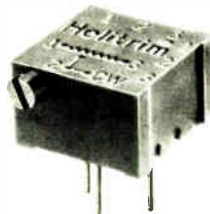

Model 68

- Low-cost
- Sealed for board washing
- 18 turns for adjustment accuracy
- 3/8" square housing
- Brush contact
- 3 pin styles for efficient packaging
- Broad resistance range: 10 Ω to 2 meg Ω
- Operates with 1/2 watt at 25°C

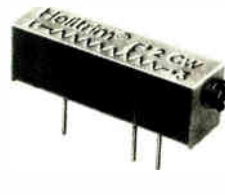

Model 89

- Our lowest cost multiturn
- Sealed for board washing
- 3/4" rectangular, 0.250" high
- 15 turns for accurate adjustment
- 7 pin styles for mounting versatility
- Panel mount available
- Resistance range: 10 Ω to 2 meg Ω

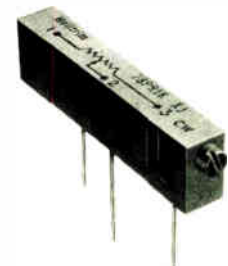

Model 78

- Military performance, industrial price
- 1 1/4" rectangular, 0.195" wide
- Sealed
- 3 terminal styles: flex leads, P.C. pins, solder lugs
- Power rating: 0.75 watt at 70°C
- 22 turns of adjustment
- Resistance range: 10 Ω to 2 meg Ω

BECKMAN®

HELIPOT DIVISION

PRINTED CIRCUIT JACKS/PINS

STANDARD & CUSTOM

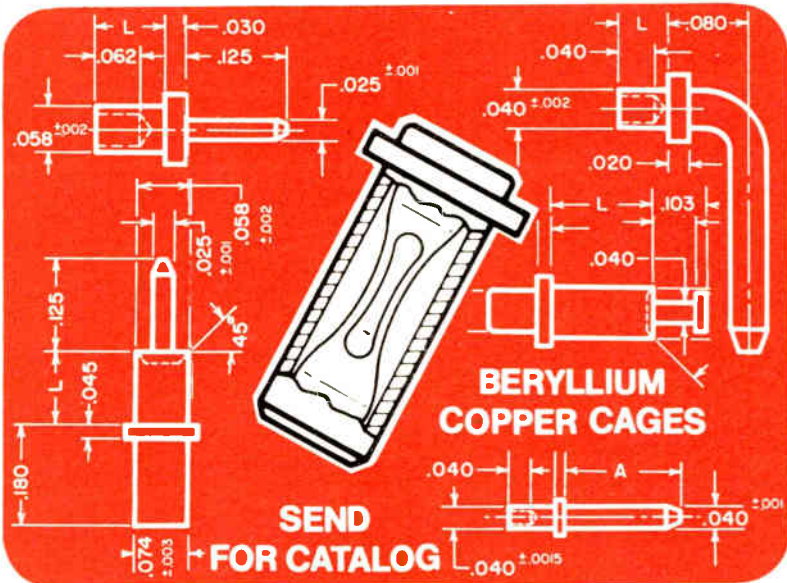

CONCORD ELECTRONICS CORPORATION

37 GREAT JONES STREET, NEW YORK, N. Y. 10012
(212) 777-6571 TWX 710-581-4930

Circle 146 on reader service card

New products

pects the L429 to appeal most strongly to users who already own a large tester and who need to increase their board-testing capacity. They can increase the throughput of their large machines by putting their boards through the shorts detector first and then feeding the short-free boards into the more sophisticated testers. The economic sense of this approach is obvious: a typical large tester sells for about \$175,000; an L429 with 160 points of test electronics goes for only \$19,500. Expansion modules, in 200-point increments, are \$2,500 each. The spring-loaded bed-of-nails test plates are about \$1,000 each, and the fixturing kit sells for \$2,300. Delivery time is 10 weeks.

Teradyne Inc., 183 Essex St., Boston, Mass. 02111. Phone (617) 482-2700 [393]

Programmable sorter/counter provides 64 intervals

The model PSC programmable sorter/counter is a microprocessor-controlled instrument that can be used either as a frequency counter or as a device for sorting components into as many as 64 bins on the basis of their deviation from a reference value. Originally designed to sort devices like crystals by measuring their frequency, it can operate on other parameters, such as voltage and resistance, if an external digital multimeter or other instrument is used. A seven-digit binary-coded-decimal port is provided for connect-

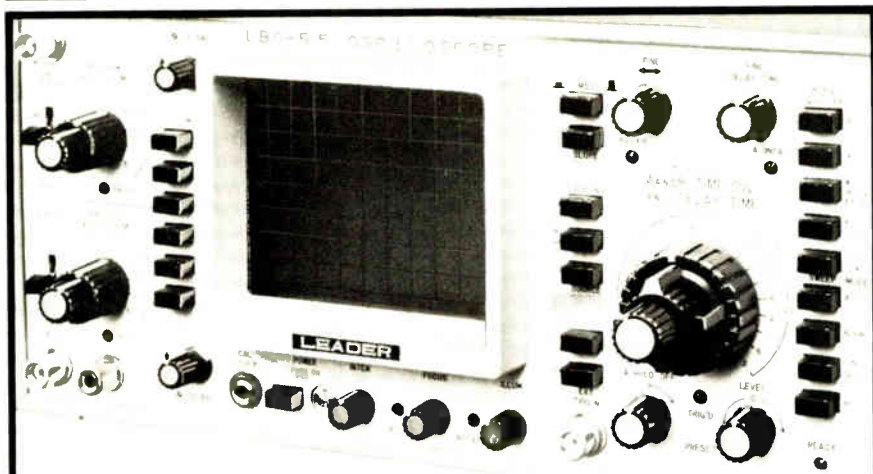

THE 25MHz "NOW" SCOPE with 5sec-1µsec DELAYED SWEEP DUAL TRACE/DUAL CHANNEL

- Built-in delay circuitry, continuously variable, from 1µsec to 5sec plus 5mV/Div sensitivity.
- Selectable synchronization — automatic, normal, single trace and reset modes with H-F rejection
- X10 magnification, ± 3% overall accuracy both chan's
- Displays leading edge of pulse or pulse train for quick functional determination.
- 20,000:1 delay jitter — X-Y phase difference below 3° @ 100KHz.
- External Sweep Sensitivity (X-Y) 5mV/Div to 2V/Div, 10 steps \$1395 with accessories

LEADER Instruments Corp.

Tests More... Tests Better... for Less!

151 Dupont Street, Plainview, N. Y. 11803 (516) 822-9300
In Canada: Omnitronix Ltd. Montreal, Quebec



The real test for a display's readability is direct sunlight. Most of them are washouts.

By comparison, Beckman displays stand out. With wider viewing angles and more brightness by the foot. Important factors when you're looking at critical readouts in the air or on the ground.

The reason for most of our product advantages can be summed up in two words: *Superior Technology*. For example, Beckman's unique raised-cathode construction method insures a smooth, even glow over all the segments. The result: Optimum visibility through a feat in *human engineering*.

Besides outstanding visibility, Beckman displays give you letter-perfect numbers. No breaks or gaps. Natural, flowing lines that are pleasing to the eye. In any number. And, in vibrant orange, filterable to bright red. Perfect for the designer who wants his numbers to look like numbers. Not like jigsaw puzzles.

Beckman displays are designer's designs. Modular.

In character heights from 1/3" to 1". Arranged on one-to-four-digit, plug-in building blocks that save space and assembly time. Or, if you need a custom display, we stand out in that picture, too.

Reliability is another place where Beckman displays really shine. Assured by extensive in-process testing and 100% burn-in. As a result, we can give you a warranty that's good for one year. (Or, you may qualify for our Warranty Plus Option.)

To top it all, Beckman displays can give you a visible edge in your market - a simple case of product differentiation.

This is how Beckman displays beat the daylights out of all others. Point for point, digit by digit. Clearly and decisively. If you're not convinced, just plug in one of ours. Compare it to theirs. The difference will show up day or night.

For complete details, write: Beckman Information Displays Operations, P.O. Box 3579, Scottsdale, AZ 85257; or, call (602) 947-8371.

Beckman beats the daylights out of all other displays.

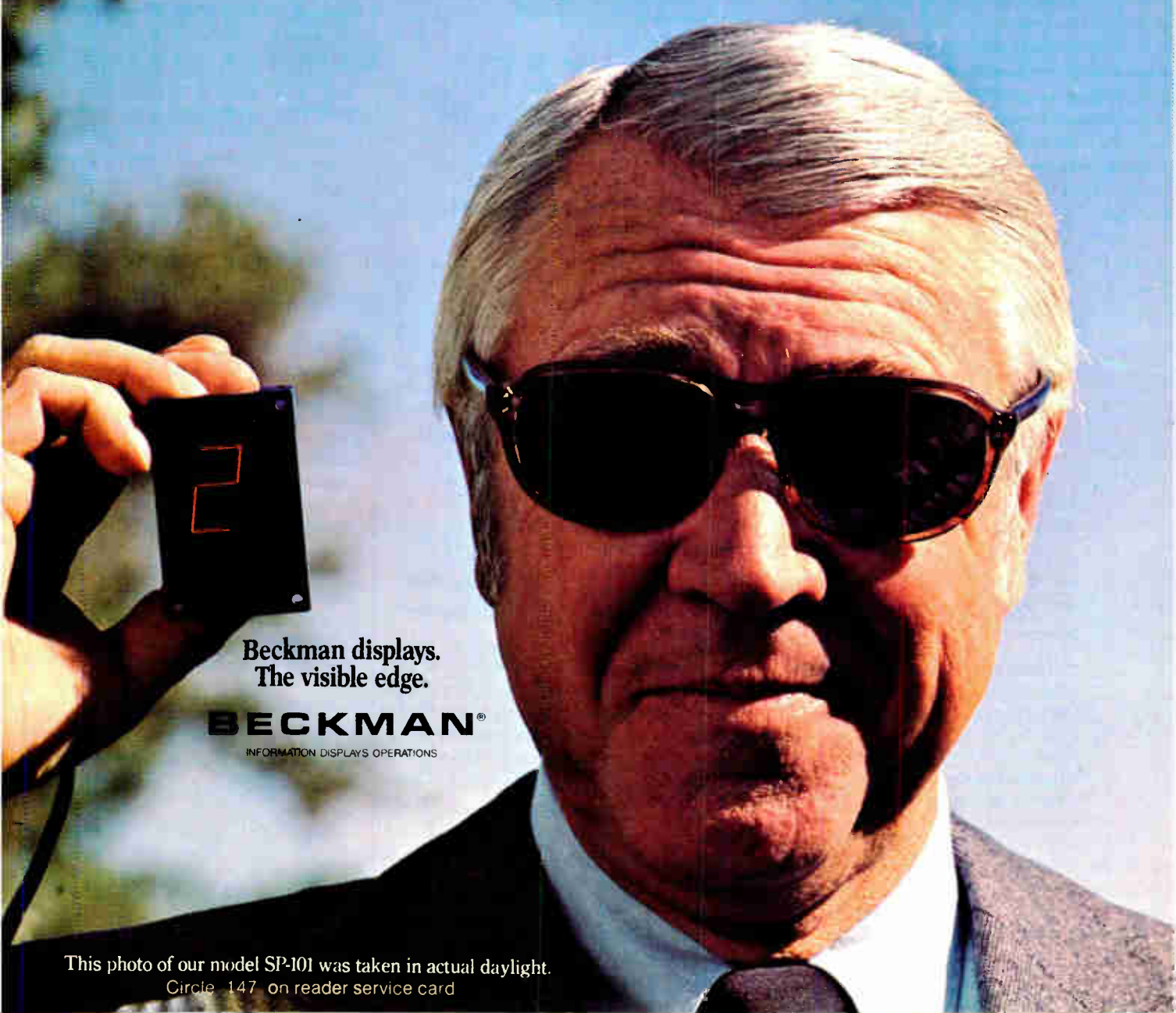

Beckman displays.
The visible edge.

BECKMAN®

INFORMATION DISPLAYS OPERATIONS

This photo of our model SP-101 was taken in actual daylight.

Circle 147 on reader service card

BUCKEYE flex-i-pak™ INSTRUMENT CASES

This is "THE" PACKAGE
for prototype or production!

Design your case interior with standard
accessories. 5 Heights — 3 Depths.

Write Today for
free catalog

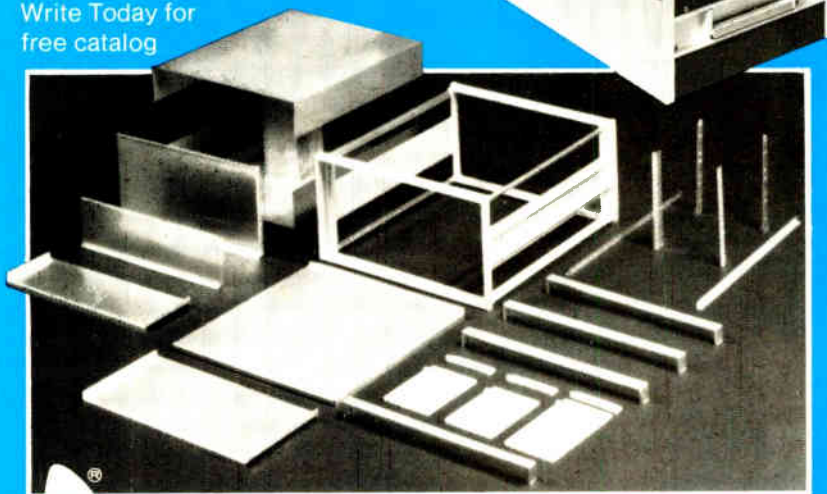

the BUCKEYE stamping co.

555 Marion Rd., Columbus, Ohio 43207 Ph 614-445-8433

Circle 150 on reader service card

Specify Pentaflow fans one time

Once you specify a Pentaflow fan from Pamotor, chances are you'll never need to replace it. Pentaflow fans are so reliable we guarantee them for a full five years.

Pentaflow fans are **ideal** for cooling your limited production, premium quality electronic equipment where cooling failure simply can't be risked, or in situations where fan failure has been a recurring problem.

As are all Pamotor fans, Pentaflows are designed with durable all-metal construction, are light-weight, operate quietly and at a low temperature. All are UL recognized, CSA approved and conforms to IEC and VDE standards.

Two models are available: the 4600XP (4½" x 4½" x 1½") which delivers 120 cfm with only 34 dB SIL, and the 8500P (3⅜" x 3⅜" x 1½") delivering 43 cfm at a low 22.3 dB SIL.

Write for technical assistance, literature, and name of nearest distributor. Pamotor, 770 Airport Blvd., Burlingame, CA 94010. Or phone (415) 347-1203.

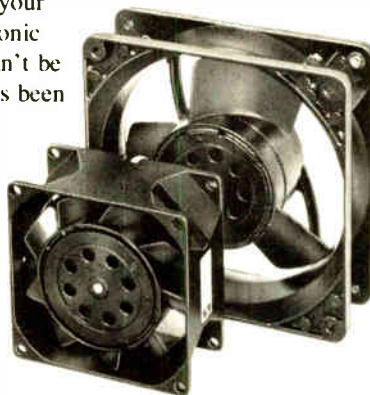

PAMOTOR

ONE OF THE PURDY GROUP OF COMPANIES

150 Circle 201 on reader service card

WorldRadioHistory

New products

available in the popular 4.375-by-4.862-inch and 7.0-by-7.353-in. sizes. Prices for the line of boards range from \$18.90 for the basic board to \$110.95 for the 700 series high-density socket board.

Hybricon Corp., 410 Great Road, Littleton, Mass. 01460. Phone Dan Murphy at (617) 861-6692 [396]

Vacuum device picks up
chips, wafers, lenses

The Roto-Pic is a simple, hand-held, vacuum device designed to simplify the manual handling of chips and wafers. It has a hold-and-release bar that allows the operator to lift his finger without dropping the object being handled. It also features a rotating nose wheel that will rotate a full 360° in either direction so that chips can be picked up and aligned to any position.

A variety of tips is available in various sizes for picking up wafers from either trays or boats as well as for picking up chips. Silicone rubber cups are also available for handling such smooth and delicate items as optical lenses. The device is offered as a kit, model number 2000K, consisting of a vacuum pump, a hose, and the Roto-Pic.

Frem Corp., 3740 Skypark Drive, Torrance, Calif. 90505 [395]

Dry-plasma unit strips
photoresist automatically

A fully automated dry-plasma instrument uses end-point detection to strip photoresist from semiconductor wafers in a reliable and efficient manner. Called the Plasmaline 400, the stripper monitors the plasma discharge during the stripping cycle and ends the cycle when the stripping is completed. The unit has a nonreactive aluminum chamber with a capacity of 50 4-inch wafers. The compact device measures only 23 by 23 by 16 inches.

Tegal Corp., 860 Wharf St., Richmond, Calif. 94804. Phone (415) 232-1757 [397]

Electronics / July 7, 1977

Gates introduces the future in energy cells.



There's now a new energy source that's a superb alternative: Rechargeable, sealed lead-acid batteries from Gates.

We call these batteries the future in energy cells. And for good reason.

They have all the product advantages you need plus economic advantages that may well give a new dimension to your product pricing.

Advantages: Gates Energy Cells are as compact as nickel cadmium or gelled type cells. And they are completely sealed, so that no acid vapor can leak out (they also include a self-sealing vent for extra safety). Gates Energy Cells provide low internal impedance for high discharge rates (more than 100 amps from the D cell and 100 amps from our X cell for short periods of time). And can be operated or stored in any position.

Gates Energy Cells offer great packaging

flexibility. In fact, our individual cell availability allows you to choose your own specific voltage (in 2-volt increments) and current, as well as configuration.

Just as important as what Gates Energy Cells have to offer is what they don't have to offer. Like outgassing problems. Or cell reversal. Or "memory" problems.

Because Gates Energy Cells are made from low-cost materials that are readily available. They're very high in watt-hr. per dollar value. Which means that if you specify them, you'll probably save your company more than a few dollars. And make yourself into something of a hero in the bargain.

To find out more about the future in energy cells, circle our reader service number or write us. We'll send you *free* literature containing features, application information, ratings and specifications. George Sahl, Gates Energy Products, Inc., 1050 S. Broadway, Denver, CO 80217.

Gates
Energy Products

**Where the
energy future is now**

PuriTan™

four case sizes that fit this spec to a "T"

MIL-C-39006/22A
(CLR79)

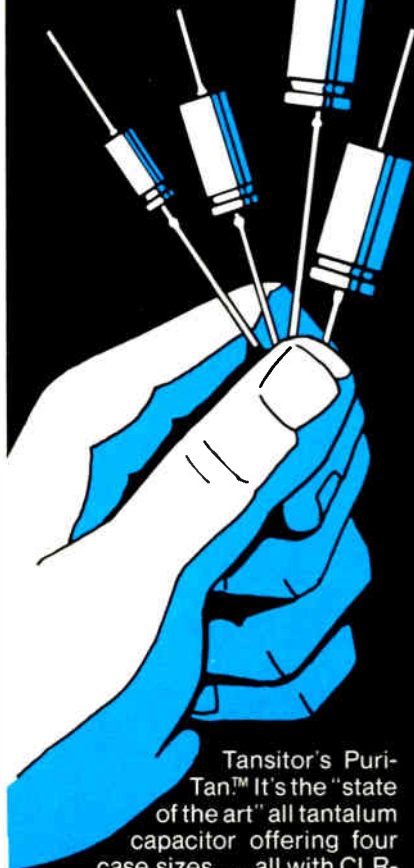

Tansitor's PuriTan™ It's the "state of the art" all tantalum capacitor offering four case sizes . . . all with CLR-79 approval. And PuriTan performs. The unique tantalum-glass-tantalum compression seal prevents electrolyte seepage. There's a reverse bias capability of 3 V. The AC ripple characteristics are greatly increased and silver migration is eliminated.

Today, check the specs on PuriTan. It's pure performance. Call your local Tansitor rep . . . or contact . . .

 **Tansitor**
ELECTRONICS
DIVISION OF AEROTRON, INC.

West Road, Bennington, Vermont 05201
Phone: (802) 442-5473
TWX: (710) 360-1782

Specialists in Tantalum Capacitors

TM Trademark of Tansitor Electronics

New products

Semiconductors

Gate array cuts interconnect delay

Family from Fairchild LSI
operates at up to 500 MHz
with 700-picosecond delays

As the trend toward bigger and better computers continues, there is a growing need for integrated circuits with subnanosecond speeds. But interconnect delays prevent high-performance computer architecture from utilizing the speed offered by fast bipolar and emitter-coupled logic of the small- and medium-scale IC types. Such delays have therefore become a proportionally greater factor in system performance.

Now, however, the LSI Group of Fairchild Camera and Instrument Corp. has found a way to eliminate this interconnect problem: a new family of 300-gate-equivalent subnanosecond ECL gate arrays capable of operation up to 500 megahertz.

Designed in conjunction with Control Data Corp. of Minneapolis, Minn., the Fairchild ECL gate array consists of 168 discrete gates that have complete hookup flexibility. This allows the interconnected gate array to achieve an effective 300-gate-equivalent network.

The typical internal gate-propagation delays are about 750 picoseconds, and the input and output are compatible with Fairchild's standard F100K family, allowing the system designer to make use of standard parts in conjunction with the gate array for maximum system performance and lowest cost.

The 173-by-130-mil device consists of a six-by-six array of internal cells, each of which consists of four two-input gates and 24 output buffer gates. Each of the 24 output gates has two inputs, and for every two output gates there is one set of two transistors for expansion to four inputs on one of the two gates.

The result is that any combination between 24 two-input gates and 10 two-input gates plus 14 four-input gates is possible. The internal-gate-switch current is 2 milliamperes, and the external-gate-switch current is 6 mA. Typical external-gate propagation delay is 850 ps.

The array is designed for 48 input/output pins and multiple supply voltages. It has space for 48 wiring channels in one direction on the first layer of metal and 78 wiring channels on the second layer in the other direction.

Available now, this semi-customized family of standard ECL arrays is priced depending on the application. Fairchild Camera and Instrument Corp., 464 Ellis St., Mountain View, Calif. 94042 [411]

Decoder/driver for LCDs takes BCD inputs

The HMUX0190 decoder/driver is a 40-pin complementary-metal-oxide-semiconductor device that converts multiplexed binary-coded-decimal data into signals suitable for driving a liquid-crystal display. The component, which is compatible with a four-decade counter, can be applied to any system that uses a parallel-drive LCD and a four-digit multiplexed BCD input. In thousands, it has a price of \$8. It is housed in a plastic dual in-line package. Delivery time is 30 days.

Hughes MOS Products, 500 Superior Ave., Newport Beach, Calif. 92663. Phone (714) 548-0671 or (800) 854-3515 [417]

Fast 4,096-bit static RAMs pull as little as 370 mW

Four new MOS random-access memories from Intel are 4,096-bit static devices that require from 50% to 75% less power than standard 1,024-bit static RAMs. The memory family, which consists of two 18-pin devices and two 20-pin units, offers compatibility with transistor-transistor-logic levels on all inputs and outputs. It also features operation from a single

MCC builds custom IC's using I²L to provide Consumer Product Prices

If you need the performance improvements that can be realized only with an IC circuit custom designed for YOUR product or system — minimum power, ultimate miniaturization, optimized OEM pricing, PLUS the security of a proprietary circuit — Micro Components Corporation is ready to answer your critical questions . . . and to ask a few which may save you time and money and result in a better product. I²L designs permit interface power output capability not available with CMOS plus the combination of linear and digital functions in the same chip! This means fewer external components for lower costs and higher reliability.



We've considerable experience in developing and manufacturing high performance, high reliability IC circuits especially for consumer products. For example, for the KODAK EK4 and EK6 Instant Cameras, we developed a unique circuit which combines both the silicon photo detector and control circuit in a single, optically transparent DIP.



Because our business is, of necessity, confidential, we cannot divulge specific circuit details in most cases, but we CAN show you some intelligent solutions to problems involving sophisticated performance specifications, exceptionally high volumes and stringent pricing.

We'll send you our Custom IC brochure and look forward to speaking with you about your requirements. Please write us at: 99 Bald Hill Road, Cranston, R.I. 02920 or
Call (401) 463-6000

In a variety of packages, including Flip-Chip leadless semiconductors for hybrid circuits, we've supplied custom circuits for:

- Automatic Cameras
- Smoke Detectors
- Camera Flash Circuits
- Automotive Systems
- Peripheral Circuits for Microprocessors
- Motor Speed Controllers
- Fire, Theft & other Security Systems
- Mobile Communications
- Remote Radio Control
- Timer Circuits

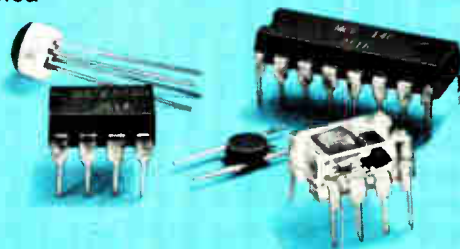

MICRO COMPONENTS CORPORATION

New products

5-volt supply. The 18-pin units are 1,024-by-4-bit devices that provide the highest storage density available in static RAMs. The model 2114 has a power dissipation of 525 milliwatts, while the low-power 2114L draws only 370 mw. The 20-pin units, the 2142 and 2142L, have the same configuration and power rat-

ings as the 18-pin memories, but they have a second chip-select input and an output-disable control input.

Each series offers units with three different speeds: 200-, 300-, and 450-nanosecond maximum access and minimum read or write cycle times. In hundreds, prices vary from \$13.35 each for the 450-ns 2114 in a

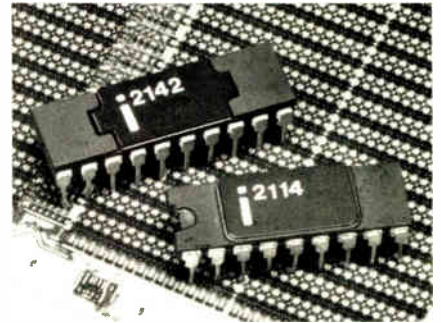

plastic package to \$31.50 each for the 200-ns 2114L-2 in a ceramic DIP. The 2142 is offered only in a ceramic DIP package.

Intel Corp., 3065 Bowers Ave., Santa Clara, Calif. 95051. Phone (408) 246-7501 [415]

Semicustom C-MOS chip contains 200 gates

The newest semicustom complementary-metal-oxide-semiconductor chip from Master Logic, the Master Logic 200, has a capacity of 200 gates of random logic or about 50 counter stages. Prototype development from customer logic drawings to working circuits requires eight weeks and costs \$6,600. Production prices range from \$7 to \$17 depending on quantity and packaging.

Master Logic Corp., 1623 Finch Way, Sunnyvale, Calif. 94087. Phone (408) 732-7777 [414]

Unit decodes BCD, drives liquid-crystal displays

A four-digit decoder/driver, the DF411, contains all of the circuitry needed to decode up to four digits of multiplexed binary-coded-decimal information and to create the ac signals required to drive four seven-segment liquid-crystal-display digits. The monolithic device consists of a BCD-to-seven-segment decoding read-only memory, four 7-bit latches, an on-board oscillator, and control logic. Its output consists of square waves with a 50% duty cycle, so they contain no direct-current component, which could shorten the

After you look at the specs, look how long they're guaranteed.

The accuracy specs for the Dana 5100 5½ digit multimeter are guaranteed for a full year. Not 90 days. Not 6 months. That means you only have to calibrate it once a year.

All other multimeters have to be calibrated an average of three times a year. At about \$75 a pop. Which makes their \$995 units a lot more expensive to own than the Dana 5100 at \$1145*.

Instead of sitting in the shop for six weeks over the course of the year, the Dana 5100 will stay right where you are. Measuring AC, DC, Ohms and *frequency* (yes, frequency too) with very high accuracy. Just like the specs say. For a year at a time.

When you look at it that way, one thing becomes obvious. The cost of owning a multimeter is a lot more important than the price.

Write Dana Laboratories, Inc., 2401 Campus Drive, Irvine, CA 92715 for all the specs. And take a good look. With specs that good, you'll be glad you only have to give it up once a year.

DANA®

Others measure by us.

*U.S. domestic prices



Dana 5100.

Ask for a free demonstration before you consider anything less.

OUR DETECTORS ARE INTO EVERYTHING

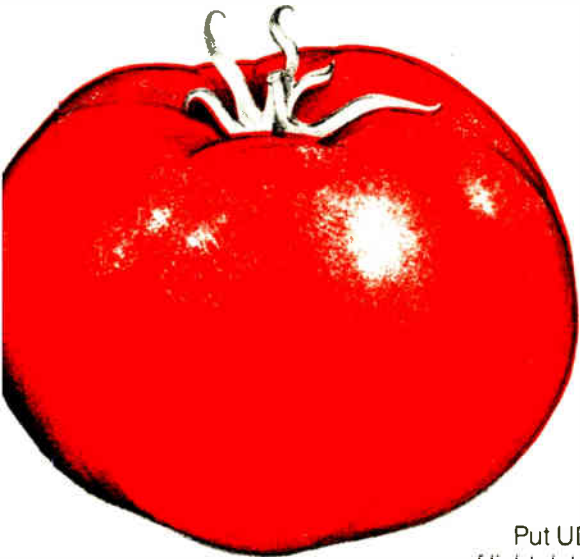

THANKS TO OUR APPLICATIONS ENGINEERS

What does a light detector have to do with a tomato? Plenty, if your job is to determine ripeness by color analysis. That's a big jump from missile guidance systems, but it's the range of applications our detectors work in every day. And, thanks to our engineers, it's the right detector for the job.

Put UDT into your product or process. We make all kinds of light detection devices, instruments and systems — and we can show you how to apply them. It doesn't matter whether you're into:

- Medical Electronics** (such as blood analysis with our UV or blue enhanced photodiodes)
- Consumer Products** (monitoring digital displays with our LED measurement systems)
- Communications** (communication links with our Low Noise series or Detector/Amplifier Combinations)
- Office Machines** (character recognition with the UDT Long Lines)
- Photographic Processes** (measuring thickness of film coating with our General Purpose PIN-10DP)
- Navigation** (star tracking or missile guidance with our Position Sensors)
- Industrial Process Control** (non-contact, optical alignment with the "SC" position sensor or the 131A Linear Displacement Monitor)
- Food Processing** (color analysis with our large area, low cost PIN-220DP or any of our other General Purpose detectors)
- Research & Development** (photometry/radiometry with the UDT 111A, 40X, 8CX)

The right light detection and measurement solution can reduce your costs while improving accuracy, efficiency and reliability. Let UDT provide the products, know-how and design assistance you need.

Get us involved today! Call (213) 396-3175.

Years Ahead in the Detection, Measurement and Application of Light.

Circle 155 on reader service card

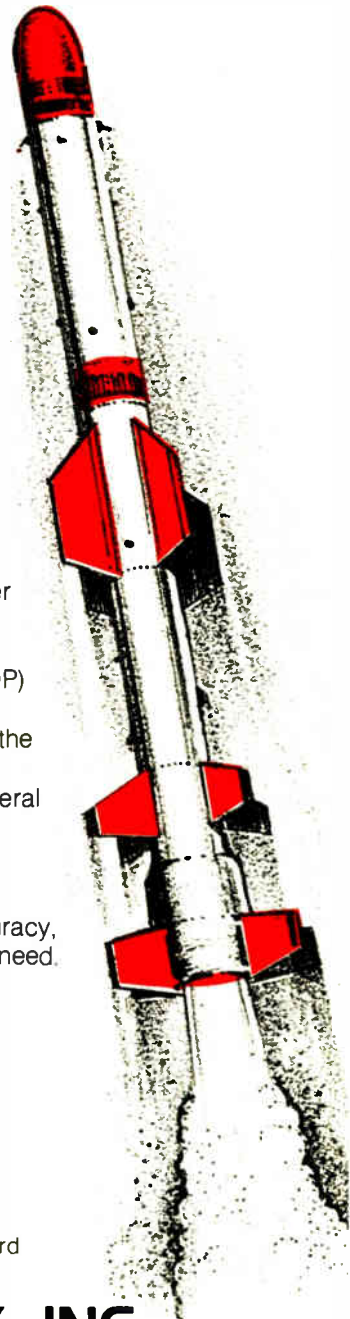

 **UNITED DETECTOR TECHNOLOGY, INC.**

2644 30TH STREET, SANTA MONICA, CA 90405 • TELEPHONE (213) 396-3175 • TELEEX 65-2413

When Clear Displays Count

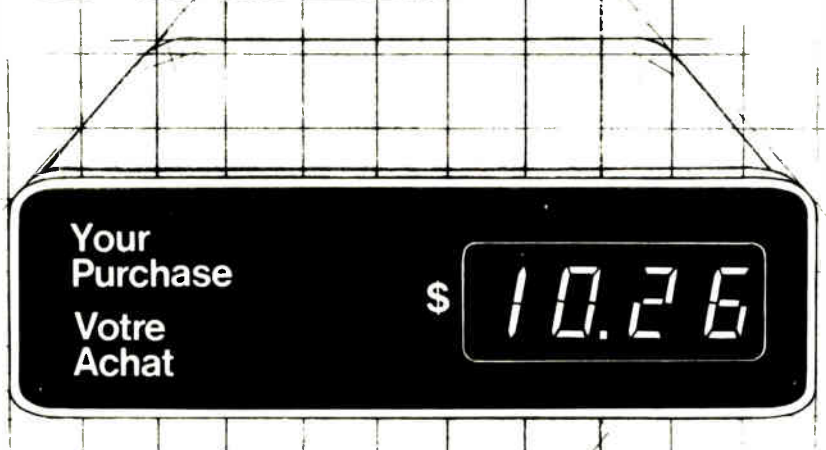
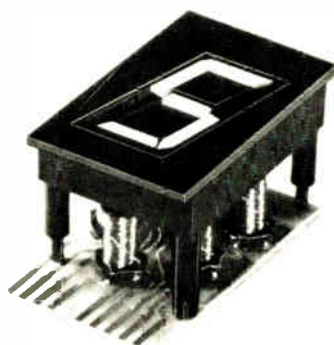

You can count on Ferranti-Packard's electromagnetic 7-Bar display module to give you the electronic compatibility you need plus the reliability and visibility your customers demand.

Only 7 moving parts to each display module — no complex mechanical linkages to wear out, or incandescent lamps and neon tubes to burn out.

Performance-proven for over 5 years, the simple design and construction, backed by Ferranti-Packard research and engineering, gives you the combination of reliability, visibility and flexibility that no other read-out component can match.

When you design an electronic read-out system, Ferranti-Packard display modules will help you do it better. It's clearly the display module you should consider. See the difference for yourself, write or call us and we'll prove it.

When clear displays count — Specify Ferranti-Packard.



Ferranti-Packard Limited

Electronics Division,
121 Industry Street,
Toronto, Ontario, M6M 4M3, Canada
Telephone: (416) 762-3661
Telex: 06-22007

New products

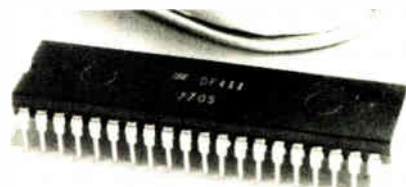

normal useful life of the LCD display.

Power consumption of the DF411J is a low 1.5 milliwatts, making it well suited for use in battery-powered portable instruments. Housed in a plastic package and rated for operation from 0°C to 70°C, the DF411J sells for \$9.29 in small quantities, \$7.42 in lots of 30 to 99 pieces, and \$6.49 for 100 to 999 pieces.

Siliconix Inc., 2201 Laurelwood Road, Santa Clara, Calif. 95054. Phone (408) 246-8006 [416]

Latest Monochip is an n-channel digital device

Monochips—the semicustom devices consisting of a standard array of elements without the interconnecting metalization—have heretofore been strictly analog devices. Now, Interdesign has announced its first digital Monochip—an n-channel, silicon-gate, Isoplanar device that contains the equivalent of 262 gates. Developed in collaboration with Fairchild

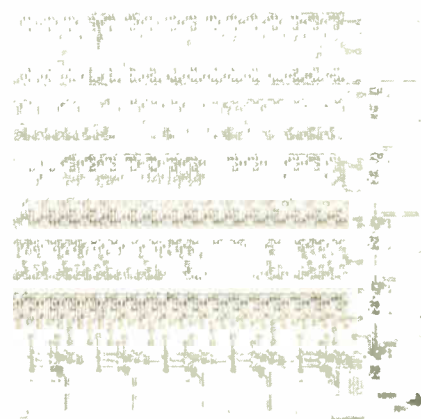

Semiconductor, the 138-by-138-mil chip has been laid out so that custom designs can be completed in a matter of a few days.

The tooling charge for any Mono-

We know your needs. Electronics Magazine Book Series. Zero-risk trial offer.

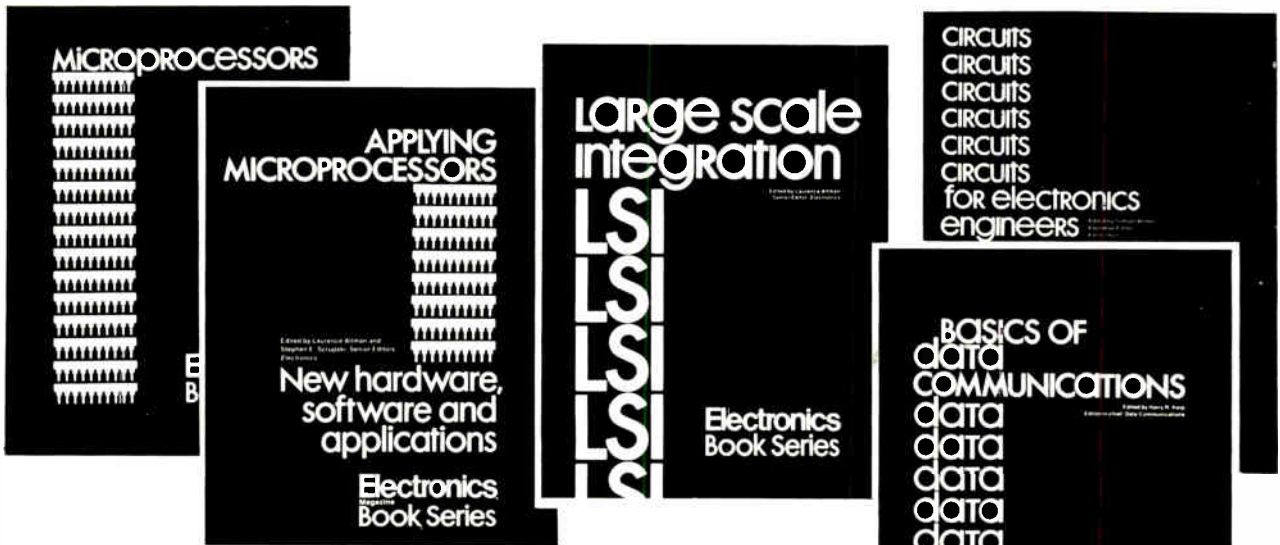

1. Microprocessors

What you must know about available microprocessor technology, devices, information, 4th printing. \$8.95

2. Applying Microprocessors

2nd and 3rd generation technology. 26 detailed applications from data networks to video games. \$9.95

3. Large Scale Integration

Covers the basic technology, new LSI devices, LSI testing procedures, plus system design and applications. \$9.95

4. Basics of Data Communications

Includes 47 articles from Data Communications magazine covering more than 11 key areas. \$12.95

5. Circuits for Electronics Engineers

Contains 306 circuits arranged by 51 functions from Amplifiers to Voltage Regulating Circuits. Saves design drudgery. \$15.95

Electronics Book Series
P.O. Box 669, Hightstown, N.J. 08520



1. Send me _____ copies of "Microprocessors" at \$8.95 per copy.
2. Send me _____ copies of "Applying Microprocessors" at \$9.95 per copy.
3. Send me _____ copies of "Large Scale Integration" at \$9.95 per copy.
4. Send me _____ copies of "Basics of Data Communications" at \$12.95 per copy.
5. Send me _____ copies of "Circuits for Electronics Engineers" at \$15.95 per copy.

Discounts of 40% on orders of 10 or more copies.

I must be fully satisfied or you will refund full payment if the book is returned after ten-day trial examination.

Payment enclosed Bill firm Bill me

Charge to my credit card:

- American Express Diners Club
 BankAmericard Master Charge

Acc't No. _____ Date exp. _____ Interbank No. _____

On Master Charge only, first numbers above name _____

Name _____ Title _____

Company _____

Street _____

City _____ State _____ Zip _____

Signature _____

New Mod Look from Adam.

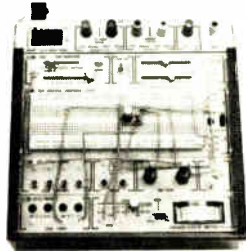

Modular breadboarding system. \$510.00*

It's Adam. E&L Instruments' new modular breadboarding system. To provide you with added flexibility for expansion and development. Adam gives you the 5005 Mainframe that contains all the power supplies necessary to operate each of the separate modules. And here's what else you get:

- 103 Signal Source Module
- 101 Function/Pulse Generator Module
- Two 302 Universal Component Socket Modules
- 502 Readout and DC Multimeter Module

And you make all connections on the panel mounted SK-10 socket with common 22 gauge solid conductor wire. No special patch cords and no soldering needed.

Put this valuable design tool to work in your lab today. Write E&L, or contact your local representative listed below.

*Quantity discounts available.



E&L INSTRUMENTS, INC.
61 First Street, Derby, Conn. 06418
(203) 735-8774 Telex No. 96 3536

Authorized Stocking Representatives

Los Angeles, Calif.
(213) 377-0975
San Francisco, Calif.
(415) 961-2828
Woodbridge, Conn.
(203) 397-1461
Denver, Colorado
(303) 534-1356
Orlando, Florida
(305) 351-1841
Chicago, Illinois
(312) 956-8090
Kansas City, Kansas
(913) 649-8952
New York, N.Y.
(201) 467-8585
Syracuse, N.Y.
(315) 699-2651

Dayton, Ohio
(513) 222-0011
Philadelphia, Pa.
(215) 723-8733
Dallas, Texas
(214) 328-5484
Fairfax, Virginia
(703) 273-1803
Seattle, Washington
(206) 938-4166

Canada
Edmonton, Alberta
(403) 455-4122
Winnipeg, Manitoba
(204) 774-6286
or 772-9295
Vancouver,
British Columbia
(604) 687-2621



Circle 158 on reader service card

New products

chip, including the new digital device, is \$2,800. The first 50 prototypes have a delivery time of four weeks.

Interdesign Inc., 1255 Reamwood Ave., Sunnyvale, Calif. 94086. Phone (408) 734-8666 [413]

Pulse transistor line
operates in L band

A family of seven transistors, the MRP-0912 series, features broadband output levels of greater than 250 watts and narrowband outputs of more than 300 w. Four units in the series are internally matched for the 960-to-1,215-megahertz band and have gains ranging from 6.2 to 8 decibels.

TRW RF Semiconductors, 14520 Aviation Blvd., Lawndale, Calif. 90260 [418]

TOPICS

Semiconductors

Silicon Transistor Corp., Chelmsford, Mass., has received qualification approval per MIL-S-19500/498 for its JAN-2N6306 and JAN-2N6308 high-voltage, fast-switching power transistors. . . . **Texas Instruments Inc., Houston, Texas,** has been granted joint Army Navy (JAN) approval for its TMS4050 and TMS4060 read-only memories. The 4,096-bit dynamic MOS ROMs are reported to be the first large-scale-integrated circuits ever qualified to JAN MIL-M-38510. . . . **Siliconix Inc., Santa Clara, Calif.,** is producing a low-cost, low-voltage light-emitting-diode flasher, the LM3909. A second source to National Semiconductor's part with the same number, the bipolar device contains an oscillator and a high-current output transistor on the same chip. . . . **Motorola Semiconductor Products Inc., Phoenix, Ariz.,** has added 35 power transistors to its TO-220 line of discrete transistors. The devices are second-source components for units made by TI and RCA.

ENVIRONMENTALIZED. OUR DIGITAL PANEL METERS ARE RUGGED.



Our IMPAC™ DPMs can withstand extreme temperatures and are totally immersible in water. That's 100% humidity. 15Gs of vibration in any direction and 30Gs of shock is what we call punishment and our tough little DPMs can take it. Available with 3, 3½, 4 and 4½ digit displays. Check our reader service card for more information.



velonex

560 Robert Avenue
Santa Clara, Ca 95050
(408) 244-7370

**NOW...
a large table
ELECTRO-
DYNAMIC
VIBRATOR For
Mil. Std. 781-C**

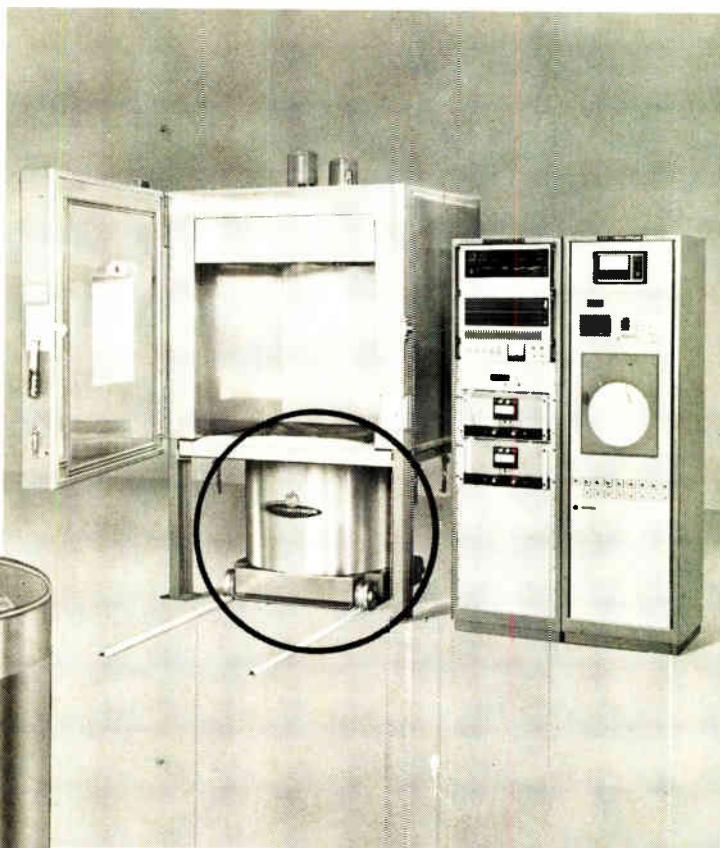

RANDOM (and sine) Electro-Dynamic excitation for Mission Profile realism.

A full 24" table, 33" height that fits existing Thermotron AGREE chambers. Lower purchase price and operating cost put this new Dynamic System's Vibrator in a class by itself.

Features include: • 20-2000 Hertz • 25 Stainless Steel, Thermally Isolated Standoffs for fixture mounting and test items • Air-cooled Power Amplifier • Air-cooled Vibrator • Complete Instrumentation System • 8 Beryllium Flexures • Three Force Ratings: 1500, 2500, 4000 lbs. RMS • 33" High, 34" Wide and 34" Deep.

THERMOTRON PUTS IT ALL TOGETHER!

Integrates the new Electro-Dynamic Vibrator with time tested AGREE chambers and microcomputer controls.

IF YOU HAVE AGREE CHAMBERS AND CONTROLS...

our new Electro-Dynamic Vibrator can save you a lot of time and money. It costs less to buy and the 33" height avoids costly alterations of present equipment.

IF YOU NEED CHAMBERS...

Thermotron has produced more than 90% of all AGREE chambers in the past 15 years. We can supply a size to meet your test requirements.

IF YOU NEED CONTROLS . . .

Thermotron's 211 Microcomputer Programmer is the best answer to comply with 781-C requirements.

IF YOU WANT SINGLE SOURCE RESPONSIBILITY for . . .

Chambers . . . Vibrators . . . Moisture . . . Controls . . . Product Support. Thermotron is the one place that has it all!

Systems to simulate any Environment man or nature creates.



THERMOTRON INDUSTRIES
DYNAMIC SYSTEMS DIVISION

KOLLEN PARK DRIVE, HOLLAND 49423; PHONE 616 392-1492; TWX 810 292-6164

Offices in Principal Cities

MILITARY
APPLICATIONS

A/D CONVERTERS

by

MSK

Accuracy

Speed

Size

Repairability

Military

Temp. Range

-55° C to +125° C

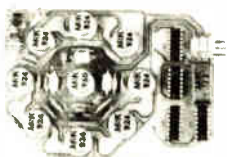

- 4 Bit/50 nSec; Low Cost
- Ideal for Radar Scan Converters
- Holds Absolute Accuracy Over Temperatures
- Tracks a 10 MHz Analog Input



- 9 Bit/ 200 nSec.
- < 2 Bit Drift Over Temperature
- Insensitive to Clock Frequency

For Further Information Call or Write

M.S. Kennedy Corp.

Pickard Drive, Syracuse, New York 13211

Tel. 315-455-7077

New products

Subassemblies

A-d converter handles 16 bits

Modular device boasts speed of 40 microseconds and offers high linearity

Accuracy, speed, and price are the principal features that a designer must trade off against each other when he is in the market for analog-to-digital converters. Intech/Function Modules Inc. is going into production on a new modular 16-bit a-d converter that the company says promises the best compromise among these three features.

Designated the A-858-16, the module is designed to fill a void that exists in the marketplace, says marketing manager Paul Pinter. He says if a user wanted a conversion time of less than 100 microseconds, the only available choices were devices in the

10-to-20-microsecond range with accuracies ranging from $\pm 3/4$ to 1 least significant bit and price tags ranging from \$800 to \$1,300. "We feel there is a place in the market for a true 16-bit converter with slightly lower speed and a considerably lower price tag," he says.

Intech's solution, the A-858-16, is a 40- μ s part priced at \$425 in single-unit quantities. It typically provides a linearity of within $\pm 1/2$ LSB at 16 bits, with ± 3 -4 LSB guaranteed. In the case of this device, linearity is equivalent to accuracy since on-board gain and offset potentiometers are provided for endpoint adjustment, Pinter says.

The gain temperature coefficient is ± 7 parts per million/ $^{\circ}$ C maximum. Offset temperature coefficient is the same. Nonlinearity vs temperature is ± 2 ppm/ $^{\circ}$ C. Noise (referenced to the input) is less than 100 microvolts peak to peak ($1/3$ LSB).

The A-858-16 offers a wide range of input voltage coding options. Its parallel data output is byte-segmented with separate enables and three-state drivers for easy connec-

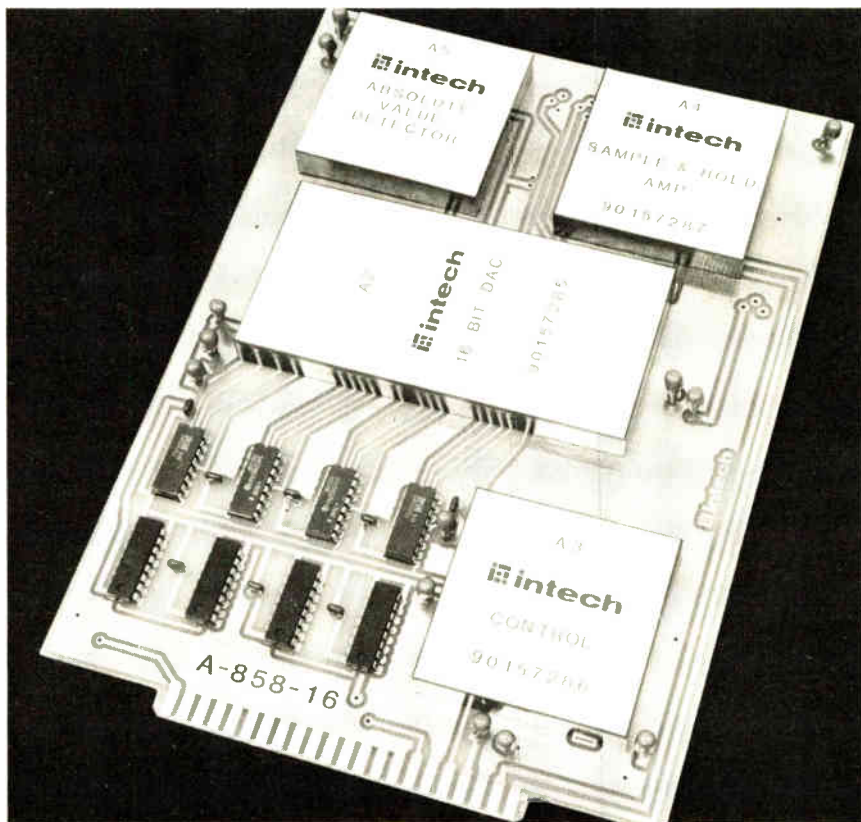

ok® wire wrapping center ok®

ANOTHER UNIQUE PRODUCT
**DESIGNED, MANUFACTURED
AND MARKETED WORLDWIDE**
BY
OK MACHINE & TOOL CORPORATION

1

BATTERY WIRE-WRAPPING TOOL MODEL BW-630



\$34.95*

STRIP / WRAP / UNWRAP TOOL MODEL WSU-30

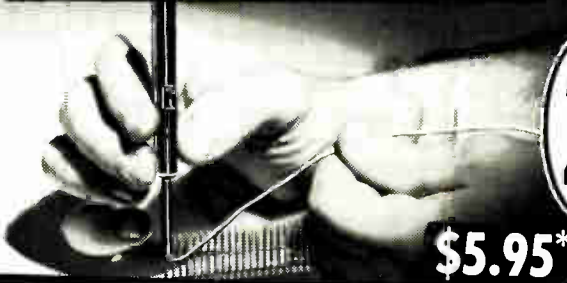

\$5.95*

2

ANOTHER UNIQUE PRODUCT
**DESIGNED, MANUFACTURED
AND MARKETED WORLDWIDE**
BY
OK MACHINE & TOOL CORPORATION

ANOTHER UNIQUE PRODUCT
**DESIGNED, MANUFACTURED
AND MARKETED WORLDWIDE**
BY
OK MACHINE & TOOL CORPORATION

3

WIRE DISPENSER MODEL
WD-30-B

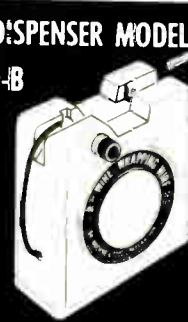

THE DISPENSER WHICH
CUTS AND STRIPS
THE WIRE

\$3.45*

DIP IC INSERTION TOOL WITH PIN STRAIGHTENER
MODEL INS-1416

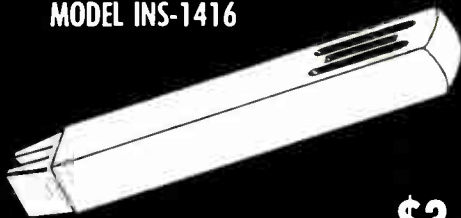

\$3.49*

4

ANOTHER UNIQUE PRODUCT
**DESIGNED, MANUFACTURED
AND MARKETED WORLDWIDE**
BY
OK MACHINE & TOOL CORPORATION

ANOTHER UNIQUE PRODUCT
**DESIGNED, MANUFACTURED
AND MARKETED WORLDWIDE**
BY
OK MACHINE & TOOL CORPORATION

5

WHAT'S ? NEXT

* MINIMUM ORDER \$25.00, SHIPPING CHARGE \$1.00, N.Y. CITY AND STATE RESIDENTS ADD TAX

OK MACHINE & TOOL CORPORATION

3455 Conner St., Bronx, N.Y. 10475 ■ (212) 994-6600 ■ Telex 125091

New products

tion with a microprocessor data bus. A serial data output from the unit is also provided.

For applications requiring high accuracy around zero with bipolar inputs, an absolute-value detector is offered as an option for sign and magnitude coding. In addition, a range of sample-and-hold amplifiers

(having settling times of 2 to 10 μ s) are also provided as options. Whether or not these options are employed, input impedance is rated at 1,000 megohms minimum, according to Pinter.

The A-858-16 is packaged on a 6-by-8-by-0.75-inch mother board with a 22-pin double-edge connector.

Delivery is from stock to within four weeks.

Intech/Function Modules Inc., 282 Brokaw Road, Santa Clara, Calif. 95050 [381]

Compact battery charger contains no transformer

By using a proprietary circuit technique, Integrated Electronics Co. has come up with a completely isolated, yet transformerless, battery charger. Called the model BC 150, the new company's first product produces output currents of 10, 25, and 50 milliamperes at 3 volts dc when connected to the ac line.

Because the unit does not use a transformer to achieve its input-to-output isolation of 1,000 v at 25°C, it can be made very small. Its four-pin package measures just 0.93 inch in length and width and has a height of only 0.5 in. Because of its small size the charger can easily be built into battery-operated equipment. It is protected against short circuits and is immune to damage from sudden load removal.

Samples of the BC 150 sell for \$20. In lots of 10 to 99 pieces, the price drops to \$15 each. Delivery time is 30 days.

Integrated Electronics Co., Box 204, Carlisle, Mass. 01741 [383]

Isolation amplifier

withstands $\pm 5,000$ V

The model IA276 isolation amplifier is an inexpensive module that isolates its output from common-mode voltages as high as $\pm 5,000$ v (ac peak or dc continuous). Because it combines double shielding with a floating output and an input guard, it is extremely effective at capturing small signals in the presence of larger common-mode noise signals. For example, in cardiac monitoring, where the heart signal is small compared to other body-related signals, the amplifier provides a common-mode rejection ratio of 80 decibels with a source imbalance as high

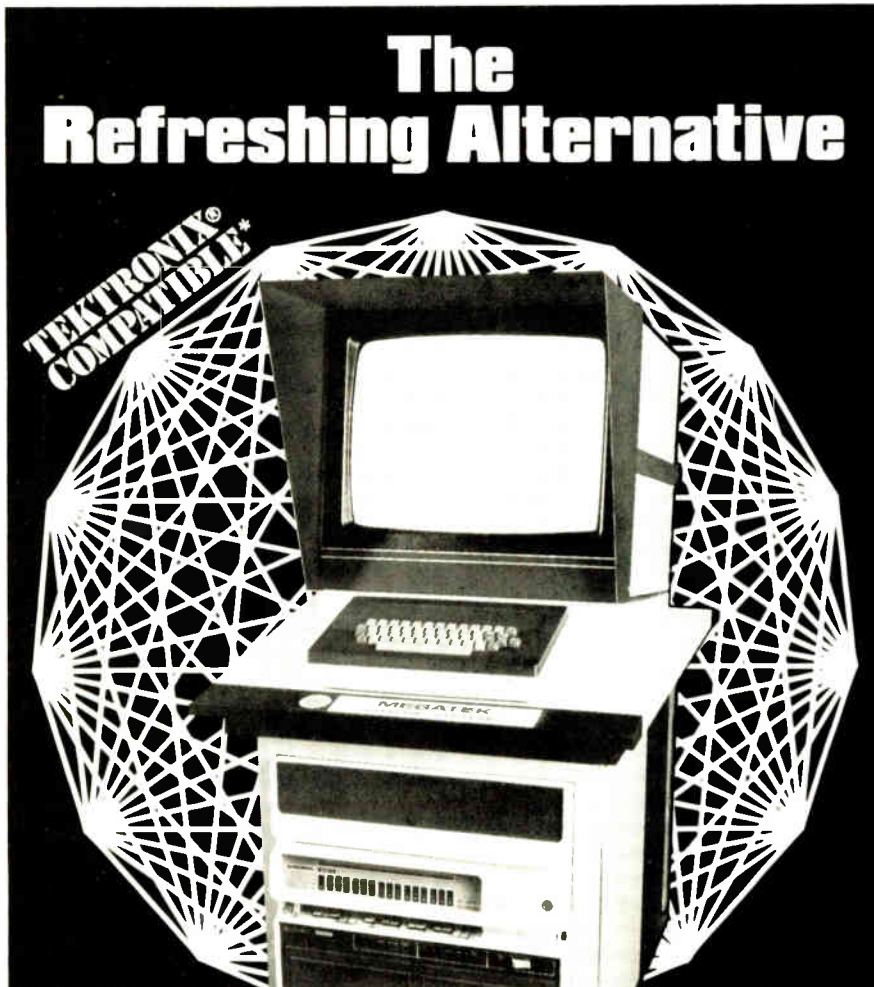

MEGATEK Graphic Systems

Local Intelligence • Full Refresh • Zoom, Rotate, Translate • Sharp, Bright Vectors • Powerful Minicomputer • FORTRAN Software • Data Tablet or Joystick • Low Cost

Our Systems are Powerful, Intelligent, and Good Looking... the features YOU look for in a graphics terminal, system or interface. Coupled with MEGATEK Quality and Value, the picture is perfectly clear—MEGATEK is The Refreshing Alternative.



MEGATEK
CORPORATION

The Refreshing Alternative

1055 Shafter Street
San Diego, California 92106
Telephone: (714) 224-2721
TWX 910-335-2056

14 rue de l'Ancien Port
1201 Geneva, Switzerland
Telephone: (021) 32 97 20
Telex 23343

*"TEKTRONIX" is a registered trademark of Tektronix, Inc., use of which in no way constitutes endorsement.

THE LOGICAL CHOICE. Third in a series

SYMMETRICAL AND UNSYMMETRICAL PULSES
0.5 Hz-5 MHz

CONTINUOUS, MANUAL ONE-SHOT & EXTERNAL TRIGGER OPERATION
External triggering to 10 MHz

INDEPENDENTLY-CONTROLLABLE PULSE WIDTH & SPACING
100 nanosec-1 sec in 7 overlapping ranges
10⁷ 1 duty cycle range

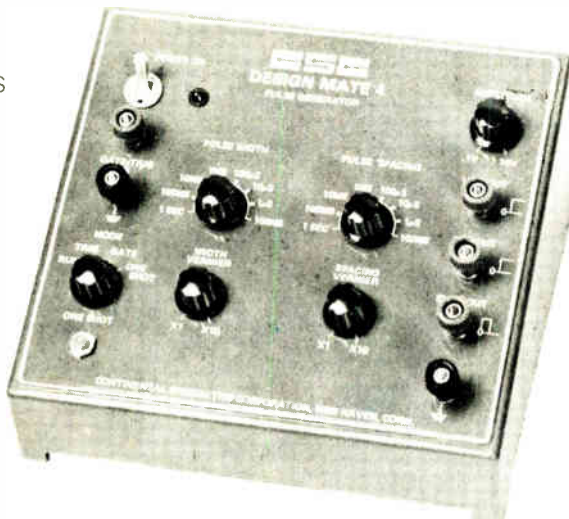

INDEPENDENT CMOS AND TTL OUTPUTS Fan-out to 40 TTL loads

SYNCHRONOUS OUTPUT GATING

100mV-10V POSITIVE OUTPUT Less than 30 nanosec rise/fall times

CSC'S DESIGN-MATE™ 4: \$124.95. NO OTHER DIGITAL PULSE GENERATOR GIVES YOU SO MUCH, FOR SO LITTLE.

Sounds hard to believe... but even a brief look at Design-Mate 4's specifications proves CSC's engineers have done it again. Whatever your application—whether you're looking for precision, flexibility or just plain economy—this compact source of fast, clean digital pulses offers the performance you need... at a price that discourages procrastination.

Use it as a clock source, delayed pulse generator, synchronous clock, manual system stepper, pulse stretcher, clock burst generator or in dozens of other applications. Use it alone or in

tandem with other DM-4's for gated control. The wide range of controls and multiple outputs give you enormous versatility... plus compatibility with all major logic families, for research, design, development, quality control, production testing, maintenance, troubleshooting... you name it.

Now, read the specs that follow... and check the price again. Or better yet, try DM-4 for yourself at your local CSC distributor. We think you'll find it's as hard to do without as it is easy to own.

For more information, pick up your phone and call your dealer—or order direct

DM-4 SPECIFICATIONS

Frequency Range: Pulse Width and Spacing Controls:	0.5 Hz to 5 MHz 100 nanosec to 1 sec in 7 overlapping decade ranges A single-turn vernier control provides continuous adjustment between ranges 10 ⁻¹ to 1 Range adjustable over entire pulse width/spacing range 100 nanosec ON 1 sec OFF to 1 sec ON and 100 nanosec OFF	ONE-SHOT Pushbutton for single pulse Output pulse occurs each time push-button is pressed
Duty Cycle:	10 ⁻¹ to 1 Range adjustable over entire pulse width/spacing range 100 nanosec ON 1 sec OFF to 1 sec ON and 100 nanosec OFF	OUTPUTS: VAR OUT Amplitude 0-10 V positive Rise/fall time Less than 30 nanosec Impedance 400Ω max
Operating Modes: RUN	0.5 Hz to 5 MHz as per width/spacing and amplitude control settings	TTL OUT Fan-out 40 TTL Loads Sink 160 milliamps—0.8 V max Rise/fall time Less than 20 nanosec
TRIG Input requirements	DC to approx. 10 MHz Sine waves 2 VP-P, pulses 1 V peak - 40 nanosec wide, maximum input ±10 V. (Input Impedance Approx. 10KΩ DC coupled)	SYNC OUT Pulse width Approx. 40 nanosec Other sync pulse specs same as TTL out Pulse lead time Sync pulse leads outputs by approx. 20 nanosec
GATE Input requirements	Synchronous gating. Leading edge of gate signal turns generator. ON Last pulse is completed even if gate ends during pulse Same as TRIG Mode	POWER 117 VAC - 10%, 50/60 Hz 5 watts (220 VAC, 50/60 Hz also available, at slightly higher cost)
		SIZE (WxLxH) 191 x 165 x 83 mm
		WEIGHT 2 lbs (0.91 Kg)

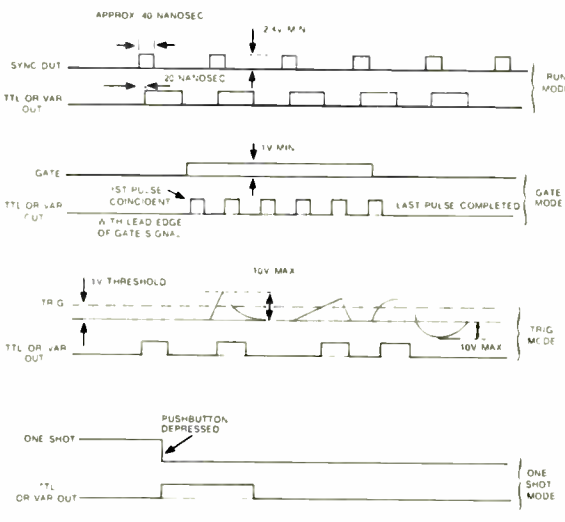

© 1976, Continental Specialties Corp

CONTINENTAL SPECIALTIES CORPORATION



EASY DOES IT

44 Kendall Street Box 1942
New Haven CT 06509 • 203-624-3103
TWX 710-465-1227
West Coast office Box 7809
San Francisco CA 94119 • 415-421-8872
TWX 910-372-7992

See your CSC dealer or call 203-624-3103 (East Coast) or 415-421-8872 (West Coast) 9 AM to 5 PM local time. Major credit cards accepted. Add \$2.50 for shipping and handling in the U.S. and Canada on direct orders of \$50.00 or less; \$3.00 for orders over \$50.00. On all foreign orders add 15% to cover shipping and handling.

Now you can display a lot of character for very little money...

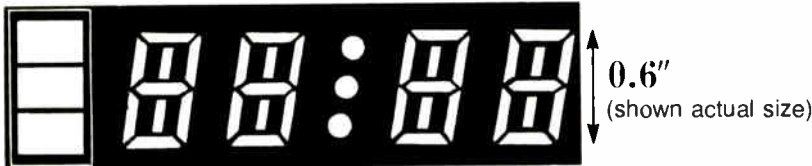

in single, double, triple or 4-digit LED clock displays.

- .3" x .6" character height
- 7 and 9 segments
- direct drive or multiplex
- wide viewing angle
- 1 year warranty
- 2 week delivery
- engineered to your specifications
- Call collect or write:
3001 Redhill Avenue
Costa Mesa, California 92626
Tel. (714) 549-0375

from the new leader in the LED marketplace **MICRO ELECTRONICS CORP.**

Circle 164 on reader service card

microFORTH® The High-Level Language For Microprocessor Development Systems

**microFORTH will Simultaneously:
Slash Software Development Time Up to 90%**

Users find that software development time is cut from three to ten times. Save important development time and money beginning today! Write for results of a recently completed study.

Slash Memory Requirements Up to 90%

On development systems - microFORTH's operating system provides powerful interactive high level capabilities and runs independently of any other system in less than 8K plus diskette. Compare with Intel's PLM, requiring 64K plus diskette!
In production systems - microFORTH produces programs 50% smaller than assembler code, 60-90% smaller than PLM or other high level languages!

Produce Transportable Programs

High level microFORTH is processor independent! This gives you a new flexibility in choosing microprocessors, you can change later without extensive re-programming.

Cut Run Time By 60%

microFORTH runs several times faster than other high level languages. This speed difference can be critical in your present or future microcomputer applications.

The microFORTH software price including Primer, Technical Manual and telephone Hot Line consultation is \$2,500.00 plus options.

For further information on microFORTH and applications, call or write:

815 Manhattan Ave., Manhattan Beach, CA 90266 (213) 372 8493

New products



as 5 kilohms. Its dual common-mode capability also reduces environmental noise, such as 60-hertz interference, by 126 db.

With its small-signal bandwidth of 1 kilohertz and its full-power bandwidth of 500 Hz, the IA276 is well suited for heart monitoring. It is housed in a module that measures 2.5 by 3.5 by 0.63 inches and sells for \$48 each in hundreds. Delivery is from stock to two weeks.

Intronics Inc., 57 Chapel St., Newton, Mass. 02158. Phone (617) 332-7350 [384]

V-f converter has high
common-mode rejection

The IVFC is a voltage-to-frequency converter with the capability of extracting small signals in the presence of large common-mode voltages. The unit, with its name standing for isolation voltage/frequency converter, has a 60-hertz common-mode rejection ratio in excess of 120 decibels independent of gain. It can withstand common-mode voltages up to 4 kilovolts.

The 10-kilohertz device is offered in versions with accuracies as high as 13 bits. Its output stage operates on +4 to +18 volts dc and can supply 10 milliamperes. The standard models have a maximum nonlinearity of 0.01% and a maximum gain drift of 20 ppm/°C. They are sealed against moisture and dirt, and any pair of input terminals is protected against a continuous voltage of 220 v and a total spike energy of 20 joules over any 10-second period. All inputs are

Ability.

It Comes Naturally With The Altair™ 8800b

The Altair 8800b from MITS: the second generation design of the microcomputer that started it all. The mainframe that has the abilities everyone is demanding from microcomputers today:

Expand-ability:

The Altair 8800b power supply and one-piece, 48-slot motherboard allow efficient and easy expandability for memory and I/O options. All Altair PC boards are designed to give you maximum capability/lowest power usage possible per board. This means that for each slot used you get more features and require less power, than with any of the "off-brand" Altair-bus-compatible boards.

Whether you buy an entire system up front or choose to expand gradually, it's easy to get the configuration you need with the complete family of Altair peripheral equipment, including floppy disk, line printer, audio cassette record interface, A/D converter, PRCM programmer, serial and parallel I/C boards,

choice of four different memory boards and many others.

Reli-ability:

The unique design features of the Altair 8800b, which have set the standard for the microcomputer industry, make it the most reliable unit of its kind. The Altair 100-pin bus, the now-standard design used by many imitators, has been "standard" all-along at MITS. The unique Front Panel Interface Board on the Altair 8800b isolates and filters front panel noise before it can be transmitted to the bus. The all-new CPU board utilizes the 8080A microprocessor, Intel 8224 clock generator and 8246 bus drivers.

Flex-ability:

Meeting the diversified demands of an ever-increasing microprocessor market requires flexibility: not just hardware flexibility but

software flexibility as well. MITS software, including the innovative Altair BASIC language, allows the full potential of the Altair 8800b computer to be realized.

8K ALTair BASIC has facilities for variable length strings with LEFT\$, RIGHT\$, and MID\$ functions, a concatenation operator, and VAL AND STR\$ functions to convert between strings and numbers.

Extended ALTair BASIC allows integer, single and double precision variables, automatic line numbering and renumbering, user-defined string functions, PRINT USING for formatted output and a powerful EDIT command for editing program files during or after entry. Extended statements and commands include IF... THEN... ELSE, LIST and DELETE program lines, SWAP variables and Trace On and Off for debugging.

Disk ALTair BASIC has all the features of Extended BASIC with the additional capability to maintain sequential and random access disk files. Utilities are provided for formatting disks and printing directories.

In all versions of ALTair BASIC you get the ease and efficiency of BASIC for the solution of real world problems.

Package II, an assembly language development system for the Altair 8800b, includes system monitor, text editor, assembler and debug.

Afford-ability:

Prices for the Altair 8800b start at \$840.00 for a kit and \$1100.00 for an assembled unit (all documentation included).

For a complete listing of prices on all Altair products and a free brochure, contact:

MITS, Inc.
2450 Aramo S.E.
Albuquerque, N.M. 87106
(505) 243-7821

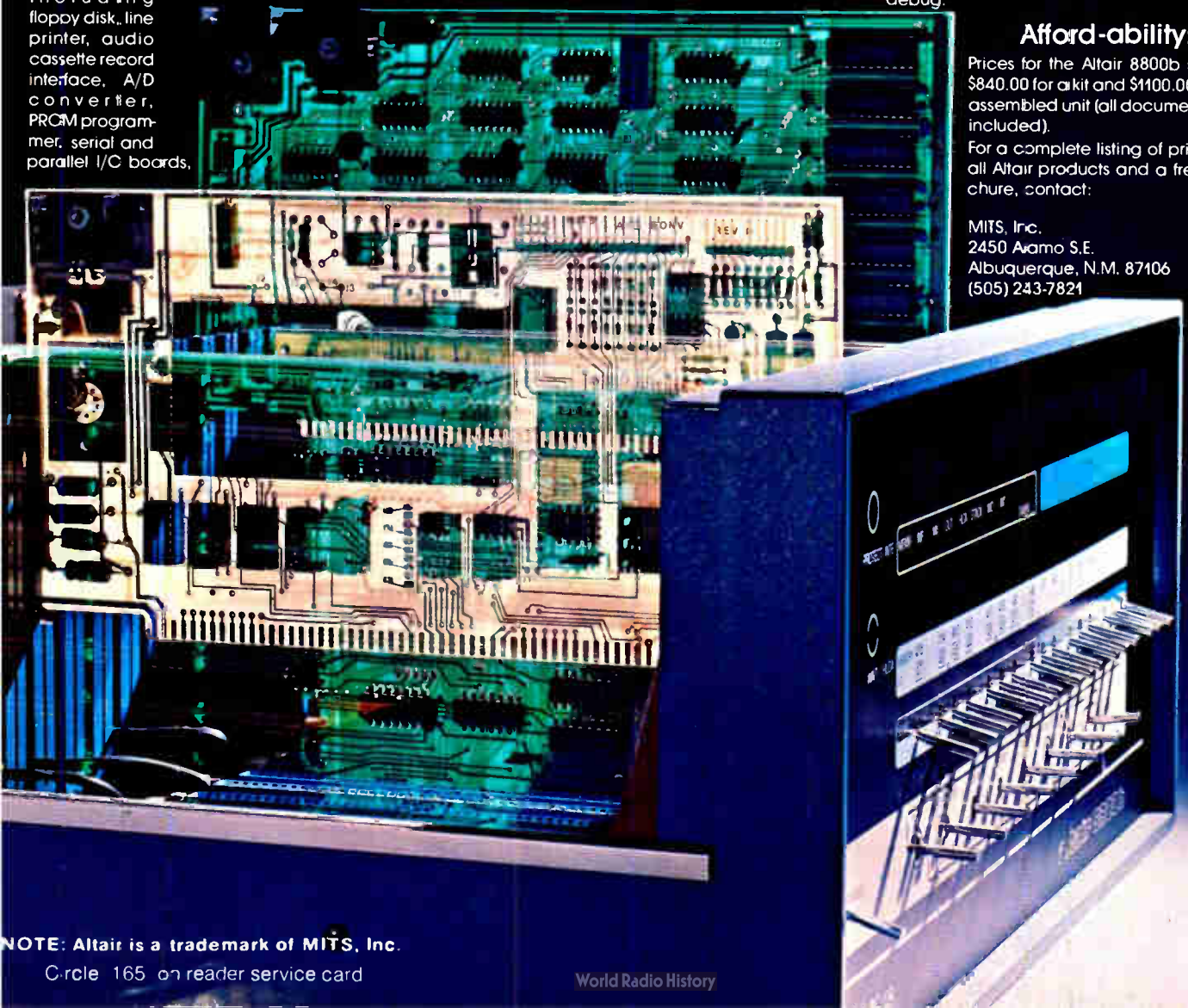

NOTE: Altair is a trademark of MITS, Inc.

Circle 165 on reader service card

World Radio History

We've got the answer to probes that are driving you bananas with poor connections.

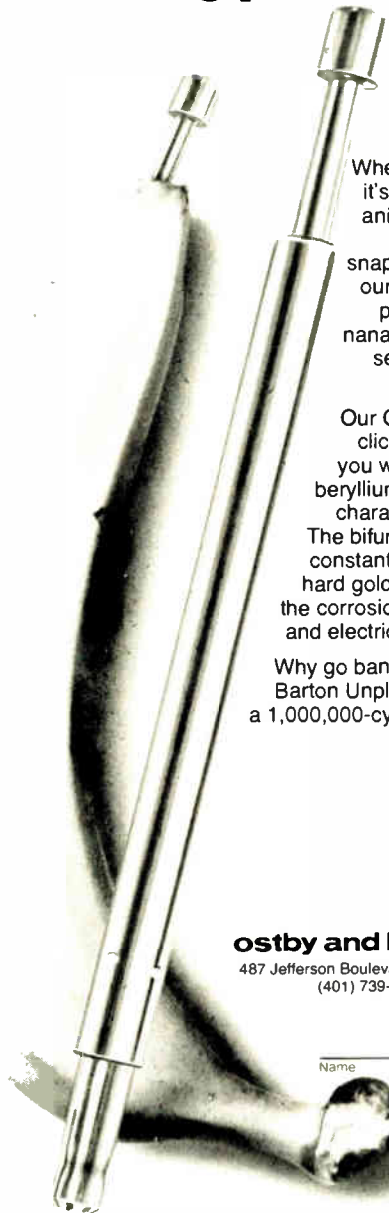

When you look at other removable probes, it's no wonder they offer such poor mechanical and electrical connections. Instead of having a special custom machined snap-in terminal and mating receptacle like our Ostby and Barton Unpluggables, their probes' shafts are simply bent like a banana and pushed into a tube. After a few insertions and removals, the banana bend straightens out and probes slip out.

Our Ostby and Barton Unpluggable probes click solidly into place and stay there until you want to remove them. The heat-treated beryllium copper terminals offer excellent wipe characteristics as they enter the receptacle. The bifurcated ball-end on the terminal insures constant mechanical contact after plug-in. And hard gold-plate over a nickel pre-plate provides the corrosion resistance, copper creep resistance and electrical characteristics of good connectors.

Why go bananas, when you can go the Ostby and Barton Unpluggables, the only ones available with a 1,000,000-cycle guarantee. Mail the coupon for full information.

ostby and barton company

487 Jefferson Boulevard, Warwick, Rhode Island 02886
(401) 739-7310 TELEX-927573



Name _____
 Position _____
 Company _____
 Phone _____
 Address _____
 City _____ State _____ Zip _____

Circle 166 on reader service card

1977 Answer Book. It makes your job easier. \$25.

Who makes what? Over 4000 products, more than 5000 manufacturers with their local contracts and distributors, directory of trade names and catalogs, post-paid inquiry cards for 5-second ordering of current catalogs.

Electronics Buyers' Guide
 1221 Ave. of the Americas
 New York, N.Y. 10020

Yes, send me a copy of The Answer Book. I've enclosed \$25 (USA and Canada only, elsewhere send \$35). Full money back guarantee if returned within 10 days.

Name _____
 Company _____
 Street _____
 City _____ State _____ Zip _____



New products

filtered in order to suppress jitter from radio signals.

Altogether, there are 16 models in the first offering of IVCFs. These include unipolar, bipolar, and field-effect-transistor-input units with various common-mode-voltage and offset ratings. Pricing starts at \$195 for singles.

Dynamic Measurements Corp., 6 Lowell Ave., Winchester, Mass. 01890. Phone (617) 729-7870 [385]

Data-acquisition system has three-state outputs

Designed to interface directly with microcomputer data buses, the MN7120 data-acquisition system is an 8-bit unit with three-state outputs. Housed in a single 32-pin hermetic dual in-line package, the MN7120 contains an eight-channel multiplexer, a sample-and-hold circuit, an analog-to-digital converter, addressing logic, and the required three-state buffers. The unit provides automatic sequential addressing of its input channels, or the user may address the channels in a random fashion. Typical conversion

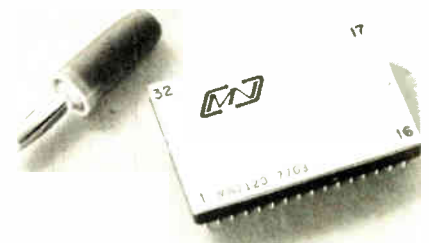

rate is 90,000 channels per second. The package takes up less than 2 square inches of board space.

The MN7120 typically draws only 680 milliwatts from standard ± 15 -volt and +5-v power supplies. The standard MN7120 device operates from 0°C to 70°C, and it sells for \$140 each in hundreds. The companion MN7120H operates from -55°C to 125°C and carries a price tag of \$280. Delivery is from stock to four weeks.

Micro Networks Corp., 324 Clark St., Worcester, Mass. 01606. Phone (617) 852-5400 [386]

10 REASONS WHY YOU SHOULD CONSIDER THE MODEL 40 OEM PRINTER FOR UNDER \$2000 INSTEAD OF SOMEONE ELSE'S FOR MORE.

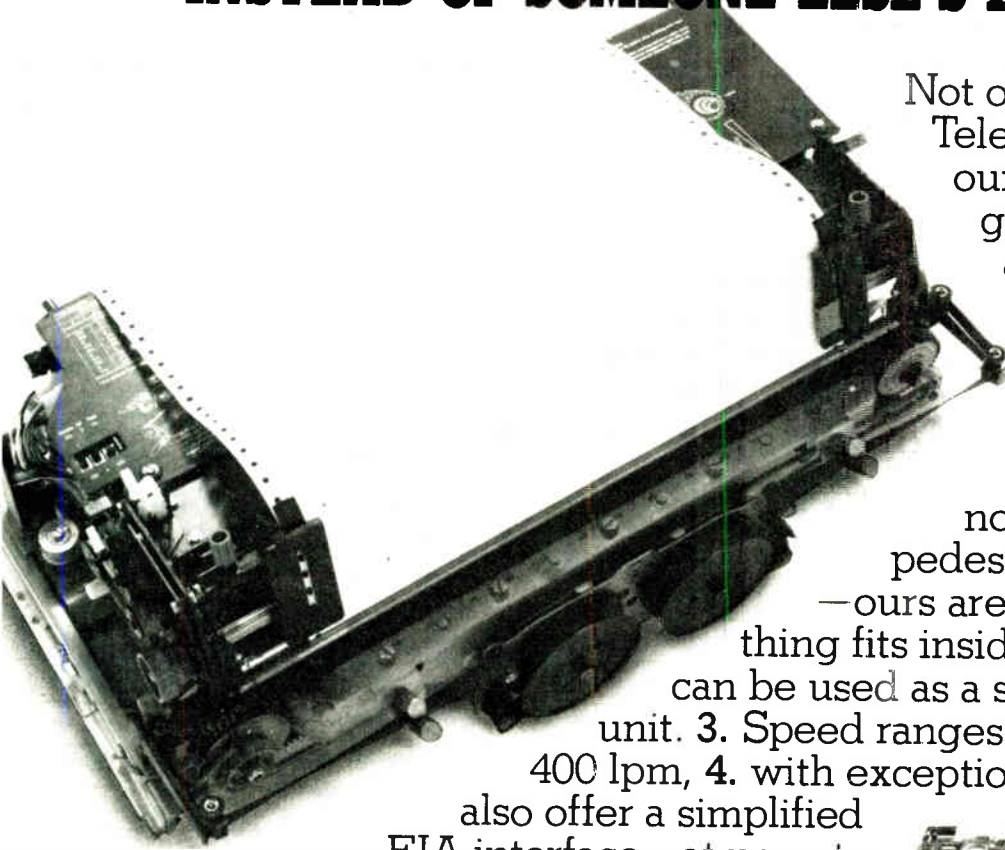

Not only do we at Teletype charge less for our printers, we also give you more quality and features for your money. 1. Like a modular, compact design with 2. state-of-the-art CMOS/LSI technology. Don't look for a pedestal full of electronics

—ours are so advanced everything fits inside the printer so it can be used as a stand-alone table-top unit. 3. Speed ranges from 200 to over 400 lpm, 4. with exceptional reliability. 5. We also offer a simplified EIA interface—at no extra cost. 6. Field maintenance is simple, too. Service intervals are 2000 hours, and built-in diagnostics

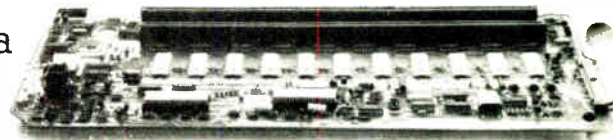

cut trouble-shooting time. 7. There's nationwide service back-up, plus an exchange repair service on everything from printed circuit cards to major assemblies. 8. Print quality from our fully-formed characters is sharp and crisp—from the original to the sixth copy. And we're now offering an optional block-style character font. 9. Parts commonality between all three printer models is 80%, for fewer logistical problems. 10. Last but not least, the model 40 printers are backed by a company people have depended on for nearly 70 years. Teletype.

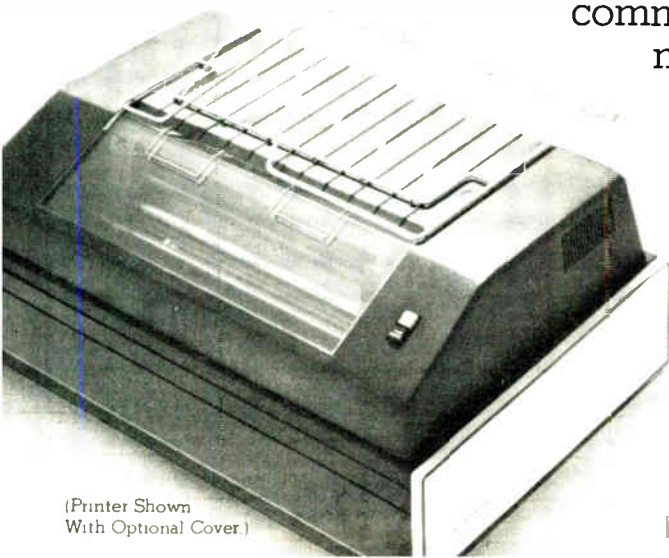

TELETYPE



**THE TELETYPE[®] MODEL 40 OEM PRINTER.
NOTHING EVEN COMES CLOSE.**

Teletype is a trademark and service mark registered in the United States Patent and Trademark Office.

World Radio History Circle 167 on reader service card

(Printer Shown
With Optional Cover.)



NEW

The d/pad one displays more intelligence than any comparable Decommuration System in the world.



The μ P-smart d/pad one is really 8 instruments in 1. And more.

This new product is an 8080 micro-processor controlled Data Processor Analyzer and Display System (we call it d/pad).

Simply stated, "d/pad one" accepts serial data, and outputs decommuted/demultiplexed parallel information in real time.

The added dimension of a micro-processor allows front panel, ASCII keyboard or computer programming of various PCM formats, with entries instantly fed back from the CRT.

The CRT displays three pages for programming entries. Six pages of diagnostic information includes automatic data limit checking and a bar

graph representation of selected data. Built in test (BITE) includes a PCM simulator.

Need PAM and PCM demultiplexed? We have d/pad II.

Need extended memory and a multiplier? We have d/pad III.

Write or call Cal Brewster for more details. Conic Data Systems, 9020 Balboa Ave., San Diego, CA 92123. Phone (714) 279-0411.

CONIC DATA SYSTEMS

A Division of Conic Corporation
the quiet leaders in communications systems

A subsidiary of Loral Corporation

Circle 168 on reader service card

Own your own holder to hold your own!

Hold your own copies of Electronics in specially designed slipcase holders. They'll keep your Electronics library neat and handy—a permanent information file, issue by issue.

Just complete the coupon and mail to Jesse Jones. He'll process your order upon receipt, postpaid.



ELECTRONICS BOXER
Jesse Jones Box Corporation
2250 E. Butler St., Philadelphia, Pa. 19137

Please send me: boxes @ \$4.95 each; 3 boxes @ \$14.00; 6 boxes @ \$24.00.
My check or money order is enclosed.

Name: _____
Address: _____
City: _____ State: _____ Zip: _____

New literature

Digital measurements. A booklet entitled "Digital Accuracy—Analog Interpretation" deals with digital plug-in applications for Tektronix' 7000-series oscilloscopes. The digital

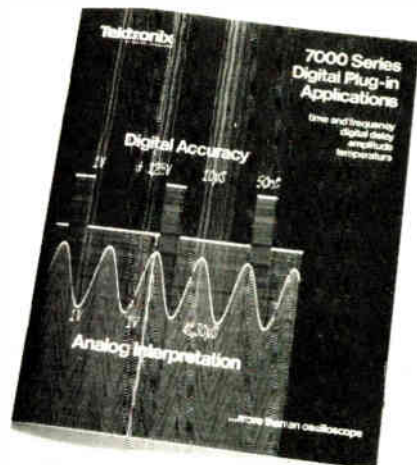

plug-ins will allow the operator to view analog waveforms while simultaneously measuring parameters with digital accuracy. Plug-ins include analog-to-digital converters, sample-and-hold units, digital delays, and counters. Tektronix Inc., P. O. Box 500, Beaverton, Ore. 97077. Circle reader service number 421.

Data conversion products. Listed in a 16-page brochure of analog-to-digital and digital-to-analog conversion modules are both a line of data conversion products and a set of selection guidelines. Error sources in converters, converter terminology, dynamic parameters of amplifiers,



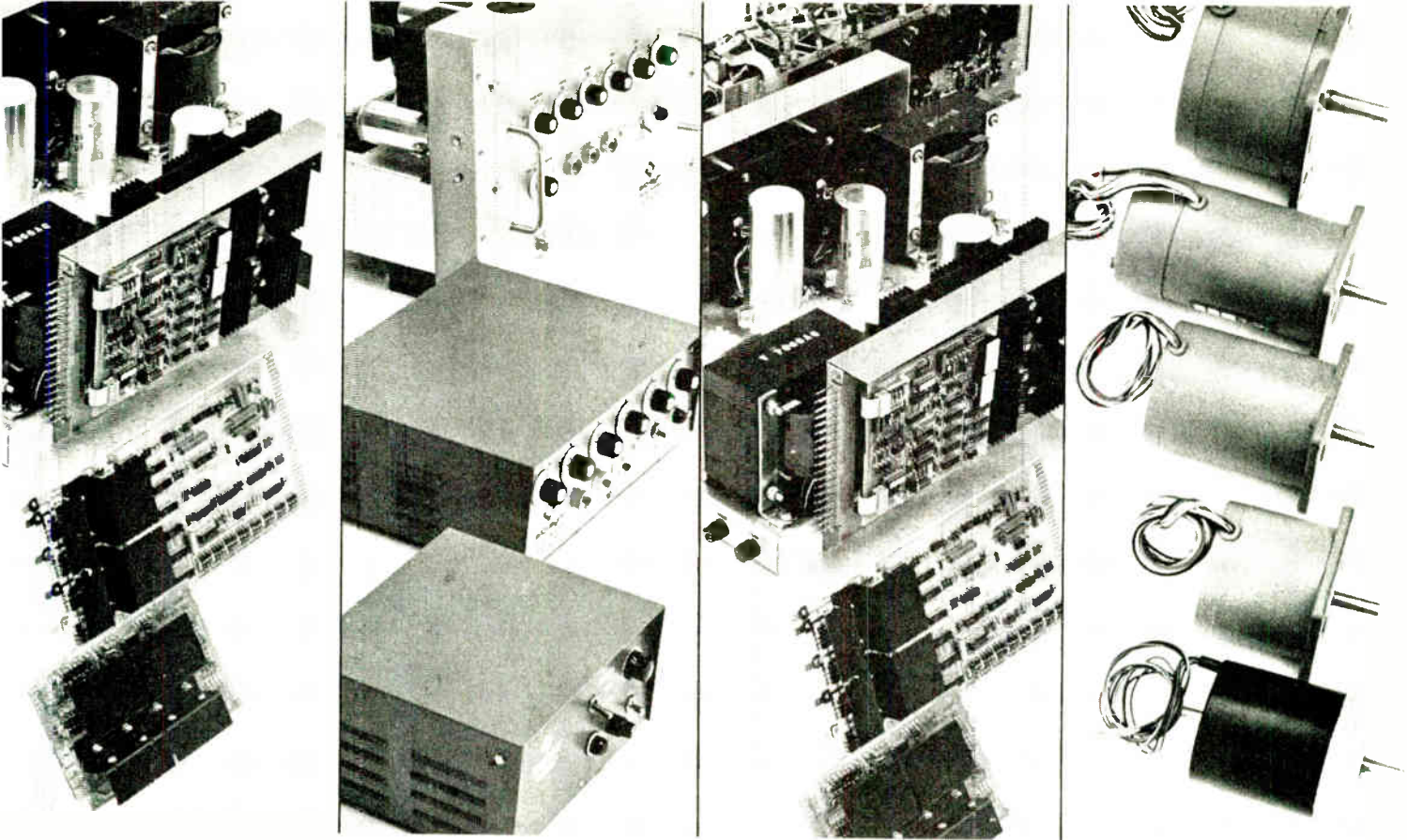

The 10-min. course in stepping motor control.

It's a new concept in step motor controls — and in learning about them. A ten minute, no-nonsense, technical course. Brief — but complete. In one cassette, much about step motors and the capabilities, interfacing, selection of control drives. Engineer-to-engineer.

At \$5.00, you buy expertise in an emerging, vital technology worth many times the modest tuition. Complete with a printed abstract that helps you sum it up.

And Superior has the product that measures up. New Slo-Syn controls that cost less, do more converting digital information to mechanical motion. With modular translator. Preset indexer. For building-block freedom while meeting exact performance criteria.

Now it's no longer cost-effective to do your own circuitry design in

stepper control — not when you can save up to 50% by assembling your tailored system from Slo-Syn modules.

Of course you can buy your drive system fully assembled. Complete with panel-mounted controls. And at a cost/performance ratio that will still surprise you.

Whether you need simple bi-directional positioning or a matrix of task-oriented motions, there is a Superior control drive for you.

**A step ahead
in positioning.**



Superior Electric

Bristol, CT 06010 (203) 582-9561

Send in this coupon today — and get Positioning Tape #1. The first in the series. Keep a step ahead.

Send me your 10-minute cassette course on stepping motor control drives. \$5.00 check or money order enclosed.

Send me new free literature on Slo-Syn control drives.

I'd like a call from my nearest Superior sales engineer.

Name _____ Title _____

Company _____

Street _____

City _____ State _____ Zip _____

New literature

and multiplexer and sample-and-hold parameters are discussed at length. Included are products introduced for the first time. Analogic Corp., Audubon Rd., Wakefield, Mass. 01880 [422]

Thermistors. Most questions about thermistors are answered in a new 34-page manual, EMC-6. Key features of the manual are: tables that

indicate the maximum deviation in the resistance of a specific thermistor at a given temperature; tables that show the percent resistance change per degree change in temperature from -60°C to $+300^{\circ}\text{C}$; and tables that give resistance-temperature conversions for 16 thermistor materials. Fenwal Electronics Sales and Applications Engineering Department, Fenwal Electronics, 63

Fountain St., Framingham, Mass. 01701 [424]

Electronic-component leads. Catalog No. 477 is a pamphlet that provides complete machine data on all equipment for processing electronic-component leads. The 12-page pamphlet contains information on three main areas: cutting and forming the leads on dual in-line packages, cutting the

One way...



HP's Universal Counters

satisfy the needs for most electronic counter measurements up to 1300 MHz, and do it without breaking your budget. Two distinctly different models are loaded with features, and a wide variety of options are available.

One way is the 5328A for high performance frequency, period and time interval measurements in a modular 8 or 9-digit unit for systems or bench use. Start with the basic 100 MHz, 100 ns unit for just \$1300*. Modules expand its capabilities to 512 or 1300 MHz for frequency, 10 ns for time interval and add 10 μV to 1000V, digital voltage measurements. Other options include ultra-stable time base, and full HP Interface Bus operation. Standard at no extra cost are burst frequency measurement and time interval averaging to

10 ps resolution... matched input amplifiers make this resolution meaningful.

The other way is the 5300B/5308A System for lower cost yet highly versatile 8-digit frequency, period and time interval measurements in a modular portable package that also can be rack mounted. In just 30 seconds, snap on any of 10 other modules including: a full capability DMM, battery pack and 1300 MHz and HP Interface Bus modules. The 5300B/5308A's low \$910* price even includes time interval averaging for resolution to 1 ns!

Use the 10855A Preamplifier for higher sensitivity with any model: 22 dB gain, 2 to 1300 MHz for just \$225*

To do it your way contact your nearest HP field engineer for full data, or write.

*Domestic U.S. prices only.

leads on components housed in radial in-line packages, and cutting and forming the leads on transistors and capacitors. Hepco Inc., 150 San Lazaro Ave., Sunnyvale, Calif. 94086 [423]

Solid-state memory. A 12-page four-color brochure on the PEP-500 Lithocon solid-state image memory/scan converters is being offered

by Princeton Electronic Products Inc., P.O. Box 101, North Brunswick, N.J. 08902 [425]

Computers. The HP 3000 Series II computer systems are the subject of a 26-page technical summary that discusses batch and interactive processing, data entry and screen formatting, data management facilities, on-line generation of inquiries

and reports, the operating system and six programming languages and utility software. Inquiries Manager, Hewlett-Packard Co., 1501 Page Mill Rd., Palo Alto, Calif. 94304 [426]

Data communications products. A 16-page illustrated data communications catalog provides information on modems, network diagnostic con-

or the other,



the right performance at the right price.

HEWLETT  PACKARD

1507 Page Mill Road, Palo Alto, California 94304

For assistance call: Washington (301) 948-6370, Chicago (312) 255-9800, Atlanta (404) 955-1500, Los Angeles (213) 877-1282

19¢^{*} ea.

An integrated bridge rectifier in a miniature dual in-line package

DI B

DUAL IN-LINE BRIDGE

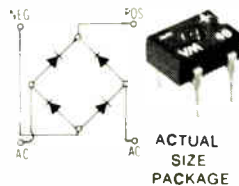

- 4-pin, low-profile DIP
- Leads on standard .10" (2,54 mm) grid
- Compatible with automatic testing, handling and inserting
- 1 Amp at 40°C (I_O)
- 25V to 1000V (V_{RRM})
- 25A Peak One-Half Cycle Surge (I_{FSM})
- Two devices will fit into standard 14-pin DIP socket
- Moisture resistant epoxy package
- Call Lee Miller 214/272-4551, Ext. 206 for more information.

* 100V; 100,000 anty.

Design us in . . . we'll stay there

VARO SEMICONDUCTOR, INC.

P.O. BOX 676 1000 N. SHILOH GARLAND TEX 75040
(214) 272-4551 TWX 910 860-5178

EUROPEAN OFFICE: UK: VARO SEMICONDUCTOR INTERNATIONAL, INC.
Deepdene House, Bellegrave Road, Welting, Kent, England DA163PY, 01-304-6519 0



VARO

New literature

trol systems, and terminals. Network diagnostic systems shown include the system 200 technical control center management system and the system 180 network diagnostic controller. Terminal products discussed are the 40+ K1 display system, the 40+ MPL data display system, and the system 400 video display terminal. International Communications Corp., 8600 N.W. 41st St., Miami, Fla. 33166 [427]

Lugs, clips and terminals. Hundreds of lugs, clips, and terminals all available from stock, are covered in catalog digest 7778. The individual specifications provided should help engineers and others choose the right components for various jobs. Zierick Manufacturing Corp., 36 Radio Circle, Mount Kisco, N. Y. 10549 [428]

Panel meters. Detailed operating and ordering information is given in a 12-page catalog on standard taut-band panel meters and accessories. Sizes of the ac and dc meters described are 1½ inches, 2½ in., 3½ in., 5 in., and 6 in. Jewell Instruments Inc., Grenier Field, Manchester, N. H. 03108 [429]

Better contrast. Information about contrast enhancement products for visual displays is discussed in a four-page color brochure. Specifications and spectral characteristics of laminated color filters, laminated polar-

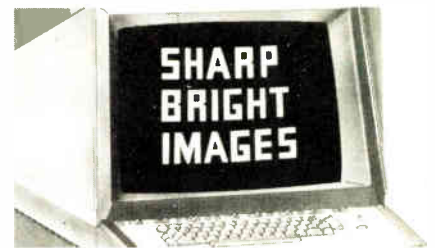

izing filters, neutral contrast filters, antireflection coatings, and conductive coatings, are given. Included are application illustrations for cathode-ray tube displays, alphanumeric displays, and mechanical displays. The Marketing Department, Technical Products Division, Optical Coating Laboratory Inc., P.O. Box 1599, Santa Rosa, Calif. 95402 [430]

Classified section FOR ENGINEERING/TECHNICAL EMPLOYMENT OPPORTUNITIES

CLASSIFIED SALES REPRESENTATIVES

Atlanta	Joe Lane	404/892 2868	Cleveland	Mac Huestis	216/781-7000	Houston	Mike Taylor	713/659-8381	Pittsburgh	Dan Ferro	412/391-1314
Boston	Holt Buchanan	617/262 1160	Dallas	Mike Taylor	214/742-1747	Los Angeles	Stan Kassir	213/487 1160	San Francisco	M.E. Kenny	415/362-4600
Chicago	Bill Higgins	312/751 3733	Denver	Shirley Klolz	303/837 1010	New York	Dave Hawksby	212/997 3594	Stamford	Holt Buchanan	203/359-2865
			Detroit	Mac Huestis	313/873 7410	Philadelphia	Dan Ferro	215/568 6161		XEROX 400 TELECOPIER	212/997-6800

Applications Engineer

Working directly with Tektronix' customers and sales engineers by telephone and travel, you will provide technical applications and product support, training, new product planning, development and introduction, and market research for assigned products.

Presently we have openings for the following products:

**Microprocessor Design Aids
Logic Analyzers
Intelligent Graphic Systems
Test Instrumentation**

Your background in design or applications of these products, good communications skills and desire to work in marketing is necessary. Experience with microprocessors and ASSEMBLY or high level programming is desirable. Formal education might include a BSEE/CS and marketing courses.

Salary is open. Benefits include educational support, insurance and profit sharing programs. Located near Portland, Oregon we are within a two hour drive from the Cascade Mountains or Ocean Beaches. The close-by nature playgrounds and the City of Portland provide for a variety of recreational and cultural interests.

Send resume to Roy Epperson, TEKTRONIX, INC., P.O. Box 500, E94, Beaverton, OR 97077.

An Equal Opportunity Employer M/F.

Tektronix
COMMITTED TO EXCELLENCE

An Exceptional Opportunity for Significant Contribution:

Optical Waveguide Process Control

Chemical (Lead) Engineer

Ability to initiate and advance major projects, and to meet extreme technical demands, is required for this Corning corporate R&D Laboratory position.

The assignment will focus initially on design, construction, and operation of a fully instrumented, computer-controlled facility for vapor phase oxidation of silicon and germanium halides, and other compounds, to produce optical fibers of extreme purity—on the order of one part per billion tolerance. Responsibilities will include generating overall project plans, gathering cost data to support capital requests, supervision of mechanical designers and construction, and coordinating the activities of a small group of professionals in disciplines ranging from sensor instrumentation to computer software.

Corning, a company over the \$Billion level and noted worldwide for major technical innovation, offers very desirable facilities and support. Our Sullivan Science Park has a staff of 800, about half with doctorates. We have already achieved unamplified optical waveguide transmission over 10 km. Process control solutions now have revolutionary implications.

At least 5-10 years of sophisticated process industry experience is required, heavily in control and instrumentation, with knowledge of both analog and digital techniques. Excellent compensation is offered, and relocation assistance to Corning, a newly revitalized small city, in N.Y.'s beautiful Southern Tier. Please send resume detailing pertinent experience and achievements, in confidence to Mr. L.E. Hambrick.

CORNING GLASS WORKS

Sullivan Science Park, Corning, New York 14830

Equal Opportunity Employer

CORNING

UNIVERSITY OF SOUTHERN COLORADO

Assistant Professor of Electronic Engineering Technology to teach electronics manufacturing and circuits in ECPD Accredited Program. Ms in EET or EE and minimum of 3 yrs. work experience in electronics desirable. Start August 22, 1977.

Contact Dr. Ray Sisson, Dean of the School of Applied Science & Engineering Technology, USC, 2200 Bonforte Blvd., Pueblo, Colo. 81001, Phone (303) 549-3260 by July 5, 1977.

USC is an Equal Opportunity Affirmative Action Employer

POSITION WANTED

Project & Technical Director/Research & System Engr. Manager — Over 15 years industrial and academic experience in electronic/electrical systems, controls, and instruments. Seek a challenging opportunity to apply my proven management and technical capabilities. Willing to discuss how I can make a major contribution to a growing organization. Reply to PW-5020, Electronics, (609) 799-1385.

Are you looking for a man in Europe? American Engineer BSEE with 7 yrs. experience in the European electronic components and equipment market seeks position of responsibility with a dynamic firm. Fluent French & German. Located in Switzerland. PW-5123, Electronics.

Will relocate. Engineering technician. 10 years experience in prototype design, assembly and troubleshooting. Worley, 1710 Arizona, Flint, MI 48506 (313) 785-2602.

BUSINESS OPPORTUNITY

How To Earn Money as a Consultant (including specimen contracts) \$17 Business Psychology Int'l 890/44 Nat. Pre:is Bldg. Washington, D.C. 20045.

We have been placing graduate **ENGINEERS**

in **FEE-PAID** positions THROUGHOUT THE U.S. since '59. Over 1,000 client companies. We are graduate engineers working full-time for you. Send resume & salary history today or request confidential application.

ATOMIC PERSONNEL, INC.

Suite L 1518 Walnut St., Phyl., Pa. 19102
An Employment Agency
For All Technical Fields

* SEMICONDUCTORS *
COMPUTERS
Design & Project Eng'rs.
• BS, MS, Ph.D. •
Nat'l Unadvertised Positions
• \$16-30K •
P'nB Consultants, Box 261 (M)
Wayne, PA 19087

The Engineers Who
Talk Your Language

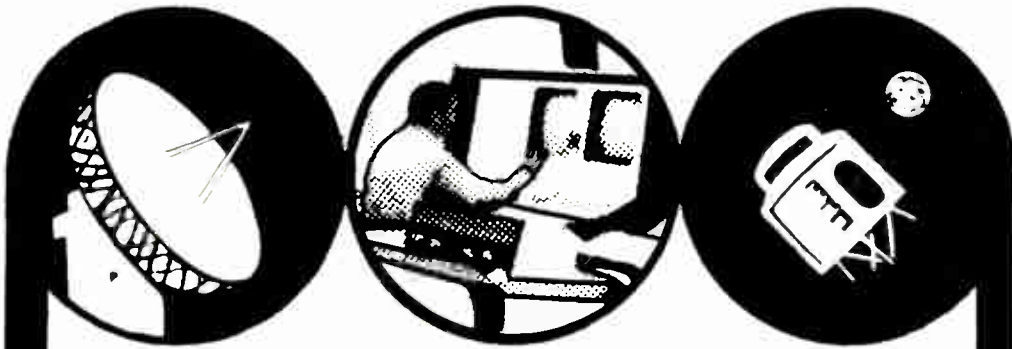

Satellite Communication Terminal Engineers

Supervisory or Principal Professionals needed on the San Francisco Peninsula.

With the continued need for Satellite Communication Terminals, opportunities have never been better for individuals to lead the design of significant portions of a complete product line of components for the terminals. BSEE or BSME required with advanced degree preferred. Openings exist in

RF Product Design

Design of microwave receiving, transmitting and frequency conversion equipment.

- ★ Architectural design for microwave receiving and transmitting equipment
- ★ RF Circuit Design
- ★ Application of MIC and THICK film
- ★ Test Instrumentation

Servo Controls Design

Design the positioning and control systems for a broad range of Satellite Communication antennas.

- ★ Control system design
- ★ Development of products for production
- ★ Analog and Digital circuit design

RF Equipment Design

Detailed design of receivers, up/down converters, SCPC modems and similar equipment.

- ★ Design architecture of RF components and subsystems
- ★ RF circuit design of modulators, demodulators, amplifiers, phase locked oscillators, etc.
- ★ Applications of MIC & THICK film

RF Power Amplifiers

Design amplifiers with output powers in the range of ten to ten thousand watts.

- ★ Application & power TWT's and subsystems
- ★ Power supply design trade-offs
- ★ Control and protection circuits

Mechanical Packaging

Mechanical packaging of electronic equipment to achieve minimum production costs.

- ★ Chassis and module packaging for RF and digital equipment
- ★ Commercial and military packaging
- ★ Development of styling, design, drafting and manufacturing standards

Take advantage of these opportunities now. For immediate consideration, please send your resume with salary history requirements to Professional Employment, Dept. J.JL-22, 3939 Fabian Way, Palo Alto, Calif. 94303. An equal opportunity employer. U.S. citizenship required.



Ford Aerospace & Communications Corporation

Western Development Laboratories Division

MAKE YOUR
NEXT
MOVE A STEP
IN THE
RIGHT
DIRECTION

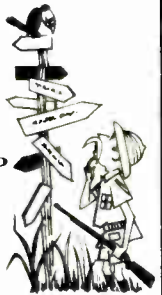

The road to professional fulfillment can be a real jungle. We can help you find the right path. Our affiliation with

National
Personnel
Associates®

keeps us informed of opportunities in the ELECTRONICS industry from coast to coast as they occur. Together with over 175 associates, we offer our knowledge and expertise at no charge to you. Fees are company paid.

POWER SERVICES, INC.
DOD/I & C CONSULTANTS
Northgate Office Building
5861 Rivers Avenue
North Charleston,
South Carolina 29405
(803) 747-0955

JIM KING & ASSOCIATES
438 Gulf Life Tower
Jacksonville, Florida 32207
(904) 398-7371

ELLS PARK PERSONNEL
SERVICES
5050 Excelsior Boulevard
Minneapolis, Minnesota 55416
(612) 927-4653

BRENTWOOD PERSONNEL
ASSOCIATES
1280 Route 46
Parsippany, New Jersey 07054
(201) 335-8700

WETERRINGS & AGNEW, INC.
425 Midtown Tower
Rochester, New York 14604
(716) 454-3888

AVAILABILITY, INC.
Engineering Consultants
1300 N. Westshore Blvd.
Tampa, Florida 33607
(813) 872-2631

CAREER OPPORTUNITY ELECTRONICS ENGINEER

BLH Electronics, a world leader in the field of strain gages, transducers and precision instrumentation has an opening in their Electronics Section for a Project Engineer.

The person we seek should have a background in the design of digital circuitry for a variety of precision instrumentation used in our growing systems business. A working knowledge of logic design, programming and microprocessing is desirable.

If you have 3-5 years of experience, a BSEE and would like to get involved in all aspects of a project, we would like to hear from you.

Please send resume with salary requirements to Employment Manager.

BLH Electronics
42 Fourth Avenue
Waltham, MA 02154

An Equal Opportunity Employer

BLH

Where you turn first.

POSITION VACANT

POSITIONS VACANT

Position available immediately for electronics engineer to work with a group of neurophysiological laboratories. Applicant should have experience in design, repair and maintenance of electronics equipment; experience with neurophysiological equipment and minicomputers would be useful. Salary negotiable. Send resume and references to: Frank P. Hunter, Research Director, University of Virginia, Division of Biomedical Engineering, Medical Center Box 377, Charlottesville, VA 22901 (804) 924-2391.

Electrical Engineering Technology—Upper division E.C.P.D. accredited Bachelor of Technology Program seeks visiting professor to replace faculty member on a two year leave of absence. M.S. Degree in Electrical Engineering required with teaching and industrial experience desirable. Position available Fall 1977, 10 month contract. Send resume and references to Prof. J. Adams, Department of Electrical Engineering Technology, Rochester Institute of Technology, One Lomb Memorial Drive, Rochester, New York 14623. RIT is an Affirmative Action Equal Opportunity Employer.

90,000 engineers and managers for \$46.00

For only \$46.00 per inch your recruitment advertising in ELECTRONICS' Classified Section will reach 90,000 career-conscious engineers and managers as they're reading to combat job obsolescence, while they're thinking about their future and bettering themselves.

There's no charge for typesetting and free layout service is provided. For more information call or write:

ELECTRONICS Post Office Box 900
New York, N.Y. 10020 • Phone: 212/997-2556

HF/SSB EQUIPMENT ENGINEERING IN THE FOOTHILLS OF THE ROCKIES

Respected and growing small manufacturer offers ground floor participation with total product responsibility to a self-starting EE. A desire to achieve plus hands-on experience in receiver/transmitter/synthesizer essential: MSEE, amateur radio background desirable.

Openings also for SSB/digital R&D, amateur radio sales/service technicians. Arkansas River Valley location enjoys unmatched recreation in one of the world's most comfortable year-round environments.

Send resume with salary history to: President, ETO, Box 708, Canon City, Colo. 81212.

SOLID STATE TECHNOLOGY

Our client has retained us to recruit several key people for their new optys in engrg, mfg & mgmt. These positions require strong technical qualifications in addition to innovative & creative skills in complex problem solving. BS, MS or PhD in engrg or science w/2-10 yrs in solid state related products will find this a unique oppty.

Attractive Mid-Atlantic suburban hqs of medium size growth co. A new div of Fortune 500 corp is developing a new high technology product line. Product will use advanced solid state techniques & have broad industrial applications. Starting salary \$20-30,000 range + excellent benefits. Client co pays all employment expenses. Reply in strict confidence to:

P.T. Morris, 215/SA7-4052,
FOX-MORRIS PERSONNEL
CONSULTANTS, 1500 Chestnut, Phila., PA 19102.

NCR ELECTRONIC DISPLAY SYSTEMS

COLORADO SPRINGS, COLORADO

NCR's Electronic Display Systems group offers challenging and rewarding opportunities for engineers with plasma display panel development and circuit design and development experience.

DESIGN ENGINEERS

Candidates will be responsible for alphanumeric display modules development and design including logic design, high voltage switching circuit design, MDS/LSI design and analysis. Candidates' experience should demonstrate hands-on ability to take electronic subsystems from the initial design to final production stages including test equipment design. Requires BS/MS EE, plus 3-5 years experience preferred.

DEVICE DEVELOPMENT ENGINEERS

Responsibilities will include the design, characterization and optimization of alphanumeric plasma panels. Candidates should have strong backgrounds in the Physics and Engineering of gas discharge devices with proven ability to carry out device development from conceptual stage to final product stage. Requires MS EE/Physics plus 3-5 years experience preferred.

PROCESS ENGINEERS

Responsibilities will include the development of new processes and techniques as well as yield improvement of existing processes. Candidates should have experience with thick and thin film materials, vacuum systems, thick film screening techniques and glass frit sealing. Requires BS EE/Physics plus 3-5 years experience preferred.

We invite you to be a part of our future. Submit your resume and salary requirements to:

NCR

William E. Coleman
Electronic Display Systems
NCR Corporation
4750 Edison Ave.
Colorado Springs, Colo. 80915
An Equal Opportunity Employer

Just off the press:

Newest in Electronics Magazine Book Series

New 408-page collection of electronic circuits edited for ease and practicality of use by Samuel Weber

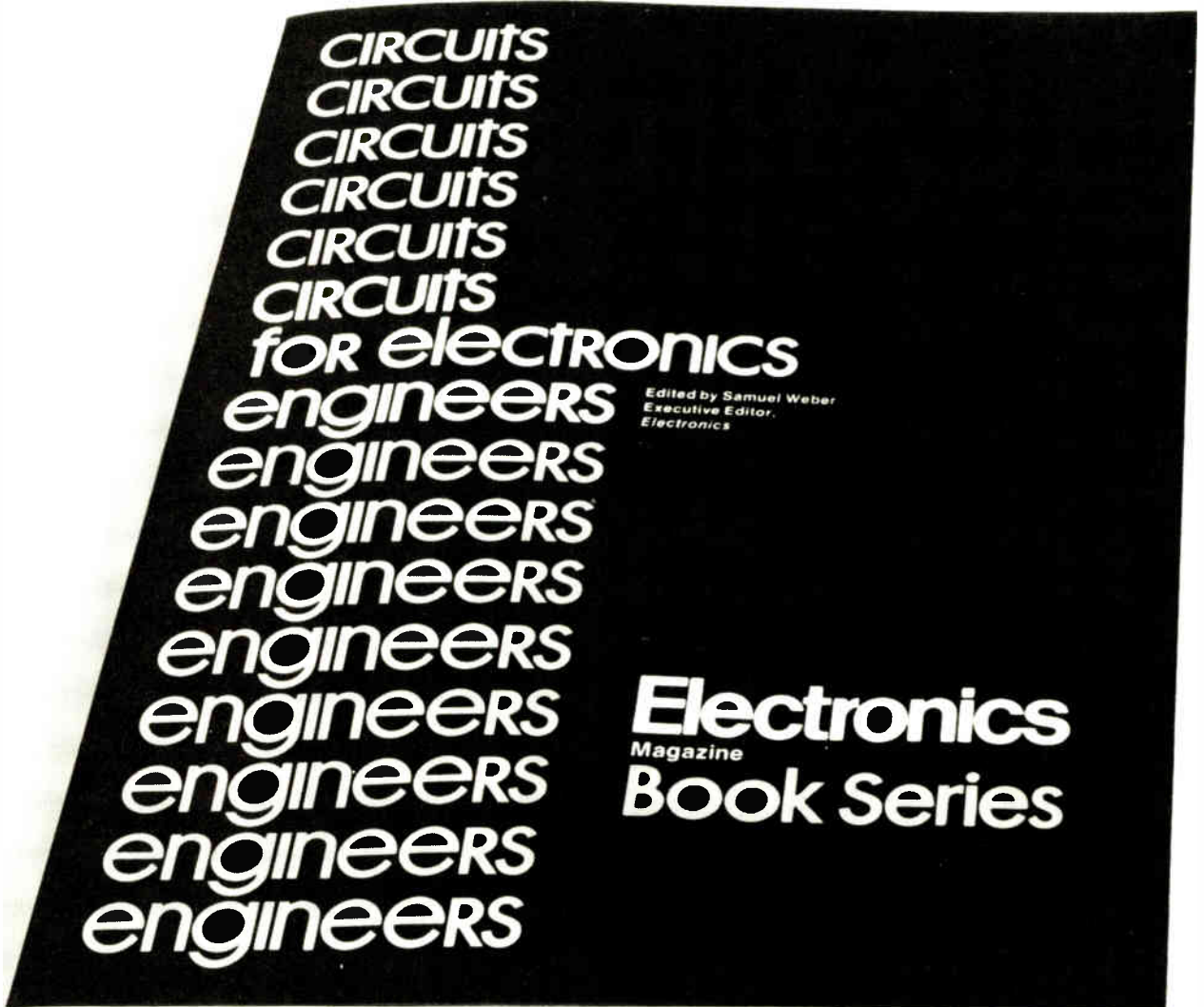

41. Protection circuits

Phase-sequence detector trips circuit breaker

By Terry Maloney
Motorola Semiconductor Products Inc., Phoenix, Ariz.

Some three-phase line-powered equipment is sensitive to the direction of rotation of the three phases. For example, if two of the connections to a three-phase motor are inadvertently reversed, the motor will reverse direction—a disaster if the motor is used to drive a pump or the compressor of an air conditioner. To guard against this failure, a low-power circuit can be built from standard complementary-MOS components that will detect the phase inversion and trigger a circuit breaker. Moreover, the circuit, which interfaces directly with CMOS logic, can be appended easily to a line-undervoltage or line-unbalance detector.

In the circuit (Fig. 1), the line voltages are stepped down and isolated by control transformers. The sine waves for phases A, B, and C are half-wave-rectified and shaped by the MR4001 diode and MP55172 transistor, and shaped again by a C-MOS inverter. The resulting rectangular waveforms are shown as A', B', and C' in Fig. 2.

The shaped outputs A', B', and C' are now combined with one another in the AND gates G₁, G₂, and G₃ to produce the waveforms A'C', A'B', and B'C' (or X, Y, and Z in Fig. 2). The pulses X, Y, Z appear sequentially; this sequence will change to YXZ, if, for instance,

the B and C phases are interchanged.

The X, Y, and Z pulse trains are applied to D-type flip-flops FF₁ and FF₂ in such a way that the Q₂ output of FF₁ is high if the sequence is XYZ (i.e., if the line phase sequence is ABC), and Q₂ is low if the sequence is XZY. For the XYZ sequence, an X pulse sets Q₁ and D₂ high, but then the Y pulse resets Q₁ and D₂ low. The Z pulse then locks the low from D₂ to Q₂, making Q₂ high.

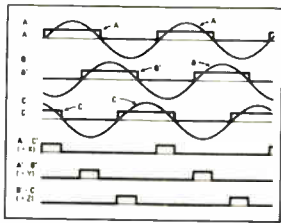

2. Operation. Line phases A, B, and C are rectified and shaped to produce waveforms A', B', and C'. Overlaps of these rectangular waves produce AND-gate outputs A'C', A'B', and B'C'. For convenience these outputs are referred to as X, Y, and Z. Line-phase sequence ABC generates XYZ sequence. ACB generates YXZ. These pulse trains cause flip-flop outputs to signal any phasing error.

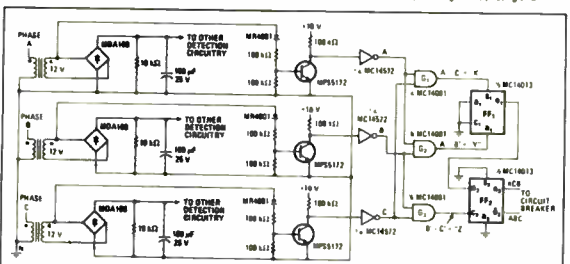

1. Phase sequence: incorrect sequence of line phases is detected by flip-flops, which trigger circuit breaker to prevent three-phase motor from running in reverse. Phase sequence ABC makes Q₂ high, but sequence ACB makes Q₂ high, either output can be used to control protection devices. This phase-reverse detector can be a simple addition to other control circuitry, as shown here.

310

Either Q₂ or Q₁ can be used to trip a circuit breaker via a solid-state or electromechanical relay, and thus pull a valuable piece of equipment off the line before it is damaged.

The MDA100 bridge rectifier, 10- Ω resistor, and 100-microfarad capacitor, shown in the gray area of

Fig. 1, are representative of typical applications requiring line-voltage detection. They are included in Fig. 1 to demonstrate how easily the phase-sequence detector can be added to other detection circuitry. They can, of course, be omitted, and the "bottom" of the transformer can be connected directly to circuit ground.

Current and power limiter protects switching transistor

By R. M. Slin
Burr-Brown Research Corp., Tucson, Ariz.

Although a switching transistor dissipates little power in normal operation, it must be protected from destructive current and power overloads. Current-limiting alone is not sufficient protection; power-limiting is also necessary. But fortunately, a few components can be added to conventional current-limiting circuitry to provide power-limiting. A voltage rise across a transistor is sensed and used to cut down the drive current.

To understand why current-limiting alone fails to provide adequate protection, consider a switching transistor controlling a 100-ohm load connected to a 100-volt supply. The power dissipated in the load might be about 100 watts, but the maximum power dissipated in the transistor is merely the load current times the transistor's saturation voltage (if switching losses are neglected). The load current is about 1 ampere, so the transistor dissipates less than 1 w. A designer might use a 3-w device and provide a current-limiting level of 1.5 amperes.

Suppose, however, that the load is short-circuited so that the collector of the switching transistor is connected directly to the 100-v supply. Then the transistor dissipates 150 w, which destroys it.

To prevent this destruction, a power-limiter is required. Power-limiting can be added to a standard current-limiter by use of only four simple components. In Fig. 1, Q₁ is the switching transistor, and the conventional current-limiter is formed by Q₂, R₂, and R₃. The power-limiter consists of capacitor C, diodes D₁ and D₂, and resistor R₁. To illustrate the operation of the circuit, assume that Q₁ is saturated and in normal operation. As the load current increases, the voltage drop across R₂ increases, turning on transistor Q₂ and thus shunting drive current away from the base of Q₁. Therefore, Q₁ begins to come out of saturation, so its collector voltage rises. This voltage across Q₁ further turns on Q₂ through R₃ and regeneratively turns off Q₁.

Diodes D₁ and D₂ form a switch so that the collector

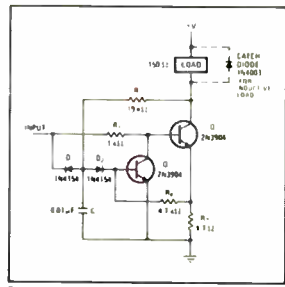

Two-way protection. Switching transistor Q₁ is protected against excess current and/or excess power dissipation if load current approaches limit I₂ or drop turns on transistor Q₂ to shunt base drive from Q₁. A voltage rise across Q₁ acts through R₃ to turn on Q₂, and turn off Q₁. Capacitor C provides delay that allows Q₂ to saturate with each new cycle and lets power-limiter ignore transient high currents. Diodes D₁ and D₂ reset power-limiter when input is low.

voltage of Q₁ is sampled only when its input is high. This switch also resets the power-limiting circuitry with each cycle of the input. The value of capacitor C is chosen to give the power-limiting portion of the circuit a turn-on delay, allowing time for Q₂ to become saturated. This delay also permits higher current transients to flow during switching, such as those that might occur in a switching regulator in which the catch diode must be discharged during each cycle.

The current-limiting portion of the circuitry is active at all times, protecting the switching transistor from current overloads. The circuit was set up to be driven by a TTL-level signal and to switch a 100-mA load at 400 Hz for nearly any input and output configuration. If a pnp-transistor switch is to be protected, transistor Q₂ should also be a pnp, and the polarities of D₁ and D₂ should be reversed.

311

Two typical pages. Note valuable explanatory text.

Here is a book compiled and organized to save electronics engineers many hours of drudgery designing what's already been designed or "re-inventing the wheel". This is the fifth in the Electronics Magazine Book Series, following *Microprocessors*, *Large Scale Integration*, *Basics of Data Communications*, and *Applying Microprocessors*.

Circuits For Electronics Engineers is a compilation of most useful circuits from the pages of Electronics magazine, most from the well-known Designer's Casebook series. More than a collection of circuit diagrams, the designer will find step-by-step rules, performance data, component values, manufacturers' type references, follow-up references, and other material for effective guidance.

The end result is a complete, practical easy-to-use manual for engineers and advanced technicians involved in research, development, design, tests, or production of any kind of electronics hardware.

Mail coupon now. Will pay for itself first time you use it.

Electronics Book Series

P.O. Box 669, Hightstown, NJ 08520

Send me _____ copies of "Circuits for Electronics Engineers" at \$15.95 per copy. Full payment must accompany order.

I must be fully satisfied or you will refund payment if the book is returned after ten-day free trial examination.

Name _____ Title _____

Company _____

Address _____

City _____ State _____ Zip _____ Country _____

Signature _____

After ten years of experience as an electronics engineer himself, Samuel Weber joined the staff of Electronics and has been Executive Editor of the magazine since 1970. In addition to his editorial responsibilities he has authored many articles on electronics and edited three books on electronics circuitry.



346 circuits from all over the world—arranged by 51 of the most useful functions designers use to implement their systems, including—Amplifiers • Analog to digital & digital to analog converters • Counters • Detectors • Discriminators • Display circuits • Function generators • Integrators • Logic circuits • Memory circuits • Operational amplifier circuits • Power supplies • Protection circuits • Switching circuits • Temperature control • Timing circuits • Voltage regulating circuits • . . . and many more.

Discounts of 40% on orders of ten or more copies.

Payment enclosed Bill firm Bill me
Credit Cards Charge My Book To:

American Express Diners Club
 Master Charge BankAmericard

Acct. No. _____

Date Card Expires _____

Interbank No. _____

1st No's above name of Master Charge only R-71A



PINPOINT HEAT

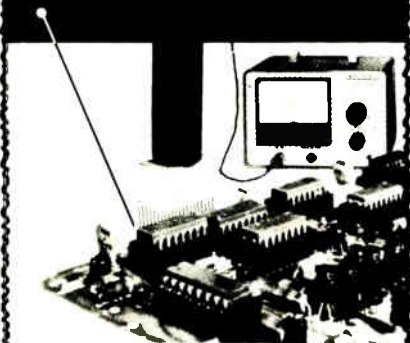

Heat any integrated circuit or electronic component to its rated temperature with a heat probe. Accuracy $\pm 3^{\circ}\text{C}$ or better. Or check the component's temperature with a thermo-couple probe. Model 810 Thermo-Probe does both. Reads out directly in $^{\circ}\text{C}$ and $^{\circ}\text{F}$ on a large $4\frac{1}{2}$ -inch meter.

Models with other temperature ranges available. For details write to:

MTI MICRO-TECHNICAL INDUSTRIES

P.O. Box 287 South Laguna, CA 92677
(714) 545-3734 • TWX910 596-1325 MOCROTEC LBEB

Circle 178 on reader service card

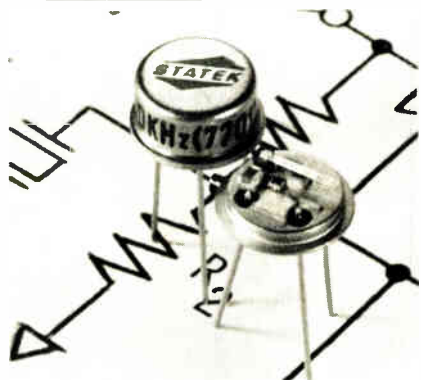

CMOS Crystal Oscillators in low profile TO-5.

Frequency range is 10 kHz to 300 kHz (divided outputs to 1 kHz, low as one cycle per month available). Low milliamp current consumption. Accuracy $\pm 0.01\%$. Shock 1000 g. Hybrid thick and thin film chip and wire design is rugged and ideally suited for portable equipment. Details in Gold Book & EEM.

STATEK CORPORATION
512 N. Main
Orange, California 92658
Telephone: (714) 639-7810
TELEX 67-8394

178 Circle 205 on reader service card

■ Abbott Transistor Labs	6	■ GenRad	13
Advanced Micro Devices	10-11	■ Grayhill, Inc.	128
American Microsystems, Inc.	37	■ Harris Semiconductor	140-141
■ American Optical - Scientific Instr. Div.	148	Heuristics	182
AMP, Inc.	18-19	■ Hewlett-Packard	1, 2, 28, 29, 67, 72, 170, 171
■ Amphenol North America Division, Bunker Ramo	82-83	• HI-G D'Italia	20E
Corporation, RF Operation		Honeywell TID	78-79
Anritsu Electric Co., Ltd.	142	■ Hughes Aircraft	43
Ansley (Thomas & Betts)	137	Hutson Industries	179
■ Associated Electronics	181	Intel-Microcomputer Components	9, 122, 123
■ Augat, Inc.	119	International Electronic Research Corp.	149
⚡ Beckman Instruments, Helipot	145	Interswitch	181
⚡ Beckman Instruments, Inc., IDO Division	147	• Italtel/Siemens	7E, 11E
CEC Division/Bell & Howell Company	40	■ M. S. Kennedy Corp.	160
Biomatron	45	■ Kepco, Inc.	5
■ Bourns, Inc.	2nd cover	■ Lambda Electronics	57, 62
■ The Buckeye Stamping Co.	150	Leader Instruments Corp.	146
⚡ Bud Industries, Inc.	138	Litronix	41
• Burr Brown	135	• Magneti Marelli	14E
■ MGR/Bussmann Mfg. Co.	143	Mallory Capacitor Company	3rd cover
■ Cherry Electrical Products	21	Megatek Corporation	162
■ Clairex Electronics	4th cover	■ MFE Corporation	139
■ Concord Electronics	146	Micro Components Corporation	153
Conic Data Systems	168	■ Micro Electronics	164
■ Continental Rentals	8	MicroTechnical Industries	178
■ Continental Specialties	163	Micro Power Systems	71
■ Dana Labs	154	Mits, Inc.	165
Data General Corp.	27	Monsanto Company	14, 15
Data I/O Corporation	51	Mostek Corporation	22, 23
■ Data Precision	86	Nitron	129
■ Digital Equipment Corporation	84-85	Nichicon America Corporation	108
■ ECD Corporation	95	• North American Phillips	18E
■ E & L Instruments	158	■ North Atlantic Industries	75
Electronic Research Division of Textron, Inc.	182	NTI America, Inc.	8
■ Emerson & Cuming, Inc.	69	■ O.K. Machine & Tool Company	161
Fairchild (Semiconductor Operations Division)	46-47	Ostby & Barton	166
Faultfinders, Inc.	39	Pamotor	150
■ Ferranti-Packard Ltd.	156	• Pertec Ped	12E, 13E
Figaro Engineering, Inc.	8	• Philips TMI	4E
■ John Fluke Mfg. Co., Inc.	133	⚡ Philips TMI	182
Forth, Inc. Responsive Computing	164	■ Piezo Technology	42
Fujitsu Limited	73	PolyMorphic Systems	134
• Ganz Measuring Works	20E	Powercube Corporation (Div. of Unitrode)	106
Gates Rubber Company - Energy Products	151	■ Precision Monolithics, Inc.	7
• GEC M-O Valve	1E	■ Premier Metal Products	20
⚡ General Electric Instr. Rental	126	■ Projects Unlimited	72

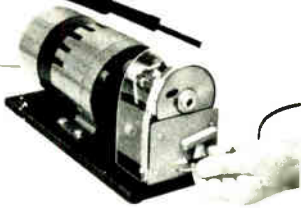

NEW MODEL CX-2

Look to WEPCO

For Wire Cutters & Strippers

CX-2 MOTORIZED COAXIAL CABLE STRIPPER

for cables or wire .075" to .435" O.D.
PRICE \$325.00

MC-2 MEASURING WIRE CUTTER

for wire and tube 1/8" to #30 AWG
PRICE \$450.00

CX-1 COAXIAL CABLE STRIPPER

for CO-AX connectors

PRICE \$44.50

THERMAL WIRE STRIPPERS

4 different models

Prices F.O.B. San Clemente

WESTERN ELECTRONIC PRODUCTS CO.

107 Los Molinos, San Clemente, Calif. 92672
Telephone: (714) 492-4677

Circle 206 on reader service card

RF & MICROWAVE SOURCES INFRA-RED, LF, UHF and VHF

RADAR SYSTEMS: 150 MHZ to 35 GHZ

AUTOTRACK ANTENNA MOUNTS: Nike Hercules, Nike Ajax, SCR 584. Capacity 50 lbs. to 10,000 lbs. Light Airborne to Sage Systems

RADAR INDICATORS: PPI-RHI-A/B/C/Scopes

PULSE MODULATORS: 25KW to 10 Megawatts

HIGH VOLTAGE POWER SUPPLIES: Up to 20KV 2A

MICROWAVE TUBES: TWT, Klystron, BWO, Carcinotron, Magnetron Every Frequency

MICROWAVE COMPONENTS

SONAR SYSTEMS

SEND FOR FREE 24 PAGE CATALOG ON YOUR LETTERHEAD

 **RADIO RESEARCH INSTRUMENT CO. INC.**

2 LAKE AVE. EXT., DANBURY, CT. 08610
203-792-6666

Circle 207 on reader service card

Pro-Log	30
• Recal Thermionic Ltd.	2E, 3E
Radio Research Instrument Corporation	179
Ramtek	130-131
‡ Rental Electronics, Inc.	135
Rockwell International, Colline Commercial Telecommunications Division	44
• SEPA S.p.A.	145
• Siemens AG Munich	52
■ Spectrol Electronics	24
■ Statek Corp.	178
■ Superior Electric	169
Synertek	48
Syntronic Instruments, Inc.	181
■ Tansitor Electronics	152
• Teac Corporation	138
■ Tektronix	80, 81, 120, 121
■ Teledyne Relays	17
Teletype	167
Teradyne, Inc.	64
Texas Instr., Components	35
Thermotron Corporation	159
• Thomeon CSF Division D.T.E.	9E
■ Trio Laboratories, Inc.	134
• Triplet Corporation	17E
‡ TRW/UTC Transformers	52
■ TRW RF Semiconductors	124, 125
■ United Detector Technology	155
United Systems Corp., Sub. Monsanto	136
■ Centralab/USCC	77
Varo Semiconductor	172
Velonex, Inc.	158
Viking Industries	54
• Wavetek San Diego Inc.	147
■ Western Electronic Products Co.	179
Wilhelm Westermann	16
• Yokogawa Electric Works	126

Classified and employment advertising

F. J. Eberle, Manager 212-997-2557

Atomic Personnel	173
BLH Electronics	175
Corning Glass Works	173
Ford Aerospace	174
Fox Morris	175
ETO	175
NCR	175
National Personnel	174
P'NB Consultants	173
Tektronix	173
University of Southern Colorado	173

- For more information of complete product line see advertisement in the latest Electronics Buyers Guide
- Advertisers in Electronics International
- ‡ Advertisers in Electronics domestic edition

SCRs Triacs Diacs Chips

**PLASTIC
TO-202
TO-220**

**METAL
TO-5
TO-203
TO-48**

**DIAC
DO-7**

Hutson is producing more devices than ever before! You can get rapid delivery PLUS improved reliability because Hutson computer tests all devices!



HUTSON INDUSTRIES

P.O. BOX 34235, DALLAS, TEX. 75234
2019 W. VALLEY VIEW LANE
(214) 241-3511
TWX 910-860-5537

EUROPEAN OFFICE:
30 RUE PIERRE SEMARD
YERRES, 91, FRANCE
TEL: Paris 948-8258
TELEX 21311

Circle 179 on reader service card 179

ELECTRONICS ARTICLES AVAILABLE IN REPRINT FORM

No. of
copies
wanted

New reprints

- ___ R-716 Special report—Japanese wave in semiconductor technology 24 pp \$3.00
- ___ R-714 Special report—active filter technology 6 pp \$3.00
- ___ R-713 Electron-beam lithography draws fine line 10 pp \$3.00
- ___ R-712 Special report—large-scale integration 16 pp \$3.00
- ___ R-710 Personal computers mean business 8 pp \$2.00
- ___ R-708 So you want to be a consultant 6 pp \$2.00
- ___ R-706 Low-cost dual delayed sweep method 6 pp \$2.00
- ___ R-705 Powering up with linear ICs 12 pp \$3.00

Charts

- ___ R-516 Electronic symbols \$2.00
- ___ R-213 Electromagnetic spectrum (updated 1976) \$3.00
- ___ R-326 Optical spectrum (6-page report and chart) \$3.00

Books

- ___ R-704 Thermal design in electronics \$5.00
- ___ R-701 Applying microprocessors—Electronics Book Series \$9.95
- ___ R-608 Basics of Data Communications—Electronics Book Series \$12.50
- ___ R-602 Large Scale Integration—Electronics Book Series \$9.95
- ___ R-520 Microprocessors—Electronics Book Series \$8.95
- ___ R-011 Computer-aided Design 135 pp \$4.00
- ___ R-032 Active Filters 88 pp \$4.00
- ___ R-031 Circuit Designer's Casebook 182 pp \$5.50 (outside U.S. \$12.00)

Other reprints

- ___ R-703 Special report—memories 16 pp \$3.00
- ___ R-702 World market report 1977 24 pp \$4.00
- ___ R-616 Special issue—technology update \$4.00
- ___ R-614 Power supply choices for sophisticated designs 8 pp \$3.00
- ___ R-612 Fiber-optic communications special report 24 pp \$3.00
- ___ R-610 Special report on hybrid-circuit technology 19 pp \$3.00
- ___ R-606 Special issue—microprocessors \$4.00
- ___ R-526 How reliable are today's components 16 pp \$3.00
- ___ R-600 World market report 1976 24 pp \$4.00
- ___ R-524 Special report on bipolar large-scale integration 12 pp \$3.00
- ___ R-522 Special report on power semiconductor 12 pp \$3.00
- ___ R-518 Special issue—productivity \$4.00
- ___ R-514 Eight ways to better radio receiver design 6 pp \$3.00
- ___ R-512 Design of circuits for dangerous environments 4 pp \$2.00
- ___ R-510 Bipolar advances with ¹²L microprocessor 8 pp \$2.00
- ___ R-508 Designing microprocessors with standard logic 12 pp \$3.00
- ___ R-506 The case for component burn-in 7 pp \$2.00
- ___ R-434 Designing automated systems with the new standard interface 12 pp \$3.00
- ___ R-432 An update on communications satellites 8 pp \$2.00
- ___ R-430 Choosing the right bipolar transistor model for computer-aided design 20 pp \$3.00

Payment must accompany your order

Make check or money order payable to Electronics Reprints. All orders are shipped prepaid by parcel post. Allow two to three weeks for delivery.

Cost of orders \$ _____
Plus 10% handling charge \$ _____
TOTAL AMOUNT ENCLOSED \$ _____

Mail your order to:
Janice Austin
ELECTRONICS REPRINTS
P.O. Box 669
Hightstown, N.J. 08520

SEND REPRINTS TO

Name _____

Company _____ Dept. _____

Street _____

City _____ State _____ Zip _____

Advertising Sales Staff

Advertising sales manager: Paul W. Reiss

1221 Avenue of the Americas, New York, N.Y. 10020
[212] 997-4371

Atlanta, Ga. 30309: Glen N. Dougherty
100 Colony Square, 1175 Peachtree St., N.E.
[404] 892-2868

Boston, Mass. 02116: Frank Mitchell
607 Boylston St.
[617] 262-1160

Chicago, Ill. 60611
645 North Michigan Avenue
Robert W. Bartlett [312] 751-3739
Robert M. Denmead [312] 751-3738

Cleveland, Ohio 44113: William J. Boyle
[716] 586-5040

Dallas, Texas 75201: John J. Uphues
2001 Bryant Tower, Suite 1070
[214] 742-1747

Denver, Colo. 80203: Harry B. Doyle, Jr.
123 Speer Blvd. #400
[303] 837-1010

Detroit, Michigan 48202: Robert W. Bartlett
1400 Fisher Bldg.
[313] 873-7410

Houston, Texas 77002: John J. Uphues
601 Jefferson Street, Dresser Tower
[713] 659-8381

Los Angeles, Calif. 90010: Robert J. Rielly
Bradley K. Jones, 3200 Wilshire Blvd., South Tower
[213] 487-1160

Minneapolis, Minn. 55435: Robert M. Denmead
4015 W. 65th St.
[312] 751-3738

New York, N.Y. 10020
1221 Avenue of the Americas
Michael J. Stoller [212] 997-3616
Matthew T. Reseska [212] 997-3617

Philadelphia, Pa. 19102: Matthew T. Reseska
Three Parkway
[212] 997-3617

Pittsburgh, Pa. 15222: Matthew T. Reseska
4 Gateway Center
[212] 997-3617

Rochester, N.Y. 14534: William J. Boyle
1175 Pittsford-Victor Rd., Pittsford, N.Y.
[716] 586-5040

San Francisco, Calif. 94111: Don Farris
Robert J. Rielly, 425 Battery Street.
[415] 362-4600

Paris: Alain Offergeld
17 Rue-Georges Bizet, 75116 Paris, France
Tel: 720-73-01

Geneva: Alain Offergeld
1 rue du Temple, Geneva, Switzerland
Tel: 32-35-63

United Kingdom & Scandinavia: Robert Ghey
34 Dover Street, London W1
Tel: 01-493-1451

Scandinavia: Andrew Karnig and Assoc.
Kungsholmsgatan 10
112 27 Stockholm, Sweden
Tel: 08 51 68 70 Telex: 179 51

Milan: Luigi Rancati
1 via Baracchini, Italy
Phone 86-90-656

Brussels: Alain Offergeld
23 Chaussee de Wavre
Brussels 1040, Belgium
Tel: 13-73-95

Frankfurt/Main: Fritz Krusebecker
Liebigstrasse 27c, Germany
Phone 72 01 81

Tokyo: Tatsumi Katagiri, McGraw-Hill
Publications Overseas Corporation,
Kasumigaseki Building 2-5, 3-chome,
Kasumigaseki, Chiyoda-Ku, Tokyo, Japan
[581] 9811

Business Department

Thomas M. Egan
Production Manager [212] 997-3140

Gayla Black
Production Manager [212] 997-2044

Carol Gallagher
Production Manager International
[212] 997-2045

Dorothy Carter
Production Manager Domestic
[212] 997-2908

Frances Vallone
Reader Service Manager
[212] 997-6057

Electronics Buyers' Guide

H.T. Howland, General Manager
[212] 997-6642

Regina Hera, Directory Manager
[212] 997-2544

Gayla Black, Production Manager
[212] 997-2044

Frances Vallone, Reader Service Manager
[212] 997-6057

Classified and Employment Advertising

Frank Eberle, Manager
[212] 997-2557

1702A MANUAL EPROM PROGRAMMER

Features hex keypad, two digit hex address and two digit hex data display. Controls include load, clear, go! (step), key/copy, data in/ data out, and counter up/ down. Profile card includes high voltage pulse regulator, timing, 8 bit address and 8 bit data drivers/receivers. Two 6½" x 9" stacked cards with spacers. Allows programming in 20 minutes - copying in 5 minutes. Requires +5, -9, and +80 volts.

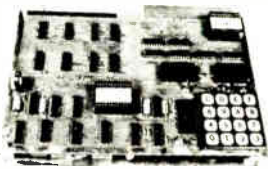

ASSEMBLED \$299.95
KIT \$189.95

NOW

The best of two worlds... use our 1702 EPROM programmer as a manual data/address entry programmer... or connect it to your processor.

IMSAI/ALTAIR computer interface (requires 3 output ports, +1 input port) and software \$49.95

Briefcase unit with power supplies and interface connectors (assembled and tested only) \$599.95

ANNOUNCING

Our NEW 16K Byte Pseudo-Static, IMSAI/ALTAIR compatible RAM. Single card slot. Uses less power than equivalent low power RAM. All memory chips socketed. Uses all prime, factory fresh ICs. High quality, two-sided, through-hole plated circuit board. Crystal controlled, totally invisible refresh system requires NO software management. Just plug it in and use like STATIC memory.

Complete kit \$349.95
Assembled, tested, and burned in \$549.95

ASSOCIATED ELECTRONICS

12444 Lambert Circle • Garden Grove, CA 92641
(714) 539-0735

Circle 208 on reader service card

A CRT Yoke for all reasons

Military

Airborne (HUD, HDD, VSD, HSD), shipboard, ground systems, missile systems.

Compact, lightweight, encapsulated to withstand physical stress. Special ferrite core designs.



Commercial

Computer terminals, monitors, medical applications, hard-copy machines, etc.

Engineered and tooled for volume production. Cost-effective and geometry corrected.



Special Designs

Phototypesetting, random graphics, flying spot scanners, mappers, vidicons.

Designed for low residual and superior resolution using special assembly techniques.



Send us your reasons for needing a better yoke. We'll supply technical data sheets, recommendations, engineering assistance.



syntronic

Syntronic Instruments, Inc.
100 Industrial Road, Addison IL 60101
Phone (312) 543-6444

See Pages 405 to 408 in EEM

Circle 181 on reader service card 181

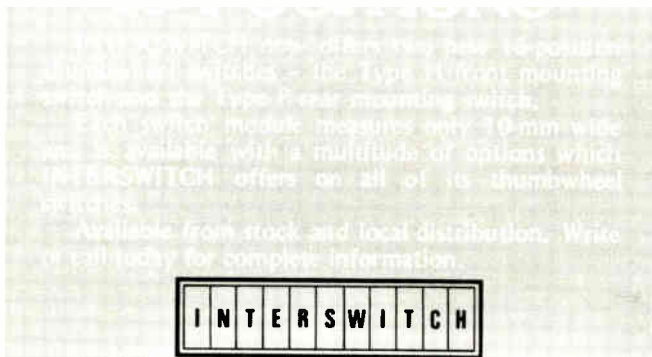

ONE OF THE PURDY GROUP OF COMPANIES

770 Airport Boulevard
Burlingame, CA 94010
(415) 347-8217 • TWX 910-374-2353



Circle 209 on reader service card



The extras make the difference

Extras like variable trigger hold-off (with displayed hold-off time) and external reset/start allow spurious signals to be ignored, multiple pulse period measurement and even measurements on sections picked out of a pulse train.

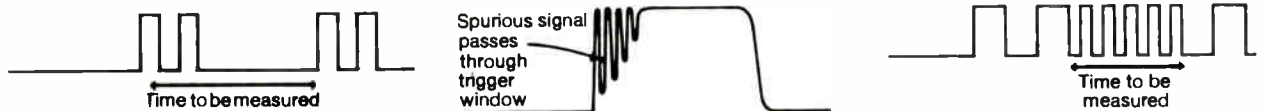

The extras add up to a very versatile 9-digit timer/counter that can make many lab measurements easier—and some even possible for a single instrument setup.

High stability timebases, BCD and analog outputs, IEEE buss, internal battery and rack mounting are some of the options available.

Philips PM6620 series timer/counters from 80 to 1000 MHz; starting at \$965.

Want more information or a demonstration? Call our toll-free Hotline number: 800 631-7172 (New Jersey residents call collect), or contact: Philips Test & Measuring Instruments, Inc.:

In the U.S.: 85 McKee Drive
Mahwah, New Jersey 07430
Tel. (201) 529-3800

In Canada: 6 Leswyn Road
Toronto, Ontario, Canada M6A 1K2
Tel. (416) 789-7188



PHILIPS

Circle 182 on reader service card

“The Power That Be...”
TRIO LABS’

MAXI-POWER[®] 682

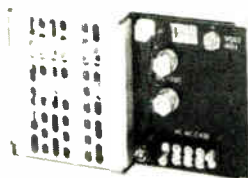

A 750 watt (5VDC at 150a) Switching Power Supply that has so many features it surpasses comparison.

- Input 208VAC nominal (115VAC-Model 683).
- Low Line -30% (146VAC).
- High Line +10% (229VAC).
- Ride through 35ms @ nominal.
- Efficiency up to 85%.
- Output 2-48VDC standard.
- Power Out up to 800w (750w @ 5VDC out).
- Output voltage adjust.
- Overcurrent protection — foldback (standard) or constant current.
- Overvoltage protection — crowbar SCR.
- Self Cooling
- Parallelable.
- U.L. recognized (approved).
- 5x8x11"
- Up to 2 watts/in³.
- As low as 63¢/watt.

TRIO LABS

The Switcher Source[®] 80 Dupont St.
Plainview, N.Y.
(516) 681-0400

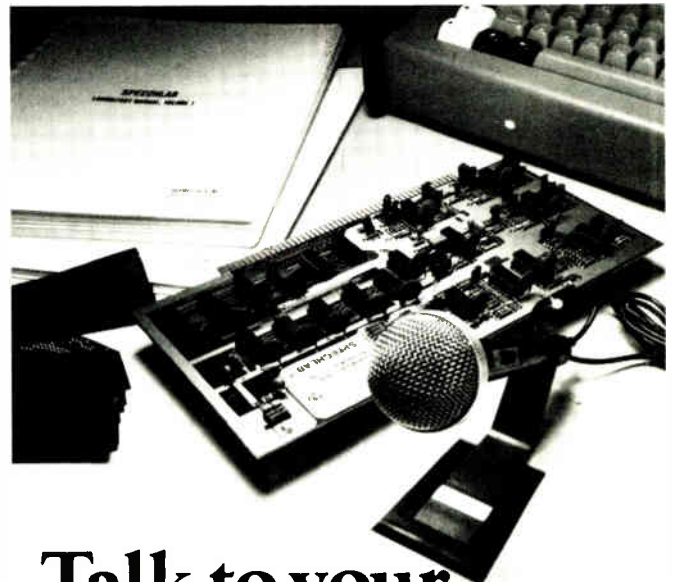

Talk to your computer for \$299.

SpeechLab™ lets you talk to and control any S-100 bus computer... Sol, Altair, IMSAI, etc. Use for computer input, research, vocal control and games. Price, \$299 assembled and tested. Complete hardware/software system, 275 page lab and 95 page hardware manuals.

Address Heuristics, Inc., 900 N. San Antonio Road, Los Altos, CA 94022.
Phone (415) 948-2548.

Heuristics

INC

182 Circle 210 on reader service card

Circle 211 on reader service card

**Uncle Sam and you want
non-PCB capacitors now.
Mallory has them now.**

Mallory non-PCB Bionol™ capacitors are in production and are available now. We've been producing them for two years, using material of the ester family. They are fully tested and we've developed an internal protector to meet UL requirements. This interrupter device is standard on motor-run applications.

Bionol non-PCB's are available in standard configurations or as specials. We're ready now for large or small orders.

We'll be completely finished with PCB production by the end of 1977. Until then our proprietary processes will go on providing the lowest PCB discharge of any company.

Mallory motor-run and power supply capacitors are further examples of our line of high performance products which makes it easier than ever to get the capacitors you need.

Available direct, or through authorized Mallory distributors in U.S. and overseas. Call your local Mallory sales representative for the complete story, including life-test documentation.

Mallory Capacitor Company, a division of P. R. Mallory & Co. Inc., Box 1284, Indianapolis, Indiana 46206 (317) 856-3731.



MALLORY

Circle Number 901 on Reader Service Card

Get more current at lower light levels

Clairex photodarlingtons exhibit the highest sensitivity in the industry with specific types having a guaranteed light current (I_L) at 0.02 mw/cm² irradiance. A broad line of phototransistors and photodarlingtons is available in the TO-18, the "micro" (Pill) and an intermediate (Post) package.

The micro package is .060" in diameter and permits the assembly of arrays utilizing .100" centers. The intermediate package has a flange diameter of .098" which permits its use for small space applications and ease of product handling.



All units are hermetically sealed with either glass windows or glass lenses. The lenses provide a narrow angular response of $\pm 17^\circ$ while the win-

dows provide an angular response of $\pm 35^\circ$.

All Clairex phototransistors and photodarlingtons are 100% tested for light current (I_L) at a

stated irradiance... either per the standard Clairex specification, or per your special requirements. In addition, most Clairex units are tested to a minimum and maximum light current (I_L) limit... normally a 3:1 spread.

Because Clairex has specialized in opto-electronics since 1953, we probably stock the phototransistor or the photodarlington with the characteristics that you need.

Call (914) 664-6602 or write Clairex[®], 560 South Third Avenue, Mount Vernon, New York 10550.

...with Clairex photodarlingtons and phototransistors.

CLAIREX ELECTRONICS

A Division of Clairex Corporation

Circle 902 on reader service card