

JANUARY 22, 1976

**TWO EFFECTIVE NEW WAYS TO TEST MICROPROCESSORS/100**

Gated-noise tests uncover system faults/91

Getting standard ICs and relays to work together/107

FOUR DOLLARS A MCGRAW-HILL PUBLICATION

# Electronics®

## A FAMILY TREE



14ZA 080420 07CA0 MAY/6  
 CS OSBORNE-JR  
 4200 SW 107 APT 2305  
 BEAVERTON OR 97005

# SHOULDN'T THE COMPANY THAT WIRES THE WORLD'S MAINFRAMES, WIRE THE WORLD'S PERIPHERALS?

Brand-Rex has been supplying wire and cable to the major mainframe manufacturers since the earliest days of computer technology. Everything from back panel wire, to signal transmission cable, to flat flexible Tape Cable®, to interconnecting cable. All UL and CSA listed; all cost/reliability engineered.

The same product diversity is available to peripheral equipment manufacturers. Is your need hook-up wire? We can usually ship it from stock. Or are you searching for plug-to-plug compatible interconnecting



cables? If they're not in stock, we're probably processing the specific item you want.

Of course, wire and cable isn't the only reason computer people come to Brand-Rex. They come because we offer unbiased

technical assistance. No preconceived solutions based on a limited product line. Because we have such a broad capability, Brand-Rex engineering specialists can always recommend the most functional, reliable and economical cable for your particular requirement.

So call on us whenever you have a wire or cable problem. We're as near as your regional Brand-Rex sales engineer. Make him part of your problem solving team. Brand-Rex Company, Electronic and Industrial Cable Division, Willimantic, CT. 06226, 203/423-7771.

## BRAND-REX

ELECTRONIC & INDUSTRIAL CABLE DIVISION

Other Brand-Rex Divisions

Abbott & Co. . wiring harnesses □ Nonotuck Manufacturing Co. . copper wire  
Pyle-National Co. . electrical connectors □ Telecommunications Cable Division  
Teltronics, Inc. . telephone equipment and components □ Brand-Rex, Ltd (Scotland), wire and cable

BRAND-REX CO. A PART OF Alzora INCORPORATED

Circle 900 readers service card

# Test Equipment: Think of it as Money

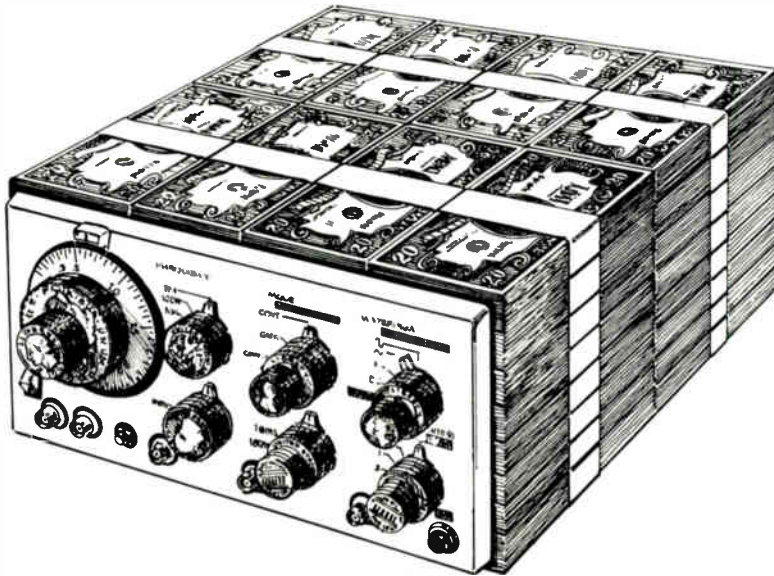

## US Instrument Rentals Helps you invest it wisely

You wouldn't let money gather dust on your shelves. Why allow unused equipment to languish there?

If some test equipment does sit idle on your shelves, maybe a better way exists to acquire that equipment. You carefully weighed alternative brands of function generators; did you weigh the alternatives of buying, renting or leasing?

To help you make a sound rent/

buy decision, U.S. Instrument Rentals wrote the only comprehensive guide on the topic. It provides an objective framework for decision making, as well as practical case studies. The financial and operational tradeoffs of renting are covered, including cash and credit conservation, obsolescence, tax considerations, maintenance and calibration, and budget stretching.

If, after reading our booklet, you decide to rent, think U.S. Instrument Rentals. The first and only rental company with a computerized inventory quotation system, repair replacements within 48 hours, automatic equipment return reminders, and much more.

Request your free copy now, before an unpredictable economy further shelves your profits.



### Regional Centers

(213) 849-5861    (301) 340-1353  
(415) 592-9230    (201) 381-3500  
(713) 462-6803    (617) 246-1515  
(312) 676-2032    (214) 234-3392  
(216) 475-6647

### Corporate Headquarters

951 Industrial Road  
San Carlos, California 94070



### Please:

Send me without cost or obligation USIR's new guide to cost effective instrumentation acquisition.

NAME \_\_\_\_\_

COMPANY \_\_\_\_\_

ADDRESS \_\_\_\_\_

CITY/STATE \_\_\_\_\_ ZIP \_\_\_\_\_

PHONE \_\_\_\_\_

951 Industrial Rd., San Carlos, CA 94070

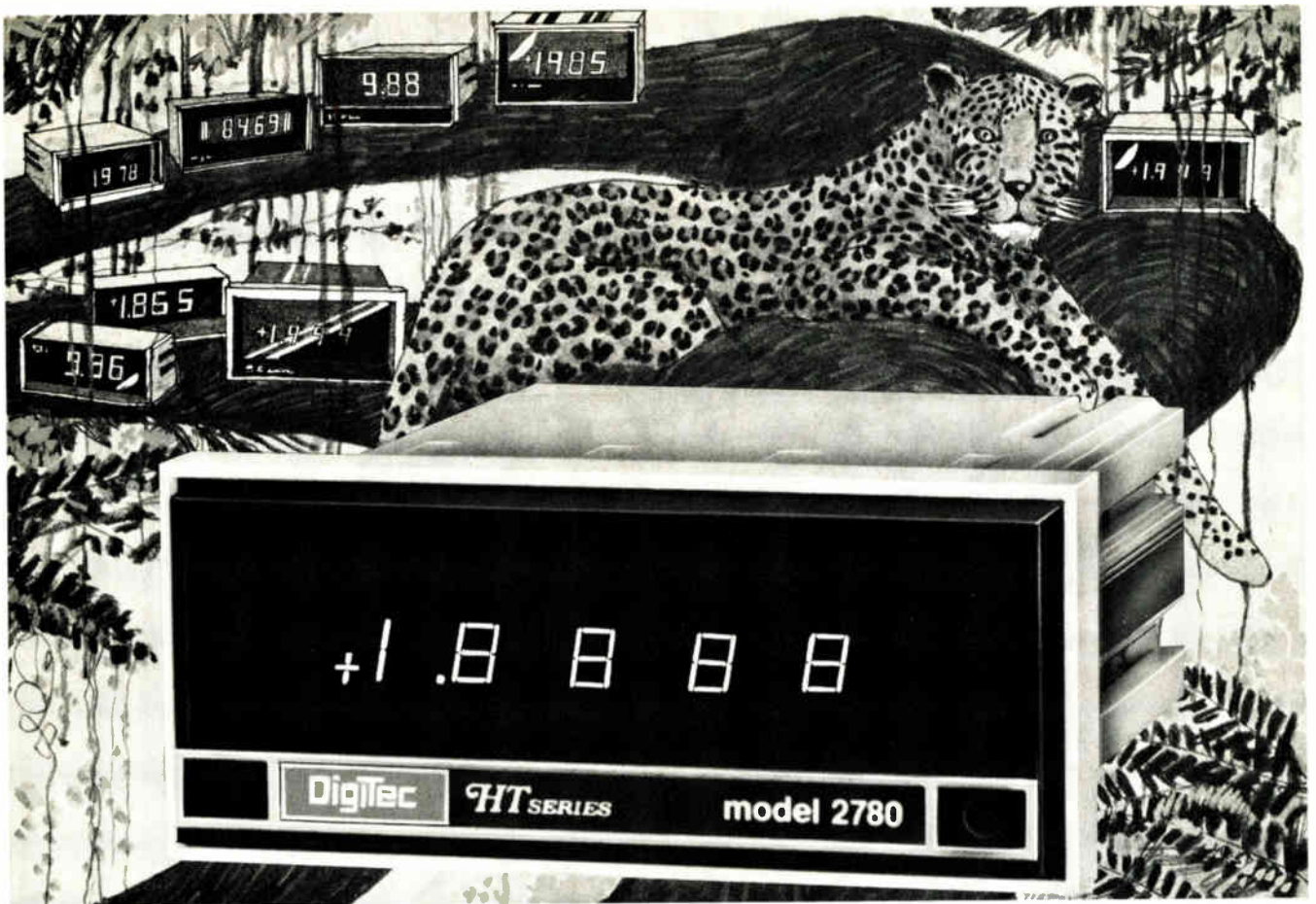

# The 'toughest' Panel Meter in the jungle!

## Fierce Reliability and Performance

There's a teeming jungle of panel meters available today. You need to slash thru the tangle of prices and specifications to the very roots. You must find a panel meter that can take anything while it gives continuous reliability and accuracy.

## Lean, muscular stamina

Every DigiTec panel meter is bred to survive and deliver under any conditions. Proprietary CMOS LSI circuitry gives a lean component count with 5 times the reliability of competitive TTL models. All components are selected for savage stamina, with critical components 100% inspected and socket mounted to avoid assembly heat damage. Every LED display is pre-tested and rated at 1 million hours. Circuit boards are immune to humidity or floods because

they're conformally coated on both sides. Shock, vibration and corrosion damage have been eliminated by extra mechanical reinforcement and gold plated connectors.

## Endurance tested and certified

All DigiTec panel meters are subjected to a minimum 168 consecutive hours of failure free burn-in at temperatures that vary from +25°C to +55°C. Before and after burn-in, each meter is visually inspected and electrically tested. When a DigiTec panel meter goes into that jungle... it's ready for anything and tough enough to last 9 lifetimes!

**Model 2780** — 4½ digits, 0.01% accuracy (shown)

\* **Model 276** — 3½ digits, unipolar, 0.1% accuracy

**Model 277** — 3½ digits, bipolar, 0.05% accuracy

Optional buffered, BCD output available - field installable.

Priced under **\$100.\*** in OEM quantities

Call your nearest United Systems representative for complete specifications.  
All models available from stock.

**DigiTec**

UNITED SYSTEMS CORPORATION

918 Woodley Road • Dayton, Ohio 45403 • Ph: (513) 254-6251 • TWX: (810) 459-1728

These instruments available under GSA Contract GS-OOS-27741

2 "Information only" circle 2 on reader service card.

"Demonstration only" circle 169 on reader service card.

## 39 Electronics Review

SOLID STATE: Enhancements boost power of 8-bit microprocessors, 39  
DATA PROCESSING: \$500 printer uses microprocessor, 40  
AUTOMATIC TEST EQUIPMENT: Color graphics aid tests, 40  
MEDICAL: Ultrasonics scans for stroke potential, 41  
DISPLAYS: Bank of LEDs shows letters and equations, 42  
COMMERCIAL: Phone company buys fire-alarm system, 42  
CONSUMER: \$19.95 watch coming from TI, 44  
GE, RCA enter citizens' band market, 46  
NEWS BRIEFS: 46  
CONSUMER: Programmable desktop calculator rings up low price, 49  
COMMUNICATIONS: AT&T rebuts attack on Dataspeed by IBM, 50

## 63 Electronics International

SWITZERLAND: Ministry automates communications lines, 63  
AROUND THE WORLD: 63

## 68 Probing the News

GOVERNMENT: NATO move changes defense game, 68  
PEOPLE: Which way will Motorola go? 70  
COMPUTERS: The problems of designing the PDP-11, 75  
COMPANIES: Singer's gamble becomes a loss, 78  
Electronic Arrays attacks high technology, 80

## 83 Technical Articles

COMPONENTS: Semiconductors yield microwave power, 83  
INSTRUMENTS: Turning up system faults with gated-noise testing, 91  
DESIGNER'S CASEBOOK: Inverting dc-to-dc converters, 96  
Photocoupler provides agc for audio communications, 97  
PACKAGING & PRODUCTION: Simplifying microprocessor testing, 100  
COMPONENTS: Relays and logic ICs can be working partners, 107  
ENGINEER'S NOTEBOOK: Proximity detector uses little power, 112  
Addressable cursor enhances linear bar-graph display, 113

## 121 New Products

IN THE SPOTLIGHT: Calibrators are remotely programmable, 121  
PACKAGING & PRODUCTION: Flat cables are pretested, 123  
INSTRUMENTS: Modifier simulates power-line dropouts, 129  
COMPONENTS: Resistors reach as high as 100 teraohms, 134  
DATA HANDLING: Microprocessor emulator speeds design, 142

## Departments

Publisher's letter, 4  
Readers' comments, 6  
News update, 8  
Editorial, 10  
People, 14  
Meetings, 30  
Electronics newsletter, 35  
Washington newsletter, 59  
Washington commentary, 60  
International newsletter, 65  
Engineer's newsletter, 116  
New literature, 149

## Highlights

### Cover: The family tree of microwave semis, 83

Every year sees a new crop of microwave semiconductors capable of generating and amplifying ever more power at ever higher frequencies. Available devices fall into six distinct categories, each suited to rather different applications. Cover is by designer Bob Strimban.

### NATO to alter its weapons policy, 68

Weapons standardization—the goal of a new NATO committee—has some people in the Pentagon delighted that costs could be less and others worried about possible damage to the weapons industry. For U.S. electronics firms operating in Europe, it may mean a radically different weapons market.

### Gated noise picks up receiver defects, 91

Faulty operation in a communications system can be detected as it develops by a tester that uses gated white noise to monitor network performance. Repairs can then be scheduled at will.

### Better ways to test microprocessors, 100

One new technique is to divide the circuitry into functional modules for testing as units. The other is to use algorithms to generate the test patterns, instead of wasting valuable memory space on them.

### And in the next issue . . .

Why digital TV is sure to catch on . . . the missing link in microcomputers . . . what makes power Schottky diodes different.

EDITOR-IN-CHIEF: Kemp Anderson

EXECUTIVE EDITOR: Samuel Weber

MANAGING EDITOR: Arthur Erikson,  
*International*

SENIOR EDITORS: Laurence Altman,  
Ray Connolly, Lawrence Curran,  
John Johnsrud, H. Thomas Maguire,  
Stephen E. Scrupski

ART DIRECTOR: Fred Sklenar

ASSOCIATE EDITORS: Howard Wolff,  
Gerald M. Walker, Alfred Rosenblatt

DEPARTMENT EDITORS  
*Aerospace/Military*: Ray Connolly  
*Circuit Design*: Don Blattner  
*Communications & Microwave*:  
Richard Gundlach  
*Components*: Lucinda Mattera  
*Computers*: Stephen E. Scrupski  
*Consumer*: Gerald M. Walker  
*Industrial*: Margaret A. Maas  
*Instrumentation*: Andy Santoni  
*New Products*: H. Thomas Maguire  
Michael J. Riezenman  
*Packaging & Production*: Jerry Lyman  
*Solid State*: Laurence Altman

CHIEF COPY EDITOR: Margaret Eastman

COPY EDITORS: Everett C. Terry, Ben Mason

ART: Charles D. Ciatto, *Associate Director*  
Patricia Cybulski, *Assistant Director*

EDITORIAL SECRETARIES: Janet Noto,  
Julie Gorgoglione, Penny Roberts

FIELD EDITORS  
*Boston*: Lawrence Curran (Mgr.), Pamela Leven  
*Los Angeles*: Larry Waller (Mgr.)  
*Midwest*: Larry Armstrong (Mgr.)  
*New York*: Ron Schneiderman (Mgr.)  
*San Francisco*: Bernard Cole (Mgr.)  
Judith Curtis  
*Washington*: Ray Connolly (Mgr.)  
*Frankfurt*: John Gosch  
*London*: William F. Arnold  
*Paris*: Arthur Erikson  
*Tokyo*: Charles Cohen

McGRAW-HILL WORLD NEWS

*Director*: Ralph R. Schulz  
*Bonn*: Robert Ingersoll  
*Brussels*: James Smith  
*London*: James Trotter  
*Madrid*: Dom Curcio  
*Milan*: Andrew Heath  
*Moscow*: Peter Gall  
*Paris*: Michael Johnson, Richard Shepherd  
*Stockholm*: Robert Skole  
*Tokyo*: Mike Mealey

PUBLISHER: Dan McMillan

DIRECTOR OF MARKETING: Pierre J. Braudé

MARKETING ADMINISTRATION MANAGER:  
Wallis Clarke

CIRCULATION MANAGER: Nancy L. Merritt

MARKETING SERVICES MANAGER:  
Tomlinson Howland

RESEARCH MANAGER: Margery D. Sholes

The drive in the North Atlantic Treaty Organization for a higher degree of standardization in weapons and communications makes a lot of sense, at least on paper. After all, there are something like 23 families of combat aircraft represented in NATO and, in the NATO navies, 36 different fire-control radars.

Yet, as we point out in a Probing the News story this issue, a number of groups are worried that standardization will cause a fundamental reshaping of the military procurement set-up. In particular, many in the U.S. electronics industry see commonality as a threat to their position as suppliers of high-technology products.

The stage is set, then, for an important confrontation between those who would simplify the array of weapons fielded by NATO forces and those who, while not really opposing a streamlining, are very concerned over how it will be implemented. You'll find the complete story on page 68.

Microwave semiconductors have always been sort of a breed apart from other solid-state devices because of the special demands required of units operating at frequencies running into the gigahertz. In this issue, you'll find a run-down on what's been happening lately as technological advances spawn new approaches to microwave device implementation.

As the cover graphically illustrates, the microwave semiconductor family tree has several branches. The main ones are the diodes—transferred-electron, impatt, trapatt, and baritt types—and the transistors—both bipolar and field-

effect. They all have their uses, their limitations, and their specialties, which the article details. What's more, developments in the laboratory are pushing at the technological frontiers. So for a first-hand look at what's going on in microwave semiconductors, turn to page 83.

It's refreshing in the fast-paced electronics field—with its pressures to never look back, to always run with technological progress—when some industry leader takes time out to detail mistakes and to draw guidance from them.

On page 75 we present some intriguing excerpts from Gordon Bell's account of the mistakes made along the development path of the highly successful PDP-11 mini-computers. In a paper prepared for a computer architecture symposium, Bell, a veteran of four computer design projects, goes into the details of the early design decisions of the PDP-11 and how they impinged on the machine's evolution as its commercial operating environment changed. Since it also talks about how the mistakes were corrected, the story makes fascinating reading.

1976 is well underway and we, as every January, are well underway in preparing the index of articles published in *Electronics* last year. A copy of the index will be mailed to any reader who requests it. Just circle number 340 on the reader service card and mail it.



January 22, 1976 Volume 49, Number 2  
92,714 copies of this issue printed

Published every other Thursday by McGraw-Hill, Inc. Founder James H. McGraw 1860-1948. Publication office 1221 Avenue of the Americas, N.Y., N.Y. 10020; second class postage paid at New York, N.Y. and additional mailing offices.

Executive, editorial, circulation and advertising addresses: Electronics, McGraw-Hill Building, 1221 Avenue of the Americas, New York, N.Y. 10020. Telephone (212) 997-1221. Teletype 12-7960 TWX 710-581-4879. Cable address: MCGRAWHILL NEW YORK.

Subscriptions limited to professional persons with active responsibility in electronics technology. Publisher reserves the right to reject non-qualified requests. No subscriptions accepted without complete identification of subscriber name, title, or job function, company or organization, and product manufactured or services performed. Subscription rates: in the United States and possessions \$12.00 one year, \$30.00 three years; Canada and Mexico \$14.00 one year, \$32.00 three years; Europe \$35.00 one year, \$87.50 three years; Japan, Israel and Brazil \$50 per year; Australia and New Zealand \$80 per year, including air freight; all other countries \$40.00 per year. Limited quota of subscriptions available at higher-than-basic rate for persons outside of field served, as follows: U.S. and possessions and Canada \$25.00 per year, Europe \$40.00; Japan, Israel and Brazil \$85.00; all other countries \$50.00. Single copies \$4.00.

Officers of the McGraw-Hill Publications Company: John R. Emery, President; J. Elton Tuohy, Executive Vice President-Administration; Gene W. Simpson, Group Publisher-Vice President; Senior Vice Presidents: Ralph Blackbourn, Circulation; Ralph R. Schult, Editorial; John D. Hogland, Controller; David G. Jensen, Manufacturing; Gordon L. Jones, Marketing; Jerome D. Luntz, Planning & Development.  
Officers of the Corporation: Shelton Fisher, Chairman of the Board; Harold W. McGraw, Jr., President and Chief Executive Officer; Robert N. Landes, Senior Vice President and Secretary; Ralph J. Webb, Treasurer.

Title registered in U.S. Patent Office. Copyright ©1976 by McGraw-Hill, Inc. All rights reserved. The contents of this publication may not be reproduced in whole or in part without the consent of copyright owner.

Subscribers: The publisher, upon written request to our New York office from any subscriber, agrees to refund that part of the subscription price applying to copies not yet mailed. Please send change of address notices or complaints to Fulfillment Manager; subscription orders to Circulation Manager, Electronics, at address below. Change of address notices should provide old as well as new address, including postal zip code number. If possible, attach address label from recent issue. Allow one month for change to become effective.

Postmaster: Please send form 3579 to Fulfillment Manager, Electronics, P.O. Box 430, Hightstown, N.J. 08520.

# five important reasons to specify the **KEPCO JQE** power supply

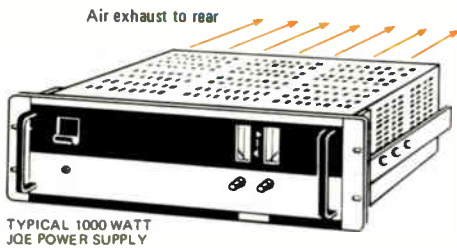

- **JQE deliver their rated output right up to +71°C** without any derating whatever. Moreover, they run cool! Internal blowers actually help circulate the air in your system to keep hot spots from developing.  
**YOUR MECHANICAL PEOPLE WILL APPRECIATE THIS.**

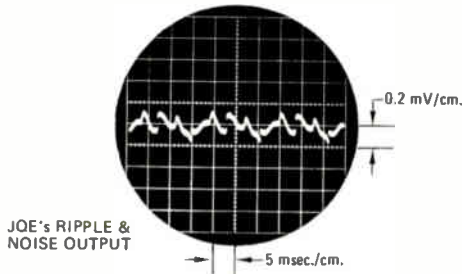

- **JQE produce clean d-c**, less than 0.2 mV rms ripple and noise (1.0 mV p-p including spikes up to 10 mHz). The output varies less than 0.0005% for the worst sort of line variation, and long-term drift is less than 0.01%.  
**YOUR LOAD WILL APPRECIATE THIS.**

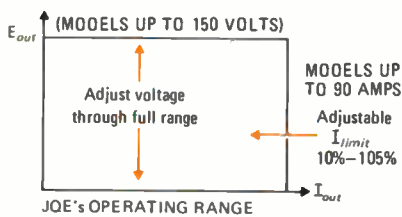

- **JQE are wide-range instruments.** Every JQE can be set from zero to its rated output. What's more, they all have one *additional* volt capacity so that wire drops do not subtract from the voltage available to your load. Buy a 0-15V model to cover the 5V, 6V, 8V, 10V, 12V and 15V loads. A 0-36V model to take care of 18, 24, 28, 32 and 36V jobs.  
**YOUR BUDGET WILL APPRECIATE THIS.**

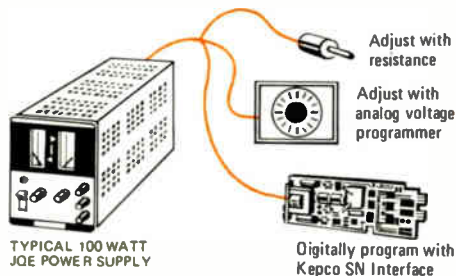

- **JQE are fully programmable**—by resistance (1000Ω/volt) or by voltage (any gain ratio you choose) or by parallel binary or BCD logic. That means you can easily interface your JQE with a computer control bus. (Use the Kepco SN Programmer)  
**YOUR SYSTEM WILL APPRECIATE THIS.**

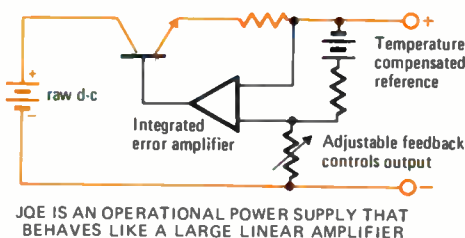

- **JQE are linear voltage stabilizers**—which means that JQE are a lot simpler and more reliable than switching machines. (You get a 5-year warranty.) A linear JQE will respond in microseconds to a load shift; will maintain its low output impedance into high frequency pulsed loads; produces no RFI/EMI and doesn't hack up the power line like SCR types.  
**YOUR NEIGHBORS WILL APPRECIATE THAT.**

## JQE

is a premium quality voltage stabilizer for the no-compromise job

Write Dept. V-14 for the new Kepco Catalog and Handbook.

**KEPCO**®

131-38 SANFORD AVENUE • FLUSHING, N.Y. 11352  
(212) 461-7000 • TWX #710-582-2631

# INTERESTED IN HIGH EFFICIENCY POWER SUPPLIES?

## ABBOTT HAS THE ANSWER

Abbott Transistor Laboratories manufactures three complete lines of hermetically sealed, switching regulated power supplies. These rugged and dependable power modules have already found wide use in many military, aerospace and industrial applications. All units are designed to meet the EMI requirements of MIL-STD-461 and the environmental requirements of MIL-STD-810.

**77%**  
EFFICIENT



**60 Hz to DC  
model VN**

Abbott's Model VN series converts 47 to 440 Hz AC lines to any DC voltage between 4.7 and 50 VDC at output powers of 25, 50 and 100 watts. Line and load regulation are controlled to 0.4% with a peak-to-peak ripple of 100 mV. Efficiencies of 77% are achieved with power densities of greater than 1 watt per cubic inch.

**70%**  
EFFICIENT



**400 Hz to DC  
model UN**

Designed to operate from 380 to 420 Hz AC lines, Abbott's Model UN series offers output powers of 25, 50 and 100 watts at all popular voltages between 5 and 50 VDC, including  $\pm 12$  and  $\pm 15$ . The full load operating temperature range is  $-55^{\circ}\text{C}$  to  $+100^{\circ}\text{C}$ . Peak-to-peak ripple of 100 mV and load regulation of 0.5% are just a few of the standard features of this line of 70% efficient power modules.

**70%**  
EFFICIENT



**DC to DC  
model BN**

Wide range DC inputs of 20 to 32 VDC can be accommodated by Abbott's BN line of high efficiency DC to DC converters. All popular output voltages between 5 and 50 VDC, including  $\pm 12$  and  $\pm 15$ , are available at output power levels of 25, 50 and 100 watts. 0.5% line and load regulation, 100 mV peak-to-peak ripple and  $-55^{\circ}\text{C}$  to  $+100^{\circ}\text{C}$  operating temperature range are a few of the standard features of the BN line.

Complete electrical specifications, size charts and prices for these units are listed in our new 60 page free catalog. Also listed are 12 additional line of power modules, including —

60  $\text{A}$  to DC  
400  $\text{A}$  to DC  
DC to DC  
DC to 60  $\text{A}$   
DC to 400  $\text{A}$

For immediate complete information on Abbott Modules, see pages 1037-1056 Vol. 1 of your 1975-76 EEM Catalog or pages 612-620 Vol. 2 of your 1975-76 GOLD BOOK.

**abbott**

**transistor**

LABORATORIES, INCORPORATED

Send for our  
new 60 page  
FREE catalog —

**GENERAL OFFICES**  
5200 W. Jefferson Blvd.  
Los Angeles, CA. 90016  
(213) 936-8185  
Telex 69-1398

**EASTERN OFFICE**  
1224 Anderson Ave.  
Fort Lee, N.J. 07024  
(201) 224-6900  
Telex 13-5332

## Readers' comments

### PMs decrease reliability

**To the Editor:** Another factor affecting reliability of electronic systems besides component reliability [Oct. 2, p.91] is preventive maintenance. As a matter of policy, many large systems have PM periods scheduled daily, weekly, monthly, every 500 hours, etc., in which they are shut down to see if they are working properly.

In such systems with frequent PMs, the reliability is inversely proportional to their frequency. The fundamental law of reliability is that the number of failures will approach the number of PMs as the lower limit.

The best policy is: if it works, let it alone. Electronic systems are not built strong enough to withstand PMs. Their reliability can be enhanced if they are designed so that operation can be checked without disconnecting any cables or otherwise disassembling them.

This may not necessarily apply to mechanical systems where there is unavoidable wear or pollution.

J. J. Kush

APO San Francisco 96245

### No one told the mosquitoes

**To the Editor:** Unfortunately, almost all of the electrical and electronic novelties that claim either to repel mosquitoes [Oct. 2, p. 48] or to destroy them in great quantities are useless when dealing with female mosquitoes.

I am enclosing a copy of "Evaluations of an Electronic Mosquito Repelling Device," by Frederick W. Kutz, from Mosquito News, December 1974—one of a number of reports that deals with the subject.

Lee H. Goldberg

Winnipeg, Manitoba

■ Reprints are available from Kutz at the technical services division, office of pesticide programs, U.S. Environmental Protection Agency, Washington, D.C. 20460.

### 1975 index is available

The index of articles in Electronics in 1975 can be obtained by circling 340 on the reader service card.



# Understanding the most revolutionary Signal Generator of our time.

Learn how the feature-packed Fluke 6011A gives you new levels of capability and flexibility.

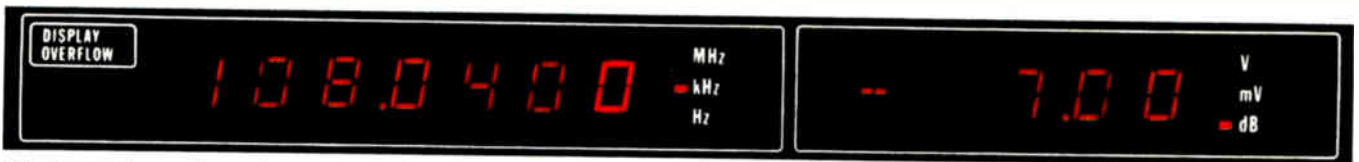

Storing and recalling nine different frequencies and amplitudes is just the tip of the iceberg. Fluke's new 6011A is loaded with features and functions to save users' time and cut costly measurement errors. A microprocessor calculates most of the computations you once worked.

**Edit Control** lets you easily modify your frequency or amplitude with a simple turn of a dial. After you "call up" or enter a setting, change any decade—indicated by the bright digit—using the edit control. Increment or decrement with complete carry-over and borrow capability. What's more, a recalled frequency or level may be modified without changing the original stored entry.

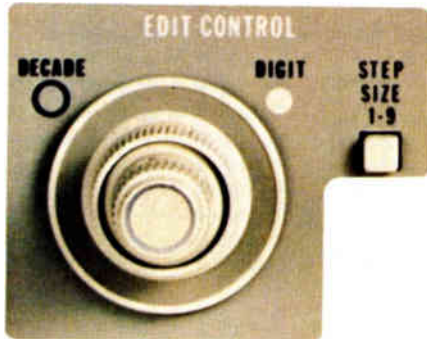

The **Reference Mode** lets you add or subtract frequencies or levels relative to previously entered references.

For frequently used settings, **Memory Mode** not only stores and recalls frequency and amplitude combinations, but remembers output and modulation settings as well. **Level Limit** eliminates damage to sensitive devices. An operator can't use an output greater than a pre-programmed "safe" limit.

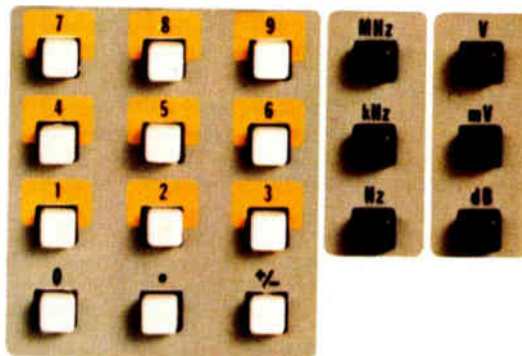

Take a look at the keyboard. You'll like free form entry of volts, millivolts, dBm, Hz, kHz and MHz. And for memory tasks, you'll like storage through the numeric keys for nine combinations of output settings. Recall settings in any order by simply pressing the appropriate button.

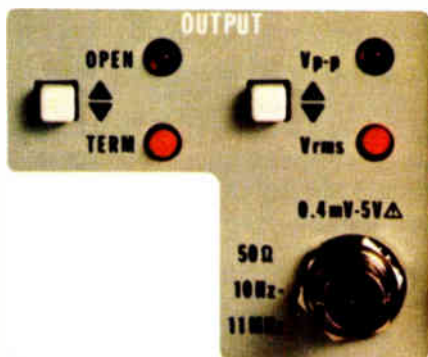

Simplify testing by defining the output in terms of volts peak-to-peak or rms volts terminated in 50 ohms or open circuit. An rms sensor controls the output accuracy to better than  $\pm 0.05\text{dB}$ . Frequency response is flat to within  $\pm 0.025\text{dB}$  from 100 Hz to 5MHz.



U.S. price for the 6011A is \$3995. That's 40% less than remotely comparable instrumentation.

## Arrange a demonstration. Get more information.

To arrange a demonstration or get data out today, in the continental U.S. dial our toll-free hotline 800-426-0361. If more convenient, call your nearby Fluke sales engineer or write us directly.

John Fluke Mfg. Co., Inc.  
P.O. Box 43210  
Mountlake Terrace, WA 98043

For a demo, circle # 220  
For literature only, circle # 7



# THE NEW 4151. WORLD'S FIRST MONOLITHIC IC VFC.

Raytheon Semiconductor introduces the 4151 Voltage-to-Frequency Converter. \$5 in lots of 100, versus \$30 to \$60 for other VFC's — there is no comparison. And that's not all. The 4151 comes in a standard 8-pin dual in-line package or a TO-5 metal can. The pulse output is compatible with all logic forms. It has high noise rejection, single-ended input referenced to ground. And it

provides frequency-to-voltage conversion, too. It's the simplest and most cost-effective method for analog-to-digital conversion. And Raytheon Semiconductor is the only company with a device like it.

Contact Raytheon Semiconductor or your local distributor for complete details. For your *free sample*, write Raytheon Semiconductor on your company letterhead.



## News update

■ At the end of 1974, the talk at the Chicago Fall Conference on Broadcast and Television Receivers was of digital television tuning. That was the year that the appearance of inexpensive 1-gigahertz dividers to interface with broadcast oscillator frequencies that reach 931 megahertz made the frequency-synthesis approach economically and technically feasible. One of the digital tuners displayed at Chicago was the result of a joint development effort by Plessey Semiconductors Inc. of Santa Ana, Calif., and National Semiconductor Corp. of Santa Clara, Calif. [Dec. 26, 1974, p. 26]. Now, says National, it has two customers committed to the digital tuning system. It won't say who they are, but promises that deliveries will commence in June, when set makers will introduce their own digitally tuned TV receivers.

■ Born of the need for a common language so that instruments could "talk" to each other as they acquire more skills, the proposed instrument-interface-bus standard based on a Hewlett-Packard Co. concept is inching its glacier-like way toward universal approval. Already nearing approval by the International Electrotechnical Commission and adopted by the IEEE, the standard has gained another significant backer. It has been accepted by the American National Standards Institute Inc., where it is listed as ANSI MC1.1-1975.

Most American instrument makers approve of the common standard [Sept. 19, 1974, p. 67], though one, while accepting it as a means of opening up the instrumentation industry competitively, predicts that it won't be adopted totally by instrument manufacturers for another four or five years. It will mean, predicts another, that some companies will lose captive customers, but they'll gain other customers that have been using competitive systems but will now be able to shop around.

—Howard Wolff

# If you need HYBRIDS...

## TELEPHONE HIGH BAND ACTIVE FILTER

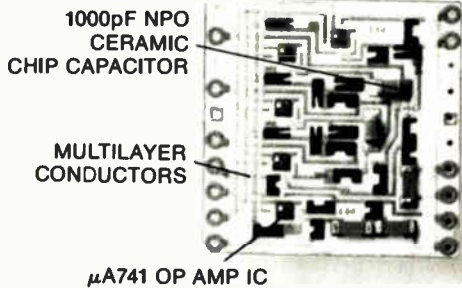

## AUDIO FREQUENCY MODULATOR

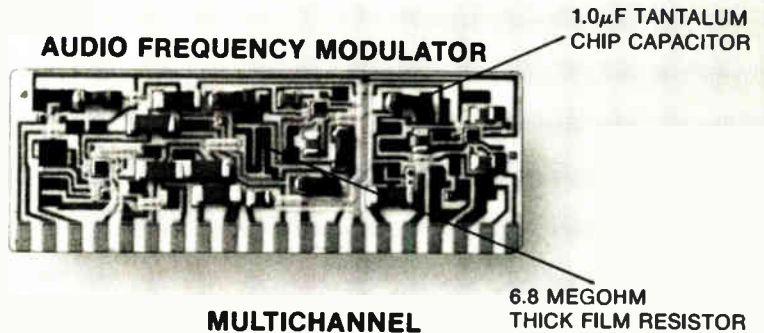

## 13-BIT MULTIPLYING DAC

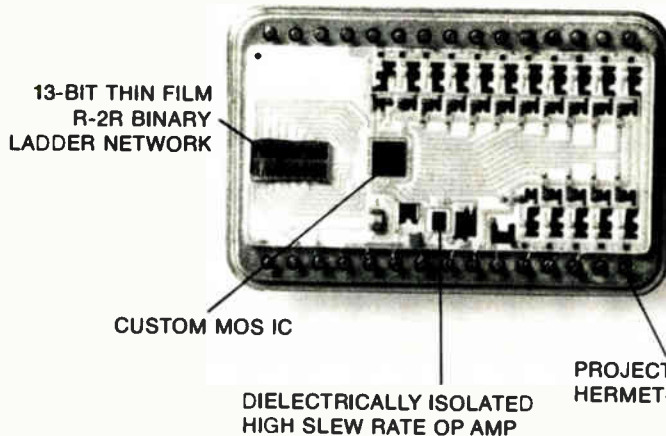

## MULTICHANNEL TIME DELAY

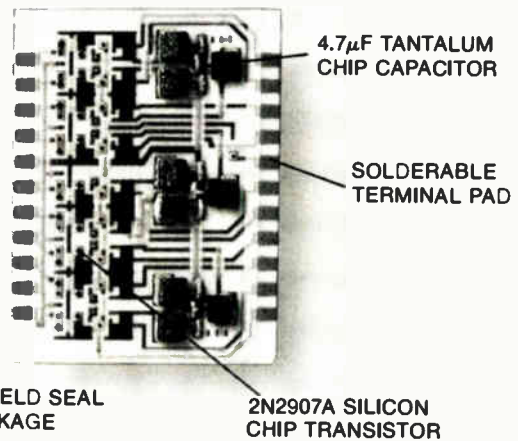

# you should know about BECKMAN!

We offer *expert* application assistance and *quality products* at *competitive prices*.

Beckman Hybrids can solve your system packaging problems in:

- Active Filters and Telephone Tone Filter/Modem products
- DACs and ADCs from Industrial to Military standards
- Power Linears from Amplifiers to Voltage Regulators
- Complex Customs from Passive Substrates to Multilayer Digital hybrids

For fast response, call (714) 871-4848, Ext. 1776

**Beckman**<sup>®</sup>  
HELIPOT DIVISION

## Why no action on the mid-career crisis?

Results of *Electronics* magazine's questionnaire on the mid-career crisis have confirmed the intensity of feeling harbored by EEs of all ages and in every job category, including those in management and supervisory positions. Yet in reviewing these results other hard questions emerge.

Essentially, these questions boil down to why engineers in electronics, despite their strong feelings about the apparent erosion of their job status, stop short of real action. For instance, if age bias is as widespread as the respondents indicate, why, in this period of militancy shown by so many other special-interest groups, have EEs remained virtually silent?

If significant numbers of engineers are yearning for an outspoken organization, a strong union or the like, to represent them in management dealings, why hasn't it happened? Have attempts to organize engineers failed, not from lack of common interest, but from lack of adequate leadership among the organizers?

Another question that many EEs themselves are raising now concerns the engineering schools. If the mid-career crisis is unique to electronics engineering, as the survey suggests, why do engineering schools continue business as usual in the knowledge that graduates will be obsolescent by age 40? Are the schools

more interested in keeping their undergraduate classrooms filled than in the down-the-road consequences to the individual students?

Compared to the number of diploma mills turning out fresh graduates, how many universities have set up solid continuing education programs geared to meet the practicing engineer's real needs? On the other hand, EEs who reported that they have taken refresher courses to help fend off obsolescence may not have been candid. Is there much evidence that engineers have been clamoring for these courses? Is there much evidence that companies have been encouraging continuing education courses at universities?

Engineers seem to be united in thought, but not on action, and they are certainly not getting much more than lip service from their traditional organizations. Indeed, a reservoir of ill will toward employers, educators, and complacent institutions that would be foolish to ignore is building up among a number of articulate engineers. Whether the potential energy of these mid-career crisis feelings can be effectively converted to positive action remains to be seen. But one crucial question stands out: when, if ever, will individual engineers really start applying pressure to their companies, organizations, schools, and Government?

# FACTORY SALE: 1 MILLION 18-PIN 4K RAM's.

One million of the best 4K RAM's money can buy. Now. First come, first served.

They're terrific.

If you'd rather not start with the whole million, we'd be happy to break the set. \$8,000 for a thousand (AM9050CPC). The best offer over \$60,000 for ten thousand.

Like the story? Wait till you read the book. Write for it and it's yours.

## The Am9050's.

A 150ns to 200ns improvement in your system cycle time compared with equivalent-speed 16-pin parts. If you don't need the speed, enjoy the safety margin.

One less clock than the 16-pin. Less noise and error in your system.

100% hot testing—functional, parametric and refresh—at worst case temperatures.

### They're plug-in replacements for the TMS4050's. And then some!

Processed to MIL-STD-883. For free.

Purely capacitive inputs that are easier to drive, eliminating extraneous current surges.

Static input circuitry for simpler timing, easier operation and better margins.

**Note:** For you 22-pin users, the Am9060 is a plug-in replacement for the TMS4060.

## Advanced MOS/LSI



Advanced Micro Devices • 901 Thompson Place, Sunnyvale, California 94086 • Telephone (408) 732-2400 • Distributed nationally by Hamilton/Avnet, Cramer and Schweber Electronics.

Circle 11 on reader service card

# This display makes oscilloscope timing measurements easier, faster and more accurate.

## Main sweep has two intensified zones.

Two intensified zones on the main sweep correspond to the two expanded, delayed sweeps shown below. They are quickly and independently positioned to provide a visual approximation of the  $\Delta$  time measurement.

## Two expanded sweeps.

Both intensified zones are expanded at a faster rate for better resolution and are swept alternately with the main sweep trace for a complete, powerful measurement display.  $\Delta$  time accuracy is enhanced by superimposing one trace over the other, yet they can be vertically separated for independent analysis.

## Sweep rates displayed digitally.

Digital crt readout displays both sweep rates for measurement ease and convenient photographic documentation. To the left is the main sweep rate and to the right is the sweep rate for the two alternate (or delayed) sweeps.

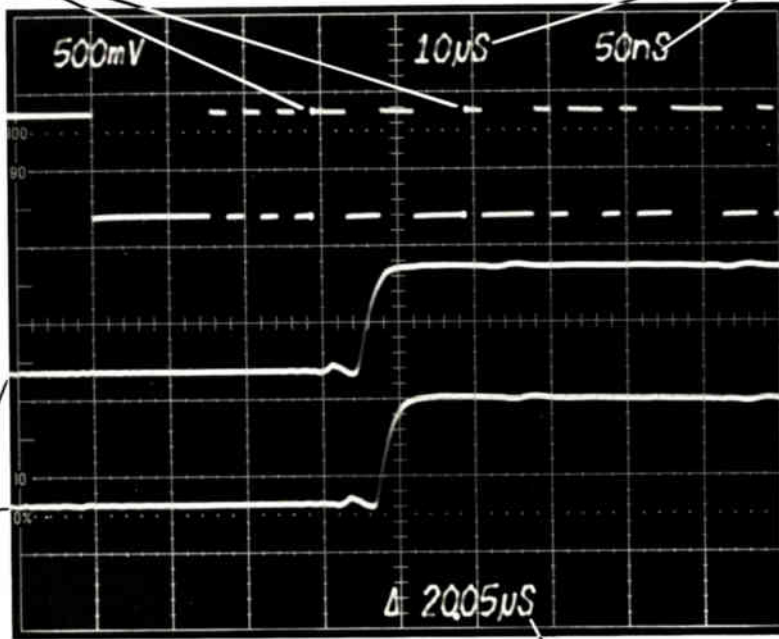

## Time difference is computed and displayed digitally.

The time difference ( $\Delta$  time) between each of delayed sweeps (or intensified zones) is digitally computed and displayed directly on the crt for swift and convenient measurement. When similar points on each of the alternate delayed traces are aligned, the  $\Delta$  time readout gives you a highly accurate measurement of the time between the points.

CRT display, photographed on a 7904 oscilloscope, shown full size.

Fill out and mail to: Tektronix, Inc., P.O. Box 500, Beaverton, OR 97077

Please send me

- The new 7B80-Series brochure
- $\Delta$  time measurement application notes.
- A catalog of 7000-Series oscilloscope mainframes and plug-ins.

Please have a Tektronix Field Engineer contact me about a demonstration.

Name \_\_\_\_\_ Position \_\_\_\_\_

Company \_\_\_\_\_ Mail Sta \_\_\_\_\_

Address \_\_\_\_\_

City \_\_\_\_\_ State \_\_\_\_\_ Zip \_\_\_\_\_

Phone ( \_\_\_\_\_ ) \_\_\_\_\_

# Only these new plug-in time bases make it possible.

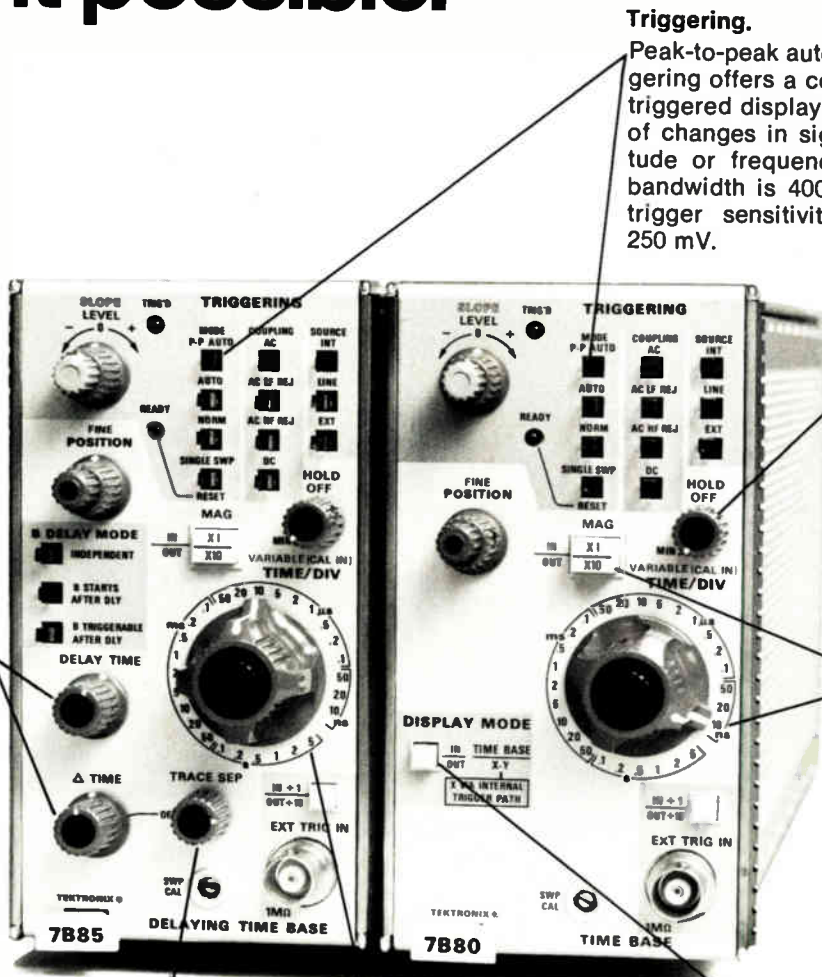

### Triggering.

Peak-to-peak automatic triggering offers a continuously triggered display regardless of changes in signal amplitude or frequency. Trigger bandwidth is 400 MHz with trigger sensitivity at least 250 mV.

### Trigger holdoff adjustable.

Variable trigger holdoff allows you to obtain stable displays on complex signals like digital data trains.

### Controls position both intensified zones.

DELAY TIME positions the first intensified zone.  $\Delta$  TIME positions the second intensified zone relative to the first. The  $\Delta$  delay time value — the time between the two intensified zones — is presented digitally on the crt.

### 7B80 sweep rates.

The alternate (delayed) sweeps can be set to any rate up to 1 ns/division on the 7B80. Naturally, other 7000 Series time bases with different performance features can be used with the 7B85 to make  $\Delta$  time delay measurements.

### Alternate traces can be separated.

TRACE SEPARATION activates the  $\Delta$  delay time mode and permits the two delayed traces to be vertically positioned with respect to each other for your most convenient display.

### 7B85 sweep rates.

Sweep rate for the main sweep can be set from 1 ns/division to 5 s/division.

### Optional X-Y mode.

For phase relationship measurements, an optional X-Y mode routes the X (horizontal) signal from an oscilloscope vertical amplifier to the horizontal sweep unit without changing input probes.

## Here's how to get more information

Your nearby Tektronix Field Engineer will be happy to show you how these new time bases combine with a 7000-Series oscilloscope mainframe and other 7000-Series plug-in instrumentation to fit your measurement needs. Just call your local Tektronix Field Office or send the coupon to Tektronix, Inc., P.O. Box 500, Beaverton, OR 97077. In Europe, Tektronix Limited, P.O. Box 36, St. Peter Port, Guernsey, Channel Islands.



**The 7000 Series...more than an oscilloscope**

For Technical Data circle 12 on reader service card  
For Demonstration Circle 13 on reader service card

Now  
you have  
a choice!

RCL

...A SECOND  
SOURCE FOR

BW's

Molded  
Wire-Wound Resistors



...AS LOW AS 5¢ EACH!

"SPECIALS" AVAILABLE

△ VALUES AS LOW  
AS .01 OHMS!

△ TCs AS LOW AS  
10 PPM!

△ TOLERANCES AS  
LOW AS 1%!

Send For New '76 Catalog Or  
Call our Hotline For Name  
Of Your Local Representative  
Or Stocking Distributor.

(603) 627-3831

AMF

RCL Electronics

195 McGregor Street  
Manchester, N.H. 03102

## People

Rosenzweig seeks society  
of telecom consultants

As new communications options become available to business-telephone users, independent telecommunications consultants are facing a potential crisis of confidence. At least Stan Rosenzweig, the president



**Warning.** Consultants must guard against bad apples, says Stan Rosenzweig.

of National Telephone Planning Corp. in Yonkers, N. Y., thinks so.

That is why he recently sent letters to some 200 consultants across the country inviting them to Denver on Feb. 15 for an organization meeting of the Telecommunications Consultants Association. Previous attempts to form an association have bogged down in petty bickering, says Rosenzweig, who adds that consultants must act now to squelch the "bad apples" who may be responsible for growing rumors of interconnect kickbacks and other unethical practices.

**Code of ethics.** Rosenzweig, who regards himself as a catalyst in trying to form the association (he has hired a professional organizer to run the Denver meeting), says he would like the association to "provide the industry with a forum to discuss professional problems, to allow the industry to speak with a single voice, and to develop standards of

ethics and competence that previously have been lacking."

"There are three types of 'consultants' in this industry," says the 34-year-old former New York Telephone Co. communications consultant.

"The salesman is no problem because everyone knows he is a salesman. Then there is the professional consultant who is competent and has the right attitude and who believes in building his business through good service."

The problem is with "that group in the middle—the guy who says 'Don't show me what you've got, I know it's wrong,'" continues Rosenzweig. "Many of them aren't really consultants. They either have some arrangement with someone who sells equipment, or they tell the client to cut out 20 phones, take some money, and three months later, the client has to call the phone company and tell them to put the phones back because he finds he can't do business without them."

"There are people like that who will still practice," says Rosenzweig, "but they won't be members of the association. There are good guys and bad guys in every industry. It's time the good guys got together and did something about the bad guys."

Young EE's ideas to  
alter AMI's direction?

Because of the work of a 27-year-old research engineer, American Microsystems Inc. in Santa Clara, Calif., is on the verge of committing itself in a big way to V-MOS—an n-channel metal-oxide semiconductor technology that will compete with the new, faster and denser bipolar static designs and processes.

The engineer is T. J. Rodgers who, as a doctoral candidate in electrical engineering at Stanford University in nearby Palo Alto, invented the V-groove MOS process [*Electronics*, Sept. 18, p. 65]. His goal was to push MOS technology to





# From General Electric New Transient Protection Manual

New 112 page manual combines in one publication theory, knowledge and experience relating to transient cause, detection and protection accumulated by General Electric scientists and engineers...includes a comprehensive selection guide and product specification sheets for determining the optimum GE-MOV® Varistor.

Copies are available from any authorized GE distributor, GE OEM Electronic Components Sales Office, or by sending \$2.50 plus applicable tax to General Electric, Semiconductor Products Department, Electronics Park, Bldg. 7-49, Syracuse, New York 13201.

**GENERAL  ELECTRIC**

# Pulse withstand capacitors for colour T.V.

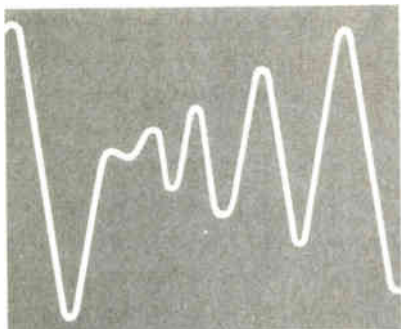

## WIMA FKP 1

Polypropylene film and extended foil electrode capacitors encapsulated in cast resin. Self-healing properties. Suitable for sharp-edged or short rise time pulses in thyristor deflection circuits.

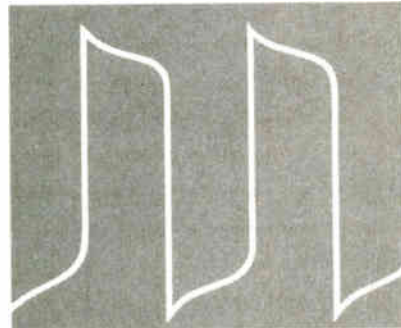

## WIMA MKC 10

Metallized polycarbonate capacitors. Particularly suitable for stringent pulse and surge conditions. Low power factor at high frequencies. Self-healing properties. Plastic case design.

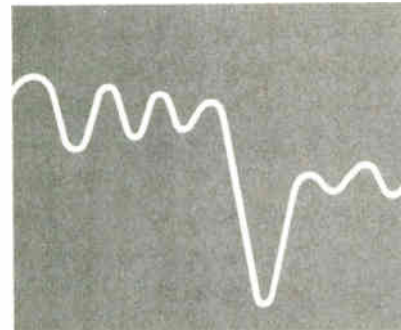

## WIMA MKP 10

Metallized polypropylene capacitors in plastic cases. Self-healing properties. Suitable for both high current and pulse circuits owing to low dielectric losses.

- Other special capacitors in metal cases.
- One year successful field experience in equipment by leading manufacturers.
- Suitable for advanced solid-state equipment.
- For professional electronics.



## WILHELM WESTERMANN

Spezialvertrieb Elektronischer Bauelemente  
D-68 Mannheim 1  
Fed. Rep. of Germany  
Augusta-Anlage 56  
P.O. Box 2345  
Tel.: (621) 40 80 12

Write for our new catalogue.

## People

its limits so it would achieve bipolar speeds as well as high speed-power products and high packing densities in read-only and static random-access memories, random logic and microprocessor designs.

**Hobbyist's knowledge.** He came to Stanford in 1970 with double degrees in physics and chemistry from Dartmouth College but with scarcely more than a hobbyist's knowledge of transistors. By the beginning of his second year, however, he had developed a V-groove process for bipolar circuits that solved many of the problems Raytheon Semiconductor Inc. had encountered with its V-ate air-isolation process. "My idea was a good one," says the quiet, self-confident Rodgers, "but it soon became apparent that Fairchild had a better one with its oxide-isolated Isoplanar process."

He then turned his attention to MOS and after accumulating a thick notebook and "a hundred lousy ideas," the pieces of the V-MOS structure fell into place. Two years' more work culminated in an award-winning paper on V-MOS at the 1974 International Solid State Circuits Conference in Philadelphia.

Five minutes after he gave the paper, AMI's vice president of technical development, J. Donald Trotter, invited him to coffee. A little later there was lunch with James Early, Fairchild Semiconductor's director of R&D, and offers of employment from Intel Corp.

**First devices.** Over the past 15 months, AMI has built prototype devices that achieve significantly higher density and higher speed than conventional n-MOS structures, according to Rodgers. He will describe the first of these devices—a 5 volt, 200-nanosecond, 16,384-bit ROM—in a paper at the ISSCC in Philadelphia next month.

"The major hurdle that V-MOS faces," says Rodgers, "is the test of LSI yield. If it passes that test, there will be a wide variety of high-density, high-speed V-MOS LSI parts." And this is what AMI is about to determine.



# MEASUREMENT COMPUTATION

innovations from Hewlett-Packard

# NEWS

JANUARY 1976

## Measure AC volts, DC volts, AC current, DC current, and ohms with NEW autoranging digital multimeter—\$225

HP offers a new compact 3½ digit, five-function, fully autoranging digital multimeter at a low price achieved through a major technological advance. Development of fine-line, tantalum nitride resistor technology has eliminated the use of more costly discrete precision resistors. This not only reduces the cost but improves the reliability and temperature stability.

Typical accuracy for dc voltage measurements is 0.5%. Dc current accuracy is 1.0%. On ac voltage ranges, fre-

quency is specified to 10 kHz, while ac current measurement is to 5 kHz.

Voltages can be measured from  $\pm 100$  microvolts to  $\pm 1000$  volts dc and from 300 microvolts to 700 volts rms dc. Resistance is measured from 1 ohm to 11 megohms. Current can be measured from 100 microamperes to 1.1 ampere dc and 300 microamperes to 1.1 ampere ac. Autozero, autopolarity and autoranging are built in.

*(continued on third page)*

### in this issue

New microwave switch for signals DC-18 GHz

Into the data domain with Logic State option

Measure binary and code errors with new digital test set

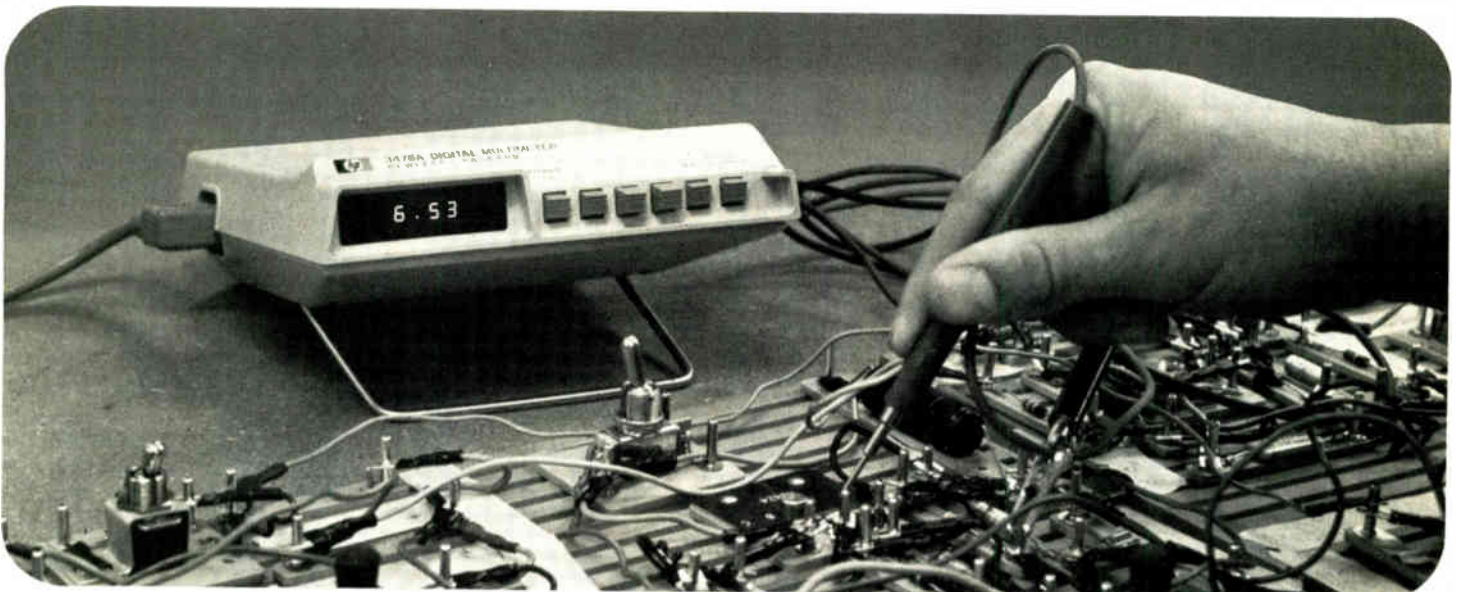

The 3476A/B with autorange is a faster, easier way to measure current, voltage, and resistance. It offers you measurement confidence by combining capability, convenience, and low cost.



The programmable calculator's capabilities are extended with such added peripherals as the 9862 graphic plotter.

## More design time available when you verify network results with desk-top calculator system

Hewlett-Packard offers a broad line of calculating equipment and design techniques so that you no longer must plod through hand calculations and pencil annotations in order to verify network results right at your desk.

The HP 9830, utilizing BASIC, has the power and memory of a mini-computer without the inconvenience and expense often encountered. Plug-in read-only memories (ROMs) perform functions with the R/W memory without reducing memory size.

Verify hardware performance prior to committing to expensive prototypes. To graphically see the effects on circuit performance as you change component values, add an HP 9862A X-Y plotter to your system.

A new Application Summary, "Circuit Analysis on the HP 9830" describes the hardware and software necessary for such design applications as ac analysis, dc analysis all with calculator-aided design.

For your copy, check N on the HP Reply Card.

## Graphically enhance your calculator system with an HP 9862A plotter

Adding the HP 9862A plotter to your calculator system provides hard copy graphic solutions to problems solved by any of the 9800 series programmable calculators. Whether your applications require the production of graphs under total program control or by manually entering data coordinates through the calculator, the 9872A provides fast, accurate transformation of tabulated data into meaningful graphics.

Features of the plotter include the use of disposable ink pens facilitating the rapid changing of ink colors plus the ability to plot on any paper up to 10 x 15 inches.

Maximum plotting versatility is obtained with a plotter ROM which provides complete alphanumeric capability, X-Y axis generator, automatic function scaling and special symbol plotting. The end result is a finished plot that is completely titled, scaled and labelled.

For more information, check O on the HP Reply Card.

## Display baseband amplitude response with new accessory for microwave link analyzer

Measurement capability in the baseband (BB) region is now possible with the new HP 3744A BB Sweeper Accessory for use with an HP microwave link analyzer (MLA) having a center frequency of 70 MHz, and the newly-introduced 140 MHz IF MLA, (Model 3790A/3792A).

It is now convenient to perform swept level baseband measurements in the range 100 kHz to 15 MHz. The BB sweeper accessory allows the MLA to display the BB amplitude response of a microwave radio system. The 3744A can measure flatness of a system with an accuracy better than 0.1 dB.

Small and compact, the instrument consists of three operationally independent sections—transmitter, receiver and attenuator.

The 3744A allows local, remote or simultaneous two-way measurements to be made. The BB sweeper also has a range of connector options, allowing it to interface with HP MLA connector options and existing link equipment.

For more information, check C on the HP Reply Card.

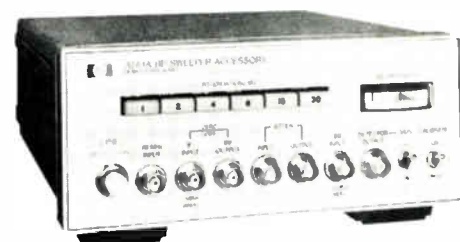

Baseband sweeper accessory accepts BB frequencies up to 15 MHz.

## Measure AC volts, DC volts, AC current, DC current, and ohms with NEW autoranging digital multimeter

*(continued from first page)*

Repetitive measurements can be completed faster with the range hold feature that allows the instrument to be locked to any desired range. The LED readout gives all voltage readings in volts, all resistance readings in kilohms and all current readings in amperes.

Model 3476A is ac line powered only; Model 3476B is ac line powered and also includes rechargeable nickel cadmium batteries.

Both units measure 6.5 cm (2.3 in) high, 16.8 cm (6.6 in) wide and 26 cm (8.1 in) deep. Model 3476A weighs 0.7 kg (1 lb. 9 oz.) and Model 3476B weighs 0.91 kg (2 lb.)—small enough to fit into your attache case or your pocketbook.

*To learn more about this easy-to-use, compact multimeter, check A on the HP Reply Card.*

## Fully protected, low voltage dc power supplies

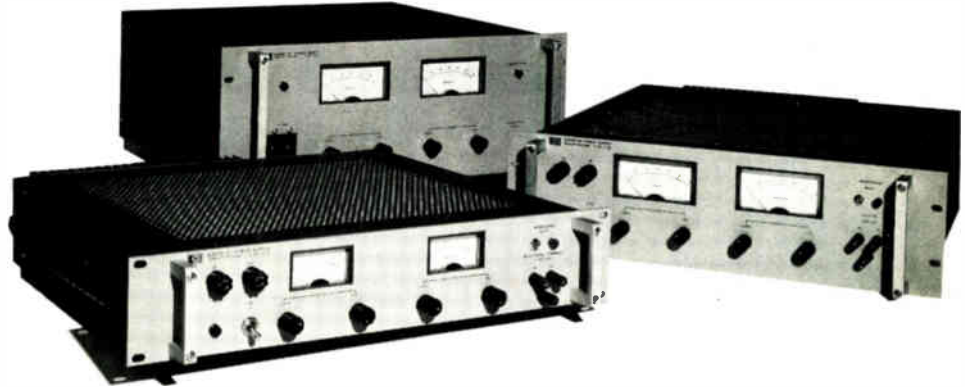

HP's fully protected low-voltage dc supplies come in power ratings from 120 to 2000W.

If your system power requirements call for a dc supply with superior performance and the benefits of built-in overvoltage and overcurrent protection, take a close look at HP's family of low-voltage rack supplies.

These supplies boast load and line regulation of 0.02%, with less than 10mV peak-to-peak ripple and noise, and full load efficiencies from 54% to 80%. Output voltage and maximum current limit are fully adjustable, while the overvoltage crowbar trip point can be independently set between approxi-

mately 10 and 110% of rated output voltage. Other advantages include automatic crossover between constant-voltage and constant-current modes, remote programming, and remote sensing.

This power supply product line includes 13 models (6256B through 6274B) covering four output voltage ratings: 10V at 20, 50 or 100A; 20V at 10, 20, or 50A; 40V at 3, 5, 10, 30, or 50A; and 60V at 3 or 15A.

*For additional information, check J on the HP Reply Card.*

## Fast, accurate TTL and ECL testing with a single pulse generator

HP's full-capability Model 8082A is the *one Pulse Generator* answer for all fast bipolar logic testing requirements. 250 MHz repetition rate with transition times **variable down to 1 ns** offers unparalleled performance to engineers working with ECL circuits and systems. In addition, its full 5 volt output (into 50 ohms) and speed reserves to cover future, faster designs make the 8082A an ideal choice for TTL applications.

Complementing its speed, the Pulser also brings new precision to high speed logic testing. Its **low-reactance 50 ohm source** absorbs 98% of all reflections from signals up to 4 volts. The result?

Clean pulses, not just from the generator but at the IC input, where you need them, even *without a terminating resistor*.

Switch-selectable fixed ECL levels, square wave mode to 250 MHz, and a human-engineered front panel that minimizes the chances of incompatible control settings, further contribute to making your high frequency pulse testing faster, easier, and more precise than ever before.

Note: for lower speed applications consider HP's lower cost Model 8007B with 100 MHz, 2 ns speed.



Sampling scope display of 8082A's 1 ns rise-time output pulse.

*For more information on HP pulse generators, check K on the HP Reply Card.*

## Any scope in this family with the Logic State gold button can put you into the data domain

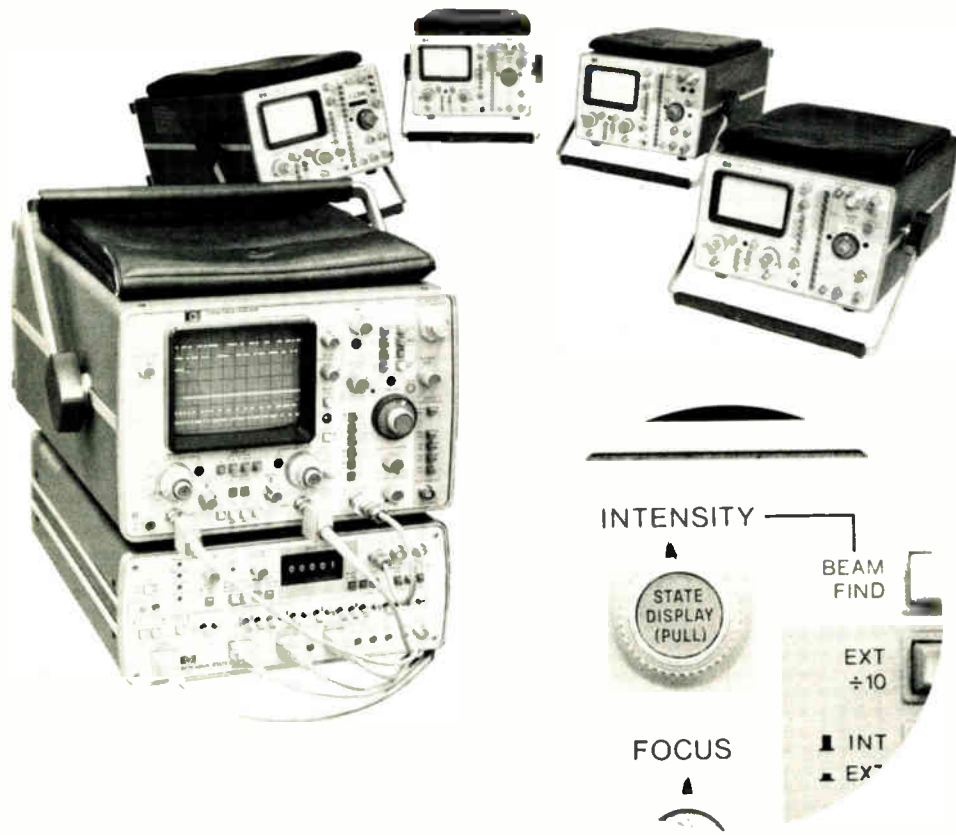

Now, you can display both functional and electrical measurements with the same instrument.

Pick any one of these HP scopes. Add the optional Logic State Switch, (Option 101) and the 1607A Logic State Analyzer, and you have an economical and convenient way to time-share the display between traditional time-domain measurements and the new data domain.

Select the data domain and your scope's CRT displays the results of your measurements in 1's and 0's. Select time domain and you have a display of electrical waveforms.

Data domain capability is an option available for the above scopes. Reading left to right, pictured are the:

**1740A 100 MHz** The third channel trigger view allows you to see the trigger signal simultaneously with the other two channels.

**1722A 275 MHz** Dual-delayed sweep, microprocessor and LED display in this scope giving you direct 3½-digit

readout of time, frequency, voltage and relative amplitude expressed in percent.

**1712A 200 MHz** Low-cost scope gives you the measurement convenience and accuracy of dual-delayed sweep, and scaled voltage output for direct readout of time intervals on your DVM.

**1720A 275 MHz** Here's real bandwidth value in a dual channel scope featuring exceptionally stable triggering.

**1710B 200 MHz** General purpose scope with dual-delayed sweep.

Pick the scope that best fits your needs and your budget. Then add the 1607A Logic Analyzer. Include the Logic State Switch Option and you're ready to begin tackling problems in both the time and data domain.

For additional details, check B on the HP Reply Card.

## Four new sweeping Application Notes

Applications that capitalize on the versatility of the new HP 8620C Sweeper mainframe and its wideband RF plug-ins are described in several new application notes:

*AN 187-2, "Configuration of a 2-18 GHz Synthesized Frequency Source Using the 8620C Sweep Oscillator,"* describes a calculator-controlled, phase-locked system whose stable signals can be easily set with high resolution. Program listings for HP calculators are included. (AN 187-1 covers the same topic for the 8620A mainframe). For your free copy, check R on the HP Reply Card.

*AN 187-3, "Three HP-IB Configurations for Making Microwave Scalar Measurements,"* uses the HP 436A Power Meter, 8755 Frequency Test Set, or 8410B Network Analyzer as the measurement partner of the 8620 sweeper for reflection and transmission measurements. Advantages and trade-offs of each alternative are discussed. The Hewlett-Packard Interface Bus permits these tests to be automatic; sample programs are included. Check S on the HP Reply Card.

*AN 187-4, "Configuration of a Two-Tone Sweeping Generator,"* presents a system which generates two swept signals offset by a very stable fixed frequency. Such a system is extremely useful for testing broadband mixers and receiver front-ends; the difference frequency (or IF) can be anywhere from 10 to 300 MHz. This system can sweep test from 2-18 GHz using two HP 86290A/8620C sweepers. Check T on the HP Reply Card.

*AN 187-5, "Calculator Control of the 8620C Sweep Oscillator,"* gives detailed information on the simple programming that puts the 8620C sweeper operation under calculator control. An example shows how to set operating frequencies with high precision by adding a frequency counter as the feedback element. Check U on the HP Reply Card.

## New high sensitivity sensor measures microwave power to $-70$ dBm

Combining ultra-high sensitivity and low SWR, the new HP 8484A Power Sensor further extends microwave power measurements down to  $-70$  dBm (100 picowatts).

The new sensor is compatible with both the HP 435A analog power meter and the new HP 436A digital meter. Now, in conjunction with the 8481A sensor ( $-30$  to  $+20$  dBm) and 8481H ( $-10$  to  $+35$  dBm), a measuring range of 105 dB is available from 10 MHz to 18 GHz.

The important contribution of low barrier Schottky diode technology is the very low SWR which resulted, without sacrifice of sensitivity. Since the LBS diodes are so consistent, excellent match to a 50 ohm line is achieved without padding. SWR is 1.3 at 18 GHz (1.2 over 30 MHz to 10 GHz). Such low SWR substantially reduces overall measuring error, and nicely complements the high instrumentation accuracy of the 435A and 436A power meters.

The sensor is designed to minimize thermal drifts, a critical factor when measuring extremely low power levels. An individual calibration factor curve is attached to each unit. Rugged design allows overload limits to 200 mW.

Absolute calibration is achieved at  $-30$  dBm by measuring the 1 mW calibrator signal available on the power meter using a highly accurate, low SWR, 30 dB, 50 MHz accessory pad (HP 11708A furnished).

*For a data sheet, check M on the HP Reply Card.*



Measure power from 100 pW to 10  $\mu$ W over a frequency range of 10 MHz to 18 GHz with new 8484A power sensor.

MEASUREMENT & COMPUTATION NEWS

## Now, eight channels of tape recording on quarter-inch tape

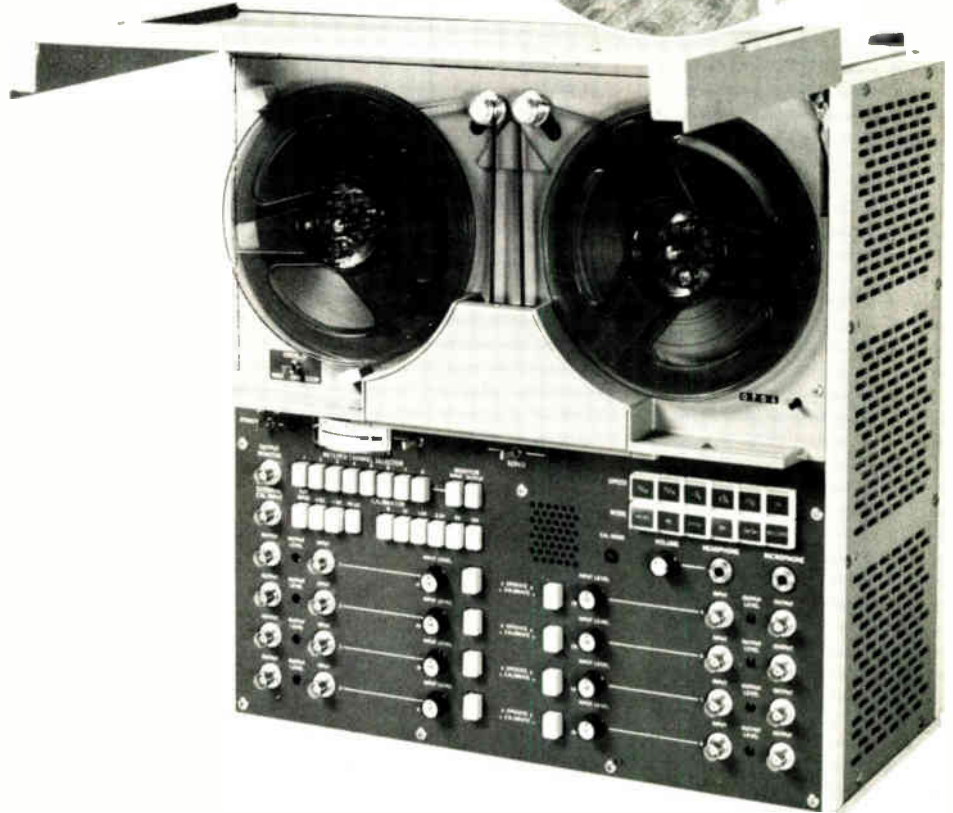

The 3968A is designed and packaged to meet the demands of the individual or OEM user.

The new HP 3968A Instrumentation Tape Recorder offers you significant benefits usually found in much larger tape systems. Eight channels of data collected on  $\frac{1}{4}$ -inch tape provide significant savings including lower cost per reel, minimal storage space, and availability from many sources.

Capable of FM and Direct recording/reproducing, with six tape speeds from 15/32 ips to 15 ips, this recorder performs in a large assortment of applications—medical, chemical, geological, engineering, oceanographic, and scientific research.

Standard features include remote control and status of all tape speeds and operational modes, internal AC/DC

calibrator, tape/tach servo mode, and flutter compensation. Flutter compensation is available with the flip of a rear panel switch. The FM signal-to-noise ratio can be improved up to 12 dB in this mode.

In addition to recording data, channel eight may be interrupted for voice annotation. The Electronics-to-Electronics mode (FM only) automatically transfers the input to the output, bypassing the heads when the 2968A is in fast forward, rewind, or stop.

*For a full color brochure with detailed specifications, check E on the HP Reply Card.*

## Quality control or troubleshooting with automatic x-ray system

Now, you can look inside encapsulated components, pinpoint defects in electronic assemblies, castings, or quickly view registration problems in PC boards right at your workbench with the HP 43805 cabinet x-ray.

Automatic exposure control simplifies operation of the unit. Place your object inside the fully radiation-shielded cabinet; the voltage setting is indicated to the operator. An ion sensor determines the correct exposure time and turns the machine off when sufficient radiation has reached the film.

The unit has adjustable output voltage from 10 to 130 kVp with 3 mA current, ensuring good contrast over a range of thicknesses and densities.

High resolution films and enlarge-

ments are possible or Polaroid prints can be produced in seconds.

*Check H on the HP Reply Card.*



Use x-rays to pinpoint defects in small intricate devices, occlusions in castings, critical points in contacts, relays, or connectors.

## Ruggedized Cesium Standard for on-board applications



Operating temperature range:  $-28^{\circ}\text{C}$  to  $+65^{\circ}\text{C}$ . Ruggedness: passed the 400-lb. hammer blow test under operating conditions.

The Hewlett-Packard 5062C Cesium Beam Frequency Standard offers both the precision of the best lab standard with the ruggedness of military hardware in a compact package. It maintains  $3 \times 10^{-11}$  accuracy over a wide operating temperature range and requires only 20 minutes of warm-up time even from  $-28^{\circ}\text{C}$ .

With a calculated MTBF of 25,000+ hours, the 5062C is highly serviceable. Twelve critical circuits are monitored by the front panel meter. The unit is  $5\frac{1}{4}$ " high and will fit into a standard 19" rack. The basic 5062C weighs 50 lbs.

This new frequency standard is ideally suitable for navigation, communication, guidance systems, among other on-line system applications where high performance in field environments is required.

Optional digital display clock and standby battery available at extra cost.

To receive complete technical data, and a copy of the just-off-the-press Application Note 52-2, "Timekeeping and Frequency Calibration," check G on the HP Reply Card.

## Extend test equipment measurement range with these RF amplifiers

When RF measurements between 100 kHz and 1300 MHz are limited by sensitivity or power output, it's quite likely one of the HP 8447 series of broadband lab amplifiers can help. There are low-noise preamps spanning 100 kHz-400 MHz, 100 kHz-1300 MHz, and 400-1300 MHz. Power amplifiers covering 30-300 MHz and 100 kHz-1300 MHz are offered. These solid state units all feature high gain of 20 dB or more and flat frequency response.

Use the preamps to improve the effective sensitivity of such instrumentation as RF voltmeters and power meters, spectrum analyzers, oscilloscopes, and frequency counters. Dual-channel preamps are especially useful with wideband scopes and network analyzers.

The power amplifiers provide a simple convenient way to boost the output of RF signal sources and sweepers to above 20 mW.

Send for details on these general purpose amplifiers. Check L on the HP Reply Card.



Use the HP 8447 preamp with a spectrum analyzer to make accurate measurements of low-level signals.



## New low noise microwave transistor

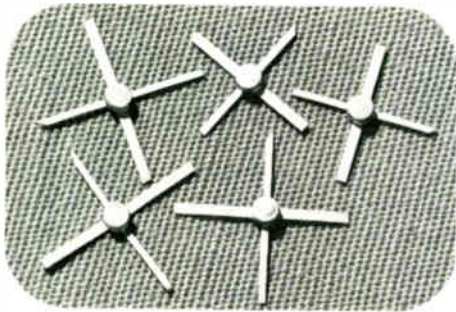

New transistors offer guaranteed tuned gain in rugged confined metal/ceramic package.

The new HP 35868 series is an NPN bipolar transistor optimized for low noise and high gain at 4 GHz. The 35868L features a guaranteed noise figure of 4.5 dB max at 4 GHz with a minimum associated gain of 7 dB. Typical  $G_a$  (max) is 14 dB at 2 GHz and 10 dB at 4 GHz.

Gain and noise are specific and guaranteed under fixed optimum source and load impedance conditions simplifying the designer's job in extracting the maximum performance possible from the device.

For detailed specifications, check Q on the HP Reply Card.

## Now, four bright colors in subminiature solid state lamps

Choose from red, high efficiency red, yellow or green solid state lamps encapsulated in a radial lead subminiature package of molded epoxy. The 5082-4100/4150/60/90 series offer long life with solid state reliability.

High on-off contrast and wide-angle viewing are provided by the use of a tinted, diffused lens. The low-profile package and 2.21 mm center-to-center spacing are features of interest if you are working with space restrictions.

Arrays are available in a molded linear configuration with separately accessible radial leads for each device. Center-to-center spacing is then 2.54 mm.

For additional details, check F on the HP Reply Card.

Maximum average forward current for red lamps is 50 mA; 20 mA for high efficiency red and yellow, 30 mA for green.

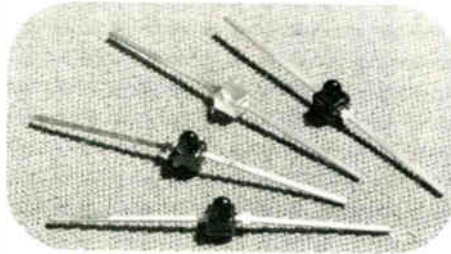

## New microwave coaxial switch with 90 dB isolation at 18 GHz

A new microwave switch is available which provides single-pole, double-throw action for signals from dc to 18 GHz. The HP 33311B is distinctive because it features internally-switched 50 ohm loads which maintain a low-SWR match for the ungated secondary port. The switch has isolation greater than 90 dB at 18 GHz, important for applications requiring wide dynamic range.

The new switch is designed using "Edge-Line" transmission line techniques and switches only the center conductor to yield typical repeatability of  $\pm 0.03$  dB after 1,000,000 switchings. SWR is 1.4 and insertion loss is 0.8 dB at 18 GHz and the switch is usable to 24 GHz. The 33311B will handle 1 watt average with 100 W peak, and connectors are SMA.

The switch mechanism is self latching using a permanent magnet and provides special contacts which disconnect the coil after the switching operation, minimizing heat dissipated in the unit. Coil voltages are available for both 5 and 24 volts, and momentary energizing power is approximately 3 watts. Switching time is 30 mS.

The small size (5.5 x 7 x 1.5 cm) and environmentally rugged construction makes the 33311B particularly well-suited for designing into microwave instruments and systems.

For detailed specifications, check P on the HP Reply Card.

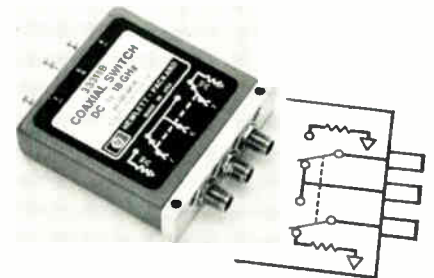

DC-18 GHz SPDT coaxial switch has internal matching loads.

## LED digits for watches

In response to the high consumer demand for digital watches, Hewlett-Packard is currently shipping digits to several major watch manufacturers and willing to consider special digit requirements from other watch producers.

Also being developed is a new family of LED digits for watches. These digits which are scheduled for introduction this year have been designed to meet the specific needs of manufacturers of solid state watches. The digits will be

available in a variety of sizes and character styles.

Hewlett-Packard is able to do this because of our in-house materials capability, long experience in producing large quantities of digits for the calculator market, and our computer testing techniques.

Direct your inquiries to Hewlett-Packard Opto-electronics Division, 640 Page Mill Road, Palo Alto, CA. 94304.

# New 50 Mb/s digital transmission test set for PCM/TDM systems

The 3780A Pattern Generator/Error Detector is a new bit-by-bit error measuring set. Data is provided at standard levels in both ternary-coded (AMI, HDB3, B6ZS, etc.) and binary format. Clock recovery, and frequency offset generation and measurement facilities are available at three internal crystal frequencies. The crystals can be chosen to cover measurements on the first three levels of the PCM hierarchies for CEPT, North American and Japanese systems.

Random or systematic binary errors are measured by stimulating the system under test with a PRBS pattern. The output of the system is compared bit-by-bit with a separate, internally generated error free pattern and any errors present are counted. Random errors can also be counted using Word patterns. Both binary errors and code errors can be counted over a chosen gating period and displayed directly as bit error rate or total error count.

Clock recovery performance evalua-



The 3780A Pattern Generator/Error Detector is a complete 1 kb/s to 50 Mb/s error measuring set in one portable package.

tion can be carried out using the zero add facility in the 3780A. For testing  $4\phi$ PSK digital radio systems, an additional data output, 6 bits advanced on the main data output, is provided. Pattern-sensitive problems in digital transmission and terminal systems can be investigated with the selectable 4-bit or,

optionally, 16-bit Word patterns. Unattended long-term measurements are possible by using the BCD printer and/or strip chart recorder outputs.

*For more details, check D on the HP Reply Card.*

**HEWLETT**  **PACKARD**

East-4 Choke Cherry Road, Rockville, MD 20850  
Ph. (301) 948-6370.  
South-P.O. Box 28234, Atlanta, GA 30328,  
Ph. (404) 434-4000.  
Midwest-5500 Howard Street, Skokie, IL 60076,  
Ph. (312) 677-0400.  
West-3939 Lankershim Blvd, North Hollywood, CA  
91604, Ph. (213) 877-1282.  
Europe-P.O. Box 349, CH-1217 Meyrin 1, Geneva,  
Switzerland, Ph. (022) 41 54 00.  
Canada-6877 Goreway Drive, Mississauga, Ontario,  
L4V 1L9, Ph. (416) 678-9430.  
Japan-Yokogawa-Hewlett-Packard Ltd., Ohashi  
Bldg., 59-1 Yoyogi, 1-chome, Shibuya-ku,  
Tokyo 151, Ph. 03-370-2281/92.

# “Cold Trap”<sup>\*</sup> cuts solvent loss up to 50% in open top vapor degreasing

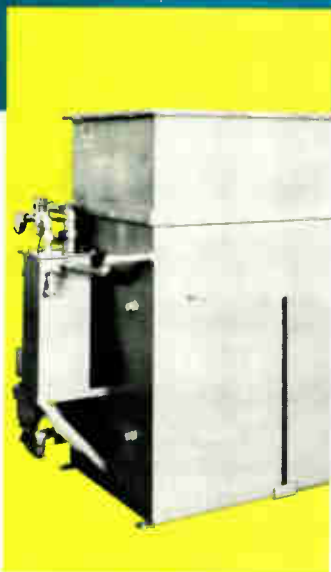

\*Baron-Blakeslee's "Cold Trap" is covered by U.S. Pat. No. 3,375,177

## —in addition, elimination of exhaust systems saves waste of costly heating/cooling energy

The Baron-Blakeslee "Cold Trap" system puts a super-cooled blanket of air over the solvent vapor in an open tank parts cleaner. Solvent emissions into the surrounding air are reduced as much as 50%. Result? Your cleaning operations with a Baron-Blakeslee open tank degreaser keep solvent emissions into the air *below* accepted OSHA and EPA levels.

You not only save up to 50% of your cleaning solvents lost in the air, but you eliminate costly exhaust systems. Without these exhaust systems which *remove thousands of cubic feet of heated/cooled air* from your

plant each hour, you realize additional substantial energy savings.

Investigate the very real savings in solvents and reduced heating/cooling energy that this Baron-Blakeslee "Cold Trap" system can mean in your open top parts cleaning operations. (You can also include it on conveyORIZED cleaning systems.)

WRITE TODAY for full details.



**Baron-Blakeslee**

1620 SOUTH LARAMIE AVE., CHICAGO, ILLINOIS 60650  
Nationwide Manufacturing & Distribution Facilities  
OFFICES IN ALL PRINCIPAL CITIES

Circle 27 on reader service card

# HIGH RELIABILITY



Get the **high reliability** that eliminates trouble. RN DIP sockets make contact with the wide, flat sides of your IC leads. This provides **100% greater surface contact** for positive electrical connection.



# DIP SOCKETS **for the price you're paying for junk!**

**Robinson Nugent "side-wipe" DIP sockets make 100% greater contact than any edge-bearing socket on the market.**

This 100% greater contact with the wide, flat surface of your IC leads is your guarantee of unmatched reliability. This RN "side-wipe" contact provides constant low contact resistance. No edge-bearing contact can possibly deliver this long term dependability. This designed-in reliability of RN DIP sockets is your assurance of trouble-free IC interconnects—yet they cost no more than ordinary sockets.

**Put an end to troublesome junk sockets!** Write today for catalog and informative book "What to Look for in IC Interconnects." It's free from RN—the people who make more kinds of high reliability IC sockets than anyone.

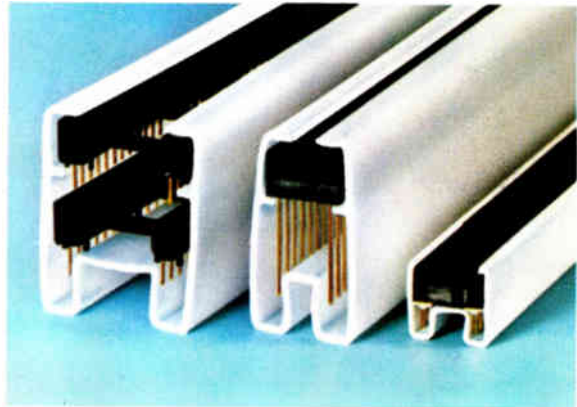

**They're even packaged for high reliability.**

"Protecto-pak"® packaging delivers consistently perfect RN sockets to your production line—for automated or manual assembly.

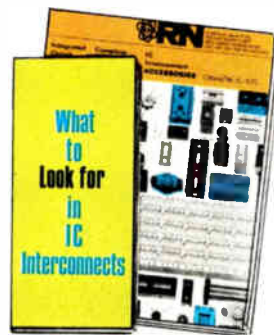

# **RN** **ROBINSON NUGENT, INC.**

800 East Eighth Street • New Albany, Indiana 47150 • Phone: (812) 945-0211

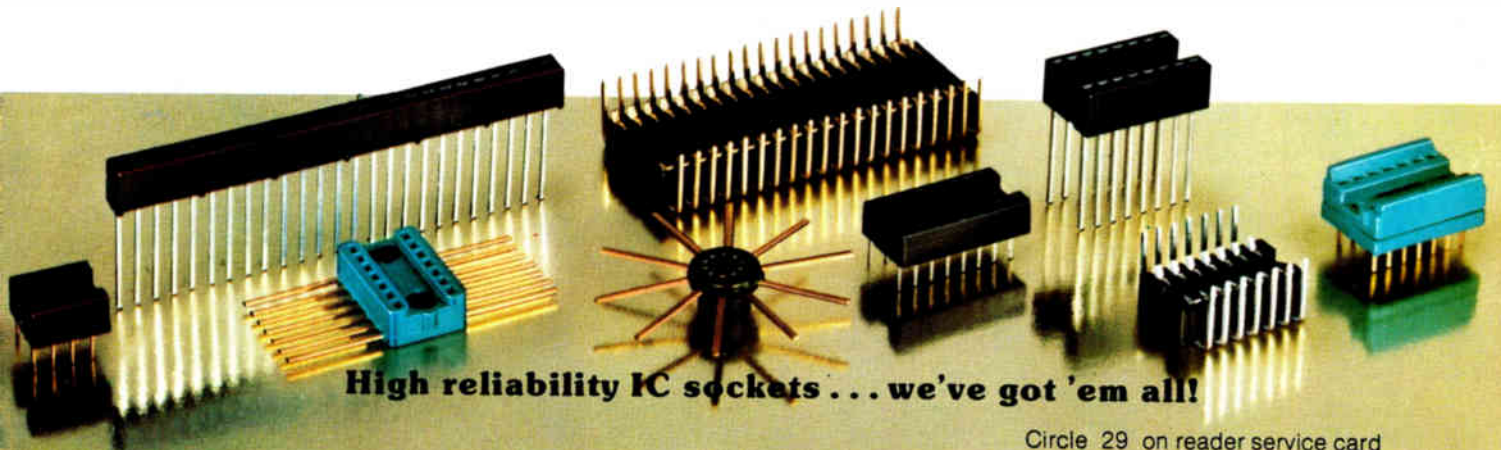

**High reliability IC sockets . . . we've got 'em all!**

Circle 29 on reader service card



## Let's face it. People do judge by the cover.

Even the most sophisticated customers can't help being influenced by the way a product looks. That's why we're so careful about the design of our Optima enclosures. Because first impressions count.

Of course, we think about more than styling when we build our enclosures. We also design them with enough strength to last indefinitely. And we provide for just about any optional feature you might want. Detachable panels, chassis slides, hinged doors and the like.

The point of it all is real, honest quality. Optima enclosures are probably the very best you can buy. And they look it. And most important, that's how they can make your product look.

For a better idea of the broad range of Optima enclosures, ask for our color catalog.

### OPTIMA

Write Optima Enclosures, a division of Scientific-Atlanta, Inc.  
2166 Mountain Industrial Blvd., Tucker, Georgia 30084 or call (404) 939-6340  
For Cabinets Circle 30 on Reader Service Card  
For Racks Circle 203 on Reader Service Card  
For Consoles Circle 204 on Reader Service Card

### Own your own holder to hold your own!

Hold your own copies of Electronics in specially designed slipcase holders. They'll keep your Electronics library neat and handy—a permanent information file, issue by issue.

Just complete the coupon and mail to Jesse Jones. He'll process your order upon receipt, postpaid.



**ELECTRONICS BOXER**  
Jesse Jones Box Corporation  
2250 E. Butler St., Philadelphia, Pa. 19137

Please send me:  boxes @ \$4.25 each;  3 boxes @ \$12.00;  6 boxes @ \$22.00.  
My check or money order is enclosed.

Name: \_\_\_\_\_

Address: \_\_\_\_\_

City: \_\_\_\_\_ State: \_\_\_\_\_ Zip: \_\_\_\_\_

## Meetings

**Wincon—Aerospace & Electronic Systems Winter Convention, IEEE, Sheraton-Universal Hotel, North Hollywood, Calif., Feb. 18-20.**

**ISSCC-76, International Solid State Circuits Conference, IEEE, Sheraton Hotel, Philadelphia, Feb. 18-20.**

**Comcon Spring, IEEE, Jack Tar Hotel, San Francisco, Feb. 24-26.**

**Nepcon '76 West and International Microelectronics Exhibition, Industrial & Scientific Conference Management Inc. (Chicago, Ill.), Anaheim Convention Center, Anaheim, Calif., Feb. 24-26.**

**Federal DP Expo '76 (Data Processing in the Federal Government), Instrumentation Fair Inc. (Beltsville, Md.), Sheraton Park Hotel, Washington, D.C., March 2-3.**

**ACM Conference on Programing Micro/Minicomputers, Association for Computing Machinery (New York, N.Y.), Delta Towers Hotel, New Orleans, March 4-6.**

**IECI '76—Industrial Applications of Microprocessors, Process Measurement, and Failure Mode Analysis, IEEE, Sheraton Hotel, Philadelphia, March 8-10.**

**International Zurich Seminar on Digital Communications, IEEE, Swiss Federal Institute of Technology, Zurich, Switzerland, March 9-11.**

**Control of Power Systems Conference, IEEE, Ramada Central Convention Inn, Oklahoma City, Okla., March 10-12.**

**Ninth Annual Simulation Symposium, Society for Computer Simulation, Association for Computing Machinery, and IEEE, Sheraton-Tampa Motor Hotel, Tampa, Fla., March 17-19.**

**Eleventh Annual Meeting of Association for the Advancement of Medical Instrumentation, AAMI (Arlington, Va.), Regency-Hyatt House, Atlanta, Ga., March 21-25.**

## New from Potter & Brumfield

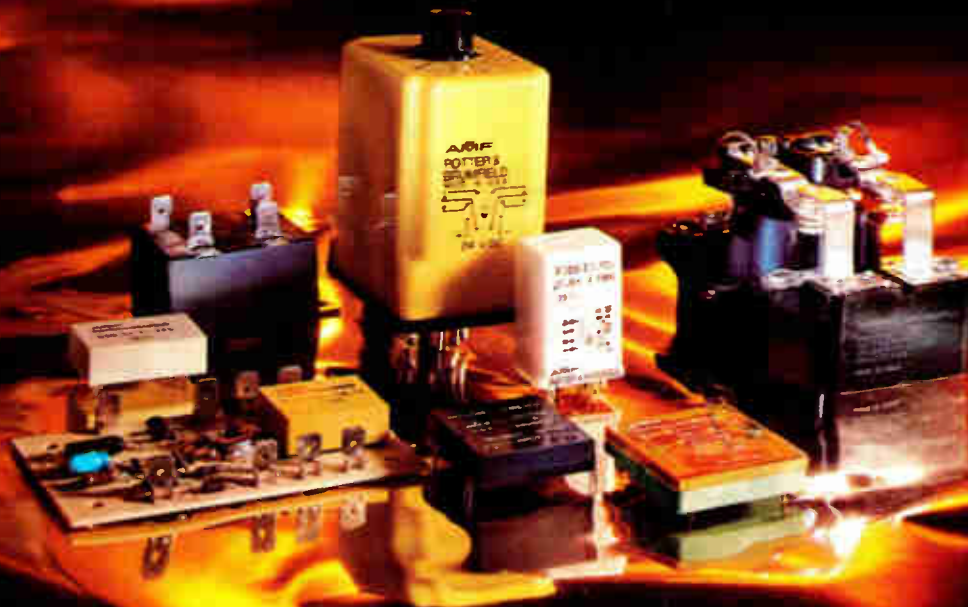

### 8 major P&B relays to solve today's design challenges.

1. R10S. Sensitivity to 5mW per pole. Available in 1, 2, and 4 Form C contacts. Ratings from dry circuit to 3 amps. Less than \$3.00 in lots of 500.

2. R50 relays. Help you solve cost and space problems. Less than \$2.00 in quantity, the R50 allows 0.6" center-to-center pc board spacing.

Coil ratings of 5, 6, 12, 24, and 48 VDC. Available in 1 and 2 Form C contacts.

3. CG relay. Extended-range CMOS IC time delay or interval timer. Repeatability including first cycle is typically .01% for DC units and 0.1% for AC units. Time delays up to 100 minutes standard.

4. R16 time delay module. Offers big savings at under \$7.00 in quantities. Timing ranges, potentiometer adjustable, are 0.2 to 2, 2 to 30 and 10 to 100 seconds for delay on operate.

5. T10 series relays. Only 0.375" high. Ideal for high density applications—permit pc boards to be mounted on 0.5" centers. Two and 4 Form C contacts provide 0.1 to 3 amp switching @30 VDC. Coil ratings: 6, 12, 24 and 48 VDC.

6. JDO relays. Solid state switching with total opto-coupler isolation. Zero voltage turn on and zero current turn off minimizes EMI and RFI. Low profile

permits pc board mounting on 0.5" centers. Coil ratings: 5, 6, 12 and 24 VDC. Shockproof.

7. EOT series relays. Opto-coupled, all solid state. Solve high cyclic switching problems. Synchronous zero crossover switching virtually eliminates EMI and RFI. Output: 2, 4, 5 or 7 amps @ 120 VAC standard.

8. PRD series power relays. New improved design. Interchangeable with famous PR series. Save 50% at list price! UL and CSA listed. Rugged terminals designed for power screwdrivers.

For detailed product specifications, contact the Potter & Brumfield sales representative or authorized distributor nearest you, or write Potter & Brumfield Division AMF Incorporated, Princeton, Indiana 47671. Telephone 812-385-5251.

EUROPE: Electrical Products Group, AMF International Limited, AMF House, Whitby Road, BRISTOL BS4 4AZ.

England.  
Telephone:  
(0272) 778383  
Telex: 449481  
AMMAFOCO  
BRSTL

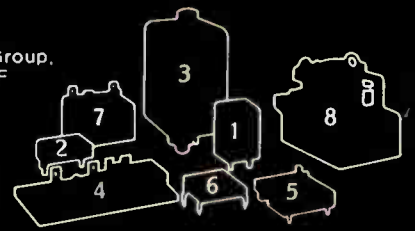

Solving switching problems is what we're all about.

Circle 31 on reader service card

# What our bottom-of-the-line

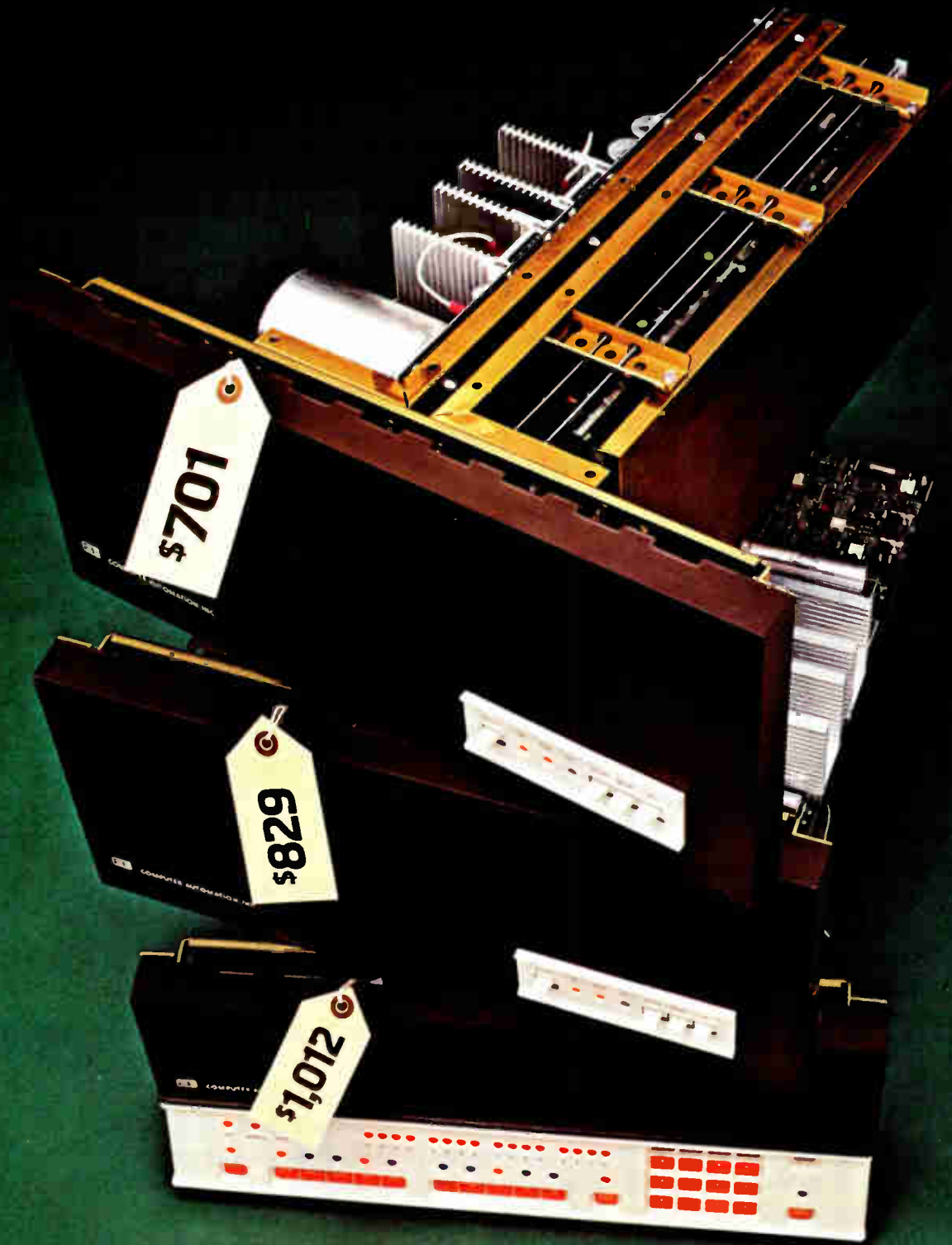

## The New ALPHA™ LSI-3/05

Introducing the lowest priced, 16-bit, full-scale, fully compatible, packaged computers in the world.



# can do for your bottom line.

Stack the new ALPHA LSI-3/05 millicomputer up against any other low-end computer.

Preferably while you're sitting down, because on price alone, you're bound to be astounded.

Ready? \$701 total packaged price. And that's complete with 256 words of MOS RAM, and a CPU that offers a really powerful instruction set, Power Fail Restart, Real-Time Clock and Autoload capability.

Try to buy an equivalent computer at twice the price.

## Have it your way.

You also get the capability to configure your computer pretty well the way you want it. A choice of packaging, of course, that includes either the Operator's or the Programmer's Console, power supplies and so on.

A choice of two standard I/O options.

And a choice of optional memory configurations that

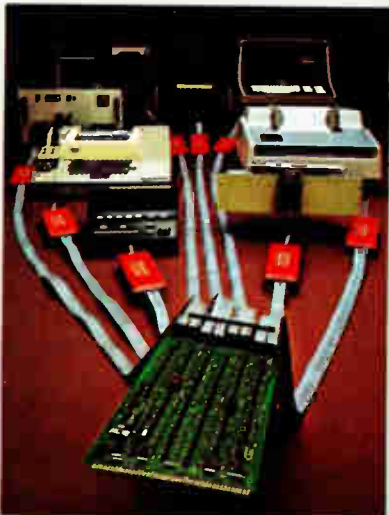

Maxi-Bus compatible ALPHA LSI-3/05 achieves unprecedented cost-effectiveness with ComputerAutomation's new Distributed I/O System.

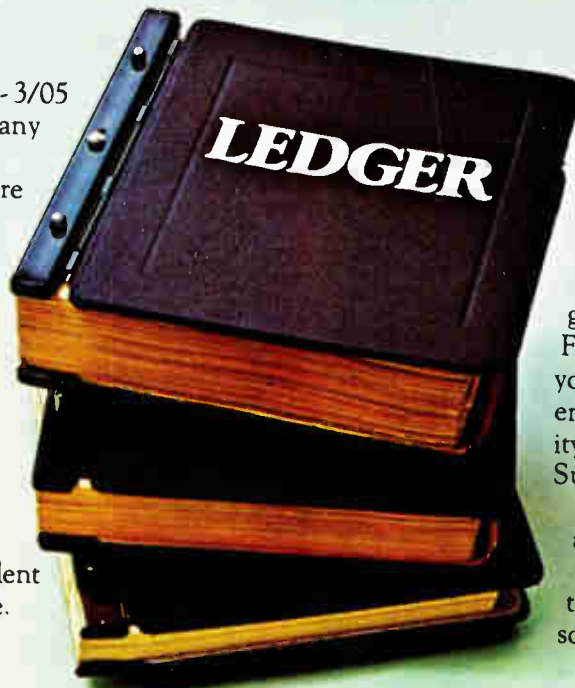

include RAM/ROM, RAM/EPROM and RAM-only in sizes from 256 words all the way up to 32K words. Totally addressable.

## Family connections save you still more money.

So far, what we've been talking about could easily add another five or six figures to the bottom line of your ledger.

But there's more. Really big savings on off-the-shelf software, peripheral controllers and I/O interfaces.

The reason is that the ALPHA LSI-3/05 millicomputer is a full-fledged member of ComputerAutomation's LSI Family... Maxi-Bus compatibility and the whole works. So, every piece of Family hardware we've ever developed will work like it was made for the ALPHA LSI-3/05. Including ComputerAutomation's exclusive new Distributed I/O System... just like you see it in the picture.

With this versatile interface system, you can interface virtually any kind or combination of peripherals. Parallel or serial. Just by plugging them in.

Your cost? Probably less than \$200 per interface.

## The pros know.

Computer-wise OEM's will tell you that product requirements sooner or later get ahead of the hardware. For instance, the computer you buy today may not have enough I/O or memory capacity for tomorrow's Mark II Super Widget.

Then you'll have to scrap all your software and your interface designs, because they're not about to work on some other machine.

You lose.

Of course, with our LSI Family of compatible computers you don't.

You can switch to a different CPU or a different memory anytime. Faster, slower, bigger, smaller. The electrical interface will still be the same; the original programming will still work.

You win.

## From the people who brought you the NAKED MINI®

And the NAKED™ MILLI.  
And the Distributed I/O System.  
And the PICOPROCESSOR.

And now the ALPHA LSI-3/05 millicomputer.

One cost breakthrough after another. Breakthroughs that didn't just happen... a lot of profits got plowed back into R&D.

But then, that's the price of leadership.

 **ComputerAutomation**  
NAKED MINI Division

U.S.A. 18651 Von Karman, Irvine, CA 92664  
(714) 833-8830

EUROPE 31/35 Clarendon Road, Watford,  
Hertfordshire, WD1, IJA England (0923) 39627

# Hot-molded resistors provide low temperature coefficient and unmatched reliability.

The Resistance Temperature Coefficient of Allen-Bradley hot-molded fixed resistors is typically less than 200 PPM over the entire resistor range shown in the normal equipment operating temperature of +15°C to +75°C. Excellent RTC ratings have always been an Allen-Bradley benefit. And consistency of Allen-Bradley resistors means repeatable results and tight performance patterns. Allen-Bradley resistors offer the **lowest cost—on the board—**where it counts!

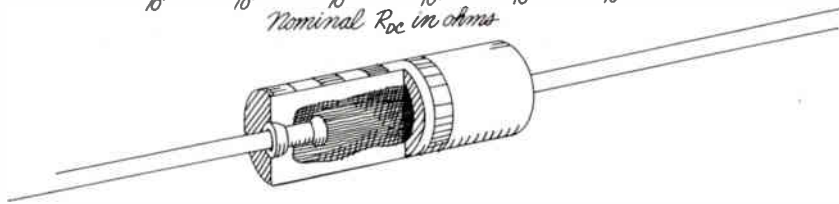
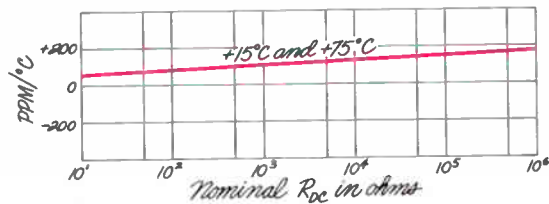

## *Reliability*

is unsurpassed. Over 700 million unit test hours without a single failure.

## *No coatings*

Insulation and resistance element integrally molded into one solid structure.

## *Pulse handling*

characteristics offer outstanding protection against surges and transients.

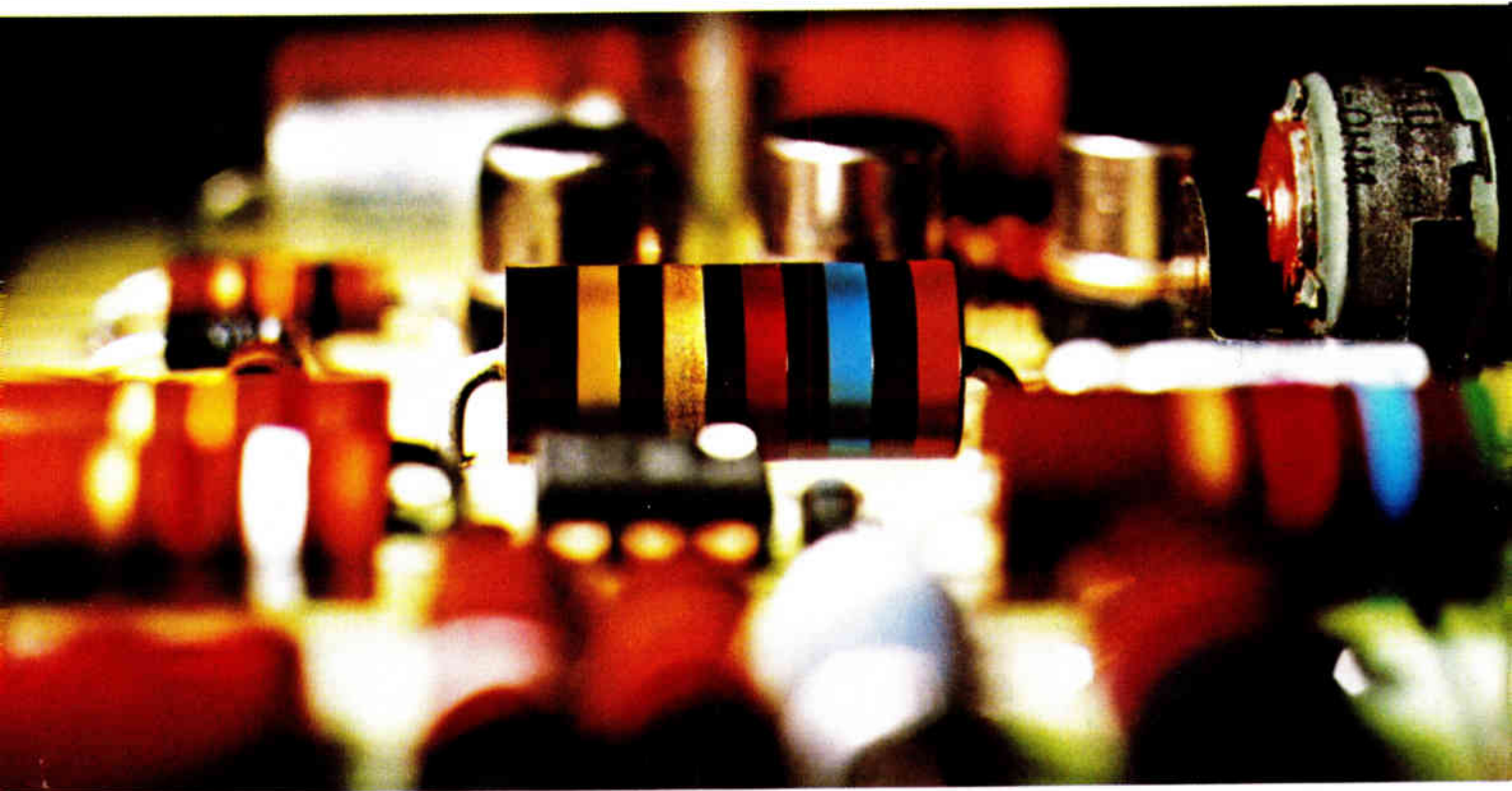

## Quality in the best tradition.



### ALLEN-BRADLEY

Electronics Division  
Milwaukee, Wisconsin 53204

EC113

## Teletext decoder for British homes built around I<sup>2</sup>L

The heart of a 14-chip Teletext decoder being tested by Texas Instruments Ltd. for television receivers in the UK is a 1,300-gate processor made with integrated injection logic. **The decoder, to be marketed in late spring for \$260, enables the viewer to receive data, such as stock tables, for on-screen display.** The processor, which transmits data pulses at 6.9375 megabits per second during the field-blanking interval of TV transmissions, is as complex as TI's SBP 0400 I<sup>2</sup>L microprocessor, but has different architecture. It has an access time of 50 nanoseconds per gate level and operates from a single power supply. The module also contains Schottky read-only memory, low-power Schottky, and n-channel metal-gate MOS circuits.

## Timex watched as timepiece prices plummet

Now that the vertically integrated digital watchmakers have brought retail prices down to the \$20 range (see p. 44), the big question is what Timex will do. The giant watchmaker is **still selling an \$80 liquid-crystal-display version** introduced last year. Dealers attending the Consumer Electronics Show in Chicago report that Timex will start shipping a \$49.95 light-emitting-diode watch in April.

"Timex could easily blow more watches through its distribution system than we could make in a year," comments one chip-maker turned watchmaker. But Timex' distribution has two steps: distributors add a markup of 15% to 20%, and retailers about 30%—so semiconductor manufacturers **doubt that the firm can meet their prices.** About 90% of the 60 million watches sold in the U.S. each year retail for less than \$50; 42% go for less than \$20.

## Air Force defers I<sup>2</sup>L, EFL study contracts

The Rome Air Development Center's Reliability Branch, the Air Force's watchdog over the semiconductor industry, will have to delay by up to six months its requests for proposals for outside reliability study contracts in several totally new areas for the branch. These include integrated injection logic and emitter-follower logic. Because of a misunderstanding between the Air Force and the Senate Armed Services Committee, **the branch has been without its own funds since last July,** and has had to operate on funds from other RADC branches [Electronics, Oct. 16, 1975, p. 25].

David F. Barber, head of the Reliability Branch, says that RFPs on study contracts in I<sup>2</sup>L, EFL, and other areas, normally out this month, may not be out until June, on the eve of fiscal year 1977. "We anticipate proper funding for fiscal 1977," says Barber.

According to Barber, the Air Force commands are already considering both I<sup>2</sup>L and EFL for use in several types of systems. "We can see a need for these types of devices in Air Force equipment."

## IBM bolsters low-end models

IBM's Atlanta-based General Systems division, source of the fast-selling System/32 small business computer system, is making a move to **strengthen its position in low-level distributed data systems.** It is doing this by giving the 32 more mass-data storage capability as well as new ability to work in distributed-data collection systems. The 32 will now be available with 13.7 megabytes of disk storage (9.1 megabytes

before) and will also be able to work with punched cards—both 80-column and 96-column versions.

A new data collection terminal, the 5320, will work with the System/32 as a remote entry station. Workers can enter information from punched cards, badges, or a keyboard for inventory control and other purposes. A third new machine from Atlanta is a model in the System/3 line, the model 4, which will **control a group of terminals in an on-line work-station environment**. The model 4 has 64 kilobytes of MOS memory and can handle up to five work-station terminals with visual displays.

## **DEC introduces first computer in new family**

A new class of mid-range computer from Digital Equipment Corp., the DEC System-20, will start shipments next month. The new model bridges the gap **between the company's top-of-the-line minicomputer, the PDP-11/70, and the low end of its higher-priced DEC System-10 line**. The new entry will sell for between \$275,000 and \$350,000, a price that puts it squarely in competition with IBM's model 370/115. Heart of the DEC System-20 is a new processor, the KL20. The 36-bit processor uses emitter-coupled logic accessing a main memory implemented in core because, says DEC, core is more reliable and cheaper than semiconductors.

Besides the KL20 processor, the system includes a PDP-11/40 minicomputer CPU to serve as a communications processor. The minimum system consists of two CPUs; 64,000 36-bit words of core with the KL20 and 32,000 16-bit words with the PDP-11; a 100 megabyte disk drive, a tape unit on the KL20 processor, and a keyboard-printer.

## **FMC, Swiss firm sign deal in power devices**

Switzerland's Brown, Boveri and the FMC Corp. of Chicago have negotiated a long-term agreement to cooperate in **development, production, and marketing of power semiconductors**. Brown, Boveri is to supply its knowhow to the U.S. firm, which will then sell the power devices made under Brown, Boveri license on the American market. The Swiss company, in turn, will offer certain FMC power components on European markets.

## **Addenda**

Honeywell Information Systems is about to bring out a new line of minicomputers aimed initially at original-equipment manufacturers in the low end of the market. The new minis, **which will use MOS memories and TTL Schottky circuits** in the central processor, will probably compete most directly with the low ends of Digital Equipment Corp.'s PDP-11 and Data General Corp.'s Nova series. . . . Taking a cue from its programable calculator, Hewlett-Packard's Avondale, Pa., division has **applied a similar magnetic-card programing technique to its newest reporting gas chromatograph**, the 5840A. Operating instructions entered through the keyboard are recorded on 6-inch-long magnetic cards, which then can program the machine in seconds, as against the usual 5 to 20 minutes. . . . The success of last week's winter Consumer Electronics Show in Chicago has induced the EIA to change its plans and **continue with a January-June show format** instead of switching to a once-a-year fixture in April. . . . Thomson CSF Laboratories Inc. of Stamford, Conn., has developed an **8-lb CCD color TV camera**. The smallest portable TV cameras now weigh about twice that.

# Elpower builds better solid gel batteries

T.M.



## and backs them with better service

### Better performance –

Rechargeable Solid Gel™ maintenance-free, no cell reversal, no memory.

**Better price –** Elpower batteries give you more power per dollar.

**Better quality –** Quality so high that the Elpower battery is guaranteed not to leak...EVER...or we replace it.\*

**Better versatility –** Elpower batteries can be operated or charged in any position; standard sizes include 6 and 12 volts, 1 AH to 24 AH.

\*If used in accordance with Elpower published instructions, available upon request

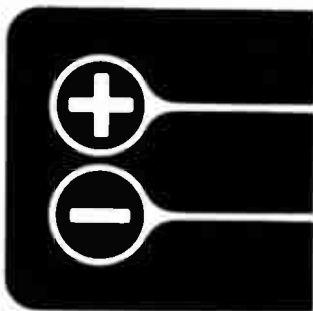

### Better technical service –

Technical service and assistance with specific applications as near as your phone. Evaluation samples available.

**Better delivery –** One week delivery on quantities up to 500 (most models).

**Better reliability –** Millions of Elpower Solid Gel™ batteries presently in service and specified by leading manufacturers of emergency lighting, alarm systems, televisions, cash registers, calculators, video equipment and others with requirements for low cost reliability.

### ELPOWER CORPORATION

Subsidiary of Eldon Industries, Inc.

Contact us or one of our many sales representatives for additional information.

2117 South Anne Street, Santa Ana, California 92704/Tele. (714) 540-6155/TWX 910 595-1934  
In Canada: Eldon Industries of Canada Inc./50 Prince Andrew Place, Don Mills, Toronto/Tele. 449-2866

If your counter looks this good...

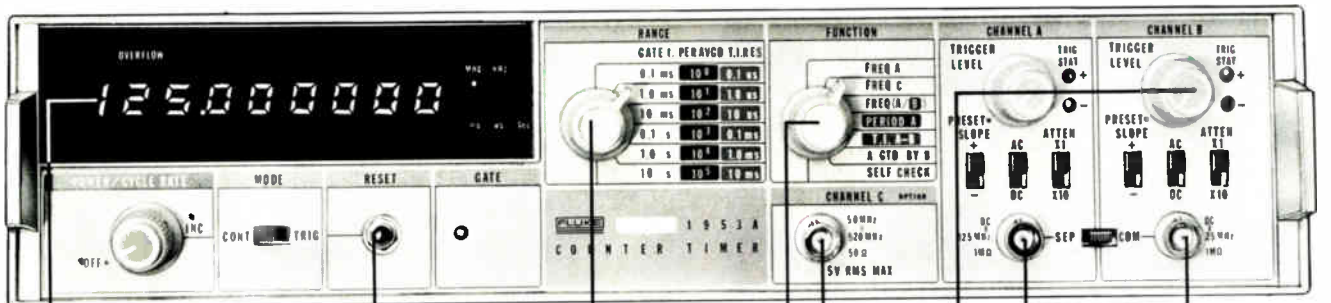

SHARP  
9-DIGIT  
LED DISPLAY

RESET/DISPLAY  
CHECK

SIX RANGES  
• Gate times  
• Period averages  
• Time interval  
resolution

CHANNEL C  
OPTION  
• 520 MHz  
• 1000 MHz  
• 1250 MHz

FULL  
TRIGGERING  
CONTROL  
• ± Status lights  
• Preset or variable  
• ± AC/DC, X1/X10

TWO INPUT  
CHANNELS  
• DC to 125 MHz  
• DC to 25 MHz

VERSATILE MEASUREMENTS

- Frequency
- Frequency ratios
- Period and period averages
- Time interval
- Gateable totals
- Self check

and gives you these options...

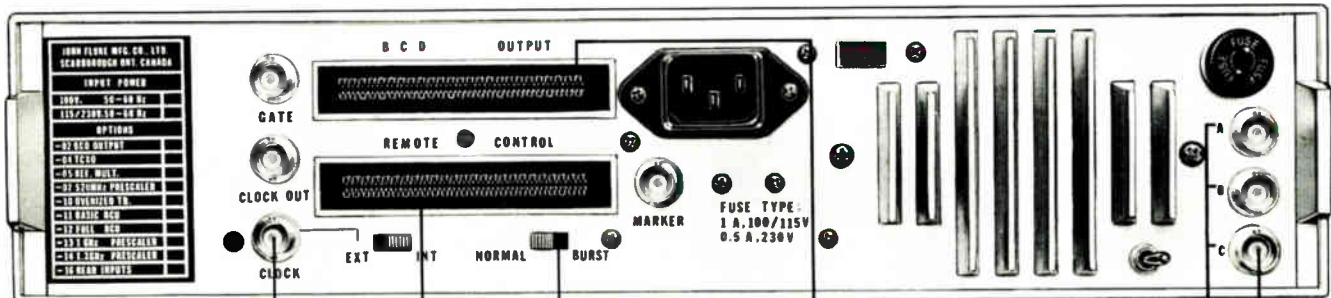

HIGHER  
ACCURACY  
TIMEBASE  
Options 04  
and 10

PRESCALERS  
520 MHz  
prescaler,  
Option 07  
1000 MHz  
prescaler,  
Option 13  
1250 MHz  
prescaler,  
Option 14

TIMEBASE  
MULTIPLIER  
Option 05

REMOTE  
PROGRAMMING  
Options 11  
and 12

BURST OR CW  
MEASUREMENTS  
Option 05

PARALLEL BCD OUTPUT  
Option 02

REAR INPUTS  
Option 16

CHANNEL C  
• 520 MHz - Option 07  
• 1000 MHz - Option 13  
• 1250 MHz - Option 14

it must be a Fluke

1953A Programmable Universal  
Counter/Timer \$99500\*

\*U.S. price FOB Buffalo, N.Y.  
Remote programming and other options extra.



John Fluke Mfg. Co., Ltd.  
P.O. Box 43210  
Mountlake Terrace, WA 98043  
(800) 426-0361  
TWX 610-492-3214

For data out today, dial our toll-free number, 800-426-0361

## Design enhancements boost performance of 8-bit microprocessors

A new company, Zilog Inc., will have first enhanced devices to handle 8- and 16-bit words next month

After a period of relative calm in which microprocessor manufacturers consolidated their existing designs, they are starting a new era of intensified design activity. They are feverishly pursuing the goal of increasing microprocessor speed and computing capabilities on two fronts. First, new and more powerful 16-bit devices have been introduced. And now, manufacturers are boosting the performance of present 8-bit designs—enhancing them to handle both 8- and 16-bit words with equal facility.

The first of the new 8-bit devices will be available, not from a leader in the field, but from a recently organized company. Next month, Zilog Inc. of Los Altos, Calif. [*Electronics*, Dec. 25, p. 25], will make available samples of its Z80 enhanced 8-bit system that is aimed not only at the industry's 8-bit leader—Intel Corp.'s 8080—but at the new 16-bit designs as well.

In addition to sample quantities of the 40-pin central processing unit, says Frederick Faggin, Zilog president, a complete hardware/software development system with a stand-alone floppy-disk-based system will be available next month.

There will be samples of a 40-pin parallel input/output and 28-pin control timer in April; a 40-pin direct memory access controller is due in June, and a 40-pin serial I/O in

September.

But Zilog won't be alone with enhanced 8-bit devices for long. Both Intel and Motorola Semiconductor Products, another leading supplier of 8-bit devices, are readying enhanced versions.

**Performance.** Faggin boasts that the Z80 system has a 5-volt depletion-load n-MOS microprocessor chip, which is capable of 25% to 100% more throughput and requires 25% to 50% less memory space than the fastest Intel chip—the 8080A—as well as being 20% faster and requiring less than half as many interface and control circuits.

The new chip will reduce memory costs, Faggin asserts. This comes, in part, from a technique “whereby the

memory address is generated very early in memory cycles, permitting the high-speed CPU to operate with standard-speed memories,” and generate all the control signals. Other cost reductions come from the Z80 component set, which needs only four general-purpose programmable I/O circuits, compared to the 8 to 10 for the 8080A.

Perhaps the most important capability of the Z80 is its repertoire of 158 software instructions, which use the same operating codes as the 8080A. The original 78 instructions of the 8080A are included, Faggin points out. “Thus, the Z80 can execute 8080 or 8080A programs stored in existing read-only memories.”

But 80 new software instructions

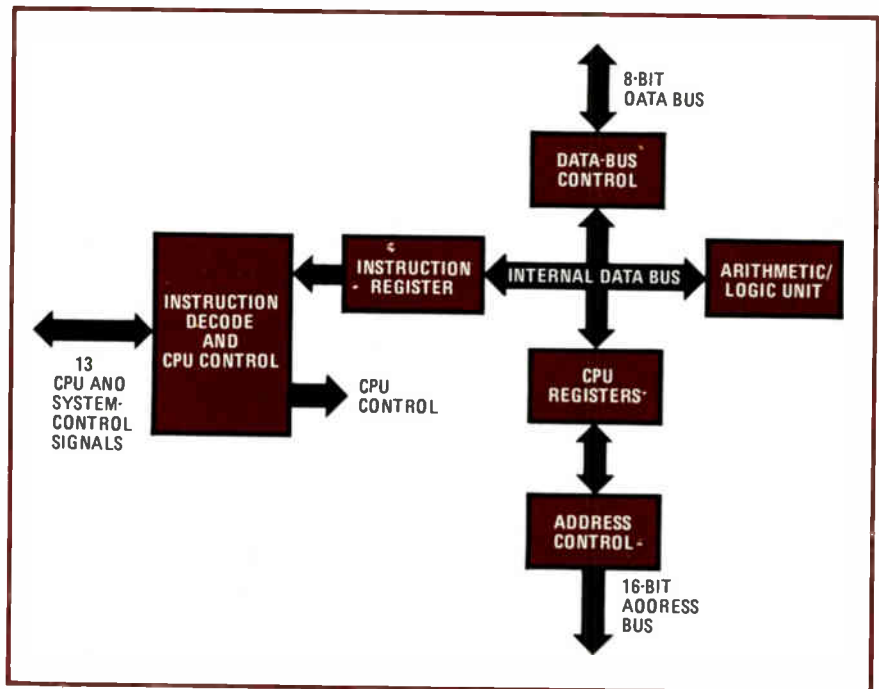

**Microprocessor enhancer.** With its 8-bit data bus and 16-bit address bus, Zilog Inc.'s Z80 central processor gives the user added information-handling capability.

provide such expanded capabilities as: additional addressing modes, including indexed and relative modes; memory-to-memory block transfers and searches; bit manipulation and testing in any register or memory site, and expanded 16-bit and binary-coded decimal arithmetic.

**Power.** The key to the power of the Z80 is the CPU, measuring 203 by 205 mils. It contains the equivalent of 8,200 devices yet is only 12% larger than the 8080A, which contains 4,500 transistors. Because it is built with depletion-load technology, like the Motorola 6800, it requires only a single +5-v power supply. In contrast, the 8080A needs -12-, -5-, and +5-v supplies. Power requirements are close to those of the 8080A—about 1 watt. A single-phase clock, rather than the two-phase approach of Intel, gives the Z80 a cycle time of 400 nanoseconds and an execution time for non-memory reference instructions of 1.6 microseconds. For the 8080A, these times are 500 ns and 2 ms, respectively.

The Z80 CPU is architecturally similar to, and retains total software compatibility with, the 8080A. But it has greater capability, such as 17 16-bit word registers (two of which are real-index registers) compared with seven or eight 8-bit registers of the 8080A. Moreover, the Z80 CPU has an internal 16-bit-wide data bus, plus external 8-bit data and a 16-bit address buses so that the chip can handle either 8- or 16-bit word lengths in one cycle. □

### Data processing

## \$500 printer uses microprocessor

A microprocessor-controlled moving printing head has so simplified the design of a high-performance electrostatic line printer that it can sell for \$500 in quantity. Axiom Corp. of Pasadena, Calif. is building this 120-line-per-minute EX-800 series printer for use in original-equipment systems. It will provide

real-time printouts for word-processing equipment consisting of video terminals linked to mini-computers.

"The most important thing responsible for the \$500 price is the fresh look we took at the market need and price," says Axiom vice president Simon Harrison. Other

line printers available range from \$1,000 up and are overly complex with "all kinds of wheels, pendulums, and gears." He and company president Stuart Spence concluded this amounted to overkill. "The simplest design would do the job" with a microprocessor-directed printer.

## Color graphics coming

Soon to be added to Grumman Aerospace Corp.'s CAT-D automated test system is the first color CRT display to diagram tests in progress.

With most systems, the operator must check the output of a line printer to find out what the machine is doing, searching for a printout of out-of-spec conditions. The cathode-ray-tube terminal developed at Grumman's Product Support department, Bethpage, N.Y., simplifies this task by presenting a diagram of the unit under test with different colors keyed to show the condition of the parts. For example, green might represent "pass;" red, "fail;" gray, "test to come," and yellow, "test in progress."

Such displays as a flow chart of a test sequence, a schematic of a circuit, or a representation similar to an assembly drawing of a printed-circuit board are possible. The terminal can display the assembly that failed and, in conjunction with software diagnosing the faults, pinpoint which test lead should be probed to locate the failed part more precisely (as shown in the photo).

Still another display diagram developed by Grumman uses the width of color bars to represent signal levels at calibration-adjustment points that interact with each other. As each point is "tweaked," the bars vary in width between upper- and lower-level limits displayed on the CRT. A circuit can be adjusted more quickly and accurately than before.

Like other new equipment for the CAT-D, the terminal is designed around the HP 9500 series test systems, but, says Grumman's John McDonald, color graphics can be added to any computer-based automated test equipment system for \$20,000 to \$50,000. Software and electrical design of the Grumman terminal are already completed; packaging design should be finished and the units ready for sale later this year, he says.

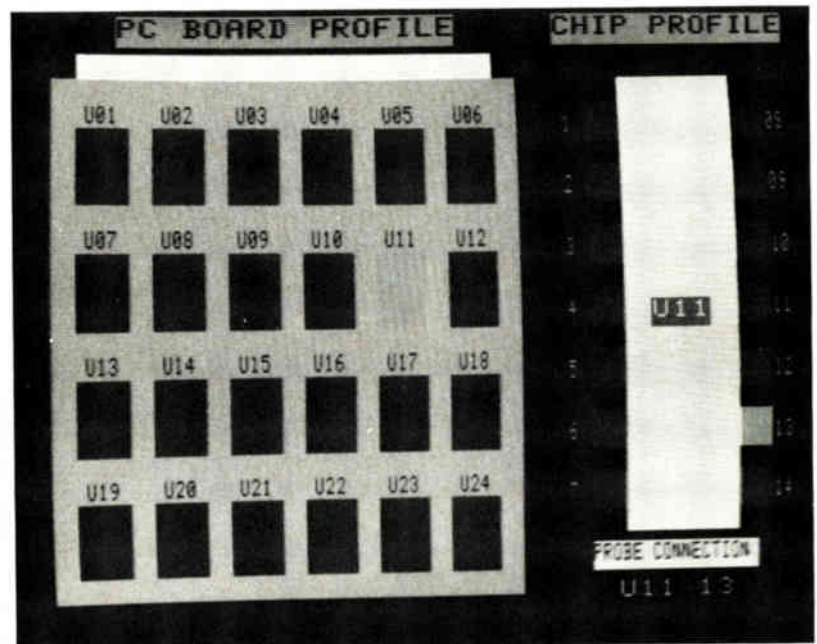



In this way, they could leave as much as possible to the microprocessor software that operates pared-down mechanical and electronic hardware. At first, they didn't anticipate the price being quite as low as \$500 in 200-plus quantities, but design and production savings added up rapidly, according to Harrison. Single unit price is under \$1,000.

**Print head is simplified.** In the Axiom printer a simple moving print head is the key, tracked for accuracy by the microprocessor that compensates for any positioning irregularities. This does away with the need for relatively expensive stepping motors and related components. An ordinary ac motor can drive the head. The microprocessor system monitors positioning by a magnetic pickup and a spinning disk attached to the cam driving the print head.

Harrison also points out that the electronic interface is equally simplified, using only six chips along with a masked read-only memory containing software. Through microprocessor control, the ROM performs a number of functions. For example, it holds the addressing code for instructions and matrix dots that generate print characters.

Axiom's first customer, Triformation Systems Inc. of Stuart, Fla., already has packaged the Axiom printer into its stand-alone equipment, primarily teletypewriters. In the past, office users of processing equipment have largely ignored electronic line printers as too costly and instead utilized Teletypes, even though they are relatively noisy and lack speed for many real-time operations.

Guy Carbonneau, president of Triformation, says he's pleased with the EX-800's low cost and reliability, but adds that the flexibility offered by microprocessor control of software ranks as an equally important feature. "It enables us to design a system around a user's specific requirements without changing any hardware," he says. As for costs, "no other printer on the market com-

petes with it," he claims, "and it's eight times faster than a teletypewriter."

In the EX-800 series, three models are available, for 20, 40 or 80 columns per line. Each comes equipped with the Intel 4004 microprocessor-controlled, 64-character ASCII interface board for directing data input and printing format and for tracking the moving head of the printer.

The printer has either parallel or serial data entry. The maximum parallel rate is 1,500 characters per second while the serial data entry is up to 12,000 bits per second. With serial entry, an input buffer can store up to 160 characters of multiline information for continuous printing.

A 5-by-7-dot matrix achieves a high-contrast printout on electro-sensitive paper costing about 1.25 cents per linear foot in OEM quantities. Completely self-contained, the nonimpact printer is 8¾ in. wide by 10½ in. deep by 4¾ in. high, including a 240-foot paper roll. □

---

## Medical

---

### Ultrasonics scans for stroke potential

Fast screening of potential stroke victims will be possible soon with a noninvasive ultrasonic scanner under development at Stanford Research Institute, Menlo Park, Calif.

Until now, the only means of diagnosing atherosclerosis, or hardening of the arteries, was through the painful and sometimes risky X-ray angiogram. Patients suspected of carrying plaque—fatty and fibrous deposits in the carotid artery near the thyroid gland—are injected with a dye opaque to X rays. Plaque can cause a stroke if it blocks the passage of blood to the brain or even restricts its flow there.

"There are problems whenever you enter the body with a foreign material, particularly with a person who has plaque," says the scanner's inventor, Philip S. Green, program

manager for ultrasonics at the institute. Questions about the safety of the angiogram have prevented its being routinely used during office checkups.

The scanner, developed jointly with the Mayo Clinic, Rochester, Minn., under the sponsorship of the National Heart and Lung Institute in Washington, D.C., relies on a water-filled, rubber bag that is attached to a wall-mounted, articulated arm. It is wrapped around the patient's neck, where the carotid artery is located. Water is used inside the bag, Green says, because it resembles tissue in its reaction to sound, leaving little room for distortion of image.

**Transducer pair.** Inside the bag, two transducers, each with its own lens, mechanically scan the artery at 15 frames per second. One transducer provides a real-time 3-by-3-centimeter picture of the artery and surrounding organs. Moreover, two-to-one magnification is available for a closer look at an area.

The other transducer provides a doppler velocity graph that can be superimposed over the CRT picture of the artery to show blood flow. If, for instance, the graph shows a strong blood flow on the left side of the artery, but nothing on the right, doctors can determine that something is already beginning to block the artery. "The picture and flow profile tell more than either one separately," Green says.

The transducer that scans the artery itself works at 10 megahertz, allowing resolution of one-half millimeter. Most ultrasonic scanners, Green says, operate at only 2 MHz. Achieving the 10-MHz range "presented a great engineering challenge."

The tradeoff was depth of penetration. But Green says that is not important in artery scanning. "We were able to use 10 megahertz because the arteries are near the surface." Scanners that look at the abdomen, for instance, would have to use the lower frequency. The transducer for the velocity graph operates at 5 MHz.

Perhaps being unduly modest,

Green says he does not believe the scanner will necessarily replace the angiogram, but rather will "supplement it and allow a larger population of people to be screened." But he sees further applications down the road, such as looking at organs of newborn babies, detection of breast and thyroid cancer, and diagnosis of vein thrombosis (blood clotting).

Such mass screening is a few years off, however. The Mayo Clinic is beginning to perform tests with the scanner. When those are completed, Green believes the scanner, for which SRI has applied for a patent, will be licensed. □

### Displays

## LED bank shows letters and equations

Light-emitting-diode arrays are lighting up calculator displays, watches, and instrument panels all over the world, mostly in single rows of numbers. But the technology of producing LEDs has progressed to where monolithic arrays can be built to display much fancier graphics—the alphabet and mathematical equations containing subscripts and superscripts.

**GaAsP arrays.** At Hewlett-Packard Laboratories, the big instrument firm's corporate advanced development center in Palo Alto, Calif., researchers have succeeded in fabricating half-inch-square monolithic arrays of junction-isolated gallium-arsenide-phosphide (GaAsP) diodes. The arrays use two-level metal interconnections to form an addressable X-Y matrix. Each chip contains a 30-by-36 array of LEDs—a total of 1,080, each of which measures 0.005 inch square on 0.014-inch centers.

Moreover, four of the chips have been assembled edge to edge, to form a ½-inch-high-by-2-inch-wide matrix of 144 columns of 30 diodes each. The complete panel can continuously display 36 alphanumeric characters in up to three rows (see

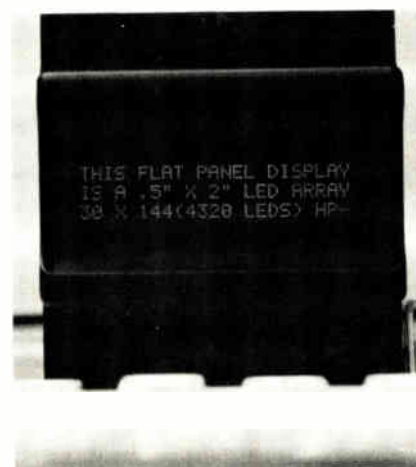
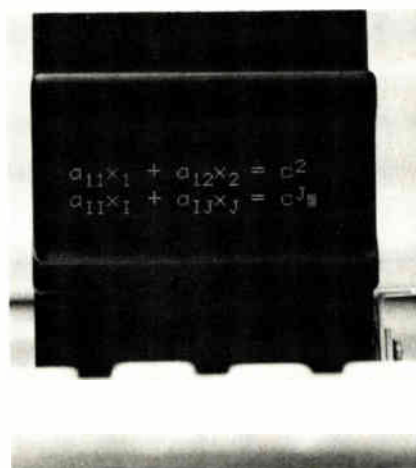
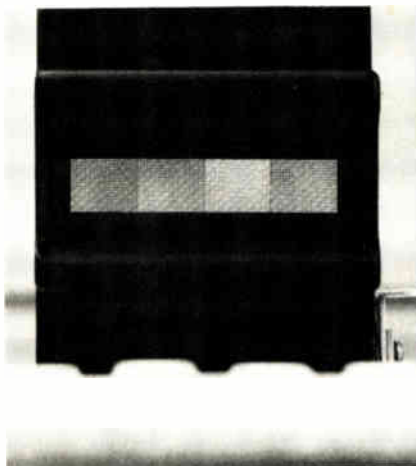

**Diode picture.** Hewlett-Packard's matrix of 144 columns with 30 light-emitting diodes per column, top, comes in four separate chips to measure ½ inch high by 2 inches wide. It can display mathematical equations, center, or rows of ordinary alphanumeric characters, bottom.

the photos at the left).

To line up the chips, researchers Bert Frescura and Herman Luechinger had to solve the problem of handling the large number of bonding pads needed to energize and address each array. Their solution was the two-level metal interconnections, which allow the bonding pads to be placed at the top and bottom of the chip, rather than at the sides. This enables the chips to be assembled side by side on a printed-circuit board. There is no connection between chips. Pads for 36 cathode leads are at the top of the chip; across the bottom are pads for 66 anode leads plus one pad for contacting the substrate.

In operation, the four-chip display is strobed at a 60-hertz rate, a column at a time. Maximum power dissipation is about 2 watts, including about 0.9 w lost in the lead resistances.

**Good yields.** Frescura says the ease with which the large arrays were produced, even at this early stage of development, surprised him. Five percent of the arrays were perfect, and 20% had only one or two defective diodes. He sees no barrier to extending the technique to even larger chips, say, 1 inch square, which could be assembled into 1-by-4-inch, or 2-by-2-inch displays containing more than 20,000 diodes. These diodes could display 276 characters in a 5-by-7-dot format.

Although HP says it hasn't formulated any plans to use this technology in any commercial product, obvious applications lie in instruments, microprocessors, and specialized areas where small cathode-ray tubes might be too bulky. □

### Commercial

## Phone company buys fire alarms

Bell Canada has installed three intercom/fire-alarm systems in three high-rise buildings near Toronto and is marketing others. Developer

# THE GOLD BUG

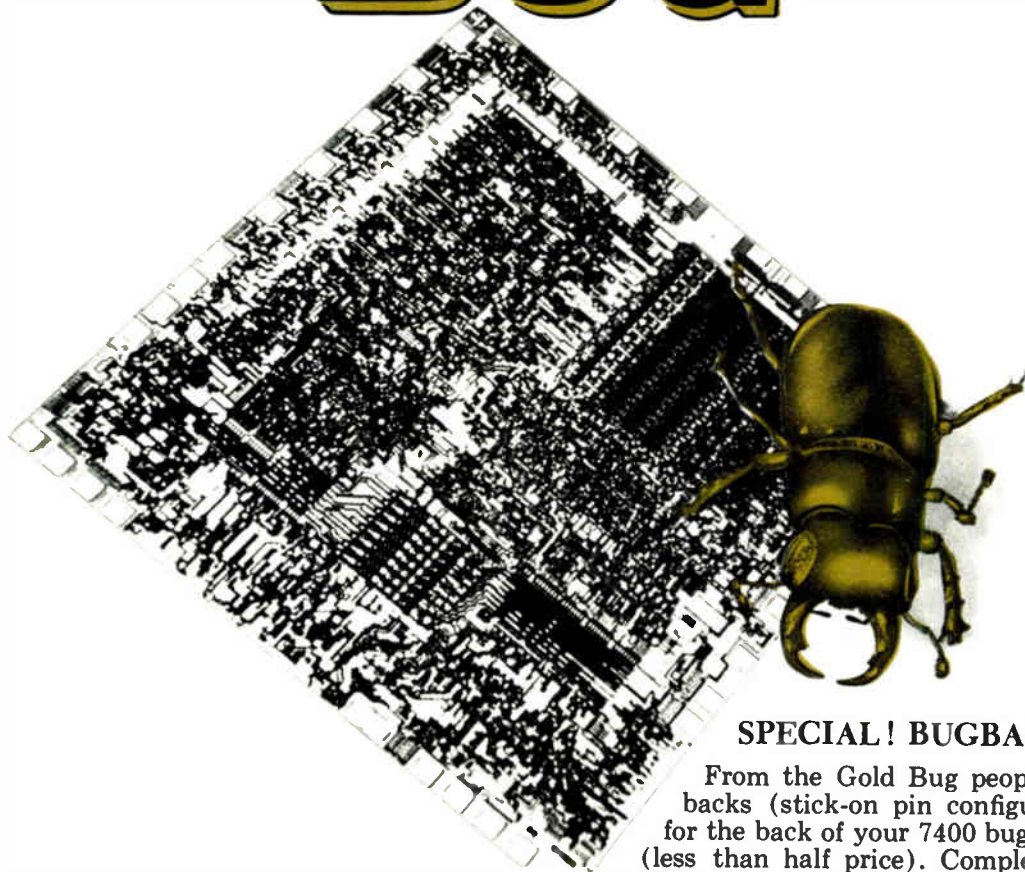

## SPECIAL! BUGBACK OFFER

From the Gold Bug people, 500 bugbacks (stick-on pin configuration labels for the back of your 7400 bugs). Only \$2.50 (less than half price). Complete the coupon and we'll send them right away.

Where do you look for help with microprocessors? And micro-computers? Circuit design equipment? Or complete digital electronics teaching aids?

The answer is the Gold Bug. But it's no Edgar Allan Poe mystery. The Gold Bug is E&L's new symbol of its broad range of products available to circuit designers.

You are probably most familiar with E&L's solderless breadboarding sockets. But how about our plug-in modules. Power supplies. Pulse generators. Circuit design instruments. Digital electronics and complete microprocessor teaching systems.

Break the code of the Gold Bug. And circle the reader service number. Or if you want some bugbacks at half price, send in the coupon. Either way, E&L will help take the mystery out of circuit design.



**E&L INSTRUMENTS, INC.**  
Circuit Design Aids  
61 First Street  
Derby, Conn. 06418  
(203) 735-8774

Gentlemen:

Please send me 500 bugbacks for \$2.50

NAME \_\_\_\_\_

COMPANY \_\_\_\_\_

ADDRESS \_\_\_\_\_  
\_\_\_\_\_

Enclose Check/MO

and manufacturer of the system is Mitel Corp. of Kanata, Ontario, Canada, which is also trying to interest Bell companies in the U.S.

"Only the phone companies really have the resources to provide the maintenance such systems need—they have most of the cities and buildings wired, and they have the good will of the authorities concerned," points out Terry Matthews, Mitel's director of marketing.

**Valuable asset.** Matthews expects to build on the belief of most fire chiefs, including the fire commissioner of Ontario, that if the phone company does it, it will work well. Objectively more important, though, is the fact that the equipment, which uses the telephone lines and unmodified telephones, is likely to be used daily. "Fire authorities have always been afraid that equipment not exercised periodically may stop working. And frequent checks with equipment that uses only sirens or bells often cause people to ignore them when there's a real emergency," observes Matthews.

A communications panel is part of the Mitel system. Fire personnel or others in authority would use it to give directions to occupants and talk to fire fighters through emergency phones on each floor. For emergencies, the system is equipped with a bell to raise the initial alert when a fire alarm is pulled, plus voice commands that can then be directed through public address units in lobby, garage, laundry, or parking areas and to each apartment on every floor. In an apartment, all information comes through a wall-mounted speaker/amplifier unit connected across the telephone line, or through the telephone receiver itself if it's in use.

Future Mitel systems will use sirens instead of bells and will allow communication with anyone wishing to gain entry to the building. When the doorbell is pushed, the Mitel unit emits a tone unlike a telephone ring. If the apartment-dweller's phone is on when the tone sounds, he can put the outside call on hold to talk with the party at the door. He can even unlock the door

by dialing a code into the phone.

Matthews says the three systems sold to Bell Canada have already gone into operation. Since these installations were completed, Bell Canada has found it can check the speaker/amplifier units in each apartment in each 18-floor building from its central office.

Matthews says that Bell companies in the U.S., though interested, are taking a wait-and-see attitude. One obstacle he points to is the differing fire laws and requirements concerning warning systems throughout the U.S. □

### Consumer

## \$19.95 watch coming from TI . . .

With inventories lean and business on the rebound, dealers showed up in unprecedented numbers at this month's Consumer Electronics Show in Chicago. They got everything they bargained for: watch prices tumbled, calculator prices continued to crumble, and a score of citizens' band radio suppliers patiently explained why deliveries are up to nine months behind orders.

Texas Instruments stole the show with a plastic-cased, five-function, light-emitting-diode watch that will sell for \$19.95—a price retailers

didn't expect until 1978. The Dallas-based firm backed up its entry with a line of base-metal versions starting at \$29.95, and Fairchild Consumer Products Inc., Palo Alto, Calif., unveiled a new low-cost "Timeband" brand that also starts at \$29.95.

**Competition.** National Semiconductor Corp.—expected with TI and Fairchild to dominate the low end of the digital-watch market—was caught with its prices up. It lowered them in mid-show. Calling the TI pricing move "the most expensive advertising ploy we've ever seen," Richard Stadin, watch marketing manager for National's Consumer Products operation, said: "We came to the show with our printed price lists, we saw what happened, and we made an adjustment. We're not going to let anyone make inroads on our production." Beginning Feb. 29, National's low-end "Exelar" line will start at around \$22.

TI is taking orders for third-quarter deliveries, but will ship limited quantities in the second quarter. It reportedly is negotiating with Sears, Roebuck and Co. to sell a version under a "Sears by Texas Instruments" label.

"The strategy we're pursuing is simple and straightforward," says Bill Heye, manager of TI's Time Products division. "We're trying to produce a watch that more people can afford."

Fairchild marketing vice presi-

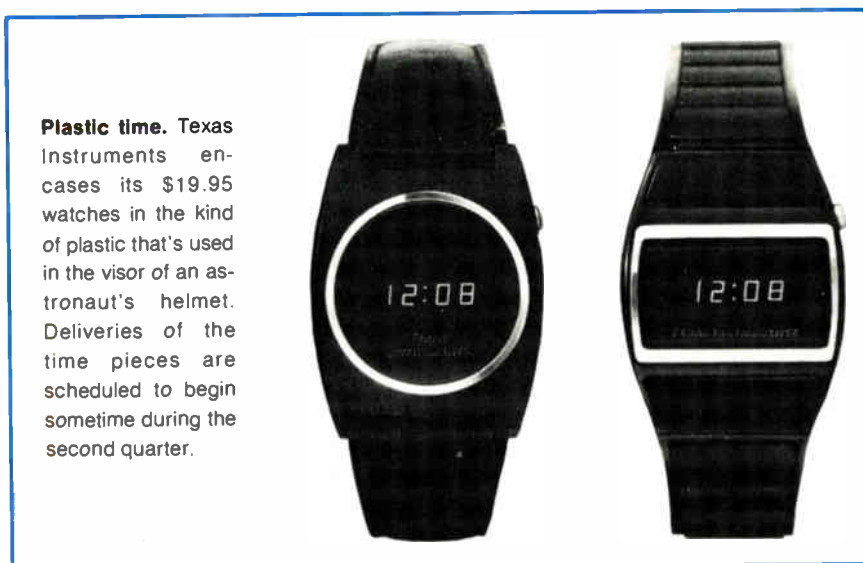

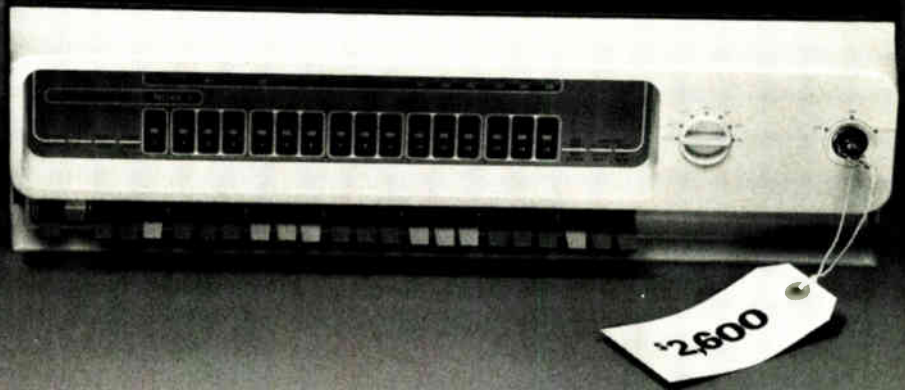

## Has your \$500 micro ended up costing more than our \$2,600 mini?

If you've had to spend a lot of money on a low priced micro, you may be in a position to appreciate the cost advantages of a higher priced computer.

Our \$2600 Nova 3\*.

When you buy a Nova 3, you don't have to put as much into it to get it to do your job.

You don't have to create your own operating systems. Nova 3 is software compatible with our other Novas. So you get to use all the existing Nova operating systems, language processors and utilities.

And you don't have to worry about performance. Nova 3 executes instructions in 700 nanoseconds using MOS memory. And its sophisticated architecture lets you use up to 128K Words with the optional Memory Management Unit.

You don't have to buy more

computer than you need. Nova 3 has the broadest range of compatible configurations you can get in an OEM minicomputer line. There's a 4 slot Nova 3. A 12 slot Nova 3. (It has an optional expansion chassis that gives you 12 more slots of I/O.) And you can configure multiple processor Nova 3 systems.

You don't have to worry about Nova 3 availability. We're manufacturing virtually every part of the Nova 3. Including the silicon gate N-channel MOS RAM memories. (They're coming from our Sunnyvale, California facility.)

And you don't have to go it alone. Because when you buy a Nova 3, you can get all the support Data General offers an OEM.

Write or call for the Nova 3 brochure. It may persuade you to buy more and spend less. \*\$2600 is the single unit price for a 4K MOS memory Nova 3. Before the OEM and quantity discounts get figured in.

# DataGeneral

## Nova 3: The biggest thing to ever hit the OEM market.

• Data General, Dept. L.I., Route 9, Southboro, Mass. 01772 (617) 485-9100. Data General (Canada) Ltd., Ontario. Data General Europe, 15 Rue Le Sueur, Paris 75116, France. Data General Australia, Melbourne (03) 82-1361/Sydney (02) 908-1366.

dent Charles E. McDonald says: "We can make a \$19.95 watch out of base metal, and we'll introduce it when we can ship it." Fairchild also plans to introduce a liquid-crystal version in the second quarter.

Other new watches at the show included a one-chip LCD chronograph for \$79.95 from Microma Inc., an Intel subsidiary in Cupertino, Calif. The back-lit chronograph includes four stopwatch functions, two more than the \$295 Seiko digital chronograph.

**Calculators.** Calculator activity at the Consumer Electronics Show centered around reports that Rockwell was getting out of the business—vigorously denied by the Anaheim, Calif., firm. All consumer calculators, however, eventually will be assembled with Rockwell components in the Orient, and they will continue to be sold here under the Rockwell name, indicated Robert E. Hilchey, vice president and general manager of the Microelectronic Product division.

Prices hit a new low of \$5.99, and that's for a machine assembled in the United States. The calculator is a 4-function, 6-digit machine built in Rahway, N.J., around a National Semiconductor Corp. chip by Fantasia Calculator Corp. And National dropped the Novus name from high-end and programable calculators—it will use "National Semiconductor" instead—and introduced an \$89.95, 54-function scientific unit comparable to the \$195 HP-45. Coming later this year in the new family will be more key-programable versions, with looping and branching capabilities. □

## . . . GE, RCA enter citizens' band

General Electric Co. and RCA's Distributor and Special Products division used the Chicago show to launch themselves into the already-crowded citizens' band radio market—both with Japanese-built units that will be available later this year.

They joined more than 50 sup-

## News briefs

### Plants being closed by Western Electric

Western Electric, coming off its first loss for a three-month period in 25 years and operating at only about 60% manufacturing capacity, says it plans to close its plants in Buffalo, N.Y., and Greensboro, N.C. WE officials blame the closings on the recession, on product changes resulting from improved technology, and on sharply declining orders for Bell Telephone equipment in the past two years.

The Buffalo facility, actually three buildings covering more than 1.1 million square feet, makes switchboard wire and cable, telephone and connector cables. It employs 1,950 people, most of whom will be offered transfers and relocation payments. The 286,000-square-foot Greensboro facility, which houses printed-circuit-board manufacturing, long-distance switching subassembly and WE's Government production work, employs about 850 people and will be consolidated into plants in Burlington and Winston-Salem, N.C. The North Carolina plants are expected to be closed by the end of this year; closing the Buffalo facilities will take about two years. WE's total employment is now 149,200, down from approximately 200,000 two years ago.

### Retailers see new terminals

Two new electronic terminals for retail stores were shown at last week's National Retail Merchants Association meeting in New York. General Instrument Corp.'s Unitote/Regitel division, Hunt Valley, Md., showed a pair of point-of-sale terminals, the 420 controlled by a central minicomputer and the stand-alone 430. They automate several selling functions, such as delivery-fee and service-charge computations, that previously had to be calculated manually. The fully interactive models are compatible with GI's current 300-series units. Also, TRW Inc.'s Data Systems division introduced a new credit-authorization system for small retail stores. It's the first in a series of systems with fewer options than TRW's present, more sophisticated systems.

### Typewriter group opens R&D center

SCM Corp.'s Smith-Corona typewriter group opened a research and development facility in Danbury, Conn., this month for advanced typewriter technology research, including electronics applications. Applied research and developmental engineering projects will continue to be conducted at the Smith-Corona laboratories in Cortland, N.Y., where the company makes most of its typewriters.

### TI, Westinghouse get \$19 million more for FAA radars

The Federal Aviation Administration has awarded \$19.6 million to Texas Instruments, Dallas, and Westinghouse Electric Co., Baltimore, in follow-on contracts for advanced air-traffic-control radars. TI begins the new year with \$8.45 million for 20 improved terminal area radars known as ASR-8s, including two that will be used by the Navy. The radars have twice the power of earlier units, plus expanded low-angle coverage, reduced sensitivity to ground clutter, and an improved light aircraft detection capability for high- and medium-density airports. Westinghouse gets \$11.2 million for 10 long-range radars for en-route surveillance radar to be used to monitor aircraft in heavy-traffic areas.

### Police adapt pattern recognition for 'mug shots'

Pattern recognition is being adapted for use with police "mug shots" to speed criminal identification. The Law Enforcement Assistance Administration has awarded \$226,043 to the University of Houston to develop a system in which a victim's description of a criminal's head and face will be fed into a computerized picture file. The computer will then select those pictures that most closely match the description. The technique is expected to eliminate time-consuming searches and lead to faster identification.

**Our competitors  
will know  
a good thing  
when they see it.**

**But don't wait for them to copy  
our new 5-inch tube axial blower.  
Get more air and less noise now from the original.**

The exclusive blade design and proven motor delivers up to 20% more cooling air, and at a lower sound level, than 4½-inch units.

The Torin TA500 uses the maximum space available in standard 5¼-inch panels, and has an alternate set of mounting holes compatible with present 4½-inch installations.

The bearing system is the same design that has been so reliable in our TA450 unit.

Any breakthrough product is bound to be copied. We don't resent that. We'd just like you to take advantage of our new TA500 (already in field use) now instead of waiting for the others to gear up for production on their versions. We're ready to ship your order.



Circle 47 on reader service card

**Torin Corporation • United States:** Torrington, Connecticut/Van Nuys, California  
**Canada:** Oakville, Ontario **England:** Swindon, Wiltshire **Belgium:** Nivelles  
**Australia:** Sydney **Spain:** Alcalá de Henares

Photograph  
actual size,  
depth dimension  
1.49 inches.



**Torin TA500**

Model A30200  
115V A C  
0.26 Amps  
50 60 Hz  
Impedance  
protected

MADE IN U.S.A. I

WESTCOTT

8

7

6

5

4

3

2

in c

# ALL 8080As DON'T COME FROM THE SAME PLACE.



Meet the  $\mu$ PD8080A. From NEC Microcomputers, Inc. The microprocessor that's both fully software and pin compatible with Intel's new 8080A. And it's backed by all the chips, support systems, software, and service you need to make it into a complete microcomputer system — the  $\mu$ COM-8.

## THE CHIPS.

We start with not one, but four 8080-type microprocessors.

At the top of the line is the  $\mu$ PD8080A. It gives you everything their 8080A does, plus extras like full BCD capability for both addition and subtraction. For low-cost applications, we also have a 1.25 MHz option — the 8080A-E. Plus there are two other models, featuring improved I/O.

In addition, we can give you the best in RAMs, ROMs, and PROMs, includ-

ing the only Electrically Alterable PROM with the speed to match the processor.

## THE SUPPORT SYSTEMS.

We offer both a full-scale microcomputer — the PDA-80 — for software development and hardware emulation; *and* a microcomputer-on-a-board — the EVAKIT — for evaluation purposes.

## THE SOFTWARE.

For the PDA-80 we have a full line of resident software. Or, we can give you a full line of cross software, available on national timesharing services or installed on your own computer system. This includes our unique Macro

Maintenance Program (MMP) for storing common macros and sub-routines for use with our Macro Assembler.

## AND THE SERVICE.

The  $\mu$ COM-8 package also includes complete documentation, an ever-expanding library of Applications Notes, and a responsive, in-depth applications engineering service, available nationwide.

## SO...

Whatever your application or your needs — first source or second source, large volume or small, chips or complete systems — take a look at everything *our* 8080A gives you.

You really can't afford not to.

NEC Microcomputers, Inc., Five Militia Drive, Lexington, Mass. 02173, 617-862-6410.

# NEC microcomputers, inc.



# WHERE TO BUY IT.

## New England:

Circuit Sales Company  
Lexington, MA  
617/861-0567

## Mid-Atlantic:

Trionic Associates, Inc.  
Great Neck, NY  
516/466-2300

C.H. Newson & Associates  
Philadelphia, PA  
215/248-3377

C.H. Newson & Associates  
Hershey, PA  
717/233-8576 (Harrisburg)  
301/825-0001 (Baltimore)

## Southeast:

Perrott Associates, Inc.  
Orlando, FL  
305/275-1132

Perrott Associates, Inc.  
Clearwater, FL  
813/726-1549

## Midwest:

McFadden Sales, Inc.  
Columbus, OH  
614/221-3363

Bitronics Sales Company  
Minneapolis, MN  
612/835-7744

RF Specialists  
Park Ridge, IL  
312/698-2044

## Southwest:

Merino Sales Company  
Dallas, TX  
214/233-6002

Tri-Tronix  
Albuquerque, NM 87110  
505/265-8400

Summit Sales  
Scottsdale, AZ 85251  
602/994-4587

## Northwest:

Tri-Tronix  
Bellevue, WA  
206/454-0940

## So. California:

Electronic Component Marketing  
Woodland Hills, CA  
213/340-1745

Electronic Component Marketing  
El Toro, CA  
714/830-3939

Electronic Component Marketing  
San Diego, CA  
714/295-6122

## No. California:

Trident Associates  
Mountain View, CA  
415/967-7031

## Canada:

R.F.Q., Ltd.  
Toronto, ONT.  
416/625-8874

R.F.Q., Ltd.  
Montreal, QUE.  
514/626-8324

## Electronics review

pliers of CB gear at the show in agreeing demand will outstrip supply again in 1976. Acute shortages include antennas and crystals, and "if not crystals, then rotary switches," comments one manufacturer. "New product developments and innovations will be precipitated by the expansion of service [channels]" expected from the Federal Communications Commission by midyear, says Don Saxon, general manager at Midland International Corp.'s Communications division, North Kansas City, Mo.

**Fewer crystals.** Phased-locked loop systems that require two or three crystals instead of 14 to synthesize today's 26 channels are already becoming commonplace. Several manufacturers, including Sharp Electronics Corp. and Royce Electronics Corp. showed new units with light-emitting diode displays.

By June, SBE Inc., Watsonville, Calif., expects to be selling an advanced phase-locked loop radio that uses a single crystal, 10-digit keyboard input and LED display, says David Thompson, president. It's designed around a single chip, built by Nitron, the Cupertino, Calif. wafer-fabrication subsidiary of McDonnell Douglas Corp. The chip is mask-programable for synthesis of CB, marine, and land-mobile channels.

**Video games coming.** Finally, buyers packed six deep into booths of a handful of video games manufacturers, who had few products but many promises of items they're bringing to the summer Consumer Electronics Show in June. Magnavox is hinting at another version of Odyssey, now priced at \$99.95 and \$129.95. Broadmoor Industries plans to have a control-board unit in June at \$69.95. It now sells a version at \$349 including a black-and-white TV monitor. Universal Research Laboratories will begin delivering its Video Action III next month, after withdrawing an earlier model from the market because it didn't have FCC approval. And National Semiconductor and APF Electronics both plan to enter the market in June with multiple-game units priced between \$79 and \$89. □

## Programmable unit rings up low price

Texas Instruments is making a major upward marketing step with introduction of a programmable desktop calculator that communicates with the user. The "prompting" display allows even a novice to work complicated business and scientific problems immediately.

TI is "trying to create a whole new market for specialized customer-designed business and scientific applications," says Robert E. Crocker, manager of the new SR-60 program. He says a small-business owner with little mathematical training should have little trouble mastering the new unit.

At \$1,695, the SR-60 is priced well under comparably performing desktop calculators. It costs about \$1,200 more than any of TI's other desktop calculators.

The prompting display means the SR-60 user can run alphanumeric programs and receive operating instructions on a LED display at successive stages in a problem. The calculator waits for a response before continuing with the problem.

The SR-60 has 95 keys, including 40 for mathematical functions, 46 for scientific functions, and the rest mostly for instructions. It has 480 program memory locations and 40 data memories, expandable to 1,920 program locations and 100 data memories with a \$700 optional module.

**General-purpose operation.** The unit can also be operated as a general-purpose calculator. It has left-to-right algebraic entry and nine levels of parentheses to allow users to enter problems as they normally would say them. At the users' option, answers can be displayed, printed out on a dot-matrix thermal printer, or both.

Crocker says the TI calculator is generally comparable in performance to Hewlett-Packard Co.'s 9815A (\$2,900), Canon Inc.'s SX310 introduced last June (\$2,895), and

**NEC microcomputers, inc.**

# RF power

We've made the most of it... You can, too!!

All wrapped up in a neat little package, our Model 510L is an ultra-wideband RF power amplifier whose wide range of frequency coverage and power output provide the user with the ultimate in flexibility and versatility in a laboratory instrument. Easily mated with any signal generator, this completely solid state unit amplifies AM, FM, SSB, TV, pulse and other complex modulations with a minimum of distortion.

Constant forward power is continuously available regardless of the output load impedance match making the 510L ideal for driving highly reactive loads.

Unconditional stability and instantaneous fail-safe provisions in the unit provide absolute protection from damage due to transients and overloads.

This outstanding unit covers the frequency range of 1.7 to 500 MHz with a linear power output of more than 9.5 watts and there is no tuning.

For further information or a demonstration, contact ENI, 3000 Winton Road South, Rochester, New York 14623. Call 716-473-6900 or TELEX 97-8283 E N I ROC



## ENI

The world's leader in solid state power amplifiers

## Electronics review

Sharp Electronic Corp.'s more recently introduced Model 2610 (\$3,200).

TI is shipping the SR-60 with 10 basic program cards. An additional 100 cards, designed for specific technical and business applications, will be available by March, priced from \$95 each.

Crocker explains the calculator's low price by emphasizing the cost-effective design philosophy. He says TI was able to hold down the SR-60's manufacturing cost (and its price) by making almost everything in the unit, including the case.

**Hand-held unit.** TI also plans to introduce a medium-priced key-programmable calculator before April for around \$180. Designated SR-56, it will be a 100-step, 10-memory hand-held unit, competitive with Hewlett-Packard Co.'s HP-25. Moreover, the TI calculator will be compatible with a \$295 plug-in printer model introduced by TI at the Consumer Electronic Show earlier this month in Chicago. The SR-56 will have nine levels of parentheses, seven pending operations, and branching and looping operations, similar to those also found in the SR-60. □

## Communications

### AT&T rebuts attack on Dataspeed 40

American Telephone & Telegraph Co. has warned the Federal Communications Commission that it would be using too restrictive a definition of data processing if it accepts the conclusions of IBM and others that AT&T's new Dataspeed 40 terminals are computers and not communications gear subject to FCC regulations.

The mid-January warning came in reply to petitions by IBM, the Computer and Business Equipment Manufacturers Association (CBEMA), and the Computer Industry Association urging the FCC to reject proposed tariffs for the new terminals [*Electronics*, Jan. 8, p. 34].

"The kernel of the petitioners' position," AT&T charges, "is based on self-serving and incorrect definitions of 'data processing,' which, if accepted, would not only impose a permanent technological freeze on the provision of important and needed common carrier communications services but would also place beyond this Commission's jurisdiction the offering of services traditionally and universally recognized as telecommunications." The FCC has yet to rule on the tariffs for the new Dataspeed hardware.

**Not data processors.** While the Dataspeed 40 terminals can interconnect computers, AT&T argues they are not data processors since they do not enhance the net worth of the information being transmitted "by changing its inherent informational content." Instead, says AT&T, its equipment is useful only for data communications.

The CBEMA filing cites three Dataspeed features—new keys, display buffer addressing, and format control—that are "unique and necessary for operation as part of a data processing system." AT&T, however, contends the features "have long been incorporated in AT&T-provided teletypewriter terminal equipment."

**Features are ordinary.** The new keys, according to AT&T, are used by an operator to "signal the distant end to cause a predesignated action" similar to the transmission of control signals by prearranged sequences of characters used in earlier equipment.

Display buffer addressing, AT&T explains, permits the positioning of text in a predetermined location on a display screen. Such text-positioning features "have for many years been incorporated in AT&T-provided teletypewriter terminal equipment."

The format control feature, AT&T says, is designed to protect designated areas of the display screen and is analogous to the preprinted paper forms used with earlier teletypewriters, and to the use of format control paper tapes on certain teletypewriters to prevent recording of particular types of characters in predetermined fields. □

# We thumbs prefer **Cherry** thumbwheel switches

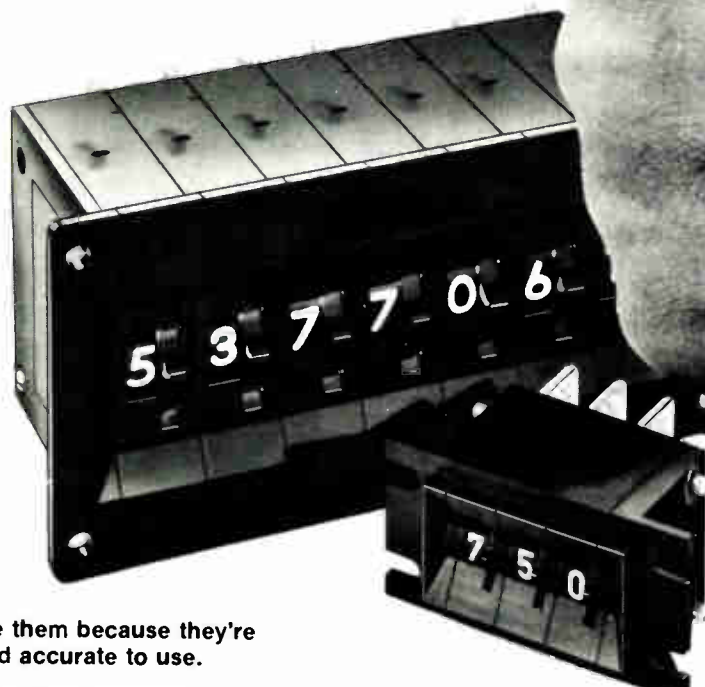

"We like them because they're easy and accurate to use.

You'll like them because of selection, features and price."

You'll also like Cherry quality. The kind of quality you always hope for . . . but that is only realized when a company (like Cherry) has total in-house manufacturing capabilities. To make sure the thumbwheel or leverwheel switch you order is the finest available. Anywhere. Combine this dedication to quality with the broadest line and lowest prices, and you'll understand why our customers say "thumbs up" to Cherry thumbwheels.

**NEW! The smallest thumbwheel switch of them all.**

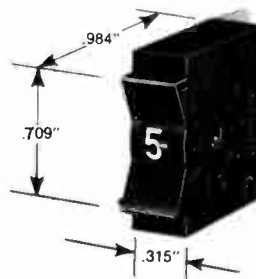

The new T-50 sub-subminiature thumbwheel that takes only 8mm x 18mm front panel space . . . just 32mm depth back of panel.

For complete data and specs: TWX 910-235-1572 . . . or PHONE 312-689-7700 . . . or circle reader service number.



ELECTRONIC DATA ENTRY KEYBOARDS



PLASMA-LUX GAS DISCHARGE DIGITAL DISPLAYS

CHERRY ELECTRICAL PRODUCTS CORP.

Sunset Avenue • Waukegan, Illinois 60085

# Meet Sorensen's cool watt.

If your heat load is up and your cabinet space is down, our new SSD series can solve both problems at once.

Their power density is 3 times that of linears and 1½ times previous switchers yet they dissipate *less* heat (25 watts less in the 5-volt model).

No forced air cooling required.

SSDs come in 10 models covering the entire range from 1.8 to 56 volts, accept universal input voltages, and operate at efficiencies of 76 to 80%.

And they're guaranteed for five years.

We'd like to send you the information, along with our new catalog of over 200 power supply products. Sorensen, a Raytheon Company, 676 Island Pond Road, Manchester, N.H. 03103. (603) 668-4500. Sorensen A.G., Hohlstrasse 608/610, 8048 Zurich, Switzerland.  
Tel: 01/62 3400.

**SORENSEN**  
POWER SUPPLIES

A Raytheon Company

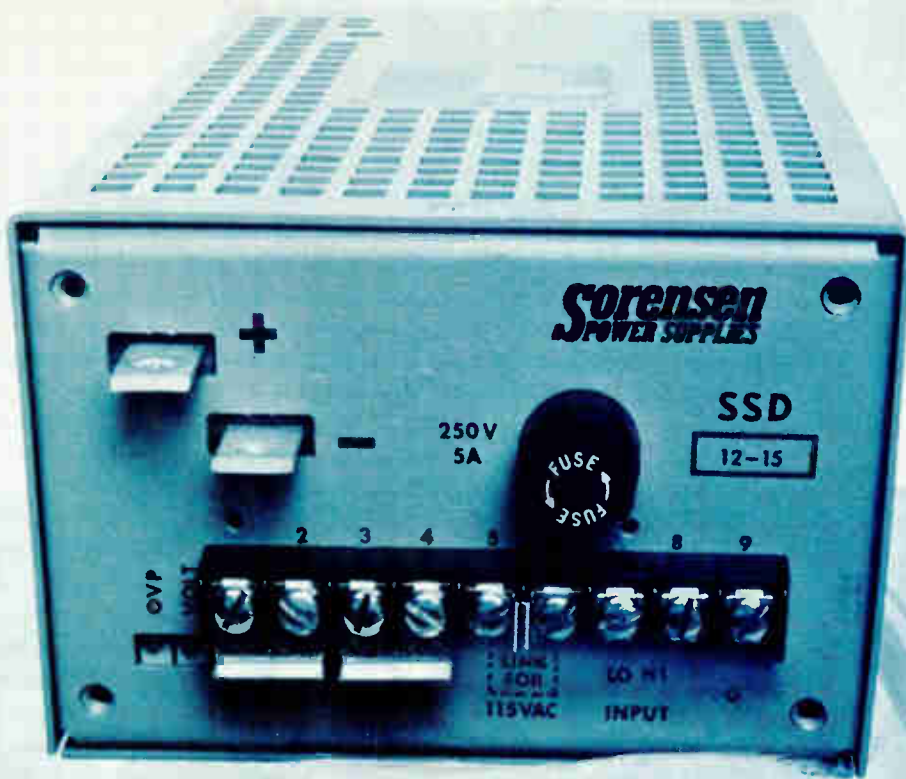

# AMI 6800: The whole Kit.

## Smart Terminal.

Complete program editing through CRT and keyboard. Also includes Modem communication to remote computers. (Avail. Feb.)

## Magnetic Tape.

Cross product software— assembler, loader, simulator.

## AMI 6800 Family.

It's all here: MPU, RAM, ROM, PIA, ACIA, PROM, USRT and Modem. By test, the best.

## Evaluation Board.

Includes everything you need to evaluate parts, program PROMs and, connected with a peripheral, run programs.

## Dual Floppy Disk.

Storage for resident software— assembler, editor, etc. (Avail. Feb.)

## Disk Program Storage.

500K bytes for program development and on-line data storage. Cuts out the paper tape! (Avail. Feb.)

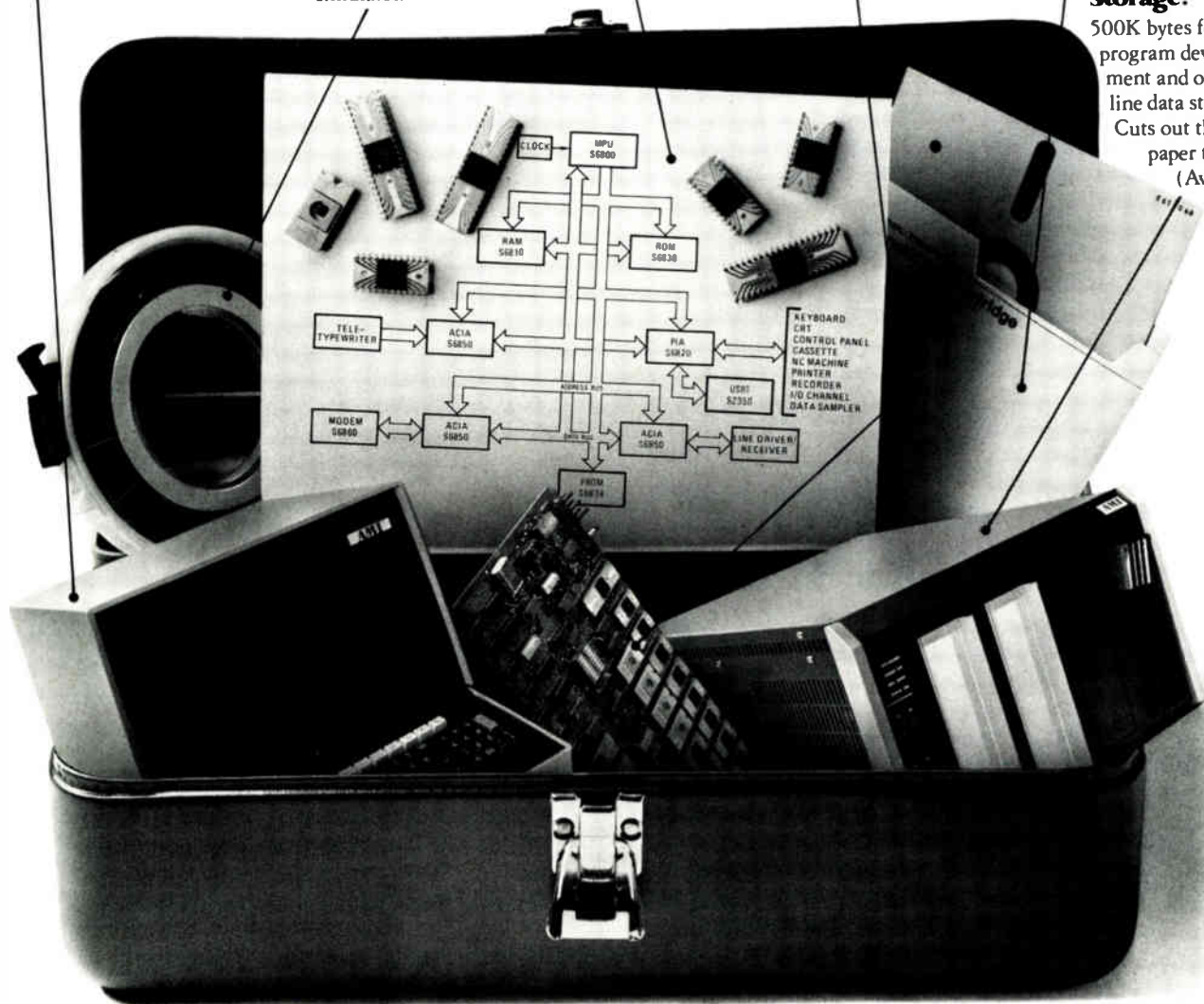

Our AMI 6800 Kit is a big step forward in simplifying your design, evaluation and test programs. For example, our intelligent CRT is simple to operate with either resident or remote software. It really is smart, because it contains an S6800! And it's planned to have an in-circuit emulator added later.

Our dual disk is extremely useful for developing programs, and saves you hours of paper tape shuffling. And our Evaluation Board is loaded with

all the parts you need to get your product on the market on time.

Now for the Caboodle. The dictionary calls it a "package." You'll call it the neatest set of instructions for any kit you've ever bought.

Now why don't you call your nearest AMI sales office or distributor, and ask them for the whole Kit and Caboodle. Or write AMI, 3800 Homestead Road, Santa Clara, CA 95051. What could be easier?

## Here's where you pick up your Kit.

### SALES OFFICES

Manhattan Beach CA • (213) 379-2452  
San Jose CA • (408) 249-4550  
Altamonte Springs FL • (305) 830-8889  
Elk Grove Village IL • (312) 437-6496  
Norwood MA • (617) 782-0726  
Livonia MI • (313) 478-9339  
Minneapolis MN • (612) 559-9004  
Monsey NY • (914) 352-5333  
Cleveland OH • (216) 292-8850  
Ambler PA • (215) 643-0217  
Richardson TX • (214) 231-5721

# And Caboodle.

## Software Brochure.

A rundown on AMI software products including assembler, loader and simulator.

## AMI 6800 Brochure.

List of goodies. All you want to know about the AMI 6800 family.

## Evaluation Board Application Notes.

The why and wherefore of our Prototyping System, and how to make the most of it!

## NCSS Users Manual.

All the magic necessary to work with National CSS time-sharing network.

## Assembly Language Programming Manual.

Describes the instruction set and how to use the AMI Assembler and Simulator.

## AMI Guide to Standard Products.

All the MOS you might need in addition to microprocessors.

## Hardware Reference Manual.

A detailed description of each component in the system, and how to make them work!



### DISTRIBUTORS

ALTA ELECTRONICS  
Utah—Salt Lake City (801) 466-7227  
ARROW ELECTRONICS  
Minnesota—Bloomington  
(612) 888-5522

CENTURY ELECTRONICS  
New Mexico—Albuquerque  
(505) 292-2700  
Utah—Salt Lake City (801) 467-8551

INTERMARK ELECTRONICS  
Washington—Seattle (206) 767-3180

SCHWEBER ELECTRONICS  
California—Costa Mesa (714) 924-5594  
and (714) 558-3880  
Connecticut—Danbury (203) 792-3500

Florida—Hollywood (305) 927-0511  
Georgia—Atlanta (404) 449-9170  
Illinois—Etk Grove Village  
(312) 593-2740

Iowa—Cedar Rapids "Lorenz Sales"  
(319) 393-0100  
Maryland—Rockville (301) 861-3300  
Massachusetts—Waltham  
(617) 890-8484

Michigan—Troy (313) 583-9242  
Minnesota—Edina (612) 941-5280  
New Jersey—Somerset  
(201) 469-6008

New York—Rochester (716) 461-4000  
Westbury (516) 334-7474  
Ohio—Beachwood (216) 484-2970  
Texas—Austin (512) 637-2690  
Dallas (214) 661-5010  
Houston (713) 784-3600

Canada—Mississauga, Ont.  
(416) 678-9050

SEMICOMP CORP.  
California—Newport Beach  
(213) 971-5253 and  
(714) 833-3070

STERLING ELECTRONICS  
Arizona—Phoenix (602) 258-4531  
Louisiana—Metairie  
(504) 867-7610

Massachusetts—Watertown  
(617) 926-9720

New Jersey—Perth Amboy  
(201) 442-8000

New Mexico—Albuquerque  
(505) 345-6601

Texas—Dallas (214) 357-9131  
Houston (713) 627-9800

Virginia—Richmond "Meridian"  
(804) 335-8521

R.V. WEATHERFORD CO.:  
Arizona—Phoenix (602) 272-7144  
California—Anaheim (714) 547-0891  
Glendale (213) 849-3451

Palo Alto (415) 493-5373  
Pomona (714) 623-1261  
San Diego  
(714) 278-7400

Colorado—Englewood  
(303) 761-5432

New Mexico—Albuquerque  
(505) 842-0868

Texas—Dallas (214) 243-1571  
Houston (713) 688-7406

Washington—Seattle  
(206) 243-8340

it's  
standard  
at AMI.  
AMERICAN MICROSYSTEMS, INC.

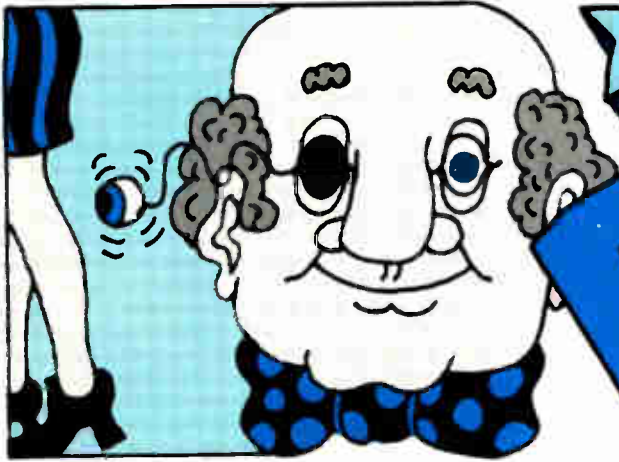

# The fleeting glance

Anything fleeting—any transient phenomenon—is meat for Biomation's waveform recorders. If you've got a sensor to sense it, we've got the recorder to catch it and play it back for the kind of close scrutiny most fleeting glances never get and probably don't deserve.

# Catch a falling star

Q-switch a laser. Snap an electronic shutter. Plot the gurgles and whistles of underwater mammals. Shoot a 9-pound chicken into a 747 to simulate a chance encounter with a flying fowl. IF YOU CAN OPERATE A SCOPE (and find a 9-pound chicken), you can do all these fun things on a waveform recorder. They're very versatile. And the nice thing about our recorders is that you can't miss. If your event takes place, our recorder will catch it.

## The Pre-Trigger Recording REASON

**1** This is a somewhat simplified diagram of a semiconductor memory. It's currently OFF.



**2** Now the power is on and stuff is starting to march through at, say, 5MHz.

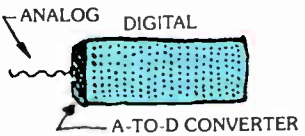

**3** Now it's humming. Data is pouring through and dumping out onto the floor, waiting for your trigger.



**4** Here comes your BIG EVENT and you're already recording ...



**5** Trigger on your signal and the delay tells you when to stop recording. You have caught data fore and aft.



**6** Here's your Big Event—digitized. Now you can play it out. Nice deal, right? No more misses!

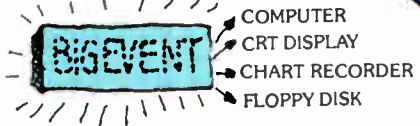

# Sonofagun!

If a fast signal you're looking for happens only once and doesn't let you know when it's coming, you need a Biomation waveform recorder. You'll capture it more surely than you could with scope cameras, and the digitized data is infinitely more useful; you can play it out onto a flicker free CRT screen, write it on a recorder, or feed it to a computer for all manner of wonderful manipulations.





# BIOMATION

ABOUT WAVEFORM RECORDERS



## Greased lightning

If what turns you on is an electrical quickie, grasp it with a Biomation waveform recorder. Your UHV transient is just another fast analog waveform to us. We'll digitize it at speeds up to 100MHz. That should effectively degrease your problem lightning.

## SPECS for your bedazzlement

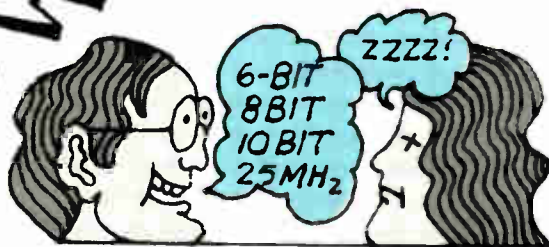

- ★ 6-bit, 8-bit, 10-bit A/D conversion
- ★ time resolution to 1 point in 4000
- ★ bandwidths to 25MHz
- ★ digitizing speeds to 100MHz
- ★ memories to 4000 words

AND DON'T FORGET, FOLKS,  
BIOMATION'S SPECIAL PLUS ... pretrigger  
recording. (See the really strange diagram  
over there.)

Also ... **Very Interesting Idea**  
... you can let your computer  
remotely control signal  
acquisition of our 8100  
waveform recorder through a  
full digital interface. Let your  
mind wander over that one for  
a moment.

## THEN ACT!

There's a ton more we can tell you about putting a Biomation Waveform Recorder to work for your unique one-of-a-kind set-up. **The idea's not new. Neither are we.**

Thousands of Biomation recorders are doing it all over the world.

We've got a very slender (though all-inclusive) short form catalog. And can give applications help at the drop of a phone call. For the catalog, circle the bingo. For help, yell. (408) 255-9500.

## It's all happening at

10411 Bubb Road,  
Cupertino, CA 95014.

**biomation**  
Creating tools for technology

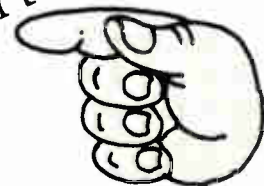

# JOIN OUR BME-KAP<sup>TM</sup> SAVINGS PLAN

## SAVE 30% TO 50% ON THE COST OF MONOLITHIC CERAMIC CAPACITORS

This major cost saving is the result of our new BME<sup>TM</sup> capacitor technology. We've eliminated precious metals entirely from the electrodes and terminations of our BME<sup>TM</sup> capacitors. No precious metals means lower cost. So now we offer you our complete line of monolithic ceramic capacitors — BME Chips<sup>TM</sup>, BME Radials<sup>TM</sup> and BME Axials<sup>TM</sup> — at a genuine savings of 30% to 50%.

This significant reduction is not based on a momentary drop in precious metal prices. This is a long-term solution due to the replacement of precious metals by non-noble metals which are not subject to the same dramatic cost spirals.

## SAVE WITH RELIABILITY

Our BME<sup>TM</sup> capacitors have not sacrificed the inherent electrical and mechanical Ceramolitic<sup>®</sup> quality. Their reliability can be demonstrated by the extensive test procedures to which they have been subjected. Write to our Applications Engineering Department for complete test reports.

## SAVE WITH DESIGN FLEXIBILITY

Now you can seriously consider monolithics to replace micas and tantalums. Our BME<sup>TM</sup> capacitors feature non-polarity, a wide range of capacitance value, low leakage, high volumetric efficiency, availability in chip, radial and axial packages at prices competitive with mica below 1000pF and tantalum up to 2.2 $\mu$ F.



### TYPICAL SELLING PRICES PER UNIT QUANTITIES OF 5000 OR MORE

BME <sup>TM</sup> "J" DIELECTRIC (COG)	BME-Chip <sup>TM</sup>	BME-Axial <sup>TM</sup>	BME-Radial <sup>TM</sup>
1 thru 100 pF, 5%, 50WVDC	5.1¢	6.8¢	7.5¢
1000 pF, 5%, 50WVDC	12¢	16¢	16¢
BME <sup>TM</sup> "S" DIELECTRIC (X7R)	BME-Chip <sup>TM</sup>	BME-Axial <sup>TM</sup>	BME-Radial <sup>TM</sup>
.01 $\mu$ F, 20%, 50WVDC	3.5¢	5.8¢	5.8¢
.1 $\mu$ F, 20%, 25WVDC	9¢	16¢	14¢
1.0 $\mu$ F, 20%, 25WVDC	52¢	—	73¢
BME <sup>TM</sup> "R" DIELECTRIC (Z5U)	BME-Chip <sup>TM</sup>	BME-Axial <sup>TM</sup>	BME-Radial <sup>TM</sup>
.1 $\mu$ F, +80 -20%, 25WVDC	5.7¢	8.8¢	8.8¢
.47 $\mu$ F, +80 -20%, 25WVDC	13¢	16.5¢	16.5¢
1.0 $\mu$ F, +80 -20%, 25WVDC	19¢	27¢	25¢
2.2 $\mu$ F, +80 -20%, 25WVDC	35¢	—	49¢

## JOIN THE USCC/CENTRALAB BME<sup>TM</sup> CAPACITOR SAVINGS PLAN

Get all the details today. Write on your company letterhead for your concise Savings Plan Price list — your pass book to the lowest monolithic ceramic capacitor prices available. Compare it with anyone else's price list and see.

Remember, USCC/Centralab— Quality, Volume, Savings.



**USCC/Centralab**

Electronics Division • Globe-Union Inc

4561 Colorado Boulevard ■ Los Angeles, Ca. 90039

(213) 240-4880



# Washington newsletter

---

## **FCC plans to expand interconnect rules; costs hit**

The Federal Communications Commission is scheduling action by March 18 expanding competition in the market for PBX switchboards and key system terminals by adding such customer-provided equipment to its registration program. The two product lines—major markets for Western Electric, AT&T's manufacturing arm—are now expected to be added to the FCC's Nov. 7 order on Docket 19528 from which they were excluded. **But the proposed FCC action could be stalled by challenges** in the U.S. Court of Appeals by the North Carolina Utilities Commission and U.S. Independent Telephone Association. AT&T may also go to court later if it does not get favorable FCC action on its Jan. 9 petition to stay implementation of the first phase of the docket, under which equipment registration is now scheduled to begin April 1.

## **Commerce revising controversial study of telecommunications**

A Commerce department report, "Lowering Barriers to Telecommunications Growth," has "proved to be highly controversial" and is being revised, concedes John M. Richardson, acting chief of the agency's Office of Telecommunications. Its Science and Technology Telecommunications Task Force prepared the draft. Most of the 50 electronics companies surveyed for the report and the Electronic Industries Association's Communications division **were highly critical of the report** and urged it be withheld until it could be revised [*Electronics*, Dec. 25, p. 42]. The 95-page report dealt with direct satellite communications, fiber-optic and broadband cable distribution networks, and land-mobile radio services. It was widely interpreted as a move by Commerce to expand the office's operations. Richardson said the report "was misunderstood."

## **Increasing foreign investment in Datran studied by FCC**

The possibility that Data Transmission Co. of Vienna, Va., a specialized common carrier, may be violating Federal laws concerning foreign investment and control is being weighed by the FCC. The issue entails **increasing investments in and loans to Datran and its parent, Wyly Corp. of Dallas, by the Swiss company Haefner Holding AG** and its owner, Walter Haefner. Alien ownership of more than 25% of any U.S. communications company is illegal.

The issue arose when Datran recently sought FCC permission for Haefner to invest up to \$20 million more in convertible debentures in the company. Since 1973, Haefner's holdings in Datran and Wyly Corp. have increased to an estimated \$39.8 million.

## **1975 avionics sales pass \$100 million for general aviation**

1975 avionics sales for general aviation probably passed the \$100 million mark for the first time, say industry officials. They base the prediction on the General Aviation Manufacturers Association's report that U.S. **aircraft sales for the year set a record** of \$1.4 billion, up 13.6% from the \$909 million of 1974. Unit shipments for the 12 months of 14,072 were down fractionally from the 14,166 reported in 1974, however. GAMA is forecasting another record for 1976 with shipments of 15,000 planes worth nearly \$1.2 billion.

## Competition vs regulation: a Justice Department view

*The premise that competition will destroy regulated industries like telecommunications and air transportation is gradually being disproved, notably by the actions of the Federal Communications Commission over the past seven years. Jonathan C. Rose, deputy attorney general for antitrust, proposed in Washington in January that regulated companies like American Telephone & Telegraph could become more profitable if they devoted a fraction of the resources to competition that they now spend on fighting it. Excerpts from his remarks to the National Association of Manufacturers committee on telecommunications follow. —Ray Connolly*

We are repeatedly told that "chaos" will result if additional competitors are permitted in any particular aspect of a regulated industry like communications. Indeed, as a relative newcomer to this field, I have been astonished to learn from established firms and other interests that their economic futures apparently are so fragile, almost balanced on a knife's edge, or so they seem to argue. I have always thought that Triple A rated public utilities and major broadcasting firms were relatively secure and profitable operations. I now am told that they are really in peril, indeed an almost endangered species. They must be protected, it is said, particularly from the so-called "baby dinosaurs," or else "inevitably" they and the vital public services they provide will falter.

### Threatening beasts

I have asked who those "baby dinosaurs" are. "Baby dinosaurs," according to the spokesman for one utility, are all those small potential competitors. While one might think that all those small firms are too insignificant to do any harm, we are urged not to forget that baby dinosaurs grow up into very threatening beasts indeed.

There is no credible evidence to support the gloomy predictions put forward by the carriers in opposition to new, competing entries. Predictions that competition would cause AT&T to abandon essential services have not yet materialized. Residential phone bills have not risen more rapidly than they might have otherwise. The number of persons injured annually because of customer use of non-Bell equipment, if indeed any ever were, has not gone way up. The independent telephone companies serving much of rural America have not been driven precipitously into bankruptcy. "Service problems" have not increased—indeed, in Rochester,

N.Y., where very liberal interconnection criteria were adopted, line troubles actually declined.

### Fiction of failure

When regulated industries and regulators confront rapidly shifting patterns of consumer choice, they sometimes will reluctantly admit that competition is the most effective way to meet the needs of an ever-changing market. The impact of competition both provides consumers with an abundance of options and stimulates the established carriers into offering consumers products held off the market for rate-making purposes. To the extent that consumers have paid for the development and talent that the common carrier industry has assembled, competition gives them the chance to obtain more of the fruits of carriers' technological capabilities.

But, whenever any regulated industry is first confronted with competition and the need to change, predictions of chaos inevitably follow. In imagination and abundance, these predictions of inevitable failure following the entry of competition are perhaps unparalleled in the history of American fiction and creative writing.

### Rechanneling resources

Of course, the communications industry is not alone in its doomsday predictions about the effect of more competition and less regulation. Last October, the Airline Transport Association charged that the Administration's aviation deregulation bill "would tear apart a national air transportation system recognized as the finest in the world." The next month the head of the Truckers' Association followed up with a calm assessment of the Administration's truck bill: "The Administration's proposal to dismantle regulation of truck regulation," he said, "is the ultimate in Government irresponsibility. Such action would not only destroy essential stability in transportation, but would completely disrupt the nation's entire marketing and distribution system. The result would be economic chaos."

If the regulated industries in this country would spend only 20% of the resources they currently spend to fight competition on actually competing, the public benefits would be substantial. Instead of crying from the rooftops "I am a monopolist," a communications company president could proudly say "I am a competitor in the great American tradition of free enterprise." Ultimately, he might also be able to run the business himself instead of having Government make many of the key decisions for him.

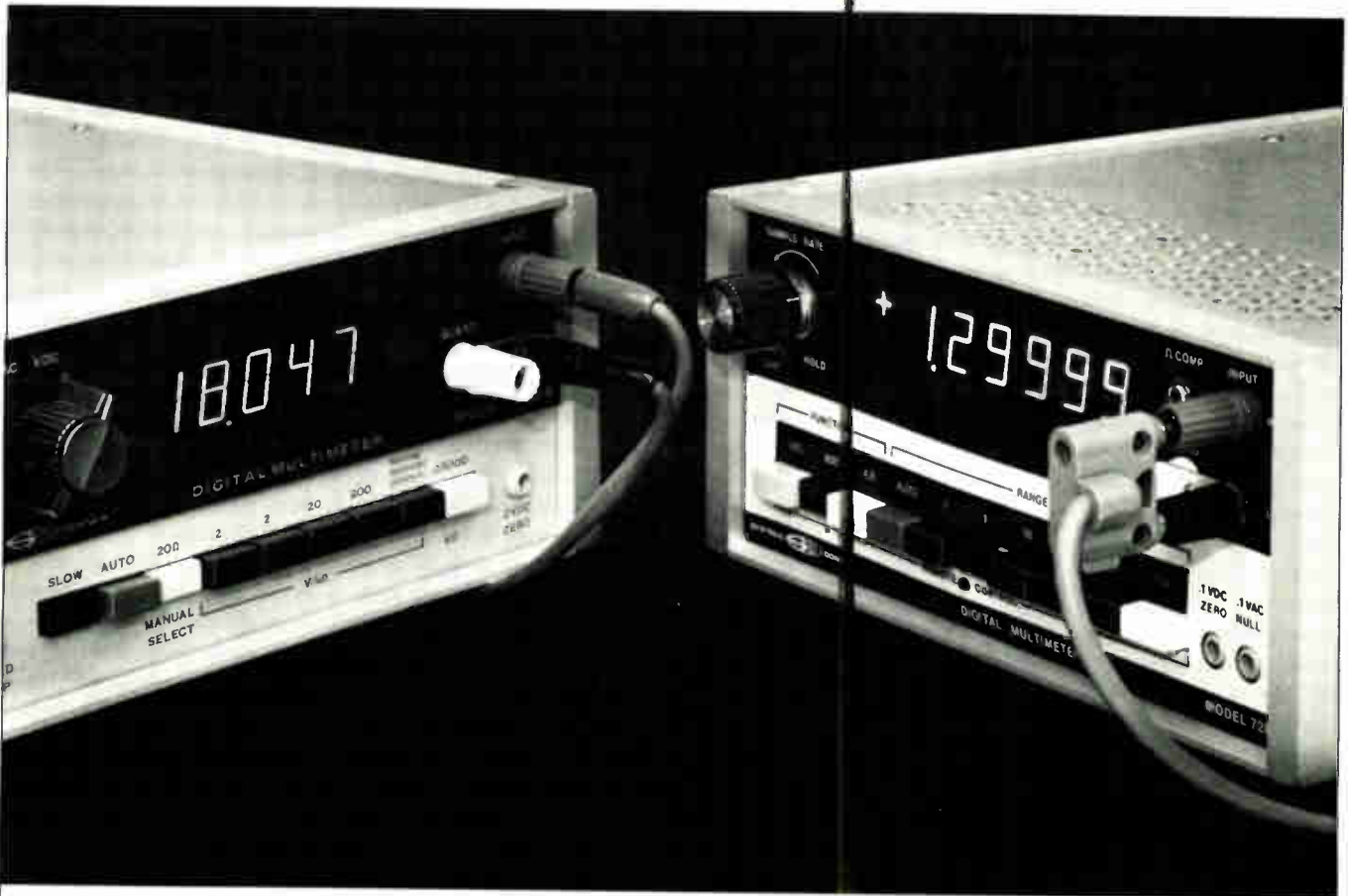

# Are all 4½ and 5½ digit DVM's alike?

Definitely not. For example, take Systron-Donner's 4½-digit auto-ranging **Model 7224 multimeter**.

It's the only one in its price range to offer a True RMS or averaging AC converter option that you can buy now or add later. Two other options (optically isolated BCD outputs and DC to DC ratio) also can be purchased now or added later. Everything else you need is standard! That's S-D's way of protecting your investment for the life of the instrument.

**Model 7215: another different DVM.** How many inexpensive DVM's offer complete systems programmability . . . let alone the option of buying it now or adding it later? Only S-D's 5½-digit autoranging Model 7215 offers you such flexibility. To convert it from bench to systems use, just order plug-in card option 04 and put it in yourself!

No, we're not sure whether all aspirin is alike or not, but we do know that all DVM's aren't. For complete details on the DVM's with a difference, call Scientific Devices or contact S-D at 10 Systron Drive, Concord, California 94518. Phone (415) 676-5000. Overseas, contact Systron-Donner in Munich; Leamington Spa, U.K.; Paris (Le Port Marly); Melbourne.

SYSTRON  DONNER



## The complete solution to the micro madness: PDP-11 software for the LSI-11.

The most expensive part of using micros isn't paying for the hardware. It's developing the software. With every kind of micro device except one:

The LSI-11. Digital's powerful 16-bit microcomputer on an 8½" x 10" board.

Because thanks to our RXV11 Dual Floppy Disc Drive, you can use the proven software from our famous PDP-11 mini-computers. To get your applications going. Fast.

You can program in easy-to-use BASIC, FORTRAN, or FOCAL, in addition to the assembly-level language other micros force you to use from the start.

You get utilities for editing,

compiling, assembling, loading, linking, and de-bugging your programs. Our RT11 operating system for real time task-oriented control. Even applications programs, through our DECUS customer network.

The RXV11 also helps you develop programs right on the LSI-11, without using time-sharing facilities or development machines, although if you want, we have those too.

And we haven't forgotten the hardware either. In addition to the basic CPU and 4K of RAM, we also offer CORE, ROM, and PROM memories; additional modules for system expansion; plus the PDP-11/03 — the LSI-11 in a nice neat box,

ready to be plugged in.

And it's priced at just \$634 in 100's for the CPU and 4K of RAM.

LSI-11. Powerful software for the micro market.

For details, call 800-225-9480 (MA 617-481-7400, ext. 6410).

Components Group, Digital Equipment Corp., One Iron Way, Marlborough, Mass. 01752. Canada: Digital Equipment of Canada, Ltd. Europe: 81 Route de l'Aire, 1211 Geneva 26, Tel. 42 79 50.

Prices apply to USA only.

**digital**  
**COMPONENTS**  
**GROUP**

## Swiss ministry begins to computerize telephone directories and services

Even for a small country like Switzerland, the paper work involved in keeping telephone directories and inquiry services up to date is staggering. Right now, clerks in 17 regional centers have to shuffle some 20 million file cards to do the job. But the end of the card-shuffling routine is in sight for the Swiss post and telecommunications ministry.

This month, national telephone service is beginning to install the first of 700 intelligent terminals for a \$38 million computer system that will automate directory services across the nation by the spring of 1978, if all goes well. After that, the system—called Terco for telephone rationalization with the aid of computers—will be expanded to cover other directory-related services. For instance, it will keep track of requests for new lines, answer fault complaints, store the file of equipment locations, and keep tabs on teletypewriters and leased lines.

**Configuration.** For the first phase of Terco, the main data bank will be sited at Lucerne, where an IBM System/370-158 will hold all the directory information for Switzerland. The 17 regional centers will be linked to the main center through some 60 special lines operating at 4,800 bauds. At the outset, each regional center will get five video terminals; when the first phase is completed in 1978, the 700 terminals will have been split up among 80 clusters. Thomson-CSF, the leading professional electronics producer in France, has won the contract to supply the terminals with its T-VT-6000 hardware.

When the system gets going, most of the terminals will be assigned to operators for inquiry services. Swiss phone users will dial either 11 or 111 to raise a local information operator. She, in turn, will tap out the caller's query on her terminal key-

board and then push a transmission button to access the Lucerne data bank. The answer will come back in real time on the terminal display.

**Services.** Along with requests for phone numbers, Terco will be programmed to take care of call-transfer instructions. And a smaller batch of terminals will be assigned to update the data bank with changes in subscriber listings. What's more, every 18 months or so, the computer at

Lucerne will spew out tapes for photo-typesetting conventional printed directories.

All told, the ministry figures Terco will give it the means to vastly improve its service on information calls. Better still, the automated directory network will do the job with some 350 fewer people than it takes now. That adds up to a net saving of some \$15 million for the first phase of Terco. □

### Around the world

#### Self-alignment improves bipolar transistors

A new self-alignment method produces bipolar transistors that operate at higher frequencies than if they were made by conventional techniques with masks of equal precision. The developer, Mushashino Electrical Communication Laboratory of the Nippon Telegraph & Telephone Public Corp., plans to cooperate with manufacturers in application of this technology to small-signal transistors, power transistors, and integrated circuits. Although the three precision mask-alignment processes are eliminated, the new technique reduces spacing between the base metal and emitter junction to about 0.4 micrometer from the usual 1.5 to 2.0  $\mu\text{m}$ . This reduction typically cuts the extrinsic base resistance in half and also halves the transistor area. This area reduction leads to halving of output capacitance and typically doubles the transistor's operating frequency.

An experimental transistor made by the new process has an emitter area of 350  $\mu\text{m}^2$ . The maximum oscillating frequency is 12 to 13 gigahertz, and the scattering-parameter cutoff frequency is 8.4 GHz. This cutoff is about 2 GHz higher than values achieved with conventional transistors. Two types of selective etching are used to fabricate the new transistors, which are interdigitated on a conventional n-type substrate with a p-channel epitaxial layer. Highly doped polysilicon, which etches faster than if it were moderately doped, is used to etch mesas with tops that are broader than their bases. Because silicon dioxide implanted with impurity ions etches faster than a nonimplanted region, diffusion and metalization regions can be self-aligned.

#### CCD helps convert digital signals

Adaptive or programmable filters are often used in signal-processing systems to sort out the correct signals by applying digital values to samples of the analog signals. But when charge-coupled devices are used for the filters, conventional interface circuitry, which takes up a lot of room, must still perform the digital-to-analog conversion.

In a move to reduce space problems, an engineering group at the University of Edinburgh, Scotland, has developed a CCD-based d-a converter for CCD filters controlled by microprocessors. Made by standard MOS technology, the converter is a surface-channel, three-phase, 16-bit, metal-gate CCD. Floating-gate reset techniques developed by the Edinburgh group nondestructively sense the charge in every tap. The unit is described as a "pseudo-two-phase device" in which the third phase (the capacitor) is replaced by individual electrodes connected to the gate of an MOS-transistor.

# Announcing

## THE PREFERRED Digital Panel Meters

**NOW IN THE  
BALLANTINE TRADITION  
OF HIGH RELIABILITY . . .**

- **42 MODELS:** Voltage: 200 mV to 1000V  
Current: 200 mA to 2A
  - **2½, 3½, 4½ DIGITS:** to 10  $\mu$ V resolution...  
Engineering Units . . . Custom or Standard
  - **LOW POWER:** less than one watt — cool  
running
  - **EASY TO READ:** high contrast, large 0.5" LCD's  
with a **THREE YEAR WARRANTY.**
  - **RFI SHIELDED:** small, sturdy metal case.
  - **PURE QUIET INPUT:** no output hash from auto-  
zeroing circuits.
  - **TRUE TRANSFORMER INSULATION:** high CMR . . .  
Input low isolated from power ground, case and digital  
ground.
- Call or write for **EVALUATION SAMPLES** or use the reader  
service number for our **NEW BROCHURE.**



**Ballantine**

Ballantine Laboratories, Inc.  
P.O. Box 97, Boonton, New Jersey 07005  
Phone (201) 335-0900, TWX (710) 987-8380



Circle 64 on reader service card

Manufactured under exclusive North American license from TEKELEK-AIRTRONIC.



## **British laser may reveal molecules in semiconductors**

A laser that emits sub-picosecond pulses without "chirping" is so fast that it could be useful in studying the properties of semiconductor and other electronic materials. The developers, in the physics department of Imperial College, London, are confident that their **mode-locked dye laser, which now emits pulses of a third of a picosecond, can be refined to emit pulses as short as 0.1 ps.**

Since the pulses would be shorter than the vibrations of most solids and liquids, stop-action photography could be used to study the molecules of semiconductor materials. The laser, which has a rhodamine dye in a water solution as the laser medium, fires in the 6,000-angstrom range. Peak power inside the cavity is about 300 watts.

## **Fujitsu teams with U.S. firm in PBX venture**

Private branch exchangers are to be produced and sold in the American market by a company being formed by Japan's Fujitsu Ltd. and American Telecommunications Corp. of El Monte, Calif. The main product is to **be an electronic exchange with a capacity of about 400 lines to compete with the Bell System's Dimension.** The PBX will be produced initially by Fujitsu, and sales are to begin in March immediately after startup of the new company, initially capitalized at \$1 million. Fujitsu, which will own 82%, has budgeted \$33 million for the first five years. The president will be Henry Marcheschi, the American Telecommunications president.

## **Change in France's ministers delays switching contracts**

The French telecommunications industry is in turmoil again. Just as manufacturers were preparing to win large orders for space-division switching hardware, President Valéry Giscard d'Estaing replaced post and telecommunications minister Aymar Achille-Fould. His successor is former foreign trade minister Norbert Ségard. Industry sources now expect at least a six-month delay in letting the contracts.

**The new telecommunications chief is not expected to change the policy of using foreign space-division systems to bridge the gap until the French-designed time-division technology can span the whole product range later in this decade.**

## **Siemens boosts computer sales, despite economy**

Apparently undaunted by the recent demise of the international Unidata computer combine in which it was a partner, West Germany's Siemens AG is optimistic about its future in data processing. Despite Europe's contracting EDP market last year, the Munich-based company increased its sales by 10% to about \$400 million. More than 25% of the total was sold abroad. In the near future, Siemens is anticipating annual sales gains of 11% to 12%.

**Particularly successful for Siemens have been its activities in integrated remote data-processing systems, which now account for more than half of all EDP equipment the firm has installed and which are expected to reach 30% by 1980.** Overall, the German company claims a 17.5% share of the domestic market for medium and large-size computer systems—1.6% higher than in 1974. Its share of the European market for such equipment is about 7%.

## **Workers strike for pay hikes in Spain**

Standard Electrica, 65% owned by ITT, is the largest of 87 companies shut down by wildcat strikers in Spain to test their strength under the new government of King Juan Carlos. Standard Electrica workers, seeking to gain leverage because Spain is being scrutinized by European capitals for possible membership in the European Economic Community, are asking an across-the-board pay hike of \$198 a month for the duration of a two-year contract that was to have started this month. **The company says the cost for its 19,750 workers would be \$54.6 million a year—more than its after-tax profits in 1975.** But to dampen inflation, the government wants to keep pay hikes within limits of a cost-of-living increase plus 2%.

## **France stimulates numerical-control tool production**

France's market for numerical-control machine tools will get a shot in the arm through an ambitious government program aimed at pulling that industry out of its perennial slump. In hopes of placing 350 new N/C machines by 1980, the government will step up its financial aid, which has accounted for 100 N/C orders during the past two years. **Other measures include consolidation of small toolmakers into groups, government aid to research, and reorganization of export networks.** France's machine-tool industry, the world's sixth largest, ranks only eighth among tool exporters, while imports claim more than 50% of the French market.

## **British military inks \$100 million air-missile pact**

A \$100 million contract to build medium-range air-to-air missiles over the next several years has been awarded by Britain's Ministry of Defence to Hawker Siddeley Dynamics. The XJ521, an offshoot of the U.S. Sparrow, is an all-weather guided weapon intended for upcoming generations of fighters, including the pan-European multi-role combat aircraft and the U.S. General Dynamics F-16 fighter recently adopted by four European countries. The XJ521, expected to be effective into the 1990s, includes new British electronics. **The homing head is made by Marconi Space & Defence Systems, and the fuse system by EMI Electronics.**

## **Philips markets infrared receiver**

**An infrared audio system that can be plugged into any television receiver, regardless of make or age,** is being marketed by Philips GmbH, the German subsidiary of the Dutch firm. The system can also be used with other types of audio equipment. A transmitter in the plug-in unit sends the sound on a carrier of 95 kilohertz on an IR wavelength of 950 nanometers to a receiver the viewer wears suspended from the neck or clipped to a pocket. A headset is hooked to the receiver.

## **Danes merge firms to strengthen marine electronics**

In a move to strengthen Danish marine electronics in the wake of a shipping slump, **Dansk Radio A/S, which produces marine communications gear, is to be merged about mid-year with Terma Electronics, which manufactures small radar sets.** Faced with competition from such foreign giants as ITT and Raytheon, Dannenborg, the Danish shipping company that owns Dansk Radio, is buying Terma from European Enterprises Development Co. S.A., a French firm, for about \$800,000.



# BE A WINNER!

ENTER TELEDYNE/CRYSTALONICS' HYBRIDIZATION CONTEST.

**\$3,000 IN CASH PRIZES!**

One Grand Prize of

**\$500**

Ten First Prizes of

**\$200** each

Ten Second Prizes of

**\$50** each

**21 WINNERS IN ALL!  
YOUR CHANCES ARE GREAT!**

It's easy to enter. Design or select a hybrid or discrete circuit that can be hybridized by Crystalonics. Send your circuit design, along with a description of the circuit, the function it performs and how it operates, to Crystalonics. (All entries must be accompanied by an entry form.)

Winners will be selected by a panel of 3 independent judges, active in hybrid design, on the basis of:

1. General usefulness.
2. Ratio of complexity of circuit to ease of hybridization.

Winners will be notified by May 1st and announced in the May 10th issue of Electronic Engineering Times Magazine.

**CONTEST CLOSES APRIL 1st, 1976.**

Don't delay . . . circle the reader service number for your entry form today!

 **TELEDYNE**

**CRYSTALONICS**

147 Sherman Street, Cambridge, Mass. 02140  
Tel: (617) 491-1670 • TWX: 710-320-1196

# Probing the news

Analysis of technology and business developments



**Weapon types.** To cut down on the duplication of weapon families is prime objective of new NATO planning body.

## NATO may alter procurement

Independent Planning Group being formed by European members  
will aim at increased share of military market

by Ray Connolly, Washington bureau manager, and Sarah Kemezis, McGraw-Hill World News

The market for American defense electronics firms operating in Europe could be on the verge of some radical changes. The first shadows of those changes will be cast next month at the organizational meeting of the Independent Planning Group, made up of the European members of the North Atlantic Treaty Organization. Its object: to promote NATO weapons standardization and to push sales of European military gear to the U.S.—the so-called two-way street.

The planning group was formed on a vote of all 15 NATO members—including the U.S. But that endorsement puts American defense officials in the difficult position of, on the one hand, endorsing the planning group's goals while, on the other, pushing greater U.S. arms sales in Europe.

Reflecting that dichotomy, the

American defense establishment is deeply divided over implementation of standardization. While the Electronic Industries Association's Government Products division has no established position on the matter, its individual member companies naturally view the effort as a threat to U.S. companies' military electronics sales in Europe.

"The concept looks real good," says one firm's vice president for military marketing, "until you begin speculating on what DOD's goal of eventually cutting the ratio of U.S. products in NATO from 10-to-1 to 2-to-1 is going to do to your business. Then you get nervous."

**Pushed by costs.** It is rising U.S. defense costs that have provided the major push within the Pentagon to have America's NATO partners pick up a larger share of the economic burden by producing weapons sys-

tems for the alliance. Leading the drive for greater standardization and NATO cost-sharing is the Directorate of Defense Research and Engineering and its chief, Malcolm R. Currie. On the opposite side is the office of the Assistant Secretary of Defense for International Security Affairs, whose charter covers pushing sales of U.S. military hardware abroad.

"Excessive duplication and lack of standardization have become a serious problem," says Currie, largely because of the highly industrialized, technologically advanced societies of the countries that make up the alliance.

Currie estimates that in Central Europe alone, NATO forces are using 23 different families of combat aircraft, 7 families of main battle tanks, 8 families of armored personnel carriers, and 22 families of anti-

## Interoperability may mean opportunity

For American communications contractors, increased interoperability may prove more significant than other forms of standardization because it requires systems made by many firms to interface. "Frankly, we have a bit of a mess in communications from the NATO point of view," explains Gordon Tucker, NATO assistant secretary general for special systems. "Several nations are working on a new generation of equipment and, unless something is worked out, they won't be able to talk to each other."

For long-distance communications, NATO is solving the problem by building a single system to be operated by NATO itself. Known as the NATO Integrated Communications System, it will be operational down to corps level by 1978.

NICS will use 18 automatic telegraph relay equipments, known as Tares, and 24 automatic telephone switches linking field commanders to NATO headquarters and to national governments. Bids have already been received and are being analyzed for both the Tares and the telephone switches. Philips, Litton Inc., and Burroughs Corp. are vying for the Tares contracts, while GTE-Sylvania, North Electric, and Siemens are in the running on the telephone contract.

A decision is expected soon, though the Tares award has been delayed by a NATO ruling that the Philips bid is noncompliant. The Dutch government has challenged this decision, and contract awards are being held up pending a ruling by a NATO committee. Each contract is worth around \$30 million to \$35 million.

tank weapons. Similarly, NATO naval forces use 36 different fire control radars, 8 surface-to-air missile systems, 6 antiship missiles, and more than 20 different calibers of weapons of 30 mm or larger. "There are over 100 separate tactical missile systems alone within the alliance," moans Currie.

Of the three approaches to NATO standardization—joint developments, interdependency, and interoperability—none is without problems, according to Currie. In simplest terms, Europeans like joint development and procurement with *pro rata* sharing of R&D and production; Americans don't.

Interdependence in R&D is the approach promoted by the U.S. since 1972. One nation is assigned responsibility for developing a product to be used by a number of NATO allies. "To remove U.S. industry from an adversary role with its European counterparts," Currie explains, "DOD has encouraged direct U.S.-European industrial teaming through licensing agreements prior to requests for proposals."

But some Europeans don't like the U.S. hooker requiring American production, which protects the U.S. trade balance and prevents dependency on offshore production of major weapons systems. Yet the U.S.

position is that 'interdependency is working,' and it supports that view by citing the American selection of the German-French Roland II missile for its short-range air defense system, known as Shorad.

This leaves interoperability, which gives U.S. vendors a better opportunity for follow-on business. It's also an area where NATO can achieve relatively fast results for a relatively small investment, in the U.S. view. In communications, Currie points out, 10 of 13 sites for long-haul NATO and U.S. telecommunications have been interconnected in the past two years, and the remaining three, to be completed this year, have taken longer only because they require microwave links. This has been done, says the Pentagon, "at virtually no cost to U.S. or NATO."

**Paying off.** Moreover, DOD says interoperability is paying off by permitting NATO satellite ground terminals in Europe to use the U.S. defense communication satellite on a *quid-pro-quo* basis. Other short-range efforts include a program to define complete interoperability of the data-handling systems of NATO ships. For telecommunications, member nations are developing standard information exchange formats, common interface standards, and a common director system. □

# All you need to know about synthesizers



## ...and amplifiers.



### The highlights:

The PRD 7828 Frequency Synthesizer has 1 kHz phase-lock steps from 1 kHz to 80 MHz, has optional vernier, is fully programmable and offers excellent stability. The PRD 7808 Signal Generator/Frequency Synthesizer-Sweeper has digital synthesizer performance yet provides AM, FM and pulse modulation and sweep capabilities. Both are remarkably cost-effective.

The PRD 7805 Broadband Linear RF Amplifier is an all-purpose, 10-watt instrumentation amplifier in the 0.05 to 80 MHz range. The PRD 7815 Tunable Amplifier is ideal for obtaining up to 8 watts in the 10 to 500 MHz range. Both are perfectly matched to the synthesizers.

### The whole story:

Everything else you need to know is in our "PRD RF and Microwave Catalog." Ask for it today. Call (516) 334-7810. Or write:



HARRIS CORPORATION  
PRD Electronics Division  
1200 Prospect Avenue  
Westbury, L.I., N.Y. 11590



People

# Which technology for Motorola?

Colin Crook, director of LSI operations, has several options, but he finds the capability of MOS is still impressive

Colin Crook, director of LSI operations at Motorola Inc.'s Semiconductor Products division, has one of the more difficult jobs in semiconductor management. He's responsible for deciding for Motorola which of the LSI capabilities under his control is right for which product and when the product is to be marketed.

The job is particularly sensitive because millions of dollars must be spent just to nurture an LSI technology to the point where it can be sensibly evaluated against a competitive technology for a particular job. And once committed, there's precious little room for recovery if the project begins to sour.

Nothing illustrates this challenge better than the need to determine just where integrated injection logic fits into the product spectrum, if, indeed, it fits anywhere. Since Crook's job is to evaluate I<sup>2</sup>L and determine whether Motorola should follow it or MOS technology in the next round of product design, the editors of *Electronics* discussed it with him at his Phoenix offices. Excerpts of that discussion follow.

*Q. As you know, technology decisions now being made throughout the semiconductor industry will affect the course of product development for several years to come. Of the two competing approaches—some form of n-channel MOS or some form of I<sup>2</sup>L—which do you back?*

*A. Right now we're backing both because you can't really tell where a technology can go until you take it there with some form of real hardware design. Unfortunately, paper studies just aren't enough.*

*Q. What do you think about the*



**Decision maker.** Motorola's Colin Crook is evaluating MOS and I<sup>2</sup>L as opposing technologies for the next round of LSI.

*growing feeling of many MOS suppliers that I<sup>2</sup>L won't make it as a main-line digital technology because it will not overtake the ever-improving MOS performance?*

*A. At present, it's still very chancy to commit for all time to one at the expense of the other. But let's face it—you've got to be enormously impressed with MOS capability. It's truly awesome. Methods to enhance MOS are already going into production at Motorola, like using depletion-load logic in microprocessor de-*

*signs and two-level connectors in memory designs.*

The new 16-k RAM we're about to sample is an example of what's possible now with MOS technology. Another example is MOS microprocessors that are coming with 10 times today's throughput. And behind these silicon-gate products are even greater performance possibilities—with V-MOS, D-MOS, and so on.

In short, I<sup>2</sup>L will have to overcome an enormous momentum that's developed in MOS throughout the semiconductor industry.

*Q. Judging from the results of your work so far with I<sup>2</sup>L, what are the odds it will make it?*

*A. Here's the problem. You look at the performance parameters of an individual I<sup>2</sup>L transistor, and you've got to sit up and notice—micro-power dissipation, less than 1 picowatt performance, and so on. But can you put those devices into LSI forms? I mean, is I<sup>2</sup>L really an LSI technology? What haunts everyone is that after two and three years of time and money you find that I<sup>2</sup>L falls smack in the middle of the MOS capability.*

*Q. What performance levels will I<sup>2</sup>L have to achieve for it to be a success in LSI?*

*A. Forgetting yield for a moment, there are three criteria determining the performance of an LSI technology: speed, power, and density. On speed, I<sup>2</sup>L will have to get below 5 nanoseconds before it can move away from n-channel capability. From what we've seen, it's not quite there yet, at least without some form of Schottky processing, and that's rough but not impossible to do in*

# Who is the largest supplier of OEM semiconductor memory systems?

If you're in the computer or systems business you probably already know that it's Intel. You also know the importance of getting your systems out of engineering and into the marketplace. Nothing happens until you get an order.

If the semiconductor memory part of your system is delaying things or if you have two important memory projects but only one design team, then you should talk to us. Chances are we may already have just the memory system you need. That's why more and more computer companies and system houses are coming to Intel for help. We're helping them get the competitive jump in the marketplace—with a memory as good as their own.

We're talking about big memories, like 8 megabytes in a single frame. And high speed

memories as fast as 150 ns access time, 300 ns cycle time. And memories to interface with your TTL or ECL logic, with or without error correction.

We're already shipping over 50 multi-megabit systems, plus thousands of single board memories every month. That means we'll be able to support your volume production requirements. And because we're the world's largest manufacturer of both semiconductor memory systems and components you get the best possible price/performance package.

It's easy to get started. Call Gary Andersen, OEM Marketing Manager, (408) 734-8102 Ext. 451, or send your memory specifications to Intel Memory Systems, 1302 N. Mathilda Avenue, Sunnyvale, California 94086.

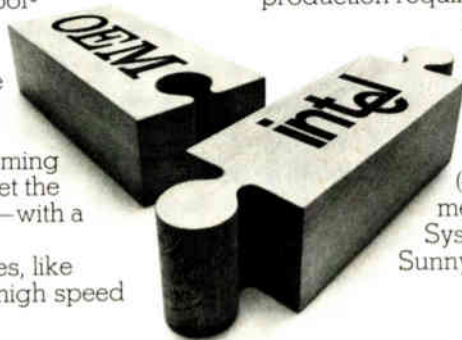

**intel memory systems**  
A DIVISION OF INTEL CORPORATION

REAL TIME SPECTRUM ANALYSIS  
WITH 70 dB DYNAMIC RANGE  
AND DUAL DISPLAY... FOR UNDER \$10,000!

# SPECTRASCOPE II

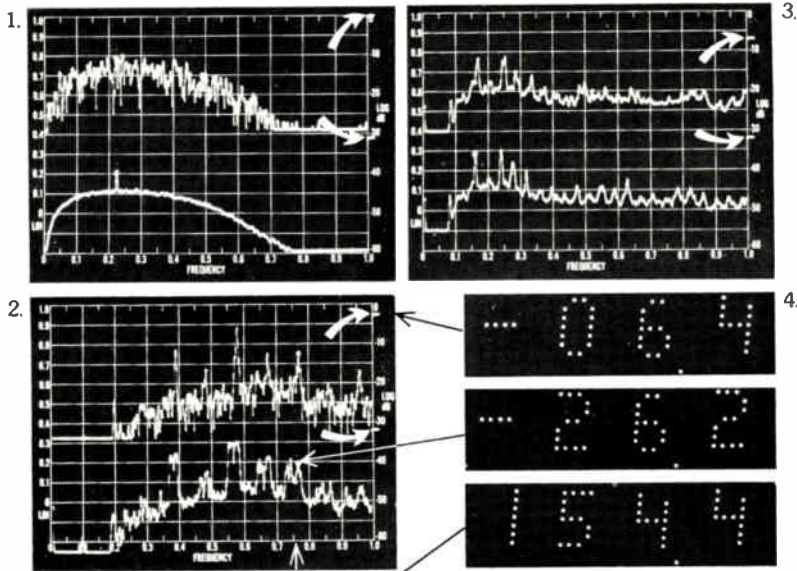

1. **Direct Comparison** of Real Time (upper) and Averaged (lower) spectra, showing dominant vibration peak.
2. **Direct Comparison** of Real Time machinery-noise spectrum (upper) and Peak Hold spectrum (lower).
3. **Direct Comparison** of aircraft engine noise spectra averaged at 2490 rpm (upper), 2340 rpm (lower).
4. **Instant Readout** of... Overall (rms) level (top), Amplitude (center), Frequency (bottom).

Arrows on photos point to overall (rms) level indications which appear automatically at right end of each Real Time, Averaged, or Peak Hold spectrum.

Above are just a few of the ways Spectrascope-II—our new SD335 Real Time Analyzer—displays instantaneous and/or averaged spectra at the same time... on the same screen. Built-in dual memories, averager and scope let you make such direct comparisons of data on-the-spot for monitoring test trends... checking the effects of a design change... or measuring a frequency shift as operating parameters change. Features? Consider these...

- Linear dynamic range to 70 dB ■ 500-line resolution
- 0.06 Hz to 50 kHz operation in 10 analysis ranges (with option all the way to 150 kHz) ■ Automatic, updated indication of the instantaneous overall (rms) level of each spectrum on scope, LED readout and X-Y plotter ■ 5-digit LED readout of frequency and amplitude (lin or log) under instant cursor control ■ "SIMULPLOT" for making X-Y plots under complete analyzer control while you're viewing the same data on the scope ■ Portability: carry the Spectrascope-II right to the job ■ Spectral's world-famous field serviceability and product support.

We've saved all the details—and the usual BIG PICTURE of the control panel—for the data sheet, which you should send for now.

(Also available: SD330A "Spectrascope," a 250-line RTA for under \$8,000.)

 **Spectral Dynamics Corporation**  
OF SAN DIEGO  
P.O. Box 671, San Diego, Calif. 92112 (714) 565-8211, TWX 910-335-2022

## Probing the news

LSI. As for density, MOS designs with silicon gates, double-level interconnects, and so on are already achieving memory cells in the 0.5-square-mil range, and that's going to be very hard for  $I^2L$  to beat in a real-world production circuit that can compete with MOS costs. In fact, right now only on power dissipation can  $I^2L$  give the designer a clearcut LSI advantage over MOS.

*Q. What happens when you throw in yield?*

A. Yield can really tilt it toward the MOS device. Our yield levels on the 6800 microprocessor and 4-k RAMs, for example, are truly remarkable. You can predict learning curves even on the most complex MOS circuits. With  $I^2L$ , on the other hand, there's no production history on yield.

In any case, building large LSI slices with bipolar technology will never be a picnic—there are some yield-killing mechanisms built in, like very narrow bases, that just aren't there with MOS. Clearly, what's needed in  $I^2L$  is some high-volume vehicle on which to shake down the technology. The trick is to find that vehicle.

*Q. What digital products are you developing with  $I^2L$ ?*

A. Our new bipolar LSI family—we call it Megalogic—will have  $I^2L$  parts for interfacing with our 6800 microprocessor family. We picked  $I^2L$  because we wanted good performance at high levels of complexity. Examples here are a floppy-disk generator, programmable delay module, 8-by-8 multiplier, parity interrupt controllers, and so on. Here  $I^2L$  makes a good LSI alternative to TTL.

*Q. Outside the main digital area, are there any applications where  $I^2L$  is a sure thing?*

A. The most promising area for us outside of memory and microprocessors is in analog design. Here  $I^2L$  can be truly revolutionary because it can add digital functions to analog chips naturally with no process change. We have strong activity here—in digital tuning circuits, auto, and so on. Analog-to-digital conversion with  $I^2L$  techniques is also very promising. □



# NATIONAL SEMICONDUCTOR REVEALS THE PRINCIPLE BEHIND ITS 18-PIN 4K RAM.



selection, because all our parts are speced at 200ns worst case access time using an MOS level clock.

P/N	Chip Enable Input	Access Time	Read/Write Cycle	Read/Modify/Write Cycle Time	Package
5280	MOS	200 NSEC	400 NSEC	520 NSEC	22 pin
5270	MOS	200 NSEC	400 NSEC	580 NSEC	18 pin
5281	Bipolar	250 NSEC	400 NSEC	510 NSEC	22 pin
5271	Bipolar	250 NSEC	400 NSEC	560 NSEC	18 pin

You also get a bunch of exclusive features with our 18-pin. Like logical chip select, the Tri-Share Input, that allows you to build large memory cards and eliminates the cost of extra chip enable decoding.

And tri-state output, a feature that does away with external pull-up resistors. And superior read/modify/ write timing for use with error correction coding.

But even if you're already committed to 22-pin, there's no reason to despair. Because we make both the 18 and 22 devices from the same die. That means higher overall volume for us and lower cost and greater reliability for you in either pin types.

Now if this sounds like the kind of power and performance you want from 4K, return the coupon and we'll send you everything we've got on our 18-pin 4K RAM.

And, if you're still wondering how we got all that density into one chip, you'll find the key on just about any can of sardines.

The idea was to cram the same powerful 22-pin functions into an 18-pin package. To give you double the density without sacrificing speed.

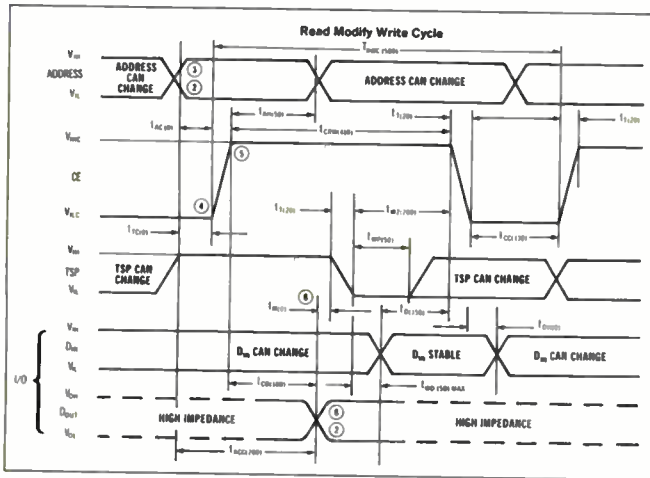

And what we did was open up a whole, new world. A world so compact, you save money on PC cards, connectors, support circuitry and system costs.

So, while you're losing a few pins, you're gaining a lot of efficiency.

And, because our 18-pin is so fast, you can use the same high yield part for any system.

You don't even pay a premium for speed

E 1/6

Name \_\_\_\_\_

Company \_\_\_\_\_ Title \_\_\_\_\_

Address \_\_\_\_\_

City \_\_\_\_\_ State \_\_\_\_\_ Zip \_\_\_\_\_

My area of responsibility is (check one):

Management  Design Engineering

Engineering Services  Purchasing  Others

Mail to: National Semiconductor Corporation  
2900 Semiconductor Drive, Santa Clara, California 95051

**National Semiconductor**

# GOULD/Brush Analog and Digital Recording Systems. The Most complete Line.

GOULD/Brush direct writing recorders produce written records of highest accuracy, trace clarity, crispness and uniformity.

Gould offers a complete selection of general purpose, high performance direct writing and strip chart recorders with many exclusive features.

Most models are available in both portable and rack mounted versions. These quality recorders are ideally suited for industrial and scientific applications that require the highest precision, sensitivity and accuracy. PHONE FREE (800) 648-4990 FOR FULL LINE BROCHURE.

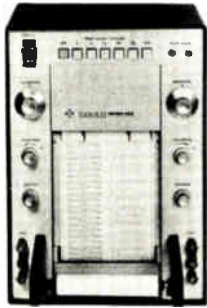

GOULD/Brush 222 • 2-CHANNEL. Portable battery operated version of Brush 220 recorder. Internal re-charger. 30Hz frequency response. Sensitivity 1mV/div. to 500Vf.s.

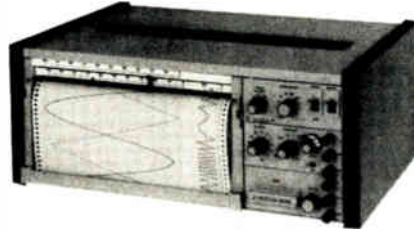

GOULD/Brush 110 STRIPCHART. Most versatile 10-inch recorder. One or two channels; integrator optional. Lifetime thermal pen guarantee. 0.25 sec. f.s. response.



GOULD/Brush 816 • 8-CHANNEL HI-SPEED MULTIPPOINT. Data is recorded at a rate 2 sec. / point to 16 points / sec.

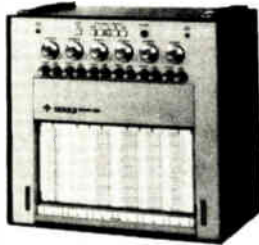

GOULD/Brush 260 • 6-CHANNEL. High precision and operator conveniences. Built-in preamps. 1mV/div. to 500Vf.s. sensitivity.

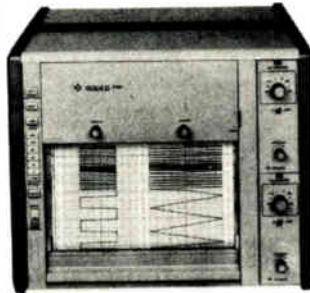

GOULD / Brush 2400 • 2-CHANNEL. Channels are a true 100mm wide. Plug-in preamps. 30Hz frequency response.

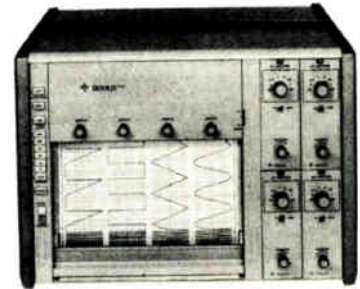

GOULD / Brush 2400 • 4-CHANNEL. 50mm channels. 50Hz frequency response, 99.65% linearity.

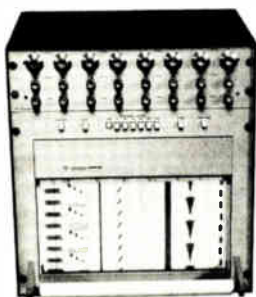

GOULD/Brush 481 • 8-CHANNEL. 1mV/div. to 500 V f.s. sensitivity. Model 480 available without preamps.

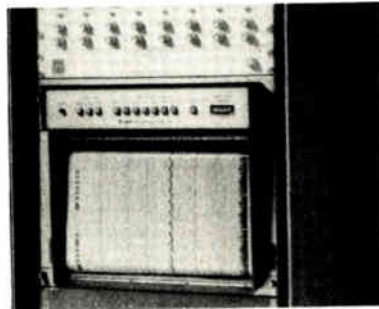

GOULD/Brush 200 • 8-CHANNEL. The world's standard for high performance recorders. Tailored to your specific requirements.

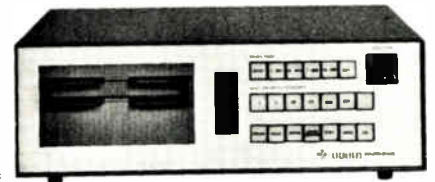

GOULD 6100 DATA ACQUISITION SYSTEM. 128 floating and integrating inputs, real time monitoring, 200 points/sec., 3M tape cartridge.

Gould Inc., Instruments Systems Division  
3631 Perkins Avenue, Cleveland, Ohio 44114  
Telephone (216) 361-3315

/or GOULD ALLCO S.A., 57 rue St. Sauveur, 91160 Ballainvilliers, France

 **GOULD**

Electronics/January 22, 1976

Computers

# Designing PDP-11: trials, triumphs

DEC's Gordon Bell tells of the errors and corrections on the way to one of the most successful minicomputer series

by Stephen E. Scrupski, Computers Editor

"There is only one mistake that can be made in a computer design that is difficult to recover from—not providing enough address bits for memory addressing and memory management." And when Digital Equipment Corp. made that mistake with the PDP-11, it "followed the unbroken tradition of nearly every known computer."

That's typical of the insights provided by Gordon Bell, DEC engineering vice president, as he recounts with unusual candor the trials and tribulations of designing the PDP-11 series of minicomputers. In a paper presented Jan. 20 at the Symposium on Computer Architecture in Clearwater, Fla., he details the good and bad times of the Maynard, Mass., firm's engineers in designing what has become one of the world's most successful minicomputers. There are 20,000 in use.

The paper, "What have we learned from the PDP-11?" is by Bell and William Strecker, DEC supervisor of computer-architecture research, who presented the paper at the meeting.

"The paper attempts to look at the PDP-11 in a scientific fashion to assist us and others in understanding more about computer science and computer architecture," Bell says. "As such, it may appear overly critical; e.g., other computers aren't compared or examined. Independent of this criticism, I feel the 11-family is the best of the minicomputers, and the development was executed in a superior fashion."

Nevertheless, address capacity did become a problem, as it did with all preceding DEC designs except the PDP-10. A paper presented by Bell

and his associates at the 1970 Spring Joint Computer Conference said that a major weakness of minis—in-sufficient memory-address capacity—would be solved in the upcoming PDP-11 simply by providing enough main-memory capacity. However, two years later, an elegant memory-management scheme had to be designed. That, says Bell, was embarrassing.

Of some other weaknesses described in 1970, and how they were handled in the PDP-11, Bell says:

■ *Not enough registers.* "Solved by providing eight 16-bit registers. Subsequently, six more 32-bit registers were added for floating-point arithmetic."

■ *Lack of stacks.* "Solved, uniquely, with the auto-increment/auto-decrement addressing mechanism."

■ *Limited interrupts and slow context switching.* "Generally solved by the 11 Unibus vectors. [The Unibus] direct-interrupts when a request occurs from a given I/O device. Implementations, however, could go further by providing automatic context savings in memory or in special registers. This detail was not specified in the architecture, nor has it evolved from any of the implementations to date."

**Unibus lesson.** Perhaps Bell's most telling remarks concern one of the PDP-11's most innovative features—its Unibus structure. The Unibus handles input/output for all peripherals with each peripheral given its own address. The designers therefore had to provide enough addresses to handle as many peripherals as could be added.

"At the time the bus was designed, it was felt that allowing 4 kilobytes for addressing the control registers for all the I/O controllers was sufficient. It is a very large address space for an individual system. However, the space has not been adequate to assign devices to unique addresses for all time."

It is possible, but inconvenient, for the architectural group to keep track of all device addresses, he says. There are a number of alternatives to such bookkeeping, but they proved expensive because they were not "invoked early enough, due to lack of architectural control and understanding."

Typical solutions, he says, are: using a large address with adequate



**It all adds up.** DEC's Gordon Bell, in his description of the design of the PDP-11, says he was sometimes embarrassed.

## Probing the news

space: dynamically assigning the devices by using an adder in each; placing a special ROM in each system with the names and addresses of all devices; randomly assigning the devices at installation and letting a program read their names, sort out the conflicts, and dynamically assign them.

Bell digresses from the PDP-11 story to comment on the significant subject of multiprocessors. Adding processors to an in-place system allows smooth, incremental upgrading to handle more work. Bell gives five basic reasons that he thinks are why multiprocessors have not gained acceptance faster:

- "The basic nature of engineering is to be conservative. Given, there are a number of risks in a product

already, it is unclear why one should build a higher-risk structure that may require a new way of programming.

- "The market doesn't demand them.

- "We can always build a better single, special processor.

- "There are more available designs for new processors than we can build already.

- "Planning and technology are asynchronous. Within DEC, not all products are planned and built at a particular time; hence, it is difficult to get the one right time when a multiprocessor would be better than an existing uniprocessor, together with one or two additional new processors."

Of the PDP-11, Bell says in conclusion: "With hindsight, we now clearly see what the problems with the initial design were. Many faults occurred, not through ignorance, but because the design was started too late. As we continue to evolve and improve the PDP-11 computer structure over the next five years, it will indeed be interesting to observe whether the PDP-11 can continue to be significant. In other words, the ultimate test is use." □

## BAUSCH & LOMB StereoZoom<sup>®</sup> microscope

### The inspector with the perfect record

Almost twenty years on the job and still the industry leader. High resolution optics throughout the entire zoom range, and bright, sharp images over a wide field of view mean less eyestrain, less fatigue, and a lower percentage of errors. And that means tighter production control, less returned product and more satisfied customers.

The Bausch & Lomb StereoZoom Microscope—dependable quality at economical prices. Write for a free catalog today and discover why the Bausch & Lomb StereoZoom outsells all competitive stereomicroscopes in the electronics market... worldwide.



Bausch & Lomb, Scientific Optical Products Division,  
62301 North Goodman Street, Rochester, N.Y. 14602.

### A man of ideas

Gordon Bell overflows with ideas. They have been pouring from his active mind since he joined Digital Equipment Corp. in 1960 as an MIT graduate student, during his term as a professor of electrical engineering and computer science at Carnegie-Mellon University in Pittsburgh, and now as DEC's engineering vice president. He was the mini-computer firm's first or second engineer—no one remembers exactly which—and has held corporate office or consulted there ever since. He first worked on logic modules, then was made responsible for the PDP-4, got supervisory responsibility for the PDP-5, and began the PDP-6 effort. The PDP-6 was the antecedent of the PDP-10, for which he worked on logic circuits. His paper, "What have we learned from the PDP-11?" springs logically from his passion to teach.

# HERMES LOOP ANTENNA

THREE SAMPLE SITES  
ON THE NORTH AMERICAN  
CONTINENT —

DIFFERENT LATITUDES  
DIFFERENT CLIMATE



64°N



42.5°N

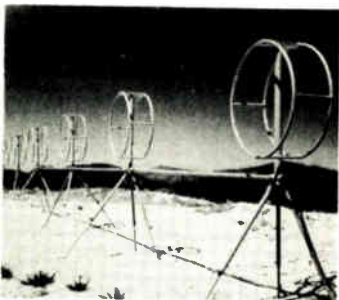

32.5°N



## Good Listeners maintain a low profile

Even in the solitude of the forest depths, from rooftops, arctic tundra, swamps to sweltering tropics, 'neath snow, sand or ice,

the Hermes Loop antenna keeps an ear to the sky.

The amazing aperiodic antenna does away with vast log periodic and rhombic arrays - those towering antenna farms.

In rosette configuration, the Hermes loop antenna provides an omnidirectional broadband receiving array in space merely 1/100th that of the traditional antenna farm.

More than 53 government agencies around the world have pressed the loop antenna into service.

A new, even more compact version is available.

Only Hermes Electronics makes it.

**2-32MHz  
BROADBAND**



**ASK US Send for our Brochure**

Hermes Electronics Limited

Suite 315

2020 F Street NW

Washington, DC 20006 USA

202-296 2978

TWX 710 822 1106

Companies

# Singer's gamble turns into loss

Low profits on Sears contract helped lead to closing of Business Machines division, but remaining electronics units are profitable

by Ron Schneiderman, New York bureau manager



Now that the troubled Singer Co. has closed, sold, and trimmed an armful of its operations, company watchers are scrutinizing the electronics divisions that have survived. And analysts are picking over the remains of the recently closed Business Machines division looking for the causes of its death [*Electronics*, Jan. 8, p. 28].

The early line on the surviving electronics operations is that they are doing fairly well. But the larger question, in view of Singer's broad problems, is why the Business Machines division, with its retail terminals and data systems, has not lived up to the promise it showed in 1971, when it landed its first big contract to furnish point-of-sale terminals to Sears, Roebuck & Co.

Despite an increasing sales base, the business machine operation was losing money—\$60 million in the last five years, mostly in the past year. Unfavorable general economic conditions notwithstanding, the division faced a number of serious special problems, including costly modifications in design of certain POS terminals. These modifications necessitated the transfer of managers and engineering personnel from Singer's aerospace units to the Business Machines division.

**Narrow margin.** Moreover, the division had invested heavily in the development of a supermarket POS terminal and had installed a number of them before recognizing that the product would have a narrow profit margin with little chance for an early return on investment. Equally troublesome was Singer's massive ongoing investment and growing competition in its POS mar-

kets. At least one major restructuring of the division's marketing organization, the closing out of obsolete product lines, and the concentration of resources on more promising areas, didn't seem to help.

Several observers strongly suspect, however, that in the long run what led to the division's undoing was its arrangement with Sears. Singer was so anxious to get the Sears contract as its showcase entry into the billion-dollar POS market, those observers believe, that it agreed to terms more beneficial to Sears than to Singer. Sears, in fact, accounts for well over half of Singer's installed POS base.

Ironically, William F. Schmied, a Singer executive vice president, last year stated proudly during an interview with *Electronics* that Singer "pioneered large-scale POS systems with Sears. They're working well, and we continue to deliver them." But then he admitted that "we sacrificed a lot of margin doing it, and most of that was at the front end."

**POS killed.** It was against this background that Joseph B. Flavin, barely a month after taking over Singer's helm as chairman and president from Donald P. Kircher, has announced that the company "is not able to fund the future development and growth of the Business Machines division and still provide adequate capital for the fundamental businesses which possess basic and long-term strength, in addition to near-term profit potential."

Earlier, the company had closed other operations. But the remaining electronics operations aren't doing too badly.

The Simulation Products division



**New head.** Joseph B. Flavin, Singer's new chairman and president, has closed the company's Business Machines division. It turned out POS equipment such as the model 928 free-standing terminal (top).

in Binghamton, N.Y., which is working on several multimillion-dollar contracts, is profitable. The Librascope division in Glendale, Calif., which builds command and control systems for the Navy, primarily for use in antisubmarine warfare, will grow steadily through 1976, division officials predict. Not only is this segment of the military-electronics market one of the few slated for expanded budgets, but demand from overseas customers is increasing dramatically, executives say. Librascope now employs about 1,300, about 100 more than a year ago, and the number is expected to be increased to 1,600 by year end.

**Aerospace work slows.** Singer's Kearfott division in Little Falls, N.J., which makes aerospace systems, is profitable. However, it's in what division vice president Winton S. Smith calls an "interim period." Work on the division's biggest military programs has been nearly completed. As a result, employment is down to 4,700 from a peak of about 6,000 in the 1970-1972 period.

Major new programs such as Kearfott's contract to build the navigation system for the Air Force's lightweight fighter aircraft, and a new contract to furnish remote area approach and landing systems for Marine Corps V/STOL (vertical and short takeoff and landing) aircraft, won't move into the production stage for at least another year or two. Meanwhile, says Smith, the division will work off its backlog and continue to pursue what few new military requests for quotations come along and will develop its commercial and international markets.

A potentially bright spot for Singer is its Athena 2000, the first electronically controlled household sewing machine to be placed on the market. Engineers from the company's sewing-machine operations cooperated with engineers in the aerospace operations to build the Athena. Despite its \$779.95 price tag, a Singer spokesman says production is running behind order rates. Edwin J. Graf, a Singer executive vice president, predicts that 50,000 Athena 2000 models will be sold during 1976, its first year on the market. □



## Conap Conformal Coatings for Printed Circuits

### • Proven Reliability • High Performance

Expect Conap's conformal coatings to be different. Each product in this family of polyurethane and epoxy coatings was developed specifically for protecting printed circuit boards and electrical/electronic parts from adverse environments.

They are not intended for use as general purpose protective coatings or for other purposes. This accounts for their high quality performance in circuit board applications. Reliable performance attested to by years of successful on-the-job service and backed with a full staff of customer service specialists.

### Broad Selection of Coatings

Conap's economical, easy-to-process printed circuit coatings include both single component and two part systems conforming to MIL-I-46058C, Type UR requirements. There are formulations for dipping, spraying, or brushing. Coatings that cure at room temperature or elevated temperatures. Available in quart, gallon, 5-gallon and 55-gallon containers as well as convenient, easy-to-use, aerosols.

### High Performance Properties

Films are available to provide excellent resistance to reversion, abrasion, impact, chemicals and solvents, fungus, thermal shock. Good electrical properties are a common denominator.

These coatings will protect assemblies from water, high humidity, contamination, and other severe environmental conditions. At the same time, they can ruggedize units against shock and vibration.

Excellent adhesion, uniform coating thickness, and easy repairability are other important features.

### Free Bulletin, Low Cost Evaluation Kits.

Send for Conformal Coatings Brochure C-110 containing complete specifications and information on inexpensive evaluation kits.

### Conap Means Many Things

• Epoxy and Urethane Resins • Chemical Specialties • Adhesives, Sealants and Coatings • Potting and Casting Systems • Fabricated Elastomer Components. For an over view of Conap's complete capabilities, write on letterhead for copy of Brochure FB-1.

# CONAP

Conap, Inc. / Olean, N.Y. 14760 / 716-372-9650

Conap (Canada) Ltd. / Mississauga, Ont. 416/625-2520

Companies

# Getting back to high technology

Electronic Arrays takes on the big companies as it balances mix of watches and calculators and new RAMs and microprocessors

by Bernard Cole, San Francisco bureau manager

**Electronic Arrays Inc.**, formed in 1967 as a technology company before falling into the hands of marketers and being vertically integrated and diversified almost out of existence, is now firmly back in the hands of technologists.

And under the year-old presidency of W.D. (Don) Bell, Texas Instruments alumnus and a founder of Silicon General Co., the company in Sunnyvale, Calif., is pushing a hard course away from the low-technology areas, such as read-only memories, calculators, and watches. Bell has hired a group of executives, mostly from TI, who are steering the company into the mainstream of high technology—microprocessors and random-access memories. Bell is committed to tilting the present product mix of 55% calculators and watches, 30% custom read-only memories, and 15% random-access memories and microprocessors sharply toward the last category.

To do this, Electronic Arrays is plowing an impressive 13% to 15% of its annual sales back into research and development. It is looking very hard at depletion-load, ion-implantation techniques to push n-channel MOS as far as possible in memories and microprocessors; at technologies like V-groove MOS [*Electronics*, Sept. 18, 1975, p. 65] to take MOS to higher speeds and higher densities in static RAMs and ROMs; and to such derivatives of charge-coupled-device technology as the split gate [*Electronics*, Oct. 2, 1975, p. 78] to take dynamic RAMs to 16 kilobits, 32 kilobits, and 65 kilobits in the next round of products.

These ambitious goals have put Bell and his company on the spot.

Instead of taking the usual route of a small firm—finding the market niche and occupying it—he's rushing head-on across the board to challenge the big guys: Intel Corp., Texas Instruments, and Motorola Semiconductor. Bell is hinging his hopes on the next generation of advanced MOS devices and processes, and to make sure that Electronic Ar-

**New direction.** Don Bell, president of Electronic Arrays, is turning his company toward high technology RAMs, microprocessors.



## An impressive array

Electronic Arrays has collected an impressive cast of executives during the past six months. They include:

David Simpson, vice president of engineering. A 16-year veteran at Texas Instruments, he, as operations manager, was responsible for the development of TI's highly successful 54-series TTL line. As engineering manager for MOS products, he headed development of TI's one-chip calculator. As manager of the MOS division, he directed transfer of TI's 4-kilobit RAM technology from the lab to production.

Edmund Ward, manager of advanced-technology development. A 10-year TI man, he, as manager of MOS-process development, headed the technical efforts on TI's n-channel process.

William Wickes, manager of microprocessor development. As manager of advanced technology at TI, he directed the pioneering "discretionary-LSI" effort. As director of systems engineering at Rockwell Microelectronics, he was responsible for the 4- and 8-bit PPS microprocessor systems.

Harry Hollack, vice president of operations. An 11-year TI man, as operations manager for the digital-circuits division, he was responsible for getting one of the industry's most advanced automated film-transport IC-assembly systems—the Minimod—up and running.

Joseph Perry, manager director of MOS process engineering. As MOS process engineering manager at Fairchild for the past three years, he headed development of its Isoplanar MOS process.

David Mueller, manager of quality assurance. He got his training at Texas Instruments and Western Digital in MOS memory and microprocessors.

Rory Rice, senior process engineer/advanced technology. As engineering supervisor for process development and photoresist technology at Mostek Corp., he directed yield and process-improvement efforts in the company's p-MOS calculators, n-MOS memories, and C-MOS watch circuits.

Michael Bowen, manager of consumer products. Another TI veteran, he was founder and president of Corvus Corp.



rays is one of the first out of the gate, Bell has gathered around him a coterie of experienced and enthusiastic technology managers and MOS-process engineers, seduced mainly from his alma mater, Texas Instruments (see "An impressive array," p. 80), but also from Fairchild Camera and Instrument Corp., Rockwell Microelectronics, and Mostek Corp. Typical is David Simpson, a 16-year veteran of TI, who is vice president of engineering.

"What I saw in EA was a turnaround company with all the earmarks of a start-up operation and none of the disadvantages," he says. "The basic engineering team is in place, the product lines are defined, and the finances are substantial. And as one of the first companies into the MOS business, the basic process technology is there. The job is bringing it all together."

The new manager of MOS-process engineering, Joseph Perry, is impressed with the company's commitment. "Unlike some companies I know of, EA is dedicated to MOS—totally, with no second thoughts and no diversions." The vice president of marketing, Edward Tourney, was a founder of Advanced Micro Devices Inc., "so I'm familiar with start-up operations," he says. "It won't happen overnight, but EA will be a formidable factor in the marketplace."

**Cautious.** Investors such as J. Burgess Jamieson, a general partner in the \$20 million Institutional Venture Associates of Menlo Park, Calif., is a bit more cautious. His firm started investing in Electronic Arrays in late 1974 and now owns "at least 5%" of the company. "But we view the investment as one with considerable risk," he says. "Whether it pays off is contingent on how well Don Bell rebuilds the management team."

First, the company will be introducing a spate of new standard n-channel parts. Bell plans to be in volume production by the end of the first quarter with a 16-k ROM, and has started development on a 32-k ROM. In the works for the second and third quarters are seven new calculator alarm clock and watch chips, several 256-by-4-bit n-MOS RAMs, and 16- and 22-pin 4-k RAMs. □

## THE SYSTEM IS MIXED TTL AND ECL. IT WORKS AT 20 MHz. IF IT FAILS ONCE IN EVERY BILLION OPERATIONS SHE HAS TO FIX IT.



By now almost everyone agrees that the conventional oscilloscope isn't the best tool for finding failures in digital systems. The old 'scopes have been superseded by logic analyzers—multichannel devices that observe a set of digital signals, trigger on a particular combination of them, and display a timing diagram or bit array that shows the events before and after the trigger.

A wonderful idea.

But of all the logic analyzers on the market, only the E-H model 1320 Digiscope™ can find the trouble in this high speed word generator. Here's why:

### DUAL-THRESHOLD ACQUISITION

Any failure that occurs so rarely probably isn't a decent logic level. It's probably a glitch, a slow risetime, or a logic chase that only occasionally causes trouble. Only the Digiscope can spot all these before or after the trigger.

### MIXED LOGIC CAPABILITY

Most logic analyzers will let you check TTL. Or ECL. Or MOS. The Digiscope lets you check two different logic families at once. You can even observe a set of logic outputs and make a go/nogo test on an analog level. Or select normal or tight tolerances for a threshold pair.

### PLUGIN VERSATILITY

Some logic analyzers plug into 'scopes. Our analyzer has plugins of its own. You get a choice of level selection, combinatorial emphasis, internal or external clocking, and triggering.

An even better idea. And the Digiscope has other virtues:

### 50 MHz DATA ACQUISITION

### HIGH-IMPEDANCE, WIDE-RANGE PROBES

### COMPOSITE VIDEO OUTPUT. For classroom display.

### WATCH MODE FOR SLOW SIGNALS. The traces march politely across the screen.

The best idea yet.

## WITH A DIGISCOPE, SHE CAN FIX IT

**EH** research laboratories, inc.

515 11th Street □ Box 1289, Oakland, California 94604 □ (415)834-3030 □ TWX 910-366-7258  
In Europe: E-H Research Laboratories (Ned) B.V., Box 101B, Eindhoven, The Netherlands □ Telex 51116  
In Japan: E-H International — Tokyo Branch, 1-5, 3-Chome, Naka-cho, Musashino-shi, Tokyo, Japan □ 0422-54-9261

# THE BIG BUY

# THE BEST BUY



## api Meter-Relays

*You know we're good*

LFE is the world's largest manufacturer of meter-relays. We can provide the meter-relay best suited for your requirements.

**AVAILABLE** Available nationwide from our distributors and mod centers. If they can't handle your special requirement, we'll build it from scratch in 2 to 8 weeks — faster than any other manufacturer.

**VERSATILE** API meter-relays are available in over 1,400,000 combinations of ranges, output modes, setpoints, and contact configurations. We've got the *only* magnetic meter-relays with a failsafe memory needing no external power. We've got the *only* all solid-state meter-relay line, immune to vibration and with no lamp to burn out. API meter-relays can be used

with your control circuitry, with our control modules, or as Compact controllers with built-in control circuitry.

**FUNCTIONAL** API meter-relays come in sizes from 2" to 10", with durable acrylic or tough phenolic cases and molded-in mounting studs that don't wiggle away when they shouldn't. Separate setpoint knobs and vernier drive provide the simplest, most precise setability available.

**RELIABLE** A reputation for quality and reliability is earned by performance, not salesmanship. API is synonymous with reliability. We maintain the most stringent quality standards in the industry.

**ECONOMICAL** Marginal designs aren't cheap when they fail — and a

process, line or system goes down. API meter-relays perform when you need them most, at surprisingly competitive prices.

**SUPPORTED** After the sale, we have direct factory-trained field engineers to furnish applications support across the U.S. and in Canada. A nationwide service network provides instant help — if you need it.

For full details call or write LFE Corporation, Process Control Division, 1601 Trapelo Road Waltham, Massachusetts 02154 Telephone 617-890-2000.

**LFE**  
CORPORATION

Process Control Division

# SEMICONDUCTORS PROVE FRUITFUL FOR MICROWAVE POWER DEVICES

by Bert Berson, Microwave Semiconductor Division, Hewlett-Packard Co., Palo Alto, Calif.

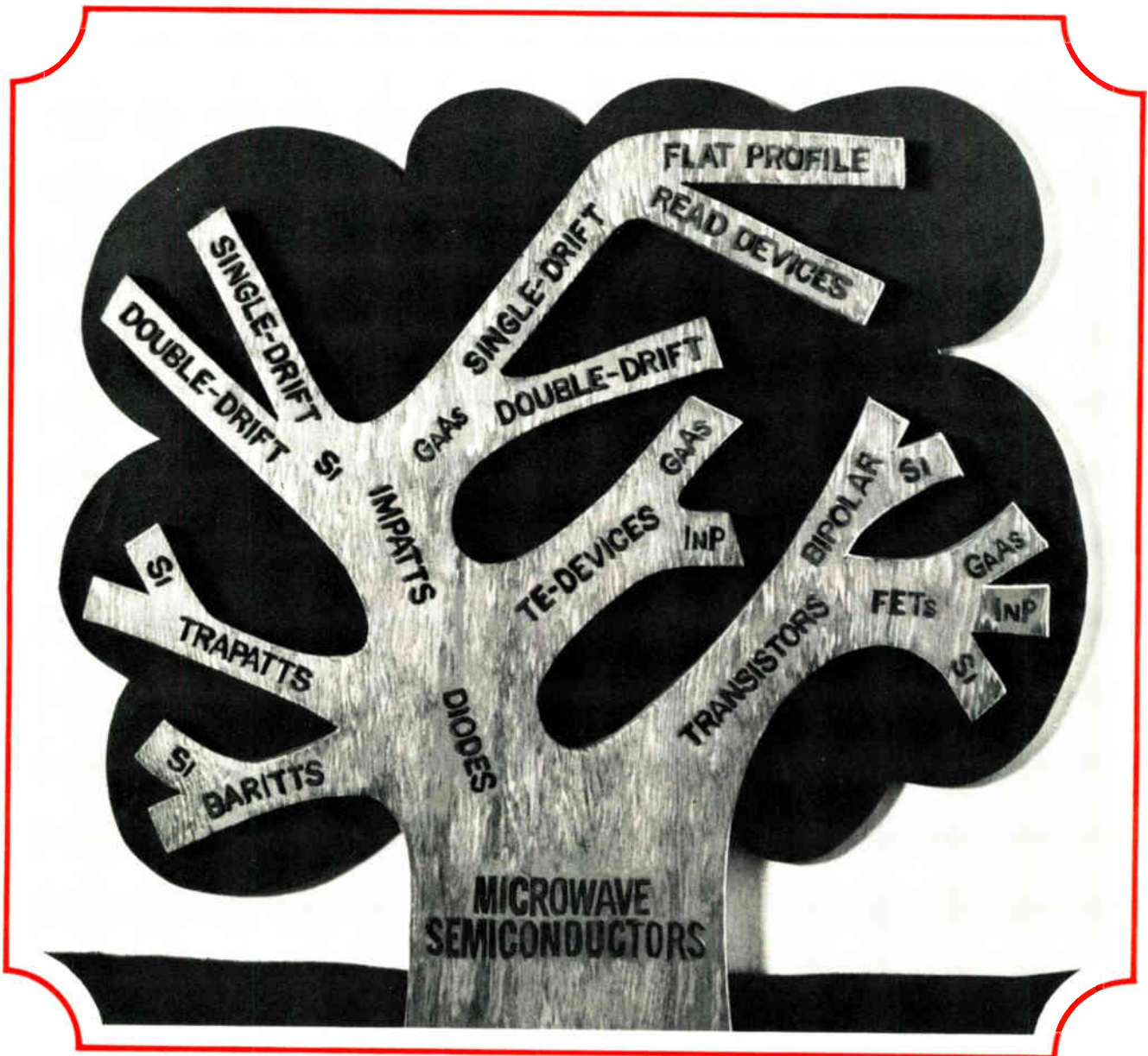

□ Within the last few years, microwave semiconductors for power generation and amplification have branched out in a half-dozen technological directions till today they definitely put electron tubes in the shade. By now, a broad selection of device types is available, and their performance improves noticeably every year. Each has a characteristic assortment of strengths and weaknesses.

Current developments revolve around transistors as well as diodes. As the family tree of the devices shows, there are four diode classes—transferred-electron devices, impatts, trapatts, and baritts—and two transistor classes—bipolar and field-effect devices. Each class is suited to a variety of oscillator and amplifier applications, which Table 1 lists.

Tunnel diodes are also part of this family of microwave semiconductors but, having been around for a fairly long time, they are not covered in this survey of the state of the art. Their performance has more or less stabilized—they can develop 1 milliwatt or so at frequencies up through X band. Of all the diodes, they suffer least from noise, particularly at high frequencies, and are used primarily to build low-noise amplifiers. (But today's microwave FETs produce even less noise.) Furthermore, tunnel diodes are highly susceptible to power overload and tend to burn out.

Unlike these devices, the microwave diodes covered here can develop several hundred milliwatts or more at frequencies of 1 gigahertz or higher. The basic differences between them are pointed out in "The differences between the diodes," page 85.

### A catalog of the semiconductors

Transferred-electron (TE) devices are made of either gallium arsenide or indium phosphide and operate in one of three modes—the Gunn or transit-time mode; the quenched-domain mode; or the limited-space-charge-accumulation (LSA) mode. Those that operate in the first mode are commonly called Gunn diodes. Besides being tunable over a broad range of frequencies, TE devices can develop hefty power outputs at low operating voltages, and they produce relatively little noise.

The power outputs of impatt diodes are higher still,

but then so is their noise and their operating voltage. They are primarily fabricated from either silicon or GaAs as single-drift or double-drift structures. The power outputs and efficiencies of double-drift devices are higher than those of single-drift devices. However, single-drift GaAs structures can be built with different doping profiles to approximate the performance of the Read diode, which is a nearly ideal impatt.

Trapatt devices are generally made from Si. They can develop very high pulsed-power outputs at very high efficiencies and over narrower bandwidths than impatts. In contrast, baritt diodes offer relatively low power outputs and efficiencies, but they exhibit an excellent self-detection sensitivity that can be useful in consumer radars, like burglar alarms.

As for three-terminal devices, the bipolar transistors can develop extremely large power outputs, but are limited in operating frequency to 10 gigahertz or so. They are always made from Si. FETs are the converse: they have much lower power outputs below 6 GHz, but can operate at far higher frequencies and also suffer less from noise. They can be fabricated from Si, GaAs, or InP. For a more detailed look at the differences between these materials, and the current state of their technologies, see "How three semiconductor technologies compare," page 87.

### To start with—the oscillators

The most meaningful way to evaluate the performance of microwave semiconductors is first to look at the largest power output obtainable at the highest possible operating frequency. Then efficiency and noise must be factored in, too, since they are also important.

The power performance of oscillators built with TE devices is illustrated in Graph 1. Here, output power is plotted as a function of frequency for both GaAs and InP devices in continuous-wave and pulsed service. For pulsed GaAs devices, it's possible to obtain power outputs on the order of 6,000 w at relatively low duty cycles from LSA-mode devices in L band, dropping to about 2,000 w in C band. Continuous-wave GaAs devices can produce power outputs as high as 2 w in X

TABLE 1: TYPICAL SYSTEMS APPLICATIONS

Type of device	Local oscillator	Pulsed transmitter	Cw transmitter	Amplifiers			Parametric amplifier pump	Self-mixing radar
				Cw low-noise	Cw power	Pulsed power		
Transferred-electron devices								
Impatts								
Trapatts								
Baritts								
Bipolar transistors								
FETs								

## The differences between the diodes

The diodes that are used in generating or amplifying microwave power—whether transferred-electron devices, impatts, trapatts, or baritts—all convert dc energy to rf energy directly, and all use negative resistance to do so. But there the resemblance ends. Functionally, they each derive their negative resistance from very different semiconductor phenomena. Even structurally, they are usually quite unlike.

The transferred-electron (TE) diode shown in (a) is usually made from doped n-type gallium arsenide or indium phosphide. The electron-drift velocity of these materials decreases with increasing electric field after the field passes a certain threshold level. The deceleration occurs as the electrons jump from a high-mobility energy band to a low-mobility one.

A GaAs TE device may operate in any of three possible modes—the Gunn or transit-time mode; the quenched-domain mode; or the limited-space-charge-accumulation (LSA) mode. Although the operating modes of an InP TE diode are believed to be similar, their mechanisms are not yet fully understood.

A GaAs TE device operating in the transit-time mode is popularly called a Gunn diode. This is the simplest mode, and in it space-charge domains, made up of regions of electron accumulation and depletion, are formed at the cathode and travel across the drift region to the anode, where they are collected. As a result, short current pulses are generated at intervals approximately equal to the transit time of the domains. In the drift region, the charge carriers do not accelerate but simply move across this portion of the device structure with constant velocity. The dimensions of the drift region influence operating frequency, as well as efficiency.

In the quenched-domain mode, operating frequency is higher, and the formation and extinction of space-charge domains is controlled by the surrounding circuit. If operating frequency is increased still further, the device then functions in the LSA mode.

The most power can be developed with a LSA-mode device, because the entire structure becomes a negative resistance during a portion of the operating cycle. No domains are present in this mode, since the operating frequency is so high that they cannot form. The frequency of oscillation is determined by the surrounding circuit and is independent of the transit time of the charge carriers. Generally, for better efficiency, a LSA-mode device has a much thicker drift region than a Gunn diode.

The impatt (impact avalanche transit time) diode is actually an avalanche junction diode—that is, it produces a negative resistance by combining impact avalanche breakdown with charge-carrier transit-time effects. It is generally made from GaAs or silicon as a single-drift or double-drift structure, as shown in (b).

When the impatt's junction breakdown voltage is exceeded, electron-hole pairs form at the junction by avalanching. In a single-drift structure, it's mainly either electrons or holes that pass through the drift region and help generate power. But a double-drift structure has a second complementary drift region, so that both holes and electrons contribute to power generation, and its power output and efficiency are therefore higher.

The Read diode is a nearly ideal impatt, which confines avalanching to a narrow well-defined region. In practical impatts, avalanching tends to occur over most of the de-

(a) TRANSFERRED-ELECTRON DIODE



(b) IMPATT DIODE

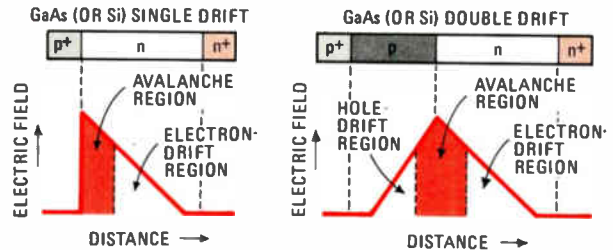

(c) TRAPATT DIODE



(d) BARITT DIODE



pletion region. The best approximations to the Read diode to date are single-drift GaAs impatts fabricated with high-low and low-high-low doping-level profiles.

The trapatt (trapped-plasma avalanche transit time) diode is also an avalanche junction diode, like the impatt, and its structure is essentially identical to the impatt's, as (c) shows. Actually, the trapatt, which is usually fabricated from n-type or p-type silicon, is simply an avalanche junction diode operating in a different mode—the same n-type structure can be operated as an impatt at fairly low current levels or as a trapatt at higher currents but lower frequencies.

In the trapatt diode, the avalanche zone traverses the depleted space-charge region, creating such a dense crowd of electron-hole pairs that they approximate a plasma or a gaseous state. This plasma is then extracted from the device by means of the electric field in the space-charge region. After the carriers have been extracted, the diode's terminal voltage returns to its breakdown value.

The baritt (barrier injection transit time) diode has two junctions separated by a flat-profile zone, which is called the transit-time region, as seen in (d). During operation one junction is forward-biased and injects carriers into the transit-time region, while the other is reverse-biased and collects the injected carriers. The phase difference between the device's voltage and current, which results from the time it takes the carriers to traverse the flat-profile region, produces a low negative resistance. Although the simple baritt structure shown here is sometimes altered slightly for improved efficiency, the basic principle of operation remains the same.

band, and can operate at frequencies of almost 100 GHz. InP devices are generally used at frequencies above X band. Their pulsed-power outputs are up around 2 w at 10 GHz, while cw versions are now delivering as much as 0.5 w in K band.

A convenient way to evaluate the power performance of two-terminal devices in oscillators is to compute the product of output power times the square of operating frequency ( $Pf^2$ ). This figure is a standard of comparison for transit-time-limited devices, and it should remain constant regardless of frequency. (In a transit-time-limited device, the over-all performance is governed by the transit time of the charge carriers across part of the device's structure.) For TE oscillators, the best  $Pf^2$  product of pulsed GaAs units is about  $9.8 \times 10^4$  w-GHz<sup>2</sup>, compared to 1,000 w-GHz<sup>2</sup> for pulsed InP devices. Similarly, in continuous-wave operation, GaAs oscillators exhibit a higher  $Pf^2$  product—460 w-GHz<sup>2</sup>, as opposed to 200 w-GHz<sup>2</sup> for InP units.

The efficiency of laboratory cw GaAs TE oscillators ranges from 3% to 12.5%, with commercial X-band devices having efficiencies of up to 6%. The highest effi-

ciencies, about 32%, can be obtained from pulsed GaAs devices. Continuous-wave InP TE oscillators exhibit efficiencies of 3–10%, while pulsed InP oscillators attain efficiencies as high as 6–20%.

In Graph 2, output power versus frequency is plotted for impatt and trapatt oscillators. In impatts, the highest  $Pf^2$  product is obtained from the Si devices, both cw and pulsed, which can operate at efficiencies of 10–15% in X band. Although the lowest  $Pf^2$  product among the impatts belongs to cw GaAs devices, they exhibit the highest efficiencies and also the most cw power in C and X bands. In Read-type structures, some are providing efficiencies of almost 36% in X band, while others are delivering 12 w at around 9 GHz with 25% efficiency. However, the efficiency of all the impatts falls off with increasing frequency. The highest operating frequencies—up to 160 GHz—have been obtained with silicon devices, which can offer efficiencies of 3–10% at up around 100 GHz.

Trapatt oscillators are characterized by very high pulsed powers, particularly around 1 GHz, and efficiencies can range from 20–60%, the highest for any solid-state oscillator built with two-terminal devices. For cw trapatt oscillators, efficiencies generally are between 20–40%, while power outputs are on the order of 5 w in X band.

Baritt oscillators generate cw power outputs of up to

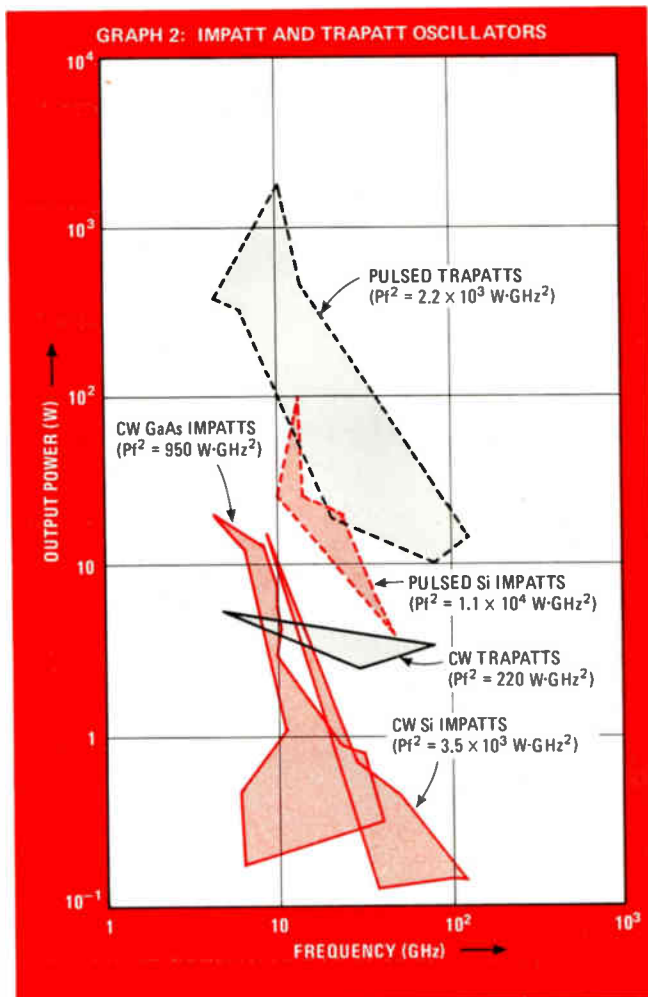
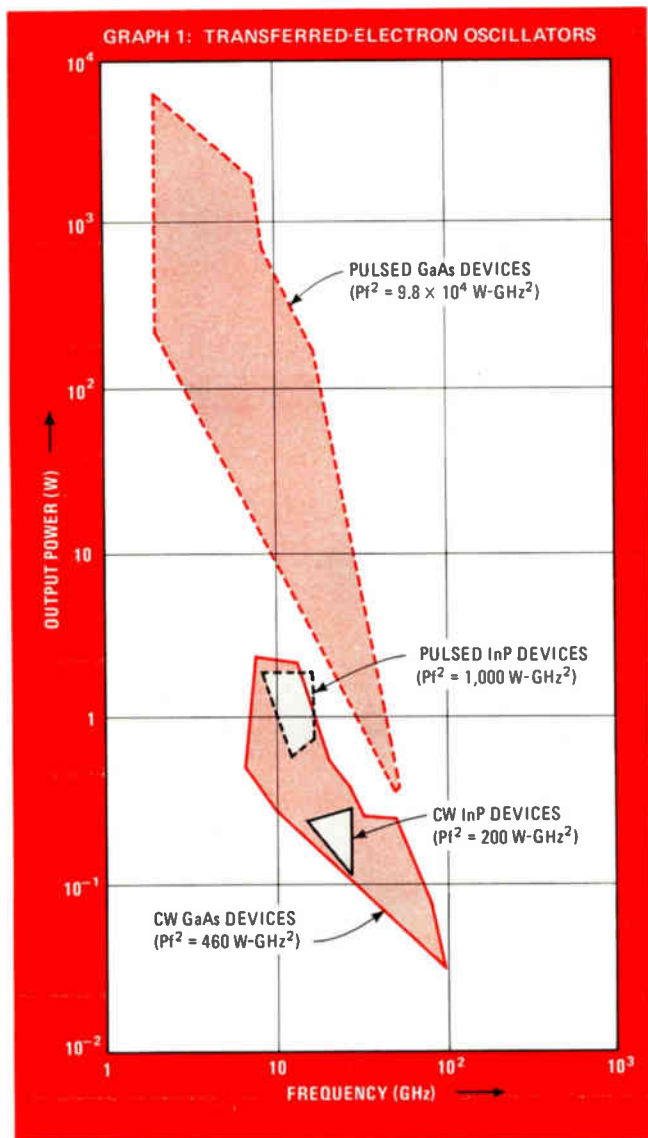

## How three semiconductor technologies compare

The semiconductor materials generally used for fabricating microwave devices are silicon, gallium arsenide, and indium phosphide. Of the three, silicon technology is by far the most advanced. Process control is superior, devices are reproducible, and the range of fabrication techniques is wide. GaAs technology has started to come of age. Unlike Si, GaAs permits true semi-insulating substrates to be grown for complete monolithic circuits as well as discrete devices that operate at microwave frequencies. InP technology, on the other hand, is about 10 years behind GaAs developmentally.

■ **Material characteristics.** As the table indicates, the three materials vary considerably in their basic properties. For instance, the electron mobility of GaAs is highest, making it a low-loss material that yields devices having high efficiency, high gain, and high output power. Since InP has the highest electron-drift velocity, its electron transit times are short, and devices made of it can operate at very high frequencies. (Also, GaAs and InP exhibit the transferred-electron effect, but Si does not.)

The field in which the maximum electron-drift velocity occurs is also important, since its strength determines how far a device can swing over a wide operating voltage range yet still be efficient at high power levels. This property is highest for Si, lowest for GaAs.

The other critical property is thermal conductivity. Because the rate of heat removal determines the allowed input power, this property often limits the power, efficiency, and reliability of devices being used in either continuous-wave or high-duty-factor-pulsed service. Si offers the highest thermal conductivity, GaAs the lowest.

■ **Epitaxial growth.** Epitaxial growth on a substrate layer is carried out in the vapor phase with Si, and in either the vapor or liquid phase with GaAs arsenide and InP.

Highly doped n and p Si substrates can be grown in a variety of orientations; four-inch Si wafers are now available, and 6-in. ones are already beginning to appear in laboratories. GaAs may also have highly doped n and p substrates, although the maximum attainable doping level is about an order of magnitude lower than that of silicon; various orientations are possible, as are semi-insulating substrates for device isolation, and, while most GaAs wafers are 1 in. across, 2-in. diameters are beginning to appear. Only n-type highly doped substrates are now grown from InP, and they are doped to about two orders of magnitude lower than silicon; assorted orientations, semi-insulating materials, and 2-in. wafers are available.

To form the differently doped regions, diffusion and/or ion implantation may be used. With Si, n and p diffusions and ion implantation are all possible. What's more,

several hundred milliwatts in X band, their highest operating frequency being about 12 GHz. They provide efficiencies of up to 5%, at very low current densities, and their  $Pf^2$  product is about 34 W-GHz<sup>2</sup>. The detection sensitivity of baritts operating in a self-mixing mode is about 15 to 20 decibels higher than that of impatts and another 10 to 12 dB above that of Gunn devices—a characteristic that should make them suitable for use as self-mixing local oscillators/transmitters in low-cost commercial radar applications.

Two-terminal devices can be used to build not just oscillators but amplifiers, too, although in this application

BASIC MATERIAL PROPERTIES*			
Property	Si	GaAs	InP
Electron mobility (cm <sup>2</sup> /V-s)	700	4,500	3,300
Electron-drift velocity, max (cm/s)	1 × 10 <sup>7</sup>	1.7 × 10 <sup>7</sup>	2.5 × 10 <sup>7</sup>
Field for max drift velocity (V/cm)	20	4	12
Thermal conductivity (W/°C/cm)	1.45	0.44	0.68

\*At room temperature

proton-enhanced diffusion or a combination of diffusion and ion implantation can be used to obtain very sharp junctions. For GaAs, p diffusions are fairly well characterized, but n diffusions are limited to very shallow junctions. However, isolation can be obtained by damaging the material with proton bombardment, and ion-implantation techniques are currently being developed. For InP, some work has been done on diffusion of zinc into n-type material, but ion implantation is still in its infancy.

■ **Dielectric films.** Generally oxides, these play a critical role in semiconductor processing, including masking, and are also needed for device protection. In Si, both vapor-deposited oxides and thermal oxides are well characterized, as are anodic oxides (those grown in the presence of a voltage). Also, polycrystalline silicon can be used for isolation. GaAs thermal oxides are just being reported, and some work on anodic oxides has begun with this material. InP is still in too early a stage of development for any meaningful data to be available.

■ **Etching.** For Si, needless to say, etching technology is well developed—even anisotropic etching, which gives precise control over etching geometries. Etching rates with GaAs, however, are generally less easy to reproduce and control than with Si, while anisotropic etching is just getting under way and may never work as well as with silicon. There are very few choices of etching techniques for InP, and the etching rates are even less reproducible than those for gallium arsenide.

■ **Contacts.** Low-resistance contacts are necessary for good over-all performance, and with Si they can be made to any n<sup>+</sup> or p<sup>+</sup> material. However, contact resistance for GaAs is many times higher than that for Si, and an alloy contact, which requires processing at fairly high temperatures, is needed. The same holds for InP.

■ **Bonding.** The final consideration is die attachment of finished devices. With Si, the options include thermo-compression, ultrasonic, and pulse bonding. All of these techniques may be used with the other materials, but dice made of GaAs or InP are brittle, fracture easily, and really aren't easy to work with for any kind of bonding.

microwave circulators are required to provide the input/output isolation that the diodes lack. Table 2 summarizes the performance of amplifiers built with TE devices, impatts, and trapatts. (The bandwidth of baritts is too narrow for many amplifier applications.)

### About diode amplifiers

In TE amplifiers, operating frequencies range from about 5 GHz up through about 37 GHz. The bandwidths are quite broad, typically greater than 30%, while power outputs are generally modest—only a few hundred milliwatts. Still, these are communications amplifiers, which

TABLE 2: DIODE AMPLIFIERS

Type of diode	Center frequency (GHz)	Bandwidth (%)	Saturated output power (W)	Gain (dB)	Efficiency (%)	Notes
GaAs transferred-electron devices	6	67	0.1 cw	7.5		
	9.8	40	0.4 cw	25		3 stages
	13.3	22	0.25 cw	10		
	14.1	50		9.5		
	16	35	0.25 cw	30		4 stages
	21.9	16	0.01	15		2 stages; P <sub>OUT</sub> at 1-dB compression
	33	36	0.01	10		stagger-tuned; P <sub>OUT</sub> at 1-dB compression
	36.5	4	0.25 cw	30		4 stages
Impatts	6	3.3	4 cw	18		2 stages; Si output, GaAs driver
	6.2	9.6	10 cw	31.5	7	3 stages; 34-dB noise figure; GaAs flat-profile diodes
	6.2	9.6	5 cw	37	10 – 15	3 TED stages; 5 impatt stages; GaAs Read output; 25-dB noise figure; 15% efficiency for Read stages
	7.75	1.3	13 cw	36	5	TED first stage
	8.15	6	1.5 cw	36		7 stages; Si diodes
	8.25	6	4.5 cw	4.5	22	1 stage; GaAs Read diode
	9.2	1.3	20 cw	3		16 Si diodes combined
	10	1	13 cw	26	5	1 TED stage; Si output
	10.3	1.5	100 pulsed	11	7.2	locked pulsed oscillator; 8 Si double-drift diodes combined
	11.2	2.6	2 cw	10		Si double-drift diodes
	36	1.4	0.2 cw	15		2 stages; Si diodes
	94	2	0.1 cw	18		2 stages; Si diodes
Trapatts	2.61	8	214 pulsed	8.7	30	0.2- $\mu$ s pulse width
	3.3	12	100 pulsed	7		1- $\mu$ s pulse width
	3.3	3	150 pulsed	8.8		50 $\mu$ s pulse width
	3.5	10 (1 dB)	45 pulsed	7	21	50 $\mu$ s pulse width
	3.5	1	70 pulsed	4.8	9.1	100- $\mu$ s pulse width
	8.35	9	33.9 pulsed	4.9	13.1	0.1- $\mu$ s pulse width
	9	5	5 cw	5	16.4	

generally involve relatively low power levels. The small-signal gain for a single-stage amplifier is around 6 or 8 dB, but even so, multistage amplifiers can be built with gains as high as 30 dB. Noise figures are as low as 15 dB for GaAs amplifiers and 10 dB for InP amplifiers.

For impatt amplifiers, operating frequencies are primarily in C and X bands, but bandwidths are much more modest than for TE assemblies. Power outputs, on the other hand, are about an order of magnitude higher than those for the TE units, and efficiencies are generally higher too, reaching 5–22%. Although the gain per stage is lower by 5–6 dB, high gains can be obtained from

multistage configurations. Impatt amplifiers may be fabricated from either GaAs or Si devices, and in some cases, a TE amplifier is used to set the noise figure with subsequent GaAs or Si impatts providing the power amplification.

In trapatt amplifiers, there is a high concentration of units in S band for radar applications. The 3-dB bandwidths indicated here are somewhat wider than those for impatt units, even though trapatts have a narrower theoretical bandwidth capability. Pulsed-power outputs are very large, and efficiencies very good, the best of all the diode amplifiers. Gains range from 6 to 8 dB for a



single stage, and pulse widths of up to 100 microseconds can be obtained at relatively low duty-cycle factors.

Before going on to microwave transistors, some perspective is helpful to assess the merits and demerits of the diodes covered here. Although an analysis of this sort can never be completely definitive, it can aid in making wiser design choices.

### Pause for comparison

In addition to wide dynamic range and excellent tunability, TE devices offer the advantages of high pulsed power and efficiency, as well as good amplitude and phase linearity. What's more, they require low bias voltages, have excellent noise characteristics, and are extremely reliable. However, they can develop only medium-level cw power outputs, and their cw efficiencies are moderate. Also, the temperature stability of their output power is relatively poor, and they exhibit fairly high oscillator noise near the carrier frequency.

Impatts, on the other hand, offer good temperature stability, and they can develop very high cw or pulsed powers. Efficiencies are also high, and reliability is good, although the reliability of Read-type GaAs devices is not yet proven. Impatts provide a wide range of operating frequencies, but they have a relatively limited gain-bandwidth product and only moderate dynamic range and tunability. Their phase and amplitude linearity is fair, and they are prone to relatively high amplifier noise, as well as high oscillator noise, both near and far from the carrier frequency. Additionally, they require somewhat complex associated circuitry, and bias voltages are high.

Like impatts, trapatts provide both high power and efficiency, as well as good temperature stability of power. However, they can operate only over a relatively

limited range of frequencies, and their reliability has not been proven yet. Their amplitude linearity is poor, although phase linearity is adequate. They require high bias voltages and very complex associated circuitry. Their gain-bandwidth product is limited, dynamic range low, and tunability narrow. Finally, they exhibit poor noise characteristics, and their impedance shifts with changes in duty cycle.

Although baritts can develop only very low cw power outputs and efficiencies, they are highly reliable and have good phase linearity and superior noise characteristics. Their bias voltages are relatively high—greater than for TE devices, but less than for impatts. Amplitude linearity and dynamic range are somewhat limited. Furthermore, their circuit impedance levels are low, and their range of operating frequencies is extremely restricted. As might be expected, both tunability and gain-bandwidth product are rather limited.

### Moving on to transistors

Three-terminal devices are primarily used to build amplifiers, where their inherent input/output isolation permits simpler designs than diodes and saves the expense of circulators. Moreover, microwave transistor amplifiers can be optimized for either low-noise or power performance, depending on the devices selected. To compare transistors having different gain and noise-figure characteristics, a quantity called noise measure is commonly used. Briefly, the noise measure is the best noise figure obtainable from a given transistor installed within a system.

In bipolar transistors, there is a large selection of devices for both power amplification and low-noise work. At present, bipolar devices are available with noise measures from 1.3–3 dB at 1 GHz, 2.5–5 dB at 3 GHz, and 2.5–6 dB at 4 GHz. Physically larger devices, like those listed in Table 3, are available for power jobs. Single bipolar transistors can now put out up to 35 W at 1 GHz, or operate at frequencies as high as 10 GHz while delivering 1 W cw. And multiple-transistor arrays are delivering up to 3 W at 10 GHz. Gains range from 10 dB at 1 GHz, down to 5–6 dB at higher frequencies. And collector efficiencies are quite high, above 30% for the most part.

As a rule, FETs exhibit better low-noise characteristics than bipolar transistors at microwave frequencies. Table 4 summarizes the performance of narrow-band amplifiers built with low-noise GaAs FETs. As it shows, these devices have maximum noise figure of under 6 dB,

TABLE 3: POWER BIPOLAR TRANSISTORS

Frequency (GHz)	Output power (W)	Gain (dB)	Efficiency (%)
1	35 cw	10	65
1.1	200 pulsed	9	45
1.5	25 cw	8	60
2	20 cw	7	45
3	8 cw	7	45
4	5 cw	5	35
5	4.5 cw	5	15
6	1.5 cw	4	36
10	1 cw	7	26

TABLE 4: LOW-NOISE GaAs FET AMPLIFIERS

Frequency range (GHz)	Maximum noise figure (dB)	Typical gain (dB)	Maximum gain variation (dB)	Typical output power (dBm)	Number of stages
3.7 – 4.2	3.5	25	± 0.5	+12	3
4 – 8	5.4	24	± 0.7	+13	3
4.4 – 5	3.1	16	± 0.5	+ 7	2
5.9 – 6.4	3.6	30	± 0.5	+ 5	4
7.9 – 8.3	3.9	18	± 0.5	+ 5	2
8 – 12	6.9	20	± 1.3	+13	3
11.7 – 12.2	5.6	20	± 0.2	+10	3

even up around 12 GHz, dropping to less than 4 dB at frequencies below 8 GHz. Moreover, they suffer very little gain variation over a broad bandwidth.

Theoretically, InP FETs should provide better noise and gain performance than GaAs FETs. To date, however, it has not been possible to fabricate such superior InP devices, although performance comparable to that of GaAs FETs has been obtained.

Today, a lot of work is going into developing power FETs. Table 5 presents the salient results for GaAs devices. Power outputs range from 1.6 W at 2 GHz to around 2.2 W at 8 GHz, and efficiencies are usually quite high, about 30%. Since the gains indicated here are the ones at which the power outputs are obtained, small-signal gains would be somewhat higher. Some work is going on in power Si FETs for ultra-high-frequency operation. Units have been fabricated that can develop 16.5 W at 0.7 GHz with 35% efficiency and 6-dB gain.

TABLE 5: POWER GaAs FETs

Frequency (GHz)	Output power (W)	Gain (dB)	Efficiency (%)
2	1.6 cw	5	30
3	1.2 cw	5	19
4	0.7 cw	8	35
6	1 cw	6	35
8	1.5 cw	3	45
8	2.2 cw	4.2	22
9	1 cw	4.2	16

As with microwave diodes, bipolar transistors and FETs each have different performance advantages. Below 6 GHz, the powers and efficiencies of bipolars are excellent, but above that frequency their efficiency is only moderate. Similarly, noise remains low below 4 GHz but can become high above 4 GHz. Bipolar transistors provide good temperature stability, as well as established reliability, and they can operate from low bias voltages. Gain, bandwidth, and linearity are adequate, while power outputs above 6 GHz are moderate.

### Bipolar transistors vs FETs

GaAs FETs offer a higher maximum frequency of oscillation, as well as broader bandwidth, than bipolar devices. Their noise and linearity characteristics are exceptional, and bias voltages are low. They provide high efficiencies at all operating frequencies, while power outputs are large above 6 GHz but relatively poor below this frequency. Temperature stability is adequate, and reverse isolation is better than that of bipolar transistors. Although the reliability of FETs is still unproven, it should ultimately be as good as that of bipolar units.

Microwave semiconductors are available from a variety of worldwide sources. The manufacturers tend to specialize in certain types of devices, and Table 6 lists the major areas of activity for leading suppliers. □

*For this article, the author wishes to acknowledge the contributions of Joseph Barrera, Charles Lieciti, Octavius Pizalis, George Pfund, Craig Snapp, and Ray Solomon.*

TABLE 6: WHO'S DOING WHAT

Company	Transferred-electron devices	Impatts	Trapatts	Baritts	Bipolar transistors	GaAs FETs
Avantek						
Bell Telephone Labs						
Communications Transistor Corp.						
Fujitsu						
Hewlett-Packard						
Hitachi						
Hughes						
IMA						
Lincoln Labs, MIT						
Microwave Associates						
Microwave Semiconductor Corp.						
Nippon Electric Corp.						
Philips						
Plessey						
Raytheon						
RCA Corp.						
Sperry						
Thompson CSF						
TRW						
Varian						
Westinghouse						

# Turning up system faults with gated-noise testing

Monitoring parameter changes and system performance when burst and square-wave-modulated noise is injected into communications and radar systems enables operators to detect deterioration and developing faults

by Norman E. Chasek, Stamford, Conn.

□ Noise, which normally limits performance of electronic systems, can be used as a tool to increase maintenance efficiency. This test noise, which is gated to minimize interference with a system's operation, can be generated by a solid-state noise source. The source, which can provide noise of constant amplitude from dc to 20 gigahertz, can continuously test radar sets and communications networks—everything from small, hand-held radar devices to large, maybe worldwide communications networks.

A relatively inexpensive noise-test set, connected on line, eliminates the need for taking a system out of service for routine testing as well as the expensive test equipment normally required to perform these tests. The Federal Aviation Administration, for example, found that it was possible to eliminate the daily routine calibration procedures normally performed on radar sets (see "Field tests prove burst-noise technique," p. 93).

Such a test set, which contains a noise source and detection unit, can be adapted to older systems, as well as designed into new ones. The test results warn when performance is deteriorating or a fault is developing so that repairs can be made when downtime will cause the least inconvenience and expense.

To be useful for testing without interference, white noise, which has a constant power density and is uniformly distributed over a wide frequency spectrum, must be gated (turned on and off) for preset times. Gated low-level noise appears similar to continuous-wave white noise until square-law detected, when it produces a sine wave that can be filtered and used for convenient measurements.

Two types of gated noise—burst and square-wave-modulated—are used for testing receiver systems. Square-wave-modulated noise can be submerged in the noise of a system for continuous monitoring of such parameters as noise figure, gain, linearity, voltage standing-wave ratio, gain-tracking and phase-tracking.

Burst noise is used to determine the difference between actual system performance and the minimum acceptable level. The higher-level bursts of white noise are

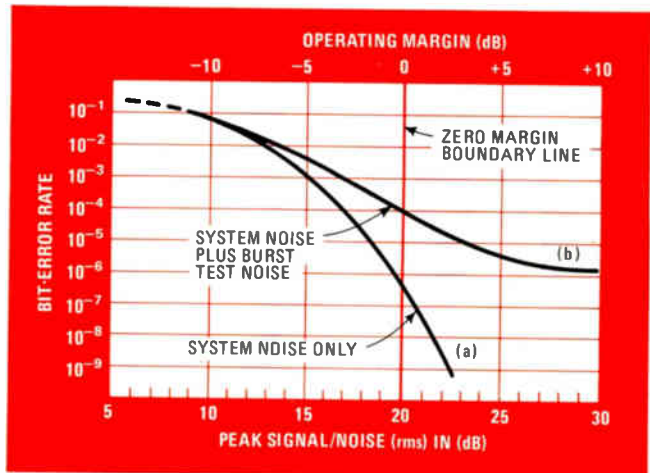

**1. Added noise.** Adding a known amount of burst noise to the system noise provides a way to perform in-service testing of a pulse system margin. Curve (a) is a standard plot of bit-error rate resulting from gaussian noise; curve (b) plots the bit-error rate for fixed amount of test noise superimposed onto the existing system noise.

inserted during intervals when its interference with system operation is minimal. The burst periods are much less than the 50% duty cycle of square-wave-modulated noise.

The interactive use of both parameter monitoring and margin verification leads to improved fault prediction and fault localization. Monitoring of key system parameters provides early indication of a developing fault as well as information useful for locating the fault. The over-all system-performance or margin-verification tests help the operator to evaluate the significance of changes in system parameters and determine how quickly he must take corrective action.

## Square-wave modulation

Unlike cw white noise, square-wave-modulated noise, after being square-law detected, has a sinusoidal component at the gating frequency and each of its harmonics. This component can be filtered out and measured. The interference caused by low-level gated noise is

## Closing the loop

The author will be available during the week of Feb. 2 to answer any questions readers may want to ask about this article. Call Norman Chasek at (203) 322-7256 during office hours.

minimal on system performance because gated noise before detection retains all the properties of white noise, and it's buried in the system noise.

However, after being square-law detected, the amplitude of the resulting coherent sine wave is directly proportional to the rms level of the amplitude of the gated noise ahead of the detector. The sine wave is easily separated from the system noise by a narrow-band filter tuned to the fundamental gating frequency. Its amplitude is a direct indication of the parameter being tested.

The maximum depth that the square-wave-modulated noise can be buried into the existing system's noise and still be extracted from background noise is proportional to the square root of the ratio of the bandwidth of the narrow-band filter to the input bandwidth of the test noise prior to square-law detection. For example, if the bandwidth of the narrow-band filter is 1 kilohertz and the predetection noise bandwidth is 10 megahertz, the gated noise can be extracted and measured when buried below the system noise by 20 decibels. Linearity measurements, for instance, require a capability to extract signals as low as 40 dB below system noise.

### System tests use burst noise

Periodic burst noise is similar to square-wave-modulated noise, except that the duty cycle is much shorter. Burst noise is used for monitoring or for determining system margins as expressed in signal-to-noise ratio, bit-error rate, false-alarm rate, and minimum discernible signal. Enough margin is built into most systems so that the error rate is too low to be measured practically. However, by inserting a precise reference-noise level that is equal to the zero-margin condition, the system can be continually tested while in service.

Margin determinations are particularly important in digital communications systems. Excessive error rates are caused by a combination of noise, distortion, timing-pulse jitter, and the like. The curves in Fig. 1 indicate how the burst-noise test can be used to determine the system's margin. Curve (a) is a standard plot of the bit-error rate that results when a known amount of gaussian noise is superimposed on a suitable pulse, such as the framing pulse (the framing pulse can tolerate a much higher bit-error rate before system performance is

affected). The plot is the average peak signal-to-rms-noise ratio, which fixes the bit-error rate.

Curve (b) is the plot of the bit-error rate that results when a fixed amount of burst noise is superimposed on the system noise. The fixed amount of burst noise added to the system noise is usually equal to the minimum acceptable performance of the system. The difference between the curves and the zero-margin boundary line is the system's margin.

Most communications systems are designed to operate at signal-to-noise ratios substantially below a bit-error of  $10^{-6}$ . If the bit-error rate is  $10^{-6}$  when measured by a pulse-rate counter at the receiver output after the test-burst noise is added to the system noise, the system's margin is at least 10 dB higher than the design value.

The difference in dB is equal to the operating-margin line that intersects curve (b). If the bit-error rate is increased to  $5 \times 10^{-5}$ , the margin would be 5 dB. If the system had been operating with zero margin, the bit-error rate would have been  $10^{-4}$ . A system that is 3 dB worse than its specified margin would show a bit-error rate of only  $10^{-3}$ . A typical setup to measure over-all margin of a repeater system on line is shown in Fig. 2. By sequentially inserting burst noise down the chain of repeaters, the one causing trouble can be located. The system's bit-error rate will drop abruptly when the defective repeater has been passed.

Using an injection-locked crystal-controlled oscillator as one signal to the coincidence gate makes sure that the noise burst is inserted at the exact time that the framing pulse is expected. This signal ensures that any instantaneous jitter on the digital pulse stream is included as a factor in the bit-error-rate measurement.

Another example of using burst noise to check margin verification is in a satellite earth-station receiver (Fig. 3). In this system, the margin to the limiter threshold in the fm receiver is the critical quantity to be verified. When the limiter reaches threshold, the rate of popping-noise transients generated by the limiter increases rapidly.

Because these large-amplitude noise spikes are easy to separate from other signals, a margin test simply consists of adjusting the attenuator at the output of the

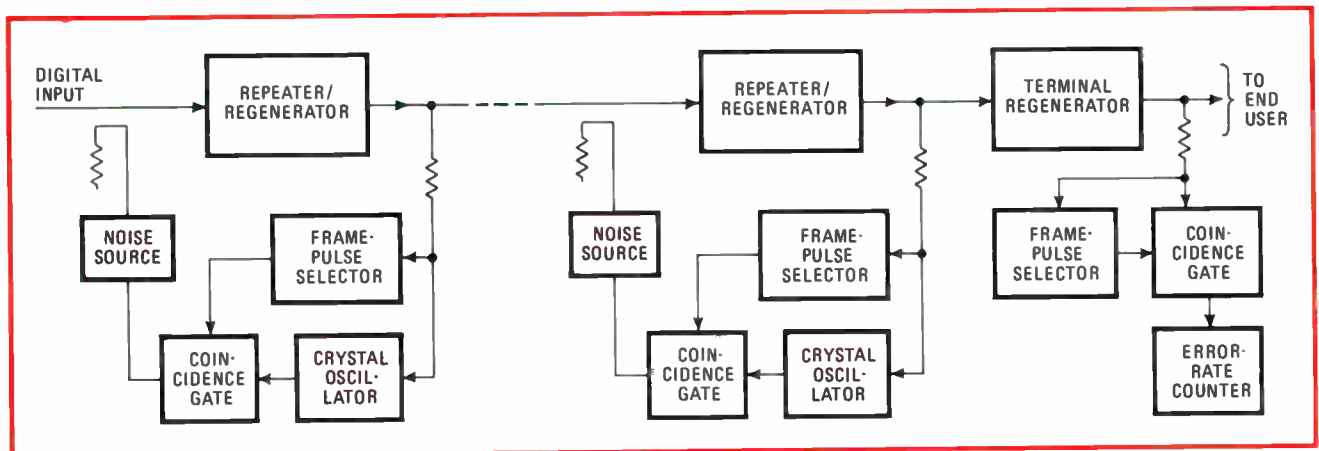

2. **Finding fault.** Inserting burst noise sequentially into each of the inputs in a chain of repeaters will uncover the faulty one. The system's error rate drops abruptly after the defective repeater is passed. The error measurement includes jitter on the pulse stream.

## Field tests prove burst-noise technique

Recent tests by the Federal Aviation Administration have demonstrated that noise bursts inserted into a radar system immediately behind the antenna provide an effective, on-line, in-service monitoring technique for an operator to appraise visually the over-all performance of the radar's receiving system. What's more, this appraisal takes into account what must be considered the entire working system—including the operator's visual capabilities and cathode-ray-tube adjustments, as well as the radar circuitry involved. The tests cover rotary joints, transmission lines, transmit/receive tubes, and the receiver front end.

Most appraisals made visually using a PPI display were within 2 decibels of the measured value of minimum discernible signal from a signal generator and an "A" scope. Tests made with a radar video processor as a detector instead of a human operator produced similar results.

To qualitatively evaluate radar performance, two separate noise bursts were injected into the system. The burst levels were separated by 3 dB, and one was delayed so that both would be discernible as targets on the CRT monitor. From this setup, it was possible to continuously appraise the degree to which the radar performance had deteriorated. When both targets created by the noise bursts were discernible after every sweep of radar, the system was at peak performance. With only one target present on the CRT, the system performance had moderately deteriorated. And when neither pulse was discernible, system performance had seriously deteriorated.

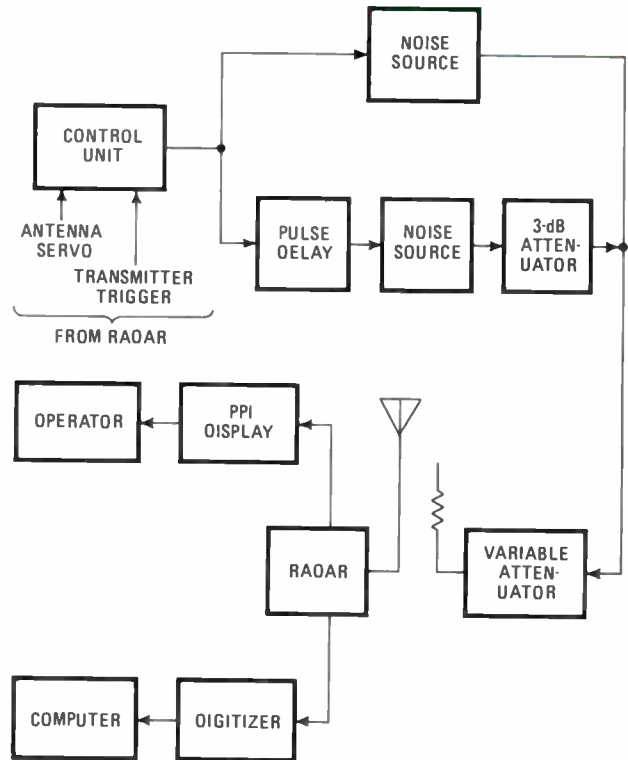

noise source so that an average of one transient per second is observed in the rate counter when the system is working normally. This test takes into account the effects of system-noise temperature, received-signal levels, and receiver bandwidth, as well as gain and limiter performance.

The attenuator must be adjusted so that the average transient rate is low enough to have no effect on system performance but is still fast enough to be conveniently measured on the rate counter. At any given time, the difference between the original reference attenuator setting and amount of attenuation needed to produce the same error rate corresponds to the system's operating margin.

### Square-wave-modulated noise tests parameters

Parameter-monitoring provides the earliest indication of a developing fault and yields information useful in locating that fault. A square-wave-gated noise is used as a signal source because it is broadband and does not interfere when injected into the system at a level below system noise. And once the gated noise is square-law detected, the resultant coherent sine wave can be extracted from the system noise. The amplitude of the sine wave is used as a measure of the particular parameter designed.

Instead of monitoring with an error-rate counter, as in burst-noise-testing, parameter-testing requires difference-measuring equipment. This equipment is referred to as a time-displaced ratiometer (TDR) and a correlating voltmeter (CVM). The former measures the ratio of

two levels of noise displaced in time, and the latter measures the absolute magnitude of a coherent sine wave in a noisy environment.

The time-displaced ratiometer and correlating voltmeter can be combined easily into a parameter test set (Fig. 4) that also includes two ac amplifiers separated by

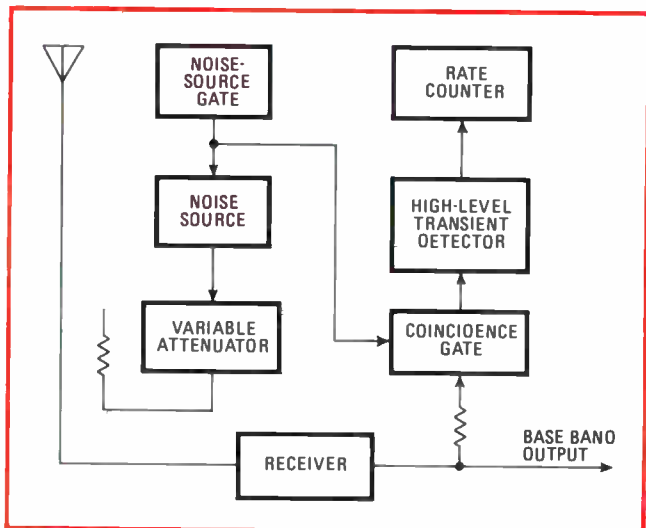

**3. Threshold-margin monitoring.** Once an attenuator setting establishes a reference reading on the rate counter, any change in operating margins can be easily detected. The attenuator setting is then readjusted to produce the original error rate, and the difference between the initial and final attenuator settings corresponds to the change in the system's operating margin.

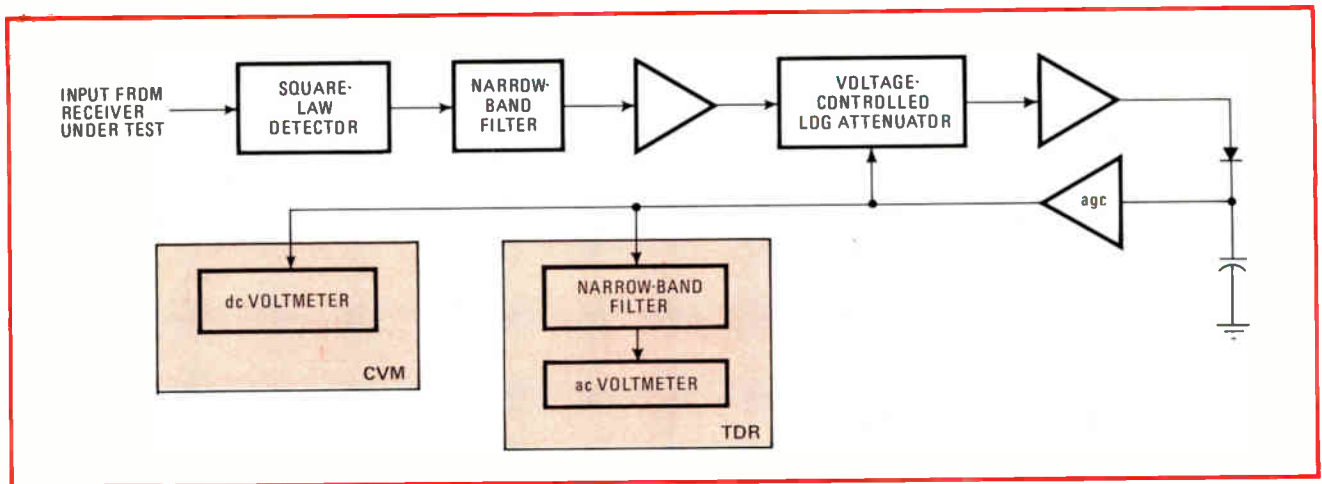

**4. Parameter monitoring.** After detection and processing, both ac and dc components are present. The ac component is used for measuring VSWR, noise figure, and gain-tracking. The magnitude of the dc component is used to determine gain, phase-tracking, and linearity.

a voltage-variable logarithmic attenuator. The output of the second amplifier is detected, amplified, and fed back to control the attenuator. This automatic gain control forms a loop with a time constant fast enough to follow the changes in level between the two time-displaced signals used for the ratiometer mode.

The voltage output of the agc amplifier contains an ac and dc component. The frequency of the ac component corresponds to the frequency at which the gated noise is switched between coupling ports of a directional coupler for VSWR tests, between amplifiers for gain-tracking checks, or merely switched on and off for noise-figure tests. The rms magnitude of the ac component, which is directly proportional to the ratio of these two time-displaced levels of noise, is used as a measure of VSWR, gain-track, or noise. The magnitude of the dc component at the output of the agc amplifier is proportional to the magnitude of the input test noise. This measurement is used to determine gain, phase track, and linearity.

#### Monitoring noise temperature

By periodically injecting a precise amount of square-wave-modulated reference noise available from the solid-state noise source into a receiver front end and coupling a portion of the intermediate frequency or video output into the TDR, the resulting ac output voltage is proportional to the system's noise figure, or noise temperature. The TDR technique has two advantages over other techniques: no referencing adjustments are required, and the noise source can be operated independently and remotely from the TDR without interconnection between the two units. This remote capability is convenient for large systems because the point of noise injection may be distant from the point of measurement.

A simple setup can also be used to measure receiver and amplifier gain. By inserting a known level of square-wave-gated test noise into the unit under test and then measuring the magnitude of the output-signal level, the amplifier gain can be read directly on a pre-calibrated correlating voltmeter.

An instrument designed to measure both system

noise and gain of low-noise amplifiers is shown in Fig. 5. TDR and CVM circuitry and calibrating settings are built in to measure reference gain and noise temperature. Limit adjustments can provide suitable output for a remote alarm or to cut over standby equipment.

Square-wave gated noise, alternately switched between a dual directional coupler's ports will generate a time-displaced signal at the output of the receiver. The ratio of the amplitude of these signals is proportional to return loss, which is directly related to VSWR. The VSWR, or return-loss, measurement is particularly important for checking the condition of antennas and transmission lines. Such faults as corrosion, moisture accumulation, physical damage, wear on rotary joints, and ice-coating can be detected as changes in VSWR.

#### Tracking phase and gain

If the output of a square-wave gated-noise source is divided between two receivers through equal trans-

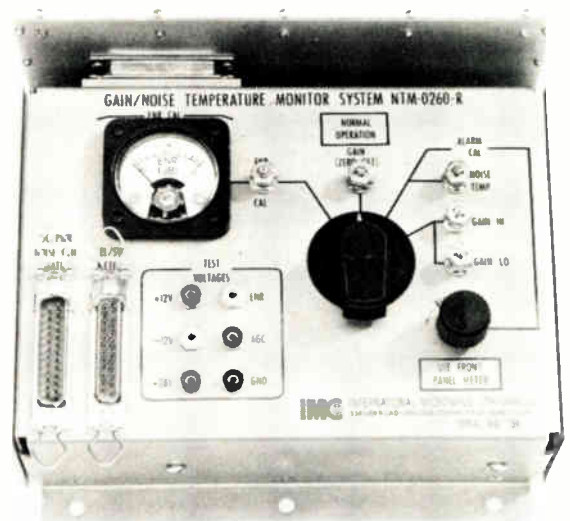

**5. Automatic monitor.** Designed to measure system noise temperature and gain of low-noise amplifiers in a satellite earth station, the unit has a built-in time-displacement ratiometer and correlating voltmeter in an upper compartment. External meter (not shown) reads the noise temperature, noise figure, and variations in rf gain.

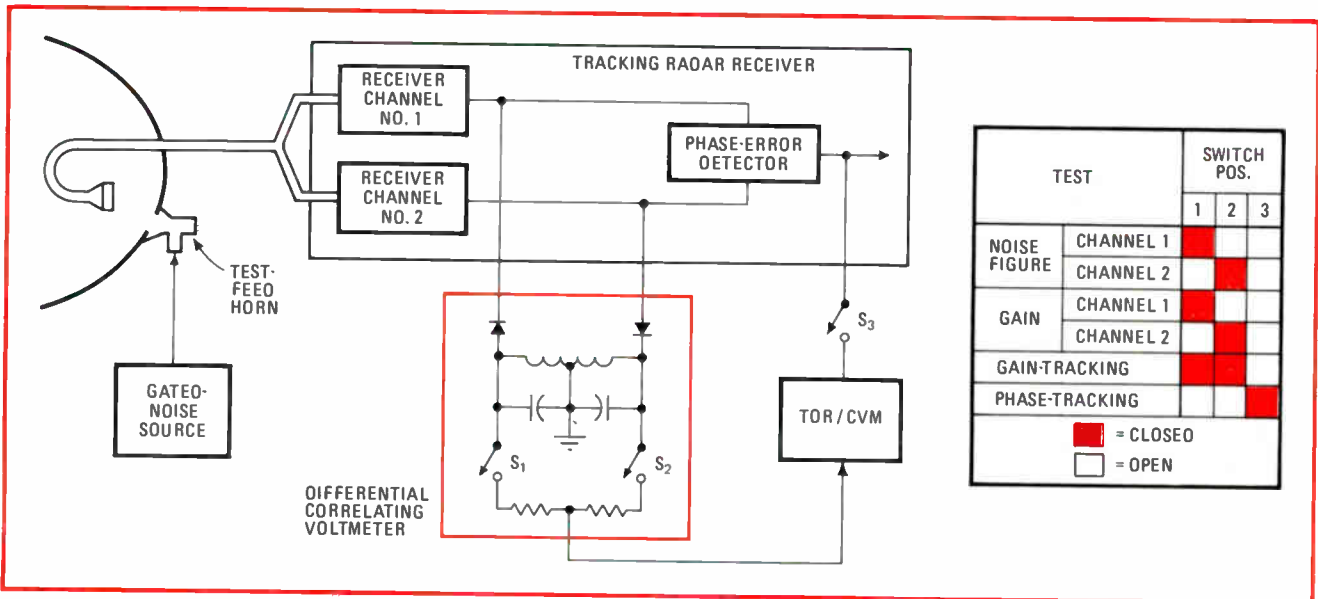

**6. All in one.** A test feed horn provides an easy method of injecting noise signals into both channels of a tracking receiver. The measurement techniques are similar except that differential correlating detector is required in addition to the TDR and CVM.

mission lines, the output of the receiver's i-f phase comparator (normally present in all tracking radars) will contain, after detection, a coherent sine wave that is proportional to the average phase error over the entire passband of the receiver. The amplitude of the sine wave, which is measured by a correlating voltmeter, shows zero if the phase track is perfect. The meter can be calibrated for values other than zero.

To determine how well the gain of two receivers tracks, the gated-noise source is switched alternately between both channels of a tracking receiver and then both outputs are added together before driving the TDR circuits. If the gain track is perfect, the ratio observed on the TDR will be unity. The TDR meter can also be calibrated to indicate other values.

### Monitoring tracking-receiver performance

An example illustrating complete parameter monitoring of a tracking radar receiver is shown in Fig. 6. This single setup checks noise figure and gain, as well as gain- and phase-tracking, of the receiver. The noise source provides equal amounts of gated noise to each channel via a test-feed horn mounted on the antenna dish so that the noise energy illuminates the feed horns equally.

The i-f output of each receiver is tapped and fed to a differential correlating detector (DCD), which consists of two detecting diodes of opposite polarity, a narrow-band filter tuned to the noise-gating frequency, and two switches. The DCD output drives the correlating voltmeter. The output-phase error from a phase detector feeds directly into the correlating voltmeter.

The small-signal tests set the basic reference for overall system performance. However, large-signal tests are used to confirm that the small-signal phase and gain track hold over the full dynamic range of the receiver. Such tests are performed with variable-amplitude test signals inserted into the receiver's i-f amplifier. Obtaining high-level-noise signals is more convenient at i-f

than at microwave frequencies. Microwave sources just don't provide a high enough noise level.

Gated-noise signals can also be used to check system linearity essential in proper operation of repeater elements of long communications-transmission systems. The linearity of a system is usually defined either in terms of amplitude or phase. Amplitude linearity is usually determined by the amount of gain nonlinearity introduced by amplifiers or slope nonlinearity in modulators and demodulators. Phase linearity is the deviation from a straight line of the phase shift versus frequency of the transmission network.

Cable-television-transmission systems are particularly sensitive to amplitude nonlinearities because many different TV signals are passed through a common repeater-amplifier. If the amplitude linearity of the amplifier becomes degraded, cross-modulation will increase and the quality of the TV signal will deteriorate. A repeater amplifier that becomes excessively nonlinear can be located simply and inexpensively.

One method uses a low-frequency square-wave-modulated rf carrier inserted into any of the unused frequency spaces and transmitted down the cable system along with the TV signals. Each repeater/amplifier has a high-level noise source coupled into its input, which is normally turned off. The square-wave-modulated rf carrier then sequentially turns each of the noise sources on for only a few seconds and then off again. At the output of the cable system, the noise is monitored in the unused frequency space by means of a bandpass filter and a correlating voltmeter. Amplitude nonlinearity in a specific repeater causes a transfer of square-wave modulation from the test carrier to the test noise throughout the bandpass of the repeater. The excessively nonlinear repeater amplifier will produce an abrupt drop in detected level in the CVM as the noise source at its input is turned on. These gated noise-source signals can also be used to measure net gain per repeater section and gain flatness. □

## Inverting dc-to-dc converters require no inductors

by Craig Scott and R.M. Stitt  
Burr-Brown Research Corp., Tucson, Ariz.

Many systems require a modest negative power source where only a positive power supply is available. Such a negative voltage can be produced by an inverting dc-to-dc converter installed right where it is needed. This arrangement is especially convenient in systems where the dc power is supplied remotely because only two wires need to be run to the point of use, instead of three. The inverting dc-to-dc converter described here requires no expensive transformers or inductors. Noise spikes asso-

ciated with switching inductive loads are therefore eliminated.

To understand the operation of the circuit, consider first the -5-volt converter shown in Fig. 1. Resistor  $R_1$ , capacitor  $C_1$ , and two inverters form a free-running 100-kilohertz oscillator. The remaining four inverters in the hex-inverter package form a power driver. On the positive swing at the output of the power driver,  $C_2$  is charged through diode  $D_1$  and transistor  $Q_1$  (assuming that  $Q_1$  is on). When the output of the power driver drops back to zero,  $D_1$  reverse-biases and  $D_2$  forward-biases, so charge is transferred to  $C_3$ .

As the cycle repeats,  $C_3$  is charged to a negative voltage that approaches the positive-output swing minus the diode drops, power-driver drop, and the drop across  $Q_1$ .  $Q_1$  is held on by  $R_2$  until the base-drive current is shunted away by the breakdown of  $D_{Z1}$ . This occurs when the negative output voltage exceeds the break-

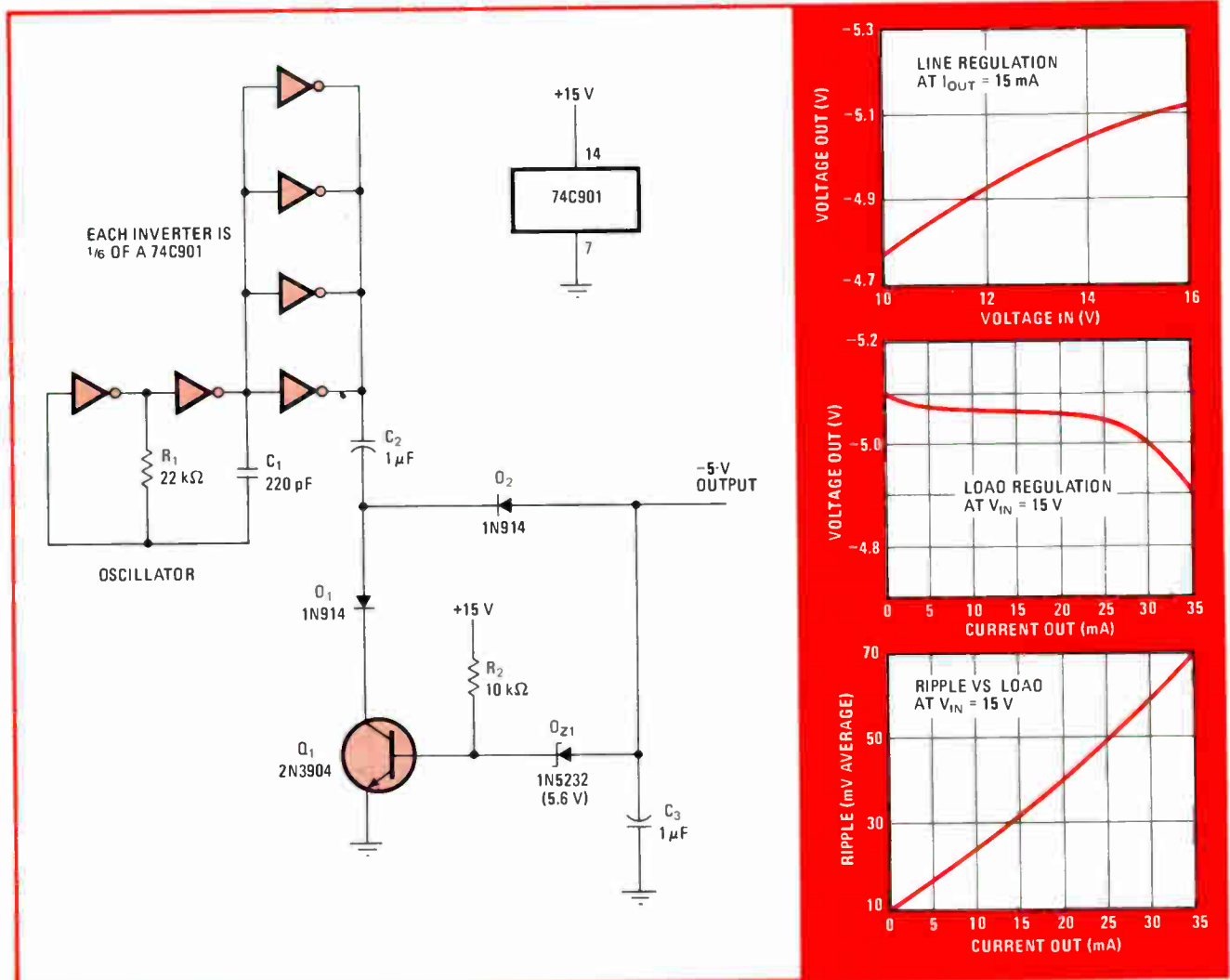

1. **Converts and Inverts.** Dc-to-dc converter provides inverted regulated output of -5 volts without use of transformer or inductor. Instead, it puts negative potential on  $C_3$  by discharge of  $C_2$  during off-cycle of oscillator. Performance curves show data for typical units.



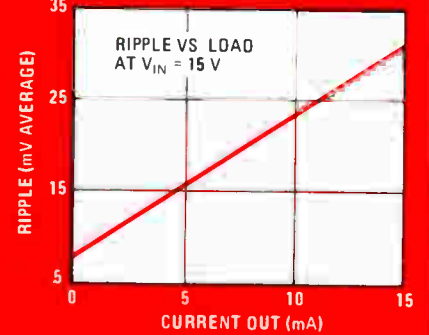
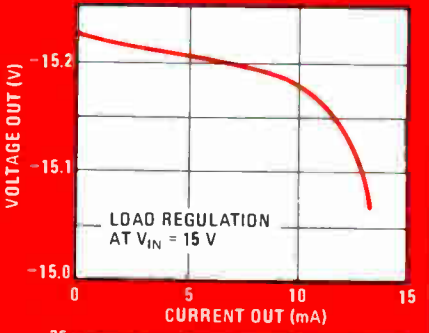
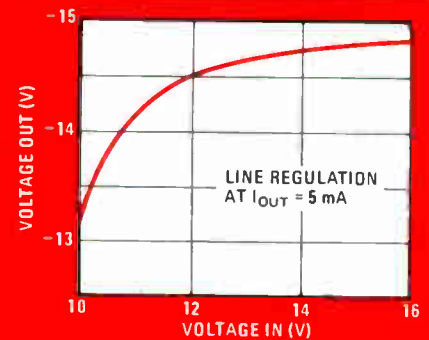
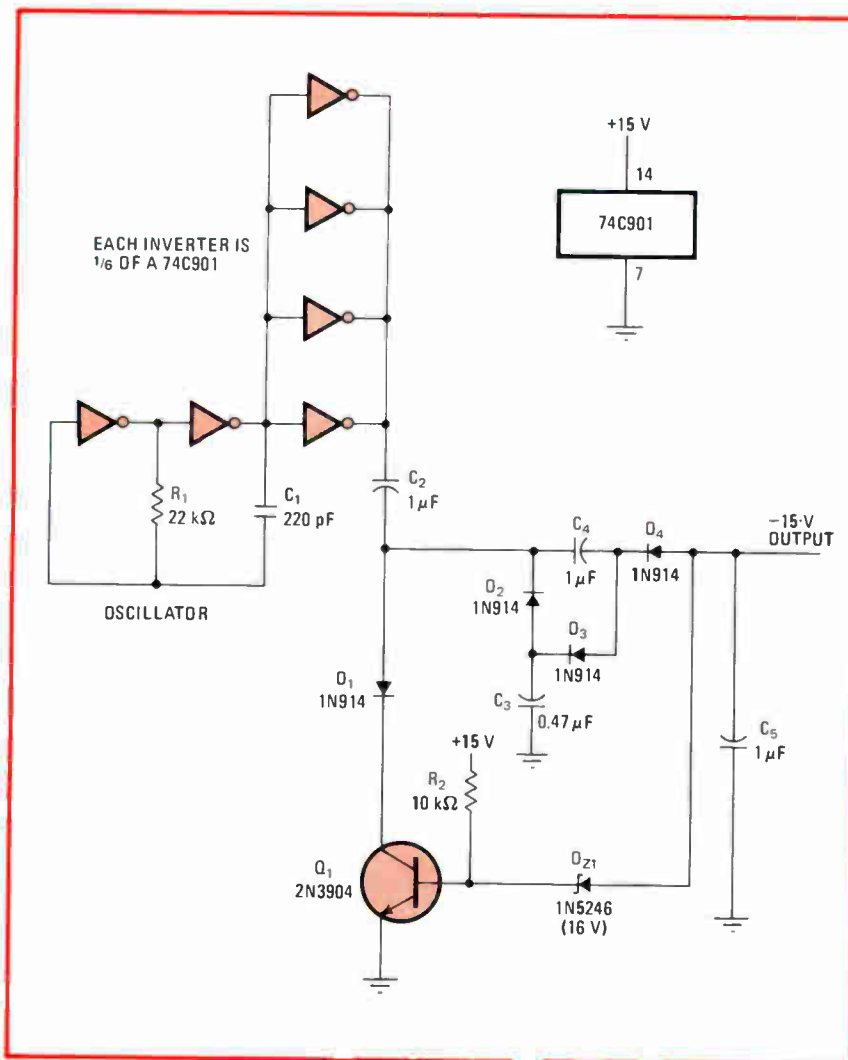

**2. More volts.** Addition of voltage-multiplier stage to circuit in Fig. 1 allows it to deliver a regulated output of -15 V. These inverting-converter circuits are convenient for producing negative voltages at locations remote from the main positive power source.

down voltage rating of  $D_{Z1}$ , less the  $V_{BE}$  of  $Q_1$ . Thus, the output voltage is regulated at  $V_{out} = -(V_{Z1} - V_{BE})$ .

With the output loaded, the negative output voltage of this circuit evidently cannot exceed that of the positive power-supply input in size. It is possible, however, to modify the circuit so that it produces a negative voltage equal to or larger than the input voltage. By adding a voltage-multiplier stage to the circuit of Fig. 1, for instance, the maximum possible output voltage can be doubled.

Such a circuit is shown in Fig. 2, in which  $C_1$  is charged through  $D_3$  on the positive swing of the power-

output stage. However, now  $C_4$  is charged from the negative voltage that appears at the negative terminal of  $C_3$ . The voltage across  $C_4$  then approaches twice the input voltage, minus the drops. This voltage is transferred to the output capacitor as before. The negative-output voltage can therefore approach twice the input voltage, less the drops. □

Have you used a microprocessor to replace either hard-wired or mechanical logic in a circuit or made some other use of these versatile devices? Engineers who are just starting to design with microprocessors would be interested in learning about your experiences. We'll pay \$50 for each microprocessor item published, as we do for all published Designer's Casebook ideas. Please send them to our Circuit Design Editor, summarizing the problem and how a microprocessor provides a novel solution.

## Photocoupler provides agc for audio communications

by Richard K. Dickey  
California Polytechnic State University, San Luis Obispo, Calif.

In all communications systems that have speech input, some form of automatic gain control is desirable to maintain the optimum signal level despite wide variations in the amplitude of the input level. To eliminate fluctuations caused by varying transmission efficiency, agc is also desirable at the receiving terminal.

A good agc system should introduce no amplitude or frequency distortion and should have a fast attack and a

**Model 211—read and write.** Similar to Model 210 in function, including card capturing, except also writes to up-date encoded data—mass-transit ticketing, etc. Features a tachometer-controlled motor and control circuitry, gear-driven rollers, to meet stringent requirements for card encoding.

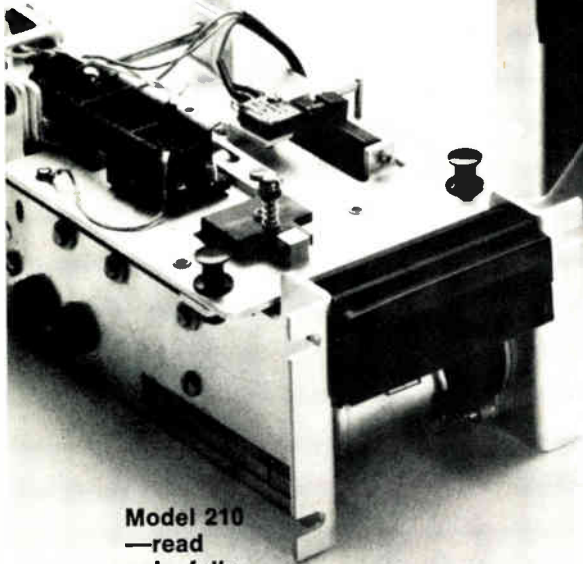

**Model 210—read only, fully automated.** Highly engineered for read functions in unattended remote stations. Also verifies, returns, or captures stolen or expired cards. Widely used for magnetic-encoded banking, travel, credit cards.

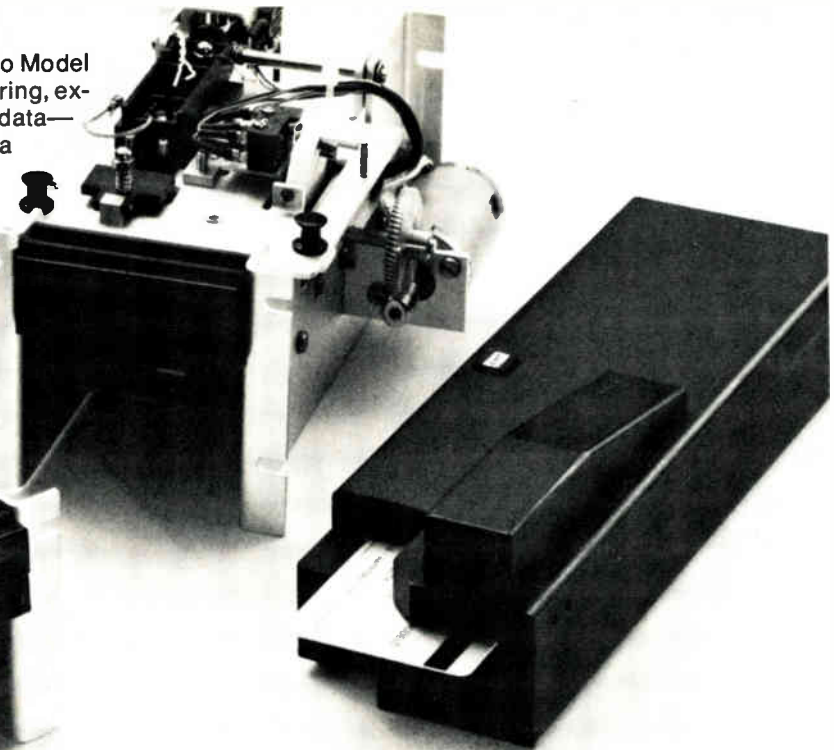

**Model 75—read only.** Reliable, low-cost way to enter data into a computer from stand-alone peripherals. Ideal for identification, access control, credit validation. Manually operated, so no external power for transport. Extremely low profile.

# AMP magnetic card readers. Just the features you need, for the savings you want.

We make such a wide variety, you get a reader that's just right for your application. You're not locked in with buying a unit that's loaded with features you can't use.

And you avoid the expense of custom-made specials for standard work. Yet AMP magnetic card readers have such built-in versatility, they quickly adapt in the field for special-purpose duty—with a wide range of options for multifunctions and control.

AMP magnetic card readers conform to ANSI specifications on total equipment, and come to you electronically interfaced, ready to work with other components in your system.

No other manufacturer offers such complete, economical variety—in compact, space-saving packages.

For immediate information, contact: AMP Captron Division, Elizabethtown, Pa. 17022. (717) 367-1105.

AMP is a trademark of AMP Incorporated.

**AMP**  
INCORPORATED

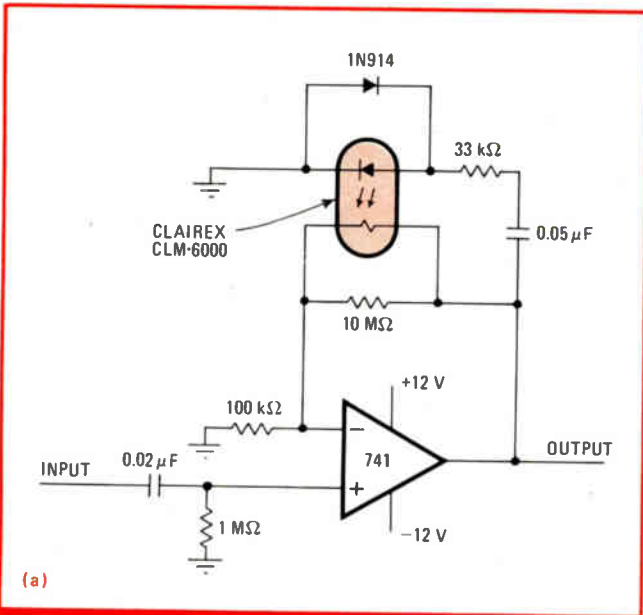

(a)

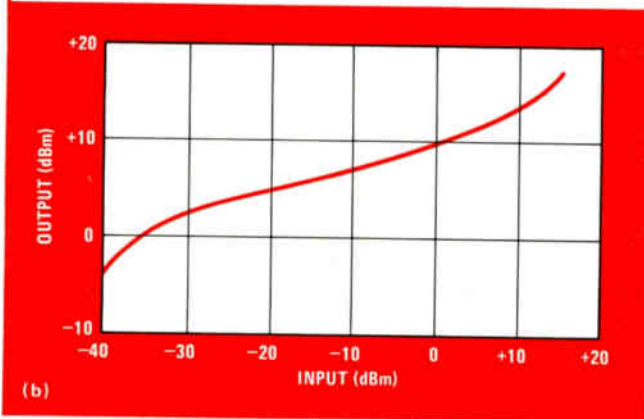

**1. Agc amplifier.** Photoresistor in optical coupler provides feedback path for operational amplifier circuit in (a); output signal drives LED to reduce photoresistance and thus reduce gain. Transfer characteristics are shown in (b); 0 dBm is taken as 0.775 volt rms. The lower limitation on agc is shown by the curved portion of the characteristic at low input levels. Gain approaches unity at high input levels.

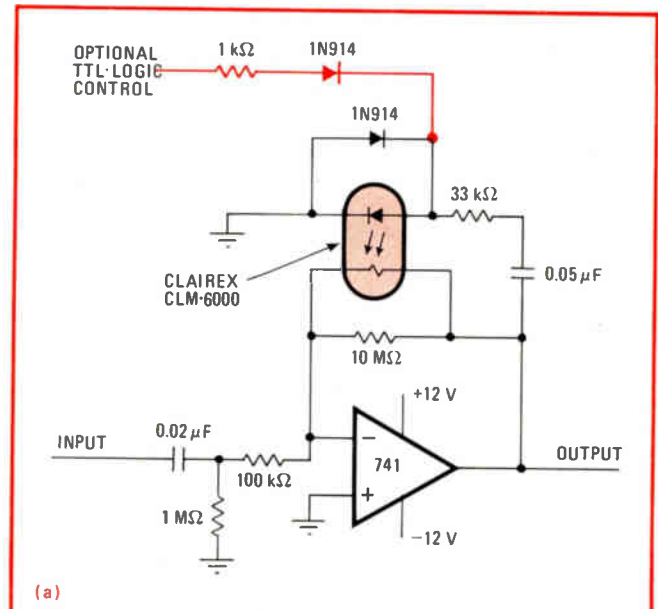

(a)

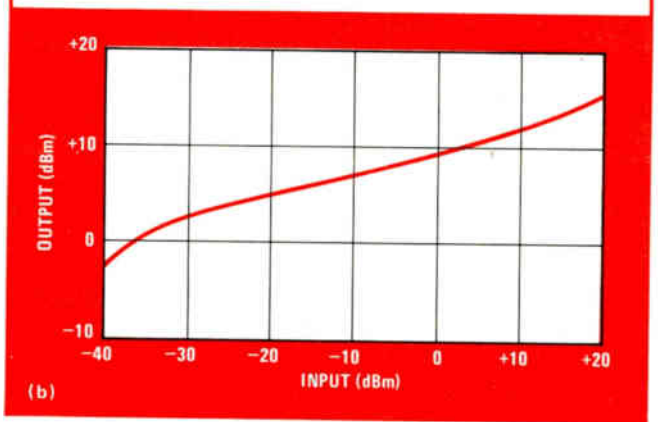

**2. Wider range.** Inverting connection of op amp (a) provides greater agc; transfer characteristics (b) show that 50-dB variation of input signal produces only 12.6-dB variation at output. The input impedance is less than for noninverting connection used in Fig. 1, and a constant low driving impedance is required. Optional portion of circuit shown in color allows a TTL signal to turn off output.

moderately slow decay. The circuit of Fig. 1(a), which has all these features, can reduce an input variation in excess of 50 decibels to an output variation of only 16 dB. This circuit uses a 741 operational amplifier connected in the noninverting mode. The gain of this configuration is  $1 + R_F/10^5$ , where  $R_F$  is the feedback resistance (in ohms). The feedback resistor is the photoresistor of a CLM-6000 optical coupler.

Unlike the more common phototransistor couplers, the CLM-6000 has a photoconductive cell; op-amp output voltage in excess of the forward drop of the coupler's light-emitting diode (about 1.4 v) decreases the photocell resistance. Therefore the 741 operates as a linear amplifier with a gain that is controlled by its own output. The characteristics of the photoresistor include a quick drop in resistance when illuminated and a slow recovery of resistance after darkness begins. The compression characteristics of the agc amplifier are shown in Fig. 1(b).

The 1N914 diode that shunts the LED completes the

circuit for the negative phase of the ac signals, so that the 0.05- $\mu$ F capacitor can discharge. The 10-megohm shunt across the photoresistor is necessary to prevent loss of dc feedback and consequent output saturation in the absence of signal. If output saturation were allowed to occur, the system would lock up, and no ac signal could appear at the output.

For a wider dynamic range, the inverting-mode operational amplifier circuit of Fig. 2(a) can be used; the input impedance is finite (100 kilohms), and a constant low driving impedance is required. For large input signals, the gain of this circuit goes below 1, so the circuit becomes an attenuator.

An additional feature of this configuration is that the output may be effectively switched off by a transistor-transistor-logic signal applied to the LED as shown. When the TTL signal is high, the LED emits so much light that the photoresistor conducts strongly and forces the gain to zero. When the TTL signal is low (less than 0.8 v), the circuit operates normally. □

# Two new approaches simplify testing of microprocessors

Circuitry is divided into functional modules for checking as units; after sequences are devised to thoroughly exercise a digital IC, patterns are generated by algorithms to minimize storage needs

by Albert C. L. Chiang and Rick McCaskill, *Macrodata Corp., Woodland Hills, Calif.*

□ The conventional methods of testing integrated circuits cannot cope with the complexities of microprocessors. A microprocessor's logic structure is not simply a collection of gates, nor is it a well-ordered assemblage as in a large-scale-integrated memory. The classic dc tests used to check these earlier devices, such as measuring high- and low-state output voltages, can do little to ensure satisfactory microprocessor performance. In addition, the commonly used computer-aided simulation technique, which tests the microprocessor with a string of inputs in a burst, proves merely that the device is free of steady-state faults such as being stuck at logic 1 or stuck at logic 0.

However, two new techniques can provide comprehensive tests of microprocessors. Implementation of these techniques is as straightforward as their names are formidable—module sensorialization and algorithmic pattern generation. Whether used individually or together, they can simplify testing of microprocessors and reduce costs by reducing the amount of memory space required and the time needed for processing and applying stimuli to the unit under test.

Module sensorialization has evolved from earlier approaches to simplifying the task of writing test programs needed in digital integrated-circuit testing. The complexity of small- and medium-scale ICs has led to considering these ICs as collections of gates instead of individual transistors, and each gate is tested as a unit, without regard to the parameters of its constituent devices. Extending this approach, the greater complexity of large-scale ICs now leads to module sensorialization: individual gates are ignored in favor of even larger blocks—functional subsystems or modules.

## Providing bit patterns

Algorithmic pattern generation is applied after a sequence appropriate for testing a microprocessor or other digital IC has been devised—either by module sensorialization or some other method. In most presently available automatic test systems, the sequence of bit patterns necessary to stimulate a unit under test is either generated by a computer program or held in mass memory. As the test proceeds, these patterns are transferred into a large random-access memory, then transmitted in a burst to the unit under test. A better method is to create the bit patterns as needed in a generator that

executes various rules, such as adding 1 to the previous pattern. These rules are written in a microprogram, or algorithm.

To apply module sensorialization, the test engineer first studies the hardware architecture and software-response specifications of the microprocessor under test. Architecture refers to the internal organization of the device: an ordered set of modules such as a program counter, arithmetic logic unit (ALU), accumulator, stack pointer, and so on. Software response refers to the set of instructions a user can apply and by which the user can monitor the operation of various modules. When the engineer gains complete knowledge of a microprocessor's architecture and software response, he can develop an ordered set of test sequences in the microprocessor's programming language for testing all the modules one by one.

There is great variety in the microprocessor units on the market today, and each has its own architecture. But of all the product types, 8-bit units like the 8080 have

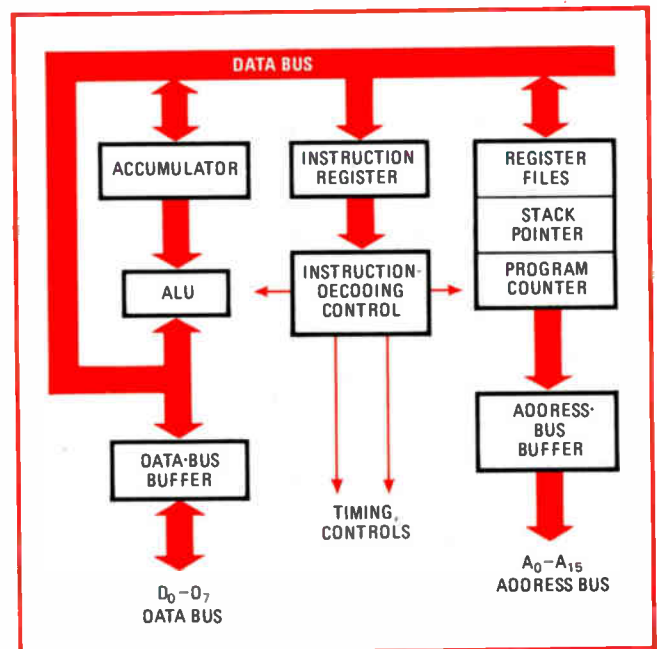

1. On the bus. Microprocessors may be viewed as assemblies of independent functional blocks that can be tested separately. Address and data buses tie the blocks together and provide access to each.

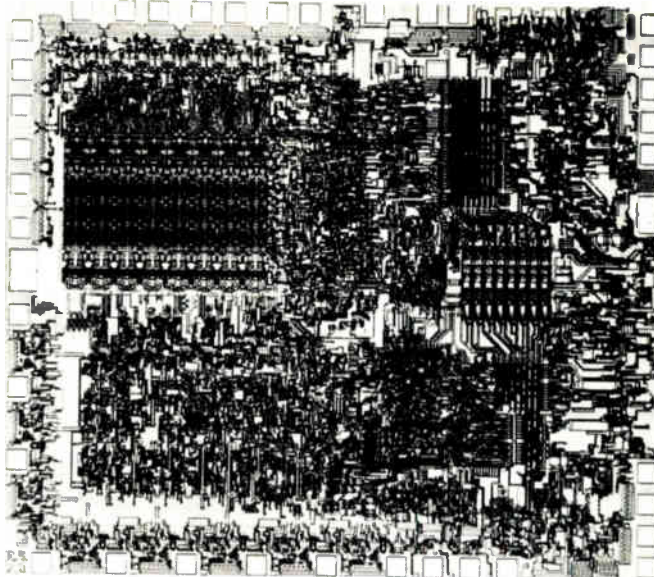

**2. On the chip.** The physical layout of elements on a microprocessor chip closely tracks the block diagram. The data bus is centrally located so that it can communicate with almost every function block within the assembly.

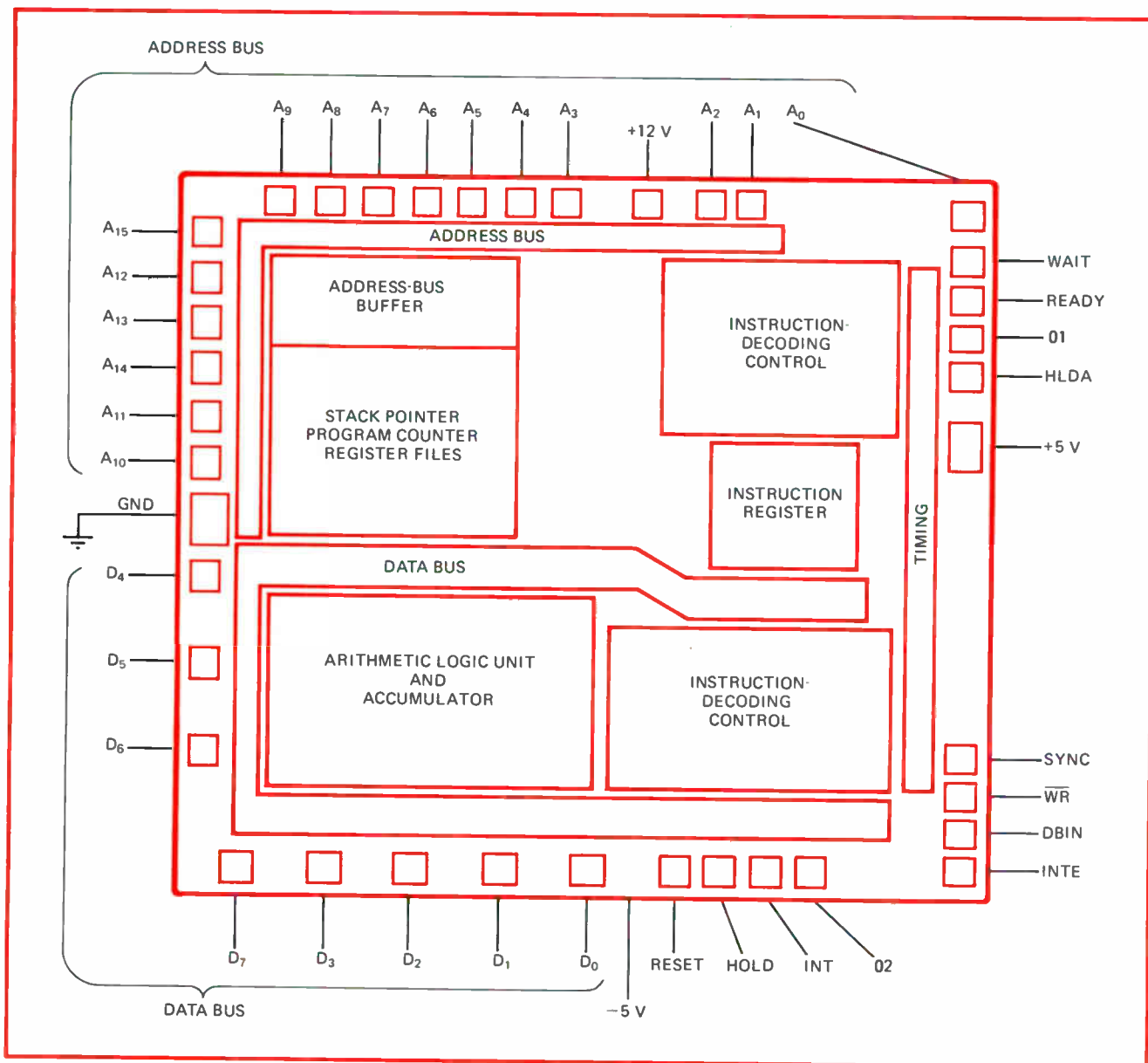

TEST-FLOW CHART	FUNCTIONAL-TEST DESCRIPTION	INSTRUCTIONS USED
RESET	Reset microprocessor by stimulating the reset input.	None
PROGRAM-COUNTER TEST	Increment the program counter through its full range.	NDP
MEMORY TEST	Load directly the H and L memories with a 0. Then transfer both the H and L memories to all other memories. After each transfer, transfer that memory back to the H or L memory, then output the H and L memories through the program counter. Then load the H and L memories with transfers. Continue doing this until all 256 numerical combinations have been loaded into the H or L memory.	LXI H PCHL MOV r1r2
STACK-POINTER TEST	Transfer the H and L memories to the stack pointer and then verify that the stack pointer can increment and decrement through its full range. Verify by transferring through the H and L memories to the program counter.	LXI H SPHL INXSP DCXSP PCHL DADSP
ALU	Verify that the ALU will add, subtract, detect a 0, detect a positive value, detect a negative value, perform a carry, and perform all logical instructions.	ADDr ADCr SUBr SBBr ANAr XRAr ORAr CMPr JC JNC JZ JNZ JP JM
ACCUMULATOR	Verify load, readback, rotate, and transfer operations with all pattern combinations.	STAX B STAX D LDAX B LDAX D CMA RLC RRC RAL RAR
TIMING AND CONTROL	Exercise all external stimulae and verify their correct action.	None
INSTRUCTION DECODER	Perform all instructions that have not been previously exercised.	All others

**3. Test flow.** In testing a microprocessor, each function block is examined in sequence, and each instruction is executed at least once. At each step, as shown, a segment of the microprocessor is tested by addressing the chip with specific microprocessor instructions. The instruction-decoder test also serves as a catch-all for instructions that have not been exercised in previous steps.

gained the widest market acceptance. This makes an 8-bit parallel microprocessor like the 8080 a good example for describing the application of module serialization, though the technique is applicable to all microprocessors.

In general, a microprocessor has two internal buses: an 8-bit bidirectional data bus and a 16-bit unidirectional address bus (Fig. 1). The data bus carries both instruction codes and data. Instructions are decoded and executed in connection with appropriate controls, and data goes to both the arithmetic logic unit and the accumulator to be manipulated by specified arithmetic or logic operations. The address bus links with main memory, where both instruction codes and data are housed. Stack pointers, program-location counters, and register files also supply information to the address bus.

The layout of function modules on a microprocessor chip closely follows the block diagram (Fig. 2). Modules are physically implemented in a separable manner, making it feasible to test them that way.

### Taking steps

After the architecture is understood, the first step in microprocessor testing is to partition the device into modules, some of which may overlap. Each module should be accessible on the input/output bus by executing a proper set of microprocessor instructions. In other words, each module should be able to propagate its result directly or indirectly to the bus for sensing externally by executing a defined set of instruction sequences in the microprocessor's own language.

When dealing with each particular module, every effort should be made to run a worst-case test pattern, subject to the executability of the necessary instructions. For example, a galloping-1s-and-0s pattern should be generated for a random-access-memory module if it is determined that there is a sensitivity to this pattern. As soon as the first module is thoroughly tested, the same procedure is applied to all succeeding modules to fully test the hardware.

To begin the examination of the microprocessor's software response, a set of instructions should be executed when testing the first module. Then, proceeding toward the second module, a new set of instructions (which may contain some instructions executed in the first stage) should be executed. This procedure applies to all modules and all sets of instructions until all specified instructions are executed one or more times. Since some instructions may not be used in testing any of the modules, a last step to exercise all untested instructions may be necessary (Fig. 3).

### Finding faults

This approach provides information for diagnosing faults in both hardware and software response. From a hardware viewpoint, a faulty module on the chip will be isolated. The modularity of the procedure makes a break point inherent in the test flow, facilitating the modular diagnosis. And since a set of instructions will be executed in conjunction with each module, any malfunction on a specified instruction or set of instructions can be identified. In an 8080, a typical test flow starts

with the program counter, followed by register files, stack pointer, ALU, and so on, until both the hardware and the software instructions are thoroughly tested.

Once the set of bit patterns necessary to test a microprocessor has been determined, whether by module sensorialization or any other technique, some method must be devised for an automatic test system's hardware to generate these patterns and feed them into the unit under test. The most common way to implement a test program on an automatic system is by the storage-pattern method.

In this approach, test patterns, each of which consists of input stimuli to and expected results from the device under test, are stored in a mass memory. A sequence of test patterns is transferred to high-speed random-access memory or shift registers just before the test is performed, and the test is implemented by transferring the bit patterns in a burst into the device under test. The outputs from the unit under test are then compared with the corresponding stored output patterns to verify functionality.

This conventional method is far from ideal. It suffers from at least four major drawbacks:

- Large, expensive memory. High-speed random-access memories or shift registers become quite expensive when any great amount of memory is needed. In testing the program counter for the 8080, for example, 262,000 distinct patterns are required. A memory test on the register array of an 8080 takes approximately 50,000 patterns. The cost of memory can quickly become a major part of the total cost of the test system.

- Long transfer time. The overhead time required to transfer a long pattern from disk, core, or other mass memory to high-speed RAM can make a large dent in the throughput rate of the test system. If transferring a 1,024-bit pattern from disk to RAM takes 50 milliseconds—a typical figure—transferring the test pattern for the program counter takes 13.1 seconds of overhead time ( $262 \times 50 \times 10^{-3}$  seconds) in addition to the test-execution time.

- Inflexible program. The stored program cannot easily be modified while tests are in progress. This rigidity makes it difficult to perform special or unusual tests on a single unit. A substantial amount of off-line software support is therefore needed if such tests are to be accomplished.

- Lack of diagnostics. Virtually no information is generated to indicate which instructions or parts of the device caused a failure. Analysis of faults requires a separate test routine or a sophisticated program to interpret the results of the stored-program tests.

### Programing patterns

Algorithmic pattern generation eliminates these problems. In the algorithmic method, a sequence of defined patterns is formed by a high-speed pattern generator under microprogram control. The user can change the program easily, even while tests are in progress, to generate a variety of distinct patterns. This technique, which eliminates the cost of memory for pattern storage and the delay time in transferring patterns from mass memory, is extremely efficient and flexible in generating

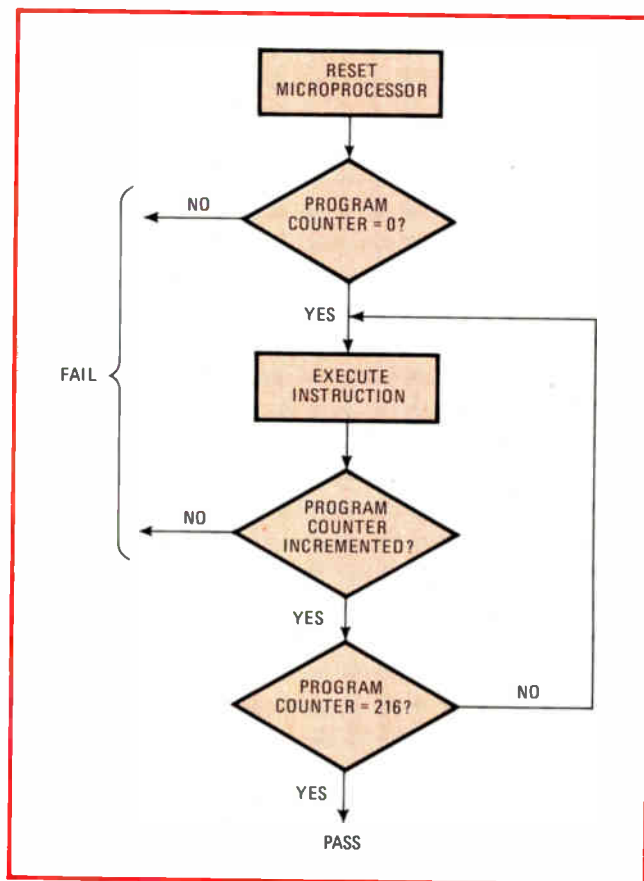

4. Counter test. Algorithmic pattern generation makes testing the program counter in an 8080 microprocessor a simple matter. A single instruction is executed repeatedly, and after each command, the counter is examined to make sure that it incremented.

patterns for logic modules such as binary counters, random-access and read-only memories, and shift registers, as well as microprocessors.

When used in conjunction with module sensorialization, algorithmic pattern generation permits faults to be diagnosed so that the particular module or instruction that caused a failure can be isolated.

### Testing the 8080

The advantages of algorithmic pattern generation can be well illustrated by tests on the program counter and memory of an 8080. Only six micro-instructions are needed to perform the test, and there are no lengthy test patterns to be stored. The conventional method would require storage of 262,000 patterns for the same test.

All that is needed to test the program counter is to ensure that the counter can move incrementally through its full range. A simple instruction is executed 262,000 times, and the unit under test is examined after each instruction to make sure that the program counter has moved (Fig. 4).

The test setup for the program counter contains a T register that can be connected to the unit under test (Fig. 5). If the T register increases in step with the program counter, this register can be used for comparison with the output of the program counter to verify the operation of the counter. A second register, called the B

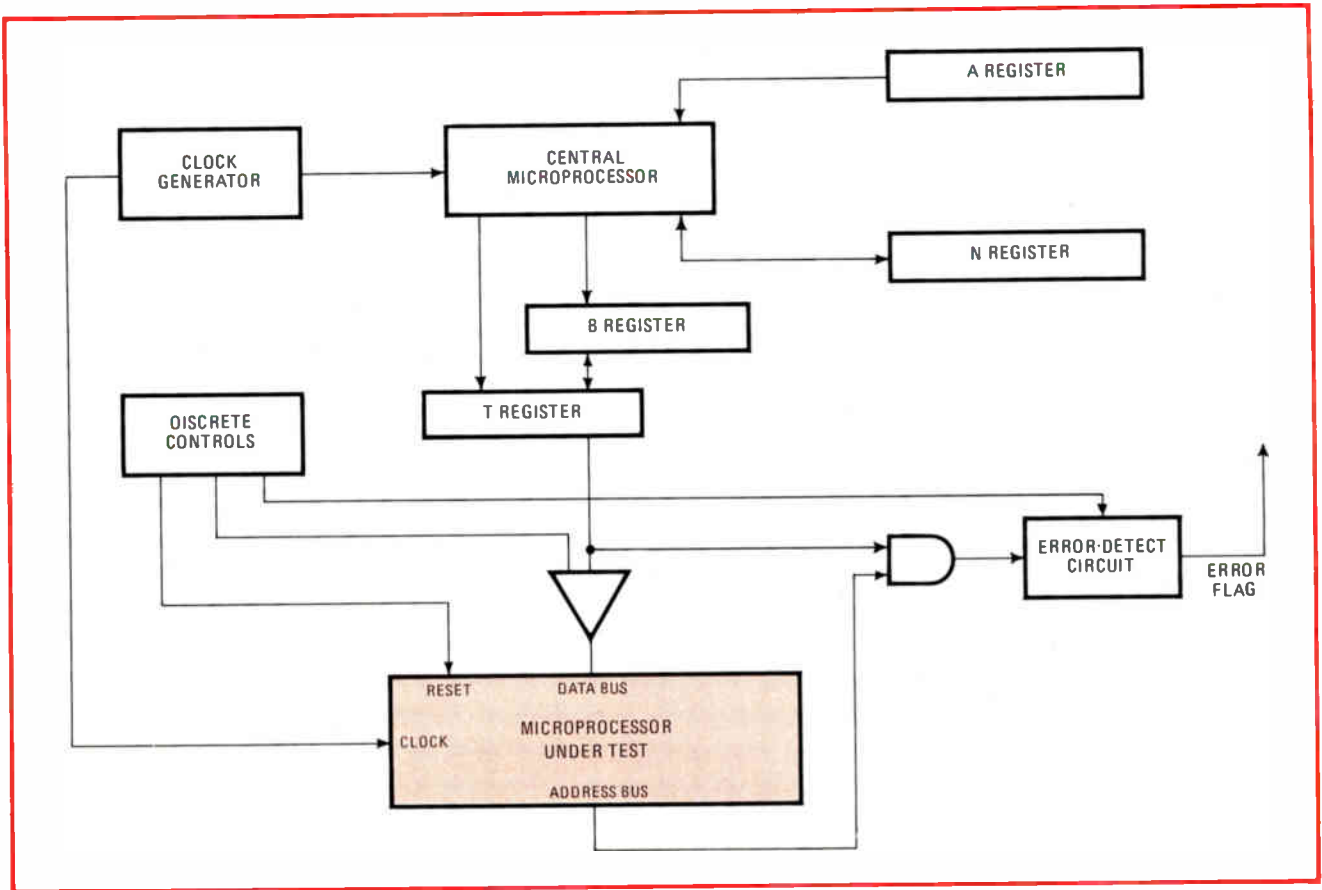

**5. Setup.** In this microprocessor test system, the T register feeds commands to the unit under test. The A register is incremented at each step and is compared with the N register, which holds the total number of steps to be performed, to determine when the test has been completed.

register, contains the microprocessor instruction, and its data can be loaded into the T register. This capability enables the T register to be connected to the data bus of the unit under test so that the T register actually supplies the executable instructions.

Another memory, the A register, keeps track of how many times the basic repeatable pattern is performed, and the fourth memory, the N register, keeps track of the maximum number of times the pattern is to be repeated. When the contents of these two registers are equal, the test system increments out of the test loop (Fig. 6).

Discrete controls enable the reset line of the unit under test, enable the data bus, and control at what time the comparison between the T register and the address bus from the microprocessor under test should be performed.

### Generating more complex tests

The program-counter test is a trivial example, but it illustrates dramatically the advantage of the algorithmic-pattern-generation technique. The memory test detailed in Fig. 3 is a more complex procedure. The memory test requires that the test pattern be changed and that more than one microprocessor instruction be accepted during the test run.

More hardware is needed to perform this test with the algorithmic-pattern-generation technique (Fig. 7). To perform the memory test, storage space is needed for

Micro-processor cycle	Instruction number	Description instruction
N/A	1	Reset MPU for 4 clock cycles
T <sub>1</sub>	2	(a) Test T register = program counter (b) Interchange B and T registers to fetch microprocessor instruction
T <sub>2</sub>	3	Enable microprocessor instruction into microprocessor from T register
T <sub>3</sub>	4	(a) Interchange B and T registers to recover program counter's test pattern
T <sub>4</sub>	5	(a) Compare if A register = N register to determine last test cycle. If no comparison, jump back to instruction 2. If comparison, increment to next instruction. (b) Increment T register to simulate program counter's incrementation (c) Increment instruction-cycle address
N/A	6	Jump to PASS

**6. Test plan.** In the microprocessor program-counter test, one instruction is repeated until all states have been checked. If the test is completed successfully, the device is acceptable.



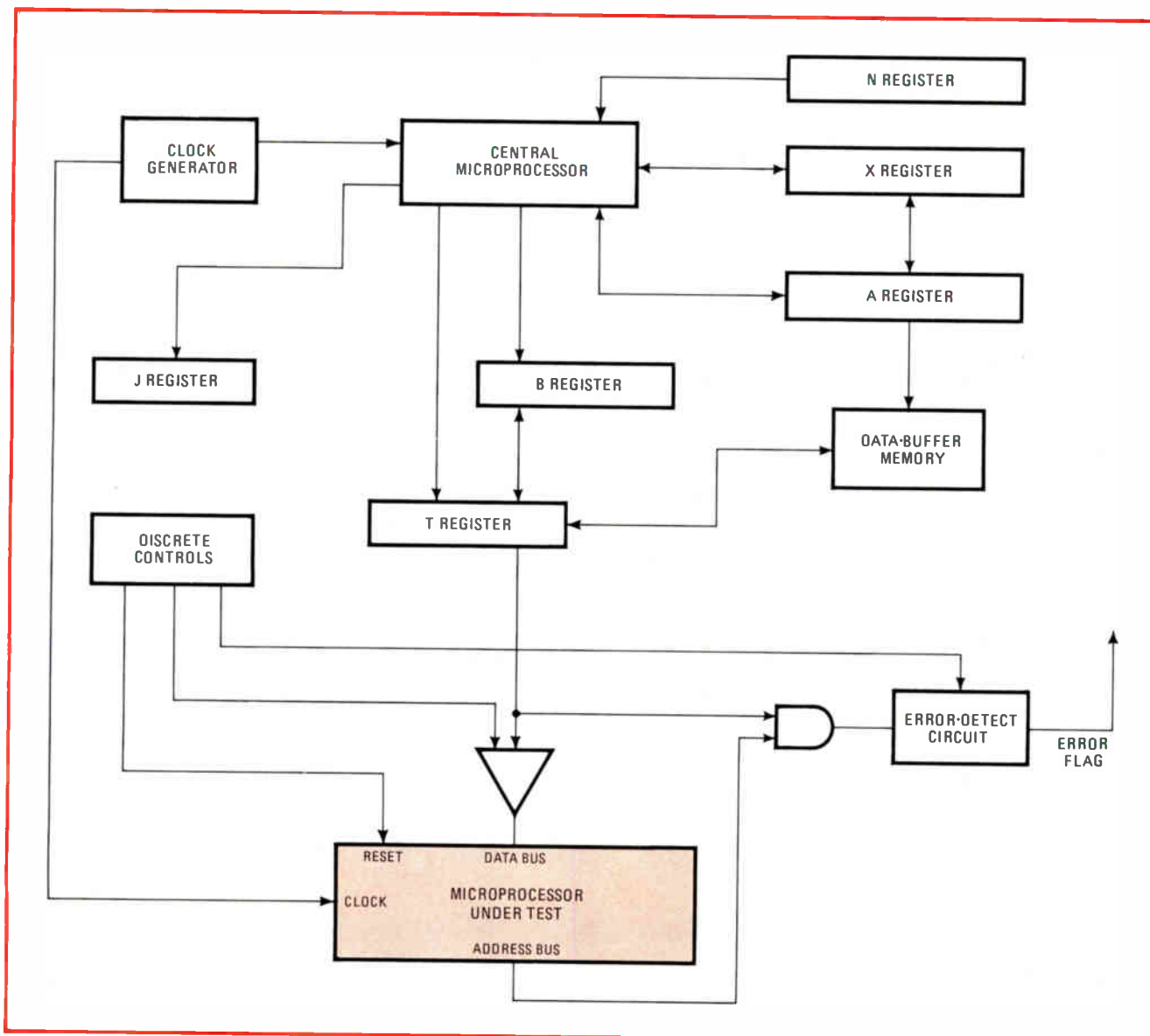

**7. Memory test.** Testing a microprocessor's memory requires more hardware than testing the program counter. A data-buffer memory is needed to store the microprocessor instructions to be used because there is now more than one instruction in the test sequence. Since the A register addresses the data-buffer memory, a new element, the J register, keeps track of the number of times the basic test is performed.

the 32 microprocessor instructions that must be executed and the 50 micro-instructions that control the test system. This space requirement, however, is minimal; if the storage-pattern method were used, 50,000 patterns would have to be stored.

The first hardware addition is a data-buffer memory, which stores the microprocessor-instruction sequence. There is a path between the data-buffer memory and the T register so that the T register can provide the executable instruction to the microprocessor, as in the program-counter test.

### Shifting registers

Since in this test the A register is used to address the data-buffer memory, another register is needed to keep track of the number of times the basic test is performed. This J register allows the user to write one basic test and then index it so that it can be performed over and over

again by using only one micro-instruction.

To finish checking out an 8080 microprocessor, the other function blocks on the chip must be examined. As outlined in Fig. 3, the program counter and memory tests are followed by stack pointer, arithmetic logic unit, accumulator, timing and control, and instruction-decoder checks.

Algorithmic pattern generation can be used in each of these tests. Commercial test systems such as the Macrodata MD-501 are specifically designed for algorithmic pattern generation as well as pattern-storage testing, but they are not required to apply the technique. Special-purpose testers can be built in-house for specific applications.

Regardless of the test hardware used, algorithmic pattern generation, with or without module sensorialization, can cut the costs and lessen the difficulties encountered in testing microprocessors. □

# Rockwell is there with a complete microcomputer on two chips.

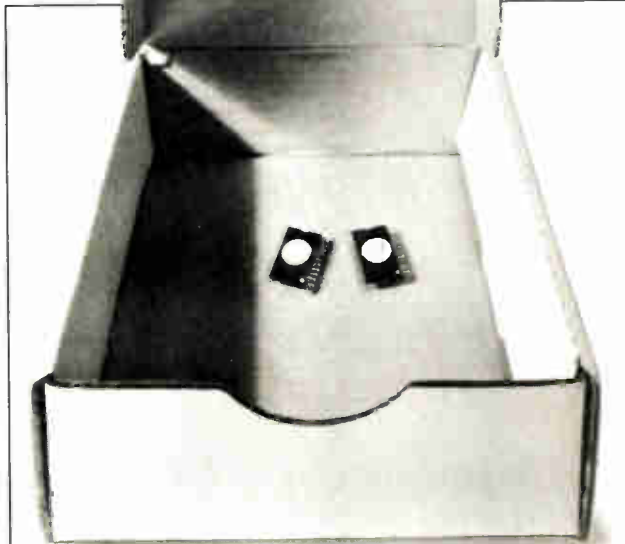

## WE'VE CUT THE NUMBER OF COMPONENTS

One chip of our new PPS 4/2 contains a clock, CPU, and 12 I/O lines.

The other holds 2K x 8 ROM, 128 x 4 RAM and 16 bidirectional I/O lines.

There you have it: a complete microcomputer on two chips. For many applications, that's all you'll ever need.

## SO YOU CAN CUT COSTS

For example, the complete PPS 4/2 system is priced at less than \$35 in quantities of 1000.

As your needs grow, you can add any of seventeen I/O, memory, or peripheral controller chips to your system at similar cost savings.

## EIGHT-BIT PERFORMANCE FROM A FOUR-BIT MICROPROCESSOR

Rockwell's parallel processing and independently intelligent I/Os throughout the microprocessor system permit simultaneous performance of various functions, freeing the

CPU for system thinking. In fact, with Rockwell's unique parallel processing system (PPS), your 4-bit system will actually outperform many 8-bit systems.



## APPLICATIONS GALORE

The PPS 4/2 will control any number of mechanical or electromechanical devices — office machines, vending machines, electronic

games and low-end cash registers to name a few.

It will also serve well as peripheral controller on larger microprocessing systems, including non-Rockwell CPUs you've already programmed.

**For samples, specs or sage advice, call**

**714.632.3729**

Because Rockwell's applications people and engineers all have backgrounds in systems and product design, they'll be able to give you specific answers as to how the PPS 4/2 relates to your product. Just call (714) 632-3729 and ask for Scotty Maxwell.

For technical literature or samples — without the advice — just drop us a line:

Department 3 B 122  
Microelectronic Device Division  
Rockwell International  
P.O. Box 3669  
Anaheim, CA 92803

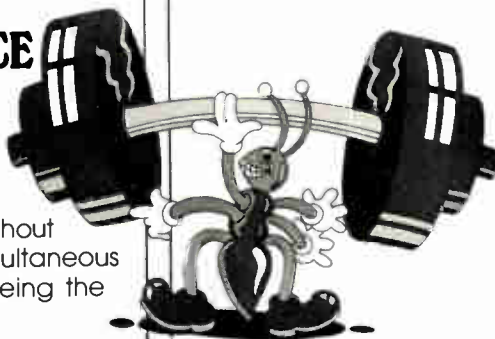

**Rockwell International**

...where science gets down to business

# Relays and logic ICs can be working partners

Direct interface of mechanical relays and standard logic families provides economy and power-handling capability for many applications

by Patrick M. Crane, Potter and Brumfield Division, AMF Inc., Princeton, Ind.

It's time to dispel the long-standing myth that electromechanical relays are not directly compatible with logic integrated circuits. Standard logic ICs that are capable of driving relays directly have been around for years.

Besides direct compatibility with ICs, electromechanical relays offer designers several other advantages. They are not falsely activated by surges or transients, nor do their contacts require protection from such intermittent conditions. Furthermore, the contacts need not be derated for increasing operating temperature, and heat sinks are unnecessary. But perhaps the best reason logic designers should consider electromechanical relays is the ease with which these devices can be incorporated into logic systems.

## Electromechanical vs solid-state

There is a tendency among designers to believe that a TTL or C-MOS gate cannot handle an inductive load

without being damaged. On the contrary, logic systems can be terminated with IC drivers capable of switching in excess of 300 milliamperes at up to 60 volts dc—more than enough to drive a relay that will handle a 30-ampere load or a 1-horsepower motor. Even standard TTL or C-MOS buffers can be used with high-sensitivity relays for switching sizable loads of up to 10 A.

Many designers are unaware of these facts and tend almost automatically to think of a solid-state device, like a thyristor or a solid-state relay, to control the load. The approach seems simple, but it can sometimes prove more complex or costly.

In many systems, the load characteristics may require a dv/dt network to protect the solid-state device from false turn-on by line voltage transients. Also, a space-consuming heat sink may be needed, or isolation may be required between logic and load. What's more, for reliable trouble-free operation, the solid-state device must be carefully matched to the system and the load.

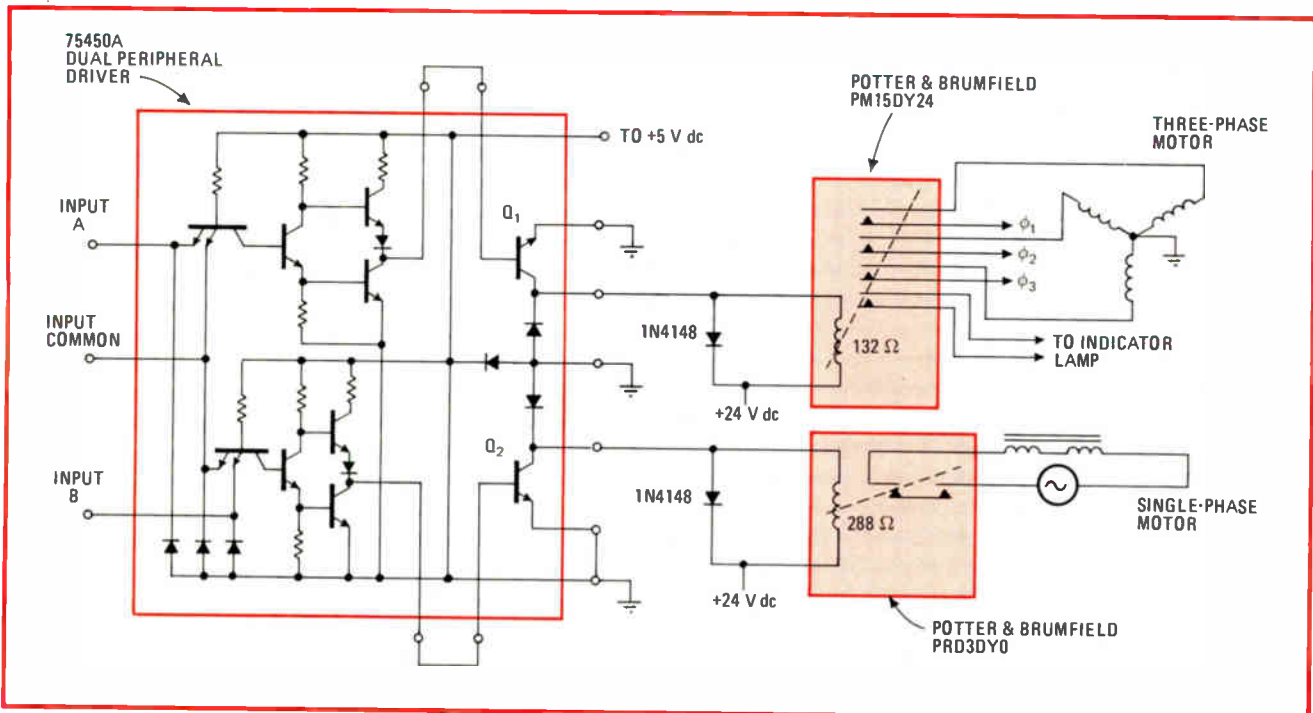

1. TTL drives power relays. Conventional TTL interface circuit, a dual peripheral driver, controls a pair of electromechanical power relays, which together can switch up to 125 A. Total power dissipation required of IC package is only 176 mW, well below the 800 mW allowed.

Though all of this can add up to a good deal of time and expense, the designer may end up with what amounts to only a single-pole switch. Yet often he could take advantage of a relay's economy, inherent isolation, power-handling capability, and multi-pole switching.

Furthermore, a designer sometimes opts for the solid-state route only to find that he must turn to electro-mechanical relays in the long run. Even with  $dv/dt$  protection, his solid-state device may not be 100% failsafe, or perhaps the heat-sinking required would consume space that is just not available, or switching multiple loads may far exceed the allotted budget.

Even after realizing that he is forced to use an electro-mechanical relay, the designer may think he needs a transistor or thyristor to interface between his logic and the relay. Or, he may try to salvage his switch design for driving the relay. However, more often than not, an electro-mechanical relay simply does not require such an interface. Chances are that the logic gate, buffer, or driver terminating his logic system can do the job quite well. A couple of examples will help to illustrate how it can be done.

### Interfacing with TTL

Standard TTL peripheral drivers used to terminate logic boards can deliver sizable outputs of up to several hundred milliamperes. Such IC drivers make ideal circuits for controlling relays. For instance, the 75450A-type interface circuit is a dual peripheral driver made up of a pair of 7400-type TTL NAND gates and two uncommitted npn transistors, each rated at 35 v dc and 300 mA. The circuit is housed in a 14-pin dual in-line package capable of dissipating up to 800 milliwatts continuously.

In Fig. 1, the 75450A is driving a pair of electro-mechanical power relays. The upper relay has four sets of single-pole single-throw contacts, each rated for up to 25 A at 250 v ac or 1 hp at 120/240 v ac. The lower relay has a single contact set, also rated at 25 A or 1 hp. This means that the total relay load switching capability here is 125 A or five 1-hp motors.

The upper relay is being used to control a three-phase wye-connected motor and to close a circuit containing an indicator lamp that signals motor actuation. The lower relay is controlling a single-phase motor. The relay coil voltages are set at 24 v dc for the sake of convenience.

To determine if the IC driver can meet the power demands of the relays, the power dissipated in the npn transistors must be computed. This power is the product of coil current times the forward voltage drop across the collector and emitter of each transistor. The power that must be dissipated by the transistors should not be confused with relay coil power, which is the product of coil current times coil voltage.

Since the relay coil voltages are 24 v dc, the coil of the upper relay draws about 182 mA, while the coil of the lower relay requires around 83 mA. This sort of data can be obtained from the relays' specification sheets, and the data for the npn transistors can be obtained from the 75450A's published specifications. At 182 mA,  $V_{CE(SAT)}$  is approximately 0.5 v dc for transistor  $Q_1$  and

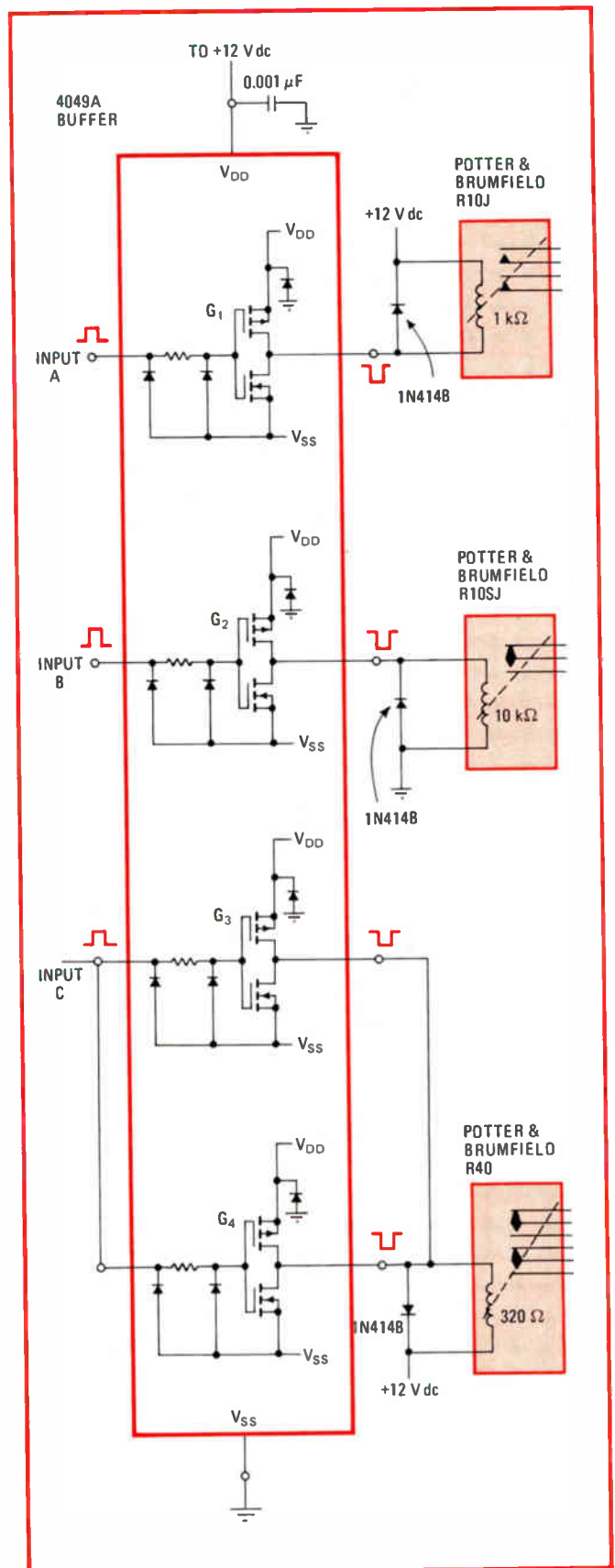

**2. Operating relays from C-MOS.** Standard C-MOS buffer gates can directly control high-sensitivity relays (gates  $G_1$  and  $G_2$ ) or share the coil current of general-purpose relay (gates  $G_3$  and  $G_4$ ). Allowable dissipation is 200 mW, but only 68 mW are consumed here.

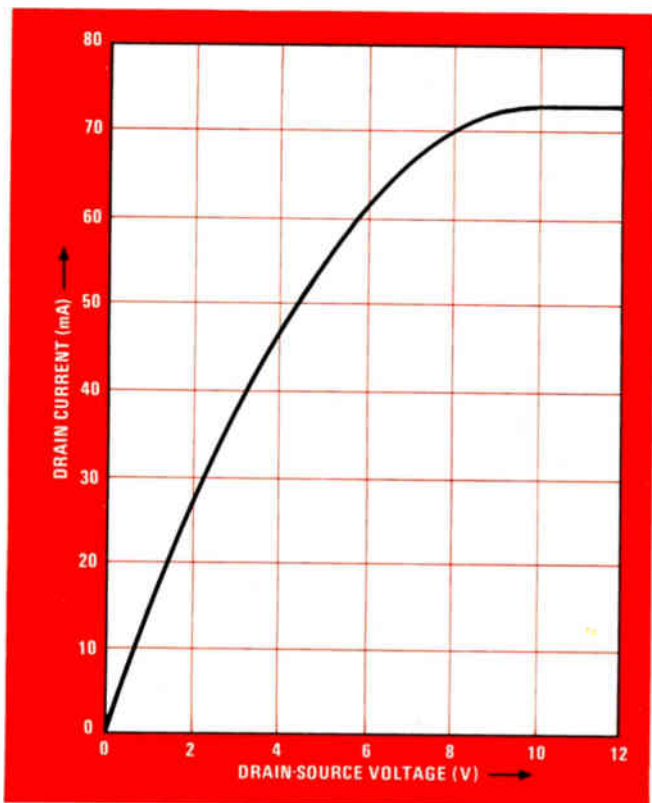

**3. C-MOS at 12-V supply.** Output voltage of C-MOS device driving electromechanical relay can be determined from drain characteristic. This curve from RCA Corp. is for a 4049A-type buffer gate operating from supply voltage of 12 V dc at 25°C ambient temperature.

about 0.3 V for transistor  $Q_2$  at 83 mA. The transistor power dissipation can be calculated as:

$$P_D = V_{CE(SAT)} \times (\text{coil current})$$

For transistor  $Q_1$ , the dissipation is:

$$(P_D)_{Q_1} = (0.5 \text{ V}) \times (182 \text{ mA}) = 91 \text{ mW}$$

And for transistor  $Q_2$ , the dissipation is:

$$(P_D)_{Q_2} = (0.3 \text{ V}) \times (83 \text{ mA}) = 25 \text{ mW}$$

The two transistors, therefore, dissipate a total of 116 mW. The dissipation of the two NAND gates—about 60 mW total—must be added to this figure, so that the total package dissipation comes to just 176 mW, which is less than a quarter of the maximum allowable continuous package dissipation.

Each relay coil is shunted by a signal diode whose cathode faces the positive coil supply voltage. This diode permits back emf generated during coil de-energization to recirculate through the coil, rather than through the device driving the relay. Although the diode lengthens the dropout time of the relay, its presence is absolutely essential for proper circuit protection. The turn-on time of the diode should be at least as fast as that of the device driving the relay.

Operating temperature should also be considered when a designer is “matching” a relay and a TTL device. Relay current requirements are usually specified at 25°C, whereas TTL current-sinking capability is generally given at either -55°C or 0°C, even though the TTL

data sheet may not call out this fact specifically.

At 25°C, TTL can sink more current than it can at -55°C—perhaps two to three times as much—without exceeding its maximum dissipation rating. For example, suppose a TTL gate is rated to sink 20 mA at a worst-case condition of -55°C. It is probably capable of safely sinking 60 mA at 25°C, which is more than sufficient to drive a reed relay pulling 25 mA at 5 V dc and 25°C.

### Relays work with C-MOS, too

Standard C-MOS circuits, like the 4049A-type hex buffer, can also be used for driving electromechanical relays directly. The 4049A, which consists of six inverting buffer gates, is normally intended for logic-level conversions between C-MOS and TTL devices. Each buffer gate offers a maximum dissipation rating of 100 mW, but the maximum total dissipation of the 16-lead package cannot exceed 200 mW.

Figure 2 shows four of the buffer gates driving three general-purpose relays. The other two gates of the 4049A are not used simply because they are not needed for this application. Of course, the inputs of any unused gate in a C-MOS package must be connected to ground.

The upper relay contains a pair of normally open spst contacts, each rated at 10 A maximum. The middle relay has one single-pole double-throw contact set rated at 3 A maximum. The bottom relay contains two spst contacts having ratings of 7.5 A maximum. Since the coil current of the bottom relay is too much for a single gate, two of the buffers are wired to share this relay's coil current. The other two relays are high-sensitivity devices; therefore, their coil currents are moderate, and a single gate is sufficient in each case.

With C-MOS, current must be shared by gates diffused on the same substrate. If current sharing is attempted between gates of separate packages—even though the ICs seem identical—the small difference in gate turn-on times may result in a brief, but excessive, current in the first gate that turns on.

Although C-MOS works quite well at supply voltages from 3 to 15 V, designers often prefer to operate in the range from 12 to 15 V, where noise immunity is better than down around 5 or 6 V. Moreover, at the higher supply levels, relay coils require less current. Here, both the C-MOS gates and the relays are operating from the same 12-V supply. A decoupling capacitor may be added at the positive supply lead, as done here, to help guard against any coil back emf that might interfere with proper gate operation.

For each gate, a positive input (logic high) results in a negative output (logic low). In other words, a positive input turns off a gate's p-channel device and turns on the n-channel device. Conversely, a negative input turns the p-channel device on and the n-channel device off.

Since the upper relay is connected across the p channel of gate  $G_1$ , it will draw current through  $G_1$ 's n channel when this device is on, so that  $G_1$  will be operating in the current-sinking mode. On the other hand, the middle and lower relays parallel the n channels of their respective gates, so that these gates operate in the current-sourcing mode.

Such current-sourcing operation, though possible

with MOS devices, is not possible with TTL devices having totem-pole outputs. The TTL devices, unlike their MOS counterparts, contain a current-limiting pullup resistance in their positive supply lead. If a relay coil current is passed through this resistance, the TTL gate will be destroyed. Consequently, when operated from TTL, a relay can be driven in the sink mode only.

To compute the total power dissipation of the C-MOS package, the drain characteristic of an individual gate operating from the appropriate supply voltage is needed. Such a curve can be obtained from the C-MOS data sheet. The one shown here in Fig. 3 is the minimum n-channel drain characteristic for the 4049A at 25°C and a drain supply voltage of 12 v. As before, the coil currents of the relays can be determined from their respective data sheets.

At 12 v dc, the upper relay draws 12 mA, the middle relay 1.2 mA, and the bottom relay 38 mA. From the curve in Fig. 3, the output voltages of the gates can be determined. The 12-mA current requirement of the upper relay will cause an output voltage of about 0.9 v across the n channel of gate G<sub>1</sub>. For the 1.2-mA coil current of the middle relay, output voltage will be approximately 0.2 v across the p channel of gate G<sub>2</sub>. And the 38 mA required by the bottom relay will be shared as 19 mA through the n channels of gates G<sub>3</sub> and G<sub>4</sub>, so that the output voltage will be 1.5 v across each n channel. Therefore, for gate G<sub>1</sub>:

$$(P_D)_{G1} = (0.9 \text{ v}) \times (12 \text{ mA}) = 10.8 \text{ mW}$$

For gate G<sub>2</sub>:

$$(P_D)_{G2} = (0.2 \text{ v}) \times (1.2 \text{ mA}) = 0.24 \text{ mW}$$

For gate G<sub>3</sub>:

$$(P_D)_{G3} = (1.5 \text{ v}) \times (19 \text{ mA}) = 28.5 \text{ mW}$$

And for gate G<sub>4</sub>:

$$(P_D)_{G4} = (1.5 \text{ v}) \times (19 \text{ mA}) = 28.5 \text{ mW}$$

Total package dissipation is found by simply adding up the dissipations of the individual gates, bringing the sum to slightly less than 68 mW—well below the 200 mW allowed.

These two examples have demonstrated that a variety of electromechanical relays can be driven directly from standard TTL or C-MOS ICs. In addition to the pair of ICs suggested here, there are several other readily available drivers, buffers, and gates suitable for controlling relays, as indicated in the table.

Standard 7400-series TTL buffers and drivers can be used to drive conventional general-purpose relays that require coil currents as low as 36 mA, yet provide multi-pole 10-A contacts. Other popular general-purpose relays are also capable of switching from low-level conditions to 10-A loads and can be operated from the gates and buffers of high-threshold logic at 15 v dc or emitter-coupled logic at 5.2 v dc. Additionally, high-sensitivity multi-pole printed-circuit-board relays, which require as little as 1.2 mA of coil current at 12 v dc, may be driven directly from many standard C-MOS logic gates.

In addition to its direct compatibility with ICs, an electromechanical relay affords considerable economic

#### LOGIC ICs FOR DRIVING ELECTROMECHANICAL RELAYS

Logic device	Type of relay
TTL peripheral driver	power, general-purpose, reed, high-sensitivity
TTL buffer gate	general-purpose, reed, high-sensitivity
TTL gate	reed, high-sensitivity
C-MOS peripheral driver	power, general-purpose, reed, high-sensitivity
C-MOS buffer gates (current sharing)	general-purpose, reed, high-sensitivity
C-MOS buffer gate	reed, high-sensitivity
C-MOS gate	high-sensitivity
ECL buffer gate	general-purpose, reed, high-sensitivity
ECL gate	reed, high-sensitivity
HTL buffer gate	general-purpose, reed, high-sensitivity
HTL gate	reed, high-sensitivity

advantages. It is fairly inexpensive itself, costing from a few dollars for a general-purpose multi-pole unit to perhaps \$15 for one capable of switching a polyphase motor. And troubleshooting it is easy because no resistance and/or voltage measurements must be made. Checkout can be done visually—one can see if the contacts are transferring properly.

#### Relays are easy to use

Although there is a voltage drop across the contacts, it is relatively low. This voltage drop is a product of the contact-to-contact resistance, which is often under 50 milliohms. Also, an electromechanical relay has an inherently high isolation between its coil (input) and contacts (output)—generally on the order of 100 megohms or greater. Moreover, its dielectric strength usually exceeds 1,000 v at 60 hertz.

What's more, electromechanical relays can provide long operating life under a variety of load conditions, since their contacts can be made from a number of different metals and alloys. If a set of contacts has a life expectancy of 100,000 operations at maximum rated conditions, this means that the contacts will switch the rated load at least 100,000 times. When the load requires somewhat less current than the maximum rating of the contacts, life expectancy may well be five to 10 times longer than what is specified at full load conditions.

Then, too, mechanical life expectancy, which is always much greater than the life at full rated load, can be as high as 10 million operations. However, this does not mean that a set of 20-A contacts will provide millions of operations at, say, 10 mA. Many contacts require a specific minimum current to prevent buildup of surface contamination—the current keeps the contamination burned away. But 20-A contacts are often used to switch a 5-A load to achieve a long life of several hundred thousand operations, which may even exceed the life of the load.

Best of all, electromechanical relays are easy to design with—once the specifications of a relay and a logic IC are known, it takes only a few moments to determine whether the two are compatible. Furthermore, since both relays and ICs come in a multitude of models, styles, and ratings, quite often what the designer needs is already in stock at his local distributor. □

# Space Data Distortion

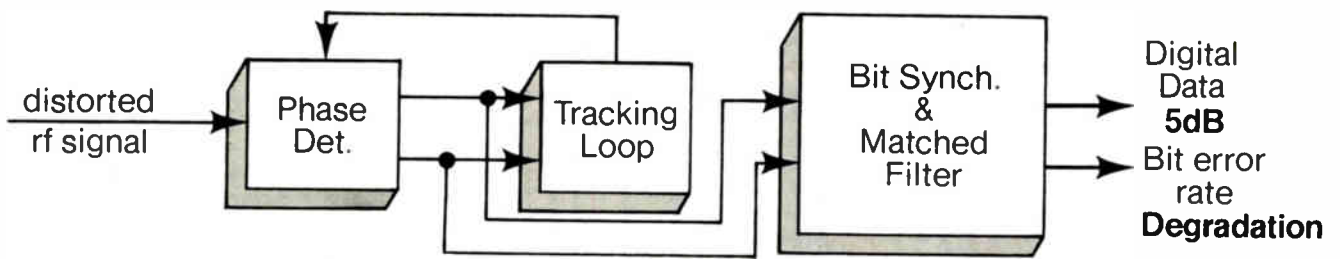

## One-Half Off.

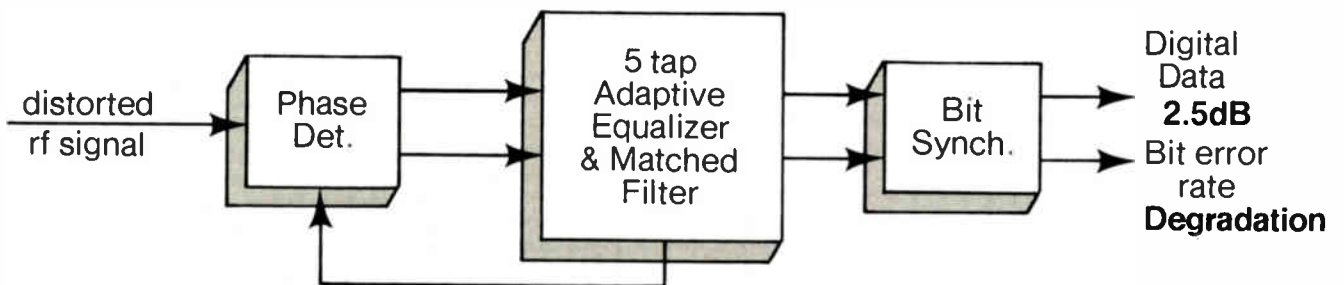

*State-of-the-art... a 5-tap adaptive equalizer has been demonstrated to recover over half the degradation caused by both rf multipath distortion and dominant sources of hardware distortion."*

**Background.** Adaptive equalization techniques had solved major distortion problems in handling high-speed data over land lines. But no one made the principle work in a high-data rate microwave QPSK link. We did. *Successfully.*

### Here's what it can mean to you.

The reduction of both distortion and cost in a wide range of high speed data systems.

The creative application of adaptive equalization and our other high technologies to the solution of data system challenges.

And right now we can demonstrate results applicable to wideband data systems at rates up to 1 gigabit per second with significant designed-in savings.

(1) Stilwell, J. H. and Ryan, C. R., Performance of a High Data Rate Adaptive QPSK Modem Under Media Distortions, paper presented June 1975.

Our experience includes 7-bit resolution, 20 megasample per second low power A-D converters, gigabit/second multiplexers and digital processors, and transmitters and receivers.

Add to this: 1) years of experience in designing advanced circuits and building hardware to exacting DoD and NASA specifications; 2) careful integration of complex functions into complete data-to-readout systems; 3) a unique I/C capability, and you get a combination unmatched in industry. With this combination, on-schedule, on-budget delivery of the most advanced high data rate systems becomes a dependable reality.

For more data without distortion on a design-to-cost budget, call or write Floyd Danielson at 602-949-3305 at Motorola Government Electronics Division, 8201 E. McDowell Road, Scottsdale, AZ 85257.



## Inductive proximity detector uses little power

by Matthew L. Fichtenbaum  
General Radio Co., Concord, Mass.

A contactless limit switch and a tachometer pickup are two possible applications for the inductive proximity detector described here. This detector changes its output level from high (9 volts) to low (0 v) whenever a conducting object is close by. It uses less power than a photocell pickup and is immune to environmental dust and dirt.

The sensing element is an unshielded high-Q inductor coil wound on a ferrite core. When a metallic object is brought close to the inductor, eddy currents that are induced in the metal absorb energy from the rf field of the coil and thus reduce its Q.

The active elements in the detector circuit are four of the C-MOS MOSFETS in a CD4007A package, and two 1N3604 diodes are included. FET  $Q_1$  and its associated

components, together with the inductor, constitute an oscillator that operates at about 100 kilohertz. The two diodes develop a dc voltage proportional to the peak-to-peak value of the oscillator signal. This voltage is applied to a Schmitt trigger composed of  $Q_2$ ,  $Q_3$ , and  $Q_4$  and holds this circuit in the "on" state.

A conductive object near the coil absorbs energy from the magnetic field of the coil, so that the oscillator amplitude drops. The rectified voltage therefore drops, and the Schmitt trigger turns off. The variable resistor adjusts the oscillator's operating level and hence its sensitivity to metal objects.

The inductor used in this circuit consists of 150 turns of #34 enameled wire inside half of a Ferroxcube 1811-PL00-3B7 pot core set, as shown in the figure. The inductance is approximately 2 millihenries. The circuit can detect the presence of metal objects at distances up to a centimeter from the open end of the coil.

This circuit draws about 250 microamperes at 9 v. It may be used to drive C-MOS logic directly or to drive a buffer that in turn drives TTL. □

Engineer's Notebook is a regular feature in Electronics. We invite readers to submit original design shortcuts, calculation aids, measurement and test techniques, and other ideas for saving engineering time or cost. We'll pay \$50 for each item published.

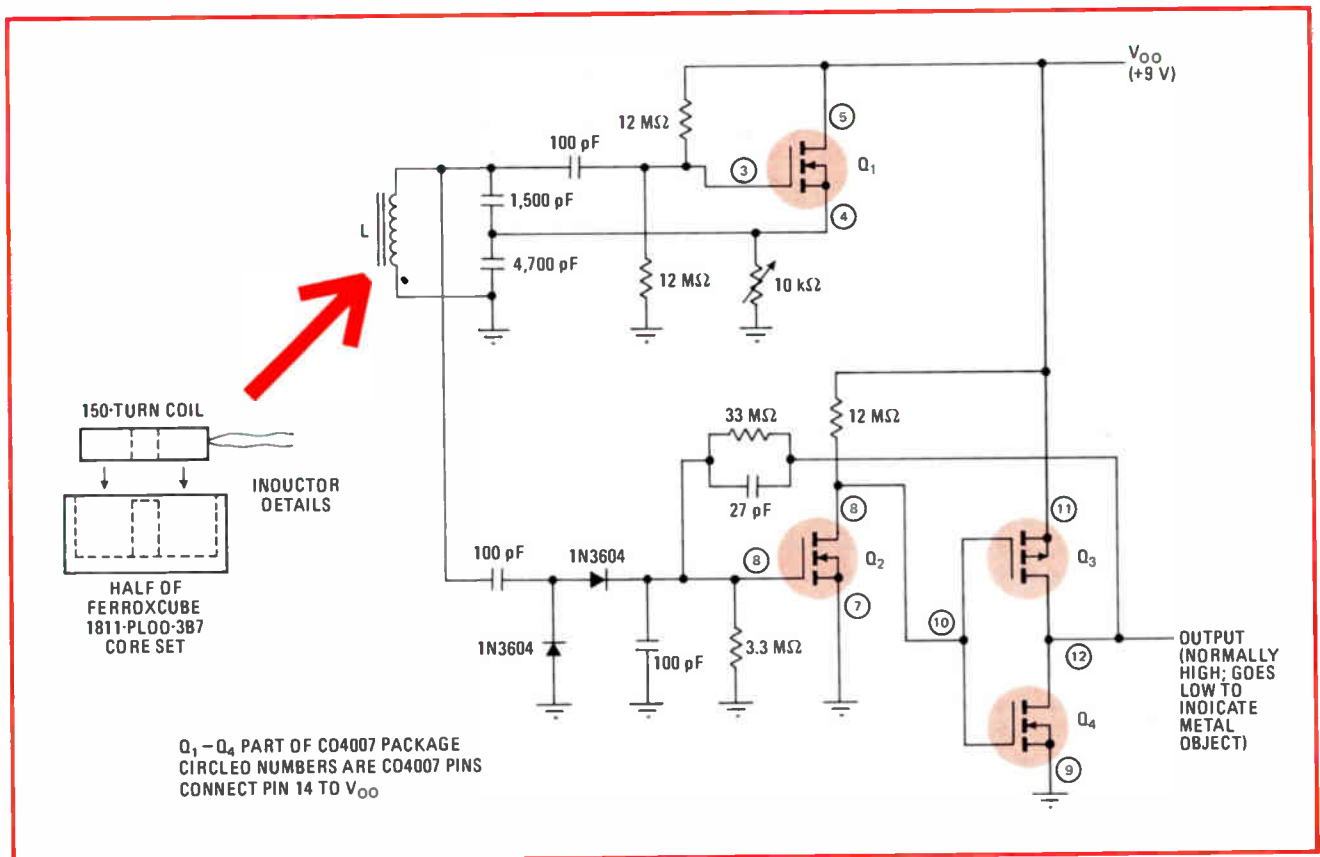

**Detects metal.** Proximity detector consists of modified Colpitts oscillator, amplitude detector, and Schmitt trigger. Output signal is normally high; but when oscillator coil is loaded by presence of metal object, amplitude decreases and output from Schmitt trigger goes low. Detail drawing shows construction of the oscillator coil in a proximity detector that serves as the noncontacting pickup for a tachometer.



# Addressable cursor enhances linear bar-graph display

by Robert C. Moore  
*Johns Hopkins University, Applied Physics Laboratory, Laurel, Md.*

A handful of medium-scale integrated circuits can add an addressable cursor feature to a neon dual linear bar-graph display. The bar-graph display is a digitally addressed Burroughs Self-Scan tube which normally displays two linear bars. The length of each bar is directly proportional to a voltage or a digital number. The modification described here, however, makes the entire length of both bars glow dimly, and the input voltages or digital numbers produce bright cursor lines across the bars. With cursor operation, the entire bar is always visible, and the cursor divides the bar into two fractions

so that it is easy to see at a glance the position of the cursor relative to full scale. In many display applications, this cursor display is preferable to a bar graph that does not have a full-scale reference. Anything that indicates fractional displacement (such as a ship's rudder indicator or a gage that shows the level of the liquid in a container) is indicated more clearly by a cursor display than by a bar graph.

Each bar is a neon lamp with one large anode and 201 cathode segments. The first cathode, called a "reset" cathode, is used to initiate the neon glow at one end of the bar. Cathode 2 is connected to cathodes 5, 8, 11, . . . 200. This group of cathodes is called the phase-one ( $\phi_1$ ) group. Similarly, a  $\phi_2$  group consists of cathodes 3, 6, 9, . . . 201, and a  $\phi_3$  group consists of cathodes 4, 7, 10, . . . 199.

By driving these three phases of cathodes with a three-phase scanning clock, the neon glow can be made to "walk" along the entire length of the bar. When cycled fast enough, this scan presents a flicker-free dis-

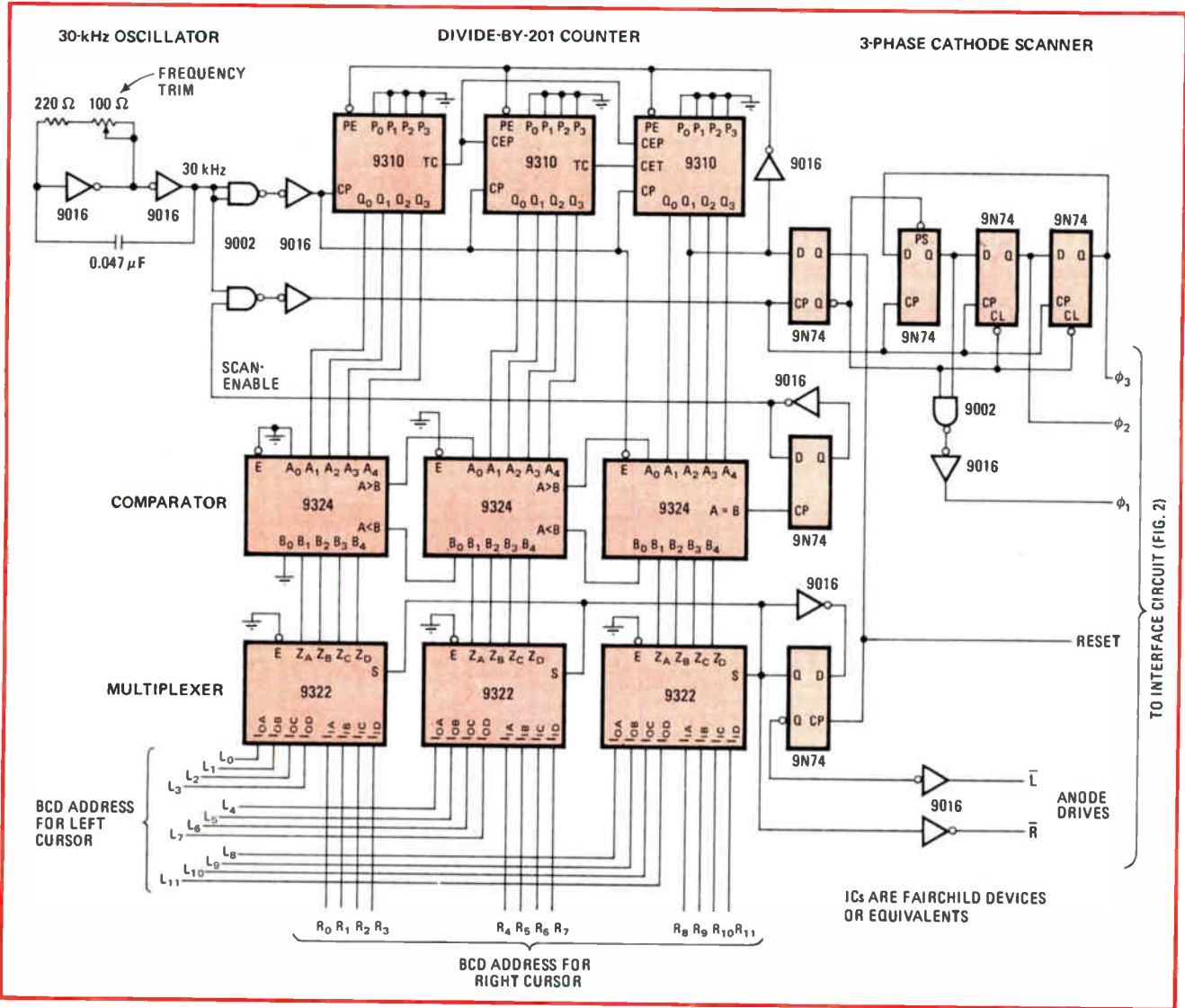

1. **Scanner.** Digital logic produces scanning signals that convert neon dual bar-graph display to dual addressable cursor display. Addresses of desired cursor locations are supplied as three-digit BCD codes between (000)<sub>10</sub> and (200)<sub>10</sub>. Logic causes scan to pause at selected addresses for 25% duty cycle, producing a bright line that shows the value of a variable against a background that indicates full-scale value.

**2. Driver and display.** Six npn transistors interface the TTL logic of Fig. 1 to the neon bar-graph-display tube. All of the bar-graph segments glow dimly except for the two addressed segments, which glow brightly and show as cursors. Each cursor is one of 201 segments, so the resolution is  $\pm 0.5\%$ .

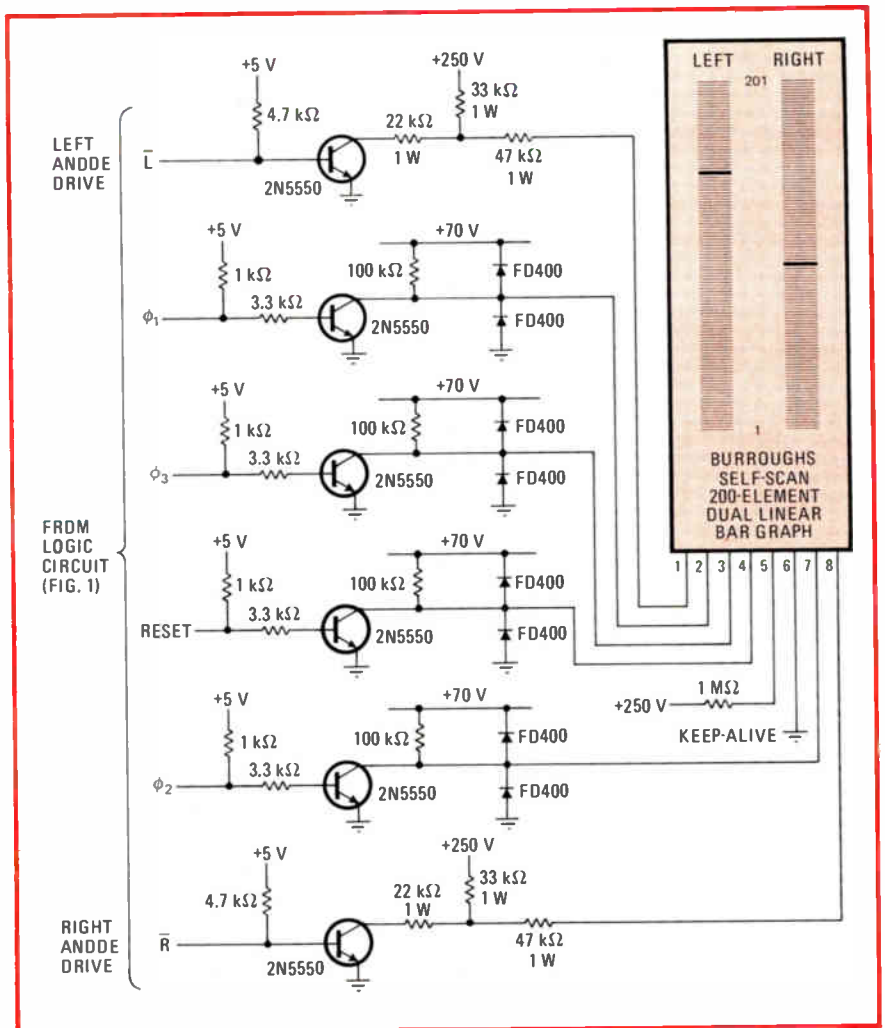

play. At any time during the scan, the glow can be extinguished by lowering the anode voltage below the extinction voltage of the tube.

One addressable cathode segment can be made to appear brighter than the rest if the scan pauses briefly at that segment, showing it up as an addressable cursor. The bright segment can be caused to appear at any of the 201 cathode locations in the bar by controlling a digital address. The second bar in the tube is time-multiplexed with the first to provide a dual addressable cursor.

Figure 1 shows the digital transistor-transistor logic required to accomplish the scanning, pausing, and multiplexing. A 30-kilohertz oscillator drives a modulo 201 BCD segment counter and a reset/three-phase cathode scanner. The content of the counter is compared with the input signals that are the addresses of the desired cursor locations.

When the counter output is the same number as the cursor address, the cathode scanner is inhibited, and the neon glow pauses at the addressed segment. When the divide-by-201 counter again reaches the address, as determined by the comparator, the cathode scanner is enabled. When cathode No. 201 is reached, the alternate anode and address are selected, and the whole process is repeated.

The duty cycle of each addressed segment's glow is therefore  $202/804 = 25.1\%$  while the duty cycle of each nonaddressed segment is  $1/804 = 0.124\%$ . With a 30-kilohertz clock, each segment is energized for 33.3 microseconds, a duration more than adequate to ensure reliable operation of the device. A complete scan of both bars (including the pauses on the two addressed segments) is  $804 \times 33.3 \mu s = 26.8 \text{ ms}$ , so the over-all display rate is 37.3 Hz. Since this rate is faster than the flicker rate of the human eye, the display is flicker-free.

Figure 2 shows how the TTL MSI circuit of Fig. 1 is interfaced to the dual linear bar-graph tube. Six high-voltage npn transistors provide level translation from TTL levels to 70-v and 250-v levels for the neon tube. The 70-v supply can be derived from the 250-v supply with a simple 1-watt zener regulator. The 250-v supply also biases on the "keep-alive" glow, which is hidden from view by its opaque anode.

For bar-graph tubes with fewer elements, the modulus of the counter can be changed to equal the total number of cathode segments. A corresponding change must be made in the range of acceptable input addresses. For tubes with a single bar graph, the multiplexer can be eliminated and the single anode can be wired permanently on by connecting it through a 75-kilohm 1-watt resistor to 250 v. □

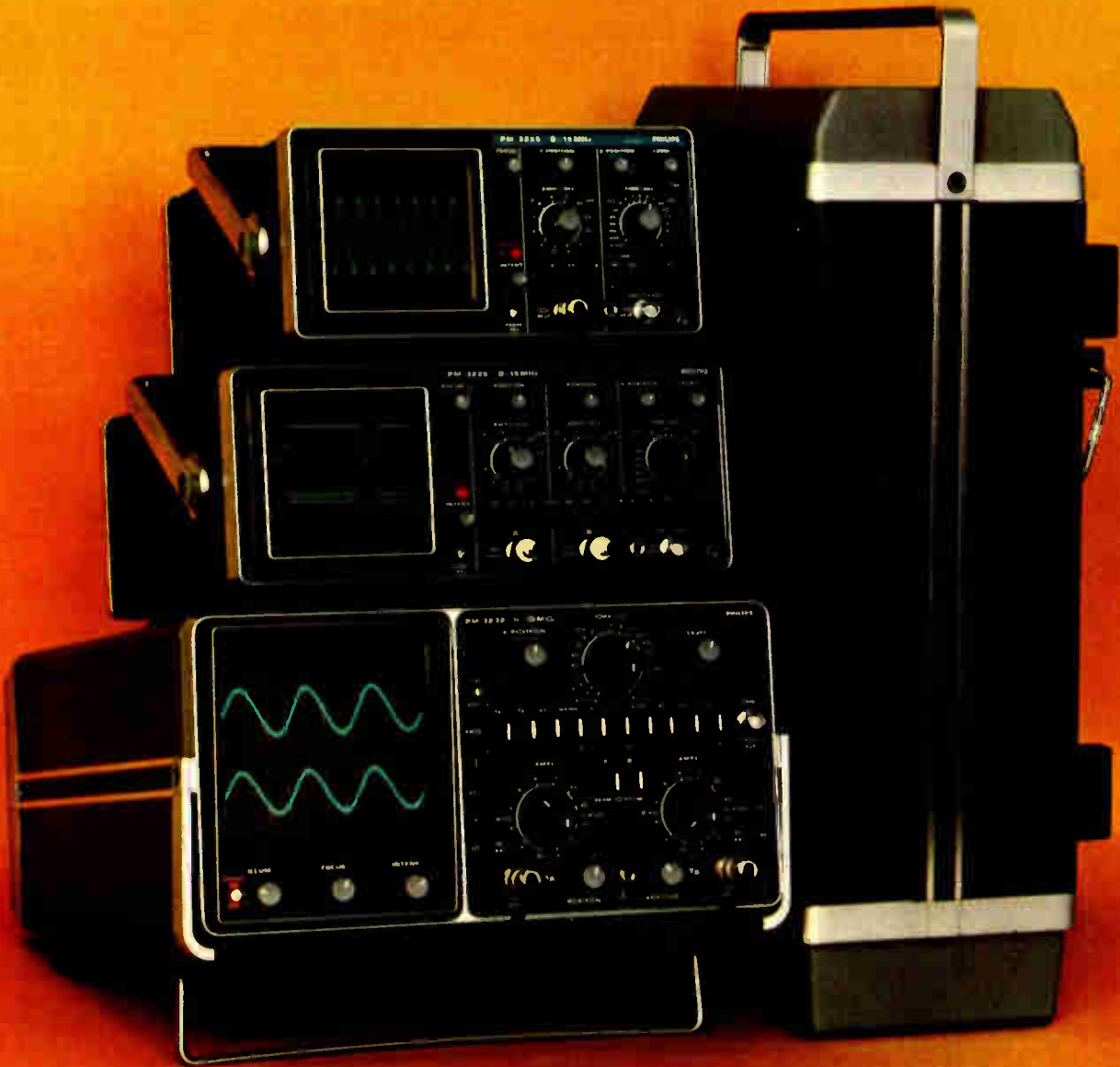

# It wasn't easy to design **TWO NEW SCOPES, EACH HAVING SUCH A UNIQUE COMBINATION OF FEATURES** as our dual beam has .....we almost succeeded!

## TWO NEW COMPACTS!

### THE NEW PHILIPS PM3225 SINGLE TRACE OSCILLOSCOPE

Only 8 pounds, 2 ounces  
 5.4" H x 10.1" W x 12.4" D  
 Sensitivity 2mV/div at 15 MHz bandwidth  
 8 x 10 division screen  
 Complete triggering facilities: Auto, Line, Ext., TV line or frame  
 Automatic DC balancing and drift control  
 Logical layout of operating controls for quick error-free setup

### THE NEW PHILIPS PM3226 DUAL TRACE OSCILLOSCOPE

Only 9 pounds, 10 ounces  
 5.4" H x 11.9" W x 12.4" D

## THE POPULAR AND PROVEN -

### PHILIPS PM3232 and PM3233 DUAL BEAM OSCILLOSCOPES

True dual beam display  
 2mV/cm at 10 MHz  
 10KV brilliant display  
 Comprehensive triggering facilities: Auto, AC, DC and TV  
 Logical layout of operating controls for quick error-free setup

Act now and find out how you get more from Philips. For complete price and technical data, call our toll free HOT LINE number 800 645-3043. New York State residents, call (516) 921-8880 collect. Philips Test & Measuring Instruments, Inc.



In the United States:  
 400 Crossways Park Drive  
 Woodbury, New York 11797  
 (516) 921-8880

In Canada:  
 6 Leswyn Road  
 Toronto, Ontario M6A 1K2  
 (416) 789-7188

# PHILIPS

Circle 115 on reader service card

## Anything a 16-bit chip can do, these 8-bit chips can do—almost

Look for war to break out between suppliers of 8-bit and 16-bit microprocessors. Two major 8-bit suppliers (who prefer not to be named at this time) will introduce enhanced 8-bit systems as early as the first quarter—sooner than originally planned. The new chips will compete head on with the growing camp of 16-bit devices. They will be faster and will have greater instruction-handling capability than previous designs. What's more, they'll take on a 16-bit chip's most obvious asset—they too will process two 8-bit bytes of data at a time (input and output, as well as on chip). The idea is to allow users to upgrade their systems yet retain existing peripheral designs and software programs.

## How not to get burned in sealing liquid-crystal displays

Manufacturers of liquid-crystal displays now have a cure for one of their biggest production headaches—the high temperatures required for sealing the crystal module. Corning has a solder glass (code 7555) that seals at 450°C, or almost half the temperature needed for other seals. Displays sealed at this temperature **suffer very little change in the resistivity of the conductive coatings used to contact the display plates.** Moreover, the 450°C sealing temperature is lower than the annealing endstrain points of the glass so that it reduces distortion, relieves stresses, and increases life. Corning Glass Works, Corning, N.Y. 14830, will supply samples of the material.

## The way to figure a negative-tempco thermistor's resistance

There's no need to measure the new resistance of a negative-temperature-coefficient thermistor every time you change the setpoint temperature. Chances are, you can compute it instead, says Donald F. DeKold, president of Deko-Labs in Gainesville, Fla. All you need to know is the thermistor's resistances at temperatures above and below the desired setpoint temperature. Better yet, this simple method is **more accurate than using tables of normalized values or the traditional exponential equation for thermistor resistance.**

Here's how it works. Let  $R_x$  be the unknown resistance at the desired operating temperature ( $T_x$ );  $R_1$  the resistance at some lower temperature ( $T_1$ ), say 0°C; and  $R_2$  the resistance at some higher temperature ( $T_2$ ), say 100°C. (Temperatures  $T_x$ ,  $T_1$ , and  $T_2$  must all be expressed in units of degrees Kelvin.) Then resistance  $R_x$  equals  $R_1(R_1/R_2)^A$ , where  $A$  equals  $(T_2/T_x) \times (T_x - T_1)/(T_2 - T_1)$ . This technique is accurate to within about 1°C over a 100°C range, between the freezing and boiling points of water. However, the equation itself is not restricted to this temperature range.

## The lowdown on the standard interface for programable gear

If you've read all the articles on the IEEE standard interface for programable instrumentation but are still not sure how to build one, you may be interested in a new videotape and textbook course put out by the originators of the system, Hewlett-Packard. Obviously, it focusses on how to use the HP 9830A for the purpose, but it also contains a **good deal of general information on hooking up a bus network.** The package consists of four video tapes and four booklets and costs \$475. You can find out more about it by writing to HP's inquiries manager at 1501 Page Mill Rd., Palo Alto, Calif. 94304.

—Laurence Altman

## asking about INDICATORS?

Our answers come in any size or configuration you're likely to need. They're CM and Drake LED, incandescent or neon indicators. Backed by more than 65 years experience in lamp and lighting technology, plus on-site help in solving your tough application problems. Give us a call at (312) 784-1020, or write us at 4433 N. Ravenswood Avenue, Chicago, Illinois 60640.



# CHICAGO MINIATURE HAS THE ANSWER!

**CHICAGO MINIATURE/DRAKE**

SUBSIDIARIES OF  
GENERAL INSTRUMENT CORPORATION



**KEITHLEY OFFERS:  
A 3½-DIGIT MULTIMETER.  
4 EXCLUSIVE FEATURES.  
\$315.**

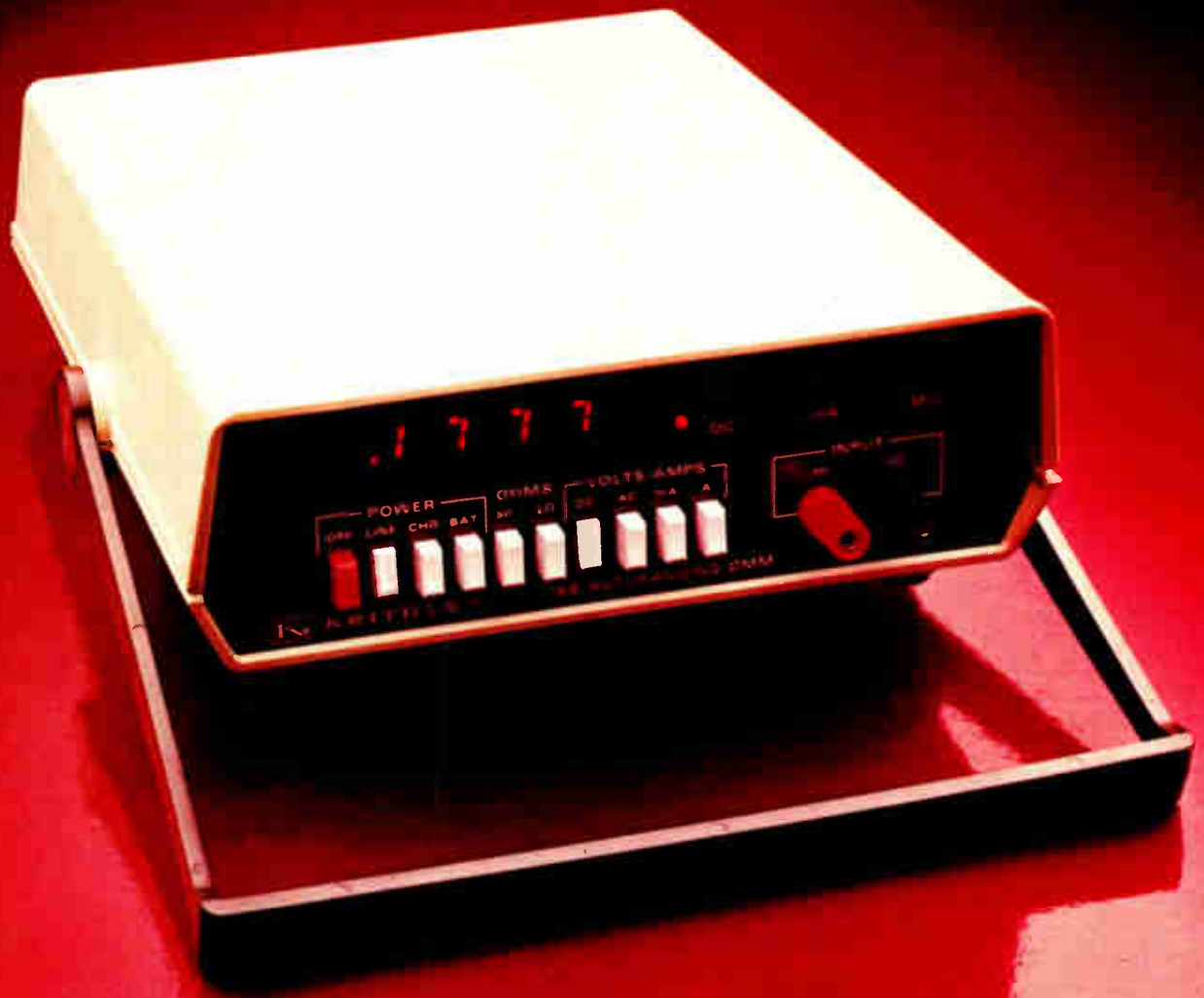

The Keithley 168 Digital Multimeter gives you every key performance feature offered by other first-line 3½-digit DMMs.

But only the Keithley 168 gives you 4 extra features—all useful and all at a competitive price. Compare our 3½ with the others and you'll come to an inescapable conclusion: the 168 is the best buy in 3½-digit DMMs.

**For \$315: a superior DMM**

For openers, you get a rugged, reliable, easy-to-read, general-purpose, 5-function DMM with more ranges than you'll normally need. Measure from 100 microvolts to 1000 volts dc, 100 microvolts to 500 volts ac, 100 milliohms to 20 megohms, 100 nanoamps to 1 amp, ac or dc. Basic accuracy is 0.1%. All modes fully overload protected. The 168 brings Keithley quality to general-purpose measurement.



**4 extra features, no extra cost.**

- *Automatic ranging* gives you the most accurate reading, with decimal in the right place, faster than you could do it with switches. Saves you time every time you make a measurement.
- *HI-LO Ohms* lets you turn on a semiconductor junction to see if it's good or measure an in-circuit resistance without turning on a semiconductor.
- *2-terminal input* for all measurements on all functions. You can't get it wrong. Terminals accept banana plugs, alligator clips, spade lugs or bare wire.
- *Lighted function indicator* so you know precisely what you're measuring, instantly.

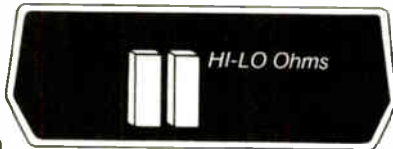

**Surprise: more valuable features.**

That's not all. We've packed even more value into the 168. Optional battery pack that you buy now or add later. Patented A-D converter to simplify circuitry. No-nonsense, full-year guarantee on parts, workmanship, and specs—including accuracy. Convenient calibration instructions right inside the cover. Light weight for easy portability.

**Full complement of accessories.**

Use these optional accessories to make your Keithley 168 DMM even more versatile: Wide-range RF probe. Test lead sets. Clamp-on ammeter. 50-amp shunt. High-voltage probe. Carrying case. Rack mount kit.



**Now the logical choice.**

The 168 is out-front in value. And it's backed up by our reputation for quality. Don't you wish all decisions were this easy?

Ordering a 168 is easy, too. Just contact: Keithley Instruments, 28775 Aurora Road, Cleveland, Ohio 44139. (216) 248-0400. Europe: D8000 München 70, Heiglhofstrasse 5, West Germany. (089) 7144065.

**DMMs for all your needs.**

We know you have a variety of measurement requirements. So we offer a growing family of DMMs to meet your application and price objectives. Send for our Selector Guide.



180: 4½-digits, 30 nV sensitivity.

171: 4½-digits, wide ranging, 5-functions.

190: 5½-digits, high-stability, outstandingly low price.

616: dc, 3½-digits, down to 0.1 picoamp full scale!

160B: dc, 3½-digits, high-sensitivity, low price.

**KEITHLEY**  
The measurement engineers.

Circle reader service #118 for a demonstration #119 for technical data.



## **Congratulations. Your designer has just made your board tester obsolete.**

Few things can change as fast as a circuit designer's mind. Or a production line's requirements.

So when you're looking at an automatic board tester, you want to be sure it's flexible enough to meet your production requirements. For years to come.

And that's where we come in. With the most flexible automatic board test systems you can buy.

The key to flexibility in a computer-controlled tester is software. And software is where we excel.

Our standard software package, with its simple UUT interfacing and interactive programming capability, was designed to make set-up a snap. Add our CAPS

Circle 122 on reader service card

Computer Aided Programming Software and you get even faster set-up for new designs and automatic verification for board redesigns.

In addition, CAPS gives you something you'll get from nobody else. The only software package that combines the speed of a fault dictionary with the accuracy of on-line fault simulation and the resolution of a computer-guided probe. For the lowest troubleshooting costs of any automatic board test equipment on the market today.

And along with all this super software comes the super support that's made us number one in automatic board testing.

Call or write for our new brochure "The Difference in Software Is the Difference in Testers." It'll tell you all you need to know about our 1792 series of logic and hybrid circuit testers. The systems.

And the savings.

General Radio, GR Test Systems Division, 300 Baker Ave., Concord, Mass. 01742, 617-369-8770.

**The difference  
in software is  
the difference  
in testers.**





---

## New products

---

Packaging & production

### Flat cables are pretested

---

Low-cost assemblies  
have molded-on connectors  
and built-in check points

---

Mass-terminated flat vinyl cable assemblies the user puts together with special tools are now widely used. Next month, AP Products Inc. will introduce an alternative: a directly

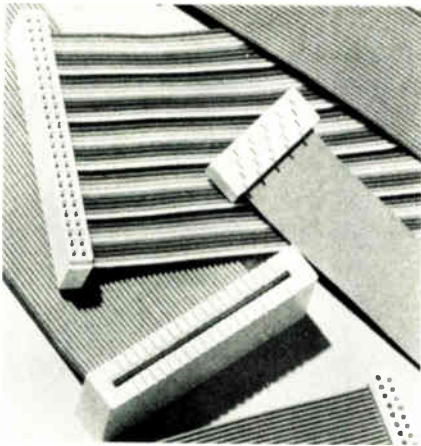

interchangeable, fully assembled and fully tested jumper line.

The AP Products jumpers also will have molded-on connectors with strain reliefs and will be delivered to the user with line-by-line test points. The Ohio company says the price will be such that two fully assembled and tested jumpers will cost about the same as the component parts for a conventional jumper.

Two factors contribute to the price advantage, the company says. All manufacturing and testing is automated, and the contact material is a low-cost trinary copper alloy.

Three basic terminations will be available: socket connector, printed-circuit-board connector, and card-edge connector. Each will be offered in the five standard, most widely used sizes: with 20, 26, 34, 40 or 50 contacts.

In each of the types and sizes, AP

Products will have 60 single-ended configurations and 135 double-ended configurations. In addition, the company can provide customized daisy-chain assemblies.

Standard ribbon cable is insulated in 28-gauge pink laminated vinyl. A red stripe on one edge provides cable orientation. On single-ended assemblies, rainbow cable with a tear-down feature (end wires fanned out) is an option.

Delivery time for the assembled and tested jumpers is two weeks. A special three-day service is available at no extra cost.

AP Products Inc., Box 110-E, Painesville, Ohio 44077 [391]

---

### Switching method boosts artwork digitizer's accuracy

Advanced switching techniques are credited by Talos Systems for improved performance in what the company describes as its line of second-generation digitizers for printed-circuit artwork. All of the company's digitizers use the principle of the phase-locked loop. The null detection and loop lock produce a stable output, while the closed-loop nature of the writing servo assures high accuracy.

In the new line, called the 600 series, the addition of advanced switching to the company's Cybergraphic electronic-servo technology results in a 10-to-1 increase in performance and in immunity to error introduced by environmental factors, Talos says. Instead of digitizing the entire surface at once, a 600-series unit electronically breaks the surface into 1-by-1-inch squares.

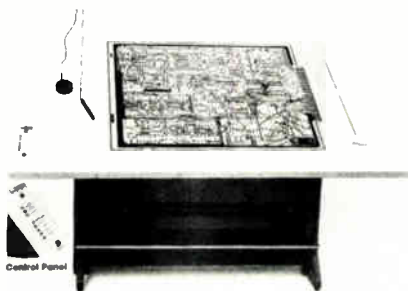

The digitizer first determines on which square the pen or cursor is located, then digitizes that square. Accuracy is a function of the servo working over only a 1-sq.-in. area, therefore the size of the writing surface is not a significant factor.

Sizes of the digitizers range from 11 by 11 in. to 44 by 60 in., with resolution to 0.001 in.

Talos Systems Inc., 7311 East Evans Rd., Scottsdale, Ariz. 85260. Terry Shankland (602) 948-6540 [393]

---

### Flexible circuits built for printers, interconnect units

A group of flexible circuits comes in a variety of configurations for use with thermal printers and as interconnect assemblies. All of the circuits share identical substrate and adhesive thicknesses, in accordance with listings given them by Under-

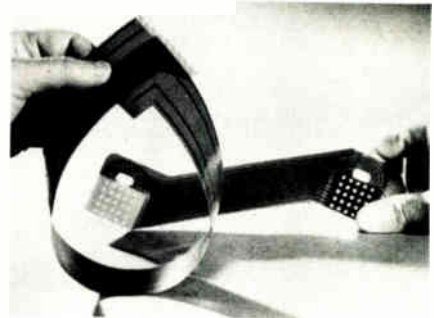

writers' Laboratories. These are, for the thermal-printer assembly, 0.001-inch Kapton H and 0.001-in. D8970 adhesive, both sides; and for the interconnect cable assembly, 0.005-in. Kapton H and 0.001-in. D8970 adhesive, both sides, plus a paper-base phenolic support layer.

Rogers Corp., Chandler, Ariz. 85224. Phone (602) 963-4584 [395]

---

### Humidity/temperature reader also controls equipment

Developed for use in electronics manufacture and other industrial applications, the Humitemp 2 indicator/controller directly measures

Here's the answer  
to your  
Miniature  
Switch needs

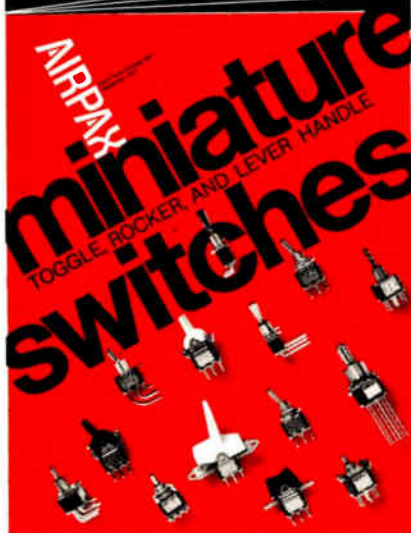

- TOGGLE
- ROCKER
- LEVER HANDLE

Get full information on Airpax competitively priced, American made miniature switches . . . the product of years of experience in the design and manufacture of electromechanical devices.

Airpax Short Form Catalog 3001 describes the basic switching functions, contact ratings, terminations, handle types, and hardware options; all arranged to simplify the selection and ordering of the specific switches you require.



ACTUAL SIZE

Send for your catalog today

**AIRPAX™**

Airpax Electronics/CAMBRIDGE DIVISION  
Cambridge, Maryland 21613  
Switches, Circuit Breakers,  
Glass/Ceramic-to-Metal Seals

Other Airpax Divisions:  
**CONTROLS DIVISION,**  
Ft. Lauderdale, Fla. -  
Instruments for Industry  
**AMERICAN DATA,**  
Huntsville, Alabama  
TV Products



## New products



and controls both humidity and temperature. The instrument uses a special sensing probe that includes a humidity sensor and two precision G-31 platinum, glass-sealed temperature sensors—one for direct temperature readout and the other to compensate for the temperature coefficient of the humidity sensor. All sensors are housed in a fiber-filled phenolic probe assembly. Readouts are linearized and cover 0-100% RH and 0-100°C. The Humi-temp 2 provides linear analog output-signal jacks for recording, computer interfacing, or remote readouts. Two on/off control-point settings are backed up by separate output-power relays.

Phys-Chemical Research Corp., 36 West 20th St., New York, N.Y. 10011 [394]

## Machine checks out DIPs at high temperatures

A total of 5,000 dual in-line packages per hour can be tested at high temperatures by Daymarc's 952 High Temp. All devices are visible throughout the operation. Devices feed from the input sticks into a 90-



position carousel for preheating, then go to the probe station. Tested devices are binned in two to five categories. A closed-circuit hot air system heats the devices to the selected temperature from 40°C to 125°C, and the temperature is sensed by a thermocouple located at the test station. A servo-operated swing track directs each tested device to the proper output channel.

Daymarc Corporation, 301 Second Ave., Waltham, Mass. 02154. Phone (617) 890-2345 (396)

## Lamp sockets come with wire leads or solder lugs

Designed for use with all-glass, wedge-base lamps, a line of sockets is available with either wire leads or solder lugs and a variety of standard mounting brackets. The CIC-9000 series sockets are for either T-3½ or T-5 low-voltage lamps and are

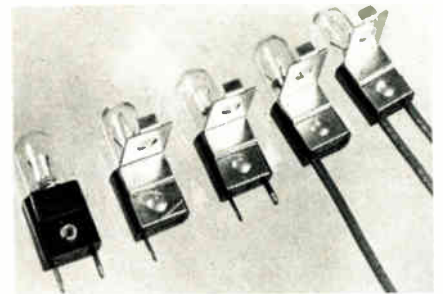

molded from a flame-retardant material. The sockets can be ordered with a single wire lead, or single terminal, and bracket ground; or two wires or two terminals and insulated brackets. They are also available with terminals only, for use with printed-circuit boards.

Christiana Industries Corp., 6500 N. Clark St., Chicago, Ill. 60626 [393]

## Industrial stethoscope is electronically amplified

An industrial stethoscope called the Minearscope 500A electronically amplifies the sounds of electrical, mechanical and hydraulic parts in

# WE'RE WARMING YOU...

... loud and clear. You'll get more attention with these exceptional new piezo crystal solid state audio indicators. Many models to choose from. Series X10 (continuous tone) or Series X11 (pulsing) with pins, wires, or fastons, for computer terminals, remote control fault detection devices ... Series X40 for panel-type home or factory warning and alarm systems ... Series X50 for all types of fire, security and backup alarms. Some models rated to 85 dBA at ten feet.

Write for complete specifications and application data.



3680 Wyse Road, Dayton, Ohio 45414  
Tel. 513-890-1918, TWX 810-450-2523

*Distributors throughout the world.*

# Ben would have liked you.

Ben thought that there had to be more to lightning than just fire in the sky. So he ignored what people told him and did a little rainy-day research on his own.

Determined curiosity—like Ben's—has guided your imaginative progress in the microelectronics field. At Kodak, we have combined extensive research with a deep understanding of your industry, so that our skilled representatives can help improve your product or production techniques.

We try to make your job

a little easier, a little more efficient.

For more information about our products for microelectronics, write Eastman Kodak Company, Dept. 412L (48-F), Rochester, N.Y. 14650.

## RESULTS COUNT



action, deep within equipment. A medical-type headset shuts out unwanted and distracting shop noises. The 500A has a heavy chrome-plated amplifier and probe assembly and uses a photographic-type battery. Price of the stethoscope, including a carrying case, is \$127.50.

Minear Company, P.O. Box 547, One First St., Los Altos, Calif. 94022. Phone (415) 941-8780 [397]

## TOPICS

### Production

**Xincom Systems, Chatsworth, Calif.**, has reduced by as much as 37% the prices for optional equipment on its model 5554 semiconductor memory test system. . . . The number of standard electronic cables packaged in a reel-less dispenser carton, called Unreel, has been expanded to 113 designs by **Belden Corp., Geneva, Ill.** . . . Silkscreen printing on polycarbonate and other thermoplastic films is available from the **Electrocal Division of The Bristol Brass Corp., South Windsor, Conn.** Applications include back-lighted panels for computers and instruments. . . . Metric-sized IC pluggable packaging assemblies are being produced by **Garry Manufacturing Co., New Brunswick, N.J.** to meet the needs of European electronics manufacturers and for the machine-tool industry. . . . **Cambridge Memories Inc., Bedford, Mass.** is taking prototype and production orders for double-sided flexible and standard printed-circuit cards requiring fine lines and high resolution. Cambridge has been producing standard cards for internal use for five years.

**SAM, ARE YOU THE CLOWN WHO TORE THE MINICOMPUTER ARTICLE OUT OF THE NOVEMBER 27th ELECTRONICS?**

Sam?  
Is that you,  
honey?



Life in the office has its little hangups. We can take one off your hands for \$12.

Twelve dollars is what it costs to have your personal subscription to Electronics delivered to your home. You get a lot for 46 cents a copy.

You get a current, clean, fresh magazine with current, clean, fresh news and information.

You get the time to read it.

If you want to clip a page or two, feel free. At home, nobody can call you a clown except your wife and kids.

You (and we) are in the business of changing technology. And when change occurs, obsolescence is not far behind. Obsolescence of products, of

technology and, unfortunately, of people. Much as we'd like to, we can't change this fact. We can only help you cope with it.

Give us one hour of reading time every two weeks and we will keep you aware of what's going on around you, and around the changing world of electronics technology.

**Fight back. Fill out and mail the subscription postcard in the back of this copy.**

**Electronics**  
The one worth paying for.



# Here's why your display is only as good as our 1980A says it is.

Now there's a reliable and absolute way to find out if your LEDs, CRTs, digital displays or other light sources are meeting brightness specs: The 1980A Spectra® Pritchard® Photometer. But don't take our word for it. Electro-optics experts will tell you the "Pritchard" is the only light measuring system known for its superior performance, high sensitivity, and maximum versatility in the lab or in the field. Consider the reasons.



## Precision-Designed

Our 1980A combines three dynamic features no other light measuring system does. And it's this unique combination that virtually eliminates human error, manual operations and computations while maintaining a precise, error-free direct readout. They include our patented AutoComp™, AutoRanging™, and AutoZero™ features.

## Mistake-Proof AutoComp

To provide error-free readout the 1980A's computer-like Auto-

Comp system automatically computes to correct for any changes in filter, electronic gain, or aperture settings. The results? Absolute accuracy and reliability. And all without manual computations!



## Electronic AutoRanging

The AutoRange function covers 4 full ranges, giving you 6 decades of direct readout — without any operator adjustments — selectable over a full-scale sensitivity range from  $10^{-5}$  to  $10^7$  foot-Lamberts. That's like measuring light output almost pitch-dark to sun-bright!

## Automatic Zeroing

For added convenience, accuracy, and ease of set-up, our AutoZero system automatically zeros out the dark current.

## Simple Operation

Using a 1980A Pritchard Photometer is just like using a camera. Just aim at the light source, focus, and read the light output. It's that simple!

## Direct Readout

Our standard 1980A provides direct readout of brightness (luminance) in foot-Lamberts, with NBS-traceable calibration maintained by a highly stable internal light source.

## Versatility Plus

Maybe you have other light parameters to measure — like color, uniformity, contrast or



MTF of displays. All the better. Because we have a wide variety of interchangeable lenses and accessories for use with the 1980A, or with our 1980A-PL pulsed-light model. And it makes sense to have more than one way to measure steady state or pulsed-light sources, since there are an infinite number of applications.



But you don't have to know a lot about our 1980A photometer accessories right now, as long as you know they're there when you need them. Meanwhile there may be a lot more about our 1980A Spectra Pritchard Photometer you ought to know. For full technical data, write or call us, collect.

**PHOTO RESEARCH**  
A Division of Kollmorgen Corporation

3000 No. Hollywood Way, Burbank, CA 91505  
(213) 849-6017 • Telex 69-1427

**The light measurement people**

## New products

### Instruments

# Unit simulates line dropouts

Just as an autotransformer is used to test the tolerance of a piece of equipment to static, or slowly varying, changes in line voltage, the model PLM-103 power-line modifier can be used to test equipment tolerance to power-line dropouts. It allows the user to induce line dropouts of from 0.5 cycle up to 500 cycles in 0.5-cycle increments. Both

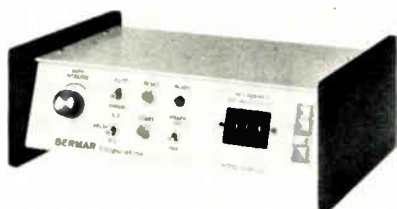

manual and automatic modes of operation are provided.

In the manual mode, the selected number of cycles drops every time the START button is pushed. In the automatic mode, the dropouts are introduced at a repetition rate that can be varied from about 0.3 hertz up to 5 Hz. The instrument has a sync output that can trigger a scope every time a dropout is produced. It has lamps that warn of three line faults: no ground, no neutral, and reversed neutral and hot lines.

The PLM-103 sells for \$585 in small quantities. It has a delivery time of three to five weeks.

Bermar Corp., Box 1043, Nashua, N. H. 03060. Phone B. A. Leinfelder at (603) 888-1300 [351]

### Coupler links instruments for data acquisition

Able to couple any two instruments with binary-coded decimal or binary outputs to any recording or display device to form a data-acquisition system, the model 1700 dual instrument coupler is intended for



use in pollution monitoring, medical applications, and general data logging. The device is essentially a versatile serial-to-parallel and parallel-to-serial converter with various output options suitable for driving teletypewriters, paper-tape punches, magnetic-tape recorders, IBM 029 card punches, and any device with an EIA RS-232-C interface. The model 1700 sells for \$845 and has a delivery time of 30 days.

Data Works Instrumentation, 9748 Cozycroft Ave., Chatsworth, Calif. 91311. Phone Jerry Mercola at (213) 998-8985 [353]

### Secondary voltage standard is accurate within 50 ppm

The AN3100 secondary dc voltage standard is a five-digit instrument that can provide voltages from 100 microvolts to 11.111 volts within an accuracy of 50 ppm of setting  $\pm 50 \mu\text{V}$ . The accuracy specification is valid, at room temperature, for a period of six months following calibration. Temperature coefficient is no more than 2 ppm/ $^{\circ}\text{C}$  over the temperature range from  $0^{\circ}\text{C}$  to  $60^{\circ}\text{C}$ . The portable line-powered calibrator has a rear-panel output connected to the main output through a 100:1 voltage divider. It thus puts out voltages from 1  $\mu\text{V}$  to 111.11 millivolts simultaneous with the front-panel output. Both outputs are ungrounded and may be floated up

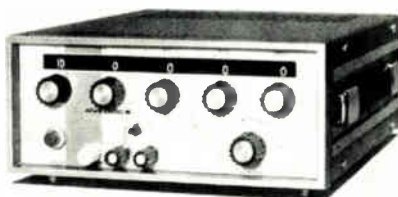

to 500 v dc above or below ground. Polarity is switch-reversible, and the output is protected against short circuits. The AN3100 sells for \$695 and is available immediately.

Analogic, Audubon Rd., Wakefield, Mass. 01880. Phone (617) 246-0300 [354]

### Logic recorder sells for \$495

Priced at only \$495, the model 102A logic recorder is a two-channel instrument that converts almost any oscilloscope into a basic logic analyzer. The device acquires data at various rates from 250 samples per second to 12.5 million samples per second and then provides an output for an oscilloscope at a sweep speed of 100 microseconds per division.

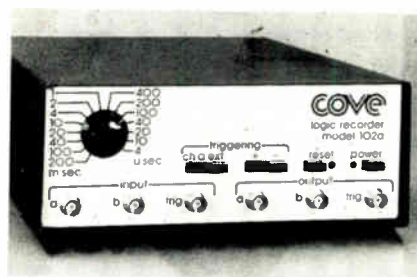

Triggering is either from input-channel A or from an external trigger input. Pushing a front-panel reset button clears the recorder and gets it ready to accept the next trigger pulse that comes along. Delivery time for the 102A is two weeks.

Cove Electronics Inc., 8072 Engineering Rd., San Diego, Calif. [355]

### Level meter provides narrow and wideband modes

Push a button on the model AT-608 level meter, and you convert it from a wideband instrument capable of making precision measurements on a communications line carrying 600 voice channels to a frequency-selective meter that can distinguish between a carrier and a pilot tone that are separated by less than 100 hertz. The instrument covers the fre-

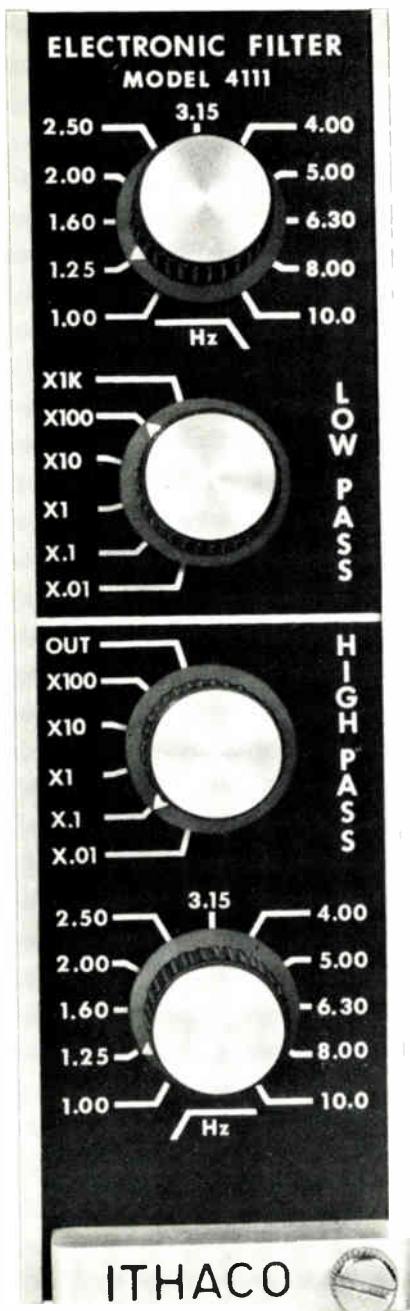

## The predictable filter.

Get  $\pm 1\%$  gain,  $\pm 1\%$  frequency and  $\pm 2^\circ$  phase accuracy. 24 dB/octave. From .01 Hz to 1 MHz. With tenth decade step switch positions for repeatability. Available as shown or dual low-pass. For information on electronic filters, AC instrumentation amplifiers, dynamic strain gage amplifiers, and auto-gain amplifiers, contact: Ithaco, Box 818-MD3, Ithaca, N.Y. 14850. 607/272-7640.

**ITHACO**

## New products



frequency range from 200 Hz to 4.5 megahertz with a maximum error from all sources—including frequency response, temperature changes, and attenuator settings—of less than 0.3 dB. Frequency tuning is indicated on a digital display to a resolution of 10 Hz and an accuracy of within 30 Hz. In its wideband mode, the rms-responding instrument can measure total master-group power, total supergroup (60-channel) power, or total power in a single voice channel. In its selective mode, it has effective noise bandwidths of 1.74 kilohertz, 500 Hz, and (optionally) 25 Hz. Four input connectors with impedances of 75, 124, 135, and 600 ohms are provided as are a built-in demodulator and a loudspeaker. The meter sells for \$3,485; the 25-Hz filter adds approximately \$200. Delivery is from stock. W & G Instruments Inc., 119 Naylor Ave., Livingston, N. J. 07039. Phone Ken Chipman at (201) 994-0854 [356]

### Low-cost scope camera is easy to use

Designed for the large majority of oscilloscope photography applications that do not need the speed and complexity of expensive scope cameras, the model 124A is a simple fixed-focus camera with only two

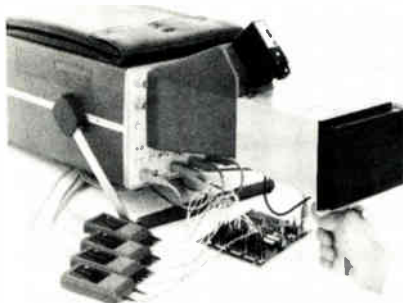

controls: an on/off switch for its flash unit, and the shutter release. The flash unit provides graticule illumination for scopes that lack it. The camera uses a wide-latitude film with an ASA rating of 3,000. This allows the use of a fixed aperture small enough to give the unit sufficient depth of field for fixed-focus operation. Like the aperture and focus, the camera's shutter speed is fixed, but exposure can be increased simply by triggering the shutter more than once. The model 124A sells for \$250; delivery time is two to six weeks.

Hewlett-Packard Co., 1501 Page Mill Rd., Palo Alto, Calif. 94304 [357]

### Tape converter minimizes group delay distortion

When telemetered data is recorded on tape, the performance of the entire data-acquisition system is often limited by the converter that translates the 21.4-megahertz intermediate-frequency output of the telemetry receiver down to a frequency suitable for recording on a wideband tape recorder with an upper frequency limit of 2 MHz. To deal with this limitation, Watkins-Johnson has introduced its model FT-210E i-f tape converter which includes an equalizer for minimizing group delay distortion. The unit has a maximum group-delay variation of  $\pm 200$  nanoseconds over the frequency range from 200 kilohertz to 2 MHz. Other features include automatic gain control.

Watkins-Johnson Co., 700 Quince Orchard Rd., Gaithersburg, Md. 20760. Phone (301) 948-7550 [359]

### Edgewise units contain two panel meters in one

A line of dual edgewise analog panel meters from International Instruments contains five meters: a standard 3½-inch meter, a rugged 3½-in. unit, a 6-in. switchboard instrument, a 5-in. military-grade de-



# HIGH IN CURRENT LOW IN PRICE

75A, 100A and 150A  
HI-REL POWER TRANSISTORS

Three new series of high-current, high reliability NPN silicon power transistors have been added to the Solitron line.

All of these 75A, 100A and 150A rated devices are constructed with a single planar chip — and feature low saturation voltage at high current. They're designed for power supply and motor driver applications or as SCR replacements. Typical specifications are as follows:

$I_C$ (max)	$V_{CE0}$	$V_{CBO}$	$V_{CE(sat)}$	$h_{FE}$
75A	150-200V	225-275V	@ 50A = 0.7V	10-50, $I_C$ = 50A
100A	150-200V	225-275V	@ 75A = 1.4V	10-50, $I_C$ = 75A
150A	100-125V	175-200V	@ 100A = 0.8V	15-75, $I_C$ = 100A

Best of all, these versatile high current transistors are priced lower than what you'd expect, and can be shipped from factory stock. Just call us today toll-free 800-327-8462 for information and costs.

**75 AMP**  
SDT 55405  
SDT 55407



**100 AMP**  
SDT 55905  
SDT 55907



**150 AMP**  
SDT 55903  
SDT 55904



**100 AMP**    **150 AMP**  
SDT 55505    SDT 55503  
SDT 55507    SDT 55504

**Soliton**  
DEVICES, INC.

1177 Blue Heron Boulevard, Riviera Beach, Florida 33404  
Tel.: (305) 848-4311 • TWX: (510) 952-7610

PLANTS IN: CALIFORNIA • FLORIDA • NEW YORK • ENGLAND • HONG KONG • MEXICO

# OUR PROTO-CLIP™ CAN PAY FOR ITSELF THE 1ST TIME YOU USE IT.

The reason's as simple as the time you'll save testing, signal tracing or wiring in DIP's. Not to mention the cost of IC's ruined by accidental shorts. A Proto-Clip is the foolproof, short proof way to bring up leads from crowded circuit boards. Its patented, molded design and unique gripping teeth free hands for other work. Built to withstand tough day-to-day use, CSC clips are available with or without cable for 14-, 16-, and 24-pin DIP's, starting at \$4.50\* For more information,

see your dealer or write for our full-line catalog and distributor list.



CONTINENTAL SPECIALTIES CORPORATION



44 Kendall Street, Box 1942  
New Haven, CT 06509 • 203-624-3103  
TWX: 710-465-1227  
West Coast office: Box 7809,  
San Francisco, CA 94119 • 415-421-8872  
TWX: 910-372-7992  
Canada: Len Finkler Ltd., Ontario

U.S. Pat. No. 3,914,007  
\*Mfr's sugg. retail  
© 1975, Continental Specialties Corp.

Circle 132 on reader service card

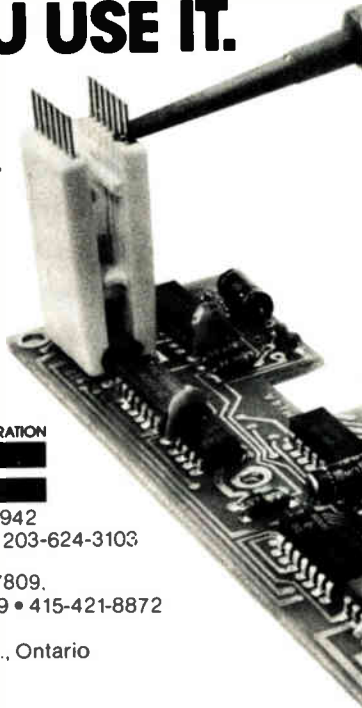

## New products

INTERNATIONAL INSTRUMENTS DUAL PANEL METERS

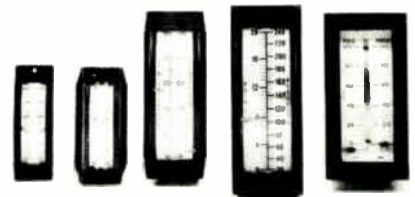

MODEL 2500 MODEL 1746 MODEL 1251 MODEL 2152 MODEL 5204

vice, and a special meter for nuclear instrumentation. Each meter contains two pointers and two scales. This arrangement not only saves space and money, but also makes it very easy to compare related parameters because it displays them side by side.

International Instruments Div., Sigma Instruments Inc., 88 Marsh Hill Rd., Orange, Conn. 06477. Phone John Connelly, (203) 795-4711 [358]

## TOPICS

### Instruments

**Graphic Controls Corp., Cherry Hill, N.J.**, has introduced a series of fiber-tipped recorder pens capable of writing up to 12,000 inches. Available in four sizes and four colors, the pens will fit most flat pen arms on most round-chart recorders. Free samples are offered by the manufacturer.

**Spectracom Corp., Penfield, N.Y.**, has added the model 8161 frequency-calibration receiver to its line of WWV receivers. The unit provides outputs at 0.1, 1.0, 5.0, and 10.0 MHz that are all locked to the 60-kHz WWVB carrier.

**Ailtech, City of Industry, Calif.**, announces a wideband solid-state power amplifier that can put out 10 watts over the frequency range from 1 to 200 MHz. The linear instrument includes a built-in directional power meter.

**Hewlett-Packard Co., Palo Alto, Calif.**, has developed a portable data tape recorder that can record eight channels of analog data on a quarter-inch tape. The model 3968A has both direct and fm modes, and sells for \$8,800.

## Automatic transistor tester works in-circuit when others can't



**BK PRECISION**  
520 Dynapeak™  
\$150.00

**TESTS IN ONLY 9 SECONDS** Tests diodes, SCR's and unijunctions, too. Avoids time wasting unsoldering of good transistors that tested bad in circuit and then good out-of-circuit because of erroneous testing. B&K-Precision 520 Dynapeak™ even tests automatically in-circuit with shunts of 10 ohms or 50 mfd. Random lead connection; turn the switch—the rest is automatic: Pulsating audio tone and LED indicates good device; PNP/NPN, Ge/Si shown by LED. No-charts leakage tests. Tests transistor action, not just junction or diode characteristics. Write today!

**BK PRECISION**

PRODUCTS OF DYNASCAN

1801 W. Belle Plaine Avenue • Chicago, IL 60613

Your opportunity to up-date your electronics know-how  
—bring yourself abreast of all the latest advances!

# McGraw-Hill COURSE IN CONTINUING EDUCATION FOR ELECTRONICS ENGINEERS

*Integrated-circuit technology . . . analog and logic circuit design . . . memory and display devices—all in 8 compact self-study lessons prepared by a panel of top electronics experts*

**TODAY "OPPORTUNITY KNOCKS"** for the electronics engineer who's right on top of the present state of the art—and you can be that up-to-the-minute expert sooner and more easily than you think! In fact, you are just 16 reading hours away from a new and extended proficiency in today's (and tomorrow's) major electronics advances, concepts, and techniques!

### Catch up at home—at your own pace!

If you got your degree five, ten, or more years ago and you've been concentrating on your job ever since, you know it's a real struggle to keep on top of the latest technology and on top of new job and promotion opportunities. Now this amazing new Course offers an easy, systematic, and convenient way to catch up on developments in a fast-moving field—and even get a jump on future developments!

Now—without taking time away from your job—without boxing yourself into inconvenient class schedules—you can bring yourself completely up to date on recent development in integrated electronics. You'll discover the latest information on what it is, what it can do, and how you can best use it!

### Gives working knowledge of vital advances

Complete in eight lessons, the McGraw-Hill COURSE IN CONTINUING EDUCATION FOR ELECTRONICS ENGINEERS is one of the first available high quality, low cost, self-study courses to enable you to bring yourself *up to date* and *up to top proficiency* in major areas of technology. The Course covers operational-amplifier concepts and applications—active-filter design for a variety of circuits—logic design with TTL—memories for numerous applications—electronic display devices and systems—comparative values of competing technologies—latest advances in the electronics field—latest solutions for troublesome problems—and latest designs!

Each of the eight lessons is compact (from 42 to 96 pages—about two-hours reading time), generously illustrated with appropriate diagrams and charts, and includes a self-checking quiz (with answer keys) so you can gauge your command of the topic. Each lesson is also introduced by a Study Guide that tells you just how to get the most out of it. A Course Completion Certificate is awarded to those who successfully complete and return the final examination.

### Pre-test the Course for yourself—free!

Simply return the coupon and we'll send you the *Master Outline and Guide* and *Lesson One: Integrated Circuit Processes*. Look these materials over for 10 days. If you decide the Course is not for you, simply return the materials *with no further obligation whatsoever*. Otherwise, we will begin sending you Lessons Two through Eight at six-week intervals. You pay nothing until you decide whether to keep the *Master Outline and Guide* and *Lesson One*. Then you have the option of paying for each Lesson as you receive it, or **saving over 10%** by paying for the Course in full!

If you're disappointed in the Course at any stage, just notify us and we will stop sending the Lessons and invoices. And if you have paid in advance, we will refund the difference between the value of the Lessons you have received and the payments you have made. So return the "Opportunity Knocks" Coupon below today—*get yourself headed in the direction of bigger and better professional opportunities!*

## YOUR "OPPORTUNITY KNOCKS" FREE-EXAMINATION COUPON!

McGraw-Hill BOOK COMPANY  
Professional & Reference Books—25th Floor  
1221 Avenue of the Americas, New York, N.Y. 10020



Yes! Send me for 10 days' free examination *Lesson One* plus the *Master Outline and Guide* for the McGraw-Hill COURSE IN CONTINUING EDUCATION FOR ELECTRONICS ENGINEERS.

At the end of ten days, if I want to continue in the Course, I will make my first payment of \$6.50 plus local tax, postage and handling. And I understand that each subsequent Lesson will be accompanied by an invoice for \$6.50 plus local tax, postage, and handling . . . for a total cost of \$52.00 for the eight Lessons. (The Lessons will be shipped at six-week intervals.)

If I pay for the entire course after examining the *Master Outline* and *Lesson One*, McGraw-Hill will pay *regular* postage and handling and send me the rest of the lessons at six-week intervals for only \$46.50 plus local tax . . . a saving of better than 10%! If I decide not to continue in the Course after the ten-day examination period, I will return the *Master Outline* and *Lesson One* *postpaid*, and the matter will be closed.

Name \_\_\_\_\_

Address \_\_\_\_\_

City \_\_\_\_\_

State \_\_\_\_\_

Zip \_\_\_\_\_

*Offer good only in U.S., and subject to acceptance by McGraw-Hill*

41-18583

Components

## Resistors reach 100 teraohms

Offered with working-voltage ratings from 400 volts to 125 kilovolts and standard tolerances from 3% to 20%, a family of carbon-film resistors includes units with resistances as high as 100 teraohms. The resis-



tors have power ratings from 0.5 watt to 100 w, and the minimum available resistance is 20 ohms. A total of 10 basic styles is offered, as are hermetically sealed resistors that comply with MIL-R-14293. Prices range from 60 cents each to \$59.66 each depending on specifications and quantity. Delivery is from stock to eight weeks.

American Components Inc., RPC Division, Eighth Ave. at Harry St., Conshohocken, Pa. 19428. Phone William A. Mulligan at (215) 825-6200 [343]

## Varistors handle transients of more than 150 joules

A line of zinc-oxide varistors from Siemens is intended for the protection of sensitive circuitry from volt-

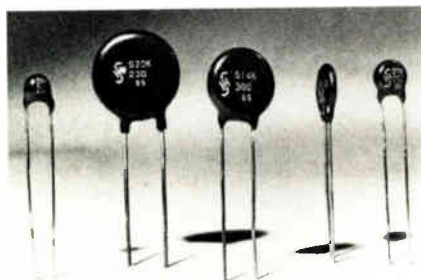

age transients. Called ZIVs, the devices have electrical characteristics similar to those of back-to-back zener diodes, except that the ZIVs can handle higher currents and energies. Available voltage breakdowns range from 18 v dc and 14 v ac to 1,500 v dc and 1,000 v ac. Energy-handling capabilities range from 1 joule to 150 J. The ZIVs are housed in packages similar to those used for disk capacitors. Prices begin at 64 cents each in hundreds. Delivery is from stock to six weeks.

Components Group, Siemens Corp., 186 Wood Ave. S., Iselin, N. J. 08830. Phone Tony Laconti at (201) 494-1000 [345]

## Lamp brightness is mechanically adjustable

Simply rotating the lens cap on an incandescent-lamp housing is enough to vary the lamp's brightness. In some models, the lamp can be blacked out completely; in others, a small amount of light can al-



ways reach the lens, so that key warning signals, for example, won't be missed if the housing is inadvertently closed. Two types of adjustable housings are offered: one has a variable diaphragm like that in a camera, and the other has a pair of polarizers, one of which is rotatable. The lamps are particularly recommended for use on a ship's bridge or in an airplane cockpit, where the ambient light varies tremendously from day to night. Typical prices of the lamps, in lots of 1,000, start at \$1.81 each for the subminiature units, \$2.06 for the miniatures, and \$2.76 for the larger devices. Delivery is from stock.

Dialight, North American Philips Co., 203 Harrison Pl., Brooklyn, N. Y. 11237 [347]

## Conductor-only circuits offered in DIPs

Available in 8-, 14-, 16-, and 18-pin dual in-line packages, a line of conductor-only circuits is intended to eliminate the time-consuming installation of individual jumper wires. The series 760 modules are useful for busing, logic-programing,

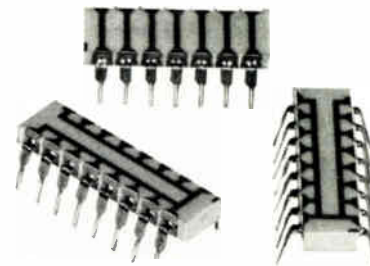

microprograming (such as code conversion and rate multiplication), and testing. Various standard conductor patterns are available now, and specials can also be made on a custom basis. Prices depend on module size and conductor pattern.

CTS of Berne Inc., 406 Parr Rd., Berne, Ind. 46711. Phone James A. Long at (219) 589-3111 [344]

## Subminiature slide switches mount like DIP switches

By strip-mounting its low-cost miniature and subminiature slide switches, Stackpole has devised a competitor for the DIP switch, but the newcomer is believed to last longer and cost less than earlier devices. The Stackpole switch is ac-

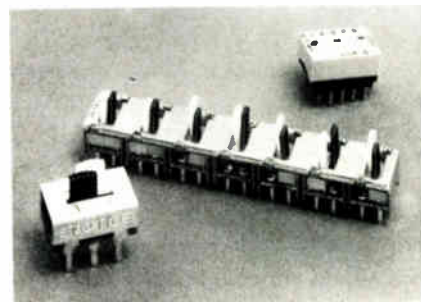

# Now ready!

A new line of VHF tetrodes with **PYROBLOC®** grids...  
for super-reliable FM-radio transmitters

- 3 kW to 30 kW of output power.
- Only one power tetrode needed.
- Direct solid-state drive for the output stage.

With a big extra plus: THOMSON-CSF's own RF line-circuit designs for optimum overall amplifier performance and reliability!



**THOMSON-CSF**

THOMSON-CSF ELECTRON TUBES / 750 BLOOMFIELD AVENUE CLIFTON NJ 07015 / TEL. : (201) 779 1004 / TWX : 710 989 7149

France - THOMSON-CSF Division Tubes Electroniques / 38 rue Vauthier 92100 BOULOGNE-BILLANCOURT / Tel. : (1) 604.81.75

Germany - THOMSON-CSF Elektronenröhren GmbH / 6 FRANKFURT/MAIN / Am Leonhardsbrunn 10 / Tel. : (0611) 70 20 99

Italy - THOMSON-CSF Tubi Elettronici SRL / Viale degli Ammiragli 71 / I - 00136 ROMA / Tel. : (6) 638 14 58

Japan - THOMSON-CSF Japan K.K. / Kyōsho Building / 1-9-3, Hirakawa-cho / Chiyoda-ku / TOKYO / 〒 102 / Tel. : (03) 264 63.41

Spain - THOMSON-CSF Tubos Electronicos S.A. / Alcalá 87 / 7° Doha / MADRID 9 / Tel. : (1) 226 76.09

Sweden - THOMSON-CSF Elektronrör AB / Box 27080 / S 10251 STOCKHOLM 27 / Tel. : (08) 22 58 15

United Kingdom - THOMSON-CSF Electronic Tubes Ltd / Ringway House / Bell Road / Daneshill / BASINGSTOKE RG24 0QG / Tel. : (0256) 29155 / Telex : 858865

Circle 135 on reader service card

## PINPOINT HEAT

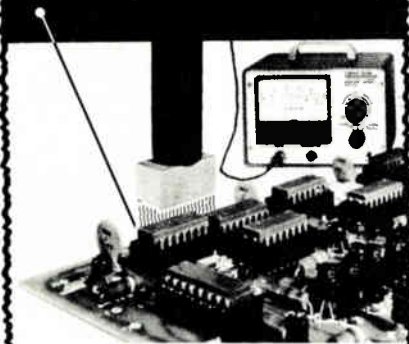

Heat any I. C. or semiconductor component to its rated temperature with a heat probe. Accuracy  $\pm 1/2^\circ\text{C}$ . Or check the component's temperature with a thermocouple probe. Accuracy  $\pm 1^\circ\text{C}$ . Model 810 Thermo-Probe does both. Reads out directly in  $^\circ\text{C}$  and  $^\circ\text{F}$  on a large  $4\frac{1}{2}$ -inch meter.

**PRICE \$272.50 F.O.B. South Laguna**

Models with other temperature ranges available. For details write to:

**MTI MICRO-TECHNICAL INDUSTRIES**

P.O. Box 287 South Laguna, CA 92677  
(714) 545-3734 • TWX 910-587-3425 MICRO OHM ELM

Circle 136 on reader service card

## Gas Sensing Semiconductor

# FIGARO GAS SENSOR

**TGS** quickly senses even small amount of gas.

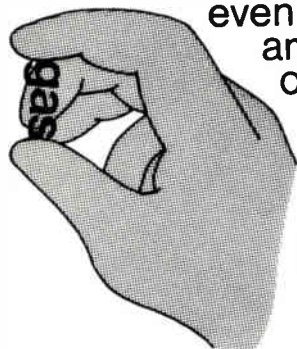

'75 New Models, some with highly sensitive CO sensor, now on the market.

Please contact the address below directly for catalogs and price/delivery information.

**FIGARO ENGINEERING INC.**

3-7-3, Higashitoyonaka, Toyonaka City, Osaka 560, Japan/Tel: (06) 849-2156

Cable: FIGARO TOYONAKA/Telex: 05286155 FIGARO J

136 Circle 171 on reader service card

## New products

tually an array of double-pole, double-throw slide switches with split-toggle conversion to spdt operation. The switches, which use wiping action to minimize contamination effects, sell for as little as 9 cents per function. Delivery time is four weeks.

Stackpole Components Co., P.O. Box 14466, Raleigh, N. C. 27610. Phone Ted McGowan at (919) 828-6201 [346]

## Tiny porcelain capacitors have high Q values

A line of very small porcelain capacitors intended for use at radio frequencies has a guaranteed minimum Q value of 10,000 at a frequency of 1 megahertz. Typical values are about 40,000. The devices have capacitance values from 0.1 picofarad to 120 pF in the 50-mil square size, and 0.1 pF to 1,200 pF in the 100-mil square size. Insulation resistance exceeds  $10^6$  megohms for values up to 470 pF, and  $10^5$  megohms beyond that. The capacitors are guaranteed to withstand all soldering tests—high temperatures, high-activity fluxes, solvents, etc.—with no degradation in performance or life. Offered in seven tolerance ranges, the capacitors are extremely stable and are claimed to exhibit no measurable drift with applied voltage, frequency, temperature, or age. Units are available for delivery from stock.

Dielectric Laboratories Inc., a subsidiary of Ceramic Magnetics Inc., 64 Clinton Rd., Fairfield, N. J. 07006. Phone (201) 575-8922 [348]

## Mercury tilt switch can handle 500 mA

A mercury tilt switch with a diameter of 0.156 inch and a body length of 0.25 in. is hermetically sealed and can switch currents as high as 500 milliamperes. Of steel construction, the rugged switch makes or breaks on any deviation of  $3^\circ$  or more from its recommended horizontal posi-

# CHANGING YOUR ADDRESS?

Please take the following steps to ensure continuing, prompt receipt of your Electronics subscription. Allow 4 weeks advance notice.

**1** Remove your current mailing from the cover and attach where indicated below.

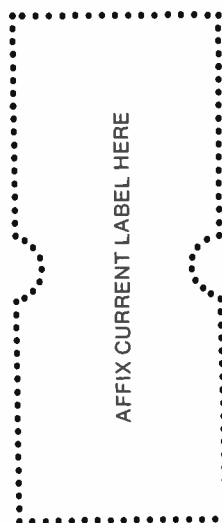

**2** Fill in new address as follows (please print):

Name \_\_\_\_\_

Company \_\_\_\_\_

Address \_\_\_\_\_

City \_\_\_\_\_

State \_\_\_\_\_ Zip \_\_\_\_\_

**3** Mail this entire form to:

Electronics  
McGraw-Hill Inc.  
Subscription Dept.  
P.O. Box 514  
Hightstown, N.J. 08520

Electronics/January 22, 1976



## Hutson Is Shipping Thick-Film Thyristors!

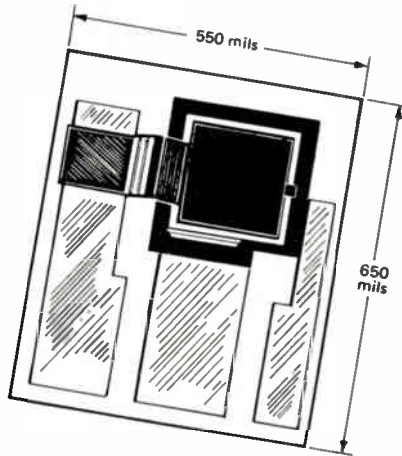

Maximum Thermal Impedance

$I_{T(RMS)}$	$\theta_{JC}$
10A	1.2° C/W
25	0.9
40	0.7

tion. Designed originally as part of an electric watch, the switch can be used in other hand-held appliances, in safety and security equipment, in medical and dental tools, as well as in office machines, computer systems, and other general electronics applications. According to its manufacturer, the switch has a clean snap action with no chatter. And, of course, the switching action is silent. Designers interested in testing the Micro-Mini switch may request a free sample by writing on their letterheads to Paul Phillips, General Sales Manager.

Durakool Inc., 1010 N. Main St., Elkhart, Ind. 46514 [349]

... For more than a year, Hutson Industries has been producing and shipping thick-film thyristors. Note our emphasis on *shipping!*

Hutson's thick-film thyristor line ranges from 10 to 40 amp Triacs and 4 to 40 amp SCR's, either single chip or back-to-back. All Hutson thick film substrates use the flip-chart approach. The outline shown is representative of our 25 amp Triac.

Typical pricing on a 400-volt, 25 amp Triac in lots of 5,000 is \$2.82, compared with \$3.61 for a press-fit... a savings of over 20%. And this does not include any benefit of the smaller size!

The technique developed and proven also allows Hutson to produce custom thick-film substrate designs. For additional technical and pricing information, contact your local Hutson representative... or call Hutson direct.

### REPRESENTATIVES

ARIZONA Phoenix: Gassner & Clark (602) 968-9037. CALIFORNIA Los Angeles: Orion Sales (213) 240-3151; San Francisco: Parks & Pruitt (415) 364-1640. COLORADO Denver: Electrodyne, Inc. (303) 757-7679. FLORIDA Light-house Point: R. C. Simon (305) 941-2757. GEORGIA Atlanta: K & E Associates (404) 427-0241. ILLINOIS Chicago: L-Tec, Inc. (312) 286-1500. INDIANA Greenwood: Valentine/Schlinger (317) 888-2260. MARYLAND Baltimore: Stemer Associates (301) 944-8232. MASSACHUSETTS Boston: Gerber Sales Corp. (617) 890-8040. MICHIGAN Detroit: Greiner Associates (313) 499-0188. MINNESOTA Minneapolis: Bitronics Sales (612) 835-7744. MISSOURI St. Louis: Dytronic, Inc. (314) 731-5798. NEW YORK New York City: Murray Gallagher, Inc. (201) 399-4350; New York State: Precision Sales (315) 458-2223. OHIO Dayton: Midwest Marketing Associates (513) 433-2511. OREGON Portland: N. R. Schultz Co. (503) 643-1644. PENNSYLVANIA Philadelphia: Sunday-O'Brien (609) 429-4013. TEXAS Dallas: Precision Sales (214) 423-7618. WASHINGTON Seattle: N. R. Schultz Co. (206) 454-0300. CANADA Toronto: Weber Electronics (416) 638-1322.

### DISTRIBUTORS

CALIFORNIA Newport Beach: Semicomp (213) 971-5253 or (714) 833-3070; San Diego: Semicomp (714) 560-0373; San Leandro: KEA Electronics (415) 352-2277. FLORIDA Clearwater: Diplomat/Southland (813) 443-4514; Miami: All American Transistor (305) 754-5531. ILLINOIS Chicago: Zeus Electronics (312) 622-8183. INDIANA Indianapolis: Sheridan Sales (317) 547-7777. KANSAS Overland Park: Sheridan Sales (913) 383-1636. MICHIGAN Farmington: Sheridan Sales (313) 477-3800. MINNESOTA Minneapolis: Sheridan Sales (612) 835-7744. MISSOURI Florissant: Sheridan Sales (314) 837-5200. NEW JERSEY Elizabeth: Thor Electronics (201) 354-2400. NEW YORK Rochester: Rochester Radio Supply (716) 454-7800; New York City Area: Zeus Electronics (914) 592-4120. OHIO Beachwood: Sheridan Sales (216) 831-0130; Cincinnati: Sheridan Sales (513) 761-5432; Dayton: Sheridan Sales (513) 277-8911. PENNSYLVANIA Philadelphia: Wilshire Electronics (215) 627-1920; Pittsburgh: Sheridan Sales (412) 244-1640. TEXAS Dallas: Altair (214) 231-5166; Dallas: KA Electronic Sales (214) 634-7870. Houston: Altair (713) 462-3029. UTAH Salt Lake City: Diplomat/Altland Electronics (801) 486-7227. AUSTRALIA Victoria: Namco Electronics 96-5076. CANADA Toronto: Semad Electronics (416) 625-9880. DENMARK Copenhagen: E. V. Johanssen A-S (01) 295622. ENGLAND Hertfordshire: Claude Lyons Ltd. (09924) 67161. GERMANY Muenchen: Metronik GmbH (089) 6114063. HOLLAND Rijswijk (Z-H) Rodelco BV (070) 995750. NORWAY Strommen: Intelco A. S. 472702272. REPUBLIC OF SOUTH AFRICA Pinetown: Radiokom 48-5712. SPAIN Madrid: Belpot Electronics 234-62-62. SWEDEN Sundryberg: Electrolux A. B. 06-28-5940. SWITZERLAND Dubendorf: D. Leitgeb 051-852201.



## HUTSON INDUSTRIES

P.O. Box 34235  
2019 West Valley  
View Lane  
Dallas, Texas 75234  
(214) 241-3511  
TWX 910-860-5537

EUROPEAN OFFICE:  
30 Rue Pierre Semard  
Yerres, 91, France  
Telephone: Paris  
925-8258  
TELEX 210-311

Neon indicator lamp  
is 0.395 inch long

A T-1½ subminiature neon indicator lamp is available in a high-brightness (model NE4-10H) and a standard-brightness (NE4-10L) light output. The lamp is only 0.395 inch long, has an over-all diameter of 0.160 in., a wire length of 1 in., and a lead-wire diameter of 0.012 in. The subminiature unit offers a life expectancy of 15,000 hours and operates on a circuit voltage of 105-125 volts, although 220 v can be used with a change of resistor. Maximum breakdown voltage for the NE4-10H is 95 v ac and 135 v dc, and the NE4-10L lamp has a maximum breakdown voltage of 65 v ac and 95 v dc. Applications include any subminiature indicator assembly where compactness is required, including panel-board readouts, microwave ovens and smaller electrical appliances. Samples of the

## DC-DC CONVERTERS

-- like Magic!!

### FEATURES:

- \* Mobile or station use
- \* Small size
- \* Rack mount option
- \* Isolated, floating input and output
- \* Current limited
- \* High efficiency - low standby current
- \* 20KHz silent switching
- \* Low cost, under \$300
- \* Rugged Construction
- \* Parallel operation



INPUT VOLTAGES 12, 24, 32, 48, 130 VDC (nominal)  
OUTPUT VOLTAGES 12, 24, 48, 60, 130 VDC (nominal)  
POWER OUTPUT up to approximately 200 watts  
Options on request.

### GLENAYRE ELECTRONICS LTD

1551 Columbia Street  
North Vancouver, B.C.  
Canada V7J 1A3  
PHONE: (604) 980-6041  
TELEK: 04-352520

In the U.S.  
GLENAYRE ELECTRONICS INC  
3631 Interlake Avenue, N  
Seattle, Washington 98103  
PHONE (206) 633 4500

DEALER ENQUIRIES WELCOME

Circle 138 on reader service card

## New products

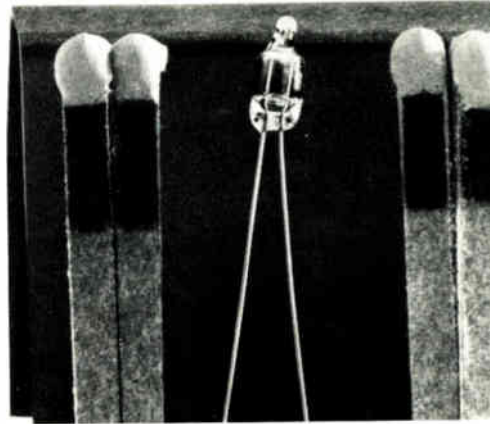

lamp are available for inspection now.

ELT Inc., Glow-Lite Division, Pauls Valley, Oklahoma 73075. Phone Bob Parkey (405) 238-5541 [350]

## TOPICS

### Components

**Grayhill Inc., La Grange, Ill.,** announces that its 42A and 44A style family of enclosed rotary switches is listed by UL as suitable for handling 1 ampere at 125 volts ac. . . . **Analog Devices Inc., Norwood, Mass.,** is offering a custom service for user-designed thin-film resistor networks. The nichrome-on-ceramic circuits are packaged in 10-, 14-, 16-, or 24-pin ceramic flatpacks. DIPs and chips are also available. . . . **EECO, Santa Ana, Calif.,** is offering its Thumbpot voltage dividers with illuminated numerals. . . . **Custom Electronics, Oneonta, N. Y.,** has developed a new epoxy processing technique for mica-paper capacitors. The technique is reported to increase corona and breakdown levels by as much as four times. . . . **Duncan Electronics, Costa Mesa, Calif.,** has announced a method by which any of its potentiometers can be produced in a hybrid of wirewinding and conductive plastic. The results combine the essentially infinite resolution and long life of plastic with the temperature stability of metal wire.

# Hot Semis? Get relief fast!



## IERC



## Heat Sinks

INTERNATIONAL ELECTRONIC RESEARCH CORPORATION / A SUBSIDIARY OF DYNAMICS CORPORATION OF AMERICA / 135 WEST MAGNOLIA AVENUE, BURBANK, CA 91502



# If you need a few custom ICs and can't afford them, call us.

When others quote you high prices for a few custom ICs, it's because they treat them as a sideline. At Silicon Systems, custom ICs are our bread and butter. Especially low quantity orders—even under 5000. Priced to compete with catalogue ICs.

One reason for our low prices is our proprietary design system. Developed in our own computer lab, this system helps us solve design problems in any technology—TTL, Schottky, ECL, Linear, PMOS, NMOS, CMOS, I<sup>2</sup>L—whatever is best for you. Designs that are fully protected because they can't be copied.

Over the years, we've become expert at satisfying all kinds of special design requirements. With ICs that replace entire groups of catalogue ICs, saving you board area, power, cooling, testing, spares—money and grief.

So when you think you can't afford custom ICs, write us. Silicon Systems, Inc., 2913 Daimler Street, Santa Ana, CA 92705. Better yet, call:

**(714) 979-0941**

**Silicon Systems  
The One-of-a-Kind IC Company**

Circle 139 on reader service card

## TRY OUR NEW TRANSPORT!



- Low in cost (only \$195 in quantity)
- Compact, reliable. Only 2 moving parts
  - "Accu-Rate™", new concept in electronic tape speed control
  - Takes only 1 voltage (14-30 VDC)
  - "POPS™" cassette release (Push to Open, Push to Shut)

Looking for transport reliability? For low power consumption, short IRG, excellent speed control?

Then we think you'll be impressed with our newest transport. Check it out.

**BRAEMAR  
COMPUTER  
DEVICES, INC.**

11950 TWELFTH AVENUE SOUTH  
BURNSVILLE, MINNESOTA 55337  
(612) 890-5135

# YES!

I'd like to know more about the new CD-200.

Send literature.

Let's arrange for a demo. Call me at \_\_\_\_\_

Name \_\_\_\_\_

Title \_\_\_\_\_

Firm \_\_\_\_\_

Address \_\_\_\_\_

City \_\_\_\_\_ State \_\_\_\_\_ Zip \_\_\_\_\_

**THE DIGITAL CASSETTE PEOPLE  
OVER 30,000 IN THE FIELD**

Data handling

## CPU emulator speeds design

---

System for debugging can also perform production testing

---

In developing microprocessor-based systems, a lot of time goes into designing and debugging the prototype. To speed these processes for systems being built around the Motorola 6800 microprocessor, Digital Electronics Corp. has introduced a CPU emulator called DICE/68. It provides users of the 6800 and the Motorola Exorciser development system with in-circuit emulation of the central processing unit. Other features of the design/debug tool, says president Imsong Lee, include status indicators for data and address buses and system control capabilities.

By plugging a 40-pin DICE/68 adapter directly into the 6800 CPU socket on one's own hardware, Lee says, it is possible to debug a 6800 system prototype, complete with random-access and read-only memories, input/output circuitry and two-phase clock, using the full range of diagnostic aids available through the Motorola Exbug operating system. The user can, after specifying through DICE/68 the block of memory allocated to the prototype system, begin the hardware debugging phase.

A major advantage of the DICE/68 CPU emulation technique, according to Lee, is that the Exorciser system bus is effectively extended onto the prototype 6800 system bus, allowing access to all user memory and I/O interfaces on the prototype through Exorciser software. No special interfaces or test devices need to be constructed, saving design and development time. Executing software from an Exorciser RAM and through the DICE/68 emulation system, the designer is

able to test, modify and finalize his control program as it runs in the user-system environment.

The DICE/68 system consists of two electronic assemblies, plus interconnecting flat cable and the 40-pin adapter. One assembly is a printed-circuit card designed to plug directly into the Exorciser; this card connects through flat cable to a system status console, which gives the user further flexibility during hardware troubleshooting. Lights on the panel indicate the states of address and data lines on the system bus. Controls on the console allow the user to single-step through the control program, to initiate an interrupt, a system halt, or a reset.

The DICE/68 system, in addition to being a debugging aid, can also be used in production testing. Its price is \$795.

Digital Electronics Corp., 2126 Sixth Street, Berkeley, Calif. 94710 [361]

---

## HP desktop calculator acts like a minicomputer

A powerful medium-priced desktop programable calculator with many features previously found on minicomputers is now available from Hewlett-Packard.

The 26-pound model 9825A, priced at \$5,900, is designed primarily for use in engineering, research and statistics. Its speed, interfacing abilities, and computer-like features make it particularly useful as the

controller of an instrument system (see photo), for pilot process-control applications, remote data collection and production control. It also can be a powerful stand-alone computing tool.

Significant features incorporated in the 9825A include: interrupt; input/output speeds up to 300,000 bytes per second; live keyboard; direct memory access; high-performance, bidirectional tape drive; multidimensional arrays; automatic memory record and load; extended internal calculation range ( $\pm 10^{511}$  to  $\pm 10^{-511}$ ), and optional plug-in read-only memories.

The 9825A uses a high-level programming language, called HPL and aimed at controller applications as well as data processing. HPL handles subroutine nesting and flags and allows 26 simple variables and 26 multidimensional-array variables, limited only by the size of the calculator memory. Error locations are identified by a flashing cursor in the 32-character LED display. Fixed-and floating-point formats can be set by the user from the keyboard.

The 9825A's keyboard has 12 special function keys that, with a shift key, can handle 24 different operations. With the live keyboard, the user can perform simple calculations, examine and change program variables, and list programs while the calculator is performing other operations. Although the calculator appears to be doing these tasks simultaneously, the interrupt capability is actually apportioning operations on a priority basis. The speed of the 9825A makes it seem as if everything is happening at once. The unit has a 32-character LED display and a thermal printer.

With search and rewind speeds of 90 inches per second and read/write speed of 22 in./s, the 9825A's built-in tape cartridge drive gives an average access time of 6 s. It provides automatic verification during recording.

The 9825A comes with 8,000 bytes of internal read/write memory, expandable in optional 8-k increments to a total of 32-k bytes. Four plug-in slots in the front of the



# CHANGING YOUR ADDRESS?

Please take the following steps to ensure continuing, prompt receipt of your Electronics subscription. Allow 4 weeks advance notice.

**1** Remove your current mailing label from the cover and attach where indicated below.



**2** Fill in new address as follows (please print):

NAME \_\_\_\_\_

COMPANY \_\_\_\_\_

ADDRESS \_\_\_\_\_

CITY \_\_\_\_\_ STATE \_\_\_\_\_ ZIP \_\_\_\_\_

**3** Mail this entire form to:

Electronics, McGraw-Hill Inc. Subscription Dept.  
P.O. Box 514, Hightstown, N.J. 08520

## dollar-wise precision...

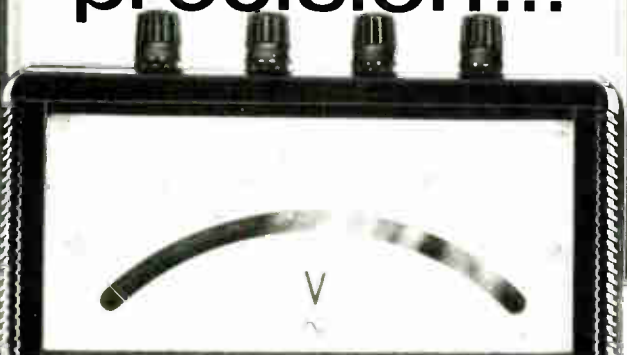

Portable precision doesn't have to cost a bundle... not when YEW precision portables with 0.5% accuracy start at \$120. What's more, every YEW tautband precision portable is backed by YEW's famous unconditional 1 year guarantee, a service and calibration capability second to none and over 60 years of experience. If value is part of your precision decision, consider YEW's portables.

YEW

YOKOGAWA  
CORPORATION  
OF AMERICA

5 Westchester Plaza, Elmsford, New York 10523  
Telephone: 914-592-6767

Circle 175 on reader service card

# The Ten Most WANTED INSTRUMENTS



Brush 260

Oscillograph



Nicolet

Digital Storage Oscilloscope

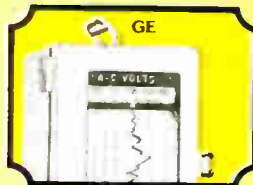

GE

Chart Recorder



Data Research

Transient Voltage Recorder



Esterline Angus

Chart Recorder

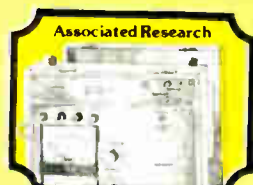

Associated Research

Insulation Tester



Kaye

Data Acquisition System

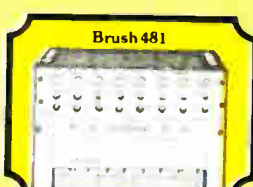

Brush 481

Oscillograph



Biddle

Megger

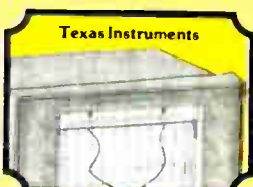

Texas Instruments

Temperature Recorder

## RENT'EM FROM GE

Short or long term rentals on over 5,000 most wanted instruments are available from General Electric, shipped the same day. Want your FREE Rental Catalog? Call collect, (518) 372-9900.

GENERAL  ELECTRIC

Circle 143 on reader service card 143

# UNINTERRUPTIBLE POWER SYSTEMS

FROM 700 VA TO 37.5 KVA

- Single Phase & Three Phase
- On Line Systems
- Minimum MTTR
- Maximum MTBF
- Seismic IE Qualified

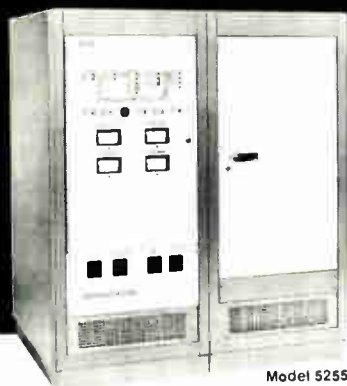

Model 5255  
15 KVA

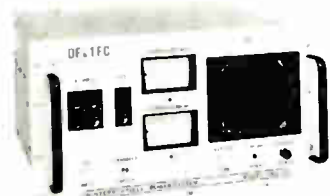

Model DSU-710  
700 VA

WRITE FOR FREE POWER SELECTION GUIDE. Deltec has compiled detailed data to assist you in specifying a standard reliable system to meet your application. Installation requirements, including suggestions as to possible methods of maintaining maximum MTBF and MTTR at the most economical price, are also included.

Deltec's standard Uninterruptible Power Systems solve numerous types of power problems - blackouts, brownouts, transients - that cause expensive down time on critical electronic and computer systems. Our on line power equipment is available as standard single systems and as partially or totally redundant component systems. Options include an electronic transfer switch for ultimate reliability and load sharing between redundant systems for no break power, and complete monitoring and control systems for remote indication or other computer control.

Deltec enjoys a growing reputation for producing advanced designed power conversion systems which meet specific customer requirements. Our equipment is engineered with the users' requirement in mind and that means ease of installation and maintainability by your own local electricians with complete factory support.

## DELTEC

CORPORATION

980 Buenos Avenue • San Diego, CA 92110  
(714) 275-1331 • TWX 910 335 1241

Circle 144 on reader service card

## Portable Digital Multimeter at an Analog Price

MODEL 280  
**\$99<sup>95</sup>**



Enjoy the benefits of auto-polarity digital read-out plus full overload protection and high-low power ohms for accurate tests in solid-state circuits.

**Accuracy better than analog VOM's!**

### 22 RANGES

Reads in decades: AC and DC volts and mA, 1-1000; ohms, 100-10 meg. Resolution: 1mV, 1mA, 0.1ohm.

Accuracy: DC typically  $\pm 1\%$  F.S.; AC and ohms typically  $\pm 2\%$  F.S. except  $\pm 2.5\%$  on highest range. Uses "C" cells. Optional AC adapter/charger.

**In stock at your local distributor**

### BK PRECISION

PRODUCTS OF DYNASCAN  
1801 W. Belle Plaine Avenue Chicago, IL 60613

144 Circle 170 on reader service card

## New products

calculator provide space for optional ROMs.

The 9825A uses what HP calls second-generation n-channel MOS circuitry designed to provide high-speed internal calculation. The n-MOS chips consist of a binary processor chip, an input/output chip, and an extended math chip. There are four bipolar display chips.

The calculator will be available for delivery in eight weeks.

Hewlett-Packard Company, Calculator Division, 815 Fourteenth St., S.W., Loveland, Colo. 80537 [362]

## DEC offers microcomputer timesharing system

Digital Equipment Corp. has introduced its Multi-User/11V03 disk-based timesharing system, built around the company's PDP-11/03 microcomputer. The system, which can serve up to four users, sells for



less than \$20,000. Programs for the system may be written in Basic, Fortran IV (optional for \$700), or Macro assembly language. Any combination of up to four video-display or hard-copy terminals may simply be plugged into the system. The MU/11V03 contains 28-k words of main memory, with dual flexible disks adding more than half a million bytes of mass storage. The company is aiming initially at the education market. First deliveries of

Electronics/January 22, 1976

the system are scheduled for this month.

Digital Equipment Corp., Maynard, Mass. 01754 [363]

---

### High-level language developed for M6800

A high-level language and compiler for the M6800 microcomputer have been developed by Motorola. The language, called MPL, is a subset of the widely used programming language PL/I. A special feature of the compiler is that it translates source programs into assembly language rather than machine code. This makes it easier to optimize program segments that involve input/output hardware elements, and it also speeds the task of program debugging. The MPL compiler is available now on the General Electric Mark III Information Services International Network.

Technical Information Center, Motorola Semiconductor Products Inc., P.O. Box 20294, Phoenix, Ariz. 85036 [364]

---

### Hand-held computer terminal weighs only 1.5 pounds

Able to interact with its central processor by means of an acoustic coupler or a hard-wire connection, the Termiflex hand-held computer terminal is a truly portable device that measures only 2 by 4.25 by 7 inches and weighs only 1.5 pounds. The unit provides all 128 ASCII characters and can display two lines of 10



salon international des  
**composants  
électroniques 76**

**PARIS**  
5-10 avril



Organisation S.D.S.A.  
20, rue Hamelin  
F 75116 Paris  
☎ 33 (1) 553.11.09  
☎ 630 400 F

---

Invitation cards will be sent on request  
French Trade Shows  
1350 Avenue of the Americas  
New York, N.Y. 10019  
(212) 582 4960  
Telex 237 757 FREN UR

Publi-Service Conseil

# Our attenuators can be

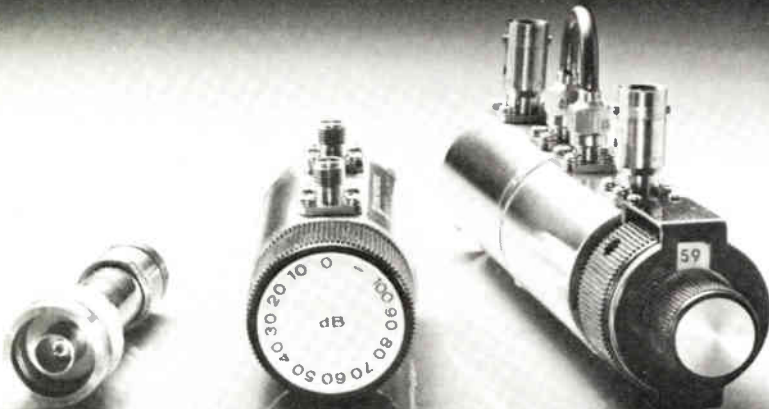

## Fixed Rotated Ganged

If your design calls for any type of attenuator in the DC to 4 GHz range, talk to Telonic first. We have 'em for handling .1 dB all the way to 140 dB. The solid-state, thick film resistors we use give longer service life, higher accuracies and power capabilities of 3 watts or better. Prices start at \$28.00, even lower in quantities. Our attenuator catalog is yours on request. Write or call.

**TelonicAltair**  2825 Laguna Canyon Rd. · Box 277  
Laguna Beach, California 92652  
Tel: 714 494-9401 · TWX: 910 596-1320 · Cable: TELENG

**Telonic—the name for attenuators**  
Circle 146 on reader service card

## Need a current catalog?

Use your EBG to order the catalogs you need. Last year, 80,000 requests for catalogs were generated through the use of EBG Catalog Inquiry Cards. Put EBG to work for you—and your company.



**Electronics  
Buyers'  
Guide**

THE **ACTION** BOOK



## PRODUCTS WANTED!

Well-established, leading high quality manufacturer of electro-mechanical and electronic devices seeks expansion of product base through acquisition of product lines and/or patent rights to marketable products compatible to its present operations. If you represent an organization with a product line to sell or hold patent rights to a product meeting our criteria, we welcome your confidential inquiry. Replies should include description of the product; its applications, competitive advantages and market potential; patent situation; and other relevant information. **ONLY PRINCIPALS NEED RESPOND.** Replies will be held in strict confidence and may be directed to: P-13, P. O. BOX 2066, Philadelphia, Pa. 19103.

## New products

characters each. A 1,000-character input buffer may be scrolled by the user. The terminal offers switch-selectable data rates of 10, 15, 20, or 120 characters per second and includes an RS-232 interface.

Termiflex Corp., 17 Airport Rd., Nashua, N. H. 03060. Phone (603) 889-3883 [366]

Bipolar microcomputer  
stores up to 4,000 words

The System 40 microcomputer is a bipolar system with a 300-nano-second instruction time, 224 input/output points, and up to 4,000 words of program storage. The system's large I/O capability makes it



suitable for process-control, traffic-control, and communications-switching applications. The one-board computer has 256 bytes of working memory and sells for \$461 in hundreds. The quoted price is exclusive of I/O and working-storage specifications.

Scientific Micro Systems, 520 Clyde Ave., Mountain View, Calif. 94043 [365]

Data-cartridge system  
is extremely compact

A data-cartridge system with an average capacity of 100,000 eight-bit bytes uses cartridges that measure only 2.5 by 3.25 inches, and a cartridge drive that is containable within a five-inch cube. Intended for use in point-of-sale terminals, electronic calculators, automatic typing systems, and similar applications, the DCD-1 data cartridge drive and DC100A data cartridge operate at a speed of 30 inches per second for an average transfer rate of 2,530 bytes

# Classified section

FOR EMPLOYMENT  
AND SALES OPPORTUNITIES

RATES \$46 per advertising inch (1/4") Commissionable.

SIZES 1/4" to 10" deep in widths of one column (1 1/4"), two (3 1/4"), three (5 1/4"), and four (7")

CLOSING Two weeks prior to mailing.

MAILING One week prior to issue date

ISSUE DATE Every other Thursday

AD ORDERS/BOX NUMBER ANSWERS

Send to Electronics, Post Office Box 900, New York, N.Y. 10020

## MICROWAVE ENGINEER

Experienced microwave engineer supervise creation of microwave irradiation facility and conduct biomedical research in cancer research laboratory. M.S. or Ph.D. plus at least 3 years relevant experience. Salary negotiable. Send resumé to:

Dr. J. E. Robinson  
Radiobiology Section  
Univ. of Md. School of Medicine  
660 W. Redwood St.  
Baltimore, Md. 21201

## OPPORTUNITIES IN THE PACIFIC NORTHWEST

Large multi-industry firm involved in diversified computer technology has positions available for qualified individuals. Positions available:

- Software Systems
- Circuit Design
- Electronics Manufacturing Testing and Quality Assurance

IF YOU HAVE EXPERIENCE IN ANY ONE OF THE ABOVE FIELDS, FORWARD YOUR RESUME AND SALARY REQUIREMENTS IMMEDIATELY. IN ADDITION TO BEING IDEALLY LOCATED, THIS COMPANY OFFERS EXCELLENT FRINGE BENEFITS. MAIL YOUR REPLY TO:

Personnel Department  
P.O. Drawer 2727  
Spokane, WA 99220

EEO

DON'T forget the Box Number when answering the replies.

CHECK for Accuracy.

### INCORRECT

Box Numbers may result in a delay in re-forwarding your reply.



per second. Life expectancy of the cartridges is more than 5,000 passes. The DCD-1 sells for \$475, and the cartridges are priced at \$16 each for a minimum of five. Evaluation quantities of the cartridge system will be available in April.

3M Co., Mincom Division, Building 223-5E,  
3M Center, St. Paul, Minn. 55101 [367]

## TOPICS

### Data handling

**Data Works Instrumentation, Chatsworth, Calif.**, has introduced its model 226 microprocessor card which contains an Intel 8080 microprocessor, DMA address and data-bus drivers, status latches, a crystal clock, and eight-bit vectored priority-interrupt hardware. . . . **Information Processing Techniques Corp., Palo Alto, Calif.**, is offering an enhanced cross assembler for Intel 8008 and 8080 microprocessors. The cross assembler includes a simulator for program debugging. . . . **NEC Microcomputers Inc., Lexington, Mass.**, has made four programs for the development of 8080A systems available on General Electric's worldwide Mark III time-sharing network. . . . **Control Logic Inc., Natick, Mass.**, has announced that delivery times for its M and L series of microcomputer modules have been reduced from 90 days to 30 days.

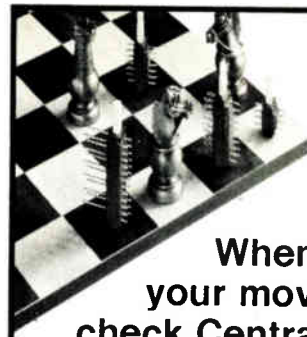

When it's  
your move  
check Centralab

High quality  
pushbutton  
switches at  
a low cost



Centralab switches are engineered for quality. Then they're produced on high-speed automated machines to keep your cost down. This means...

**Low Price:** A Centralab 2-pole lighted switch, for example, costs only \$1.36 including lamp, in 1,000 quantities.

**Quality:** Up to 250,000 MTBF in ganged assemblies. Over 500,000 operations on contact systems.

**Plus Options:** Diallyl phthalate housings • gold contacts • epoxy-sealed terminals • 2, 4, 6 and 8 poles • four types of lockouts • and much more for *only pennies more*.

**Newest Additions:** Non-lighted status indicator • low-cost lighted switch • 5 amp line switch.

When you can have quality *and* low price from Centralab, why settle for less? For full information, call your Centralab Pushbutton Distributor or send reader service card, or write...

Isostat Licensed



**CENTRALAB**

Electronics Division

GLOBE-UNION INC

P.O. BOX 858

FORT DODGE, IOWA 50501

# THE FEDERAL EXPRESS PARTSBANK. IT WILL CHANGE THE WAY YOU THINK ABOUT DISTRIBUTION FOREVER.

This little part can shut down an entire plant.

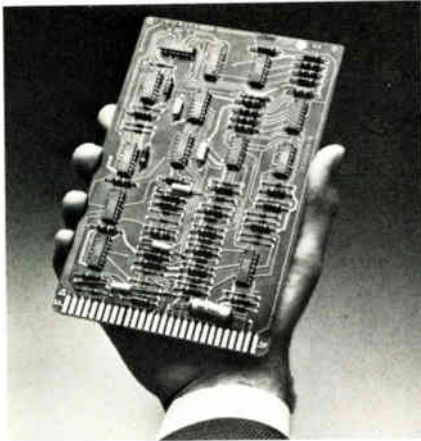

But so far, it's had to go through a complex series of separate operations and companies to get it where it's needed: regional warehouses, air freight forwarders, commercial airlines, and trucking firms. And nobody's been very happy with the results.

Now Federal Express has come up with a solution. And like all great ideas, this one is simple.

## A WAREHOUSE WITH ITS OWN AIRLINE.

*Air Freight Supplement* called it "the coup of the year in respect to air freight and physical distribution."

We call it The Federal Express PartsBank.

What it is, is a warehouse and an airline combined.

It's located in the "air center" of the United States, Memphis.

And once you put your parts in The Federal Express PartsBank, they're only 100 feet from the Federal Express jets.

And on the average they're only 6 hours from any place in the country.

## FEWER MOVING PARTS.

The advantages of The Federal

Express PartsBank seem to put every other system of distribution at a disadvantage.

First, you don't need as much inventory.

With one central warehouse that can serve the entire country in a matter of hours, you don't need a lot of regional warehouses full of expensive inventory.

And that money can be used to work for you in other areas.

Aside from money, we can save you a lot of aggravation.

A broken machine is an unhappy customer.

And there's no faster, more efficient way for machines scattered all across the country to get the parts they need than from The Federal Express PartsBank.

It also offers more control. Because it's easier to keep track of everything if it's all in one place.

We receive, store, take orders for, select, pack and fly your parts for you.

And we do it 24 hours a day, 7 days a week, to virtually every city in the country.

Say one of your customer's computers breaks down in Seattle at midnight. Just call us by 2:00 a.m. and the part

will be in Seattle hours later, where either you can pick it up or we'll deliver it to you with one of our trucks.

Only Federal Express can perform this feat because we're the only airline that flies mainly overnight.

And if a Federal plane isn't the next one leaving, we'll have it in the air on one of the hundreds of commercial airline flights that serve Memphis.

That's the theory. Now for the results.

## IT'S WORKING.

At this point, 25 companies are using The Federal Express PartsBank.



It's costing them the same or less than the way they were doing things before.

And instead of getting complaints for their service, they're starting to get some compliments.

We think The Federal Express PartsBank is the ultimate in fourth generation field support.

If you're interested, call Wylie Tate, Vice President, at 800-238-5345.

He'll arrange for you to talk to some of our customers to get their opinions.

Or he'll do a systems and cost analysis of the way you're distributing now versus the way we would do it.

And if you like, he can arrange for you to try us on a 4-week trial basis.

We know if we can change your thinking about distribution for 4 weeks, we can change it forever.

**FEDERAL EXPRESS**  
**PartsBank**



The Federal Express PartsBank.

An average of 6 hours from anywhere.



## New literature

A 24-page applications brochure published by Intel Corp., "Designing Nonvolatile Memory Systems with Intel's 501 RAM," covers use of the ultra-low-power 1,024-bit static random-access memory. Designated AP 12, the brochure describes the internal circuitry and operation of the 501, which is organized as 256 words by 4 bits, and outlines various circuit techniques. Copies may be obtained by writing to Joanne Rush, Intel Corp., 3065 Bowers Ave., Santa Clara, Calif. 95051 [421]

Small tools needed for the communications, telephone and other electronic industries are described and pictured in a catalog published by P. K. Neuses Inc. Items include cable and wire tools, spring-tension gages, thickness gages, and test connecting tools. The catalog is available from P. K. Neuses Inc., P.O. Box 100, Arlington Heights, Ill. 60006 [422]

A graphical method for obtaining the weight per unit area for foils and coatings and weight per unit length of wires is provided in a weight/thickness calculator from Cotronics Corp., 37 West 39th St., New York, N.Y. 10018. The calculator can be used for metals, ceramics, and composites, requiring only the knowledge of the material's density. A table of densities is included. [423]

How to specify uninterruptible power systems (UPS) is discussed in a 21-page brochure, called the IPM-875. It explains how 3-phase UPS machines work and which type is right for a specific application, no matter how large or small the load. Copies of the brochure may be obtained from International Power Machines Corp., 3328 Executive Blvd., P.O. Box 724, Mesquite, Texas 75249 [424]

A distributor catalog describes the full line of components made by Guardian Electric Manufacturing Co. Included in the 16-page catalog are dimensional drawings, specifications, ordering data and prices.

There are sections devoted to relays, stepping relays, solenoids, and solid-state controls. Copies of the catalog are available from Guardian Electric Manufacturing Co., 1550 West Carroll Ave., Chicago, Ill. 60607 [425]

How to use benchtop ultrasonic cleaning units in manufacturing plants, laboratories, and repair shops is the topic of a 20-page booklet. Included are discussions of two basic cleaning methods, selection of

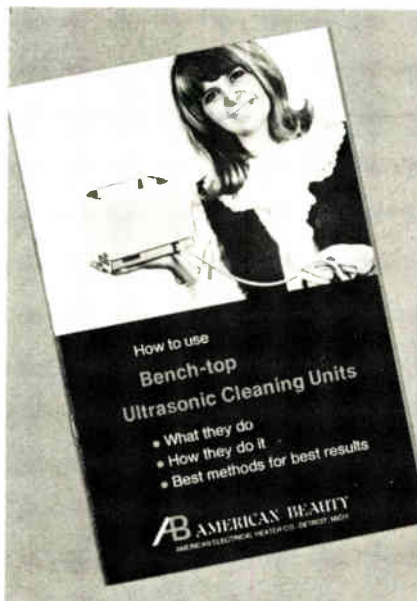

cleaning agents, and use of accessories. The illustrated booklet is published by the American Beauty Division of American Electrical Heater Co., 6110 Cass Ave., Detroit, Mich. 48202 [462]

Chip capacitors are described in a 24-page catalog from Johanson Dielectrics Inc. Seven basic product sections cover a variety of dielectric materials and special designs. Each section contains suggested application data for the dielectric material and other technical information, some of it in graphic form. Other parts of the catalog are devoted to chip-capacitor theory, feed-through capacitors, prototyping kits, modules, and temperature-compensating dielectrics. Write to Johanson Dielectrics Inc., Box 6465, Burbank, Calif. 91510 [427]



When it's  
your move  
check Centralab

## Visual display

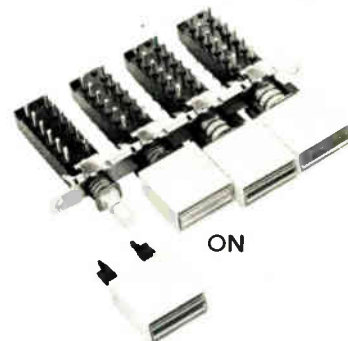

## in a non-lighted pushbutton switch

Now you can add visual display to Centralab non-lighted pushbutton switches. Our new status indicator button with a unique fluorescent reflective surface operates with ambient light to indicate switch status when activated. No power is required. There are no lamps to burn out.

Other features include:

- Choice of 6 display colors, 3 lens options and 5 button colors.
- Available with push-push or interlocking action.
- 140° peripheral viewing angle.
- Vertical or horizontal button mounting.

See your Centralab Pushbutton Distributor or send inquiry card for complete specifications.

Isostat Licensed



CENTRALAB



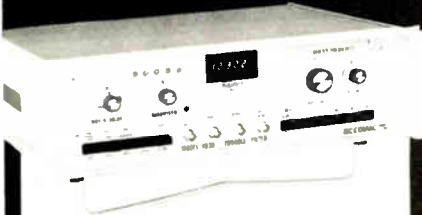

Electronics Division  
GLOBE-UNION INC.

P.O. BOX 858  
FORT OODGE, IOWA 50501

# The EDMAC Frequency Sleuth.



New Edmac Model 8030 Hi-Q Tunable Filter lets you search out those hard-to-identify frequencies. With it you can...

-  Eliminate unwanted background signals during signal analysis.
-  Analyze spectral components.
-  Measure harmonic distortions.
-  Secure adjustable, simultaneous band-pass and band-reject outputs.
-  Locate specific frequencies which indicate trouble areas during machine operation and testing.

Model 8030 tunes in selected frequency ranges from 1 to 30,000 Hz with corresponding independent bandwidth selections in a ratio of 100 to 1 for any given frequency, thus permitting maximum Q's of 100 to 1000. Sweeps through a preset frequency band in response to a remote voltage signal and can operate in a selectable mode to lock on and follow the strongest signal in a preset band. 130 microvolt RMS Filter background noise. Dynamic range to 95 db.

Find out more about the Model 8030 filter for your application. Write for descriptive literature.



**EDMAC  
Associates, Inc.**

333 West Commercial Street  
East Rochester, N.Y. 14445 (716) 385-1440

## Electronics advertisers

January 22, 1976

■ Abbott Transistor Labs Inc.	6	° Gardner Denver Company	117
Advanced Micro Devices	11	General Electric Semiconductor Products Department	15
° AEG Telefunken	158	General Electric Instrument Rental Division	143
° Alltech	9E	General Magnetics	154
■ Airpax Electronics Inc.	124	‡ General Radio	122
Allen Bradley Company	34	Glenayre Electronics	138
American Microsystems Inc.	54, 55	■ Gould Inc., Instrument Systems Division	74
AMF/Potter & Brumfield	31	Harris Corporation/PRD Electronics Division	69
■ AMP Incorporated	98	Hermes Electronics, Ltd.	77
■ Ballantine Laboratories	64	■ Hewlett-Packard	17-26
‡ Baron-Blakeslee	27	Hutson Industries	137
Bausch & Lomb Inc.	76	Intel Corporation	71
‡ Beckman Instruments Inc. Helipot Division	9	° International Devices, Inc.	115
Blomation	56, 57	International Electronics Research Corporation	172
B & K Precision Division Dynascan Corporation	132, 144	■ Ithaco, Inc.	130
Braemar Computer Devices	173	Keithley Instruments	118-119
■ Centralab Electronics Division of Globe Union Inc.	147, 149, 151	■ Kepco Inc.	5
■ Cherry Electrical Products Inc.	51	° Leybold Heraeus	48
‡ Chicago Dynamics Industries	117	LFE Corporation Process Control Division	82
Computer Automation	32, 33	McGraw-Hill Book Company	133
■ Conap Inc.	79	Motorola Government Electronics	111
■ Continental Specialties Corporation	132	■ National Semiconductor Corporation	73
Data General Corporation	45	‡ Nec Microcomputer Inc.	48, 49
Davis Adv.	146	° Phillips Industries	2E-3E
Delta Air Lines	176	° Phillips N.V. Pit/T&M Division	10E-11E
■ Deltec	144	‡ Phillips Test & Measuring Instruments Inc.	115
■ Dialight Corporation	153	Photo Research	128
‡ Digital Equipment Corporation (OEM)	62	° Plessey Semiconductors	27
Eastman Kodak Company GMD CI Photofabrication- Microelectronics	126	Projects Unlimited Inc.	125
EDMAC Associates	150	Raytheon Semiconductor	8
E-H Research Labs. Inc.	81	■ RCL Electronics Inc.	14
■ E&L Instruments Inc.	43	Riken Denshi Co. Ltd.	49
‡ E. L. Power	37	Robinson Nugent Inc.	28, 29
‡ Federal Express Inc.	148	Rockwell International Electronics Group	106
Figaro Engineering Inc.	171		
■ Fluke Manufacturing Co., John	7, 38		

# When you want a small package delivered fast, it's in the bag.



Delta's DASH guarantees delivery on the flight or routing you specify between most Delta cities. Packages accepted up to 50 lbs. with length plus width plus height not to exceed 90"

Bring your package to Delta's passenger counter or air freight terminal at the airport at least 30 minutes before scheduled departure time. Package can be picked up at DASH Claim Area next to airport baggage claim area 30 minutes after flight arrival at destination.

Charges for DASH shipments are nominal. Delta reservations will be pleased to quote actual charges between specific points. Payments accepted in cash, by company check, most general-purpose credit cards, special credit arrangements or on government shipments by GBL. **DELTA**  
The World's Premier Service

Rate examples	(Tax included)
Atlanta-Washington	\$21.00
Boston-Miami	\$26.25
Los Angeles-New Orleans	\$31.50
Dallas/Ft Worth-Los Angeles	\$26.25
San Francisco-Atlanta	\$31.50
Philadelphia-Houston	\$26.25
New York-Tampa	\$26.25
Chicago-Orlando	\$26.25
Detroit-Memphis	\$21.00

For full details, call Delta reservations.

## Delta is ready when you are.

° Rohde & Schwarz	1E
° Schlumberger SOMV	12E
Scientific Atlanta Optima Division	30
SDSA	145
° S. E. Labs (EMI) Ltd.	9
° Siemen A.G. Munich	62
Silicon Systems	139
Solltron Devices Inc. Transistor Division	131
■ Sorensen	52, 53
Spectral Dynamics Corp.	72
■ Superior Electric Company	120
■ Systron Donner Concord Instrument	61
° TEAC Corp.	123
■ Tektronix Inc.	12, 13, 140, 141
Teledyne Crystalonics	67
Telonic Altair	146
Thomson CSF	135
Torin	47
■ U.S. Capacitor Corporation	58
‡ U. S. Instrument Rentals Inc.	155
° Wavetek San Diego	1
Wima Westermann	16
Yokogawa Corporation of America	143

### Classified & Employment Advertising

F. J. Eberle, Manager 212 997-2557  
**Employment/selling opportunities**  
 University of Maryland .....147

- For more information on complete product line see advertisement in the latest Electronics Buyers' Guide
- ° Advertisers in Electronics International
- ‡ Advertisers in Electronics domestic edition



When it's your move check Centralab



## 5 amp pushbutton switch

You'll meet even the most stringent requirements with this new line switch. It's UL listed for TV-5 rating (120V, 5A, 78A peak in-rush current).

Other features include:

- Furnished as a single station or for left or right mounting on any Centralab pushbutton switch assembly.
- Three circuit options — SPDT, SPST, normally open and SPST, normally closed.
- Button options include lighted, non-lighted or status indicator button (shown above).

See your Centralab Pushbutton Distributor or send inquiry card for complete specifications.

Isostat Licensed



**CENTRALAB**

Electronics Division  
 GLOBE-UNION INC  
 P.O. BOX 858  
 FORT OODGE, IOWA 50501

# FEATURE ARTICLES FROM *ELECTRONICS* AVAILABLE IN REPRINT FORM

No. of  
copies  
wanted

## New reprints

- \_\_\_ R-600 World market report 1976  
24 pp \$5.00
- \_\_\_ R-526 How reliable are today's com-  
ponents 16 pp \$3.00
- \_\_\_ R-524 Special report on bipolar  
large-scale integration 12 pp  
\$3.00
- \_\_\_ R-522 Special report on power semi-  
conductors 12 pp \$3.00
- \_\_\_ R-514 Eight ways to better radio re-  
ceiver design 6 pp \$3.00
- \_\_\_ R-512 Design of circuits for dan-  
gerous environments 4 pp  
\$3.00
- \_\_\_ R-510 Bipolar integration advances  
with  $\mu$ L microprocessor 8 pp  
\$2.00
- \_\_\_ R-508 Designing microprocessors  
with standard-logic devices  
12 pp \$3.00
- \_\_\_ R-506 The case for component  
burn-in 7 pp \$2.00

## Charts

- \_\_\_ R-516 Electronic symbols (chart)  
\$2.00
- \_\_\_ R-211 Electromagnetic spectrum  
(16-page report and chart)  
\$4.00
- \_\_\_ R-213 Electromagnetic spectrum  
(chart) \$2.00
- \_\_\_ R-326 Optical spectrum (6-page re-  
port and chart) \$3.00
- \_\_\_ R-327 Optical spectrum (chart)  
\$2.00

## Books

- \_\_\_ R-520 Microprocessors—Electronics  
Book Series \$8.95
- \_\_\_ R-11 Computer-aided Design 135  
pp \$4.00
- \_\_\_ R-032 Active Filters 88 pp \$4.00
- \_\_\_ R-031 Circuit Designer's Casebook  
182 pp (U.S. only) \$5.50  
(foreign) \$12.00

## Other Reprints

- \_\_\_ R-518 Special issue—productivity  
\$4.00
- \_\_\_ R-434 Designing automated systems  
with the new standard inter-  
face 12 pp \$3.00
- \_\_\_ R-432 An update on communi-  
cations satellites 8 pp \$2.00
- \_\_\_ R-430 Choosing the right bipolar  
transistor model for com-  
puter-aided design 20 pp  
\$3.00
- \_\_\_ R-428 Designing with low-cost la-  
sers 6 pp \$2.00
- \_\_\_ R-504 U.S. forecast 1975 20 pp  
\$3.00
- \_\_\_ R-502 European forecast 1975  
20 pp \$3.00
- \_\_\_ R-500 Japanese forecast 1975  
16 pp \$3.00
- \_\_\_ All three forecasts \$7.50
- \_\_\_ R-426 Special issue—technology up-  
date 1974 \$4.00
- \_\_\_ R-424 Microprocessor applications  
28 pp \$3.00
- \_\_\_ R-422 A microprogrammable mini-  
computer 8 pp \$2.00
- \_\_\_ R-420 Computerized text-editing  
and typesetting 8 pp \$2.00
- \_\_\_ R-418 Computer analyses of rf cir-  
cuits 8 pp \$2.00
- \_\_\_ R-416 Optical waveguides look  
brighter 8 pp \$2.00
- \_\_\_ R-414 The ion-implanted n-channel  
process 6 pp \$2.00
- \_\_\_ R-412 Liquid cooling of power semi-  
conductors 6 pp \$2.00
- \_\_\_ R-410 Special report on passive  
components 16 pp \$3.00
- \_\_\_ R-408 Bringing sight to the blind  
8 pp \$2.00
- \_\_\_ R-406 Designing with the new logic,  
C-MOS and bipolar 16 pp  
\$3.00
- \_\_\_ R-328 Special issue—pervasiveness  
of electronics \$2.00
- \_\_\_ R-324 Semiconductor memories are  
taking over data-storage ap-  
plications 16 pp \$3.00
- \_\_\_ R-322 Special report: new displays  
complement old 10 pp \$2.00
- \_\_\_ R-320 Special report on designing  
with flat cable 14 pp \$3.00
- \_\_\_ R-318 Special report on auto elec-  
tronics 16 pp \$3.00
- \_\_\_ R-316 Hybrid circuits solve tough  
design problems 16 pp \$3.00
- \_\_\_ R-312 Leadless, pluggable IC pack-  
ages reduce costs 7 pp \$2.00
- \_\_\_ R-310 Penetration color tubes are  
enhancing information dis-  
plays 6 pp \$2.00
- \_\_\_ R-308 Program for transition from  
nonlinear to linear transistor  
model 6 pp \$2.00
- \_\_\_ R-306 Charge-coupling improves its  
image, challenging video  
camera tubes 8 pp \$2.00
- \_\_\_ R-209 Semiconductor RAMs land  
computer mainframe jobs  
15 pp \$2.00
- \_\_\_ R-207 Technology gap starts to  
close for computer peripher-  
als 16 pp \$3.00
- \_\_\_ R-205 Bridging the analog and dig-  
ital worlds with linear ICs  
16 pp \$3.00
- \_\_\_ R-203 East Europe market report  
16 pp \$2.00
- \_\_\_ R-113 Optoelectronics makes it at  
last 34 pp \$4.00
- \_\_\_ R-107 Wanted for the '70s: easier-  
to-program computers 24 pp  
\$4.00
- \_\_\_ R-104 The new concept for memory  
and imaging: charge-coupling  
12 pp \$2.00
- \_\_\_ R-023 Special report on tomorrow's  
communications 32 pp \$3.50
- \_\_\_ R-15 Special report on LSI pack-  
aging 18 pp \$3.00

## Payment must accompany your order

Make check or money order pay-  
able to Electronics Reprints. All  
orders are shipped prepaid by  
parcel post. Allow two to three  
weeks for delivery.

Back issues now available:  
1960 to 1969, \$5.00 each  
1970 to 1973, \$3.00 each  
1974 to 1975, \$4.00 each

## USE THIS PAGE AS YOUR ORDER FORM

Cost of orders \$ \_\_\_\_\_  
Plus 10% handling charge \$ \_\_\_\_\_  
TOTAL AMOUNT ENCLOSED \$ \_\_\_\_\_

Mail your order to:  
Janice Austin  
ELECTRONICS REPRINTS  
P.O. Box 669  
Hightstown, N.J. 08520

## SEND REPRINTS TO

Name \_\_\_\_\_

Company \_\_\_\_\_ Dept. \_\_\_\_\_

Street \_\_\_\_\_

City \_\_\_\_\_ State \_\_\_\_\_ Zip \_\_\_\_\_

## Advertising Sales Staff

**Pierre J. Braudé** New York [212] 997-3468  
Paris Tel: 720-73-01  
Director of Marketing

**Atlanta, Ga. 30309:**  
100 Colony Square, 1175 Peachtree St., N E  
[404] 892-2868

**Boston, Mass. 02116:** James R. Pierce  
607 Boylston St. [617] 262-1160

**Chicago, Ill. 60611:**  
645 North Michigan Avenue  
Robert W. Bartlett (312) 751-3739  
Paul L. Reiss (312) 751-3738

**Cleveland, Ohio 44113:** William J. Boyle  
[716] 586-5040

**Dallas, Texas 75201:**  
2001 Bryant Tower, Suite 1070  
[214] 742-1747

**Denver, Colo. 80203:** Harry B. Doyle, Jr.  
123 Speer Blvd. # 400  
[303] 837-1010

**Detroit, Michigan 48202:** Robert W. Bartlett  
1400 Fisher Bldg  
[313] 873-7410

**Houston, Texas 77002:**  
2270 Humble Bldg. [713] CA 4-8381

**Los Angeles, Calif. 90010:** Robert J. Rielly  
Bradley K. Jones, 3200 Wilshire Blvd., South Tower  
[213] 487-1160

**New York, N.Y. 10020**  
1221 Avenue of the Americas  
Warren H. Gardner [212] 997-3617  
Michael J. Stoller [212] 997-3616

**Philadelphia, Pa. 19102:** Warren H. Gardner  
Three Parkway,  
[212] 997-3617

**Pittsburgh, Pa. 15222:** Warren H. Gardner  
4 Gateway Center, [212] 997-3617

**Rochester, N.Y. 14534:** William J. Boyle  
9 Greylock Ridge, Pittsford, N.Y.  
[716] 586-5040

**San Francisco, Calif. 94111:** Don Farris  
Robert J. Rielly, 425 Battery Street,  
[415] 362-4600

**Paris:** Alain Offergeld  
17 Rue-Georges Bizet, 75 Paris 16, France  
Tel: 720-73-01

**Geneva:** Alain Offergeld  
1 rue du Temple, Geneva, Switzerland  
Tel 32-35-63

**United Kingdom & Scandinavia:** Keith Mantle  
Tel: 01-493-1451, 34 Dover Street, London W1

**Milan:** Luigi Rancati  
1 via Baracchini, Italy Phone 87-90-656

**Brussels:** Alain Offergeld  
23 Chaussee de Wavre  
Brussels 1040, Belgium  
Tel 13-73-95

**Frankfurt/Main:** Fritz Krusebecker  
Liebigstrasse 27c, Germany  
Phone 72 01 81

**Tokyo:** Tatsumi Katagin, McGraw-Hill  
Publications Overseas Corporation,  
Kasumigaseki Building 2-5, 3-chome,  
Kasumigaseki, Chiyoda-Ku, Tokyo, Japan  
[581] 9811

**Australasia:** Warren E. Ball, IPO Box 5106,  
Tokyo, Japan

## Business Department

**Thomas M. Egan,**  
Production Manager [212] 997-3140

**Carol Gallagher**  
Production Manager International [212]  
997-2045

**Dorothy Carter,** Production Manager Do-  
mestic  
[212] 997-2908

**Frances Vallone,** Reader Service Manager  
[212] 997-6057

## Electronics Buyers' Guide

**George F. Werner,** Associate Publisher  
[212] 997-3139

**Regina Herz,** Directory Manager  
[212] 997-2544

# Dialight sees a need:

(Need: The widest choice for your every application.)

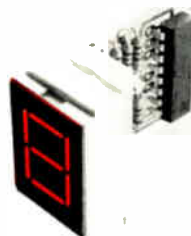

**730 SERIES** Your choice . . . a red or green LED readout with large 0.625" characters . . . low power, operates with standard IC power supply levels. Comes in plus-minus module. Display uses standard or high brightness LEDs for maximum light output arranged in a seven-segment format. Available with or without on-board decoder/driver. Unique lens design generates bright, highly legible characters.

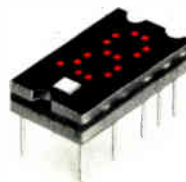

**745-0007** LED hexidecimal display with on-board logic operates from 5 to 6 volt supply, low power consumption. Integral TTL MSI chip provides latch, decoder and drive functions. 0.270" character display has wide angle visibility and mounts into standard 14-pin DIP socket.



Dialight, the company with the widest choice in switches, LEDs, indicator lights and readouts, looks for needs . . . your needs . . . and then they develop solutions for your every application. No other company offers you one-stop shopping in all these product areas. And no other company has more experience in the visual display field. Dialight helps you do more with these products than any other company in the business, because we are specialists that have done more with them. Talk to the specialists at Dialight first. You won't have to talk to anyone else. Send for your free new copy of Dialight's current catalog.

## DIALIGHT

Dialight, A North American Philips Company  
203 Harrison Place, Brooklyn, N. Y. 11237  
(212) 497-7600

# See Dialight.

# Solid State Sine-Cosine Synchro Converter

This new encapsulated circuit converts a 3-wire synchro input to a pair of d-c outputs proportional to the sine and cosine of the synchro angle.

- Complete solid state construction.
- Operates over a wide temperature range.

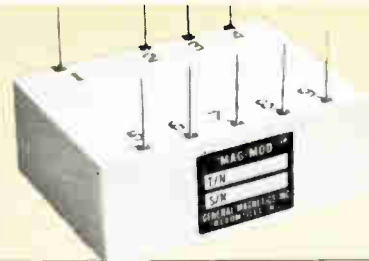

UNIT	DMD 1436-1	DMD 1430-1	DMD 1403-2	DMD 1361-6	DMD 1361-4	DMD 1193-4	DMD 1361-8	DMD 1446-1	DMD 1193-5	DMD 1193-6	DMD 1361-10	DMD 1472-2
L-L SYNCHRO INPUT (VRMS)	11.8	90	95	90	11.8	11.8	11.8	11.8	11.8	11.8	11.8	90
FREQUENCY (Hz)	400	400	60	400	400	400	400	400	400	400	400	60
FULL SCALE OUTPUT (VOC)	± 10	± 10	± 3	± 3	± 3	± 10	± 10	± 10	± 10	± 10	± 10	± 10
OUTPUT IMPEDANCE	<1Ω	<1Ω	<1Ω	<1Ω	<1Ω	<1Ω	<1Ω	<10Ω	<1Ω	<1Ω	<1Ω	<1Ω
L-L INPUT IMPEDANCE	>10K	>30K	>5K	>30K	>5K	75K	>5K	>5K	>5K	>5K	>5K	>5K
REFERENCE VOLTAGE (VRMS)	26	115	115	115	26	115	26	115	115	115	26	115
ACCURACY SIN/COS (+25°C)	± 6MIN	± 6MIN	± 6MIN	± 6MIN	± 6MIN	± 6MIN	± 6MIN	± 0.5%	± 6MIN	± 6MIN	± 6MIN	± 6MIN
FULL TEMPERATURE SIN RANGE ACCURACY COS	± 15MIN	± 15MIN	± 15MIN	± 15MIN	± 15MIN	± 15MIN	± 15MIN	± 0.5%	± 15MIN	± 15MIN	± 15MIN	± 15MIN
O.C. SUPPLY (VOC)	± 15	± 15	± 15	± 15	± 15	± 15	± 15	± 15	± 15	± 15	± 15	± 15
O.C. SUPPLY CURRENT	<30MA	<30MA	<30MA	<30MA	<30MA	<30MA	<30MA	<30MA	<30MA	<30MA	<30MA	<30MA
BANDWIDTH	>10Hz	>10Hz	external set	>20Hz	>5Hz	>10Hz	>10Hz	>10Hz	>2Hz	>40Hz	>5Hz	external set
SIZE	1.1x3.0 x1.1	2.0x2.25 x1.4 dual channel unit	1.1x3.0 x1.1	1.5x1.5 x0.6	1.85x0.85 x0.5	2.01x2.25 x1.4 dual channel unit	0.85x1.85 x0.5	2x2.25 x1.4 dual sine output unit	2x2.25 x1.4 dual channel unit	2x2.25 x1.4 dual channel unit	2.15x1.25 x0.5	1.1x3.0 x1.1
NOTES	-	-	-	-	-	-	-	-	-	-	-	-
TEMPERATURE RANGE	-40°C to +100°C	-40°C to +100°C	-40°C to +100°C	-40°C to +100°C	-40°C to +100°C	-40°C to +100°C	-40°C to +100°C	-40°C to +100°C	-40°C to +100°C	-40°C to +100°C	-40°C to +100°C	-40°C to +100°C

## High Precision Analog Multipliers

PRODUCT ACCURACY (MCM 1519-1) ± ½% OF ALL THEORETICAL OUTPUT VALUES OVER FULL MILITARY TEMPERATURE RANGE OF -55°C TO +125°C. ZERO POINT ERROR FOR ANY INPUT COMBINATION IS ± 2MVRMS



### Features:

- No external trims required
- Distortion free AC output over entire dynamic range
- Linearity, product accuracy and zero point virtually unaffected by temperature

- All units are hermetically sealed and are not affected by external fields
- High analog product accuracy and wave quality allows dual multiplier assemblies to be matched with 1% of point over the specified temperature range
- Full four quadrant operation
- Package size, power supply requirements and other specs. may be altered to your exact requirements at no extra cost.

### Specifications:

- Transfer equation:  $E_o = XY/10$
- X & Y input signal ranges: 0 to ±10V PK
- Maximum zero point error (X=0; Y=0 or X=±10; Y=0 or X=0; Y=±10): 2MVRMS
- Input impedance: Both inputs 20K min.
- Full scale output: ±10V peak
- Minimum load resistance for full scale output: 2KΩ
- Output impedance: 1Ω
- Short circuit duration: 5 sec.
- Frequency response characteristics (both inputs) 1% amplitude error: DC to 1200 Hz (min.) 0.5 DB Amplitude error: DC to 3500 Hz min. 3 DB point: Approx. 10K hz Roll off rate: 18 DB/octave
- Noise Level: 5MV PK-PK @ 100K Hz approx.
- Operating temp. range: See chart
- Storage temperature range: -55°C to +125°C
- DC Power: ±15V ±1% @ 30MA
- Dimensions: 2" x 1.5" x .6"

Type No.	Product Accuracy	Operating Temperature Range
MCM 1519-1	± 0.5%	-55°C - +125°C
MCM 1519-2	± 0.5%	-25°C - +85°C
MCM 1519-3	± 0.5%	0°C - +70°C
MCM 1520-1	± 1.0%	-55°C - +125°C
MCM 1520-2	± 1.0%	-25°C - +85°C
MCM 1520-3	± 1.0%	0°C - +70°C

## Precision AC Line Regulator

Total Regulation 0.15% Max.



### Features:

- Low distortion sinusoidal output
- Regulation control better than ten times superior to commercial AC voltage regulators transformer product lines
- No active filters or tuned resonant circuits employed resulting in immunity to line frequency changes
- 6.5 watt output level
- Small size

- Output set to ±1% accuracy — this includes initial set point plus line, load, frequency and temperature changes
  - Foldback short circuit protection provided resulting in protection against overloads and short circuits of any duration
  - Low profile package with straight pins makes the unit suitable for PC board mounting (unit is hermetically sealed)
  - Transformer isolation between all power inputs and the outputs.
- \*Other units available at different power levels. Information will be supplied upon request.

### Specifications Model MLR 1476-2:

- AC input line voltage: 115V RMS ±20% @ 400 Hz ±20%
- Output: 26V RMS ±1% (for any condition)
- Load: 0 to 250 MA, RMS
- Total regulation: ±0.15% maximum (any combination of line, load or frequency)
- Distortion: 2% maximum
- AC input line current: 100 MA. max. at full load
- DC power: ±15 V DC ±5% @ 15 MA. max.
- Phase angle: 1° max.
- Temp. Range: -40°C to +85°C
- Case Material: High permeability nickel alloy
- Terminals: Glass to metal hermetic seal pins

**GENERAL MAGNETICS • INC**

135 Bloomfield Ave., Bloomfield, New Jersey 07003 - Tel. (201) 743-2700

Circle 154 on reader service card

# Electronics

## Reader Service

For additional information on products advertised, new products or new literature, use these business reply cards.

Complete entire card. Please print or type.

Circle the number on the Reader Service postcard that corresponds to the number at the bottom of the advertisement, new product item, or new literature in which you are interested.

To aid the manufacturer in filling your request, please answer the three questions.

All inquiries from outside the U.S. that cannot reach Electronics before the expiration date noted on the Reader Service postcard must be mailed directly to the manufacturer. The manufacturer assumes all responsibilities for responding to inquiries.

### Subscriptions & Renewals

Fill in the subscription card adjoining this card. Electronics will bill you at the address indicated on the card.

**Electronics** January 22, 1976 This Reader Service card expires March 22, 1976.

NAME \_\_\_\_\_ TITLE \_\_\_\_\_

PHONE (\_\_\_\_\_) \_\_\_\_\_ COMPANY \_\_\_\_\_

STREET ADDRESS \_\_\_\_\_

CITY \_\_\_\_\_ STATE \_\_\_\_\_ ZIP \_\_\_\_\_

#### Industry classification (check one):

- |  |  |   |
|--|--|---|
| <input type="checkbox"/> a Computer & Related Equipment            | <input type="checkbox"/> e Test & Measuring Equipment      | <input type="checkbox"/> j Independent R&D Organization |
| <input type="checkbox"/> b Communications Equipment & Systems      | <input type="checkbox"/> f Consumer Products               | <input type="checkbox"/> k Government                   |
| <input type="checkbox"/> c Navigation, Guidance or Control Systems | <input type="checkbox"/> g Industrial Controls & Equipment |   |
| <input type="checkbox"/> d Aerospace, Underseas Ground Support     | <input type="checkbox"/> h Components & Subassemblies      |   |

#### Your design function (check each letter that applies):

- x I do electronic design or development engineering work.  
 y I supervise electronic design or development engineering work.  
 z I set standards for, or evaluate electronic components, systems and materials.

Estimate number of employees (at this location): 1.  under 20 2.  20-99 3.  100-999 4.  over 1000

1 16 31 46	61 76 91 106	121 136 151 166	181 196 211 226	241 256 271 348	363 378 393 408	423 438 453 468	483 498 703 718
2 17 32 47	62 77 92 107	122 137 152 167	182 197 212 227	242 257 272 349	364 379 394 409	424 439 454 469	484 499 704 719
3 18 33 48	63 78 93 108	123 138 153 168	183 198 213 228	243 258 273 350	365 380 395 410	425 440 455 470	485 500 705 720
4 19 34 49	64 79 94 109	124 139 154 169	184 199 214 229	244 259 274 351	366 381 396 411	426 441 456 471	486 501 706 900
5 20 35 50	65 80 95 110	125 140 155 170	185 200 215 230	245 260 275 352	367 382 397 412	427 442 457 472	487 502 707 901
6 21 36 51	66 81 96 111	126 141 156 171	186 201 216 231	246 261 338 353	368 383 398 413	428 443 458 473	488 503 708 902
7 22 37 52	67 82 97 112	127 142 157 172	187 202 217 232	247 262 339 354	369 384 399 414	429 444 459 474	489 504 709 951
8 23 38 53	68 83 98 113	128 143 158 173	188 203 218 233	248 263 340 355	370 385 400 415	430 445 460 475	490 505 710 952
9 24 39 54	69 84 99 114	129 144 159 174	189 204 219 234	249 264 341 356	371 386 401 416	431 446 461 476	491 506 711 953
10 25 40 55	70 85 100 115	130 145 160 175	190 205 220 235	250 265 342 357	372 387 402 417	432 447 462 477	492 507 712 954
11 26 41 56	71 86 101 116	131 146 161 176	191 206 221 236	251 266 343 358	373 388 403 418	433 448 463 478	493 508 713 956
12 27 42 57	72 87 102 117	132 147 162 177	192 207 222 237	252 267 344 359	374 389 404 419	434 449 464 479	494 509 714 957
13 28 43 58	73 88 103 118	133 148 163 178	193 208 223 238	253 268 345 360	375 390 405 420	435 450 465 480	495 510 715 958
14 29 44 59	74 89 104 119	134 149 164 179	194 209 224 239	254 269 346 361	376 391 406 421	436 451 466 481	496 701 716 959
15 30 45 60	75 90 105 120	135 150 165 180	195 210 225 240	255 270 347 362	377 392 407 422	437 452 467 482	497 702 717 960

**Electronics** January 22, 1976 This Reader Service card expires March 22, 1976.

NAME \_\_\_\_\_ TITLE \_\_\_\_\_

PHONE (\_\_\_\_\_) \_\_\_\_\_ COMPANY \_\_\_\_\_

STREET ADDRESS \_\_\_\_\_

CITY \_\_\_\_\_ STATE \_\_\_\_\_ ZIP \_\_\_\_\_

#### Industry classification (check one):

- |  |  |  |
|--|--|--|
| <input type="checkbox"/> a Computer & Related Equipment            | <input type="checkbox"/> e Test & Measuring Equipment      | <input type="checkbox"/> j Independent R&D Organizations |
| <input type="checkbox"/> b Communications Equipment & Systems      | <input type="checkbox"/> f Consumer Products               | <input type="checkbox"/> k Government                    |
| <input type="checkbox"/> c Navigation, Guidance or Control Systems | <input type="checkbox"/> g Industrial Controls & Equipment |  |
| <input type="checkbox"/> d Aerospace, Underseas Ground Support     | <input type="checkbox"/> h Components & Subassemblies      |  |

#### Your design function (check each letter that applies):

- x I do electronic design or development engineering work.  
 y I supervise electronic design or development engineering work.  
 z I set standards for, or evaluate electronic components, systems and materials.

Estimate number of employees (at this location): 1.  under 20 2.  20-99 3.  100-999 4.  over 1000

1 16 31 46	61 76 91 106	121 136 151 166	181 196 211 226	241 256 271 348	363 378 393 408	423 438 453 468	483 498 703 718
2 17 32 47	62 77 92 107	122 137 152 167	182 197 212 227	242 257 272 349	364 379 394 409	424 439 454 469	484 499 704 719
3 18 33 48	63 78 93 108	123 138 153 168	183 198 213 228	243 258 273 350	365 380 395 410	425 440 455 470	485 500 705 720
4 19 34 49	64 79 94 109	124 139 154 169	184 199 214 229	244 259 274 351	366 381 396 411	426 441 456 471	486 501 706 900
5 20 35 50	65 80 95 110	125 140 155 170	185 200 215 230	245 260 275 352	367 382 397 412	427 442 457 472	487 502 707 901
6 21 36 51	66 81 96 111	126 141 156 171	186 201 216 231	246 261 338 353	368 383 398 413	428 443 458 473	488 503 708 902
7 22 37 52	67 82 97 112	127 142 157 172	187 202 217 232	247 262 339 354	369 384 399 414	429 444 459 474	489 504 709 951
8 23 38 53	68 83 98 113	128 143 158 173	188 203 218 233	248 263 340 355	370 385 400 415	430 445 460 475	490 505 710 952
9 24 39 54	69 84 99 114	129 144 159 174	189 204 219 234	249 264 341 356	371 386 401 416	431 446 461 476	491 506 711 953
10 25 40 55	70 85 100 115	130 145 160 175	190 205 220 235	250 265 342 357	372 387 402 417	432 447 462 477	492 507 712 954
11 26 41 56	71 86 101 116	131 146 161 176	191 206 221 236	251 266 343 358	373 388 403 418	433 448 463 478	493 508 713 956
12 27 42 57	72 87 102 117	132 147 162 177	192 207 222 237	252 267 344 359	374 389 404 419	434 449 464 479	494 509 714 957
13 28 43 58	73 88 103 118	133 148 163 178	193 208 223 238	253 268 345 360	375 390 405 420	435 450 465 480	495 510 715 958
14 29 44 59	74 89 104 119	134 149 164 179	194 209 224 239	254 269 346 361	376 391 406 421	436 451 466 481	496 701 716 959
15 30 45 60	75 90 105 120	135 150 165 180	195 210 225 240	255 270 347 362	377 392 407 422	437 452 467 482	497 702 717 960

# Electronics Reader Service

If the cards below have already been used,  
you may obtain the needed information  
by writing directly to the manufacturer,  
or by sending your name and address,  
plus the Reader Service number and issue date,  
to Electronics Reader Service Department,  
P.O. Box No. 2530, Clinton, Iowa 52732.

Affix  
Postage  
Here

## Electronics

P.O. Box No. 2530  
Clinton, Iowa 52732

Affix  
Postage  
Here

## Electronics

P.O. Box No. 2530  
Clinton, Iowa 52732



# What Every Designer or Specifier Should Know About RESISTOR NETWORKS!

A wise man once said, "A chain is only as strong as its weakest link".

That phrase says as much for electronic circuitry today . . . as it originally did for the value of the individual quality of a man. For example, the failure of a single tiny printed conductor path in a resistor network can cause the failure of an entire circuit . . . or system.

Bourns doesn't want that to happen to one of your circuits. For that reason, we want to share some "inside" information about the design and manufacture of thick-film networks . . . so that you can be a more knowledgeable and more selective specifier.

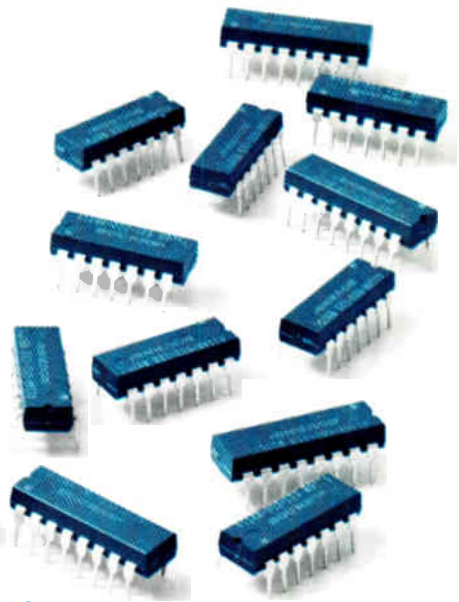

## 1. Lead Termination Failure

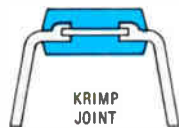

During Bourns initial design program, customer interviews indicated that commonly used "lap joint" and "butt joint" lead termination designs were subject to failure due to weakening of the solder termination during PC board wave soldering operations, and in-circuit heat cycling and vibration. These design-types depend heavily on solder alone for both mechanical and electrical bonding of leads to the substrate.

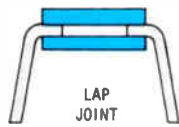

With this in mind, Bourns engineers developed the "Krimp-Joint™" lead frame termination design to protect customers from this hazard.

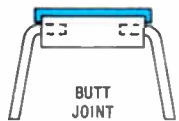

Bourns Krimp-Joint leads are firmly crimped onto the network element, much like a vise grasps a piece of lumber. To "cinch" the electrical connection, a special high temperature, reflow resistant solder is also used.

## 3. The Packaging

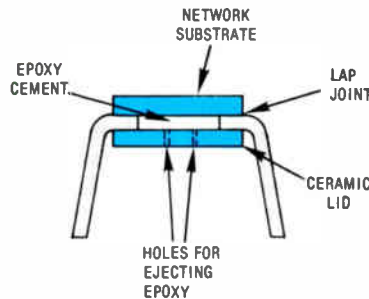

Various types of DIP packaging are utilized of which the molded and "sandwich" types seem most common. One problem that frequently occurs with the sandwich types is delaminating. This happens when air in tiny voids remaining in the epoxy filler (bonds the substrate to the sandwich "lid") expands in hot operating environments to the extent that the package comes apart and fails.

Bourns Krimp-Joint networks are encased in a homogenous molded thermoset plastic package, which is highly heat resistant. Both 14- and 16-pin DIP models are machine insertable, and are available in handy cartridge packages.

## 4. Power

Bourns uses a high-copper alloy lead material to enhance power dissipation capacity. Other materials — ferrous and brass alloys — do not have comparable performance. Furthermore, there is potential for rust with the ferrous alloy material. The high-copper alloy costs us more . . . but we think your satisfaction is worth it.

## 5. A Good Coat Is Important

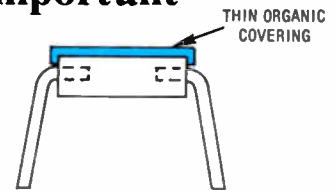

Our little network package must "weather" the homo sapien as well as the electrical environment. Example? Some users report that marking the top of thinly coated networks actually changed internal resistor values. With the tight board spacing found in most equipment cabinets, components occasionally get scraped when boards are inserted and/or removed. Customers report that some thinly protected networks have shorted-out or opened under these conditions. Bourns networks wear a heavy coat of molded plastic to weather the homo sapien climate.

## 2. Krimp-Joint Eliminates "Edge-Arounds"

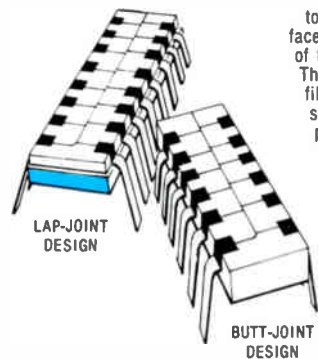

EDGE-AROUND CONDUCTOR PATHS

"Edge-around" thick-film printing techniques are required by some designs to electrically connect the network circuit — printed on the horizontal surface of the substrate — to pin leads which are always "buted" to the edge of the substrate, or are "lap-jointed" to the opposite side of the substrate. The latter condition exists with lap-joint designs when more complex thick film circuits are executed which require printing on both sides of the substrate (such as resistor/capacitor networks, dual terminators, special application circuits, etc.). Edge-around printing leaves a natural conductor path weakness on the fine edges of the substrate, resulting in the possibility of a very "tenuous" connection. Such connections are subject to failure after exposure to heat cycling, shock, vibration, etc., and can result in an open circuit condition. Sometimes an intermittent condition results, which makes fault diagnosis more difficult.

Since most packages are not tested at full rated power during manufacturing QC, weak edge-arounds sometimes pass final tests . . . and then burn-out (like a fuse), when subjected to full power in an operating circuit.

Bourns Krimp-Joint mechanically contacts both top and bottom surfaces of the resistor network substrate, resulting in a strong, positive connection between pin lead and both sides of a network circuit. No edge-around paths are required.

## FREE SAMPLES

Try the Bourns "Krimp-Joint" Resistor Network Design. Write to us on your company letterhead telling us

1. current manufacturer's part number you are now using,
2. what resistance values you need . . .

and we will send samples for your evaluation. We'll also include a complete data packet, with a handy cross-reference guide.





# Photoconductors

**Because Clairex makes them all, you can get exactly what you need.**

Clairex will select the right photoconductive material and package it properly to give you exactly the photoconductor you need for your application. Clairex can provide cells:

1. With spectral response in the UV, visible spectrum, or near infra-red range.
2. Hermetically or non-hermetically sealed.
3. In plastic, metal, or glass packages.

4. With low or high resistance.
5. In large or small diameter configurations.

Clairex can provide cells from stock or design cells specifically for your application. For complete data or special assistance with your "light" problems, call (914) 664-6602 or write Clairex,® 560 South Third Avenue, Mount Vernon, New York 10550.

## CLAIREX ELECTRONICS

A DIVISION OF CLAIREX CORPORATION

Circle 902 readers service card