

OCTOBER 3, 1974

Op amp IC combines C-MOS and bipolar devices/103  
I<sup>2</sup>L: a flexible new approach to large-scale integration/111  
Troubleshooting digital systems with logic scopes/119

FOUR DOLLARS A MCGRAW-HILL PUBLICATION

# Electronics®



**Busy signal for  
communication  
satellites**

14ZA 080#22 AHCA3 MAY76  
CS OSBORNE - JR  
22 ATHOL AV  
EDWARDS CA

93523

**HD/CMOS**  
is a proprietary  
process which made  
**CMOS** practical  
for custom  
large-scale integration.  
We invented it.

**We sell more than circuits.  
We sell solutions.**

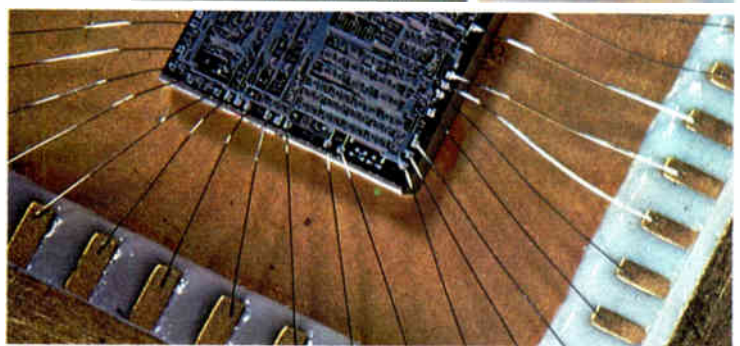
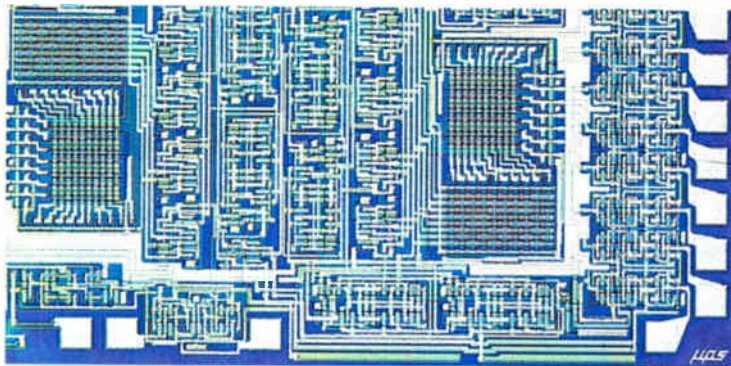

**MICRO POWER SYSTEMS**

3100 Alfred Street, Santa Clara, CA 95050  
Telephone (408) 247-5350

# Value Packed Spectrum Analyzers

**Communications**  
10Hz - 43MHz  
(or 400MHz)

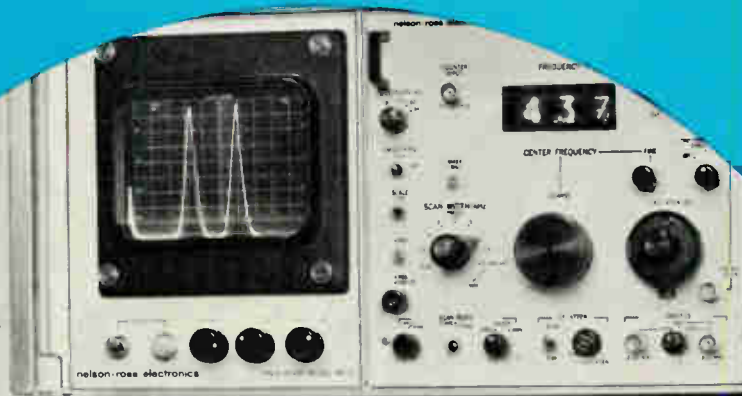

**Broadband**  
100Hz - 25MHz

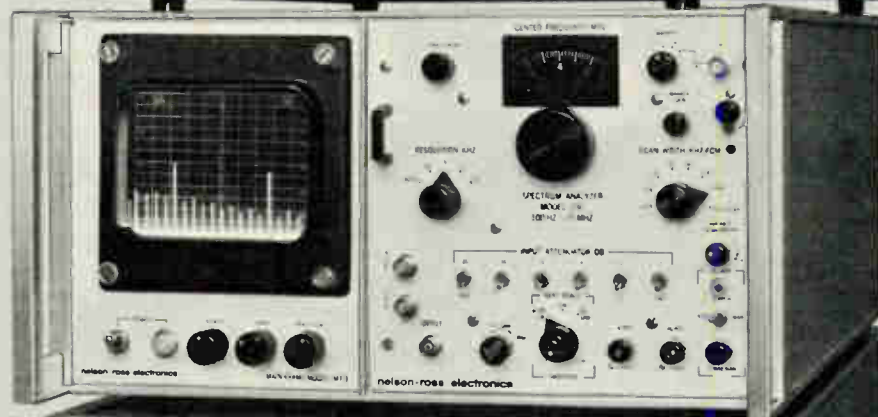

**Microwave**  
10MHz - 6.5GHz

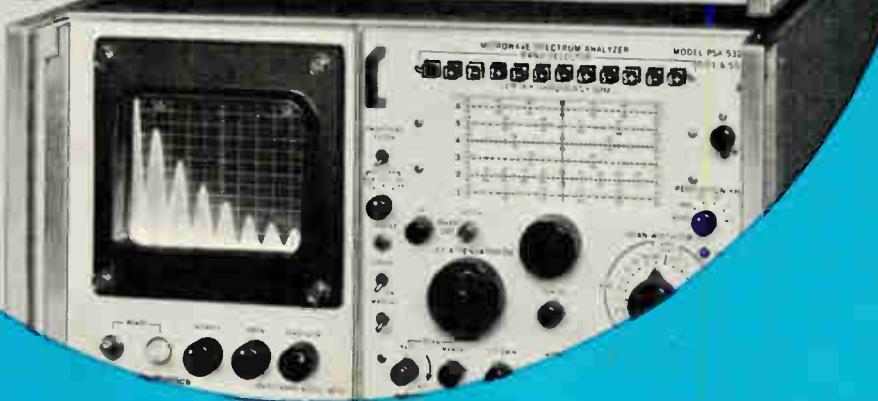

**Sub-Audio thru Microwave 0.5Hz to 6.5GHz**  
**Self-Contained Analyzers or Plug-Ins for hp & Tek Scopes**

Nelson Ross, the "SPECIALIST" in Spectrum Analyzers, offers you the most comprehensive selection of reliable, easy-to-use instruments — and backed by 15 years of spectrum analysis leadership.

Select from more than 30 models: Sub-Audio, Audio, Ultrasonic, Broadband, Telemetry, RF/SSB, RF/UHF, TV, Microwave . . . all at lowest cost.

Ask for your new NR SPECTRUM ANALYZER CATALOG with specifications and prices. Chances are that we have the right Spectrum Analyzer for you.

**nelson • ross electronics**

*A Division of Polarad Electronics Corp.*

5 Delaware Drive / Lake Success, New York 11040 / 516-328-1100 / TWX 510-223-0414

**Spectrum  
Analyzers**

*complete instruments and plug-in analyzers*

Circle 1 on reader service card

# GIANTII

GENERAL INSTRUMENT ADVANCED N-CHANNEL ION IMPLANT TECHNOLOGY

(CONT'D)

**SEPTEMBER**  
**monday 30 1974**

<b>STATIC ROMS</b> <b>5K</b> <i>(R0-3-5120)</i> <i>512 x 10</i> <i>Single +5V supply</i> <i>t<sub>acc</sub> 0.5 μs max.</i> <i>150 mW typ.</i> <b>\$5.00</b>	<b>4K</b> <i>(R0-3-4096)</i> <i>512 x 8</i> <i>Single +5V supply</i> <i>t<sub>acc</sub> 0.5 μs max.</i> <i>150 mW typ.</i> <b>\$4.50</b>
---	--

*For 50,000 per. & up*

**AND MORE GIANTII'S COMING...**

**NEXT. UAR/T<sup>+</sup> 60 kbaud**

**NEXT. 1024 BIT S/R DC - 2 MHz**

**NEXT. 16K ROM STATIC**

**NEXT. 256 X 4 RAM WITH LATCH**

**NOW AVAILABLE**

**JUNE 17 1974**  
**monday**  
**256x4 STATIC RAM**  
**(RA-3-4256)**  
*Shipping now for 20,000 @ \$1.50*

For complete information call toll-free 800-645-9247 (In New York State call 516-733-3107) or write. General Instrument Corporation, Microelectronics, 600 W. John St., Hicksville, N.Y. 11802

**GENERAL INSTRUMENT CORPORATION  
 MICROELECTRONICS**



## 43 Electronics Review

NAVIGATION: Low-cost inertial system meets accuracy spec, 43  
MEMORY: MOS target in vacuum tube leads to fast, compact memory, 44  
CONSUMER: TV-screen dot yields a hard copy, 45  
AVIONICS: FAA wants crash-warning systems, 46  
SOLID STATE: Plastic packages boost sos outlook, 48  
NEWS BRIEFS: 48  
RADAR: Military backs new test-range radar, 50  
CONSUMER: National's watch entry broadens consumer push, 52

## 66 Electronics International

GREAT BRITAIN: Agency shows color display fed by TV tube, 66  
AROUND THE WORLD, 66  
JAPAN: Researchers push 1-chip CPU speed, 67

## 79 Probing the News

ELECTRONICS ABROAD: Brazil draws big companies, 79  
COMPANIES: Augat has EEs thinking mechanical, 82  
Intel, National are so different—but so much the same, 86  
COMMUNICATIONS: Automatic broadcast gear gets a boost, 88

## 95 Technical Articles

COMMUNICATIONS: Users start to hop aboard satellites, 95  
SOLID STATE: Putting C-MOS and bipolars on chips improves specs, 103  
DESIGNER'S CASEBOOK: Op amp regulator nearly powers itself, 106  
Analog filter can be programmed digitally, 107  
Attenuating transients in analog FET switches, 108  
SOLID STATE: Integrated injection logic improves bipolar LSI's, 119  
INSTRUMENTATION: Logic scopes speed digital-fault diagnosis, 119  
ENGINEER'S NOTEBOOK: Tester pinpoints cable trouble, 125  
High-gain triple Darlington has low saturation voltage, 126  
TTL-level tester identifies logic levels by audible tone, 127

## 135 New Products

IN THE SPOTLIGHT: Temperature sensor is linear, 135  
12-bit d-a converter put in one package, 139  
DATA HANDLING: Talking directly with the System/3, 142  
SEMICONDUCTORS: 4-bit microprocessor for control, 145  
PACKAGING & PRODUCTION: Artwork generator resolves 1 $\mu$ m, 149  
COMMUNICATIONS: Uhf transistor puts out 80 watts, 151  
MATERIALS: 154

## Departments

Publishers letter, 4  
Readers comment, 6  
40 years ago, 10  
People, 14  
Meetings, 20  
Electronics newsletter, 39  
News update, 56  
Washington newsletter, 63  
International newsletter, 69  
Engineer's newsletter, 128

## Highlights

### Cover: Communications satellites catch on, 95

Suppliers of satellite services, potential customers, and the FCC are debating how to organize this expanding new communications industry. Should IBM be allowed into the market? How should AT&T handle satellite interconnections? Should radio and TV broadcasting wait for higher-frequency equipment or start now? These and other questions are covered in this special report. Cover is by photographer Mitchell Funk.

### Two firms double their annual sales, 86

Intel Corp. and National Semiconductor Corp. have pushed their sales up to the \$150–200 million level by exploiting high technology. Intel concentrates on MOS memories and microprocessors, while National's success is based on a broad line of IC products.

### I<sup>2</sup>L turns bipolar LSI into a front-runner, 111

A remarkably small and simple gate, consisting of a complementary transistor pair and nothing else, is responsible for the high density and low speed-power product of integrated injection logic. The low-cost technique can be used for the entire range of microcircuit applications, up to and including 16-bit microprocessors.

### Logic scopes diagnose digital IC faults fast, 119

Unlike conventional oscilloscopes, logic scopes store many channels of data in binary form, including bits preceding a trigger event, and then display it in the form of a timing diagram. Overshoot, ringing, and other functional circuit errors become easier to identify.

### And in the next issue . . .

Special issue devoted to the state of technology in computers, communications, instruments, consumer electronics, solid state, and components, plus reports on R&D and what Washington wants.

EDITOR-IN-CHIEF: Kemp Anderson

EXECUTIVE EDITOR: Samuel Weber

MANAGING EDITORS: Lawrence Curran, *News*;  
Arthur Erikson, *International*

SENIOR EDITORS: John Johnsrud,  
H. Thomas Maguire, Laurence Altman,  
Ray Connolly, Stephen E. Scrupski

ART DIRECTOR: Fred Sklenar

ASSOCIATE EDITORS: Howard Woff,  
Gerald M. Walker, Alfred Rosenblatt

DEPARTMENT EDITORS

*Aerospace/Military*: Ray Connolly  
*Circuit Design*: Lucinda Mattera  
*Communications & Microwave*:

Stephen E. Scrupski

*Computers*: Wallace B. Riley

*Consumer*: Gerald M. Walker

*Industrial*: Michael J. Riezenman

*Instrumentation*: Stephen E. Grossman

*New Products*: H. Thomas Maguire

*Packaging & Production*: Andy Santoni

*Solid State*: Laurence Altman

COPY EDITORS: Margaret Eastman,  
Everett C. Terry, Bill Dunne

ASSISTANT EDITOR: Marilyn Offenheiser

ART: Charles D. Ciatto, *Associate Director*  
Patricia Cybulski, *Assistant Director*

PRODUCTION EDITOR: Arthur C. Miller

EDITORIAL SECRETARIES: Janet Noto,  
Julie Gorgoglione, Penny Roberts

FIELD EDITORS

*Boston*: Gail Farrell

*Los Angeles*: Paul Franson (Mgr.)

*Midwest*: Larry Armstrong (Mgr.)

*San Francisco*: Bernard Cole (Mgr.)

Judith Curtis

*Washington*: Ray Connolly (Mgr.)

Larry Marion

*Frankfurt*: John Gosch

*London*: William F. Arnold

*Paris*: Arthur Erikson

*Tokyo*: Charles Cohen

McGRAW-HILL WORLD NEWS

*Director*: Ralph R. Schulz

*Bonn*: Robert Ingersoll

*Brussels*: James Smith

*London*: Marvin Petal

*Milan*: Peter Hoffmann, Andrew Heath

*Moscow*: Peter Gall

*Paris*: Michael Johnson, Richard Shepherd

*Stockholm*: Robert Skole

*Tokyo*: Mike Mealey

PUBLISHER: Dan McMillan

DIRECTOR OF MARKETING: Pierre J. Braudé

ADVERTISING SALES SERVICE MANAGER:  
Wallis Clarke

BUSINESS MANAGER: Stephen R. Weiss

CIRCULATION MANAGER: Nancy L. Merritt

MARKETING SERVICES MANAGER:

Tomlinson Howland

RESEARCH MANAGER: Margery D. Sholes

There are no national boundaries when it comes to electronics. While some countries hold an edge in one or another segment of electronics technology, production, or application, there are few barriers to either the flow of technology or the impact of new developments. Take the case of I<sup>2</sup>L, an international electronics development, if there ever was one.

I<sup>2</sup>L, which is short for integrated injection logic, is a new approach to bipolar chip design. Its advantages: high density coupled with a performance that allows either nanosecond delay or microwatt power dissipation. Its developers: Philips in the Netherlands and IBM in West Germany. Its impact: on designers in the U.S. and around the world.

As the authors of our I<sup>2</sup>L article point out in the first detailed publication of the technique (see p. 111), the "source of all the excitement is I<sup>2</sup>L's elegant gate layout, from which the space- and power-consuming current sources and load resistors of transistor-transistor logic are noticeably absent. As a result of this simplicity, up to 3,000 gates or 10,000 bits or memory can be packed into a single high-yield chip. Moreover, the speed-power product can drop, at low power, to an astonishing 0.13 picojoule, 1,000 times better than today's TTL circuits."

The approach promises to significantly alter bipolar LSI design. Indeed, it has "become the best bet for the realization of truly high-performance bipolar LSI circuitry"—to quote the authors again. So here is a case where the leading edge of technology swept through research labs in Europe and pushed an important development to other countries.

Progress in using satellites to speed the flow of information around the world is not waiting for more technological advances. The technology, to a large extent, is perfected and well on its way to being applied. More important to the future course of satellite communications are economic and organizational questions.

That's the theme of our eight-page report on where satellite communications stands now that the first operational domestic communications bird has been orbited and the broad outlines of commercial satellite systems are beginning to take shape. You'll find the report, put together by Steve Scrupski, our communications and microwave editor, on page 95.

With the first of the craft up and running, the earth-bound competition for customers, channel space, and follow-on satellites is speeding up. With all this activity, there are the inevitable problems and uncertainties. One is IBM's move to buy into the field as a joint owner of a satellite company, a move that is undergoing FCC scrutiny. Another is AT&T's application to become more active in satellite earth stations. And there are technological developments to come—"rooftop" earth stations, the potential of going to higher transmission frequencies, and the like. So don't miss our report on the fascinating and growing field of communications satellites.



October 3, 1974 Volume 47, Number 20  
94,097 copies of this issue printed

Published every other Thursday by McGraw-Hill, Inc. Founder: James H. McGraw 1860-1948. Publication office 1221 Avenue of the Americas, N.Y., N.Y. 10020; second class postage paid at New York, N.Y. and additional mailing offices.

Executive, editorial, circulation and advertising addresses: Electronics, McGraw-Hill Building, 1221 Avenue of the Americas, New York, N.Y. 10020. Telephone (212) 997-1221. Teletype TWX N.Y. 710-581-5234. Cable address: MCGRAW HILL N.Y.

Subscriptions limited to persons with active, professional, functional responsibility in electronics technology. Publisher reserves the right to reject non-qualified requests. No subscriptions accepted without complete identification of subscriber name, title, or job function, company or organization, including product manufactured or services performed. Subscription rates: qualified subscribers in the United States and possessions, Canada, and Mexico \$12.00 one year, \$24.00 three years; all other countries \$25.00 per year, except Japan \$50.00 per year, Brazil \$40.00 per year, Australia and New Zealand \$60 per year, including air freight. Limited quota of subscriptions available at higher-than-basic rate for persons outside of field served, as follows: U.S. and possessions and Canada, \$25.00 one year; all other countries \$50.00. Single copies: \$4.00.

Officers of the McGraw-Hill Publications Company: John R. Emery, President; J. Elton Tuohig, Executive Vice President-Administration; Gene W. Simpson, Group Publisher-Vice President; Senior Vice Presidents: Ralph Blackburn, Circulation; Walter A. Stanbury, Editions; John G. Hoglund, Controller; David G. Jensen, Manufacturing; Gordon L. Jones, Marketing; Jerome O. Luntz, Planning & Development.

Officers of the Corporation: Shelton Fisher, Chairman of the Board and Chief Executive Officer; Harold W. McGraw, Jr., President and Chief Operating Officer; Wallace F. Trendly, Group President, McGraw-Hill Publications Company and McGraw-Hill Information Systems Company; Robert N. Landes, Senior Vice President and Secretary; Ralph J. Webb, Treasurer.

Title registered in U.S. Patent Office; Copyright ©1974 by McGraw-Hill, Inc. All rights reserved. The contents of this publication may not be reproduced in whole or in part without the consent of copyright owner.

Subscribers: The publisher, upon written request to our New York office from any subscriber, agrees to refund that part of the subscription price applying to copies not yet mailed. Please send change of address notices or complaints to Fulfillment Manager; subscription orders to Circulation Manager, Electronics, at address below. Change of address notices should provide old as well as new address, including postal zip code number. If possible, attach address label from recent issue. Allow one month for change to become effective.

Postmaster: Please send form 3579 to Fulfillment Manager, Electronics, P.O. Box 430, Hightstown, N.J. 08520.

When you've got to power noise sensitive logic,  
*what do you want for the job?*

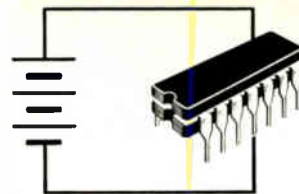

When your system draws a pulsating load current,  
*what do you want for the job?*

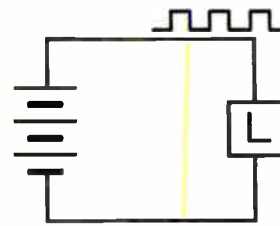

When your specs call for adjustable voltage,  
*what do you want for the job?*

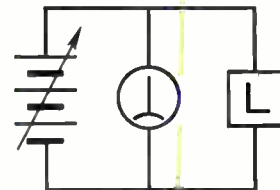

When your programmed level must be accurately reproduced, when the current limit must be adjustable and square (not folded back), when you want a power supply that doesn't lose half its current rating at +71°C (or at -20°C)...

**the power supply you want for your job is the**

**KEPCO JQE**



Quarter-rack  
100 watts



Half-rack  
250 and  
500 watts



Full-rack  
1000 watts

JQE Power Supplies are *linear* voltage stabilizers (not complex switching units). They can be adjusted or remotely programmed from true zero to maximum output with better than 0.01% linearity. They vary less than 0.0005% for 105–125V a-c source changes and have such low output impedance that a zero to full load change influences the stabilized output by less than 0.005%. Ripple and noise is well under 200 microvolts rms, 1 millivolt p-p.

31 JQE linear voltage stabilizers are manufactured in 4 sizes: 100 Watts, 250 Watts, 500 Watts and 1000 Watts in voltage ranges from 0–6V to 0–150V. Metered bench and rack-panel style and unmetred modular form for the OEM. Adjustable overvoltage protection available.

If *your* job needs a linear voltage stabilizer, call Kepco for the details on the JQE, or write Dept. V-14



**KEPCO®**

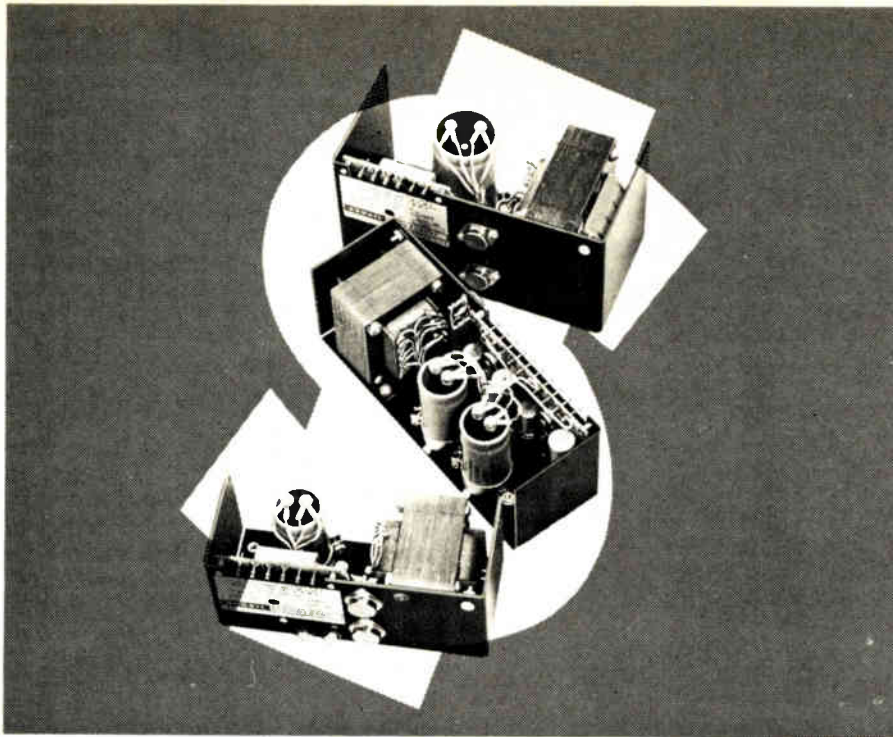

## Start Getting Your Money\$worth Out of Power Modules





Now, you can really start getting your moneysworth out of power modules with Abbott's new LOW COST series. Designed to give you 100,000 hours of trouble-free operation (that's 11½ years), these reliable units meet the needs of OEM engineers. Their purchase price is about \$7 per year of service. The model LC series feature:

- 47-420 Hz Input Frequency
- 0.1% Regulation
- +50°C. Ambient Operation
- Single and Dual Outputs
- 1 Day Stock Delivery

These units provide more quality per dollar compared to similar items on the market. See table below for prices on some of our LC models. Many other LC models are listed in our catalog.

If analyzing the many similar power supplies on the market is confusing; if you are concerned about the long-term reliability of those units, then decide on an Abbott power supply for your system. Your best buy in OEM power modules is ABBOTT.

Abbott also manufactures 3,000 other models of power supplies with output voltages from 5 to 740 VDC and with output currents from 2 milliamps to 20 amps. They are all listed with prices in the new Abbott Catalog with various inputs:

60  to DC  
 400  to DC  
 28 VDC to DC  
 28 VDC to 400   
 12-24 VDC to 60 

5V @ 6 Amps	5V @ 10 Amps	12V @ 10 Amps	15V @ 4 Amps	28V @ 1 Amp	±12V @ 1.2 Amps	±15V @ 4 Amps
LC5T6	LC5T10	LC12T10	LC15T4	LC28T1	LLC12T1.2	LLC15T4
\$72	\$81	\$99	\$81	\$72	\$99	\$135

Please see pages 581-593 of your 1973-74 EEM (ELECTRONIC ENGINEERS MASTER Catalog) for complete information on Abbott Modules.

Send for our new 56 page FREE catalog.

# abbott transistor

LABORATORIES, INCORPORATED  
 general offices eastern office

5200 W. Jefferson Blvd./Los Angeles 90016  
 (213) 936-8185 Telex: 69-1398

1224 Anderson Ave./Fort Lee, N.J. 07024  
 (201) 224-6900 Telex: 13-5332

6 Circle 6 on reader service card

## Readers comment

### Designing for the worst case

To the Editor: The analysis in "Designing class A amplifiers to meet specified tolerance" [*Electronics*, Aug. 8, p. 115] does not consider component tolerances. If the example problem is recalculated with worst-case 5% component tolerances, the maximum quiescent-current variation is 40%—thus violating the design specifications by a factor of 2. Mr. [Ward J.] Helms' excellent device-tolerance analysis must be combined with a component worst-case analysis to achieve the desired result.

Ronald A. Mancini  
 Odessa, Fla.

■ *Mr. Helms replies:* This article was primarily concerned with circuit variations caused by the statistical distribution and temperature variation of transistor parameters. These variations normally are sufficiently great that an acceptable stage design is obtained, even though resistor tolerances are neglected in its derivation. If the stage once operates near its design center quiescent current, the technique guarantees that it will not shift by more than the specified amount with a change of transistor and/or temperature, providing the biasing resistors have reasonable temperature coefficients.

However, you are correct that for absolute pathological worst-case design, component tolerances must be included. This consideration could possibly be included in my technique by adding a term to equations 8 and 10 to take into account uncertainties in  $V_{BB}$  and  $R_E$ . I will look into this possibility in the near future.

### Misprint is misleading

To the Editor: Ward J. Helms' article, "Designing class A amplifiers to meet specified tolerances," [*Electronics*, Aug. 8, p. 115], is most commendable. There are, however, a couple of points I would like to see clarified. Either equation 8 is faulty, or the value given for  $V_{BEX}$  in iteration 1 is wrong. I get a value of 0.3916, rather than 0.344. Also, there is no indication of what value to use for  $T_{Amin}$ .

Working back from  $T_{min}$ , shown



# Get up to speed on high frequency power switching for just 10¢



**A 10¢ stamp gets you the basics on what you need to know about using high-power, fast-switching Darlington transistors to reduce the size, weight and costs of switching regulated power supplies and motor controls.**

Want to know how the Darlington figures in Buck, Boost or Buck-Boost Regulators, Full Bridge, Half Bridge, or Push-Pull Regulator Converter circuits?

Want to replace SCR's and associated commutation circuitry in inverter circuits below 30kva?

TRW has put down the facts for quick study in a free brochure. All you have to do is fill out the coupon and mail it in. If you want the facts faster, call John Power (213) 679-4561 at TRW Power Semiconductors, an Electronic Components Division of TRW, Inc., 14520 Aviation Blvd., Lawndale, California 90260.

## **TRW** POWER SEMICONDUCTORS

### **TRW Power Semiconductors**

14520 Aviation Boulevard, Lawndale, California 90260

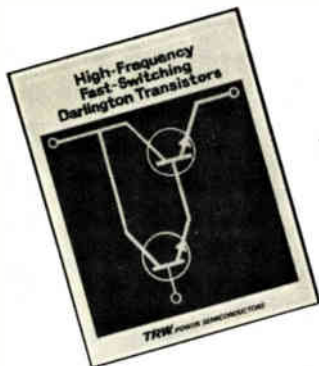

**Please rush  
me your  
free brochure  
on high  
frequency  
power  
switching.**

NAME

POSITION

FIRM NAME

ADDRESS

CITY

STATE

ZIP

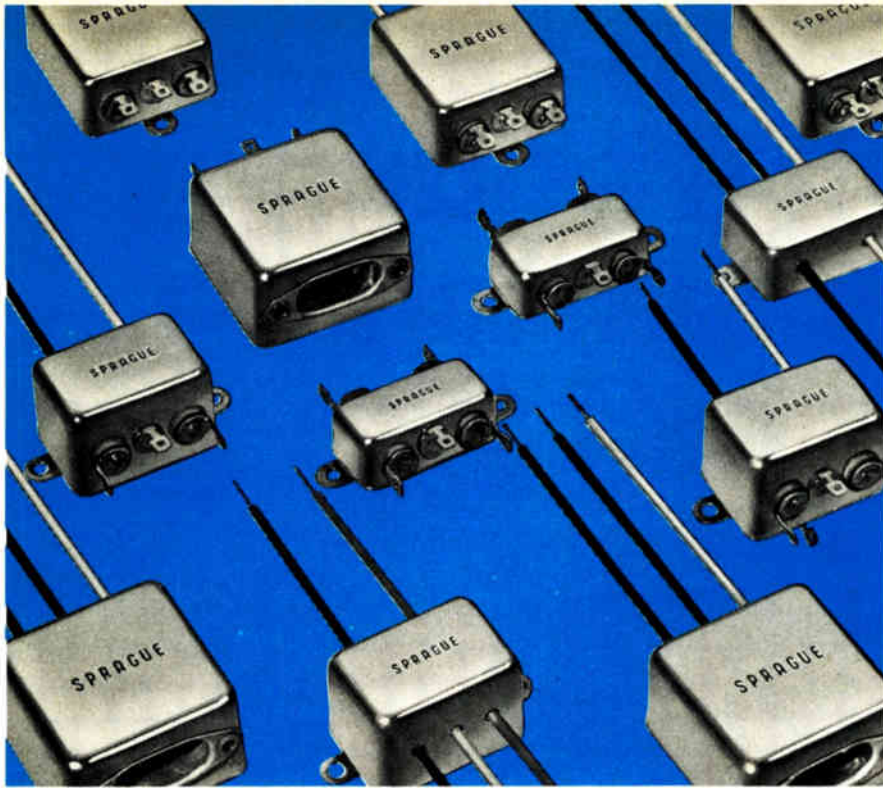

## FILTERS THAT WORK. FILTERS THAT FIT. FILTERS YOU CAN AFFORD.

### Sprague JX5100 Series EMI Powerline Filters give you the right blend of efficiency/size/cost.

The lower cost of these general-purpose filters makes them especially suitable for higher-volume production-assembled equipment such as computer peripherals, cash registers, credit card verifiers, electronic service instruments, etc.

Series JX5100 Filters are designed to protect equipment from line noise as well as to protect the line from equipment noise, particularly equipment with high impedance loads. Smaller in size than many filters with comparable performance, they control line-to-ground interference with a high degree of efficiency. Filtering both sides of the line, the need for two filters is eliminated.

Available in a wide variety of current ratings (1 to 30 amps) and several different terminal configurations, Series JX5100 Filters withstand a test voltage of 2100 VDC, assuring protection against high-voltage transients. Line-to-ground capacitance is only  $.01\mu\text{F}$ , and maximum leakage current (each line to ground, @115V, 60Hz) is 0.5mA.

Sprague maintains complete testing facilities for all commercial, industrial, and government interference specifications.

For complete technical data, write for Engineering Bulletin 8210.11 to: Technical Literature Service, Sprague Electric Company, 35 Marshall Street, North Adams, Mass. 01247.



THE BROAD-LINE PRODUCER OF ELECTRONIC PARTS

8 Circle 8 on reader service card

### Readers comment

in iteration 1, would seem to indicate  $25.8^\circ$  was used. If so, why  $25.8^\circ$  instead of  $25^\circ$ ? As a result of these two items, all subsequent values are, accordingly, in disagreement with the example.

Billie J. H. Abraham  
Commerical Electronics Inc.  
Indianapolis, Ind.

■ *The author replies:* The problem stems from a misprint on line 4 of the right-hand column of page 118. The current  $I_1$  is incorrectly listed as .001 A instead of .003 A. The three lines above this one contain the correct value of  $I_1$ , although it is not explicitly named. The minimum ambient temperature, taken as  $0^\circ\text{C}$  in this example, is identified in line 35 of the left-hand column on page 118.

### Award honors avionics pioneer

To the Editor: The "40 years ago" column of Aug. 22 hit a particularly responsive chord because it mentioned several people in aviation, including William E. Jackson, who passed away in 1972. I am chairman of the William E. Jackson Award Committee of the Radio Technical Commission for Aeronautics. RTCA expects to start active solicitation of candidates early this fall in anticipation of the first award presentation, which will recognize an outstanding graduate or undergraduate student for noteworthy work in aviation systems. This award is an appropriate way of acknowledging Bill's encouragement and support to young engineering students in aviation-electronic systems.

William T. Carnes  
Aeronautical Radio Inc.  
Annapolis, Md.

### U. S. firm challenges claim

To the Editor: Fujitsu's claim to being first with a small virtual-memory computer system ready for delivery in February 1975 [*Electronics*, International Newsletter Aug. 22, p. 56] ignores at least Reality, the small virtual-memory computer system being delivered since December 1973 by Microdata Corp.

Donald W. Fuller  
Microdata Corp.  
Irvine, Calif.

# you can see why...



## the time is right with **PANAPLEX™** clock panel displays

PANAPLEX clock panels are designed to be read. These large, bright, easy-to-see, pleasing numerals are easily read in any light — even bright sunlight.

These four- and six-digit clock panels are compatible with MOS clock chips, and have the high reliability and quality that has made the PANAPLEX family of displays the choice of calculator manufacturers.

PANAPLEX clock panels can display either 12- or 24-hour time systems and have integral AM/PM indicators and colons.

Available in two standard sizes (0.5 and 0.7 inch), these thin panels (0.2 inch excluding tubulation) offer design flexibility that's hard to beat

The soft, neon-orange color is easy to read at a glance: — no magnifier

needed, no eyestrain, no LED-red fatigue factor.

For additional information on the PANAPLEX clock panels, write Burroughs Corporation, Electronic Components Division, P. O. Box 1226, Plainfield, New Jersey 07061, or call (201) 757-3400 or (714) 835-7335.



### You can see the difference

## Burroughs



**DISTRIBUTORS:** Hamilton Electro Sales/Culver City, Cal.; Hamilton/Avnet Electronics/San Diego, Seattle, Mountain View, Cal., Phoenix, Denver, Salt Lake City, Albuquerque, Houston, Dallas, Prairie Village, Kan., Hazelwood, Mo., Schiller Park, Ill., Livonia, Mich., Minneapolis; Arnold Barnes Associates, Inc./Richardson, Tex.; Cramer Electronics/Syracuse, N.Y., Newton, Mass.

## 40 years ago

From the pages of *Electronics*, October, 1934

### Television: an editorial

Television is here, and ready for the public, so far as receiver technique is concerned. There can be no doubt of that in the mind of anyone who has made the rounds of the laboratories where serious work is being done. Television pictures today are clear, well illuminated, and compare in quality and detail with home movies.

But the transmission problem in television introduces tremendous difficulties, chiefly financial. To provide television programs throughout the country would require an initial investment estimated at fifty to two hundred million dollars or more.

This sum seems staggering to private capital. But to a government that is handing out billions for purposes that seem less constructive, even \$200,000,000 for television is not unthinkable.

Television transmitters really have a sounder claim to government financing, in the present unemployment situation, than do many other enterprises that have received generous federal aid. For each television transmitter built will be the means of initiating the manufacture of thousands of television receivers, involving starting up factories, restoring employment, and injecting vast new impetus into the lagging machine of national business. Indeed, television may be the long-sought "new industry" to pull us out of the depression.

### Wanted—a pocket radio

The commercial advent of the tiny "shoe-button" or acorn radio tube calls attention again to the popular market that exists for a pocket radio set.

A real addition to radio convenience would be such a battery-operated receiver, no larger than a pocket camera, with a self-contained ear-phone which could be used to listen to news reports, special speeches, time signals, etc. Business men, travelers, young people, would all find frequent use for a radio set always at hand.

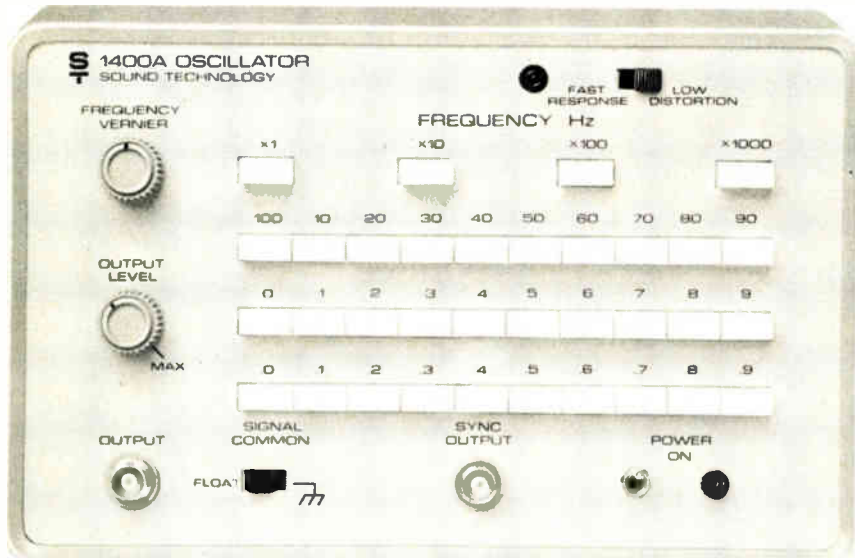

# ULTRA-LOW DISTORTION OSCILLATOR

**10 Hz-110 kHz:** pushbutton tuned for high repeatability, 3-digit resolution. **FLOATING OUTPUT:** selectable by panel switch. **ULTRA-LOW DISTORTION:** typically .001% in audio range (see curve). **FAST SETTLING:** settles to .001% distortion in 5 seconds. Faster alternate mode. **FREQUENCY RESPONSE:** flat within 0.2 dB. **PRICE:** only \$570.

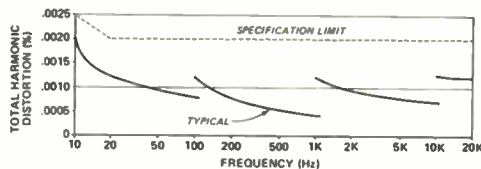

### CALL NOW

Call Larry Maguire or Bob Andersen now for full information on this important new Model 1400A.

**SOUND TECHNOLOGY**  
1400 OELL AVENUE  
CAMPBELL, CALIFORNIA 95008  
(408) 378-6540

# The 25S09.

A remarkable new shift register,  
more or less.

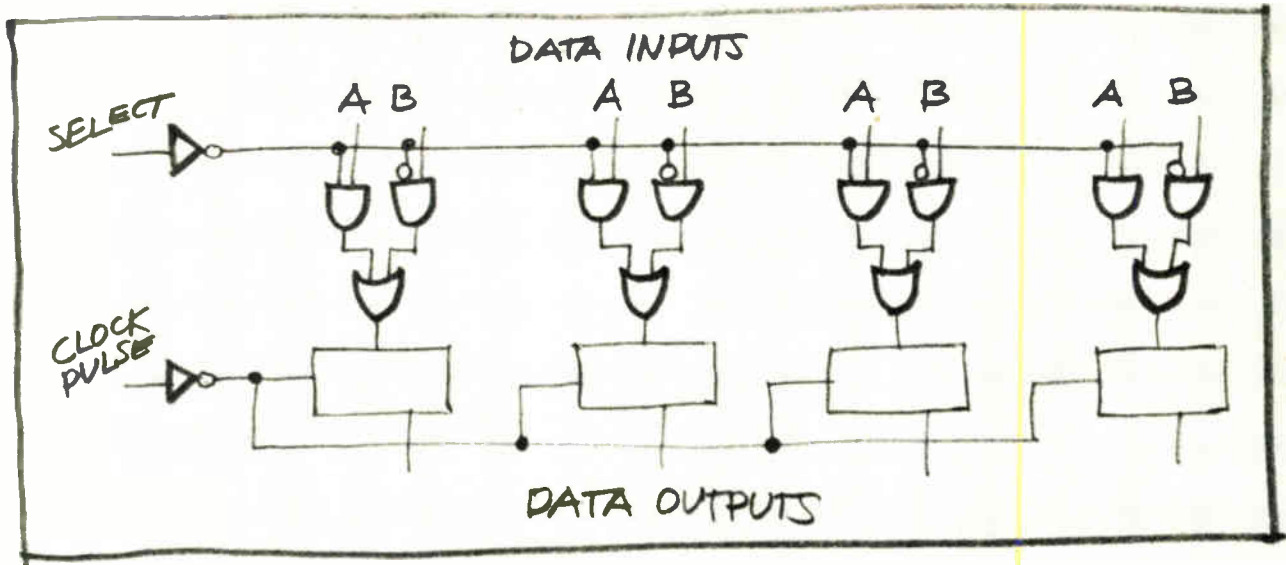

Now there's twice as good a way to do the 74S158/74S175 job. All it takes is one high-speed register: the Am25S09.

**More:** Speed. It's 24% faster. System applications. It has a positive edge trigger. It's Schottky.

**Less:** Space. One package instead of two. Power. It takes 24% less.

And here's everyone who makes it:

	Speed	Power
74S158	6 ns	320mW
74S175	17ns	504mW
working together to perform this function	23ns	824mW
<b>25S09</b>		
doing the same function as the two units above	17.5ns	630mW
<b>SAVINGS</b>	5.5ns	194mW
or in percentages	24%	24%

## Advanced Micro Devices

Corporate offices are at 901 Thompson Place, Sunnyvale, California 94086. Telephone (408) 732-2400 or toll free from outside California (800) 538-7904/Southern California office: Beverly Hills (213) 278-9700/Mid-America: Oak Brook, Illinois (312) 323-9600/Edina, Minnesota (612) 835-4445/Eastern United States: Roslyn Heights, New York (516) 484-4990/6806 Newbrook Ave., E. Syracuse, New York (315) 437-7546/Baltimore, Maryland (301) 744-8233/Lexington, Massachusetts (617) 861-0606/Britain: Advanced Micro Devices, Telephone Maidstone 52004/West Germany: Advanced Micro Devices, Munich, Telephone (089) 53 95 88. Southern Europe: Advanced Micro Devices, S.A., Neuilly, France, Telephone: 747-4194. Distributed nationally by Hamilton/Avnet, Cramer and Schweber Electronics.

# The 2401 overhead in half.

Intel's 2401 n-channel 2048-bit shift register does much more than chop register board area and assembly cost in half.

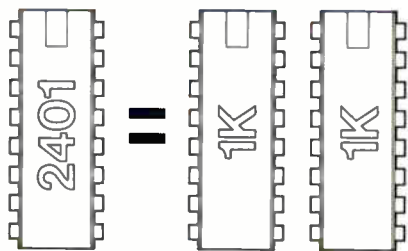

It is also a remarkably efficient, easy to drive, TTL compatible register

that cuts all your other overhead costs in half, too. Maybe more.

All inputs and outputs operate at TTL logic levels, including the single clock input and the single +5 volts  $V_{CC}$  supply pin on the corner of the 16-pin plastic DIP. That lets you trim off the high voltage sections of your power

supply and eliminate MOS/TTL interfaces.

The maximum capacitance of all inputs, including the single-phase clock input, is only 7 pF and the outputs only 14 pF. Clock capacitance is about 1/80th of the total presented by a pair of two-phase 1K p-channel regis-

ters. Other capacitances are reduced about 50%. So, remove drivers, simplify the clocking logic, and pare down the power supply some more.

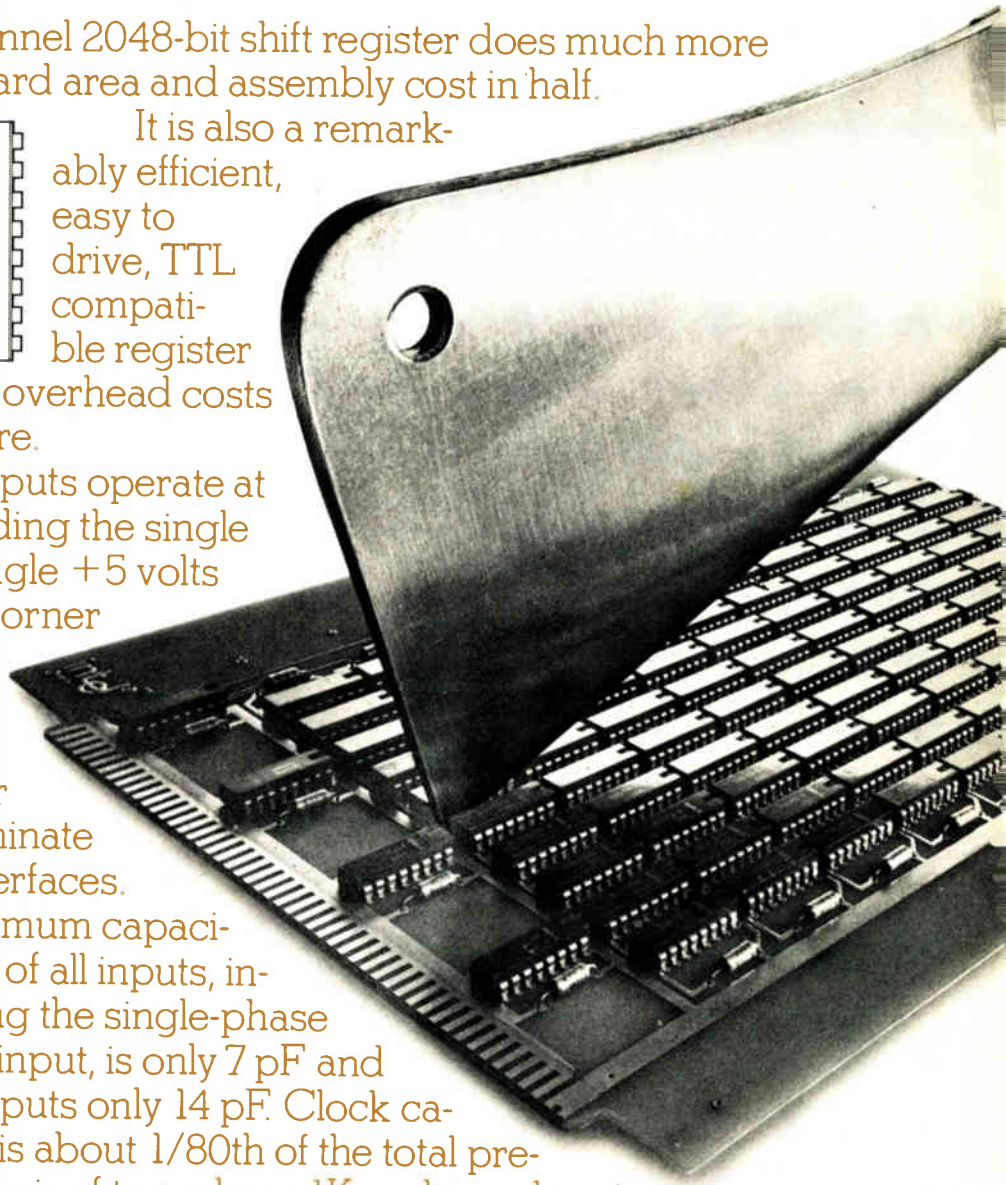

# cuts shift register Maybe more.

Furthermore, the 2401 has on-chip X-Y chip select controls

**TODAY'S SPECIAL**  
**n-Channel**  
**2K**

and separate write/recirculate controls in each 1024-bit section. That minimizes external logic for OR-tied arrays and gives you the flexibility of single 2K or dual 1K operation.

In other words, the 2401 has advantages in serial storage designs like the 2102 (the world's most

popular static 1K RAM) has in random access designs. And the 2401 is as easy to buy as the 2102 because both are made with the same high volume, silicon gate n-channel technology.

We hope all this makes you think twice about

using expensive static registers or lesser dynamic registers in buffer, CRT refresh, key to tape, signal sampler and other serial memories.

Think instead about cutting system overhead in half (maybe more) with our big, efficient, completely TTL compatible 2401.

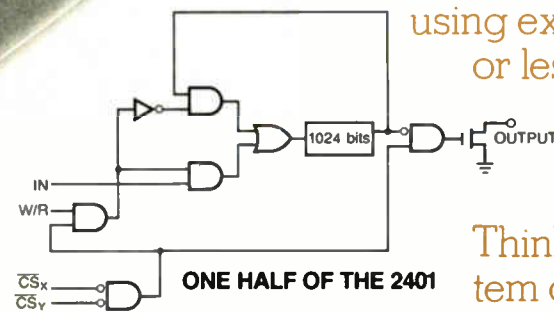

MSI DATA CORP.  
PORTABLE TERMINAL

Intel Corporation, 3065 Bowers Avenue, Santa Clara, California 95051.  
(408) 246-7501.

**intel® delivers.**

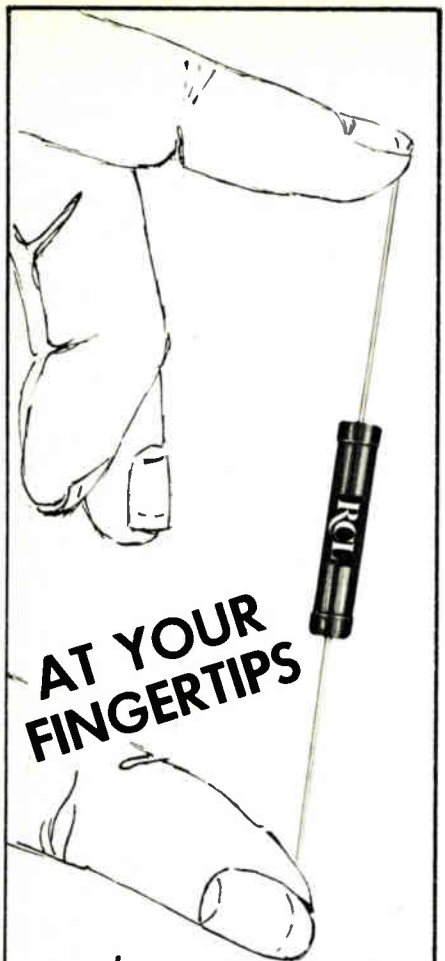

AT YOUR  
FINGERTIPS

Industry's Best  
Delivery On Every

**Precision/  
Power  
Wire-wound  
Resistor**

In Our Catalog

Call our hotline for prompt  
service and delivery.  
(201) 374-3311

**RCL**

**ELECTRONICS, Inc.**

General Sales Office:  
700 So. 21st Street  
Irvington, N. J. 07111

## People

Cunningham: Instruments  
can thrive on custom ICs.

James R. Cunningham, who 17 years ago helped found Systron-Donner Corp., Concord, Calif., surprised a lot of people when he resigned earlier this month as general manager of the \$44-million instru-



**Responsibility.** At Interdesign, Cunningham hopes to be calling more of the shots.

ment company's Computer Systems division. And he surprised even more people when he became president of Interdesign Inc., a small \$2.5 million company in Sunnyvale, Calif., which until now specialized in custom integrated circuits.

Why did he make the move? The answer is simple. Cunningham was bored and bugged.

"I got into a static slot at Systron-Donner, and I wanted a change," he says. "I wanted to call the shots, to totally run an operation. Interdesign was an opportunity for me to have all operations responsibility, to utilize all my marketing skills."

**Instrument maker.** Moreover, as president of Interdesign, Cunningham feels that he will also get a chance to return to his first love—instruments—a field Interdesign is just now getting into because of its know-how in custom ICs.

"For years I've been bugged by the inability of most instrument houses to produce relatively sophisticated instruments at truly low prices—say the \$50 to \$200 range—and to do it profitably," he says. "It can be done, I'm sure. The key is

finding a way to produce ICs, especially linear ICs, in low volume and at a low cost. It was a dilemma I thought was insoluble until I came to Interdesign."

Founded in 1970, Interdesign is best known for its monochip, a low-cost IC kit for custom designing circuits. The kit consists of three bipolar chips on which are placed a large number of standardized ICs. By varying only the final metalization layer, the entire prototype cycle from layout to sketch to finished IC takes less than three weeks, compared to at least six months for an ordinary custom IC, says Cunningham. Typical startup costs are less than a twentieth the industry norm, he points out.

"When we assessed the directions the company wanted to go recently, we asked ourselves why should our customers be the only ones to take advantage of this approach," says Cunningham. "It was obvious that in certain areas, such as instrumentation, we had the key to our future growth."

The firm's first instrument is a \$150 pulse generator built around the monochip, which Cunningham calls "the poor man's custom IC."

Cunningham has rosy expectations for the near future. Even with the slowdown in the economy, his company will grow, he says, by at least 20% to 30% a year because he believes there will always be a market for the low-cost custom ICs Interdesign can produce.

Bendix's McCormick:  
billion-dollar man?

Most engineers might pale at being responsible for R&D that's expected to create billions of dollars in sales. But Joseph L. McCormick, recently named engineering director at Bendix Corp.'s Communications division, Towson, Md., says that for him, it's "no problem."

McCormick, who has been with Bendix ever since earning his bachelor's degree in physics from Baltimore's Loyola University in 1957, is



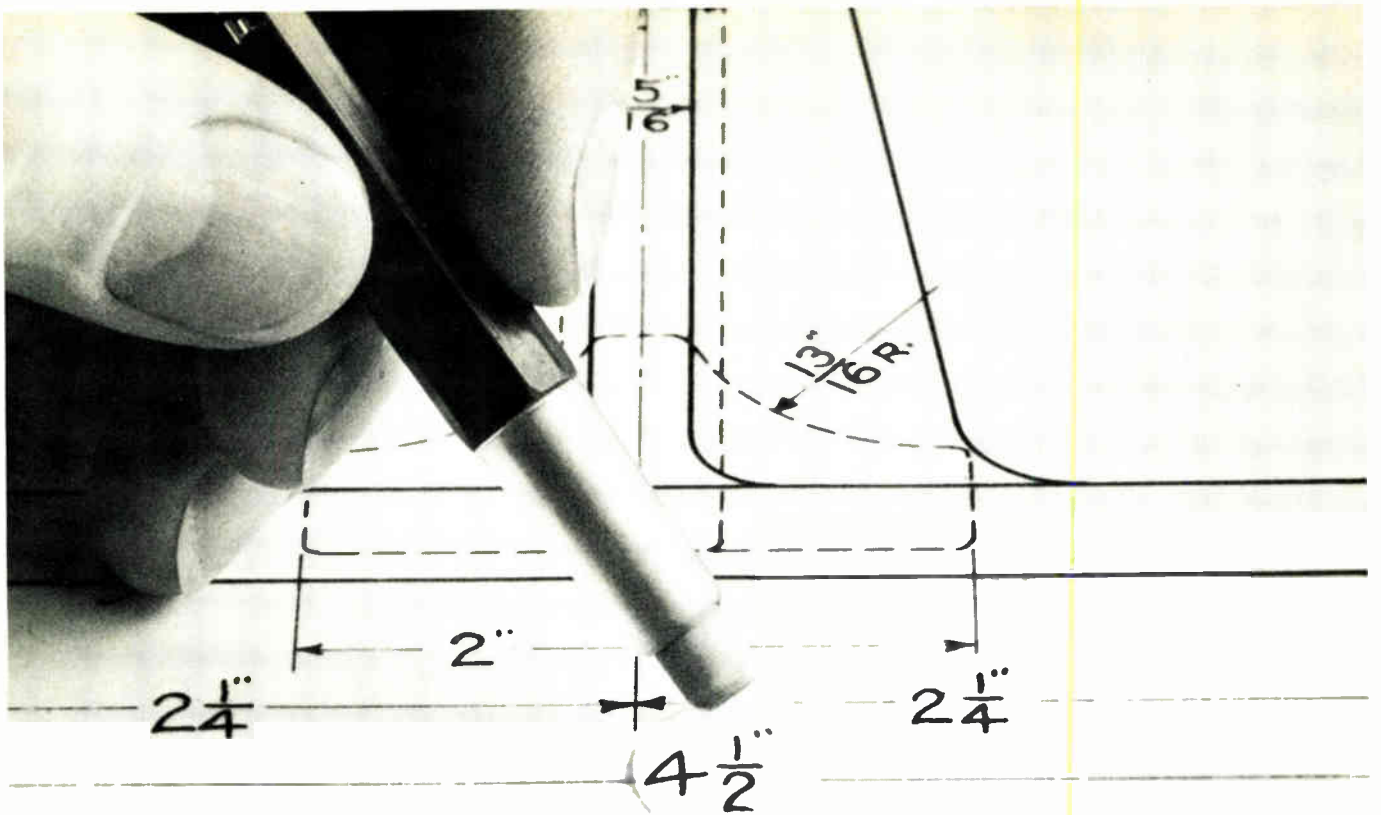

# Get the drop on redrawing drudgery.

---

Shortcuts with Kodagraph materials can turn drafting hours into minutes.

---

Nobody likes to retrace a whole drawing just because a few revisions are necessary. You don't have to if you make a second original on Kodagraph wash-off film. Simply wet-erase what you don't want—using plain water and a soft eraser—draw in the new details and the job is done.

If on the other hand, you're faced with repetitive details, draw them once. And then order as many Kodagraph film or paper reproductions as you need. Cut them out,

tape down on drawing form, rephotograph and you have a new original.

When you need to restore a battered, old drawing, have a reproduction made on Kodagraph film. Stains virtually disappear. Weak lines come back strong. And you end up with a crisp, legible black-on-white print.

---

Get the details.

---

Write for information on how you can reduce drafting time with photoreproduction techniques. Eastman Kodak Company, Business Systems Markets Division, Dept.DP793, Rochester, N.Y. 14650

**Kodak products for engineering data systems.**



IC's  
require  
small  
C's

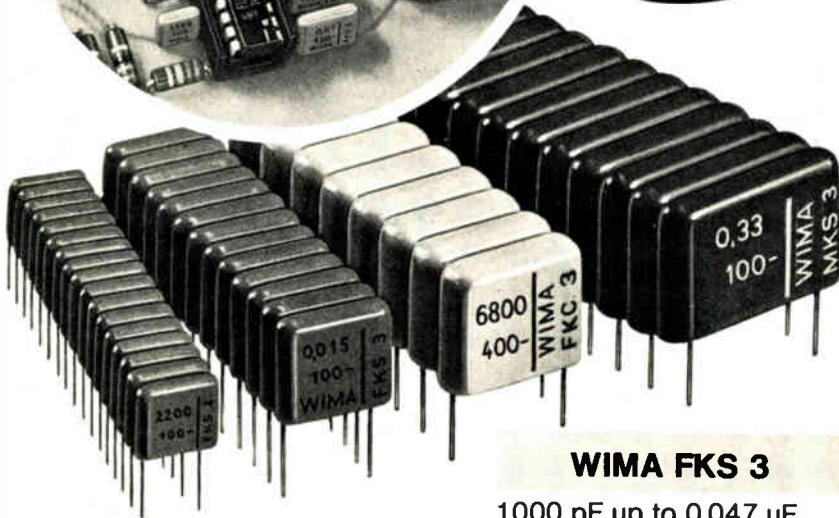
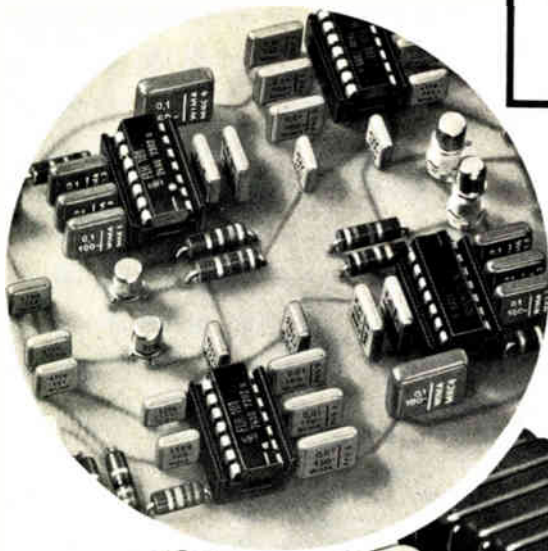

**WIMA FKS 3**

1000 pF up to 0.047  $\mu$ F

**WIMA FKC 3**

100 pF and up

**WIMA MKS 3**

Up to 0.47  $\mu$ F

**WIMA FKS 2 min**

P.C.M. 5 mm  
1000 pF to 0.047  $\mu$ F

## Cast-moulded capacitors

are an excellent aid in designing your IC-equipped printed boards. Use the new plug-in WIMA® capacitors which are smaller and have regular dimensions.

Write for our new catalogue.



**WILHELM WESTERMANN**

Spezialfabrik  
für Kondensatoren  
D-68 Mannheim 1  
Fed. Rep. of Germany  
Augusta-Anlage 56  
P. O. Box 2345  
Tel.: (0621) 40 80 12

used to being in charge of "big-ticket" electronics projects. For example, he was project manager for production of the APX-72 transponders, 14,000 of which were produced for the U.S. military air fleet.

The difference now is that instead of one or two projects at a time, McCormick is responsible for Bendix Communications' entire R&D program. This includes the efforts of about 600 engineers and as many technicians. Among other projects, they're working on a microwave landing system for the Federal Aviation Administration, a system for controlling surface traffic at airports, and a prototype discrete-address beacon system.

**Best payoff.** The biggest potential profits lie in the microwave landing system for which Bendix is competing with Texas Instruments, ITT Gilfillan division, and Hazeltine Corp. Both ground-based and airborne equipment are involved, and it could earn up to \$1 billion.

Although mainly concerned with management, McCormick has also been able to keep his hand in as an engineer. He and two other Bendix designers have patented the trilateration scheme for the surface-traffic control system. It relies on interrogators to obtain ground coordinates from aircraft transponders.

McCormick's new job is also turning him into something of a juggler, as he shifts his staff from one project to another and then back to a later phase of an earlier project. And while golf and swimming were once frequent leisure-time activities, the 39-year-old McCormick finds much less time for them now. If he stays trim, it will have to be because of the exercise he gets chasing those billion-dollar plums.

**Hopeful.** The possibilities are huge at Bendix for R&D director McCormick.



# The first bipolar microcontroller.

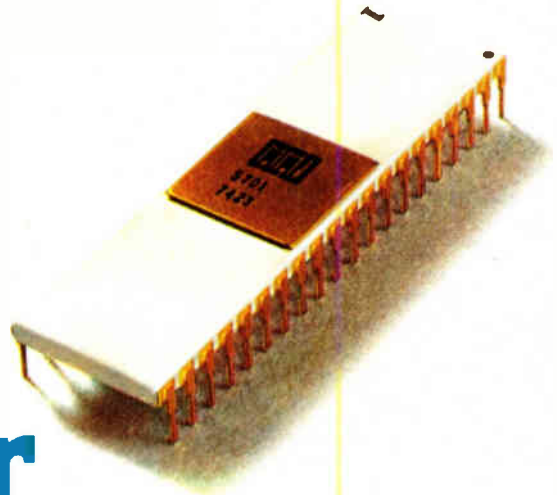

**Monolithic Memories' bipolar microcontroller.  
It's a complete 4-bit expandable  
TTL/LSI data slice.  
A single chip in a 40-pin DIP.  
And you thought we only made memories.**

# MMI's bipolar

**Our microcontroller is flexible. Expandable. Something you design with, not around.**

When we announced our 10K ROM, we proved that bipolar processing could match MOS memory densities and still keep all the product advantages of the Schottky TTL. Now we're proving it again in logic. Monolithic Memories has driven ahead to the next major growth step in device integration in the world of logic. The MMI 5701/6701 bipolar microcontroller is the result.

It's a natural stage in the development of bipolar integration following the evolution of logic technology from discretes to MSI to LSI. But with complexity of over 1000 gates, our microcontroller deserves a descriptive title that's even beyond LSI.

#### What's included:

MMI's versatile microcontroller, designed to be used as a 4-bit processor slice of a conventional CPU, can also be easily designed into peripheral controllers where Schottky TTL speeds are required. Or you might want to use it in a host processor to control several slow microprocessors. Its two-address capability and nano-instructions let you design 200-nanosecond-cycle-time CPU's or emulate conventional machines by adding a few off-chip ROMs/P.ROMs for your microprograms. (MMI can easily supply the supporting ROMs, P.ROMs and RAMs. Even build the boards to your specs.)

The 5701/6701 will handle the data flow section of most computers. It's expandable in

4-bit increments without any significant speed penalty. Look-ahead outputs are included. 16 general purpose accumulators on the chip give you the computing power of the top-line 16-bit minis or 24- and 32-bit computers.

In conventional TTL equivalents, the 5701/6701 does what it now takes 25 MSI parts to do. Saves 375 I/O pins, 30 square inches of printed circuit board area and 5.6 watts of power: The savings on parts, pins and power speak for themselves. (See chart)

#### Process, Power and Performance

MMI's 5701/6701 (Mil/Commercial) microcontroller is a standard Schottky bipolar single-layer-metal device. Needs only 5V and ground. All inputs and outputs are TTL compatible. The 5701 is specifically designed to dissipate maximum power at low temp and minimum power at high temperature for improved mil temp range performance and reliability.

Speed? The 6701 can perform complex multiple operations which are performed in each cycle without timing problems. Fetch two operands, subtract, shift, and store, in one 200ns cycle!  $(A_i - B_j \rightarrow B_j)$

#### The MMI 5701/6701 microcontroller features:

1. Over 1000-gate complexity Schottky LSI.
2. Proven reliability of single-layer-metal process.
3. 36 instructions—21 arithmetic, 15 logic, and shifting capability with overflow detection. Active high or active low logic.
4. Performs multiple nano-instructions such as fetch, subtract, shift and store in one cycle. 200ns max. (Over temp and  $V_{cc}$ ).
5. Replaces 25 TTL MSI packages; saves 5.6 watts.
6. 16 directly addressable 2-port general purpose accumulators. Full 2-address capability, some 3-register operations.
7. Separate on-chip register for use as a scratchpad or accumulator extension.
8. Direct data-in and accumulator operations.
9. Separate low fan-in data input bus and a 3-state output bus.
10. Expandable to handle N-bit words with full carry look-ahead capability.
11. Both zero detect and overflow conditions are brought out.

Function	TTL#	#14 Pin or #16 Pin Pkgs.	#24 Pin Pkgs.	Advertised Gate Complexity (Each Pkg.)	Gate Complexity Total	Typical Power Each (Watts)	Total Power (Watts)
32 x 9 G 8 x 8 ROMs	7488	3		70	210	.50	1.50
16 x 4 Multiport RAM	74172		4	110*	440	.56	2.24
Arithmetic Logic Unit	74181		1	75	75	.55	.55
Storage Latches	7475	2		28	56	.16	.32
J-K Flip Flop (Q Reg)	74107	2		22	44	.10	.20
4 to 1 MUX	74153	6		16	96	.20	1.20
O/I True Complement	74H87	2		18	36	.27	.54
Dual 4 Bit Select	74157	2		15	30	.15	.30
Quad 2 to 1 MUX with 3 State Outputs	74S257	2		15	30	.30	.60
3 State Buffer	DM8094	1		5	5	.18	.18
<b>Totals</b>		<b>20</b>	<b>5</b>		<b>1022</b>		<b>6.63</b>

\*NOTE: The 74172 is advertised at 201 gate complexity but we are using only 2 of the 3 address capability, hence we have counted it as 110 gates.

# microcontroller.

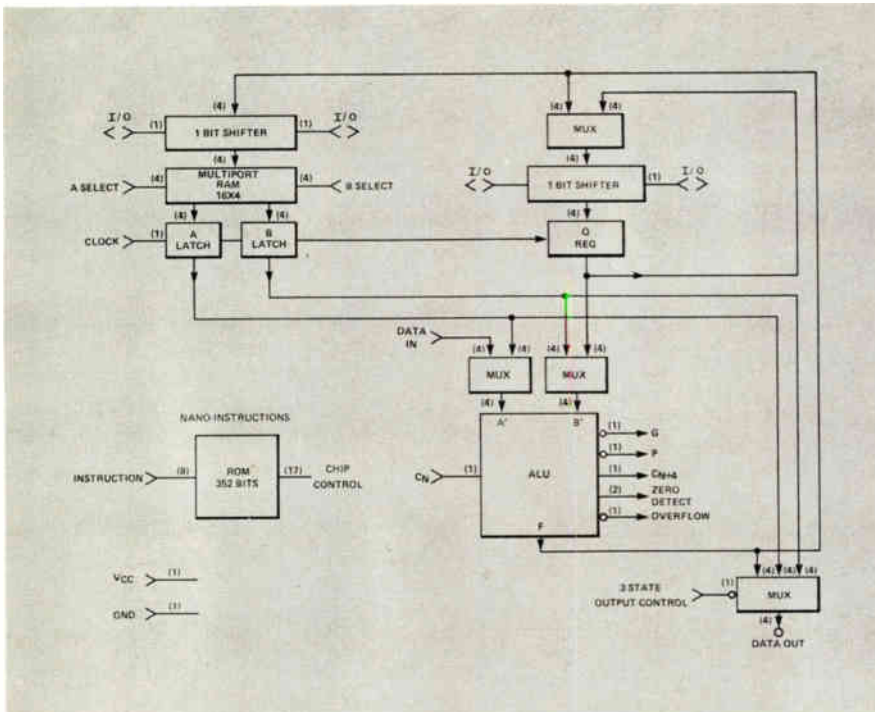

## Where you can use it

The most appealing application for this powerful new device is in upgrading or replacing existing CPU's while maintaining all your existing software. Four of our 6701's, for instance, with about 24 other standard TTL parts, can emulate a 110-package 16-bit mini-level computer.

Equally important applications for MMI's 5701/6701 are in distributed processing applications. Its TTL speed in communications processors improves bit packing, and lowers phone line costs. Processing speed is also a key factor in concentrator applications for POS systems, intelligent terminals and other multiprocessors.

The ability to implement special purpose dedicated instruction sets makes our 6701 a perfect fit for machine and process control, navigation systems, and traffic control applications. Most systems using 74181, 9340, 9341 or 74S281 ALU's can now get better performance with our 6701.

## How to get into it

If you design with TTL and have existing software, MMI's bipolar microcontroller fits right in. Because it's 4-bit expandable, you can tailor it to fit your system. Easy. And our applications people will be glad to help.

Best of all, you'll find prices on the MMI 5701/6701 are competitive to standard TTL. Learn more about prices, specs and

delivery. Write **Monolithic Memories, Inc.**, 1165 East Arques Avenue, Sunnyvale, CA 94086. Better yet, call your local MMI sales office or representative listed below.

**EASTERN AREA SALES OFFICE:**  
 (617) 653-3158 • **NEW ENGLAND REGION:** (617) 475-8883 • **NEW YORK REGION:** (914) 831-4590 • **MID-ATLANTIC REGION:** (215) 643-5391 • **CENTRAL AREA SALES OFFICE:** (214) 369-7952 • **MINNEAPOLIS REGION:** (612) 881-1600 • **WESTERN AREA SALES OFFICE:** (714) 556-1216

## Representatives:

**ALABAMA,** Huntsville (205) 539-1771; **ARIZONA,** Phoenix (602) 264-7971; **CALIFORNIA,** Palo Alto (415) 369-4671; **COLORADO,** Denver (303) 423-1020; **CONNECTICUT,** North Haven (203) 239-9762; **FLORIDA,** Orlando (305) 423-7615; **ILLINOIS,** Chicago (312) 593-0200; **INDIANA,** Ft. Wayne (219) 432-5591; **INDIANAPOLIS** (317) 359-9283; **IOWA,** Cedar Rapids (319) 393-8703; **KANSAS,** Kansas City (913) 236-4646; **KENTUCKY,** Louisville (502) 893-7303; **MARYLAND,** Baltimore (301) 825-3330; **MASSACHUSETTS,** Boston (617) 444-2484; **MICHIGAN,** Detroit (313) 358-2020; **Grand Rapids** (616) 451-8901; **MINNESOTA,** Minneapolis (612) 884-7471; **MISSOURI,** St. Louis (314) 432-2830; **NEW JERSEY,** Teaneck (201) 692-0200; **NEW MEXICO,** Albuquerque (505) 265-5655; **NEW YORK, N.Y.C./L.I.** (201) 692-0200; **NORTH CAROLINA,** Raleigh (919) 834-6591; **OHIO,** Cincinnati (513) 521-2290; **Cleveland** (216) 228-7525; **Dayton** (513) 298-9546; **PENNSYLVANIA,** Pittsburgh (412) 344-7277; **Willow Grove** (215) 674-3850; **TEXAS,** Dallas (214) 239-9148; **Houston** (713) 721-1054; **WISCONSIN,** Wauwatosa (414) 786-6330.

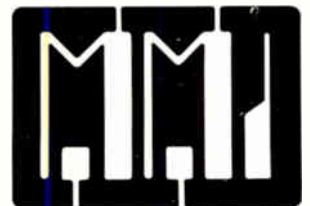



**Ever Since the  
One-Tube RF-Amplifier/Detector  
Was the Hottest New Idea  
in Communications...**

If it's experience that counts in ability to design and build antenna insulators, nobody can touch Lapp! Solving problems—both electrical and mechanical—with insulators has been our business for more than 50 years.

Structural guy insulators . . . antenna strain insulators . . . base insulators for both self-supporting towers and guyed masts with strength ratings up to 9,000,000 lbs. ultimate. In fact, the bigger they are, the better off you are when you rely on Lapp's know-how.

Write for new catalog of  
Lapp RF Insulators and Assemblies:

LAPP INSULATOR DIVISION  
INTERPACE CORPORATION  
LE ROY, N. Y. 14482

Heavy-duty tower base insulators featuring triple "compression-cone" insulators



Double strain insulator assembly for radials of top-loaded vertical radiators



Large structural-guy insulator assembly with grading rings



New design fail-safe structural guy insulator featuring compression post insulator, increased leakage and flashover ratings



Moderate-duty mast base insulator

**Antenna Tower  
Insulators** by



**Meetings**

**Eascon '74, Electronics and Aerospace Systems Conference**, IEEE, Marriott Twin Bridges Motor Hotel, Washington, D.C., Oct. 7-9.

**IAS '74, IEEE Industry Applications Society**, William Penn Hotel, Pittsburgh, Oct. 7-10.

**Tenth Annual International Telemetering Conference**, EIA et al., International Hotel, Los Angeles, Oct. 15-17.

**National Electronics Conference**, sponsored by the National Electronics Conference Inc. (Oak Brook, Ill.), Hyatt Regency O'Hare Hotel, Chicago, Oct. 16-18.

**1974 Symposium of the International Society for Hybrid Microelectronics**, (Montgomery, Ala.), Sheraton-Boston Hotel, Oct. 21-23.

**ISA Conference and Exhibit**, Instrument Society of America (Pittsburgh, Pa.), New York Sheraton Hotel and New York Coliseum, Oct. 28-31.

**Nerem-74, Northeast Electronics Research and Engineering Meeting**, IEEE, Sheraton-Boston Hotel and John B. Hynes Veterans Auditorium, Boston, Oct. 29-31.

**International Symposium on Information Theory**, IEEE, Notre Dame, Ind., Oct. 27-31.

**'74 ASSC, Automatic Support Systems Symposium for Advanced Maintainability**, IEEE, Sheraton Inn, Harbor Island, San Diego, Calif., Oct. 30-Nov. 1.

**Ultrasonics Symposium**, IEEE, Pfister Hotel, Milwaukee, Wis., Nov. 11-13.

**International Semiconductor Laser Conference**, IEEE, Atlanta Inn, Atlanta, Ga., Nov. 18-20.

**Specialist Conference on Technology of Electroluminescent Diodes**, IEEE, Atlanta Inn, Atlanta, Ga., Nov. 20-21.

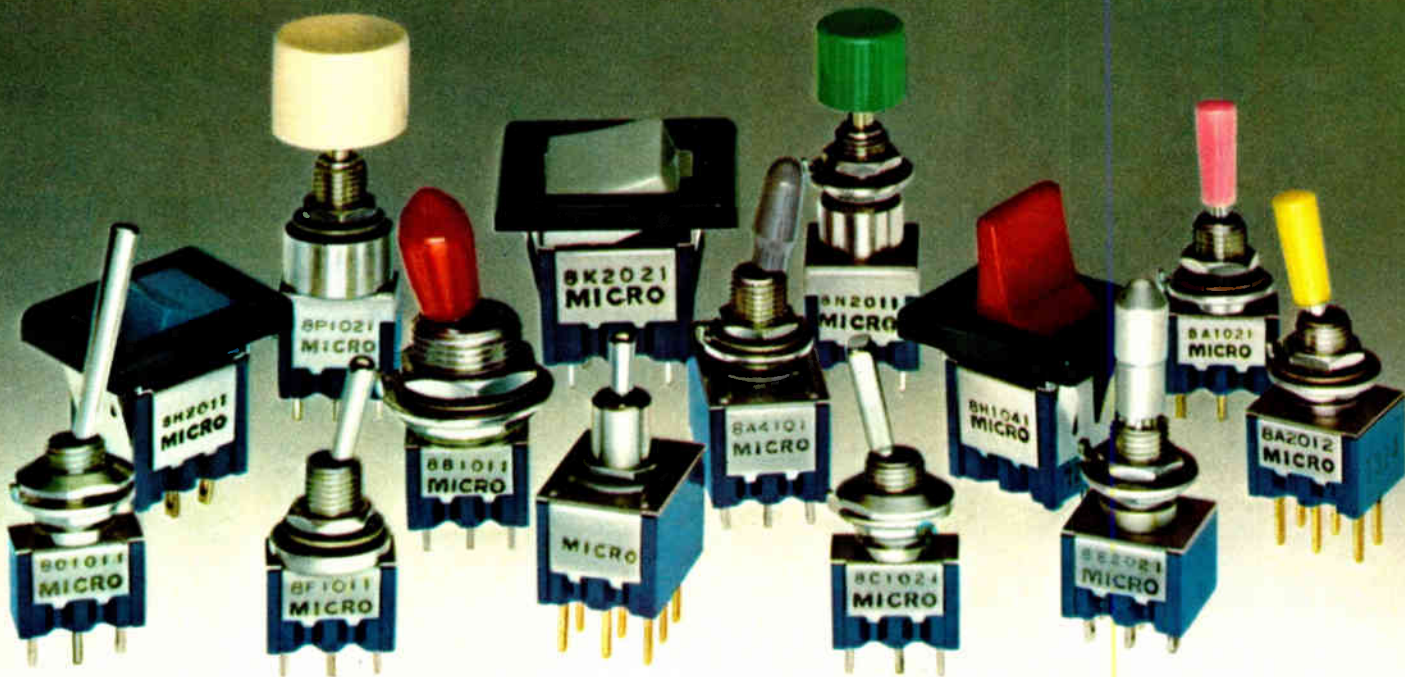

## They look like miniature manual switches. But they're really just responses.

Every one of the miniature manual switches in the MICRO SWITCH Series 8 line is the direct result of a design need.

And, because design needs change continually, so do the miniature manuals we offer.

In the last year alone, we've added hundreds.

So you can choose from toggles, paddles, rockers—lighted and unlighted—and pushbuttons. With terminal variations that include solder, quick-connect, PC board and wire wrap.

They're all U.L. listed at 6 amps, 125VAC. With low energy versions available in every design.

And they all come with standard features like traditional MICRO SWITCH quality. Including inspection to a one percent Acceptable Quality Level. And nationwide, off-the-shelf availability, so there's no waiting.

They're also available with new features, like panel and bushing-sealed pushbuttons and toggles. A non-threaded bushing on PC mounted toggles. And colored sleeves for the 15/32-inch diameter bushing toggles.

If you'd like more information on the MICRO SWITCH Series 8 miniature manual switches, call, toll-free, 800/645-9200 (in N.Y., call 516/294-0990, collect) for the location and phone number of your nearest MICRO SWITCH Branch Office or Authorized Distributor.

Find out why you need only one source for the right miniature manual switch, at the right price, at the right time.

And how that source will work with you, just in case it doesn't make exactly what you need. Yet.

MICRO SWITCH products are available worldwide through Honeywell International.

### MICRO SWITCH

FREEMONT, ILLINOIS 61032

A DIVISION OF HONEYWELL

Circle 21 on reader service card

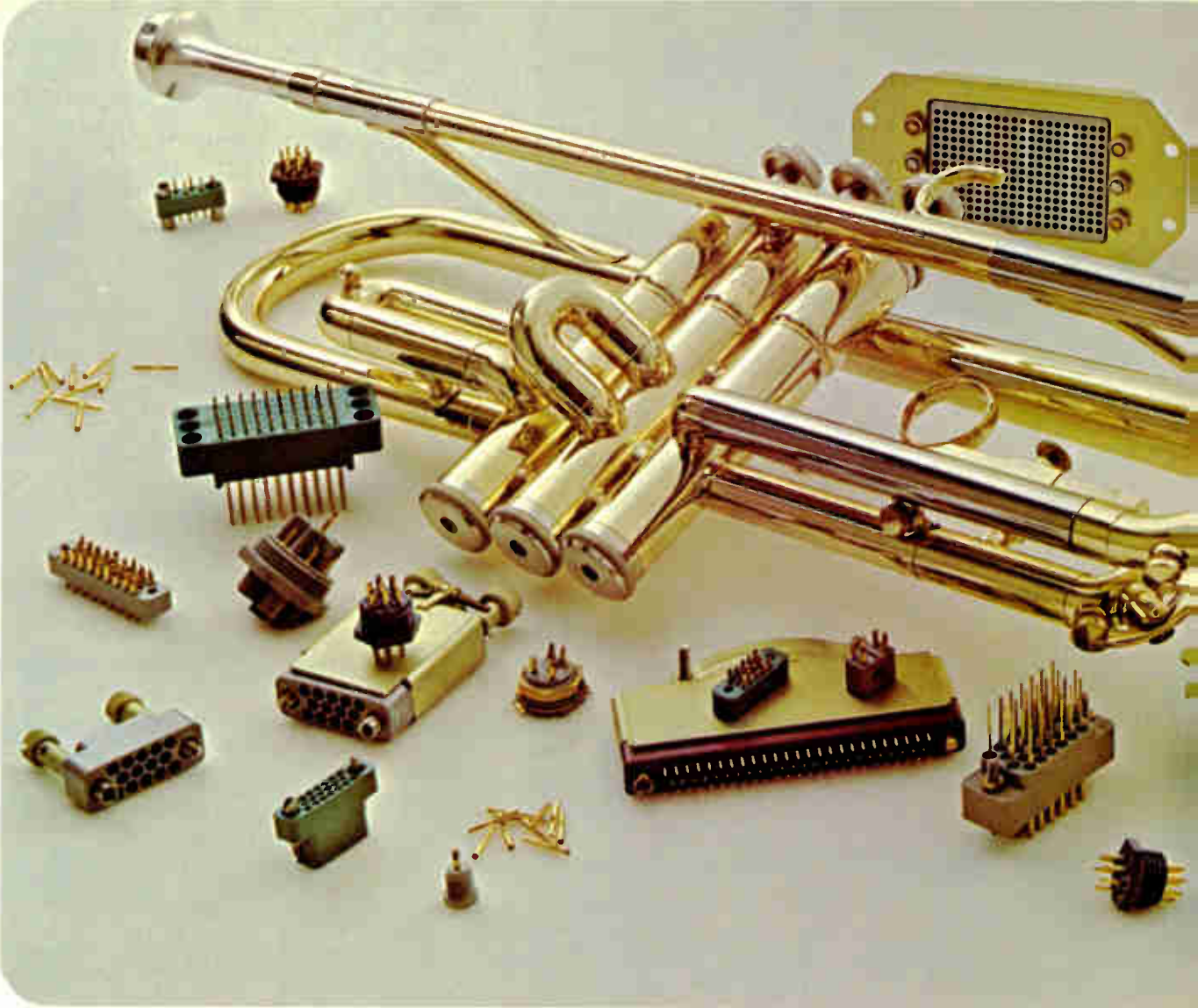

# Get on the horn!

## Winchester Electronics Rack & Panel Connectors

### Authorized Winchester Electronics Distributors

Avnet Electronics  
Culver City, California 90230  
Telephone 213-559-4111  
Telex 87-3692  
TWX 910-340-6364  
Cramer Electronics, Inc.  
Newton, Massachusetts 02159  
Telephone 617-969-7700  
TWX 710-335-1971  
Elmar Electronics  
Mt. View, California 94042  
Telephone 415-961-3611  
TWX 910-379-6437

Elmar Electronics  
Commerce City, Colorado 80022  
Telephone 303-287-9611  
TWX 910-936-0770  
Greene-Shaw Company, Inc.  
Newton, Massachusetts 02195  
Telephone 617-969-8900  
Telex 92-2498  
Hamilton-Avnet Electronics  
Phoenix, Arizona 85034  
Telephone 602-275-7851  
TWX 910-951-1535

Hamilton-Avnet Electronics  
Schiller Park, Illinois 60176  
Telephone 312-678-6310  
TWX 910-227-0960  
Hamilton-Avnet Electronics  
Edina, Minnesota 55435  
Telephone 612-941-3801  
Hamilton-Avnet Electronics  
Westbury, L.I., New York 11590  
Telephone 516-333-5800  
TWX 510-222-8237

Hamilton-Avnet Electronics  
Bellevue, Washington 98005  
Telephone 206-746-8750  
TWX 910-443-2449  
Hamilton-Avnet International (Canada) Ltd  
St. Laurent  
Montreal, Quebec H4S1G2, Canada  
Telephone 514-331-6443  
TWX 610-421-3731  
Hamilton-Avnet International (Canada) Ltd  
Mississauga, Toronto, Ontario, Canada  
Telephone 416-877-7432  
TWX 610-492-8867

Harrison Electronics Corporation  
Farmingdale, L.I., New York 11735  
Telephone 516-293-7990  
TWX 510-224-6403  
Lelectron, Inc.  
St. Charles, Missouri 63301  
Telephone 314-946-6424  
TWX 910-760-1720  
Liberty Electronics  
Phoenix, Arizona 85017  
Telephone 602-257-1272  
TWX 910-951-1530

Liberty Electronics  
El Segundo, California 90245  
Telephone 213-322-8100  
TWX 910-348-7111  
Liberty Electronics  
San Diego, California 92121  
Telephone 714-565-9171  
TWX 910-335-1590  
Liberty Electronics N/W  
Seattle, Washington 98108  
Telephone 206-763-8200  
TWX 910-444-1379



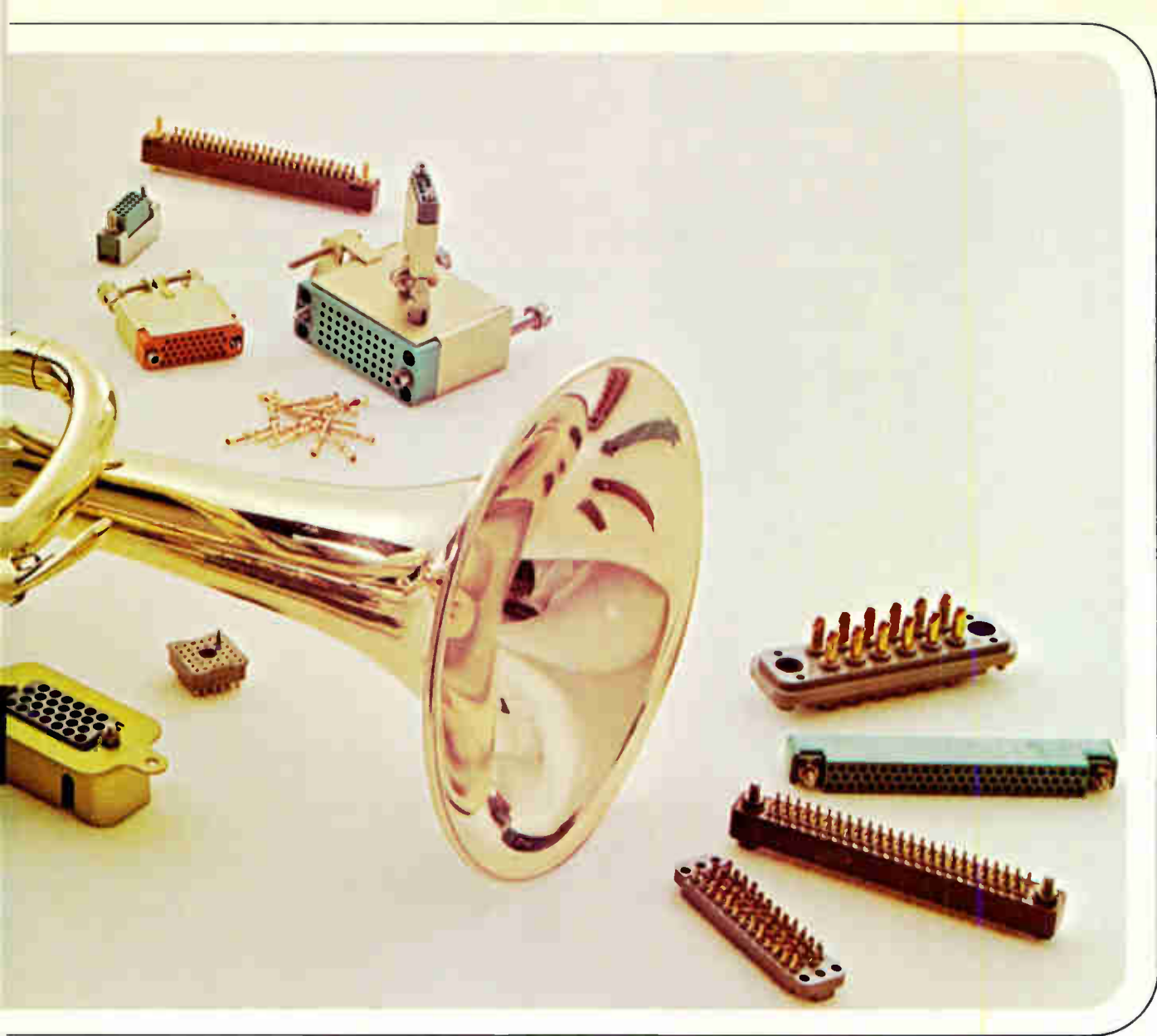

When your new electronic packaging design idea is making sweet music, you don't need sour notes.

But it happens. Your idea stops in mid-beat. The critical, "standard" rack and panel connector you've specified isn't available. Your symphony goes unfinished. And you've got to start over.

But don't. Instead, get on the horn to your local Authorized Winchester Electronics Distributor. Your design will begin to make good sounds, again. Because he'll have exactly the rack and panel connector you want — off-the-shelf. He will because Winchester Electronics backs up the responsive, professional Authorized Distributors serving you. So you order from a truly broad, comprehensive array of rack and panel connectors . . . with literally thousands of configuration possibilities to fit your idea. It's design-by-specifying . . . our consistent refrain of design-flexible, "custom" rack and panel connectors available immediately and at non-custom prices.

You can specify from our MRAC Series. With 12 configurations covering 9 to 104 crimp removable contact patterns. With polarizing hoods. Guides. And vibration locks equal to 750G shock impacts. Or use subminiatures like our SREC Series for close quarters and light weight. Or our RW Series for high density, automatic wiring techniques. Or order NIM Series types for nuclear instrumentation modules. All these and more.

So keep us in mind. When you've got a connector problem that could stop the music, your Authorized Winchester Electronics Distributor has the solution. He'll solve your problem quickly and harmoniously . . . to let your design play. Winchester Electronics, Main Street & Hillside Avenue, Oakville, Connecticut 06779 (203) 274-8891.



**WINCHESTER ELECTRONICS**

Litton

Motronics  
Southgate, California 90280  
Telephone 213-773-8521  
TWX 910-580-1947  
Pan Electron, Inc.  
Higashikata-Machi, Midori-ku  
Yokohama 226, Japan  
Telephone 045-471-8321  
Telex 382-2865  
Powell Electronics/Huntsville  
Huntsville, Alabama 35807  
Telephone 205-539-2731  
TWX 810-726-2231

Powell Electronics/California  
Mt. View, California 94040  
Telephone 415-964-0820  
TWX 910-379-6970  
Powell Electronics/Florida  
Miami Springs, Florida 33166  
Telephone 305-592-3260  
Powell Electronics  
Orlando, Florida 32809  
Telephone 305-859-1450  
TWX 810-850-0155

Powell Electronics/Washington  
Beltsville, Maryland 20705  
Telephone 301-937-4030  
TWX 710-828-9710  
Powell Electronics/Philadelphia  
Philadelphia, Pennsylvania 19101  
Telephone 215-265-1900  
TWX 710-670-0465  
Radio Distributing Company, Inc.  
Chicago, Illinois 60635  
Telephone 312-237-1105

Radio Distributing Company, Inc.  
South Bend, Indiana 46624  
Telephone 219-287-2911  
TWX 810-299-2583  
Radio Distributing Company, Inc.  
Cleveland, Ohio 44143  
Telephone 216-461-9090  
Stack Industrial Electronics, Inc.  
Binghamton, New York 13902  
Telephone 607-723-6326  
TWX 510-252-1997

Sterling Electronics  
Dallas, Texas 75229  
Telephone 214-357-9131  
Telex 73-2352  
Sterling Electronics  
Houston, Texas 77027  
Telephone 713-623-6600  
Telex 77-5299  
Summit Distributors, Inc.  
Buffalo, New York 14202  
Telephone 716-884-3450  
TWX 710-522-1692

Wishire Electronics/New England  
Burlington, Mass 01803  
Telephone 617-272-8200  
Namco Electronics  
Victoria 3816, Australia  
Telephone 96-2891  
Telex AA31261  
Radokom (1965) (Pty) Ltd  
Randburg, South Africa  
Telephone 48-5712  
Telex 43-0838 SA

# SOLID ROCK

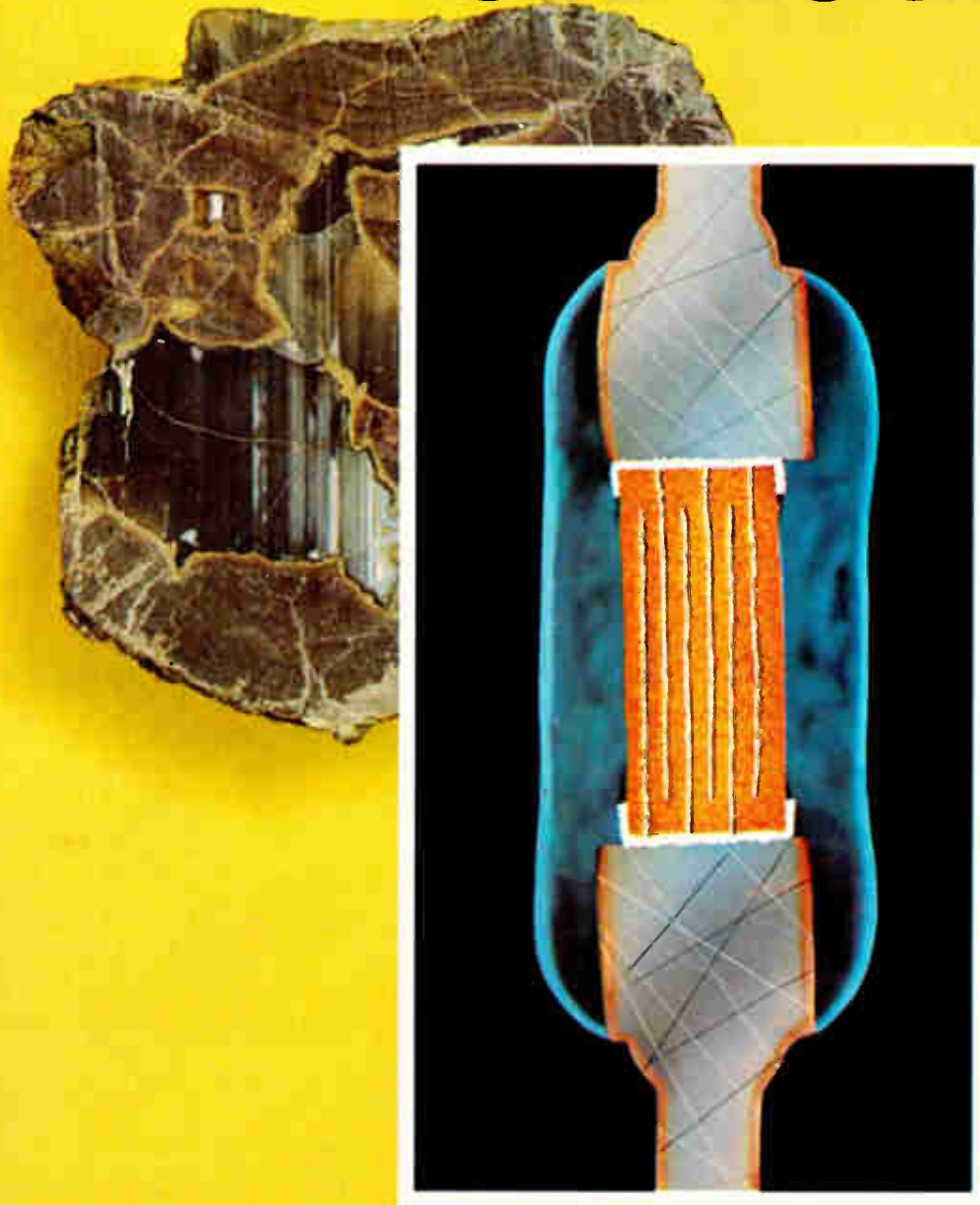

## ROCK SOLID

The most solid, stable glass-sealed ceramic capacitors around. Processed with unique and proprietary techniques (patents pending). That's what makes GTI/Tensor's glass-sealed ceramic capacitors as solid and tough as a rock. Results:

- **No point contact resistance**
- **50% lower ESR**
- **Dielectric stability**
- **Higher insulation resistance**
- **Greater volumetric efficiency**
- **Smaller size (resulting in greater component density on the board)**

Body characteristics available: NPO (COG), X7R (BX) and Z5U (GP).

GTI/Tensor tapes and reels your order for automatic insertion.

For hard facts and rock-solid deliveries, write or call us or one of our representatives; while you're at it ask for our new catalogs on Glass Sealed Ceramic Capacitors and Monolithic Chip Capacitors.



**tensor  
electronics, inc.**

11558 Sorrento Valley Road  
San Diego, California 92121  
(714) 453-7262 Telex: 69-5056

OCTOBER, 1974

## in this issue

A new business  
pocket calculator

Get two function  
generators in one

New super-sensitive  
x-y recorder

### Desktop calculator now doubles as data terminal

New data communications capability for the 9830A allows it to be used as an interactive or batch terminal.

Thanks to a new interface, you can inexpensively and easily add data communications capability to 9830A desktop calculator systems. Now, you not only have a powerful programmable self-contained calculator, but you can also use the unit as an interactive terminal to communicate with a batch computer, timeshare system, or another 9830A calculator.

The 11285A data communications set includes an interface cable and a read-only-memory (ROM). New BASIC statements in the ROM enable the 9830A to send and receive data and strings from a remote terminal or computer via telephone lines. Programmable asynchronous or synchronous transmission and data rates

*(continued on page 3)*



## The HP-70: new business companion to the HP-80 financial specialist

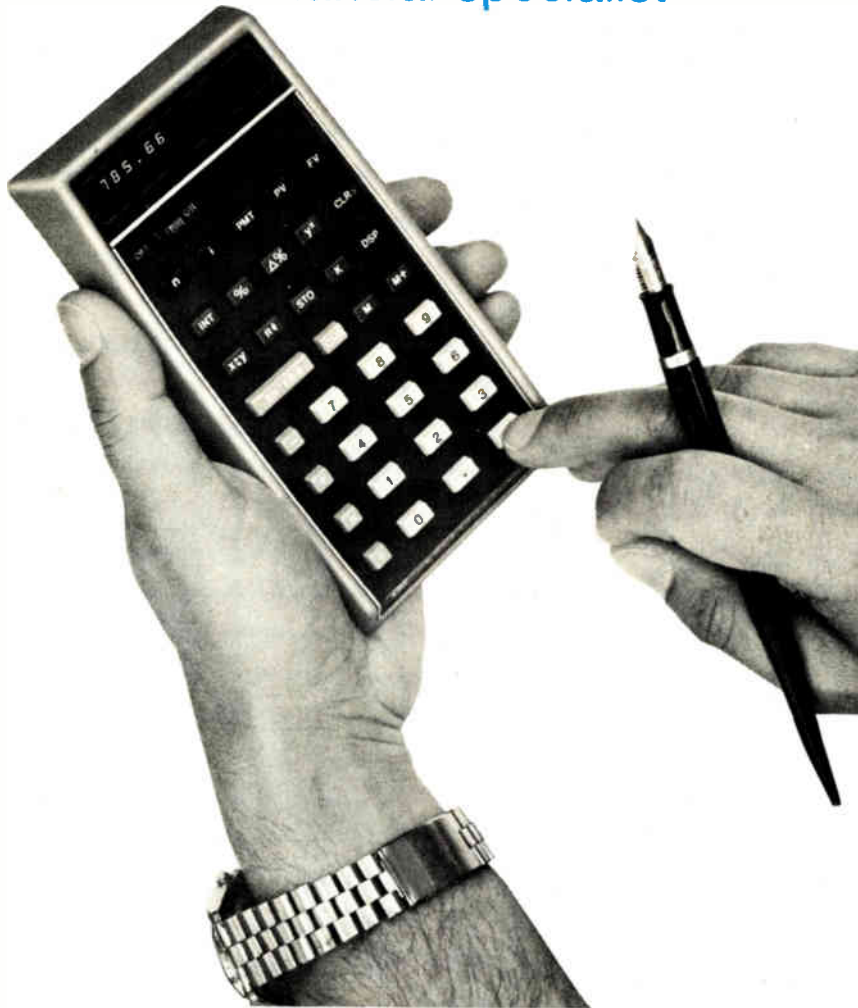

The HP-80 gave the financial world the first pocket-sized computing calculator designed specifically to handle over 100 most commonly used financial calculations. Now, Hewlett-Packard puts the same quality of design in a more generalized business pocket calculator, the new HP-70.

The versatile new HP-70 pocket calculator solves more than 100 complex financial problems...most of them in less than 20 seconds. It has more memory storage than any other business pocket calculator on the market, yet costs less than you'd expect.

Now, you can figure a loan payment, U.S./foreign currency conversions, or return on investments—at your fingertips. Use the HP-70 at work, at meetings, on sales calls, or on a plane. Wherever and whenever your time-and-money problems occur, the HP-70 helps solve them, with accuracy to 1 penny in a million dollars.

The HP-70's superior memory power gives you:

- Four memories in the memory stack that automatically store intermediate answers;

- Two addressable memories—one for accumulations, the other for constants;
- A financial memory bank that lets you change any number at any time. Thus, you can explore alternatives without having to key in all the information again.

Not only does the amazing HP-70 help at the office, it helps at home. Use it to figure mortgage payments, calculate your income tax, or help select the most profitable investment opportunities.

Like all HP pocket calculators, the HP-70 uses a non-algebraic approach that gives you answers you can trust.

*For more on HP-70 versatility and value, check B on the HP Reply Card.*

## Now, cover UHF needs with precision AM/FM signal generators

A new internal doubler extends the frequency of HP 8640 AM/FM signal generators from 512 to 1024 MHz. With the new high-band option (002), total range is a wide 0.5 to 1024 MHz (overrange to 1100 MHz). Calibrated output in the extended band is +13 dBm to -145 dBm into 50 $\Omega$  and is leveled to  $\pm 1.5$  dB.

With new assignments for land mobile radio services in the 900 MHz region, the extended frequency capability of the 8640 gives you a precision test instrument to serve these applications, as well as needs in the HF/VHF/UHF bands.

We've preserved the desirable precision modulation, signal purity, and direct frequency and amplitude readout of the standard 8640 generators. Precision FM, with calibrated peak deviation to 5.12 MHz and rates to 250 kHz, is provided, as well as calibrated AM.

The frequency extension option is offered with both the 8640A (dial readout of frequency) and 8640B (digital readout). The 8640B includes internal phase-lock for highest stability plus a 500 MHz frequency counter.

If you already have an 8640 signal generator, you can purchase a field-installable kit to double your frequency coverage.

*For more information, check N on the HP Reply Card.*



**The best RF signal generator, the 8640 now offers extended coverage to 1024 MHz.**

## Get the inside story on HP pocket calculators

If you're about to spend more than \$100 on a pocket calculator, you owe it to yourself to choose carefully. Before buying, you should know the differences between algebraic and non-algebraic logic systems, then determine the best one for your calculating needs.

HP's non-algebraic system lets you see each intermediate answer as you progress through a problem, so you can correct errors as you go. With this continuous feedback, you end up with answers you can trust.

A new informative booklet compares 3 representative calculators using "real world" scientific problems. After reading it, we think you'll agree that HP's non-algebraic approach offers the most efficient, most consistent way to solve complex problems.

For your free copy, check S on the HP Reply Card.



## Calculator—data terminal

(continued from page 1)

from 110 to 9600 bits/second are available, as well as programmable parity, automatic dialing and answering, "end-of-transmission" character, and half- or full-duplex mode.

Two other ROMs add further capability. One provides remote batch capability using IBM binary synchronous line protocol. The other ROM provides timesharing capability and allows you to receive and transmit programs in other languages, such as FORTRAN.

For more information, check O on the HP Reply Card.

## New generator gives you more functions for your money

HP's new 3312A function generator offers more variety in output selection than any comparably-priced generator on the market. It has sine, square, triangle, positive and negative ramps, as well as a number of other features.

It's actually two independent generators in one—the main generator delivers 0.1 Hz to 13 MHz in eight decade ranges, and the modulation generator delivers 0.01 Hz to 10 kHz in three ranges. You can trigger the main generator with the modulation generator to get sweep functions, AM, FM, frequency shift keying, gating and tone bursts. Output of the main generator is 10 V p-p into 50Ω for all waveforms, adjustable over a 60 dB range. Its <18 ns risetime makes the 3312A an ideal source for applications that require medium speed pulse trains.

All these versatile functions enable you to use the 3312A for sonar testing, pulse doppler testing, and shock wave simulation, as well as traditional amplifier, receiver and filter testing.

For details and specs, check D on the HP Reply Card.



The new 3312A function generator has sine, square, triangle, positive and negative ramps. Accuracy is  $\pm 5\%$  of full scale.

## Now, measure to 23 GHz with HP microwave counter

Shown here with a satellite communications antenna, the 5340A microwave counter now measures higher carrier frequencies.

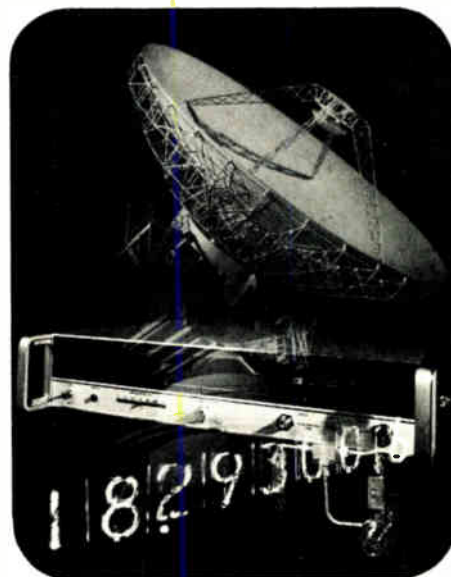

That's right—with special option H10, our proven 5340A microwave counter now counts signals as high as 23 GHz. Sensitivity is significantly better than that of other microwave counters, yet the 5340A is rugged enough to take +30 dBm inputs.

It's easy to use: simply apply your signal to a 50Ω connector, then measurements are entirely automatic. The 8-digit display positions the decimal point automatically and specifies unit notation in kHz, MHz, or GHz. Frequency range is 10 Hz to 23 GHz. Dynamic range is 42 dB wide (-35 dBm to +7 dBm). If you need higher input impedance, a second input is available, 10 Hz to 250 MHz with 1 MΩ impedance.

The 5340A fits nearly every microwave application. Use it to measure carrier frequency, align receivers, calibrate signal generators, identify ECM carriers, automatically test VCOs, or test microwave communications systems.

For complete details, check J on the HP Reply Card.

## Improve lab recording with HP's fastest and most sensitive x-y recorder

A special combination of acceleration and sensitivity, the 7047A x-y recorder is the fastest, most sensitive recorder that HP has ever built. Sensitivity ranges from 50  $\mu\text{V}/\text{in.}$  to 10  $\text{V}/\text{in.}$  (20  $\mu\text{V}/\text{cm}$  to 5  $\text{V}/\text{cm}$ ). Acceleration on the y axis is greater than 3000  $\text{in}/\text{sec.}^2$  (7620  $\text{cm}/\text{sec.}^2$ ) while on the x axis, acceleration is 2000  $\text{in}/\text{sec.}^2$  (5080  $\text{cm}/\text{sec.}^2$ ). Slewing speed is 30  $\text{in}/\text{sec.}$  (76  $\text{cm}/\text{sec.}$ ).

To meet the demands of the most exacting lab work, the 7047A recorder has a switchable input filter, fully-guarded input, 130 dB common mode

rejection, 11 scales of calibrated offset, an internal time base, and TTL remote control. And the 7047A is easier to use than any other x-y recorder available: its internal guard circuit enables you to use the 7047A with virtually any input connection configuration. In most applications, there's no need for external guard connections.

*For details and specifications, check K on the HP Reply Card.*

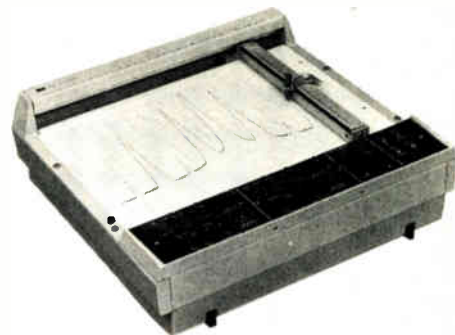

**The 7047A: the best x-y recorder HP has ever developed.**

## Six models cover your high-voltage power supply needs

Set output voltage easily and precisely with the 3-decade thumbwheel switch plus a thumbwheel vernier providing 0.002% resolution.



When your application calls for a system or lab power supply in the range of 0-4 kV, HP has six models to fill your need. Three of them are constant voltage/constant current supplies with sufficient output current to power devices such as klystrons, magnetrons, backward-wave oscillators, high-power gas lasers, and electron-beam welding devices. Model 6521A delivers 0-1 kV at 0-200 mA; model 6522A delivers 0-2 kV at 0-100

mA; while model 6525A supplies 0-4 kV at 0-50 mA.

Two lower cost models are also available. The 6515A power supply delivers 0-1.6 kV at 5 mA, while the 6516A supplies 0-3 kV at 6 mA. Their small size, low price and short-circuit-proof operation make them the choice where current requirements are low.

*For specs, check R on the HP Reply Card.*

## New pulse generator sets new standards in pulse fidelity

With 250 MHz repetition rate, variable transition times down to 1 ns, and low reactance 50 $\Omega$  source, the new 8082A pulse generator meets the stringent demands of today's fast logic like ECL and TTL-S. Yet it's easy to operate because of its logical front panel layout and switch-selectable ECL outputs.

The low-reactance 50 $\Omega$  source impedance helps provide a clean pulse at the input of the device to be tested. When operating without an external termination, the 8082A 50 $\Omega$  source absorbs 98% of reflections from

signals up to 4V, leaving only 2% distortion.

The low transition time degradation produced by the high quality 50 $\Omega$  source, combined with fast 1 ns transition time, lets you test ECL circuits at their maximum operating speeds and still leave a speed margin. The degradation of the transition times that always occurs under actual load conditions can be accommodated without exceeding the manufacturer's specifications.

Custom-made hybrid ICs eliminate the need for fans, reduce power con-



**Maximum pulse rate is 250 MHz; maximum amplitude, 5V.**

sumption, and contribute to high reliability.

*For specifications, check L on the HP Reply Card.*

## New RF adapter extends handheld dmm ac range to 500 MHz

Here, a technician uses the dmm probe and RF adapter to check a printed circuit board in a TV camera.



A new RF probe adds 100 kHz to 500 MHz ac measurement range to HP's handheld 970A digital multimeter. Accuracy within this range is greater than 1 dB. The new 97003A RF adapter measures 0.25 to 30 V full scale. Maximum input is 30 V rms, plus 200 Vdc.

The pocket-sized digital multimeter measures ac and dc volts and ohms. Basic ac voltage range is 100  $\mu$ V to 500 V, 45 Hz to 3.5 kHz. Input resistance on the ac range is 10 M $\Omega$ . Input resistance of the new RF probe is >25 k $\Omega$ , shunted by <4 pF.

The 97003A adapter is a peak detector calibrated to read the rms value of a sine wave input, then convert it to dc voltage. Thus, you simply set the dmm to read dc volts when you use the RF adapter. No other adjustments are necessary since the 970A is fully autoranging with autopolarity.

For more information, check P on the HP Reply Card.

## Three new scope probes simplify parallel triggering

Three new AND-gate trigger probes now enhance the use of oscilloscopes, logic analyzers, and other test equipment. Model 10250A works with TTL logic; 10251A, with MOS circuitry; and 10252A, with fast ECL. With any of the three, you can trigger on four parallel events. The four inputs can be switched to Hi, Lo or Off for convenient selection of the trigger point. And you don't need a separate power supply because power is obtained from the circuit under test.

The new trigger probes are great service, production and troubleshooting tools. Now, you can easily take electrical measurements that were almost impossible to make in complex digital sequences. The 10250A TTL trigger probe has an added "glitch filter." By varying the external trigger level of a scope, you can eliminate the effect of short glitches (<250 ns) that cause unwanted logic states.

These small probes directly connect to dual in-line packages and backplane pins. The tips easily slip off the



Trigger any oscilloscope from digital signals with HP's new TTL trigger probe.

probe wire for direct connections to 0.6 mm square pins, IC test clips, and wirewrap pins.

For more information, check Q on the HP Reply Card.

## HP catalog for microwave measurements

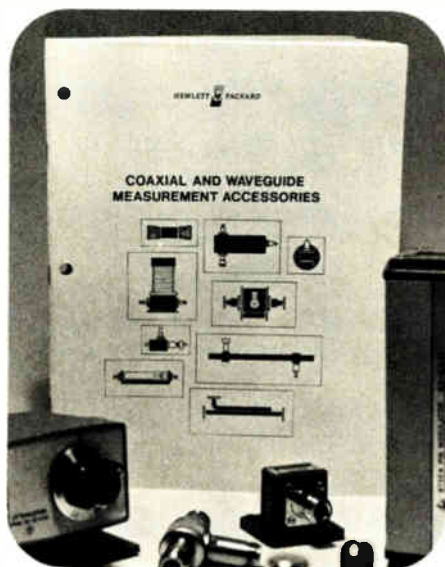

In case you missed it before, HP is again offering its 64-page catalog of coaxial and waveguide instrumentation. Specifications are presented for such items as:

- Directional couplers
- Slotted-line equipment
- Attenuators
- Frequency meters
- Detectors
- Mixers
- Filters
- Modulators
- Terminations

This book describes all the precision hardware you might need to help make accurate microwave measurements.

Check T on the HP Reply Card for your copy.

## Get both batch and timesharing in new super-timeshare system

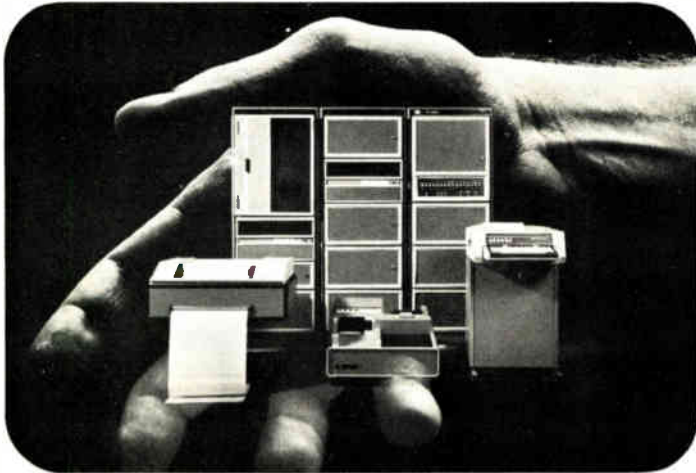

The new HP 3000/model 100 timeshare system is the most powerful BASIC system on the market. Besides offering terminal access to as many as 16 users, the new super-timeshare system simultaneously compiles and executes programs in batch mode, in FORTRAN, COBOL and our own system programming language (SPL). Unlike its competition, the HP system can handle integers, real, long-precision, and complex numbers, all in the same program.

This new disc-based system in-

cludes 96 bytes of core memory and storage of 9.8 million bytes on the disc. It's an outstanding in-house timesharing system for manufacturing, engineering, finance, operations research, technical centers, and universities. And the new advanced software, BASIC/3000, provides more power and capability with less programming effort.

For the complete story, check C on the HP Reply Card.

Need a hand with your computer processing? The new HP timeshare system calls up batch compiled programs as subroutines—for 10 to 100 times faster execution.

## Three new application pacs for the HP-65

Now, we've taken common problems in the areas of finance, aviation, and navigation—and HP has written the programs for you. So, it's easier than ever to use your HP-65 fully programmable pocket calculator. Simply slip in a program card, key in your variables, and instantly your answers appear on the 10-digit display.

The new finance pac contains 38 programs including calculations for loans, savings, annuities, investment analysis, depreciation, leases and business statistics.

The new aviation pac with 31 programs lets you compute ETA, fuel consumption, fuel reserves, true ground speed, and more...in seconds, preflight and in flight.

The new navigation pac lets you make 25 tedious calculations without tables. It virtually replaces the tradi-



The new finance pac puts all the compound interest tables that you need on tiny magnetic cards.

tional nautical almanac.

To find out more about the HP-65 and HP application program pacs, check A on the HP Reply Card.

## Universal counters fit virtually any application



Here are just 4 of the 6 models you can choose.

The HP 5326/5327 series of counters/timers make precise measurements for a wide range of applications. For communications applications, you can automatically measure the frequency of CW or burst signals to 550 MHz. An ultra-high stability oven oscillator (with aging rate  $< 5 \times 10^{-10}$ /day) provides exceptional accuracy.

A unique time interval averaging technique gives resolution to 100 ps for applications such as precision logic timing measurements. That's 1000 times better than conventional techniques, and works for intervals as short as 150 ps.

A built-in DVM helps set trigger levels with digital accuracy, plus measure dc volts in three ranges. Thus, the counter becomes two instruments in one.

All functions can be remotely programmed for systems applications.

To learn more, check I on the HP Reply Card.



## Expandable low-cost counters for changing needs

The 5300 series of electronic counters consist of a display, 6 functional units, a battery pack, and a digital-to-analog converter. You merely snap together the appropriate modules to meet your requirements.

The 5300A display mainframe combines with any of the following frequency and functional units:

- 10 MHz counter with totalize
- 525 MHz counter with optional time base
- 10 MHz timer/counter
- Digital multimeter (acV, dcV, Hz and ohms)
- High-resolution counter

You can add additional units later as your needs and budget grow.

The 5310A battery pack makes any of the above a rugged, lightweight, portable measurement system that you can carry into the field.

For easy strip-chart recording, the 5311A digital-to-analog converter converts any measurement into an analog signal.



Quality electronic counters needn't be expensive: the 5300 series offers several low-cost counter solutions.

Check H on the HP Reply Card for details.

# HEWLETT-PACKARD COMPONENT NEWS

## New high-speed dual isolator is TTL compatible

HP's new dual-channel hermetically-sealed isolator provides maximum ac and dc circuit isolation between each input and output while achieving TTL circuit compatibility. Isolation and coupling is achieved with a typical propagation delay of 55 ns. Standard and high-reliability screened versions are available.

The 5082-4365 isolator consists of a pair of inverting optically-isolated gates, each with an LED and a high-gain integrated photon detector in a hermetically-sealed ceramic package.

For prices and specifications, check F on the HP Reply Card.

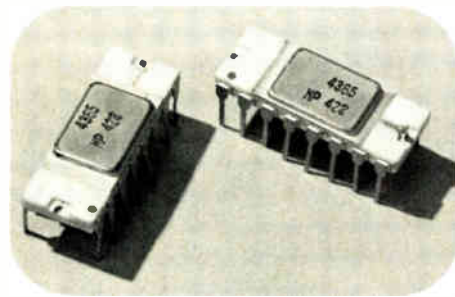

Use the 5082-4365 isolators in line receivers, logic ground isolation, and computer-peripheral interfacing.

## New hermetic Schottky mixer diodes

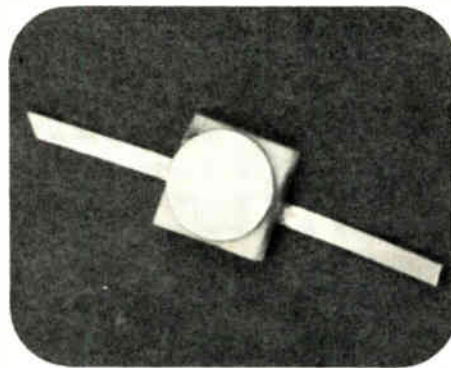

The new Schottky mixer diode has a low noise figure of <math><6\text{ dB}</math> at 9 GHz.

HP's new 5082-2200 series Schottky mixer diodes are designed for both broad and narrow band stripline mixer assemblies (1-12 GHz) where low noise figure and hermeticity are important. Thanks to the excellent uniformity of RF characteristics, you can replace these devices in the field without circuit adjustments. You can use these diodes in telecommunication receivers, microwave synthesizers, and ECM/radar front ends.

For details, check E on the HP Reply Card.

## Four new high-power IMPATT diodes

HP offers four new double-drift, high-efficiency IMPATT diodes. The 5082-0600 series is designed for CW power sources from 10 to 14 GHz, and provides a choice of 1.5W and 2.5W power output. Their high output power, efficiency and reliability make these devices ideal for X-band oscillators and amplifiers.

The 5082-0700 series IMPATT diodes are designed for X-band and Ku-band applications. Stable operation at high peak power levels makes them especially suitable for pulsed radar applications, lightweight man-pack radar, and active phased array radar.

To learn more, check G on the HP Reply Card.

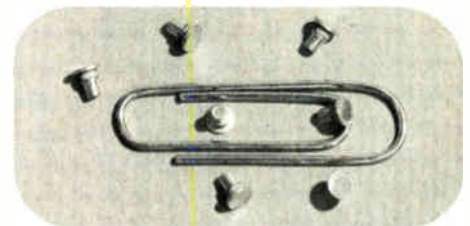

Besides greater power and efficiency, double-drift IMPATTs have lower junction capacitance and lower fm noise compared to single-drift IMPATTs.

## New broadband sweeper: big in performance, small in size

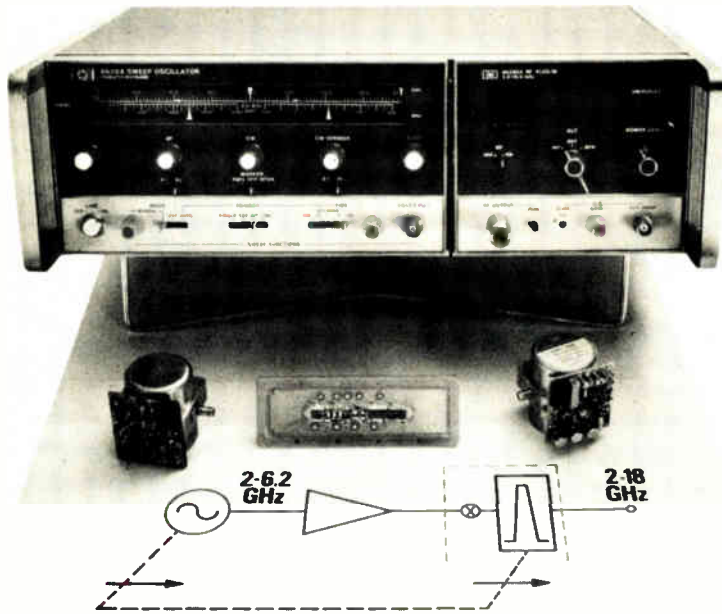

Advanced microwave technology now brings you a broadband 2-18 GHz sweeper with the performance precision needed for stringent lab and production tests, as well as size and weight advantages for field applications. The new 86290A plug-in in the 8620A mainframe is the smallest

2-18 GHz swept source available. You can easily carry this lightweight microwave sweeper (33 lb/15 kg) to field measurement sites.

By combining a YIG-tuned microwave oscillator with a broadband microwave power amplifier and a YIG-tuned frequency multiplier, we are

Wide range (to 18 GHz) sweeper uses advanced microelectronics for lab precision and field portability.

able to offer a sweeper whose frequency, accuracy, linearity, stability and signal purity ratings rival octave-bandwidth signal generators. Output is at least +5 dBm over the entire 2-18 GHz range, and it's internally leveled to  $\pm 1$  dB.

Versatility is another major contribution: the 8629A/8620A is uniquely compatible with HP network analysis instrumentation for widest range, spurious-free swept measurements. And provision is made for effective phase-locking, for alternate leveling techniques, and for simplified remote programming (optional).

*For full details about this new sweeper's many advantages, check M on the HP Reply Card.*

**HEWLETT**  **PACKARD**

East-20010 Century Blvd., Germantown, MD 20767, Ph. (301) 428-0700.

South-P.O. Box 2834, Atlanta, Ga. 30328, Ph. (404) 436-6181.

Midwest-5500 Howard Street, Skokie, Ill. 60076, Ph. (312) 677-0400.

West-3939 Lankershim Boulevard, North Hollywood, Calif. 91604, Ph. (213) 877-1282.

Europe-Post Office Box 85, CH-1217 Meyrin 2, Geneva, Switzerland, Ph. (022) 41 54 00.

Canada-6877 Goreway Drive, Mississauga, Toronto, L4V 1L9, Ph. (416) 678-9430.

Japan-Yokogawa-Hewlett-Packard, 1-59-1, Yoyogi, Shibuya-ku, Tokyo, 151.

# Assume your connector is made by TRW/Cinch



When your problem is to find a particular connector — in whatever category — assume it's made by TRW/Cinch Connectors. We're confident you won't be disappointed. Why? Because TRW/Cinch makes more types of interconnection devices, for more applications, than most other manufacturers in the world.

In the universe of connector categories, some that we cover completely include

- Printed circuit connectors
- Rack and panel connectors
- Cylindrical connectors
- Component and IC sockets
- Back panel assemblies
- IC logic panels
- Barrier terminal blocks
- Telephone system connectors...

And, if your concern is availability, assume that any reasonably standard connector is probably stocked by your Cinch distributor. We offer more types for immediate distributor delivery than any other connector supplier.

You can quickly prove for yourself that these assumptions can be safely made. Get full information in the detailed EEM listings or through your local TRW/Cinch sales office, or by calling toll-free (800) 645-9201 for the name of your nearest TRW/Cinch distributor.

Or write TRW/Cinch Connectors, an Electronic Components Division of TRW Inc., 1501 Morse Ave., Elk Grove Village, Ill. 60007. Phone (312) 439-8800.

CM-7402

## **TRW** CINCH CONNECTORS

Circle 35 on reader service card

When the man from Honeywell Test Instruments comes calling, you may have more and better reasons to see him than you ever realized.

*He sells solutions, and if your problem can be solved best by a simple plug-in module, that'll be his recommendation.*

But if your needs require sophisticated oscillographs, magnetic tape recorder/reproducers or custom analog measuring and recording systems, he has the breadth of line and combinations of instrumentation to

make an exactly-right recommendation. With complete confidence, because in addition to his own expertise, he's backed by the best design, production, application and metrology experts in the instrumentation business.

Honeywell Test Instruments Division — the top trouble-shooters. Call on them when you have any test instrumentation problem. For a quick look at our complete line of test instruments, write for FREE 20-page condensed catalog. Dept. 218, P.O. Box 5227, Denver, Colorado 80217.



# Honey

**TEST INSTRUMENTS DIVISION**



# ywweil

Circle 37 on reader service card

# Resistor networks: we deliver through thick and thin.

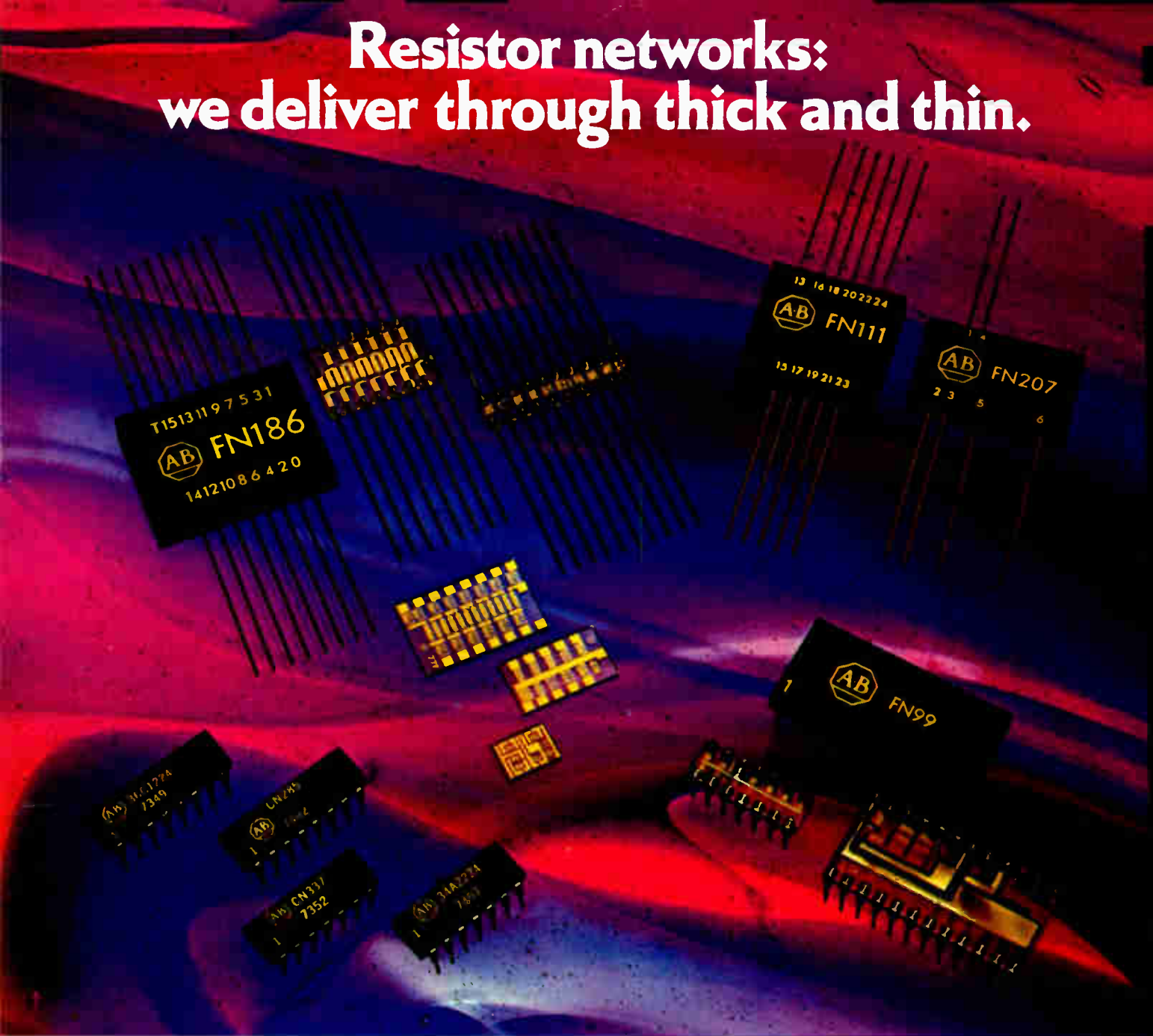

Seventeen years of film resistor experience combined with quality production capabilities give you prompt solutions to your network needs. Whether you require precision thin film or semi-precision thick film in prototype or mass production quantities. Thin film in chip, conformal coat, flat pack and DIP. Thick film in standard 14 and 16 pin DIPs with resistor or resistor/capacitor configurations. Popular pull-ups and terminators off-the-shelf. Contact your local A-B sales office or write for our 5800 series publications. Standard items are available through your appointed Allen-Bradley Electronics Distributor. Allen-Bradley Electronics Division, 1201 South Second Street, Milwaukee, WI 53204. International Division, Milwaukee, WI 53204. Canada: Allen-Bradley Canada Limited, Cambridge, Ontario. United Kingdom: Allen-Bradley Electronics, Limited, Jarrow, County Durham NE32 3EN.

SELECTED SPECIFICATIONS		
	Thin Film	Thick Film
TCR	±10 to ±25 ppm/°C	±100 and ±250 ppm/°C
TCR tracking	±5 ppm/°C	±50 and ±100 ppm/°C
Absolute tolerance	as low as ±.01%	as low as ±1.0%
Matching or ratio tolerance	as low as ±.005%	as low as ±2.0%
Resistance range	1K to 10 Megs (special 10 ohms to 50 Megs)	10 ohms to 1 Meg

**If you're really serious about cost, be serious about quality.**



**ALLEN-BRADLEY**

Milwaukee Wisconsin 53204

## **Computer program offered to catch IC-design-rule flaws**

A small IC-design company has developed a computer program aimed at solving a nagging problem as ICs become increasingly complex—poor yields resulting from design rule violations. Silicon Systems Inc., Santa Ana, Calif., attacks such problems as too narrow lines and spacing between diffusions and metalization, which may not keep a circuit from working but could degrade yield. **The program checks for both obvious and subtle errors involving as many as three masks.** The IC maker submits masks to Silicon Systems, which digitizes them and runs the data through the program. Errors are flagged and can be corrected by either the IC maker or Silicon Systems, which produces a magnetic tape with the corrected data and runs it on automated mask-making equipment. **The firm charges \$940 to put layout rules into the computer library,** then about 25 cents per square mil of net chip area needing metalization (other than duplicated areas of such repetitive parts as memories).

## **Xerox plans late '74 introduction of fast fax unit . . .**

**Xerox Corp. will announce a laser-based, 2-minute facsimile transceiver later this year and is aiming at an early 1975 market introduction.** Observers say Xerox has been putting off the new product announcement on a month-to-month basis since about March, presumably to try to depreciate its present machines over a greater period. Xerox will have plenty of competition in the fast-fax market from Rapifax Corp. and Comfax/Electronic Associates Inc., both with sub-minute models, and Graphic Sciences Inc., whose 1-minute machine should be demonstrated early next year. But its new laser unit will be the first sub-3-minute fax backed by a major national sales and service force.

## **and presses FCC on tariff for international traffic**

Meanwhile, in further attempts to increase its market penetration, particularly offshore, **Xerox has been urging the Federal Communications Commission to accept a tariff for international fax traffic,** and will press for international compatibility standards at the Consultive Committee International Telegraph and Telephone meeting in London later this month. The committee, an advisory group established under the United Nations to recommend worldwide standards, is expected to review fax compatibility standards for possible adoption at its major quadrennial gathering in 1976.

## **Motorola adds digital scrambler to 2-way radio**

One of the first to put custom LSI in portable radios, the Motorola Communications division has used it in a **digital speech scrambler for its hand-held HT-220 series of two-way portable radios.** To get acceptable voice quality and voice security within a single channel, the Schaumburg, Ill., giant turned to a delta modulation approach—a special type of differential pulse-code modulation that produces 1 bit per speech sample. The bits are then scrambled. The technique offers millions of possible coding combinations.

Although Motorola officials decline to put a price on the system, it will **begin shipping the secure two-way radios** under a \$3.7 million contract next year to the Justice Department's Drug Enforcement Administration **for use along the U.S. border with Mexico.**

## **TI to push display sales in the U.S.**

Texas Instruments, which has been selling light-emitting-diode calculator displays on a limited scale mostly to foreign calculator manufacturers, **plans a big push in the domestic market.** Attributed to "increased production capacity" rather than to any softening in TI's calculator sales, the line consists of six-, nine-, and 12-digit displays in magnified and unmagnified versions, in both of which the eye sees the digits as 100-plus mils high.

The unmagnified versions, at 65 and 70 cents per digit in production quantities, are discrete LED chips mounted directly on the display printed-circuit board. Magnified displays are smaller—monolithic single-digit displays that are matched and mounted on a mother board at about 50 cents per digit. Coming by the first quarter of next year: a **two-digit, half-inch display for color TV channel readouts**, and a four-digit, half-inch clock display.

## **General Automation plans semiconductor memory options**

General Automation Inc. is building up facilities to offer **high-speed semiconductor memories as options in its minicomputer products that now have core memories.** The Anaheim, Calif., maker of computer-based automation systems will use the same approach previously announced for its LSI-16 microcomputer—small plug-in hybrid silicon-on-sapphire "superchip" assemblies using up to eight individual 1,024-bit chips. General Automation buys the chips, makes the multilayer substrates, and assembles and tests the circuits. The memory chips are now supplied by various vendors, but the company expects to begin getting devices soon from Synertek, a San Francisco-area MOS firm that General Automation partially owns. **The Synertek chips are expected to be fast, 100-ns versions of the 1103 RAM**, but the hybrid assembly can also accept 4,096-bit chips.

## **FCC investigation of IBM satellite entry seen; opposition strong**

**An in-depth Federal investigation of International Business Machines Corp.'s plan to enter the domestic-satellite business** jointly with Comsat General Corp. is expected to result from strong industry opposition to the proposal. The Federal Communications Commission is considering the joint petition of IBM and Comsat General to restructure CML Satellite Corp. by acquiring the interests of MCI Communications Corp. and Lockheed Aircraft Co. [*Electronics*, July 11, p. 26]. **A number of companies asserted that approval would be anticompetitive and in violation of antitrust laws.**

Calling on the FCC to reject the plan were **RCA Global Communications and RCA Alaska Communications, American Satellite Corp., Western Union Telegraph Co., ITT World Communications, Data Transmission Co., and Sanders Associates Inc.** Expressing reservations and calling for more information were American Telephone & Telegraph Co., Sperry Rand's Univac division, and the Computer Industry Association.

Conditional approvals were offered by the North American Telephone Association and Southern Pacific Communications Co., a special-service common carrier.



# These new Unitrode 300V power darlington

## perform like this

$I_C$ A	$V_{CE0}^\dagger$ V	$h_{FE}$ @ $I_C = 1A$	$V_{CE(sat)}$ V	Type No.	Package (Modified)	Polarity	Power Dissipation 100°C Case W
2	300	1000 @ $I_C = 1A$	1.5* @ 2A	U2T103	TO-33	NPN	5
2	300	1000 @ $I_C = 1A$	1.5* @ 2A	U2T203	TO-66	NPN	20
5	300	1000 @ $I_C = 3A$	1.5* @ 5A	U2T303	TO-3	NPN	50

$^\dagger V_{CE0}$  measured at 10 mA

\*Forced gain = 100

## and...

**Like all Unitrode Power Darlington**s these new 300-volt units exhibit the lowest saturation voltages available.

**Like all Unitrode Power Darlington**s their short turn-on and turn-off times mean unusually high efficiency in fast-switching applications.

**Like all Unitrode Power Darlington**s they give you greater savings in design and assembly time and lower component cost than is possible with discrete components.

**Like all Unitrode Power Darlington**s they are planar for the highest reliability and stability.

Unitrode's full line of Power Darlington's includes PNP and NPN transistors and a wide choice of characteristics in single and dual, mixed or matched, units.

Send for complete details on the entire line of Unitrode Darlington's. For faster action, call Peter Jenner at (617) 926-0404. Describe your application on your company letterhead and we'll send a suitable sample.

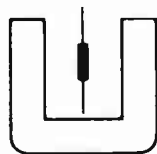

# UNITRODE

Circle 41 on reader service card

580 PLEASANT STREET, WATERTOWN, MA 02172

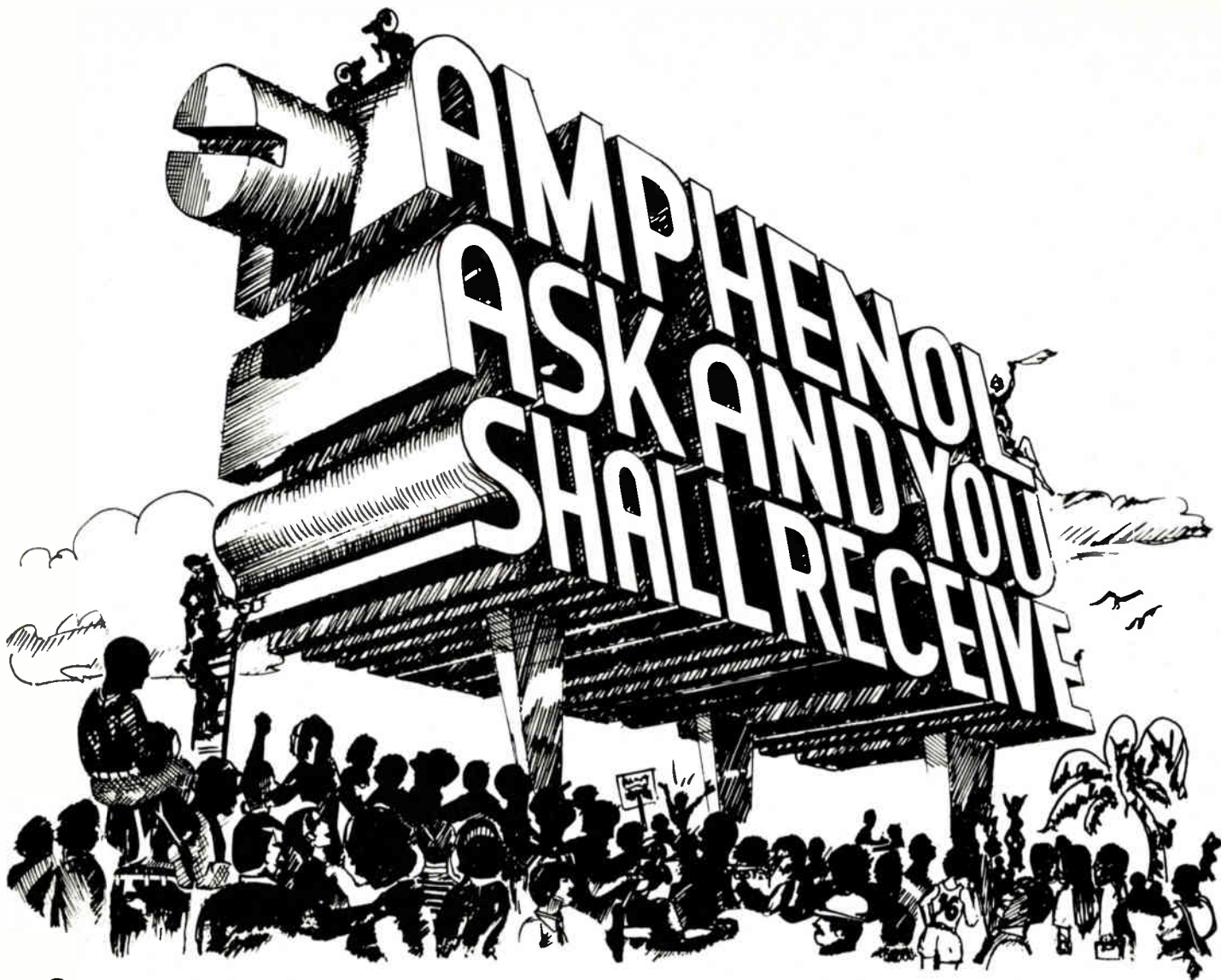

**A**vailability is one of the most important factors in selecting trimmers. Amphenol can promise immediate off-the-shelf delivery, from its network of strategically located distributors —plus a price that's trimmed to boost your profits.

Whether you need a 3/4" rectangular cermet or wirewound trimmer, "Just Ask and You Shall Receive" our Series 6034 or 3810.

These 3/4" sealed trimmers are available in all pin spacings and styles. The 6034 cermet is an industry standard of excellence. Specifications of the 6034 cermet are: resistance values of 10Ω to 1 meg.Ω ± 10%; infinite resolution; the CRV is 3% of total resistance or 20Ω, whichever is greater; temperature coefficient is 100 ppm/°C nominal.



The 3810 wirewound features the unique Vista-Trim top that allows you to see the adjustments you make. Specifications of the 3810 wirewound are: resistance values of 10Ω to 20,000Ω ± 10%; resolution 1.78% to 0.22% respectively; temperature coefficient is 50 ppm/°C nominal; ENR 100Ω max.

Let us show you how these trimmers can fulfill your specific requirements. For additional information and immediate action, contact the Amphenol sales office in your area or local Amphenol distributor by dialing our toll-free hotline (800) 645-9200. (In New York State) dial collect (516) 294-0990.

**There's a reason to ask for us by name.**

**BUNKER RAMO AMPHENOL**

**AMPHENOL CONNECTOR DIVISION**  
2801 South 25th Ave., Broadview, Ill. 60153 Tel: 312-345-9000

## Low-cost inertial navigation system passes test

Autonetics navigator uses strapdown guidance; applications could include aircraft, missiles, helicopters

The Air Force, pushing for accurate inertial-navigation systems that cost only a fraction of what they cost now, appears to have one on the way. Recent flight tests of Micron, the "universal" strapdown inertial-navigation system being developed by the Autonetics division of Rockwell International Corp., have hit the accuracy goal defined by the military. And the developing strapdown guidance technology, with its inherently simpler, smaller, and lower-cost structure, is proving feasible for a wide variety of applications.

Autonetics' strapdown electrostatic gyro system has racked up errors of only 1.01 nautical mile per flight hour (the goal was 1) on a company Sabreliner jet. Flights on an F-4 fighter and C-141 transport are scheduled for this fall at Holloman Air Force base.

Autonetics has designed its system for medium-ac-

curacy applications on tactical missiles, fixed-wing Air Force aircraft, and Army helicopters—the first time that a common system has been designed for such diverse applications. And as such, demand could hit high volume—potentially as many as 20,000 units—although Autonetics' Micron program manager J.A. Schwartz says he'll be happy with production orders for 4,000.

**Price.** Because of the high-volume requirement, cost is important. Schwartz sets the price goal at \$35,000 for the 500th unit; this compares to an average of \$128,000 for equivalent systems now in the inventory, and \$400,000 for the Auto-

netics-built N-16 navigation system used on the F-111 fighter bomber, he says. Maintenance costs should also be much lower, with a mean time between failures of 2,000 hours compared to the 50 to 100 hours of systems in the inventory.

Micron's projected low cost derives from its simplified gyro technology and its elimination of the complex gimballed support structure of conventional systems; the gyros are literally strapped down to the vehicle. The two gyros in each system consist of only one moving part—a solid beryllium sphere, 1 centimeter in diameter, that spins at 150,000 revolutions per minute in a

vacuum while suspended electrostatically by capacitive plates with 300 microns of clearance. The same spinning spheres also serve as sensing elements, instead of conventional accelerometers. The spheres and the hemispheres that support them are the only precision mechanical parts. Gimbaled gyros require 20 times as many electromechanical parts, including gimbals for supporting the gyros, torquers, resolvers, synchronizers, and relays.

The gyro unit is rigidly attached to

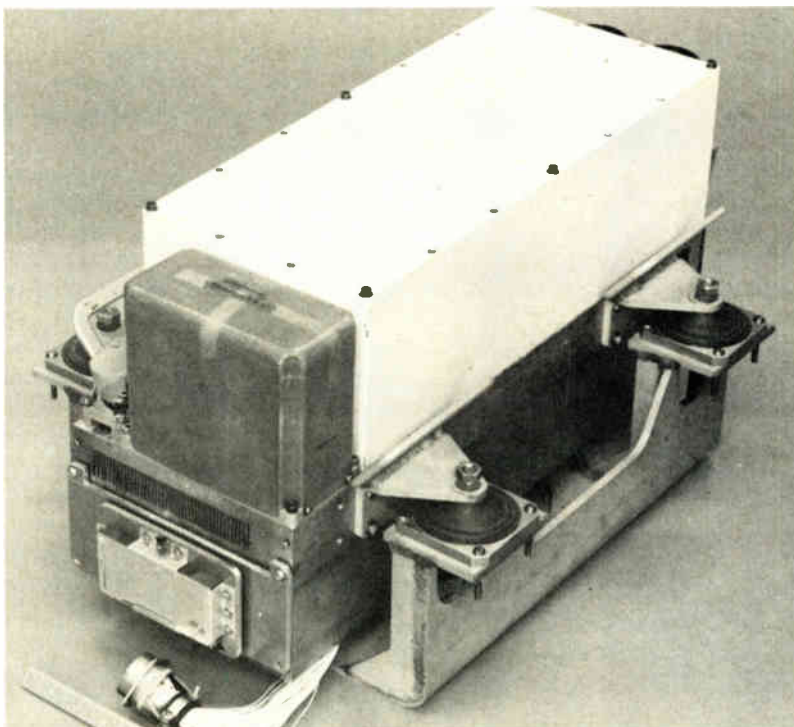

**Brassboard.** Strapdown guidance system flown on recent tests had accuracy to within 1.01 nautical mile per flight hour. Goal is to produce the system for \$35,000.

the frame of the aircraft rather than floating—only the spinning spheres float. Although this greatly simplifies the mechanical arrangement, it exacts a price in increasing the complexity of the data-processing. In its present model, Rockwell is using a computer it developed, the D216, which has a MOS large-scale-integrated processor and 5-mil-plated-wire memory. However, production units are expected to use a semiconductor memory, ideally made of nonvolatile metal-nitride-oxide (MNOS) devices.

Initial efforts were aimed at a radiation-hardened navigator, with complementary-MOS circuits on sapphire substrates; hence, the use of the radiation-resistant plated-wire memory. But this requirement has now been eliminated, and the plated-wire memory is too expensive if the target production price is to be met.

Rockwell's brassboard unit oc-

cupies about 1 cubic foot in volume, compared to the 2½ ft<sup>3</sup> of the N-16 system. The goal for the final model is only 200 cubic inches (about 0.1 ft<sup>3</sup>). Schwartz says, however, this figure may not be achievable, although the navigation system will still be exceptionally small. The final version will weigh about 10 pounds, also an order of magnitude less than the N-16.

The Anaheim, Calif., company is now in phase 2A of its contract, being supervised by Capt. Robert Warzynski of the Avionics Laboratory at Wright-Patterson Air Force Base, Ohio. Flight-testing and component refinement are the major efforts at present.

The next step in the Micron contract should begin early next year, when Autonetics is to develop 18 prototypes—eight for the Army and 10 for the Air Force. These could be delivered some time in 1977, Autonetics officials say. □

## Memory

### MOS target in a vacuum tube yields fast, compact memory

There's nothing unusual about the Air Force turning to solid-state MOS technology for fast, compact computer memory. Almost everybody is doing it.

What is unusual is that the Air Force is turning to vacuum tubes at

the same time. The result so far looks extremely promising: Stanford Research Institute, Palo Alto, Calif., has delivered a working model of the electron-beam-addressed memory (EBAM) that in its final configuration could pack 64

million bits of information into a module occupying only two cubic feet. By contrast, 64 million bits is the largest main memory IBM supplies for its 370/168, the top-of-the-line computer in its 370 series. And this MOS memory occupies considerably more space.

The prototype, delivered to the Memory Technology group of the Air Force's Avionics Laboratory's Advanced Electronics branch at Wright-Patterson Air Force Base, Ohio, is geared for an airborne memory system. E.A. Buvinger, Air Force project monitor for EBAM, says potential applications could be in airborne command posts where the Air Force is looking for higher speed and capacity. "The system conceivably could replace tape, disk, or drum systems," she says.

The experimental SRI system has a single EBAM tube, a 12-inch long, 2-inch-diameter device with an MOS storage target. The tube was exercised with a 65,000-bit capacity, but Stanford Research's memory-program director, John Kelly says more refined test circuitry would enable the tube to store 4 million bits; an operational system would consist of 16 tubes. Production could begin in 1976.

Besides its compactness, the EBAM memory is fast. Kelly says the prototype has a random-access time of 3 microseconds, a writing speed of 16 megabits per second and a reading time of 160 Mb/s.

"An electron beam can be switched at extremely high speeds from one memory location to another," he explains. "In fact, the only practical limit to the speed is the time to convert computer information from digital to analog form, and for the deflection amplifiers to settle. Random access times of 0.5 microsecond or less should eventually be possible.

**Hole store.** The EBAM storage target makes it all happen. Its half-inch-square surface is covered with millions of simple capacitors, which are able to store digital information having a very high density (about 70 million bits per square centimeter).

Holes are etched through the

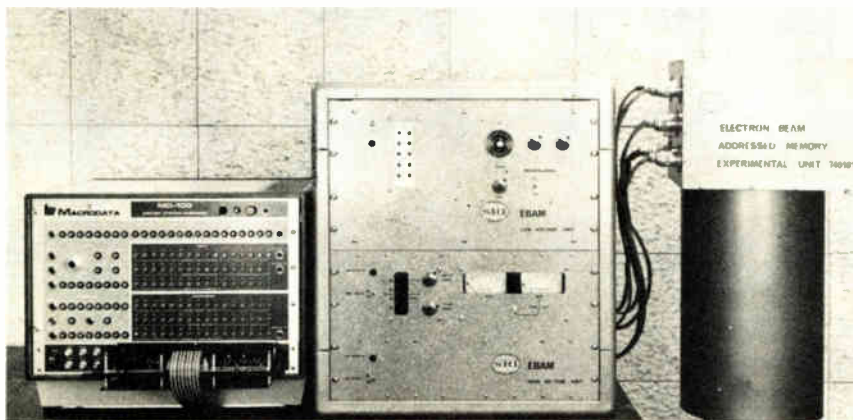

**EBAM.** Electron-beam-addressed memory, right, was tested with a Macrodata MD 100 memory exerciser, left. Eventually, 64 million bits could fit in 2 cubic feet.

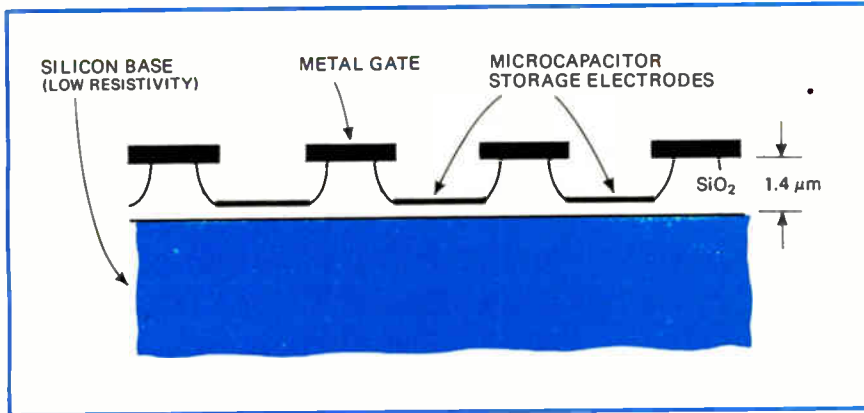

**Store.** Microcapacitors formed on silicon are the charge-storage elements in the memory tube's target. Extreme magnification shows the capacitors formed into perfect circles, right.

metal gate of the MOS structure into the oxide by means of an electron lithographic technique developed at SRI. In each of these holes is deposited an isolated metal electrode, a microcapacitor. The holes measure about 6 micrometers in diameter on centers 9  $\mu\text{m}$  apart. The oxide thickness atop the silicon base is about 1.4  $\mu\text{m}$ .

Information is written by deflecting an electron beam in somewhat the same manner as a return-beam vidicon or a storage tube. The 2,000-electronvolt beam can be deflected to the target's edge by 26 volts. Binary ones are stored as a negative charge (typically -40 v with respect to the gate electrode) and zeroes as zero charge. Information is read from the beam by detecting the electrons—a function of stored charge—scattered from the target area and amplifying this into a usable signal.

Traditional deflection techniques were not precise enough for the tube, says Kelly. Instead, SRI developed an eight-pole deflector—eight electrodes arranged symmetrically around the beam axis. They share a common center of deflection and have equal sensitivities.

The single-tube prototype supplied to the Air Force is controlled by an off-the-shelf memory exerciser, which produces data-pattern addresses and read/write commands. Data, address, and operational commands are passed to an interface unit where all the timing is determined. From the interface,

logic signals control the digital-to-analog converters for switching the beam, and provide the deflection voltages and the target bias for reading and writing. In the experimental system, says Kelly, it's the memory exerciser that limits the number of address locations usable in the tube. Later versions would use a larger-capacity exerciser.

## Consumer electronics

### TV-screen dot yields hard copy

Television sets have long offered the intriguing possibility of transposing the picture on the screen to a piece of paper that the viewer could carry away with him. Precisely what need this would fulfill is, however, another question—probably one of the reasons why, along with cost, such systems have not yet appeared on the market.

Atlantic Research Corp., Alexandria, Va., is taking a shot at the problem—but instead of making a hardy copy of the entire picture, it's satisfied to use the TV set as a receiver for digitally coded information that's piggy-backed onto the regular picture signal. This data can then be printed out.

The system, called Data-Dot, uses a photosensor that is attached to the TV screen by means of a rubber suction cup, similar to that found at the

end of a toy arrow. The sensor picks up a small dot located in the corner of the TV screen that flashes on and off at the receiver's rate of 60 TV fields per second. This information can drive a low-speed thermal printer, developed by Atlantic, or it can be stored on a standard audio tape cassette recorder for printout later.

The company envisions a gamut of information that could be presented to viewers—news, stock market reports, weather, background information on programs, cooking recipes, and the like. Although marketing plans and cost estimates are not complete, Atlantic may end up franchising it to local TV stations, according to George Summers, ARC director of advanced programs.

**Special.** The TV studio would be equipped with a special-effects generator—a data insertion unit (DIU)—which comprises an attache-case-sized electronics package and a keyboard. The video signal is routed through the DIU, which adds the dot information to the signal, controlling the dot's shape, size, and location on the screen.

Up to 60 words per minute can be transmitted using ASCII code, up to 90 words per minute with a Baudot format. However, higher speeds could be attained with a multiplexing arrangement, Summers points out. On the TV screen, the system is quite tolerant of dot-sensor misalignments, he says. The printer uses a thermal print head with a 5 by 7

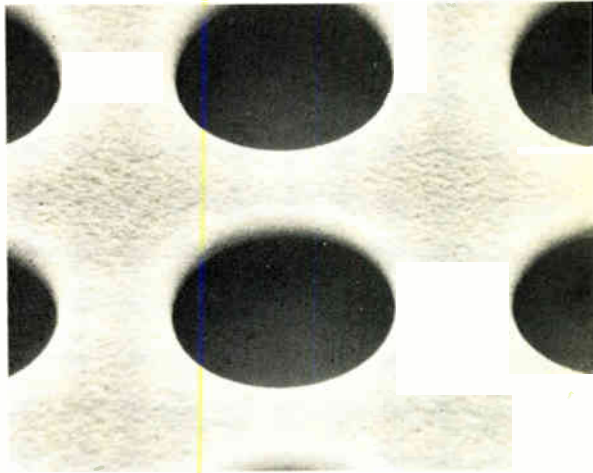



**Dot's right.** White square on TV screen shows relative area to be occupied by Data-Dot. Thermal printer will decode data and print out message transmitted with the TV picture.

matrix, although Summers says that future units may go to 7 by 7 for better legibility. Eighteen characters are printed on each line of the present design.

The system could also be used for educational purposes. For instance, the dot information could be coded with a correct answer to a question asked on the TV screen. The student could respond with a special-handheld unit connected to the sensor. His answer would be internally compared with the coded correct answer and a "yes" or "no" light-emitting diode would light up to tell him whether he is right or wrong. An audible "reward" signal could also be designed into the system to sound off for correct answers. □

### Avionics

## FAA wants proximity warning systems

After saying for six years that ground-proximity warning systems weren't needed, the Federal Aviation Administration, reacting to pressure from Congress, is again proposing that they be required on commercial jets and turboprops. The nation's airlines and other owners of such aircraft would have to in-

stall systems within two years, or even sooner if continued congressional prodding succeeds.

Industry officials estimate that up to 3,000 aircraft would require the system, at an average cost of \$11,000 per plane, including installation. Only one company, Sundstrand Data Control Inc., Redmond, Wash., currently manufactures the system. But Bendix Corp.'s Avionics division, Ft. Lauderdale, Fla., is also developing a design of its own and has made proposals to airframe makers and the airlines.

The FAA issued a similar proposal in April 1973 [*Electronics*, May 10, 1973, p. 49], and asked for industry comment, then remained silent for more than a year. But Congress and the National Transportation Safety Board, an independent agency of the Department of Transportation, wouldn't let it die. And FAA administrator Alexander Butterfield pushed his agency to produce the rule-making proposal a week before a scheduled hearing of the House Interstate Commerce Committee's subcommittee on investigations. Congressional observers say he did so only to avoid scathing criticism.

"Whoop, whoop." Sundstrand's black box is at present installed in Boeing Co. jets at the factory and is being retrofitted on Pan American World Airways Inc. aircraft. Pan American began its retrofit program

following a second fatal air crash early this year.

The Sundstrand system monitors inputs from various altimeters and other sensors and automatically emits a visual and audible signal—"Whoop, whoop, pull up," according to the manufacturer—when the aircraft approaches a certain altitude or does not gain altitude fast enough during takeoff. The unit is completely solid-state.

More than 35 airlines throughout the world, including the Soviet Union's Aeroflot, have ordered the unit, the company says. But only five are U.S. flag carriers. The first to fly an operational system, which Sundstrand started developing eight years ago with its own funds, was a Scandinavian Airlines System DC-9 in 1970.

Up to 90% of aircraft accidents involving "inadvertent flight into terrain,"—administrator Butterfield's euphemism for a crash—could have been avoided if an automatic signal system had been installed. Approximately 55% of all aircraft fatalities in the last few years have been attributed to aircraft-ground collisions, according to congressional testimony. The FAA insists that these accidents were caused by incorrect pilot behavior, "distraction, confusion and just plain inattention to duties and detail," says Butterfield, but adds that the Sundstrand system is not a "panacea."

The audible signal "floods the cabin," according to congressional staffers, so that "there's no way a pilot can ignore it." However, the Air Line Pilots Association has opposed the installation, saying that pilots do not need yet another audible signal in the cockpit.

**Interim measures.** Conceding that Sundstrand may not be able to make systems fast enough, the FAA has proposed an interim measure. Airlines would have six months to install an aural warning-only device on current radio altimeters. Then, the airlines would have to install the more complex device as it became available. This would be capable of warning based on computed height of the aircraft above terrain and

# Another technical knockout

## *the first 100 / 150 W single sideband devices*

There's more talk-power available on efficient single-sideband radio and Motorola now introduces state-of-the-art 100 and 150 W units for unprecedented PEPs in your new SSB lineups.

The MRF421 and MRF422 contain the biggest single RF chips in production today.

And that means single-chip ruggedness and consistency.

Each chip incorporates 648 individually-ballasted emitter sites. The geometry was precisely computer-designed for optimized cell placement within the silicon real estate to ensure uniform temperature throughout the chip area.

And that means optimized reliability.



Computer-designed 248 x 140 mil chip

And cooler chips mean improved dynamic linearity and enhanced IMD.

OEM applications help to aid you in building your 12.5 and 28 V single-

SSB type	PEP	$G_{PE}$ dB Min.	$V_{CC}$ V	Package
MRF406	20 W	12 dB	12.5 V	211-03
MRF420	75 W	10 dB	12.5 V	211-02
MRF422	150 W	10 dB	28.0 V	211-04
MRF421	100 W	10 dB	12.5 V	211-04

sideband radio is available through your Motorola rep. And a new Engineering Bulletin, EB-27, is ready to give you the right directions. Get

detailed information on the construction of matching transformers, schematic diagram, printed circuit board and performance. Be first with the first...

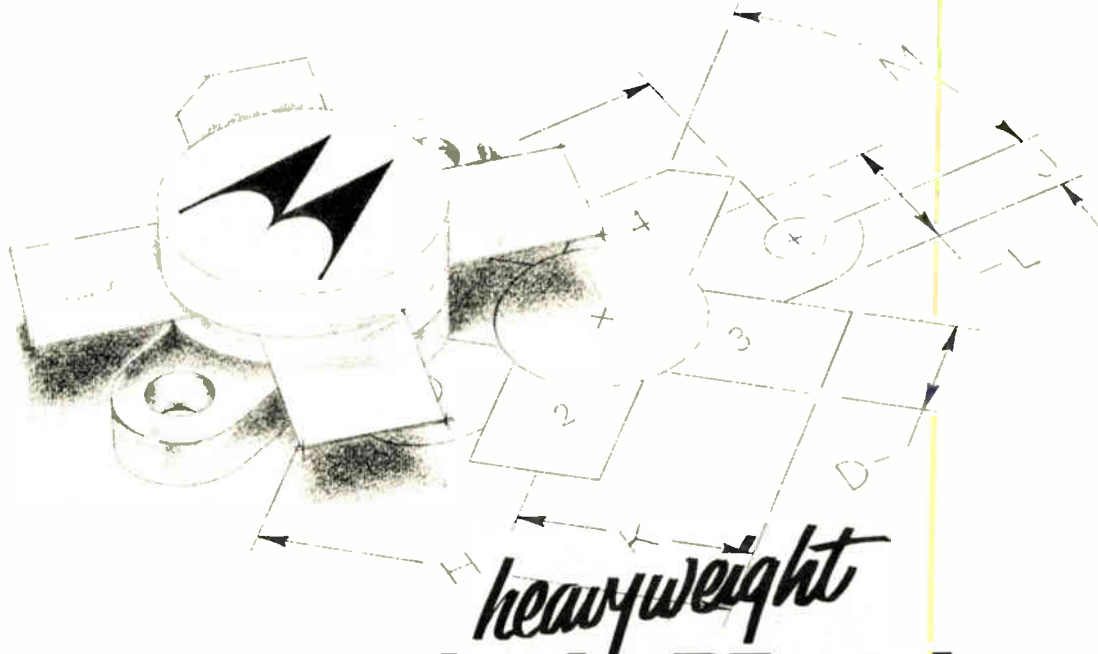

**from Motorola, the RF producer.**

would use a hard-wired computer to determine the combined effect of landing gear and flap positions, aircraft performance, and wind conditions. □

---

**Solid State**

---

## Plastic packages boost SOS outlook

Designers will now have a more difficult job when it comes to choosing complementary MOS-circuits. By the end of the month, a full line of standard C-MOS-on-sapphire circuits will be available from Inselek Corp. in relatively low-cost plastic packages. Plastic versions of half of the firm's commodity INS4000 line have already been introduced and are already in stock.

SOS C-MOS circuits offer speed and power advantages over C-MOS built on bulk silicon substrates. However, they have been substantially more expensive in commercial grades because Inselek, the sole source of standard C-MOS-on-sapphire products, has used only ceramic packages. And bulk-silicon C-MOS has been available in plastic packages at about half the price of ceramic-packaged SOS.

Now the problem of deciding which form of C-MOS to buy is made more difficult, and the problem of justifying a switch to SOS simpler. Inselek's plastic-packaged versions of its standard SOS line is priced at or near the equivalent 4000-Series C-MOS parts. SOS gates are priced at 59 to 73 cents in thousand quantities; similar bulk-silicon products from such competitors as RCA Solid State division, Somerville, N.J., and Solid State Scientific, Montgomeryville, Pa., are priced at or just below the low end of that scale. Rockwell International Corp., Anaheim, Calif., Inselek's partner in the development of some SOS parts, does not market a commodity C-MOS line.

In larger-scale parts, the choice is even more difficult. Inselek prices its SOS INS4040 12-stage ripple counter

## News briefs

### **Laser holograms sort fingerprints for police**

A one-of-a-kind fingerprint-recognition system using laser holograms has been installed by McDonnell Douglas Electronics Co. at New York City's new police headquarters building. Basically, the system compares fingerprints on master cards with suspects' prints to reduce the number of master cards that must be searched manually. Using a laser and a Fourier lens, the system produces a holographic representation of the print that is automatically compared with those on the cards at a rate of 144,000 per hour. Worst-case yield on this raw correlation, if partial or smudged prints are used, is 20%. This means only 20% of the file must be searched manually, according to the St. Peters, Mo., company.

The New York Police Department is testing the system operationally under a \$300,000 grant from the Justice Department's Law Enforcement Assistance Administration.

### **Medium-scale Data General computer on the way**

Data General Corp., the minicomputer maker, is thinking bigger. A new computer, to be unveiled this week, is the company's first development of a medium-scale machine. It is expected to inaugurate a new family of computers that will have more capacity than those in the software-compatible Nova series. Sources say the new machine will outstrip the Digital Equipment Corp. PDP 11/45, which has 850-nanosecond cycle time and a maximum capacity of 124,000 bits of 16-bit storage.

### **Navy deploys F-14 Tomcat, E-2C Hawkeye . . .**

Despite its financial difficulties, Grumman Aerospace Corp., Bethpage, N.Y., has seen two of its big Navy aircraft programs reach deployment. In mid-September, two 12-plane squadrons of Grumman's supersonic, swing-wing F-14 Tomcat fighter went aboard the USS Enterprise headed for the Western Pacific. And later that month, the company's E-2C Hawkeye airborne early-warning command and control aircraft was scheduled to begin an operational tour of duty in the Mediterranean Sea aboard the USS Saratoga.

### **. . . while it also merges two weapons labs**

The Naval Surface Weapons Center is the new name assigned to the merged operations of the Naval Ordnance Laboratory at Silver Spring, Md., and the Naval Weapons Laboratory, Dahlgren, Va. The consolidation, approved last month, will be complete by July 1975. Capt. Robert Williamson II, USN, at Silver Spring, is commander of the new center; James Colvard, at Dahlgren, is technical director.

### **New IBM System/3 aims at communications**

A fourth model of the System/3 line of small computers has been announced by IBM. Intended for communications-oriented installations, it takes advantage of recent advances in input/output devices. The original System/3, now known as the model 10, substituted the small 96-column punched card for the larger 80-column card that had been in use for nearly half a century. But the new model 8 dispenses with this medium entirely, in favor of a built-in communications adapter and an entry station based on IBM's floppy disk.

IBM also announced that a 3340 disk-storage unit, in which the read-write heads are inside the disk modules, could now be used on the System/3 model 15. Previously, the unit fit only System 370 computers.

### **Computer security getting organized**

The field of computer security is getting its own service organization: Computer Security Institute has been formed in Northboro, Mass. The privately owned institute will publish a bimonthly newsletter, manuals, and a buyers' guide, besides conducting seminars and sponsoring research projects in the field. John C O'Mara is the institute's director.



# THE FAMILY THAT PLAYS TOGETHER.

## Compatibility.

You rarely see it on an RFQ.  
Nobody talks much about it.  
End users couldn't care less about it.

But the pros know. Volume users who have been the computerization route can tell you all about it.

A lot of them got smart the hard way when somebody sold them stripped-down end-user mini-computers. And end-user software.

They looked a lot like our NAKED MINI® hardware and software. Stripped down price included. Impressive specs, too. But let's face it, mainly it was a big name that impressed the buyer.

But if you're going to put your faith somewhere, it had better be in hardware and software designed expressly for product computerization. Because you're going to live with them for a long, long time. For better or worse.

What's the difference?

Plug-in interchangeability, for one thing. The NAKED MINI has it. No fine-tuning, adjustments, or calibrations. You pull out the old one and put in the new one. Just like a light bulb.

That's the way it has to be. Volume users can't afford to fiddle around with a system out in the field.

Profits won't hold still for it. And neither will the customer.

OEM-unique software, for another. Like our new FORTRAN IV which generates optimized programs to minimize run-time size. So you don't end up paying for more memory than you really need.

There's an even bigger difference. The entire family of NAKED MINI's are totally compatible. Which means, simply, that when your product changes (and it will), you can easily change to a different machine. Faster or slower. Bigger or smaller. For example, the lowest cost LSI-1, or the twice as fast LSI-2/10, or the four times as fast LSI-2/20. Or our brand new LSI-2/25 with special features for business and communication processing.

The mechanical interface is the same on all of our machines. The original programming will still work.

We've always built our machines and software that way. We always will.

Because we understand the problem.

 **ComputerAutomation**  
Naked Mini Division

18651 Von Karman  
Irvine, California 92664 (714) 833-8830



at \$3.75, the same as RCA's CD4040 price. Solid State Scientific prices its 4040 at \$2.80.

The new line also involves Inselek's first fling at offshore assembly.

Until now, explains Bob Burlingame, manager-device applications, the firm did all of its own production work because it could not find a well-qualified Far East assembler for ceramic-packaged circuits. Now, for the plastic line, IC dice are being shipped to a Taiwan contractor for packaging, which should help lower costs. Final test and marking operations will still be performed at Inselek's Princeton, N.J., headquarters.

Inselek is also planning additions to its INS4000 line. Within the next few weeks, the firm will introduce an SOS version of the CD4061 256 x 1-bit static RAM. This part will use SOS technology to reduce chip size rather than increase speed, explains Burlingame, because Inselek already has a higher-speed 256-bit RAM. "People who want high speed would go to the INS4200 anyway," he says.

First parts of an Inselek 1024 x 1-bit RAM should be available within the next few weeks, with formal introduction scheduled by the first quarter of next year. A 1024 x 1-bit silicon gate version will follow, as will a 1024 x 8-bit mask-programmable ROM.

Inselek plans to have the beginnings of a microprocessor line available by the end of next summer. After a false start on an 8-bit microcomputer design, says Burlingame, the company shifted gears and started work on a 4-bit arithmetic logic unit with a 300-nanosecond cycle time design goal. □

## Radar

### Military backs new test-range radar

The military services are getting the message about inflation. Rather than fund separate programs, the



**Tracker.** RCA technician Charles Peterson checks out computer control of Digital Instrumentation Radar. Housed in mobile shelter, system will be used on test ranges.

Army, Navy and Air Force are pooling their resources to buy a new digital instrumentation radar (DIR) for their test ranges. Developed by RCA's Missile and Surface Radar division, Moorestown, N.J., the radar is compatible with existing range instrumentation and can also be custom-designed to meet each service's requirements through some 15 "elective" modifications.

Three AN/TPQ-39(V) radars are being bought for \$4 million. This low figure, according to L. E. Kitchens, RCA's DIR program manager, was achieved mainly by using a programmable minicomputer, the Data General Nova 800, but also by using modular subsystems, including a "fairly conventional" rf portion. In this way, the company claims to have held down the cost of the system to at least a third that of any previous, comparable, short-range instrumentation radar.

**Measurement.** Unlike most radar systems that track multiple targets simultaneously, the DIR tracks a single target and is actually a measurement system. In bomb scoring, for instance, the DIR would deter-

mine an aircraft's precise position at the moment it released its bombs. Or the radar could be used to keep precise track of an airborne vehicle's position during any kind of mission. Such data could be useful in mission evaluation. Kitchens says that, while the contract specifications called for maximum tracking range of 34,000 yards, a recent test conducted by the Navy tracked a 6-inch sphere at 45,000 yards.

The system can be transported by air, land or sea, is operated by only one man, and is housed in a mobile shelter measuring approximately 12 by 7 by 11 feet. That shelter accommodates all the systems electronics, including a transmitter, a receiver, timing and interfacing electronics, antenna pedestal electronics, CRT terminal, mission-oriented controls, and the minicomputer.

Kitchens says that this is the first time that an instrumentation radar has had a minicomputer totally integrated into it. The system incorporates 16,000 words of core memory which may be expanded to 32,000 words.

In actual operation, the mini-

# SCIENCE / SCOPE

Indonesia will unite its 5,000 islands with a synchronous communications satellite system -- first in the Eastern Hemisphere -- which will provide nationwide television for education and entertainment and island-to-island telephone service for most of its 120 million people. Mountains, jungles, and vast stretches of ocean have made it difficult to link existing telecommunications with conventional microwave relays and submarine cables. Lack of communications in remote locations has hindered development of many mineral-rich areas of the 3,000-mile archipelago.

Work is now under way at Hughes to define the Indonesia system, which includes two satellites and 50 earth stations. The satellites are similar to those now in service for Telesat Canada and Western Union, which were also built by Hughes. Operations are scheduled to begin in mid-1976.

A mobile dockside trainer for U.S. Navy ship combat teams is now being built by Hughes under a recently awarded contract. Called MISTER (for Mobile Integrated System Trainer, Evaluator, and Recorder), it will allow the Navy to prepare and execute simulated fleet exercises by simultaneously presenting realistic tactical problems to the combat teams of two ships and to evaluate their performance. Up to five MISTERS can be tied into one exercise to provide coordinated task-force-level training. Because the exercises are controlled by minicomputers, the combat teams train at actual battle stations without need for ship deployment or electromagnetic radiation, which results in a significant reduction in fuel and other operating costs.

The Hellfire (Helicopter-Launched Fire and Forget) missile, which Hughes is now developing under contract to the U.S. Army Missile Command, is an advanced modular missile for use against tanks, vehicles, and ground emplacements. The next-generation missile beyond the Army's present TOW, Hellfire has a greater range and can use four different seeker-heads -- laser, radar frequency-infrared, optical contrast, or imaging infrared -- which give it an all-weather, day-night capability. Hughes has one year to build a prototype missile, launcher, functional cockpit mock-up, and other equipment for a competitive evaluation.

Systems Engineers and Analysts: Our Field Service and Support Division has personnel requirements for design and developmental work on the MISTER program for: logic design engineers (BS or MS in EE or Physics, digital design experience); system engineers (BSEE or Physics, training simulator experience); real-time programmer/analysts (technical degree, real-time simulation experience). U.S. citizenship required. Please send your resume to: D.I. Wingate, Hughes Aircraft Company, P.O. Box 90515, Los Angeles, CA 90009. An equal opportunity M/F employer.

X-ray lithography for batch production of microelectronic devices has been brought closer to practical application by Hughes research scientists. Their technique involves exposing X-ray sensitive polymeric resists through a high-resolution mask generated by scanning electron-beam systems. Advantages of X-ray lithography include large-area parallel exposure, 0.2-micron resolution, off-contact exposure, insensitivity to dust and contamination, use of positive or negative resists, uniform exposure with depth, and no requirement to place mask or substrate in a vacuum.

Creating a new world with electronics

**HUGHES**

HUGHES AIRCRAFT COMPANY

# Efficiency Experts

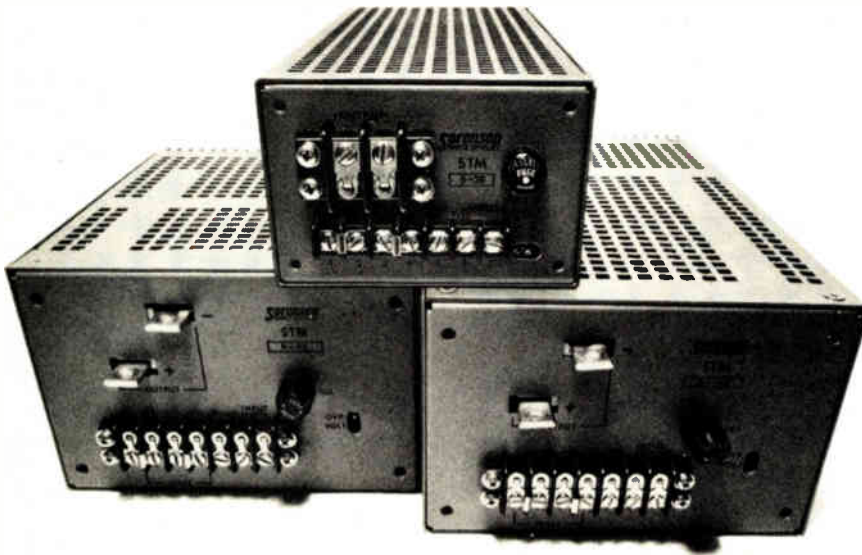

Built to save energy—modular STM switching-transistor power supplies from Sorensen. Exceptional power density and efficiency. Up to 1.5 watts per cu. in., and up to 75% efficiency in half the space of comparable competitive units. 40 models offer outputs from 72 to 780 watts (3 to 56 volts)—all with these features: cool running . . . excellent performance characteristics . . . built-in overvoltage protection . . . quiet operation . . . adjustable current limiting. For complete data, contact the Marketing Manager at Sorensen Company, a unit of Raytheon Company, Manchester, N.H. (603) 668-4500.

## Representative Specifications—STM

Regulation (comb. line & load)	0.05%		
Ripple (PAR)	rms: 3 to 10 mv. p-p: 30 mv. typ.; 50 mv. worst case		
Module Sizes & Prices	Module	Size	Price
	III	5.12" x 3.31" x 9.50"	\$240-270
	IIIA	5.12" x 3.31" x 14"	\$300-330
	IVA	7.5" x 4.94" x 10.5"	\$475-495
	VI	7.5" x 4.94" x 14"	\$600-650

**Sorensen**  
POWER SUPPLIES

computer serves as a control switching unit. Control information, entered on a keyboard and displayed on a CRT terminal screen, includes the general position to be searched, scan-area size, the gain of the receiver, and transmitter frequency. Also, all six DIR servo loops are closed through the computer, which provides the servo filters and gain constants. The loops are range, azimuth, elevation, frequency, gain, and constant false-alarm rate. In standard configuration, the system operates in the C band (5,400–5,900 megahertz) range, the frequency range at which most existing instrumentation radars operate. Thus, says Kitchens, the radar can be made part of a larger range-instrumentation complex.

By designing the DIR to accommodate elective features, RCA says it was attempting to avoid costly retrofitting. The various users can develop the system to meet their particular needs. Among the electives available with the DIR are a data plotter (which the Army expects to adopt), a remote control data link, bore-sight television, and beacon coding capability.

RCA's initial contract calls for one unit each to be delivered to the Air Force Flight Test Center, Edwards Air Force Base, Calif.; the Naval Air Test Center, Patuxent River, Md.; and the Army's Yuma Proving Ground, Yuma, Ariz. Primarily, the DIR will supplement other instrumentation radar installations. But at Patuxent River, the DIR will replace older, outmoded instrumentation radar systems. □

## Consumer electronics

### National enters watch market

Undeterred by warnings that semiconductor makers face withering competition in the digital-watch market from traditional watch-makers, National Semiconductor Corp.'s Novus Consumer Products

Heights of  
integrated circuits.  
Thin films on  
metals and ceramics.  
Thickness  
of transparent films,  
foils and coatings.  
Paper surface  
characteristics.  
Depth of etchings.  
Roughness of  
"smooth" surfaces.

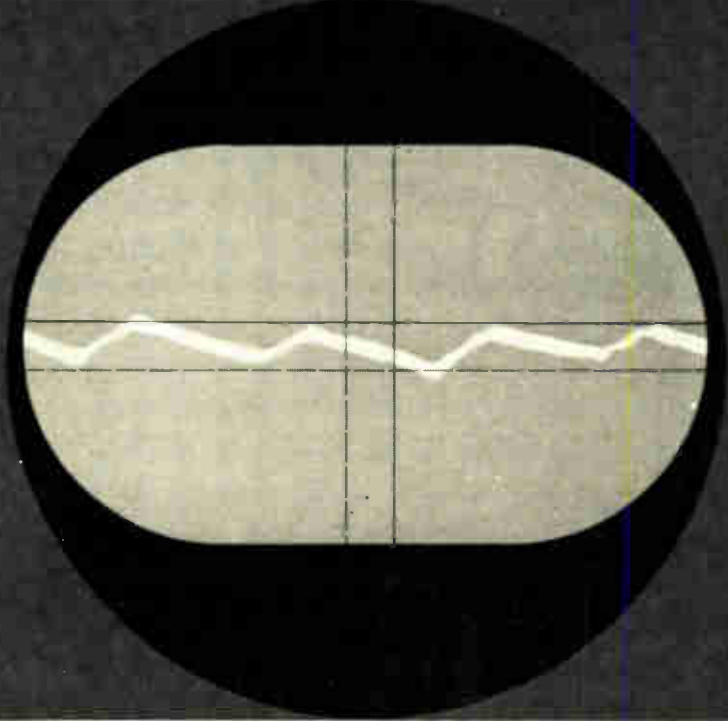

Measuring  
microscopic differences?

Use a microscope.

It won't hurt  
a thing.

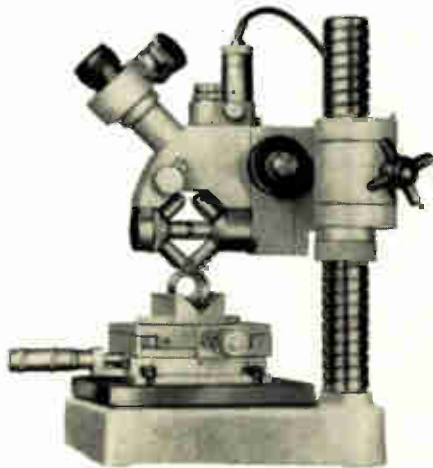

Completely non-destructive and amazingly accurate measurements of surface roughness and film thickness can be taken optically. And with such ease that even a completely inexperienced technician can learn how in minutes.

The instrument that does it is the ZEISS Light Section Microscope. Its principle is simple: a razor-edge beam of light is projected so that when viewed through the microscope it clearly profiles the surface. Then, by fine-tuning a reference line coupled to a micrometer, you can easily obtain direct readings of irregularities ranging from 0.000040 to 0.016 inch. Or find the thickness of transparent films by simply reading the difference between the top and bottom surfaces and factoring in the refractive index.

For permanent records or reference standards, a camera attachment permits you to take Polaroid® or 35 mm photos.

We think we've only begun to explore the possibilities of this unique quality control instrument. If you'd like to exchange ideas, or obtain complete information, just write Carl Zeiss, Inc., 444 Fifth Avenue, New York, N. Y. 10018.

Nationwide service.

**ZEISS**

THE GREAT NAME IN OPTICS



Circle 53 on reader service card

BRANCH OFFICES: BOSTON, CHICAGO, COLUMBUS, HOUSTON, LOS ANGELES, SAN FRANCISCO, WASHINGTON, D. C.

# BASIC TRAINING IN GEORGIA.

Through our Quick Start Program, Georgia trains workers for new industries. Free of charge.

We help in other ways, too. Through our location service, we'll prepare an exhaustive confidential site selection program for your company. Tailored to your requirements.

Using our 16-man research staff and computer facilities, we'll provide detailed appraisals of com-

munities which satisfy your various needs. Then we'll arrange for your personal inspection.

Georgia's industrial experts are primed to expedite every facet of your site selection process. And we have a close working association with all other developers in the state.

Send in the coupon, and let us put our training to work.



Georgia Department of Community Development  
Industry & Trade Division, Dept. EI-53  
Box 38097  
Atlanta, Georgia 30334



Name \_\_\_\_\_

Title \_\_\_\_\_

Company \_\_\_\_\_

Street \_\_\_\_\_

City \_\_\_\_\_ State \_\_\_\_\_ Zip \_\_\_\_\_

**GEORGIA.**  
WE MEAN BUSINESS.

## Electronics review

division has jumped in with six watches and three electronic clocks. The move comes in time to get brand recognition in jewelry and department stores during the Christmas-shopping season.

The Novus watches will be priced between \$125 and \$220, the clocks between \$34.95 and \$60. Evidence that the National division is serious about becoming a major producer of digital timepieces is provided by three related actions. In the past two months, Novus has firmed up distribution agreements with 17 large jewelry outlets and 12 department-store chains. It has established a service center at the division's Santa Clara, Calif., home base and plans a second center for the East Coast in the first quarter of 1975. In that same quarter, it will introduce another line of digital watches, including a date indicator.

**Shakeout.** The same rationale that has thrust Novus into a prominent position in the consumer-calculator business is behind the entry into the watch business: Novus officials foresee a shakeout coming among digital watchmakers, and expect the vertically integrated semiconductor makers to win most of the market.

These are the companies that fabricate the major components, which in watches include the IC counter/divider circuitry, the display, and possibly the quartz-crystal oscillator. For its watch, National makes the counter/divider circuitry and the display. "We've been working on this for a year," says National president Charles Sporck, "and we don't expect to make any mistakes."

The watches, which all feature 0.1-inch light-emitting-diode (LED) displays to show hours, minutes, and seconds on push-button command, have a typical accuracy of about 1 minute a year. The watch module, which drops into the case without screws or casing adjustments, consists of three ICs—the C-MOS circuit and bipolar digit and segment drivers, the LED display, and a time base composed of a capacitor-trimmed 32,768-hertz quartz-crystal oscillator. □

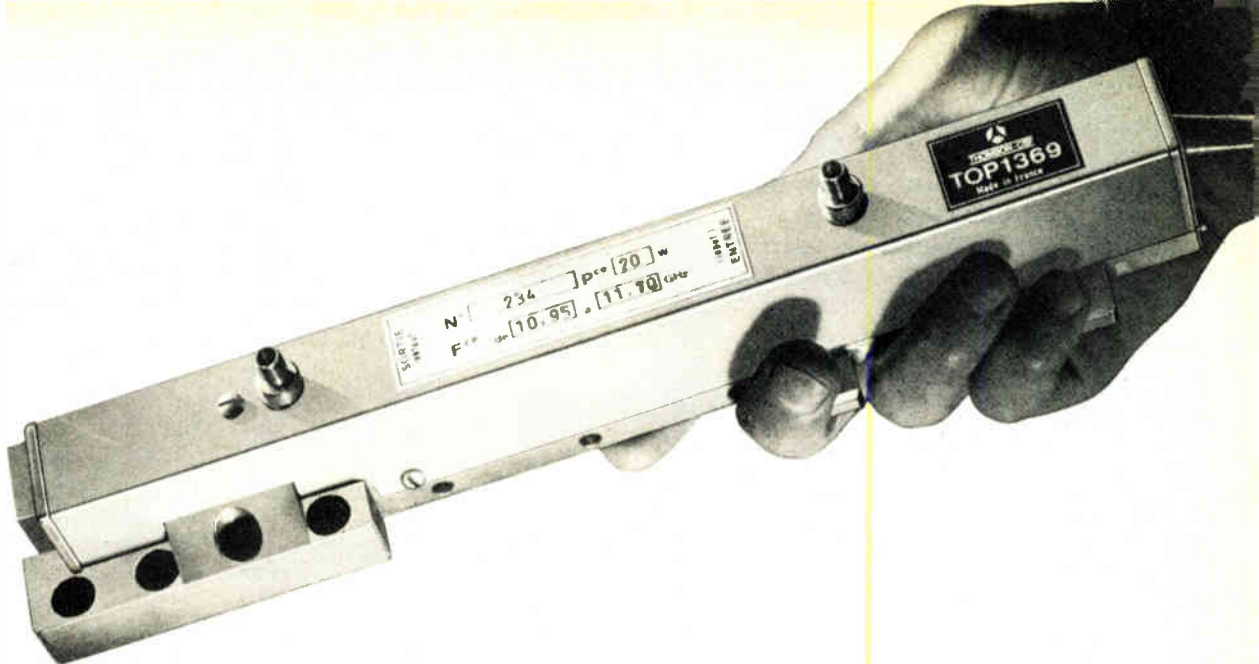

# For the next generation of communications satellites

## You don't want yesterday's space TWT...

...or even today's. No, for INTELSAT V, the European Communications Satellite or your advanced national-satellite system, you want a traveling wave tube for tomorrow - one that embodies a true advance in the state-of-the-art. Which is exactly why you should choose one of our new 20-watt, 12 GHz tubes, specifically developed for these future communications-satellite programs. It's worth noting that they've been the object of COMSAT and ESRO R&D contracts won in the face of severe international competition. Three different models are currently available, as indicated by the table, all featuring high gain, exceptional linearity, and designed for at least seven years of continuous

in-space operation. The latest of these TWT's, the TH 3525, features an outstanding efficiency of 40% (minimum), through use of a two-stage collector. The incorporation of a tapered helix holds the small-signal to saturation phase shift down to a typical 36°. An added bonus in this exceptional tube is a thermal-dissipation characteristic that is essentially traffic-independent.

Type	Frequency range (GHz)	Efficiency (min)	Gain at Saturation (dB)	Noise Figure (typical)
TOP 1369	10.95-11.70	30%	55	26 dB
TH 3529	11.70-12.20	30%	55	26 dB
TH 3525	10.95-11.70	40%	55	27 dB

Results like these well illustrate why you should come to us for your state-of-the-art tubes for satellite-transponder use - or any other advanced electron tubes you need. Contact us directly, or circle the appropriate number on the Reader's Service Card for more details.

THOMSON-CSF ADVANCED SPACE TWT's.



**THOMSON-CSF**

THOMSON-CSF ELECTRON TUBES, INC. / 750 Bloomfield Avenue CLIFTON NJ 07015 / Tel. (201) 779 1004 / TWX : 710 989 7149

France - THOMSON-CSF Groupement Tubes Electroniques / 8, rue Chasseloup-Laubat / 75737 PARIS CEDEX 15 / Tel. (1) 566 70 04

Germany - THOMSON-CSF Electronenröhren GmbH / Am Leonhardsbrunn 10 / 6 FRANKFURT / MAIN / Tel. (0611) 70 20 99

Italy - THOMSON-CSF Tubi Elettronici SRL / Viale degli Ammiragli 71 / ROMA / Tel. (6) 38 14 58

Japan - THOMSON-CSF Japan K.K. / Kyosho Building / 1.9.3. Hirakawa-cho / Chiyoda-ku / TOKYO / 〒 102 / Tel. (03) 264 6341

Sweden - THOMSON-CSF Elektronrör AB / Box 27080 / S 10251 STOCKHOLM 27 / Tel. (08) 22 58 15

United Kingdom - THOMSON-CSF Electronic Tubes Ltd / Bilton House, Uxbridge Road, Ealing / LONDON W 5 2TT / Tel. (01) 579 55 11 / Telex : 26 659

## News update

**Company is no more, but cable system lives on** Wayne Engineering Ltd. of Chatsworth, Calif., has gone out of business. Just another name on the bottomless list of small companies in electronics that tried and failed, one might say. True, except that a small piece of Wayne appears to have a chance to make it. That piece is an automated system for forming cable harnesses, one of which was delivered last year to a Western Electric plant in Mesquite, Texas [June 21, 1973, p. 33]. When Wayne folded, two of the men who worked on the cable unit went to work at Standard Logic Inc. in Santa Ana, Calif., a company that specializes in inexpensive semiautomatic wire-wrap equipment. Now, Standard Logic is coming out with a system similar to Wayne's, although there are some differences. For one thing, it's larger—7 feet wide and up to 20 ft. long, compared with the original's 6 ft. by 12 ft. For another, Standard Logic uses its own X-Y positioner rather than a table made by Xynetics Corp. And the final difference—one that might be most significant—is the use of a microcomputer controller for greater versatility instead of the previous hard-wired logic.

**Puerto Rico lengthens tax-free periods** Don't forget Puerto Rico. Amid the excitement about "offshore" facilities in other places—like Brazil (see p. 79), [March 21, p. 76], Puerto Rico has sweetened the pot for industry. The island commonwealth, which claims to have originated the concept of tax exemption with its Operation Bootstrap, has expanded the inducement to include 100% exemption from all taxes for periods up to 30 years, three times as long as the original Bootstrap was offering two decades ago. Since then, while U.S. industry was investing \$3.2 billion in Puerto Rican plants of all sizes, electronics has become one of the fastest growing industries on the island. From a slow start—just 17 plants with a production value of \$19 million in 1960—the industry now has nearly 190 plants that shipped \$200 million worth of product to the U.S. last year.

**Lenkurt shrugs off counter-phreak line** Whatever happened to the "phone phreaks," those free spirits who bedeviled the Bell System by beating the phone company out of its long-distance toll charges? Don't ask GTE Lenkurt Inc. of San Carlos, Calif., which developed a signaling system designed to foil the phreaks [March 29, 1973, p. 25]. A Lenkurt spokesman says the company has 70 products more important than its counter-phreak gear, but it will make the system as long as it has orders. Question: Does Lenkurt have any orders? Answer: This can't be determined now. Conclusion: Phone phreaks are safe from GTE Lenkurt.

**Rendezvous in Bucharest turns out as expected** Everything went according to TC-66's plan in Bucharest. That James Bond-like message has nothing to do with spies, cloaks, or daggers. Rather, it concerns a meeting in Romania of Technical Committee 66 of the International Electrotechnical Commission last month aimed at establishing a common instrument-bus standard [Sept. 19, p. 67]. According to Don Loughry of Hewlett-Packard Co., the principal author of the proposed standard, nations represented at the meeting were solidly behind the proposal and voted to relay it to their national agencies for consideration. Loughry adds, "It can now safely be assumed that within a year a number of companies will develop products compatible with the interfaces as defined in the TC-66 document." One glitch: the only issue left unresolved is that of connectors, which is still under discussion, but Loughry hopes a solution will come within a few months. As things stand now, final adoption of the rest of the standard is about a year off, because translation will take about six months and then the member nations—15 attended the Romanian get-together—have six months to vote. But as pointed out by the chief U.S. delegate, M.G. Domsitz of the National Bureau of Standards, once approved, the standard is likely to be adopted quickly in Europe, where governments can speed adoption by making the standard mandatory.

**NASA's space relay a little bit late** The National Aeronautics and Space Administration for years has had a soft spot in its heart for a satellite system that could replace all those foreign ground stations. The appeal is obvious: one or two craft keeping track of low-earth-orbit NASA satellites and transmitting their data to earth is certainly more elegant and manageable than a string of terrestrial telemetry depositories around the world. In its latest incarnation, the NASA plan would have private industry build the system and then lease it to the space agency [Feb. 21, p. 30]. Well, the \$150 million plan is facing what NASA calls "normal delays" in getting off the ground. Requests for proposals were to have gone out in August, but program manager Lorne M. Robinson says requests for proposals are now expected next month, with delivery pushed back to 1980 from 1979. Procurement of the system, which Robinson says would serve "all of NASA's tracking and data-acquisition needs" in the 1980s, will be in two steps. The first will be the selection of qualified applicants from those answering the RFP, to submit detailed designs and cost estimates within six months. The second will be selection of a builder-owner-operator.

—Howard Wolff

Intended to bring *Electronics* readers up to date on news stories of the past months





**One  
Good  
Interface  
Deserves  
Another...**

Circle 57 on reader service card

# And Another,

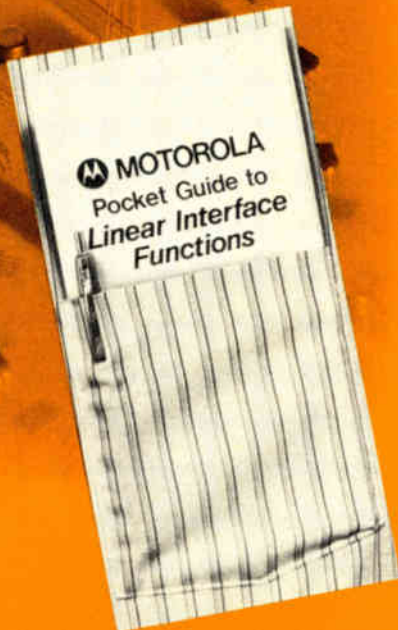

... ultimately generating a kaleidoscope of bilingual bonds between digital logic and associated circuitry. Like modem, memory, display and data bus interface. Peripheral, D/A and A/D and twisted pair interface. Industry firsts, innovative custom designs, and a lineup of popular second-source devices. Each a hue of the Motorola interface rainbow. A variegation that includes:

- the first quad versions of the MC75107-110 line drivers/receivers, the TTL compatible MC3450-53.
- the first quad high speed comparators (MC3430-33) with unique "input sensitivity" specing to refresh a stale op amp heritage.
- a major producer first in low-cost monolithic A/D, D/A converters, the MC1505, 6, 7 and 8.

And on and on. The choice is yours. Make it easy with the new 20-page "Pocket Guide to Linear Interface Functions" which includes function block diagrams, temperature ranges, and package descriptions and outlines. Read all about it. Just one thin request via coupon or reader service number.

# And Another,



A new generation of interface for a new generation of design requirements. Interface shedding its linear genealogy and adopting digital technologies. Chips of LSI density.

Advanced MOS memory drivers and core-memory sense amplifiers, bus transceivers for minicomputer and microprocessor interface and high-voltage display drivers. High speed logic interface and instrument interface (G.P.I.B.) for measurement systems. More first generation monolithic A/D and D/A converters. Advanced refinements, like higher speed; and space saving strides, like quads, for existing device types.

Tomorrow's components sired by today's technologies. Preview their maturity in "Interface—The Coming of Age", a comprehensive report on the trends and developments in interface. Request it today and behold the benefits of allying your future with the future of Motorola interface.

# And...?

Interface. Big challenges today. Bigger challenges tomorrow.

Motorola. A myriad of solutions today. Solutions transcending tomorrow. Solutions with you in mind.

After all, our success is riding on your success.



## MOTOROLA LINEAR

*Interface—The End Is Nowhere In Sight*

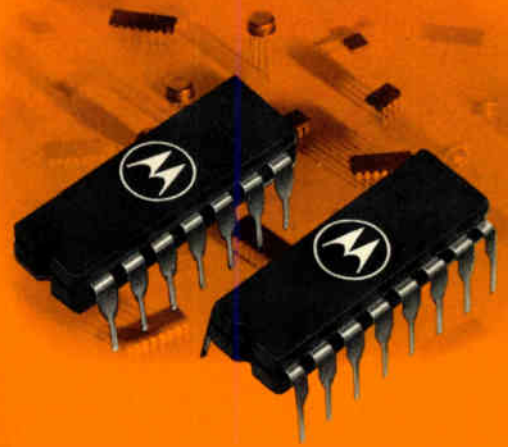

### MOTOROLA LINEAR INTERFACE FUNCTIONS

#### MEMORY INTERFACE

MC1540 Core Memory Sense Amplifier  
MC1541 Dual-Channel Gated Sense Amplifier  
MC1543 Dual MECL Core Memory Sense Amplifier  
MC7522 Dual High-Speed Sense Amplifier  
MC7524 Dual High-Speed Sense Amplifier  
MC7528 Dual High-Speed Sense Amplifier  
MC7534 Dual High-Speed Sense Amplifier  
MC7538 Dual High-Speed Sense Amplifier  
MMH0026 Dual MOS Clock Driver  
MC75325 Dual Memory Driver  
MC1544 AC-Coupled Four Channel Sense Amplifier

#### MODEM INTERFACE

MC1488 Quad MDTL Line Driver RS-232C  
MC1489 Quad MDTL Line Receiver RS-232C  
MC1489A Quad MDTL Line Receiver RS-232C

#### DISPLAY INTERFACE

MC75491 Multiple Light-Emitting Diode (LED) Driver  
MC75492 Multiple Light-Emitting Diode (LED) Driver

#### PERIPHERAL INTERFACE

MC75450 Dual Peripheral Positive "AND" Driver  
MC75451 Dual Peripheral Positive "AND" Driver  
MC75452 Dual Peripheral Positive "NAND" Driver  
MC75453 Dual Peripheral Positive "OR" Driver  
MC75454 Dual Peripheral Positive "NOR" Driver  
MC75461 High Voltage Dual "AND" Driver  
MC75462 High Voltage Dual "NAND" Driver  
MC75463 High Voltage Dual "OR" Driver  
MC75464 High Voltage Dual "NOR" Driver

#### D/A AND A/D INTERFACE

MC1506 Six Bit, Multiplying Digital-To-Analog Converter  
MC1508 Eight Bit, Multiplying Digital-To-Analog Converter  
MC1505 Analog-To-Digital Converter Subsystem  
MC1507 Analog-Digital Control Circuit

#### COMPARATOR INTERFACE

MC1710 Differential Comparator  
MC1711 Dual Differential Comparator  
MC1514 Dual Differential Comparator  
MLM111 High Performance Voltage Comparator  
MC3430 Quad High Speed Voltage Comparator  
MC3431 Quad High Speed Voltage Comparator  
MC3432 Quad High Speed Voltage Comparator  
MC3433 Quad High Speed Voltage Comparator

#### TWISTED-PAIR INTERFACE

MC3450 Quad Line Receivers with Common Three-State Strobe Input  
MC3452 Quad Line Receiver with Open-Collector Outputs  
MC3453 Quad Line Driver with Common Inhibit Input  
MC75107 Dual Line Receiver  
MC75108 Dual Line Receiver  
MC75109 Dual Line Driver  
MC75110 Dual Line Driver  
MC75140 Dual Line Receiver

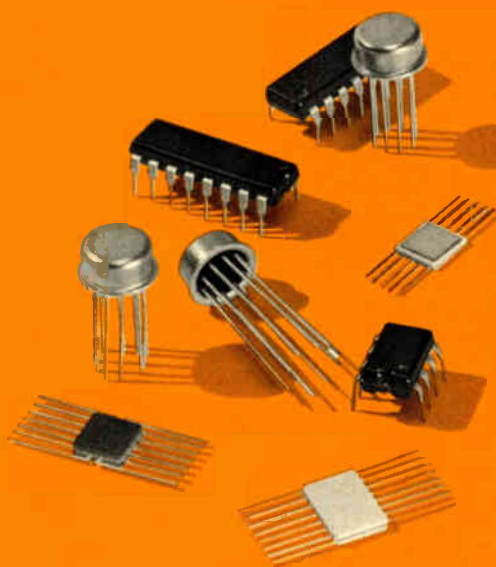

**For quick response, snip out and attach to company letterhead.**

*Turn me around to Motorola Interface*

Send:  Pocket Guide to Linear Interface Functions

Interface — The Coming of Age

Name \_\_\_\_\_

Title \_\_\_\_\_

Mail Drop \_\_\_\_\_

**Mail To:** MOTOROLA INTERFACE  
P. O. BOX 20912, PHOENIX, ARIZONA 85036

Circle 59 on reader service card

**We got**  
**the**  
**4K RAM**  
**in**  
**production**  
**NOW!**

Your wait is over! The Company that took the lead in p-channel silicon gate data com and calculator circuits now offers our first leadership entry into the memory business - the RM1701H 4K RAM - for immediate delivery! Our 4K RAM is n-channel MOS/LSI designed for top performance...to save you \$ and reduce your system overhead! And you can use our 4K RAM in those empty sockets. It's functionally and pin-compatible with those others you've designed in but can't get. There's no end to our RAM's versatility! Use it to replace magnetic core memories...for buffer stores...for main memories. Look at what makes our 4K RAM leader of the pack - 4096 x 1 organization, single clock input with a low power dissipation of 400 mW operating and 2 mW standby, access time of 300 ns maximum with a 470 ns maximum cycle time. That's not all! Our RAM incorporates address and chip select registers to reduce your system overhead. All inputs (except single clock) are TTL compatible and without pull-up resistors. Three-state output buffers have guaranteed fan-out of two standard TTL gates. Power supplies are industry standard +12V, +5V and -5V. Operating temperature range is 0°C to 70°C. And, what's more, you can improve your system efficiency, because our device requires only 16 cycles to refresh the entire RAM!

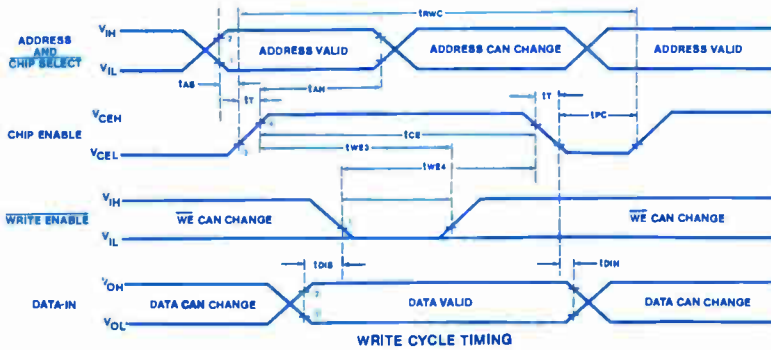
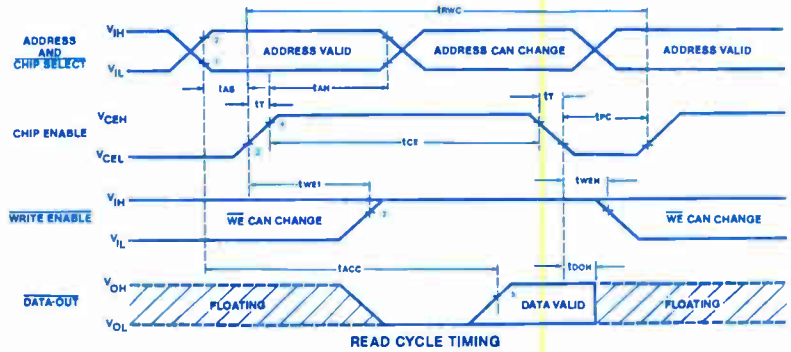

...to save you \$ and reduce your system overhead! And, what's more, you can improve your system efficiency, because our device requires only 16 cycles to refresh the entire RAM!

We call our RAM the RM1701H ...and it's available NOW FOR IMMEDIATE DELIVERY! It comes in an economical 22-pin plastic cavity package, and it sells for only \$27.00 in 100-up quantities.

The day of the 4K RAM is here...NOW. Order your system prototypes today for delivery tomorrow.

Contact your local Western Digital representative...or call, write, or twx 4K RAM headquarters - Western Digital Corporation.

Maximum Access Time .....	300 ns	Power Supply Voltages .....	Standard +12, ±5V
Maximum Cycle Time (Read or Write) .....	470 ns	Operating Temperature Range .....	0-70°C
Refresh .....	Only 16 cycles every 2 ms	Price .....	\$27.00 at the 100-up level
Power Dissipation .....	400 mW Active 2 mW Standby	Availability .....	NOW

# smarter mos/lsi

## WESTERN DIGITAL

C O R P O R A T I O N

3128 RED HILL AVENUE P.O. BOX 2180  
 NEWPORT BEACH, CALIFORNIA 92663  
 TELEPHONE: 714-557-3550  
 TWX: 910-595-1139

- UPSTATE NEW YORK:  
TECH-MARK, INC.  
(607) 748-7473
- NEW YORK STATE, NORTHERN  
NEW JERSEY, FAIRFIELD  
COUNTY, CONNECTICUT:  
NORTHERN ELECTRONICS  
COMPONENTS CO., INC.  
(201) 461-2789
- TENNESSEE, ALABAMA,  
GEORGIA, FLORIDA, MISSISSIPPI:  
TECH-REP ASSOCIATES  
(615) 595-2834
- ILLINOIS, INDIANA, IOWA, AND  
EASTERN WISCONSIN:  
LIGHTNER ASSOCIATES  
(312) 398-3000
- TEXAS, OKLAHOMA, ARKANSAS,  
LOUISIANA:  
ROBERT R. THOMAS COMPANY  
(214) 233-8235
- NORTHERN CALIFORNIA,  
NORTHERN NEVADA, ARIZONA,  
NEW MEXICO:  
W. W. POSEY COMPANY  
(415) 948-7771
- MAINE, NEW HAMPSHIRE,  
VERMONT, MASSACHUSETTS,  
CONNECTICUT, RHODE ISLAND:  
BLAKE ASSOCIATES  
(617) 391-7890
- SOUTHERN NEW JERSEY,  
EASTERN PENNSYLVANIA:  
JADELECTRONIC  
ASSOCIATES, INC.  
(215) 647-5151
- OHIO, WESTERN PENNSYLVANIA,  
KENTUCKY:  
ENGINEERING MARKETING  
ASSOCIATES  
(513) 433-2800
- MINNESOTA, NORTH DAKOTA,  
SOUTH DAKOTA,  
WESTERN WISCONSIN:  
S & R COMPONENT SALES, INC.  
(612) 554-3022
- COLORADO, UTAH, WYOMING,  
MONTANA:  
R. G. ENTERPRISES, INC.  
(303) 447-9211
- SOUTHERN CALIFORNIA AND  
SOUTHERN NEVADA:  
ELECTRONIC COMPONENT  
MARKETING  
(714) 830-3939
- MARYLAND, VIRGINIA,  
WASHINGTON D.C., DELAWARE:  
MARKTRON, INC.  
(301) 762-6210
- MICHIGAN:  
A. BLUMENBERG  
ASSOCIATES, INC.  
(313) 557-1934
- KANSAS, MISSOURI, NEBRASKA:  
NEYCO, INC.  
(816) 421-1751
- OREGON, WASHINGTON, IDAHO  
& BRITISH COLUMBIA:  
ARNESON ASSOCIATES  
(206) 762-7664

# THE FIRST OF THE BIG COUNT TIMERS

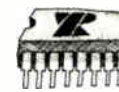
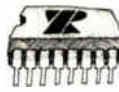
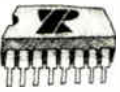
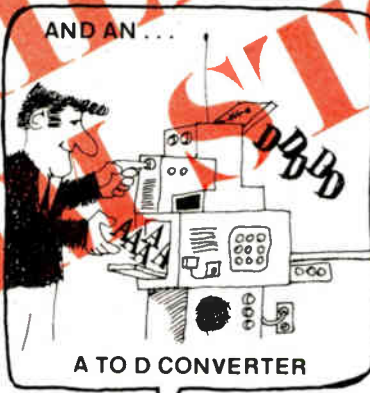
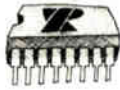
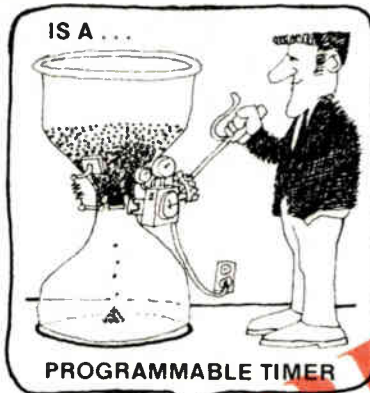
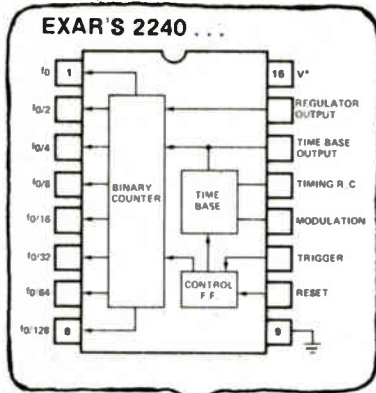

Exar's new XR-2240 counter/programmable timer solves so many tough problems that designers will unanimously agree that it's really the universal timer.

With its unique combination of analog and digital timing methods, you can now replace inadequate and complex assemblages of monolithic and electromechanical timers with the much simpler XR-2240. As a bonus, you get greater flexibility, precision operation, and a reduction in components and costs for most applications.

Because of built-in programmability, you can also use the XR-2240 for frequency synthesis, electronic music synthesis, digital sample and hold, A to D conversion, binary counting and pattern generation, and more.

With a single XR-2240 you can now generate

precision time delays programmable from 1RC to 255RC, a range of microseconds to 5 days. By cascading only two XR-2240 timers, you can extend the maximum delay by a factor of  $2^N$ , where  $N = 16$  bits, resulting in a total delay of 3 years!

The XR-2240 operates over a 4V to 15V supply range with an accuracy of 0.5% and an 80 ppm/°C temperature stability. It's available in either a 16-pin ceramic or plastic dual-in-line package for military or commercial applications. Prices start at \$4.50 in 100 piece quantities.

For the more conventional timing applications, look to our other timers: the XR-320 timing circuit and the XR-2556 dual timers. Call or write Exar, the timer leader, for complete information.

## EXAR SPEAKS YOUR LANGUAGE

R-OHM CORPORATION  
EXAR INTEGRATED SYSTEMS  
P.O. BOX 4455, IRVINE CA 92664  
TELEPHONE: (714) 546-8780  
TWX: 910-595-1721

**Rohm**  
QUALITY · RELIABILITY

R-OHM ELECTRONICS GMBH  
EXAR INTEGRATED SYSTEMS  
MÜHLENSTRASSE 70  
4051 KORSCHENBROICH  
FEDERAL REPUBLIC OF WEST GERMANY

Members of the International R-OHM Group

# Washington newsletter

## Commerce's Office of Telecommunications may be eliminated

The more-than-200 employees in the Department of Commerce's Office of Telecommunications are expected to be **victims of President Ford's plans to reduce the size of Government and cut Federal spending.** A recommendation to eliminate OT has been made to the White House by the Office of Management and Budget, according to reliable Government sources, and is **expected to be implemented in the fiscal 1976 budget** that will be delivered to Congress in January. John Richardson is acting director of OT, **which costs roughly \$10 million a year**, including about \$4 million for work for agencies other than Commerce. The OMB recommendation is reported to be based on its **judgment that much of OT's work duplicates that done by other agencies.**

## FAA to pass airport radar from General Dynamics to TI

Eighteen months and millions of dollars later, **General Dynamics Corp. has failed to produce 37 Airport Surveillance Radar systems for the Federal Aviation Administration, so expect the agency to award Texas Instruments an \$18 million contract for 40 radars.** TI lost to General Dynamics in the bidding in 1970. FAA staffers confirm that the agency will give \$12 million to General Dynamics for one radar and 40 antennas and then terminate the contract.

An industry source says the company "lost their shirts" on the radars' production and that termination of the contract by the FAA was a bail-out gift. **Congressmen such as Jack Brooks (D., Texas) have already taken the FAA to task for wasting taxpayer money on fiascos** such as the electronic voice switch [*Electronics*, Aug. 22, p. 49] and are expected to rake the FAA over the coals for this, say congressional sources. Congressional staffers say that after the election recess this fall, **an investigation may get under way.** "This certainly whets my curiosity," says a congressional investigator.

## FCC changes rules for digital microwave systems

The Federal Communications Commission has amended its rules on digital modulation techniques used in common-carrier microwave radio. The action on docket 19311 establishes limitations on out-of-band emission for digital microwave systems: it sets **stricter limits on the bands below 15 gigahertz because of the heavy use of analog systems in the lower bands**, and assumes that future systems above 15 GHz will probably be mostly digital.

The rules also require digital microwave systems to use scramblers to eliminate repetitive bit patterns that could cause in-band harmful emissions. To assure "reasonably efficient use of the spectrum," **digital transmissions carrying voice circuits will be required to carry a minimum number of voice channels—96 of them at 2 GHz, and 1,152 each at 4, 6, and 11 GHz.**

## OTP calls summit to improve spectrum analysis . . .

The Washington vogue for summit conferences to cope with national problems is catching up with users of the rf spectrum. John Eger, acting director of the White House Office of Telecommunications policy, says OTP has set Nov. 6-7 for a **closed meeting of eight communications electronics experts from industry and Government to review and recommend improvements in electromagnetic compatibility analysis and tech-**

**niques for spectrum management.** Wilfrid Dean, OTP's assistant director for frequency management, will chair the proposed "free-wheeling" session. Invitees include engineering executives from Bell Laboratories, MIT's Lincoln Lab, the Naval Research Lab, ITT, the Directorate of Defense Research and Engineering, Communications Satellite Corp., and several consultants.

The conference is one of several OTP actions taken in response to a newly completed General Accounting Office study of spectrum management which notes that, **because of the nation's \$90 billion investment in spectrum-dependent electronics, "demands for spectrum services are increasing more rapidly than technology can find space in the available range of frequencies."**

## **. . . and acts to counter shortage of spectrum managers**

A General Accounting Office warning that "the numbers of people and their technical competence" in spectrum management are declining throughout the Government has also prompted the Office of Telecommunications Policy to set up a career development program. An ad hoc committee of the Interdepartment Radio Advisory Council has already met and expects to complete the study and organization phase of **a program to establish a Government-wide system for training and development in spectrum management.** The number of spectrum managers in the military services alone has dropped by a third to more than half between 1967 and 1973, said GAO. It added that **the lack of experienced personnel "may jeopardize U.S. interests" at the 1979 World Administrative Radio Conference,** which will consider reallocation of the spectrum for national and international needs.

## **Car makers seen killing amended a-m/fm radio bill**

Watch for Detroit's auto makers to mount strong opposition to and probably kill **the so-called all-channel radio legislation that was passed by the Senate but now has been amended by the House Commerce Committee to apply only to auto radios.** As originally proposed, the bill required all radios retailing for more than \$15 in the U.S. to have both a-m and fm capability [*Electronics*, June 27, p. 53]. The fm broadcasters, its chief proponents, wanted it passed so that they could reach the auto radio audience. **The bill's restriction to car radios—a position supported by the Electronic Industries Association, which otherwise opposes the bill—is expected to make the powerful auto industry lobby surface in opposition.** At least, radio manufacturers are hoping the lobby will call the bill inflationary, warn that it will further raise car prices if passed, and thus help them kill the bill.

## **Bureau of Mines wants solid-state dosimeter**

The Bureau of Mines is giving Arthur D. Little and Co., Cambridge, Mass., **an \$80,000 grant to develop a new type of semiconductor device that will be the basis for a solid-state radiation dosimeter and personal alarm to be used by miners, supervisors, and inspectors.** Twenty prototype devices are to be delivered by May 1975. According to the bureau scientists, chemical dosimeters found in laboratories are not rugged enough for use outdoors or in the humid, dusty atmosphere of a mine. The bureau expects thousands of the dosimeter-alarms to become standard equipment, once they are perfected.



# If you have any of these tape transports...

**Honeywell**  
HEWLETT  PACKARD  
**GENISCO**  
**SANGAMO**  
**BELL & HOWELL**  
**AMPEX**

## Then it's easy to put time on your tape.



Model 8120 Time Code Generator



Model 8134 Time Code Reader/Tape Search and Control Unit

Systron-Donner's time code instrumentation is compatible with most, if not all, analog tape transports. Your transport manufacturer will probably recommend Systron-Donner—the leading manufacturer of quality time code instrumentation. Exactly what does S-D provide?

1. Time code generation and reading, IRIG formats, NASA formats, and others.
2. Automatic tape search using your transport to automatically locate selected tape segments during playback.
3. Computer-controlled tape search to permit automatic location and identification of selected tape segments for data reduction.

Because S-D offers a complete line of time code instrumentation, we can meet your specific requirements. Request our new brochure "Time Code Instrumentation". (Free)

For an authoritative and practical treatise on timing, S-D offers a newly revised timing handbook entitled "Precision Timekeeping and Tape Search". Price \$3.50

Contact your Scientific Devices office or Systron-Donner at 10 Systron Drive, Concord, CA 94518. For immediate details, call our timing products department (415) 676-5000. In Europe: Munich, W. Germany; Leamington Spa, U.K.; Paris (Le Port Marly) France. Australia: Melbourne.

**SYSTRON**  **DONNER**

Circle 65 on reader service card

## UK's radar agency shows color display fed by monochrome TV

Researchers at Britain's Royal Radar Establishment showed a bench-built electro-optic display in color late last month at the European Solid State Physics Device Research Conference. A monochrome television-receiver tube energizes a flat panel of 4 by 6 inches mounted in front that contains a sandwich of polarizing and birefringent filters and an electrically switched liquid-crystal cell. However, in all fairness, the system, which attracted a great deal of interest at the conference, has a restricted viewing angle, and the flicker is disturbing.

Plans call for improving the technology for applications involving raster-scan displays and possibly random-addressed displays. Whether or not it leads to a cheap commercial flat color panel, its first use is likely to be either as a radar display or as a dynamic battlefield map in color for the military.

Using a well-known principle, the researchers rely on a twisted nematic (parallel) cell to perform in the sandwich in the same way that mechanical rotating polarizing sheets change the color of light passing through them. The sandwich consists of a polarizing layer, the cell, a birefringent plastic layer, and another polarizing layer.

**Switch.** By passing as much as 10 volts of alternating current through the cell, the sandwich becomes a color switch. But one major problem with liquid-crystal displays is that they have rather slow response times. This display, however, can be switched at speeds greater than 25 hertz and has rise and fall times of 1 millisecond.

The sandwich, mounted in front of a monochrome CRT, sequentially presents 50 frames of alternating color per second. Synchronizing the rapidly switched colors with the frames on the CRT enables the viewer's eyes to integrate the frame

sequence to yield displays of two or more colors. Even more complex sandwiches of two or more twisted nematic cells and more birefringent layers could be made to switch electrically between four or more colors, claims Ian A. Shanks, research fellow on the project.

Replacing the CRT with a flat panel that is equally powerful presents some problems that the

RRE is trying to solve. As a step toward a flat panel, the CRT might be replaced by a dc electroluminescent display that uses zinc-sulphide-phosphor, doped with copper and manganese. Researchers hope this approach will lead to a complex flat-panel display, that will provide a frame-sequential, broad-band, red-yellow-green combination.

Although a three-color, sequential

## Around the World

### German system mixes dyes and computes cost

Carl Zeiss, the German optics firm, has teamed with the Swiss chemical producer Sandoz AG to build a color-matching system it says can work out formulations for a specific color within five minutes after the fabric to be matched is put into the machine. The cost with the computerized system, Zeiss maintains, is 42% less than working out recipes by hand.

And instead of a single formulation, the system develops up to 75 of them and analyzes the costs for each. Zeiss has sold the \$90,000 system in Spain, Denmark, Switzerland, and West Germany. Zeiss's RFC 3/24 color-matching gear is tied to a Hewlett-Packard HP-2100 minicomputer. The fabric to be color-matched is illuminated by polychromatic light. The reflected light is analyzed by an array of at least 16 color filters.

### Cells detect losses in optical fibers

Of great concern to communications engineers is the amount of scattered light that radiates from glass fibers used as a transmission medium. Even in the best of present fibers, this radiation constitutes a major loss, whereas the absorption by the glass itself is relatively insignificant. But measuring scattered radiation requires a complex setup and may be time-consuming.

John P. Dakin, a researcher at West Germany's AEG-Telefunken has come up with a simple technique whereby a pair of solar cells measuring 2 by 2 centimeters is sandwiched in a gap of 100 to 200 micrometers in the fiber to be measured. To determine the scattering losses, the laser light pumped into the fiber is chopped at a rate from 500 to 1,000 hertz to get a readily detectable ac output.

### Monitor warns when brakes wear out

A brake-wear monitor soon to be marketed by West Germany's Robert Bosch GmbH is a transducer-indicator combination that determines the amount of brake wear and triggers a warning light on the dashboard when abrasion gets to a critical point. The system can be used either on drum or disk brakes.

A transducer, essentially a ceramic-base plate, has six thick-film resistors embedded in its surface connected in parallel via conductors deposited on small ceramic segments that extend downward. The opposite friction pad is a stepped shearing plate with each of its six steps directly opposite a segment on the transducer. As the two friction pads wear thinner, the transducer and the shearing plate move closer to each other, and each of the shear-plate steps breaks off the corresponding segment on the transducer. Once that thickness gets down to 20%, the warning lamp is turned on.

presentation is theoretically possible, repetition rates would have to be raised above 100 Hz, meaning that each color will have to be repeated at a rate faster than 40 Hz. Liquid-crystal and phosphor technologies haven't progressed that far yet, although some promising research is being done with the ester class of liquid-crystal materials, Shanks says. But he warns that too many technical problems remain to be solved to consider this development the threshold of flat-panel color television.

The present CRT-based system requires careful design considerations involving the trade-offs of frequencies, currents, and response times of the liquid-crystal cell. The effect of temperature is important too. For a practical system, a complex color filter should be able to change rapidly enough for frame-sequential presentation in synchronization with the video frames. □

## Japan

### Researchers push 1-chip CPU speed

Single-chip central-processing units that operate faster than conventional units, but have a higher degree of integration are the two goals of a team at Nippon Electric Co.'s Central Research Laboratories. But researchers are pinning their hopes on enhancement-type Schottky-barrier field-effect transistors (ESBFETs), which have gate-power levels in the femtojoule range.

The CPU is being designed for the Japanese government's pattern-information-processing project. The 9-millimeter-square chip will contain about 5,000 gates. Although the instruction cycle will be a fast 200 nanoseconds, total power input will be a relatively low 600 milliwatts. Completion is scheduled for the end of March 1978.

The production method yields much better than those for bipolar circuits and about the same as those

for other types of FET circuits, although the circuits are smaller than bipolars. Preliminary experiments using a number of circuits connected as a ring oscillator have also shown that delay-power products of gates, with fan-in and fan-out of one, are in the appropriate range.

The researchers next plan to fabricate a 4-bit arithmetic/logic unit with about 100 gates to compare direct-coupled transistor logic with one of the circuits containing diodes. The 4-bit ALU will be similar in performance to Texas Instruments' SN74181 TTL device.

**ALU.** Plans call for a direct-coupled-transistor-logic ALU to be built on a chip 1.2 millimeter square. It will have a power drain of 10 milliwatts and should have an instruction cycle of about 25 nanoseconds. A diode-logic or diode-diode-logic device, to be built on a chip 1-mm square, will also have a power drain of 10 mW and should have an instruction cycle of about 30 nanoseconds. The devices operate satisfactorily at supply voltages on the order of 1 v. Under this condition, the logic swing is 0.4 v, which is compatible with low-level common-mode bipolar logic.

The ESBFET devices are fabricated on a p<sup>-</sup> silicon substrate. An early process step is p<sup>+</sup> diffusion that forms isolation between the n-type silicon active regions. This is followed by n<sup>+</sup> diffusion of the source

and drain regions, and n<sup>+</sup> regions for resistors and diodes are fabricated in the same diffusion.

The n-type active regions are fabricated by implanting phosphorus ions at an accelerating voltage of 80 kilovolts. Next, the platinum silicide-to-silicon contacts, which form Schottky contacts for the gates in the n-type silicon regions and ohmic contacts (for source, drain, resistors, and diodes) in the n<sup>+</sup> regions are produced. These Schottky junctions are a constant depth beneath the surface of the silicon and maintain a well-controlled threshold voltage.

Schottky-gate and ohmic-contact depth are controlled by depositing metal thin films of carefully controlled thickness on a wafer having a silicon-dioxide mask with appropriately opened windows. The first thin film is platinum, and its thickness controls the process. The next film is molybdenum, followed by another film of platinum. Then the wafer is heated to alloy the platinum with the silicon to form platinum-silicide contacts.

The alloying process continues until all the platinum at each window forms platinum-silicide alloy. It then stops because the molybdenum will not react with the silicon. Thus, the platinum-silicide contact extends into the wafer an amount controlled by the thickness of the initial platinum metalization layer. □

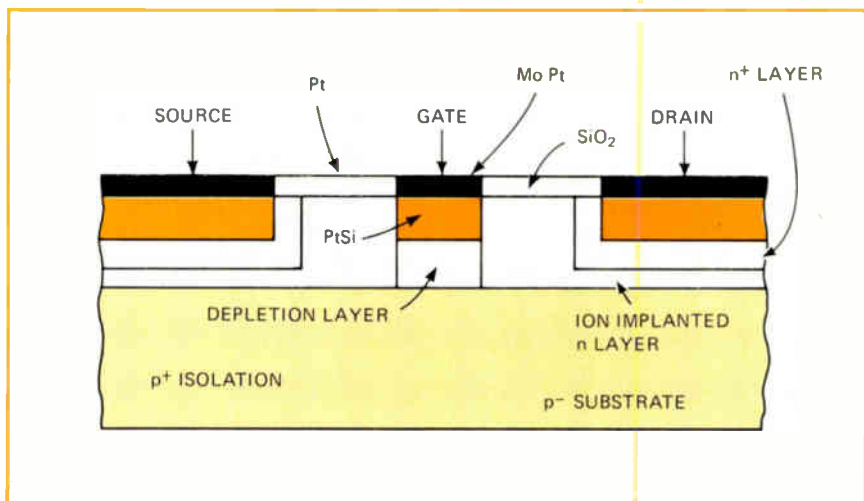

**Integrated speed.** Nippon Electric researchers are trying to kick up both speed and degree of CPU integration with this enhancement-type Schottky-barrier FET.

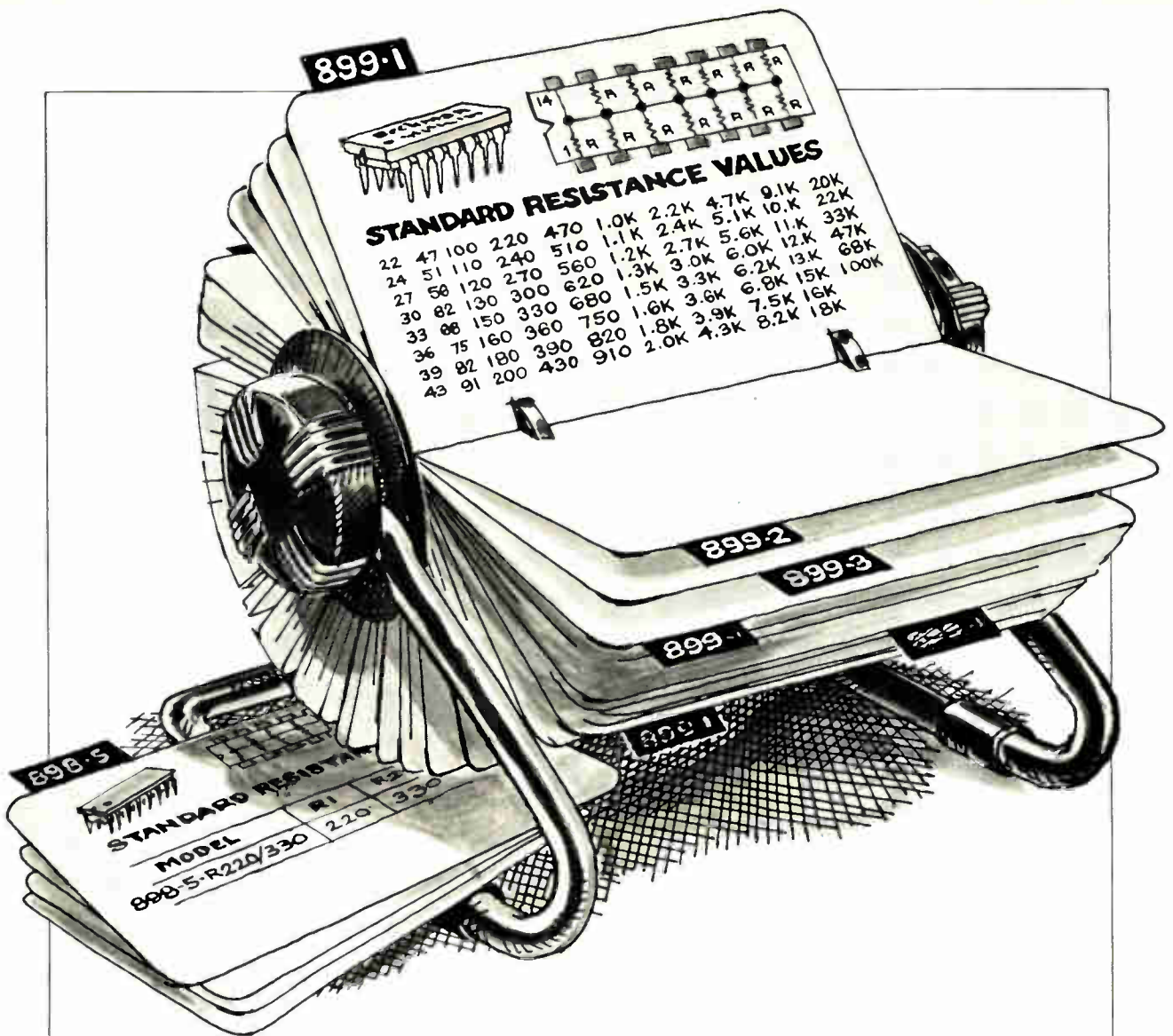

## Still rolling up the score. Now, 223 standard Beckman DIPs.

We're adding more and more models to the RESNET™ DIP resistor line to make things easier for you.

Now there are 223 standard RESNET DIPs to give you wider selection, greater variety of resistance values, and less need for custom components.

Use them for applications involving pull-up/pull-down, line termination, LED current limiting, ECL termination, or interface networks. And most models are second-sourced, too.

RESNET DIPs are dimensionally uniform, ideal for automatic insertion techniques. They're also laser-tailored for precise resistance values. And every part is 100% tested.

Ours is the broadest line available and it's stocked locally by your Beckman/Helipot distributor for immediate delivery.

Prices? Truly competitive, actually giving you the quality of cermet technology at plastic prices.

Considering breadth of line, quality, availability, and good pricing, you don't have to look farther than Beckman for standard resistor networks. Or for expertly produced custom versions as well.

Check us out. For immediate literature or the phone number of your Beckman/Helipot representative, call toll-free (800) 437-4677.

**Beckman®**

**HELIPOT DIVISION**

## **Hard times hit telecommunications in West Germany**

After losing much of its steam in recent years, West Germany's once-buoyant telecommunications industry is now reeling under the one-two punch of slackening consumer demand and drastic cuts in investment spending by the government, which runs the telephone and data networks. **As a result, many of the country's 30-odd communications houses have either gone on shorter work weeks or are about to trim their work force.** At Siemens AG, for example, the 22,000 workers engaged in telephone switching systems will be cut by 6,000 people during the coming year. And, at Standard Elektrik Lorenz AG, an ITT subsidiary, four-day work weeks will be in effect for some 3,000 employees until year's end. On top of that, SEL is considering the layoff of 600 field technicians. Though the figures are different, the situation is much the same at many other companies.

**Behind the gloom are the government's budgetary policies,** which mean less money for some public sectors, including the post office, the largest single customer for the big communications companies. At SEL, for instance, orders received from the post office during the first eight months of this year were about 25% lower than during the same period last year.

**Slackening consumer demand for telephone service stems from recent hikes in phone charges,** the highest in Europe even before the increase became effective. This rate situation is keeping many potential customers from applying for telephones and for various phone services offered by the post office.

## **Ferranti crisis staved off till after elections**

What final plans the government might make to rescue Ferranti Ltd. from its financial straits won't be made until sometime after the outcome of the October 10 general election is known. The high-technology electronics and avionics manufacturer has been temporarily saved by a government guarantee of loans up to about \$12 million after the company's leading banker, fearful of the company's low cash balance, refused to extend any more credit. **Speculation is that, no matter who wins the election, the important defense contractor will be kept intact and not split up among other, stronger corporations.** But the Bank of England worries publicly that there may be more companies in Ferranti's situation. What caught the company have been rising costs, an unprofitable business—transformers—and unusually high investment in basic development.

## **Lloyds upgrades network for cash dispensing**

Lloyds Bank is ordering 100 automated sidewalk banking terminals from IBM to create one of the biggest on-line cash-dispensing networks. Built by IBM in the United Kingdom, the 3614 terminals will let customers withdraw cash, **as well as put in credits, request checkbooks and statements of current accounts, and transfer funds from one account to another**—which Lloyds claims is a first in service options. Costing totally about \$2.5 million, the new machines, plus 100 older terminals, will extend the bank's computerized cash dispensing to stores, factories, and other non-banking locations when delivery begins in 1976.

The total 700-terminal network, expected to cost about \$13-million, is part of Lloyds automated fund-transfer program and has **the goal of handling 25% of the bank's cash transactions with customers.**

## **West Germans find improved thin-film resistor material**

Researchers at the Philips laboratory in Aachen, West Germany, have hit upon an improved material for producing thin-film resistors in hybrid circuits. **As a replacement for chromium-nickel, they use zirconium boride, a material that better resists temperature effects.** Chromium-nickel layers, during high-temperature bonding, exhibit sharp and irreversible resistance increases. To get around this shortcoming, special coatings must be applied before bonding, and this means an increase in production costs.

With zirconium boride, on the other hand, there are no such problems. This temperature-effect immunity, as J. Trevor Calow, a British researcher at the Aachen lab points out, **stems from zirconium boride's resistance to oxidation and structural phase changes.** Like chromium-nickel, zirconium boride can be applied by sputtering. It adheres well to ceramic or glass substrates and can be manufactured with specific resistance values of up to 300 ohms per square. The material's temperature coefficient is low—less than  $10^{-4}/^{\circ}\text{C}$ , which compares well with the value for chromium-nickel, Calow says. **Resistors made from zirconium boride have already been used in an experimental transistorized medium-power microwave oscillator built at the lab.**

## **Japanese develop liquid-crystal dot-matrix display**

An experimental liquid-crystal matrix panel—measuring 150 dots wide by 100 dots high—has been made by three Japanese companies under a \$1.67 million subsidy from the Japanese government. By the end of next March, they expect to complete a prototype panel measuring 50 centimeters wide by 40 centimeters high with a matrix of 500 by 400 points. **It will display 600 alphanumeric characters.**

The companies—Hitachi Ltd., Asahi Glass Co., and Dai Nippon Toryo Co.—use a nematic liquid crystal operating in dynamic scattering mode. The unit produces static displays with contrast ratios between 13:1 and 20:1. Writing is line sequential, and the time required for writing or erasing the display is about half a second.

## **Addenda**

**It's up to West Germany to approve the next stage of development for the all-European Multi-Role Combat Aircraft** after Britain agreed to the prototype testing stage and renamed the plane Tornado. The final hurdle will come in late 1975 when the partners come to approve production of Western Europe's largest single defense project—800 planes at about \$10 million each. . . . **A two-year public trial of the digital "magazine of the air,"** called Ceefax by the British Broadcasting Corp. and Oracle by the Independent Broadcasting Authority, has been okayed by the British government as the next step toward implementation. The concept uses presently unutilized time slots in the TV signal to transmit coded pulses that, decoded by an adapter, show up as printed text on a screen.

**FREE  
REAL ESTATE**  
CALL "CONTROLS" AT 714 684 1700

BOURNS  
3850  
Series

**...switch to BOURNS  
and get the most  
power-for-size in  
low-cost panel controls**

Save valuable "real estate" behind the panel . . . switch to BOURNS® unique SPACE SAVER controls design. Extends only ¼" behind your panel, yet handles as much power as bulkier alternatives.

Choose Bourns CERMET CONTROLS for maximum power-for-size optimum stability.

Choose Bourns NEW CONDUCTIVE PLASTIC CONTROLS for low noise and long life. Ideal replacement for bulky carbon controls.

Quality and Service are what you've come to expect from BOURNS . . . the BEST!

Bourns controls are available off-the-shelf at 92 distributor locations nationwide. Standards can be shipped direct from factory stock in 24 hours.

For your custom requirements, call our application engineers for assistance.

CTS  
550

ALLEN  
BRADLEY  
"J"

**FREE SAMPLE**

Call "CONTROLS" at 714-684-1700 and tell us about your application. We'll send you the Bourns Control that best suits your needs. Pronto.



TRIMPOT PRODUCTS DIVISION • 1200 COLUMBIA AVE., RIVERSIDE, CALIF. 92507

Circle 71 on reader service card

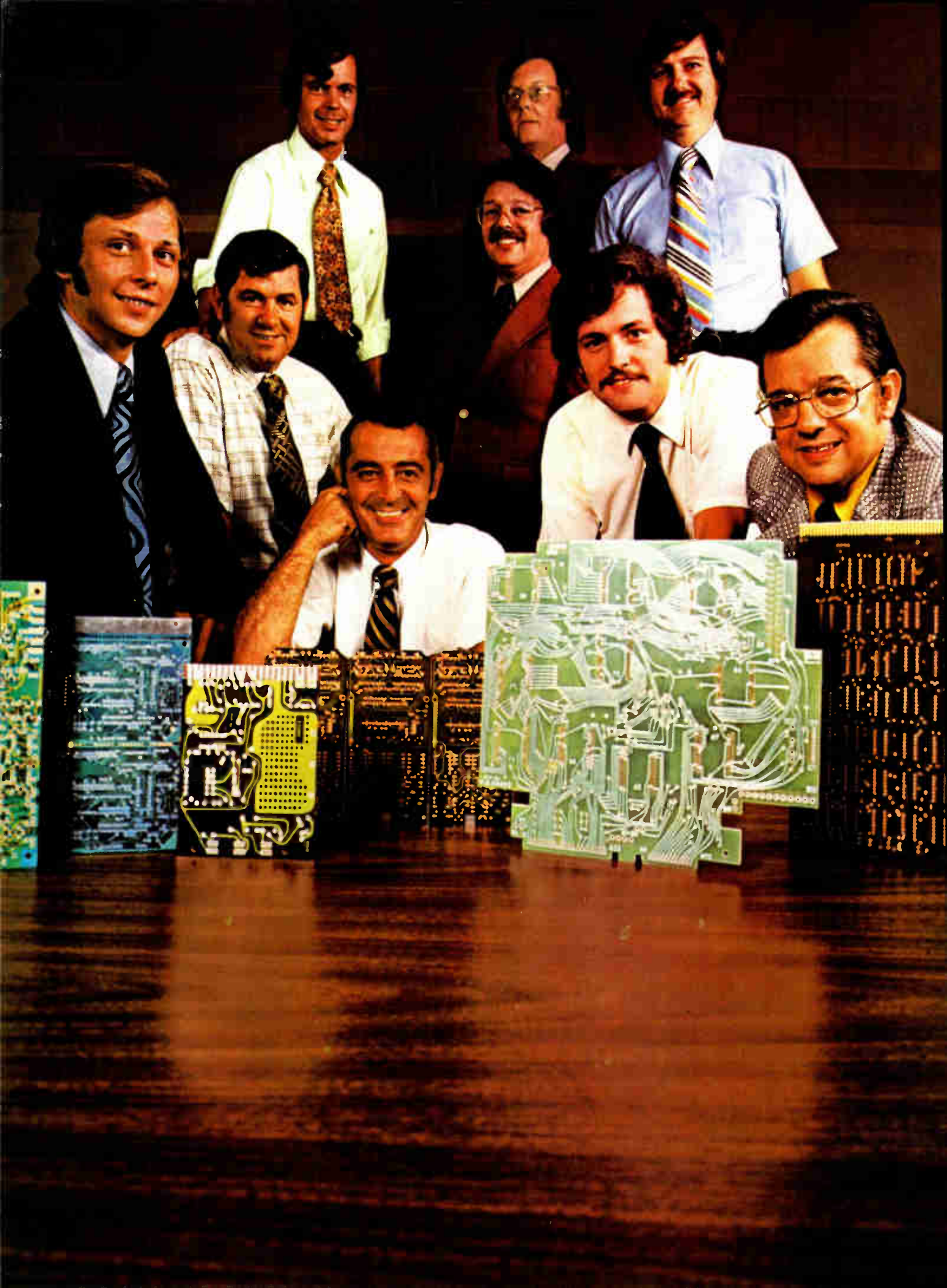



# "To make sure you get all the PCB's you need to feed a mass market, we give you a boss to deal with."

Brian Patterson, Sales/Marketing Manager



"Response is the key word in making mass-produced electronics. Not electrical response, but the human kind.

"Today, our customers react to market conditions at a pace that would be considered impossible just two or three years ago. To do a better job of helping them, we at Photocircuits have turned our organization upside down.

**"Serving mass producers is the name of our game.**

"Today, no PCB house can be all things to all customers. So we've fine-tuned our organization—plants and people—to meet the needs of mass-producers. Both their production line needs and product development needs.

"Our philosophy: printed circuitry for mass-produced electronics. Our commitment: to on-time delivery of cost-effective quality PCBs.

**"The 'nine boss' approach to keeping commitments.**

"The biggest cause for failure to keep commitments is when people who make the commitment are not responsible for fulfilling it. We've eliminated that problem.

"Today, our organization is highly decentralized. We have nine (tomorrow it might be ten) product manufacturing groups. Each has its own boss who can make commitments to customers on board specifications, price, quality and delivery. And each has its own direct manufacturing capability, process engineering and production control to keep them.

**"We offer market specialists, instead of jacks-of-all-trades.**

"The circuit board needs of telecommunications, computer peripherals and home entertain-

ment markets differ sharply in product and service.

"To meet these differing needs, each of our product groups has a primary market focus: i.e., telecommunications, EDP, automotive, mobile communications and consumer products.

"And every customer can expect better service because it comes from specialists in his own markets.

**"Additive or subtractive? We have no axe to grind.**

"Those are suspect words from the company that developed the copper-additive PCB process. But frankly, there's good reason.

"Our customers want boards best suited to their needs. Boards that meet their specs, and their customers' specs. Our commitments, then, are to just that. Not to additive or subtractive, as such.

"So we can begin by giving any customer the precise board he needs. Then, if it looks like another of our technologies can do something for him in quality or price, we'll be fast to let him know.

**"We're putting our money on mass-produced electronics.**

"In Riverhead, Long Island we are building the most advanced PCB plant in the industry. On one hand, high capacity with high yields. On the other, zero pollution.

"This capacity, added to that of our present large, modern Glen Cove facility, will let us provide 'printed circuitry' to many more mass-producers.

"To find out about this capacity...or to put it to work right now, please drop me a note or give me a call. It's my job to see that you get your 'boss' to work with. I'm Brian Patterson, Photocircuits Division, Kollmorgen Corporation, Glen Cove, New York 11542. (516) 676-8000."

## Photocircuits

Printed circuitry for mass-produced electronics

# We fit right in

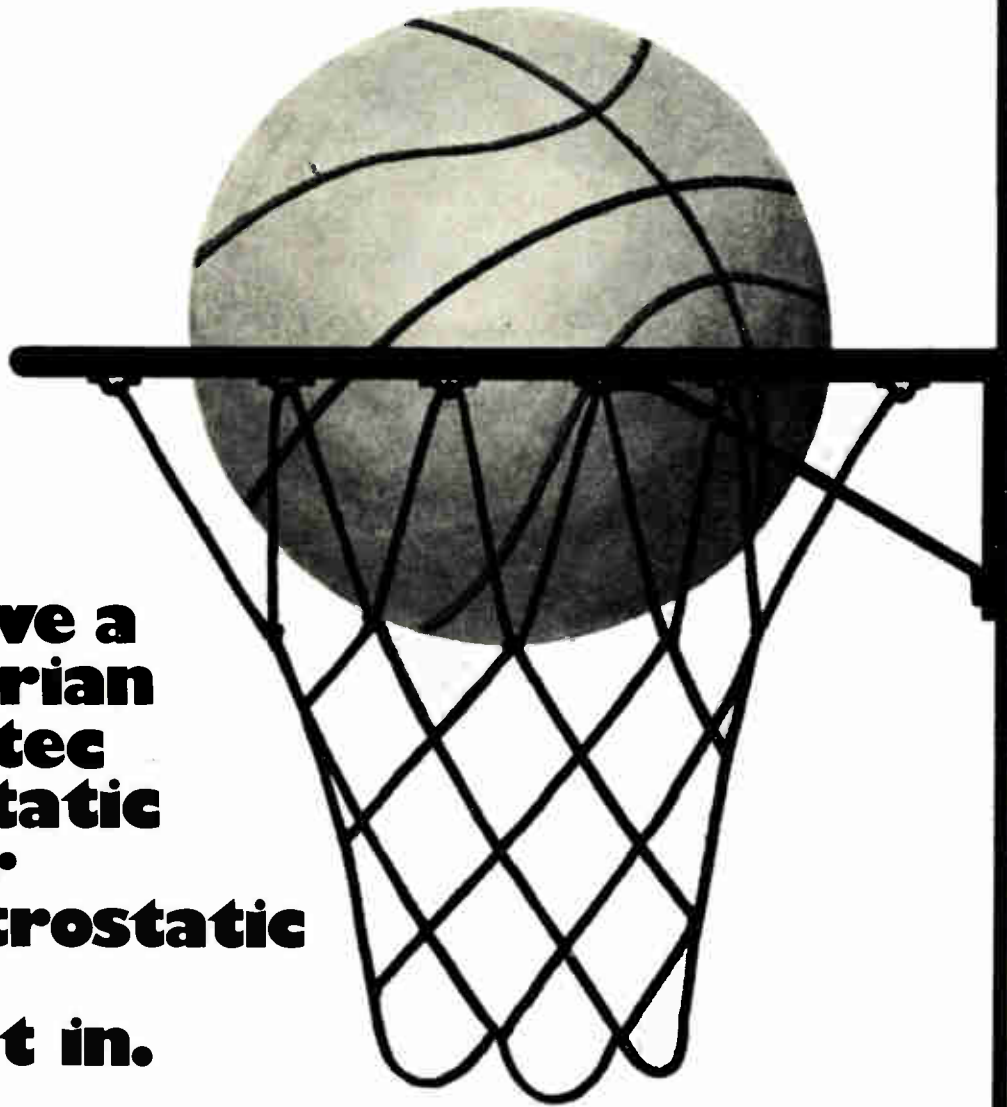

**If you have a  
Gould, Varian  
or Versatec  
electrostatic  
recorder  
our electrostatic  
paper  
fits right in.**

Our nationwide distribution system provides one source of supply, delivered when you want it as you want it, from inventory. And you'll save money in the bargain!

For your special needs we offer preprinted grids in any color and configuration.

For more information write or call Ray Newstead, Industrial Products Manager, Graphic Controls Corporation, Recording Chart Division, 189 Van Rensselaer Street, Buffalo, N.Y. 14210. Telephone: (716) 853-7500. Ext. 352.



**RECORDING CHART DIVISION  
GRAPHIC CONTROLS CORPORATION**  
189 VAN RENSSELAER STREET, BUFFALO, NEW YORK 14210

# Texas Instruments SR-50 scientific calculator. A technological milestone.

In sheer math power.  
And in price  
**\$149.<sup>95</sup>**

From the moment  
you open this box  
you'll begin to work  
with mathematics  
as never before.

Now, right at your  
fingertips, you have  
an unmatched  
combination.

In performance  
and value.

Accuracy  
and efficiency...



# Compare the SR-50. Feature for feature. Function for function. Dollar for dollar.

Algebraic keyboard. Accuracy to 13 significant digits. Display rounded to 10 digits. Single function keys for finding powers, roots, factorials, logarithmic, trigonometric, and hyperbolic functions. For sum and store. For converting answers to scientific notation. Unmatched capability and performance for just \$149.95.

## Lots of choices, few standouts.

Today, scientific calculators are available in a wide range of prices and capabilities. New models, new brands, new manufacturers have recently entered the market. But, when you want the best in a full-function slide-rule calculator, the choices narrow down fast.

Still, only two names and three models stand out. The SR-50 outperforms the HP-35 and costs less—about \$75 less at the time of this writing. The HP-45, on the other hand, offers some features not found on the SR-50, but cost \$175 more.

It boils down to basic value analysis. And, in that light, the SR-50 is unmatched.

## FUNCTIONS

	SR-50	HP-35	HP-45
LOG, LN	yes	yes	yes
TRIG (ARC, SIN, COS, TAN)	yes	yes	yes
HYPERBOLIC (ARC, SIN, COS, TAN)	yes	no	no
DEG ↔ RAD CONVERSION	yes	no	no
DEG/RAD MODE SELECTION	yes	no	yes
DEC ANGLES ↔ DEG/MIN/SEC	no	no	yes
POLAR COORD ↔ RECT COORD	no	no	yes
$Y^X, e^X$	yes	yes	yes
$X^2$	yes	no	yes
$\sqrt{X}$	yes	yes	yes
$\sqrt[n]{Y}$	yes	no	no
$1/X$	yes	yes	yes
$X!$	yes	no	yes
EXCHANGE X WITH Y	yes	yes	yes
METRIC CONVERSION CONSTANTS	no	no	yes
%, AND $\Delta$ %	no	no	yes
MEAN AND STANDARD DEVIATION	no	no	yes
STORE, RECALL	yes	yes	yes
$\Sigma$ TO MEMORY	yes	no	yes

## FEATURES

ROUNDING TO TEN DIGITS	yes	no	no
ALGEBRAIC NOTATION (SUM OF PRODUCTS)	yes	no	no
DEG/RAD SWITCH	yes	no	yes
MEMORY (OTHER THAN STACK)	1	1	9
FIXED DECIMAL OPTION	no	no	yes
KEYS	40	35	35
SECOND FUNCTION KEY	no	no	yes

An extension of your professional capability. The SR-50 delivers the math power today's technical environment demands. It can help you get more complex mathematical work done faster. With greater accuracy.

It can save you valuable time and magnify your

talents. An SR-50 lets you use your technical imagination with more freedom. You have time to explore more options—use “brute force” approaches such as successive approximations, educated guesswork, trial and error.

And, at \$149.95, an SR-50 is within practically anyone's budget. Whether you are at the top of your profession or a beginning student. In fact, at this price, it becomes a practical consideration for productivity-minded managers and administrators to equip virtually every professional in their organization with an SR-50 scientific calculator.

And, you can get them now from TI, individually or in volume quantities, within short lead times.

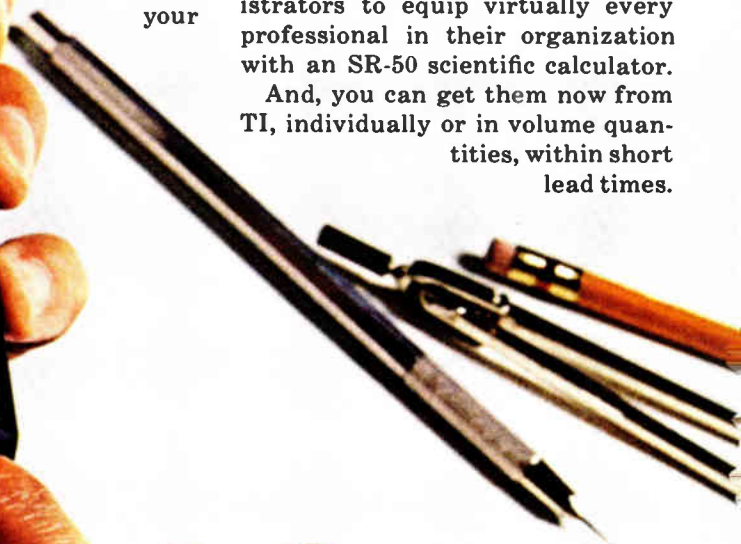

# Keys that solve complex mathematical calculations as easily as simple arithmetic.



**On/Off**—Slide to the right applies power, slide to the left removes power. Power-on indicated by a number in the display.



**DEG/RAD Switch.** Interprets displayed angle in degrees or in radians.



**ARC.** When pressed as prefix to sin, cos, or tan key, tells calculator to determine the inverse trig function.



**Sine.** Determines the sine of the displayed angle.



**Cosine.** Determines the cosine of the displayed angle.



**Tangent.** Determines the tangent of the displayed angle.



**Clear.** Clears the calculator. The memory is not affected.



**Hyperbolic Function Key.** Instructs the calculator to determine the hyperbolic function of the displayed value when pressed as a prefix to the sin, cos, or tan key.



**Angle Change Key.** If the DEG/RAD switch is set for degrees, pressing the D/R key instructs the calculator to convert the displayed angle from radians to degrees. If the switch is set for radians, pressing this key instructs the calculator to convert the displayed angle from degrees to radians.



**Natural Logarithm.** Determines logarithm to the base e of the displayed number.



**e to the x Power.** Raises e to the power of the displayed number.



**Common Logarithm.** Finds the logarithm to base 10 of the displayed number.



**Square.** Squares the number displayed.



**Square Root.** Finds the square root of the number displayed.



**Reciprocal.** Finds the reciprocal of the number displayed.

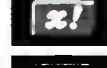

**Factorial.** Finds the factorial of the number displayed.



**The xth Root of y.** Finds the xth root of a y number.



**Store.** Stores the displayed quantity in the memory.



**Recall.** Retrieves stored data from the memory.



**Sum and Store.** Adds the displayed number algebraically to the number in the memory.



**Exchange.** Tells calculator to exchange the x and y quantities in  $y^x$  or  $x\sqrt{y}$  before the function is processed. Operands in times (x) and divide ( $\div$ ) can also be changed with this key.



**y to the x Power.** Raises a number to a power.



**Clear Entry.** Clears last keyboard entry.



**Enter Exponent.** Enters the subsequent number as exponent of 10.



**PI.** Enters pi to 13 significant digits. Display indicates value rounded off to 10 significant digits.

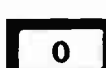

**0** **9** **Digit Keys.** Enter numbers 0 through 9 to a limit of a 10-digit mantissa and a 2-digit exponent.



**Decimal Point.** Decimal is assumed to be to the right of any number entered unless it's positioned in another sequence with this key.



**Change Sign.** Changes the sign of either the mantissa or exponent.



**Display.** Power-on and numerical information. Provides indication of a negative number, decimal point, overflow, underflow and error.

**Overflow & Underflow Indications.** Display flashes when number entered or calculation result is entered or calculation is larger than  $\pm 9.999999999 \times 10^{99}$  and when number entered or calculation is closer to zero than  $\pm 1. \times 10^{-99}$ .

**Fast Rechargeable Battery Pack.** Provides 4 to 6 hours' operation without recharging. Recharging for about 3 hours restores full charge.

**Fast and easy. No calculator in its class is so easy to master.**

The SR-50 lets you key the problem just as you would state it. A unique register system provides a sum of products capability directly at the keyboard. This ability to store the first product while the second is being calculated is in addition to the memory accessed by the memory keys. The efficiencies are suggested by this simple problem:

$$(2 \times 3) + (4 \times 5) = 26$$

TI's Algebraic Entry Method:

$$2 \times 3 + 4 \times 5 = 26$$

Reverse Polish Entry Method:

$$2 \uparrow 3 \times 4 \uparrow 5 \times + 26$$

# The reason the SR-50 has so much math power at the price lies beneath the keyboard.

A full-function scientific calculator is a state-of-the-art product reflecting state-of-the-art technologies. It's logical, then, to look first to the manufacturer known worldwide for both—Texas Instruments.

TI has long been a leader in solid-state technology and has pioneered a series of landmark developments relating directly to calculators: The original integrated circuit. Key patents in

basic MOS/LSI technology. The “calculator-on-a-chip” integrated circuit which became the heart of miniature calculators. And the basic patent on the miniature calculator itself.

TI is steeped in calculator technologies from start to finish, making all critical parts and controlling quality every step of the way. And that's the key to the exceptional quality and value of the SR-50.

## 15-day no-risk evaluation

What's more, we'll let you experiment with your SR-50 for 15 days at no risk. Then if you change your mind, we'll refund your money without question.

Don't put off getting your SR-50 any longer. The SR-50 has the math power today's work world requires. In the office or in the classroom. In the lab or on the drawing board.

## Evaluate an SR-50 for 15 days at no risk.

Mail this coupon today. Try the SR-50 for 15 days at no risk. Send this order form and enclose a check, money order, or company purchase order of \$149.95 for each SR-50. Use the SR-50 for 15 days. Then, if you decide it's not the best value you've seen, just return it in the original carton with all accessories for a full refund.

TO: Texas Instruments Incorporated  
P.O. Box 3640, M/S 84M, Dallas, Texas 75221

Dear Sir:

I enclose a ( ) check ( ) money order ( ) company purchase order for \$\_\_\_\_\_ for the purchase of \_\_\_\_\_ SR-50(s). I understand that I'll get my money back if anytime during the 15-day trial I'm not completely satisfied.

Name \_\_\_\_\_

Address \_\_\_\_\_

City/State/Zip \_\_\_\_\_

Company \_\_\_\_\_

Please add state and local taxes where applicable.\*

EMI

\*States requiring submission of taxes: AZ, CA, CO, FL, IL, IN, KY, MA, MI, MN, NJ, NM, NY, PA, TN, TX, UT, VA, WA.

The SR-50 includes AC adapter/charger which operates on either 115V/60 Hz or 230V/50 Hz; cushioned vinyl carrying case; and user's manual/application guide.

### Full year warranty.

Texas Instruments warrants each scientific calculator for a period of one year against defective parts and workmanship. If you ever do need service, you can get it through TI's Customer Service Center.

TEXAS INSTRUMENTS  
INCORPORATED

# Probing the news

Analysis of technology and business developments



## They make a lot of TV sets in Brazil

Other electronic products in growing demand in \$325 million-a-year domestic market

by Ray Connolly, Washington bureau manager

If Brazil makes you think of "a sleeping giant" populated by a citizenry that earns its cruzeiros picking coffee beans, your thinking is years behind the times. To Brazilians, such notions are as unreal as Carmen Miranda movies.

Brazil still produces one-third of the world's coffee, but that crop now accounts for no more than 22% of the republic's export receipts, instead of 50% to 60% of prior years. Brazil is becoming heavily industrialized under an active government program to attract foreign investment capital for mining,

refining, and the manufacture of everything from iron and steel, to petroleum and petrochemicals, to textiles and electronics. Brazil's list of multinational investors is impressive, with names like Nippon Steel, Shell Oil, DuPont, Monsanto, Mitsubishi, General Electric, IBM, Philips, Burroughs, GTE Sylvania, Philco-Ford, Sony, Sharp, RCA, Admiral, Zenith, Fairchild Semiconductor, and Texas Instruments, among others.

To the electronics companies, Brazil is a market of more than 90 million souls whose \$325 million an-

**Downtown.** With 6.5 million residents, Latin America's largest city São Paulo is the center of Brazil's electronics industry.

nual outlay for electronic products generates another \$100 million in component sales alone.

**TV tops.** The domestic market for computers and calculators made by Brazilian subsidiaries of American companies is one of the more promising growth opportunities. Entertainment electronics, however, still tops Brazilian sales. Television in particular is now a major growth area, since color transmission only began in March 1972.

According to a Brazilian electronics market study reportedly prepared for the U.S. government and being circulated in Washington, Philco-Ford made 21.8% of the 1.11 million Brazilian-made TV receivers sold in 1972, followed by the 16.7% share of the domestically-owned Colorado line, while the Dutch-owned Philips placed third with 15.3% among the top 15 manufacturers. When Philco's output is added to the respective 6.3% and 7.2% shares of General Electric and the Empire line of GTE Sylvania, American subsidiaries accounted for 35.3% of the receiver market. Another 4.6% was about equally split between joint Brazilian-U.S. ventures supported by Admiral and Zenith. What is impressive to Americans familiar with those numbers is that they all represent the monochrome market, before the advent of color.

Brazilian production of color picture tubes by 1977, the U.S. study forecasts, will climb from this year's 150,000 units worth \$13.3 million, to 330,000 valued at \$25 million. As for CRT imports, the forecast is that they have already peaked at about 40,000 to 50,000 units a year and will be limited to the 12-inch, short-neck screen size that Brazil now does not produce in quantity. The switch to color, however, could produce dramatic changes in market shares, according to the analysis, even to the possible detriment of U.S. subsidiaries.

The biggest picture tube producer

in Brazil is a subsidiary of Philips S/A known by the awkward acronym Ibrape, derived from the equally unwieldy Indústria Brasileira de Productos Eletrônicos e Elétricos. Ibrape, one of three big Philips-owned components operations, is estimated to have 40% of the Brazilian CRT market. Not far behind is GTE Sylvania Indústria e Comercio Ltda., with 35%, while RCA Electronica Ltda. reportedly holds a 20% share. So far, the RCA subsidiary has been the only CRT maker not committed solely to supplying tubes for its own end product. But, with the news that RCA is building receiver manufacturing facilities in Brazil, that situation is expected to change.

**Multifactors.** In the opinion of the Brazilian consultants who drafted the market analysis, considerations ranging from global economics to the availability of domestic maintenance technicians are affecting home-entertainment market strategies in Brazil. For example, the fact that more than seven Brazilian-owned receiver manufacturers managed to capture only 37% of the domestic market—compared to the 35.5% share divided among three U.S.-owned producers—“reflects not only the lack of adequate financial resources but, more importantly, the absence of adequate research and development facilities in the wholly Brazilian operations.”

The creation of a Manaus duty-free zone “will undoubtedly hasten the trend to ICs in television circuitry,” in the view of the Brazilian analysis, since “the assembly process is cheaper, the ICs are imported duty-free and are released virtually tax-free into the Brazilian economy in a completed product, and the lower weight of the chassis will reduce freight charges—an important consideration since all goods will have to be airlifted.” How successful the made-in-Manaus label will become is still a matter of conjecture at this stage.

Brazil's expectations are that Manaus, which lies 700 miles into the interior, will become the headquarters for production of entertain-

## Brazil turned on early

With a land mass of nearly 3.3 million square miles, Brazil is the world's fifth largest country, most of it covered by uninhabited jungles and mountain ranges. Combine these features with a climate that ranges from tropical to subtropical and it becomes easy to understand why Brazil, early in its history as a republic, turned to radio communications as a partial substitute for its lack of railroads and highways.

From the 1930s onward, radio was the most effective medium of advertising and promotion, just as television today is replacing radio in the homes of Brazil's more than 90 million citizens. A nation dependent on radio gave the electronics industries an early start, one that has led to a development “that has outstripped other industrial sectors with the sole exception of the automotive industry,” according to a Brazilian consultant group's study now circulating in Washington.

Concomitant with Brazil's rapid industrial growth—much of it through the investment of multinational corporations—telephone services are being expanded, enlarging the market for electronic switching, microwave, and satellite-assisted systems. As heavy industries, like petroleum, petrochemicals, and steel, move in to tap Brazil's underdeveloped resources and abundant labor supply, electronics manufacturers see other new opportunities for automation and data processing hardware sales.

ment and consumer products for the domestic market, while manufacturing operations in the south, around São Paulo, will serve the export market.

With its 6.3 million people and its location on the more temperate south Atlantic coast, São Paulo's position as Brazil's biggest city and the center of industrial development is hardly threatened by the fledgling Manaus. With the exception of GE, which has a capacitor plant in Rio de Janeiro, every components manufacturer of significance makes its Brazilian headquarters in the São Paulo region.

In addition to the Philco-Ford and Sanyo transistor operations, GTE Sylvania's and RCA's tube plants other multinationals based in São Paulo include such capacitor makers as Mallory-licensee Arbane; the French-owned Thomson-CSF operation which is expanding into silicon transistors, diodes, and ICs; West Germany's Semikron, whose subsidiary of the same name makes silicon-controlled rectifiers, triacs, silicon diodes, and power rectifiers, and Siemens AG's Icotron, maker of silicon transistors and fixed electrolytic film capacitors; Mial of Italy's Mialbras, producer of ceramic capacitors, carbon potentiometers, and adjustable resistors; Kanda of Japan, another capacitor house, and, of course, Holland's

Philips, owner of Ibrape in São Paulo as well as two other large components producers, known as Telewatt in Petropolis and Constanta in Riberão Pires.

Texas Instruments at nearby Campinas is still considered to be in the São Paulo orbit. TI assembles an estimated 1.5 million ICs each month for shipment out of Brazil to Dallas, according to the report, while it imports other circuits from its U.S. operations for use in its Brazilian-assembled pocket calculators.

Fairchild has also started up a plant in Brazil that plans to turn out diodes at the rate of 50 million a year. As for IBM, its circuit imports are reportedly invoiced from its U.S. operations, “possibly part, if not all, are of French origin,” according to the analysis, including reed relays used in computer peripheral equipment.

Nevertheless, IBM's Brazilian production—60% of which was for local consumption in 1973—could soar if reports prove accurate that IBM-Brazil will become a supplier to IBM-Japan. The Burroughs Corp. effort in São Paulo is less diffuse, limited largely to the assembly of computer core memories from imported components for the export market. The operation's estimated consumption of imported diodes and diode arrays in 1973 was 3 million units, the study says. □



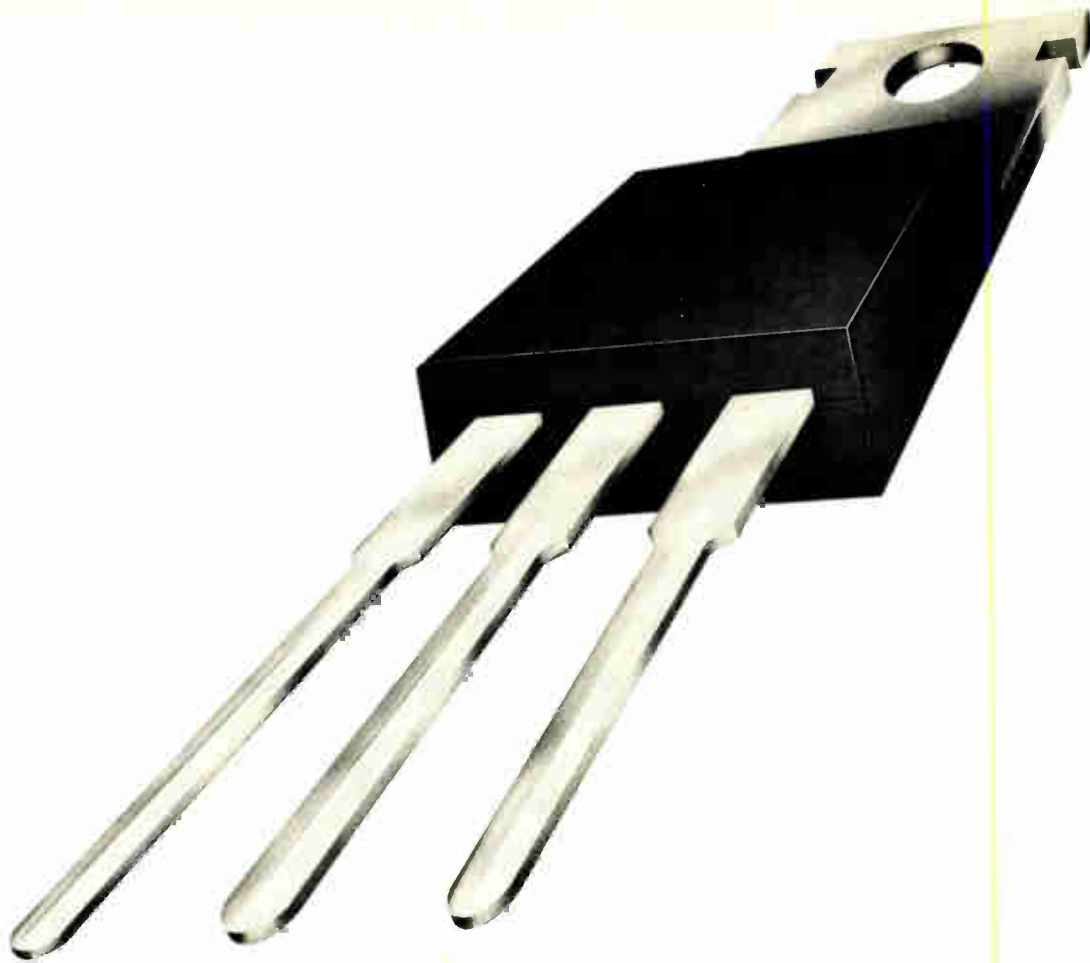

## The RCA 300 volt Triac. It can knock the 400 volt triac right out of the box.

The RCA T2800C is a solid 300 volt, 8 amp. triac. And sets a whole new standard for the industry. Until now, if you wanted added protection for 120V line operation, you were forced to go from 200 volts all the way up to 400 volts. More protection than you needed. More price than you should be paying. Matter of fact, right now there are a lot of black boxes containing 400 volt triacs that could easily have used the RCA T2800C, 300 volt device.

It's rugged enough to handle just about any 120V line job you have in mind or that's 'on the boards'—from motor controls and solid state relays to power switching systems. It has features like: glass passivated junction, 100 A peak surge full-cycle current rating, shorted-emitter center-gate design, low switching losses, low thermal resistance and it comes in our rugged Versawatt package. Perfect for dependable operation in a 120 volt line non-consumer environment.

Another important feature is that you "buy it off the shelf" either from your local RCA distributor or directly from RCA Solid State.

Its 1K price is 96¢ — sufficiently lower than the 400V device to save you money while still playing it safe.

### T2800 FAMILY

RCA TYPE	VOLTAGE RATING	1K PRICE
T2800B	200V	\$0.88
T2800C	300V	0.96
T2800D	400V	1.04
T2800M	600V	1.50

For more information contact your local distributor or RCA Solid State, Section 70J3, Box 3200, Somerville, N.J. 08876. Phone (201) 722-3200, Ext. 3134.

For a free sample, send RCA a note under your company's letterhead stating the application.

**RCA** Solid State

International: RCA, Sunbury-on-Thames, U.K., or Fuji Building, 7-4 Kasumigaseki, 3-Chome, Chiyoda-Ku, Tokyo, Japan. In Canada: RCA Limited, Ste. Anne de Bellevue 8 10, Canada.

Companies

# Think mechanical, says Augat

That's how plug-interconnection pioneer figures its concept can beat out double-layer and multilayer pc boards

by Gail Farrell, Boston bureau manager

Some design engineers are beginning to think of the mechanical interconnection before they consider the electrical specs, says Richard M. Grubb, marketing vice president, and that's fine with him and the rest of the managers at Augat Inc.

The Attleboro, Mass., company pioneered the market in plug-and-socket wire-wrap panel boards, and now has about 50% of the U.S. market for plug-interconnection boards. Augat considers its market the one now dominated by double-sided and multilayer boards.

Augat managers say the initial appeal of the wire-wrap panel lies in its versatility, quick design turnaround, and ease of field service. Users of interconnect systems are constantly hit with changes in wiring, logic, and discrete packages; with a wire-wrap panel, ICs are simply unwound, replaced, and wound again, while with a printed-circuit board each change means a new board. Augat president Roger Wellington claims that circuit-design time can be cut in half.

John Gerlack agrees. He is group manager in product design at the computer design section at Hughes Aircraft Co.'s aerospace operations in Culver City, Calif. Gerlack used Augat boards in avionics test equipment and says, "If we had used conventional multilayer circuit boards, we would have been locked in and changes would have been very expensive." He estimates that the dual-in-line-package Augat boards he used took two man-months to develop, compared to the four and a half to six months it would have taken for etched circuit boards.

Designers usually have their first

experience with Augat systems in breadboarding and prototyping; the start-up costs are less than with pc boards since there is no artwork or layout. Wellington says the majority of large customers "started out with the belief they would go to multilayer for the final product, but never converted." Even so, selling panels into final products is apparently more difficult, since users assume that in large quantity it's cheaper to produce gear on pc boards.

For example, Frito-Lay Inc. has used the Augat approach for the interface electronics in 50 proprietary process-control machines. "There's just no comparison between pc boards and wire-wrap panels when you compare layout time and turnaround time," says Travis Williams, manager of Frito-Lay's electronics and controls group in Irving, Texas. "In high-volume applications of

fixed, proven designs, however, I would have to give a good hard look to pc-board systems."

One reason is the higher cost of Augat panels, due to the inner contacts in its sockets, which are machined rather than stamped. Augat managers say that machined contacts are more reliable (Grubb claims he has never heard of a contact problem in the field) while less expensive stamped contacts may not be concentric and might oxidize.

Competitors disagree. Robert Munier of Cambridge Thermionic Corp.—Cambion—says both machined and stamped parts can do the same job, so "which one is better is a toss-up unless you take cost into consideration. Though there comes a point where a part must be made to meet certain specifications that only a machined process can meet." But on the whole, he says it's better

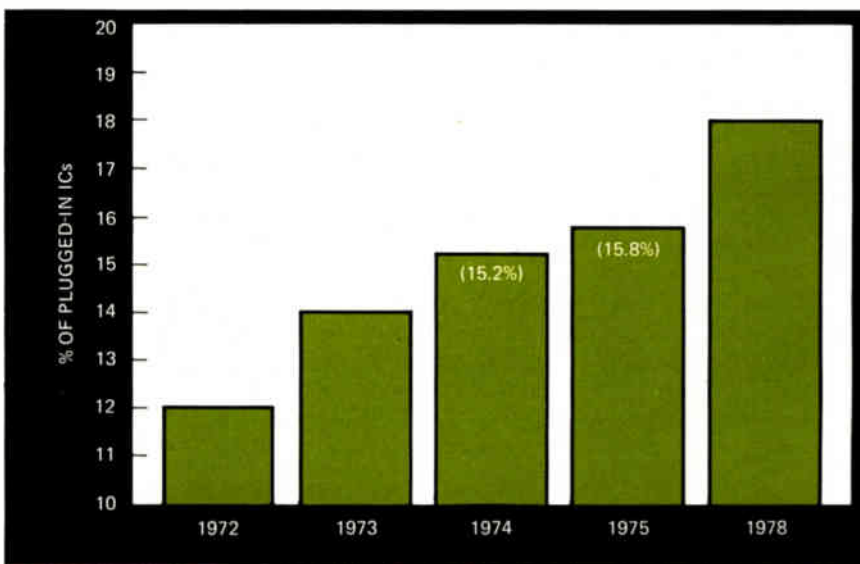

**Going up.** Chart shows that the plug-and-socket approach is making headway, and should account for 18% of IC interconnections in four years. Data was provided by Amp Inc.

# When RCA says its 2023-12 GIGAMATCH delivers 12 watts at 2.3 GHz, 12 watts is what it delivers.

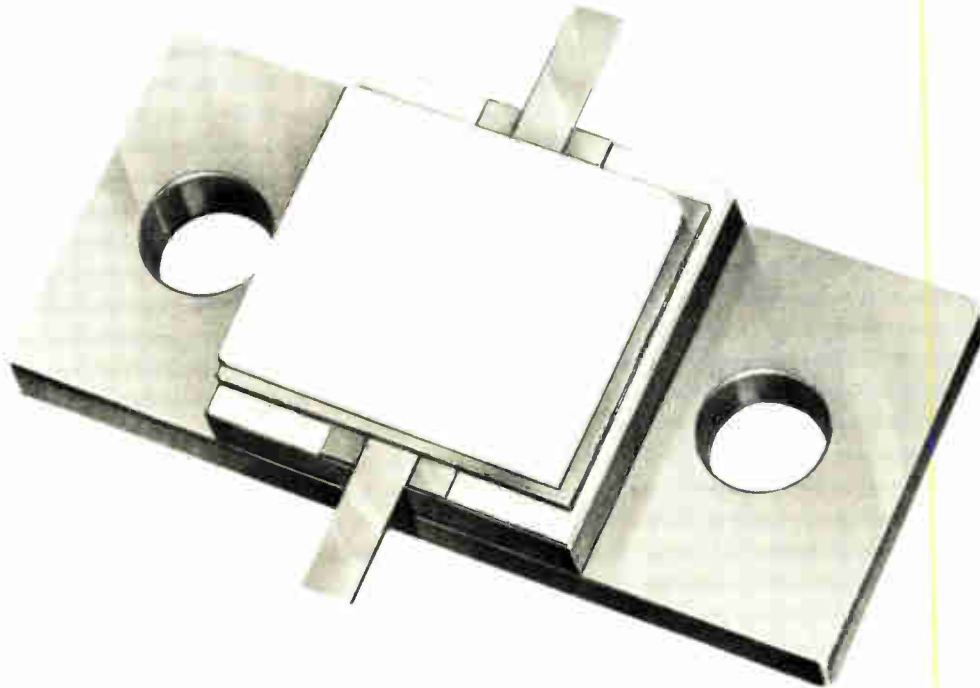

## That's technology you can use.

If 12 watts is what you need at 2.0 to 2.3 GHz, 12 watts is what you're going to get. Because at RCA we're working to make our technical leadership important to your product's performance. And to you.

For example, we've used our experience on epitaxial and overlay emitter-electrode construction technologies to bring you the RCA 2023-12. It's internally matched for use in amplifier applications in the 2.0 to 2.3 GHz range.

The RCA 41044 discrete transistor is another case in point. Here's an RF power oscillator that delivers 350 milliwatts of power at 4.3 GHz.

At that frequency, that's a lot of performance.

And that's just the tip of the iceberg.

Last year, we announced 18 families and 29 types of products in the RF power area. Products such as the RCA 2000 and the RCA 3000 series. A new family of 2-GHz and 3-GHz microwave power transistors. A series in inventory, in quantity, and ready to ship.

This year, it's more. We've recently announced the RCA 2310 discrete transistor. We believe this device offers the highest power output for a single transistor to date (10w min.) for S-band telemetry service at 2.2 to 2.3 GHz.

And more is on the way.

In the high power microwave area, we're working on L-, S- and C-

bands. Our line of GIGAMATCH devices (transistors with built-in input and output matching) is being expanded to cover the following additional frequency bands: 0.6-1.0 GHz, 1.2-1.4 GHz, 1.4-1.7 GHz, 1.7-2.0 GHz and 3.6-4.2 GHz.

All these devices will be usable at the frequencies and power outputs specified. So when you think of RF power devices that live up to their specifications, RCA should come to mind and you should contact your local RCA Solid State Distributor.

For data on new microwave transistors write RCA Solid State, Section 70J3, Box 3200, Somerville, N.J. 08876. Phone (201) 722-3200 Ext. 3435.

**RCA** Solid State

**A power house in RF transistors**

# Kill bad ICs. On sight. And get off easy.

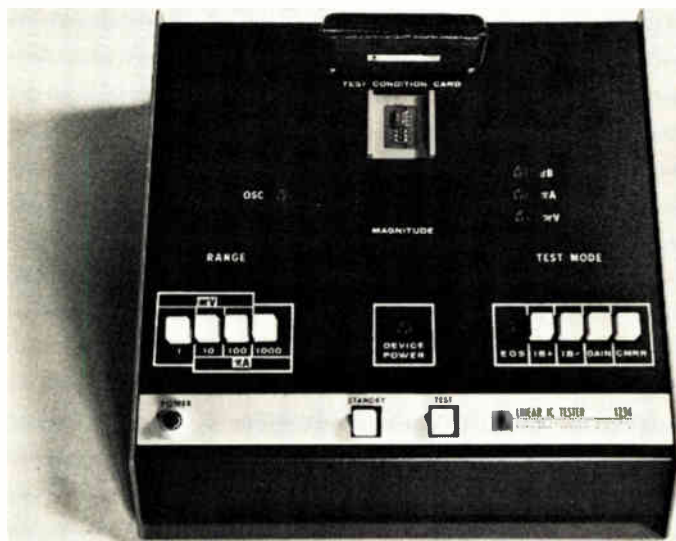

**\$785 Model 1234 Linear IC Tester**

A malfunctioning IC hiding out on your circuit board is bad news. It costs time and money to find and replace it.

Kill it first. With one or both of our compact, inexpensive IC testers. Before it hides out in your circuit.

The 1248 Digital IC Tester for TTL, DTL, and CMOS logic families performs a functional test, making  $2^{20}$  inspections in from 2 to 5 seconds. The digital test code identifies the disasters.

The 1234 Linear IC Tester makes the six most important op amp measurements, allowing you not only to identify the clunkers but to sort by parametric test performance. The digital readout displays their condition.

Send for the full information on these solid-state, self-contained, ten-pound troubleshooters. And ask about our free trial plan.



**\$535 Model 1248 Digital IC Tester**

Electro Scientific Industries  
13900 N.W.  
Science Park Drive  
Portland, Oregon  
97229.

Telephone:  
(503) 646-4141.



## Probing the news

to design a product around stamped parts. And Steve Hague, regional manager, connector systems department of Texas Instruments, feels that a good stamped contact is as good as a machined contact.

But Augat feels that it is over the hurdle of initial acceptance for its panels, which accounted for about 50% of its 1973 sales of \$18.15 million, and IC sockets, which accounted for another 25%. Wellington hopes to keep the growth rate between 25% and 30% annually for the next few years, and one way this is being done is to broaden applications. For instance, it has devised a method of interconnecting emitter-coupled logic, which requires three planes instead of two, by adhering a second board with a plane of its back to the first board, for a total of three planes. And it is also working on methods of using Schottky transistor-transistor logic.

Also, within the past two years Augat has started to vigorously pursue the foreign market, which now accounts for 10% of its sales. Wellington plans to expand that by a few percent every year, and to that end he says Augat will build a new plant in Belgium in 1975.

When he came on as president in late 1972, Wellington took an inventory of Augat's strengths and weaknesses, and saw "real opportunities in the electronics area of electromechanical components. The skills required are precision and a mechanical orientation"—the same as required for wire-wrap panels. The first step in this direction was taken in mid-September when he announced a tentative agreement to acquire Alco Electronic Products Inc., of North Andover, Mass. Alco manufactures subminiature switches and related front-panel components. Estimated 1974 earnings are over \$4.5 million.

Wellington also sees growth possibilities outside the traditional computer and computer peripheral markets, since Augat panels can be applied anywhere that computer logic is applicable, such as in process control. About 40% of Augat's sales are into such applications. □

# NEW GE-MOV™ VARISTORS BETTER THAN ZENERS FOR TRANSIENT PROTECTION

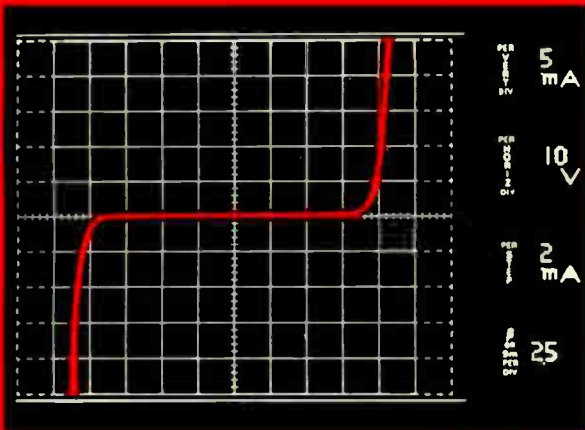

Actual photograph of V33ZA1 Characteristic

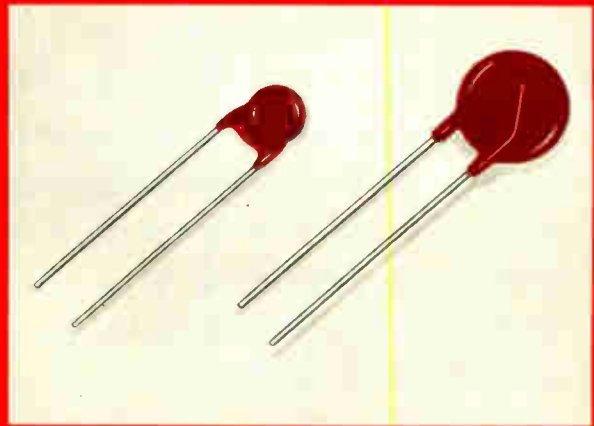

Actual Size

NEW "ZA" Series GE-MOV™ metal oxide varistors are voltage dependent symmetrical resistors which...

- Exhibit characteristics similar to back-to-back zeners when used for transient protection
- Offer up to 10X improvement in peak pulse current capabilities compared to zeners.
- Are characterized to  $\pm 10\%$  RETMA values at 1 mA DC
- Offer better characteristics than zeners, silicon carbide, selenium or R-C networks when used for transient protection

## NEW 26V DC "ZA" SERIES

- 26-81V DC, 20-80V RMS
- Up to 250A peak pulse current
- 1-15 Joules energy absorption
- 14 Types, 2 package sizes
- 41¢ each, suggested resale 10,000 lot quantities
- New "ZA" Series complements over 100 other GE-MOV™ varistor types offering transient protection up to 1000V RMS, up to 2,000A peak pulse current
- Available now from any authorized GE Electronics Component Distributor
- For free sample, write on letterhead to: General Electric Semiconductor, Electronics Park, Bldg. 7-49, Syracuse, N.Y. 13201 stating desired voltage—AC or DC and application.

GENERAL



ELECTRIC



# So different—but so much the same

Intel and National have Fairchild roots, both have doubled sales in past year, and both know exactly what they want to do

*by Bernard Cole, San Francisco bureau manager*

## Probing the news

Only two semiconductor makers in the \$100-million class have doubled their sales in the past year, and both of them call Santa Clara, Calif., their home. Intel Corp. and National Semiconductor Corp. also are remarkably similar in that they have consistently maintained their compass headings and stable, strong managements—and both have their roots in Fairchild Semiconductor. Their market objectives, however, are decidedly different.

Intel specializes in high technology, picking its sales targets carefully and limiting them strictly to areas it thinks it can dominate. National, on the other hand, sells a broad range of products and systems that it can make well.

Intel, started in 1968 with sales of \$556,000, had reached \$66 million by calendar 1973, and expects to gross \$140 million to \$150 million this year. It accounts for 30% to 40% of that in overseas sales.

From the very beginning, the company has zeroed in on semiconductor memories. With only 2,000 employees at the start of 1974, it still dominates the MOS random-access-memory market; its profit margin is so wide it can withstand price attrition that would be fatal to its competitors.

Intel claims 80% of sales of the 1103 memory, a model number virtually synonymous with dynamic 1,024-bit RAMs. It has pushed down the cost of making each unit to near \$1.50, far below the current average selling price of \$3.50.

National, with some 17,000 employees around the world (although recent layoffs have cut into that figure) has used its broad product line to become one of the three largest suppliers of ICs in the U.S., while accounting for 25% of its sales overseas. Its fiscal 1973 sales of \$99 million jumped to \$213 million the fiscal year which ended May 31. It

supplies standard devices in three principal lines—digital bipolar (both transistor-transistor and diode-resistor logic), MOS, and linear. National also makes standard hybrid circuits as well as discrete bipolar and field-effect transistors; it's a significant force in C-MOS logic with its 54/74C. In fact, National probably has a broader technology base than any other semiconductor maker.

National is also having some success with its diversification program. Its point-of-sale and calculator operations, which represented less than 10% of sales last year, are now profitable and the company's fastest growing operations. What's more, National says its GPC/P (for general-purpose controller/processor) family of LSI functional building blocks is making a considerable dent in the microprocessor market.

**Brothers.** More eloquent, perhaps, than their differences, are Intel's and National's similarities. Consider that both were put on the map by men who emerged from that great Silicon Valley incubator of semiconductor entrepreneurs, Fairchild Semiconductor. Charles Sporck, president of National, was Fairchild's general manager until 1967 when he took over National. With him went many key Fairchild people, among them Floyd Kvamme, now vice president and general manager of the Semiconductor division; Pierre Lamond, who was vice president and general manager of semiconductor manufacturing operations and who remains a director; and Fred Bialek, vice president and general manager of the Systems division.

Intel's founders, president Robert Noyce and executive vice president Gordon E. Moore, are two of the famous "young Turks" who left Shockley Transistor in 1957 to found Fairchild Semiconductor. When Noyce and Moore, in turn, left Fairchild in 1968 to found Intel, among the key people who accompanied them was Andrew S. Grove, now vice president for manufacturing operations.

To Sporck and his associates at National, Fairchild's mistakes in the mid-1960s were: too much emphasis on high technology; not enough emphasis on high-volume production

of standard products; and lack of a broad customer, product, and market base. To Noyce, Moore, and Grove, whose experience was primarily in research, development, and production, Fairchild's mistakes were an inability to translate high technology into new products and in trying to push the state of the art in too many areas.

Says Sporck: "When we started out we had some pretty definite ideas as to what we wanted to do. One of them was a commitment to operating on a profitable basis."

Sporck points out that National has taken pains to control its growth. "Initially we specifically stayed out of markets that would have overwhelmed our delivery and service capabilities—like the consumer and computer markets. It's only been in the last year or so that we've started looking at these as well as other promising areas."

Growth also has special meaning at Intel.

"When Bob [Noyce] and I started this company we wanted to do something differently," says Gordon Moore. "We didn't want to build a company the way everybody else had. We wanted to create a company that was both a technology leader and a high-volume production leader."

The kinds of markets Noyce and Moore look for are what they call displacement markets—those dominated by an older technology but which are ripe for replacement by a newer technology that offers a faster, more efficient, and cheaper alternative—like MOS for core.

**Right on.** Microprocessors also fit the displacement strategy perfectly. With associated memory, such a device can replace up to 150 TTL chips as well as certain custom MOS circuits. Intel estimates that the displacement potential in the SSI and MSI TTL market will be \$220 million in 1974, \$225 million in 1975, and \$230 million in 1976.

Future growth, says Noyce, while not quite as phenomenal as in the past few years, will continue with the advent of the 4,096-bit RAM. And to follow it the company has begun development of a 16,384-bit RAM and a number of charge-coupled-device memory products. □

**Out front.** At top, from the left, are Intel's Moore, Grove, and Noyce. Below, also from the left, are Sporck and Kvamme of National. All came from Fairchild Semiconductor, all have been with their respective companies right from the start.

Communications

# Transmitter makers standing by

FCC prepares for rule-making on automatic broadcast gear after 10 years of delays; 10% market increase could result

by Larry Marion, Washington bureau

A part of the electronics industry that has been plodding along for almost two decades without major changes in technology may get a shot in the arm. The industry is the manufacture of broadcast equipment; the shot in the arm would result from the Federal Communications Commission's belated readiness to listen to requests for approval of automatic systems. Industry sources say that FCC approval of such equipment could mean a 10% annual sales increase in a market now approaching \$100 million worldwide.

The FCC may hold its rule-making hearing by the end of the year. That ray of hope is enough to dazzle equipment makers, coming as it does after 10 years of discussion, petitions, proposals, and studies. And in an industry whose infrequent improvements in basic transmitter theory have earned it the name of the Volkswagen of electronics design, that's progress indeed.

There is a great deal of interest among broadcasters for self-monitoring and self-regulating equipment, says Ralph E. Green, director of engineering for CBS Radio. He was one of the four industry members who assembled a report to the FCC sponsored by the National Association of Broadcasters. And a massive replacement of television transmitters may be in the offing because most transmitters were purchased in the early 1950s or 1960s, he says. Though manufacturers of broadcast transmitters are not unanimous in their predictions about automatic equipment, they agree with Harold L. Kassens, assistant chief of the FCC Broadcast Bureau,

when he says, "in 10 or 15 years everyone will have it."

When Collins Radio Co. of Dallas petitioned the FCC for a rule on automatic transmitters in 1968, it caught the industry by surprise. "Other companies then realized that Collins was five years ahead of them in transmitter design," says an industry source. Although many in the industry reject that reason for the poor reception given the Collins petition, they say that it was premature. Collins designs would have required new transmitters and also would have required stations to tie their broadcast monitors into the Collins black box. So the plan died.

The FCC also was suspicious of the operational characteristics of automatic transmitters—it wanted to see units with automatic shut-off systems when frequency or modulation parameters were exceeded,

while the NAB and others say transmitters can be outfitted with controllers to self-modify output signals. The FCC insists on shut-off rather than self-correct, but new studies indicate that equipment will shut down if the signal continues to go beyond licensed parameters after self-correcting action.

But one thing is certain: the idea's time has come. "Equipment is much improved in the last few years. It is substantially more reliable and more stable," says E. Noel Luddy, manager of broadcast consultant relations for RCA Corp. and the Electronic Industries Association representative to the NAB. He attributes improvements in reliability and stability to the onset of solid-state circuitry in the last five years. And even though completely automatic transmission systems have not been available, off-the-shelf components

**Automatic transmission.** This is RCA's entry in the automatic broadcasting picture, an automatic modulation control loop around a pair of parallel transmitters.

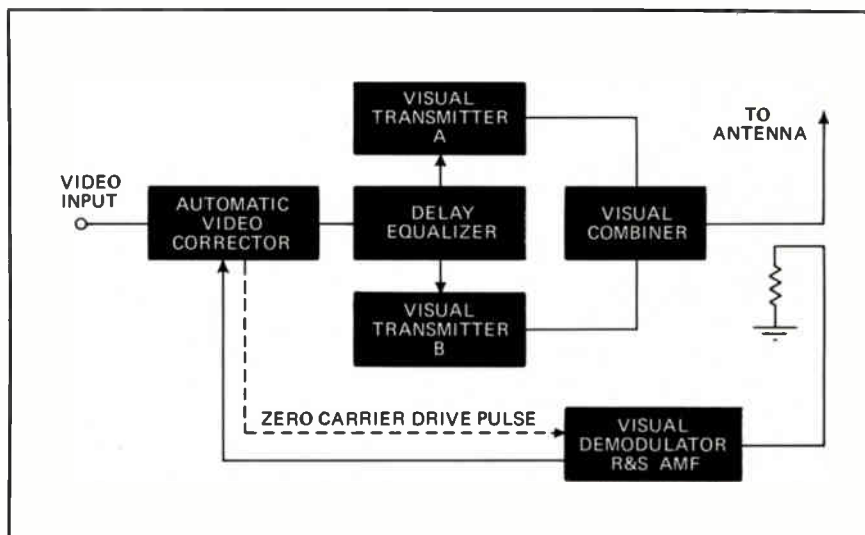



could be used to automate existing transmitters. These add-ons would replace the remote-controlled systems employed by most stations, which continuously monitor audio (and video for TV) modulators, level controls, and frequency signal generators. "Manufacturers expect automatic transmission systems to be the thing of the future," Luddy says. RCA has already tested the concept by using add-ons at a transmitter in Pittsburgh. RCA and Harris Corp.'s Gates division, the two largest competitors in the domestic market, have developed systems that can take add-ons.

Television broadcasters have been using remote-controlled transmitters for the last few years, while radio stations have had them for more than five years. The difference between remote units and the automatic systems lies in FCC operating requirements. A remote system must be monitored by an engineer at his console, the transmitter must be physically checked once a day, and the engineer must have a clear line of sight between his office and the transmitter. These rules worked to the advantage of smaller stations in rural areas, but didn't do much for others. An unattended transmitter would have monitoring meters on the announcer's console and would not be subject to once-a-day visits, or the line-of-sight requirements. By removing the baby-sitting requirements, many manufacturers say, their units also would be more reliable—less meddling by engineers bored by merely watching dials.

The NAB report tells the FCC not to worry about such exotica as automatic logging equipment and other operational concerns. All the FCC should worry about, says the report, is if the unit transmits an out-of-parameter signal. Automatic logging equipment, the report continues, should be an option to help station engineers monitor performance and schedule maintenance.

All that remains to be done by the FCC and the broadcasters is to determine which comes first, the equipment or the hearing. And there appears to have been a compromise on that—the EIA and NAB have outlined what could be made and the FCC is expected to rule on it. □

# You get a lot in a little package with General Electric Reed Switches

GE Reed Switches feature rugged design, fast operation, long life. For complete information, use the reader service card, or write GE, 316 E. 9th St., Owensboro, Ky. 42301

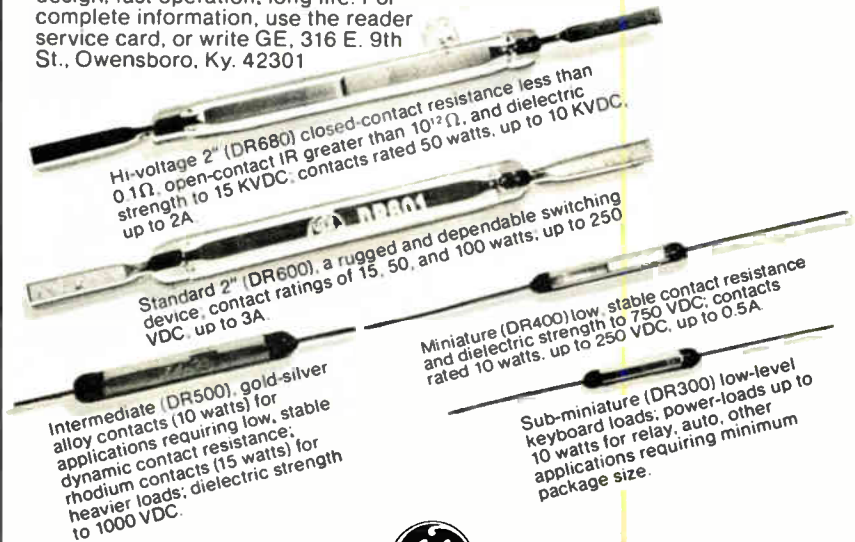

Hi-voltage 2" (DR680) closed-contact resistance less than 0.1Ω, open-contact IR greater than 10<sup>12</sup>Ω, and dielectric strength to 15 KVDC, contacts rated 50 watts, up to 10 KVDC, up to 2A.

Standard 2" (DR600), a rugged and dependable switching device, contact ratings of 15, 50, and 100 watts, up to 250 VDC, up to 3A.

Intermediate (DR500), gold-silver alloy contacts (10 watts) for applications requiring low, stable dynamic contact resistance; rhodium contacts (15 watts) for heavier loads; dielectric strength to 1000 VDC.

Miniature (DR400) low, stable contact resistance and dielectric strength to 750 VDC, contacts rated 10 watts, up to 250 VDC, up to 0.5A.

Sub-miniature (DR300) low-level keyboard loads, power-loads up to 10 watts for relay, auto, other applications requiring minimum package size.

**GENERAL  ELECTRIC**

364-01

Circle 89 on reader service card

## The Real Time Spectrum Analyzer you've needed...



**is now within your budget!**

If you've been "making do" with sound level meters, tracking filters, wave analyzers or other limited frequency analysis techniques — we've got exciting news for you.

For only \$5000 you can now buy all the advantages of real time narrow band spectrum analysis with our 200-line Saicor 51B Real Time Analyzer/Digital Integrator... and get built-in spectrum averaging and linear, peak hold and exponential averaging modes. A superior frequency analysis technique for thousands of dollars less than ever before. Can you afford not to find out more? Call for a demonstration or write today for our free "25 Ideas" brochure.



**Honeywell**

Signal Analysis Operation/Test Instruments Division  
595 Old Willets Peth/Hauppauge, New York 11787/(516) 234-5700

SIEMENS

Dickson  
has a big  
new name

# Siemens

Dickson Electronics Corporation has merged with Siemens Corporation as the Siemens Components Group. This means that Dickson Zener diodes, TC Zeners, tantalum capacitors and Dickson microelectronic products will now carry the Siemens brand, along with such quality products as Siemens capacitors, diodes, ferrites, flash tubes, surge voltage protectors, relays, switches, electro-optic products, microwave components and other semiconductors. Headquartered in Scottsdale, Arizona, the Components Group will provide local service through an existing organization of Group sales offices, representatives and stocking distributors.

For the phone number of your Siemens Components Group sales office, PHONE TOLL FREE 800-645-9200 (in New York call collect 516-294-0990).

Call us, today, But call us Siemens.

## Siemens Corporation Components Group

P.O. Box 1390, Scottsdale, Arizona 85252  
(602) 947-2231 TWX 910-950-1292 Telex 667-406

Circle 91 on reader service card

# NOW, FOUR 1K RAMS.

**NMOS, PMOS, TTL and ECL.  
And all Isoplanar.**

There are plenty of 1K RAM houses today.

But did you know that only Fairchild offers production quantities of 1K RAMs in all four principal technologies?

That's a fact.

Because we make all four kinds of 1K RAMs, we make it that much easier to choose the exact device that's best for your memory need. Whether it's mainframe or peripheral.

(Just point your finger anywhere on a power/performance matrix, and chances are you'll find it pointing at a Fairchild 1K RAM.)

And no matter which Fairchild device you choose, it'll have our exclusive *Isoplanar* fabrication to save space, maximize performance.

**1103 and 2102  
MOS memory.**

For example, if you're looking at lower-cost mainframe memory, we've developed a high-speed (and completely compatible) 1103/1103-1 PMOS that does away with pattern sensitivity problems often found in ordinary 1103's.

And for peripheral memory, we now have our 2102F/2102-1/2102 NMOS series with access times from 350nS to 650nS. All are TTL compatible and require only a single 5V power supply. And all are available in either plastic or ceramic packages, in both commercial and full MIL temp grades.

**93415 and 10415  
BiPolar memory.**

For cost-effective high-speed CPU and digital data processing applications, we offer the TTL industry standard 93415. In addition, we have a new low-power version, the 93L415 which combines access time of less than 100nS with power requirements comparable to MOS. Neither version

requires any special clocks, refresh or interface circuits. Both are available in plastic or ceramic 16-pin packages.

For even higher-speed applications, there's our voltage compensated 35nS access time 10415 ECL, the only 1K ECL memory available in quantity today.

And just for the record, we've shipped more TTL and ECL RAM bits than all other

makers put together.

The point is, if you're thinking about memory, this is definitely the time to think about your friendly Fairchild Distributor or Representative.

Give him a call today.

Semiconductor Components Group, Fairchild Camera & Instrument Corp., 464 Ellis St., Mountain View, CA 94040.

Telephone (415) 962-5011.  
TWX: 910-379-6435.

Match-up of Fairchild 1K RAMS with typical memory applications

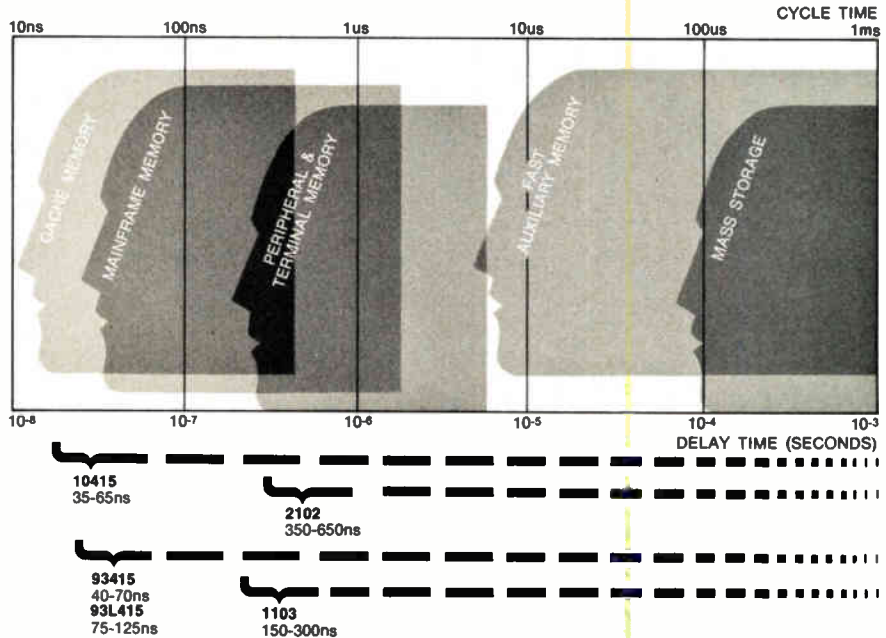

**MADE IN  
FAIRCHILD  
No.1 for memory.**

# A STAR IS BORN TO SAVE SPACE



## api Series 1000 Edgewise Meters

Save space and money, too. The api 1015 (1.5") and 1025 (2.5") stackable edgewise meters were created to provide attractive, economical, and accurate analog display in a minimum of panel space. Because they're new, these meters provide a number of user benefits available nowhere else.

**STYLE**—Sculptured, crystal-clear window and molded black flange crisply define the dial for an appearance of modern engineered precision. No separate bezel is required.

**MOUNTING**—Both the 1015 and 1025 fit standard

panel cutouts, yet the snap-in mounting is simpler than any other edgewise mounting method, saving you time and money.

**ACCURACY**—The unique flat d'Arsonval pivot-and-jewel mechanism provides 2% accuracy for vertical or horizontal scale orientations; and complies with ANSI C39.1 performance and C39.5 safety standards.

**AVAILABILITY**—Standard ranges are stocked by a distributor near you. Authorized modification centers can provide special ranges and dials fast. Quantity

OEM requirements are handled with traditional quick response and high quality.

**ETCETERA**—Frankly, we think you'll be surprised how much the Series 1000 beats inflation. Bulletin 0540-PB has detailed photos, drawings, specs and prices. Please write or call today for your free copy. LFE Corporation, Process Control Division, 1601 Trapelo Road, Waltham, MA 02154, (617) 890-2000.

**LFE**  
CORPORATION

Process Control Division

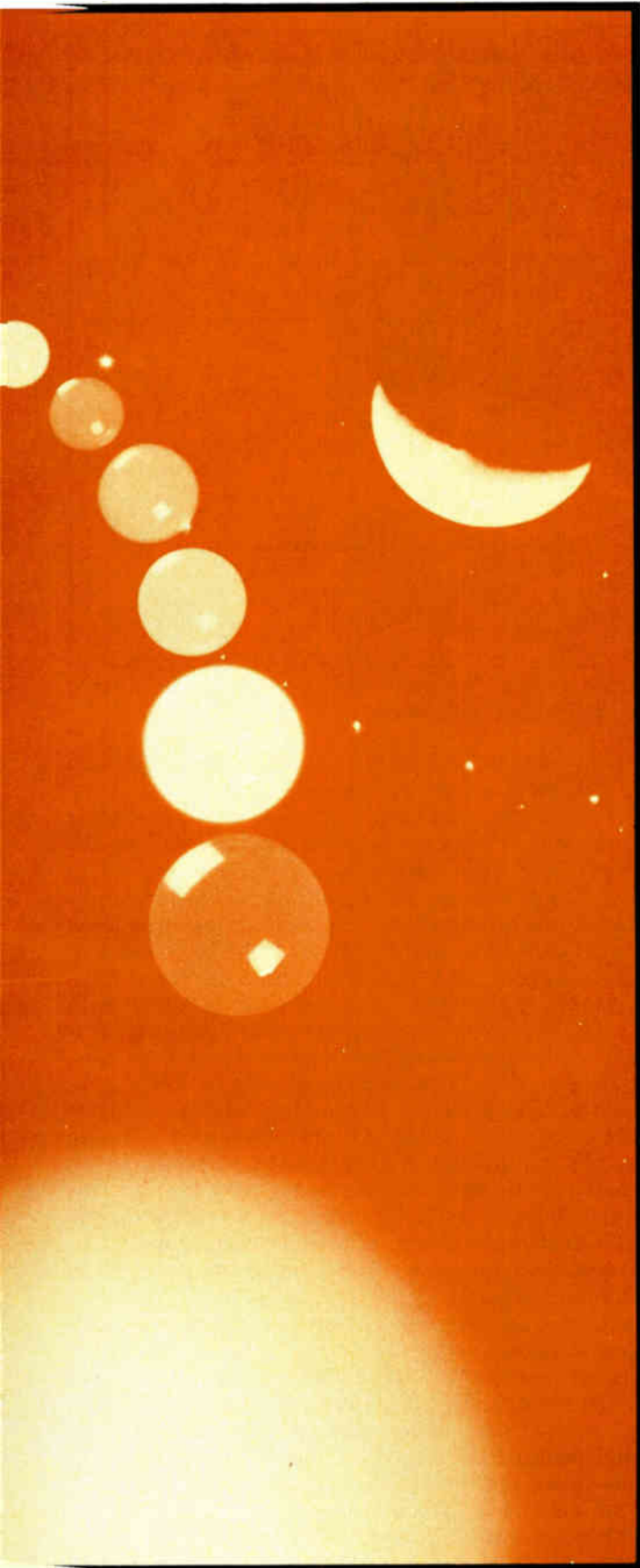

# Users starting to hop aboard U.S. communications satellites

---

Now that most technical problems have been solved for first-generation 4/6-GHz equipment, communicators are studying ways to employ them; however, some wait for 'birds' that can operate at higher frequencies

---

by Stephen E. Scrupski, *Communications & Microwave Editor*

□ Domestic commercial satellite communications systems in the U.S. are beginning to take shape. There is already one satellite in orbit—Western Union's Westar I. Two other companies have leased time on satellites—American Satellite Corp. on Westar I, and RCA Global Communications Inc. on Telesat Canada's Anik II—as the first phase of their service offerings. And a maritime satellite will be launched in a few months.

Two giants, AT&T and IBM, have made strong moves into the business and are being eyed suspiciously by competitors. Satellite technology, for the most part, is readily available, although for the higher frequencies now being contemplated, the hardware has yet to go through a final checkout phase.

Of course, not all the problems facing the satellite communications industry are technological ones. Wilbur L. Pritchard, former vice president and director of Communications Satellite Corp. Laboratories and now head of Satellite Systems Engineering, a consulting firm in Arlington, Va., says, "In any expanding or growing

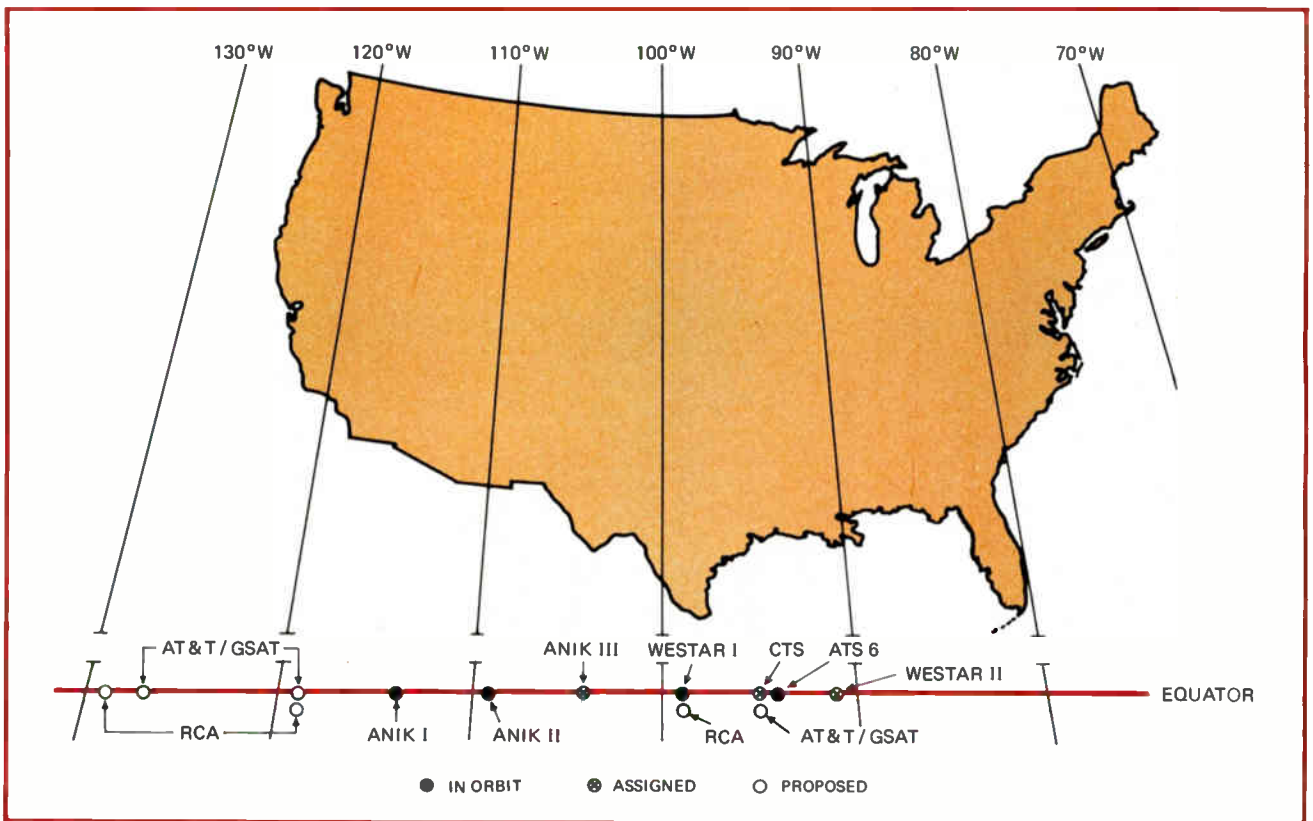

**1. Open skies filling up.** Satellite orbital locations over equator are assigned by Federal Communications Commission, which is leaning toward a 4-degree spacing, although the Canadian Anik satellites have been assigned positions 5 degrees apart.

field, there are always technological problems, but I don't think such problems are pacing the development of the satellite field. It's the economic and institutional problems. Who does what, and where does the money come from to pay for it?"

Ralph Mitchell, Commercial Systems division marketing manager at Hughes Aircraft's Space and Communications Group, Los Angeles, agrees that "technology is not the leading edge of commercial communications satellites any more. It's not a question of what you can do, but what you *should* do. The communications-satellite business is a serious, mature business." Even though it's a new one, it's expanding at a rapid rate.

### Summing up the situation

Westar I, the first domestic commercial satellite, was launched in April into geostationary orbit above the equator at 99° west longitude (about directly south of Dallas). All five Western Union earth stations—built by ITT Space Communications, Inc. and located at Glenwood, N.J., Estill Fork, Ala., Lake Geneva, Wis., Steele Valley, Calif., and Cedar Hill, Texas—are in operation.

The launch of the second satellite, Westar II, has been delayed by problems with the Delta launch vehicle, but the company expects Westar II to go into orbit later this month. Westar III was recently accepted from the manufacturer, Hughes Aircraft, and is in storage at the Hughes plant until the Westar II launch. If Westar II is successful, Westar III will be saved until traffic on the first two satellites warrants a third, but if

the launch fails for some reason, Westar III will be sent up in its place as soon as possible.

American Satellite Corp. has leased two transponders on the Westar I and is now providing service to its customers. ASC will probably also exercise an option to lease a third transponder early next year. The company has its own earth stations now in operation—near New York, Los Angeles and Dallas—and provides service to San Francisco and Chicago via leased terrestrial facilities. ASC earlier this year canceled an order with Hughes for its own satellite, but the company says it is still conducting studies to develop its own satellite, which it hopes may be launched as early as 1977.

RCA Global Communications Inc. (Globcom) and a subsidiary, RCA Alaska Communications Inc., have leased a transponder on Anik II, Telesat Canada's satellite, to provide service to Alaska and the other 48 continental states. RCA Globcom has been waiting for the FCC's final approval to make it a domestic, as well as an international, carrier, but it may in the end be forced to establish a separate corporate entity to preside over domestic service. Nevertheless, RCA is going ahead with plans to launch the first of its own three domestic satellites in December 1975. The first one is under construction at the RCA Astro-Electronics division in Princeton, N.J. Also, RCA is building earth stations near New York, San Francisco, Los Angeles, and in Alaska, and is planning other sites at Dallas, Seattle, Denver, Chicago, Washington, D.C., and in Hawaii.

One of the more visible and important nontechnical problems on the horizon is the outcome of the bid by



IBM Corp. to buy into CML Satellite Corp., which is now the property of Comsat General, MCI Communications Corp., and Lockheed Aircraft Corp. Under the proposed arrangement, now undergoing FCC scrutiny, IBM and Comsat General would displace MCI and Lockheed entirely, with IBM controlling 55% of the stock and Comsat General 45%.

Western Union, among others, is contesting the venture on grounds that the combination of Comsat General and IBM, each dominating its own field, "could forge an impenetrable barrier to competition." Critics also express concern that once the telephone giant, AT&T, launches its own satellite, AT&T and IBM would constitute a "duopoly." One would control data and the other voice transmissions.

If FCC approval of the IBM-Comsat General venture does come, system operation probably could not start until the late 1970s. Many observers think that the biggest commercial user of the IBM/Comsat satellites will be IBM itself.

On another front, AT&T and GTE Satellite Corp. (GSAT) have applied for FCC approval to combine their satellite operations, which include plans for seven earth stations. The proposed venture would have AT&T operating four of the stations and GSAT the other three. But neither of the two would actually own the satellites, they would lease them from Comsat General. Under an FCC restriction, however, AT&T will not be allowed to provide private-line service on the satellites for the first three years of operation. The FCC intends this to give fledgling communications carriers a head start in the private-line field. For the first three years, therefore, AT&T would use the satellites only to supplement its long-distance terrestrial facilities of the switched telephone network.

### Antennas on the roof

Another controversy surrounds the development of so-called "rooftop" earth stations. These would give a user direct access to a satellite without having to go through local-loop leased lines. As an example of the related issues that could be affected in this regard, Western Union is complaining to the FCC about problems in obtaining leased-line connections from AT&T for its satellite-communications customers.

However, it's possible that wide-scale use of small earth stations may have to wait for the next generation of satellites, which will operate in the 12-GHz and 14-GHz bands. All other U.S. satellites operate with 500-megahertz bandwidths centered at about 4 GHz for the down-link and 6 GHz for the up-link. Unfortunately, these bands are shared with common-carrier terrestrial microwave links, and, because of interference, it's becoming increasingly difficult to locate earth stations in large metropolitan areas.

American Satellite Corp. says there's a strong possibility that its own satellite—when it's launched—will have the 12- and 14-GHz capability. CML Satellite Corp. says that frequencies of 12 and 14-GHz have been strong "candidates," for its satellite, but IBM's potential entry has delayed those plans. Kenneth Crandall, CML director of development planning, points out that 12- and

14-GHz components are generally available today. "They may not have the life-test data," he admits, "but there are no technical problems involved."

But Louis Cuccia, senior scientist at Philco-Ford Corp.'s Western Development Labs in Palo Alto, Calif., thinks it may take two or three years to de-bug a 12/14-GHz system. "It took some time to settle down the whole 4/6-GHz technology," he points out. "There were four generations of Intelsats, and it took several design generations of parametric amplifiers, high-power amplifiers, and tracking systems before today's level of reliability was realized.

"There are plenty of things we don't know about 12 and 14 GHz, particularly from the propagation standpoint. For example, the question of outages due to rainfall in an operational system must be determined. And what about system problems relative to new digital communications systems, such as time-division-multiple access systems and single-channel-per-carrier?"

As for still higher frequencies, the AT&T-GSAT satellite, planned for launch in 1976, will operate at 4/6-GHz, but will include an experiment for measurement of propagation at 19 and 28 GHz. Two cross-polarized signals will be sent to the ground on 19 GHz, while only a vertically polarized signal will be sent at 28 GHz. Bell Labs will study rain attenuation, rain depolarization, statistics on usable bandwidth, and signal-scattering caused by rain.

The next generation of AT&T satellites will probably operate at the higher frequencies, industry observers predict, because of the bandwidths of 2,500-MHz to 3,500-MHz available there. Such bandwidths are useful only if the operator has the traffic to fill them, and if anyone does, it's AT&T.

Attenuation from rainfall will almost certainly be a problem with the 18/30-GHz bands. Thus, says Mitchell, "space-diversity" earth stations, ones located about 20 miles apart, will be required—"a foregone conclusion at 18 and 30 GHz, and possibly even at 12 GHz." The spacing is based on the assumption that heavy rainfall simultaneously 20 miles apart is improbable.

Japan's experimental communications satellite, now being built by Philco-Ford Corp. for Mitsubishi Electric Corp., will test the use of 18 and 30 GHz, as well as 4 and 6 GHz. However, one industry insider observes that the Japanese probably will eventually go the 18/30-GHz route because of the high density of microwave terrestrial links that criss-cross the country. Launch (from U.S. facilities) is set for early 1977.

### The user's satellite—CTS

The first practical test of the usefulness of the 12/14-GHz bands will begin in early 1976, after the Communications Technology Satellite (CTS) is launched. The CTS is a joint effort between the Canadian and U.S. governments. Canada is providing the satellite, the U.S. will launch it.

The major component on the CTS is a new 200-watt traveling-wave tube developed by Litton Industries, which will provide the satellite with an effective isotropic radiated power of 58 dBW for the 11.7-to-12.2-GHz down-link. The up-link employs 14- to 14.3-GHz, and

information is sent in two 85-MHz channels separated by guard bands. The two antennas on the satellite can be individually steered to aim a spot beam at any point in the U.S. or Canada.

The CTS will be launched in December 1975 and placed in stationary orbit at 95° west longitude, a prime location for serving the U.S. and Canada. Since it operates at the higher frequencies, the CTS will not interfere with any of the existing satellites, but it does use S-band signals for tracking, telemetry, and control.

The CTS position is only 1° away from the present position of NASA's ATS-6, called ATS-F before launch [*Electronics*, May 2, p. 69], which also uses S-band. However, by late next year, ATS-6 will have been moved to a new location over Kenya for experiments by the Indian government.

The U.S. and Canada will share time on the CTS equally, and groups in each country are now assembling hardware for the experiments. The U.S. experiments are primarily aimed at testing the concept of low-cost ground stations with small antennas, trading off small ground stations for higher power on the satellite.

Most U.S. experiments are related to use, rather than technology. For example, the American Red Cross will test a small transportable ground station (being built by Comsat) to set up emergency communications in disaster areas.

The Veterans Administration will test video transmissions between hospitals. The New York State Department of Education will test the transmission of documents to libraries throughout the U.S. About the only technological experiment will be run by NASA-Goddard, which will test propagation characteristics of the 12 and 14-GHz signals through rain.

### Limited parking in orbit

The satellite companies still are engaged in a controversy over satellite positions in orbit, an important consideration in designing small ground stations. The smaller the receiving antenna, the wider the beam needed. Thus, although it may be possible to install, say, a four-foot antenna with enough sensitivity to reliably pick up a satellite transmission, the beam may be so wide that it picks up transmissions from a neighboring satellite.

This problem is bothering some potential users of small receive-only stations. One such customer says that, although he might be convinced that a receiving antenna would work properly today, he is hesitant about entering any long-range program until he finds out where neighboring satellites will be. He fears he may find later that his receive-only terminal is fine in all respects, except that it picks up unwanted transmissions.

Until earlier this year, the FCC appeared to be leaning toward 3° spacing, but now has issued a "guideline" for 4° spacing. The American domestic satellites will be kept 5° away from the 10° cluster of three Canadian satellites—Anik I is at 114°W, Anik II is at 109°W, and Anik III, if launched as expected next year, will be at 104°W.

The FCC agreed to these positions (rather "generously," reports one observer) because the Canadian sat-

## Repeaters in space

The Westar I satellite—an HS-333 Hughes Aircraft unit—is a slightly modified version of the Canadian Anik spacecraft. It is a cylinder about 6.3 feet in diameter and 5.1 feet high, with an antenna on top that brings the total height to 11.8 feet. Weight at launch was 1,265 pounds. The surface of the cylinder holds about 20,500 solar cells to provide power, except during the twice-yearly eclipses, when the two batteries take over (during the spring and fall equinoxes, geostationary satellites are shielded by the earth from the sun for a short time around midnight for about a 45-day period; maximum eclipse time is about 70 minutes). The solar cells are designed to supply about 200 watts of electrical power even after seven years in orbit.

The satellite is spin-stabilized—that is, the body spins to maintain stability in orbit while the antenna is despun to keep it pointing at the earth. The antenna can cover the contiguous 48 states, as well as Alaska and Puerto Rico, while a separate spot beam covers Hawaii. Four feed-horns illuminate the antenna reflector: three of them combine to give the continental U.S. coverage, while the fourth provides Hawaii the spot beam.

The satellite carries 12 amplifiers, or transponders, each with a 36-MHz bandwidth that can carry 1,200 voice channels, one color-TV signal, or data at 50 megabits per second. A wideband receiver covering the full band from 5,927 to 6,403 MHz feeds two multiplexers that split the 12 channels into two groups of six. Traveling-wave-tube amplifiers, one per channel, then amplify the signals, which are remultiplexed before being sent to the antenna for transmission to earth in the band from 3,702 to 4,178 MHz.

The planned RCA satellite will contain 24 transponders operating in the 4/6-GHz band, each with a bandwidth of 36 MHz. Its main body is about 5.3 feet by 4.1 feet, and it has two extended solar arrays with a total area of 71.5 square feet, as well as three nickel-cadmium batteries for use during eclipses. It will use a three-axis attitude-control system, rather than a spinning system, to stabilize it and to keep the antenna pointing at the earth. The antenna also covers the continental U.S. and Alaska, and uses a spot beam to cover Hawaii.

Weight at launch, which will be handled by a new version of the Thor-Delta rocket, will be 2,000 pounds. RCA says its use of lightweight graphite-fiber epoxy-composite (GFEC) material, rather than the heavier Invar, for the multiplex filters, waveguides, and antenna feeds, along with the lighter weight required by the three-axis control system, allows it to attain the 24-transponder operation with only a slight increase in weight.

**Western Union's satellite** (opposite page, upper left) uses a de-spun antenna, while RCA's (upper right) uses a three-axis attitude control system. Block diagram of Western Union satellite's communications circuitry shows 6-GHz tunnel diode amplifier, down converter, 4-GHz amplifier, and 12 TWT's driving a multiplexer, which combines 12 channels for transmission. Telemetry and command signals are handled by omni-directional antenna atop reflector.

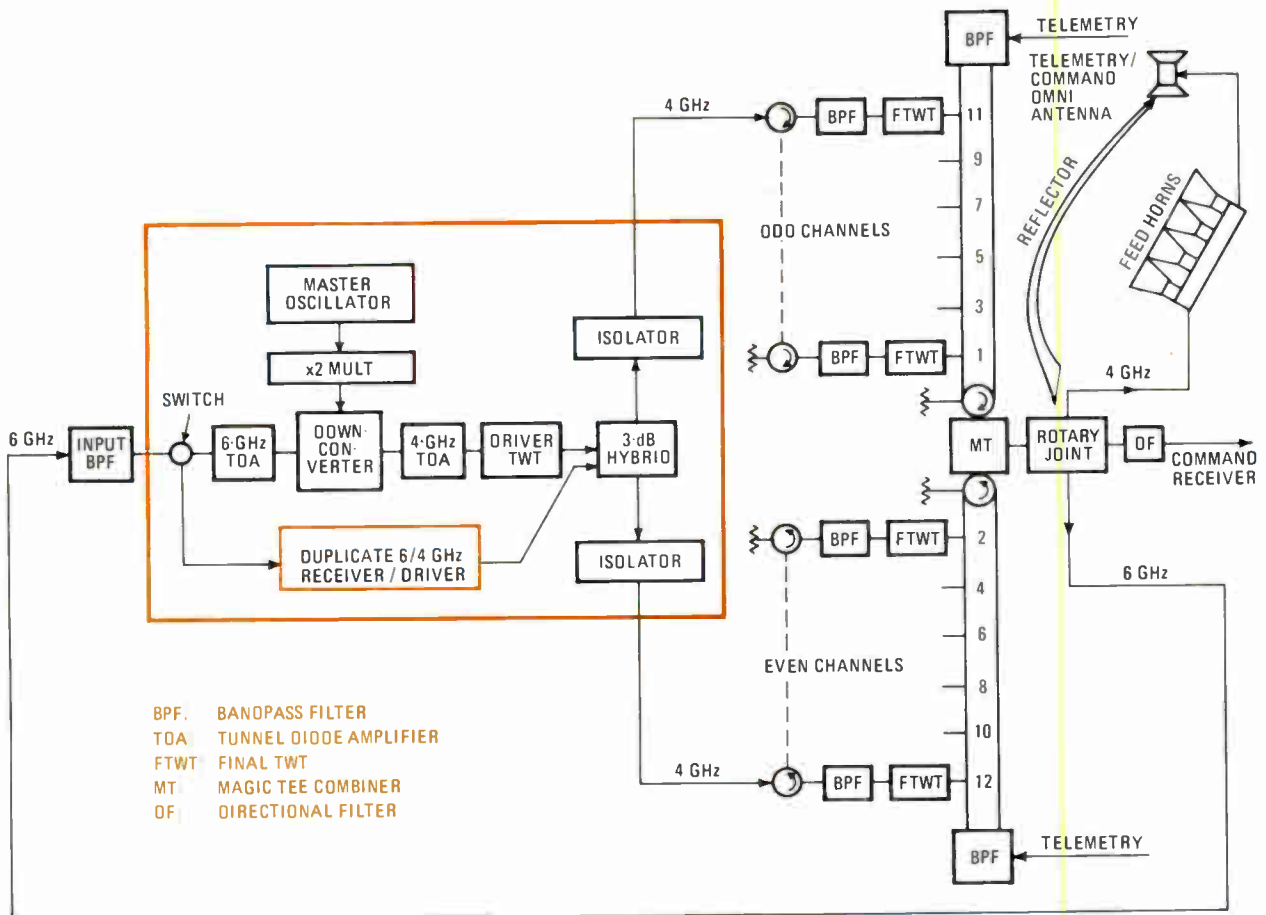
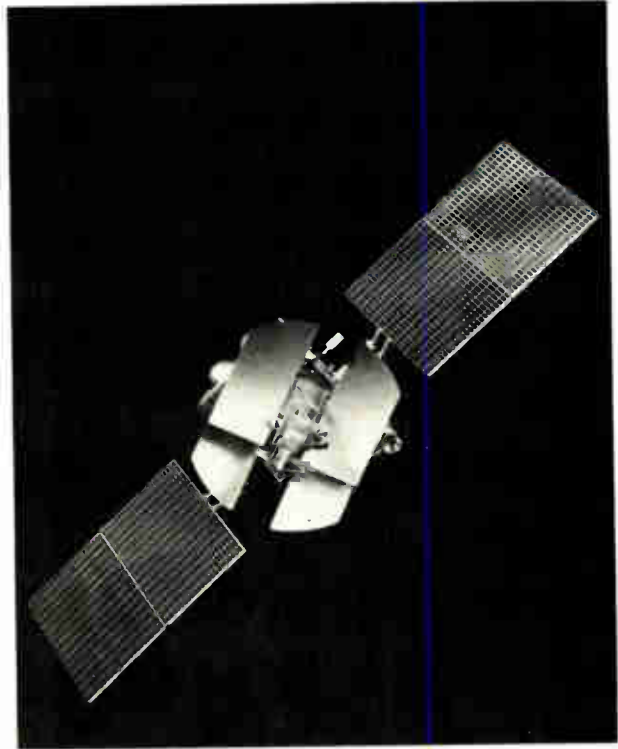
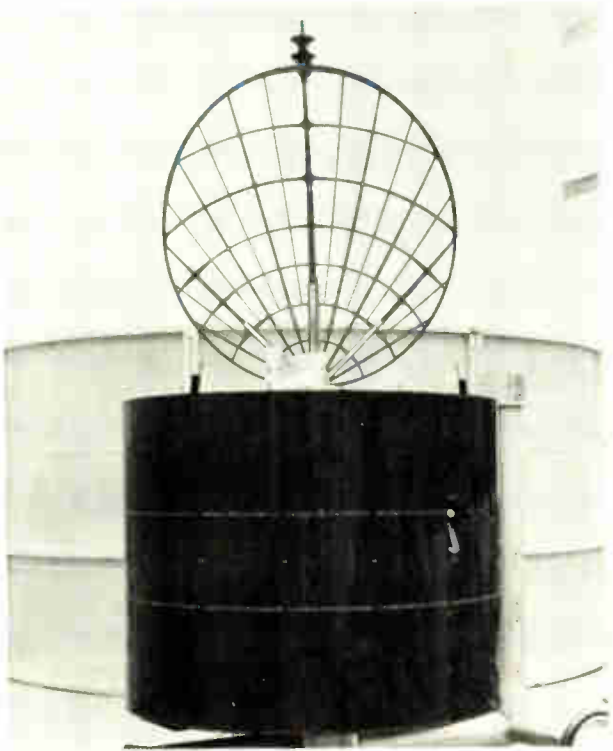

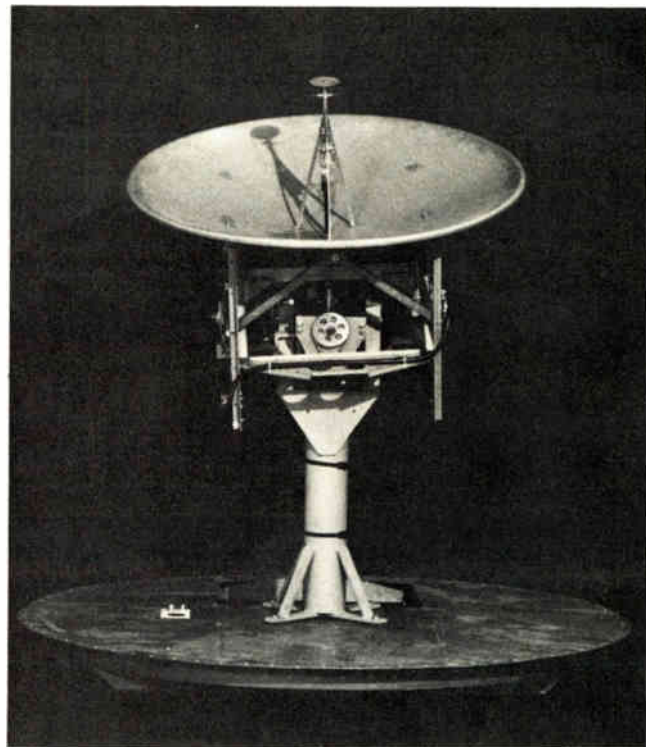

**2. Under the dome.** The Marisat shipboard terminal being built for Comsat General by Scientific Atlanta has a 4-foot antenna and uses a low-noise transistor amplifier. The platform, which is stabilized for pitch and roll, is covered with a fiberglass radome.

ellite coverage includes spots in the far north. Thus, the first available orbital slot to the east is  $99^{\circ}\text{W}$ , the location of Westar I. The FCC has assigned  $91^{\circ}\text{W}$  to Westar II, but has made no other assignments. However, Westar II will be temporarily parked at  $90^{\circ}\text{W}$  until ATS-6, now at  $94^{\circ}\text{W}$ , is moved next year.

Even the  $99^{\circ}\text{W}$  position of Westar I is not permanent, and RCA Globcom has applied for this slot for one of its three satellites. It also has asked for  $129^{\circ}\text{W}$  and  $119^{\circ}\text{W}$ , from which it will serve Alaska and Hawaii. The FCC has said it will reserve spots to the west of the Aniks for satellites that will serve those two areas.

AT&T, in its 1973 application, applied for  $93^{\circ}\text{W}$ ,  $119^{\circ}\text{W}$ , and  $128^{\circ}\text{W}$ , positions that were based on a  $3^{\circ}$  spacing. Now, with the likelihood of  $4^{\circ}$  spacing, an AT&T spokesman says it would like  $127^{\circ}\text{W}$ ,  $119^{\circ}\text{W}$  and  $95^{\circ}\text{W}$  positions, which partially conflict with the RCA applications.

### Broadcasts from space

The clash of interests over satellite positions is merely one more of the nontechnical growing pains that must be dealt with by industries hankering to utilize the potential of satellites. Still another set of problems is apparent in the keen interest being shown by the cable-television industry.

Last year, a group of companies involved in cable TV, headed by Rex Bradley, president of TeleCable Corp., Norfolk, Va., organized the Cable Satellite Access Entity (CSAE) for a concerted look into ways that satellites might be utilized. In an early report, the CSAE noted that satellite broadcasting of CATV programs is well within the state of the art.

The questions that are bothering the industry, says Bradley, are ones of programing, and organizing groups to pay for the programing. "Even so," Bradley adds, "it looks like a viable idea to us, and the earth stations look like they'll cost about \$75,000 each." Bradley cites other matters—such as interconnections and regulation by the FCC—as prime sticking points as the industry explores entry into the field.

The Public Broadcasting Service also is studying the feasibility of leasing transponders on a satellite to broadcast to 152 licensees, which would own and operate their own earth stations. The stations would have terminals near the studios so there would be little or no cost in a terrestrial link. Earlier this year, PBS leased an earth terminal, owned by Teleprompter, and took it around for tests at 18 PBS studios throughout the east and as far west as Des Moines, Iowa. The PBS, says John Ball, manager of PBS transmission engineering, is particularly interested in tests in the Northeast, where there are dense concentrations of Bell System TD-2 microwave systems operating in the 4-GHz band.

PBS arranged with the Canadian Broadcasting Corp. to receive the transmitted television signals from Anik I at each site, checked reception, and looked for interference from terrestrial systems. The broadcaster also scanned the orbital arc (where future satellites may be), checking interference at each azimuth, in  $5^{\circ}$  orbital-arc steps from about  $70^{\circ}$  to  $120^{\circ}\text{W}$ .

Interference varied from site to site, reports Ball. He says that at L'Enfant Plaza in Washington, D.C., for example, there was little or no interference, but severe interference from terrestrial systems was encountered in Toledo, Ohio, and Boston.

To follow up on the experiments, Ball is now performing a computer analysis to predict likely sources and levels of interference at the sites and to compare them with measured data. He does, however, expect the computed data to show more severe interference than that actually encountered, since the computer does not account for shielding by such masks as buildings. Once Ball determines the primary azimuth from which interference emanates, he expects to revisit some of the sites to see if some kind of shielding will help. Although it has returned Teleprompter's terminal, PBS will purchase a similar terminal from the same manufacturer, Scientific Atlanta, for these near tests. Ball hopes to complete the technical study and reach some conclusions by the end of the year and then leave it up to PBS management to make the decision on the basis of economics.

### The hybrid satellite

For the future, Ball says that he would like to see a "hybrid" satellite, with a 4-GHz down-link and a 14-GHz up-link. Today's 6-GHz up-link is a difficult one for broadcasters, he says, because of the problems of avoiding interference when the transmitter might be used at a remote location for a news broadcast pick-up. He points out that while the 14-GHz band is wide open, the 4-GHz receiving stations would be at fixed locations and could have their interference problems solved on-site. The higher frequency could also mean a smaller remote transmitter.

Paul Visher, president of National Satellite Services, El Segundo, Calif., a Hughes Aircraft subsidiary, also feels that a 4-GHz down-link is a good choice. The technology has matured, there is minimal attenuation from rainfall, the bandwidth is 500-MHz, and there would be little difficulty in interference coordination with existing microwave systems, since the receiving antenna can be shielded from interference.

"And, because 14 GHz is much easier to coordinate, since it's reserved for satellites, we think that 14 GHz up and 4 GHz down make a good pair." As for the 12-GHz down link, "right now, 12-GHz down has no threshold limitation on power [such as the FCC imposes on 4-GHz down-links] but we think that advantage will disappear at the next CCIR [Consultative Committee on International Radio] meeting," he says.

Visher also notes that although the 14-GHz ground station could use a slightly smaller dish, it would require more power because of attenuation caused by rainfall. "But power on the ground is cheap—a few cents a kilowatt hour, whereas power in space—from solar cells—is expensive."

Visher suggests another frequency for the satellite's complement—2.5 GHz for a down link. He points out that the ATS-6 is using this band in its experiments in distributing educational-television programs, and low-cost receive-only sets were designed for that experiment. "We think that, in the U.S., 14, 4, and 2.5 GHz make an attractive combination."

Visher says National Satellite is "in a bit of holding pattern right now," because GSAT has dissolved its earlier relationship with NSS in order to join AT&T on its first satellite. He does add that, although the original fil-

## Satellites talk internationally

The European Space Research Organization (ESRO) is planning a satellite to carry telephone and television signals for its nine member-nations (Belgium, Denmark, Federal Republic of Germany, France, Italy, Netherlands, Sweden, Switzerland, and the United Kingdom). Scheduled to begin operating in 1980, the satellite will work in the 11- and 14-GHz bands. However, before the operational satellite is launched, a smaller Orbital Test Satellite (OTS) will be sent up in 1977 to check operational concepts of later systems.

Japan is planning both a television broadcast satellite, operating in the 12- and 14-GHz bands, and a communications satellite, which probably will operate in the 18- and 30-GHz bands. General Electric will build the broadcast satellite, which will probably be launched in 1977. Philco-Ford is building the communications satellite for launch in the same year.

The U.S.S.R. has had a satellite-communications system in operation since 1965, when it launched its Molinya I group of three. A second series, the Molinya II, was launched in 1970. Unlike most other communications satellites, the Molinyas follow an elliptical orbit, rather than being geostationary. Orbital periods are 12 hours, so that the satellites retrace their paths once a day. The elliptical orbit is necessary to allow earth stations located in the far north to access the satellites with a significant elevation angle, higher than, say, 5°. A satellite over the equator would entail much lower elevation angles from earth stations on the USSR's northern land mass. The Molinya II satellites use a 500-MHz bandwidth for communication—the up link is between 5,725 and 6,225 MHz, and the down link is between 3,400 and 3,900 MHz.

Other countries, such as Brazil, Indonesia, and Algeria, are considering leasing channel space on the Intelsat satellites for use in domestic communications.

ing with GSAT called for only 4 and 6 GHz, NSS is considering amending it to add 14 GHz and 2.5 GHz.

Such use of satellites to broadcast TV will come before there are audio broadcasts, in the opinion of Sidney Topol, president of Scientific Atlanta. Topol says "it's still not all that expensive to send audio by telephone lines."

### Music in the air

One company that may go counter to this opinion is Muzak Corp., Westbury, N.Y., the supplier of preprogrammed music to subscribers via leased telephone lines or leased subcarriers on fm broadcasting stations. In August, Muzak demonstrated reception of music sent through Anik II, by means of transmitting facilities from RCA's Valley Forge, Pa., earth station [*Electronics*, Sept. 5, 1974, p. 36]. Muzak used a receiver set up by AII Systems Inc., Moorestown, N.J., which had a 4-foot antenna, an uncooled parametric amplifier, an AII down-converter, and a standard fm radio receiver. But one observer questions how the FCC will react, in view of its position on spectrum conservation. "They may not like seeing one whole transponder, capable of 36-MHz coverage, used for a single voice channel."

Muzak's Paul Warner, vice president and general

manager of the product division, says Muzak will study during the next year the technology and the economics of distributing programs via satellite. Warner says there's potential procurement of more than 75,000 receive-only earth stations, each with a 2.5-foot or 3-foot dish, for each Muzak subscriber.

Although a 2.5-foot dish may not seem much different from a 3-footer, there could be significant differences in the system operation, points out AII vice president Robert Heinz. Heinz notes that, at 4 GHz, a 2.5-foot antenna has a gain of about 28 dB, while a 3-footer antenna has a gain of about 30 dB, therefore, the 2.5-foot dish would require a "good" uncooled parametric amplifier—one with a noise figure of about 2 dB. However, the extra 2-dB gain of the 3-foot antenna could be applied to the amplifier and thus allow the use of a 4-dB noise figure, with an amplifier which can now be built with transistors.

The price difference between the two antennas is minor, says Heinz, but the price difference between the two amplifiers could be significant—as much as \$1,000 each in small quantities. Even considering the 75,000-plus quantities mentioned by Muzak, Heinz considers that it's problematical just how much the cost of a parametric amplifier could be reduced, since it will always require a pump, circulator, and some tuning operations, while the low-noise transistor amplifier could be mass produced in those quantities.

Another radio application, but not for broadcast, will be handled for the American Broadcasting Co. by the American Satellite Corp. The satellite (Westar I, on which American Satellite has leased two transponders) can carry programs in two voice channels—one for each direction—between New York and Los Angeles to supplement ABC's leased terrestrial facilities.

The satellite will also allow "drop-ins" of news items during broadcasts, says ABC engineer William Gilmore. In the east, Chicago, Washington, D.C., and New York are connected in a duplex round-robin arrangement, so that any of three centers can originate a segment of an ABC news broadcast. However, between Chicago and Los Angeles, amplifiers must be switched for each direction, and the 4-second switching time now prevents direct drop-ins from Los Angeles. The duplex voice channel on the satellite will avoid the switching time required by the amplifiers.

### To the ships at sea

One of the most obvious applications of satellite technology is for communication with moving vehicles on land and ships at sea. Much is happening in this area. The maritime satellite, Marisat [*Electronics*, June 13, p. 78] will be launched in the first quarter of 1975 (the schedule has slipped slightly because of the launch problems at Cape Kennedy) and commercial service will begin about 30 to 45 days after launch, according to Comsat General, the majority partner (along with RCA Globcom, Western Union International, and ITT World Communications).

The Navy, which will use most of the satellite capacity for the first two years, has the option to decide over which ocean the first satellite will be placed, and the

second satellite will be launched about two months after the first one. Two-ocean service thus will probably begin by mid-1975. Comsat General has contracted for 200 transmitter-receiver ship terminals from Scientific Atlanta, and will soon name a supplier for the below-decks equipment—data terminals and modulators—for each ship.

The Maritime Administration (Marad) of the Department of Commerce has been sponsoring a series of experiments, using the ATS satellites, to demonstrate the usefulness of communications and position-fixing by satellite. Marad has a 10-meter earth station at Kings Point, N.Y., that it's been using to access ATS-3, ATS-5, and, since May, ATS-6.

Tests are underway with two ships in the European trade—the United States Lines' American Ace and the Prudential-Grace Lines' Lash-Atlantico—using ATS-6 for communications and ATS-5 for position-fixing.

The goal, says Harry A. Feigleson, Marad program manager for advanced communications and navigation

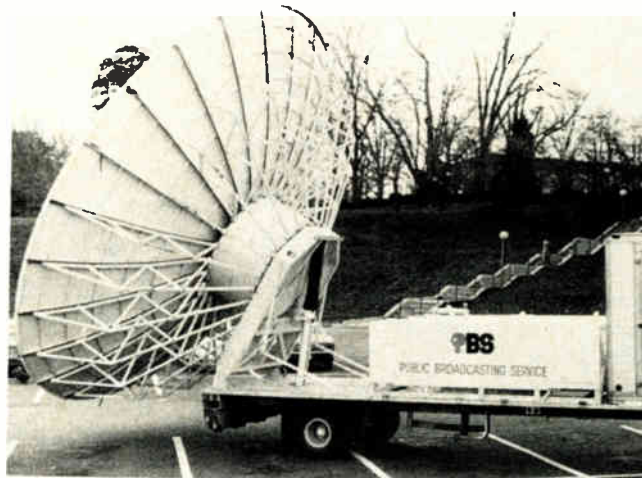

3. TV tests. The Public Broadcasting System used a 10-foot trans-portable earth terminal for television reception tests from Anik 1.

projects, is to provide ships with the same grade of communications as a company's branch office, thus keeping the ship within the management loop. Nowhere else, Feigleson points out, is there a multimillion dollar plant that often is completely out of communication with management headquarters.

Marad will also use some time on Marisat during the summer of 1975. Each of about 10 to 15 shipping companies will equip one of its ships with transmit-receive terminals, which will be used for computer-aided control of the ship's engines.

The next few years will see many more users of the facilities offered by communications satellites. The business atmosphere, now clouded by such factors as IBM's potential entry into the field, and the arguments before the FCC regarding AT&T's handling of local interconnections to satellite customers, will, in time, shake out. What is clear now is that a new industry is taking shape in communications, with benefits small and large for business and consumers alike. □

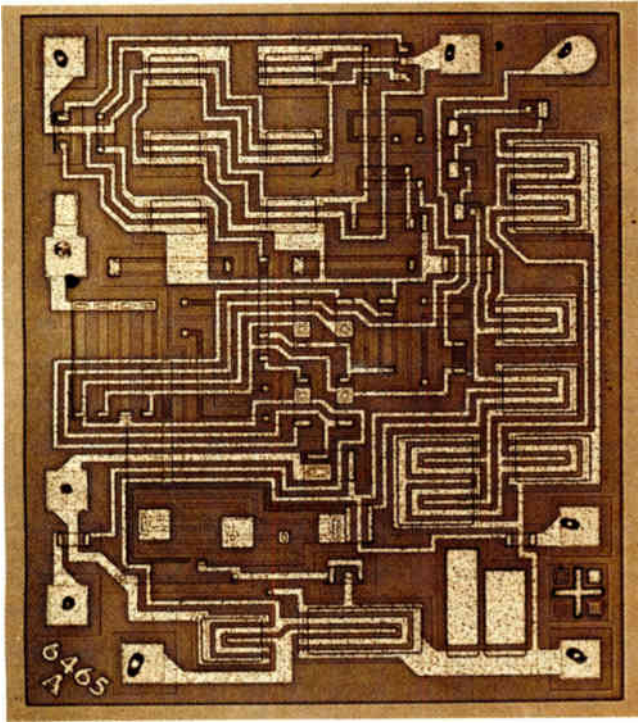

# Building C-MOS, bipolar circuits on monolithic chip enhances IC specs

Fabrication involves the use of only one additional processing step, a photoresist operation; applications for new approach include converters, operational amps, timers, comparators

by R. L. Sanquini,  
*RCA Solid State Division, Somerville, N.J.*

□ Conventional IC manufacturing techniques can seldom deliver the optimum combination of parameters for a given circuit function. Tradeoffs are involved once the designer chooses among bipolar, MOS, or complementary-MOS approaches. By combining C-MOS and bipolar processes on a monolithic chip, however, one IC can be made to do more—more cost-effectively.

The process, called C-MOS bipolar, allows bipolar and both n- and p-channel metal-oxide-semiconductor devices to be used on a single chip to perform analog and digital functions without sacrificing the performance capabilities of either. Because it yields circuits with a number of improved characteristics, it has potential in a wide range of products—from automobiles to computers.

## Digital, linear integration

Many consumer circuits, for example, perform functions that are partly linear and partly digital. Take the case of horizontal and vertical countdown circuits for TV sets. Here, C-MOS logic can be used to divide a clock input and generate a 15.75-kilohertz horizontal-drive signal and a 60-hertz vertical-drive signal. C-MOS logic can implement a composite synchronization process to check sync pulses for equalization. And it can generate a vertical-process signal for clocking the vertical-drive pulse. With the new technique, these functions can be done on the same chip that handles the analog functions performed by a comparator circuit and the vertical drive waveform generator that produces the pulse.

Besides integrating digital and linear functions on one chip, the combination of C-MOS and bipolar processes gives a number of advantages, including:

- P-channel MOS speed and bandwidth better than conventional pnp lateral transistors,
- Low-current MOS input and buffer characteristics.

- Very accurate MOS input transistor current matching.
- Interface compatibility with other C-MOS circuits.
- High noise immunity when using C-MOS logic in analog/digital circuits.

Figure 1 shows the simple yet sophisticated circuit of a new operational amplifier—the CA3130. The first commercially available product using the technique, it utilizes C-MOS and bipolar circuit elements in its design. Interdigitated p-channel MOS transistors are used in the input stage, giving a typical input-offset voltage of only

2 millivolts. The temperature-tracking characteristic of the offset voltage is 5 microvolts per °C. Along with these matched characteristics, the input has an open-loop differential-input impedance of 1,000 megohms and an input current of 5 picoamperes. What's more, this circuit has the unusual ability to operate from a single or dual power supply with equal ease.

In the second stage—a bipolar-MOS design—an npn transistor drives cascaded p-channel MOS devices. The high output resistance of this configuration coupled

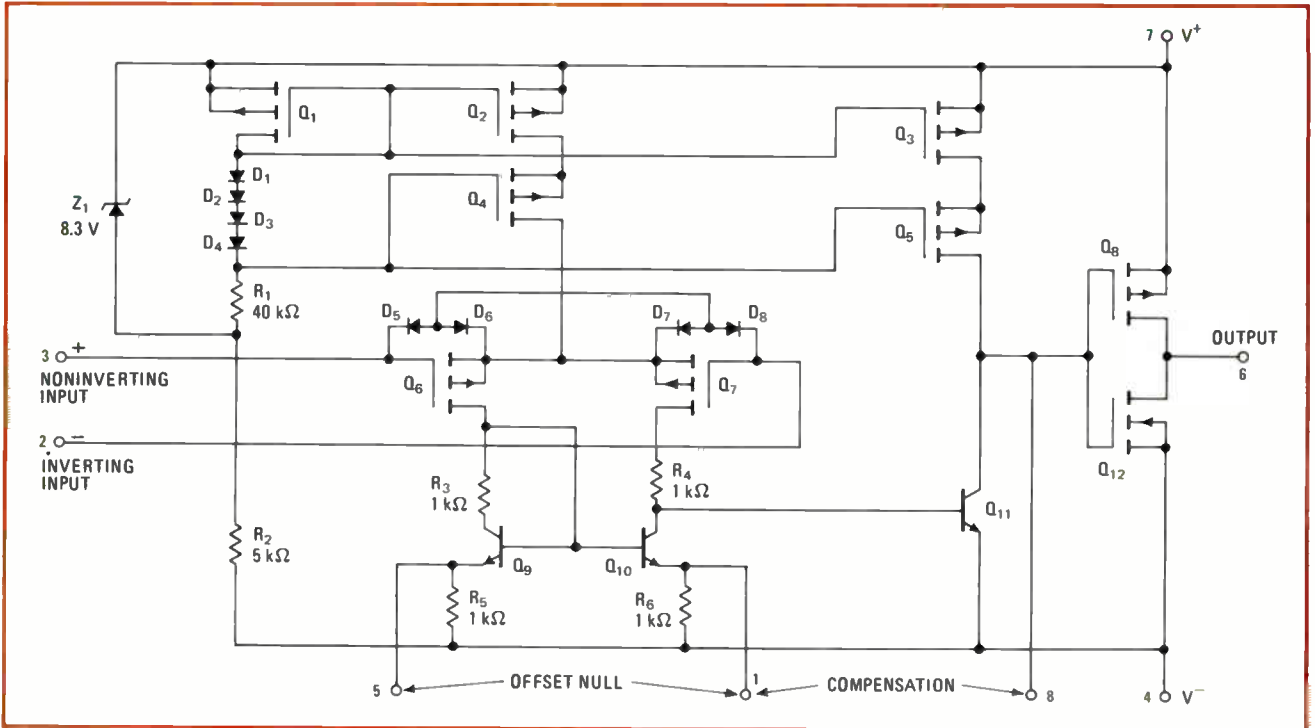

1. Op amp. The CA3130 operational amplifier developed by the RCA Solid State division overcomes some of the basic problems of bipolar technology by employing a combination of p-MOS, C-MOS, and bipolar elements on a monolithic chip.

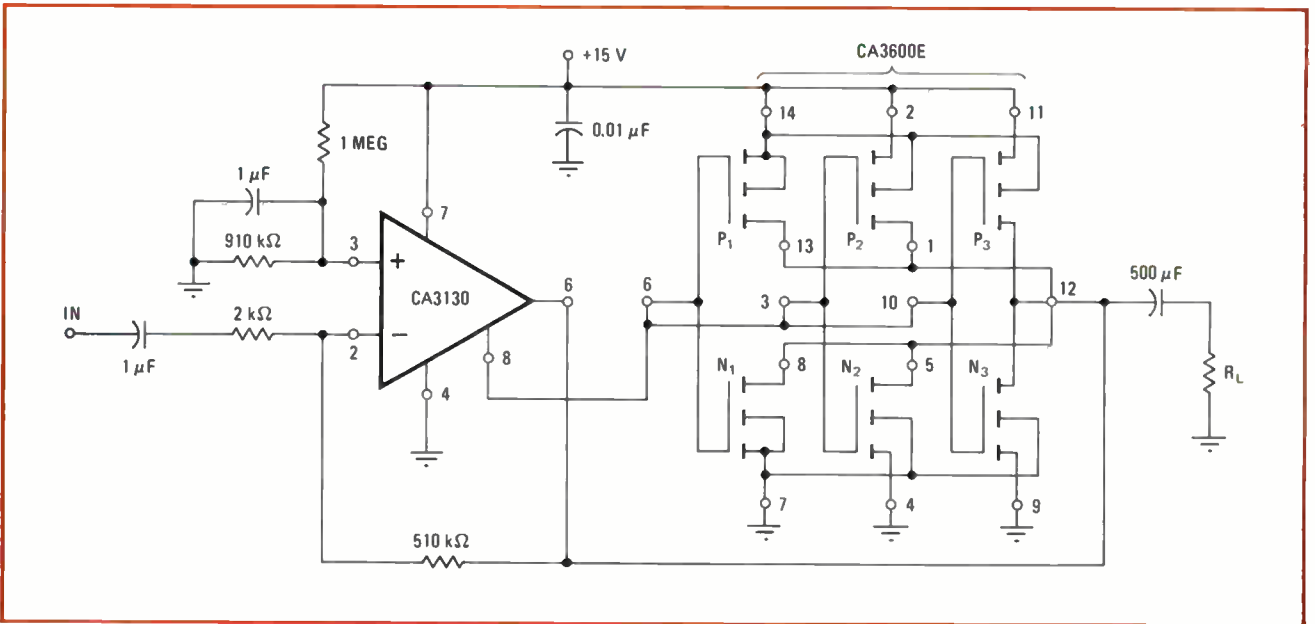

2. Output enhancement. The CA 3130 can sink or source 20 milliamperes, and since the gate of the output inverter is available, that current-handling capability can be increased by connecting additional C-MOS inverters in parallel with the output.



## Bringing C-MOS and bipolar processes together

Essentially an evolution of complementary metal-oxide semiconductor and linear bipolar processes, the C-MOS bipolar approach requires one additional photoresist step over the procedure used to make linear ICs with MOS capacitors, like the 741 operational amplifier. The structure of a device made by the process is shown in the cross-section diagram.

In C-MOS bipolar processing, channel oxidation, and annealing for MOS devices occur after the formation of bipolar devices, and are executed at temperatures low enough and in periods of time short enough to prevent any appreciable change in the preceding diffusions. In order to fabricate the n-channel device, it is necessary to introduce a p-well diffusion into an n-well. The depth of the p-well is chosen so that a reasonable compromise can be reached between the voltage breakdown of the p-well and the p-substrate and the reach-through voltage between the n-channel drain and n-well.

The masking operations and their required sequence

are as follows: 1. n<sup>+</sup> buried layer, 2. p<sup>+</sup> isolation, 3. p-well, 4. p base, resistor, source, and drain, 5. n<sup>+</sup> emitter, source and drain, 6. channel definition, 7. contact, 8. metallization, 9. protection.

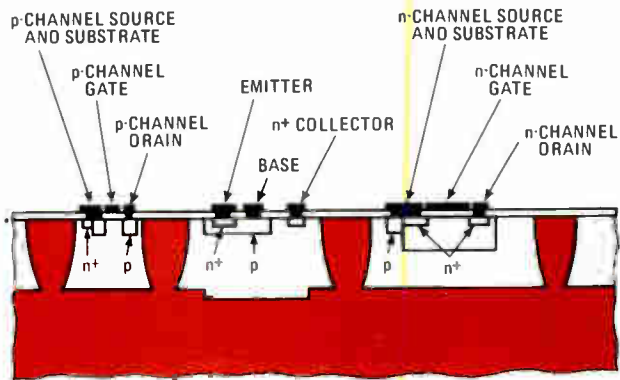

with a C-MOS output inverter gives a voltage gain of 6,000. With this approach, the operating speed is increased and the size of the compensation capacitor is kept to a minimum.

The output stage is a C-MOS inverter, operating class A. It can provide a voltage swing that reaches within a few millivolts of the power supply. The CA3130 can sink output currents of up to 20 milliamperes, as well as provide a 20-mA output source. What's more, the availability of the output inverter's gate permits the user to increase current handling capacity without introducing the unwanted crossover distortion experienced with some other op amps. This procedure is done simply by connecting additional C-MOS inverters in parallel with the output, as in Fig. 2, where a CA3600 inverter is used. The designer also has the option of using the gate terminal for strobing, a technique which can reduce power dissipation by 30%.

Short-circuit protection is another important feature made possible by the C-MOS output stage, one that is unavailable with other monolithic op amp devices. Indeed, most bipolar circuits must use active short-circuit protection, which can significantly degrade the output characteristics of the op amp.

In contrast, the CA3130's C-MOS output transistors have built-in short-circuit current limiting, a function of the transistor's gate-to-source voltage. And since the mobility  $\mu$  is inversely proportional to temperature, the short-circuit current, in fact, decreases with increasing temperature.

Another plus of the CA3130 is the temperature independence of the output voltage, again a result of the noise and temperature stability of the C-MOS structure. On the other hand, the output characteristics of standard op amps, such as the 741, have output voltages that are a function of collector-emitter and base-emitter voltages, both of which are extremely temperature-sensitive.

Typical applications can demonstrate the unusual

### CA3130 TYPICAL PERFORMANCE CHARACTERISTICS

$V^+ = 15\text{ V}$ ,  $T_A = 25^\circ\text{C}$

$V_{IO}$ input offset voltage	2 mV
$V_{IO}/\Delta T$	$5\ \mu\text{V}/^\circ\text{C}$
$I_{IO}$ input offset current	5 pA
$I_I$ input bias current	5 pA
Voltage gain (large-signal)	100 k V/V
Common mode rejection ratio (CMRR)	90 dB
Common mode input voltage range	0 – 11 V
Sink	20 mA
Maximum output current source	22 mA
Maximum output voltage	10 mV to 14 V
Power supply rejection	$32\ \mu\text{V}/\text{V}$
Unity gain crossover	15 MHz
Slew rate (unity gain, noninverting)	8 V/ $\mu\text{s}$

performance characteristics of the CA3130. Since its inputs can be driven below the negative rail by at least 1 volt, it can be used as a single-supply comparator that will operate well with a near-ground reference voltage in a noisy environment. When the reference voltage or input goes more negative than ground, the comparator continues to maintain its proper sense, avoiding the use of additional compensating circuit elements.

Another important application is threshold detecting, where the device's high-current C-MOS output capability makes it possible to use trip voltages that are dependent only on the supply voltage and external feedback-resistor tolerances, and not on any internal device characteristic.

Voltage-converter applications makes use of the CA3130's high current-range capability. This circuit can be used in electrometer applications. For example, a simple meter circuit with a current range from 20 pA to 2 mA can be designed quite simply with the CA3130.

The ramifications of the C-MOS bipolar process obviously go beyond the CA3130. Probably the most important application area will be in large-scale analog/digital circuits. □

## Regulator for op amps practically powers itself

by Richard Eckhardt  
*Electronics Consulting & Development, Cambridge, Mass.*

Here's a rather novel way to build a dual-voltage regulator for powering operational amplifiers that offers good tracking, as well as low ripple. Tracking between the two output voltages is good because only one reference source is used for both the positive and negative sides of the regulator. Although the circuit employs two op amps itself, they receive their power inputs from their own outputs. Furthermore, the circuit's output-current capability is on the order of several amperes, and output ripple is held to less than 1 millivolt peak-to-peak.

The circuit, shown in the figure, operates as a conventional series-pass regulator on its positive side to de-

velop its +15-volt output. Amplifier  $A_1$  is used for error-detection. The pass transistor for the positive side is biased on from the unregulated +20-v input supply voltage. The output voltage from amplifier  $A_1$  then adjusts this transistor's output.

On the negative side (-15-v output) of the regulator, amplifier  $A_2$  operates as a unity-gain follower. The pass transistor on the negative side is biased in a manner similar to its positive counterpart. The value of the biasing resistor for the negative pass transistor is different from the value of the biasing resistor for the positive pass transistor in order to bring  $A_2$ 's output closer to the negative supply voltage.

Since amplifier  $A_2$  is wired in a follower configuration, the reference voltage developed by the zener diode can be used for both the positive and negative sides of the regulator. The two output voltages, therefore, track each other within approximately 50 mV.

With suitable modification, the same circuit approach can be used to build a regulator for devices other than op amps that require a split supply. □

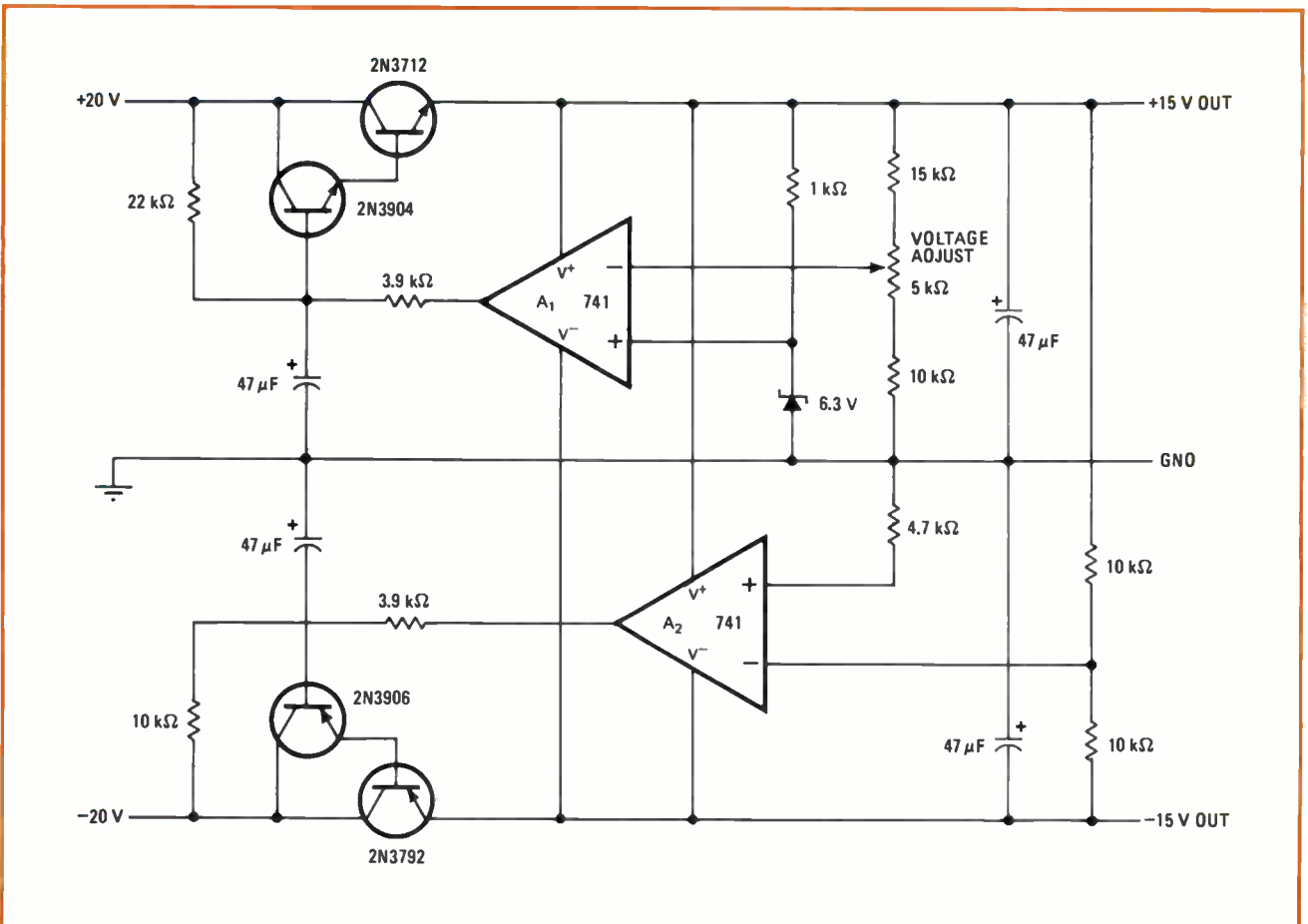

**Split supply.** Regulator circuit for op amps develops  $\pm 15$ -V outputs from a  $\pm 20$ -V unregulated source with less than 1 millivolt of ripple. Although the regulator uses op amps itself, they receive their power inputs from their own outputs. Amplifier  $A_1$  acts as an error detector, while amplifier  $A_2$  is a voltage follower. The single zener voltage reference means that tracking is good between the positive and negative sides.

# Analog filter can be programmed digitally

by Leonard M. Smithline  
Lansing Research Corp., Ithaca, N. Y.

The frequency response of an analog active filter can be selected digitally, yet with the resolution and accuracy of resistive tuning and the dc stability of capacitive tuning. The filter accepts TTL inputs, permitting it to be controlled directly by a computer and making it ideal for electronically switched systems. Furthermore, this digitally programmable filter is cost-competitive with mechanically switched types of filters, especially for high-order filter functions.

A simple first-order low-pass filter is drawn in (a). The corner frequency of this circuit is determined by the proportion ( $\alpha$ ) of the amplifier output voltage (V) that is applied to the feedback capacitor (C). Since applying a voltage of magnitude  $\alpha V$  to capacitor C produces the same feedback current as applying a voltage of magnitude V to capacitor  $\alpha C$ , the value of capacitor C is effectively multiplied by  $\alpha$ . Therefore, the filter's corner frequency can be written as:

$$\omega_b = 1/\alpha R_f C$$

where  $R_f$  is the feedback resistor. The over-all dc gain of the circuit is unaffected by loop gain  $\alpha$ .

The effective multiplication of capacitance C by gain  $\alpha$  can be used to control the filter's corner frequency, as shown in (b). In this circuit, the filter's corner frequency is determined by logic inputs through a voltage-divider setup. Resistor  $R_a$  is the upper leg of the divider, while the resistance of the lower leg is selected by enabling the appropriate TTL inverter buffer. When a logic input turns on one of the buffers, the resistor associated with that buffer is shorted to ground.

Resistor  $R_b$  provides the appropriate bias voltage for the buffers. The transistor, which is wired as an emitter-

follower, reduces the resistance of the voltage divider that is reflected forward in series with capacitor C. This Thevenin equivalent resistance ( $R_T$ ) is divided by the current gain ( $\beta$ ) of the emitter-follower. For the circuit to operate properly:

$$R_T/\beta \text{ must be much less than } R_i \parallel R_f$$

where  $R_i$  is the input resistor. Since the dc levels of both the buffers and the transistor are blocked by the capacitor, there is no need for any bias stabilization circuitry.

If the effects of biasing resistor  $R_c$  are neglected, programmable gain  $\alpha$  can be expressed as:

$$\alpha = 1/[1 + (R_a/R_b) + \sum R_n G_i]$$

where  $G_i$  represents the conductance of those resistors,  $R_1$  through  $R_n$ , whose buffers are enabled. The filter's corner frequency now becomes:

$$\omega_b = \omega_o(K + \sum R_n G_i)$$

where:

$$\omega_o = 1/R_f C$$

$$K = 1 + (R_a/R_b)$$

The filter's starting frequency—that is, the corner frequency of the filter with none of the logic buffers enabled—is equal to  $K\omega_o$ . And each increment above this frequency, as each logic buffer is enabled, is equal to  $\omega_o R_n G_i$ . Since the effects of the enabled buffers are additive, the filter can be programmed to accept either standard binary codes or a binary-coded-decimal input. For the component values cited in the figure,  $\omega_o$  is 100 radians/second, K is 2, the starting frequency is 200 rad/s, and the frequency increment is 250 rad/s.

Moreover, the programming approach that is shown here can be extended to higher-order filters through the use of either the standard biquad or state-variable filter configurations.<sup>1,2</sup> □

## REFERENCES

1. A.E. Schultz, "Active Filters Are Moving toward Standardization," *Electronic Products*, June 18, 1973.
2. G.E. Tobey, J.G. Graeme, L.P. Huelsman, "Operational Amplifiers—Design and Applications," McGraw-Hill Inc., 1971.

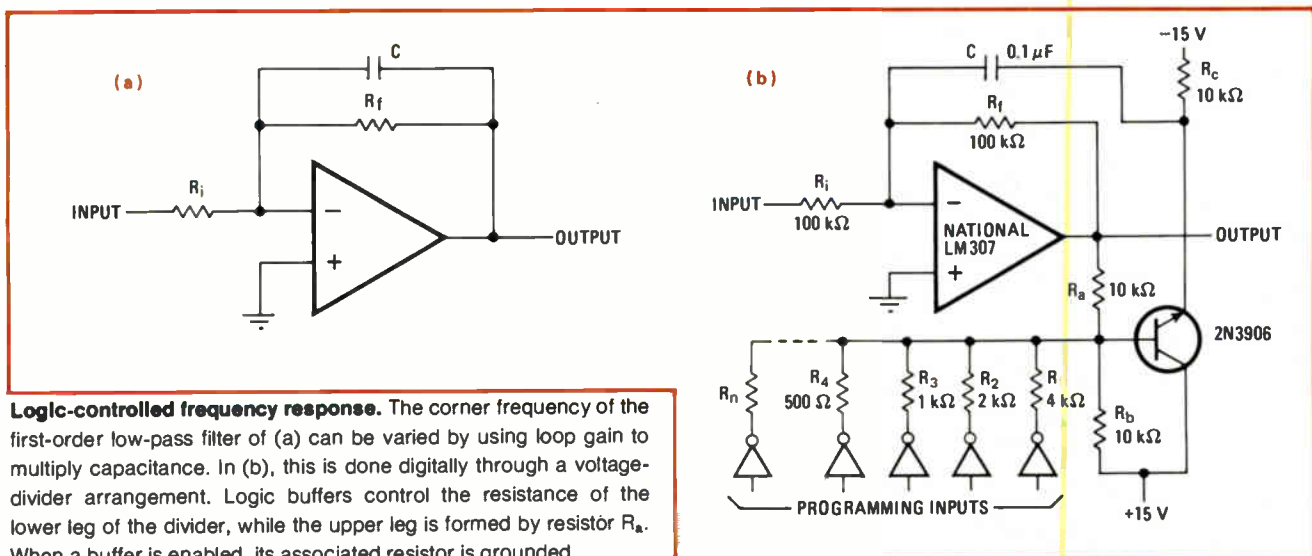

**Logic-controlled frequency response.** The corner frequency of the first-order low-pass filter of (a) can be varied by using loop gain to multiply capacitance. In (b), this is done digitally through a voltage-divider arrangement. Logic buffers control the resistance of the lower leg of the divider, while the upper leg is formed by resistor  $R_a$ . When a buffer is enabled, its associated resistor is grounded.

# Attenuating transients in analog FET switches

by Leland Shaeffer  
Siliconix Inc., Santa Clara, Calif.

Analog field-effect-transistor switches may be high-speed devices, but the faster they are toggled, the greater is the risk of unwanted output switching transients. The amplitude of these glitches or spikes can be greatly attenuated by synchronizing the toggling of one FET switch with a second FET switch through logic pulses that have variable rise times and fixed fall times.

Undesirable spiking can occur at the output of an analog switch during toggling because, inside the device, charge can be coupled through either its gate-source or gate-drain capacitance. Previous attempts to cancel these glitches by applying out-of-phase spikes from a second switch failed because turn-on and turn-off times generally vary too much between devices.

In the circuit shown here, TTL inverters having open-collector outputs are used to develop the synchronizing logic pulses. Since these inverters have a pull-down current that is an order of magnitude greater than their pull-up current, the rise time of their output pulses can be increased without appreciably affecting the fall time of their output pulses. Fixed resistors ( $R_L$ ) establish the pull-up currents for the inverters.

The output rise times of the inverters determine the times required to reach the toggling thresholds of analog switches  $S_1$  and  $S_2$ . For the FET devices used here, this threshold is approximately 1.4 volts. Variable capacitors ( $C_1$  and  $C_2$ ) at the outputs of the inverters permit the rise times of these units to be set at the values needed to synchronize switches  $S_1$  and  $S_2$ .

Now the turn-on of switch  $S_1$  can be made to coincide with the turn-off of switch  $S_2$ , and the turn-off of  $S_1$  can be synchronized with the turn-on of  $S_2$ . When the switches are properly matched in this way, the transients appearing at the output of  $S_1$  can be reduced by a factor of 5 or more if  $R_L$  is greater than or equal to 10 kilohms and  $C_1$  and  $C_2$  are about 12 picofarads. For  $R_L = 75$  ohms, the magnitude of the unwanted transients will at least be halved.

Transient attenuation can be improved still further by connecting a zener diode (a 6.8-v device, in this example) shunted with a bypass capacitor in series with the negative power supply. The glitches will then be reduced by an additional factor of 2 for both  $R_L = 75$  ohms and  $R_L = 10$  kilohms. However, the analog output voltage swing, which is normally +15 v to -7.5 v, will now be limited to +15 v and  $-\frac{1}{2}$  v.

To adjust the circuit properly, first set capacitor  $C_3$  at its minimum value and adjust capacitor  $C_1$  for a minimum turn-off transient. The value of capacitor  $C_3$  is then increased until maximum transient cancellation is obtained. Next, capacitor  $C_2$  is adjusted for a minimum turn-on transient. Capacitors  $C_1$  and  $C_2$  will interact slightly with each other, and some compromise may be necessary in the adjustment of  $C_3$  for minimum turn-on and turn-off transients.

In the circuit drawn in the figure, only one signal source is used, and switches  $S_1$  and  $S_2$  provide single-pole, single-throw switching action. To accommodate a second signal source and obtain single-pole, double-throw action, the drain of  $S_1$  is connected directly (without capacitor  $C_3$ ) to the drain of  $S_2$ . The second signal source is then applied to the source terminal of switch  $S_2$ . When the switches are wired in this manner, the make-before-break interval is about 30 nanoseconds. □

Designer's casebook is a regular feature in Electronics. We invite readers to submit original and unpublished circuit ideas and solutions to design problems. Explain briefly but thoroughly the circuit's operating principle and purpose. We'll pay \$50 for each item published.

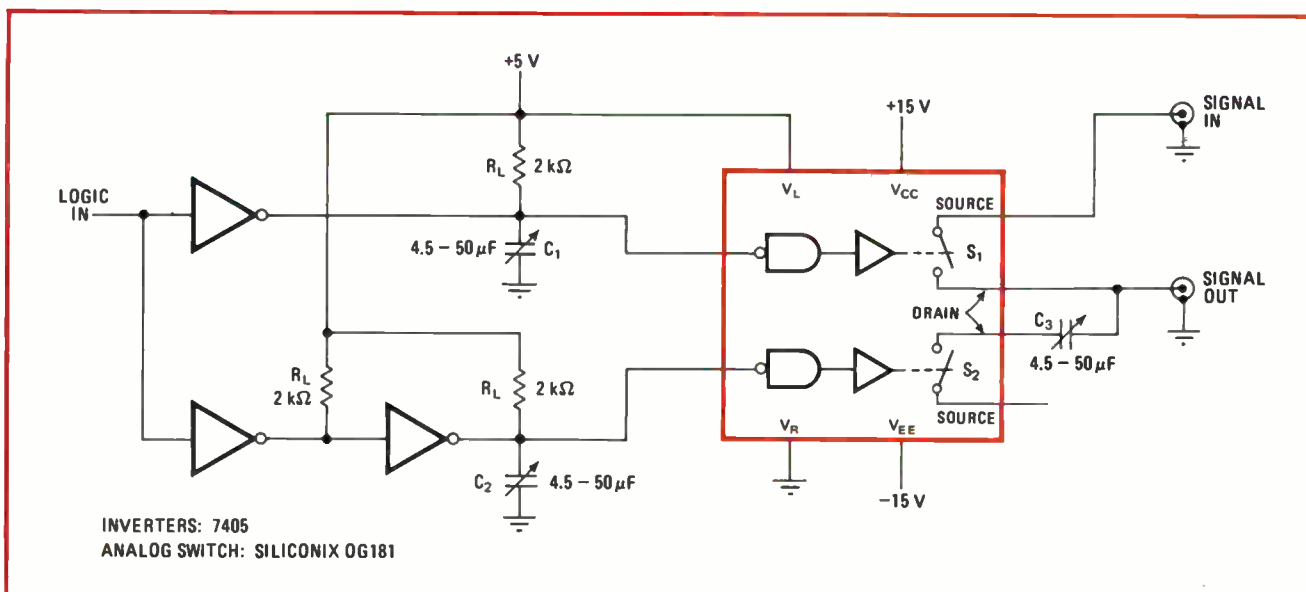

**Squelching spikes.** Switching transients at the output of an analog FET switch can be greatly attenuated by synchronizing the turn-on and turn-off of one switch with those of a second switch. Open-collector TTL inverters produce logic pulses whose output rise times can be varied while their output fall times remain fixed. The turn-on of switch  $S_1$  is made to coincide with the turn-off of switch  $S_2$ , and vice versa.

# Announcing: 164 assemblies per hour

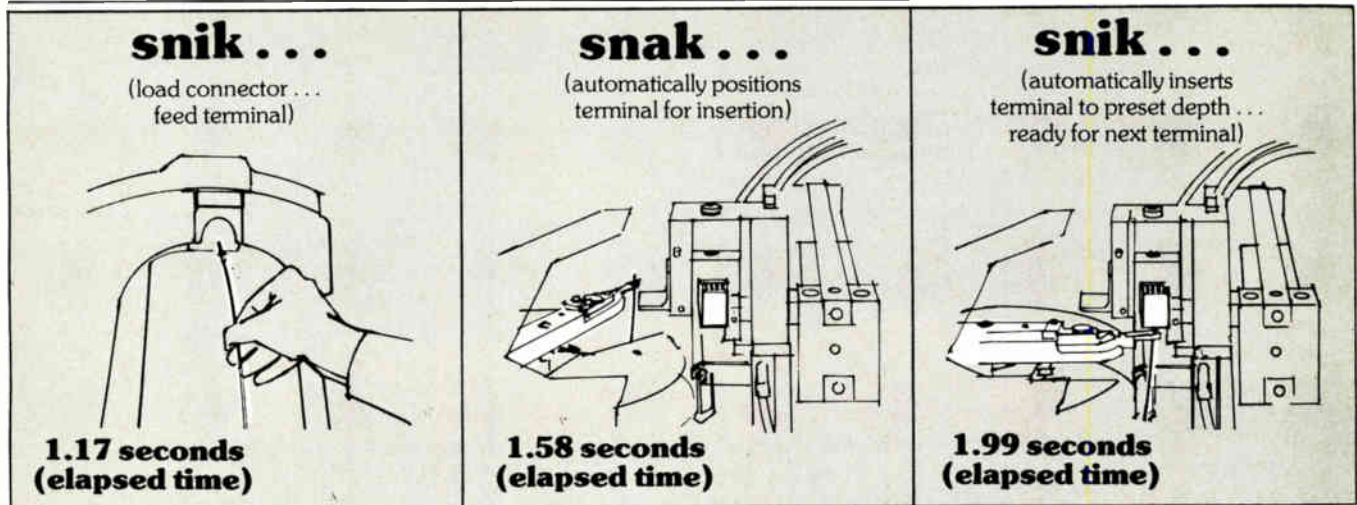

**. . . times 11 terminals**

one completed connector every 21.9 seconds\*  
or 164 connector assemblies per hour

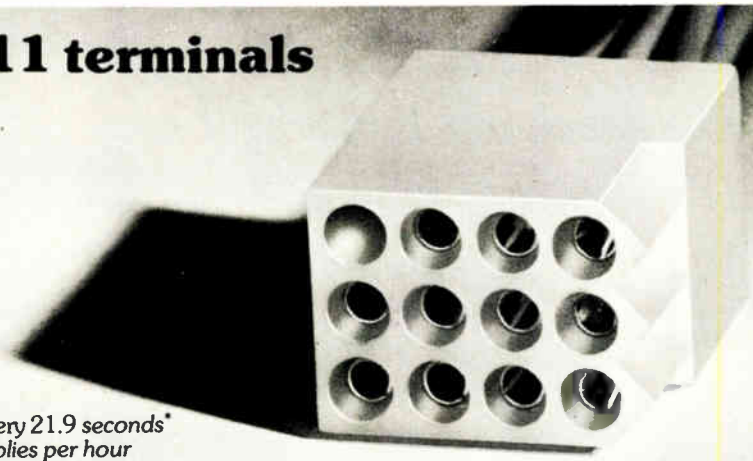

\*Based on an inexperienced operator using a new Molex A-Matic machine to insert 11 wire leads with Molex .093 dia crimped terminals into 12-circuit Molex connectors.

## You'll need two hand assemblers to keep up with the new Molex-A-Matic machine.

Molex first brought you economy with its .093 crimped terminals and connectors.

Now we bring you *speed* . . . with the new Molex-A-Matic assembly machine that puts Molex connectors together 50% faster than you can by hand.

All the operator does is load the Molex-A-Matic with connector housings and feed it wires terminated with Molex .093 male or female leads. Molex-A-Matic is programmed



to do the rest: position housing . . . insert terminal to exact depth and lock it in place . . . repeat until the preset number of terminals are inserted . . . then eject the completed connector — *all automatically*.

Molex-A-Matic can cut your per unit assembly costs in half while it cuts rejects, and helps eliminate the need for visual inspection. It's designed to handle 14-24 AWG wire, 3 to 36" long with insulation diameter .058 to .125.

**molex** . . . *Affordable Technology*

Molex Incorporated, Dept. E1074, 2222 Wellington Court, Lisle, Illinois 60532

# 39.999999 MHz



MODEL 5500

## BEST

## FREQUENCY SYNTHESIZER

- **10 KHz to 39.999999 MHz Range**
- **1 Hz Resolution throughout range**
- **LED Display of Programmed Frequency**
- **Full Programmability & Fast Switching** — 1 MS TYPICAL
- **High Spectral Purity:**
  - 70 dB SPURIOUS
  - 60 dB PHASE NOISE
  - 40 dB HARMONIC
- **High Stability:**
  - $\pm 2 \times 10^{-8} / ^\circ\text{C}$  STANDARD
  - $\pm 2 \times 10^{-10} / ^\circ\text{C}$  OPTIONAL
- **1 v RMS Output (+13 dBm)**
- **Amplitude Modulation:** 0-95%, 400 Hz, 1 KHz, EXTERNAL
- **Auxiliary TTL Square-wave Output**
- **ASCII, Calculator and Minicomputer Interface Options**

### SOME APPLICATIONS:

- Communication systems alignment and calibration.
- Precision sweep testing of High Q networks.
- Frequency agile automatic systems.
- Programmable local oscillator.

For immediate information on how Rockland can meet your specific application and delivery requirements — call our local rep or Dave Kohn directly at:

# ROCKLAND

ROCKLAND SYSTEMS CORPORATION 230 W. Nyack Rd., W. Nyack, N.Y. 10994 • (914) 623-6666

Circle 110 on reader service card

# Bipolar LSI takes a new direction with integrated injection logic

Using conventional processes, simplified gate structure of I<sup>2</sup>L boosts yields and density, while reducing power consumption a thousandfold; the low-cost technique is applicable to both analog and digital circuits

by C. M. Hart, A. Slob, and H. E. J. Wulms, Philips Research Laboratories, N. V. Philips' Gloeilampenfabrieken, Eindhoven, The Netherlands

□ Integrated injection logic, the new approach to bipolar chip design, is catching the imagination of logic designers throughout the world with its high-density capability and its performance that features either nanosecond delay or microwatt power dissipation. Conceived almost simultaneously by Dutch and German researchers at Philips Gloeilampenfabrieken, Eindhoven, and IBM Deutschland, Boeblingen, I<sup>2</sup>L quickly spread to the United States and Japan, where it's become the best bet for the realization of truly high-performance bipolar LSI circuitry.

Ultimate source of all the excitement is I<sup>2</sup>L's elegant gate layout, from which the space- and power-consuming current sources and load resistors of transistor-transistor logic are noticeably absent. As a result of this simplicity, up to 3,000 gates or 10,000 bits of memory can be packed into a single high-yield chip. Moreover, the speed-power product can drop, at low power, to an astonishing 0.13 picojoule, 1,000 times better than today's TTL circuits.

Thus, while operating at speeds almost as fast as TTL, thousands of gates will dissipate no more power than today's 100-gate devices. Or, where speed isn't essential, as in watch circuits, I<sup>2</sup>L chips will offer microwatt dissipation while providing direct high-current drive capability for light-emitting-diode displays.

To top it off, this revisionary bipolar logic is extremely versatile. I<sup>2</sup>L enables designers to put both digital and analog circuits on the same chip and, because it uses conventional bipolar processes, is low-cost and can be applied to the full range of microcircuit applications. Among these are single-chip digital data processors, large-scale integrated logic arrays, watch chips, digital voltmeter circuits, high-frequency counters, digital tuners, read-only memories, shift registers, converters of all kinds, control logic for complex calculators, frequency dividers for electronic organs, and linear circuits for radio and television. Although not presently at Philips, commercial production of 8- and 16-bit microprocessors and high-frequency watch circuits is beginning. Touch control circuits for radio and TV tuning and circuits for telephone tone-dialing systems are also on the way [*Electronics*, July 11, p. 25].

Injection logic reduces a gate to a single complementary transistor pair. A vertical npn transistor with multiple collectors operates as an inverter, a lateral pnp

transistor serves both as current source and load, and no ohmic resistors are required for either the source or load function. In contrast, a typical TTL gate is constructed out of six or eight transistors as well as source and load components.

When the I<sup>2</sup>L gate is laid out on silicon, both circuit elements can be merged and fitted into the area of a single transistor, in the process eliminating completely the space-consuming necessity of device isolation. Structural complexity almost vanishes, being reduced to that of a single planar transistor.

This, plus the absence of resistors and current sources, accounts for injection logic's greatly increased circuit density, which, as Table 1 shows, can be up to 100 times greater than that of TTL chips. As Table 1 also shows, an I<sup>2</sup>L gate is somewhat slower than a TTL gate, but in most applications this is more than compensated for by its far lower speed-power product.

## Origin of the I<sup>2</sup>L gate

Injection logic derives its layout from the old direct-coupled transistor logic (DCTL) structure shown in Fig. 1a. The circuit between the dashed lines consists of a number of transistors in parallel. Clearly, when one or more of them are on, they act as a short circuit, and no current is supplied to the load gates. Conversely, when they are all in the off state, current moves to the bases of the transistors in the load gates.

If the two transistors that have their bases connected

TABLE 1: COMPARISON OF TYPICAL I<sup>2</sup>L AND TTL PROPERTIES

	I <sup>2</sup> L	TTL
Packing density (7- $\mu$ m mask details)	120 - 200 gates/mm <sup>2</sup>	20 gates/mm <sup>2</sup>
Speed-power product	0.1 - 0.7 pJ/gate	100 pJ/gate
Minimum delay	30 ns	10 ns
Supply voltage	1 - 15 V	3 - 7.5 V
Logic voltage swing	0.6 V	5 V
Current range (per gate)	1 nA - 1 mA	2 mA

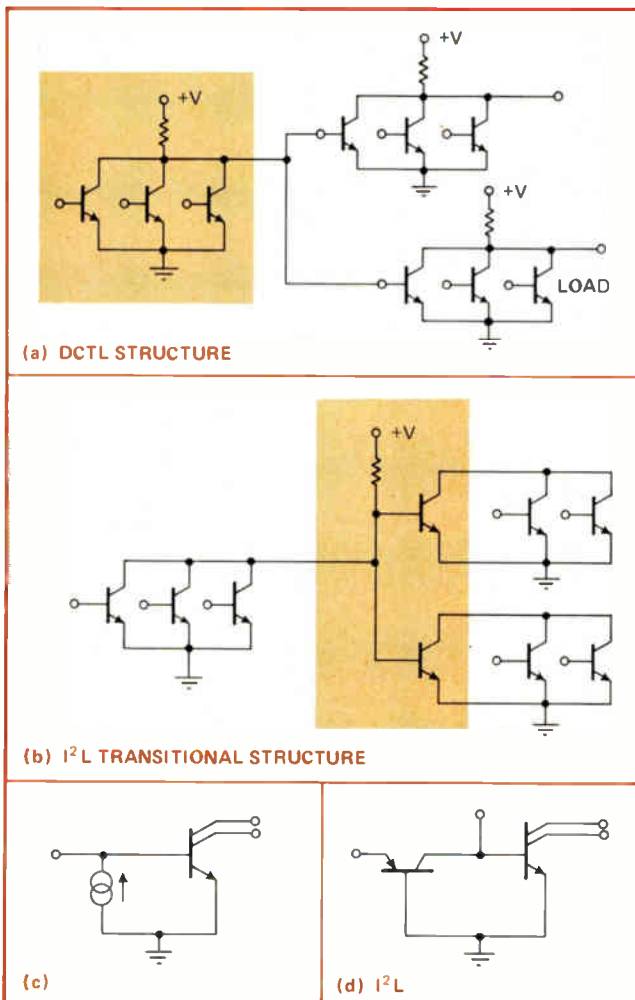

**1. Starting point.** Direct-coupled transistor logic (DCTL) can be converted into integrated injection logic (I<sup>2</sup>L) if the transistors with connected bases (a) are placed in a common region (b) and finally replaced by a multi-collector npn transistor (c). The resistor in (b) is replaced by a current source as in (d)—a pnp transistor where the collector is common to the emitter of the npn transistor.

in Fig. 1a are placed in a common region, the result is the circuit between the dashed lines in Fig. 1b.

Next, the resistor in Fig. 1b is replaced by an active current source (to be described later), and transistors with connected bases are replaced by a multi-collector transistor—an easy thing to do because all the DCTL transistors have a common emitter that is connected to ground. This basic I<sup>2</sup>L configuration is presented in Fig. 1c.

The simple pnp transistor shown in Fig. 1d can serve as the current source, by injecting minority carriers into the emitter region of the npn transistor. (Alternatively, injection could be done by a light source for electro-optical applications.)

In any case, it is readily seen that the base of the npn transistor is common to the collector of the current source, while the base of the pnp current source is common to the emitter of the npn transistor. The emitter of the pnp, common for all gates, is called the injector. On silicon the entire gate takes up the room of a single multi-emitter transistor.

The original DCTL structure had its faults. Referring again to the structure in Fig. 1a, consider the case where all transistors between the dashed lines are in the off state and current is supplied to the bases of the load transistors. Because of the differences that process variations during normal production runs and temperature differences during operation cause in the emitter-base junction voltages, not all bases will receive the same current. For example, a transistor operating at a higher temperature will receive more current than one operating at a lower temperature.

Fortunately, this condition, known as current hogging, does not arise in I<sup>2</sup>L structures because the different bases and emitters are now combined in the single multi-collector transistor and are formed by the diffusion step. What's more, the hogging of input currents by high fan-in gates—another type of current hogging in DCTL—is negligible in I<sup>2</sup>L gates because of the inherently high inverse current gain of the upside-down npn transistors.

### Building an I<sup>2</sup>L circuit

Figure 2 shows the cross section of a typical circuit that combines I<sup>2</sup>L gates with conventionally isolated transistors. Fabrication of this circuit starts with a p-type substrate containing discrete n<sup>+</sup> buried layers. The buried layer in the I<sup>2</sup>L part of the circuit acts as a common emitter for the npn transistors, while in conventional TTL or emitter-coupled logic they act as the collector for the isolated structures.

After the n-type epitaxial layer has been grown, a deep p<sup>+</sup> diffusion is performed to isolate the conventional components, while in the I<sup>2</sup>L part the gates are isolated from each other by a deep n<sup>+</sup> diffusion. A p-type diffusion is then carried out to form all base regions and emitters of the lateral npn transistors (the injectors of the I<sup>2</sup>L gate). Next, a shallow n<sup>+</sup> diffusion forms both the collectors in the I<sup>2</sup>L part of the circuit and the emitter and the collector contact regions for the conventional transistor structures. Two additional mask steps are needed for the contact holes and metalization.

In all, only seven masks are needed to manufacture both conventional isolated and I<sup>2</sup>L transistors on the same chip. No extra processing is required. Most important, any standard bipolar process can be used to build the circuit elements—with one limitation: gold doping may not be used on the conventional transistors to boost their speed and reduce their loading effects because it would decrease the inverse current gain of the I<sup>2</sup>L transistors.

### It's flexible

From the top view and cross sections of some typical I<sup>2</sup>L gates, (Fig. 3), it is apparent that the n<sup>+</sup> buried layer acts as a common emitter region for the multi-collector npn transistors, and a long narrow p-type area (the injector) acts as the emitter of the pnp transistor. The gates are situated on both sides of the injector.

This layout guarantees that the total current, supplied over an external resistor to the injector rail, is divided equally among the gates. And since only one external resistor controls the current, the level of this current can



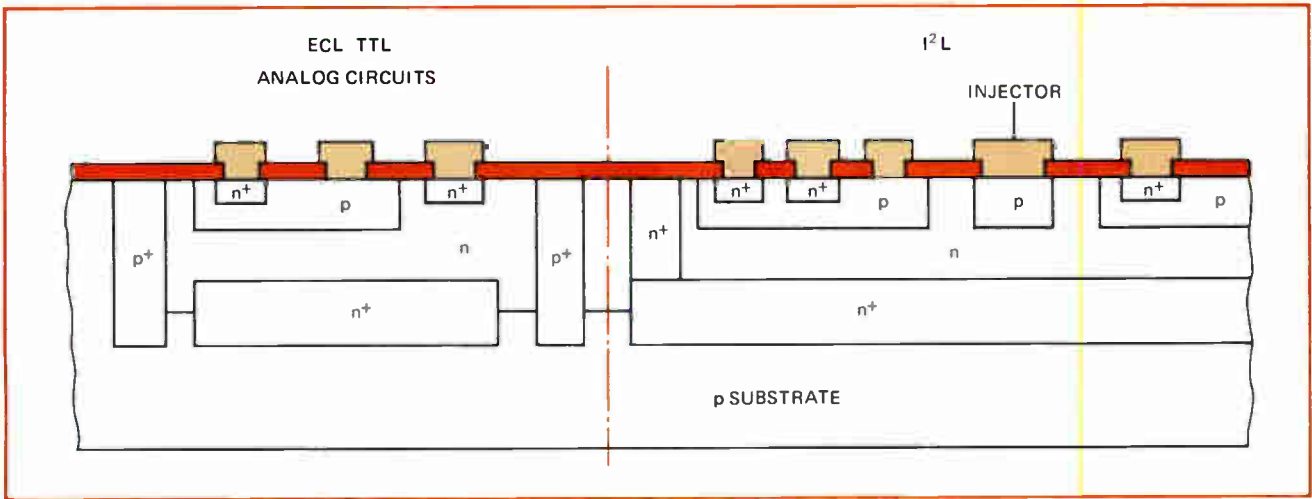

**2. Good combination.** An inherent advantage of the bipolar I<sup>2</sup>L technique is its ability to combine with conventionally isolated transistors on one chip. On the right are the I<sup>2</sup>L gates, on the left the conventional npn transistor structures. This part of the chip can be used to make TTL, ECL or analog circuits or any combination, any of which altogether need only seven masks.

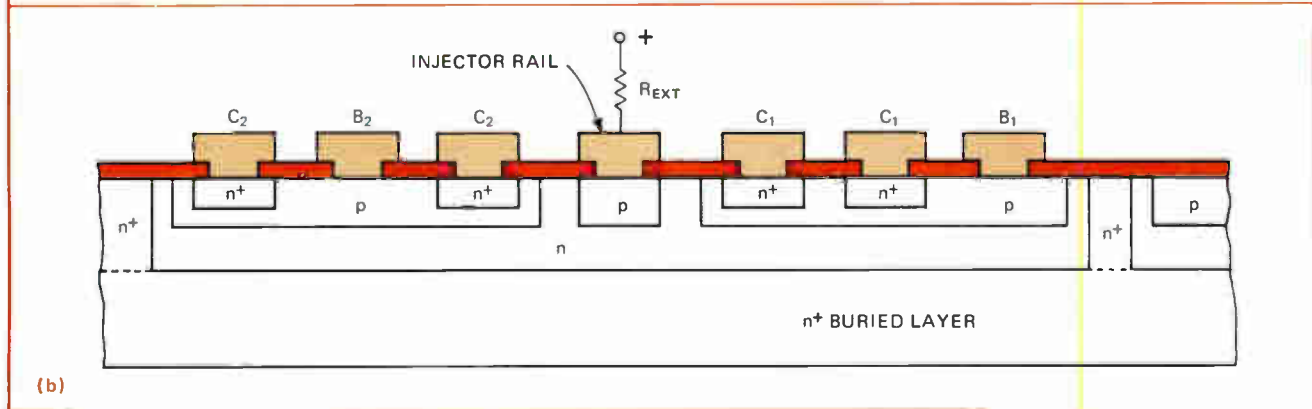
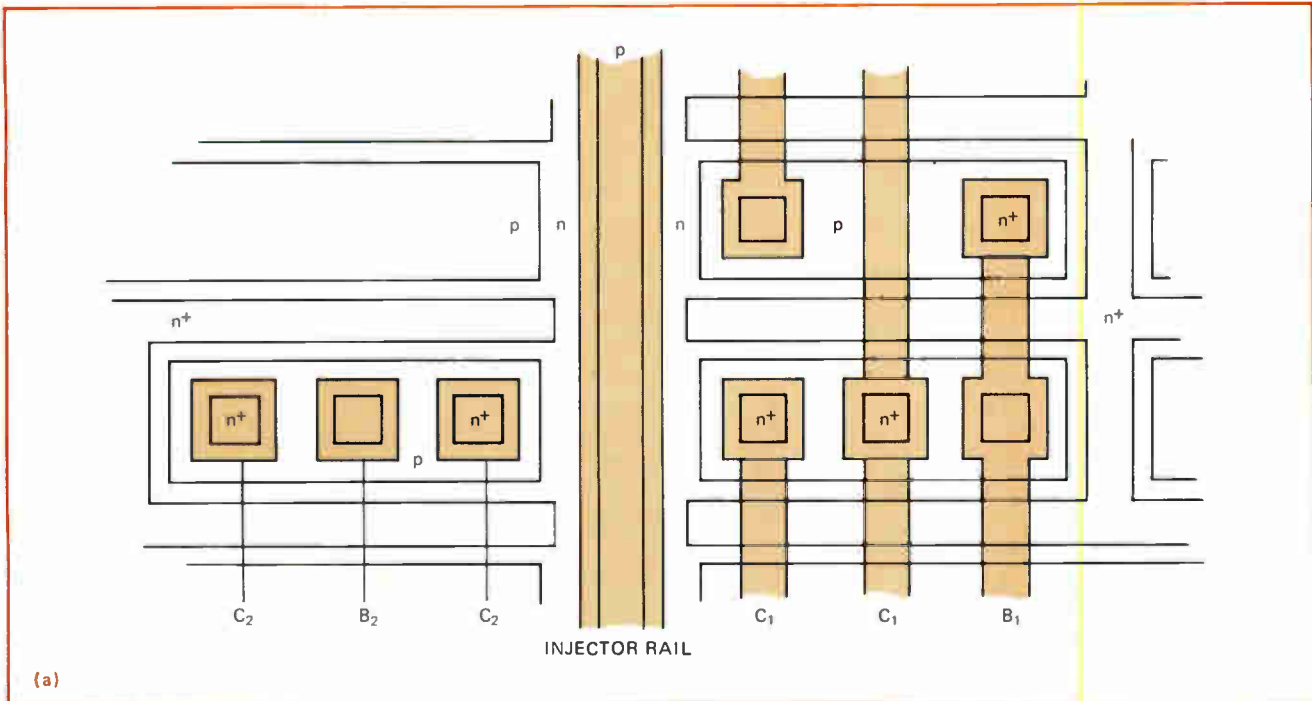

**3. Construction.** Gates of an I<sup>2</sup>L chip (a) are situated on both sides of an injector rail, which forms the emitter of the lateral pnp current source transistor. A heavily doped n<sup>+</sup> isolation region increases the current amplification factor of the npn transistor and kills the parasitic effects of the pnp transistors between two adjacent gates. In (b) are shown the space-saving features of I<sup>2</sup>L.

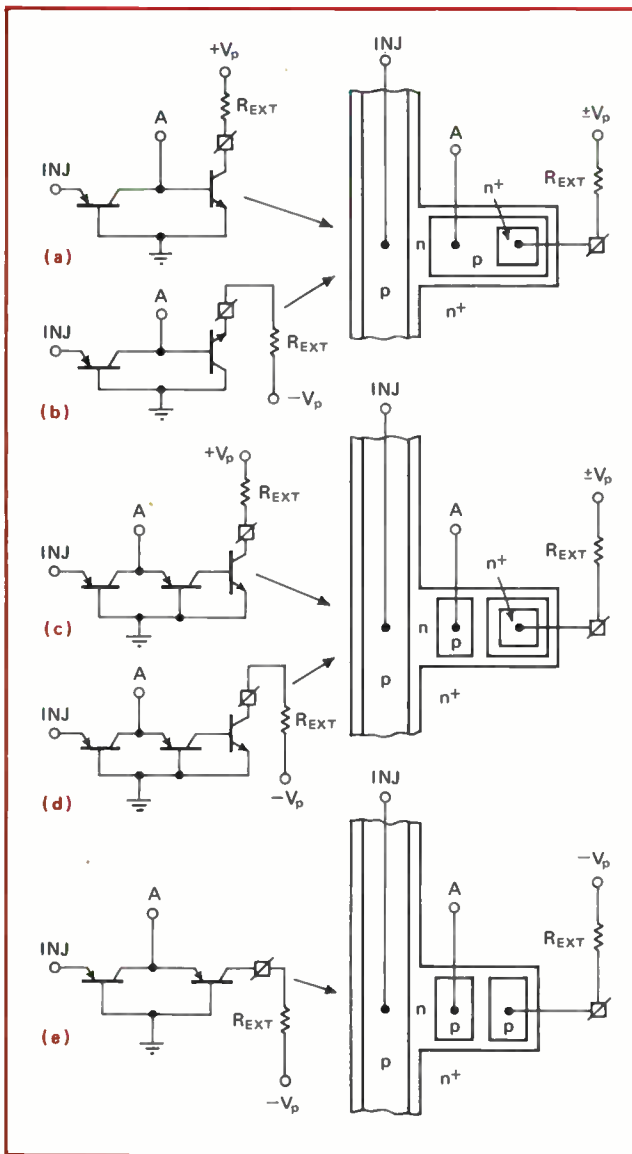

**4. Basic interface circuits.** These configurations show the circuit schematic and the corresponding chip geometry of five basic I<sup>2</sup>L interface circuits. Because each configuration uses standard processes, realization of any type of interface circuitry is easy.

be chosen even after the circuit has been processed, offering a designer great flexibility in tailoring his design to a particular current-level requirement.

Such a layout also allows a designer to adapt the base contact and collectors to a particular logic wiring pattern. Moreover, besides saving space, the compactness of the gate keeps parasitic capacitances to a minimum, preventing them from degrading circuit speed. Also, the gate's small logic voltage swings result in rapid charging and discharging of the cell capacitances, which in turn is responsible for the low speed-power product.

Injection logic can operate at very low current levels (1 nanoampere) and low logic swings (0.6 volt). Consequently, several I<sup>2</sup>L gate element configurations and interface circuits are necessary, if they are to be used along with conventional TTL and analog circuits that require higher currents and voltages.

Fortunately variations on the basic I<sup>2</sup>L layout can be readily constructed, offering the designer a multitude of tradeoffs to achieve various circuit goals. The standard I<sup>2</sup>L output device of Fig. 4a can serve as a basic current amplifier. In it, the n<sup>+</sup> collector region is connected to a positive voltage V<sub>p</sub>. The logic levels therefore become 0 and V<sub>p</sub> volts, the latter being determined by the collector-to-emitter breakdown voltage—about 10 v—of the I<sup>2</sup>L transistor. But here the maximum output current in the gate's on state is pretty low—in the 1-microampere to 1-milliampere range, depending on both the current gain of the relatively low-capacitance I<sup>2</sup>L transistor and on the value of the injected current.

#### Other basic I<sup>2</sup>L circuits

For higher current outputs, the same layout can be used if the gate's resistor is connected to a negative supply voltage (Fig. 4b). Now the n<sup>+</sup> area acts as an emitter and makes the transistor behave as an emitter follower. In this case a much higher current gain in the transistor is available and yields a considerably increased maximum output current in both logic states (10 microamperes and 10 milliamperes). But the high current output is obtained at the expense of two low-voltage logic levels, 0 and -0.7 v—and such a small difference between the two levels may be difficult to handle in certain applications.

To remedy the difficulty, a pnp transistor can be added to the output of the basic circuits (Fig. 4c) in a way that hardly changes the layout. Now, two polarities of output voltage can be obtained. For positive polarities the circuit is analogous to the basic current amplifier of Fig. 4a, in that the difference in voltages between the two logic levels is several volts. But the problem of low output currents in the on state remains.

The answer is to use a negative supply voltage (Fig. 4d). Now the difference in voltage between the two logic levels is increased because the base of the npn transistor is driven by a current instead of a voltage and the low logic level is limited by the high (10-v) collector-to-emitter breakdown voltage of the npn transistor. True, the maximum output current in this case is somewhat lower than the configuration in Fig. 4b, because the common base current gain of a lateral pnp transistor is less than 1, but it is still a respectable 0.5 mA. In any case, essentially the same layout is used for all four configurations, so that even in a packed circuit a designer is still at liberty to choose the solution that is best suited to his application.

Sometimes really high logic voltage swings are needed, in high noise environments, for example. Then the circuit of Fig. 4e might be used, to take advantage of the very high (40-v) collector-to-emitter breakdown voltage of the lateral pnp transistor. Again, this is paid for by sacrificing output current in the on state (0.1 μA–0.1 mA) due to the low current gain of lateral pnp transistors. This type of circuit is also handy in a digital-to-analog converter, where it is used to weigh the individual components.

The design of the current amplifier in Fig. 5 evolves straightforwardly from the simple configuration of Fig. 4a. In this circuit, since the current output capability in

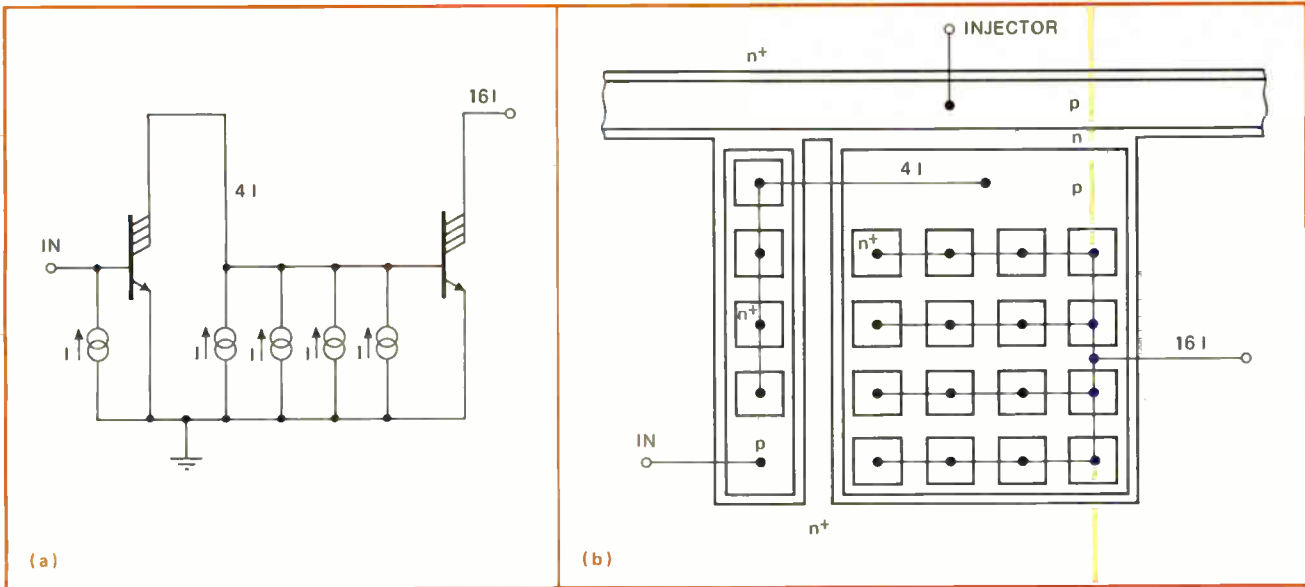

**5. Current amplifier.** This equivalent circuit (a) and the layout (b) of an I<sup>2</sup>L current amplifier show a minimum current sink capability of 16. This can be doubled by using two stages. The four current sources in parallel are realized by making the total injecting area in the second stage four times larger than in the first stage. Subsequent stages are developed similarly.

the gate's on state is linearly proportional over a large range to the n<sup>+</sup> collector area, current amplification can be obtained by cascading I<sup>2</sup>L gates and taking care to increase the collector area at each step.

The current gain in this I<sup>2</sup>L amplifier can be determined by noting that each collector is guaranteed to sink a current equal to its base current, so that the minimum current gain of the npn transistor  $h_{FE} = 1$ . To provide noise margin,  $h_{FE}$  typically should be 2. Thus in Fig. 5b, the minimum current sink capability is 16, and typically 32, obtained in two stages.

### A digital-to-analog converter

A digital-to-analog converter, shown schematically in Fig. 6a, can be built with I<sup>2</sup>L techniques by combining the basic current amplifier (transistors S<sub>1</sub> to S<sub>4</sub>) with the lateral pnp interface output configuration of Fig. 4e. Now, if the input of S<sub>1</sub> is high, then the current I delivered by the lateral pnp transistor P<sub>1</sub> is short-circuited by S<sub>1</sub>. In that case no current flows in the collector of the output transistor T<sub>1</sub>. On the other hand, if input A of S<sub>1</sub> is low, it draws no current but instead allows a collector-current  $\alpha I$  to flow in T<sub>1</sub>, where  $\alpha$  is the common base-current gain factor of T<sub>1</sub>.

This is the first amplification stage of the converter. Each successive stage contains twice as many elements as its predecessor, and any number of the stages can be cascaded to achieve the desired converter resolution—four stages for a 4-bit device, six stages for a 6-bit device, and so on.

The layout of a 4-bit d-a converter is shown in Fig. 6b, where an I<sup>2</sup>L transistor is used for S<sub>1</sub> and where the proper signal summing is achieved by doubling the number of transistors in each succeeding stage. On silicon this means putting two transistors of the P<sub>1</sub> type in parallel for a sum of P<sub>2</sub>, putting two T<sub>1</sub>s in parallel for a sum of T<sub>2</sub>, and so on. As a result, transistor S<sub>2</sub> of Fig. 6a must now be able to sink 2I, a requirement that can be

realized by simply doubling its collector area.

In the same way 4I and 8I current values can be realized in succeeding stages, and, depending on the logic levels of the four input terminals A, B, C, and D, a current from 0 to 15  $\alpha I$  is available at the output terminal. High-resolution accuracy can be obtained because the circuit is built up from a number of identical transistors—to realize the second, third and fourth stage, the right number of transistors is simply put in parallel.

### TTL compatibility

For the many applications where I<sup>2</sup>L circuits must be combined with TTL circuits on the same chip, compatibility between the logic elements must be assured. That is to say, the switching threshold point and current levels of the two logic families must be made compatible.

Generally a TTL load current is 1.9 mA per fanout for a low logic condition and 20  $\mu A$  or less for its high condition. Since an I<sup>2</sup>L gate, on the other hand, works at a current level between 1 and 20  $\mu A$  per gate, two types of interface circuits are necessary—one at the gate inputs as an interface from TTL to I<sup>2</sup>L, and one at the gate output as an interface from I<sup>2</sup>L to TTL.

The electrical diagram of the input condition is shown in Fig. 7a. For the situation where the TTL gate is at its low logic level, the realization of the proper interface condition follows automatically because a normal TTL input current will flow if appropriate resistor values are chosen. For the high logic TTL condition, however, care must be taken that the inverse current gain of I<sup>2</sup>L transistor T<sub>1</sub> does not affect the input current of the TTL transistor.

In normal TTL fabrication, this is achieved with a gold diffusion in the transistor base to diminish the loading effect of a high inverse current gain. But on a chip containing I<sup>2</sup>L gates, the I<sup>2</sup>L inverse current gain has to be high for proper gate operation. The way round this dilemma is to short-circuit the collector-base junc-

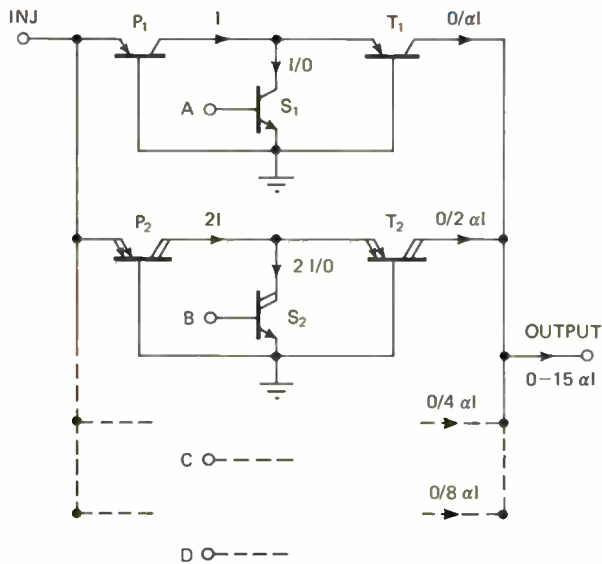

(a)

**6. Digital-to-analog conversion.** Schematic of the first and second stage of a 4-bit d-a converter shows that by putting the right number of  $P_1$ ,  $T_1$  and  $S_1$  structures in parallel any number of bits can be realized. In the schematic layout of a 4-bit d-a converter (b), the transistors  $P_2$ ,  $P_3$  and  $P_4$  are built up by putting several  $P_1$  structures in parallel. The same is done for  $T_2$ ,  $T_3$  and  $T_4$ .

tion of transistor  $T_1$  in the interface circuit and add an extra diode  $T_2$  to make the input threshold voltage again equal to the required TTL threshold level.

The corrected transistors  $T_1$ ,  $T_2$ , and  $T_3$  are redrawn in Fig. 7b. Since  $T_1$  and  $T_2$  have a common base and collector, they are drawn as a multi-emitter structure with the base-collector junction short-circuited. One emitter serves as the input of the interface circuit, the other connects to the base of  $T_3$ . And because  $T_3$  has a common collector with  $T_1$  and  $T_2$ , all three can be located on one isolated island, as shown in Fig. 7c.

As for transistor  $T_4$ , its emitter is connected to ground giving the designer the freedom of building it as a conventional isolated transistor or as an inverted  $I^2L$  transistor without current source. The choice depends on the number of fanouts desired. For use as a clock or a reset line, say, the normal high-gain version is preferable. For a few fanouts the  $I^2L$  transistor type can be used.

Figure 8 shows the circuit for interfacing  $I^2L$  to TTL. Here the problem of linking the low  $I^2L$  current level of 1 to 10  $\mu A$  per gate to the much larger TTL current of 1.9 mA is solved in two steps. The first step is the current amplifier, as realized in Fig. 5b and here serving as a first input buffer. The second step is an output stage of isolated transistors that exploit the high  $I^2L$  forward-current amplification factor to boost the current into the TTL input range. The layout of this current amplifier depends on the current level of  $I^2L$  and on the number of TTL fanouts required.

Today's technology requires the circuit designer to use two chips to build a low-level digital logic array and

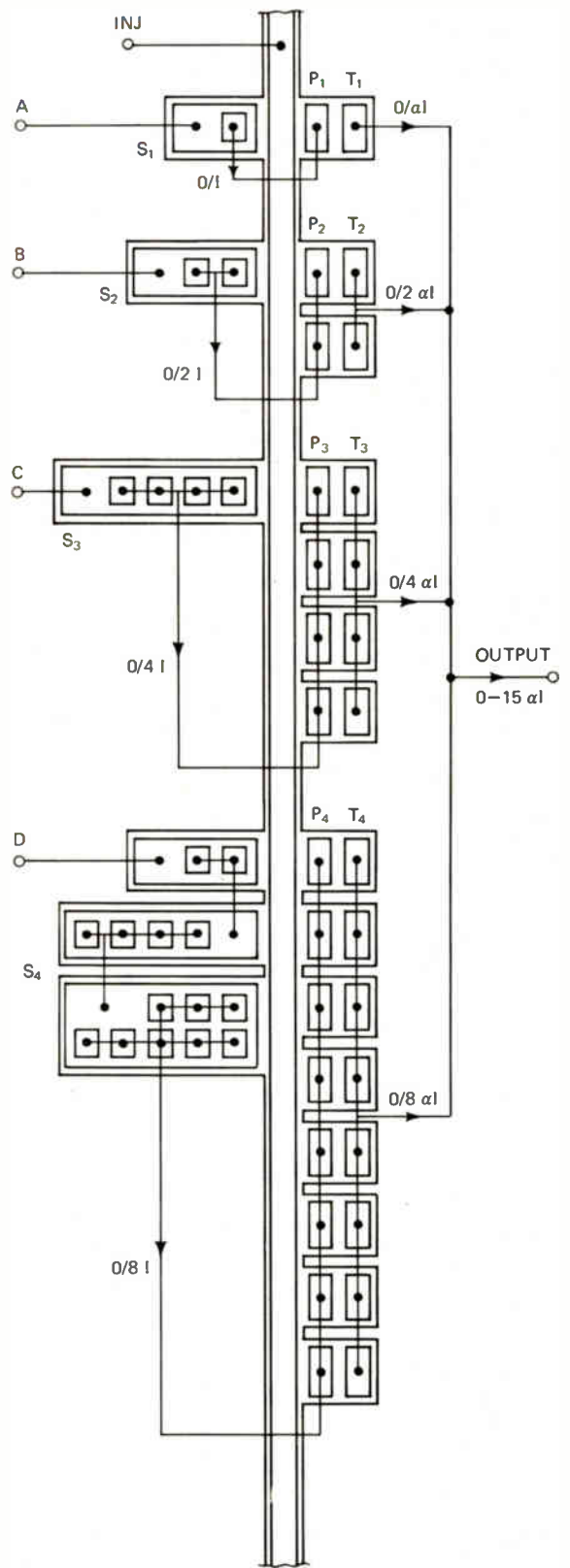

(b)

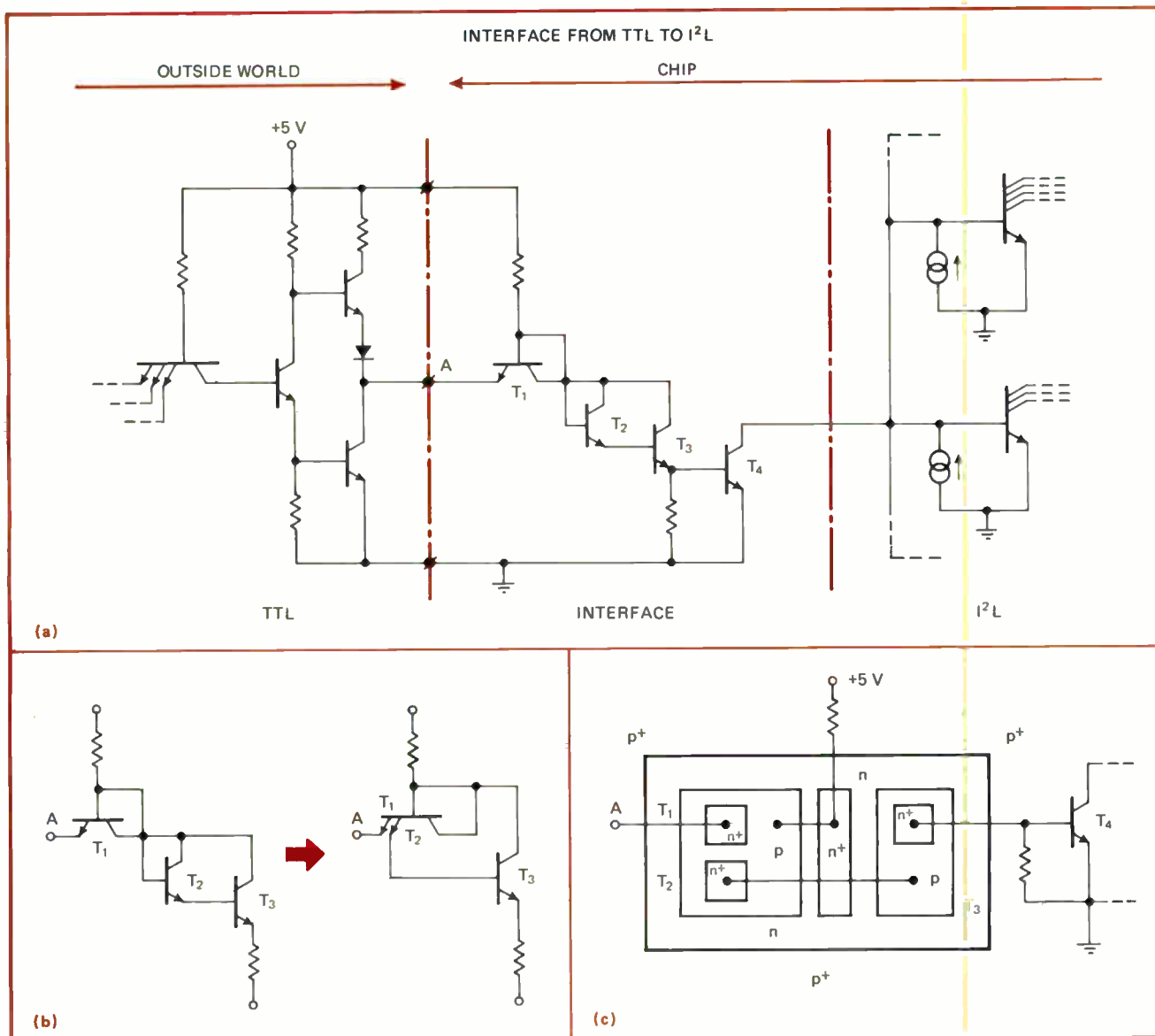

**7. Interfacing.** The basic interface circuit (a) from TTL to I<sup>2</sup>L has three buffer transistors T<sub>1</sub>, T<sub>2</sub>, and T<sub>3</sub>. To go from I<sup>2</sup>L to TTL in (b), T<sub>1</sub> and T<sub>2</sub> form a current amplifier. On silicon, T<sub>1</sub> and T<sub>2</sub> can be realized with a multi-emitter structure (e).

the necessary power output circuits. The I<sup>2</sup>L approach lets him do both on the same chip. An example is an 8-bit shift register with latches and power output circuits (Fig. 9), built as a driver stage for alphanumeric display systems. The I<sup>2</sup>L section of the chip is on the left near the chip's center. It is laid out so that the gates are on either side of an injector rail that's covered with aluminum to maintain a uniform current distribution.

The inputs to the I<sup>2</sup>L circuits, located at the top of the chip, are made TTL-compatible with the interface circuit of Fig. 7c. At the right and bottom part of the chip are the eight power-output circuits of an open collector type, supplying an output current of typically 100 mA—an example of how low-power I<sup>2</sup>L gates (10 μA) can be combined with high-drive power output circuits (100 mA) on one chip. Some typical data on the 8-bit power shift register is summarized in Table 2.

The details of the I<sup>2</sup>L region are discernible on the shift-register chip, where the gates on both sides of the

injector rail and current amplifier are clearly evident. The required power up-conversion is done by interconnecting several collector regions. It takes two stages, the first stage forming a part of the I<sup>2</sup>L gate of the subsequent stage to save space.

### A motor speed control chip

Another circuit combining I<sup>2</sup>L and analog circuits on one chip is the motor speed control chip of Fig. 10 where revolutions of the motor are sensed by a photodiode that delivers input pulse data to the chip. There, a 9-bit counter counts these pulses. The four most significant bits of the counter output control first-order motor power. The five least significant bits are stored in latches which drive a 5-bit d-a converter. The output of this converter is amplified, and the amplified signal in turn controls the fine range of power supplied to the motor.

Again, the I<sup>2</sup>L gates are located in the center of the chip, on both sides of two injector bars laid out from top

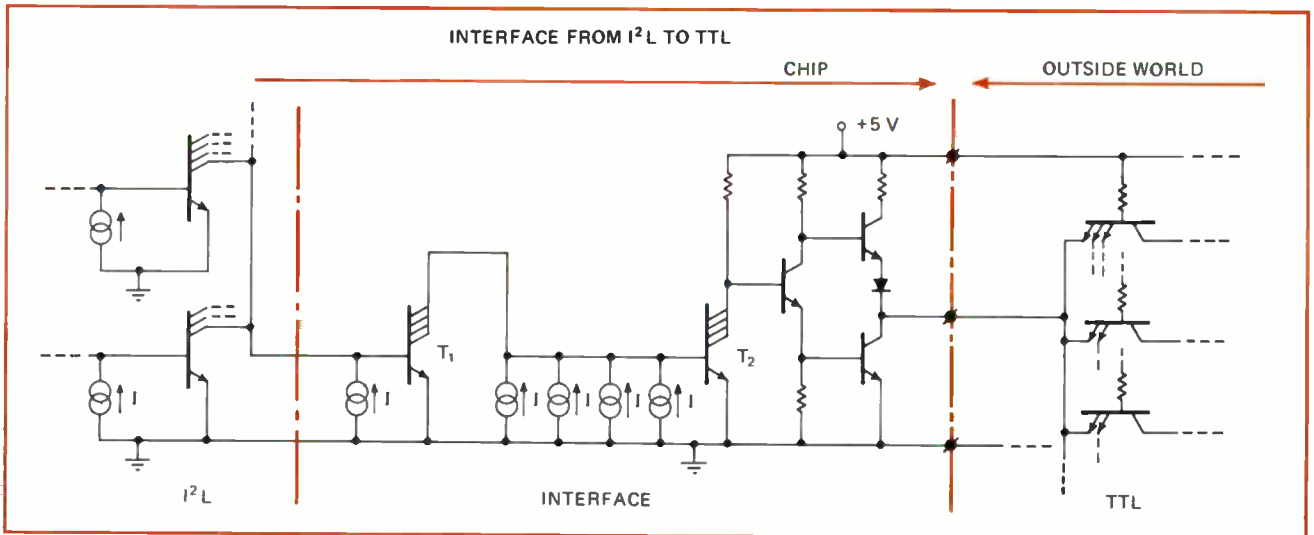

8. **Sharing.** Schematic layout of the basic interface circuit shows that because transistors  $T_1$ ,  $T_2$  and  $T_3$  have common collectors, all elements can be designed in one island. This layout can be used at the inputs of TTL-compatible  $I^2L$  chips.

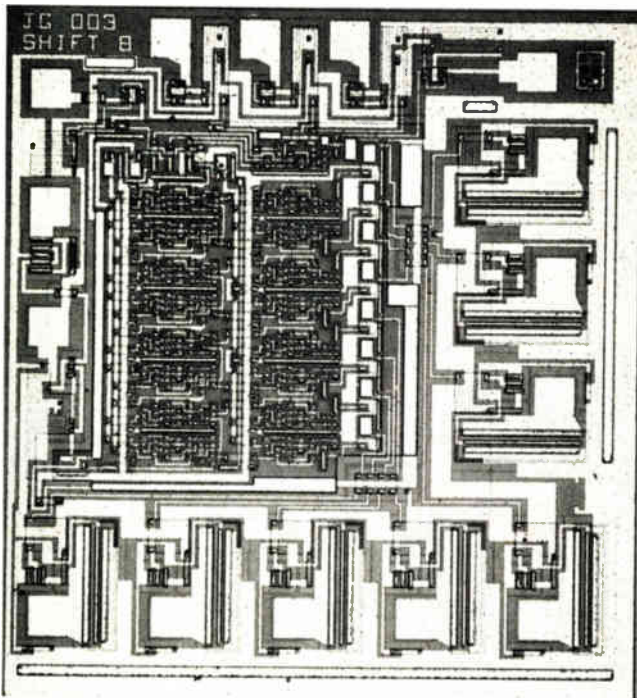

9. **Implementation.** Microphotograph of 8-bit power shift-register chip (a) shows the  $I^2L$  gates at the center and the power output stages at the bottom and right, between the bonding pads.

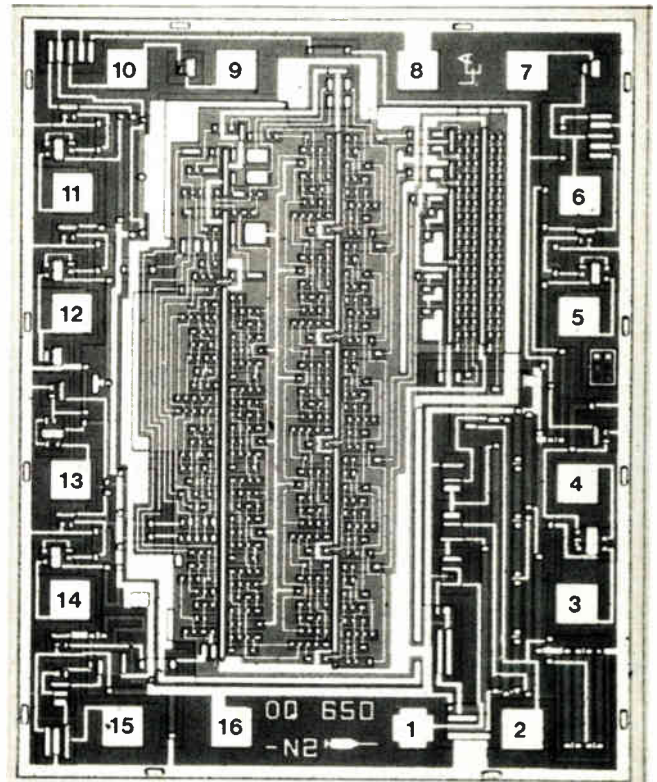

10. **At the controls.** Microphotograph of motor speed control circuit has  $I^2L$  elements in the center as well as TTL input interface circuits between the bonding pads on the left.

to bottom. The inputs (bonding pads 5, 11, 12, 13 and 14, for instance) have been made TTL-compatible, again with the interface circuit of Fig. 7c.

In this respect, it's interesting to note that the interface circuits can also be used to realize logic functions. If the input transistor  $T_1$  in the basic interface circuit (Fig. 7a) has a multi-emitter-structure, then the normal AND function of the input signals is obtained.

This principle has been applied in the motor control chip on inputs 3 and 4. One output is a TTL totem-pole (bonding pad 15), while the motor outputs, forward and reverse (bonding pads 10 and 6 respectively), are open-collector-type structures with a current sink capability

greater than 20 mA and a saturation voltage less than 300 mV. The data is tabulated in Table 3.

Note that the 5-bit d-a converter has  $1 + 2 + 4 + 8 + 16$  equal current sources. In addition, 16 other equal current sources work with an on-chip operational amplifier to control the injector current. The voltage drop over the injector bars could result in nonuniform current distributions, and care has been taken to minimize it so that the output of the d-a converter shows no discontinuities. □

# Logic scopes speed diagnosis of faults in digital circuits

Glitches, ringing, and other errors occur more often as digital systems grow in complexity; the job of analysing them is simplified by digital scopes that include the data preceding a trigger event on their multi-channel displays

by Martin Marshall, *E-H Research Laboratories Inc., Oakland, Calif.*

□ The analysis of today's complex digital systems often requires a succession of signals to be viewed simultaneously and on several channels—an impossibility with analog instrumentation. Even if enough electron guns could be packed into a cathode-ray-tube envelope, the conventional oscilloscope still would not permit an engineer to view the events that precede a trigger. Yet he needs to be able to identify glitches, ringing, undershoot, and perhaps even the occurrence of incorrect bits prior to some system error.

Special digital measurement techniques do, however, give him just this ability to look backward in time at signals on eight or 12 channels simultaneously. These techniques are the basis of the instruments known generically as logic analyzers or logic scopes. Their most significant difference from conventional oscilloscopes is that they divorce signal acquisition completely from signal display.

Each signal measured by a logic scope is sensed with a probe, converted into a rectangular pulse or pulses by an analog-to-binary converter, and strobed into an acquisition register.

Assume the acquisition register can store 100 bits and

a trigger event is set at bit 73. The register cycles through until the trigger logic flags at bit 73. It stores bits 00 through 73 and continues to fill up the register with bits 74–99 with the post-trigger data. It then transfers the entire 100 bits to a display register. Once those bits are in the display registers, the signal information may be displayed on a television-type video monitor along with a CRT readout of whatever programing has been executed by the instrument.

It is the independence of the acquisition and display functions that frees the instrument from the constraints inherent in the traditional real-time, voltage-versus-time analog presentation. Writing rates, deflection factors, and triggering stability don't limit measurement capability. Instead of displaying voltage versus time on the CRT, a logic scope presents the viewer with logic states versus time. A fast and sophisticated logic scope can also preserve rise-time information and detect glitches, ringing, and out-of-tolerance levels as well.

Figure 1 illustrates the range of information obtainable from a logic scope's display. Both data of interest and the scope's program and timing settings are shown. The trigger delay bar at the bottom is set to cell 73, al-

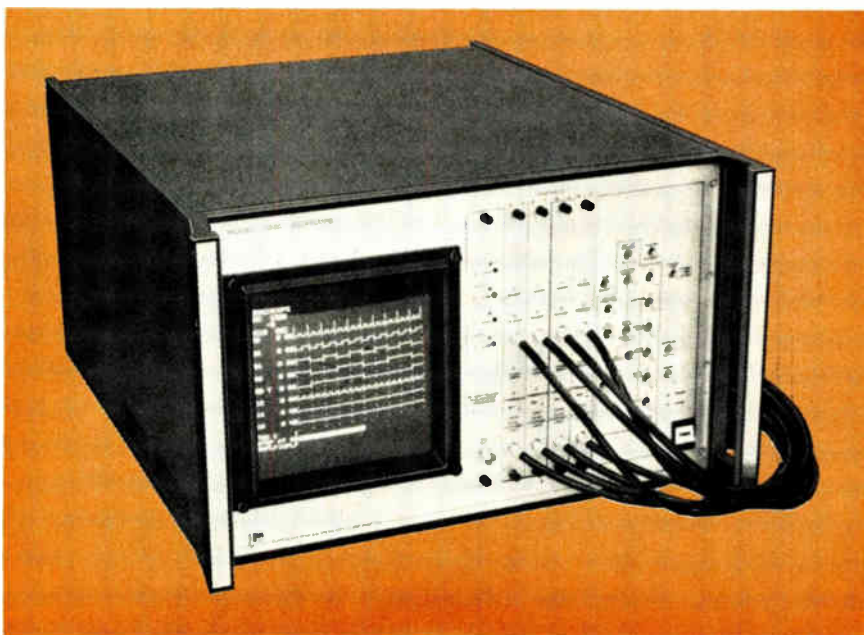

**Instant history.** A logic scope presents the viewer with a record of several sequences of events that have just occurred concurrently on several binary channels. Bar at the bottom of the display marks the trigger point. Thus data both before and after a chosen trigger point can be scrutinized.

1. All at once. Data on as many as eight channels is displayed simultaneously on the screen of an AMC 1320 logic scope shown here. Time base is  $2 \times 10^{-7}$  seconds or 200 nanoseconds per division. High-repetition-rate pulses on channel 06 denote rise and fall times. A similar pulse train on channel 12 denotes a low logic 1.

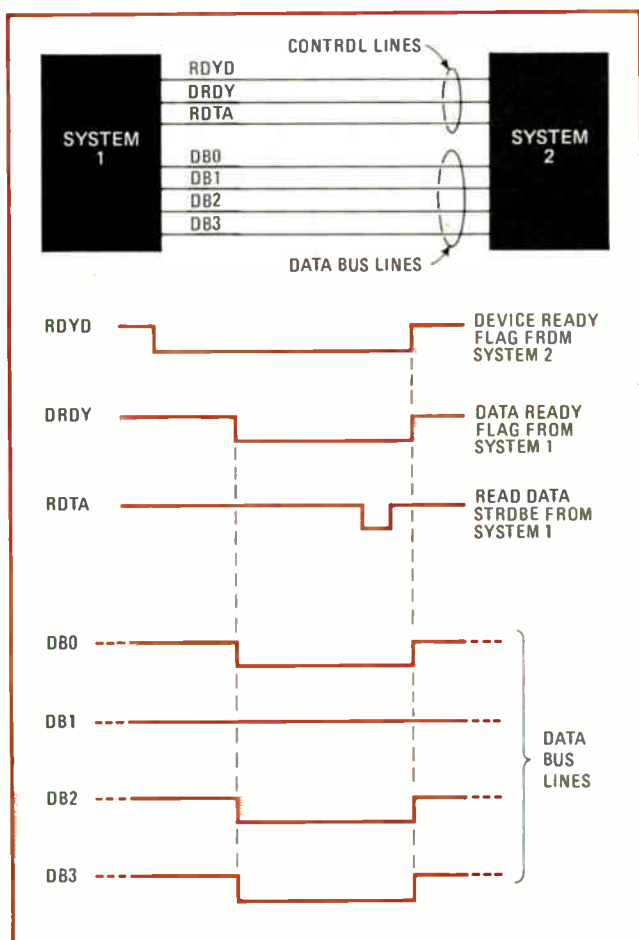
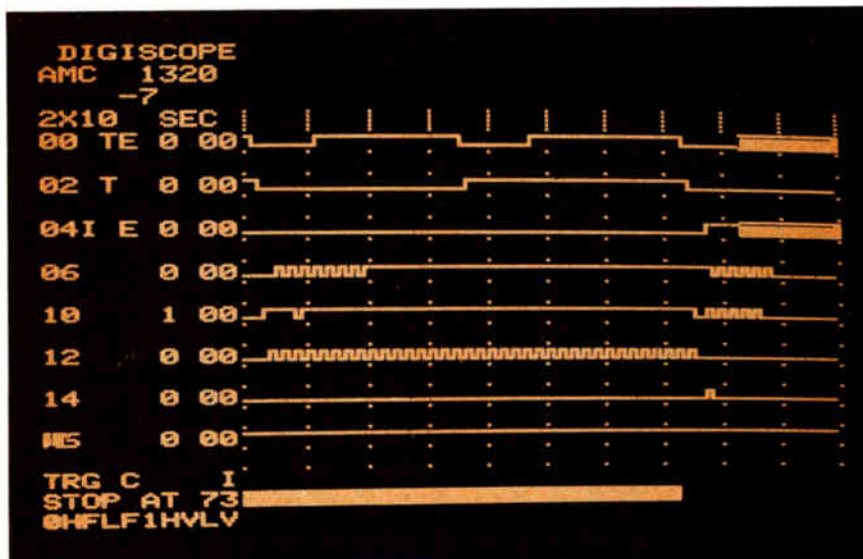

2. Handshaking. A logic scope is ideal for examining the interchange of data between two systems that's carried out by interconnecting their control and data lines. System 2 tells system 1 it is ready to receive data (DEVICE READY flag). When system 1 has set data on the data bus, it tells system 2, it is ready to send data (DATA READY flag). Then system 1 strobbs the data on the data line into system 2. Both flags must be on for data to transfer. If the READ DATA signal skews and shifts out of the DATA and DEVICE READY window, then data will not be transferred properly. Logic scopes are a natural instrument for examining the entire process.

lowing the observer to view 73 data bits before the trigger point and 27 after. The time scale is  $2 \times 10^{-7}$  second (200 nanoseconds) per division.

Channels 00 and 02 present the outputs of a clock and a counter, while 04 displays a computer flag. The alternating highs and lows on channel 06 represent a single pulse and indicate that it has a rise time of 280 ns and a fall time of 200 ns. Channel 10 shows a signal that rings for 120 ns on the leading edge. Channel 12 reveals a low logic 1 voltage level sufficient to exceed the low-voltage ( $V_L$ ) level of the comparator but not the high-voltage ( $V_H$ ) level. On channel 14, a glitch is captured and displayed in its true time relation to the other signals. Channel 16 shows a constant dc level.

As Fig. 1 amply demonstrates, the ability to advance the trigger to an earlier moment in time, also called negative trigger delay, is the logic scope's most important contribution to testing, since it allows an engineer to look "upstream" at a signal channel before some critical event. He can trigger on any combination of logic states he chooses, such as a coincidence of 1s on three signals and 0s on five other signals. The display then presents him with a timing diagram, showing the logic states both before and after the selected event. For the first time, an engineer can then compare his timing diagram on paper with its actualization on screen and determine if his system is performing as expected.

### Using a logic analyzer

A natural application for the logic scope is in analyzing events at an asynchronous digital interface. The so-called "handshaking" process by which systems exchange information usually demands a carefully timed interaction of signals from both systems. As shown in Fig. 2, a DEVICE READY flag (RDYD) from system 2 must be received by system 1. When system 1 has set the data on the data bus, it sends a DATA READY flag (DRDY) to system 2, causing the data on buses DB<sub>0</sub>, DB<sub>1</sub>, etc., to register in system 2. On a parallel line, a READ DATA (RDTA) strobe pulse is also sent from system 1 to 2.

In order for the data to be registered in system 2, both DRDY and RDYD must be high when the READ DATA



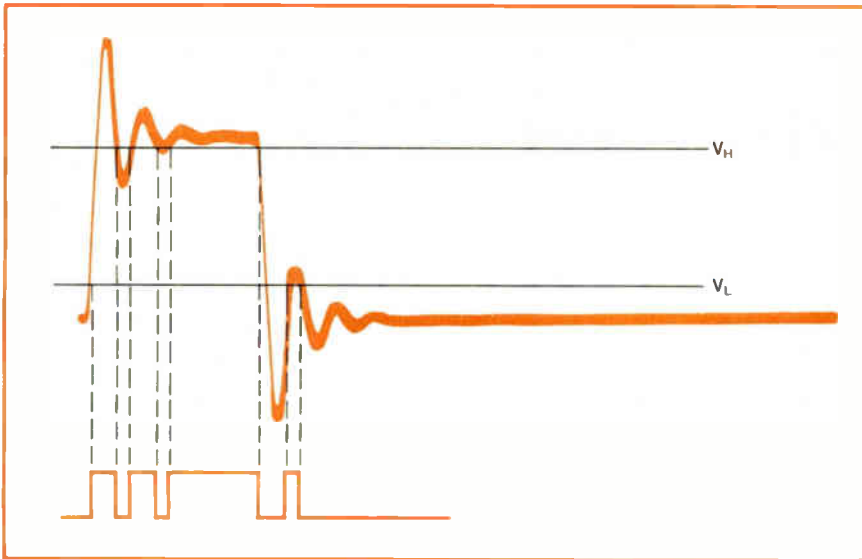

**3. Ringing.** Ringing, as it would appear on an oscilloscope, is shown left. This appears on a logic scope as an irregular series of alternating 1s and 0s as shown here. The periods of alternating 1s and 0s correspond to signal values between  $V_L$  and  $V_H$ . These are adjustable threshold values set by the user.

strobe reaches system 2. If either signal is skewed with respect to the data strobe RDTA, the data may not register properly.

An engineer without a logic scope will know he has a malfunction, but he may be at a loss to explain exactly where or how. He cannot "see" what happened before the malfunction. But with a logic scope he can, by as much as 100 bit occurrences before the malfunction. And, since all the data which appears on his logic scope display was captured at the same instant, he knows that any skew he sees is real, not a measuring error.

### Ringling

A logic scope can reveal still other malfunctions. If it has a dual-threshold analog-to-binary converter, it can also tell him if the levels are within tolerance. Suppose, for example, that the DB<sub>1</sub> data shown in Fig. 1 exhibits ringing—oscillations that exceed the specified 0 and 1 levels. This malfunction can cause ambiguity in registering data in system 2 and could show up as an intermittent fault.

When it happens, it shows up on a logic analyzer as an irregular series of 1 and 0 levels. The 1s and 0s alternate as shown in Fig. 3 because the dual-threshold converter on the scope compares the signal against the threshold of the most recently registered state. If the signal has risen above  $V_L$  and registered as a 1, it is compared against  $V_H$  on the next analyzer measurement. If it is below  $V_H$  on that measurement, the logic analyzer registers it as a 0 and compares it to  $V_L$  next time. Thus, if a signal does not stabilize at the proper 0 or 1 level, but settles between the threshold levels, then the logic scope will produce an alternating 0-1 pulse string, characteristic of the effect.

### Rise and fall times

A logic scope with a dual-threshold converter also provides a convenient method of calculating rise and fall times. During a rise or fall time the signal is between threshold levels and is displayed as an alternating series of 1s and 0s, as shown in Fig. 4. Thus rise and fall time may be calculated with the aid of the calibrated

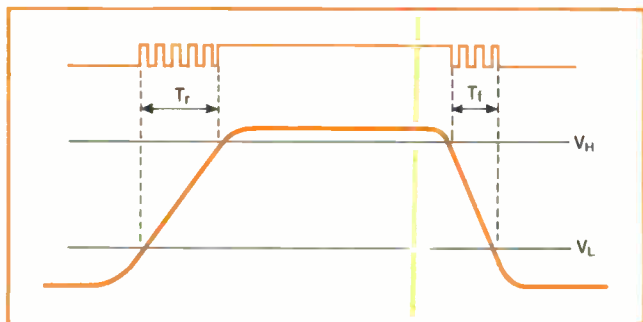

**4. Delay.** Logic scope informs observer of a rise ( $T_R$ ) or fall ( $T_F$ ) time by generating a pulse train whenever the magnitude on the line is between the preset threshold levels,  $V_H$  and  $V_L$ .

time scale on the display.

Low 1s and high 0s reside in the neither state between the  $V_H$  and  $V_L$  thresholds. Thus they also appear as strings of alternating 1s and 0s. For example, a low 1 (positive true) would appear as in Fig. 5. The display of these malfunctions differs from ringing in that the alternating pulse train continues so long as the monitored level remains in the neither state.

### Glitches

Spurious pulses, often termed glitches, are perhaps the most elusive malfunction of all. But they are easily captured by the logic scope. The glitch is recorded automatically on some logic scopes and appears as a single bit on the screen (Fig. 6). Here it is shown in cell 39. Since most glitches do not last the full duration of a bit, the logic scope captures the glitch and stretches it to one bit time. Consequently, the way to distinguish a glitch from a bona-fide signal one bit wide is to switch the scope's time base to a faster time scale. The glitch remains a single bit wide, but the "real" signal increases in width. A logic scope can detect and display a glitch as narrow as 10 ns.

Speed is one important difference between logic scopes. Performance of a system using transistor-transistor-logic circuitry cannot be captured on a 10-megahertz logic scope, but a 50-MHz logic scope can resolve

## Logic scope rescues time-sharing system

The features of combinatorial-logic triggering and negative trigger delay provided by a logic scope enable a direct assault on some subtle problems found in digital systems. In the following case history both of these features were necessary for the happy ending.

Two processors in a large West Coast time-sharing system shared a single mass storage unit on a job-to-job basis. Two or three times a week the system would "clog" as queues of data waiting to be transferred to the mass store completely filled the working storage of the system. This problem had persisted for months. The status of the mass-storage controller provided the only clue to the malfunction. Each processor was being sent a signal, "OTHER PROCESSOR HAS CONTROL." Con-

sequently, each processor would stand idle, ignoring all other signals in the interface and initiating no jobs.

The first measurement made with a logic scope employed the two signals, "A HAS CONTROL" and "B HAS CONTROL," to trigger the instrument. Whenever both signals went high it meant that the controller had entered an illegal state. The measurement was performed in single-shot mode because the trigger event was rare. The events before the trigger were of interest so the negative trigger delay was set near its maximum ("STOP AT 90") as shown in (a).

The SET lines for both the "A HAS CONTROL" and "B HAS CONTROL" flip-flops that provided the signals were monitored on other logic-scope channels along with their common CLEAR line and three additional signals that could have been related to the failure. The measurement showed that the failure was caused by SET pulses that were generated for both flip-flops simultaneously as shown in both (a) and (b). Since these pulses follow other signals in the sequence, the second measurement, using the same two control signals for the trigger event, concentrated on the steering logic which functions prior to generation of the SET pulses as shown in (b).

The steering logic was governed by these Boolean expressions:

GIVE A CONTROL =  $\overline{\text{BUSY}} (\overline{\text{RQB}} + \text{A PRIORITY}) \text{RQA}$

GIVE B CONTROL =  $\overline{\text{BUSY}} (\overline{\text{RQA}} + \text{A PRIORITY}) \text{RQB}$

i.e. processor A gets control whenever it requests the mass-store channel, assuming the channel is not busy and that either processor B is not also requesting control of the channel or processor A has priority.

The term A PRIORITY was derived from a flip-flop which toggled at the completion of every job. The second measurement showed that this A PRIORITY flip-flop was changing state at the precise instant that the two simultaneous SET pulses were being generated. Since this was definitely not the proper time for the A PRIORITY flip-flop to change state, a third measurement focused on its function, while still using the coincidence of "A HAS CONTROL" and "B HAS CONTROL" as the trigger.

The clear, the preset, the data, and the clock inputs for "A HAS PRIORITY" were monitored, as well as  $V_{cc}$  and ground in the proximity of the "A HAS PRIORITY" flip-flop. One of the dual-threshold pairs on the logic scope was set to  $V_H = 4.5 \text{ V}$  and  $V_L = 0.3 \text{ V}$ .

The third measurement showed glitches on  $V_{cc}$ , ground, set, and clear (c). These glitches appeared because they represented a signal which rose above the  $V_L$  threshold level or below the  $V_H$  level. It was reasonable to suppose that these glitches occurred more often than the system failed. The reason is that a system failure would happen only when false toggling of the A PRIORITY flip-flop coincided with the few nanoseconds required at the start of each job to select the controlling processor, and even then no failure would result unless both processors were requesting control. The glitches themselves were used to trigger subsequent measurements.

These measurements determined that the amplitude of the glitches depended upon the difference in the number of 1s transmitted in successive words. The cause of glitches was traced to excessive current drawn by certain line-driver cards. A simple modification to the line-driver cards eliminated the problem.

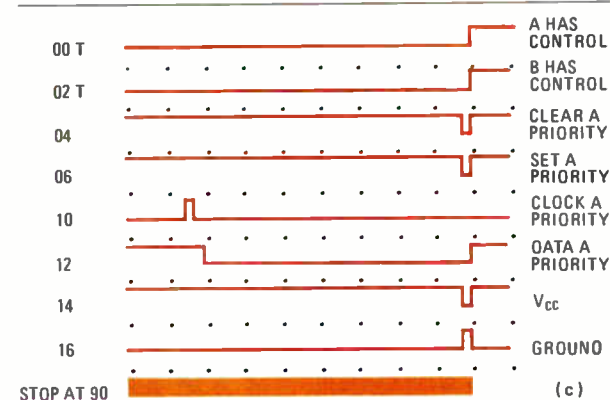
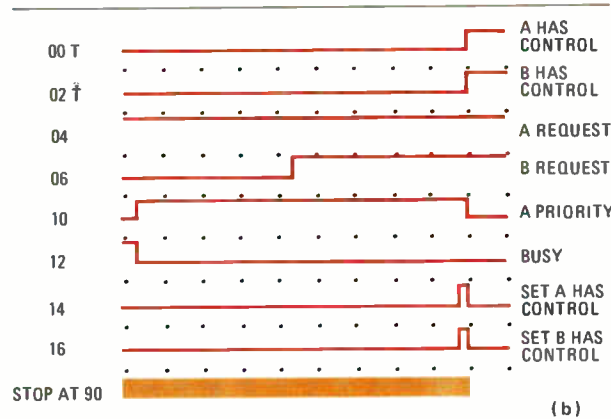
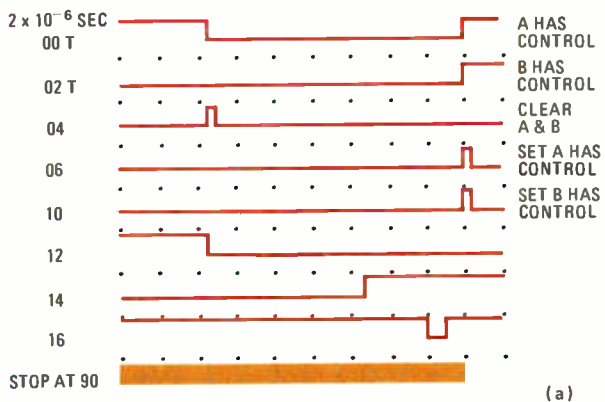

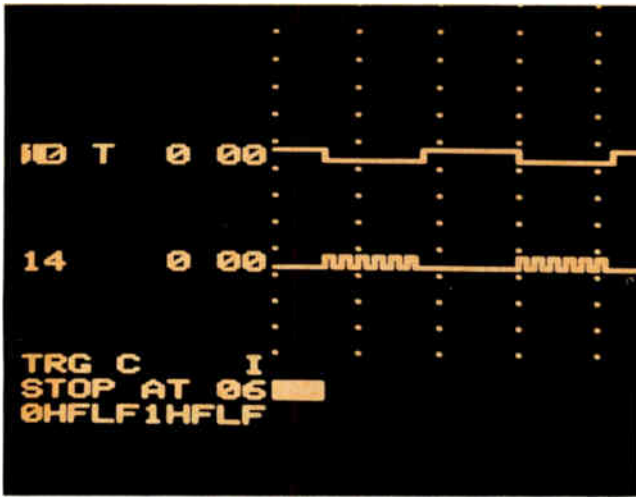

**5. Trouble.** Logic scope informs viewer that the logic 1 voltage on trace 14 is below required level. Instead of remaining high during the gated periods of trace 10, the signal alternates 1s and 0s.

all signals in TTL systems and most signals in Schottky TTL systems.

### Helping the design effort

Having a logic scope around could save the design engineer significant amounts of time. Far too often he spends months testing and debugging a new circuit. He may break up his system into several subsystems for each of which he then designs a one-of-a-kind test setup. This is costly, because each is usually an independent design effort in itself. Also, since it is specialized to a particular circuit, it will in all probability be useless in the next test application that comes along.

If debugging normally accounts for over 50% of total system development time, a logic scope can cut that down by two fifths, to about 30% of total development time. In addition, the scope would save the time required for building special test sets and would probably also be more reliable. In fact, it could revitalize some circuit designs that have been scrapped as untestable.

Obviously, the instrument can also aid quality control. One logic-scope maker, E-H Research Laboratories Inc., examined the impact of its AMC-1320 on its own QC department and concluded it could save 30% to 50% of system debugging time.

A logic scope is particularly valuable for tracking sequential logic. To obtain a plot of logic states versus time using analog equipment, a common trigger is used and the signals are looked at one by one, being picked up each time by running through the device's sequence. This method is time-consuming and lacks the simultaneity of multiple logic channels. With a logic scope, the relevant logic states can be captured simultaneously.

The single-shot capability of the logic scope is handy in debugging a system that starts, then dies quickly. Under these conditions, the repetitive methods of analog and sampling scopes fail. But with a logic scope set to single-shot mode, the events preceding the breakdown are captured and displayed. The single-shot mode is also helpful in pursuing a malfunction that occurs sporadically. It offers a total display of the bit patterns



**6. Capture.** Glitch on trace 14 occurs at the trigger point denoted by end of trigger delay bar at screen bottom. This, teamed with transitions on other channels, could cause a system malfunction.

when the malfunction happens once, rather than a multitude of partial readouts after it has happened many times.

The sophistication of today's logic scopes is reflected in their programming. This allows the engineer to trigger on any logical combination of inputs he chooses and on either the leading or trailing edge of a pulse. It offers up to 30 time ranges, from 100 ns/div to 500 s/div. If glitch capturing is not wanted, a noncaptive strobing mode can be selected which enhances the noise rejection capability of the logic scope. A trace may be readily inverted. Also, the display pattern may be frozen by setting up an inhibit switch. Alternatively, the pattern can be made to creep slowly across the screen in a "watch" mode. Some logic scopes offer multiple-threshold set selection, so that MOS threshold limits can be set on one channel and bipolar limits on another.

### Internal and external clocks

Finally, there's the choice between using an external or internal clock. An external clock allows data compression, and, if it's necessary to read out a ROM for control sequencer, it helps to have a synchronized external clock. However, externally clocked instruments miss everything between the clock pulses, including rise-time and glitch information.

Makers of externally clocked logic scopes have responded to the latter problem by including a special "spike" mode that searches for glitches. Nonetheless, asynchronous anomalies such as memory-access lines which are pulled down between clock pulses are still missed.

With an internal clock, the ability to synchronize with an external clock is lost, but all the asynchronous anomalies and timing information are retained.

But whichever instrument an engineer chooses, the logic scope's ability to display several parallel series of events preceding a trigger will enable him to track a malfunction from an incorrect output back to the culpable switch, the bad IC—or perhaps even to the timing diagram itself. □

# NEW DIB\*

## DUAL IN-LINE BRIDGE

# An integrated bridge rectifier in a dual in-line package

ACTUAL SIZE PACKAGE

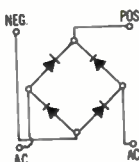
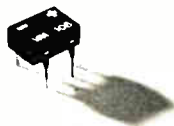

Another **FIRST** from Varo Semiconductor, Inc. An integrated bridge rectifier in a miniature, 4-pin, low-profile DIP.

The DIB, dual in-line bridge, is compatible with automated testing, handling and inserting equipment for production economy, handling ease and greatly reduced assembly errors. They are 100% surge tested at 25 AMPS and meet moisture resistance requirements of MIL-STD 2021, method 106C. Higher component density, reduced labor and materials costs are among other advantages offered by the DIB.

For simplified board layout the four leads are on 0.10" (2,54mm) grid spacing. The bridge can be used with standard DIP sockets.

\* TM-Varo Semiconductor, Inc.

Typical applications include electronic calculators, small permanent magnet motors (such as used in shavers and hair dryers), solid state relays and similar applications where full-wave rectification and small size is required.

Two DIB series are available: ½ Amp  $I_o$  at 55°C, ( $T_A$ ) with 25V, 50V, 100V and 200V ( $V_{RRM}$ ), and a 1 AMP  $I_o$  at 40°C, ( $T_A$ ) with 50V, 100V, 200V, 400V, 600V, 800V and 1000V ( $V_{RRM}$ ).

You may never build another discrete diode bridge.

Call Charlie Merz (214) 272-4551 for prices and complete information.



Design us in . . . we'll stay there

## VARO SEMICONDUCTOR, INC.

P.O. BOX 676, 1000 N. SHILOH, GARLAND, TEX. 75040 (214) 272-4551 TWX 910-860-5178

### Varo Sales Representatives

AL Buchanan & Abrams Assoc. 305-898-7444 • AZ W. W. Posey Co. 602-949-5873 • AR Whiteside Sales 214-231-9771 • CA (NO) W. W. Posey Co. 415-948-7771 • CA (SO) Corcoran Assoc. 213-823-4589 • CO Sage Sales 810-531-0531 • CT Comp Rep Assoc., Inc. 203-239-9762 • DE Tom Davis Marketers 302-998-0123 • FL Buchanan & Abrams Assoc. 305-898-7444 • GA Buchanan & Abrams Assoc. 305-898-7444 • IA Coombs Assoc. 312-298-4830 • IL (NO) Varo Semiconductor, Inc. 312-627-3802 • IL (SO) Beneke & McCaul 314-567-3399 • IN Technical Reps., Inc. 317-849-6454 • KS Beneke & McCaul 816-765-2998 • KY Technical Reps., Inc. 317-849-6454 • LA Whiteside Sales Co. 214-231-9771 • ME Comp Rep Assoc., Inc. 617-444-2484 • MD Tom Davis Marketers 703-591-7390 • MA Comp Rep Assoc., Inc. 617-444-2484 • MI Davis-Martensen Co. 313-474-8300 • MN Loren F. Green Assoc. 612-781-1611 • MS Buchanan & Abrams 305-898-7444 • MO Beneke & McCaul, Inc. 314-567-3399 • NB Beneke & McCaul 816-765-2998 • NJ (NO) Cooper-Simon & Co. 516-487-1142 • NJ (SO) Tom Davis Marketers 302-998-0123 • NM W. W. Posey Co. 602-949-5873 • NY (METRO) Cooper-Simon & Co. 516-487-1142 • NY (UPST) Bob Dean, Inc. 607-272-2187 • NC Buchanan & Abrams Assoc. 704-332-4974 • OH (NO) J. C. Hofstetter Co. 216-241-4880 & 216-725-4477 • OH (SO) J. C. Hofstetter Co. 513-296-1010 • OK Whiteside Sales Co. 214-231-9771 • OR C. K. Shanks & Assoc. 503-292-5656 • PA (E) Tom Davis Marketers 302-998-0123 • PA (W) J. C. Hofstetter Co. 412-561-5454 • RI Comp Rep Assoc., Inc. 617-444-2484 • SC Buchanan & Abrams Assoc. 704-332-4974 • TX Whiteside Sales Co. 214-231-9771 • UT Sage Sales 801-531-0531 • VA Tom Davis Marketers 703-591-7390 • WA C. K. Shanks & Assoc. 206-632-4290 • WI Varo Semiconductor, Inc. 414-782-7590 • CANADA • ONT Cantronics, Ltd. 416-661-2494 • QUE Cantronics, Inc. 514-341-5207

# Engineer's notebook

## Simple cable tester spots faults, identifies repairs

by Edward L. Raub, Jr.  
Precision Tool Company of New London Inc., New London, Conn.

Automatic testing of small cable harnesses is all very well in production, but engineers are often confronted with smaller quantities of cables in differing configurations that still add up to a substantial total. In this situation, even as basic a tester as the one proposed in *Electronics*, August 22, p. 110, would be too specialized. But a vastly simpler scheme can be surprisingly effective.

This simple tester checks circuits as fast as an operator can push buttons, taking less than one second per circuit to verify faults and locate all pins involved in short and open circuits, transpositions, and misroutings. For example, a tester containing two 20-button jukebox switches easily checks a 40-conductor harness, including any jumpers, in 40 seconds. The unit does not require preprogramming, and the principal component is a multi-button push switch with two poles per button, at least one of which is double-throw.

When the cable is initially connected to the tester, normally closed contacts of the push-buttons make all conductors electrically common at one end. As each button is pushed, one at a time, it separates a single conductor from the bundle, checks its continuity via the green lamp, and tests it for short circuits with other wires in the cable through the red lamp. The indicator lamps describe the condition of the cable as shown in the table.

If a fault is disclosed, a simple test procedure identifies both conductors of a mutually short-circuited pair, both members of an interchanged pair, both ends of an incorrectly routed wire, or both ends of a jumper. For example, if one button gives a green-and-red indication, it should be held down while each remaining button is pushed in turn. One of them will remove the red indication and leave green only, showing that the conductors associated with these two buttons are interchanged or shorted. This same procedure, applied to a red-only indication, identifies both ends of an incorrectly connected wire.

Where cables purposely are not wired straight through (pin 1 to pin 1, pin 2 to pin 2, etc.), a short adapter cable can be introduced between one end of the production cable and the tester. The adapter has the crossed connection reversed to emulate a single straight-through cable. The tester can accommodate cables with various connector types if appropriate matching connectors are added in parallel at the tester.

It's a good idea to keep a notebook with the tester which pictures each cable type and specifies the presence of jumpers and skipped pins. Otherwise, these would look like short and open circuits. But, with little practice, minimal reference is necessary to check out even cables with multiple jumpers. A series of these testers will pay for themselves many times over. □

INDICATION	CONTINUITY	TERMINATION
Green only	Good	Correct
Red only	Good	Incorrect
Green and red	Good	Correct with short circuit
None	Open	—

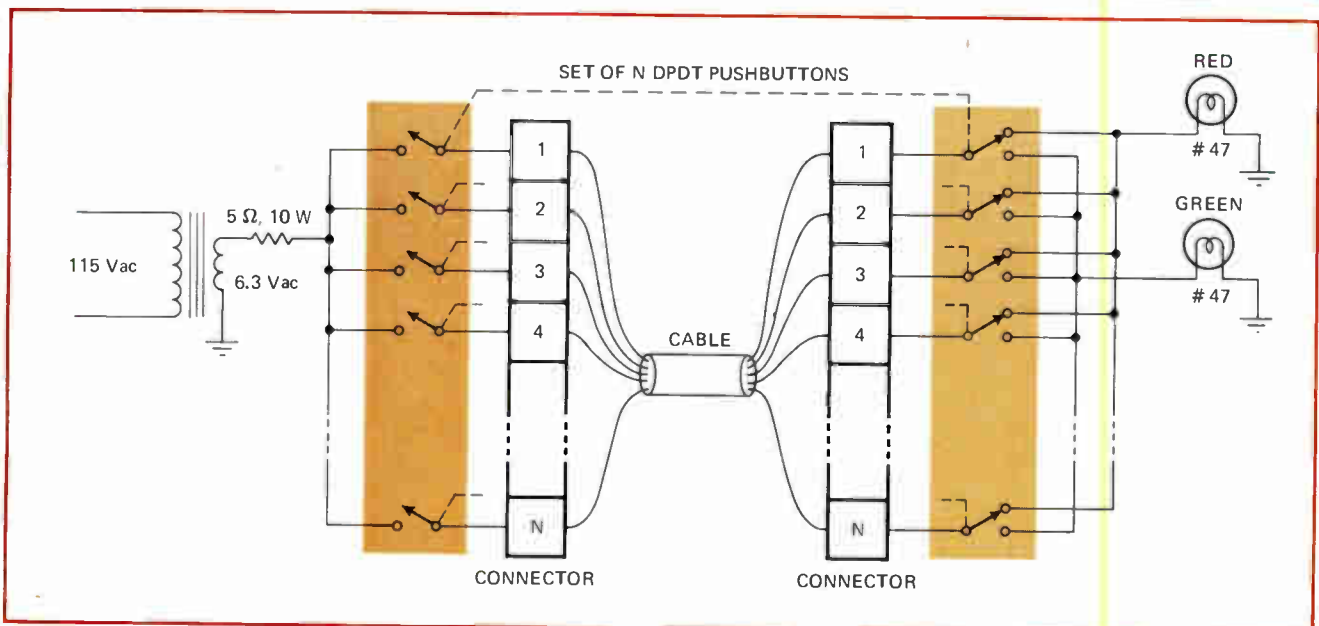

**Comprehensive.** Automatic cable tester can check circuits as fast as operator can push buttons, one circuit per second or faster. Red and green lamps indicate shorts, opens, transpositions, and misroutings of conductors in even the most complex cables.

# High-gain triple Darlington has low saturation voltage

by Eric Burwen  
G&S Systems Inc., Burlington, Mass.

A triple Darlington amplifier can be useful in situations that require a minimum of base drive, such as high-efficiency switching regulators or buffer amplifiers with high input impedance. Combining very high current gain and a saturation voltage equal to that of the two-transistor Darlington, this circuit was originally conceived for use in high radiation environments, where the  $\beta$  parameter of a transistor can readily degrade to 5 or even less.

In the conventional Darlington amplifier (Fig. 1), the total saturation voltage is the sum of the base-to-emitter voltage of  $Q_1$  and the saturation voltage of  $Q_2$  alone. Although no transistor or circuit attains the ideal 0-volt saturation voltage, that of the Darlington amplifier is suitably low. But if three transistors of like polarity were cascaded (Fig. 2), the  $V_{sat}$  of the resulting amplifier would be nearly double that of the conventional two-transistor circuit.

On the other hand, a triple Darlington made of complementary transistors (Fig. 3) has the same saturation voltage as that of the double Darlington. This is true whenever the saturation voltage of  $Q_3$  taken alone is

less than or equal to the combination of:

$$V_{be1} + V_{sat2} - V_{be2}$$

Because the current gain of the triple Darlington is large, the currents in  $Q_1$  and  $Q_2$  are large, so that these three voltages do in fact add up to a level larger than  $V_{sat3}$  alone. (When  $Q_3$  is in the circuit, of course, its saturation voltage is exactly equal to the combination, by Kirchhoff's law.)

In an experimental version of the triple Darlington (Fig. 4), a current of 8 microamperes controls a load of 2 amperes—a gain of 250,000. The saturation voltage at 2 A is 1.2 volts, the sum of  $V_{be1} = 0.9$  v and  $V_{sat2} = 0.3$  v. Transition times are  $t_{on} = 200$  nanoseconds and  $t_{off} = 500$  ns; storage time is 1 microsecond. □

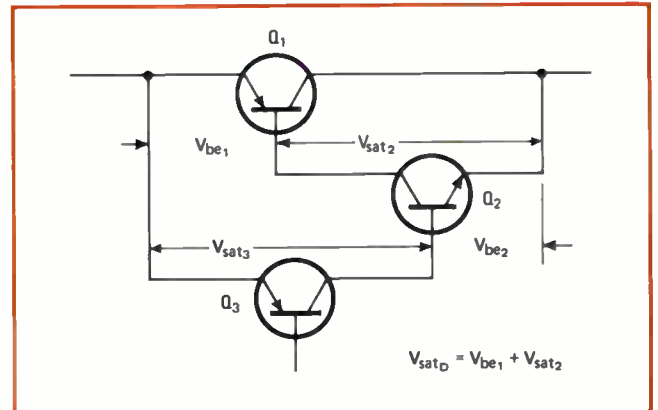

**3. Triple Darlington.** Making the circuit out of two pnp and one npn transistors gives high gain without boosting saturation voltage.

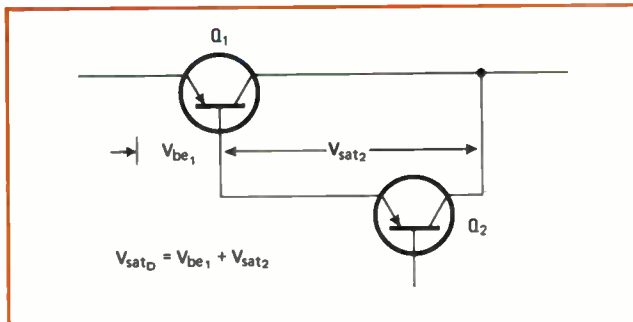

**1. Conventional.** Two-transistor Darlington amplifier has high current gain, compensating for degraded  $\beta$ , and low saturation voltage.

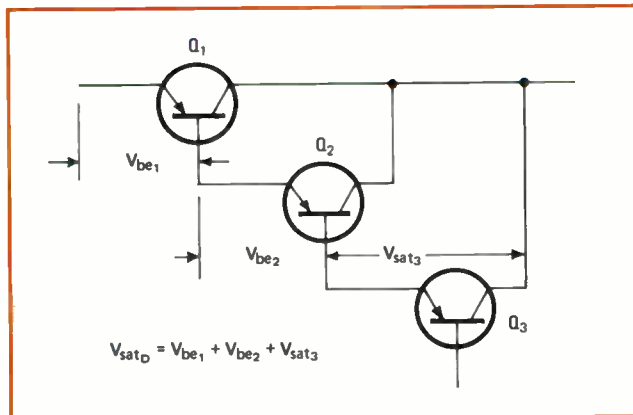

**2. Unsatisfactory.** Simply cascading three similar transistors gives a saturation voltage that is much too high.

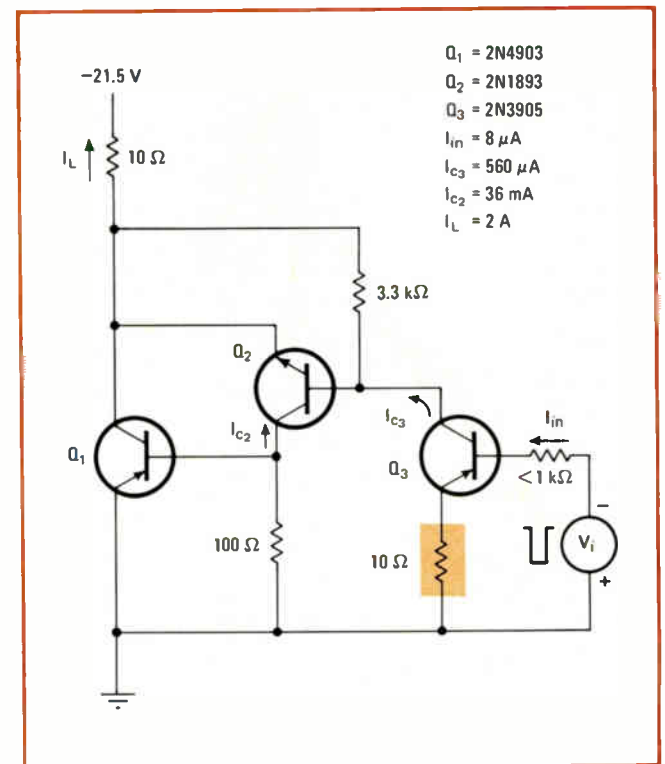

**4. Switching-time test circuit.** Gain is 250,000 in this circuit. The 10-ohm resistor (color) is required to limit the current in  $Q_3$ ; otherwise, when that transistor saturates, its large current will pass through the base of  $Q_2$  and reduce the  $\beta$ .

# TTL level tester identifies logic levels by audible tone

by John M. Jamieson  
 Technical Analysis Corp., Atlanta, Ga.

When checking a large number of test points for static TTL levels, turning one's attention from a probe to an oscilloscope or voltmeter is inconvenient and time-consuming at best, and disastrous if the probe should slip off the pin to contact a nearby high-voltage bus. This circuit was designed to simplify such checking.

The circuit produces one of two tones in an earphone or loudspeaker: low-pitched when the probe is in contact with a pin at less than 0.8 volt, and higher-pitched when the voltage is between 2.0 and 5.0 v. If the voltage is between 0.8 and 2.0 v, or if the test point is an open circuit, no tone is produced. The circuit uses a single quad operational amplifier such as the National Semiconductor LM324; two amplifiers serve as comparators and the other two generate the tones.

As shown in the diagram, the comparators test the voltage on the probe for one of the two TTL levels. Pin 3, the non-inverting input of one comparator, is held at 0.8 v by a 100-kilohm resistor  $R_1$  in series with two forward-biased diodes. When the probe is on an open circuit, the inverting input of the same comparator (pin 2) is held at about 1.5 v by a voltage divider  $R_2$ - $R_3$ . Because the inverting input is at a higher level than the non-inverting input, the output (pin 1) of this comparator is near ground; but if a voltage less than 0.8 v is applied to the probe, the output goes to about 5 v.

Likewise, pin 13, the inverting input of the other comparator, is held at 2.0 v by another voltage divider,  $R_4$ - $R_5$ . Here again, when the probe is on an open circuit, the inverting input is higher and the output (pin 14) is near ground; but if a voltage higher than 2.0 v is applied, the output goes to about 5 v.

When both pins 1 and 14 are near ground, pin 6 is also near ground, held there by the 1-megohm resistor,  $R_6$ ; pin 7, the output of the tone generator, is near the supply voltage, 5 v. From this the 0.01-microfarad capacitor,  $C_1$ , is charged through resistor  $R_7$ .

When pin 1 rises to its higher level, the 0.33- $\mu$ F capacitor,  $C_2$ , charges through the 10-kilohm resistor,  $R_8$ . Likewise, when pin 14 is high,  $C_2$  charges, more quickly this time, through the 2.2-kilohm resistor,  $R_9$ . Either way, when it exceeds the 2.0-v level on pin 5, the output of the tone generator drops to ground, and  $C_1$  discharges. Eventually its level drops below that same 2.0 v, also on pin 9, dropping the output of the fourth amplifier, pin 8, to ground. That discharges  $C_2$  and the cycle begins again.

Thus the signal on pin 7 is a square wave, the frequency of which is determined by the rate at which  $C_2$  charges—through either  $R_8$  or  $R_9$ . At either frequency, the square wave is approximately symmetrical, because  $C_1$  both charges and discharges at all times through  $R_7$ .

The output on pin 7 is sufficient to drive most earphones. Additional loading affects the absolute values of the two frequencies, but not their relative values. If the earphones are unsatisfactory for any reason, the 10-kilohm resistor  $R_{10}$  and a pnp emitter follower  $Q_1$  can drive a small loudspeaker. □

Engineer's Notebook is a regular feature in Electronics. We invite readers to submit original design shortcuts, calculation aids, measurement and test techniques, and other ideas for saving engineering time or cost. We'll pay \$50 for each item published.

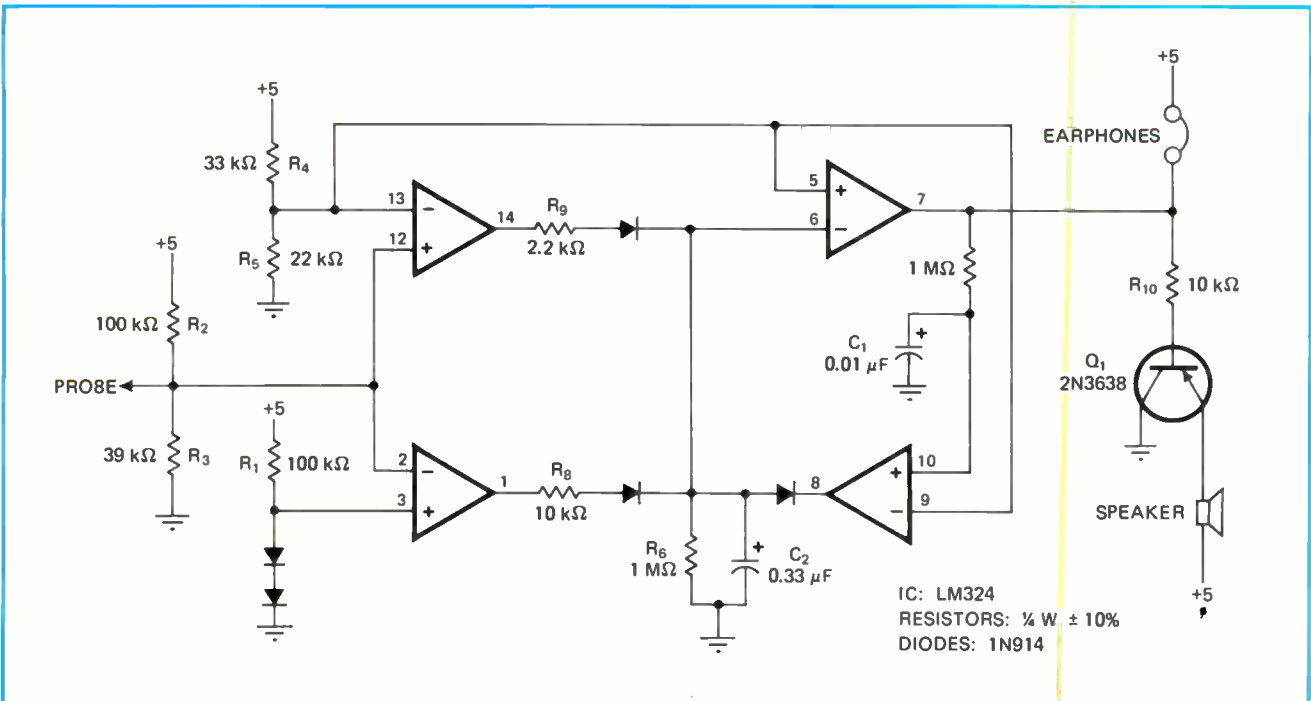

**Beep-beep, boop-boop.** Checking for static TTL levels is simplified when the voltage level is indicated by one of two audible tones in an earphone or loudspeaker. This circuit does the trick with only one quad op amp for level-comparing and tone-generating.

## **EIA updates its specification standard**

To help the circuit designer make short work of the games manufacturers play with component specifications, the Electronic Industries Association is publishing an updated specification standard, RS-419. The document was developed jointly by semiconductor device manufacturers and users and **gives technically complete and unambiguous definitions of values to be used in specifying semiconductor devices and registration formats.**

RS-419 should go a long way toward simplifying the maze of current, voltage, temperature, and pressure specifications now found in device ratings and characteristics.

## **Smooth ends on glass fibers are a snap**

Attention, designers of fiber-optic communication systems. If you're faced with the problem of producing smooth ends on glass fibers that will insure low laser-to-fiber and fiber-to-optical receiver transmission losses, and you're **dissatisfied with the rather rough and loss-producing fiber ends produced by mechanical cutting**, take advantage of the new temperature shock cutting method that's been developed by scientists at Siemens AG.

**The technique uses the effects of thermal stresses on the fiber material.** You simply apply heat—a flame, for example—for a short time to any point along the fiber length, then give the fiber a little pull or push, to break it at the point of thermal stress. It breaks easily, and **the end surface is both extremely smooth and vertical to the fiber axis.** What's more, results are more reproducible with this method than with conventional cutting, the Siemens specialists say.

## **Check for continuity with a scope**

To assure that some solid-state devices and microwave components are OK for use, they need only be checked for continuity—but if you use an ohmmeter to make that simple check, you may only succeed in damaging the component.

**A safe way to test for continuity is with an oscilloscope set to its high-gain position**, says Bernard H. Serota of Philadelphia, Pa. Hold one lead of the device to the scope's vertical input jack, and touch the other lead with your hand. **Any change in the pattern or deflection on the scope face signifies that the device is good.** No change indicates an open device.

## **How to design with microprocessors**

To be published this month is a new book that's packed full of hard-to-get information on **how to put together a cost-effective design with microprocessors.** For example, it tells the system designer how to slash 20% to 50% off the chip count of a board using the Intel 8008. Title of the 300-page book is "Micromputer Design." Although it's based largely on the 8008 and Intel's newer 8080 microprocessor, it does describe other types now available and **generalizes the design techniques so that they are applicable to any 8-bit unit.** Offered by Martin Research Ltd., 1825 S. Halsted St., Chicago, Ill. 60608, it will sell for \$100. Publication is slated for Oct. 15.

—Laurence Altman



# Single-Shot Storage to 100 MHz

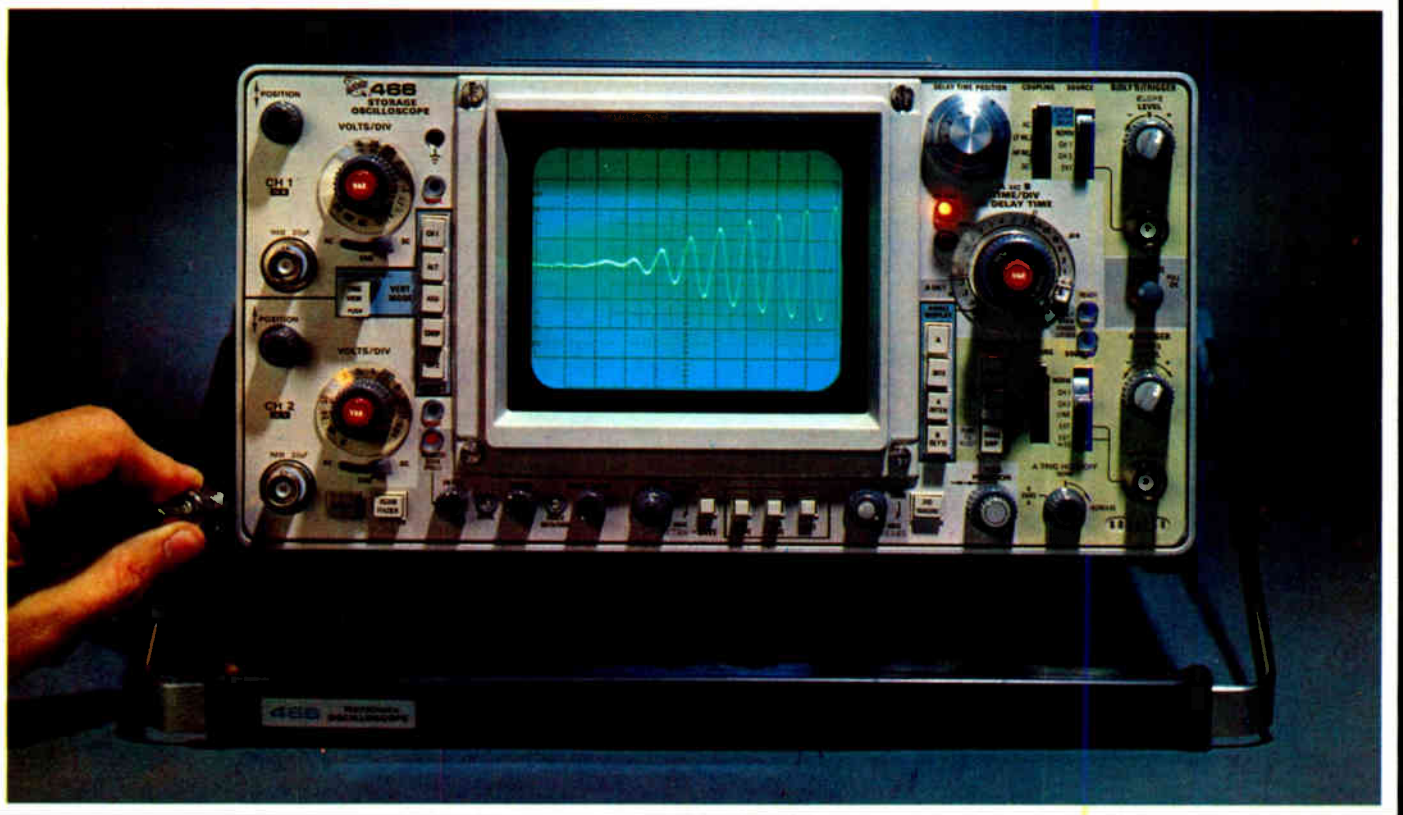

## for DESIGN

The 466 Portable offers the fastest stored writing rate of any Tektronix direct-view oscilloscope—1350 cm/ $\mu$ sec. That's more than enough speed to capture and retain pulses at the upper limit of the scope's 100 MHz bandwidth (5 divisions magnitude for single shot 100 MHz sine wave, or equivalent to storing a 5 division pulse of 3.5 nsec risetime). It provides up to a 5 nsec/division sweep rate through the X10 magnifier and vertical deflection sensitivity to 5 mV/division. You can view and retain fast rise, low repetition rate, single shot or slow moving waveforms. Here are Tektronix' reliable trigger characteristics and CRT's that minimize residual image and burn problems. Now you can view with ease phenomena that could never before be displayed on an oscilloscope.

## for PRODUCTION

The 466's fast stored writing rate offers the production engineer unequalled capabilities. Stored waveforms are brighter—more visible in the high ambient light of assembly areas. Stored waveforms allow personnel to make faster, more accurate decisions and they permit study, comparison to a photo standard, and review by supervisors. Here is an oscilloscope that is essential in computer, aerospace, and many areas of communications. It is designed for minimum training of personnel. And on a dollar per MHz of bandwidth comparison, it is by far your best storage scope buy.

## for FIELD SERVICE

The 466 is the answer to field troubleshooting and calibrations that require the same exacting standards as those originally specified in the lab, production, or engineering. Weighing under 30 lbs., it carries easily. And the 13-position handle provides a versatile support stand. Take an instrument with Option 7 to a missile site or into an aircraft and power it with 12-24 VDC or the 1106. Or use the 1105 battery pack. The 466's 1350 cm/ $\mu$ sec stored writing rate can make the Tektronix 466 your most valuable test instrument.

If the high writing speed of the 466 is not required, the 464 (which is otherwise identical) features 110 div./ $\mu$ sec. 466 Oscilloscope, \$3850. 464 Oscilloscope, \$3300.

Discover what the 466 can mean to you. For a demonstration or more information, contact your local Tektronix Field Engineer, or write Tektronix, Inc., P. O. Box 500, Beaverton, Oregon 97005. In Europe write Tektronix Ltd., Guernsey, C.I., U.K.



For a demonstration circle 128 on reader service card

Circle 129 on reader service card

# How National gets of a falling

This is our temperature transducer (A) that is activated by the heat of the cigar and transmits a signal by the 2-Wire Transmitter (B) to the device that tips the steel ball off its perch, activating — as it rolls down the ramp causing a whoosh of air — the pressure transducer (C), which signal is transmitted again via the 2-Wire Transmitter (B) to the A/D Converter (D) which converts this analog signal to a digital signal which feeds into our IMP-16 microprocessor (E) which is programmed to react to this particular

input by activating a digital read-out (F) which flashes a coded warning to the unsuspecting man (H), and in case this warning isn't heeded, activating, after going through a D/A Converter (G), a device which pushes the man out of the way of the falling steel ball.

What's the point?

The fact that nowadays the



# you out of the way steel ball.

heart of just about any new control system is a microprocessor...and National Semiconductor makes 'em. In 4, 8 and 16-bit versions. In chip, card and system form.

Of course, the microprocessor must communicate with the "outside world." And we make most of the stuff you'll ever need for that, too...some of which is shown here.

We also have technical field application engineers in your area to work with you on your particular problem.

Even problems more prosaic than getting out of the way of a falling steel ball.

Please rush me the following information:

- |  |   |
|--|---|
| <input type="checkbox"/> Interface                         | <input type="checkbox"/> MICROPROCESSOR |
| <input type="checkbox"/> Special Function                  | <input type="checkbox"/> Transducer     |
| <input type="checkbox"/> Send a Field Application Engineer | <input type="checkbox"/> LED            |

Name \_\_\_\_\_ Title \_\_\_\_\_

Company \_\_\_\_\_

Address \_\_\_\_\_

City \_\_\_\_\_ Zip \_\_\_\_\_

National Semiconductor 2900 Semiconductor Drive,  
Santa Clara, Calif. 95051 Attn: Marketing Services

## NATIONAL

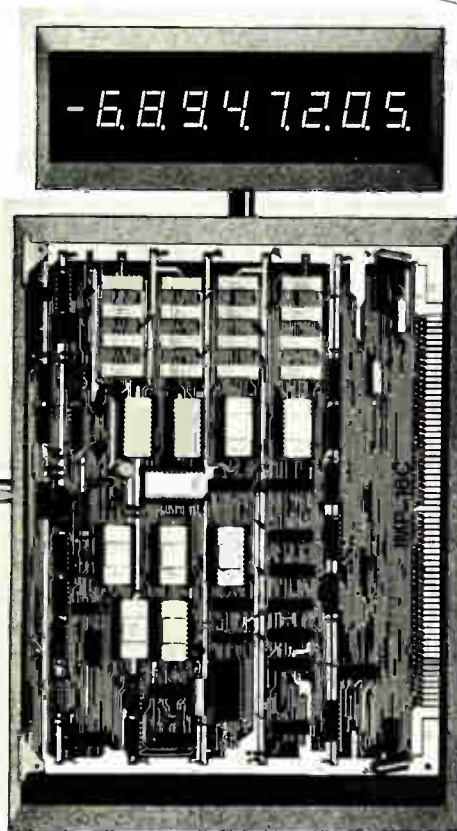

**F** NSA198  
Digital read out

D/A1200

**D**

IMP 16  
Card

**E**

**G**

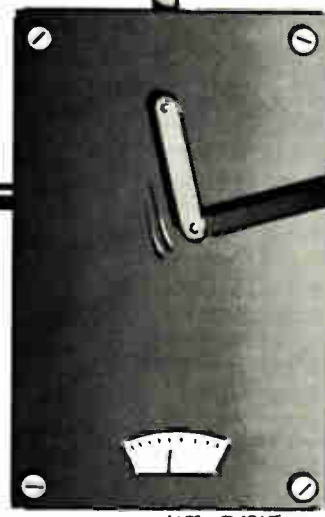

**H**

**H**

**H**

**H**

**H**

**H**

**H**

**H**

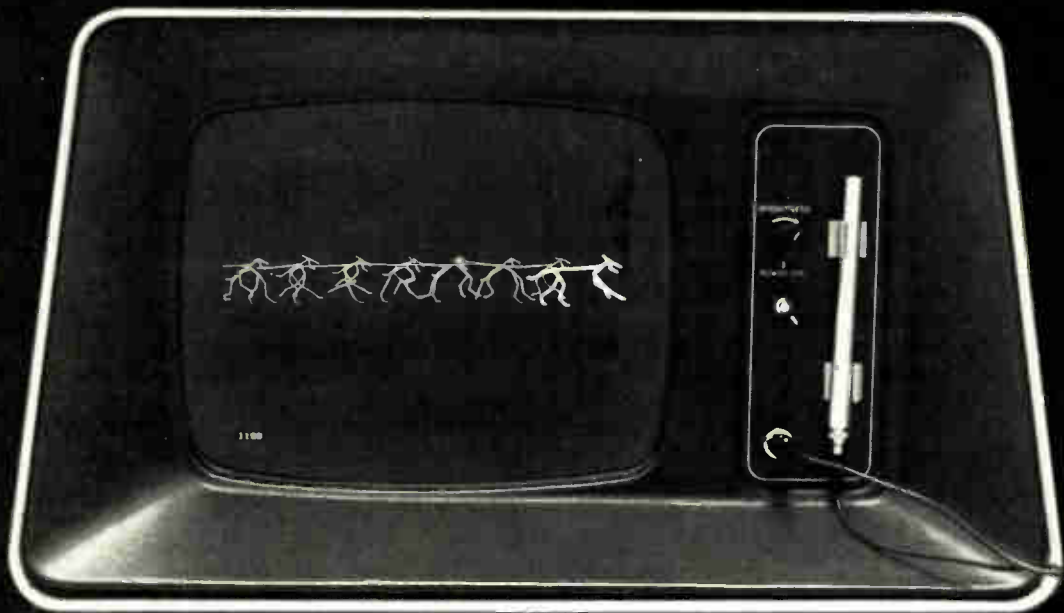
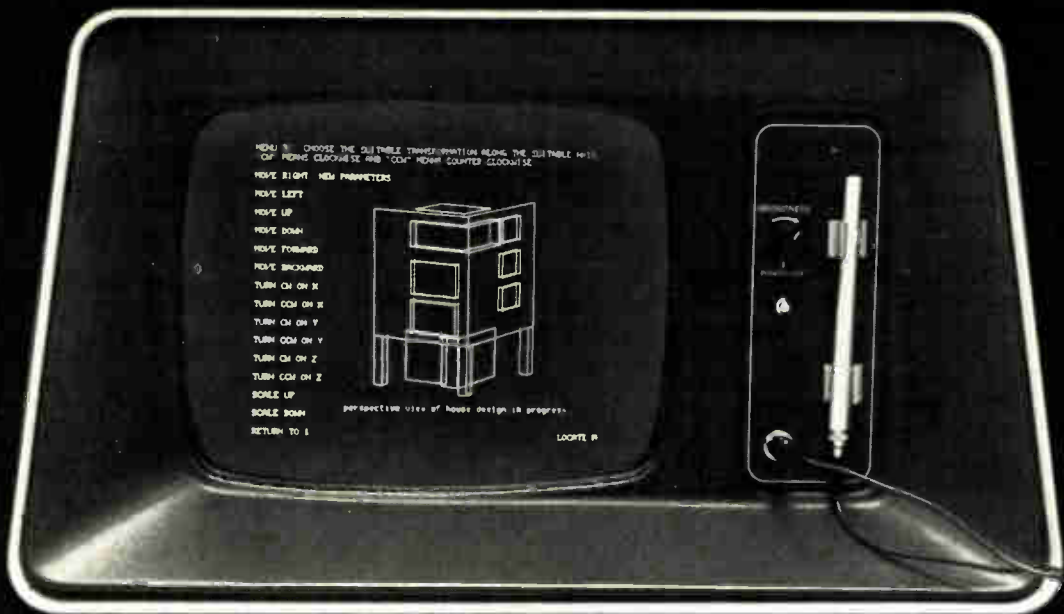

# Digital announces a whole

Right now is the time to look at graphics in a way you've never looked before.

Because graphics has come of age. And Digital feels you're about to see a tremendous increase in the use of graphic systems. In science, research, medicine, business and industry.

Harnessing computer speed with visual display convenience has made it easier

and more effective to monitor, compute, evaluate and modify designs or events, wherever you want a better picture of the problem.

We're pointing this out to you because we're committed to meeting your graphic needs. In fact, we've been making graphic systems almost as long as we've been making computers. And today, we may have the broadest range of

computerized graphic systems available.

In our GT Series alone, Digital offers three multi-purpose graphic systems. The GT40's complete graphics capability includes a PDP 11/10 processor, 8K words of memory, keyboard, and 12" screen with light pen. Extensive peripheral and application software offerings are also available. For expanded needs, the

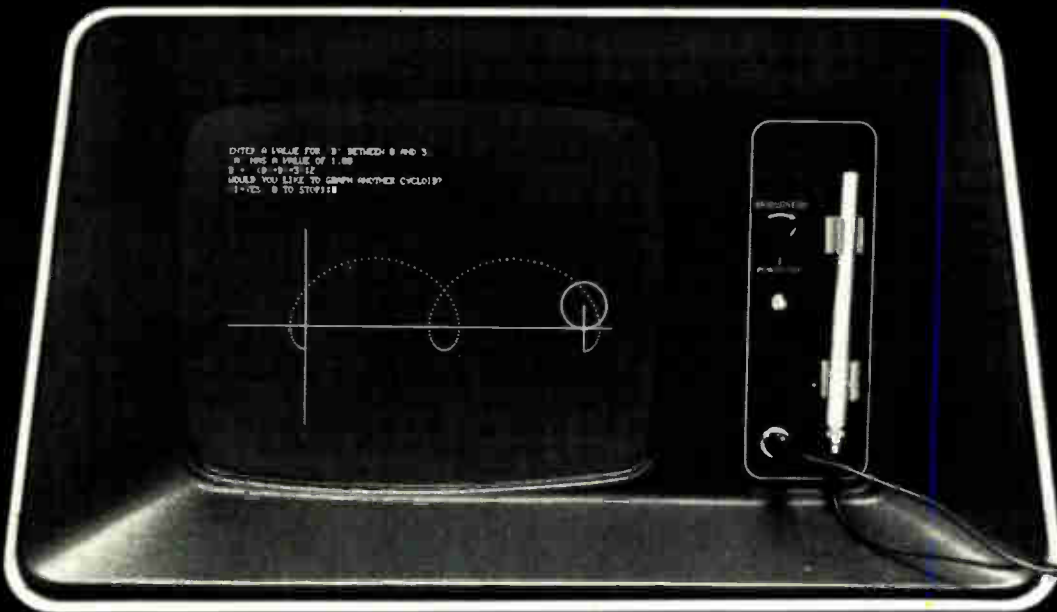

# new way to look at graphics.

GT42 offers a 17" screen with light pen and communications interface. And a powerful GT44 system provides a high performance PDP 11/40 processor with 16K words of memory, 17" screen with light pen, and our own DECwriter for your hard copy needs. These are powerful, complete computer systems based on the PDP-11, the most popular 16-bit computer. Besides graphics, you

can use these systems for virtually any computer application. They're backed by an extensive array of peripherals and software. Plus Digital's worldwide service organization.

And should you already be a PDP-11 user, a graphic add-on may give you a totally new perspective on meeting your needs.

So if you're looking into graphics, be sure to see us.

Please contact your local Digital office. Or write Graphics Group, Digital Equipment Corporation, Marlboro, Mass. 01752. Or call (617) 481-9511, Ext. 6936. European headquarters: 81 route de l'Aire, 1211 Geneva 26. Tel: 42 79 50.

**digital**

Circle 133 on reader service card

# A new autoranging multi-function counter using LSI/MOS from the "Counter House" the 1900A



## Fluke's new 1900A multi-counter offers you...

... a superb autoranging counter with outstanding features ... like leading zero suppression to end confusion ... autoreset, so your first reading is always correct no matter how often you change the function ... 5 Hz to 80 MHz dynamic range ... autoranging in both frequency and period measurement modes ... signal input conditioning ... 25 mV sensitivity, typically 15 mV ... event counting to  $10^6$  with overflow indication ... six digit LED display ... automatic annunciation ... and 20% hysteresis on autoranging to eliminate bothersome range switching. All this and more for \$349.

With the 1900A you get a rugged, compact and reliable instrument with all the performance and quality that Fluke is famous for. Including Fluke's full 12-month guarantee.

If you want battery operation we'll install an optional internal battery pack that gives you five hours of continuous operation between charges. Or if you need a data output we can provide it.

For fast, fast delivery order your 1900A from your local Fluke distributor - he has them in stock. Or write or phone us direct.

\$  
**349**

**FLUKE**  
**COUNTER DIVISION**

John Fluke Mfg. Co. Ltd.,  
Counter Division  
P.O. Box 1094, Station "D"  
Buffalo, N.Y. 14210  
Phone (716) 842-0311  
TWX 610-492-3214

## Temperature-sensitive resistor is linear

Low-cost nickel-film component is suitable for a variety of applications because its value changes linearly from  $-20^{\circ}\text{C}$  to  $+150^{\circ}\text{C}$

by Lucinda Mattera, Circuit Design Editor

Problems of temperature sensing and compensation have long been vexing enough for circuit designers to welcome a new line of temperature-sensitive resistors with guaranteed linear characteristics over a broad range of temperatures.

The Electronic Products division of Corning Glass Works, Bradford, Pa., will start off its new resistor line with two devices, both having nominal resistances of 1,000 ohms at  $25^{\circ}\text{C}$ . At this temperature, one unit offers a resistance tolerance of  $\pm 1\%$ , while the other unit has a tolerance of  $\pm 5\%$ . Both units will provide the resistance values shown in the table below, from  $-20^{\circ}\text{C}$  to  $+150^{\circ}\text{C}$ . Nominally, their operating temperature range extends from  $-55^{\circ}\text{C}$  to  $+250^{\circ}\text{C}$ . In addition, Corning is guaranteeing part-to-part interchangeability between resistors hav-

ing the same tolerance.

Application possibilities exist wherever temperature sensing must be done over widely separated extremes. In the automotive area, Corning expects its new resistors to be a key element in electronic fuel-injection systems. In appliances, the resistors can serve as temperature sensors. And for many circuit applications, the resistors offer a sound, economical, and simple approach to temperature compensation, such as adjusting for the inherent drift that plagues semiconductor junctions.

Unlike precision wirewound and semiconductor temperature-sensitive devices, Corning's series TSR units are not expensive—in volume, the  $\pm 1\%$  resistor—number TSR5-1001F—will sell for about \$1, and the  $\pm 5\%$  resistor—number TSR5-1001J—will be about 50 cents.

Because of their broad operating temperature range, low price, and tight linearity, the new resistors are rather unusual, says Michael Teters, a marketing analyst at Corning. But, he notes, they are not intended to compete with low-cost thermistor devices, which generally have tolerances to within  $\pm 20\%$  and do not offer tight linearity.

The linearity of the TSR resistors depends on temperature. From  $-20^{\circ}\text{C}$  to  $+60^{\circ}\text{C}$ , the maximum linearity deviation is  $+0.7\%$  and  $-0.4\%$ . But from  $-20^{\circ}\text{C}$  to  $+150^{\circ}\text{C}$ , the maximum linearity deviation is somewhat greater,  $+3.7\%$  and  $-1.4\%$ .

The positive temperature coefficient for these  $\frac{1}{2}$ -watt units is  $+5,900$  ppm/ $^{\circ}\text{C}$  or approximately  $+0.6\%/^{\circ}\text{C}$ , which is large enough to obviate the need for expensive associated circuitry. Moreover, the resistance change occurs rather quickly—between  $0^{\circ}\text{C}$  and  $100^{\circ}\text{C}$ , the TSR devices reach 63% of their total final resistance value at a given

GUARANTEED RESISTANCE VALUES					
Temperature ( $^{\circ}\text{C}$ )	Nominal ( $\Omega$ )	$\pm 1\%$ unit		$\pm 5\%$ unit	
		Maximum ( $\Omega$ )	Minimum ( $\Omega$ )	Maximum ( $\Omega$ )	Minimum ( $\Omega$ )
-20	789.6	804.9	779.4	855.7	747.9
-10	834.3	847.0	825.3	890.1	792.0
0	881.0	890.3	872.6	925.5	837.4
10	927.5	937.2	918.7	974.4	881.6
20	975.9	985.4	965.9	1024.5	926.9
25	1000.0	1010.0	990.0	1050.0	950.0
30	1024.8	1034.9	1014.4	1075.9	973.4
40	1075.2	1085.5	1064.0	1128.5	1021.1
50	1126.5	1137.5	1114.9	1182.5	1069.9
60	1179.3	1190.6	1167.0	1237.7	1119.9
70	1232.9	1245.0	1220.3	1294.3	1171.0
80	1288.0	1300.6	1274.8	1352.1	1223.3
90	1344.3	1357.5	1330.5	1411.2	1276.8
100	1401.8	1415.6	1387.5	1471.6	1331.5
110	1461.2	1477.0	1443.6	1535.4	1377.3
120	1521.2	1539.6	1500.9	1600.5	1424.1
130	1582.9	1603.5	1559.4	1666.9	1471.9
140	1646.3	1668.6	1619.1	1734.6	1520.6
150	1711.2	1735.1	1679.9	1803.7	1570.2

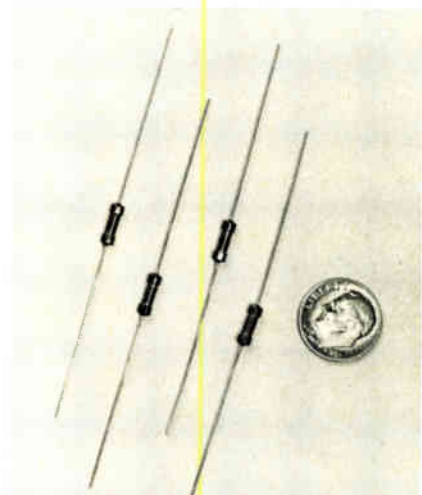

# 1

AMERICAN MADE

## Tolerance SCHAUER 1-Watt ZENERS

**Immediate Shipment  
Low Prices**

ANY voltage from 2.0 to 16.0

Quantity	Price each
1-99	\$1.07
100-499	.97
500-999	.91
1000-4999	.86
5000 up	.82

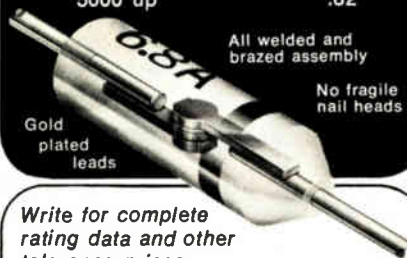

Write for complete  
rating data and other  
tolerance prices.

**Buy the kit-  
Save  
a lot**



Kit contains a 51-piece assortment of SCHAUER 1% tolerance 1-watt zeners covering the voltage range of 2.7 to 16.0. Three diodes of each voltage packaged in reusable poly bags. Stored in a handy file box. Contact your distributor or order direct.

A \$54.57 value for  
**ONLY \$24<sup>50</sup>**

Semiconductor Division

**SCHAUER**  
Manufacturing Corp.

4514 Alpine Ave. Cincinnati, Ohio 45242  
Telephone: 513/791-3030

### New products

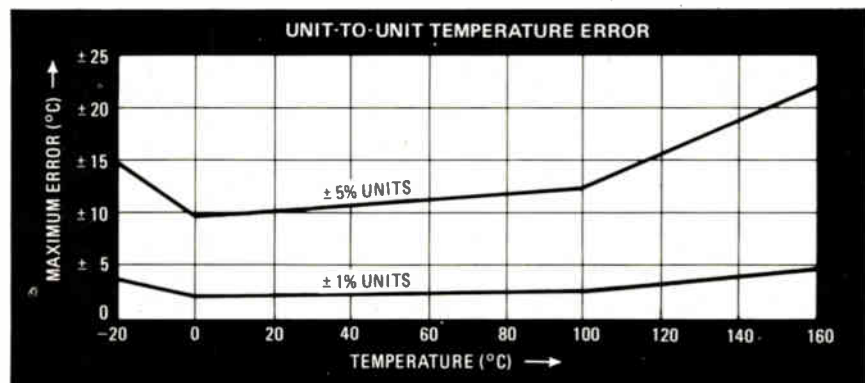
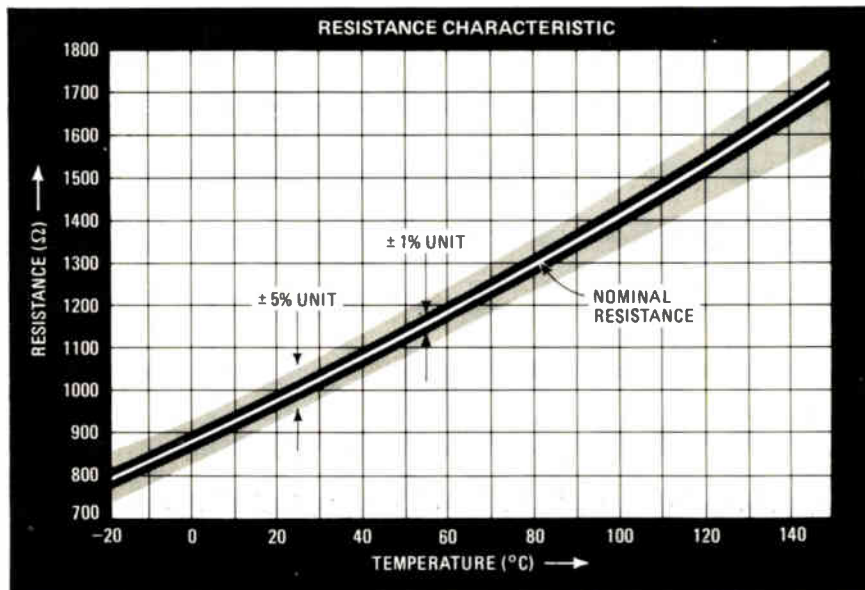

temperature within 1 second.

To manufacture its TSR series, Corning first deposits a nickel film on a solid cylindrical glass rod. Then, before the end caps are pressed on, the resistors are laser-spiraled. In this process, a laser burns the nickel film off a resistor that is spinning, creating a fine helical pattern in the nickel film.

The laser spiraling increases the resistance of the nickel film to a usable high level, nominally 1,000 ohms. After laser spiraling, the resistors are coated with polyimide for environmental protection.

Corning chose nickel as its resistive material for two reasons. Nickel is not a precious metal, and therefore resistor cost can be kept low. Also, nickel has one of the highest temperature coefficients of resistance of any metal.

The plot (top, above) of the resist-

ance characteristic of both TSR devices shows their linear resistance change with temperature, as well as the effect of their resistance tolerances. The other plot indicates how accurately the resistance of any TSR device pinpoints the temperature at which it is operating. For the  $\pm 1\%$  resistors, the unit-to-unit temperature error is less than  $\pm 5^\circ\text{C}$  between  $-20^\circ$  and  $+150^\circ\text{C}$ . For the  $\pm 5\%$  resistors, the unit-to-unit error can be as large as  $\pm 20^\circ\text{C}$  at high temperatures.

Corning will make, on a custom basis, a temperature-sensitive resistor having a nominal value of less than 1,000 ohms. At this time, the company has no immediate plans to add more standard units to its line. The two current standards are available in quantity from stock.

Corning Glass Works, Electronic Products Division, 550 High St., Bradford, Pa. [338]



# 1K/4K PROGRAMMABLE RAM TESTER FOR UNDER \$10,000!

**Now! For a limited time only--through  
November 30, 1974.**

**This turnkey  
Production/  
Engineering System  
at a special low price  
which includes:**

- The MD-100 Microprogrammable Pattern Generator
- One Personality Card for any commercial 1K or 4K RAM (See lists)
- A Device Test Program including worst-case test patterns and multiple voltage iterations

## 1K MOS RAM's

- INTEL 1103, 1103-1, 1103A, 2102, 2105 • MOSTEK 4006, 4008, 4009, 6028, 6029 • AMS 6002, 7001  
• EA 1500, 1501 • INTERSIL 7552  
• NATIONAL 1103 • AMI 2103, 2102  
• SIGNETICS 1103 • AMD 2102  
• And Others

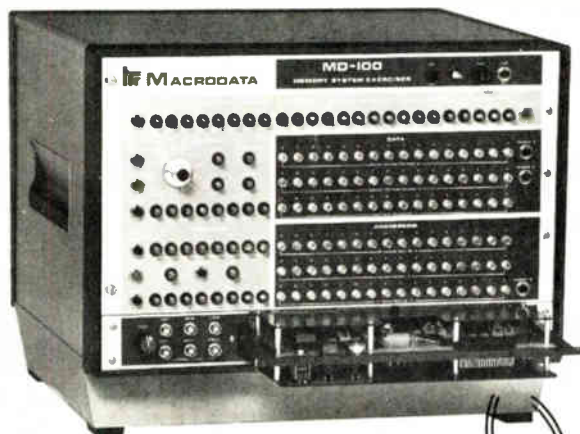

**Macrodata's MD-100  
is the world-wide  
standard for memory  
testing. Over 350 in  
use throughout the  
world.**

## Additional MD-100 System Features:

- Operation by unskilled operators
- Expandability for testing ROM's, PROM's, Shift Registers, UAR/T's
- Expandability for testing RAM cards, up to 65K x 16

## 4K MOS RAM's

- TI TMS 4030 • MOTOROLA 6605  
• MOSTEK MK4096 • INTEL 2107,  
2107A, 2107B • AMI S6103 • MIL  
7112 • And Others

**U.S. PRICE\***  
~~\$20,000+~~  
**Now! \$9995.**

\*U.S. List Price F.O.B. Woodland Hills, Calif.

► Fill out this coupon and mail it immediately, or call us on one of these MD-100 Hot Lines — East Coast — (516) 543-8600; Midwest — (312) 297-8746; Northern California — (408) 735-9560; Southern California — (213) 887-5550; Munich, Germany — (0811) 34 56 00; Tokyo, Japan — (03) 985-5266. There is a full 90-day warranty on all hardware.

**MACRODATA** Corporation, 6203 Variel Avenue, Woodland Hills, Ca. 91364, Phone: (213) 887-5550, Telex: 65-1345

**MACRODATA** Name \_\_\_\_\_ Title \_\_\_\_\_

I'm ready to buy. Bring one out.

Company \_\_\_\_\_

Please reserve a Model MD-100 for me at the sale price until you bring one out to demonstrate.

Address \_\_\_\_\_ Phone \_\_\_\_\_

I need more information. Send a brochure.

City \_\_\_\_\_ State \_\_\_\_\_ Zip \_\_\_\_\_



# Program waveforms with or without lifting a finger.

**With.** Your finger, and Model 159's keyboard, can generate sines, squares, triangles, and ramps. Control frequency, amplitude, and offset to three digits. Reverse phase, polarity, activate triggered and gated modes at the touch of a button. A bright L.E.D. display shows



each command as you enter it on the keyboard.

**Without.** Model 159 and its remote-control-only version, Model 158, can be programmed by all types of remote ASCII sources, including computers, TTYs, even other Model 159



keyboards. Model 158/159 ranges: frequency—1 Hz to 3 MHz; amplitude—20 mV to 10 V; DC offset—up to  $\pm 5$  V. For more information, circle our reader service number or contact Wavetek direct.

**WAVETEK**<sup>®</sup>

P.O. Box 651  
San Diego, CA 92112  
Tel. (714) 279-2200 TWX 910-335-2007

Circle 138 on reader service card

# Customized ICs make up d-a converter

12-bit high-performance unit, which is partitioned into a pair of custom monolithic chips within a single DIP, is priced at only \$39

by Andy Santoni, Packaging & Production Editor

Trying to combine high performance with cost-effective integrated-circuit processing has been one of the toughest tasks for designers of converter circuits.

One solution has been to use conventional hybrid techniques, mounting standard IC chips and discrete devices on a single substrate. But that route can be expensive. Another approach, one that is gaining in popularity, is to use custom IC dice, mounted and interconnected on a substrate.

Analog Devices Inc., which calls this alternate approach compound monolithic integration, employs the technique, along with high-speed active laser trimming, in a new high-performance 12-bit digital-to-analog converter, designated the AD562. By partitioning a complex function into a minimum number of monolithic chips, each specifically designed to interact with the others, Analog Devices is able to keep chip size down, yields high, and the device cost low.

If a one-chip version of the two-chip AD562 were to be attempted at this time, yields would drop to an uneconomically low level. But Analog Devices' approach results in state-of-the-art performance at an attractively low price.

The AD562 offers 12-bit accuracy and is priced from \$39 in 100-unit quantities. It is available in a hermetically sealed, 24-pin dual in-line package and offers accurate temperature performance formerly available only from standard hybrid d-a converters.

At 25°C, versions for use in the military-temperature range have a maximum total error as low as ±0.1

least significant bit, referred to full scale. Differential-nonlinearity temperature coefficient is 1 ppm/°C referred to full scale, which guarantees monotonicity over a 100°C temperature variation. Maximum gain temperature coefficient is 3 ppm/°C.

The gain of the AD562 is also extremely stable with power-supply voltage variations. Maximum gain sensitivity is guaranteed to be 1 ppm of full-scale range per percent variation in positive supply voltages from 4.75 to 15.8 v dc. This sensitivity increases to 2 ppm for the -15-v dc supply.

The high immunity to supply-voltage variations results from a nonsaturating, fully differential, thermally balanced current-switching cell structure. Current levels in the switching cells have been optimized to maximize the conversion speed of all bits, reducing the delay in switching lower-order bits.

The AD562 has several other significant performance features. Its input-circuit configuration, which handles positive true binary code decimals or binary logic inputs, is

compatible with TTL, DTL, and C-MOS devices. Moreover, the converter's input circuitry is protected against failures caused by active logic inputs applied before the unit's power supply is turned on.

When the converter is used with a suitable output amplifier, five output voltage ranges can be programmed: 0-5, 0-10, ±2.5, ±5, or ±10 v.

The converter is specified for operation over three temperature ranges. The AD562K, with accuracy within ±½ LSB and differential-nonlinearity temperature coefficient of 2 ppm/°C maximum, operates from 0°C to 70°C and is priced at \$39 in 100-lots.

The AD562A, priced at \$49 in the same quantities, has the same accuracy and temperature specs and operates from -25°C to +85°C.

The military-temperature-range model AD562S, priced at \$100, has an accuracy to within ±¼ LSB in the binary version and to within ±0.1 LSB in the BCD-input version.

Analog Devices Inc., P.O. Box 280, Route 1 Industrial Park, Norwood, Mass. 02062 [339]

**Two-chip special.** Add a voltage reference and an output amplifier to the AD562, shown covered and uncovered, to get a 12-bit converter with error as low as ±0.1 LSB.

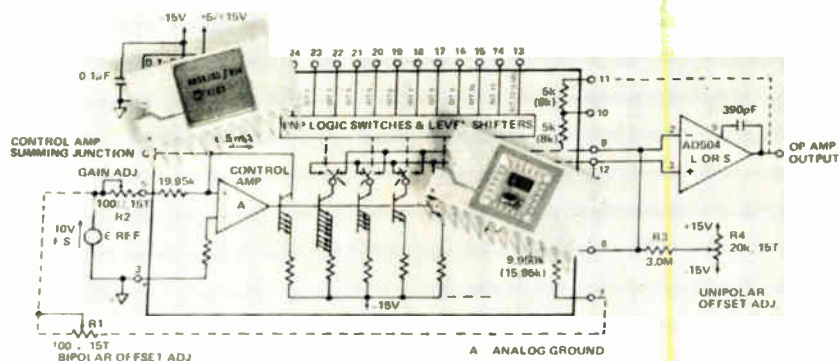

Are you all alone with a hybrid circuit problem?



# Relax. You have some friends at Boeing.



If you're trying to figure out the trade-off between pc's and hybrids, Boeing specialists can provide prompt, precise answers. Or, if you've never specified hybrids, Boeing can help and put your mind at ease. More than 150 people are engaged in this activity at the Boeing microcircuit facility near Seattle.

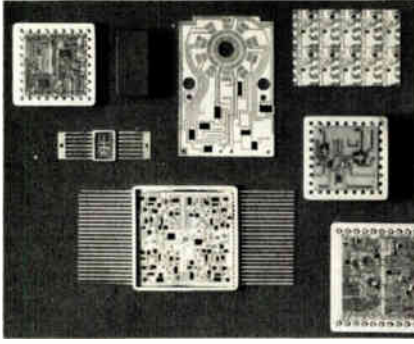

Boeing does just about everything that can be done in hybrids — precision thin film, multilayer thick film, high volume commercial circuits and complex high rel circuits. We go full tilt for customers who've never used hybrids. And we've always been a consistent performer for some of the largest accounts around.



Boeing has a technical team in the field that understands your hybrid circuit applications. Whether your business is computers, communications, medical electronics, electronic watches, calculators or automotive electronics. Our people are trained to act quickly and to stay on top of the job until it is finished.



Boeing has a tremendous investment in hybrid capability. We're in this business to stay. For example, few manufacturers in the business can match the quality and throughput capacity of the Boeing thick film facility. And when it comes to laser trim systems — we have three for resistor trim.



Every step of the way, your order is processed with care and dedication to absolute perfection. This attitude prevails throughout the entire Boeing organization. It's true in building the giant 747s, the Lunar Rovers that went to the moon and in every phase of hybrid circuit production.

If you'd like immediate action, you can call Gordon Arenz, (206) 773-9111.

**BOEING MICROELECTRONICS**  
P.O. Box 24666, Seattle, WA 98124

Dear Gordon Arenz:

- I'd like to arrange a conference to discuss my hybrid circuit requirements.
- Keep me up-to-date on your technical developments in hybrid circuits.

Name \_\_\_\_\_

Company \_\_\_\_\_

Title \_\_\_\_\_

Address \_\_\_\_\_

City \_\_\_\_\_ State \_\_\_\_\_ Zip \_\_\_\_\_

Phone \_\_\_\_\_

**BOEING**

E



Circle 141 on reader service card

Data handling

## Talking directly with System/3s

---

Data-communications unit can exchange information either on line or off line

---

Probably more IBM System/3 computers have been shipped than any other current model—25,000, according to one authoritative estimate. Yet only 5% or fewer of these machines are equipped with a communications option. (However, IBM claims the proportion is increasing and has just announced a fourth model of System/3, the model 8, which has an integrated communications adapter.)

One reason for the paucity of communications-oriented System/3s is probably the price of the option. A typical small System/3 configuration rents for about \$1,500 per month; the communications option adds another \$500 or so—a full one-third increment on the base rental, counting all the necessary external accessories. This contrasts with an increment of 5% or so for the optional communications controller on the System/370.

One alternative for the System/3 user would be to add an off-line communications system. But if he does this with IBM equipment, he still finds it expensive. Until now, the only input media the System/3 could accept were the 96-column punched card and the disk cartridge for the auxiliary storage. (The model 8 uses a floppy-disk unit instead of a card reader.) Remote-batch terminals from a variety of manufacturers are available at a wide range of prices and performances, but they almost invariably work with the older standard 80-column card, magnetic-tape cassettes, or paper tape—none of which can be used directly on the System/3.

Decision Data Computer Corp. hopes to plug this hole in the market

with its new CS 200 data-communications system, which can exchange data directly with another CS 200 or with a System/3, using a standard telephone line as its channel. In its off-line mode, it can exchange data between distant sites in punched-card form; a 100-character-per-second printer is available for hard copy. Data can go directly into a System/3 on line, but this interrupts processing in the System/3, which can't carry out the two functions concurrently. The CS 200 can also be used in local mode as an ordinary data recorder, the unit that keypunches, verifies, reproduces, interprets, and gang-punches 96-column cards for the System/3.

The CS 200 rents for \$285 a month, about half the IBM price. Users of either the IBM or the Decision Data machine would require two of them—one at the System/3 location and the other in the remote office.

Decision Data Computer Corp., 100 Witmer Rd., Horsham, Pa. 19044 [361]

---

### Tape drives are added to remote-batch terminals

Designed for the Singer-M&M 2780/3780 remote-batch terminals, nine-track IBM-compatible drives receive and transmit data in both card image and print image that conform to the 2780/3780 communications-line discipline. Basic terminal configuration includes an intelligent processor, card reader, and line printer. Optional peripherals include an operator's console, paper-

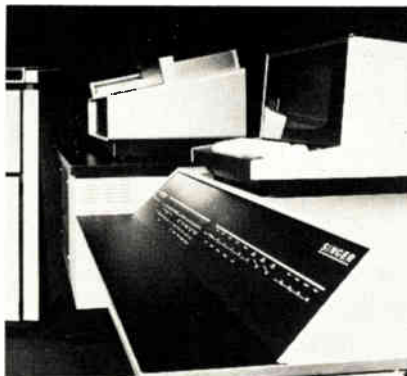

tape punch, reader, and card punch, as well as the new magnetic tape drives.

Singer-M&M Computer Industries, Inc., 2201 North Glassell Street, Orange, Calif. 92665 [364]

---

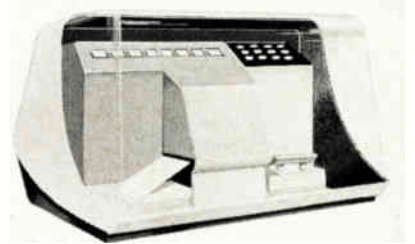

### Magnetic-card drive cuts data-processing costs

A magnetic-card drive that provides an operating cost per bit of 0.005 cent transfers 104,000 bits of data from a magnetic card in 100 milliseconds. Called the MCD-1000, the card drive is capable of updating magnetic cards. The unit can tie into a main memory bank and thus enlarge the computer's storage capacity many times. When tied to a controller, the unit can direct a maximum of 10 tape drives simultaneously. The MCD-1000 can read, write, erase, protect data, and select a single card from a stack of 500. It automatically checks data and parity, and accepts ASCII or BCD codes. The read/write heads are guaranteed for 5,000 hours. Price in quantity is less than \$6,000 each.

Advanced Magnetic Products Inc., 7067½ Vineland Ave., N. Hollywood, Calif. 91605 [367]

---

### Multipurpose modem has secondary channel

A flexible multipurpose modem with a secondary channel is designed the model 2400/300. It transmits and receives main-channel data at 2,400 bits/second over dial-up or dedicated lines. A synchronous or asynchronous secondary

channel operates at speeds as high as 300 b/s. Synchronous data rates of 75, 150, or 300 b/s can also be selected. In a typical application, the user's remote terminal or printer can communicate with the central processor full-duplex over a two-wire dial line. The keyboard character information is transmitted to the central processor over the low-speed channel. In this application, the low-speed channel operates asynchronously. The central processor returns data to the terminal at 2,400 b/s. Price is \$1,920.

Penril Corp., 5520 Randolph Rd., Rockville, Md. 20852 [366]

### Cassette recorder offers high-density storage

A buffered digital cassette recorder, called the 8400 Datacassette, offers high-density tape storage of 145,000 characters per cassette. Switch-selectable speeds are 110, 300, 1,200



and 2,400 bits per second. The recorder also can remotely control all machine functions; can automatically search at 1,000 characters per second, and permits editing of both characters and lines. The 8400 also offers a MOS-type buffer, and provides a code-controlled partial back-up of tape for editing and retransmission. Price is as low as \$889 each in OEM quantities, and delivery time is 45 days.

Techtran Industries Inc., 580 Jefferson Rd., Rochester, N.Y. 14623 [368]



## SPENDING 2 HOURS A DAY BREADBOARDING? You could be wasting money!

That's right! If you start using E&L products, you'll save  $\frac{2}{3}$  the time and money you spend using conventional equipment. This time/cost savings means you can amortize sophisticated E&L instrumentation like the Elite 2 (\$1395) in less than 4 months.

Need something a bit less sophisticated? E&L also offers a complete line of less expensive breadboarding instruments to fit your specific requirements.

Write today for our free catalog.



**E&L INSTRUMENTS, INCORPORATED**  
61 First Street, Derby, Conn. 06418 • Phone (203) 735-8774



# Identify and test wire and cable assemblies with dollar savings and increased productivity

If it's been some time since you investigated the high labor intensive costs of your wire harnessing and cable assembly operations — then consider the Cable-Scan System — a wire identification and test system that consistently provides man-hour savings of 30-75%.

Lower cable assembly costs are realized through increased production as well as using a more reliable and efficient method of trouble-shooting. Our Cable-Scan System can eliminate costly mistakes and the entire "rework" cycle.

Initial equipment costs are negligible — especially since the majority of our customers are able to return their original equipment investment in a matter of weeks. So how can you lose? Send for our free evaluation kit. It's your first step to realizing lower installed costs. Our kit is complete with detailed Cable-Scan instrument specifications, cost studies, case histories, customer lists and price information. We've even included an offer for a free Cable-Scan evaluation unit. Write us soon!

1. Return on Your Investment\*

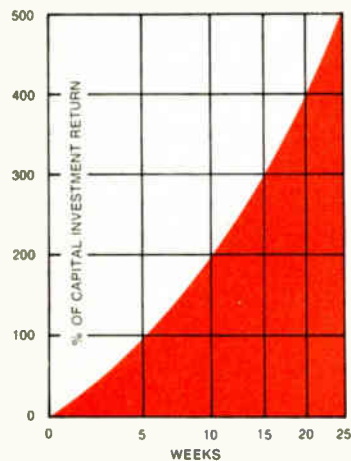

2. Dollars Saved with Cable-Scan\*

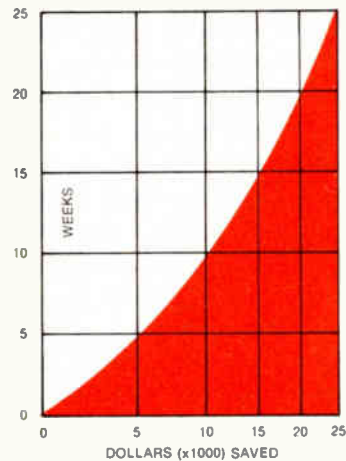

3. Cost Comparison\*

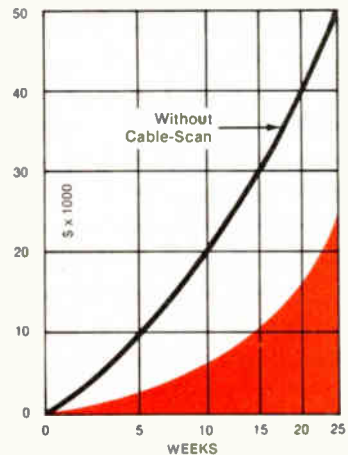

\*based on actual case study

## Cable-Scan Inc.

Subsidiary of Thomas & Betts Corporation

145 East Emerson Avenue • Orange, California 92665 (714) 998-1961

Circle 144 on reader service card



Semiconductors

## Microprocessor for control

---

4-bit unit for dedicated  
industrial applications has  
2-microsecond cycle time

---

Since the introduction about two years ago of several 4-bit microprocessors, the trend has been toward larger and faster 8- and 16-bit processor sets intended for applications up to the minicomputer level. Recently, however, there has been a growing realization that an even larger area of expansion is available for a sophisticated 4-bit processor in a number of dedicated-controller applications.

These include industrial-process controllers, machine-tool controllers, small-business machines, terminal controllers, and electronic cash-register controllers. It has been estimated that in the 1980s such applications will constitute as much as 90% of the microprocessor market.

To exploit this market, National Semiconductor Corp. is expanding its integrated microprocessor (IMP) family to include a 4-bit machine called the IMP-4. Like the 4004 and National's own IMP-8 and IMP-16, the IMP-4 is built with p-channel MOS technology. It is a micro-programmable parallel processor, consisting of three MOS LSI chips: a control read-only memory, a register arithmetic/logic unit, and a 4-bit interface-logic unit. Phil Roybal, microprocessor marketing manager at National, says the IMP-4 offers 42 instructions. In its basic configuration, the IMP-4 can directly address 4,096 bytes of any kind of memory, expandable to 65,536 bytes in four increments.

Cycle time is 2.0 microseconds, and typical instruction execution times range from 12  $\mu$ s for non-memory reference charts to 20  $\mu$ s for memory reference. All three chips operate on +5- and -12-volt power

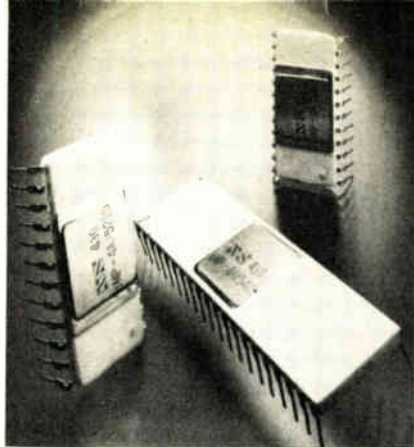

supplies, with four-phase non-overlapping clocks. Interface signals between the three chips are MOS-level, while those intended for interface with the rest of the processor system are TTL-level. Roybal says the IMP-4 macroinstruction set contains nine classes of instructions. However, not all operation codes are used, which, he says, allows for expansion of the basic set to meet custom requirements.

Additional expansion or modification of the basic instruction set to meet users' specific needs can be accomplished by the addition of one or more custom-programmed CROMs (control read-only memories). Each macroinstruction in a user's program is brought into the processor under the control of the CROM's microprogram instruction-fetch routine. This instruction is then decided, and the ROM address control in the CROM directs the control sequence to an entry point in the microprogram. The sequence continues until execution is completed. Then the CROM goes through another instruction-fetch cycle to bring in the next macroinstruction. The process is repeated continuously until directed otherwise.

The IMP-4 is priced at \$150 each for one to 24, and \$80 each in 1,000-lots.

National Semiconductor Corp., 2900 Semiconductor Dr., Santa Clara, Calif. [411]

---

12-bit d-a converter  
aimed at low-power uses

---

Designed for C-MOS, low-power applications, a 12-bit digital-to-analog converter includes C-MOS switching, an R-2R binary ladder network, a micropower output buffer amplifier,

and an internal  $\pm 10$ -volt precision reference. Typical power dissipation levels are 4.5 milliwatts for the d-a converter portion of the hybrid, and 40 mw for the precision reference section, which can be operated separately or disconnected. In the model 872-D1, accuracy is guaranteed within  $\pm \frac{1}{2}$  LSB in 10 bits over the range from  $-55^\circ$  to  $+125^\circ$ C. In model 872-D2, accuracy is guaranteed within  $\frac{1}{2}$  LSB in 9 bits over the same temperature range. Both accuracy codes feature a typical offset specification of  $\pm 1.0$  millivolt and can be connected for the 0 to +10 v or -10 v range by external corrections. Price for one to nine units of the 872-D1 is \$88 each; of the 872-D2, \$66 each.

Beckman Instruments Inc., Technical Information Section, Helipot Division, 2500 Harbor Blvd., Fullerton, Calif. 92634 [420]

---

Plastic-encapsulated line  
includes binary counter

---

A plastic-encapsulated version of the INS4000 SOS C-MOS logic family, a high-speed pin-for-pin replacement for the RCA CD4000 line, includes the INS4024E, a seven-stage binary counter that offers a minimum guaranteed operating frequency of 10 MHz at 10 volts. Worst-case switching times for all products in the family are specified over the temperature range of  $-40^\circ$ C to  $+84^\circ$ C with load capacitance of 15 picofarads and 50 pF. Additionally, since all Inselek SOS C-MOS products are dielectrically isolated, the SCR-

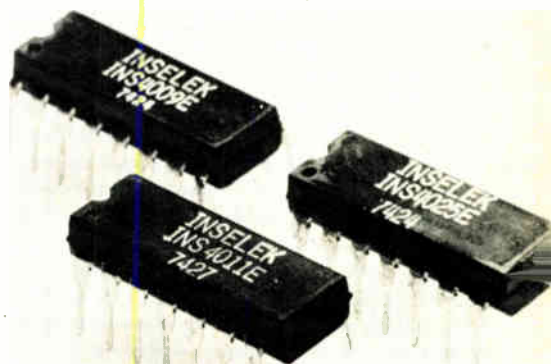

## Keithley's new DMM really does have a difference!

That's the best way to describe the auto-ranging Model 168 Digital Multimeter. It's got the sensitivity (100 microvolts) and full function capability (ac/dc volts, amps, ohms) needed for bench work, plus the carrying ease and optional battery operation needed for portability. And more. Only \$299. Send for data now.



**KEITHLEY  
INSTRUMENTS**  
U.S.A.: 28775 AURORA RD., CLEVELAND, OHIO 44139  
EUROPE: 14, AVENUE VILLARDIN, 1009 PULLY, SUISSE

Circle 146 on reader service card

## New products

type "latchup" failures experienced with some conventional C-MOS logic families cannot occur. The INS4024E is priced at \$2.02 in 1,000-lots.

Inselek Inc., 743 Alexander Rd., Princeton, N.J. 08540 [415]

## 4-k RAM has cycle time of 470 nanoseconds

An MOS LSI 4,096-bit random-access memory, designated the RM1701H, is a single-chip device functionally and pin-compatible with Texas Instruments and Intel types. The RM1701H has a 4,096 × 1 organization, and refresh requires 16 cycles. The device features single-clock input with a low power dissipation of 400 milliwatts operating and 2 mw standby. Access time is 300 ns maximum, with a 470-ns maximum cycle time. The model RM1701H incorporates address and chip select registers to reduce system overhead. All inputs (except clock) are TTL-compatible and do not require pull-up resistors. Three-state output buffers have guaranteed fan-out of two standard TTL gates. Price is \$27 in 100-lots.

Western Digital Corp., 3128 Red Hill Ave., P.O. Box 2180, Newport Beach, Calif. 92663 [414]

## Isolators combine LEDs, cadmium-sulfide cells

Two LED photoconductive isolators are called Photomod series models CLM 8500 and the CLM 8500/2. The CLM 8500 combines a cadmium-sulfide hermetic cell with a LED. Line-voltage capability and fast response time of the photocell are suited for triac switching circuitry. The CLM 8500/2 combines a dual-element CdS hermetic photocell with a LED. The dual output, balanced over a wide range of input currents, is suited for applications requiring two-channel control.

Clairex Electronics, 560 South Third Ave., Mount Vernon, N.Y. 10550 [417]

## FREE 1975 HEATHKIT CATALOG

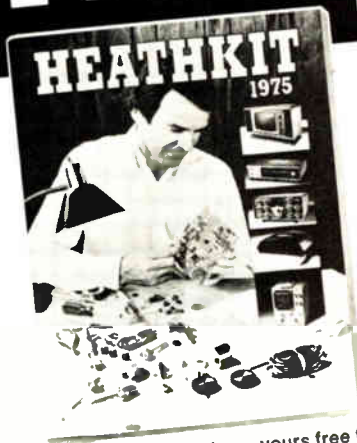

World's largest selection of electronic kits — starring Heathkit digital-design color TV, digital date & alarm clocks, calculators, weather instruments, stereo & 4-channel hi-fi, fishing & marine gear, metal locators, automotive tune-up gear, a comprehensive Amateur Radio line-up, R/C modeling, test instruments... hundreds more. See them all in the new Heathkit catalog — yours free for the asking. Just fill out & mail in the coupon below.

Heath Company, Dept. 53-10  
Benton Harbor, Michigan 49022

Send my FREE 1975 Heathkit Catalog

Name \_\_\_\_\_

Address \_\_\_\_\_

City \_\_\_\_\_ State \_\_\_\_\_ Zip \_\_\_\_\_

HEATH

Schlumberger

CL-531

146 Circle 173 on reader service card

Electronics/October 3, 1974

# Grayhill introduces

## the different DIP Switch

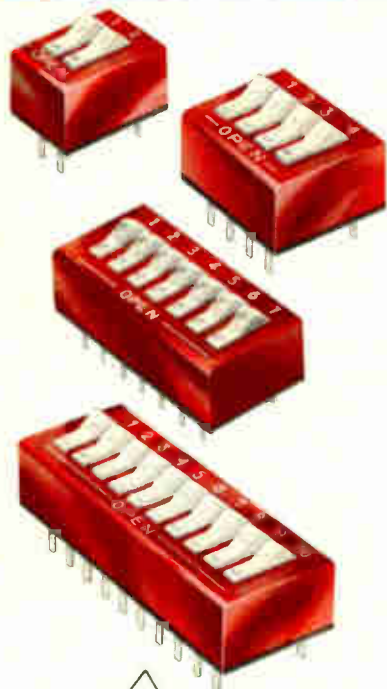

### different contact system

This exclusive Grayhill technique provides positive contact with wiping action and tease-proof reliability. The spring-loaded sliding ball contact insures that the switch is either in the open or closed position, and can't be "hung-up" at some point which could produce an intermittent effect. High resistance to shock or vibration.



### different life span

Tested to 50,000 mechanical operations, with commensurate electrical life, far in excess of what is required for the typical logic application... a performance standard provided without price premium over other brands.

### different sizes, from 2 to 10 poles

Available in 9 sizes, even a hard-to-find 2-rocker version, on up to 10 rockers. All SPST, each switch independent, rocker actuated.

### different color

The most visible difference... the red housing is only important because it tells you it's made by Grayhill, a name synonymous with precision and quality in miniature switches! (Also offered in black.)

Of course, the different DIP Switch—Grayhill's Series 76—also offers the standard DIP benefits: easy PC board mounting, compact high density design, cost savings from use of industry-accepted package dimensions, multi-function programmable PC boards, and elimination of mounting hardware or hand wiring interconnections. Get the full story, including detailed specifications and prices, in Grayhill Engineering Bulletin #238, available free on request, from Grayhill, 561 Hillgrove Avenue, La Grange, Illinois 60525, Phone (312) 354-1040.

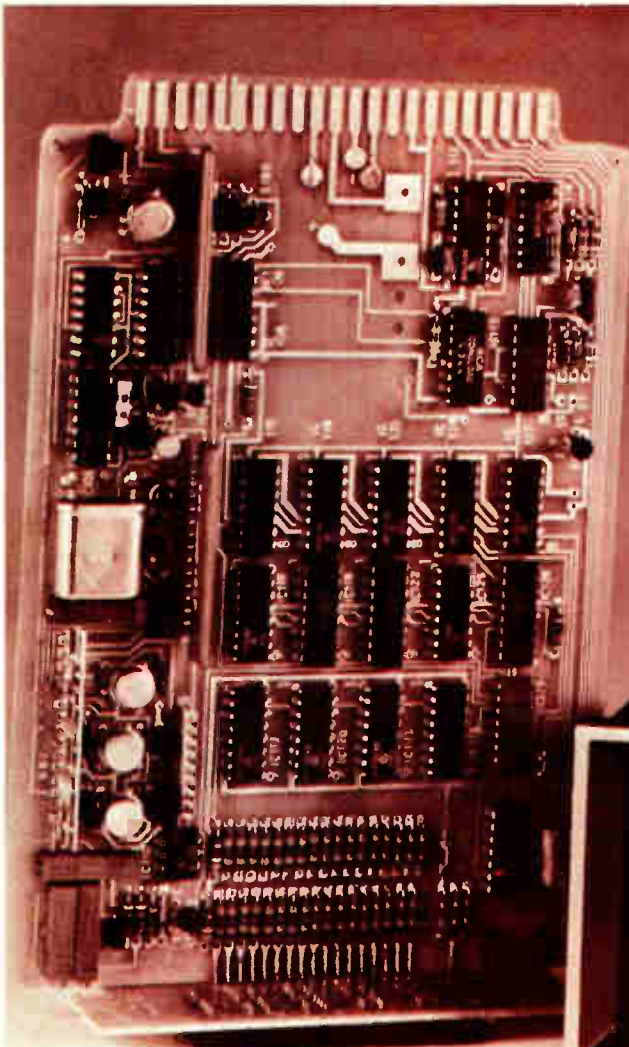

# Bigger and Better



Series 3500

While most DPM manufacturers strive to compress their meters into a one inch cube, ERC has succeeded in making a producible and maintainable low-cost voltmeter with optically isolated parallel BCD outputs and 5999 count full-scale for reliability-conscious engineers in a package only 2.4" H x 5.06" W x 6.38" D, AND for only \$148 in quantities of 100...\$185 in single quantities. If the world's smallest DPM isn't your prime requirement but quality is, contact us for specs and delivery.

electronic research co. • a telectron div.

7618 Wedd  
Overland Park • Kansas 66204  
Mail to: P.O. Box 913  
Shawnee Mission • Kansas 66201  
TWX: (910) 749-6477  
Telephone: (913) 631-6700



Packaging &amp; production

## Art generator resolves 1 $\mu\text{m}$

---

Photoplotting system for integrated circuits uses laser interferometer

As the complexity of large-scale integrated circuits grows, so does the accuracy with which their patterns must be defined and drawn. Pattern accuracies in the range of millionths of an inch are anticipated, and to obtain this The Gerber Scientific Instrument Co. has developed an artwork generator that relies for its positioning on a laser interferometer. The system also uses a redesigned dual photohead for finer lines and increased light intensity.

The model 1434 Ultra-Precise Artwork Generator has a plotting accuracy of  $\pm 40$  microinches (0.00004 inch) or 1 micrometer over the entire plotting area of 16 by 22 inches, and  $\pm 20$  microinches over a 6-in.-square area. Precision over the entire area is within  $\pm 10$  microinches. This precision is reached at speeds up to 120 in. per minute in the X and Y axis, and 60 in. while off-axis. Acceleration from 0 to 60

in./min is under 300 milliseconds.

Prior to the 1434, Gerber's most accurate generator had an accuracy of  $\pm 5$  mils (0.005 in.) and precision of  $\pm 2$  mils (0.002 in.). The new unit consists of a movable large-area plotting table, a photo-optical exposure head with two lamps, a laser interferometer, and a computer to calculate and control the position of the light beam. The introduction last year of dependable laser interferometers was a major element in allowing the 1434 to ignore mechanical errors introduced by roll, pitch and yaw caused by vibration and movement of the plotting table, and thereby achieve greater accuracies. Gerber uses Hewlett-Packard's 5526A laser calibrator system, in which one laser beam feeds two orthogonal interferometers to locate the work point directly.

The 1434 is driven by a closed-loop servo system, and the computer is in the servo loop. Position information from the laser goes directly to a controller, a Hewlett-Packard 2100 minicomputer, with a memory of 12,288 words of 16 bits each. The X and Y carriages are each driven by a dc servo motor; damping is achieved by a rate feedback loop around the dc motor to the controller. The position feedback information from the interferometer is compared with position information derived from the input data. An

analog-to-digital converter decodes the difference and applies it to the servo-control-drive circuitry.

The \$300,000 system is adaptable to most input devices such as magnetic and high-speed paper-tape readers, as well as working on line with computers such as the IBM 1130. A punched paper tape reader is provided to implement the control program and diagnostic routines.

The Gerber Scientific Instrument Co., 83 Gerber Rd., South Windsor, Conn. [391]

---

## 2-piece LED connector needs only simple tooling

Manufacturers of hand-held calculators will find interest in a two-piece LED connector which requires simple tooling. The section of the insulator body containing the contacts is a thermoset material casting that's highly resistant to distortion. The other segment—that which holds the



pc board and the LED display in place—is an SE-1 self-extinguishing thermoplastic. The two segments snap together to form the unit. The connector mounts to the printed circuits board by means of plastic hooks.

Methode Manufacturing Corp., Div. of Methode Electronics, Inc., 1700 Hicks Rd., Rolling Meadows, Ill. 60008 [393]

---

## Connector has closed-entry pin and socket contacts

A family of two-piece wire-wrap-to-solder connectors is designed with closed-entry pin and socket contacts and shrouded insulators for pin protection and high reliability. Connectors are available with 36, 52, 54, 72, 78, or 108 contacts. Contact spacing



## Corrosion Problems? We Have Salt Spray Chambers!

Associated manufactures Salt Spray-Corrosion Test Chambers: One will satisfy your testing requirement to arrest any corrosion problem.



### Check These Specs!

- Four standard sizes, 4 to 40 cu. ft.
- All lucite chamber construction enabling testing with most acids.
- Stylish bench top design—stainless steel base.
- Accomplishes most MIL and ASTM specs.
- Lucite allows product to be seen at all times.
- Low prices.

Call or write today for information on ASSOCIATED's complete line of environmental chambers.

### Associated Environmental Systems



Div. Craig Systems Corp.  
360 Merrimack St.  
Lawrence, Mass. 01842  
(617) 683-9501

NEPCON, Booth 110  
Circle 150 on reader service card

## New products

is on 0.100-inch centers with dual and triple rows of 18, 26 and 36 positions. Connectors may be mounted on 0.062-in., 0.093-in., or 0.125-in. printed-circuit boards. Polarization of the connectors is accomplished without loss of contact positions.

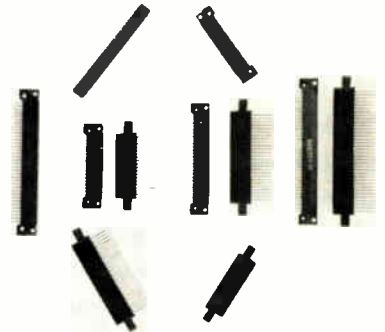

The right-angle solder connector is suited for multilayer or plated-through-hole printed-circuit boards of all sizes. Price is from \$6.50 per mated pair in 100-lots.

Mupac Corp. 646 Summer St., Brockton, Mass. 02402 [396]

# instant pulse

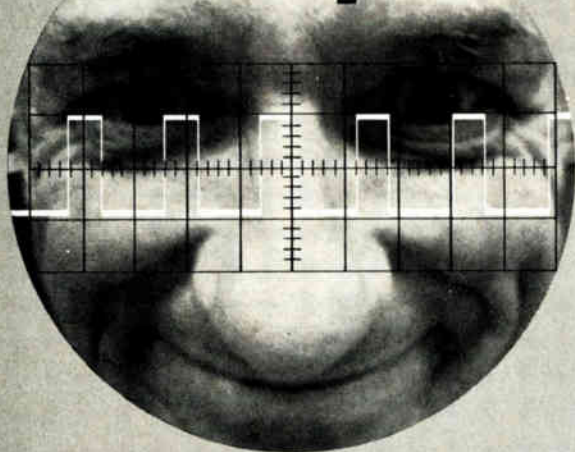

## Interstate Pulse Generators have Constant Duty Cycle

Engineers are always surprised when they select the Constant Duty Cycle mode and adjust the width control on an Interstate Series 20 Pulse Generator — they get an instant pulse. It's "countdown-free," too.

For the whole story on Interstate's Instant Pulsers, call John Norburg collect. He'll send you Interstate's Series 20 Pulse Generator catalog — instantly.

Phone (714) 772-2811



Subsidiary of A-T-O Inc.

Dept. 7000, Box 3117, Anaheim, California 92803  
TWX U.S.A. 910-591-1197 TELEX U.S.A. 655443 & 655419

Circle 174 on readerservice card

## Three-level circuit board has built-in heat sink

A three-level metal-core circuit board handles high thermal density and also offers reduced noise and crosstalk. With a metal substrate between dielectric coatings, the board has a built-in ground plane, allowing the elimination of ground lines



on the board along with their associated noise. And while the substrate is distributing heat over the entire board, it also shields against crosstalk from one side to the other.

International Electronic Research Corp., 135 W. Magnolia Blvd., Burbank, Calif. 91502 [397]

## Communications

**Uhf transistor puts out 80 W**

---

400-MHz unit, designed for tactical radios and ECM, has all-gold metalization

---

The power race in uhf power transistors may not, simply because of package limitations, continue much longer, but it's still not over. Latest entry is a TRW transistor with a minimum output of 80 watts at 400 megahertz. The part is designed for the 225-400-MHz band for aircraft and ground tactical equipment.

Gain at 400 MHz for the 28-volt unit is a minimum of 7 decibels, says communications product manager Robert L. Boughan at the TRW Semiconductor operations. Typically it is 8 to 9 dB.

The transistor uses an all-gold metalization system, with the gold used on the chip itself as well as for wire bonds, and even for the MOS capacitors that provide its internally matched input. Gold is especially important at these high frequencies and high powers because aluminum metalization is subject to migration that can affect operation with the

narrow, thin-metal patterns required.

The J02015 uses emitter-ballasting for short-circuit and overload protection, enabling it to stand an infinite voltage standing wave ratio at 50 watts output and 28 volts. The resistors, moreover, are diffused, as opposed to the thin-film nichrome resistors conventionally used. Engineering manager Richard Battisti says the larger diffused resistors provide better heat dissipation than nichrome and permit a wider range of resistance values. The technique also reduces metal migration problems; the diffused resistors are more significant at the higher frequencies and power levels. TRW pioneered their use in the gigahertz range.

Because the transistors are designed for military applications, both communications and electronic countermeasures, unusual attention was paid to reliability in areas other than the use of gold. One such area is that the layout was computer-designed for optimum thermal dissipation. The parts are glass-passivated and encased in a special, J0 ceramic package for lowest thermal and electrical impedance.

The J02015 is priced at \$92 each in quantities of one to 24, and \$80 each for 25 to 99.

The company also has a complete line of drivers, and is working on 150-watt vhf and 100-watt uhf ver-

sions, close to the top rating of the package.

TRW Semiconductors, 14520 Aviation Blvd., Lawndale, Calif. 90260 [401]

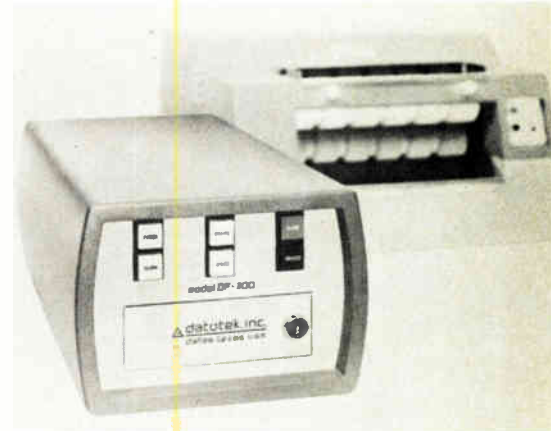

---

**Facsimile scrambler works over standard links**

Built for scrambling facsimile transmissions, a security device designated the model DF-300 operates in conjunction with standard commercial model facsimile machines over standard communication links. The DF-300 incorporates digital timing circuitry to acquire and maintain synchronization over long-distance domestic and international circuits where transmission times and signal variations may be significant. Operation of the unit is automatic, allowing unattended reception of both clear and private scrambled messages intermixed.

Datotek Inc., 13740 Midway Rd., Dallas, Texas 75240 [403]

---

**Communications processor links Nova to terminals**

A multiport communications programmable interface for Data General's Nova series of computers features eight serial input/output ports. The MCPI-1 interface allows up to eight data terminals or computers of varying baud or code structures to communicate directly with a common mini. With a wide baud-selec-

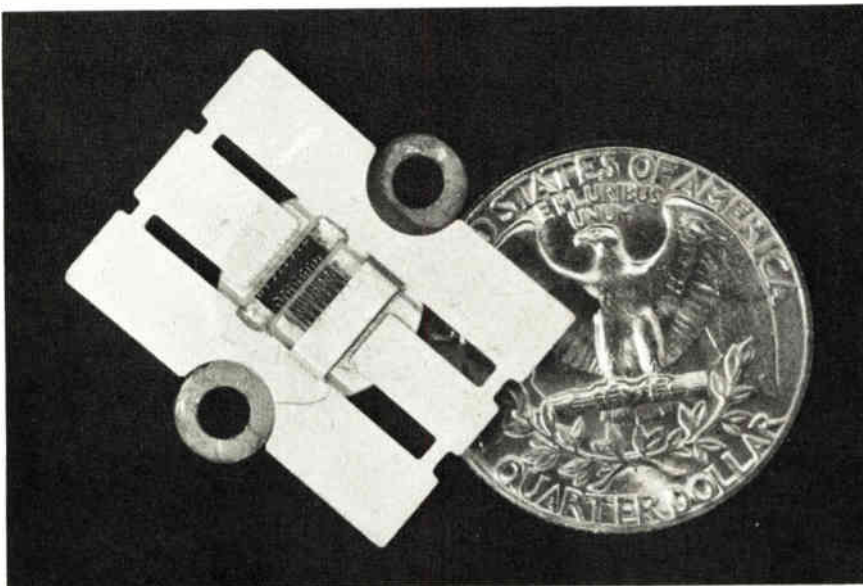

# RF-PACKAGES—MICROWAVE SYSTEMS

WORLD'S LARGEST RADAR & MICROWAVE INVENTORY

## AUTOTRACK ANTENNA SCR-584 RADAR SYSTEM

360 deg az 210 deg ele. Better than 1 mil. accuracy. Missile vel. accel. and slew. rates. Amplitude servo control. Handle up to 20 ft. dish. Compl. with control chassis. ALSO in stock 10 cm. van mounted radar system. Conical scan. PPI, 6 ft. dish. Ideal telemetry, balloon missile rocket trk, ECM range. 600 pg. instr. bk. on compl. radar avail. \$25 ea.



## 1 MEV LINEAR ACCELERATOR

Dual Mode, Ion or Electron. RF Drive, 300 KHZ at 45 KW. Includes control console, RF unit, accelerator, etc.

## MOD IV HI-RES MONOPULSE TRACKER

Instrumentation radar, freq. 8.5-9.6 GHz, Pwr: 250 KW, 1 mil tracking accuracy. 6' Fresnel lens antenna with 4 horn monopulse feed. Trk. Rng. 50 or 200 mi.

## PULSE MODULATORS + H.V.P.S.

245 KW LINE PULSER Output 16 KV at 16 amp. .25 μs at 4000 PPS.

405 KW FLOATING DECK PULSER Output 20 KV at 20 amp. 1 μs to 10 milisecond pulse.

500 KW LINE PULSER Output 22 KV at 28 amp. 4/1.75/2.25 μs at 2500, 550, 300 PPS.

1 MW HARDTUBE MIT MODEL 9 Output 25 KV at 40 amp. .25 μs at .002 D.C.

2.0 MW LINE PULSER Output 30 KV at 70 amp. 1/2 μs at 600, 300 PPS.

3 MW LINE PULSER Output 39 KV at 75 amp. .25/1 μs at 500 PPS.

10 MW LINE PULSER Output 76 KV at 135 amp. 2.5 μs at 350 PPS.

17 MW LINE PULSER Output 17 KV at 1000 amp. 2-5 μs at 150-2000 PPS.

## RECON DRONE CONTROL RADARS

X Band systems autotrack and search complete with plotting boards. Fully mobile van mounted. Gnd to air links and beacons also in stock.

## MICROWAVE LINK EQUIPMENT

Freq. 7.1-7.9 GHz, Pwr. 100 mw., 4 channels. Transmits video, pulse, synchro, and voice information. Mfr: Motorola. Others in stock.

SEND FOR FREE 24 PG. CATALOG ON YOUR LETTERHEAD

## SPARE PARTS IN STOCK

Nike Ajax, Nike Hercules, M-33, MPS-19, TPS-ID, TPS-10D, FPS-6, SPS8, SCR-584, HIPAR. Many more, write.

## RADAR & RF PKGS.

34ghz 40 kw Pulse RF pkg

24ghz 40 kw Pulse bomb toss system

16ghz 130 kw Pulse B-58 search radar system

X BAND SEARCH 40 KW PULSE WEATHER RADAR

BAND AUTOTRACK AUTOTRACK GPG-1/MPQ-29

X BAND AUTOTRACK 250KW PULSE M-33

X BAND BEACON 400 W PULSE AN/SPS-5

X BAND AUTOTRACK 50KW PULSE B-47 FIRE CONTR.

C BAND WEATHER RADAR 250 KW PULSE CPS-9

C BAND HT. FDR. FPS-26, 5 MW; TPS-37, 1 MW

U BAND 285 KW PULSE Search AN/SPS-5

S BAND AUTOTRACK 500 KW PULSE 10' DISH

S BAND 1 MEGAWATT COHERENT AN/FPS-18

S BAND 1 MEGAWATT PULSE NIKE ACQ.

S BAND 5 MEGAWATT HEIGHT FINDER AN/FPS-6

S BAND MORTAR LOCATOR 250 KW MPO-10A

L BAND 500KW PULSE AN/TPS-ID/E & FPS-75

L BAND 5 to 20KW PULSE

400 mhz 1KW CW AN/FPS-23

225mhz 1 MEGAWATT PULSE AN TPS 28

CW 4.4-5ghz 1 KW

CW .950-5ghz 150 WATTS

CW 1.5 mhz-10.5ghz 5 WATTS

CW 1.7-2.4ghz 10 KW

## 60 FT. DISH

Complete with Az-El pedestal, ready for installation. Immed. delivery! Write or call.



**Radio Research Instrument Co., Inc.**

3 QUINCY ST., NORWALK, CONN. 06850  
(203) 853-2600

CIRCLE 951 ON READER SERVICE CARD

# Job-seekers... be the first to know with McGraw-Hill's Advance Job Listings

By having our new weekly ADVANCE JOB LISTINGS sent First-Class (or by Air Mail, if you prefer) to your home every Monday you can be the first to know about nation-wide openings you qualify for both in and out of your field.

This preprint of scheduled employment ads will enable you to contact anxious domestic and overseas recruitment managers BEFORE their advertisements appear in upcoming issues of 22 McGraw-Hill publications.

To receive a free sample copy, plus information about our low subscription rates (from one month to 12), fill out and return the coupon below.

ADVANCE JOB LISTINGS / P.O. BOX 900 / NEW YORK NY 10020

PLEASE SEND A SAMPLE COPY OF ADVANCE JOB LISTINGS TO:



NAME \_\_\_\_\_ ADDRESS \_\_\_\_\_  
CITY \_\_\_\_\_ STATE \_\_\_\_\_ ZIP \_\_\_\_\_

E10/3/74

SAME DAY SHIPMENT  
Minis & Peripherals

**PRINTERS**  
"BRAND NEW"

## DATA PRODUCTS

2440— 700 LPM

2470—1250 LPM

MDS 4320—300 LPM

ALSO  
CENTRONICS, POTTER, CDC  
A. B. DICK, IBM, HIS, UNIVAC  
617/261-1100

Send for Free Report "Maintenance of Computers"

AMERICAN USED COMPUTER CORP.

P.O. Box 68, Kenmore Sta., Boston, MA 02215

member COMPUTER DEALERS ASSOCIATION

CIRCLE 952 ON READER SERVICE CARD

## free catalog

POTTING APPLICATORS  
MANUAL OR AIR OPERATED

2 1/2cc 6cc 12cc 30cc  
FOR POTTING, ENCAPSULATING ETC.

**PHILIP FISHMAN CO., INC.**  
7 CAMERON ST. WELLESLEY, MASS. 02181

CIRCLE 953 ON READER SERVICE CARD

## FREE ALARM CATALOG

Full line of professional burglar and fire alarm systems and supplies. 96 pages, 450 items. Off the shelf delivery, quantity prices.



mountain west alarm  
4215 n. 16th st., phoenix, az. 85016

CIRCLE 954 ON READER SERVICE CARD

## FREE CATALOG

HARD-TO-FIND PRECISION TOOLS

Lists more than 2000 items—pliers, tweezers, wire strippers, vacuum systems, relay tools, optical equipment, tool kits and cases. Also includes ten pages of useful "Tool Tips" to aid in tool selection.

**JENSEN TOOLS**  
4117 N. 44th Street, Phoenix, Ariz. 85018

CIRCLE 956 ON READER SERVICE CARD

## PROFESSIONAL SERVICES

Thorough Patent and Trademark Searches for Professional Engineers and Research & Development Firms. Patent Consultants, 422E Washington Building, Washington, D.C. 20005. (202) 638-1666.

Q. Whom do I contact or call to renew my classified ad or make corrections?

A. Write Electronics, Class. Adv. Dept., P.O. Box 900, NY, NY 10020 or call: (212) 997-6585 or 6586. Give full company name, size of ad, & date or dates it is scheduled to appear.



## New products

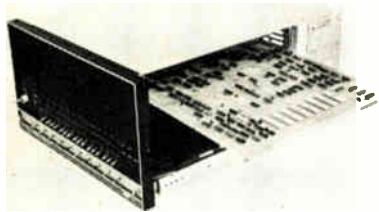

tion capability, transmit and receive rates are individually software-programmable from 6 baud to 12,800 baud. Compatible with any RS-232 type modem, the interface features send-and-receive unattended operation and allows a single Nova to interact with terminals of different speeds and code structures. Speed may range from that of a teletypewriter to an on-line computer. Code structures may have odd or even parity, one or two stop bits, or 5 to 8 data bits.

MetroData Corp., 1250 Mercer St., Seattle, Wash. 98109 [404]

## I-f amplifiers designed for satellite systems

A line of i-f amplifiers for telecommunications operate at 70 MHz, 700 MHz and 1,100 MHz. The amplifiers are especially designed for satellite systems such as Comsat, Intelsat, and Satcom, for use in up-and

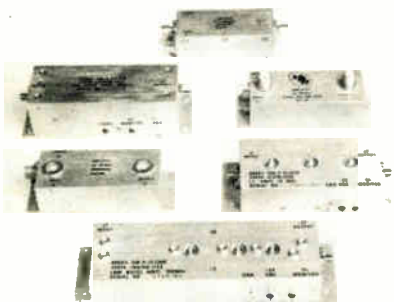

down-converters. The series IFA features a group delay of 0.5 nanosecond, 0.1-dB bandpass flatness, 30-dB reverse isolation, and return losses of 23 dB.

Microwave Power Devices Inc., Adams Court, Plainview, L.I., N.Y. 11803 [409]

# CONDUCTIVE ELASTOMERIC CONNECTERS

- Conductive and resilient elastomeric contact elements •
- Low cost • Variable contact sizes, spacing, and configurations •
- Compensates for surface irregularities • Isolates vibration •
- No soldering required • Built-in stops • Speeds assembly and reduces package volume • Free sample available upon request.

**TECKNIT**®

**Technical Wire Products Inc.**

Eastern Division • 129 Dermody St., Cranford, NJ 07016 (201) 272-5500  
Western Division • 427 Olive St., Santa Barbara, CA 93101 (805) 963-1867

Circle 153 on reader service card

## The Brush recorder module. It gives your system the competitive edge.

OEM recorder modules give you design flexibility along with all the Brush exclusives.

Choose single or dual channel, low profile or vertical models. There's a wide range of chart speed options.

Plus Brush exclusives like pressurized ink writing and Metrisite® servo loop feedback system that assures 99.5% linearity.

Write Gould Inc., Instrument Systems Division, 3631 Perkins Avenue, Cleveland, Ohio 44114. Or Kouterveldstraat Z/N, B 1920 Diegem, Belgium.



**GOULD**

Circle 175 on reader service card

# WHAT'S YOUR ANGLE? NATEL CAN TELL!

Model 4071 ANGLE POSITION INDICATOR reads your angle in 4 or 5 digits from any synchro or resolver.



For DIGITAL, ANALOG, or SINE/COSINE presentation NATEL has the proper synchro converter.

## NEED AN ANGLE?

Get it from NATEL's DIGITAL TO SYNCHRO CONVERTER or ANALOG to SYNCHRO CONVERTER or SINE/COSINE to SYNCHRO CONVERTER.

## HOW ABOUT PERFORMANCE?



Model SD512 SYNCHRO to DIGITAL CONVERTER Typical Tracking Accuracy:

±0.05° at 4000°/Sec constant velocity.  
±0.05° at 8000°/Sec<sup>2</sup> acceleration.  
Static Accuracy: ±0.02°

## DON'T TAKE OUR WORD FOR IT, TEST IT!

Please call or write for complete information.

### NATEL ENGINEERING COMPANY

8954 Mason Avenue, Canoga Park Cal. 91306

Tel: 213-882-9620

Circle 154 on reader service card

## WORLD'S LIGHTWEIGHT CHAMP!

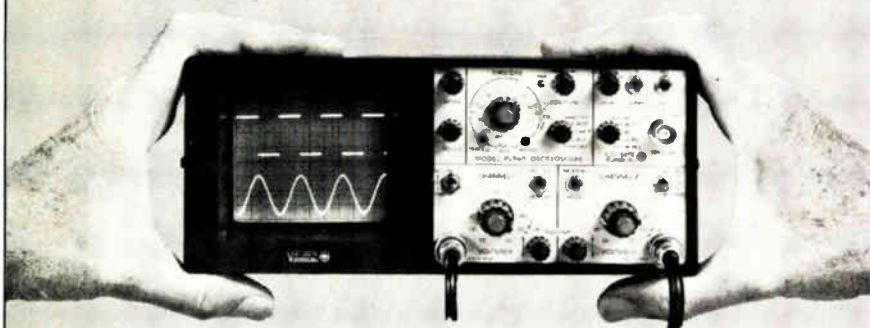

### A 9½ pound, dual-trace 20 MHz scope that fits in a briefcase . . .

- Mini-portable Oscilloscope
- Battery, AC or DC powered
- DC - 20 MHz bandwidth
- Computerized triggering
- Delay line
- 10 mV/div sensitivity
- 21 sweep ranges to 100 nsec/div

If you're tired of working with the "Heavyweights," but still need a high performance portable scope that can handle your trouble-shooting needs, then consider Model PS940A. This dual-trace "mini-scope" provides all the basic features and quality of a sophisticated lab scope, yet its weight and size make it easy to carry to every job—at the plant or in the field. And it is simple to operate. Computerized triggering guarantees a stable CRT display at all times. Also, both traces can be vertically positioned in the DC coupled trigger mode without the need for trigger level readjustment.

AVAILABLE NOW FOR ONLY **\$1095**

INTERESTED? Call Hal Wardein at (714) 279-6572, or write to us at 7170 Convoy Court, San Diego, California 92111. For local ordering information, dial TOLL-FREE 800-645-9200; in N.Y. State call collect (516) 294-0990.

From a Leader in Mini-Portable Oscilloscopes



## New products/materials

A video oxide for high-energy video tape is called Videox HiEn 527. In contrast to the commonly used cobalt-doped gamma-iron oxides, it is a high-energy ferrite. Its coercivity on tape is about 525 oersteds, approximately equivalent to chromium dioxide. The new ferrite is said to be highly stable against magnetostrictive and thermally induced changes in magnetization.

Hercules Inc., 910 Market St., Wilmington, Del. 19899 [476]

Mereco 4501 is a nonsolvent epoxy-resin system designed to cure into a transparent rubber-like gel. It can be used for encapsulation when transparency is desired for inspection and repair. The epoxy resin has low viscosity, a dielectric constant of 3.0, and a dissipation factor of 0.02. It is intended to replace silicone for embedding electronic components.

Mereco Products Division, Metachem Resins Corp., 530 Wellington Ave., Cranston, R.I. 02910 [477]

An etching-bath additive that is not a metallic salt is used for etching MOS devices. FC-93 reduces the surface tension of acid etches to improve surface wetting and bubble release, thus reducing rejections that are caused by air entrapment. The additive is supplied as a 25% solution, and at a recommended use range of 0.04% to 0.4% FC-93, surface tension of an oxide-etch solution becomes as low as 19.0 dynes per centimeter; and of an aluminum etch, 19.4 dynes/cm.

3M Co., Dept. CH4-17, Box 33600, St. Paul, Minn. 55133 [478]

A urethane potting compound, because it is derived from castor-bean oil, is not dependent on petroleum supplies. Called RF70, it costs less than silicone resins or epoxy and has high impact and peel strength. The compound can be used in casting both thick and delicate parts and is available in quantities from pints to 55-gallon drums. Delivery is from stock.

Resin Formulators Co., Division EVRA, Inc., 9601 Jefferson Blvd., Culver City, Calif. 90230 [479]

# MV5050-series GaAsLITEs: Worth looking into.

Viewing angle for various devices ranges from 50 to 110 degrees. Choose from full-flooded diffused, or pinpoint lens effects, either red or clear.

Long life and shock resistance are inherent to the GaAsLITE design. No filament or glass to break. .001"-dia. gold connecting wire is bonded by thermo-compression to die and anode lead, and encapsulated.

Automated handling becomes a possibility with a new cylindrical barrel design that makes the MV5050-series lamps fit precisely into .200-inch aperture. Flattened flange, denoting cathode, speeds handling.

High brightness GaAsP chip is eutectically bonded to header.

The virtually unbreakable "bulb" can take temperatures up to 125°C without deforming. It's made from a unique formulation of a modified bisphenol Type A epoxy system.

Bendable, solderable, wire-wrappable leads are plated copper for best heat transfer and stability characteristics. They mount easily in PC boards on 100-mil centers.

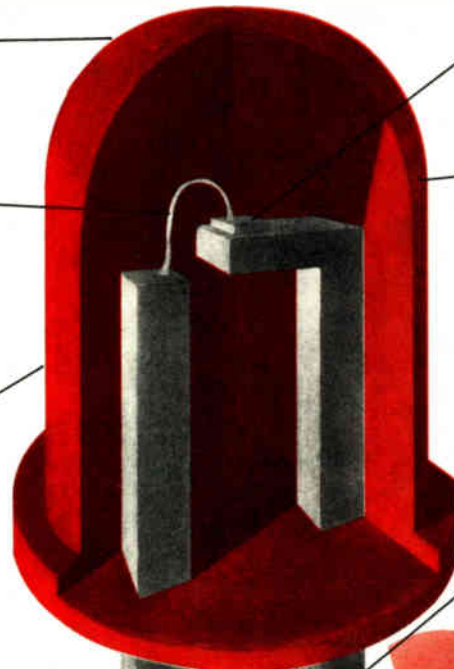

Six solid-state indicator lamps



Three solid-state illuminators

Installation is a snap with our mounting grommet, supplied on request at no extra cost.

Here's our newest family of low-cost, long-life solid-state indicators and illuminators. They're all IC-compatible and use new high brightness materials. Like all our GaAsLITEs, they shine with very little power and are a snap to design into your equipment. Compact, rugged and reliable, the MV5050-series gives you the widest selection of lens effects in the industry. Pin-point. Soft diffused. Flooded. And your choice of viewing angles. All the details are on the data sheet.

For illumination, our MV5054-series GaAsLITEs use high-performance GaAsP to light up a 1/4"-dia. circle. Choice of three brightness levels. And the MV5054-1 has a *new reduced price*. For complete specs and pricing information, ask any of our distributors or write **Monsanto Commercial Products Company** Electronics Special Products 3400 Hillview Avenue Palo Alto, CA 94304 (415) 493-3300/

*Putting innovation to work*

# Monsanto

# Electronics advertisers

October 3, 1974

Abbott Transistor Labs, Inc. Technical Advertising Agency	6	‡ Graphic Controls Corp. Conklin, Labs & Bebee, Inc.	74	• Rohde & Schwarz	1E
Advanced Micro Devices Keye/Donna/Pearstein	11	■ Grayhill, Inc. Stral Advertising Company, Inc.	147	• Rhone Progil	13E
Allen Bradley Company Hoffman, York, Baker & Johnson, Inc.	38	‡ GTI-Tensor Electronics Market Finders	24	■ Rockland Systems Rolf Johnson, Inc.	110
‡ Amphenol Connectors Division, Bunker Ramo Corp. Dimensional Marketing, Inc.	42	■ Heath/Schlumberger Scientific Instruments Advance Advertising Services	146	R-OHM Corp. Diversified Corporate Services, Inc.	62
Associated Environmental Systems, Inc. A.D. Adams Advertising, Inc.	150	■ Hewlett-Packard Corporate Marketing Communications	25-34	Schauser Manufacturing Corp. Nolan, Keator & Siles	136
‡ Beckman Instruments, Inc., Hellipot Division N.W. Ayer/Jorgensen/MacDonald, Inc.	68	■ Honeywell Test Instrument Division Campbell-Mithun, Inc.	36,37,39	• Seacosem Bazaine Publicite	66
The Boeing Aerospace Company Cole & Weber Inc.	140-141	■ Hughes Aircraft Company Foote, Cone & Belding	51	Siemens Components Division N.A. Winter Advertising Agency	90-91
‡ Bourns, Inc. Marlborough Assoc., Inc.	71	Intel Corp. Regis McKenna, Inc.	12-13	• SMK Europe	11E
Burroughs Corporation Conti Advertising	9	■ Interstate Electronics Corp. Chris Art Studio, Inc.	150	Sorensen Company Division of Raytheon Co. Provandie Eastwood & Lombardi, Inc.	52
‡ Cable-Scan S. Michelson Advertising	144	Keithley Instruments, Inc. Chagrin Valley Marketing Associates	146	Sound Technology Frank Burkhard Company	10
Cinch Connectors, Operation of TRW Electronics Components Stral Advertising Company, Inc.	35	■ Kepco Inc. Weiss Advertising	5	• Spectrol Reliance Limited JMR Advertising	8E-9E
■ Clairax Corporation Black-Russell-Morris	4th Cover	■ Lapp Insulator Div., Interpace Corp. Wolf Associates, Inc.	20	Sprague Electric Company Harry P. Bridge Company	8
Computer Automation Cochrane Chase & Company, Inc.	49	LFE Corp., Process Control Division LFE Advertising	94	• Stoiz AG Buero fuer technische Werbung	109
■ Concord Electronics Corp. Sound Advertising	158	Macrodata Company JMR Advertising	137	Syston Donner Concord Instruments Fred Schott & Associates	65
■ Continental Specialties Corp. Robert A. Paul	158	Micro Power Systems Associated Ad Ventures, Inc.	2nd Cover	Technical Wira Products, Inc. TWP Advertising	153
Digital Equipment Corporation Creamer, Trowbridge, Case & Bastford, Inc.	132-133	■ Micro Switch Division of Honeywell N.W. Ayer & Son, Inc.	21	■ Tektronix, Inc. Tektronix Advertising	129
Eastman Chemical Products Inc., Industrial Chemicals J. Walter Thompson Company	158	‡ Molex Incorporated Howard H. Monk and Associates, Inc.	109	• Telcon Metals Ltd. Oliver Dawkins Ltd.	10E
‡ Eastman Kodak Co. Business Systems Markets Division- Engineering Data System Micrographics J. Walter Thompson Company	15	Monolithic Memories, Inc. Paul Pease Advertising, Inc.	17-19	■ Texas Instruments-Scientific Calculators Tracy-Locke	75-78
Electronic Research Company ERC Advertising	148	Monsanto Commercial Products Co., Electronic Special Products Advertising Promotion Services	155	Thomson CSF Bazaine Publicite	55
Electromask, Inc. JMR Advertising	157	Motorola Semiconductor Products, Inc. E.B. Lane & Associates, Inc.	47,57-59	■ TRW Semiconductors The Bowes Company	7
■ Electro Scientific Industries Commark Group, Inc.	84	• Motorola Semiconductor Graham & Gillies Limited	53	■ Unitrode Corporation Culver Advertising, Inc.	41
■ EL Instruments, Inc. Langeler-Stevens, Incorporated	143	Natel Engineering Co., Inc.	154	Varo Semiconductor Warren-Guild	124
Fairchild Semiconductor, Inc. Carson/Roberts, Inc. Advertising Division of Ogilvy & Mather	92-93	■ National Semiconductor Corp. Chiat/Day, Inc. Advertising	130-131	Vu-Data Manning-Bowen and Associates	154
■ John Fluke Mfg. Co., Ltd. Lennox Marketing Limited	134	■ Nelson Ross Electronics, Div. Polarad Electronics McCarthy-Scelba-DeBiasi Advertising Agency	1	• Wandel und Goltermann Werbeagentur	15
■ General Electric Co. Semiconductor Products Department Advertising & Sales Promotion Syracuse Operation	85	• Norton Technik Marketing	16E	Wavetek San Diego Chapman Michetti Advertising	138
■ General Electric Company, Tube Products Department Robert S. Cragin, Inc.	89	• Oscilloquartz SA, Neuchatel Publicitas	16E	Western Digital Corporation W D C Advertising	60-61
■ General Instrument Corporation, Microelectronics Div. Norman Allen Associates, Inc.	2	• Philips Elcoma Intermarco Nederland	42	Wims, Westermann Oliver-Beckmann GmbH	16
General Magnetics McCarthy/Scelba/DeBiasi Advertising Agency, Inc.	3rd Cover	• Philips Electrologica Intermarco Nederland	4E	Winchester Electronics Renaccio Advertising & Marketing, Inc.	22-23
• General Radio Grad Associates	7E	• Philips N.V. PR/T & M Division Brookies Communications System SA	68	• Yokogawa Electric Works, Ltd. General Advertising Agency, Inc.	74
Georgia Department of Community Development Gerald Raifshoon Advertising, Inc.	54	Photocircuits Ries Cappiello Colwell, Inc.	72-73	‡ Carl Zeiss, Inc.-Micro Michel Cather	53
■ Gould, Inc./Instrument Systems Division Carr Liggett Advertising, Inc.	153	‡ Raytheon Company, Sorensen Department Provandie Eastwood & Lombardi, Inc.	52		
		RCA-Solid State Division Marsteller, Inc.	81,83		
		• RCA Ltd. Marsteller, Ltd.	2E-3E		
		■ RCL Electronics, Inc. Morvay Advertising Agency	14		
		• Rita MK Marknadskommunikation AB	71		

## Classified & Employment Advertising

F. J. Eberle, Manager 212-971-2557

EQUIPMENT (Used or Surplus New) For Sale	
American USED Computer Corp.	152
Philip Fishman Co., Inc.	152
Jensen Tools	152
Mountain West Alarm	152

■ For more information on complete product line see advertisement in the latest Electronics Buyer's Guide  
 • Advertisers in Electronics International  
 ‡ Advertisers in Electronics domestic edition

# "OUR 'IMPS' ARE ONLY AS GOOD AS OUR MASKS, BUT OUR MASKS ARE THE BEST!"

"The high reliability that our customers expect out of our IMP-16 series microprocessor chips and boards starts in my IC mask shop. All the fabrication processes that follow maskmaking could be useless if the masks aren't right in the first place.

"That's why in the step-and-repeat operations for our RALU's (Register and Arithmetic Logic Units) and CROM's (Control and Read Only Memories), I insist on the kind of precision and absolute accuracy that



I have found provided only by the Electromask Image Repeater.

"This is just another example of how we at National employ only the very finest state-of-the-art equipment to help us achieve better yields with maximum reliability in all of our products."

**Randy Parker, Manager  
Mask Shop, National  
Semiconductor Corp.**

The Electromask Image Repeater is the fastest and most precise step-and-repeat system available for producing photomask arrays on either photoresist or emulsion surfaces. It is the only such system positioned by laser beam, with stages floating on frictionless

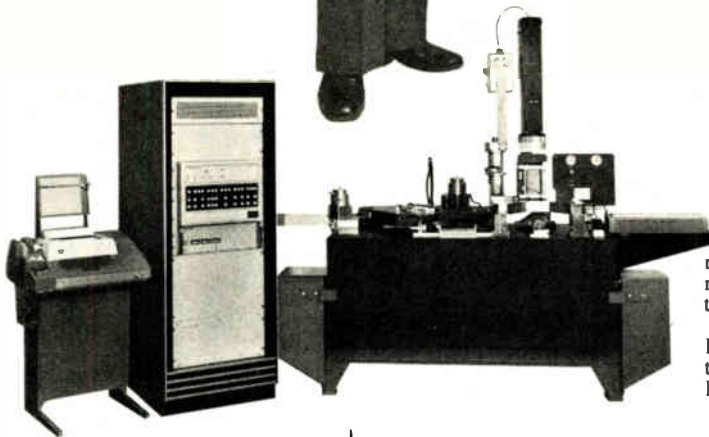

air-bearings, thus eliminating mechanical contact and providing non-degradable accuracy down to less than 0.5 of a micron.

For more information on the Electromask Image Repeater, use the reader service card, or contact Electromask directly.



**ELECTROMASK, INC.**

A subsidiary of TRE Corporation, 6109 De Soto Ave., Woodland Hills, Calif. 91364, Phone: (213) 884-5050, Telex 67-7143

**For bonding  
metal-  
to-metal-  
to-glass-  
to-glass-to-  
plastics-  
to-plastics-  
to-rubber-to-  
rubber-to-  
metal-to-etc-  
to-etc.**

One drop goes a long way in fastening almost anything to almost anything.

Eastman 910<sup>®</sup> adhesive bonds fast, too. Almost instantaneously. With only contact pressure.

Tensile strength? Up to 5000 psi at room temperature.

New Eastman 910 MHT and THT/Grades hold when the heat's on. Even over 400° F.

For further data and technical literature, write: Eastman Chemical Products, Inc., Kingsport, Tennessee 37662.



158 Circle 158 on reader service card

**Advertising Sales Staff**

**Pierre J. Braudé** New York [212] 997-3468  
Director of Marketing

**Atlanta, Ga. 30309:** Joseph Lane  
100 Colony Square, 1175 Peachtree St., N.E.  
[404] 892-2868

**Boston, Mass. 02116:** James R. Pierce  
607 Boylston St. [617] 262-1160

**Chicago, Ill. 80611:**  
645 North Michigan Avenue  
Robert W. Bartlett (312) 751-3739  
Paul W. Reiss (312) 751-3738

**Cleveland, Ohio 44113:** William J. Boyle  
[716] 586-5040

**Dallas, Texas 75201:** Charles G. Hubbard  
2001 Bryant Tower, Suite 1070  
[214] 742-1747

**Denver, Colo. 80202:** Harry B. Doyle, Jr.  
Tower Bldg., 1700 Broadway  
[303] 266-3863

**Detroit, Michigan 48202:** Robert W. Bartlett  
1400 Fisher Bldg.  
[313] 873-7410

**Houston, Texas 77002:** Charles G. Hubbard  
2270 Humble Bldg. [713] CA 4-8381

**Los Angeles, Calif. 90010:** Robert J. Rielly  
Bradley K. Jones, 3200 Wilshire Blvd., South Tower  
[213] 487-1160

**New York, N.Y. 10020**  
1221 Avenue of the Americas  
Warren H. Gardner [212] 997-3617  
Michael J. Stoller [212] 997-3616

**Philadelphia, Pa. 19102:** Warren H. Gardner  
Three Parkway,  
[212] 997-3617

**Pittsburgh, Pa. 15222:** Warren H. Gardner  
4 Gateway Center, [212] 997-3617

**Rochester, N.Y. 14534:** William J. Boyle  
9 Greylock Ridge, Pittsford, N.Y.  
[716] 586-5040

**San Francisco, Calif. 94111:** Don Farris  
Robert J. Rielly, 425 Battery Street,  
[415] 362-4600

**Paris:** Alain Offergeld  
17 Rue-Georges Bizet, 75 Paris 16, France  
Tel: 720-73-01

**Geneva:** Alain Offergeld  
1 rue du Temple, Geneva, Switzerland  
Tel: 32-35-63

**United Kingdom & Scandinavia:** Keith Mantle  
Tel: 01-493-1451, 34 Dover Street, London W1

**Milan:** Robert Saldel  
1 via Baracchini, Italy Phone 86-90-656

**Brussels:** Alain Offergeld  
23 Chaussee de Wavre  
Brussels 1040, Belgium  
Tel: 13-73-95

**Frankfurt/Main:** Fritz Krusebecker  
Liebigstrasse 27c, Germany  
Phone 72 01 81

**Tokyo:** Tatsumi Katagiri, McGraw-Hill  
Publications Overseas Corporation,  
Kasumigaseki Building 2-5, 3-chome,  
Kasumigaseki, Chiyoda-Ku, Tokyo, Japan  
[581] 9811

**Osaka:** Ryji Kobayashi, McGraw-Hill  
Publications Overseas Corporation, Kondo  
Bldg., 163, Umegae-cho Kita-ku, Japan [362] 8771

**Australasia:** Warren E. Ball, IPO Box 5106,  
Tokyo, Japan

**Business Department**

**Stephen R. Weiss, Manager**  
[212] 997-2044

**Thomas M. Egan,**  
Production Manager [212] 997-3140

**Carol Gallagher**  
Assistant Production Manager [212] 997-2045

**Dorothy Carter,** Contracts and Billings  
[212] 997-2908

**Frances Vallone,** Reader Service Manager  
[212] 997-6057

**Electronics Buyers' Guide**

**George F. Werner,** Associate Publisher  
[212] 997-3139

**Regina Hera,** Directory Manager  
[212] 997-2544

**NEW!  
Power-On  
Hands-Off  
Signal Tracing  
PROTO-CLIP<sup>®</sup>  
...under \$5**

Now trace signals or trouble-shoot fast. Inject signals or wire unused circuits into existing boards. Scope probes, test leads lock onto Dynagrip inset. Plastic construction — no springs or pivots. Thousands of operations. Narrow throat for high density pc boards.

14-pin Proto-Clip: \$4.50 each.  
16-pin Proto-Clip: \$4.75 each.

Order today from distributor or  
Continental Specialties Corp.  
Box 1942,  
New Haven, CT 06509  
Telephone: 203/624-3103

Unique  
DYNAGRIP  
inset keeps  
probes from  
slipping



Circle 177 on reader service card

**BUY  
DIRECT!**

call CONCORD for:

**JACKS**

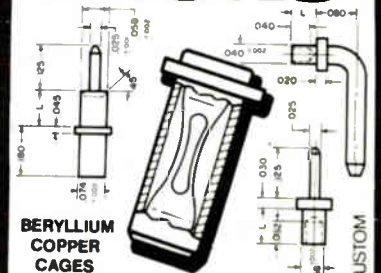

**& PINS**

**CONCORD ELECTRONICS CORPORATION**

37 GREAT JONES STREET • NEW YORK N.Y. 10012  
(212) 777-6571 • TWX 710-581-4930

FREE CATALOG AVAILABLE.

Circle 178 on reader service card

## 3 WIRE SYNCHRO TO LINEAR D.C. CONVERTER

ACCURACY 1/2 %



#MAC 1422-1

Provides a linear conversion of a synchro angle to a DC Voltage

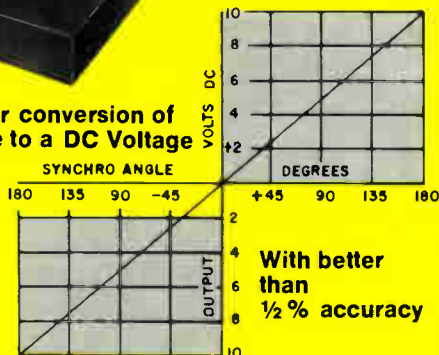

With better than 1/2 % accuracy

### Specifications

Accuracy:  $\pm 1\%$  over temperature range  
 Input: 11.8V, 400 HZ line to line 3 wire synchro voltage  
 Output Impedance: less than 10 Ohms  
 Input Impedance: 10K minimum line to line  
 Reference: 26V  $\pm 10\%$  400HZ (Unit can be altered to accommodate 115V if available at no extra cost)  
 Operating temp. range:  $-25^{\circ}\text{C}$  to  $+85^{\circ}\text{C}$   
 Storage temp. range:  $-55^{\circ}\text{C}$  to  $+100^{\circ}\text{C}$   
 DC power:  $\pm 15\text{V} \pm 1\%$  @ 75ma (approx.)  
 Case material: High permeability Nickel Alloy  
 Weight: 6 Ozs. Size: 3.6" x 2.5" x 0.6"

## SOLID STATE SINE-COSINE SYNCHRO CONVERTER - NON VARIANT

This new encapsulated circuit converts a 3 wire synchro input to a pair of dc outputs proportional to the sine and cosine of the synchro angle independent of a-c line fluctuations.

- Complete solid state construction.
- Operates over a wide temperature range.
- Independent of reference line fluctuations.
- Conversion accuracy — 6 minutes.
- Reference and synchro inputs isolated from ground.

### Specifications Model DMD 1508-2

Accuracy: Overall conversion accuracy 6 minutes. Absolute value of sine and cosine outputs accurate to  $\pm 30\text{MV}$   
 Temperature Range:  
 Operating  $-40^{\circ}\text{C}$  to  $+85^{\circ}\text{C}$   
 Storage  $-55^{\circ}\text{C}$  to  $+125^{\circ}\text{C}$   
 Synchro Input: 90V RMS  $\pm 5\%$  LL 400Hz  $\pm 5\%$   
 DC Power:  $\pm 15\text{V DC} \pm 10\%$  @ 50MA  
 Reference: 115VRMS  $\pm 5\%$  400Hz  $\pm 5\%$   
 Output: 10V DC full scale output on either channel @ 5ma load  
 Temperature coefficient of accuracy:  
 $\pm 15$  seconds/ $^{\circ}\text{C}$  avg. on conversion accuracy  
 $\pm 1$  MV/  $^{\circ}\text{C}$  on absolute output voltages  
 Size: 2.0" x 1.5" x 2.5"  
 Units are available with wider temperature ranges and 11.8V LL, 24V reference synchro inputs. Information will be supplied upon request.

## A.C. LINE REGULATION

A new method has been developed which allows us to provide a low distortion highly regulated AC waveform without using tuned circuits or solid state active filters of any kind.

The result is a frequency independent AC output regulated to 0.1% for line and load with greater than 20% line variations over a wide temperature range.

### Features:

- 0.1% total line and load regulation
- Independent of  $\pm 20\%$  frequency fluctuation..
- 1 watt output
- Extremely small size
- Isolation between input and output

Specifications: Model MLR 1476-1

AC Line Voltage: 26V  $\pm 20\%$  @ 400Hz  $\pm 20\%$

Output: 26V  $\pm 1\%$  for set point

Load: 0 to 40ma

Total Regulation:  $\pm 0.1\%$

Distortion: 0.5% maximum rms

Temperature Range:  $-55^{\circ}\text{C}$  to  $+125^{\circ}\text{C}$

Size: 2.0" x 1.8" x 0.5"

Other units are available at different power and voltage levels as well as wider temperature ranges. Information will be furnished upon request.

## 4 QUADRANT MAGNETIC ANALOG MULTIPLIER

DC x DC = DC OUTPUT

DC x DC = DC OUTPUT

DC x DC = DC OUTPUT

DC x DC = DC OUTPUT

DC x DC = DC OUTPUT

DC x DC = DC OUTPUT

DC x DC = DC OUTPUT

DC x DC = DC OUTPUT

DC x DC = DC OUTPUT

DC x DC = DC OUTPUT

DC x DC = DC OUTPUT

DC x DC = DC OUTPUT

DC x DC = DC OUTPUT

DC x DC = DC OUTPUT

DC x DC = DC OUTPUT

DC x DC = DC OUTPUT

DC x DC = DC OUTPUT

DC x DC = DC OUTPUT

DC x DC = DC OUTPUT

DC x DC = DC OUTPUT

DC x DC = DC OUTPUT

DC x DC = DC OUTPUT

DC x DC = DC OUTPUT

DC x DC = DC OUTPUT

DC x DC = DC OUTPUT

DC x DC = DC OUTPUT

DC x DC = DC OUTPUT

DC x DC = DC OUTPUT

DC x DC = DC OUTPUT

DC x DC = DC OUTPUT

DC x DC = DC OUTPUT

DC x DC = DC OUTPUT

Product Accuracy is  $\pm 1/2\%$  of all theoretical product output readings over Full Temperature Range of  $-55^{\circ}\text{C}$  to  $+125^{\circ}\text{C}$ .

Maximum Output Error for Either

X = 0, Y = 10V

Y = 0, X = 10V

X = 0, Y = 0

would be  $\pm 2$  MV over Entire Temperature Range.

#MCM 1478-1

### Specifications Include:

Transfer Equation:  $E = XY/10$

X & Y Input Signal Ranges: 0 to  $\pm 10\text{V}$  peak

Maximum Static and Dynamic Product Error:  $1/2\%$  of point or 2MV, whichever is greater, over entire temperature range

Input Impedance: X = 10K, Y = 10K

Full Scale Output:  $\pm 10\text{V}$  peak

Minimum Load for Full Scale Output: 2000 ohms

Output Impedance: Less than 10 ohms

Bandwidth: 1000Hz

DC Power:  $\pm 15\text{V}$ , unless otherwise required, at 20ma

Size: 1.3" x 1.8" x 0.5"

Output is short circuit protected

Circle 901 on reader service card

There is No Substitute for Reliability



**GENERAL MAGNETICS • INC**

135 Bloomfield Ave., Bloomfield, New Jersey 07003 - Tel. (201) 743-2700

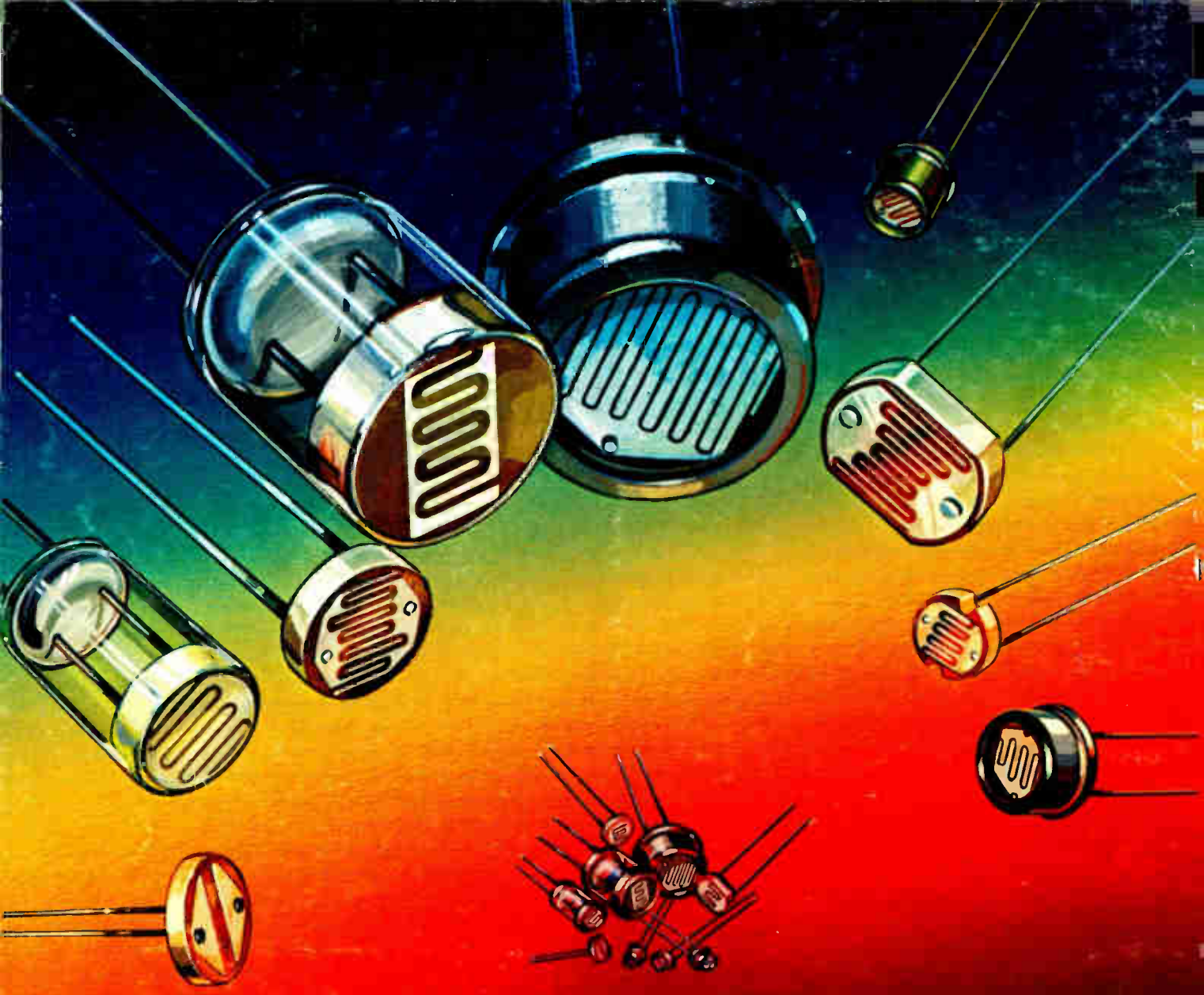

# Photoconductors

**Because Clairex makes them all, you can get exactly what you need.**

Clairex will select the right photoconductive material and package it properly to give you exactly the photoconductor you need for your application. Clairex can provide cells:

1. With spectral response in the UV, visible spectrum, or near infra-red range.
2. Hermetically or non-hermetically sealed.
3. In plastic, metal, or glass packages.

4. With low or high resistance.
5. In large or small diameter configurations.

Clairex can provide cells from stock or design cells specifically for your application. For complete data or special assistance with your "light" problems, call (914) 664-6602 or write Clairex,® 560 South Third Avenue, Mount Vernon, New York 10550.

## CLAIREX ELECTRONICS

A DIVISION OF CLAIREX CORPORATION  
Circle 902 on reader service card