

- 66 Point-of-sale gear heads for supermarket checkout
- 70 New colors paint rosy picture for light-emitting diodes
- 111 Minicomputers in action: typesetting and editing

# Electronics®



*22 Alford Ave  
Edwards Cal 93523*

1420 JBU:20 AECAT MAY76  
CS OSBORNE JR  
1202 N AVENUE HILL  
LANCASTER CA  
93534

**PASSIVE COMPONENTS**  
**1974**  
**PEACE**



*1986  
LIFE 89 2/20*



# Dialight sees a need:

(Need: Single source supply for all indicator lights.)

# See Dialight.



## INCANDESCENT OR NEON MINIATURE AND LARGE INDICATORS

Designed to accommodate either incandescent (2-250V) or neon (105-250V) lamps for panel mounting in 11/16" or 1" clearance holes. Units meet or exceed MIL-L-3661 requirements; all are listed in Underwriter's Recognized Components Index. Wide selection of lens shapes, colors,

finishes and terminations. Many lenses may be hot stamped, engraved or offered with film legend discs. Oil-tight units with unique "O" ring construction make them oil, water and dust tight on the face of the panel. Available off the shelf for prompt delivery.



## LED, INCANDESCENT OR NEON ULTRA-MINIATURE DATALITES®

Meet or exceed MIL-L-3661. Replaceable plug-in cartridges for 1.35-125V operation. Indicators mount as close as 1/2" centers; available with red, green, amber, blue, white translucent, light yellow or colorless lenses in wide range of lens shapes, legends and finishes. Off-the-shelf.



## INCANDESCENT OR NEON SUB-MINIATURE INDICATORS

Meet or exceed MIL-L-3661. Mounts in 15/32", 1/2" or 17/32" clearance holes. Incandescent for 1.35-28V; neon has patented built-in current limiting resistor. Choice of cylindrical, faceted, convex, flat, square and round lens shapes, colors, finishes, legends. Off-the-shelf.

Circle 900 on reader service card

## DIALIGHT

Dialight, A North American Philips Company  
203 Harrison Place, Brooklyn, N. Y. 11237 (212) 497-7600

SEND ME FREE INDICATOR LIGHT PRODUCT SELECTOR GUIDE.



# Shouldn't a CRT display reflect your system's true performance?

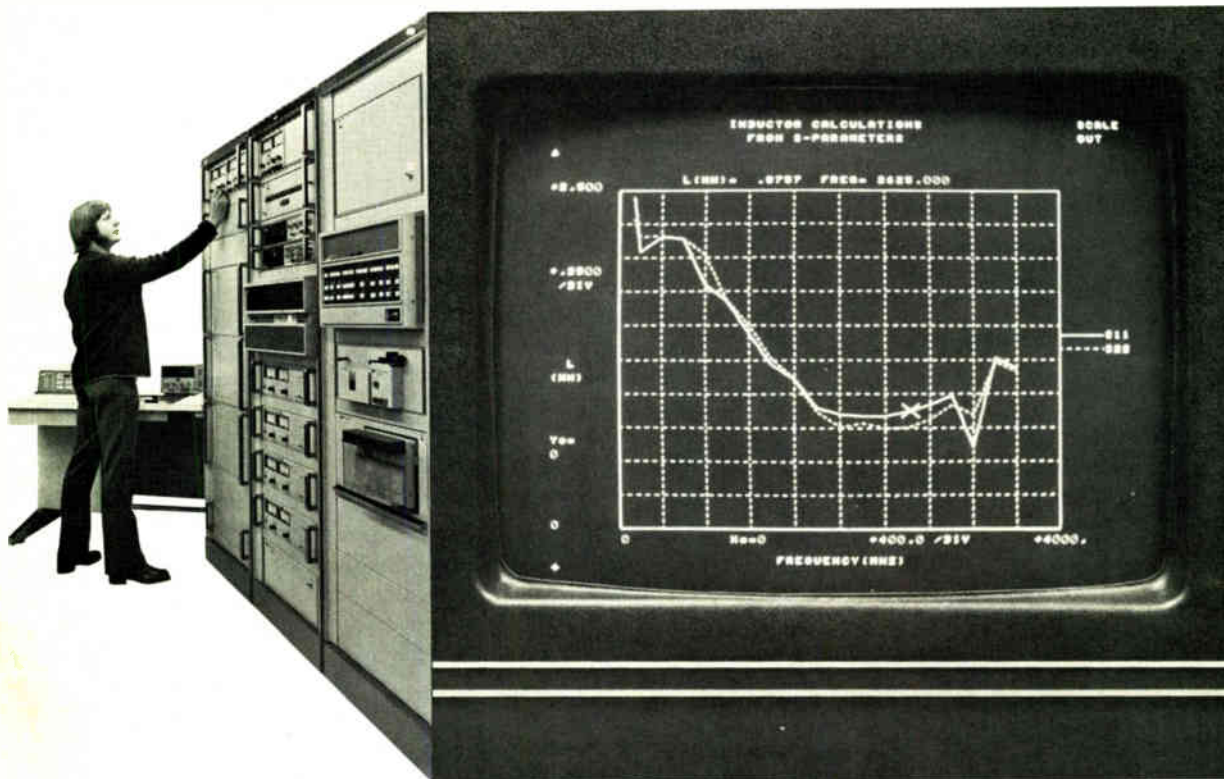

HP displays will. Our family of large-screen displays has the top performance you need for your OEM systems. The high writing speed and fast settling time of our 14- through 21-inch displays means simplified output programming and greater information density in computer graphics, analytical research, radar and other display applications. Yokeless electrostatic deflection simplifies operation, eliminates geometric correction circuitry and unnecessary delay lines, and reduces required power by a factor of 5 or more. Bright, easy-to-read displays result from the 28.5 kV accelerating potential. And dynamic

focusing assures a sharp trace at any screen location, over a wide range of intensities.

You also get versatility in HP displays. A variety of standard options allow you to tailor a display to your system's needs. Our rugged new 1317A and 1321A models give you options of TTL blanking input, differential inputs and gamma correction to match your system design and simplify interface problems. You have a choice of CRT sizes and shapes for stand-alone or rack-mounted applications. And you can get various phosphors that range from slow P-7 and P-39 to fast P31.

In addition to top performance

and versatility, you get the quality, reliability, and product safety you expect from a leader in CRT technology. Units are UL listed...plug-in board construction simplifies servicing...and HP's worldwide support means rapid parts replacement and service—an important consideration when you're designing a display into your system. So, for a display that reflects your system's true performance, look into HP's large-screen display family. For more information, contact your local HP field engineer. Or, write Hewlett-Packard.

084/6

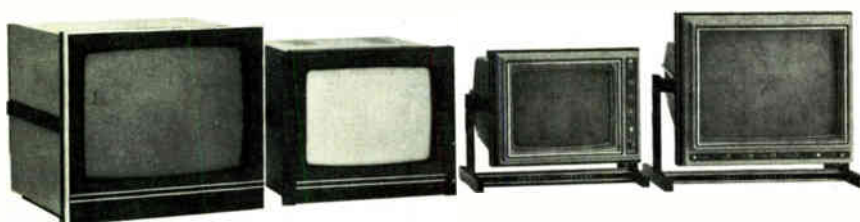

**HEWLETT *hp* PACKARD**

Sales and service from 172 offices in 65 countries.  
1501 Page Mill Road, Palo Alto, California 94306

# Reliable low-energy switching is not new at MICRO SWITCH.

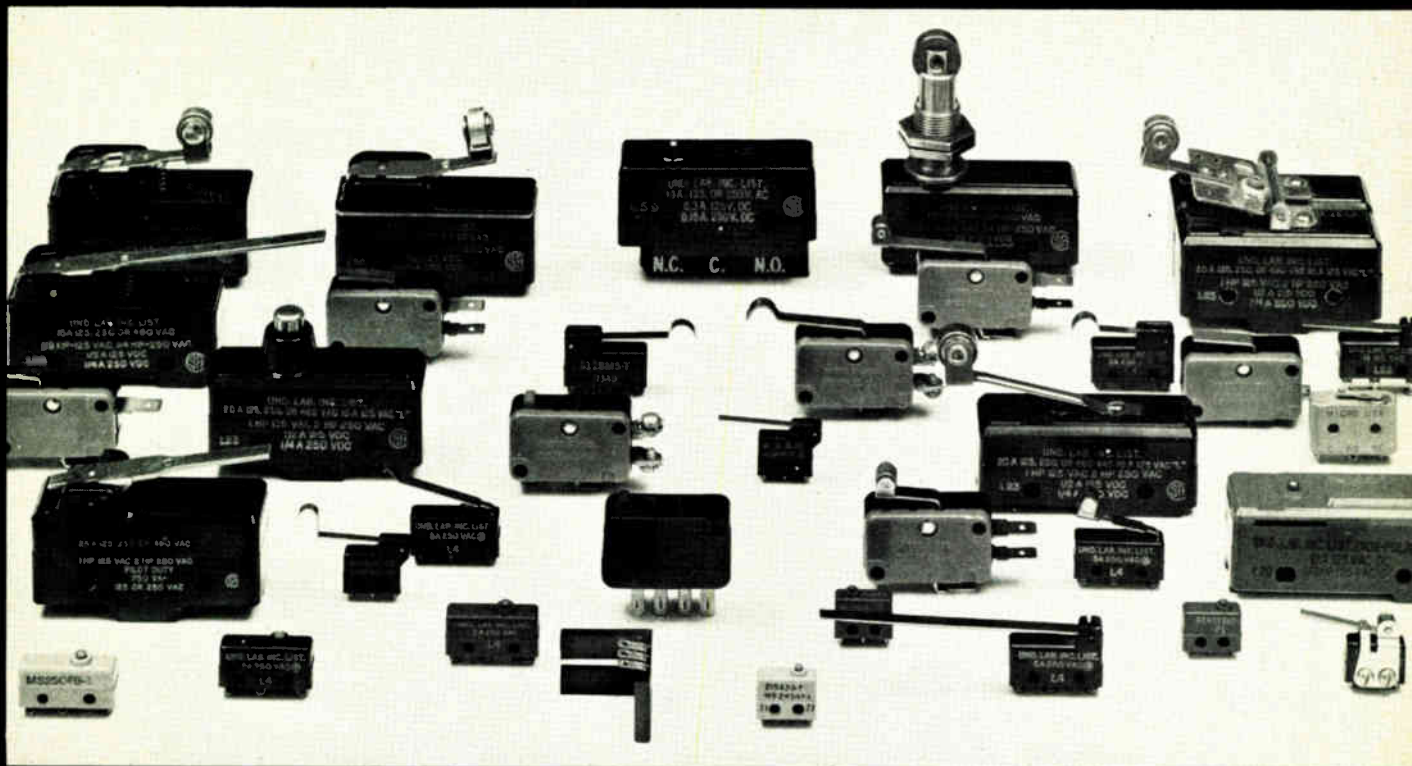

We developed our first high fidelity gold contact switch in 1953. This was only the beginning. Advances include bifurcated and cross-point contacts. Today we offer an entire low-energy basic switch line. From subminiature types less than 1/2" wide to versatile thumb-size basics.

With important features: A spring design that contributes to millions of operations. Choice of integral or auxiliary actuators. Terminal types such as solder screw, quick-connect and PC mount.

If your switching energy needs are in the milliamp range, MICRO SWITCH has a complete line of Hall-effect, magnetically operated, solid-state switches. They directly interface with logic circuits. Output options include sinking or sourcing, digital or analog.

We also offer precision switches for power functions to 25 amps. Again, choice of actuators and terminals.

Low energy, solid-state, power—for a comprehensive catalog of available switches for all energy levels, contact MICRO SWITCH.

For the address and telephone number of your nearest MICRO SWITCH Branch Office or Authorized Distributor, call toll-free 800/645-9200 (in N. Y., 516/294-0990, collect).

Circle 2 on reader service card

MICRO SWITCH products are available worldwide through Honeywell International.

## MICRO SWITCH

FREEMONT, ILLINOIS 61032

A DIVISION OF HONEYWELL

## 29 Electronics Review

PRODUCTION: X rays highlight move to tiny IC patterns, 29  
ORGANIZATIONS: IEEE president: "I can do the job" 30  
COMMERCIAL ELECTRONICS: Oil locator accepts 1,024 channels, 31  
Low-cost color added to CRT data terminals, 31  
TRADE: Japan's share is down as U. S. imports drop, 32  
COMPONENTS: Thin films get DIPs at thick-film prices, 32  
GOVERNMENT ELECTRONICS: What Iran wants in electronics, 34  
COMPUTERS: Micro CPU smartens dumb remotes, 34  
MILITARY ELECTRONICS: MARS gears up for new fighters, 36  
NEWS BRIEFS: 38  
SOLID STATE: Motorola to slash MECL prices, 38

## 52 Electronics International

FRANCE: Thomson-Brandt readies color video disk unit, 52  
WEST GERMANY: Data recorder uses novel tape, 53  
AROUND THE WORLD: 53

## 66 Probing the News

OPTOELECTRONICS: Color LEDs come on stronger, 66  
CONSUMER ELECTRONICS: Piling up supermarket sales, 70  
COMPANIES: Analog Devices: an intermediate company, 76  
MEMORIES: Bubble devices at the crossroads, 76

## 89 Technical Articles

SPECIAL REPORT: Passive components live, 89  
Capacitors lead charge of passives, 91  
Resistor technology booms with new types and sizes, 98  
Thick and thin films vie for network applications, 101  
Relays switch direction to increase performance, 104  
DESIGNER'S CASEBOOK: Voltage regulator protects transistors, 106  
Generating tone bursts with only two IC timers, 107  
Simplifying correction logic for adding two BCD numbers, 108  
COMPUTERS: Editing and typesetting are computerized, 111  
ENGINEER'S NOTEBOOK: Ternary coding speeds data transmission, 119  
In-circuit IC tester checks TTL and C-MOS, 120

## 128 New Products

IN THE SPOTLIGHT: IC tester aims at small user, 128  
Frequency synthesizer is priced at \$1,595, 129  
PACKAGING & PRODUCTION: Patterns created without masks, 130  
COMPONENTS: Molded single in-line packages hold capacitors, 134  
DATA HANDLING: SOS mini consists of two small boards, 140  
SUBASSEMBLIES: Calculator keyboard is watch size, 148

## Departments

Publisher's letter, 4  
Readers comment, 6  
40 years ago, 8  
People, 14  
Update, 18  
Meetings, 20  
Electronics newsletter, 25  
Washington newsletter, 49  
Washington commentary, 50  
International newsletter, 55  
Engineer's newsletter, 122  
New literature, 154

## Highlights

### The cover: Passive components live! 89

Although relatively few discrete passive components are found in each IC-based product, over-all demand is booming because the products themselves are selling in unprecedented numbers—witness the calculator. Credit must go, too, to the passive-component manufacturers for keeping pace with changing technological needs. Cover is by Art Director Fred Sklenar.

### There's no stopping at red for LEDs, 66

Growing technological knowhow about orange-, yellow-, and green-light-emitting diodes is eliminating the earlier fabrication difficulties and encouraging manufacturers to predict high-volume sales for next year.

### Minicomputers prove fit to print the news, 111

Part 8 of the series, "Minicomputers in action," describes how "hot-metal" Linotype machines, which have been used to set newspapers for nearly 80 years, are being replaced by photocomposition machines under minicomputer control.

### Precision frequency-source is easy to read, 129

Intended to upstage the \$600-\$1,000 test oscillator, a new frequency synthesizer offers a compact LED display, 5-digit resolution, and a long-term frequency drift specification of 1 in  $10^5$  per year—all for the not much higher price of \$1,595.

### And in the next issue . . .

A low-cost laser for high-volume applications . . . overcoming the errors in fast Fourier transforms . . . semiconductor memory technology updated.

EDITOR-IN-CHIEF: Kemp Anderson

EXECUTIVE EDITOR: Samuel Weber

MANAGING EDITORS: Lawrence Curran, *News*;  
Arthur Erikson, *International*

SENIOR EDITORS: John Johnsrud,  
H. Thomas Maguire, Laurence Altman  
Ray Connolly, Stephen E. Scrupski

ART DIRECTOR: Fred Sklenar

ASSOCIATE EDITORS: John N. Kessler,  
Howard Wolff, Gerald M. Walker

### DEPARTMENT EDITORS

*Aerospace*: William F. Arnold  
*Circuit Design*: Lucinda Matterna  
*Communications & Microwave*:  
Stephen E. Scrupski

*Components*: Joel DuBow  
*Computers*: Wallace B. Riley  
*Consumer*: Gerald M. Walker  
*Instrumentation*: Michael J. Riezenman  
*Military*: Ray Connolly  
*New Products*: H. Thomas Maguire  
*Packaging & Production*: Stephen E. Grossman  
*Solid State*: Laurence Altman

COPY EDITORS: Margaret Eastman,  
Everett C. Terry

ASSISTANT EDITOR: Marilyn Offenheiser

ART: Charles D. Ciatto, *Associate Director*  
Patricia Cybulski, *Assistant Director*

PRODUCTION EDITOR: Arthur C. Miller

EDITORIAL SECRETARIES: Janet Annunziata,  
Julie Gorgoglione, Penny Roberts

### FIELD EDITORS

*Boston*: Gail Farrell  
*Los Angeles*: Paul Franson (Mgr.)  
*Midwest*: Larry Armstrong (Mgr.)  
*New York*: Alfred Rosenblatt (Mgr.)  
*San Francisco*: Bernard Cole (Mgr.)  
Judith Curtis  
*Washington*: Ray Connolly (Mgr.),  
William F. Arnold  
*Frankfurt*: John Gosch  
*London*: Michael Payne  
*Paris*: Arthur Erikson  
*Tokyo*: Charles Cohen

### McGraw-Hill World News

*Director*: Ralph R. Schulz  
*Bonn*: Robert Ingersoll;  
*Brussels*: James Smith;  
*London*: Marvin Petal;  
*Milan*: Peter Hoffmann, Andrew Heath;  
*Moscow*: Axel Krause;  
*Paris*: Michael Johnson, Richard Shepherd;  
*Stockholm*: Robert Skole;  
*Tokyo*: Mike Mealey

PUBLISHER: Dan McMillan

DIRECTOR OF MARKETING: Pierre J. Braudé

ADVERTISING SALES SERVICE MANAGER:  
Wallis Clarke

BUSINESS MANAGER: Stephen R. Weiss

CIRCULATION MANAGER: Nancy L. Merritt

MARKETING SERVICES MANAGER:  
Tomlinson Howland

RESEARCH MANAGER: Margery D. Sholes



**W**e often use this column to give you the story behind the story. This time, we thought you would be interested in the picture behind the cover picture.

In early discussions of the idea that became the special report on components (see p. 89), we used the working title "Passive Components Live." And, because that label was reminiscent of phrases scrawled on walls of many a major city, it was also natural to seek out a wall and do our thing.

Our art director, Fred Sklenar (left), and associate editor, Jerry

Walker (right), who helps coordinate special reports, went to New York's Central Park to create the cover on the wall surrounding the extension of the Metropolitan Museum of Art—one of the few walls around on which the creative art of graffiti is encouraged.

And, as you read the components report, you'll discover how much time and talent went into its creation, too. With inputs from our far-flung field bureaus, both in the United States and abroad, and his own extensive reporting, components editor Joel DuBow put together the report.

## We're looking for an editor

The expansion of our coverage of the electronics industries has created an opening on our editorial staff. Our editors travel extensively, write and edit technical articles, and cover stimulating new developments in electronic technology.

Specifically, the ideal candidate will have an engineering degree and extensive experience in the packaging and production of electronic products. Of course, writing ability is an obvious requirement.

We're part of McGraw-Hill, one of the world's best-known publishing companies, and we offer excellent working conditions and fringe benefits. What's more, the salary level is as good as or better than the industry rates for engineers.

If you qualify, send your résumé with salary requirements to: The Executive Editor, ELECTRONICS Magazine, 1221 Avenue of the Americas, New York, N. Y. 10020.

May 30, 1974 Volume 47, Number 11

95,598 copies of this issue printed

Published every other Thursday by McGraw-Hill, Inc. Founder: James H. McGraw, 1860-1948. Publication office: 1221 Avenue of the Americas, N.Y., N.Y. 10020, second class postage paid at New York, N.Y. and additional mailing offices.

Executive, editorial, circulation and advertising addresses: Electronics, McGraw-Hill Building, 1221 Avenue of the Americas, New York, N.Y. 10020. Telephone (212) 997-1221. Teletype TWX N.Y. 710-581-5234. Cable address: MCGRAW HILL L N Y.

Subscriptions limited to persons with active, professional, functional responsibility in electronics technology. Publisher reserves the right to reject non-qualified requests. No subscriptions accepted without complete identification of subscriber name, title, or job function, company or organization, including product manufactured or services performed. Subscription rates: qualified subscribers in the United States and possessions, Canada, and Mexico \$12.00 one year, \$24.00 three years, all other countries \$25.00 per year, except Japan \$50.00 per year, Brazil \$40.00 per year, Australia and New Zealand \$60.00 per year, including air freight. Limited quota of subscriptions available at higher-than-basic rate for persons outside of field served, as follows: U.S. and possessions and Canada, \$25.00 one year; all other countries \$50.00. Single copies: United States and possessions and Canada, \$1.50; all other countries, \$2.00.

Officers of the McGraw-Hill Publications Company: John R. Emery, President; J. Elton Tuohy, Executive Vice President-Administration; Gene W. Simpson, Group Publisher-Vice President; Senior Vice Presidents: Ralph Blackburn, Circulation; Walter A. Stanbury, Editorial; John D. Hoglund, Controller; David G. Jensen, Manufacturing; Gordon L. Jones, Marketing; Jerome D. Luntz, Planning & Development.

Officers of the Corporation: Shelton Fisher, President; Wallace F. Trendly, Group President; McGraw-Hill Publications Company and McGraw-Hill Information Systems Company: Robert N. Landes, Senior Vice President and Secretary; Ralph J. Webb, Treasurer.

Title registered in U.S. Patent Office. Copyright © 1974 by McGraw-Hill, Inc. All rights reserved. The contents of this publication may not be reproduced either in whole or in part without the consent of copyright owner.

Subscribers: The publisher, upon written request to our New York office from any subscriber, agrees to refund that part of the subscription price applying to copies not yet mailed. Please send change of address notices or complaints to Fulfillment Manager; subscription orders to Circulation Manager, Electronics, at address below. Change of address notices should provide old as well as new address including postal zip code number. If possible, attach address label from recent issue. Allow one month for change to become effective.

Postmaster: Please send form 3579 to Fulfillment Manager, Electronics, P.O. Box 430, Hightstown, N.J. 08520.

# Precision waveforms at everyone's fingertips with KH pushbutton oscillators.

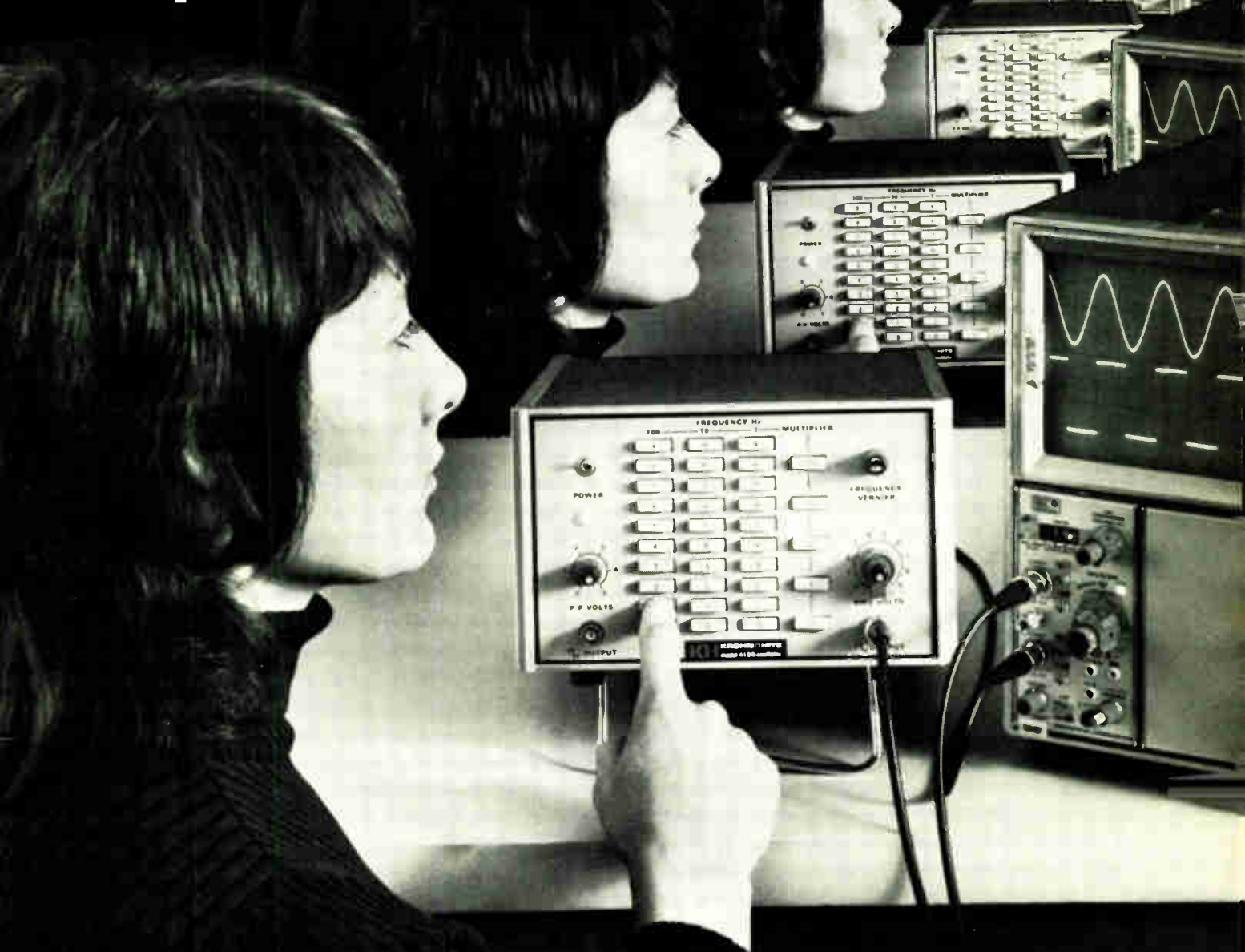

The Model 4100A is as simple to use as a pushbutton telephone — yet it's as precise, stable and distortion-free as instruments costing much more — more to purchase and more to operate. The 4100A is only \$595.00 and you don't need technically skilled people to operate it. Its simplified operation and outstanding speed and accuracy make it ideal for production line testing. The 4100A provides sine and square waves simultaneously from 0.01Hz to 1MHz. Frequency accuracy is within 0.5% and distortion is less than 0.02%. For fast action call (617) 491-3211, TWX 710-320-6583, or contact your local representative listed below.

**KH KROHN-HITE**  
CORPORATION

580 Massachusetts Avenue, Cambridge, Mass. 02139

SALES OFFICES: ALA, Huntsville (205) 534-9771; ARIZ, Scottsdale (602) 947-7841; CAL, San Jose (408) 292-3220, Inglewood (213) 674-6850; COLO., Denver (303) 934-5505; CONN., Glastonbury (203) 633-0777; FLA., Orlando (305) 894-4401; HAWAII, Honolulu (808) 941-1574; ILL., Des Plaines (312) 298-3600; IND., Indianapolis (317) 244-2456; MASS., Lexington (617) 861-8620; MICH, Detroit (313) 526-8800; MINN., Minneapolis (612) 884-4336; MO, St. Louis (314) 423-1234; N.C., Burlington (919) 227-3639; N.J., Haddonfield (609) 795-1700; N.M., Albuquerque (505) 299-7658; N.Y., E. Syracuse (315) 437-6666, Rochester (716) 328-2230, Vestal (607) 785-9947, Elmont (516) 488-2100; OHIO, Cleveland (216) 261-5440, Dayton (513) 426-5551; PA., Pittsburgh (412) 371-9449; TEX., Houston (713) 688-9971, Richardson (214) 231-2573; VA., Alexandria (703) 354-1222; WASH., Seattle (206) 624-9020; CANADA, Montreal, Quebec (514) 636-0525, Toronto, Ontario (416) 444-9111, Stittsville, Ontario (613) 836-4411, Vancouver, British Columbia (604) 688-2619.

Circle 5 on reader service card

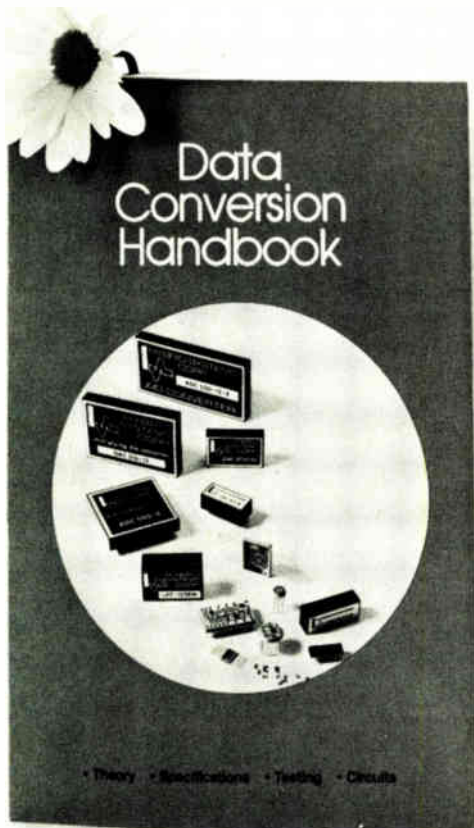

## The Book... From Hybrid Systems, Naturally.

This 176-page handbook is offered as a guide to design engineers and others who specify and/or buy electronics... and who are tired of groping their way through the muddle and mystique of data conversion.

It's readable... because it was written by practitioners rather than theoreticians, not to amaze but to inform. It defines the qualities, specifications and techniques that combine to give D/A and A/D converters their special character. It relates those considerations to specific areas of application.

Chapters include: DIGITAL-TO-ANALOG CONVERTERS  
• ANALOG-TO-DIGITAL CONVERTERS • SAMPLE/HOLDS  
• ANALOG MULTIPLEXERS • CODES.

Mail \$1.50 (for postage and handling) to:  
87 Second Avenue, Burlington, Massachusetts 01803

**Hybrid Systems**  
CORPORATION

## Readers comment

### Laying on the logic

**To the Editor:** Compliments on your article, "Logic's leap ahead creates new design tools for old and new applications," [*Electronics*, Feb. 21, p. 81]. It collects in one place many useful facts that have been scattered all over until now. However, I'd like to spotlight a couple of weak points.

There is a distressingly vague statement about the output-drive capability of Schottky TTL and the convenience of intermixing various kinds of TTL. The fan-out of Schottky TTL when not driving other Schottky TTL is the customary 10—not 12. The 12 figure may be reasonable when driving standard TTL, but 11 might be more prudent if full noise immunity is to be maintained. And, of course, when standard TTL drives Schottky TTL, the fan-out is about 8.

A remark about the characteristics of the input circuits for low-power Schottky TTL may be potentially misleading. Since for all 74LS gates and most 74LS flip-flops the input circuitry is actually DTL, rather than TTL, it is somewhat of a misrepresentation to say that "... the Schottky-diode clamped inputs are the same ones that have simplified many designs."

Lawrence W. Johnson  
Hewlett-Packard Laboratories  
Palo Alto, Calif.

### Blaming the auto makers

**To the Editor:** The auto makers have no one but themselves to blame for their electronics problems ["Is electronics heading the wrong way?" *Electronics*, March 7, p. 75]. In the first place, it's up to them to prepare meaningful specifications. In the second place, they're getting a dose of their own medicine.

I stopped buying from Detroit years ago because of poor cost-effectiveness and poor reliability—not to mention poor workmanship. Detroit has a long way to go in the successful application of electronics. How many managers making the real decisions are electronics men?

Edward W. Rummel  
Scott Graphics Inc.  
Holyoke, Mass.



# The Bright Guy's Jumbo Diffused LED Digits are Lighter on the Eyes, Easier on the

# Wallet and Bolder than the other guys.



Help out yourself and your customers by putting Litronix DL-747 0.6" diffused LED digits into that new control, instrument, clock or point of sales display. You'll save money and get bolder brighter displays.

Everybody benefits because we produce these jumbos with our Encapsulated Light Diffusion process, which makes them look better while reducing their cost. The ELD process captures the LEDs' light in special light pipes molded in a high contract background plastic.

Brightness is high — 5.0 mcd at 20mA. But the light is soft and the digits are perfectly shaped — you can see how the segments are mitered.

The DL-747 jumbos are our second

family of low-cost, diffused LED digits.

DL-746	±1 overflow	common anode
DL-747	seven segment	common anode
DL-749	±1 overflow	common cathode
DL-750	seven segment	common cathode

We also use the ELD process to produce equally neat DL-707 0.3" digits.

You can't get more economical, reliable displays. Prices in 1K quantities are only \$3.60 for the 0.6" digit series. And the savings really rise when you figure in the savings on support components.

See our diffused LED digits for yourself. Call or write today.



## litronix

Litronix, Inc. 19000 Homestead Road, Cupertino, California 95014  
(408) 257-7910 TWX: 910-338-0022  
European Headquarters: Litronix, Inc. Bevan House, Bancroft Court  
Hitchin, Hertfordshire SG5 1LW England Tel: 2676 Telex: 825-497

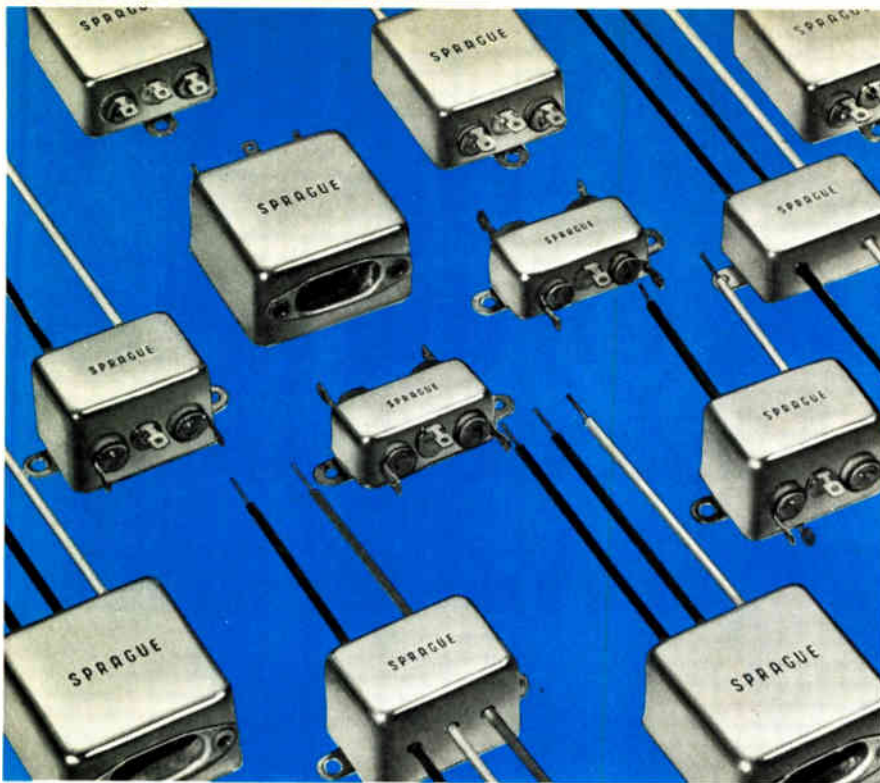

## FILTERS THAT WORK. FILTERS THAT FIT. FILTERS YOU CAN AFFORD.

### Sprague JX5100 Series EMI Powerline Filters give you the right blend of efficiency/size/cost.

The lower cost of these general-purpose filters makes them especially suitable for higher-volume production-assembled equipment such as computer peripherals, cash registers, credit card verifiers, electronic service instruments, etc.

Series JX5100 Filters are designed to protect equipment from line noise as well as to protect the line from equipment noise, particularly equipment with high impedance loads. Smaller in size than many filters with comparable performance, they control line-to-ground interference with a high degree of efficiency. Filtering both sides of the line, the need for two filters is eliminated.

Available in a wide variety of current ratings (1 to 30 amps) and several different terminal configurations, Series JX5100 Filters withstand a test voltage of 2100 VDC, assuring protection against high-voltage transients. Line-to-ground capacitance is only .01 $\mu$ F, and maximum leakage current (each line to ground, @115V, 60Hz) is 0.5mA.

Sprague maintains complete testing facilities for all commercial, industrial, and government interference specifications.

For complete technical data, write for Engineering Bulletin 8210.11 to: Technical Literature Service, Sprague Electric Company, 35 Marshall Street, North Adams, Mass. 01247.



THE BROAD-LINE PRODUCER OF ELECTRONIC PARTS

## 40 years ago

From the pages of *Electronics*, May, 1934

### Recorders

Two types of semi-professional recorders have been placed on the market by the Universal Microphone Company, Inglewood, Calif., to be used by broadcast stations, agencies and sponsors, for air checks, making permanent records of radio programs, personal recordings, and other purposes.

The recorder models come equipped with a volume indicator, volume control, off-and-on switch and a Universal combination pick-up and recording head. There are two speeds, 33 $\frac{1}{3}$  and 78 rpm. One type records on blank aluminum discs up to 12 inches; the other up to 16 inches.

### Universal test instruments

The Sound Engineering Corporation, 416 North Leavitt Street, Chicago, Ill., has combined three separate test instruments to form the latest thing in analytical test sets. The components are:

1. The No. 90 multi-range universal ac.-d.c. voltmeter, milli-ammeter and ohm-meter, providing seven voltage ranges, five current ranges and three resistance ranges, as well as means for measuring inductance, capacitance and impedance.

2. The No. 91 point-to-point analyzer, for rapidly testing sets, circuits and tubes.

3. The No. 92 modulated electron-coupled oscillator, covering the entire band of frequencies from 90 to 1,600 kilocycles without using harmonics; when required, harmonics can be used to cover the higher frequencies.

### Television transmitter

Television Laboratories, Ltd., of San Francisco and Philadelphia, have licensed Heintz & Kaufman, radio manufacturers at San Francisco, to construct television transmitting equipment under the Philo T. Farnsworth patents for television by aid of cathode-ray tubes.

Heintz & Kaufman are the manufacturers of all the code-communication equipment used by Globe Wireless, Ltd.

# The first name in sweep generators has met its match.

Telonic Sweepers and Display Oscilloscopes. Totally compatible and definitely synergistic.

There are four sweepers in the 1200 Series (with frequency ranges to 1.5 GHz), any of which may be coupled to a Model 121 single trace scope or a Model 122 dual-trace scope. Any combination gives you a complete facility for lab or production line testing and alignment operations over the entire RF and near-microwave frequencies.

All Telonic Sweep Generators have built-in frequency markers, attenuators, variable sweep rates and over 20 years of design experience.

SWEEP GENERATORS

	Model 1201	Model 1202	Model 1204	Model 1205
Frequency (MHz)	.2-30	.1-120	1-500	1-1500
Sweep Width (MHz)	.5-30	.1-120	.2-500	.2-600
Output (dBm)	+19	+13	+10	+7
Flatness (dB)	±.10	±.25	±.25	±.50
Linearity (%)	1	2	1	1
Markers	Single and Harmonic			
Circuits	Solid State/Modular			
Price	1895	995	1095	1395

DISPLAY OSCILLOSCOPES

	Model 121	Model 122
Modes	Single Trace	Dual Trace
CRT	11" Diagonal	
V Bandwidth (kHz)	15	
H Bandwidth (kHz)	1	
V Sensitivity/div.	1, 10, 100 mv, 1v	
H Sensitivity/div.	100 mv	
Input Imped.	10 K ohms	
Price	475	695

Telonic Display Oscilloscopes incorporate 11" CRTs (P4 or P7 phosphor), have 15 kHz bandwidths, and are ideal for X-Y presentation of swept frequency response.

Discuss a trial marriage with your Telonic representative; he will be glad to make the arrangements. **OR WRITE FOR OUR DATA PACKAGE COVERING SWEEPERS, SCOPES, AND ACCESSORIES.**

**TelonicAltair**

21282 Laguna Canyon Road, Box 277, Laguna Beach, California 92652  
Tel: 714 494-9401 • TWX: 910 596-1320

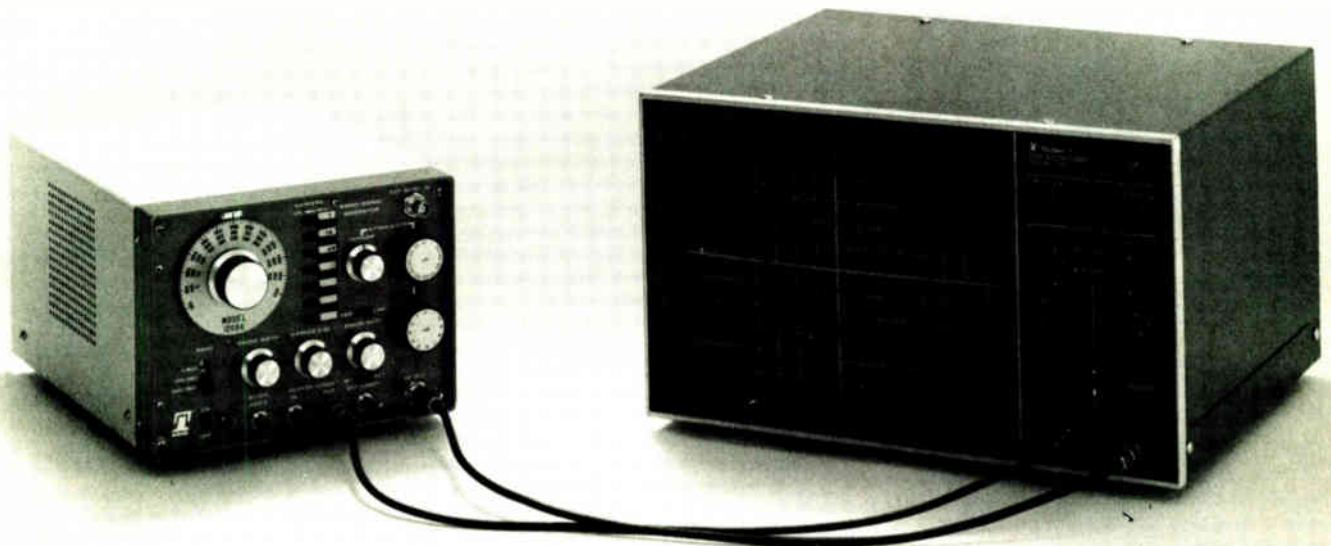

**9102.**

Circle 258 on reader service card

# Remember the name. It's the best 2102 you can buy.

Specification	The Am9102	Anybody's 2102 including ours
*Stand-by Voltage	Guaranteed 1.6V DC Typical 1.0V DC	No Guarantee Typical 2.5V
*Stand-by Power	Guaranteed 64 mW Typical 16 mW	No Guarantee Typical 75 mW
Fan-Out	Guaranteed 2.0 TTL loads	Guaranteed 2.0 TTL loads
Access Time	Guaranteed .65 $\mu$ sec (9102) Guaranteed .50 $\mu$ sec (9102A) Guaranteed .40 $\mu$ sec (9102B)	Guaranteed 1.0 $\mu$ sec (2102) Guaranteed .65 $\mu$ sec (2102-2) Guaranteed .50 $\mu$ sec (2102-1)
Worst Case Noise Immunity	400 mV	200 mV
Logic Levels	TTL Compatible TTL Identical	TTL Compatible Not TTL Identical
Full Military		
Temperature Range	Yes	No
Power Dissipation	263 mW maximum	316 mW maximum
MIL-STD-883	Of Course	??

\*Retains data above guaranteed voltage.

We didn't invent the 2102. We weren't even the first alternate source. (And the way the device has taken off, we're obviously not going to be the last source.) We're just the best. Advanced Micro Devices has something

better than the 2102: The Am9102. If you want the traditional models, we've got them. But if you want more performance for no more money, if you want the most 2102 you can get, get the Am9102. Talk to Advanced Micro Devices, the next giant.

# Advanced Micro ~~Devices~~ MEMORY

Corporate offices are at 901 Thompson Place, Sunnyvale, California 94086. Telephone (408) 732-2400/Southern California office: Beverly Hills (213) 278-9700/Mid-America: Des Plaines, Illinois (312) 297-4115/Edina, Minnesota (612) 835-4445/Eastern United States: Roslyn Heights, New York (516) 484-4990/Baltimore, Maryland (301) 744-8233/Lexington, Massachusetts (617) 861-0606/Britain: Advanced Micro Devices, Telephone Maidstone 52004/West Germany: Advanced Micro Devices, Munich, Telephone (089) 53 95 88. Southern Europe: Advanced Micro Devices, S.A., Neuilly, France, Telephone: 747-4194. Distributed nationally by Hamilton/Avnet and Cramer Electronics.

# The 2102 to get as it is to

The Intel 2102 n-channel RAM is the most popular 1024 bit static memory available today. It is *the* general purpose RAM with more second sources than any other semiconductor memory component.

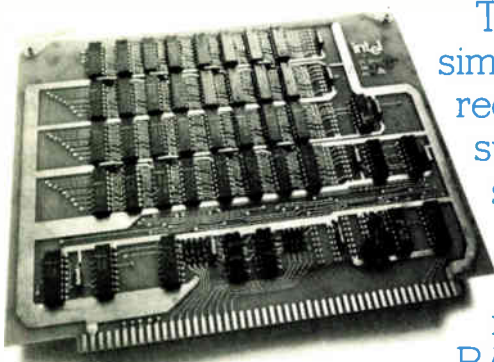

INTEL IN-26 MEMORY SYSTEM

The 2102 is extremely simple to use because it requires no peripheral supporting circuits, no special supplies, nor does it require the extra design effort needed by most RAMs to interface with TTL.

By using the 2102, you can achieve greater system economy because it does not require level shifters, MOS drivers, interface circuits, clocks, refresh and decode circuits, nor even pull-up resistors.

Every pin is TTL compatible, including the + 5 volt  $V_{cc}$  supply and the three-state, OR-tie data output that simplifies memory expansion. To connect the 2102 to TTL, just add solder dots. In fact, the 2102 RAM performs exactly as if it were a TTL circuit.

The 2102 speed specs are efficient also. Guaranteed maximum access time is 1 microsecond, typical access time is 500 nanoseconds. Minimum read and write cycle time is also 1 microsecond.

The 2102 costs less per bit in quantity than penny candy. And when you

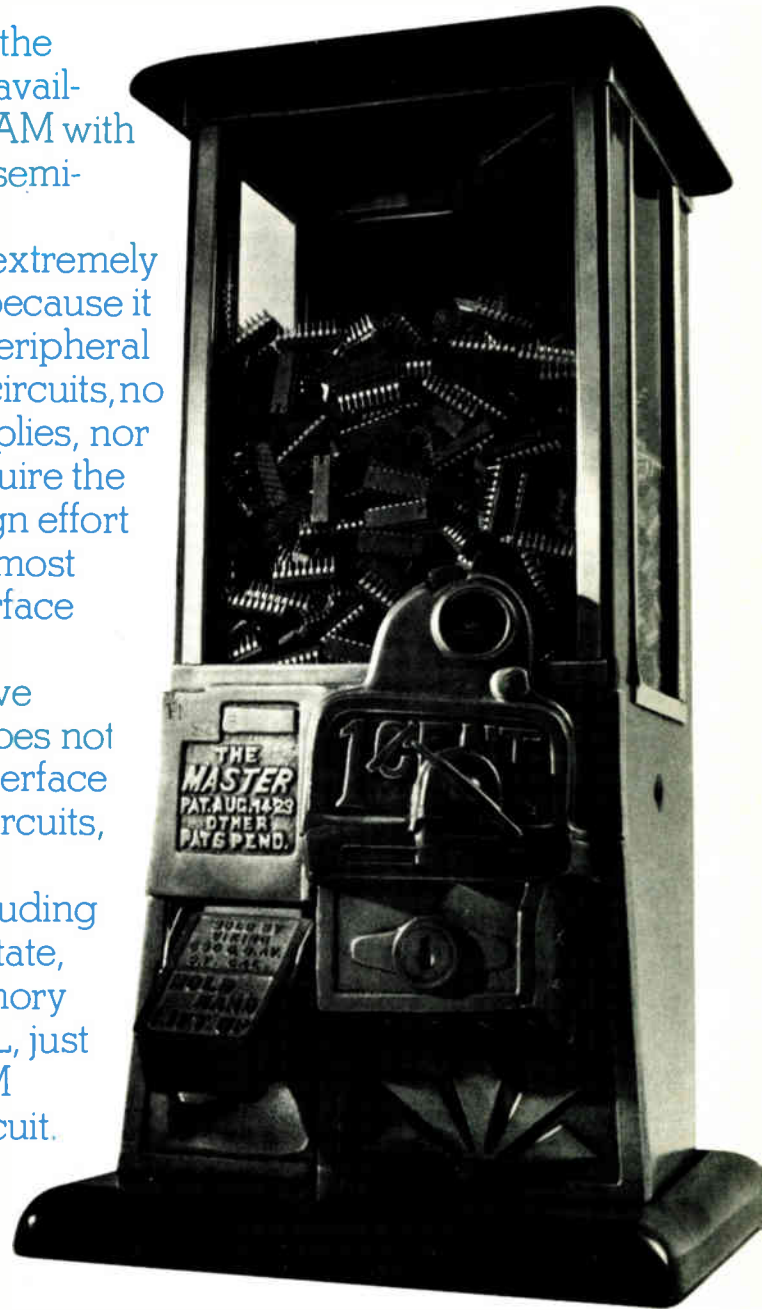

# RAM is as easy use.

## N-C HANNEL

subtract what you don't spend on design time, other parts, special supplies, boards and labor, the 2102 is easily the most economical static RAM for a wide range of applications.

What's more, the Intel 2102 is easy to get. We have been producing it in volume since early 1972 with the industry's most mature n-channel silicon gate technology. Today, we ship more 2102's than the combined outputs of the dozen or so announced second sources.

The Tektronix 31 Programmable Calculator uses the 2102 and millions of our 2102's are now being used in peripheral equipment, instrumentation and microcomputer

systems. It's a favorite with designers who want to simulate buffer, refresh and variable

length registers with something more convenient and less costly than custom MOS registers.

The 2102 is only one of Intel's popular MOS RAMs available in volume and from distributor stock. Send for a full catalog of our products including RAMs, ROMs, PROMs, interface circuits and Microcomputers.

Write to: Intel Corporation, 3065 Bowers Avenue, Santa Clara, California 95051. (408) 246-7501.

**intel® delivers.**

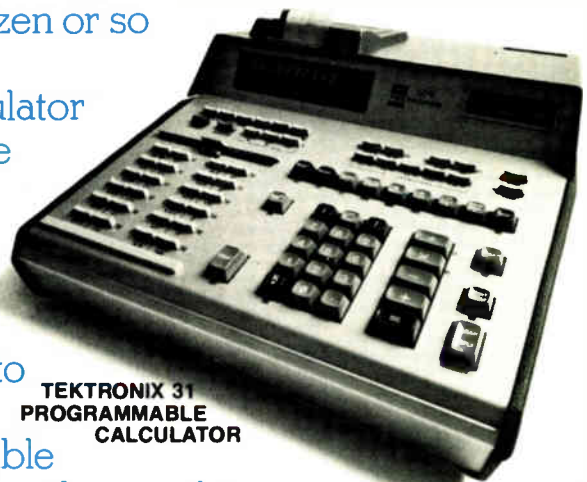

TEKTRONIX 31  
PROGRAMMABLE  
CALCULATOR

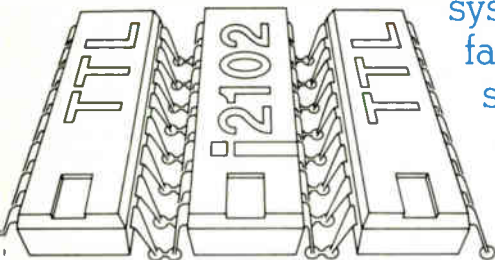

EVERY PIN IS TTL COMPATIBLE

# Tubes? Forget them.

# HERE'S 100 WATTS OF SOLID-STATE RF POWER!



#### A state-of-the-art amplifier.

ENI's new Model 3100L *all-solid-state* power amplifier provides more than 100 watts of linear power and up to 180 watts of pulse power from 250 kHz to 105 MHz. This state-of-the-art class A unit supplies over 50 watts at frequencies up to 120 MHz and down to 120 kHz. All this capability is packaged in a case as small as an oscilloscope, and it's just as portable.

#### Extraordinary performance.

Featuring a flat 50 dB gain, the Model 3100L is driven to full power by any signal generator, synthesizer or sweeper. AM, FM, SSB, TV and pulse modulations are faithfully reproduced by the highly linear output circuitry. Immune to damage due to load mismatch or overdrive, the 3100L delivers constant forward power to loads ranging from an open to a short circuit.

Solid-state reliability is here.

The price? \$5,690.

Write for complete information: ENI, 3000 Winton Road South, Rochester, N. Y. 14623  
Call (716)-473-6900 or TELEX 97-8283  
Dept. E 524

**ELECTRONIC  
NAVIGATION  
INDUSTRIES**

**ENI . . . The world's leader  
in solid-state power amplifiers.**

## People

### Aigrain moves from MIT into industry

Pierre Raoul Aigrain, former general delegate to the prime minister of France for research and technology and now the first holder of the Henry R. Luce professorship at the Massachusetts Institute of Technology, will embark on a new career in September.

In his first venture into private industry, he is replacing Henri Angles d'Auriac as the general technical director for France's Thomson-Brandt, a group that includes Thomson-CSF, the country's largest non-consumer electronics company.

Aigrain will head the Direction Technique Générale, the group of



**To Industry.** Pierre Aigrain, now at MIT, will become general technical director for France's Thomson-Brandt.

senior executives involved in the decision-making process for the company's technology management and product planning. He will report directly to group president, Paul Richard. Thomson-Brandt, which employs nearly 100,000 people, has an annual R&D budget of about \$160 million.

"The job does carry a lot of administrative responsibility, and it is conceivable that it can be held by someone without scientific ingenuity, but I don't think that would be advisable," says Aigrain. For Aigrain, 50, the position is "the start of

a new career. I've been in academic science and government administration, but never in industry."

Now, a sabbatical. During the past year, the scientist has held the Luce professorship in environment and public policy, covering problems of scientific and technological policy with emphasis on solid-state technology and non-equilibrium thermodynamics. He is well known to MIT, having been a visiting professor there in 1957, 1959, 1961, and 1962. Aigrain calls his year's professorship "a sabbatical" after six years as the chief scientist for the French government. The general delegate for research and technology had to deal with the whole range of technical, environmental and educational problems as they related to public policy and French industrial development.

Aigrain's early scientific activities were in circuit theory, as well as communications theory and technology. His later work has been mostly in solid-state physics, especially semiconductors and energy-conversion.

### Beckman's Chapin helps broaden product line

Beckman Instruments is still making some of the Helipot potentiometers that got the firm into the electronic-component business 20 years ago, soon after Leslie W. Chapin joined the company. But ever-increasing aggressiveness by this blue-chip but conservative supplier has resulted in a greatly broadened product line today. And much of this is due to

**Goals.** Les Chapin at Beckman plans to automate and broaden product line.





# Great American Logic. From Jefferson, Franklin, Madison, and HiNIL.



Give your industrial control system a great constitution with HiNIL, the high noise immunity logic from Teledyne. It works reliably in adversity—like the great political logic our Founding Fathers used in the Constitutional system.

HiNIL doesn't operate illogically when it sees electrical noise and high voltage transients. With a 3.5 volt guaranteed noise margin (versus 1.0 V for CMOS and 400 mV for TTL), it runs without shielding.

HiNIL also runs true when the power supply doesn't. It doesn't need expensive regulated supplies, filters and spot regulators because HiNIL's power supply tolerance is a comfortable  $\pm 1$  V.

And HiNIL is slow—that's right, slow not fast. Its 100 nanosecond propagation delay is fast enough for most control systems. But it won't be switched falsely by noise spikes when a fork lift rolls by (can you say the same for the hair-trigger logic you've been using?).

Like the Constitution, HiNIL is adaptable. It interfaces easily with TTL, DTL, RTL, MOS and CMOS directly, through open-collector outputs or through interface circuits. And it comes in about 40 types: from diode-expandable gates to quad schmitt triggers, shift registers, display decoder/drivers and a dozen other complex MSI functions. All conveniently packaged in ceramic or molded silicone DIPs.

Finally, HiNIL is cheap. It's priced right in there with TTL so you can save a small fortune on supply regulation, noise suppression and other "extras" you'll no longer need.

So if you want to read about great logic, trade in your history books for Teledyne's free literature on HiNIL. Better yet, experience HiNIL in your own designs. Get it from Teledyne, reps or distributors. Write or call now.

 **TELEDYNE**  
**SEMICONDUCTOR**

1300 Terra Bella Avenue Mountain View, California 94043  
(415) 968-9241 TWX: 910-379-6494 Telex: 34-8416

# BEST



Model 5100  
U.S. Pat. No. 3,735,269

## FREQUENCY SYNTHESIZER

- **\$2795**
- **0.001 Hz to 2 MHz Range**
- **0.001 Hz Resolution**
- **Full Programmability** BINARY OR BCD
- **No Switching Transients**
- **Direct Digital Techniques**  
NO MIXING OR PHASE LOCKING
- **High Spectral Purity** —70db SPURIOUS  
—55db HARMONIC
- **High Stability**  $\pm 2 \times 10^{-8}/^{\circ}\text{C}$  STANDARD  
 $\pm 2 \times 10^{-10}/^{\circ}\text{C}$  OPTIONAL
- **Precision Attenuator**  
0 TO 85db IN 1db STEPS PLUS CONTINUOUS CONTROL  
(PROGRAMMABLE ATTENUATION OPTIONAL)
- **High Output Voltage**  
10 VOLTS P-P, 50-OHM SOURCE IMPEDANCE

For immediate information on how Rockland can meet your specific application and delivery requirements — call our local rep or Dave Kohn directly at:

# ROCKLAND

Rockland Systems Corporation 230 W. Nyack Road, West Nyack, N. Y. 10994  
(914) 623-6666 TWX 710-575-2631

## People

Chapin, who has recently been promoted to manage the Helipot division. Chapin, recognized as one of the hybrid industry's experts, received an award from the International Society for Hybrid Microelectronics last year.

Helipot is moving up, too—expanding to fill 100,000 square feet vacated in Fullerton, Calif., when Beckman's scientific and medical instruments division moved to Irvine.

The name of Helipot is a bit misleading. The division also makes trimmer potentiometers, hybrid microcircuits, passive networks, and alphanumeric displays.

Along with additions to its product base, Beckman has become very aggressive in distribution. Chapin sees an increasing role for strong industrial distributors and feels that changes have had considerable effect on his group's sales.

Automate. In all operations, Beckman has gone the route of automation rather than offshore assembly. "We've tried to eliminate the routine and drudgery by mechanization, and get better quality, too."

The company has had a large—over \$1 million invested—in-house liquid-crystal effort and is now a major supplier to Gruen for its digital watches.

But Chapin admits that liquid-crystal displays are very difficult to manufacture, and the production effort is still in the early stages. Beckman has also bought Sperry-Rand's Scottsdale, Ariz., planar gas-discharge group, and has been getting deeply involved in operations since it took over command in December.

Chapin admits to production problems there, but feels that the people he has installed in manufacturing and quality control have turned the corner. "Sperry is a \$2.5 billion company and didn't devote a lot of attention to the information displays group," he says.

The gas displays, which are being pushed for consumer and industrial uses, seem to have caught on well. At the Society for Information Displays Conference in San Diego, Calif., May 21, the gas-discharge display group introduced a 512-character panel.

# NAME **3** PRODUCERS OF HIGH VOLTAGE CERAMIC CAPACITORS

If you name ERIE first, you're right on target. For we produce a full line of quality High Voltage Ceramic Capacitors . . . 3kV to more than 30kV . . . in the capacitance value and temperature characteristic to suit your circuit needs. We have all sizes and shapes with the terminal arrangement you want. In fact, you name the application . . . chances are ERIE has a standard unit available. If not, let's talk about it.

You'll find ERIE HV Capacitors in electric utility transformers. Miniature power supplies. CRT displays. Lasers. Lightning arrestors. TV power supplies. Image intensifiers for night vision apparatus. Just about any application where high voltage is involved.

So look to ERIE first. When it comes to High Voltage Ceramic Capacitors, ERIE continues to lead the way. Your letterhead request will get you our new catalog HV/SC-200 . . . or call Customer Engineering at our State College, Pa. plant — 814/237-1431.

ERIE TECHNOLOGICAL PRODUCTS, INC.  
Erie, Pennsylvania 16512

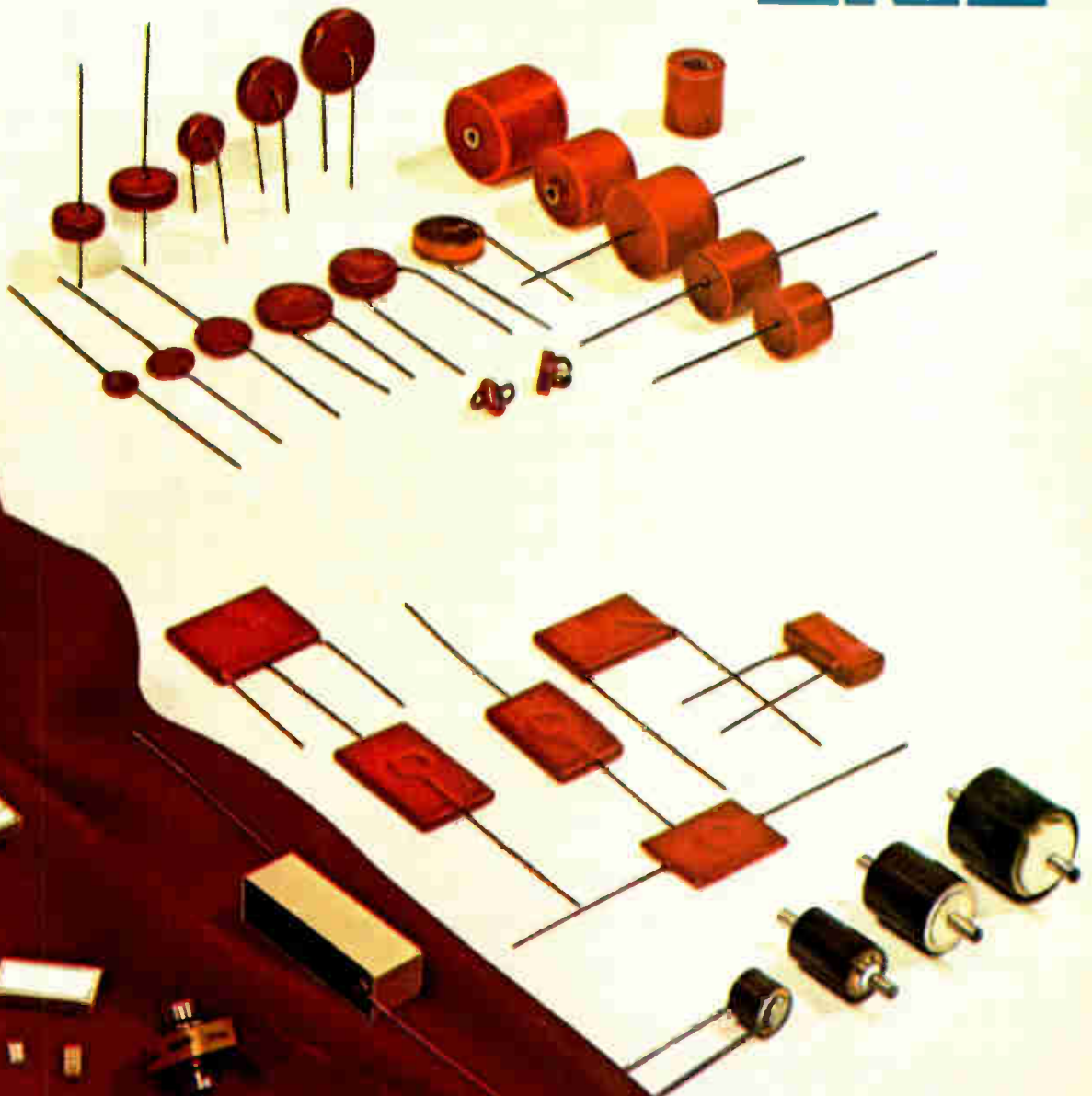



## GET CRYSTAL STABILITY AT RC/LC PRICES WITH STATEK CRYSTALS

### Typical Applications

- Tone Telemetry
- Ultrasonic Alarms
- Industrial Timers
- FM Tuners
- Motor Drives
- Communications Equipment
- Telephone Carrier Equipment

### Specifications

FREQUENCY RANGE - 10 kHz to 250 kHz in 20 Stock Frequencies

STABILITY - 0°C to 50°C ..... 0.045%  
-40°C to +85°C ..... 0.07%  
(Better specifications available.)

RUGGEDNESS - Withstands up to 1000G Shock, 50G Random Vibration, 10 to 2000 Hz

COST - From \$2.15 Ea. for 250; \$1.70 Ea. for 1000, \$1.20 Ea. for 10,000

## KITS

Try SX-1 crystals in an oscillator kit (Model CK-1) you can assemble in minutes. \$27 Each.

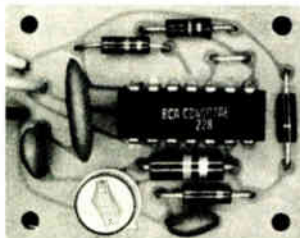

ASSEMBLED CK-IV KIT

**STATEK CORPORATION**  
1233 Alvarez Avenue  
Orange, California 92668  
Phone: (714) 639-7810  
Telex 65-5430

## Update

When the **Schlage Lock Co.** of San Francisco introduced its electronic, remote-sensing lock [June 21, 1973, p. 38], it was intended for one-door systems. Now Schlage has systems designed for two- to 10-door installations in banks, computer rooms, and condominiums. An elevator system is in use at the Chicago Play-boy Club's bunny quarters. And the Schlage affiliate that makes its electronic locks, Proximity Devices, plans to introduce this fall a computerized system called the 473, which will feature a readout showing all entries to a room by time and door, and it will include a time lock.

**Two more airlines** have purchased the voice-encoding system developed by Threshold Technology Inc. of Cinnaminson, N.J., for automatic baggage-handling. It was first installed for United Air Lines at Chicago's O'Hare Airport [Nov. 20, 1972, p. 42]. Now it is also being used by TWA at New York's Kennedy International Airport and is about to be installed by another carrier. Threshold Technology's executive vice president, Marvin Herscher, says that the company is also talking to officials at O'Hare about expanding the system there.

**A line of gold-free LSI** ceramic packages using palladium-silver metalization [May 10, 1973, p. 121] has been dropped by du Pont. "It was just not economically feasible," says a spokesman. That was the fate, too, of the Multilox product line of which it was a part. Also, the packages were found to be too big to market.

**The so-called pinhead laser** developed at Bell Laboratories [June 7, 1973, p. 35] continues to indicate that it may overcome one of the major obstacles to laser communications via fiber-optic light pipes—durability. Previous semiconductor lasers have had lifetimes of about 30 hours. Bell Labs engineers at Murray Hill, N.J., had hoped their tiny hetero-junction device would operate for 10,000 hours, and it's beginning to look as if it will. A spokesman at the lab reports that the laser—it's actually about a third the size of a grain of salt—has been operating for more than 10,000 hours at room temperature. Output has been constant for 7,000 of those hours after some changes during the first 3,000 hours.

**A yellow flashing light**, activated by a monolithic IC to warn following drivers that you're slowing down, could be the next safety product to be added to your car. Called Cyberlites, they were installed on 250 San Francisco taxis in a test last year [June 21, 1973, p. 27] and helped reduce rear-end collisions by 60%. The California Highway Patrol granted approval, on condition that brightness be reduced by a factor of three. That accomplished, developer John Voevodsky says he's now after the U.S. Department of Transportation to adopt the California standard.

**Last year, a light-controlled voltage divider** for reactor TV tuners was introduced by Chicago's Standard Components [June 6, 1973, p. 36]. Since then, it has been designed into a Magnavox 36-channel cable-television converter called the Opticon 36. Standard Components, which will build the converter for Magnavox, is still angling for an OEM application and will show the Opticon at next month's IEEE Broadcast and TV Conference. The voltage divider offers longer life and better reliability than its predecessors.

—Howard Wolff

Intended to bring *Electronics* readers up to date on news stories of the past months.

# Put us to the test.



Our family of TRACER-flo® and CENTRISAFE® solid state device testing equipment enables you to verify the hermetic seal and mechanical integrity of semiconductors and microelectronic devices at a **fraction of a cent per test**. Whatever the commercial or military specification, there's a model to satisfy your needs.

The small cost per device spent before shipment can dramatically reduce field failures and costly returns.

To eliminate the time consuming practice of loading devices into sticks by hand, our new automatic Bulk-to-Stick Loader orients and loads 4000 DIPs an hour into sticks.

Put us to the test. Call us for a demonstration or a complete technical literature package on our family of equipment.

## TRACER-flo® hermetic seal leak testing to 5000 devices/hr.

Low cost \$10,950 half gallon gross and fine leak testing system. Performs quantitative testing as well as Go-No-Go. Meets or exceeds MIL-STD-883, -750, -202, NAS 728, MIL-R-5757E and -6106 requirements. Lowest per part cost available today.



## Economy gross leak bubble tester.

Bench top. Completely self-contained. Plugs into 120V outlet. Solid state temperature controlled immersion heater, submerged lighting, built-in timer. Meets MIL-STD-883, Method 1014, MIL-STD-750A, Method 1071, and MIL-M-38510 requirements. Low price: \$325.

## Automatic hermetic seal gross leak testing station.

The "Step Two" Pressure System meets MIL-STD-883, Method 1014, Condition C, Step 2 requirements. Fully automatic processing. Available with 2, 3, or 4 each 1-gallon activation stations and up to 5-gallon storage chamber.

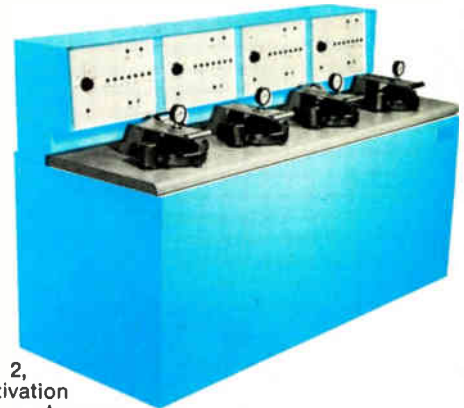

## Automatic DIP bulk-to-stick loading at 4000 devices/hr.

Automatically orients and loads bipolar 14- and 16-lead TTL, DTL and CTL devices into stick carriers. Just place devices in the vibratory feeder bowl; the rest is automatic. Eliminates the hand loading bottleneck.



## CENTRISAFE® centrifuging to verify device mechanical integrity.

Five different models are available from an economy variable-speed to a high horsepower, all with a complete line of fixturing.



## TRIO-TECH, INC. OF CALIFORNIA

Testing services are available on above equipment at the addresses listed below.

**Burbank, California 91504**  
2435 N. Naomi St. (213) 846-9200

**Mountain View, California 94040**  
1954-M Old Middlefield Way (415) 969-9600

**Framingham, Massachusetts 01701**  
100 Fountain St. (617) 879-8520

**1** AMERICAN MADE  
**Tolerance**  
**SCHAUER**  
**1-Watt**  
**ZENERS**

**Immediate Shipment**  
**Low Prices**

ANY voltage from 2.0 to 16.0

**Quantity Price each**

1-99	\$1.07
100-499	.97
500-999	.91
1000-4999	.86
5000 up	.82



All welded and  
 brazed assembly

No fragile  
 nail heads

Gold  
 plated  
 leads

Write for complete  
 rating data and other  
 tolerance prices.

**Buy the kit-**  
**Save**  
**a lot**



Kit contains a 51-piece assortment of SCHAUER 1% tolerance 1-watt zeners covering the voltage range of 2.7 to 16.0. Three diodes of each voltage packaged in reusable poly bags. Stored in a handy file box. Contact your distributor or order direct.

A \$54.57 value for  
**ONLY \$24.50**

Semiconductor Division

**SCHAUER**  
 Manufacturing Corp.

4514 Alpine Ave. Cincinnati, Ohio 45242  
 Telephone: 513/791-3030

## Meetings

**Consumer Electronics Show, EIA, McCormick Place, Chicago, Ill., June 9-12.**

**Chicago Spring Conference on Broadcast and Television Receivers, IEEE, Marriott Motor Hotel, Chicago, June 10-11.**

**Power Electronics Specialists Conference, IEEE, Bell Laboratories, Murray Hill, N. J., June 10-12.**

**Quantum Electronics International Conference, IEEE, Hyatt Regency, San Francisco, June 10-13.**

**Symposium on Human Resources and Medical Programs of the Department of Defense, EIA, Pick-Congress Hotel, Chicago, June 11-12.**

**Automotive Electronics Conference and Exposition, Electronics Representatives Association, Cobo Hall, Detroit, June 11-13.**

**International Microwave Symposium, IEEE, Atlanta, Ga., June 12-14.**

**Utilities Telecommunications Council Annual Meeting, UTC, Chalfonte-Haddon Hall Hotel, Atlantic City, N. J., June 16-20.**

**Design Automation Workshop, IEEE, Holiday Inn, Denver, June 17-19.**

**International Conference on Communications, IEEE, Leamington Hotel, Minneapolis, June 16-19.**

**1974 Government Microcircuit Applications Conference, DOD, NASA, AEC, U. of Colo., Boulder, (clearance required), June 25-27.**

**Precision Electromagnetic Measurements Conference, Royal Society, IEE, London, July 1-5.**

**Electromagnetic Compatibility Symposium, IEEE, Hilton Hotel, San Francisco, July 16-18.**

**The Second Jerusalem Conference on Information Technology, The Jerusalem Economic Conference and its Computer Committee, Jerusalem, Israel, July 29-Aug. 1.**



Your closest **SIGNETICS** distributor is...

**ARIZONA**  
 Phoenix: Hamilton/Avnet Electronics (602) 275-7851  
 Phoenix: Kieruff Electronics (602) 273-7331

**CALIFORNIA**  
 Culver City: Hamilton Electro Sales (213) 870-7171  
 El Segundo: Liberty Electronics (213) 322-8100  
 Los Angeles: Kieruff Electronics (213) 685-5511  
 Mountain View: Hamilton/Avnet Electronics (415) 961-7000  
 Palo Alto: Kieruff Electronics (415) 968-6292  
 San Diego: Cramer Electronics (714) 565-1881  
 San Diego: Hamilton/Avnet Electronics (714) 279-2421  
 San Diego: Kieruff Electronics (714) 278-2112  
 Sunnyvale: Cramer Electronics (408) 739-3011

**CANADA**  
 Downsview: Cisco Electronics (416) 661-0220  
 Downsview: Cramer Electronics (416) 661-9222  
 Montreal: Cisco Electronics (514) 735-5511  
 Montreal: Hamilton/Avnet Electronics (514) 735-6393  
 Ottawa: Cisco Electronics (613) 729-5118  
 Ottawa: Hamilton/Avnet Electronics (613) 725-3071  
 Quebec City: Cisco Electronics (418) 524-3518  
 Vancouver: Bowtek Electric Co. Ltd. (604) 736-7677

**COLORADO**  
 Denver: Cramer Electronics (303) 758-2100  
 Denver: Hamilton/Avnet Electronics (303) 534-1212

**CONNECTICUT**  
 Hamden: Arrow Electronics (203) 248-3801  
 Georgetown: Hamilton/Avnet Electronics (203) 762-0361  
 North Haven: Cramer Electronics (203) 239-5641

**FLORIDA**  
 Hollywood: Hamilton/Avnet Electronics (305) 925-5401  
 Hollywood: Schweber Electronics (305) 927-0511  
 Orlando: Hammond Electronics (305) 241-6601

**GEORGIA**  
 Atlanta: Schweber Electronics (404) 449-9170  
 Norcross: Hamilton/Avnet Electronics (404) 448-0800

**ILLINOIS**  
 Elk Grove: Schweber Electronics (312) 593-2740  
 Elmhurst: Semiconductor Specialists (312) 279-1000  
 Schiller Park: Hamilton/Avnet Electronics (312) 678-6310

**INDIANA**  
 Indianapolis: Semiconductor Specialists (317) 243-8271

**KANSAS**  
 Lenexa: Hamilton/Avnet Electronics (913) 888-8900  
 Lenexa: Hall-Mark Electronics (913) 888-4747

**MARYLAND**  
 Hanover: Hamilton/Avnet Electronics (301) 796-5000  
 Rockville: Pioneer Washington Electronics (301) 424-3300  
 Rockville: Schweber Electronics (301) 881-2970

**MASSACHUSETTS**  
 Burlington: Hamilton/Avnet Electronics (617) 273-2120  
 Newton: Cramer Electronics (617) 969-7700  
 Waltham: Schweber Electronics (617) 890-8484

**MICHIGAN**  
 Detroit: Semiconductor Specialists, Inc. (313) 255-0300  
 Livonia: Hamilton/Avnet Electronics (313) 522-4700  
 Troy: Schweber Electronics (313) 583-9242

**MINNESOTA**  
 Edina: Hamilton/Avnet Electronics (612) 941-3801  
 Minneapolis: Semiconductor Specialists (612) 854-8844

**MISSOURI**  
 Hazelwood: Hamilton/Avnet Electronics (314) 731-1144  
 St. Louis: Hall-Mark Electronics (314) 521-3800

**NEW MEXICO**  
 Albuquerque: Cramer Electronics (505) 265-5767  
 Albuquerque: Hamilton/Avnet Electronics (505) 765-1500

**NEW YORK**  
 Buffalo: Summit Distributors (716) 884-3450  
 Farmingdale, L.I.: Arrow Electronics (516) 894-6800  
 Rochester: Schweber Electronics (716) 328-4180  
 Syracuse: Hamilton/Avnet Electronics (315) 437-2642  
 Westbury: Hamilton/Avnet Electronics (516) 333-5800  
 Westbury: Schweber Electronics (516) 334-7474

**NORTHERN NEW JERSEY**  
 Cedar Grove: Hamilton/Avnet Electronics (201) 239-0800  
 Saddlebrook: Arrow Electronics (201) 797-5800

**SOUTHERN NEW JERSEY AND PENNSYLVANIA**  
 Cherry Hill, N.J.: Milgray-Delaware Valley (609) 424-1300  
 Moorestown: Arrow/Angus Electronics (609) 235-1900  
 Mt. Laurel, N.J.: Hamilton/Avnet Electronics (609) 234-2123

**CENTRAL NEW JERSEY AND PENNSYLVANIA**  
 Somerset, N.J.: Schweber Electronics (201) 469-6008

**NORTH CAROLINA**  
 Greensboro: Hammond Electronics (919) 275-6391

**OHIO**  
 Beechwood: Schweber Electronics (216) 464-2970  
 Dayton: Hamilton/Avnet Electronics (513) 433-0610  
 Cleveland: Arrow Electronics (216) 464-2000  
 Cleveland: Pioneer Standard Electronics (216) 587-3600  
 Kettering: Arrow Electronics (513) 253-9176

**TEXAS**  
 Dallas: Cramer Electronics (214) 350-1355  
 Dallas: Hamilton/Avnet Electronics (214) 661-8661  
 Houston: Component Specialties (713) 771-7237  
 Houston: Hamilton/Avnet Electronics (713) 526-4661

**UTAH**  
 Salt Lake City: Alta Electronics (801) 486-7227  
 Salt Lake City: Hamilton/Avnet Electronics (801) 262-8451

**WASHINGTON**  
 Bellevue: Hamilton/Avnet Electronics (206) 746-8750  
 Seattle: Cramer Electronics (206) 762-5722

# Super speed in plastic: Finally, ECL 10k you can afford.

## 35 economy devices to double or triple your system performance.

For super-speed logic you can't beat ECL 10k. But until now, cost has been the problem. Just the kind of problem we like to sink our teeth into.

Plastic's the ticket. It makes ECL 10k a standard in your budget. Because we've put so many low-cost plastic devices into low-cost volume production, our super-speed prices are competitive with other high-speed alternatives at last.

Now, in designing high performance systems for today's and tomorrow's market, you've got a choice. Before you might have designed with standard high-speed TTL logic costing 50¢/gate (100-up). Now you're suddenly able to design with super-speed ECL 10k logic in plastic costing 55¢/gate.

Variety? You bet. Early on we recognized the diversity you'd need—to cover design requirements of terminals, minicomputers, add-on memories... you name it. Signetics offers you a complete standard logic family of ECL 10k in plastic. And there's more to come, including the higher power MSI counters, shift registers and adders.

Here's the clincher: availability. Everything listed is in production. Everything in production—on our distributors' shelves. NOW. Should a local run clean a device out of stock, it's only temporary.



We can expand availability on short notice—meaning days or a few weeks, not months.

Enough said—it's your move. The parts list is here; your distributor's number is on the facing page. Take it from there.

<b>GATES</b>	10111	10116	10135
10101	10112	10124	
10102	10113	10125	<b>ENCODERS &amp; DECODERS</b>
10103	10117	10190	
10104	10118	10216	10132
10105	10119		10134
10106	10121	<b>LATCHES &amp; FLIP FLOPS</b>	10158
10107			10159
10108	<b>INTERFACE</b>	10130	10171
10109	10114	10131	10172
10110	10115	10133	10173

CLIP AND ATTACH TO YOUR LETTERHEAD FOR FAST ACTION

Signetics—Plastic ECL 10k  
P.O. Box 3004-30  
Menlo Park, California 94025

Rush me your line card, and application information on Signetics economical ECL 10k in plastic.

Name \_\_\_\_\_

Title \_\_\_\_\_

Signetics Corporation, a subsidiary of Corning Glass Works, 811 East Arques Avenue, Sunnyvale, California 94086 (408) 739-7700.

## signetics

# Growing with the

**Amphenol connectors help assure correct weight in new automatic weighing system.**

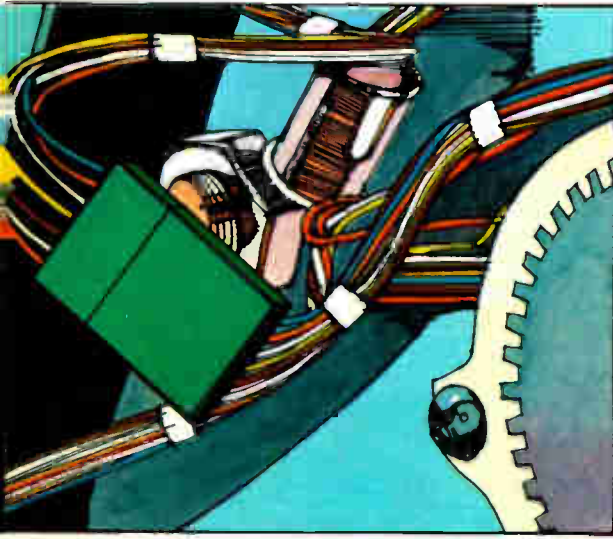

Meat merchandising has taken a big step forward with advanced solid state circuitry. The system includes a scale, mini-computer, and a printer in an integrated modular package that can weigh and price meat in seconds.

Amphenol 221 Series micro-miniature connectors share the responsibility for transmitting weight and price data to the mini-computer. Their low cost, sturdy design, and high-reliability contact configuration make them ideal for this application.

The 221 Series does the same kind of reliable work in a variety of equipment in the electronic data processing, telecommunications and home entertainment industries.





# new electronics

**Amphenol connectors help transmit computer data in new high speed printer.**

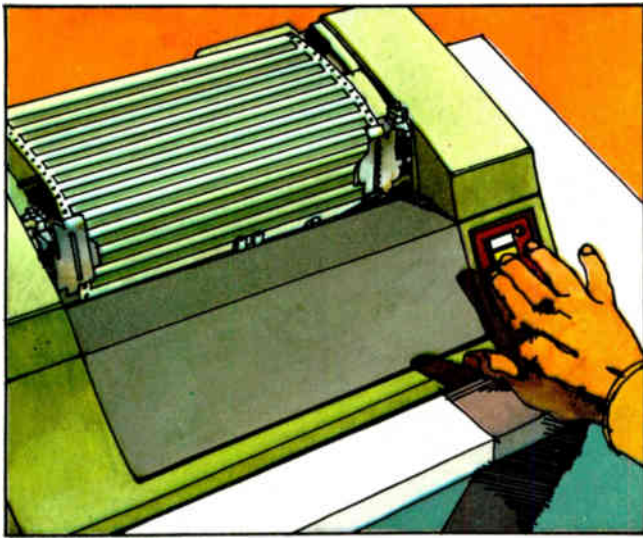

A unique modular matrix printer was recently developed to interface with mini-computers, medium-speed batch terminals, and other installations requiring high speed data output. Data is received at up to 75,000 characters per second. The data is then carried through PC cards to a printing head with an output of up to 165 characters per second.

Precise signal input and data output depend on consistent and accurate information flow. That's why this peripheral systems manufacturer specifies Amphenol 225 Series PC connectors and 6034 Series trimmers. They also rely on Amphenol connectors as an important link to the power supply portion of the printer.

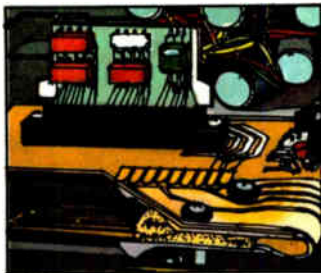

**Amphenol assembly services help produce new credit card verifier.**

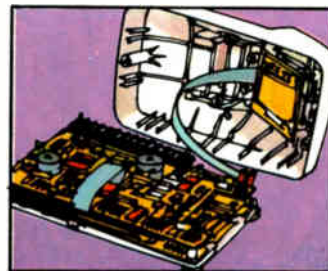

A major computer corporation recently developed a new computerized credit system. To eliminate a costly invest-

ment in production equipment and inventories, they turned to the Amphenol Cadre Division.

All assembly and material supply is now handled by Amphenol people including component preparation, stuffing and wave soldering of printed circuit boards, hand wiring, and mechanical assembly. In addition, unique quality control tests are carried out.

Over 500 units have already been produced with excellent turnaround time and high product quality. They are now in use by a nationwide resort and restaurant chain for added customer convenience and man-hour savings.

**BUNKER  
RAMO**

# AMPHENOL

For more information, contact these manufacturing/sales facilities. United States: Amphenol Components Group, 1830 S. 54th Av., Cicero, IL 60650 Canada: Amphenol Canada Ltd., 44 Metropolitan Rd., Scarborough, Ont. Great Britain: Amphenol Ltd., Thanet Way, Tankerton, Whitstable, Kent, England West Germany: Amphenol-Tuchel Electronics GmbH, 8024 Deisenhofen bei Munchen, West Germany France: Usine Metallurgique Doloise, 92a98 Avenue de Gray, 39100—Dole, France Australia: Amphenol Tyree Pty. Ltd., 10-18 Charles St., Redfern, N.S.W. 2016, Australia India: Amphetronix Ltd., 105 Bhosari Industrial Area, Box 1, Poona 26, India Japan: Daiichi Denshi Kogyo K.K., 20, 3-Chome, Yoyogi, Shibuya-ku, Tokyo, Japan 151

# Introducing the new standard of quality in cermet film fixed resistors.



Now Allen-Bradley quality is available in cermet film fixed resistors. We coupled 40 years of know-how in reliable fixed resistor mass production with 15 years of experience in metal film resistive elements.

The result will change your thinking about film resistor suppliers.

Features? Capless design that does away with problems associated with end cap construction. And an alumina core with superior thermal characteristics and physical strength to resist fractures. Solderable/weldable leads. Even dual markings that are easy to read.

Now available in preferred number values from 10 ohms to 1 meg; 1% tolerance;  $\frac{1}{4}$  watt at 70°C,  $\frac{1}{8}$  watt at 125°C; Size 0.250 L. by 0.090 D. Approved to MIL-R-10509 for style RN55, characteristic D. With tape reel packaging if you prefer.

For complete technical information on the Type CC cermet film fixed resistor, write Allen-Bradley Electronics Division, 1201 South Second St., Milwaukee, Wisconsin 53204.

**There's more to resistors than resistance.**

Circle 24 on reader service card

Actual Size

EC68



**ALLEN-BRADLEY**  
Milwaukee, Wisconsin 53204

## **Signetics, Asahi negotiating joint venture in Japan**

Watch for a joint venture in Japan between Signetics and its Japanese sales agent, Asahi Glass Co. **Talks between the firms are under way** in anticipation of relaxation later this year of Japan's import and capital-investment restrictions on the semiconductor industry. Such a joint venture would help boost Signetics' sales in Japan, which now run around \$7 million annually. Asked to comment on the negotiations, a Signetics spokesman would only confirm that such talks are starting.

## **Consumer products ordered to show date of manufacture**

Makers of consumer electronic products have lost their battle with the Bureau of Radiological Health in the Food and Drug Administration. After Jan. 1, 1975, **every product subject to radiation-performance safety standards will have to be labeled** by its maker with its month and year of manufacture. Previously, manufacturers were allowed merely to code this information on products, provided they gave the bureau the key to the code. The bureau, which proposed the standard last September in response to consumer requests, will continue to permit companies to use code for the place of manufacture.

However, while this will save manufacturers of popular U.S. brand-name products like TV receivers from disclosing that their products are made in such places as Taiwan and Japan, companies still **fear that consumers will reject buying a product made earlier in favor of another with a more recent date.** But one company official opposed to the labeling program protests, "Electronics doesn't go sour like a bottle of milk or a pound of butter because it has been on the shelf for a while, but we are afraid a lot of consumers may act as though it does."

## **Semiconductors suddenly flood mini maker**

"They're shoving them down our throats." That's how David H. Methvin, president of Computer Automation Inc., describes the semiconductor-supply situation in what he says is a sudden change from conditions a short while ago. **"We and other firms are up to our eyeballs in ICs,"** he says.

Methvin cites one case in which his Irvine, Calif., firm called a supplier to try to stop a \$40,000 order, only to be told that the parts had just been put on a truck. After the order arrived, paper work showed that **the trucking company had received the semiconductors two days after the phone call.**

## **Signetics reported also developing new injection logic**

Integrated injection logic, the bipolar LSI introduced in Europe by Philips and IBM [*Electronics*, Feb. 21, p. 92], may be gaining another disciple. Reported doing serious investigative work into the process is Signetics Corp. of Sunnyvale, Calif. Texas Instruments and Intel Corp. previously announced work.

**The attractions of I<sup>2</sup>L—characterized by some observers as the bipolar LSI of the future—are its density, speed-power product, versatility, and low cost.** The technology is capable of squeezing 1,000 to 3,000 gates, or more than 10,000 bits of memory, on a single chip; has a speed-power product as low as 1 picojoule, compared to 100 pJ with TTL; can handle digital and analog functions on a single chip; and is made with a five-mask process without the need for current-source and load resistors.

## **Motorola offers new TVs despite sale negotiations**

Outwardly unruffled by attempts to block the proposed sale of its television-set business to Matsushita Electric Co. (Panasonic), Motorola's Consumer Electronics division is **busily introducing its new line of Quasar receivers this week.** The move is apparently intended to hold on to Motorola's network of dealers.

Meanwhile, Zenith Radio Co., which surprised the industry earlier this month by offering to buy two of Motorola's plants, says it is considering legal action to block the Motorola-Matsushita deal. Zenith's offer, an attempt to outflank Matsushita, was rejected by Motorola.

## **First Naked Mini LSI Having chip woes**

Computer Automation Inc., the Irvine, Calif., minicomputer maker best known for its Naked Mini machines, is still having difficulties with the custom semiconductor chip set [*Electronics*, Feb. 21, p. 144] used in its first LSI computer—the Naked Mini LSI Type I machine. President David H. Methvin has five of his engineers working full time to solve the problem: **the chip set's voltage margins are too limited.** Computer Automation designed the chips, which are reportedly being made by National Semiconductor. Methvin estimates that it may be six months before the machine, announced in May 1973, is in production.

Meanwhile, the company hasn't lost any customers because of the slippage, Methvin maintains. In fact, the Naked Mini LSI Type II, developed in parallel with the Type I but announced several months later, is being produced at the rate of 1,000 per quarter, **and more than 1,000 of the newer machines have been shipped.** Nor is CA hurting noticeably in sales without the Type I though Methvin admits they would be higher. The company's third quarter, ended March 31, was the 11th consecutive quarter of record sales and profits. Sales for that quarter hit \$5.6 million, with profits at \$1.06 million.

## **Pressure change varies resistance of new substance**

A researcher in Leonia, N.J., has developed a rubbery plastic material with electrical resistance that varies with pressure. And it does so linearly over a sizeable portion of its operating range. The manufacturer claims that the new material, Dynacon, **can have a high—more than 10 megohms—resistance in a relaxed form, but resistance drops to less than 1 ohm when enough pressure is applied.**

Harold Charles, president of Dynacon Industries Inc., says the material's operation depends upon conducting metal particles suspended in a binder sheet of rubber or plastic binder. The substance resembles the conductive elastomers used in such things as electromagnetic shielding that are now finding their way into connectors for watches [*Electronics*, Jan. 24, p. 32].

But his material's conduction of electricity depends on a different phenomenon, Charles says. Since less metal is needed, weight is lower, and the material can be cycled indefinitely. Right now, Charles is looking for applications. Some possible uses: **weight sensors for bathroom scales and pressure sensors for such devices as robot "hands," intrusion detectors, switches, and motor controls.**

# Perfect for power supply design.

Unitrode's new ESP Power Switch provides the power transistor and catch diode functions required in switching regulator applications. One convenient package delivers the extra *Efficiency, Speed, and Power* needed to improve response time over regulating components commonly used in power supplies... and at no extra cost.

Unitrode selects and matches its exclusive ESP high speed rectifiers and power transistors to produce a single, plug-in TO-66 package... saving hours of design time.

This new ESP power switch operates with more than 80% efficiency. That's at least 15% better than most switching regulator circuits. Switching rates can be increased from the normal 10-20 KHz to 50 and even 100 KHz. And the ESP power switch can be driven by any IC regulator with no external biasing required.

Since no diode recovery spike is generated, there's less noise and RFI. Circuit designers can use a smaller LC filter, further reducing total power supply size, weight and cost.

For detailed specifications and performance characteristics on both 5A and 15A units, send for our ESP Power Circuit literature. Or, for faster action call Ernie Crocker at (617) 926-0404.



## New Unitrode ESP Switching Regulator Power Switch

Type	Max. Output Current $I_o$	Max. Input Voltage $V_{i-2}$	Typical Efficiency %	Typical Rise Time $t_r$	Typical Fall Time $t_f$
POSITIVE OUTPUT					
PIC600 PIC601	5A	50V 60V	85% @ 2A	30nSec	50nSec
PIC625 PIC626	15A	60V 80V	82% @ 10A	45nSec	70nSec
NEGATIVE OUTPUT					
PIC610 PIC611	-5A	-60V -80V	85% @ -2A	40nSec	50nSec
PIC635 PIC636	-15A	-60V -80V	82% @ -10A	50nSec	85nSec

\*Measured with  $V_{in} = 25V$ ,  $V_{out} = 5V$ ,  $f = 20\text{KHz}$ , input pulse width = 10 $\mu$ Sec.  
See Electronics Buyers' Guide Semiconductors Section for more complete product listing.

Circle 27 on reader service card

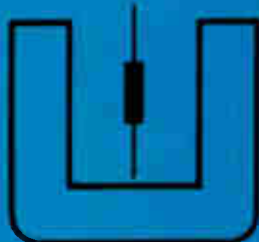

**Available  
off the shelf**

# UNITRODE

580 PLEASANT STREET, WATERTOWN, MA 02172

# Thyristors, Rectifiers and Capacitors for Inverters

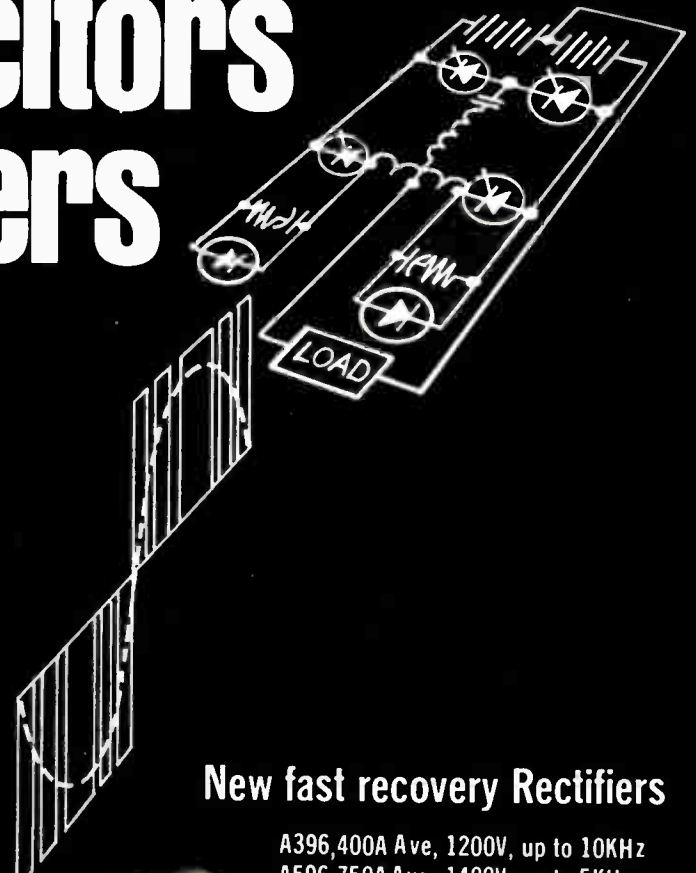

## 6 new high speed Thyristors

C609 SWITCHES 1400A pk @ 5KHz  
C509 SWITCHES 1000A pk @ 5KHz

New involute interdigitated pellet configuration allows more than double the frequency-current capability of comparable competitive types.

C364, 275A RMS, up to 600V, 10  $\mu$ sec tq  
C365, 275A RMS, up to 600V, 20  $\mu$ sec tq

For high speed, low-loss power switching in 1-10 KHz range.

C149, 63A RMS, up to 600V, 10 and 20  $\mu$ sec tq  
C148, 55A RMS, up to 1200V, 30 and 40  $\mu$ sec tq

15° C cooler operation than competitive types at same case temperature; 1/4"-28 stud mount package.

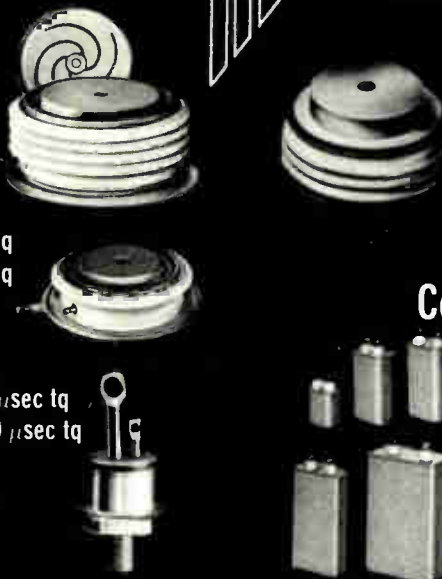

## New fast recovery Rectifiers

A396, 400A Ave, 1200V, up to 10KHz  
A596, 750A Ave, 1400V, up to 5KHz

Companions to GE inverter SCR types C398, C509, C609. Better ratings and characterization than comparable competitive types.

## Commutating and Snubber Capacitors

Metal-encased paper, metalized paper and poly-carbonate film dielectric capacitors are available in a variety of case styles and several lead terminations. Ratings from 0.1 to 150  $\mu$ f and up to 2,000V DC.

For more information contact  
General Electric Semiconductor, Electronics Park 7-49  
Syracuse, N.Y. 13201

GENERAL  ELECTRIC

## X-ray lithography highlights move to tiny IC patterns

While not yet out of the laboratory, X-ray exposure of sensitized wafers may soon become practical

In the quest for smaller and smaller geometries on integrated-circuit masks, two techniques have been pursued: the use of electron beams and X rays instead of light for exposing sensitized wafers. Both overcome resolution problems by operating at much shorter wavelengths than the ultraviolet light presently used.

And now X-rays appear to have features that may give them the edge over electron beams, as well as

over conventional approaches. These features include:

- Resolution of 0.1 micrometer.
- Depth of field of 10  $\mu\text{m}$ , which permits noncontact printing for longer mask life.
- Insensitivity to dust particles and other contaminants—critical factors with conventional systems.
- Constant depth of exposure.
- Capability to be used with positive or negative resists.

Bell Laboratories, IBM Corp., Lincoln Laboratories, and others have been working with X-ray lithography for several years, and now the technique appears about to emerge from the laboratory. Paul A. Sullivan, head of the micropattern replication group of the Ion Physics department at Hughes Research Labo-

ratories, Malibu, Calif., and J.H. McCoy, also a member of that group, described recent advances at this month's Sixth International Conference on Electron and Ion Beam Science and Technology in San Francisco.

**Uses in logic, bubbles.** Hughes researchers have been working to produce surface-wave acoustic devices, which typically require lines as narrow as 0.6  $\mu\text{m}$ , as well as microwave field-effect transistors. The process also appears suitable for ultra-high-speed logic circuits and magnetic-bubble memories.

Basically, the technique is to use electron beams to make the masks but to expose the wafers to X-rays, which, Sullivan says, will permit 0.2- $\mu\text{m}$  resolution, compared to the 0.6-

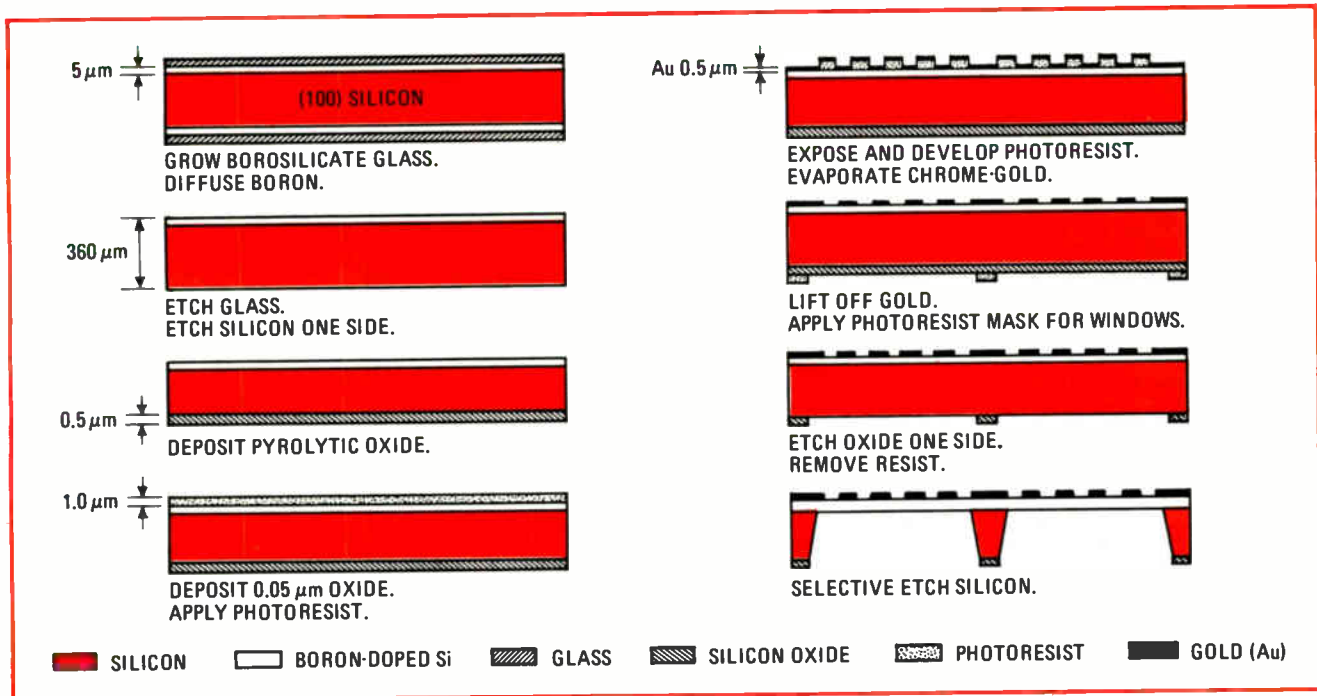

**X-ray mask fabrication.** Gold-on-silicon masks for X-ray exposure are made much like conventional silicon wafers. The mask is written with electron-beam techniques, however, and must be etched to a thickness of a few micrometers.

$\mu\text{m}$  limit of present electron-beam photolithographic technology.

The X rays used are soft (8 kilovolts) and present no health hazard, being unable even to penetrate human skin, says Sullivan. They are generated by high-energy electrons hitting a target (Hughes has used a 3-kw Balzers electron-beam evaporator with an aluminum target). Their wavelength is 8 angstroms, compared to the 4,000 Å of the ultraviolet. A thin (8- $\mu\text{m}$ ) aluminum-foil heat shield is required between the target and mask, which are about 8 centimeters apart.

The gold-on-silicon mask has a thermal coefficient that matches the thermal properties of the silicon wafers used for the device. The mask substrate is 2 to 5  $\mu\text{m}$  thick.

**Alignment.** A scanning electron microscope is used to write the pattern on the mask. The relative slowness of this process is not a serious limitation, says Sullivan. He feels

that the previously difficult problem of mask-alignment has been solved by his approach's accuracy, kept within 0.1  $\mu\text{m}$ .

His system uses a complex optoelectronic technique to align registration marks on the mask and wafer. Exposure requires less than 2 minutes over a 2.5-cm wafer for fast resists and the relatively high power of 9 kilowatts.

The X-ray technique appears to overcome some fundamental problems with electron-beam exposure of wafers, notably distortion caused by imperfect fields, backscattering of electrons from a substrate, and the necessity to keep the substrate in a vacuum. For these reasons, Sullivan thinks that X rays will ultimately prove superior for making devices with submicrometer dimensions.

He also feels that the simplicity and relatively low cost may well lead to far wider utilization of the

ultrahigh resolution capabilities of masks made by scanning-electron-beam lithography. □

## Commercial electronics

### Oil-locator accepts 1,024 input channels

There was a time when electronic oil-exploration systems brought site information to a computer, but now at least two companies are taking the computer to the site. Heretofore, the average number of information channels that funneled into this type of computer was 48; however, Geophysical Systems Corp., Pasadena, Calif., has developed Geocor II, a system that accepts 1,024 input channels for what is claimed to be the highest resolution available for mapping geological structures.

## IEEE president John Guarrera insists:

### "I can do the job" despite business problems

Responding to criticism that outside business pressures make him unable to devote full energy to IEEE, the institute's president John Guarrera has stated that he can handle his presidential duties. The situation, unusual for the staid IEEE, involves a series of problems plaguing SaCom, the microwave-equipment

and communications-terminal firm Guarrera heads. The critic calling for Guarrera's resignation has been Irwin Feerst, whose self-financed newsletter regularly needles IEEE management.

**Subpoena.** Guarrera's business problems consist of an investigation of SaCom's underwriters by the Securities and Exchange Commission that included a subpoena of financial records, plus a complicated change of auditors that has intensified his financial woes, plus a fiscal year of heavy losses. However, he denies that the SEC private order for investigation either reflects wrongdoing by SaCom or impinges on his ability to head the IEEE.

"It's correct that I could easily devote more time to IEEE because this job is endless and would not be possible to do without the support of the executive committee and the headquarters staff. But I've done a reasonably good job, though I'm concerned with the company,"

Guarrera states. "I really don't think I've neglected either my IEEE responsibility or my companies financial interests."

Because the SEC will not release information on an investigation in progress, the only details on record indicate the commission is looking into the circumstances of public offerings of SaCom's common stock on Oct. 31, 1972.

For his part, Guarrera says that he's in the dark about the exact nature of the SEC probe, but he does expect the situation to reach some conclusion in about two months.

Meanwhile, the executive board and staff of IEEE have not echoed Feerst's charge that Guarrera is too preoccupied to be effective as president. Comments Donald Fink, IEEE general manager, "We're not convinced that the president has neglected his duties; John Guarrera has enough energy to make himself felt here. We're not running scared at IEEE." □





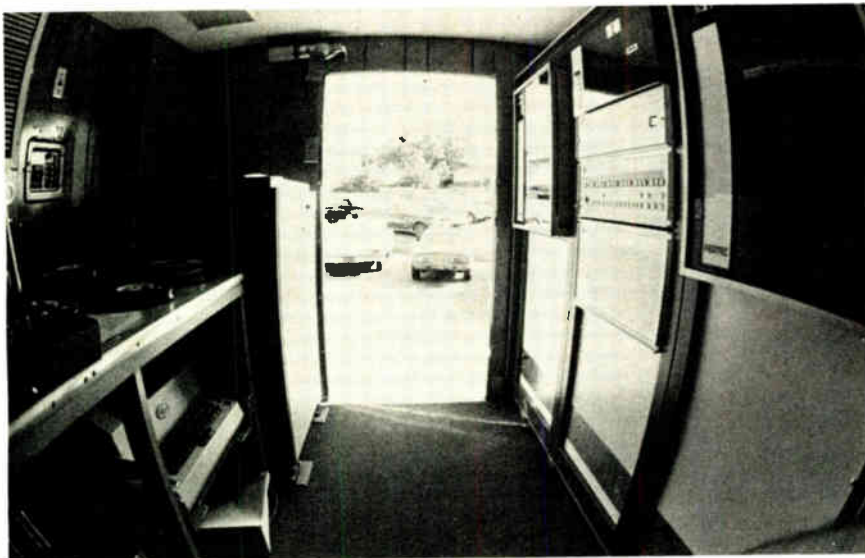

**Portable oil locator.** Developed by Geophysical Systems Corp., the Geocor II can be used to locate geophysical faults as well as oil deposits.

Texas Instruments, which started in oil exploration and then branched to computers and semiconductors, introduced its on-site processing system, called Timap, last October at the Society of Exploration Geophysicists meeting in Mexico City. Timap has a 256-channel capability, and normally operates with full 32-bit final correlation. It also has such peripherals as disks, tape drives, printer, and electrostatic plotter. Geophysical Systems, however, claims that its 1,024 input channels give higher resolution. "We gather single-bit information but cross-correlate it against a full 16-bit envelope," says Robert Fort, Geophysical Systems vice president.

And the company points to the advantage that, rather than depending on a central computer for batch-processing, Geocor II is a real-time acquisition system in a self-contained exploration van. Right in the field, it produces a two- or three-dimensional plot on a Varian Data Machines Statos electrostatic printer.

**Ears to the ground.** The Geocor II system uses a Varian V-73 computer, plus a Geosystems array terminal and special high-speed fast-Fourier-transform processor. Fort says the fast-Fourier transform is vital to provide the necessary high-speed compression of the large number of inputs.

To use the system, large numbers of Geophones are arranged around a vibrator that "chirps" the earth's surface for 24 seconds at a frequency of 10 to 60 hertz. The system includes feedback so that the computer adjusts the chirp frequency for best definition.

**Transmitted shock.** The Geophones also collect shock waves transmitted from the van. As these waves bounce off strata in the ground, the system processes them. This information can then be displayed on line or stored for later printout. The display will be a new 22-inch wide Varian Statos printer; the model 15 is now used. Cathode-ray-tube terminal, line printer, and magnetic tape are also provided.

The system is now undergoing field tests in California's San Joaquin Valley and is claimed to have located both known and new reserves in a previously well-explored area. □

## CRTs for data add cheap color display

Although color CRT data displays have been available almost as long as color TV, relatively few customers have been willing to pay the premium asked for them and their ac-

companying convergence circuitry. But engineers at two Midwest firms have developed a shortcut to low-cost color data displays that will, for some applications, yield the color feature for less than double the cost of monochrome. And since the color is implemented in a standard monochrome tube, color displays with 80-character line resolution will for the first time be available in screens as small as 8 to 12 in.

The concept is simple: use stripes, bands, or blocks of different phosphors on selected screen areas of a standard monochrome CRT. Called Programmable Color by its developers, the technique is useful only for applications where data is presented in fixed formats. The technique is being implemented for the Miratel division of Ball Brothers Research Corp., St. Paul, Mo., by tube-maker Clinton Electronics Corp., Rockford, Ill.

Miratel pegs the price of a monochrome 12-inch data display between \$100 and \$150, "depending on quantities and options," says George H. Wagner, director of marketing "and 10 times that for a Shadow-mask display with adequate convergence to yield the resolution required for 80-character lines. Programmable color displays will sell in the neighborhood of \$200 each in lots of 500, roughly a two-thirds increase over monochrome.

Clinton is putting down phosphors of a particular color in a particular area. The user can't change the color of an area at will as he can in a Shadow-mask tube. "But you can't get anywhere near the degree of resolution in a Shadow mask," says Alan D. Bedford, Miratel's chief engineer. "You're limited by the size and spacing of phosphor dots, and the typical spacing between like-color dots is 22 to 29 mils in the popular color tubes." Since monochrome has no dot-triad structure, beam size is the only limiting factor, and dot size for monochrome CRT displays is 12 to 15 mils.

The two firms have seen the most interest for colors laid down in column formats for terminals used for stock market, inventory control, and banking applications, and for the fa-

miliar airline display of flight number, destination, and status. "Horizontal, or row, formats are also possible," says Carl G. Phillipps, sales manager at Clinton. "Medical instruments, for example, might use a two-stripe horizontal display where the trace is normally green. Shifting the trace to the red band would be used to indicate an alarm condition." Long- and short-decay phosphors could be provided in the same tube for other medical applications, he adds. And because phosphors can be put down in any configuration, circles and checkered formats are available for manufacturers of electronic games.

Since the technique essentially relies on relatively simple standard monochrome drive circuitry, column format displays can be retrofitted into unmodified monochrome chassis already in the field. "Modifications, if any, would be made in the software," he points out, but "for row-format programable color, we'd have to do some stabilization of the vertical-deflection and high-voltage circuitry to make sure the characters fall within the stripes of color." □

### Trade

## Japan's share down as U.S. imports drop

First-quarter U. S. imports of home-entertainment electronics dropped to \$371 million, a 7.4% decline from the \$401 million reported from January to March, 1973, according to the U. S. Department of Commerce. Foreign suppliers' shares of the U. S. audio-video equipment market also underwent some drastic changes, as shipments from Japan, the leading foreign supplier, dropped an unprecedented 26% or \$66 million to a \$190 million total for the quarter. At the same time, large dollar gains were posted by Taiwan and Korea, the agency reported, confirming an earlier forecast [*Electronics*, March 21, p. 36].

Taiwan, second-largest U. S. for-

U.S. IMPORTS OF CONSUMER AUDIO						
U.S. Imports of Consumer Audio and Video Products by Country of Origin (thousands of dollars)						
	Jan.-March 1972	Percent of total	Jan.-March 1973	Percent of total	Jan.-March 1974	Percent of total
Japan	\$257,791	70.3	\$255,987	63.9	\$190,223	51.2
Taiwan	46,711	12.7	60,179	15.0	86,940	23.4
Hong Kong	21,658	5.9	22,606	5.6	24,502	6.6
Korea	2,589	0.7	6,533	1.6	19,142	5.2
United Kingdom	18,945	5.2	19,530	4.9	17,565	4.7
Canada	5,980	1.6	8,529	2.1	9,130	2.5
Singapore	2,479	0.7	5,064	1.3	8,048	2.2
West Germany	3,743	1.0	4,858	1.2	5,980	1.6
Brazil	-	0.0	2,773	0.7	5,294	1.4
Mexico	4,328	1.2	7,507	1.9	3,141	0.8
Others	2,494	0.7	7,383	1.8	1,306	0.4
<b>Total</b>	<b>\$366,718</b>	<b>100.0</b>	<b>\$400,949</b>	<b>100.0</b>	<b>\$371,271</b>	<b>100.0</b>

—Source: Bureau of Census

ign supplier, posted a 44% gain in shipments with an \$87 million total. Imports from Korea, almost exclusively by rapidly expanding Korean-Japanese joint operations, registered the largest gain of any country, rising 193% to \$19 million. The increase pushed Korea up from sixth to fourth place, displacing the United Kingdom and ranking it right after Hong Kong (see table).

**Prices up, imports down.** The decline in value of imports came despite significant increases in unit prices of imports. The Government says that a representative sampling of unit import prices shows that auto radios from Hong Kong cost \$13.72, compared to \$8.40 each in the first 1973 quarter. Similarly, tape players for automobiles from Taiwan rose to \$17.22 from \$14.55; Japanese color-TV receivers with screens of 10 inches and smaller climbed to \$170.33 from \$160.16, while Korean-made monochrome TVs of the same screen size rose to \$52.25 from \$50.75.

Imports of color TVs, the product in which the U. S. remains most competitive, declined almost 14% to 250,000 units. Unit decreases were also registered in radio/phonograph combinations (down 55.3%), home

radios (down 21.9%) tape recorders/players (down 19.6%), phonograph/record player/turntables (down 19.6%). Minimal import gains during the first quarter were made in auto radios and monochrome TVs. □

### Components

## DIPs go to thin film at thick-film prices

Thin-film resistor networks deliver higher precision than their thick-film counterparts, but users have always had to pay for that precision. Both types have been available in dual in-line packages recently. Now TRW/IRC Fixed Resistors is taking aim at both thick-film and discrete carbon-composition resistors with a soon-to-be-introduced line of thin-film networks housed in DIPs.

TRW/IRC's line of resistor networks, made of tantalum thin film, is intended to be price-competitive with thick-film networks. The tantalum process, an offshoot of one used currently by IRC for custom IC networks, could also be used for re-

## THE 577 CURVE TRACER....

### A NEW WAY TO MEASURE COMPONENT CHARACTERISTICS.

For years the Tektronix Curve Tracers have been meeting the exacting measurement needs of the semiconductor industry. The same measurement techniques can be applied with equal success to electronic components such as: switches, relays, connectors, incandescent lamps, fuses, gas discharge devices, small motors, capacitors, inductors, resistors and transformers.

One unique advantage of the curve tracer is its ability to reveal non-linear resistance. When you think of it, all resistances are non-linear if viewed over a large range of current or voltage. Often this nonlinearity is of critical importance. While an ohmmeter yields only a single, fixed point on the resistance curve, the 577/177 plot current versus voltage at any desired level. Or, it plots the resistance over a wide range of input levels.

The 577/177 measures dynamic resistance from less than  $0.001 \Omega$  to over 1,000,000  $M\Omega$ . This means that you can measure the low resistance of circuit board runs, connectors and closed con-

tacts; or the high resistance between circuit board runs, adjacent connectors and open contacts.

The movement of a relay armature in the magnetic field generates a forward voltage on closing, and a back voltage on dropout. Relay coil resistances, pull-in voltage, pull-in current, dropout voltage and dropout current can all be viewed on a single display using the 577/177 with CRT storage.

577/177 with storage module D1 . . \$2495

Let us help you make your measurements. To see this curve tracer, call your local Tektronix field engineer; he'll be glad to demo one for you. If you prefer, for additional information write Tektronix, Inc., P.O. Box 500, Beaverton, Oregon 97005. In Europe, write Tektronix Ltd., P.O. Box 36, St. Peter Port, Guernsey, C.I., U.K.



**TEKTRONIX®**

committed to  
technical excellence

For a demonstration circle 165 on reader service card

Circle 33 on reader service card

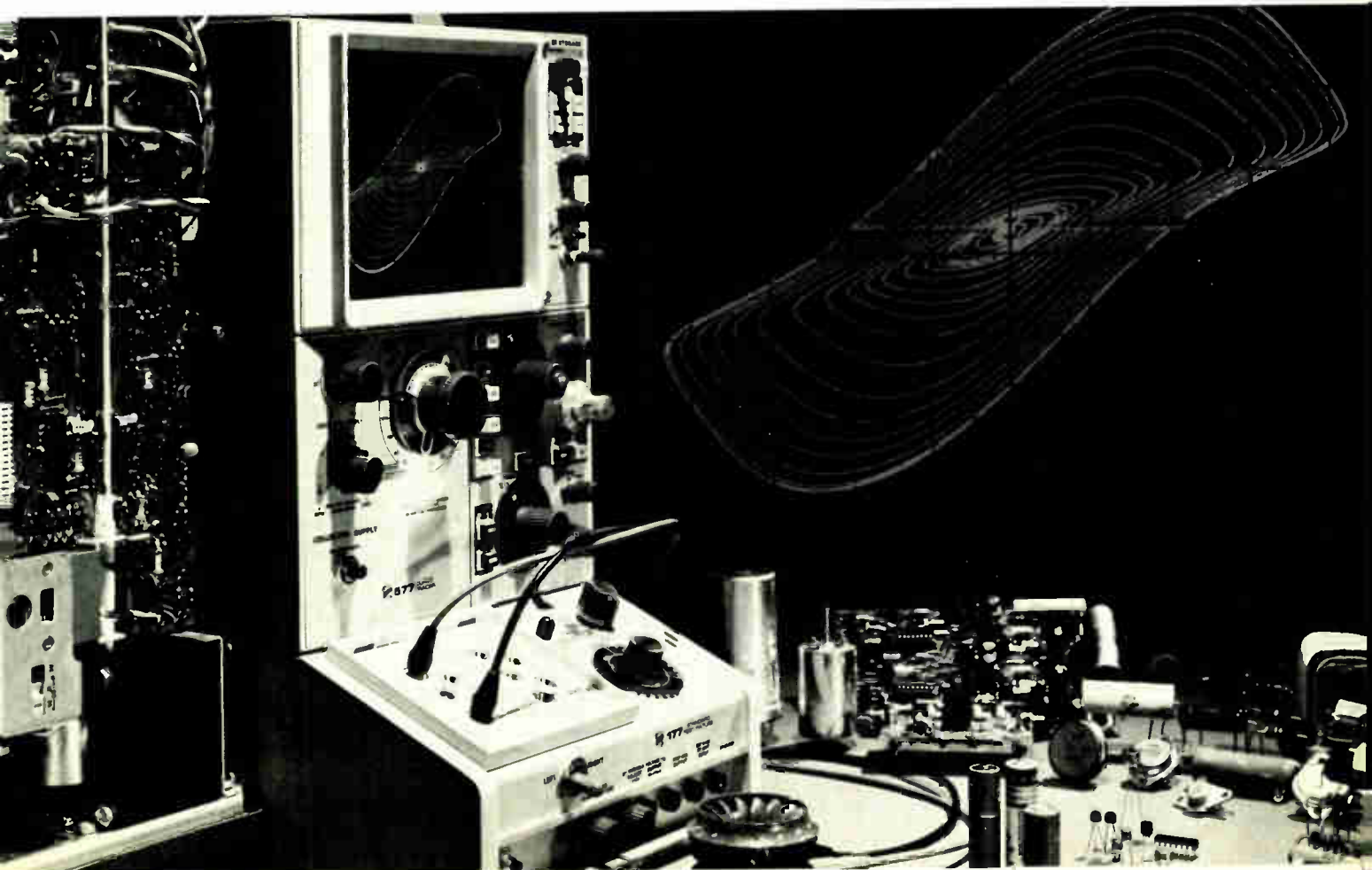

sistor-capacitor networks, as well as resistor networks.

IRC has adapted its thin-film technique for rough-and-tumble applications that precision thin film is seldom used for: pull-ups, pull-downs, line terminators, ladder networks, attenuators, and current-limiters. What's more, at 40 to 45 cents each for 14- and 16-pin DIPs in quantities of 10,000, prices will be competitive with those of thick film.

The thin-film technology offers advantages over thick film in noise, tracking, and temperature coefficient, "but this doesn't seem to be a key advantage in penetrating the commercial market," says Sylvester Mattie, network-development manager of TRW/IRC Network Operations, Philadelphia, Pa. "There does seem to be an advantage in stability over the long term," and IRC is generating 10,000-hour data for the parts' July introduction. With 8,000 hours logged on prototype networks, drift over load life at maximum rated power (0.125 watt/resistor) is running 0.25% typically and 1.0% maximum, he says.

The firm is using a modification of the tantalum-nitride process developed by Western Electric and currently used by several manufacturers, including IRC, for precision resistor networks and custom-IC networks.

**The process.** A tantalum-nitride resistor film is sputtered onto a 99.5% alumina-ceramic substrate. For the commercial parts, IRC evaporates nichrome onto the tantalum, copper onto the nichrome, and flashes the copper with palladium for protection. Terminal pads and then resistor areas are photolithographed onto the substrate and etched out.

The key to the competitive cost is the number of networks processed on a single ceramic blank. IRC obtains 48 networks from a 2½-by-3½-inch substrate and is planning to double that output by moving to 4-by-4-inch blanks and a larger sputterer later this year. "The thick-film producer can't generally screen over that large an area with the accuracy and yields that we get," Mattie says. "He'd have to adjust more

and cut in longer to get up to the final ranges he needs."

Trimming for resistor adjustment is done before the plate is laser-scribed and broken into networks, and the plate is screened with a solder paste for fitting into lead frames. After firing to connect pads to terminals, the individual networks are packaged in molded TO-116 DIPs. First parts will be seven- and eight-resistor networks, rated from 51 ohms to 100 kilohms, and 13- and 15-resistor nets ranging from 51 ohms to 51 kilohms with a common terminal. □

## Computers

### Micro CPU smartens dumb remotes

A remote data-acquisition and monitoring system developed for utilities illustrates how the new breed of microprocessors-on-a-chip will be increasing the intelligence of dumb terminals. And in the process, it shows how to ease the work load on both computer and personnel at complex central master stations.

With initial units to be shipped in July, Quindar Electronics Corp., Springfield, N.J., now has developed its smart remote terminal to handle

basic data reduction, thereby taking the load off the central monitoring computer to which it is tied. Moreover, the terminal can also perform programmed control functions that, until now, had to be relayed in proper sequence from the central master station. Thus, the remote terminal can on its own be involved in such things as the sequential starting and stopping of power generators.

"It's a big change for us," declares Stanley Green, Quindar's manager of research and development. A long-time supplier of remote data-monitoring gear for utilities and pipelines, Quindar had relied on multiplexed digital signals containing the monitored data to be sent back over telephone lines to a master station. Years earlier, Quindar had switched to the digital control from discrete tone generators.

**Bogged.** "We originally went to the digital system because, as systems became more complex, the number of tone channels got very large," explains Green. "But even with a fairly large computer, the system could become data-logged because the dumb remotes had to send everything back to the master station." The result was that even the master station became bogged down when responding to the needs of many remote stations.

With a micro-processor—National

### Wanted: telecommunications-equipment data

The government of Iran has embarked on an ambitious telecommunications effort for which it is seeking information from U.S. companies. The Program Management Office in the Iranian Government Ministry of Posts, Telegrams, and Telephones is helping set up that ministry's microwave telecommunications system.

For that system, plus a communications-satellite system, the PMO is asking for two copies of sales literature, technical brochures and other engineering information that will help in specifying telecommunications equipment and materials.

"Our interests lie in every aspect of telecommunications," a PMO official says, including: power supplies; prime movers and generators; multiplexing equipment; rectifiers; ac-control panels; antenna systems and towers; vhf, uhf, and microwave radio-relay equipment; and trans-horizon radio-relay equipment. The PMO also needs information about audio-visual equipment required for a technician-training program.

Interested companies should write to E. C. McCollogh, executive director, Program Management Organization, Ministry of Posts, Telegraph, & Telephones, Imperial Government of Iran, Tehran.

yes,  
yes,  
no,  
yes,  
no.

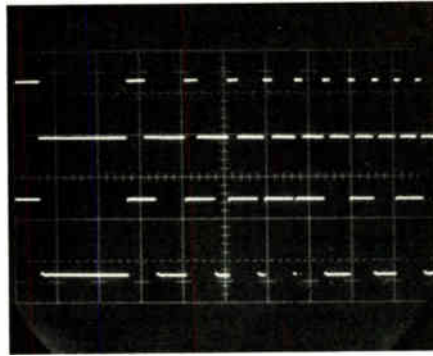

Upper trace: Constant Duty Cycle pulses over a 10:1 frequency range.  
Lower trace: Normal pulses over same range.

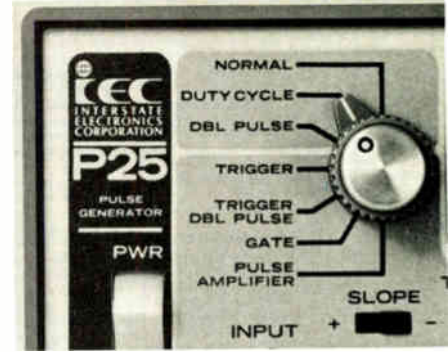

A single control selects all 7 modes.

"Standard pulses with predetermined width are fine for most requirements, but when I'm changing repetition rates I have to fiddle with the width control to make sure that I don't lose the pulse. Does your 'Constant Duty Cycle' mode let me set width as a percent of pulse period so I can change rep rates *without* tweaking the other controls?" (YES)

"That Duty Cycle mode could come in handy, but I also want the regular pulses that I'm used to, and double pulses, and 50% squarewaves to 50 MHz. How about trigger, gate, triggered double pulse, and pulse shaping? (And all of these modes better be easy to set!)" (YES)

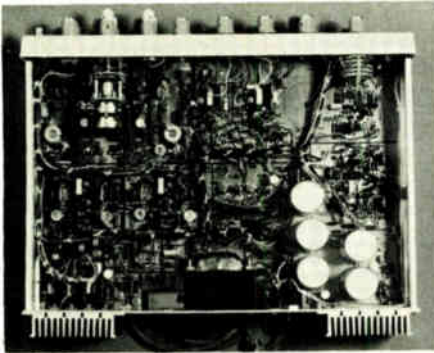

All components are fully accessible.

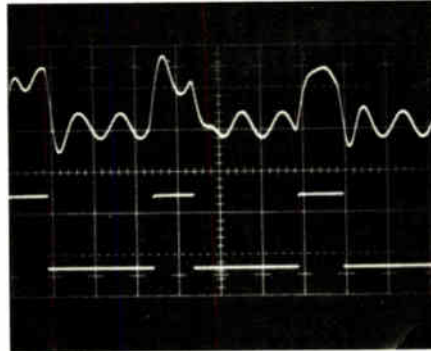

Upper trace: distorted, noisy input.  
Lower trace: pulse generator output (Pulse Amplifier Mode).

"Reliability and maintainability count, too. I want a generator that works! But in case it needs service I'd like to specify plug-in sockets for dual in-line IC's, and a parts list minus factory widgets. If I put my money on your model, will my QC man hate me?" (NO)

"My application calls for pure pulses with a bare minimum of overshoot and squiggles. And I need to clean up distorted signals — you know, send in a crummy pulse train and get out a nice squared-up pulse with the offset, amplitude, and rise/fall times I've set up on the generator. Can do?" (YES)



Four SERIES 20 models are available from \$575.

"Your \$1095 P25 Pulse Generator has it all, including simultaneous positive and negative outputs, each with adjustable d-c offset and variable rise/fall times from 5 nanoseconds. But if I only need a single output or faster, fixed rise times, am I out of luck?" (NO)

## ask a 50-MHz pulse generator these 5 questions if the answers are yes, yes, no, yes, no, it's INTERSTATE

the Interstate man with all the answers is John Norburg — call collect (714) 772-2811



**INTERSTATE ELECTRONICS CORPORATION**  
Subsidiary of A-T-O Inc.

U.S. HEADQUARTERS: Dept. 7000, Box 3117, Anaheim, CA. 92803; OVERSEAS SALES OFFICES: AUSTRALIA, Parameters Pty., Ltd.; BELGIUM-LUXEMBOURG, Regulation-Mesure S.P.R.L.; FINLAND, Havulinna Oy; FRANCE, Tekelec Airtronic, S.A.; ITALY, Tekelec Airtronic; ISRAEL, Redat International Company Ltd.; JAPAN, Asahi & Co., Ltd.; NETHERLANDS, Tekelec Airtronic, N.V.; NEW ZEALAND, David J. Reid, Ltd.; REPUBLIC OF CHINA, Bons International Co., Ltd.; SPAIN, Teico, S.L.; SWEDEN, M. Stenhardt AB.; SWITZERLAND, Traco Trading Co., Ltd.; UNITED KINGDOM, Euro Electronic Instruments, Ltd.; WEST GERMANY, Tekelec Airtronic GMBH; CANADA, Radionics, Limited. TWX U.S.A. 910-391-1197 TELEX U.S.A. 655443 & 655419

## Microprocessors drive to Detroit

With automakers accepting the role of minicomputers in their manufacturing and assembly operations, it is certain they will soon be seriously applying microprocessors as well. The Process Interface division of Process Computer Systems Inc., Flint, Mich., for example, has proposed a microprocessor "renovation" of an existing carburetor-test facility at a Ford Motor Co. plant.

A microprocessor at each test stand would acquire data and perform a limited amount of preprocessing, then send the information back for the more detailed numerical analysis and decision-making to a central General Electric 4060 that Ford already has on hand. Now, the GE machine is host to some 55 test stands and is close to the limits of its capabilities. Microprocessors, could readily accommodate some 90 stands, and the system could probably be expanded even more.

By contrast, a system recently installed by General Motors' Rochester Products division, Rochester, N.Y., uses a SPC-16 minicomputer from General Automation Inc. at each of more than 100 test stands. The minis handle data reduction and analysis, but because, among other things, each has more memory than a microprocessor has, it probably costs more per station.

If the GE computer were not available, a Process Computer Systems spokesman says the job could be handled by a pair of minicomputers—one for communications, and the other for the actual data manipulation and analysis.

Semiconductor's IMP-16 central-processing unit—designed into the remote stations, plus "special buffering for the power utility environment," the remote station only sends back the data it has to. This could include such things as the monitored points that fall out of present limits or indicate changes in the system's status.

Green points out that buffering for the microprocessor is extremely important and that it would be prohibitively expensive to buffer an off-the-shelf minicomputer to withstand the sharp transients found on power lines. All essential programing of limits is done in a 4,096-bit read-only memory. Transitory information for calculations, such as readings from analog transducers, are stored in 1,024-bit random-access-memory chips.

**Over-all view.** The system itself consists of plug-in printed-circuit boards, containing such items as the four-chip central processor plus the buffering ROMs and RAMs, analog-to-digital conversion, multiplexer, and a transceiver/modem card, which transmits the digital signals over voice-grade telephone lines.

Coding of the signals is done in software, rather than in hardware,

Green says. Quindar uses a 16-bit word in its system to "tag" events with time from an absolute time source. This couldn't be done by the older, hard-wired remote stations, he says. Now, if a disturbance occurs in a power grid, for example, the events can be tagged with a time base so that a history of the event can be reconstructed to millisecond accuracy.

Typical instruction times must be executed within 8 to 10 microseconds, says Green, which can be easily done by the National part. As for programing the microprocessor, Green reports this has been remarkably simple so far. □

## Military electronics

### MARS gears up for new fighters

To cut the costs of ultra-sophisticated military aircraft, the Pentagon is looking at a new class of lightweight fighters. And a key element in such aircraft would be a lightweight radar, such as the modular attack radar system (MARS) de-

signed by Rockwell International's Missile Systems division.

The R209A, a multimode radar weighing less than 350 pounds, could be Rockwell's ticket to as many as 1,000 orders—if military programs being proposed take off and if Rockwell can beat the Westinghouse and Hughes designs.

Part of the Pentagon's interest in new air-combat fighters stems from the excellent performance of lightweight but fast and maneuverable Mirage fighters against sophisticated MIG-21s in the Yom Kippur War. Cost is also a factor.

The Navy and Air Force are worried that they won't be able to buy enough of the sophisticated but expensive F-14 and F-15 multimission fighters to equip their forces. The lightweight contenders are Northrop's P530 Cobra international fighter, and the experimental Northrop YF-17 and General Dynamics YF-16. Although limited in application mostly to air combat, these planes can cost only half as much as the \$20 million of the F-14 and F-15.

**Capability.** The radar is a vital factor in the aircraft, which may only be armed with cannon and Sidewinder-type missiles. George J. Widly, assistant chief engineer for Rockwell's Missile Systems division, Anaheim, Calif., says the radar could range from none at all—highly unlikely—to the ultimate Sparrow capability. He suspects the optimum will be just below the ultimate, and that's where MARS could fit.

The first demonstration of the YF-17, rolled out last month by Northrop, contained a simple range-only radar built by Rockwell from scratch in eight months for only \$165,000 for two units. Widly thinks a more capable radar will be built for production aircraft, however.

The company-funded MARS is basically aimed at air superiority, with options for ground-support operations. For air use, it includes rejection of both fixed and moving ground targets, something that Widly says is not available on production radar. Its display is also unusual, a daylight TV-type screen with no windshield-wiper effect. Its

# SIEMENS

## Cost Effective Solutions to Semiconductor Test Problems



### GENERAL PURPOSE IC TESTER COMPUTEST 716A

Low-cost parametric and functional tester for digital and linear circuits

### DIGITAL CIRCUIT TESTERS COMPUTEST 720 SERIES

Provides complete DC parametric and functional verification of digital IC's

### LINEAR CIRCUIT TESTER COMPUTEST 735

Tests operational amplifiers, regulators, comparators, sense amplifiers and custom linear circuits

### BENCH-TOP MEMORY TESTERS COMPUTEST 901 SERIES

Provides real-time verification of semiconductor memory performance from the device to the complete memory systems level

**FOR APPLICATIONS ASSISTANCE . . .  
CALL US!**

**FREE!**

Send for the Computest catalog of Semiconductor Test Equipment and our Semiconductor Program Library



NAME \_\_\_\_\_

COMPANY \_\_\_\_\_

ADDRESS \_\_\_\_\_

CITY \_\_\_\_\_

STATE \_\_\_\_\_ ZIP \_\_\_\_\_

**Siemens Corporation**  
Electronic Systems Division  
Computest Products

3 Computer Drive, Cherry Hill, N.J. 08002 (609) 424-2400

Circle 37 on reader service card

popular  
A/D & D/A  
converters

ADC 12QZ  
and  
DAC 12QZ



from...

**Altex** INC.

940 DETROIT AVE., CONCORD, CALIF. 94518  
(415) 686-6660 TWX 910-481-9477

call...

GENE LAVIELLE ... (415) 686-6660

or one of our International Distributors.

AUSTRALIA, SYDNEY	772-1655
AUSTRIA, VIENNA	0222/527898
BELGIUM, BRUSSELS	02/35-21-35
DENMARK, LYNGBY	(01) 88 38 33
FRANCE, BOIS-COLOMBES	242.53.97
GERMANY, LUEBECK	(0451) 52991
ISRAEL, TEL-AVIV	444572
ITALY, MONZA	(039) 360021
JAPAN, TOKYO	03-503-3711
NETHERLANDS, AMSTERDAM	020-717353
NORWAY, OSLO	41-22-85
SOUTH AFRICA, JOHANNESBURG	838-8531
SPAIN, MADRID	457 53 12
SWEDEN, TABY	08/7563900
SWITZERLAND, ZURICH	01/626662
UNITED KINGDOM, LONDON	01-902-5941

Circle 38 on reader service card

## Electronics review

500,000 bits of read-only memory provide storage and refresh the image at a 60-hertz rate. The same display can be used for such other sensors as infrared.

For ground support, which may

not be required, MARS uses doppler processing to detect moving targets. Mapping, tracking, and ground-ranging are also offered.

**Digital mostly.** Digital circuitry is used, except where analog tech-

### News briefs

#### Six-foot solar-cell ribbons promise low cost

Gaining momentum in its effort to develop methods for fabricating low-cost solar cells. [*Electronics*, April 4, p. 99], Tyco Laboratories, Waltham, Mass., with the aid of theoreticians at Harvard University in nearby Cambridge, has fabricated single-crystal silicon solar cells in inch-wide ribbons up to six feet long. Earlier ribbons were only about 18 inches long. Pulled from a silicon melt through a precision die in an "edge-defined film-fed growth" process, the ribbon is approximately 10 mils thick. Both this thickness and the 10% conversion efficiency means the cells are quite similar to solar cells made with conventional crystal pulling, sawing, polishing, and diffusing techniques. Both the National Science Foundation and NASA, through its Jet Propulsion Laboratory, are sponsoring the research, which is in the second year of a two-year effort.

#### Magnavox vice president nominated for IEEE president

The IEEE has made Arthur P. Stern, vice president and general manager of the Advanced Products division of Magnavox Co., Torrance, Calif., its presidential nominee for 1975. Joseph K. Dillard, manager for advanced-systems technology, Westinghouse Electric Corp., East Pittsburgh, Pa., has been nominated for vice president of the institute.

#### Hotel/motel management gets RCA mini

The minicomputer that RCA Corp. rescued from the demise of its computer operations is being applied by the company to a hotel-motel property-management system. The first such system has been installed at a motel in Memphis, Tenn. Called Dataway, it automates such routine operations as assigning rooms, keeping track of which rooms have been cleaned, controlling the use of guests' telephones, and keeping records. The basic system, built by the Palm Beach division, Palm Beach Gardens, Fla., the old home of RCA's computer plant, includes a 400-series minicomputer, display consoles, journal printers, and an interface for a private automatic branch exchange.

#### Aegis system scores two hits

In some ways, RCA's Aegis advanced fleet air-defense system may be too successful. Out in the Pacific Ocean off the coast of southern California, the system had its first sea-to-air successes during tests aboard the U.S.S. Norton Sound. The system's phased-array radar twice launched Standard missiles that intercepted a jet target drone simulating a missile attack. The second shot, to the consternation of Naval officers, actually knocked the expensive drone out of the sky when only a near miss within prescribed limits would qualify as a kill.

#### Diesel engine-analyzer earmarked for refrigerator cars

PRD Electronics division of Harris Corp., which developed the Versatile Avionic Shop Test (VAST) system for testing Navy avionics, continues to branch out in automatic testing. The company says it has an order from the Railroad Owned Refrigerator Car Committee, Chicago, for three automatic diesel-engine diagnostic analyzers for testing diesel generator sets aboard refrigerator cars. Several on-board monitors for spotting operating malfunctions will also be supplied. PRD, in Syosset, N.Y., has also been developing for more than the past year a diesel engine diagnostic system for diesel-engine-and-truck manufacturer Mack Trucks Inc.



# Frankly, you asked for it. New low-load 7800 Series Voltage Regulators in TO-92. About 50¢.

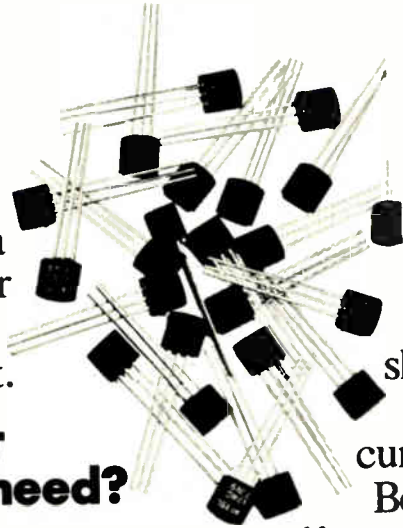

You always wanted a low-cost voltage regulator to handle loads up to 100mA. Now you've got it.

## Why pay for power capacity you don't need?

The 78L Series is the newest member of our growing family of 7800 positive 3-terminal voltage regulators.

And because it has lower power capacity, it has a lower price. About 50¢ in 100-up quantities.

Low price, plus lower installation cost, elimination of outboard resistors and transistors, and reduced board space, component count and system design time—all make the 78L extra economical.

## Superior performance. With self-protection, too.

With the 78L, you also get output voltages of 2.6, 5.0, 6.2, 12 and 15. And two grades of product with output voltage tolerance of 5% and 10% over the full temperature range, including effects of line and

load regulation.

What's more, internal current limiting and thermal shut-down protects the device and the load circuit from current and power fluctuations.

Because it's complete and self-contained, it's extra simple to use, too. No calculations or design time required. Just add normal line de-coupling capacitor.

And you can use the versatile 78L where you want. Power source. Remote chassis. PC cards. Almost anywhere.

The versatile 78L Series—both in TO-92 and TO-39—is now in stock at your friendly Fairchild Distributor. Contact him or your Fairchild Sales Office for complete data.

**MADE IN  
FAIRCHILD**

Semiconductor Components Group, Fairchild Camera & Instrument Corp.,  
464 Ellis St., Mountain View, CA 94040. Telephone (415) 962-5011. TWX: 910-379-6435.

## 12 BIT A/D CONVERTERS . . .

Just 2 years  
ahead  
in . . .  
**SIZE**  
**COST and**  
**PERFORMANCE**



Micro Networks has continually led in the production availability of dip packaged and MIL-range D/A and A/D's.

Model MN5200 successive approximation converter is the industry's first 12 bit A/D in a dip, complete with internal reference and guaranteed  $\pm 1/2$  LSB linearity.

### MN5200 Series converters are:

- Totally adjustment free... and factory trimmed.
- Hermetically sealed 24 pin dip package.
- Low Power . . . 700Mw.
- High Speed . . . 50 $\mu$ sec conversion time.
- $\pm 1/2$  LSB linearity for 0 to 70C.
- Available to full MIL operation -55 to +125C ("H" Models only)

### Prices:

MN5200 (1 to 24) . . . \$225.

MN5200H (1 to 24) . . . \$375.



Available from stock. Full technical data available. Write or call . . . today.

**Micro Networks Corporation**  
5 Barbara Lane • Worcester, Mass. 01604 / Tel: (617) 753-4756

## Electronics review



**MARS is sophisticated.** The tiny S band microwave microstrip IC replaces a large waveguide used in earlier radars.

nology is faster or simpler. The memory now uses Advanced Memory Systems' 4,096-bit random-access memories, which have 61,440 bits on each of eight boards. The drive to the traveling-wave-tube output is from a microstrip microwave integrated circuit. The TWT itself is unusual; it operates at only 15 kilovolts, instead of the 60kv of a typical klystron, greatly dropping transmitter stresses. Its output is 120 watts average and 4 kw peak. This is relatively low, but Widly says, "we put the brawn in the processor instead of the transmitter." In line with that, Rockwell-made surface-wave acoustic devices are used for pulse-compression, and a time-domain filter performs rapid fast-Fourier analysis of received signals.

The range for small targets is 20 nautical miles. The system operates in the X band and has a mean time before failure of more than 150 hours, while its modularity reduces the mean time to repair to under 12 minutes. The mechanically scanned antenna covers 2.8° azimuth and 3.3° elevation and has a gain of 33 decibels. □

## Solid state

### Motorola to slash MECL prices

After reducing MECL 10,000 prices at a steady rate of 15% per year since 1971, Motorola is about to slash them almost 45% in one fell

swoop. The reduction, MECL marketing manager Jack Burns says, drops prices of ceramic gates from \$1.67 to 99 cents each in quantities of 100.

The price drop is made possible, at least in part, by an anticipated greater efficiency and yield resulting from Motorola's imminent conversion to 3-inch wafers in MECL.

About 90% of the price cuts are for ceramics, but prices are also being dropped from \$1.42 to 79 cents each for plastic packages. Burns says the move should pay off in higher sales volume, particularly for smaller systems.

MECL has not been moving as fast as desired, and European and Japanese sales have been better than in the U. S. In fact, ECL sales have hovered around the \$35 million mark for two years, and many semiconductor authorities are looking for little more than \$40 million in world-wide sales this year (Electronics, Jan. 10, p. 99).

But Burns is more bullish for this year because of the advent of computers using MECL. The new Control Data Corp. Cyber 170 series uses MECL 10K (the earlier 70 used emitter-coupled-logic circuitry made with tiny, but discrete, transistors).

The new Univac series, which will also use 10K, has been delayed so as not to affect the company's present line, but the computers will be introduced later this year. Burns estimates that worldwide ECL sales in 1974 will be \$70 million, and the U.S. will account for \$45 million—considerably increasing its share from the 50% of the market it had in 1972. The total sales should hit \$200 million in about four of five years, he says.

Burns has also given a few more details on the upcoming MECL 20,000 subnanosecond-logic family that will start to appear in early 1975. The line will have both voltage and temperature compensation, something 10K lacks, and will be in a new high-density package that will be both smaller and higher in pin count to reduce the interconnect delays brought about by the DIP configuration. □

When you talk about  
high reliability hybrids,

# Quote a Highly Reliable Source

—Raytheon/Quincy.

Did you know that we're a leading source of high reliability beam-lead and chip-and-wire hybrid microcircuits?

Do you know why? Because 98% of Raytheon/Quincy hybrids are purchased for military and medical electronics applications—the ones that demand high reliability. And you can quote us on that.

For complete data on Raytheon hybrids, contact Raytheon Company, Industrial Components Operation, 465 Centre Street, Quincy, Mass. 02169. (617) 479-5300.

RAYTHEON

# Intersil's new 2048-bit P/ROM.

## Avalanche Induced Migration in action.

A 9- $\mu$ S constant current pulse is applied to a semi-conductor diode junction, transforming the diode, with resistance of greater than  $10^{10}$  ohms, into a conductor of less than 10 ohms. This diagram shows a cross-section of an avalanched diode. Bits created by AIM are permanent, never returning to their unprogrammed state.

# What makes it more reliable?

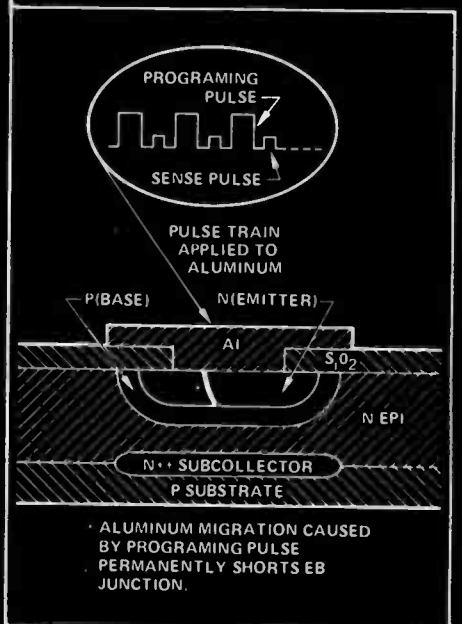

**AIM  
technology  
makes the difference.**

Introducing the IM5604, Intersil's new 2048 bit bipolar P/ROM . . . the reliable one. Avalanche-Induced Migration — AIM — technology is what gives it a leg up on fusible-link P/ROMs. This patented\* programing method is field proven in over 3 years use, and has created over 1 billion memory bits. There has never been a failure of a programed AIM bit. And AIM technology helps at the programing stage, too. With it, you can fully program a 2048-bit memory in **less than one second**, and consistently get the highest known programing yield of any method.

\*U.S. Patent No. 3,742,592

# Intersil



**Check  
the specs and see.**

The IM5604 is easy to use, with the same pinout as other 2048 P/ROMs. It's fully decoded and organized 512 words by 4 bits. Typical access is 50nS, it requires less than 275  $\mu$ W per bit, and will drive an output load of 16mA at 0.45 Volts. It has DTL and TTL-compatible inputs and outputs. And it comes with resistor pullup (IM5604) or active pullup (IM5624) output options.

**That's right.  
Delivery NOW.**

Today. They're in stock at Intersil distributors, waiting for you to come get them. Here are price and package details.

Temperature Range	Package (16 pin)	Price (100-999)
0 to + 75°C	Dual-In-Line	\$ 45.00
-55 to +125°C	Dual-In-Line	\$ 80.00

**Get 'em here.**

**Intersil stocking distributors.**

Elmar/Liberty Electronics.  
Schweber Electronics.  
Semiconductor Specialists.  
Weatherford.

**Intersil area sales offices.**

Boston (617) 861-7380.  
Chicago (312) 371-1440.  
Los Angeles (213) 532-3544.  
Minneapolis (612) 925-1844.  
New York (201) 567-5585.  
San Diego (714) 278-6053.  
San Francisco Bay Area (home office) (408) 257-5450.  
Upstate New York (315) 463-3368.

**Representatives in all major cities.**

**Engineering opportunities.**

Write or call John Waller, Intersil, Inc., 10900 North Tantau Ave., Cupertino, CA 95014. Phone (408) 257-5450.

# Intersil means memory

Circle 43 on reader service card

Not just a second source. But a

# Introducing Harris'

Here they are—22 device types offering true alternate-source availability for 54C/74C CMOS. Combined with our existing 4000 series and custom LSI capability, addition of these new units makes Harris one of the few suppliers with total CMOS capability. So, choose from our 54C/74C series—44 devices with more on the way.

Our **54C/74C series**, designed to reduce system costs, is pin-for-pin and function-for-function equivalent to T<sup>2</sup>L 7400 devices. Among their cost-saving features are low power supply requirements, less power supply regulation, fewer bypass capacitors, simpler design, and simplified power

distribution. The units also offer high noise immunity—typically 45% of supply voltage, and they have a guaranteed 1V noise margin. This means that 1V of noise at the input will not cause the output to rise beyond T<sup>2</sup>L levels. As a result, logic errors are less likely.

Applications are easy, too, with industry standardized input and output characteristics. Experience acquired with the 7400 series can also be applied directly to use of the 54C/74C's. For details, see your Harris distributor or representative.

## 100-999 UNITS

–55°C to +125°C

0°C to +70°C

	–55°C to +125°C	0°C to +70°C
HD-54C00/74C00 Quad 2 NAND Gate _____	2.98	.69
HD-54C02/74C02 Quad 2 NOR Gate _____	2.98	.69
HD-54C04/74C04 Hex Inverter _____	3.30	1.04
HD-54C10/74C10 Triple 3 NAND Gate _____	2.98	.69
HD-54C20/74C20 Dual 4 NAND Gate _____	2.98	.69
HD-54C42/74C42 BCD to Decimal Decoder _____	7.15	3.30
HD-54C73/74C73 Dual J-K Flip Flop with Clear _____	4.75	2.26
HD-54C74/74C74 Dual D Flip Flop _____	4.20	1.45
HD-54C76/74C76 Dual J-K Flip Flop with Clear and Preset _____	4.75	2.26
HD-54C107/74C107 Dual J-K Flip Flop with Clear _____	4.75	2.26
HD-54C151/74C151 8 Channel Digital Multiplexer _____	6.40	3.95
HD-54C154/74C154 4-Line to 16-Line Decoder/Demultiplexer _____	16.20	5.40
HD-54C157/74C157 Quad 2 Multiplexer _____	5.10	2.88
HD-54C160/74C160 Decade Counter with Asynchronous Clear _____	10.40	5.70
HD-54C161/74C161 Binary Counter with Asynchronous Clear _____	10.40	5.70
HD-54C162/74C162 Decade Counter with Synchronous Clear _____	10.40	5.70
HD-54C163/74C163 Binary Counter with Synchronous Clear _____	10.40	5.70
HD-54C164/74C164 8-Bit Parallel Out Serial Shift Register _____	11.00	4.35
HD-54C173/74C173 Three State Quad/D Flip Flop _____	9.15	3.80
HD-54C192/74C192 Synchronous 4-Bit Up/Down Decade Counter _____	10.30	5.65
HD-54C193/74C193 Synchronous 4-Bit Up/Down Binary Counter _____	10.30	5.65
HD-54C195/74C195 4-Bit Register _____	5.70	3.75

**WHERE TO BUY THEM:** ARIZONA: Phoenix—Hamilton, Liberty, Weatherford; Scottsdale—HAR (602) 946-3556 CALIFORNIA: Anaheim—Weatherford; El Segundo—Liberty; Glendale—Weatherford; Long Beach—HAR (213) 426-7687; Mountain View—Elmar; Palo Alto—Weatherford, HAR (415) 964-6443; Pomona—Weatherford; San Diego—Liberty, Weatherford COLORADO: Commerce City—Elmar; Denver—Hamilton; Englewood—Weatherford CONNECTICUT: Danbury—Schweber; Norwalk—Harvey FLORIDA: Hollywood—Hamilton, Schweber; Melbourne—HAR (305) 727-5430 GEORGIA: Atlanta—Schweber; Norcross—Hamilton ILLINOIS: Elk Grove Village—Schweber; Schaumburg—HAR (312) 894-8824; Schiller Park—Hamilton INDIANA: Indianapolis—Pioneer KANSAS: Lenexa—Hamilton MARYLAND: Baltimore—Hamilton; Rockville—Schweber MASSACHUSETTS: Burlington—Hamilton; Lexington—Harvey; Wellesley—HAR (617) 237-5430 MICHIGAN: Livonia—Hamilton; Troy—Schweber MINNESOTA: Edina—Hamilton, Schweber; Minneapolis—HAR (612) 432-6111 MISSOURI: Hazelwood—Hamilton NEW JERSEY: Cedar Grove—Hamilton; Mt. Laurel—Hamilton; Somerset—Schweber NEW MEXICO: Albuquerque—Hamilton, Weatherford NEW YORK: East Syracuse—Hamilton; Melville—HAR (516) 249-4500; Syracuse—HAR (315) 463-3373; Rochester—Schweber; Westbury—Schweber; Woodbury—Harvey NORTH CAROLINA: Raleigh—Schweber OHIO: Beachwood—Schweber; Cleveland—Pioneer; Dayton—Pioneer, HAR (513) 226-0636 PENNSYLVANIA: Wayne—HAR (215) 687-6680 TEXAS: Dallas—Hamilton, Weatherford, HAR (214) 231-9031; Houston—Hamilton, Weatherford UTAH: Salt Lake City—Hamilton WASHINGTON: Seattle—Liberty, Weatherford WASHINGTON, D.C.: HAR (202) 337-3170 CANADA: Mississauga, Ontario—Hamilton; Montreal, Quebec—Hamilton, Ontario—Hamilton

**LEGEND FOR HARRIS SALES OFFICES & DISTRIBUTORS:** Elmar Electronics (Elmar); Hamilton Avnet Electronics (Hamilton); Harris Semiconductor (HAR); Harvey Electronics (Harvey); Liberty Electronics (Liberty); Pioneer Standard Electronics (Pioneer); Schweber Electronics (Schweber); R. V. Weatherford Co. (Weatherford).

source with total CMOS capability.

# New 54C/74C Series

Our 4000 (S) series offers you the fastest, low-power logic devices available today. With 10-volt power supplies, speeds are typically twice that of comparable IC's. Power supply range is 3 to 15VDC, while noise immunity is typically 45% of supply voltage. Other advantages are low power dissipation and elimination of SCR latch-up problems. All units are pin-for-pin compatible with the CD-4000A series. And you have a choice of high-speed or direct CD-4000A replacement characteristics. To order a high-speed unit just add the suffix "S" to the HD-4000 part number (HD-4000S). For a direct CD-4000A replacement add an "A" to the number (HD-4000A).

In addition to the HD-4000 series, we offer the HD-4800 group of Harris proprietary devices. Among these devices are six units which together comprise the first family of three-state CMOS interface circuits available. By providing the ability to regulate the state of hard wired outputs, these interface circuits permit an extremely high level of flexibility in buss oriented systems design. These units also have buffered outputs for driving high capacitive lines and T<sup>2</sup>L directly. When four circuits are utilized, they permit the user to perform logic translation (i.e. MOS to T<sup>2</sup>L) directly at the buss line. For complete details on our 4000 and 4800 series, see your Harris distributor or representative.

	100-999 UNITS			
	-40°C to +85°C		-55°C to +125°C	
	A	S	A	S
HD-4000 Dual 3 NOR Gate plus Inverter, 14 pin DIP	.78	1.86	1.17	3.10
HD-4001 Quad 2 NOR Gate, 14 pin DIP	.78	1.98	1.17	3.30
HD-4002 Dual 4 NOR Gate, 14 pin DIP	.78	2.04	1.17	3.40
HD-4007 Dual Complementary Pair plus Inverter, 14 pin DIP	.78	1.59	1.17	2.65
HD-4009 Hex Inverter/Buffer, 16 pin DIP	1.69	3.15	2.54	5.25
HD-4010 Hex Buffer, 16 pin DIP	1.69	3.15	2.54	5.25
HD-4011 Quad 2 NAND Gate, 14 pin DIP	.78	1.98	1.17	3.30
HD-4012 Dual 4 NAND Gate, 14 pin DIP	.78	2.07	1.17	3.45
HD-4013 Dual D Flip Flop, 14 pin DIP	1.62	2.85	2.43	4.75
HD-4019 Quad AND/OR Select Gate, 14 pin DIP	1.91	3.03	2.87	5.05
HD-4023 Triple 3 NAND Gate, 14 pin DIP	.78	2.06	1.17	3.44
HD-4025 Triple 3 NOR Gate, 14 pin DIP	.78	2.06	1.17	3.44
HD-4030 Quad Exclusive OR Gate, 14 pin DIP	1.63	2.27	2.45	3.79
HD-4804 Three State Hex Buffer with Level Translator, 16 pin DIP	-	6.15	-	7.67
HD-4805 Three State Hex Buffer Inverter with Level Translator, 16 pin DIP	-	6.15	-	7.67
HD-4806 Three State Triple True/Complement Buffer with Disable, Independent Level Translator, 16 pin DIP	-	6.15	-	7.67
HD-4807 Hex Buffer with Disable, 16 pin DIP	-	6.15	-	7.67
HD-4808 Three State Hex Buffer with Disable, 16 pin DIP	-	6.15	-	7.67
HD-4809 Triple True/Complement Buffer, 16 pin DIP	1.69	3.15	2.54	5.25
HD-4810 Three State Triple True/Complement Buffer with Disable, Common Level Translator, 14 pin DIP	-	6.15	-	7.67
HD-4811 Quad Exclusive NOR Gate, 16 pin DIP	1.63	2.27	2.45	3.79
HD-4814 Hex Inverter, 16 pin DIP	.97	2.27	1.45	3.80

# Harris



**HARRIS**  
SEMICONDUCTOR  
A DIVISION OF HARRIS-INTERTYPE CORPORATION

P.O. Box 883, Melbourne, Florida 32901  
(305) 727-5430

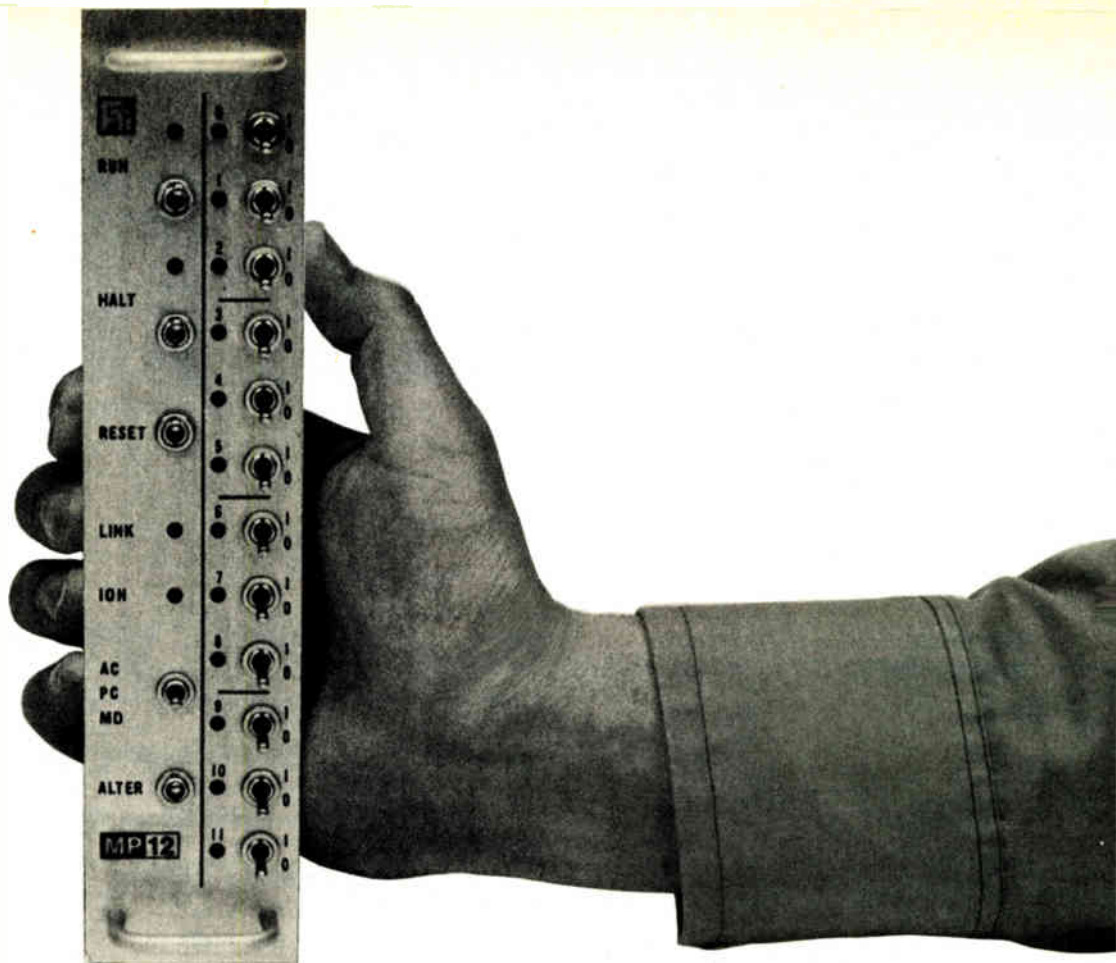

## ANNOUNCING AN EXCITING NEW OEM SYSTEM COMPONENT.

It's the MP12... Fabri-Tek's new microprocessor that performs like a minicomputer. The MP12 helps you get your application system up and running faster, easier and with more capability than ever before. No MOS microprocessor can match its performance in data acquisition, automated assembly, point-of-sale and other dedicated digital control applications.

**Completely Operational**—The MP12 CPU is a completely self-contained operational unit. All the digital electronics you need are built in along with 4K of reliable core memory, an operating console, power fail-auto restart and more. Everything comes in a compact 2.0" x 9.5" x 15.0" package.

**Supporting Software**—You also get all the software you need to develop and check out your own application programs. MP12 supplied programs are completely documented and include assembler, debug, loaders,

360/370 cross-assembler, source edit utility, processor diagnostic and utility sub-routines. Instruction set is PDP-8 compatible.

**Easy Interfacing**—You never had a processor so easy to interface. In fact, it's plug-in easy. The MP12 comes with all the timing and control necessary to interface with almost any peripheral. And it has enough power to drive up to 64 peripherals... printers, teletypes, CRT's, card equipment, on and off-line storage devices.

**Quick Delivery, Low Price**—There's a lot more you'll like about Fabri-Tek's MP12. Delivery and price, for instance. It's available for off-the-shelf delivery for as little as \$990 in quantities of 100. It can actually help you cut your overall manufacturing costs.

The MP12 could be the most useful component you've ever seen. For complete specifications and option information just write to MP12 at the address below.

**FABRI-TEK INC.**  
**COMPUTER SYSTEMS**

5901 South County Road 18 • Minneapolis, MN 55436 (612) 935-8811

**SALES  
OFFICES IN:**

Boston  
(617) 969-5077  
Chicago  
(312) 437-4116

Dallas  
(214) 661-3155  
Denver  
(303) 753-0631

Detroit  
(313) 487-5940  
Long Beach  
(213) 420-2493

New Jersey  
(201) 964-4770  
Orlando  
(305) 857-1050

Phoenix  
(602) 266-4448  
Sunnyvale  
(408) 739-4780

Hong Kong  
K-331383  
Munich  
089-755-8298

Tokyo  
(03) 432-6901  
United Kingdom  
Maidenhead 37321-4



## **Concern over radiation damage mounts . . .**

Advocates of a larger, consolidated, Federally funded program of research on the **biological consequences of long-term exposure to low-level electromagnetic radiation** are beginning to build congressional support, following a report by the White House Office of Telecommunications Policy that 1973 programs showed **"a few tentative and preliminary indications"** that radiation effects occur **"at lower levels than anticipated in the past."** While cautioning that low-level radiation effects on "the nervous system and behavior, normal developmental and growth processes, and possibly in some metabolic and biochemical parameters" are as yet "not scientifically validated," the report noted that they were **significant enough to warrant intensive and extended research. Manufacturers' representatives in Washington withheld public comment, but one said privately, that if the report proved right, "it would open a whole host of new problems for us just as the pollution problem did for oil."**

## **. . . and OTP pushes for more research funding**

The various Federal agencies' research studies into the long-term effects of low-level radiation, which the Office of Telecommunications Policy coordinated for the first time last year, were funded altogether at \$6 million in fiscal 1973, \$7 million in fiscal 1974. But **the fiscal 1974 funds were less than the \$10.6 million recommended, and OTP's electromagnetic radiation management advisory council calls the funding level "too low" and "not responsive to the level of public, professional or governmental concern."** A **fiscal 1975 level of \$15.2 million is being sought,** although this seems unlikely to be appropriated now.

## **Agencies seek to make radiation standards compatible**

Industrial electronics manufacturers subject to Federal radiation control standards will have two Government agencies, not one, monitoring their performance, now that **the Food and Drug Administration and the Occupational Safety and Health Administration have agreed to cooperate in establishing uniform Federal standards for the manufacture and use of radiation-producing electronics products and in enforcing industry's compliance with those standards.** Goal of the agreement is **to prevent possible conflicts of interest between the two agencies and to eliminate duplication of effort,** and its main provision is that the two will consult with each other before making any standards public to insure that one agency's standards are compatible with the other's.

## **Larger Federal subsidies will boost Medicaid EDP**

Thanks to a new ruling by the Department of Health, Education, and Welfare, computer makers can look for a **rapid expansion of the market for systems used by the states in Medicaid information retrieval and claims processing.** HEW's Social and Rehabilitation Service has ruled that the Federal Government is to pay 90% instead of just 50% of a state's costs in modernizing systems used in the multi-billion dollar medical assistance program. Moreover, **the Government will also pick up 75% of a state's operating costs for an approved Medicaid computer system, provided it is in continuous operation.** Computerized Medicaid systems now operate only in Ohio and New Hampshire, but **are under consideration in 23 other states,** according to Howard N. Newman, SRS commissioner of medical services administration.

## 'Liberalizing' Japan's computer market

Japan's announced policy of "liberalizing" import regulations so that its home computer market can be opened to foreign competition will not be as liberal as advertised. This is the suspicion of Government trade specialists in Washington—a suspicion fed by reports from the U. S. embassy in Tokyo.

The most recent report, an April 17 newspaper story published in *Nikkan Kogyo*, indicated that the Ministry of International Trade and Industry plans to invoke various domestic statutes and international agreements to protect the Japanese computer industry's market share after liberalization. The story prompted an immediate inquiry by the embassy at the request of the U. S. Department of State. Was it true? No, said MITI, according to an embassy cable to Washington, although the all-powerful ministry indicated that it would like to see domestic and foreign manufacturers develop "a cooperative relationship to maintain orderly marketing."

One man's cooperative relationship is sometimes another's coercion. But MITI's Kunio Komatsu, director of the electronics policy division in the Machinery and Information Industries Bureau, failed to define the nature and extent of the cooperation expected from foreign producers. Komatsu did, however, volunteer his personal feeling on what would constitute an orderly and "ideal" division of the Japanese computer market: 50% for the Japanese, and 50% for everybody else.

### The uncertain future

Japan does not yet have a firm, long-range policy for its computer industry, although a clearer picture of what outsiders can expect during the 1980s should emerge in August. That is when the information industry subcommittee of the Industrial Structure Deliberation Council—a MITI-sponsored advisory group of technical experts, academicians, computer makers, and end-users—is scheduled to submit an interim report on its computer policy plans. In Washington, meanwhile, the Departments of State and Commerce are anxiously awaiting its publication.

According to Komatsu, it was a minority of one or two members of the subcommittee who urged safeguards be invoked in the post-liberalization period to protect Japan's domestic computer makers. But, he added, this view—apparently the source of the *Nikkan Kogyo* story—was not shared by other committee members. Some U.S. officials are not so sure.

Four safeguards for computer makers report-

edly were being explored by MITI. These included:

- Invocation of article 19 of the General Agreement on Tariffs and Trade, an emergency measure by which a GATT member country can limit trade in products that pose a threat to a domestic industry.
- Application of the Specified Electronic Industry and Specified Machinery Industry Promotion Temporary Measures Law, popularly known as Law 17 and passed in 1971.
- Application of anti-monopoly laws.
- Advocacy of a new international treaty to regulate international market control by a small number of enterprises and also of an international organization to watch and control monopolistic actions.

"That last one," observes our State Department source, "really drives IBM up the wall."

### MITI's contradictions

One of the more fascinating aspects of Komatsu's statement to the U.S. embassy is its contradiction of an earlier statement made last year by Kazuo Fujimoto, head of MITI's Electrical and Electronic Machinery division [*Electronics*, Dec. 20, 1973, p. 68]. Komatsu's April denial of the report that MITI has no plan to protect its domestic computer industry contained the observation that MITI doesn't consider the Japanese computer industry to be as weak as the article implied. Therefore, he did not foresee "the necessity of even contemplating such action." In December, Fujimoto put down a judgement by the U.S. National Research Council that Japan is making big plans to compete in the world's computer markets by noting that the Americans overrated his nation's computer capabilities. Fujimoto professed the belief that Japan's computer technology would not catch up with that of the U.S. for a decade or more."

What, then, can U.S. and other computer makers expect to encounter in Japan's period of post-liberalization? In every case, the answer of Washington's Asian trade specialists comes out, "Frankly, I don't know yet." But they quickly add that their ignorance stems only from the fact that Japan itself has not yet disclosed its plans.

What can be safely concluded, however, is that the U.S. computer industry must face up to the reality that those who succeed in Japan will likely be those who invest in joint ventures, rather than those who try to expand their Japanese market shares through exports only.

—Ray Connolly

# Proven Performance.

<b>Computer:</b>	General Automation SPC-12/20. Step and repeat, mirror image, automatic rewind. Handles variety of formats.
<b>Spindle feed rate:</b>	20-250 ipm. Accuracy to within 2% of setting. Stroke limit adjustable, 0.001-in. increments.
<b>Table travel speed:</b>	400 ipm each axis. Computer-driven, high-torque, high-speed, low-inertia servo motor gives instant acceleration.
<b>Drill hit rate:</b>	200/min. Quality holes on ¼-in. movement with 3-high stacks and 0.002 chip load.
<b>Spindle motor speed:</b>	15,000-45,000 rpm electric motors; 15,000-60,000 rpm liquid-cooled, frequency-controlled motors; 30,000-80,000 rpm air-bearing frequency-controlled motors.

## The Excellon Mark III. Nobody's equalled it yet.

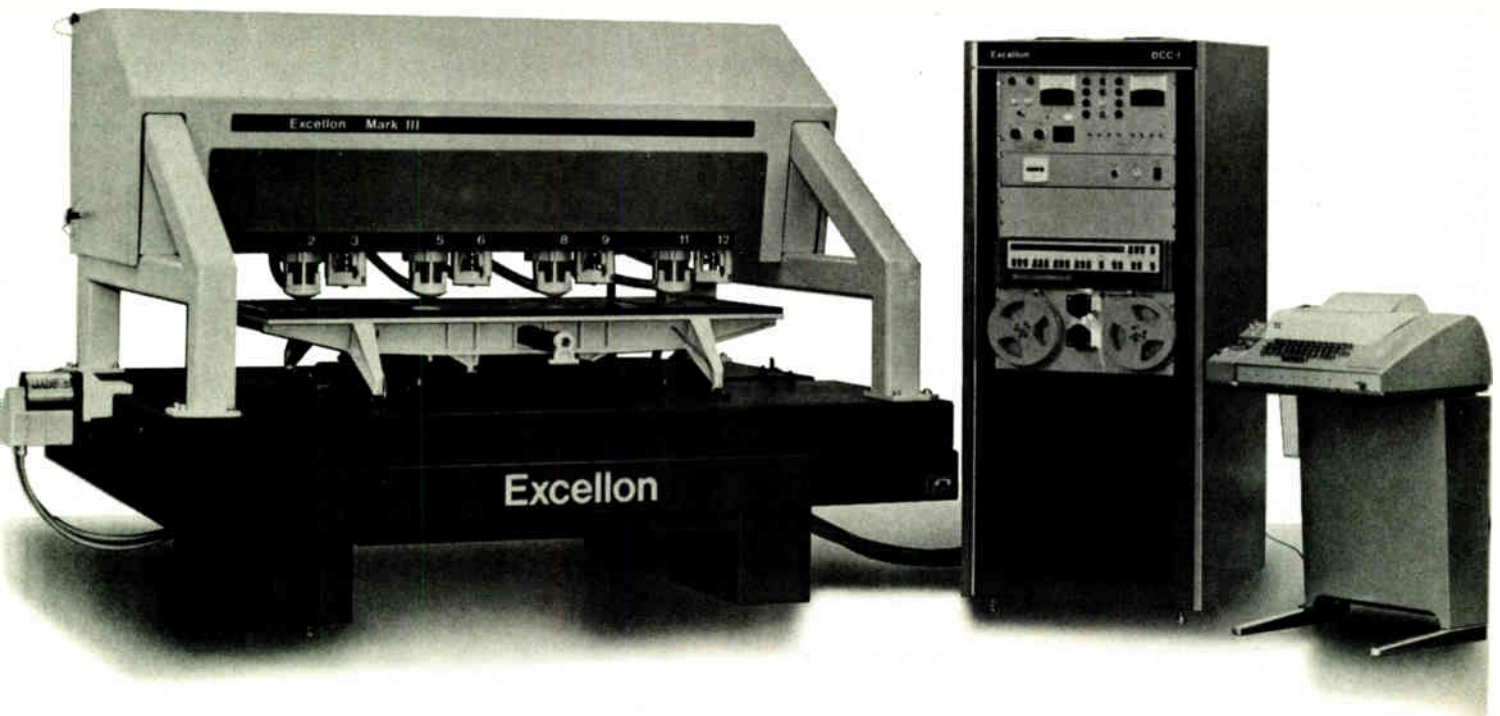

The Excellon Mark III is the most advanced p.c. drilling system in the industry today.

We've had more than our share of advances over the years. The fact is, when we added up the knowledge we've gained from our successes (and failures), we had all the makings of a major breakthrough.

The magnificent Mark III, for instance. World-wide, the Excellon Mark III

is giving unequalled performance with highest production rates possible... at the lowest hole costs possible, with high accuracy and clean, smear-free holes.

It has no competition because nobody's equalled it yet. *Call or write Excellon International, Arkwright 18, Astmoor Industrial Estate, Runcorn, Cheshire. Phone: Runcorn 66545. Telex: (851) 627496.*

### Excellon Automation

A Division of Excellon Industries

23915 Garnier Street

Torrance, California 90509

Phone: (213) 325-8000

Telex: 67.45.62 Cable: Excellon Torrance



Excellon Sales and Service in ENGLAND • FRANCE  
SCANDINAVIA • W. GERMANY • HOLLAND • AUS-  
TRALIA • HONG KONG • TAIWAN • JAPAN

## Thomson-Brandt readies a color video disk recorder

Latest to join the video-record race is France's Thomson-Brandt, which is planning an imminent demonstration debut of its optical video disk recorder. Thomson-Brandt thus finds itself lined up in the optical ranks with Philips Gloeilampenfabrieken, which unveiled its VDR some 20 months ago [*Electronics*, Sept. 11, 1972, p. 29].

Although both Thomson-Brandt and Philips agree that light is right, there are significant differences between their hardware. Philips works with a rigid reflective disk, while Thomson-Brandt's is flexible and transmissive. Both spin 30-centimeter disks at the same 1,500-rpm speed, and both have lasers as the readout beam source, but Thomson-Brandt has a somewhat simpler groove-tracking system. As a result, the company says, the French VDR can be priced below the Dutch one, which Philips says will cost about the same as a color-TV set. Production costs for the disks themselves are essentially the same—between 40 and 60 cents.

Despite the differences, Thomson-Brandt has high hopes that some kind of agreement on a standard format for the disks can be settled on within a year or so. Georges Broussaud, the prime mover behind the French VDR, sees no reason why a semi-transparent reflective disk good for both machines wouldn't be possible if "groove" characteristics were the same. As it is now, Philips has a 2-micrometer pitch, which gives 30 minutes of play for a 30-centimeter record and Thomson-Brandt a 2.5 micrometer pitch for 20 minutes play.

"We can get down to 2 microns if we want to," Broussaud insists, "we chose 20 minutes because that seemed the best time segment for television disk programs." Both disks can store tens of thousands of still images.

A standard record playable on

both machines, obviously, would be a step over a big market barrier. But Thomson-Brandt is not rushing to get VDRs onto the market. "Late 1976 would be early enough for the French market," Broussaud says.

The machine Thomson-Brandt has in mind was developed at the Corbeville central research laboratory of Thomson-CSF, the professional-electronics company of the group. Broussaud is director of research at Corbeville, some 50 miles southwest of Paris, and has been mulling over the idea of video records for a long time. He first proposed the idea of looking into VDRs to Thomson-Brandt brass five years ago. Since then, Broussaud has spearheaded the development; but he says much credit in the hardware development goes to groups headed by Erich Spitz, Claude Tinot, and François Le Carvenec.

In the French concept, the composite video signal and two audio channels are frequency modulated and recorded on a transparent flexible disk as pits 1.7 micrometer wide and 0.3 micrometer deep. The

length and spacing of the pits along the spiral track represent the signal, and each revolution of the track stores the signals for a complete television frame, each of its two fields put down successively.

As the disk whirls under the read-out head, the pits diffract the laser spot focussed on them and thus vary its landing position on a photo-sensor array underneath the disk. The array output is amplified and processed to obtain the composite video signal.

It sounds simple, but it isn't. At the light-spot sizes involved—0.7 micrometer—depth of field of the microscope that focusses the laser beam on the diffracting pits is a severe limit. The distance between the microscope objective and the upper surface of the disk must be held constant with a precision of 2 micrometers or better, and vibration amplitudes alone can run 1.5 millimeters. To keep on the right track, the light spot's midpoint must be positioned with an accuracy of 0.3 micrometer.

Philips uses a servo system to

**Angles.** Thomson-Brandt developers use dihedral plates to stabilize transparent video disk as it spins past read-out array at 1,500 rpm.

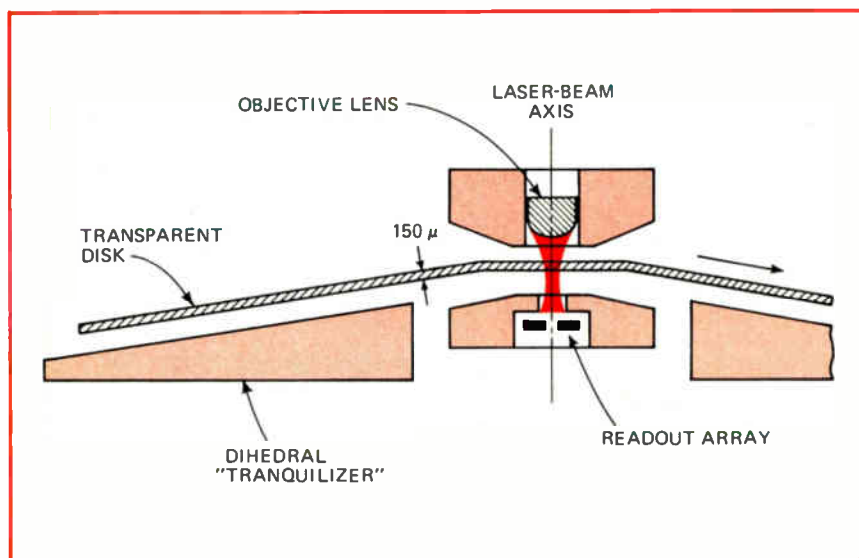

keep its light spot focussed. "But you need so much gain," says Broussaud, "that we felt that a servo system wasn't compatible with the consumer-grade components we plan to use." So the Corbeville crew invented an air stabilization system. The readout head mounts in a stirrup that stabilizes the disk aerodynamically as it whirls between the stirrup jaws. The angle of flex assumed by the disk as it passes through is about 20°. And to help the disk take that angle, dihedral plates flank the stirrup. The stabilizer holds the upper surface of the disk—where the pits are—in place, and so the thickness of the disk can vary as much as 50 micrometers without affecting the readout.

As does Philips, Thomson-CSF uses a servo-driven mirror to keep the light spot centered on the tracks. But here, too, the French designers managed a simplification. The readout spot itself, rather than a pair of auxiliary beams, serves as a source for the error signal.

To achieve this, the Corbeville machine's readout array is split into four elements, two of which lie parallel to the track tangent and the other two across it. Whenever the spot strays from the center of the track, one of the parallel elements has a higher signal output, and that produces a differential-amplifier output that serves as the servo error signal needed to correct the mirror position. Mirror movements also shift the beam from track to track at the end of each revolution. The mirror signals also control a motor that drives the disk carrier to its rough position under the readout head. □

## West Germany

### Data recorder uses novel tape

Using a novel metal-coated paper tape as the storage medium, designers at a Black Forest EDP-equipment firm have put together a highly portable and secure data-collection system.

## Around the world

### Sony fields a magnetic-card video recorder

The long-established magnetic approach to video recording has been given a new twist by Sony Corp. engineers. At the Toronto International Magnetism Conference, company researchers took the wraps off a magnetic-card system that they claim offers all the advantages of disks, but avoids the close tolerances required in disk-based systems. The result: a system that packs 10 minutes of color programming into a card coated with chromium dioxide and measuring 6¾ by 8½.

The "Mavicaard" is encased in a protective jacket, and the card and cover are inserted in the machine. There, the magnetic card is withdrawn and fed out along the guides of a cylindrical frame surrounding a rotating head. When the card is completely threaded around the frame, the head starts rotating as the card advances along the axis of the cylinder. When the record or playback operation is completed, the card is pulled back into the envelope, and the envelope and card ejected.

During playback, the card motion can be controlled manually to provide single frames or slow motion. Sony says that in slow motion a very clear picture, free from guardband noise, is obtained.

The cards can be easily reproduced by contact printing, Sony men say, and a large commercial printer will be available, as will a smaller model for school and library use. The large model will be able to print about 40 cards a second. Sony will not estimate the market cost of a blank card, but says the raw material cost is about 10–15 cents. Going into market, however, says a Sony man, "is a matter of software. The hardware can be ready within two years."

The system employs a phase-modulation method in which the central phase of the carrier in one track coincides with that of the carrier on the adjacent track. Thus, signals that are overlapped in playback are merely a combination of the signals in the two tracks without the generation of a beat. A skip-field technique is also employed, so that the recording density is increased and slight shifts in tracking cause almost no deterioration of playback image quality.

In order to obtain an acceptable signal-to-noise ratio, a wavelength of 2 micrometers normally requires a track width of 20 micrometers. However, with Sony's pulse-modulation method, no guard band is necessary, and playback can be achieved with an overlap of two or three frames. Sony says that this means the track pitch can be reduced from 20 micrometers to as low as 8 micrometers with a fairly good picture.

A product of Kienzle Apparate GmbH in Villingen, the 8-channel primary data-collection system is designed around a small recorder in which data is registered by burning it into a thin aluminum layer covering a paper tape. The color contrast between the marks and the metallic layer allows fast and reliable opto-electronic readout.

The metalized tape offers equipment users a number of advantages, a Kienzle official says. For one thing, the markings allow easy visual inspection of the recorded data. For another, since the markings cannot be erased, a high degree of data security is guaranteed. Furthermore, the tape is insensitive to temperature, moisture, and air pressure variations, as well as magnetic,

electromagnetic, or electrostatic influences.

The system's input equipment collects the information and changes it into a five-channel binary-coded-decimal signal. The data then goes to the recorder, which accepts it in parallel-by-bit, serial-by-character form and burns it onto the tape as small coded lines. Burn-in voltages range from 8 volts to 32 v.

The recorder's metalized tape is contained on two reels that are housed in a transparent plastic cassette. About 120 feet long, the tape can carry 60,000 bytes of information. The recorder works either off battery or line power, and its operation can be triggered remotely or by a button on the unit. □

# REI has one question for people who buy electronic test equipment.

## Why?

**When you need it fast . . . rent it.** Purchasing equipment usually involves long delivery lead times. When you rent your electronic equipment from REI it's a safe bet that you can get what you need within 36 hours of the time you call in your order, sometimes sooner. This fast service is possible because we maintain 9 Instant Inventory Centers throughout the U.S. and Canada, stocking millions of dollars worth of equipment.

**When you need it for only a short time . . . rent it.** Need equipment for a short-term project? Rent it from REI. When you don't need it any more, return it to us. It's the easy, low-cost way to use the equipment you need for just the time that you need it.

**When you care about what it costs . . . rent it.** Renting from REI can be less expensive than purchasing. There's no capital investment to adversely affect your company's cash flow. This means you'll get more mileage from your equipment budget. And, since you can treat your monthly payments as an expense in most situations, you'll also achieve tax advantages from renting.

All REI rental equipment is guaranteed to meet manufacturers' specifications and is operationally checked out prior to shipment. Routine maintenance is provided free of charge. Certification and calibration are available upon request. Our flexible arrangements include rental, rental-purchase and leasing packages to give you the use of equipment from one week to three years or more.

Get your free copy of our 1974 catalog that lists virtually every item in our rental inventory. Use reader service card, or write Rental Electronics, Inc., 99 Hartwell Ave., Lexington, MA 02173. For immediate information, call your local REI Instant Inventory Center listed below. Once you rent from REI, you may never buy electronic test equipment again.

## Rental Electronics, Inc.

A PEPSICO LEASING COMPANY

Burlington, MA (617) 273-2770 • Gaithersburg, MD (301) 948-0620 • Oakland, NJ (201) 337-3757 • Ft. Lauderdale, FL (305) 771-3500  
Des Plaines, IL (312) 827-6670 • Dallas, TX (214) 661-8082 • Mountain View, CA (415) 968-8845 • Anaheim, CA (714) 879-0561  
Rexdale, Ontario (PLC Leasing Ltd.) (416) 677-7513



**Think about renting.  
It's the smart way to go.**

## Telefunken mulls withdrawal from computer market

Europe's computer industry is buzzing with reports that West Germany's **Telefunken Computer GmbH (TC)** is about to throw in the towel and wind up as part of the international Unidata combine. TC is the joint large-mainframe manufacturer launched by AEG-Telefunken and Nixdorf Computer AG two and a half years ago [*Electronics*, International Newsletter, Dec. 20, 1971]. **Leading to TC's demise is the company's dismal financial performance since its foundation Jan. 1, 1972.** Although sales rose from \$56 million dollars in 1972 to \$60 million last year, losses jumped from \$7 million to \$29 million during that period. These losses, which, according to the joint-venture contract, AEG-Telefunken has to pick up, "could not be compensated by price hikes nor by streamlining operations," a company spokesman says.

Right now, AEG-Telefunken officials are holding talks with the Bonn government, aimed at finding out how TC's research-and-development potential can be saved so that the three Unidata partners—Siemens AG of West Germany, Philips of the Netherlands, and Compagnie Internationale pour l'Informatique of France—will find its absorption into the combine more attractive. **In on these talks is Siemens, which is representing Unidata's interests. It's unlikely that AEG-Telefunken will become a fourth partner in that combine.**

## French producers enjoy growth in telecommunications

**French producers of telephone and telegraph equipment expect no letup in the strong growth they've achieved during the past five years.** They've marked up annual sales gains of better than 25% since 1969, and last year, these manufacturers turned in a 26.2% increase to reach roughly \$1 billion. Order backlogs indicate that the same kind of performance will continue for the next few years.

The bulk of the business is coming from the home market, where the government has a massive spending program under way to improve the telephone network. But makers of telephone and telegraph equipment in France have also scored in export markets. Last year's sales abroad topped \$100 million, triple the figure for 1968.

## Trade restrictions frustrate Italian components makers

Italian components manufacturers report chaos in the wake of their government's recent moves to right the drastic trade-balance deficit. The industry's trade association, ANIE, **has presented its problems to the industry, foreign-trade, and budget and planning ministries** in an effort to bring some order into the emergency measures.

**Italy's February trade deficit of \$1.15 billion was higher than that for all of 1972, and it was an all-time record.** In an attempt to block the outflow of foreign exchange, the government has slapped import restrictions on a wide-ranging selection of some 600 product groups. Importers of these items, which include a range of electronics materials, are now obliged to deposit 50% of the import value of the goods with the Bank of Italy for six months at no interest. **With interest rates running at about 16%—where restricted credit can be found—the measure effectively adds 4% to the cost of imports.**

A components manufacturer says that inconsistencies in the new measures are creating additional havoc. For example, "importers are free to bring in made-up semiconductors, and yet we are unable to import materials that are necessary for our MOS-production lines.

A similar situation exists for discretes. General Instrument's European vice chairman, Sergio Minoretti, reports that **his company is now unable to import capacitors that it manufactures at plants in Malta, Taiwan, and elsewhere.** He also adds that some of the suppliers of raw materials and parts have reduced their terms of payment to compensate for the higher credit charges the new restrictions have ushered in. Another related effect, the company and others report, is that orders are being reduced until clients work off their inventories because money is now more costly and increasingly hard to find.

## **Berlin's Bogen to build factory for Soviet audio heads**

Against heavy competition by Japanese, Italian, and other German firms, West Berlin's Wolfgang Bogen GmbH has landed a contract to put up a facility in the Soviet Union to build magnetic heads for cassette recorders. **Valued at \$10 million, the contract is the largest one the Soviet Union has ever placed with a West Berlin company.** It was negotiated between the consulting firm Berlin-Consult GmbH and Moscow-based foreign-trade organization Promashimport.

**The contract provides for Bogen to lay out and completely equip a factory capable of producing 1.5 million magnetic heads a year.** The facility, to be built at the Ukrainian capital of Kiev, is to start production by late 1976. Bogen, Europe's largest independent producer of magnetic heads for consumer and industrial applications, will also supply the manufacturing know-how to the Kiev facility.

## **Spain's Piher broadens base**

Piher, Spain's leading native components producer, is broadening its business base at home and abroad. **This month, Juan Luis Heredero, who founded the firm, acquired a 40% interest in Telesincro, Spain's only computer producer.** Next month, Piher plans to open a sales subsidiary in Stockholm and line up a site for a British carbon-film-resistor plant. **The company expects to get the UK plant on line fast—hopefully by September—largely because the machinery for it was built at the same time Piher tooled up for its Boston resistor plant last year.**

## **Computer sales in Japan stay healthy**

While most of Japan's electronics industry is tightening its belt because of severe profit declines, outlook for domestic computer sales is better than ever. Japan Electronic Computer Co., a jointly owned computer rental firm established to promote computer usage in Japan, has announced record sales for fiscal 1973—**and is predicting that rentals this year will grow another 20% to \$400 million.** JECC, in an agreement with Japan's six computer makers, purchases computers for lease following conclusion of rental contracts negotiated by the makers themselves.

## **Addenda**

Continuing its forays into the Middle East market, **Pye TVT Ltd. has received a \$19 million pact from the Sultanate of Oman to provide a complete national color-TV network, including towers and transmitters.** Pye has sold equipment to Abu Dhabi, Dubai, and Iraq. . . . **Beating out companies from Canada, France, and the U.S., Plessey has won a \$2 million contract from the People's Republic of China for nine instrument landing systems.**





# Our priority is you!

When you deal with Piher you know you are dealing with one of Europe's foremost component manufacturers – and that's important to you, the customer. Because we only manufacture for you. No question of giving you long delivery dates because we divert components for our own product lines. We haven't any. Our component manufacture is for you – totally.

We have a wide range of high quality components – at really competitive prices. Demand for our carbon film resistors, for instance, is so high that our current production is committed months ahead. Our new manufacturing plant in the U.S.A. – operational early in 1974 – will help speed resistor deliveries. But we have other

shorter-term delivery components available. Trimmer, spindle and rotary potentiometers, semi-conductors, ferrites, capacitors – all high quality items.

Send for our data sheets if you want to be kept in touch with the Piher range. Find out more about us, it pays.



Head Office—Spain - Riera Cañadó, s/n. Apartado de Correos 53, Badalona (Barcelona) Spain. Tel: 389 03 00. Telex: 59521

UK – PIHER International LTD, Romar House, The Causeway, Staines, Middlesex, England. Tel: Staines 56157. Telex 934167.

USA – PIHER International Corp, 1239 Rand Road, Des Plaines, Illinois 60016, U.S.A. Tel: 312 297 1560. Telex 282154.

Germany – PIHER International GmbH, 85 Nurnberg, Tuchergartenstrasse 4, W. Germany. Tel: 0911 533 051. Telex 623354.

France – PIHER International SARL, 83, Rue Etienne Dolet, 94230, Cachan, France. Tel: 656 26 07. Telex 27107.

Italy – PIHER International SPA, Via Cenisio 34, 20154 Milan, Italy. Tel: 314532/316213.

Circle 57 on reader service card

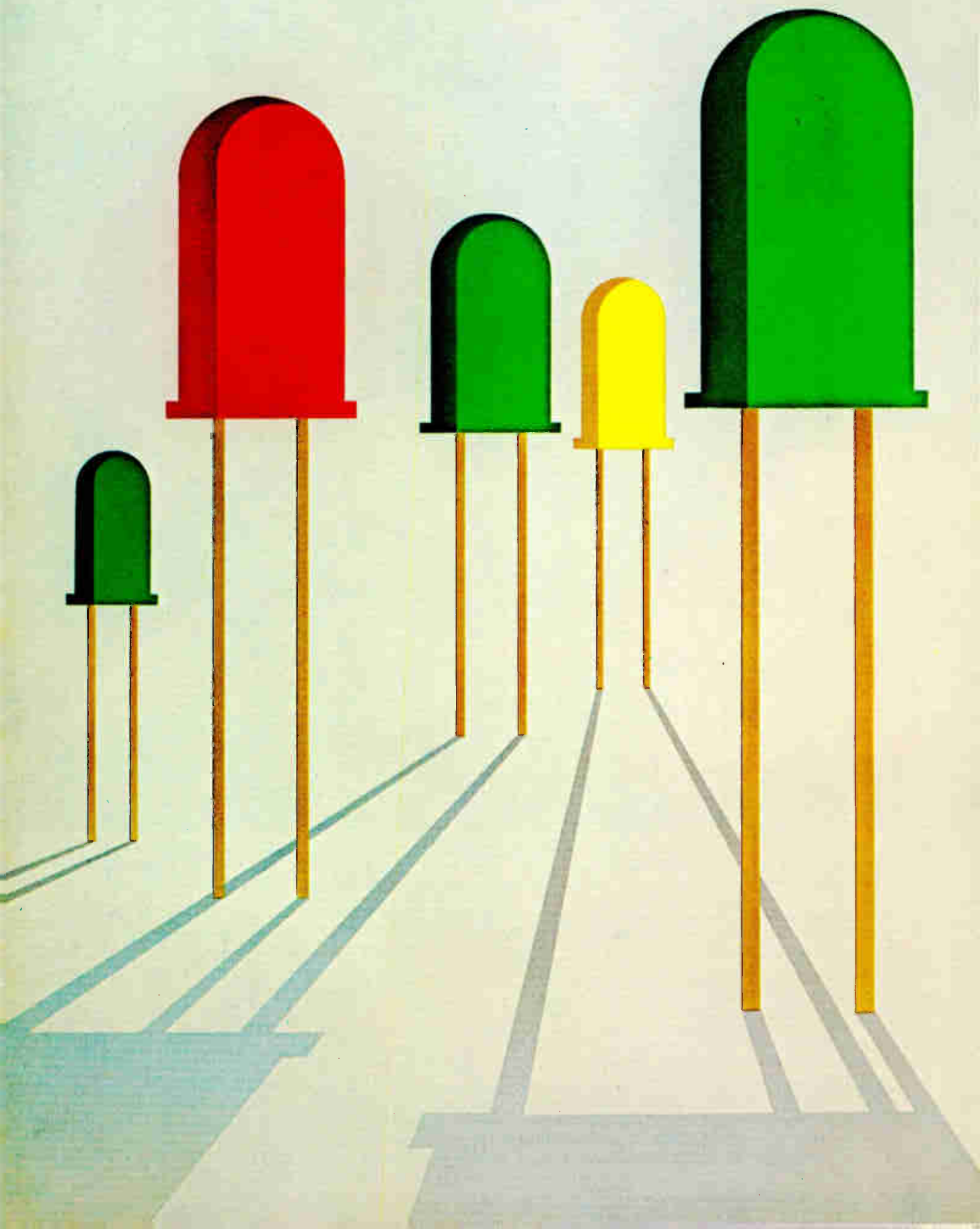

# Pass your next design test with flying colors

- Engineer Motorola LEDs and op amps into industrial controls.
- Innovate Motorola LEDs and A/D converters into test instruments.
- Design Motorola LEDs and zener diodes into PC board service aids.
- Use Motorola LEDs and tuning diodes in home entertainment.
- Introduce Motorola LEDs and MOSFets into RF communications.
- Plug Motorola LEDs and MECL into computers.
- Apply Motorola LEDs and McMOS in automotive control panels.
- Install Motorola LEDs and thyristors in home appliances.
- Utilize Motorola LEDs and regulators in fault indicators.
- Originate Motorola LEDs and plastic transistors in cameras.
- Employ Motorola LEDs and counters in telephone instruments.
- Initiate Motorola LEDs and rectifiers into backlighting.
- Go to Motorola LEDs and memories in computers.
- Admit Motorola LEDs and opto couplers into airborne instruments.
- Bring Motorola LEDs and DTL into small appliances.
- Insert Motorola LEDs and DVMs into hand-held instruments.

MOTOROLA LEDs HAVE MORE THAN  
20,000 SEMICONDUCTOR DESIGN ADVANTAGES.  
SEE A GREAT SELECTION: BOX 20912, PHOENIX.

**GET IT ALL TOGETHER NOW...**

*obvious*  
**From Motorola, the LED producer.**

# INTRODUCING LITTELITES FROM LITTELFUSE



## SNAP-MOUNT PLASTIC LITES

For rectangular,  $\frac{5}{16}$ ", and  $\frac{1}{2}$ " diameter mounting holes. Flex arms insure positive retention and protection against shock and vibration.



## SUBMINIATURE LAMP HOLDERS

Eight series of holders for front or rear mounting into  $\frac{3}{8}$ ",  $1\frac{1}{32}$ ", or  $1\frac{1}{32}$ " clearance holes. For use with replaceable neon or incandescent midget flanged base lamps.



## MINIATURE LAMP HOLDERS

For front mounting into  $1\frac{1}{16}$ " clearance holes. Designed to accept replaceable bayonet based neon and incandescent lamps.

## CARTRIDGE LAMPS AND LAMP HOLDERS

Available with solid state, incandescent, and neon lamps. Mating holders mount into  $\frac{3}{8}$ " clearance holes.

**The most unique indicator light  
and service program ever offered  
to manufacturers**

# We're out to win you over to Littelites with top quality, fast service, and hard facts. Judge for yourself:

**FACT 1.** Littelfuse is the only manufacturer that offers all four types of indicator lights, saving you time, paperwork, and money.

**FACT 2.** Littelfuse has all new tooling and total in-house production capabilities for top quality, better control, and faster processing.



**FACT 3.** Littelfuse has a computerized service center that can cross reference, price, and provide availability information ... all within seconds.

**FACT 4.** Littelfuse means fast, prompt delivery.

**FACT 5.** Littelfuse has a Littelites team of R & D and sales engineers to assist you.



**FACT 6.** Littelfuse offers the widest selection of packaging available.

**FACT 7.** Littelfuse offers one-stop shopping for your additional circuit protection and control device needs.

## FOR MORE INFORMATION

Contact Littelfuse or your local Littelfuse representative and ask for our

Littelites Product Guide or individual product catalogs:



Cartridge Lamps and Lampholders	Cat. No. LL-C574
Subminiature Lampholders	Cat. No. LL-S574
Miniature Lampholders	Cat. No. LL-M574
Snap-Mount Plastic Lites	Cat. No. LL-P574

# LITTELFUSE LITTELTITES

Your indication of quality and service

800 E. Northwest Highway  
Des Plaines, Illinois 60016  
(312) 824-1188

**Subsidiary of Tracor**

Circle 61 on reader service card

# Beckman<sup>®</sup> HYBRID MICROCIRCUITS

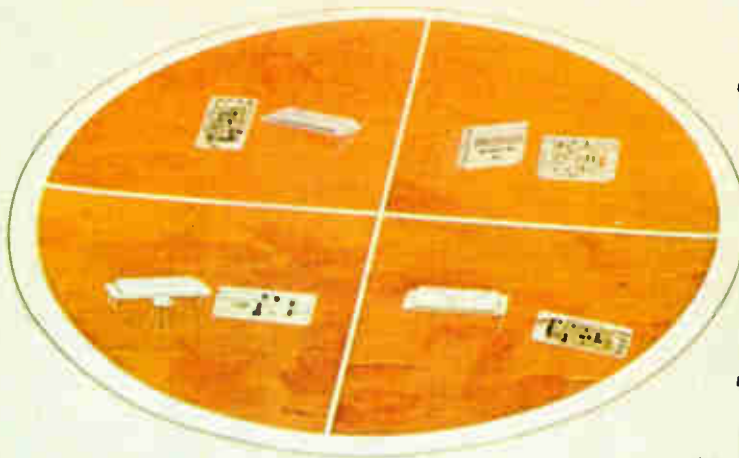

- UNIVERSAL ACTIVE FILTERS
- TELEPHONE TONE FILTERS
- PRECISION LADDER NETWORKS
- DAC/ADC PRODUCTS
- POWER AMPLIFIERS
- VOLTAGE REGULATORS
- INDUSTRIAL CONTROL CIRCUITS
- CUSTOM DISPLAY SUBSTRATES
- HYBRID MEDICAL FUNCTIONS
- MODEM FILTERS
- MIL-PERFORMANCE MICROCIRCUITS

## Beckman Electronic Component Distributors

### EASTERN REGION

**Arrow/Angus**  
P O Box 126  
Moorestown N J  
(609) 235-1900  
(215) 928-1800

**Arrow Electronics, Inc.**  
5207 East Dr  
Baltimore Md  
(202) 737-1700  
(301) 247-5200

**Arrow Electronics, Inc.**  
900 Route 110  
Farmingdale N Y  
(516) 694-6800

**Arrow Electronics, Inc.**  
295 Treadwell St  
Hamden Conn  
(203) 248-3801

**Arrow Electronics, Inc.**  
No 15 A Street  
Burlington, Mass  
(617) 273-0100

**Arrow Electronics, Inc.**  
285 Midland Ave  
Saddle Brook N J  
(201) 797-5800

**Harvey R & D Electronics**  
44 Hartwell Ave  
Lexington, Mass  
(617) 861-9200

**Kierulff Electronics, Inc.**  
49 Bestpage Rd  
Hicksville N Y  
(516) 433-5530

**Kierulff Electronics, Inc.**  
5 Industrial Dr  
Rutherford N J  
(201) 935-2120

**Lynch-Gentry Associates, Inc.**  
1932 Drew Street  
Clearwater Fla  
(813) 443-2697

**Lynch-Gentry Associates, Inc.**  
3470 Bowman Dr  
Winter Park Fla  
(305) 671-7649

**Marshall Industries**  
**G. S. Marshall Products Group**  
88 Needham St  
Newton Highlands Mass  
(617) 965-5115

**Marshall Industries**  
**G. S. Marshall Products Group**  
230 Sherwood Ave  
Farmingdale, L. I., New York  
11735 (516) 293-4141

**M & C Sales**  
1106 Burke St  
Winston-Salem, N C  
(919) 723-1001

**M & C Sales**  
304 Bob Wallace Ave  
Huntsville Ala  
(205) 539-8476

**Ossmann Component Sales Corp.**  
395 Cleveland Dr  
Buffalo, N Y  
(716) 832-4271

**Ossmann Component Sales Corp.**  
411 Washington Ave.  
Kingston, N Y  
(914) 338-5505

**Ossmann Component Sales Corp.**  
280 Metro Park  
Rochester, N Y  
(716) 442-3290

**Ossmann Component Sales Corp.**  
132 Pickard Building  
Syracuse, N Y  
(315) 454-4477

**Ossmann Component Sales Corp.**  
1911 Vestal Parkway East  
Vestal N Y  
(607) 785-9949

### CENTRAL REGION

**Magnuson Electronics**  
2420 Oakton St  
P O Box 130  
Mount Prospect Ill  
(312) 956-0700

**Magnuson Electronics**  
1246 West 7th St  
St Paul, Minn  
(612) 227-8495

**Norvell Electronics**  
10210 Monroe Dr  
Dallas, Tex  
(214) 350-6771

**Norvell Electronics**  
6440 Hillcroft Ave.  
Houston, Tex  
(713) 774-2568

**Norvell Electronics**  
3340 S Memorial Dr  
Tulsa, Okla  
(918) 663-1247

**Sheridan Sales Co.**  
Box 37826  
Cincinnati, Ohio  
(513) 761-5432

**Sheridan Sales Co.**  
Box 4457  
Cleveland, Ohio  
(216) 524-8120

**Sheridan Sales Co.**  
Box 423  
Dayton, Ohio  
(513) 277-8911

**Sheridan Sales Co.**  
33708 Grand River Ave  
Farmington, Mich  
(313) 477-3800

**Sheridan Sales Co.**  
P O Box 677  
Florissant, Mo  
(314) 837-5200

**Sheridan Sales Co.**  
Suite 5009  
1717 Penn Ave  
Wilkinsburg, Penn  
(412) 244-1640

### WESTERN REGION

**Almac/Stroum Electronics**  
8888 S W Canyon Rd  
Portland Ore  
(503) 292-3534

**Almac/Stroum Electronics**  
5811 Sixth Ave South  
Seattle, Wash  
(206) 763-2300

**Marshall Industries**  
**G. S. Marshall Products Group**  
5633 Kendall Court  
Arvada Colo 80002  
(303) 423-9670

**Marshall Industries**  
**G. S. Marshall Products Group**  
835 W 22nd Street  
Tempe Ariz 85282  
(602) 968-6181

**Marshall Industries**  
**G. S. Marshall Products Group**  
9674 Telstar Ave  
El Monte, Ca  
(213) 968-0141

**Marshall Industries**  
**G. S. Marshall Products Group**  
17975 Sky Park Blvd  
Irvine, Ca 92707  
(714) 556-6400

**Marshall Industries**  
**G. S. Marshall Products Group**  
8057 Raytheon Rd  
San Diego, Ca  
(714) 278-6350

**Marshall Industries**  
**G. S. Marshall Products Group**  
788 Palomar Ave  
Sunnyvale, Ca  
(408) 732-1100

### Wyle Distribution Group:

**Elmar Electronics**  
6777 East 50th Avenue  
Commerce City Colo  
(303) 287-9611

**Elmar Electronics**  
124 Maryland Street  
Mt View Ca  
(415) 961-3611

**Liberty Electronics**  
124 Maryland Street  
El Segundo Ca  
(213) 322-8100

**Liberty Electronics**  
3130 North 27th Avenue  
Phoenix, Ariz  
(602) 257-1272

**Liberty Electronics**  
8248 Mercury Court  
San Diego, Ca  
(714) 565-9171

**Liberty Electronics**  
5305 Second Avenue South  
Seattle Wash  
(206) 763-8200



# For breadth of line in microcircuits or in information, hit the right books.

Reliable, at-hand sources are some of the good things in life. Like the encyclopedia, for compact information. And, to more and more electronic designers, Beckman for our broad line of high-quality hybrid microcircuits at competitive prices.

Our distributors are a main reason. All around the country, they're stockpiled with the full line of standard hybrids, as well as with our industry-leading DIP resistor networks, trimmers, dials and pots. So they can offer delivery as fast as any in the industry, and usually faster.

Typical Beckman standards include universal active filters, for example. And telephone tone frequency filters. Precision ladder networks. Four-quadrant multiplying DACs. Successive approximation ADCs. High-power, high-slew FET input Op Amps. High-reliability MIL voltage regulators. And dual-tracking voltage regulators.

Our custom hybrid service is also something to turn to. Because we produce custom alterations or new products

in infinite variety. To time schedules few others can meet. We either build to customer design and specs or supply the design help when needed.

Typical custom units are modem and tone frequency filters. Entertainment system hybrid DACs and equalization filters. Custom display substrates (calculators, watches). Medical diagnostic timing and control functions. MIL-performance log amps, regulators, DACs, ADCs, and many others.

The point is, as a hybrid source, the Beckman line and distributor system are front-runners. For high quality and fast delivery. For competitive price and thorough service — including even a toll-free telephone express system to get literature to customers in just days. (Call toll-free 800-437-4677.) It's no wonder thousands of designers think of the Beckman catalog as a "most-valued reference work."

**Beckman**

HELIPOT DIVISION

Circle 63 on reader service card

# **MOSTEK's 16-pin 4K RAM makes memory design easy.**

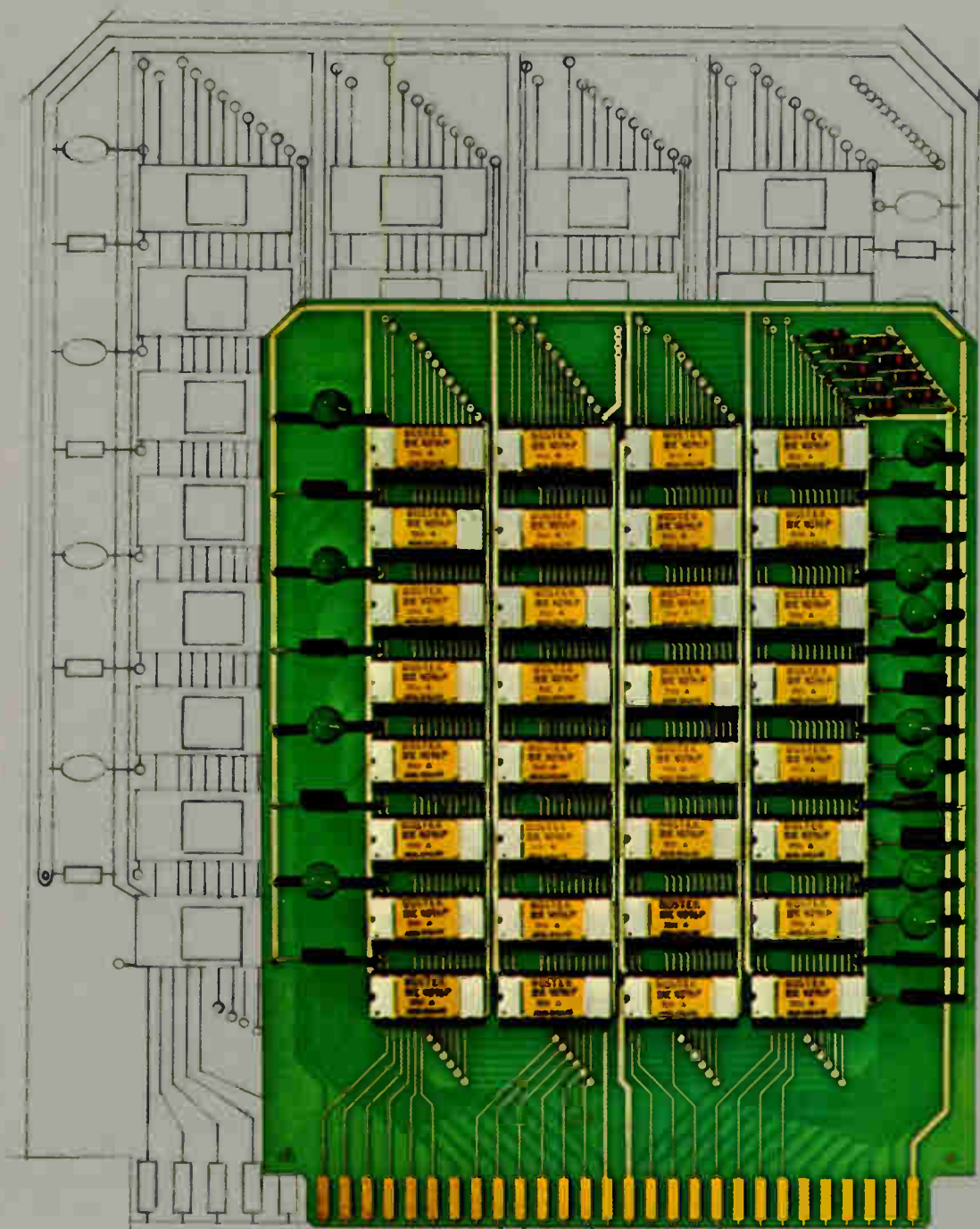

**MOSTEK's MK 4096P enables you to reduce memory board size by 50%.**



**With MOSTEK's MK4096P you can reduce memory board size by 50% and power dissipation by 45% over 22-pin RAMs with no increase in package count. Add up the advantages for yourself.**

The MK4096 incorporates TTL-compatible clocks, eliminating the need for special high-voltage clock drivers required by 22-pin competitive devices. Low clock line capacitance with the MK4096 means fewer drivers and less delay.

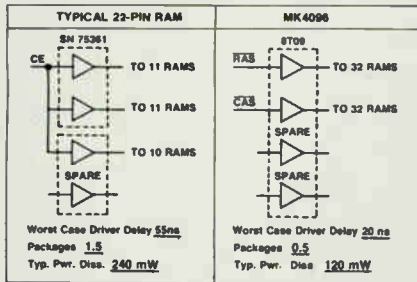

**Fewer signal lines and signal drivers required.** Compared with 22-pin packages, the MK4096 requires six less address lines to be driven throughout the memory matrix. In addition to making PC layout easier, this means fewer address drivers are required.

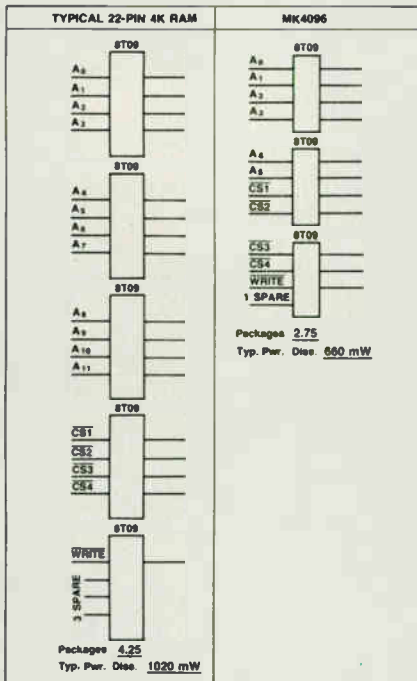

**Only standard TTL required for chip select decode logic.** Using MOSTEK's MK4096, two-level decode logic for

a 16K by 8 memory matrix can be implemented with standard or "L" series TTL, whereas "H" or "S" series is required by competitive 22-pin 4K RAMs. This is because the MK4096 requires decoded chip select information to be valid at the Column Address Strobe (CAS) leading edge which is 150 nsecs into the cycle. The 22-pin alternates require valid chip select information no later than 70 nsecs after the cycle begins.

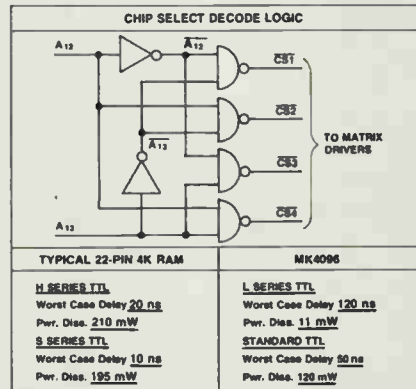

**No additional packages required for second strobe or clock signal.**

Timing specifications for the MK4096 allow use of the existing WRITE signal timing logic as the Column Address Strobe generator so no additional timing channel needs to be added to the memory controller. Thus there is no requirement for additional packages.

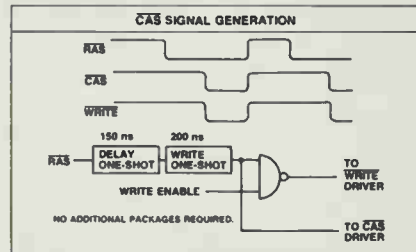

**Address multiplexing is accomplished easily.** Multiplexing of addresses is common to all memory systems using dynamic RAMs due to the refreshing requirement. 22-pin 4K RAMs require a 6-bit refresh address as does the MK4096. The only additional requirement with the MK4096 is that the address be multiplexed in two 6-bit bytes, accomplished with a multiplexer that is 3-wide instead of 2-wide and a multiplexer control that is 2-bits wide instead of 1-bit wide.

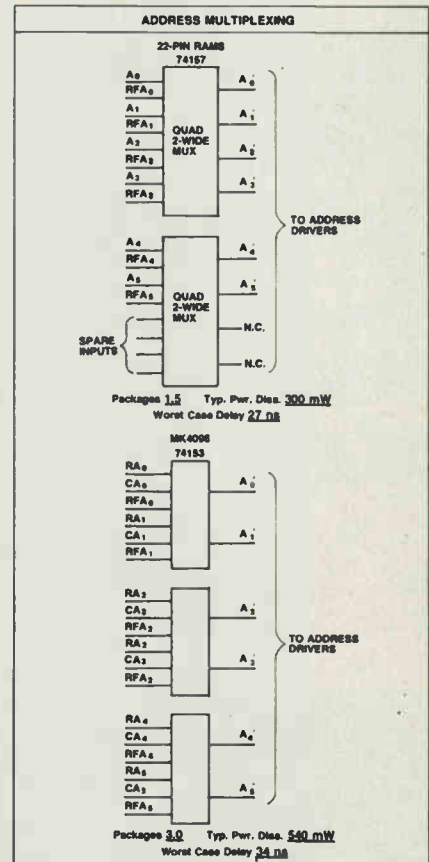
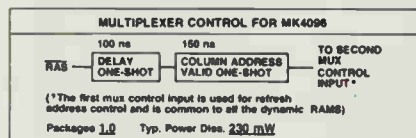

**Result? The MK4096 scores highest in density, lowest in power dissipation and requires no additional packages in the memory controller.**

	TYPICAL 22 PIN 4K RAM	MK4096
Total Packages	7.25	7.25
Total Typical Power Dissipation	1770 mW	1561 mW
Total Power Dissipation Including Rams	23.53 W	14.36 W

Add up the advantages of MOSTEK's 4K RAM and you'll understand why it's already becoming the industry leader in design ease, performance and volume availability. Call your nearest MOSTEK distributor or representative for more details or contact MOSTEK, 1215 West Crosby Road, Carrollton, Texas 75006, (214) 242-0444.

*Now... alternate sourcing of the MK4096 by Fairchild!*



# Probing the news

Analysis of technology and business developments

## Color LEDs come on stronger

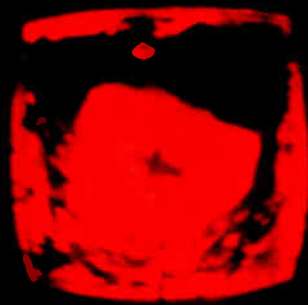
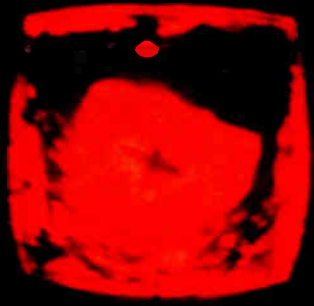

---

Researchers' efforts to improve brightness and extend lifetimes of green, yellow, and orange diodes while cutting prices are beginning to pay off

---

by Bernard C. Cole,

San Francisco bureau manager

The "other" colors are coming. Makers of light-emitting diodes, buoyed by recent improvements in manufacturing technology and encouraged by increasing customer interest, are working to improve efficiency and reliability as almost everyone in the industry inches past red to orange and green, then proceeds with caution to yellow.

But even with all that, and with the optimism fairly oozing from promotional statements, it will still be a while before the other colors become as pervasive as red. The major reason is that still more improvement is needed in methods of handling gallium arsenide phosphide and gallium phosphide so that the prices of color LEDs—now two to four times those of red—come down. And, even though red is hard on the eyes, difficult to see in bright light, and psychologically associated with danger, there still is some resistance to other colors.

"Right now the volume business is in red," says Thomas Recine, National Semiconductor's marketing manager for discrete products in Santa Clara, Calif., "We don't think there will be a volume demand for greens and yellows until late next year—and we'll be ready with production quantities by then." Recine's view is typical as manufacturers large and small prepare for or accelerate volume production.

**Rough trip.** The major reason for the somewhat rough trip of color LEDs to the market has been the high cost of the raw GaP substrates, the basic material for colors other than red, and the low-volume manufacturing techniques used to grow the epitaxial layers. The result is that red GaAsP wafers cost less than \$15 per square in. in volume compared to \$60 for GaP.

Also, there is still some debate about which of the closely related fabrication techniques is best. The choice is from among GaP on GaP, GaAsP on GaP, GaAsP on GaAs, and GaP on GaAs. And there is a choice of epitaxial approaches: vapor-liquid or liquid-liquid. Another decision for the manufacturer is which color to go after first: orange because it's closest to red, yellow because it's easier than green, or green because it's hardest and can teach the most about the process. Finally,

there is the option of large digits with light pipes for amplification or small monolithic displays. What it generally boils down to is marketing strategy and its efficiency-cost tradeoffs.

In contrast, red devices, with their GaAsP substrates, are produced with vapor-phase epitaxial deposition in very large batches. The technique and equipment are similar to those used in making silicon ICs. GaP wafers, on the other hand, are usually handled a few at a time.

But decisions are being made. One competitor, HPA division of Hewlett-Packard Co., Palo Alto, Calif., has developed a way to combine GaAsP's easier-to-make pn junction with a GaP substrate [*Electronics*, May 2, p. 34]. The division plans to introduce yellow and green discrete diodes and a high-efficiency red version next month.

**GaP power.** Fairchild's Optoelectronics division in Palo Alto, Calif., is sticking to GaP on GaP and liquid-phase epitaxy because its engineers are well along the learning curve and feel they can produce a high-efficiency green at a reasonable cost. And since GaP substrates are transparent to light, causing poor character definition, the company will stick to larger digits and light pipes. At Texas Instruments, GaP on GaP is also preferred.

Litronix, of Cupertino, Calif., on the other hand, with its monolithic green digit, has chosen to go the GaP-on-GaAs route precisely because of the transparency problem. Because GaAs is opaque, says Anthony Domenico, manager of materials research and development, it eliminates crosstalk between the segments.

The relatively small and new Xciton Corp. in Latham, N.Y., is sticking with its proprietary liquid-epitaxial process for GaP which, says president Allen M. Barnett, results in diodes from three to five times more efficient than other GaP devices. The company announced green LED lamps in November 1973, followed with a yellow lamp in January and a distinct orange-emitting diode in March. Xciton also fabricates 0.3-in yellow and green digits magnified by light pipes.

"The price differential is kept small because all the colors are

## Probing the news

made with the same technology," he says. "This means we have been able to drive manufacturing costs down for all four colors at the same time."

But Bowmar Canada uses GaAsP on GaP for yellow and orange LEDs and straight GaP for greens because "that is the only way to get it," says marketing manager Eric Heiman.

TI announced in February and is now in volume production with three discrete green LEDs: a 200-mil-diameter point source designed for backlighting and 115- and 200-mil LEDs in diffused packages for panel mounting. As for digits, TI plans to use reflector-optics packages both for GaAsP and GaP. The first digit will be a 0.3-inch green followed by a 0.3-in. yellow. Half-inch versions will be announced later this year.

Monsanto in Palo Alto, Calif., is turning out production quantities of 0.3-in. reflector digits in green and yellow, says Wayne Stewart, product marketing manager of the Electronic Special Products division. Monsanto will come out with 0.4-in. digits in yellow and green in the third quarter and 0.7-in. yellow, green, and red digits in the fourth quarter.

At Fairchild, Optoelectronics division, general manager E.C. Frye reports that the company will have sample quantities of color digits

available by the end of the year, design quantities by the first quarter of next year, and production by mid-1975 with 0.25-, 0.357-, and 0.50-in. green and yellow digits using the light-pipe approach.

Pricing is another key factor in acceptance of other-than-red LEDs. While estimates now place them at four times red at the materials level and double at the package level, several industry sources estimate that the package differential will be down to 20% by 1975 or 1976.

John Hall, marketing manager for solid-state lamps at General Electric's Solid State Lamp department in Cleveland, is a bit more optimistic. "Our best price for red lamps is 25 cents in 10,000 quantities," he says. "Green is 35 cents in the same quantities. Within six to 12 months green should be fairly close to red GaP prices."

Barnett of Xciton claims that his lamps—yellow and green, as well as orange—are already only 20% more expensive than red for comparable power outputs. Prices range from 49 cents to 79 cents for color LEDs in 1,000 quantities compared to 42 cents to 49 cents for red.

And according to David Laws, product marketing manager at Litronix, his firm will be offering its green monolithic digits in production quantities at about the same price as red—\$1.06 to \$1.10 per digit.

It will have sample lots available in June and production quantities

much later in the year. Green GaP digits—using light-pipe magnification—in the 0.3-in. and 0.63-in. sizes will be available in limited quantities in July. And yellow lamps and digits will follow late in the year—possibly the fourth quarter—according to George Smith, vice president of corporate research and development. Green lamps and larger digits will be about 20% to 30% higher than their red counterparts, which range from 17 to 49 cents.

It is agreed, though, that the price of yellow digits especially will be somewhat steep initially, since it is difficult to make one for much less than \$1. On this basis, it is estimated that yellow digits would have to be sold at \$2 to \$2.50 each in volume.

No matter how long it takes prices to equalize, it appears likely to some that red LEDs always will dominate the market. As GE's Hall puts it: "Red is the standard color in instrumentation and test applications." He expects to see an eventual market mix of 60% red, 30% green, and 10% yellow—although there may be new applications in which those numbers won't hold up, especially in digits. And Ralph Miller, marketing manager at Fairchild's Optoelectronics division, lists the major markets this way:

- **Autos.** The potential market is 36 million lamps a year of all colors.
- **Clock radios.** Several hundred million digits a year by 1977, as more people discover that green is more pleasant to wake up to.
- **Television.** A sleeper market in 1979 or 1980 if the industry goes to electronic channel selection with digital readouts.
- **Hand-held calculators.** In three or four years, this market will reach its saturation point of 30 million to 40 million units a year, meaning 300 million to 400 million digits.
- **Appliances.** A potential for 30 million digits a year by 1978 if digital readout and status indicators become important and if color LEDs that don't wash out in bright kitchen light can be developed.

"There's one big if in all of this," says Miller. "If the industry can't get beyond the 20% to 30% price differential between reds and other colors, to within at least 2% to 3%, forget all these markets, except possibly autos." □

**Aglow.** Lighted diodes on p. 66 are from TI, while numeric display below is a Litronix device using GaP on GaAs. This, says Litronix, eliminates crosstalk between segments that's commonly found in displays using GaP substrates. Digit shown is 0.045 inch high.

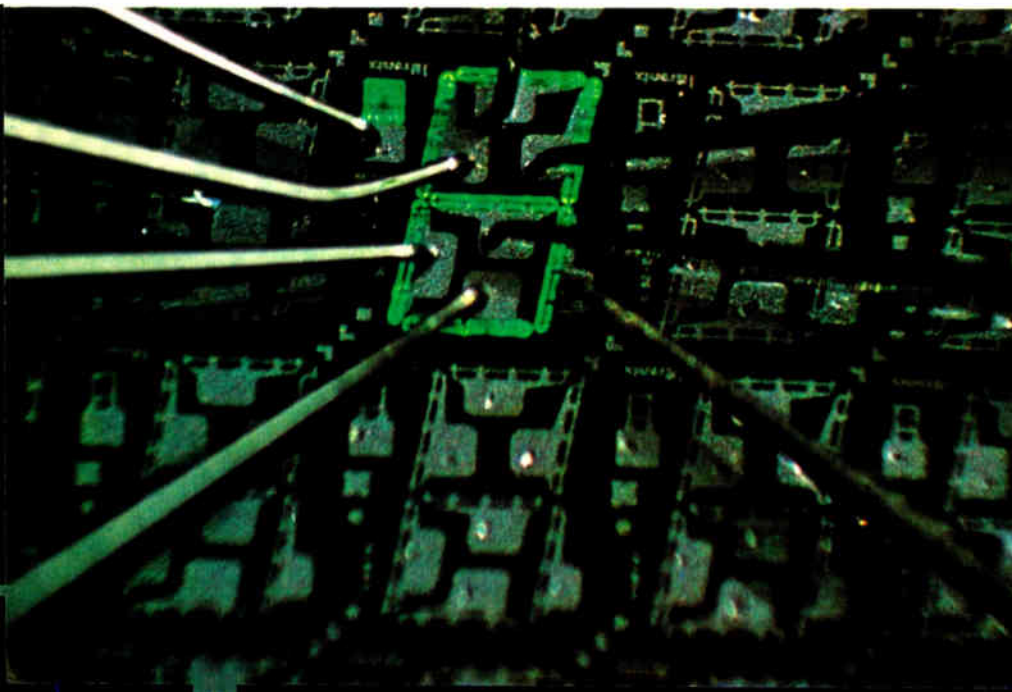

# Anyone can find fault with the Teradyne L100.



If you're testing a fair number of digital circuit boards without benefit of automatic fault isolation, you're probably spending much more money on troubleshooting than you have to. Consider:

Board *testing* usually ends and board *troubleshooting* begins once you know that an output pin is in the wrong logic state. Automatic fault isolation, available with Teradyne's L100, picks up the trail at that point, automatically telling the operator where to probe, step by step, until the source of trouble is reached. Instructions are in plain English, in terms of specific pins of specific ICs. The whole procedure might take less than a minute, even with

a complex board. Best of all, it requires no special technical skills.

Maybe you think all this diagnostic power adds up to one big programming headache. Not at all. *The same probe you troubleshoot with, you program with* — simply by letting the system learn the logic on a known good board.

To learn how you can find fault with the L100 Automatic Digital Circuit Test System, write: Teradyne, 183 Essex Street, Boston, Massachusetts 02111. In Europe: Teradyne Europe S.A., 11 bis, rue Roquépine, 75 Paris 8<sup>e</sup>.

## TERADYNE

CHICAGO (312) 298-8610 / DALLAS (214) 231-5384 / NEW ENGLAND (617) 458-1256 / NEW YORK (516) 364-9797 / SUNNYVALE (408) 732-8770  
LONDON (093-28) 61111 / PARIS 265 72 62 / ROME 59 47 62 / MUNICH (0811) 33 50 61 / TOKYO (03) 406-4021

Consumer electronics

## Supermarket sales begin to pile up

Over 20 manufacturers are vying for a billion-dollar bonanza in checkout counter equipment

by Gerald M. Walker, Associate Editor

Electronic cash registers, electronic scales, and front-end processing systems are about to invade America's supermarkets in a really big way. The annual market for such systems is heading toward \$1 billion plus by 1980, \$2 billion thereafter—figures based on the \$105,000 to \$110,000 it typically costs to equip an eight-lane supermarket with a fully automated scanner checkout system, including communications equipment and minicomputer controller.

For the 20 or more hardware manufacturers now lining up for the checkout counter business, this rich territory opened up properly only a year ago, when the supermarket industry at last agreed on a standard code for identifying all products and their manufacturers on machine-readable tags. Called the Universal Product Code, it produces a 10-digit optical bar symbol that's now appearing on more and more items on the supermarket shelves.

**Printers.** Use of the code has also created a demand for in-store label printers, to tag the produce and meats packaged by the individual store. In the most elaborate of these machines, an electronic scale is programmed to weigh different types of meat and direct a printer to bang out a coded tag and an alphanumeric label—the first for the scanner, the second for the buyer.

Because the supermarket business has still not taken off, competition is intense. As yet there is no clearcut leader. Few hardware manufacturers can claim more than a dozen customers, and most of the rest are still mainly involved in experimental installations. But all of this



**Super systems.** Sweda's register, top, is used with checkstand that includes scanner. National Semiconductor's entry in the competition is shown, bottom, with an X scanner.

will begin to change rapidly, starting this fall, when new systems designed around Universal Product Code (UPC) scanners will be ready.

The competition centers on five types of equipment: minicomputer-controlled store systems; stand-alone electronic cash registers with key entry; fixed-head slot scanning with either X scanners or raster scanners; hand-held scanners, and store-level UPC symbol-printing equipment. The scanners are generally sold as part of a register-and-checkstand package, which may include a place for an electronic scale tied directly to the register.

While the conversion from electromechanical to electronic checkout has been enthusiastically sup-

ported by industry's powerful Supermarket Institute, and while early trials have shown improvements in customer throughput and employee productivity, users are being cautious about the timing of installations. One reason is that the ultimate system—register, scanner, and computer controllers—is by far the most expensive to install and maintain, so that its cost savings will have to be the most attractive. This problem is compounded by uncertainty as to what percent of a store's total inventory will need to be coded before the high cost of the ultimate system is justified.

Another problem confronting the supermarketeters is the cost of training and the systems preparation re-



quired to get an efficient electronic checkstand program underway. Also, the store itself has to be carefully planned around the system.

Last, but certainly not least, is the anticipated reaction of shoppers to the product code and the high-speed checkstands. Individual price tags will probably disappear from the items on the shelves, once a complete store system is up and running, and items will have code labels only. Prices will be maintained in the store-level computer and will be looked up when the item is scanned at the checkstand and the transaction recorded. Consequently, once the customer has taken an item from the shelf, he will not know its price until checkout time, and this creates two tasks for the supermarket. First, shelf prices will have to be prepared and mounted more carefully than in the past. Second, consumers will have to be informed via promotion programs.

**Benefits.** David Carlson, vice president of information systems for Chatham Super Markets, Warren, Mich., put it succinctly at the recent Supermarket Institute convention in Dallas. He observed there are probably 23 areas where the checkstand could benefit from electronics, the top two being increased productivity and accuracy, but there are 11 where costs could increase. His fear was that if a system is misapplied or mismanaged, the costs could easily run away from the benefits and "never before could we lose so much money so fast at the front end." Yet despite his warnings, he added, "If placed properly, we could also make all the benefits."

The benefits promised from the Universal Product Code are now part of the standard pitch of the hardware manufacturers. And as a consequence it's getting harder to tell their systems apart without the software.

New products announced recently have emphasized scanners. Sweda International, Bunker Ramo, NCR, National Semiconductor, MSI Data Corp., Singer, and Data Terminal Systems all unveiled entries. IBM and Sperry Univac had previously demonstrated UPC-scanning systems. Both Spectra-Physics and Schiller Industries Inc. have developed laser scanners supplied to

some of the companies making front-end systems.

**Add lasers.** However, a number of the stand-alone registers can be upgraded to laser scanners, thus making it possible for a supermarket to enter sales data by register keyboard until enough goods on the shelf carry the UPC tags. On this score, another user speaking at the supermarket convention—Garry Potter, industrial engineer for Do-

minion Stores Ltd.—reported that it took his stores 14 man-months to set up two pilot systems without scanners. He estimated a 2.2-year pay-back on the investment, the number of customers checked out per hour jumping from 16.2 to 18.9.

"Scanning systems promise a 45% improvement throughput," he stated, "but why wait? The savings are real enough to stop us buying electromechanical registers now." □

## 8 CASES FOR SWITCHING TO NATIONAL® SCRs



16-1600 Amperes rms  
25-1700 Volts  
Power and Inverter SCRs  
Patented Regenerative Gate

*Call or write for full details*



**NATIONAL ELECTRONICS**

a varian division

geneva, illinois (312) 232-4300

Companies

# Module makers go vertical

Analog Devices, like its competitors, feels breath of monolithic IC houses; result is upward climb into headier product areas

by Gail Farrell, Boston bureau manager

The handwriting has been on the wall for some time for manufacturers of modular functional circuits such as operational amplifiers, digital-to-analog and analog-to-digital converters, and multipliers: the monolithic IC boys are nipping at their heels, beginning to chip away at the lower end of the performance spectrum for such functions.

Some of the makers of functional circuits have been reading the handwriting well and moving upward into more sophisticated product sectors. Take Burr-Brown Research Corp. of Tucson, Ariz. Jim Burns, vice president and general manager, talks about more complex subsystems, modular instruments, and a family of products aimed at the data-acquisition market.

The company also has an in-house thin-film hybrid capability—the acquired Sloan Microelectronics; while its own IC designs are now being fabricated outside, the plan is to move such manufacturing into Burr-Brown itself.

Another module house, Datal Systems Inc. of Canton, Mass., has been in subsystems for the past two years. John Gallagher, marketing vice president, says the reason is not so much to stay ahead of IC houses but to expand into new markets.

“With d-a and a-d converters amounting to only a \$40 million-a-year market, we just had to grow elsewhere,” he explains. Now Datal is expanding into modular instruments, with a complete line to be announced this fall.

While the threat from semiconductor makers is not quite as im-

mense as Teledyne Philbrick. The company has advanced from operational amplifiers to a-d and d-a converters, and has plans for a line of converters combining dielectric isolation and thin-film.

On the West Coast, Mike Preletz, president of Zeltex Inc. of Concord, Calif., agrees that, while his com-

pany's first goal is to capture an increased share of the converter market, its next objective would be to integrate upward.

But among modular circuit makers, perhaps the most ardent disciple of the gospel of such vertical integration is Ray Stata, president of Analog Devices, the Norwood, Mass., company that may be reading the handwriting best of all—in fact, Burr-Brown's Burns concedes that Analog is “probably further ahead than

anyone else;” Preletz of Zeltex agrees. Stata has been preaching to customers and investors alike the benefits of what he calls the intermediate-products business—a niche falling somewhere between the classical division of electronics companies into end-equipment manufacturers and component makers.

The result is that the module maker has graduated to modular instruments and plans to further integrate vertically into small systems.

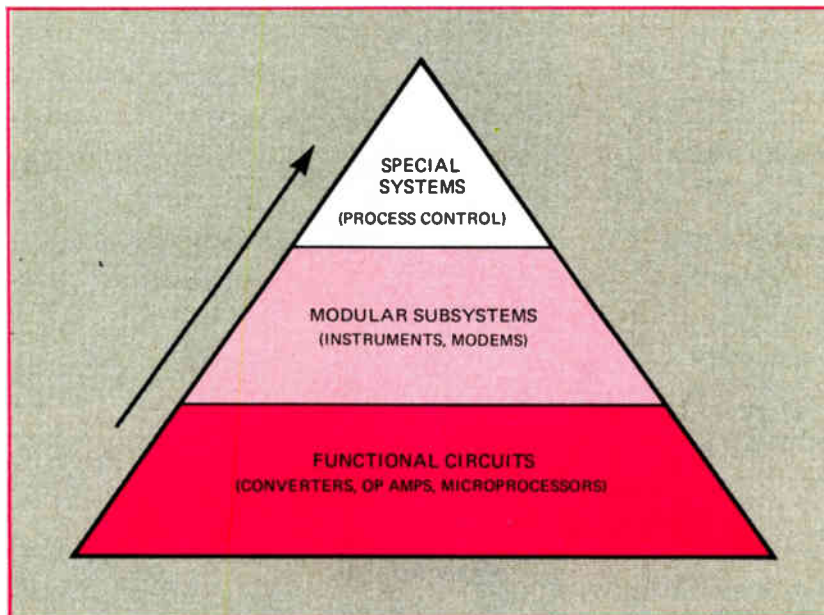

**Moving up.** Ray Stata, president of Analog Devices, sees his company as a supplier of “intermediate” products, moving up through the complexity levels of this hierarchy.

mediate for Analogic Corp. as it is for other module makers—because its line consists primarily of digitizing equipment—the Wakefield, Mass., company is well aware of the potential danger. So Analogic's answer is the vertical-integration route: producing instruments and subsystems that use both semiconductor components and Analogic's own modules as building blocks.

Another Massachusetts firm following the route up the sophis-



At the same time, the firm has converted its investment in the former Nova Devices, a monolithic IC maker, into full ownership: it's now Analog Devices Semiconductor, a wholly owned subsidiary.

To date, most of Analog's sales are still in functional circuits, with modular instruments, such as digital panel meters, just reaching production maturity. But a few years out, modular instruments and system-like products will account for a larger chunk of the business than they do now. And the semiconductor operation is the fastest-growing part of the company, a fact that can't be lost on Analog's traditional competitors in the functional circuits business—such as Burr-Brown and Teledyne Philbrick.

But vertical integration won't be without problems. For one thing, as a company moves up the hierarchy into more complex products, it exposes itself to a whole different class of competitors. In the traditional module business are Analog Devices, Analogic, Datel, and Zeltex Inc. as well as Burr-Brown and Teledyne Philbrick. In ICs, there are Motorola in monolithic d-a converters, National Semiconductor in linear ICs, and Precision Monolithics in converters. Still, Analog intends to stay with its direct sales policy. "We have no distributor sales," says Stata. "We feel that the instrument maker deserves the services of a direct selling effort; you can't relegate that to a distributor."

At the modular instrument level of the hierarchy, Analog, says Stata, "feels pressure to supply products that are more committed, more complex than in the past. It is a natural evolution to move in that direction. We have a modular manufacturing capability and as our ICs obsolete our discrettes, we don't want to abandon our processes."

Analog's policy of pursuing the intermediate market seems to be paying off—sales grew by 41% in 1973 to nearly \$22 million, and in 1974 may reach \$30 million. Over the long term, Stata looks for 25% annual growth as a reasonable goal; "we serve a market that has a hunger," he says. And he believes it is a market that is growing faster than the end-user market, since it involves a shift in buyers and seller. □

## CABLE-BILITY WOVEN'S FLAT GOT IT!



### Ribbon Cable IC Interconnects Custom Harnesses

A total source for flat interconnect systems, Woven Electronics offers unlimited design capabilities combining signal/power transmission with specialized functions. Independently insulated conductors give tighter transmission control, more protection, allow easy lead exposure.

Specify sizes, color coding, insulations, custom break-outs without restrictions of other cable forms.

**Cable and ability. Get the best of both from one source.**

### WOVEN ELECTRONICS

P.O. Box 189 Mauldin, South Carolina 29622  
803/963-5131

**Announcing  
the 21 most  
logical additions  
to the  
first family in  
CMOS.**

**From the industry's  
most logical  
source.**

**With a 30% increase in the industry's broadest line, the RCA CD4000 family now provides greater design flexibility for a wider range of applications.**

**21 NEW TYPES AVAILABLE NOW.**

Gates/Inverters	MSI	LSI
CD4066 Quad Bilateral Switch	CD4060 14-Stage Counter/Oscillator	CD4059 4-Decade Divide-By-N Counter
CD4069 Simple Hex Inverter	(Multiple Output)	CD4061 256-Bit Static RAM
CD4071 Quad 2-Input OR Gate	CD4518 Dual BCD Up Counter	CD4062 200-Bit Shift Register
CD4072 Dual 4-Input OR Gate	CD4520 Dual Binary Up Counter	
CD4075 Triple 3-Input OR Gate	CD4063 4-Bit Magnitude Comparator	
CD4081 Quad 2-Input AND Gate	CD4514 4-to-16 Line Decoder (Outputs High)	
CD4082 Dual 4-Input AND Gate	CD4515 4-to-16 Line Decoder (Output Low)	
CD4073 Triple 3-Input AND Gate	CD4085 Dual 2-Wide 2-Input And-Or-Invert Gate	
CD4068 8-Input NAND Gate	CD4086 Expandable 4-Wide 2-Input And-Or-Invert Gate	
CD4078 8-Input NOR Gate		

**10 NEW TYPES AVAILABLE SOON.**

CD4070 Quad Exclusive OR Gate	CD4093 Quad NAND Schmitt Trigger	CD4510 BCD Up/Down Counter
CD4076 Quad D-Type Flip/Flop	CD4527 BCD Rate Multiplier	CD4516 Binary Up/Down Counter
CD4077 Quad Exclusive NOR Gate	CD4502 Strobed Hex Inverter	CD4528 Dual Retriggerable/Resetable Monostable Multivibrator
CD4089 Binary Rate Multiplier		

We're adding 21 new types to the standard CMOS family that first brought you high noise immunity and low power consumption over a wide operating voltage range.

21 new types in the front-running CD4000 series the rest of the industry has chosen to second source.

21 new types you told us would give you wider vistas, and make possible more cost-effective designs.

21 new types from the people who developed more production capability and delivered more CMOS than anyone in the industry.

There's a 256 bit static RAM that requires no precharge or refreshing. What may be even more important to you is that it requires only micro-watts of standby power. Which makes it ideal when memory protection is important.

Typical access time is 250 nano-seconds. Operating range is from 3 to 15 volts.

Our four decade divide-by-N counter lets you divide by 3 to 15,999 in a single package.

Our CD4069 gives you a Hex inverter at gate prices. So you can save some money if you don't need high output drive current.

Spend what you save on our new CD4066 quad bilateral switch which offers a lot lower "on" resistance than our popular CD4016.

And now you have a series of AND and OR gates to complement our NAND and NOR gates.

There's more coming too. Ten of them, real soon.

All of which goes to prove two important points relative to RCA.

The continuing progress of the people who invented CMOS.

And a continuing commitment to the solid state technology that's come on strong and is here to stay.

With all this behind you, you can start plugging our new COS/MOS circuits into your plans. (COS/MOS is the RCA name for CMOS.) To order samples, contact your nearest RCA Solid State distributor, call your RCA field office, or write RCA Solid State, Section 70E30, Box 3200, Somerville, N.J. 08876. For information phone Pat Lindblad (201) 722-3200, Ext. 2355.

**RCA Solid State**  
The first house in CMOS

**A great place  
to start  
expanding  
your company  
is right here.**



Our 16 page book talks about the labor force, about deep water ports, about utilities, temperatures, taxes. There's everything here from financing to flying times, from industries to schools—all the things that make Northwest Florida one of the most profitable, most livable business climates in the country. And it's free.

Gulf Power Company  
Manager, Area Development  
Department D-8  
P.O. Box 1151  
Pensacola, Florida 32520  
Please send me your book.

Name \_\_\_\_\_

Title \_\_\_\_\_

Company \_\_\_\_\_

Address \_\_\_\_\_

City \_\_\_\_\_

State \_\_\_\_\_

Zip \_\_\_\_\_

## Probing the news

Memories

# Bubble memories reach crossroads

Rockwell to produce commercial products in 1976; Interomag Conference reports spur optimism

by Howard Wolff, Associate Editor

The word has gone out. For bubble memories, as Paul V. Michaelis of Bell Laboratories puts it, "it's the put-up-or-shut-up period." And the feeling is that the people working with magnetic bubbles—tiny magnetized areas in thin films of magnetic materials that can store and process vast quantities of data—are going to put up.

For Michaelis and his counterparts just back from this month's Interomag (International Magnetics) Conference in Toronto, the beat is definitely up in terms of attitudes and papers presented. "People are getting down to doing things," says the Bell Labs engineering physicist, "and they're talking about real problems involving such things as detection noise in the bubble memories, operating sequences, and ways to test the devices. There were lots of

honest-to-goodness facts, instead of speculation and talk about 'break-throughs.'"

Michaelis' feelings are backed by some of the work described at Toronto, including that which his group—subsystems—is doing at the Murray Hill, N.J., lab. There, researchers headed by Peter L. Bon-yhard have come up with the first working, fully populated magnetic-bubble memory [*Electronics*, May 16, p. 29]. The prototype has a capacity of 500,000 bits, and that could be scaled up to a million. And the device could replace fixed-head rotating-drum and disk memories within two years.

**Optimism.** The optimism extends to the West Coast, too. In Anaheim, Calif., William C. Mavity, manager of memory development at Rockwell International's Microelectronic

**Bubbling.** In IBM's amorphous-film approach, bubbles can be moved from one circuit element to another by alternating polarity of each element by rotating external magnetic field.

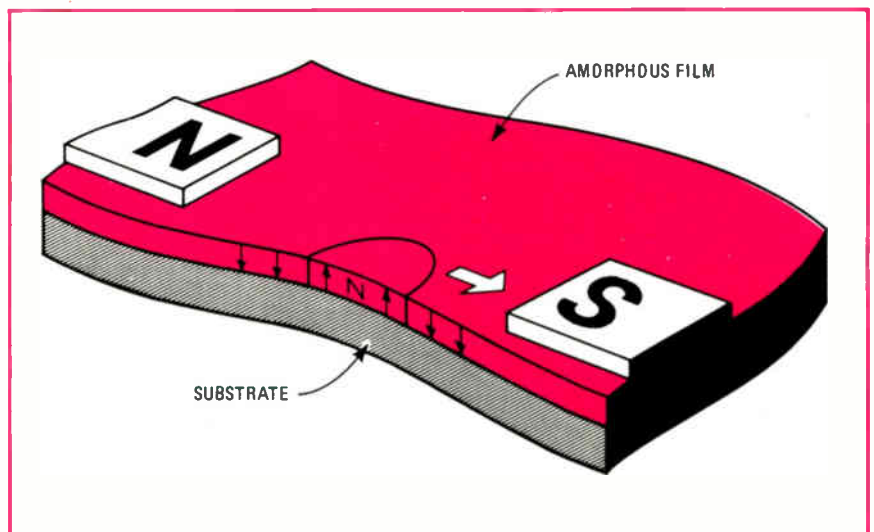

Here's Ramtek's new color graphic display system, the FS 2000, for the manager who has nothing— but gauges, strip charts, plot boards and so forth.

Who needs it?

Anyone responsible for process supervision, power utility control or financial management information processing.

Ramtek introduces the FS 2000 System for the manager who is involved in monitoring the flow of raw materials through his industrial process to a profitable conclusion.

We've utilized the design experience of our highly successful GX 100 Series System and applied it to the development of the FS 2000 System. Here's what the new system offers:

- The ability to address a character to any location on a 256 x 256 grid.
- Four character sizes, the smallest of which allows 85 characters per line.
- Graphic line generation of any thickness or length with four bytes—only one byte required to modify either.
- Automatic overwrite of a character on a graphic entity—no erase step necessary.
- Ability to overlay or completely overwrite characters non-destructively allowing convenient combinations.
- Two byte relocation of any display block—allowing convenient "visual subroutines."
- Dual intensity available on each of seven colors.
- Ability to blink any entity from full brightness to half brightness or off.

Need more information? Contact:  
Ramtek Corporation, 292 Commercial Street, Sunnyvale, California 94086. Telephone (408) 735-8400

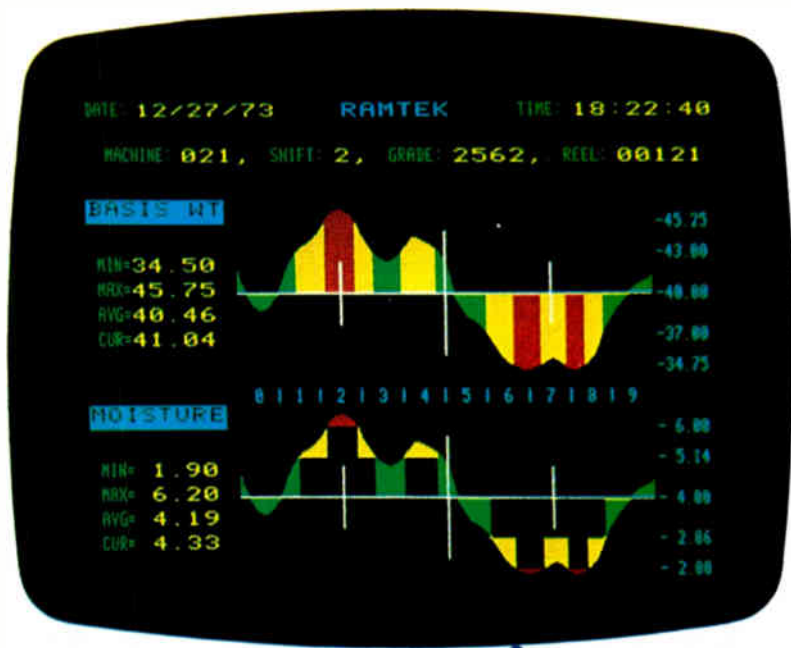

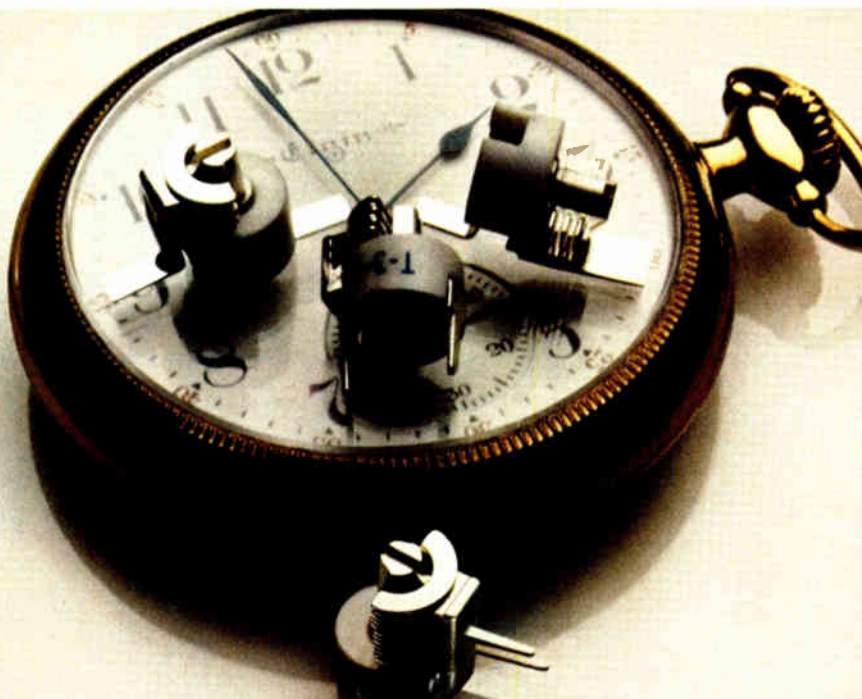

**We can deliver the world's smallest  
180° air variable capacitors.  
On time.**

And since we're nice people, we don't even charge much for them. So if you have an application that calls for a sub-miniature capacitor that you can "tweak" to a specific frequency, these Johnson trimmers are ideal.

You can choose from either PC or stripline mount, either vertical or horizontal tuning. These Type "T" capacitors are about one-third the size of the familiar type "U" capacitors, so you can save space, cut costs and insure improved performance in the most compact electronic equipment.

Rotors and stators are precision-machined from solid brass extrusions, resulting in exceptional stability and uniformity. High Q—typically 2000 at 150 MHz. Temperature coefficient is a low plus  $30 \pm 15$  ppm/°C. High torque (1½ to 8 oz./inches) holds rotor securely under vibration. They're designed to meet or exceed EIA-RS 204 and MIL Standard 202C Methods 204A and 201A.

In short, these capacitors may be just what you've been looking for. It'll only cost you a stamp to get more information. And if you give us your phone number, we'll call you and send free samples after we have clarified your application.

E. F. JOHNSON COMPANY  
3005 Tenth Ave. S.W. / Waseca, MN. 56093

- Please send me technical information on the type T.
- Also, include information on your entire line of variable capacitors.
- I want test samples. Please call me at \_\_\_\_\_

NAME \_\_\_\_\_  
TITLE \_\_\_\_\_  
FIRM \_\_\_\_\_

ADDRESS \_\_\_\_\_  
CITY \_\_\_\_\_ STATE \_\_\_\_\_ ZIP \_\_\_\_\_



**E. F. JOHNSON COMPANY**

Device division, says his division will deliver demonstration commercial bubble products this year. Production, says Mavity, will begin in 1976. Meanwhile, an Intermag paper from Rockwell's Electronic Research division described a 61,440-bit bubble memory for use in space. That memory is considered a building block in the fabrication of memories with a capacity of 100 million bits [*Electronics*, May 16, p. 30]. And a researcher from the same division described a flight recorder.

Scientists from IBM's Watson Research Center in Yorktown Heights, N.Y., described a text-editing system, as well as the use of amorphous films to obtain bubbles as small as 1 micrometer in diameter, compared with the usual 4 or 5  $\mu$ m, and using electron-beam lithography to make the bubbles in thin amorphous films, rather than in the garnet materials usually used. And to complete the Intermag lineup of companies doing bubble work, Hewlett-Packard Co. discussed its design work, including a new symmetrical layout of the magnetic poles atop a bubble material that promises more efficient propagation and movement of the bubbles. Outside observers believe H-P is aiming its bubble work at a new desk calculator.

**Customers.** But all this activity, of course, presupposes a market—or, as Rockwell's Mavity puts it, "the customers must come on stream, too." And with bubble systems now thought of as replacements for small to medium-size disks, it's easy to see that the interest of IBM is for its computers and Bell for electronic switching.

Computer makers across the country are experimenting with the new memory systems, but most refuse to admit more than that and adding that they find bubbles interesting. However, the implication is clear: they're watching and waiting. Fred S. Lee, manager of the bubble program at Honeywell Informations Systems' Advanced Systems and Technology group in Oklahoma City, puts his finger on a major improvement that must be made to satisfy computer makers: bubbles must be made smaller.



## **Honeywell had a perfectly good main frame connector. What in the world made them change it?**

A copper alloy called CA 725. Now they use it for new main frame connector springs.

Honeywell's experience with CA 725 has been outstanding. Since bare CA 725 solders readily, resists corrosion and tarnishing, it was possible to eliminate costly gold plating over most of the contact spring.

This allowed Honeywell to get more gold where it is needed — at the contact point. More gold at the contact point increased connector life ten times; made possible by CA 725.

Honeywell's connector manufacturer, Winchester Electronics, knows that CA 725 has a lot to offer in the way of good mechanical properties and excellent fabricability. CA 725 is a standard material available from many copper and brass sources.

Why don't you consider a change for the better? For more detailed facts about CA 725, write The International Nickel Company, Inc., Dept. 3373, One New York Plaza, New York, New York 10004.

Honeywell's new main frame connectors are manufactured by Winchester Electronics.

# **INCO**

THE INTERNATIONAL NICKEL COMPANY, INC.

Circle 79 on reader service card

# THAT MAGNIFICENT NEW BELL & HOWELL MACHINE

State-of-the-Art Recorder/Reproducer.  
STARR™.

This is a laboratory grade magnetic tape instrumentation recorder whose credentials are as impressive as the name Bell & Howell. It offers high performance. Reliability. Elegance. Human engineering.

Plus: state-of-the-art engineering epitomized by ferrite record/reproduce heads for ultra-long life. Phase-lock servos for flutter suppression and TTL (transistor-transistor logic) to allow direct computer control and interface. Improved transport and signal system performance. Unparalleled precision in tape tension control.

## More Pluses

Adaptability and flexibility made possible by three types of plug-in electronics. Wideband phase-lock servo and linear tape tension control. Improved time base error, dynamic skew and cumulative flutter. Upgraded flutter floor and flutter sideband performance. Flutter suppression using a phase-lock servo with a correction range of 300 Hz.

And that's not all.

STARR offers Direct, FM and Pulse Code Modulation. STARR can record up to 33,000 bits of data per inch per track of tape with an error rate of 1 in 10 million bits. And that no one in the industry can match.

## It's Human-Engineered

That's right. Human-engineered, for ease of operation, maintenance and astonishing good looks. Back-lighted controls, easy to read, are at waist height for immediate access. Double-swing doors reduce floor space requirements.

STARR can be had with the broadest line of accessories anywhere to provide total system capability. These include bin loop adapters, monitor scopes and meters, front panel attenuators, voice logging, shuttle control, tape footage counters, automatic degaussers, FM calibrators, analog test sets, digital PCM data simulators and bit error rate checkers.

This is STARR—the state-of-the-art recorder/reproducer that provides solutions.

For more information, please mail the coupon. You'll like what you see.

Bell & Howell  
360 Sierra Madre Villa, Pasadena, California 91109

Yes, I agree that STARR sounds like the answer to my data acquisition problems. Please send me more information immediately.

Name \_\_\_\_\_ Title \_\_\_\_\_

Company \_\_\_\_\_

Address \_\_\_\_\_

City \_\_\_\_\_ State \_\_\_\_\_ Zip \_\_\_\_\_

Phone number \_\_\_\_\_





**BELL & HOWELL**



**BELL & HOWELL**

**BELL & HOWELL**

**BE HOWELL**

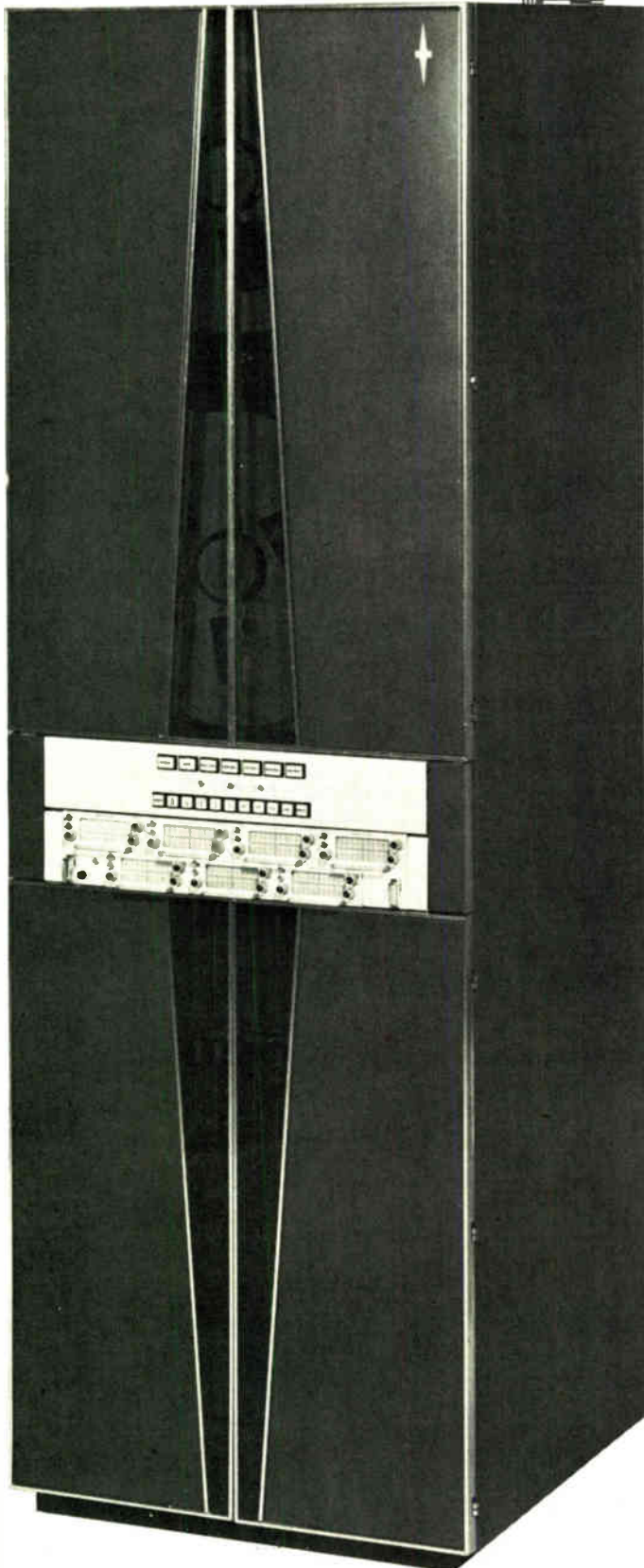

Circle 81 on reader service card

# We've lined up some great ways for you to go

You've got a direct line to the best possible RF and microwave power amplifiers. At competitive prices. Because TRW makes the best—and broadest—line of competitively priced RF transistors.

That means performance, ruggedness and reliability. It means gold metallization, ballasted emitters and the best thermal dissipation characteristics.

Reliability is designed right in. Along with top performance.

From the highest powers with the lowest IMD's at HF — to microwave with highest powers and lowest  $\theta_{j-c}$ .

So no matter what you're making, new design or current production item, you'll make it better...with the best.

**If you make RF and microwave amplifiers, use these TRW transistors to make them better**

## OSCILLATORS 1.5-3.0 GHz



PT5784  
1.5-2.0 GHz



2N5482  
1.8-2.3 GHz



PT5798  
2.3-3.0 GHz

For complete set of data sheets, circle Reader Service Card number 201

### Features:

300mW — 1W output.  
Low noise figure.  
Gold metallized for reliability.

## SINGLE SIDEBAND RADIO—12V. Marine, mobile, amateur 1.5-30 MHz

10mW →



PT5701



2N6458



using two  
PT66460

→ 120 WATTS MIN.  
—32 Db IMD  
1.5-30 MHz

For data sheets and 100W application note CT-129, circle Reader Service Card number 202

### Features:

Up to 75W per device—PEP or CW.  
Infinite VSWR. Better than —32Db IMD.  
High gain, broadband design.

## SINGLE SIDEBAND RADIO—28V. High power base stations, marine radio 1.5-30 MHz

25mW →



PT8551



2N5707

























using two  
PT6665A

→ 180 WATTS MIN.  
—32 Db IMD  
1.5-30 MHz

For data sheets, 320W and 1KW application note CT-129, circle Reader Service Card number 203

### Features:

Full 1KW broadband amplifier easily made from combination of four 320W modules.  
Up to 100W per device—PEP or CW.  
Infinite VSWR. Better than —32Db IMD.  
High gain, broadband design.

<p><b>VHF/UHF AMPLIFIERS</b>—VHF/UHF communications, tactical radio, instrumentation.</p> <p><b>VHF, 30-200 MHz:</b></p> <p>200mW →  →  →  → 125 WATTS MIN. AT 175 MHz</p> <p>PT9732      PT9733      using two J01001</p> <p><b>UHF, 200-600 MHz:</b></p> <p>100mW →  →  →  → 55 WATTS MIN. AT 400 MHz</p> <p>PT9700      PT9703      using two PT9704A</p> <p>For complete data sheets, circle Reader Service Card number 204</p>	<p><b>Features:</b> High gain. High power. Ballasted for ruggedness. Get required output with fewer devices.</p>
<p><b>UHF TACTICAL RADIO</b>—225-400 MHz broadband operation</p> <p>1mW →  →  →  →  →  → 275 WATTS MIN. 225-400 MHz</p> <p>CA870      PT9701      J02005      J02015      using four J02015</p> <p>For data sheets and broadband 120W/60W amplifier application note CT130, circle Reader Service Card number 205</p>	<p><b>Features:</b> Designed for high power broadband operation. Drivers and finals input matched.* TRW gold system for reliability.</p>
<p><b>MOBILE BASE STATION—RADIO RELAY—ECM—600-1000 MHz (28V)</b></p> <p>1W →  →  →  → 36 WATTS MIN. AT 1000 MHz</p> <p>2N5482      2N5595      using two 2N5596</p> <p>For complete set of data sheets, circle Reader Service Card number 206</p>	<p><b>Features:</b> High gain. Ballasted for ruggedness. Gold metallized for long life. True hermetic package.</p>
<p><b>ECM—TELEMETRY—RADIO RELAY—INSTRUMENTATION—400-1000 MHz</b></p> <p>100mW →  →  →  → 35 WATTS 400-600 MHz</p> <p>PT9700      PT9703      J02401</p> <p>300mW →  →  → 18 WATTS 600-1000 MHz</p> <p>MRA0610-3      MRA0610-18</p> <p>For complete set of data sheets, circle Reader Service Card number 207</p>	<p><b>Features:</b> Broadband high power. Gold metallized. Ballasted for ruggedness. Internally matched final devices.*</p>
<p><b>RADIO RELAY—TELEMETRY—ECM—INSTRUMENTATION—1-2.3 GHz</b></p> <p>100mW →  →  →  →  → 20 WATTS AT 2.3 GHz</p> <p>TRW2001E      TRW2003      TRW2010      using two TRW2010</p> <p>For complete set of data sheets, circle Reader Service Card number 208</p>	<p><b>Features:</b> Will withstand infinite VSWR. Highest gain. Gold metallized for long life.</p>

Your TRW Distributor has data sheets and application notes on the full line of TRW RF power transistors. For additional information, write TRW Semiconductors, an Electronic Components Division of TRW, Inc., 14520 Aviation Blvd., Lawndale, California 90260. Or call Don Comm at (213) 679-4561.

\*TRW Patent 3,317,006

**TRW SEMICONDUCTORS**

**These products are available through the following authorized distributors:**

Almo Electronics  
Bell Industries  
Cramer Electronics Inc.

Electronics Marketing Corp.  
Elmar Electronics Inc.  
Hall-Mark Electronics Corp.

Pyttronic Industries Inc.  
Rochester Radio  
Semiconductor Concepts Inc.

R. V. Weatherford Co.  
Westates Electronics Corp.  
Wilshire Electronics

# Counters: Another new way to think of Tektronix

You get more quality, functions, and counting-time capability per dollar with the Tektronix DC 505 Universal Counter. This compact, dual channel counter performs virtually any counting-timing function up to 225 MHz.

Various functions include conventional frequency operation on channel A, ratio of channel A frequency to channel B frequency, period of signal B time interval from channel A start to channel B stop, width of signal in channel B, number of events in channel A during channel B gate, and totalize. The DC 505 also features in-

dependent selectable averaging factors and clock rates to 10 ns. By use of maximum averaging on width or interval measurements of repetitive waveforms, resolution to better than 100 picoseconds is possible. With all these features, the DC 505 is priced at only \$1,295

Other Tektronix counters in our expanding line include:

DC 501 Seven digit, 110 MHz counter and totalizer . . . . . \$ 625

DC 502 Similar to DC 501 with divide by 10 pre-scaler for counting to 550 MHz . . . . . \$ 975

- Frequency range: 225 MHz (both channels)
- Time interval: single-shot resolution to 10 ns
- Time interval averaging: resolution to 100 ps
- Repetitive pulse width measurements to 2.5 ns

Counter  
Price, \$1,295  
Actual Size

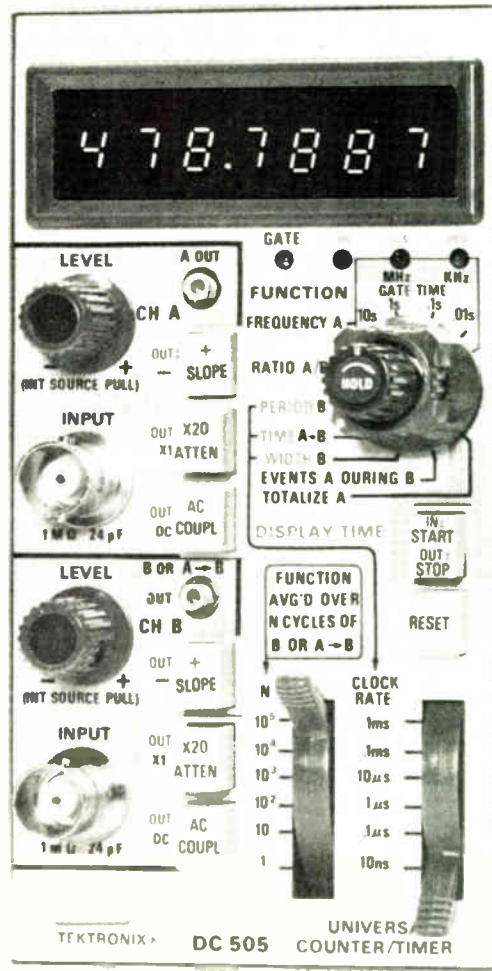

Simulated Display

DC 503 Seven digit, 100 MHz universal counter with dual channels .....\$ 725

DC 505 Seven digit, universal counter, 225 MHz on both channels .....\$1,295

Tektronix offers many other test and measurement instruments in the TM 500 Series in addition to counters. These include: multi-meters, power supplies, signal sources, signal processors, and CRT monitors. Presently, 24 general purpose modular test instruments are available with many more to come. These instruments are inter-

changable. They plug into one compartment (\$115) or three compartment (\$150) power units. Instruments in the three compartment unit can be interconnected via a common interface board. This results in increased measurement capabilities and can actually produce synergistic effects. The TM 500 Series is based on the latest technology and proven principles developed in oscilloscopes. In addition, the TM 500 Series gives you more performance per dollar than competing instruments. Send for a free brochure and spec sheets on counters, and our

other TM 500 test and measurement instruments. They're all new ways to think of Tektronix.

Write: Tektronix, Inc.  
P.O. Box 500  
Beaverton, Oregon 97005

In Europe write:  
Tektronix Ltd.  
P.O. Box 36  
St. Peter Port, Guernsey, C.I., U.K.

U.S. Sales Prices FOB Beaverton, Oregon



Digital Multimeter  
Price, \$395 to \$505

Pulse Generator  
Price, \$1,150

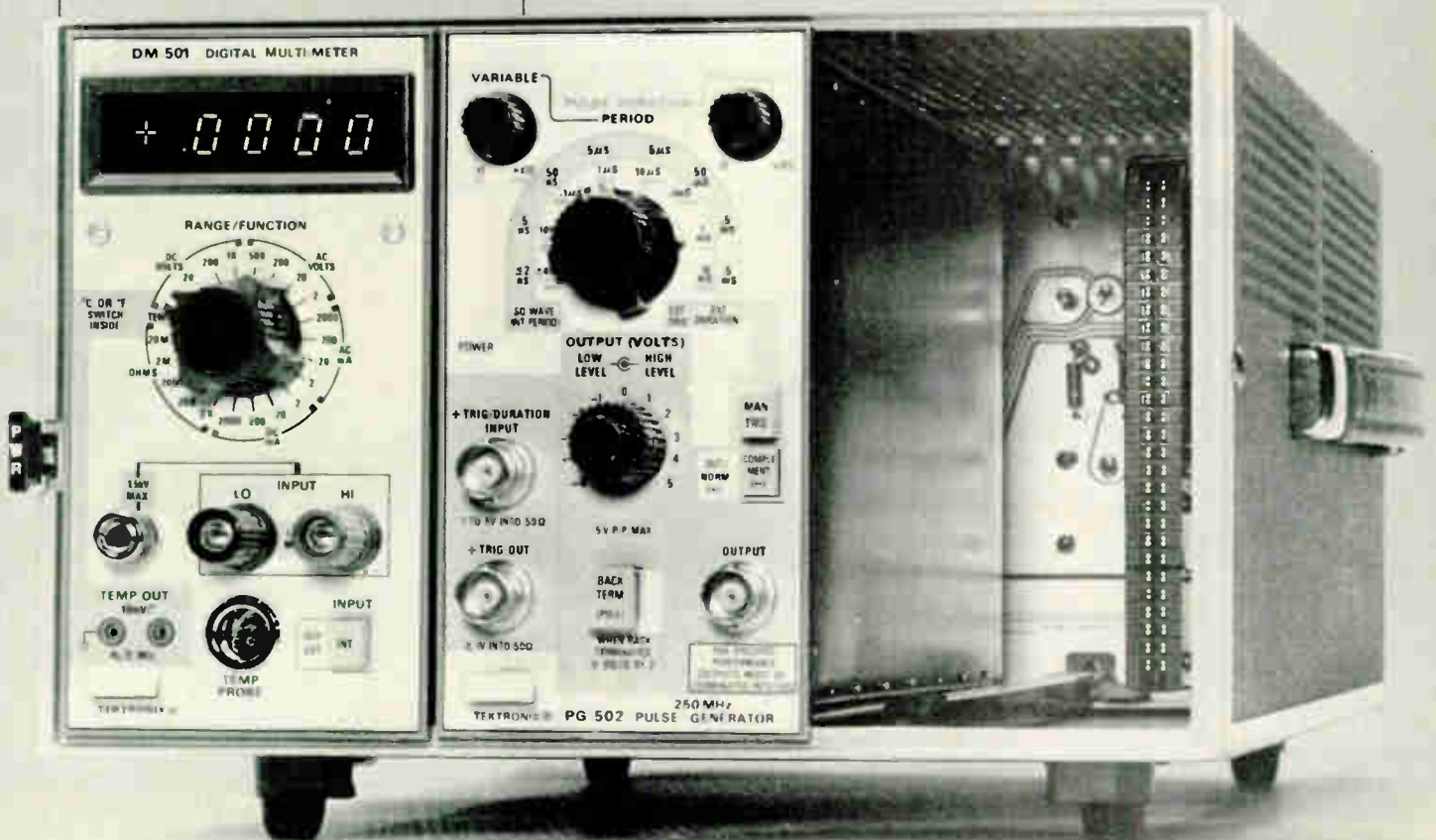

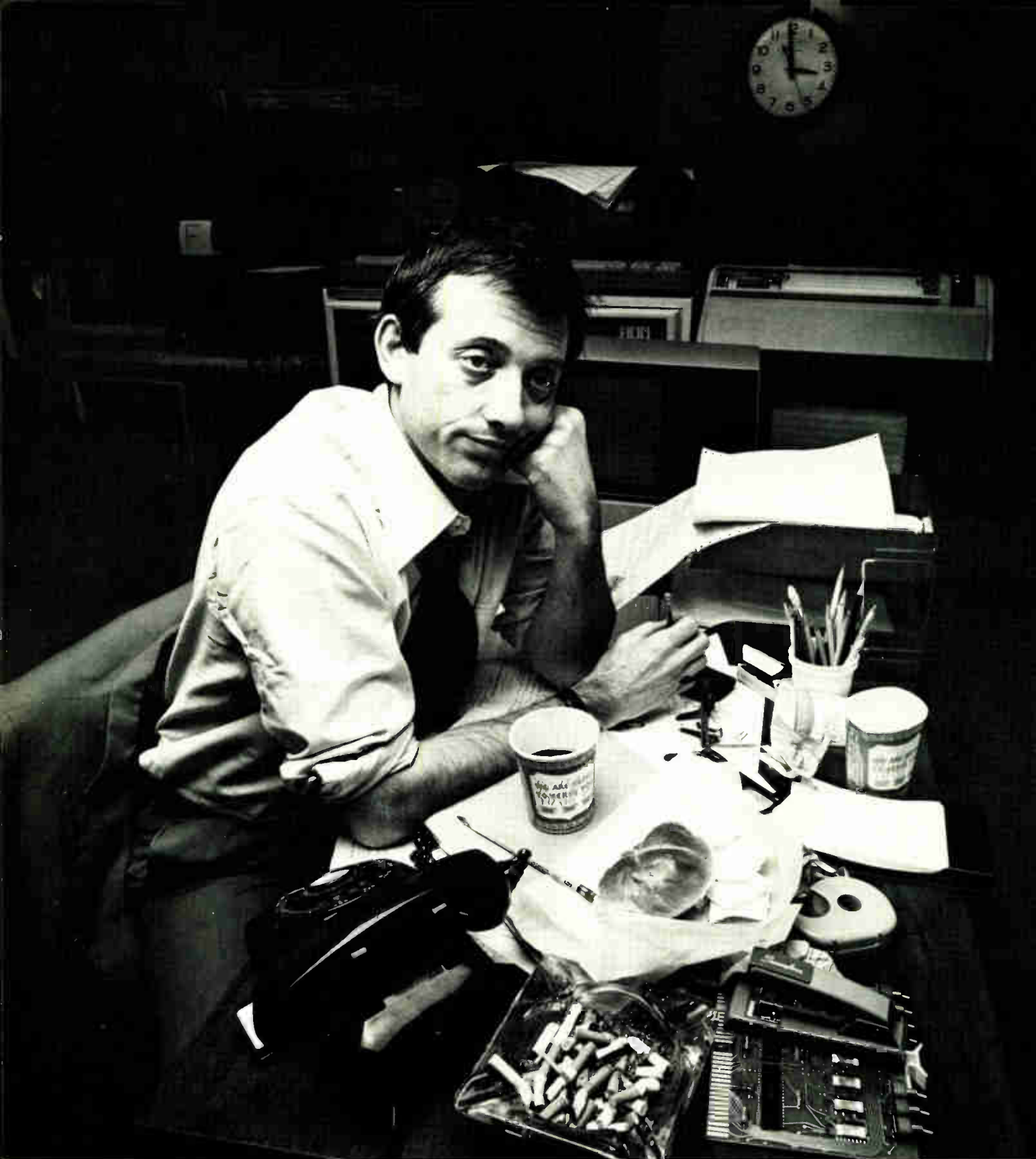

**It's hard to love the hardware  
when the software is keeping you  
up all night.**

There's a lot of great hardware around. But not much great systems software.

Which explains why a lot of programmers don't get much sleep. And why software development usually ends up costing more than the hardware.

When we make a computer, we put as much work into the software as the hardware.

So there's less work for you to do. And the work you have to do goes a lot faster.

Our Real-Time Disc Operating System (RDOS) lets you work the way you want. Interactively. Or Batch. It has a file management system that doesn't need any work at all. (It'll fit any application as is.) RDOS supports higher level languages. And utilities like MACRO Assembler, Text Editor and Symbolic Debugger make it easy to pull everything together.

And once you've finished your applications software, your job is done. Because RDOS helps run your programs as much as it helps write them.

It even lets you do two things at the same time. Like write new programs while you're running old ones. Or run Timesharing and Batch. Or Remote Job Entry and Timesharing.

Buy a Nova 840 from us and we'll give you RDOS. Free.

Then maybe you and your programmers can go home and get a good night's sleep.

# DataGeneral

The computer company you can understand.

◆ Data General Corporation, Southboro, Massachusetts 01772, (617) 485-9100.  
Datagen of Canada Ltd., Hull, Quebec (819) 770-2030/Data General Europe, Paris, France 504-23-44.

Circle 87 on reader service card

# Remember the time you wanted something special in 3½ digits?

## Your time has come.

When we at Analog Devices introduced the 5-volt digital panel meter, we said there'd be more — a lot more. Look what we can offer you in 3½ digits alone.

Why so many? To give you a choice. So you won't have to order or build specials anymore. Because now we've made what you need a standard.

Let's say you need 3½ digit resolution. You can get it displayed in Numitron, LED, or even Sperry.

In Numitron, we can even give you a choice of green or red.

Now you have to power it. Most of our meters are 5 volts DC

because so much of what you're working on is in TTL logic. But if you need one that can run on 115 volts AC, you've got it. The AD2006 with Sperrys — in AC or DC. It's our latest DPM. But not our last.

You may even be designing something that will end up in another country. We can help you there too. With meters that will operate on voltages in Europe, the U.K., Japan, and just about anywhere else.

If you look closely, you'll see that one meter isn't a meter at all. It's a remote display. Sometimes you need that kind of thing.

But then giving you what you need is what it is all about. Like reliability. And extra features like card edge connectors. Ratiometric inputs. .05% accuracy. And low prices. Ours start at \$49 in hundreds for the remote display.

Now, would you like to see what we can do for you in 4½ digits — or 2½ digits? Give us a call. We'll see that you get a copy of the "Designer's Guide to Digital Panel Meters." And any other help you may need.

Analog Devices, Inc., Norwood, Mass. 02062. On the East Coast, call (617) 329-4700. In the Midwest, (312) 297-8710. And on the West Coast, (213) 595-1783.

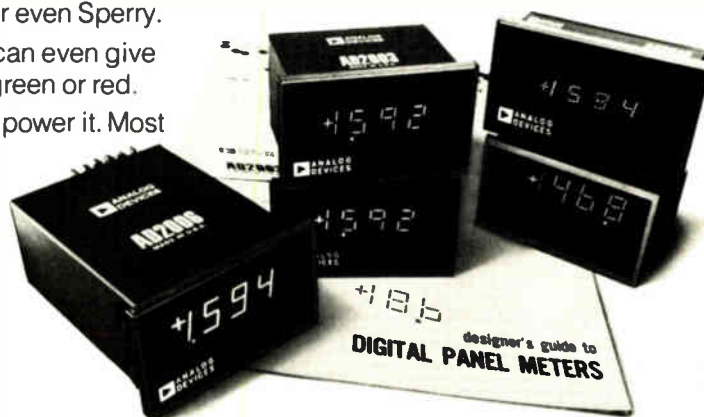

 **ANALOG  
DEVICES**

## Then it was special. Now it's a standard.





---

**Passive component makers—once seemingly threatened by integrated circuits—are, instead, adapting to demands of IC technology through miniaturization, new materials, and better packaging**

---

by Joel DuBow,  
*Components Editor*

# SPECIAL REPORT

□ These are boom times for passive components. There is now a ferment of demand and technological innovation fully as exciting, but less visible, than for their more glamorous cousins, the integrated circuits.

As ICs have increased their penetration into previous existing applications and have spawned entirely new applications, passives have developed concurrently to complement them. And, even though integration has decreased the need for passives in some pieces of equipment, demand for many more products has increased the demand for passives.

For example, each hand-held calculator chip requires four outboard capacitors. Each automobile seat-belt interlock needs 12 different passive components. A multimeter typically requires five ICs and 10 passives. Every power supply in every computer system requires resistors and electrolytic capacitors. And many transistor-transistor logic circuits require pull-up resistors.

Manufacturers of passive components have met these challenges with new components, new materials, and advances in older products to meet the power and speed demands of IC systems. These advances span the frequency range from dc to 5 gigahertz and a voltage range from 5 volts to 50 kilovolts. To complement the operation of ICs—a major application for passives—size, power, and voltage ratings have been reduced along with decreases in cost.

A significant trend in the passive-component industry has been the gradual shift from the military/aerospace market, where high performance was paramount, to consumer and industrial markets, where cost per unit performance is the critical parameter. This is particularly true in automotive, television, audio, and other consumer applications.

Another major trend is miniaturization. Engineers

	Dielectric constant	1-MHz dissipation factor to	Capacitance per cm <sup>2</sup>	Capacitance per 100 mil <sup>2</sup>	Voltage rating
Silicon monoxide	6.0	0.5	6,000 pF	375 pF	40 V
Silicon dioxide	3.8	0.03	3,800 pF	240 pF	60 V
Silicon nitride	9.4	1.0	9,400 pF	600 pF	100 V
Aluminum oxide	9.0	0.05	9,000 pF	560 pF	100 V

have demanded, and manufacturers have produced, resistors having smaller power specifications and sizes. Capacitor voltage ratings, far in excess of IC operating voltages, have been reduced, and smaller, faster relays for solid-state applications have been developed.

The greatest technical advances have been made in three main areas:

- Development of new materials and better control and understanding of standard materials.
- Computerizing control of production lines for such tasks as laser-trimming, wire-winding, and assembly.
- Improving types of packages and automation of packaging techniques.

### Technology advances

The recent materials shortage has led to advances in technology. Thinner films are being investigated for plastic-film capacitors, and intensive efforts are being made to develop inks for thick-film networks and for capacitors that do not contain any of the increasingly expensive rare earths, such as silver, palladium, or platinum.

What's more, during the past five years, there have

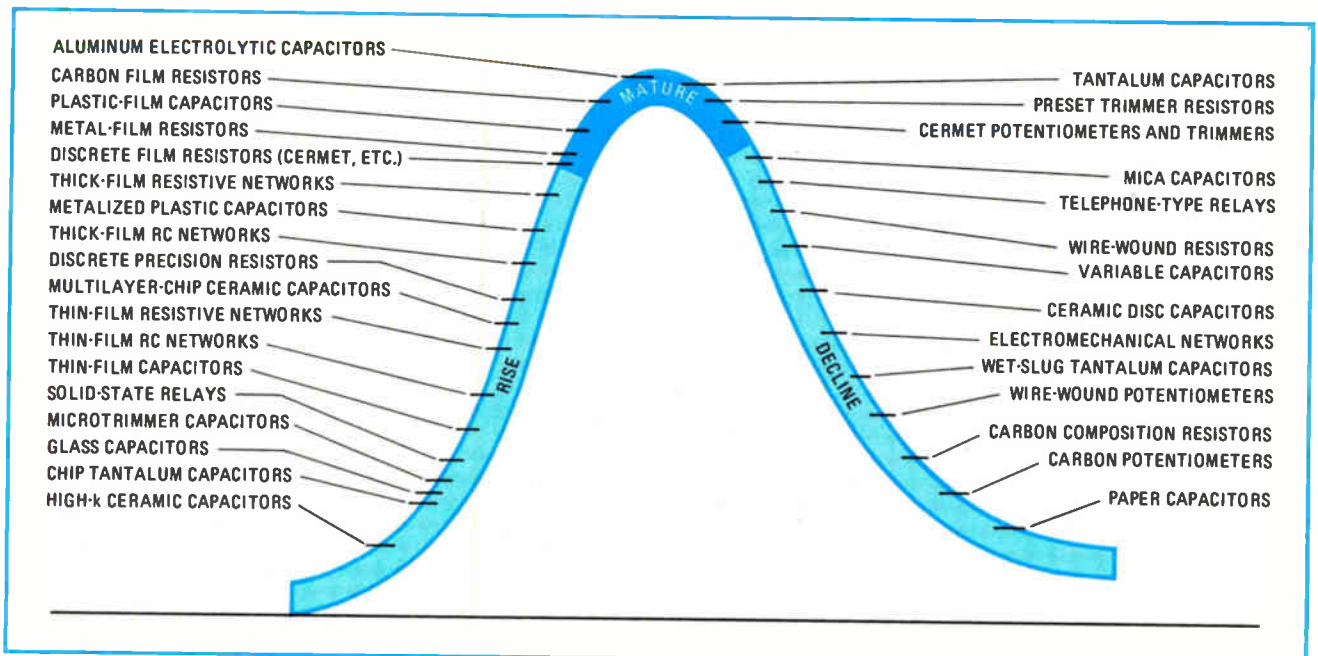

1. **Life-cycle curve.** The relative position in life cycles of various passive components are charted on a bell curve. Generally, the newer technologies occupy the ascending portion of the curve, and the superseded technologies are on the declining portion.

been changes in product mix, development of new components, and technical advances in some older products. New technologies in semiconductors and instrumentation have led to demands for different passive components and for different forms of existing passives.

For instance, the stacked-foil aluminum electrolytic capacitor, which extended the operating frequency into the range of tens of kilohertz, was developed for high-frequency switching and ferroresonant-type power supplies. Not in existence a few years ago, the stacked-foil capacitor is now one of the fastest-growing passives.

- Multilayer ceramic-chip capacitors have been a boon to digital-circuit designers by providing high-frequency bypass with short lead runs and have helped improve microwave-circuit designs. Five years ago, these chips were hardly available.

- Tolerances, costs, and stability of discrete resistors have been improved through the use of laser trimming.

- Solid-state relays offer speed, electrical isolation, and reliability in an IC-compatible form and switch high currents that would be difficult and too expensive if done any other way.

- Networks in dual in-line and molded single in-line packages, compatible with automatic-insertion equipment, provide compactness, savings, and closer tolerances than their discrete-assembly counterparts.

In addition, the performance of many passives has been upgraded. New designs dissipate less power and can utilize the space savings and cost advantages of lower-power designs. A discrete resistor now can handle lower power and offer closer tolerances. The discrete resistor standard five years ago was  $\frac{1}{2}$  watt, 10% tolerance; today it is  $\frac{1}{4}$  W, 5% tolerance. In a few years, it will probably be  $\frac{1}{5}$  or  $\frac{1}{10}$  W.

### Life goes on

An examination of the estimated points in the life cycles of various components (Fig. 1) helps in understanding the technical trends in the passive-components industry during the past few years. Most of the technical effort will be directed at the more rapidly growing areas, which are shown on the left-hand, rising, portion of the curve. These are applications that are simply not amenable to integration.

Indeed, many properties of passive components are difficult, if not impossible, to realize on IC chips. For example, one resistor rated at 10%,  $2 \times 10^{11}$  ohms, operates over a temperature range of  $-270^{\circ}\text{C}$  to  $+200^{\circ}\text{C}$  and has 0.1 picofarad shunt capacitance. Using resistors 1 micrometer thick and 100 ohms per square on silicon would require, with lines 0.5-mil wide, a path 10 inches long and require about three times the area of a typical LSI chip, to say nothing of tolerance, temperature range, repeatability, noise, and parasitic capacitance.

Just how difficult it is to integrate capacitors is shown in Table 1, where the allowable values for the three types of capacitor-chip dielectrics are listed. The chart indicates that a 0.1- $\mu\text{F}$  silicon-nitride bypass capacitor would occupy 10  $\text{cm}^2$ , or about 60 times the area of the 200-mil<sup>2</sup> chip it is to bypass. In addition, a 0.1- $\mu\text{F}$  ceramic disk might cost 5 cents, while the silicon-nitride capacitor, which could occupy one third of a three-inch wafer, would be considerably more expensive.



## Capacitors lead charge of passive components

Capacitors have grown faster than other passive components, and their long-term growth rate is expected to continue strong at 12% a year.

The biggest demand has come in automotive equipment, digital circuits, power supplies, and, more recently, microtrimmer capacitors for digital watches. Each of these applications has its own particular capacitance requirements. For the design engineer, new developments in capacitor technology have created new options and improved performance for such circuit functions as bypassing and filtering.

A combination of new dielectrics and improvements in old dielectrics allows a designer to choose an optimum dielectric for the capacitors he needs. For example, Table 2 lists key parameters for the most popular dielectrics. Special values, such as solid-tantalum capacitors with closer than  $\pm 5\%$  tolerance, are available, but, like most custom components, the cost of such units is higher.

In addition, a knowledge of such parameters as temperature coefficients and dissipation factors enables the knowledgeable designer to characterize the device he actually has in the circuit and not some idealized element. This can be crucial at high frequencies, where a capacitor can begin to act like an inductor or a resistor and thereby invalidate calculations that assume a purely capacitive impedance.

In general, the parameters of interest in selecting a capacitor are:

- Value: capacitance, measured in microfarads and picofarads, to ensure calculation of proper reactance characteristics.

- Capacitance tolerance: the maximum deviation, expressed in per cent, from nominal capacitance value at a standard temperature, frequency, and voltage.

- Temperature coefficient: the change in capacitance per degree Celsius, expressed in parts per million.

- Temperature-coefficient tolerance: the maximum percentage of uncertainty in temperature coefficient.

- Dissipation factor: the ratio of reactance to equivalent series resistance of the capacitor (Fig. 2). This is the inverse of the Q, or quality factor.

- Insulation resistance: ratio of dc voltage across a capacitor to the dc current through it. This is measured after steady state is reached.

# SPECIAL REPORT

- **Stability and aging:** change in capacitance as a fraction of time when operated near the rated voltage.
- **Dielectric absorption:** the charge remaining after a fully charged capacitor is momentarily discharged, expressed as a percentage of the original charge.
- **Voltage coefficient of capacitance:** the change in capacitance from an applied dc or ac voltage, caused mainly by dielectric deformation and polarization change.
- **Frequency variation of capacitance:** differs from the ordinary decrease in reactance with frequency, and actually results in a smaller reactance than is expected. It arises when the capacitor begins to act like a transmission line. This generally occurs when the wavelength of the frequency to be passed approaches the physical size of the capacitor, including the leads. The property is most pronounced in porous-anode tantalum capacitors.
- **Maximum dc and ac voltage:** may be different, especially for electrolytic capacitors. Exceeding these values often degrades a capacitor or ruins it.
- **Equivalent series resistance and inductance:** parasitic elements, which are a function of such factors as dielectric losses and lead lengths. They can dominate the impedance at high frequencies.

The combination of various electrical parameters, physical configuration of the dielectric, and ease of manufacture leads to a natural division of capacitance values for each dielectric. Figure 3 shows the available capacitance ranges for the most common dielectrics.

## Selecting an electrolytic

Before one can appreciate the improvements in electrolytic capacitors—whether ceramic, tantalum, or aluminum—it is necessary to understand the terms that define their performance limitations. To begin with, an electrolytic capacitor is actually a series-resistance-capacitance-inductance circuit (Fig. 2).

At low frequencies, impedance is dominated by ca-

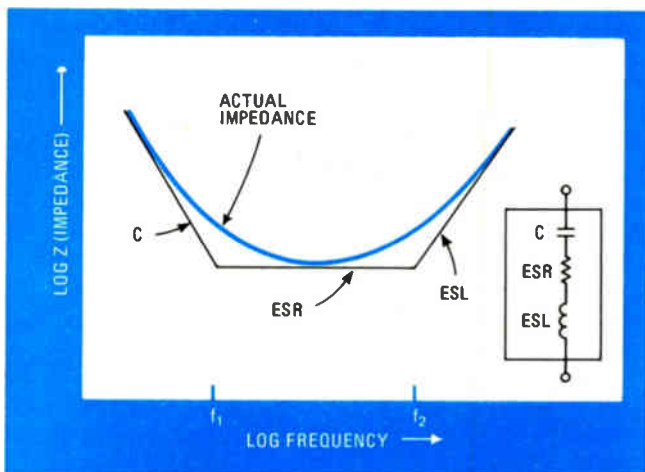

**2. Actual capacitance.** The capacitor is limited by its series resistance and series inductance. Reducing these parasitic quantities makes the capacitor's behavior approach the ideal over a wider frequency band. Capacitance also varies with temperature and voltage.

pacitance, which decreases as the inverse of the frequency. At some minimum impedance value, the equivalent series resistance (ESR), which may be in milliohms, dominates impedance. But at higher frequencies, the equivalent series inductance (ESL), which includes lead inductance, dominates the impedance. For example, a  $10^5$ -microfarad aluminum electrolytic capacitor with 1 milliohm ESR and 1 nanohenry ESL will have an  $f_1$  of 1.16 kHz and an  $f_2$  of 40 kHz.

Therefore, above 40 kHz, the filter capacitor suddenly begins to act like an inductor. Similarly, values may be calculated for ceramic and tantalum capacitors, and the frequency,  $f_1$ , may be calculated for the point at which they cease to be good bypass capacitors. Figure 4 shows the useful operating-frequency range for various types of capacitors. Values indicated by dotted lines indicate potential performance in special configurations.

The requirements for a good bypass and filtering capacitors are similar. Both components require low ESR and low ESL. For bypass and filtering applications, this will reduce resistive losses, which vary as the product of ESR, capacitance, and frequency, allowing higher frequency of operation.

## Regulating power supplies

For regulated power supplies of the switching or series-regulated type, which operate far above the 60-Hz line frequency, typically in the range of 20 to 30 kHz, the capacitors act both as filters and energy-storage elements. For energy storage, a high value of capacitance is needed. For filtering, however, the ripple current at the power-supply operating frequency is dissipated in the capacitor ESR and ESL combination. This leads to

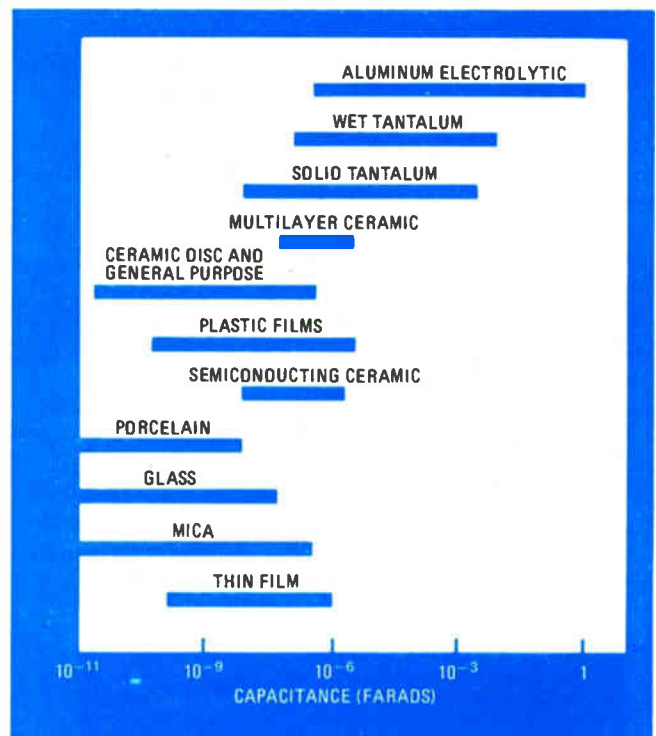

**3. Charting the size.** The combination of achievable dielectric constant, usable dielectric thickness, and producibility limit the capacitance value associated with a given material. Ranges from 1 farad to fractions of picofarads are available.

heating, and, if the ripple-current rating of the capacitor is exceeded, to device degradation and failure.

As integrated-circuit logic speeds were increased, the need arose for improved electrolytic bypass and coupling capacitors. Basically, when the inductive and capacitive reactance cancel, the resulting impedance becomes purely resistive at that point, and the capacitor ceases to bypass. This again calls for low ESR and ESL. A useful figure of merit, which is called the low-Z factor, is defined as the ratio of the capacitance (in microfarads), to the product of ESR (in milliohms) and ESL (in nanohenries).

Nevertheless, other factors such as cost, the size, and the available voltage ratings, are also important in selecting capacitors. If units with low ESR and ESL are large and costly, then it would be desirable to buy two less-costly units and put them in parallel, especially if a design isn't cramped for space.

The term CV product, or volumetric efficiency, is useful for evaluating capacitors. Volumetric efficiency is defined as capacitance (in microfarads) times voltage rating (per cubic inch). Since size and cost are important considerations in design, a useful over-all figure of merit for electrolytic capacitors is the cost/performance/size factor (CPS). The higher the CPS, the better the unit. This is expressed as:

$$CPS = \frac{\text{capacitance} \times \text{voltage rating}}{\text{cost} \times \text{size} \times ESL \times ESR}$$

where capacitance is in microfarads, voltage rating in volts, cost in dollars, size in square inches, ESL in nanohenries, and ESR in milliohms.

#### Aluminum stacks up well

Each technology has its own peculiar advantages, and, in different applications, different advantages may be dominant. For high-capacitance filtering, aluminum electrolytic capacitors have the advantage, but for low-capacitance bypass, ceramic chips are superior. Therefore a couple of parameters such as capacitance, voltage rating, and perhaps size must be chosen, and then the CPS or the dielectrics should be compared. A given di-

electric may have a good CPS factor, but it may not look as good for the size and voltage rating needed.

Of course, there are also special applications where price is the only consideration. In others, such as rf and microwave-amplifier design, cost could be secondary to low Z factor. The various figures of merit are useful to the engineer who knows what his requirements are.

The big news in aluminum electrolytic capacitors is the stacked-foil construction. Compared to conventionally wound constructions, the stacked-foil configuration reduces both the ESR and ESL by more than an order of magnitude. This raises the useful frequency of operation from 5 kHz to 50 kHz. Moreover, since power-supply ripple current is dissipated in ESR, the ripple-current tolerance of these devices is also higher. Although the cost is 50% higher, volumetric efficiency is 50% lower because the stacked foil, which comes in cylindrical cans, has about one half the capacitance per unit volume of older units. In addition, for units with a voltage rating greater than 50 v, the ESRs of stacked-foil and conventional units begin approaching each other, although stacked-foil units retain their advantage in ESL. This suits the stacked-foil electrolytics ideally for supplying low-voltage dc to ICs.

However, stacked-foil construction, pioneered by Sprague Electric Inc., North Adams, Mass., in this country and Siemens in Europe, is merely the most visible advance in new capacitor design. The guts of the electrolytic capacitor are in the oxide system. Ronald McManus, applications manager for aluminum and tantalum capacitors at Sprague, points out that improved aluminum-foil etching and forming, abetted by improved purity of the base metals, has led to aluminum oxides that are resistant to both dc and ac. Previously, capacitors were designed to operate with either dc or ac, and it was fortuitous if they functioned well with both kinds of current.

During the next couple of years, manufacturers of aluminum electrolytic capacitors will strive to reduce ESL and ESR further in an effort to extend the useful operating frequency (Fig. 3) from the current tens of kilohertz into the megahertz region. Another technical

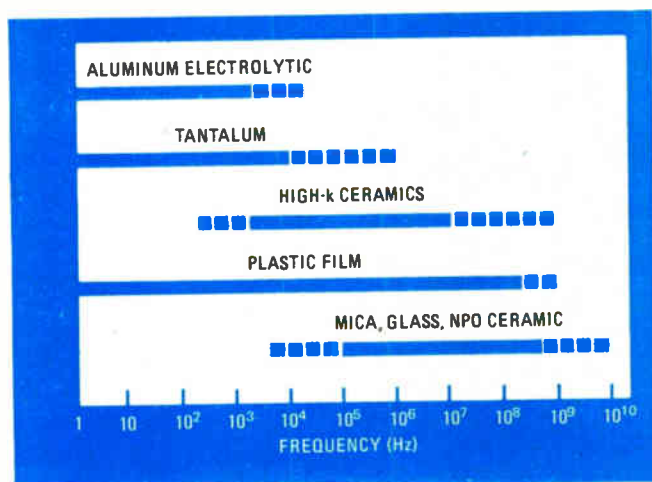

4. Frequency of use. Adjusting the dimensions and configuration of a dielectric varies the parasitic resistance and inductance. The individual dielectric properties and intrinsic losses determine its ultimate upper frequency of operation.

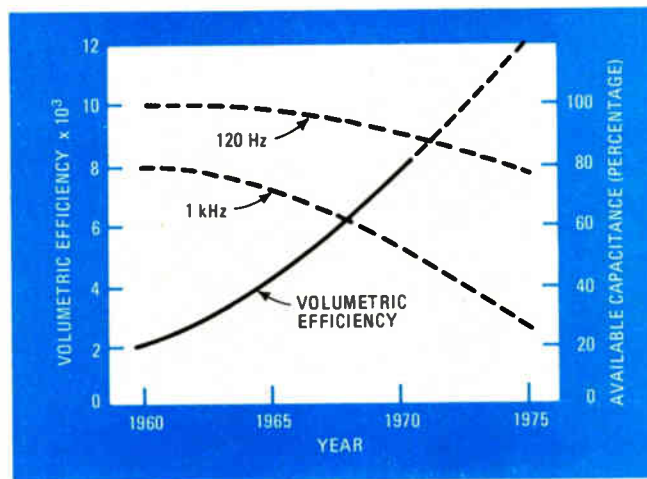

5. Tantalum in progress. Reduction in particle size and control of tantalum powder have decreased the potential loss of capacitance at higher frequencies, increased the capacitance per unit volume, and increased the upper frequency.

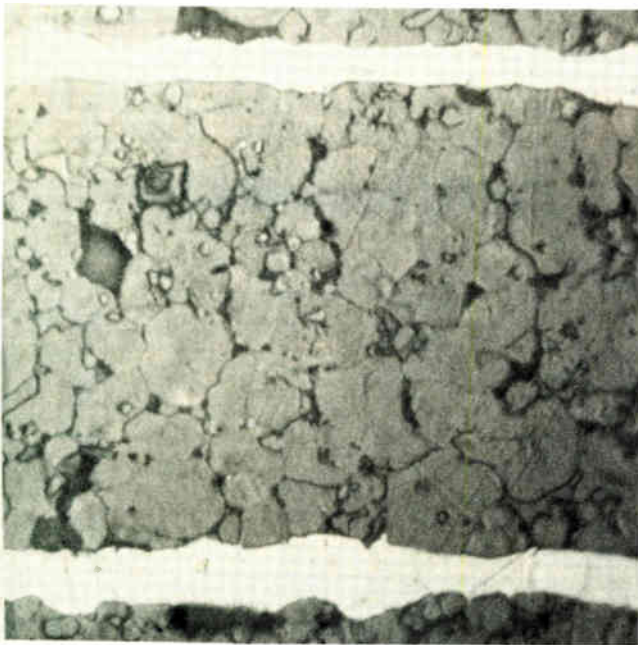
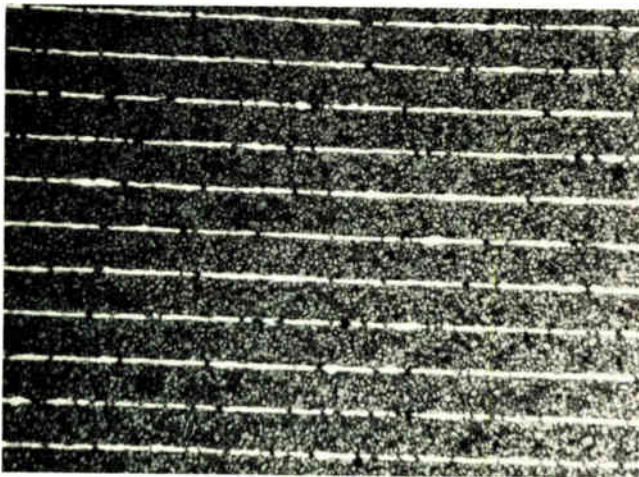
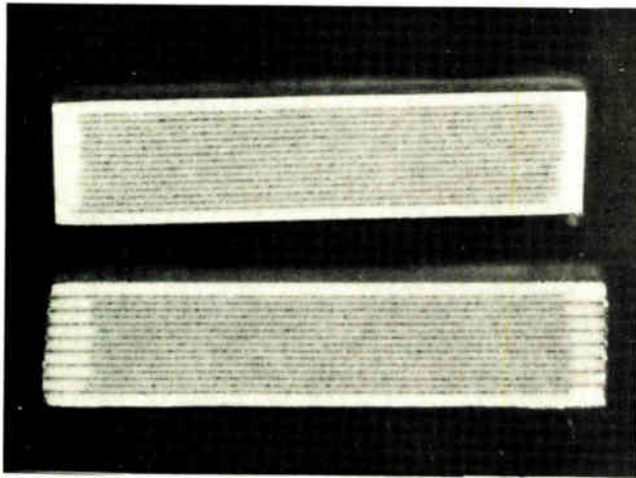

**6. A grain of truth.** The multilayer ceramic capacitor, magnified above, is growing in popularity. Reducing layer thickness would make these ceramics even more attractive by providing for higher frequencies of operation and higher capacitance per unit volume.

effort will concern producing smaller capacitors for such applications as switching-regulator power supplies. Now, while these supplies have eliminated bulky transformers, they are left with bulky capacitors, necessitated by the requirement for low ESR.

### Tantalum takes a powder

Progress in tantalum capacitors has followed another route. These capacitors have a high volumetric efficiency and provide high capacitance in small chip sizes. Their physical shape is flexible because they are made differently from the essentially parallel-plate style of other capacitance types.

A high-purity tantalum powder is pressed into a slug or pellet, and then a tantalum wire, which will form the anode, is pressed into the pellet. This slug is then sintered in a vacuum at high temperatures, which yields a porous structure, and then is anodized in an acid bath. This results in a thin (typically 3.5- $\mu\text{m}$ ) tantalum-pentoxide dielectric in the pores and on the surface. Finally, the electrolyte and cathode electrode are formed by either dipping in manganese nitrite and converting that pyrolytically to manganese dioxide or by introduction of a gelled sulfuric acid.

By the first method, a solid-tantalum capacitor is formed; by the second, a wet-slug tantalum capacitor results. The solid-tantalum capacitor offers more stability with time and temperature. The wet-slug tantalum offers low leakage current and high volumetric efficiency.

The strength of another type, the tantalum-foil capacitor, is in high-voltage, nonpolar designs, but the trend today is to lower voltage ratings, and tantalum foil is declining in usage relative to the lighter and cheaper aluminum electrolytics. Because the dielectric in tantalum is so thin, transient voltages must not exceed maximum ratings. In addition, high-level ac applications can cause excessive heating, which can also damage the dielectric.

### Porosity provides efficiency

The porous construction of tantalum capacitors makes possible high efficiency at low cost. There has been an upsurge in their use as bypass capacitors in digital circuits because of their economy and capabilities of power-handling at low frequencies.

Although the series resistance of the tantalum capacitor can arise from either the sintered electrolyte material itself or the contacts and leads, experimental studies have shown that electrolyte resistance is normally the greater of the two. Therefore, over the past few years, the tantalum pellet has been extensively studied for ways to reduce losses and increase volumetric efficiency.

By altering the geometry of porous-tantalum-slug capacitors, a development pioneered by P.R. Mallory & Co., Indianapolis, and used in its THF series, ESR has been reduced by a factor of three, and operating range has been extended to 1 MHz. In addition, the decrease of capacitance at higher frequencies that is characteristic of tantalum has been eliminated, thereby making the impedance-vs-frequency curve more nearly approximate the stated capacitance. Figure 5 shows the increase of tantalum's volumetric efficiency and the at-

TABLE 2. CAPACITOR APPLICATIONS

Characteristic of capacitor		DIELECTRIC							
		Electrolytic aluminum	Tantalum wet anode	Tantalum dry anode	Paper	Multilayer ceramics	Mica receiving	Metalized polycarbonate	Teflon
Capacitance	Capacitance range (μF)	0.5-1,000,000	1.7-5000	0.047-330	0.001-200	0.000005 to 2.5 μF	0.000001-0.1	0.01-5.0 mfd.	0.001-4
	Tolerance standard %	+50, +100, +150, -10	p/m 20% -15, +30, 50, 75	±20	±20	±5 50 GMV	±5	±10%	±10
	Tolerance minimum %	±20	±5%	±5	±2	±5	±1	±1%	±2
Volts	Dc operating	2.5-700	4-125	6-35	50-200,000	20-200	50-2500	50-600	50-1000
	Ac 60 Hz operating	≤50 continuous ≤330 intermittent	Limited	Limited	50-75,000	Seldom used	Seldom used	330 Max.	Seldom used
Dissipation factor	Dissipation factor % at 60 Hz	120 Hz 6 and up, depending on C/V rating	120 Hz varies from <1 to 100, depending on C and V	At 120 Hz 10% max.	0.2-0.5	Seldom used	Seldom used	0.75	<0.1
	% at 1,000 Hz	-	-	-	0.2-0.5	0.01-2.5	<0.1	1.0	0.02-0.05
	% at 1 MHz low-capacitance values	-	-	-	Higher; varies with type	0.1% for NPO	<0.1	0.5-1.0	0.04-0.07
Insulation resistance	Insulation resistance megohm at 25°C	Leakage current 0.1 μA and up depending on C/V rating	Leakage 0.00040-0.0060 μA/μF/volt	Leakage at 25°C 0.02 μA/μF/volt	3000-20,000	100,000	20,000-100,000 megohms/unit	>50,000	>100,000
	Insulation resistance at 85°C, compared to 25°C	Leakage current 4 x 25°C value	Leakage 2-10 times 25°C value	Leakage 10 x 25°C value	1/100	1/20-1/60	1/7	1/20	1/10
Temperature	Operating range °C	-80 +150	-80 +125	-55 +125		-55 +125	-55 +150	-55 +125	-55 +250
	Coefficient TC in % or ppm	See selector chart	Cap. drops from 12-50% at -55°C	Cap. drops 12% max. at -55°C		-	0 to +70 normal ppm controllable	Max. cap. change -2.5 to 2.0% from -55°C to +125°C	±1%
Stability	Capacitance change with temp. aging	Small to large	10%	Medium ±10	Medium	Small	Very small; excellent	Small	Medium
Dielectric absorption	% dielectric absorption at 25°C	-	-	-	0.6-3, depending on impreg.	-	0.3 max.	0.05	0.02-0.05
Size	Varies as	CV approx.	CV approx.	CV approx.	CV <sup>2</sup>	CV <sup>2</sup> and K	CV <sup>2</sup>	CV <sup>2</sup>	CV <sup>2</sup>
	For equivalent CV rating	Very small	Very small	Very small	Medium small	Small	Large	Small	Large
Cost	Relative cost for equivalent CV rating	Very low	Moderate	Moderate	Low	Low	High	Moderately high	Very high
Mil. specs.	MIL-C-	39081	3965	26655	25	11015	5	55514	19978
	MIL-C-	3871			11693				
	MIL-C-				12889				

Notes: Filtering: Low frequency - Aluminum, Tantalum  
High frequency - Ceramic, Teflon, Porcelain  
Bypass: Mica, Ceramic

Starting motors and lamps: Plastic Film  
Temperature compensating: Mica, NPO Ceramic

## SPECIAL REPORT

tendant reduction of available capacitance. All fine-grained, high-efficiency powders lose available capacitance because of distributed impedance effects in the porous anode, but the increased efficiency of modern powders more than compensates for this.

The porous tantalum slugs give high capacitance density, and powders have smaller particle size and increased volumetric efficiency at the expense of ESR and temperature stability. Reducing impurity levels in these powders has substantially improved stability and reduced series resistance. In fact, Wayne Etter, vice president for capacitors for P.R. Mallory, predicts that electrolyte powder and geometry improvements will extend tantalum's frequency range to 100 MHz, as well as increase volumetric efficiency and power-handling capabilities.

This view is supported by Duane Blough, general manager of General Instrument Corp.'s capacitor division, Chicopee, Mass. He declares that the volumetric efficiency of new powders will enable tantalum to invade applications where aluminum now dominates, such as in certain TV circuits. In these applications, which track the general trend toward miniaturization, size will be a critical parameter. However, small, high-value aluminum electrolytics are also in the works, and the designer should keep track of what is available to see which type maximizes the figure of merit for particular applications (see Table 2).

### Ceramic fires up for growth

Ceramic-capacitor technology, spurred by the upsurge in chip-capacitor demand, is attracting a great deal of attention from manufacturers. Capacitor chips

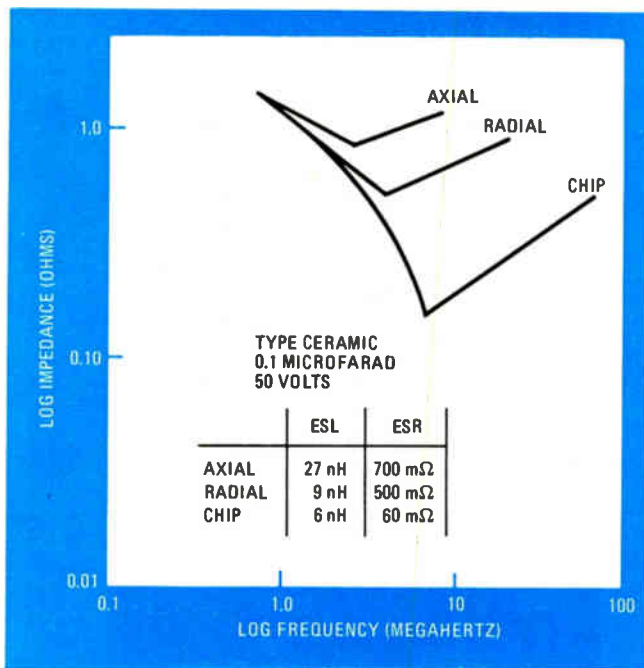

**7. Impedance of ceramics.** At a characteristic frequency higher than 1 megahertz, the ratio of inductance to capacitance for axial, radial, and chip capacitors begins to increase. This higher ratio degrades the utility of these components.

can save space and achieve values that are unattainable by either thick-film or thin-film capacitors. Typical limits of thin-film capacitors are in the range of 1 to 2,000 pF. Thick-film technology can reach as high as 10,000 pF. However, 100,000 pF is readily achievable with ceramic multilayer chips that typically measure 180 by 100 mils. The capacitor chip is extensively used both in hybrid ICs and as bypass and coupling for digital ICs.

Ceramic capacitors exist in three forms—each with its own strengths and weaknesses (see Fig. 7). These are multilayers, NPOS, and disks. Having high-k, medium-k and low-k dielectrics, they operate over wide ranges of voltage and temperature, and they come in a wide range of sizes. What's more, their characteristics can be tailored by varying the mix of the component powders.

However, two factors have motivated the technical push in ceramics. One is the low price. A disk ceramic rated at 0.1 μF costs less than a nickel. The other is the development of the multilayer monolithic chip capacitor (Fig. 6), which combines small size, high capacitance, and better high-frequency performance than equivalent tantalum devices (Fig. 5). In hybrid circuits and off-board IC applications, ceramic reigns for capacitances in the range from 0.01 to 2 μF because their small size, cost, and good high-frequency bypass characteristics are superior to those of film and tantalum capacitors with corresponding specifications.

For example, a comparison of tantalum with ceramics in Table 2 shows that ceramic has a dissipation factor one or two orders of magnitude lower than that of tantalum, which makes it superior at high frequencies. However, tantalum has a volumetric-efficiency advantage, which suits it better for use where high values of capacitance are needed in small volumes.

In addition, the more layers a multilayer capacitor has, the less reliable and more expensive it is. About 100 layers seems to be nearly the current industry limit for volume production. This sets an upper limit of operation at about 2 to 3 μF.

In off-chip bypass applications, multilayer chips are used because they have higher volumetric efficiency than ceramic disks and because they can be obtained in dual in-line and single in-line packages and can be mounted near the ICs by automatic insertion equipment.

### Multilayer ceramic chips

Since most ICs operate at 5 v to 15 v, capacitance rated higher than 25 v is essentially wasted. Therefore, thinner dielectrics would improve volumetric efficiency, probably improve frequency responses, and allow higher capacitance to be attained for the same number of layers.

Manufacturers of ceramic capacitors are aiming for these higher capacitance values. Currently, ceramic chips are limited to about 2 μF. On the other hand, tantalum-chip capacitors start becoming economically feasible at capacitances higher than 10 μF. In the near future, the battle should be joined between ceramics and tantalums for the region from 1.0 μF to 10 μF. It is likely that ceramics will hold sway to 3 or 4 μF, and tantalums will dominate above that level.

There should be three key developments in the next



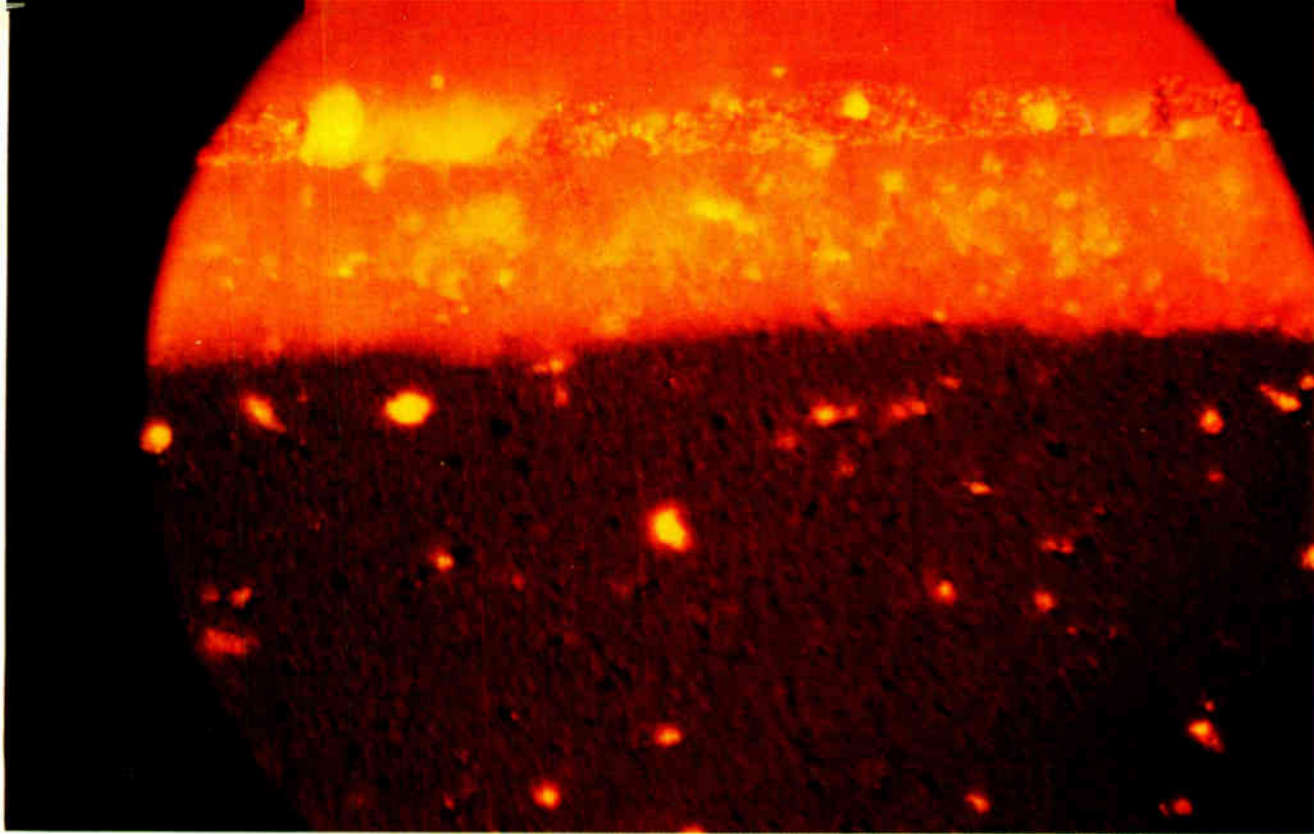

**8. Reduced capacitor.** A substrate capacitor is formed by an oxidation-reduction cycle on a ferroelectric substrate. The oxide acts as the dielectric, and the reduced layer as a semiconductor. Metallic contacts to both ends complete the device.

few years. Any of these developments could change the cost/performance tradeoffs for chips in the range of 0.1  $\mu\text{F}$  to 10  $\mu\text{F}$ . These are the use of thinner layers of film, introduction of high-k dielectrics, and new base-metal inks, which will reduce prices because they are much cheaper than the precious-metal inks now in use.

One company that is working on thin-film dielectrics is Gudemann Capacitor Corp., Chicago, which has developed a capacitor chip rated at 3  $\mu\text{F}$  and 25 v that is two thirds the size of conventional chip ceramics. It uses a ceramic 1 mil thick, compared to the usual thickness of 1.5 mils.

A barium-titanate dielectric with a k of 50,000 has been discovered by Siemens in Germany, and it is under development by Erie Technological Products, Erie, Pa. This substance attains six times the effectiveness of current high-k units, and it therefore promises higher volumetric efficiency with a smaller number of layers, which will reduce the need for precious-metal inks accordingly. Since the cost of precious-metal inks accounts for the bulk of materials costs, this development promises a considerable reduction in cost per microfarad. Siemens developed the barium-titanate material a couple of years ago, but the company has not yet introduced a product.

Another promising trend is the development of cheap base-metal inks from such materials as lead solder and nickel. These would replace platinum, which costs \$200 an ounce and palladium, which is priced at \$200 a pound. Hopefully, the capacitors manufactured with base-metal inks will be as reliable as their precious-metal-ink counterparts.

Nello Cotta, vice president for engineering at Erie Technology, predicts that base metal inks will be developed in the next couple of years. How fast they will go

into products is another matter. "If no new process steps are required, it could occur in a few months. If a couple of new steps are required, it might take a couple of years. It also requires a year or two to establish a reliability data base and educate customers."

#### Specialized ceramics

The advances in rf and microwave circuits and devices have been matched by a corresponding development of outboard capacitors capable of handling these frequency advances. Loss mechanisms, scattering parameters, and the best geometries to optimize capacitors for particular rf frequencies have been developed.

Chip porcelain ceramic capacitors offer high-frequency performance unattainable in thin- or thick-film form. For example, American Technical Ceramics of Huntington, N.Y., manufactures two sizes of its porcelain capacitor— a 5.1-pF chip usable to 3.6 GHz and a 100-pF chip usable to 900 MHz. Each is optimized to minimize the L/C ratio at a particular frequency range.

The electronic-watch industry is giving rise to a whole new set of ceramic microminiature variable-trimmer capacitors. A representative capacitor in this line is Erie's low-profile (0.08 inch long by 0.196-in. diameter) trimmers, which can provide tuning from 0.5 pF to 40 pF. Sprague and Johanson Manufacturing Corp., Boonton, N.J., have also announced products in this area. Johanson is offering five different ceramic dielectrics and temperature coefficients.

Another ceramic-capacitor development is the so-called semiconducting capacitor. Shown in Fig. 8, this device consists of an oxide dielectric, sandwiched between silver metalization and a reduced and then reoxidized ferroelectric layer, which is semiconducting and also acts as the bottom contact. TDK of Tokyo, Japan,

## SPECIAL REPORT

has recently introduced a line of semiconductor capacitors using a ceramic based on titanium-strontium oxide. A thin barrier layer between the reduced oxide and metalization acts as the dielectric.

This type of capacitor offers the designer higher volumetric efficiency and better temperature stability than other types of ceramic capacitors because of the inherently higher stability and thinner ferroelectric. For TDK's unit, capacitance stays within  $\pm 5\%$  from  $-30^{\circ}\text{C}$  to  $+85^{\circ}\text{C}$ , compared to  $+20\%$  to  $-30\%$  for conventional ceramic capacitors.

### Plastic films win support

The furor over the chemical used to impregnate paper capacitors, polychlorinated biphenyl (PCB), has provided an impetus for manufacturers to reexamine plastic-film capacitors as a possible replacement. PCB is a persistent atmospheric pollutant. But, although it is still allowed for capacitor use, it now appears that film capacitors will gradually replace paper ones.

The main technical thrust of the past few years has been to supply large quantities of pinhole-free films. Many companies, including a number of European firms, have attempted to reduce film thickness from 3 to 1.5 mils to compensate for the relatively low dielectric constant of films (see Table 2). These thinner films have not yet proven feasible on a production basis, but could well come on stream in the next few years.

One perhaps surprising aspect of film-capacitor technology is its adaptation for storage of electricity. Engineers are used to seeing huge oil-filled paper capacitors for this purpose. But Maxwell Laboratories of San Diego, Calif., claims that polyester films can attain energy density of 100 joules per pound and vertical voltage gradients of 60 kv per inch; this is 15 times greater than oil-filled paper and twice as good as the MIL-type M 12-kv cylindrical capacitors. Their main area of application should be in multijoule, high-voltage systems.



## Resistor technology booms with new types and sizes

Resistor technology has had a long, honorable history, but it is still dynamically adapting to modern electronics requirements. New techniques of materials analysis and automated production have led to improved characteristics and higher reliability. For example, five years ago, the specification range for metal-glaze resistor was essentially from 10 ohms to 500 kilohms, maximum operating voltage was 500 v, and temperature coefficient was 250 parts per million. Today, these resistors, through new formulations and production processes, have capabilities from 1 ohm to 100 megohms, maximum operating voltage of 35 kv, and temperature coefficients of 50 to 100 ppm. In evaluating these advances, certain major trends become clear:

- **Miniaturization.** Standard power ratings for resistors have gone from  $\frac{1}{2}$  to  $\frac{1}{8}$  watt and will probably be even further reduced in the future.
- **Materials development.** The performance of standard resistors has increased at only a small premium in price. Noise and the temperature coefficient of resistance have both been lowered. Stability and reliability have been improved. Manufacturers now use state-of-the-art equipment to characterize their resistor materials.
- **Packaging sophistication.** Dual in-line and single in-

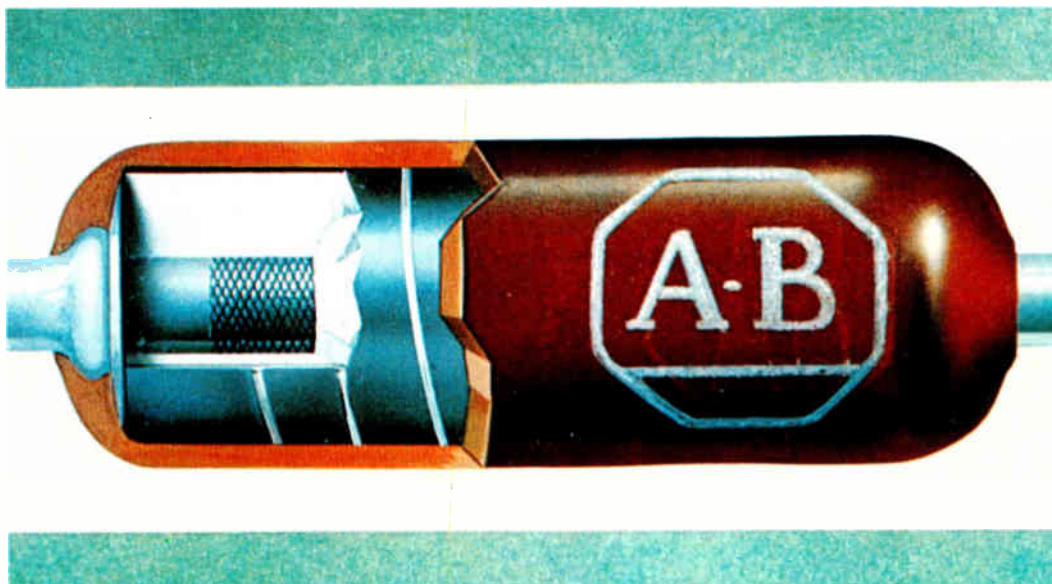

**9. Discrete cermet film.** Cermet materials have been used for networks for many years. They recently have been introduced as discrete film resistors. This Allen-Bradley resistor utilizes many recent industry advances, such as capless construction.

TABLE 3. FIXED RESISTORS — VARIOUS TYPES AVAILABLE

Category	Type	Key property	Power	Temperature coefficient, °C	Resistance range
General purpose > 5% tolerance > 200 ppm	Carbon composition	Cost	1/8 – 2 W	> 500	1 ohm – 100 Megohm
	Molded wire-wound	Tempco	1/2 – 2 W	> 200	0.1 ohm – 2.4 kilohm
	Ceramic wire-wound	Low voltage W	2 – 50 W	> 200	0.1 ohm – 30 kilohm
	Metal glaze	Flexibility	1/8 – 5 W	200	4.3 ohm – 1.5 Milohm
	Tin oxide	Reliability	1/8 – 20 W	200	4.3 ohm – 2.5 Milohm
	Carbon film (import)	Cost	1/4 – 2 W	> 200	10 ohm – 1 Megohm
	Cermet film	Stability	1/4 – 3 W	150	10 ohm – 10 Megohm
	Semiprecision > 1 < 5% < 200 ppm	Metal glaze	Flexibility	1/8 – 2 W	< 200
Tin oxide		Stability	1/8 – 2 W	< 200	4.3 ohm – 1.5 Megohm
Power > 2 W	Ceramic wire-wound	Cost	2 – 50 W	> 200	0.1 ohm – 30 kilohm
	Axial lead coated WW	Auto insertion	1/2 – 15 W	< 50	0.1 ohm – 175 kilohm
	Tubular and flat WW		4 – 250 W	< 100	0.1 ohm – 1 Megohm
Precision < 1% < 100 ppm	Metal film	Tolerance	1/10 – 1 W	20	0.1 ohm – 1 Megohm
	Metal glaze	Environmental	1/10 – 1 W	< 100	1 ohm – 1 Megohm
	Tin oxide	Power	1/10 – 1/2 W	< 100	10 ohm – 1 Megohm
	Thin film	Size, networks	1/20 – 5 W	< 100	10 ohm – 100 Megohm
	Encaps. wire-wound	Power, Tempco	1/20 – 1 W	< 20	0.1 ohm – 1 Megohm
Ultraprecision < 0.5% < 25 ppm	Thin film	Flexibility	1/20 – 1/2 W	< 25	20 ohm – 1 Megohm
	Encaps. wire-wound	Noise	1/20 – 1 W	< 20	0.1 ohm – 1 Megohm
Variable devices (pots, trimmers)	Wire-wound	Tempco	5 at 70°C	± 20	10 ohm – 100 kilohm
	Conductive plastic	Rotational life	2 at 70°C	± 250 – 500	1 kilohm – 100 kilohm
	Cermet	Environmental	12 at 70°C	± 250 – 500	500 ohm – 2 Megohm
	Carbon	Cost	5 at 70°C	± 300 – 2000	100 ohm – 2 Megohm
Networks	Thick film	Cost	< 2 W/pkg.	< 200	10 ohm – 10 Megohm
	Thin film	Performance	< 2 W/pkg.	< 100	10 ohm – 1 Megohm

line-packaged discrete-resistor sets and networks have been extensively developed. Figure 12 shows identical resistor networks packaged as SIPs and DIPs. Molded SIPs offer improved high-frequency performance, heat flow, and packing density. However, most automatic insertion equipment is set up for DIPs, and many types of active, as well as passive components, are available in DIPs. Many different molded configurations have come into use.

■ **New types.** Although a large variety of resistors has been available during the past five years, there has been an upsurge in demand for the cost/performance advantages offered by resistors of types other than carbon-composition. These are summarized in Table 3. A key factor in this shift has been the volume-price cycle. As larger quantities of these resistors have been used, prices have come down. This has led to use of larger numbers, which has allowed further reductions.

To produce the best designs, an engineer should be aware of the tradeoffs offered by the various resistor technologies. In order to do this and to properly specify resistors, he should understand the terms used to describe them. In selecting a resistor, he must choose desired values of such key parameters as:

■ **Tolerance (accuracy):** the maximum deviation from

the nominal value, measured at room temperature and at low voltage.

■ **Temperature coefficient of resistivity:** the change in resistance per unit change in temperature, usually expressed in ± parts per million per degree Celsius. Note that the temperature is that of the resistor, not that of the ambient. If the resistor is dissipating enough power to cause its temperature to rise well above ambient, a term called self-heating coefficient of resistivity is used. This is expressed in ppm per watt of dissipation.

■ **Voltage coefficient of resistance:** change in resistance at fixed temperature, caused by molecular distortion of the material and expressed in ppm per volt.

■ **Time stability (drift):** change in resistance under stated conditions of use per 1,000 hours, expressed as ± per cent or ± ppm per 1,000 hours. Drift is more severe with high-value resistors. Short-term drift is usually greater than the long-term variety.

■ **Noise index or thermal-noise level:** the noise level is the equivalent rms noise voltage generated by the resistor over a given bandwidth and for given operating conditions, expressed as volts per square-root hertz. The noise index is the ratio of rms noise voltage to the applied dc voltage, expressed in decibels.

■ **Useful frequency range:** the highest frequency at

## SPECIAL REPORT

which the impedance differs from the resistance by more than the stated tolerance. A resistor is actually shunted by a capacitor and has an inductance (caused by such additions as leads) in series with it. These have to be considered in determining the useful frequency range. The parameter that characterizes this is the ac/dc impedance ratio—the ratio of the complex impedance, typically the shunt capacitance, to the dc resistance.

■ **Maximum ratings:** maximum power capability, maximum operating voltage, and maximum operating temperature should never be exceeded. This is especially crucial in pulse or digital operation on film-type resistors, where average values may be well within limits, but instantaneous values are too high for the component to handle. This is discussed in the section on film resistors.

Table 3 summarizes tradeoffs in certain parameters for the materials currently available. Of course, special parameter values are available upon special request.

Technical advances have also been registered in materials, production, and packaging of both discrete resistors and networks. The dominant changes vary from product to product, and they are discussed in the section relating to each component.

Many passive-component manufacturers have laboratories that would be the envy of a researcher in a semiconductor lab. It can be argued that studying fundamental resistive and dielectric properties of materials requires as much research as investigating problems with silicon devices and integrated circuits. As an example, in Allen-Bradley's test facilities, researchers studying resistors are utilizing, among other techniques, thermogravimetric analysis, differential thermal analysis, X-ray and electron-diffraction apparatus, scanning and transmission-electron microscopy, electron-microprobe and backscatter apparatus, gas chromatography, polarography, and infrared optical and atomic-absorption spectroscopy.

New production technologies, together with demands by the integrated-circuit and semiconductor industries

for higher accuracy, stability, and power have altered the product mix of many resistor companies. Lower-power resistors are now readily available. High-speed computer-controlled laser trimmers can perform 10 trims per second, and each trim is more accurate than the slower abrasive or chemical trimming can achieve.

### Discrete progress

During the past few years, new techniques and special materials for use with laser-trimming have been developed to provide uniformly high precision. The results have been cheaper precision and semiprecious metal and thick-film resistors that now compete with carbon-composition resistors on a cost/performance basis. In addition, these resistors exhibit significantly lower temperature coefficients. For example, carbon composition exhibits 500 ppm/°C temperature coefficient, while metal film attains only 50 ppm/°C.

The new technology of ultra-precision bulk-metal films, which exploits the difference between the expansion coefficients of metal films and their underlying glass substrates. Heating creates compression in the metal alloy, and this compression creates a negative temperature coefficient in the alloy, which tends to cancel the normally positive temperature coefficient of the alloy. This technology makes possible temperature coefficients of 1 ppm/°C from 0 to 60°C.

Thick films are also attracting more attention. Bill Means, marketing manager for the Film Resistor division of Dale Electronics, Norfolk, Nebr., says that thick-film resistors, by virtue of their lower price, are replacing carbon-composition resistors in many applications. In three to five years, thick-film precision resistors may well be doing the job now handled by precision thin-film and wire-wound resistors. An example of this is Allen-Bradley's cermet-film resistor shown in Fig. 9.

Progress in achieving uniformity in wire thickness, thermal flow between the core and the wire, and better production control have improved wire-wound resistors. What's more, through making power-dissipation distribution more uniform, increased power ratings are now available in smaller packages. Previously, any nonuniformity in thickness would cause nonuniformity of current density and cause hot spots.

In addition, nonuniformity caused by such mechanical forces as pressure from winding, lead-forming, handling, and packaging could induce resistance changes in parts of these resistors. Alleviation of these difficulties gives the designer increased overload and emergency-power-handling capabilities for wire-wounds. For example, Dale Electronics' standard 5-W wire-wound can withstand 24 W pulses for 1 millisecond, equivalent to 24 kV, and far in excess of capabilities five years ago.

Manufacturers say they have solved two problems of concern five years ago—noise and unreliability. Noise has been decreased by improving contacts to resistor elements and by better materials uniformity. And reliability has been improved by reduction of failure mechanisms, along with tighter production control.

### Trimming the pots

There are three kinds of variable resistors—the single-turn potentiometer, the multi-turn pot, and the trimmer

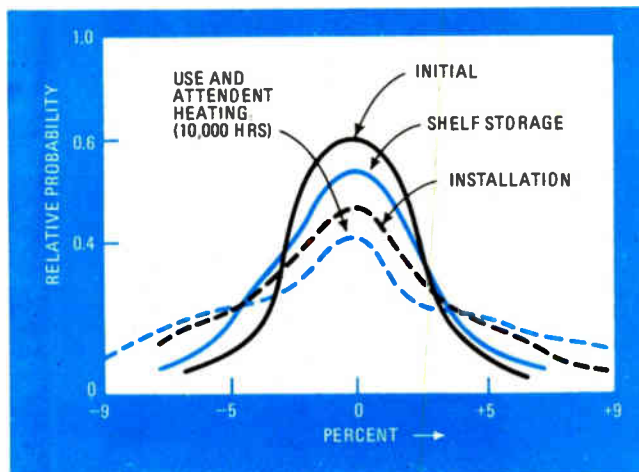

**10. Spreading with age.** Stress applied to a resistor material can alter its value. This results in widening the distribution of resistance values. As shown, a 5% resistor should be chosen for a job requiring a 10% resistor that must undergo normal storage, soldering.

(which is a set-and-forget device). Three materials have come to dominate the field—wire-wound, cermet, and conductive plastic. Finally, there are three electrical parameters that are unique to variable resistors—resolution (how finely a pot can be set, expressed as a percentage of full value), linearity (the variation with resistance as the shaft on the potentiometer is rotated), and stability (the repeatability of the resistance setting).

The carbon potentiometer, which once dominated the entire market, is now only a major factor in the trimmer area. Wire-wound, which is probably the dominant technology now, has lowest temperature coefficient of the three materials. Cermet potentiometers offer infinite resolution range, have the highest available power dissipation, are the most rugged environmentally, and have the best linearity.

The newest material, conductive plastic, offers the longest rotational life and the best linearity, but it currently is susceptible to humidity. Characteristically, it comes in three forms—bulk conductive plastic, co-molded films, and deposited (such as severed or sprayed) film.

One way to increase reliability and decrease noise is to use multi-fingered contact brushes for potentiometers. Instead of a single large brush, between 2 and 30 small brushes are utilized. Another major development has been in packaging and miniaturization. Again, low-power ICs and high-density packaging on printed-circuit boards have spurred this development, which is exemplified by Allen-Bradley's Mod Pot rectangular-profile potentiometers.

In product mix, Erving Liban, marketing manager for pots and trimmers at Allen-Bradley, predicts that the biggest growth potential is in inexpensive trimmers—the kind of device that gets reset only a few times. This component is used for TV and other applications that require only occasional adjustment. Integrated circuits have reduced the need for continual fine tuning, but occasional alignment problems will still exist.



## Thick and thin films vie for network applications

Passive networks are made of both thick and thin films. As shown in Fig. 11, one of these networks can replace several discrete passive components. Thick-film networks are made by screening inks and bonding chip components on ceramic substrates. Thin-film networks are plated, evaporated, sputtered, or deposited by pyrolysis onto a substrate, and the pattern is formed by photolithography.

Thick films are generally less expensive and have larger tolerances and lower temperature coefficients than thin films. Thin-film networks generally provide better stability, higher accuracy, and more precision, but the price is higher. However, as technology develops, the capabilities and chief characteristics of the two types of films are drawing closer together.

Walt Woroby, RC networks manager at Bell Laboratories in Allentown, Pa., declares that when base-metal inks are developed, the materials cost of thick films will make them more expensive. Moreover, thin-film networks will tend to become less expensive as volume increases and production equipment can be improved so

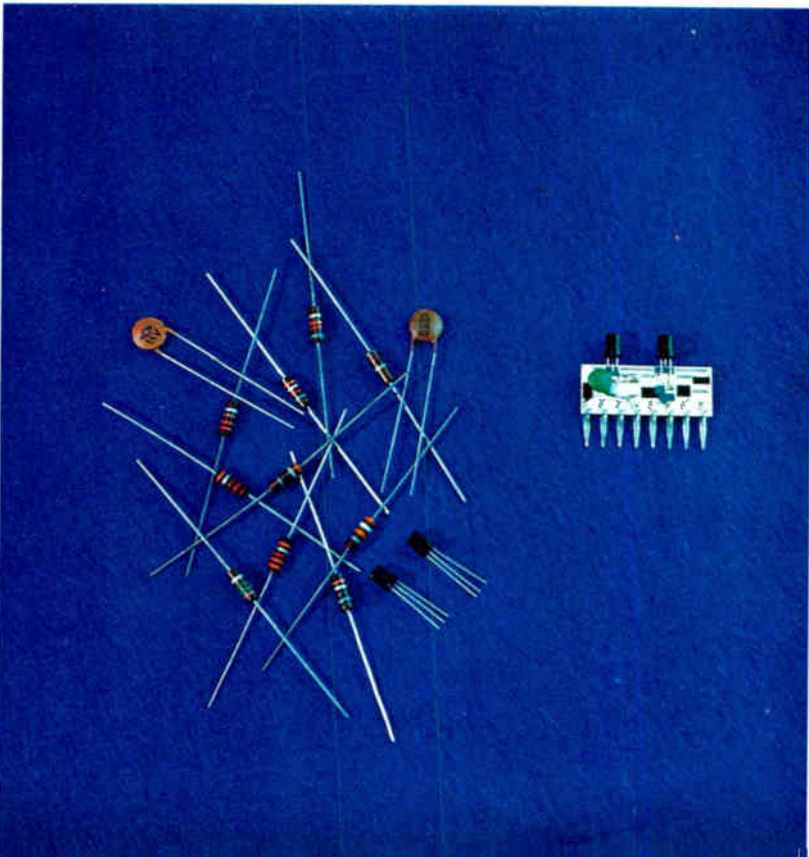

**11. In the nets.** This collection of discrete components (left) can all be incorporated in the network shown at the right. It is often cheaper to use networks for volume applications. Also, device-to-device tracking and tolerances are often tighter.

## SPECIAL REPORT

that it can process large substrate areas.

Bell uses tantalum for its thin-film resistive and resistor-capacitor networks because of its high bulk specific resistivity, high melting and recrystallization temperature (which provides stability against grain growth and defect motion), the ease in which high permittivity oxides are formed anodically or thermally, and the capability to use a single materials technology for both resistors and capacitors.

Supporting Woroby's prediction on reduction of costs for thin-film networks is a recent announcement by Analog Devices Inc., Norwood, Mass., to enter the resistor-network market with high-volume thin-film nichrome technology. By combining rf sputtered and evaporated nichrome, resistance ranges over six orders of magnitude can be accommodated. In addition, Thomas J. Parello, resistor-marketing manager for Analog Devices, declares that these thin-film networks will cost only 50% to 75% more than equivalent thick-film networks but will have a significant number of technical advantages and a better cost/performance ratio.

For example, tolerances will be tighter than for thick-film networks; absolute stability of 0.1% per year is specified. What's more, the voltage coefficient of resistivity is practically zero, and the temperature coefficient of resistance is 25 to 75 ppm vs 100 to 150 for thick-film networks. The initial applications for these networks is expected to be for analog-to-digital and digital-to-analog conversion systems. For the designer, this development means that the gap is being bridged between ultrahigh performance, ultrahigh-cost, thin-film networks and inexpensive, moderate-performance, thick-film networks.

### In the thick of it

More moderate in performance than thin-film components until now, thick-film resistor networks that can vie with the more expensive thin-film components are being developed. For example, cermet films with 50 ppm temperature coefficients are on the horizon. This will make them competitive in performance with thin films. Indeed, the gap between the technologies will be bridged by higher-quality thick films at slightly higher costs and thin films of slightly reduced quality at lower costs. In addition, production techniques and materials technology are improving the performance of even low-cost thick-film networks.

An example of the impact computer-controlled automation and materials are having on thick films is Centralab's carbon-resistor system. The use of new ink systems, computer-controlled laser trimming, automatic screening, and automated assembly operations has led to a tolerance improvement from  $\pm 10\%$  to  $\pm 15\%$ , a temperature-coefficient improvement from  $-1,700$  ppm/ $^{\circ}\text{C}$  to  $-375$  ppm/ $^{\circ}\text{C}$ , and a three-fold decrease in percentage of resistance change that can be caused by moisture and temperature cycling. To the designer, this means that the same network, made from the same material that he used a couple of years ago, has significantly im-

proved specifications, which relaxes design tolerances.

Three major technical issues of the next few years will be standardization, the development of resistor inks without precious metals, and laser-trimming installed at the user's plant.

Of common concern to users of resistors—whether thick- or thin-film—is developing standard products (see "The case for standardization"). The lack of standard packages and standard networks can make resistor networks less competitive with discrete-component alternatives. To compare costs of networks with those of discrete, the evaluation must be made for total system cost, covering engineering and layout, including figuring actual cost of the parts plus costs of inventory, storage, and testing.

Most thick-film inks contain precious metals such as platinum, palladium, silver, and ruthenium. Prices are rising so rapidly for these metals that some companies, instead of quoting a fixed price, charge a customer the price effective on the date of shipment.

The manufacturer who develops an ink from a base metal, such as copper, nickel, or aluminum, will provide a significant cost advantage to the engineer and the packaging industry. Activity in this field is intense, and most manufacturers of networks and capacitors, as well as chemical companies, are studying the problem. Wayne Barden, vice president of engineering and development at CTS Inc. of Elkhart, Ind., feels that air-fired base-metal inks are a distinct possibility within the next five years. Inks now in use have to be fired in an inert or reduced atmosphere to alleviate the possible reactions, such as oxidation, that can occur during air-firing.

A third development is trimming installed at the user's plant to provide low-cost systems optimization. Today, a component manufacturer trims a resistor network at his plant, then the customer inserts it in his system and hopes for the best. During the next couple of years, more companies that can afford the \$25,000 or so for a computer-controlled laser-trimming system will be

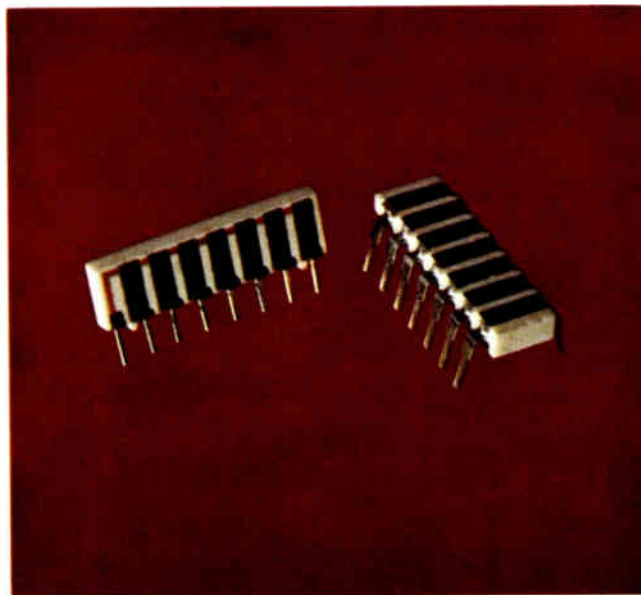

12. SIPs and DIPs for nets. Identical resistor networks are shown in DIP and SIP configurations. The SIP uses less board area but the DIP is more compatible with automatic insertion equipment.

able, with help from the manufacturer, to trim the resistor network after the outboard passive components and integrated circuits are in place. This will bring about such benefits as accurate balancing of bridge networks and elimination of zero offset voltages in linear circuits.

### Using networks

There is often more than meets the eye to properly using resistors and resistor networks. Frequency response, long-term drift, and power-handling capability also require consideration. Bob Gornich, systems engineer at CTS Corp., states that temperature coefficient alone is overemphasized as a measure of quality.

Another factor to be considered is the long-term resistance spread or tolerance of the resistor and the effect of environmental stresses on the resistance and temperature coefficient. For example, a resistor with a 5% initial tolerance may end up with a 9% tolerance spread when finally in place in a circuit.

Figure 10 shows the effect of various operations on resistance tolerance. The magnitude of the change depends upon type of resistor and magnitude of the stress. Design tolerance =  $\pm$  purchase tolerance  $\pm 3\delta R$ , where  $\delta R$  is the change in resistance resulting from shelf storage, soldering, use at near rated power, and other stresses to the material.

Like a capacitor, a resistor is actually an RLC circuit. The effect of shunt capacitance or long lead lengths is to decrease the resistance of the resistor. This is usually expressed in terms of the ac/dc impedance ratio, and, for a noninductive type of resistor, may be expressed as

$$Z/R = 1/[1 + (2\pi fRC)^{1/2}]$$

A useful measure of frequency response is the characteristic frequency ( $f_c$ ), which is  $\frac{1}{2} RC$ . For example, for a 10-kilohm resistor with 1-pF parasitic capacitance, the  $f_c$  is 17 MHz.

A third factor that digital-system users should consider is the pulse-power-handling characteristics of a thick- or thin-film resistor, which is usually quite different than the dc-power rating. For a pulse input, the film resistor is thermally decoupled from the substrate. The input energy is dissipated in the mass of the resistor and then is transmitted to the substrate.

This can lead to destruction of a resistor at power levels well below the rated dc-power dissipation. For example, a 100-v, 1- $\mu$ s pulse into a 10-ohm resistor dissipates 1 kw on a transient basis, but the energy into the resistor equals the power times the time, or

$$E = V^2R \times tp$$

Therefore the energy, put into the small mass of the resistor, generates heat. The maximum energy-handling capacity in a resistor is a function of resistance, and it is usually not specified. However, even for fast, low-duty-cycle pulses, a resistor that can handle the average power may not survive higher-power pulses.

In general, it is best to consult with a manufacturer concerning resistor requirements. Most of them are willing to discuss applications, will not divulge proprietary details, and can head off the non-obvious problems before they are designed into a circuit.

## The case for standardization

The issue of device characterization and standardization is a sore point for users and manufacturers of components alike. Users complain that they can't find the information they need, and manufacturers complain that each engineer wants a proprietary design and won't accept a standard package that would cost less. Standardization, both claim, will reduce costs by increasing quantity, reducing design time, and allowing more complete characterization of parameters.

Today, even standardized and military-specified components of identical value, voltage rating, and tolerance, purchased from two different manufacturers, may look like different devices. This means that necessary design information is often lacking. Dr. Victor Roberts, new-lamp-development engineer at General Electric's Large Lamp division, Cleveland, Ohio, complains that while investigating capacitors for ballasts in new higher-frequency fluorescent lamps, he couldn't find information concerning the complex impedance of the capacitors he was using at the frequencies of interest.

Privately, most manufacturers admit the problem. Mil specs, it is said, are written to eliminate sole-sourcing. Most large passive-component manufacturers in the U.S. claim that their devices exceed published mil specs. They are loath to publish complete specifications, since they can vary the geometry and starting material to optimize certain characteristics for components with the same terminal value and tolerance. This works quite well for OEMs, but the engineer on the bench trying to cope with a new design may not be aware of these options.

Manufacturers have their own bone to pick when it comes to standardization. Many marketing managers declare that they would welcome the establishment of standard test procedures and ratings. For example, Ed Geistler of Sprague Electric Co., North Adams, Mass., notes that pulse and sine-wave characteristics of a capacitor often vary and that many users often have to test their capacitors by finding out if they work in the desired circuits.

Corning Glass Works, Corning, N.Y., has attempted to provide some form of standard network configuration with its Cordip RC networks, but it recently had to abandon that effort. Robert Gress, marketing manager for tantalum capacitors at Corning, says that Cordip was a generalized approach with a wide variety of options that offered resistors, capacitors, and diodes in dual in-line packages. But Cordip couldn't compete head-on with networks specifically designed for a particular application. It was too general an approach, and the sales volume didn't get high enough to force costs down. Until this happens, Gress declares, the standard-network market won't take off.

However, a middle ground may be reached during the next few years. Passive-component manufacturers are finding it profitable to work with users and publish more complete specifications as time goes by. Users are getting more sophisticated about cost/performance tradeoffs and are becoming more amenable to accepting standard passive components that will do the job and save them design time. Even the military is under pressure to define its needs better and find out if it can get by with less-expensive off-the-shelf components.



## Relays switch direction to increase performance

Like the capacitor and resistor, the electromechanical relay has retained its role as an integral component in today's equipment designs by virtue of manufacturers' ability to incorporate technical innovations in new products. Miniaturization and packaging in IC-type configurations for automatic insertion have been combined with improved relay characteristics to enable electromechanical relays to be integrated with IC assemblies. Equally significant, the development of solid-state relays has provided a new tool for the designer by adding speed, reliability, sensitivity, and contactless switching to the isolation and high-current capabilities of conventional relays.

Miniature electromechanical relays now available in dual in-line packages can switch at lower signal levels than the older relays because they are more sensitive. For example, reed relays that previously required 2.0- to 5.0-v switching levels can now be switched by voltages as low as 50 mV, making them compatible with standard bipolar logic. These reeds are in miniature DIPs and in axial-lead configurations (0.09 inch in diameter and 3/8-in. long), giving them greater utility in today's IC

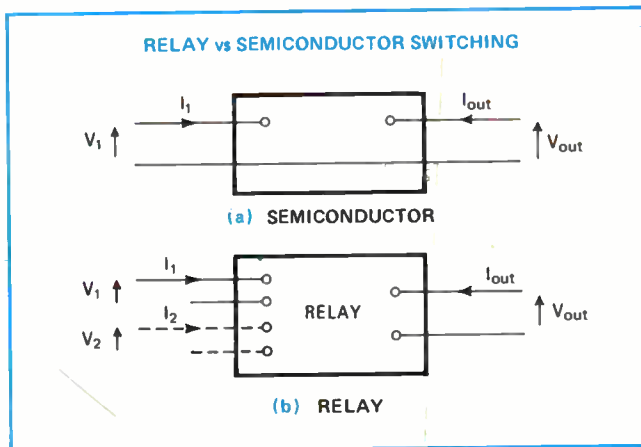

**13. Relay Isolation.** A semiconductor doesn't isolate a load, since it isn't really a four-terminal, two-port device. Because relays are, they eliminate ground loops and crosstalk between the components that have to be switched.

assemblies. And they are fast and versatile. Reed relays in DIPs switch as fast as 0.25 millisecond, with switching currents from 10 milliamperes to 5 A.

What's more, electromechanical time-delay relays have been teamed with solid-state timers to combine the high isolation and power-switching characteristics of electromechanical devices with the precision timing characteristics of solid-state devices.

But, although solid-state relays are potentially capable of replacing electromechanical ones, certain properties ensure a place for the electromechanical types. Electromechanical relays are true four-terminal devices, which ensures complete input-to-output isolation. Single semiconductor devices, inherently three-terminal devices, suffer from ground loops and input/output cross talk (see Fig. 13). Besides, multiple-pole switching is more convenient with electromechanical relays than with solid-state devices because adding more poles has only a small effect on price.

### Solid-state relays

Nevertheless, because of the inherent reliability of contactless switching, the most significant development of the past few years has been the solid-state relay, used both for switching and time-delay applications. Until now, the bulk of these relays have been reed types that trigger triacs or other solid-state output devices. The trend, however, is to all-solid-state units, which have opto-isolator inputs and semiconductor-switch outputs. Also in the works are one-chip solid-state relays.

Compared to their electromechanical counterparts, solid-state relays are faster and more reliable because there are no moving parts. They are also smaller, require less power, and generate less noise. On the other hand, they are four to five times more expensive than electromechanical devices.

When the price of solid-state relays will come down is still a matter of conjecture. Jack Rowell, marketing manager for Guardian Relay Inc., Chicago, Ill., states the classic dilemma for solid-state relays: "the price can't come down until volume goes up, but volume won't go up until price comes down."

Nevertheless, Don Stalker, marketing manager at Teledyne Relay, Sepulveda, Calif., states that solid-state relays, which weren't in existence five years ago, make up 30% of the market today and should eventually seize and hold 60% of the market.

A significant industry question is whether semiconductor companies, like Monsanto and Hewlett-Packard Associates will ever take over a large share of the solid-state-relay market, since they are the ones supplying the internal components for the relays. However, Phil Gardiner, marketing manager of Magnecraft Electric Co., Chicago, Ill., a company that builds electromechanical relays, points out that the high level of experience by relay manufacturers in marketing, distribution, and applications, enables them to select the best isolator-SCR device for the given application and provide these devices in optimized packages to OEMs at lower cost than the OEMs can manufacture them. □

Reprints are available at \$3 each. Write to Electronics Reprint Department, P. O. Box 669, Hightstown, N. J. 08520. Copyright 1974 by Electronics, a McGraw-Hill publication.



**For PBX, computer memory  
and instrument power  
supply applications**

# turn to CTS

**for cermet resistor networks**

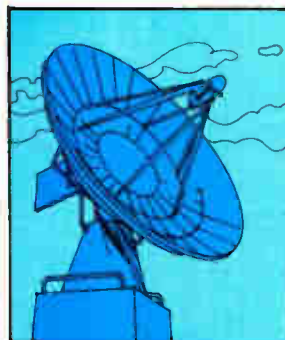
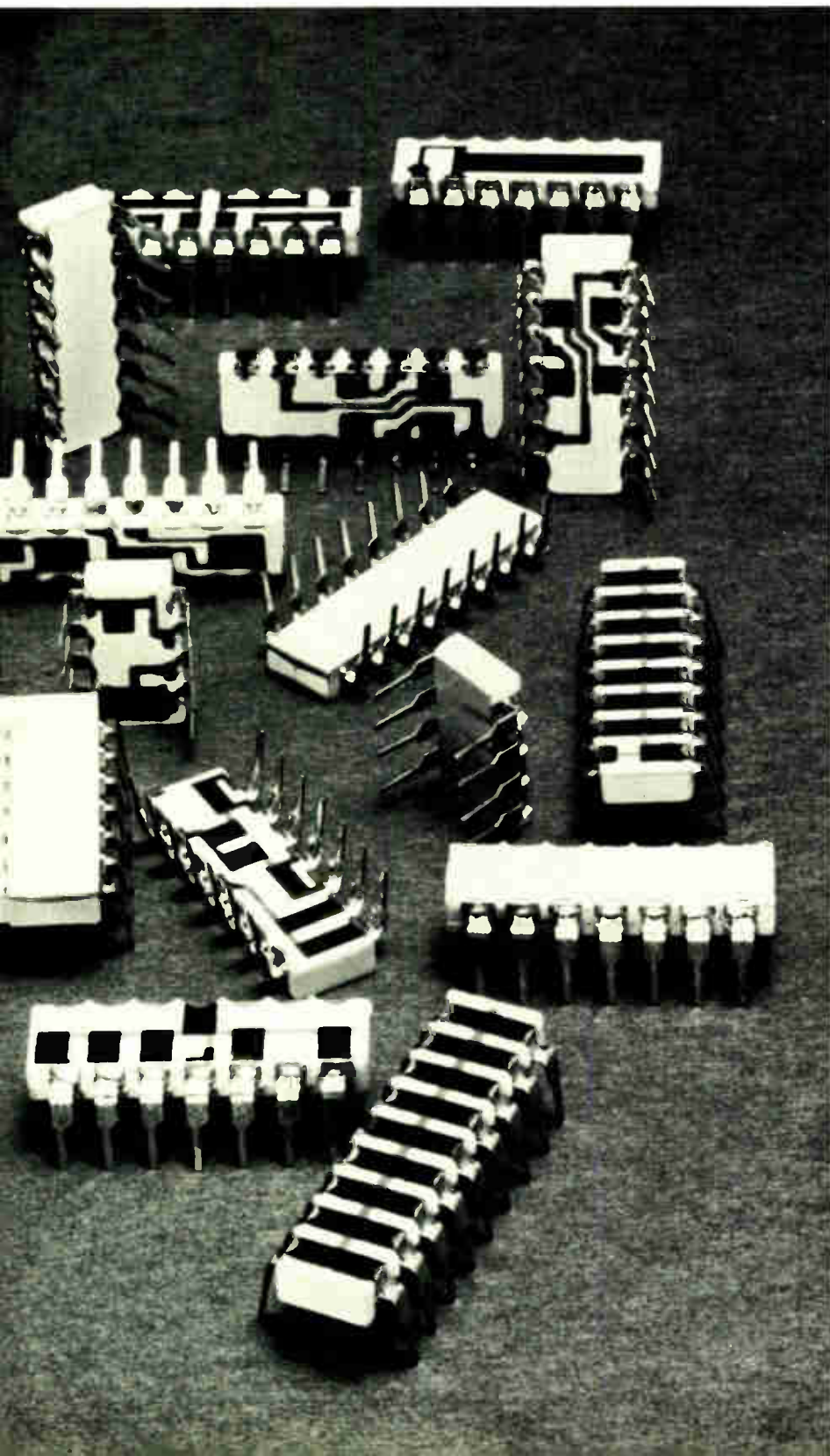

**Save Space. Money. Time.** It's easy with CTS Series 760 DIP Cermet Resistor Networks. Four popular packages . . . 8, -4, -16 and -18 lead styles . . . provide an infinite number of circuit combinations.

Compact, low profile design puts the squeeze on PCB space. Cost cutters, too. All designs eliminate lead forming and lead trimming for low cost automatic insertion along with IC's and other DIP components. Time saving? One 18-lead CTS 760 Series package can replace up to 32 separate components.

Available without organic cover coat, so you can trim for circuit balance. Precision .100" leads; rated up to 2 watts on 18 lead style; 5-lbs. pull strength on all leads.

Immediate delivery on standards. Custom designs to specifications. Be a saver. Turn to CTS of Berne, Inc., 406 Parr Road, Berne, Indiana 46711. Phone: (219) 589-3111.

Circle 105 on reader service card

**CTS CORPORATION**  
ELKHART, INDIANA



A world leader in cermet and variable resistor technology.

## Voltage regulator protects logic pull-up transistors

by Stephen F. Moore  
Resdel Engineering Corp., Arcadia, Calif.

A monolithic three-terminal voltage regulator and a Norton-type operational amplifier can provide excellent short-circuit protection—particularly for the transistor that's providing active pull-up at the output of a logic circuit.

All too often, transistors operated in this way are destroyed when the logic output is inadvertently shorted to ground. Sometimes, too, protecting these transistors is further complicated because the logic must be run at 28 volts. An easy solution would appear to be a current regulator. But most current limiters have one of two drawbacks—either they introduce an unacceptably large voltage drop, or they create excessive heat in biasing resistors.

A monolithic three-terminal voltage regulator, however, has neither defect. When the regulator is not overloaded, the voltage drop across the device is only about 1.5 v. When it is overloaded, the heat it creates remains within an acceptable range. Usually, the highest output voltage that one of these regulators can supply is 24 v.

But, if the device's ground terminal is biased at 2 v (depending on the manufacturer's recommendations), the output of a 24-v regulator can be increased to 26.5 v.

When connected as shown, the regulator provides current limiting in two ways. Through its internal circuitry, it acts as a surge-current limiter of about 2 amperes. It also operates as a thermal-current limiter that reduces that output voltage when the current demand becomes excessive. This keeps the power dissipated in the regulator from exceeding the maximum allowable limit. Here, the thermal-current limiting will start at around 400 milliamperes.

Limiting the current available for the active-pull-up transistor will prevent the transistor from being destroyed as long as it is kept in saturation or in cutoff. A Norton amplifier allows both these conditions to be met—its current-sinking capability is greater than 30 mA, and it has an active pull-up in its output circuit. Because of the voltage drop across the regulator, this active pull-up creates a reverse bias on the transistor being protected, eliminating the need for the transistor's pull-up resistor. Also, a Norton amplifier will work reliably with a single-ended power supply at, as well as above, a supply voltage of 28 v.

The diode at the output of the circuit protects the transistor from overvoltages. For example, this diode will guard against an overvoltage caused by an inductive kickback that could forward-bias the base-collector junction of the transistor. □

**Guarding against short circuits.** An IC voltage regulator and a Norton amplifier keep this active-pull-up transistor from being permanently damaged if the input logic signal is mistakenly shorted to ground. The regulator provides both surge-current limiting and thermal-current limiting. The Norton amplifier keeps the transistor either fully saturated or fully cut off, and the output diode protects against overvoltages.

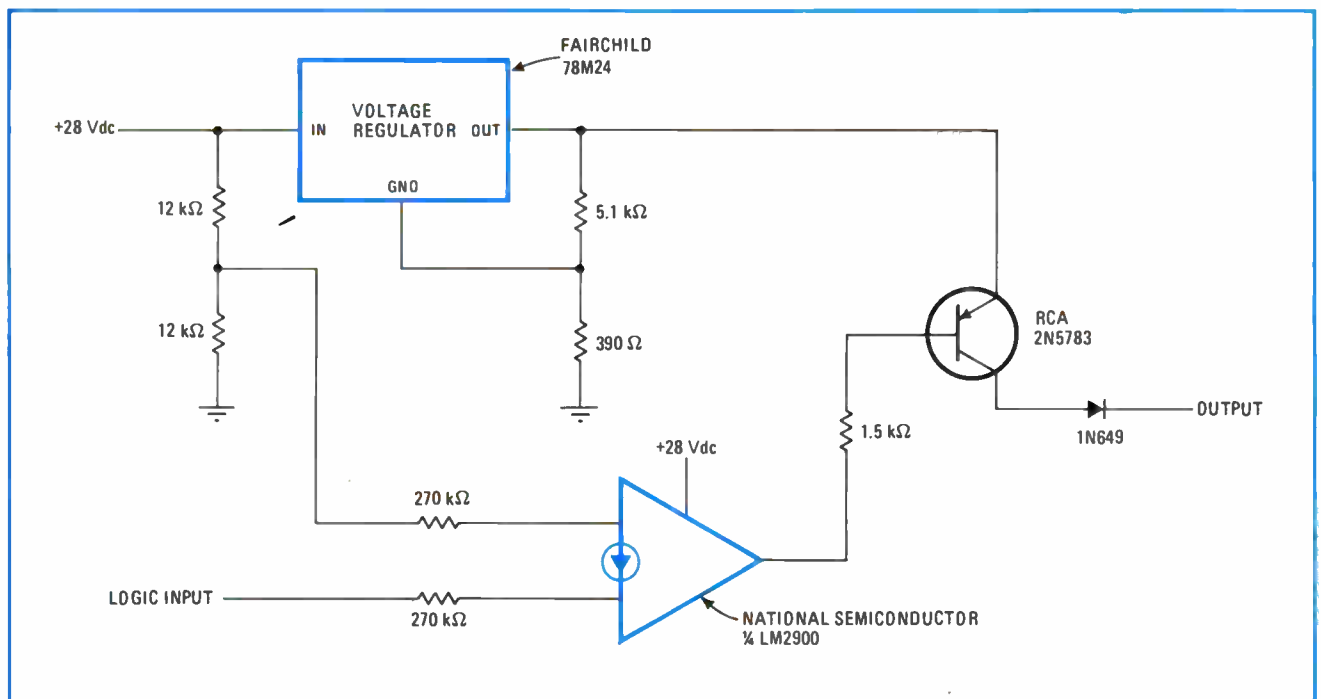

# Generating tone bursts with only two IC timers

by L. W. Herring  
LWH Associates, Dallas, Texas

With very few external components, two IC timers can be made to function as a tone-burst generator that is useful for radio and telephone applications. In the circuit shown here, one timer controls the tone burst, and the other generates its frequency.

Normally, a tone-burst generator is built with three timers, two being required for the control function. Although a single timer in its delay mode could provide the initial time period, the second timer is required to generate the burst length and reset the first timer. Alternatively, in the astable mode, a single timer's output duty cycle could be adjusted for the quiet and burst periods, except for one thing—the time to the first burst would be almost twice as long as the time to subsequent bursts because the initial charging period of the timing capacitor is longer than later periods.

Nevertheless, a single timer can in a sense be fooled into providing the control function on its own if an RC network (resistor  $R_2$  and capacitor  $C_2$  in the figure) is added to the timer's (TIMER<sub>1</sub>) threshold and trigger inputs. Of course, the larger primary timing network (resistor  $R_1$  and capacitor  $C_1$  in the figure) remains connected to the timer's discharge circuit.

TIMER<sub>1</sub> is set up as an astable oscillator. But its threshold inputs are kept high by the additional RC network ( $R_2$  and  $C_2$ ) for longer than it takes the timer's discharge circuit to completely discharge the main RC network ( $R_1$  and  $C_1$ ). This assures that the output period of

TIMER<sub>1</sub> remains almost constant, no matter if the burst is the first one or the last one.

The period that TIMER<sub>1</sub>'s output remains high can be approximated by the standard equation for delay-mode operation:

$$T_{on} = 1.1R_1(C_1 + C_2)$$

The burst output time (when the output is low) can be adjusted to the desired value by the  $R_2C_2$  network. This period is approximated by the equation for astable-mode operation:

$$T_{off} = 0.693R_2C_2$$

When the added time period (burst length) approaches or exceeds the main time period, the two timing networks interact.

For this circuit, the output of TIMER<sub>1</sub> remains high for 1 minute and goes low for a half second. The best way to activate the circuit is to switch the  $V_{CC}$  supply lead for the entire circuit. Diode  $D_1$  assures that capacitor  $C_1$  will be discharged after any partial periods.

The control timer (TIMER<sub>1</sub>) can provide the output for a lamp, bell, buzzer, or other signaling device. (This timer's output must be used to sink the signaling device, which must also be wired to the supply line.) TIMER<sub>2</sub> operates as the tone oscillator, determining the frequency of the tone burst. The manner in which TIMER<sub>2</sub> is keyed eliminates the need for an intermediate device to invert the output of TIMER<sub>1</sub> to operate the reset lead of TIMER<sub>2</sub>.

This simple tone-burst generator can be used as an audible timing reminder for long-distance telephone calls or for radio repeaters that have 3-minute shutdown timers. The same arrangement can be used to generate sampling pulses for a sample-and-hold circuit or for a serial-to-parallel data converter for Ascii-character detectors. □

**Saving a timer.** This tone-burst generator requires two, instead of three, IC timers—TIMER<sub>1</sub> controls the tone-burst signal, while TIMER<sub>2</sub> determines the burst frequency. An extra timing network (resistor  $R_2$  and capacitor  $C_2$ ), rather than an extra timer, is used to keep TIMER<sub>1</sub>'s output period constant so that the first burst has the same length as other bursts. Here, the burst interval is 1 minute.

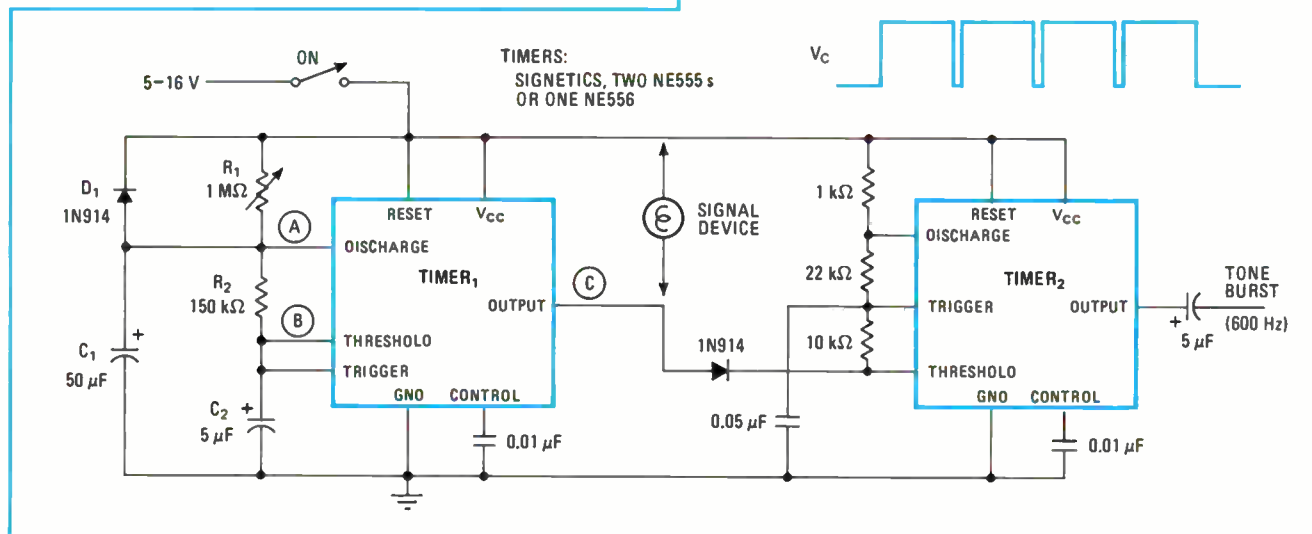

# Simplifying sum-correction logic for adding two BCD numbers

by Robert D. Guyton  
Mississippi State University, Mississippi State, Miss.

To add two numbers in binary-coded decimal form, much less logic hardware is needed if one of the numbers is converted to the excess-6 binary code before the addition is done. The other number remains unchanged.

The block diagram of (a) outlines the approach. One BCD input is converted to the excess-6 code by a second-level logic circuit, which is drawn in (b). This translated number and the unchanged BCD number are then added by a 4-bit binary adder. The resulting output

carry is correct, but the sum must still be corrected—and can be corrected by a simple second-level logic circuit, rather than a multilevel type of logic circuit based on half and full adders.

The BCD-to-excess-6 translator circuit needs four NAND gates and three inverter gates. The rest of the over-all addition circuit is shown in (c): the four-bit binary adder requires four full adders, while the sum-correction circuitry requires 10 NAND gates and three inverter gates.

The complete excess-6 addition circuit, therefore, consists of 14 NAND gates, six inverter gates, and four full adders. As against an addition circuit based on excess-3 code conversion, that's a savings of six NAND gates, three inverter gates, one full adder, and two half adders. □

Designer's casebook is a regular feature in Electronics. We invite readers to submit original and unpublished circuit ideas and solutions to design problems. Explain briefly but thoroughly the circuit's operating principle and purpose. We'll pay \$50 for each item published.

**Conserving logic hardware.** The circuit for adding two binary-coded-decimal numbers can be implemented with fewer devices by changing one of the BCD numbers to the excess-6 code format. When this conversion is done, simple logic gates can be used to perform the necessary sum correction. The figure shows the circuit's block diagram (a), the excess-6 code translator (b), and the complete circuit (c).

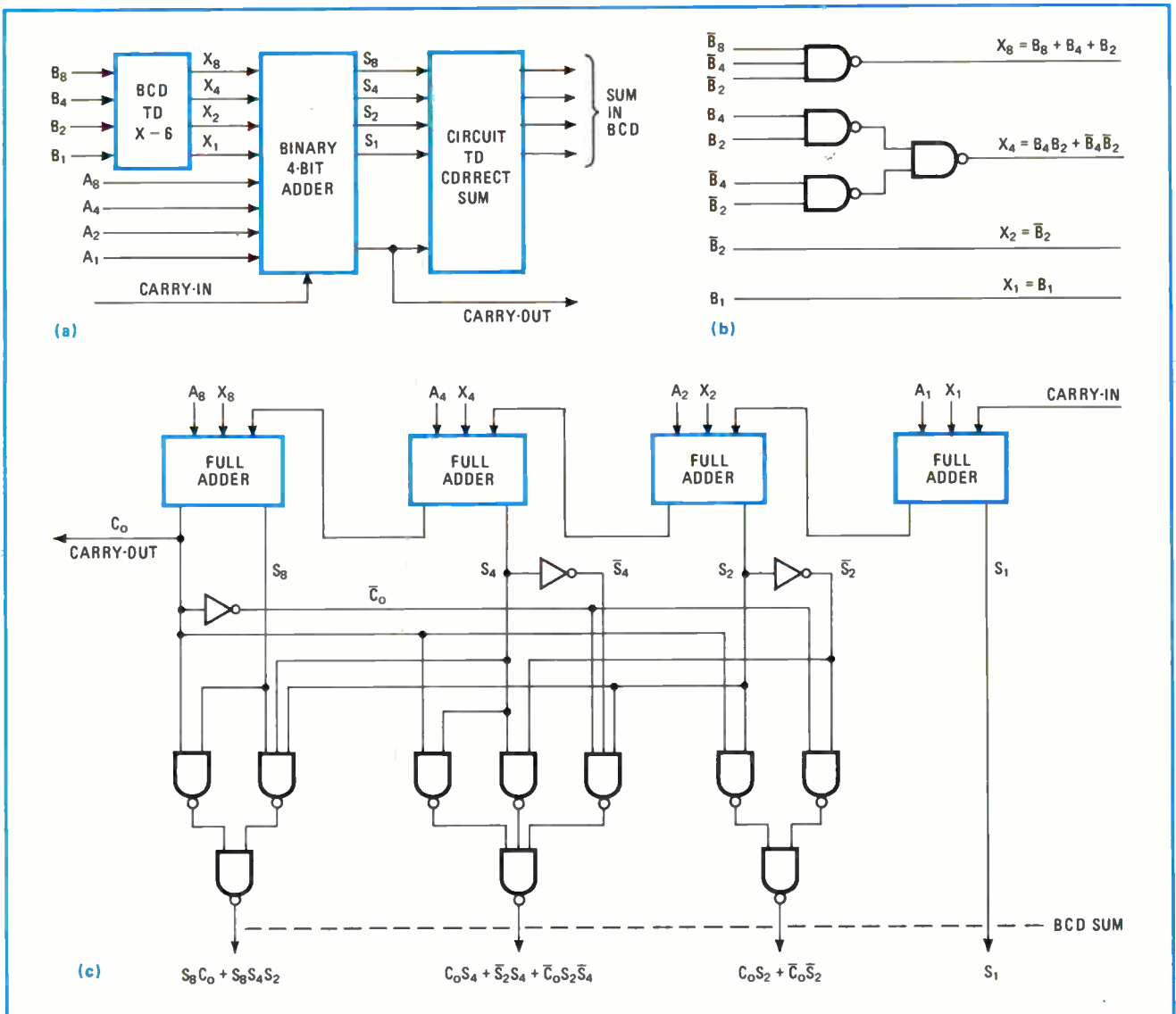

A New Standard For Accuracy!

# 3½ Digit A/D Converter

The LD110/LD111 A/D converter sets the pace for accuracy with a specification of 0.05% of reading,  $\pm 1$  digit. The set consists of two ICs, and with the addition of a reference voltage and clock becomes a full 3½-digit analog-to-digital conversion system. LD110/LD111 features and specifications make the converter set an ideal choice for digital display processors in

- DPMs
- Thermometers
- DVMs
- Scales
- Controllers
- Tachometers
- Instrumentation

#### Specifications

- Accuracy of 0.05% of reading,  $\pm 1$  count
- $Z_{IN} > 1000 M\Omega$
- 4 pA typical input bias current (25°C)
- 100  $\mu V$  resolution (200.0 mV range)
- 40 dB NMRR @ 60 Hz

#### Features

- Auto-zero minimizes effect of offset, drift and temperature
- Auto-polarity
- Sampling rates from 1/3 to 12 samples/second
- Two voltage ranges: 2.000V and 200.0 mV
- TTL-compatible outputs
- \$28.60 per set (100-set price)

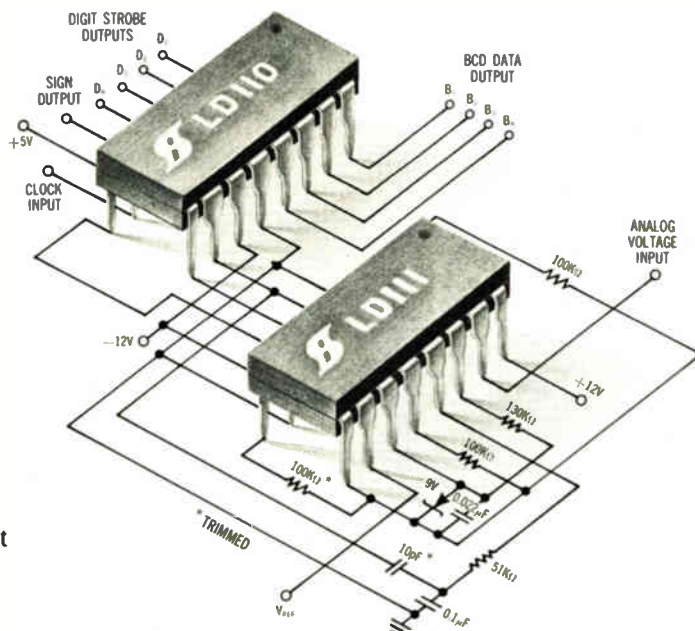

The unique conversion technique uses a single reference and a single full-scale adjustment to achieve a highly-accurate strobed 3½-digit output of up to 3100 counts plus sign. LD111 analog processor employs monolithic PMOS/bipolar construction and interfaces directly with the LD110 digital processor, which has a monolithic PMOS structure. For further information

**write for data**

IC Applications: (408) 246-8000, Ext. 120



**Siliconix incorporated**

2201 Laurelwood Road, Santa Clara, California 95054

# DigiTec introduces another product in the

## HT SERIES (a breakthrough in High Technology)

### 4½ digit, precision Digital Multimeter.

DigiTec's new Model 2210, Digital Multimeter is a full 4½ digit, bi-polar instrument, combining pushbutton convenience with laboratory accuracy and performance. Consistent with the design standards of the HT Series, the Model 2210 delivers the highest level of reliability and serviceability. DigiTec's new, revolutionary "HT Converter," A to D conversion technique, coupled with the use of proprietary LSI, has significantly reduced

component count providing the basis for high reliability. All circuitry and components are state-of-the-art, with plug-in ICs, LEDs and circuit board for easy maintenance. As with all DigiTec HT Series instruments, the Model 2210 is housed and protected by a contemporary, designer-styled, aluminum enclosure that provides an outward appearance as advanced as the technological innovations it contains.



Model 2210 Digital Multimeter **\$525.**

**Features:** Revolutionary "HT Converter" / DC ranges to 1000 volts with autopolarity, sensitivity 100 $\mu$ V / AC ranges to 1000 volts, sensitivity 100 $\mu$ V / Basic accuracy .02% / Resistance ranges to 20 megohms, sensitivity 0.1 $\Omega$  / 4½ digit, large easy-to-read Monsanto LED display / 13 measuring ranges, pushbutton selected / Rack mountable, diecast and extruded aluminum enclosure / Compact half-rack size / Optional, optically isolated parallel BCD output / Available from stock / Generous OEM quantity discounts on request.

UNITED SYSTEMS CORPORATION  
918 Woodley Road, Dayton, Ohio 45403  
Ph (513) 254-6251 Twx (810) 459-1728  
a subsidiary of

**Monsanto**

**DigiTec.**

"information only" circle 110 on reader service card.

"demonstration only" circle 111 on reader service card.

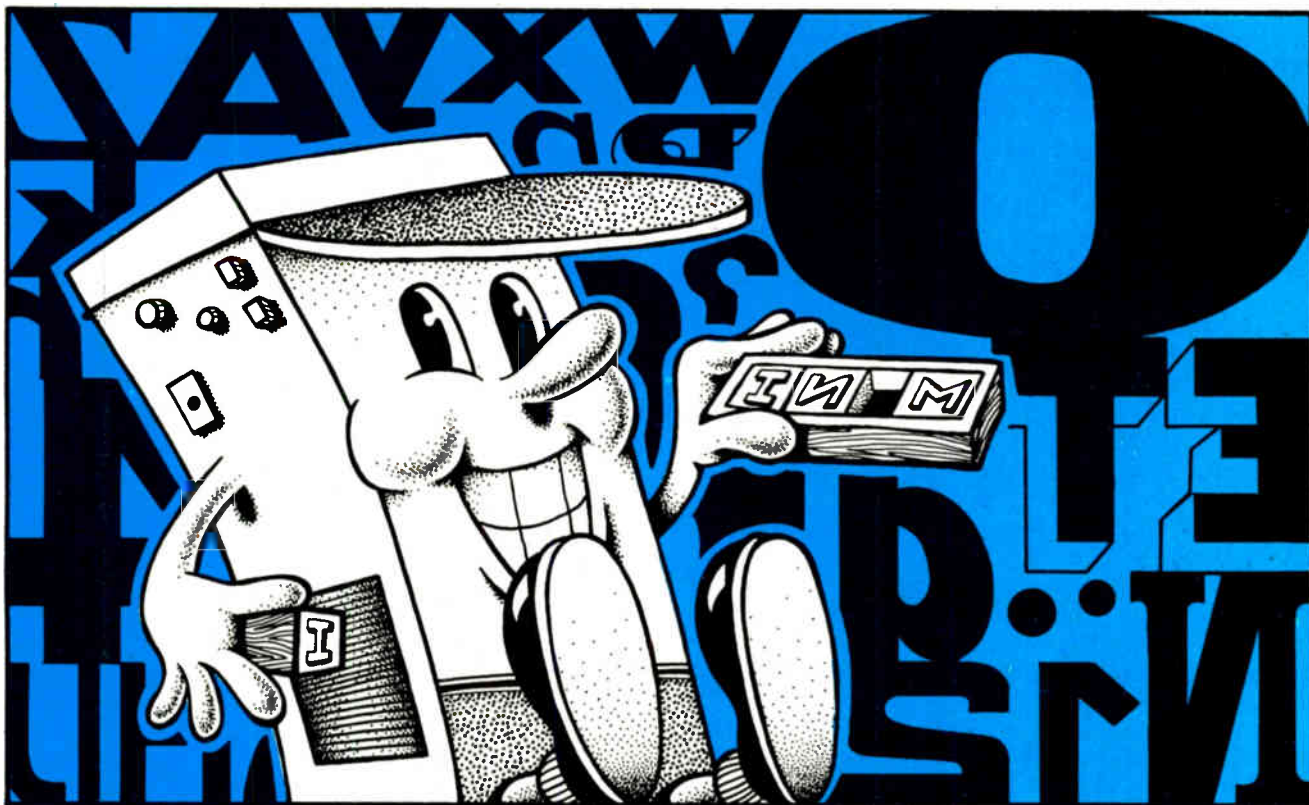

## Computerized text-editing and typesetting make headlines

Hot-metal techniques for setting type are being replaced by computers, which are taking over control of photocomposition machines; on-line editing eliminates costly proof-reading and error correction

by Laurence S. Liebson and Albert L. Bushkoff,  
*Xylogic Systems Inc., Natick, Mass.*

□ The high performance and low costs of mini-computers are bringing about a technological revolution in the printing, publishing, and newspaper industries. In only three years, many newspapers have replaced their techniques for hot-metal production, established in the 1890s, with comprehensive mini-computer-based text-editing and typesetting systems.

These computer-controlled systems are capable of executing the entire type-composition process. They accept on-line input of text from optical character readers (OCRs), on-line keyboards, and remote transmission devices; store text on high-speed disk memories; provide editing and formatting of text through video display terminals; and automatically hyphenate and justify text for high-speed photocomposers, which produce final copy ready for page makeup.

Developing such a system is a combined hardware/software effort, illustrating many of the problems encountered in applying minicomputers. Once the basic operational parameters are determined, several approaches must be analyzed to determine which hardware and software configuration will be most cost-effective, versatile, and reliable. Obviously many tradeoffs must be considered and value judgments made.

Comprehensive production systems, such as the Star/Xylogic copy-processing system, have already been installed by several newspapers in several cities around the U.S. and Canada. These systems have given editorial departments the control they want, while providing production people with the speed and accuracy they need.

The conventional composition process is a time-con-

suming, labor-intensive process that provides many opportunities for human errors. Rising wages and pressure for more up-to-date news create great interest in partially or fully automating the production processes.

In conventional composition, the principal descriptive phrases are "hot-type," or "hot-metal," derived from the molten lead alloy that forms lines of type. The key to the "hot-type" method is the Linotype machine (Fig. 1, on left) and its variations, which execute almost completely mechanical processes. A typical Linotype operator can set three to five lines of type per minute, and is likely to make an error once in every 10 to 20 lines of type.

In recent years, the introduction of paper-tape-driven typesetting machines has improved the speed of the hot-type process. An operator punches copy and hyphenations into tape with a typewriter-like machine; the tape is then fed into a reader that drives the Linotype. Subsequently, paper-tape-oriented mini-computer systems were programmed to produce the tape for the Linotype, which could then produce 10 to 15 lines per minute. The operator still has to punch the tape, but the minicomputer takes over the hyphenation and justification of lines of type.

But the Linotype and other hot-metal processes, even when automated by direct paper-tape drives, are inherently slow and inflexible. In their place, the photocomposition or phototypesetting machine (Fig. 1, on right) has revolutionized the basic method of getting words into print.

### **Photocomposition**

Essentially, a photocomposition machine translates the input by optical, electronic, and chemical means into a columnar readout in the form that it will finally have in the newspaper, at speeds from 25 to 1,000 lines per minute. Phototypesetting output is a positive image on either film or paper, which is pasted onto a newspaper-size dummy page, and photographed onto a film negative (Figs. 2 and 3). From this negative, a plate for the printing press is made by any of various methods.

A typical photocomposition machine, the Star Graphic Systems CompStar 191 (Fig. 4), accepts input from paper tape, magnetic tape, or directly from a computer system. The CompStar has a revolving film-font master, with a maximum of eight different fonts and eight lenses that project type sizes from 5½ to 48 points over a film plane up to 45 picas wide. (A font is a particular type style—Spartan Bold, Bodoni, Gothic, and so forth. Font sizes are expressed in points, with 72 points to the inch, while line lengths are given in picas, 6 picas to the inch. *Electronics* is set in 10-point Times Roman, with headlines and captions in Vega Light; columns are 20 picas wide in articles like this and 13 picas wide in the news sections.) A high-intensity xenon flash lamp projects the character image from the film via one of the lenses and a rotating mirror, onto the output paper or film (Fig. 5). The degree of enlargement of the basic font establishes the point size; the rotating mirror scans each line to set the characters side by side across

the page. The machine can produce up to 150 newspaper lines per minute.

In a newer class of photocomposer, characters are generated from computer storage directly on a cathode-ray-tube display, from which they are projected onto the photographic material. These machines set copy at 150 to more than 1,000 lines per minute.

### **Watch for pitfalls**

A fully integrated system is essential when making the transition from hot metal to photocomposition. The main disadvantage of the "cold-type" operation is that error correction can be much more time-consuming. With hot type, any operator could compose a line of type and conveniently replace the bad line. However, with the new process, an operator must punch a paper tape, process it through a stand-alone hyphenation and justification controller, set the line of type from the new justified tape, develop the film, then cut and paste the new correct line on top of the original film.

Another major problem area for newspaper is regenerating the classified-ad section. With hot-type production techniques, metal slugs could be hand-sorted in trays for each day's classified section. But arranging and manipulating small pieces of photographic paper is next to impossible. One solution is to paste each individual ad on a Styrofoam block, but the result is not easily readable.

To overcome these difficulties, a comprehensive text-editing and typesetting system based on a mini-computer has been developed by Xylogic Systems, an engineering, manufacturing, and consulting firm. The system simultaneously coordinates the input, editing, hyphenation, and justification; produces clean copy directly to the phototypesetter; and virtually eliminates the need for paper tape. Its first installation was made in September 1971 at the Daytona Beach, Fla., News-Journal. Since then, Xylogics has entered into a worldwide agreement with Star Graphic Systems, a wholly owned subsidiary of Dymo Industries, to market and service the system.

The Star/Xylogic Copy Processing System, in its standard configuration (Fig. 6), simultaneously accepts on-line inputs from optical character readers, press wires, keyboards, and video display terminals (VDTs), storing the copy on high-speed, fixed-head disk memories. All text, whether news or advertising, is corrected and edited on the VDTs.

### **Inputs far and near**

Basically, the system has two types of inputs, local and remote. Local inputs include news, classified advertising, and display advertising; remote inputs are the Associated Press and United Press International wire services. The most commonly used local-input devices are on-line typewriters and optical character readers, but VDTs and high-speed paper-tape readers are also available. Although the VDT is a flexible input device, its cost is high and it lacks a hard-copy facility, so that most users reserve it for the most sensitive editing and markup functions. If a user prefers VDTs for input, line printers can produce hard copy.

The specific equipment configurations in a particular



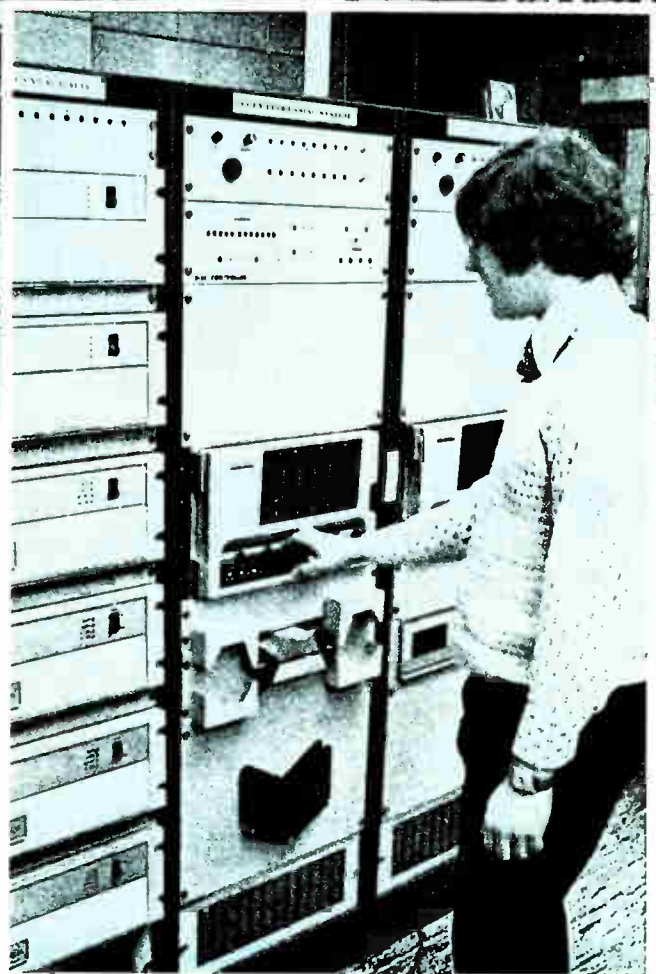

**1. Before and after.** Linotype machines (left), which are the classic semiautomatic typesetters, cast a single slug from molten type metal for each line of printed copy. Their noisy and dirty environment contrasts sharply with the surroundings of photocomposition machines (right), which are typically quiet and clean—so clean that the floors under them may even have wall-to-wall carpeting.

## MINIS IN ACTION

**2. Photocomposition output.** Instead of hot slugs with raised letters along one edge, the newer process produces a positive image from a print of which a dummy page is pasted up for the camera.

**3. Ready for platemaking.** The camera's output is a film negative, and from this negative a printing plate for an offset press is made.

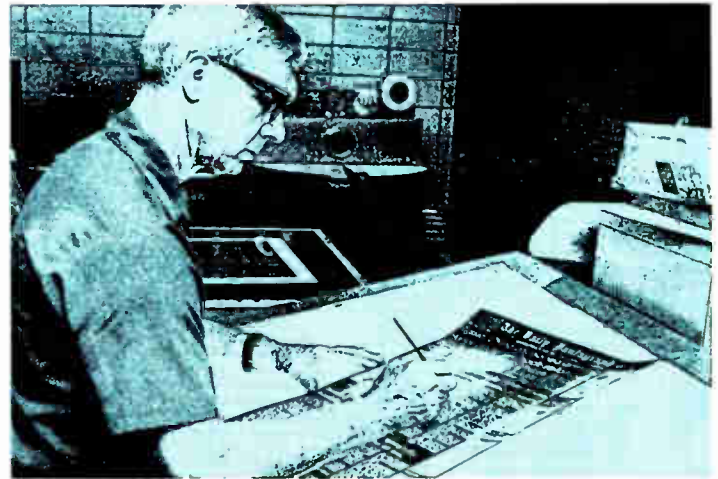
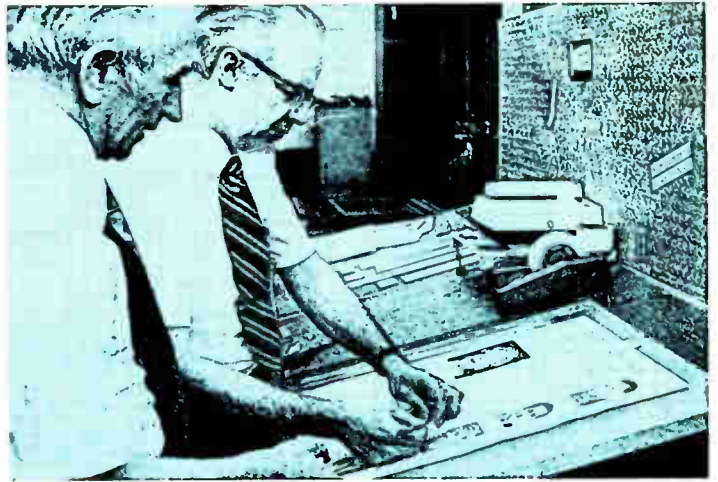

**4. Photocomposition machine.** Paper, magnetic tape, or a computer memory can provide input for this unit, which produces up to eight different fonts in sizes from 5½ to 48 points, 45 picas wide. (There are 12 points to a pica, which is 1/6 inch wide.)

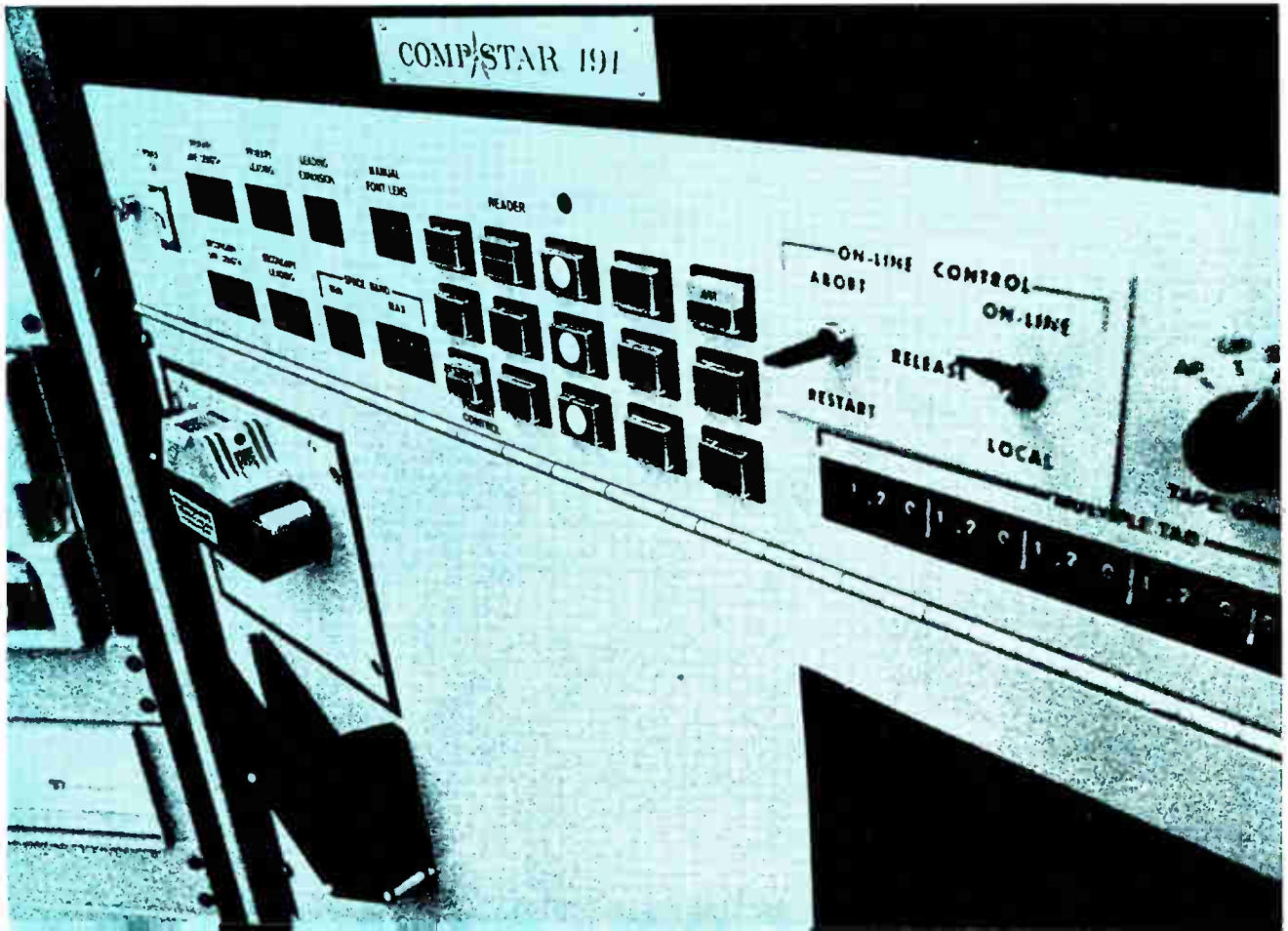

installation are usually determined by local labor-union rules and the number of news and advertising personnel who will use the system—as well as by personal preference. For example, the Farmington, N.M., Daily Times has 12 on-line input typewriters on news and ad-takers' desks; the Daytona Beach News-Journal has five on-line typewriters, used by union punch operators, and one OCR; the Waterloo, Iowa, Daily Courier has only two on-line OCRs. At the Bloomington Ill., Daily Pantagraph, which also uses OCRs, 43 IBM Selectric typewriters in the news, classified, and display departments are equipped with a typing element that prints OCR-readable characters.

In each of these cases, UPI and AP wires go directly into the system, while producing hard copy simultaneously on a teleprinter. The news-copy control desk refers to these printouts to keep track of stories.

After either local or remote copy has been entered into the system, the hard copy is returned to its respective copy-control desk. The editor at the control desk, using a VDT (Fig. 7), can edit any stored material before it is set in type, and add various commands to the copy to change such variables as column width, type size, headlines, and bylines. From the VDT, the editor can also obtain the length of the text, necessary for laying out a story, and review the justified copy, complete with indentations, runarounds, bold-face indicators, hyphenation points, and other copy-fitting requirements. When he is finally satisfied with the story, the final version can be sent on line to a phototypesetter.

Since the copy was proofread before being sent to the typesetter, proofreading the output galley is not necessary, and the need for manual corrections is nearly eliminated. Instead of being held for correction, the galleys produced by the typesetter can be passed directly to the page-makeup facilities. This saves significant amounts of cost and time.

Similarly, the advertising-copy desks use the VDTs to process classified and display-advertising material. Software has capabilities to simplify marking the formats and tabulation of complex ads, as well as to sort and merge new ads each day into the master file. After the sorting and merging, the system produces the entire classified-ad file in photocomposed columns ready for page paste-up, and records each day's classified master file on magnetic-tape cassettes, for protection in case the disk-storage subsystem fails.

### **A tool for printers**

Because some resistance to the system by the personnel who use it was anticipated, the system was designed as a production tool, rather than an advanced computer system. Considerable effort was devoted to achieving ease and logic of operation and to fail-safe conditions when inevitable operational mistakes were made. For example, simple mnemonics are used for important functions, such as "M" for line-measure change, "S" for type-size change, "C" for "copy-fitting," and so forth. In addition, whenever a story is edited, the original version is reserved, so that it can be recalled if a VDT operator accidentally removes or destroys some valuable text. Furthermore, as stories are transmitted on line to the typesetter, a teleprinter produces a log, and the system's

memory retains the text, so that lost galleys—a not uncommon occurrence in the high-pressure newspaper-production environment—can readily be regenerated.

Challenging design considerations were also encountered in attempting to satisfy the newspaper's production requirements. Like many other production and process-control environments with real production deadlines, comprehensive systems in newspaper offices must operate 24 hours a day, seven days a week, and 52 weeks a year.

The Xylogics system has built-in redundancy so that it performs the required functions if a component fails, but doesn't need a costly second system for backup. This built-in redundancy distributes all processing and text storage on at least two devices—that is, instead of one large minicomputer and one large disk, the system is divided between two smaller minicomputers and at least two disks.

In addition, all peripheral devices are on dedicated lines, so that a single component failure cannot render all devices of a particular kind inoperative at once. For example, all VDTs could be multiplexed into the computer, but if the multiplexer were to fail, all VDTs would be inoperative. The alternative provides a separate interface for each terminal.

### **From either to any**

A specially designed multi-computer disk controller coordinates the activities of both processors and all disks so that either computer can address any disk. If either computer or any disk fails, the system will function with backup software programs in a scaled-down version, with only slight degradation of service. A spare disk controller protects against controller failure.

The most important criterion in the choice of equipment was cost-effectiveness and maintainability by newspaper personnel with little or no electronic training—to the extent that they will be able to locate the faulty device and bypass it by means of a standard backup procedure.

The central control unit (CCU) coordinates all the text-processing and text-storing requirements of the copy-processing system. It simultaneously coordinates 64 on-line devices, including press wires, OCRs, VDTs, on-line typewriters, phototypesetters, and other equipment. A typical CCU configuration contains two 16-bit minicomputers, one dual-computer mass-memory controller, two status-alarm and system-monitor panels, six half-million-character fixed-head disks, and one magnetic-tape cassette subsystem.

Its two minicomputers are GRI-99 models manufactured by GRI Computer Corp. Their architecture is based on the universal-bus concept and an unlimited priority-interrupt structure. These capabilities make the minicomputers very efficient input-output controllers. The instruction cycle time is 440 nanoseconds, core memory cycle time is 1.76 microseconds, and the I/O transfer rate is 568,000 16-bit words per second. Maximum memory size is 32,768 words or 65,536 bytes. Both internal and external system elements communicate directly with one another on common data paths along the universal data bus. This direct communication eliminates many computer cycles that data ma-

## MINIS IN ACTION

manipulation normally requires, and it greatly simplifies service and system maintenance.

### Choosing the equipment

The choice of video-display terminals depends on character readability, editing facilities, and cost. Once this choice is made, any changes on the text are actually performed by the terminal. Thus, the system's main responsibility in text editing is to maintain filing, access, and communications for these terminals.

The communications aspect of the system is heightened by the need simultaneously to take inputs from a number of sources. These may be press wires operating at 6 to 10 characters per second, on-line manually oper-

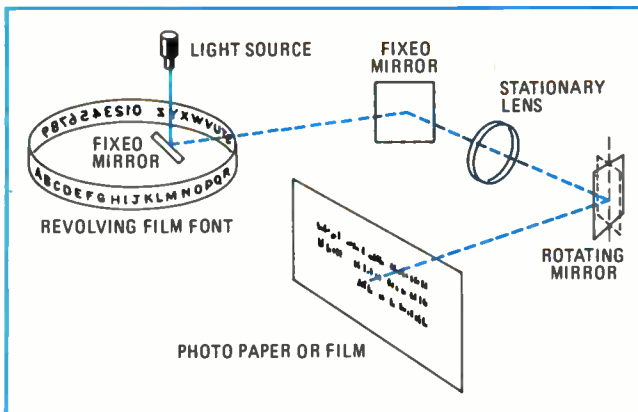

5. **Direct exposure.** A flash lamp projects a character from a rotating filmstrip through lens-and-mirror system. This system defines the character's size as well as its position in a line.

ated typewriters operating at a maximum of 10 characters per second with a minimum of about 50 milliseconds between characters, and such faster devices as paper-tape readers and optical character readers, which could operate asynchronously as fast as 300 characters per second.

The system's main responsibility is to move data between various peripheral devices and the mass memory. For versatility, these communications should go through the computer under program control, to permit varying code conversions, story-boundary recognitions, and formats. These are important considerations in typesetting because different wire services, typesetters, and newspapers all have their own divergent conventions, which they frequently change.

To minimize the use of computer time, all input interfaces present data in parallel to the computer, one full character at a time. Some inputs are normally in this format, but the press wires, which transmit in bit-serial format, require serial-to-parallel converters.

A program-interrupt facility is another important computer time-saver, especially when many input devices are in use. It enables the external device to interrupt the program whenever the device has data available.

Essentially, the interrupt hardware causes the computer to stop after executing the current instruction, store the location of the next instruction in the main program so that operation can resume after servicing the interrupt, and then execute an interrupt routine, another set of instructions that actually brings in the data. When this processing is complete, the computer resets the interrupt hardware, and returns to the main program.

Although most computers provide some sort of inter-

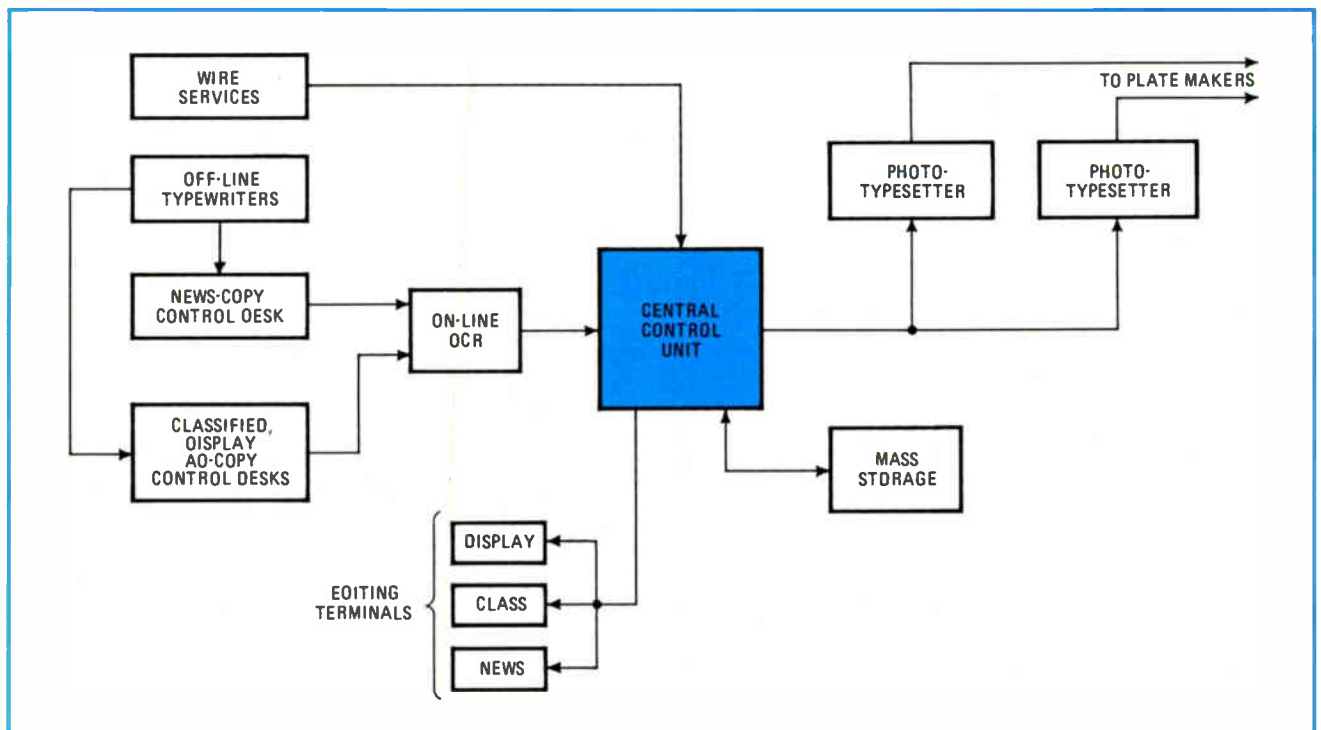

6. **Copy-processing system.** Standard configuration works with the wire services, on-line and off-line keyboards, and optical character readers, stores the data on magnetic disks, hyphenates and justifies the copy, and drives photocomposition machines for output.

rupt facility, they differ widely on the ease of programming the interrupt and the amount of overhead time that interrupt-processing requires. Since the copy-processing system uses interrupts extensively, the chosen computer must provide a powerful interrupt facility, as well as convenient input and output instructions to use with it. This was one of the reasons for choosing the GRI computer.

Other important considerations in choosing the computer were efficiency of data-handling in the coding format to be used, sufficiently fast calculations and manipulations, easy modification of system configuration, simple maintenance, and low price. For handling data in 8-bit Ascii, a machine with a 16-bit word length can fit two characters into each word. With a 12-bit word length, 4 bits in every word would be unused, and the mass memory would be used inefficiently. But with two characters per word, the computer should still be able to individually manipulate each character. A low-cost option in the GRI-99, this is part of the standard configuration in the CPS.

### Universal bus

Easy system configuration and maintainability are enhanced by the universal-bus system, which is the central organizing concept of the computer. This concept is used today in many computers, but when CPS was designed, it was unique to GRI. Under this concept, all devices, including internal registers, arithmetic operators, and input/output interfaces, are attached to a single bus and are addressed in the same way. All instructions specify a device from which to take data, another to receive it, and modifications to be made "on the fly." Since all devices are accessed in the same manner, data from the paper-tape reader, for example, can be used just like data from an internal general-purpose register. Furthermore, switches on the console can send data to any device on the bus or read out data from the device. These switches, which are extremely valuable for debugging interfaces and peripherals, can easily be used by on-site maintenance personnel.

### Memory-performance factors

The choice of mass memory involves consideration of the system's activities. In processing the inputs, the system takes in characters, converts the codes to Ascii if necessary, and stores the characters in a buffer in the main memory until a prescribed number of characters has been received. Then the entire block is transferred to the mass memory device.

To edit the text, a block of characters is read from the mass memory into main memory, and then transferred to a VDT, or vice versa. Likewise, text to be justified and hyphenated, or sent to a typesetter, would be buffered via the main memory. The mass memory also contains a dictionary of words with hyphenation rules, a directory of the stories on file, and special programs and blocks of data that are swapped to and from the main memory when they are needed.

These various functions are performed randomly and unpredictably, which eliminates any magnetic-tape mass-memory system because it would have to be serially accessed. Semiconductor and large core memories

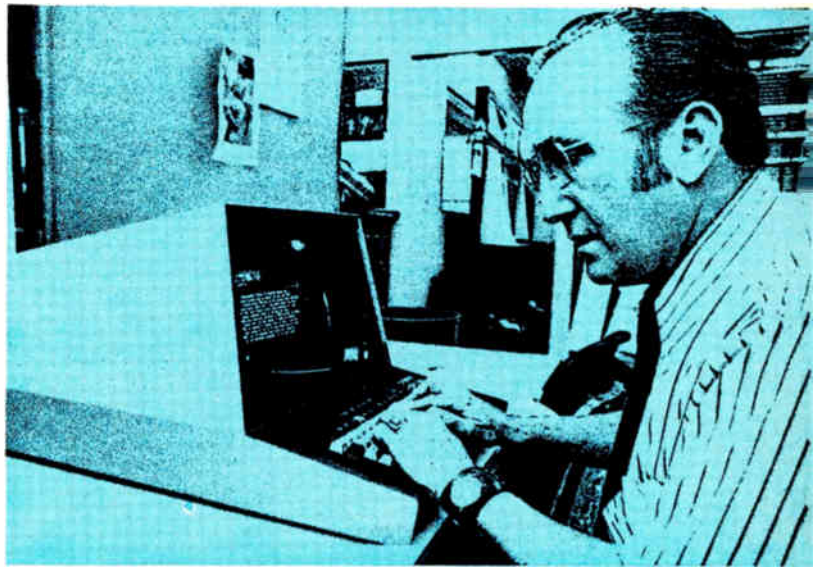

**7. On-line editing.** Any stored copy can be brought out to a display terminal and altered to fit layout restrictions or have new material incorporated. In addition, proofreading is done at this stage.

were too expensive at the time the system was designed. Thus, the clear choice is disk memory. A moving-head disk would provide a large storage capacity at low cost, whereas a fixed-head disk provides considerably shorter access time, but much lower capacity for a given cost. An analysis of storage requirements shows that the prime criterion is access time.

The required access time depends on the number of disk accesses that are made in a given time period, the way the computer handles the data, what it does while waiting for the data transfers from the disk, and how the access time would affect the response time as seen by the people who would be using the system.

For one thing, the computer can do little other than process interrupts while waiting for completion of a disk access. When a VDT user orders a story to the screen for editing, the system makes at least one access to the story-directory disk, followed by another access to get the first block of text. As later blocks of text are transmitted to the terminal, the computer makes repeated accesses to the disk. Meanwhile, other accesses are required for dictionary lookup and hyphenation, typefont information, and formats.

Furthermore, each VDT operator should be independent of other system users. In a system with 12 VDTs, five simultaneous accesses could be expected during a peak editing period. Each terminal transmission rate is approximately 640 characters per second, and each block of text contains 256 characters. Thus 12.5 disk transfers would be required each second, corresponding to an average rate of 80 milliseconds per transfer—not counting the disk accesses required for directory-filing, dictionary lookup, text input from OCRs, text output to the photocomposer, and the frequent disk-data transfers required by the justification program.

### Too slow

But the maximum access time of moving-head disks that were available when the system was designed, taking into account both the time to position the head and

## MINIS IN ACTION

the rotational time, is about 100 to 120 milliseconds, and the average access time is about 50 to 60 ms. Furthermore, to ensure accurate head positioning in the disk unit used with the earliest CPS models, the track address is written permanently at the beginning of every data block on the disk. When data is read, this address is simply checked, but a write operation on the disk is preceded by reading and checking the track address, and then writing on the next revolution. The change from read mode to write mode takes too long to be done on the fly between the address and the data-block area. This, of course, adds the time of one extra revolution to every write operation, which thus has an average access time of 150 to 180 ms and a maximum of 200 to 240 ms.

Obviously, an average transfer rate of 80 ms per block can't be maintained under these conditions. But fixed-head-disk access times are about 25 ms maximum and 12.5 ms average, making them a clear choice. Furthermore, the lost time is not necessary in write operations to check head-positioning, nor is the track address required in each block, permitting fixed-head disks less data-bit overhead in each data block.

However, many improvements have been made recently in moving-head disks. Head-positioning time has been drastically lowered and higher bit densities have permitted an extra switching gap to be added to each data block, obviating an additional revolution of the disk for write operations. These and other advances

have made a moving-head disk feasible in some later models of the copy-processing system and, consequently, for supplementary storage to fixed-head disks in large configurations.

### Future trends

A recently completed add-on module to the system is the Xygraph (Fig. 8). The device can show complex display ads in greater detail than can a conventional VDT, which has one type face and displays only one character size. The Xygraph, in conjunction with the system, interactively simulates a phototypesetter. It plots a wide variety of fonts in any size, positioning each character in the correct location. And a facility called zooming and windowing enables the user to view areas larger than the display screen or to magnify selected portions of the display image to show additional detail.

The display is based on a Digivue plasma panel manufactured by Owens-Illinois Inc. and includes special-purpose hardware and software developed by Xylogics. The panel is essentially an array of individually addressable neon light bulbs packed 60 per inch horizontally and vertically. Each addressable dot may be individually turned on or off, so that the panel serves as both the display and the storage element.

A more ambitious project would be to develop an elaborate software package that would eliminate page makeup entirely. The software would enable the editor to lay out the copy for a page, digitizing and storing photographs with the aid of a graphic scanner, and transmit fully made-up pages, text, and half-tones to a high-resolution phototypesetter 100 picas wide. □

<small>Iceberg</small> Lettuce	\$ .45	<small>Iceberg Large Head</small> Lettuce	\$ .45
<small>California</small> Tomatoes	\$ .82	<small>California poly pack</small> Tomatoes	\$ .82
<small>French</small> Red Radishes	\$ .29	<small>French 1 lb pkg</small> Red Radishes	\$ .29
<small>Shady Washington Delicious</small> Apples	\$ .09	<small>Shady Washington Delicious ea</small> Apples	\$ .09
<small>Tropicana</small> Orange Juice	\$ .89	<small>Tropicana half gal</small> Orange Juice	\$ .89
<small>granulated</small> G. W. Sugar	\$ .58	<small>granulated 5 lb bag</small> G. W. Sugar	\$ .58
<small>Killdo</small> Wieners	\$ .79	<small>Killdo 12 oz pkg</small> Wieners	\$ .79
<small>Delaney's Polish</small> Sausage	\$ 1.09	<small>Delaney's Polish 1 lb</small> Sausage	\$ 1.09
<small>Roll</small> Roll Sausage	\$ .79	<small>Roll 1 lb pkg</small> Roll Sausage	\$ .79
<small>Domestic</small> Pineapple	\$ .45	<small>Domestic 8 oz can</small> Pineapple	\$ .45
<small>Kidney Beans</small> Ketchup	\$ .26	<small>Kidney Beans 14 oz bottle</small> Ketchup	\$ .26
<small>Red</small> Kidney Beans	\$ .39	<small>Red 16 oz can</small> Kidney Beans	\$ .39

8. Xygraph. New display device, which is based on a plasma panel, helps newspaper staff to visualize layout before it is committed to camera. Graphic cathode-ray tube could do as well, but would be bulkier and much more expensive.

## Data transmission is faster with ternary coding

by T. Bruins

Cern European Organization for Nuclear Research, Geneva, Switzerland

Although data is usually transmitted in binary form, much faster bit rates can be realized, even over long distances, if the data is converted to ternary form. With optimized filters and sensitive receivers, for instance, a ternary data transmission system can achieve an effective rate of up to 6 megabits per second over a 1-mile line of ordinary twisted-pair cable.

Although twisted-pair drivers have been around for quite some time, they have only been used to carry binary information. Here, logic 1s and logic 0s are defined by the two opposite polarities on the two transmitter outputs. Decoding these voltage differences into ordinary TTL levels is normally done with voltage comparators. The common-mode noise immunity that this system offers has made it one of the most popular transmission techniques in recent years.

Strangely enough, however, nobody has considered the usefulness of a third state, which would still retain a

certain immunity to common-mode noise. This state is defined by the absence of any voltage difference at the transmitter outputs. It is primarily useful for sending ternary-coded data over long distances. In case bit speeds are of no great importance, binary data could still be transmitted in the conventional way. The third state would then be used for status information or for system synchronization.

There are several ways of implementing a ternary data transmission system. Over distances of a mile or more, special-purpose balanced line drivers providing a choice of differential or single-ended operation must be used. In these cases, a tristate line driver like National Semiconductor's DM8831 unit is a good choice. The single-ended state may be detected with biased voltage comparators.

If two comparators are used, biased, for example, to different polarities, the third state can be decoded with a mere exclusive-OR logic operation, as shown in (a). This is a simple scheme for low bit rates. It is particularly useful if status or control information is transmitted on the same twisted pair as the data but must nevertheless be distinguished.

For very long lines or for transmission rates of greater than 1 megabit per second, it is best to use two tristate line drivers, establishing a grounded symmetrical transmission system. The three states are easily generated

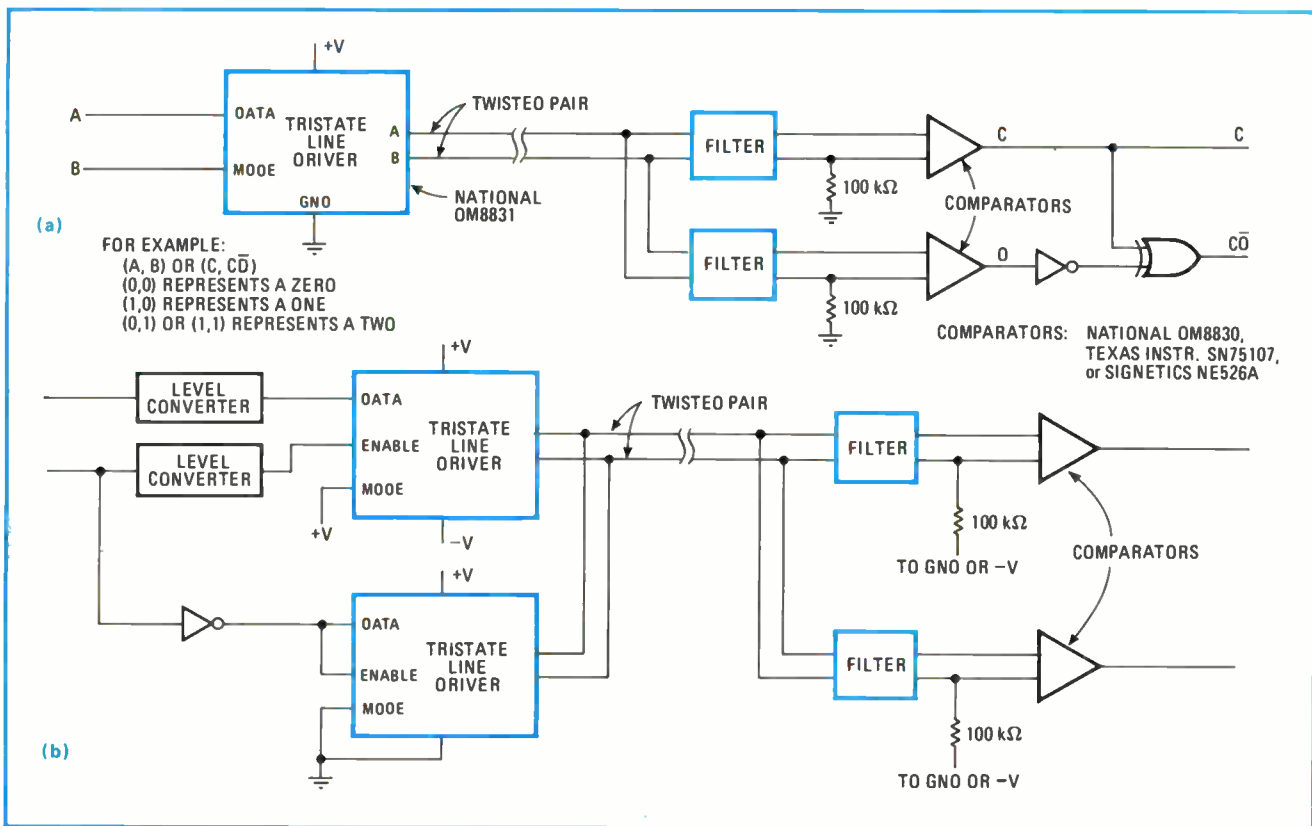

**Getting more out of a twisted pair.** Ternary-coded data can be transmitted at megabit rates through ordinary twisted pairs over long distances. A single integrated tristate line driver can be used to send the data at low bit rates, as in (a); or two drivers can be employed, as in (b), for higher bit rates. If desired, the third state can be used for synchronization purposes or to transmit status or control information.

with two line drivers, as in (b). One driver operates differentially (at  $-2\frac{1}{2}$  and  $+2\frac{1}{2}$  volts, instead of the usual 0 and 5 v), while the other driver operates in its single-ended mode at normal voltage in a complementary fashion.

To change binary-coded data into ternary-coded data does not require an excessively complicated conversion circuit. Consider, for example, that a fully decoded 16-bit binary word reduces to 10 ternary bits— $(1\ 111\ 111\ 111\ 111\ 111)_{\text{base}2} = (1\ 022\ 220\ 020)_{\text{base}3}$ . In this case, full code conversion provides a bit reduction of 10/16. This means that a ternary-coded transmission system that is able to carry 4 megabits per second of binary-coded data now can effectively carry 16/10 times more information, or 6.4 megabits per second.

Code conversion can be simplified greatly if the binary bits are coded in subgroups. If two binary bits are taken as a subgroup, two ternary bits are required to convert each subgroup. But if subgroups of three binary

bits are used, again only two ternary bits are needed (since  $111_{\text{base}2} = 21_{\text{base}3}$ ) and, therefore, 16 binary bits can be coded into 11 ternary bits.

One application for a ternary transmission system is the use of ternary parity bits. Since there are three states (instead of two), two flip-flops (instead of one) are required. The parity check, then, can just be the modulo-3 addition of the information bits. In this way, a large number of even errors will be detected, but not all odd errors.

With  $k$  free binary bits as information carriers and  $n - k$  dependent ternary error detection bits, there are  $2^k$  information words out of  $2^k \times 3_{n-k}$  possible bit combinations. Therefore, the ratio of nondetectable errors to all possible errors will be:  $(2^k - 1)/(2^k 3^{n-k} - 1)$ , which approximately equals  $\frac{1}{3}n^{-k}$ . If one single ternary parity check is used, then two thirds of all possible errors will be detected, instead of only half the errors, as in the case of the modulo-2 parity.  $\square$

## In-circuit IC tester checks TTL and C-MOS

by Ronald G. Ferrie  
Communications & Controls Co., Pittsburgh, Pa.

An in-circuit IC logic tester, which can be built easily and inexpensively, can check ICs operating from supply voltages of 5 to 15 v. This means that the tester can be used for C-MOS devices, as well as TTL devices. The IC, however, must be powered from a single-polarity supply.

Although the test circuit draws its operating power from the IC being checked, it does not load the IC's logic points. Total operating current is usually less than 60 milliamperes for a typical 16-pin IC package.

Figure 1 shows what the test circuit looks like for checking three logic points. Light-emitting diodes are used to indicate whether the input signal is logic 0 or logic 1. As the truth table indicates, a logic 1 at an input causes the LED associated with that input to light. A pair of junction diodes and an inverting C-MOS buffer are

used to gate each logic signal for driving the LED.

This simple arrangement can be easily extended to handle any number of logic inputs by simply adding more stages—an additional buffer, diode pair, LED, and current-limiting resistor for each new logic input to be checked.

To conserve power, the indicator LEDs are operated at 2 mA. Because of this, the LEDs will have a low luminous output, making it necessary to mount them so that they do not compete with ambient light. Recessing the lamps slightly and providing a dark background color is usually adequate. For this tester, the LEDs and their associated electronics were mounted in a small plastic box and connected to the IC under test by means of a cable terminated in a dual in-line test clip.

Figure 2 shows a complete test circuit for a 16-pin DIP. Resistor  $R_2$  is included here at each input to prevent ambiguity when an IC with uncommitted terminals is being measured. The power supply formed by the zener diode and the transistor is poorly regulated—its main purpose is to limit the voltage driving the LEDs and thereby conserve current consumption.  $\square$

Engineer's Notebook is a regular feature in Electronics. We invite readers to submit original design shortcuts, calculation aids, measurement and test techniques, and other ideas for saving engineering time or cost. We'll pay \$50 for each item published.

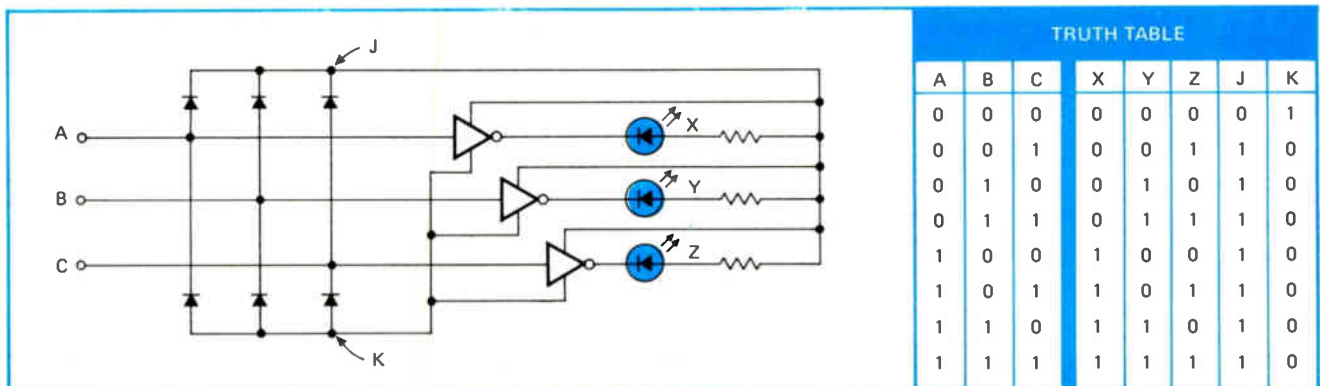

1. Simple go/no-go check. The basic circuit employed by the in-circuit IC tester is illustrated here for three logic inputs. Light-emitting diodes indicate the presence of a logic 1 at the input. A C-MOS buffer and a pair of junction diodes gate each logic signal.



**2. Complete tester for 16-pin DIP.** This in-circuit IC tester derives its power from the device being checked without loading that device. The indicator LEDs are operated at a very low light level. A resistor ( $R_2$ ) at each input helps to eliminate signal ambiguity.

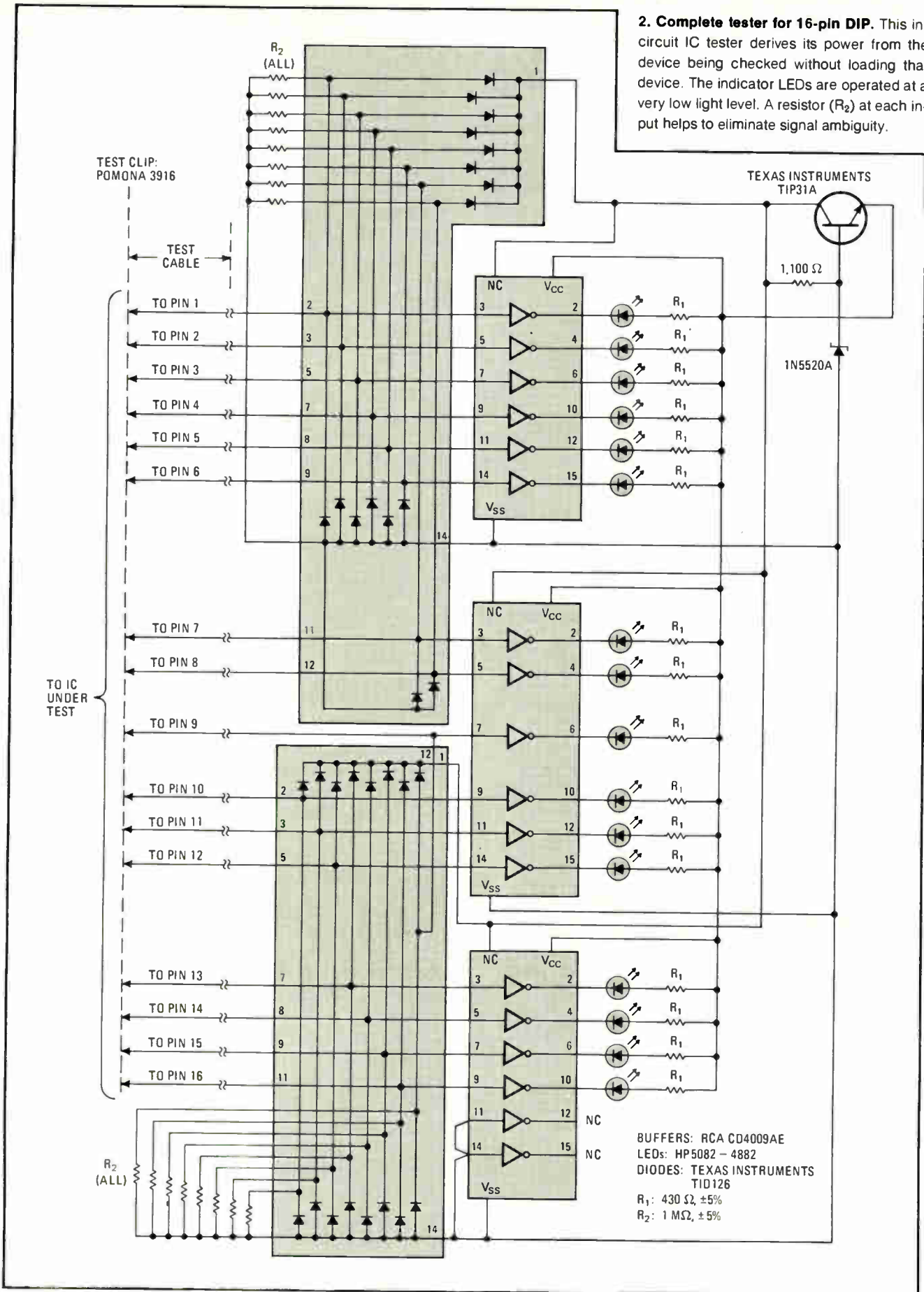

## Who'll be best at designing with microprocessors?

Manufacturers wanting new equipment designed around the new microprocessors may be having **trouble deciding which type of engineer to hire for the job**. Should it be one with hardware experience who can be taught software, or a programmer who must then be taught hardware analysis? A better type may be a **computer service engineer—specialists that computer companies send out to troubleshoot their customers' problems in both hardware and software**. According to John Scott, director of engineering for computer products at International Communications Corp., Miami, Fla., these engineers **"could be naturals for the job."**

## Paper mask for pc board keeps solder in its place

Gauges for measuring high pressures in military and industrial systems—**shock-wave and wind-tunnel analysis, jet-engine measurements, and the like**—have usually depended on quartz-crystal transducers. But the **quartz devices must be very large**, since a piezoelectric crystal's output is proportional to its size.

A better approach is to **replace the quartz transducer with one made of lithium niobate (LiNbO<sub>3</sub>)**, which is much more pressure-sensitive and produces high voltages even in configurations with only 1-inch diameters. LiNbO<sub>3</sub> gauges fabricated by scientists at Sandia Laboratories, Albuquerque, N.M., have measured pressures of 250,000 psi created by shock waves lasting only a few nanoseconds.

## Pressure transducers of lithium niobate are very small

Need a quick, rough way to mask off the not-to-be soldered regions on printed-circuit boards headed for a wave-soldering machine? Use solder wave masks. **Cut from 7-mil paper tape, these adhesive-backed masks survive 5 to 8 seconds in a 510°F solder bath**. Then they're simply stripped from the boards, leaving no residue. Various sizes are available from stock, at about \$2.15 a thousand, from Webtek Corp., 4326 W. Pico Blvd., Los Angeles, Calif. 90019.

## How to eliminate big base-line shifts from radar video signals

When radar video information is transmitted, the **RC-coupled transmission lines often introduce a base-line shift in the signal**. If the shift is large enough, the unwanted voltage can be mistaken for a signal voltage—and sadly, **conventional diode clamping techniques employed in compensating for small base-line shifts cannot eliminate large ones**.

There is a simple solution, says James R. Kaneses, Pacific Missile Range, Point Mugu, Calif.—**use a pulse amplifier as a video clamp**. Besides producing a stable zero-volt baseline, it drives any load from 75 ohms to 1 megohm with low loss.

The circuit consists of a single transistor and two resistors. The input signal is applied directly to the transistor's emitter, and the output is taken directly from the collector. One resistor (from emitter to ground) provides a ground return for any output coupling capacitance in the circuitry preceding the clamp. The other resistor (from base to ground) prevents the base-emitter junction from loading down the source.

In this way, the input video signal pulse provides the emitter drive voltage, as well as power to the collector. If the transistor is a type 2N393 or 2N1143, the input resistor 75 ohms, and the base resistor 240 ohms, **the circuit will develop a 2-V output from a 3-V input**.



**WE'RE  
STILL  
SELLING  
TTL'S AND DTL'S  
AT THE  
SAME OLD  
CORNER!**

For your convenience, our Sales Department starts work at 7:30 A.M. Pacific Time. Dial toll free.

Out-of-State Call toll free. Dial: **800-538-7906** and ask about price and delivery.

## Get a Stewart-Warner quote before you buy!

Although we have a great new custom C/MOS capability—don't forget our 7400 TTL's and 930 DTL's. They're still our bread-and-butter, and wouldn't you rather do business with somebody who takes

bipolar seriously? There aren't too many of us left, but we've been at it for too long to run out on you now. So if you're looking for 7400's or 930's, get our quote before you buy. Call us directly or contact our

nearest representative or distributor.

**SYMBOL OF**  
**SW**  
**EXCELLENCE**

**STEWART-WARNER MICROCIRCUITS DIVISION**  
**STEWART-WARNER CORPORATION**  
730 E. Evelyn Ave. • Sunnyvale, Ca 94086 • (408) 245-9200

Contact your nearest authorized representative, or get your quote on our out-of-state toll-free line—(800) 538-7906.

#### WESTERN STATES

Washington, Oregon, Idaho, Montana,  
British Columbia, Alaska  
SD R<sup>2</sup>  
Bellevue, Wash 12061 743 9424

Northern California  
P.M. SALES  
Los Altos, Calif (415) 941-5444

Southern California  
VARIGON ASSOCIATES  
El Segundo, Ca 12131 644 3611

Arizona and Southern Nevada  
DE ANGELO, ROTHMAN & CHEEVER, INC  
Scottsdale, Ariz 16021 948-2240

Utah, Colorado, New Mexico, and Wyoming  
WALGAMAN ASSOCIATES, INC  
Wheatridge, Colo 13031 423 1029  
Albuquerque, New Mexico 15051 265-4097

#### MID-WESTERN STATES

Minnesota, North Dakota, South Dakota,  
and Western Wisconsin  
S & R COMPONENT SALES  
Minneapolis, Minn 16121 544-3072

Michigan and Northwestern Wisconsin  
STEWART-WARNER MICROCIRCUITS  
Sunnyvale, Calif (408) 245-9700

Illinois and Southern Wisconsin  
L.T.E.C. INC  
Chicago Ill (312) 286 1500

Indiana and Kentucky  
G & D ELECTRONIC SALES INC  
Fort Wayne, Ind (219) 432 5835  
Texas, Oklahoma, Arkansas, and Louisiana  
EVANS & DOWELL ASSOCIATES  
Dallas, Texas 12141 238 7157  
Houston, Texas 11311 777 1782

Kansas, Nebraska, Missouri,  
and Iowa  
DY TRONIX INC  
380 Breaky Drive Suite 102  
Hazelwood, MO 63042 13141 731 5799

#### EASTERN STATES

Mississippi and Alabama  
20th CENTURY MARKETING  
Huntsville, Alabama 12051 772-9237

Florida  
CARTWRIGHT & BEAN, INC  
Orlando, Florida 13051 427-4531  
Plantation, Florida 13051 791-3989

Ohio, Kentucky, West Virginia  
CREST COMPONENT SALES  
Chagrin Falls, Ohio 12101 543-9800

Maine, New Hampshire, Vermont,  
Massachusetts, Rhode Island,  
and Connecticut  
COM SALE

Waltham, Mass 16131 890 0011

Meriden, Conn 12031 634 0179  
Maryland, Washington, D.C. and  
Virginia  
MONTEIRO ASSOCIATES, INC  
King of Prussia, Penn. 12151 265-0634

Metropolitan New York and  
Northern New Jersey

MARK INTERNATIONAL EXPORTS  
New York, N.Y. (616) 538-3844

S.J. SALES ASSOCIATES, INC  
Jamaica, N.Y. (212) 291 3232

Upstate New York

STEWART-WARNER MICROCIRCUITS  
Sunnyvale, Calif (408) 245-9200

Eastern Pennsylvania, and  
New Jersey

MONTEIRO ASSOCIATES, INC  
King of Prussia, Penn (215) 265-0634

Georgia, Western Tennessee

STEWART-WARNER MICROCIRCUITS  
Sunnyvale, Calif (408) 245-9200

North Carolina, South Carolina, Eastern  
Tennessee

STEWART-WARNER MICROCIRCUITS  
Sunnyvale, Calif (408) 245-9200

#### CANADA

Canada

SPACE ELECTRONICS SALES  
CORPORATION

Montreal 307, Quebec, Can (514) 735-5775

Reynolds, Ontario, Can (416) 741-6362

Ottawa 2, Ontario, Can (613) 745-6300

OVERSEAS

Great Britain

BEAM Components  
Rochester, Kent, England Telex 851 965166+

Germany, Austria, and Switzerland

INTERNATIONAL MICRO ELECTRONICS  
5021 Koenigsplatz  
Lutherstr., 9 Germany

#### Japan

S. KIMURA AND COMPANY, LTD  
Tokyo, Japan Telephone 1031 217 4841

Israel

TELSVS LTD  
Ramat Gan, Israel

Telephone 739865 - 722362

India

ZENITH ELECTRONICS  
Bombay, India Telephone 367717

Palo Alto, Calif,  
Telephone (415) 493-1788

# Only TRW/IRC offers you complete resistor choice.



# You get exactly the resistor you need for your application.

## No compromises. No "favorites." Just quality.

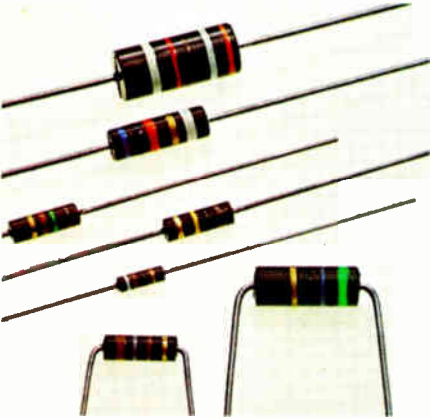

### Carbon comp.

Billions used in consumer, industrial, military applications. TRW/IRC carbon comp. capability ranges from standard commercial types through established reliability RCR's, to ultra-high range ( $10^{11}$  ohms). Where you're using carbon comp.'s in automated assembly, TRW/IRC packaging options can help cut the cost of interfacing with your machines. Card packs, lead tape reels, cut and formed leads...we'll be glad to explore the potential economies with you.

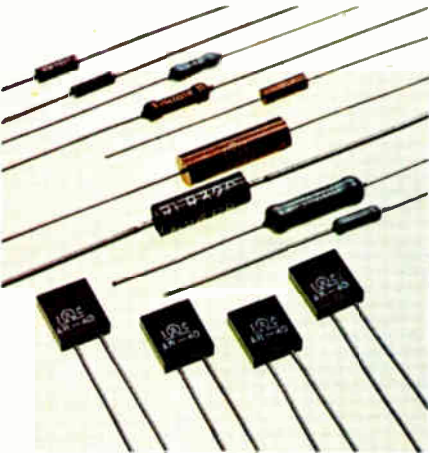

### Metal Film

TRW/IRC has brought the state of the art in thin-film to a performance level equaling high-stability wirewounds. Capabilities include resistors with tolerances to  $\pm 0.01\%$  and  $\pm 3$  PPM T.C. ...high-rel units... precision subminiatures...and, of course

the popular RN's. You can also look at alloy films offering high-temperature and high-voltage capability at low cost.

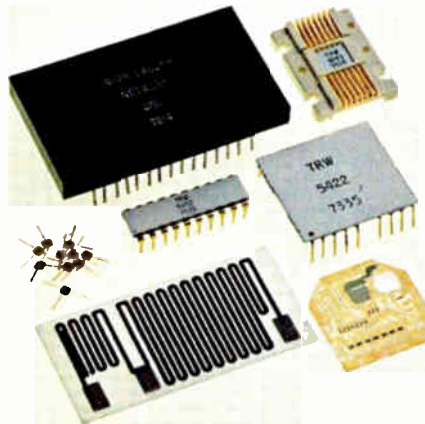

### Resistive Networks

Advanced resistor technology here. These IC compatible, precision tantalum-film circuits provide inherent low noise, excellent stability, and hermetic performance without hermetic cost. Tolerances from 5% to 0.05% available in custom designs. TRW/IRC also offers the industry's most complete line of discrete fixed resistors.

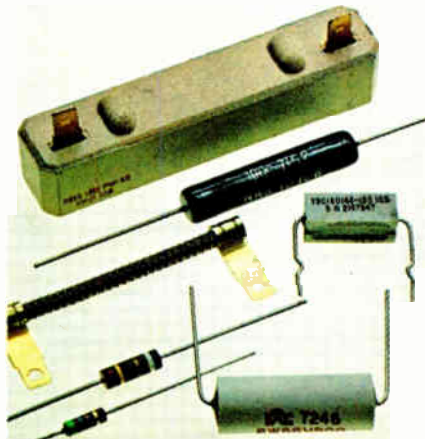

### Wirewound

The line starts with molded wirewound resistors—"space-savers" that bridge the cost-performance gap between composition resistors and precision wirewounds. It proceeds to standard, non-insulated types

for appliance/automotive use...to precision subminiatures offering high power density... to low cost fusible, flameproof units for consumer and industrial applications... to tubular and flat power wirewounds with ratings to 250 W.

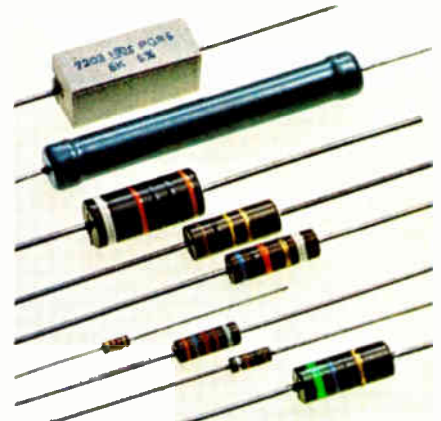

### Metal Glaze™

This is TRW/IRC's thick-film technology—for all types of low power resistor applications. Metal Glaze is widely accepted for its built-in power handling reliability, resistance range, and cost effectiveness. Numerous standard and special designs—precision, semi-precision, flameproof, high-rel, high-voltage.

### All types...all technologies... one source

To wrap it up, TRW/IRC offers you the most complete line of fixed resistors in the business, with many of the popular types available from one source—your local TRW/IRC distributor. Having a direct pipeline to each of our plants, he can give you fast delivery.

Contact your local TRW sales office for application assistance, custom designs, and special engineering help when you need it. TRW/IRC Resistors, an Electronic Components Division of TRW, Inc. Plants at Boone, N.C., Burlington, Iowa, and Philadelphia, Pa. Write TRW/IRC Resistors, 401 N. Broad St., Philadelphia, Pa. 19108. Or call (215) 923-8230.

# TRW<sup>®</sup> IRC RESISTORS

Circle 125 on reader service card



# The OEM Factory announces a 30% reduction in price.

Here they come. Full-scale PDP-11/05's. From the largest, most efficient OEM minicomputer factory in the world.

Complete 16K minicomputers with real-time clock, serial line interface and power fail/restart built right in.

Just \$7,495 in quantities of one.

But single unit quantities aren't what The OEM Factory is all about. So when you pur-

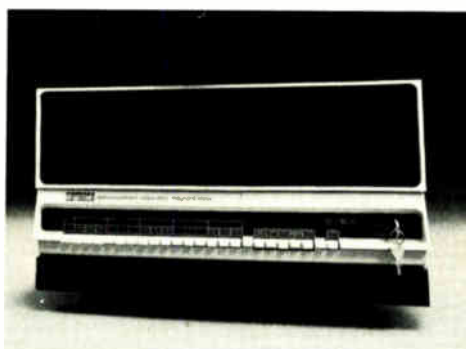

chase in lots of 50, the price drops to \$4,947.

You already know about the product and service rea-

sons for buying from Digital. There's another reason. Price. Made possible by The OEM Factory.

Write or call Digital Equipment Corporation, Maynard, Mass. 01754. (617) 897-5111, Ext. 2038. European headquarters: 81 route de l'Aire, 1211 Geneva 26. Tel: 42 79 50. Digital Equipment of Canada Ltd., P.O. Box 11500, Ottawa, Ontario K2H 8K8.

**digital**

# New products

If  
you  
think all card  
readers  
are alike...

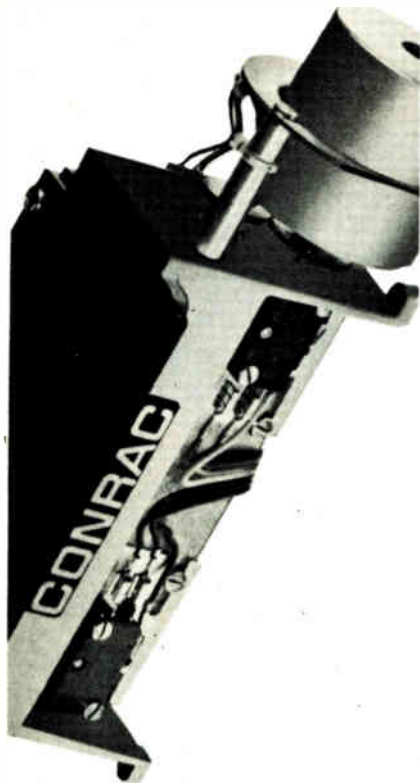

take a look  
at  
CONRAC

Take a good, long look before you specify... check and compare all the features offered by the CONRAC A-31 Series Magnetic Card Reader. Here are only a few: • Read or write on Standard Magnetic Cards • Industry Compatible Credit Cards— IATA, ABA, THRIFT, NTT • Card remains stationary and visible at all times—minimizing chances of card loss, damage or jamming • Card-in-place switch—insures proper insertion of card before operation • USA designed and made for OEM applications requiring rugged, long life • All this plus more and it's one of the lowest priced. <sup>500</sup>

Write For Descriptive Literature.

**CONRAC** CRAMER DIVISION  
CORPORATION

Mill Rock Road, Old Saybrook, Conn. 06475  
(203) 388-3574

## New products

Packaging & production

### Patterns created without masks

Electron-beam system  
exposes wafers directly  
and reduces design time

A computer-controlled electron-beam micropattern generator is said to require significantly less design and prototype time than conventional mask-dependent methods of fabricating semiconductors and other devices, including bubble memories, surface-wave acoustic units, and some Josephson devices. The system, developed by Radiant Energy Systems and called the EBMG-600, exposes sensitized wafers directly, without the use of masks. It can also be used as a scanning-electron microscope with a television-like display and a resolution of better than 90 angstroms.

The EBMG-600, priced below \$200,000, consists of a computer-aided-design system, a pattern-data generator, a scanning-electron microscope, a computer-controlled deflection system, an automatic X-Y table, and a laminar-flow load lock. Complete operator training is also provided. The operator, using the system's interactive graphic display, can design a device and then write the required patterns immediately on a silicon wafer or other substrate by means of the electron-beam generator.

The conventional method of development and fabrication typically depends on a computer-aided system for design, but then requires rubylith cutting and photo generation or optical pattern-generation and photo-reduction. Both systems produce masks that are used to expose wafers and fabricate devices.

An important function of the EBMG-600 is its scanning-electron microscope, which enables problems with devices to be found quickly. An ultra-low-voltage operating mode permits inspection of substrates

without exposure of the resist-coated pattern, and insulators can be examined in the field-emission microscope without metal coating. Accelerating voltage for the microscope is variable from 0.5 to 20 kilovolts.

As a pattern-generator, the system can create designs by combining any of three basic operating modes: rectangular geometries, vectors, and point-by-point plots. The system has a 14-bit (16-bit optional) high-speed digital-to-analog converter, an effective writing field of 1.6 by 1.6 millimeters, and resolution and deflection accuracies within 0.1 micrometer. Larger fields can be scanned with less resolution. Depth of field is approximately 100  $\mu\text{m}$  at 1- $\mu\text{m}$  resolution. Pattern-edge sharpness is 0.05  $\mu\text{m}$ .

Stepping motors can position the X-Y table in 3- $\mu\text{m}$  steps over 1 by 1 inch at the rate of 1 millimeter per second. Optional are tables measuring 2 by 2 and 3 by 3 inches, X-Y tables controlled by laser interferometers, and automatic alignment.

Radiant Energy Systems Inc., 1500 Lawrence Dr., Newbury Park, Calif. 91320 [391]

### Bonders process devices fast

A series of bonders for handling semiconductors or hybrid circuits at high speeds includes both a wire bonder and a die bonder. The die bonder, the model HDB-980, offers a choice of two die pickup and placement targeting modules. Cycle rate is 3,600 dice per hour. The wire bonder, the model TCB-440, a steady-heat version, or the HPB-440

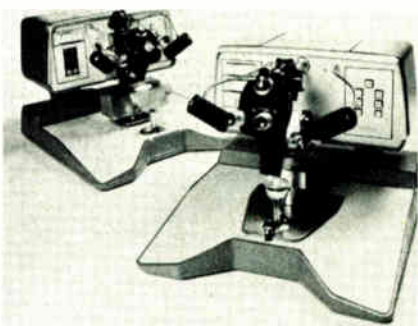



pulsed version, offers a cycle rate of 6,000 bonds per hour. These bonders are equipped with a target and spot bond locator to eliminate search requirements.

Hughes Metal Bonding Products, 2020 Oceanside Blvd., Oceanside, Calif. 92054 [394]

### Ultraminiature connectors permit dense packaging

A line of ultraminiature coaxial connectors and multicontact connectors with four, seven, and 12 pins satisfies needs for high-density packaging in space, aircraft, instrument,

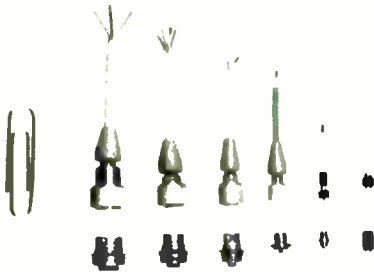

and medical applications. Assembly is also simplified since parts are partly pre-assembled at the factory. For example, a coaxial-cable assembly is fabricated simply by threading the cable into the plug. Price is as low as 95 cents in quantities over 1,000.

Microtech Inc., 777 Henderson Blvd., Folcroft, Penn. 19032 [393]

### Laser scriber handles up to 100 wafers an hour

A laser wafer-scriber for semiconductor and integrated-circuit production has a maximum of 100 wafers per hour. The model 1400AX has only one moving part, an electromagnetic "forcer" unit that moves over a ferromagnetic platen on an air bearing, thus avoiding the wear and recalibration problems of mechanical techniques. The forcer unit carries a vacuum wafer chuck.

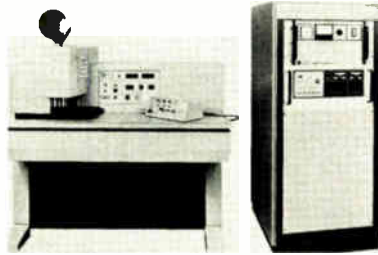

Accuracy is within 0.0005 inch over the total area of travel, and the scribing speed is variable from 0.5 to 10 inches per second. Price of a basic model 1400AX is about \$63,500.

Electroglas, 2901 Coronado Dr., Santa Clara, Calif. [395]

### High-power dissipators designed for DIP pairs

Heat dissipators, called the UP-348-CB and HP1-348-CB and configured for two 14- or 16-pin DIPs, are suitable for devices such as Darlington amplifiers, resistor networks, solid-state relays and voltage regulators. The HP1, for example, can dissipate almost 8 watts in a closed cabinet with natural convection. The units are designed to be used in conjunction with the IERC standard retainer, which provides a thermal interface between the DIP and the dissipator.

International Electronic Research Corp., 135 W. Magnolia Blvd., Burbank, Calif. [396]

### Termination mates with edge-mount connectors

Easy access to circuitry is provided by a termination that mates with standard edge-mount printed-circuit connectors. With a simple pull-slide-push action, the modular 11-position Slide 'n Switch circuit-selector switches from one circuit to another without contact with intermediates. A special bus that is contacted during the switch-out position serves as a warning or make-ready circuit.

Sealectro Corp., 225 Hoyt Street, Mamaroneck, N.Y. 10543 [397]

# We've made a great tape transport a lot better.

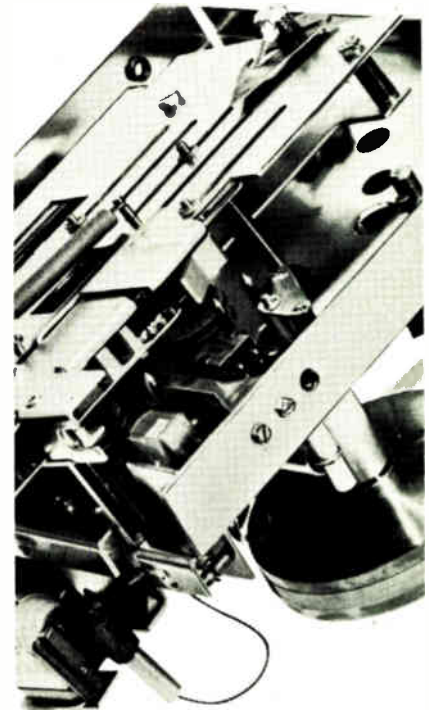

## take a look at CONRAC

Now, there's no reason for you to "trade-off" when specifying an audio cassette tape transport...not if you specify the Conrac CAS-4. Here are only a few reasons why: • USA designed and manufactured • 3 motor design • No mechanical clutches or brake bands required • Designed for remote control • OEM priced. 501

Write for descriptive brochure

**CONRAC** CRAMER DIVISION  
CORPORATION

Mill Rock Road, Old Saybrook, Conn. 06475  
(203) 388-3574



# Bern Golbeck's nifty idea gave a crisp new feel to rotary switches.

A few years back, Oak's Director of Engineering, Bern Golbeck, had a hunch. Use two ball bearings instead of one, and let them index a simple starwheel. This would give crisp detenting while greatly reducing the wear on any single moving part.

It worked. The two ball bearings, controlled by flat springs, travel independently over notches in the starwheel. Detenting is smooth, even and sure.

Positioning is precise. And it gives a crisp, uniform feel that you're sure to recognize.

We call this fancy detent system Unidex<sup>®</sup> and it's just one of many improvements Oak engineers like Bern have pioneered.

Since Unidex, we've added molded rotors and molded sections to our rotaries—innovations that are now benchmarks of the industry. And today we're busy incorporating PC board mountings into almost all our switch designs for the quickest and simplest installation possible.

We think you and the people who use your products will notice the difference great ideas like Unidex make. Just try, for example, the storage select switch on an IBM System/370 Model 145 operator's console. Or the sweep selector on a new Hewlett-Packard 1220A oscilloscope. You'll feel it.

While you're at it, write Dave Clifton at Oak. He'll send you free literature detailing the broadest line of quality rotaries in the industry. And he'll pass along some of Bern's helpful ideas on how to choose the right rotary switch for your job.

**DAK** Industries Inc.

SWITCH DIVISION / CRYSTAL LAKE, ILLINOIS 60014  
TELEPHONE: 815 • 459 • 5000 ■ TWX: 910 • 634 • 3353 ■ TELEX: 72 • 2447

**"Nice going Bern"**

Circle 133 on reader service card

**Components****SIP capacitors are molded**

---

Sprague line of eight-lead packages contains seven ceramic capacitor sections

---

For many years, dual in-line packages have seemed about to eclipse all other types of passive-network and multicomponent packages. But now Sprague Electric Co. is coming out with a line of molded single in-

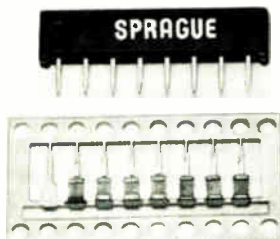

line packages containing seven capacitor sections. The eight-lead components are the first molded SIP versions of a capacitor network to be offered by the company.

DIPS are compatible with automatic insertion equipment used for ICs and provide a low profile for small board-to-board spacing, whereas the competing SIPs have been epoxy-dipped rather than molded, giving them much wider dimensional tolerances and making automatic insertion all but impossible. A molded SIP package, on the other hand, has the tight dimensional tolerances that would allow use with automatic insertion equipment.

What's more, the SIP has its own set of advantages. For one thing, cooling is possible from both sides of the package. For another, two SIPs can be mounted in the same board space as one standard DIP. Then, too, lead length is shorter for single in-line packages, and the resulting lower level of lead inductance means improved high-frequency performance.

Sprague's new SIP line is available in values from 18 picofarads to 0.01 microfarad at a rating of 100 volts dc. Standard tolerances are  $\pm 20\%$  or  $\pm 10\%$ , although  $\pm 5\%$  units are available. Designated the Type 460C Multi-Comp single in-line Monolithic ceramic capacitor networks, they are intended for use in signal- and data-processing equipment where repetitive capacitor values and patterns are often required.

Sprague Electric Co., North Adams, Mass. 01247 [341]

---

**Mercury displacement relay has 35-ampere capacity**

Hermetically welded and enclosed in stainless steel, a mercury displacement relay rated at a capacity of 35 amperes has a life expectancy of several million operations. Its operating time is 50 milliseconds typi-

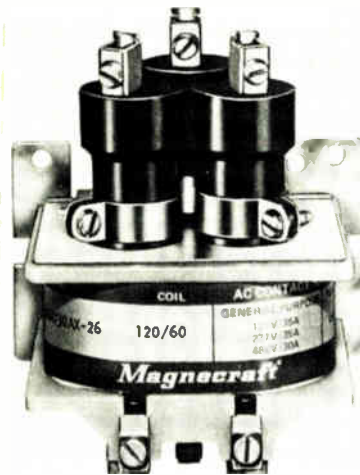

cal, and its release time is 80 milliseconds typical. Contact resistance is less than 0.002 ohm, terminal to terminal. Operating temperature is from  $-35^{\circ}$  to  $+75^{\circ}\text{C}$  ambient under continuous load.

Magnecraft Electric Co., 5575 N. Lynch Ave., Chicago, Ill. 60630 [345]

---

**Solenoid valves mount directly on pc boards**

For applications where valves must be small and their power consump-

tion low, notably in medical instrumentation, computer interfaces with hydraulic or pneumatic machinery, and gas-sampling for pollution control, the series 11, two-way, three-way, and directional control miniature solenoid valves will be useful. Spade lugs, which may be rotated, let each model mount directly onto a printed-circuit board. Because air controls can be brought directly to

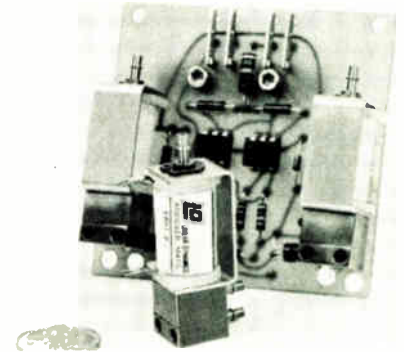

the electronic circuitry, this is a space-saving feature that is especially important in portable equipment. Other features include a life expectancy of greater than 100 million cycles, a current rating of 150 mA at 12 V dc, and operating pressure of vacuum to 50 psi. Price is \$15 in quantities of one to nine.

Linear Dynamics, 204 Andover St., Andover, Mass. 01801 [343]

---

**Precision potentiometers include 3-, 5-turn devices**

The Pixiepot line of miniature precision wire-wound potentiometers now includes three- and five-turn devices. These pots are  $\frac{3}{4}$  inch long and  $\frac{7}{8}$  in. in diameter and have a



**SURPRISE!**

**SURPRISE!**

**SURPRISE!**

# SURP



**2½ times  
brighter green.**



**6 times  
brighter yellow.**

# RISE!



**6 times  
brighter red.**

Electronics/May 30, 1974

HP brings you three new LED's that are many times brighter than our standard T-1 red lamps. All offer a 180° viewing angle, plus high axial luminous intensity and a good on-off contrast ratio. Ideal for front panel applications.

Our new green lamp (5082-4984) uses high efficiency gallium phosphide to generate a typical luminous intensity of 2 mcd at 20 mA.

Our new yellow LED's are really yellow. The 5082-4584 lamp offers 2.5 mcd typical at 10 mA.

And red has been dramatically brightened six times in output using non-saturating gallium arsenide phosphide. With a luminous intensity of 2.5 mcd at 10 mA our 5082-4684 high-efficiency red is unbeatable.

Just \$0.80\* in 100 quantities.

Contact Hall-Mark, Schweber or the Wyle Distribution Group for immediate delivery. Or, write us for more details. They're the brightest way to improve your product.

\*Domestic USA price only.

01404

HEWLETT  PACKARD

Sales and service from 172 offices in 65 countries.  
1501 Page Mill Road, Palo Alto, California 94304

Circle 137 on reader service card 137

mechanical life of 500,000 shaft revolutions. The shafts are made of stainless steel and are available in metric versions, along with metric bushings.

Duncan Electronics, 2865 Fairview Rd., Costa Mesa, Calif. 92626 [346]

### Relay built for rf or thermocouple circuitry

A printed-circuit board is an integral part of a relay that is to be used in rf or thermocouple circuitry. The board allows intricate conductor patterns to be designed that both serve as the fixed contact and provide any characteristics needed in specialized switching applications. The width, spacing and configuration of the patterns, as well as the

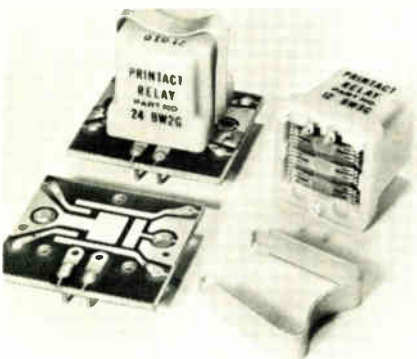

application of grounding planes, can be adjusted to (1) match the characteristic impedance of incoming transmission lines in the range of 50-75 ohms, (2) achieve cross-talk isolation of 70-50 dB. over the frequency range of 50-250 MHz, and (3) yield an acceptable VSWR. For thermocouple switching, the copper-conductor pattern on the printed-circuit board is first plated with a nickel barrier, then with hard gold.

Printact Relay Division, 29-10 Thomson Avenue, Long Island City, N. Y., 11101 [347]

### Reference junction replaces ice baths, ovens

The model LXCJ thermocouple reference junction is a self-powered replacement for ice baths and ovens.

A battery life indicator, which tells the user when the life of the 5,000-hour mercury power cell is over, eliminates the need to reference the thermocouple to the ice point of water and is said to maintain reference accuracy to within 0.25°C when the ambient varies by 10°C. Fifteen dif-



ferent calibrations are available for the unit, the price of which starts at \$85.

Omega Engineering Inc., Box 4047, Stamford, Conn. 06907 [344]

### Curve-matched thermistors are rated to 300 ohms

Now available as part of the Uni-Curve line of interchangeable, curve-matched thermistors are: 100- and 300-ohm units at 25°C with an accuracy within ±0.2°C over -20°C to 50°C, plus 500- and 1,000-ohm units at 25°C with an accuracy within ±0.2°C from 0°C to 70°C. The thermistors are designed specifically for high-volume, low-cost applications where maximum temperature does not exceed 150°C. Applications include temperature measurement, indication and control, and compensation for ambient-temperature effects on copper coils, transistors, and integrated circuits.

Fenwal Electronics, 63 Fountain St., Framingham, Mass. 01701 [349]

### 8-ampere solid-state relay has true zero-crossing

The type E11 relay, which is rated at 8 A and can handle transients as high as 100 A, will be useful in switching motors, solenoids, or with incandescent lamps. Moreover being compatible with both TTL and C-MOS devices, the type E11 can be interfaced directly with computers



and heavy-duty industrial equipment. True zero-crossing eliminates electrical noise from the relay, which also features input/output isolation and is epoxy-encapsulated against hostile environments. Dc models are reverse-polarity-protected.

Allied Control Co. Inc., 100 Relay Rd., Plainfield, Conn. [348]

### Overvoltage protectors handle up to 16.5 V dc

Smallest in the series 10 dc overvoltage protectors for semiconductor circuits is a 5-ampere hybrid dc device. Its thick-film hybrid circuit contains a sense amplifier, control circuit, and SCR crowbar. A voltage transient or overvoltage at or above the selected trip point causes the SCR to fire, shunting the line to ground within 500 nanosec-

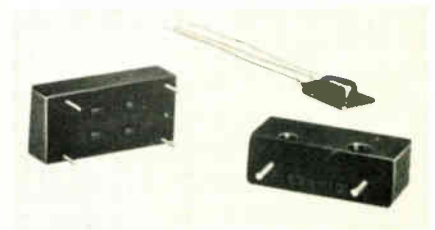

onds, before any damage can be done. The short is sensed by an external device, such as a circuit breaker, which removes the load from the line about 10 milliseconds later. For operating currents higher than 5 A, protectors are made of discrete components and offer the same protection, economy, and ease of assembly onto circuit boards. The series 10 dc can handle up to 10 A; the series 30 dc, 30 A. For all models, standard trip voltages are 6.5 and 16.5 v dc, with 5.5 and 32 v dc available on special order.

Heinemann Electric Co., Trenton, N.J. 08602 [350]



# Plug-in transformers specifically designed for telephone interconnect!

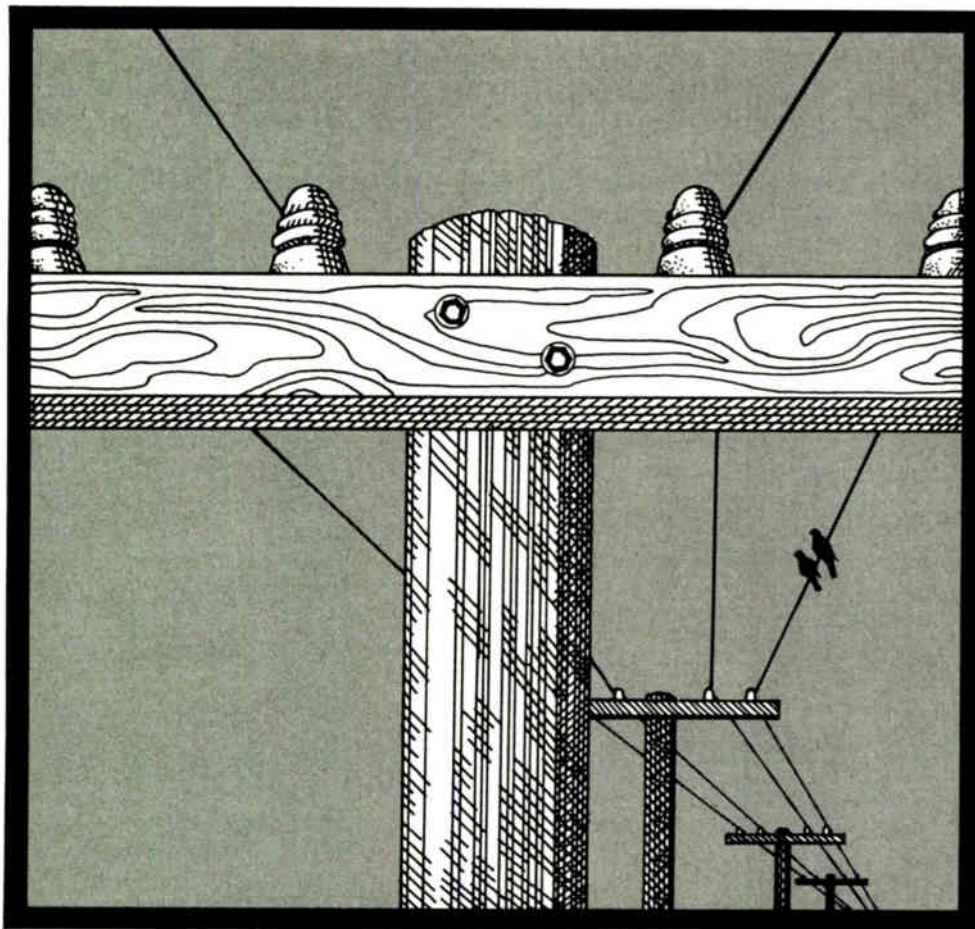

## Low-profile line meets or exceeds all modem and voice transmission impedance-matching requirements.

If you're designing modem or voice interconnect equipment you now have a complete line of TRW/UTC plug-in transformers to work with.

They are specifically designed for the telephone interconnect market, meeting or exceeding all specifications for low distortion, longitudinal balance, insertion loss and return loss balances.

What's more, our low-profile Ouncers, Subouncer and

Sub-subouncer units are designed for wave soldering and quick insertion on card mounts.

TRW/UTC is the leader in transformer miniaturization. We have the capacity and expertise to deliver the exact impedance-matching transformers you need.

For complete information, call or write TRW/UTC Transformers, an Electronics Components Division of TRW, Inc., 150 Varick Street, New York, N.Y. 10013. Tel: (212) 255-3500.

# **TRW** UTC TRANSFORMERS

Circle 139 on reader service card

THE WORLD'S BIGGEST  
"LITTLE BLACK BOX"



IS COMING YOUR WAY.

Data handling

## Mini consists of two small boards

---

SOS technology, novel packaging of 32k memory used in 16-bit machine

---

Less than six months after introducing the industry's first silicon-on-sapphire microcomputer [*Electronics*, Dec. 6, p. 39], General Automation has developed a full 16-bit SOS minicomputer [*Electronics*, May 16 p. 38].

The microprocessor-based computer system consists of two circuit boards, each measuring only 7¼ by 11 inches. The first, a two-chip microprogrammed processor, designated the LSI-16, has the full capability of GA's earlier SPC-16 minicomputer. With 1,024 words of memory, it is priced under \$1,000 in lots of 200.

The second board is a 32,768-word-by-18-bit (16 bits plus parity) memory system, also on a single 7¼-by-11-inch board. This high density is achieved by mounting 1103-type MOS memory chips in groups of eight on ceramic substrates that plug vertically into the mother board (see photo below). GA buys unpackaged 1103-type chips and houses them in hybrid packages of its own design, an unusual procedure for a minicomputer house.

Each substrate provides a 1-kilobyte building block, and the memory can be expanded in the field in 4-kiloword-by-16-bit blocks. Cycle time is under 500 nanoseconds, and access under 300 ns. The mother board is a six-layer circuit board made by a GA subsidiary. The

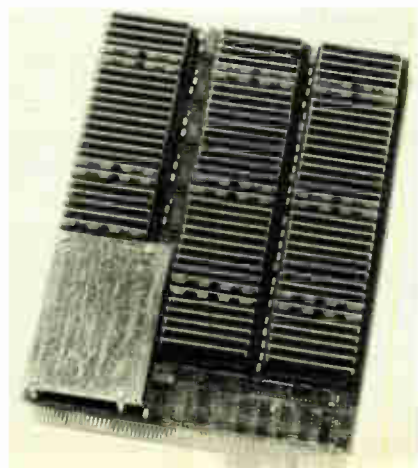

memory can be expanded to 128 kilowords by replacing the 1103 chips with 4,096-bit RAMs.

The minicomputer and its memory, according to Lawrence Goshorn, GA chairman and chief executive officer, permit the company to "offer in two small printed-circuit boards all the power and performance previously found in six large circuit boards in the original SPC-16 minicomputer."

The two SOS chips on a board that make up the processor, are an arithmetic logic unit and a control read-only memory. The ALU packs the equivalent of 8,000 transistors in a chip 200 mils square. The control ROM contains the control functions for the ALU chip. Both are made by Rockwell Microelectronics.

Standard features include power fail/automatic restart, real-time clock, operation-monitor alarm, and a cold-start capability right on the single CPU board. A second board provides such optional features as a teletypewriter controller, initial program load, direct memory address, and a piggyback read-only memory.

A 32-kiloword minicomputer system, including the chassis, is priced at \$9,450 in the minimum quantity of five units, and is less than \$5,700 in quantities of 200.

The LSI-16 and the 32-kiloword memory board will be available for deliveries late in 1974.

General Automation Inc., 1055 South East St., Anaheim, Calif. 92805 [361]

---

### Firmware provides 48 bits of floating-point routines

Improvements in execution time by factors of 7 to 15 can be achieved on the Hewlett-Packard 3000 Series minicomputers with long floating-point firmware. Designated the 30011A extended instruction set, the firmware consists of a single plug-in circuit board that contains a set of 48-bit-long floating-point routines stored in a bipolar read-only memory. Executing these routines with a fast microcode boosts throughput efficiency of the pro-

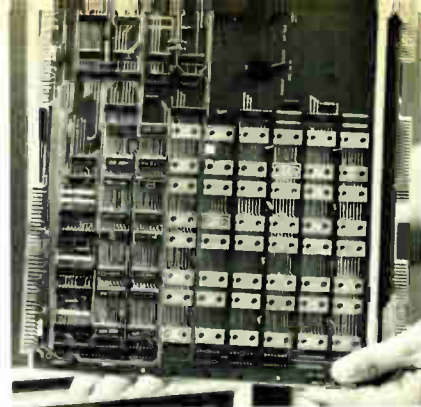

grams. The six arithmetic instructions this firmware provides are long floating-point addition, subtraction, multiplication, division, negation, and comparison. Each instruction is associated with its own machine code. The compiler generates a subroutine call to the program library where the subroutine is changed to a machine code. Execution of the code calls a firmware routine so the microprocessor can execute the instructions at high speed. The extended instruction set sells for \$2,250.

Inquiries Manager, Hewlett-Packard Company, 1501 Page Mill Road, Palo Alto, Calif. 94394 [363]

---

### Process-control display

replaces tote boards, meters

A process-control display, offering both alphanumeric characters and graphics, is designed to replace tote boards and meters conventionally used in process-control systems. Applications for the model FS2000 include: power-utility control, to monitor power distribution by measuring which switches and transformers are on; financial-management information, where information such as sales data stored in the CPU can be instantaneously plotted in bar-chart form and displayed; and fluid control, in a petroleum or chemical plant, for example. Equipped with 128 characters in four sizes (single and double height, and single and double width), the display can plot histograms and trend lines in rectangular form with the use of rectilinear graphics. The FS2000 also allows the user full screen address, where any entity can be placed in any of 256 by 256 locations. Graphic lines requiring only four

bytes can be generated in any thickness or length. The use of rectilinear graphics gives the capability of plotting graphs by means of a single code instruction, rather than by the one-by-one matching of graph dots to each unit on the chart, as in order systems. A one-channel display costs \$8,000, and the price is about \$4,000 for each additional channel.

Ramtek Corp., 292 Commercial St., Sunnyvale, Calif. 94086 [364]

### Disk system can store up to 200 million words

A large-capacity disk system that will give minicomputer users access to up to 200 million words of on-line memory is designated the DS330. The package consists of a controller and from one to four disk drives, each capable of storing up to 50 million 16-bit words. Designed to interface to the direct-memory-access channel of the TI 960 and 980 series minicomputers, the DS330 offers features generally found only in larger IBM and Univac systems, Texas Instruments says.

The controller, for example, provides data chaining, for transfer of data between disk and noncontinuous memory locations, as well as data-error detection and correction logic. It also transfers data in blocks of from one to 119,000 words per block and operates at a rate of more than 403,000 words per second. Eight data-transfer commands are standard, including unformatted read and write, read with or without error correction, write header and data, write data with or without pro-



NEWS  
FROM  
AIRPAX

## about *Magnetic and Digital PICK-UPS*

Airpax manufactures "passive" analog and "active" digital transducers (pick-ups) to provide the most effective and accurate means of converting mechanical motion into usable voltage control signals...without mechanical linkage. These magnetic pick-ups operate by accurately detecting moving ferrous discontinuities. Want to know more about pick-ups?... How is the selection made? How does the gear or discontinuity affect the pick-up output?

### *These questions are answered*

in the new 20 page AIRPAX Text #8510

#### **"MAGNETIC PICK-UPS AT WORK."**

Send for it today!

**AIRPAX**  
Controls Division  
P.O. Box 8488  
Fort Lauderdale, Florida 33310

Phone 305 587-1100

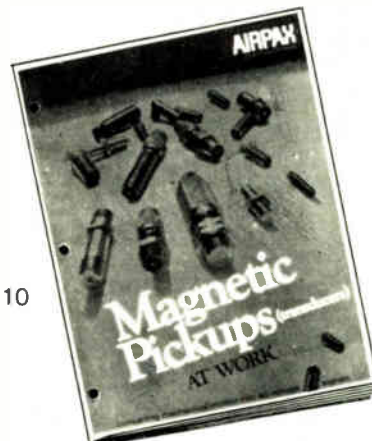

# AIRPAX™

## New products

tect override, and compare data. Other controller features include a variable-length record format, accepting one to more than 6,000 words, and built-in testing of the computer-to-controller interface. The controller will sell for \$15,960; disk drives are tagged at \$17,650. Texas Instruments Incorporated, Digital Systems Division, Box 2909, Austin, Texas 78767 [365]

Paper-tape reader operates to 450 characters/second

The Fly Reader model 45, a photoelectric punched-paper-tape reader, performs bidirectional or random/aperiodic character readings at speeds up to 450 characters per second. The unit can read 1-inch

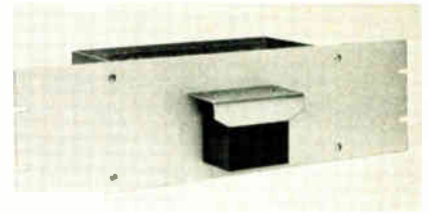

tape having transmissivity of less than 60%, including oiled paper, Mylar and metalized Mylar. An option also allows it to read advanced-feed-hole typesetting tapes. The light source is a spring-loaded line filament lamp, rated at 5 volts, with 15,000 hours of life. The nine phototransistors in the detector array are pre-matched with a worst-case output of 3 v. Output is fed to a high-input-impedance Schmitt trigger that supplies 2 v of noise immunity. The tape drive uses a stepper motor that dissipates 4 watts. The model 45 costs \$625 in lots of 1-10.

Teleterminal Corp., 12 Cambridge St., Burlington, Mass. 01803 [366]

## OUR ANGLE: More Synchro Conversion For Less Cost

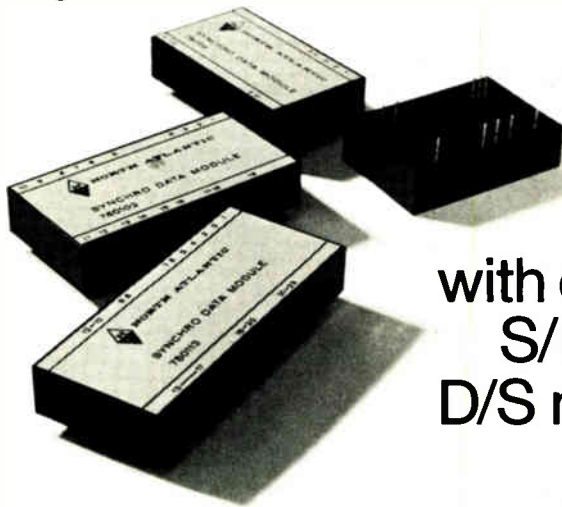

with our  
S/D and  
D/S modules

How does a choice of 14-bit resolution (greater for 2-speed S/D), 60 or 400 Hz data frequency, high accuracy, 11.8V to 90V line-line voltages and all kinds of self-protection circuitry — look from your angle? Not to mention that as few as 5 modules make up a complete S/D or D/S converter, or that all modules are replaceable one-for-one without trimming! And, economically too!

New 2-speed S/D sets are now available with accuracies typically better than 20 seconds from all error sources including resolution. D/S specifications include 4 minute accuracy, 1.25 VA output with optional 20 VA output for torque receiver applications.

Key performance specifications for both converters include 14-bit (0.022°) resolution over 360°, 4000°/sec analog data rates and 0-70°C operation. Some units available for operation from -55°C to +105°C. All units are DTL and TTL compatible.

Prices start at \$650.00 for a set of modules. Delivery from stock. Call toll-free (800) 645-9200 for the name and address of your local sales engineering representative.



**NORTH ATLANTIC industries, inc.**

200 Terminal Drive, Plainview, New York 11803 • Phone (516) 681-8600  
California District Office: 13418 Wyandotte Street, N. Hollywood, CA 91605 • Phone (213) 982-0442

Microprocessor emulates  
larger computer systems

The Micro-One microprocessor, which is suited for dedicated volume applications, can be micro-programmed to emulate other general- or special-purpose computers. Interface hardware is available to provide plug-to-plug compatibility with other Microdata computers

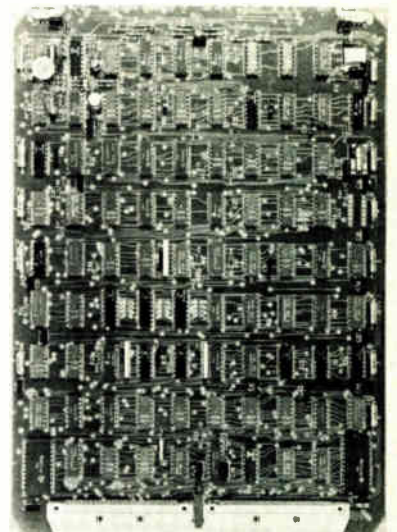

and peripherals. The Micro-One is a microprocessor version of the Microdata 800/1600 series computer. With 1,024 words of ROM and 1,024 bytes of MOS memory, it occupies one 8½-by-11-inch board. The small size is achieved by utilizing ROMs for the control logic of the central processing unit. Features and operating characteristics of the Micro-One include: bipolar circuitry; CPU and command ROM on one board; memory addressing to 65,000 bytes; compatibility with MOS or core-memory modules; 1.2-microsecond full cycle memory, and an 8-bit arithmetic/logic unit. Price is less than \$1,000.

Microdata Corp., 17481 Red Hill Ave., Irvine, Calif. 92705 [367]

Floppy disk offers  
48 tracks per inch

A random-access diskette or floppy-disk memory system for the Prime line of small computers is priced at \$4,700. The system includes dual-diskette drives, controller board, power supply, mounting hardware and cables. The diskette has 77 tracks (48 tracks to the inch), with a recording density of 3,200 bits per inch. It spins in the drive at 360 revolutions per minute. The drive is a moving-head, contact-recording, small-cartridge drive, while the floppy-disk system features a transfer rate of 250,000 bits per second, a 10-millisecond track-to-track access time and a 10-millisecond head-settling time. Other features include an 83-millisecond average latency, a 50-millisecond head-loading time, and a frequency-modulation record-

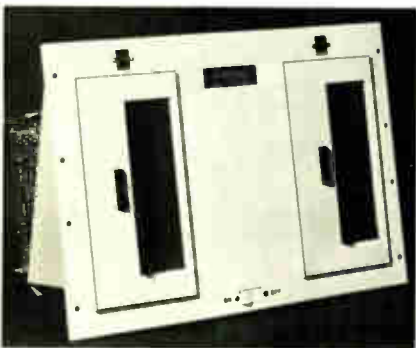

Electronics/May 30, 1974

**When performance counts!**

**For a long time,  
Eastern Air Devices  
has meant  
the best  
fans and blowers  
you can get.  
That's still true  
today.**

**HC EAD** Eastern Air Devices, Inc.  
Dover, N.H. 03820 • (603) 742-3330 • TWX: (510) 297-4454

Syn & Ind Motors • Gearmotors • Fans • Blowers

Circle 143 on reader service card

# ASSEMBLED COUNTERS FROM HEATH: WE'VE PUT TOGETHER THE HIGH PERFORMANCE AND LOW COST YOU'VE COME TO EXPECT FROM US OVER THE YEARS

**the \$225, 30 MHz, 6-digit  
autoranging counter**

SM-118A



**the \$325, 110 MHz, 7-digit  
autoranging counter**

SM-128A



**the \$395, 110 MHz, 7-digit,  
high stability, autoranging counter**

SM-128B



**the \$495, 200 MHz, 7-digit  
counter**

SM-110A



**the \$625, 200 MHz, 7-digit,  
high stability, programmable counter**

SM-110B



**the \$795, 600 MHz, 7-digit,  
high stability, programmable counter**

SM-110C



HEATH COMPANY

*we haven't forgotten  
what you want*

## New products

ing mode. The read error rate is  $1 \times 10^9$  bits read (soft error) and  $1 \times 10^{12}$  bits read (hard error). The seek-error rate is one in  $10^6$  seeks.

Prime Computer Inc., 17 Strathmore Rd., Natick, Mass. 01760 [368]

Data recorder provides line-printing capability

A range of simple but time-consuming computer operations may be eliminated by a data recorder with line-printing and reporting capabilities. Called the Data Reporter, the on-line printer is designed for the family of Decision Data 96- and 80-column data recorders and prints information from a buffer storage located within the controlling data recorder. Speed of the Data Reporter is 100 characters per second for multi-part as well as single-copy paper. The number of distinct characters that may be printed is 64.

Decision Data Computer Corp., 100 Witmer Rd., Horsham, Pa. 19044 [369]

Buffered formatter stores up to 4,096 characters

A buffered formatter features automatic rewrite and reread, external parity, and data storage capacities of up to 4,096 characters. The unit provides asynchronous data transfer to and from the Pertec line of synchronous magnetic-tape transports. Designed to increase capacity and throughput, the formatter can make single-block transfers into and out of the buffer at asynchronous rates from zero through 1 MHz, and continuous data transfers with no data loss, at rates up to 80 kHz (phase-encoded) or 50 kHz (NRZI), are possible. Applications for the buffered formatter include asynchronous data acquisition, minicomputers, off-line tape-oriented systems, data-entry systems, plotters, printers and computer-output-microfilm systems.

Pertec Corp., Peripheral Equipment Division, 9600 Irondale Ave., Chatsworth, Calif. 91311 [370]

# LOOK TO SPECTRUM FOR TOTAL CAPABILITY

## EMI FILTERS

**Pi Filters**  
Bushing sizes from .156 hex. to .500 hex.  
Rated 50 Vdc to 2500 Vdc



**L Section Filters**  
Available in these outside diameters .250, .312, .375 & .690  
Rated from 10 to 25 amps and from 50 Vdc to 240 Vac



**L, Pi, T Section Styles**  
.375, .410, .690 max. o.d.  
Ratings range from 50 Vdc to 150 Vdc 125 Vac to 240 Vac 10 amps to 25 amps



**Multi-section Filters**  
6 section, 12 section and many custom styles. U. L. types also available.

**L Filter**  
Solder Mount  
Rated 500 Vdc



**Pi Filters**  
Solder Mount  
Rated 250 Vdc to 500 Vdc

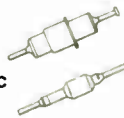

—EMC CONSULTING—  
APPROVED TESTING FACILITIES TO MEET:  
MIL-STD-461 HEW 90-602  
MIL-I-6181 FCC PARTS 15 & 18

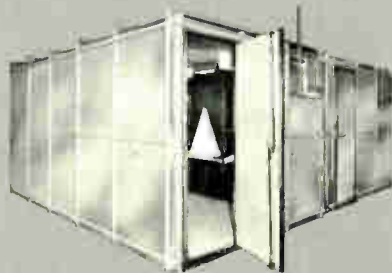

**SPECTRUM CONTROL INC.**  
152 EAST MAIN ST. • FAIRVIEW, PENNSYLVANIA 16415  
*specialists in electromagnetic compatibility*

SPECTRUM CONTROL, INC. has purchased the ALLEN BRADLEY COMPANY'S entire line of filters and capacitors, as well as their technology and patent rights. This acquisition now gives SPECTRUM CONTROL the broadest line of EMI/RFI filters and feed-thru capacitors in the electronics industry. We also hold more QPL listings to MIL-F-15733 than any other filter manufacturer. So whenever you need total capability, look to SPECTRUM CONTROL.

## FEED-THRU CAPACITORS

The most complete ranges of sizes, cap. values, and ratings, for your selection. MIL-C-11015 types.



## CERAMIC TRIMMERS

A full line of variable capacitors available in .218, .375 & .500 dia. MIL-C-81 types.



## MULTI-LAYER FEED-THRU CAPACITORS

These unique components are available in a wide range of capacitance values to 1 MFD.



Multi-layer feed-thru capacitors and miniature feed-thru filters designed for filtered connector pins.

## CERAMIC CHIP CAPACITORS

Available in sizes from .080 x .050 x .050 to .375 x .285 x .090 and the following dielectric characteristics: COG, X7R, X7S and X7U.

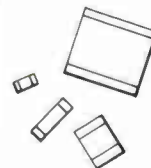

**All those little  
wires have been  
pushed around  
long enough.**





Until now, all those wires have been at the mercy of packaging materials that expand when things get hot.

So we developed new Dow Corning® 480 semiconductor molding compound.

Dow Corning 480 has a low coefficient of thermal expansion.

So it virtually eliminates the hot intermittent open. And moisture penetration.

Which means that an integrated circuit stays integrated. Through all sorts of temperature and atmospheric extremes.

But that's not all that's different about 480 molding compound.

Its resistance to salt spray is excellent.

And it reduces your packaging costs because it saves time. Molding times are short—less than one minute for some components. Post curing is unnecessary.

Of course, Dow Corning 480 molding compound also has the advantages of our other silicones. Consistency. Long shelf life. Less cleaning downtime because there's no buildup. Non-flammability. And, because it doesn't irritate skin, there's no need for special handling.

Dow Corning 480 semiconductor molding compound is the kind of improved product you can expect to keep getting from Dow Corning. Our Technical Service and Development Department has more manpower and greater technical facilities than any other in the industry.

If you want to know more about 480, call us at 517 636-8000, or write Dow Corning Corporation, Dept. B-4334, Midland, Michigan 48640.

**DOW CORNING**



## Subassemblies

**Keyboard is watch size**

---

17-key unit for tiny calculator uses layer of conductive rubber

---

The trend toward miniaturization in electronics is being pushed even further by the watch industry, which is showing interest in wristwatch-size calculators. Chomerics Inc. of Woburn, Mass., is responding to this interest by introducing a keyboard measuring only  $\frac{3}{4}$  by 1 inch with 17 keys on  $\frac{5}{32}$ -inch centers.

The key array includes a moving decimal point, constant, clear, multiply, divide, add-equal, and subtract-equal keys that are as easy to read as a watch face. The full calculator would probably have either a four-digit liquid-crystal display or a six-digit light-emitting-diode readout.

This keyboard makes use of Chomerics' materials technology in conductive elastomers, paints, and inks, and its capability in full-size keyboards. The miniature keyboard uses the same materials as the large subassemblies, but they are put together differently. The keyboard consists of a phenolic printed-circuit board, screened with a silver paint that provides a permanently conductive contact surface.

Over this is laid a 0.005-inch-thick Mylar spacer with holes directly under the keys, a layer of conductive rubber, and a Mylar legend



sheet that has the keys on it. When the Mylar is deflected, an electrical impulse that is set up in the conductive rubber travels through the holes in the Mylar spacer to the printed-circuit board.

Typical contact rating of the miniature keyboard is 30 to 40 milliamperes at 12 volts, lower than for a full-scale keyboard, since the lines plated on the pc board are shorter. Contact resistance is typically 0.1 ohm, plus the circuit board resistance. Contact bounce, the time it takes to close a contact, is a maximum of 5 milliseconds. Life is 50 million operations, and operating force is 3 to 5 ounces. Operating temperature ranges from  $-40^{\circ}\text{F}$  to  $+180^{\circ}\text{F}$ . Encoding capacity is up to three contacts per key.

Chomerics says the keyboard was developed as a result of inquiries from watch companies, and samples have been supplied to at least 10 of them. In volume, the manufacturer says, the keyboards could sell for less than \$2 each.

Chomerics Inc., 77 Dragon Court, Woburn, Mass. 01801 [381]

---

**Voltage sources are digitally programed**

Modular, digitally programed voltage sources, designated the models 4800 and 4801, may be used in computer-controlled test equipment and process-control systems and can be interfaced with any minicomputer. Each model combines a digital-to-analog converter with a high-powered output stage, digitally programable current limit, digitally programable output ranges, storage registers for all digital inputs, current sense output, and digital output flags to indicate current limiting and voltage settling. The units have two digitally selectable output voltage ranges;  $\pm 10$  vdc and  $\pm 60$  vdc, both at 200 mA. Output settles to  $\pm 0.01\%$  in 100  $\mu\text{s}$  to facilitate high-speed testing. The 4800 and 4801 will safely drive capacitive loads to 1  $\mu\text{F}$ . The load regulation is  $\pm 0.0015\%$  full load to no load. Output accuracy is within  $\pm 0.012\%$ . Price for one to

nine units is listed as \$650 each. Burr-Brown Research Corp., International Airport Industrial Park, Tucson, Ariz. 85706 [384]

---

**Dividers offer accuracy without external trimming**

The model 540 family of dedicated dividers uses an improved version of the variable transconductance technique to achieve accuracies within  $\pm 0.5\%$  (model 540J),  $\pm 0.25\%$  (model 540K) and  $\pm 0.1\%$  (model 540L) over a 100-to-1 divisor range without requiring external trimming. The dividers' error-nulling technique also ensures that the accuracy will be stable over the full temperature range. The model 540 family gener-

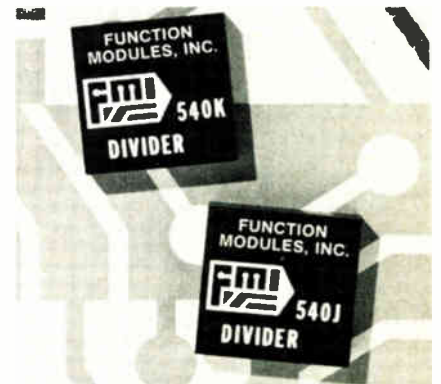

ates a two-quadrant division function directly where the accuracy can be optimized for dividing. The output bandwidth is nearly independent of divisor magnitude. Price of the 540J is \$69; the K version, \$89; and the L version, \$139. Quantity discounts are available.

Function Modules Inc., 2441 Campus Dr., Irvine, Calif. 92664 [386]

---

**Dc power supplies provide constant-current capability**

Offering control of current to within 0.1% for special inductive-load requirements, a series of constant-current dc power supplies comes in a variety of types with compliance voltages from 8 v dc to 30 v dc and adjustable current ratings from 0.1



to 12 amperes. The supplies are suitable for resistive measurements, and for circuits incorporating lamps or light-emitting diodes. The units are available in OEM quantities at a price of \$55 to \$125. Quantity discounts are also offered.

Standard Power Inc., 1400 S. Village Way, Santa Ana, Calif. 92705 [389]

### Spike-rejecting filter offers rapid recovery

The model IPVC-1 and IP1 are voltage-controlled low-pass non-linear spike-rejecting filters with recovery rapid enough to introduce no phase lag into signals passing through them. The slope limit of the filters is set by two capacitors nomi-

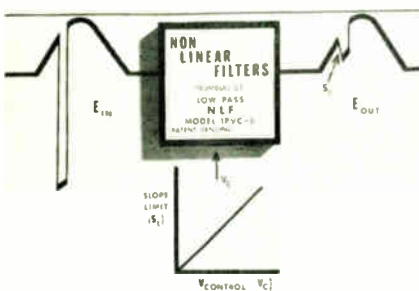

nally equal in value. The slope limit of the IPVC-1 can also be controlled by an external voltage over a dynamic range of 330 to 1—a feature that enables the IPVC-1 to filter noise spikes in high-quality audio and communications systems without reducing the bandwidth.

Non Linear Filters, Box 338, Trumbull, Conn. 06611 [390]

# There's a world of difference between Dow Corning and the other semiconductor packaging-materials suppliers.

The difference is that only Dow Corning has available worldwide a complete line of silicone molding compounds, an accomplished technical service and development team, the advantage of a completely compatible product line, and the convenience of worldwide delivery and service. If you want to give your packaging operation a competitive advantage, just call or write. One of our representatives is nearby.

J. Guillot  
DOW CORNING S.A.R.L.  
140, Avenue Paul Doumer  
92500 Rueil Malmaison  
France  
Telephone: 977.00.40

M. Tedone  
DOW CORNING SpA  
Viale Restelli 3/7  
20124 Milan, Italy  
Telephone: 688.2458

### ASIA

H. Takahashi  
DOW CORNING ASIA LTD.  
P&O Building, 9th Floor  
21 Des Voeux Road, C.  
Hong Kong  
Telephone: 5-258035

H. Hotta  
DOW CORNING ASIA LTD.  
Room 803, Cathay Building  
Mount Sophia  
Singapore - 9  
Republic of Singapore  
Telephone: 321213-5

### AUSTRALASIA

H. Tuynman  
DOW CORNING AUSTRALIA PTY. LTD.  
36 O'Dea Avenue  
Waterloo, N.S.W. 2017  
Sydney  
Telephone: 699 8055

P. Winter  
DOW CORNING AUSTRALIA PTY. LTD.  
103 High Street  
Prahran, Vic. 3181  
Telephone: 51 5450

Dow Corning semiconductor molding compounds...quality and dependability worldwide.

B-4135

### NORTH & SOUTH AMERICA

Resins and Chemicals Marketing  
DOW CORNING CORPORATION  
Midland, MI 48640  
Telephone: 517 636-8682

### EUROPE

R. Hediger  
DOW CORNING INTERNATIONAL LTD.  
Chaussée de La Hulpe 177  
1170 Brussels, Belgium  
Telephone: 73.80.60

B. Sneddon  
DOW CORNING LTD.  
Reading Bridge House  
Reading RG1 8PW  
Berkshire, England  
Telephone: Reading 57251

R. Jones  
DOW CORNING GmbH  
1150 Vienna  
Mariahilferstrasse 180/4  
Austria  
Telephone: 83.85.38

S. Haberer  
DOW CORNING GmbH  
8000 Munchen 50  
Pelkovenstrasse 152  
West Germany  
Telephone: 14.861

## DOW CORNING

DOW CORNING

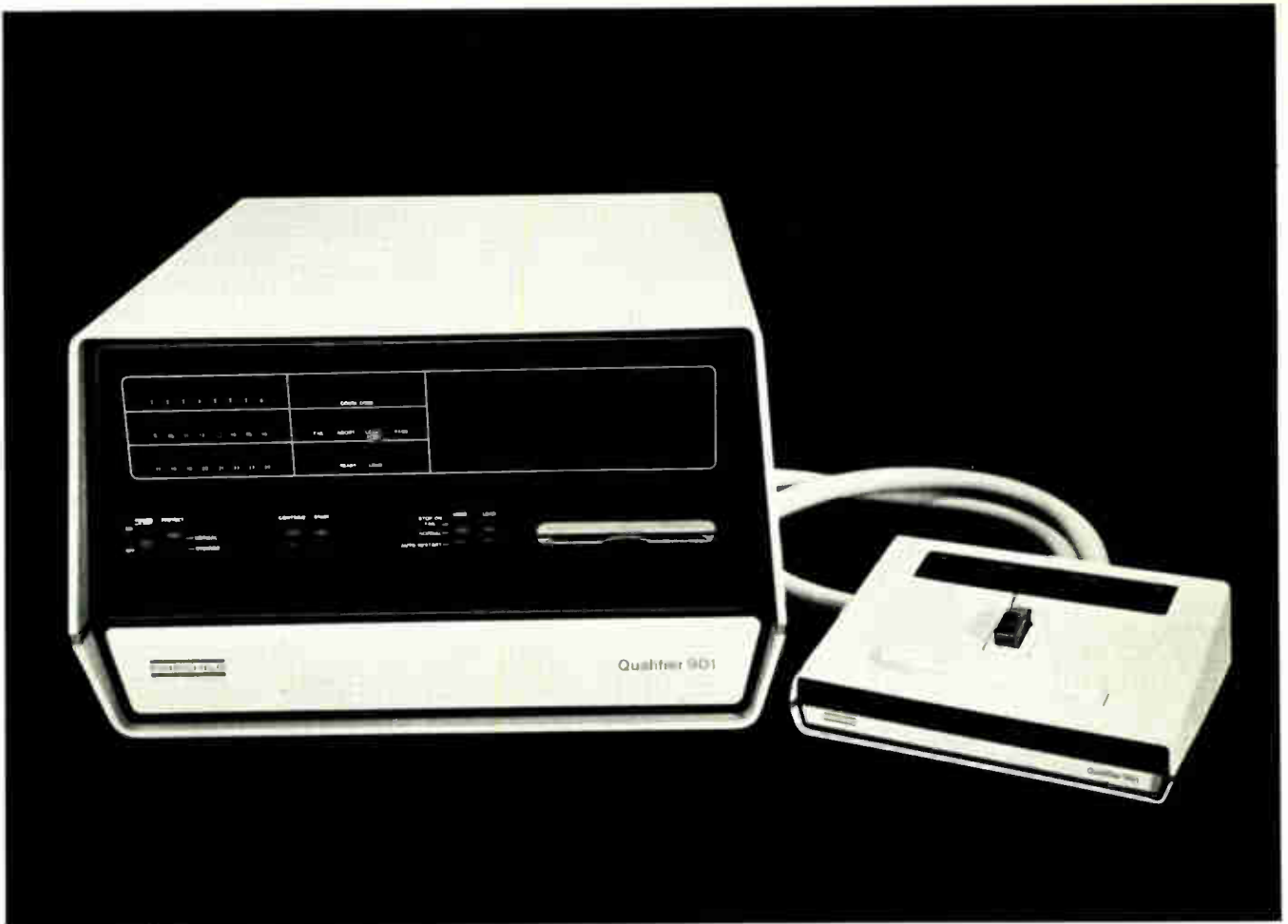

## Our new logic IC tester.

Here's how you get your money back. Take one of the durable plastic Qual Cards\* that is specifically coded to program your new Fairchild Qualifier\* 901 for incoming inspection of C-MOS, DTL and TTL logic IC's. Slide the Qual Card into the reader. Notice how flexible and unbreakable it is. Observe that there are no operators to be trained or dials to be set. Everything is in the Card. It absolutely dictates what is to be measured, to what levels and to what accuracy. In 60 to 200 milliseconds your 16- or 24-pin IC has been tested. Functionally and parametrically.



Everytime the photo-optically programmed Qual Card enters your Qualifier, money you spent on the machine is coming back. In lower costs for device programs. In convenience of program availability and storage. And in error-free, failure-analyzed IC testing. That's why our Qual Cards are your money back guarantee.

### The Qualifier is sophisticated and flexible.

Without being big and expensive. Besides the savings you'll get with the Qual Cards, the 901 is cost competitive on purchase price. And it's a high performance logic tester for incoming inspection that is architecturally innovative. Cross-bar switching has been eliminated. You can shift from one family of IC's to another. Instantly. The essence of the Qualifier 901 is speed. You can test common TTL parts in 60 milliseconds. A 2% failure rate of IC's at the top of the line can mean a 50% failure rate at the end of the line. The Qualifier 901 is the surest, least expensive way to avoid faulty IC's in your finished product.

For under \$8,000 you start with the Qualifier 901, a 16-pin basic test unit. For another \$2,400 you can expand that capability to a 24-pin field. That's one machine to test the two common usage IC packages. Or two machines for the price of one and a quarter.

### Before the Qualifier tests your IC's, it tests itself.

When the system is turned on, a comprehensive self-test analysis is performed. Everytime a program is

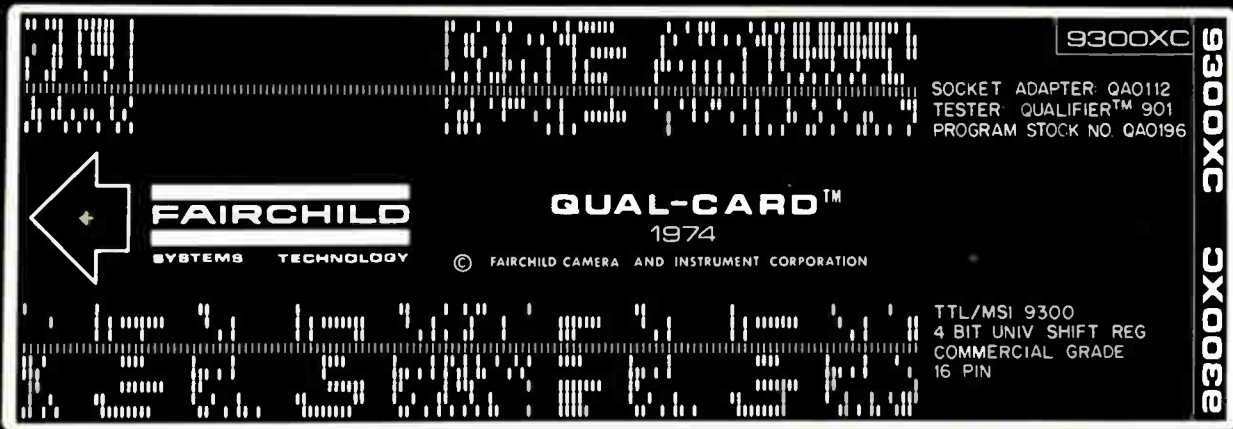

# Our money back guarantee card.

loaded, the microprocessor checks all data paths, registers, memories and the Qual Card reader. After everything checks out, the 'ready light' goes on. The Qualifier also comes with a packet of diagnostic program cards which can verify the accuracy of the drive and measurement circuits. If the machine checks out and the program's right, there's only one thing that might be faulty: the IC you're testing. And that's exactly the condition you're looking for.

## The proof is in the programming.

The Qual Card is the first virtually indestructible program medium. It leaves nothing to chance. Your Qual Card is written for you and verified by us. When it comes back by return mail, all you do is put it in the machine.

## Your operator can't miss.

There's only two things to remember.

Insert the Qual Card and IC—and read the results. There's no time lost training technicians to read time

consuming data sheets. The flexible Qual Card eliminates messy paper tapes, and takes up less room than the hard wired program boards. As for cost, the Qual Card comes in at from \$20 to \$60 each. That's more than just in the ball park price-wise when you consider the expendability of a hard wired program card that can cost up to \$300.

The Qualifier has much more than just a card-up on other IC logic testers. It's the first in a series of architecturally sophisticated testers that will be dedicated to a major family of devices. If you'd like more information on the Qualifier 901, we'll send you a brochure, a list of representatives and a growing library inventory of 200 Qual Cards now available. Call collect or write today. Start getting your money back tomorrow.

Fairchild Systems, 3500 Deer Creek Road, Palo Alto, California 94302 (415) 493-5011 TWX: 910-373-1204

**FAIRCHILD**  
SYSTEMS TECHNOLOGY  
A DIVISION OF FAIRCHILD CAMERA AND INSTRUMENT CORPORATION

\* Trade mark of Fairchild Camera and Instrument Corporation

# Maybe the grass will look greener in Connecticut



Take the time to look at a whole new way of life... and work. You and your family will enjoy a full range of recreational activities in the Connecticut countryside... and at the shore. And you'll respond to the interesting and rewarding assignments in this expanding company. Right now we are seeking:

**CIRCUIT DESIGNERS**

**TEST EQUIPMENT INSTRUMENTATION**

**SYSTEMS DESIGNERS**

**PRELIMINARY DESIGN**

**SCIENTIFIC PROGRAMMERS**

TO INTERVIEW, please forward your resume, stating present salary, to Mr. E. M. Bilanchone, Professional Placement, Hamilton Standard, Windsor Locks, Conn. 06096



## POSITIONS VACANT

**Positions Available—Electrical & Electronic Eng's.** Over 1000 US client co's pay our fees for selected technical referrals. Est. 1959. Send resume with pres. sal. Atomic Personnel, Inc., Box L, 1518 Walnut St., Phila., Pa. 19102.

**University of Utah—Electronics Engineer MS or Ph.D.** Physicist or Engineer with strong background in electronics is needed to head small electronics support group in University Chemistry Department. Should have a broad background in instrumentation generally and possess a high level of professional competence in electronics design. Must have ability to work with people who have technical training in chemistry but widely varying knowledge of physics and electronics. Experience with digital circuitry, pulse techniques, and wide range of instrumentation essential. Salary range \$16,000-19,000 depending upon qualifications. Respond with brief resume including names of two previous employers who may be contacted for reference and send to: Lon Addams, Business Manager, Department of Chemistry, University of Utah, Salt Lake City, Utah 84112. Equal Opportunity Employer.

**Community College—Electronics Technology Instructor** needed in old established institute type of program in electronics leading to a certificate of completion. Must be able to meet state certification requirements. Have a good background of work experience in DC-AC principle uses. BSEE degree desired. Contact: Daytona Beach Community College, Personnel Department, P.O. Box 1111, Daytona Beach, Florida 32015.

**Communications-Electronics Sales Engineer,** Paris based, salaried, preferably ex-U.S. officer, familiar with latest advances in data handling, military command and control for marketing liaison with Governmental authorities throughout Europe. P-5420, Electronics.

## EMPLOYMENT SERVICES

**Growth Positions, \$14-30,000. Fees Paid.** Nationwide. Longberry of Pittsburgh. Suite 962-G, Two Gateway Center, Pittsburgh, Pa. 15222.

**SAME DAY SHIPMENT**  
Minis & Peripherals

**PDP SPECIALISTS**  
8, 8I, 8L & 11

**NEW 300 LPM PRINTERS**

**PDI CARD READERS**

**BRPE PUNCHES**

**\$750 Minis**

**TELETYPE 35 & 37**  
**DEC & HONEYWELL Modules**  
617/261-1100

Send for Free Report "Maintenance of Computers"  
**AMERICAN USED COMPUTER CORP.**  
P.O. Box 68, Kenmore Sta., Boston, MA 02215  
member COMPUTER DEALERS ASSOCIATION

CIRCLE 951 ON READER SERVICE CARD

**WRIST WATCH**  
**LIQUID CRYSTAL DISPLAY**  
• 3-1/2 digit, 7 segment  
• Only 1-1/16 x 1 1/16 x 1/4"

See Photo (Left) for details. This building your own electronic digital wristwatch using the Liquid Crystal Display (LCD) as its basic. Easy to see, 3 1/2 digit display. Requires less than 1/1000 of power. LCD's Visibility increases with ambient light. Infrared reading of LCD's. Requires less than 1/1000 of power. LCD's. NO NEED OF TRANSMITTER-RESISTOR interface, as LED's. This smaller package. This contains holder, key, connecting terminals, and slide-on-place chrome spring face plate. Size of display in holder: 1 1/16" x 1 1/16" x 1/4". Operating freq. 12 kHz. 48-microamps of power. Operates from 1.5V hearing aid cell. See the new and latest MOD micro-circuitry. We include copy of write up from PE magazine.

**\$19.95**

Lowest Prices      • Factory Marked Buy 3 or more, 10% discount  
Buy 100 — Take 20 %

## Largest Selection TTL IC's

• Money Back Guarantee

Type	Sale	SN7455	SN74126	.71	
SN7400	\$0.30	SN7460	.30	SN74138	1.25
SN7401	.30	SN7461	.35	SN74140	1.25
SN7402	.30	SN7462	.35	SN74145	1.55
SN7403	.30	SN7464	.30	SN74148	4.50
SN7404	.35	SN7465	.35	SN74150	1.61
SN7405	.35	SN7470	.50	SN74151	1.25
SN7406	.45	SN7471	.55	SN74152	4.95
SN7407	.55	SN7472	.50	SN74153	1.60
SN7408	.30	SN7473	.55	SN74154	2.10
SN7410	.30	SN7477	.55	SN74155	1.55
SN7411	.35	SN7475	1.00	SN74156	1.45
SN7413	.95	SN7476	.65	SN74157	1.85
SN7415	.55	SN7478	.95	SN74158	1.55
SN7416	.55	SN7479	.60	SN74166	2.05
SN7417	.55	SN7488	1.25	SN74161	1.95
SN7420	.30	SN7482	.99	SN74163	1.95
SN7421	.55	SN7483	1.25	SN74164	2.95
SN7422	.35	SN7485	1.41	SN74165	2.10
SN7425	.80	SN7486	.95	SN74166	2.05
SN7426	.36	SN7489	4.50	SN74173	2.50
SN7430	.30	SN7490	1.49	SN74174	3.20
SN7432	.35	SN7491	1.35	SN74175	3.20
SN7437	.55	SN7492	1.35	SN74176	2.10
SN7438	.55	SN7493	1.35	SN74177	2.10
SN7440	.30	SN7494	1.35	SN74179	2.10
SN7441	1.40	SN7495	1.35	SN74180	2.10
SN7442	1.50	SN7496	1.35	SN74181	4.90
SN7443	1.50	SN7498	.55	SN74182	1.20
SN7444	1.50	SN7497	.70	SN74185	2.50
SN7445	1.50	SN74108	.95	SN74192	1.95
SN7446	1.65	SN74112	.95	SN74193	1.95
SN7447	1.45	SN74113	.95	SN74194	1.95
SN7448	1.50	SN74114	.95	SN74195	1.25
SN7450	.30	SN74121	.60	SN74196	2.50
SN7451	.30	SN74122	.95	SN74197	2.50
SN7453	.30	SN74123	1.20	SN74198	2.65
SN7454	.30	SN74125	.71	"DIP" Packages	

Terms: add postage. Rated net. © 1979  
Phone Orders: Wakefield, Mass. (617) 245-3829  
Retail: 16-18 Del Carmine St., Wakefield, Mass. (off Water Street) C.O.D.'S MAY BE PHONED

## POLY PAKS

P.O. BOX 9425, LYNNFIELD, MASS. 01940

CIRCLE 952 ON READER SERVICE CARD

## ATTENTION!

200 000 pcs 2N 1305  
100 000 pcs 2N 404

Ratheon—originally packed at 100 pcs. Samples upon request —will quote on inquiries.

## UNITRONIC GmbH

4000 Düsseldorf, Postfach 33 0429  
Tel.: 0211/634214/624439 : TX: 0-8586434

CIRCLE 953 ON READER SERVICE CARD

RADAR SYSTEMS GROUND AND AIRBORNE AUTOMATIC TRACKING ANTENNA SYSTEMS, NIKE AJAX NIKE HERCULES M-33 MSO-1A MPS-19 MPS-9 SCR 584 TPS-10 TPS-28 FAA-ASR-2 AIRBORNE SYSTEMS, APN-84 APN-102 APS-20 APS-27 APS-45 DPN-19 DIGITAL COMPUTERS IBM 650 IBM 704

LARGEST INVENTORY OF RADAR AND MICROWAVE EQUIPMENT IN THE WORLD.

**RADIO RESEARCH INSTRUMENT CO.**  
3 QUINCY ST., NORWALK, CONN. 06850 12031 853-2600

CIRCLE 954 ON READER SERVICE CARD

**free catalog**

**POTTING APPLICATORS**  
MANUAL OR AIR OPERATED  
2 1/2cc 6cc 12cc 30cc  
FOR POTTING, ENCAPSULATING ETC.

**PHILIP FISMAN CO., INC.**  
7 CAMERON ST. WELLESLEY, MASS. 02181

CIRCLE 956 ON READER SERVICE CARD

## FREE ALARM CATALOG

Full line of professional burglar and fire alarm systems and supplies. 96 pages, 450 items. Off the shelf delivery, quantity prices.

**mountain west alarm**  
4215 n. 16th st., phoenix, az. 85016

CIRCLE 957 ON READER SERVICE CARD



## Now you can get a foreground/background system for less than \$25,000. And that's before discounts.

Now there's a foreground/background disk-based system available for thousands of dollars less than any other hardware/software combination. And it offers more performance than has ever been available before.

It's based on RT-11, Digital's new F/B operating system, and the PDP-11E10. (RT-11 is also available on other PDP-11 systems.) And you can run the single job version with just 8K words of memory and a dual DECTape drive for less than \$18,500.

RT-11 is designed for the on-line user who is involved in program development and/or

real-time applications. It's a fast, low-overhead (less than 3K resident) system. And you don't have to be a computer scientist to use it...or even to modify it.

New, high performance, extended versions of Dartmouth-compatible BASIC and ANSI-Standard FORTRAN IV are available. Both offer high level language support of sequential and direct access files, chaining, overlays, A/D's, D/A's, clocks, digital I/O, graphics, plotting, signal processing... And there's more coming. And the minimum FORTRAN and BASIC are supported on just 8K of memory.

These are just some of the features that make RT-11 the highest performing on-line system with the lowest price in the market.

For additional details on RT-11 performance, write Digital Equipment Corporation, Maynard, Mass. 01754 (617) 897-5111, Ext. 2083. European headquarters: 81, route de l'Aire, 1211 Geneva 26. Tel: 42 79 50. Digital Equipment of Canada Ltd., P.O. Box 11500, Ottawa, Ontario K2H 8K8. (613) 592-5111.

**digital**

Circle 153 on reader service card

Atlanta · Seattle · Dallas · Denver · Newark  
Los Angeles · Philadelphia · Portland  
Salt Lake City · San Francisco · Chicago

## Which plant site offers the greatest profit potential for an electronics computer manufacturer?

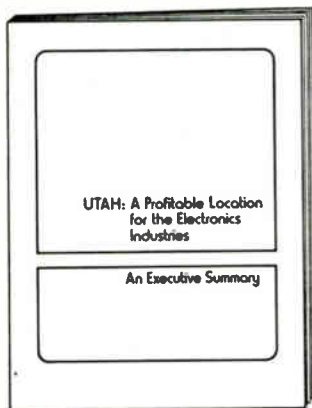

Where are labor costs lowest?  
How do taxes compare? What  
about utility costs?

A new research study examines  
these and other critical profit  
factors for a hypothetical  
electronics computer firm  
employing 1000.

The plant is hypothetical, but  
the cost/benefit figures are real.  
And the wide variance in profit  
from one plant site to another  
is real too.

We've prepared a 24-page  
Executive Summary of the  
findings, and it's yours for the  
asking. Just drop your business  
card in an envelope and mail to:

**John Rencher, Director**  
**Utah Industrial Promotion**  
**Division**  
No. 2 Arrow Press Square,  
Dept. E-530-4  
Salt Lake City, Utah 84101

## New literature

**Knitted wire.** Metex Corp., 970 Durham Rd., Edison, N.J. A 20-page booklet describes the physical properties of knitted wire mesh. Many products are illustrated, including heat-transfer materials and electronics-shielding materials. Circle 421 on reader service card.

**Packaging products.** Bivar Inc., 1617 E. Edinger Ave., Santa Ana, Calif. 92705, has published a 24-page catalog providing information on a line of printed-circuit-card guides, card ejectors, and component-mounting spacers. [422]

**Microwave networks.** Karkar Electronics Inc., 245 Eleventh St., San Francisco, Calif. 94103. Microwave multiplex combining and splitting networks that provide two-, three-, four-, five- and six-way functions at a microwave junction, with zero loss between all inputs and outputs, are discussed in a four-page brochure. [423]

**Computer products.** Tektronix Inc., Box 500, Beaverton, Ore., has issued the 1974 edition of its computer products catalog. The 48-page booklet discusses computer display terminals, interfaces, software, and other accessories. [424]

**Power conversion.** A 12-page catalog describing a line of miniature modular power converters and power supplies is available from Arnold Magnetics Corp., 11520 W. Jefferson Blvd., Culver City, Calif. 90230. Specifications and ordering information are provided. [425]

**Accelerometers.** Kulite Semiconductor Products Inc., 1039 Hoyt Ave., Ridgefield, N.J. 07657. A four-page bulletin describes the range of solid-state integrated-sensor accelerometers, giving electrical and physical specifications. [427]

**Power transistors.** Energy Electronic Products Corp., 6060 Manchester Ave., Los Angeles, Calif. 90045, has issued a data sheet describing 3- and 6-ampere power transistors for 1,300-, 1,500- and 1,700-volt applications. [428]



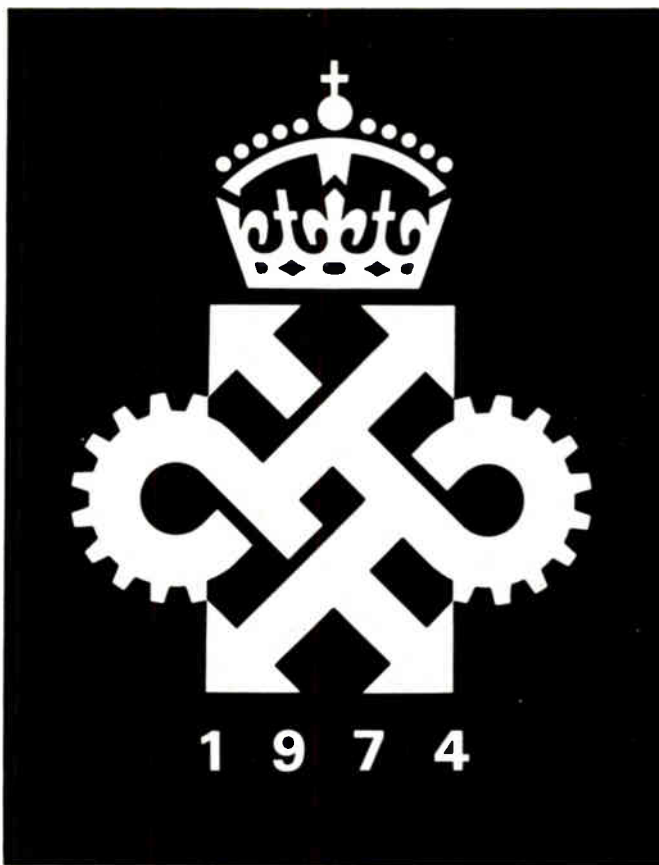

# The world's fastest IC wins the Queen's Award

Plessey Process III has gained the Queen's Award for Outstanding Technological Innovation.

In the Plessey SP600 range, the SP616  $\pm$ 4 GHz IC, currently in volume production—it's the world's fastest—is just one of the outstanding devices from the award winning Process III. The SP600 series is the most advanced range of synthesiser and instrumentation IC's in the world.

Another series of highly successful IC's from Plessey is the SL600, fast becoming one of the world's most successful IC ranges for communications.

This award to the Allen Clark Research Centre, of which we are justly proud, demonstrates Plessey leadership in technical innovation and products in the IC field.



**PLESSEY**  
**Semiconductors**

Cheney Manor, Swindon, Wiltshire SN2 2QW.  
Tel: Swindon (0793) 6251 Telex: 449637.

USA: Plessey Semiconductors—170 Finn Court, Farmingdale, Long Island, New York 11735  
Tel: 516 594 7377 Telex 961457; 1674 McGaw Avenue, Santa Ana, California 92705,  
Tel: 714 540 9979 Telex 685 544.

Years ago we made a decision to let the other guys knock out all of the simple printed circuit boards they could make. We wanted the tough jobs.

Multilayer and two-sided PCs. Complex drilling, printing and plating.

And we wanted to do them better than anybody in the business. Since then, we've been doing

more of the hard work than anyone. And delivering it on time. With precision and economy.

We built a reputation on hard work. We're not about to take things easy now.

If you've got a tough job, call us at (213) 722-6810 collect. Or write Data Products Division, 6201 East Randolph Street, Los Angeles, California 90040.

**We built a reputation on hard work.**

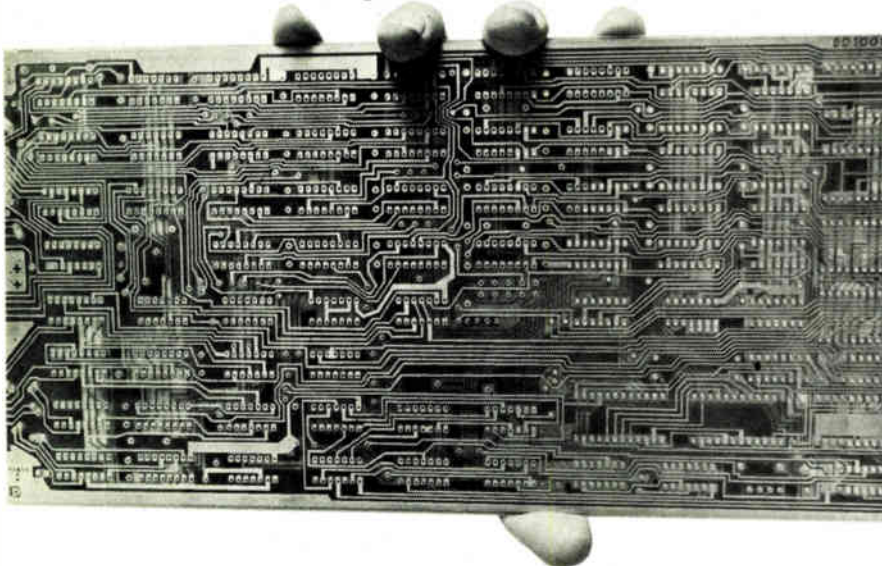

**Lockheed Electronics—First In Complex PCs**

15 YEARS OF LEADERSHIP IN ELECTRONICS. 1959-1974.

Circle 156 on reader service card

# The Quick Way

New Electronics Buyers' Guide  
Easy-to-use, single volume source for:

- Information on 4,000 products
- Over 6,000 company listings and phone numbers
- **EBG EXCLUSIVE:** quick access to over 800 catalogs through a Direct Inquiry Service

Here is the international world of electronics at your fingertips. Find suppliers . . . fast . . . accurately . . . and locally! If you don't have your own copy, send \$15.00 (USA and Canada only; elsewhere send \$25.00) to address shown below.

## Electronics Buyers' Guide

A McGraw-Hill Publication • 1221 Ave. of the Americas • New York, N.Y. 10020



### Advertising Sales Staff

**Pierre J. Braudé** New York [212] 997-3468  
London 01-493-1451  
Director of Marketing

**Atlanta, Ga. 30309:** Joseph Lane  
100 Colony Square, 1175 Peachtree St., N.E.  
[404] 892-2868

**Boston, Mass. 02116:** James R. Pierce  
607 Boylston St. [617] 262-1160

**Chicago, Ill. 60611:**  
645 North Michigan Avenue  
Robert W. Bartlett (312) 751-3739  
Paul W. Reiss (312) 751-3738

**Cleveland, Ohio 44113:** William J. Boyle  
[716] 588-5040

**Dallas, Texas 75201:** Charles G. Hubbard  
2001 Bryant Tower, Suite 1070  
[214] 742-1747

**Denver, Colo. 80202:** Harry B. Doyle, Jr.  
Tower Bldg., 1700 Broadway  
[303] 266-3863

**Detroit, Michigan 48202:** Robert W. Bartlett  
1400 Fisher Bldg.  
[313] 873-7410

**Houston, Texas 77002:** Charles G. Hubbard  
2270 Humble Bldg. [713] CA 4-8381

**Los Angeles, Calif. 90010:** Robert J. Rielly  
Bradley K. Jones, 3200 Wilshire Blvd., South Tower  
[213] 487-1160

**New York, N.Y. 10020**  
1221 Avenue of the Americas  
Warren H. Gardner [212] 997-3617  
Michael J. Stoller [212] 997-3616

**Philadelphia, Pa. 19102:** Warren H. Gardner  
Three Parkway,  
[215] 997-3617

**Pittsburgh, Pa. 15222:** Warren H. Gardner  
4 Gateway Center, [212] 997-3617

**Rochester, N.Y. 14534:** William J. Boyle  
9 Greylock Ridge, Pittsford, N.Y.  
[716] 586-5040

**San Francisco, Calif. 94111:** Don Farris  
Robert J. Rielly, 425 Battery Street,  
[415] 362-4600

**Paris:** Alain Offergeld  
17 Rue-Georges Bizet, 75 Paris 16, France  
Tel: 720-73-01

**Geneva:** Alain Offergeld  
1 rue du Temple, Geneva, Switzerland  
Tel: 32-35-63

**United Kingdom & Scandinavia:** Keith Mantle  
Tel: 01-493-1451, 34 Dover Street, London W1

**Milan:** Robert Saidel  
1 via Baracchini, Italy Phone 87-90-656

**Brussels:** Alain Offergeld  
23 Chaussée de Wavre  
Brussels 1040, Belgium  
Tel: 13-73-95

**Frankfurt/Main:** Fritz Krusebecker  
Liebigstrasse 27c, Germany  
Phone 72 01 81

**Tokyo:** Tatsumi Katagin, McGraw-Hill  
Publications Overseas Corporation,  
Kasumigaseki Building 2-5, 3-chome,  
Kasumigaseki, Chiyoda-Ku, Tokyo, Japan  
[581] 9811

**Osaka:** Ryji Kobayashi, McGraw-Hill  
Publications Overseas Corporation, Kondo  
Bldg., 163, Umegae-cho Kita-ku, Japan [362] 8771

**Australasia:** Warren E. Ball, IPO Box 5106,  
Tokyo, Japan

### Business Department

**Stephen R. Weiss, Manager**  
[212] 997-2044

**Thomas M. Egan,**  
Production Manager [212] 997-3140

**Carol Gallagher**  
Assistant Production Manager [212] 997-2045

**Dorothy Carter,** Contracts and Billings  
[212] 997-2908

**Frances Vallone,** Reader Service Manager  
[212] 997-6057

### Electronics Buyers' Guide

**George F. Werner,** Associate Publisher  
[212] 997-3139

**Regina Hera,** Directory Manager  
[212] 997-2544

## DIACON'S AUTOMATIC ENVIRONMENTAL STORAGE HANDLER:

- 200 DEVICES IN 029 CARRIERS
- RELIABLE • SIMPLE
- EASY TO MAINTAIN

Fewer moving parts inside the environment (two bushings only) provide long, maintenance-free operation. The Diakon storage handler is quiet and mechanically uncomplicated. Which helps eliminate down-time. Operates on 120 or 240 V.

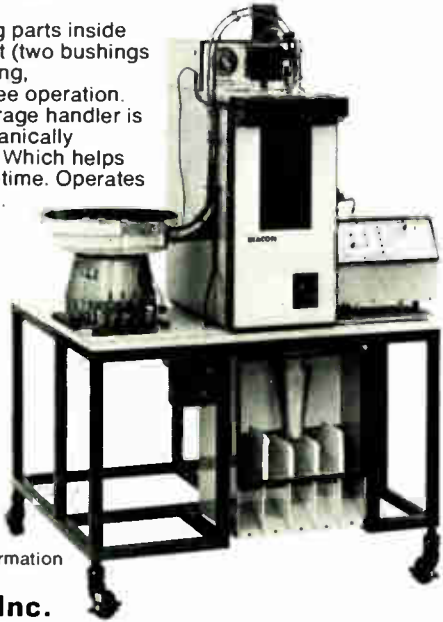

For complete information and specs, write:

**DIACON, Inc.**  
4812 Kearny Mesa Rd.  
San Diego, Calif. U.S.A.  
(714) 279-6992

Circle 183 on reader service card

## GAUSSMETERS



model 811

high accuracy  
excellent repeatability  
rugged

Bell gaussmeters measure magnetic field strength from .0001 gauss to 100,000 gauss. There are six gaussmeter models and 110 probe models for each gaussmeter. The resulting combinations meet the challenging requirements of all magnetic field measurement applications.

F. W. Bell has the experience and know-how to offer you the best instruments that are available. Your local representative is equipped to give you a demonstration. Use the inquiry card to find out how these instruments can benefit you.

4949 Freeway Drive East  
Columbus, Ohio 43229  
Phone: 614/888-7501  
TWX: 810-337-2851



a subsidiary of Arnold Engineering

Circle 182 on reader service card

## take your pick... RF power from Zenith



Here's a new solid state, wide band RF power amplifier that operates over a frequency range of 10 to 110 MHz and delivers 4 watts of CW power across an external 50 OHM load. And Zenith gives you a choice of the Model 4W power amplifier only or the Model WPA-40 that includes the amplifier, regulated power supply, line filter, power output meter, and cabinet.

As to performance, Zenith's Class A unit maintains a flat response to within  $\pm 1.5$  DB over the entire frequency range. Extends power output levels of signal and sweep generators, frequency synthesizers and other signal sources. Accepts CW, AM, FM, pulse, SSB and all forms of complex modulation.

Originally designed for use in driving Zenith Acousto-Optic modulators and deflectors, the unconditionally stable amplifier can also be used in transmitter and communications systems, component and material testing, ultrasonics, and antenna testing as well as a general laboratory power source. Whatever your power needs, Zenith is the one to pick. Contact our Optical Systems Group for the specifications on the Model WPA-40 and Model 4W Amplifiers.



OPTICAL SYSTEMS GROUP

**ZENITH RADIO CORPORATION**

2001 N. JANICE AVENUE • MELROSE PARK, ILL. 60160 • 312 379-4600

Circle 157 on reader service card

# The world's biggest little black box is on the road



It's a unique display of TRW Electronic Components' newest products, circuit applications and ideas—coming right to you.

Picture a typical electronics chassis, grown to mammoth proportions. In fact, to the size of a 40-foot tractor-trailer; far and away the world's *biggest* "little black box." Inside, you'll find components which look like nothing you've ever seen before—because the scale is *giant*. Five feet high for some.

Our technical experts will be on hand to answer your questions on more than 1000 different products from the 14 separate divisions that form TRW Electronic Components.

And the show is on the road right now. We're zig-zagging our way across country, stopping at 155 plants in 27 states. Watch for announcements when we'll be in your area. TRW's little black box is where electronics is, and we're bringing it where you are. Because we *are* TRW.

**TRW** ELECTRONIC COMPONENTS

Connectors • Resistors • Semiconductors • Capacitors • Motors • PC Boards • Potentiometers • Transformers • Coils and Inductors • Wire and Cable

# Electronics advertisers

May 30, 1974

<b>Advanced Micro Devices</b> Keye/Donna/Pearlstein	10-11	<b>Heath/Schlumberger Scientific Instruments</b> Advance Advertising Services	44	<b>SGS-ATES</b> McCann-Erickson	7E-8E
<b>AEG Telefunken</b> Werbeagentur Dr. Kuhl GmbH	44	<b>Hewlett-Packard</b> Richardson, Seigle, Rolfs & McCoy, Inc.	135-137	<b>Siemens Corp.-Electronic Systems Division</b> JL Associates	37
<b>Airpax Electronics, Inc.</b> Robert B. Walker & Associates, Inc.	141	<b>Hewlett-Packard</b> Tallant Yates Advertising, Inc.	1	<b>Signetics Corp., Sub. of Corning Glass Works</b> Hall Butler Blatherwick, Inc.	20-21
<b>Alcatel</b>	20E	<b>Hybrid Systems Corporation</b> Henry Scammell Associates	6	<b>Silcontix</b> Robertson West, Inc.	109
<b>Allen Bradley Company</b> Hoffman, York, Baker & Johnson, Inc.	24	<b>Industrie Bitossi s.a.s.</b>	10E	<b>Spectrum Control, Inc.</b> Egon Jackson Advertising	145
<b>Amphenol Components Group</b> Bunker Ramo Corp. Marsteller, Inc.	22-23	<b>Intel Corp.</b> Regis McKenna, Inc.	12-13	<b>Sprague Electric Company</b> Harry P. Bridge Company	8
<b>Analog Devices, Inc.</b> Schneider Parker, Inc.	88	<b>International Nickel Company</b> Ogilvy & Mather, Inc.	79	<b>Statek Corporation</b> Ron Jenner & Company	18
<b>Anritsu Electric Co., Ltd.</b> Diamond Agency Co., Ltd.	15E	<b>Interall, Inc.</b> Tyce-Fultz	42-43	<b>Stewart-Warner Microcircuits</b> JMR Advertising	123
<b>Beckman Instruments, Inc., Hellpot Division</b> N.W. Ayer/Jorgensen/MacDonald, Inc.	62-63	<b>Interstate Electronics Corp.</b> Chris Art Studio, Inc.	35	<b>TEAC Corp.</b> Dentsu Advertising Ltd.	60
<b>Bell, F.W.</b>	157	<b>Invest Export-Import</b> Interwerbung	51	<b>Tekelec Airtronic</b> S.P.F.D.	5E, 45
<b>Bell &amp; Howell-Electronics &amp; Instruments Group</b> Boyhart, Lovett & Dean	80-81	<b>Johnson Company, E.F.</b> Martin Williams Advertising	78	<b>Tektronix, Inc.</b> McCann-Erickson, Inc.	33, 84-85
<b>Computer Components, Inc.</b>	19E	<b>Krohn-Hite Corp.</b> Impact Advertising, Inc.	5	<b>Teledyne Semiconductor</b> Regis McKenna, Inc.	15
<b>Cramer Division of Conrac</b> McCarthy, Scelba, DeBlasi	130-131	<b>Littlefuse, Inc.</b> LF Advertising, Inc.	60-81	<b>Telonic Altair</b> Jansen Associates, Inc., Marketing Services	9
<b>CTS Corporation</b> Reincke, Meyer & Finn, Inc.	105	<b>Litronix, Inc.</b> Regis McKenna, Inc.	7	<b>Teradyne, Inc.</b> Quinn & Johnson, Inc.	69
<b>Cushman</b> Murphy Advertising, Inc.	63	<b>Lockheed Electronics Co.</b> McCann-Erickson, Inc.	156	<b>Trio-Tech Inc. of California</b> Robert A. White Advertising, Inc.	19
<b>Dale Electronics Inc., A Sub. of the Lionel Corporation</b> Swanson, Sinkay, Ellis, Inc., Advertising	4th Cover	<b>LTT</b>	17E	<b>TRW, Electronic Components Division</b> The Bowes Company	158
<b>Data General Corporation</b> Scall, McCabe, Sloves, Inc.	86-87	<b>Micro Networks Corporation</b> Briant Advertising	40	<b>TRW/IRC Resistors</b> Gray & Rogers, Inc.	124-125
<b>Datel Systems, Inc.</b> John Donlan Advertising	3rd Cover	<b>Micro Switch Division of Honeywell</b> N.W. Ayer & Son, Inc.	2	<b>TRW Electronics, Semiconductor Division</b> The Bowes Company	82-83
<b>Diacon</b> Rogondino Advertising and Marketing	157	<b>Mostek Corporation</b> David W. Evans, Inc./Texas	64-65	<b>TRW-UTC Transformers</b> The Bowes Company	139
<b>Dialight Corporation</b> Michel-Cather, Inc.	2nd Cover	<b>Motorola Semiconductor Products, Inc.</b> E.B. Lane & Associates, Inc.	58-59	<b>United Systems Corp., A Sub. of Monsanto Co.</b> Advertising & Merchandising, Inc.	110
<b>Digital Equipment Corporation</b> Creamer, Trowbridge, Case & Basford, Inc.	126-127, 153	<b>Motorola Semiconductor</b> Graham & Gillies Limited	52	<b>Unitrode Corporation</b> Culver Advertising, Inc.	27
<b>Dow Corning Industrial</b> Ketchum, MacLeod & Grove, Inc.	146-147, 149	<b>National Electronics</b> Lea Advertising	71	<b>Utah Industrial Promotion Division</b> Harris & Love, Inc/Advertising	154
<b>Eastern Air Devices</b> Weston Associates, Inc.	143	<b>North Atlantic Industries, Inc.</b> NOAT Advertising Company	142	<b>Woven Electronics</b> Prentiss Court Advertising	73
<b>Electronics Measurements, Inc.</b> Hill Advertising Agency	160	<b>Oak Switch</b> Marsteller, Inc.	132-133	<b>Zeltex</b> Zeltex Advertising Agency	38
<b>Electronic Navigation Industries</b> Hart Conway Co., Inc.	14	<b>Philips Elcoma</b> Intermarco nederland	54	<b>Zenith Radio Corporation-Optical Systems Group</b> Mills, File & MacDonald, Inc.	157
<b>Erie Technological Products, Co., Inc.</b> Altman Hall Associates Advertising	17	<b>Pher International Ltd.</b> Scott MacTaggart Advertising	57	<b>La ZincoLere S.p.A.</b> Studio Dr. Giuliano Blei	62
<b>Excellon Industries</b> Graham & Sparkman Advertising etcetera	51	<b>Plessey Semiconductor</b> Rumrill-Hoyt, Inc.	155		
<b>Fabri-Tek, Inc.</b> Midland Associates, Inc. Marketing and Advertising Services	48	<b>Ramtek, Corp.</b> McDonough Communications	77		
<b>Fairchild Semiconductor, Inc.</b> Carson/Roberts, Inc., Advertising Division of Ogilvy & Mather, Inc.	39	<b>Raytheon Company, Industrial Components Operation</b> Provandie Eastwood & Lombardi, Inc.	41		
<b>Fairchild Systems Technology</b> Hall Butler Blatherwick, Inc.	150-151	<b>RCA Electronic Components</b> Al Paul Lefton Company, Inc.	16E		
<b>General Electric Co., Semiconductor Products Department</b> Advertising & Sales Promotion Syracuse Operation	28	<b>RCA-Solid State Division</b> Marsteller, Inc.	74-75		
<b>General Instruments Micro Electronics Ltd.</b> T. Richards Johnson Ltd.	41	<b>Rental Electronics, Inc.</b> Humphrey Browning MacDougall, Inc.	54		
<b>General Instrument Corporation, Semiconductor Comp. Division</b> Norman Allen Associates, Inc.	46-47	<b>Rhone Progil</b>	13E		
<b>Gulf Power Company of Pensacola, The</b> Cargill, Wilson & Acree Inc., Advertising	76	<b>Rifa</b> MK Marknadskommunikation AB	61		
<b>Harris Semiconductor</b> Tucker Wayne & Company	44-45	<b>Rockland Systems</b> Rolf Johnson, Inc.	16		
		<b>Rohde &amp; Schwarz</b>	1E		
		<b>Schauer Manufacturing Corp.</b> Nolan, Keelor & Stites	20		
		<b>Sesocsem</b> Bazaine Publicite	2E		

## Classified & Employment Advertising

F. J. Eberle, Manager 212-997-2557

<b>EQUIPMENT (Used or Surplus New) For Sale</b>	
American USED Computer Corp.....	152
Philip Fishman Co., Inc. ....	152
Hamilton Standard div. of United Aircraft Corp.....	152
Poly Paks Inc.....	152
Radio Research Instrument Corp.....	152
Unitronic GMBH.....	152

■ For more information on complete product line see advertisement in the latest Electronics Buyer's Guide  
 • Advertisers in Electronics International  
 ‡ Advertisers in Electronics domestic edition



# POWER SUPPLIES

Electronic Measurements has designed and built many power supplies to solve a wide range of applications. Design reliability has been field proven since 1968. We have a wealth of application experience and the ability to power

## QUESTION: (EARN \$1.00 FOR YOUR ANSWER)

ASSUMING YOU'VE SEEN THIS ADVERTISEMENT BEFORE; AND MAYBE EVEN SENT FOR THE SALES LITERATURE, "HOW CAN YOU STILL JUSTIFY SPECIFYING SORENSEN, H-P OR LAMBDA."

**MAIL ME YOUR ANSWER AND I'LL SEND YOU A NEW ONE DOLLAR BILL FOR YOUR THOUGHTS.**

**BOB HILL**

from a short-form catalog, use the Reader Service card, or contact Electronic Measurements.

Rating	Price	
	EM	SCR
6V-600A	\$1,900	\$2,200
7.5V-300A	1,200	1,400
10V-250A	1,200	1,400
10V-500A	1,900	2,200
20V-125A	1,100	1,300
20V-250A	1,500	1,800
20V-500A	2,300	2,700
30V-100A	1,100	1,300
30V-200A	1,500	1,800
40V-60A	1,100	1,300

Rating	Price	
	EM	SCR
40V-125A	\$1,400	\$1,700
40V-250A	2,100	2,500
50V-200A	2,300	2,700
80V-30A	1,100	1,300
80V-60A	1,400	1,700
100V-100A	2,300	2,700
120V-20A	1,100	1,300
120V-40A	1,400	1,700

Rating	Price	
	EM	SCR
160V-15A	\$1,100	\$1,300
160V-30A	1,400	1,700
160V-60A	2,100	2,500
250V-10A	1,100	1,300
250V-20A	1,500	1,800
250V-40A	2,300	2,700
500V-5A	1,400	1,600
500V-10A	1,900	2,200

19" Rack, 20" depth. Voltage and current adjustable over wide range.

See EEM Vol. 1, Pages 673, 674, 675 for additional product information.



**ELECTRONIC MEASUREMENTS INC.**

405 Essex Road, Neptune, N. J. 07753

Phone: (New Jersey) 201 - 922-9300 • (Toll-Free) 800 - 631-4298

Specialists in Power Conversion Equipment

**FREE!!** 70 page Handbook

# ENGINEERING PRODUCT HANDBOOK

## A/D and D/A Converters

- ANALOG MULTIPLEXERS
- SAMPLE AND HOLDS
- DC AMPLIFIERS
- MODULAR DATA ACQUISITION SYSTEMS
- V/F & F/V CONVERTERS
- ACTIVE FILTERS
- POWER SUPPLIES
- DIGITAL PANEL METERS

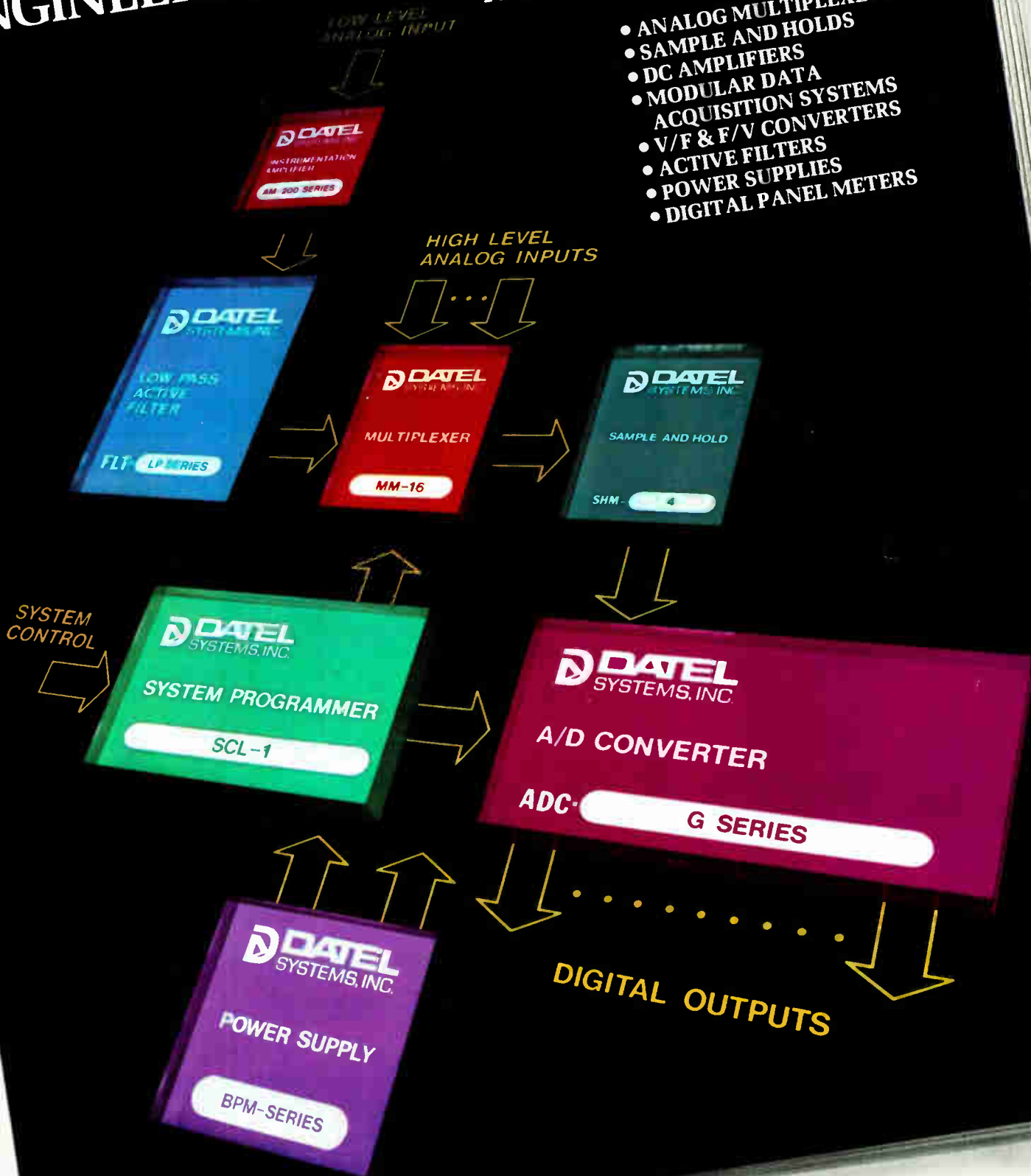

FOREIGN SUBSIDIARIES:  
WEST GERMANY/DATELEK SYSTEMS GmbH-8 MUNCHEN 71 • TEL 089/78 40 45 • TELEX 5212855  
FRANCE/DATEL SYSTEMS SARL, 750 16 PARIS, FRANCE • TELE 603-06-74/603-05-31  
UNITED KINGDOM - BASINGSTOKE, HAMPSHIRE, RG-24 9NT • TELE BASINGSTOKE (0256) 66721

**DATEL**  
SYSTEMS, INC.

1020 TURNPIKE STREET, CANTON, MASS. 02020  
• TEL. (617) 828-8000  
• TELEX 924461 • TWX 710-348-0135

Circle 901 on reader service card

# How to cut the cost of special resistors

(even if you don't know what you want)

Project costs don't have to escalate when you find you can't use a standard resistor. There are positive ways you can save money and time—and even come out ahead in the bargain.

You can start cutting project costs by reducing what we call "visualization loss". This is the expensive extra time required to figure out an exact set of electrical, physical, environmental and dimensional parameters for the special part you need. *Don't go too far.* Especially don't wait until you're completely bogged down before you ask Dale for help. In electrical terms, we've long since figured out practical ways to deliver resistance as low as .001 ohm... tolerance as low as .01%... TC as low as  $\pm 5$  ppm and power just as high and as stable as you want it to be. And we can put your non-standard electrical parameters in unique packages that are one part sophistication and one part mid-western ingenuity. Every day we're showing companies how they can bend, squeeze,

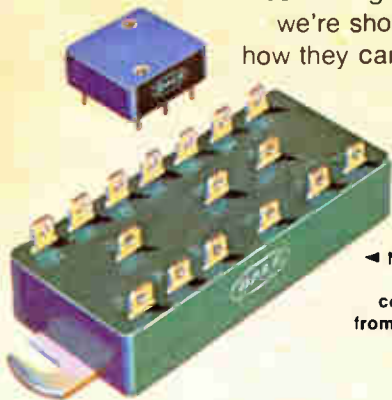

Space-saving P.C. board module containing 3 non-inductive resistors. (Far left)

◀ Network with 16 quick couple connections containing 12 resistors from .025 ohm 50 watts to .1 ohm 10 watts.

High Pulse Wattage railway safety resistor. Special housing for underground use.



Voltage Sensing Shunt...  
.05 ohm-24.5K ohms...20 PPM/° C.

mill, tap, bury and inter-connect resistors for special purposes. We even put in plumbing, when required. Your non-standard resistor may only need a different kind of lead or it may look like a Rube Goldberg nightmare. Either way, you'll find Dale is unique among resistor suppliers in the ability to help you quickly visualize what you need... and to deliver a prototype with a minimum of design lag. We've already designed and built nearly 5,000 special resistors—so it's quite possible we've already blueprinted the design you need.

Call us. You'll be glad to find someone is working to make the basics better.

Send for our free Functional Guide to Non-Standard Resistors.

DALE ELECTRONICS, INC.  
1300 28th Avenue, Columbus, Nebraska 68601  
A subsidiary of The Lionel Corporation  
In Canada: Dale Electronics Canada Ltd.  
In Europe: Dale Electronics GMBH,  
8 Munchen 60, Falkweg 51, West Germany

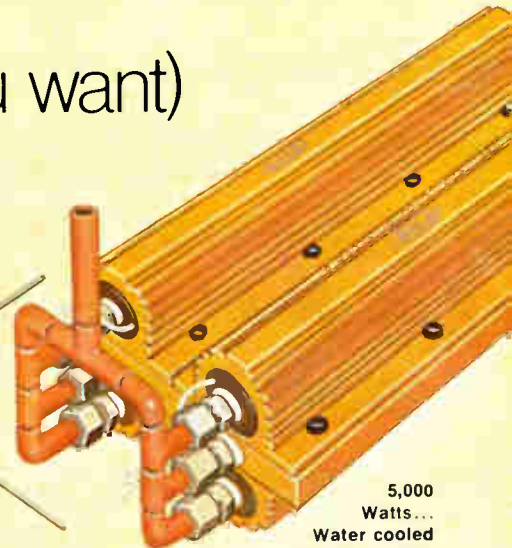
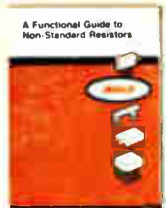

5,000 Watts...  
Water cooled  
.1 ohm-500K ohms,  
0.5%-5% tol.

