

- 68 The Nixon budget: record spending for electronics
- 103 Thermal design, Part 5: cooling with liquids
- 114 Solid progress in solid state reported at ISSCC

# Electronics®



1420 080120 AECAT MAY76  
CS OSBORNE, JR  
1202 N AVENUE H11  
LANCASTER CA  
93534

**SPECIAL REPORT**  
**A NEW DAY**  
**FOR**  
**LOGIC DESIGN**

# Maddox Speaks.

## DAC's make the difference in displays.

Some really *clear, sharp* pictures are being generated for demanding computer CRT Display jobs like Air Traffic Control, Avionic Heads-Up, and others.

To get sharp, clean output on high speed X-Y deflection displays you have to start with good spot definition and intensity and then drive it with a clean deflection signal. And that's where high-speed display DAC's come in.

### Here's how.

Display DAC's convert digital position commands to analog voltage levels which will position the spot on the CRT face. New commands are usually clocked in at a steady update rate. The spot is positioned to the start of a line or character and then moved by progressive commands to draw the line.

If the DAC's behave, all is well, but often lines wiggle, and show intensity variations.

### Who's the culprit?

*Glitch*, (transient *spike* or bump in the DAC output) and *differential non-linearity*, (a wrong size step in a series of steps).

Display DAC's are "de-glitched" to achieve very low output glitch values, and are designed to have damn good differential linearity.

### How to define spec limits?

First, determine maximum allowable glitch voltage as measured through a test filter which simulates your deflection circuit's passband. The test filter is the key. You can even lump together the effects of glitch and differential non-linearity. Then, ramping the DAC and comparing its band-limited output to an

ideal ramp, you can check the errors. And after limits are set for intensity variation and wiggle, you can graphically arrive at ramp error limits for the DAC's.

### Among other things.

You can also have an inherent lack of line fidelity due to the staircase-like DAC output. Smaller steps through greater DAC resolution will help. But beware, for the limits of maximum available update rate and minimum picture refresh rate set a resolution limit for line drawing. We can show you some filter techniques that can improve ramp fidelity by 10 to 1 or more, solving this staircase problem.

Settling is really important, too, and long settling tails must be absent so that line starting points will land where you planned.

Things like large-signal settling time, slew rate, zero offset, large scale linearity, and scale factor can normally be obtained much better than available deflection circuits, so use care; don't over-specify the DAC's. Save yourself some money.

### Talk to the experts.

There are a lot more parameters to be considered in specifying high-speed display DAC's, so if you are into this, or going to be, probably the best approach is to consult us. After all, we have standard products such as our 12 or 13 bit DAC's (Models 4014 and 4017), and a lot of display knowledge and real experience. We've built and shipped more high-speed display DAC's than anybody else in the world.

Telephone, toll-free (800) 225-7883, in Mass. (617) 329-1600. Or write us, Dedham, Mass. 02026. In Europe, Tel. 73.99.88, Telex: 25881. Or write, 1170 Brussels, Belgium.

 **TELEDYNE  
PHILBRICK**

Circle 900 on reader service card

"See us at IEEE/Intercon  
Booth 2122"

Ed Maddox, Sr. Engineer

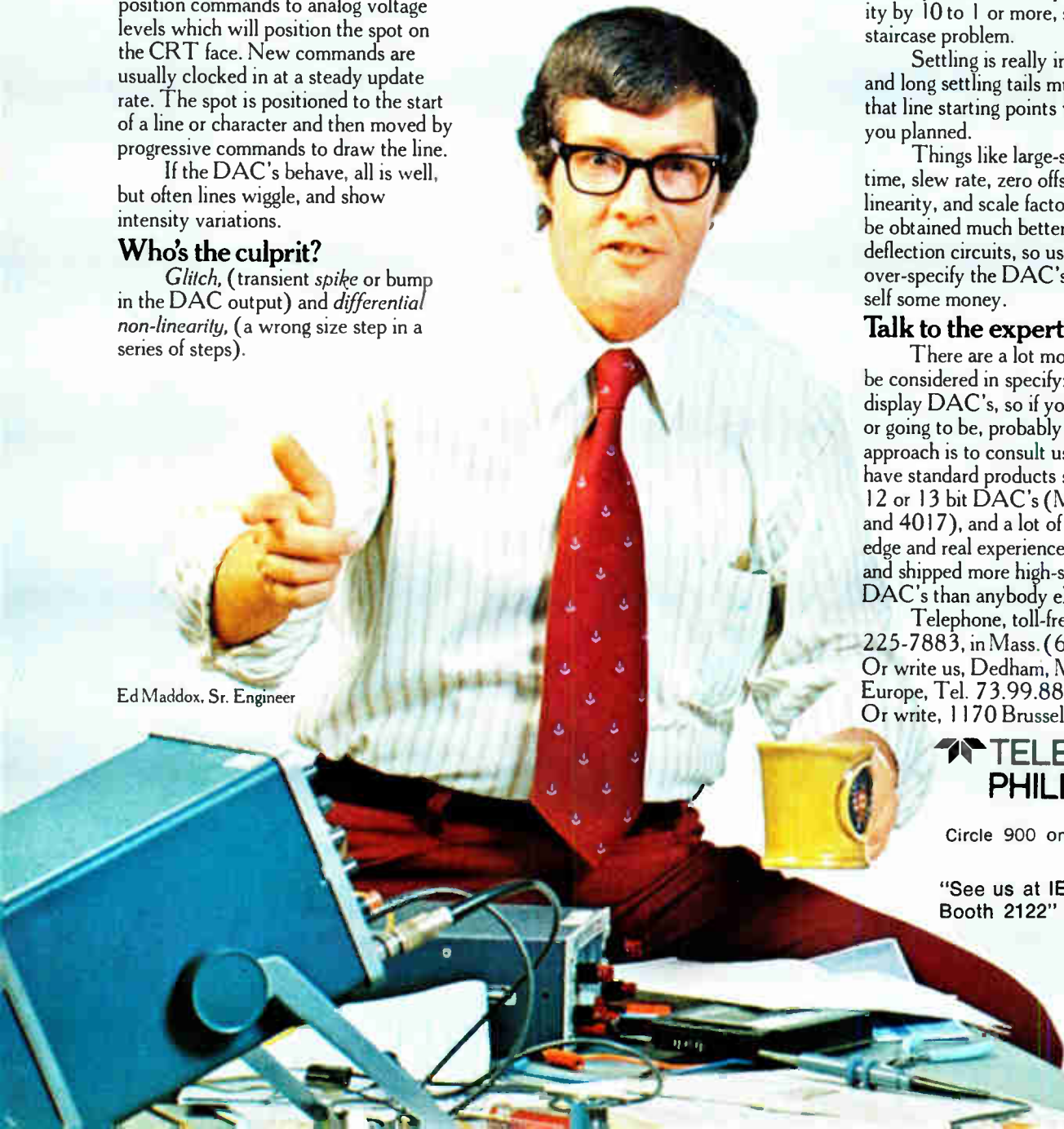



## Calculator-Aided Design — The Fastest Way from Concept to Prototype

Put an HP 9820 or 9821 programmable calculator on your desk and you can slash days—perhaps weeks—from your electronic design schedule. Because you have complete interactive control of the design process. You no longer have to interface with a time-share system, or wait around for the data processing center to run your job. Just enter your component values and our X-Y plotter will draw a Bode diagram that shows the effect of those changes. It's all done automatically—on the plotter or built-in printer, completely documented—before you commit your design to time-consuming breadboarding. It's the cost-effective way to use your design time.

So, whether you're looking for tools to help increase engineering efficiency, or looking for new and better ways to design, consider an HP Calculator-Aided Design solution. For example,

we have CAD programs for network analysis, filter synthesis, logic circuit minimization, microwave design—all giving you improved efficiency from concept to hardware.

For complete details about an HP calculator system specifically tailored to your type of electronic design problems, just fill out and return the attached coupon. We think you'll be surprised to learn how much time and money this new, low-cost, interactive technique can save you. The HP 9820 System with plotter leases for as little as \$261\* per month. Call or write today.

\*Domestic U.S.A. price only. Lease, where available, includes service contract.

**HEWLETT *hp* PACKARD**

Sales, service and support in 172 centers in 65 countries.  
P.O. Box 301, Loveland, Colorado 80537

Please tell me about HP's Calculator-Aided Design solutions:

Information only     Hands-on demonstration

I am planning to use your calculator for: \_\_\_\_\_

Name \_\_\_\_\_

Company \_\_\_\_\_

Address \_\_\_\_\_

Telephone (\_\_\_\_) \_\_\_\_\_ Zip \_\_\_\_\_

Hewlett-Packard Co.  
P.O. Box 301, Loveland, Colorado 80537

E 2/74

# SURPRISE!

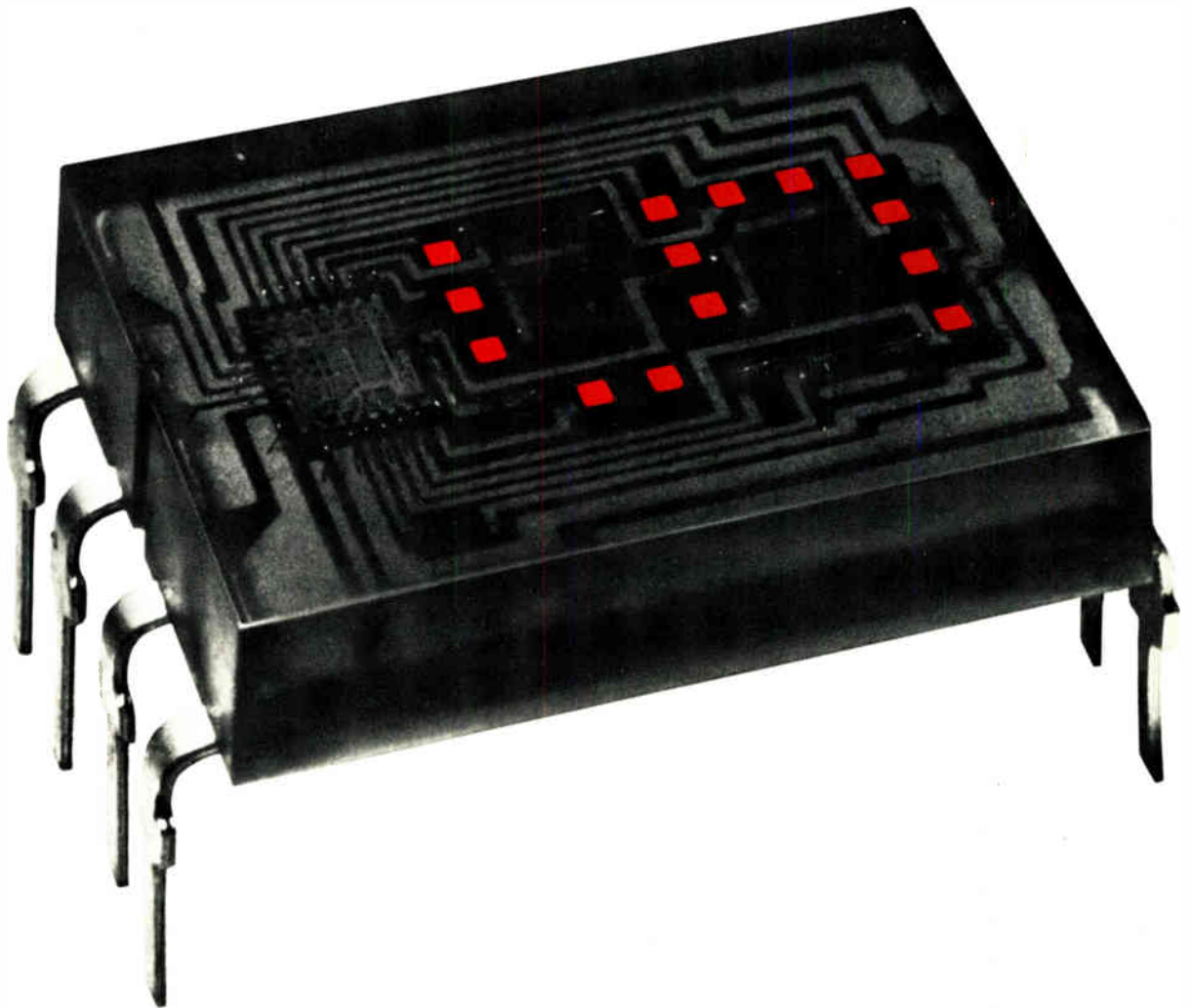

## We built in the decoder/driver so you don't have to.

Not only the decoder/driver, but the memory too! It's all in the HP 5082-7300 series solid state display. Available *now*. In quantities to meet your production needs.

It's completely TTL compatible. All you do is address it directly with four-line BCD input. The on-board IC allows for either the storage of input data or real-time display. You save design time, space and money, and get a completely reliable integrated display system.

A bright 0.290 inch high, shaped character gives excellent readability over a wide viewing angle in a compact 0.600 inch by 0.400 inch package.

And best of all, the price is only \$8.25\* in 1K quantities. If you need a larger character write for information on our 1.5" 5082-7500 solid state display.

It's also TTL compatible and has the decoder/driver built in. For immediate delivery on the HP 5082-7300 or 5082-7500 call your nearby HP distributor today.

01329

\* Domestic USA price only

HEWLETT  PACKARD

Sales, service and support in 172 centers in 65 countries.  
Palo Alto, California 94304. Offices in principal cities throughout the U.S.

## 29 Electronics review

SOLID STATE: CCDs image resolution improved by factor of six, 29  
COMMUNICATIONS: Boeing plot to find squad cars, 30  
SATELLITES: NASA proposes to lease data system, 30  
MICROWAVES: Millimeter waves get solid-state treatment, 31  
ENERGY: Battery charger uses solar power, 32  
COMPUTERS: New microprocessor design cuts gates, 32  
Index of activity, 34  
Dual minis now a standard product, 34  
NEWS BRIEFS: 34  
MILITARY ELECTRONICS: Military argues over plastic semis, 38  
COMPONENTS: Isoplanar prescaler is first of LSI family, 40  
MEDICAL ELECTRONICS: Monitor warns of heart attack, 41

## 55 Electronics International

WEST GERMANY: Two systems for human-organ X rays, 55  
AROUND THE WORLD: 55

## 68 Probing the News

THE 1975 BUDGET: Embattled Nixon primes the pump, 68  
DEFENSE: New chief seeks to replenish cupboard, 69  
AEROSPACE: NASA gets a raise, but FAA is slashed, 72  
TRANSPORTATION: There's a role, and cash, for electronics, 73  
ENERGY: A marginal R&D market, 74  
SCIENCE: How real is the R&D increase? 75  
SOCIAL PROGRAMS: More money in hands of the people, 75

## 81 Technical Articles

SOLID STATE: Logic's leap ahead creates new design tools, 81  
More complex logic tradeoffs multiply designers' options, 83  
Bipolar logic steps up to LSI, with the smart money on I<sup>2</sup>L, 91  
DESIGNER'S CASEBOOK: Adjustable discriminator cuts noise, 98  
Controlling ac loads with C-MOS bilateral switches, 99  
IC timer makes economical automobile voltage regulator, 100  
THERMAL DESIGN: Liquid cooling protects power semiconductors, 103  
ENGINEER'S NOTEBOOK: Trimming closed resistor loops, 109  
Graphs aid selection of a-d converters, 110  
ISSCC ROUNDUP: Finer processing benefits design types, 114  
New bipolar and n-MOS push performance of digital ICs, 114  
CCDs will compete with dense MOS imagers, 115  
Chips to cut cost of electronic watches and 4-channel sound, 116  
Microwave devices work better as processing is refined, 116  
Analog ICs gain in accuracy, DMOS aids heart-imaging system, 117

## 120 New Products

IN THE SPOTLIGHT: 120-MHz scope is light, low-priced, 120  
Switch functions as solid-state fuse, 123  
INSTRUMENTS: Autoranging multimeter is priced at \$299, 127  
SEMICONDUCTORS: Redesign widens market for IC generator, 135  
DATA HANDLING: Naked Mini has 300-nanosecond cycle time, 144  
PACKAGING & PRODUCTION: Die bonders are semiautomatic, 150  
MATERIALS: 162

## Departments

Publisher's letter, 4  
Readers comment, 6  
People, 12  
40 years ago, 16  
Meetings, 20  
Electronics newsletter, 25  
Washington newsletter, 49  
Washington commentary, 50  
International newsletter, 55  
Engineer's newsletter, 112  
New literature, 168

## Highlights

### The cover: A new day dawns for logic, 82

Advances in bipolar and MOS processing that have done so much for semiconductor memories are now being applied to logic. This two-part Special Report surveys the busy scene, telling how standard ECL and TTL are being upgraded, how new and revived technologies compare with them, and how bipolar LSI is about to become VLSI—very large-scale integration. Cover is by illustrator Richard Rosenblum.

### How much will the budget help? 68

Fiscal 1975's proposed spending deficit of \$9.4 billion may help counter a recession in the country at large, and the record defense budget also offers opportunities to electronics firms. But elsewhere the grants will be distributed at the local and state level, slowing the development of electronic hardware markets in areas like education and mass transportation.

### When high-power systems need liquid cooling, 103

Liquids have a large margin of reserve cooling power that, in a high-power electronic system of limited volume, more than compensates for the inconveniences of plumbing. This is the fifth article in the series on thermal design.

### Bipolar LSI shines at ISSCC, 114

More and more semiconductor devices are now profiting from improved processing and subtler circuit design, as this five-part report on last week's International Solid State Circuits Conference makes plain.

### And in the next issue . . .

IEEE: preview of Intercon 74 sessions and products . . . also, how an EE's performance is evaluated . . . plasma displays take on a new look.

EDITOR-IN-CHIEF: Kemp Anderson

EXECUTIVE EDITOR: Samuel Weber

MANAGING EDITORS: Lawrence Curran, *News*;  
Arthur Erikson, *International*

SENIOR EDITORS: John Johnsrud,  
H. Thomas Maguire, Laurence Altman  
Ray Connolly, Stephen E. Scrupski

ART DIRECTOR: Fred Sklenar

ASSOCIATE EDITORS: John N. Kessler,  
Howard Wolff, Gerald M. Walker

#### DEPARTMENT EDITORS

*Aerospace*: William F. Arnold  
*Circuit Design*: Lucinda Mattera  
*Communications & Microwave*:  
Stephen E. Scrupski  
*Components*: Joel DuBow  
*Computers*: Wallace B. Riley  
*Consumer*: Gerald M. Walker  
*Industrial*: Alfred Rosenblatt  
*Instrumentation*: Michael J. Riezenman  
*Military*: Ray Connolly  
*New Products*: H. Thomas Maguire  
*Packaging & Production*: Stephen E. Grossman  
*Solid State*: Laurence Altman  
*Special Issues*: Harry R. Karp

COPY EDITORS: Margaret Eastman,  
Everett C. Terry

ASSISTANT EDITOR: Marilyn Offenheiser

ART: Charles D. Ciatto, *Associate Director*  
Patricia Cybulski, *Assistant Director*

PRODUCTION EDITOR: Arthur C. Miller

EDITORIAL SECRETARIES: Janet Annunziata,  
Julie Gorgogione, Penny Roberts

#### FIELD EDITORS

*Boston*: Gail Farrell  
*Los Angeles*: Paul Franson (Mgr.)  
*Midwest*: Larry Armstrong (Mgr.)  
*New York*: Alfred Rosenblatt (Mgr.)  
*San Francisco*: Judith Curtis  
*Washington*: Ray Connolly (Mgr.),  
William F. Arnold  
*Frankfurt*: John Gosch  
*London*: Michael Payne  
*Paris*: Arthur Erikson  
*Tokyo*: Charles Cohen

#### McGRAW-HILL WORLD NEWS

*Director*: Ralph R. Schulz  
*Bonn*: Robert Ingersoll;  
*Brussels*: James Smith;  
*London*: Marvin Petal;  
*Milan*: Peter Hoffmann, Andrew Heath;  
*Moscow*: Axel Krause;  
*Paris*: Michael Johnson, Richard Shepherd;  
*Stockholm*: Robert Skole;  
*Tokyo*: Mike Mealey

PUBLISHER: Dan McMillan

ADVERTISING SALES MANAGER: Pierre J. Braude

ADVERTISING SALES SERVICE MANAGER:  
Wallis Clarke

BUSINESS MANAGER: Stephen R. Weiss

CIRCULATION MANAGER: George F. Werner

MARKETING SERVICES MANAGER:  
Tomlinson Howland

RESEARCH MANAGER: Margery D. Sholes

**A** special report on logic is the major feature article this issue. We have brought you a steady diet of new logic development in recent months. But, we feel, so much has been happening that it was high time to put all those developments into perspective. On page 81, you'll find the beginning of the report, which was written by our Solid State Editor, Larry Altman.

As Altman rightly points out in the 16-page report "This is the year of logic." Not only are TTL and ECL being significantly improved, but new forms of bipolar LSI are growing to rival MOS. What's more, some of the logic forms that never quite made it to the marketplace are holding out promise now in LSI form. Microprogramming logic circuits, furthermore, are challenging traditional logical methods.

That's a lot of ferment, and you'll find out all about it in our special report. An important outgrowth of logic design, microprocessors, by the way, will also be getting a fair share of editorial attention in the months ahead.

**A**nd speaking of logic and the resurgence of bipolar methods, we've put together a wide-ranging review of last week's International Solid State Circuits Conference, where the spotlight was on bipolar LSI techniques. Injection logic was one of the high spots, and there were presentations on ion-implanted emitter-follower logic, and streamlined versions of Schottky TTL memory designs.

In other areas, CCD imagers, analog circuits, electronic watch and four-channel sound circuits, and microwave devices attracted attention.

So turn to page 114 for a run-down of the significant developments from ISSCC. It's the next best thing to having been there yourself.

**T**he biggest Federal budget in American history has been proposed to Congress. In the briefings that preceded the budget's announcement, our team of reporters and editors sought out its implications for the electronics industries. The conclusions: inflation and the slowing of the economy will seriously impact electronics, yet the field will certainly benefit from increased defense spending.

In the days following the budget's release, our team—which included Larry Curran, Managing Editor, News, Ray Connolly, our Washington bureau chief, Howard Wolff, head of the magazine's Probing the News section, Bill Arnold, Al Rosenblatt, and Marilyn Offenheiser—fanned out around the nation's capital to dig out the details about the dollars that are destined to go to electronics companies. You'll find our in-depth report on the budget, as critical in this year of shortages as it was in the years of hefty research funding, starting on page 68.

**T**he index of articles published in *Electronics* in 1973 is available. For a copy, circle number 475 on the reader service card inside the back cover.



February 21, 1974 Volume 47, Number 4  
92,878 copies of this issue printed

Published every other Thursday by McGraw-Hill, Inc. Founder James H. McGraw 1860-1948. Publication office 1221 Avenue of the Americas, N.Y., N.Y. 10020 second class postage paid at New York, N.Y. and additional mailing offices.

Executive, editorial, circulation and advertising addresses: Electronics, McGraw-Hill Building, 1221 Avenue of the Americas, New York, N.Y. 10020 Telephone (212) 997-1221 Teletype TWX N.Y. 710-581-5234 Cable address MCGRAWHILL N.Y.

Subscriptions limited to persons with active, professional, functional responsibility in electronics technology. Publisher reserves the right to reject non-qualified requests. No subscriptions accepted without complete identification of subscriber name, title, or job function, company or organization, including product manufactured or services performed. Subscription rates: qualified subscribers in the United States and possessions, Canada, and Mexico \$9.00 one year, \$18.00 three years, all other countries \$25.00 per year, except Japan \$50.00 per year and Brazil \$40.00 per year, including air freight. Limited quota of subscriptions available at higher-than-basic rate for persons outside of field served, as follows: U.S. and possessions and Canada, \$25.00 one year, all other countries \$50.00. Single copies: United States and possessions and Canada 1.00; all other countries, \$1.75

Officers of the McGraw-Hill Publications Company: John R. Emery, President; J. Elton Tuohig, Executive Vice President-Administration; Gene W. Simpson, Group Publisher-Vice President; Senior Vice Presidents Ralph Blackburn, Circulation, Walter A. Stanbury, Editorial, John D. Hoglund, Controller, David G. Jensen, Manufacturing; Gordon L. Jones, Marketing; Jerome D. Luntz, Planning & Development.

Officers of the Corporation: Shelton Fisher, President; Wallace F. Traudly, Group President; McGraw-Hill Publications Company and McGraw-Hill Information Systems Company: Robert N. Landes, Senior Vice President and Secretary; Ralph J. Webb, Treasurer.

Title registered in U.S. Patent Office, Copyright © 1974 by McGraw-Hill, Inc. All rights reserved. The contents of this publication may not be reproduced either in whole or in part without the consent of copyright owner.

Subscribers: The publisher, upon written request to our New York office from any subscriber, agrees to refund that part of the subscription price applying to copies not yet mailed. Please send change of address notices or complaints to Fulfillment Manager, subscription orders to Circulation Manager, Electronics, at address below. Change of address notices should provide old as well as new address, including postal zip code number. If possible, attach address label from recent issue. Allow one month for change to become effective.

Postmaster: Please send form 3579 to Fulfillment Manager, Electronics, P.O. Box 430, Hightstown, N.J. 08520

When you've got to power noise sensitive logic,  
*what do you want for the job?*

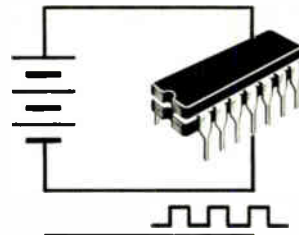

When your system draws a pulsating load current,  
*what do you want for the job?*

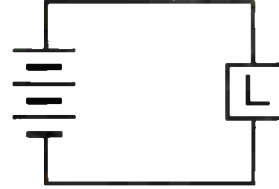

When your specs call for adjustable voltage,  
*what do you want for the job?*

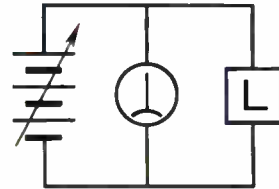

When your programmed level must be accurately reproduced, when the current limit must be adjustable and square (not folded back), when you want a power supply that doesn't lose half its current rating at +71°C (or at -20°C). . . .

*the power supply you want for your job is the*

# KEPCO **JQE**



Quarter-rack  
100 watts

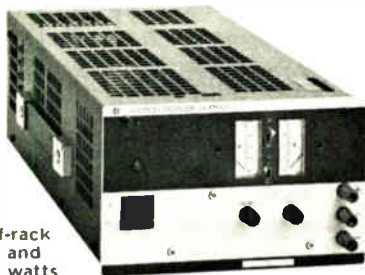

Half-rack  
250 and  
500 watts

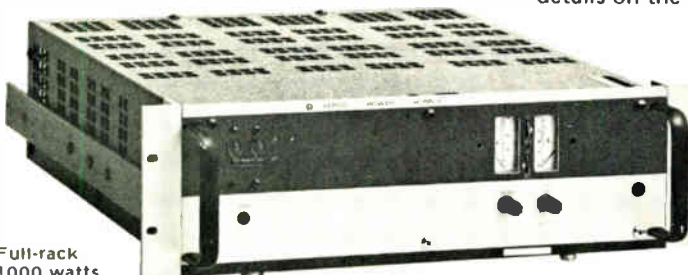

Full-rack  
1000 watts

JQE Power Supplies are *linear* voltage stabilizers (not complex switching units). They can be adjusted or remotely programmed from true zero to maximum output with better than 0.01% linearity. They vary less than 0.0005% for 105–125V a-c source changes and have such low output impedance that a zero to full load change influences the stabilized output by less than 0.005%. Ripple and noise is well under 200 microvolts rms, 1 millivolt p-p.

31 JQE linear voltage stabilizers are manufactured in 4 sizes: 100 Watts, 250 Watts, 500 Watts and 1000 Watts in voltage ranges from 0–6V to 0–150V. Metered bench and rack-panel style and unmetred modular form for the OEM. Adjustable overvoltage protection available.

If *your* job needs a linear voltage stabilizer, call Kepco for the details on the JQE, or write Dept. V-14



**KEPCO**<sup>®</sup>

# When You Buy a Power Supply, Why Not Get the Best?

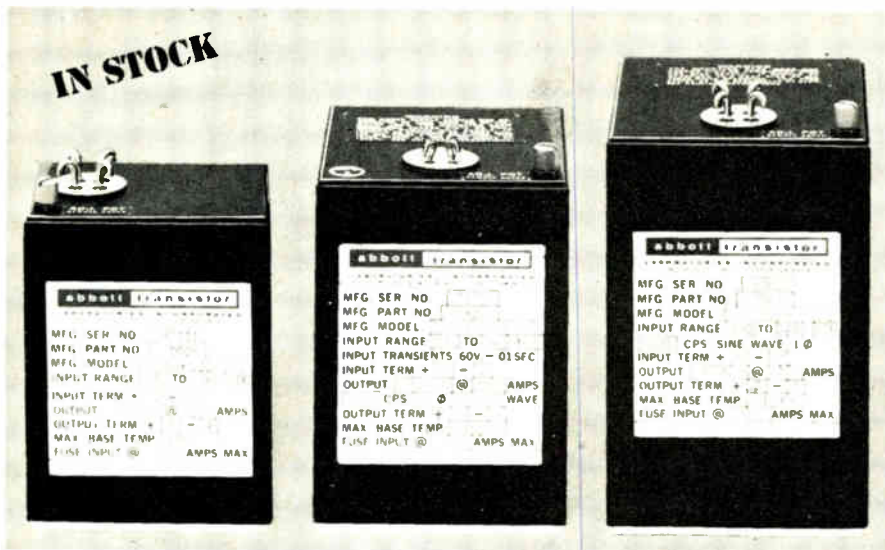

28 VDC to DC  
(55,463 Hrs.)  
Model C95D

28 VDC to 400 A  
(61,387 Hrs.)  
Model 53D

400 A to DC  
(56,148 Hrs.)  
Model W5D

## Abbott's New Hi-Performance Modules

are designed to operate in the stringent environment required by aerospace systems — (per MIL-E-5100K or MIL-E-5272C) and MIL-STD-461 for electromagnetic interference.

**RELIABILITY** — MTBF (mean time between failures) as calculated in the MIL-HDBK-217 handbook can be expected in excess of 50,000 hours at 100°C for all of these power modules. The hours listed under the photos above are the MTBF figures for each of the models shown. Additional information on typical MTBF's for our other models can be obtained by phoning or writing to us at the address below.

**QUALITY CONTROL** — High reliability can only be obtained through high quality control. Only the highest quality components are used in the construction of the Abbott power module. Each unit is tested no less than 41 times as it passes through our factory during fabrication — tests which include the scru-

tinizing of the power module and all of its component parts by our experienced inspectors.

**NEW CATALOG**—Useful data is contained in the new Abbott Catalog. It includes a discussion of thermal considerations using heat sinks and air convection, a description of optional features, a discussion of environmental testing, electromagnetic interference and operating hints.

**WIDE RANGE OF OUTPUTS** — The Abbott line of power modules includes output voltages from 5.0 volts DC to 3,650 volts DC with output currents from 2 milliamperes to 20 amperes. Over 3000 models are listed with prices in the new Abbott Catalog with various inputs:

- 60A to DC, Regulated
- 400A to DC, Regulated
- 28 VDC to DC, Regulated
- 28 VDC to 400A, 1 $\phi$  or 3 $\phi$
- 24 VDC to 60A, 1 $\phi$

Please see pages 581 to 593 of your 1973-74 EEM (ELECTRONIC ENGINEERS MASTER Catalog) for complete information on Abbott modules.

Send for our new 56 page FREE catalog.

# abbott transistor

LABORATORIES, INCORPORATED

5200 W. Jefferson Blvd./Los Angeles 90016  
(213) 936-8185

1224 Anderson Ave., Fort Lee, N.J. 07024  
(201) 224-6900

## Readers comment

### Pursuing promising products

**To the Editor:** For the past three years, I have been reading articles, casebook designs, and advertising blurbs extolling the virtues of this device or that chip, this amplifier or that timer, and the wonders that can be performed by C-MOS or some other logic.

Upon applying to my suppliers in an attempt to obtain these "wonder drugs" of electronics, I am almost invariably given delivery times varying from two weeks to six months. Usually, of course, the longer delivery time is for the device that is most desired; this is not the fault of the electronics industry—it is merely the operation of Murphy's law.

Obviously, by the time I could have gotten the miracle device, the job has had to be done by some other means. I lose time, patience, and money; the industry loses a sale. It would seem to me that manufacturers ought to restrain their attempts to market devices, which, after having been sold to the customer by ingenious advertising, simply cannot be bought.

D. J. Latham  
University of Miami  
School of Marine and Atmospheric  
Science  
Coral Gables, Fla.

### Two outlooks differ

**To the Editor:** In Probing the News [*Electronics*, Jan. 10, 1974, p. 72], I was quoted as being "less optimistic than most of the electronics executives" on the 1974 semiconductor industry outlook. Apparently, the author confused my views on the over-all economy with those on the semiconductor industry.

With respect to the economy, we feel that the energy crisis has indeed decelerated further an already sluggish outlook for 1974. But with respect to the semiconductor industry, we firmly believe that the recession year of 1974 will be quite a strong one for semiconductor companies.

In fact, in sharp contrast to 1970, the current year should instead be a year in which technology companies do what they are supposed to do—



If time is your business, you need Burroughs' new PANAPLEX™ clock panels\* for clear, legible display. In two character heights (0.5" and 0.7"), four or six digits per panel, with AM/PM indicator, for maximum design flexibility. Easy to see and read; wide viewing angle; low power requirements; compatible with MOS circuits; assured long life and dependability because PANAPLEX clock panels are backed by Burroughs' years of pioneering technology and manufacturing know-how . . . and they are available at competitive prices. Time will tell how much that means to you and your customers. For more information, write Electronic Components Division, P.O. Box 1226, Plainfield, N.J. 07061, or call (201) 757-3400 or (714) 835-7335.

*\*Sample quantities of panels available immediately.*



**Burroughs**



Circle 7 on reader service card



# the EMI suppressors

**Series JX2000/3000 Subminiature Filters . . .  
Broadest Line of Ultra-Small Interference  
Control Components Available . . .  
in 4 weeks or Faster!**

- High performance filters available in 5 different circuits—Feed-thru, L, PI, T, 2L . . . for a wide variety of applications, including power and control lines.
- High insertion loss characteristics . . . based on requirements of MIL-F-15733.
- Hermetically-sealed . . . with glass-to-metal seals in corrosion resistant metal cases.
- Small in size yet big in reliability . . . particularly useful for industrial and military high-density packaging applications.
- Excellent stability, even under adverse environmental conditions, over operating temperature range of  $-55^{\circ}\text{C}$  to  $+125^{\circ}\text{C}$ .
- Threaded-neck construction . . . effectively isolates input and output terminals.

**selected units NOW available  
OFF-THE-SHELF from your  
Sprague Industrial Distributor**

For complete information, write for our new 16-page Engineering Bulletin 8132 to: Technical Literature Service, Sprague Electric Company, 35 Marshall St., North Adams, Mass. 01247.

THE BROAD-LINE PRODUCER OF ELECTRONIC PARTS



## Readers comment

that is, to grow independently of the business cycle, rather than in consonance with it.

Benjamin M. Rosen  
Coleman & Co.  
New York, N. Y.

### Analyzing steady-state ac

**To the Editor:** In my Engineer's notebook, "Program analyzes all-resistive dc circuits," [*Electronics*, Jan. 24, p. 114], it should be noted that my computer program is useful for steady-state ac analysis, as well as for dc analysis.

Moreover, the example given in the article is actually a steady-state ac analysis, and not a dc analysis as indicated in the figure caption. In this transistor-amplifier example, the two coupling capacitors are shorted to simulate steady-state ac conditions. A dc analysis can also be performed but, of course, the capacitors must then be treated as open circuits.

Mark Jong  
Wichita State University  
Wichita, Kan.

### Achieving high Qs

**To the Editor:** I'd like to clarify a few points about my Designer's casebook, "Narrowband digital filter achieves high Qs" [Nov. 22, 1973, p. 118].

The filter's center frequency is  $f_0$  (1 kilohertz), its clock frequency is  $2Nf_0$  (4 kHz), where N is the number of counter stages, and the input signal is divided into time periods ( $T_k$ ) that equal  $1/Nf_0$  (250 microseconds).

The upper operating frequency of the filter is limited by the maximum toggle frequency divided by N of flip-flop FF<sub>1</sub> or by the bandwidth of the operational amplifiers used, whichever is less. For the circuit shown, this upper frequency limit is not 2.5 megahertz, as stated.

Thomas A. Visei  
University of Illinois  
Urbana, Ill

### 1973 Index is available

The index of articles published in *Electronics* in 1973 is now available. For a copy, circle 475 on the reader service card inside the back cover.

# TRW LVA diode... the sharpest knee below 10 Volts.

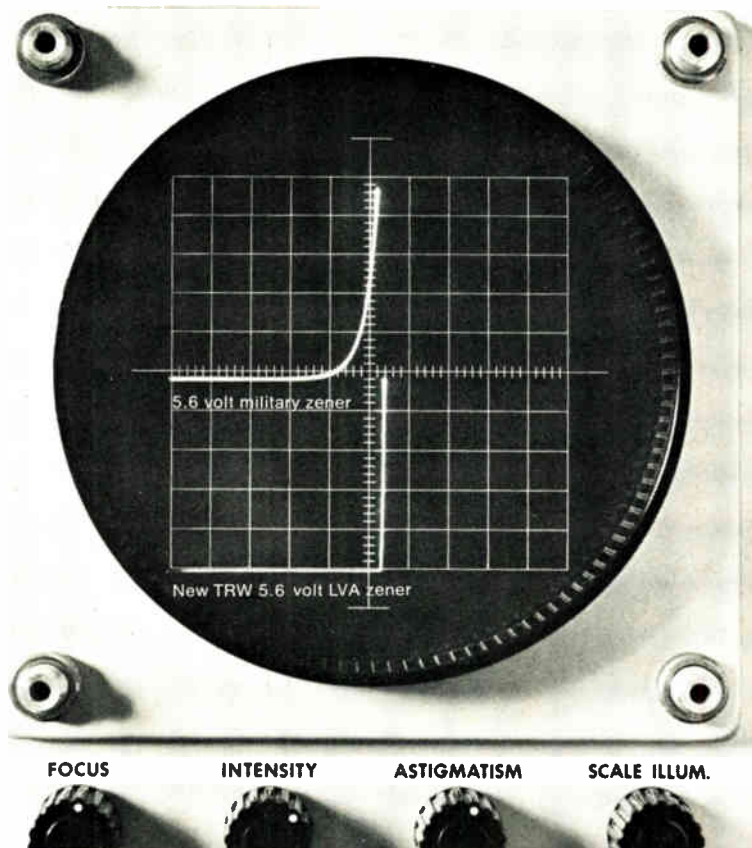

## The current saver.

No other zener can approach TRW's LVA performance below 10 volts. Available for operation down to 4.3 volts, TRW LVA diodes minimize power consumption in portable-battery operated equipment. They're also ideal for instrumentation, where, as reference elements, they draw as little as 50  $\mu$ Amps.

TRW LVA's are available in various package configurations, including passivated chip form for hybrid-

compatible packages. If you have a need for a low current voltage regulator or any other product that demands low current consumption, you should check out TRW LVA zeners. When it comes to current, they're really misers!

For product information and applications assistance write TRW Semiconductors, an Electronic Component Division of TRW Inc., 14520 Aviation Boulevard, Lawndale, California 90260. Phone (213) 679-4561.

These products are available through the following authorized distributors:

Almo Electronics  
Bell Industries  
Cramer Electronics Inc.  
De Mambro Electronics

Eastern Radio Corp.  
Electronics Marketing Corp.  
Elmar Electronics Inc.  
Hall-Mark Electronics Corp.

Harvey-Michigan Inc.  
Liberty Electronics  
Powell Electronics  
Pytronics

Semiconductor Concepts Inc.  
Summit Distributor  
R. V. Weatherford Co.  
Westates Electronics Corp.

## TRW SEMICONDUCTORS

# You can buy a 54/74123 from AMD.

The Am54/74123 is a more-than-faithful reproduction of the dual one shot made popular by TI.

Not only is it guaranteed to meet all the original specs, but it's built to MIL-STD-883; and it's available for immediate delivery in both military and commercial temp versions. Just contact your nearest AMD sales rep or distributor.

## Or you can buy something better.

The new Am26123: Our pin-for-pin, improved performance replacement for the 54/74123 dual one shot.

First of all, the Am26123 has a guaranteed typical pulse width stability of  $\pm 1\%$  over the  $0-75^{\circ}\text{C}$  temperature range. (Without external compensation, the best the 74123 can offer is  $\pm 6\%$ .)

Second, the Am26123 has been designed to eliminate any possibility of false triggering caused by noise on the timing nodes. (A built-in output latch does the trick.)

Best of all, you can buy our new Am26123 for the same price as our Am74123, which is exactly the same price as the original 74123.

The only thing you need to do now is decide which AMD dual one shot will best suit your needs, then contact your nearest AMD sales rep or distributor. He'll send you all the parts or all the information you need.

Being big shots in one shots is going to help us become the sixth largest maker of integrated circuits in the U.S. by 1975.

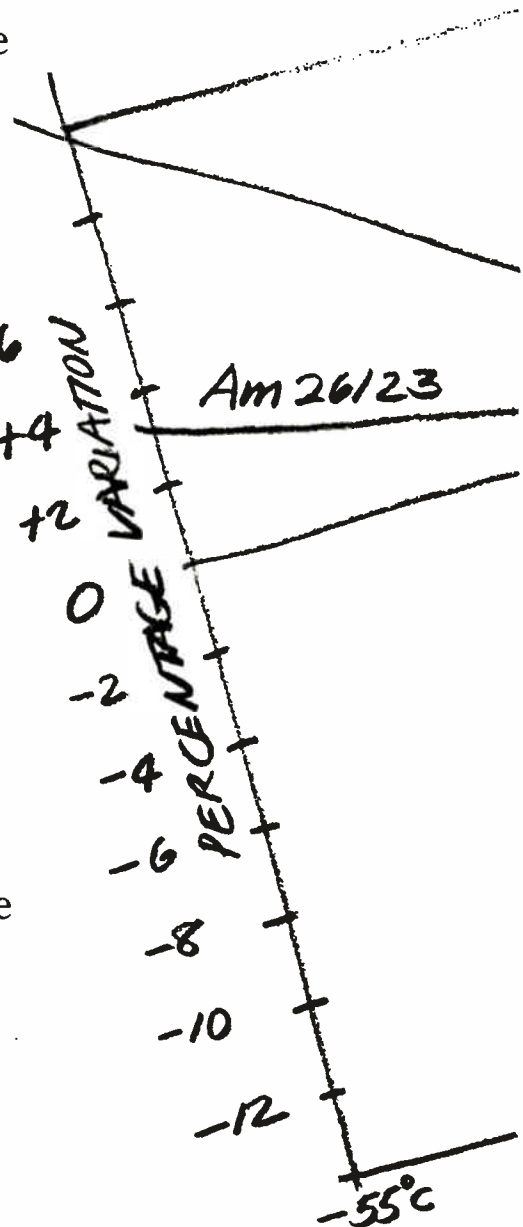

# Advanced Micro Devices, Inc.

(#15, going on #6.)

TYPICAL PULSE-WIDTH  
VARIATION  
NORMALIZED TO 25°C  
V<sub>CC</sub> = 5.0V

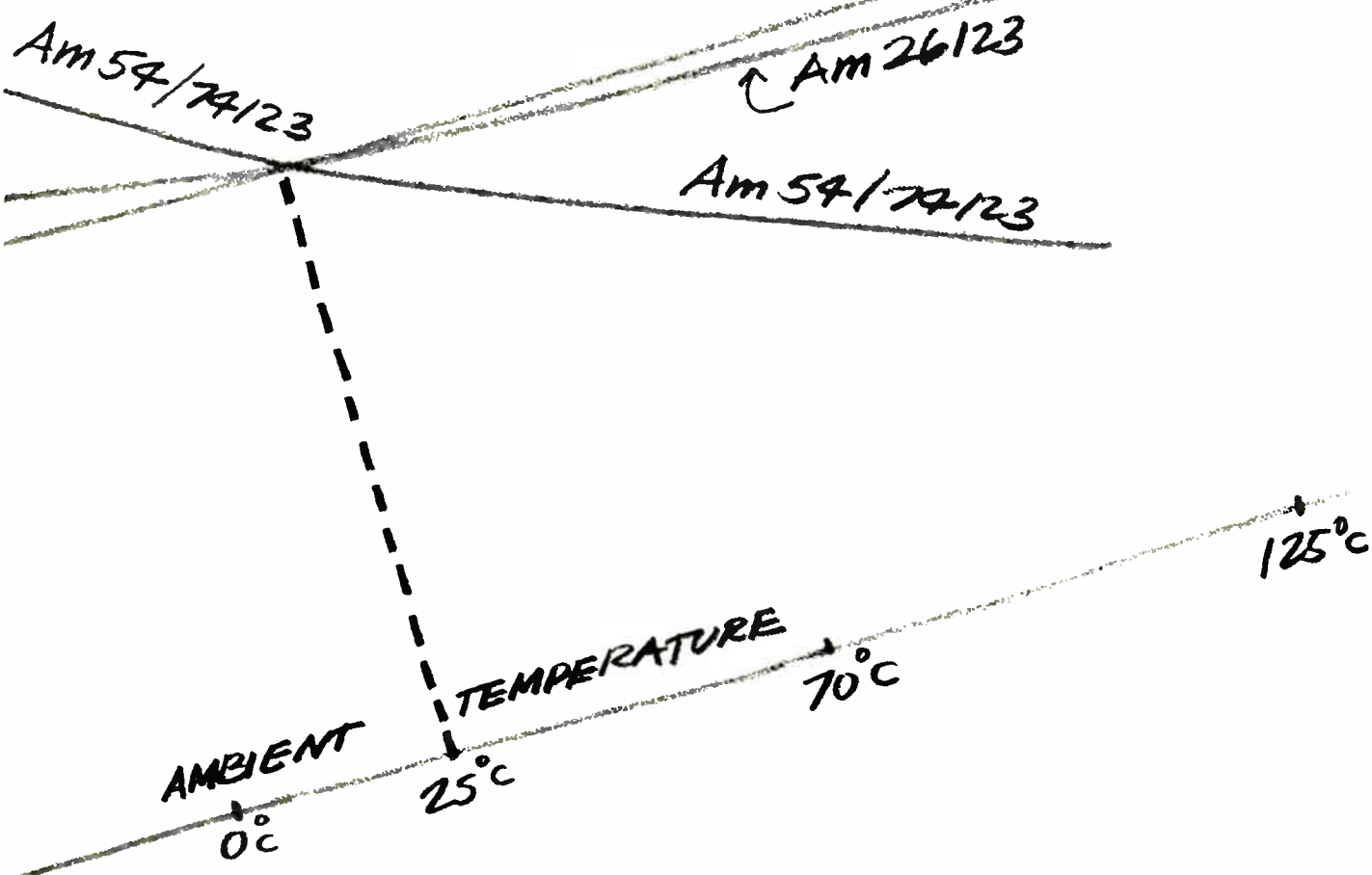

Advanced Micro Devices, Inc., 901 Thompson Place, Sunnyvale, California 94086 / TWX 910-339-9280 / TLX 346306

For Product or sales information, call the AMD sales representative nearest you. In the San Francisco Bay Area, Bill Siefert at (800) 538-7904 (toll-free from outside California) or (408) 732-2400, or Dave Haun (415) 967-7031. In the eastern United States, Steve Marks or Jack Maynard at (516) 484-4990; in Washington/Baltimore, Ken Smyth at (301) 744-8233; in Boston, Paul Macdonald at (617) 861-0606. In Mid-America, Chuck Keough at (312) 297-4115. In the Los Angeles area, Steve Zelencik or Russ Almand at (213) 278-9700. In the Northwest, Shel Schumaker at (408) 732-2400. In the United Kingdom, Des Candy at Herne Bay (Kent) 61611; and in Germany, Herman Lichotka at (0811) 594-680.

Advanced Micro Devices is distributed nationally by Cramer and Hamilton / Avnet Electronics.

Circle 253 on reader service card

NEW '74 EDITION  
COMPLETELY REVISED  
AND UPDATED!

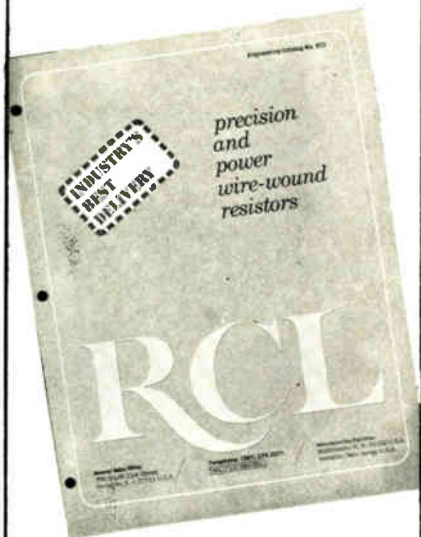

## WIRE-WOUND RESISTOR ENGINEERING HANDBOOK

the industry's most extensive and most accurate compilation of engineering information on wire-wound resistors

### PRECISION/HI-SPEED POWER/WIRE-WOUND RESISTORS

including: established reliability resistors, beryllium oxide core power resistors . . . 22 special temperature coefficients from -50 PPM to +6000 PPM . . . sub-miniature precision resistors . . . ladder and summing networks.

Write for your free copy today!

# RCL

ELECTRONICS, INC.  
700 South 21st Street  
Irvington, New Jersey 07111

## People

### Economist Schlesinger takes up DOD budget battle

In the fall of 1965, Robert S. McNamara, at the wheel of the Pentagon, was steering the U.S. military machine toward the quagmire of Southeast Asia.

James R. Schlesinger, then 36 years old, and director of strategic studies at the Rand Corp. in Santa Monica, Calif., expressed to a visitor the belief that Robert McNamara was blind to the consequences of his policy of controlled escalation. McNamara's industrial-management expertise made him, in Schlesinger's opinion, "a helluva Secretary of Defense but a lousy secretary of war."

In less than a decade, Schlesinger has moved from his small cubicle at the Rand Corp. to the panelled office of the Secretary of Defense. Now the pipe-puffing, prematurely gray defense chief has presented his first Pentagon budget to the Congress (see P. 68).

It is the largest defense budget in U.S. history. With it, Schlesinger hopes to get a firm national commitment from the Congress for "the long haul"—when the country has no immediate wartime requirements—as well as for a more efficient defense force. Contractors might note that Schlesinger equates efficiency with simplicity when it comes to hardware. As he reminded the Congress in presenting his budget, "Eli Whitney, rather than the medieval craftsmen, must become our model."

Schlesinger's current interest in reordering strategic nuclear-missile policy—including his plan to de-

velop more precise guidance systems so they may be used against military targets smaller than large enemy cities—is admittedly controversial. But it is no surprise to those who knew him at Rand, where he specialized in strategic analysis with emphasis on nuclear weapons.

If he masters the position at Defense, what he learned in his prior roles as assistant director of the Office of Management and Budget, chairman of the Atomic Energy Commission, and director of the Central Intelligence Agency, will certainly have been a factor. Probably more important, however, will be his background in economics, in which Harvard granted him a doctorate in 1956. He then taught economics at the University of Vir-



**DOD chief.** In military hardware, James Schlesinger equates efficiency with simplicity.

ginia for eight years. His 1960 book, "The Political Economy of National Security," still represents his views on national defense.

### Apollo's Rhine takes on BART

BART, the Bay area's financially and technically beleaguered "space-age" transit system, is faced with a mounting deficit, projected to reach \$100 million in five years. And glitches in its automatic train-control system continue to delay the opening of service between the East Bay and San Francisco, originally scheduled for 1969.

In San Francisco's attempt to sew together the patchwork array of modifications and additions to the Westinghouse-designed system, BART has hired former manager of

# OPEN WIDE AND SAY "Ahhh... Now that's what I call a **SNAP SWITCH CATALOG!"**



—Send for this new Cherry Handbook and Guide

Just what the doctor ordered: "instant access" and "tell-all data" on scores of basic Cherry Snap-Action Switches and tens of thousands of variations. Complete with the unique Switch Selector-Locator that lets you choose—in seconds!—the right snap switch for any application. Plus engineering drawings, specifications, operating characteristics and technical data. Plus, never-before-published "inside" information on Cherry's plant facilities, equipment, in-house manufacturing capabilities and worldwide sales offices. All in a handsome new, easy-to-use 72-page format. And it's yours for the asking: Just TWX 910-235-1572 . . . or PHONE 312-689-7700 . . . and ask for Frank.



# CHERRY



**CHERRY ELECTRICAL PRODUCTS CORP.**  
3608 Sunset Avenue, Waukegan, Illinois 60085



Cherry affiliates worldwide • Hirose Cherry Precision Co., Ltd., Tokyo • G. W. Engineering Pty. Ltd., Sydney  
Cherry Electrical Products (U.K.) Ltd., St. Albans, Herts • Cherry Mikroschalter GmbH, Bayreuth, Germany

Circle 13 on reader service card

if you're into...

# ANALOG FILTERS

- **WIDE RANGE**—CUT-OFF FREQUENCIES FROM 0.001 Hz to 1.1 MHz
- **DIGITAL TUNING**—INSTANT RESETTABILITY
- **FLEXIBILITY:**
  - Modes:** Low pass, high pass, band pass, band reject, notch.
  - Roll-Offs:** 24, 48, & 96 db/octave
  - Functions:** Butterworth, Bessel, RC.
  - Passband Gains:** 0, 20, 40 db
- **REMOTE PROGRAMMABILITY**—A ROCKLAND EXCLUSIVE!

## DUAL HI/LO: Models 1022F and 1042F

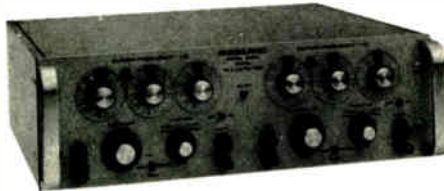

**Frequency Range:** .001 Hz to 111 KHz  
**Roll-Off:** 24 db/octave/section (1022F)  
 48 db/octave/section (1042F)  
 (Cascading sections doubles roll-off)  
**Responses:** Butterworth, RC.  
**Passband Gains:** Selectable 0, 20, 40 db.

## VARIABLE ANALOG: Models 1100 and 1200



**Frequency Range:** 10 Hz to 1.1 MHz  
**Roll-Off:** 24 db/octave  
**Response:** Butterworth and Bessel  
**Passband Gain:** 0 db.

## PROGRAMMABLE DUAL HI/LO: Series 1500

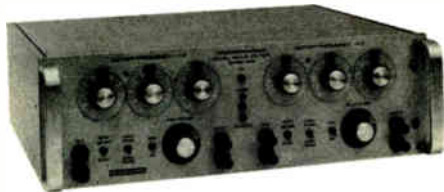

**Frequency Range:** 0.001 Hz to 111 KHz  
**Roll-Off:** 24 db/octave/section  
 (Cascading sections doubles roll-off)  
**Response:** Butterworth, RC.  
**Passband Gain:** 0, 20, 40 db.  
**Programming options:**

**Programming:** Local and/or Remote of all Functions

02; 1-2-4-8 BCD positive logic,  
 03; 1-2-2-4 BCD positive logic.

# ...you're into ROCKLAND

For immediate information on how Rockland can meet your specific application and delivery requirements — call our local rep or Dave Kohn directly at:

**Rockland Systems Corporation** 230 W. Nyack Road, West Nyack, N.Y. 10994  
 (914) 623-6666 • TWX 710-575-2631

Circle 14 on reader service card

## People



**Problem-solver.** William J. Rhine is charged with ironing out BART's glitches.

NASA's Houston Apollo guidance and navigation project office, William J. Rhine, who may be able to apply his space-systems knowledge to the ground-transportation world.

The 46-year-old Rhine, now director of engineering at BART, labels its difficulties "unique" but not unsurmountable. "I don't know of any major problem to which we don't have a solution," he claims, "but it's going to be a hell of a lot of work." Helping him will be 80 engineers, from Parsons-Brinckerhoff-Tudor and Bechtel, BART's general contractor, as well as from Westinghouse.

Two major technical problems concern train-detection flaws, which occur when a track circuit fails to detect a train's presence on the track or, conversely, detects the presence of a nonexistent train. Hewlett-Packard Co., however, has already designed circuits that will correct these flaws and provide an automatic check-in, check-out system.

Rhine shuns the popular Bay-area pastime of pointing the finger at BART, but he does ask why much more wasn't in the original specs, in particular, those for the automatic train-control system. "It is very important that the most important part of the system gets the right amount of attention, and the ATC got only 15%," he says.

Rhine is optimistic that the system can be working in time to start trans-Bay service by BART management's present target date of September 1974.



New options & accessories

Low ohms  
2 and 20 $\Omega$ ,  
0.001 $\Omega$   
resolution

High  
current  
10A cont.  
20A  
momentarily

Low  
cost  
RF  
Probe



Recharge-  
able  
battery  
pack

Deluxe  
test  
leads

High  
voltage  
probe,  
1kV to 40kV

Clamp on  
AC current  
probe,  
2 to 600A

Carrying  
cases

Dust  
cover

Digital  
printer  
output

Rack  
mount  
kits

Options and accessories already available

Fluke adds **MEASURE  
POWER**

# The best selling 3½ digit DMM. Now even better.

**More new options & accessories.** New AC/DC high current option lets you measure 10 Amps continuously or up to 20 Amps momentarily. New low ohms capability with 2 and 20 ohms full scale ranges provides maximum resolution of 0.001 ohms. New RF measurement capability available with low cost probe.

The Fluke 8000A Digital Multimeter brought a new standard of excellence and reliability to the low cost field. Today, with expanded capability, the 8000A brings that standard to even more of your measurement applications.

**And don't forget what you get in the standard instrument.**

With or without options and extras, the Fluke 8000A is the best digital multimeter for the money. You get a basic

dc accuracy of 0.1%. You get 26 ranges to measure ac/dc volts from 100 microvolts to 1200 volts, current from 100 nanoamperes to 2 amperes and resistance from 100 milliohms to 20 megohms.

We back the instrument with a guaranteed 20,000 hour Mean Time Between Failures. We expect you'll get 56,000 hours service . . . roughly the equivalent of 15 years everyday use.

**Or the options already offered.**

The option list includes in addition to those described above, a rechargeable battery pack, digital printer output, deluxe test leads, 40 kV high voltage probe, 600 ampere ac current probe, two types of carrying cases, dust cover and rack mounts.

**For data out today, dial our toll-free hotline, 800-426-0361**

In the continental U.S., dial our toll free number 800-426-0361 for the name and address of your nearest local source. Abroad and in Canada, call or write the office nearest you listed below, John Fluke Mfg. Co., Inc., P.O. Box 7428, Seattle, Washington 98133. Phone (206) 774-2211. TWX: 910-449-2850. In Europe, address Fluke Nederland (B.V.), P.O. Box 5053, Tilburg, The Netherlands. Phone 013-67-3973. Telex: 844-52237. In the U.K., address Fluke International Corp., Garnett Close, Watford, WD2 4TT. Phone, Watford, 33066. Telex: 934583. In Canada, address ACA, Ltd., 6427 Northam Drive, Mississauga, Ontario. Phone 416-678-1500. TWX: 610-492-2119.



Circle 15 on reader service card

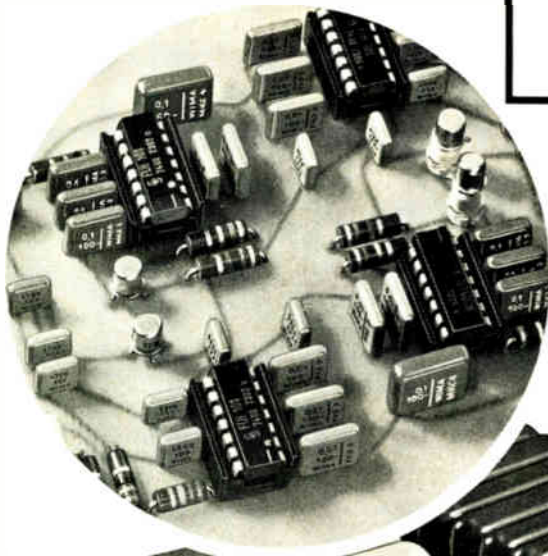

IC's  
require  
small  
C's

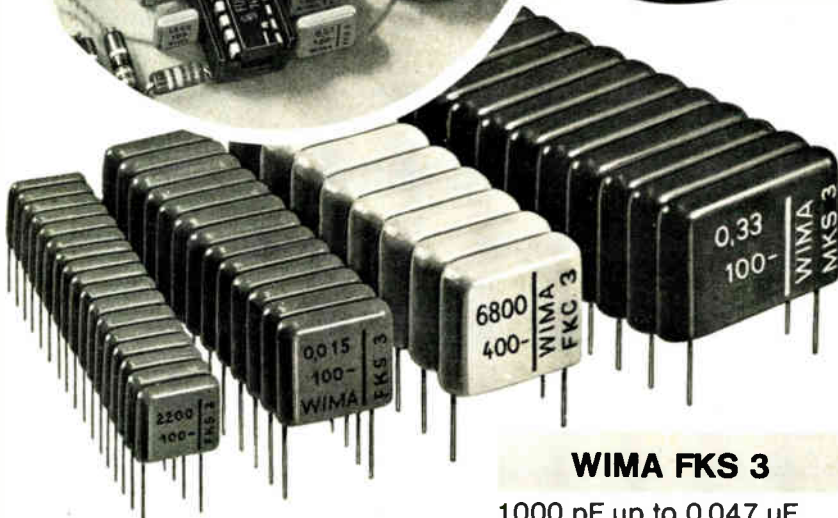

#### WIMA FKS 3

1000 pF up to 0.047  $\mu$ F

#### WIMA FKC 3

100 pF and up

#### WIMA MKS 3

Up to 0.47  $\mu$ F

#### WIMA FKS 2 min

P.C.M. 5 mm  
1000 pF to 0.047  $\mu$ F

## Cast-moulded capacitors

are an excellent aid in designing your IC-equipped printed boards. Use the new plug-in WIMA<sup>®</sup> capacitors which are smaller and have regular dimensions.

Write for our new catalogue.



### WILHELM WESTERMANN

Spezialfabrik  
für Kondensatoren  
D-68 Mannheim 1  
Fed. Rep. of Germany  
Augusta-Anlage 56  
P. O. Box 2345  
Tel.: (0621) 40 80 12

## 40 years ago

From the pages of Electronics, February 1934

### Auto radio forges ahead

Spurred on by the remarkable expansion in 1933 of automobile radio sales, manufacturers look forward with eagerness to the 1934 market. Reports from Detroit of record-breaking orders for new cars following the Automobile Show in New York and elsewhere must be a sign of good omen to the radio industry, although it was rather discouraging to see the small turn-out of radio people at the New York Show and to note the apathy of those actually in attendance.

Sales figures for 1933 indicate that between 600,000 and 700,000 auto-radio sets were sold for installation in the nation's cars during the year just passed. This is a vast jump from the previous year and a great hurdle over the most optimistic estimates of the 1933 market made earlier in the year. Prognosticators, not to be caught napping again, place their estimates for 1934 between one million and a figure half again as large.

Some of these radio sets will bear the automobile maker's name; others will bear the name of the radio set, and still others will have hyphenated names. Packard, Studebaker and Chrysler will actively sell radios especially built for them.

Philco (Transitone) has been most active and successful in this special market, making receivers for 7 automobile people. These sets look different from receivers sold to the trade through dealers and distributors. The other manufacturers, RCA Victor, Crosley, Zenith, et al., have one or more special clients using receivers made by them.

Automobile manufacturers are not keen to see anyone break the ice on the matter of putting radios in every car of a model or style. At present, competition in the lower-priced cars has forced manufacturers to steer clear of increasing the cost of manufacture; the margin is already low. But all realize that someone may kick over the traces, put a radio in every car as it leaves the factory and make the radio industry very happy, indeed.

# How to multiply your draftsmen's time.



---

Shortcuts from Kodak turn drafting hours into minutes—on job after job.

---

Routine redrawing chores take a lot of valuable board time. Kodak can show your draftsmen how to restore drawings, make revisions, and handle repetitive elements—without redrawing. You'll save hours of drafting time and save money, too.

It's easy, because it's done photographically! We'll explain how to do it and help you select the proper Kodagraph films and papers for your particular work. And we can show you how, with an automated Kodak

processor, you can get reproductions back to your draftsmen faster, to save even more time.

There are other ways that Kodak can help multiply your draftsmen's efficiency. Microfilming your drawings will make them more accessible, save filing space, provide security, and give you other benefits, too.

---

Get the details.



---

For additional information write: Eastman Kodak Company, Business Systems Markets Division, Dept. DP538, Rochester, N.Y. 14650.

**Kodak products for drawing reproduction.**

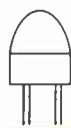

# How to select

Lamp Size	< T-3/4	T-1	T-1 3/4				
Packages	Point Sources	Wide Viewing Angle	Wide Viewing Angle				
							
Lens Diameter	.050 x .100	.120	.200				
Construction	Cup	Cup	Cup				
Lens Height	.090	.130	.215				
Color	Mat'l.	Diff.	Clr.	Diff.	Clr.	Diff.	Clr.
Red	GasP	● 107	● 199 ● 198	● 102 ● 108 ● 101 ● 115 ● 116	● 110 ● 111		
Green	GaP						
Yellow	GaP						
Red	GaP						

To order a lamp, add FLV to number. Example: FLV350.

# solid state lamps.

**We make solid state lamps. Lots of them.**





*On the Quick Selection Guide you can easily find the lamps that fit your needs.*

- Production quantities of red GasP.
- Growing volume of GaP in red, green and yellow.
- High intensity point sources, indicators, backlighters, narrow or wide beams.
- Low and high profiles.
- Clear and diffusing lenses.
- With or without flanges.
- With or without molded headers.
- All standard lead thicknesses.
- T-1 $\frac{3}{4}$  and smaller packages.
- Easily retrofits incandescent lamps.
- Luminous intensity to 15.0 mcd.
- Priced from 9¢.

We're a major manufacturer, a world leader, in discrete solid state devices. Our production capability is vast. Right now, today. It's being used to make a line of lamps as broad as anyone's: *Every major kind of lamp.* And special types built to your own specs. At the most competitive prices. If you need it we've got it. In volume. Try us. You'll see.

But before you make your final selection, you should actually *see the lamps* and compare them to others, any others. There's no other way to be sure. So call your friendly Fairchild distributor for a demonstration at your desk. It'll only take a minute.

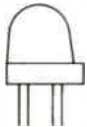
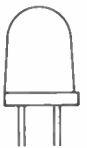
**MADE IN  
FAIRCHILD**

T-1 $\frac{3}{4}$	T-1 $\frac{3}{4}$	T-1 $\frac{3}{4}$	T-1 $\frac{3}{4}$	T-1 $\frac{3}{4}$	T-1 $\frac{3}{4}$
4° Angle	Cartridge Lamp	Short Profile	Medium Profile	Tall Profile	.025 x .025 Leads
					
.200	.200	.200	.200	.200	.200
Lead Frame	Lead Frame	Lead Frame	Lead Frame	Lead Frame	Lead Frame
.350	.235	.230	.285	.340	.340
Diff. Clr.	Diff. Clr.	Diff. Clr.	Diff. Clr.	Diff. Clr.	Diff. Clr.
●104	●130 ●131	●103 ●141 ●140	●110 ●111 ●112 ●118 ●117 ●119	●150 ●152 ●151	●160 ●162 ●161
	●331 ●336	●341 ●346	●310 ●315	●350 ●356 355 ●352 ●351	●360 ●365
	●440 ●445			●450 ●455	●460 ●465
	●240			●250 ●252 ●251	

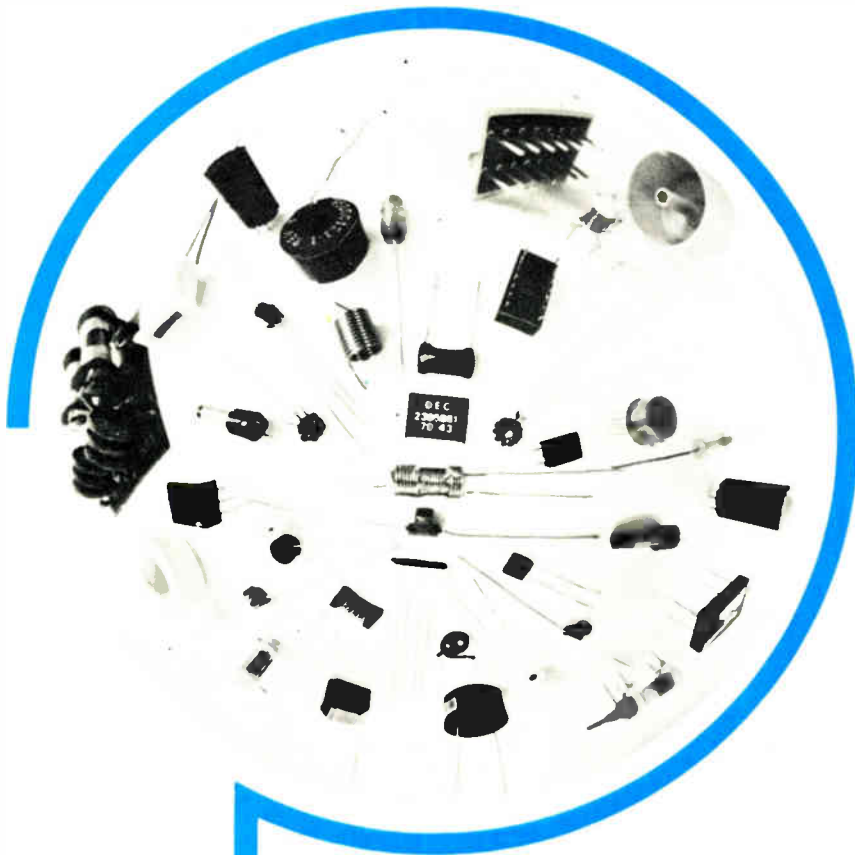

**Some Delevan designs  
are very special...**

**THEY'RE NOT MADE YET.**

Applications for inductive devices are virtually unlimited... and not even Delevan's broad line of *standard* designs can fit every requirement. That's where Delevan's Application-Engineering capability comes in! No matter how unusual or highly-specialized your application may be... Delevan can provide a custom-engineered design to meet the most demanding specifications, the most unique applications.

At Delevan, the design of inductive devices is far more than an art... it is a highly-sophisticated science. State-of-the-art techniques in winding and molding, the instant availability of computerized data, and utilization of new materials and procedures... combined with the proven expertise of Delevan engineers... equals unmatched capabilities. If you have the application, Delevan can provide the design.

**Delevan**  
Division



**AMERICAN  
PRECISION  
INDUSTRIES INC.**

270 QUAKER RD. / EAST AURORA, N. Y. 14052  
TELEPHONE 716/652-3600      TELEX 091-293  
OTHER DIVISIONS OF AMERICAN PRECISION INDUSTRIES INC  
BASCO • DUSTEX

**Meetings**

**Computer Conference (Comcon):** IEEE, Jack Tarr Hotel, San Francisco, Feb. 26-28.

**Nepcon '74 West:** Electronic Packaging and Production magazine, Anaheim Convention Center, Anaheim, Calif. Feb. 26-28.

**Aerospace and Electronics Systems Winter Convention (Wincon):** IEEE, Marriott Hotel, Los Angeles, March 12-14.

**Zurich Digital Communications International Seminar:** IEEE, Swiss Federal Institute of Technology, Zurich, Switzerland, March 12-15.

**International Convention (Intercon):** IEEE, Coliseum and Statler Hilton Hotel, New York, March 26-29.

**Salon des Composants Electroniques:** SDSA, Porte de Versailles, Paris, France, April 1-6.

**International Reliability Physics Symposium:** IEEE, MGM Grand Hotel, Las Vegas, Nev., April 2-4.

**International Optical Computing Conference:** IEEE Computer Society, Zurich, Switzerland, April 9-11.

**Optical and Acoustical Micro-Electronics:** IEEE, Commodore Hotel, New York, N.Y., April 16-18.

**Carnahan Conference on Electronic Crime Countermeasures:** IEEE, University of Kentucky, Lexington, April 17-19.

**International Circuits and Systems Symposium:** IEEE, Sir Francis Drake Hotel, San Francisco, April 21-24.

**Communications Satellite Systems Conference:** IEEE, International Hotel, Los Angeles, Calif., April 22-24.

**Pittsburgh Conference on Modeling and Simulation:** ISA, University of Pittsburgh, Pa., April 24-26.

**National Computer Conference,** AFIPS/IEEE Computer Society, McCormick Place, Chicago, Ill. May 6-10.

# The first interactive graphic calculator.

## It's the 31/10 system.

A powerful calculator, graphic terminal and software combination. The first ever to place math-power, graphics and alphanumeric display at your fingertips!

The 31/10 is personal. Fast. And highly interactive. It lets you explore ideas and concepts on the spot. Plot single variable functions, specify X-Y coordinates and a lot more. Corrections and plot changes are immediate. From data entry to display, your ideas are quickly brought to light. That's responsive!

Plug in our software packages. They put the 31/10 to work. No heavy programming experience

needed. So you can deal in your concepts and not the mechanics of programming. And get graphic and alphanumeric output from natural math input.

There's more to our 31/10. Such as add-on memories for long programs. The optional silent thermal printer for listing and keeping track.

Peripherals like our hard copy unit to put in hand what's on the screen.

The costs are low, the results are priceless.

Get the facts about the 31/10 and the Tektronix reliability and worldwide service behind it. See your Tektronix sales engineer for a demonstration or write: Dwain Quandt, IDD Calculators, Tektronix, Inc., P. O. Box 500, Beaverton, Oregon 97005.

**Our programmable calculators. Natural. Powerful. Significantly less expensive.**



**TEKTRONIX®**

For a demonstration circle 236 on reader service card  
Circle 21 on reader service card



# More ideas from Amphenol's

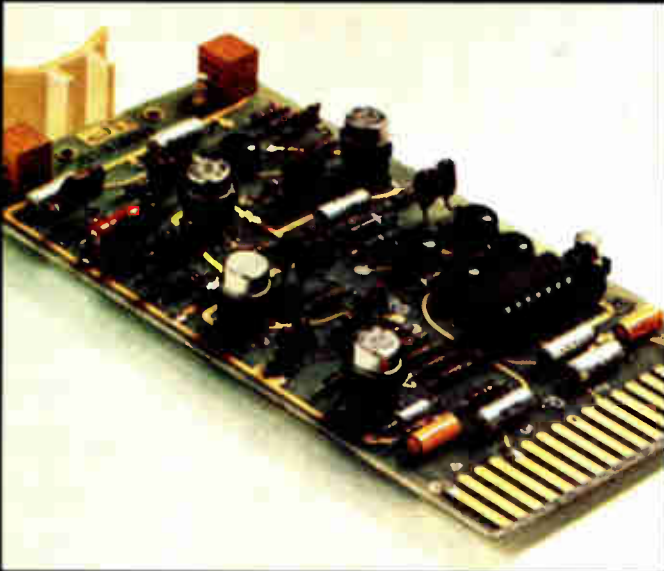

**level 1** Low-cost sockets for transistors in TO packages (above) allow easy replacement and service. ■ New IC sockets are end and side stackable for maximum single board density. Low profile design also allows maximum multi-board density.

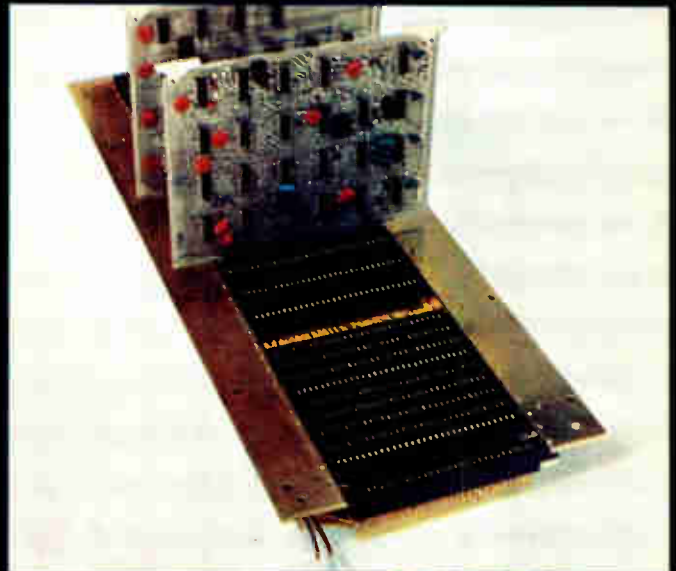

**level 2** Back panel edge board connectors with bifurcated contacts (above) can be wire wrapped or clip-terminated. ■ Bellows contact PC connectors (below) cut interconnection costs without sacrificing performance.

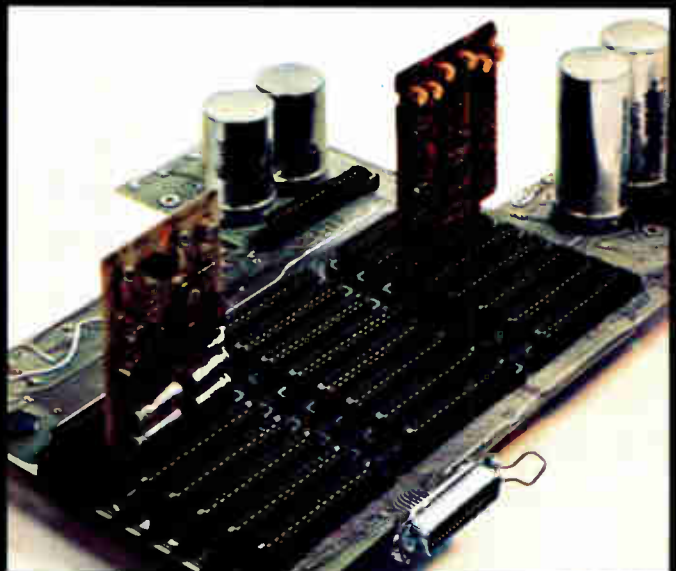
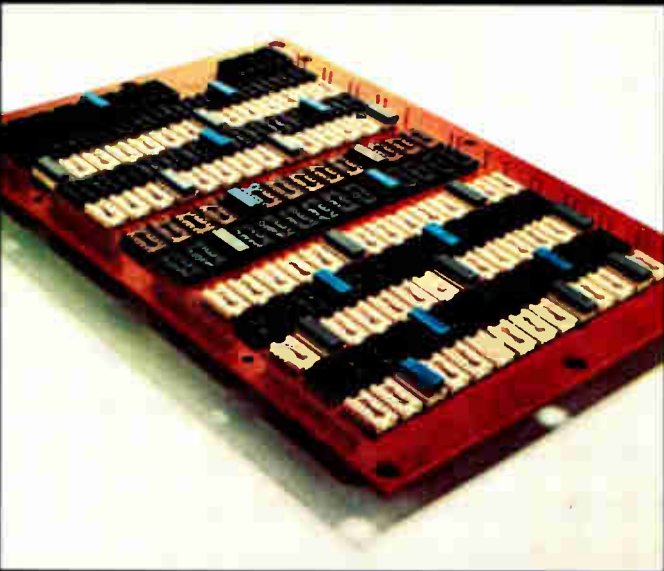

Above are seven new ideas from Amphenol Industrial Division's Spectrum of interconnection capability.

Amphenol's SPECTRUM offers you *all four* levels of interconnections from our unmatched breadth of product line:

**Level 1 . . . DEVICE TO BOARD OR CHASSIS.** We offer interconnections for components such as tubes, relays, transistors, IC packages, trimmers, resistors or capacitors to a PC board or chassis.

**Level 2 . . . BOARD TO MOTHERBOARD OR BACK PLANE.** We offer interconnections for PC boards or

other sub-circuit modules to a motherboard or to a back plane.

**Level 3 . . . MOTHERBOARD OR BACK PLANE WIRING.** We offer interconnections for levels to each other and to other sub-circuits with multi-layer circuit boards, wire wrapping, clip terminations, jumper techniques and dip-soldering.

**Level 4 . . . INPUT/OUTPUT CONNECTIONS.** We offer interconnections for power and signals to and from a system. This interface may be between sub-assemblies within the same enclosure or between individual units.



# Spectrum of interconnections.

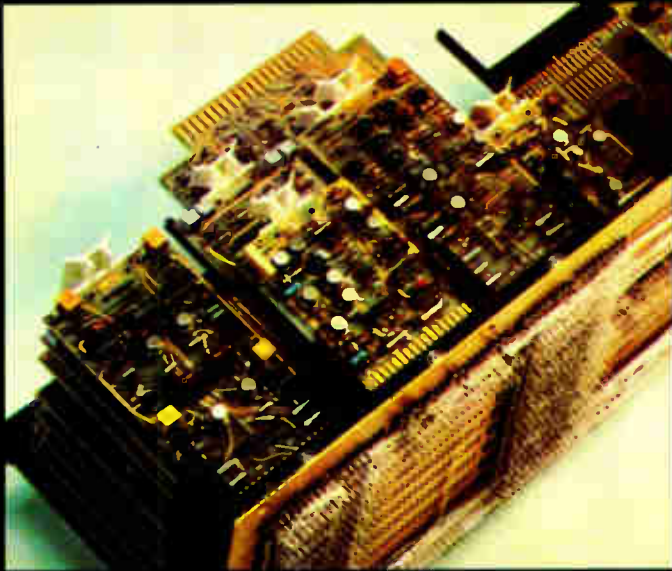

**level 3** Direct entry plate assembly offers modular packaging flexibility. Custom designed plates accommodate any size or style PC board with no tooling cost to you. Rectangular posts are true positioned for automatic wire-wrapping.

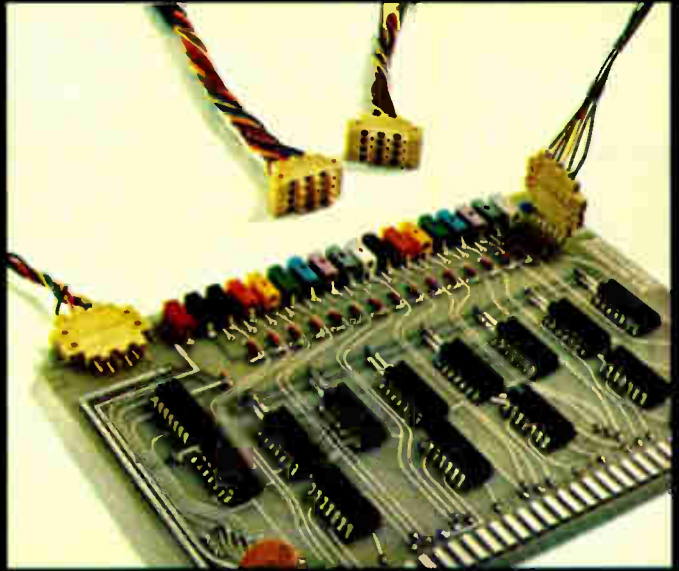

**level 4** Miniature contact (3 input, 3 output) hermaphroditic connectors can be snapped together to connect as many circuits as required. ■ Single finger-tip mounting of low cost connector saves assembly time. Available in UL Class SE-1 flammability rated material.

Write for our Spectrum brochure covering all levels of interconnections.

**Spectrum**  
OF INTERCONNECTION CAPABILITY

AMPHENOL  
INDUSTRIAL DIVISION

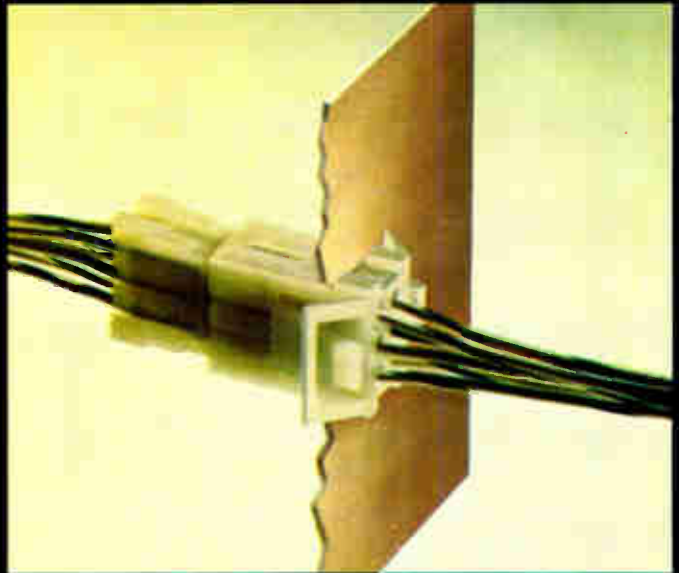

From the simple tube socket—to a myriad of electrical/electronic connectors—to complete and complex termination systems . . . SPECTRUM.

But SPECTRUM is far more than products. It is a depth of capability in engineering, manufacturing and quality control. Amphenol's SPECTRUM is a new height of service, availability and distribution backed by seven Amphenol interconnection-oriented divisions.

Amphenol can fulfill your total interconnection requirements because we are not limited to specifics such as one or two product lines, one or two levels.

Therefore we approach your interconnection needs with complete open-mindedness.

For more new ideas and specific information, write for your copy of "SPECTRUM." Amphenol Industrial Division, Bunker Ramo Corp., 1830 South 54th Ave., Chicago, Illinois 60650.

**BUNKER  
RAMO**

**AMPHENOL**

Circle 23 on reader service card

**Quality  
resistor networks  
now available  
off-the-shelf.**

**Pull ups or  
terminators,  
in popular  
values.**

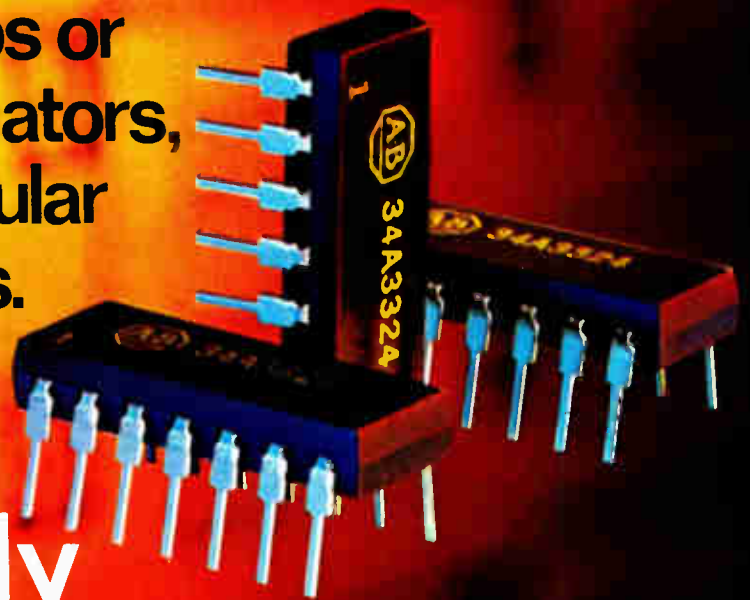

**If you're really  
serious about cost,  
be serious about quality.**

Now our most popular thick-film resistor networks are ready and waiting, in quantity, at your A-B electronics distributor. Pull-up networks and terminator networks with tolerances of  $\pm 2\%$  in popular values from 68 ohms to 22K ohms. All in compatible

14 lead .300 series DIP's. Or if you need something special we'll quickly custom design any circuit that'll fit into a 14 or 16 lead DIP. And we mean quickly. Overall specs include: absolute tolerances to  $\pm .5\%$ . Tracking  $\pm 50$  ppm/ $^{\circ}\text{C}$  (and lower). TCR to

$\pm 100$  ppm/ $^{\circ}\text{C}$ . Write for free technical publications 5850 and 5851. Allen-Bradley Electronics Division, 1201 S. Second St., Milwaukee, WI 53204. Export: Bloomfield, NJ 07003. Canada: Cambridge, Ontario. United Kingdom: Jarrow, Co. Durham NE32 3EN.



Actual Size



**ALLEN-BRADLEY**  
Milwaukee, Wisconsin 53204

Circle 24 on reader service card

## **IBM reports biggest solid-state image array**

In a unique application of standard MOS fabrication, IBM has developed the **largest solid-state image array ever reported**. The half-million-element optical scanner, built on a giant 1,050-by-1,600-mil chip, employs bucket-brigade circuit techniques. When the device is used for facsimile, copy illuminated by a tungsten light is focused on the surface of the chip. Then, the collected charge is shifted out of the device by normal bucket-brigade shift-register action. **The chip consists of 524,288 photo elements**, which IBM calls PELs. Each PEL consists of one bit of a bucket-brigade shift register.

## **Timex to introduce under-\$100 liquid-crystal watch**

The Timex Corp. is going to introduce a **liquid-crystal-display watch this summer and sell it for less than \$100**, says vice chairman Edward T. Carmody. The field-effect liquid crystals will show hours and minutes. This venture into electronic-display timepieces is a first for the company, which specializes in mass-marketing inexpensive watches.

## **TTL microcontroller replaces 24 MSI packages**

The trend to greater bipolar integration is being speeded along by Monolithic Memories' four-bit expandable TTL microcontroller. It **sports a gate equivalence of more than 1,000—almost 10 times that of any other bipolar processor chip on the market**—and does it with conventional Schottky processing. According to Dale Williams, marketing manager, the 40-pin-DIP microcontroller, to be announced in March, **replaces 24 standard TTL MSI packages and saves over 5 watts of power into the bargain**. The chip is capable of 256 arithmetic and logic operations in a fast cycle time averaging 150 nanoseconds.

To illustrate the savings possible with this chip, it can emulate full 16-bit Nova operation with only 28 packages—4 microcontrollers, 14 packages of memory, 5 registers, and some gates.

## **First C-MOS microprocessor built by RCA**

RCA has built the first C-MOS microprocessor—an eight-bit, two-chip version that not only offers microwatt power performance but also gives the user good noise immunity and tolerance to power variations.

The two-chip design, a joint effort of RCA's former computer facility in Palm Beach, Fla., and its Solid State Technology Center in Somerville, N.J., **has as its heart a 16-by-16 scratchpad RAM**. Access to the memory is made over one of these 16 registers. This unique architecture permits 65,536 eight-bit bytes to be accommodated. **The complete set of 25 instructions can be executed in under 6 microseconds**. Also, an eight-bit, two-way data bus interconnects the processor, any mixture of RAM and ROM, and the peripheral devices.

RCA says that sample quantities will be available in the fourth quarter. It is also designing a single-chip, eight-bit version using tighter layout rules to keep chip size to less than 200 mils on a side.

## **Phillips to offer three I<sup>2</sup>L parts**

Announced just two years ago and still an experimental technology at most semiconductor laboratories, integrated injection logic (see p. 81 and p. 114) is already a commercial reality for at least one company. Philips Gloeilampenfabrieken's Components division **will come out shortly with three I<sup>2</sup>L consumer products**, a digital tuning chip for touch-control radio and TV sets, a control chip for telephone tone dial-

ing, and a frequency divider/amplifier for electronic organs. Philips has also developed a 1,024-bit random-access memory, but has made no marketing decision on the part.

## **16,384-bit ROM from GI to run on 5 volts**

Look for the General Instrument ion-implanted n-channel process, developed at the University of Utah Research Institute, to yield a 16,384-bit read-only-memory **that operates on a single 5-volt power supply**. Expected at midyear, the 500-nanosecond device was designed with five basic cells, repeated as required, to keep the chip size to 160 by 165 mils. **The same technique is used on GI's new 5,120-bit ROM, now being sampled.**

The 16,384-bit product, organized 4,096 by 4, achieves through an input-latch circuit what GI calls a "statically dynamic" ROM. At logic 1, the ROM operates in the dynamic mode, but logic 0 turns off the inputs to keep the output at the same level.

## **Avco to build automated car tester prototype**

The Department of Transportation will probably award Avco Systems division, Wilmington, Mass., a small contract to develop a **prototype automated system for inspecting and diagnosing defects in the safety and pollution controls on motor vehicles**. To be tested through July 1976 in Washington, D.C., the system will link several minicomputers and sensors. The test, however, will delay any contract awards by the National Highway Traffic Safety Administration to other states for larger operating systems and could retard a market for automated testing systems [*Electronics*, Aug. 16, 1973, p. 53].

## **H-P shift register uses EFL process**

Hewlett-Packard has developed a 100-megahertz, 128-bit shift register **using its bipolar emitter-function-logic process**. The part, with 1,000 gates on a 100-by-150-mil chip, dissipates about 1 watt and is designed for use in instrumentation that won't be out this year.

Zdenek Skokan of H-P, who developed the process, indicates that **it is the forerunner of a family of 1-gigahertz devices that will exhibit a 300-picosecond propagation delay**. The firm's present process gives about 0.6 nanosecond, still very fast by current standards. The EFL process gives very high speed plus excellent density.

Although H-P's EFL is not the same as TRW's version, it is similar. TRW's uses substrate pnp transistors without gain rather than npn transistors with gain. TRW's EFL appears identical to the early complementary transistor logic, with advances in production techniques permitting higher performance than early CTL parts.

## **Addenda**

Rockwell International's Autonetics division is setting up a separate facility to make military and aerospace MOS circuits. The present, commercially oriented, Microelectronics division does \$50 million a year, **but it's felt that small-volume, high-reliability parts can be handled better by a separate dedicated operation**. . . . Dow Corning has a new silicone molding compound with an **improved ability to survive saline environments**. Silicone outshines its competitors—phenolic and epoxy—in resisting moisture, but has proved more vulnerable to saline atmospheres.

# C-LINE POWER DARLINGTONS

...how and where to use them

## new application notes contain more than 15 Power Darlington circuits

Here in one place is everything you've always wanted to know about Darlington... how to design for higher speed, lower saturation voltage and high gain in less space. Major applications include pulse and switching circuits, power supplies and linear amplifiers. Four typical applications are illustrated below.

### SWITCHING VOLTAGE REGULATOR

Unitrode Power Darlington are optimized for switching-regulator service with very fast switching, very low  $V_{CE(sat)}$  and high current gain. In this circuit, the full load efficiency can be better than 95%.

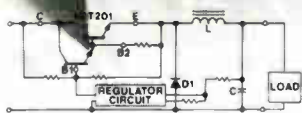

### PUSH-PULL INVERTER

The high current gain of the Unitrode Darlington allows it to be driven directly from a logic-level multivibrator. The low  $V_{CE(sat)}$  not only raises efficiency, but indirectly reduces the magnetizing inductance requirement of the transformer. At 10KHz and full load, the circuit attains an inversion efficiency of approximately 90%.

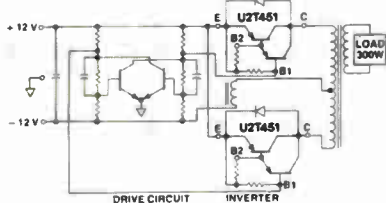

### HIGH SPEED SWITCH FOR INDUCTIVE LOADS

Used with loads such as solenoids, phase shifters and small DC motors, this circuit is not only a switch, but (in the ON state) a constant current source which can drive an inductive load to its steady-state current in less than the time constant of the load itself.

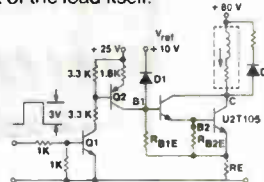

### MOTOR CONTROLLER

Unitrode Power Darlington are most suited for applications where high-speed jogging, fast dynamic braking or high slew rates are required, and conventional power transistors will not satisfy the highest speed requirements.

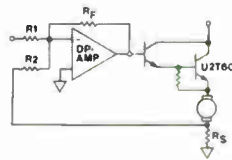

In all applications presented, the circuits have been proven with Unitrode's U2T Series Power Darlington in both NPN and PNP types—from 2 to 20 amps, 60 to 150 volts in TO-33, 3 pin TO-66 and 3 pin TO-3 packages. 100 quantity prices for the series range from \$1.25 for 5A, 60V devices to \$5.40 for 20A, 150V types.

Unitrode Corporation, Dept. 27Y, 580 Pleasant Street, Watertown, Mass. 02172 Tel. (617) 926-0404

Use the Reader Service Card for your free copy of the new Power Darlington Application Booklet.

Circle 27 on reader service card

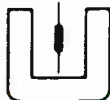

**UNITRODE** quality takes the worry out of paying less.

Unitrode Sales Representatives: **ALA.**, Huntsville, 20TH CENTURY MARKETING INC. (205) 772-9237; **ARIZ.**, Scottsdale, FRED BOARD, ASSOC. (602) 994-9388; **CAL.**, Burlingame, BROOKS TECHNICAL GROUP (415) 347-5411, Escondido, CIROLIA ELECTRONIC SALES, INC. (714) 743-3015, Sherman Oaks, UNITRODE CORP. (213) 783-1301; **COL.**, Littleton, SIMPSON ASSOC., INC. (303) 794-8381; **CONN.**, Hamden, COMPAR NEW ENGLAND (203) 288-9276; **FLA.**, Boca Raton, CONLEY & ASSOC. INC. (305) 395-6108, Oviedo, CONLEY & ASSOC. INC. (305) 365-3283, Tampa, CONLEY & ASSOC. INC. (813) 933-3183; **ILL.**, Chicago, CARLSON ELECTRONIC SALES CO. (312) 774-9022; **MD.**, Baltimore, DANIEL & COMPANY (301) 825-3330; **MASS.**, Reading, KANAN ASSOC. (617) 944-8484; **MICH.**, Detroit, RATHSBURG ASSOCIATES, INC. (313) 882-1717; **MINN.**, Minneapolis, CHARLES E. BOHLIG CO. (612) 922-7011; **MO.**, St. Louis, CARLSON ELECTRONIC SALES CO. (314) 991-0262; **N.Y.**, Clifton, N.J., COMPAR NEW YORK, INC. (201) 546-3660, Albany, COMPAR ALBANY, INC. (518) 489-7408, Endwell, COMPAR ALBANY, INC. (607) 723-8743, Fairport, COMPAR ALBANY, INC. (716) 271-2230, Liverpool, COMPAR ALBANY, INC. (315) 471-3356; **N.C.**, Burlington, P. J. NAHSER, INC. (919) 226-8053; **OHIO**, Cincinnati, BAEHR, GREENLEAF & ASSOC., INC. (513) 891-3826, Cleveland, BAEHR, GREENLEAF & ASSOC., INC. (216) 221-9030, Columbus, BAEHR, GREENLEAF & ASSOC., INC. (614) 486-4046, Dayton, BAEHR, GREENLEAF & ASSOC., INC. (513) 426-5485; **PENN.**, Willow Grove, DANIEL & COMPANY (215) 674-3850, Pittsburgh, COVERT & NEWMAN CO. (412) 563-0303; **TEX.**, Houston, SEMICONDUCTOR SALES ASSOC. (713) 461-4197, Richardson, SEMICONDUCTOR SALES ASSOC. (214) 231-6181; **UTAH**, Salt Lake City, SIMPSON ASSOC., INC. (801) 486-3731; **WASH.**, Bellevue, N.E.M.C.O. (206) 747-6863; **CANADA**, Downsview, Ontario, KAYTRONICS LTD. (416) 638-5511, Montreal 267, Quebec, KAYTRONICS LTD. (514) 487-3434.



We've put all this  
into one small box.

## The PS<sup>2</sup>L.

It's new from Acme Electric Corporation . . . a programmable solid state load device.

The PS<sup>2</sup>L load tests DC power supplies and batteries faster, more efficiently and with greater accuracy than conventional test equipment. It's ideal for incoming test, quality control and lab work. The PS<sup>2</sup>L saves set-up time and eliminates recalibration and maintenance that's necessary with conventional test equipment.

Most other load testing devices use a resistive load.

They heat up. Need constant adjustment.

Loss efficiency.

None of this happens with the PS<sup>2</sup>L. It can be programmed to *simulate* the load. This means no heating up and no load fluctuations. So down goes your test time, up goes your efficiency. The PS<sup>2</sup>L dissipates up to 1000 watts within a voltage range of 2 VDC to 50 VDC and a maximum current of 110 amps when de-rated per the power dissipation curve provided. It's equipped with two modes of operation: 1) constant current and 2) constant resistance. For dynamic loading, the PS<sup>2</sup>L is provided with a program input for external connection of a pulse or signal generator. Two models available: 500 and 1000 watts. For more information, write for our PS<sup>2</sup>L brochure: Acme Electric Corporation, Cuba, New York 14727.



**Acme Electric**

## CCD design opens way for high-quality data and video jobs

High resolution has required tight tolerances, but Bell Labs three-level sealed structure relaxes specifications

Although the usefulness of charge-coupled device techniques for imaging applications was proven several years ago [*Electronics*, May 11, 1970, p. 112], high-density video-quality arrays have not gone into manufacture. The problem has been defects—pinholes in the oxide and shorts between electrodes—which caused spots and streaks that degraded the image quality of closely spaced arrays. Now, researchers at Bell Laboratories, Murray Hill, N.J., have developed a three-level polysilicon structure that achieves both high packing density and high yields in a completely sealed image chip.

**Six times better.** The CCD chip has been built into laboratory versions of video cameras capable of the 256-by-220-line resolution required by Picturephones. This is six times the resolution of the 100-by-100 CCD arrays for imaging already on the market [*Electronics*, Aug. 30, 1973, p. 36]. Both black-and-white and three-chip color cameras have been assembled. Although Bell Labs has not indicated that these device types could be put into Picturephone cameras, these cameras are clearly available for Picturephone system evaluation.

Mike Tompsett, who heads the CCD image group, says that the new sealed three-level structure alleviates the problems with the old bare transfer gaps of earlier single-

level metal devices, which suffered from charge instabilities and were sensitive to ambient light. By retaining the overlap electrodes, Tompsett says very low transfer efficiencies are still obtained—less than  $10^{-4}$  per transfer at 1-megahertz transfer rates—while the dark current values remain a respectable 10 milliamperes per square centimeter, with the goal of less than 5 nanoamperes per  $\text{cm}^2$  apparently attainable with the same structures.

**Relaxation.** Perhaps most important for the commercial realization of CCD images is the new structure's greatly relaxed demands on mask making and photolithography. In the Bell device, no narrow gaps must be etched. The smallest device features are the electrodes themselves, which—being 16 micrometers wide—should cause no trouble to an industry capable of routinely fabricating line widths down to  $5\mu\text{m}$ . What's more, the fully protected gaps between electrodes are a wide  $32\mu\text{m}$ .

Furthermore, intralevel shorts no longer cause fatal defects, since only electrodes connected by the same bus bars are shorted together. Fatal defects, however, are caused by interlevel shorts from pinholes in the areas of electrode overlap. However, even here the pinhole density in a thermally grown oxide or polysili-

con is extremely low. These two factors, taken together, promise very high fabrication yields.

Conversely, the simple cell geometry, the relaxed tolerances, and a relatively uncritical mask alignment allow the fabrication of very small cells. The cell length can



**Ring around a prism.** Bell Labs' CCD color camera of the Picturephone type has three CCD chips arranged around a prism to form the color images. Several other devices have been made using the three-level polysilicon approach.

be on the order of  $3W$ , where  $W$  represents the minimal allowable feature dimension—as low as  $5\mu\text{m}$ , for example. The small cell size makes this structure attractive for high-resolution linear image sensors, as well as video-tape area imaging.

In fact, a variety of CCD devices has been built using this three-level polysilicon approach. These include linear analog delay lines and a linear sensor for facsimile appli-

cations with 1,600 elements for high-resolution, slow-scan image-sensing. □

Communications

A Boeing plot to find squad cars

By simplifying the principle underlying the inertial navigation systems used on airliners, the Boeing Co. has developed an automated digital fleet-location and reporting system that can reckon the location of a police car within 50 feet.

In inertial navigation systems, an on-board computer constantly updates heading and distance data. But with Boeing's system, called Flair, the computer is located in a central station and receives digital responses indicating heading and distance every 2 seconds from as many as 1,500 cars.

The computer displays the location of each car as a dot on a dispatcher's TV map of a city. "Each police car has an inertial navigation system in a sense," explains A.J. (Joe) Henson, program manager at Boeing's Wichita, Kan., division. However, "the sensors we use are not gyros or accelerometers. We tie in to the car's odometer and use a magnetic heading sensor [a compass] to get dead-reckoning information."

A Varian 73 minicomputer in the

central station queries RCA 7000-series mobile radios, compares the responses to actual street locations, and makes any corrections. The results are shown on a Sony color-TV receiver. The equipment in the squad car consists of the little keyboard on the dash, a standard police radio, and a "shoe box" full of digital electronics in the trunk.

After 18 months and 10,000 miles of testing with Wichita and St. Louis, Mo., police cars, Boeing will begin installing Flair units in 25 St. Louis cars this summer during a three-month, \$800,000 demonstration project partially funded by the Law Enforcement Assistance Administration [*Electronics*, Feb. 7, p. 36]. If St. Louis likes what it sees, it may decide to buy a 500-vehicle system over two phases for about \$2 million. Wichita also is interested, Boeing says, but the company will not actively market Flair until it is satisfied the system is bug-free.

**Push buttons.** In addition to the car-locating features of the two-way system, a police officer can transmit up to 99 different coded messages in 10 milliseconds by punching two numbers on the keyboard. And by punching an emergency button, he can sound an alarm at the dispatcher's station and cause the dot representing his car to flash. Boeing is also working on a portable transmitter that would enable an officer away from his squad car to use the car transmitter as a repeater.

At the dispatcher's screen, five

different symbols represent detective, patrol, staff, investigator, and special duty cars throughout the city. The system ranks queries as high or low priority, or routine. On command, Flair will highlight the cars nearest to an emergency, display a car's number for direct voice communications, and zoom in on a neighborhood TV map for more precise dispatching. Operating on any dedicated voice channel, it should cut voice traffic overall, Henson says.

Boeing thinks that fire, ambulance, and taxi fleets may turn out to be bigger markets than police systems. Interstate truck fleets could employ it, too, Henson says, using one uhf channel on a satellite to track trucks across the country. General Motors has already inquired about using Flair to keep tabs on a fleet of forklift trucks in a mammoth warehouse. □

Satellites

NASA proposes to lease data system

If it gets the OK from the White House Office of Management and Budget and the Congress, the National Aeronautics and Space Administration may start leasing communication services from private industry. NASA plans to issue

**Vehicle locator.** Developed by Boeing, the Flair system uses in-car sensors that transmit digital signals indicating heading and distance.

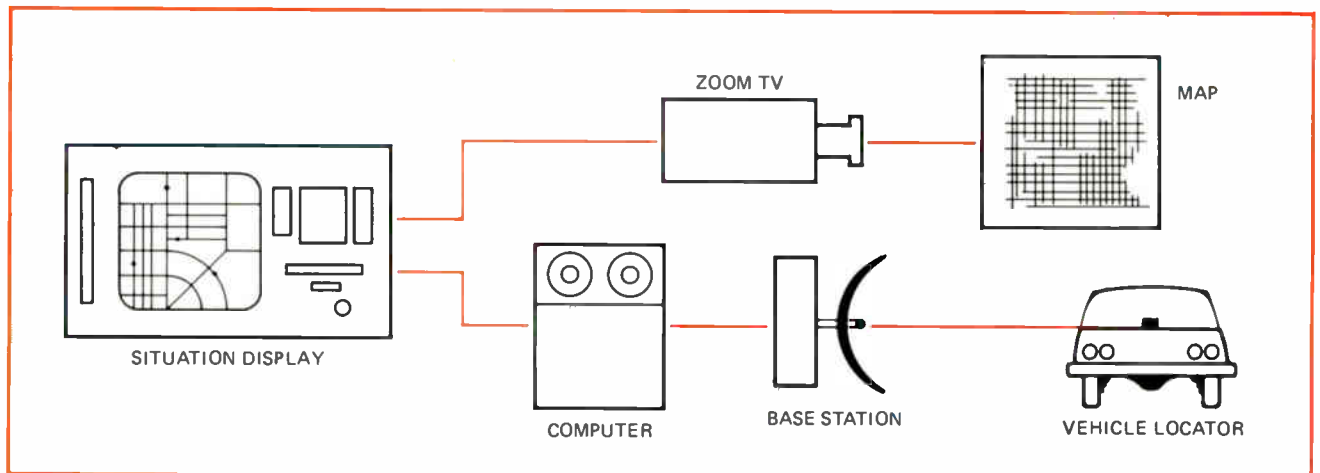



requests for proposals in August for a tracking and data-relay satellite system that would do in orbit in 1979 what ground stations abroad now do: keep track of satellites and relay their data to ground communications systems.

NASA has told 24 inquiring companies that it would take a hefty \$150 million investment in two spacecraft and ground stations before the supplier of services got anything back. However, NASA would lease the system for 10 years at \$40 million a year to serve such spacecraft as earth observation satellites and the space shuttle—a gain on investment of about 12% a year for the winner. Even so, only 11 companies say they are interested, and the agency figures that possibly only three will decide to answer the RFP.

The interested companies include American Satellite, AT&T, Comsat General, Grumman, GTE Satellite, IBM, ITT Worldcom, Philco, RCA, and Rockwell International. Rockwell and Hughes already have performed design-study contracts for NASA.

The program timetable calls for company responses to be back in October, a contract award in April 1975, and service to begin in early 1979. NASA proposes the leasing of the satellite services under a directive from the White House Office of Telecommunications Policy that states Government agencies should buy communications services from private industry whenever possible.

**Nearly global.** The system would augment NASA's widely scattered space-tracking and data network and shut down foreign-based tracking stations, at an over-all saving, NASA hopes. Two 750-pound spacecraft, to be three-axis-stabilized, would provide nearly global coverage and handle satellites up to 5,000 kilometers in altitude for the command and data-relay requirements. Essentially a synchronous-orbiting "antenna feed farm," each satellite would serve up to 20 users simultaneously or single users at data rates between 5 and 300 megabits per second, explains Paul F. Barritt, program manager.

The multiple-access system would

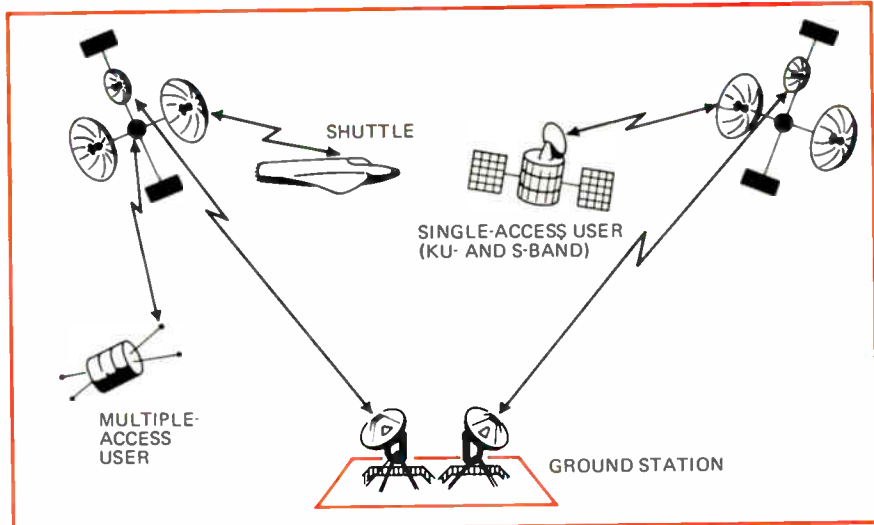

**Leased line.** NASA says it wants to lease a satellite communication system—an antenna feed farm—with each satellite serving 20 users simultaneously.

use S-band phased-array antennas operating at 100 kilobits per second. Two single-access systems—using 3.8-meter steerable, parabolic antennas—would handle 5 kilobits per second at S band and 300 kilobits per second for quadriphased data at Ku band and are time-shared among S- and Ku-band users.

A feature of the multiple-access system is the 26° phased-array antenna that can be controlled from a ground station. By properly phasing the signals received by each array element, ground control can "point a 5° beam from the antenna at each user. The single-access system uses two high-gain, narrow-beam antennas, which divide the S band into 10-hertz channels. The Ku-band antenna can be divided in any ratio. The minimum ground-station gear would be one 18-meter antenna and associated electronics for each orbiting system. □

## Microwaves

### Millimeter waves get solid-state treatment

To lower the cost of millimeter-wave circuitry, integrated circuits are being developed that permit replacement of precisely machined and expensive metal waveguides

with guides made of solid dielectric. Still experimental, the circuits are much more compact than those made from conventional "plumbing" and might eventually cost one-tenth that of today's millimeter-wave circuits, according to Harold Jacobs, the team leader at the U. S. Army Electronics Command, Ft. Monmouth, N.J.

Most work thus far has involved two materials—single-crystal silicon with exceptionally high resistivity (dielectric constant, 12) and aluminum oxide (dielectric constant, 9.9). There is also some interest in gallium arsenide. Also working with the command's Electronics Technology and Devices Laboratory, headed by Clare Thornton, are the Hughes Aircraft Co. facility in Torrance, Calif., and the Illinois Institute of Technology Research Institute, Chicago.

By next December, Hughes—funded in part by the Army—should have a receiver operating at 60 gigahertz that is built around a silicon dielectric waveguide, says Jacobs. With active devices mechanically embedded in rectangular pieces of highly polished silicon, the receiver will contain a waveguide input, local oscillator, hybrid balanced mixer and mixer diodes, and an intermediate frequency transistor amplifier. It should all measure somewhere around 1 by 2 inches.

IITRI, on the other hand, is con-

centrating on aluminum oxide. It should have an experimental receiver measuring 1.75 by 4.1 inches ready by the end of March.

**Solid.** The dielectric waveguides are simply solid pieces of rectangular material inside which electromagnetic waves may propagate just as they do in metal waveguide, stripline, and microstrip.

"Energy is maintained in the guide by internal reflection, with anywhere from 10% to 15% leaking out," says M. Metro Chrepta, physicist at the command. "This leakage is not in the form of radiation but is an evanescent field that propagates along with the field in the guide."

The energy propagates in a hybrid mode with very low loss because conduction losses, the prime loss mode with metal guides, is nonexistent, continues Chrepta. For example, with the silicon resistivity ranging between 10,000 and 30,000 ohm-centimeters—ordinary transistor-type silicon has resistivities of less than 1 ohm-centimeter—most of the loss is due to free carriers in the material. In the range of 60 to 140 gigahertz, attenuation in the metal guides is 10 times higher, says Chrepta. Moreover Jacobs says that the figure of merit for the dielectric guides should be two to three times higher than metal waveguides at these higher frequencies.

**Advantages.** The two materials offer unique advantages, Jacobs explains. Silicon development may eventually result in active devices being deposited directly in the waveguide—"like in a true monolithic IC." This should offer great cost and size advantages. Aluminum oxide offers low cost and, in its soft, green form before firing, can be fabricated into transmission lines and passive components such as directional couplers and ring filters simply by pressing out patterns much like cookies are pressed with a cookie cutter. Jacobs is also thinking of the possibility of combining both materials—active devices embedded in the silicon and joined by transmission lines, filters, and couplers made from the alumina.

Jacobs' laboratory has already fabricated a variety of the inte-

grated millimeter-wave devices, using both solid dielectric and image lines in which the dielectric guide rests on a metal plane. Included are oscillators for the 14–20 GHz range (Ku band), in which Impatt and Gunn diodes have been imbedded; phase shifters with p-i-n diodes on top of a silicon waveguide; switches; and electronic attenuators at Ku and W bands, in which p-n junctions have been diffused into the silicon. With the junction forward biased, one piece of silicon measuring 1 by 3 by about 5 millimeters yielded an attenuation of 50 decibels at 70.5 GHz, according to Jacobs. □

---

## Energy

---

### Battery charger uses solar power

To convince people that a new idea works, it's sometimes better to start off small. That's what Solarex Corp., Rockville, Md., has done to try to prove that solar cells especially designed for terrestrial use really work. The company is introducing a solar energizer to maintain the charge on batteries of parked cars and docked boats. And it plans to follow the charger with larger arrays for buoys, lighthouses, and microwave repeat-

---

**In full sun.** Battery charger for cars and boats produces 12 volts at 0.1 ampere.



One key to making silicon cells available for such jobs is to get their costs down. Using proprietary design and fabrication tricks, Solarex has developed a cell with the surface electrode in patterns shaped like chevrons.

Solarex president Joseph Lindmayer [*Electronics*, Oct. 11, 1973, p. 14] declines to describe the chevron cells in any detail, except to say that they are sliced from a silicon ingot to about 10-mil thickness—substantial enough that they do not need structural support in mounting. No anti-reflecting optical coating is used because "it isn't worth the extra efficiency," he says.

**Efficiency.** Whatever the trick, the cells produce an ample 15% efficiency, Lindmayer says. Some 30 cells are mounted on a panel, measuring 3.5 by 15 by 0.2 inches to form the energizer. Each cell is one-quarter of an ingot slice. The three-ounce panel will supply up to 30 watt-hours per week, producing 12 volts at 0.1 ampere under load at full sun. The price per single unit is \$72.50 with quantity prices available.

The panels can be interconnected for any voltage requirements, and larger systems can be assembled from individual panels. Large systems also are available for charge-control circuits and dc-to-ac converters. Furthermore, Lindmayer points out that the durable energizer is maintenance-free—layers of dust or dirt don't harm its efficiency too much and are washed off by rain, anyway. The surface can be cleaned with soap and water, if necessary. □

---

## Computers

---

### New microprocessor design cuts gates

While nearly all commercially available microprocessors hover at the 2,000-gate mark, a unit that can perform as well with less than half the number of gates may seem unlikely. But a new design, called Hummingbird, which uses part of a com-

# Picture video copies like these as part of your system.

## \$2950, single unit price.

Hard copies are the record keeper of modern display systems. They're a time-saver, too, providing output for busy people to read at their leisure. Unfortunately, however, copy quality has been inconsistent. Until now. Look at our versatile, low-cost 4632 Video Hard Copy Unit!

Our 4632 gives your systems consistent high quality, high resolution, grey scale and black and white copies on 8½" x 11" paper. In other words, copies you can read.

It interfaces quickly to alphanumeric or graphic display terminals and scan converters. All you need is access to one of these video sources:

1. Composite video;
  2. Video, horizontal drive, vertical drive;
  3. Video, composite sync.
- And it operates at any standard line rate.

The 4632 is a dry process performer using 3M® Dry-Silver paper. It's light and compact, yet built sturdily for hard use and designed for easy servicing.

We have more display ideas for your system, too. Such as scan converters and a full line of monitors and displays. OEM and end user quantity discount prices available. For the complete picture, phone your nearby Tektronix office or write:

Tektronix Information Display Division,  
P. O. Box 500, Beaverton, Oregon 97005.



**Graphics. The mind's eye, for those who think tomorrow.**

For a demonstration circle 32 on reader service card

Circle 33 on reader service card

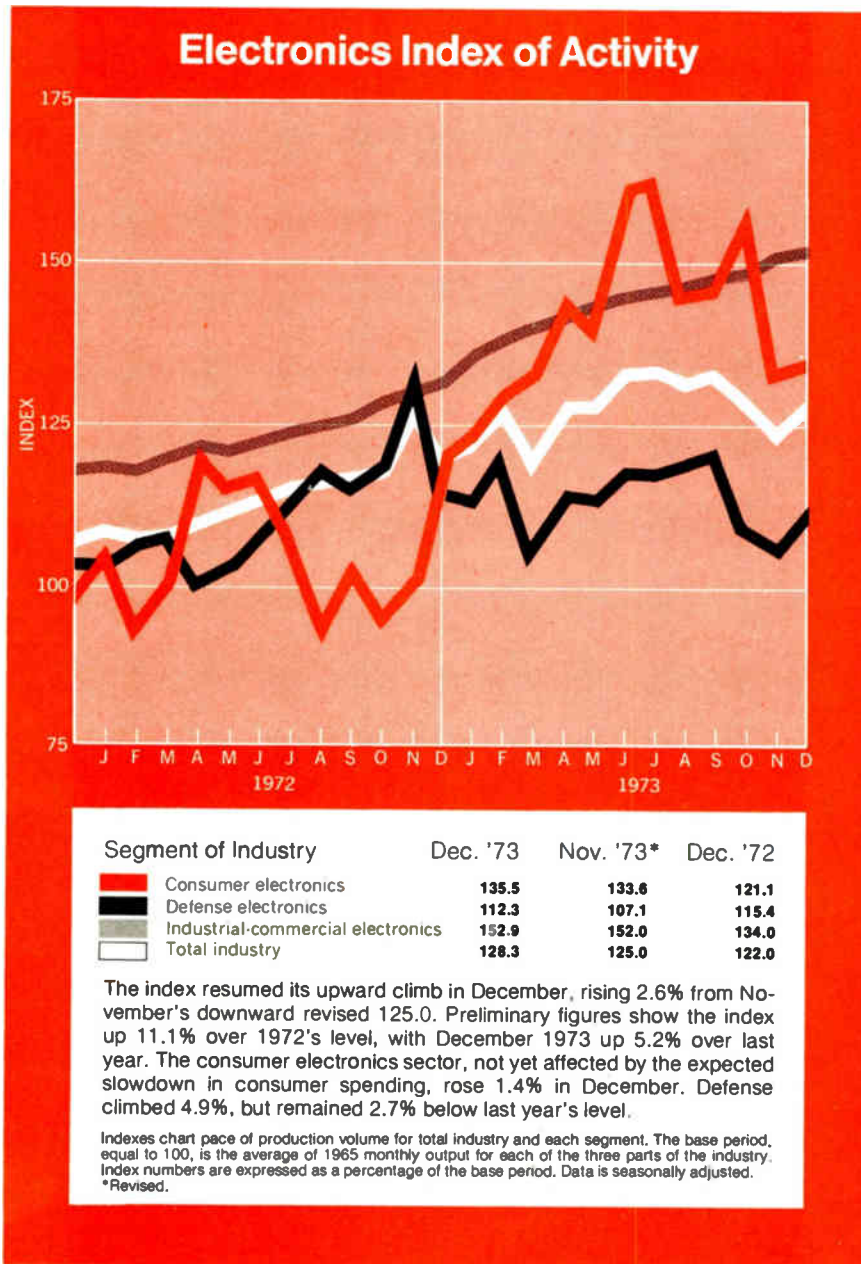

puter's main memory as a register file, makes possible a 12-bit parallel microprocessor with only 700 logic gates and a 16-bit unit with only 900 gates, according to Wynne Calvert, who heads his own computer company in Boulder, Colo.

Like most microprocessor designs, Calvert's calls for an external memory—the processor itself comprises only an arithmetic unit, a few working registers, and the necessary control logic. But most other microprocessors also contain a number of internal general-purpose registers that store operands and inter-

mediate results between accesses to the main memory.

Because Calvert's design uses main memory as a register file, the speed of his system suffers—"by a factor of about two." But for many applications, Calvert says, high speed is not necessary.

**Tradeoffs.** Calvert describes his design as being completely parallel. "The Intel 8008 requires two cycles just to specify the address of data in memory, before it can actually work on that data," he says. "In my design, that's not necessary." Calvert does admit to a tradeoff: this highly

parallel operation requires the microprocessor to be mounted in a 44-pin package. The multiplexing of pin functions would permit the use of a smaller package, but the multiplexing would reduce parallelism and require additional external circuits to demultiplex the pins.

Calvert has built engineering models of the two microprocessors with conventional TTL gates, and he has assembled the software to make them work. He is now negotiating with one semiconductor manufacturer to produce the design commercially as a single large-scale integrated circuit.

The process would probably be some form of MOS, like most other microprocessors. Calvert points out that the gate count is in the vicinity of the upper limit achieved to date with C-MOS, in which p- and n-channel circuits are paired at the expense of circuit density. "If we can implement this design in C-MOS," he says, "our speed will be increased and the power dissipation decreased. We could achieve a 2- $\mu$ s command cycle." □

## Dual minis are now standard products

Minicomputer users have a variety of good reasons for combining two minis into dual-processor systems. An extra computer may be needed to take over all functions if the primary computer is down. And in applications like a store-and-forward switching system, the load at peak times may create an overflow that must be handled by a backup computer.

However, the hardware and operating software to interconnect such dual-processor systems have generally been available only on a custom basis. Now, with its new Dual Nova, the Data General Corp., Southboro, Mass., says it is able to supply a dual processor as a standard system with standard software and high-level language support. This "computing utility" consists of two computers, a shared disk memory, soft-

# The digital world is a COS/MOS world.

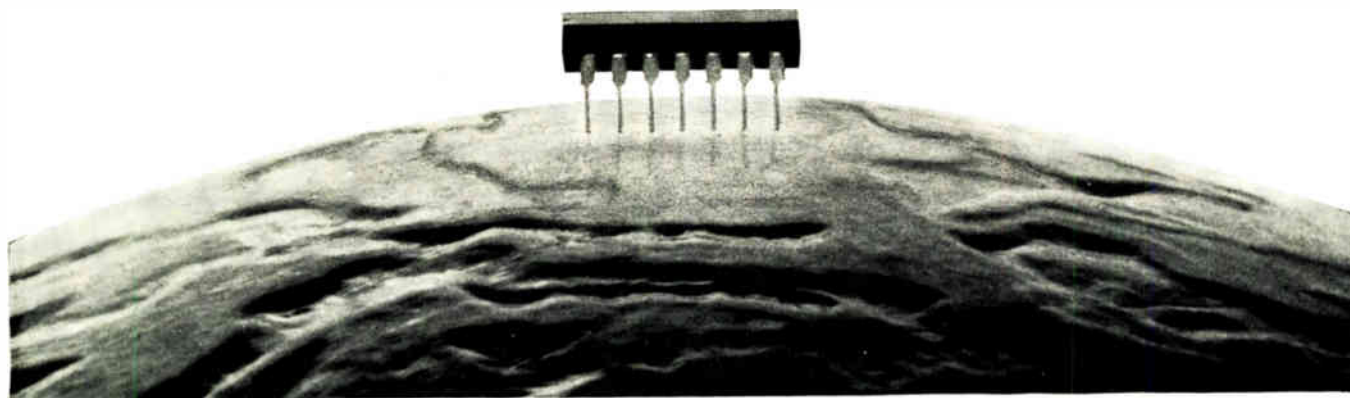

RCA COS/MOS widens your world of digital applications. It offers a combination of features that can't be matched by other digital technologies.

Features like ultra-low power consumption... 10 microwatts per gate! This permits high chip-packing density, use of small power supplies, and a money-saving reduction in cooling requirements.

So COS/MOS is ideal for battery-operated equipment. No longer do you need to be tied down by the power cord.

COS/MOS circuits work great from 3 to 15 volts. That means you can use inexpensive power supplies without fancy regulators. You can use long wires and simple low cost P.C. boards without worrying about signal attenuation.

COS/MOS noise immunity is among the highest of any technology (typically 45% of supply voltage), making it suitable for use in high noise environments such as the automotive and industrial control industries.

The stable transfer character-

istics of COS/MOS typically change less than 3.0% over the full military temperature range. So you can place COS/MOS circuits just about anywhere without worrying about them being overheated.

And you get more system cost effectiveness in the broad selection of COS/MOS circuits: from simple gates like the CD4011 Quad NAND to highly complex functions like the CD4057 Arithmetic Logic Unit.

Let RCA, originator and the world's largest producer of the industry standard CD4000 Series, introduce you to the world of digital COS/MOS. We believe you'll soon be convinced that RCA COS/MOS is the best answer for your digital system designs.

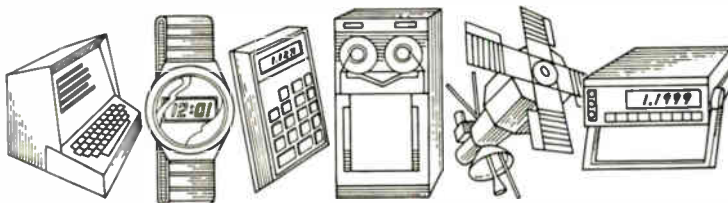

Send for complete data packet, including the new 1973 COS/MOS Product Guide. Write: RCA Solid State, Section 70B-21, Box 3200, Somerville, N.J. 08876. Or phone: (201) 722-3200.

**RCA** Solid State  
products that make products pay off

International: RCA, Sunbury-on-Thames, U.K., or Fuji Building, 7-4 Kasumigasaki, 3-Chome, Chiyoda-Ku, Tokyo, Japan. In Canada: RCA Limited, Ste. Anne de Bellevue 810, Canada.

ware, and interprocessor buffer.

While any two of the Nova line of computers can share mass storage, Data General is packaging standard configurations of the Dual Nova around three processors: the 210 with 1-microsecond cycle time, the 1200 Jumbo with 1,200-nanosecond

cycle time, and the 840 with 800-ns cycle time. The three shared disk options include a 0.5-million-character fixed-head Nova disk with a 250,000 character-per-second data-transfer rate, a 2.5-million-character cartridge disk with a data rate of 180,000 characters per second, and a

25-million-character disk pack with a data rate of 312,000 characters per second. Thus, a total of nine different Dual Nova configurations are available as standard items.

The interprocessor bus, which allows the two computers to communicate with each other, consists of an

### News briefs

#### **Tull Aviation lands IMLS standard**

The Federal Aviation Administration selected Tull Aviation's Interim Microwave Landing System as the national standard, bypassing Boeing and Singer-Kearfott units and qualifying Tull for Federal matching grants for the small-airport market. However, this might not end the protracted competition; tiny Tull and the agency have yet to agree on how much manufacturing data and licensing rights must be turned over for a stipulated \$25,000 [*Electronics*, July 19, 1973, p. 42], and the competitors will be watching to protest any alleged irregularities in the negotiations or to re-enter the lists should Tull falter.

#### **Xerox system links 22 multiprocessors**

Two new multiprocessor computers from Xerox, called the 550 and 560, are the latest replacements for earlier models in the company's Sigma line. The architecture of the new units is similar to that previously used only in very large computers—the larger 560 model comprises up to 22 interlinked processors. And the price-tag is relatively low, typically \$280,000 for the 550 and \$725,000 for the 560. In addition, Xerox is also introducing magnetic-tape and disk units and line printers for the series.

#### **Navy telephone operates with fiber optics**

A telephone system using fiber optics instead of electrical cables has been developed at the Naval Electronics Laboratory Center, San Diego, and installed aboard Sixth Fleet flagship USS Little Rock. Composed of six telephone stations and a central switching station, the system provides for more secure communications and also eliminates crosstalk and interference found on electrical wires, says the center.

Operationally, voice goes into the phone as an electrical signal and is converted by an LED into pulse-frequency-modulated light signals, which are carried by a fiber-optic bundle to the switching station. The signals are then converted back to electrical signals and digitally processed and directed to the station called.

#### **AMS works three-day week**

Advanced Memory Systems Inc., Sunnyvale, Calif., has gone on a three-day work week for its assembly employees. Begun to improve operating efficiency, the program, according to Robert Lloyd, chairman, is improving the company's production figures. Four shifts of assemblers work 12 hours a day for 3 days under the new schedule.

#### **Medical market to spur instrument growth**

The market for analytical instrumentation in the U.S. is growing by a steady 9 to 10% through the early 1980s re-

ports a study by Ovum Ltd. of London, England. The biggest single contribution to this growth, the study states, will come from the medical market, which is forecast to double from \$215 million in 1973 to \$433 million in 1980.

#### **Tektronix offers first semiconductor testers**

A new product line from Tektronix Inc., Beaverton, Ore., a series of modular semiconductor memory test systems, has been introduced to complete the firm's automatic test equipment family. Called the 3400 Series, four initial models, starting at about \$30,000, will offer both interactive and stored program operation, in addition to functional and parametric testing of bipolar and MOS memories. The modules, which the company says will allow customization of systems, are being supplied by Xincom Corp., Chatsworth, Calif.

#### **FCC claims interconnection authority**

As expected, the Federal Communications Commission repelled attempts by North Carolina and other states to lay claim to jurisdiction over intrastate telephone interconnections by staking out authority over the whole "indivisible" telephone network [*Electronics*, Nov. 8, 1973, p. 49]. The FCC ruling will likely produce court tests over states' power to restrict private attachments to a telephone company's interconnections.

#### **Incoterm shows new intelligent terminals**

The Incoterm Corp., Natick, Mass. has introduced two new intelligent terminals: the SPD-320, a compatible replacement for the IBM 3270, and the SDP-20/20, a unit that can handle up to 16 display stations. The terminals, which can be expanded into full processing systems, are aimed at markets where large-capacity, expandable information processing is needed at remote sites, as in banking and insurance applications. Both models contain programable core memories that can be expanded from 8,000 bytes to 32,000 bytes, and each has an access time of 800 nanoseconds. All major terminal components are controlled by software.

#### **AT&T asks for 37 million more circuit miles**

American Telephone and Telegraph Company has asked the Federal Communications Commission for authorization to construct and install about 37 million additional circuit miles of telephone facilities to keep pace with the anticipated demand for communications services. The application, filed by the company's Long Lines Department on behalf of itself and 16 Bell System operating companies, estimates the cost of construction will amount to about \$73.8 million.

# More than 6,000,000 good reasons...

## To insist on RCA Rectifiers and SCR's for your fast-switching applications.

If you have an immediate need for fast-switching devices, come to RCA where large quantity production of quality products is a way of life.

We produced over six million fast-switching thyristors for TV production during the past twelve months ... and millions of fast-switching rectifiers and SCR's for other industry needs during the same period.

These low cost dependable devices represent a lot of good reasons why you should insist on RCA Thyristors and Rectifiers.

Want more good reasons?

RCA offers a large selection of fast-switching devices for your most demanding applications. High-speed inverters, choppers, high-current pulse circuits, or "free-wheeling" diode circuits ... whatever your needs

are ... you'll find the right SCR or rectifier to match your circuit design.

RCA's all-diffused SCR's bring you the best combination of features ...

- fast turn-off time
- high di/dt and dv/dt
- high peak current capability
- exceptional uniformity and stability of characteristics

Match this combination with RCA's fast recovery rectifier features ...

- low reverse-recovery current
- low forward-voltage drop
- low thermal-resistance design ... and you can rest assured that your equipment is backed by the industry's leader in fast-switching technology.

No need to be concerned about quantity, availability, or cost. RCA fast-switching devices are available in quantity ... at prices you can afford.

Want more information? Write: RCA Solid State, Section 70B-21, Box 3200, Somerville, N.J. 08876. Or phone: (201) 722-3200,

Fast Switching SCR's		40555	S3704	S5210	2N3653	2N3658
Package		TO-66	TO-66	¼" stud	TO-48	TO-48
I <sub>RMS</sub>		5 amps	5 amps	10 amps	35 amps	35 amps
T <sub>OFF</sub> (Microseconds)		2-6	6-10	5-10	10-15	6-10
1K Price:	200V	1.67	.90	3.00	7.24	7.89
	600V	2.89	1.30	12.20	15.60	17.20

Fast Recovery Rectifiers		TA7895	44938	43884	43894	43904	40960
Package		DO-26	DO-15	DO-4	DO-4	DO-5	DO-5
I <sub>AV</sub>		1 amp	1 amp	6 amps	12 amps	20 amps	40 amps
T <sub>RR</sub> (Nanoseconds)		50-500	150-500	150-350	150-350	150-350	150-350
1K Price:	200V	.44	.42	1.79	2.42	3.20	3.40
	600V	.72	.66	3.13	4.37	6.00	6.70

**RCA Solid State**  
products that make products pay off

International: RCA, Sunbury-on-Thames, U.K., or Fuji Building, 7-4 Kasumigaseki, 3-Chome, Chiyoda-Ku, Tokyo, Japan. In Canada: RCA Limited, Ste. Anne de Bellevue 810, Canada.

AMERICAN

MADE

# Tolerance SCHAUER 1-Watt ZENERS

## Immediate Shipment Low Prices

ANY voltage from 2.0 to 16.0

Quantity	Price each
1-99	\$1.07
100-499	.97
500-999	.91
1000-4999	.86
5000 up	.82



Write for complete  
rating data and other  
tolerance prices.

## Buy the kit- Save a lot



Kit contains a 51-piece assortment of SCHAUER 1% tolerance 1-watt zeners covering the voltage range of 2.7 to 16.0. Three diodes of each voltage packaged in reusable poly bags. Stored in a handy file box. Contact your distributor or order direct.

A \$54.57 value for

ONLY **\$24<sup>50</sup>**

Semiconductor Division

# SCHAUER

Manufacturing Corp.

4514 Alpine Ave. Cincinnati, Ohio 45242

Telephone: 513/791-3030

## Electronics review

interprocessor buffer, a data path, and an interval timer on a 15-inch-square pc board. One board plugs into each computer, and the boards are cable-connected. The bus is basically a digital device and primarily uses TTL logic.

The buffer is a 16-wire interlocked communications path used by the processing system to solve the problem of simultaneous access to the same file. One central processing unit can communicate with the other to see if it is updating a particular file.

**Sharable.** Steven J. Gaal, marketing manager for processing products, notes that the Dual Nova has been evolving at Data General for the past three to four years. The company's disk subsystems have always been "sharable," and as the firm built more dual-processing hardware systems, it decided to add the bus capability. Previously, Gaal says, dual processors were unable to resolve competing access.

A full-duplex 16-wire, eight-bit asynchronous data path, available through an applications program, allows the processors to communicate with each other at the rate of 2,000 to 3,000 characters per second, depending on the speed of the processor. The third subsystem of the bus is an interval timer that is updated every second. If it is not updated, the other processor is signaled to take over via a two-wire path.

The Dual Nova can share up to 4 million characters of fixed-head disk storage and 200 million characters of moving-head-disk storage, but the computers' main memories are not shared in any way, and they do not contend for each other's files. While one computer is doing a real-time job, the other computer can develop new programs, do batch processing, or other tasks, independently. Since the shared disk only loosely couples the processors, the risk of both memories failing is eliminated.

Each processor in the Dual Nova package has 32,000 words of memory, automatic program load, automatic restart for sensing failure of ac power, a real-time clock, and a

Teletype terminal. The standard Dual Nova housed in a cabinet includes a paper-tape reader for loading programs and tests. In addition, the system will accept the full line of Data General peripherals. Gaal notes that a time-sharing system could get twice the throughput with a Dual Nova having 16 terminals on each processor. The system can also be configured with a backup disk to prevent memory downtime.

The operating system includes the real-time disk, foreground/background, a Fortran-4 compiler and run-time system, ISA extensions for real-time work, a re-entrant code, and two other language processors for Data General's Extended Basic and Algol 60.

Prices for the Dual Novas run from about \$45,000 for a Nova 210 with 0.5 million characters of shared storage to about \$83,000 for an 840 with 25 million characters of storage. In addition, the interprocessor bus is available separately at a price of \$4,100 for the two cards and the cable. □

## Military electronics

### Military argues over plastic semis

The military services, long adamantly opposed to plastic encapsulated semiconductors, may be forced into using them by 1975. At least that's the judgment of Bernard Reich, special assistant for reliability, and Edward B. Hakim, physicist, from the U.S. Army Electronics Technology and Devices Laboratory, in Ft. Monmouth, N.J.

Reich feels that present trends to plastic packaging for commercial devices will increase plastic's share to 90% of domestic production by the end of the year—a figure already reached in Europe—and some hermetic devices will be unavailable by 1975. The situation will get progressively worse through the end of the decade.

**Isolate failures.** But Reich says that the plastic failure modes are



# Who Needs Stewart-Warner Microcircuits ? You Do!

For your convenience, our Sales Department starts work at 7:30 A.M. Pacific Time. Dial toll free.

Out-of-State  
Call toll free. Dial:  
**800-538-7906**  
and ask about  
price and  
delivery.

## Here's Why...

- We come through when the going is tough! *(Our delivery commitments are sacred—ask our customers).*
- High standards in product quality. *(Send for our Q.A. brochure).*
- Keep your options open. *(Consider Stewart-Warner as your next source).*
- You can choose from our broad 7400 TTL line, and our 930 DTL's. *(Ask for our catalog).*
- Our multi-million-dollar expansion has significantly improved our deliveries. *(Try us with a quote!)*



SYMBOL OF  
**STEWART-WARNER MICROCIRCUITS DIVISION**  
**STEWART-WARNER CORPORATION**

730 E. Evelyn Ave. • Sunnyvale, Ca 94086 • 1408, 245 9200 • TWX 910 339 9210

**We've bailed out the best of 'em!**

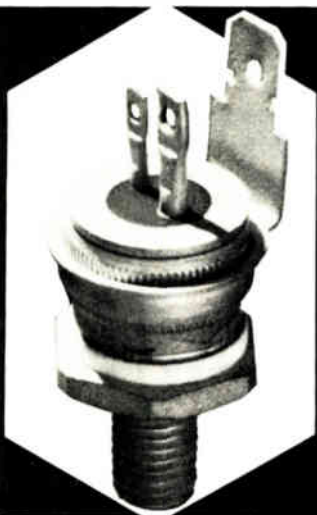

# triacs

## ELECTRICALLY ISOLATED

1/2" press-fit series  
(IT (RMS)) 6 A to 40 A  
(VDRM) 50V to 600V

Two new additions to Hutson's 1/2" press-fit series: isolated press-fit and stud mount with BEO insulators for greatly improved thermal characteristics.

All 1/2" press-fit devices feature Hutson's unique construction and void-free glass-passivated center gate chips.

Call or write for complete information.



## HUTSON INDUSTRIES

BOX 34235 • 2019 W VALLEY VIEW  
DALLAS, TEX. 75234 (214) 241-3511  
TWX 910-860-5537

Distributed by:  
in U.S.A.: BODELLE CO., INC.  
Chicago, Ill. 312/468-1016  
THOR ELECTRONICS  
Elizabeth, N.J. 201/354-2430

In Canada:  
SEMAD ELECTRONICS  
Downsview, Ontario  
416/634-9880

Hutson Industries  
International  
30 Rue Pierre Semard, Yerres,  
91 France. Tel.: Paris 925-8258  
TELEX 21-311.

In Europe:  
Belgium: C. N. ROOD S.A., Brus-  
sels 02-352135. Denmark: E. V.  
Johanssen A/S, Copenhagen  
(01) 295622. Norway: INTELCO,  
Oslo, 47 2 207451. Spain: BEL-  
PORT, Madrid 234.62.62. Swe-  
den: ELEKTROFLEX, Sundry-  
berg 08-28-9290. Switzerland:  
D. LEITGEB, Dubendorf 051 85  
9666. UK: CLAUDE LYONS,  
LTD., Hoddeston, Hertfordshire  
(09924) 67161.

## Electronics review

well known and can be isolated. With proper testing and specification, he feels that the controlled use of plastic devices for tailored applications may be given consideration now. One such application would be in benign environments, such as computer rooms.

But even at that, semiconductor producers, who are back-ordered in consumer and industrial parts, seem to have little interest in supplying plastic parts that meet proposed military requirements. Reich says, "we have extreme difficulty in buying plastic semiconductors to our specifications. They will burn in the parts, but don't want to make any other environmental tests."

**Disagrees.** Not everyone in the military agrees on the future use of plastic encapsulation, however. David Barber, chief of the reliability branch, at Rome Air Development Center, Rome, N.Y., thinks that Reich is overreacting to the supply situation, and adds a warning: "Saying plastic will do the job will assure that we won't be able to get ceramics." Reich and other speakers also pointed out that beam-lead sealed-junction parts may be the solution for some applications, since they eliminate the need for additional sealing.

The military specifications for semiconductors, MIL-S-19500 (discretes) and MIL-M-38510 (integrated circuits), specifically preclude the use of plastic-encapsulated parts. The rationale is that plastic semiconductor products are more likely to fail certain tests—notably bond integrity, moisture leakage, and salt-atmosphere problems.

Reich says that bond failures are the most immediate problem, and this can be minimized by careful selection of plastics with low thermal-expansion coefficients and wide temperature range, plus stronger bonding techniques. Since bond failures show up quickly, they can be found by thermal-cycle sampling over 0° to 100°C five times. If the parts can't meet a 0.025% acceptable-quality level from this test, they must undergo a severe 100% fluoro-chemical-fluid thermal-shock test.

Moisture resistance can be checked with a pressure-cooker test, or even more severe, at 1,000 hours with bias applied at 85°C in 85% relative humidity. This appears to give an acceleration factor of 500 to 1,000.

Based on the tests already run, including those at the Army's Panama test facility, Reich predicts failure rates per 1,000 hours of 0.003% to 0.050% for plastic packaged pnp transistors, 0.003% to 0.023% for npn transistors, and 0.027% to 0.12% for integrated circuits. He also notes that the more recent semiconductor devices seem to have much improved characteristics over earlier devices. □

## Components

### Isoplanar prescaler is first LSI of family

The latest application of Fairchild Semiconductor's Isoplanar II technology is a 1-gigahertz monolithic prescaler. This is the first time Isoplanar II has been used to build an LSI logic product.

Although the part is aimed at instruments and communications applications—and not at computers—it may be a bellwether of Fairchild's intentions for supplying subnanosecond logic for high-speed computer mainframes.

Thomas A. Longo, vice president and group general manager for integrated circuits at the Palo Alto, Calif., firm, says that the prescaler is part of a subnanosecond family that will have as many as 25 members by the end of 1975. The first member of the family, a 650-picosecond dual gate, was introduced last year [*Electronics*, Feb. 15, 1973, p. 41].

The new prescaler divides by four, and its output is in a range of more conventional integrated circuits. Like the other Fairchild-developed ECL parts, it incorporates both temperature and voltage compensation. Longo says that the circuit itself is the same as the one used in the company's non-Isopla-

nar 375-megahertz parts. The prescaler does incorporate tighter geometries and transistors of much higher frequency—more than 4 GHz instead of only 1 GHz as in 2-ns ECL 10K or 9500-type parts. Prototypes will be available in the second quarter. The only other 1-GHz integrated-circuit divider available commercially is made by Plessey Semiconductors Ltd.

Present temperature range is 0° to 70°C. Despite the high operating frequency, Longo says, power dissipation is not a problem. He attributes this partly to the Isoplanar technology with its low capacitances, resulting in a low speed-power product.

And Longo says, "I don't see 1 GHz as the limit. There is a large application at 1 GHz, however, and we don't intend to get into the microwave device situation where we make five of this part or 10 of another." □

## Medical

### Monitor warns of heart attack

Every day, more than a thousand heart-attack victims in the U.S., who might have been saved by prompt medical aid, die before reaching a hospital. What's needed is a way to detect early symptoms of acute heart attack and to let the patient know he must seek immediate guidance from his physician. And if he can't get medical aid, the monitor must guide the patient to self-administer emergency treatment.

This philosophy is incorporated in a device called the CardioBeeper, an electronic portable heart monitor developed by Survival Technology Inc., of Bethesda, Md. The CardioBeeper is about the size of a pocket calculator, so the cardiac-prone patient can carry it with him at all times. It is fitted with two small plastic electrodes at the end of a pair of wires. If he feels the onset of symptoms, or as part of a routine check, the patient places the elec-

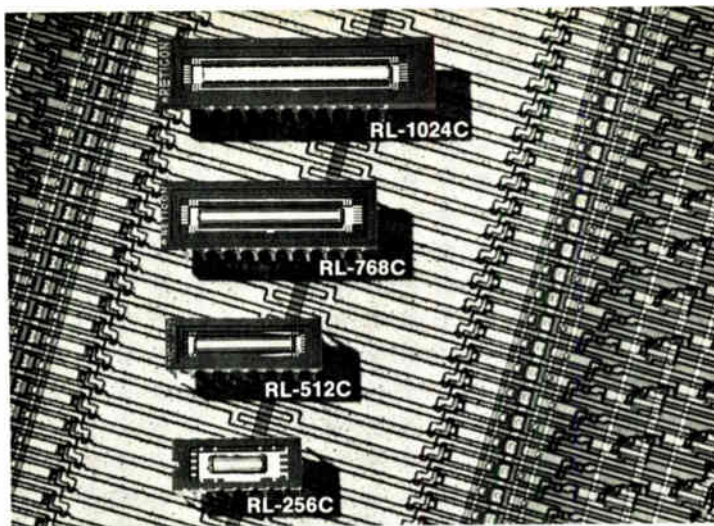

## Solid State Image Sensing

Reticon offers the most complete line of solid state image sensors for OCR, facsimile, page/document reader, film scanning, real time spectroscopy, non contact measurement and inspection applications.

High resolution of up to 1024 elements on 1 mil centers is available on a single monolithic chip with serial video readout. Charge storage mode operation provides high sensitivity with scan rates up to 10 MHz. Low power dissipation of less than 10 mwatts and the highest quality silicon gate process assures minimum dark currents and maximum dynamic range.

Circuit cards (RC series) containing complete drive and video amplifier circuits are also available from inventory for any Reticon image sensor.

Our RL256C through RL1024C devices are much improved pin compatible replacements for previous designs.

Write or call for detailed data sheets and external circuit information.

## RETICON®

450 E. Middlefield Road, Mountain View, CA 94043

(415) 964-6800 TWX 910-379-6552

HOTLINE (415) 964-3033

This SPECIAL OFFER is to introduce our "C" devices, which will be shipped complete with the RC series circuit cards providing all external drive and video amplifier circuits. Specify RL256C/RC, RL512C/RC, RL768C/RC and RL1024C/RC. Order must be received within 30 days from publication date and must be entered directly with the factory. Only one per customer. Offer is for U.S.A. domestic sale only.

**\$100/bit**  
 plus \$250 (for inclusion of complete drive & video circuitry)  
 as low as 25¢/bit in large OEM quantities

# Efficiency Experts

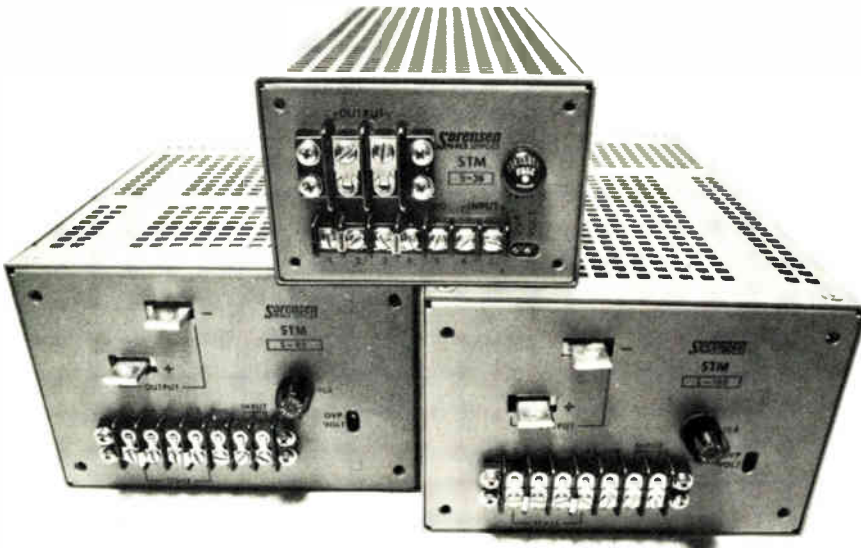

Built to save energy—modular STM switching-transistor power supplies from Sorensen. Exceptional power density and efficiency. Up to 1.5 watts per cu. in., and up to 75% efficiency in half the space of comparable competitive units. 40 models offer outputs from 72 to 780 watts (3 to 56 volts)—all with these features: cool running... excellent performance characteristics... built-in overvoltage protection... quiet operation... adjustable current limiting. For complete data, contact the Marketing Manager at Sorensen Company, a unit of Raytheon Company, Manchester, N.H. (603) 668-4500.

## Representative Specifications — STM

Regulation (comb line & load)	0.05%		
Ripple (PARD)	rms: 3 to 10 mv p-p: 30 mv, typ. 50 mv, worst case		
Module Sizes & Prices	Module	Size	Price
	III	5 1/2" x 3 3/16" x 9 5/8"	\$240-270
	III A	5 1/2" x 3 3/16" x 14"	\$300-330
	IV A	7 5/8" x 4 9/16" x 10 5/8"	\$475-495
	VI	7 5/8" x 4 9/16" x 14"	\$600-650

**Sorensen**  
POWER SUPPLIES

trodes under his armpits. The CardioBeeper differs from previous systems, which required a patient to wear the alarm unit continuously [*Electronics*, Aug. 2, p. 43].

**Red or green.** The device can operate in one of two modes. In the "beep" mode, the patient hears an audible tone at his own heart rate, and sees a flashing red or green light on the device. The audible signal tells the patient if his heart rate is irregular. The flashing light indicates if his heart rate is higher or lower than a preset standard. If any of these occur, the patient can call his doctor on the telephone, place the handset over the CardioBeeper, and in the EKG mode, transmit his electrocardiogram to the doctor's office. The physician is then able to instruct the patient on what further steps to take.

These further steps might include injecting himself with drugs from one or both of two automatic injector cartridges carried as part of the CardioBeeper kit.

**The circuit.** Heart of the CardioBeeper is a pair of integrated circuits designed and produced by ITT Semiconductors of West Palm Beach, Florida. They include a high-gain feedback controller amplifier with appropriate time constant to filter out the electrode noise, and comparators to measure the heart rate and determine if the rate set into the device exceeds that of a preset oscillator. Only the physician has access to the control that presets the oscillator. In the EKG mode, a voltage-controlled oscillator sends modulated tone bursts over a normal phone line to a decoder at the doctor's office.

The power supply is a 9-volt battery, and the circuit carries a test feature that warns the patient when about 90 minutes of battery life remain.

Although the distribution of the CardioBeeper and the drug-injector cartridges awaits approval by the Food and Drug Administration, Survival Technology has signed an agreement with Wyeth Laboratories, a Philadelphia, Pa., pharmaceutical company, which will market them. □

# Finally:

**A monolithic chopper-stabilized op amp.  
An offset voltage drift of  $0.2\mu\text{V}/^\circ\text{C}$ .  
An offset current drift of  $1\text{pA}/^\circ\text{C}$ .**

This new device is a true breakthrough—the industry's first monolithic chopper-stabilized op amp. And, in addition to its single-chip advantages, it offers the precision advantages of almost unbelievably low offset current and voltage drifts. And that's only the

beginning. The device incorporates a fully differential input, an initial offset voltage of less than  $50\mu\text{V}$ , an offset current of  $0.05\text{ nA}$ , and an open loop gain of  $5 \times 10^6$ . The gain bandwidth product is  $3\text{ MHz}$  and the slew rate is  $2.5\text{ V}/\mu\text{S}$ , while the CMRR and PSRR are both

$160\text{db}$ . Together, these features permit design applications in precision linear systems not feasible before with conventional monolithic amplifiers and hybrids.

This new device represents a major landmark in the development of Harris' expanding family of highly diversified monolithic linears. Its innovative design is the result of combining a number of advanced technologies into a standardized process, which permits volume production of a superior quality product. For more details see your Harris distributor or representative.

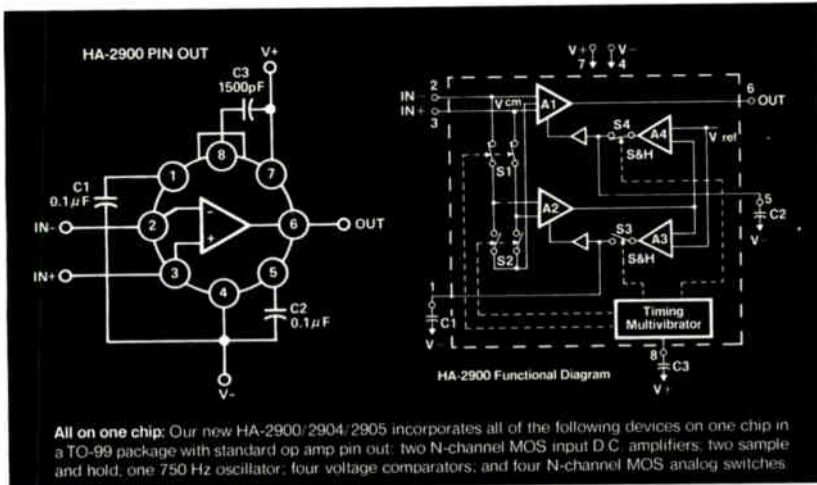

Supplied: TO-99 can with standard pin-out

Part Number	Temperature Range	Price (100-999 units)
HA-2900	$-55^\circ\text{C}$ to $+125^\circ\text{C}$	\$88.00
HA-2904	$-25^\circ\text{C}$ to $+85^\circ\text{C}$	\$71.50
HA-2905	$0^\circ\text{C}$ to $+75^\circ\text{C}$	\$55.00

# Harris



**HARRIS**  
**SEMICONDUCTOR**  
A DIVISION OF HARRIS-INTERTYPE CORPORATION

P.O. Box 883, Melbourne, Florida 32901  
(305) 727-5430

**WHERE TO BUY THEM:** ARIZONA: Phoenix—Liberty, Weatherford; Scottsdale—HAR (602) 946-3556 CALIFORNIA: Anaheim—Weatherford; El Segundo—Liberty; Glendale—Weatherford; Long Beach—HAR (213) 426-7687; Mountain View—Elmar; Palo Alto—Weatherford; HAR (415) 964-6443; Pomona—Weatherford; San Diego—Liberty COLORADO: Denver—Elmar; Weatherford WASHINGTON, D.C.: HAR (202) 337-3170  
FLORIDA: Hollywood—Schweber; Hamilton; Melbourne—HAR (305) 727-5430 GEORGIA: Atlanta—Schweber ILLINOIS: Chicago—Schweber; Schaumburg—HAR (312) 894-8824; Schiller Park—Hamilton INDIANA: Indianapolis—Pioneer KANSAS: Lenexa—Hamilton MARYLAND: Baltimore—Hamilton; Rockville—Schweber MASSACHUSETTS: Lexington—R&D; Waltham—Schweber; Wellesley—HAR (617) 237-5430 MICHIGAN: Livonia—Hamilton; Troy—Schweber MINNESOTA: Edina—Hamilton; Minneapolis—Schweber; HAR (612) 432-6111 MISSOURI: Hazelwood—Hamilton NEW JERSEY: Cedar Grove—Hamilton; Mt. Laurel—Hamilton; Somerset—Schweber NEW MEXICO: Albuquerque—Weatherford NEW YORK: Melville—HAR (516) 249-4500; East Syracuse—Hamilton; Syracuse—HAR (315) 463-3373; Rochester—Schweber; Westbury—Schweber  
NORTH CAROLINA: Raleigh—Schweber OHIO: Beachwood—Schweber; Cleveland—Pioneer; Dayton—Pioneer; HAR (513) 226-0636 PENNSYLVANIA: Wayne—HAR (215) 687-6680 TEXAS: Dallas—Hamilton; Weatherford; HAR (214) 231-9031; Houston—Weatherford WASHINGTON: Seattle—Liberty; Weatherford.

**LEGEND FOR HARRIS SALES OFFICES & DISTRIBUTORS:** Harris Semiconductor (HAR); Elmar Electronics (Elmar); Hamilton Avnet Electronics (Hamilton); Harvey/R&D Electronics (R&D); Liberty Electronics (Liberty); Pioneer Standard Electronics (Pioneer); Schweber Electronics (Schweber); R.V. Weatherford Co. (Weatherford); Western Radio (Western)

Circle 43 on reader service card

# Counters: Another new way to think of Tektronix

You get more quality, functions, and counting-time capability per dollar with the Tektronix DC 505 Universal Counter. This compact, dual channel counter performs virtually any counting-timing function up to 225 MHz.

Various functions include conventional frequency operation on channel A, ratio of channel A frequency to channel B frequency, period of signal B, time interval from channel A start to channel B stop, width of signal in channel B, number of events in channel A during channel B gate, and totalize. The DC 505 also features inde-

pendent selectable averaging factors and clock rates to 10 ns. By use of maximum averaging on width or interval measurements of repetitive waveforms, resolution to better than 100 picoseconds is possible. With all these features, the DC 505 is priced at only \$1195.

Other Tektronix counters in our expanding line include:

DC 501 Seven digit, 110 MHz counter and totalizer . . . . . \$ 550

DC 502 Similar to DC 501 with divide by 10 pre-scaler for counting to 550 MHz . . . . . \$ 895

- Frequency range: 225 MHz (both channels)
- Time interval: single-shot resolution to 10 ns
- Time interval averaging: resolution to 100 ps
- Repetitive pulse width measurements to 2.5 ns

Counter  
Price, \$1,195  
**Actual Size**

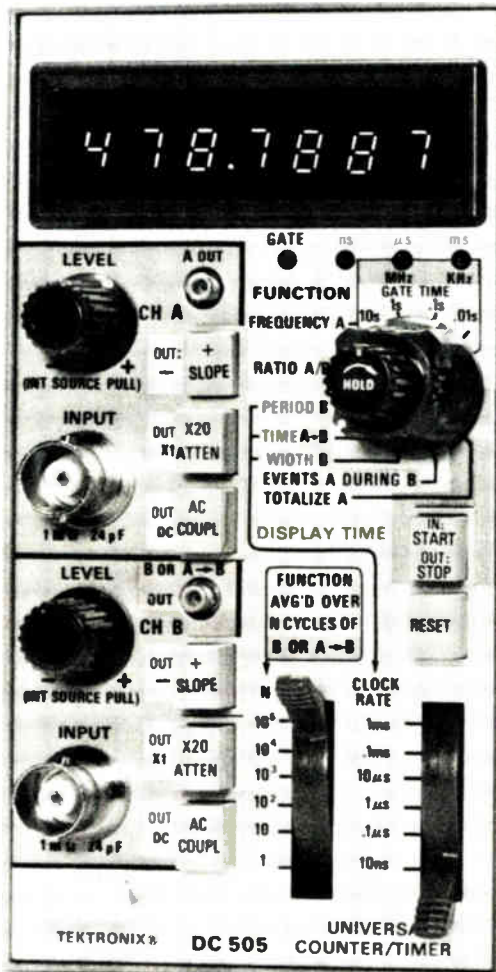

Simulated Display

DC 503 Seven digit, 100 MHz universal counter with dual channels .....\$ 695

DC 505 Seven digit, universal counter, 225 MHz on both channels .....\$1195

Tektronix offers many other test and measurement instruments in the TM 500 Series in addition to counters. These include: multimeters, power supplies, signal sources, signal processors, and CRT monitors. Presently, 24 general purpose modular test instruments are available with many more to come.

These instruments are interchangeable.

able. They plug into one compartment (\$115) or three compartment (\$150) power units. Instruments in the three compartment unit can be interconnected via a common interface board. This results in increased measurement capabilities and can actually produce synergistic effects. The TM 500 Series is based on the latest technology and proven principles developed in oscilloscopes. In addition, the TM 500 Series gives you more performance per dollar than competing instruments.

Send for a free brochure and spec sheets on counters, and our other

TM 500 test and measurement instruments. They're all new ways to think of Tektronix.

Write: Tektronix, Inc.  
P.O. Box 500  
Beaverton, Oregon 97005

In Europe write:  
Tektronix Ltd.  
P.O. Box 36  
St. Peter Port, Guernsey, C.I., U.K.



Digital Multimeter  
Price, \$395

Pulse Generator  
Price, \$995

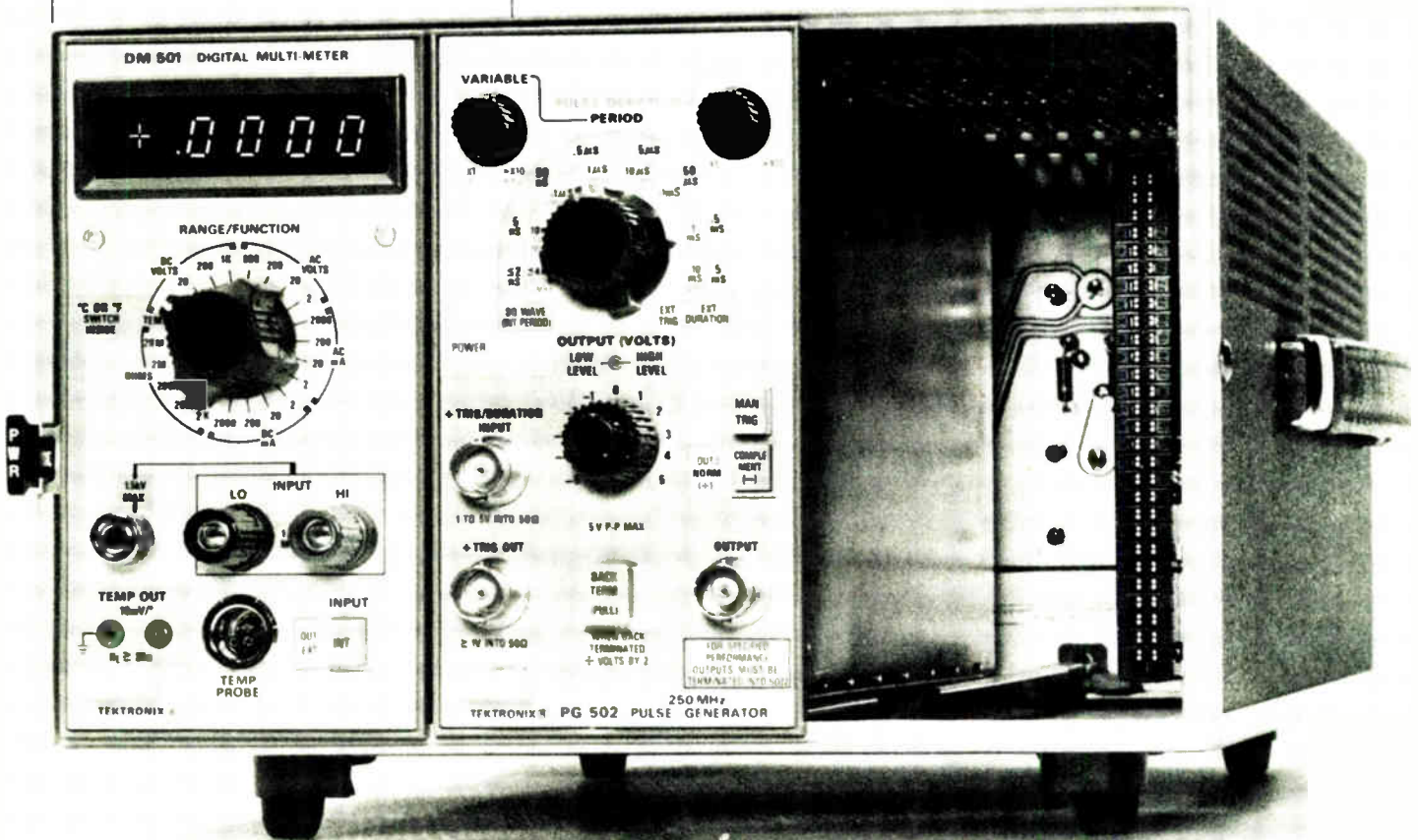

For a demonstration circle 44 on reader service card

Circle 45 on reader service card

# All kinds of thyristors.

## As simple as this:

No rationing. No sales by appointment. No waiting in line. No energy crisis.

In the face of an ever-increasing industry crunch on availability of SCRs, Triacs, unijunctions and trigger devices, Motorola has and will have the capability, deliverability and devices in nearly all current categories to keep you on top of your production lines in '74.

Our competition will say "exaggeration."

Because they can't boast a doubled '73 production capacity over '72 like Motorola can.

They didn't ship 100 million thyristors during the last 5 years . . . 30 million of that in one year like Motorola did.

They couldn't expand to 3 world-wide thyristor manufacturing locations like Motorola could.

They didn't add 418 new thyristor devices in the last 18 months to an existing broad line like Motorola did.

They can't ship from 1,000 to 100,000 of all devices listed on the next page within 4 to 6 weeks like Motorola ships.

And they've never been known as "production house of the industry." Motorola has. And will be through thick, thin and '74.

Prove it to yourself. Contact your Motorola distributor about quantities of any listed device.

He's got all kinds of them.

The factory's got all kinds of them.

They're all available . . .

## You can quote

Motorola has more Thyristor availability than any other supplier. Pick the series you need from the

### SCRs

Current Rating	GE Series	RCA Series	Motorola Series
800 mA	C103	—	2N5060
7 A	—	40654, 40655	MCR320
7 A	—	40833	MCR320
8 A	C122	40867-40869	2N4441
16 A	2N1842	2N1842	2N1842
20 A	C20	—	MCR3818
20 A	C22	—	MCR3818
20 A	C220	40737-40740	MCR3818
20 A	C222	40741-40744	MCR3918
20 A	—	40745-40848	2N6167
20 A	—	40749-40752	MCR3818
20 A	—	40753-40756	MCR3918
20 A	—	40757-40760	2N6167
25 A	2N681	2N681	2N681
35 A	C30	—	MCR3935
35 A	C31	—	MCR3935
35 A	C32	—	MCR3835
35 A	C33	—	MCR3935
35 A	—	2N3870-73	2N3870-73
35 A	—	2N3896-99	2N3896-99
35 A	—	40680-40683	2N6171
80 A	C45	—	MCR81
80 A	C147	—	MCR81

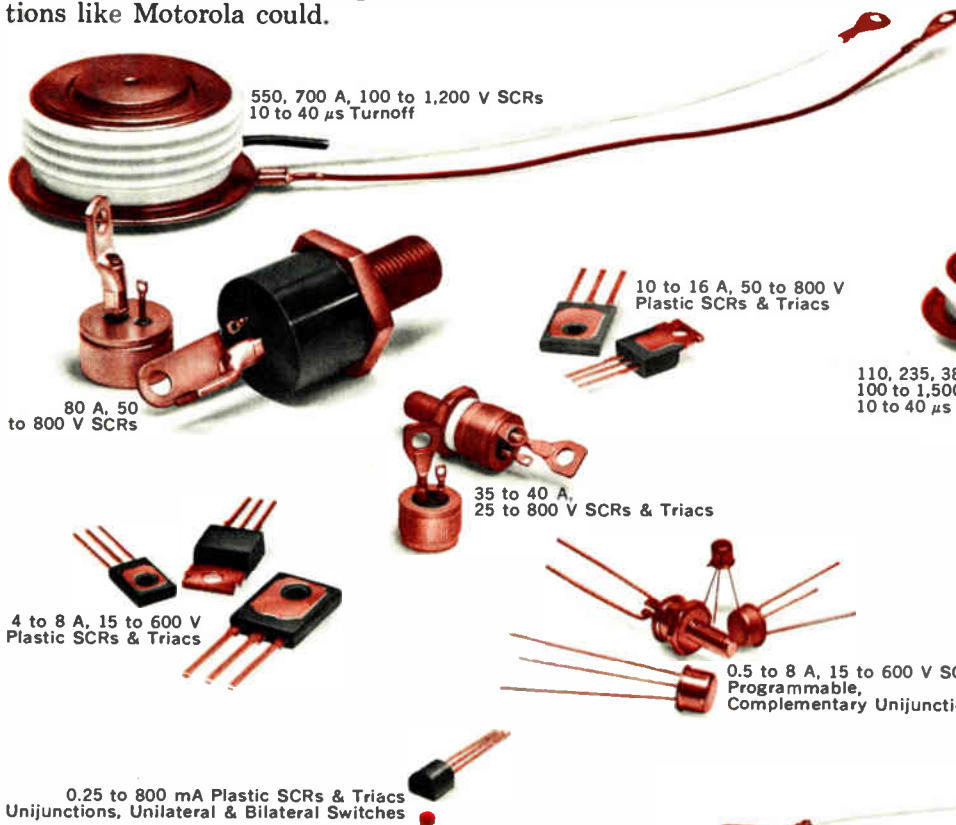

550, 700 A, 100 to 1,200 V SCRs  
10 to 40  $\mu$ s Turnoff

10 to 16 A, 50 to 800 V  
Plastic SCRs & Triacs

110, 235, 380 & 470 A,  
100 to 1,500 V SCRs  
10 to 40  $\mu$ s & Standard Speed

80 A, 50  
to 800 V SCRs

35 to 40 A,  
25 to 800 V SCRs & Triacs

4 to 8 A, 15 to 600 V  
Plastic SCRs & Triacs

0.5 to 8 A, 15 to 600 V SCRs  
Programmable,  
Complementary Unijunctions

20 to 30 A, 25 to 800 V  
Metal SCRs & Triacs

0.25 to 800 mA Plastic SCRs & Triacs  
Unijunctions, Unilateral & Bilateral Switches

*365-day*

# From Motorola, the thyristor



# All kinds of availability.

## us on that.

list below, fill in the coupon and find out for yourself.

With the quote we'll send our

latest brochure detailing Thyristor specs, characteristics, symbols, definitions, terminology, and cross-referencing of more than 350 indi-

vidual SCRs, Triacs, unijunctions and trigger devices.

There's a Motorola Thyristor to fit your design need in '74.

### Triacs

Current Rating	GE Series	RCA Series	Motorola Series
10 A	SC141	—	2N6151
10 A	—	40668-40669	2N6151
10 A	—	40842	2N6151
10 A	SC146	—	2N6151
10 A	SC240	—	2N5571-72
10 A	SC240-23	—	MAC40799-40801
10 A	SC241	—	2N5567-68
10 A	SC245	2N5569-70	2N5569-70
10 A	SC245-23	40799-40801	MAC40799-40801
15 A	SC246	2N5567-68	2N5567-68
15 A	SC250	2N5573-74	2N5573-74
15 A	SC251-23	40802-40804	2N6145
15 A	SC251	2N5571-72	2N5571-72
25 A	SC60	—	MAC38
25 A	SC61	—	MAC37
30 A	SC60-23	—	2N6163
30 A	—	40660-40661	2N6157
30 A	—	40662-40663	2N6157
30 A	—	40805-40807	2N6163

### High Current SCRs

RMS Current Rating	GE Series	Motorola Series
55 A	C45/46	MCR45/46
110 A	C50	2N1909-16
110 A	C60	2N2023-30
110 A	C52	2N1792-98
110 A	C62	MCR62
110 A	C150/152	MCR150/152
110 A	C154	MCR154
110 A	C155	MCR155
110 A	C156	MCR156
110 A	C157	MCR157
110 A	C158	MCR158
110 A	C159	MCR159
225 A	C354	MCR235A
225 A	C355	MCR235C
225 A	C358	MCR235D
275 A	C364	MCR380A
275 A	C365	MCR380C
400 A	C380	MCR380
400 A	C385	MCR380C
500 A	C387	MCR550D
500 A	C388	MCR550C
550 A	C392	MCR550C
550 A	C393	MCR550D
800 A	C390	MCR800
800 A	C501	MCR800



### UJTs & Triggers

Device	GE Series	RCA Series	Motorola Series
UJT	D5G515/2N2417A	—	2N4851
UJT	D5G516/2N2422A	—	2N4852
UJT	2N4221B	—	2N4948
PUT	2N6027	—	2N6027
PUT	2N6028	—	2N6028
DIAC	—	—	1N5758/A
DIAC	—	45411	1N5759/A
SBS	2N4991	—	MBS4991

Mail your *request-for-Thyristor-Quote* coupon to: Box 20912, Mail Drop TB 209, Phoenix, Az. 85036.

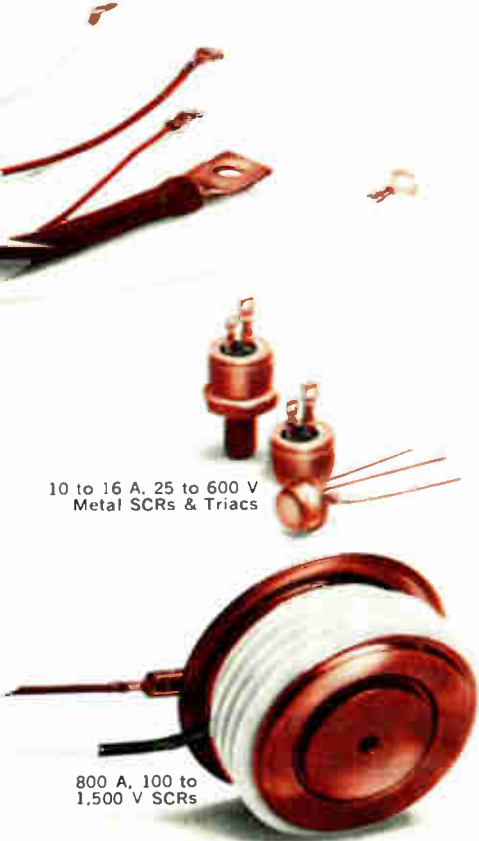

10 to 16 A, 25 to 600 V Metal SCRs & Triacs

800 A, 100 to 1,500 V SCRs

# producer.

Give me price and delivery on the . . .

Series/device:                      With these prime specs:                      In this quantity:

_____	_____	_____
_____	_____	_____
_____	_____	_____
_____	_____	_____
_____	_____	_____
_____	_____	_____
_____	_____	_____
_____	_____	_____
_____	_____	_____
_____	_____	_____

Name \_\_\_\_\_

Company \_\_\_\_\_

Address \_\_\_\_\_

City \_\_\_\_\_ State \_\_\_\_\_ Zip \_\_\_\_\_

# THE FIRST OF THE BIG COUNT TIMERS

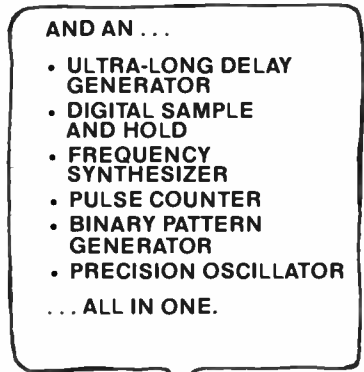
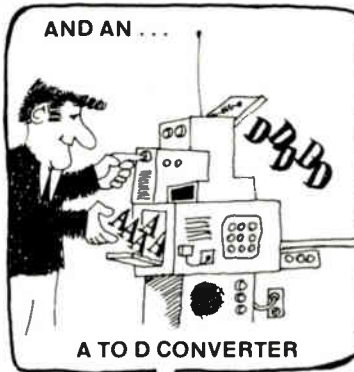
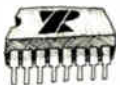
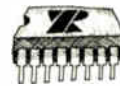
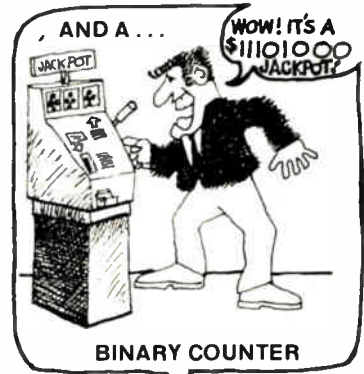
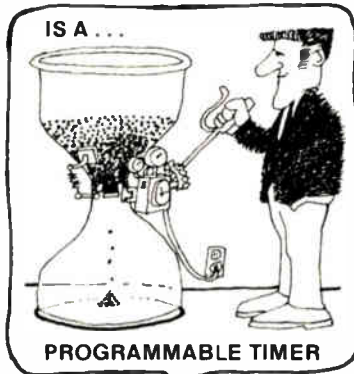
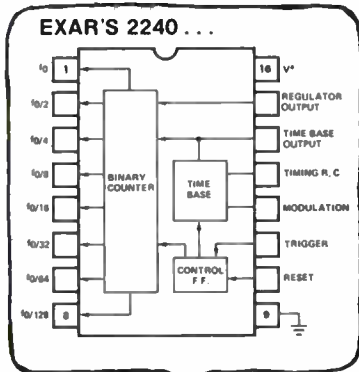

Exar's new XR-2240 counter/programmable timer solves so many tough problems that designers will unanimously agree that it's really the universal timer.

With its unique combination of analog and digital timing methods, you can now replace inadequate and complex assemblages of monolithic and electromechanical timers with the much simpler XR-2240. As a bonus, you get greater flexibility, precision operation, and a reduction in components and costs for most applications.

Because of built-in programmability, you can also use the XR-2240 for frequency synthesis, electronic music synthesis, digital sample and hold, A to D conversion, binary counting and pattern generation, and more.

With a single XR-2240 you can now generate pre-

cision time delays programmable from 1RC to 255RC, a range of microseconds to 5 days. By cascading only two XR-2240 timers, you can extend the maximum delay by a factor of  $2^N$ , where  $N = 16$  bits, resulting in a total delay of 3 years!

The XR-2240 operates over a 4V to 15V supply range with an accuracy of 0.5% and a 50 ppm/°C temperature stability. It's available in either a 16-pin ceramic or plastic dual-in-line package for military or commercial applications. Prices start at \$3.00 in 100 piece quantities.

For the more conventional timing applications, look to our other timers: the XR-220/230 timing circuit and the XR-2556 dual timers. Call or write Exar, the timer leader, for complete information.

**EXAR SPEAKS YOUR LANGUAGE**



**EXAR INTEGRATED SYSTEMS**

750 Palomar Sunnyvale, California 94086 (408) 732-7970 TWX 910-339-9233

EXAR DISTRIBUTORS Semiconductor Concepts: Woodland Hills: (213) 884-4560 Hauppauge, L. I.: (516) 273-1234 EEP Corporation: Culver City (213) 838-1912 Intermark Electronics: Sunnyvale: (408) 738-1111 San Diego: (714) 279-5200 Santa Ana: (714) 540-1322 Denver: (303) 963-8284 Seattle: (206) 767-3160 Graham Electronics: Indianapolis: (317) 634-8202 Lafayette: (317) 742-4006 Ft. Wayne: (219) 742-4346 Cincinnati: (513) 733-1661 Radio Electric Service Co.: Baltimore: (301) 823-0070 Gerber Electronics: Dedham: (617) 329-2400 Yankee Electronics Supply: Londonderry: (603) 625-9746

## **DOD seen using \$1.5 billion to bolster economy**

As much as \$1.5 billion of the Defense Department's record \$85.8 billion fiscal 1975 spending program could be employed to "accelerate" a sagging national economy, according to B.A. "Dolph" Bridgewater of the Office of Management and Budget. **Flight simulators for military pilot training are but one example cited by Bridgewater of where DOD funds could be pumped quickly into the industrial mainstream.**

The simulators—which would also contribute to reducing consumption of costly jet fuel in pilot training programs—are **budgeted in the coming year for expenditures of \$325 million.** Of that, \$200 million was "late additions" to the budget, says Bridgewater.

## **IBM readies new computer for space agency**

This spring, IBM will finish testing a developmental Space Ultra-reliable Modular Computer (SUM-C) and turn it over to NASA's Marshall Space Flight Center for possible use on the Space Tug planned for the 1980s. Basic building blocks of the 14-pound computer, as in the System 360, are low-power, bipolar LSI chips interconnected into multilayer, multichip, thick-film hybrid modules, the company says. **Major modules are the hybrid power supply, central processing unit, input/output section, and main memory, which has a maximum of 32,000 16-bit words with an 880-nanosecond cycle time.** The microprogramed control executes a standard instruction set.

## **Military command cuts spur officers to seek new jobs**

Washington contractor representatives are already being sounded out on the prospect of corporate job opportunities by an increasing number of disgruntled military officers. The reason: **More officers see declining opportunities for promotion and the prospect of forced retirement resulting from Defense Secretary James Schlesinger's plan to free more funds for hardware buys by cutting the fat out of the command chain.** With DOD's annual cost-per-soldier having doubled to \$11,000 since 1968, Schlesinger is moving swiftly to cut the 10-to-1 ratio of support to combat troops.

**The Army has been the first to feel the axe.** Schlesinger wants to expand it by two thirds of a division this year to 14 full divisions. To do that without any manpower increase, he has already ordered the phasing out of the Army Intelligence Command, Fort Meade, Md., over a six-month period, as well as five other headquarters commands in fiscal 1975.

## **NASA seeks color scanner for Nimbus G**

In March, NASA's Goddard Space Flight Center will ask interested firms to answer requests for proposals for development of a coastal-zone color scanner that will be put aboard the proposed Nimbus G environmental satellite. **Winning company, expected to be chosen during the summer, will build engineering, prototype flight, and flight models in a program funded at under \$10 million,** says NASA. The electronic scanner is a **six-band scanning radiometer operating in the visible, near-infrared and middle-infrared spectrum.** It will measure the temperature and various ingredients and pollutants of ocean water and currents. The Nimbus G craft is now slated for a 1978 launch.

## Redirecting defense R&D

Can state-of-the-art advances in electronics plus just plain improvements in equipment performance give the U.S. military a viable economic alternative to soaring aircraft costs? That question is not as self-serving of the interests of readers of this magazine as it at first appears, for an increasing number of the Pentagon's civilian leadership believe the answer is yes.

Consider, for example, the lightweight fighter. Competitive prototypes of the new Air Force plane are well along at General Dynamics, Fort Worth, Texas, and Northrop Corp., Hawthorne, Calif. Its critics ask, what good is it? As one of the Pentagon's crustier weapons specialists put it recently, "Match it up against any of the Russian high-performance fighters, and it will make no difference how much it cost. What good are thousands of inexpensive planes if they can't kill anything?"

In the Directorate of Defense Research and Engineering, the answer from the lightweight fighter's advocates—and they are increasing in number—is that the aircraft will be able to hold its own against high-performance opposition. And it will be able to do so because of a new and better radar that will go far to offset the lightweight fighter's aerodynamic limitations. Just such an advanced radar is now being developed competitively at Hughes Aircraft, Rockwell International, and Westinghouse Electric, and DDR&E is impressed with what it has seen so far.

### The new leaders

The lightweight fighter and the technological challenges it presents to makers of military electronics are but one example of the changing direction of weapons policies within the Department of Defense under its new leadership. For not only is there a new leader at the top in the person of secretary James R. Schlesinger, but there is whole new crew directing R&D. Heading DDR&E is laser specialist Malcolm R. Currie, an alumnus of Beckman Instruments and Hughes, while each of the services has a new assistant secretary for R&D.

Like Schlesinger and Currie, all of the three men have been in their Pentagon offices for less than a year. Norman Augustine came to the Army by way of McDonnell Douglas and LTV Aerospace; ocean scientist David S. Potter was previously with General Motors' Allison Diesel division, while physicist Walter LeBerge, now in the Air Force slot, has worked both with the Navy at China Lake, Calif., and with Philco-Ford.

Like his counterparts, the Army's Norman Augustine is concerned with what he calls the military's escalating "people costs." But the Army, with its all-volunteer force, is the service most heavily affected by pay and other personnel-benefits increases.

Moreover, increases in R&D spending, he points out, are 10 times more vulnerable to congressional surgery than personnel costs. As a consequence, Augustine believes "we need to improve systems we already have, not begin the costly R&D process all over again." U.S. contractors also must show "more eagerness to develop systems developed by our allies" if they can fulfill a mission requirement.

The Air Force's Walter LeBerge holds views much like Augustine's. His caution: "Industry must learn to fit technology into [existing] aircraft, rather than build all-new aircraft. The A-10, the F-15, and the F-111 are going to be around for a long, long time." Electronics will play a major role in upgrading such weapons.

### Guerillas in-house

The uniformed military chiefs are somewhat less than enthusiastic about this trend, of course, and they are struggling mightily to keep the R&D machine moving in the direction of new weapons, rather than toward improving the performance of older ones. The Air Force, in particular, is dismayed at the prospect that the lightweight fighter looms as a successor to the McDonnell Douglas F-15, and could possibly foreshorten its production run.

Some military bureaucrats are also disturbed at David Potter's interest in reexamining the Navy's need for 10 in-house laboratories staffed with 28,000 people and budgeted at more than \$1 billion a year [*Electronics*, Dec. 20, 1973, p. 49]. Potter's rationale is that more of the Navy labs' efforts should be performed by industry in peacetime "when production runs are short and competition is tough to maintain." This diversion of in-house funds to industry, Potter asserts, is required to hold successful industrial engineering operations together.

Those combinations of R&D views are already generating guerilla actions within the Pentagon by some unhappy military leaders. The irony of it all is that those brush fires—begun on the premise that Schlesinger and his subordinates are not doing enough—will pale by comparison with the upcoming budget battle on Capitol Hill. There the leadership of the Congress is convinced that DOD's record budget is again too much.

—Ray Connolly

# interface- ability

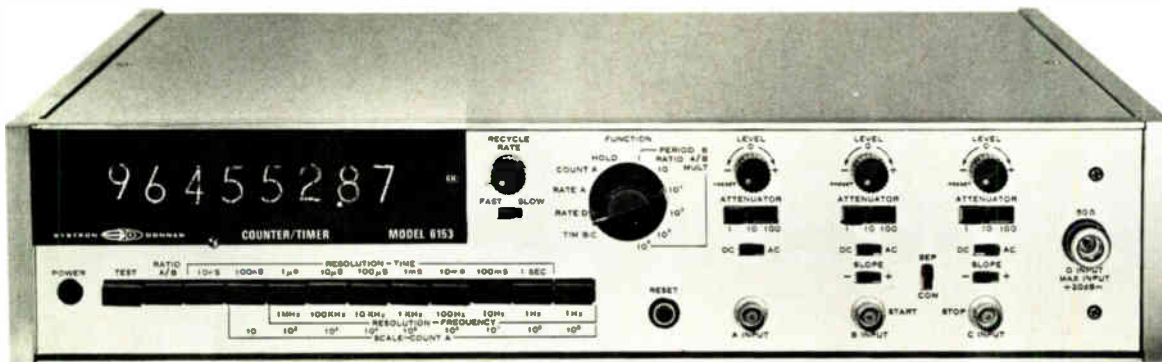
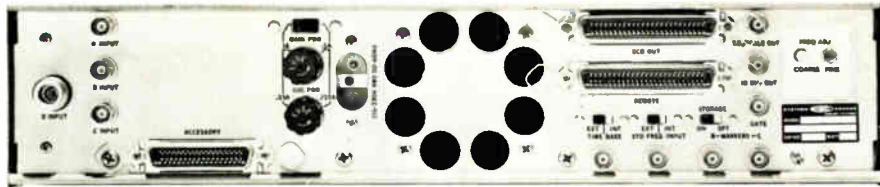

## Or why **systems people** buy more S-D counters

- 6 remote **programming** options
- 4 BCD** outputs (low and high level)
- Special codes, formats, logic levels
- Universal counter/timer functions
- 50, 200, 512 MHz, 3 GHz

For details or a demo on series 6150 counters, call your Scientific Devices sales and service office (listed below). Or contact Concord Instruments Division, 10 Systron Drive, Concord, CA 94518. Phone (415) 682-6161. In **Europe**: Systron-Donner GmbH, Munich, W. Germany; Systron-Donner Ltd., Leamington Spa, U.K.; Systron-Donner S.A. Paris (Le Port Marly) France. **Australia**: Systron-Donner Pty. Ltd., Melbourne.

SYSTRON  DONNER

Albuquerque, (505) 268-6729; Baltimore, (301) 788-6611; Boston, (617) 894-5637; Burlington, NC (919) 228-6279; Chicago, (312) 297-5240; Cleveland, (216) 261-2000; Denver, (303) 573-9466; Dayton, (513) 298-9904; Dallas, (214) 231-8106; Detroit, (313) 363-2282; Ft. Lauderdale, (305) 721-4260; Hamden CT (203) 248-9361; Huntsville, AL (205) 536-1969; Houston, (713) 623-4250; Indianapolis, (317) 783-2111; Kansas City, KS (913) 631-3818; Los Angeles, (213) 641-4800; Minneapolis, (612) 544-1616; New York City area (201) 871-3916; Norfolk, (703) 499-8133; Orlando, (305) 424-7932; Philadelphia, (215) 825-9515; Phoenix, (602) 834-1682; Rochester, NY (716) 334-2445; San Antonio, (512) 694-6251; San Diego, (714) 249-6642; San Francisco area (415) 964-4230; Seattle, (206) 454-0900; St. Louis, (314) 731-2332; Syracuse, (315) 457-7420; Washington, DC area (703) 451-6500

# Proven Ideal for Instrumentation Manufacturers!

## High Frequency Counters from PLESSEY.

Most leading manufacturers of 512 MHz counters have one great thing in common: Plessey high-speed divider circuits in the front end of their instruments. The reason for their unanimous choice? Plessey makes the best possible device for their application. Yours, too.

In fact, Plessey Semiconductors offers a comprehensive line of high-frequency dividers up to 1 GHz... all state-of-the-art... all ideal for virtually every counter application.

### Divide by 2, 4, 5 or 10

You can specify Plessey counter IC's to divide by 2, 4, 5 or 10. With some decade devices, you get BCD outputs, too. And you get guaranteed frequency of operation over the entire temperature range of 0°C to +70°C on commercial grades, -55°C to +125°C on MIL Grades.

### Higher Frequency, Lower Power Consumption

You've probably heard this statement from Plessey before. As usual, nobody even comes close to our input frequencies of up to 1,000 MHz. With an incredibly low power drain, as you can see from the tables.

### Plessey offers Custom Counters, too

Send for our data sheet with all the facts. Whatever your counter application, we bet you'll find Plessey has the best approach. And, in the rare case where we don't have a standard counter for your exact requirements, let us quote on a custom. For more information, write or call today. **You'll find it pays to specify Plessey.**

### YOUR CHOICE OF HIGH FREQUENCY COUNTERS

Type*	Modulus	Speed (MHz)**	Power Drain (mA typ)
SP600A & B	÷4	250	16
SP601A & B	÷4	150	16
SP602A & B	÷2	500	12
SP603A & B	÷2	400	12
SP604A & B	÷2	300	12
SP607B	÷2	600	12
SP613B	÷4	700	60
SP614B	÷4	800	60
SP615B	÷4	900	60
SP616B	÷4	1,000	60
SP620B	÷5	400	55
SP621B	÷5	300	55
SP622B	÷5	200	55
SP630B	÷10	600	70
SP631B	÷10	500	70
SP632B	÷10	400	70
SP634B	÷10 w/BCD outputs	700	80
SP635B		600	80
SP636B		500	80
SP637B		400	80

\* Guaranteed operating temperature for "A" types -55°C to +125°C, "B" types 0°C to +70°C.

\*\* Guaranteed input frequency range (sine wave).

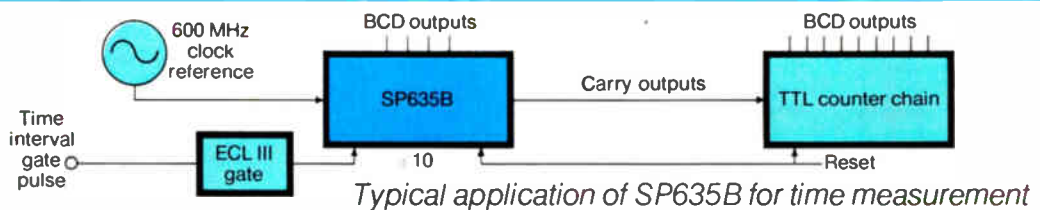
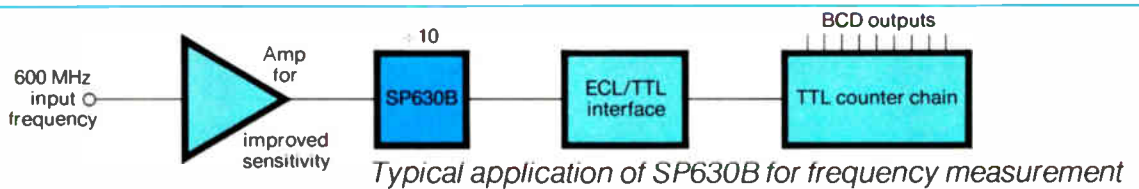

**PLESSEY SEMICONDUCTORS**

1674 McGaw Avenue, Santa Ana, California 92705, (714) 540-9945

## Philips develops systems for 3-d display of human-organ X rays

Researchers for Philips in West Germany have come up with two techniques—one is holographic and the other electronic—for 3-d radiographs of human organs. With the methods, patients need be exposed to only a small amount of radiation.

Developed by Gunther Groh and his team of co-workers at the Philips Research laboratories in Hamburg, the techniques are a big improvement over 3-d radiography—also called tomography—as practiced since the 1930s. In conventional tomography, only one layer of a 3-d image of an organ can be obtained at a time by moving the X-ray source over the patient in a pattern synchronized with a film cassette under the table to which he's strapped during the exposure. The difficulty, Dr. Groh says, is that the radiologist never knows precisely to which layer the X-ray source must be adjusted. This means that conventional tomography is often hit-or-miss with 20 or more exposure runs.

**Pulsed power.** The new Philips techniques are a way out of this dilemma. In both, the exposures are made by X-ray sources pulsed 24 or 48 times during one run. Thus, a series of different-perspective radiographs is obtained in only a few seconds. Then, by a process Philips calls tomosynthesis, discrete radiographs taken from the differently positioned X-ray source are superimposed to produce a complete 3-d picture. The synthesis of the images is made after the patient's X-ray treatment.

In storing the recorded radiographs and in superimposing them, the Philips techniques prove of most value. In holographic tomosynthesis, an image intensifier first records and stores the radiographs on 70-millimeter film. The individual radiographs are then imaged time-sequentially through a step-wise rotating photographic plate by

### Around the world

#### Robots find faults in telephone nets

Keeping pace with telephone maintenance in the overloaded Paris telephone system is a herculean task. The city has 1.5 million telephone lines—one third of the total French network—and it takes a full year to carry out a detailed fault check on the 165 separate exchanges. But by April 1, Paris telephone engineers will be using an automatic electronic fault-tracking system that will cut that 12 months of work to only 15 days. The system, Amalric, hardly could have come soon enough for the telephone administration, since, during the next four years, the number of Paris exchanges will be more than doubled to 400 in an effort to catch up with soaring demand for telephones.

Amalric replaces laborous manual tests with a computer-controlled network of test robots installed in each exchange. Each robot measures a series of 13 functions on as many as 10 test lines in each exchange. The robots measure such parameters as the delay interval before a dial tone is heard, the quality of the sound transmission, the proportion of misdirected calls, and the accuracy of the call charge mechanism. The test process is controlled by the computer, which transmits orders to all robots every second and receives replies sequentially at the same rate.

#### System to automate navy battle control

Construction has started on HMS Invincible, technically called a helicopter cruiser, but looking more like a small aircraft carrier. At 16,000 tons, it's the biggest ship to be built for the Royal Navy in a quarter century. Its missiles and helicopter—and possibly a small number of vertical-take-off Harrier fixed-wing strike aircraft, if the money is forthcoming to develop a naval version—will be sent into action and controlled by an extensive system of radars and sonars, computers and displays. The computer system is being supplied by Ferranti Ltd., the displays and probably the sonars by Plessey Co., and most of the radar installations will come from Marconi Co. The ship's function is mainly to control the operations of other ships—for instance, in convoy protection—and organize their joint defense against submarines and air attack.

a lens-projection system with a laser light source behind it.

By superimposing a spherical reference wave, a circularly arranged set of holograms, each having stored one radiograph, is recorded on the photographic plate. Then, by illuminating this composed hologram from a monochromatic point source, a 3-d image of the organ is reconstructed. This image is projected onto a frosted-glass plate that can be adjusted at will as to depth and orientation. Thus, a continuous set of tomograms can be inspected directly or on the TV monitor.

The electronic technique starts with the same set of radiographs.

But instead of being recorded on film, they are stored in the form of TV images on a magnetic video disk. These images, which represent the organ's individual layers, are then superimposed on one another in a storage tube. The correct amount of displacement of each image is calculated in a minicomputer to which coordinate data is fed from the revolving X-ray source.

The pictures of the different layers so synthesized are also stored on the video disk. From there, they are fed to the TV screen for display. With the electronic technique, images of 50 layers can be made seconds after the exposure cycle. □

# The standard voltage/current generator is programmable and employs a calibration-free, pulse-width modulation method.



- RANGE: OUTPUT VOLTAGE  $1\mu\text{V}$ -1199.999V; OUTPUT CURRENT 1mA-119.9999mA
- ACCURACY:  $\pm 0.001\%$  (DCV),  $\pm 0.004\%$  (DCA) TRACEABLE TO THE NATIONAL STANDARD
- STABILITY:  $\pm 0.0005\%$ -OF-SETTING A DAY
- PROGRAMMABLE BY 14 BUILT-IN MEMORIES, MANUAL AND EXTERNAL
- EXTERNALLY CONTROLLABLE
- CONTINUOUSLY VARIABLE OUTPUT SETTING

The 6120 is a standard voltage/current generator which employs a unique pulse-width modulation method (wherein the reference voltage is divided by pulse trains made by the logic circuits). Because of the pulse-width modulation method, the stability of the output is excellent and calibration-free.

The 6120 has 14 built-in memories into which output, limit level, polarity and range can be programmed. The programmed output can be taken out in either random, step, single-scan, or repeat-scan modes.

The 6120 is remotely controllable for systems application. The unique feature of the generator is its continuously variable 3 digits. Output setting of any 3 continuous digits can be continuously varied by one control switch. This is convenient in setting continuously varying output.

Thanks to these features, the 6120 has a wide range of application which includes application to an automatic test of components, and instruments such as variable capacitors, diodes, transistors, A/D converters, meters, PC boards, amplifiers and many others.

Illustrated below is one of the application examples.

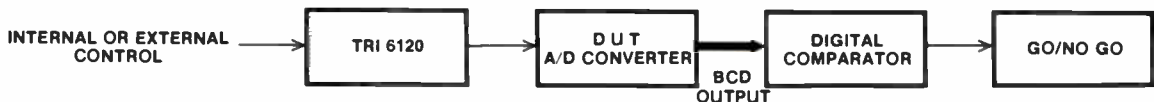

Programmed outputs in the 14 channels are fed into the input of the A/D converter in a desired scanning mode. The output of the BCD is then compared by the digital comparator. Compared linearity of the A/D converter is thus easily tested.

For further information and a demonstration, please call or write T.R.I. Corp.



505 West Olive Avenue • Sunnysvale, California 94086 • Tel: 408-733-9080



## Japan names satellite suppliers

The Japanese space agency has nailed down the suppliers of two of its three upcoming joint-venture satellites. A **General Electric-Toshiba team landed the \$40 million B-Sat experimental television satellite**, while Mitsubishi and **Philco-Ford, a late starter in the competition, beat out Nippon Electric Co., Hughes, and TRW for the Japanese Communications Satellite**. The JCS is a 1,550-lb spin-stabilized satellite designed to perform at 4, 6, 18, and 30 gigahertz. The program is budgeted at above \$30 million with \$20 million expected to go to the U.S. partner. **By the end of March, suppliers will be named for the third spacecraft**, an experimental test satellite called ETS-2. The small, 105-kilogram electronics communications package will be launched on the Japanese N rocket.

In announcing the B-Sat award, GE says that it will get \$30 million to build the 1,500-lb spacecraft, slated for launch into geostationary orbit in late 1976 or early 1977. **The satellite will use two Ku-band transmission channels to connect all of the Japanese islands via the government TV system**, "Tried and proven components are going into it" to run TV and audio transmission tests, GE says.

## Some RAF multi-role planes to get intercept radar

Marconi-Elliott Avionic Systems Ltd. will develop a **new airborne intercept radar for use in the British-German-Italian multi-role combat aircraft (MRCA)**. So far, it's intended only for MRCAs for the Royal Air Force and only a minority of them. The RAF expects to get upwards of 350 MRCAs, and so far is alone in planning to use some of them in an aircraft search and intercept defense role to replace Phantoms.

No cost or quantity figures for the new radar have been released, but Ferranti Ltd. is a major subcontractor and will develop the transmitter amplifier and the hydraulic antenna drives. **Signal processing and radar data handling will be digital**, probably sampling the signal at about 30 megahertz, digitizing to six or eight bits, and comparing digitized samples to derive information.

## Millimeter waveguide to be tested in West Germany

West German postal engineers are getting set to install a waveguide system for millimeter-wave communications over a 26-mile test link. The waveguide, to run between Heidelberg and Darmstadt, would have a **capacity equivalent to up to half a million voice circuits and have such low losses that no repeater-amplifiers are needed along the entire stretch**. By way of contrast, the post office says, the most modern coaxial cables designed for 60,000 telephone channels require repeaters at intervals of 1 mile or so. The new waveguide communications project follows an earlier one that the post office research institute started several years ago. It involved experiments with three different kinds of waveguides, each about 2 miles long, and the encouraging results obtained triggered the preparations of the current project.

Like the earlier systems, the Heidelberg-Darmstadt link will have a waveguide with a 7-centimeter inner diameter. Besides experimental communications, it will be used for checking out line repeaters built by a consortium of private firms and technical universities under a government-financed development project. The first repeater will be delivered this August.

## France puts finishing touches on computer net

France will have a nationwide network of 15 large interconnected scientific computers in experimental operation by year-end. **Dubbed Cyclades, the system is claimed to be comparable to the Arpanet** built by the Advanced Research Projects Agency in the United States.

The French network uses a packet message-switching technique handled by small Mitra-15 computers built by Compagnie Internationale pour l'Informatique. Four of the main data-bank computers are already linked up, enabling dialogue on scientific data from research laboratories, universities, and institutes in Rennes, Grenoble, Paris, and Toulouse. **Early next year, the project will move into a fully operational stage** with a total of 20 scientific computers linked by six switching units to five separate data-processing centers with their own terminals.

## British to supply undersea phone cables

**AT&T will buy over 4,000 nautical miles of undersea telephone cable for use in its projected transatlantic and transpacific links from Britain's Standard Telephones and Cables Ltd.** About 2,500 miles of the STC product will be used in the 3,600-mile link between the U.S. East Coast and France, and 1,500 miles in the 7,000-mile link from the West Coast to Okinawa. The deal is worth some \$50 million to STC.

**The Atlantic cable will be of a new type with a bandwidth of about 38 megahertz, well over twice the largest bandwidth already in use, which is 14 MHz on Cantat-2 across the Atlantic.** The main development necessary to accommodate the large bandwidth is a new polyethylene insulation to control high-frequency attenuation. **Capacity will be 4,000 telephone circuits.** Repeaters will be made by Western Electric, and terminal equipment by Compagnie Generale d'Electricite of France. The Pacific system will have a capacity of 845 circuits, and use established cable technology.

## Intermetall signs Rumanian deal

Intermetall GmbH, a member of the ITT Semiconductor group, has negotiated a long-term agreement under which it will supply Rumania with the necessary know-how to produce several million television tuner and switching diodes a year. Specifically, the deal provides for **an exchange of specialists with Rumanian production engineers to be trained at Intermetall's Freiburg facilities, and experts from the German company would help set up and get manufacturing lines going in Rumania.** The agreement, which is to run for five years, also calls for Intermetall to supply instructions as to the procurement and operation of the required production equipment, which is to be installed at Rumania's sole semiconductor plant, located in Bucharest.

## National Semiconductor makes waves in Europe

National Semiconductor is attacking the European microprocessor market with a vengeance. In the marketplace for just six months or so, **the company aims to corner 10% of the market by the end of next year.** That would mean several tens of millions of dollars in new business for National. In the last half of 1973, National's world sales reached over \$100 million. That's higher than for the whole financial year 1972-1973. At the same time, profits jumped from \$3.7 million in the whole year 1972-73 to \$7.3 million for the last six months of 1973. As John W. Jordan, European director, puts it: "We see fantastic growth. There is no reason for not doubling our figures again next year."

# how to get your money's worth in a \$495 function generator

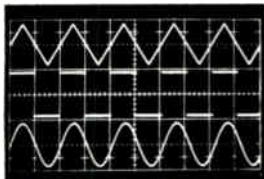
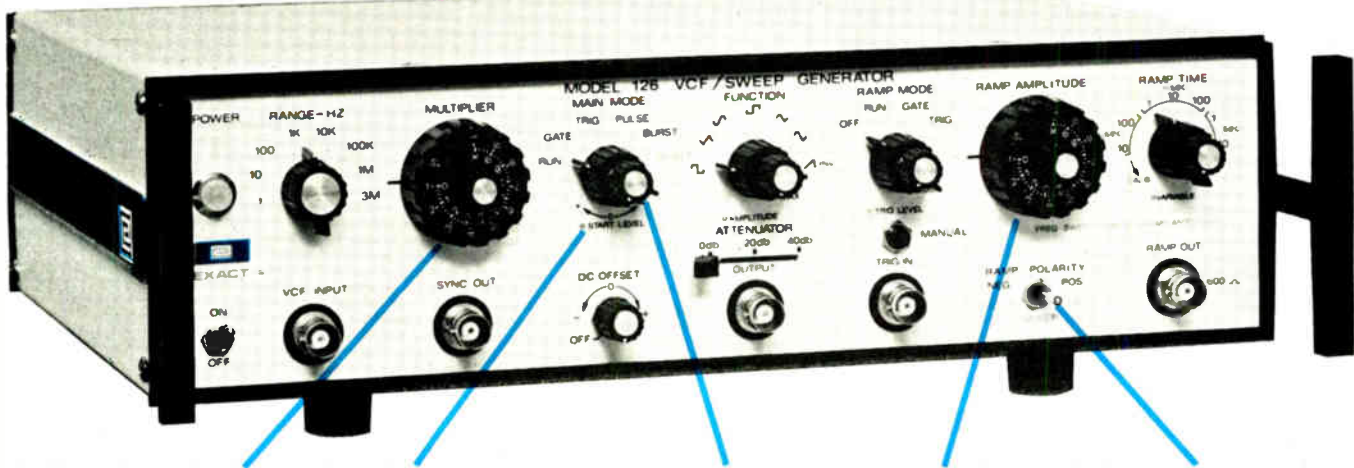

1. Precise Frequency Control with Kelvin-Varley divider that gives you 10-turn resolution and stability.

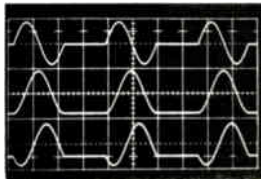

2. Variable Start/Stop control permits varying start/stop point 360 degrees in trigger, gate, pulse and burst modes.

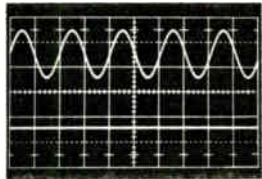

3. Get DC Signal Only out of the power amplifier to the output merely by using the trigger mode to switch off AC signal.

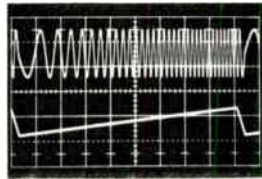

4. Calibrated Sweep Width control uses Kelvin-Varley divider to set stop frequency. Just select positive going ramp to sweep up, negative going ramp to sweep down, without measuring with a counter.

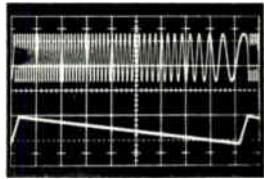

5. Sweep Up or Down the selected frequency range. Just select positive going ramp to sweep up, negative going ramp to sweep down.

## more reasons the Exact Model 126 VCF/sweep generator is the most waveform generator ever sold for \$495:

**TWO-IN-ONE.** A main generator for sine, square, triangle, pulse and sync, *plus* a ramp generator for sweeping or triggering the main generator, or for use as an independent signal source.

**WIDE BANDWIDTH.** 0.1 Hz to 3 MHz frequency range, with ramp time of 10  $\mu$ sec to 100 sec. (.01 Hz available on the main generator.)

**SWEEP.** Ramp generator can sweep main generator over a 1000:1 range. Sweep width adjustable from zero to 3 full decades.

**PULSE.** Independently variable width and repetition rate.

**TRIGGER/GATE.** Both generators can be triggered (one shot) and gated (burst) independently.

**SEARCH MODE.** Main generator can be swept manually over 3 decades.

**VERSATILE RAMP.** Ramp available at main output and via its own connector. (Convenient for x-y and Bode plots.) Ramp gate output connector on rear panel can be used as a pen lifter or for blanking or unblanking.

**COMPACT.** Only 3½" high, 12½" wide, 10½" deep. Weighs only 9 lbs. Simple maintenance because all components values, test points and calibration adjustments are printed on the P.C. card, identified and easily accessible.

**LOW COST.** Model 126 only \$495. Model 127 with 3-digit thumbwheel frequency dials, \$595. Model 128 with log sweep, ramp hold, 20 Hz-20 kHz range, \$695.

MODEL 127 DIGITAL-DIAL/SWEEP GENERATOR



\$595

MODEL 128 LIN-LOG/SWEEP GENERATOR

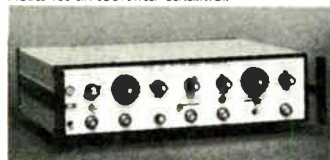

\$695

**EXACT**  
electronics, inc.

Box 160  
Hillsboro, Oregon 97123  
Telephone (503) 648-6661  
TWX 910-460-8811  
A subsidiary of  
Danalab, Inc

**INTERDATA  
ANNOUNCES  
A KICK  
IN THE TEETH  
FOR SOFTWARE  
SKEPTICS.**

# SIX NEW SOFTWARE PACKAGES FOR THE INDUSTRY'S FIRST 32-BIT MINICOMPUTER LINE.

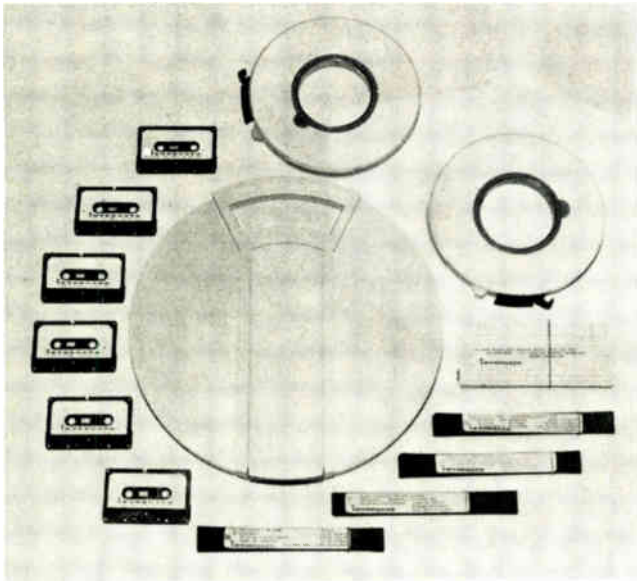

First came our new 32-bit 7/32 minicomputer. Up to a million bytes of directly addressable memory. Under \$10,000.

And the new 16-bit 7/16. PDP-11 performance at a Nova 2 price.

Now for the skeptics who think minicomputers never have powerful software:

Six new software packages that let you do all the things the hardware was designed to do.

Getting Interdata software is easy. We don't hamstring you with high prices or a restricting license deal. We sell it for a reasonable price and then back it up.

It's all available on our own cassettes, too. Simple. Convenient. Compact. The way you need it.

Best of all, we've gone to great lengths to do something nobody else has ever done—protect your software investment. Any software package you

OS/32 MT	A super-fast real-time operating system with a file handler to optimize storage utilization or access time. A multi-programming, multi-tasking scheduler that finds the place for your programs instead of making you worry about it.
OS/32 ST	An easy-to-use, comprehensive 32-bit program development oriented operating system that takes only 32K bytes of memory.
OS/16 MT	A small—as little as 4K bytes—operating system with multi-programming and multi-tasking capability, ISA real-time FORTRAN extensions, and all the capabilities you need to cut the cost of implementing your system.
FORTRAN V	Full FORTRAN V capabilities, yet requires only 24K bytes compared to other piggish 56K-byte FORTRAN V systems.
Multi-User Extended Basic	A low-cost, powerful multi-user system utilizing Extended Basic language that can support 4 users with less than \$10,000 of hardware. Can be expanded to support 32 users.
Utilities	A raft of utility software, including CAL, an assembler that optimizes your 16- or 32-bit code; EDIT, our new text editing package that simplifies maintenance of source files; OS Aids, new interactive debugging package that finds your program errors quickly and easily.

buy to run on one Interdata processor has been designed to run on any larger Interdata processor as well.

So don't spend a fortune on software only to watch it go up in smoke two years from now. At Interdata, we worry about your software when we're designing our hardware.

That's something even a skeptic can get excited about.

**● INTERDATA®**

2 Crescent Place, Oceanport, New Jersey 07757 (201) 229-4040.  
 New York - (201) 947-2200. Boston - (617) 890-0557. Washington - (703) 525-4806.  
 Pittsburgh (412) 941-5738. Philadelphia - (215) 436-5579. Orlando - (305) 851-6962.  
 Chicago - (312) 437-5120. Detroit - (313) 356-5515. Dayton - (513) 434-4193.  
 Kansas City - (913) 384-1606. Houston - (713) 783-3060. Dallas - (214) 238-9656.  
 Denver - (303) 758-0474. Los Angeles - (213) 640-0451. Phoenix - (602) 968-2477.  
 San Diego - (714) 565-0602. San Francisco - (408) 249-5540. Seattle (206) 455-0680.  
 Toronto - (416) 677-8990. Tokyo - (270) 7711. Sydney - 439-8400.  
 London - Uxbridge 52441. Munich - 0811-8543887.

Do you face a make or buy decision on power supplies? **BUY LAMBDA'S LZ SERIES MOUNTABLE POWER SUPPLY.**

LZS-34  
5V, 1400mA  
**\$95**



LZD-12  
± 15V, 50 mA  
**\$35**

LZD-35  
± 15V, 300 mA  
**\$95**

### LZ-10 SERIES SINGLE OUTPUT

MODEL	2½" x 3½" x ¾"		PRICE <sup>(2)</sup>
	VOLTAGE <sup>(1)</sup> VDC	CURRENT mA	
LZS-10	3	317	\$35
LZS-10	4	384	35
LZS-10	5	450	35
LZS-11	10	225	35
LZS-11	12	195	35
LZS-11	15	150	35

### LZ-20 SERIES DUAL TRACKING OUTPUT

MODEL	2½" x 3½" x 1¼"		PRICE <sup>(2)</sup>
	VOLTAGE <sup>(1)</sup> VDC	CURRENT mA	
LZD-21	± 3	217	\$55
LZD-21	± 4	258	55
LZD-21	± 5	300	55
LZD-22	±10	61	40
LZD-23	±10	114	55
LZD-22	±12	73	40
LZD-23	±12	129	55
LZD-22	±15	90	40
LZD-23	±15	150	55

### LZ-10 SERIES DUAL TRACKING OUTPUT

MODEL	2½" x 3½" x ¾"		PRICE <sup>(2)</sup>
	VOLTAGE <sup>(1)</sup> VDC	CURRENT mA	
LZT-36	5 ±15	500 50	\$70

### LZ-20 SERIES SINGLE OUTPUT

MODEL	2½" x 3½" x 1¼"		PRICE <sup>(2)</sup>
	VOLTAGE <sup>(1)</sup> VDC	CURRENT mA	
LZS-20	10	247	\$55
LZS-20	12	268	55
LZS-20	15	300	55
*LZD-22	24	73	40
*LZD-23	24	129	55
*LZD-22	28	84	40
*LZD-23	28	143	55

\*Single output ratings for dual output models connected in series

### LZ-30 SERIES SINGLE OUTPUT

MODEL	2½" x 3½" x 1¼"		PRICE <sup>(2)</sup>
	VOLTAGE <sup>(1)</sup> VDC	CURRENT mA	
LZS-30	3	633	\$65
LZS-30	4	767	65
LZS-30	5	900	65
LZS-33	10	293	65
LZS-33	12	336	65
LZS-33	15	400	65
LZS-34	3	950	95
LZS-34	4	1180	95
LZS-34	5	1400	95
*LZD-32	24	186	65
*LZD-32	28	208	65
*LZD-35	24	240	95
*LZD-35	28	280	95

\*Single output ratings for dual output models connected in series

# ...PRINTED-CIRCUIT BOARD

## LZ-30 SERIES DUAL TRACKING OUTPUT

MODEL	2½" x 3½" x 1½"		PRICE <sup>(2)</sup>
	VOLTAGE <sup>(1)</sup> VDC	CURRENT mA	
LZD-31	± 3	333	\$65
LZD-31	± 4	417	65
LZD-31	± 5	500	65
LZD-32	±10	163	65
LZD-32	±12	186	65
LZD-32	±15	220	65
LZD-35	±10	200	95
LZD-35	±12	240	95
LZD-35	±15	300	95

## LZ-30 SERIES TRIPLE OUTPUT

MODEL	2½" x 3½" x 1½"		PRICE <sup>(2)</sup>
	VOLTAGE <sup>(1)</sup> VDC	CURRENT mA	
LZT-36	5	500	\$70
	±15	50	

NOTES: (1) LZ models are adjustable between the following limits: LZS-10 2.5 to 6V LZS-11 8 to 15V LZS-20 8 to 15V LZS-30 2.5 to 6V LZS-33 8 to 15V LZS-34 2.5 to 6V LZD-12 ± 14.5 to ± 15.5V LZD-21 ± 2.5 to ± 6V LZD-22 ± 8 to ± 15V LZD-23 ± 8 to ± 15V LZD-31 ± 2.5 to ± 6V LZD-32 ± 8 to ± 15V LZD-35 ± 8 to ± 15V LZT-36 2.5V-6V for + 5V output only, ± 14.5 to ± 15.5 for ± 15V output only. Contact factory for current ratings at voltage settings not indicated in the tables. (2) All prices and specifications are subject to change without notice.

## SPECIFICATIONS FOR LZ SERIES

### Regulation

0.15%—line or load; models LZS-10, LZS-30, LZS-34, LZD-21 and LZD-31 have load regulation of 0.15% + 5mV; model LZD-12 has line or load regulation of 0.25%; LZT-36 line regulation 0.15% (±5V) 0.25% (±15V); load regulation 0.15% + 10mV (+5V), 0.25% (±15V).

### Ripple and noise

1.5mV RMS, 5mV, pk-pk

### Temperature coefficient

0.03%/°C

### Overshoot

no overshoot on turn-on, turn-off, or power failure

### Tracking accuracy

2% absolute voltage difference for dual output models only and only for the ±15V output in LZT-36; 0.2% change for all conditions of line, load and temperature

### Ambient operating temperature range

continuous duty from 0°C to + 50°C

### Wide AC input voltage range

105 to 132 Vac, 57-63 Hz

### Storage temperature range

-25°C to +85°C

### Overload protection

fixed automatic electronic current limiting circuit

### Input & output connections

printed circuit solder pins on lower surface of unit. For model LZT-36 the ± 15V outputs are independent from the 5V output.

### Controls

screwdriver voltage adjustment over entire voltage range.

### Mounting

tapped holes on lower surface

### Physical data

Size

see tables

Weight

LZ-10 series 10 oz. net 18 oz. ship.

LZ-20 series 17 oz. net 25 oz. ship.

LZ-30 series 24 oz. net 32 oz. ship.

### 60-day guarantee

60-day guarantee includes labor as well as parts

## LZ SERIES NOW AVAILABLE IN NEW TRIPLE OUTPUT MODEL



MODEL	VOLTAGE <sup>(1)</sup> VDC	CURRENT mA	PRICE <sup>(2)</sup>
LZT-36	5V	500	\$70
	±15V	50	

**1 DAY DELIVERY  
60 DAY GUARANTEE**



**LAMBDA  
ELECTRONICS CORP.**

A  Company

MELVILLE, NEW YORK 11746 515 Broad Hollow Road Tel. 516-694-4200 ARLINGTON HEIGHTS, ILL. 60005 2420 East Oakton St. Unit Q Tel. 312-593-2550 NORTH HOLLYWOOD, CALIF. 91605 7316 Varna Ave. Tel. 213-875-2744 MONTREAL, QUEBEC 100C Hymus Blvd., Pointe Claire, Quebec 730 Tel. 514-697-6520 HIGH WYCOMBE, BUCKS, ENGL. Abbey Barn Road, Wycombe Marsh Tel. High Wycombe 36386/7/8 ORSAY, FRANCE 91 Gometz le Chatel.

Circle 61 on reader service card

# PDP-8's going after you

Here we are again with some more good news for OEM's.

PDP-8 price reductions of up to 40% for single units. Plus quantity discounts of up to 36%.

But that's not the half of it. Our Standard-8 OEM systems can be had for less, too. (Complete hardware and peripheral packages at a bargain price.)

And many dollars off on interfaces.

And peripherals. Save big on software, too. Surprised? You shouldn't be. This sale is only part of our never-ending OEM campaign to make more computer cost less. What

**PDP-8/M (4K)**  
(Programmer's console)

**WAS**  
**\$2,554**  
**NOW**  
**\$2,432**

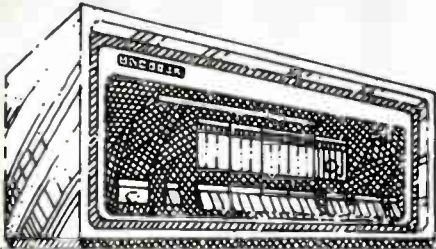

**PDP-8/M (8K)**  
(Programmer's console)

**WAS**  
**\$3,296**  
**NOW**  
**\$2,688**

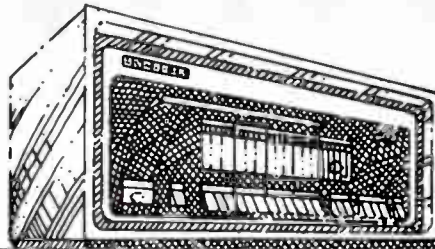

**PDP-8/M (16K)**  
(Programmer's console)

**NEW**  
**\$3,712**

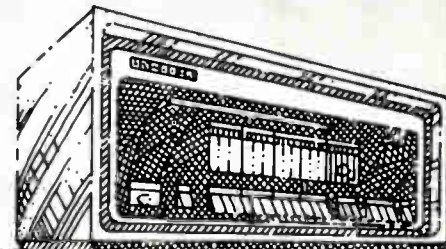

**PDP-8/M (4K)**  
(Operator's panel)

**WAS**  
**\$2,362**  
**NOW**  
**\$2,048**

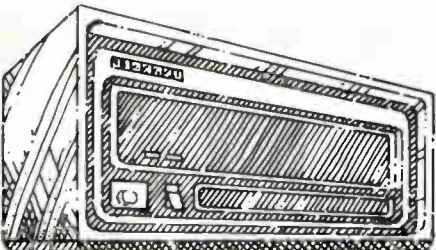

**PDP-8/M (8K)**  
(Operator's panel)

**WAS**  
**\$3,104**  
**NOW**  
**\$2,304**

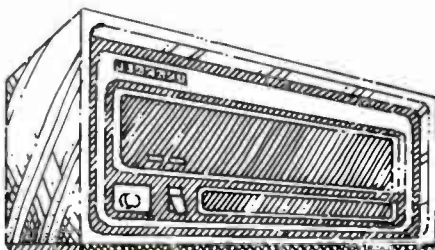

**PDP-8/M (16K)**  
(Operator's panel)

**NEW**  
**\$3,328**

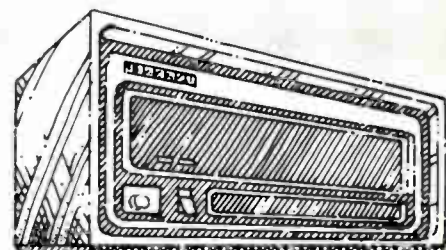



# OEM business sale. Part 3.

you see here is simply Digital doing it again. (8M, KL8-J, MR8-F, TA8 and PROM 8-M prices in quantities of 100.) Delivery 60 days.

Write. Or call. Digital Equipment Corporation, Maynard, Mass. 01754. (617) 897-5111, Ext. 3185. European headquarters: 81 route de l'Aire, 1211 Geneva 26. Tel: 42 79 50.

Digital Equipment of Canada Ltd., P.O. Box 11500, Ottawa, Ontario K2H 8K8. (613) 592-5111.

**digital**

Circle 63 on reader service card

STANDARD-8 (8K)  
 WAS  
**\$21,735**  
 NOW  
**\$18,000**  
 (before discount)

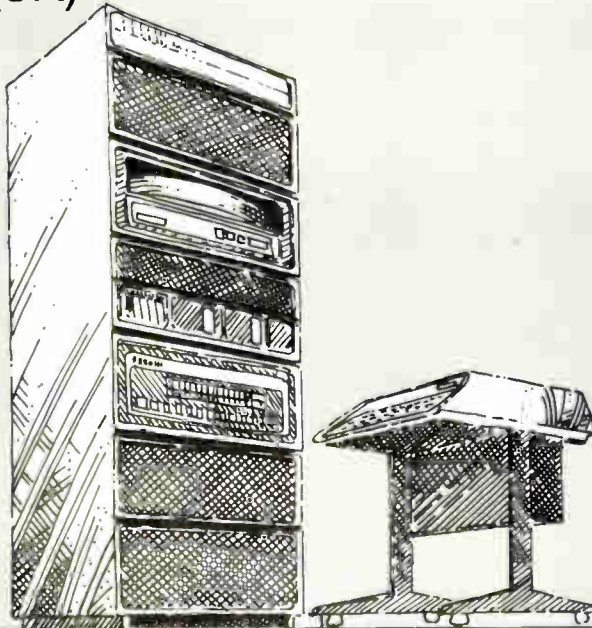

PROM-8/M (1K)  
**\$1,760**  
 PROM-8/M (2K)  
**\$2,240**

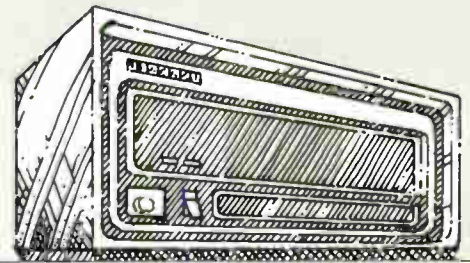

OS-8 III  
**\$300**  
 (before discount)

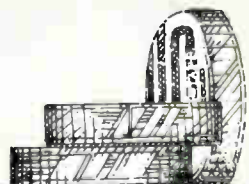

FORTRAN IV  
**\$700**  
 (before discount)

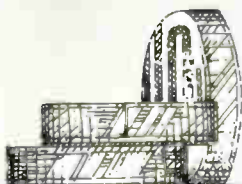

KL8-J  
 (Communication interface)  
**\$272**



MR8-F  
 (Programmable read-only memory)  
**\$800**

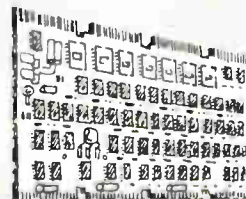

TA8  
 (Cassette)  
**\$2,496**



# Centralab perspectives

FOR USERS OF ELECTRONIC COMPONENTS



CENTRALAB

Electronics Division  
GLOBE-UNION INC.

5757 NORTH GREEN BAY AVENUE  
MILWAUKEE, WISCONSIN 53201

## Ceramic capacitors are now available with lead times as short as 6 weeks.

In the last year, Centralab increased production and established a new distribution center. That means they have larger inventories of quality ceramic disc capacitors to meet today's requirements.

In January 1973, when industry-wide lead times on capacitor deliveries were at an unprecedented high, Centralab took positive action. As a result, today they are able to assure the electronics buyer of 12 to 16 week delivery on any of their broad line of reliable disc capacitors. And some types in 6 weeks!

The first step in Centralab's Capacitor Service Program was a drastic one. In January 1973 they began refusing orders rather than accepting them for extended delivery. They then moved to bring to full production a new capacitor assembly plant in Juarez, Mexico. To provide dual sources for raw fired ceramic discs, they increased capacity at their plants in Milwaukee and Mexico City. At the same time, a new Service and Distribution Center was established in El Paso, Texas. Its 40,000 square feet provided for broadening capacitor inventories received from Centralab's five manufacturing locations.

Within six months most large OEM orders were on schedule, the backlog reduced and, with inventories of selected types available, orders were again accepted. Today, with inventories of all types and production facilities running at full capacity, Centralab offers capacitor buyers the only reasonable answer to meet their requirements. A buyer placing an order at the beginning of his 13 or 20 week planning cycle, for example, can be certain of on-time delivery of the types he needs.

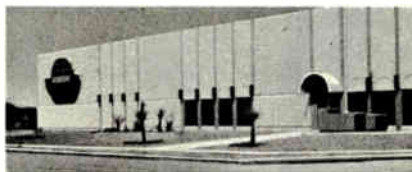

Located just across the border from Centralab's Distribution Center in El Paso, this Juarez, Mexico plant has helped shorten lead times on capacitor delivery.

Centralab's Distribution Center in El Paso is a key reason why today they can provide better service on capacitor orders. Its 10 man customer service staff is equipped to handle any capacitor delivery problem from order entry through special shipments. An application engineering staff is also on call to help with design problems. After reviewing a cus-



Inventories of Centralab capacitors from its Distributor Products stock in Menomonee Falls, Wisconsin are in addition to those in the 40,000 square foot Distribution Center at El Paso to assure customers of off-the-shelf delivery.

tomers' specifications, for example, they may even be able to recommend stock types which eliminate the need for special requirements. That could be important when delivery is critical.

Customer service is important — to the buyer and to Centralab. It requires more than fancy promises. It takes positive action. Centralab has done just that to help you meet your capacitor needs. For further information or assistance, call Bob Michaels at 915/779-3966 or write Centralab, Milwaukee.

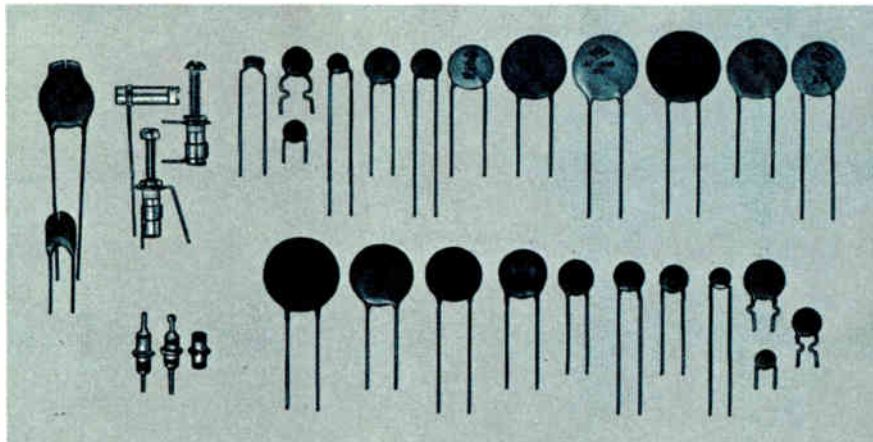

The extensive line of Centralab capacitors includes both disc and tubular types, with sizes and ratings designed for a variety of functions.

## Centralab perspective:

### WHEN THE CHIPS ARE DOWN WE DELIVER!



CAPACITORS  
THAT IS

We said it and we meant it. We're USCC/Centralab and we said we were preparing to meet the capacitor delivery crisis by substantial commitment to automated production machinery and facilities expansion.

We did it, and we've got the chips to prove it — ELEVEN MILLION in stock, most in the following popular sizes:

- BC - .080±.010x.050±.010
- BF - .100±.010x.050±.010
- BI - .150±.010x.050±.010
- DJ - .180±.010x.080±.010
- FH - .125±.010x.095±.010

We'll also deliver non stock and custom chips in not more than 8 to 12 weeks A.R.O.

Whether it's an immediate or future requirement, contact our applications engineering department now at (213) 843-4222.

USCC/Centralab  
2151 N. Lincoln Street  
Burbank, California 91504



## Centralab perspective:

### Rotary switches.

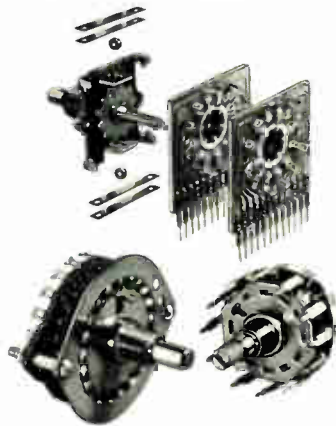

### Designed with human factors in mind.

Select a Centralab miniature or sub-miniature rotary switch and you meet human engineering requirements three ways:

1. **EASY TO SET** — operation is with a natural wrist motion for quick and precise changes from one setting to another.
2. **CONTROLLED TORQUE** — light, medium or heavy feel to suit operator's touch. Dual ball side thrust index and adjustable springs provide variable torque.
3. **PANEL GRAPHICS** — space-saving mounting, best appearance. Choice of degree throw from 15° minimum to 120° maximum.

Open-frame rotary switches give you more switching for your dollar. That's a human factor too. Contact Centralab for Bulletin EP2197.



## Centralab perspective:

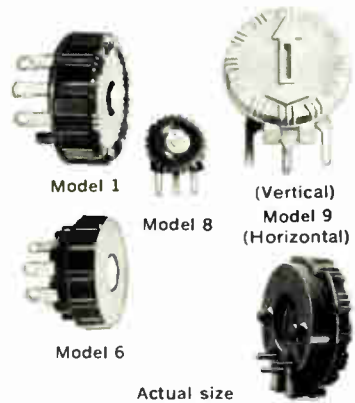

### Miniature pots at a mini-price.

Centralab gives you more to choose from in miniature potentiometers. Take the 1/8 watt, 45/64" dia. Model 9 for example. Typical pricing, in production quantities of 1000, is 34¢. That's economy because you also get:

- Rotational life in excess of 25,000 cycles.
- Choice of mountings — perpendicular or parallel plug-in.
- Resistance Range — 100 ohms to 10 megohms.
- Adjustability — Knob edge or screwdriver slot.
- Tolerance — ± 20%

For quantities under 250 contact your local Centralab Distributor.

Three other miniature potentiometers in the Centralab line of standard controls are:

- Model 1 — 5/8" dia. 1/8 watt (Available with switch)
- Model 6 — 1/2" dia. 1/10 watt (Available with switch)
- Model 8 — 9/32" dia. 1/10 watt

Get complete specifications on all four. Write Centralab for Bulletin No. EP2184.



# Design

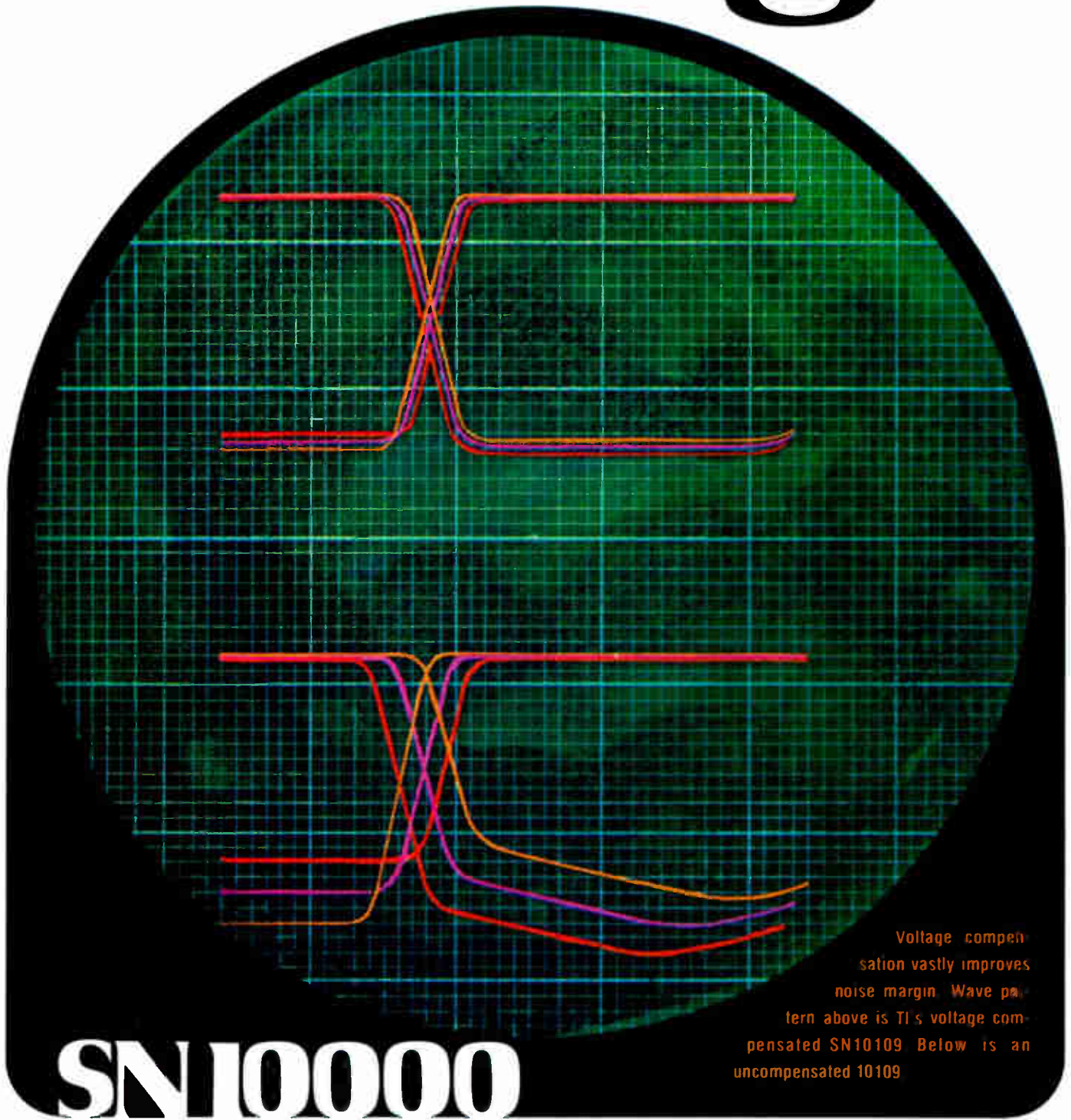

# latitude

**34 voltage compensated ECL functions ease power distribution constraints...up to  $\pm 10\%$ .**

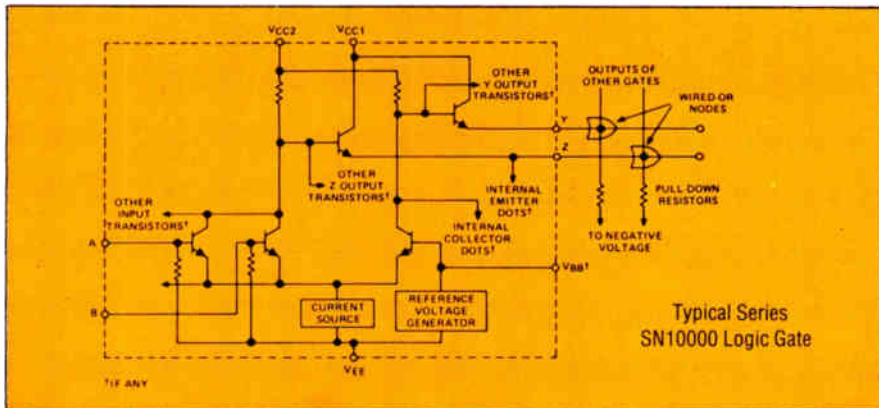

Most ECL functions on the market today are not voltage compensated. Texas Instruments SN10000 devices are. All 34 of them.

Here are some reasons why:

Voltage compensation improves noise margin – by as much as 140%. It also increases power distribution tolerance – up to  $\pm 10\%$  – giving you greater design latitude.

SN10000 devices also let you reduce your system IC count. Especially over logic forms that do not offer complementary OR/NOR outputs with wired-OR connection capability. Conventional or controlled circuit boards can be used.

So voltage compensated SN10000 devices offer you both relaxed design rules and reduced system costs. Plus, you get high ECL speed (2 ns) with low power (25 mW/gate). And, pin-for-pin compatibility with other 10000 families. Operation is guaranteed from 0° to 85° C.

SN10000 devices are available now in 16-pin plastic, dual-in-line packages through TI distributors or directly from Texas Instruments.

For a data sheet booklet covering the SN10000 Series, write on company letterhead to Texas Instruments Incorporated, P. O. Box 5012, M/S 308, Dallas, Texas 75222.



## Gates, Drivers and Receivers

	100-Piece Price	
SN10100	Quad 3-Input NOR Gate (One Input Common).....	\$1.40
SN10101	Quad 2-Input OR/NOR Gate (One Input Common) .....	1.40
SN10102	Quad 2-Input Gate (3 NOR, 1 OR/NOR) .....	1.40
SN10103	Quad 2-Input Gate (3 OR, 1 OR/NOR) .....	1.40
SN10104	Quad 2-Input AND Gate .....	1.76
SN10105	Triple OR/NOR Gate (2, 3, 2 Inputs) .....	1.40
SN10106	Triple NOR Gate (4, 3, 3 Inputs) .....	1.40
SN10107	Triple 2-Input Exclusive OR/NOR Gate .....	1.76
SN10109	Dual OR/NOR Gate (4, 5 Inputs) .....	1.40
SN10110	Dual 3-Input OR Line Driver .....	1.76
SN10111	Dual 3-Input NOR Line Driver .....	1.76
SN10112	Dual 3-Input OR/NOR Line Driver .....	1.76
SN10115	Quad Line-Receiver .....	1.40
SN10116	Triple Line-Receiver (Complementary Outputs) .....	1.40
SN10117	Dual 2-Wide 2-3 Input OR-AND/OR-AND Invert Gate .....	1.76
SN10118	Dual 2-Wide 3-Input OR-AND Gate .....	1.76
SN10119	4-Wide 4-3-3-3 Input OR-AND Gate .....	1.76
SN10121	4-Wide 3-Input OR-AND/OR-AND Invert Gate .....	1.76

## Complex Functions

SN10124	Quad TTL to ECL Translator .....	3.66
SN10125	Quad ECL to TTL Translator .....	3.66
SN10130	Dual D-Type Latch .....	3.66
SN10131	Dual D-Type Master Slave Flip-Flop .....	4.78
SN10132	Dual D-Type Latch .....	3.80
SN10160	12 Bit Parity Checker/Generator (Odd) .....	5.61
SN10161A	3 to 8 Line Decoder (1 of 8 Lines Low) .....	4.92
SN10164A	8 to 1 Multiplexer .....	5.61
SN10174A	Dual 4 to 1 Multiplexer .....	5.61
SN10175	5 Bit Register .....	5.61
SN10179A	Carry Look-Ahead .....	5.61
SN10184	Quint ECL to MST Translator .....	5.61
SN10185	Hex MST to ECL Translator .....	5.61

## Memories

SN10140JE	64 x 1 RAM (15 ns) 90 $\Omega$ Load .....	10.00
SN10147JE	128 x 1 RAM (15 ns) 50 $\Omega$ Load .....	15.00
SN10148JE	64 X 1 RAM (15 ns) 50 $\Omega$ Load .....	11.88

**TEXAS INSTRUMENTS**  
INCORPORATED



## Budget aims to counter recession

Electronics opportunities exist in record defense request; NASA gets a boost, too, but inflation and pay hikes minimize real growth.

### How do you define a recession?

Secretary of the Treasury George Shultz specifically evaded answering that question during a weekend of February press briefings that preceded the delivery of president Nixon's Federal budget to the Congress. But, however it may be defined, the Nixon spending program for fiscal 1975, which begins July 1, is designed hopefully to counter a slide in the national economy.

The new Nixon budget, with its recommended 11% increase in Federal outlays to a record \$304.4 billion, reflects a number of other changes in the President's attitudes, as well. For example, the document contrasts sharply with that submitted to the Congress a year ago. Then it was a confident Richard Nixon, flushed with a great political victory, seeking to cut back sharply in the size of the Federal bureaucracy and eliminate what he believed were unnecessary Federal programs. That fiscal 1974 budget was followed by a string of vetoes of

Congressional appropriations and continued impounding of appropriated funds.

Now, troubled by Watergate, an energy shortage, a continuing inflationary spiral, and rising unemployment, Richard Nixon is trying to leave his fiscal options open in his new spending program. Rather than trim the Federal payroll, as he proposed a year ago, the Nixon program calls for approximately 22,000 more Federal workers—as well as a pay boost for all of them, plus one for the Congress. "That will never fly," says one congressional staff economist. "Congress would never vote itself a pay hike in an election year—and the President knows it."

**Trouble.** More troubling to fiscal conservatives than the higher personnel numbers, however, is the proposed spending deficit, which the Administration puts at \$9.4 billion for the next fiscal year. Most officials acknowledge privately that the deficit likely will be substantially higher, just as the estimated deficit

for the current fiscal year is expected to exceed the projected \$4.7 billion. In fiscal 1973, the actual deficit turned out to be \$14.3 billion, and multiple Government and private economists estimate that the fiscal 1975 deficit will exceed that level. "It all depends on how well inflation and unemployment can be controlled," says one of them.

The ongoing shortage of energy supplies, particularly petroleum, is at the heart of the problem. Energy directly impacts both inflation and jobs, as layoffs already ordered in the automotive industry have demonstrated. And the electronics industries seem certain to feel the impact generated by declining car sales in orders for such items as semiconductor seat-belt systems, even though Government officials say that energy, *per se*, offers few opportunities for electronics technology. As for inflation, it is expected to continue "at a high level," says Herbert Stein of the Council of Economic Advisers. In view of

Stein's prior record for optimistic forecasting, that pre-budget acknowledgment has left industry officials uncertain.

**Offensive.** For these and other reasons, the fiscal 1975 budget proposes major spending shifts, as well as increases in areas where the White House believes money can be moved swiftly into the economy.

One of the changes proposed is what Nixon phrasemakers dub "the New Federalism"—the device by which Federal revenues will be turned over in block grants to states, counties, and other jurisdictions for local spending to meet broad needs in such areas as education and public transportation. Indeed, some funds—particularly in education—will go directly to individuals, rather than institutions, if Congress buys this aspect of the new plan.

Under the New Federalism philosophy—which "holds that state and local authorities are best able to make decisions on local and statewide needs"—grants in fiscal 1975 are projected to rise \$3.4 billion to a total of \$51.7 billion. For high-technology industries like electronics, the real effect of this approach is likely to slow the development of hardware markets in such fields as education and mass transportation.

Not only are manufacturers interested in developing this business going to have to build local marketing and intelligence organizations, but makers of computerized learning systems will be competing "against school buses and football-uniform manufacturers," moans one company specialist in Washington. Under the grant program, money for education or any other local need can be spent in virtually any manner the community sees fit.

**Growth.** The bright side of the new fiscal year's program for the electronics industries is clearly in the area of defense spending. Like the total Federal budget of which it is a part, defense-spending requests, by any measure, set records. What is called the first peacetime defense budget since World War 2 now exceeds that of any year—including those of World War 2—regardless of whether the funds are viewed in terms of the \$85.8 billion in new obligatory authority, the \$92.6 billion sought as total obligatory au-

thority when funds carried over from prior years are added on, or the maximum \$98.8 billion level to which the Pentagon budget authority can be raised by adding the \$6.2 billion supplemental request for fiscal 1974 that was submitted to Congress along with the new budget.

Beyond the new opportunities in military-electronics procurement and research and development reflected in the Nixon request, the macroeconomic view of Pentagon spending plans is that the funds generally can be programed quickly into the economy, should it begin to falter at a faster rate than the Government finds acceptable. By the Defense Department's own estimate, its new spending program should increase defense-related jobs in industry by 10,000.

**Opposition.** Nevertheless, even such congressional advocates of economic pump-priming as Wisconsin's vocal Senate Democrat, William Proxmire, believe the choice of the Pentagon as one of the pumps to be primed is the wrong one for the Administration. "On the job-creating side, the country has been presented with an upside-down policy," declares Proxmire, vice chairman of the Congressional Joint Economic Committee. "Instead of stimulating big job-creating programs like housing, where small Federal outlays have a rippling effect throughout the economy, the President has opted for a massive increase in military spending, where there are fewer 'jobs for the buck' than in almost any other activity." Also, "this means we have no inflationary policy whatsoever at a time of rampaging inflation."

However, Nixon Administration

economists and most of their opposition agree that Federal budgets are becoming increasingly inflexible as the amount of uncontrollable spending mandated by law and prior-year commitments increases steadily year by year. Last year, the controllable portion of budget outlays was less than 28% of the total. In fiscal 1975, the controllable percentage has slipped to 26%, despite a much larger total for spending. Compare those figures with, for example, outlays in fiscal 1967, when 41% of the budget was controllable.

Why the decline? The Nixon budget message gives three principal reasons: the relative decline in controllable defense spending, brought about by sharp increases in military pay and retirement benefits, plus commitments to long-term procurement programs; the growth in mandatory grants to state and local governments, and "the growth in human-resources programs (which largely take the form of benefit payments, set by law, to individuals and families)" under programs like Social Security.

Thus do economic analysts find themselves confronting two undesirable problems that the Nixon budget for fiscal 1975 has yet to resolve: for the short term, there is the acknowledged spectre of an economic slump—"mini" or otherwise—coupled with no apparent slowdown in inflation. For the longer term, there is a clear need to review the Federal budgeting process itself—and the legislation it produces—in such a way that will permit a President greater flexibility in preparing his spending proposals by limiting the amount of uncontrollable spending. □

---

## New defense chief confronts Congress with budget designed to refill cupboard

Despite careful and frequent Pentagon references to the price, pay, and retirement benefits that account for much of the growth in its fiscal 1975 budget—the largest ever—there are enough new starts to encourage the electronics community. And there is a flock of programs budgeted for big, new spending (see p. 71).

Defense Secretary James R. Schlesinger's first budget is one that he believes will substantially restock a Defense Department larder drained by Southeast Asia and the Middle East. How well he sells it to the Congress—increasingly bombarded by talk from the White House of "a generation of peace"—is still



an open question. First reactions from Capitol Hill have been predictable, with Senate Majority Leader Mike Mansfield (D., Mont.) typically calling the budget request "far too high." Nevertheless, Mansfield and his counterparts in the House failed last year to achieve significant reductions in the current defense appropriation. Schlesinger knows that, of course, just as his Pentagon colleagues know that in this election year the Congress is less likely to be concerned with cutting specific military outlays than it will be with avoiding a major recession and considering impeachment.

**Leadership.** Nevertheless, Schlesinger seems determined to confront the Congress on the issue of how much is enough for defense. And his first appearance before the Senate Armed Services Committee to present and defend his philosophy was impressive. One senior committee staffer believes Schlesinger is "smarter than McNamara" but not as politically "shrewd as Laird—not yet." Favorable comparisons with such former Pentagon superstars as Robert McNamara and Melvin Laird, however qualified, don't come easily on Capitol Hill to newcomers like Schlesinger (see p. 12).

In laying out the Pentagon's pro-

posal to spend \$85.8 billion in fiscal 1975 out of \$92.6 billion in total obligational authority that includes unspent funds from prior years [*Electronics*, Feb. 7, p. 41], the defense secretary stressed repeatedly that all of the expenditure boosts are earmarked for pay and price increases. The total request, he said, "is a substantial one, but I offer no apologies for it." Compared to a year ago, he said, "it means doing no more than holding our own." Of the \$2.8 billion increase budgeted for what the department calls its "investment programs"—procurement, RDT&E, and construction—officials say more than 53% of the rise "is attributable to inflation."

**Spending.** The new budget envisions total procurement authority of almost \$19.9 billion, of which it plans to spend some \$16.4 billion. Both totals are some \$1.2 billion above fiscal 1974 levels. In RDT&E, there is also a sharp increase of more than 12% in the \$9.4 billion total budgeted—a dollar increase of more than \$1 billion from a year ago. Spending for RDT&E, however, budgeted at \$8.9 billion, will rise by only \$476 million, or 5.6%.

Of interest to makers of guidance and control systems should be the \$85 million in R&D monies for increasing missile accuracy. These break down into \$20 million for a Maneuverable Advanced Reentry Vehicle, known as MARV, \$32 million for an advanced Minuteman-3 guidance system, plus another \$33 million for improving the accuracy of submarine-launched ballistic missiles. On top of this is another \$106.9 million for Advanced Ballistic Reentry Systems, budgeted for a 58% increase from last year's figure. The ABRES programs are \$25.4 million for MARV-evasion techniques; \$5 million for an Advanced Intercontinental Ballistic Missile Reentry Vehicle; \$25 million for new ICBM development; \$32.5 million for a Missile Performance Measurement Program, and \$19 million for improved reentry vehicles.

**Hardware.** In terms of hardware, the Airborne Warning and Control System (Awacs) is one of at least two procurement programs bound to draw early congressional fire. For Awacs, which for years languished in R&D, the Air Force now wants to

buy 12 Boeing 707-320B aircraft to carry the Westinghouse radar and associated avionics. Thus, the Awacs request has soared from \$163.4 million a year ago to a whopping \$769.5 million in fiscal 1975.

Schlesinger may please the Congress—just as for different reasons he pleased the Navy—with his proposal to spend \$16 million to begin developing a new class of ICBM-launching submarines. Of appeal to both the Navy and the Congress, the new nuclear boats would have shorter lead times and presumably be less expensive, since they would employ the quiet-reactor propulsion unit developed for the SSN-671 Narwahl class of attack boats. The new missile-launching subs are dubbed "small" by the Navy—they are smaller than the Trident—but they in fact will be about the size of existing Poseidon boats and carry up to 15 of the Trident-1 class missiles with a 4,500-mile range.

**Cheaper.** Of appeal to the Congress—though not the Navy—is that a less expensive Narwahl could be deployed as a substitute for the larger, more expensive Trident if the second round of Strategic Arms Limitation Talks with the Soviet Union produces meaningful restrictions on the escalating arms race. Depending on what the Soviets do, said Schlesinger, "we are prepared to go in either direction" by building more than the 10 Tridents now proposed at a price of \$12.5 billion, or reverting to the Narwahl.

The existing attack version of the Narwahl, similar to the Navy's Sturgeon class in design, is fitted with the BQQ-2 sonar as its principal piece of electronics. Additionally, the Navy's "quieting" program calls for a large measure of electronic controls to compensate for the elimination of noisy nuclear-reactor cooling pumps and related systems.

Meanwhile, funding for Trident continues to soar, rising by nearly 53% to \$1.38 billion in the new budget from the amount in fiscal 1974. Acceleration of the Trident's engineering development with a request for two boats, rather than the one originally planned, is the reason. Its interim missile, the Trident-1, under development by Lockheed, is ticketed for \$661.4 million, up almost 25%.



In addition to the Air Force's B-1 bomber, budgeted for a 10% increase at \$499 million, there are other aircraft programs like Awacs that are likely to become congressional targets this year. Two of these include new Navy and Air Force fighters, for which new funds of \$34 million and \$36 million, respectively, are sought. The Navy wants a VF-X fighter prototype. The proposed Air Force Air Combat Fighter, as it is now called, is defined as a follow-on to the McDonnell Douglas F-15.

In tactical missiles, the Navy's antishipping missile, Harpoon, is budgeted to move out of R&D and into procurement. For the first 150-missile purchase, the service wants \$139.4 million. In the same category is the Standard Active missile, for which the Navy is asking \$34.9 million for 74 of the ship-launched surface weapons. Harpoon's platform, the Patrol Hydrofoil Missile Ship, moves from \$22.8 million this year up to \$108 million.

Most of the "bread-and-butter" tactical-aircraft and missile programs that are well into the procurement phase are down for big outlays. These include the Air Force F-15 and Navy F-14 fighters, the Navy S-3A antisubmarine-warfare aircraft, the Sparrow and Maverick missiles, and the Army Hawk air-defense missile. Another Air Force-fighter program, the F-5F, is in for its initial procurement of 28 planes at a cost of \$105.2 million.

The Air Force needs to replenish stores of Maverick air-to-surface missiles depleted by "loans" of the electro-optically guided weapon to the Israelis during the October war. The proposed purchase of 6,000 missiles is double that of last year, and \$88.4 million is sought to cover it. Similarly, the purchase of Sparrow radar-guided air-to-air missiles will jump to 600 from 175 last year with a Navy request for \$107.2 million. And while the numbers are down, there will still be a substantial purchase of Improved Hawk air-defense missiles by the Army, with a \$109.8 million request for 750 more missiles—200 less than in 1974.

The request for intelligence and communications funds totals \$6.5 billion, an increase of \$600 million over the figure of last year, but

## MAJOR REQUESTS FOR WEAPONS SPENDING

(in millions of dollars; quantities in parentheses)

	FY1974	FY1975	Contractor
<b>Aircraft Procurement, Army</b>			
*AH-1Q Cobra/TOW	\$ 7.2	\$ 28.7 (21)	Bell Helicopter
CH-47C Chinook	54.3	63.4 (27)	Boeing Vertol
UH-1 Iroquois	61.2	69.0 (205)	Bell Helicopter
<b>Aircraft Procurement, Navy</b>			
A-4M Skyhawk	116.2	67.0 (24)	McDonnell Douglas
A-6E Intruder	137.3	142.6 (12)	Grumman
EA-6B Prowler	120.0	123.1 (6)	Grumman
A-7E Corsair II	150.0	158.6 (34)	Vought
F-14F Tomcat	737.2	756.3 (50)	Grumman
UH-1N Iroquois	23.0	16.6 (20)	Bell Helicopter
AH-1J Sea Cobra	26.2	30.6 (20)	Bell Helicopter
P-3C Orion	202.0	152.0 (12)	Lockheed
S-3A Viking	552.8	573.6 (45)	Lockheed
E-2C Hawkeye	158.5	118.7 (6)	Grumman
<b>Aircraft Procurement, Air Force</b>			
*A-10 Close Air Support	107.4	267.7 (26)	Fairchild
*E-3A AWACS	163.4	769.5 (12)	Boeing
*F-5F Intl. Fighter	32.1	105.2 (28)	Northrop
F/TF-15A Eagle	1,128.6	1,076.0 (72)	McDonnell Douglas
<b>Missile Procurement, Army</b>			
Hawk air-defense	137.3	109.8 (750)	Raytheon
Dragon antitank	62.7	129.4 (16,578)	Multiple
TOW antitank	153.8	149.1 (30,319)	Hughes/Emerson
Lance surface-to-surface	81.3	64.7 (184)	LTV
<b>Missile Procurement, Navy</b>			
Sparrow air-to-air	54.3	107.2 (600)	Raytheon/G.D.
Sidewinder air-to-air	24.0	17.3 (800)	Raytheon/Philco
Phoenix air-to-air	100.4	99.5 (340)	Hughes
Shrike air-to-air, air-to-surface	43.7	37.2 (1,200)	Multiple
*Harpoon antiship	81.1	139.4 (150)	McDonnell Douglas
Standard med. range, surface-to-air	48.0	29.7 (200)	General Dynamics
Standard anti-radar, surface-to-surface	15.2	10.4 (62)	General Dynamics
*Standard active, surface-to-surface	8.2	34.9 (74)	General Dynamics
<b>Missile Procurement, Air Force</b>			
Minuteman III ICBM	712.1	730.7 (61)	Multiple
Maverick air-to-surface	60.7	88.4 (6,000)	Hughes
<b>Ship Procurement, Navy</b>			
Trident missile sub.	902.0	1,381.3 (2)	Not selected
SSN 688 attack sub.	919.9	512.1 (3)	Newport News/G.D.
*DLGN-38 frigate	81.3	246.3 (1)	Newport News
DD-963 destroyer	590.3	463.5 (7)	Litton Systems
*Sea Control Ship, V/STOL carrier	29.3	142.9 (1)	Nat'l. Steel & Ship
Patrol Frigate, support ship	-0-	463.5 (7)	Bath Iron Works
*Patrol Gunboat, coastal patrol	-0-	15.7 (2)	Not selected
*Patrol Hydrofoil Missile Ship	22.8	108.0 (4)	Boeing
<b>Other Procurement</b>			
*SLBM Phased Array Radar/USAF	-0-	49.7	Not selected

## WEAPONS IN RESEARCH & DEVELOPMENT

	FY1974	FY1975	Contractor
<b>Army</b>			
E-4A Advanced Airborne Command Post, USAF	49.6	90.0	Boeing
Heavy Lift Helicopter, Army	59.9	57.7	Boeing-Vertol
UTTAS Army helicopter	102.7	54.1	Boeing Vertol
Advanced Attack Helicopter, Army	49.3	60.8	Hughes
Low-Altitude Forward Area Air Defense	13.4	44.7	Not selected
SAM-D air-defense missile system	194.4	111.2	Raytheon/Martin
<b>Navy</b>			
*VF-X fighter prototype	-0-	34.0	Not selected
Standard II anti-aircraft missile	15.9	32.2	General Dynamics
Strategic Cruise Missile	2.6	45.0	General Dynamics
AEGIS missile, surface-to-air	40.2	67.0	RCA Corp.
Surface Effect Ship	60.9	58.0	Aerojet General
CIWS (Phalanx) missile	29.0	32.1	General Dynamics
<b>Air Force</b>			
Lightweight Fighter Prototype	47.0	22.7	G.D./Northrop
Advanced Medium STOL Transport	25.0	55.8	Boeing/McDonnell
B-1 Bomber	448.5	499.0	Rockwell Intl.
EF-111A Tactical Jamming Aircraft	15.0	36.7	G.D./Grumman
*Air Combat Fighter	-0-	36.0	Not selected
Advanced ICBM technology	4.2	37.3	Not selected
Air Launched Cruise Missile	11.0	80.0	Boeing
NAVSTAT Global Positioning System	7.4	25.4	G.D./Philco
Close Air Support Weapon (lasered Maverick)	8.0	20.0	Not selected
Precision Emitter Location Strike System	9.8	25.1	IBM

\*Identifies first procurement or new R&D program

again, pay and price increases consume all but \$200 million of the boost. The \$100 million actual growth in communications funds is

earmarked for small improvements to the communications systems of each of the services, plus the Defense Communications System. □

## NASA gets first raise in 10 years but FAA suffers 17% slash in R&D



Aerospace electronics companies looking for new opportunities in fiscal 1975 got more good news than bad from the budgets of their two major civilian customers—the National Aeronautics and Space Administration and the Federal Aviation Administration. NASA received its first budget boost in a decade with \$3.25 billion in new obligational authority as the Nixon Administration appears persuaded that it requires the kind of quick-funding flexibility the space agency can provide to counter recessionary influences in the national economy. Though NASA's \$100 million increase—a modest 3% rise—seems insufficient to counter the effect of inflation, the diminished manned-space-flight program has freed funds for several new programs in space applications and space science that seem sure to have congressional appeal [*Electronics*, Feb. 7, p. 60].

**Reductions.** The FAA budget of \$2.1 billion reflects an increase of \$130 million overall, although its research and development account—the key to future procurements—was cut more than 17% to \$91.2 million. Hardest hit were Advanced Air Traffic-Automation funds. As air carriers took advantage of America's fuel crisis to cut back on flight schedules, the FAA took advantage of the reduction in traffic to stretch out automation enhancement of the Computerized Air Traffic Control system. That falling domino slashed the R&D budget for air-traffic control by 46% to \$16 million—sad news for contractors Sperry-Univac and IBM Corp., who are now performing enhancement studies. Nevertheless, the FAA says it plans to continue development of other enhancement activities such as the Discrete Address Beacon System (DABS), Intermittent Positive Control (IPC), airport surface detection equipment, and wake-vortex sensors.

Much of the FAA's money is for bricks and mortar, of course. This comes under the \$250 million it wants for facilities and equipment procurement, as well as the \$350 million planned for obligations in airport-development grants. However, some of these funds will be earmarked for navigation and landing aids and radar purchases.

**Better year.** Despite the FAA's R&D downturn, David R. Israel, acting deputy administrator for research and engineering, mentions several programs to show that the new fiscal year will be better than the last. Requests for proposals should go out shortly for a prototype of a third-generation airport Surface Detection Equipment (ASDE) to keep tabs on taxiing planes. The agency could eventually buy 20 or so of the units. About \$2 million is allocated for the total ASDE effort in fiscal 1975.

Selection should begin early in fiscal 1975 of a contractor to build a prototype Discrete Address Beacon System (DABS) made up of three ground facilities and 20 sets of transponders. The total DABS program is funded for \$8 million in the next fiscal year. The program has the potential to become a new operational aircraft-surveillance system. In August, the agency plans to choose between doppler and scanning-beam techniques for the Universal Microwave System.

NASA's good news includes two new applications programs, Seasat-A, an ocean-monitoring satellite to be launched in 1978, and a Heat Capacity Mapping Mission (HCMM), an Explorer-sized thermal-sensing spacecraft slated for launch in 1977; and one new program in space science, the 1978 Pioneer Venus probes (see table). The agency also announced that the Hughes-General Electric team had beaten out the TRW-Martin Marietta team to build the spacecraft for the dual missions for the program, which will cost less than \$170 million [*Electronics*, July 5, 1973, p. 29]. TRW received good news, however, when the agency announced that it plans to revive the approximately \$200 million High Energy Astronomical Observatory (HEAO) program with three spacecraft to be launched later this decade.

**NASA: MORE UP THAN DOWN**  
(key programs in millions of dollars)

	FY74	FY75	Change
<b>APPROPRIATIONS TOTAL</b>	<b>\$3,040</b>	<b>\$3,247</b>	<b>+207</b>
<b>Manned Space</b>	<b>1,057</b>	<b>1,125</b>	<b>+68</b>
Shuttle (Rockwell)	475	800	+325
<b>Space Science</b>	<b>602</b>	<b>547</b>	<b>-55</b>
HEAO (TRW)	5	40	+35
MJS 1977 (JPL, manager)	31	70	+39
*Pioneer Venus (Hughes-GE)	—	27	+27
<b>Space Applications</b>	<b>161</b>	<b>178</b>	<b>+17</b>
Nimbus G (GE)	9	27	+18
*SEASAT A (not selected)	—	8	+8
*HCMM (NASA managed)	—	3	+3
5th band scanner (Hughes)	1	4	+3
*New procurement			

In applications, requests for proposals should go out to industry during the fiscal year for the 2,000-pound Seasat-A, says Charles W. Mathews, associate administrator for applications. The approximately \$50 million program will be funded during three fiscal years, beginning in fiscal 1976.

RFPs also should be out before June for the estimated \$40 million Tiros-N, a new generation weather satellite that has been much delayed the last several years [*Electronics*, Feb. 15, 1973, p. 73], Mathews says. But a decision hasn't been made whether or not to go sole-source to the Tiros-series builder, RCA. NASA also hopes to select a contractor during fiscal 1975 for the \$6 million Laser Geodynamic Satellite (Lageos), one of last year's few new starts.

Hughes also will develop a five-channel multispectral scanner for a possible Earth Resources Technology Satellite (ERTS) C, as the launch of ERTS B was moved up to early 1975 instead of 1976, Mathews says. GE may finally get its sole-source contract for the Nimbus G weather satellite announced last year, he adds.

"Space science is going low this year as the Viking program is past its peak funding," declares George M. Low, deputy NASA administrator. Despite the budget drop, space science got its two big starts, Pioneer Venus and HEAO, now "shrunk down" to three 10,000-lb satellites to be launched in consecutive years, beginning in 1977, says John E. Naugle, associate administrator for space science.

And the Office of Space Science will build an infrared deep-space

telescope, a \$6.4 million three-meter "light bucket to collect photons" in Hawaii, and a \$4 million X-ray telescope at Marshall Space Flight Center to support HEAO B, he says. Also, RFPs for small parts of the Mariner-Jupiter-Saturn program (the old outer planets missions) should come out this year from its manager, Jet Propulsion Laboratory.

## In transportation, there's a role, and some cash, for electronics

As usual in transportation budgets, the nation's highways grab the lion's share—the Federal Highway Administration eats up two-thirds of the Department of Transportation's request of \$9.8 billion for fiscal 1975. But DOT's budget contains a \$450 million increase, signaling a greater emphasis on and funding for urban mass-transit programs. More than 20% of the increase goes to the Urban Mass Transportation Administration (UMTA), whose budget jumps \$365 million to \$1.4 billion. Of that sum, \$1.2 billion will be granted to states for capital equipment.

All told, DOT plans to spend about \$1.4 billion on urban mass transit, of which \$200 million will come from highway authorizations, and about another \$1 billion on urban highways. The department also proposes legislation creating \$16 billion over the next six years for urban transportation, of which \$9.5 billion will be new money.

These numbers suggest that electronics companies will have a healthy crack at supplying the auto-

Implied in the fiscal 1975 budget are potential new programs that could show up later, perhaps in fiscal 1976. For example, studies continue for a \$350 million Large Space Telescope (LST), a space-shuttle-compatible orbiting observatory containing some electronic sensing; the Earth Observatory Satellite (EOS), a heavyweight craft for which RFPs for design studies have been issued [*Electronics*, Feb. 7, p. 48], and the Space Tug, an orbital ferry for the 1980s. NASA contemplates a tracking and data-relay satellite (TDRS), which, says administrator James C. Fletcher, will be leased from a private organization that will allow the agency to phase out some ground stations abroad (see p. 29).

But NASA's new programs didn't come without some cost. The Space Shuttle was stretched out again—for the last time, Fletcher insists—to spring 1979, raising total project costs by \$50 million. □

mation and communications needed to help speed urban mass-transit improvements. But how much of that pie they can slice depends on several things. For one, much of this money is discretionary, meaning the localities can elect to buy buses, rather than automated subway systems. For another, DOT officials acknowledge that the White House Office of Management and Budget closely scrutinizes proposals for new subway construction.

**Running third.** And, when automated mass-transit systems are built, command-and-control equipment comes in third for funding behind concrete and rolling stock, comments Robert H. Cannon Jr., assistant secretary for systems development and technology. He estimates that less than 10% of a system's cost goes for command-and-control gear. "It's unfortunate," he says, "because if they spent more money on command and control, the systems would work better."

Nevertheless, the new budget is a harbinger of new developments and new markets. UMTA's budget for re-

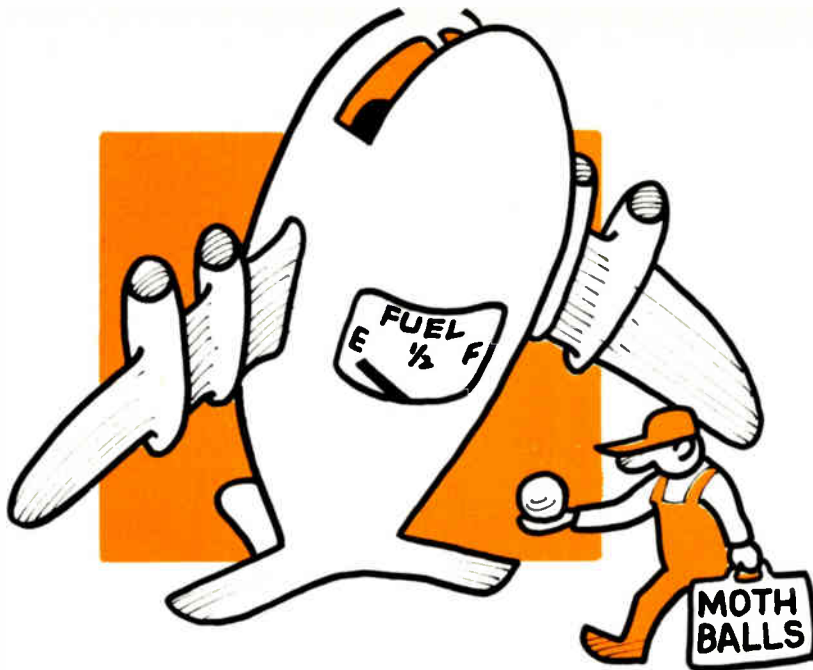

search, development, and programs goes up \$8.8 million to \$75 million. Included is about \$10 million for development of second- and third-generation personal-rapid-transit systems. Requests for proposals for the second-generation Denver demonstration system [*Electronics*, Oct. 25, 1973, p. 205] have been sent out,

with proposals due back in April. About \$2 million is slated for third-generation research.

**Ships.** The Coast Guard, whose \$913 million budget is almost 14% higher than last year, wants to spend \$21 million for R&D, a 50% increase of \$7 million. Particular emphasis is being placed on improv-

ing ship-to-helicopter communications. Other major projects include improving the distress-alerting and locating system (DALs), and design and development of prototype helicopter-sensor systems.

Requests for proposals to start work on vessel-traffic systems for the Ports of New York and New Orleans will be out no earlier than spring [*Electronics*, Sept. 27, 1973, p. 53]. A smaller computer-radar system is scheduled for Port Valdez, Alaska, and the service is mulling systems for the Long Beach, Calif., Baltimore, and Philadelphia harbor areas.

An increase of \$42.4 million over the 1974 allocation is being asked by the Federal Railroad Administration, largely for research and development. Excluding Amtrak funds, the FRA's budget reaches \$86.3 million—more than double that of a year ago. All told, \$64.2 million in budget authority is being requested for R&D on high-speed ground transportation, including continued work at the high-speed ground test center near Pueblo, Colo., and for research directed at solving safety problems and improving freight service. A nice \$35 million will be devoted to a computerized accounting system to keep track of the freight cars; it's being developed with the aid of the Association of American Railroads [*Electronics*, Jan. 24, p. 36].

**Less cash, more R&D.** At another transportation-related agency, the Maritime Administration, the budget went down by \$14 million to \$569 million, but the R&D portion went up by \$3.9 million to \$24 million. Included is development work in shipyard automation (\$1.5 million,) shipboard automation (\$2 million), and another \$2 million to continue with maritime satellite-communications experiments.

The agency is working with General Electric on automated navigation problems, Sperry for a radar transponder, GTE for a digital call selector for deep-ocean communications, and RCA on an on-board transmitter. Also, the agency is planning to conduct satellite-communications tests on Applied Technology Satellite (ATS) F and the Maresat Comsat-Navy maritime satellite. □

## Energy R&D: a marginal market

By almost any measure of the fiscal 1975 Federal budget, opportunities for electronics are slim in energy-related research and development. Nixon Administration officials tout the 81% increase contained in the \$1.8 billion budgeted for energy R&D, as responsive to national concerns, and the effort is indeed geared to programs with near-term payoffs—among them nuclear-power sources and accelerated development of synthetic and improved fossil fuels, notably coal.

Beyond the obvious ancillary role for test, measurement, and control instrumentation in energy R&D, new opportunities for electronics are constrained to semiconductor technology and its potential in development of photovoltaic devices for conversion of the sun's rays directly to electricity. This long-term solar-energy effort, led by the National Science Foundation, is budgeted for \$8 million—roughly a fourfold increase from a year ago. Nevertheless, NSF's photovoltaics program is but 16% of its \$50 million proposed for solar-energy conversion.

The main thrust of NSF's photovoltaic R&D is aimed at reducing the cost of manufacturing solar cells by factors of 10 to 100, observes Alfred J. Eggers, assistant director for research applications. Silicon and cadmium-sulfide materials will receive the most attention. Also to be considered is the design of solar concentrators for increasing the light flux at the cells' surface.

Most of the nation's energy-R&D money will continue to go to the Atomic Energy Commission, where nuclear fusion, including laser and magnetic-containment systems, weigh in for \$168.6 million, up 67% from fiscal 1974. Reactor technology, however, will get the bulk of AEC's R&D funds, some \$724.7 million—a 37% increase.

Coal-mining technology is set for an impressive increase of 160% to \$415.5 million, but only \$52.1 million of this will go to the Interior Department, where interest has been shown in such electronics-oriented programs as laser-directed mining machinery and automated coal cars.

## Administration wants people to get money allotted for social programs

One of the smaller problems of Nixon Administration publicists is that "energy crisis" is receiving far greater citizen acceptance than the White House buzzword for social programs—New Federalism. Nevertheless, that concept of letting Federal revenues flow back down *en bloc* to states, counties, and cities is being pursued with vigor by those who administer Federal social programs.

In fiscal 1975, the program is being carried one step further. This year, the new byword is expected to be "people," as new programs are initiated to put the money directly into the hands of individuals, rather than institutions. Under this concept, money for electronics technologies that was hard for manufacturers to track down before will now disappear.

The so-called "people program" was explained this way by Secretary

of Health, Education, and Welfare Caspar W. Weinberger: "Financial assistance to individuals is the quickest, most direct, and most equitable way to meet essential human needs. More importantly, it allows the individual freedom to make his own decisions." The question quickly raised on Capitol Hill in rebuttal of that rationale: Is it legal? Some lawmakers visualize the direct-grant program as a way around court rulings on such touchy issues as expenditure of Federal funds on, for example, sectarian education.

In any event, the policy is not yet as clearly thought out as Secretary Weinberger's statement. And until some clarity emerges, the result is merely another element of uncertainty, added to the usual ones associated with finding where the electronics opportunities lie among HEW's labyrinthine bureaus,

## R&D: how real is the increase?

Although the Nixon Administration makes much of the 10% increase in obligations it is seeking for federally sponsored research and development in fiscal 1975, the amount it expects to spend—\$18.6 billion—will rise only 6%, or 2% less than last year's inflation rate. But not all segments of the R&D community are unhappy because some elements are down for larger increases than others. As in prior Nixon years, the emphasis is again on development programs with their near-term payoff. Where the proposed \$11.3 billion in expenditures for development represents an increase of nearly 7% above fiscal 1974, the \$7.3 billion budgeted for research expenditures reflects an increase of only 5%.

For such high-technology industries as electronics, there is more good news than bad; for universities and colleges, there is less bad news than there was a year ago. While the \$2.26 billion budgeted for expenditures in the academic community represents a 7% increase, its big gains come in work proposed for the Atomic Energy Commission, up 11% at \$94 million, and the National Science Foundation, with its \$409 million representing a 7.2% increase. However, the largest single dollar amount for universities and colleges continues to reside in the Department of Health, Education, and Welfare, with its \$1.2 billion budget raised 6% from last year.

At the National Science Foundation, there may be meaningful new projects for the electronics industries in its budget for support of scientific-research projects. Materials research, for example, is slated for a 28% boost in its budget to \$45.4 million.

In macroeconomic terms, the Nixon Administration clearly considers Federal support for science and technology R&D one of its "hole cards" with which to counter any economic downturn. One evidence of this: more than \$900 million was added to the R&D budget between the time of its February presentation to Congress and the printing of budget documents only weeks before.

## SPECIFIER'S GUIDE TO INDUSTRIAL ADHESIVES



New ECCOBOND® booklet and fold-out wall chart gives specifications and use criteria for a broad line of industrial/electrical adhesives, epoxies and others. Send for FREE copy.

Circle 150 on reader service card

## NEW -- FREE -- DATA PLASTIC/CERAMIC FOAMS



ECCOFOAM® is the broadest line of plastic and ceramic foams for electronics. Foam-in-place; sheet stock; pourable syntactic; artificial dielectrics all described and properties tabulated in new booklet. Send for copy.

Circle 182 on reader service card

## NEW BOOKLET DESCRIBES SURFACE COATINGS FOR ELECTRONICS



ECCOCOAT® Surface Coatings include transparents for PC boards and components; dip-coats for transformers and coils; easy-mix and one-part systems for automatic production; and a wide range of special properties such as 500°F capability; resistivities to 10<sup>14</sup> ohms/sq. Several chemical types. Send for copy.

Circle 183 on reader service card

## Emerson & Cuming, Inc.



CANTON, MASS.  
GARDENA, CALIF.  
NORTHBROOK, ILL.  
Sales Offices  
in Principal Cities

EMERSON & CUMING EUROPE N.V., Oevel, Belgium

agencies, and task forces. If the feeling persists that a department whose fiscal 1975 budget request amounts to \$113.7 billion—\$7.3 billion more than 1974's—must be a potentially good market, take a quick dose of such items as the Social Security Administration's miniscule allocation of \$132,000 for purchases of data-processing equipment, and the feeling will go away.

Data-processing equipment—the

major electronics market in the social-services segment of any Federal budget—does better at the General Services Administration, the combined purchasing agency and housekeeper for the Government. Capitalizing on its appointment several years ago as the central agency for procurement and lease of all general-purpose computing equipment, the GSA's automatic-data-processing fund request jumps 35% in fiscal

1975 to \$46.9 million. This breaks down to \$39.9 million—a 19% increase—for Government-wide services.

Under GSA's separate lease account, which increases by more than six times to nearly \$7 million, the agency will fund leasing, as well as procurement of both hardware and software for subsequent lease to other using agencies.

The increasingly important role of the GSA as a customer for computer and telecommunications equipment and services is reflected also in the 17% increase to \$8.3 million it is seeking for automated data and telecommunications services.

Justice. Law enforcement as a market for electronics—notably telecommunications hardware—continues to expand steadily in fiscal 1975. The Justice Department's Law Enforcement Assistance Administration is planning a \$61 million increase in outlays to \$910 million. But the market is spreading, too, as the LEAA grants more and more to state and local government.

For example, LEAA Administrator Donald E. Santarelli is budgeting \$48 million—an increase of nearly 25%—in technology analysis, development, and dissemination. But nearly \$45.2 million of that will be spent outside of Washington by local jurisdictions on research and development of techniques, systems, and equipment to reduce crime.

Similarly, nearly all but \$1 million of the \$16 million down for technical assistance, an account under which companies can sometimes pull down funds to support local law enforcement authorities, will be spent at the local level.

At the Federal Bureau of Investigation, identifiable electronics opportunities seem paltry, compared to the \$1.9 million that the bureau proposes to spend on its move from its present headquarters in the department of Justice across the street into its own new building, now named for the late J. Edgar Hoover. The bureau plans outlays of \$147,000 more for its automated fingerprint classification and matching system, and another \$177,000 for additional communications for the National Crime Identification Center.

The Department of Commerce

## CMOS/LSI SUBSYSTEMS CAN HELP YOU IMPROVE PRODUCT PERFORMANCE AND SLASH PRODUCTION COSTS.



### WE CAN HELP, TOO.

That's our business—helping our customers extend their design and manufacturing capabilities to include the most advanced semiconductor technologies.

Whether your product can be improved through the application of CMOS/LSI subsystems, the high precision of Bipolar linear circuits—or a combination of both—our people have the proven knowledge and access to the industry's most advanced processing equipment. This combination of skills and facilities just might enable us to help reduce your system costs.

Our customers choose to work with us because of the harmony and mutual integrity which characterize the close working relationship we feel is essential to doing a proper job.

We've helped develop some of the industry's most sophisticated integrated circuits for high-volume production, including High-Density CMOS (CMOS utilizing two separate layers of interconnect) and precision Bipolar ICs incorporating high-value thin-film resistors.

If you feel your products might benefit from the application of these advanced techniques, you should know more about us. Give us a call or drop us a line today. Call, write, or circle reader service number 245 today. If we can't help, we'll say so.

### MICRO POWER SYSTEMS

3100 Alfred Street, Santa Clara, CA 95050, Phone: (408) 247-5350, TWX: 910-338-0154  
Japan: Yas Kanazashi, 21 Mori Bldg., 2-2-5 Roppongi, Minato-ku, Tokyo, Phone: 586-0471

**Datacraft® SLASH 4 Virtual Memory  
Computer System.**

Delivers power, economy, flexibility and versatility. All you'll ever want. Or need. For concurrent multi-batch processing. Critical real-time. Remote job entry. Time sharing.

Whatever your application, the SLASH 4 VM's 750 nanosecond cycle time, automatic program relocation, re-entrant processors, and effective memory utilization deliver higher throughput for you. Big single programs...up to 256K...are handled with ease in a multi-task oriented architecture that virtually eliminates costly software penalties.

**That's Efficiency.**

**That's Money Saved.**

**That's the SLASH 4 VM Computer System.**  
You'll be amazed at what you get. And how much you can do. Contact us for all the facts. Datacraft®, 1200 Gateway Drive, Fort Lauderdale, Florida 33309, Telephone (305) 974-1700. For international inquiries write: Techmation N.V. Gebouw 105/106, Schiphol-Oost, Holland.

# **Datacraft®**

SUBSIDIARY OF HARRIS-INTERTYPE CORPORATION



## **SLASH 4 VM COMPUTER SYSTEMS**

Circle 77 on reader service card

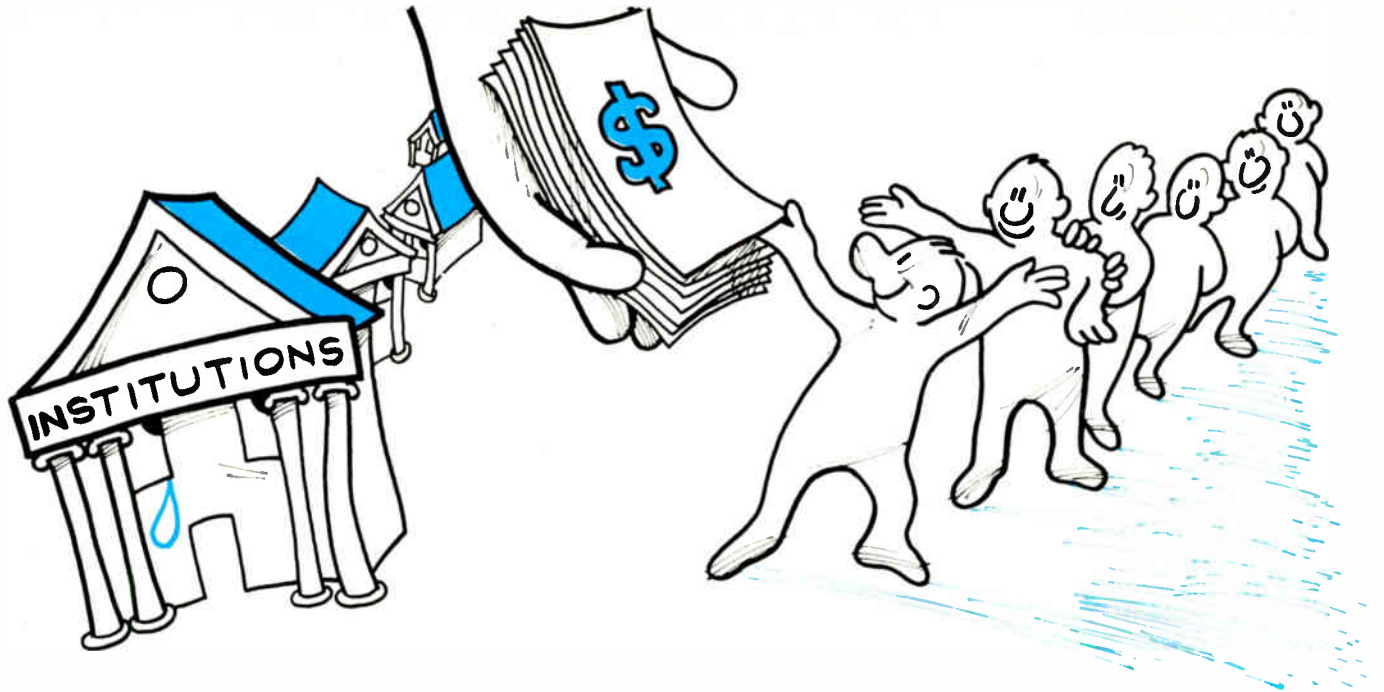

receives a modest 7.8% increase included in its \$1.76 billion budget for fiscal 1975. Both inside and outside of the department, sources say the increase was held down partly because of the return by the U. S. last year to a positive trade balance.

"This led to scrapping a number of plans to accelerate exports of technology to counter rising imports," explains one department official.

The fact that virtually all of the rise in exports was registered by agricultural raw materials—such as Ja-

pan's soaring purchases of soybeans and forest products—and not by high-technology products, appears to have had little bearing on the budgetary judgment to drop some proposals affecting electronics. Neither did budgeters consider that

HP COUNTERS PROMISE A LOT — AND DELIVER IT ALL.

# The counter system that

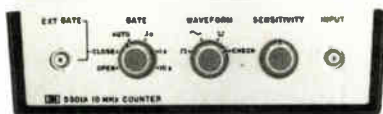

**5301A — 10 MHz Module:** 10 Hz to 10 MHz range. Direct counting and totalizing to over 10 MHz. Automatic or manual gating. Input waveform selector. External gate control. \$145.

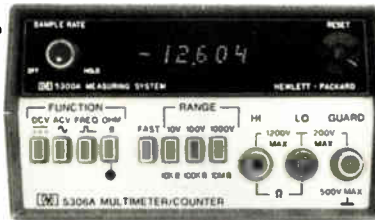

**NEW 5306A — Digital Multimeter/Counter Module:** Six-digit frequency readings to 10 MHz. Five full digits of AC/DC volts, ohms. Floating, guarded input. Automatic zero adjust. Up to 10 readings/sec. Overload protection. \$450.



**5303B — 525 MHz Counter Module:** DC to 525 MHz range, burst or CW frequency. 50Ω or 1 MΩ input. Automatic gain control. Fuse protected front end. Optional high stability time base (FCC Type-Approved). \$800.

The heart of HP's versatile frequency/time/volts/ohms measurement system is the sophisticated six-digit HP 5300A mainframe (\$395) which contains basic counting circuitry. Snap this mainframe onto the bottom module you need and it instantly becomes one of six feature-loaded instruments — each with traditional HP quality and ruggedness . . . each operating

from power line or optional battery pack.

Best of all, once you have the mainframe, it's the low cost way to build a complete workshop of first-line instruments.

It's the one system that truly does stay on top of your needs — and your budget.

Send for a free detailed brochure on HP's 5300 Series Counters.



**Battery Pack Module:** Sandwiches in between any mainframe/module combination. Permits up to 5 hours of continuous operation. Battery level indicator. Recharge while in use. Carrying handles and shoulder strap. \$195.

02306

All prices domestic U.S.A. only.



much of the export gain was spurred by a devalued dollar that made U. S. raw materials needed by other countries even more attractive.

"People concerned with trade balances generally go straight to the bottom line" of the balance sheet, observed one trade specialist. "If the bottom line number is favorable, then the pressure is off" to produce export gains in other areas.

Funds on the domestic side of the Commerce Department are relatively better, if widely dispersed. As a computer customer, for example, the department has budgeted \$73.6 million for data processing, of which \$12.5 million will be for the purchase and lease of new hardware. The \$3.5 million increase in the agency's EDP total is precisely the amount proposed for a new computer by the Social and Economics Statistics Administration.

The National Bureau of Standards, another arm of Commerce, is asking for a small \$4.4 million increase in fiscal 1975 to \$69.3 million,

exclusive of funds it receives for services to other agencies such as the Pentagon's Advanced Research Projects Agency. Nevertheless, outlays for electronics at NBS remain fixed. So NBS programs, like its effort in semiconductor technology, will hold level, despite expected inflation. As semiconductor-technology spending holds at \$579,000, so will the transducer and electronic-components programs remain unchanged at \$900,000.

At the National Oceanic and Atmospheric Administration, the fiscal 1975 program shows an increase of more than 10% in the \$63.7 million for environmental-satellite services, including the first launch of the Geostationary Operational Environmental Satellite. NOAA will take over operation of the GOES-A system after launch and checkout by NASA later this year. If it's successful, NOAA wants to spend \$13.9 million to begin procurement of two more GOES satellites, the first of which was built by Philco-Ford. And an-

other \$1 million is sought for a follow-on polar orbiting satellite system for launch in fiscal 1977. Despite the increase, however, NOAA associate administrator John Townsend Jr. says: "The satellite program has just about leveled off. We are within a couple of million of being level right now."

But NOAA officials believe that more can be done through its environmental satellite services office. Public forecast and warning services, for example, are programmed for \$5.7 million more than in this fiscal year to \$49.1 million. Part will go for automation of local weather bureaus with high-speed communications, computers, and displays.

For the new fiscal year, however, the picture in some other areas is less expensive for NOAA. The agency's Data Buoy program, for example, has no funding increase in its \$8.5 million budget. □

This report was prepared by Ray Connolly, William F. Arnold, Lawrence Curran, Howard Wolff, Alfred Rosenblatt, and Marilyn Offenheiser.

# stays on top of your needs.

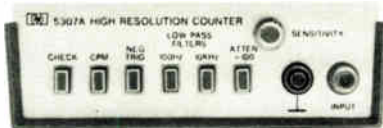

**NEW 5307A — High Resolution Module:** Range, 5 Hz to 2 MHz and 50 to  $1 \times 10^7$  counts/minute (CPM). Measures frequency and RPM much faster than conventional counters... 0.0001 Hz or 0.001 CPM resolution in less than 1 second. \$350.

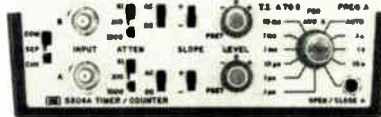

**5304A — 10 MHz Timer/Counter Module:** DC to 10 MHz range. 100 nsec. time interval accuracy. Unique "Time Interval Holdoff" ignores input ringing or contact bounce. Two DC coupled amplifiers with attenuators, slope, polarity and gain control. \$325.

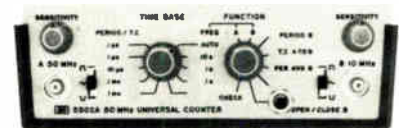

**5302A — Universal 50 MHz Counter Module:** 10 Hz to 50 MHz range. Automatic or manual gating. 100 nsec. time interval accuracy. Period, period average, ratio and totalize functions too. Input waveform selector. \$275.

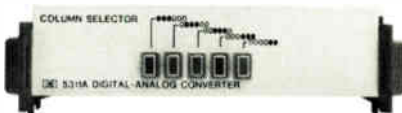

**Digital-to-Analog Converter Module:** Sandwiches in between modules — even with battery in place. Permits high resolution analog plots of digital measurements. Galvanometer and potentiometer recorder output. \$295.



Sales, service and support in 172 centers in 65 countries. Palo Alto, California 94304. Offices in principal cities throughout the U. S.



Phosphor Bronze, 100% of surface gold plated, 30 micro inches thick.

Copper Alloy 725, 3% of surface gold striped, 100 micro inches thick.

## Cut gold plating 90% on contact springs with CA-725.

CA-725 is the copper-base spring alloy that is rapidly becoming the standard of the electronics industry. Bare CA-725 has outstanding wrap-resistance stability. It's easy to solder and has good corrosion resistance without gold plating. Some gold is still used for resistance stability in critical circuits. But can be concentrated only where you need it... at the contact points.

That means proven cost reductions: Actual experience has confirmed CA-725's ability to cut gold plating by 90%. This substantially reduces the cost of the finished part even with increased gold thickness at the contact points. One main frame-connector user reports bare CA-725 connector springs with heavier gold at the contact points outlasted former springs by 10 times in wear tests.

Stay ahead of your competition: Copper Alloy 725 is rapidly gaining acceptance with the

largest electronic component users. You should know more about it. It is available from your regular brass and copper suppliers. Gold-striped material is available from composite metal producers. Call them today. Or write to Dept. 7173, The International Nickel Company, Inc., One New York Plaza, New York, N.Y. 10004.

The amount of gold you save depends on your design. Here is our calculation for an average-size connector spring:

Design	Spring Alloy	Gold Plating Thickness		Relative Amount of Gold Required
		At Contact	Overall	
Overall plating	CA-510 (Phosphor Bronze)	30	30	10
Stripe	CA-725	100	Bare	1

# Inco

THE INTERNATIONAL NICKEL COMPANY INC ONE NEW YORK PLAZA, NEW YORK N Y 10004

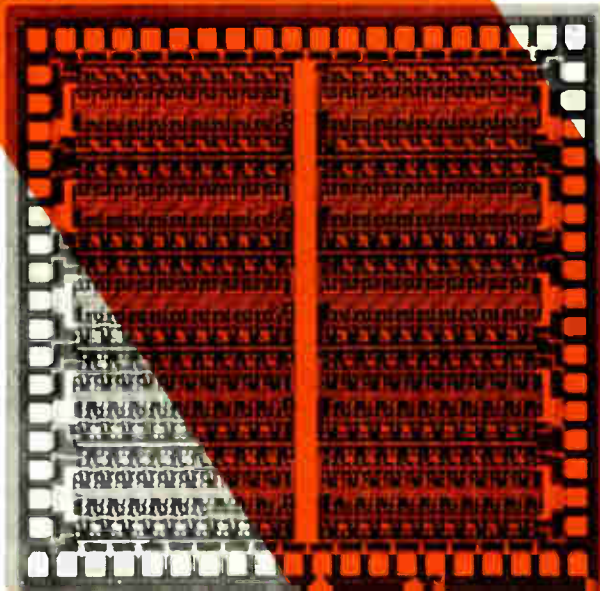
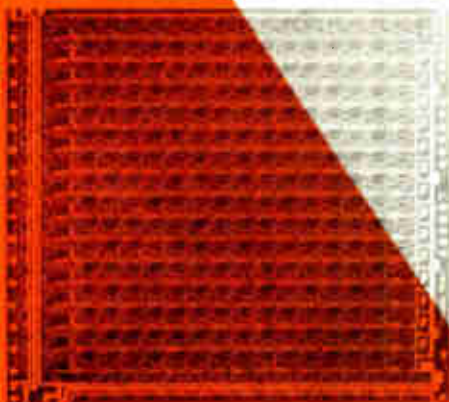
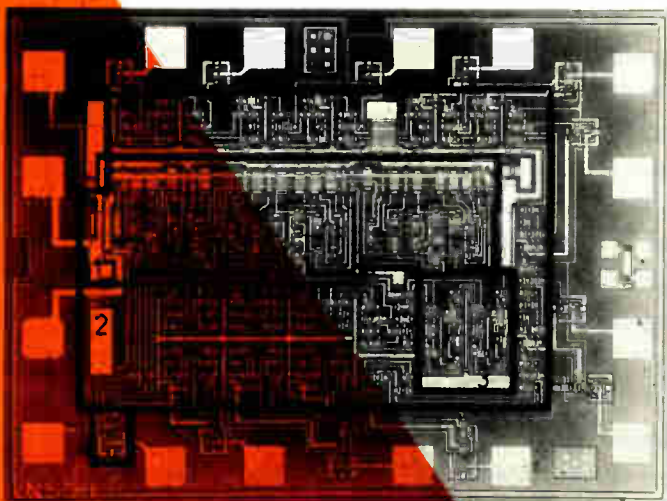
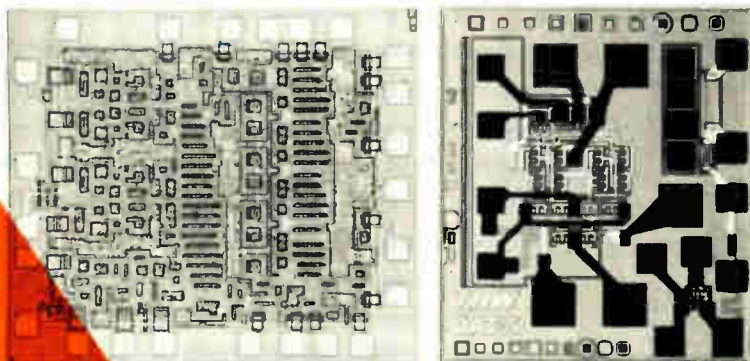

## Logic's leap ahead creates new design tools for old and new applications

Enriching the designer's options is an unprecedented number of new logic families; shown here (from top to bottom) are TI's low-power Schottky TTL ALU (left), TRW's oxide-isolated ECL gate (right), a  $2^{19}$  injection logic counter from Philips, TRW's 16-by-16-bit EFL multiplier with 3,000 equivalent gates, and a 400-gate Motorola TRL chip

by Laurence Altman,  
*Solid State Editor*

□ This is the year of logic.

After the explosion of semiconductor memory in the last few years (see the Special Report, *Electronics*, Aug. 28, 1972, pp. 63-77), manufacturers have turned their high technology to logic, and the results are exciting. Not since the introduction of integrated logic in the early 1960s has the system designer been both blessed and challenged with such a diverse array of powerful new circuit tools.

The activity is wide-ranging. The established transistor-transistor and emitter-coupled logic are being sharply upgraded in several different ways. New forms of bipolar large-scale integration are beginning to emerge that rival metal-oxide-semiconductor LSI for cost-effectiveness while retaining bipolar performance. Early forms of logic are being revived in LSI form. But perhaps most significant of all are microprocessor circuits—an out-and-out break with traditional methods of performing logical functions.

Schottky TTL, a developmental technology a short time ago, is now available from a host of manufacturers in a popular family of circuits. Together with standard TTL, they are boosting the speed-power performance of new equipment, from measurement instruments to computers and telecommunications switching networks.

Low-power Schottky TTL has finally arrived, and manufacturers are rushing to fill out their logic lines with devices that achieve TTL speeds with almost a 10th the power dissipation. Available in small and medium-scale packages, they have suddenly opened the door to fast micropower circuit designs in aerospace communications, portable computers, and low-power industrial controllers.

The next generation of emitter-coupled logic is here to enrich new mainframe designs and push computer performance to new limits. The fully compensated ECL now standard throughout the industry eliminates the former ECL need for expensive power-supply regulation and tight temperature controls. Subnanosecond ECL gates have become a reality, and circuits with propagation delays of 400 to 600 picoseconds promise gigahertz speeds in measurement instruments cache memories that provide nanosecond word access.

Moreover, oxide-isolated ECL techniques, by reducing circuit layouts to a fraction of their former area, point to new attainments in low cost and high performance, with hundreds of gates operating at picosecond speeds. Already an oxide-isolated ECL prescaler with a gate equivalence of 200 has been designed for use in 50-MHz and up control systems.

Of the various new kinds of bipolar LSI, many consider integrated injection logic to be the next wave of logic technology. Being readied at semiconductor laboratories throughout the world, an I<sup>2</sup>L chip may contain as many as 3,000 gates operating at less than 10-nanosecond speeds, and dissipate just 1 nanowatt of power per gate. These

circuits will be appearing in a multitude of old and new applications—in electronic wristwatches, single-chip bipolar central processing units, 5-chip minicomputers, and single-chip controllers for industrial, automobile, and data processing systems. With a speed-power product as low as 0.1 picojoule, 100 times smaller than that of any other bipolar logic, I<sup>2</sup>L is destined to have as much influence on the way logic is built as TTL had in the 1960s.

Equally significant, old logic forms long abandoned have been given new life with new processing techniques such as implanted transistor elements and isolations, mask variations and oxide-isolations, and double-diffused epitaxial layers. Emitter-follower logic, which predated TTL, has lately been resurrected in such ambitious designs as a bipolar multiplier that packs over 3,000 gates onto a single jumbo chip measuring 301 by 276 mils on a side. Transistor-resistor logic, another ancient bipolar configuration, has been streamlined into a full complement of LSI gate arrays. Even a modified TTL configuration, dubbed T<sup>2</sup>L, has appeared, in which a third transistor is added to the output of the gate to boost drive capabilities and increase noise immunity.

But nothing can rival the microprocessor circuits for newness. N-channel MOS microprocessors, together with an assortment of input-output circuits and read-only and random-access memories, now provide a diversified family of versatile logic and memory techniques capable of performing in many controller and processor applications. Now, by microprogramming a ROM on the microprocessor chip, a logic designer can implement in one package, together with some ancillary memory, a function that often took 50 TTL packages. He can change a design simply by changing a software program—and reprogrammable ROMs can be used to change systems in the field. Indeed, he may soon become a programmer, discarding his tedious but till now essential logic optimization techniques.

Still more importantly, this trend to implementing logic by means of a microprogrammable microprocessor is being extended to the higher-performing, traditionally bipolar designs, such as the minicomputer, the midcomputer, and even powerful machines in the IBM 360 class. Here, through the use of emerging Schottky TTL microcontrollers and software programs, designers are turning ever more often to the great assortment of read-only memories and programmable logic arrays to realize their designs. A four-bit slice of a CPU is already available, so that only four processor chips, three or four memories, and half a dozen or so input-output series are now needed to simulate a full 16-bit computing capability. And coming to complement these multichip techniques is the bipolar analog of the MOS microprocessor—a single-chip bipolar microprocessor with 8 to 16 bits of parallel processing and less than 10-nanosecond instruction times.

## More complex logic tradeoffs multiply designers' options

Not so long ago the performance tradeoffs between the available logic families were well-known and straightforward. The decision whether to use ECL or one of the five types of TTL was almost made for the designer—he had only to look at a simple chart and determine what speeds were available, at what cost in power.

But over the past two or three years, the picture has become much more complicated. A dozen or so new logic families have now appeared, with overlapping specifications (Fig. 1) that make it far harder to decide which family now comes closest to satisfying a given set of requirements.

In simpler times, if high speed was the overriding need—to control a fast mainframe, for instance—the obvious choice was emitter-coupled logic, which provides gate propagation delays of 1 to 3 nanoseconds. To pay for it, the designer put up with a per-gate power dissipation of about 30 milliwatts and some compensating circuitry to maintain voltage and temperature stability. For most industrial controllers, medium-performing instruments, and for peripherals and small computers, standard 7400 transistor-transistor logic was most suitable: its delays of 10 ns would certainly be tolerable, its power dissipation of 10 mw per gate certainly manageable, and its flexibility was undoubted, a rich mix of small- and medium-scale integrated circuits being readily available.

Conversely, if low power was essential but speed was not—in portable instruments, industrial logic designs and the like—the designer naturally opted for 74L, a low-power TTL family that operated at 1 mw per gate but could seldom be pushed faster than about 30 ns. For designs requiring some speed and tolerant of power dissipation, the 74H was always there, running at about 5 ns and 20 mw per gate. And that was it, the designer made the best of it.

### Greater liberty

The new logic families give the designer more freedom but also make him work harder. Not only do their specifications overlap, but many families are not interchangeable, so that it's impossible to mix, say, the micropower capability of complementary metal oxide semiconductor and the nanosecond capability of ECL on the same circuit board. Power-supply requirements vary, fanouts are different, drive capabilities are never the same, and so on.

Therefore, one chooses carefully, with great circumspection. When low power is the principal requirement, the line-up now includes C-MOS, low-power Schottky, and low-power TTL. But if C-MOS is selected, the question is, should it be run at a 5- or 10-volt drive? With 10-v C-MOS, 1-megahertz logic is possible, but now the same circuit probably could be built with low-power

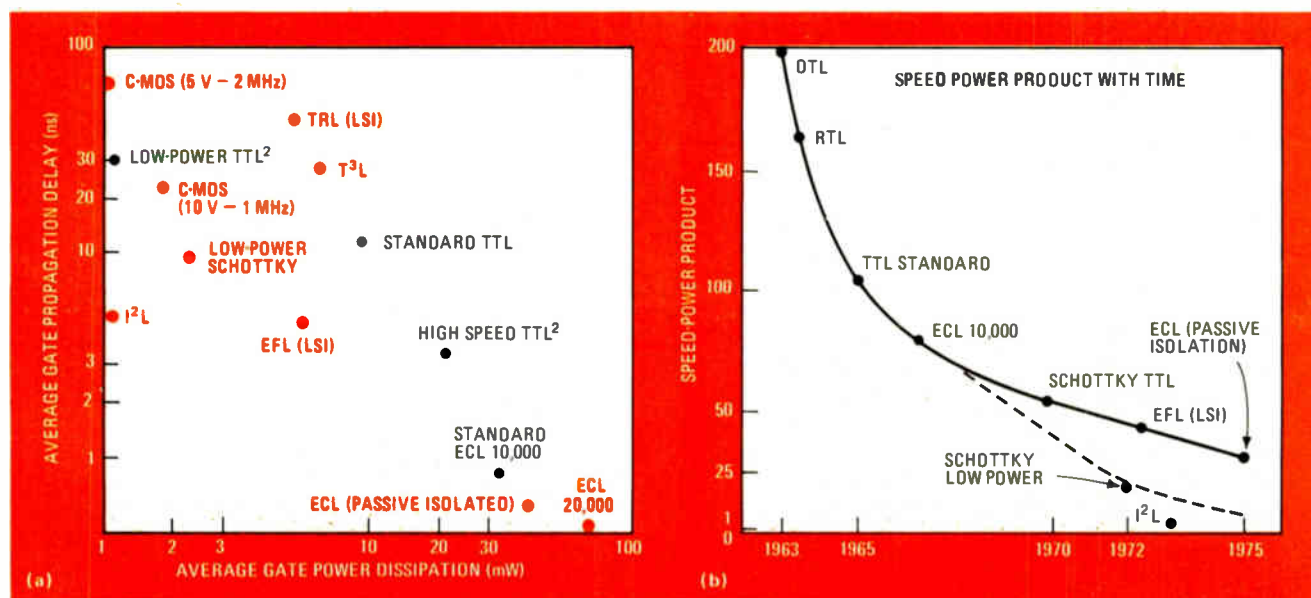

1. **More complications.** In the old days, a logic designer had about four or five logic families to choose from (shown in black), that fell into distinct power-delay product categories. Now a host of new families (in red) with overlapping characteristics complicates the picture.

# LOGIC

TABLE 1: PROPAGATION DELAYS OF ECL AND SCHOTTKY TTL

Part	Specification	ECL 10,000	Schottky TTL	Ratio
Gate	Typ	2.0 ns	3.0 ns	1.5
	Max	2.9	5.0	1.7
Flip-flop	Typ	3.0	5.0	1.7
	Max	4.5	7.0	1.6
MSI	Typ	4.0	8.0	2.0
	Max	6.0	12.0	2.0
LSI ALU	Typ	8.0	14.0	1.75
	Max	11.0	22.0	2.0

TABLE 2: TOGGLE RATES OF ECL AND SCHOTTKY TTL

Circuit	Specification	ECL 10,000		Schottky TTL
		125 MHz	200 MHz	
Dual "D" flip-flop	Min	125	200	—
	Typ	160	225	90 MHz
Dual J-K flip-flop	Min	125		80
	Typ	140		125
4-bit shift register	Min	150		75
	Typ	200		110

TTL and operated at only 5 v. What's more, low-power Schottky provides almost the same power saving as C-MOS, while operating still faster than TTL and at the lower 5-v supplies—but currently its components cost more than either C-MOS or low-power TTL.

Or in his search for low cost, should the designer put aside the standard logic family in favor of a custom LSI design? Here he can compare transistor-resistor logic, emitter-follower logic, and soon-to-be-available integrated injection logic. If he opts for TTL, he can choose from low-cost logic gate arrays, but he must be satisfied with 35-ns propagation delays. He must also justify his refusal to turn to C-MOS, which would provide him with noise immunity and power-supply tolerance at the penalty of a higher drive voltage system and probably more packages and assembly costs.

T<sup>3</sup>L, on the other hand, will give the designer some of the same desirable noise immunity and power-supply tolerance that's available with C-MOS, and do it at the lower TTL voltages. But, since T<sup>3</sup>L requires an additional transistor per gate, it cannot provide high gate densities. The money saved on power supplies may well be taken up in assembling and wiring costs. (See pp. 91-96 for an extended discussion of bipolar LSI.)

Clearly, the choice of a logic family is a complicated exercise, made yet more complex by the need to buy at the right price. But some rules of thumb, based on the experience of the last few years, will help steer the designer to the logic family most suitable for his particular application.

For the industrial environment, for example, where noise immunity and protection from power-supply variations are the chief considerations but high speed is rarely needed, C-MOS is the best bet. Time-keeping and

portable equipment applications also fall into this category, while, in designs where both low power and high speed are needed, low-power Schottky may compete with standard C-MOS. Standard TTL still dominates the mainline logic applications—all the timing, processing, and controlling that make up the bulk of instrument and computer mainframe and peripheral logic. Here, a moderate price for moderate speed is generally the key. TTL gates and flip-flops are now available at 15 cents apiece and appear in a variety of MSI circuits that minimize wire and assembly costs. However, it is in this area that the emerging technologies of I<sup>2</sup>L, RTL and EFL will first make their impact. The high-speed area is still dominated by ECL designs, though they may encounter some competition from Schottky TTLs.

## Taking the Schottky route

While the other tradeoffs keep shifting with the introduction of each new logic family, one has stabilized: since the introduction of Schottky TTL in 1970, increasing numbers of designers have been turning to it to upgrade the performance of their TTL systems. A Schottky family generally has a speed-power product almost half that of standard TTL (60 picojoules as against about 100 pJ), so substituting it for a standard family will almost double the speed of a design, without increasing the power dissipation.

Indeed, Schottky-clamped TTL circuits were originally designed by Texas Instruments as an extension to standard TTL and are one-for-one replaceable with standard TTL circuits. This has encouraged designers to freely mix both types, opting for the faster Schottky wherever speed is essential in a design, and using standard types elsewhere. In many new minicomputers, for example, Schottky has been used for the computation registers—adders, multipliers, accumulators, and the like—while standard TTL has remained in the input-output stages, memory drivers and other interface circuits. Thus, by replacing 25% of his TTL parts with Schottky circuits, a manufacturer can significantly boost the performance of

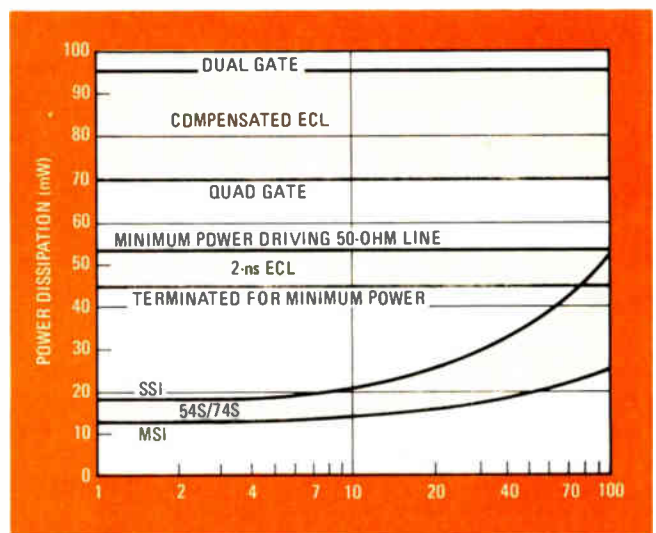

2. Power tradeoff. In the low and medium operating ranges, Schottky TTL operates at less power dissipation per gate than does ECL. But Schottky's power consumption goes up dramatically above 20 MHz, and in fact exceeds that of ECL at very high frequencies.

his machine by, say, reducing an instruction cycle of 15 ns to one of less than 5 ns. No new hardware redesign is required. Also, system wire costs and board space are often reduced because many of the Schottky circuits combine several standard functions in one MSI package.

A comparison of specifications shows how Schottky TTL performance compares with that of other standard TTL families. Since standard TTL contains 10-ns NAND gates and 35-MHz flip-flops, it can be used to design a 2-MHz system. Following the same design rules and replacing all the conventional circuits with Schottky circuits would result in a system operating at about 8 MHz, since the flip-flops would be five times as fast, and the gates three times faster.

Schottky TTL performs better than standard TTL on other parameters, too. Schottky gates, with their lower output impedances, can drive loads of higher capacitance and are therefore less susceptible to ac noise. The Schottky-clamped input diode suppresses the effects of line noise (ringing) because the transfer characteristics are much sharper than in standard TTLs and reduce undershoot risetime effects. Moreover, the terminated lines or control impedance circuit boards necessary in most ECL designs are not normally required with Schottky TTLs, thanks to their higher drive characteristics.

The fact that Schottky TTL utilizes the same threshold logic levels and power supplies as conventional TTL also means that single power supplies can be used in any design mix. Indeed, with the exception of ECL, no level shifters or logic buffers of any kind are needed to interface Schottky with any of the conventional logic families (TTL, DTL, or low-threshold MOS).

But there are some design tricks to extracting the best possible performance from a Schottky and TTL mix. For example, a high-logic-level threshold (above 1.5 v) will drive any of the family types, while a dc noise margin of between 2 and 2.5 v will insure proper noise margins on the high logic level. At the same time, noise margins below 0.5 v will insure proper operation of the low logic levels. And, since Schottky TTL circuits have a fanout of greater than 12, as against the standard 10, Schottky logic designs can be implemented with greater freedom in any mix required for standard TTL circuits.

### Where ECL fits in

If Schottky TTL can upgrade a TTL design, what about ECL? True, designers have for a decade been using ECL for all-out speed in 50- to 500-MHz logic systems for computers and instruments. But since both Schottky and ECL are high-speed logic families, the ability to selectively substitute Schottky TTL for ECL in some designs would seem desirable, especially since Schottky has a lower speed-power product (60 pJ compared to about 100 pJ for ECL 10,000).

But such a Schottky and ECL mix has not in fact appeared, even in those parts of a system that make no use of ECL's 2-to-5-ns speeds. The trouble is that no convenient interface exists between any of the TTL families and ECL, probably because mixing them would require fairly complex power-supply reroutings and TTL/ECL level shifters. Consequently, designers who need emitter-coupled logic's speed in any part of their system usu-

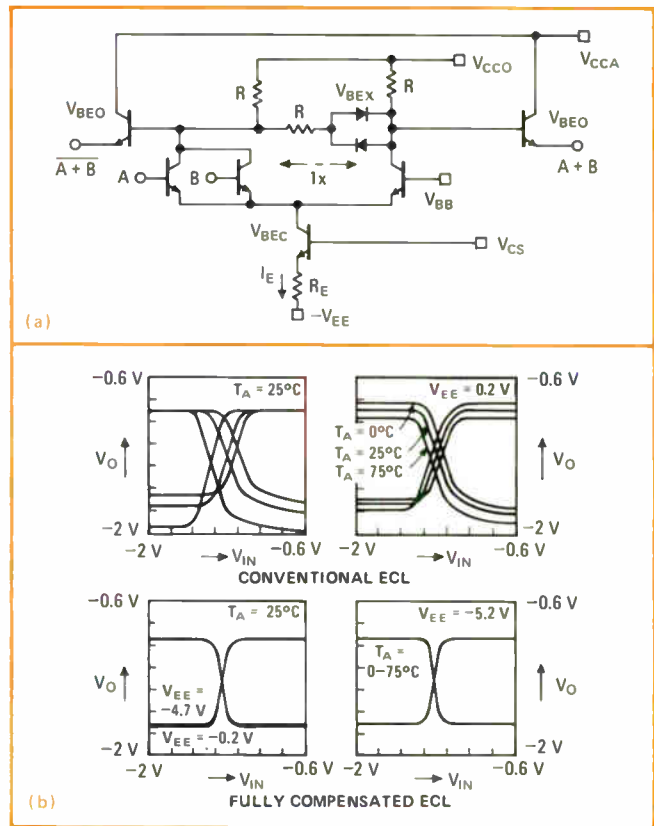

**3. Full compensation.** Fully compensated ECL circuits, the operation of which is not dependent on temperature and voltage changes, include a compensation network like the one shown in (a). This makes for a single switching characteristic (b).

ally have stayed with an all ECL system.

This highlights Schottky TTL's biggest single advantage over the faster ECL: compatibility with TTL and DTL circuits as well as with 74S, 74L, and 74H parts. But ECL is still the choice over Schottky where the fastest possible speed is needed, as Table 1 shows.

The basic ECL 10,000 gates have 2-ns typical delays with 2.9 ns maximum, while the Schottky gates are 3 ns typical and 5 ns maximum (at 25°C). What's more, ECL maximum gate delay over temperature is 3.3 ns for the standard temperature range of -30° to +85°C and 3.7 ns for the full military temperature range of -55° to +125°C.

Another ECL advantage is also shown in Table 1. The propagation-delay ratios between the two logic types improve for ECL 10,000 as circuit complexity increases. The standard ECL 10131 dual flip-flop, for example, has a 3-ns typical and 4.5-ns maximum delay from the clock input to Q output. The delay of the fastest Schottky dual flip-flop is 5.0 ns typical and 7.0 ns maximum.

What this means in terms of MSI function speed can be understood by considering a typical binary 1-to-8 decoder. In this case the ECL propagation delay would be half that of the Schottky part. The largest function common to both families is the 181 four-bit arithmetic unit. The ECL version of this large circuit is almost twice as fast.

Indeed, those who have gone to the trouble of determining delays of the various part types in a system have found the ECL circuits to be nearly twice as fast as com-

# LOGIC

parable Schottky TTL parts. They have also found that the worst-case ECL 10,000 propagation delays are normally faster than typical Schottky TTL delay times.

Toggle rates of the ECL flip-flops are also significantly faster than those of Schottky TTL circuits (Table 2). The basic ECL 10131 toggles typically at 160 MHz and is guaranteed 125 MHz minimum. The Schottky J-K flip-flop, on the other hand, is 125 MHz typical and 80 MHz minimum. Moreover, the 125 MHz of the 10131 can be extended to 200 MHz with the pin-compatible ECL II 10231 translator and up to 500 MHz with the standard ECL III 1690 translator.

As for system specifications, Schottky does have two slight advantages, in needing only a single +5-v supply, and in operating at easily detected logic levels. ECL normally operates on a -5.2-v supply, although +5-v operation is possible if care is taken to minimize noise on the +5-v supply line. But although not compatible with the TTL world, the normal logic levels of ECL 10,000 (-0.9 v and -1.7 v) are directly compatible with the faster ECL III and also, with proper loading, with ECL II.

Translators can of course be used to couple ECL and TTL logic levels, but they introduce about 5-ns propagation delays into the logic sequence and could destroy

the speed advantages ECL circuits have over TTL. The use of ECL in redesigns, however, does become practical when major sections of large systems are upgraded with ECL circuits.

## Where ECL and Schottky TTL are quits

While speed is on ECL's side, the tradeoffs in wiring rules between the two families are mostly at a standoff. Indeed, in a nonterminated-line environment, the wiring rules of the two logic types are comparable. With Schottky TTL a ground plane is recommended for interconnection lines over 6 inches long, and the same rule is also good for ECL 10,000. The recommendation that twisted-pair lines be used for distances over 10 in. when designing with Schottky TTL holds good also for ECL 10,000. However, the use of series damping resistors (reverse termination) is recommended only for the longer Schottky interconnecting paths, while this technique is normal with ECL to improve interconnect signal waveforms. And when parallel termination techniques are not used, the wiring rules for both circuit types are equally restrictive and more complex than for slower forms of logic: the Schottky TTL rules are intended to reduce cross talk to safe levels, while, on the other hand, the ECL wiring rules control signal distortion due to reflections.

Finally, when comparing Schottky with ECL on power dissipation, each of them wins a little. The power dissipation of an ECL function is relatively constant over the full range of operating frequencies (Fig. 2), while in a typical Schottky gate the power consumption is very much less at low and medium operating frequencies (say 10 to 20 MHz, where most functions operate even in high-performance systems). On the other hand, at the higher frequencies, the average power dissipation of a Schottky circuit increases due to the overlap of the low impedance totem-pole output of Schottky designs and to the stray capacitance that must be driven.

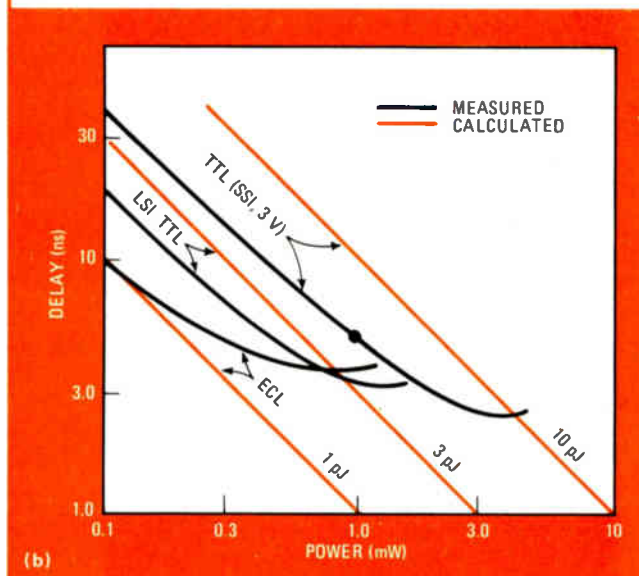
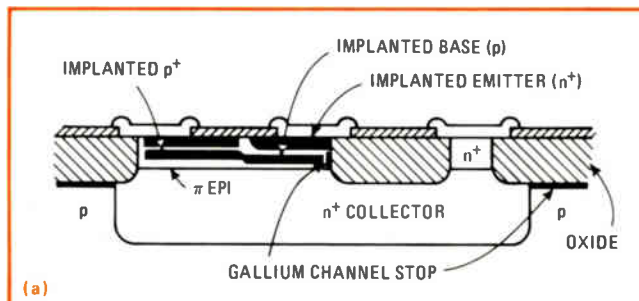

**4. Smaller, better.** Oxide isolation increases the density and speed of TTL and ECL circuits, especially when combined with ion implantation. Bell's OXIM transistor, with implanted base, emitter and collector (a), operates at very low speed-power levels (b).

## Expanding the limits of standard logic

Recent developments are pushing the performance limits of ECL both toward easy-to-use conventional logic families and toward entirely new subnanosecond logic families that borrow advanced fabrication techniques, like oxide isolation, from memory technology.

Once ECL began to expand beyond the well-controlled computer mainframe environment, it entered areas like communications, instrumentation, and even peripheral equipment, where it was more difficult and expensive to control such circuit parameters as power-supply variation, voltage, and temperature. The new users of ECL therefore began demanding compensated circuits, and this entailed eliminating environmental influences (thermal or supply voltage gradients) on ECL output levels and thresholds.

To meet this demand, manufacturers began putting temperature and voltage compensation circuits directly on their ECL chips, so that soon fully compensated ECL families began to appear. Both their output levels and thresholds were invariant with changes in temperature and supply voltage, thus insuring constant noise immunity in high-noise environments for all practical system conditions.



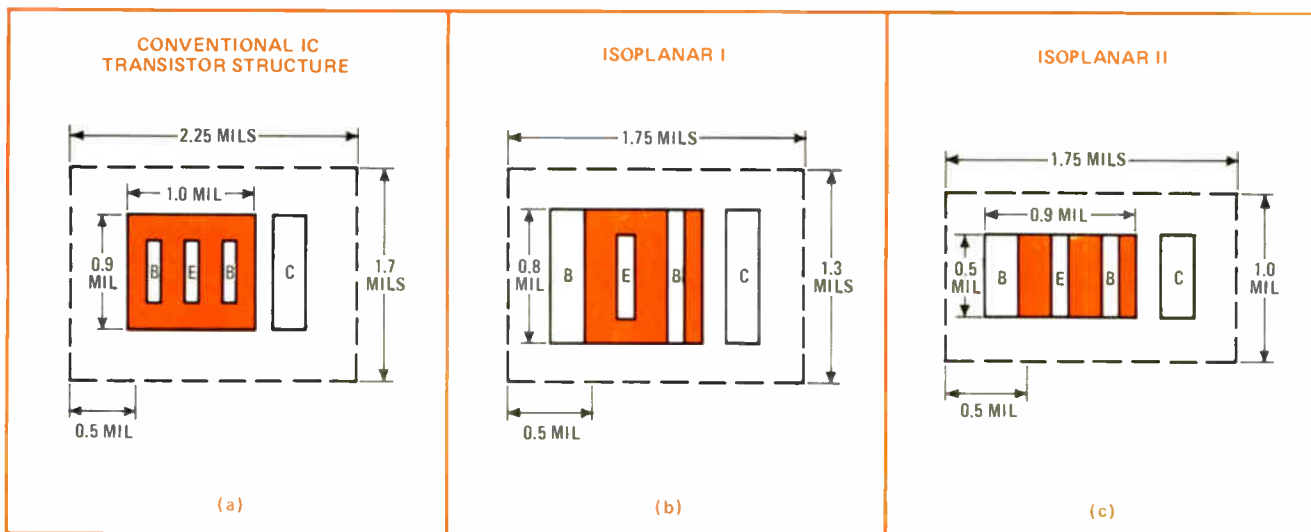

5. **Closing the gates.** For a given emitter size, the collector-base junction areas of conventional IC transistors (a) require twice the area of Fairchild's Isoplanar II transistors (c), and the base regions of Isoplanar II devices are reduced even further.

This compensation was particularly important for instruments and telecommunications systems, where many small-scale ECL circuits caused thermal and voltage gradients at their many and various interfaces with other components. The thermal gradients were generally due to ambient conditions within the system, but also to power-supply variations with circuit and load power, while voltage gradients were due to distribution gradients and/or to power-supply variations. In these cases, noise immunity protection had to be specified at worst case, requiring either a specially built compensation network on the circuit board, or a tightly regulated and expensive power-supply systems, or both.

Today, most makers of ECL 10,000 offer fully compensated circuits that are guaranteed to operate within tight tolerances over temperature. The chip itself includes a compensation network (Fig. 3a), so that the switching characteristics are invariant with temperature and voltage characteristics (Fig. 3b). This, together with a standard voltage-clamped circuit, not only ensures that both input thresholds and output levels are stable with temperature and supply voltage changes, but also makes propagation delay far less sensitive to variations in ambient, thus permitting significantly higher worst-case system speeds.

In addition to making their standard logic families easier and less costly to use, semiconductor manufacturers are now building ECL circuits that are faster and denser and consume less power. While compensation requires new circuit techniques, higher performance is generally achieved through new fabricating processes, of which the most popular are oxide isolation and ion implantation. Both increase speed and packing density by reducing parasitic device capacitance.

### Oxide-isolated ECL

Just how much area can be conserved in an oxide-isolated ion-implanted transistor is indicated in the device profile of Fig. 4a. This experimental Bell Labs transistor, for example, built with an early version of oxide-isolation technique called OXIM, has a fully implanted base, emitter, and collector. The oxide surrounds and

isolates the transistor's emitter area, which can therefore be significantly smaller than in a conventional TTL transistor.

In fact, the OXIM structure yields a device that is five to 10 times smaller and has an equally impressive reduction in propagation delay. This results in the extremely low delay-power product shown in Fig. 4b, which gives the calculated and measured parameters for both TTL and ECL structures. These OXIM structures point to LSI devices with a delay-power product of 1 to 2 pJ, even when fabricated with conventional 10-micrometer rules.

New oxide-isolated-transistor structures have already been incorporated in commercially available products from Fairchild Semiconductor. A device with a 650-ps gate from Fairchild was introduced last year as the beginning of a family of subnanosecond ECL products. Others are expected to follow from Fairchild, as well as from Motorola, throughout the year. The Fairchild products are built with an improved oxide-isolation method, called Isoplanar II, with which it is possible for LSI components to achieve speeds above 1 gigahertz. (The first LSI product in this family will be a gigahertz prescaler for automatically tuning vhf/uhf TV tuners, signalling the beginning of new digital tuning techniques.)

In an extension of the concept of passively isolating devices, the Isoplanar II process eliminates the diffusion of the base region beyond the emitter ends, thus further reducing the collector-base junction area and consequently the area per transistor. Figure 5 compares a conventional IC transistor with an Isoplanar I and an Isoplanar II transistor. For a given emitter size, an Isoplanar II transistor requires only 50% of the collector-base junction area otherwise needed for the conventional planar transistor. Most significantly, the process uses only half the total silicon area per transistor required in conventional IC techniques. In addition, the silicon islands in which the circuit elements are constructed are defined by a thick-field silicon dioxide that permits the use of oversize masks and eliminates the pinholes that seriously hurt yields of typical thin-oxide

devices. This, together with the ion-implanted, oxide-isolation techniques, raises yields and shrinks devices without reducing photolithographic tolerances, and points the way to implementation of fully LSI functions in bipolar technology.

## Where C-MOS is heading

New isolation techniques are also being applied to C-MOS, which originally got its start when the n-channel process was established. At this point, semiconductor circuit designers began combining it with p-channel devices to obtain a complementary MOS structure with the great advantage of needing very little power. The introduction of the standard C-MOS family by RCA, followed by Motorola, Solid State Scientific, Harris Semiconductor, then National and others, suddenly gave logic designers a low-power alternate to TTL for applications where high speed was not needed.

C-MOS basically has an inverter configuration, with n- and p-channel devices connected in parallel. When one MOS device is on, the other is off, and the net quiescent current, which is determined by the leakage current of the off device, is in the barely perceptible nanoampere region.

Even when switching, the device requires little power since now both n- and p-channel transistors are only partially on, and only microamperes of current flow.

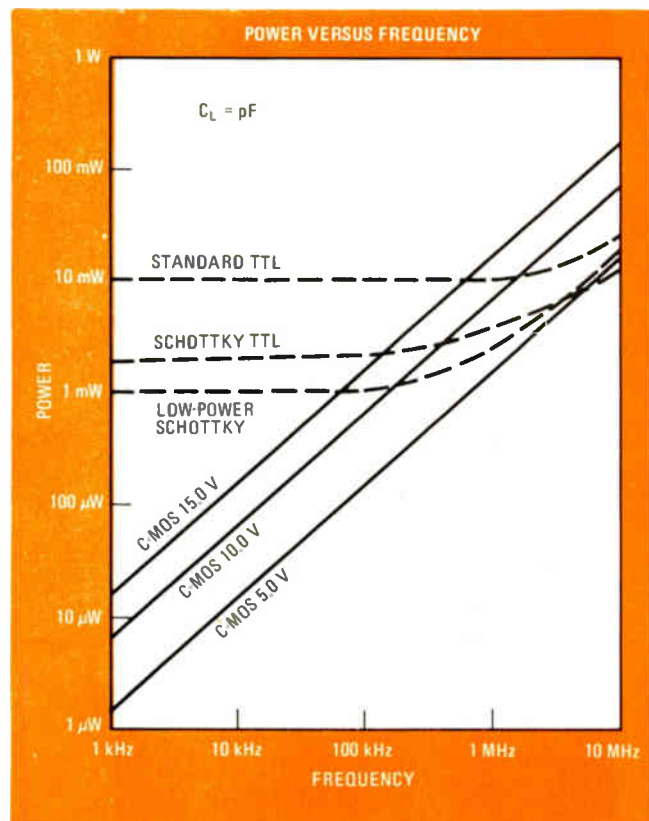

**6. Low power, low frequency.** At frequencies below 10 kHz, C-MOS can operate at dissipations of 10 microwatts per gate and is unbeatable by other logic families. But its power rates climb sharply at higher frequencies and above 100 kHz exceed those of TTL.

This means that at moderate speed, say, below 1 kilohertz, power dissipation per gate can be as low as 1 microwatt (Fig. 6).

Two other properties also make C-MOS extremely valuable in industrial applications: its noise immunity, and its ability to work from single supply voltages of wide tolerances—anywhere from 3- to 15-v power supplies. This means that the expensive close-tolerance power supplies can be eliminated in favor of a cheap unregulated supply.

Its noise immunity is perhaps even more important and derives from C-MOS' near ideal logic transfer characteristic and extremely sharp cutoff between a logic 0 and a logic 1. Indeed, with a guaranteed noise immunity of approximately 1.5 v compared to TTL systems with noise margins of only 0.4 v, C-MOS logic circuits for seat-belt interlocks, electronic ignition, and injection fuel systems are already being built. Also making use of C-MOS' high noise immunity are industrial process control and manufacturing equipment where standard C-MOS logic circuits, which can operate undisturbed by high electrical factory noise, are rapidly replacing TTL packages.

As a replacement for TTL, C-MOS is well known to be extremely cost-effective. But what is less known about C-MOS is its ability to operate at fairly high speeds (up to 1 MHz) at increased but still moderate power consumption. In fact, C-MOS has a lower propagation delay-power product than any of the TTL family. By operating just below TTL speeds, medium- and large-scale integrated C-MOS packages can perform the same logic functions as TTL but with the added advantage of lower power-supply requirements, high noise immunity, and lower costs.

However, being composed of complementary structures, C-MOS circuits require an additional device per gate over other MOS structures, as well as an additional isolation region. Consequently, they are only about a third as dense as either n- or p-MOS devices, even though they are smaller than most equivalent bipolar structures. This tends to place C-MOS in applications where low power is extremely desirable, where medium-scale integration can be used, and where high speeds are not essential—in other words, in the industrial and communications segment.

Still, the new fabricating techniques that are boosting the performance and the circuit densities of bipolar logic chips are doing just the same for C-MOS. For example, Fairchild has recently introduced the first C-MOS chips in which oxide isolation increases the operating speeds and stability of the logic outputs and makes the devices a third more compact. Some of the space so gained is used to add a buffered output structure, of which more shortly.

## A denser C-MOS

Figure 7a illustrates a conventional, unbuffered two-input NOR gate. One n-channel transistor, connected to the supply voltage,  $V_{SS}$ , will conduct when either input is high, causing the output to go low through the on resistance of the device. If both inputs are high, both n-channel devices go on, in effect halving the on resistance and making the output impedance (and hence pro-

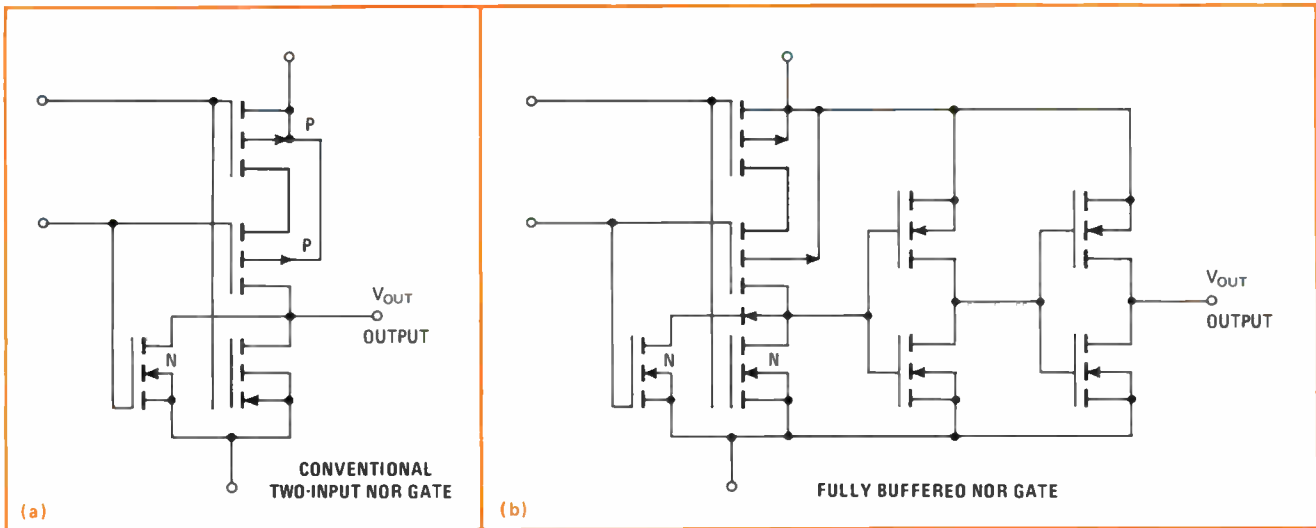

**7. Buffering C-MOS.** Fairchild's use of oxide isolation to build C-MOS circuits reduces gate area and makes room for a buffered gate structure. This improves noise immunity and output drive capabilities and eliminates delay sensitivities.

propagation delay) a function of input variables. Similarly, the p-channel devices are switched on by low signals; i.e., when both inputs are low, conduction from the drain voltage,  $V_{DD}$ , to the output will occur.

Now, since the p-channel devices are in series, their chip area must be enlarged so that their on resistance will decrease and hold the high impedance of the output within specification. And, as the number of gate inputs increases, even larger p-channel devices are required, causing severe variations of the output impedance with input patterns to  $V_{SS}$ . For example, in an unbuffered C-MOS, the two-input NAND gate interchanges parallel and serial transistor gating to achieve the dual logic function. The change in output resistance moves to the p-channel transistors connected to  $V_{DD}$ , while the n-channel devices, being serially connected, must be increased in size. Needless to say, this sensitivity of propagation delay to input pattern can cause all sorts of mysterious system problems—for example, errors may occur only with certain data patterns.

To eliminate any pattern sensitivity of propagation delay and to standardize delay and output drive, the recently announced oxide-isolated line of C-MOS logic adds an output buffer state to the gate configuration

(Fig. 7b). This technique actually reduces chip size, since now only two large output transistors are required, and it also improves noise immunity because the increased voltage gain results in nearly ideal transfer characteristics. The high voltage gain of greater than 10,000 also provides significant pulse shaping, since output transitions are independent of input risetimes.

The oxide-isolated C-MOS not only increases output drive capability, but, when combined with silicon-gate techniques, it achieves an approximately 35% saving in chip area by eliminating the need for the channel stops and guard rings of conventional C-MOS. Conventional C-MOS circuits are fabricated on n-type substrates (Fig. 8a). A p-type well, required as a substrate for the complementary n-channel MOS, is obtained by diffusing a lightly doped p region into the n-type substrate. Every p-channel device must be surrounded by a continuous  $n^+$  guard ring; similarly, a heavily doped  $p^+$  guard ring must surround every n-channel device, increasing chip size and lowering circuit speeds. All this is eliminated in oxide-isolated structures (Fig. 8b), and, in addition, their operating speeds are also increased by the self-alignment of the silicon gate and the reduction in sidewall capacitance.

**C-MOS on silicon on sapphire**

There are schemes afoot to use a better insulating epitaxial substrate, such as silicon on sapphire in a C-MOS configuration, instead of the conventional bulk silicon substrate. The great advantage of C-MOS on SOS is that it can be built into configurations that are two to three times denser than bulk silicon circuits, with twice to three times more speed. Moreover, power dissipation at higher speeds is greatly reduced, yielding a speed-power product unmatched by any other technology except integrated injection logic. The implication is clear—a high-performing family of circuits suitable both for LSI logic applications in calculators, processors, and controllers, and for mainstream SSI and MSI standard-logic applications.

In this process, a thin film of single-crystal silicon is grown on an electrically insulated substrate like sap-

**TABLE 3: COMPARISON OF TYPICAL SPEED POWER PERFORMANCE OF TTL FAMILIES**

TTL family	Standard TTL	Low-power Schottky TTL	Low-power Standard TTL
Average propagation delay (ns)	10	10	33
Average power dissipation (mW)	10	2	1
Speed-power product (pJ)	100	20	33
Number of loads (fanout)	5	20	40

# LOGIC

phire, and etched into perfectly isolated islands for the fabrication of C-MOS transistors and cross-unders. (Thin-film silicon virtually eliminates the parasitic capacitance that seriously degrades performance of bulk silicon C-MOS circuits.) Already 256-bit dynamic shift registers of C-MOS on SOS are available with 20-ns access times and dynamic power dissipation of less than 100 microwatts per bit. Moreover, since SOS allows more dividers to be built in smaller spaces, C-MOS-on-SOS clock circuits can be built with higher-frequency (and therefore smaller) crystals, making the miniature micro-power electronic watch a reality. (See p. 116.)

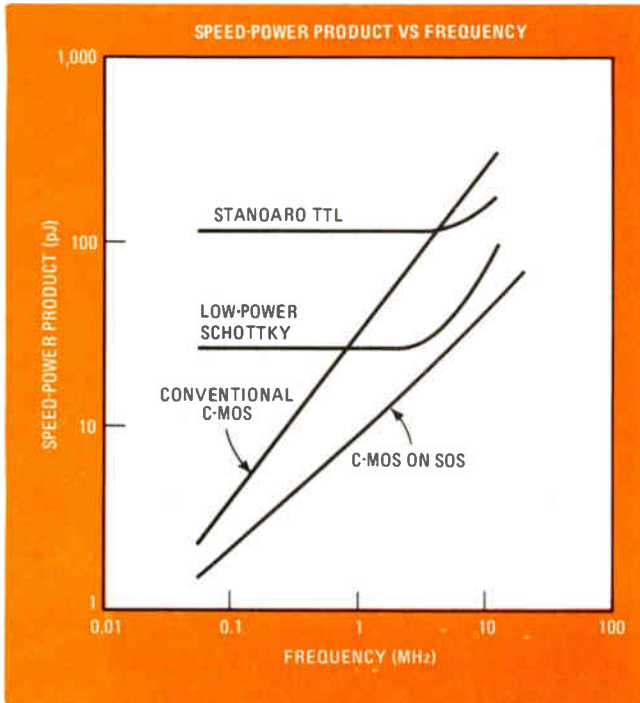

**8. Power struggle.** Low-power Schottky could take over some jobs from C-MOS. It operates at optimum speed-power tradeoffs for many applications, especially in the 100- to 500-kHz range, where it dissipates about twice the power of C-MOS but runs 10 times as fast.

Many people close to SOS development, however, feel that the real payoff for its speed improvement will be in complex LSI functions for computers. Here, of course, n-channel technology will also profit from using SOS substrates. Indeed, what is so exciting to the computer industry is the prospect of large subsystems using n-channel MOS or C-MOS on SOS and operating with ultra-low power dissipations at subnanosecond speeds (less than 1 ns per function). Nor is the sapphire substrate the final word in the evolutionary MOS process—for example, at RCA, work is also being done with spinel, which crystallographically matches silicon more closely than sapphire and also is easier to machine.

## Low-power Schottky in the race

C-MOS for low-power applications, yes—but still another low-power form of logic now emerging from several semiconductor manufacturers could well give C-MOS a run for its money. Low-power Schottky was introduced last year by TI, Signetics followed, and National and Fairchild will soon join them. The circuits match C-MOS' low power at frequencies of 1 MHz and perform at significantly lower powers at higher speeds (Fig. 9). Typically they're specified at 10 ns and 1 to 2 mw per gate (Table 3). This means that today's data processing systems, which operate at standard-logic frequencies of 3 to 5 MHz, could make good use of low-power Schottky.

Low-power Schottky also has the advantage of being pin for pin compatible with standard TTL, so that the same type of system upgrading that designers do with standard Schottky is now possible with low-power Schottky. No new design rules are needed, since fanout and loading characteristics are like those of the other TTL families. Indeed, the Schottky-diode clamped inputs are the same ones that have simplified many designs. In addition, the low-power Schottky family, which comes in a wide assortment of MSI and SSI parts, has switching times virtually insensitive to variations in power supply and temperature. Frequently, too, designers find that the reduced power-supply requirement easily makes up for the cost premium now required for low-power Schottky over standard TTL and Schottky devices. □

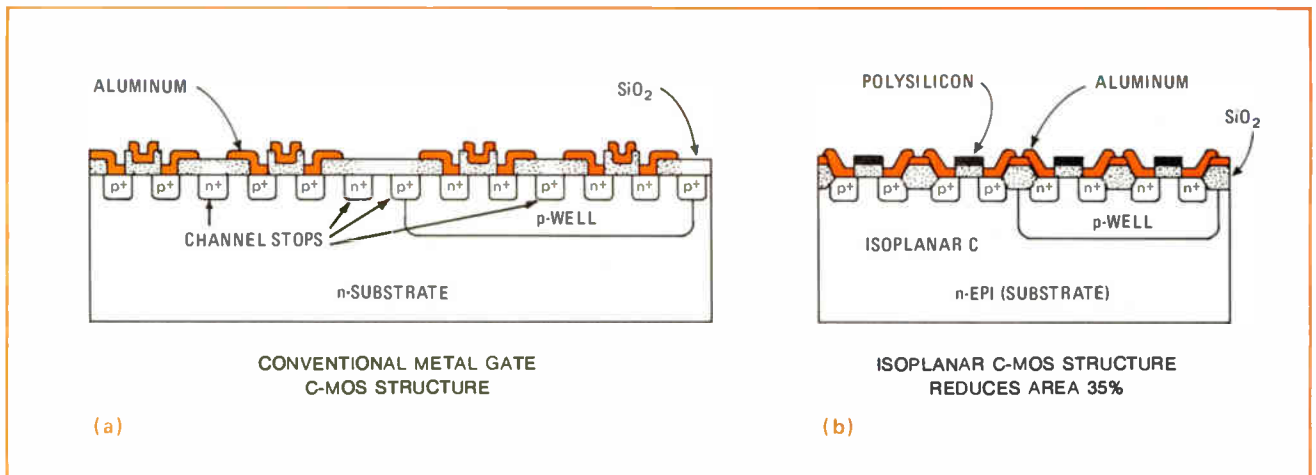

**9. Isolating C-MOS.** The active junctions that isolate devices in conventionally fabricated C-MOS (a) waste space. In Fairchild's oxide-isolated C-MOS structure, the heavily doped p<sup>+</sup> guard rings are eliminated, reducing area and the capacitance that degrades speed.

# Bipolar logic steps up to LSI, with the smart money on I<sup>2</sup>L

Developments in conventional logic, though swift, have been essentially evolutionary, giving the system designer ever more powerful and ever more varied circuit tools. The impact of bipolar LSI technology, however, will be more radical, for the developments currently under way in this area promise to revolutionize the entire approach to system design. With today's advanced LSI designs, a system is no longer a hierarchy of distinct logic, memory, and peripheral interface segments but, instead, merges all these functions on a few chips.

Single chips containing serial memory, random-access and sequential memory, and sequential logic will begin to replace the traditionally separate hard-wired logic and memory boards. Soon analog control and detecting circuits will be integrated onto the logic and memory chip along with display drivers and control logic for peripheral terminals. Suddenly, all classes of semiconductor technology are being integrated on a very few large high-performing LSI chips.

Table 4 shows the array of monolithic LSI circuits now being developed as large-block system components. It also charts the dramatic progress made since the mid-1960s. Random-access memories have increased from 16 bits per chip in 1966 to over 2,000 bits with both MOS and bipolar fabricating techniques, and by 1980 single-chip RAMs are expected to contain 64,000 bits of memory, to form a three-to-five-chip randomly accessible data bank to interface with single-chip logic modules. Serial memories, today at the 16,000-bit level, are expanding to 50,000 bits, thanks to charge-coupled-device techniques, so that a designer, using CCD serial memories has the equivalent of a megabit data disk file on a few low-cost chips. The same CCD technology

should be capable of yielding chips with millions of bits of memory, pointing to single-chip logical systems interfacing with low-cost serial memories in compact, megabit computers.

Similarly, random logic circuits, today at the 500-gate level, are expected to increase to 10,000 gates by the end of the decade. Along with digital correlators capable of over 2,000-bit logic management, they will enable mini-computer control processor units to be built on a single bipolar chip. And this single-chip minicomputer, operating with 50-megahertz clock rates and average instruction times of 50 nanoseconds, will be capable of simulating the operations of a 360 level machine that today requires dozens of conventional circuit packages. Already the promise of this super-chip technology, called by some VLSI (very large-scale integration), is being borne out. TRW Systems is working on a central processing unit on 11 VLSI chips that will operate at 5 MHz, includes 8,192 words of memory, and is expected to cost less than \$2,000 per unit.

Feeding these developments is an array of technologies remarkable for their diversity and ability to enhance component performance. Figure 10 lists no fewer than 13 distinct bipolar LSI technologies based on three distinct approaches to circuit construction—epitaxial-collector techniques, three-diffusion techniques, and oxide-isolation techniques—while metal-oxide-semiconductor technology also can list four to six distinct circuit forms suitable for LSI. Today, the semiconductor manufacturer has at his command at least 20 different circuit technologies capable of yielding a truly high-performing LSI technology.

Table 5 shows just how sensational by current standards this technology will be. By 1980 digital circuit clock rates will be as high as 2,000 megabits per second, compared with 300 megabits now and 25 MHz seven years ago. Speed-power products will improve by another order of magnitude, dropping from today's 3 to 10 picojoules to the 0.1-pJ range. LSI will pack up to 10 transistors into every square mil of silicon and so allow up to 200,000 transistors on a chip a half inch on a side.

## Schottky LSI Starts it off

Bipolar LSI got its start from the increased complexity and speed now being wrung out of today's Schottky TTL and ECL processes. Chips with gate complexities greater than 100 have appeared from several sources. Motorola has just announced an ECL multiport register capable of writing two bits at the same time as reading four bits of parallel processing. TI last year, capping a trend to more

TABLE 4: TYPICAL MONOLITHIC CIRCUITS	Industry Capability		
	1966 (SSI)	1974 (LSI)	1980 (VLSI)
Random-access memory	16 bits	2,048 bits	64,000 bits
Serial memory	32 bits	30,000 bits (CCD)	5 X 10 <sup>6</sup> bits (CCD)
(Random) logic	4 gates	500 gates	10,000 gates
Digital correlator	—	64 bits	2,048 bits
Rf analog circuits (bipolar)	—	—	S-band rf circuits
Secure code generator	—	32 bits	1,024 bits
Sensor mosaics (CCD)	—	100-by-100 elements	1,000-by-1,000 elements
Minicomputer CPU (bipolar)	—	10 chips at 5 MHz	1 chip at 50 MHz

# LOGIC

complex Schottky logic, developed a full four-bit binary accumulator on a single chip.

Equivalent to 115 to 120 gates, this single-chip Schottky accumulator can reduce package count in a typical central processing system by half a dozen and has become an instant winner in the intelligent terminal and high-performance processor market. By integrating an arithmetic logic unit and function generator circuit with a shift storage matrix, the chip performs the functions of at least four chips of the preceding generation. Indeed, the ALU can add, subtract, take the complement or increment of, transfer, and so on.

The next step in Schottky bipolar integration is already under way—to produce a single-chip microcontroller. This CPU, combined with a control logic chip, such as a controllable ROM, a first-in, first-out ROM, a programable-logic-array sequencer, and one or two chips of memory, will result in full minicomputer capability in the fewest packages yet.

A big step toward the goal of a single-chip bipolar processor is Monolithic Memories' soon-to-be-announced Schottky controller—a four-bit slice of a CPU that has a gate equivalence of better than 1,000. Indeed, just four of these chips, plus perhaps a dozen control and memory packages, will be the equal of a medium-size computer that nowadays uses at least 50 packages.

The microcontroller can be used as a four-bit processor slice of a conventional CPU, besides serving in peripheral controllers (tape, disk, and so on), or as the heart of a microprocessor, terminal, or computer. It contains an impressive array of circuitry: bit shifters, a multiplexed 16-by-four-bit RAM, control registers, multiplexers, an ALU, 352 bits of ROM, clocks and output control drivers. Up to 256 instructions can provide full arithmetic logic and shifting capability. There are also 16 directly addressable, two-port, general-purpose accumulators, and a separate accumulator extension register.

TABLE 5: TYPICAL INDUSTRY CAPABILITY

LSI Parameter	1966 (SSI)	1973 (LSI)	1980 (projected) (VLSI)
<b>Performance</b>			
Clock rate (maximum) (MHz)	25	300	2,000
Transistor bandwidth (GHz)	0.3	1	6
Speed-power product (pJ)	100	3-10	0.1-1
<b>Complexity</b>			
Chip size (maximum) (mil)	100	250	500
Device density (mil <sup>2</sup> )	20-50	2-5	0.1-0.3
Transistors per chip (maximum)	50	5,000	200,000

Moreover, the chip is expandable to handle n-bit words. In just one 150-ns micro-instruction cycle, it can perform several instructions, like subtract, shift, and store. Indeed, it's ideal for upgrading or replacing existing computers. For example, a 32-bit microprogrammed CPU can be built with under 30 packages. A machine at the level of a Nova can be emulated with 28 packages—four controllers, 14 ROMs, five registers, three gate packages, and two multiplexers. (A conventional Nova board contains 175 packages.)

## Integrated logic looks like a winner

An altogether new approach to LSI is integrated injection logic. Introduced simultaneously by Philips, Eindhoven, and IBM, Boeblingen, its potential is astounding:

- Because it can be merged into a single-device format, I<sup>2</sup>L is capable of putting 1,000 to 3,000 gates, or more than 10,000 bits of memory, on a silicon chip.
- Having a speed-power product as low as 0.1 pJ, as against the 100 pJ of today's TTL, I<sup>2</sup>L can produce micro-power circuits—standard logic arrays, and micro-processors, and also watch and instrument control logic chips.
- The technique is extremely versatile, allowing both

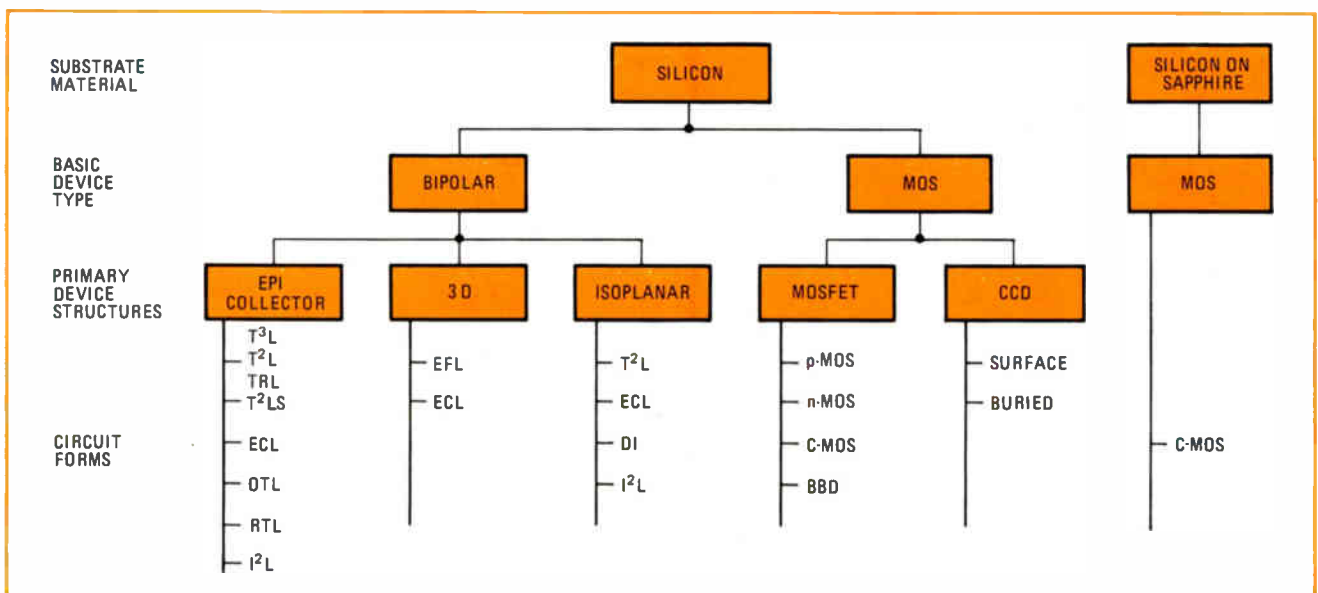

**10. Diversified technology.** Responsible for the growth in logic is an impressive array of processes. There are at least 13 bipolar LSI technologies using three distinct circuit approaches, and four to six MOS LSI techniques. The chart is modified from a TRW source.

the need for all current source and load resistors. It may well make standard TTL look expensive.

### What an I<sup>2</sup>L gate is like

Injection logic employs a radically different and remarkably simple form of bipolar logic, which reduces a gate to a simple complementary transistor pair (Fig. 11a). A vertical npn transistor with multiple collectors operates as an inverter, a lateral pnp transistor serves both as current source and load, and no ohmic resistors are required for either source or load function. A typical TTL gate, in contrast, needs six to eight transistors.

Yet more interesting, when laid out on silicon, both I<sup>2</sup>L circuit elements can be merged and fitted into the area of one transistor and in the process completely eliminate the problem of device isolation. Structural complexity almost vanishes, being reduced to that of a single planar transistor. This, plus the absence of ohmic resistors, accounts for the greatly increased circuit densities of I<sup>2</sup>L.

A cross section of an I<sup>2</sup>L gate is shown in Fig. 11b. The n<sup>0</sup> substrate forms the common emitter, E<sub>n</sub>, of the gate transistors, and the upper n<sup>0</sup> islands are used as the multiple collectors C<sub>1</sub>, C<sub>2</sub>, and C<sub>3</sub>. That is, the transistors are upside down—the equivalent, in terms of a standard bipolar structure, of using common-collector npn transistors in the inverse mode.

Figure 12a shows the implementation of the logic NOR function that's basic to of any kind of complex logic. Since the emitters of all npn transistors are tied to a common reference potential, usually ground, they are normally used in a common plane—in this case, the substrate. The current source, which is simply the lateral pnp transistor of a preceding stage, provides the drive current for the base of the npn transistor—the transistor switch—as well as the charge current for the circuit capacitance.

To supply current in this way, without an ohmic resistor being tied to a positive voltage supply, a collection of excess minority carriers must be generated in the vi-

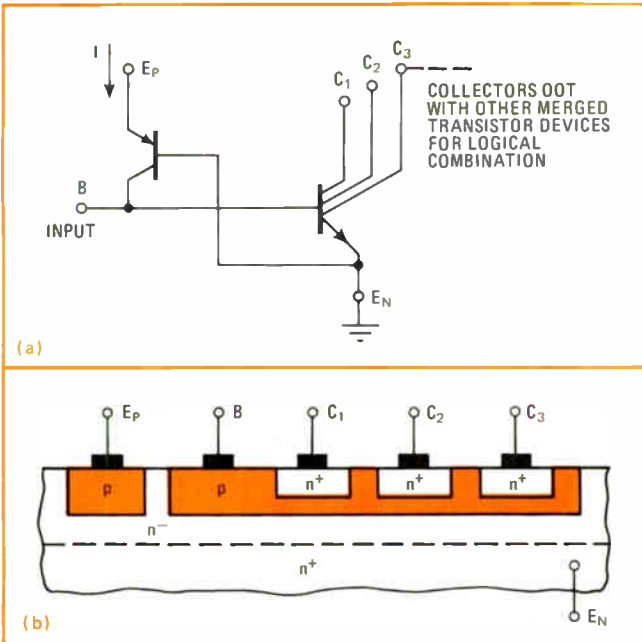

**11. Merging.** In the I<sup>2</sup>L structure, the gate is reduced to a single complementary transistor pair, one of which is a vertical npn transistor with multiple collectors (a). As shown in this IBM structure, on silicon it merges into the space of just one device (b).

digital and analog functions to be built together on a chip. Examples are an I<sup>2</sup>L digital-voltmeter chip containing both the decade counters and segment decoders; ROM stores, shift registers, and control logic for complex calculators; frequency dividers for electronic organs; even a-d and d-a converters on memory and logic control chips, and digital tuning and color controls for TV. Already being prepared for commercial production at Philips Components division are I<sup>2</sup>L touch control circuits for radio and TV tuning and a telephone tone dialing system.

Finally, I<sup>2</sup>L should be extremely cost-effective, being a five-mask process with a gate structure that eliminates

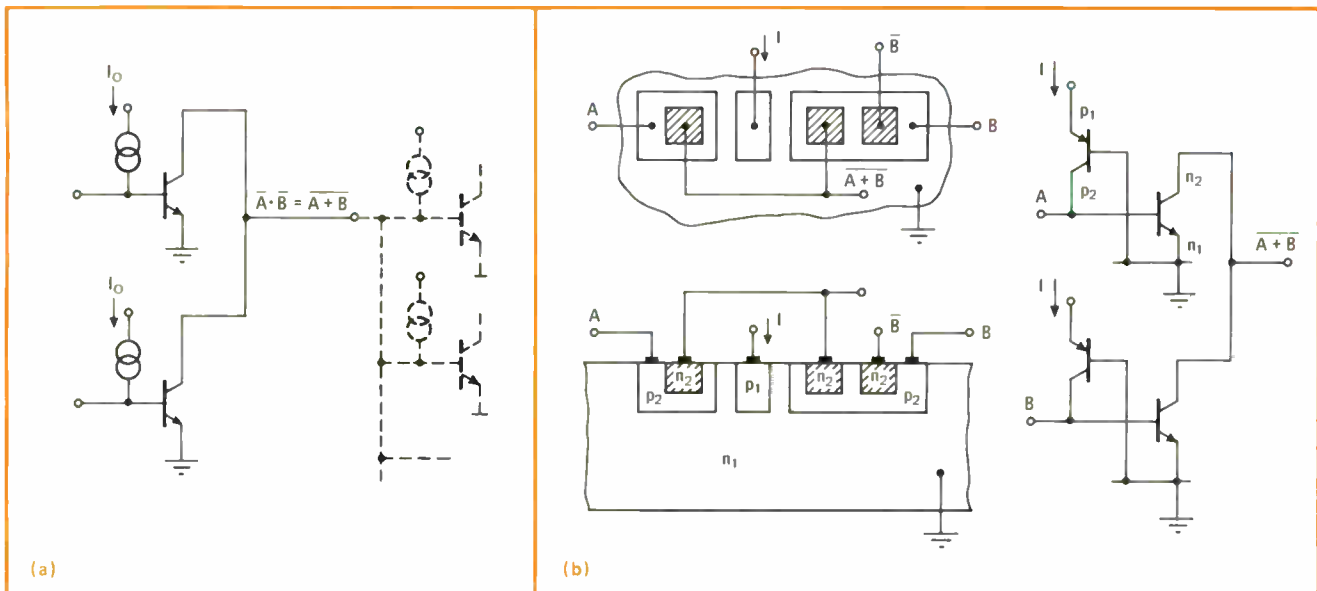

**12. Function.** Great space savings are made with I<sup>2</sup>L in implementing logic functions, like this NOR function, because all the emitters of all npn transistors are tied to a common substrate (a), and current is injected into the device, thus eliminating current-source resistors (b).

# LOGIC

cinity of the emitter-base junction. In  $I^2L$  configurations these carriers are generated in the common n-emitter region by a hole injection from the p emitter—in other words, from the action of the complementary pnp. Therefore, as seen in Fig. 12b, the pnp transistor represents the action of the emitting  $p_1$  zone and in effect serves as the emitter, the common  $n_1$  region becomes the base, and the base region,  $p_2$ , of the npn transistor becomes the collector.

It's possible to achieve high current gains (beta greater than 5) with  $I^2L$ , since the emitter efficiency depends not only on the doping ratio but also on the ratio of diffusion length to base width, which can be made very large. This means that injection logic is also suitable for high-drive linear applications, in watches, instruments, consumer, and communications systems.

## Experimental evidence

The results obtained on some experimental  $I^2L$  chips bear out the value of this technology. At Philips Research Laboratories in Eindhoven in the Netherlands, power-delay products as low as 0.25 have been obtained

on devices built with standard 5-micrometer photolithographic rules and packing density configurations of 400 gates per square millimeter. What's more, by using a geometry that lets current enter the npn transistor from three sides instead of one, Philips researchers have reduced the power-delay product to an astonishing 0.13 pJ per gate. Propagation delays of 7 ns, on the other hand, have been achieved in devices with shallow diffusions, answering those critics who maintain that  $I^2L$  is not capable of high speeds. Figure 13 shows that  $I^2L$  devices, performing in the nanowatt-per-gate range at propagation delays of less than 10 ns, are a formidable rival for typical MOS and bipolar devices.

A valuable property unique to  $I^2L$  is that devices on the same chip can be made to operate at different speeds if the layouts of the inverters are changed. For example, if the base region is laid out perpendicularly to the injector, the lateral voltage drop in the base resistance causes the current density in the base to decrease from left to right (Fig. 14a). The inhomogeneity of current density then makes collector 1 switch at maximum speed, but collectors 2 and 3 switch at lower speeds. Therefore, different speeds can be designed into different chip sections at the mask stage to allow maximum circuit efficiency. If all collectors are required to

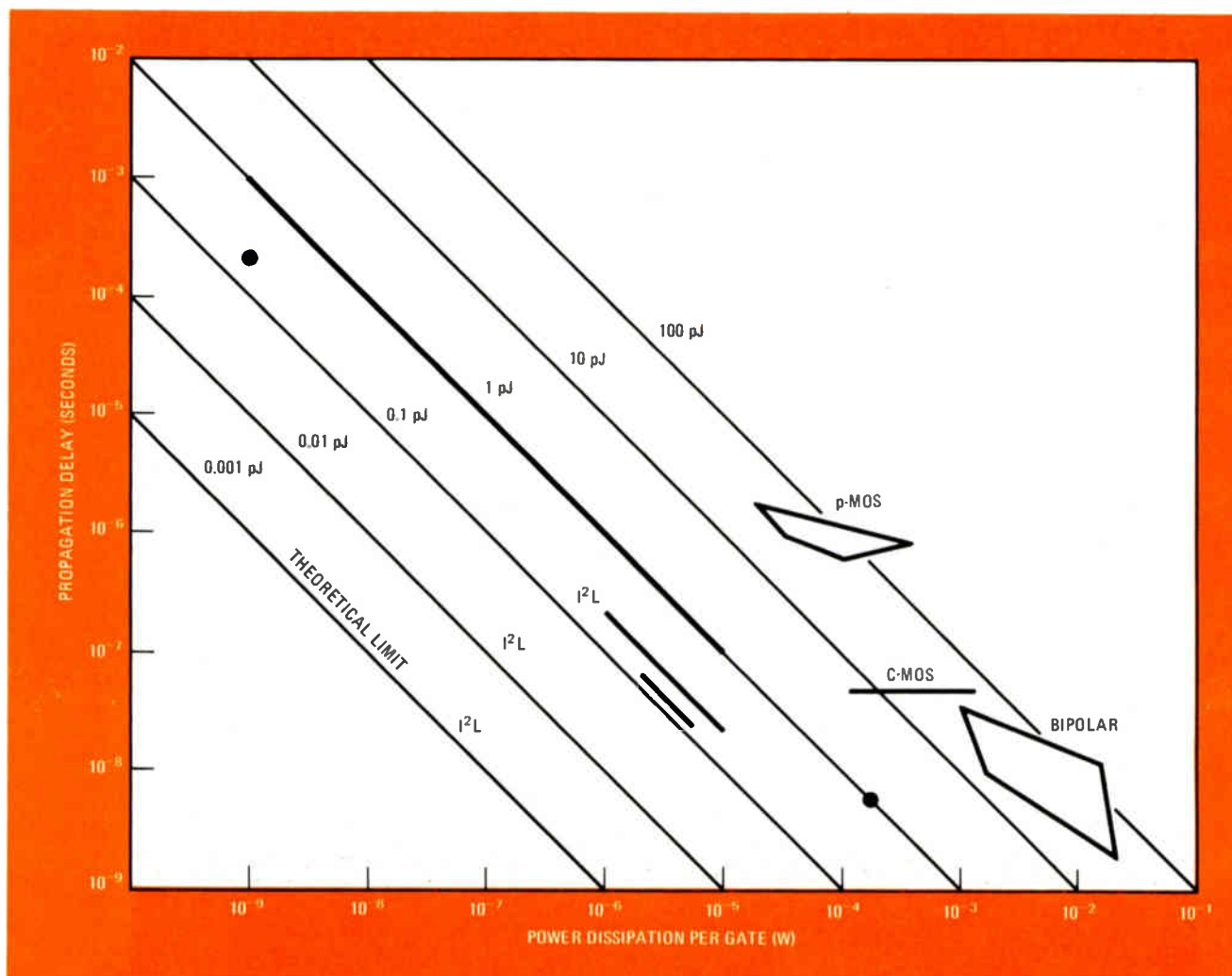

**13. Far out.** The performance of  $I^2L$  far exceeds that of other logic families, MOS or bipolar, because it can operate at nanowatts per gate in less than 10 nanoseconds per gate. The projected speed-power product is less than 0.1 picojoule (for today's TTL, it is 100 pJ).



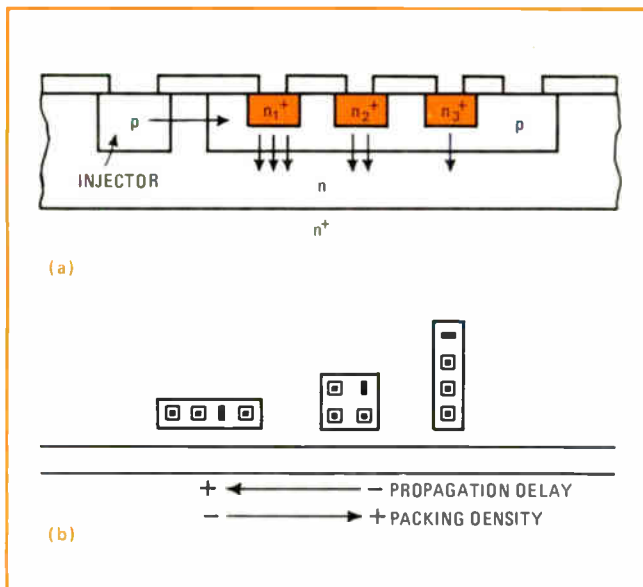

**14. Variable speed.** I<sup>2</sup>L has the virtue of operating at different speeds depending on device layout. Here collector 1, being closer to injector p, operates at higher speeds than collector 2 and collector 3 (a). The propagation and packing density rules are given in (b).

switch at maximum speed, the inverters are simply laid out in parallel to the injector rail, allowing all collectors to receive equal amounts of current. In this case the packing density decreases. Therefore, design tradeoffs are available that can provide just the right speed-density relationship (Fig. 14b).

If a seven-mask system is used, various types of logic and analog circuitry can be built together with I<sup>2</sup>L on the same chip (Fig. 15). All types of interface circuits are possible. For example, Fig. 16 shows a fast 2<sup>19</sup> counter in which the first two stages are built with MOS logic (region 1) and the remaining stages with I<sup>2</sup>L gates (regions 2 and 3), while emitter-follower output stages are laid out in region 4. Notice that the two I<sup>2</sup>L flip-flops in region 3 have a different layout from the other I<sup>2</sup>L flip-flops because they alone have to operate at maximum speed.

Finally, Table 6 compares I<sup>2</sup>L chip density with various types of MOS used in the control logic of a calculator. The same layout rules were used for all the MOS

**15. Mixing technologies.** It's possible to build analog devices onto digital chips with I<sup>2</sup>L techniques, making various kinds of interface circuits feasible. Here an ECL, TTL, and analog circuit is put on the same chip as a I<sup>2</sup>L logic circuit.

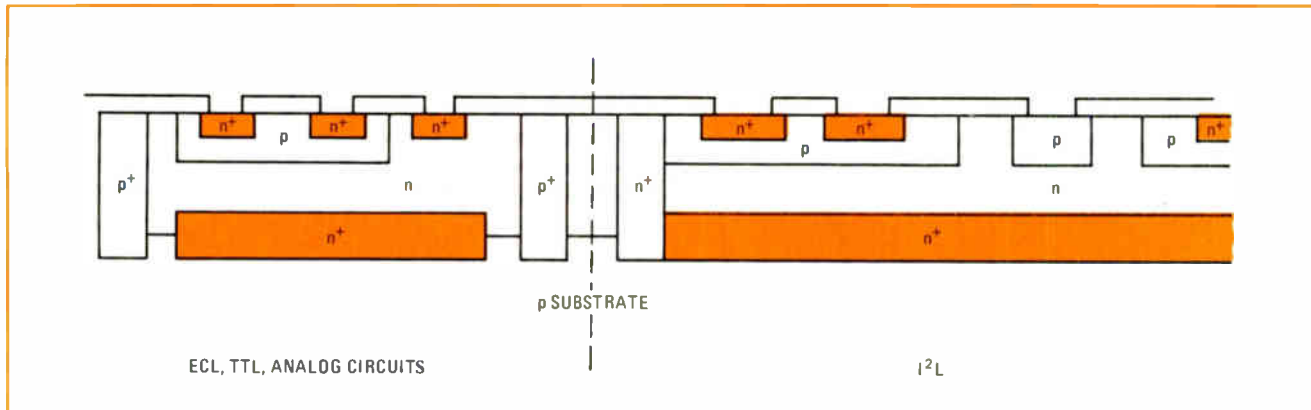

silicon-gate and I<sup>2</sup>L circuits. The results are singularly impressive. I<sup>2</sup>L needs less chip area of any of the MOS technologies, yet operates at bipolar performance levels.

### Emitter-follower LSI: a real sleeper

Oddly enough, bipolar LSI has a strong performer in emitter-follower logic, a pre-TTL configuration dating back to the early days of integrated circuits. (Fairchild called it CTL.) TRW Systems Group, Redondo Beach, Calif., has developed an EFL 64-bit parallel correlator for an airborne computer system, and it contains 5,000 devices on a single 220-by-230-mil chip and operates at 20 MHz.

What's more startling, the TRW group, using a triple-diffused form of EFL, has just completed a monolithic 16-by-16-bit parallel multiplier. This mammoth 301-by-279-mil superchip, containing no fewer than 16,700 bipolar devices (a gate equivalence of over 3,000), is truly a candidate for the new logic category of very large-scale integration, or VLSI. The multiplier chip is being incorporated into a 16-bit 6-MHz computer containing a total of only 10 chips, four of which are VLSI. Its instruction time of 400 to 800 ns will make it one of the fastest in operation.

At present, TRW is producing these LSI chips only as custom circuits to satisfy its own system requirements, says Barry Dunbridge, laboratory manager of the microelectronics center. But the technique could have great commercial success because it is extremely simple. It requires only three diffusions—an n collection, a  $p\delta$  base diffusion and an  $n\delta$  emitter diffusion—and five photoresist steps. Since mask tolerances and diffusion depths are not critical, the process yields are very high—three good dies out of 19 per wafer—and can be as high as 30% even on very large chips.

The reason the EFL process originally lost out to buried-layer epitaxial construction was that the desired light collector diffusion was very difficult to control. But now ion implantation can control the collector deposition routinely within 5%, and fortunately, no problems are caused in LSI configurations by the limited accuracy of resistors (within 20% only, because they are made with a collector-under-a-base diffusion).

The three-diffusion EFL process permits several device elements to be fabricated in a single diffusion. For

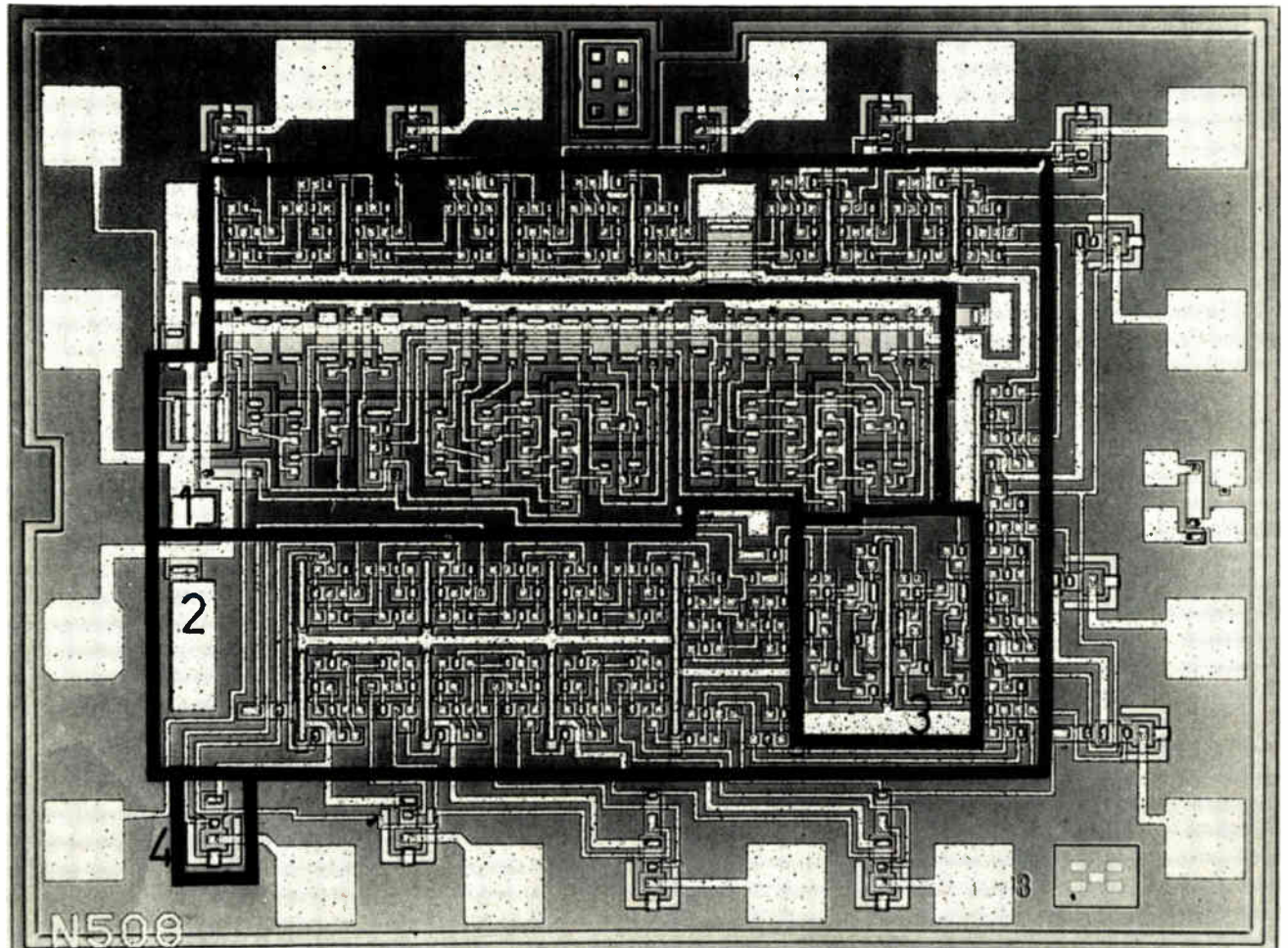

**16. Mixing It up.** In this  $2^{19}$  counter, the first two stages are built with MOS logic (region 1) and the remaining stages with  $I^2L$  (regions 2 and 3.) Note that the two  $I^2L$  flip-flops in region 3, with different layout rules from those of region 2, operate with different speeds.

example, the emitter-base regions of the pnp transistors are formed during the base-collector diffusions of the pnps. Because the collectors of the pnps are common to one another and are formed in the p-type substrates, the pnps must be operated in a common-collector or emitter-follower connection.

According to Jim Buie, senior scientist at TRW's microelectronics center, who was instrumental in developing TRW's triple-diffused EFL process, the ability to run

these devices into each other plays a large part in making the packing density and manufacturing tolerances similar to those of MOS technology. In these circuits the closest spacing—emitter to emitter—is  $3 \mu\text{m}$ . The smallest metal line has a  $6\text{-}\mu\text{m}$  width, comparable to standard commercial microcircuit processing. With these rules, typical layout designs require only 7 to 10  $\text{mil}^2$  per device or about a fifth the space needed for a TTL device. Indeed a typical master-slave flip-flop occupies only 4.6  $\text{mil}^2$ .

EFL's future is even more promising, say Dunbridge and Buie. An improved process further reduces device areas and upgrades performance. Halving dimensions and tolerances will quadruple densities, so that 400-by-400-mil chips will become possible, each containing 25,000 bipolar gates, or 125,000 devices, and capable of speeds in the hundreds of megahertz range.  $\square$

*In a later issue, a final article will discuss the impact that microprogramming techniques and the new microprocessors are having on logic design.*

**TABLE 6:**  
CHIP AREAS FOR CALCULATOR CONTROL LOGIC (101 GATES)

Type of Circuit	Area ( $\text{mm}^2$ )	Ratio
$I^2L$	0.75	1
C-MOS	1.11	1.48
Static enhancement P-MOS ( $\overline{AND - OR}$ )	1.30	1.73
Static enhancement P-MOS with depletion load ( $\overline{AND - OR}$ )	1.17	1.56
Dynamic enhancement P-MOS ( $\overline{AND - OR}$ )	1.08	1.44
Dynamic enhancement P-MOS (NAND)	1.41	1.88

Reprints of this Special Report are available at \$3.00 each. Write to Electronics Reprint Department, P.O. Box 669, Hightstown, N.J. 08520.  
©Copyright 1974, Electronics, A McGraw-Hill Publication.

# this is one of the two best 5½ digit multimeters ever made . . .

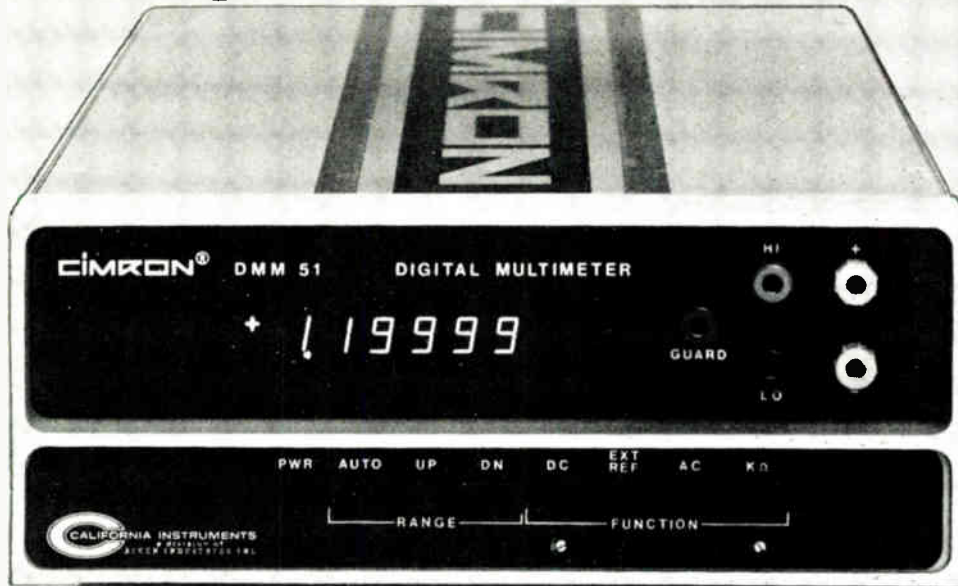

**DMM-51  
\$795**

Compare the price/performance features of the DMM-51 with units offered by the other big three DMM manufacturers. No other 5½-digit multimeter that's anywhere near the price of the DMM-51, provides the wide choice of functions available on this, the lowest cost, autoranging, 5½-digit meter on the market.

The basic unit measures DC volts and DC/DC 3-wire ratios with 1 $\mu$  volt sensitivity. To this you can add your choice of: resistance to 1 milliohm and AC volts—choice of averaging or true RMS; 4-wire bipolar ratio; AC and DC current; high voltage DC to 30 KV; and fully isolated data outputs. And, you can buy them with the DMM-51 or add them later.

## and **CIMRON** makes the other one, too.



**DMM-50  
\$1195**

The world's finest 5½-digit systems multimeter combines all the features and functional capability of the DMM-51 . . . plus the unique Saint Logic A/D conversion technique affording high speed, high accuracy measurements even when measuring extremely noisy inputs. When equipped with the Data Output/Remote Control option, data is available in both parallel and serial-character format. The DMM-50 is the ideal systems DMM whether you're interfacing to a computer or a printer. It's also available with directly compatible interfaces which eliminate the cost of changing software and cabling, and provide you with a second source if you're already committed to a competitive DMM.

For complete details, call or write:



5150 CONVOY ST. • SAN DIEGO, CA 92111 • (714) 279-8620  
For more information on DMM 51 circle 97 on reader service card.  
For more information on DMM 50 circle 98 on reader service card.

## Adjustable discriminator cleans up signal noise

by Dennis D. Barber  
University of Houston, Houston, Texas

Telemetry signals or other logic signals often pick up a lot of extra noise during transmission. But they can easily be cleaned up at the receiving end by a discriminator circuit having adjustable hysteresis.

The voltage discriminator shown in the figure can clean up signals containing as much as 70% noise without the need to alter the signal amplitude or dc level. The input to the amplifier that serves as the voltage-discriminator (amplifier  $A_4$ ) is kept constant at 5 volts peak-to-peak. But the signal to be conditioned, the one at the input to the circuit, does not have to be critically maintained or its level known precisely.

Amplifier  $A_1$  is gain-controlled, with field-effect tran-

sistor  $Q_1$  acting as the gain-control element. This FET, which functions as a voltage-variable resistor, is controlled by amplifiers  $A_2$  and  $A_3$ . Amplifier  $A_4$  is the voltage-discriminator stage that provides the adjustable hysteresis through its variable regenerative feedback.

Before the capacitively coupled input signal goes positive or negative, the output of amplifier  $A_1$  may be treated as if it were at ground. The gain of amplifier  $A_1$  is then at its maximum since the inputs to amplifiers  $A_2$  and  $A_3$  are below (in absolute magnitude) their respective reference voltages. The output of each amplifier is now positive, and diodes  $D_1$  and  $D_2$  are back-biased, which allows transistor  $Q_1$  to turn fully on.

If the input signal goes positive, the output of  $A_1$  will move towards the positive power-supply level. When it reaches the reference voltage of  $A_2$ , the output of  $A_2$  quickly swings negative, turning transistor  $Q_1$  partially off and thus lowering the gain of  $A_1$ . The output of  $A_1$  is held at the positive reference voltage until this reference level is greater than the input voltage multiplied by the maximum gain of  $A_1$ . At this point, the input voltage is only a few millivolts above ground.

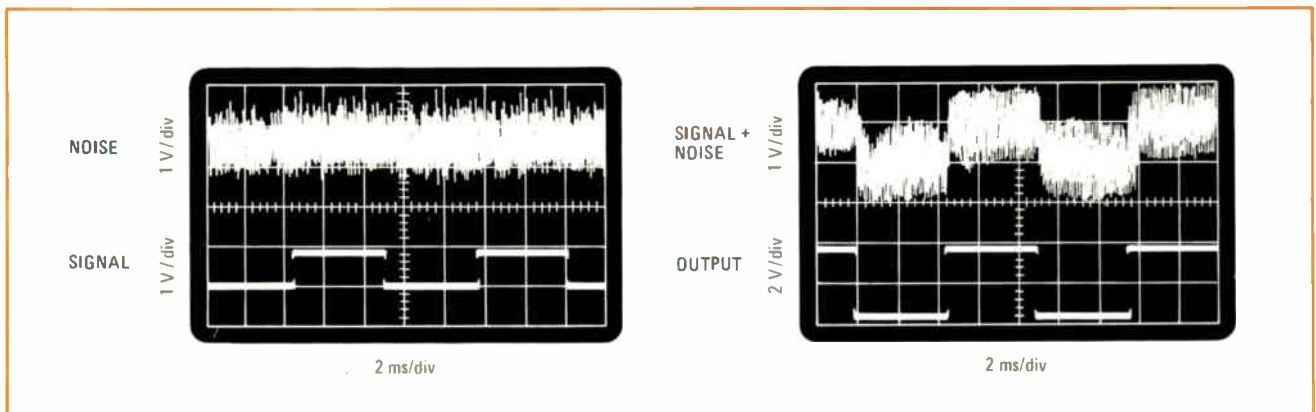
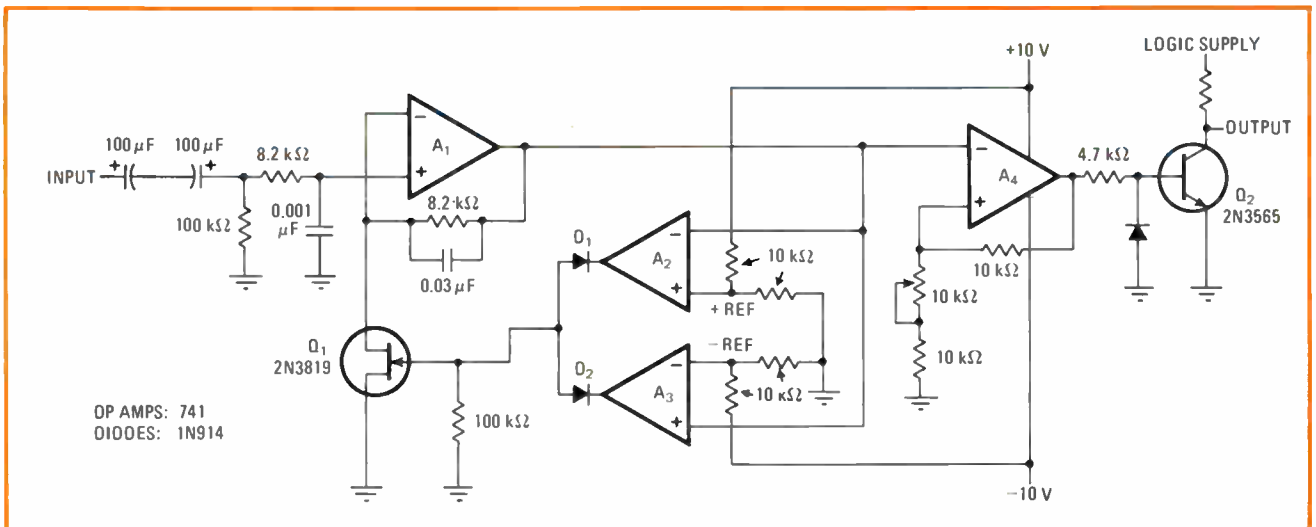

**Pulling the data out of the noise.** Adjustable-hysteresis voltage discriminator makes significant improvement in signal-to-noise ratios, as can be seen from the scope traces. The level of regenerative feedback of amplifier  $A_4$ , the voltage-discriminator stage, is adjusted to provide optimum noise immunity. The gain of amplifier  $A_1$  is controlled by transistor  $Q_1$ , which is operated as a voltage-variable resistor.

As the input signal swings from positive to negative, the output of amplifier A<sub>2</sub> goes positive, but the output of amplifier A<sub>3</sub> becomes negative. The gain of amplifier A<sub>1</sub>, therefore, is limited until the input signal again returns to very near ground.

In this way, the input voltage to amplifier A<sub>4</sub>, the voltage discriminator, is maintained at a constant level. The threshold voltages for A<sub>4</sub> can be set slightly less than the reference voltages of A<sub>2</sub> and A<sub>3</sub>, enabling the circuit to provide excellent noise immunity.

The capacitors at the input of the circuit are used to limit the amplitude of high-frequency spikes. The 100-microfarad capacitor values indicated in the diagram function well over a frequency range of 1 cycle per min-

ute to 1,000 cycles per second and over an input amplitude range of 1 to 10 v pk-pk.

Transistor Q<sub>1</sub> can be almost any junction FET. Transistor Q<sub>2</sub> is included to make the output of the circuit compatible with the type of logic being used. Many types of general-purpose op amps should work in the circuit, and even Norton amplifiers like the type-3900 units can probably be used if the appropriate circuit modifications are made.

The oscilloscope photographs show how dramatically this discriminator can clean up signals. One photo shows separate signal and noise voltages, while the other photo shows the total input signal and the resulting output. □

## Controlling ac loads with C-MOS bilateral switches

by Arthur Johnson  
Darlington, Md.

Power to an ac load can be efficiently controlled by an integrated complementary-MOS quad bilateral switch and a capacitively triggered sensitive-gate triac. The necessary gate-triggering current comes, not from the low-voltage C-MOS power supply, but from the ac line.

Capacitor-triggering is best for firing the triac because it produces the maximum current (at 90° phase shift) when the ac voltage crosses the zero-voltage level. Therefore, the fullest possible use is made of gate-triggering current. Also, the triac is switched into conduction at a low voltage to reduce switching transients, and maximum power is delivered to the load.

The driver circuit for ac loads is drawn in the dia-

gram. Because the on-resistance of each C-MOS bilateral switch is several hundred ohms, circuit voltages could falsely trigger the triac. The triac gate therefore needs to be isolated by the series switch, which, in turn, needs to be protected in its nonconducting state by the shunt switch from possibly damaging high voltages.

Two power-supply voltages, +7.5 volts and -7.5 v, are needed to control both positive and negative ac voltage excursions. This may prove to be a minor inconvenience. But since the necessary gate-triggering current does not have to come from these supplies, they may be simple half-wave-rectified high-resistance sources.

The sensitive-gate triac used here has a maximum current-carrying capacity of 1 ampere. If a larger load must be handled, a triac with higher ratings can be controlled by the smaller triac. In this way, a large load can be controlled without wasting a large amount of energy.

The capacitor value is chosen to provide the required triac-triggering current of 5 milliamperes maximum:

$$C = (5 \text{ mA}) / 2\pi f E_{\text{max}}$$

where  $f$  is the ac frequency and  $e_{\text{max}}$  is the zero-to-peak ac voltage level. □

**Ac-load driver circuit.** C-MOS bilateral switches are used to capacitively trigger a sensitive-gate triac that can carry up to 1 ampere. To keep switching transients to a minimum, the triac is fired at a low voltage derived from the ac line. The series switch provides isolation to prevent false triggering of the triac, while the shunt switch protects the series switch from possibly damaging high voltages.

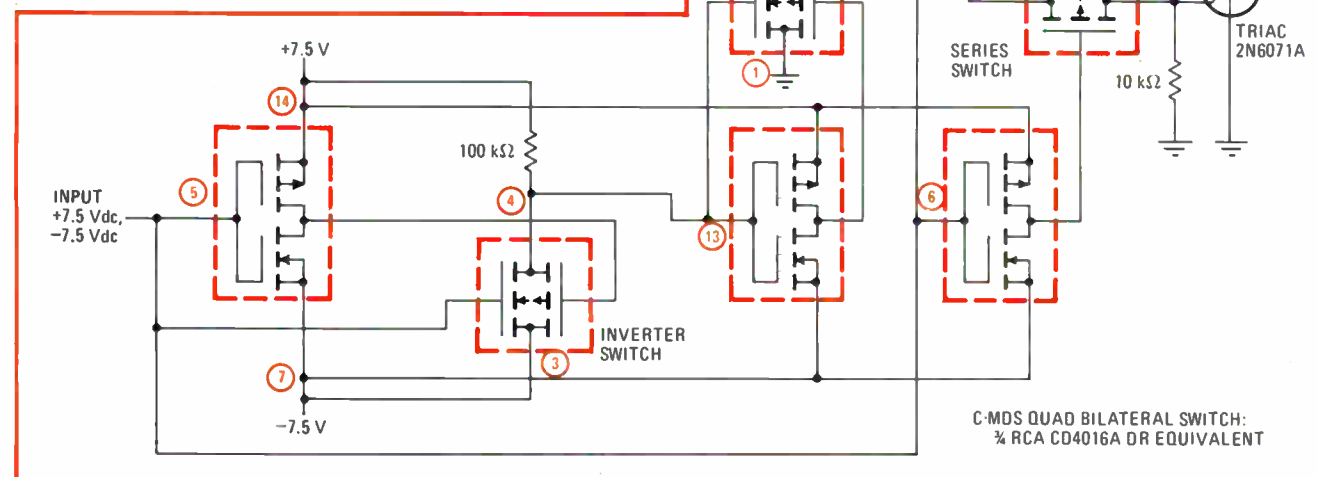

# IC timer makes economical automobile voltage regulator

by T.J. Fusar  
Powell-Mac Electronics, Madison, Wis.

A 555-type IC timer, in combination with a power Darlington transistor pair, can provide low-cost automotive voltage regulation. Such a regulator can even make it easier to start a car in cold weather.

As the diagram shows, the circuit requires very few parts. The value of resistor  $R_1$  is chosen to prevent the timer's quiescent current, when the timer is off (output, pin 3, low), from turning on the Darlington pair.

If battery voltage becomes too low, the timer turns on, driving its output high and drawing a current of about 60 milliamperes through resistor  $R_2$ . This causes a sufficient biasing voltage to be developed across resistor  $R_1$  and the Darlington turns on, supplying the energizing current to the field coil of the car's alternator. Diode  $D_1$  suppresses the reverse voltage of the field coil when the Darlington pair is turned off.

The regulator's low-voltage turn-on point is fixed by setting the voltage at the timer's trigger input (pin 2) to approximately half the reference voltage existing at its control-voltage input (pin 5). The high-voltage turn-off point is set by making the voltage at the timer's threshold input (pin 6) equal to the reference voltage at pin 5. At 77°F, the turn-on voltage is typically 14.4 volts, and the turn-off voltage is typically 14.9 v. These voltage levels, of course, should be set to match the charging requirement of a given car's specific battery-alternator combination.

The value of the reference voltage is established by the diode string,  $D_2$  through  $D_5$ ; here, it is approximately 5.9 v. The output voltage has a negative temperature coefficient of -11 millivolts/°F.

A transistor and a couple of resistors can be added to the circuit for better cold-weather starting. These parts are drawn in color in the figure. During starting, the transistor holds the timer in its off state, lightening the load on the car's cranking motor. (And to prevent radio interference, a 10-microfarad capacitor can be connected from the Darlington emitter to ground.) □

Designer's casebook is a regular feature in Electronics. We invite readers to submit original and unpublished circuit ideas and solutions to design problems. Explain briefly but thoroughly the circuit's operating principle and purpose. We'll pay \$50 for each item published.

**Regulating car voltage cheaply.** Monolithic 555-type timer is the heart of this simple automobile voltage regulator. When the timer is off so that its output (pin 3) is low, the power Darlington transistor pair is also off. If battery voltage becomes too low (less than 14.4 volts in this case), the timer turns on and the Darlington pair conducts. The parts drawn in color permit easier starting in cold weather.

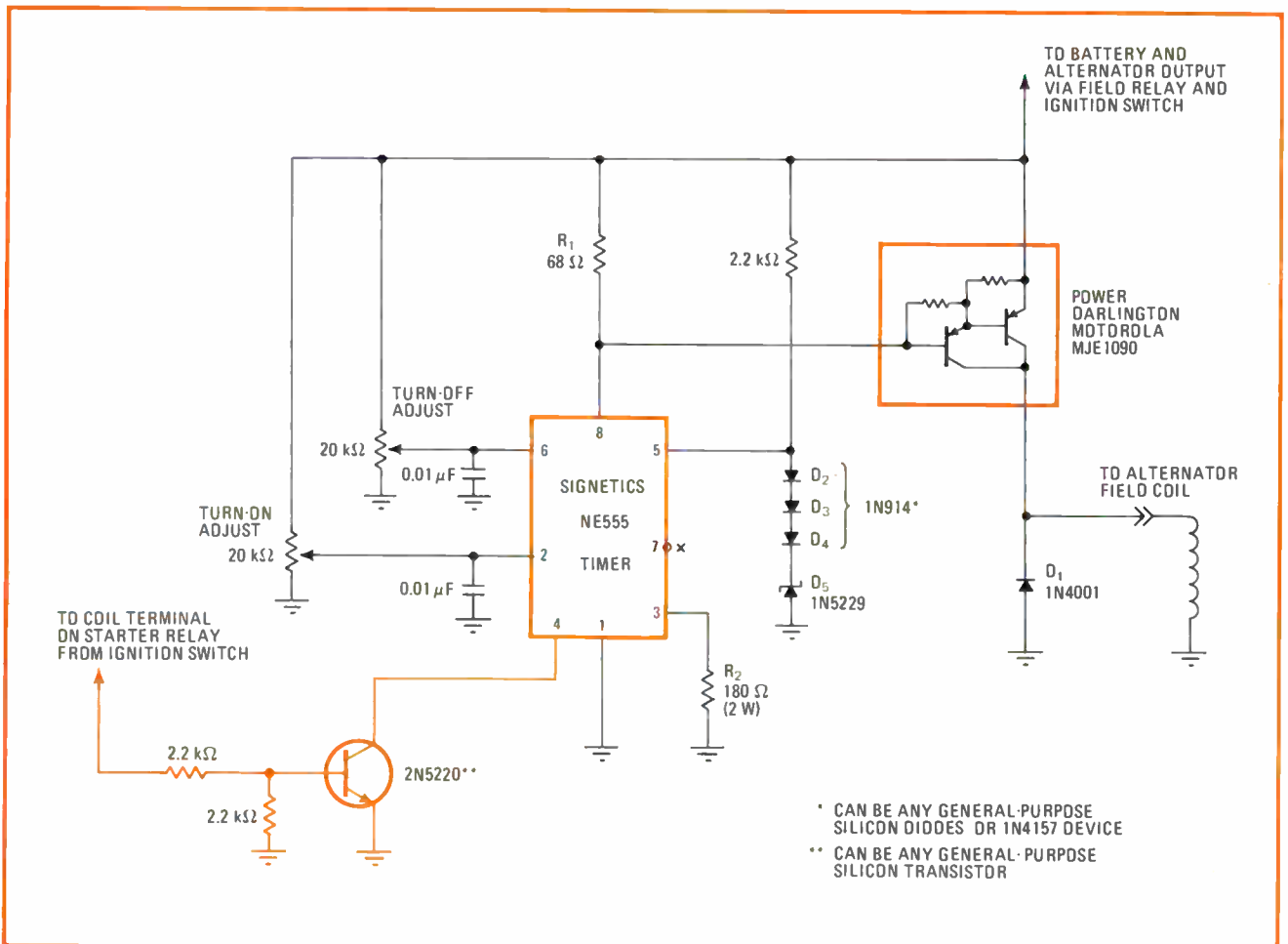

# 150 Microwatt Triple Op Amp

The L144 monolithic triple op amp draws only  $50\mu\text{A}$  of current per amplifier, from a  $\pm 1.5\text{ V}$  supply. What's more, it is

**AVAILABLE NOW FROM YOUR LOCAL DISTRIBUTOR!**

L144 features include:

- Monolithic triple op amp in DIP or Flatpac packages
- Wide power supply range— $\pm 1.5\text{ V}$  to  $\pm 15\text{ V}$
- Internal compensation
- Programmable power dissipation
- Programmable input bias current
- Single programming resistor
- 80 dB gain with  $20\text{ K}\Omega$  load
- Cost effective: \$1.63 per single op amp<sup>(1)</sup>

<sup>(1)</sup>L144CJ 100-piece price

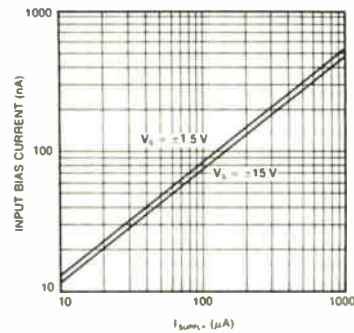

Applications examples:

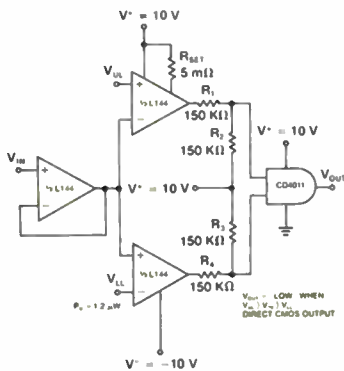

DOUBLE-ENDED LIMIT COMPARATOR

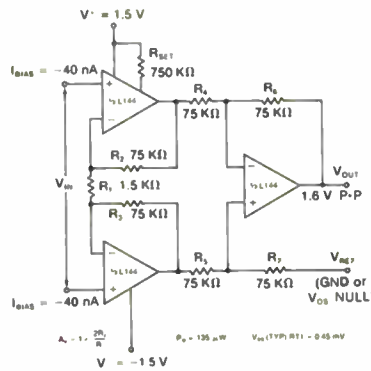

INSTRUMENTATION AMPLIFIER

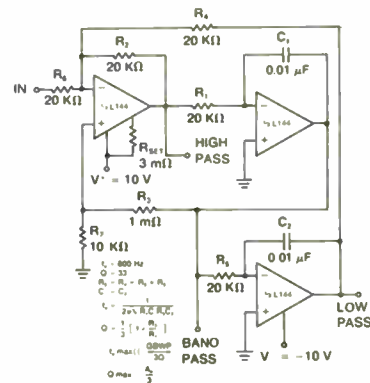

ACTIVE FILTER

The L144 is a practical industry-standard operational amplifier for use when low current drain, low voltage, low power, or very small physical size are controlling criteria. If your circuit requirements are unique—and whose aren't—our applications people are eager to help.

For complete information

**write for data**

IC Applications: (408) 246 8000, Ext. 120



**Siliconix incorporated**

2201 Laurelwood Road, Santa Clara, California 95054

# DIVA'S COMPUTROLLER, PDP 11, AND 3330 TYPE DISC DRIVE UNITE.

## AN INCREDIBLE MARRIAGE.

### *An Episode in the True Chronicle of the DIVAS, Proudest Peripheral Family in the Computeworld.*

The computeworld stares in awe at the incredible wedding scene which has unfolded before them. The bride is minicomputer PDP 11, offspring of the illustrious maxi-computer clan, begat of Abacus. The bridegroom is DIVA COMPUTROLLER, scion of this proud, most respected peripheral family. Officiating at the ceremony is Duke DIVA Disc Drive, direct descendant of IBM compatible 3330 type disc drives.

Realizing the great impact this interfacing will have on the computeworld, our happy guests monitor the wedding with joyous solemnity.

"Mated," Interdata 70 whirrs, "PDP 11 will have access to 100 million bytes of data on a single spindle or 200 million bytes on a dual spindle disc drive unit within an average access time of 32 msec."

"And with COMPUTROLLER providing a buffering sector, data will be transferable at the rate of 645,000 bytes/sec," marvels Nova II.

"And keep in mind," interrupts a breathless TI 980A, "that with COMPUTROLLER controlling eight drives, mini will have access to 1.6 billion 8-bit bytes of data!"

But, hush! Listen to Duke DIVA repeating those always-inspiring words: "With the data stored in me, and with provided interconnecting cables and distribution panel, I now pronounce you linked in holy matrimony."

Resounding cheers befitting the occasion arise from the crowd. "A toast! A toast! A toast!" they roar. As is the custom, the proud parents, mini processor and DIVA controller, propose the toast to the dazzling couple: "To the most splendid and significant union in all our memories."



Mini PDP 11

"Vive, DIVA! Vive, DIVA! Vive, DIVA!" Everyone unwinds.

But even as we listen to the clink of ceremonial glasses and the exuberant laughter, we sense an underlying sadness. Those unchosen minis — do they count for nothing now? Will they not be able to enter the world of high speed data storage/access and low cost/bit performance? And why — throughout this entire festivity — has COMPUTROLLER remained hidden under his purple robe? Is there more to

COMPUTROLLER than meets the eye? Be sure to join us for the next episode in the True Chronicle of the DIVAS when we will hear the horrendous accusation: "Bigamy! BIGAMIST!"

In the meantime, learn COMPUTROLLER'S inside story. Find out about the free implementation and training courses, the software packages, and warranties that go with each disc system. All you PDP 11 users call George Roessler at 201-544-9000 for cost and delivery information. Or write: DIVA, Inc. 607 Industrial Way West Eatontown, N.J. 07724 TWX 710-722-6645.

REGIONAL SALES OFFICES:  
CT: 203-526-3222  
CA: 415-349-3482  
Wash. DC: 703-370-5211.  
GSA CONTRACT NO. GSS-OOC-00159.







**THERMAL DESIGN PART 5**

# Liquid cooling safeguards high-power semiconductors

Liquid coolants require less heat-sink volume than forced-air systems to carry away heat from kilowatt-level circuits

by John A. Gardner Jr., *Wakefield Engineering Inc., Wakefield, Mass.*

□ Liquid systems have seldom been used to cool semiconductors in the past because convective-air cooling has usually proven adequate at low power levels. But as semiconductor rectifiers and thyristors grew in power capability, design engineers were confronted with the problem of cooling devices that dissipate hundreds and sometimes thousands of watts.

When semiconductors were first used, it seemed that large heat sinks, together with high-capacity fans and blowers could fulfill the most extreme cooling requirements. However, as power levels and device sizes were increased, space requirements for cooling grew exponentially and demanded precious space in the electronic packages; designers, consequently, turned to liquids.

Liquid provides a larger margin of reserve cooling

power than other cooling techniques to cope safely with peak loads and transient conditions because thermal inertia enables fluid to absorb momentary heat pulses with only a slight temperature rise. Liquid cooling also minimizes acoustic interference, a persistent problem when cabinets are air-cooled. Noise can be readily abated by locating the heat-exchanger and pumping equipment at a distance from the electronic components being cooled.

If a designer had his choice, he would select natural convection cooling to reap the benefits of cost and reliability that must be sacrificed by adding the electro-mechanical components required for forced-air and fluid systems. However, costs and complexity of liquid-cooling systems cannot be denied. And many engineers

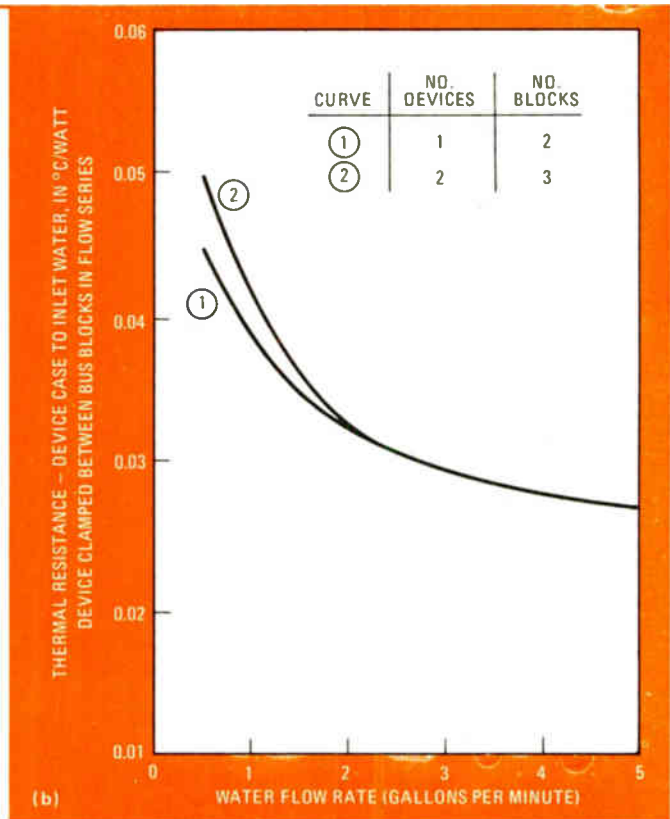
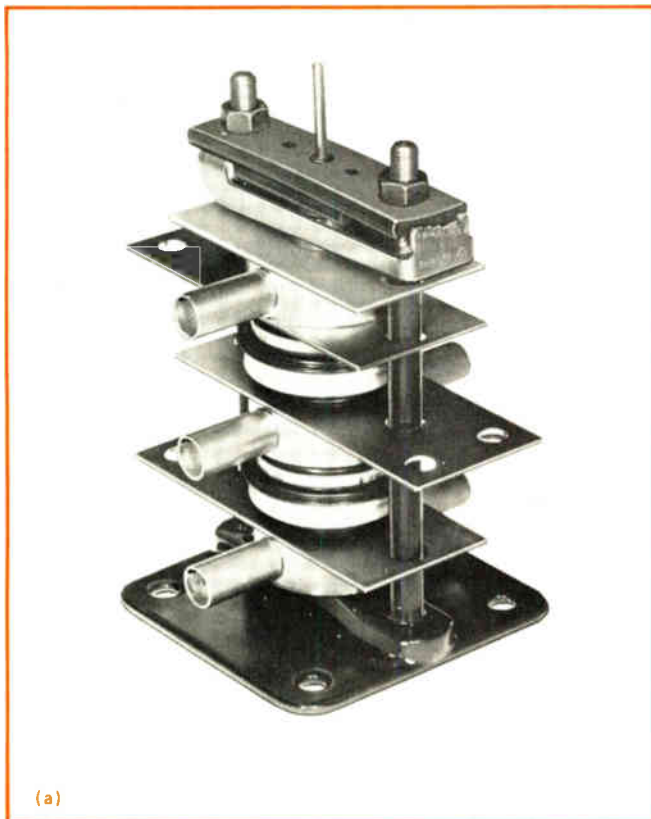

**Two stories.** Stacking two pressure-mounted devices, such as semiconductor rectifiers and thyristors, in a liquid-cooled assembly (a) is a compact technique for cooling kilowatt-level devices. Thermal resistance from the case to the coolant is low at low flow rates, and it diminishes little at flow rates above two gallons per minute (b). Adding the second device (curve 2) raises the thermal resistance a trifle (curve 1).

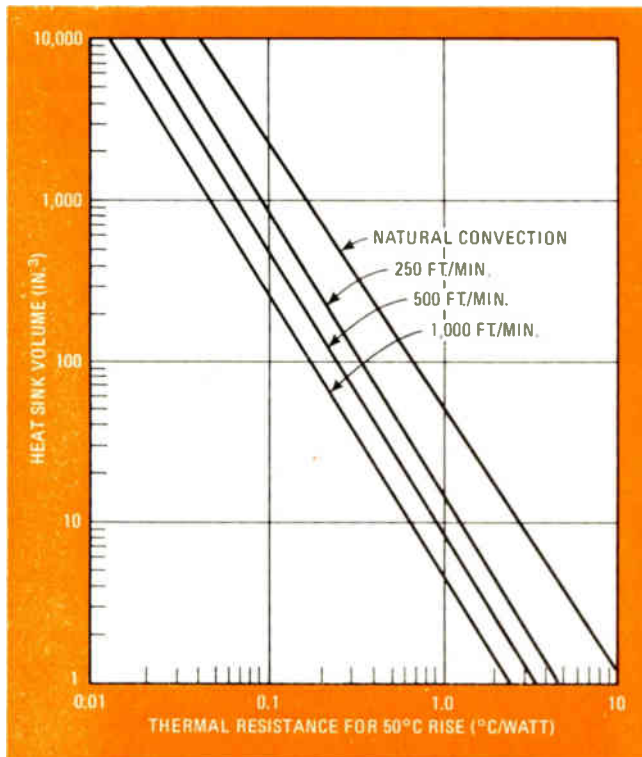

**1. Gobbling space.** The volume of an air-cooled sink grows enormously as a designer lowers the thermal resistance. These curves indicate the various sink volumes for cooling by natural convection and forced air. However, liquid-cooling requires much smaller sink volumes—desirable for compact electronic packaging.

are reluctant to plumb a liquid circuit into an electronic-equipment cabinet because of the likelihood of corrosion, leakage, and condensation.

Moreover, factors such as component reliability and maintenance demands all weigh in favor of air-cooled systems. But despite these drawbacks, liquid cooling is proving to be a highly satisfactory technique for compact, silent cooling of high-power semiconductors and electronic systems.

### Thermal resistance

As power dissipation rises, the packaging engineer must whittle away at the case-to-ambient thermal resistance ( $\theta_{C-A}$ )—the temperature rise in degrees for each watt of power transferred. As a rule of thumb, each time he halves the thermal resistance in a natural convective system, the designer must quadruple the heat-sink volume. Obviously, the demand for space becomes enormous when dissipation levels rise into the kilowatt range and thermal resistance falls below  $0.1^\circ\text{C}$  per watt.

Figure 1 illustrates the envelope volume required for several widely used shapes of heat sinks for a range of thermal resistances. The four curves show the relationship of volume to thermal resistance for natural convection cooling and forced-convection cooling at velocities of 250, 500, and 1,000 feet per minute, based on  $50^\circ\text{C}$  sink-temperature rise above ambient.

If natural convection is out of the question, then the designer must turn either to forced air or liquid cooling, and both are feasible in the range of 500 to 1,000 w. However, when volume is a crucial consideration, liquid

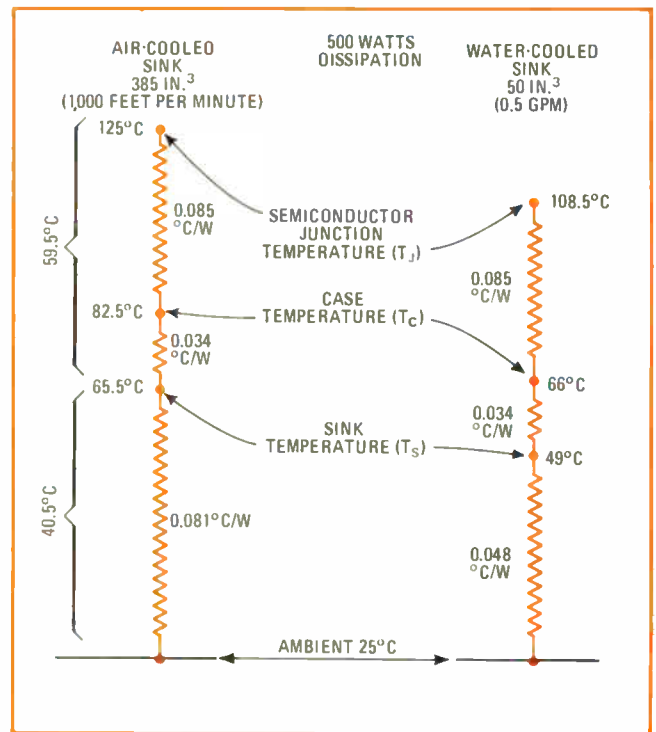

**2. Cool the junction.** Holding the semiconductor junction below a limiting temperature is crucial to thermal cooling—a key factor in long-term reliability. Here, circuit equivalents have been drawn for both an air- and a water-cooled sink dissipating 500 watts. The water-cooled system keeps the junction almost  $17^\circ\text{C}$  cooler and requires about one seventh the volume of the air-cooled sink.

has the edge. A forced-air cooling system requiring 500 cubic inches of heat-sink volume can't compete with liquid, which can deliver the same cooling capability in a sink volume from 60 to 120 cubic inches—an improvement of a full order of magnitude.

Whereas air-cooled systems require careful analysis of localized ambients within equipment cabinets to avoid interactive heating effects, analysis for liquid-cooling systems is relatively straightforward.

The arguments favoring cooling with liquids at higher-power levels emerge more clearly in an example.

### A high-power example

Consider a 500-w pressure-mounted semiconductor rectifier with a maximum junction temperature of  $125^\circ\text{C}$  and junction-to-case thermal resistance, as shown on the manufacturer's data sheet, of  $0.085^\circ\text{C/w}$ . The case-to-sink thermal resistance is determined from experimental data to be an additional  $0.034^\circ\text{C/w}$ . Adding the two thermal resistances and multiplying by 500 w yields a rise of  $59.5^\circ\text{C}$  between the sink and junction.

These thermal resistances and the temperature rises across the resistances are shown schematically in Fig. 2. Such sketches help the designer to visualize how each portion of the thermal path contributes to the rise above the ambient temperature. If the ambient is assumed to be  $25^\circ\text{C}$ , the rise from ambient to sink is limited to  $40.5^\circ\text{C}$ . This means that the sink-to-ambient thermal resistance can be  $40.5^\circ\text{C}/500\text{ w}$ , or  $0.081^\circ\text{C/w}$ , at most. Figure 1 discloses that this thermal resistance requires a sink volume of about 385 cubic inches if air flow is to be

1,000 feet per minute. This requirement can be satisfied by two sinks of about 3 inches by 7 in. by 7.5 in.

By contrast, consider the requirements for liquid-cooling the same semiconductor rectifier. Figure 3(a) shows the device clamped between liquid-cooled blocks. Thermal resistance values for blocks of this type are shown in Fig. 3(b). At a flow rate of 0.5 gallon per minute, the sink-to-inlet water thermal resistance of the water system is  $0.048^{\circ}\text{C}/\text{w}$ —about half the value of the previously calculated forced-air system.

As for volume, the sinks occupy about 50 cubic inches, a mere 13% of the sink size required in the moving-air system. Liquid flows from the lower coolant block to the upper one in flow series, resulting in only a slight warmup of the water passing through the lower block. This heating is of little consequence.

### Series flow

Stacking of devices, as shown on page 103, adds only slightly to the volume and causes little degradation of the case-to-inlet-water thermal resistance for the water system. At the same rate of 0.5 gallon per minute, cooling a second device in series degrades the thermal resistance only  $0.005^{\circ}\text{C}/\text{w}$ —the difference between plots 1 and 2 in the performance graph on page 103. Plot 1 is the case-to-inlet-water thermal resistance of a single pressure-mounted semiconductor. Plot 2 is the thermal resistance for each of two devices mounted in a stack so that both devices share a common pole piece.

Plots 1 and 2 are virtually coincident because the conductive path from the devices to the coolant-pole pieces is far more efficient than the thermal path between adjacent semiconductor devices. However, this is seldom the case in air-cooling systems.

Liquid cooling is also attractive for cooling groups of lower-power devices, such as semiconductor devices in TO-3 cases that have power levels in the range of 50 to 150 w, as shown in Fig. 4. The channel-plate cooler (Fig. 5) is designed as an inexpensive arrangement for cooling both stud-mounted and bolted semiconductor devices. Sink thermal resistances range from about 0.6 to  $0.25^{\circ}\text{C}/\text{w}$ , depending on the center-to-center spacing of the devices and coolant-flow rate.

On the other hand, the high-density cooler shown in Fig. 4 is virtually unaffected by thermal interaction because the devices are located directly over the coolant-flow lines, thereby optimizing the thermal path to the fluid. This arrangement is well suited for cooling large numbers of such smaller devices as those mounted in the popular TO-3s. This cooler, which measures 6 in. by 7 in. by 1 in. and occupies a volume of 85 cubic inches, is capable of dissipating 2 kw if the coolant-inlet temperature is  $40^{\circ}\text{C}$  or below.

Table 1, which lists the thermal resistivities of various liquid-cooler geometries, shows that the pressure-mounted assemblies offer thermal resistances an order of magnitude lower than the channel-plate mountings and the high-density cooler. However, the latter are more than adequate for clusters of lower-power, smaller devices. The pressure-mounted coolers offer an additional advantage. Since the bus plates and the bolts are cooled along with the device, the bus-current rating can be higher than in an air-cooled configuration. In gen-

eral, thermal resistances diminish substantially as flow rates are raised to 2 gallons per minute, but not beyond.

When a semiconductor must be electrically isolated from a liquid-cooled sink, an interface material, such as beryllium oxide, offers high thermal conductivity and excellent electrical isolation. The penalty is a rise in over-all thermal resistance, caused by an increased interface thermal resistance, as indicated in the second column of Table 1.

Electrical isolation between pressure-mount cooling

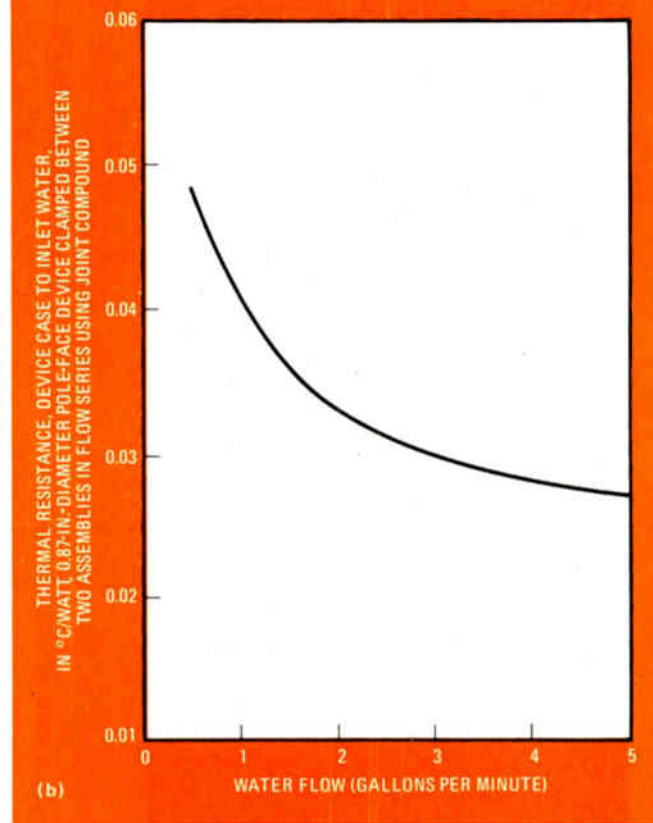
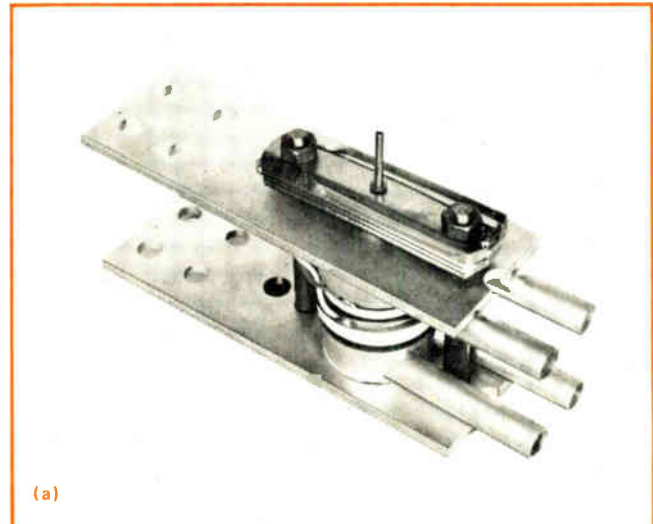

**3. Cool cooler.** The liquid-cooled solid-state copper blocks sandwiching the semiconductor device (a) provide two thermal paths (top and bottom) and dissipate 2 kilowatts. Clamp puts an 800- to 2,000-pound bite on the semiconductor device to assure a low thermal resistance—on the order of  $0.034^{\circ}\text{C}$  per watt at the interface (b).

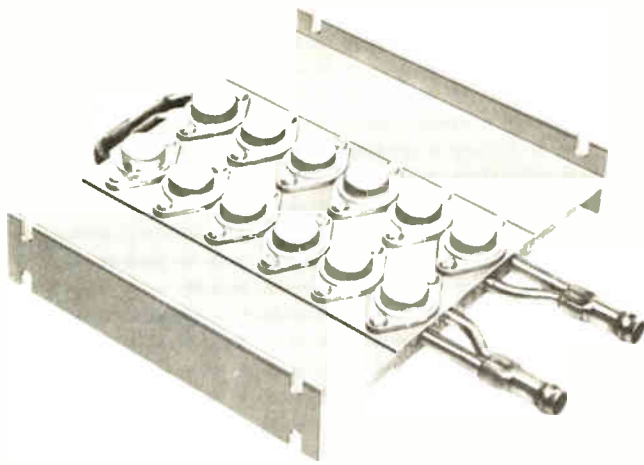

**4. Dense package.** This configuration is well suited for cooling TO-3 packages because the devices are placed directly over the coolant lines, ensuring short, efficient thermal paths to the coolant. Unit can dissipate 2 kilowatts, but occupies only 85 cubic inches.

blocks can be achieved with rubber liquid-transport tubing. A good rule of thumb is to employ one foot of tubing for each 1,000 volts of potential difference.

#### Open and closed loops

Liquid systems are commonly designed in an open-loop configuration in which tap water is fed to the cooler or cold plates through a pressure-reducing station, which ensures a constant flow rate. The heated water is then discharged into a drain, and no attempt is made to control water temperature. This is usually acceptable if the inlet water temperature never rises above 30°C. However, during humid summer months, condensation can form on cold plates and transport tubes, which may be troublesome.

By contrast, the closed-loop systems of Fig. 6 offer a number of advantages, including temperature control, water conservation, and reduced susceptibility to flow-rate variation. Moreover, by operating the coolant system so that the water temperature remains above the dew point, condensation on cold surfaces can't occur. Finally, a closed-loop system enables the user to add selected solutions to the water to attain desired coolant properties.

The hardware components of a closed-loop system include a cooler, a circulating pump to sustain the flow, an air-liquid heat exchanger to transfer the heat from the liquid to the surrounding air, and storage tank to allow for expansion.

The storage tank permits normal expansion and contractions that accompany temperature variations in fluids. It is also a deaeration point for the system and enables periodic sampling and replenishment of the coolant. The relative costs of forced-air, open-, and closed-loop systems are listed in Table 2. The entries, in all cases, apply to a dissipation requirement of 1 kw.

#### Heat exchangers

The air-liquid, high-efficiency heat exchanger with an attached fan, shown in Fig. 7, is typical of a compact series of exchangers suitable for closed-loop cooling of electronic components. Copper and brass lines are commonly used to carry the coolant and provide long-

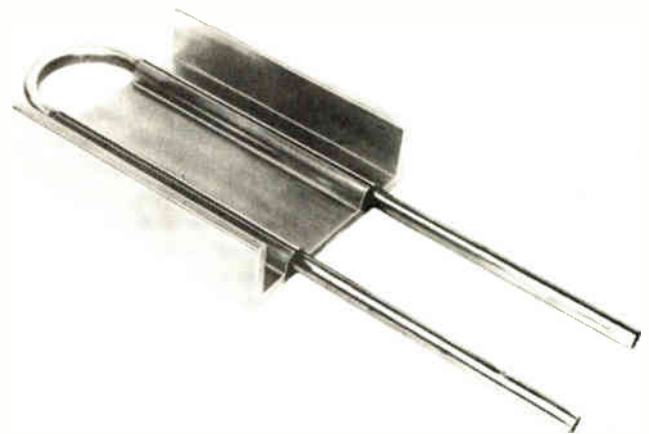

**5. Channel chiller.** This economical U-shaped aluminum plate, priced at \$16, can cool a small number of relatively high-power devices. Thermal resistance varies from about 0.25°C/W to 0.6°C/W, depending on spacing between devices and coolant-flow rate.

term high performance with most heat-transfer fluids.

This type of cooler is available with either single or double-pass flow on the water side. With double-pass flow—this means that the water makes a round trip through the exchanger region—thermal performance is enhanced. Also, inlet and outlet fittings mount on the same side of the exchanger, which is frequently a convenience. However, a larger-capacity pump is required to cope with the increased pressure drop that is characteristic of the double-pass system.

The fan of the illustrated exchanger draws the air through the exchanger core before the air passes through the fan itself, which produces even heat distribution across the core. Thus, the operating temperature of the fan assembly, including the bearings, will be elevated above the ambient temperature. And since the life of fan motors depends on their operating temperature, the temperature of the air leaving the core is a critical parameter in length of fan life.

#### Designing a liquid-cooled system

Generally, design requirements of a liquid-cooled system are less complex to compute than those of an air-cooled system because the string of thermal resistances from the device case to the coolant loop is less critical. That is because the thermal capacity of the liquid-cooling loop is large enough that the interacting secondary resistances among devices play a negligible role. This is not true when air-cooled sinks are employed.

Once the designer knows the power dissipation required in a cooler or cold plate and selects a flow rate, he can readily determine the rise in the cooler's water temperature by using the alignment chart in Fig. 8. As an example, for 1,000 w and eight gallons per minute, the rise is less than 1°C.

If the eight gallons per minute were to be split equally among four cold plates, each dissipating a kilowatt, the water temperature rise would only be 2°C. However, a careful analysis is mandatory because, in some cases, the temperature rise may be substantial.

Here are the parameters required to determine the thermal resistance ( $\Theta$ ) of a heat exchanger:

- Total power dissipated by the components that need cooling ( $P$ ).
- Temperature of the water entering the heat exchanger ( $T_{\text{water in}}$ ). The temperature drop from the cold plates to the heat exchanger should be subtracted if it is not negligible.
- Ambient air temperature ( $T_{\text{air in}}$ ).

These values enable the designer to calculate the thermal resistance of the heat exchanger:

$$\Theta = (T_{\text{water in}} - T_{\text{air in}}) / P \text{ in } ^\circ\text{C}/\text{W}$$

Once this thermal resistance is determined, the designer should check performance curves for various heat exchangers. These curves show that the flow rates of

both the water and the air govern the performance of the exchanger.

It is likely that more than one type of heat exchanger will fulfill the cooling requirement. Selection can be narrowed by examining such factors as available space and position of inlet and outlet fittings. Finally, the pressure drop of the exchanger and all coolers, lines, and fittings must not exceed the pump capacity.

### Selecting a pump

Once the heat exchanger and the coolers are selected, the drop in pressure through the cooler plates, the heat exchanger, and all interconnecting tubing and fittings is summed to determine the total head that must be deliv-

TABLE 1. LIQUID COOLERS — SOME REPRESENTATIVE THERMAL RESISTANCES

Type	Thermal resistance per device case-to-inlet water at 2 gallons per minute ( $^\circ\text{C}/\text{watt}$ )
Liquid-cooled bus, 0.87-in. device interface, cooled on both ends	0.033
Same as above, but electrically isolated from the cooler	0.078
Channel plate 1 in.-diameter-devices, 2 in. center-to-center spacing, 0.038 $^\circ\text{C}/\text{watt}$ case-to-sink impedance	0.38
High density cooler, TD-3 case style, thermal grease on device interface	0.30

TABLE 2. COMPARISON OF COOLING SYSTEM COSTS

System	Devices	Approximate cost
Forced-air convection	Two, pressure-mounted	\$75
Liquid-cooled bus blocks, open-loop system	Two, pressure-mounted	\$58
Liquid-cooled channel plate, open-loop system	Four, stud-mounted	\$16
Liquid-cooled, high-density cooler, open-loop system	12, bolted	\$21
Closed-loop system, cost to be added to liquid systems above	—	\$138

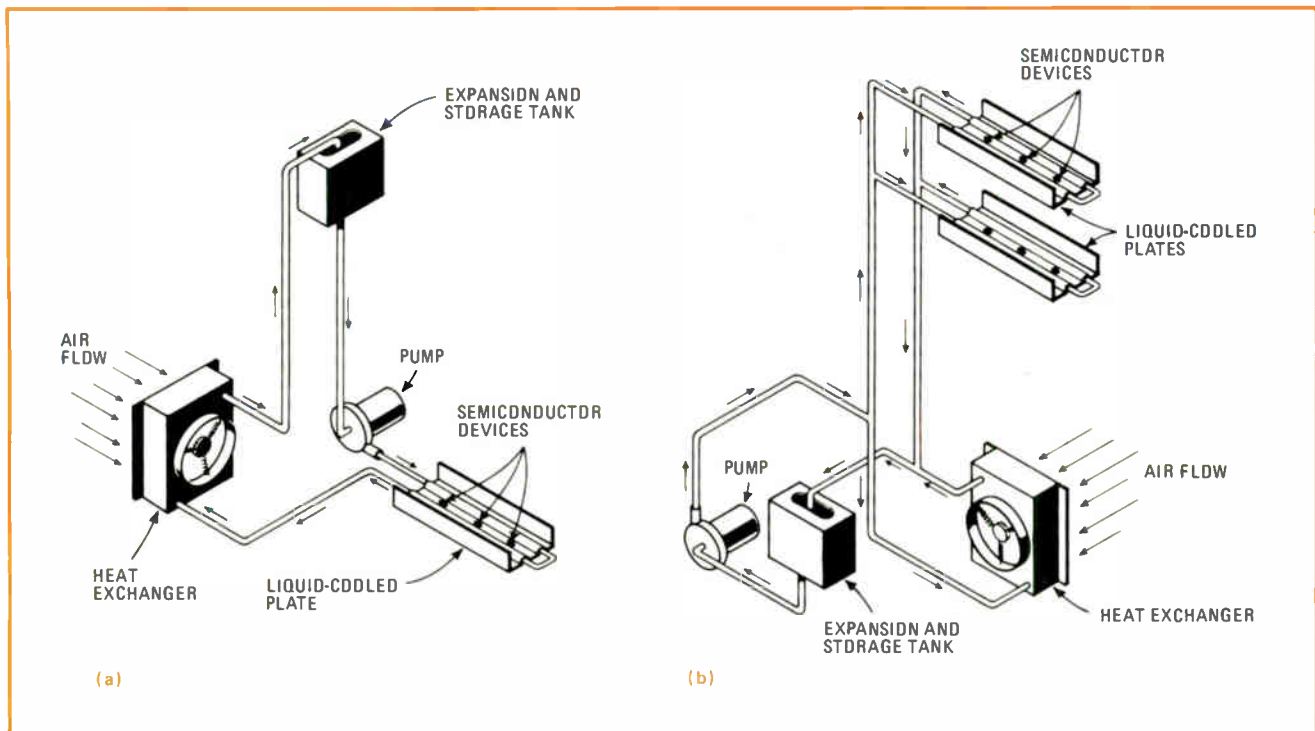

**6. Flow system.** A simple series-flow system is well suited for cooling a single cold plate (a). Connecting two or more liquid-cooled plates in a parallel-flow system (b) reduces the pressure drop so that a large-capacity pump isn't needed.

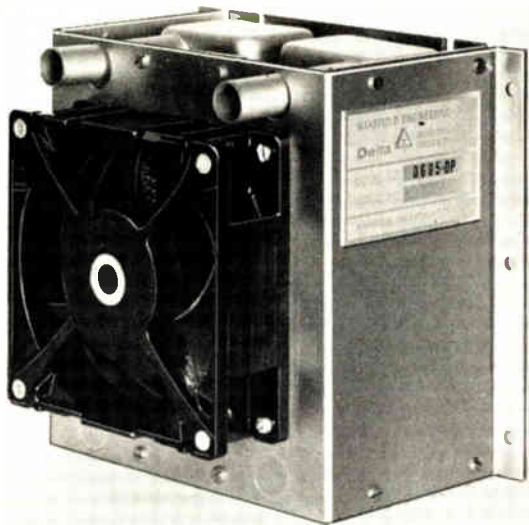

**7. Cool exchanger.** This double-pass heat exchanger transfers heat from the entering liquid to an air stream that is driven through the exchanger by a fan. The liquid enters and exits through the fittings above the fan. Raising the air and liquid-flow rates improves thermal performance. However, to minimize erosion and corrosion, liquid-flow rates through coolant lines should not exceed 10 feet per second.

ered by the circulating pump. Head is the pressure, in pounds per square inch, delivered by a pump at a specified flow rate. Heat-exchanger manufacturers usually supply this necessary data. During the past several years, a number of centrifugal pumps have been developed to operate without rotating shaft seals so that long-term leakproof operation is assured. Flow capacities are sufficient for most electronic-package cooling.

If the pressure drop through a closed-loop system appears to be excessive, the parallel-flow system of Fig. 6(b) may be suitable. The advantage is that, unlike a series-flow system, the flow rate through each cold plate is not necessarily the same as the flow rate through the heat exchanger. And since drop in pressure through cold plates is usually much higher than it is through a heat exchanger, parallel connection limits pressure drop without significantly degrading cooling performance. Moreover, the flow rate of the heat exchanger can remain at a relatively high value, assuring high performance as a result of low thermal resistance.

Reliable transport of a liquid demands careful attention to both flow velocities and the materials contacting the fluid. Although copper tubing is relatively expensive, it offers the best envelope because the smooth wall surface resists corrosion in most environments. Copper also conducts heat well and resists the mechanical erosion and the chemical corrosion which are most severe at such points of high turbulence as sharp bends. Copper tubing, which is also easy to install, offers a good electrochemical and thermal match with other materials commonly employed in heat-exchanger and cold-plate construction.

### Selecting the fluid

Water offers the best over-all coolant characteristics in terms of density, viscosity, thermal conductivity, and

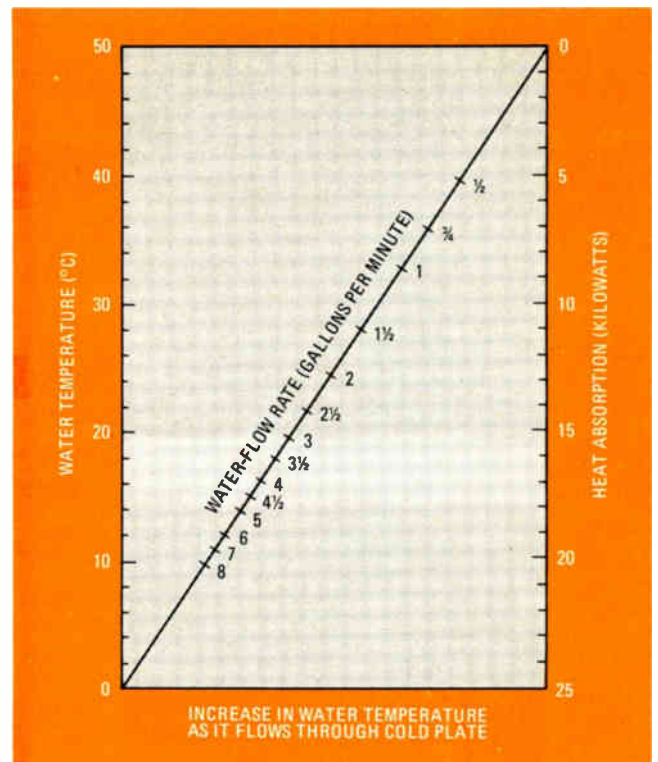

**8. Warmup.** By aligning a straight edge with values of the heat absorption and the water-flow rate in a cold plate, the temperature rise can be read from the scale at the left. A similar chart, found in heat-exchanger manuals, enables the designer to determine the temperature rise through a heat exchanger.

heat capacity. In closed-loop operation, where control of the content of the circulating fluid is possible, additions to compensate for losses of fluid can be made from time to time. Water that has been distilled, deionized, and demineralized provides the most efficient long-term performance. When both aluminum and copper-brass metals are present in a fluid circuit, specially-inhibited ethylene-glycol solutions can prevent deterioration of the fluid passages. However, because of their lower thermal conductivity, they do degrade thermal performance. Solutions of this type are mandatory where the ambient temperature can drop below the freezing point of water, or where surface temperatures exceed the boiling point of water.

Exotic dielectric oils are employed where severe electrical-insulation requirements team with freezing temperatures. Unfortunately, many of these oils, especially the chlorinated series, place severe demands on pump seals and plumbing joints in the fluid circuits. Again, even the best dielectric oils, as well as the series of silicone oils, require higher-performance heat exchangers than do water-cooled systems.

There are a number of variations in liquid-cooling systems, and one is the cold-sump system. This technique employs a refrigerant loop to cool a reservoir of refrigerated water, which is then circulated through a closed-loop cooling system. Cold sumps usually have a large cooling capability and may serve a number of heat loads simultaneously at remote locations. They are frequently selected for large complexes like computer installations. □

## Accurately trimming closed resistor loops

by R. M. Stitt,  
Burr-Brown Research Corp., Tucson, Ariz.

Adjusting or tuning circuits could often be considerably simplified if resistors that are connected in a closed loop could be measured and trimmed to the desired value. This is particularly true for thick-film-resistor layouts, which could be significantly improved if the right adjustments could be made.

A circuit that allows measurement and trimming of closed resistor loops is shown in the figure. (The closed resistor loop formed by resistors  $R_1$ ,  $R_2$ , and  $R_3$  is highlighted.) The circuit provides a metered readout, as well as two light-emitting diodes for visual indication of both positive and negative deviations from the desired resistance value.

With the connections shown, resistor  $R_2$  is the segment of the loop to be measured. Resistor  $R_2$  is placed in the negative-feedback loop of amplifier  $A_2$ , and all of the external nodes of this amplifier are grounded. Therefore, whatever current is injected into  $A_2$ 's inverting input must flow through resistor  $R_2$  and must appear at  $A_2$ 's output as a negative voltage that is equal to the input current times the resistor value. If the input current is  $-1$  milliampere, then  $A_2$ 's output voltage will be equivalent to the value of resistor  $R_2$  in kilohms.

Resistor  $R_3$  simply acts as the load resistance of amplifier  $A_2$ . On the other hand, resistor  $R_1$  acts as a sum-

ming resistor that is tied to ground, but it makes no contribution to  $A_2$ 's output voltage. Since there is no voltage drop across this resistor, no current flows through it.

The network consisting of amplifier  $A_1$ , zener diode  $D_Z$ , and resistors  $R_4$ ,  $R_5$ , and  $R_6$  forms a voltage reference for amplifier  $A_2$ . To assure optimum performance, the zener regulates its own operating current. Amplifier  $A_3$  is connected as a summing amplifier with a milliammeter in its feedback loop, and amplifier  $A_4$  performs as a comparator (with hysteresis so that the LEDs are both dark when a null is reached).

When resistor  $R_2$  is equal to the desired resistance value, that of the standard resistor ( $R_{STD}$ ), the output voltage of amplifier  $A_2$  will equal  $-V_{REF}$ , and no current will flow through the meter. Because the meter is connected inside a full-wave bridge, it will indicate both positive and negative deviations from the null point as positive deflections. And since a regulated current flows in the feedback loop of amplifier  $A_3$ , any voltage drops across the bridge diodes will not affect the meter's reading.

Amplifier  $A_4$ , the comparator, drives the LEDs so that they indicate whether the deviation from the null is positive or negative. Its output current (10 milliamperes) is adequate to drive the LEDs directly. The LEDs clamp each other, preventing their rather low reverse breakdown voltage ratings from being exceeded.

There are a few restrictions to keep in mind about the circuit. Amplifier  $A_2$ , for instance, must be capable of driving the load formed by the closed loop, and its input impedance must be high enough for measuring the value of resistor  $R_2$  accurately. For a more sensitive null indication, the values of summing resistors  $R_7$  and  $R_8$

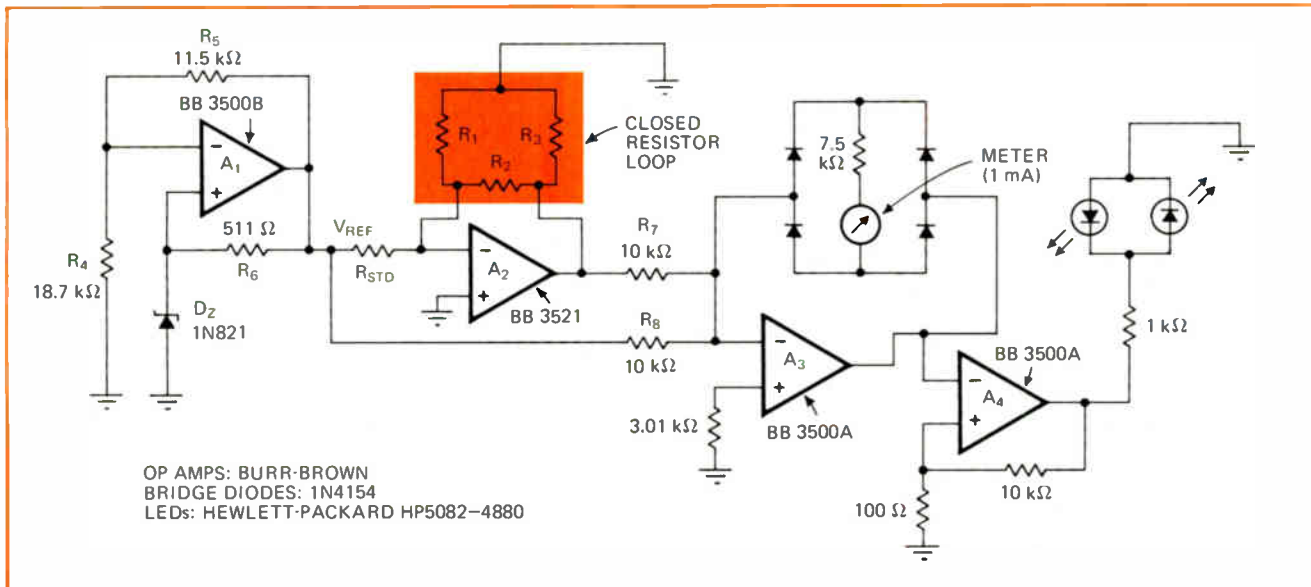

**Trimming circuit.** Individual resistors in closed resistor loop ( $R_1$ ,  $R_2$ , and  $R_3$ ) can be trimmed to desired value ( $R_{STD}$ ). The resistor to be trimmed ( $R_2$  in this case) is placed in the negative-feedback loop of amplifier  $A_2$ . When  $R_2 = R_{STD}$ , the milliammeter indicates a null, and both light-emitting diodes are dark. The LEDs show whether  $R_2$ 's resistance deviation is positive or negative with respect to the null.

can be made smaller. But since the output-current ratings of amplifiers  $A_1$  and  $A_2$  must be observed, a more sensitive meter is required if the circuit's sensitivity is to be increased significantly.

Furthermore, the output-current rating of amplifier

$A_1$  must be considered when resistor  $R_{STD}$  is chosen. If low-value resistors are to be trimmed, the magnitude of  $V_{REF}$  must be reduced to avoid overloading amplifier  $A_1$ . An inverting amplifier with a gain of less than unity could be inserted at the output of  $A_1$ . □

## Graphs aid selection of a-d converters

by Raymond J. Tarver  
Raytheon Co., Equipment Division, Wayland, Mass.

Although analog-to-digital converters are widely used circuit components these days, they are frequently not specified properly by designers. In addition to the correct resolution, accuracy, speed, and temperature stability, a-d converters must be able to provide a given system dynamic range or signal-to-noise ratio.

Too often, designers neglect to take into consideration how converter quantization noise relates to other system noises. The result is a poor effective dynamic range or signal-to-noise ratio. The graphs given here make it easier to pick the right converter for the job.

For an ideal system, one that has no internal or external noise sources, and one in which the required variations on the signal are actually part of the signal, the signal-to-quantization noise power ratio is:

$$(SNR)_q = 12[S(t)]^2/Q^2 \quad (1)$$

where  $S(t)$  is the signal, and  $Q$  is the quantization increment. This latter variable is given by:

$$Q = R/N = R/(2^m - 1) \quad (2)$$

where  $R$  is the range or maximum magnitude of the signal being quantized,  $N$  is the number of available discrete quantization levels, and  $m$  is the number of bits (including the sign bit) provided by the converter.

In the real world, Eq. 1. is equivalent to defining any additive noise as part of the signal, or having a signal with noise-like variations. The signal-to-noise ratio of a real system having internal and external additive noise is given by:

$$SNR = [S(t)]^2 / [(N_i(t))^2 + (N_a(t))^2 + (N_q(t))^2] \quad (3)$$

where  $N_i(t)$  is the input noise,  $N_a(t)$  is the internal noise, and  $N_q(t)$  is the a-d quantization noise. This latter quantity can be expressed as:

$$N_q(t) = Q/\sqrt{12}$$

Naturally, the quantization noise can be made arbitrarily small by adding more bits to the a-d converter, although practical limitations, such as cost and availability, often limit the number of bits. In any event, if  $N_q(t)$  is reduced to the point where  $N_a(t)$  and/or  $N_i(t)$  dominates the signal-to-noise ratio, obviously there is little reward in decreasing  $N_q(t)$  further. This is another

practical limitation on the number of converter bits chosen for a particular application.

Furthermore, cost and availability also enter in the reduction of  $N_i(t)$  and  $N_a(t)$ . Hence, there must be a trade-off between the three noise sources. In high-data-rate radar applications, the remainder of the system is often designed around what value of  $N_q(t)$  can be achieved with reasonable risk.

Equation 3 can be rewritten as:

$$SNR = S^2(t) / [(N_i(t))^2 + (N_q(t))^2]$$

where:

$$[N_i(t)]^2 = [N_i(t)]^2 + [N_a(t)]^2$$

Let:

$$N_i(t) = kN_q(t)$$

then, for values of  $k$  greater than or equal to 0:

$$SNR = S^2(t)/(k^2 + 1)[N_q(t)]^2 \quad (4)$$

where  $k$  represents the ratio of the root-mean-square value of fixed noise to the rms value of quantization noise:

$$k = \frac{\text{rms fixed noise}}{\text{rms quantization noise}}$$

Equation 4 can be further simplified by normalizing the signal,  $S(t)$ , to unit range ( $R$ ):

$$SNR = 12/(k^2 + 1)Q^2 \quad (5)$$

Substituting Eq. 2 in this last equation yields:

$$SNR = 12(2^m - 1)^2/(k^2 + 1) \quad (6)$$

Graph 1 is a plot of Eq. 6 with  $k$  as a parameter. As the nomograph shows, increasing values of  $k$  mean that more converter bits are needed to preserve a system's signal-to-noise ratio or dynamic range.

If dynamic range is defined as the ratio of the peak signal to the rms noise level, then Eqs. 5 and 6 also define the dynamic range as a function of the number of bits of quantization for a linear unipolar signal. For a bipolar signal, Eq. 6 is high by a factor of two, since half the range is expended quantizing the opposite polarity.

Graph 2 is a normalized plot of Eq. 6 that shows the degradation in dynamic range (or signal-to-noise ratio) as  $k$  departs from its ideal value of  $k = 0$ . At about  $k = 1$ , which corresponds to the knee of the curve, the dynamic range starts to deteriorate rapidly. □

### BIBLIOGRAPHY

A. Papoulis, "Probability Random Variables and Stochastic Processes," McGraw-Hill, 1965  
J.B. Thomas, "Statistical Communication Theory," John Wiley, 1969  
D.K. Barton and H.R. Ward, "Handbook of Radar Measurement," Prentice-Hall, 1969

Engineer's notebook is a regular feature in Electronics. We invite readers to submit original design shortcuts, calculation aids, measurement and test techniques, and other ideas for saving engineering time or cost. We'll pay \$50 for each item published.



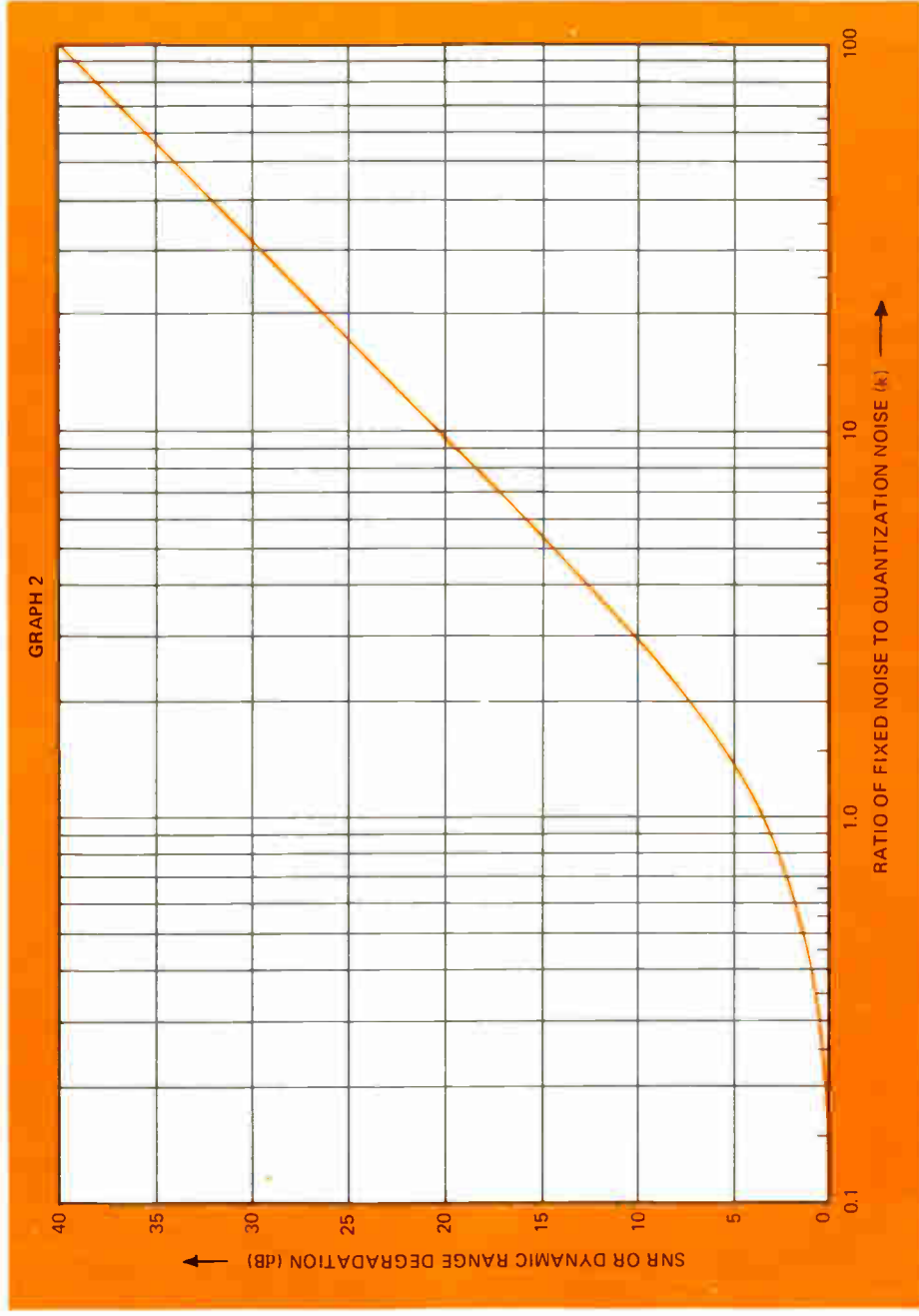
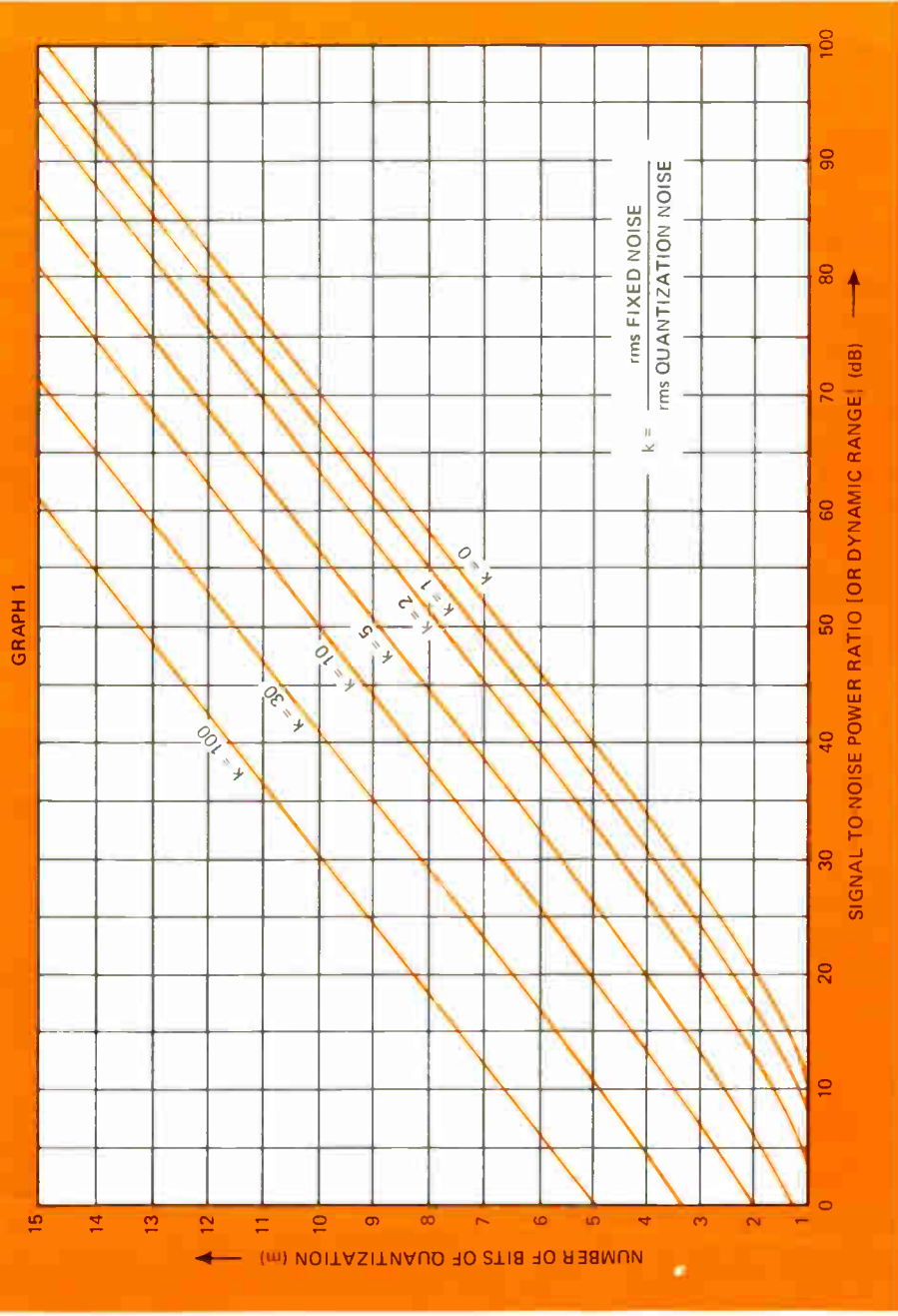

## **Coloring keys converts calculator to resistor decoder**

You can convert your pocket calculator into a resistor decoder if it has an "enter exponent" key, as does the Texas Instruments' SR-10 unit. **Simply color (with paint or colored tape) the corners of the digit keys,** suggests Robert O. Engh, principal research scientist, Honeywell Inc., Bloomington, Minn., so that they correspond to the standard resistor code. Black is 0, brown is 1, red is 2, orange is 3, yellow is 4, green is 5, blue is 6, violet is 7, gray is 8, and white is 9.

**To use your decoder, depress the keys in the order of the resistor's color bands (from left to right),** remembering to push the "enter exponent" key before depressing the key for the third color. The calculator's display will then show the value of the resistor.

## **Research revives PLZT ferroelectric ceramic technology**

Optical designers should take another look at PLZT ferroelectric ceramics. This lanthanum-modified lead-zirconate-titanate material would be **ideal for making compact modulators, shutters, Kerr and Pockels light valves, and even high-density real-time storage mediums for optical memories and display 5,** but it has not been easy to get in uniform, defect-free slices. Now, however, both its reflective and transmissive modes of operation have been perfected, material quality has been greatly improved, and techniques have been developed for depositing thin, transparent, electrodes of indium tin oxide on the PLZT. Because of this, **simple gates and shutters made from PLZT are now easily within the capabilities of even small laboratories.** What's more, major research into the more complex modulator and memory applications is being done at Radiation Inc. of Melbourne, Fla., Sandia Labs in Albuquerque, and Plessey of England.

## **Collector ring lengthens life of display drivers**

Many designers have found to their amazement that, although gas-discharge displays are extremely long-life devices, the high-voltage drive transistors that drive them are not. A tip for choosing high-voltage drive transistors from Dick Saxon of Burroughs Electronics Components division makes the point that it's not enough to choose a transistor with a sustaining  $V_{CE}$  that exceeds the maximum voltage you expect to use because continuous operation near the transistor-design limit can result in large increases in leakage current. **The trick is to make sure your transistor is of a type that employs a guard ring around its collector.**

## **Bias voltage is integrated on the chip**

Many MOS circuits require both a positive voltage and a very low-current negative voltage for bias. Since it can be expensive for a low-cost chip to have to supply the extra voltage, American Microsystems Inc., Santa Clara, Calif., integrates the supply with the rest of the chip. The current drain is miniscule, so **a small RC oscillator plus a voltage doubler does the trick.**

## **Microfringe viewer checks flatness**

Checking the flatness of silicon wafers, masks and substrates is easy with a miniature microfringe viewer from Rank Precision Industries Inc., 411 East Jarvis Ave., Des Plaines, Ill. 60018. Though it measures only  $5\frac{3}{4}$  by  $7\frac{1}{2}$  by 2 inches, **it can calibrate thickness on items 4 inches in diameter and  $\frac{1}{4}$ -inch thick.**

**Some products are so good  
you don't have to  
brag about them...**

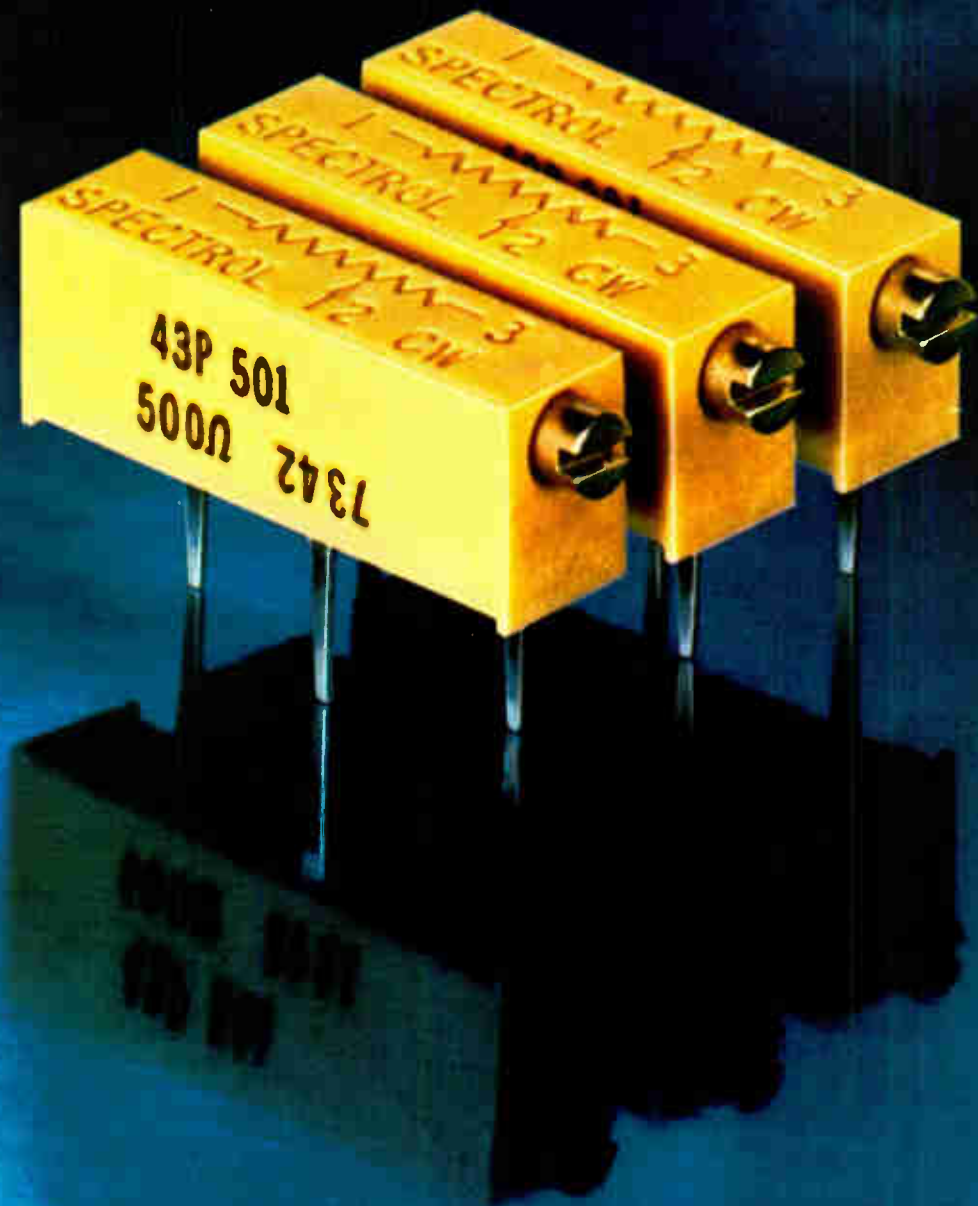

**The Spectrol Model 43 Cermet Trimmer.**

This  $\frac{3}{16}$ -inch cermet trimmer is available from the factory or any of our 75 distributor outlets. 100-piece price — \$1.10.

**Spectrol**

*Want to know more? Send for a data sheet or call for a quote.*

**SPECTROL ELECTRONICS GROUP**

**UNITED STATES** Spectrol Electronics Corporation 17075 E. Gale Avenue, City of Industry, Calif. 91745, U.S.A. • (213) 954-6569 • TWX (910) 564-1514

**UNITED KINGDOM** Spectrol Reliance Ltd. Drakes Way, Swindon, Wiltshire, England • Swindon T1151 • TELEX: 44882

**ITALY** SP Elettronica spa Via Carlo Pisacane 7, 20075 Pesto (Milan) Italy • 36 30 541 • TELEX: 56097

Circle 113 on reader service card

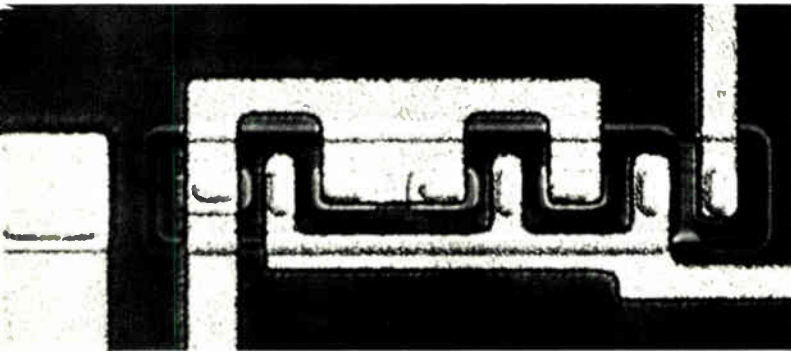

1. **New gate.** This I<sup>2</sup>L gate from IBM Boeblingen occupies space of one bipolar transistor, can operate at 0.1-pJ speed-power product.

## ISSCC shows finer processing is benefitting more device types

At the International Solid State Circuits Conference last week in Philadelphia, the spotlight was on bipolar LSI techniques, with injection logic by far the best bet as the next major logic family. CCD imagers and signal processors are ready for commercial markets, while technological refinements are boosting microwave and analog circuit performance. The following four pages focus on the more significant events at ISSCC.

## New bipolar and n-MOS techniques push performance of digital ICs

Evidence of the semiconductor industry's renewed interest in bipolar approaches to large-scale-integrated logic and memory chips was everywhere at last week's ISSCC. Major presentations on integrated injection logic, ion-implanted emitter-follower logic, and streamlined versions of Schottky TTL memory designs dispelled once and for all the notion that MOS is the only road to cost-effective LSI microcircuitry.

Integrated injection logic (I<sup>2</sup>L), the name given it by Philips, Eindhoven, is the same as the merged-transistor logic (MTL) of IBM, Boeblingen—in fact, device specialists from the two companies announced the new circuit form simultaneously at ISSCC 1972. But whatever it's called, injection logic is being hailed as the next logic generation because of its extremely simple and compact LSI gate structure (Fig. 1).

Laid out on silicon, the gate needs no current-source resistors and occupies only 1 to 2 mil<sup>2</sup>, or the space of one transistor. It is capable of logic speeds down to 5 nanoseconds, at power dissipations of nanowatts per gate, and so achieves speed power products of 0.1 picojoule. Moreover, because it can be built into high-gain linear as well as digital structures, it has applications throughout the spectrum of semiconductor products—3,000-gate memory and logic circuits, watch circuits, and logic and control circuits for instruments and communication systems. (For further details on the I<sup>2</sup>L or MTL capabilities and design parameters, see p. 91.)

Not as radical a change, but equally important for the direction of future low-cost semiconductor memory design, is a modified Schottky TTL cell. Disclosed by Intel in a new 1,024-bit random-access memory, this structure was designed to eliminate as many isolating regions as possible, without resorting to the tough passive-isolation techniques that have characterized kilobit bipolar memory designs but often kill yields. (Fairchild apparently is the only manufacturer presently shipping oxide-isolated 1,024-bit memories in volume.)

Surprisingly, the cell has much in common with the I<sup>2</sup>L approach. It consists of a pair of inverted transistors in a cross-coupled flip-flop configuration, with emitter-base resistors as loads (Fig. 2). The inverted transistor flip-flop requires no isolation in the horizontal direction since its collector, which serves as an emitter, is shared with the cells in the same row. In the vertical direction, however, the flip-flop does require isolation from the emitter-follower transistors. The compact 10-mil<sup>2</sup> cell that results, even with conventional processing tolerances, packs a 1,024-bit RAM onto a chip only 130 by 180 mils in area.

The thrust in MOS technology, very apparent at ISSCC, is towards upgrading p-channel designs with c-MOS on sapphire and n-MOS techniques.

Intel's new n-channel eight-bit single-chip micro-

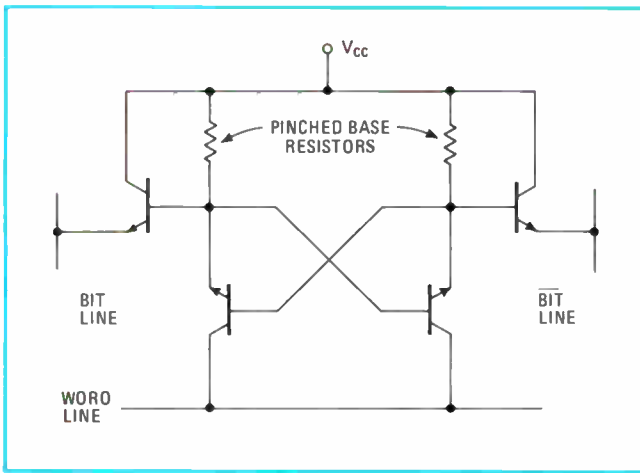

**2. Schottky update.** Intel's Schottky TTL memory cell consists simply of inverted-transistor flip-flop with emitter-base loads.

processor, catalogued the 8080, is an extension of the p-channel 8008 MPU chip introduced about a year ago. The higher substrate concentrations and lower supply voltage possible with n-channel devices lets channels be shorter, so that input capacitance and power operation are lower. The end result is a microprocessor chip with much greater capabilities than p-channel versions. The n-MOS 8080, for example, has 78 instructions compared to the p-MOS 48. It also has 10 times the instruction execution speed, due mostly to a reorganization of the functional blocks in the CPU.

The boost given to MOS memory performance by sapphire substrates is borne out by Siemens' C-MOS on SOS cell design—the basis for a fully static 4,096-bit RAM on a chip that includes word and bit decoders, sense circuits, and cell matrix yet measures a mere 4.2 by 3.5 mm. SOS substrates, by reducing parasitics, let geometries be tighter—the complementary transistors and load resistors can be directly connected to the flip-flop to save cross-over space between interconnections. Space-saving features add up to a 2.4-mil<sup>2</sup> cell.

## Easier-to-manufacture CCDs will compete with dense MOS imagers

The technologies of solid-state imaging have taken a big jump forward since last year's ISSCC. CCDs for both image- and signal-processing have been brought much closer to general production, and MOS imagers are also competing hard.

Bell Labs, whose Willard Boyle and George Smith won this year's ISSCC Liebmann award for the original work on CCDs, has by now developed a CCD camera that is capable of full Picturephone resolution—220 by 256 lines (TV is 525 by 525). On the way, Bell designed a new CCD structure (Fig. 3) that relaxes fabrication tolerances and dimensions, increases yields, and generally makes high-density facsimile and video-quality CCD im-

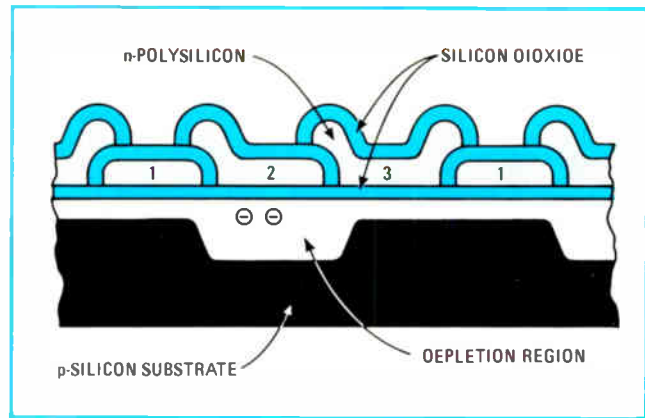

**3. Easy to manufacture.** Bell's CCD image structure, part of a Picturephone-type imager, has relaxed tolerances and high yields.

agers easier to manufacture. (For a discussion of the Bell camera, see p. 29.)

IBM, General Electric, Reticon, Stanford University, and others, however, are all using MOS processing techniques to build very dense area imagers for facsimile, video and medical systems. The IBM device, fabricated at the Systems Product division, Essex Junction, Vt., to show the value of MOS bucket-brigade imaging techniques, is a 512-by-1,024-bit optical scanner—at half a million bits, by far the largest solid-state imager yet reported. The Stanford scanner, developed by Roger Mellen, incorporates a unique MOS photodiode readout structure in a self-scan sensor, so that noise is significantly lower than that found with conventional MOS scanning techniques.

At GE, researchers Michon and Burke are forging ahead with a 100-by-100-element charge-injection imager made up of an X-Y addressed array of storage MOS capacitors. To read the image out, charge is sequentially injected into the substrate and the resulting displacement current is detected to create a video signal.

Significantly, GE's charge-injection device uses a larger silicon area to generate photons than to store charge—a development that not only makes better use of space but also lowers the dark current. The dark current, which limits contrast and resolution, is reported with this design to be a very tolerable 6 nA/cm<sup>2</sup> at 25°C. Peak output signal exceeds rms noise by more than 50 decibels, and dynamic range is greater than 500 to 1, so that the approach is attractive for low-light-level applications.

As for the application of CCDs to other kinds of analog signal-processing systems, progress is gratifying. Coming along are compact and easy to fabricate Fourier transformers, matched filters and correlators, and adaptive filters. Researchers at the Westinghouse Advanced Technology laboratory in Baltimore, Md., have devised an analog signal-processing scheme that combines a CCD delay line with a metal-nitride silicon (MNOS) device to make the CCD output programmable. The MNOS device is built onto a CCD tap and electrically altered to match its conductivity to desired output function. This amounts to a transversal filter with electrically reprogrammable analog taps and eliminates the costly business of programming the CCD weighing function into the mask configuration during the fabricating

process. Indeed, one device can be used for many codes, pointing to significant saving in the costs of signal-processing systems.

---

## New chips to lower cost of electronic watches and 4-channel sound

---

Because they are growing attractions for consumers, electronic watches and quadrasonic sound also attracted attention at ISSCC.

The demand is for ever smaller watch circuits that use ever less power—two requirements that can conflict. For instance, the high-frequency AT-cut quartz crystals long used for precision frequency standards would be ideal for watches because of their low cost, temperature stability, ruggedness, and lack of aging. But small enough crystals of this kind operate above 2 megahertz, therefore require more countdown circuitry, which in turn, with a conventional MOS approach, dissipates more than the desired limit of about 15 microwatts at 1.5 volts.

A C-MOS-on-sapphire technology helps out. Researchers Alfred C. Ipri and John C. Sarace from RCA's Princeton Labs found that, if they combined COS/MOS technology with a Pierce oscillator configuration, they could build a counter that works off a 1.4–1.6-v supply, dissipates less than  $15\mu\text{W}$ , yet functions with a 2-4-MHz AT-cut crystal. Their experimental watch counter chip consisted of an oscillator inverter, two additional inverters, three dynamic counter stages, 19 static stages, pulse width shaping circuits and output buffers, all contained in 400 devices on a 71-by-79-mil area.

If four-channel disk systems are to become less than a luxury for wealthy audiophiles, the cost of playback units will have to come down. Integration of the demodulator for such systems is one way to achieve economy while maintaining high performance.

One of the major four-channel systems, the CD-4,

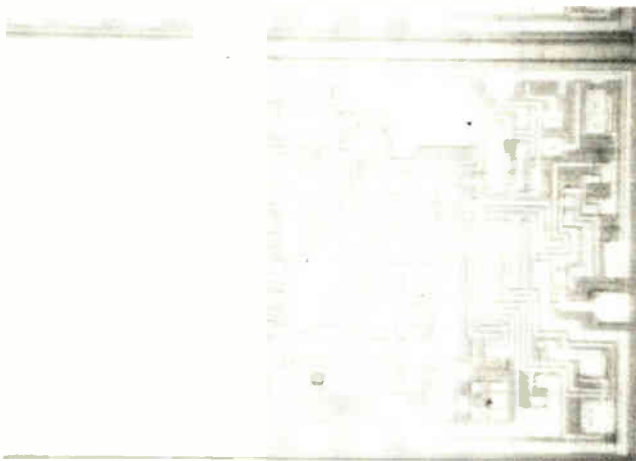

**4. Keener op amp.** For high accuracy, Analog Devices' precision op amp has input featuring high gain but low input parameters.

was developed by the Victor Company of Japan (JVC), which is recording and marketing CD-4 disks in the U.S. in partnership with RCA. But to broaden the market base for equipment makers it licenses, JVC turned to Signetics Corp. for help in reducing the components count of CD-4 demodulators. The first step was to redesign the demodulator around the Signetics phase-locked-loop IC, the 565, and this chip has by now been supplied by the thousand in a screened version. JVC's next step was to ask Signetics to help devise a custom circuit for the CD-4, incorporating the phase-locked-loop principles but improving performance and with a higher degree of integration. The result, the CD4-392, is partitioned in such a way that the components most sensitive to cost/performance tradeoff are external to the chip. Thus, designers can build either high-performance or low-cost demodulators with the same IC.

The CD-4 system uses a multiplexing technique similar to fm stereo broadcast, except that the subchannel is angle-modulated by front minus rear data. The difference signal is further processed before modulation of the subchannel carrier, to improve the signal-to-noise ratios.

The 392 chip, according to Signetics' W.H. Hoeft and G. Kelson and JVC's N. Takahashi, consists of a limiter amplifier, synchronous detector, a phase detector, a current-controlled oscillator, audio amplifier, automatic noise-reduction circuits and matrix amplifiers. A 62-by-100-mil die contains 125 active components, and two dice are required for a four-channel demodulator.

---

## Microwave devices perform better as processing is refined

---

Microwave circuits, too, are benefitting from the increasing sophistication of bipolar device processing. By now, bipolar transistors, with their desirable low impedance, can be boosted up to about 8 gigahertz (though the GaAs FETs are still best from 8 to 18 GHz), while in the power area, from 18 to 30 GHz, Impatt diodes will prove most useful.

The edge resolution and hence current-handling capabilities of devices has been increased by the greater reliability and stability of multilayer metalization systems. This in turn has enabled device designers to take full advantage of the narrow line widths afforded by projection photolithography and electron beam lithography. These advances, together with ion implantation and advanced surface treatment, have allowed controllable diffusions less than 1,000-angstroms deep.

Now, too, computer-aided-design techniques are now being used to optimize devices for their intended end applications. Previously, the device was optimized, and circuit designers had the complex task of incorporating this performance in particular applications.

For instance, bipolar devices with half-micrometer emitter widths were used in an integrated S-band am-

plifier described at the conference by George Vendelin, John Archer, and George Bechtel of Fairchild Semiconductor, Palo Alto, Calif. The narrow widths were achieved by having the base diffuse under the emitter, and the amplifier attained a low noise figure of 3 decibels, along with a 23-dB gain in the 3.1–3.5-GHz range.

Hewlett-Packard's P.T. Chen and Jerry Gladstone employed high-resolution sputter etching, platinum-silicide alloy metalization, and a 900-angstrom-deep emitter diffusion in a 12.4-GHz YIG-tuned transistor oscillator. The transistor, which exhibited 20-dBm output power with 6-dB associated gain at frequencies up to 8 GHz, was based on an S-parameter oscillator model.

To obtain high-power Impatt-diode microwave amplifiers, two Allentown, Pa., researchers found a way to extract 8 watts at 4 GHz from two noncommercial GaAs Schottky-barrier Impatt diodes connected in parallel. They got over 20 W at 13.5% efficiency from three diodes. The technique, developed by Bell Labs' R. Knerr and Western Electric's J. Murray, requires only a single tuned cavity with a single transformer, single dc supply, and single current-regulated source. (Previous circuits needed one source per diode.)

Combinatorial techniques were used by Robert Harp and Kenneth Russell of Hughes Research Labs., Malibu, Calif., to improve the bandwidth and frequency capability of microwave power devices. In one version of their basic 16-diode power combiner, bandwidth was increased by lowering the Q factor yet maintaining power handling capabilities. The other version operated at a higher frequency ( $K_a$  band) than previously announced devices.

Trapatt uhf and L-band oscillators are small, easy to tune, simple to adjust, and perform well. A lumped-element S-band Trapatt amplifier built by A.S. Clorfeine, A. Rosen, and J.F. Reynolds of RCA Labs had a 6.1-dB gain across a 15-dB bandwidth at 75 W of output power. Also, their fully integrated, class C, coupled-line microstrip amplifier delivered 100 W at 7-dB gain across a 14-dB bandwidth.

## Analog ICs gain in accuracy, DMOS aids heart-imaging system

Ingenuity with transistors was central to other advances reported at ISSCC in analog circuits and in medical equipment.

To increase the accuracy of a high-precision operational amplifier, A. P. Brokaw and M. A. Maidique of Analog Devices took advantage of a FET's high impedance input to combat offset current drift. The offset voltage drift of a FET differential amplifier, however, is poor and, being sharply dependent on the current biasing scheme used, requires optimizing with an offset nulling circuit that will maintain drift at less than 1 microvolt per °C while handling up to 10 millivolts offset.

Brokaw and Maidique therefore designed a special

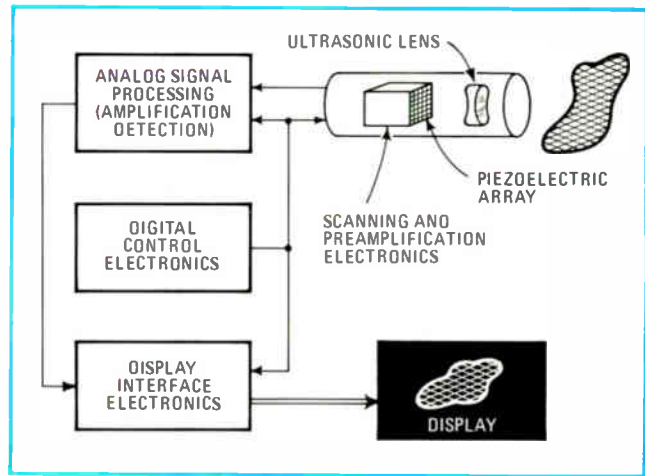

**5. Heart at work.** Cardiologists can study heart action with system that beams ultrasonic bursts into body, observes real-time echo.

bipolar chip, to serve as an input stage that would minimize the FET drain-current mismatch. They used a new pnp structure that attains the current-multiplying effect of the Darlington connection, without the attendant degradation in offset voltage and current drift of the Darlington (Fig. 4).

To increase analog multiplier accuracy, a new technique was devised by Barrie Gilbert, a British consultant to Analog Devices. As a rule, monolithic analog multipliers using linear transconductance principles have greater bandwidth and are cheaper than those using the pulse width height modulation technique, but they are rarely more accurate than 1% full scale, as against the 0.1% achieved with the other technique. Gilbert gets 0.2% to 0.3% full-scale accuracy, mainly by taking great care to match the six transistors of his linear transconductance multiplier.

Double-diffused MOS (DMOS) transistors proved vital to a noninvasive, nonradiating imaging system for observing the body's internal organs. Three members of the electrical engineering department at Stanford University, J. D. Plummer, J. D. Meindl and M. G. Maginness, said that operating prototypes of the system (called Ulisys, for ultrasonic imaging system) have already been used by cardiologists to observe human heart action in real time.

Figure 5 is a block diagram of the system. A two-dimensional 10-by-10 array of piezoelectric transducers are sequentially excited by bursts of energy at about 3 megahertz. Each element transmits an ultrasound pulse into the region of interest in the body. Echoes from tissue interfaces are focussed back to the array, are time-gated out, and undergo appropriate signal processing. When the array is scanned in time periods much shorter than the cardiac cycle, real-time images of heart movement can be displayed.

Double-diffused DMOS transistors fitted the multiplexing needs of this type of application, being able to handle large voltages and peak currents up to 0.25 ampere, and having a wide dynamic range with low noise and little parasitic capacitance. The level-shifting circuits also use DMOS components and, in addition, contain high-voltage lateral pnp transistors and vertical npn devices, all on the same chip. □

# Were very big on small

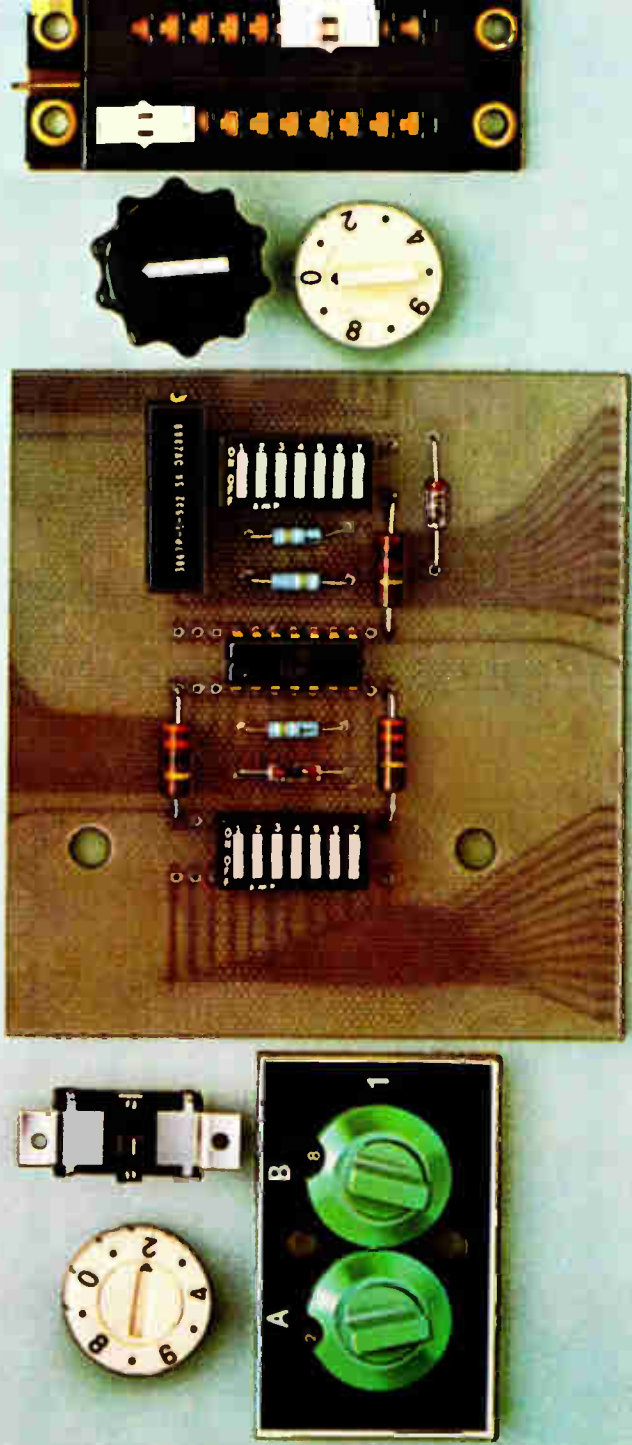



When it comes to miniaturized switches, you'll find true AMP innovation. And because they're made by AMP, you know you're getting economy and reliability.

Take our multipole switch for pc boards, a new addition to our dual in-line switch group. It increases our ability to give you an even wider variety of configurations in high-density DIP switches. From double-, triple-, 4- and 5-pole single-throw to single-pole double-throw 4-terminal form Z.

What else is new? Our 2-, 3- or 4-position switches, each having double-pole double-throw capability. In a single dual in-line enclosure. They're only .275" high, which includes the screwdriver-operated actuator.

For low-cost applications, consider AMP's unique pull-to-set slide switch. It's available as a module for mounting on pc boards. Or preassembled as a programmable matrix slide switch.

In addition, we have a complete line of matrix rotary switches and switch kits designed for panel mounting. They're simple and economical ways of manually programming various types of electrical/electronic equipment. Without external switch wiring.

Our pc board rotary switch gives you a wide choice of outputs. Plus truly versatile application possibilities. While our 5-position slide switch permits maximum slide positions in a minimum switch size.

So think small. Think AMP mini-switches. Call (717) 564-0101. Or write AMP Incorporated, Harrisburg, Pa. 17105.

**AMP**  
INCORPORATED

AMP is a trademark of AMP Incorporated.

Visit AMP Booth 401  
at the NEPCON West Show.

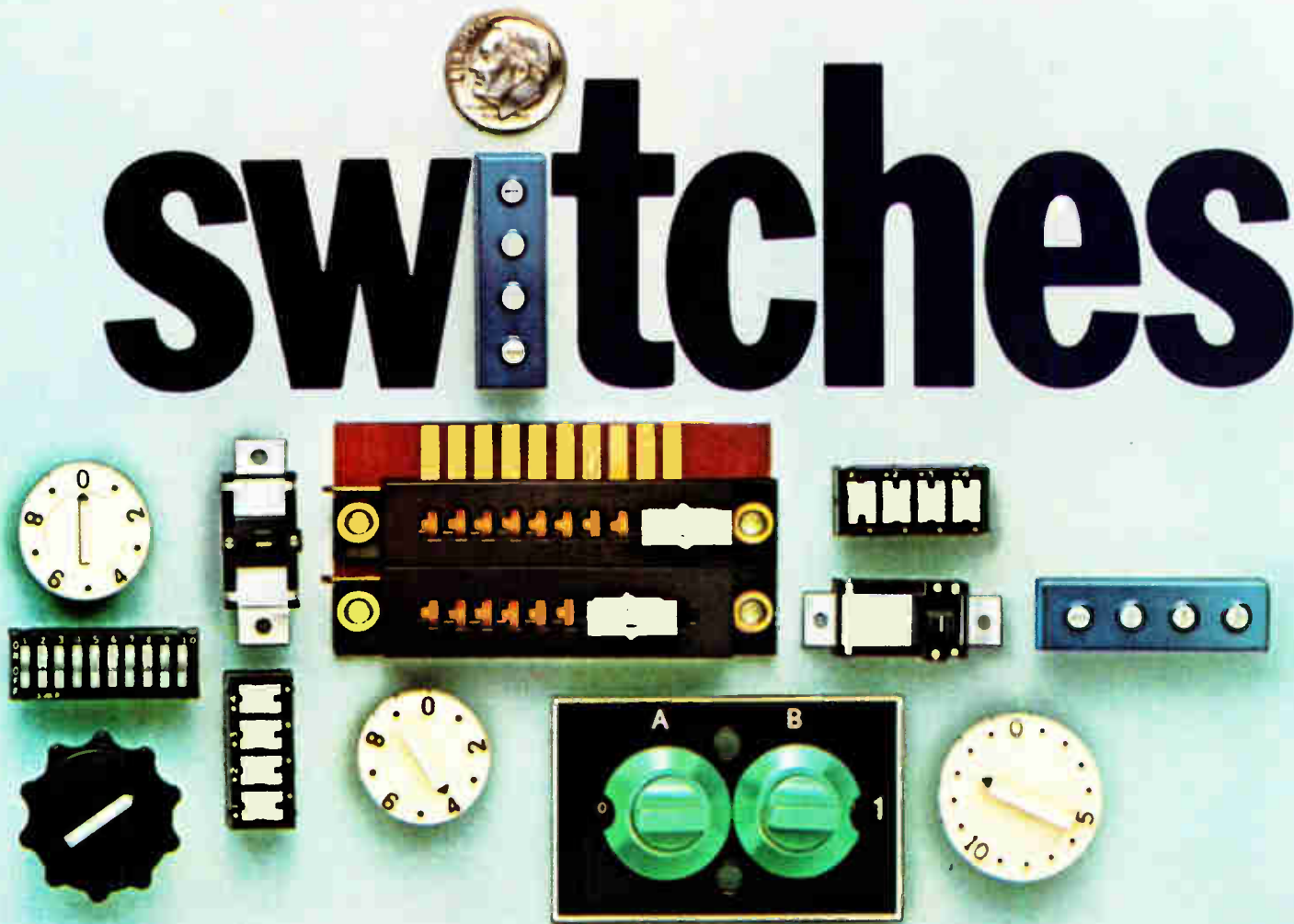

## New products

# 120-MHz scope is light, priced low

Philips invades computer field-service market with portable unit; front-panel layout specially designed for crowded user locations

by John Gosch, Frankfurt bureau manager

One of the largest segments of the oscilloscope market has been created by the demand for portable, low-cost instruments designed for servicing computer equipment in the field. A portable oscilloscope that meets these requirements will be introduced March 25 to 29 by Philips Gloeilampenfabrieken at IEEE Intercon 74 in New York. Designated the PM-3260, the instrument is a dual-channel, 120-megahertz scope that can display pulses

with rise times as short as 3 nanoseconds.

The PM 3260 is the first in a new series of Philips scopes. It will be followed by higher- and lower-bandwidth models having multiplier and storage options. The screen of the new scope measures 8 by 10 centimeters, and weight is only 20 pounds. The 3260, built for the serviceman in the field, as well as the designer in the laboratory, is priced at \$1,850.

Philips, the giant among European scope makers, says its studies have shown that the market demands a portable instrument that can cope with Schottky-TTL circuits and other high-speed devices in data-processing equipment and communications systems. "Beyond that," adds Jacques Wouters, a product engineer at the Philips Industrial Equipment division in Eindhoven, "our customers wanted a lightweight unit that could be hand-carried from one service point to another and that was small enough for use in crowded places."

Considered alone, the scope's 120-megahertz bandwidth may not seem unusually large. But that bandwidth, combined with low weight and portability in an under-\$2,000 instrument, Wouters says, is unusual.

In developing the PM 3260, the Philips designers first attacked the problem of weight reduction without sacrificing mechanical rigidity. This was solved by making the main castings from magnesium, a lighter-than-aluminum material.

Another contribution to low weight comes from a power-supply principle Philips developed some time ago. Instead of the incoming voltage going directly to a conventional transformer, it's first directed to a converter, where it is brought down to a low dc value and then changed to a 20-kilohertz voltage. At this high frequency, the transformer that follows needs only a tiny iron core.

With this supply, the scope consumes little power—only 45 watts, compared with 80 w for conventionally powered equivalent-bandwidth models, so there is no need for a



# From those wonderful folks who gave you clean waveforms...

## ...come some of the dirtiest waveforms ever.

Because the new Model 132 generates precise calibrated outputs of digital or analog noise. And because it's really two generators in one, the 132 also puts out super-clean sine, square and triangle waveforms over the frequency range of 0.2 Hz to 2 MHz. You can even mix the clean signals with noise and get calibrated signal-to-noise ratios. Cleans and dirties from Wavetek for only \$795.

### WAVETEK®

P.O. Box 651, San Diego, California 92112  
Telephone (714) 279-2200, TWX 910-335-2007

Circle 121 on reader service card

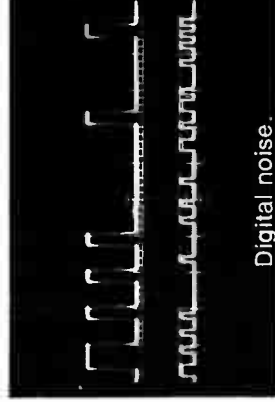
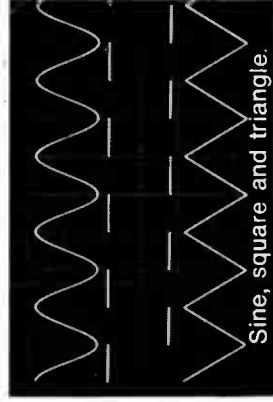
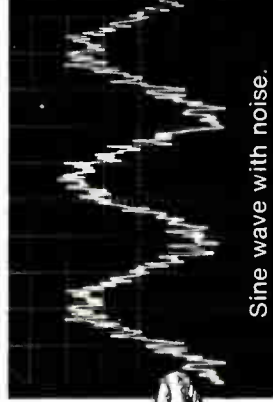
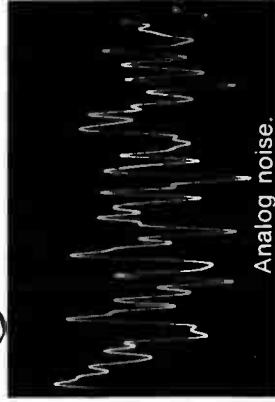

DESIGN ENGINEERS:

# Custom's Capacitors have what you need

Do you deal with specifications like these in your work:

- capacitance over 40 pf up
- frequencies in MHz
- voltage over 1000 VDC

**Then reconstituted mica capacitors are what you need.**

Do you work with energy density of .05-.25 joules/in.<sup>3</sup>, at high voltage?

**Reconstituted mica capacitors will best fill your requirements.**

Looking for high voltage in small packages?

**You need reconstituted mica capacitors!**

Another of the many advantages of reconstituted mica capacitors is excellent performance under environmental extremes.

Custom can meet your needs better, because each process in our capacitor production begins and ends with quality control to avoid failure in the field. Let us show you how we can fill your requirements.

See our page in *Electronic Buyer's Guide* and *EEM* and write for **FREE** product sheets today.

P.S. Oil exploration personnel: Custom can help you with your logging tool problems.



**CUSTOM ELECTRONICS, Inc.**  
12 Browne St., Oneonta, N.Y. 13820  
PH: (607) 432-3880 TWX: 510-241-8292

## New products

cooling fan and accompanying air filters, which also reduces weight. The PM 3260 operates off line voltages from 90 v to 250 v at frequencies from 46 Hz to 440 Hz. Battery-powered-operation is also possible.

Weight is reduced also by using integrated circuits and micro-miniature transistors. These are deposited together with passive components on thin-film hybrid circuits that make for a high packing density on the component boards.

Although the thin-film-hybrid approach is somewhat more expensive than the all-discrete way, it pays off, Wouters asserts. For calibrating the vertical amplifier, for example, only 10 adjustments are necessary, instead of as many as 30 for a discrete-component vertical amplifier.

Also, the proximity of components fabricated by the hybrid techniques provides high circuit stability, which, Wouters points out, doubles the interval between scope calibrations. To enhance quality, the leads inside the hybrid modules are gold-layered, and all resistors are made of thin film. Military standards are followed in encapsulation and sealing methods.

The PM 3260 Philips-made cathode-ray tube meets users' requests for the high writing speeds needed to handle the fast rise times of, say, single-shot pulses in communications equipment. In the new CRT, a high write speed, coupled with sharp focusing and good line contrast, is achieved by using 20 kilovolts on the tube—double the value ordinarily employed.

Enhancing the CRT's high-frequency response are segmented deflection plates. Each segment is connected to a delay network, which ensures that the beam's electrons passing between the plates are affected by equal-valued deflection signals during their entire transit time. A so-called domed mesh, about halfway between the gun and the screen, is necessary in the short-length, high-frequency tube for good beam deflection across the CRT's relatively large screen.

The Philips engineers have gone to great lengths in the PM 3260's

front-panel layout. "something for which we've spent a lot of money," says Wouters. For getting an optimum panel layout, a Dutch industrial-design institute was hired to gather data on how long it takes experienced scope users to find certain controls and go through specific measurements. In these time-motion studies, the user's hand movements and even his comments were recorded and evaluated.

The resulting panel layout Philips considers the optimum and most logical for field technicians and lab personnel alike. Constrained by small panel size, the scope designers chose to arrange the controls into five functional groups—two for the amplifiers, two for the time-base portions, and one for the CRT. In each group, the knobs and buttons are positioned according to the frequency with which they are used. So are the main time-base controls more prominently positioned than those for the delayed time-base, which are handled only 15% of the user's time, according to the institute's data.

The special attention paid to front-panel design extends even to the shape of the push buttons, to the spacing between them, and to their functions. Instead of being multiple-purpose types, each push button has only one function. Consequently, Wouters says, users need not ascertain their settings for certain measurements.

To further enhance scope handling, the lead receptacles are so arranged that cables cannot obstruct the view of any front-panel controls, and the screen is positioned well off to one side. Circuit boards are located for easy serviceability and convenient access to connectors. To facilitate replacement of components, one-layer mounting principles are used.

To suit the man in the lab, the PM 3260 provides high sensitivity and good triggering. Its normal vertical-input sensitivity is 5 mv per division. Triggering is also possible with signals up to 200 MHz.

Philips Gloeilampenfabrieken N.V., Industrial Equipment Division, P.O. Box 523, Eindhoven, the Netherlands [338]

# Switch functions as solid-state fuse

Current-controlled hybrid module uses existing devices; high-speed, resettable switch can also limit transients and surges

by Joel DuBow, Components Editor

Most solid-state switching applications have utilized normally open voltage-controlled devices of the breakdown or regenerative type. This group includes four-layer diodes and three-layer trigger diodes. Their common characteristic is a fast change of state brought about by positive feedback when a certain voltage level is exceeded. A gate terminal is frequently provided to allow triggering at lower voltages and to vary the pulse-repetition rate.

Devices of this type are normally in the high-impedance state and change to a low-impedance state upon reaching the trigger or breakdown voltage.

A wide range of applications, including replacement for the conventional fuse, can be handled by a device that normally has a low impedance and switches to a high impedance upon triggering. Such a unit, developed by Ohmic Instruments Co., is a two-terminal, normally closed, current-controlled,

switch. The block diagram (at left below) shows elements of the hybrid module, and the current-voltage characteristics of the switch are shown at right.

The device is normally in its low-impedance state and acts as a resistive element. When the switching current ( $I_S$ ) is reached at a given switching voltage ( $V_S$ ), the switch goes through a negative-resistance transition to an open, or high-impedance, state. Once tripped, it remains in the high-impedance state until the holding voltage drops below its rated value  $V_H$ . Typically, the holding voltage is a few volts and the resulting current only a few microamperes.

The current-controlled switch is available in both unidirectional (dc) and bidirectional (ac) configurations. The device is also available in a three-terminal configuration with a programming, rather than a controlling, input. An external resistor allows variation of the switching current over a 5-to-1 range. Maximum

voltage ratings range from 32 to 250 v. Switching current may vary from 0.1 to 200 milliamperes.

The module is available in TO-5 and TO-18 case sizes, as well as in a 3AG fuse housing. Turn-off times are internally adjustable from a few microseconds to 10 milliseconds. Among advantages over conventional fuses, the switch is resettable, operates faster, and will open up in 1 ms at 200% overload. A 2-mA 8AG fuse opens up four hours at 4 mA; thus the new device functions as a high-speed fuse with indefinite life. If it is operated in excess of its rated voltage, it stays open permanently.

In addition to fuse applications, the switch can limit transients and surges, as well as operate as a switch, a base-protector for power transistors, and a remotely pulse-controlled multicircuit current interrupter. It is available in limited production quantities at \$15 each.

Ohmic Instruments Co., 15 Lincoln Park Center, Annapolis, Md. 21401 [339]

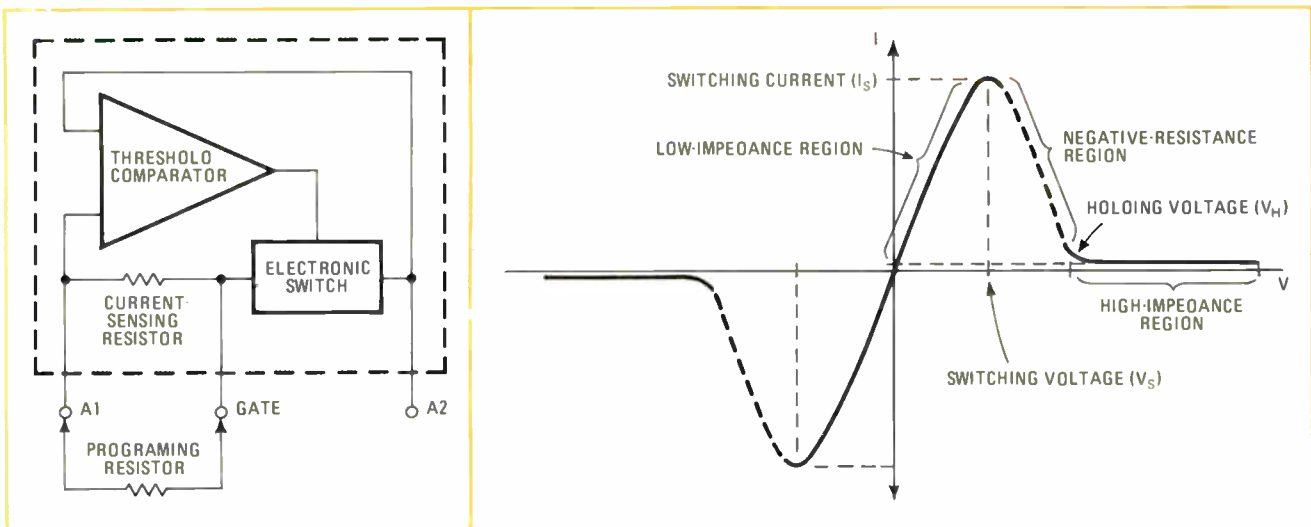

# Only the Gould 6000 gives you 128 floating and integrating inputs, real time monitoring, 200 points/sec. and a 3M computer grade tape cartridge in a Data Acquisition System.

The Gould 6000 is an analog to digital data logger-reader that's the best way we know of to monitor and record low frequency data. It scans up to 128 input channels, converts the data to digital form, displays the data for real-time monitoring and stores the results on 3M 1/4" computer grade magnetic tape.

## High performance, high or low scanning speed.

Our full-floating integrating front end minimizes signal noise and eliminates sampling errors inherent with other data collecting systems. Each analog input is fully floating with respect to the chassis ground and continuously integrated during the entire scanning period.

The Gould 6000's 128 inputs may be all analog or up to 48 digital

and 80 analog. There are four full scale programmable gain sensitivity ranges:  $\pm 10\text{mV}$ ,  $\pm 100\text{mV}$ ,  $\pm 1\text{V}$  and  $\pm 10\text{V}$ .

To select the scanning rate, push one of the six buttons on the front. The rate can be varied from 200 points per second to 1 scan every ten minutes. In an external record mode, a scan can be triggered by an external clock or an event.



**A significant advance in tape handling.**

The 1/4" computer grade magnetic tape in a front loading reel-to-reel cartridge represents a significant improvement in tape handling. The 3M cartridge has 8 times the storage capacity of a cassette while eliminating tape handling problems frequently associated with large, expensive 1/2" reel-to-reel transports.

In addition, the cartridge combines plug-in convenience, foolproof operation with a single

motor drive, a built-in File Protect, 4-track read-write capability.

**A typical writing error rate approaching one part in 100 million.**

The Gould 6000's typical error rate which approaches 1 part per 10<sup>8</sup> translates to only one writing error for every 12 tape cartridges used.

**Connect up to 128 inputs to the Gould 6000 and you won't miss a thing.**

The Gould 6000 can be used just about anywhere to monitor just about anything. It's being used for pollution monitoring, chemical processing and refining, weather and seismic recording, product testing, and applied research in various fields.

The Gould 6000's light-weight (under 36 pounds), easy to use controls and rugged construction make it a natural for portable, as well as on-site data acquisition jobs.

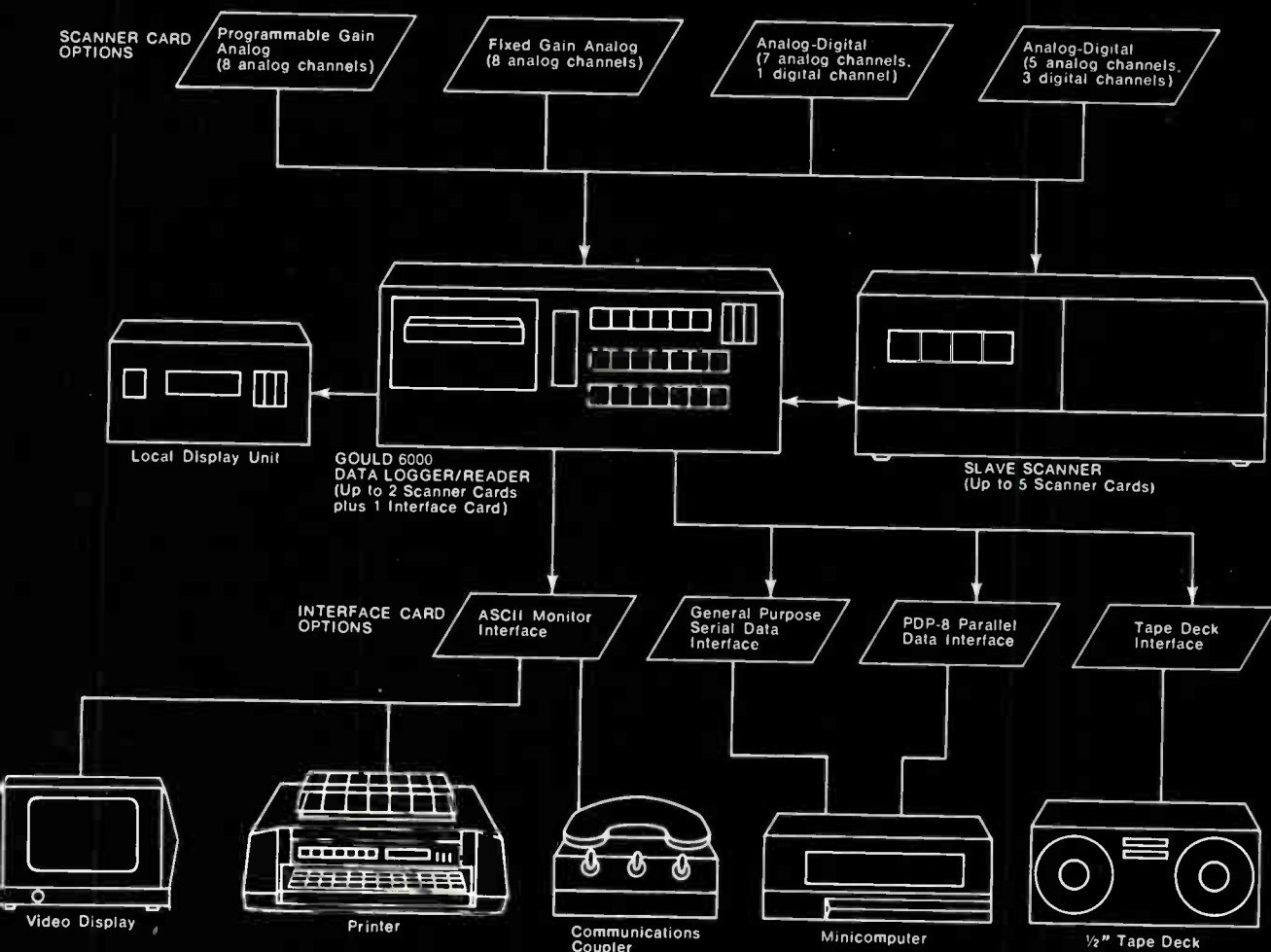

**The complete data acquisition system.**

The Gould 6000 is truly an operational definition of what a high performance data logger-reader should be. If your research requires an instrument of this quality, contact your nearest Gould

Sales Engineer or Representative. Or write us for detailed performance information and specifications. Gould Inc., Instrument Systems Division, 3631 Perkins Avenue, Cleveland, Ohio 44114 or Kouterveldstraat Z/N, B 1920, Diegem, Belgium.



Circle 125 on reader service card

# Only one of these synchronous motors



## is a genuine Synchron<sup>®</sup> Motor.

Synchron motors are made in five major styles. Speeds from 900 rpms to one revolution per week. Torque from 8 through 98 oz-in at one rpm. Hundreds of output options.



## Look alike aren't perform-alikes.

Not by a mile. And once a motor is installed in your product, who cares what it looks like? As long as it does its job, is trouble-free and lasts a specified time.

But how do you know which of the three will perform the best? Do you gamble and just pick one, assuming they're all about the same? Hardly. You specify the one that's made by a company that's just as interested in how well the motor performs as you are . . . who will stand by it 100% . . . who will deliver it when you need it . . . at a fair price.

But most of all, from a company dedicated to helping you solve your problems with the best product made. The motor on the left is the one we're talking about. It's the genuine Synchron.

**Call or write for complete Synchron motor specifications and the name of your Hansen representative.**

**MALLORY**



**HANSEN MANUFACTURING CO.**  
a division of P. R. MALLORY & CO. INC.  
Princeton, Indiana 47670

We make every Synchron motor as if our name were on your product.



## New products

### Instruments

# \$299 meter has autoranging

3½-digit, five-function multimeter operates off line or battery power

Taking dead aim at the lucrative 3½-digit multimeter market that was opened up about a year and a half ago by the Fluke 8000A, Keithley Instruments Inc., will introduce at the IEEE show next month its model 168 autoranging digital multimeter. Carrying a \$299 price tag, the 168 measures ac and dc voltage, ac and dc current, and resistance.

Unlike other meters in its price/performance class, the new instrument is strictly an autoranging machine. The operator selects the desired measurement function by means of a front-panel push button, and the meter does the rest: it selects the proper range, moves the decimal point into the correct position, detects and displays the polarity of dc quantities, and displays the reading along with any pertinent function information. This last feature—the display of function data—makes it unnecessary to check the positions of the various push buttons in order to be able to tell what the instrument is reading.

The model 168 has two overlapping ohms ranges. The high range, which spans 1 ohm to 20 megohms, applies a maximum of 0.9 v across the unknown resistance; the low range spans 0.1 ohm to 2 megohms, and applies a maximum volt-

age of 90 millivolts. Since 0.9 v is enough to turn on almost any semiconductor junction, and 90 mv is low enough to turn on none, the two ohms ranges provide a convenient method for making in-circuit resistance checks with the semiconductors either turned on or off, at the user's discretion.

For dc voltage, the meter has five ranges—from 0.2 v full scale to 1,000 v full scale. Maximum error on each range is  $\pm(0.1\%$  of reading + 1 count). Input resistance is 10 megohms, and temperature coefficient is  $\pm(0.02\%$  of reading + 0.01% of range) per degree centigrade.

As an ac voltmeter, the 168 responds to the average value of the input signal and is calibrated in rms volts for a pure sine wave. It has the same ranges as for dc voltage, but the maximum reading is 500 v rms. Maximum error on ac voltage is  $\pm(0.5\%$  of reading + 3 counts) for the four lower ranges, and  $\pm(2\%$  of reading + 3 counts) for the 1,000-v range. Frequency response is 20 Hz to 5 kHz for the lowest and highest ranges; 20 Hz to 10 kHz for the three middle ranges.

Both dc and ac current are measured on four ranges—0.2 mA, 2.0 mA, 0.2 A, and 1.0 A full scale. All voltage ranges are electronically protected to withstand a maximum input of 1,200 v (dc plus peak ac) of either polarity. Further, the low side of the input port can be floated as much as 1,200 v above ground. All ohms ranges can withstand 250 v rms (from a sine wave) or 250 v dc without damage. Current ranges are protected by fuses.

A field-installable rechargeable battery pack is available as an option at a price of \$60. The battery pack can be recharged while the

meter is being operated from the line. When fully charged, the battery pack provides at least six hours of operation, and recharging takes 1.5 hours per hour of discharge.

The meter weighs 3.5 lb without the battery pack, and 5.5 lb with it. Line-power consumption is 6 w without the battery pack, and up to 10 w if the batteries are being recharged.

Keithley Instruments Inc., 28775 Aurora Road, Cleveland, Ohio 44139 [351]

### Digital rf wattmeter measures to 1,000 W

The model 4371 Thruline directional high-power wattmeter is a digital-insertion instrument for measuring forward or reflected continuous-wave power in coaxial transmission lines. The instrument measures power flow under any load condition from 25 to 520 megahertz and from 1 to 1,000 watts in six ranges. Insertion VSWR in 50-ohm systems is 1.1, and accuracy is within  $\pm 5\%$  of full scale. The unit can also be calibrated in the field to known rf power standards. In addition to continuous-wave measurement, the 4371 also measures a-m, fm, and single-sideband signals. Price is \$950.

Bird Electronic Corp., 30303 Aurora Rd., Cleveland, Ohio 44139 [354]

### Pulse generator offers operation to 20 MHz

A 20-megahertz pulse generator, called the model 8005B, has simultaneous +10-volt and -10-v outputs, which are ample for HTL levels, discrete and analog circuits, and DTL and RTL integrated circuits. The unit also has a separate TTL-compatible output held to a constant level. Moreover, the model 8005B offers selectable-output-source impedance, 50 ohms or current-source, and a normal-complement switch to change conveniently from positive to negative logic without readjusting offset. Price is \$1,165, and delivery



**Finally!**  
**A filter so precise,**  
**filter characteristics**  
**for every setting**  
**are printed**  
**on top.**



We've built a variable electronic filter that's so precise, it has enabled us to print the cutoff frequencies, center frequency, bandwidth, noise bandwidth and filter gain, for every setting, *on top of the instrument*. Besides being the easiest-to-use filters on the market, our 4200 series filters are twice as accurate, have less than half the self-noise, and provide 10 dB greater outband rejection than any other filters. Frequency coverage is .01 Hz to 1 MHz. Built-in selectable post-filter gain and remote preamplifiers are optional. A Butterworth response is used in the NORMAL mode and a Bessel response in the PULSE mode (transient response is superior to conventional "RC" or "Low Q" modes of other filters).

The price? \$695.

For complete specifications and your free copies of our variable electronic filter application notes, write to: Ithaco, Inc., Box 818-7R, Ithaca, New York 14850. For immediate response, call Don Chandler at 607-272-7640 or TWX 510-255-9307.

**ITHACO**

## New products

time is estimated at nine weeks.  
 Hewlett-Packard Co., 1501 Page Mill Rd.,  
 Palo Alto, Calif. 94304 [356]

Rf power amplifier puts out  
 10 watts over wide band

An rf power amplifier, the M310, produces 10 watts of linear rf power from 300 kilohertz to 300 megahertz with low harmonic and intermodulation distortion. The amplifier accepts input from a-m, fm, ssb, pulse, and other modulations over the entire frequency range. Offering



40 decibels of gain, the unit can be driven to full power by any standard sweep or signal generator capable of supplying 1 milliwatt of signal level into its 50-ohm output. Price of the M310 is \$1,970. Another model in the series, the M305, puts out 5 W and is priced at \$1,225. RF Power Labs Inc., 11013 118th Pl. N.E., Kirkland, Wash. 98033 [357]

Time-jitter meter checks  
 PCM system performance

Designated the model 74 series, time-jitter meters measure both pulse-code-modulation time-jitter and short-term timing disturbances (hits) in digital communications systems. The units are available in a variety of configurations to meet specific requirements. Rms jitter is displayed on a multirange meter with full-scale ranges of 0.03, 0.2, 0.3, 1.0, and 3.0 bits. Timing hits exceeding a preset threshold are accumulated and displayed on a digital readout. Frequency-weighting

Relieve your  
semiconductor  
headaches fast...

call CRYSTALONICS

At Crystalonics, we welcome those "tough-nut" requirements that cause you headaches. Sure, we offer a broad line of standard semi's, but we do a lot of specialized packaging, too. And much of our business involves strict testing requirements. That's why JAN-TX and JAN-TXV devices figure so prominently in our sales.

And what about those "occasional" times when an  $H_{fe}$  or  $BV_{ebo}$  becomes super

critical and you need a whole bunch of semi's with narrower Betas or higher breakdown ratings? No headache. We're set up to provide that kind of selection. We can provide matched dynamic ratings like  $V_{CE(sat)}$ ,  $r_{EC(sat)}$ , and  $h_{FE}$ ; and if your program requires, we'll even furnish traceability to the raw materials involved in each production lot.

So stop suffering. Whatever's causing your headache, call us at CRYSTALONICS, 617-491-1670

or 714-557-5372. Talk to our applications engineering group. You'll find it very comforting. You'll find our service and delivery soothing on your nerves, too.



TELEDYNE  
CRYSTALONICS

147 Sherman St. • Cambridge, Mass. 02140  
Tel. 617-491-1670

2082 S.E. Bristol, Suite 4  
Newport Beach, Ca. 92707  
Tel. 714-557-5372

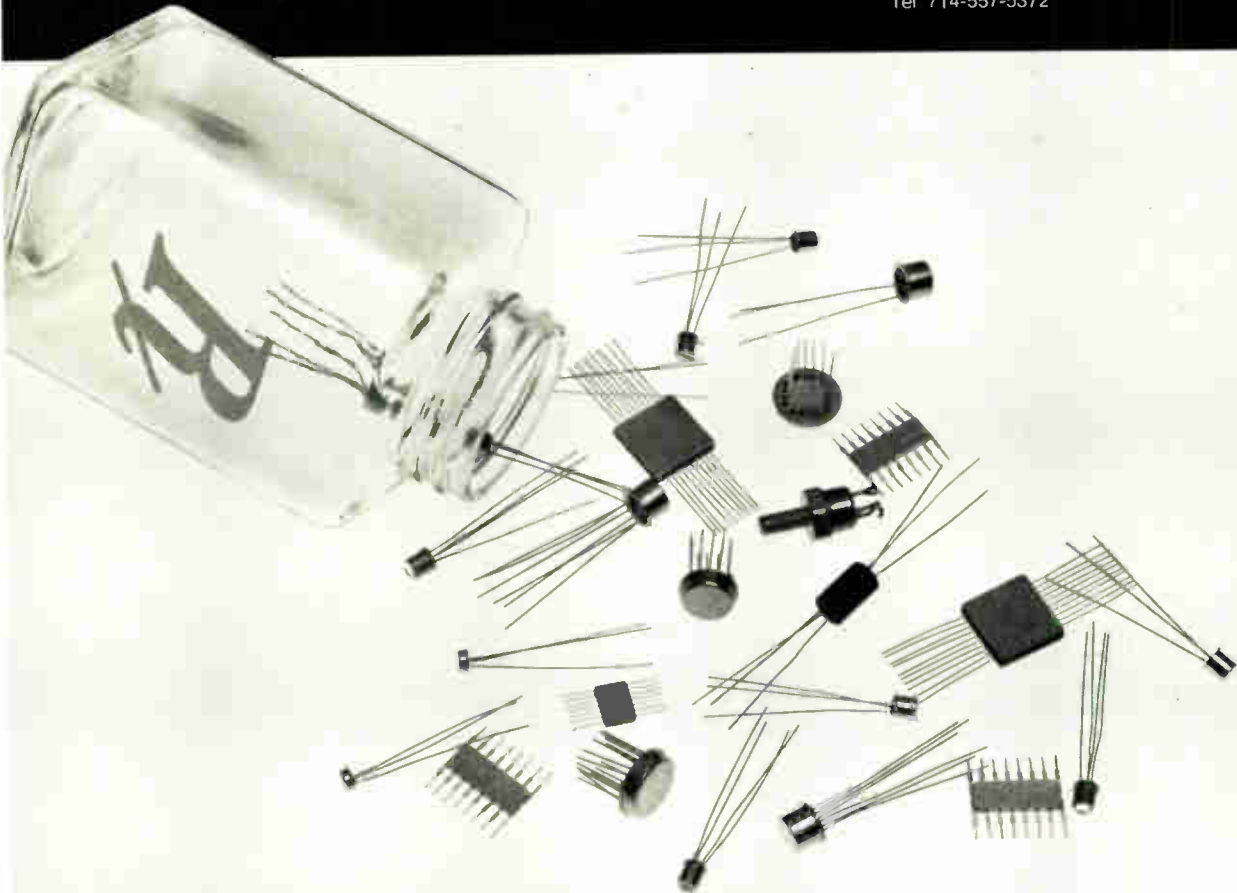

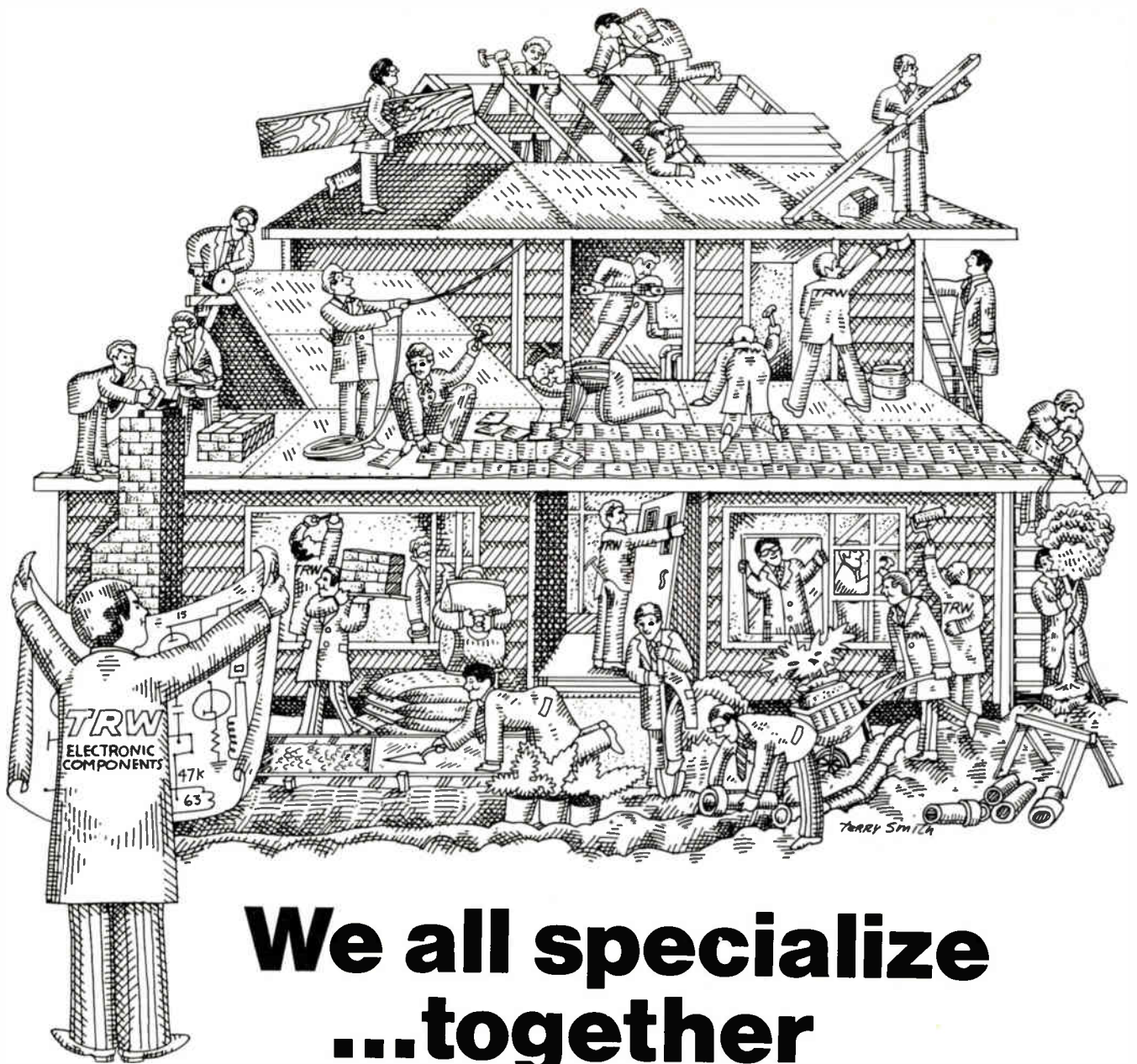

# We all specialize ...together

**TRW** CAPACITORS

**TRW** CINCH CONNECTORS

**TRW** CINCH-GRAFIK

**TRW** CINCH-MONADNOCK

**TRW** CONSUMER INTERNATIONAL

**TRW** GLOBE MOTORS

**TRW** HOLYOKE WIRE & CABLE

**TRW** IRC POTENTIOMETERS

**TRW** IRC RESISTORS

**TRW** SEMICONDUCTORS

**TRW** SUPERMET PRODUCTS

**TRW** UTC TRANSFORMERS

We are the Electronic Components Divisions of TRW Inc. Each of us specializes in a particular area of manufacturing, making over 300 different kinds of electronic components.

But for all our specialization, we are still part of a single entity. We all follow the same basic TRW plans, operate under the same TRW standards of quality, reliability and service.

Individually we specialize; together we build.

And what we have built is a source for whatever you need in the way of electronic components. Either we already make it, or we can make it. High-technology or high-volume—or both. Among our specialties, we cover the field. So, as a group, you might say our real specialty is... serving your needs.

Because we are TRW.

**TRW** ELECTRONIC COMPONENTS

10880 Wilshire Boulevard, Los Angeles, CA 90024

## New products

characteristics from 0.1 hertz to 10 kilohertz and data rates from 4.8 kilobits per second to 150 megabits per second are selected by push buttons.

Hekimian Laboratories Inc., 15825 Shady Grove Rd., Rockville, Md. 20850 [358]

## Frequency counter features 50-millivolt sensitivity

The model SC-1A 40-megahertz frequency counter offers accuracy to eight digits by overranging, and has a precision 10-megahertz quartz-crystal time-base generator. Also offered are counter reset to within 200 milliseconds of completed count, leading-zero suppression, and an input sensitivity of 50 millivolts. Frequency range is from 1 hertz to 40 MHz. Price is \$185.

Scarpa Laboratories Inc., 46 Liberty St., Brainerd Station, Metuchen, N.J. 08840 [359]

## Displacement transducer has output of 0 to 10 V dc

A linear displacement transducer, designated the model DCT, uses an ultrasonic principle to provide an analog output of 0 to 10 volts dc, for use in stroke control and measuring applications. The instrument is said to have infinite resolution and an accuracy within better than 0.1% of

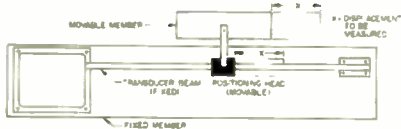

full scale. Several models are available, with displacement ranges of 0 to 12 inches and 0 to 60 in. Further, repeatability is better than 0.02%, and input is +15 volts at 250 milliamperes or -15 v at 25 mA.

Tempo Instrument Inc., E. Bethpage Rd., Plainview, N.Y. 11803 [360]

# New SOLID-STATE FET-INPUT MULTIMETER

from  
**SIMPSON**  
of course

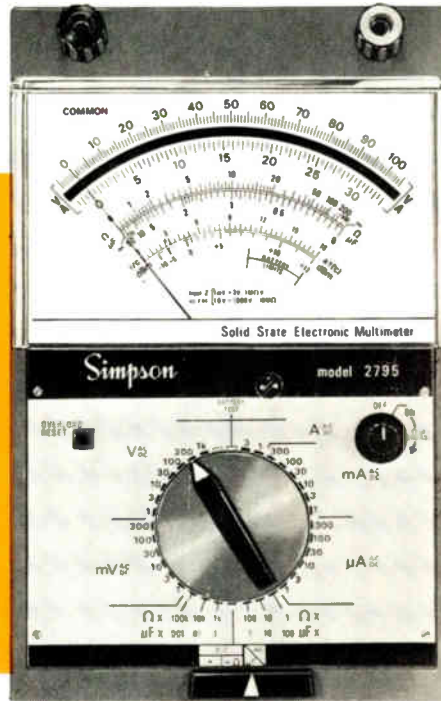

**Model  
2795**  
**PORTABLE,  
LABORATORY  
ACCURACY,  
SOLID-STATE  
ELECTRONIC  
MULTIMETER**

- 68 Switch Selectable Functions:
  - 13 AC and DC Voltage Ranges (as low as 1 MV, full scale)
  - 14 AC and DC Current Ranges (as low as 1  $\mu$ A, full scale)
  - 6 low power (IC compatible) Resistance Ranges
  - 6 completely self-contained Capacitance Ranges
- Plus 12 Output Ranges
- Circuit Breaker Overload Protection
- High FET-Input Impedance
- $\pm 1\%$  Accuracy for AC and DC
- Negligible Voltage Drop
- Simple, Straight-Forward Operation
- Size: 8.07" High, 5.04" Wide, 3.94" Deep. Only 3.3 lbs.

**2795 MULTIMETER** supplied complete with batteries, test leads and operator's manual. Complete accessories available.

**\$250<sup>00</sup>**

WRITE FOR BULLETIN L-1010 . . . OR CONTACT YOUR SIMPSON INSTRUMENTATION PRODUCTS DISTRIBUTOR FOR OFF-THE-SHELF DELIVERY

**Simpson**  
INSTRUMENTS THAT STAY ACCURATE



## SIMPSON ELECTRIC COMPANY

5200 W. Kinzie Street, Chicago, Illinois 60644

Phone (312) 379-1121

EXPORT DEPT.: 400 W. Madison St., Chicago, Ill 60606. Cable Simelec

IN CANADA: Bach-Simpson Ltd., London, Ontario

IN INDIA: Ruttonsha-Simpson Private Ltd., International House, Bombay-Agra Road, Vikhroli, Bombay



**Another fun-filled challenge  
from National Semiconductor.**

The person who guesses closest will win the camper. (In the event of a tie, earliest postmark).

And the next 15 closest guesses will also win prizes (turn the page for details and entry blank).

(Clue: there's 305 boxes of FETs in the camper).

So get your slide rule out.

Now, you may think all this is kind of dumb.

Like a fox.

We're trying to make a point. That National makes FETs, and we've got a lot of them.

This camper full of FETs will, we think, make our point that we've got a lot of FETs.

This list may help, too.

**National makes:**

36 kinds of general purpose N-channel amps. 14 general purpose P-channel amps. 6 ultra-low input current amps. 12 low-frequency-low noise amps. 8 VHF/UHF amplifiers/mixers/oscillators. 22 RF/VHF amps. 48 switching (chopper) N-channel. 16 switching (chopper) P-channel switches. 39 general purpose duals. 10 low-frequency-low noise duals. 6 wide band-low noise duals. 12 low leakage — high CMRR — wide band duals. And hundreds of other FET types.

# Guess the in this camper



That's a lot of FETs. And we have a lot of each of them, too.

The only thing we don't have is production or delivery problems.

We've got 'em, and we can get most types to you in just about any quantity in 2 to 3 weeks.

We want to drive home the point that National has lots of FETs.

It could lead to your being able to drive home more than a point.

**Don't be too unhappy if you don't win the camper.**

You could win one of our fifteen other prizes.

1st prize is a camping trailer or a snowmobile. 2nd prize, patio furniture or two pairs of skis.

3rd, a tent or a battery-pack TV.

4th, a set of luggage or a chain saw. 5th, portable refrigerator or movie camera.

And many other prizes including fishing outfit, sleeping bag, ice chest, hammock, lantern, jet fogger, knapsack, skin divers watch, picnic food tote and picnic blanket.

So put on your thinking cap and guess the number of

# number of FETs and win it.

FETs in the camper. Make your guess on the entry blank and on the lower left-hand corner of the outside of your envelope, and mail it before March 31, 1974 along with your "Request for Quote" (or order) on your FETs requirements.

And cross your fingers.

**Our new  
NDF 9401-10 Series**

One of our new FETs that we're pretty proud of is a process 94 — NDF9401-10 for most critical op amp input applications where process 83-2N5196-99 won't quite hack it.

The leakage,  $I_G < 5\text{pA}$  at 35V and  $\text{CMRR} > 120\text{dB}$ , means flexibility in design permitting negligible error with large voltage swings. The high  $g_{fs}$  typically means low noise particularly in broadband applications. It's even monolithic for unexcelled thermal stability.

# Grand Prize

Volkswagen Camper

## 1st Prize

Apache Camping Trailer  
or  
Scorpion Snowmobile

## 2nd Prize

Telescope 14 pc. Set of  
Patio Furniture  
or  
Northland Matching His 'n  
Hers Stein Eriksen Skis

## 3rd Prize

Thermos Prairie  
Schooner Camping Tent  
or  
Sony Battery Pack 9"  
B&W TV

## 4th Prize

Samsonite 4 pc. Set of  
Action Pack Luggage  
or  
Orine Mustang Chain Saw

## 5th Prize

Bernzomatic Portable  
Electric 12 & 110 volt  
Refrigerator  
or  
GAF Super 8 Movie Camera  
And 10 other great prizes.

**Our recent addition, the  
2N5397-8 High  
Frequency Amplifier/  
Mixer/Oscillator.**

Some designers were not quite satisfied with the 2N4416 type of FET. They wanted more gain, particularly common gate and lower noise at 450 MHZ. 2N5397, 2N5398 or U312 gives it to them. Featuring typically 10dB Gps and 3dB NF at 450 MHZ, common gate, un-neutralized design is easy.

**Our new  
U310 VHF-UHF  
Amp/Mixer/Oscillator**

The new U310 offers the designer high frequency performance and enough common gate power gain (typically 16 dB's at 100 MHZ and 13dB's at 450 MHZ) to satisfy circuit requirements. High input and output isolation means an excellent oscillator.

### You do not have to buy our FETs in order to enter the contest.

On the other hand, you do not have to *not* buy our FETs in order to enter the contest, either.

The # FETs in the camper is \_\_\_\_\_

Please send me:

An RFQ on Device #'s \_\_\_\_\_ Quantity \_\_\_\_\_

Your new FET Selection Guide. My area of interest \_\_\_\_\_

Mail to: National Semiconductor  
P.O. Box 3, New York, New York 10046

Name \_\_\_\_\_ Title \_\_\_\_\_

Company \_\_\_\_\_

Address \_\_\_\_\_

City \_\_\_\_\_

State \_\_\_\_\_ Zip \_\_\_\_\_

#### Rules for the "National Semiconductor" Contest

1. On an official entry blank, print your name, address and your estimate of the number of FETs in the camper.
2. Mail your entry to: National Semiconductor, P.O. Box 3, New York, N.Y. 10046.  
IMPORTANT: Write your estimate of the number of FETs on the lower left hand corner of the outside of the envelope.
3. Entries will be judged under the supervision of Marden-Kane and independent judging organization whose decisions are final, on the basis of who estimated the closest number of FETs in the camper. In the event of ties, the entry bearing the earliest postmark will win.
4. Entries must be postmarked by March 31, 1974, and received by April 15, 1974. Contest open to residents of the United States except employees and their families of National Semiconductor, their advertising agencies and Marden-Kane, Inc.  
No purchase necessary. Void where prohibited or restricted by law. All Local, Federal and State laws apply. No Purchase Required.

**National** the FET people.



## New products

Semiconductors

# Redesign widens market for IC

Generator with new VCO is aimed at instrument and communications fields

More than two years ago, Exar Integrated Systems Inc. introduced its first monolithic waveform generator [*Electronics*, Feb. 14, 1972, p. 127]. But because of its relatively high sine-wave distortion and temperature-frequency drift, as well as short sweep range, the unit was purchased primarily by hobbyists. But now the California company has redesigned the generator in the expectation that its improved performance will open new markets for use in general-purpose and laboratory instruments, communications devices, and OEM equipment.

The new function generator comes in two versions—prime and industrial. The prime model, designated the XR-2206, has sine-wave distortion, without adjustment, of less than 2% and, with adjustment, of less than 1%. Units specified for operation from 0 to 70°C are priced at \$8 each in lots of 100, and those built for operation from -55° to 125°C, at \$20 each. The industrial version, the XR-2306, is rated for 0 to 70°C, has an adjusted sine-wave distortion of less than 3% and, with adjustment, less than 1.5%. A kit version of the 2306, including two ICs, a printed-circuit board, and assembly instructions will sell for \$12. Production quantities of the function generator will be available in May, Exar says.

Focal point of the redesigned generator is a new voltage-controlled oscillator. Designated the XR-2207, the VCO has a typical frequency drift of less than 20 parts per million/°C and a maximum of 50 ppm over 0 to 75°C. Frequency sweep, within 5% of linearity, is 1,000 to 1. In redesigning the function generator, Exar has, in effect,

added sine-wave functions to the new VCO and eliminated a diode-resistor network that turned triangular waveshapes into sinusoids by breaking them up into discrete lines. With such a network, the user must continually readjust for sine distortion while sweeping. In the new oscillator, the differential input signal is increased until the input transistors are driven into cutoff. The gradual transition between active state and cutoff, which is logarithmic, can be used to round off the sharp peaks of the triangular input.

The new oscillator design has also been incorporated in a demodulator chip, the XR-2211, but Exar says it has no plans to put the generator and demodulator together into a two-chip modem. The 2211 demodulator will sell for about \$10 each in lots of 100.

Exar Integrated Systems Inc., 733 N. Pastoria Ave., Sunnyvale, Calif. 94086 [411]

## Ion-implanted diodes offer full octave tuning range

A series of vhf diodes with hyper-abrupt, or extremely narrow, junctions provides a full octave tuning range or, alternatively, half-octave tuning with straight-line frequency performance. The ion-implanted diodes are designed for tuning LC resonant circuits, for low-distortion frequency modulators, and for linear voltage-tuned crystal oscillators over the 1-to-200-megahertz portion of the spectrum.

The diodes offer capacitance ratios as high as 7:1 and capacitances from 20 to 500 picofarads at 4 volts. The group designated KV2001-2701 is for octave tuning over a 4-to-20-v bias range or for half-octave tuning for ultrahigh-Q applications over an 8-to-20-v range. Devices designated KV2002-2702 are tuned from 3 to 8 v in order to give straight-line frequency performance with typical linearity within ±1%. Diodes are available as close-tolerance parts (±5%) or for economy applications, and the company says the ion-implantation process provides good large-signal handling and tightly

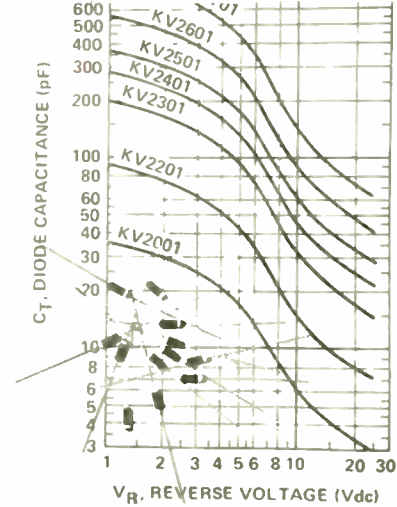

specified C-V curves.

Systems applications include cable and master-antenna television equipment, rf-test equipment, and military, marine, and land-mobile communications. Prices range from 93 cents to \$7.60 each for 100 to 999 units.

KSW Electronics Inc., So. Bedford St., Burlington, Mass. 01803 [412]

## GaAs LED is designed for continuous or pulsed use

A gallium-arsenide infrared-light-emitting diode, designated the model SG1009, is designed for either continuous or pulsed service. The device emits a narrow beam of radiant flux at 940 nanometers and is supplied in a hermetically sealed TO-18 package. Operating case temperature ranges from -40° to +125°C. In continuous service, typical power output is 3.5 milliwatts at 100 milliamperes; in the pulsed mode, typical power output is 26 mw at 1 A and 115 mw at 8A at a case temperature of 27°C. Applications include high-speed counting and sorting, intrusion alarms, and data-transmission systems. Price is \$2.50.

RCA Commercial Engineering, 415 S. 5th St., Harrison, N.J. 07029 [413]

## Voltage regulators built for low-cost applications

Three-lead integrated voltage regulators in TO-125 plastic packages are designated models L129, L130, and L131. Suitable for low-cost applications requiring small compo-

## New products

nents with low-to-medium output current, the units offer tight tolerances in output voltages. The L129 gives an output voltage of 5 v with an input voltage of from 7.5 to 20 v, the L130 delivers 12 v with inputs from 14.5 to 27 v, and the L131 puts out 15 v with inputs of 17.5 to 27 v. The devices supply 850, 720, and 600 milliamperes of regulated current, respectively. Price for all units is \$2.10 each for 1 to 99; and in 100-lots, price is \$1.40.

5 V



12 V



15 V



SGS-Ates Semiconductor Corp., 435 Newtonville Ave., Newtonville, Mass. 02160 [414]

Tone generator supplies full octave plus one note

Designated the MK 50240 series, an octave tone generator replaces a wide variety of components by providing a full octave plus one note on the equal tempered scale. By dividing the frequency of 2.00024 megahertz, 13 notes of the musical scale are generated on a single chip. The

# HP announces the most cost-effective OEM disc system.

device is intended to serve as the master tone generator in electric organs, and it can also be used for musical toys, tuning instruments, and

music synthesizers. Price is \$10 each in 100-lots.

Mostek Corp., 1215 W. Crosby Rd., Carrollton, Texas 75006 [415]

Optical pairs permit interrupter flexibility

Two sets of matched light-emitting-diode/detector pairs are for use in interrupter applications requiring

varied spacing arrangements. The devices produce no contact pressure. Each of the two pairs consists of a gallium-arsenide LED and a silicon detector housed separately in a TO-92 side-looking package. Type H17A1 has a transistor detector, and type H17B1 provides a Darlington detector. The separate packaging of the devices permits optional, instead of preset, spacing. Typical applications include shaft encoders, counters, position sensing,

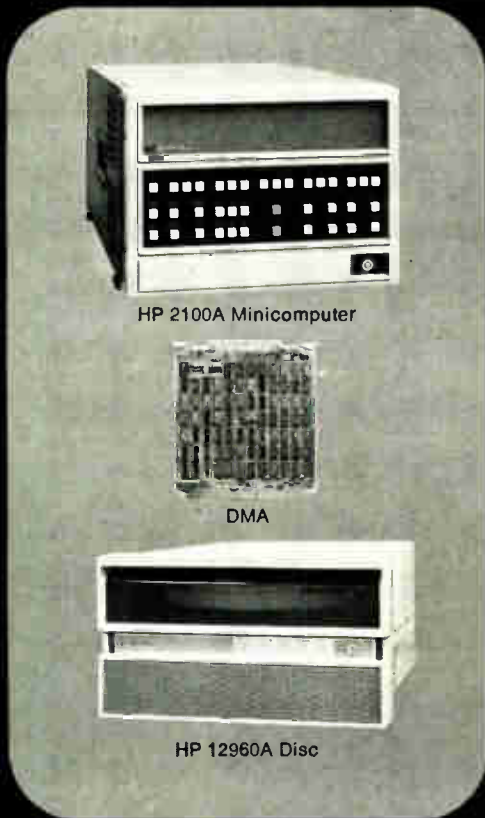
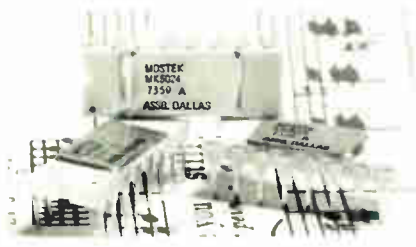

HP 2100A Minicomputer

DMA

HP 12960A Disc

HP's 2123A, with the fastest disc you can get in a \$16,660.\* system.

\*OEM price for 25; Domestic USA price only.

## Hewlett-Packard Computers

bring OEM's a 16k word CPU, memory parity, memory protect, hardware multiply/divide, power fail/restart. Plus a 5 Mbyte disc with 30 ms average access time. And all of it designed, produced and supported by Hewlett-Packard.

And with HP's Writable Control Store, the 2123A is the only OEM disc system that is user microprogrammable.

For all the details, send the coupon. Or phone your nearby HP field engineer.

I am interested in the Hewlett-Packard 2123A Disc Based OEM System

- Have a representative call for an appointment.  
 At this time, mail me literature only.

Name \_\_\_\_\_ Phone \_\_\_\_\_

Title \_\_\_\_\_

Company \_\_\_\_\_

City \_\_\_\_\_

State \_\_\_\_\_ Zip \_\_\_\_\_

**HEWLETT  PACKARD**

Sales and service from 172 offices in 65 countries.  
 1501 Page Mill Road, Palo Alto, California 94304

22409A

## You say you want a

low-profile snap-in-mounting push button switch or matching indicator that is interchangeable with most 4-lamp displays... available in a full range of cap colors... with a choice of bezels with or without barriers in black, gray, dark gray or white.

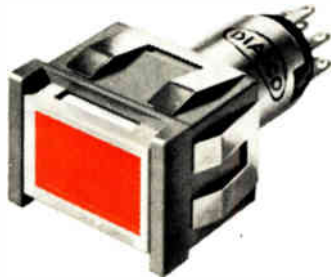

## and a

legend presentation that's positive (like this one) or negative (like the one below) or just plain (like the one above)... one that's white when "off" and red, green, yellow (amber), blue or light yellow when "on"... or colored both "on" and "off."



## and a

highly reliable switch proven in thousands of installations... available in momentary or alternate action... N.O., N.C. or two circuit (one N.O., one N.C.)... that accommodates a T-1 3/4 bulb with midget flanged base, incandescent, in a range of voltages from 6-28V.



*etc.  
etc.  
etc.*

*Now, for the first time  
Dialight gives you  
custom panel designing  
with a standard line of  
push-button switches and  
matching indicators*

Dialight offers a broader range of switch and indicator possibilities than you'll find anywhere in a standard single-lamp line. Sizes: 3/4" x 1", 5/8" and 3/4" square and round. Send today for our new full-color catalog.

# DIALIGHT

A North American Philips Company  
Dialight Corporation, 60 Stewart Ave., Brooklyn, N.Y. 11237

## New products

level sensing, and limit-switch and micro-switch replacement. Price in 100-lots is about \$1.25 for the A

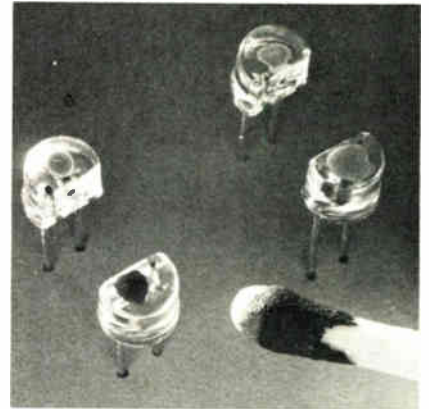

series and \$1.35 for the B series. General Electric Co., Semiconductor Products Department, Building 7, Mail Drop 49, Electronics Park, Syracuse, N.Y. 13201 [417]

Dual-timer IC replaces two timer circuits

The model D555 dual-timer integrated circuit is designed to replace two type-555 timer circuits. The device therefore saves hardware and

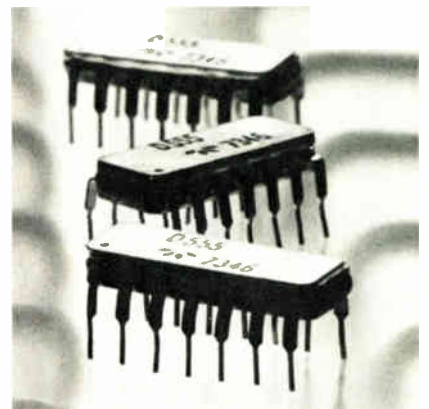

space, and reduces complexity in applications requiring two or more timer circuits. These include uses in sequential timing and synchronization, clock-pattern generation, and pulse modulation. The D555 can also be used in circuits for pulse shaping, frequency division, keyed oscillation, and other one-shot applications. Compatible with TTL,

# We've found an ideal ROMmate for your microprocessor.



## Big ROM contributes 16K bits program storage at lowest cost ever

Every little 8-bit microprocessor needs a companion ROM willing to share cramped quarters and supply low-cost program storage. And there's no more perfect companion than EA's 4800 MOS ROM. It has a compatible 2048 x 8 organization and a 100-piece price of \$28. It will eagerly move in, custom-programmed, to join your microprocessor in 6 to 8 weeks.

Your microprocessor will find our big ROM is extraordinarily undemanding to

live with. It doesn't need a clock because it's static. It gets along without address decoding circuits because it's decoded internally. It doesn't require input pull-up resistors because they're already on the chip. It demands only two supply voltages, +5v and -12v. And it will welcome more ROMmates with outstretched OR-wired outputs.

Our ROM's maximum access time is 1.2 $\mu$ sec — fast enough to satisfy your microprocessor. Power dissipa-

tion is a low .032 mW/bit. It's clothed in a 24-pin silicone-molded DIP. And it will also take on a 4096 x 4 organization to mate with any 4-bit microprocessors you happen to have around.

Contact us right now for data showing how easily the EA4800 interfaces with popular microprocessors. Electronic Arrays, Inc., 550 Middlefield Road, Mountain View, Calif. 94043. Phone (415) 964-4321.

Cramer Electronics is our distributor nationwide.

**electronic arrays** 

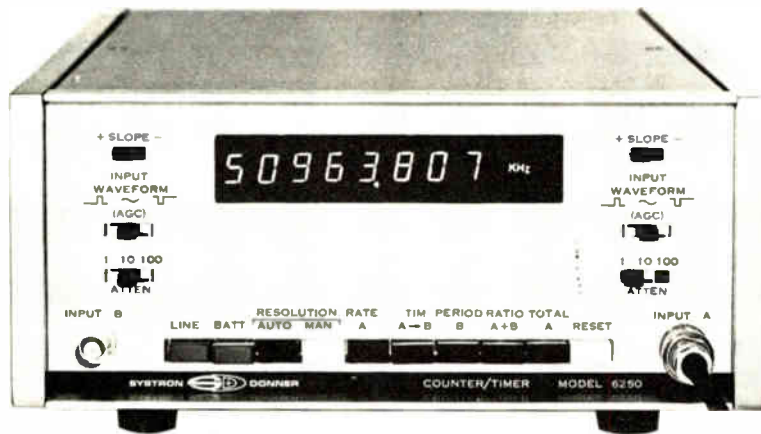

## 50 MHz automatic counter/timer

Frequency, TIM, period, ratio, totalize  
Automatic gain control  
Autoranging  
Leading zero suppression  
8-digit readout (standard)  
25 mV input sensitivity  
BCD output

### Model 6250 Options include:

Choice of 5 higher oscillator stabilities  
Internal battery pack

Contact your Scientific Devices office or Concord Instruments Division,  
10 Sysatron Drive, Concord, CA 94518. (415) 682-6161  
Europe: Munich, W. Germany, Leamington Spa, U.K.

**SYSTRON**  **DONNER**

Circle 140 on reader service card

SALON INTERNATIONAL DES

# composants électroniques

**PARIS 1-6 / 4 / 74**

COMPONENTS - MEASURING  
MATERIALS - EQUIPMENT

Organisation S.D.S.A. - 14, rue de Presles 75740 Paris Cedex 15

FRENCH TRADE SHOWS 1350 Avenue of The Americas  
NEW YORK, N.Y. 10019 Tel.: (212) 582-4960. 1

140 Circle 230 on reader service card

## New products

DTL, and ECL levels, the D555 is priced at \$1.50 each in 100-lots. Teledyne Semiconductor, 1300 Terra Bella Ave., Mountain View, Calif. 94043 [418]

C-MOS/SOS design kit is aimed at IC manufacturers

A C-MOS silicon-on-sapphire kit is offered to integrated-circuit manufacturers who would like to do complete C-MOS processing on SOS wafers. The basic kit consists of: 40 2-in.-diameter wafers with p and n



silicon islands etched into the silicon, a set of photomasks to process the Inselek INS4007S dual complementary pair plus inverter, and a set of processing instructions for use with the photomasks. Several variations of the kit are available. Price of the basic kit is \$2,450.

Inselek Inc., 743 Alexander Rd., Princeton, N.J. 08540 [416]

Three-chip calculator set drives printer, gas display

A set of three integrated circuits provides the complete electronics for a 12-digit calculator using a printer, gas-discharge display, or both. The model S-141 set is designed to drive the Seiko 104 printer, but it can be modified by the manufacturer to drive other printers. Features include percent add-on and discount, exchange key, constant key, floating-in, fixed-out decimal system, automatic underflow, and automatic overflow protecting the 12 most-significant digits. Price is \$30 per set for 100 to 999.

Electronic Arrays, 550 Middlefield Rd., Mountain View, Calif. 94043 [419]

# NEC's mold thyristors feature $V_{RRM}$ 50V-400V @ 2 Amps.

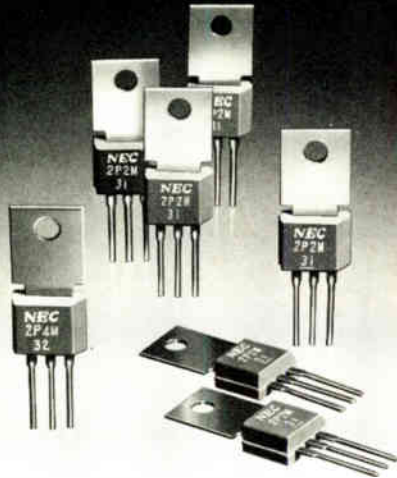

NEC's Models 2P05M, 2P1M, 2P2M, & 2P4M are P-gate all-diffused mold thyristors with an average on-state current of 2 Amps. ( $T_c = 54^\circ\text{C}$ ). Surface treatment of the pellets with glassivation technique guarantees a high degree of reliability.

With their miniature size and thin electrode leads, these thyristors are easy to install, while lowered holding current distribution offers endless design variation.

Adequate stock is on hand now, so rapid delivery can be guaranteed. Likewise, bulk orders are no problem.

**NEC**  
Nippon Electric Co. Ltd.  
Tokyo, Japan

**NEC America, Inc.**  
Head Office: 277 Park Avenue, New York, N.Y. 10007, U.S.A.  
Los Angeles Office: Tishman Airport Century Bldg. (TAC-3),  
9841 Airport Boulevard, Los Angeles, Calif. 90045, U.S.A.

Circle 189 on reader service card

## METAL CARD GUIDES

FOR GROUNDING or  
SHIELDING  
FOR HEAT DISSIPATION

Positive grip of boards with 3/4 hard phosphor bronze or beryllium copper spring fingers effectively solves problems of grounding p.c. boards directly through the card guide and into the surrounding chassis. This not only affords grounding but shielding as well. For "hot boards" the metal card guide acts as a heat transfer to dissipate heat from the board into the chassis.

Metal Versamount for isolated boards on chassis. Card guide rivets to Versamount.

Metal channel bar, available for spanning open areas with metal card guide.

# UNITRACK™

UNITRACK Division, Calabro Plastics, Inc.  
8738 West Chester Pike, Upper Darby, Pa. 19082  
Telephone (215) 789-3820

Circle 141 on reader service card

Engineering samples on request.

## May we offer you a light?

The super-dependable light of C&K's newest ILLUMINATED ROCKER SWITCHES. Available in SPDT and DPDT models, these contemporary, sub-miniature snap-in switches are completely "made-in-America" from quality materials, yet the prices are surprisingly competitive! Front relampable, they accommodate midget screw base bulbs in popular T-1½ and T-1¾ sizes, and you can choose snap-off actuator/lens in either Red, Green, Amber or White. And, quite honestly, they're matchless!

**C&K COMPONENTS, INC.**, 103 Morse Street, Watertown, MA 02172. Tel: (617) 926-0800 TWX: 710-327-0460.

Circle 231 on reader service card 141

**OUR POWER  
SEMICONDUCTORS  
ARE SO GOOD  
WE USE THEM OURSELVES.**

**20,000 TIMES A DAY.**





That's the rate at which Delco Electronics supplies a variety of products for GM cars.

Under one roof we design and manufacture complete systems, including the power semiconductors that help make those systems work. This can mean a lot to you. Here's why:

We know the requirements and standards that must be met to produce over 20,000 systems a day. We know what it means to deliver on time, to meet our own production schedules. And we know the importance of component quality in assuring reliability of the end product.

Our semiconductor devices are used

in the Delco AM radios, AM/FM radios and stereo tape systems we produce for GM cars. They are also used in the GM high-energy ignitions systems, I.C. voltage regulators, alternators, and in the new combination front seat/shoulder belt interlock systems you find in all the 1974 GM cars.

And all the capabilities that go into Delco semiconductors can work for you, too.

There are select distributors with stock on hand strategically located coast to coast. For the distributor nearest you, phone

your closest Delco Electronic regional sales office: Kokomo, Ind. (317) 459-2175, El Segundo, Cal. (213) 640-0518, Union, N.J. (201) 687-3770.

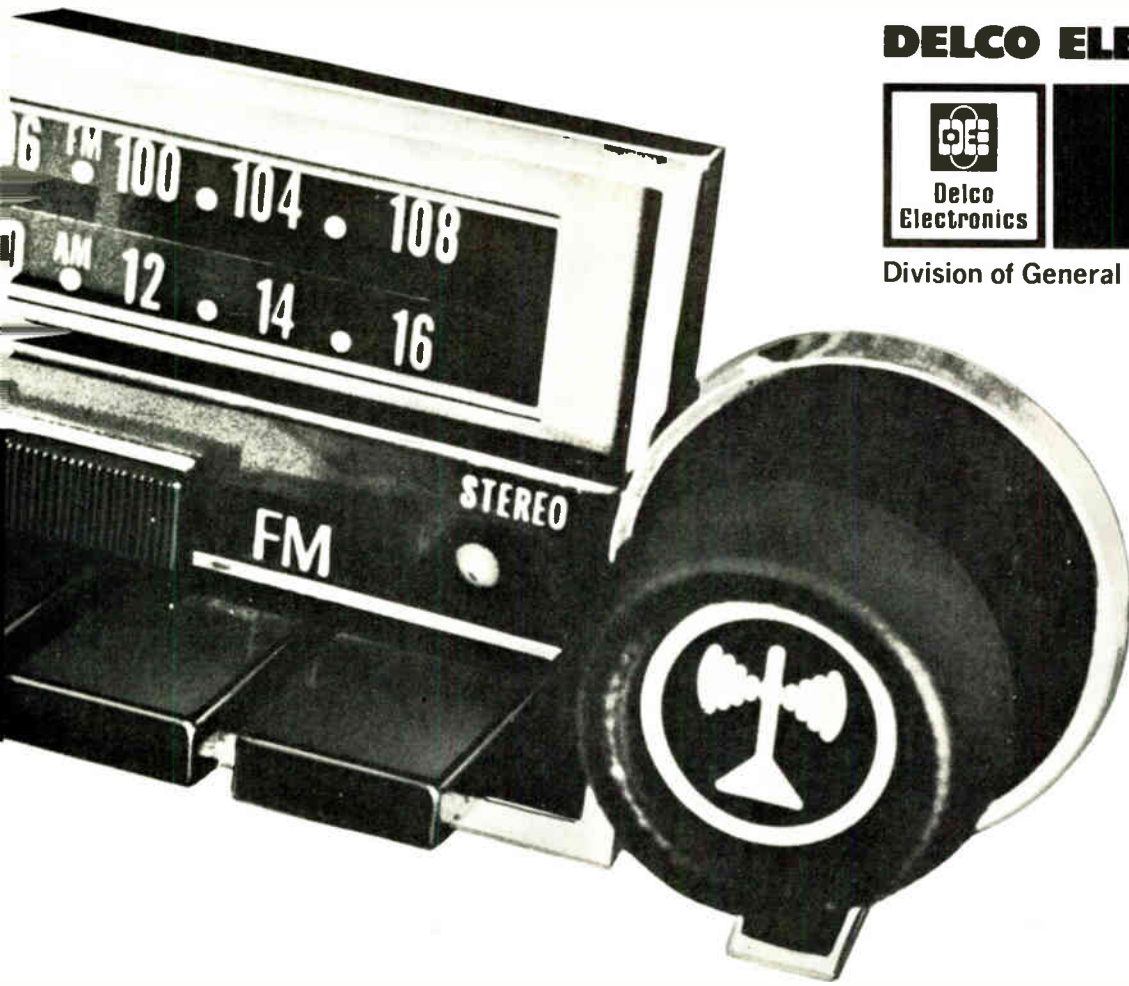
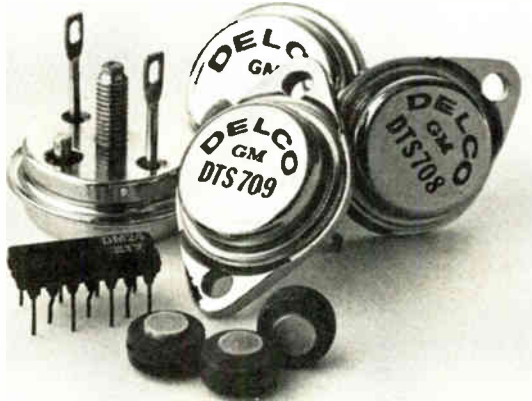

### DELCO ELECTRONICS



Division of General Motors Corporation

Data handling

## Naked Mini has 300-ns cycle

---

Second, faster type of LSI computer offers choice of core, semiconductor memory

---

Less than a year after introducing the first Naked Mini LSI [*Electronics*, June 7, 1973, p. 109], Computer Automation Inc. has developed a new, higher-speed minicomputer aimed at the OEM market and described as "a true replacement" for the company's earlier computers. Units of the second version, called type 2, are being delivered, but the company says that type 1, although introduced earlier, has been held up until late April by required changes in its MOS LSI circuits.

The two, which are field-interchangeable in the motherboard, use the same software, memory options, and interconnections. However, in the type 2, which is physically somewhat larger than the type 1, the processor is made with bipolar ICs that occupy one whole 16-by-17-inch circuit board plus a small piggyback board. All memory and interface circuits go on separate boards—as contrasted with the type 1, in which the seven-chip processor and 8,000 bytes of memory all fit on one board. The computers draw power and control from equipment that they are used in. However, power supply, control panel and chassis are available as options.

The type 2 Naked Mini LSI is a 16-bit computer with a 300-nano-second internal cycle time, compared with 1,600 ns in the type 1. However, performance of the type 2 depends on the memory options chosen. Core, semiconductor read-write, and read-only memory are available, to a total capacity of 262,144 words. Choices range from 980 ns to 1,600 ns in cycle time and 2,048 to 16,384 bytes per modules, in various combinations. Semiconductor RAM has access time of 1,200

ns in modules of 2,048, 4,096, and 8,192 bits, and ROM is available in various sizes with the read-write memory.

The new processor allows the computer to take full advantage of the speed of the memory, but the earlier computer was limited to a cycle time of 1,600 ns, regardless of the memory speed. Most instructions use a single word, and 168 basic instructions are provided. Hardware multiply/divide and direct memory access of 768 words are



provided, and 32,768 words or 65,536 bytes are indirectly addressable. Numerous software packages are available. The type 2 is contained in a circuit-board case measuring 8.7 by 19.5 by 18.5 in.

Power requirement is +5 volts at 13.5 amperes, +12 v at 0.6 A, and -12 v at 2.8 A. A packaged version of the minicomputer, called the Alpha LSI, type 2, is also available. Price of the Naked Mini/LSI 2 with 16,384 words of core is \$3,031 each in quantities of 200. The Alpha/LSI 2 is priced at \$4,190 in the same quantities. Delivery time is 20 days. Computer Automation Inc., 18651 Von Karman, Irvine, Calif. 92664 [361]

---

Floppy-disk storage system provides 2.5 megabits/disk

A minicomputer-compatible floppy-disk system consists of a disk drive, controller, interface, and software package. The system provides 2.5 megabits of storage per disk, with a data-transfer rate of 250 kilobits per second. Maximum storage density is 3,200 bits per inch. The disk has 64 tracks with options of 2, 4, 8, 16, or



32 sectors per track, while rotation speed is 375 revolutions per minute, and single-track read-write time is 160 milliseconds. Access time is 10 ms for slewing-track, track-to-track positioning, and settling time at final track.

Diva Inc., 607 Industrial Way West, Eatontown, N. J. 07724 [363]

---

Formatter links with any disk drive, most minis

A disk-drive formatter, called the XDF-20, can interface by couplers to any cartridge disk drive. The unit also provides two disks in one drive and an access time of 35 milliseconds. Further, the formatter uses one pc board, which minimizes con-



ductor problems and eliminates the need for a fan. A crystal-controlled oscillator references all timing and control signals, and multiple-sector transfers are provided without additional programming. The XDF-20 is compatible with most major minicomputers and is priced at \$3,625.

Xebec Systems Inc., 566 San Xavier Ave., Sunnyvale, Calif. 94086 [367]

---

Data modem operates at 4,800 bits per second

The model 4800I data modem is designed to comply with the International Telegraph and Telephone Consultative Committee standards

**FUJI**

## Non Volatile, Low Cost & High Reliability

# SMALL CAPACITY **RAM** PERFECTION

## POS TERMINAL, CASH DISPENSER, MICRO PROCESSOR, CREDIT CARD CERTIFIER, ELECTRONIC CASH REGISTER

It has been generally assumed that MOS IC memory systems are less expensive and more suitable to use than a ferrite core memories to employ in a field of small-capacity random access memories whose capacities are smaller than 8K bytes.

However, today this assumption shall be contradicted. FUJI's new series of memories, Small-capacity Ferrite Core Memory Modules, incorporated with Hybrid integrated circuit as its peripheral circuits, offering a more economical price and better reliabilities rather than MOS IC memories.

Everyone knows that volatility and reliability of stored information is the most important factor in handling of cash transactions at banking system as well as operating cash registers, POS terminal machines, and on-line devices. Consequently, at least the last digits of calculation must be nonvolatile.

Which do you think is more rational...a system designed by a MOS IC memory with the last calculated digits to be stored by a nonvolatile core memory or a whole entire system simply designed with a nonvolatile core memory? Answer is clear, that is FUJI Core Memory!

### STANDARD MODELS

A wide variety of standard models are available over a wide range of memory capacities from 128 words-4 bits to 8K words-9 bits. Furthermore, we are ready to design and manufacture special systems with quick delivery service, according to your requirements.

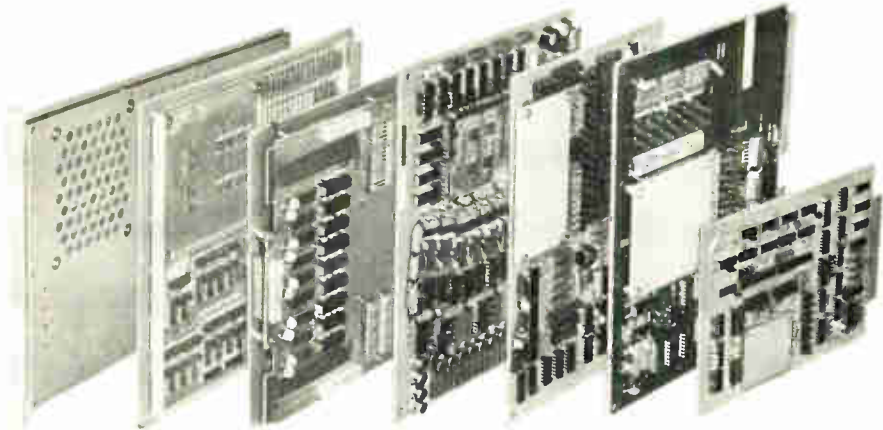

MODEL	CAP.	CT.	POWER	SIZE
CMS2101A	128W-4b	3 $\mu$ s	$\pm$ 5V	5.8x8.7x0.5 inch
CMS2101B	256W-4b	3 $\mu$ s	$\pm$ 5V	5.8x8.7x0.5 inch
CMS2112	512W-4b	3 $\mu$ s	+5V	6.0x8.0x0.5 inch
CMS2113	1024W-4b	3 $\mu$ s	+5V	6.0x8.0x0.5 inch
CMS2114	2048W-4b	3 $\mu$ s	+5V	8.0x10.0x0.5 inch
CMS2115	4096W-4b	3 $\mu$ s	+5V	8.0x10.0x0.5 inch
CMS2116	1024W-9b or 512W-18b	1.5 $\mu$ s	$\pm$ 5V, +24V	9.8x11.8x0.6 inch
CMS2201A	1024W-10b	1 $\mu$ s	$\pm$ 5V	9.5x10.5x0.5 inch
CMS2201B	2048W-10b	1 $\mu$ s	$\pm$ 5V	9.5x10.5x0.5 inch
CMS2107	1024W-18b	1.5 $\mu$ s	$\pm$ 5V, +24V	7.4x8.3x1.4 inch
CMS2401	4096W-18b or 8192W-9b	1 $\mu$ s	$\pm$ 5V	10.0x15.0x0.5 inch
CMS2403	4096W-18b or 8192W-9b	1.5 $\mu$ s	+5V	10.0x15.0x0.6 inch

**FUJI MEMORIES****FUJI ELECTROCHEMICAL CO.**

Head Office: Hamagomu Bldg., 5-36-11, Shinbashi, Minato-ku, Tokyo, Japan  
TEL: 434-1271

Overseas Office: New York, TEL: (212) 532-5630  
Los Angeles, TEL: (213) 620-1640  
Dusseldorf, TEL: (211) 89031

TAD. ISHIZUKA  
SAM. YOSHINO  
TAD. KOMURO

**The tough little competitor  
can deliver. Fast.**

Call us on your OEM power supply requirements.

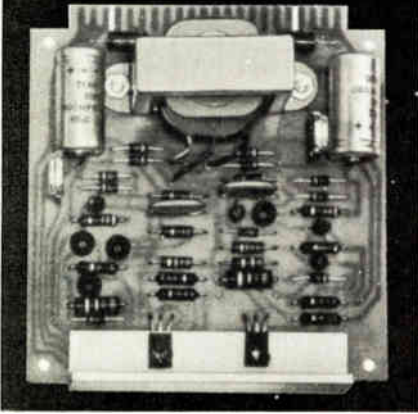

**Typical Specifications— DTS Series**  
\$32.95 (10-99 unit quantity)

- Input: 105-125VAC, 60 to 400Hz
- Line Regulation: 0.1% Max.
- Load Regulation: 0.1% Max.
- Ripple & Noise: 2MV. RMS. Max
- Stability: ±0.1% after warm up
- Temperature Coefficient: Better than .02%/°C
- Operating Temperature: -20°C to +70°C\*
- Storage Temperature: -20°C to +85°C
- Short Circuit Proof:
- Tracking Outputs:
- \*Current is derated at temperature over +50°C.



Mighty Mouse © Viacom International

**SALIENT FEATURES**

- exceptional reliability
  - exceeds computer grade specifications
  - packaged for computer peripheral equipment
  - meets U.L. and C.S.A. requirements
- All standard supplies available in both discrete and I.C. versions. Liberal mix or match discounts available. All AMPSCO products are backed by unconditional 10-year guarantee.**



A Tough Little Competitor

American Power Systems Corp. • 51 Jackson St. • Worcester, Massachusetts 01608 • (617) 753-8103  
Circle 146 on reader service card

**New products**

for modems operating at 4,800 bits per second, and the unit is intended primarily for the international market. The 4800I incorporates a range of built-in diagnostic capabilities, including local loop-back, dc, audio bus-back, and such optional features as remote loop-back, alternate



voice/data, secondary channel and multiplexer.

Codex Corp., 15 Riverdale Ave., Newton, Mass. 02195 [368]

**Word processor allows  
interchangeable type fonts**

A line of computer-based word-processing systems has been given two new features that enable multiple type fonts to be interchanged while preparing a document and also allow the systems to link with other magnetic-tape computer systems. To use more than one type face while preparing a document, a control card is inserted to stop the typewriter and then restart it when the type change has been made. The interfacing software allows users to convert documents created on stand-alone devices to a more flexible format and to interface with devices such as those in photocomposition systems.

Documate, Division of Index Systems Inc., 1 Broadway, Cambridge, Mass. 02143 [369]

**Parallel interface extenders  
include readers, printers**

The family of PIX (parallel interface extenders) has been expanded to include high- and medium-speed card readers and line printers for use with the PIX remote channel. The new peripherals are designed to

PIKE'S PEAK AS SEEN FROM HEWLETT-PACKARD

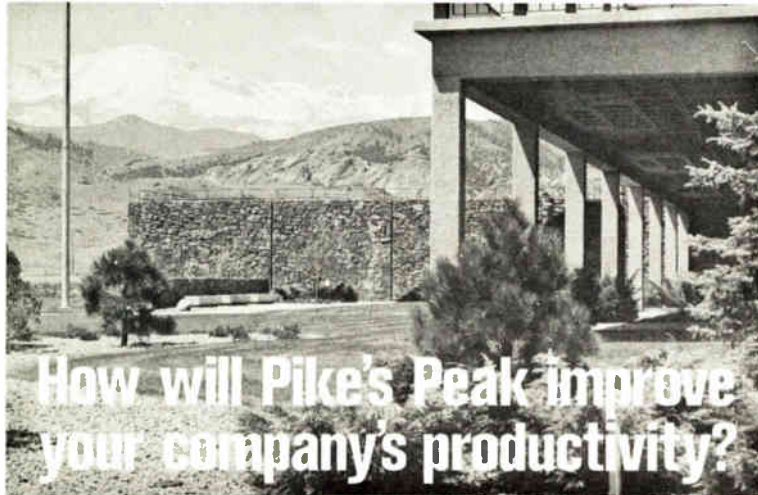

**How will Pike's Peak improve  
your company's productivity?**

Instead of tall skyscrapers lost in the smog, Colorado Springs has Pike's Peak rising majestically into the clear blue sky. The clean air is only one reason why your workers will be happier and more productive in Colorado Springs. Countless recreational activities, low humidity, very few traffic problems, and an excellent transportation system are some of the other reasons.

There are many good reasons why your company will grow and prosper just as Hewlett-Packard, RCA, Ampex, NCR, Holly Sugar, Kaman Sciences, TRW, and many others already have.

Find out more about why a move to Colorado Springs is a good move. Just write us or call (303) 471-8183 (collect), and we'll send you our story . . . all in strictest confidence.

**Mr. Leland Smith, Director  
Economic Development Department  
Chamber of Commerce  
P.O. Drawer B Dept. E  
Colorado Springs, Colorado 80901**



# BUCKEYE KNOBS

Supplementing Buckeye's full-line of matching instrument series knobs with unique facilities for fine markings of all types are complete instrument-packaging products crafted by experts and recognized for high quality. Labor-saving P.C.B. guide modules — Front-loading, rackable or portable cases — Full size-range of colorful cabinets — Four sizes of Bord-pak racks — and safe-locking, retractable tilt-stands.

Write today for free colorful literature!

the BUCKEYE stamping co.  
555 Marion Rd., Columbus, Ohio 43207

"QUALITY PRODUCTS SINCE 1902"



**GUIDES • CASES • CABINETS • RACKS**

Circle 191 on reader service card

# POWER SUPPLY HANDBOOK YOUR'S FREE

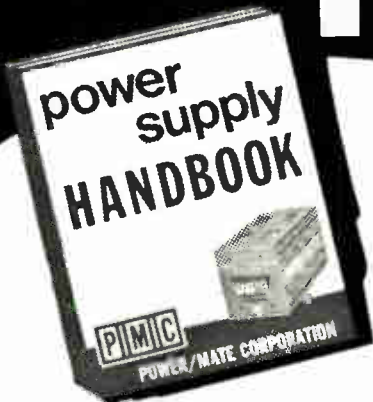

A complete reference of definitions, principles of operation, load connections and performance measurements. A working tool for the Engineer. Yours for the asking . . . and its FREE from Power/Mate.

SEND FOR YOUR FREE COPY



**POWER/MATE CORP.**

514 S. RIVER STREET HACKENSACK, N. J. 07601  
Phone (201) 343-6294 TWX (710) 990-5023

Circle 192 on reader service card



## Licon takes the "butterflies" out of pioneering.

By putting its double-break, double reliable Butterfly® switches to work in radar tracking stations around the world.

If you are doing some pioneering on your own, such as the initial design of equipment requiring lighted pushbutton switches, put the Licon team to work for you.

The same quality and reliability required to track the endless reaches of space are yours in every Licon® switch you specify.

Licon's lighted pushbutton switches are offered in a wide variety of switching configurations, button styles and current capabilities.

Your Licon representative or distributor has a switch solution for you.

**LICON**

Division Illinois Tool Works Inc.  
6615 W. Irving Park Road  
Chicago, Illinois 60634  
Phone (312) 282-4040  
TWX 910-221-0275



# LICON

puts ideas to work  
in electronics

The Innovative Electronic Group of ITW...  
LICON ■ ELECTRO MATERIALS ■ PAKTRON

© ILLINOIS TOOL WORKS INC. 1974  
Circle 147 on reader service card



# Unique precision voltage source

- 6-digit resolution and readout—0-1,000 VDC in four ranges with 0.003% accuracy, 0.001% stability, 0.0002% regulation.
- You control all functions by pushbutton or program them with DTL/TTL input. BCD output available.
- Unique circuit\* limits signal flow to analog section—output voltage is independent of switch characteristics or quality.
- You can change any decade of a selected voltage individually.
- 100 millisecond programming speed in either polarity.
- Output current 50 ma from 0-100 volts, 5 ma from 100 to 1K volts.

The S-D M106 Precision Digital Voltage Source has no equal for automatic test and process control systems. Its low cost, dependability and ease-of-use make it the best instrument for all calibration applications.

For full information, contact your nearest Scientific Devices Office or S-D at 10 Systron Drive, Concord, CA 94518. Phone (415) 682-6161.



\*Patents pending

Circle 148 on reader service card

## The new ROTASWITCH® 820 Encoder is so small it fits in a space this size.



See!

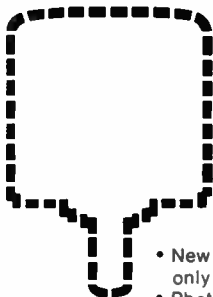

- New 820 Series ROTASWITCH Encoder is only 1" in diameter; size 11 servo housing
- Photoelectric type, uses LED sources
- Single or quadrature, sine or TTL compatible
- $\square$  output
- Up to 500 pulses per revolution
- High quality components for top dependability
- Low cost (\$150.00 in single quantities)

Complete specifications in Bulletin 820. Write or call

DISC Instruments, Inc. 102 E. Baker St., Costa Mesa, Calif. 92626, Phone (714) 979-5300

Disc Instruments Division  
Finnigan GmbH  
Dachauer Strasse 511, 8 Munchen 50, Germany  
Phone: (0811) 142291 (2)

Disc Instruments Division  
Finnigan Instruments Ltd.  
Paradise, Hemel Hempstead, Herts, England  
Phone: (0442) 57261

148 Circle 193 on reader service card

### New products

help high-speed data-communications users reduce costs and increase reliability in using the IBM System/360 and 370 for remote input and output of data. The PIX system transmits at 4,800 bits per second on dial-up or leased lines using



IBM record software. PIX card reader and line pointers are leased on two-year contracts and are priced from \$300 to \$950 per month, depending on the unit.

Paradyne Corp, 8550 Ulmerton Rd., Largo, Fla. 33540 [367]

Punched-tape reader is photoelectrically operated

A photoelectric punched-tape reader, designated SAM, handles six-, seven-, or eight-level tapes of paper, paper-polyester, or metalized-polyester material. A single light source, fiber-optic distributor and nine-element phototransistor



sensing system perform the reading. A stepping motor and dual-sprocket drive system transport the tape through the read head at asynchronous speeds up to 100 characters per second. The dual-sprocket drive eliminates tape skew and assures positive data registration.

Decitek, 15 Sagmore Rd., Worcester, Mass. 01605 [370]



**We're bringing more than 45 years of electronic experience to the world's watchmakers.**

Motorola components for quartz timepieces are exceptionally reliable, because they're the result of over 45 years of experience. And that's how we're helping to solve your quartz timepiece component problems; by having products you can rely on. Inquiries about quartz componentry should be directed to Marketing Director, Motorola Timepiece Electronics, 3102 North 56th Street, Phoenix, Arizona 85036 (602) 244-4406.



Circle 149 on reader service card

# Alone in the field, as all leaders are.

## And our field is WAFER PROBING.

Our Model 1034X Automatic Wafer Prober is the most advanced prober available anywhere.

The exclusive and unique X-Y motion system contains only ONE MOVING PART, which floats on air; thus no wear and no consequent degradation of accuracy. The high-speed chuck completes the UP/DOWN travel time in less than 20 mSec. without any discernable vibration. This prober gives you:

- Higher throughput
- Simplified operation
- More economical service
- Production flexibility

For more information call or write to:



**electroglas**

A XYNETICS COMPANY  
150 Constitution Drive  
Menlo Park, California 94025

TWX: 910-373-1219      415/325-1536

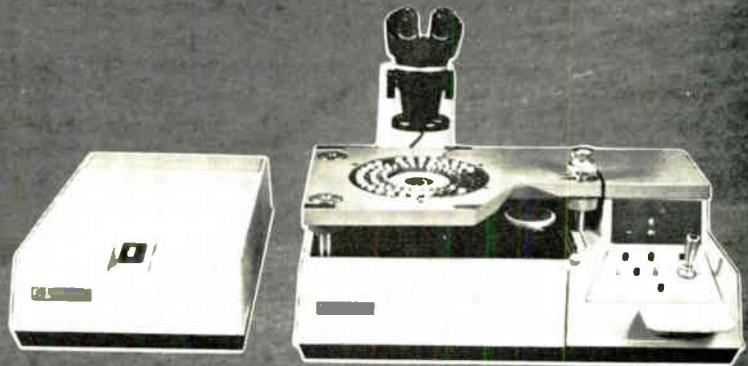

Features are:

- Five inch stage travel
- Stage travel speed of 5.0" per second
- High-speed chuck with less than 20 mSec. UP/DOWN time without vibration
- Resolution of .5 mil
- Quick probe ring changeover capability
- Up to 60 probe points on one ring
- Adapters for wide variety of R&K fixed point probe cards

# solid state fre- quency convert- ers

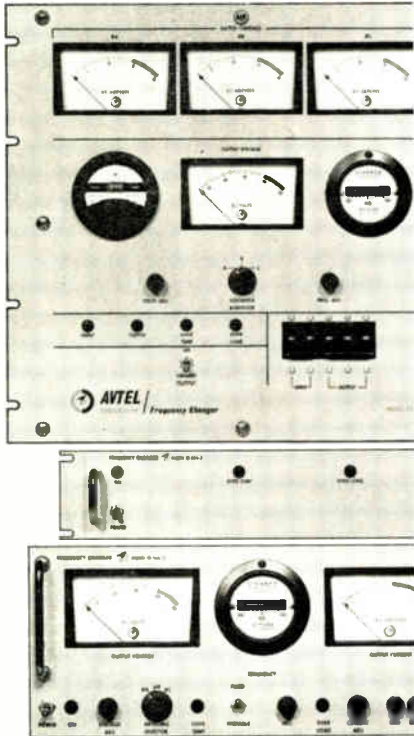

**Compact, Efficient, Reliable, Quiet.** Avtel's Solid State Frequency Converters offer many performance and installation advantages when compared with rotating motor-generators or even other solid state approaches. And you get the lowest cost-of-ownership consistent with quality performance.

The next time you need 50 or 400 Hz power and only have 60 available, call Avtel. Standard models available in 50, 60 or 400 Hz outputs from 50, 60 or 400 Hz inputs in power levels from 500 VA, to over 500 KVA.

Avtel also manufactures solid state 'Ininterruptible Power Sy. ems (UPS).



1130 East Cypress St. • Covina, Calif. 91724  
(213) 331-0661

Circle 150 on reader service card

## New products

Packaging & production

### Die bonders are semiautomatic

Epoxy and eutectic types handle 4,000 bonds an hour; dice aligned by operator

Two semiautomatic die bonders from Radiant Energy Systems operate at maximum speeds of 4,000 bonds per hour. One, the model 4500, is a eutectic bonder, and the other, model 4600 (below), uses epoxy attachment. The basic machines are identical in construction; only the actual bonding mechanism differs. Both will be demonstrated at Nepcon '74 West, Feb. 26 to 28, in Anaheim, Calif.

The bonders are magazine-fed, headers are indexed, and bonds are made automatically. The operator needs only to align the separated dice. The pickup arm travels a full 6½ inches so that dice can be chosen from a 5-in. area. This makes it possible to use wafers larger than 3 in., as some semiconductor manufacturers are now considering, and it also permits the use of fully expanded 3-in. wafers. Radiant also makes a die-matrix expander to separate the cut dice from each other for simpler pickup.

By using an optional light spot and cross hairs, the operator can align one die while another is being bonded. Machine speed can be adjusted to pace the operator, but maximum speed is 4,000 single-chip transistor-package bonds per hour, about 10 times the speed possible

with manual techniques. The speed is varied by changing the delay period of the transverse arm, rather than simply slowing the arm down. For ease of alignment, the bonders can also be used in the manual mode. Controls are simple: only one height adjustment is necessary, for example.

Because a vacuum pickup is used, no push is required beneath the wafer. If the air does not pick up a die, the unit automatically returns to home position, rather than perform the bonding step. Likewise, a sensor detects when the headers run out. The headers are presently loaded on a 40-transistor carrier, but automatic carrier-loading is to be introduced in 90 days.

For epoxy-bonding, a 2.5-cc container has adequate capacity for about 4 hours of typical use. The amount of epoxy dispensed can be changed by changing the hypodermic needle and period of flow. The eutectic version scrubs in a rotary motion, rather than in the common back-and-forth movement. Ron Clark, product marketer, says this seems to give fewer voids and permits the use of a smaller bond area. Maximum rotational movement is 7°. A heat-timing control is also provided.

A special slide arrangement makes it possible to use the same microscope for both bond alignment and dice pickup. Other equipment often requires separate optics for these functions.

Both bonders have modular construction and plug-in logic boards. For servicing, only four screws need to be removed to free the entire top cover. The epoxy 4600 is priced at \$13,000, and the eutectic 4500 at \$13,300. Microscopes and acces-





The new TH361 tetrode is designed to fulfill the most important features of your FM transmitter. A high gain of 27dB permits operating this tube and reaching 10kW with just a solid state driver; an output power rating significantly lower than the upper limit insures easy operation and long life. The accompanying cavity TH18106

is specially designed to match the outstanding capability of the tetrode and to offer a compact and reliable package. Both the TH361 tetrode and TH18106 cavity combination are available for immediate delivery.

For more information please circle the Reader Service card or contact us directly. \*All losses included.

Typical operating points. Class B—FM Amplifier			
Anode Voltage	7kV	DC Anode Current	2A
DC Grid 2 Voltage	500V	DC Grid 2 Current	125mA
DC Grid 1 Voltage	-100V	DC Grid 1 Current	10mA
Driving Power	25W*	Load Output Power	10kW

## New FM transmitter tetrode/cavity combination boosts 25W to 10kW.



**THOMSON-CSF**

THOMSON-CSF ELECTRON TUBES, INC. / 50 ROCKEFELLER PLAZA / NEW YORK, N.Y. / TEL. (212) 489-0400

France - THOMSON-CSF Groupement Tubes Electroniques/8, rue Chasseloup-Laubat/75737 PARIS CEDEX 15 / Tel. 566 70.04

Germany - THOMSON-CSF Elektronenröhren GmbH/Am Leonhardsbrunn 10/6 FRANKFURT/MAIN/Tel. 70 20.99

Italy - THOMSON-CSF Tubi Elettronici SRL/Viale degli Ammiragli 71/ROMA/Tel. 638 14.58

Japan - THOMSON-CSF Japan K.K./Kyosho Building/1-9-3 Hirakawa-cho/Chiyoda-ku/TOKYO/TEL. (03) 264.6341

Sweden - THOMSON-CSF Elektronrör AB/Box 27080/S 10251 STOCKHOLM 27 / Tel. (08) 22 58.15

United Kingdom - THOMSON-CSF Electronic Tubes Ltd./Bliton House, Uxbridge Road, Ealing/LONDON W 5 2TT/Tel. (01) 579 55.11/Telex: 25 659

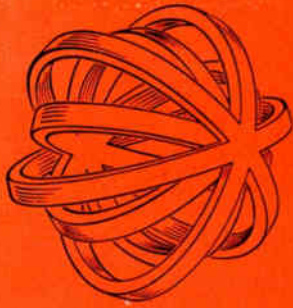

SALON INTERNATIONAL DES

# composants électroniques

PARIS 1-6 / 4 / 74

COMPONENTS  
MEASURING

MATERIALS  
EQUIPMENT

The U.S. Pavilion for companies displaying new and technologically advanced electronic components is sponsored by the U.S. Department of Commerce.

FRENCH TRADE SHOWS 1390 AVENUE OF THE AMERICAS  
NEW YORK, N.Y. 10019 - TEL. (212) 962-4890-1

PUBLI-SERVICE

## New products

series add about \$2,000 to each price.

Radiant Energy Systems Inc., 1500 Lawrence Dr., Newbury Park, Calif. 91320 [391]

Shuttle trimmer and former handles 200,000 DIPS a day

Four operating personnel can produce about 200,000 dual in-line packages a day with a shuttle trim and form system from Kras Corp.

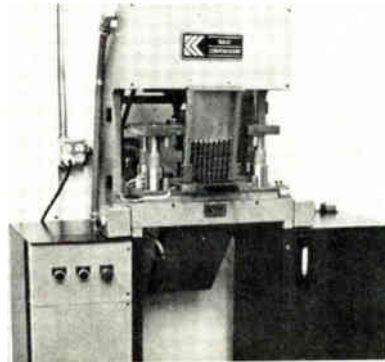

The company compares this operating rate to five conventional systems requiring 16 operators. The new system consists of an eight-ton hydraulic press and a progressive die containing a magazine with approximately 90 strips of devices, which are loaded into the press.

Kras Corp., 99 Newbold Rd., Fairless Hills, Pa. 19030 [393]

Printed-circuit drill offers built-in programing

The model 1098 printed-circuit-board drill is a high-speed machine with internal programing capability. Thus, the unit programs and generates a first-piece sample with a 6-inch, 10-power scope. Features in-

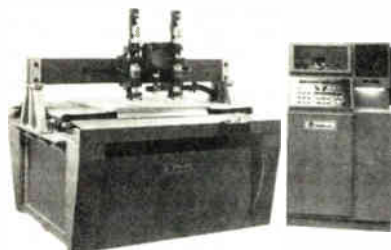

## CATV LICENSE

Applications for a license from the Town of Framingham, Massachusetts, to construct and operate a Community Antenna Television System (Cable Television System) within said town are hereby solicited in accordance with procedural regulations promulgated by the Community Antenna Television Commission pursuant to Massachusetts General Laws C. 166A. Applications on a form prescribed by the said Commission, together with a fee of One Hundred Dollars must be received by the Selectmen's Office, Town of Framingham, Framingham, Mass. 01701 not later than May 7, 1974.

Circle 200 on reader service card

# \$500\*

## BALANCED



### MIXER

MODEL MD-108

- DC - 500 MHz
- 7dB Conversion Loss
- 30dB Isolation
- 8 - Pin Relay Header

\* 500 piece qty. 1-49 pieces (\$7.00)  
50-499 pieces (\$6.00).

anzac  
ELECTRONICS



39 Green Street, Waltham, Mass.  
(617) 899-1900 • TWX 710-324-6484

# FREE



## NEW HEATH/SCHLUMBERGER ELECTRONIC INSTRUMENTS CATALOG

● The latest issue...32 pages of high performance, low cost instrumentation for Industrial, R&D and educational applications. Frequency counters...strip chart recorders...oscilloscopes...generators...power supplies...VTVMs, DVMs and portable multimeters...mini-computer Interface systems...the famous Malmstadt-Enke Lab Stations...and much more...all factory-assembled and calibrated...all fully warranted for one year...and all available at low mail order prices.

*Return the postcard now for your FREE copy.*

Name \_\_\_\_\_

Title \_\_\_\_\_

Company/Institution \_\_\_\_\_

Street \_\_\_\_\_

City \_\_\_\_\_

State \_\_\_\_\_

Zip \_\_\_\_\_

PC-103

581-284

**PLEASE  
SEND NEW  
ELECTRONIC  
INSTRUMENTS  
CATALOG**



# SEND THIS CARD TODAY FOR YOUR FREE ELECTRONIC INSTRUMENTS CATALOG

32 pages of Instruments...many of them new. And all of them have the low mail order prices and high quality you've come to expect from Heath. Typical examples are shown below. Return this card NOW to get your copy.



**Frequency Counters:** 6-digit, 30 MHz auto-ranging counter only \$225\*...7-digit, 110 MHz autoranging counters as low as \$325\*...600 MHz FCC-type accepted counter with total remote programming capability, just \$795\*.



**Strip Chart Recorders:** A complete selection to cover every need. A 12 speed, 10-250 mV, 10" recorder for only \$330\*. Our new 10 speed, 10 mV-10 V, 10" recorder, only \$335\*. And our 23 speed, 1 mV-500 V, 10" system with DC offset, just \$675\*.



**Oscilloscopes:** Single-channel DC-5 MHz scope, only \$179.95\*. Single-channel DC-15 MHz, 10 mV scope with complete triggering controls, just \$475\*. Dual trace DC-15 MHz, 50 mV scope only \$595\*.



**Power Supplies:** Low voltage bench supplies start as low as \$65\*. High voltage power supplies are as low as \$100\*.

\*Mail order prices; FOB factory.

**BUSINESS REPLY MAIL**

No Postage Stamp Necessary If Mailed In United States

Postage will be paid by

**Heath/Schlumberger Instruments**

Benton Harbor, Michigan 49022

FIRST CLASS PERMIT

No. 395

Benton Harbor,  
Michigan 49022

# New HEATH/SCHLUMBERGER INSTRUMENTS CATALOG

# FREE



**12 New  
Test Instruments**  
New \$335,  
10mV-10V, 10 Speed  
Chart Recorder  
New \$325, auto-ranging  
110MHz Counter

from Heath/  
Schlumberger

HEATH  
Schlumberger  
Copyright Heath Company 1973  
Catalog 811/05

The latest issue . . . includes complete details and specifications on dozens of high performance, low cost instruments for design, R&D and teaching applications. Here are just a few examples:

**New 10 mV to 10 V Strip Chart Recorder**...only \$335\*. Four calibrated, hi-Z input ranges . . . full 10" chart . . . ten digitally-derived chart speeds from 10 to 0.01 inches or cm/minute . . . switchable input filtering . . . complete remote programming capability . . . easy conversion to metric work . . . pushbutton chart advance . . . rack mount design.



**600 MHz Frequency Counter** . . . just \$795\*. 1 Hz to 600 MHz guaranteed range . . . input sensitivity: 10 mV @ 35 MHz, 15 mV @ 200 MHz, 50 mV @ 600 MHz . . . 50 and 1 megohm inputs . . . high stability TCXO time base . . . complete remote programming capability for all inputs, outputs & functions, plus BCD output . . . FCC type-approved for AM & FM broadcast.



**Dual Trace 15 MHz scope** . . . only \$595\*. 15 MHz vertical bandwidth with 24 ns risetime . . . 50 mV/cm sensitivity . . . 1 megohm/35 pf input impedance . . . 9 position attenuator . . . 18 calibrated sweep rates from 0.2 us/cm to 100 ms/cm . . . Chop, Alternate, Ch. 1, Ch. 2 and X-Y modes . . . Internal/External, AC/DC, +/- triggering . . . external trigger input, sweep gate output. Standard camera mount bezel.



For your FREE copy, use postcard or coupon NOW!

Heath/Schlumberger Instruments  
Dept. 531-284  
Benton Harbor, Michigan 49022  
Please send electronic instruments catalog.

Name \_\_\_\_\_  
Title \_\_\_\_\_  
Company/Institution \_\_\_\_\_  
Address \_\_\_\_\_  
City \_\_\_\_\_ State \_\_\_\_\_ Zip \_\_\_\_\_

\*Mail order prices; FOB factory.

EK-415

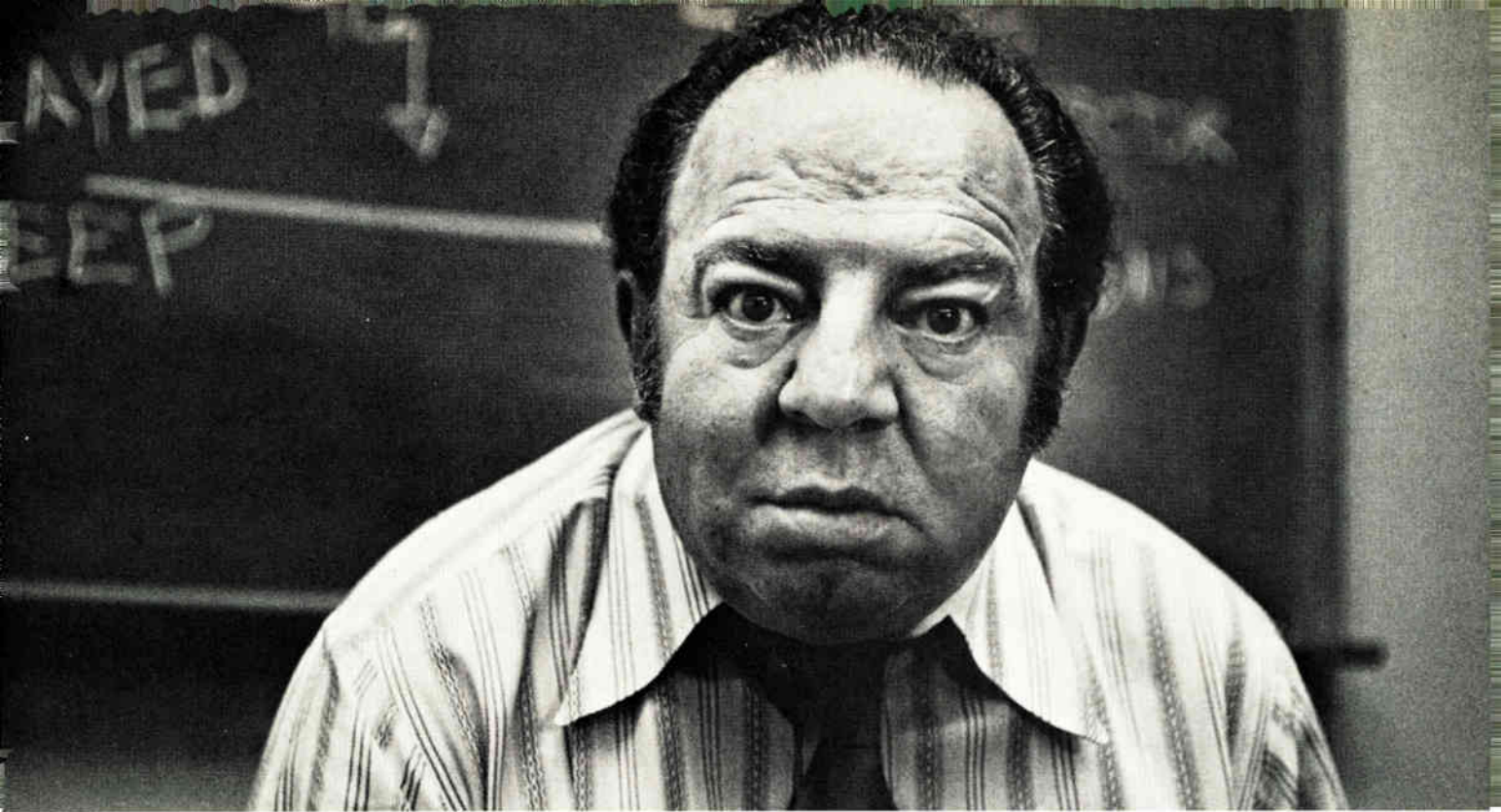

**“Sure I’m nervous.  
We’re due to start production  
in eight months and it’s taking  
three vendors to get the ROM  
organizations and patterns we need.  
“If any one of them  
falls through, we’re up the creek.”**

## **Give him the good news:**

You don't have to gamble any more. At AMI, we can design and produce all five types of ROMs in quantity—and run them in parallel. So you don't have to worry about compatibility, whether you need a 4K x 4, 512 x 10, 2K x 4, or a 64 x 9 x 7 character generator. And being the Number One MOS company, you don't have to sweat out the prototyping and production of that final ROM, because we finish them up at the same time. On time. For further information, write to AMI, 3800 Homestead Road, Santa Clara, CA 95051.

Phone (415) 246-0330.

Or ask your distributor.

**AMI**

AMERICAN MICROSYSTEMS, INC.

# It takes a lot of ROMs to make them right.

We've been building ROMs for over four years. In that time, we've developed 1500 individual ROM patterns—more than anyone else in the business.

As the Number One MOS ROM company in terms of volume and product variety, we can handle all your ROM needs. We cover all the bases, whether your application is for code conversion, microprogramming, or character generation.

And we give you other advantages, like the best data rate in the industry (2MHz), the densest circuits (up to 16K), TTL compatibility and a choice of dynamic or static, custom or standard.

So the next time you're planning a product that needs plenty of ROMs and no production delays, remember this: if we didn't deliver, we wouldn't stay on top. And that's where we intend to stay.

## Some typical ROM specifications from an untypical MOS company.

P/N	Size	Organization	Power Supply (V)	Data Rate (MHz)	Access (ns)	Power (mW)	Directly Replaces
S8457	1536	128X12	+ 5, -12	1.0	1000	1000	
S8499	2240	64X5X7	+13, -13	0.5	2000	400	TMS 4100
S8564	4032	64X9X7	+ 5, -12	2.0	450	1000	
S8614	2560	512X5	+ 5, -12	2.0	450	1000	
S8771	5120	512X10	+ 5, -12	2.0	450	1000	
S8772	4096	512X8	+ 5, -12	2.0	450	1000	
S8773	2560	256X10	+ 5, -12	2.0	450	1000	MK 2400
S8865	8192	2048X4	+ 5, -12	0.5	1.3	600	SIG 2580
S8866	4032	64X7X9	+ 5, -12	2.0	450	1000	
S8996	16384	4096X4	+ 5, -12	0.6	1400	300	SIG 2580
S8996	16384	2048X8	+ 5, -12	0.5	1800	300	

# AMI

## New products

clude operation of up to 200 cycles per minute, joy-stick control with three table speeds for programing. One 24- by 24-inch drilling and programing area is provided, along with two 16- by 24-inch drilling areas.

Rapidril Inc., Eleanor Rd., Box 232, Somers, Conn. 06071 [394]

## DIP-handling tools prevent static-electricity problems

Two tools for handling C-MOS devices in dual in-line packages are called the DIP-A-DIP inserter and the PIC-A-DIP dispenser. Both units can be grounded together to prevent

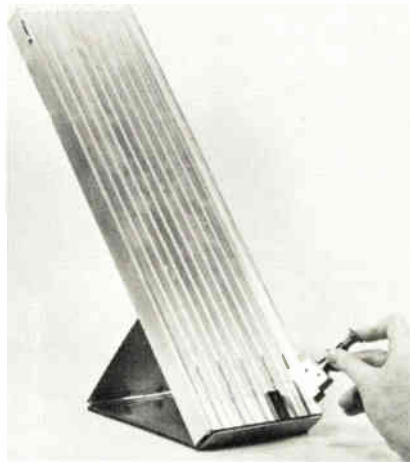

static-electricity problems often found in C-MOS devices. A flexible cable between the two tools is said to increase production rates and reduce possibility of device losses. The PIC-A-DIP works as both a 10-channel 0.3-inch dispenser or a five-channel 0.6-inch dispenser made of unanodized aluminum. Price starts at \$87 each for single quantities.

Micro Electronic Systems Inc., 8 Kevin Dr., Danbury, Conn. 06810 [395]

## Zig-zag plugboards supply three voltage buses

Designed specifically for ECL 10,000-series logic or other systems requiring more than one supply voltage, a series of zig-zag

## Different hopes for different folks.

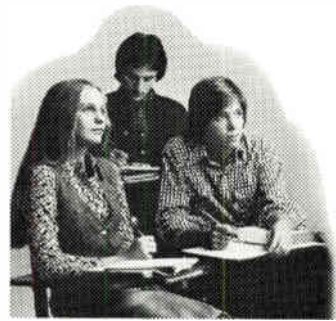

People want different things from a college education.

But they all agree on one thing. It takes more than brains to get a diploma.

Why not make the burden a little easier? Start buying U.S. Savings Bonds now.

Bonds are a dependable way to build a college fund for your children. And an easy way to start saving them is by joining the Payroll Savings Plan.

Start a college fund now with U.S. Savings Bonds. They just might let your kids spend more time studying and less time working to stay in school—whatever they hope to be.



## Take stock in America.

Buy U.S. Savings Bonds

Now E Bonds pay 5 1/2% interest when held to maturity of 5 years, 10 months (4% the first year). Bonds are replaced if lost, stolen, or destroyed. When needed they can be cashed at your bank. Interest is not subject to state or local income taxes, and federal tax may be deferred until redemption.

The U. S. Government does not pay for this advertisement. It is presented as a public service in cooperation with The Department of the Treasury and The Advertising Council.

# The Real Time Spectrum Analyzer you've needed...



**is now within your budget!**

If you've been "making do" with sound level meters, tracking filters, wave analyzers or other limited frequency analysis techniques — we've got exciting news for you.

For only \$5000 you can now buy all the advantages of real time narrow band spectrum analysis with our 200-line Saicor 51B Real Time Analyzer/Digital Integrator . . . and get built-in spectrum averaging and linear, peak hold and exponential averaging modes. A superior frequency analysis technique for thousands of dollars less than ever before. Can you afford not to find out more? Call for a demonstration or write today for our free "25 Ideas" brochure.

## Honeywell

Signal Analysis Operation/Test Instruments Division  
595 Old Willets Path/Hauppauge, New York 11787/(516) 234-5700



Circle 158 on reader service card

Try it first. Send for a free sample.

# Tempilabel<sup>®</sup>



### Temperature Indicating Labels

The center spot on a Tempilabel<sup>®</sup> turns black when the surface to which it is affixed reaches the specified temperature (from 100° to 600°F).

Tempilabels<sup>®</sup> are available with single spots, or with multiple spots for monitoring safe operating temperatures. They provide permanent temperature records, and are thus useful in designing components and selecting materials.

If you are not now using Tempilabels<sup>®</sup>, fill in the coupon. We'll be glad to send you a sample that you can try in your own plant or laboratory.

## Tempilabel<sup>®</sup>

Division, Big Three Industries, Inc.  
Hamilton Blvd., South Plainfield, N.J. 07080  
Phone: 201 • 757-8300 • Telex: 138662

Send sample of Tempilabel<sup>®</sup>.

For use at      °      temperature.

Name \_\_\_\_\_

Title \_\_\_\_\_

Company \_\_\_\_\_

Street \_\_\_\_\_ City \_\_\_\_\_

State \_\_\_\_\_ Zip \_\_\_\_\_

# Can you spot your limitations?

## New products

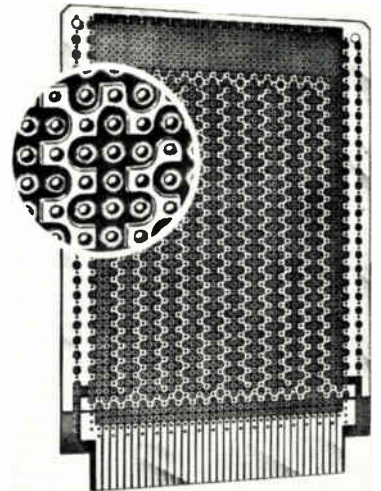

plugboards provides three buses without multilayer lamination, which can be costly. The boards are designated series 4066-4, and they accommodate up to 34 DIP positions for breadboard, prototype, or low-volume production using both solder and wrapped-wire interconnections. Two separate zig-zag patterns for two of the buses are interleaved on the wiring side between DIP positions, and the third bus consists of a continuous ground plane on the component side. The ground plane is etched to prevent shorting. The boards are priced at \$12.95 each for 1 to 19 pieces.

Vector Electronic Co. Inc., 12460 Gladstone Ave., Sylmar, Calif. 91342 [396]

### Pluggable circuit board

eliminates cable connectors

A pluggable printed-circuit board especially suitable for device-dependent port applications eliminates the need for cable-type connectors, while reducing signal noise. Design-

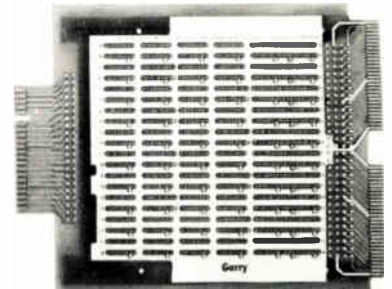



# Open a Savings Account with our new megapower SCRs



When you invest in IR's new Megapower SCR Family Savings Plan you start earning dividends three important ways.

First, you can eliminate over 70% of the devices and parts normally needed (see the 3-phase converter "savings account" below for full details). That gives you a lower total system cost, plus more reliability.

Second, having fewer parts cuts assembly time sharply, increases reliability and makes your field servicing that much easier, too.

Third, Megapower SCRs give you more production power with only a minimum change in your equipment size.

If you want to parallel Megapower SCRs, there's a special bonus. Our epitaxial process

yields SCRs of virtually identical switching characteristics, so you eliminate expensive current balancing equipment. It also produces the high voltage SCRs you need. Specifically: 700A(av) 500 to 2100V; 850A(av), 500 to 2000V; 1000A(av), 500 to 1500V, and 1600A(av), 500 to 1200V.

## IR'S 4800 Amp, 3-PHASE CONVERTER SAVINGS ACCOUNT

Parts Per Assembly	4800A Assy. Using 3-550A SCRs Per Leg	4800A Assy. Using 1-1600A SCR Per Leg	Parts Saved Per Assy.
1. SCRs	18	6	12
2. Heat Sinks	21	9	12
3. Clamps	18	6	12
4. Fuses	18	6	12
5. Balancing Reactors	18	0	18
6. Trigger Pulse Pwr. Amplifiers	6	0	6
7. Isolated Gate Drive Windings	18	6	12
<b>Totals</b>	<b>117</b>	<b>33</b>	<b>84</b>

There is also an extra dividend in overall productivity because Megapower SCRs will keep your equipment on line longer. Their surge capability is so high, they can ride through massive overloads without resorting to protective fuses.

Open a savings account today. Call your IR branch office, or bank headquarters (213) 678-6281; Telex: 67-4666. International Rectifier, 233 Kansas Street, El Segundo, CA.

# International Rectifier

International Rectifier, 233 Kansas Street, El Segundo, CA 90245. . . . *the innovative power people*



**Thin-Film  
Resistor  
LADDER  
NETWORKS**  
for  
**D/A Converters**

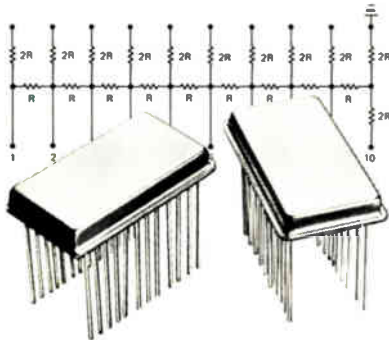

**HIGH PRECISION,  
HIGH STABILITY** ladder networks compatible with a variety of quad current switches are being supplied by LRC in both chip networks and 24-pin ceramic DIPs.

<b>Bits</b>	4-12
<b>Resistor Values</b>	Customer Specified
<b>Accuracy</b>	$\pm 1/2$ LSB (typ.)
<b>Temp. Tracking</b>	<1 ppm (typ.)
<b>TCR</b>	As low as -15 ppm, typ. -50 ppm
<b>Ratio Accuracy</b>	<0.012% full scale (for 12-bit network)

**Mil-Std-883 Screening Available**

**LASER TRIMMING** facilities permit rapid delivery of standard and custom networks in volume with excellent reliability. Single chip ceramic substrate design minimizes parasitic capacitance and results in fast settling speed. LRC can also provide custom feedback resistors plus compensation for switching resistance.

*Give us your  
CUSTOM REQUIREMENTS  
today.*



11 Hazelwood Road  
Hudson, N.H. 03051  
(603) 883-8001  
(603) 883-9351  
TWX 710 228-1377

**New products**

nated ECTD 162, the board is linked to other circuits through standard edge-card connectors. Typical applications include computer systems and communications equipment.

Garry Manufacturing Co., New Brunswick, N.J. 08902 [397]

Wire-wrap DIP socket reduces board thickness

Using a one-piece contact and terminal system, a U-type above-the-board wire-wrap DIP socket permits

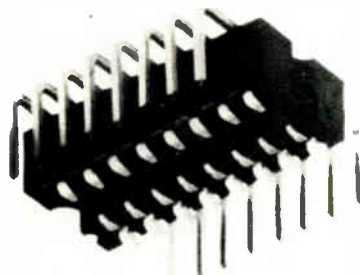

use of thin boards. The device also permits wire-wrapping on the same side of the board on which packages are mounted, eliminating board-flipping during wiring and checkout. Body height of the sockets is 0.175 inch, allowing ICs to be plugged in on 0.5-inch centers.

Robinson, Nugent Inc., 800 E. 8th St., Box 470, New Albany, Ind. 47150 [398]

ROM programmer handles Fairchild, National models

A ROM programmer, designated the model FN-2448, is designed to handle Fairchild's models 93416 and 93426, as well as National Semiconductor models 8573 and 8574 ROMs. The semiautomatic portable unit handles these 1,024-bit devices, and an addressing capability of 2,048 bits is provided for use with the larger ROMs of the future. The programmer also verifies data in field- and mask-programmed ROMs that are similar to the Fairchild and National devices. Price is \$995.

MilerTronics, 525-A Airport Rd., Greenville, S.C. 29607 [400]

**For bonding  
metal-  
to-metal-  
to-glass-  
to-glass-to-  
plastics-  
to-plastics-  
to-rubber-to-  
rubber-to-  
metal-to-etc-  
to-etc.**

One drop goes a long way in fastening almost anything to almost anything.

Eastman 910<sup>®</sup> adhesive bonds fast, too. Almost instantaneously. With only contact pressure.

Tensile strength? Up to 5000 psi at room temperature.

New Eastman 910 MHT and THT/Grades hold when the heat's on. Even over 400° F.

For further data and technical literature, write: Eastman Chemical Products, Inc., Kingsport, Tennessee 37662.



# LOW POWER RAMS

64 BIT TTL

At Monolithic Memories we're expanding our line of low power RAMs to solve your 3101A and 31L01 problems.

Chances are you've already seen our L5530/L6530 low power, bipolar 256-bit RAMs. Now we're introducing four new devices into our growing family. The L5560 (Open Collector) and L5561 (Three State) 64-bit RAMs operate over the full mil temp and voltage range with a maximum access time of 100ns (at 35mA max  $I_{CC}$ ).

The commercial parts, L6560 (Open Collector) and L6561 (Three State) 64-bit RAMs, have an access time of 80ns max (at 35mA max  $I_{CC}$ ). All four are low power. All four are bipolar. And all four are **available**. In stock. Now.

Maybe you've been using 3101A's and want to save up to 350mW of power per package. Or

maybe you need 3101A's in a three state version. Or maybe you've been buying 3101A's on a waiver or looking high and low for 31L01's. Now you'll find that our L6560/61 and L5560/61 are pin-for-pin compatible with the 3101A and interchangeable with the 31L01.

	-55°C to +125°C	0°C to 75°C
Open Collector	L5560	L6560
Three State	L5561	L6561
Price (100-999)	\$18.00	\$8.00

Please call our nearest sales office, rep or distributor. Or call, write or wire Dale Williams, Monolithic Memories, 1165 East Arques Avenue, Sunnyvale, CA 94086, (408) 739-3535, TWX 910-339-9229.

## Monolithic Memories, Inc.

EASTERN AREA SALES OFFICE: (617) 653-3158 • NEW ENGLAND REGION: (617) 475-8883 • NEW YORK REGION: (607) 748-3211 • CENTRAL AREA SALES OFFICE: (317) 844-3241 • WESTERN AREA SALES OFFICE: (714) 556-1216  
 Representing your best buy in memories: ALABAMA, Huntsville (205) 539-1771; ARIZONA, Phoenix (602) 264-7971; CALIFORNIA, San Diego (714) 743-3015; Palo Alto (415) 369-4671; COLORADO, Denver (714) 556-1216; CONNECTICUT, North Haven (203) 239-9762; FLORIDA, Orlando (305) 423-7615; ILLINOIS, Chicago (312) 593-0200; INDIANA, Ft. Wayne (219) 744-4331; IOWA, Cedar Rapids (319) 393-8703; KANSAS, Kansas City (913) 236-4646; KENTUCKY, Louisville (502) 893-7303; MARYLAND, Baltimore (301) 825-3330; MASSACHUSETTS, Boston (617) 444-2484; MICHIGAN, Detroit (313) 358-2020; Grand Rapids (616) 451-8901; MINNESOTA, Minneapolis (612) 929-6721; MISSOURI, St. Louis (314) 432-2830; NEW JERSEY, Teaneck (201) 692-0200; NEW YORK, N.Y.C./L.I. (201) 692-0200; NORTH CAROLINA, Raleigh (919) 834-6591; OHIO, Cincinnati (513) 521-2290; Dayton (513) 298-9546; Cleveland (216) 228-7525; PENNSYLVANIA, Willow Grove (215) 674-3850; Pittsburgh (412) 242-0100; TEXAS, Dallas (214) 239-9148; Houston (713) 721-1054; WASHINGTON, Seattle (206) 455-2778; WISCONSIN, Waukesha (414) 786-6330.

**A great place  
to start  
expanding  
your company  
is right here.**



Our 16 page book talks about the labor force, about deep water ports, about utilities, temperatures, taxes. There's everything here from financing to flying times, from industries to schools—all the things that make Northwest Florida one of the most profitable, most livable business climates in the country. And it's free.

Gulf Power Company  
Manager, Area Development  
Department D-8  
P.O. Box 1151  
Pensacola, Florida 32520  
Please send me your book.

Name \_\_\_\_\_

Title \_\_\_\_\_

Company \_\_\_\_\_

Address \_\_\_\_\_

City \_\_\_\_\_

State \_\_\_\_\_

Zip \_\_\_\_\_

## New products/materials

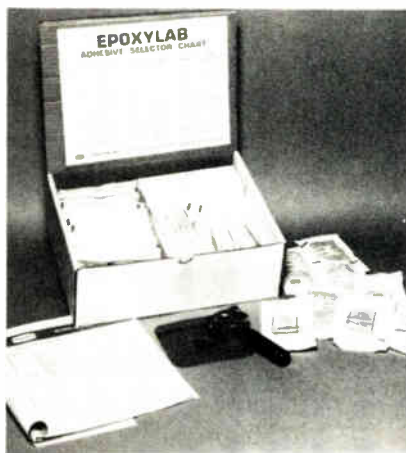

A 51-piece epoxy assortment called EpoxyLab Kit covers 17 epoxies available for a variety of applications. Included, for example, are room-temperature and high-temperature cure adhesives, thixotropics, heat-resistant epoxies, and organic and inorganic compounds. Each epoxy system comes in its own ready-to-use package, which contains a measured amount of resin and hardener. The kits are priced at \$25 each.

Tra-Con Inc., Resin Systems Division, 55 North St., Medford, Mass. 02155 [476]

A line of copper bus conductors for use in commercial power circuits is available in rectangular bars, flat wire, rods, round tubes, square tubes, channels and angles, and hollow copper conductors. Standard sizes of each form are available, and mechanical and electrical properties are designed to meet a variety of needs.

Anaconda American Brass Co., Box 830, Waterbury, Conn. 06720 [477]

Aluminum evaporation charges include evaporation wire in four standard diameters for wire-fed electron-beam deposition systems, and discrete charges in eight sizes for use in conventional evaporation sources. The charges are available in three purity categories, one for the most critical processes, one for MOS and bipolar devices, and one for applications where processing latitude allows flexibility in purity specifications. Charges made to user specifications are also available.

Cominco American Inc., Electronic Mate-

rials, Building 101, Spokane Industrial Park, Spokane, Wash. 99216 [478]

A self-extinguishing conformal coating, called material 1510, exhibits inertness to inorganic reagents, water, elevated temperatures, sunlight and other radiation. The material is resistant to chemicals and provides good electrical properties. Material 1510 can be applied by dipping, spraying, or brushing.

Applied Plastics Co. Inc., 612 E. Franklin Ave., El Segundo, Calif. 90245 [479]

Ultracast 553 is a zirconia-base ceramic which can be cast into complex shapes, has a temperature resistance to 4,000°F. For use in sintering boats and heating elements, the material contains no alkaline metal ions and can therefore be used in high-vacuum systems. Also good as a thermal insulator, the material becomes electrically conductive above 1,500°F. Price for a one-quart kit is \$40.

Aremco Products Inc., Box 429 Ossining N.Y. 10562 [473]

A formulation of thermally conductive silicone dielectrics conforms to the mating surfaces of power devices and sinks but does not bleed or cold-flow. Called Cho-Therm 1662, the material has an impedance of 0.45°C/watt. Other formulations are available with impedances of 0.27°C/w and 0.19°C/w. Price per sheet in 100-sheet quantities is from \$3.80 to \$45, depending on rating.

Chomerics, 77 Dragon Ct., Woburn, Mass. 01801 [474]

Poly-Coat is the designation for a polyimide film coated with 0.001 inch of thermosetting adhesive, and Poly-Core is a copper-clad polyimide film laminate using a strong-bonding, high-temperature adhesive system. For printed-circuit-board applications, Poly-Core is available in stress-free static press sheets and continuous rolls, while Poly-Coat is available in continuous rolls only. Poly-Coat provides adhesive on one or two sides for a wide range of multilayer applications.

Fortin Laminating Corp., 1323 Truman St., San Fernando, Calif. 91340 [475]

# THERE'S A BETTER WAY TO GO.



Energy shortages tell us we have to change our driving style. Now! It doesn't mean we have to go back to horse and buggy days. But it does mean we have to make every drop of gas give us the most go for our money. Anyone with horse sense knows that a well-tuned car gets better mileage, and in times of fuel shortages, better mileage means a lot.

The Mark Ten B Capacitive Discharge System keeps your car in better tune so it burns less gas. Using Mark Ten B is more than horse sense. It's the smart move under the hood, helping a nation survive an energy crisis and keeping you on the road. Delta Mark Ten. The best way to go.



## DELTA PRODUCTS, INC.

P.O. Box 1147, Dept. E  
Grand Junction, Colo. 81501  
(303) 242-9000

Please send me free literature.  
Enclosed is \$\_\_\_\_\_  Ship ppd.  Ship C.O.D.  
Please send: \_\_\_\_\_ Mark Ten B assembled @ \$59.95 ppd. \_\_\_\_\_ Mark Ten B Kit @ \$44.95 ppd. (12 volt negative ground only) \_\_\_\_\_ Standard Mark Ten assembled, @ \$44.95 ppd. \_\_\_\_\_ 6 Volt: Neg. Ground Only \_\_\_\_\_ 12 Volt: Specify \_\_\_\_\_ Pos. Ground \_\_\_\_\_ Neg. Ground \_\_\_\_\_ Standard Mark Ten Deltakit™ @ \$29.95 ppd. (12 Volt Positive or Negative Ground Only)  
Car Year \_\_\_\_\_ Make \_\_\_\_\_  
Name \_\_\_\_\_  
Address \_\_\_\_\_  
City/State \_\_\_\_\_ Zip \_\_\_\_\_

# Numerical Indication Tube Driver

	TYPE	APPLICATION	CCT/PACK	FUNCTION	FEATURES
LED DRIVER	KB-6400 KB-6401 KB-6402	Segment Digit Digit	7 6 4	Invert Invert Invert	: Bipolar IC and thin-film resistors use for high performance and high reliability.
# NIXIE TUBE DRIVER	KH-6286 KH-6288 KH-6800 KH-6811 KH-6813 KH-6814	Segment Segment Digit Digit Digit Digit	9 8 6 9 6 9	Convert Invert Invert Invert Convert Convert	: High break-down voltage. BVces ≥ 150V : High performance, high reliability. : High density packaging.
FLUORESCENT TUBE DRIVER	KM-6608 KM-6609	Segment & Digit	4 6	Convert Invert	: Direct connection possible to LSI. : High performance, high reliability. : High withstanding voltage-low power consumption.
PRINTER DRIVER	KH-6270 KH-6298 KH-6275 KH-6269	Channel Channel Channel Channel	10 7 9 7	Invert Invert Invert Invert	: Low input through use of Darlington transistors. : High density packing. : Direct connection possible to LSI. : Includes spark killer diodes.

# Trademark of Burroughs corporation.



11-18, 2 Chome, Sonan, Sagamihara-shi,  
Kanagawa-ken, Japan  
TEL: 0427-42-6731 ~6  
CABLE ADDRESS: KELIC MACHIDA  
TELEX: 2872-239 KELIC

Circle 164 on reader service card

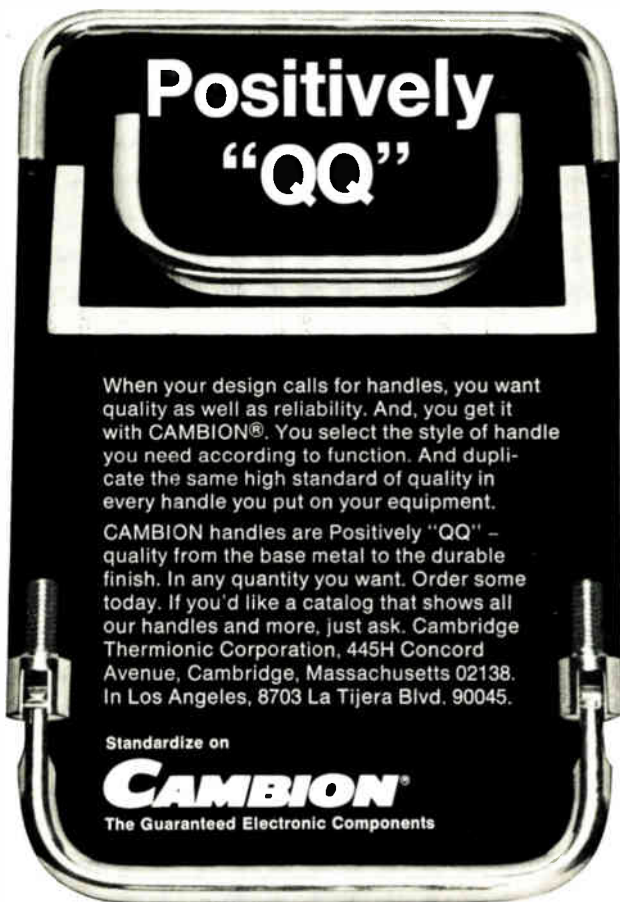

**Positively  
"QQ"**

When your design calls for handles, you want quality as well as reliability. And, you get it with CAMBION®. You select the style of handle you need according to function. And duplicate the same high standard of quality in every handle you put on your equipment.

CAMBION handles are Positively "QQ" – quality from the base metal to the durable finish. In any quantity you want. Order some today. If you'd like a catalog that shows all our handles and more, just ask. Cambridge Thermionic Corporation, 445H Concord Avenue, Cambridge, Massachusetts 02138. In Los Angeles, 8703 La Tijera Blvd. 90045.

Standardize on  
**CAMBION®**  
The Guaranteed Electronic Components

164 Circle 225 on reader service card

## DIACON'S AUTOMATIC ENVIRONMENTAL STORAGE HANDLER:

- 200 DEVICES IN 029 CARRIERS
- RELIABLE • SIMPLE
- EASY TO MAINTAIN

Fewer moving parts inside the environment (two bushings only) provide long, maintenance-free operation. The Diakon storage handler is quiet and mechanically uncomplicated. Which helps eliminate down-time. Operates on 120 or 240 V.

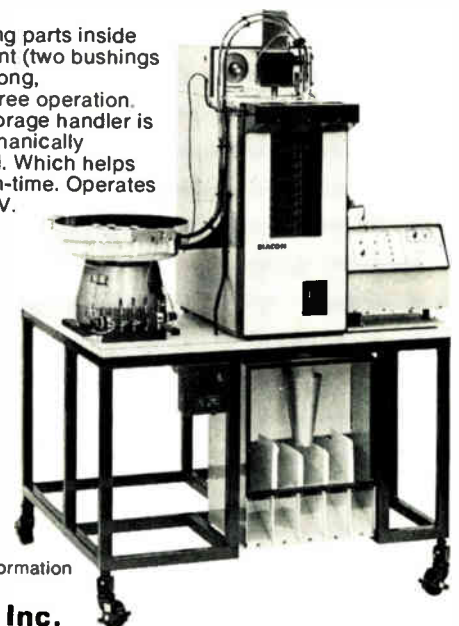

For complete information and specs, write:  
**DIACON, Inc.**  
4812 Kearny Mesa Rd.  
San Diego, Calif. U.S.A.  
(714) 279-6992

Circle 198 on reader service card

# Your files are not up-to-date until you get this Solid State Lamp (LED) data from General Electric.

## FREE

Each item includes data new or revised since October, 1973.

- Solid State Lamp catalog with complete GE family of infrared and visible SSL's. #3-3358. (Oct. 73)
- Industry cross reference of solid state lamps. #3-3493. (Oct. 73)
- GaP vs. GaAsP informative bulletin. #3-489. (Feb. 74)
- Photoelectric Systems Guide. #3-3471.
- Set of Infrared SSL Product Bulletins.
- Set of Visible SSL Product Bulletins.

## ONLY \$1.00/SET

Complete Two-Part SSL Manual. Covers theory, characteristics and applications with 108 pages of diagrams, graphs and circuit applications. #3-488.

## EXCLUSIVE OFFER — ONLY \$1.75. Tell-Tale Infrared Detector. #3-3361.

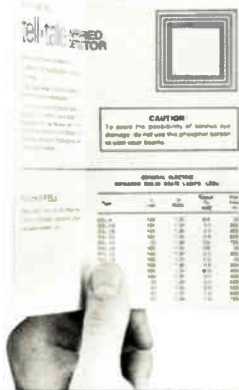

GE's unique Tell-Tale Infrared Detector is great for checking, installing or aligning opto coupled devices or systems. It is a one square-inch phosphor screen mounted on a 4" x 6" card that converts the invisible infrared energy into a visible image. Get yours now for only \$1.75.

All this worthwhile information is available from your GE electronic distributor listed below. Or from GE's Miniature Lamp Products Department listed in your Yellow Pages. Or write General Electric, Nela Park, #4454-M, Cleveland, Ohio 44112. Or call GE collect

at (216) 266-6651 and ask for Bill Lenkner. And remember, GE makes a full line of competitively priced visible and infrared SSL's. Most popular lamps are available for immediate delivery. Let us quote you on your requirements.

## GE electronic distributors (listed alphabetically by company name)

Almac/Stroum Electronics  
Seattle, WA 97108

Almo Electronics  
Philadelphia, PA 19114

Barnhill Five, Inc.  
Denver, CO 80226

Brill Electronics  
Oakland, CA 94600

Carlton-Bates Company  
Little Rock, AR 72209

Cramer Electronics  
East Syracuse, NY 13057  
Irvine, CA 92705  
Mt. Prospect, IL 60056  
Newton Center, MA 02159  
Sunnyvale, CA 94086

Cramer New Mexico, Inc.  
Albuquerque, NM 87108

Electra Distributing Company  
Nashville, TN 37203

Electronics Marketing Corp.  
Columbus, OH 43212

Electronics Parts Company  
Denver, CO 80226

Electronic Supply  
Riverside, CA 92507

Elmar Electronics  
Mt. View, CA 94043

General Electric Supply Company  
Rochester, NY 14623

General Radio Supply Co.  
Camden, NJ 08102

Gerber Electronics  
Dedham, MA 02026

Graham Electronics Supply Co.  
Indianapolis, IN 46204

G. S. Marshall Company  
El Monte, CA 91731

Hamilton/Avnet Electronics  
Burlington, MA 01803  
Culver City, CA 90230

Dallas, TX 75207  
Denver, CO 80211  
Hazelwood, MO 63042  
Houston, TX 77019  
Lenexa, KS 66215  
Mt. View, CA 94040  
Salt Lake City, UT 84119  
Schiller Park, IL 60176  
Syracuse, NY 13211

Hamilton Electro Sales  
Hanover, MD 21076

Hammond Electronics  
Orlando, FL 32802

Harpe Electronics, Inc.  
Chattanooga, TN 37408

Hughes/Peters, Inc.  
Cincinnati, OH 45227  
Columbus, OH 43211

Kierulff Electronics, Inc.  
Los Angeles, CA 90040

L Comp  
North Kansas City, MO 64116

Lykes Electronics Corp.  
Atlanta, GA 30325

Milgray Electronics  
Freeport, NY 11520

Newark Electronics  
Chicago, IL 60624

Newark Electronics, Inc.  
Salt Lake City, UT 84115

Oil Capitol Electronics Corp.  
Tulsa, OK 74115

Olive Industrial Electronics, Inc.  
St. Louis, MO 63130

Pioneer/Dayton  
Dayton, OH 44481

Pioneer/Cleveland  
Cleveland, OH 44105

R.S. Electronics  
Detroit, MI 48227

Rem Electronics  
Warren, OH 44481

Rochester Radio Supply Co., Inc.  
Rochester, NY 14614

Rome Electronics, Inc.  
Rome, NY 13440

Schweber Electronics  
Atlanta, GA 30340  
Beachwood, OH 44122  
Elk Grove Village, IL 60007  
Hollywood, FL 33020  
Rochester, NY 14624  
Rockville, MD 20852  
Somerset, NJ 08873  
Waltham, MA 02154  
Westbury, PA 15591

Semiconductor Specialists, Inc.  
Elmhurst, IL 60126  
Indianapolis, IN 46241  
Pittsburgh, PA 15238

Southeastern Radio Supply Co.  
Raleigh, NC 27603

Standard Electronics, Inc.  
Cheektowaga, NY 14225

Sterling Electronics  
Houston, TX 77027

Sterling Electronics Corp.  
Dallas, TX 75229

Western Electromotive  
Culver City, CA 90230

Zack Electronics  
San Francisco, CA 94102

GENERAL  ELECTRIC

# You're O.K., we're O.K.

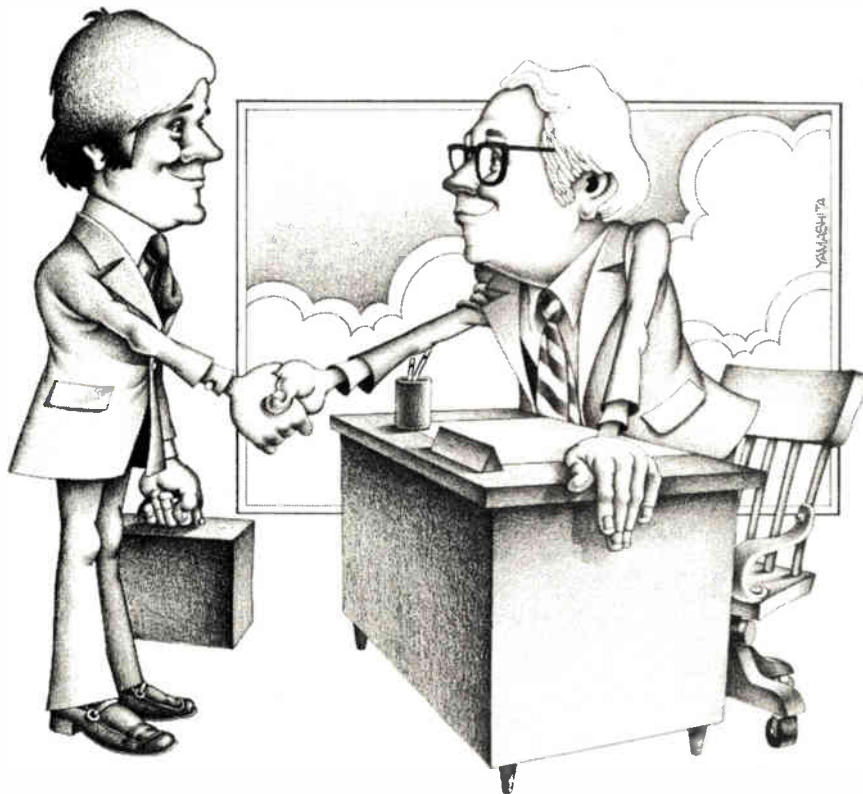

*You're O.K.*—if you're abreast of latest developments in one of the vital technologies of the aerospace/electronics industry—electro-optics—and if you want a wide open opportunity to exercise your capacity to create and grow.

*We're O.K.*—if we offer you a challenging assignment, a congenial ambience, an attractive salary, and a promising, long term future.

We believe we do.

We're at work on some 550 projects and programs in 80 major areas. We're a friendly stimulating outfit that recognizes ability and rewards it. We're proud of our pioneering new technologies and building sophisticated systems of superb reliability. We believe it's the reason our sales and backlogs are steadily growing.

**HUGHES**  
HUGHES AIRCRAFT COMPANY  
U.S. citizenship required.  
Equal opportunity M/F employer.

We especially need *senior staff engineers* to perform conceptual design, analysis, and test of integrated infrared focal planes using charge coupled devices for readouts and signal processing, and *packaging engineers* who have a working knowledge of hybrid and LSI technology, high density packaging techniques, and micro-miniaturization for space-qualified units and subsystems. And we always have openings for good airborne weapons *systems engineers* and creative *conceptual design engineers*. While these positions

offer opportunity for advancement, they are *not* managerial.

So if we sound O.K. to you, please airmail us your resume. It could be the best 11¢ you ever spent.

Write: Mr. Robert A. Martin, Head of Employment, Dept. 44, Hughes Aircraft Company, Equipment Engineering Divisions, 11940 W. Jefferson Blvd., Culver City, CA 90230.





## Five days that can change your future

We're rather good at changing the future. After every I.E.A. exhibition, the world's never quite the same again!

Because the I.E.A. exhibition is the world's unique show window for the latest technical developments in process control instrumentation, automatic test equipment, electronic components, process control, production equipment, scientific instrumentation, computer hardware and data handling equipment.

And because each I.E.A. exhibition acts as a "think tank" for engineers from all over the world, who examine, compare and discuss the developments since the last exhibition.

The exhibition itself continues to escalate. Since its foundation in 1957 it has more than tripled in size. In 1972 it attracted over 700 companies from 22 countries, and 4,824 visitors from 69 overseas countries.

I.E.A. '74 is a special landmark – the first to be held since the setting up of the enlarged EEC.

### Olympia, London

Olympia has good bus and underground connections with London's West

End, and is close to the West London Air Terminal. There is a multi-storey car park adjacent to the exhibition hall. Overseas visitors will be provided with special amenities and facilities – information centres, lounges, interpreters and help with travel and accommodation.

### Travel

To make your visit trouble-free and enjoyable, our official travel agents, Louis Duforest, will take care of your travel to London, accommodation, transfers to and from airport and hotel, and excursions. These can be booked individually or as a "package". For full details of this comprehensive service, just fill in the coupon.

To Industrial & Trade Fairs Limited,  
Commonwealth House, 1-19 New Oxford  
Street, London WC1A 1PB, England.  
Telephone: 01-242 9011. Telex: 262567.  
Cables: Indatfa London WCI.

1. Please send me further details and.....  
complimentary tickets for IEA '74
2. Please send me details of the special  
travel  hotel accommodation   
and package deal  facilities offered by  
the official IEA travel agent.

Name .....

Company .....

Address .....

.....

Country .....

## International Instruments Electronics Automation Exhibition

13th-17th May 1974 Olympia,  
London. Open daily 10.00-18.00



# HIGH PURITY ELEMENTS

We offer  
more than  
anyone else.

- Antimony
- Arsenic
- Bismuth
- Cadmium
- Copper
- Gold
- Indium
- Lead
- Selenium
- Silver
- Sulphur
- Tellurium
- Thallium
- Zinc

Asarco has the broadest selection of high purity elements in the business. All 99.999+ % pure. All ready for prompt delivery. For semiconductors, electronics, metallurgy, research, and other applications.

Our high-purity elements are also available in commercial quantities.

For more information on Asarco's array of high purity elements, write our By-Products Department at 120 Broadway, New York, N.Y. 10005.

75 Years of Progress in Metals

**ASARCO**<sup>75</sup>  
American Smelting and Refining Company

## New literature

**Selector switches.** CTS Keene Inc., 3230 Riverside Ave., Paso Robles, Calif. 93446, has published catalog 4223A, which provides information on a 223 Series of 1-inch selector switches. Circle 421 on reader service card.

**Tape-data protectors.** Ad-Vance Magnetics Inc., 226 E. 7th St., Rochester, Ind., has issued a four-page technical catalog on tape-data protectors. Included in the brochure are causes of tape degradation and how to avoid these hazards, specifications on the company's Presidential line of tape-protection equipment, and engineering reports on the shielding effectiveness of the company's equipment. [422]

**Active filters.** Various types of active filters are described in a brochure available from Kinetic Technology Inc., 3393 De La Cruz Blvd., Santa Clara, Calif. 95050. Descriptions, specifications, and applications are included. [423]

**Job safety.** The U.S. Department of Labor, Office of Information, Publications and Reports, Washington, D.C. 20210, has published the first in a series containing questions and answers about job safety and health standards. The 30-page booklet deals with electrical hazards and other topics of engineering interest. It is also available through OSHA regional offices. [424]

**Word processing.** Advanced word-processing systems are described in a six-page brochure issued by Redactron Corp., 100 Parkway Dr. S., Hauppauge, N.Y. 11787. Design features and applications are included. [425]

**Power supplies.** Rack-mounted power supplies with outputs from 1.5 to 50 V dc are described in a bulletin from Acopian Corp., Easton, Pa. 18042 [426]

**Potentiometers.** Weston Components, Archbald, Pa. 18403, has published a catalog giving information on a line of cermet and wire-wound trimming potentiometers for

## FLATPACK

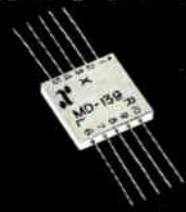

## BALANCED

## MIXER

MODEL MD-139

- 500 KHz-500 MHz Frequency Range
- +30dBm Input 3rd Order Intercept Point
- <35dB Isolation
- 8dB Noise Figure

anzac  
ELECTRONICS



39 Green Street, Waltham, Mass.  
(617) 899-1900 • TWX 710-324-6484

Circle 199 on reader service card

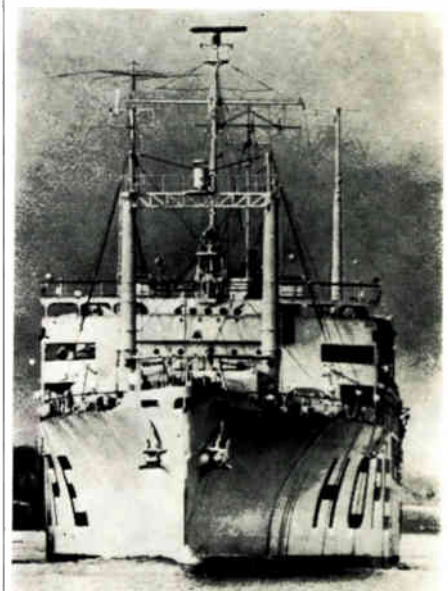

## S.S. HOPE, M.D.

Doctor... teacher... friend to millions on four continents—this floating hospital is a symbol of America's concern for the world's disadvantaged. Keep HOPE sailing.

**PROJECT  
HOPE**

Dept. A, Washington, D.C. 20007

# "When we were evaluating Augat panels, we had to be absolutely sure they would withstand the shock and vibration of a hard-working storage system.

## "Now we're sure."

Chuck Bates  
Senior Development Engineer  
Clark Equipment Company, Storage Systems

"Clark automated storage systems utilize a computer directed stacker crane. The heart of the system is a Clark-designed electronic logic package, built around Augat plug-in socket panels.

"When we were designing the system, we of course looked for density and design flexibility. And at the same time we found the cost of wire-wrapped panels attractive.

"What concerned us was if the socket panel concept could withstand shock and vibration with a high degree of reliability. Clark storage systems often work 24 hours a day. We found that Augat's unique machined socket contact stood up very well in test

Testing control box featuring Augat panels.

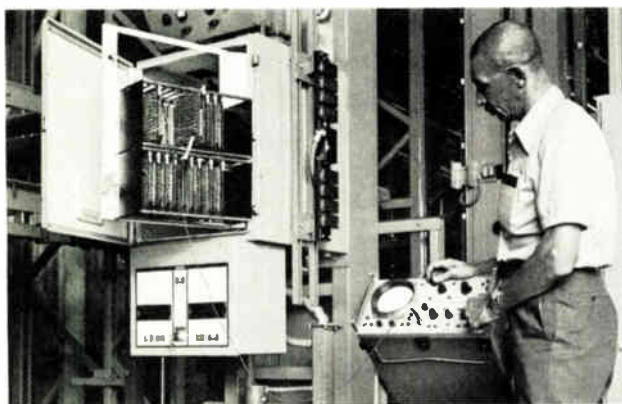

Chuck Bates

and in the field as well.

"Augat gave us an interconnection system which met our requirements from a cost, reliability and design standpoint."

All of which just might tell you why Augat has become the world's leading producer of wire-wrapped socket panels and other IC interconnection products. But Augat has more to offer than just hardware. Augat's technical experience is ready to help you meet your interconnection requirements.

Call or write to us today. We'll send you our free brochure and complete product information. Augat, Inc., 33 Perry Avenue, Attleboro, Massachusetts 02703. Represented and distributed internationally.

### AUGAT®

Circle 169 on reader service card

Europe—Augat International, Inc., Boulevard A. Reyers, 103, 1040 Brussels, Belgium, Tel. (02) 36-93-99.  
Japan—Kyokuto Boeki Kaisha Ltd., New Otemachi Bldg., 2-1, 2-Chome Otemachi, Chiyoda-Ku, Tokyo 100-91, Japan, Tel. (03) 244-3788.

# Procond

Synthetic film  
capacitors  
Electrolytic capacitors  
Filters  
Push Buttons

PROCOND S.p.A.  
32013 Longarone (Belluno) Italy

telephone (0437) 76145/76355  
telex 44029

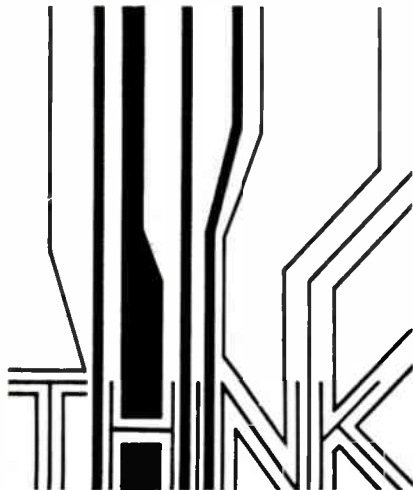

## New literature

industrial, general-purpose, and military applications. [427]

**Power modules.** Powercube Corp., 214 Calvary St., Waltham, Mass. 02154. A 24-page catalog describes miniature power modules, including preregulators, inverters, regulated and complementary converters, regulators, and filters. Specifications and design aids are given in the catalog. [428]

**Back-panel connectors.** Malco, 5150 W. Roosevelt Rd., Chicago, Ill. 60650. A direct-entry back-panel connector system is described in a product-information bulletin giving general information and test results. [429]

**Test systems.** A 40-page brochure describing applications of computer-controlled test systems and providing configurations of specific systems is available from Instrumentation Engineering Inc., 769 Susquehanna Ave., Franklin Lakes, N.J. 07417 [430]

**Power sources.** More than 50 models of welding power sources are described in a 24-page bulletin from Miller Electric Manufacturing Co., 718 S. Bounds St., Appleton, Wis. 54911 [431]

**Linear circuits.** Motorola Semiconductor Products Inc., Box 20924, Phoenix, Ariz. 85306. The third edition of the company's Linear Integrated Circuits Data Handbook, expanded to 800 pages, is available at \$3 per copy. [432]

**Power converters.** Tecnetics Inc., Box 910, Boulder Industrial Park, Boulder, Colo. 80302, is offering a 28-page catalog describing dc-dc converters, 400-Hz-input power supplies, ac-dc modules, and power-supply kits. [433]

**Computer-aided design.** Indiana General, 405 Elm St., Valparaiso, Ind. 64383. A 20-page engineering bulletin describes application of computer-aided-design techniques to the development of permanent-magnet motors. [434]

## Your closest SIGNETICS distributor is...

ARIZONA  
Phoenix: Hamilton/Avnet Electronics (602) 275-7851  
Phoenix: Kierulff Electronics (602) 273-7331  
CALIFORNIA  
Culver City: Hamilton Electro Sales (213) 870-7171  
El Monte: G. S. Marshall (213) 886-1500  
Los Angeles: KT/Wesco Electronics (213) 685-9525  
Mountain View: Hamilton/Avnet Electronics (415) 961-7000  
Palo Alto: Wesco Electronics (415) 968-3475  
San Diego: Hamilton/Avnet Electronics (714) 279-2421  
San Diego: Kierulff Electronics (714) 278-2112  
Sunnyvale: Cramer Electronics (408) 739-3011  
CANADA  
Downsview: Cesco Electronics, Ltd. (416) 661-0220  
Downsview: Cramer Electronics (416) 661-9222  
Montreal: Cesco Electronics, Ltd. (514) 735-5511  
Montreal: Hamilton/Avnet (514) 735-6393  
Ottawa: Hamilton/Avnet Electronics (613) 725-3071  
Ottawa: Cesco Electronics, Ltd. (613) 729-5118  
Quebec: Cesco Electronics, Ltd. (418) 524-3518  
COLORADO  
Denver: Hamilton/Avnet Electronics (303) 534-1212  
Denver: Cramer Electronics (303) 758-2100  
CONNECTICUT  
Hamden: Arrow Electronics (203) 248-3801  
Georgetown: Hamilton/Avnet Electronics (203) 762-0361  
North Haven: Cramer Electronics (203) 239-5641  
FLORIDA  
Hollywood: Hamilton/Avnet Electronics (305) 925-5401  
Hollywood: Schweber Electronics (305) 927-0511  
Orlando: Hammond Electronics (305) 241-6601  
GEORGIA  
Atlanta: Schweber Electronics (404) 449-9170  
Norcross: Hamilton/Avnet Electronics (404) 448-0800  
ILLINOIS  
Elk Grove: Schweber Electronics (312) 593-2740  
Elmhurst: Semiconductor Specialists, Inc. (312) 279-1000  
Schiller Park: Hamilton/Avnet Electronics (312) 678-6310  
INDIANA  
Indianapolis: Semiconductor Specialists (317) 243-8271  
KANSAS  
Lenexa: Hamilton/Avnet Electronics (913) 888-8900  
MARYLAND  
Hanover: Hamilton/Avnet Electronics (301) 796-5000  
Rockville: Pioneer Washington Electronics, Inc. (301) 424-3300  
Rockville: Schweber Electronics (301) 881-2970  
MASSACHUSETTS  
Burlington: Hamilton/Avnet Electronics (617) 273-2120  
Needham Heights: Kierulff/Schley (617) 449-3600  
Newton: Cramer Electronics (617) 969-7700  
Waltham: Schweber Electronics (617) 890-8484  
MICHIGAN  
Livonia: Hamilton/Avnet Electronics (313) 522-4700  
Detroit: Semiconductor Specialists, Inc. (313) 255-0300  
MINNESOTA  
Minneapolis: Semiconductor Specialists, Inc. (612) 854-8844  
Edina: Hamilton/Avnet Electronics (612) 941-3801  
MISSOURI  
Hazelwood: Hamilton/Avnet Electronics (314) 731-1144  
NEW YORK  
Buffalo: Summit Distributors, Inc. (716) 884-3450  
Farmingdale, L. I.: Arrow Electronics (516) 694-6800  
Rochester: Schweber Electronics (716) 328-4180  
Syracuse: Hamilton/Avnet Electronics (315) 437-2642  
Westbury: Schweber Electronics (516) 334-7474  
Westbury: Hamilton/Avnet Electronics (516) 333-5800  
NEW MEXICO  
Albuquerque: Cramer Electronics (505) 265-5767  
NORTH CAROLINA  
Greensboro: Hammond Electronics (919) 275-6391  
NORTHERN NEW JERSEY  
Cedar Grove: Hamilton/Avnet Electronics (201) 239-0800  
Saddlebrook: Arrow Electronics (201) 797-5800  
Moorestown: Arrow/Angus Electronics (609) 235-1900  
SOUTHERN NEW JERSEY AND PENNSYLVANIA  
Mt. Laurel, N. J.: Milgray-Delaware Valley  
New Jersey (609) 424-1300 Philadelphia: (215) 228-2000  
Somerset, N. J.: Schweber Electronics (201) 469-6008  
OHIO  
Beechwood: Schweber Electronics (216) 464-2970  
Cleveland: Arrow Electronics (216) 464-2000  
Cleveland: Pioneer Standard Electronics (216) 587-3600  
Kettering: Arrow Electronics (513) 253-9176  
TEXAS  
Dallas: Hamilton/Avnet Electronics (214) 661-8661  
Dallas: Cramer Electronics (214) 350-1355  
Houston: Component Specialties (713) 771-7237  
Houston: Hamilton/Avnet Electronics (713) 526-4661  
UTAH  
Salt Lake City: Alta Electronics (801) 486-7227  
Salt Lake City: Hamilton/Avnet Electronics (801) 262-8451  
WASHINGTON  
Bellevue: Hamilton/Avnet Electronics (206) 746-8750

# BCD arithmetic, all in a single IC.

Figure on whopping savings in parts, design time, systems costs.

## NEW MATH

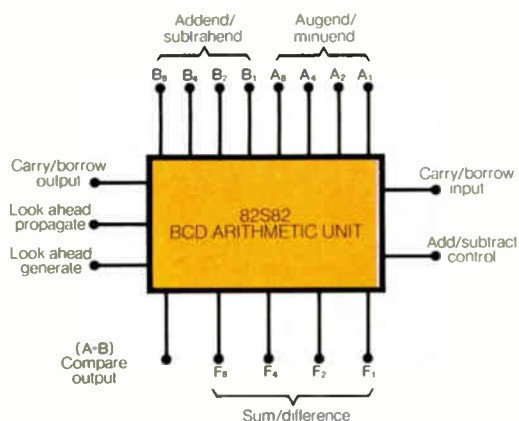

## OLD MATH

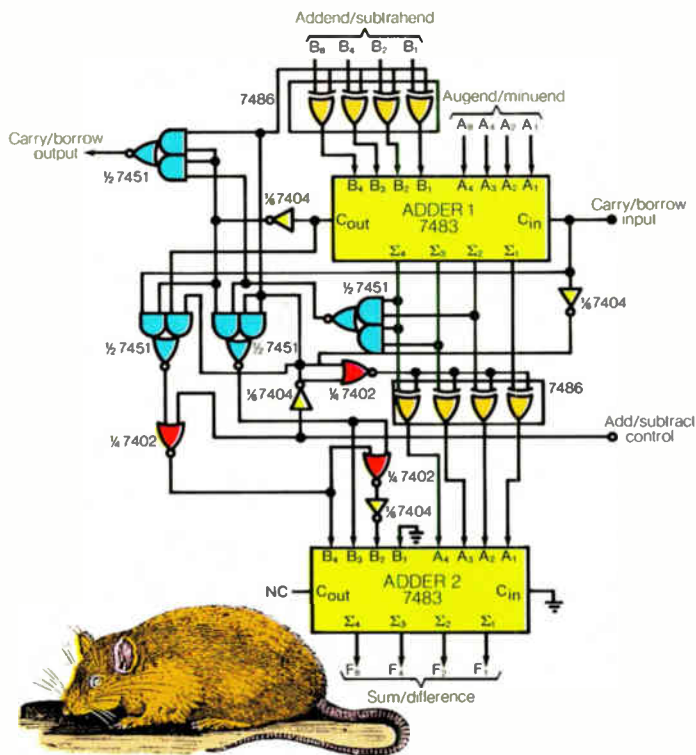

We've cut BCD arithmetic down to size. By applying Schottky MSI to those functions where it counts, we're delivering revolutionary tools in superfast processing — that are real power misers at a fraction (about half) of conventional circuitry costs. A lot more of exactly what you need. For less cost going in and coming out.

Available from Signetics, the under ten buck (100 up) 82S82 Adder-Subtractor slashes inventory requirements. Replaces four MSIs, and a rat's nest of gates and connections, now wasting valuable board space. With a staggering improvement in performance. Quadruples speed (22ns typical propagation delay). Cuts power 50%-67%. Wipes out a huge chunk of design, checkout and assembly time.

Versatile? Stand back. This unique Arithmetic Unit adds and subtracts in BCD directly, compares two BCD words, and can even be used for binary-to-BCD conversion. Cascades to operate on multiple decades. If you need ultra-high speed, get complete look-ahead carry with our 74182 fast-carry extender. What does the 82S82 do? Everything.

For a straight BCD add without all the bells and whistles, our companion 82S83 Adder gives you the same bonuses as the 82S82 Arithmetic Unit. Eliminates two MSI packages and a fistful of logic elements. Saves time, saves dollars — works better, faster, cheaper. Has to, for the same reasons as with the 82S82. It's less than seven bucks per 16-pin device, in 100-up quantity.



The way to get big, rich and famous: deliver faster, smaller, more powerful processors. Now you can. Get the facts quick. (And for immediate evaluation quantities, see your local Signetics Franchised Distributor. His name and telephone number are in the adjoining column.)

FOR SPEED ATTACH COUPON TO LETTERHEAD AND MAIL FAST

Signetics — BCD AU/Adder  
811 East Arques Avenue  
Sunnyvale, California 94086

You have what counts, can't miss it. Send me your new, comprehensive MSI 82S Data Booklet with full specs of the BCD AU/Adder, (containing also your complete family of 100MHz counters, 60MHz universal shift registers, parity checkers, decoders, multiplexers, and exclusive OR/NOR functions.)

Name

Title

Signetics Corporation — A subsidiary of Corning Glass Works

**signetics**

# How much do your "free" magazines cost you?

Free electronics magazines come flying across your desk month after month. But have you ever stopped to figure what these giveaways actually cost you?

Time is money, and you can spend a pile of it plowing through "free" publications looking for the information you need.

ELECTRONICS is different. It has the manpower and the expertise to edit out what's inconsequential and to hone down what is important so that you can get to the heart of the subject matter quickly. The result: you cut hours off your reading time.

In ELECTRONICS, you get *all* you need to know in a fraction of the time it takes you to wade through any free magazine. Every

issue of ELECTRONICS is packed from cover to cover with up-to-date information, the breaking news of the ETM-Electronics Technology Marketplace in the U.S. and worldwide.

ELECTRONICS tells it faster, cleaner and straight to the point. Every time.

Isn't it worth 8 dollars a year to make sure you stay on top of what's happening in the Electronics Technology Marketplace? Only one magazine stays on top—ELECTRONICS. ELECTRONICS is the Source.

And you can get ELECTRONICS where you can find the time to read it—at home. Go to *the Source*, today. Just fill out the subscription card enclosed in this issue, and send it off.

**Electronics**   
**IS THE SOURCE.**

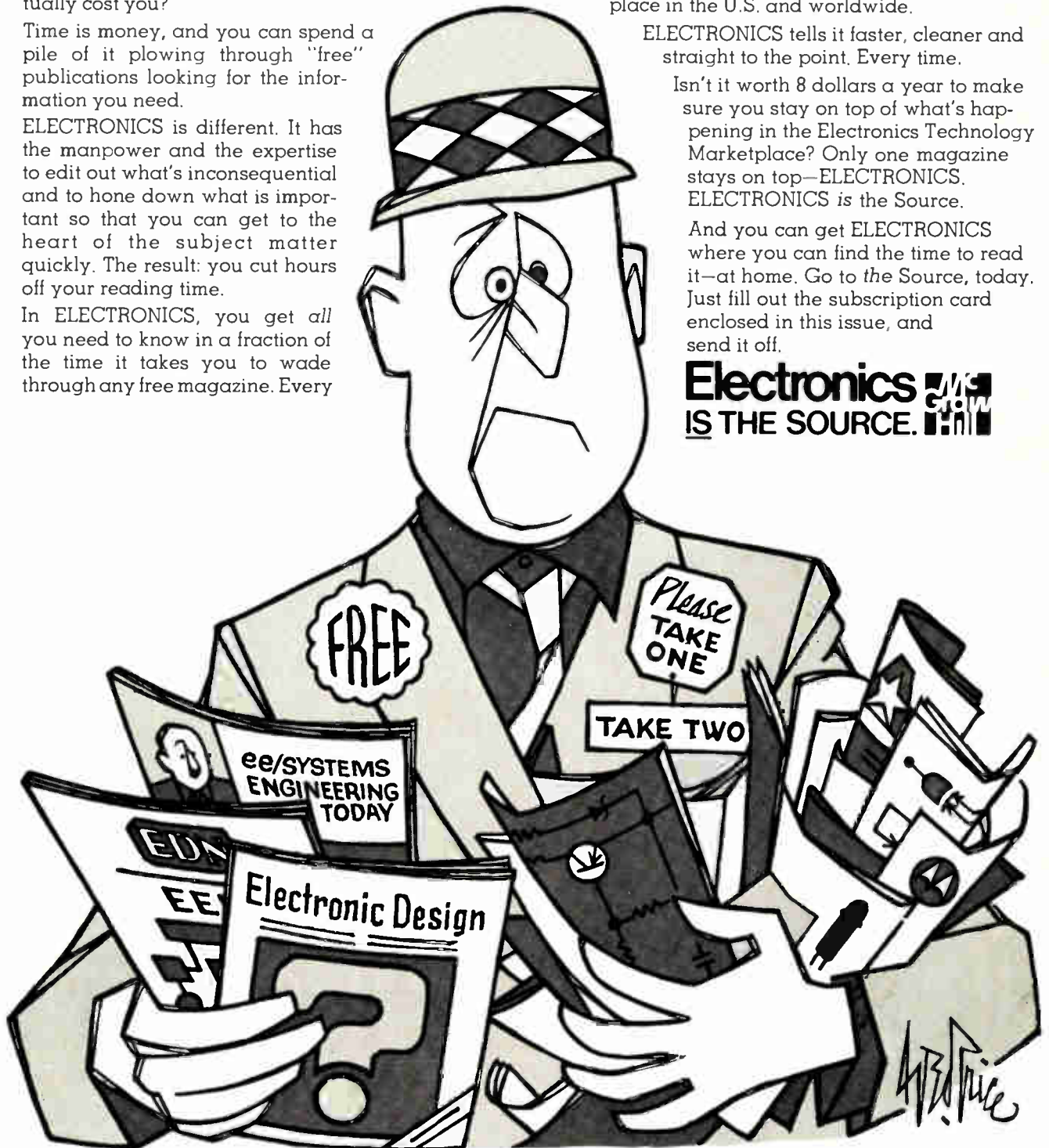

408/245-7342  
 SUNNYVALE, CALIF. 94086  
 716 NORTH PASTORIA AVENUE  
 MICRO MASK, INCORPORATED



That's a four-inch-square chrome photo-mask of the highest quality you can buy. And you can buy it from any of several photomask manufacturers, all of whom are price-competitive. Therefore, you may rightfully ask: "If that's true then why is MICRO MASK smiling?"

Actually, your own comments, more than anything, have led us to consider ourselves your best bet in chrome photomasks. From input we've received, apparently we have proven ourselves over the years as a strong, service-oriented company—a company you've long looked to for emulsion; and now for chrome. We're pleased you think of us that way.

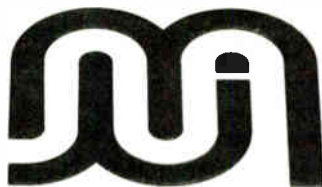

MICRO MASK, INCORPORATED  
 716 North Pastoria Avenue  
 Sunnyvale, CA 94086  
 408/245-7342

# Two-for-One Money Saver New from Monsanto.

## 1. It's A Function Generator!!

- Frequency Range 10Hz to 1MHz
- Setability and Resolution to 0.1Hz with digital display
- Low Distortion—typically 0.1%
- Functions: Sine, Square and Offset Square Waves
- Attenuator—3,20db sections plus vernier to 4VRMS

## 2. It's A Counter!!

- Frequency Range 5Hz to 15MHz
- Six gate times for resolution to 0.1Hz
- 4 Digit LED display with memory
- Input sensitivity, 50mV RMS
- Crystal Controlled Time Base

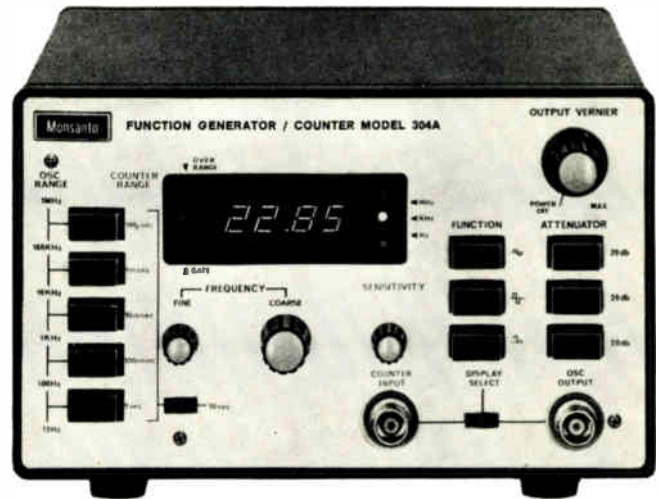

It's A Function Generator/Counter!! **Only \$445.**  
United Systems Corporation, 918 Woodley Road,  
Dayton, Ohio 45403 (513) 254-6251  
A Subsidiary of

# Monsanto

"Information Only" Circle 172 on Reader Service Card

"Demonstration Only" Circle 202 on Reader Service Card

# "His flight training was worth \$300,000. It didn't cost us a cent."

*Mr. Walter A. Foley, Port Angeles, Washington*

"Our son is a Navy jet pilot. And the way I figure it," says Mr. Foley, "if his flight training is worth more than a quarter million, he's got to be good."

If your son is a senior or college graduate who can qualify, the Navy will guarantee him a place in flight training school before he joins. If he's a sophomore or junior, our Aviation

Reserve Officer Candidate Program reserves him a place in Naval aviation before he graduates.

Think your son can qualify? Suggest he see his Navy Recruiter. Or mail the coupon below. Or call 800-841-8000 toll-free. Ask for the Air Desk.

## The Navy.



TO: Captain Robert W. Watkins,  
NAVY OPPORTUNITY INFORMATION CENTER  
P.O. Box 2000, Pelham Manor, N.Y. 10803

PSA

Yes, I'd like to help my son get \$300,000 worth of flight training. Please send more information on:

- Pilot training (AOC Program).  
 Navigation, radar, electronics training (NFOC Program).  Aviation Reserve Officer Candidate (AVROC Program).

NAME (Please Print) \_\_\_\_\_

ADDRESS \_\_\_\_\_

CITY \_\_\_\_\_ PHONE \_\_\_\_\_

STATE \_\_\_\_\_ ZIP \_\_\_\_\_





# Highlight of the year for electro- engineering

For 9 days the Hanover Fair is the world centre for the electro-engineering industry. The range of products on offer extends from micro-building elements to large transformers and from laying out a control loop up to planning complete national grids. In Hanover you obtain a panoramic view and detailed information in the shortest possible way.

Due to the fact that Hanover is such an important event (84 % of buyers regard the visit to the Hanover Fair as essential\*). They collect information and ideas not only from their own particular branch but also from other sections of industry such as automation, internal combustion engines, gears, transmissions and drives.

Plan your stay in Hanover. The world class range of products on display at Hanover ensure that your visit will be a success – after all, the fair only takes place once a year and there is only one Hanover Fair in the world.

\*) refer to the brochures entitled "The transparent market".

*The exhibitors  
invite you  
and Hanover  
welcomes you.*

Information, ideas  
**Hanover  
Fair '74**  
Thursday, April 25  
to Friday, May 3

## For planner and buyers

### Electric energy, plant and equipment

Electric power generation and conversion: Electrical machines, Transformers, Static converters, Primary and secondary power sources, Heavy-current capacitors.

Electric power distribution: High-voltage switchgear, Low-voltage switchgear, Conductors and wiring, Cables, Cable fittings and line fittings.

Electrical apparatus for machining and processing: Electro-mechanical machining, Electric welding and soldering, Electro-thermal treatment, Electro-chemical and electro-physical processing, Electrical apparatus for manufacture and operation.

### Electric and electronic instrumentation and automation

Individual apparatus, Equipment and systems, Apparatus and equipment (classified by measured quantities), Apparatus and equipment (classified by measuring methods)

### Electronic components

Active components, Passive components, Electro-mechanical components, Assemblies and subassemblies.

### Lamps and light fittings

Illumination engineering: Light fittings, Incandescent lamps, Discharge lamps

Electrical installation: Installation equipment, Electric conduit

### Telecommunications

Communication by wire, Communication by radio, Signalling and security, Timing apparatus

### Leisure electronics/Audio-visual apparatus/Domestic installations and wiring

Leisure electronics/Audio-visual apparatus: Radio, TV and phonographic apparatus, Receiving antennas, Electro-acoustic components and accessories, Audio-visual apparatus for commercial purposes.

Domestic installations and wiring: Installation equipment, Electric conduit, Electric household appliances

Obtain the following information leaflets from the Deutsche Messe- und Ausstellungs-AG, D-3 Hannover-Messegeleände, Tel: (0511) 8 91 telex: 09 22 728,

- the list of exhibitors from the electrical engineering section
- lamps, lighting and installation engineering
- entertainment electronics
- telecommunications
- electronic components
- measuring and automation

CLASSIFIED ADVERTISING  
**SEARCHLIGHT SECTION**  
 BUSINESS OPPORTUNITIES  
 USED OR SURPLUS EQUIPMENT

Lowest Prices • Factory Marked • Buy 3 or more 10% discount  
 Buy 100 — Take 20%

## Largest Selection TTL IC's

• Money Back Guarantee

Type	Sale	SN7455	.55	SN74126	.71
SN7400	\$0.30	SN7460	.30	SN74139	1.25
SN7401	.30	SN7461	.35	SN74140	1.25
SN7402	.30	SN7462	.35	SN74145	1.55
SN7403	.30	SN7464	.40	SN74146	1.50
SN7404	.35	SN7465	.50	SN74150	1.61
SN7405	.35	SN7470	.50	SN74151	1.25
SN7406	.45	SN7471	.55	SN74152	4.95
SN7407	.55	SN7472	.50	SN74153	1.60
SN7408	.35	SN7473	.55	SN74154	2.10
SN7410	.30	SN7474	.55	SN74155	1.55
SN7411	.35	SN7475	1.00	SN74156	1.45
SN7413	.95	SN7476	.65	SN74157	1.55
SN7415	.55	SN7478	.95	SN74158	1.55
SN7416	.55	SN7480	.65	SN74160	1.95
SN7417	.55	SN7481	1.25	SN74161	1.95
SN7420	.30	SN7482	.99	SN74163	1.95
SN7421	.55	SN7483	1.25	SN74164	2.95
SN7422	.35	SN7485	1.41	SN74165	2.10
SN7425	.30	SN7486	1.35	SN74166	4.05
SN7426	.36	SN7489	4.50	SN74173	2.50
SN7430	.30	SN7490	1.49	SN74174	3.20
SN7432	.35	SN7491	1.35	SN74175	3.20
SN7437	.55	SN7492	1.35	SN74176	2.10
SN7438	.55	SN7493	1.35	SN74177	2.10
SN7440	.30	SN7494	1.35	SN74179	2.10
SN7441	.40	SN7495	1.35	SN74180	1.20
SN7442	1.50	SN7496	1.35	SN74181	4.90
SN7443	1.50	SN74106	.95	SN74182	1.20
SN7444	.50	SN74107	.70	SN74185	2.50
SN7445	1.50	SN74108	.95	SN74192	1.95
SN7446	1.65	SN74112	.95	SN74193	1.95
SN7447	1.45	SN74113	.95	SN74194	1.95
SN7448	1.50	SN74114	.95	SN74195	2.25
SN7450	.30	SN74121	.60	SN74196	2.50
SN7451	.30	SN74122	.95	SN74197	2.50
SN7453	.30	SN74123	1.20	SN74198	2.65
SN7454	.30	SN74125	.71	"DIP" Packages	

**SPECTROL CERMET Any 2 "MICRO" POTS**

Model No. 41-2-1 for \$1

- 1 1/2 x 3 x 160" rectangular, 15-turn, wedge-gular, 1/2 watt 20"
- 1k 50k shaped pins, for easy pc
- 20 2k 100k work, 1/4 watt 20"
- 50 5k 200k screwdriver side.
- 100 10k 500k Model No. 53-1-1
- 200 20k 1 Meg. 3 1/2" dia., 5/16" high.

Model No. 53-2-1 — Single-turn, 3-leads, 5/16" cube, single-turn, screwdriver top, 1/2 watt, screw-adjust, front, 1/2 TO-5 transistor size, fits transistor sockets.

Terms: add postage. Rated: net .30  
 Phone Orders: Wakefield, Mass. (617) 245-3829  
 Retail: 16-18 Del Carmine St., Wakefield, Mass. (off Water Street) C.O.D.'S MAY BE PHONED

**POLY PAKS** IC's, Semi's, Parts  
 P.O. BOX 942S, LYNNFIELD, MASS. 01940

**FREE ALARM CATALOG**

Full line of professional burglar and fire alarm systems and supplies. 80 pages, 400 items. Off-the-shelf delivery, quantity prices.

mountain west alarm  
 4215 n. 16th st., phoenix, az. 85016

CIRCLE 952 ON READER SERVICE CARD

**IMMEDIATE DELIVERY**  
 Minis & Peripherals  
**DEC—HIS—NOVA**  
**SEL—HP—MOHAWK**

CPU, Card, Printer, Tape, Disk  
**NEW • MOHAWK 4320 PRINTERS**

**PDP 11 PERIPHERALS**  
**CPU, MEMORY**

**PDP 8 CPU \$1500**

**\$750 Minis**

**TELETYPE 35 & 37**  
**DEC & HONEYWELL Modules**  
**617/261-1100**

Send for Free Report "Maintenance of Computers"  
**AMERICAN USED COMPUTER CORP.**  
 P.O. Box 68, Kenmore Sta., Boston, MA 02215  
 member COMPUTER DEALERS ASSOCIATION

CIRCLE 953 ON READER SERVICE CARD

RADAR SYSTEMS GROUND AND AIRBORNE. AUTOMATIC TRACKING ANTENNA SYSTEMS. NIKE AJAX NIKE HERCULES M-33 MSQ-1A MPS-19 MPS-9 SCR 584 TFS-1D TFS-2B FAA-ASR-2 AIRBORNE SYSTEMS APN-84 APN-102 APS-20 APS-27 APS-45 DPN-19 DIGITAL COMPUTERS IBM 650 IBM 704

LARGEST INVENTORY OF RADAR AND MICROWAVE EQUIPMENT IN THE WORLD

**RADIO RESEARCH INSTRUMENT CO.**  
 3 QUINCY ST., NORWALK, CONN 06850 (703) 853-2600

CIRCLE 954 ON READER SERVICE CARD

**FREE CATALOG**

**HARD-TO-FIND PRECISION TOOLS**

Lists more than 1700 items—pliers, brazers, wire strippers, vacuum systems, relay tools, optical equipment, tool kits and cases. Also includes four pages of useful "Tool Tips" to aid in tool selection.

**JENSEN TOOLS**  
 4117 N. 44th Street, Phoenix, Ariz. 85018

CIRCLE 956 ON READER SERVICE CARD

**free catalog**

**POTTING APPLICATORS**  
 MANUAL OR AIR OPERATED

2 1/2cc 6cc 12cc 30cc  
 FOR POTTING, ENCAPSULATING ETC.

**PHILIP FISHMAN CO., INC.**  
 7 CAMERON ST. WELLESLEY, MASS. 02181

CIRCLE 957 ON READER SERVICE CARD

**EMPLOYMENT OPPORTUNITIES**

Send New Ads to:  
 Electronics  
 Class. Adv. Dept.  
 P.O. Box 900, N.Y., N.Y. 10020

**POSITIONS VACANT**

**Assistant Professor of Electrical Engineering Technology—Immediate appointment.** Successful applicants MSEE, Preferably industrial controls/computer experience, research and promotional interests. To teach associate and bachelor State-of-the-Art Programs at mature 145 year old institution. Reply to John C. Spille, Dean, Ohio College of Applied Science, Cincinnati, Ohio 45210. Equal Opportunity Affirmative Action Employer.

**Positions Available—Electrical & Electronic Eng's.** Over 1000 US client co's pay our fees for selected technical referrals. Est. 1959. Send resume with pres. sal. Atomic Personnel, Inc., Box L, 1518 Walnut St., Phila., Pa. 19102.

**Q. Whom do I contact or call to renew my classified ad or make corrections?**

**A. Write Electronics, Class. Adv. Dept., P.O. Box 900, NY, NY 10020 or call: (212) 997-6585 or 6586. Give full company name, size of ad, & date or dates it is scheduled to appear.**

**Advertising Sales Staff**

**Pierre J. Braudé** [212] 997-3485  
 Advertising Sales Manager

**Atlanta, Ga. 30308:** Joseph Lane  
 100 Colony Square, 1175 Peachtree St., N.E.  
 [404] 892-2868

**Boston, Mass. 02116:** James R. Pierce  
 607 Boylston St. [617] 262-1160

**Chicago, Ill. 60611:**  
 645 North Michigan Avenue  
 Robert W. Bartlett (312) 751-3739  
 Paul L. Reiss (312) 751-3738

**Cleveland, Ohio 44113:** William J. Boyle  
 [716] 586-5040

**Dallas, Texas 75201:** Charles G. Hubbard  
 2001 Bryant Tower, Suite 1070  
 [214] 742-1747

**Denver, Colo. 80202:** Harry B. Doyle, Jr.  
 Tower Bldg., 1700 Broadway  
 [303] 266-3863

**Detroit, Michigan 48202:** Robert W. Bartlett  
 1400 Fisher Bldg.  
 [313] 873-7410

**Houston, Texas 77002:** Charles G. Hubbard  
 2270 Humble Bldg. [713] CA 4-8381

**Los Angeles, Calif. 90010:** Robert J. Rielly  
 Bradley K. Jones, 3200 Wilshire Blvd., South Tower  
 [213] 487-1160

**New York, N.Y. 10020**  
 1221 Avenue of the Americas  
 Warren H. Gardner [212] 997-3617  
 Michael J. Stoller [212] 997-3616

**Philadelphia, Pa. 19102:** Warren H. Gardner  
 Three Parkway,  
 [212] 997-3617

**Pittsburgh, Pa. 15222:** Warren H. Gardner  
 4 Gateway Center, [212] 997-3617

**Rochester, N.Y. 14534:** William J. Boyle  
 9 Greylock Ridge, Pittsford, N.Y.  
 [716] 586-5040

**San Francisco, Calif. 94111:** Don Farris  
 Robert J. Rielly, 425 Battery Street,  
 [415] 362-4600

**Paris:** Alan Offergeld  
 17 Rue-Georges Bizet, 75 Paris 16, France  
 Tel: 720-73-01

**Geneva:** Alan Offergeld  
 1 rue du Temple, Geneva, Switzerland  
 Tel: 32-35-63

**United Kingdom & Scandinavia:** Keith Mantle  
 Tel: 01-493-1451, 34 Dover Street, London W1

**Milan:** Robert Saidei  
 1 via Baracchini, Italy Phone 87-90-656

**Brussels:** Alain Offergeld  
 23 Chaussee de Wavre  
 Brussels 1040, Belgium  
 Tel: 13-73-95

**Frankfurt/Main:** Fritz Krusebecker  
 Liebigstrasse 27c, Germany  
 Phone 72 01 81

**Tokyo:** Tatsumi Katagin, McGraw-Hill  
 Publications Overseas Corporation,  
 Kasumigasaki Building 2-5, 3-chome,  
 Kasumigasaki, Chiyoda-Ku, Tokyo, Japan  
 [581] 9811

**Osaka:** Ryji Kobayashi, McGraw-Hill  
 Publications Overseas Corporation, Kondo  
 Bldg., 163, Umegae-cho Kita-ku, Japan [362] 8771  
 Tokyo, Japan

**Australasia:** Warren E. Ball, ITO Box 5106,  
 Tokyo, Japan

**Business Department**

**Stephen R. Weiss, Manager**  
 [212] 997-2044

**Thomas M. Egan,**  
 Production Manager [212] 997-3140

**Carol Gallagher**  
 Assistant Production Manager [212] 997-2045

**Dorothy Carter,** Contracts and Billings  
 [212] 997-2908

**Frances Vallone,** Reader Service Manager  
 [212] 997-6057

**Electronics Buyers' Guide**

**George F. Werner,** Associate Publisher  
 [212] 997-3139

**Regina Hera,** Directory Manager  
 [212] 997-2544

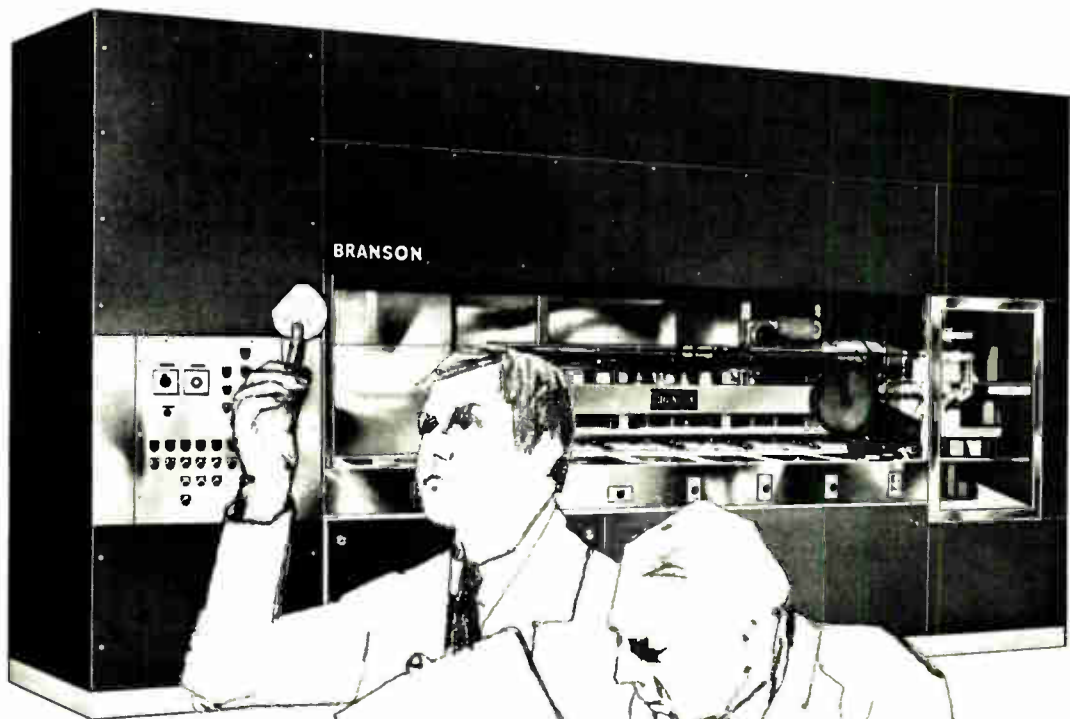

# Production Cleaning Problem?

# Branson Ultrasonics — the Sound Solution



Ultrasonic cleaning is the only way to meet cleaning specifications for semi-conductors or precision mechanisms. You can even clean complete assemblies, with improved yields, and in far less time — making ultrasonics the economical solution. Branson systems, customized from standard modular generators and immersible transducers, pay off in precision, consistency, and efficiency.



Custom Branson Ultrasonic Cleaning Systems are used throughout industry to clean all types of products, such as ring and precision gears; integrated circuits; fuel injector nozzles; printed circuit boards; bearings; electrical devices.



**Cleaning Division**  
Dept. E, Progress Drive  
Stamford, Conn. 06904  
(203) 359-2800

# BRANSON

# Electronics advertisers

February 21, 1974

<b>Abbott Transistor Labs Inc.</b> Technical Adv Agency	6	<b>Fairchild Semiconductor, Inc.</b> Carson/Roberts, Inc. Adv. Division of Ogilvy & Mather, Inc.	18-19	<b>RCL Electronics, Inc.</b> Morvay Advertising Agency	12
<b>Acme Electric</b> Hutchins/Darcy Inc.	28	<b>* Fluke</b> Marsteller	11E-13E	<b>Reticon Corporation</b> Kassler Noble Advertising	41
<b>* Advanced Micro Devices</b> Keye Donna Pearlstein	24E	<b>Fluke Manufacturing Co., John</b> Bonfield Associates	15	<b>Rockland Systems</b> Roll Johnsons, Inc.	14
<b>Advanced Micro Devices</b> Keye/Donna/Pearlstein	10-11	<b>Fuji Electrochemical Co., Ltd.</b> General Advertising Agency, Inc.	145	<b>* Rohde &amp; Schwarz</b>	1E
<b>* AEG Telefunken</b>	17	<b>General Electric Co.,</b> <b>Miniature Lamp Division</b> Carr Liggett Advertising, Inc.	165	<b>Schauer Manufacturing Corp.</b> Nolan, Keeler & Stites	38
<b>Allen Bradley Company</b> Hoffman, York, Baker & Johnson Inc.	24	<b>General Magnetics</b> 3rd Cov McCarthy/Scelba/DeBiasi Adv. Agency, Inc.	7E	<b>S.D.S.A.</b> Public Service	140,152
<b>American Microsystems Inc.</b> Wilton Coombs & Colnett Inc Advertising	156-157	<b>* General Radio</b> Grad Associates	7E	<b>* Siemens Aktiengesellschaft</b> Linder Presse Union GmbH	52
<b>American Power Systems Corp.</b> Eflenson/Nusbaum/Richard/Advertising	146	<b>Gold Inc./Instrument Systems Div.</b> Carr Liggett Adv., Inc.	124-125	<b>Signetics Corp.,</b> <b>Sub. of Corning Glass Works</b> Hall Butler Blatherwick, Inc.	170,170A
<b>American Smelting and Refining Company</b> Clyne Maxon, Inc.	168	<b>Gulf Power Company of Pensacola, Inc.</b> Cargill, Wilson & Acree Inc. Advertising	162	<b>Siliconix</b> Robertson West., Inc.	101
<b>AMP Incorporated</b> Aitkin-Kynett Co., Inc.	118-119	<b>Hansen Mfg., Co.</b> Keller-Crescent Co	126	<b>Simpson Electric Co.</b> Amerad Advertising Services, Inc.	131
<b>Ampenol Industrial Division,</b> <b>Bunker Ramo Corp.</b> Marsteller, Inc.	22-23	<b>Harris Semiconductor</b> Tucker Wayne & Company	43	<b>* SMK Europe</b>	22E
<b>Anzac Electronics</b> Ken Puleo Advertising	168,152	<b>Heath/Schlumberger Scientific Instruments</b> 153-155 Advance Advertising Services	2	<b>* Sodeco</b> PR Service	4E
<b>Augat</b> Creamer, Trowbridge, Case & Basford., Inc.	169	<b>Hewlett-Packard</b> Richardson, Seigle, Rolfs & McCoy, Inc.	136-137	<b>† Sorenson Company A Unit of Raytheon Company</b> 42 Provandie Eastwood & Lombardi, Inc.	113
<b>Avtel Corporation,</b> <b>an Airtronics Subsidiary</b> Herb Grondorf Design & Illustration	150	<b>Hewlett-Packard</b> Richardson, Seigle, Rolfs & McCoy, Inc.	1	<b>Spectrol Electronics Corp.</b> J M R Inc.	8
<b>Branson Instruments Co.</b> Langeler-Stevens Inc.	175	<b>Hewlett-Packard</b> Tallant/Yates Advertising Inc.	78-79	<b>Sprague Electric Company</b> Harry P. Bridge Company	39
<b>The Buckeye Stamping Company</b> Wheeler Knight & Gainey, Inc.	21E	<b>Honeywell Test Instrument Division</b> Campbell Mithun, Inc.	158	<b>Stewart-Warner Microcircuits</b> J M R Advertising	51,140,148
<b>* Burndy</b> Axis Spri	7	<b>Hughes Aircraft Company</b> Footo, Cone & Belding	166	<b>* TEAC Corp.</b> Dentsu Advertising Ltd.	64
<b>Burroughs Corp.</b> Conti Advertising Agency, Inc.	97	<b>Hutson Industries</b> Greene, Webb Associates., Inc.	40	<b>* Tekelec Airtronic</b> S.P.F.D.	23E,9E,16E,18E
<b>California Instruments</b> Manning/Bowen and Associates	164	<b>Interdata</b> Shaw Elliott, Inc.	58-59	<b>Tekelec, Inc.</b> James Bischof & Associates	177
<b>Cambridge Theronic Corporation</b> Chirurg & Cams, Inc.	19E	<b>International Electronic Research Corp.</b> Van Der Boom, McCarron, Inc., Advertising	178	<b>Tektronix Inc.</b> McCann Erickson, Inc.	44-45
<b>* Canon Amsterdam N.V.</b> Euro Advertising B.V.	64-65	<b>International Nickel Company</b> Ogilvy & Mather., Inc.	159	<b>Tektronix-IDD</b> Young & Roehr, Inc.	21,33
<b>† Centralab Electronics Div.,</b> <b>Globe-Union Inc.</b> Action Communicators	13	<b>International Rectifier Corp.,</b> <b>Semiconductor Div.</b> William E. Wilson Company	119	<b>Teledyne Crystallonics</b> S. Gunnar Myrbeck & Company., Inc.	129
<b>Cherry Electrical Products., Corp.</b> Kolb/Tookey and Assoc., Inc.	141	<b>* Invest Export-Import</b> Interwerbung	167	<b>Teledyne Philbrick</b> Ingalls Associates., Inc. Advertising	2nd Cov.
<b>C &amp; K Components</b> Van Christo., Inc.	4th Cov	<b>ITF IEA Exhibition</b> Clements Frankis Powell Ltd.	128	<b>Tempit Ind. Div. of Big Three Ind.</b> Black-Russell-Morns	158
<b>Clalrex Corporation</b> Black-Russell-Morris	122	<b>Ithaco, Inc.</b> Stahlka Faller, Inc.	5	<b>Texas Instruments Inc.</b> <b>Semiconductor Group</b> Tracy-Locke Advertising Inc.	66-67
<b>Custom Electronics., Inc.</b> Laux Advertising, Inc.	77	<b>* Kepco., Inc.</b> Weiss Advertising	164	<b>Thomson-CSF/Dumont</b> Raniere, Saslaw, Mohr and Associates., Inc.	151
<b>Datacraft</b> Resource Marketing, Inc.	142-143	<b>Kyodo Electronic Laboratories., Inc.</b> Sanko Tsushinsha Ltd.	60-61	<b>Town of Framingham</b>	152
<b>Delco Electronics Division,</b> <b>General Motors Corp.</b> Campbell-Ewald Company	20	<b>Lambda Electronics Corp</b> Michel-Cather, Inc.	147	<b>† T.R.I. Corporation</b>	54
<b>Delevan Division,</b> <b>American Precision Industries, Inc.</b> Comstock Advertising., Inc.	163	<b>LICON division Illinois Tool Works Inc.</b> Post Keyes Gardner Inc.	160	<b>TRW, Electronic Components Division</b> The Bowes Company	130
<b>Delta Products, Inc.</b> The William Loughran Company	173	<b>LRC, Inc.</b> Robert J. Allen	171	<b>TRW, Electronics Semiconductor Division</b> The Bowes Company	9
<b>Deutsche Messe AG, Hannover</b> Wilkins WPT	164	<b>Micro Mask, Inc.</b> Kassler/Noble Advertising	76	<b>United Systems Corp.,</b> <b>A sub. of Monsanto Co.</b> Advertising & Merchandising., Inc.	172
<b>Diacon</b> Grant Rogondino Millard, Inc.	138	<b>Micro Power Systems</b> Associated Ad Ventures., Inc.	161	<b>Unitrack Division, Calabro Plastics., Inc.</b> Richard L. Renner Industrial Advertising	141
<b>Dialight Corporation</b> Michel-Cather., Inc.	62-63	<b>Monolithic Memories., Inc.</b> Paul Pease Advertising., Inc.	46-47	<b>Unitrode Corp.</b> Culver Advertising., Inc.	27
<b>Digital Equipment Corporation</b> Creamer, Trowbridge, Case & Basford, Inc.	148	<b>Motorola Semiconductor Products, Inc.</b> E.B. Lane & Associates., Inc.	149	<b>Wavetek San Diego</b> Chapman Michetti Advertising	121
<b>Disc Instruments, Inc.</b> Jansen Associates, Inc.	102	<b>Motorola Timepiece Electronics Unit</b> Bozell & Jacobs, Inc.	132-134	<b>Wima, Westermann</b>	16
<b>Diva., Inc.</b> Hallott & Caine	160	<b>National Semiconductor Corp.</b> Chat/Day, Inc Advertising	141	<b>* Yokogawa Electric Works., Ltd.</b> General Advertising Agency., Inc.	118
<b>Eastman Chemical Products., Inc.,</b> <b>Industrial Chemicals</b> J. Walter Thompson Company	17	<b>* Nippon Electric Co., Ltd.</b> Hakuhodo, Inc.	24E		
<b>† Eastman Kodak Company,</b> <b>Business Systems Markets Div.</b> J. Walter Thompson Company	54	<b>* Nortron</b> Technik Marketing	52		
<b>Economic Development</b> <b>Department (Colorado)</b> Praco., Ltd	149	<b>* Philips N.V. PR/T &amp; M Division</b> Brookies Communications Systems SA	52		
<b>Electroglas, Inc.</b> Roy Minor/Graphic Arts	139	<b>† Plessey Semiconductors</b> Basso/Buechting/Boatman	147		
<b>Electronic Arrays</b> Bonfield Associates	75	<b>* Power/Mate Corporation</b> Spectrum Marketing Associates	170		
<b>Emerson &amp; Cuming., Inc.</b> Edwn F. Hall	48	<b>Procond S.p.A.</b> QUADRAGONO	14E-15E		
<b>Exar Integrated Systems</b> Regis McKenna Inc.	57	<b>* R 2 E</b> Sagha	2E-3E		
<b>Exact Electronics</b> Hugh Dwight Advertising		<b>* RCA Ltd.</b> Marsteller., Ltd.	35,37		

## Classified & Employment Advertising

F. J. Eberle, Manager 212-971-2557

<b>EQUIPMENT (Used or Surplus New) For Sale</b>	
American Used Computer Corp.....	174
Philip Fishman Co.....	174
Jensen Tool & Alloys.....	174
Mountain West Alarm.....	174
Poly Paks.....	174
Radio Research Instrument Co.....	174

For more information on complete product line see advertisement in the latest Electronics Buyer's Guide  
 \* Advertisers in Electronics International  
 † Advertisers in Electronics domestic edition

# At last, it's all perfectly clear!



This new 3½ digit portable DMM is the first and only instrument with function indicators — **all five of them** — built into the long life "Field Effect" Liquid Crystal display!

And it's delivered complete with built-in re-chargeable nickle-cadmium batteries and a separate AC Power Supply/Battery Charger —

**all for only \$269.00!**

And to complete the spectacular new TEKELEC line, there's a 3½ digit **and** a 4½ digit laboratory multimeter! They're complete, too, with all five functions, 25 ranges, pushbutton controls, front panel reading rate controls, and all of the sensitivity you expect from high performance laboratory instruments!

You can make either one into a portable by simply adding optional nickle-cadmium batteries, and the fully isolated parallel BCD option gives you a digital interface to your printer, computer or controller.

And there's even an optional probe that will take — **and hold** — your readings for you!

For all the details on the outstanding quality, reliability, and performance of these new DMMs, just call or write to Dave Froelich at TEKELEC, INC., 31829 W. La Tienda Drive, Westlake Village, California 91361, Tel: (213) 889-2834.

And to see them in person, ask the TEKELEC representative or your local authorized distributor for a demonstration. Then you'll say "get a TEKELEC," too!

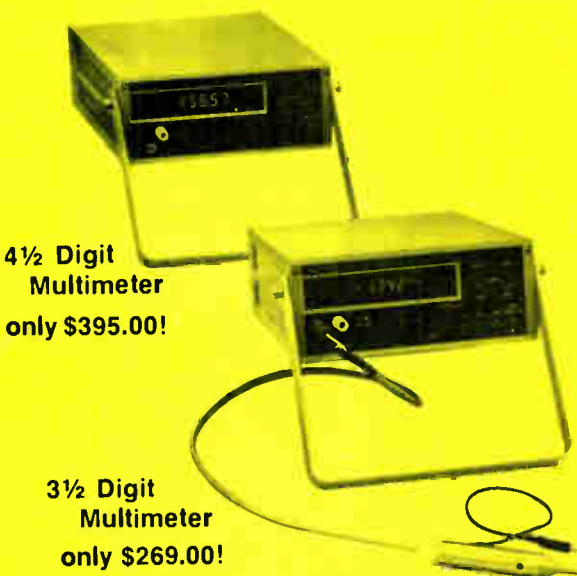

**4½ Digit  
Multimeter  
only \$395.00!**

**3½ Digit  
Multimeter  
only \$269.00!**

**TEKELEC, INC. TA**

# These semiconductor cooling ideas improve circuit performance and reliability, cut costs.

No. 7 of a Series

Engineers use Staggered Finger heat dissipators, Thermal Links, Fan Tops, and other IERC thermal management devices to solve

a wide range of circuit design and packaging problems dealing with power, reliability, switching speeds, circuit density, stability,

reproducibility, and cost. Here are four ideas that may suggest new ways you can put IERC dissipators to work for you.

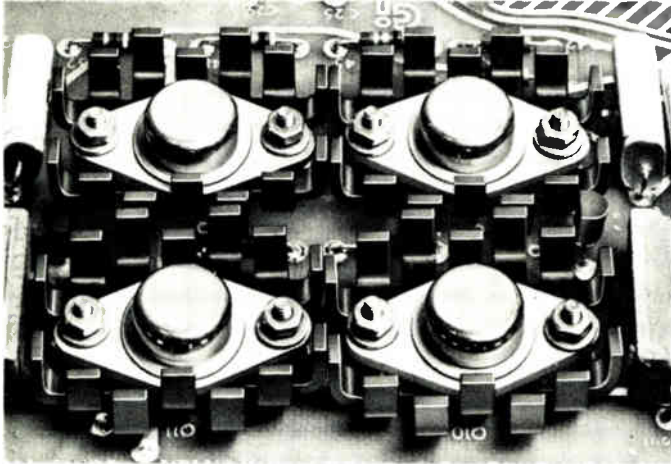

**More power, higher reliability** from the same TO-66s is a paradoxical requirement, but designer met it in this amplifier circuit with I.B. Series Staggered Finger dissipators. Nominal case rise above ambient of 90°C for bare case TO-66s permits 3 watts dissipation per device. Adding LB's doubled transistor life by giving 10°C temperature drop while increasing power to 5.5 watts per device.

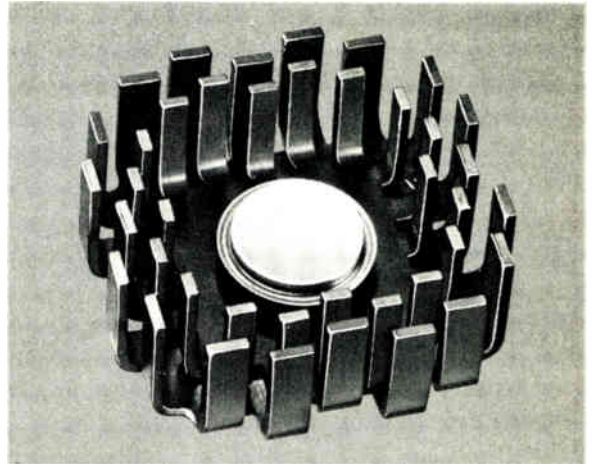

**Design-to-cost** criteria were missed in a touchy servo amplifier because 4 parallel devices required too much testing and matching. Designers went to single TO-6 cooled by nested HP1 and HP3 Staggered Finger dissipators. At 100°C case rise above ambient, the single TO-6 dissipates 36 watts, plenty for the application.

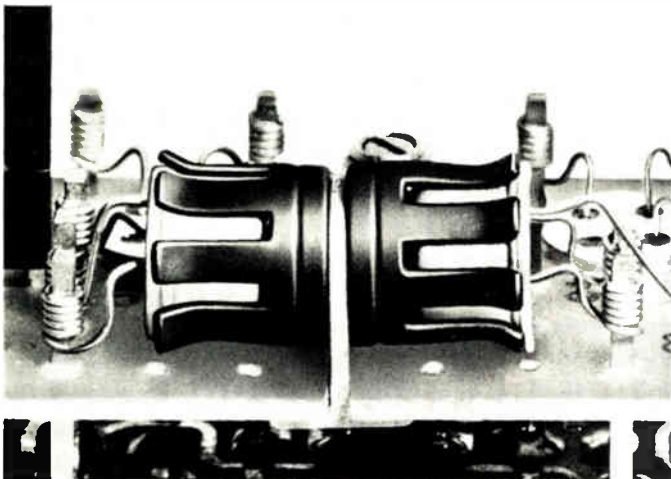

**Erratic flip-flop** in high-G environment posed problem until IERC Thermal Links came to the rescue. Thermal Links held the TO-5s firm, increased their thermal mass, and linked the two cases to a common heat sink. Resulting lowered junction temperature permitted more stable operation and higher reliability while thermal matching assured a balanced circuit.

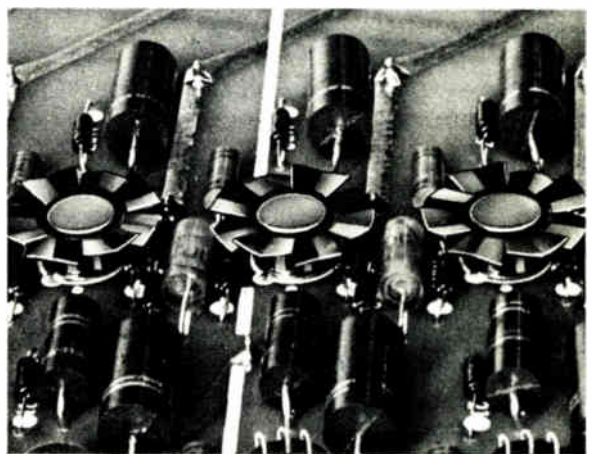

**Faster switching speeds** and lower junction temperatures at the same power levels without spending a bundle was called for after bread board testing of this circuit. Adding IERC Fan Top dissipators to the TO-5s held junction temperatures well below maximums and substantially improved rise and fall times. And the press-on Fan Tops cost just pennies.



#### For more information

on heat sinks and dissipators for milliwatts to kilowatts, send for the IERC Short Form Catalog today. It covers the most complete line of thermal problem solving devices available anywhere.



**Heat Sinks/Dissipators**

INTERNATIONAL ELECTRONIC RESEARCH CORPORATION / A SUBSIDIARY OF DYNAMICS CORPORATION OF AMERICA / 135 WEST MAGNOLIA AVENUE, BURBANK, CALIFORNIA 91502

# Electronics

52430

Please enter my subscription to **ELECTRONICS** for three years at \$18

1.  I prefer one year at \$9  Payment enclosed  
 Bill my company  Bill me

CHARGE MY SUBSCRIPTION TO

<input type="checkbox"/> AMERICAN EXPRESS	<input type="checkbox"/> MASTER CHARGE
<input type="checkbox"/> DINERS CLUB	<input type="checkbox"/> BANKAMERICARD
ACCT NO _____	
DATE CARD EXPIRES _____	
INTERBANK NO _____ 1st No's above name on Mastercharge only	

NAME \_\_\_\_\_ TITLE \_\_\_\_\_  
 COMPANY \_\_\_\_\_ DIV. or DEPT \_\_\_\_\_  
 COMPANY ADDRESS \_\_\_\_\_  
 CITY \_\_\_\_\_ STATE \_\_\_\_\_ ZIP \_\_\_\_\_  
 Check here if you wish publication to be sent to home address  
 STREET \_\_\_\_\_ CITY \_\_\_\_\_ STATE \_\_\_\_\_ ZIP \_\_\_\_\_

Above rates apply only to those who answer all questions listed below. All others pay higher than basic price of \$25.00 per year.

Signature \_\_\_\_\_

2.  1 PLANT  2 DEPARTMENT Indicate the primary product manufactured or service performed at your plant (Box 1) and in your department (Box 2). Be sure to indicate applicable letter in each of the two boxes even if they are the same letter.

- |   |  |  |
|---|--|--|
| A. Large computers  | K. Industrial controls, systems and equipment                        | U. Research and development organizations which are a part of an educational institution                                 |
| B. Mini-computers   | L. Sub-assemblies  | V. Government Agency and military  |
| C. Computer peripheral equipment                                    | M. Passive electronic components                                     | W. Industrial companies using and/or incorporating electronic products in their mfg., research or development activities |
| D. Data Processing Systems (systems integration)                    | N. Active electronic components                                      | X. Utilities   |
| E. Office and business machines                                     | O. Materials and Hardware  | Y. Broadcasting, sound and motion pictures and recording studios   |
| F. Test and measuring equipment                                     | P. Aircraft, Missiles, space and ground support equipment            | Z. Commercial users of electronic equipment (railroads, pipelines, police, airlines)                                     |
| G. Communications systems and equipment                             | Q. Oceanography and support equipment                                | 9. College, University   |
| H. Navigation and guidance or control systems                       | R. Medical electronics   |  |
| I. Consumer entertainment electronic equipment                      | S. Industrial equipment containing electronic components or products |  |
| J. Other consumer electronic equip. (appliances, autos, hand tools) | T. Independent R&D laboratory and consultant                         |  |

3.  Indicate your principal job function (place applicable number in box. If numbers 9, 10, or 11 are used, fill in name of college or university)
- General and corporate management
  - Design and development engineering
  - Engineering services (evaluation, quality control, reliability, standards, test)
  - Basic research
  - Manufacturing and production
  - Engineering support (lab assistant, technician)
  - Purchasing and procurement
  - Marketing and sales
  - Professor at \_\_\_\_\_
  - Senior student at \_\_\_\_\_
  - Graduate student at \_\_\_\_\_

4.  Indicate your principal job responsibility (place applicable number in box)
- Management
  - Engineering

5. Are you engaged in or do you supervise the design or redesign of electronic components or equipment? (check one)

YES  NO

6. Estimated number of employees at this location. (check one)
- 1 to 49  50 to 249  250 to 999  over 1,000

FIRST CLASS  
PERMIT No. 42  
HIGHTSTOWN, N.J.

---

# **BUSINESS REPLY MAIL**

NO POSTAGE STAMP NECESSARY IF MAILED IN U.S.

---

Postage will be paid by

**Electronics**

McGRAW-HILL, INC.  
SUBSCRIPTION DEPT.  
P.O. BOX 514  
HIGHTSTOWN, N.J. 08520

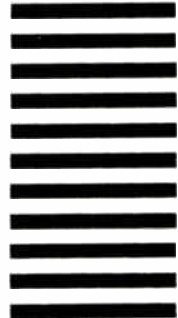





If the cards below have already been used, you may obtain the needed information by writing directly to the manufacturer, or by sending your name and address, plus the Reader Service number, to Electronics Reader Service Department, Box 2530, Clinton, Iowa 52732.

First Class  
Permit No. 217  
Clinton, Iowa

**BUSINESS REPLY MAIL**

No Postage Stamp Necessary if Mailed in the United States

Postage will be paid by

**Electronics**

P.O. Box No. 2530  
Clinton, Iowa 52732

First Class  
Permit No. 217  
Clinton, Iowa

**BUSINESS REPLY MAIL**

No Postage Stamp Necessary if Mailed in the United States

Postage will be paid by

**Electronics**

P.O. Box No. 2530  
Clinton, Iowa 52732

**Electronics Reprint Service**

Bulk reprints of editorial matter can be ordered from current or past issues. The minimum quantity is 500 copies. Price quoted on request: call 609-448-1701 Ext. 5494, or write to address below

**U.S. Market Report**

28 pages \$2.00  
Key R-404

**European Market Report 1974**

24 pages \$2.00  
Key R-402

**Japan Market Report 1974**

18 pages \$2.00  
Key R-400

**The Pervasiveness of Electronics**

Complete issue 284 pages \$2.00  
Key no. R-328

**The Optical Spectrum**

\$2.00 Key no. R-326

**Semiconductor Memory Systems**

16 pages \$3.00 Key no. R-324

**New Electronic Displays**

10 pages \$2.00 Key no. R-322

**Planar Interconnection Techniques**

13 pages \$3.00 Key no. R-320

**Automotive Electronics**

16 pages \$3.00 Key no. R-318

**Hybrid Circuit Technology**

16 pages \$3.00 Key no. R-316

**Leadless, Pluggable IC Packages**

Reduce Costs 7 pages \$2.00  
Key no. R-312

**Penetration Color Tubes are Enhancing**

Information Displays 6 pages \$2.00  
Key no. R-310

**Program for Transition from Non Linear**

to Linear Transistor Model  
6 pages \$2.00 Key no. R-308

**Charge Coupling Improves Its Image**

8 pages \$2.00 Key no. R-306

**Electromagnetic Spectrum Chart**

Key no. R-213 \$2.00

**Electromagnetic Spectrum Report**

16 pages plus Wall Chart \$4.00  
Key no. R-211

**Semiconductor Rams Mature**

15 pages \$2.00 Key no. R-209

**Computer Peripherals**

16 pages \$3.00 Key no. R-207

**Active Filters**

96 pages \$4.00 Key no. R-032

**Circuit Designer's Casebook**

162 pages \$4.00 Key no. R-031

To order reprints or for further information, please write to:

**Electronics Reprint Department**  
P.O. Box 669  
Hightstown, N.J. 08520

Only orders with cash, check, or money order will be accepted. No invoicing will be done.

## 3 WIRE SYNCHRO TO LINEAR D.C. CONVERTER

ACCURACY 1/2 %



#MAC 1422-1

Provides a linear conversion of a synchro angle to a DC Voltage

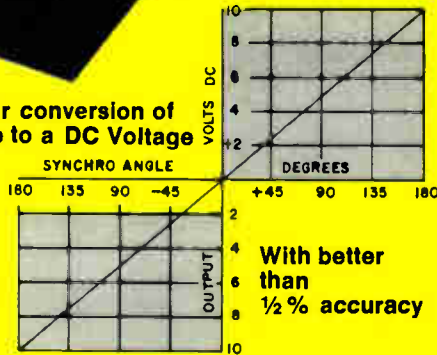

### Specifications

Accuracy:  $\pm 1\%$  over temperature range  
 Input: 11.8V, 400 HZ line to line 3 wire synchro voltage  
 Output Impedance: less than 10 Ohms  
 Input Impedance: 10K minimum line to line  
 Reference: 26V  $\pm 10\%$  400HZ (Unit can be altered to accommodate 115V if available at no extra cost)  
 Operating temp. range:  $-25^{\circ}\text{C}$  to  $+85^{\circ}\text{C}$   
 Storage temp. range:  $-55^{\circ}\text{C}$  to  $+100^{\circ}\text{C}$   
 DC power:  $\pm 15\text{V} \pm 1\%$  @ 75ma (approx.)  
 Case material: High permeability Nickel Alloy  
 Weight: 6 Ozs. Size: 3.6" x 2.5" x 0.6"

## SOLID STATE SINE-COSINE SYNCHRO CONVERTER - NON VARIANT

This new encapsulated circuit converts a 3 wire synchro input to a pair of dc outputs proportional to the sine and cosine of the synchro angle independent of a-c line fluctuations.

- Complete solid state construction.
- Operates over a wide temperature range.
- Independent of reference line fluctuations.
- Conversion accuracy — 6 minutes.
- Reference and synchro inputs isolated from ground.

### Specifications Model DMD 1508-2

Accuracy: Overall conversion accuracy 6 minutes. Absolute value of sine and cosine outputs accurate to  $\pm 30\text{MV}$   
 Temperature Range:  
 Operating  $-40^{\circ}\text{C}$  to  $+85^{\circ}\text{C}$   
 Storage  $-55^{\circ}\text{C}$  to  $+125^{\circ}\text{C}$   
 Synchro Input: 90V RMS  $\pm 5\%$  LL 400Hz  $\pm 5\%$   
 DC Power:  $\pm 15\text{V DC} \pm 10\%$  @ 50MA  
 Reference: 115VRMS  $\pm 5\%$  400Hz  $\pm 5\%$   
 Output: 10V DC full scale output on either channel @ 5ma load  
 Temperature coefficient of accuracy:  
 $\pm 15$  seconds/ $^{\circ}\text{C}$  avg. on conversion accuracy  
 $\pm 1$  MV/ $^{\circ}\text{C}$  on absolute output voltages  
 Size: 2.0" x 1.5" x 2.5"  
 Units are available with wider temperature ranges and 11.8V LL, 26V reference synchro inputs. Information will be supplied upon request.

## A.C. LINE REGULATION

A new method has been developed which allows us to provide a low distortion highly regulated AC waveform without using tuned circuits or solid state active filters of any kind.

The result is a frequency independent AC output regulated to 0.1% for line and load with greater than 20% line variations over a wide temperature range.

### Features:

- 0.1% total line and load regulation
- Independent of  $\pm 20\%$  frequency fluctuation..
- 1 watt output
- Extremely small size
- Isolation between input and output

Specifications: Model MLR 1476-1  
 AC Line Voltage: 26V  $\pm 20\%$  @ 400Hz  $\pm 20\%$   
 Output: 26V  $\pm 1\%$  for set point  
 Load: 0 to 40ma  
 Total Regulation:  $+0.1\%$   
 Distortion: 0.5% maximum rms  
 Temperature Range:  $-55^{\circ}\text{C}$  to  $+125^{\circ}\text{C}$   
 Size: 2.0" x 1.8" x 0.5"

Other units are available at different power and voltage levels as well as wider temperature ranges. Information will be furnished upon request.

## 4 QUADRANT MAGNETIC ANALOG MULTIPLIER DC x DC = DC OUTPUT

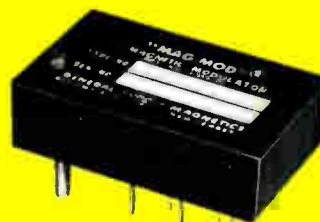

#MCM 1478-1

### Specifications Include:

Transfer Equation:  $E = XY/10$   
 X & Y Input Signal Ranges: 0 to  $\pm 10\text{V peak}$   
 Maximum Static and Dynamic Product Error:  $\frac{1}{2}\%$  of point or 2MV, whichever is greater, over entire temperature range  
 Input Impedance: X = 10K, Y = 10K  
 Full Scale Output:  $\pm 10\text{V peak}$   
 Minimum Load for Full Scale Output: 2000 ohms  
 Output Impedance: Less than 10 ohms  
 Bandwidth: 1000Hz  
 DC Power:  $\pm 15\text{V}$ , unless otherwise required, at 20ma  
 Size: 1.3" x 1.8" x 0.5"  
 Output is short circuit protected

Product Accuracy is  $\pm \frac{1}{2}\%$  of all theoretical product output readings over Full Temperature Range of  $-55^{\circ}\text{C}$  to  $+125^{\circ}\text{C}$ .

Maximum Output Error for Either

X = 0, Y = 10V

Y = 0, X = 10V

X = 0, Y = 0

would be  $\pm 2$  MV over Entire Temperature Range.

There is No Substitute for Reliability



**GENERAL MAGNETICS • INC**

135 Bloomfield Ave., Bloomfield, New Jersey 07003 - Tel. (201) 743-2700

Circle 901 on reader service card



# Photo-Darlington

**Clairex makes exactly what you need**

When you need high sensitivity at extremely low illumination levels, use Clairex Photo-Darlington. As a matter of fact, Clairex can offer you the right solution to any of your "light" problems because Clairex specializes in all opto-electronic components—

Photo-Darlington ... Photo-Transistors ...  
Photo-Conductors ... Opto-Isolators ...  
We make them all!

Call (914) 664-6602 or write Clairex®  
560 South Third Avenue, Mount Vernon,  
New York, 10550.

## CLAIREX ELECTRONICS

A DIVISION OF CLAIREX CORPORATION



