

- 78 Highlights of the Electron Devices meeting
- 103 Thermal design, Part 3: cooling power semiconductors
- 121 Digital IC models for computer-aided design: Part 1

Electronics®

EVERY MAN'S
DIGITAL METER



1420 080120 AEC47 MAY76
 CS OSBORNE JR
 1202 W AVENUE H11
 LANCASTER CA 93534

Patstone Writes.

Digitizing dynamic data.

Did you ever consider that *aperture time* and *sampling rate* may not, depending upon the application, be directly related? That they may be separate considerations to the designer converting dynamic analog data into a digital format? Well, they may not necessarily go together, but there is no doubt that they are the two most basic pieces of information required in data conversion system designs. Let me explain.

Know your frequency.

First, it is extremely important that the designer know the highest frequency component of the dynamic waveform to be digitized, since if you sample the data at less than twice the frequency of the highest signal component you build into the digitized data a non-recoverable low-frequency component; i.e. you will alias your data as shown. Thus, the frequency spectrum of the data to be sampled puts a lower limit on *sampling rate*.

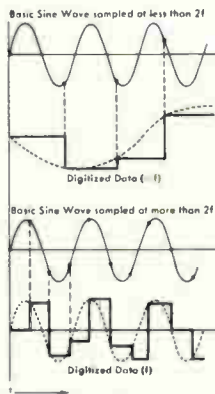

Know your accuracy.

Next it is essential to know the accuracy required of the total conversion system, often specified in percentages of full scale or in numbers of bits. Tying accuracy with the idea of the dynamics of the wave form itself, it should be evident that you only have a limited period of time to convert the data. If during this *aperture time* the signal moves more than the allowable amount, you're in trouble. Since the slope of a sine wave is maximum when it passes through zero, a sampling window at this zero-crossing point produces the greatest sampling error and the formula shown below clearly indicates that the error voltage as a percentage of full scale is proportional to the product of the

frequency and aperture time (Δt).

$$\text{Percentage Error} = \frac{\Delta V}{A} = 2\pi f \Delta t$$

Where ΔV = Aperture Time Error
 A = Maximum Signal Amplitude
 f = Maximum Signal Frequency
 Δt = Aperture Time

So, given a certain percentage, the higher the signal frequency, the smaller the allowable time window to freeze the data.

Know your application.

In many applications the conversion time of general purpose ADC's will produce insignificant aperture time errors. However, in more demanding applications that require high speed data conversion, high signal frequencies force window times to nanosecond levels, where two distinctively different solutions to conversion problems are possible. You can use a very high-speed Analog-to-Digital Converter to freeze the data accurately just because of the very short conversion time of such devices. Unfortunately, they are damn expensive! Alternately, you can use a high-speed sample-and-hold amplifier with a low aperture time, holding the data long enough to permit a slower ADC to perform the conversion.

For many applications this combination of high-speed sample-and-hold and moderate-speed ADC represents the best price performance trade-off.

Know your hardware.

The Philbrick Model 4853 sample-and-hold amplifier is designed for very high-speed data conversion systems with 12 bit accuracy.

With state-of-the-art performance features, such as 10 nanoseconds maximum aperture time and ± 1 nanosecond aperture time uncertainty, the 4853 is also ideal for display DAC deglitch circuits, fast peak and valley detectors, precision one-shot pulse recorders, fast-response automatic gain-ranging systems, etc.

If you don't know, ask.

If there's a question you have about digitizing dynamic data. Or, if you're faced with a particularly difficult problem. Telephone, toll-free (800) 225-7883, in Mass. (617) 329-1600. Or write us, Dedham, Mass. 02026. In Europe, Tel. 73.99.88, Telex: 25881. Or write, 1170 Brussels, Belgium.

 **TELEDYNE
PHILBRICK**

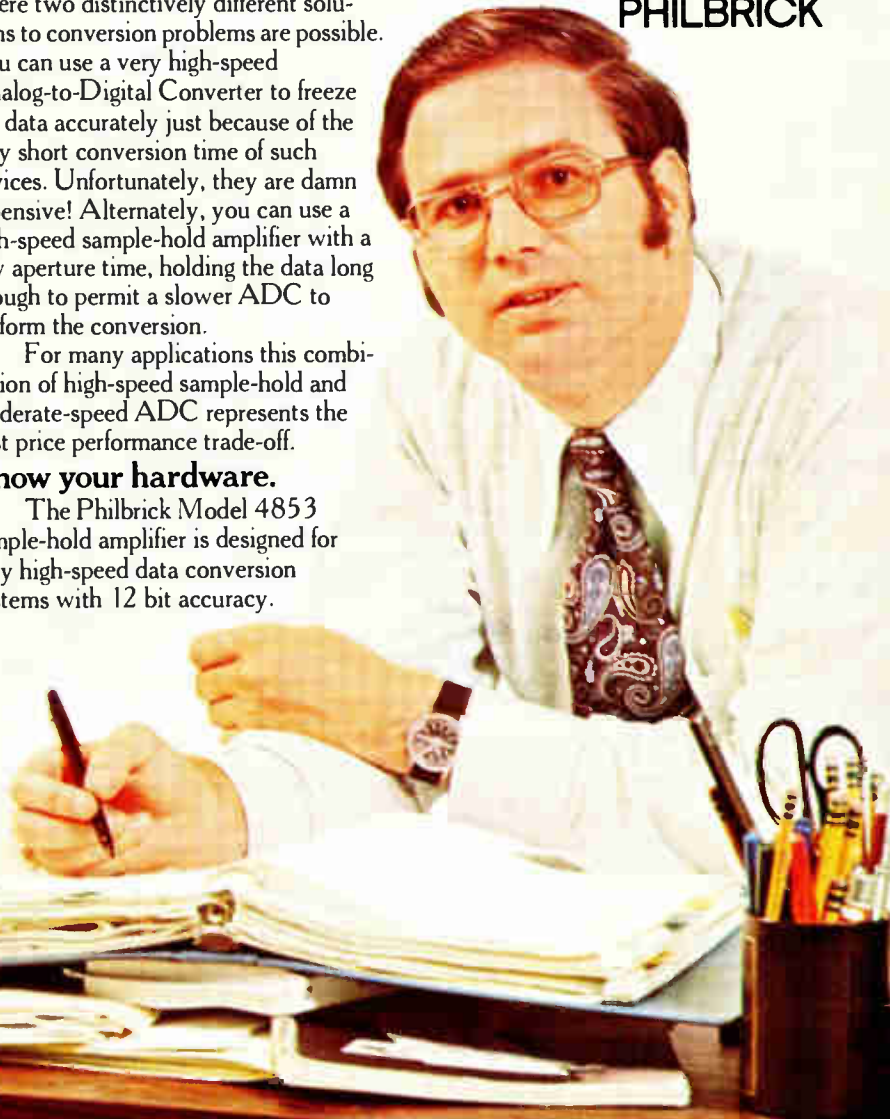

Walter Patstone
Product Manager

When you're number one you'd better deliver.

The 18 GHz Autohet Counter. Right Now.



Autohet isn't just a fast-talking operation. We can deliver. Take a look at the figures: Our automated heterodyning unit allows the correct frequency to be displayed (20 Hz to 18 GHz) in a fraction of a second. What could have taken you five minutes to determine, now appears in milliseconds without requiring you to interpret the gate time or the decimal point. And your result is infinitely easier to read. Readout appears in 11 digits instead of the 6 or 8 you've been used to.

We deliver FM tolerance.

Because we chose to automate the heterodyne method instead of the transfer oscillator approach, the Autohet counter can measure

correctly in the presence of large amounts of frequency modulation, and take 10 MHz peak-to-peak deviation at any modulation frequency, in the worst case. And in the best case, it's over 130 MHz deviation.

Nobody else can approach our FM performance and our two-week delivery, but that's what you'd expect from a company that's been the industry leader as long as we have.

We can save you more than time. We can save you almost \$2,000 compared to a manual counter with heterodyne converters. And we're cheaper than automatic transfer oscillator counters. Interested in a counter this fast, this reasonable? Then give a quick collect call to Bob Mangold at (408) 244-7975.



3130 Alfred Street.
Santa Clara, Ca. 95050

Others measure by us.

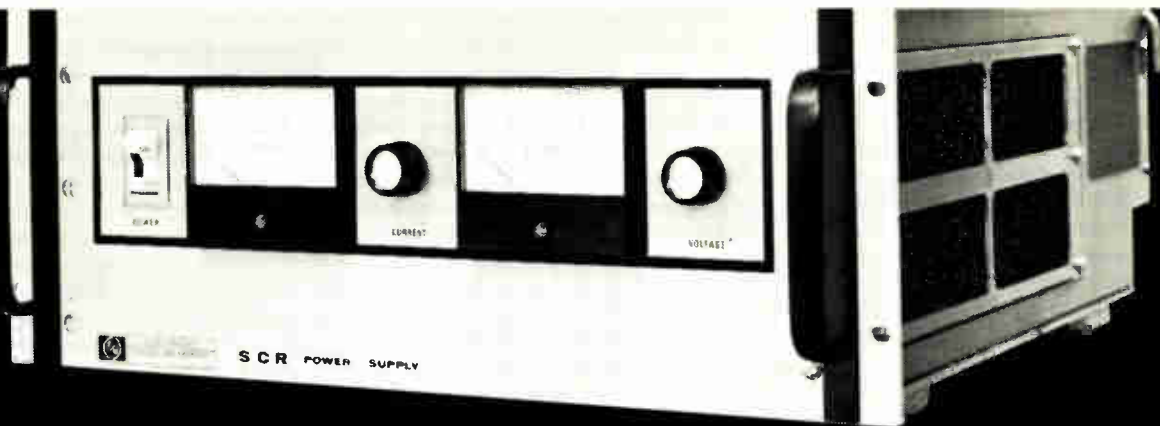

POWER SUPPLIES

Electronic Measurements has designed and built many power supplies to solve a wide range of applications. Design reliability has been field proven since 1968. We have a wealth of application experience, and the flexibility to help solve your power supply problems. Call us.

The table shows the 0.1%-regulation SCR models and 1%-regulation EM models, but Electronic Measurements has a full line, bench-type and modular, with single and multiple outputs, from 5V to 500V and from 2.5A to 650A.

And there's more: remote sensing and programming, automatic E/I crossover, stability within 0.05%, full overload protection, rugged construction that's easy to service, and a five-year guarantee.

In Power Supplies, the best is Engineer Power, from Electronic Measurements. For a short-form catalog, use the Reader Service card, or contact Electronic Measurements.

Rating	Price		Rating	Price		Rating	Price	
	EM	SCR		EM	SCR		EM	SCR
6V-600A	\$1,600	\$2,000	40V-125A	\$1,300	\$1,600	160V-15A	\$ 950	\$1,100
7.5V-300A	1,200	1,400	40V-250A	1,975	2,500	160V-30A	1,300	1,600
10V-250A	1,200	1,400	50V-200A	1,975	2,500	160V-60A	1,975	2,500
10V-500A	1,600	2,000	80V-30A	950	1,110	250V-10A	950	1,100
20V-125A	1,050	1,200	80V-60A	1,200	1,500	250V-20A	1,300	1,600
20V-250A	1,275	1,500	100V-100A	1,975	2,500	250V-40A	1,975	2,500
20V-500A	2,050	2,650	120V-20A	975	1,300	500V-5A	1,300	1,500
30V-100A	1,050	1,200	120V-40A	1,200	1,500	500V-10A	1,600	2,000
30V-200A	1,450	1,800						
40V-60A	950	1,100						

19" Rack, 20" depth. Voltage and current adjustable over wide range.

See EEM Vol. 1, Pages 791, 792, 793 for additional product information.



ELECTRONIC MEASUREMENTS INC.

405 Essex Road, Neptune, N. J. 07753

Phone: (New Jersey) 201 - 922-9300 • (Toll-Free) 800 - 631-4298

Specialists in Power Conversion Equipment

39 Electronics review

COMPUTERS: Microcomputer uses SOS technology, 39
SOLID STATE: CAD IC trimmer is fast, precise, cheap, 40
GaAs MIS FET is made in Japan, 40
COMPONENTS: New tube is half solid-state, 41
TRADE: Sony weighs expanding in North America, 42
Hogan presses for semiconductor sales to Communists, 44
COMMUNICATIONS: Value-added networks start to move, 44
INSTRUMENTS: H-P sets sights on a universal tester, 46
NEWS BRIEFS: 48
CONSUMER ELECTRONICS: IC replaces a TV power transistor, 51
DISPLAYS: Multicolor display uses laser beams, 51

62 Electronics International

JAPAN: Sony uses gas discharge for flat-TV prototype, 62
WEST GERMANY: Transistor chips attain uhf levels, 62
THE NETHERLANDS: Charge-coupled device hits megahertz speeds, 63

75 Probing the News

YOU AND YOUR CAREER: IEEE engineers a job report, 75
SOLID STATE: Electron Device Meeting previews 1974, 78
COMMERCIAL ELECTRONICS: 'Tis the shoplifting season, 82
DISPLAYS: Electrochromics glow on horizon, 87

99 Technical Articles

INSTRUMENTS: C-MOS teams with liquid crystals in digital VOM, 99
PACKAGING: Analysis can take the heat off power semiconductors, 103
DESIGNER'S CASEBOOK: Boosting regulator output current, 112
All-digital phase shifter handles 5-to-1 bandwidth, 113
Voltage discriminator has 0.1-mV resolution, 114
SOLID STATE: Versatile Norton quad amplifier reduces costs, 116
CIRCUIT DESIGN: Simulating TTL NAND gates for CAD, 121
Microstrip matching networks can be designed fast in Basic, 127
ENGINEER'S NOTEBOOK: Building your own digital voltmeter, 132
Increasing voltmeter input impedance to 10^{12} ohms, 133
Getting the most out of the digital multimeter, 134

145 New Products

IN THE SPOTLIGHT: Digital meters in wide variety hit market, 145
ECL, TTL get together on same board, 149
INSTRUMENTS: Spectrum analyzer has 100-decibel range, 151
COMPONENTS: Process protects chip capacitors, 159
SEMICONDUCTORS: Huge SCR handles 2,500 amperes, 164
DATA HANDLING: Circuit-analysis program eases design task, 172
PACKAGING & PRODUCTION: Boards handle all ECL circuits, 182
MATERIALS: 194

Departments

Publisher's letter, 4
Readers comment, 6
40 years ago, 8
Editorial, 11
People, 14
Meetings, 30
Electronics newsletter, 35
Washington newsletter, 59
Washington commentary, 60
International newsletter, 65
Engineer's newsletter, 136
New literature, 196
New books, 200

Highlights

The cover: A workaday digital VOM, 99

A digital volt-ohm-milliammeter, by using a liquid-crystal display that runs off a 6-volt power supply, achieves year-long battery life. Built around a C-MOS logic chip and a bipolar analog chip, the instrument also rivals analog VOMs in price and reliability. Cover is by Art Director Fred Sklenar.

IEEE reports on the job situation, 75

An engineering-style analysis of the engineer's changing job status provides new and concrete information on industry requirements, the manpower picture, careers, and personality factors.

How to keep power semiconductors cool, 103

The right choice of heat sink and mounting technique for a power semiconductor requires a systematic thermal analysis but pays off in reduced failure rates. This is the third in *Electronics'* series on thermal design.

Computer easily models NAND gate's function, 121

Computer models that treat digital ICs as black boxes instead of complex collections of components greatly simplify the computer-aided analysis of a system. NAND gates are covered first in this five-part series entitled "Digital-IC models for computer-aided design."

And in the next issue . . .

Electronics' annual survey of the European market . . . a computer model for flip-flops

Electron Devices meeting coverage

Reports on the International Electron Devices Meeting can be found on pages 40-41, 62-63, and 78-80.

EDITOR-IN-CHIEF: Kemp Anderson

EXECUTIVE EDITOR: Samuel Weber

MANAGING EDITORS: Lawrence Curran, *News*;
Arthur Erikson, *International*

SENIOR EDITORS: John Johnsrud,
H. Thomas Maguire, Laurence Altman
Ray Connolly

ART DIRECTOR: Fred Sklenar

ASSOCIATE EDITORS: John N. Kessler,
Howard Wolff, Gerald M. Walker

DEPARTMENT EDITORS

Aerospace: William F. Arnold

Circuit Design: Lucinda Matterna

Communications & Microwave:

Lyman J. Hardeman

Components: Joel DuBow

Computers: Wallace B. Riley

Consumer: Gerald M. Walker

Industrial: Alfred Rosenblatt

Instrumentation: Michael J. Riezenman

Military: Ray Connolly

New Products: H. Thomas Maguire

Packaging & Production: Stephen E. Grossman

Solid State: Laurence Altman

Special Issues: Harry R. Karp

COPY EDITORS: Margaret Eastman,
Everett C. Terry

ASSISTANT EDITOR: Marilyn Offenheiser

ART: Charles D. Ciatto, *Associate Director*
Patricia Cybulski, *Assistant Director*

PRODUCTION EDITOR: Arthur C. Miller

EDITORIAL SECRETARIES: Janet Annunziata,
Julie Gorgoglione, Penny Roberts

FIELD EDITORS

Boston: Gail Farrell

Los Angeles: Paul Franson (Mgr.)

Midwest: Larry Armstrong (Mgr.)

New York: Alfred Rosenblatt (Mgr.)

San Francisco: George Sideris (Mgr.)

Judith Curtis

Washington: Ray Connolly (Mgr.)

William F. Arnold

Frankfurt: John Gosch

London: Michael Payne

Paris: Arthur Erikson

Tokyo: Charles Cohen

McGRAW-HILL WORLD NEWS

Director: Walter A. Stanbury

Bonn: Robert Ingersoll;

Brussels: James Smith;

London: Marvin Petal;

Milan: Peter Hoffmann, Andrew Heath;

Moscow: Axel Krause;

Paris: Michael Johnson, Richard Shepherd;

Stockholm: Robert Skole;

Tokyo: Mike Mealey

PUBLISHER: Dan McMillan

ADVERTISING SALES MANAGER: Pierre J. Braudé

ADVERTISING SALES SERVICE MANAGER:
Wallis Clarke

BUSINESS MANAGER: Stephen R. Weiss

CIRCULATION MANAGER: George F. Werner

MARKETING SERVICES MANAGER:
Tomlinson Howland

A technical editor's dream—that's what executive editor Sam Weber calls the two big annual leading-edge-of-technology meetings: the current International Electron Devices Meeting and the International Solid State Circuits Conference held early in the year.

"When these two meetings are on," says Weber, "we can concentrate our energies, going to where the innovators are gathered and where the technological trends stand out in bold relief. Besides, so many of the steps in the advancement of electronics show up at these meetings. For example, for the past two or three years the meetings have been heavy with CCD and MOS developments that are now turning up in products."

We've prepared wide-ranging coverage of the Electron Devices meeting. In our Probing the News department, we've gathered together a host of the major developments presented at the meeting (see p. 78). You'll also find items from the meeting in the Electronics Review section, starting on page 39, and in the Electronics International section, starting on page 62.

As usual, we sent a team of reporters and editors to the meeting. Their coverage will show up in future issues as we bring you further up-to-minute news stories, in-depth trend analyses, and detailed technical articles.

When Sony Corp's president Akio Morita (at right in photo above) arrived in Washington last month to deliver an invited lecture on industrial creativity at the Smithsonian Institution, the event provided bureau manager Ray Connolly (left)



an opportunity for useful conversation with the industrialist (see p. 42).

As part of the on-going story of Japan's expansion in the world's electronics markets, and of Sony's success in particular, Morita put heavy stress on the importance of marketing—as did Sony co-founder and chairman Masaru Ibuka before the IEEE of Canada in Toronto recently [*Electronics*, Nov. 22, p. 50].

In one of his lighter moments, Morita told Connolly about how Sony became the company's name. "The story," says Connolly, "sounds too funny to be true. First, the name had to sound the same in most languages. Second, it had to be short and easy to remember. Three initials were ruled out because there were already too many used.

"Going to four letters was the next logical step," according to Morita, who told of reading many dictionaries before finding words like 'sound' and 'sonic.' Then, he discovered the song title 'Sonny Boy.' That led him to the name Sony because 'we were the sonny boys of our industry.'"

December 6, 1973 Volume 46, Number 25

92,498 copies of this issue printed

Published every other Thursday by McGraw-Hill, Inc. Founder: James H. McGraw 1860-1948. Publication office 1221 Avenue of the Americas, N.Y., N.Y. 10020; second class postage paid at New York, N.Y., and additional mailing offices.

Executive, editorial, circulation and advertising addresses: Electronics, McGraw-Hill Building, 1221 Avenue of the Americas, New York, N.Y. 10020. Telephone (212) 997-1221. Teletype TWX N.Y. 710-581-5234. Cable address: MCGRAWHILL LN. Y.

Subscriptions limited to persons with active, professional, functional responsibility in electronics technology. Publisher reserves the right to reject non-qualified requests. No subscriptions accepted without complete identification of subscriber name, title, or job function, company or organization, including product manufactured or services performed. Subscription rates: qualified subscribers in the United States and possessions, Canada, and Mexico \$8.00 one year, \$12.00 two years, \$16.00 three years; all other countries \$25.00 per year, except Japan \$50.00 per year and Brazil \$40.00 per year, including air freight. Limited quota of subscriptions available at higher-than-basic rate for persons outside of field served, as follows: U.S. and possessions and Canada, \$25.00 one year; all other countries \$50.00. Single copies: United States and possessions and Canada, 1.00; all other countries, \$1.75.

Officers of the McGraw-Hill Publications Company: John R. Emeny, President; J. Elton Tuohig, Executive Vice President-Administration; Gene W. Simpson, Group Publisher-Vice President; Senior Vice Presidents: Ralph Blackburn, Circulation; Walter A. Stanbury, Editorial; John B. Hoglund, Controller; David G. Jensen, Manufacturing; Gordon L. Jones, Marketing; Jerome D. Luntz, Planning & Development.

Officers of the Corporation: Shelton Fisher, President; Wallace F. Trendley, Group President, McGraw-Hill Publications Company and McGraw-Hill Information Systems Company; John J. Cooke, Senior Vice President and Secretary; Ralph J. Webb, Treasurer.

Title registered in U.S. Patent Office; Copyright © 1973 by McGraw-Hill, Inc. All rights reserved. The contents of this publication may not be reproduced either in whole or in part without the consent of copyright owner.

Subscribers: The publisher, upon written request to our New York office from any subscriber, agrees to refund that part of the subscription price applying to copies not yet mailed. Please send change of address notices or complaints to Fulfillment Manager; subscription orders to Circulation Manager, Electronics, at address below. Change of address notices should provide old as well as new address, including postal zip code number. If possible, attach address label from recent issue. Allow one month for change to become effective.

Postmaster: Please send form 3579 to Fulfillment Manager, Electronics, P.O. Box 430, Hightstown, N.J. 08520.

4 filters in 1

Model 3202 offers two independent low-pass or high-pass channels or single channel band-pass or band-reject from 20 Hz to 2 MHz.

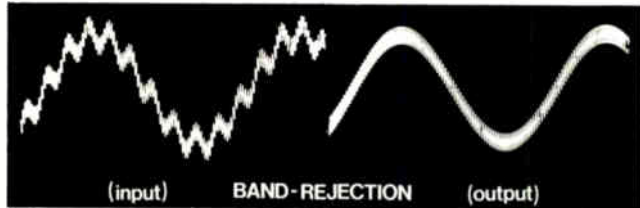
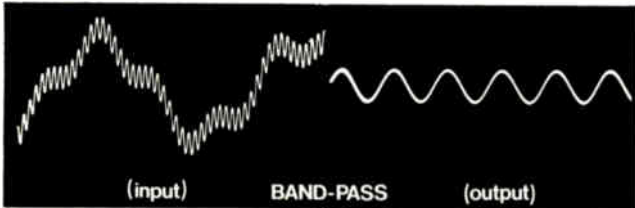
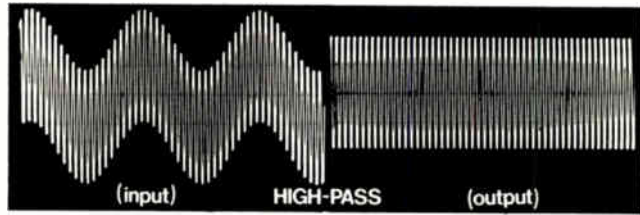
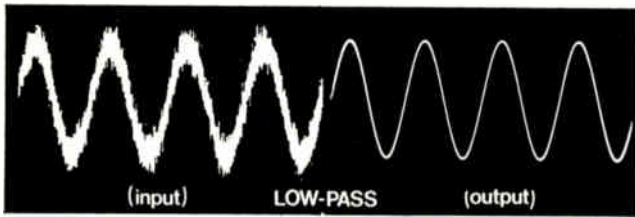

For only \$795, Model 3202 provides the flexibility essential for complex frequency or time domain measurements.

FUNCTIONS: Low-pass — direct coupled with low drift.

High-pass — upper 3 dB at 10 MHz. Band-pass — continuously variable. Band-rejection — variable broad band or sharp null.

TWO RESPONSE CHARACTERISTICS: (1) Fourth-order Butterworth or (2) simple R-C (transient free).

ZERO-dB INSERTION LOSS: All-silicon amplifiers provide unity gain passband response. 24 dB per octave slopes per channel extend to at least 80 dB.

90-dB DYNAMIC RANGE: Low hum and noise (less than 100 microvolts) eliminate costly preamplifiers.

For fast action, call the Wavemakers at: (617) 491-3211
 TWX: 710-320-6583, Krohn-Hite Corporation,
 580 Massachusetts Ave., Cambridge, Mass. 02139, U.S.A.

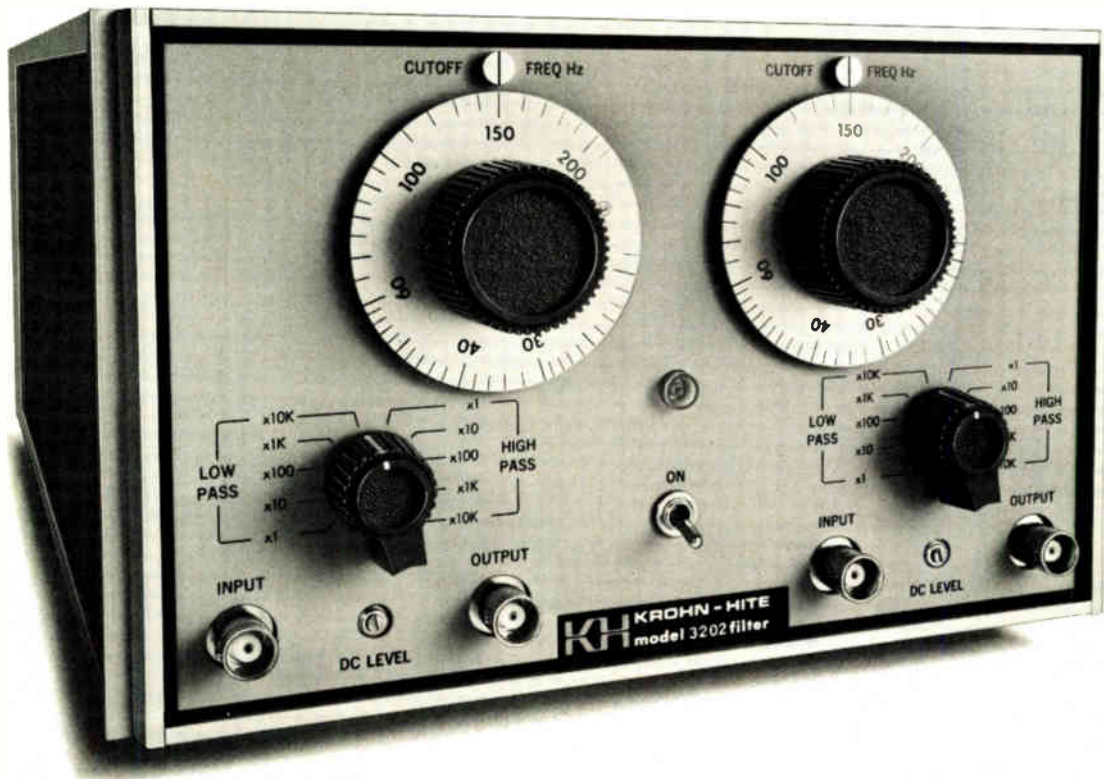

KH KROHN-HITE CORPORATION

SALES OFFICES: ALA., Huntsville (205) 534-9771; CAL., Santa Clara (408) 243-2891, Inglewood (213) 674-6850; COLO., Littleton (303) 795-0250; CONN., Glastonbury (203) 633-0777; FLA., Orlando (305) 894-4401; HAWAII, Honolulu (808) 941-1574; ILL., Des Plaines (312) 298-3600; IND., Indianapolis (317) 244-2456; MASS., Lexington (617) 861-8620; MICH., Detroit (313) 526-8800; MINN., Minneapolis (612) 884-4336; MO., St. Louis (314) 423-1234; N.C., Burlington (919) 227-2581; N.J., Bordertown (609) 298-6700; N.M., Albuquerque (505) 255-2440; N.Y., E. Syracuse (315) 437-6666, Rochester (716) 328-2230, Wappingers Falls (914) 297-7777, Vestal (607) 785-9947, Elmont (516) 488-2100; OHIO, Cleveland (216) 261-5440, Dayton (513) 426-5551; PA., Pittsburgh (412) 371-9449; TEX., Houston (713) 468-3877, Dallas (214) 356-3704; VA., Springfield (703) 321-8630; WASH., Seattle (206) 762-2310; CANADA, Montreal, Quebec (514) 636-4411, Toronto, Ontario (416) 444-9111, Stittsville, Ontario (613) 836-4411, Vancouver, British Columbia (604) 688-2619.

More power to you...

at less cost,
with Intronics'
Modular
Power Supplies.



Intronics' SM2000/5 modular power supply offers you more power for your money . . . up to 10 watts of output power. Plus, a compact size that makes this unit the natural choice to power your IC logic circuitry.

All Intronics' modular power supplies are designed for easy use and trouble free operation. Outstanding characteristics include: preset voltages to $\pm 0.5\%$, output short circuit protection, low ripple, wide operating temperature range with no derating, 50 to 440 Hz operation and 50 meg ohm transformer isolation.

Exercise your buying power. Specify Intronics' Model SM2000/5 modular power supply for your IC logic circuit applications.



intronics

57 Chapel Street, Newton, Massachusetts 02158 U.S.A.
617-332-7350, TWX 710-335-6835

Overseas call:

Brussels, Belgium 13-73-84

Maidstone, England 54224

Helsinki, Finland 11-123

Paris, France 9077844

Munich, Germany 524181

The Hague, Holland 678380

Milan, Italy 9043983

Zunch, Switzerland 93-31-61

Readers comment

Achieving statistical veracity

To the Editor: The dice in "Electronic dice ease tough decisions" [*Electronics*, Aug. 16, p.118] will not give statistically correct results. Isolated, each die will show the numbers from 1 to 6 with correct probability. The combination, however, should have 36 equally probable outcomes, but the suggested circuit gives only 12.

The second die should be clocked from the carry output of the first counter. To secure "maximum randomness," the oscillator frequency should also be as high as possible. Besides, the circuit may be considerably simplified by using a seven-segment decoder/driver to drive LEDs directly.

Counts Decoder Active Dice
input segments outcome

0	2	a,e,g,(b,d)	5
1	3	a,g,(b,c,d)	3
2	6	e,f,g,(c,d)	6
3	7	a,(b,c)	1
4	10	e,g,(d)	4
5	11	g,(c,d)	2
0	2	a,e,g,(b,d)	5

Per J. Johnson
Institute of Physics
Oslo, Norway

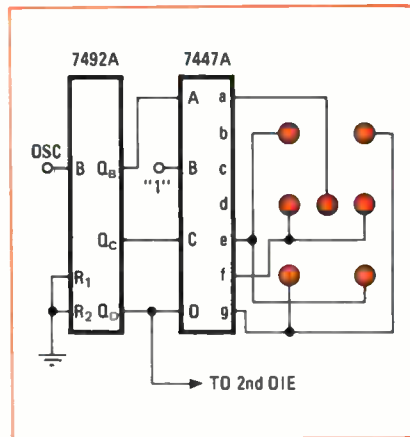

Profillemeter price pinpointed

To the Editor: Your "Zenith tests acousto-optic surface profilometer" [Oct. 11, p.36] over-estimated the price. We intend to sell in the area of \$12,000, including the laser.

Albert Hollander
Zenith Radio Corp.

1/4" x 1/4" transformers



Ultra-miniature, high reliability transformers that handle 100 milliwatts at 1KHz; 150 milliwatts at 7.5KHz; $\pm 3\text{db}$ 400Hz-250KHz; Pulse applications .05 to 100 μs ; Primary or secondary impedances 5 ohm to 30K ohm; Hermetically sealed in metal case; MIL-T-27; Inductors to 10 Henries; Extreme resistance to thermal shock; Terminals either T0-5 plug-in or insulated.

Send for 36 page catalog

PICO Electronics

50 South MacQuesten Pkwy.
Mt. Vernon, New York 10551
Telephone 914-699-5514

(All PICO Products are patented)

When Frank Riccobono, DDC's Instruments Product Manager, makes an offer to introduce you to our fine family of synchro instruments, who can refuse?

After all, what company can more logically set the pace in synchro instruments than DDC . . . the people who have set the pace in synchro converters for years!

Representing Frank's family of solid-state Synchro and Resolver Test Instruments are units from the low cost, 3 or 4 digit "panel meter" configuration SR-300 . . . to the fully militarized HMSR-102A, a $\pm 0.01^\circ$ angle indicator designed to meet the environmental requirements of MIL-T-21200 . . . to the MSR-236, a two-speed indicator in a portable, fully militarized carrying case.

Programmable standards—as well as programmable computer interfaced angle indicators—are also present and accounted for in the SR-400, SR-102, and the custom-designed instruments immediately to Frank's left.

The SR-202 combines all the best features of remote and manual control in a single, half-rack, push-

button-controlled indicator. And it's capable of interfacing with just about every commonly-used synchro or resolver at various voltages and frequencies, with accuracies to $\pm 0.01^\circ$

That's quite a complete family of Synchro Test Instrumentation already . . . and there are some newcomers on the way! Why not give Frank the opportunity to introduce them to you personally. After all, when Frank makes you such an inviting offer, do you dare refuse?

Standard and Custom Synchro Instrumentation
for Avionic, Shipboard, ATE, and Laboratory

DDC

A subsidiary of ILC Industries, Inc.

ILC DATA DEVICE CORPORATION

100 TEC STREET, HICKSVILLE, N. Y. 11801 • PHONE: (516) 433-5330

APPLICATION CENTERS

Long Beach, Calif.
(213) 597-5744

Washington, D. C.
(703) 536-2212

Bruxelles, Belgium
Tel. 62.01.59

Circle 7 on reader service card

**Come in and
meet
the family.**



Higher component density...
Lower insertion costs...with

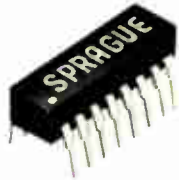

MULTI-COMP **DIP** MONOLITHIC[®]
CERAMIC
CAPACITORS



**STANDARDIZED DESIGN* FOR
BETTER AVAILABILITY, BETTER PRICES**

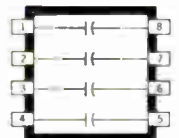

TYPE 939C
(4 capacitor sections)

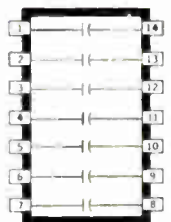

TYPE 934C
(7 capacitor sections)

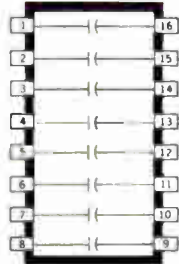

TYPE 936C
(8 capacitor sections)

Compatible with ICs and other standard DIP devices. Especially useful for noise bypassing and signal coupling in high-frequency signal or data processing systems. Molded package provides mechanical protection and reliability under severe environmental conditions. Monolithic[®] construction . . . alternate layers of ceramic dielectric material and metallic electrodes are fired into an almost indestructible homogeneous block. Standard ratings, 18pF to 0.1 μF @ 100WVDC. Temperature range, -55C to +70C.

*Other circuit configurations (including internally-paralleled capacitor sections, commoned capacitor leads, and various ratings within single package) are available on special order.

**Sprague puts more passive component families into
dual in-line packages than any other manufacturer:**

- TANTALUM CAPACITORS
- CERAMIC CAPACITORS
- TANTALUM-CERAMIC NETWORKS
- RESISTOR-CAPACITOR NETWORKS
- PULSE TRANSFORMERS
- TOROIDAL INDUCTORS
- HYBRID CIRCUITS
- TAPPED DELAY LINES
- SPECIAL COMPONENT COMBINATIONS
- THICK-FILM RESISTOR NETWORKS
- THIN-FILM RESISTOR NETWORKS
- ION-IMPLANTED RESISTOR NETWORKS

For more information on Sprague DIP components, write or call Ed Geissler, Manager, Specialty Components Marketing, Sprague Electric Co., 509 Marshall St., North Adams, Mass. 01247. Tel. 413/664-4411.



THE BROAD-LINE PRODUCER OF ELECTRONIC PARTS

40 years ago

From the pages of Electronics, December, 1933

NBC's new studios

The world's largest and finest radio-broadcasting studios are now in operation at Radio City, New York. Built by the National Broadcasting Company at an outlay of five million dollars, they incorporate many novel features . . .

Thirty-five studios of various sizes are provided, of which sixteen went into operation in November; eleven others are yet to be electrically equipped, and eight more will be installed in the unfinished floors. The mammoth three-story auditorium studio measures 78 by 132 feet and seats 1600 people. Another large theater studio is equipped with opera chairs, stage, and a sound-insulating glass curtain which slides in from the wings, in sections. A unique four-unit "clover-leaf" studio group provides four studios served by a central operating room glassed in on all sides. Suitable for eventual television productions, this studio group has immediate application for carrying out the English practice of setting up a broadcast with the vocalist, orchestra, speakers, etc., in different sound-proof quarters, and combining them at different levels to produce the desired ensemble effect. Several of the studios also have controllable acoustics in the form of motor-operated panels and curtains, which can be manipulated from the corresponding studio control-rooms to produce any degree of sound reflection in any part of the room.

Provision for future television broadcasting in the NBC studios is seen in the use of special direct-current circuits for all studio lighting, although all the rest of the Radio City group is served with the usual 60-cycle alternating current.

The electrical and audio equipment for the new Radio City studios is estimated to have cost about two million dollars. For the sound-insulated and acoustic treatment, air conditioning, etc., another two millions were expended. Thus with a million dollars for the eleven-story steel structure the total investment comes to about five millions.

Will your next frequency counter have all these features?

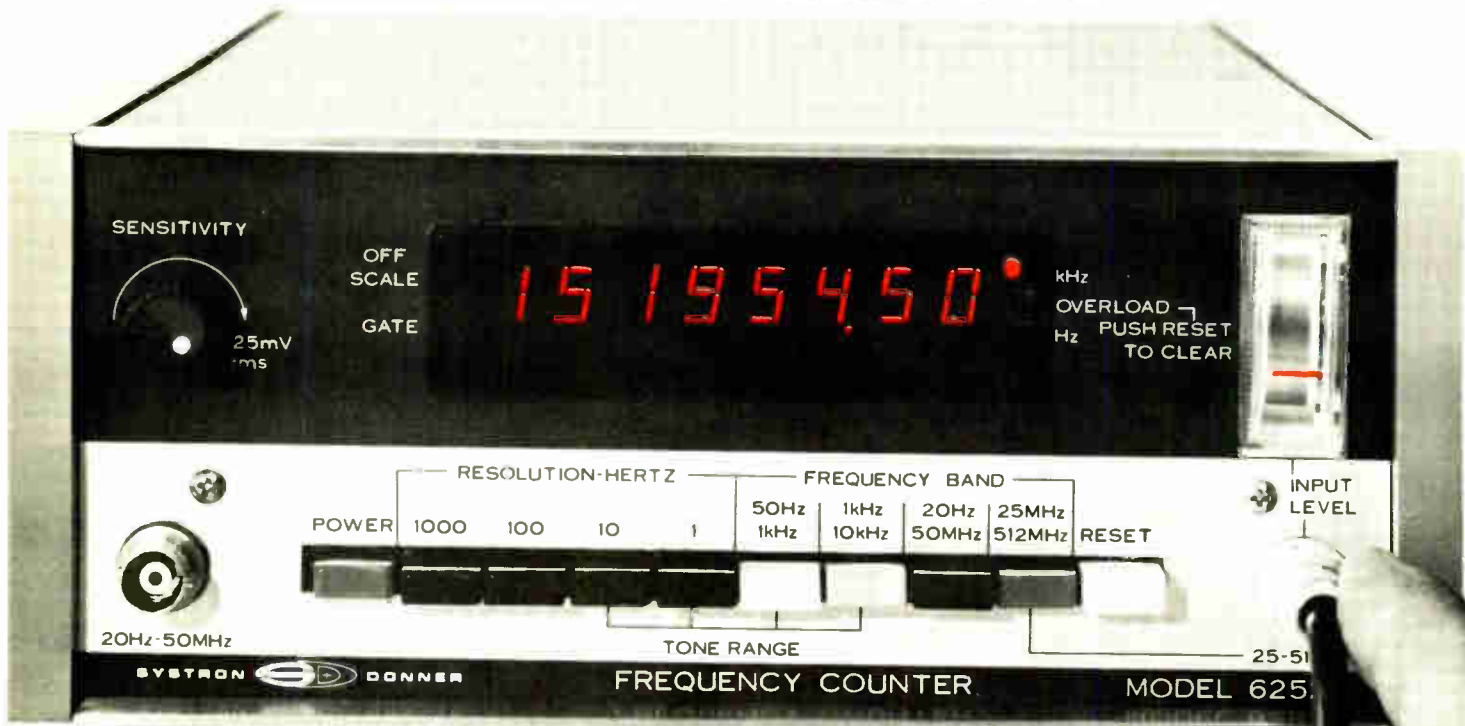

The first frequency counters designed specifically for communications people . . . Systron-Donner's 512 MHz Model 6252 (above) and 180 MHz Model 6251. They're the only counters offering all these features:

Relay input protection. RF overload disconnects input circuitry from signal. Indicator light and reset button.

Metered input. Visually indicates high/low signal strength.

Tone measurement. Example: measure 1020.001 Hz automatically in 1 second.

Accuracy. High-stability TCXOs for field use or oven oscillators to 5 parts in 10^{10} .

Built-in battery. An exclusive option. Take your counter anywhere.

FCC. Meets or exceeds FCC requirements.

All of these features, plus more for \$1,095 (Model 6252) or \$895 (Model 6251). For immediate details, call us collect on our Quick Reaction line: (415) 682-6471. Or you may contact your Scientific Devices office or Systron-Donner at 10 Systron Drive, Concord CA 94518. **Europe:** Munich, W. Germany; Leamington Spa, U.K.; Paris (Le Port Marly) France. **Australia:** Melbourne.

SYSTRON  DONNER

Albuquerque, (505) 268-6729; Baltimore, (301) 788-6611; Boston, (617) 894-5637; Burlington, NC (919) 228-6279; Chicago, (312) 297-5240; Cleveland, (216) 261-2000; Denver, (303) 573-9466; Dayton, (513) 298-9904; Dallas, (214) 231-8106; Detroit, (313) 363-2282; Ft. Lauderdale, (305) 721-4260; Hamden CT (203) 248-9361; Huntsville, AL (205) 536-1969; Houston, (713) 623-4250; Indianapolis, (317) 783-2111; Kansas City, KS (913) 631-3818; Los Angeles, (213) 641-4800; Minneapolis, (612) 544-1616; New York City area (201) 871-3916; Norfolk, (804) 499-8133; Orlando, (305) 841-8180; Philadelphia, (215) 825-9515; Phoenix, (602) 834-1682; Rochester, NY (716) 334-2445; San Antonio, (512) 694-6251; San Diego, (714) 249-6642; San Francisco area (415) 964-4230; Seattle, (206) 454-0900; St. Louis, (314) 842-2535; Syracuse, (315) 457-7420; Washington, DC area (703) 451-6500.

CTC has the industry's broadest RF power line.

Which leaves our competitors in a powerless situation.

Seeing other companies go down the tubes taught us one powerful lesson. It takes more than a song and dance to sell you.

So, in four short years, CTC has come up with the most complete line of high-powered RF transistors in the industry. Over 500 devices. That are more rugged. With higher gain and efficiency, lower thermals, and better input match across the band.

Nothing shakes up the establishment more than seeing a four-year-old with so much power. And we keep on developing. New metalization technology, sealing and packaging techniques. Unique etching and testing methods, too. It's no wonder we command the mobile-communications market with a lion's share of sockets in land-mobile sets.

But no applause. Just orders please.

Communications Transistor Corporation
301 Industrial Way, San Carlos, California 94070
Phone (415) 591-8921 TWX 910-376-4893

CTC: The power in RF power.

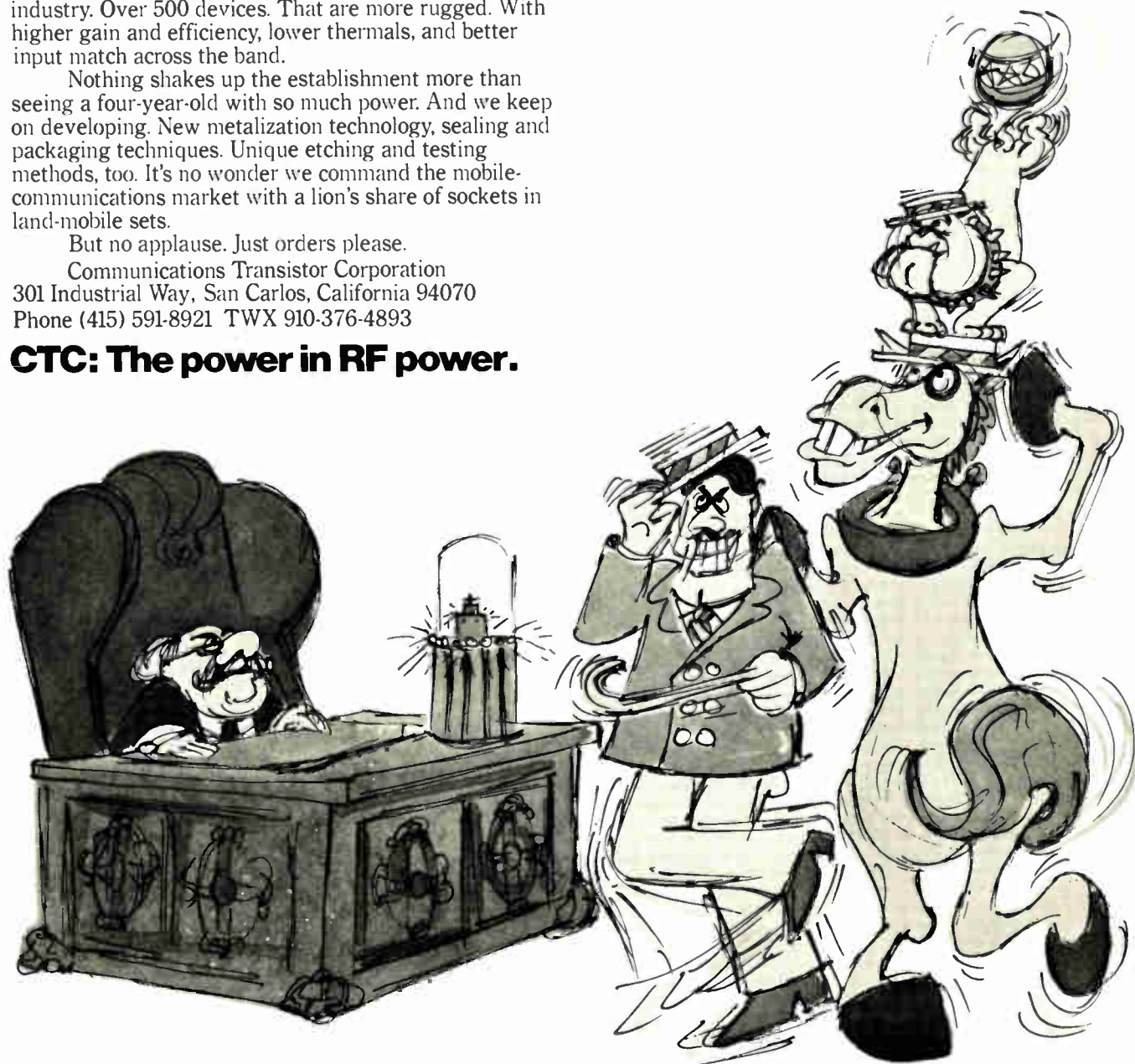

Apollo and the Arabs

For the moment the energy crisis presents the electronics industries with more problems than opportunities. And that is no surprise, for crises by their very nature focus everyone's attention on immediate problems, leaving little time for long-range planning.

Manufacturers of most things electronic talk today of keeping factories warm for the winter and semiconductor furnaces at even temperatures. Some are weighing the option of a four-day work week as a means of conserving energy while filling those order backlogs they have on hand. If they have thought about it, few are saying anything about what may happen to that order backlog if, for example, a significant slump in sales of Detroit's 1974-model gas guzzlers or a cutback in commercial and general aviation aircraft deliveries results in cancellation of subcontracts for seatbelt semiconductors and avionics.

The immediate answer to the energy problem supplied by President Nixon to the nation is a patchwork of conservation measures that have been hastily sewn together with very thin thread. And Nixon's many critics contend the patch cannot cover the energy hole.

But what about Project Independence? Advanced by President Nixon as the silver lining behind the energy cloud that hangs over the nation, he likens it to earlier American efforts to land men on the moon under the Apollo program and to develop nuclear weapons during World War II's Manhattan Project. The lessons of those two programs are in Nixon's view "the same lessons that are taught by the whole of American history: whenever the American people are faced with a clear goal and they are challenged to meet it, we can do extraordinary things."

The leaders of the Arab world know the lessons of Apollo well, of course. They know that a nation that put men on the moon probably could evolve alternatives to petroleum for energy. "That is why they are cutting back

on petroleum deliveries, not cutting them off," explains one Washington oil industry man. "They want us to hurt enough to get them a settlement" with Israel. "But they don't want us to become independent" of their resources.

Arab actions thus far have been well calculated. They know that Project Independence, as described by President Nixon, is nothing more than new frosting on stale cake. Certainly it is not a well-defined, funded, and coordinated national goal, as was Apollo.

Manned space flight costs came to more than \$26 billion in less than a decade. Project Independence funding, on the other hand, is virtually nonexistent. After you cut through the White House flimflammy that lumps together all existing Federal agency energy outlays and calls them a national program, all that is left is the Nixon proposal asking Congress for a five-year, \$10 billion package to create an energy R&D agency. The legislation—long delayed in its delivery to the Congress since its White House announcement on June 29—has gone nowhere to date. But should it pass, it can hardly be called a program of the proportions of the Apollo or Manhattan projects.

No one doubts that there are opportunities possible for electronics technology in alleviating the national energy shortage and making America independent of foreign resources. But technology—particularly electronics technology—costs money. Someone must pay for it. The Nixon Administration, for all of its apparent concerns with energy, is not yet willing to put the country's money where its mouth is when it comes to funding new energy research and development. And just as many industry managers know this, so it must be assumed that the oil sheikhs know it too.

In future editorials, we'll discuss some concrete ideas we have on how electronics ought to be tapped in helping solve this crucial problem. Meanwhile, we'd welcome your ideas and suggestions.

**INVERTER
DESIGN
with PROGRESS
IN MIND**

**GENERAL ELECTRIC
COMBINES INNOVATION
with EXPERIENCE TO OFFER YOU
THE INDUSTRY'S
BROADEST LINE OF
INVERTER SCRs, RECTIFIERS
AND CAPACITORS.**

THYRISTORS

GENERAL  ELECTRIC

SIX NEW INVERTER SCRs

RECIPIENT OF IR-100 AWARD

New involute interdigitated pellet configuration allows more than double the frequency-current capability of comparable competitive types.

C609 Switches 1400A @ 5KHz

C509 Switches 1000A @ 5KHz

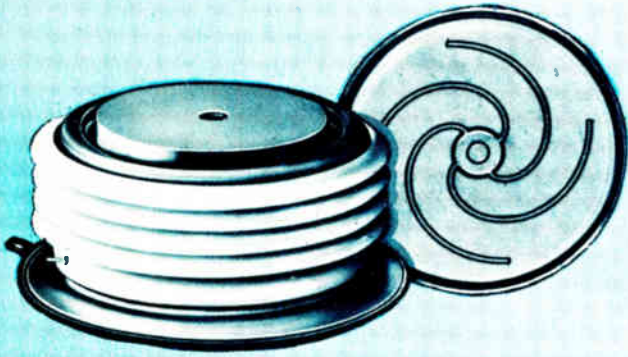

HIGH SPEED, LOW SWITCHING LOSSES

For power switching in 1-10KHz range.

C364 275A, up to 600V, 10 μ sec t_{off}

C365 275A, up to 600V, 20 μ sec t_{off}



COOL & COMPACT

15° C cooler operation than competitive types at same case temperature;

$\frac{1}{4}$ " -28 stud mount package.

C149 63A, 100-600V, 10 and 20 μ sec t_{off}

C148 55A, 600-1200V, 30 and 40 μ sec t_{off}

Prices start at \$11.00 for the C149 and \$21.00 for the C148 in 10 lot quantities.

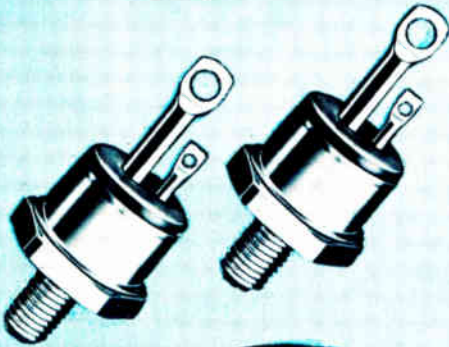

NEW 750A FAST RECOVERY RECTIFIERS

Companions to GE inverter SCR types C398, C509, C609. Better ratings and characterization than comparable competitive types.

A596 750A, 1200V DC, up to 5KHz

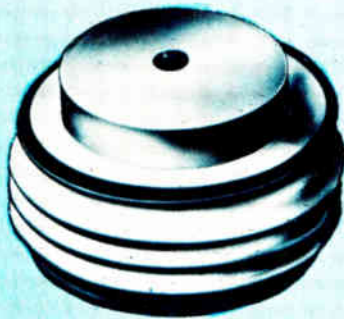

SERIES 28F COMMUTATING & SNUBBER CAPACITORS

Metal-encased paper, metalized paper and poly-carbonate film dielectric capacitors are available in a variety of case styles and several lead terminations. Ratings from 0.1 to 150 μ f and up to 2,000V DC.

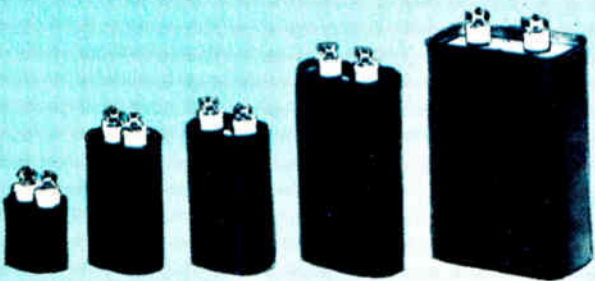

For more information, contact your authorized GE Semiconductor Distributor, GE Electronic Components Sales Office, or write to General Electric Semiconductor, Electronics Park, 7-49, Syracuse, N.Y. 13201, U.S.A. In Europe contact GE Technical Services Co., Inc., Box 265, Amstelveen, The Netherlands.

The new 420L offers everything but the pedestal you'll want to put it on.

The pedestal's optional, but the broad frequency coverage of 100 kHz to 280 MHz and a power output up to 20 watts are standard in this state-of-the-art RF power amplifier.

Linear Class A circuitry will faithfully reproduce input modulations including AM, FM, SSB, TV and pulse with minimum distortion. Completely solid-state, the 420L will supply full power output into any load impedance (from an open to a short circuit).

Driven by any signal generator, frequency synthesizer or sweeper, the 420L is a flexible and versatile source of RF power for general laboratory work, RFI/EMI testing, signal distribution, RF transmission, laser modulation and ultrasonics.

The new 420L. Offering everything but the pedestal you'll want to put it on, at \$2890.

For further information or a demonstration contact ENI, 3000 Winton Road South, Rochester, New York 14623 (716) 473-6900 or TELEX 97-8283

ENI

The world's leader in solid state power amplifiers

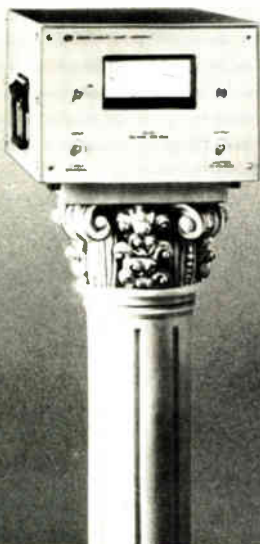

People

Ancker-Johnson:
a scientist at Commerce

Is it shortsighted for the U.S. to export its electronics manufacturing techniques to potential competitors? Or is it wiser to protect our technological expertise and limit exports to the products of that know-how? The Commerce Department's assistant secretary for Science and Technology, Betsy Ancker-Johnson, says candidly, "I don't know, and I don't think anybody else knows yet either" [*Electronics*, Oct. 25, p. 200].

The question is one of the most divisive within the electronics industries [*Electronics*, Oct. 11, p. 41]. The fact that the diminutive 44-year-old physicist, mother of four and former Boeing Co. executive, has no pat answer therefore reflects more her background in science and engineering than any unwillingness to align herself with conservative or liberal trade policies.

Positives. Now in the eighth month of her Federal assignment, Ancker-Johnson is heavily involved in developing ways to improve America's use of electronics to domestic and world markets. For example, the Patent Office recently adopted her plan to speed up the processing of patent applications relating to energy.

She is also disturbed that the Federal Government is laying out about \$17 billion this year for R&D but receiving only about 5% of the 70,000 patents awarded annually. Consequently, she has urged the National Technical Information Service to promote the licensing to industry of Government-patented technology that has been judged to

have commercial potential.

Also, the Committee on Government Patent Policy, which she chairs, has drafted and had issued through the General Services Administration new regulations permitting exclusive licensing of Federally-owned inventions for limited periods in order to encourage their commercial exploitation. "We have in mind initiatives to vastly increase the amount of Government-discovered technology that gets patented and transferred to public use," she says.

In addition to presiding over the Patent Office and NTIS, her job as assistant secretary gives her jurisdiction over the department's offices of Telecommunications, Environmental Affairs, Product

Standards, as well as the huge National Bureau of Standards. The NBS alone accounts for \$62 million, or close to half of the fiscal 1974 budget request of \$130 million for her bailiwick.

To back her decisions in these areas, Ancker-Johnson has an unusually useful set of qualifications: a doctorate *magna cum laude* from Tuebingen University in Germany, followed by positions at the University of California in Berkeley, Pennsylvania Applied Physics Laboratory, RCA, Boeing, Bell Laboratories, and Washington University.

Malco's Meyer
plans new products

It's hard to keep a long-range view in a time of critical shortages, but that is the principal task of Harry H. Meyer Jr., new vice president and general manager of Malco Manu-



At Commerce. Betsy Ancker-Johnson promotes licensing Government patents.

New from MOSTEK—a low cost clock circuit with 4 or 6 digit display, 24 hour alarm and more!

MOSTEK's new MK50250N MOS Clock Circuit makes the low-cost, multi-function electronic alarm clock practical today.

It's packed with features . . . 4-or 6-digit display plus AM/PM indication, 24-hour alarm function with "snooze" feature, power failure

indicator, intensity control and display blanking.

The activity indicator allows use of a more economical 4-digit display (hours and minutes) and still verifies circuit functioning with a single pulsating LED. Operation is from standard 50 Hz (24-hour operation) or 60 Hz (12-hour operation) input. The new circuit is compatible with gas discharge or LED displays with minimal interface circuitry.

The MK50250N is available in an easy to use 28-pin production package fully stocked for immediate delivery.

If you're making the move to electronic alarm clocks, contact MOSTEK. Whether your requirement is for evaluation circuits or volume production quantities, you can count on MOSTEK to perform . . . on time.

Call your local MOSTEK representative or contact MOSTEK, 1215 West Crosby Road, Carrollton, Texas 75006, (214) 242-0444.

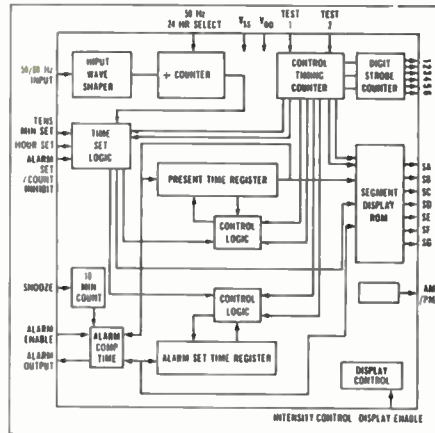

MOSTEK®

Circle 15 on reader service card

MOSTEK moves forward...in time.

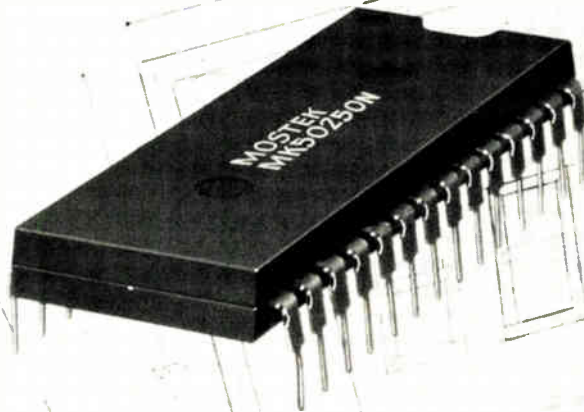

To help Underwriters Safety Device Co. fuse blocks resist heat, breakage and distortion... bases of Plenco 571

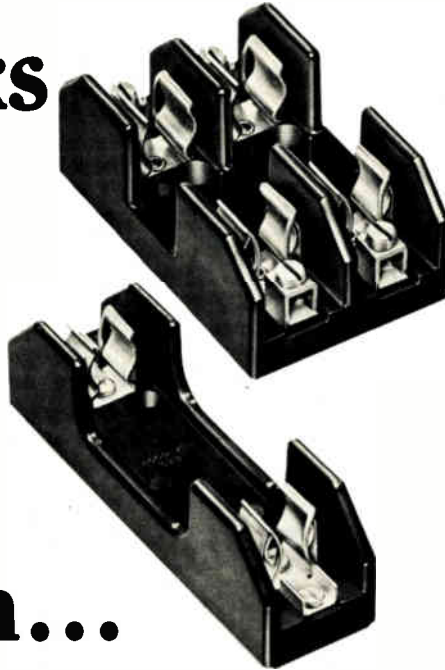

Underwriters Safety Device Co., Chicago, produces a wide variety of fuse, power and quick-connect blocks for many demanding applications. Suburban Plastics Co., Roselle, Ill., injection molds the bases to Underwriters' tough specs. They use Plenco 571, a general purpose compound. And here's what Suburban had to say:

"The configuration of these parts needs a fast rate of cure, combined with extended barrel life. These combinations give the uniformity of production required by Underwriters and Plenco 571 meets the demand."

That's Plenco at work where it counts. Plenco offers a broad spectrum of thermoset plastics for designers, molders and manufacturers in countless areas of industry.



PLASTICS ENGINEERING COMPANY
Sheboygan, Wisconsin 53081

Through Plenco research . . . a wide range of ready-made or custom-formulated phenolic, melamine and alkyd thermoset molding compounds, and industrial resins.

People

facturing Co., the Chicago-based maker of connectors and terminals. By agile footwork, Malco has avoided severe shortages. "A shaky, even keel," is how Meyer characterizes Malco's present position with its suppliers, but he admits he's wary of next year.

Nonetheless, Meyer emphasizes planned growth, including stepped-up new product development and increased acquisitions—a change from Malco's recent past and one he hopes to encourage by his separation of Malco's R&D arm from its engineering organization. As a result, Malco is studying higher-density connectors, and connectors for use in the automotive industry. Meyer believes that this and other new markets are going to be particularly important in the connector business because of the different interconnection technologies they involve.

This month the firm will introduce a simple transistor socket—the first of a family of transistor and integrated-circuit interconnect devices, and a new market for Malco. "You can either acknowledge or ignore the impact of the semiconductor business," Meyer says, "and we've decided to do something about it."

Meyer got his first look at planning with a BS in business and engineering administration from Massachusetts Institute of Technology in 1948. He joined the Maytag Co. as an industrial engineer and moved to Honeywell in 1951, where he most recently was director of engineering at Honeywell Microswitch, Rockford, Ill.

Long-range view. Harry H. Meyer emphasizes new-product development at Malco.





MEASUREMENT COMPUTATION

innovations from Hewlett-Packard

NEWS

DECEMBER, 1973

in this issue

New desktop
business calculator

Take along our portable
strip-chart recorder

A digital thermometer for
hot projects

New battery-powered dmm improves field service

Measure resistance, ac and dc voltage with a new autoranging digital multimeter that fits the palm of your hand.

HP's pocket-sized 970A digital multimeter is one of the most significant user-oriented instruments of the seventies. It operates on rechargeable batteries; automatically ranges ac, dc, volts and ohms through five ranges; displays measurements on a 3½ digit LED readout; yet weighs just 7 ounces (200 grams). This new probe is so small, so convenient that you can carry it on your belt or in your pocket—it's ideal for field service, as well as bench and lab use.

With thin film and MOS IC technologies, HP packed the electronic equivalent of 3000 transistors into this handheld probe. You can measure:

- dc voltage from 100 mV full scale

(continued on page 3)



A few ways to use HP storage displays



In this simulated radar exercise, an HP storage display helps train pilots.

Storage and variable persistence displays offer many advantages where information must be gathered over a relatively long period of time, then processed and presented for display. The bright stored information provides easy viewing in high ambient light, and highly burn-resistant CRTs ensure long life with no special operating precautions.

A unique medical application for HP storage displays is in conjunction with an ultrasonic diagnostic system that provides a "picture" of internal organs or tissues in selected areas of the body. Storage allows build-up of the display by using as many scans as needed for the desired image detail.

Now, run FORTRAN faster with new HP software

Good news for 2100A and 2100S computer users: HP's new fast FORTRAN processor (FFP) dramatically speeds execution of FORTRAN programs and subroutines. Typical applications demonstrate that FFP generally causes programs to execute 10 times faster.

FFP contains microcoded library subroutines including double-precision floating-point operations, single-to double-precision conversions, as well as address and control transfer routines. And you can call the FFP subroutines with ALGOL and assembly language,

Another application is in a simulated radar acquisition system which provides pilots with a realistic training environment. By adjusting the variable persistence in an HP 1331 storage display to match the scan rate, the pilot can see relative position trends that are not possible to view with long fixed-persistence phosphors.

A new brochure describes other storage scope and display applications. For your copy, check E on the HP Reply Card.

as well as FORTRAN.

The processor is available in Read Only Memory (ROM) chips or in binary tape with two Writeable Control Store cards; and it can be either factory or field installed.

To learn more about fast FORTRAN, check R on the HP Reply Card.

FORTRAN Double Precision Programs	Software Execution Time (Sec)	FFP Execution Time (Sec)	Improvement Factor
Conversion Process of Mathematical Equation	319	16	19.9
Analysis of Variance	1800	210	8.57
Data Conversion	3780	425	8.89

New mass memories expand calculator storage



With this new mass memory, you can store or read a complete 250-line calculator program in about 2 seconds.

For calculator users who need lots of storage, there are two new mass memories for HP's powerful 9830A programmable calculator. Now, you can have large data storage for such varied applications as general ledgers, accounts payable, personnel records, patient data, laboratory tests, real estate listings, structural design, and statistical analysis.

The 9880A is a single disc memory subsystem that stores 2.4 megabytes; the dual-disc 9880B has capacity for 4.8 megabytes. Both have a photoelectric mechanism for fast, accurate read/write head positioning. It takes just 50 ms (average) to access and transfer a data item from the memory to the calculator.

The subsystem is versatile, too. You can connect up to 4 memory discs, in any combination (A or B), to one HP 9830A calculator through a controller—or connect up to 4 calculators to one mass memory subsystem. However, only one calculator can access the memory at a time.

For more on calculator memories, check P on the HP Reply Card.

New options expand RF synthesizer capabilities

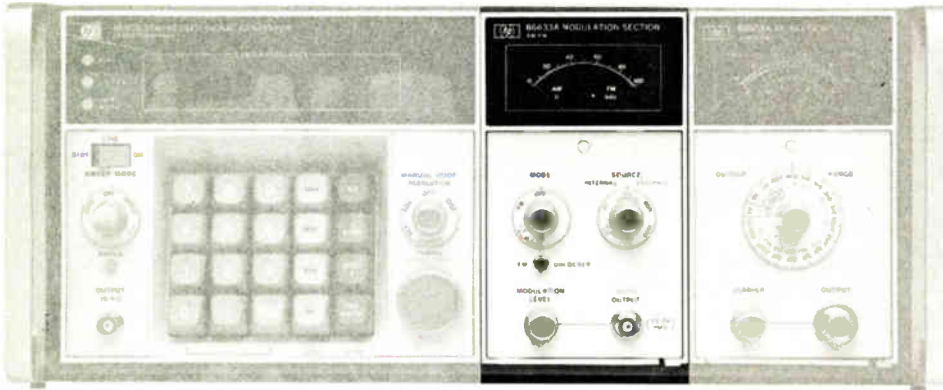

New modulation section for HP 8660 signal generators permits FM with phase-locked center frequency.

With the new 86633A modulation plug-in for HP 8660A/B synthesized signal generators, the center frequency is phase-locked while operating in the FM mode. This brings highest stability when you're making narrowband FM measurements—for example, in mobile radio receiver tests.

The 8660A/B signal generators provide fully-calibrated AM, FM and CW signals with synthesizer accuracy and spectral purity—from 10kHz to 1300 MHz. Some key performance characteristics are: 3×10^{-8} /day frequency

stability, -80 dB spurious, <1.5 Hz residual FM, and calibrated output levels from $+10$ to -146 dBm. Now, the 8660 signal generators can be supplied with an optional ASCII interface which means they can be controlled from a 9820A calculator.

For more information, check O on the HP Reply Card.

(continued from page 1)

to 500 V with worst case accuracy of $\pm 0.9\%$ at full scale.

- ac voltage from $100 \mu\text{V}$ to 500 V rms, from 45 Hz to 1 kHz, with an accuracy of $\pm(2\%$ of reading $+ 0.5\%$ of range).
- resistance from 1Ω to $11 \text{M}\Omega$, at an accuracy of $\pm(1.5\%$ of reading $+ 0.2\%$ of range).

Yet the 970A is fast and easy to use—no confusing inputs or manual adjustments need be selected. You set only one function control, and there are just two input terminals, instead of the usual three to eight.

Select one of three probe tips, depending on your application: one for normal use; a longer tip for reaching otherwise inaccessible circuit test

points; and a concave tip to cup wire-wrapped terminals and test pins. For other applications, the tip socket will accept a standard banana plug.

Simply touch the probe tip to the test point, push a button, and the LED readout displays the correct polarity and reading. Should the display be up-side down when you hold the probe, a front panel switch electronically inverts the display. Thus, you won't mistake 6's for 9's.

There's more. For all the details, check D on the HP Reply Card.

New bipolar power supply doubles as an amplifier

HP's new bipolar power supply/amplifier is really three instruments in one package:

- A fast 50W bipolar power supply with continuous through-zero output.
- A fixed-gain power amplifier with dc—40 kHz bandwidth.
- A dc—15 kHz power amplifier with programmable gain.

As a power amplifier, the supply teams up with many lab-type function generators to produce signals at voltage and current levels high enough to test deflection yokes, zener diodes, transistors, power relays, resolvers, motors, and many other devices. Individual units can supply outputs up to 40V p-p at 2A pk, 100V p-p at 1A pk, or 200V p-p at 0.5A pk. Auto-series or auto-parallel connections of multiple units further extend the range of possible outputs. Input/output impedance of $10 \text{k}\Omega/0.5 \text{m}\Omega$ means minimum loading of the signal source and plenty of output drive.

When operated as a bipolar power supply, output ratings are:

6825A/6830A: $\pm 20\text{V}$ at 0—2A

6826A/6831A: $\pm 50\text{V}$ at 0—1A

6827A/6832A: $\pm 100\text{V}$ at 0—0.5A

The voltage output of all models can be programmed remotely (0.1% accuracy).

For specifications, check K on the HP Reply Card.



Choose between the laboratory versions with meters and front panel controls (models 6825A-6827A) or the system versions with blank panels (6830A-6832A).

Now, interface HP automatic measurement systems with an IBM 360/370

A new software/hardware package enables communication between an HP Real-Time Executive (RTE) system and an IBM 360/370 system. This gives you three-level distributed systems capability, with HP 9600 series measurement systems (first level) operating as satellites to an HP 9600C/E RTE sys-



With RDTS, your measurement systems double as remote job entry terminals.

tem (second level), which in turn communicates with the IBM 360/370 batch computer (third level).

The new HP 91780 Remote Data Transmission Subsystem lets the satellite systems and RTE system operate independently, yet communicate with the IBM batch computer when desired. This gives each system access to the batch computer for large-scale computations and for storing measurement data in the IBM data base. Essentially, with RDTS the RTE system emulates an IBM 2780 Data Transmission Terminal, allowing it to operate as a remote job entry terminal.

Some major application areas are:

- **Manufacturing**
- **Military/aerospace**
- **Colleges, universities**
- **Health services**

Full information is available; just check Q on the HP Reply Card.

New business calculator challenges a computer

Now, there's an HP desktop business calculator especially for accountants, bankers, financial and tax analysts, investors, real estate agents, stock-brokers, and bond dealers. Like the popular pocket-sized HP-80, the HP-81 business calculator can perform 40 financial functions...plus interest per period, depreciation schedules, discounted rate of return for uneven cash flow, coupon equivalent yield, amortized loan schedules, bond and note calculations.

For statistical analysis, use the HP-81 to calculate mean and standard deviation, correlation coefficient, percent and % difference. You can also compute a two-variable trend line, and/or multiply and divide by any constant. Enter both x and y values of a data point; the correlation coefficients are calculated automatically when the trend line is calculated.

Answers are printed on a tape so you have a permanent record. Negative numbers are printed in red. If you make an operational error, such as dividing

by zero, the calculator immediately prints an error message.

With the time and money you'll save, the HP-81 pays for itself within weeks.

For more information, check C on the HP Reply Card.



The streamlined, compact HP-81 weighs just 13.5 lbs (6.12 kg).

HP storage oscilloscopes for a variety of uses

At the U.S. Air Force Academy, an HP 181A storage scope is used in a research project on how cracks develop in such critical structures as aircraft wings.

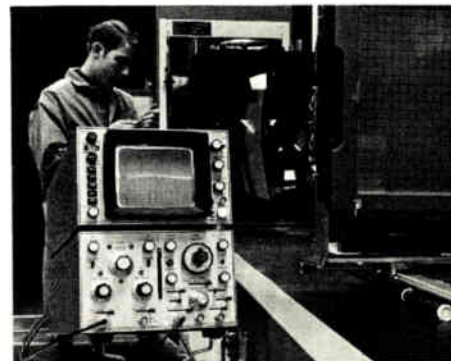

HP storage oscilloscopes enable you to capture nanosecond transients or low rep-rate signals in bright, flicker-free displays. Very high speed signals, single-shot events, or low frequency applications are easily resolved with storage writing speeds of 0.5 cm/ μ s. to 400 cm/ μ s. These stored displays are bright up to 100 foot-lamberts and are highly burn-resistant so that they require relatively little care. Improved storage CRTs make it possible to capture and view high-speed phenomena that previously you could document only by difficult photographic techniques. Multi-mode capability means that our storage CRTs also satisfy general purpose applications.

For high-speed data, the 184A storage scope with fast writing speed (up to 400 cm/ μ s) captures infrequent events and retains them long enough for visual waveform analysis.

For low duty-cycle traces that can't be seen on a conventional CRT or are barely discernible under a viewing hood, the storage scope with variable persistence integrates low rep-rate signals to a bright display without annoying flicker. Also, with variable persistence you can retain a signal until a second signal is captured, allowing you to readily compare differences in time, amplitude and shape.

For the complete storage scope story, check F on the HP Reply Card.

Two scientific calculators fit your computation needs, your pocket and your budget

HP-35



HP-45



Which HP scientific pocket calculator should you choose? That's a difficult decision. Both the HP-35 and HP-45 weigh just 9 ounces each, operate on batteries, perform trigonometric and logarithmic functions, are accurate up to 10 significant digits, and feature LED display and solid-state memories. Both are designed for a variety of applications in science, engineering, surveying, navigation, statistics, and mathematics.

The HP-35 has an operational stack of four registers, plus a data storage register for constants. The stack holds intermediate answers and, at the appropriate time, brings them back for further use. With the HP-35, you can perform addition, subtraction, multiplication, division, exponentiation, square roots, reciprocals, trigonometric and logarithmic functions in a fraction of a second... in the palm of your hand.

The HP-45 advanced scientific pocket calculator has nine addressable memory registers and, like the HP-35, a four-register stack that holds intermediate answers for future calculations. There are three trigonometric operating modes—degrees, radians or grads—and you can easily convert from any mode to degrees/minutes/seconds and vice versa. Other additional capabilities include polar/rectangular coordinate conversions, percent and % difference, metric/U.S. unit conversions, n factorial (for permutations and combinations), mean and standard deviation. A special storage register, "last x," lets you correct an error without having to start over in the midst of a long calculation.

To learn more, check A or B on the HP Reply Card.

New battery-powered strip-chart recorder goes anywhere

Now, there's a lab quality, portable strip-chart recorder that operates up to 9 hours on internal rechargeable batteries or on an external ac or dc power from 48 to 440 kHz. Compact size (5-inch or 12.7 cm writing width) and rugged durability means the new 7155 recorder works well in trucks, field stations, airplanes, or any remote location.

Seven chart speeds range from 20 sec/in. to 60 minutes/in. Accuracy is 0.5% of full scale with overshoot <0.05 in. (.13 cm). Disposable pens and coated paper give you a sharp, clean trace that dries instantly. The writing system is so trouble-free you can even run the recorder upside down. It's ideal for recording at locations where ac line power is not available—for example, monitoring air and water pollution in the wilderness. And a see-through front cover protects the recorder from dirt and moisture.

Metric scaling is available.

For more information, check L on the HP Reply Card.

Take our new strip-chart recorder into the wilderness—it weighs less than 30 lbs (13.6 kg).



HP's new digital thermometer: a hot buy at a cool price

HP's new 2802A universal digital thermometer is a medium-priced unit that contains several features usually found only in expensive thermometers—features like two measurement ranges, linear analog output, high resolution, 4½ digital readout, and battery operation.

One temperature range extends from -200° to $+600^{\circ}\text{C}$ with 0.1°C resolution. Push a button to switch to the -100° to $+200^{\circ}\text{C}$ range with 0.01°C resolution. On both ranges, accuracy is always $\pm 0.25\%$ of reading $\pm 0.5^{\circ}\text{C}$.

Linear analog output means you can connect the 2802A to any recorder for temperature charts and graphs. Snap in a 6-hour battery module, and the thermometer becomes completely portable, ready for field use. An optional BCD module for buffered output lets you send your digital temperature readings across the country. Various probes and sensors with standard or armored cable adapt the thermometer to a vari-

ety of needs. There are other optional snap-on modules that convert your thermometer to make voltage, current, and resistance measurements.

This new digital thermometer leaves expensive units out in the cold. To learn more, check G on the HP Reply Card.

Cryogenic measurements are easy with the new 2802A thermometer. Here, it measures the temperature of a device being cooled with liquid nitrogen.



New 75-ohm spectrum analyzer for communications and CATV

Spectrum analysis of CATV system signals is accurate and convenient with the HP 8558B spectrum analyzer.



For measurements in 75-ohm systems, two versions of the low-cost 8558B spectrum analyzer are now offered: one is calibrated in dBm for 75-ohm communications systems, and the other is calibrated in dBmV especially for CATV and television broadcasting. Major features of the 8558B are precision performance and ease of operation. Most measurements are made using only three controls.

Both versions offer a 0.1 to 1500 MHz frequency range and a 70 dB spurious-free amplitude display range. Resolution bandwidths are from 1 kHz to 3 MHz, and frequency response is $< \pm 1$ dB. The analyzer has digital LED readout to show either center or "start-of-sweep" frequency.

For details, check M on the HP Reply Card.

New low-cost RF signal generator is portable

The HP 8654A VHF signal generator—solid-state, portable, and low cost—provides calibrated output and versatile AM and FM modulation from 10 to 520 MHz. Compact and small in size, this precision instrument fits easily into production, mobile, airborne, and shipboard test locations.

The 8654A produces stable RF signals for testing receivers, amplifiers, antennas, and filter networks. Calibrated output range is $+10$ to -130 dBm. An auxiliary RF output is also available at the rear panel to use with a counter or other external equipment. Stability is 0.002% per 5-minute operating period, after two-hour warmup.

Portability, stability, and versatility make this a high-value VHF signal source for economy-minded users.

For specifications, check N on the HP Reply Card.



Carry it with you—the versatile 8654A AM/FM signal generator weighs just 16.5 lbs (7.5 kg).

HP offers "how to" newsletter for service technicians

Bench Briefs, a bimonthly publication, is your private line to HP Customer Service. It is offered to personnel servicing HP instruments and to service managers—and is particularly useful to anyone doing repair, calibration, incoming inspection, and system configuration of HP electronic instruments.

This attractive 8-page bulletin contains service tips, instrument modifications, new methods of testing, and new tools that simplify service and troubleshooting. *Bench Briefs* are full of practical information, such as the effects of

IC tarnish or how to remove solder flux. There are tutorial articles to upgrade your technical knowledge in areas such as digital techniques or Boolean equations. Also included periodically are listings and order forms for Service Notes, as well as factory recommendations for updating or modifying HP products.

For two sample issues and a subscription qualification form, check T on the HP Reply Card.



Bench Briefs: an HP service that improves your service.

HEWLETT-PACKARD COMPONENT NEWS

New hermetic LED meets military specs

A new hermetically-sealed gallium arsenide phosphide LED lamp has been formally approved for use in military systems as a JAN/JANTX component. The JAN 1N5765 and JANTX 1N5765 alleviate the need for users to generate a special military specification and apply for non-standard parts approval.

This hermetically-sealed solid-state lamp offers a minimum luminous intensity of 0.5 mcd at 20 mA and an operating temperature range of -65°C to $+100^{\circ}\text{C}$. The HP commercial part number is 5082-4420.

For specifications and reliability data, check I on the HP Reply Card.

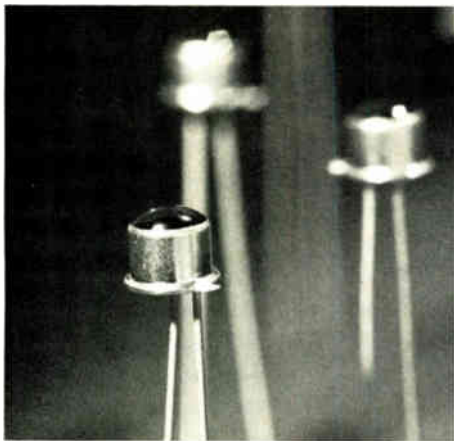

LED lamp for high reliability applications

New LED over-range digit expands display family

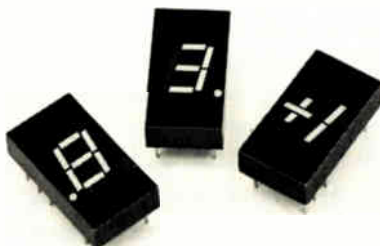

The new plus/minus one digit LED for HP 5082-7700 series LED displays.

A new plus/minus one digit is now available for applications requiring polarity designation or over-range capability. The 5082-7732 LED display is ideal for instrumentation such as digital voltmeters and digital multimeters. The unique feature of this display is the decimal point to the left of the "1" which allows the designer to show an additional range on the meter without the cost of an extra digit.

Designed for use with HP's 5082-7700 series of 0.3 inch (0.8 cm) LED displays, the 5082-7732 offers uniformly lit segments with wide viewing angle. They are available from stock or from any HP franchised distributor.

For details, check J on the HP Reply Card.

Use new medium-power microwave transistors

Our new 35850 series microwave transistors deliver $\frac{1}{2}$ watt power output to 3 GHz with documented high reliability. They're ideal for applications requiring linear, broadband power and for Class C saturated power.

Available as chips or in rugged, hermetic metal/ceramic packages, these NPN silicon bipolar transistors fill both common emitter and common base design needs. The common emitter versions provide linear power up to +26 dBm at 2 GHz for broadband amplifiers. The common base versions fit Class C saturated power amplifiers.

For specifications and reliability data, check H on the HP Reply Card.



HP's high-reliability linear microwave power transistors come in two packages plus chip form.

New logic analyzer book tells how to troubleshoot digital circuits easily

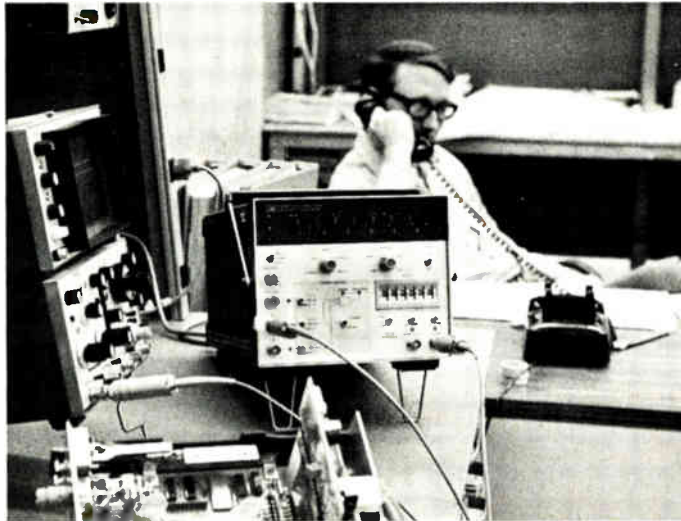

The 5000A logic analyzer solves a broad spectrum of problems that range from determining the logic state of a circuit node to locating a spike that occurs 850,000 clock periods after a trigger.

When is that short reset pulse really occurring? Or is it? What causes this flip-flop to end in the wrong state at the end of each machine cycle? Are these two lines ever HIGH at the same time? If these problems sound familiar, send for "The Logic Analyzer—A Step to Easier Digital Troubleshooting" and learn how HP's 5000A logic analyzer can help you solve such digital problems.

This new application note (167-1) describes the easy-to-use logic analyzer as a practical problem-solver. To display the sequence of HIGHS and LOWs occurring at several points in a digital circuit, simply connect the circuit clock to the analyzer, then freely probe through the circuit. The analyzer displays these HIGHS and LOWs as "bits" on two rows of LEDs. At a glance, you can determine if a flip-

flop is toggling, if the output of a shift register is following its input, or if a decade counter is really dividing the clock by ten. Even single-shot or very slow data is captured and stored for easy viewing.

The particular 32 bits displayed on each channel are selected by a combination of the versatile triggering controls and the digital delay. The trigger controls permit selection of any single input or any combination of up to three inputs for triggering. Digital delay lets you display information anywhere from 64 clock periods before the trigger event to 999,999 clock periods after the trigger event.

AN 167-1 also explains how to do more complex tasks such as investigating the output sequence generated by a ROM-controlled state machine, determining the content of Teletype data transmitted to a computer interface, or displaying jitter-free data from a moving-head disc as it is transmitted to the computer.

For your free copy, check S on the HP Reply Card.

HEWLETT  **PACKARD**

Sales, service and support in 172 centers in 65 countries.

East—W 120 Century Road, Paramus, N.J. 07652, Ph. (201) 265-5000.
South—P.O. Box 2834, Atlanta, Ga. 30328, Ph. (404) 436-6181.
Midwest—5500 Howard Street, Skokie, Ill. 60076 Ph. (312) 677-0400.
West—3939 Lankershim Boulevard, North Hollywood, Calif. 91604, Ph. (213) 877-1282.
Europe—Post Office Box 85, CH-1217 Meyrin 2, Geneva, Switzerland, Ph. (022) 41 54 00.
Canada—275 Hymus Boulevard, Pointe Claire, Quebec, Canada, Ph. (518) 561-6520.
Japan—Yokogawa-Hewlett-Packard, 1-59-1, Yoyogi, Shibuya-ku, Tokyo, 151.

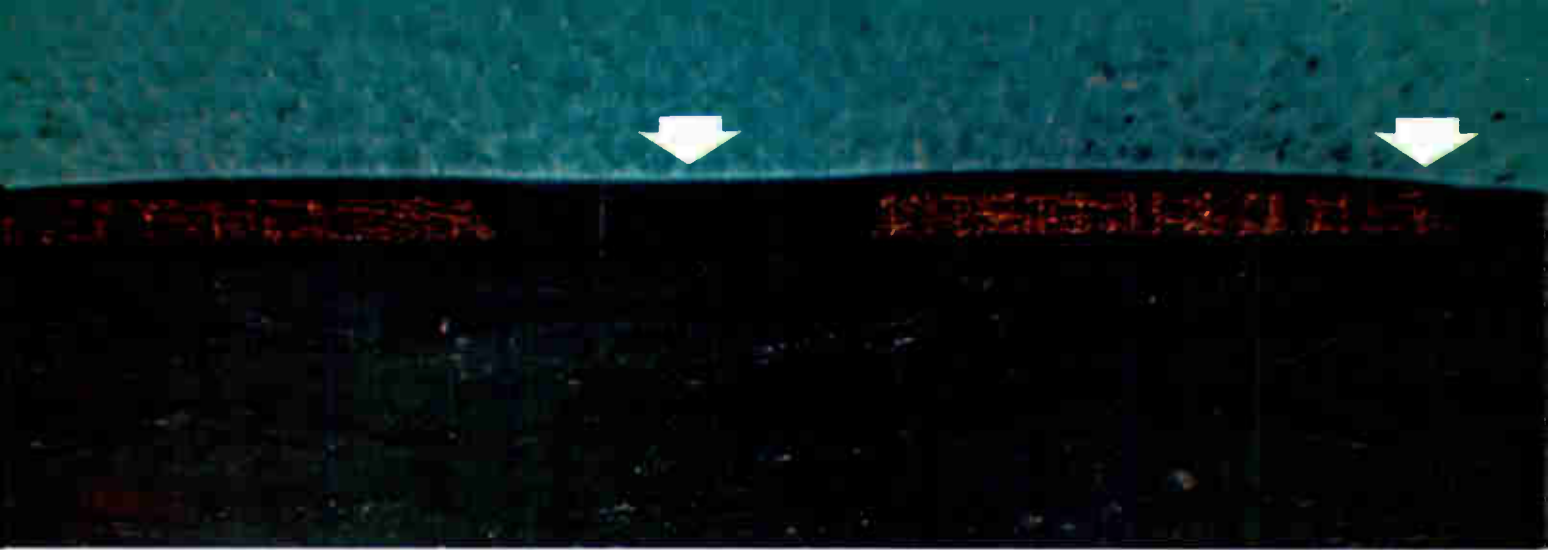

When spray or dip coatings fail...

Parylene works.



You are looking at magnified cross-sectional views of copper conductors on a circuit board . . . and why parylene protection brings the highest reliability to electronic circuitry.

The spray-applied urethane coating (top photo) bridges the channel between conductors, and offers scant protection at the edges. Urethane, silicone, epoxy . . . liquid coatings are uneven, and can produce potential failure points.

Parylene forms a thin and even coating, whatever the configuration, however complicated or delicate or densely populated. Without bridging. Without pinholes, voids, bubbles. We call it a conformal coating. From conformality comes reliability.

Parylene conformal coatings can be applied in precisely controlled thicknesses from 0.002 to 3 mils. *In one step.*

Parylene is applied at *room temperature*. No heat, no melting, no cure. No coating shrinkage. In other words, no discomfort for delicate components.

Parylene provides better barrier protection than urethanes, silicones or epoxies. It is extremely resistant to chemical attack,

exceptionally low in trace metal contamination, and compatible with all electronic solvents. Dielectrics are excellent .

Parylene has qualified under the stringent requirements of MIL-I-46058C; it does so with a 0.6 mil coating—parylene excels in the micro-electronic virtue of thinness.

Parylene conformal coatings have shown excellent cost effectiveness in many applications. On delicate, sophisticated and complex circuitry, in hybrid circuits and components, they may be the most cost effective answer for long term reliability.

Union Carbide invented the parylene system. The method is gas phase deposition, which is the only route to the reliability of conformal protection. Various patents apply; commercial use of the patented technology is licensed.

You can get complete information on parylene by writing for our 16-page brochure: Union Carbide Corp., 270 Park Ave., Dept. RB36, New York, N.Y. 10017. Further investigation will no doubt indicate a trial run, which we can perform at reasonable cost. If you would like to discuss that or any other related matters, please call Bill Loeb at (212) 551-6071 .





Beckman

HYBRID MICROCIRCUITS

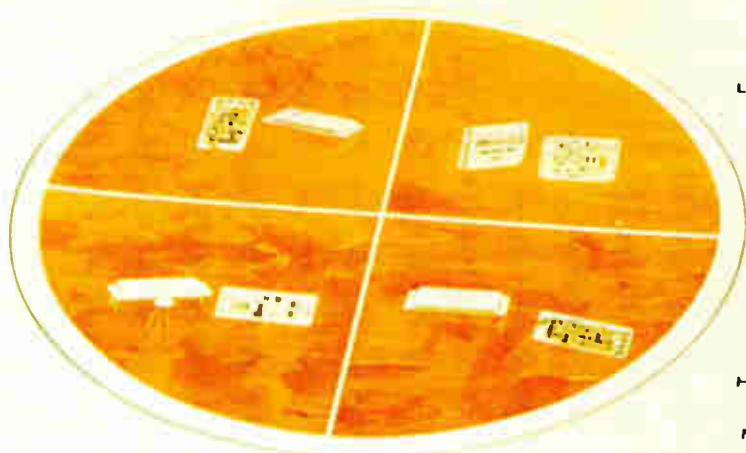

- UNIVERSAL ACTIVE FILTERS
- TELEPHONE TONE FILTERS
- PRECISION LADDER NETWORKS
- DAC/ADC PRODUCTS
- POWER AMPLIFIERS
- VOLTAGE REGULATORS
- INDUSTRIAL CONTROL CIRCUITS
- CUSTOM DISPLAY SUBSTRATES
- HYBRID MEDICAL FUNCTIONS
- MODEM FILTERS
- MIL-PERFORMANCE MICROCIRCUITS

Beckman Electronic Component Distributors

EASTERN REGION

- Arrow/Angus**
P.O. Box 126
Moorestown, N.J.
(609) 235-1900
(215) 928-1800
- Arrow Electronics, Inc.**
5207 East Dr.
Baltimore, Md.
(202) 737-1700
(301) 247-5200
- Arrow Electronics, Inc.**
900 Route 110
Farmingdale, N.Y.
(516) 694-6800
- Arrow Electronics, Inc.**
295 Treadwell St.
Hamden, Conn.
(203) 248-3801
- Arrow Electronics, Inc.**
No. 15 A Street
Burlington, Mass
(617) 273-0100
- Arrow Electronics, Inc.**
285 Midland Ave.
Saddle Brook, N.J.
(201) 797-5800
- Harvey R & D Electronics**
44 Hartwell Ave.
Lexington, Mass.
(617) 861-9200
- Kierulff Electronics, Inc.**
5 Industrial Dr.
Rutherford, N.J.
(201) 935-2120
- Lynch-Gentry Associates, Inc.**
1932 Drew Street
Clearwater, Fla.
(813) 443-2697
- Lynch-Gentry Associates, Inc.**
3470 Bowman Dr.
Winter Park, Fla.
(305) 671-7649
- Marshall Industries**
G.S. Marshall Products Group
88 Needham St.
Newton Highlands, Mass.
(617) 965-5115
- M & C Sales**
500 Plasamour Drive, N.E.
Atlanta, Ga.
(404) 875-2525
- M & C Sales**
1106 Burke St.
Winston-Salem, N.C.
(919) 723-1001

M & C Sales

- 904 Bob Wallace Ave.
Huntsville, Ala.
(205) 539-8476
- Ossmann Component Sales Corp.**
395 Cleveland Dr.
Buffalo, N.Y.
(716) 832-4271
- Ossmann Component Sales Corp.**
411 Washington Ave.
Kingston, N.Y.
(914) 338-5505
- Ossmann Component Sales Corp.**
280 Metro Park
Rochester, N.Y.
(716) 442-3290
- Ossmann Component Sales Corp.**
132 Pickard Building
Syracuse, N.Y.
(315) 454-4477
- Ossmann Component Sales Corp.**
1911 Vestal Parkway East
Vestal, N.Y.
(607) 785-9949

CENTRAL REGION

- Magnuson Electronics**
2420 Oakton St.
P.O. Box 130
Mount Prospect, Ill.
(312) 956-0700
- Magnuson Electronics**
1246 West 7th St.
St. Paul, Minn.
(612) 227-8495
- Norvell Electronics**
10210 Monroe Dr.
Dallas, Tex.
(214) 350-6771
- Norvell Electronics**
6440 Hillcroft Ave.
Houston, Tex.
(713) 774-2568
- Norvell Electronics**
3340 S. Memorial Dr.
Tulsa, Okla.
(918) 663-1247
- Sheridan Sales Co.**
Box 4457
Cleveland, Ohio
(216) 524-8120
- Sheridan Sales Co.**
Box 423
Dayton, Ohio
(513) 277-8911
- Sheridan Sales Co.**
33708 Grand River Ave.
Farmington, Mich.
(313) 477-3800
- Sheridan Sales Co.**
P.O. Box 677
Florissant, Mo.
(314) 837-5200
- Sheridan Sales Co.**
Suite 5009
1717 Penn Ave.
Wilkinsburg, Penn.
(412) 244-1640
- Sheridan Sales Co.**
Box 37826
Cincinnati, Ohio
(513) 761-5432

WESTERN REGION

- Almac/Stroom Electronics**
5811 Sixth Ave. South
Seattle, Wash.
(206) 763-2300
- Barnhill Five, Inc.**
1410-D Wyoming N.E.
Albuquerque, N.M.
(505) 299-7658
- Barnhill Five, Inc.**
1170 S. Sheridan Blvd.
Denver, Colo.
(303) 934-5505
- Barnhill Five, Inc.**
7329 E. Stetson Dr.
Scottsdale, Ariz.
(602) 947-7841
- Marshall Industries**
G.S. Marshall Products Group
9674 Telstar Ave.
El Monte, Ca.
(213) 686-0141
- Marshall Industries**
G.S. Marshall Products Group
8057 Raytheon Rd.
San Diego, Ca.
(714) 278-6350
- Marshall Industries**
G.S. Marshall Products Group
788 Palomar Ave.
Sunnyvale, Ca.
(408) 732-1100
- Almac/Stroom Electronics**
8888 S.W. Canyon Rd.
Portland, Ore.
(503) 292-3534



For breadth of line in microcircuits or in information, hit the right books.

Reliable, at-hand sources are some of the good things in life. Like the encyclopedia, for compact information. And, to more and more electronic designers, Beckman for our broad line of high-quality hybrid microcircuits at competitive prices.

Our distributors are a main reason. All around the country, they're stockpiled with the full line of standard hybrids, as well as with our industry-leading DIP resistor networks, trimmers, dials and pots. So they can offer delivery as fast as any in the industry, and usually faster.

Typical Beckman standards include universal active filters, for example. And telephone tone frequency filters. Precision ladder networks. Four-quadrant multiplying DACs. Successive approximation ADCs. High-power, high-slew FET input Op Amps. High-reliability MIL voltage regulators. And dual-tracking voltage regulators.

Our custom hybrid service is also something to turn to. Because we produce custom alterations or new products

in infinite variety. To time schedules few others can meet. We either build to customer design and specs or supply the design help when needed.

Typical custom units are modem and tone frequency filters. Entertainment system hybrid DACs and equalization filters. Custom display substrates (calculators, watches). Medical diagnostic timing and control functions. MIL-performance log amps, regulators, DACs, ADCs, and many others.

The point is, as a hybrid source, the Beckman line and distributor system are front-runners. For high quality and fast delivery. For competitive price and thorough service — including even a toll-free telephone express system to get literature to customers in just days. (Call toll-free 800-437-4677.)

It's no wonder thousands of designers think of the Beckman catalog as a "most-valued reference work."

Beckman®

HELIPOT DIVISION

The Almost

No Power C-MOS ADC

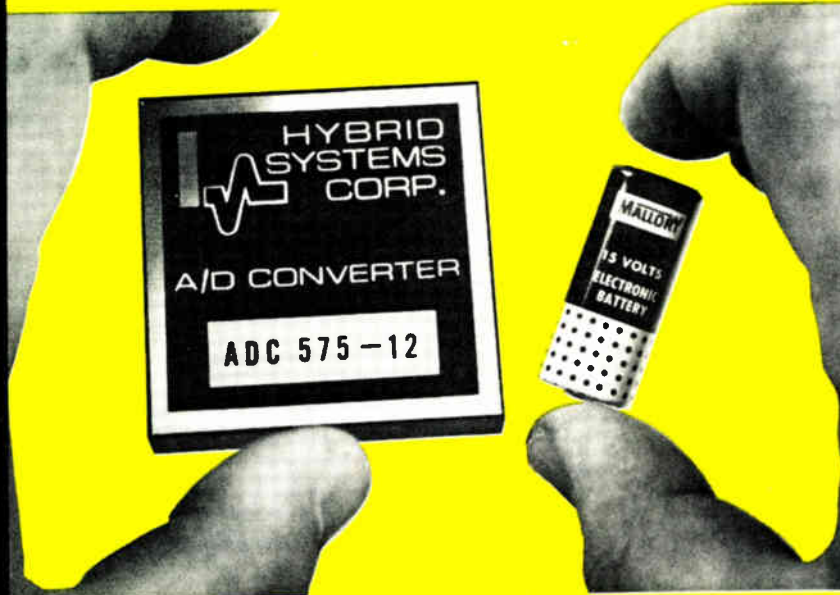

New, 12-Bit A/D Converter operates off a single +15V battery!

- Less than 20 milliwatts
- Ultra-small — 2" x 2" x 0.4"
- 1/4 the size of conventional 12-bit ADC's
- Super high input impedance $>10M\Omega$
- Conversion time — 100 mSec
- \$199 — Model ADC575-12
(does not include battery)

... the best new data conversion module
of the year.



HYBRID SYSTEMS CORPORATION

87 Second Avenue, Northwest Industrial Park, Burlington, Mass. 01803
Telephone: 617-272-1522 TWX: 710-332-7584

Meetings

Joint Conference on Sensing of Environmental Pollutants: ISA, IEEE *et al.*, Sheraton Park, Washington, D.C., Dec. 10-12.

Winter Consumer Electronics Show: EIA Consumer Electronics Group, Conrad Hilton Hotel, Chicago, Ill., Jan. 10-13, 1974.

Reliability and Maintainability Symposium: IEEE, Biltmore, Los Angeles, Calif., Jan. 29-31.

International Solid State Circuits Conference: IEEE, University of Pennsylvania, Marriott Hotel, Philadelphia, Feb. 13-15.

Computer Conference (Comcon): IEEE, Jack Tarr Hotel, San Francisco, Feb. 26-28.

Aerospace and Electronics Systems Winter Convention (Wincon): IEEE, Marriott Hotel, Los Angeles, March 12-14.

Zurich Digital Communications International Seminar: IEEE, Swiss Federal Institute of Technology, Zurich, Switzerland, March 12-15.

International Convention (Intercon): IEEE, Coliseum and Statler Hilton Hotel, New York, N. Y. March 25-29.

Carnahan Conference on Electronic Crime Countermeasures: IEEE, Univ. of Kentucky, Lexington, April.

International Reliability Physics Symposium: IEEE, MGM Grand Hotel, Las Vegas, Nev., April 2-4.

International Optical Computing Conference. IEEE Computer Society, Zurich, Switzerland, April 9-11.

Optical and Acoustical Micro-Electronics: IEEE, Commodore Hotel, New York, N.Y., April 16-18.

International Circuits and Systems Symposium: IEEE, Sir Francis Drake Hotel, San Francisco, April 21-24.

Communications Satellite Systems Conference: IEEE, International Hotel, Los Angeles, Calif., April 22-24.

CAUTION: 50,000 VOLTS



LET ERIE DESIGN and BUILD YOUR HIGH VOLTAGE POWER SUPPLIES and VOLTAGE MULTIPLIERS

When you talk about designing and packaging miniature, low current High Voltage Power Supplies and Voltage Multipliers, the name ERIE should come to mind first. Why? *No other manufacturer of these sophisticated devices has its own capacitor and rectifier technology in-house.* Only ERIE does it all. Our many years experience in producing State of the Art high voltage capacitors and high voltage silicon rectifiers — plus an unsurpassed technology in circuit designing, packaging and encapsulation, makes ERIE an ideal source for your high voltage component needs. From very low input voltages, ERIE can produce output voltages up to 50,000 volts. Application for these compact, high reliability devices includes night-vision image intensification systems. Apollo TV cameras. CRT displays. Avionics systems exposed to rugged environments. Industrial, commercial and military equipments . . . an almost infinite variety of applications. So bring ERIE in early. Let us design and build *your* High Voltage Power Supplies and Voltage Multipliers. We're equipped to handle large or small volume orders . . . in-house.

Write for our 32-page catalog . . .
High Voltage Components and
Devices . . . or for technical
assistance, call

613/392-2581

ERIE TECHNOLOGICAL PRODUCTS, INC.
Erie, Pennsylvania 16512

ERIE

Circle 31 on reader service card



Who has the broadest line of Potentiometers?

It stands to reason that we wouldn't ask the headline question unless we were certain of the answer.

And we are. Unquestionably, the answer is **BOURNS**

Compare catalogs if you like. You'll find over 12,000 model/terminal/resistance combinations offered in our **TRIMMER POTENTIOMETER** section. Single-turn and multi-turn . . . round, square and rectangular — BOURNS has them all, in wirewound or cermet models.

No need to look elsewhere for a complete line of **PRECISION POTENTIOMETERS**. Check the precision section of the Bourns catalog. Over 20 different standard bushing mount models are displayed, including the unique KNOBPOT® integral dial/potentiometer family. If you have servo-mount requirements, or need "something special" . . . our fully staffed custom design and manufacturing organization is at your service. Promptly.

More? You bet.

Bourns popular "SPACE SAVER" line of cermet **CONTROLS** are finding wide acceptance in cost-conscious consumer and industrial applications. You can expect to see exciting developments in this line.

Our cermet and composition open frame **VARIABLE RESISTORS** are super for budget PC board applications. They're priced as low as 10¢ in production quantities. They're from Bourns, so you can count on cost-effective quality and service . . . even at such low prices.



When you think of variable resistive components . . . look no farther than your Bourns Master Catalog. It's your supermarket of quality, cost-effective resistive components.



TRIMPOT PRODUCTS DIVISION • 1200 COLUMBIA AVE., RIVERSIDE, CALIF. 92507

47A-9

Repeatability in
thin film networks
is a matter of
experience.

If you're really
serious about cost,
be serious about quality.

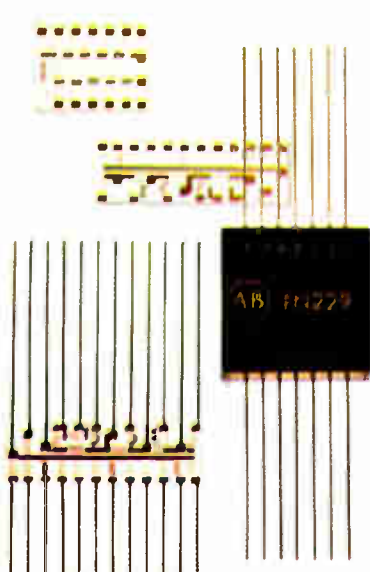

Our chrome-cobalt technology, for example, has been proven in dozens of applications ranging from D/A and A/D conversion, voltage division in digital multimeters and telemetry equipment, to communications paging devices.

In seventeen years of film resistor production, we've solved many problems that others are yet to encounter. This hard earned experience allows us to respond quickly to your custom needs. We regularly duplicate prototype performance in virtually any quantity. You get excellent delivery along with greater assurance of part-to-part quality.

Profit from the practiced teamwork of our

application, quality control and production engineers. Write for Publication 5801, Allen-Bradley Electronics Division, 1201 South Second St., Milwaukee, WI 53204. Export: Bloomfield, New Jersey 07003. Canada: Allen-Bradley Canada Limited, Cambridge, Ontario. United Kingdom: Jarrow, County Durham NE32 3EN.

Performance specifications

TCR: 10 to 25 ppm/°C
Absolute tolerance: as low as .01%
Interconnections: metal film (no soldered or welded joints)
Stability: 50 ppm/year
Packaging: chip, conformal coated, encapsulated



ALLEN-BRADLEY

Milwaukee Wisconsin 53204

EC65

Circle 34 on reader service card

Field-effect crystal promises lower threshold, drive needs

A new field-effect liquid-crystal display, now being tested by a California company, promises to operate at very low threshold and drive voltages. **The company, Antex Inc. of Mountain View, Calif., says that its material has a threshold of 2.85 volts peak to peak, and can be driven at about 3 v.** This compares with a 10-v threshold and drive voltage of 15 to 20 v for dynamic-scattering liquid-crystal displays; conventional field-effect displays must be driven at 5 to 6 v. Thus, the new material has the advantage of single-battery operation.

Equally important, it has a relatively high switching speed—**nowhere near as fast as light-emitting diodes, but fast enough to multiplex eight to 10 digits.** And Antex's founder and chief executive, Ken T. Chow, says the speed permits strobing of the digits and use of a seven-line drive for all the segments.

Data system eliminates need to change software

Without requiring any time-consuming or expensive change in host-computer software, a data-communications system developed by Computer Transmission Corp., El Segundo, Calif., **connects a high-speed line printer in one city and a data-processing computer in another city. This link is transparent in that the computer acts as if the printer were in the same room.**

The MultiTran 4000 has been installed by Time Inc. to connect its data-processing centers in Chicago and New York City. At Time, says Jon Woolley, the company's New York data-processing manager, the M-4000 operates at 7,200 bits per second in a full-duplex mode over a conditioned private line. Including some peripherals, system cost was about \$100,000, says Woolley.

10-bit DAC needs but 30 mW

Several advances in monolithic digital-to-analog converter design are claimed for a new 10-bit C-MOS multiplication DAC by Analog Devices. **The firm says this is the first microelectronic DAC—either monolithic or hybrid—to operate monotonically over the full military temperature range, the first truly low-power DAC, and the first C-MOS DAC.**

The normal range of monotonicity—about 10°C—no longer applies, since the C-MOS chip's low power dissipation (30 milliwatts maximum) and stability of the silicon-chromium R-2R resistor network cuts self-heating and temperature drift of linearity and gain. **One operational amplifier is added to the device for two-quadrant multiplication and two for four-quadrant multiplication** (unipolar and bipolar binary operation). The C-MOS chip measures only 74 by 96 mils—small enough the company says, to price the DAC competitively with hybrid converters assembled from bipolar devices.

Fairchild to offer first Isoplanar MOS RAM

The first MOS random-access memory to be fabricated with Isoplanar dielectric isolation is under development at Fairchild Semiconductor. C. Lester Hogan, president of the parent Fairchild Camera & Instrument Corp., says **the RAM will be plug-compatible with Intel Corp.'s 1103, but will operate at higher speeds.** Fairchild is aiming the new RAM at the 1103 market, Hogan says, because more than half the RAMs now sold are 1103s, a design that "will live for a long time." **The RAM is**

scheduled for introduction in the first quarter of 1974.

Previous Isoplanar products have been bipolar [*Electronics*, March 1, p. 26], except for a 1,024-bit shift register that came out this fall.

Data communications via cable TV to be tested

Experiments will begin next year on a method of transmitting business data over urban cable-television lines in the uhf spectrum. Developed by Joseph Garodnick, a staff consultant for Goldmark Communications, Stamford, Conn., **the cable system operates at 2,400 to 1 million bits per second and can handle all data information equipment** ordinarily used on telephone lines.

Black box turns TV into automatic intrusion detector

A black box that attaches to a closed-circuit-TV camera and detects changes in the video image is going on the market as a security and industrial sensor. **It will trigger an alarm if an intruder moves past the camera, turns on a light, or causes any other marked change in the video image.** It can also be used to convert a camera to a conveyor-line counting and control sensor, says Robert Simmons, general manager of Information Processing Systems of Belmont, Calif.

Circuits in the box sample the video images, integrating energy levels in the video signal and detecting changes in the energy content of the samples. The detector's output then triggers an alarm or alerts a guard to watch a TV monitor. **Many cameras may be coupled to a single monitor through bridge switches,** Simmons says, making it unnecessary for a guard to stare continuously at rows of monitors.

Hughes, Rockwell add production lines

Two major Southern California aerospace firms aggressively pursuing commercial microelectronics markets are setting up lines to produce advanced semiconductor parts such as charge-coupled devices. **Rockwell Microelectronics in Anaheim is putting together a 15,000-square-foot line,** to go onstream next year, for CCDs, silicon-on-sapphire MOS, and nonvolatile MNOS memories. In fact, Rockwell will introduce in January a 1,024-bit nonvolatile MNOS RAM compatible with its conventional 1,024-bit MOS RAM.

Meanwhile, the Industrial Products division of Hughes Aircraft is **setting up a line in Oceanside to make CCD imaging devices.** The new facility will be headed by Hans Dill, former head of Hughes' microelectronics research activity.

Addenda

A semiconductor house and a TV set maker have collaborated on a design that may go a long way toward making remote electronic TV tuning a reality while satisfying FCC rules that uhf tuning be as easy as vhf. What the two, Fairchild and Admiral, have done is **compromise by using TTL MSI circuits instead of LSI.** . . . Speculation is growing that the Justice Department is **readying an antitrust suit against AT&T** alleging, among other things, monopolization of, and unfair restraint of trade in, devices designed to protect the phone network against damage from customer-provided equipment. The Justice Department declines comment.

C-LINE POWER DARLINGTONS

...how and where to use them

new application notes contain more than 15 Power Darlington circuits

Here in one place is everything you've always wanted to know about Darlington... how to design for higher speed, lower saturation voltage and high gain in less space. Major applications include pulse and switching circuits, power supplies and linear amplifiers. Four typical applications are illustrated below.

SWITCHING VOLTAGE REGULATOR

Unitrode Power Darlington are optimized for switching-regulator service with very fast switching, very low $V_{CE(sat)}$ and high current gain. In this circuit, the full load efficiency can be better than 95%.

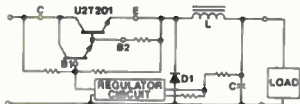

PUSH-PULL INVERTER

The high current gain of the Unitrode Darlington allows it to be driven directly from a logic-level multivibrator. The low $V_{CE(sat)}$ not only raises efficiency, but indirectly reduces the magnetizing inductance requirement of the transformer. At 10KHz and full load, the circuit attains an inversion efficiency of approximately 90%.

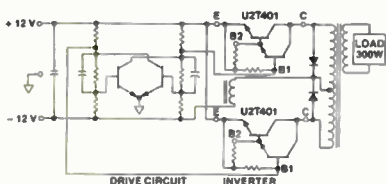

HIGH SPEED SWITCH FOR INDUCTIVE LOADS

Used with loads such as solenoids, phase shifters and small DC motors, this circuit is not only a switch, but (in the ON state) a constant current source which can drive an inductive load to its steady-state current in less than the time constant of the load itself.

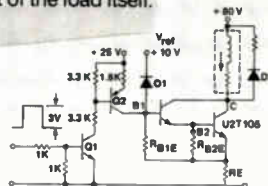

MOTOR CONTROLLER

Unitrode Power Darlington are most suited for applications where high-speed jogging, fast dynamic braking or high slew rates are required, and conventional power transistors will not satisfy the highest speed requirements.

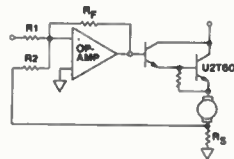

In all applications presented, the circuits have been proven with Unitrode's U2T Series Power Darlington in both NPN and PNP types - from 2 to 20 amps, 60 to 150 volts in TO-33, 3 pin TO-66 and 3 pin TO-3 packages. 100 quantity prices for the series range from \$1.25 for 5A, 60V devices to \$5.40 for 20A, 150V types.

Unitrode Corporation, Dept.22Y, 580 Pleasant Street, Watertown, Mass. 02172 Tel. (617) 926-0404

Use the Reader Service Card for your free copy of the new Power Darlington Application Booklet.

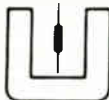

UNITRODE quality takes the worry out of paying less.

Unitrode Franchised Distributors: ARIZ., Phoenix, KIERULFF (602) 273-7331; CAL., Los Angeles, KIERULFF (213) 685-5511, Palo Alto, KIERULFF (415) 968-6292, San Diego, KIERULFF (714) 278-2112; CANADA, Toronto, SCHWEBER (416) 925-2471; COLO., Denver, KIERULFF (303) 343-7090; FLA., Hollywood, SCHWEBER (305) 927-0511; GA., Atlanta, SCHWEBER (404) 449-9170; ILL., Elk Grove, SCHWEBER (312) 593-2740; MO., Rockville, SCHWEBER (301) 881-2970, Baltimore, TECHNICO (301) 828-6416; MASS., Waltham, SCHWEBER (617) 890-8484; MICH., Troy, SCHWEBER (313) 583-9242; N.J., Somerset, SCHWEBER (201) 469-6008; N.M., Albuquerque, KIERULFF (505) 272-1055; N.Y., Rochester, SCHWEBER (716) 328-4180, Westbury, SCHWEBER (516) 334-7474; N.C., Raleigh, SCHWEBER (919) 832-8881; OHIO, Beachwood, SCHWEBER (216) 464-2790; TEX., Garland, KIERULFF (214) 271-2471, Dallas, HAMILTON-AVNET (214) 638-2850, Houston, HAMILTON-AVNET (713) 526-4661, Houston, LENERT (713) 225-1465; UTAH, Salt Lake City, ALTA ELECTRONICS (801) 486-7227; WASH., Seattle, KIERULFF (206) 763-1550.

Use Raytheon CRTs and be choosy.

Because Raytheon offers one of the most complete lines in the business. Whether your requirement is Military, Commercial, Airborne, Medical, or any other sophisticated application, there is probably a Raytheon CRT to do your job. See what we mean. Check these 6 major reasons why using Raytheon lets you be choosy.

- Choice of size — from 1" to 23" . . . shapes — round, rectangular, square.
- Choice of deflection — magnetic or electrostatic tubes. Plus a full range of anode caps, shields and sockets for the electrostatic tubes.
- Choice of phosphors — covers full range of brightness and persistence requirements. Plus penetration color tubes.
- Choice of high resolution flying spot scanner tubes.

- Choice of CRT or packaged subassembly (ready for monitor installation).
- Choice of choice — stock units (with immediate delivery of sample quantities) or fast turn-around special engineering services for custom requirements.

Look into the line that gives you choice all the way. Raytheon. For complete details on the full range of Raytheon and Telefunken CRTs, contact Raytheon Company, Industrial Components Operation, 465 Centre St., Quincy, Mass. 02169. (617) 479-5300.

RAYTHEON



SOS technology boosts performance in microcomputer

General Automation uses 160-mil-square SOS chip as the microprocessor for its LSI-12/16

While semiconductor makers are producing 8- and 16-bit n-channel microprocessors [*Electronics*, Sept. 27, p. 33], a minicomputer company, General Automation Inc., has leapfrogged them and that technology with the first known n-channel silicon-on-sapphire microcomputer.

General Automation officials believe they have jumped ahead one product evolution by offering TTL performance at MOS prices, rather than slightly reducing the cost of a TTL-type minicomputer or drastically reducing the cost of a lower-performance MOS machine, the two courses that have characterized minicomputer evolution.

With an eye to replacing low-end minicomputers and opening up new control applications, General Automation designed—using rules supplied by Rockwell International Corp.'s Microelectronics Device division—an SOS computer. Rockwell is General Automation's prime source for the chip. Both companies are in Anaheim, Calif.

The 2,000-gate-equivalent SOS processor, heart of the new LSI-12/16 computer, is one of the most complex SOS parts made for production. It is on a 160-mil-square chip and is contained in a 28-pin package. The LSI-12/16—including 2,048 bytes of random-access memory—is on a board smaller than a standard sheet of typing paper. A small piggyback board provides up

to two times more random-access memory or 8,192 bytes of read-only memory. An additional small board holds up to 32,000 bytes of memory. A battery is used for memory protection.

The LSI-12/16 is priced at about \$1,000, which includes 4,096 bytes of memory. The microcomputer is self-contained, except for its power supply, and includes a simplified control console and light-emitting-diode indicators for troubleshooting. Aside from the SOS processor and memory, the board includes system alarms, plus fail-safe and interface circuits. Deliveries are expected to start early in 1974.

The LSI-12/16's closest competitor is Computer Automation's Naked Mini LSI [*Electronics*, April 12, p. 36], although General Automation claims its machine is two to three times faster. The Naked Mini

LSI fits on a board measuring about 15 by 16 in., including a 4,096-word MOS memory and is also priced at about \$1,000 in OEM quantities.

According to Lawrence Goshorn, president of General Automation, the LSI-12/16 is equivalent to a standard 2-microsecond, 8-bit minicomputer in performance. It is slightly faster than the SPC-12 it replaces. Goshorn feels that the board microcomputer—he saves the word microprocessor for individual chips—is a new business, fitting between LSI and present minicomputers and offering the same relation to the semiconductor component business that present minicomputer systems have to basic minicomputer boxes.

Goshorn expects the SOS computer to be in full production by next summer and suggests that General Automation has other SOS

All In one. The SOS processor chip used in the LSI-12/16 contains all the functions previously housed on its predecessor SPC-12's large CPU board (background).

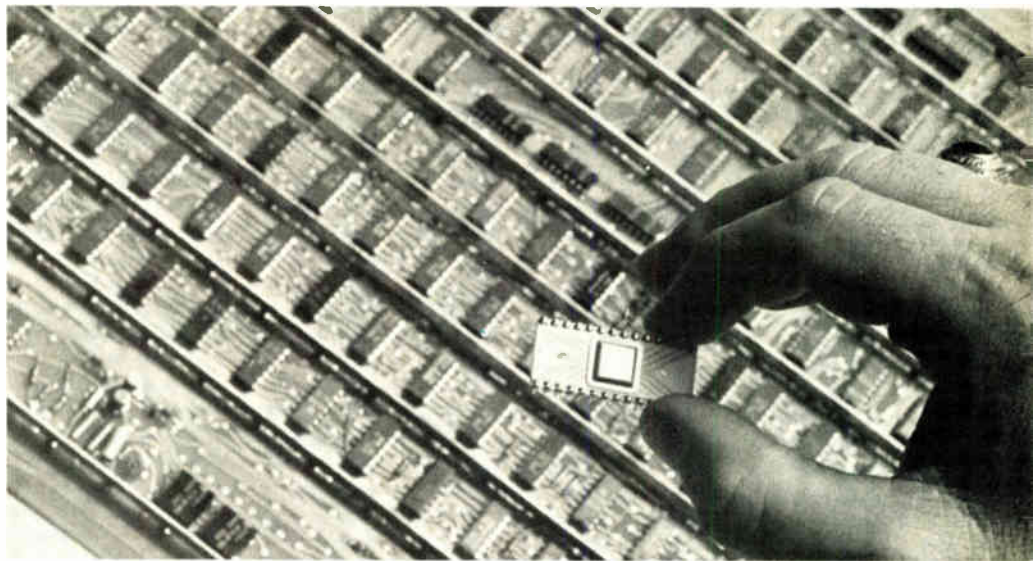

SOS sets fast pace

Silicon-on-sapphire technology is not new, but it has been of little practical use so far, despite its numerous advantages over present popular bipolar and MOS technology.

The SOS process involves making conventional MOS circuitry in a thin layer of silicon that is grown epitaxially on the surface of an insulating wafer of sapphire. The insulating substrate permits much denser spacing and far lower capacitance than conventional MOS, so that p-channel MOS on sapphire is about as fast as present high-speed n-channel MOS. General Automation and Rockwell are using n-channel MOS on sapphire, permitting speeds now possible only with bipolar TTL circuitry.

These speeds, moreover, are possible with the very low power consumption typical of MOS. Thus, complex circuitry impossible with bipolar circuits due to heat problems are expected to become commonplace in SOS. And, future complementary-MOS on sapphire offers even lower power requirements, plus speeds that may equal emitter-coupled logic. Semiconductor memories are prime candidates for SOS, and major semiconductor and computer firms are known to be working hard to bring them into use.

developments in the works. "We've been shipping minicomputers with Schottky TTL for over a year now, and where is there to go from there? ECL would require a big jump, and the SOS route gives us opportunities for much speed improvement."

General Automation doesn't yet have firm orders, but the new unit is being designed into four or five major programs, each in the 1,000- to 5,000-unit range, Goshorn says. The prospective users are present General Automation customers in the automotive, machine control, and communications businesses. □

Solid state

CAD IC trimmer is fast, precise, cheap

A unique application of the "blown fuse" technique to the pretrimming of monolithic operational amplifiers may shake up the analog-module and hybrid-IC markets. Developed by Intersil Inc., the technique will be used to trim other types of ICs in the future.

The op-amp chips are trimmed automatically during wafer-probe tests, making it practical to mass-produce monolithic equivalents of best-selling types of modules and hybrids, reports Jack Gifford, director of analog products at the Cupertino, Calif., firm.

Intersil has applied for patents on the amplifier-trimming method and design, which are adaptations of a technique the company uses to field-program read-only memories. In the ROMs, diodes diffused into the bulk silicon are "blown" with current pulses to store data in the memory array. In the amplifiers, similar diodes allow thin-film resistors to be interconnected as a parallel network that adjusts both offset voltage and the temperature drift of the offset voltage.

Six nichrome thin-film resistors, which have values of 200 ohms to 12 kilohms, are deposited on the chip along with diodes that, until blown, block the resistors out of the circuit. When blown, each diode shorts, and one resistor is added in parallel to a network that nulls the amplifier, as though a technician were adjusting the circuit with a potentiometer.

However, the trimming method is more sophisticated than one based on a potentiometer. Gifford explains that "we program toward a network with a close-to-zero temperature coefficient." As each chip on the wafer is probed to determine its basic characteristics, a computer-aided-design routine worked into the test program computes the best combination of resistors for that chip's nulling network. In effect, the CAD routine individually designs a network for each chip.

Fine tuning. One such operation generally reduces the offset voltages of an amplifier to less than 10 milli-

volts. Offsets as low as 1 mV can be obtained by alternately testing the chip and blowing diodes to "fine tune" the network. Gifford says the method costs 30% to 50% less than laser-trimming a resistor network on a hybrid IC substrate. "Besides, if the system overtrims a chip, we throw away just the chip—not a relatively expensive hybrid assembly," he says.

Gifford says Intersil engineers tried the pulse-programming method "in desperation" more than a year ago when they learned that an automatic laser-trimming system would cost \$200,000 to \$500,000 and still not provide trimming rates consistent with wafer-production rates. "If we could trim only at onesy-twosy rates, we couldn't get under module and hybrid costs." Gifford says.

Experiments started with 741-type op amps, then were shifted to a new version of Intersil's 8007 op amp, which has input field-effect transistors fabricated on the same chip as a bipolar op amp.

Since the trimming network is on the bipolar stage, it does not affect the FET characteristics. Input bias currents remain the same as in the 8007—chips with input bias currents from 1 to 50 picoamperes can be sorted from a production run.

However, offset voltages of the trimmed 8007 units range from about 1–15 mV, compared with 10–50 mV for untrimmed chips, and offset drifts of 10 or 15 microvolts. Exceptionally well-trimmed amplifiers will be offered as "specials." Prices have not been set, but Intersil plans to shave the price for modules and hybrids somewhat. □

GaAs MIS FET made in Japan

Searching for devices that can operate at higher frequencies than those made with n-channel silicon, researchers at Hitachi Ltd. have reported success at making n-channel gallium-arsenide, metal-insulator semiconductor (MIS) field-effect transistors. Higher frequencies are

possible with MIS FETs because the mobility of the electrons in gallium arsenide is at least five times greater than it is in silicon.

Hitachi's experimental devices, however, only operate to about 140 MHz because of the geometrical effects of the relatively long—50-micrometer—channel length, which was chosen for ease in making the initial devices. Details were presented at the International Electron Device Meeting [see p. 78] by Takao Miyazaki. Coauthors were Nobuo Nakamura and Takashi Tokuyama.

Other goals of the Hitachi Central Research Laboratory project include the development of practical surface-passivation techniques, which give low densities of surface states, and the development of practical planar-device techniques. Passivation is necessary in making MIS devices because the gate-insulator interface must have a relatively low number of surface states. Planar technology is necessary because the surfaces of the source and drain regions are coplanar with the channel and because it permits multidevice interconnection.

Hitachi researchers say that a basic problem in fabricating devices of this type is difficulty in obtaining high-quality gallium-arsenide single-crystal materials. The usual p-type pulled crystal has a carrier concentration of 10^{17} per cubic centimeter or greater, and bulk characteristics tend to change during the thermal processing steps. Thus, the Hitachi researchers grow, from liquid, a p-type epitaxial layer at about 700°C with a carrier concentration of 10^{15} per cubic centimeter on the wafer surface.

The next important fabrication step is formation of the n^+ source and drain at low temperatures. Two techniques have been used. In the first, two silicon-dioxide films are used—one for defining the junctions and another, doped with tin, overlaying the first. The temperature of the wafer is raised to 900°C , and tin from the doped oxide diffuses through windows in the undoped layer to form n^+ regions.

In the other method, the p-type

gallium arsenide is implanted with silicon ions at a temperature of 240°C at energies up to 175,000 electron volts. Then the implanted area is covered by a film of silicon dioxide or polycrystalline silicon and annealed for 1 hour at 850°C in a nitrogen atmosphere.

So far, engineers have deposited silicon-dioxide films on gallium arsenide with surface-state densities of $10^{11}/\text{cm}^2$ and achieved field-effect mobilities at $1,480 \text{ cm}^2/\text{volt-second}$ —a value below the theoretical maximum, but still higher than that achieved in silicon.

The gate insulator can be silicon dioxide deposited by chemical-vapor deposition in an oxygen-free atmosphere, such as nitrogen.

Until now, practical gallium-arsenide FET devices have been Schottky-barrier depletion-type devices. Carrier flow is in an epitaxial layer deposited on a nonconducting substrate. During operation, current is pinched into the interface between insulating and epitaxial layers. In general, since crystal defects are numerous in this interface, practical transistors will probably continue to achieve far less than the theoretical characteristics that are based on calculations of a low-defect crystal structure.

A gallium arsenide MIS FET was built previously by Hans Becke, Joseph White, and Robert Dawson of RCA. However, their device had a rather high concentration of surface states at the interface of semicon-

ductor and gate insulator, and there was no inversion layer. FET operation was obtained by doping the channel. □

Components

New tube is half solid state

Just when it seemed that transistors might make tubes obsolete in medium-power radio transmitters, along came a new class of tubes that could reverse the trend. These electron-bombarded semiconductor (EBS) devices were first conceived at Watkins-Johnson Co., Palo Alto, Calif. with support contracts from the Army and Navy in the late 1960s. Now the devices are almost ready for production.

An EBS device is a marriage of vacuum-tube and semiconductor technologies, but it provides capabilities not found in either. What's more, it has gain-bandwidth and voltage-rise-time capabilities 10^3 to 10^5 times greater than existing competitive devices.

In an EBS tube, the rf signal is amplified by using it to control a high-voltage electron beam that bombards a semiconductor diode, which produces the output signal. The electron beam, generated by an oxide-cathode electron gun, is controlled in one type of EBS by a grid

Hitler. An rf modulated pulled-electron beam strikes the back-biased diode target at 10 to 15 keV. Amplification is achieved through charge multiplication in the depletion region.

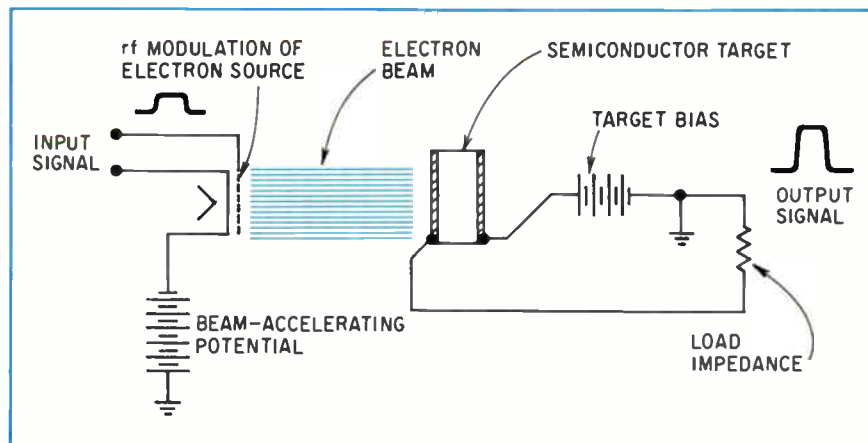

and in another by a beam-deflection structure similar to the meander lines used in some traveling-wave tubes. The beam may be deflected back and forth between two diode targets for class B amplifier operation.

Highly reliable tubes with power outputs ranging from up to 100 watts at frequencies around 300 megahertz and several watts at 1–2 gigahertz appear practical, according to D.J. Bates, the Watkins-Johnson engineer who presented an EBS-device paper at the International Electron Devices Meeting [see p. 78]. The paper is coauthored by Aris Silzars, also of Watkins-Johnson; Aaron Ballonoff, who has been developing diode targets at Signetics Corp. Sunnyvale, Calif.; and George Taylor, of Army Electronics Command's Evans Laboratory, Fort Monmouth, N.J.

Shielded. According to Bates, Watkins-Johnson is the first company to produce EBS devices. Several experimental types were used this year at military labs in R&D on new system designs. These had uncertain reliability due to diode target degradation at high voltage. Bates says that hurdle appears to be overcome with a radiation-hardened diode design from Signetics—a planar diode with beam shields deposited on passivated silicon. A layer of phosphorus-doped glass covered by metal films—like those used to form the beam of beam-lead chips—lies over the oxide coating on the junction periphery. The shield keeps diode avalanche-breakdown voltage well above the peak output voltage of the tube. Without a shield, surface charges induced by the electron beam would cause the avalanche level to drop too low.

Ten tubes have already accumulated a total of nearly 60,000 diode hours of high-voltage, high-power operation without any failures in tests conducted at Watkins-Johnson and Evans Laboratory.

"We've more or less passed the military mean-time-between-failure requirement of 7,500 hours and are now hoping for much longer MTBF and operating lifetimes of 20,000 to 30,000 hours," Bates says.

Sony Corp. considers expanding its North American operations

Sony Corp. is contemplating—but has yet to decide on—expansion of its North American manufacturing operations. Sony president Akio Morita says the company, which is in the process of expanding its television manufacturing operation in San Diego, Calif., with the addition of a picture-tube plant has "not yet" made a decision to open a second plant in the United States. Asked about reports that Sony also is considering a Canadian manufacturing operation, Morita said "no decision has been reached" on that prospect.

The disclosure by the Sony executive came during a late November visit to Washington, where he delivered an invited lecture on "Creativity in Modern Industry" at the Smithsonian Institution. In conversations before and after the lecture, the 52-year-old Sony co-founder asserted that:

■ Sony, whose approach to technological innovation has made it "a leading follower," expects to sell 1.5 million Trinitron color-TV receivers this year.

■ Productivity of U.S. workers at the company's San Diego plant is approximately 80% of that of Japanese workers in the company's domestic plants. He attributed the higher Japanese productivity in part to the generally higher degree of education of Japanese workers. Morita declined, however, to elaborate on the observation of Masaru Ibuka, Sony chairman and co-founder, in October at Toronto that the San Diego operation has encountered "minor" problems with U. S. managerial personnel.

Sen Nishiyama of Sony's international affairs staff, who accompanied Morita on his U. S. visit, confirmed that the company was disappointed by many of the more than 1,500 U. S. product applications it had received following Sony's advertisements offering to act as distributor of American goods in Japan. Many of the U. S. electronics and appliance makers Nishiyama said, apparently are unaware that Japan's electrical system operates at 100 volts, rather than the 110–115-v standard of the U. S.



Orientation. Host S. Dillon Ripley shows landmarks to Akio Morita and his wife.

He thinks that both types of amplifiers being tested—grid-controlled pulse amplifiers and deflected-beam cw amplifiers—will be ready to go into production within a year. The pulse amplifiers can drive a 100-ohm load at 400 volts with a 4% duty cycle, while the cw amplifiers put out more than 100 w in class B

service from dc to 300 MHz. Bates says that variations of the latter give power levels to 6 w at 1–2.5 GHz.

The tubes, which cost about \$1,000 in quantity, are ceramic and glass-metal devices 9 or 10 inches long and 2 in. in diameter. Their bandwidths are orders of magnitude larger than rf power transistors.

Easy Solutions to Difficult Measurements

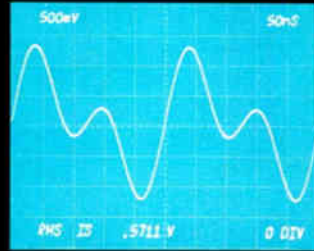
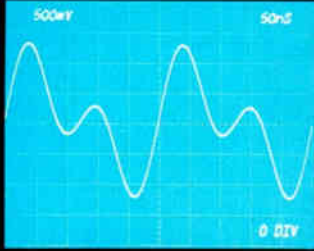

at the Press of a Key!

When a difficult and time consuming measurement is required like determining the RMS value of the above waveform, the new TEKTRONIX DPO3100-Series really performs. At the press of a single key the answer is displayed on the same CRT which displays the signal! Best of all, many types of measurements are possible. You can add, subtract, multiply, divide, log x, integrate, differentiate, signal average to name but a few. When you need more, simply program your own special functions and routines with the "User Definable" keys.

The key to the system lies in a processor unit that digitizes waveforms displayed on the CRT. The digitized waveform is available to the calculator which is programmed to perform the desired calculations.

Programming the DPO3100-Series is easy because, Tektronix has removed the language barrier. The English-like programming keys, on a simply defined keyboard, execute math functions just as you write them.

Price depends on options and plug-ins chosen. A complete operating DPO3101 can be as low as \$10,650.00. Let us tell you all the details on this versatile package, use the reader service card, contact your field engineer or write Box 500A, Beaverton, Ore. 97005. In Europe: TEKTRONIX LTD., Guernsey, C.I., U.K.

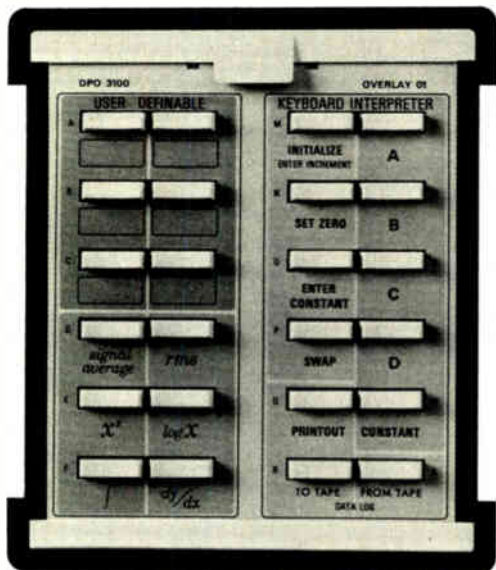

So what is the DPO3100-Series? It is a system combining a TEKTRONIX Digital Processing Oscilloscope with our Type 31 Programmable Calculator.

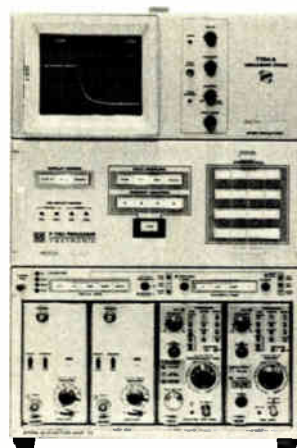

Bates says, so they have much greater gain-bandwidth and power-bandwidth products. Since each tube is really a complete amplifier, one can replace roughly 20 transistors in a transmitter, he adds.

Bates says that EBS devices should also make good instrument amplifiers—because of their dc capability he recommends them, for example, as oscilloscope amplifiers. □

Trade

Hogan presses for sales to East Bloc

They are true—those reports on the semiconductor industry grapevine that Fairchild Camera & Instrument Corp. has tentative agreements to sell semiconductor-production technology to the Soviet Union, as well as to Poland. “If I can get the Polish contract approved, I’ll be back with a Russian deal,” confirms C. Lester Hogan, Fairchild president.

The Polish contract has been submitted to the U.S. Office of Export Control. Hogan says he is hopeful that contract will be approved, but it must run a gauntlet of several agencies, including the Munitions Control Board. And there is an embargo on sales of semiconductor technology to Eastern Europe [*Electronics*, Sept. 27, p. 42; Oct. 11, p. 41].

Hogan says the embargo should be lifted because the Poles are already being taught how to make semiconductor devices by the French firm, Sescosem, and they are also being supplied with production equipment and materials by the French and Japanese. Hogan claims that the bipolar-device plant built by Sescosem in Poland is “as modern as any in the U.S.” He also says he saw at the plant items on the American embargo list, such as American-made photo-resist and Japanese step-and-repeat cameras.

Details of contract. Under terms of the contract, Fairchild would teach the Poles how to make MOS LSI circuits and provide mask sets

for such consumer products as calculators, Hogan says. In return, the Poles would pay for licenses and know-how, promise not to sublicense other countries, and guarantee Fairchild a “substantial share” of the Polish semiconductor market.

Hogan stresses that the prohibition against Poland sublicensing other countries is strict. It allows Fairchild to audit Polish operations with Fairchild people in Poland.

The contract, Hogan says, prohibits him from disclosing the dollar value or the volume of American-made devices the Poles have agreed to buy. However, he indicates that sales would be greater than those being made in Poland by Sescosem. Sescosem sales, according to Hogan, have jumped from \$20 million a year to \$36 million because of its Polish deal.

Hogan argues that it is “foolish” to forbid technology sales to Eastern Europe because of fears that American technology would allow Eastern Europe to catch up with America in military microelectronics or become competitive in civilian semiconductor markets—two often-cited arguments against such sales.

Technology sales must be made if American firms are to crack Eastern Europe, which has a semiconductor-device market that Hogan estimates

will total \$5 billion between now and 1980. “If we don’t get that market, the Japanese, British, and French will. The Japanese have been hurt by American price cuts, but they will be able to get up off the mat if they win that market,” Hogan argues. “This would cost the U.S. complete dominance of the world semiconductor market.”

MOS LSI sales won’t have much effect on military technology since other forms of semiconductors are generally required, he adds. What’s more, it will not be possible for Eastern Europeans to undercut American prices for civilian products. “We are billions of devices further along the experience curve, and we will always stay ahead.” □

Communications

Packet switching starts to move

Now that the Federal Communications Commission has approved Packet Communications Inc.’s application for its value-added network (VAN) [*Electronics*, Nov. 22, p. 26], company president Lee R. Talbert’s next move is to secure financ-

On VAN and packets

The value-added carrier leases dedicated lines from the phone company, installs modems and communications processors in major cities to be served, and then, in turn, leases time slots for packet switching on this network to customers. The advantage of a VAN is that it provides customers with the economy-of-scale savings of large networks plus the value-added services of code and speed conversion and error detection and correction. By contrast, circuit switching for data transmission dedicates an entire circuit to one customer, whether he uses it or not.

PCI and Telenet will implement their networks using packet-switching technology. For example, if the message to be sent contains 10,000 bits, it will be divided into 10 packets, each 1,000 bits long. Each packet will be routed independently of others, depending on instantaneous traffic and queuing delays between network nodes—the communications processors. Packet switching loads the lines more efficiently than circuit switching. Thus for a given volume of data traffic, the network can be made up of fewer lines and thus reduce monthly operating cost of the VAN.

The user’s computer or terminal will interface with the Bell System channels via a processor rented from a value-added-network company. The processor will convert the user’s transmission to a standard character set and protocol; similar processors will interface with network computers. Thus any terminal in the network can talk to any computer the network supports.

Quick Permanent Repairs with Confidence.

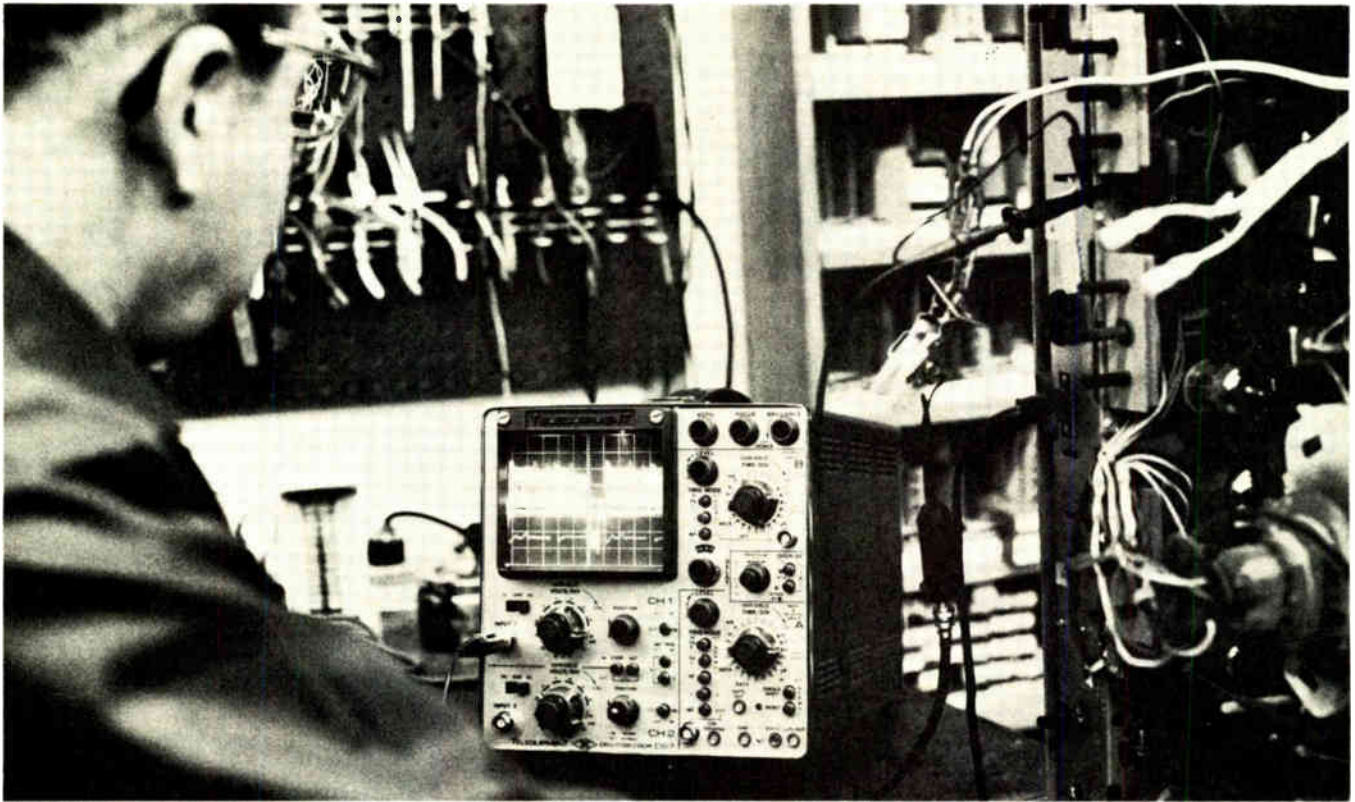

The D67 ends troubleshooting guesswork in complex TV and audio circuits—at a low price.

TV and audio equipment servicing is outdistancing the capabilities of older test instruments. Also, greater use of electronics in consumer products (pocket calculators, microwave ovens, digital clocks, home intruder alarms, etc.) is opening up new service opportunities. Telequipment offers you the high performance you need in a low-cost scope for this new service business.

The D67 combines dual-trace, delayed sweep, and 25 MHz bandwidth, at a very low price. Non-delayed sweep scopes just can't compete with the D67's delayed sweep measurement flexibility. It allows quick, accurate troubleshooting of IF tuning and color bandpass problems. You can also see fast circuit conditions after relatively long time delays.



If you don't require delayed sweep but need dual trace at 25 MHz, here's another economical, quality scope—the D66. Troubleshooting consumer digital products such as mini-calculators is made easier by using dual trace. Also a "SUM" mode with normal-invert capability makes it possible to look at small signals in the presence of common mode noise—such as power supply hum.

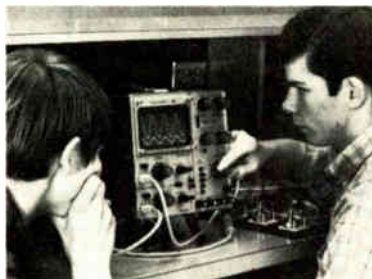

This simple to use, dual trace, 10 MHz D54 gives you low-cost, dependable performance in a wide variety of applications. Like all Telequipment scopes, it is light weight, easy to carry and is backed by Tektronix' warranty and reputation for quality. Students shown are testing amplifier circuit by measuring the gain between input and output signals.

Dual-trace waveforms displayed on a bright CRT are essential for servicing TV and high quality audio systems, where time and phase relationships between signals are critical. Whatever the consumer's electronic service problem, 25 MHz is probably all the bandwidth you will need.

Telequipment products are marketed and supported in the U.S. through the Tektronix network of 52 Field Offices and 35 Service Centers. Telequipment prices range from \$245 to \$1495. For a Telequipment catalog, and a reprint of the ET/D review of the D67, write: Tektronix, Inc., Box 500, Beaverton, Oregon 97005



TEKTRONIX®

committed to
technical excellence

TELEQUIPMENT



ing and to start buying equipment.

Assuming capital equipment is financed through third-party sources, Talbert says his Waltham, Mass., company will need equity of perhaps \$17 million over the next three to four years. The company's first stage, which may last from one to two years depending on the rate funds come in, will see the actual implementation of packet-switching technology, which is based on the Department of Defense's Arpanet [*Electronics*, Feb. 15, p. 32]. This initial venture could cost \$5-6 million, he says.

The second stage, lasting another one to two years, will see 18 cities in the PCI network, connected by 26 in-

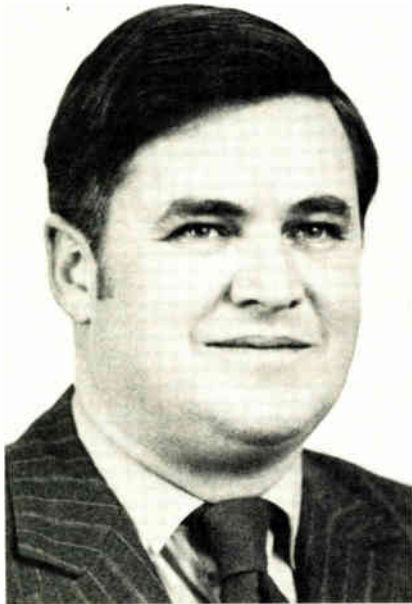

PCI chief. Lee R. Talbert's firm is the first to get FCC OK for a value-added network.

tercity lines, brought on line. Another \$10-12 million could be needed for this stage. The 18 cities, which range in size from Seattle to Boston and Chicago, were chosen on the basis of the company's projections as to where the largest markets are. By 1978 or 1979, Talbert expects 60 cities will be on the network. (See "On VAN and packets.")

Contender. Meanwhile, Lawrence G. Roberts, president of Telenet Communications Corp., a Washington-based company that has also applied for VAN certification, sees the FCC's decision as establishing

the validity of the value-added-network concept and setting a policy of liberal entry of other VAN carriers into the market.

Telenet, which received most of its original capital from Bolt, Beranek, and Newman, the Boston area operator of Arpanet, filed its application with the FCC on Oct. 9 and expects to receive authorization in early January. Telenet officials are discussing additional financing now, and the company will start procuring equipment when it gets approval from the FCC.

Stuart L. Mathison, a vice president of Telenet, says that a complete system covering eight major cities—running from Boston and New York to Los Angeles and San Francisco—will be ready by the fall of 1974 for acceptance tests.

PCI's timetable is based on "realistic guesses on growth," according to Talbert. "It is hard to tell just how it will work out. There is a great deal of latency in the marketplace. People are sending a lot of data, and they surely will send it via a network, but we don't know how explosive it will be."

But he feels that "the beauty of the technology is its ability to grow to meet traffic." Large fixed assets are not needed since each terminal-access processor will handle up to 60 low-speed terminals. Therefore, the network can grow in increments of capacity to meet market needs.

Network centers will use standard, off-the-shelf minicomputers, and Packet Communications has already made a vendor selection. General Automation Inc., Anaheim, Calif., recently signed a contract, which could total \$7-10 million over the next four years.

Packet Communications is planning on a network speed of 50 kilobits per second. The entire network will be supervised by two network operations centers—one in the Boston area and one in the Western U.S. Installation rates for full-time terminal interfaces will run from \$100 to \$300, while monthly rentals will run from \$150 to \$450. Talbert says, "We will look at any [transmission] channel which can compete on a cost basis; if satellite becomes

available we will use it"—or for that matter, laser transmission or coaxial waveguide technology. □

Instruments

H-P takes aim at a universal tester

Minicomputers have taken on another new role: simulating groups of measuring instruments while performing the more familiar chores of controlling tests and processing test results.

This month, Hewlett-Packard Co. plans to announce a \$60,000 minicomputer system that analyzes the transmission parameters of voice-grade telephone lines. The same system can also serve as a general-purpose tester, suggests Roger Rauskolb, engineering section manager for electronic applications at H-P's Santa Clara, Calif., division.

Although it generates and processes analog signals, the new HP-5453A analyzer contains no oscillators, mixers, limiters, tracking filters, or meters. It is simply an HP-2100S microprogrammable minicomputer with analog-to-digital and digital-to-analog converters and the usual peripherals—disk memory, display terminal, and printer. With the aid of the converters, the computer simulates the battery of instruments that telephone-company technicians usually lug around.

To make nine standard tests for transmission-line distortion—noise, loss, interference, phase jitter, and the like—a telephone technician need only enter the word "all" on a test list displayed by the computer. He can type in requests for such tests as special frequencies, readouts of peaks, averages, and other analyses.

The computer will also compare measurements with line standards, store the results of periodic tests, and print out trend-line analyses as a guide to preventive maintenance. The standard tests are completed in about 2 minutes, compared with the one to three hours that technicians

the 30Hz Resolution Revolution

Spectrum Analysis in the 0-to-1800 MHz region

The TEKTRONIX 7L13 adds revolutionary measurement power to spectrum analysis: 30 Hertz Resolution that is useful all the way to 1800 MHz.

There is no smearing from drift or FM in this 200 Hz/div display, even though the total sweep time is 20 seconds. Signals are resolved to 70 dB even though they are only 500 Hz apart. Center frequency is 1555 MHz.

It is generally understood that High resolution means the ability to distinguish between signals differing little in frequency. Actually, the design that makes 30 Hz resolution possible results in more than just the ability to distinguish between close together signals. The design of the 7L13 means better sensitivity, — 128 dBm; less drift, under 2kHz per hour; less FM, under 10 Hz phase locked; it means less noise . . . it means the revolutionary analyzer performance that is available from Tektronix, Inc. in the 7L13.

Because of the resolution revolution, the performance of your edge-of-the-art circuitry and devices can now be quantified, not guessed at. A discussion or demonstration of TEKTRONIX Spectrum Analyzer performance can be arranged by any Tektronix Field Engineer. Call him or use one of the two reader service numbers below.

7L13 Spectrum Analyzer—\$6500
7613 Variable Persistence Mainframe—\$2500

TEKTRONIX, INC., P. O. Box 500
Beaverton, Oregon 97005

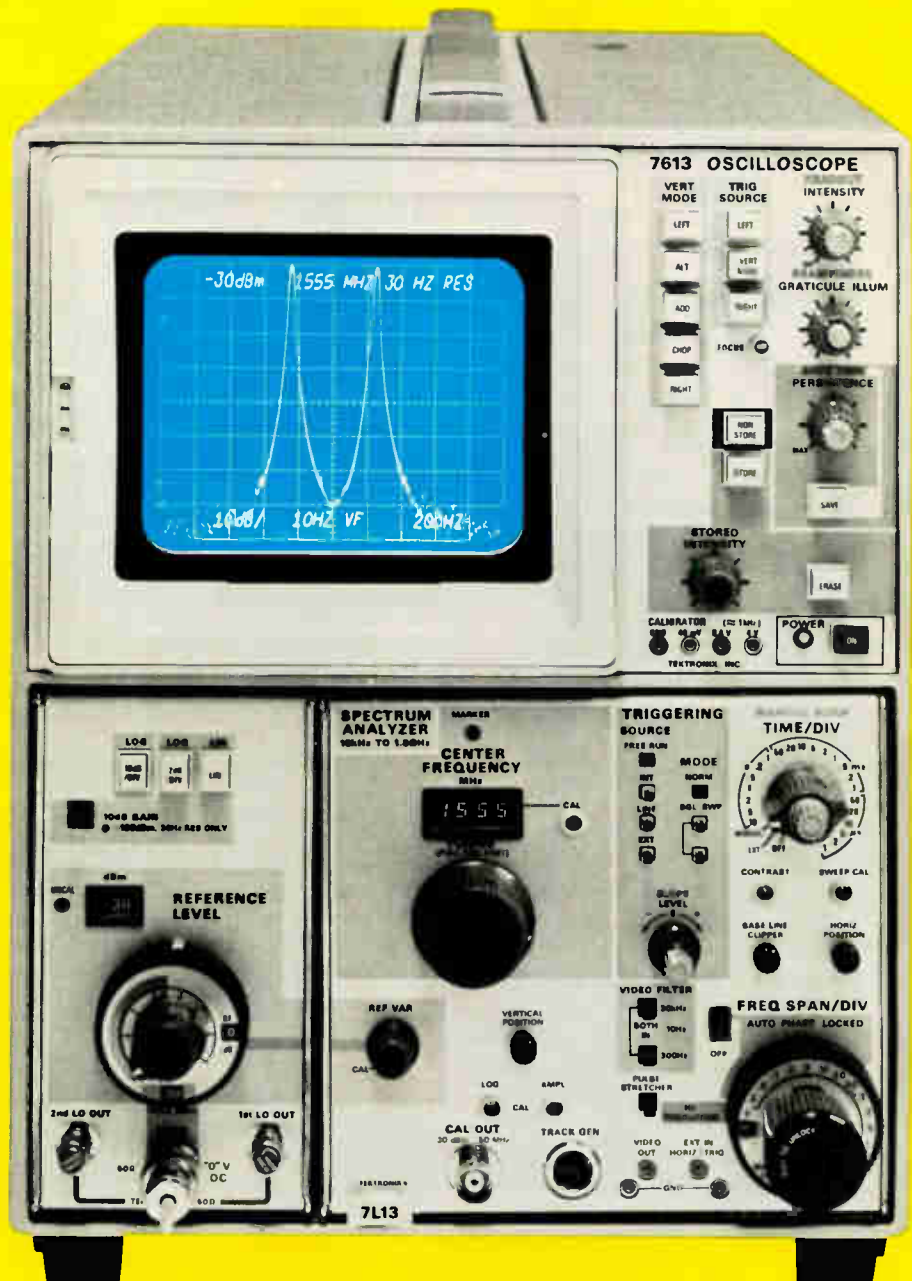

TEKTRONIX®
committed to
technical excellence

normally spend testing a line.

The minicomputer acts as a collection of analog and digital instruments because part of its software converts it to a fast-Fourier-transform processor—one that converts test signals from time domain to frequency domain and vice versa. Digitized signals and the software—which includes an interpretive compiler—are swapped between the core and disk memories as they are needed to set up, control, and process tests. Test signals are specified in frequencies on the display, but the computer generates them in the time domain.

Fast conversion. The computer generates sequences of digital words which are fed through a d-a converter to convert them to various tones needed to perform tests. For digital processing, line responses come back via the a-d converter. Transformations are completed in 100 milliseconds, which, Rauskolb points out, makes the computer extraordinarily fast at some tasks. A digital frequency counter, for instance, would have to gather samples for 100 seconds to resolve 0.01-Hz. The H-P minicomputer does it in 100 milliseconds.

Almost any kind of analysis can be made because the analyzer is not hardware limited. In contrast, conventional test sets with groups of locked receivers, for example, are tied to standard voice-line test frequencies, which generally go to only 3,200 Hz. The minicomputer can test to the frequency limit of the a-d converter itself: 100 kHz. Also, limiters are used in conventional testers so that the amplitude modulation can be killed while phase modulation is measured. The analyzer can check amplitude and pulse modulation simultaneously.

One possible commercial contender is a system developed by Honeywell Information Systems for the Defense Communications Agency [*Electronics*, July 5, p.26]. That system, however, is a large computer-controlled instrument system rather than a fast-Fourier-transform analyzer.

While H-P's system cannot test microwave performance directly,

News briefs

Postal Service plans electronic-mail system

The Postal Service is planning to sink up to \$100 million into a six-city experimental electronic-mail system to be completed by 1980. At the recent National Telecommunications Conference in Atlanta, assistant postmaster general for research and engineering Alan Schneider outlined the system as a hard-copy operation using inter-post-office facsimile equipment able to handle color-picture transmissions, as well as offering satellite transmission and teleprinter service in the home.

Oxide alignment gives high-speed, low-power chips

An oxide-aligned transistor, developed by TRW Systems Group, Redondo Beach, Calif., not only allows the fabrication of bipolar chips having a rise time of less than 1 nanosecond with low power dissipation per function, but also provides a device gain of up to 3 gigahertz.

Similar to earlier developments by Fairchild, Philips, and Bell Laboratories, the OAT uses denser layouts and reduced capacitance to overcome problems previously encountered in marrying high speed with low power in bipolar chips. The process also provides a 1-GHz divide-by-two circuit requiring 40 milliwatts of power and has an expandable four-by-four multiplier ECL multiplier with a 13.5-ns multiply time, dissipating only 1 watt.

EIA seeks semiconductor Phase 4 exemption

Exemption from Phase 4 controls for semiconductors is being sought by the Electronic Industries Association, through its Solid State Products division. A 20-page petition submitted to the Cost of Living Council, covering items falling into Government classification 3674, points out that the semiconductor industry is characterized by declining prices, consistent technological advancements, and increased productivity, which result in self-regulating noninflationary behavior.

Four TWTs are linked in parallel

A travelling-wave tube, designed by Teledyne MEC, Palo Alto, Calif., is combinable, through the use of Magic Tees, a type of 180° connector, with other devices of its kind. The company has paralleled a total of four tubes to produce up to 1 kilowatt of cw power from 10–20 gigahertz. Since random difference in noise and distortion tend to cancel each other, the four-tube combination can give noise and linearity performances equal to or better than single-tube amplifiers.

IBM investigating signature dynamics

Signature dynamics—the way a person signs his name—is being investigated at IBM's Thomas J. Watson Research Center, Yorktown Heights, N.Y., as a means of identification for access to a computer. IBM plans next to develop a device for transmitting signature information by telephone.

Common-carrier takeovers continue

Moving with a trend toward consolidation of specialized common carriers competing with AT&T's Long Lines department private-line service, United Video was acquired late last month by Southern Pacific Communications Corp. Also, Nebraska Consolidated Communications Corp. will be acquired by MCI Telecommunications Corp., New York City, pending FCC approval [*Electronics*, Nov. 22, p. 71].

Wafer standards may be near

A seminar that may produce semiconductor wafer standards will be held during the International Microelectronics/Semiconductor Conference, Feb. 26 at the Anaheim, Calif., Convention Center. Sponsored by the Wafer Standardization Committee of the Semiconductor Equipment and Materials Institute, Mountain View, Calif., the committee hopes to establish characteristics that could lead to standardization of wafer-production equipment.

considering new career dimensions? consider Tektronix sales engineering

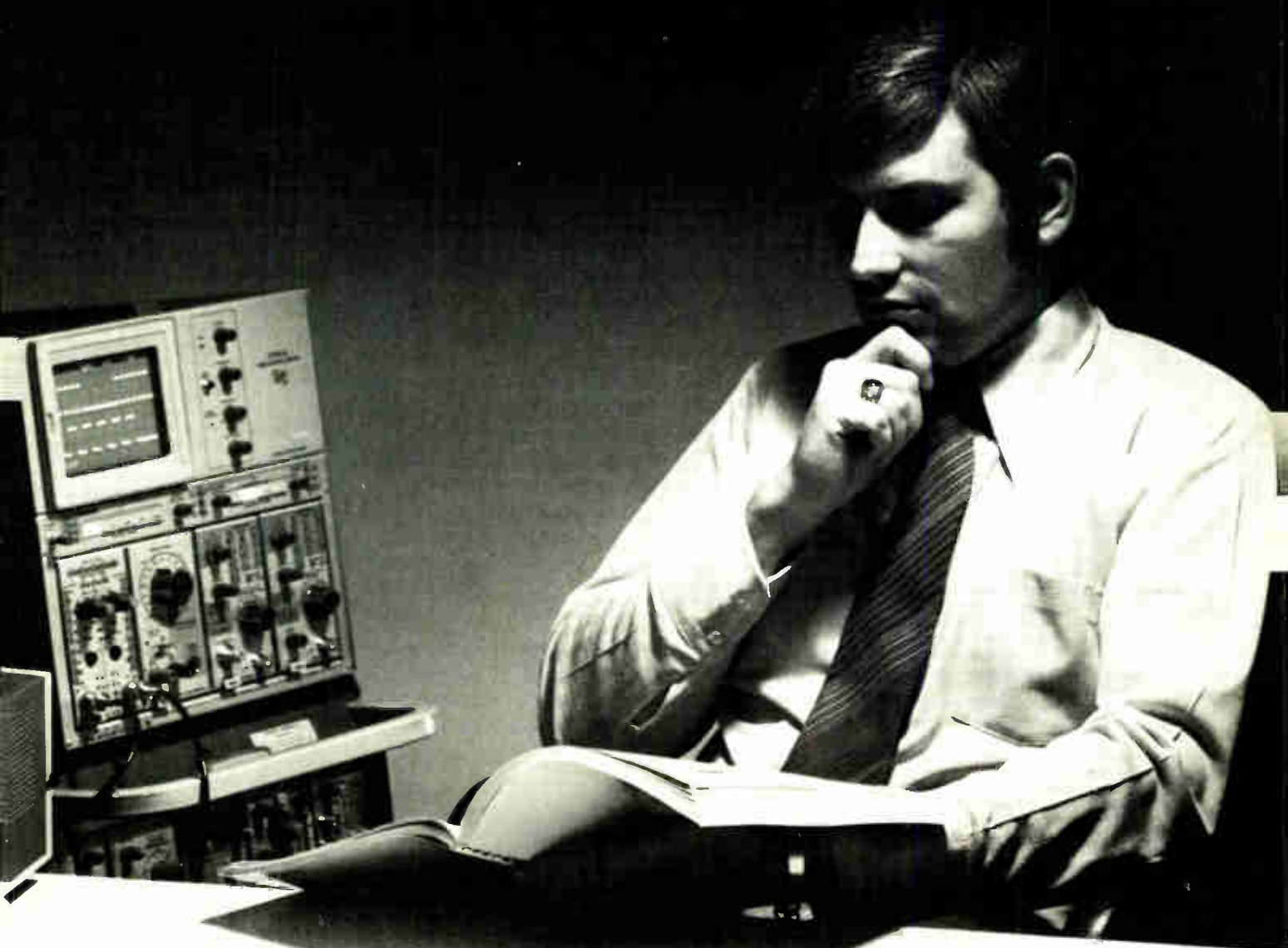

TEKTRONIX FIELD ENGINEERING has openings for engineers who want to add business and people skills to their technical skills. Tektronix customers expect exceptional performance from our Field Engineers. Are you the exceptional man for the Job?

Successful candidate will employ a strong scientific-electronics and business background to:

Provide technical consultation

regarding customer measurement requirements.

Introduce an expanding product line of state-of-the-art oscilloscopes and measurement equipment to both new and established customers.

Institute customer training and support programs.

Salary is open. Benefit programs include a substantial profit-sharing plan. For confidential consideration of your

background, please send resume to:

Dan Thompson
Marketing/Engineering
Personnel Manager

Tektronix, Inc.
P.O. Box 500
Beaverton, Oregon 97005



TEKTRONIX®
committed to
technical excellence

An Equal Opportunity Employer

Circle 49 on reader service card

SCIENCE/SCOPE

A polyurethane foam retainer to lubricate ball bearings for spacecraft was described by Hughes engineers at a recent symposium. The circular ring device serves as a lubricant reservoir as well as a retainer and separator for the bearing balls. The tough polyurethane material is chemically inert to hydrocarbons, stores 60 times more oil than the commercially produced cotton phenolic now widely used for bearing retainers, and shows virtually no wear after a year's operation. The new retainer may have applications in the aircraft, automobile, and machinery equipment industries.

Only the information an aircraft pilot requires at the moment is presented on the cockpit TV screen of a computer-controlled electronic map display developed by Hughes in a company-funded project. It stores data digitally, eliminating printed and microfilmed graphics. The map shows aircraft position and course and is updated every two seconds. It can be oriented "north up" or "heading up". The pilot has a choice of five scales, from one to 40 nautical miles to the inch. The EMD's magnetic tape unit can store up to 15 million bits of data (enough to cover the continental U.S.). A civilian version has been delivered to the FAA for testing; a military version has been developed for Air Force and Navy flight test programs.

Greater flight dependability for America's burgeoning air traffic is the goal of a 27-month project by Hughes engineers to develop specifications and a handbook for the Federal Aviation Administration's National Airspace System (NAS). Handbook will detail how the FAA can identify, handle, and strengthen any weak links in the system or equipment elements. The project is aimed at existing as well as future air traffic control systems, whose operations are expected to more than double in volume in the next 10 years.

High-speed functional testing and troubleshooting of printed circuit boards is the function of a new computer-controlled digital logic test system developed by Hughes. The Hughes 1024 is a diagnostic system with advanced disk software and dynamic response measurement at programmable rates to 10 MHz. Its software-controlled probe rapidly isolates manufacturing failures. The solid-state system provides up to 1024 bi-directional input/output lines and is expandable to three independently operated test stations using a common minicomputer.

Hughes needs a Senior Communications Project Engineer to take charge of a communication satellite subsystem. Technical responsibilities: direction of circuit design, packaging, testing. Administrative responsibilities: project direction and coordination of fabrication and assembly, date of requirements, contractual matters. Requirements: 5-15 years experience in project engineering hardware development, U.S. citizenship. Please send resume to: Mr. D.D. Rossier, Hughes Aircraft Company, P.O. Box 92919, Los Angeles, CA 90009. An equal opportunity M/F employer.

A twin radome-covered antenna test range to measure radiation patterns of communication satellite antennas during development and manufacturing is now in operation on the roof of the 12-story Hughes Space & Communications Group building in El Segundo, Calif. The 30-foot-diameter radomes enable space engineers to test antennas on a daily basis despite high winds or adverse weather. The new test facility includes a penthouse laboratory housing data-recording electronics and remote control equipment.

Creating a new world with electronics

HUGHES

HUGHES AIRCRAFT COMPANY

Circle 50 on reader service card

Electronics review

Rauskolb notes, it can do so "by inference"—the link is checked by transmission of voice-frequency test signals. If the link doesn't degrade those signals, it can be considered satisfactory.

Some production-test applications are also expected. For example, Rauskolb says, audio amplifiers of many different designs could be automatically tested for such characteristics as frequency response and harmonic distortion.

Direct tests of radio-frequency systems will have to wait until higher frequency a-d converters are developed. However, Rauskolb indicates that it may be possible to design suitable frequency converters and mixers that would bring the test signals down to the converter frequency ranges. "If this could be done, we'd have an almost universal test system, capable of simulating network analyzers and even microwave-spectrum analyzers," says Rauskolb. □

Consumer electronics

An IC replaces a TV power transistor

The horizontal-deflection systems in color-TV sets now use one power transistor for horizontal deflection and another as a power-supply regulator—to stabilize the dc voltage supplying the horizontal output stage and to nullify the effects of ac line and loading variations. But Texas Instruments Ltd.'s Advanced Technology Center, Bedford, England, has designed a circuit that does away with the second power device, cutting the cost of the horizontal deflection stage by about \$5 and reducing its power requirements as well.

"The concept of a self-stabilizing system is to integrate stabilization and deflection functions in a single circuit, using one power transistor, operating from the directly rectified ac line," says Mick Maytum, designer of the circuit and TI Ltd.'s home entertainments manager. The

TI Ltd. system taps the power transistor while it is not sweeping horizontally and uses it as a switched mode regulator, varying the time at which the transistor is turned on to control the voltage path across the inductance.

At the heart of the system is an integrated circuit placed between the horizontal oscillator and horizontal driver. This replaces the series stabilizer, which now comprises a power transistor and associated discrete components. An error amplifier within the IC compares the deflection voltage with a reference, and the amplifier's output adjusts the switching time of the transistor to control the power supply. Additional circuits monitor the power device's operation, and will shut the circuit off temporarily if an overload occurs.

The IC will first appear in a product to be announced next year by a major color-TV manufacturer, and it will be available from TI Ltd. in the second quarter for about \$1 in quantities. Power transistors to give the system maximum cost advantage will also be introduced. □

Displays

Multicolor display uses laser beams

A laser writes the data in an unusual multicolor display system, which is adaptable to large- or small-screen displays, can provide variable-persistence images, and can generate large permanent records of displayed material.

The Librascope division of Singer Co., Glendale, Calif., has already delivered one real-time system, which produces record copies of data from radar or infrared sensors, to Rome Air Development Center. A second, a large-screen tactical-mission-simulator plotter for the S-3A aircraft, has gone to Singer's Link division in Silver Spring, Md. Another version that has already been delivered provides display plus hard copies for use with a battlefield

Call Hughes for...

Image Devices



Video storage units: scan conversion memory systems (RS 229)



Direct view and scan converter storage tubes and low light level devices (RS 226)

Microwave Products



Millimeter-wave sweepers, sources, isolators, modulators, mixers, detectors and diodes (RS 220)



Microwave TWTs, TWTAs and solid state IMPATT and transistor amplifiers (RS 228)

Lasers



Gas lasers (RS 231)

Thermal Products



Heat pipes (RS 237)

Multiplex Systems



For remote communications/control (RS 230)

(213) 670-1515, Ext. 5964

Telephone for immediate information. For literature, circle reader service (RS) numbers, or write to Bldg. 6, Mail station D-135, Culver City, CA 90230.

HUGHES

HUGHES AIRCRAFT COMPANY

Cut Component Count...

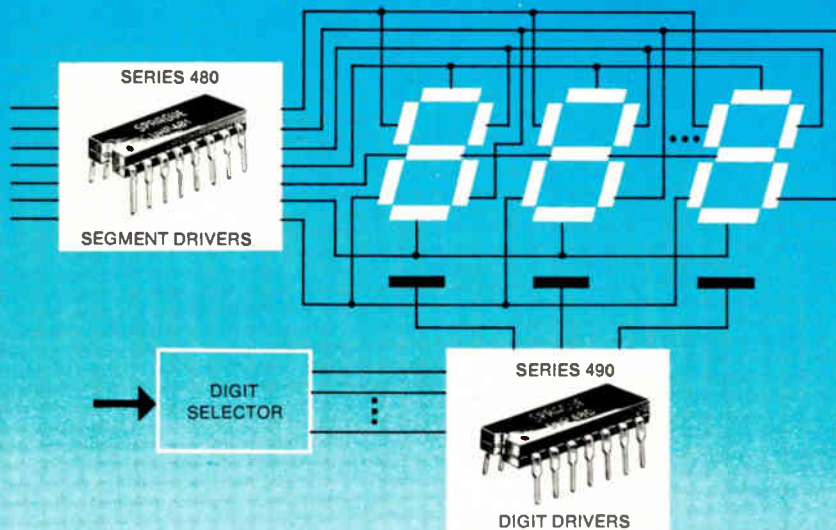

...with **SPRAGUE** SERIES 480 and 490 DISPLAY DRIVERS

Sprague High-Voltage Display Drivers are bipolar monolithic integrated circuits designed for interfacing MOS, open collector TTL, or other low-voltage circuitry with high-voltage gas discharge displays. They replace most of the discrete components normally required in interface applications of this type. Series 480/481 are high-voltage switches intended for use in the cathode portion of the display, while Series 490/491 drivers are designed for use in the anode portion. Their high reliability and small size make them an excellent choice where space-saving and dependability are important factors.

Sprague Catalog Number	Package	No. of Leads	Drivers per Package	Input Voltage	Diode Forward Current (mA)	Output Voltage	Operating Temperature Range
UHP-480	Plastic DIP	14	5	30	50	130	0°C to +85°C
UHP-481	Plastic DIP	16	7	30	50	130	0°C to +85°C
UHP-490	Plastic DIP	14	5	-30	20	-80	0°C to +85°C
UHP-491	Plastic DIP	16	6	-30	20	-80	0°C to +85°C

For more information, write for Engineering Bulletins 29301 and 29302 to: Technical Literature Service, Sprague Electric Co., 35 Marshall Street, North Adams, Mass. 01247.



Electronics review

command and briefing display.

The Singer family differs from most laser displays that have been proposed in that the laser beam itself does not strike the display screen, except in some applications where the beam is used as a cursor or to display in real time a few dynamic symbols. Instead, the beam writes on a small—generally 35-mm—film. As the image is built up on the nonprocess film, it is projected onto a screen by a conventional xenon projection lamp. An argon ion laser is used for colors from ultraviolet to blue-green, a helium-neon gas laser for red, and a neodymium YAG laser for infrared.

The film can be a red or blue variable-persistence photochromic layer for erasable displays. It can be a dry-process or metal film if a permanent record is needed. Since a projection system is used, other material—such as sector maps and grids—can be superimposed on the screen. Both red and blue can be projected from the xenon and the laser-beam optical systems. Similarly, additional lasers or projection filters could provide other colors.

Higher intensity. Singer went to lasers after working with CRTs as light sources. But even with very-high-power CRTs, such as those with fiber-optic face plates, the light intensity is marginal for creating a satisfactory image on the relatively insensitive photochromic materials, says Robert C. Dartnell, manager of electro-optics. The laser gives high intensity, an easily controlled beam, wide-modulation capability, and a spot as small as 0.8 mil.

For large, permanent copies, the dry silver film on Mylar is exposed to the image, producing in about 10 seconds an overlay that can be used with charts and maps. No processing is required, and no waste materials are produced. Singer feels that certain versions of the display system—such as the metal-film permanent-record model—are about ready for production now, and the company expects to shortly start delivering one every two months. The complete line of displays, however, is not expected to be in production for two to three years. □

Interchangeable CPUs. That's modularity.



SUE's basic CPU gives you a minicomputer that's high in flexibility yet low in cost. Other CPU models provide additional arithmetic or math capability to satisfy specific application needs.

These all slide easily in and out of the chassis. Without any wiring. In fact, you can change CPUs at your plant (or even in the field if need be) in about 60 seconds. So a SUE system can change and grow as fast as your customer's needs change and grow.

The component computer. And you're not limited to one CPU at a time. SUE's multiprocessor capability lets you hook up as many as four on a single Infibus. Just choose the combination of processors that suits the system best.

That's because SUE (the System User Engineered mini-computer) is the first of its kind: a component computer for systems. Its modular processors, memories and controllers all plug together in almost any combination to solve your application problems.

That includes I/O controllers, but you'll never



need more than two basic types with SUE: one bit serial, one word parallel. These will adapt to any I/O device.

Wider choice of peripherals.

We offer a full line of peripherals to go with SUE: IBM compatible 5440 disk drives, printers from 100 cps to 600 lpm, magnetic tapes, cassettes, punched card devices and paper tapes. Anything your system needs.



Complete software tools. To make your programming burden lighter, we offer a full set of software tools: sort/merge, DOS, assemblers, utilities and other programming aids.

And we're the only company we know of that unconditionally warrants all our software for a full year.

Built for systems builders. SUE's built-in flexibility makes it fit your systems now, makes it easily changeable later on.

You can be sure we'll be here later on, too. Which is one more advantage of dealing with an established, reputable company like Lockheed Electronics.

Let's talk. Call (213) 722-6810, collect, or write us at 6201 E. Randolph St., Los Angeles, California 90040.



That's SUE.

Lockheed Electronics
Data Products Division

Boston 861-1880 • New York metro (215) 542-7740 • Philadelphia 542-7740 • Washington (703) 525-3600
Atlanta 266-0730 • Detroit 557-5037 • Chicago 833-4600 • Dallas 231-6163 • Houston 682-2617
San Francisco (408) 257-3357 • LOCKHEED-SAIT Electronics, Brussels (02) 7620-30

A better answer.

TI's unique modular building block construction permits custom configurations at minimal cost.

Standard .150 inches travel with 2.0 ounces actuating force. Also available with .100 inches travel and lower profile.

High quality double shot molded thermoplastic keytops available in many colors. Or you can buy keyboards alone.

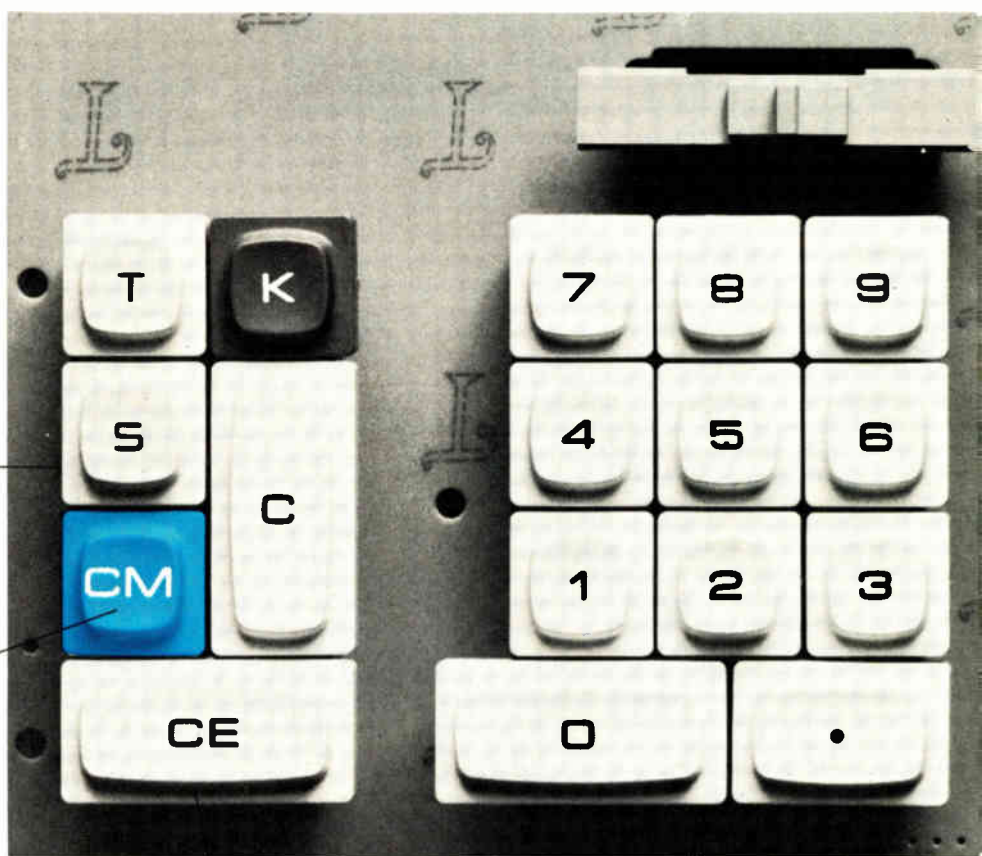

Keyswitch materials and a high length-over-diameter ratio provide the smooth, quality feel necessary for professional users.

Fully assembled on a circuit board to reduce your assembly costs.

The new 5KS desktop keyboard from Texas Instruments, the world's leading supplier of pocket calculator keyboards. A new money-saving modular keyboard system provides the design flexibility desktop calculator manufacturers need for quick and inexpensive model changes.

Before Texas Instruments modular keyboard systems, you could get keyboards for desktop calculators two ways. First you could buy individual keyswitches or keyswitch rows and assemble them yourself. (This assembly, which includes mounting on PC boards, soldering and testing, adds at least 25% to the price of the keyswitch alone.) Secondly, you could buy a custom molded assembly which requires a high tooling charge.

Now the people who brought you the pocket calculator keyboard bring you the best of two worlds. The first complete travel keyboard that gives you economy and flexibility using a unique modular keyboard system.

The keyswitches consist of only four parts for simple trouble-free operation and low cost. The keyboard assembly is a series of keyswitch clusters that can be arranged on a printed circuit board in any desired layout. Using TI's established library of available cluster modules, calculator manufacturers can change models with only a low cost circuit board revision.

This is the new 5KS from TI, a dependable low cost keyboard for desktop calculators, credit card verifiers, point-of-sale terminals, and other equipment where a keyboard is required. For more information, fill in the coupon.

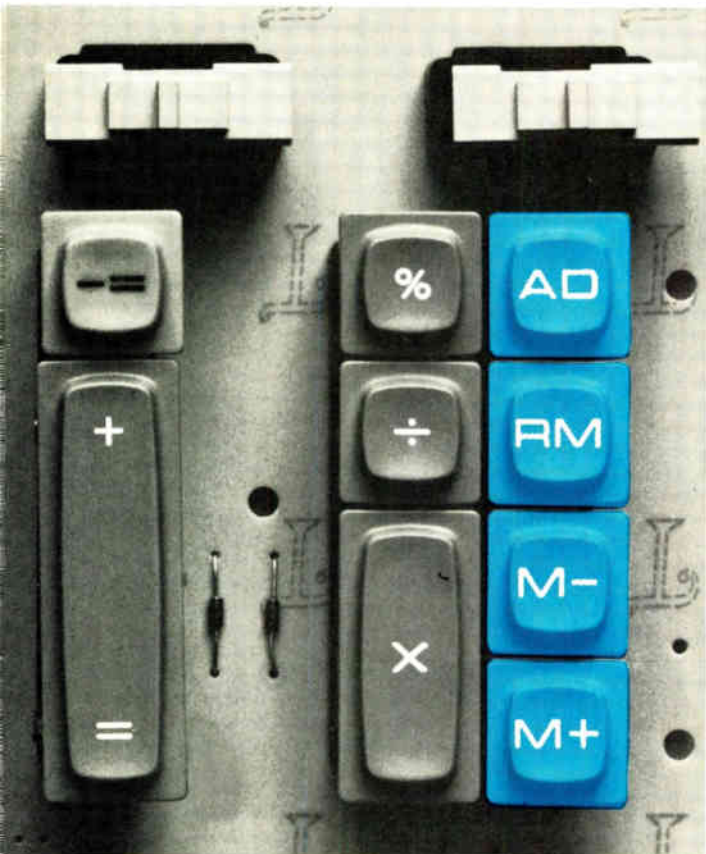

Actual size.

Texas Instruments Incorporated
Keyboard Products Marketing
MS 12-33/DE
Attleboro, Mass. 02703

Name _____

Title _____

Company _____

Address _____

City _____

State _____ Zip _____

Keyboard application:

- Desk-top Calculator Pocket Calculator
 Point of Sale Terminal Credit Card Verifier

Other _____

Application is new or existing

Approximate annual usage _____ units

Please have a TI Field Engineer call

TEXAS INSTRUMENTS
INCORPORATED

Putting new technologies at your fingertips.

**You liked our firstborn
so much, we decided
to have a big family.**

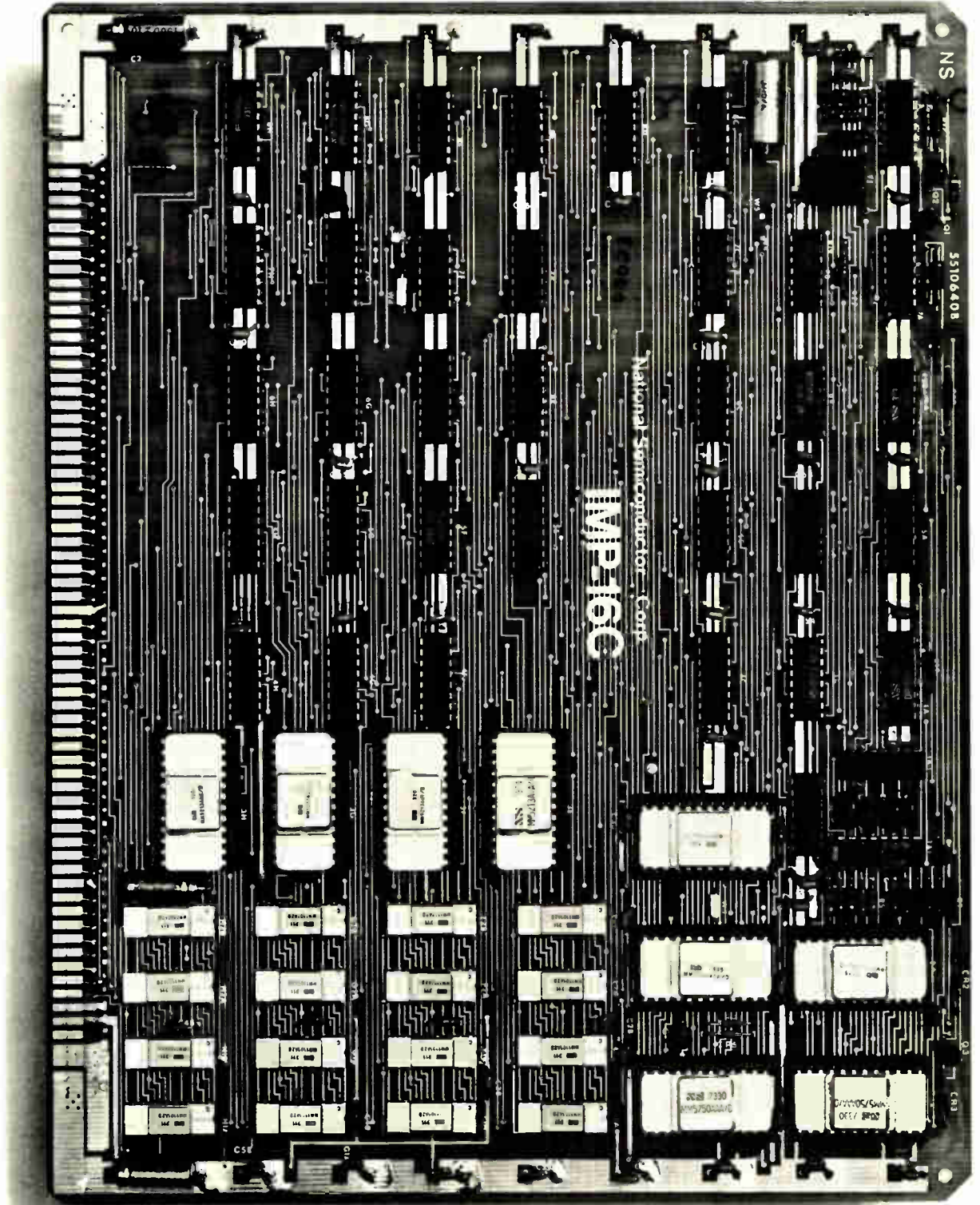

Our IMP-16C microprocessor on a card has just multiplied into a family of microprocessors.

A full line of flexible building blocks you buy off the shelf and program to your needs. And a self-assembler to help you do it fast. It's so much better than hardwiring your own stuff that microprocessors have become the hottest thing to hit electronics since the IC.

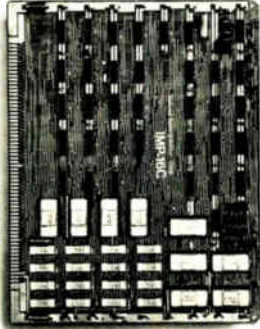

Our first was the IMP-16C, shown on the left.

Clock system, memory and I/O ports with bus drivers

(upper half of photo). 16-bit microprocessor (lower right-hand corner). 256 words of read/write random access memory (lower left). And provision for 512 words of ROM/pROM memory (left below center).

With its standard set of 43 instructions, IMP-16C is dandy for the control of equipment such as data terminals, test systems, communications equipment, machine tools, process control systems, and peripheral device control systems.

Now meet the rest of our family.

IMP-16P

Marvelous as our 16C is, you really need something to help debug your program.

The 16P.

It's a debugging tool. A prototyping tool for the IMP-16C.

The IMP-16P is an IMP-16C card with 4k memory, self assembler, programmer's panel, self-contained power supply, optional card reader interface and a lot of other goodies.

You can program the unit, then trap through your program on a step-by-step basis while you debug.

You can assemble on your in-house 360/370 or on Tymshare's network, worldwide.

And you can add 4k memory blocks as you need them for more powerful programs up to 65k.



IMP-16L

The 16L, like the P, is a 16-bit microprocessor card in a box with stuff like a programmer's panel, 4k memory and self-contained power supply.

The difference is that the L offers Direct Memory Access (DMA) architecture for applications that need high throughput. It's configured around a 1MHz asynchronous data bus which allows both programmed data transfers and direct memory access, independent of CPU operation. The system data bus also provides a means for multiprocessor systems to share a common memory.

IMP-8's

For 8-bit oriented applications we offer the IMP-8C card which contains an 8-bit CPU. 256 word words of read/write memory and sockets for up to 2k of ROM/pROM storage.

There is also an 8P prototyping system (like the 16P) to help you work out your program.

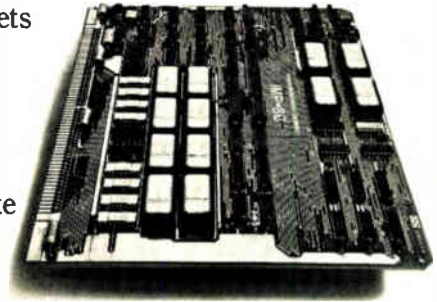

One-stop shopping

Microprocessors are going to have one helluva big impact on your business, putting relays and gears and cams in mothballs, and hardwired logic into the back seat.

From systems to chips, National is your one-stop microprocessor shop.

We've got 16-bit and 8-bit microprocessors available today.

We've got the hardware, the firmware and software support to greatly speed up your evaluation and turn around time to a new system. An interesting array of possibilities with components, cards and self-contained systems that you can start with at either the full-system or card level.

And if you'd like to know more about it, we'd be tickled to tell you.

National Semiconductor Corporation, 2900 Semiconductor Drive, in beautiful Santa Clara, California. Otherwise known as 95051.

National

Microprocessor Specialists. Available in: Mountain View, California (415) 961-4740 · Dallas, Texas (214) 233-6801
 Denver, Colorado (303) 757-7679 · Westport, Connecticut (202) 226-6833 · Miami, Florida (305) 446-8309
 Burlington, Massachusetts (617) 273-1350 · Southfield, Michigan (313) 354-9066 · Sherman Oaks, California (213) 783-8272



**We've put all this
into one small box.**

The PS²L.

It's new from Acme Electric Corporation . . . a programmable solid state load device. The PS²L load tests DC power supplies and batteries faster, more efficiently and with greater accuracy than conventional test equipment. It's ideal for incoming test, quality control and lab work. The PS²L saves set-up time and eliminates recalibration and maintenance that's necessary with conventional test equipment. Most other load testing devices use a resistive load. They heat up. Need constant adjustment.

Lose efficiency.

None of this happens with the PS²L. It can be programmed to *simulate* the load. This means no heating up and no load fluctuations. So down goes your test time, up goes your efficiency. The PS²L dissipates up to 1000 watts within a voltage range of 2 VDC to 50 VDC and a maximum current of 110 amps when de-rated per the power dissipation curve provided. It's equipped with two modes of operation: 1) constant current and 2) constant resistance. For dynamic loading, the PS²L is provided with a program input for external connection of a pulse or signal generator. Two models available: 500 and 1000 watts. For more information, write for our PS²L brochure: Acme Electric Corporation, Cuba, New York 14727.



Acme Electric

Trident budget priority seen killing Sanguine

Navy efforts to restore the \$240 million cut from the Trident missile submarine budget for fiscal 1974 are being given preference by the Pentagon over other efforts on behalf of the Sanguine extremely-low-frequency submarine communications system. **The House Appropriations Committee has eliminated all fiscal 1974 Sanguine funds—\$16.7 million—and ordered that the program be terminated,** making its outlook “very grim,” says one Pentagon budget official.

While the Sanguine cancellation is unlikely to be reversed by the vote on the House floor, **the project could be retained in the counterpart Senate appropriation.** If so, resolution of the issue will be left to the House-Senate conference committee that will settle any differences between the two bills. **Nevertheless, Naval Electronic Systems Command officials are not optimistic about Sanguine’s chances now.** The two funding cutbacks were part of a \$2.8 billion cut in the Pentagon appropriation by the House Appropriations Committee, leaving a total of \$74.5 billion.

OTP proposes national emergency medical network

The Federal Communications Commission is likely to speed up its **plans to allocate frequencies for a national Emergency Medical Services network—which could create an estimated \$50 million to \$100 million market in new and retrofitted communications gear—**after the White House Office of Telecommunications Policy publicly unveiled its proposal to set aside 38 frequencies for the network. Backed by the Departments of Transportation and of Health, Education, and Welfare, **the OTP plan would reassign frequencies in the 150-megahertz and 450-470-MHz bands** for mobile emergency communications to be used on a regional basis.

However, the network would face additional hurdles after FCC concurrence: financing the projected \$680 million network, and getting local governments to agree on operations. A system to serve two million persons in the Baltimore, Md., area would cost \$2 million for communications equipment alone. DOT and HEW this year have \$40 million in grants and equipment funds for emergency medical services in general.

Major weapons costs rise in six months

Costs of 45 major weapons systems now in procurement rose \$2.7 billion to more than \$125 billion in the first six months of the year, according to the General Accounting Office. **Largest single increase was \$2 billion for the Air Force B-1 bomber being developed by Rockwell International Inc.,** raising the program’s current cost to \$13.3 billion. The gain is attributed to the plane’s increased weight and new Pentagon inflation estimates.

Grumman’s F-14A, being built for the Navy, rose nearly \$692 million, pushing the total to just under \$6 billion because of a two-year program stretchout that will boost costs of airframes, engines, and electronics, said GAO. **The Army’s biggest increase of \$104 million for the Raytheon SAM-D air defense missile system** put the project’s total at \$4.4 billion, with the increases attributed to “refinement of the launcher group estimate and other vehicle costs.” The over-all DOD net increase would have been greater if some programs had not reported declines in estimates, due mainly to equipment cutbacks.

Public servant Strassburg

Words like bureaucrat and politician are most often used in the United States as terms of opprobrium, particularly today when public confidence in the Federal Government and the people charged with running it is at one of its lowest points in the nation's history. The time, therefore, seems appropriate to make the point that there are some outstanding public servants still around—and the Federal Communications Commission's Bernard Strassburg stands high among them.

Such eulogies are traditionally reserved for the dead in contemporary Western societies. Happily, this is an exception. Bernie Strassburg, who will retire at year's end as chief of the Common Carrier Bureau, is anything but dead—as AT&T and everyone else affiliated with the communications industry will quickly attest. Of his 31 years at the FCC, Strassburg has served the last 10 in his present assignment. And in that decade, he has been responsible for more landmark decisions in the communications common-carrier field than anyone can remember. His service represents a remarkable achievement. Many have disagreed vigorously with Strassburg's judgments, but even his opponents acknowledge his ability and integrity.

Landmarks

Year after year, when FCC chairmen have gone before the Congress to report on the state of the commission and justify their budget requests, they have put into the record a list of accomplishments that, more often than not, had their beginnings in Strassburg's bureau. Among them have been the opening of the domestic communications business to companies other than those of the Bell System—a judgment that led to the creation of a whole new class of specialized common carriers such as the MCI companies and Datran.

In addition, there have been such issues as the computer-communications inquiry and such decisions as the extension of competition to domestic satellite systems and the interconnection to the telephone network of customer-provided hardware. Moreover, Strassburg initiated and has vigorously pursued the continuing investigation of the American Telephone & Telegraph Co., its rates, and its rate-making policies.

Thus, it seems most unlikely that public servant Strassburg will disappear from the communications scene when he becomes no more than a private citizen. Now 55, he will not lack job opportunities for his special talents.

Perhaps the only negative aspect of Bernie

Strassburg's retirement is its untimeliness. The timing is poor because a number of crucial issues—interconnection in particular—are not yet fully resolved, and AT&T has mounted only recently a strong counterattack.

No one recognizes the nature of the Bell System assault better than Strassburg, who countered it sharply last month with his own critique of AT&T's views on interconnection. "Considering the size and inner momentum in the growth of its natural monopoly services," declared Strassburg before the National Association of Manufacturers' telecommunications committee, "I am at a loss to understand the policy of the Bell System, as recently articulated by its current chairman John deButts, to extend rather than contain its monopoly. For interconnection does not have the attributes that warrant treatment of the terminal market as a natural monopoly. . . . Mr. deButts makes the typical argument of the monopolist. He says that if we, the Bell System, are able to control all sources of supply in basic and ancillary services, the public will benefit in the form of higher-quality services at lower cost. No unregulated monopolist could make such an argument without risking antitrust action. Mr. deButts seeks to avoid this consequence by cloaking himself in the armor of a regulated monopoly. But a facility or service is not transformed into a natural or economic monopoly simply by either the desires of corporate management or regulatory fiat."

Taking on Goliath

Strassburg has never evidenced fear at challenging the communications giant. After noting that deButts "expressly invites more regulation, rather than less, as a tradeoff to more monopoly and not less," Strassburg posed the question once more: "Is the Bell System prepared to open procurement of all equipment by the operating companies and Western Electric to public competitive bidding so as to remove any question as to the extent of the influence or power the Bell System retains with respect to the fortunes of its suppliers?"

Such questions need to be asked and then asked again until they are answered. In the public interest, they need to be asked by the public servants of the FCC. Whether the Nixon-oriented FCC under Chairman Dean Burch wants to find another such public servant with Strassburg's courage and integrity who can and will continue to ask such hard questions is much on the minds of those in the communications industry these days. —Ray Connolly

The Rise and Fall*

of the 30MHz function generator.

It's variable.

This is the first function generator that puts out a trapezoidal waveform with adjustable rise and fall time. Which makes our Model 162 very useful for such things as comparator evaluation, measuring core memory drive circuit response, measuring amplifier response time and minimizing switching transients.

But while the trapezoidal waveform was catching your eye, maybe you missed the frequency.

30MHz!

About ten million more Hertz than you ever got from a function generator before.

And the 162 will go as low as 3 μ Hz, with continuous, triggered or gated modes and a choice of 9 output waveforms.

All this, and more (which we'll gladly tell you about) for just \$845.

You **will** buy it.

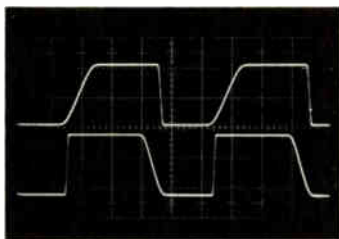

WAVETEK

P.O. Box 651, San Diego, California 92112
Telephone (714) 279-2200, TWX 910-335-2007

Sony gas-discharge TV prototype has 32 brightness levels

The dream of hanging a television screen on the wall like a picture is approaching reality with the introduction by Sony Corp. of a new type of flat gas-discharge panel. In fact, company engineers have also built a prototype that lays flat on a desk with its tuner. But the display differs greatly from the world's first flat-panel TV with matrix scan that Sony developed five and a half years ago [*Electronics*, *Electronics International*, April 15, 1968].

The new panel has a diagonal of not quite 7 inches, and together with its drivers, consumes a scant 10 watts. Another 80 w are required for other circuits, including tuner, brightness control, and memory and scan circuits. The earlier eight-foot diagonal model consumed about 10 kw of power.

Because the technique provides an easy way to illuminate the brightness scale, the new panel has a direct-current glow discharge, rather than the alternating-current plasma discharge used for many of the latest alphanumeric displays. In a second innovation, brightness is controlled by using the best features of the conventional method of varying current through the tube plus selection of the various combinations of the outputs of four monostable multivibrators for each driver.

This new system provides 32 discrete brightness levels of neon-orange. Maximum brightness of the new tube is 30 foot-lamberts with a contrast ratio of 40:1. The panel was described by researcher Yoshifumi Amano at the International Electron Devices meeting.

Sony engineers have fitted the panel, the tuner, and all circuitry into a housing measuring only 300 by 350 by 80 millimeters. Since the gas-discharge panel itself is only 6 mm deep, most of the space is occupied by circuitry. However, the panel requires further development, while the circuits can be readily in-

tegrated. Future objectives include incorporation of phosphor to provide tones of black and white, increasing the number of electrodes to increase detail, and using three sets of electrodes for color pictures.

Adaptation. The panel is fabricated by an extension of the thick-film printed-circuit techniques developed earlier by Sony for its simplified Planitron numerical-indicator tube [*Electronics*, *Electronics International*, May 24, 1971]. The prototype panel has a matrix of 210 by 280 lines with 0.5-mm spacing to give a 105-by-140-mm picture.

The TV picture is formed by the cathode glow of nearly 60,000 cross-points under the anodes. The anode conductors are printed vertically on the front glass plate, while cathodes are wider conductors printed horizontally on the rear glass plate. To separate the glows of the individual picture elements, glass frit barriers are printed perpendicularly across the cathodes so that they are located midway between the anode lines in the finished panel.

To avoid the necessity for forming gas-tight seals between adjacent sections of cathode lines to prevent the migration of ions, which would cause crosstalk, barrier electrodes were placed parallel to and midway between the anodes and the front panel. The 20 barrier electrodes, which Sony engineers consider a significant advance in panel technology, are controlled by a suitable dc potential. □

West Germany

Transistor chips attain uhf levels

Hybrid techniques have been used to fabricate ultrahigh-frequency circuits because, compared with

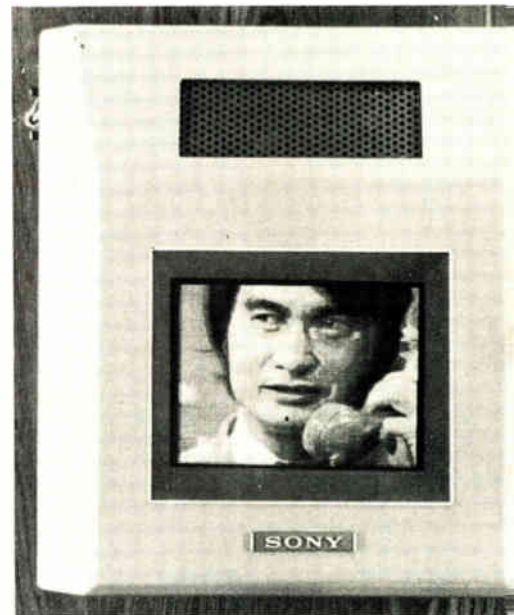

Flattened. Sony's prototype flat TV uses new gas-discharge panel that has 32 brightness levels and consumes 10 W.

monolithic methods, they offer far better performance at high frequency levels. But recent advances in semiconductor technology, which have, for example, produced discrete silicon transistors with cutoff frequencies of 10 gigahertz and more, have now made monolithic uhf circuits possible.

By optimizing conventional techniques and incorporating a few new processes, engineers at West Germany's AEG-Telefunken have come up with monolithic integrated transistors with cutoff frequencies of 4 GHz and beyond. Developed by Klaus Woerner and Arno Kostka, of the company's Heilbronn semiconductor facilities, these new transistors were discussed in a paper at the International Electron Devices meeting.

As Kostka notes, the high-frequency performance of the monolithic transistor structure is enhanced basically by keeping the horizontal and vertical dimensions as small as possible to minimize the

parasitic capacitance, the transit times, and the base resistance. Furthermore, high doping densities are used in those regions that would otherwise contribute to the total base and collector resistance and thus tend to reduce the quality of high-frequency operation.

For reasons of yield, however, the AEG-Telefunken designers had to make certain compromises in the design of a transistor structure that can meet uhf requirements. They found, for example, that a 2.5-micrometer emitter-stripe width would give reasonable yield when using chromium contact-masking techniques and molybdenum-aluminum emitter metalization. But reducing the emitter width to 1.5 μm caused problems and did not decrease the noise figure enough to make such a reduction pay off.

A similar technique was developed for the diffusion and epitaxial steps. Although high doping levels in the buried layer reduces the collector resistance, these levels lead to degradation of the epitaxial layer above the buried layer. A narrow base width, combined with moderately high doping inside the base, is achieved by positioning the emitter and base junctions near the crystal surface.

On to 4 GHz. Through these design compromises and by using phosphorus diffusion techniques, sample monolithic transistor ICs have cutoff frequencies of about 3 GHz when operated at a collector current of 20 milliamperes and collector voltage of 2 volts. This frequency value was achieved with devices having two emitter stripes, each 2.5 by 50 μm in area, a 0.5- μm emitter-junction depth, and a 0.5- μm base width.

Even better results were obtained by using arsenic diffusion for the emitter and ion implantation for the base. These techniques enabled the Heilbronn designers to push the maximum cutoff frequency for the monolithic transistor to 4 GHz and more.

Arsenic emitter diffusion offers the advantage of a steeper emitter profile, the absence of emitter dips, and less crystal damage in the

highly doped regions. The improvements realized through ion implantation result from changes in the active and inactive base profile and in better control of the process parameters.

AEG-Telefunken has thus far produced such uhf ICs as frequency mixers and dc-coupled broadband amplifiers consisting of two double stages. A capacitor connected externally to this circuit increases the voltage gain at high frequencies and also compensates for any irregularities. A high load at the output is achieved by integrating two emitter followers on the same chip.

With supply voltages of +4.2 v and -2.8 v, the total power dissipation of the amplifier is only 130 milliwatts. It is 380 mw when the emitter followers are used. The voltage gain is 23 dB at a 3-dB-down bandwidth of 750 MHz. □

The Netherlands

CCD hits megahertz speeds

A new type of charge-transfer integrated circuit that operates efficiently at speeds in the megahertz range has been developed by Philips Gloeilampenfabrieken. Philips claims that its so-called peristaltic charge-coupled device—PCCD for short—is the fastest charge-transfer IC thus far to be developed. It was named for the way in which the charges, particularly the final fractions of each charge, move. The transfer is similar to the alternate peristaltic contractions and dilations of the digestive system.

The PCCD has a charge-transfer efficiency of better than 99.99% at a rate of more than 100 megahertz. Leonard J. M. Esser, the researcher credited with its design, says that it should be possible for the PCCD to attain speeds as fast as 1 gigahertz.

Useful. Like all such devices, the PCCD can be used in such applications as imaging, delay lines, filters, and memories—to name only a few. But its high speed, coupled

with its high efficiency, make feasible an increased sophistication in these applications, Esser asserts, and it also makes possible processing of large-bandwidth signals.

Although a similar transfer efficiency can be achieved by other types of charge-transfer devices, such as the Philips-invented bucket-brigade device and the U. S.-developed charge-coupled device, Esser points out that their values are obtained at a transfer rate of only a few megahertz.

As in any charge-transfer IC, the PCCD transports a well-defined quantity of charge temporarily stored in one capacitor to the next one. The speed at which the charge is transferred is determined primarily by the transport time of the last fraction of the charge that is to be moved down the line of capacitors. It is in driving this last vestige of charge along that the PCCD differs from its predecessors.

Fractions. In the PCCD, this last fraction of charge is kept at some distance from the capacitors' electrodes—that is, deep inside the semiconductor. As in the other charge-transfer ICs, the larger part of the capacitors' charge in the PCCD is still near the electrodes so that a low switching voltage will suffice for the charge transfer.

But, because the last fractions of the charges are farther from the electrodes, they can be subjected to external drive, or fringing, fields. These external fields ensure a fast transfer of these vestiges of charges from one capacitor to the next. The input signal generates a negatively polarized charge cloud at the input, and clock voltages are applied in successive inputs that are rotated in 90° increments so that the charge is alternately pulled and pushed along, thereby kicking the final fraction of the charge abruptly from each capacitor.

In addition, the mobility of charge carriers inside the semiconductor is greater than it would be if the carriers were near the surface, which contributes to the high transfer rate. The device was described at the International Electron Devices meeting. □

Full data on all patents from 24 countries in minutes!

Derwent Publications introduces the world's fastest and most comprehensive information service on patents.

Now that patent specifications filed in Japan and many European countries are published so rapidly, they are replacing conventional trade and scientific journals as sources of information on new ideas and latest developments. Also, they provide advance information on related patent applications which will be published much later by the United States and United Kingdom patent offices.

This new interest in patents has intensified the need for a simple international patents journal wherein the whole of the patent literature of the World can be scanned, and items of interest followed up, in a unified system.

From January 1974 Derwent will be providing a new integrated service - World Patents Index - which will completely meet this need.

Each week computer-generated and phototypeset WPI covering *all* subjects will give fully indexed information on over 12,000 patents published 4-5 weeks earlier in 24 major countries. In a single gazette WPI will contain indexes which will allow in a matter of minutes searching by patentee, subject matter and keywords and will identify families of patents.

Back-up information for WPI in the form of English language abstracts for chemical subjects is provided by the highly successful Central Patents Index, operative since 1970. A companion

service for non-chemical subjects - General Patents Index - will commence at the same time as WPI. Each week GPI will publish, in book and card forms, abstracts plus drawings, available for convenience in three separate sections - General, Mechanical and Electrical.

Additional services to subscribers include:
High speed central bureau patent searches
Selective monitoring by subject, country or patentee
Copies of patent specifications on request.

No other source is able to provide patents information of such depth, accuracy and speed. Furthermore, the many advantages of these outstanding services can be obtained for a really economical subscription equivalent to only a few dollars a week.

Samples of WPI and GPI are available for you to evaluate without obligation and completely free of charge.

Write now (quoting DD) for brochure, giving full details of these services and subscription rates, and for the free samples.

Derwent Publications Ltd.,

Rochdale House, 128 Theobalds Road,
London WC1X 8RP, England. Telephone: 01-242 5823.
Telex: 267487. Cables: DERWENTINF, LONDON.
A part of The Thomson Organisation.



World leaders in patents information.

International newsletter

Telefunken video disk runs into problem

A last-minute technical problem is postponing the long-awaited market debut of the Telefunken-Teldec video disk, which was originally slated to hit retail stores on Jan. 7. What's holding back the introduction of the so-called TED—for Television Disk—system is, according to Telefunken, **the improper design of the disk-protecting paper jacket that is inserted, with the disk inside it, into the playback unit.** That jacket, as the company explains it, affects the paper-thin plastic disk during shipment and storage in such a way that small surface changes occur. These, in turn, lead to picture distortion during playback. Telefunken says that by modifying the jacket this shortcoming can be straightened out, **but it concedes that such a jacket modification may call for a design change in the playback unit as well.**

Just when the new date for TED introduction will be depends on how long the tests with redesigned jackets and with possibly revamped playback units will take. Company officials speak of "only a short-term delay," which they say means the TED market debut will still be sometime in 1974. The delayed introduction, independent observers feel, is a **decided setback for the Telefunken system because it cuts down the lead the German company has over the competing Philips-developed Video-Long-Play system,** which is scheduled for a mid-1975 market debut. Thus far, Telefunken has considered that lead one of the big plus points for its system.

Common Market looks to strengthen computer industry

The Common Market Commission is recommending a strong Community-wide program of financial aids, joint development efforts, and intercompany cooperation **aimed at making the European computer industry competitive with U.S. companies.** In a report on the industry adopted last week, the commission places priority on an all-European grouping of computer firms. While the document mentions the Unidata linkup between CCI, Philips, and Siemens, it implies that the approach does not go far enough in putting the European industry on a strong basis.

The commission envisages the regrouping of European companies in two phases: **the first starting with cooperation between firms, the second terminating in fusion of production facilities.** The document also calls for measures to aid European computer companies in selling to various national government markets. **It wants parallel efforts to strengthen the European peripheral, software, and components industries.**

Japan plans to up TV exports to Britain . . .

Japan will be able to export 25% to 30% more color-TV sets and about 10% more black-and-white sets next year, according to Noboru Yoshii, managing director of Sony Corp., leader of a Japanese team that just returned from a bilateral meeting of industry executives in London. **That will make a total of about 350,000 color and 240,000 black-and-white sets to be exported next year under Japan's self-imposed export restrictions.** The Ministry of International Trade and Industry is expected to set the actual numbers early in December. Representatives of the electronics industry in the two countries will sit down again in May in Tokyo.

Although England's domestic economy, international balance of payments, and oil situation are unclear, industry representatives at the recent meeting agreed that **next year's market for color will probably**

exceed this year's total estimated market of 2.74 million sets by at least 25%, and the market for black-and-white sets will probably exceed this year's estimated market of about 500,000 by 10%. The percentage of the market allocated to Japanese sets for next year is to be kept the same as this year.

. . . where makers continue to worry over Japanese gains

In Britain, the statement by officials of Japanese industry that it expects to raise color-TV exports to Britain to 350,000 sets next year, compared with 275,000 this year, has had mixed response among domestic set makers. The majority view is that **if the total home market increases next year so that imports from Japan make up about 10% of it, as they are this year, the imports won't harm the home industry.** However, if the market soon levels off—as is quite possible, though it's expanding now—the increased imports will start to cut into home production. Then will come the **test of Japanese protestations that they will not let their exports harm the British industry.**

Overall, British set makers are less worried than they were a year ago, mainly because Japanese set prices have been rising steadily and are now—tube size for tube size—equal to or more than British set prices. Because of this, a few industry leaders **believe the main threat from Japan has passed, and when the market slumps the imports will be the first to feel the pinch.**

In West Germany, Sunday driving, no; color-TV, yes

As much as West Germany's ban on Sunday driving is hurting some branches of the economy—inkeepers, for example, are complaining about lack of business it is **proving to be a boon to the entertainment-electronics makers.** Radio and television dealers, industry people say, are reporting sharply rising sales of their products in recent weeks, with color-TV sets doing especially well. Retailers attribute the increase not so much to the usual pre-Christmas buying spree, but rather to the no-driving-on-Sundays edict.

Several Frankfurt dealers say they are chalking up sales from 20% to 30% higher than those during the same period last year. "Just by how much the driving ban will boost nationwide color-set sales this year is hard to pin down at this time," a marketing expert at Stuttgart-based Standard Elektrik Lorenz AG says. "There's no doubt, however, that people's immobility on Sundays is intensifying color-TV business and proving to be a market factor of sorts." The ban on all non-essential Sunday driving, already in force in several Western European countries, is, of course, one result of the energy crisis currently gripping many of the world's industrial nations. **In West Germany, the ban went into effect on Nov. 25 and will continue to be enforced on all Sundays at least through mid December.**

Russia snaps up automatic-test equipment at show

Booming demand in the West for automatic-test equipment apparently has reached Russia. At an exhibition of British instruments in Moscow last month, **the Russian state buying agency Mashpriborintorg paid Marconi Instruments Ltd. \$50,000 cash for the stock demonstrator Marconi had on its stand.** It's a tape-controlled system and will be used to check component values and do functional tests on computer boards in a plant in Kiev. Marconi men say the Russians seemed not have seen a full automatic-test system before.

Need a DMM with a difference? ...Keithley's got 'em!

Tired of "general purpose" Digital Multimeter performance? Want that something extra that'll make your job easier? Then we've got the Multimeters for you. Take our new 5-1/2 digit, $10\ \mu\text{V}$ resolution, \$750, ac/dc Model 190...or our new 5-function, 32-range Model 165. It's even got a built-in 1 mA source for semiconductor testing. Then there's our model 171 ... a real do-it-all DMM. 4½ digits, $1\ \mu\text{V}$ resolution, dc volts, ac volts, ac/dc amps, ohms too.

But the Keithley family doesn't end there. We can give you resolution to 30 nanovolts, or let you measure currents of 10^{-15} amp, or resistances to over 10^{14} ohms...we've even got a DMM that has the read-out in a probe.

If you have a job that needs a DMM and then some, we can help. Send for our Digital Multimeter selector guide or call us for a demo now.



Our latest "How sweet it is" proclamation is on a marble base paperweight. It's free when you request a DMM demo. Get one now!



**KEITHLEY
INSTRUMENTS**
U. S. A. : 28775 AURORA ROAD, CLEVELAND, OHIO 44139
EUROPE: 14, AVENUE VILLARDIN, 1009 PULLY, SUISSE

New Tool New Board New Method

it's part of the TY-RAP® System

Now tie quicker than ever before...

Our new high speed tool does it all . . . feeds a TY-RAP tie around bundle, cinches to a preset tension, locks securely and trims evenly . . . all in $\frac{1}{10}$ of a second. There is no tool adjustment needed regardless of bundle diameter from $\frac{1}{32}$ " to $\frac{1}{2}$ ".

The off-the-board harnessing method allows the tool optimum use. This technique utilizes our new harness board and harnessing aids. The board is reusable and reversible. It's modular too . . . snaps together for larger work areas. It's constructed of polyethylene foam sandwiched between two metal screens — nails are pushed in by hand. It's all part of the TY-RAP System to lower your costs of harness fabrication.

Write for new catalog, The Thomas & Betts Company, Elizabeth, New Jersey 07207 (201) 354-4321. In Canada, Thomas & Betts Ltd., P. Q.

Sold Only Through Authorized T&B Distributors

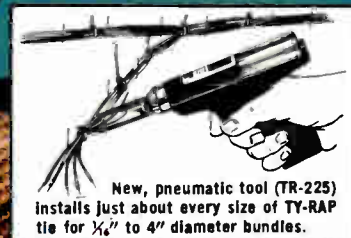

New, pneumatic tool (TR-225) installs just about every size of TY-RAP tie for $\frac{1}{16}$ " to 4" diameter bundles.



THOMAS & BETTS

Division of Thomas & Betts Corporation

517

Circle 68 on reader service card

A Major Tooling Breakthrough in Production Wire Tying

Until 1958, when the Thomas & Betts Co. introduced TY-RAP® cable ties and tools, the harnessing of wires was accomplished by either taping, lacing with string or spot tying. Today the TY-RAP system of harnessing has become the accepted way of handling wires — even in high volume production. The new T&B TR-300 automatic tying tool, the most recent addition to our tooling technology, has made harnessing a cost controlled proposition with measurable savings. With proper harness board preparation, the TR-300 tool can offer 4 to 5 times quicker installation than hand tying.

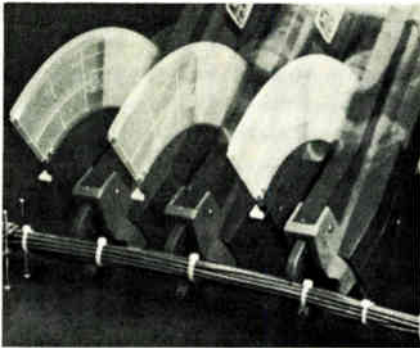

How Do You Determine Your Tooling Needs?

The selection of the best TY-RAP tying system for your operation means evaluating:

- Volume of tying vs. costs
- Present harnessing methods
- Number of people involved
- Bundle diameters & breakouts

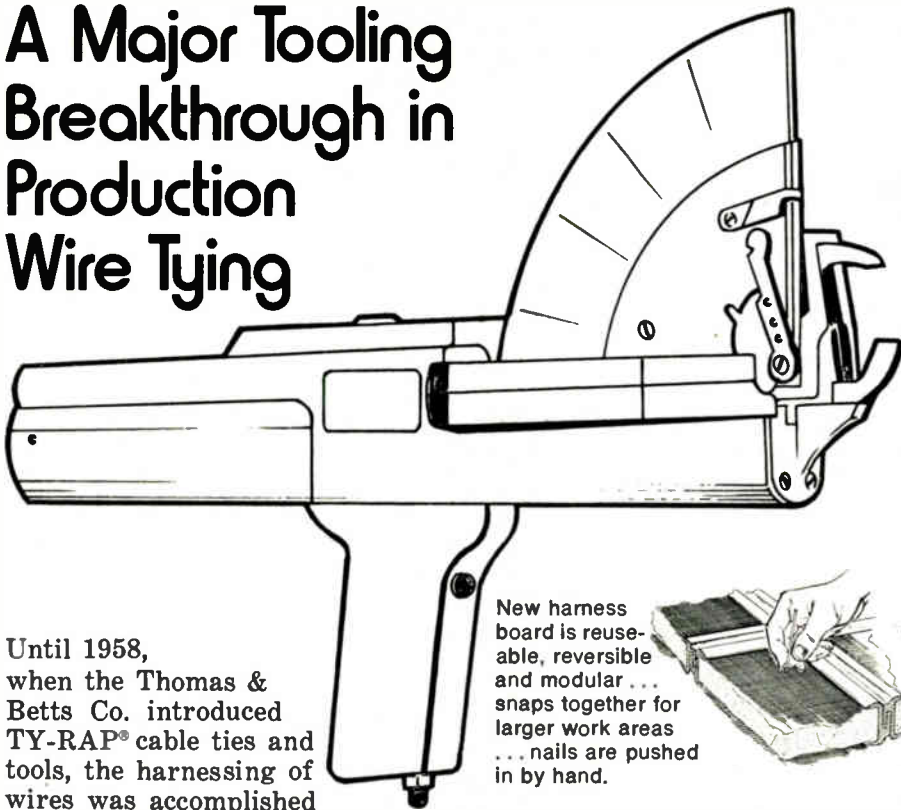

New harness board is reusable, reversible and modular... snaps together for larger work areas... nails are pushed in by hand.

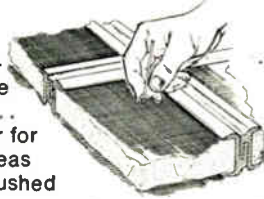

These and other considerations can be reviewed by your local T&B harnessing specialists. Your production rates, system flow and total installed costs are all of major concern to us. For example, we might recommend the New TR-225 pneumatic tool, a

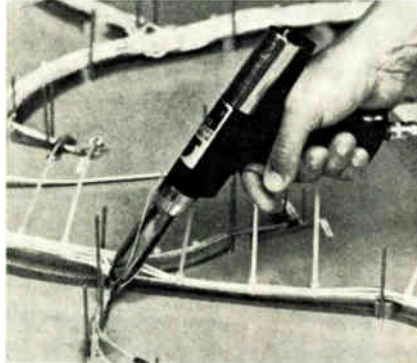

rugged design yet light weight and human engineered for both men and women operators. It was built to provide reliable performance day after day in a production environment... (has been test cycled 1,000,000 times per month without a failure). The tool accommodates most TY-RAP tie sizes... 16 in all... ranging from 1/16" to 4" bundle diameters. A further convenience is the long narrow nose that works easily at breakouts or in tight areas. If your production volume is such that it does not require the exclusive use of the TR-225, per-

haps the new WT-193 hand tool would supplement your operation.

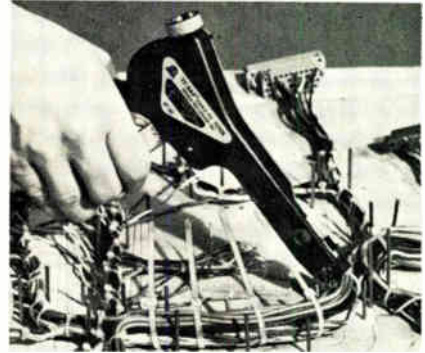

The WT-193 tool accommodates the same bundle range as the TR-225. With a similar narrow nose and long barrel, it is also well suited for tough to reach places. This particular design gives the operator the convenience of a long tying stroke with one squeeze of the trigger... the tie is cinched to a preset tension and trimmed flush with the head. The speed of tying is good for smaller volume tying as compared to the pneumatic TR-225.

Harnessing aids are available for your existing operation. The bundle shaper/retainer is effective in reducing the cost of routing wires. It shapes the bundles and holds them firmly above the surface of the board facilitating the ease of tying.

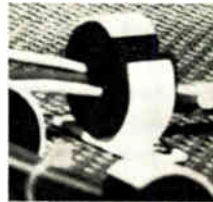

In our evaluations of harness fabricating techniques used across the country, operator performance, fatigue factors and process convenience appeared as major considerations in the cost structure of harnessing. Our harnessing specialists are equipped to study these costs as well as all pertinent factors involved in your wiring and harnessing operations. Write or call us today.

The Thomas & Betts Co., Elizabeth, New Jersey 07207, (201) 354-4321. In Canada, Thomas & Betts Ltd., P.Q.



This 10 MHz Triggered Scope is 1/3 the size of comparably performing scopes.



MODEL 1431 \$399.95

It's a lightweight 13 pounds in your hand and a heavyweight performance wideband scope with a 35 nanosecond rise time on your bench or jobsite. Whether you're servicing or designing industrial equipment or TV, there's the right sweep speed and sync for easiest operation. If you know our Model 1460, the leader in wideband 5" CRT scopes, you know our new 3" Model 1431 which gives you the same high performance in one third the size. (Only 4 $\frac{3}{4}$ "Hx7 $\frac{7}{8}$ "Wx12 $\frac{1}{8}$ "L)

Servicing, production, inspection, quality control and lab applications are all easier with this versatile all solid-state instrument. Triggering is accomplished with only 0.5V peak-to-peak. Ten millivolts per division sensitivity, 0.5 usec/cm to 0.5 sec/cm automatic and triggered sweep in 19 calibrated ranges, and external trigger input are just a few of the reasons you'll like it.

If you have been waiting to buy a portable scope until you could get all the features you'll ever need at a price you want to pay, you've been waiting for Model 1431. Contact your distributor or write Dynascan Corporation.



Shown with optional carrying cover and probe pouch.

B&K PRODUCTS OF
DYNASCAN
1801 W. Belle Plaine Ave.
Chicago, IL 60613 • (312) 327-7270

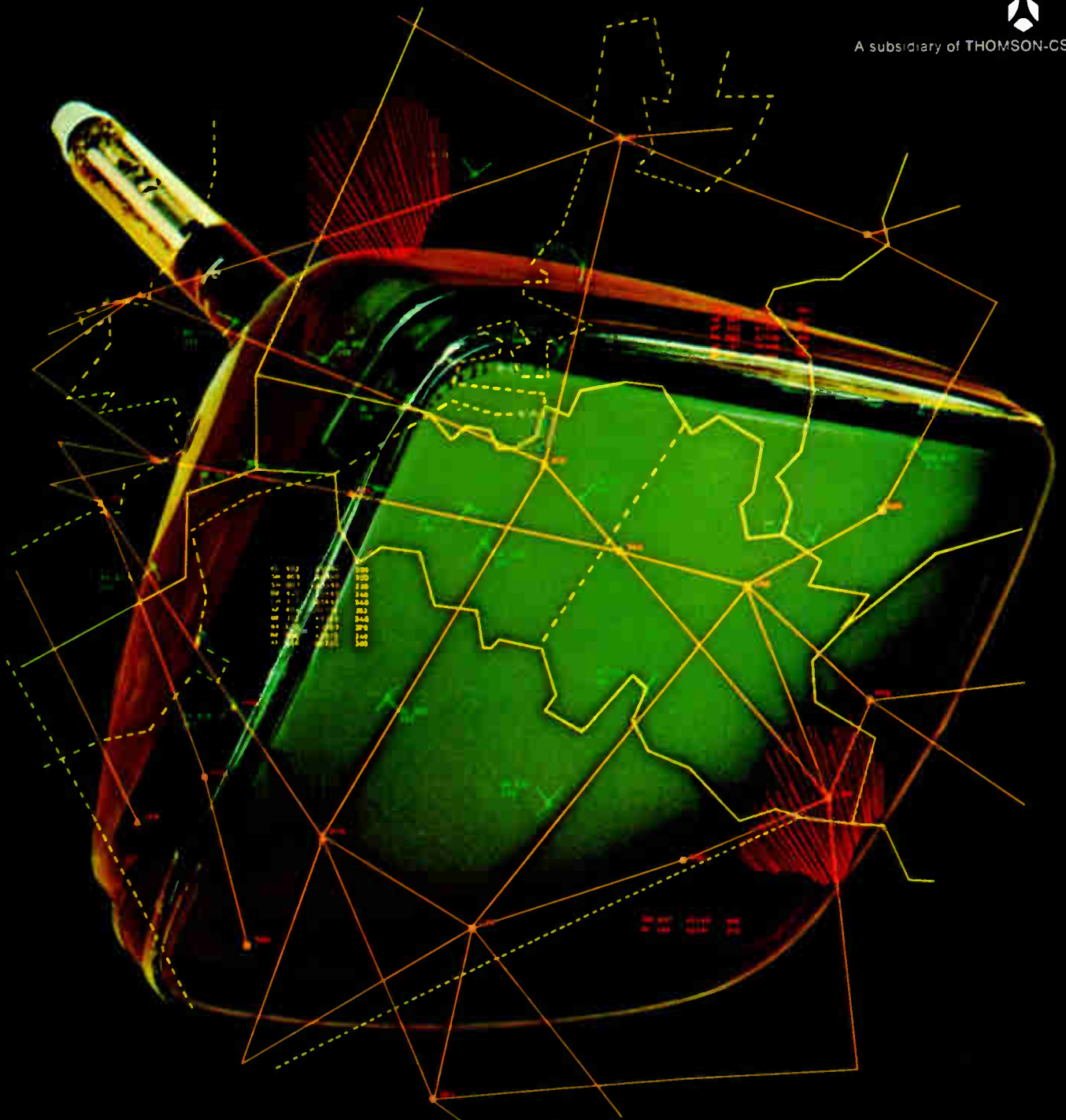

DuMont puts a brighter light in your multicolor displays.

Our color CRT's enable the viewer to accurately discriminate between modes of operation, or classes of symbols. Large numbers of complex bits can also be presented and comprehended without confusion. Superior brilliance and contrast is achieved by varying the voltage of a single electron beam scanning a multiphosphor screen. Resolution is comparable to that of high quality monochrome

CRT's. DuMont's penetration design, however, eliminates the complicated convergence circuitry employed in conventional four color displays.

Current applications utilizing our multiphosphor screen CRT's include transportation control (air and surface), biomedical research, critical path analysis, process flow charting and photographic and map interpretation. DuMont multiphosphor screen

technology is also being adopted to multipersistence penetration screens to add variable persistence capability to radar presentations. Tell us about your particular color CRT requirements. For our new brochure contact: Marketing Department, DuMont Electron Tubes and Devices Corporation, 750 Bloomfield Avenue, Clifton, New Jersey 07015 (201) 773-2000. **DuMont**

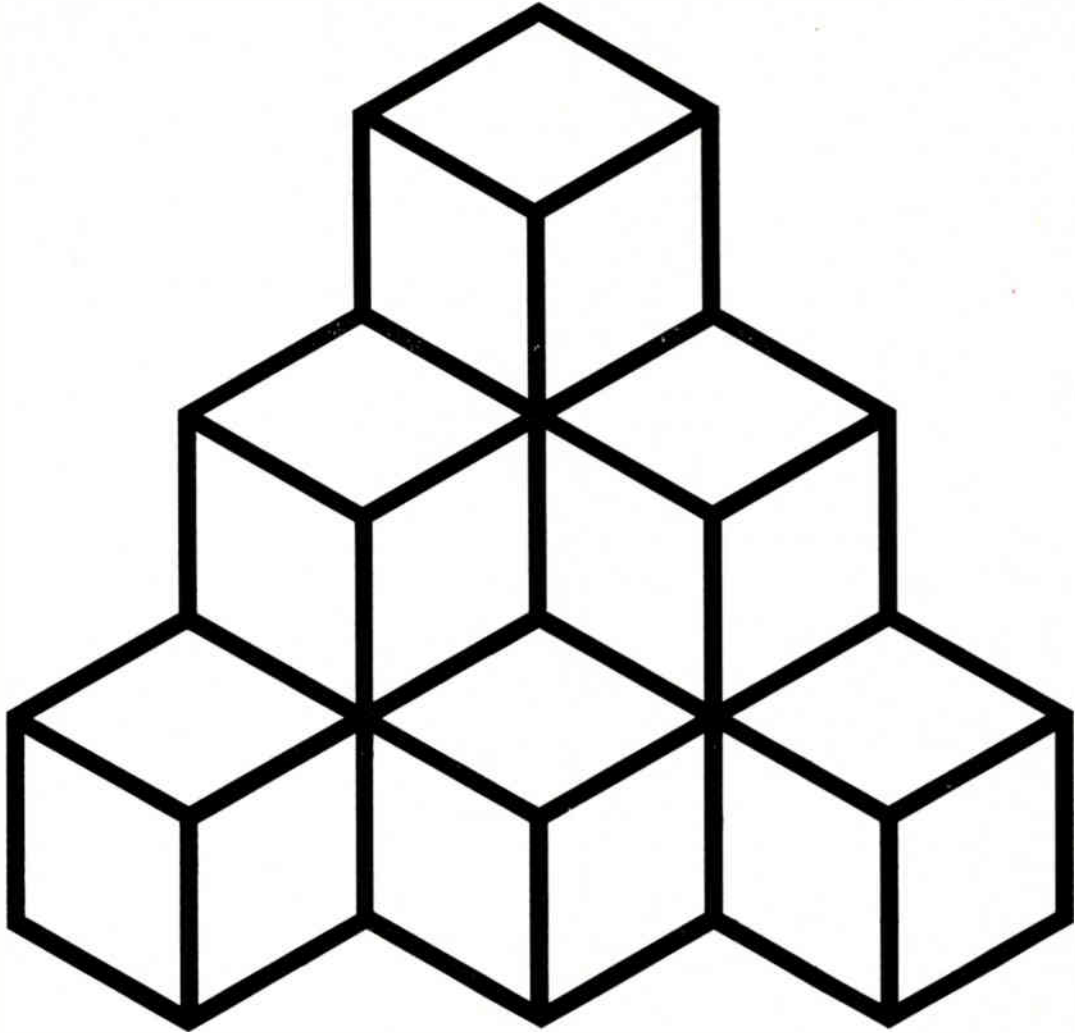

E-H PULSE GENERATORS

Building the solution to your measurement problem.

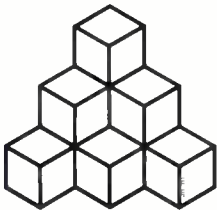

Fast, accurate pulses from E-H, the company that supplies over one-third of the world's pulse generators. A line so complete that you will find exactly the specs you need.

Take the 129, for example. It's used in more sophisticated R&D applications than any other pulse generator. It's capable of 500 MHz — with a transition time specification of 500 psec.

Or the versatile 135A with all the capability you would ever need as a workhorse for your production line.

\$395 is the cost of our 50 MHz Model 710. For this you get a pulse generator that gives you all the basic testing capabilities and a clean pulse.

All these and more — a line of 20 of the world's best pulse generators.

For complete specifications, including a convenient selection chart, use the bingo card, or call us direct.

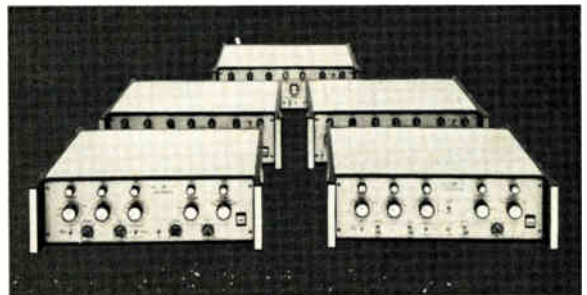

**E-H Research
Laboratories, Inc.**

515-11th Street, Box 1289
Oakland, California 94604
(415) 834-3030



Aren't you the guy who says he's always looking for a new way to improve the product?



Here's your chance.

Have you thought about lasers?

A Hughes helium-neon laser is a light source for devices that measure, align, level, detect, record... or even provide a wireless communications link.

There may be a way to incorporate a laser into your product to make it lighter, smaller, faster, more accurate or more versatile.

First, let's make sure we're talking about the same kind of laser. He-Ne lasers are low-cost, low-power, and safe. (They cost as little as \$80 and can operate on either AC or DC.) They send out a visible beam of parallel light waves that can travel for hundreds of feet with very little divergence.

He-Ne lasers don't cut, weld, or perform brain surgery. Those are other lasers.

He-Ne lasers have revolutionized surveying and construction engineering equipment.

They shoot a perfect straight line for building bridges. Digging tunnels. Laying pipes and cables. Or leveling road beds.

But there are many other kinds of equipment that incorporate lasers.

Equipment to: Align car wheels. Tell auto repair shops when a damaged body is

straight. Detect surface blemishes as products pass down a production line. Measure flow rates and machine-tool distances. Gauge thickness. Position automated machines. Inspect large prisms and lenses.

Scan production lines to keep quantitative records. Read bar-code patterns—adding totals and keeping inventory count.

They can even be used in systems that carry large amounts of audio and video information over short distances. (Like transporting TV signals from a football stadium to a transmitter van.)

Video playback systems. Non-contact printing.

Security systems. Computer readout. Holographic recording for checking filed data. Particle counting in pollution monitors.

A Hughes He-Ne laser may be the answer to your product im-

provement, too. After all, Hughes made the first working laser. And we pioneered the use of He-Ne lasers in many of the fields we've listed. We can anticipate many of your interface problems. And opportunities.

If you're serious about improving your product, give us a call.

**Call Hughes
(213) 534-2121**

If you're an OEM interested in incorporating a He-Ne laser into your product, call this number. Ask for Bob Weiner, extension 445. Or write 3100 W. Lomita Blvd., Torrance, Calif. 90509.

HUGHES

HUGHES AIRCRAFT COMPANY
ELECTRON DYNAMICS DIVISION



Put a little Teradyne in your lab.

You've probably heard of the big Teradynes—our highly sophisticated production-line test systems that have become the standards of industry.

Now hear about a little Teradyne—the J127 Accutest Circuit Analyzer, a bench-top digital IC tester that lets you lab-test ICs like never before. Quickly. Conveniently. And all for just \$3500.

The J127 has four constant-voltage supplies, a constant-current supply, four dual-limit comparators, a 24-pin crosspoint matrix, a pulse generator, and a 3½-digit panel meter.

It analyzes. It measures. It performs functional and parametric tests. It handles combinatorial and sequential logic. It's short-circuit-proof and it has programmable voltage and current limiting.

Set a switch to connect any lead of a 14-, 16-, or 24-pin device to any voltage supply, comparator, or the pulse generator. Turn a dial to set a bias or pulse level or a comparator limit. Push a button to connect the meter to a voltage or current supply, to a comparator, or to the matrix where it can then be switched to any pin on the device under test.

You can use the J127 for vendor analysis, reject analysis, pre-production inspection, and, especially, for engineering evaluation.

It has all this going for it and Teradyne behind it. Now that's a lot for \$3500—but it isn't all.

For the rest, write Teradyne, Inc., 183 Essex Street, Boston, Massachusetts 02111. In Europe: Teradyne Europe S.A., 11 bis, rue Roquépine, 75 Paris 8^e, France.

TERADYNE

Chicago (312) 298-8610 / Dallas (214) 231-5384 / New England (617) 458-1256 / New York (516) 364-9797 / Sunnyvale (408) 732-8770
London (093-28) 61111 / Paris 265 72 62 / Rome 59 47 62 / Munich (0811) 33 50 61 / Tokyo (03) 406-4021.

Circle 74 on reader service card

An engineering analysis of EE jobs

IEEE's latest report examines factors in picking a job, but the decision is still up to each EE—as usual

by Gerald M. Walker, Associate Editor

Back in the depths of the 1969–71 recession, when many engineers were on the beach, the common complaint among those attempting to remedy the situation was that there were not enough statistics—no numerical handle on how bad the situation was, who was hit hardest, and the like.

Now, at the crest of an economic boom in which there appears to be a shortage of some types of EEs, comes the IEEE's "Career Outlook in Engineering—I," the result of an arduous study to correct the lack of a good analysis of the EE job situation. Prepared by the institute's manpower committee, the report goes a long way toward providing engineers and students with a tool to help figure out the ups and downs of employment in the electronics industries and to plan some sort of strategy to cope with employers' hiring needs.

The decision-making, however, is still in the hands of the individual. This report, running some 225 pages, is not a secret potion to magically get every EE into the best of all possible jobs at just the right time. In fact, there is a certain amount of conflict within the report about whether or not there actually is or will be a job shortage, but this adds to its believability because the same conflict exists within industry, academia, and Government agencies.

Overall, the publication, which is due to be released as soon as the IEEE decides how much to charge for it, is about as thorough and exhaustive a summary of careers as an engineering paper is of a technical subject. It's indeed an engineer's view of the engineering career.

Says committee chairman Frank Astorini Jr. in the preface: "As a preliminary report in this area, it is hoped that the historical picture portrayed, along with current statistical data available, will provide a source document from which the engineer (or potential engineer) may obtain a real sense of personal perspective with regard to his professional status, as well as its changing and changeable character.

"The overriding objective of this report is to provide IEEE members with information affecting their professional status and with which they

can form individual judgments about such broad areas of concern as 'How am I doing? Where do I stand? What should I do?' and provide the means to make good decisions on the future."

Oscillation. Plainly, this collection of 14 chapters is an attempt to explain the apparent oscillation in the supply and demand of engineers and how the individual EE can ride the hills and valleys. Actually, taking the long view of employment, the rise and fall in demand has occurred along a steadily increasing total-employment curve. Never-

The audience: they're encouraged

Gary Rago and Chris Ross have read the report, and they are encouraged. And that's important because these 20-year-olds, junior EE majors at Manhattan College in New York, are typical of the young men and women the IEEE is trying to reach with its "Career Outlook in Engineering—I."

Rago and Ross agree that, until they had read the study, they had had some misconceptions about what an EE is and what he or she does. "I thought all of them did research. It turns out that only 2% do," says Ross. Rago likes the comprehensiveness and detail of the IEEE's effort, saying that it's good to have numbers backing up his feelings that EEs are doing vital work. He also points out that he had been leaning toward working with power devices after graduate school "mostly because of what some seniors and an engineer with GE told me." But the report has opened the world of sales and management to him, and now he's less sure about

power. "I really would like to go into business for myself," he says. Ross, whose inclination is toward bioengineering, likes the report's view of management qualities. "I had the impression that EEs work alone."

But both students agree that they dislike one part of the report. "We don't like the part classifying EEs as people who aren't well-rounded, who aren't able to talk with other people."



Reader. Report pleases Gary Rago.

theless, as the summary of general conclusions points out, "Even though the long-term trend will be upwards, with demand outpacing available graduates, the fluctuations of the market itself will result in the need to make an increasing number of shifts in the years ahead."

If the economists are correct, the U.S. economy—and possibly the electronics industries along with it—is due for a growth slowdown in the coming year, thus making a careful study of this report uncomfortably necessary. It's organized under four main headings: the industry picture, the manpower picture, careers in engineering, and the engineering challenge. These sections are not uniformly appealing; the writing ranges all the way from pompous to dry to intriguing. But on the whole, the report is a good career review for just about every EE. It's crammed with tables and charts covering engineering-school enrollment, job demand, business conditions, salaries, and distribution of engineers—to name just a few. And it's refreshingly free of what might loosely be labeled "the IEEE party line"—that is, the view that everything is all right out there in the working world if you will just be a good fellow, work hard, and always listen to what your boss tells you.

Balance. To be sure, there is some of that kind of thinking in the report, but it's balanced by some tough-minded advice on the characteristics of engineers, of engineering jobs, of the electronics industries, and of the cruel race known as continuing education. So it's not exactly a travelogue through the glories of engineering. Rather, it's a trip that details the fears, uncertainties, and just plain absurdities of the EE career, along with the satisfactions, excitement, and challenges.

The section on manpower begins with a study of employment trends provided by Deutsch, Shea, & Evans Inc. On the whole, it shows an encouraging picture for the EE—a notable decline in engineering enrollments, an upward-moving economy, and a technology-oriented socioeconomic structure. This spells plenty of jobs. However, DS&E

warns that companies have learned to get along with fewer engineers, and—not so good for the EE—the cost of recruiting is increasing. Thus, the individual engineer must take a conservative view of job planning and look for pensions and employment contracts that protect him from summary dismissal.

Another chapter on manpower hits a sore point these days—employment statistics: "The most serious deficiencies in the various series of national data are inconsistency in definitions, lack of coordination in collection, excessive delay in publication, lack of essential detail, and lack of coverage. Taken together, these deficiencies reveal the absence of a coordinated manpower policy, so that what exists is a collection of loosely related statistics of uneven quality and completeness."

The last three chapters in the manpower section merit the engineer's closest attention, for they reveal through a maze of charts and formulas an excellent picture of today's employment that's worth the struggle to absorb all the statistics. Significantly, conclusions in these chapters are not in complete agreement. For instance, contradicting other chapters indicating a shortage of engineers, Robert A. Rivers, chairman of the manpower committee's subcommittee on the assessment of supply and demand, concludes, "There is a large 'stored supply' of qualified engineers available." And he adds that even with a "normal" demand for more engineers, the surplus of displaced engineers may grow, while "decreasing or static demand can only result in further dislocation."

The chapters on careers in engineering touch yet another sore point among EEs: the conflict between becoming a specialist or a generalist. In one spot, the report states, "When the cards are down, it is the fact of life that industry, education, business, etc., put specific parameters on every job. Yes, there is the generalist to a fair degree, but the generalist has evolved from having gained experience in a number of specialties. For the most part, the openings from which choices can be made fall into a surprising variety of quite specialized categories."

Three pages later, this appears:

"From this analysis it is obvious that specialty experience in engineering and design, application engineering, and management aspects is in high demand." And four pages later, it says, "Overspecialization and professional inactivity have contributed the greatest barriers to enjoyment of a stable and improving job picture." Thus, the general conclusion seems to be that the EE has to be a specialist in a range of disciplines.

Character. Chapter 10, "Personal Attributes and Career Goals in the Electronics Industry," by Michael Maccoby of Harvard, gets off to a terrible start with this line: "The EE's future depends as much on his character as on his technical ability and training." But EEs should grimace only once at this one and read on, for this turns out to be an interesting chapter.

In it Maccoby describes four basic character types found among an analysis of engineers in a sample of electronics companies. They are:

- The craftsman. This engineer, who prefers to work alone and is stimulated by the task, is satisfied by seeing a design work.

- The company man. He, on the other hand, derives his security from knowing that he fits into a company structure. He is driven by a fear of failure—that is, falling from favor in the company.

- The gamesman. He plays the game of the business world. He thrives on competition and often uses football jargon like "the big play," or "the game plan." "He lacks patience and commitment to people, principles, and goals, beyond winning. His hunger for excitement and glory may distract him from realities beyond the game he is currently playing. Indeed, he can be looked upon as creating a secondary reality for himself. If life is not interesting enough for him, he makes it a game and enters a semi-fantasy world," comments Maccoby. In a striking understatement, he points out, "The gamesman and the craftsman often feel frustrated trying to communicate with one another."

- The jungle character. This type of engineer may get the job of cleaning house in an organization and probably likes knocking off others in his path. □

ULTRA-MATCHED TRANSISTORS...*made easy!*

$V_{OS} - 100\mu V$

$TCV_{OS} - 0.5\mu V/^{\circ}C$

$\Delta h_{FE} - 3.0\%$



Max!

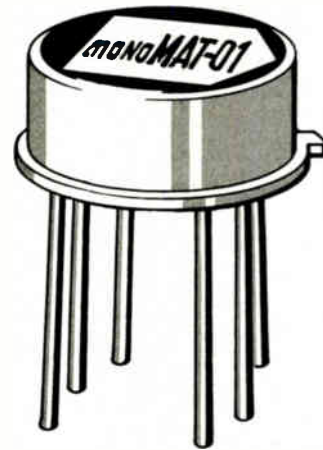

YOUR TOUGHEST APPLICATION HAS MET ITS MATCH!

Unparalleled matching at a price you can afford — and with off-the-shelf delivery too! The monoMAT-01 makes it easy to realize your toughest-spec special purpose amplifier designs! And super-matching isn't the only feature monoMAT-01's got — the extremely linear V_{be} vs $\log I_c$ is ideal for current sources, log-antilog and multiplier circuits. Micro-power circuitry will love the extremely low noise and high beta at very low collector currents ($h_{FE} = 590$

typ at $I_c = 10nA$). Of course, the monoMAT-01 receives Precision Monolithics' famous "Triple-Passivation Process" for the ultimate in reliability and long term stability.

Try one and see! (It's easy! — the 6 pin TO-99 type package directly replaces most popular duals.) You'll find the monoMAT-01 is more than a match for your toughest dual transistor application! Get 'em off-the-shelf from your Precision Monolithics distributor!

GUARANTEED MIN/MAX SPECIFICATIONS

	monoMAT-01AH	monoMAT-01H	monoMAT-01FH	monoMAT-01GH	
$V_{OS} @ 25^{\circ}C$	0.1	0.1	0.5	0.5	mV
$TCV_{OS} (-55^{\circ} \text{ to } +125^{\circ}C)$	0.5	0.5	1.8	1.8	$\mu V/^{\circ}C$
$h_{FE} @ I_c = 10\mu A$	500	330	250	250	•
$I_{OS} @ I_c = 10\mu A$	0.6	0.8	3.2	3.2	nA
$TCI_{OS} (-55^{\circ} \text{ to } +125^{\circ}C)$	90	110	150	150	$pA/^{\circ}C$
$I_B @ I_c = 10\mu A$	20	30	40	40	nA
BV_{CEO}	45	60	60	45	V
Price @ 100 pcs.	\$6.00	\$5.00	\$3.75	\$2.50	•

AUTHORIZED DISTRIBUTORS

NEW YORK METROPOLITAN AREA Harvey Radio, Woodbury, N.Y.: (516) 921-8700 • NEW ENGLAND AREA Gerber Electronics, Dedham, Mass.: (617) 329-2400 • UPSTATE NEW YORK Harvey Federal Electronics, Binghamton, N.Y.: (607) 748-8211 • NORTHEAST Newark Electronics, Malden, Mass.: (617) 321-3930 • BALTIMORE-WASHINGTON Whitney Distributors, Baltimore, Md.: (301) 944-8080 • PHILADELPHIA Hallmark Electronics, Huntingdon Valley, Pa.: (215) 355-7300 • MICHIGAN RS Electronics, Detroit, Mich.: (313) 491-1000 • SOUTHEAST Kirkman Electronics, Winston-Salem, N.C.: (919) 724-0541 • EAST CENTRAL Pioneer/Cleveland, Cleveland, Ohio: (216) 587-3600 • Pioneer/Dayton, Dayton, Ohio: (513) 236-9900 • CENTRAL Hallmark Electronics, Elk Grove Village, Ill.: (312) 437-8800 • Minneapolis, Minn.: (612) 925-2944 • St. Louis, Mo.: (314) 521-3800 • TEXAS-OKLAHOMA Sterling Electronics, Houston, Texas: (713) 623-6600 • Dallas, Texas (214) 357-9131 • SOUTHWEST Sterling Electronics, Albuquerque, N.M.: (505) 247-2486 • Phoenix, Ariz.: (602) 258-4531 • WEST Westates Electronics Corp., Chatsworth, Calif.: (213) 341-4411 • Sterling Electronics, San Carlos, Calif.: (415) 592-2353 • Intermark Electronics, San Carlos, Calif.: (415) 592-1641 • Denver, Colo.: (303) 936-8284 • Salt Lake City, Utah: (801) 359-0531 • San Diego, Calif.: (714) 279-5200 • Santa Ana, Calif.: (714) 540-1322 • Almac-Stroum, Seattle, Wash.: (206) 763-2300 • Portland, Ore.: (503) 292-3534.



1500 SPACE PARK DRIVE, SANTA CLARA, CALIFORNIA 95050
TEL. (408) 246-9225 • TWX 910-338-0528 • CABLE MONO

Solid state

Technologies prophesy products

International Electron Devices Meeting hears of innovations due in 1974 in areas ranging from CCDs to power tubes

The move from laboratory to production line is so swift nowadays that a forum on the latest technology becomes a reliable indicator of upcoming new products. For 1974, the past week's International Electron Devices Meeting in Washington promises dramatic advances in the state of the art of many products.

The list ranges from microwave power tubes to the most sophisticated kinds of memory, logic, and linear solid-state devices:

- Charge-coupled devices, already emerging as imagers and fast memories, are also reaching final development as delay lines and signal processors with efficiencies up to 99.9999%.
- The latest MOS memories achieve record bit densities on record small chips with the help of electron-beam, ion-implantation techniques, and novel isolation structures.
- MOS and bipolar technologies are being combined on the same linear integrated-circuit chip to extract high operational-amplifier performance—minimal bias-current input voltage and maximum gain from a single power supply.
- In the microwave technologies, low-noise FETS now rival bipolar devices in the 4-7-GHz range, and higher-power klystrons achieve greater efficiency (in Japan), wider bandwidth (in France), or both (in America).
- Finally, in optics, gallium-phosphide displays are brighter, gas-discharge displays are more versatile, and tunable lasers may at last make holography a reality.

Charge-coupled-device memories, already built into hardware by scores of semiconductor manufac-

turers, are destined for use in fast-access swapping memories, cathode-ray-tube-refresh memories, and sequential-access buffers, besides replacing delay lines and drum memories. CCD shift registers range from a 4,096-bit silicon-gate structure being developed at Bell Northern in Ottawa, Canada, to operate at 2 megahertz—30 times faster than ordinary disk files—to a 500-bit surface-channel CCD linear register being fabricated by Texas Instruments with double-anodized aluminum. And a 1-MHz, 8,096-bit CCD register [*Electronics*, Nov. 22, p. 25] soon will be in production.

Delay lines. CCD delay lines and signal processors for radar and telecommunications systems are in the final development stage at many laboratories. One program at Westinghouse's Defense and Space Center, Baltimore, Md., pairs a CCD analog delay line with a nonvolatile MOS nitride memory to form an electrically programable transversal filter. At General Electric Co., Schenectady, N.Y., the serial charge-transfer efficiency of CCD shift registers and variable delay lines has been recorded at an astonishing 99.9999% by virtue of a structure that allows some charge to remain in each storage site and that residue mixes with subsequent transfers.

Three ways to shrink MOS memories

Figuring prominently in MOS-memory development are Bell Laboratories in the U.S., Mullard in England, and Hitachi in Japan.

At Bell, a 1,024-bit p-channel random-access memory [*Electronics*, Dec. 18, 1972, p. 29] was refabricated with an electron-beam technique so that the entire memory circuit—address, decode and sense amplifier—fits on a chip only 47 by 71 mils on a side. That's four times smaller than today's MOS RAMs.

The single-transistor-per-cell RAM, which must be built with alignment accuracy to 1 micrometer that may also be a record for a MOS RAM—45 nanoseconds.

Some of the cell dimensions are impressive. Gate lengths of the RAM are 4 μm contact holes are 2 μm square. As in the other chip, the new

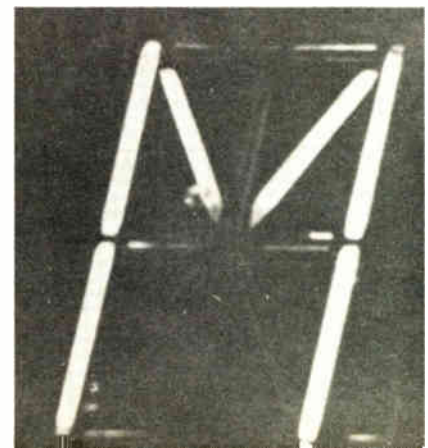
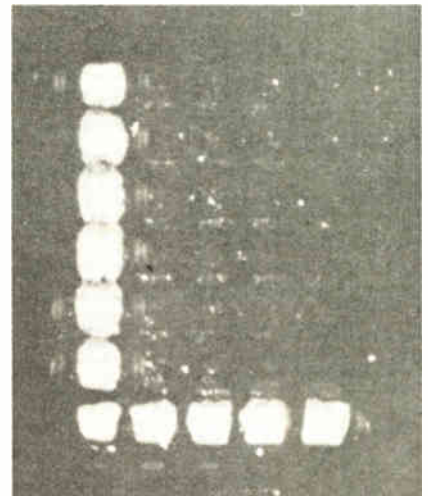

one uses ion-implanted source, drain, and channel stops, and double-level tungsten metal gates, beam leads, and silicon-nitride sealing.

Prototypes are being made available to switching-system-design groups within the laboratories for evaluation, according to R. C. Henderson of Bell's technical staff. However, the electron-beam-fabrication work is being applied to still finer designs—as much as two or three times smaller.

Bell also makes use of ion implantation for device isolation and depletion-mode operation in n-channel memories. But Mullard is unique in using ion implantation to build high-value resistors for extremely small low-power static-MOS memories that, like Bell's, promise to be faster than today's dynamic memories.

By deliberately damaging the structure of resistors in MOS and bipolar integrated circuits by ion implantation, researchers K.H. Nicholas and R.A. Ford of Mullard Research Laboratories in Surrey, England, have enhanced the properties of such resistors in a way that may lead to very small static MOS random-access memories and low-drift bipolar linear circuits.

The technique consists of adding a second boron implant to the original doping implant and annealing the resistor at elevated temperatures. Although not fully understood, the resulting improvement appears to be related to the reduction in mobility produced by the procedure. With this technique, the researchers have built experimental static RAMs that operate with an access time of 80 ns and very low power consumption—150 microwatts per bit. This is almost five times faster than conventional static RAMs.

To increase C-MOS packing density, researchers at Japan's Hitachi Ltd. developed a new isolation structure for high-density LSI circuits that also features high switching speed and reduction in parasitic effects. An oxide-isolated 16-stage binary C-MOS counter of the type used in quartz-crystal watches has already been fabricated with a cell size of only 130 by 125 micrometers, or only about half the cell area of conventional C-MOS circuits.

Useful process. Significantly, the process can be used for other types of MOS and also bipolar structures. In the C-MOS circuits, the process has the additional virtue of eliminating the space-wasteful channel

stops normally required. Moreover, the structure can provide an extra layer of wiring, making a total of four in silicon-gate MOS, three in bipolar and others.

New linear technique: mixed processing

In the linear area, designers are now combining linear and digital processes on the same chip.

The researchers at Harris Semiconductor of Melbourne, Fla., have developed a mixed linear process using complementary MOS-complementary bipolar, structures that are dielectrically isolated. This technique allows logic and linear capabilities on the same chip. Op amps, comparators and monolithic analog-to-digital conversion devices are all possible with this process.

An essential feature of the process is double-diffused high-performance npn and also pnp transistors. The npn is an 800-megahertz unit, and the pnp transistor operates up to 600 MHz.

An operational amplifier built at RCA combines a complementary MOS output structure, a p-MOSFET structure, and a bipolar gain stage and does it with conventional processing to boot. The result: an op amp needing only one power supply with input bias current of only 100 picoamperes (at 25°C), input offset of only 20 millivolts maximum, and a slew rate as high as 10 V/μs—all achievable in a device built with standard junction isolation.

According to Murray Polinsky, one of the developers of the mixed linear process at RCA, the ability to combine different processes on the same linear chip allows designers to use the device best suited for a given circuit function, independent of the process needed to build it. For example, p-channel MOS devices were used in the op amp for input structures because of their inherent low-input bias requirements. C-MOS is ideal for outputs because the combination of n- and p-channel devices means that the amplifier can track both positive and negative outputs from a single supply. Using bipolar gain stages is the most effective method of getting the required sig-

Capital devices. Bell's monolithic GaP displays can use either domed matrix array (top left) or a mesa bar format (bottom left). The new RCA op amp (below) mixes p-MOS inputs, C-MOS outputs, and bipolar gain stage for sought-after low-input parameters and high gain.

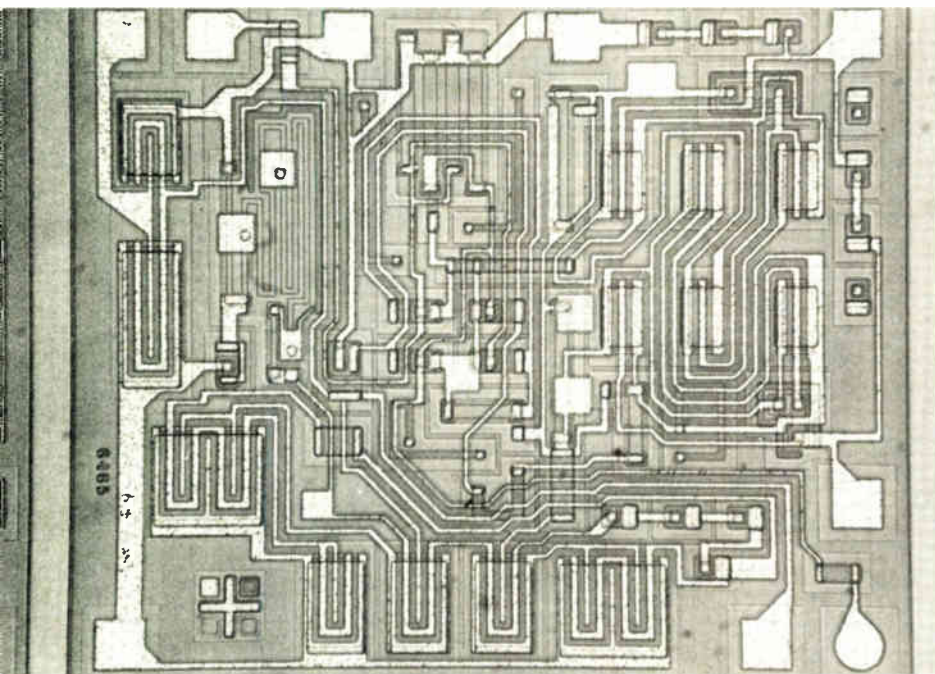

Probing the news

nal amplification with low noise.

Considerable process innovation was required to ensure that the presence of C-MOS and bipolar devices on the same linear chip would not degrade the performance of either.

The FET story: faster and smaller

Besides using such small-geometry fabricating techniques as electron-beam lithography to build MOS memories that are super-dense, researchers are making considerable progress in applying it to field-effect transistors to decrease their size. At TI, electron-beam lithography is being used to build FETs with 0.5-micrometer dimensions. The devices, which are being delivered in 100-quantities to the U.S. Army Electronics Command, operate at 6 megahertz with gains of 8.5 decibels and noise of only 4.5 dB, greatly advancing the state of the art of FET microwave production devices.

"For small-signal applications between 8 and 12 gigahertz, we felt the field-effect device is best," says John M. Pankratz, manager of TI's Advanced Microwave Transistor branch. "But in the 4-to-7-GHz range, it's a tradeoff. FETs, because of the impedance-matching problem, lose some of their apparent noise advantage. And below 4 GHz, the bipolar device will pretty much hold its own, and the noise figures are fairly close."

The tale of the tube is happily not ended

While microwave semiconductors are making inroads on several fronts, new tube designs, especially for high-power communications and electronics applications, seem to be attracting renewed interest. Dual-mode tubes now under development are typically capable of about 1 to 2 kilowatts pulsed power and 500 watts continuous power, a pulsed-power-to-cw-power ratio of about 3 dB. Such tubes would operate over

octave bandwidths and are being developed for electronic-counter-measure systems from 2 to 28 GHz.

Engineers at Nippon Electric Co. have used computer-aided design to greatly increase the efficiency of a 10-kw klystron for use in the output stage of uhf television transmitters. The design allows optimum positioning of five external cavities along the direction of the electron beam, and also optimization of the stagger tuning pattern used to achieve the 6-to-7-MHz bandwidth needed in TV transmitters. Efficiency of the new tubes is about 60%, compared with efficiencies of about 40% for conventional tubes of this type.

Working on a klystron at higher frequencies, engineers at Thomson-CSF in France have developed an S-band tube capable of delivering 200 kilowatts peak output over an unusually large bandwidth of 10% of operating frequency. The tube has been developed under a French-government contract, and according to Thomson-CSF, the technique developed to achieve the large bandwidth is applicable to other frequencies and power ranges.

Displays growing brighter and bigger

Display technology is also scoring major breakthroughs. Red and green monolithic gallium-phosphide displays with improved brightness and efficiency have been built at Bell Laboratories, Murray Hill, N.J. These mesa structures show an external surface brightness of approximately 130 foot-lamberts per ampere per square centimeter, significantly higher than previously GaP displays. In liquid crystals, Hughes has made CRT graphic displays that contain 10,000 LCD cells [*Electronics*, Nov. 22, p. 34].

Burroughs Corp.'s new 140-by-350-dot matrix gas-discharge display was built with an eye on the flat "picture-frame" type of TV that researchers have long been promising [for recent Sony work, see p. 62]. This is an extension of the company's self-scan panels that are sold commercially in alphanumeric displays. Perhaps more important than

the number of dots in the newest display is its ability to discriminate the variations a 16-step gray-scale. This variation is a measure of the display's ability to produce a sharply defined image. The discrete shades are produced by using a combination of amplitude- and pulse-length modulation applied to each dot, according to Thomas E. Maloney, manager of Burroughs' display-device development. The modulation produces a dynamic luminance range of 200:1; previously, using amplitude modulation alone, a range of only 40:1 could be produced. Burroughs is also at work developing gas-discharge displays that will glow in other colors beside the orange output produced by the neon gas generally used.

Tunable laser takes on holography

The benefits that the wideband tunability of dye lasers offer holography have been demonstrated by Peter Shajenko of the Naval Underwater Systems Center in New London, Conn.—namely, the application of holography to working media other than air. The light source can be tuned for maximum transmissivity through sea water or any other medium.

Furthermore, Shajenko points out, double-exposure holograms at two different wavelengths can display contour fringes of surfaces, so that sizes and shapes of objects can be determined. Such interferometric techniques may have applications in biology and medicine, where selective interaction of the laser light with living cells could permit measurement of minute changes in organisms and tissues.

Until now, dye lasers haven't been used in holography because there have been none with sufficient coherence and output power. But Shajenko has designed and built one with output in a single transverse electromagnetic mode, tunable over a wide spectrum. □

Reporting for this roundup—related stories are on p. 40, 41 and 62—were Laurence Altman, Samuel Weber, Lyman Hardeman, Joel DuBow, Paul Franson, Larry Armstrong, George Sideris, Charles L. Cohen, and John Gosch.

the great
comeback,
that never
left!



HW Series Connectors

You can call them classics. You can dub them old reliables. Or you can define them like so many packaging design people do — as the sure, sensible solution in edgeboard connectors for automatic wiring, today. All these credits for HW's are gratifying, of course. But they represent only one distinguished side of the HW connectors available to you, today, off-the-shelf, from our Authorized Distributors.

What is the other distinguishing side? Just this: That the HW Series is an evolutionary family of edgeboard connectors. Which means that just as the first HW Series connectors bore innovations like precisely true-positioned wrap posts . . . and Gardner-Denver true positioning holes to enhance high density automatic wiring . . . so have new ideas made the HW Series evolve continually ever since.

Here are a few in-progress evolutionary examples, as production of the HW Series continues at its fast pace. For high density wrap post interconnections and better use of space inside your package, you can choose from a variety of sizes from 22 to 50 pairs of contact positions. You can specify .100 x .200 or .125 x .250 grid spacings for our HWC or HWD connectors, respectively. And you can specify straight mounting holes . . . or molded-in #4-40 threaded inserts, of course.

What else? Here's a big one. New low force insertion/withdrawal contacts (6 and 4 ounces/contact pair, respectively for .062" PC Boards) on our HWLC and HWLD versions.

And, of course, you should know about our HWP connectors which feature between contact polarization on a .100 x .200 grid with up to 48 contact pairs. The HWP is also available with low force contacts (HWLP).

The truth is, our HW Series is so much better than ever before, you've got to call it The Great Comeback!

The New HW Series Edgeboard Connectors from Winchester Electronics. Coming back to enhance your electronic packaging design with advances, reliability-plus, producibility for today's automatic wiring techniques . . . and the best cost/performance ratio possible. Available now at your Authorized Distributor, or contact Winchester Electronics Division, Main Street & Hillside Avenue, Oakville, Connecticut 06779 (203) 274-8891.



WINCHESTER ELECTRONICS

Circle 81 on reader service card

Faster digital systems checkout with Kurz-Kasch Logic Probes

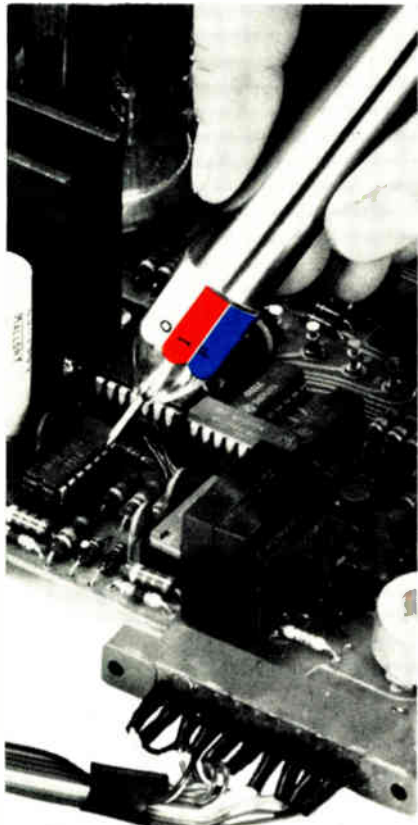

Kurz-Kasch's patented logic probes identify

- (1) logic low (TTL .0V to 0.8VDC) white light
- (2) logic high (2.4 to Vc) red light
- (3) deadbands (0.8V to 2.4V) no light
- (4) pulses (any excursion) blue light
- (5) open circuits — no light

Logic probes are also available for MOS, HTL, RTL and discrete logic. Prices from \$6995 to \$9995. Send for free literature. For a 30 day free trial probe or special information, telephone Tom Barth, General Manager, Kurz-Kasch Electronics, 2876 Culver Ave., Dayton, Ohio 45429, Telephone: (513) 296-0330



Probing the news

Commercial electronics

'Tis the season for shoplifting prevention

Stores turn to electronic measures to halt practice that costs them some \$3 billion a year

by Marilyn Offenheiser, Assistant Editor

Shoplifting is the fastest-growing larceny in the nation, says the FBI. There was an 84% increase from 1966 through 1971. And this is the season, with its crowded stores and harassed sales personnel, when shoppers a bit short of Christmas cash may succumb to the temptation to beat the system—a system that in an increasing number of stores includes electronic theft prevention.

The National Retail Merchants Association, which keeps statistics on what the retail industry euphemistically refers to as "shrink," estimates that one in every 12 persons is or has been a shoplifter. This multitude—plus larcenous store employees—managed to make away with \$3 billion worth of merchandise in 1972, says the NRMA. The antidote, many retailers believe, ranges from sophisticated closed-circuit-television arrangements to the ubiquitous microwave tags.

The tag system is simple and relatively inexpensive, a big plus for smaller stores. It includes a deactivating unit, alarm ports set up on either side of all store exits, and the tags themselves. To deactivate, the microwave diode on the tag is interrogated by a microwave deactivator tuned to the same frequency. After a sale, the tag is reused.

The Knogo Corp. of Westbury, N.Y., which says it developed the tag, aims its sales efforts at the smaller specialty shop. Some, says executive vice president Mickey Perlmuth, have reported that the system has cut pilferage by as much as 95%. Knogo's major competitor, Sensormatic Electronics Corp. of



Just looking. Shoppers are unaware of the two-way mirror over their heads.

Hollywood, Fla., claims to have 350 customers, or 80% of the big-department-store market, including Macy's of New York.

Drawbacks. Yet not all retailers are sold on the efficacy of electronic tags, nor is the NRMA. A spokesman says, "Stores are beginning to question the devices. After all, retailers used the tags because they were desperate."

The biggest drawback of the tags is accidental triggering when a clerk fails to remove one from an article. Albert Seedman, security director of Alexander's Inc. stores in the New York metropolitan area, estimates that, of 1,937 alarms set off in his stores last year, 1,328 were accidental.

Some companies—Knogo among them—are working on a tag that does not have to be removed. A

GAF® Microline diazo photoplates:

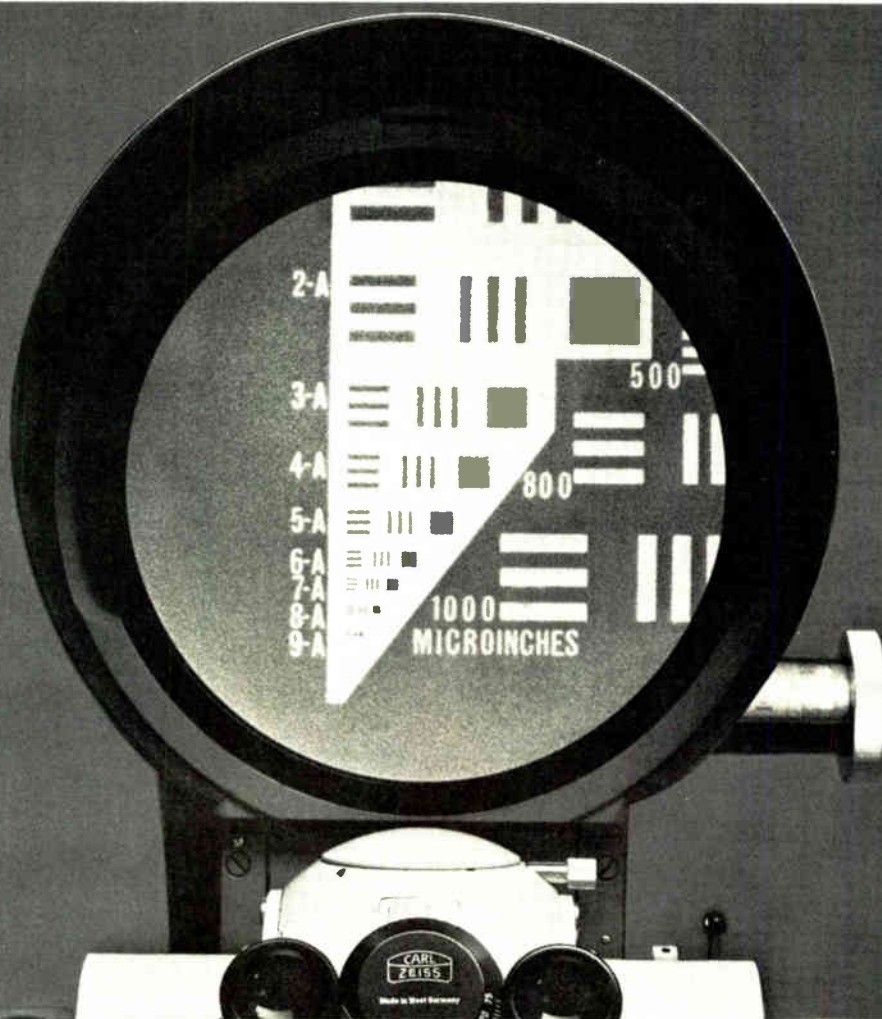

Clearly better resolution. Merely minutes to process.

Take a good look at the viewing screen of this research microscope. You're looking at a resolution test pattern on a GAF Microline® high resolution diazo photoplate.

Resolution: Extremely high; sub-micron!

Edge Sharpness: Excellent!

Etching required: None!

Wet processing required: None!

And the reason for this quality is diazo.

GAF Microline diazo photoplates consist of a thin coating of positive working, grainless, transparent, photosensitive materials. Following exposure to UV light, our photoplates are processed—in a few minutes—by a simple ammonia vapor phase technique. There is absolutely no liquid contact with the photoplate!

The results are submaster and production masks that have sub-micron resolution capability. So you can use them in your high quality microelectronic manufacturing operations. And you're assured essentially defect-free quality plus significant gain in yield and reliability of your products.

So say good-bye to the less-than-optimum resolution inherent in fine-grained sil-

ver halide emulsion plates. These Microline photoplates—manufactured from a sub-micron filtered formulation—avoid process-caused contamination and so deliver more usable devices and circuits.

Thanks to GAF Microline diazo photoplates!

Now is the time to discover the complete line of GAF Microline photoplates, imaging films, and photoresists . . . and at the same time . . . rediscover diazo. Mail the coupon today; it's your first step toward quality!



Rediscover Diazo®

© COPYRIGHT GAF CORPORATION

Circle 83 on reader service card

GAF Corporation

Photoimaging Products
Dept. 606-123
140 West 51st Street
New York, N.Y. 10020

Gentlemen: Please send

literature on: Arrange for a demonstration of: GAF Microline Photoplates
 GAF Microline Imaging Film GAF Microline Photoresists

NAME _____

TITLE _____

COMPANY _____

PHONE _____

ADDRESS _____

CITY _____

STATE _____

ZIP _____



The Hickok philosophy: match their features, beat their price.

Most people know that the Hickok line of Digit Multimeters is one of the best performing on the market. The hard fact is, you can spend a lot more for a Multimeter and still not get all the features we offer. That's why, spec for spec, Hickok is your best all-around dollar investment.

All of our 3400 series Digit Multimeters come with 4½ digits, an optional 300% overranging that enables you to read to 39999 on all five functions, an accuracy of .01%, a front panel control to vary the reading rate from 2 per second to one reading every five seconds and a solid 3-year warranty.



The Standard 3400 Multimeter is priced at just \$595. It's a rugged, non-tempermental, hard-working tool with a 10µV resolution built-in. It handles DC voltage from 10µV-1200V; AC voltage from 10µV-1000V RMS; resistance from 10mΩ-20MΩ and DC/AC current from 10nA-2A.

The 3410 Microvolt Multimeter is priced at \$695. It offers full Multimeter capability with 1µV and 1mΩ resolution. It has 10 times more sensitivity for low-level measurements. A built-in guard box virtually eliminates errors due to ground loops and power line hum and provides for additional operator safety.



The 3420 Multimeter/Counter costs \$750. There is enough measurement capability in this one compact unit to replace a four-digit multi-meter as well as a five-digit frequency counter. Time base is from 100 seconds to 10 milliseconds; 100 mV sensitivity at 20 MHz.

So remember, with Hickok your dollars will go as far as they can. Send for our 3400 Series Data Sheet for complete specifications on our digital Multimeters.

HICKOK
the value innovator

Instrumentation & Controls Division
The Hickok Electrical Instrument Co.
10514 Dupont Avenue - Cleveland,
Ohio 44108
(216) 541-8060 - TWX: 810-421-8286

spokesman for ADT Corp. of New York, a major supplier of closed-circuit TV to retail stores, says the company is anxious to enter the tag market and that "deactivatable tags are the only way to go. It's a market we'd like to get into." But Sensormatic and even Knogo aren't totally sold on the approach.

Says Knogo's Perlmuth: "Tags are intended to deter. Deactivatable tags have to be hidden. This is contrary to the deterrence principle and often challenges people to steal." Sensormatic, a three-year-old company, also is test-marketing a system called Compuvision, in which a computer monitors the CCTV. The computer triggers an alarm if it detects certain variations from the normal in the picture. Other company projects include a system to eliminate fitting-room personnel and use of microwave tags with point-of-sale devices.

The market. Industry insiders are vague about the size of the market, but they agree that it's potentially a large one. Perlmuth points out that it's difficult to stay solvent because equipment is leased. Timothy Smith, Sensormatic's manager of marketing services, says the market can't even be estimated. He says more and more skeptics are coming around as they realize that elimination of security personnel more than pays for the system—for Sensormatic's, \$95 a month plus a penny a tag.

However, two of the nation's largest chains, Allied Stores of New York and Federated Department Stores of Cincinnati, are less than enchanted with electronics. Sam Rieger, director of operations at Allied (Boston's Jordan Marsh and New Jersey's Stern Bros.) says the number of false alarms—and insulted customers—isn't worth the security of the tags. Until something better comes along, possibly deactivatable tags, well-trained personnel and store detectives are the answer, he says. However, Harry Strimell, director of security for Montgomery Ward & Co., Chicago, says that tags are an interim measure—and Ward's lost \$4 million in pilferage last year. □

FIVE CMOS DECODERS

THE FULL COMPLEMENT
FOR 2, 3, AND 4-BIT
BINARY TO 1 OF 2^N
LINE DECODING

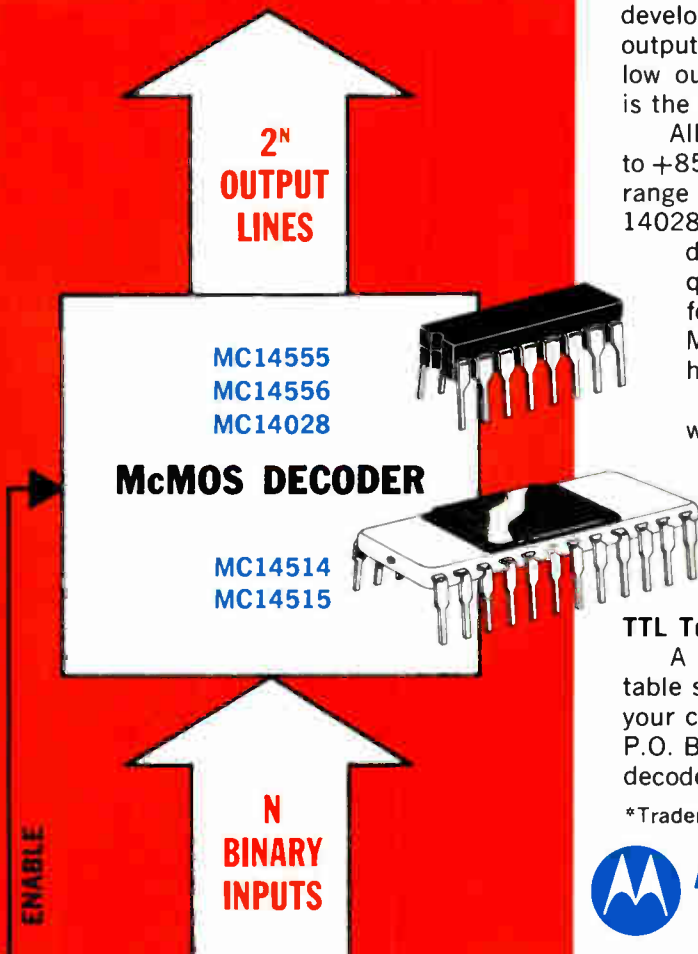

There's a McMOS* decoder for the job, whatever your need for two, three, or four-bit decoding in code conversion, data routing, memory selection, and similar CMOS systems applications. Only Motorola's user oriented CMOS family supplies this full complement.

MC14555 and MC14556 A pair of dual two-bit binary to 1 of 4 decoders. The '55 is the CMOS equivalent to a couple of popular TTL functions, with active high outputs. The '56 is the same function, but with active low outputs where the selected line goes to the low state. Expansion of the decoding function, such as binary to hexadecimal, is achieved by connecting additional units.

MC14028 This three-bit binary to 1 of 8 line decoder is versatile, also serving as a BCD to 1 of 10 line decoder. It has active high outputs and an enable input.

MC14514 and MC14515 Here are two output options of a 4 to 16 line decoder with latched inputs, developed by Motorola. The 14514 has active high outputs and the opposite number 14515 has active low outputs, but the important thing to remember is the four-bit input latches (R-S type flip-flops).

All five types are available in both McMOS' -40° to $+85^\circ\text{C}$ commercial (CL) and wide (AL) temperature range dual in-line ceramic packaging, and the MC-14028, MC14555, and MC14556 are also available in dual in-line plastic (CP). CL and CP 100-999 quantity prices are in the \$3.12 to \$3.67 range for the 555, 556, and 028 decoders, and the MC14514 and 515CLs are understandably higher at \$13.75.

These decoders, as with all Motorola CMOS whether it be second source or the predominant Motorola designed 14500 series, share the outstanding characteristics of the McMOS family of which they are all a part. They are available from Motorola distributors and sales offices.

TTL To McMOS Function Reference Available

A brand new TTL to McMOS function conversion table suitable for wall mounting is just out. Send for your copy to Motorola Semiconductor Products Inc., P.O. Box 20912, Phoenix, Arizona 85036. We'll send decoder data too.

*Trademark of Motorola Inc.

 **MOTOROLA MOS**
Expanding dimensions in digital design

McMOS

LOGIC OF THE 70's



CHOOSE ANY SEMICONDUCTOR MEMORY. WE DELIVER.

Intel Memory Systems delivers custom and standard MOS and bipolar memory systems designed to meet virtually any size, configuration and cost/performance requirement. We deliver small systems in sizes from 1K words by 4-bits up to 8K words by 18-bits per memory board; and we deliver complete packaged memory systems with up to 50 million bits.

Here are just a few examples of our standard RAM systems—any one of them can be made into the system configuration you need:

For economy, speed and reliability, we deliver the in-10 memory system designed with the 1103. It's a 4K x 18 or 8K by 9 memory, expandable to 262K by 40 bits. Its modular configuration allows easy expansion. Cycle time is 450 ns, access is 325 ns and it's TTL compatible. We've already shipped over 5,000 in-10's and have over 2 years of actual field-tested reliability data. (ask for it)

For low power and ease of use, we deliver the in-26 designed for random access buffer storage applications. It's a 4K by 8 memory that can be depopulated to 1K by 8 or expanded to 16K by 8. It has a 900 ns access, in a compact 8.175 inches

by 6 inches board and requires only one power supply voltage ± 5 .

For ultra-fast speed and ease of use, we deliver the in-50 which utilizes Intel bipolar technology to achieve 100 ns access and cycle times. It's designed for control memory disk controller, scratch pad, A to D and signal processing applications. The basis system is a 1K by 10 bit memory board which can be expanded to any word or bit length with additional boards. The system is fully buffered and requires only one power supply.

For fast speed and economy, we deliver the in-36, designed to meet bipolar speeds at MOS prices. The basic memory is 4K by 9 (soon to be available as a 4K by 18), cycle time is 300 ns, access time is 150 ns. This memory uses Intel's n-channel silicon gate technology.

For low cost semiconductor memory systems call or write the company that delivers—ask for our new catalog and the name of our representative in your area. **Intel Memory Systems Division**, 345 Middlefield Road, Mountain View, California 94041. (408) 246-7501.

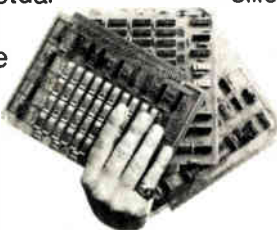

memory options unlimited

intel memory systems

A DIVISION OF INTEL CORPORATION

Displays

Electrochromics glow on horizon

Technology promises wristwatch and calculator displays with storage capability—but skeptics say they're still years away

by Howard Wolff, Associate Editor

"In the next 10 or 20 years, the study of electrochromics will open one of the least explored areas of electronics—insulating physics. What we are starting to see now is the analog to what happened 25 years ago when the study of semiconductors led to the whole field of solid-state electronics."

The speaker is that eternal enthusiast, Zoltan J. Kiss, founder and chief executive of Optel Corp. And the object of his lavish enthusiasm is a display technology that, because it has inherent memory, is generating a good deal of hot debate between those who consider it a true electronic answer to the printed page and those who suspect that it will not get much beyond the stage of the wristwatch display—if it ever gets that far. But even many of those who tend to discount Kiss's statements, along with his ebullient charm, concede that what isn't being said about electrochromics is almost as interesting as what is being said.

The companies that should logically be most involved in electrochromics research seem to be the least willing to talk about their work. One is the American Cyanamid Co., which did the original work and which holds the basic patents on electrochromic materials. All that the company will say from its Wayne, N.J., headquarters is that it does, indeed, have five patents in the technology; it also will explain briefly the basic mechanism of electrochromics.

And RCA Laboratories, pointing out that it was first to demonstrate liquid-crystal displays, will concede only that it has "had projects for several years in electrochromics and

similar effects that might have potential use in displays." Comments a scientist at a competing company: "We know that they're working hard on electrochromics. If they're not talking, it must mean that they think the work is important and significant."

And, even though insiders say that Philips Gloeilampenfabrieken in the Netherlands is Europe's leading electrochromics house, company spokesmen, like most of their American counterparts, simply are not saying much. But they do admit that the Philips display consumes very little power—for one write-erase cycle, typical consumption is 1 millijoule for a seven-segment numeral 10 millimeters high. The display is

compatible with transistor-transistor logic and injection logic.

Just what is electrochromics? Basically, the materials are organic or inorganic insulating solids that change color when injected with positive or negative charges. They are based on such transition-metal compounds as tungsten oxide or strontium titanate, and are doped with such materials as molybdenum and iron. In most electrochromic displays, the image goes from colorless to dark blue.

Familiar look. Electrochromic displays closely resemble liquid-crystal presentations—in fact, at first glance, they appear to be identical. But there are significant differences. First and most important, of course,

An innovator from Bangladesh

Satyen K. Deb is a modest man who is interested in reincarnation, the transmigration of souls, and electrochromic displays. Born 41 years ago in what is now Bangladesh, Deb received his doctorate in physics in 1959 from Cambridge University in England. "I wanted to go to America," he recalls, "because there was more money there for research—and researchers." So Deb took a job with the National Research Council of Canada, then moved south to the American Cyanamid Corp. research facility in Stamford, Conn.

Initially, he worked on photochromics, but saw difficulties and switched to electrochromics in 1965. His work led to the first display patent in the field, granted to him and Robert F. Shaw in July 1970 and assigned to Cyanamid. But Deb became disappointed with the company's decisions not to press ahead quickly in the new technology—"although I understand their reasons. After all, they are a chemical company used to selling materials by the carload."

He left and went to work this year as visiting scientist with the French national research council at Grenoble. Then, in July, Optel Corp.'s Zoltan Kiss, on one of his trips to Europe, induced the scientist to return to America, and Deb, by this time a U.S. citizen, moved his electrochromics work to Optel's crowded building on Route 1 in Princeton, N.J.



LOOK WHAT'S NEW IN CRYSTAL FILTERS



COLDWELD FLATPACKS!

THAT CUT COSTS
SAVE SPACE & WEIGHT
IMPROVE RELIABILITY

Bulova is putting a complete crystal filter network (crystals and capacitors) in coldweld flatpack cans. So now your filter requirements can be met with a unit that is truly a single component, not a handful of crystal cans and capacitors (or coils) wired together and stuck in a bigger can. Making the filter a single hermetic unit reduces the number of discrete components in your system, eliminating interconnections and cutting weight. You'll like the cost reduction, too! They are designed for p.c. board mounting with pins on standard 1/10" grid spacing. And they meet MIL Specs.

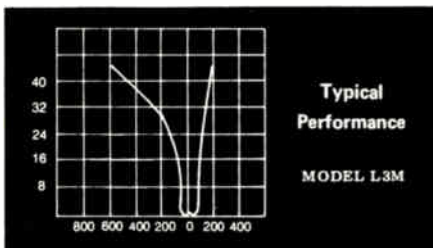

*Typical Performance Model L3M-40 Frequency 455 kHz
3 db Bandwidth, 125 Hz 3-pole response Note Space Saving!*

Models with 2, 3 or 4-pole response are available now for a frequency range of from 350 to 525 kHz, bandwidths from .005% to .02%. Weight is only 0.3 oz. for the larger units and 0.15 oz. for the smaller size. Other models for other frequencies and band widths can be produced to meet specific requirements.

Want to know more? Write to



BULOVA

ELECTRONICS DIVISION
OF BULOVA WATCH COMPANY, INC.
61-20 WOODSIDE AVENUE
WOODSIDE, N. Y. 11377 • 212. 335-6000

In a Rush? Call (212) 335-6000 Ext 744

Probing the news

is the storage capability, which inspires comparison with a printed page. Satyen K. Deb, Optel's research director, says the material stores data until it's erased or altered—reduction of power or total interruption has no effect.

Deb did the original work at Cyanamid; he and his electrochromic knowledge came to Optel last summer (see "An innovator from Bangladesh"). Also, he says, electrochromic displays absorb light, while liquid crystals scatter light. Thus, electrochromic displays have no angular dependence—there is no distortion—and they offer better contrast.

Deb also says that electrochromics have a wider range of working temperature than liquid crystals: -50°C to 100°C vs -15°C to 75°C . The big disadvantage at this point in electrochromics' development cycle is speed. Although the displays are potentially fast—ranging from milliseconds to a second—liquid crystals are faster.

Other potential advantages are pointed out by Thomas D. Hinkelman, president of Electronic Time Industries Inc. of Los Altos, Calif. Hinkelman, whose company plans early next year to introduce watches using light-emitting-diode displays, says the electrochromics memory function would give it significant advantages in cost and size over other displays. That's because it's possible to multiplex an electrochromic display with one drive line per digit and one shared drive line per segment.

Thus, a watch display could be driven with 11 lines (seven for seg-

ments, four for the three full digits and the 1) while a liquid-crystal display requires 24 lines. What's more, says Hinkelman, a liquid-crystal display requires a purely ac drive and 15-volt drive level, but an electrochromic display can be driven without the power needed by crystals. The key is that electrochromic displays need only be driven intermittently. Sums up Hinkelman: "Electrochromic displays are quite clearly the display of the future. The question is when."

Prototype coming. And that, as they say in bad novels, is the burning question. Most estimates of the state of the electrochromic art place it at approximately where liquid crystals were four or five years ago. ("However," points out one wag, "liquid crystals are where liquid crystals were four or five years ago.") Optel's Kiss says he will have a prototype wristwatch display next year. His research director, Deb, ever the cautious scientist, says only that much work still must be done in the materials area.

A more sanguine view is taken by the watchmakers at Ebauches SA of Neuchatel, Switzerland's biggest watch company. After three years of work, Ebauches showed a quartz-crystal watch with an electrochromic display at the 1973 Basel Fair. Ebauches' American partner in this work is believed to be Cyanamid, but neither company will discuss it.

For every supporter electrochromic technology has managed to inspire, there is a skeptic to point out that not enough is known about the material and that displays will have to compete with the pricing of LEDs, expected to drop to around 50 cents a digit, and liquid crystals, at about \$1 a digit. At the moment, no

From Switzerland. Ebauches' liquid-crystal watch is shown at left, with the electrochromic version at right. The firm says it will have an electrochromic prototype next year.



HYBRIDABILITY™

YOU NAME IT...

IN HYBRID APPLICATIONS

Analog Gates
Active Filter
Clock Drivers
Ladder Switches
Operational Amplifiers
Level Translators
Multipliers
Converters
Oscillators
Voltage Regulators
Lamp/Relay Drivers
Buffer Amplifiers
Multiplexers
Modulators/Demodulators

WITH HYBRID TECHNOLOGY

Thick Film
Thin Film
Multilayer
Digital
Linear
High Volume
High Reliability
Standard & Custom
Special Packaging

USING HYBRID COMPONENTS

CMOS
Bipolar ICs
MOSFETS & J-FETS
NPN & PNP Transistors
Reference, Zener & Switching Diodes
MOS, Ceramic & Tantalum Capacitors

For your application and/or a copy of General Instrument's latest Hybrid Catalog call (516) 733-3243
or write: General Instrument Corporation, Hybrid Division, 600 West John Street, Hicksville, N.Y. 11802

GI'S GOT IT! 

If the timing diagram says your logic should look like this...

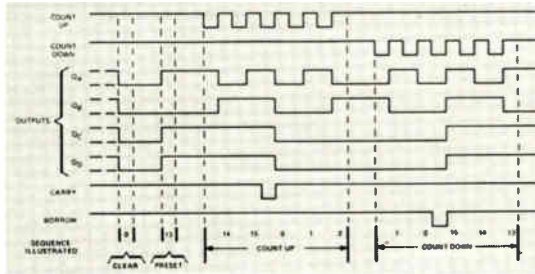

...now you can see if it does.

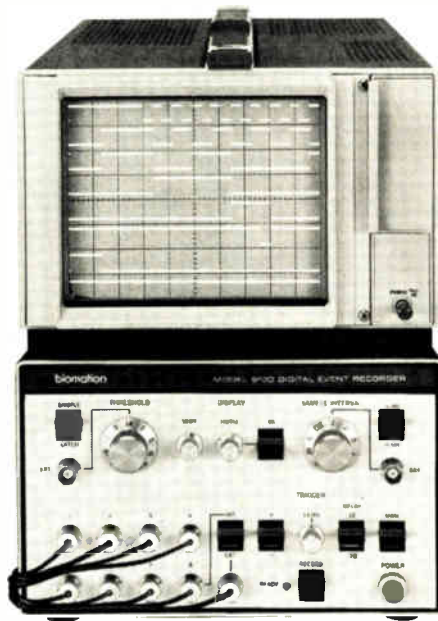

Introducing the Glitch Fixer: Biomation's new 810-D Digital Logic Recorder makes any scope a data stream display.

Analyzing a complex logic circuit—especially asynchronous logic—used to be a tough assignment. No longer. Not if you put Biomation's new Glitch Fixer—the 810-D Digital Logic Recorder—between your troubled circuit and any oscilloscope. It lets you record up to eight digital signals simultaneously. Presents them in the same format you're used to seeing on data sheets. And lets you expand the 250-bit data line (x5) to get a closer look at what you've got.

Best of all, it features an input latch that grabs hold of any random logic pulse—the glitch you're looking for—as narrow as 30 nanoseconds.

Here are some other features to mull

over: records 8 logic channels using 1 MΩ inputs selectable logic thresholds, including TTL and EIA levels synchronous clock input to 10 MHz or internal clocking selection from 20Hz to 10MHz storage of selected data ahead of trigger digital output for computer analysis or mass storage.

The Glitch Fixer is a new basic piece of diagnostic instrumentation designed for (and at the request of) logic circuit designers and troubleshooters. If you work with logic circuits, our 810-D Digital Logic Recorder will do the job. For \$1950 (without display). Get the product literature and see for yourself. Write, wire, or phone Biomation at 10411 Bubb Road, Cupertino, CA 95014, (408) 255-9500, TWX 910 338 0226.

biomation

Probing the news



From New Jersey. This is electrochromic display produced by the Optel Corp.

one is willing to hazard a guess about what electrochromic displays will cost when they hit the market.

Another disadvantage is mentioned by James Fergason, president of International Liquid Crystal of Cleveland. He points out that electrochromic displays require hermetic seals to keep out oxygen. Technology is not advanced enough, he adds, to keep the materials pure.

Opportunities? As for the commercial possibilities of electrochromic displays, Kiss of Optel predicts immediate opportunities in alphanumeric displays; timepiece applications, where display with storage is so desirable; and auto dashboard readouts—a natural use for reflective displays that thrive on bright sunlight. Then, after a decade or so, says Kiss, such areas as reversible optical storage will be opened—electrochromics could be used in optical versions of magnetic tape and magnetic disks.

But there is another big question: can liquid crystal and electrochromic displays coexist commercially? Some companies, feeling they have to select one or the other, have put their money on crystals because they have lived with the technology, know it well, and it is here for sale now! However, another school of thought believes the two can live side by side—with electrochromics going on to more exotic applications—such as the tablet envisioned by Kiss as the electronic analog of the printed page.

But whatever lies ahead for the still-gestating technology, chances are that electrochromics will force some shifting and change the thinking of many display makers.

Everything you need in ferrites

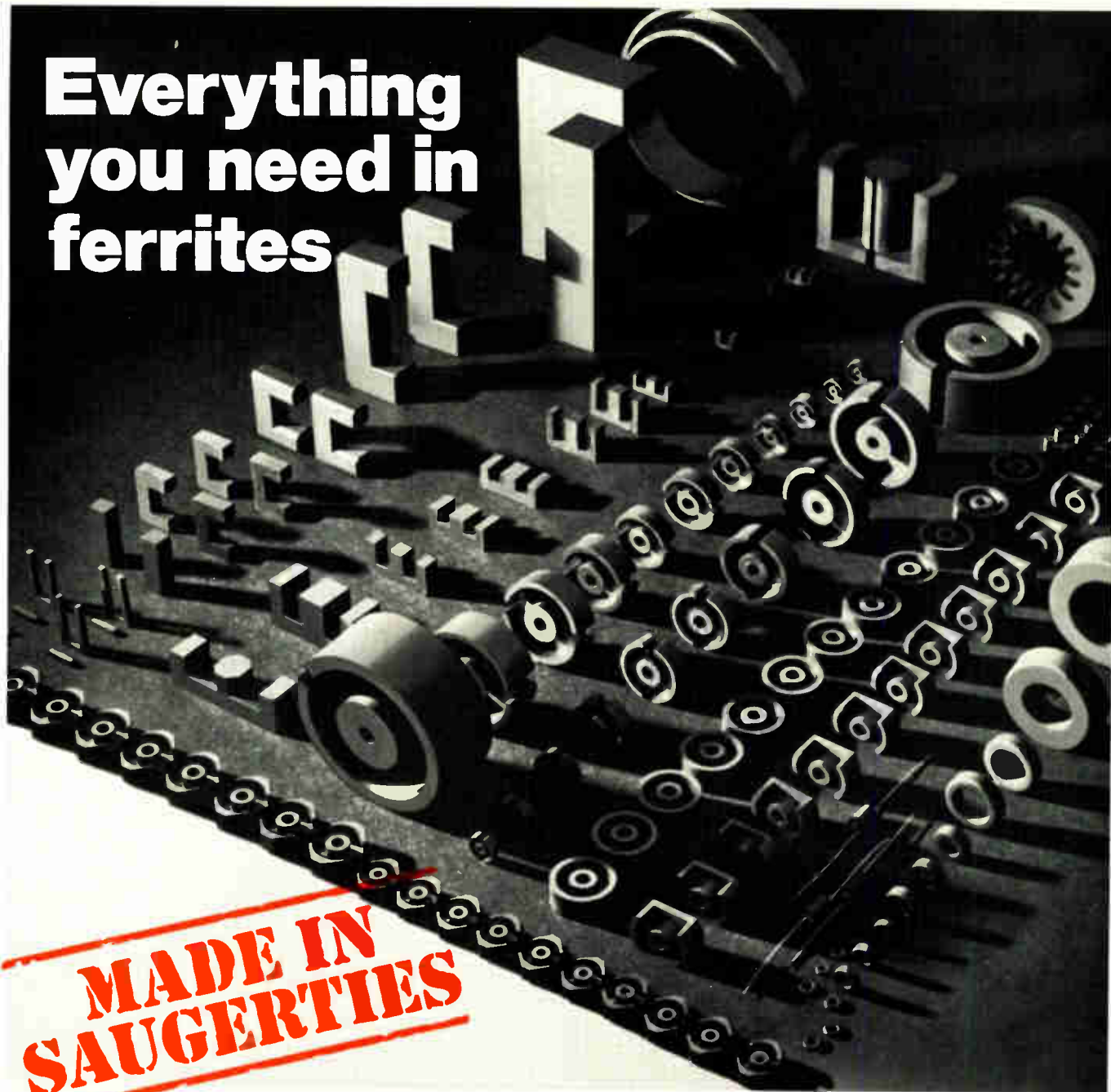

**MADE IN
SAUGERTIES**

Broad Product Line: Ferroxcube offers a complete array of sizes and shapes of ferrite cores. They're made in Saugerties, N.Y. and stocked throughout the U.S.A. Toroids for pulse transformers, pot cores or square cores for precision filters, transformer cores in all sizes and shapes— E, U, I, specials and read-only memory cores—you can trust Ferroxcube to provide the optimum core for your inductors.

Unsurpassed Materials Technology: Ferroxcube, the acknowledged U.S. leader in ferrite technology, offers a wide range of standard materials for your cores. Chances are that one of them has exactly the *right combination of characteristics* for your application. And, you can depend on Ferroxcube to deliver the same uniform,

product characteristics year after year for consistent, optimum circuit performance in your designs.

24-hour Availability: Standard components are available for 24-hour delivery from any of seven warehouses conveniently located in Boston, New York, Saugerties, Philadelphia, Chicago, Santa Clara and San Diego.

If you're up on the advantages of ferrites, discover the added values of dealing with Ferroxcube. Ask for the new 1973 catalog. If you're new to ferrites and the design possibilities they open up, talk to one of our applications engineers. Call 914•246-2811, TWX 510-247-5410 or write Ferroxcube, Saugerties, N.Y. 12477.

Ferroxcube linear ferrites—made in Saugerties, N.Y. and stocked in seven U.S. locations.



FERROXCUBE CORPORATION, SAUGERTIES, N.Y. 12477
A NORTH AMERICAN PHILIPS COMPANY

Distributed through North American Philips Electronic Components Corporation with warehouses in Boston, 617-449-1406; New York, 516-538-2300; Saugerties, 914-246-5861; Philadelphia, 215-927-6262; Chicago, 312-593-8220; Santa Clara, 408-249-1134; San Diego, 714-453-9250
16402

Prices reduced over General Electric Solid

Now you can not only get immediate delivery on these bright visible SSL's...you can also save money. For example, the SSL-22 and SSL-22L's are only 25¢ each in 10,000-lamp quantities. Contact your GE SSL distributor or your local GE representative today for price details.

When you specify GE SSL's you also gain other important advantages.

GE construction gives you these basic advantages:

First, General Electric uses GaP material in its SSL's because it gives you advantages over GaAsP material.

For example, GaP is more efficient. About 5-10 times more efficient in converting energy into light. This higher efficiency permits either generation of more light at the same low current level (under 25mA) or the use of lower power inputs to produce the same amount of light. This means GaP lamps provide more light and may eliminate the need for current drivers often required with GaAsP lamps.

GaP lamps also give more light output because light is emitted from the entire chip,

not just from the "P" side as do the GaAsP lamps.

Another construction feature is the GE patented reflector. It reflects the light output emitted from the bottom side of the GaP pellet. This increases the amount of light delivered by the lamp at least 20%.

Take exclusive guarantees, for example. Because of GE's design and construction features, we offer these guarantees: 100% lamp inspection at rated current for light output and forward voltage; reverse voltage at 10µA is 3 volts or greater for visible GaP lamps, and 2 volts or greater for GE's gallium arsenide infrared lamps. Power output of every infrared lamp is also guaranteed to be within published min-max range. GE will refund your purchase price or provide

replacements for returned lamps not meeting published specifications.

Then take service. GE is a full-line lamp manufacturer so OEM application service is available not only for SSL's but also for all your other lamp needs. GE backs up your distributor's service advice with lighting applica-

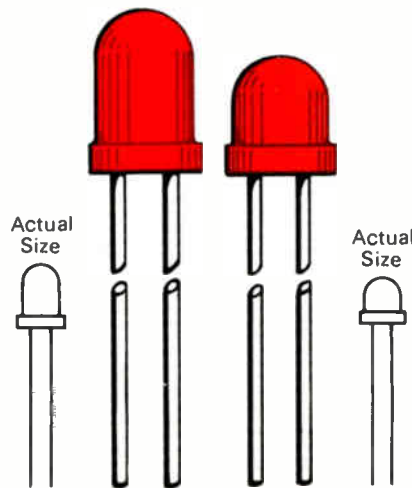

GE SSL Electronic Distributors by State:

Carlton-Bates Company
6821 Scott Hamilton Drive
Little Rock, AR 72209

Brill Electronics
610 East 10th Street
Oakland, CA 94600

Cramer Electronics, Inc.
17201 Daimler Street
Irvine, CA 92705

Cramer Electronics
720 Palomar Avenue
Sunnyvale, CA 94086

Electronic Supply Wholesale
Radio & Electronic Supplies
2486 Third Street
Riverside, CA 92507

Elmar Electronics
2288 Charleston Road
Mt. View, CA 94043

G. S. Marshall Company
9674 Telstar Avenue
El Monte, CA 91731

Hamilton/Avnet Electronics
Division of Avnet, Inc.
10912 West Washington Blvd.
Culver City, CA 90230

Hamilton/Avnet Electronics
340 East Middlefield Road
Mt. View, CA 94040

Kierulff Electronics, Inc.
2585 Commerce Way
Los Angeles, CA 90040

Western Electromotive
8467 Stellar Street
Culver City, CA 90230

Zack Electronics
1444 Market Street
San Francisco, CA 94102

Barnhill Five, Inc.
1170 S. Sheridan
Denver, CO 80226

Electronics Parts Company
1277 Broadway
Denver, CO 80203

Hamilton/Avnet Electronics
1400 West 46th Avenue
Denver, CO 80211

Hammond Electronics
911 West Central Avenue
Orlando, FL 32802

Schweber Electronics
2830 North 28th Terrace
Hollywood, FL 33020

Lykes Electronics Corp.
Div. of Jackson Electronics
1135 Chattahoochee Avenue, NW
Atlanta, GA 30325

Cramer Electronics
1911 South Busse Road
Mt. Prospect, IL 60056

Hamilton/Avnet Electronics
3901 Pace Court
Schiller Park, IL 60176

Newark Electronics
500 North Pulaski Road
Chicago, IL 60624

Schweber Electronics
1380 Jarvis Avenue
Elk Grove Village, IL 60007

Semiconductor Specialists, Inc.
195 Spangler Road
Elmhurst, IL 60126

Graham Electronics Supply Co.
133 South Pennsylvania Street
Indianapolis, IN 46204

Semiconductor Specialists, Inc.
P. O. Box 41645
Weir Cook Airport
Indianapolis, IN 46241

Hamilton/Avnet Electronics
3500 West 75th Street
Prairie Village, KS 66208

Cramer Electronics, Inc.
85 Wells Avenue
Newton Center, MA 02159

Gerber Electronics
852 Providence Highway
Dedham, MA 02026

Hamilton/Avnet Electronics
185 Cambridge Street
Burlington, MA 01803

Schweber Electronics
213 Third Avenue
Waltham, MA 02154

Hamilton Electro Sales
7255 Standard
Hanover, MD 21076

Schweber Electronics
5640 Fisher Lane
Rockville, MD 20852

Hamilton/Avnet Electronics
400 Brookes Lane
Hazelwood, MO 63042

L Comp
1520 Tanny Street
North Kansas City, MO 64116

40% on all red State Lamps (LED's)!

tion engineers in most major cities. They offer you guidance on the lamp type that is best, both technically and economically, for your specific application.

GE also offers dependability. We specify and control all lamp parts from raw materials to finished product. Mechanized manufacturing helps assure product dependability and uniformity of performance from lamp-to-lamp. We have a *new plant on-stream* ready to serve you, *devoted exclusively to manufacturing solid state lamps.* So you can count on GE as a source for continued service and availability.

For the name of your local GE SSL distributor, check below. He will gladly give you delivery details, the new low prices, and your free copy of our new Solid State Lamps catalog. (Order #3-3358, dated October, 1973).

Or contact GE directly. Call John Hall collect at (216) 266-2400. Or write General Electric, Miniature Lamp Products Department, #4454-M, Nela Park, Cleveland, Ohio 44112.

Free. Brand-new Solid State Lamp catalog, #3-3358.

Full of helpful up-to-date information on SSL Lamps (LED). Ask for your free copy, updated October, 1973.



**Special offer —
New Tell-Tale Infrared Detector**

If you work with infrared SSL Lamps (LED), you're sure to get a lot of use from GE's unique Tell-Tale Infrared Detector...handy for checking, installing, or aligning opto coupled devices or systems.

This one-square-inch phosphor screen converts the invisible infrared energy into a visible image. It can be used to determine if an infrared Solid State Lamp (LED) is operating and to get an approximate indication of the beam pattern from an SSL or the external optics.

Don't wait—get your Tell-Tale Infrared Detector now for only \$1.75—it's another exclusive available from GE. Order as many as you need today from your distributor or direct from GE. Please send check or money order.

**GENERAL ELECTRIC
INFRARED SOLID STATE LAMP LAMP**

Part No.	Qty.	Price	Total
1000	1	1.75	1.75
1001	1	1.75	1.75
1002	1	1.75	1.75
1003	1	1.75	1.75
1004	1	1.75	1.75
1005	1	1.75	1.75
1006	1	1.75	1.75
1007	1	1.75	1.75
1008	1	1.75	1.75
1009	1	1.75	1.75
1010	1	1.75	1.75
1011	1	1.75	1.75
1012	1	1.75	1.75
1013	1	1.75	1.75
1014	1	1.75	1.75
1015	1	1.75	1.75
1016	1	1.75	1.75
1017	1	1.75	1.75
1018	1	1.75	1.75
1019	1	1.75	1.75
1020	1	1.75	1.75
1021	1	1.75	1.75
1022	1	1.75	1.75
1023	1	1.75	1.75
1024	1	1.75	1.75
1025	1	1.75	1.75
1026	1	1.75	1.75
1027	1	1.75	1.75
1028	1	1.75	1.75
1029	1	1.75	1.75
1030	1	1.75	1.75
1031	1	1.75	1.75
1032	1	1.75	1.75
1033	1	1.75	1.75
1034	1	1.75	1.75
1035	1	1.75	1.75
1036	1	1.75	1.75
1037	1	1.75	1.75
1038	1	1.75	1.75
1039	1	1.75	1.75
1040	1	1.75	1.75
1041	1	1.75	1.75
1042	1	1.75	1.75
1043	1	1.75	1.75
1044	1	1.75	1.75
1045	1	1.75	1.75
1046	1	1.75	1.75
1047	1	1.75	1.75
1048	1	1.75	1.75
1049	1	1.75	1.75
1050	1	1.75	1.75
1051	1	1.75	1.75
1052	1	1.75	1.75
1053	1	1.75	1.75
1054	1	1.75	1.75
1055	1	1.75	1.75
1056	1	1.75	1.75
1057	1	1.75	1.75
1058	1	1.75	1.75
1059	1	1.75	1.75
1060	1	1.75	1.75
1061	1	1.75	1.75
1062	1	1.75	1.75
1063	1	1.75	1.75
1064	1	1.75	1.75
1065	1	1.75	1.75
1066	1	1.75	1.75
1067	1	1.75	1.75
1068	1	1.75	1.75
1069	1	1.75	1.75
1070	1	1.75	1.75
1071	1	1.75	1.75
1072	1	1.75	1.75
1073	1	1.75	1.75
1074	1	1.75	1.75
1075	1	1.75	1.75
1076	1	1.75	1.75
1077	1	1.75	1.75
1078	1	1.75	1.75
1079	1	1.75	1.75
1080	1	1.75	1.75
1081	1	1.75	1.75
1082	1	1.75	1.75
1083	1	1.75	1.75
1084	1	1.75	1.75
1085	1	1.75	1.75
1086	1	1.75	1.75
1087	1	1.75	1.75
1088	1	1.75	1.75
1089	1	1.75	1.75
1090	1	1.75	1.75
1091	1	1.75	1.75
1092	1	1.75	1.75
1093	1	1.75	1.75
1094	1	1.75	1.75
1095	1	1.75	1.75
1096	1	1.75	1.75
1097	1	1.75	1.75
1098	1	1.75	1.75
1099	1	1.75	1.75
1100	1	1.75	1.75

Olive Industrial Electronics, Inc.
6662 Olive St. Road
St. Louis, MO 63130

General Radio Supply Co.
600 Penn Street
Camden, NJ 08102

Schweber Electronics
44 Belmont Drive
Somerset, NJ 08873

Cramer New Mexico, Inc.
137 Vermont NE
Albuquerque, NM 87108

Cramer Electronics
6716 Joy Road
East Syracuse, NY 13057

General Electric Supply Company
600 Jefferson Road
Rochester, NY 14623

Hamilton/Avnet Electronics
222 Boss Road
Syracuse, NY 13211

Milgray Electronics
191 Hanse Avenue
Freeport, NY 11520

Rochester Radio Supply Co., Inc.
140 West Main Street
Rochester, NY 14614

Rome Electronics, Inc.
108 Spring Street
Rome, NY 13440

Schweber Electronics
999 Buffalo Road
Rochester, NY 14624

Schweber Electronics
Jerico Turnpike
Westbury, NY 11591

Standard Electronics, Inc.
3519 Union Road
Cheektowaga, NY 14225

Southeastern Radio Supply Co.
414 Hillsborough Street
Raleigh, NC 27603

Electronics Marketing Corp.
1150 West Third Avenue
Columbus, OH 43212

Hughes/Peters, Inc.
4865 Duck Creek Road
Cincinnati, OH 45227

Hughes/Peters, Inc.
481 East 11th Street
Columbus, OH 43211

Pioneer Standard Electronics
4800 East 131st Street
Cleveland, OH 44105

Pioneer/Dayton
1900 Troy Street
Dayton, OH 45404

Rem Electronics
264 West Market Street
Warren, OH 44481

Schweber Electronics
23880 Commerce Park
Beachwood, OH 44122

Oil Capitol Electronics Corp.
708 South Sheridan
Tulsa, OK 74115

Almo Electronics
Roosevelt Blvd. & Blue Grass Rd.
Philadelphia, PA 19114

Semiconductor Specialists, Inc.
538 Alpha Drive
Pittsburgh, PA 15238

Electra Distributing Company
1914 West End Avenue
Nashville, TN 37203

Harpe Electronics, Inc.
1845 Central Ave.
Chattanooga, TN 37408

Hamilton/Avnet Electronics
2403 Farrington
Dallas, TX 75207

Hamilton/Avnet Electronics
1216 West Clay
Houston, TX 77019

Sterling Electronics Corp.
2875 Merrell Road
Dallas, TX 75229

Sterling Electronics
4201 SW Freeway
Houston, TX 77027

Newark Electronics, Inc.
259 Crossroads Square
Salt Lake City, UT 84115

Almac/Strom Electronics
5811 6th Street
Seattle, WA 97108

GENERAL  ELECTRIC

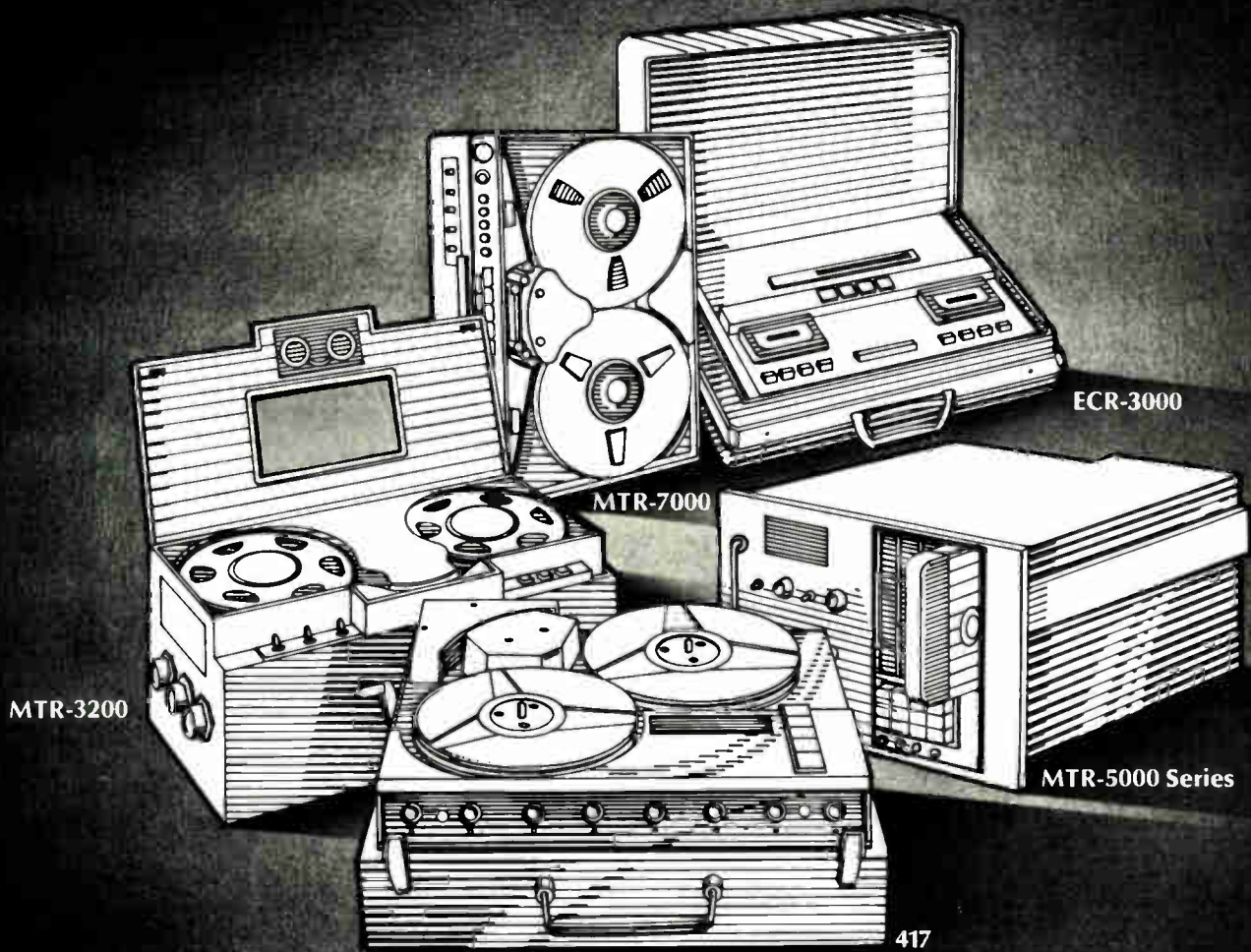

We build recorders that let you know what's going on in the world.

For years, Lockheed has been known for building advanced, custom recorders for space use. In fact, Lockheed has more recorders in space than any other manufacturer.

Now, since acquiring the recorder product line of Leach Controls Division, Lockheed has expanded its technological competence in deep space and satellite applications. And is also able to offer an expanded range of recorders for earthbound application:

417 — Lightweight, rugged and compact enough to fit under an airplane seat. Wide or intermediate band. Operates in any position.

MTR-3200 — High environment recording of aircraft and missile flight tests, shipboard and other severe environmental applications.

MTR-7000 — 7 or 14 track over 800HZ to 2 MHz. 10½" reel. Available in 14" reel in the MTR-7100.

MTR-5000 Series — A family of audio frequency

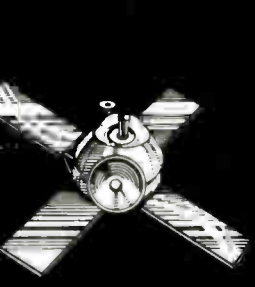

Mariner Mars 9

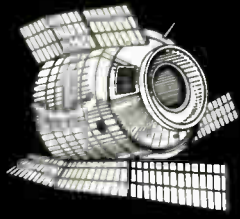

RAE

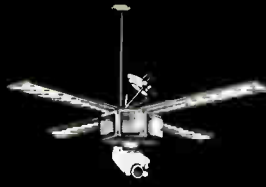

Mariner Mars 7

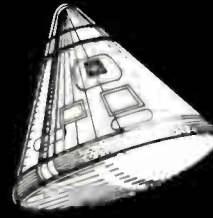

Apollo Qualification Flights



Viking Lander

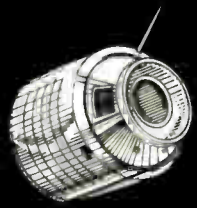

ESRO 1&2



ISIS

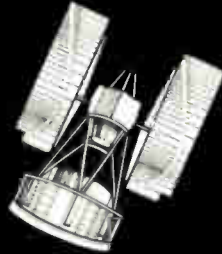

ERTS

CLASSIFIED



OSO



Atmospheric Explorer 2



Mariner Venus/Mercury 10

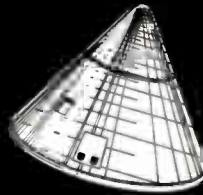

Apollo Command Modules



Viking Orbiter



UK-2

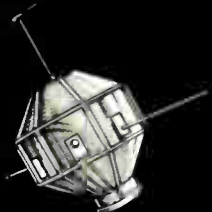

Atmospheric Research-Japan

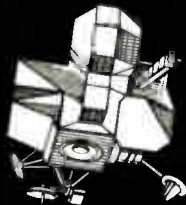

Apollo Lunar Module



Nimbus B



Mariner Mars 6

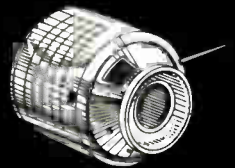

OWL

And out of it.

recorders. 4 and 12 cartridge units. Long-term, continuous monitoring or high-channel count.

ECR-3000 — Small, multi-channel courtroom recorder. Accurate, continuous recording. Operators do not need special training.

So, no matter what your recording needs, on earth or out of it, in controlled or hostile environments, check with Lockheed. We probably can give you exactly what you're looking for.

For more information, contact R. L. Major at Lockheed Electronics, Azusa, California 91702. Or call him collect at (213) 334-8211. Telex: 710-997-9541.

Our European representatives are: PTK, Cologne; Technitron, Rome; BDL, Paris; LAIAG, Geneva.

Lockheed Electronics.

Circle 95 on reader service card

THIS LITTLE SWITCH



STARTED SOMETHING BIG

CHILD

IN 1953 WE HAD ONE PRODUCT . . . AND ONE CUSTOMER. Our "factory" was a leased basement and our work force totaled 15 people.

But we introduced something besides just another product to the switch industry . . . our contribution was *creative engineering*. We gained a reputation for innovation by an ability to manufacture switches, custom for the application, at lowest possible cost.

Engineers liked our ideas and our switches and our way of doing business . . . so they helped us grow.

AND, BOY, DID WE EVER GROW! The old leased basement has grown to 170,000 square feet of modern plants. Our customer list has grown from one to over 5,000. Our 15 people have become a work force of over 1,300.

From our home in Waukegan, Illinois, we direct three manufacturing subsidiaries in Germany, England and Japan with sales offices throughout the United States and Canada and 24 other countries around the world.

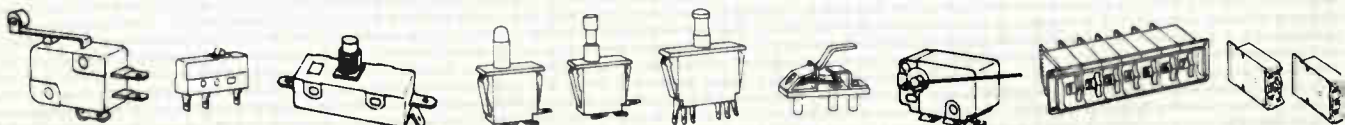

PRECISION SNAP-ACTION SWITCHES • PANEL MOUNT PUSHBUTTON • GOLD "CROSSPOINT" • THUMBWHEEL AND

CHERRY ELECTRICAL PRODUCTS CORP. 3608 Sunset Avenue, Waukegan, Illinois 60085

Cherry Worldwide: (Subsidiaries) Hirose Cherry Precision Co., Ltd., Tokyo • Cherry Mikroschalter GmbH, Bayreuth, Germany
• Cherry Electrical Products (U.K.) Ltd., St. Albans, Herts • (Licensee) G.W. Engineering Pty. Ltd., Sydney



CHERRY

WHERE DO WE GROW FROM HERE? Creative engineering produced the first snap switch with a coil spring mechanism and developed gold "crosspoint" contacts for low energy switching. Creative engineering is the basis of our lever-action thumbwheel switches, electronic calculators, keyboards and plasma displays.

We intend to keep our emphasis on *creative engineering* and *customer service* . . . so we're looking forward to even greater things in the future (like a new line of digital readouts).

CALL THE BIG ONE . . . Cherry

(312) 689-7700 if you have an application. Or, if you would like a copy of our latest complete-line catalog, circle the reader service number and watch us move *fast!* One thing is sure: we'll deliver you quality products at attractive prices. That's what Cherry is all about.

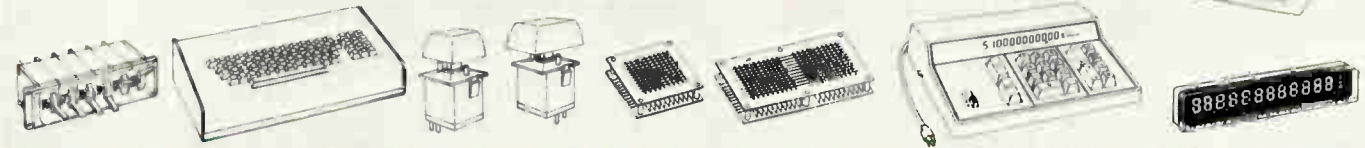
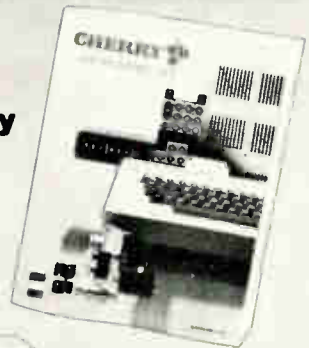

EVERWHEEL • KEYBOARDS & KEYBOARD SWITCHES • MATRIX SELECTOR • ELECTRONIC CALCULATORS • DIGITAL READOUTS

Circle 97 on reader service card

Finally:

**A monolithic chopper-stabilized op amp.
An offset voltage drift of $0.2\mu\text{V}/^\circ\text{C}$.
An offset current drift of $1\text{pA}/^\circ\text{C}$.**

This new device is a true breakthrough—the industry's first monolithic chopper-stabilized op amp. And, in addition to its single-chip advantages, it offers the precision advantages of almost unbelievably low offset current and voltage drifts. And that's only the

beginning. The device incorporates a fully differential input, an initial offset voltage of less than $50\mu\text{V}$, an offset current of 0.05 nA , and an open loop gain of 5×10^8 . The gain bandwidth product is 3 MHz and the slew rate is $2.5\text{ V}/\mu\text{S}$, while the CMRR and PSRR are both

160db . Together, these features permit design applications in precision linear systems not feasible before with conventional monolithic amplifiers and hybrids.

This new device represents a major landmark in the development of Harris' expanding family of highly diversified monolithic linears. Its innovative design is the result of combining a number of advanced technologies into a standardized process, which permits volume production of a superior quality product. For more details see your Harris distributor or representative.

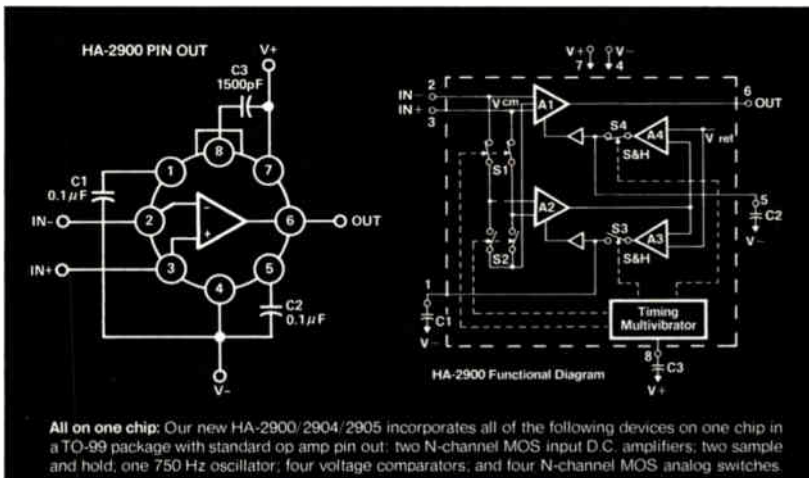

All on one chip: Our new HA-2900/2904/2905 incorporates all of the following devices on one chip in a TO-99 package with standard op amp pin out: two N-channel MOS input D.C. amplifiers; two sample and hold; one 750 Hz oscillator; four voltage comparators; and four N-channel MOS analog switches.

Supplied: TO-99 can with standard pin-out	100-999 units
HA-2900 -55°C to +125°C	\$88.00
HA-2904 -25°C to +85°C	\$71.50
HA-2905 0°C to +75°C	\$55.00

Harris



HARRIS
SEMICONDUCTOR
A DIVISION OF HARRIS-INTERTYPE CORPORATION

P.O. Box 883, Melbourne, Florida 32901
(305) 727-5430

WHERE TO BUY THEM: ARIZONA: Phoenix—Liberty, Weatherford, Scottsdale—HAR (602) 946-3556 CALIFORNIA: Anaheim—Weatherford; El Segundo—Liberty, Glendale—Weatherford; Long Beach—HAR (213) 426-7887; Mountain View—Elmar; Palo Alto—Weatherford, HAR (415) 964-8443; Pomona—Weatherford; San Diego—Weatherford; Western COLORADO: Denver—Elmar, Weatherford WASHINGTON, D.C.: HAR (202) 337-3170 FLORIDA: Hollywood—Schweber; Melbourne—HAR (305) 727-5430 GEORGIA: Atlanta—Schweber ILLINOIS: Chicago—Schweber; Schaumburg—HAR (312) 894-8824 MARYLAND: Rockville—Schweber MASSACHUSETTS: Lexington—R&D; Waltham—Schweber; Wellesley—HAR (617) 237-5430 NEW MEXICO: Albuquerque—Weatherford NEW YORK: Melville—HAR (516) 249-4500; Syracuse—HAR (315) 463-3373; Rochester—Schweber; Westbury—Schweber OHIO: Beachwood—Schweber; Dayton—HAR (513) 226-0636 PENNSYLVANIA: Wayne—HAR (215) 687-6680 TEXAS: Dallas—Weatherford, HAR (214) 231-9031; Houston—Weatherford WASHINGTON: Seattle—Liberty, Weatherford

LEGEND FOR HARRIS SALES OFFICES & DISTRIBUTORS: Harris Semiconductor (HAR), Elmar Electronics (Elmar), Harvey/R&D Electronics (R&D); Liberty Electronics (Liberty); Schweber Electronics (Schweber), R. V. Weatherford Co. (Weatherford), Western Radio (Western)

C-MOS teams with liquid crystals to make a reliable digital VOM

Low-power bipolar LSI is combined with an unloaded mercury cell as a voltage reference to keep power consumption below 1 milliwatt; because the two-layer, high-density ICs are small, costs are kept low

by Garry C. Gillette and John Crosby, Dana Laboratories, Inc., Irvine, Calif.

□ Any digital replacement for an analog volt-ohm-milliammeter should not only have the unambiguous display of a digital multimeter, it should also have the portability, year-long battery life, and versatility of the performance-proved analog instruments it is designed to replace. If digital meters are ever to gain the broad acceptance that has been enjoyed by analog VOMs for several decades, they must match or exceed the analog's extremely high reliability, interval of at least a year between calibrations, and low price.

The most important factor in the design of a digital VOM is its display. Unless the power demands of the display can be kept far below those of earlier digital instruments, it would be impossible to meet the goal of year-long battery life. This consideration makes the liquid-crystal display the only readout device that could be seriously considered for this application.

When the field-effect LCD had been developed to the point where lifetime was no longer a problem, the engineers at Dana Laboratories decided that the display could make their Danameter digital VOM a reality. The final design used International Liquid Crystal Corp.'s

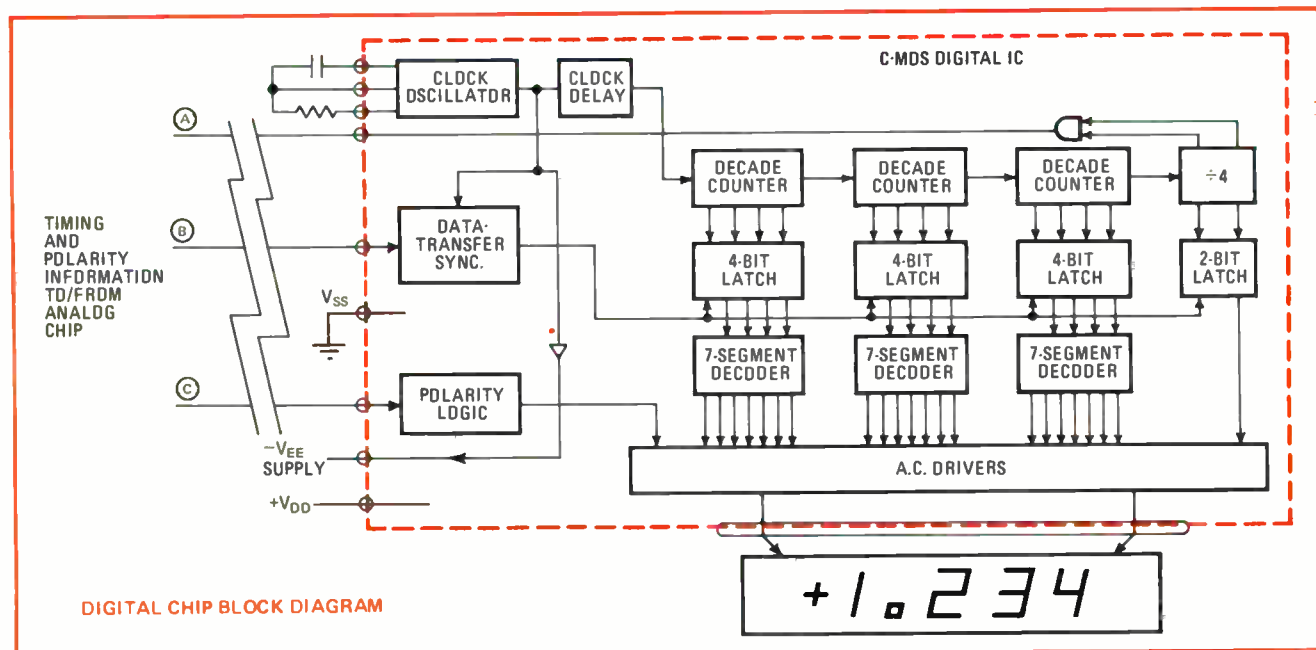
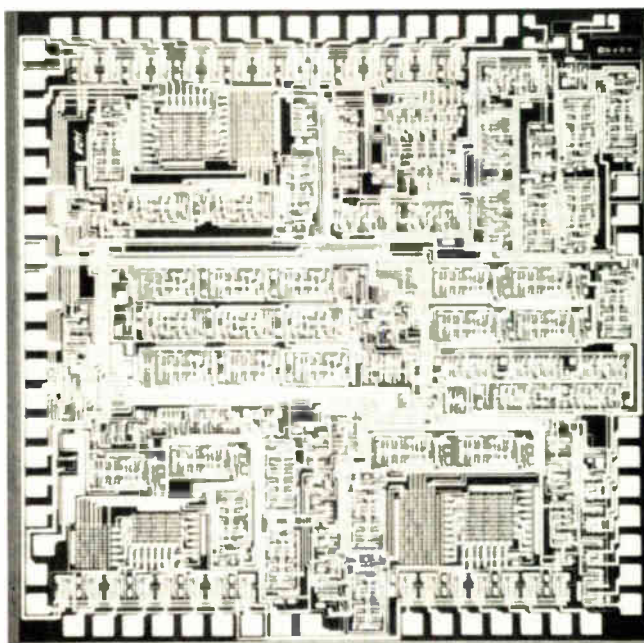

1. The digital chip. High-density C-MOS allows the integration of all digital logic functions and the clock oscillator on a single chip. Micro-Power Systems' two-layer process was used in the above chip's fabrication.

nematic birefringent display. This readout, which costs only a dollar a digit in large quantities, can be driven by a 6-volt complementary-MOS power supply. Weighing only a pound, the VOM is priced at \$195.

Dynamic-scattering-mode LCDs were rejected for the instrument largely because their appearance was regarded as unacceptable under typical conditions of use. In addition, they needed excessively high peak-drive voltages, and some units even required backlighting, which raised the display's total power consumption to an unacceptable figure.

Designing the meter

After selecting a display whose power requirements, lifetime, and cost made the digital VOM possible, the designers focused on the design of the rest of the instrument. To keep the cost down, they had to use as high a level of circuit integration as possible. At the same time, mixing too many technologies on the chip could have reduced yields, and hence, increased costs. The tradeoff between these two conflicting considerations led to the use of two IC chips—one for the digital circuitry, and the other for the analog.

The digital chip

The digital chip (Fig. 1) utilizes high-density C-MOS circuitry having a threshold of only 1 to 2 v for both the 8-kilohertz system-clock oscillator and the digital logic. Normal up-counting decade dividers are driven without interruption by the internal clock to ensure that timing signals for the dual-slope analog-to-digital integrator on the analog chip are available continuously from the previous decade divider.

Since the dividers never stop counting, some means had to be provided to extract data from them "on the fly." An array of latches was designed to perform this function by accepting data upon strobe command from the control circuitry on the analog chip. The data stored in the latches is sent to an array of seven-segment decoders and subsequently to circuitry that provides the

ac drive for the liquid-crystal display.

To ensure battery life in excess of one year when operating from a small 9-v transistor-radio battery, it was necessary to limit the total current drain of the analog chip to less than 100 μ A. Despite this power limitation, the chip had to exhibit:

- High resolution and sensitivity: resolution must be better than one part in 2,000 (3½ digits). And input sensitivity must be 100 μ v per digit to meet the desired specification of 200 mv maximum voltage drop on the current ranges.
- Auto polarity: the chip must accept inputs of either polarity, determine what the polarity is, and generate a signal for display on the LCD readout.
- High input impedance and low bias current: a basic chip input impedance in excess of 1,000 megohms and a bias current error of less than 100 pA were specified to eliminate loading errors on the 10-megohm input divider.
- Noise and overload immunity: the chip design must incorporate an active filter to reduce input noise without significantly affecting reading speed. It also must include protective circuitry to prevent damage from overloads, to detect overload conditions, and to display them.
- Capability of accurate ac measurements: the chip must include an active ac rectifier circuit to overcome the nonlinearity problems that plague passive rectifiers at low voltage levels.

2. The analog chip. Design of this chip was based on Micro-Power Systems' ability to integrate low-current npn and pnp transistors, Schottky diodes, and thin-film resistors on the same chip.

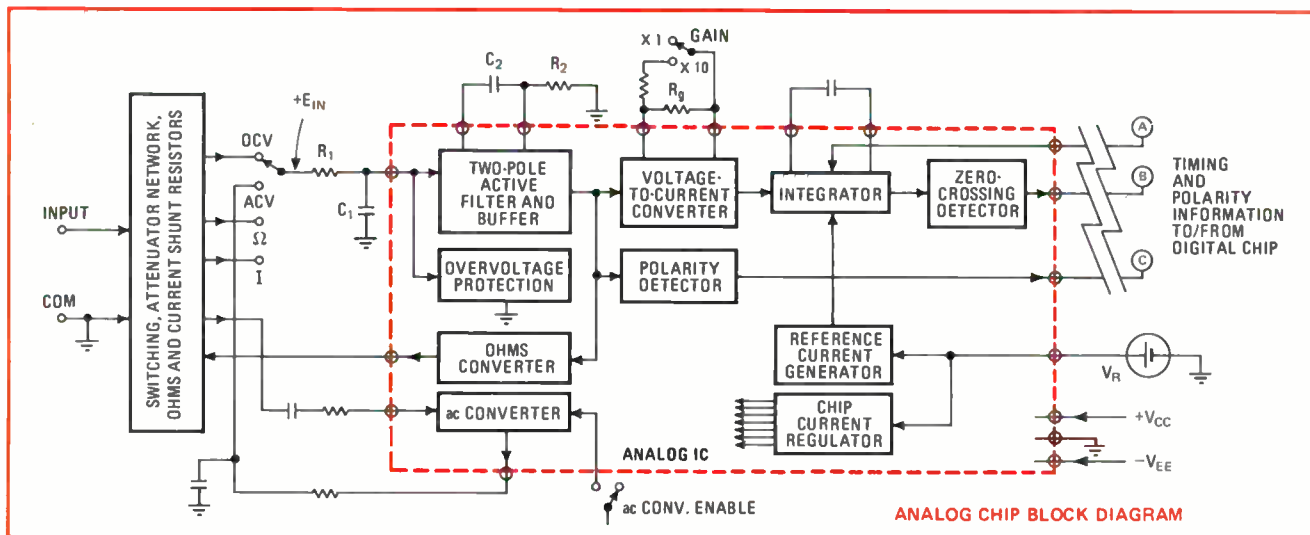
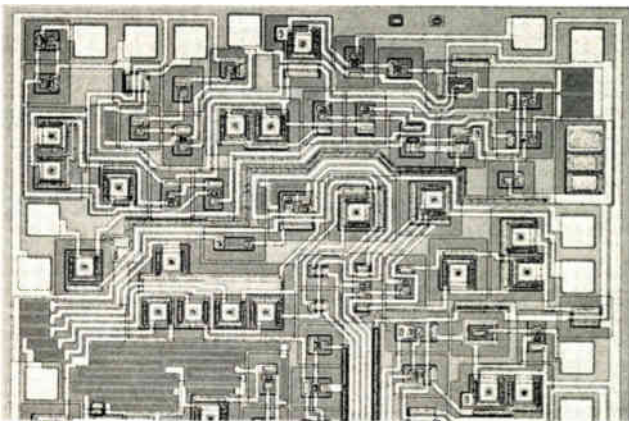

To meet the above requirements while keeping the chip size small enough to guarantee high yields and low costs, design of the analog chip was based on the integration of low-current npn and pnp transistors, Schottky diodes, and thin-film resistors. Because the thin-film resistors are deposited on top of the active circuitry (Fig. 2a), their inclusion does not affect the circuit yield. The closely matched resistors, having a value of 75 kilohms per square, reduce circuit complexity by replacing equivalent active devices; hence, they might be said to increase the yield of the analog chip.

In the fabrication of the analog chip, the processing of the vertical npn and lateral pnp transistors was adjusted to maximize the beta at low collector currents.

Close base-emitter voltage matching provides excellent thermal stability. The chip's positive supply of 6 to 10 v is obtained directly from a 9-v transistor battery. A capacitive voltage doubler driven from a C-MOS inverter on the digital chip generates the -5- to -9-v substrate bias that the analog chip requires. The two diodes and two capacitors in the voltage doubler are among the handful of components that are not integrated. A current regulator internal to the analog chip eliminates the possibility of drift problems caused by the varying supply voltages.

Analog chip has separate blocks

The block diagram of the analog chip (Fig. 2b) shows separate blocks for the two-pole active filter and buffer, as well as the voltage-to-current converter. These circuit functions are all performed by the circuit shown in Fig. 3. In that circuit, transistors Q_1 and Q_2 can be thought of as the voltage-to-current converter, operational amplifier U_3 can be thought of as the buffer, and operational amplifiers U_1 , U_2 , and U_3 , together with the various capacitors and resistors in the circuit, act as a two-pole filter. Resistor R_1 and capacitor C_1 , which are labeled on both the block diagram of Fig. 2b and the detailed circuit diagram of Fig. 3, make clear where Fig. 3 fits into Fig. 2b.

Referring to Fig. 3, negative feedback around U_1 (via Q_1 or D_1) forces voltage e_a to follow E_{in} . At the same time, feedback around U_2 (via Q_2 or D_2) causes voltage e_b to remain at a zero dc potential.

For positive input voltages, Q_1 and D_2 conduct, causing a current nearly equal to E_{in}/R_G to flow in the collector of Q_1 . No current flows through D_1 or Q_2 because they are reversed-biased. In similar fashion, negative inputs cause Q_1 and D_2 to turn off when collector current of E_{in}/R_G flows through Q_2 and D_1 .

With only R_G controlling the voltage-to-current transfer (transconductance) of the circuit, the need for the usual separate positive- and negative-input gain adjustments is eliminated. The cumulative voltage offsets of both op amps may be compensated for with only a single adjustment.

The floating differential-input configuration leads itself well to active filtering. Resistor-capacitor pairs R_1 with C_1 and R_2 with C_2 determine the cutoff frequency of the two-pole low-pass filter that the over-all circuit represents. The components were chosen to provide 50 dB of rejection at 60 Hz, increasing at 12 dB per octave.

Ohms-conversion is performed by passing a constant

current through, and measuring the voltage across, the unknown resistance. The measured voltage then becomes a direct function of the resistance. To establish the constant current, the patented Dana Ratiometric ohms-converter block (Fig. 4) is used. With this circuit, accuracy is limited only by the scaling resistors (R_2 through R_6) and is independent of the reference voltage. Although the resistance-measuring current is constant over each of the meter's resistance ranges, it is not the same on all ranges. The measurement of large resistances obviously needs less current than the measurement of small values of resistance.

Generating the constant currents

With the Ratiometric technique, the measuring current is generated by maintaining a constant voltage across the multiplier resistor associated with each range. This gives the advantage over other methods of working well throughout the very broad range of constant currents needed by an ohmmeter that has ranges from 200 ohms full-scale to 200 megohms full-scale. An on-chip, precise 1- μ A constant-current source is buffered by an op amp and then flows through adjustable resistor R_6 , across which it develops the 1-v drop for multiplier resistors R_2 through R_5 . R_1 provides overvoltage protection and also serves as part of the input noise-rejecting filters.

Note that capacitor C_1 of Fig. 2b is actually made up of two capacitors—0.03- μ F and 0.001- μ F in parallel. The two capacitors are connected in parallel for all measurements, except when the meter is switched to its 200-megohm range. Then the 0.03- μ F capacitor is switched out of the circuit to maintain an acceptable response speed for the meter.

The ac converter

Ac input signals are routed to the switchable decade attenuator via an input-coupling capacitor (Fig. 5). The attenuator, which is also used for dc functions, is a

3. Signal conditioner. The two-pole active filter, buffer, and voltage-to-current converter of the block diagram of Fig. 2b are contained in this circuit. All of the circuitry shown here is on the analog chip except resistors R_1 and R_2 , and capacitors C_1 and C_2 .

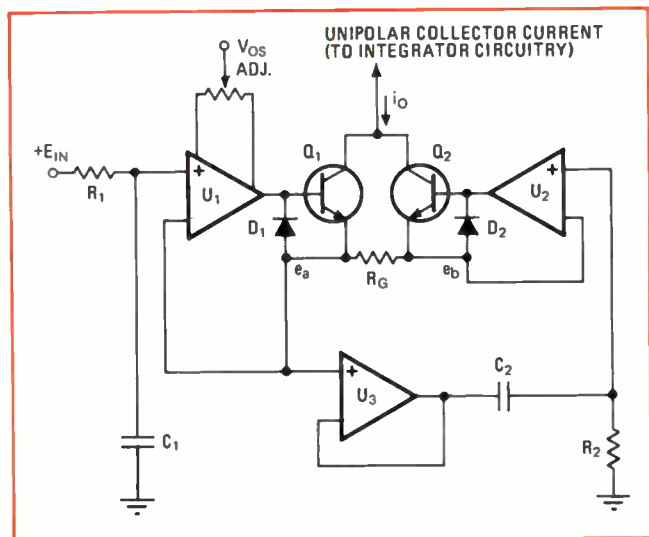

thick-film network that provides attenuation factors of 2, 20, 200, and 2,000.

Resistor R_7 serves primarily as a current-limiting resistor to protect the meter when large overloads are applied to it when it is on the 2-v ac range. Op amp U_4 , is combined with diodes D_3 and D_4 resistors R_8 through

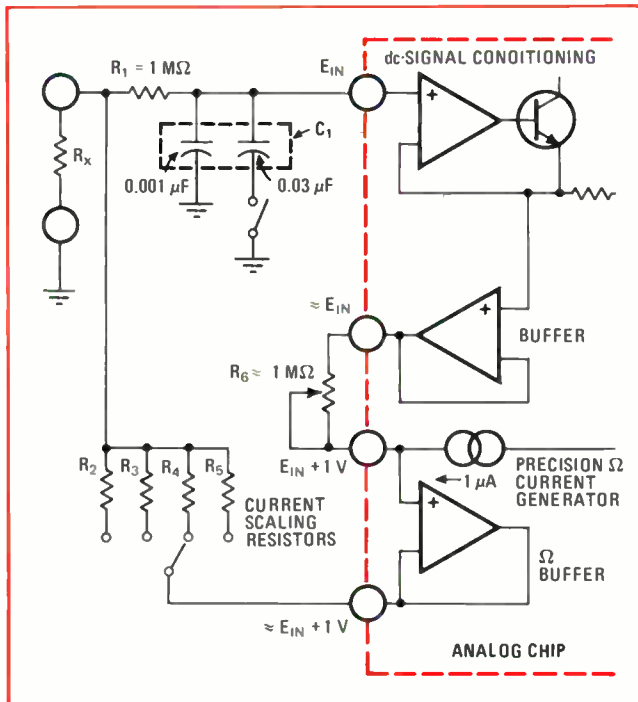

4. The ohms converter. By maintaining a constant voltage of 1 V across the current-scaling resistors, this circuit is able to push a wide range of constant currents through the unknown resistance, R_x .

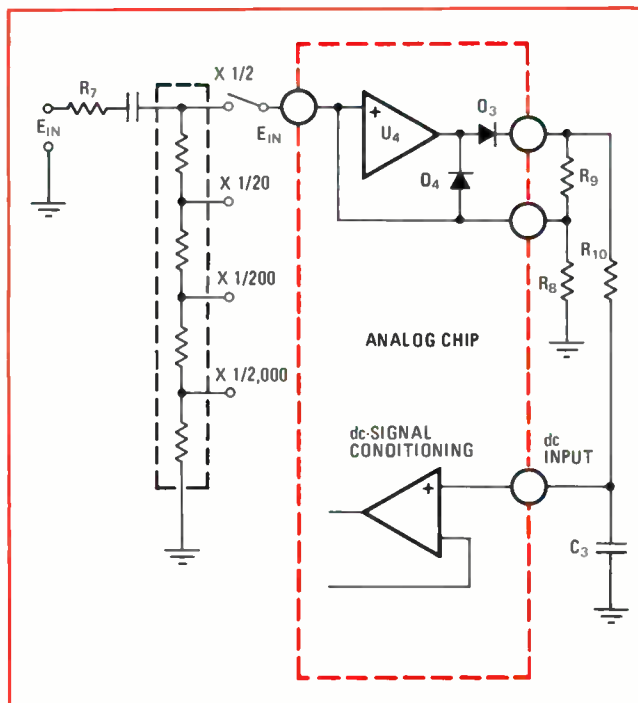

5. Ac converter. Passive rectifiers become very inaccurate at low voltage levels because of nonlinearities in the diodes. For that reason, this ac converter uses an op amp in an active rectifier configuration to keep D_3 and D_4 operating in well defined on and off states.

R_{10} , and capacitor C_3 to comprise the active rectifier circuit. R_8 and R_{10} form a simple filter, extracting the average dc value from the waveform at the output of the active rectifier. Additional filtering is provided by the active filter at the input to the dc signal-conditioning circuitry.

Mercury cell sets reference voltage

Most good dual-slope integrators use a zener diode to establish the stable reference voltage needed by these converters. But, although zeners provide excellent voltage stability, they have two drawbacks for the present application:

- The current needed to bias the zener into its constant-voltage region can significantly raise the power consumption of such a low-power instrument.
- Integrating a voltage reference onto the analog chip would significantly reduce the chip's yield, and hence, would raise the cost of the instrument.

For these two reasons, the designers finally selected the common mercury cell used to power wristwatches. Back in the 1950s, mercury cells used as voltage references developed a somewhat shaky reputation because of their relatively poor stability. Modern units, however, are extremely stable over both temperature and time, and they perform their function admirably.

Most engineers are probably aware of the voltage-versus-time characteristic of the loaded mercury cell: the voltage remains almost perfectly constant until the battery's life is over, when it drops precipitously. Such behavior, if it occurs in a meter might lead to unexpected inaccuracies. Fortunately, however, when a mercury cell is very lightly loaded, this phenomenon does not occur. Instead, when the constant-voltage part of its life is over, the cell voltage very slowly drops with the passage of time.

In the Danameter, the loading of the mercury cell is sufficiently light—about 1/1,000 of a wristwatch load—that the voltage drop at the end of the cell's life is slow enough to allow recalibration of the meter at only one-year intervals without losing rated accuracy. Eventually, after three to five years, the mercury cell would have to be replaced.

By combining a high level of integration, a mercury-cell reference that saves power and money, and a field-effect liquid-crystal display, the designers of the Danameter are confident that their digital instrument can compete effectively with conventional analog meters. □

6. The result. Unretouched photo of Danameter demonstrates visual appeal of field-effect LCD. Meter weighs one pound, costs \$195.

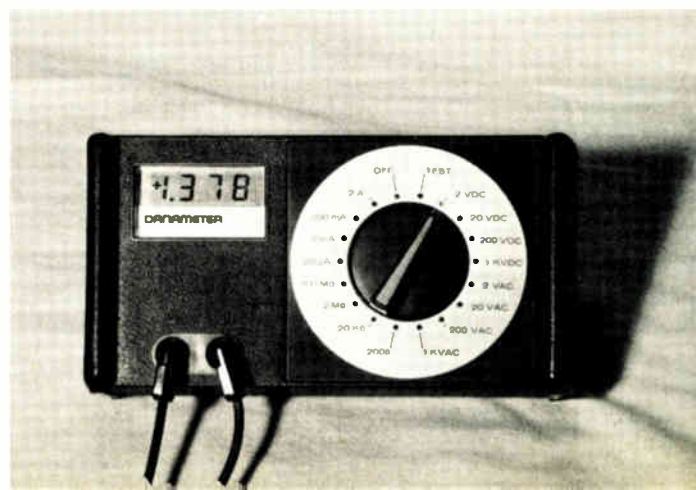



Analysis can take the heat off power semiconductors

Designing for thermal requirements with good electrical isolation ensures stability and reliable performance of these devices

by Forest B. Golden, *General Electric Co., Auburn, N. Y.*

□ Cost-conscious design engineers, well aware that a 1% component-failure rate during the warranty period can easily add 50 cents to a product's cost, are eager to reduce device temperatures. To put it simply, the cooler a device operates, the more reliable it is. Generally, if an engineer can lower its temperature by 20%, he will reduce the device's failure rate by a factor of three. This concept applies to such discrete devices as the power transistor, diode power rectifier, and thyristor family, which includes the silicon-controlled rectifier and the triac.

Thus, keeping semiconductors cool, while often thought of as a necessary evil and a chore to the design engineer, is really an intimate part of the design process. It is not enough for the designer merely to select a device that meets circuit requirements. He must follow up with a systematic thermal analysis to enable him to select a heat sink and mounting technique that will hold device temperature low and thereby assure reliable operation for a long time.

These factors should be considered in making the thermal analysis:

- Determine power dissipation and temperature limits so that the case-to-ambient thermal resistance can be calculated and the proper heat-transfer techniques selected.
- Evaluate electrical-isolation requirements of the device package.
- Ensure that the thermal resistance of the device interface is minimal.
- Verify the calculations by careful temperature measurements under operating conditions.

The thermal circuit

Semiconductor-design engineers learned early to translate heat-transfer units to understandable circuit units—watts for heat and degrees per watt for thermal resistance. Thermal resistance—the inverse of thermal conductance—is the key to selection of the cooling hardware, such as a heat sink, for a semiconductor device.

A thermal circuit (Fig. 1) includes thermal capacitor elements to account for thermal storage. However, since power dissipation of most device designs can be calculated as rms values, thermal capacitance can usually be ignored.

The thermal equation resembles Ohm's law because heat in watts is analogous to electrical current, and tem-

perature difference is comparable to potential difference:

$$\theta_{JA} = (T_J - T_A) / P_J$$

where θ_{JA} is the thermal resistance of the junction in degrees per watt, T_J is the temperature of the semiconductor junction, T_A is the temperature of the ambient, and P_J is the power dissipation in watts.

To calculate the all-important thermal resistance—from junction to ambient—the designer must determine three thermal parameters: the maximum allowable

Kilowatt cooler. This cooling package is typical of some of the highly efficient thermal packages recently developed to cool power-semiconductor rectifiers and SCRs. The enclosure, developed by Thermalloy, is 13 inches high, 14 in. wide and 16 in. deep. It can dissipate approximately 3.5 kilowatts. Devices shown are three-phase full-wave rectifiers that can handle 1,000 amperes. Each of the six modules provides a thermal resistance of 0.07°C/watt from sink to air. Assembly requires 300 cubic feet per minute of air at a pressure drop of 0.9 in. of water to achieve this low thermal resistance.

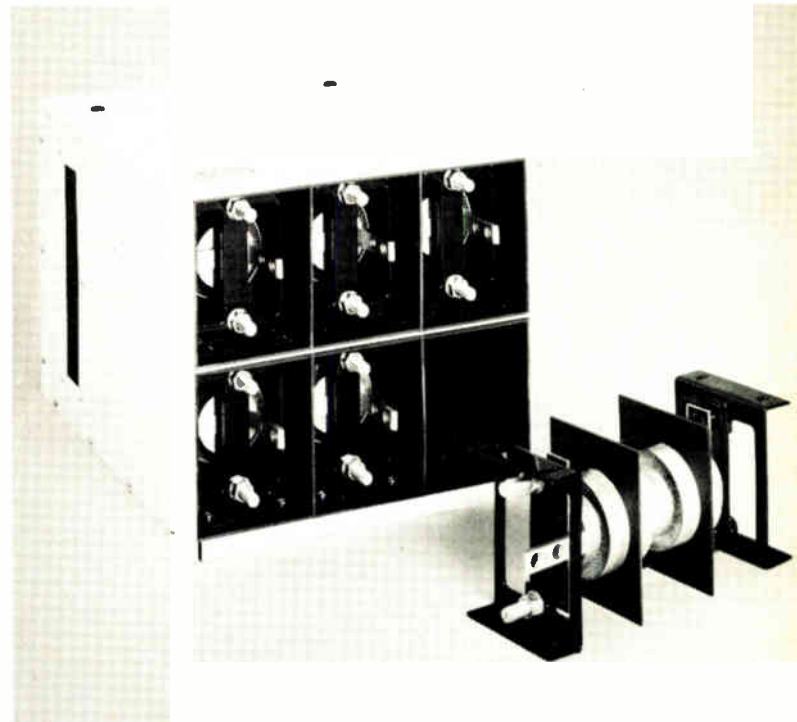

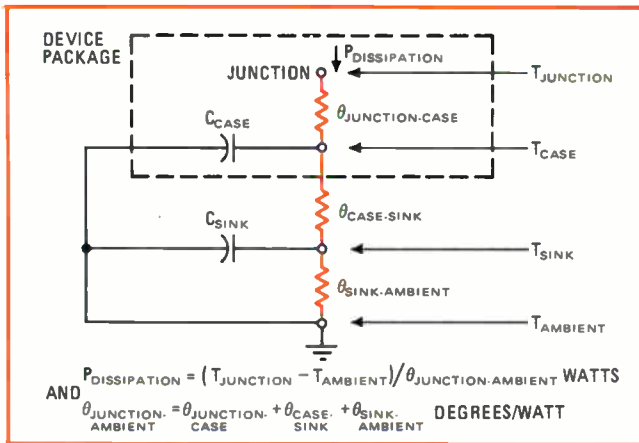

1. Thermal circuit. Circuit analogs enable the designer to analyze the thermal paths. Resistors represent the thermal resistivities of the various components. Capacitors account for storage capabilities, but are usually omitted in steady-state calculations.

temperature of the semiconductor junction, the maximum ambient temperature, and the maximum power that the device will dissipate.

Applying thermal parameters

Determining the power dissipation of a thyristor or a semiconductor rectifier is not difficult because worst-case values are specified by manufacturers' data sheets. Application of this data is illustrated by calculation of dissipation for a high-frequency inverter circuit to be used in pulse operation. The term inverter applies to a circuit that converts dc to a periodic waveform. The inverter circuit (Fig. 2a) develops a near-sinusoidal current through the SCR. A typical rating curve for such an SCR (Fig. 2b) provides the maximum watt-second loss per pulse for any sinusoidal pulse the SCR can handle.

The worst-case anode-power dissipation is determined by multiplying the repetition rate by the watt-second loss per pulse. This value will be accurate if the values of the gate drive and snubber circuit are comparable to those specified in the data sheets. (A snubber circuit is a low-pass-filter network that prevents spurious thyristor triggering.)

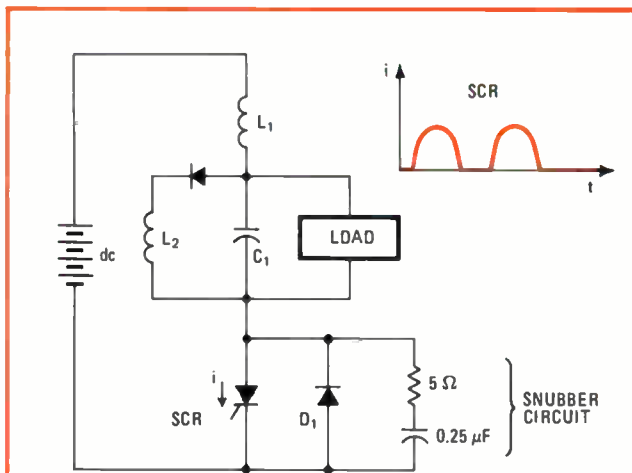

2. Pulse power. The inverter circuit (a) delivers a near-sinusoidal-shape pulse current through the SCR. Curves in (b) provide the watt-second power loss per pulse. Multiplying this value by the pulse-repetition rate yields the power dissipation.

(a)

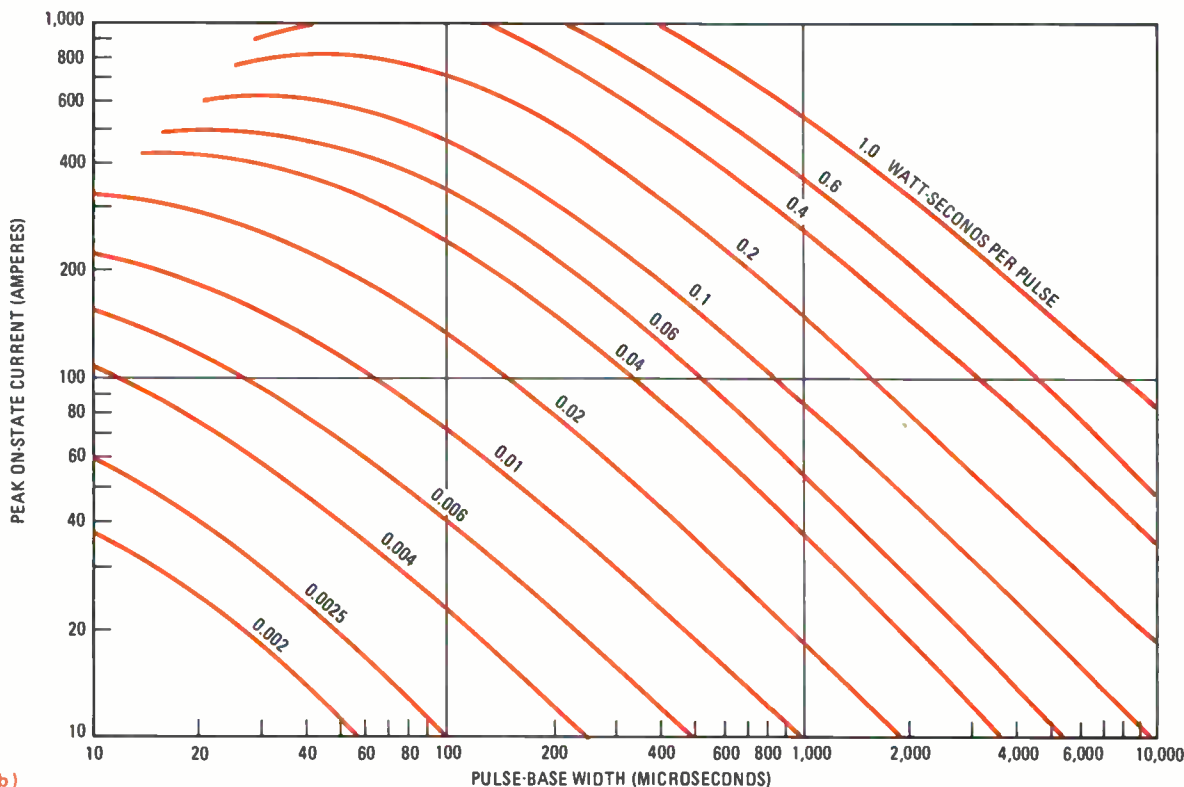

(b)

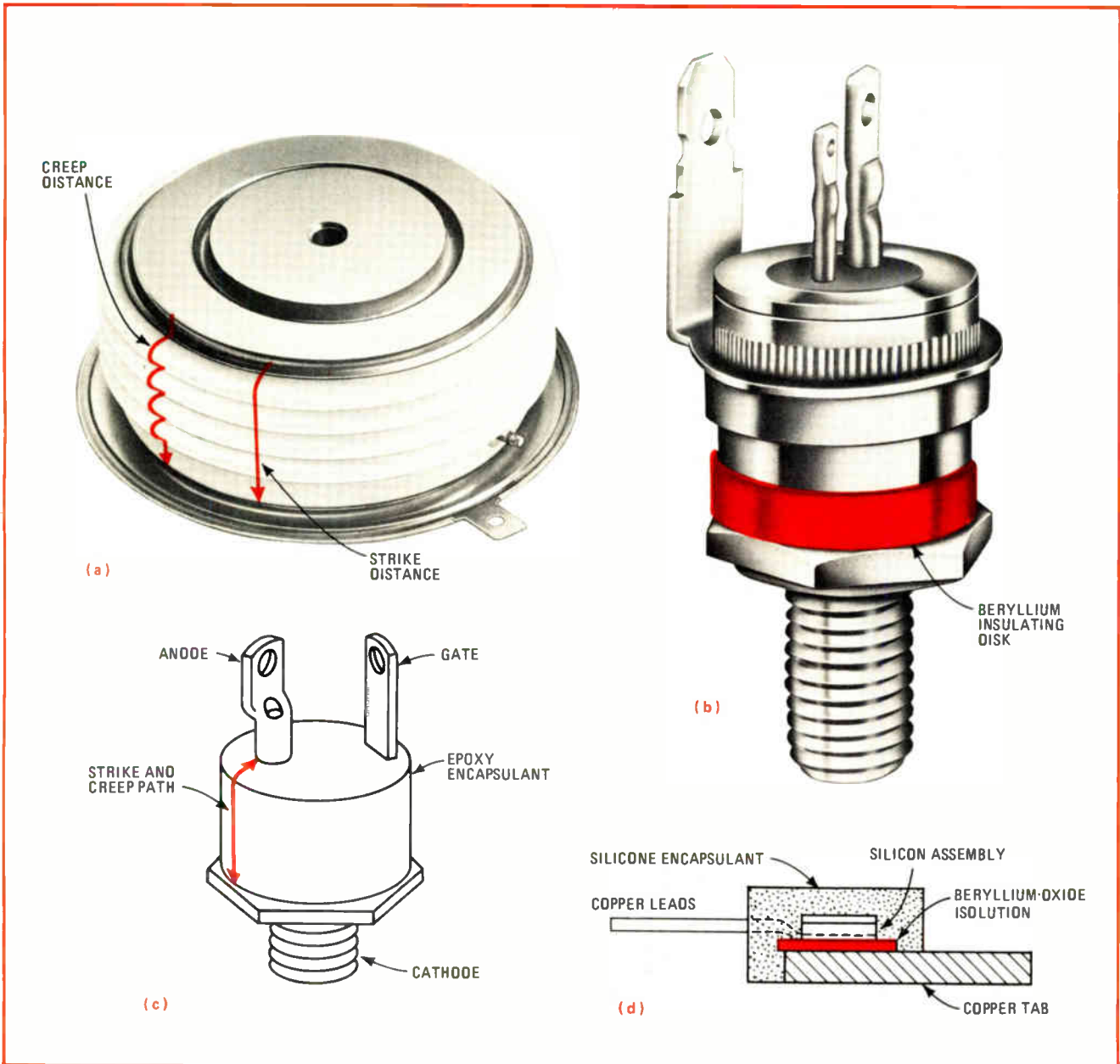

3. Power-device geometries. Electrical isolation is the principal trade-off hindering low-thermal-resistance mounting and must be weighed against the thermal resistance values in manufacturers' data sheets. The designers of the pressure-mounted disk in (a) assure adequate creep and strike distances by ribbing the surface. Thickness is 26 mm. Device can operate at 480 volts rms, and current-handling ability exceeds 500 amperes. Such devices as the stud-mounted unit shown in (b) pose an electrical-isolation problem because thickening the ceramic or increasing the diameter of the ceramic increases the thermal resistance on one hand and develops an interference with the hex-shaped base on the other. Adding an encapsulant to a stud-mounted device (c) greatly enlarges creep and strike distances required to meet NEMA and U/L requirements. By putting a thin beryllium-oxide insulator within the TO-220 package (d), electrical isolation can be obtained at minimal thermal expense. Designer can then attach the copper tab to a mounting surface with good thermal properties, thus doing away with the added cost of purchasing and mounting an independent heat sink.

However, determining dissipation data for switching transistors is considerably more difficult because the required data is seldom available. As a result, the designer has no choice but to determine the wave shapes and amplitudes of the collector-to-emitter voltages and currents, develop graphic plots of the product, and then integrate over an operating cycle to arrive at the rms power dissipated.

To ensure an accurate evaluation, these guidelines should be followed:

- Assume worst-case parameters—that is, figure on maximum voltage and current, lowest and slowest drive conditions, stiffest snubber networks, and highest frequency of operation.
- Include all power components, notably base power and blocking power.
- Test a number of devices to calculate a worst-case figure.
- To avoid measurement error caused by inductive shunting in high-frequency drive circuits, use a coaxial-

Thermal runaway

It is commonly believed that if the duty cycle of a semiconductor device is low, a heat sink is not required. But this dictum simply isn't true. Because semiconductor blocking characteristics are highly temperature-dependent, thermal runaway can develop. Blocking current is the current that flows during the off portion of the duty cycle, and, despite the fact that it may be no more than microamperes, it can contribute to a runaway condition. Runaway describes the positive-feedback chain reaction in which temperature rise causes a temperature-dependent current to increase. This, in turn, further heats the device to cause a still larger current. If unchecked, the current increases until the device destroys itself.

As an example, the peak off-state current (I_{DRM}) of a thyristor doubles for every 10°C rise in junction temperature. This doubling in current means a doubling of blocking-power loss (P_B). Such an increase under adverse temperature conditions can lead to a runaway that culminates in catastrophic failure.

Stability is not solely a function of blocking current; it is also highly dependent on the thermal resistivity of the entire junction-to-ambient path. Thus, a low-resistance heat sink can play a crucial role in assuring stable operation.

The plots below depict both stable and unstable device operation. In each case, the thermal resistivity is superimposed on the power-dissipation curve for the device. In (a), a stable thermal situation is depicted. It is stable because the dissipation capability of the over-all thermal path (P_E)—including the sink and interface—exceeds the power developed (P_D), which is the sum of the on-state conducting losses (P_O) and the off-state blocking losses

(P_B). If the ambient temperature were to rise, the (P_E) line would shift slightly to the right, but, since this line would still lie above and to the left of the P_D curve, operation would remain stable. The reason is that the dissipation capability (P_E) still exceeds the power dissipated (P_D). Note that, for stable operation, the blocking losses (P_B) are assumed to be only a small percentage of the total losses (P_O and P_B). However, in such low-duty-cycle operation as a crowbar circuit, the exact opposite may be true. That is, the on-state losses may be negligible, compared to the blocking losses.

Now, suppose a designer attempts to mount a semiconductor on a bracket that has a high thermal resistance and he makes no attempt to enhance the thermal circuit with a heat sink. This situation is depicted graphically in the unstable plot. Because of the high thermal resistance, the power-dissipation curve has a much lower slope (α_2). The designer might assume that the thermal requirement is ample because the operating temperature is lower. However, a small upward shift in the ambient temperature will shift the entire (P_E) line to the right and beyond the (P_D) plot. If this happens, the device dissipation exceeds the dissipation capability of the system, and runaway develops; that is, temperature and current rise until catastrophic failure occurs.

The prudent design engineer will want to adhere closely to the guidance contained in the data sheets for each device regarding maximum thermal case-to-ambient resistance (θ_{c-A}), for which maximum blocking ratings apply. If such data is not specified, the designer should consult the device manufacturer.

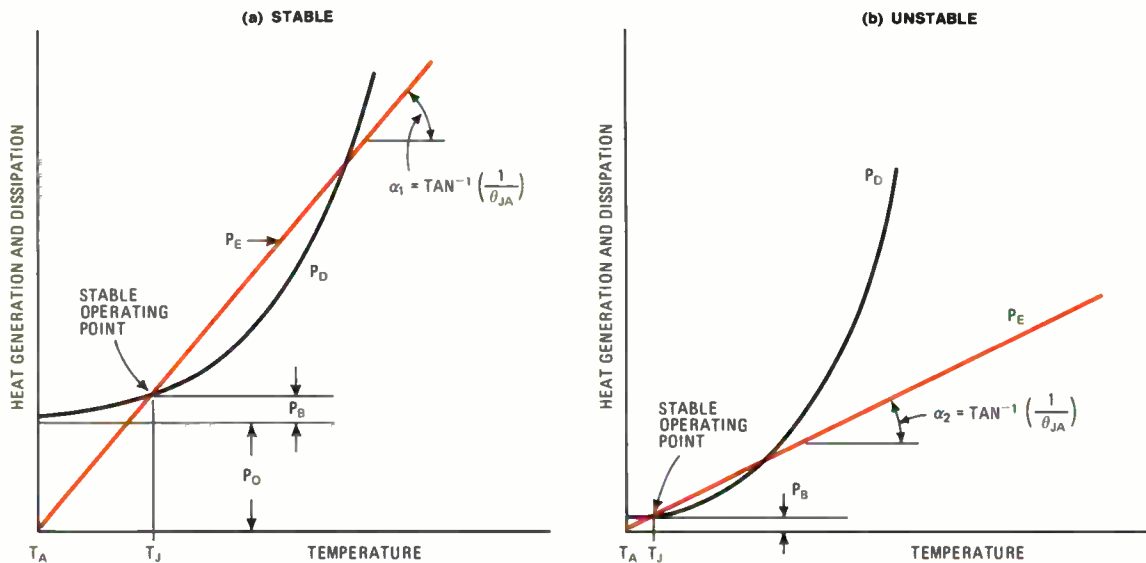

current shunt or a quality current-measuring device that has adequate bandwidth.

Worst-case junction and ambient temperatures should be found. The maximum junction temperature, shown on the device's data sheet, should not be exceeded, except where such other parameters as transistor collector-to-base voltage or thyristor anode-to-cathode voltage can be lowered, thereby raising the limit of the junction temperature.

This method of derating makes possible low-voltage

SCRs having a junction temperature of 150°C . The normal maximum is 125°C . To assure optimum reliability, design engineers will usually derate junction temperature according to a derating curve furnished by the manufacturers.

The ambient temperature may be specified in advance, or it may have to be determined. When equipment is enclosed in an unventilated cabinet, the ambient encountered by the semiconductor's heat sink may be considerably higher than the ambient outside of the

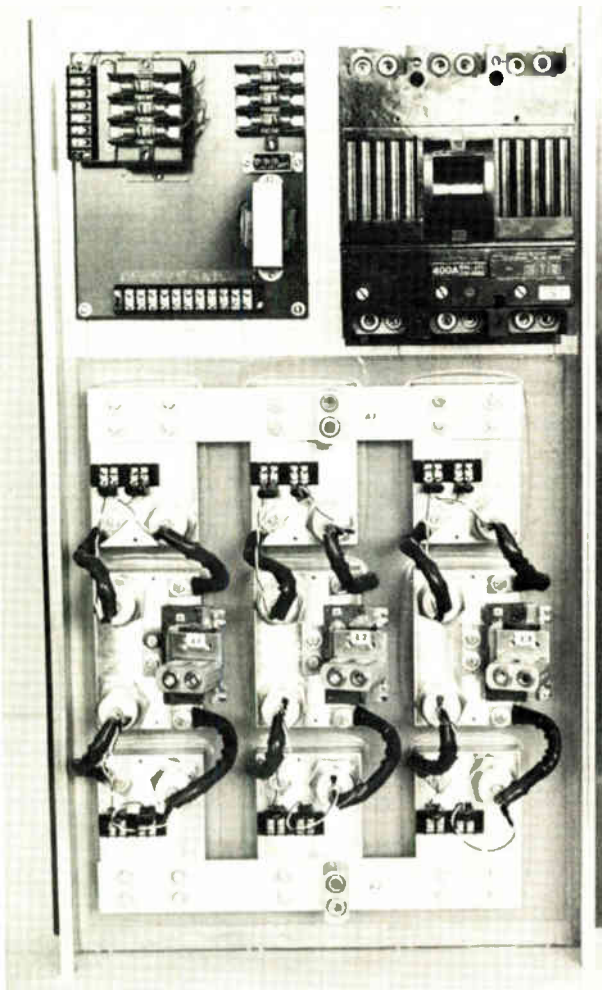

4. **Big sink.** Thyristors rated at 480 amperes rms are attached to large heat-spreader blocks, which are attached to the cabinet by an epoxy adhesive. The epoxy provides the required electrical isolation; yet, because of the large heat-transfer surface area, it does not materially hinder the thermal path to the equipment structure.

enclosure, so there is no substitute for careful temperature measurement inside the enclosure. Although papers have been published on the subject of determining ambient temperature inside of enclosures, these design guidelines produce only first-order approximations, rather than final design values.

Evaluating isolation requirements

After power and temperature values have been determined, the designer must examine carefully the system's electrical-isolation requirements. Generally, the shorter the thermal path, the better. However, the requirement for adequate electrical isolation is diametrically opposed— isolation requires a longer path.

The electrical path must be designed to prevent breakdown that might be caused by arc-over or current leakage along the surface between terminals. Sufficient air gap—known as strike distance—must be provided to prevent arcing, and a minimum surface-resistance path, called creep, must be provided between terminals by the intervening insulator surface.

Adequate electrical isolation for a large thyristor with

a 500-A rms rating and up with a silicon-pellet diameter from 33 to 40 mm (Fig. 3a) is provided by designing it as a pressure-mounted disk package with a 26-mm height to prevent strike and ribbing the surface as shown to prevent creep. As indicated in Table 1, a package 26 mm thick has more than adequate creep and strike isolation for line voltages as high as 480 v rms.

A tougher problem is posed by stud-mounted semiconductors in the range of 1 A to 50 A (Fig. 3b). Problems develop if the dimensions are altered to improve the strike and creep distances because thickening the beryllium-oxide disk increases the thermal-path length, thereby raising the thermal resistance. And if the diameter of the disk is increased, it interferes with the hexagonal base.

One way to lengthen the creep and isolation distances is to add an epoxy encapsulant (Fig. 3c). The epoxy develops adequate creep and strike distances from both anode to cathode and anode to stud to permit operation at 230 v, which is adequate to qualify the device for approval by Underwriters' Laboratories.

However, electrical isolation inside the TO-220 package shown in Fig. 3 (d) is provided internally by inserting a beryllium-oxide layer between the chip and the copper tab. Thanks to low thermal resistivity, the beryllium-oxide provides a good thermal path for the heat to travel from the chip to the copper tab. Although the chip-insulator interface has a small area that tends to degrade the thermal path, that tendency is offset by making the insulator relatively thin. This is possible because electrical strike and creep requirements are greatly reduced by the protection of the semiconductor package.

The result is roughly equivalent to the externally isolated package in respect to both electrical isolation and thermal dissipation. Because the copper tab is electrically isolated, the device can be mounted directly on an enclosure wall that can serve as the heat sink. Thus, the additional cost of a discrete heat sink can be eliminated, along with the additional labor required for its assembly.

Spreading heat through a sink is the only effective means that has been developed thus far to cope with the thermal requirements of high-current SCRs. Avtek Corp., Burlingame, Calif., has used this method to advantage (Fig. 4). The large 480-A rms thyristors are mounted on thick heat-spreader blocks that are at-

TABLE 1. STRIKE AND CREEP STANDARDS

Voltage (rms)		Distance (mm)	
		U.L. ⁽¹⁾	NEMA ⁽²⁾
130	Strike	5.08	3.18
	Creep	6.35	6.35
240	Strike	7.62	6.35
	Creep	10.16	9.53
480	Strike	10.16	9.53
	Creep	12.7	12.7

Notes: 1. Proposed U.L. standard for appliance and consumer equipment - May 1973
2. Standards for semiconductor converters - Nov. 16, 1972

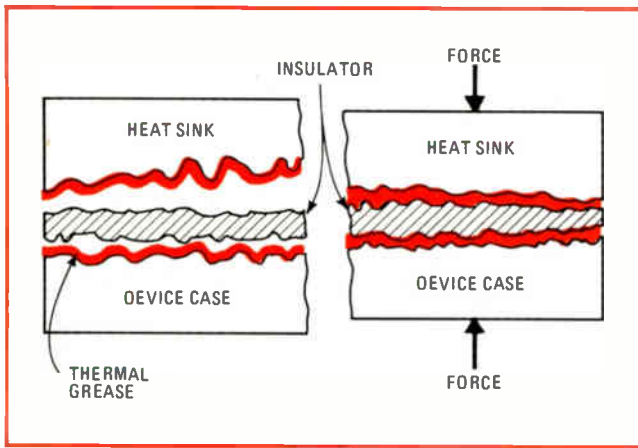

5. Mountainous. Exaggerated profile shows the thermal interfaces between a semiconductor device, an insulator, and the sink before and after engagement. Thermal grease helps to offset poor thermal path between materials that are microscopically rough.

tached by epoxy to a common convection-cooled heat sink. This sink, in reality the rear portion of the equipment enclosure, also provides a mounting surface for the fuse blocks and circuit-breaker shown. The blocks enlarge the heat-transfer area and thus offset the high thermal resistance of the epoxy.

Knowledge of the thermal-resistance limit and the constraints imposed by electrical isolation equips the designer to select the heat sink and coolant requirements. However, he must also consider carefully the thermal resistance at the interface between the semiconductor device and the heat-exchanger hardware.

The interface

The interface between the semiconductor device and the heat sink is a crucial thermal path. If the interface's thermal resistance is too high, it can render worthless the heat-transfer capability of a good heat sink.

As an example, the thermal-resistance values for the 10-32-thread, stud-mounted device listed in Table 2 range from 0.09°C/W at best to 1.2°C/W at worst—a spread of more than a full order of magnitude. In fact, 1.2°C/W is a far greater thermal resistance than that provided by a good heat-exchanging system (see illustration, p. 106).

Figure 5 illustrates the profile of the mating surfaces making up a typical interface. The roughness of the surface has been exaggerated to dramatize the mechanics of the interface. Applying force to the surfaces brings them into contact, but the net contact area is highly dependent on the ductility of the contacting metals, the surface finish, and the flatness, as well as the amount of force applied. A large void (Fig. 5) can be caused by a non-parallel fit between the device case and the sink. Thermal grease can help fill that void. And, as indicated in Table 2, an insulator would raise thermal resistance.

Although semiconductor manufacturers' guidebooks provide specific instructions, these guidelines can serve for all but the largest pressure-mounted disk packages:

- Mating surfaces should be flat to within 0.001 inch, and surfaces should be finished to a tolerance of 63 microinches or less.
- All paint and other impurities should be removed

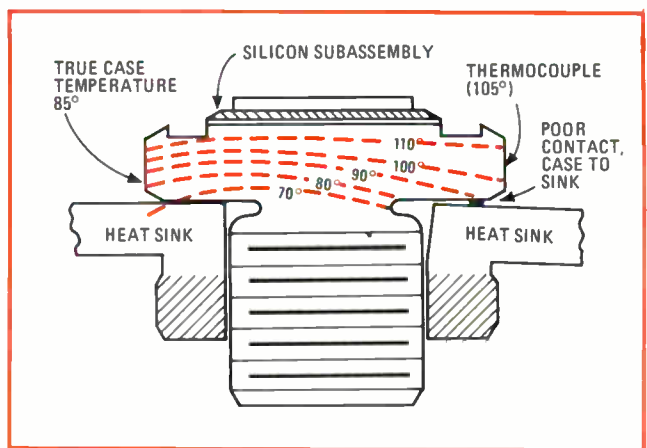

6. Poor contact. If a device's contact heat sink isn't uniform, eccentric temperature profile develops, which cause erroneous temperature measurements. Mating surfaces must be smooth so that the thermal interface will be uniform about the device's circumference.

completely by a treatment with #000 fine steel wool and silicone oil.

- The surfaces should be cleaned and wiped free of foreign matter immediately before assembly.

Measuring temperature

Initial calculations should be confirmed by actual temperature measurements. However, if results are to be meaningful, a number of pitfalls must be avoided. It is crucial to determine the actual power dissipation of the semiconductor because temperature data that overlooks this factor will lead to false calculations of thermal resistance. More is involved than merely inserting a thermocouple and waiting for the device to reach thermal equilibrium before taking a reading.

During the design and prototype stages, the designer should verify his calculations by measurements in the operating environment, according to these guidelines:

- The semiconductor device should be mounted on the heat sink in the actual enclosure intended to contain the manufactured version of the equipment. Merely rotating an air-cooled heat sink 90° can make a vast difference in its thermal properties.
- Follow manufacturer's mounting instructions carefully.
- Limit thermocouple wire diameter to 12 mils to avoid localized cooling.
- Avoid placing high-dissipation elements, such as ballast resistors and transformers, near a semiconductor. If this juxtaposition is unavoidable, make sure that both devices are dissipating their full design-power levels during temperature runs.
- Block off local air currents.
- Prevent direct sunlight from contributing to the heat measurement.
- Make sure that electromagnetic fields do not couple to thermocouple leads and destroy measurement accuracy.

Consider the problem involved in measuring the case temperature of a stud-mounted rectifier or SCR. Assume that the thermal resistance—junction-to-case—is specified at 0.3°C/W maximum and that the ambient temperature is 45°C. Assume further that the device-case

TABLE 2. SOME THERMAL INTERFACE RESISTANCES

Stud-mounted devices							
Stud size	Hex size across flats or flat base (diameter)	Thermal resistance-case-to-sink θ_{c-s} °C/watt					
		With thermal grease			Dry		
		Minimum	Nominal	Maximum	Minimum	Nominal	Maximum
10-32	7/16"	0.09	0.3	0.8	0.2	0.5	1.2
1/4"-28	9/16"	0.07	0.25	0.6	0.15	0.4	0.9
1/4"-28	11/16"	0.05	0.15	0.4	0.10	0.25	0.6
3/8"-24	1-1/16"	0.02	0.06	0.15	0.05	0.1	0.25
1/2"-20	1-1/16"	0.02	0.065	0.2	0.05	0.12	0.3
3/4"-16	1-1/4"	0.025	0.08	0.2	0.06	0.15	0.35
3/4"-16	1-5/8"	0.015	0.04	0.10	0.03	0.07	0.15
Flat Based	1-7/8"	0.01	0.025	0.07			
Stud-mounted devices insulated with 5-mil mica washer							
10-32	7/16"	1.2	2.5	4.5	—	—	—
1/4"-28	9/16"	0.9	2.0	3.5	—	—	—
1/4"-28	11/16"	0.7	1.5	2.5	—	—	—
Pressure-mounted disk packages — lubricated							
Interface diameter (inches)	Nominal clamp force (lb)	Thermal resistance-case-to-sink θ_{c-s} °C/watt					
		Minimum	Nominal	Maximum			
3/4	800	0.04	0.06	0.20			
1	2300	0.02	0.03	0.10			
1-1/4	2300	0.015	0.022	0.08			
1-1/3	4000	0.014	0.02	0.07			

temperature must not exceed 85°C, in accordance with the manufacturer's data sheet. This amounts to a power dissipation of:

$$P = (85^{\circ}C - 45^{\circ}C) / 0.3^{\circ}C/W = 133.4 W$$

Assume that the case temperature is actually measured to be 80°C. At first glance, the device appears to be below its maximum temperature, and all appears to be well. However, if the true dissipated power during the temperature measurement is less than the 133.4-w value, the actual case-to-ambient temperature is, in fact, too high. To illustrate why, assume that the power actually dissipated during the temperature measurement is 110 w. Then:

$$\theta = (80^{\circ}C - 45^{\circ}C) / 110 W = 0.318^{\circ}C/W$$

Therefore, at full rated power of 133.4 w, the true case temperature would be:

$$\begin{aligned} T_{case} &= (P \times \theta) + T_{ambient} \\ &= (133.4 W \times 0.318^{\circ}C/W) + 45^{\circ}C \\ &= 88^{\circ}C \end{aligned}$$

or 3°C above the maximum rated case temperature at full power dissipation.

To avoid this pitfall, the designer should make sure

that the device is dissipating the maximum power during the temperature measurement. To do this, a direct current is applied to the device, and the junction dissipation is adjusted by controlling the volt-ampere product.

An alternative method is to obtain a limit cell from the device manufacturer. This device, selected for worst-case power dissipation, is suited for thermal evaluation because, under actual circuit-operating conditions, its power dissipation provides a worst-case power-dissipation value.

Another factor can inhibit accurate temperature evaluation. As shown in Fig. 6, a local interface distortion can create a path of high thermal resistance directly under the thermocouple, thereby generating a false reading. If the maximum rated power dissipation and the ambient are the same as in the previous example, but the measured case temperature is 105°C, it does not necessarily mean that the heat sink is defective. It may be the local interface distortion.

To avoid this possible error, it is a prudent technique to use two or three thermocouples and to mate the semiconductor device carefully to the heat-exchanging surface to assure a uniform interface having low thermal resistance. □

**DEC,
EAT YOUR
HEART
OUT.**

For the past few months, DEC has been the biggest name in real-time and disk-based standard operating systems.

But the picnic's over.

Now we've got two new standard hardware/software systems. And both of them have price/performance stories that can beat the socks off DEC's corresponding models.

SAVE \$20,000 ON OUR NEW DBOS.

DEC's disk-based systems will run you about \$60,000.

Our DBOS-II is only \$39,500 and it's superior to any disk-based system on the market.

If we haven't got your attention yet, maybe we should mention that our DBOS-II lets you do more computation with less memory in far less time.

You get faster program generation because we give you both scientific and commercial languages.

While other systems are confined to either interactive or batch operation, DBOS-II offers a combination of both. Plus a comprehensive file management system, text editors, interactive debug routines, mathematical functions and commercial libraries. That explains our faster program implementation.

As for program execution, we do it faster because the heart of our system is the SPC-16/65 minicomputer which has the most powerful instruction set available and therefore requires less memory.

AND UP TO \$40,000 ON OUR NEW RTOS.

If you want to combine your program generation and computation with control of real-time tasks, DEC's RSX-11D will set you back more than \$80,000.

Our new RTOS-II will do the job for \$46,950. And if you don't need a line printer and card reader, we can start you out at \$29,950.

RTOS-II has all the advantages of DBOS-II in background, with a very responsive foreground for handling events that occur in real time.

And compared to DEC's RSX-11D, we pack more power and features in far less memory.

You can tailor our system to fit your application starting with as little as 16K memory, expandable to 128K.

NOW IT CAN BE TOLD.

Some manufacturers go to incredible lengths to protect their juicy trade secrets.

We publish ours.

The reasons we can give you price/performance advantages are all spelled out in "The Value of Power." For a free copy, or for more information on RTOS-II or DBOS-II, write General Automation, 1055 South East Street, Anaheim, Calif. 92805. If you're in a hurry, call (714) 778-4800.

GENERAL AUTOMATION

Temperature limiting boosts regulator output current

by Mahendra J. Shah
University of Wisconsin, Space Science & Engineering Center, Madison, Wis.

The efficiency of a precision monolithic voltage regulator can be significantly improved by limiting the junction temperature of the regulator's internal current-limiting transistor.

Conventional current limiting severely restricts the regulator's peak and average output current capability. As an example, consider the 723-type regulator, which can supply an output voltage of 7 to 37 volts. This device has a maximum storage (junction) temperature of 150°, a maximum input/output voltage differential of 40 v, and a maximum load current of 150 milliamperes.

When the regulator's metal-can package is used without a heat sink, its internal power dissipation should be limited to 800 milliwatts at an ambient temperature of 25°C. If the input voltage to the regulator is 40 v, con-

ventional current limiting places the worst-case current limit at 20 mA, or 800 mW/40 v. (The worst-case condition is an output short circuit to ground.) And a fold-back-current-limiting approach requires a limit knee setting of 24.2 mA, or 800 mW/(40 - 7) v.

Both of these approaches significantly limit the regulator's output current capability when the regulator must supply a load continuously at both intermediate and high output voltage levels, or when it must supply peak currents at any output voltage level. In contrast, temperature limiting protects the regulator from burn-out, while allowing it to provide the maximum possible output current (both continuous and pulsed), regardless of output voltage level, ambient temperature, and the amount of heat sinking.

Conveniently, the regulator's own current-limiting transistor, Q_L , can be used to implement this temperature limiting. The transistor's base-emitter junction, which has a temperature sensitivity of -1.8 millivolts/°C, can act as a temperature sensor for the regulator. And the collector terminal of transistor Q_L can be connected to limit the regulator's output current.

A stable voltage source is needed to bias Q_L 's base-emitter junction at the threshold voltage (V_{th}) that cor-

Better short-circuit protection. Current-limiting transistor Q_L of monolithic voltage regulator acts as an on-chip thermostat, controlling its own base-emitter junction temperature and, therefore, limiting regulator output current. The threshold bias voltage (V_b) of Q_L 's base-emitter junction is set to limit this junction's temperature to a value determined by Q_L 's sense voltage (V_{sense}).

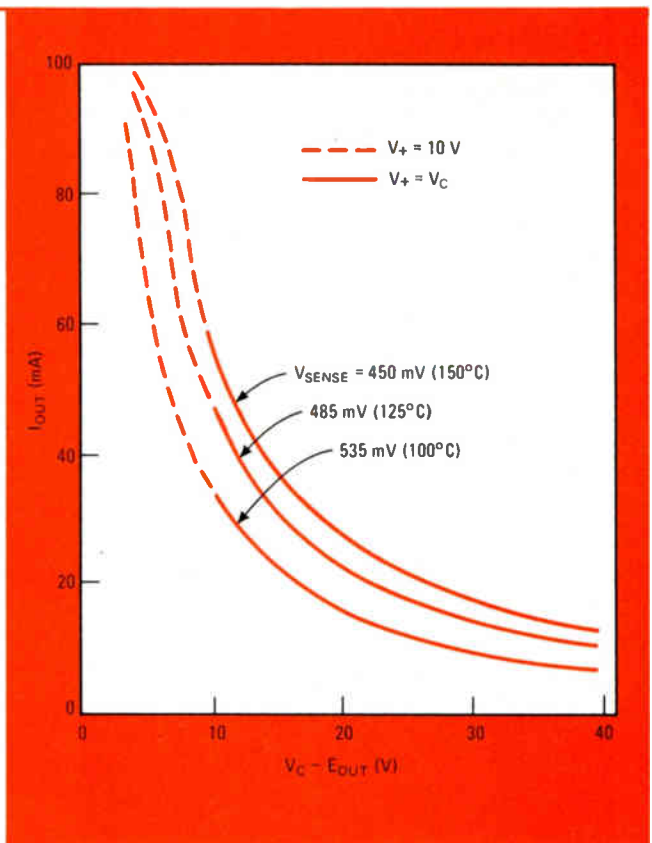
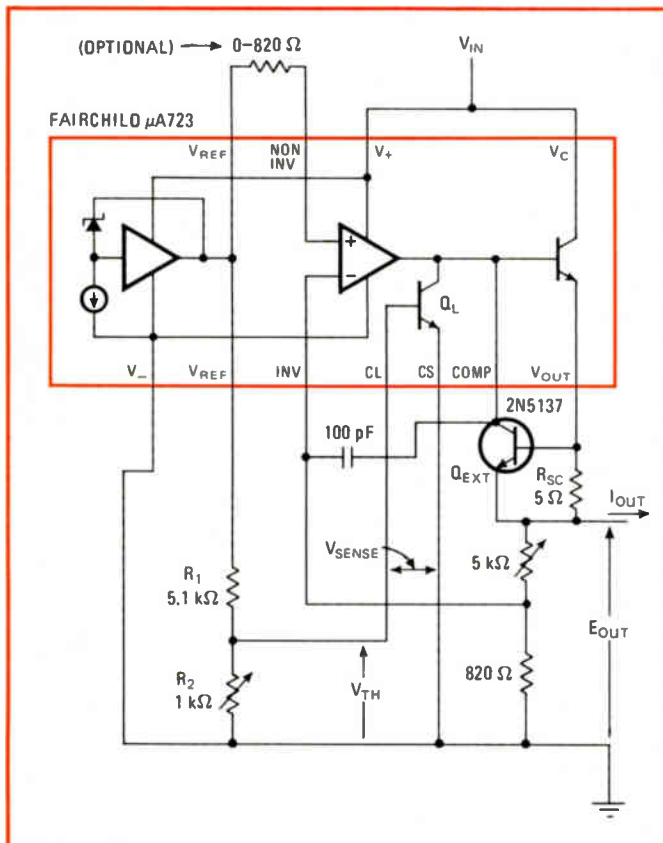

responds to Q_L 's sense voltage (V_{sense}) for a given junction temperature. V_{sense} is the voltage required across Q_L 's base-emitter junction to implement output current limiting. Values for sense voltage, limit current, and junction temperature can be obtained from the data-sheet plot of the regulator's current-limiting characteristics as a function of junction temperature.

The threshold bias voltage is easily obtained from the regulator's internal voltage reference source and the voltage divider formed by resistors R_1 and R_2 . Some other regulators, like Motorola's MC1460, MC1560, MC1461, MC1561, MC1463, MC1563, MC1469, and MC1569, have a provision for junction-temperature limiting, but they require an external regulated voltage source.

When the actual junction temperature of transistor

Q_L is lower than the junction-temperature limit, Q_L 's base-emitter voltage is higher than the threshold bias voltage, so that Q_L is off. But when Q_L 's actual junction temperature rises to the junction-temperature limit, Q_L 's base-emitter voltage drops slightly below the threshold bias voltage, and Q_L turns on, limiting its maximum junction temperature by first limiting the regulator's output current.

The external current-limiting transistor, Q_{XT} and its associated resistor, R_{SC} , are needed to limit regulator output current below the 150-mA secondary breakdown limit of the regulator's internal output transistors. (The optional resistor can be included to minimize output voltage drift.) The graph shows the regulator's output current capability over the full range of input/output differential voltage for three sense-voltage settings. □

All-digital phase shifter handles 5-to-1 bandwidth

by Aleardo Salina
Siai Marchetti, Vergiate, Italy

A digitally programable phase-shift network can be made to maintain the phase shift at its output constant, even though the frequency at its input varies by as much as a factor of five. The circuit consists mainly of digital ICs, including its input-detector stage.

The desired phase shift is switch-selectable through a three-stage counter/decoder network. Any phase shift between 0° and 360° can be chosen. Here, the angle selected is divided into 1,000 bits, but a finer resolution can be obtained by increasing the number of decade counters.

For the component values indicated, the circuit's phase angle stays locked for input frequencies from 2 to 10 kilohertz. This operating frequency range can be shifted by changing the values of the low-pass filter components and the value of the timing capacitor for the voltage-controlled multivibrator.

The circuit also produces an output whose duty cycle remains constant. □

Locking phase digitally. Circuit produces the phase shift (between 0° and 360°) selected by the three switches. This digitally programmed phase angle does not change, although the input-signal frequency may vary from 2 to 10 kilohertz. The circuit's operating frequency can be changed by adjusting the low-pass filter and the timing of the voltage-controlled multivibrator. There is also a constant-duty-cycle output.

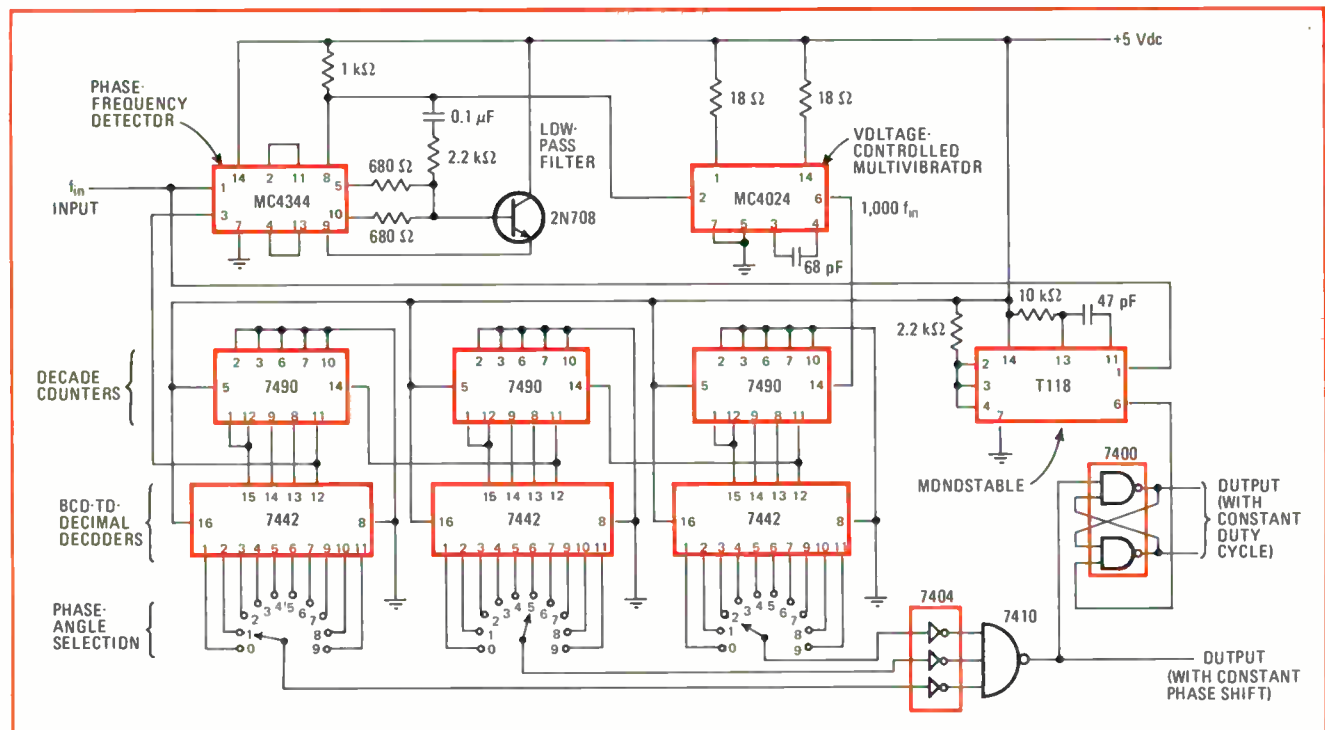

Voltage discriminator has 0.1-mV resolution

by Ryszard Bayer
Institute of Nuclear Research, Swierk, Poland

Positive feedback permits a dual IC comparator to perform as a high-resolution voltage discriminator that can detect either positive or negative pulses having amplitudes ranging from a few millivolts to 5 volts. When driven from such low-impedance sources as operational amplifiers, this discriminator has a linearity of better than 0.03% and a voltage resolution of about 0.1 millivolt.

The input signal is compared with the reference voltage by comparator A₁. The signal appearing at the moment of comparison of these two voltages is taken from the common output of both comparators and fed back

to the noninverting input of comparator A.

Because of this positive-feedback path, the discriminated signal is amplified considerably, reducing the amplifier's offset voltage and improving voltage resolution. Since the feedback signal is introduced to the noninverting input of comparator A', both inputs of comparator A₁ can be driven from low-impedance sources for better discriminator accuracy.

With capacitive feedback, as in circuit (a), the discriminator has only one stable state. With dc feedback, as in circuit (b), the discriminator becomes bistable. At the moment the input and reference signals are compared, the bistable discriminator is set to its high level. It can be reset by applying a second pulse to the inverting input of comparator A₂. This second pulse can be applied after the first pulse has been terminated for a time that exceeds the duration of the first pulse minus the discrimination-level threshold. □

Designer's casebook is a regular feature in Electronics. We invite readers to submit original and unpublished circuit ideas and solutions to design problems. Explain briefly but thoroughly the circuit's operating principle and purpose. We'll pay \$50 for each item published.

Discriminating comparators. Integrated dual comparators can differentiate between input-signal height and the reference-voltage level to within 0.1 millivolt. This high resolution is due to the positive feedback from the output to the noninverting input of comparator A₂. Capacitive feedback (a) produces a unistable discriminator, while dc feedback (b) produces a bistable one that can be reset with a second input pulse.

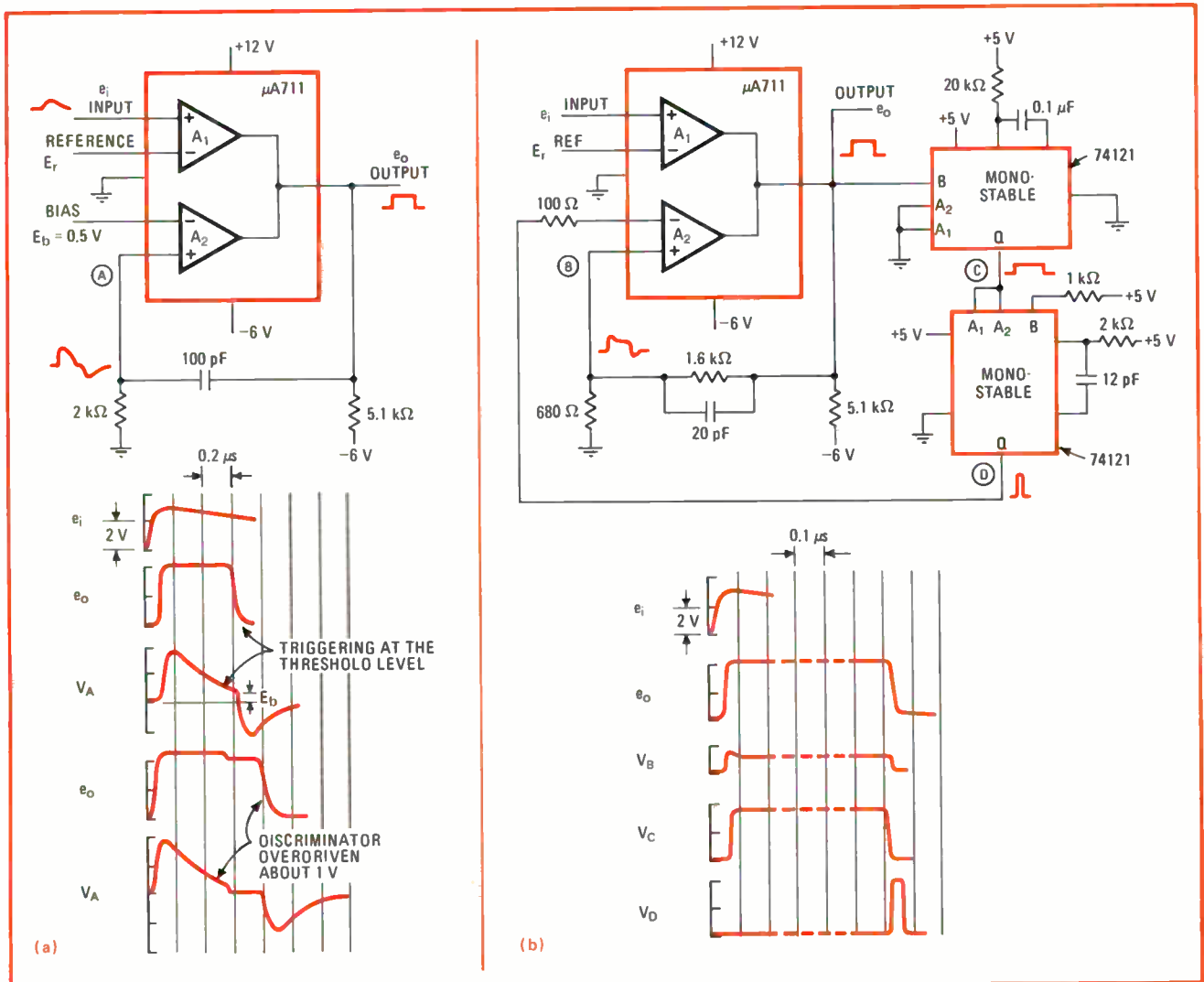

150 Microwatt Triple Op Amp

The L144 monolithic triple op amp draws only $50\mu\text{A}$ of current per amplifier, from a $\pm 1.5\text{ V}$ supply. What's more, it is

AVAILABLE NOW FROM YOUR LOCAL DISTRIBUTOR!

L144 features include:

- Monolithic triple op amp in DIP or Flatpac packages
- Wide power supply range— $\pm 1.5\text{ V}$ to $\pm 15\text{ V}$
- Internal compensation
- Programmable power dissipation
- Programmable input bias current
- Single programming resistor
- 80 dB gain with $20\text{ K}\Omega$ load
- Cost effective: \$1.63 per single op amp⁽¹⁾

⁽¹⁾L144CJ 100-piece price

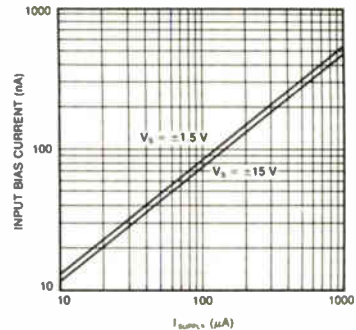

Applications examples:

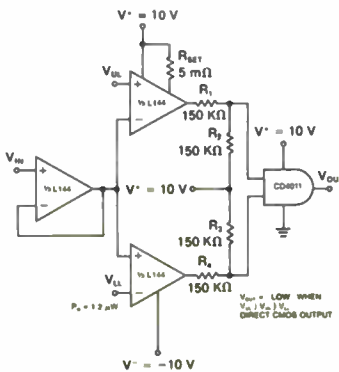

DOUBLE-ENDED LIMIT COMPARATOR

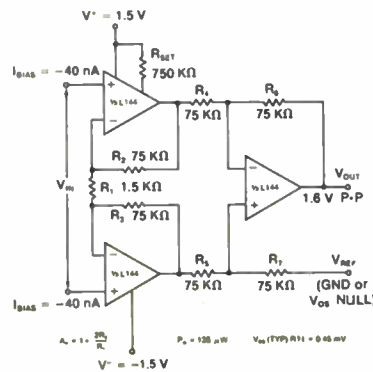

INSTRUMENTATION AMPLIFIER

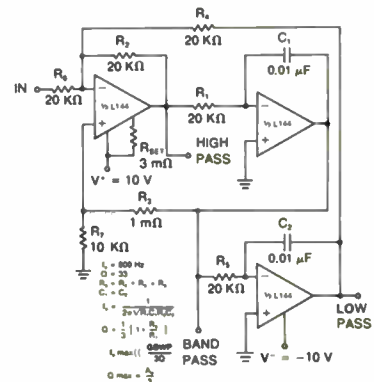

ACTIVE FILTER

The L144 is a practical industry-standard operational amplifier for use when low current drain, low voltage, low power, or very small physical size are controlling criteria. If your circuit requirements are unique—and whose aren't—our applications people are eager to help.

For complete information

write for data

IC Applications: (408) 246 8000, Ext. 120



Siliconix incorporated

2201 Laurelwood Road, Santa Clara, California 95054

Norton quad amplifier subtracts from costs, adds to design options

Consisting of four identical linear circuits on one chip, the Norton quad amplifier operates off a single power supply; biasing is simplified, and so too is the design of several waveform-generating circuits

by Thomas M. Frederiksen, National Semiconductor Corp., Santa Clara, Calif.

□ Pressured by the demands of the automobile industry, consumer electronics manufacturers, and other mass-production customers into finding new ways of producing ever cheaper components, semiconductor makers have developed a new family of linear integrated circuits. These linear ICs each contain, in a single package, four identical but independent devices—four comparators, or four conventional inverting-type operational amplifiers, or four of the rather less conventional, so-called Norton amplifiers.

All three types are available from a growing number of manufacturers. Not only do the quads each cost far less than four devices bought separately, but industrial and communications equipment designers are also attracted by their promise of reducing system cost while maintaining high levels of component operation.

The fact is that many linear circuit functions do require more than one of a similar type of comparator or amplifier. Comparators are often used in pairs, in limiting comparator circuits and crystal-controlled oscillators, for instance, while a two-decade high-frequency voltage-controlled oscillator needs three. Similarly, a simple by-pass filter requires two op amps, a phase-locked loop needs three, and a sinewave oscillator or sawtooth generator needs four.

But even if only one component of the quad is required in a given circuit, the others can be used for dozens of auxiliary circuit purposes. Examples are biasing or gain-control networks or simple gain blocks.

Most important, the new Norton quads need only a single-ended power-supply voltage and operate well over a wide range of power-supply voltages, from 3 volts dc to 32 v dc. Moreover, a typical quad Norton amplifier draws a constant low supply current of 1.3 milliamperes, and both the comparator and the operational amplifier draw a constant 0.2-mA supply current per circuit function.

The Norton quad amplifier

The most radical of all the three quad designs is the Norton amplifier, the LM3900. To obtain noninverting input signals, op-amp designs use a standard transistor differential amplifier—a fairly elaborate circuit that unfortunately requires two (a positive and a negative) supply voltages. In the Norton amplifier, this requirement was eliminated by putting the simplest type of inverting amplifier (that is, a common-emitter stage) at the input

(Fig. 1) and then adding a “current mirror” circuit across the inverting input terminal to provide a noninverting input.

Just about all the positive input current is forced into becoming collector current in the diode-connected input transistor, Q_8 . At this level of conduction, an “on” biasing voltage (V_{BE}) results across the base-emitter junction of the transistor. The same biasing voltage is applied to a second matched transistor, Q_6 , which therefore conducts the same amount of current as in Q_8 . Consequently, the current from the output of this stage equals the input current, I_{in} , which has thus been “mirrored” or reflected about ground.

In this scheme all of the voltage gain in the basic amplifier is provided by the gain transistor, Q_5 , and the output emitter-follower transistor, Q_3 , serves simply to isolate the load impedance from the high impedance that exists at the collector of Q_5 . Closed-loop stability is guaranteed by an on-chip 3-picofarad capacitor, C , which provides the single dominant open-loop pole.

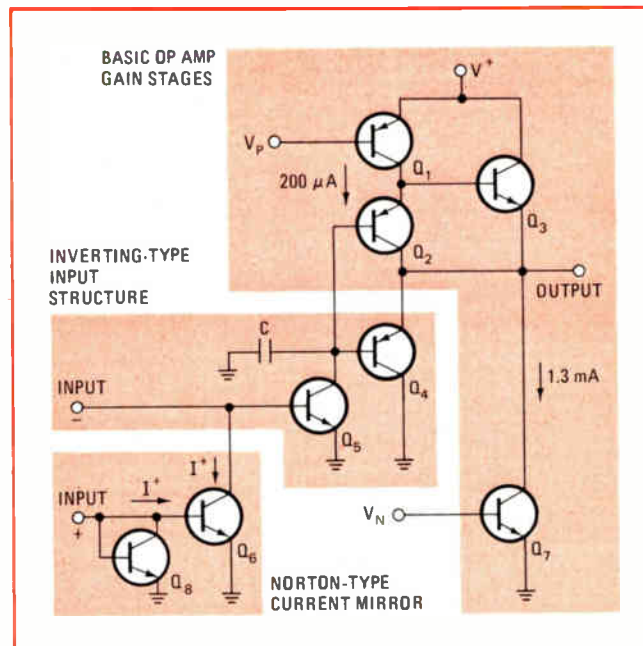

1. **Inverted inversion.** In the Norton amplifier, a current-mirroring circuit has been added to a conventional inverting-type input structure so that a noninverting input signal can be achieved from a single +5-V power supply. Such an input usually requires two supplies.

The output emitter-follower is biased for class A operation by the current source, Q_7 .

In the design of the LM3900, two pnp transistor stages have been added. The lateral pnp, Q_2 , reduces the input current and provides additional load isolation. The vertical pnp, Q_4 , converts the class A output stage to a class B stage for large signal cases. This allows the amplifier to sink larger load currents than the 1.3-mA pull-down current source would provide.

Big gain

It should be pointed out that the Norton amplifier, by making use of current source loads, achieves a large voltage gain which is constant over a wide range of power-supply voltages. The output voltage has a large dynamic voltage range—essentially from ground to the power supply voltage minus V_{BE} . Power-supply current drain is almost independent of the power-supply voltage, and ripple on the supply line is also rejected. Furthermore, a very small input biasing current allows high-impedance feedback elements to be used.

Besides simplifying the circuit configuration, the use of only a single power supply results in many biasing advantages. Since the bias currents are all derived from diode forward-voltage drops, a bias current changes only slightly in magnitude as the power-supply voltage is varied. The open-loop gain also changes only slightly over the complete power-supply voltage range and is essentially independent of temperature changes.

The open-loop frequency response of the LM3900 is compared with the 741 op amp in Fig. 2. The higher unity gain crossover frequency is seen to provide an additional 10 decibels of gain for all frequencies greater than 1 kilohertz. Also, because currents can be passed between the input terminals, designers can apply this amplifier to jobs that generally are hard for standard op amp configurations to do, like function generators and some phase-locked-loop circuits. Moreover, if external large-valued input resistors are used to convert from in-

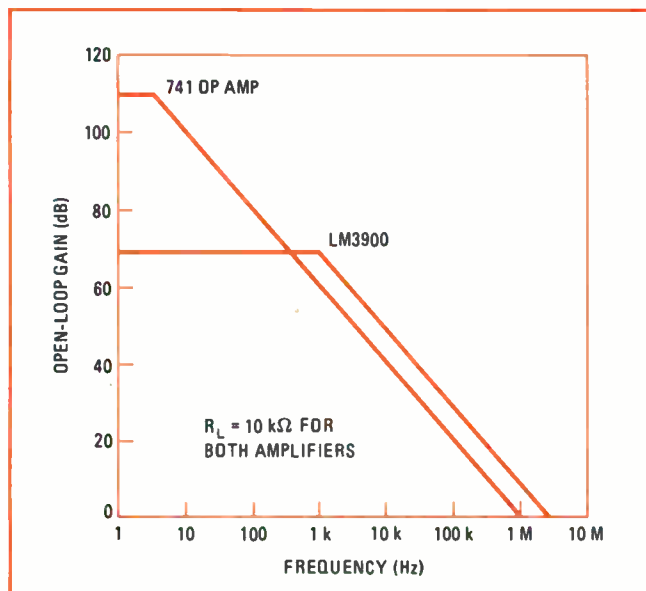

2. **Greater gain.** The open-loop gain characteristics of the LM3900, when compared with those of a conventional 741, reveal its advantage at higher frequencies—an extra 10 dB of gain above 10 kHz.

Another quad for comparison

Versatility is also a feature of another member of the quad family—the quad comparator, National's version of which is designated the LM339. The basic circuit, of which there are four per chip, shows high gain and low input current. It comprises a Darlington pnp single-supply differential-input stage, a current source as the load for the second stages, and a grounded-emitter npn output transistor (see figure). Flexibility is achieved by leaving the collector of this output transistor, Q_8 , uncommitted. As a result, the voltage to which the external load is returned is independent of the magnitude of the power-supply voltage, and the outputs of more than one comparator can be connected to a common load to provide an output OR-ing function.

The total biasing current for this comparator is only 200 microamperes, yet it achieves a transconductance of 5 mhos (the output will fully switch 1 milliampere of current for a change in the differential input voltage of 0.2 millivolt). The input currents and offset voltage are 35 nanoamperes and 3 mV respectively. Because of their simplicity, four of these comparators are easily fabricated on one die.

These comparators are also unique in that, even though they are operated from a single positive power-supply voltage, the input common-mode voltage range includes ground. Operation is possible over a wide single-supply voltage range (2 to 36 V dc) or from dual supplies (± 1 to ± 18 V dc), adding to the design's flexibility. Moreover, the supply current drain of 800 microamperes is essentially independent of the magnitude of the power supply voltage, which with a +5-V dc digital supply amounts to 1 milliwatt per comparator.

Large differential input voltages can be accommodated, and a special design for the output transistor provides an offset voltage of 1 mV. This last feature is important when the output of the comparator is used, for example, as a single-pole, single-throw switch to ground in an RC sweep circuit to precisely discharge a capacitor.

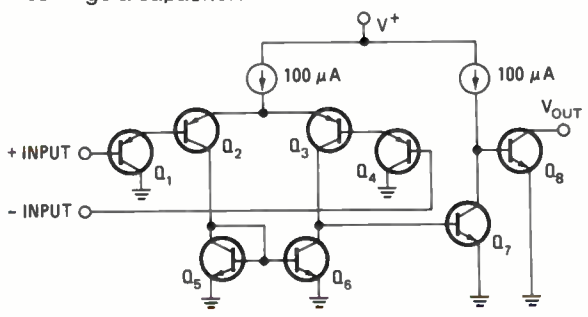

put voltages to input currents, most of the standard op-amp applications can be realized as well.

The LM 3900 Norton amplifier can be biased in several different ways. The circuit in Fig. 3a, a standard inverting ac amplifier, has been biased from the power supply that is also used to operate the amplifier. Note that if ac ripple voltages are present on the V_{ϕ} power-supply line, they will couple to the output with a gain of $\frac{1}{2}$. To eliminate this, a single source of ripple-filtered voltage can be provided for many amplifiers.

Figure 3b shows both a noninverting ac amplifier and

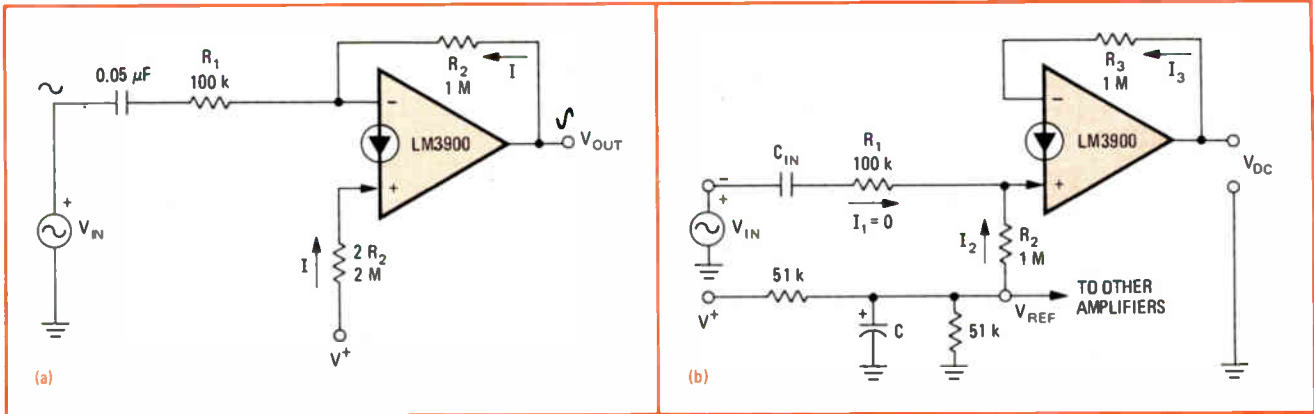

3. Straightforward biasing. One way of biasing the LM3900 takes a standard inverting ac amplifier and biases it from the supply that also powers it (a). In the dc biasing method, (b), the amplifier gain is set by the ratio of feedback resistor to input resistor.

a second method for dc biasing. The ac gain of the amplifier is set by the ratio of feedback resistor to input resistor. The small-signal impedance of the diode at the noninverting (+) input should be added to the value of R_1 when calculating gain.

By making $R_2 = R_3$, the dc voltage output will be equal to the reference voltage that is applied to resistor R_2 . This filtered ($V_{\theta}/2$) reference voltage can easily be used for other amplifiers.

Another interesting feature of this setup is that the input resistor, R_1 , is isolated from the inverting (-) input terminal by the output impedance of the transistor of the current mirror. The amplifier is therefore not operating in an input-voltage to output-voltage feedback mode but, instead, along with the feedback resistor, R_3 forms a feedback-stabilized transimpedance amplifier with a gain equal to R_3 . As R_1 is isolated from the (-) input, this represents essentially unity voltage feedback, and the resulting bandwidth is the unity gain crossover frequency (2.5 MHz) of the basic amplifier. Consequently, the value of input resistor R_1 can be made small and, by thus increasing the voltage gain without affecting the feedback factor of the basic transimpedance amplifier, can help provide large gain at high frequency.

A gain of over 100 (40 dB) is possible at 1 MHz—and the high frequency limit is now set by the slew rate of the amplifier. This is useful for many applications where gain at signal frequencies above the standard op amp limits is required.

The same effect, incidentally, could be obtained by adding a current mirror to the 741 operational amplifier. But this mirror circuit would have to be made with closely matched discrete transistors, something that is done on the chip with the LM3900.

Adding dc gain control

A dc gain control can be added to the noninverting Norton amplifier as shown in Fig. 4. A minimum biasing current passed through R_3 prevents the output of the amplifier from going into saturation as this dc gain control is varied. For maximum gain, the control rectifier D_2 is off, so that the current through R_2 as well as R_3 can enter the (+) input and cause the output of the amplifier to be biased at approximately 6.0 v (with a 10-v supply). For minimum gain, D_2 is on, and only the

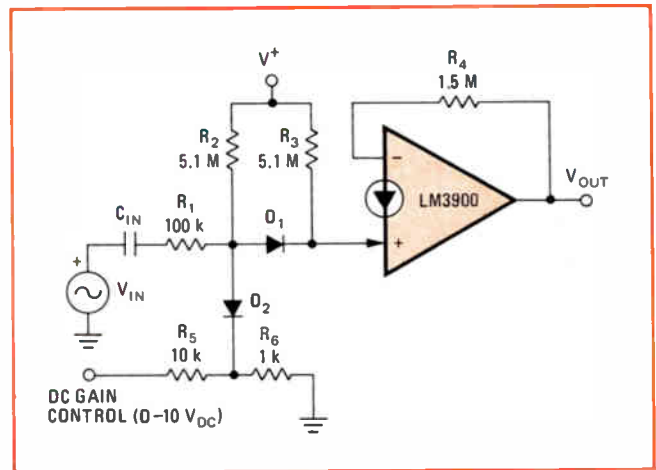

4. In control. In this simple dc gain control circuit, input voltages range from 0 V dc for maximum gain, to less than 10 V dc for minimum gain. A biasing current through R_3 prevents saturation.

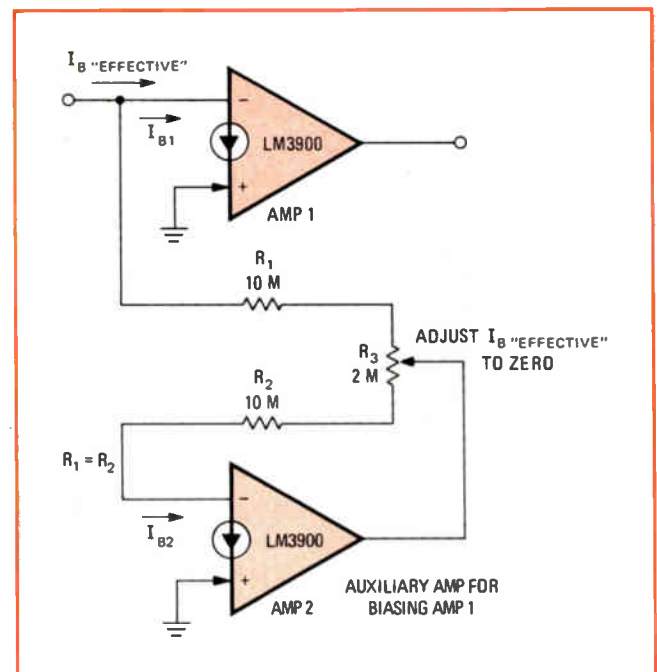

5. Useful symmetry. Four independent amplifiers available in each LM3900 package make it easy to exploit the symmetry that exists between the individual devices. Here, one amplifier is biasing another.

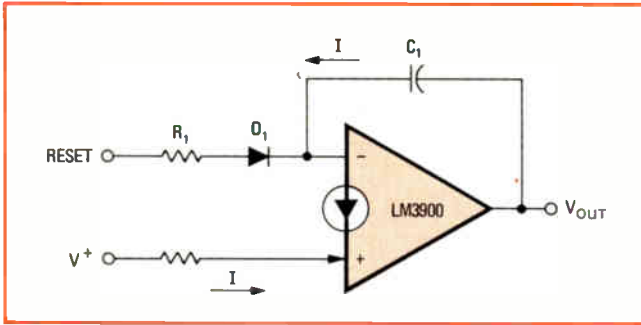

6. To and fro. In the basic Norton quad sweep circuit, current entering the noninverting (+) input causes the output to sweep linearly in a positive direction. Conversely, current entering the inverting (-) input causes the output to sweep linearly but negatively.

current through R_3 can enter the (+) input to bias the output at approximately +3.0 v. The proper output bias for large output signal accommodation is provided for the maximum gain situation. The dc gain control input ranges from 0 v dc for maximum gain, to less than 10 v dc for minimum gain.

Symmetrical amplifier designs

From these multiple amplifier packages, it is now possible to produce symmetrical designs. Historically, resistors have been the most predictable electronic components, and they gave rise to feedback amplifiers in which closed-loop amplifier performance depended only on resistors. Following this, two matched transistors were placed in a single can to make improved input stages for discrete op amps. Later still, integrated circuits derived performance advantages from their inherent resistor and transistor matching. And now multiple amplifiers in a single monolithic quad package allow designers to exploit the symmetry existing between the individual amplifiers.

The example of symmetry shown in Fig. 5 has one amplifier biasing one or more additional amplifiers. So long as the dc biasing current, I_B , is accurately supplied via R_1 , the input terminal of amplifier 1 needs supply only enough current for the amplifier signal. The adjustment, R_3 , allows a zeroing of I_B which is useful in such circuit functions as sample-and-hold, where small values of I_B are desirable. Otherwise, if R_3 were omitted, simply letting $R_1 = R_2$, and relying on amplifier symmetry could cause the effective I_B to be less than $I_B/10$ (3 nanoamperes).

Clean sweeps

Many waveform-generating circuits can be realized with the Norton quads. The basic sweep circuit is shown in the integrator circuit of Fig. 6. Current entering the noninverting (+) input causes the output voltage to sweep linearly in a positive direction, and current entering the inverting (-) input causes the output to sweep negatively. The diode isolates the inverting input when the input voltage is zero. Either input can be used as a reset control, and the faster negative-going slew rate of the LM3900 generates excellent positive-going sawtooth waveforms with a very short reset time.

A sine-wave oscillator built round the LM3900 is shown in Fig. 7. The two-amplifier RC active filter requires only two capacitors to provide the proper over-all noninverting phase characteristic. If a noninverting gain-controlled amplifier is then added around the filter, the desired oscillator configuration is obtained. Finally, the sine-wave output voltage is sensed and regulated by a differential averaging circuit, so that its average value is compared to a dc reference voltage, V_{REF} .

The averaging circuit also provides a simple way to keep the peak magnitude of the output sine wave equal to twice the value of V_{REF} . This is essentially indepen-

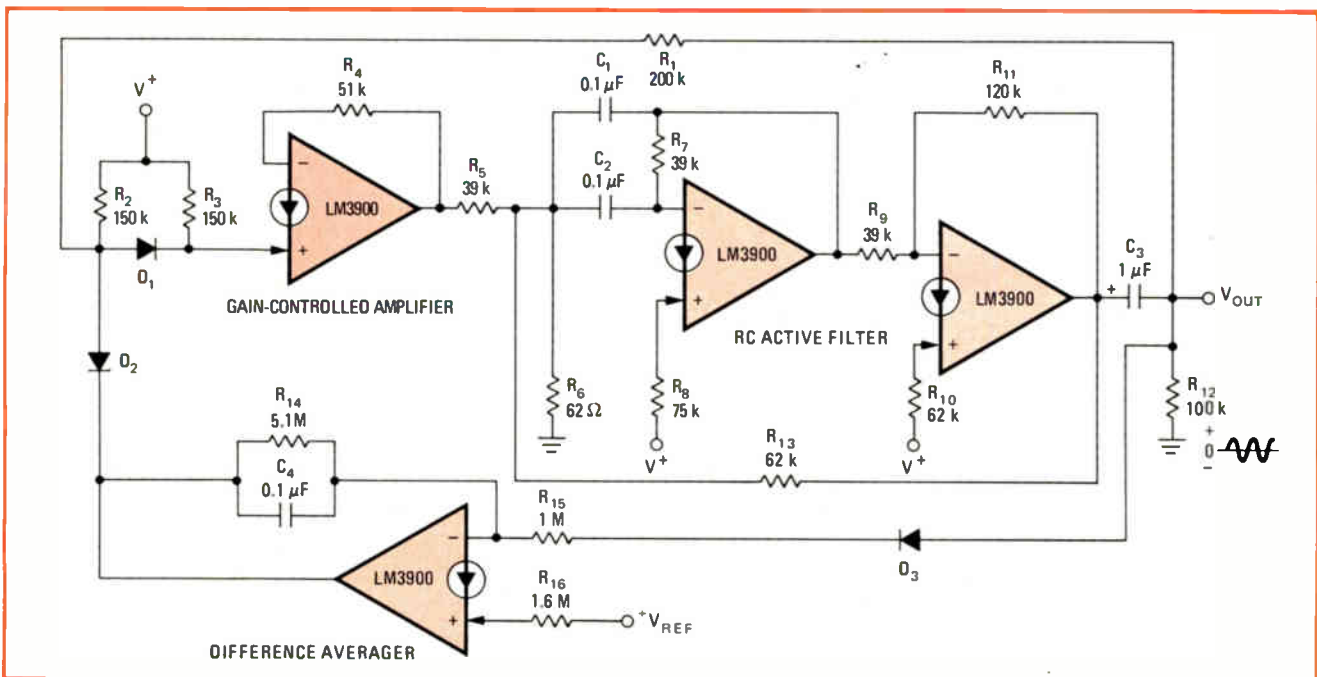

7. Sine-wave oscillator. Four Norton amplifiers can easily be interconnected to make a sine-wave oscillator. A two-amplifier RC filter and a noninverting gain-controlled amplifier are added to a differential averaging circuit for regulation.

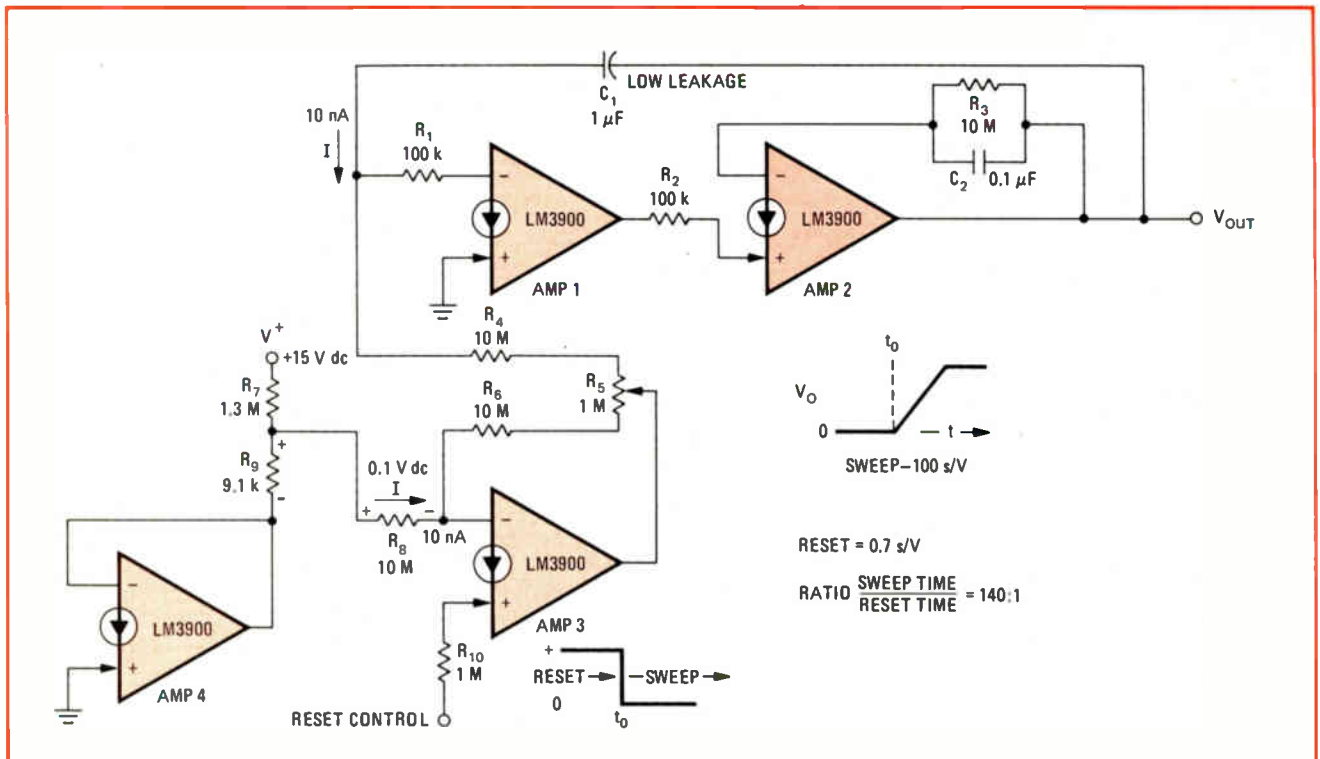

8. Slow sawtooths, too. The four amplifiers of the Norton quad work together to generate very slow sawtooth waveforms. To guarantee the required high impedance, the printed-circuit boards used with the packages should be coated with silicon to minimize surface leakage.

dent of both temperature and the magnitude of the power-supply voltage, provided V_{REF} is derived from a stable voltage source.

The LM3900 can also be used to generate a very slow sawtooth waveform, which can in turn be used to generate long time-delay intervals. This is one of the toughest circuit functions to obtain in IC form. The circuit shown in Fig. 8 uses four amplifiers. Amplifiers 1 and 2, which have the desired very slow sawtooth waveform output, are cascaded to increase the gain of the integrator, while amplifier 3 supplies the bias current to amplifier 1. Amplifier 4 provides a bias reference equal to the dc voltage at the (-) input of amplifier 3.

With resistor R_8 opened up and the reset control at zero volts, the potentiometer, R_5 is adjusted to minimize the drift in the output voltage of amplifier 2 (this output must be kept in the linear range to insure that amplifier 2 is not in saturation). The resistor divider, R_7 and R_9 , provides a 0.1-v dc reference voltage across R_9 that also appears across R_8 . The current that flows through R_8 enters the (-) input of amplifier 3 and causes the current through R_6 to drop by this amount. This causes an imbalance because now the current flow through R_4 is no longer adequate to supply the input current of amplifier 1. The net result is that this same current is drawn from capacitor C_1 and causes the output voltage of amplifier 2 to sweep slowly positive.

To guarantee obtaining the high impedance values needed for the slow sweeps, the printed-circuit board used must be cleaned and then coated with silicone rubber to eliminate the occurrence of leakage currents across the surface. Also, the dc leakage currents of the capacitor C_1 must be kept small compared to the 10-nA charging current. For example, an insulation resistance

of 100,000 megohms will leak 0.1 nA with 10 v dc across the capacitor—a leakage that increases rapidly at higher temperatures.

With the basic circuits, other sweep rates can be obtained by scaling resistor R_8 and capacitor C_1 . For the values shown in Fig. 9, the 10-nA current and the 1-microfarad capacitor establish a sweep rate of 100 seconds per volt. The reset control pulse at amplifier 3's (+) input causes that amplifier to go into positive output saturation, while the 10 megohms of R_4 provides a reset rate of 0.7 s/v.

The resistor, R_1 , prevents C_1 from discharging larger currents and thus from overdriving the (-) input and overloading the input clamp device. For larger charging currents, a resistor divider can be placed from the output of amplifier 4 to ground, and R_8 can tie from this tap point directly to the (-) input of amplifier 1.

Digital and switching circuits

A unique feature of the new Norton quad amplifiers is that they can be overdriven to provide a large number of low-speed digital and switching circuit applications. This is particularly attractive for control systems that operate from single power-supply voltages larger than the standard +5-v dc digital limit. The large voltage swing and slower speeds of the LM3900 are advantages for most industrial control systems. In this context each amplifier can be thought of as a super transistor with a β of 1,000,000 (25-nA input current and 25-mA output current) and with a noninverting input feature. In addition, the active pullups and pulldowns which exist at the output will supply larger currents than the simple resistor pullups used in digital logic gates. □

Part 1: TTL NAND gates

Computer models can be generated for accurate simulation of digital integrated circuits; the ICs are treated as simple individual devices, rather than as a complex collection of transistors and diodes

by John R. Greenbaum, *General Electric Co., Syracuse, N.Y.*

□ Acceptable computer models for use in analyzing individual transistors and diodes have been available for some time. But—until now—more complex device models, such as those needed for digital integrated circuits, simply did not exist.

Wastefully, models for digital ICs usually have followed the same procedures as those for individual transistors. In this extravagant method, each semiconductor junction must be described to the computer in detail. For example, modeling a common type-D flip-flop requires identification of 54 transistor junctions and four diode junctions, which involves nearly 200 complex relationships.

With this cumbersome classical method of device modeling, generally only one IC function can be analyzed at a time because of the size limitations of the computer, the analysis program, or both. Furthermore, complex analyses are uneconomical because they require excessive computer time.

However, a black-box equivalent of a digital IC can be developed so that a practical computer model can simulate the function of that particular device. This series of articles will present models for five different common digital-IC functions: the NAND gate, the flip-flop, the monostable multivibrator, the AND/OR inverter, and

the shift register. Although different in function, these models are similar to each other, since they are all developed as black-box equivalent circuits, and although they are simple, they are accurate and can readily be made more sophisticated.

Interestingly, model complexity depends more on the quantity and type of external interface requirements than on the internal complexity of the device itself. Every model described in this series has been validated by comparing the response of simulated test circuits with the response of actual test circuits.

Program listings for the models are given here for the Sceptre (System for Circuit Evaluation and Prediction of Transient Radiation Effects) and Circus-2 (Circuit Simulator) analysis programs. But the models can also be used with such other nonlinear computer programs as Astap (Advanced Statistical Analysis Program) and NET-2 (NETWORK analysis program), as well as the French program IMAG-2 (Institut de Mathématique Appliquées de Grenoble).

There are two NAND gate models—one for a two-input device, and the other for a four-input device. Both gates are positive-logic integrated circuits. The two-input device is modeled after the radiation-hardened type-RSN54L00 TTL quad NAND gate, and the four-in-

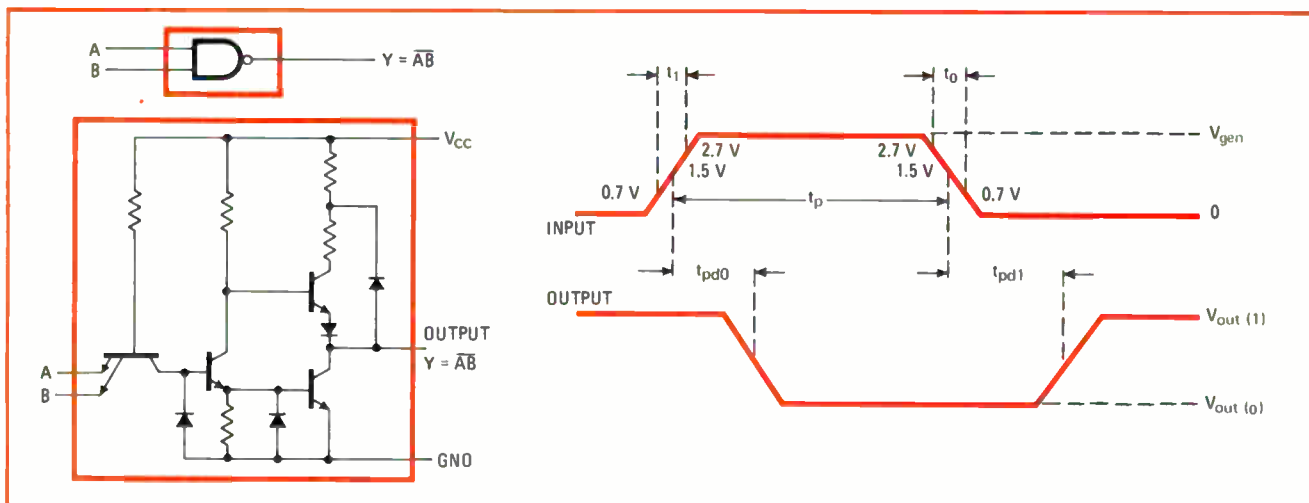

1. Device characterization. Two-input NAND gate can be adequately represented by its output signal levels and its delay characteristics. With this approach, there is no need for the wasteful classical method of modeling every transistor and diode junction.

put device is modeled after the type-9704 TTL NAND gate.

Two-Input NAND-gate model

For the two-input NAND gate, the output is logic 0 when both inputs are logic 1; all other signal conditions produce a logic 1 at the output. Figure 1 shows the NAND-gate circuit and its delay characteristics. To develop a simple computer model, the gate's maximum logic 1 output voltage can be considered to be 3.1 v, its maximum logic 0 output voltage to be 0.3 v, its minimum logic 1 input voltage to be 1.9 v, and its maximum logic 0 input voltage to be 0.8 v. Either propagation delay, t_{pd0} (negative-going or t_{pd1} (positive-going), is a maximum of 60 ns.

The computer model for the two-input NAND gate is

shown in Fig. 2, together with model descriptions written for Sceptre and Circus-2 and the associated model subprograms. These subprograms can be used with either model description. Subprogram FN2 establishes the gate's output-signal-level characteristics (according to the gate's truth table); the other subprogram, FCAP1, determines the gate's delay characteristics.

Unlike Sceptre, which includes the model's topological description and parameter values in one entry, Circus-2 requires two separate entries under the headings MODELS and DEVICES. MODELS defines the topological description, and DEVICES the parameter values.

The gate's signal-input impedances are represented as the zero-valued current sources JA and JB. In Sceptre and Circus-2, this implies that the impedance of input-signal terminals A and B is infinite, a reasonable first-

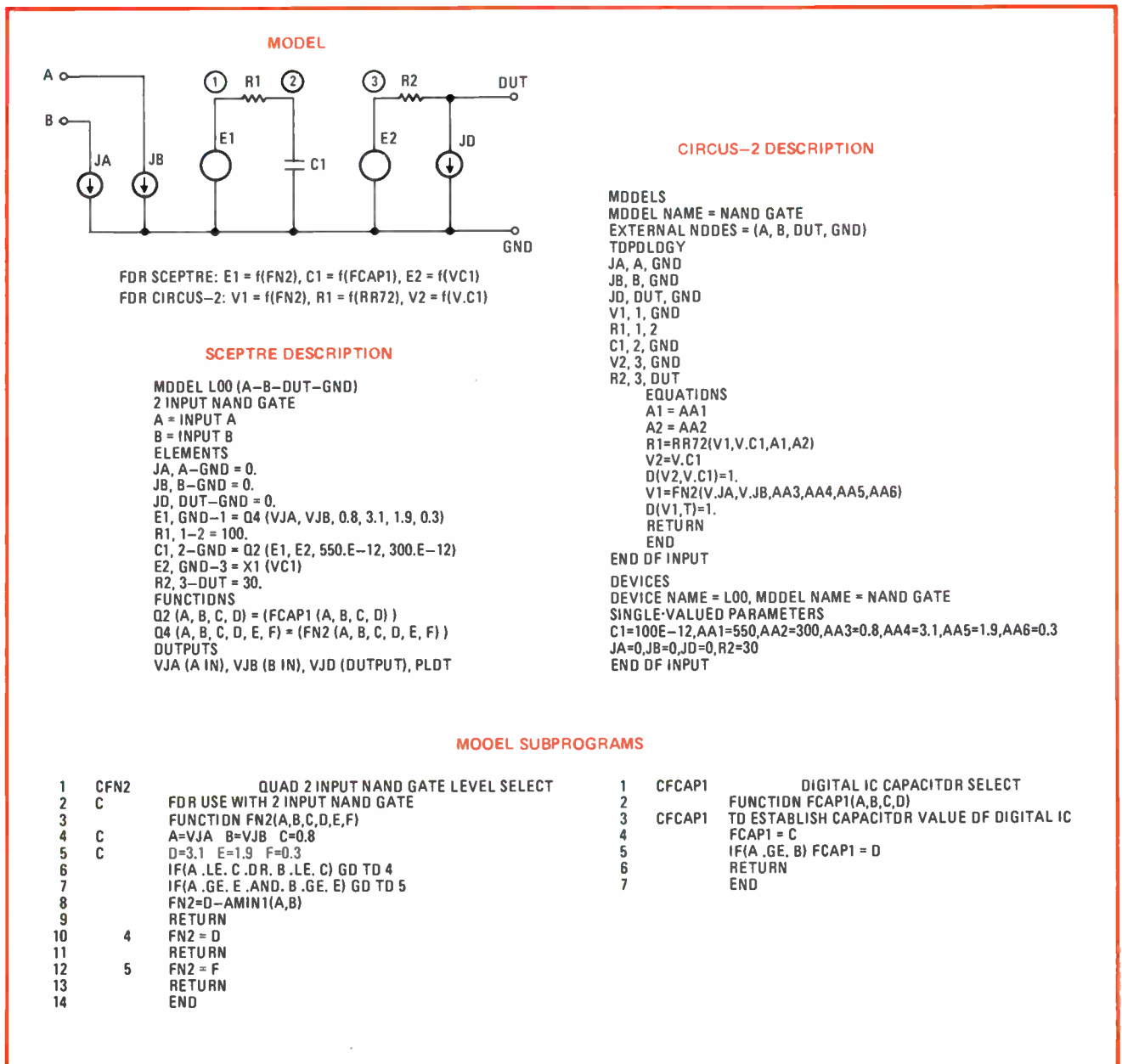

2. Two-Input NAND gate. Computer model is based on typical performance of type-RSN54L00 TTL quad NAND gate. Program listings are given for both Sceptre and Circus-2. The model subprograms, which can be used with either model description, determine the gate's output signal level characteristics (function FN2) and its delay characteristics (function FCAP1).

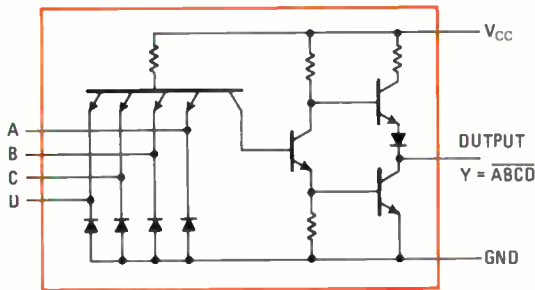

SCEPTRE DESCRIPTION

```

MODEL 9704 (A-B-C-D-OUT-GND)
4 INPUT NAND GATE
A = INPUT A
B = INPUT B
C = INPUT C
D = INPUT D
ELEMENTS
JA, A-GND=0.
JB, B-GND=0.
JC, C-GND=0.
JD, D-GND=0.
E1,GND-1=Q2(VJA,VJB,VJC,VJD,0.8,3.3,2.0,0.4)
R1,1-2=100.
C1,2-GND=Q1(E1,E2,200.E-12,150.E-12)
E2,GND-3=X1(VC1)
R2,3-OUT=25.
J4,DUT-GND=0.
FUNCTIONS
Q1(A,B,C,D)=(FCAP1(A,B,C,D))
Q2(A,B,C,D,E,F,G,H)=(FN4(A,B,C,D,E,F,G,H))
OUTPUTS
VJA,VJB,VJC,VJD
E1,E2,VR2,C1,VC1,PLDT
VJ4,PLDT

```

MODEL

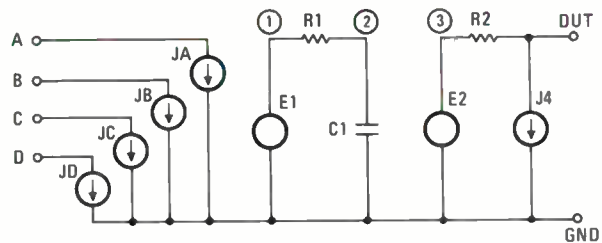

FOR SCEPTRE: E1 = f(FN4), E2 = f(VC1), C1 = f(FCAP1)
 FOR CIRCUS-2: V1 = f(FN4), V2 = f(V.C1), R1 = f(RR72)

CIRCUS-2 DESCRIPTION

```

MODELS
MODEL NAME = 4 NAND GATE
EXTERNAL NODES = (A,B,C,D,OUT,GND)
TOPDLOGY
JA,A,GND
JB,B,GND
JC,C,GND
JD,D,GND
JO,OUT,GND
V1,1,GND
R1,1,2
C1,2,GND
V2,3,GND
R2,3,OUT
EQUATIONS
A1=AA1
A2=AA2
R1=RR72(V1,V.C1,A1,A2)
V2=V.C1
D(V2,V.C1)=1.
V1=FN4(V.JA,V.JB,V.JC,V.JD,AA3,AA4,AA5,AA6)
D(V1,T) = 1.
RETURN
END
END OF INPUT
DEVICES
DEVICE NAME = 9704 MODEL NAME = 4 NAND GATE
SINGLE-VALUED PARAMETERS
C1=100E-12,AA1=200,AA2=150,AA3=0.8,AA4=3.3,AA5=2.0,AA6=0.4
JA=0,JB=0,JC=0,JD=0,JO=0,R2=25
END OF INPUT

```

MODEL SUBPROGRAM

```

1 CFN4 FOR USE WITH 4 INPUT NAND GATE
2 FUNCTION FN4(A,B,C,D,E,F,G,H)
3 FOR USE WITH 4 INPUT NAND GATE
4 C A = VJA B = VJB C = VJC D = VJD
5 C E = 0.8 F = 3.3 G = 2.0 H = 0.4
6 C DATA APPLICABLE TO 9704
7 IF(A.LE.E.OR.B.LE.E.OR.C.LE.E.OR.D.LE.E)GO TO 4
8 IF(A.GE.G.AND.B.GE.G.AND.C.GE.G.AND.D.GE.G)TO TO 5
9 FN4 = F-AMIN1(A,B,C,D)
10 RETURN
11 4 FN4 = F
12 RETURN
13 5 FN4 = H
14 RETURN
15 ENO

```

3. Four-Input NAND gate. This computer model simulates the performance of a type-9704 TTL NAND gate. The subprogram FN4 listed here establishes the gate's output signal logic levels. To adjust the gate's delay, the subprogram FCAP1 in Fig. 2 is used.

order approximation, even though the impedance is measurable and varies with the applied-signal level. For greater accuracy, current sources JA and JB can be modeled in diode-equation format or as tables of functions relating current to applied voltage.

The voltage associated with dependent voltage source E1 is determined by the function FN2, which is set up by the model subprogram by that name. This function establishes the value of voltage E1 to agree with the gate's truth table. If either of the input signals is less

than or equal to 0.8 v, then the value of E1 is set to 3.1 v, which represent logic 1. When both input signals are equal to or greater than 1.9 v, the value of E1 becomes 0.3 v, which represents logic 0. If neither of these conditions exists, as for instance, during an input transition, then E1 is computed to be 3.1 v minus the absolute value of the smaller of the two applied signals.

Although the gate's switching-delay times for both positive-going and negative-going output signals are supposed to be no greater than 60 ns, real devices often

operate with delays that are not only shorter than this worst-case value but that are also different from each other. Delay times for the model, therefore, can be adjusted by varying the value of capacitor C1 to change the model's R1-C1 time constant.

Subprogram FCAP1 determines the value of capacitor C1, setting it equal to 550 picofarads, except when voltage E1 is less than voltage E2; capacitor C1 then assumes the value of 300 pF. Since output voltage E2 is equal to the voltage across capacitor C1, the relationship between the input-signal levels and the output voltage is established.

Because of the way that Circus-2 computes values, it is considerably more efficient to maintain capacitor C1 as a constant and, instead, vary its associated resistor, R1, to change the gate's time constant. In the Sceptre listing, therefore, C1 is varied while R1 is held constant, but in the Circus-2 listing, the reverse is true. Additionally, the Circus-2 program calls for routine RR72, rather than FCAP1; the two perform identical functions, but in RR72 resistor R1 is varied, and in FCAP1, capacitor C1 is varied.

The gate's output impedance, R2, is fixed at 30 ohms. Although this is not an accurate impedance representation for all voltage and load conditions, it does provide first-order accuracy for the output-signal level. Yet another zero-valued current source, JO, is included at the output as a dummy element to permit monitoring of the gate's output signal under varying conditions.

Four-input NAND-gate model

The four-input NAND gate behaves in the same manner as the two-input NAND gate—when all four input signals are logic 1, the gate's output is logic 0; for all other input-signal conditions, the output is logic 1. Figure 3 contains a schematic of this gate, as well as its computer model and Sceptre and Circus-2 program descriptions. (The voltage waveforms illustrating the device's delay characteristics look the same as those shown in Fig. 1 for the two-input gate.)

The electrical characteristics of the four-input gate can be approximated fairly accurately. Its maximum logic 1 output voltage can be regarded as 3.3 v, its maximum logic 0 output voltage as 0.4 v, its minimum logic 1 input voltage as 2.0 v, and its maximum logic 0 input voltage as 0.8 v. Propagation-delay times can also be estimated reasonably well. The negative-going output-transition time is 8 ns typical and 15 ns maximum, while the positive-going output transition time is 12 ns typical and 22 ns maximum.

As was done for the two-input gate, the program description for the four-input gate model includes subprograms to assure that the simulated gate will conform to the desired truth table. Here, the subprogram labeled FN4 establishes the gate's output-signal-level characteristics. The same subprogram, FCAP1 in Fig. 2, used to determine the delay characteristics of the two-input gate is used for the four-input gate.

The signal-input impedances, JA, JB, JC, and JD, are again represented as zero-valued current sources and may be made variable (for greater accuracy), as noted previously. Output impedance R2 is fixed at 25 ohms as a reasonable approximation.

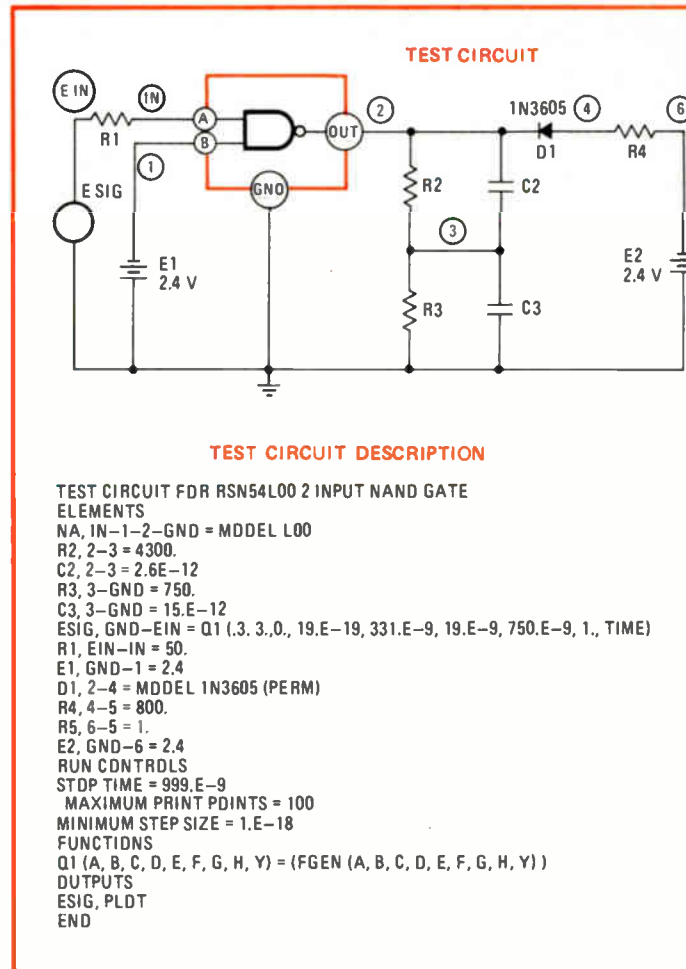

4. Model checkout. Performance of two-input NAND model closely agrees with the response of a real device.

The voltage associated with dependent source E1 is determined by the subprogram function FN4 to agree with the gate's truth table. If any of the input signals is less than or equal to 0.8 v, then voltage E1 is set equal to 3.3 v to represent logic 1. When all of the input signals are equal to or greater than 2.0 v, the value of E1 is set at 0.4 v to represent logic 0. If neither of these conditions exists, then E1 is 3.3 v minus the absolute value of the smallest of the applied signals.

As for the two-input gate, the required delay times, t_{pd0} and t_{pd1} , are established in the model by the R1-C1 time constant. In the program listing, the value of capacitor C1 is set to either 150 or 200 pF, depending upon the voltage relationships between E1 and E2, and whether the output is rising, falling, or constant.

To demonstrate the validity of any computer model, the standard procedure is to compare the response of a computer-simulated test circuit with the response of an actual test circuit. For example, the two-input NAND gate can be tested with the circuit shown in Fig. 4.

A Sceptre topological description of this test circuit, which permits the gate's load (fanout) to be varied readily, is also given in the figure. The test signal shown is applied to one of the gate's inputs, while the other input is held at a logic 1 voltage level (2.4 v). The printout of output response shows how closely the model's behavior simulates that of an actual gate. □

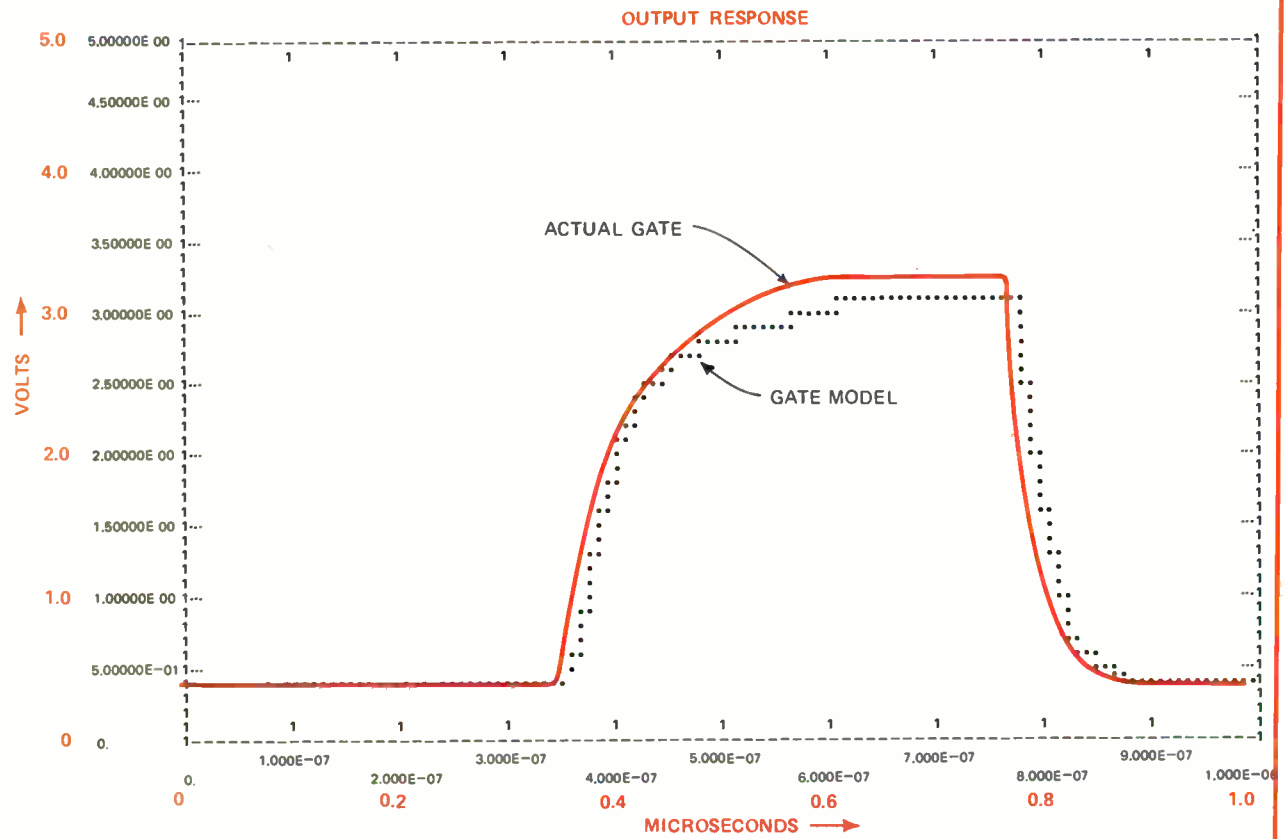
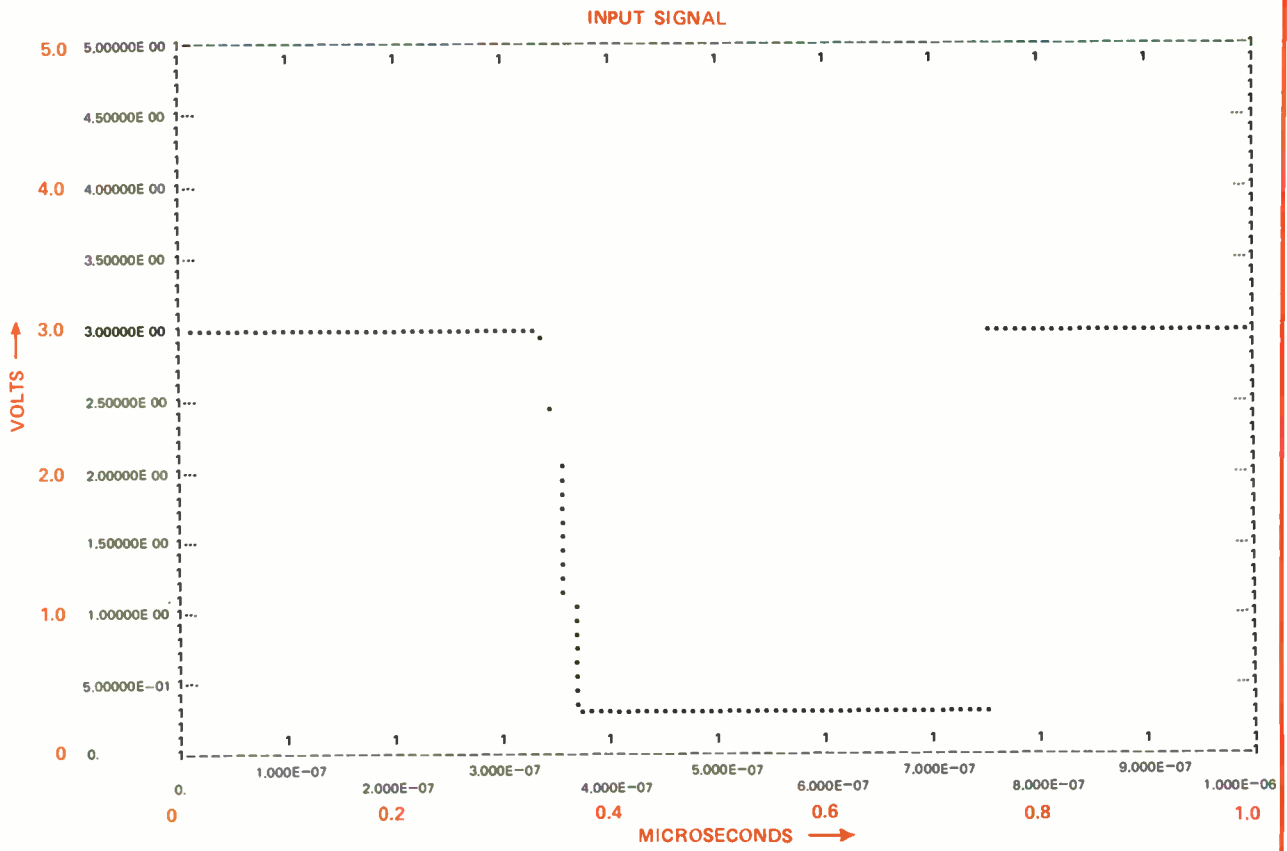

the New **BUSS**[®] **SNAP-LOCK** Rear Panel Mounted **FUSEHOLDERS**

*It's a "SNAP"
to install....*

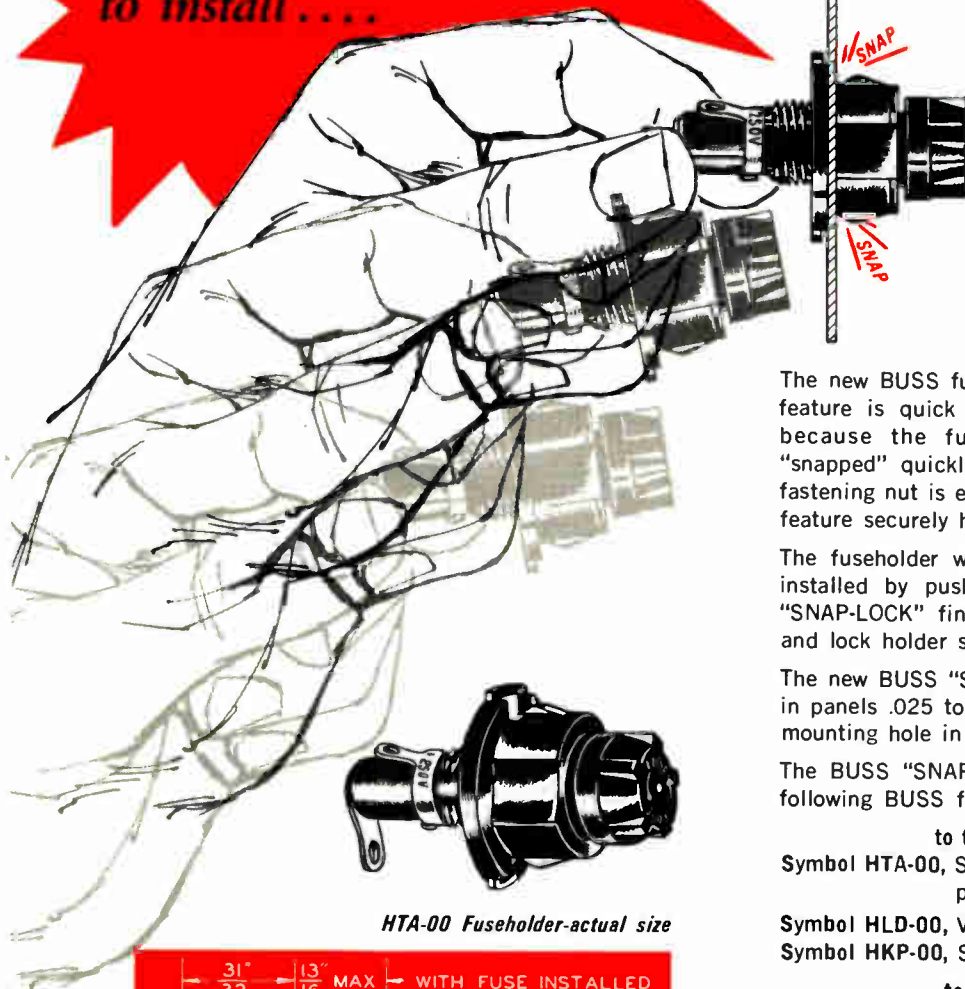

*Easy...
Quick...
Time Saving...*

The new BUSS fuseholder with special "SNAP-LOCK" feature is quick and easy to install. It saves time because the fuseholder can be pre-wired and "snapped" quickly into place from rear of panel. A fastening nut is eliminated because the "SNAP-LOCK" feature securely holds the fuseholder in place.

The fuseholder with "SNAP-LOCK" feature is simply installed by pushing it into panel from rear side. "SNAP-LOCK" fingers engage edge of hole in panel and lock holder securely in place.

The new BUSS "SNAP-LOCK" fuseholder can be used in panels .025 to .085 inch thick. (See recommended mounting hole in dimensions below).

The BUSS "SNAP-LOCK" feature is available on the following BUSS fuseholders:

to take 1/4x1/4 inch fuses:

Symbol HTA-00, Space Saver, extends just 1 in. behind panel.

Symbol HLD-00, Visual Indicating Fuseholder.
Symbol HKP-00, Standard Fuseholder.

to take 1/4x1 inch fuses:

Symbol HJM-00, Standard Fuseholder.

All are available with quick connect terminals, if so desired.

HTA-00 Fuseholder-actual size

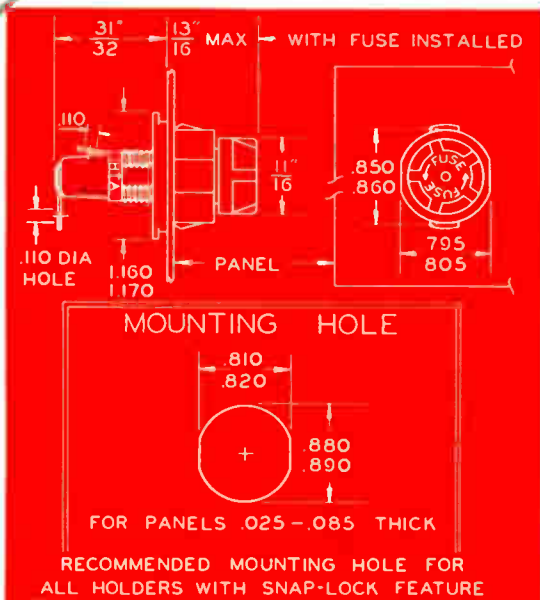

Dimensions of HTA-00 holder.
When tooling up for mounting get latest blueprint.

Also fits 1/2 in. knock-out in electrical boxes

BUSSMANN MFG. DIVISION
McGraw-Edison Company
St. Louis, Mo. 63107
Makers of a full line of Electric Fuses

SUPPLIED THE ECONOMICAL WAY
... THRU DISTRIBUTORS

BUSS QUALITY

FUSES

Microstrip matching networks can be designed fast with a Basic program

Parameter values necessary for the design of microstrip impedance-matching transformers are determined in seconds by a simple computer program; the equations solved by the computer are also presented and explained

by James J. Lev, *Autonetics Division, Rockwell International Corp., Anaheim, Calif.*

□ A simple computer program in the Basic language enables a microstrip matching network to be designed in a fraction of the usual time. All it requires, besides access to a computer, is values for six device and material characteristics, plus two assumptions about the device to be matched.

Upon entry of the required data, the computer will calculate and print out the length, width, and characteristic impedance of the microstrip transmission line required to effect a basic impedance match (i.e., a match accomplished with a single length of constant-width line). If such an impedance transformation cannot be obtained from the given data, the computer will print BASIC MATCH NOT POSSIBLE WITH DATA ENTERED and await new instructions.

Two network conditions must be met before the simplified design can be used. First, the active device to be matched must be unconditionally stable. Second, it must be assumed that the device be unilateral, which, simply stated, means that it must have a high level of output-to-input isolation. In practical applications, however, both conditions are often met.

For a device to be unconditionally stable, it must be capable of being driven and terminated in any impedance without producing oscillations. Consequently, its

scattering parameters, S_{11} and S_{22} , must be less than unity. In addition, its stability factor, K , must have a value that is greater than unity and positive. The K factor is computed from:

$$K = \frac{1 + |\Delta|^2 - |S_{11}|^2 - |S_{22}|^2}{2|S_{21}S_{12}|}$$

where $\Delta = S_{11}S_{22} - S_{21}S_{12}$

The second condition, that the device be assumed to be unilateral, is valid where S_{12} is negligibly small in the equation for network gain:^{3,4}

$$G_T = \frac{|S_{21}|^2(1 - |\Gamma_S|^2)(1 - |\Gamma_L|^2)}{|(1 - S_{11}\Gamma_S)(1 - S_{22}\Gamma_L) - S_{21}S_{12}\Gamma_S\Gamma_L|^2}$$

where Γ_S is the source reflection coefficient, and Γ_L is the load-reflection coefficient.

Exactly how small S_{12} must be is difficult to determine. However, the assumption is generally considered valid if the resulting error in device gain is less than 1 decibel.

What the program does

The program computes design data for any of the three fundamental cases of matching networks shown in Fig. 1. Together, these fundamental cases cover all situ-

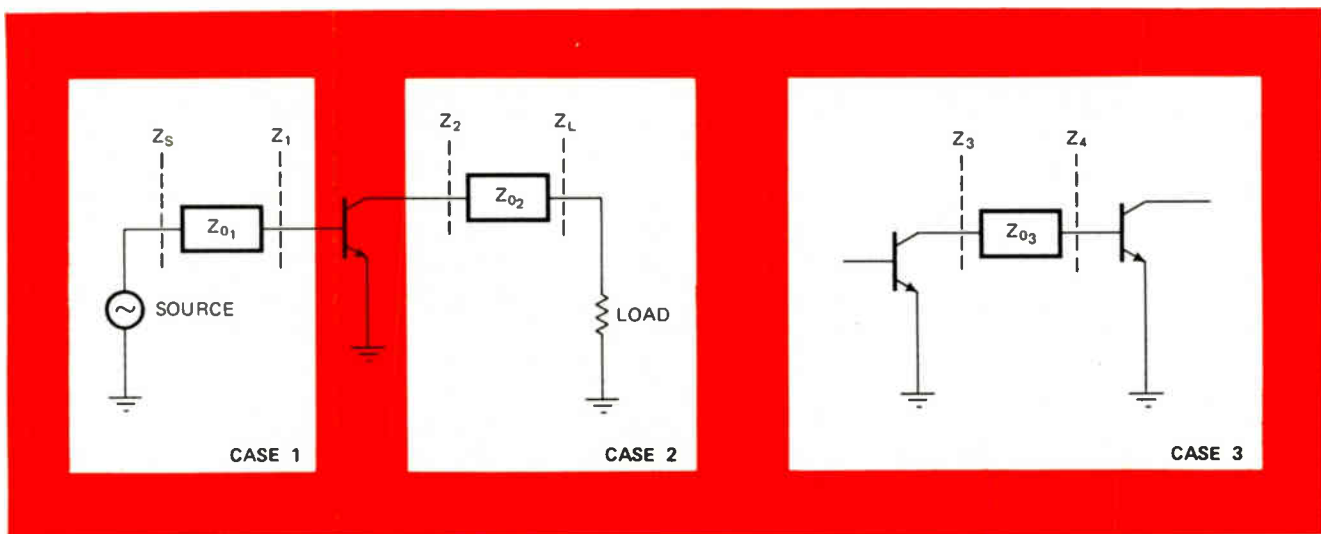

1. Three matches. These three cases together cover all situations in designing matching networks. In cases 1 and 2, the complex input and output impedances of a transistor stage are matched to the characteristic impedances of transmission lines connecting the source and load, respectively. In case 3, an optimum match is achieved between the complex impedances of two transistor stages.

```

100 REM PROGRAM FOR MICROSTRIP MATCHING
110 PRINT "ENTER DATA";
120 INPUT A,B,C,D,E,F,G,H,I
130 IF A=1 THEN 160
140 IF A>3 THEN 160
150 GO TO 180
160 PRINT "INPUT DATA NOT IN CORRECT FORMAT. RETYPE IT."
170 GO TO 110
180 PRINT
190 PRINT
200 PRINT "          DATA ENTERED"
210 PRINT
220 IF A<=1 THEN 410
230 IF C<=0 THEN 160
240 PRINT "          SOURCE IMPEDANCE      =  ",B," OHMS"
250 IF E<=0 THEN 270
260 IF E<0 THEN 290
270 PRINT "          IMPEDANCE NUMBER 1      =  ",D;"+J";ABS(E)," OHMS"
280 GO TO 360
290 PRINT "          IMPEDANCE NUMBER 1      =  ",D;"-J";ABS(E)," OHMS"
300 GO TO 360
310 IF E>=0 THEN 330
320 IF E<0 THEN 350
330 PRINT "          IMPEDANCE NUMBER 2      =  ",D;"+J";ABS(E)," OHMS"
340 GO TO 360
350 PRINT "          IMPEDANCE NUMBER 2      =  ",D;"-J";ABS(E)," OHMS"
360 PRINT "          FREQUENCY                  =  ",F," MHZ"
370 PRINT "          DIELECTRIC CONSTANT       =  ",G
380 PRINT "          SUBSTRATE THICKNESS       =  ",H," IN"
390 PRINT "          CONDUCTOR THICKNESS       =  ",I," IN"
400 GO TO 530
410 IF A=3 THEN 440
420 PRINT "          LOAD IMPEDANCE           =  ",B," OHMS"
430 GO TO 310
440 IF E<0 THEN 470
450 PRINT "          IMPEDANCE NUMBER 3      =  ",D;"+J";ABS(E)," OHMS"
460 GO TO 480
470 PRINT "          IMPEDANCE NUMBER 3      =  ",D;"-J";ABS(E)," OHMS"
480 IF C<0 THEN 510
490 PRINT "          IMPEDANCE NUMBER 4      =  ",B;"+J";ABS(C)," OHMS"
500 GO TO 360
510 PRINT "          IMPEDANCE NUMBER 4      =  ",B;"-J";ABS(C)," OHMS"
520 GO TO 360
530 IF D=B=0 THEN 570
540 LET Y=((C+D+R)*E*((D-E)*(B+D-C+E))/((C+D)+(B+E))-C)/(D-D)
550 IF Y<=0 THEN 570
560 GO TO 600
570 PRINT
580 PRINT "BASIC MATCH NOT POSSIBLE WITH DATA ENTERED."
590 GO TO 1400
600 LET Z=SQR(Y)
610 PRINT
620 IF A=3 THEN 680
630 IF A=2 THEN 660
640 PRINT "          INPUT NETWORK LINE PARAMETERS"
650 GO TO 690
660 PRINT "          OUTPUT NETWORK LINE PARAMETERS"
670 GO TO 690
680 PRINT "          INTERSTAGE NETWORK LINE PARAMETERS"
690 PRINT
700 LET X=Z*(D-E)
710 LET W=C+D+R*E
720 IF Y=0 THEN 800
730 IF W=0 THEN 850
740 LET R=ABS(X/W)
750 IF R>2+24 THEN 850
760 LET Q=(ATN(X/W))*(180/3.14159265)
770 IF W<0 THEN 870
780 LET K=Q*((X/ABS(X))+180)
790 GO TO 880
800 IF W=0 THEN 880
810 IF W<0 THEN 830
820 GO TO 740
830 LET K=180
840 GO TO 880
850 LET K=(X/ABS(X))*90
860 GO TO 880
870 LET K=0
880 LET M=K/360
890 IF M<0 THEN 920
900 LET M=M
910 GO TO 930
920 LET N=.5+M
930 IF F=0 THEN 570
940 LET O=2.997925E10/(F*2.54E9)
950 IF G<=0 THEN 570
960 LET L1=(N*O)/SQR(G)
970 IF H<=0 THEN 570
980 IF I<=0 THEN 570
990 LET P=0
1000 LET E1=(1/3.14159265)*(L0*(2*M)/I)+1
1010 LET T1=0
1020 LET T2=E1+T1
1030 LET P9=376.619437*M
1040 LET E2=P9/(SQR(G)*T2*(1+1.735*G*(-.0724)*(T2/H)+(-.836)))
1050 LET D1=E2-Z
1060 IF P=1 THEN 1150
1070 IF P=2 THEN 1210
1080 IF P=3 THEN 1270
1090 IF D1<0 THEN 1120
1100 LET T1=T1+E-2
1110 GO TO 1020
1120 LET T1=T1-E-2
1130 LET P=1
1140 GO TO 1020
1150 IF D1<0 THEN 1180
1160 LET T1=T1+E-3
1170 GO TO 1020
1180 LET T1=T1-E-3
1190 LET P=2
1200 GO TO 1020
1210 IF D1<0 THEN 1240
1220 LET T1=T1+E-4
1230 GO TO 1020
1240 LET T1=T1-E-4
1250 LET P=3
1260 GO TO 1020
1270 IF D1<0 THEN 1300
1280 LET T1=T1+E-5
1290 GO TO 1020
1300 LET T1=T1-E-5
1310 LET W2=T1/H
1320 IF W2>=0.6 THEN 1350
1330 LET K1=SQR(G/(1+.6*(G-1)*((T2/H)+0.0297)))
1340 GO TO 1360
1350 LET K1=SQR(G/(1+.63*(G-1)*((T2/H)+0.1255)))
1360 LET L=L1*K1
1370 PRINT "          IMPEDANCE                  =  ",Z," OHMS"
1380 PRINT "          LENGTH                      =  ",L," IN"
1390 PRINT "          WIDTH                        =  ",T1," IN"
1400 PRINT
1410 PRINT
1420 PRINT
1430 GO TO 110
1440 END

```

2. Basic program. Microstrip transformer can be designed quickly with the help of computer listing written in Basic language.

ations encountered in both single- and multi-stage amplifier design.

In case 1, the complex conjugate of the device input impedance, Z_1 , is matched to a source impedance, Z_s , via a transmission line of characteristic impedance Z_{01} . In case 2, the complex conjugate of the device's output impedance, Z_2 , is matched to a load impedance, Z_L , via a transmission line of characteristic impedance Z_{02} . For case 3, the complex conjugate of the output impedance, Z_3 , of one device is matched to the complex input impedance, Z_4 , of a subsequent stage via a transmission line of characteristic impedance Z_{03} .

Impedances Z_1 through Z_4 in Fig. 1 are the scattering parameters, or their complex conjugates, for the respective devices. For example, Z_4 would be S_{11} of the driven device in case 3, and Z_3 would be the complex conjugate of S_{22} of the driving device.

The S-parameter values can be measured on a network analyzer or, in many cases, obtained from manufacturers' data sheets.

The computer program is shown in its entirety in Fig. 2. Statement 120 is used to input the nine data vari-

ables, as defined in the table on page 129, that are required to find the three transmission-line parameters.

The program is interactive. After it has been loaded onto the machine, the computer prints ENTER DATA? and waits. The numerical data values must then be entered in serial form, each separated by a comma. A 50-ohm source impedance, for instance, would enter as 50,0 while a Z_3 of the $10 - j25$ ohms would be entered as 10, -25,.

A few examples will illustrate the method of data entry and the resulting computer printout:

First, consider the design of an input-matching transformer for a special-purpose amplifier operating at 1.25 gigahertz and driven by a 50-ohm source. The device manufacturer specifies an optimum matching impedance for maximum gain of $70 + j20$ ohms. The prototype circuit is to use 1/32-inch-thick Teflon material with a relative dielectric constant, ϵ_r , of 2.37 at the required operating frequency. The conductor is 1.4-mil copper. The data entry and computer printout for this example are shown in Fig. 3a.

Second, given the parameters of the above example, it may be necessary also to match the output of the device to a 50-ohm load. A network analyzer shows that S_{22} for the device is $120 - j80$ ohms. Data entry and computer printout for this example are shown in Fig. 3b.

Alternatively, instead of matching the output of the device in the above example to a transmission line, it may be desirable to construct a two-stage amplifier. For this case, suppose the S_{11} of the device in the second stage to be $15 - j11$ ohms. Data entry and computer print-out for this example are shown in Fig. 3c.

Equations solved on computer

To make full use of the program, it is helpful to take a closer look at the equations being solved. For a lossless line:⁵

$$Z_S = Z_0 \frac{Z_L \cos \beta l + j Z_0 \sin \beta l}{Z_0 \cos \beta l + j Z_L \sin \beta l} \quad (1)$$

where Z_0 = characteristic impedance of the transmission line, Z_S = input impedance, Z_L = load impedance, l = the length of the matching transformer, and $B = 2\pi/\lambda$. Here, λ is the effective wavelength of the signal in the microstrip transmission line. It is calculated to be:

$$\lambda = \frac{k \lambda_0}{\sqrt{\epsilon_r}}$$

where λ_0 = wavelength in free space, ϵ_r = the relative dielectric constant of the microstrip insulator, and k is a correction factor that is readily determined using equations developed by Sobol.⁶ This k factor adjusts for the fact that propagation along the line is in a quasi-TEM mode rather than the strictly TEM mode of a coaxial line.

Replacing Z_L and Z_S with general complex impedances $b = jc$ and $d + je$, respectively, and then equating real and imaginary parts, equations for Z_0 and l are derived to be:

$$Z_0 = \left[\frac{(cd + be) \left[e + \frac{(d-b)(bd-ce)}{cd+be} - c \right]}{d-b} \right]^{1/2} \quad (2)$$

$$l = \frac{\lambda}{2\pi} \left[\tan^{-1} \left(\frac{Z_0 (d-b)}{cd+be} \right) \right] \quad (3)$$

Note that if Z_L and Z_S are real, $c = e = 0$, and equa-

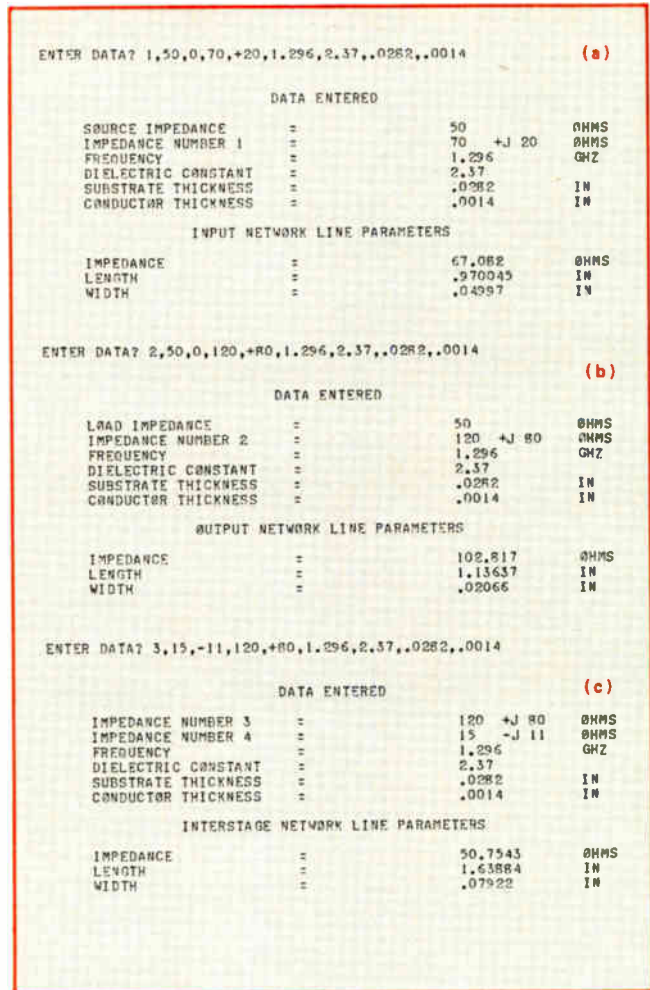

3. Sample printouts. From data on device performance and microstrip materials, the computer calculates matching-network line parameters for three application examples.

tions 2 and 3 reduce to:

$$Z_0 = \sqrt{bd} \quad \text{and} \\ l = \lambda/4$$

which are well-known expressions that define a quarter-wavelength matching transformer.

The width, W , of the transformer section is determined after the section's characteristic impedance, Z_0 , is known. This requires an interactive trial-and-error solution of the equation referred to by Sobol as follows:⁶

$$Z_0 = \frac{\eta h}{\sqrt{\epsilon_r} W \left[1 + 1.735 \epsilon_r^{-0.0724} \left(\frac{W}{h} \right)^{-0.836} \right]} \quad (4)$$

Here, η = the free space impedance of the line, and h = the substrate thickness. □

REFERENCES

- "S-Parameters . . . Circuit Analysis and Design," Hewlett-Packard Application Note 95, September 1968.
- W.H. Froehner, "Quick Amplifier Design with Scattering Parameters," Electronics, Oct. 16, 1967.
- "Transistor Parameter Measurements," Hewlett-Packard Application Note 77-1, February 1967.
- "S-Parameter Techniques for Faster, More Accurate Network Design," Hewlett-Packard Journal, Vol. 18, No. 6, February 1967.
- J.L. Potter and S.J. Fich, "Theory of Networks and Lines," Prentice-Hall Inc., Englewood Cliffs, N.J., 1963.
- H. Sobol, "Extending IC technology to microwave equipment," Electronics, March 10, 1967, pp. 112-124.

DEFINITIONS OF DATA INPUT AND OUTPUT

Data Variable	Definition
A	1, 2, or 3 corresponding to case 1, 2, or 3.
B, C	Real and imaginary parts of the Z_S , Z_L , or Z_4 (ohms).
D, E	Real and imaginary parts of Z_1 , Z_2 , or Z_3 (ohms).
F	Frequency (GHz).
G	Relative dielectric constant of substrate.
H	Substrate thickness (in.).
I	Conductor thickness (in.).

Straight talk about today's hi-rel semiconductor shortages. And why it pays military and other hi-rel users to specify Raytheon Semiconductor.

There's no question about it. Semiconductor shortages are really here. Demand is exceeding supply by twenty-five percent. And there's no relief in sight.

Those who feel the pinch most are the military/government and high-reliability commercial users. Who above all cannot accept standard grade semiconductors as substitutes.

Most other suppliers would prefer to fill orders from the high volume commercial, industrial, and computer markets. And let the military and hi-rel commercial business take what's left. Or simply go without.

Not at Raytheon Semiconductor. We've built our standard commercial business around our basic military and hi-rel nucleus. Instead of the other way around.

Sure. We have a going commercial market. And we are pursuing it vigorously. But not at the expense of our military and hi-rel commercial business.

The other suppliers would rather handle these more "glamorous" burgeoning markets—the calculator,

automobile, home electronics — because the volume is great and the design specifications relatively inexpensive on a cost-per-run basis. And because today's commercial contract isn't tomorrow's military cancellation.

We think this attitude is myopic.

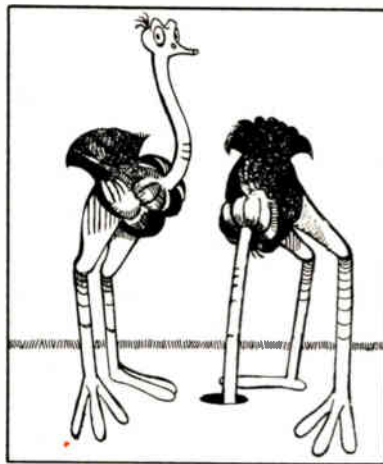

Contrary to the current trend, Raytheon Semiconductor's management is dedicated to continue its pursuit of military and hi-rel business. Not half-heartedly. But with

a firm commitment. Just because there's larger volume in more standard commercial designs doesn't mean that it's a more attractive business. Not at Raytheon Semiconductor. Not the way we manage and discipline our military and hi-rel business. Furthermore, this competency becomes well known and establishes a strong loyalty.

Why should there be anything taboo about the military business?



Every day, more and more military requisitioners are asking: "But where am I going to get parts?" And most semiconductor suppliers don't seem to care. Their long-term

marketing directions and the military business are at odds. They will tell you a variety of things. To design away from your special packages and custom devices. Or not to use your own unique specifications. But switch to standards. Consolidate your designs into fewer types so that volume will increase. In other words, stick to the industry standard of off-the-shelf components — popular, high volume, standard packages. Or else.

We have always reacted quickly to military and hi-rel needs.

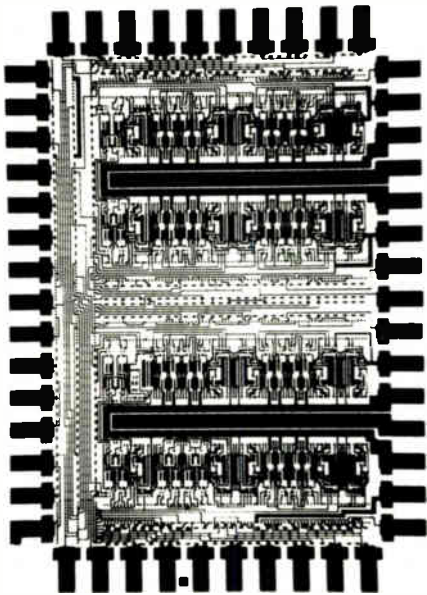

When you need linear or digital IC's, beam-lead chips or JAN TXV transistors for very hi-rel programs of a custom nature, you want them now. Raytheon Semiconductor caters to these very sophisticated requirements. Now. And doesn't ask you to stand in line 12 to 24 months to get them.

We are totally dedicated to the long-term needs of military and other hi-rel customers.

Our track record speaks for itself. We're still delivering a variety of linear and digital IC's and transistors for the Hawk, Sidewinder,

Maverick, Sparrow, and Minuteman missile programs. That's why we're not giving up the old just for the sake of the new. We're committed to products such as 930 Series DTL



ROCKWELL INTERNATIONAL SPACE DIV

and SUHL that many suppliers are phasing out. After all, why should we give up a good profit maker.

In several space programs we've been a major semiconductor source. Apollo used our 101, 709, and 741 op amps. More than three thousand of our 709's went into Skylab. And we still furnish Agena with transistors and the 930 Series.

The Viking Mars mission scheduled for 1975 will use our transistors, IC op amps, multivibrators and voltage regulators.

And, because of our leadership in beam-lead technology, we're heavily involved with development programs for the SAM-D, Trident C-4, and the B-1.

When it comes to reliability, there's none better than Raytheon Semiconductor.

Let others base their future semiconductor growth on glamorous new products for standard commercial

needs. We're building our commercial market around our basic military and hi-rel nucleus. Which explains why Raytheon Semiconductor products are integral to a heart pacer, hearing aids, a solid-state digital watch, and an antiskid

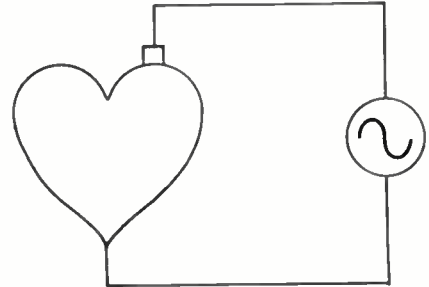

mechanism for the automotive industry. Examples of the hi-rel and advanced beam-lead technology that enhanced the reliability of these exotic new commercial products.

We'll always give you straight answers.

To help solve your military and hi-rel commercial problems contact our Hi-Rel Marketing Manager.

For a copy of Raytheon Semiconductor's hi-rel brochure, called *RayRel*, write us on your company's letterhead. And if you want copies of our Update 1 and 2, we'll be glad to send them along too.

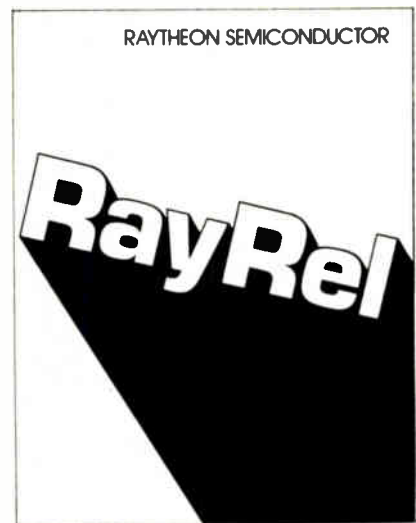

Raytheon Semiconductor, 350 Ellis Street, Mountain View, CA 94042, (415) 968-9211.

RAYTHEON

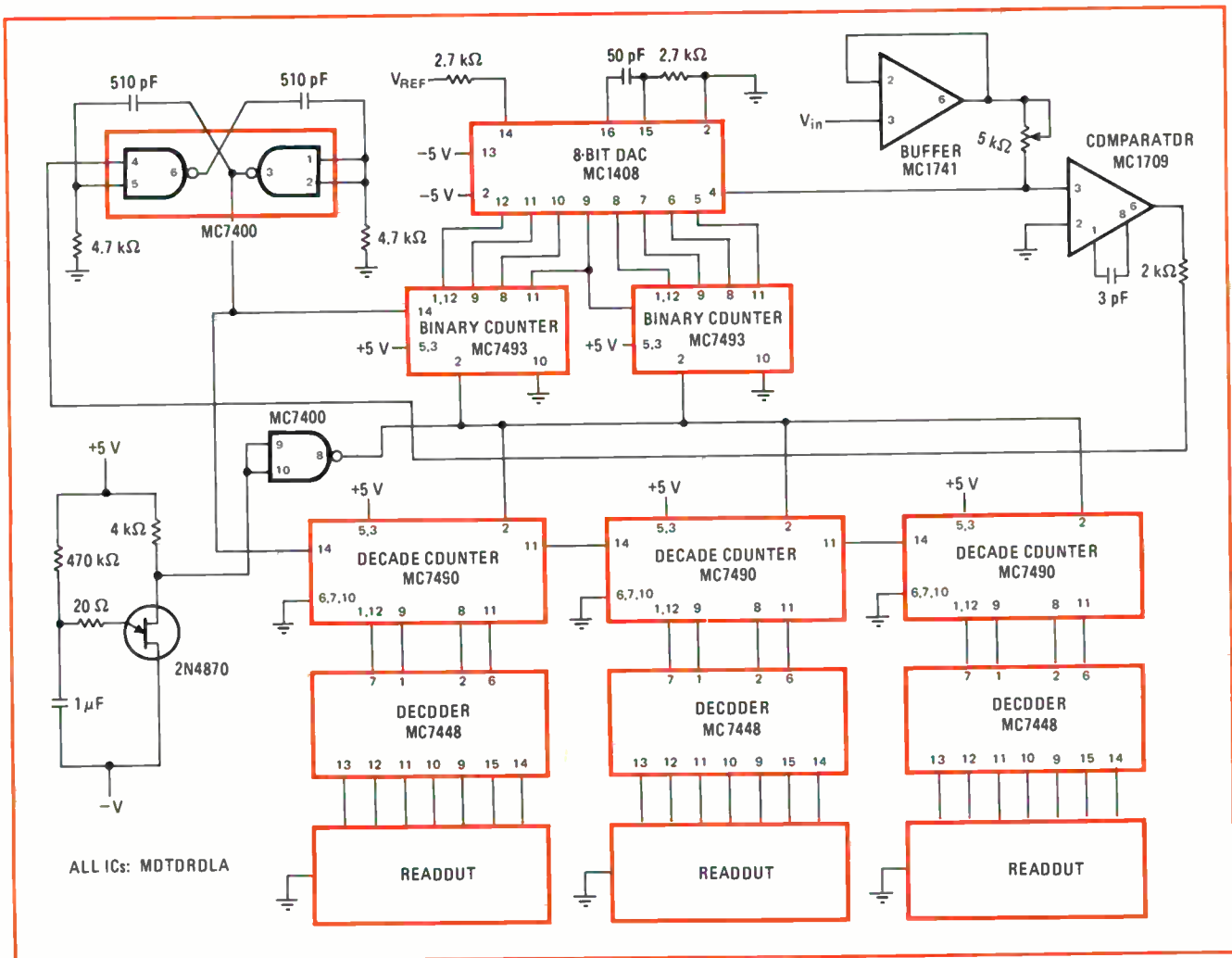

DVM details. Unknown input signal is compared to the output current from the digital-to-analog converter. When these two signals are equal, the clock is stopped. The same clock is used to drive the converter's binary counters and the display's BCD counters.

ter exceeds the current from the input buffer amplifier. A unijunction-transistor oscillator is used to reset both sets of counters so that the unknown voltage is re-sampled about every 0.5 seconds. And BCD-to-seven-segment decoders convert the outputs of the BCD counters to the proper format for the seven-segment light-

emitting-diode displays.

For the components used here, the meter can measure up to 2.55 v (to within ± 5 millivolts) in 10-mv steps. Different full-scale values can be obtained by using suitable input voltage dividers or by providing a fixed-gain, rather than a unity-gain, input buffer. □

Digital voltmeters

Increasing voltmeter input impedance to 10^{12} ohms

by J.R. Laughlin
San Jacinto College, Pasadena, Texas

Most commercial voltmeters, whether they have analog or digital readouts, provide relatively low input impedances, only on the order of 10 megohms, which makes accurate voltage measurements difficult for many circuits. But, by combining a couple of low-leakage field-effect transistors with an operational amplifier, you can

raise the input resistance of your voltmeter to approximately 1,000,000 megohms.

Any dc voltage applied to the gate of the input FET will be reproduced at the circuit's output with sufficient amplitude to drive any type of voltmeter. If Motorola's type MC1436 op amp is used with a 35-volt supply, the circuit can handle input voltages as high as 30 v without an attenuator. If a wide frequency response is desired, Signetics' type 531 op amp can be used with a lower supply voltage. And, because of its low current drain, National's type LM308 op amp is best for battery-operated voltmeters.

A voltage divider to ground at the circuit's input permits higher voltage measurements to be made, but significantly lowers the circuit's input resistance. However,

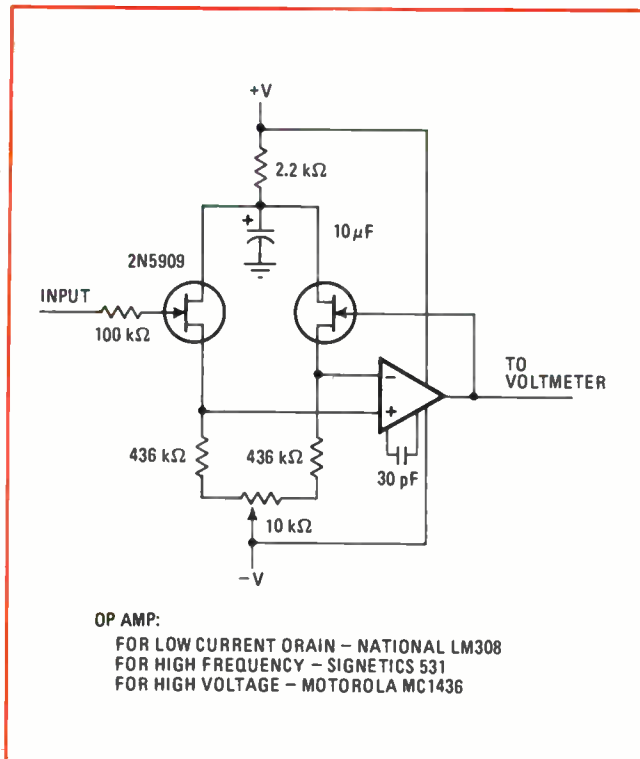

since FET gate-leakage current is in the low-picoampere range, the resistors used for the voltage divider can have values that are quite large without introducing significant errors. For example, a 1,000-megohm resistor to ground, along with another resistor having the appropriate value to obtain the desired ranging, will still provide an unusually high input resistance of several thousand megohms.

Great care must be taken to prevent extraneous leakage paths to ground. You will invariably degrade the circuit's input resistance considerably by using standard binding posts, or by providing a switching arrangement for the voltage divider, or by terminating the input FET's gate lead on a circuit board.

The circuit will handle ac voltages, although its input impedance will be reduced somewhat by stray capacitance. However, even this lowered input impedance will be much higher than what is usually available from commercial instruments.

The 10-kilohm potentiometer can be used to counteract op-amp offset and drift or to zero whatever offset voltage may result when very high resistance values are used for a voltage divider. □

High-Impedance Input. FET circuit lets you raise the input resistance of any voltmeter to 1,000,000 megohms, a factor of 10^5 .

Digital voltmeters

Getting the most out of the digital multimeter

by Louis M. Xuster, Jr.
 IBM Corp., Kingston, N.Y.

Your digital multimeter can be used in many more ways than the function switch on the front panel indicates. When it is set to measure resistance, the digital multimeter can be thought of as a precision current source plus a digital voltmeter, a combination that can be used for measurements other than determining resistance values.

To do these other jobs with your multimeter, you must first "calibrate" its ohms range settings. As an example, consider the Fluke model 8000A—its "calibration" table is:

Ohms range setting	Current	Full-scale voltage
200Ω	5 mA	0.2 v
2 kΩ	5 mA	2 v
20 kΩ	0.1 mA	2 v
200 kΩ	1 μA	0.2 v
2 MΩ	1 μA	2 v
20 MΩ	0.1 μA	2 v

The meter's precision current source can now be used to check current meters or to bias a circuit. Also, the forward voltage through a pn junction can be measured at various currents. This is useful for determining whether a device is silicon or germanium, or to match the junction

voltages of two or more transistors, or to match diodes, or to compute the effective series resistance of a junction from two readings.

You can even measure capacitance, including very large values. First connect the meter across the capacitor (observe polarity) and then short the capacitor with a jumper. When the meter reading goes to zero, remove the short and time the reading with a stopwatch. Stop the watch when the reading reaches 1,000. For the Fluke 8000A:

Ohms range setting	Each second is equal to:
200 Ω	10,000 μF
2 kΩ	1,000 μF
20 kΩ	100 μF
200 kΩ	10 μF
2 MΩ	1 μF
20 MΩ	0.1 μF

Additionally, you can use your multimeter to determine the internal resistance of a battery, one that supplies under 2 v, by computing the difference between two readings. Simply subtract the battery's no-load voltage from the voltage reading obtained on the 2-kilohm ohms range setting. This yields the battery resistance in kilohms. For instance, suppose the no-load voltage measures 1.533 v and the "2-kilohm" reading is 1.563:

$$1.563 - 1.533 = 0.030 \text{ kilohms} = 30 \text{ ohms}$$

Furthermore, you can take data for plotting a battery's charge/discharge curve. □

Engineer's notebook is a regular feature in Electronics. We invite readers to submit original design shortcuts, calculation aids, measurement and test techniques, and other ideas for saving engineering time or cost. We'll pay \$50 for each item published.

WHAT'S YOUR BAG?



Let us design and produce a **custom C/MOS** circuit for you.

Auto makers are mighty tough customers, but we've met the challenge. Two new 1974 cars are using our custom-designed C/MOS circuits: one a seat-belt interlock circuit, the other a tone generator alarm circuit.

Detroit is not alone. Many designers of electronic clocks, machine tool controls, and automotive instruments also like the inherent low battery drain and high noise immunity offered by C/MOS circuits.

Perhaps you have a design and production requirement for a custom-designed C/MOS circuit. If so, contact us and specify your need. We'll design the circuit, then produce it for you.

If you're sitting on the C/MOS fence and don't know how to get started, just write or phone Stewart-Warner Microcircuits, and ask for the C/MOS sales department. Out-of-state, use our **toll-free line: (800) 538-7906.**



STEWART-WARNER MICROCIRCUITS DIVISION
STEWART-WARNER CORPORATION

730 E Evelyn Ave • Sunnyvale Ca 94086 • (408) 245-9200 • TWX 910-339-9210

Circle 135 on reader service card

Who said a transfer oscillator can't take 1-MHz modulation?

Here's more on making measurements with microwave frequency counters. An earlier item [*Electronics*, Sept. 27, p. 131] said that transfer oscillators cannot tolerate much modulation on the signals they measure. However, according to Dick Schneider of Hewlett-Packard's Santa Clara division, **a transfer oscillator's deviation tolerance increases by at least 6 decibels per octave**, so that, for sufficiently strong signals, measurements actually can be made even when the modulation bandwidth exceeds 1 megahertz. In fact, Schneider states, **an H-P automatic transfer oscillator can be used to measure communications carriers with modulation rates in excess of 8 MHz.**

An active way around a passive shortage

Beat the shortage of passive components by using active devices instead, like back-biased transistors for resistive loads, diodes for blocking capacitors, and a FET if you need a variable resistance. **For an inductor, an op amp and an appropriate feedback network will make the op amp's gain roll-off simulate an inductive input impedance.** Besides getting around long order delays, the technique extracts fairly high inductance values (several hundred microhenries) out of small op-amp packages. **What's more, even cheap op amps have good temperature-compensation specs, which cheap inductors don't.** Fairchild Semiconductor's application note App 321 describes the technique in detail.

Look into plastic alternatives to glass

Though cheaper than glass lenses, **the new plastic lenses can do many jobs just as well, such as magnifying a panel indicator or a LED display.** Magnification is typically 30%. These little lenses, in fact, more than pay their freight by letting you use smaller, cheaper LEDs, says the "Handbook of Plastic Optics," from Precision Lens, Cincinnati.

Washing away spacer problems

A clever way of getting uniform component spacing above pc boards is to **put soluble disks between the component and board before soldering.** Available from Bivar, Santa Ana, Calif. 92705, the disks come in assorted sizes and can simply be washed away in hot or cold water.

Inductor speeds up transistor switching

When no negative supply voltage is available but you need to switch a transistor quickly (as in switching regulators where slow on/off transitions cause high dissipation and low efficiency), **connect an inductor and resistor in series between the transistor's base and emitter.** This technique, suggested by Ulf Andersson, ADDO AB, Malmö, Sweden, exploits the fundamental principle that the current through an inductor cannot change instantaneously.

With this configuration, when the drive current is removed from a conducting transistor, inductor current cannot abruptly go to zero, transistor base current is reversed, and the transistor turns off quickly. Alternatively, when the drive current is applied, inductor current rises from zero slowly, the transistor receives all the drive current for a short time, and it turns on quickly. **The inductor and the resistor (which limits inductor current) should be selected so that inductor current about equals transistor-base current during the transistor's turn-on time.**



Simply the best low cost counter you can buy.....\$299.

Now you can buy an economical counter with noise immunity and programmable offset to measure frequency, read rpm directly, or totalize events.

From lab to the production line, here's a rugged low-cost counter with all the most needed features to make industrial and laboratory measurements.

A unique digital frequency counter, the new Fluke Model 1941A operates over a frequency range of 5 Hz to 40 MHz. It measures frequency, reads rpm directly and totalizes. Sensitivity is better than 40 mV rms. Aging rate is a low 6×10^{-7} /day.

All functions are easily selectable and clearly marked. Read out is a big six-digit display clearly readable from a distance in high ambient light.



frequency



rpm



totalize

Functional "burn-in" eliminates marginal parts.

Options include programmable offset for fast, accurate go-no-go decisions even with an unskilled operator and a four line BCD output to directly drive printers and other peripheral equipment.

Best of all, there's no need to wait to put the 1941A to work. Throughout the U.S., Canada, and western Europe, this counter is in stock and available for immediate demonstration or delivery. A worldwide network of service centers provides 48 hour turn-around repairs.

In the continental U.S., dial our toll free number 800-426-0361 for the name and address of your nearest local source. Abroad and in Canada, call or write the office nearest you listed below, John Fluke Mfg. Co., Inc., P.O. Box 7428, Seattle, Washington 98133. Phone (206) 774-2211. TWX: 910-449-2850. In Europe, address Fluke Nederland (B.V.), P.O. Box 5053, Tilburg, The Netherlands. Phone 013-67-3973. Telex: 844-52237. In the U.K., address Fluke International Corp., Garnett Close, Watford, WD2 4TT. Phone, Watford, 33068. Telex: 934583. In Canada, address ACA, Ltd., 6427 Northam Drive, Mississauga, Ontario. Phone 416-678-1500. TWX: 610-492-2119.



TI-59 The First Scientific Calculator Arrays

with natural algebraic
problem
entry

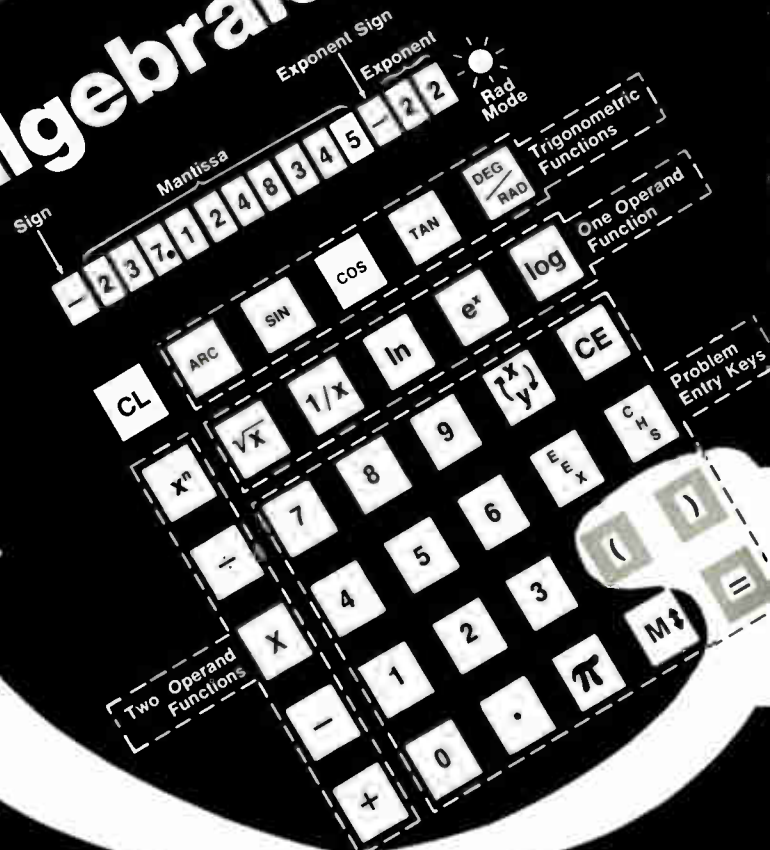
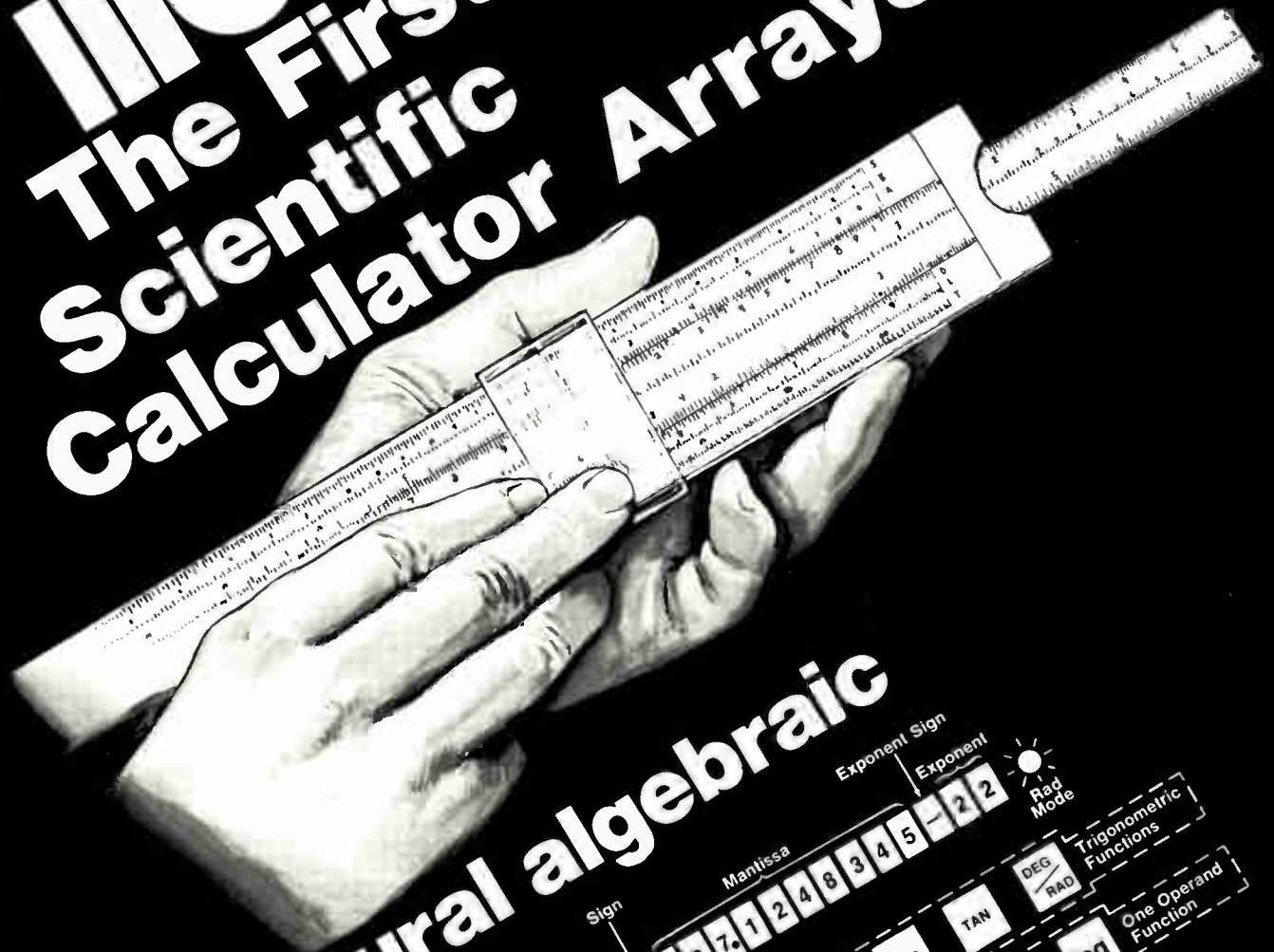

and only two MOS arrays to provide!

- Natural algebraic problem entry with two parenthesis levels
- Floating point or scientific notation number entry
- Automatic selection of floating point or scientific notation for result display
- Separate memory register; single key store or recall
- Full 10 digit precision; 10^{-99} to 10^{+99} exponent range
- Full chain calculation with any function sequence
- Automatic error detection (overflow, underflow, forbidden operations)
- Degree/Radian mode selection (with mode display signal)

with simplified electrical design

- Minimum system power consumption (< 200 MW average)
- Internal low battery and display cutoff circuits
- Direct display segment drive
- Internal clock generation
- All logic circuits provided in two 28 pin DIP'S

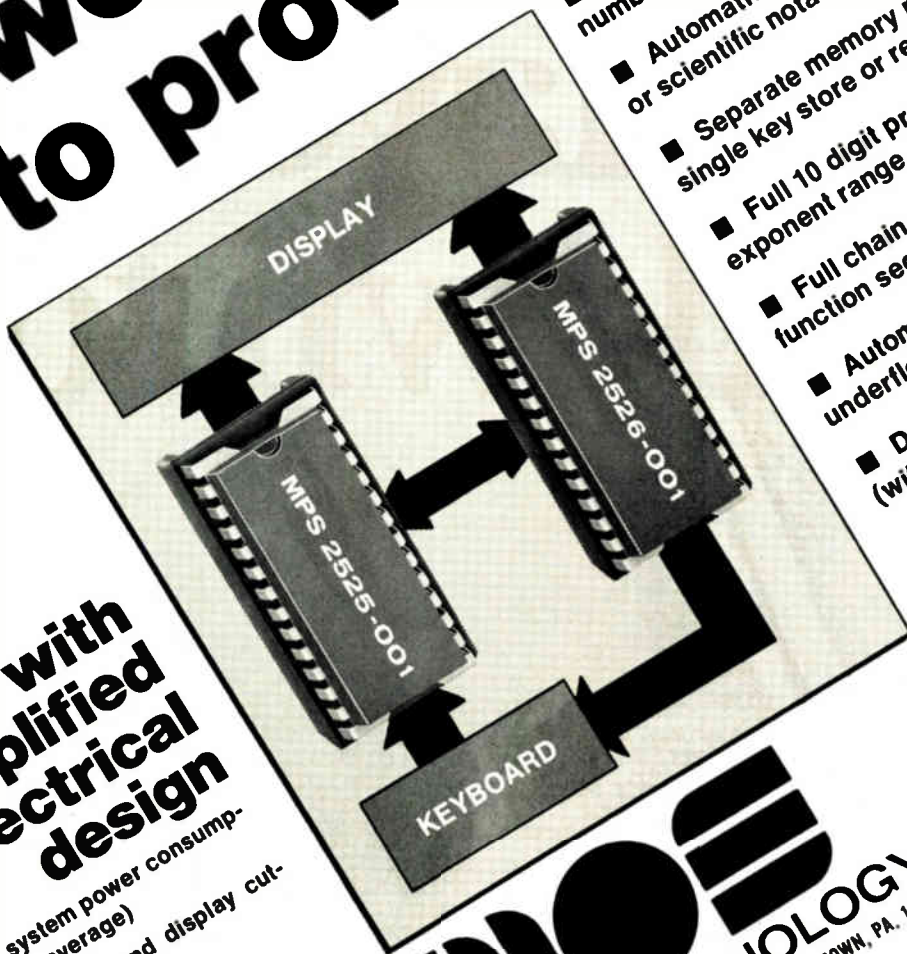

MOS TECHNOLOGY, INC.
 VALLEY FORGE CORPORATE CENTER, NORRISTOWN, PA. 19401 (215) 666-7950
 an affiliate of ALLEN-BRADLEY



HEADQUARTERS — Applications Mgr.: Mr. Julius Hertsch;
 MOS Technology, Inc., Norristown, Pa. 19401
 CENTRAL REGION — MOS Technology, Inc., 838 S. Des Plaines
 St., Chicago, Illinois 60607 • (312) 922-0288
 EASTERN REGION — Mr. William Whitehead, Suite 307 — 88
 Sunnyside Blvd., Plainview, N.Y. 11803 • (516) 822-4240
 WESTERN REGION — MOS Technology, Inc., 2172 Dupont Dr.,
 Suite 221, Palo Alto Bldg., Newport Beach, Calif. 92660
 (714) 833-1600

**The \$5,600
computer you
don't have to
talk down to.**

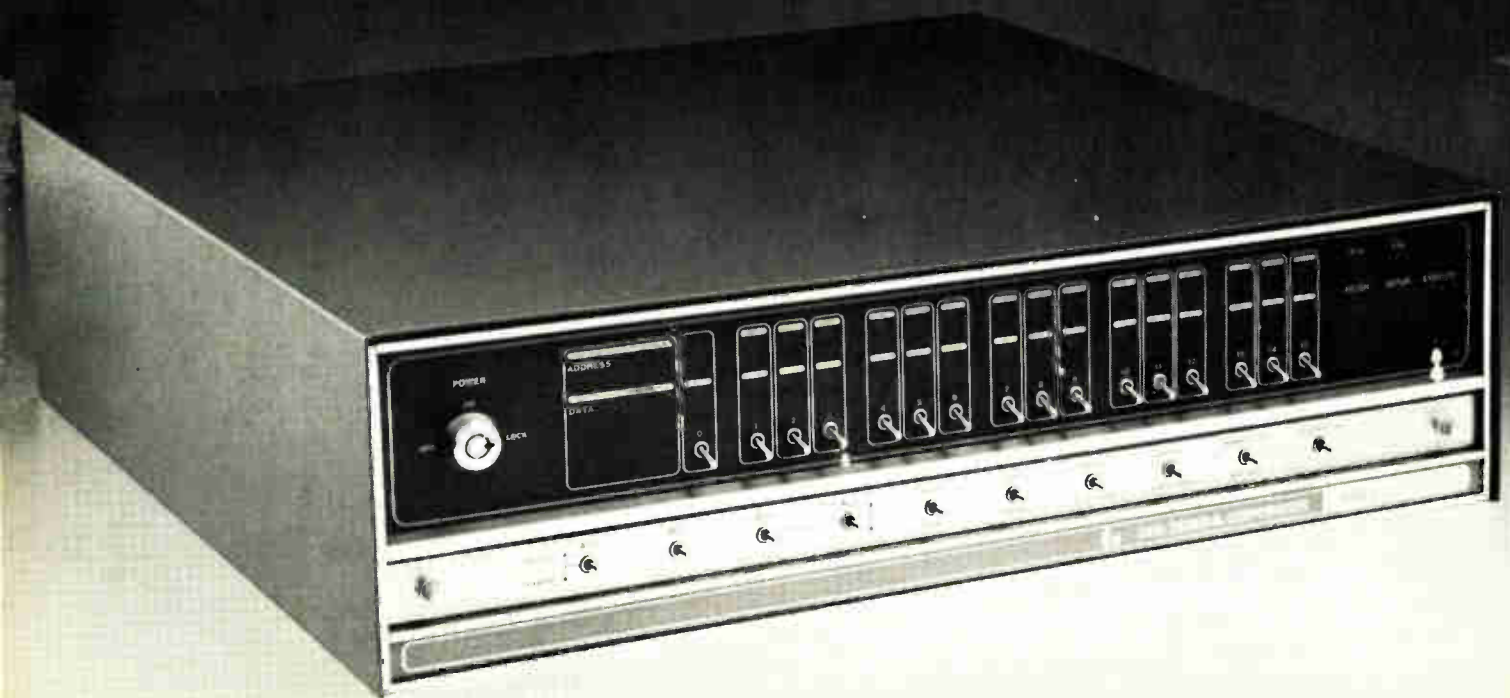

We've got an idea that ought to interest any OEM who's trying to bring down the price of his product.

Go buy yourself 5* Nova 2's with the new 16K memory boards. (Yes, we know you can probably get away with less memory. Bear with us.)

Now take a look at what you get: a high speed multi-accumulator 16 bit CPU, an I/O system with programmed data transfer, 16 levels of programmed priority interrupt, high speed Direct Memory Access, programmer's console, 4-slot mainframe, power supply and 16,384 words of 1 microsecond memory, expandable to 32K. With 4K and 8K memory modules also available.

That, you'll have to admit, is an awful lot of computer for the money. With twice the memory of other computers in that price range.

Hold on. It gets even better.

With that 16K memory, you won't have to talk down to the computer in machine language. You're going to be able to program in higher level languages.

So your programmers will be able to spend more time on what they want it to do and less on how to say it.

Which means they'll get the job done faster. And you'll get your product out on the market faster.

Both of you are going to save yourselves a lot of time and money.

Think about that for a minute.

Consider how your system costs go down when your programming time goes down.

The \$5,600 price tag looks even better now, doesn't it?

And that's before the quantity discounts get figured in.

*Five systems is the minimum order.

The 16K Nova 2 Data General

Southboro, Massachusetts 01772 (617) 485-9100.

Circle 141 on reader service card



Only the Brush 6000 gives you 128 floating and integrating inputs, real time monitoring, 200 points/sec. and a 3M computer grade tape cartridge in a Data Acquisition System.

The Brush 6000 is an analog to digital data logger-reader that's the best way we know of to monitor and record low frequency data. It scans up to 128 input channels, converts the data to digital form, displays the data for real-time monitoring and stores the results on 3M 1/4" computer grade magnetic tape.

High performance, high or low scanning speed.

Our full-floating integrating front end minimizes signal noise and eliminates sampling errors inherent with other data collecting systems. Each analog input is fully floating with respect to the chassis ground and continuously integrated during the entire scanning period.

The Brush 6000's 128 inputs may be all analog or up to 48 digital

and 80 analog. There are four full scale programmable gain sensitivity ranges: $\pm 10\text{mV}$, $\pm 100\text{mV}$, $\pm 1\text{V}$ and $\pm 10\text{V}$.

To select the scanning rate, push one of the six buttons on the front. The rate can be varied from 200 points per second to 1 scan every ten minutes. In an external record mode, a scan can be triggered by an external clock or an event.

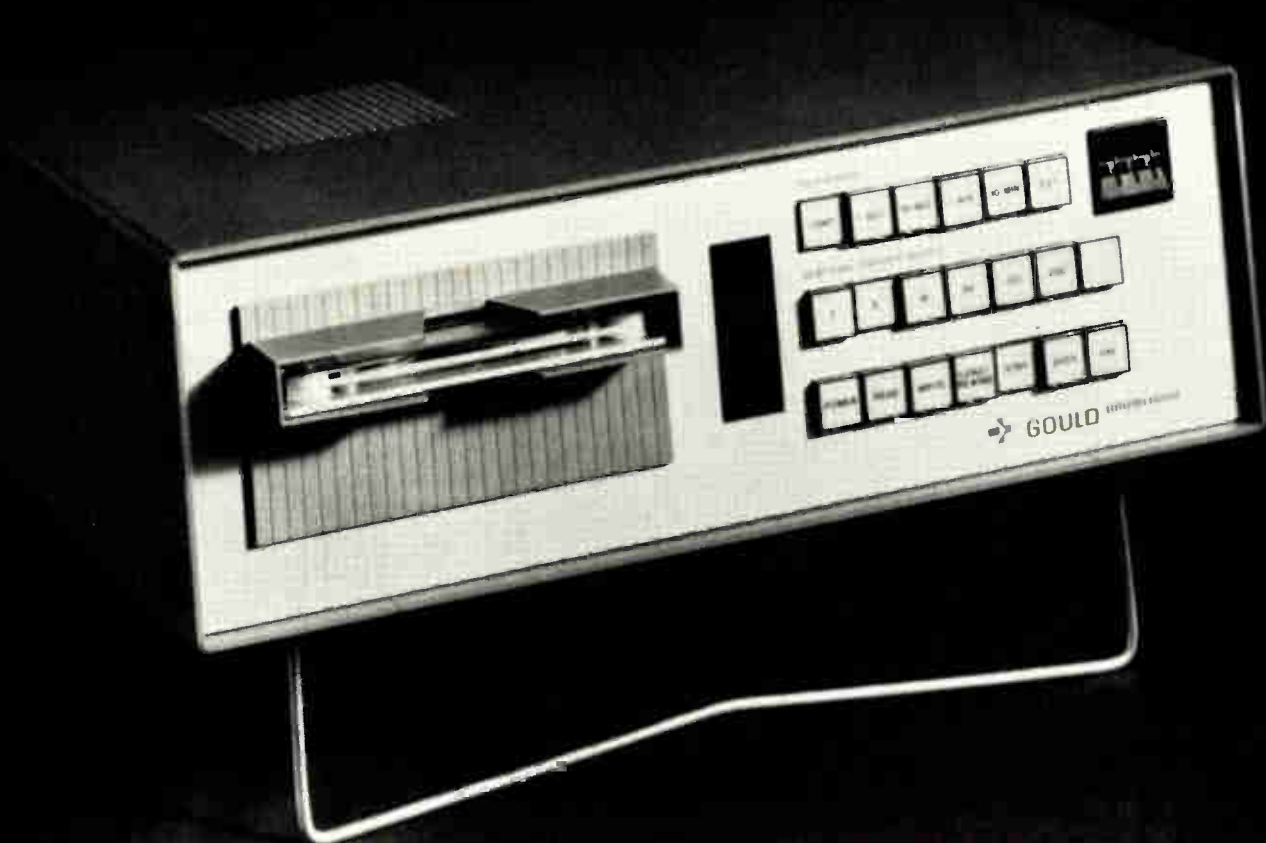

A significant advance in tape handling.

The 1/4" computer grade magnetic tape in a front loading reel-to-reel cartridge represents a significant improvement in tape handling. The 3M cartridge has 8 times the storage capacity of a cassette while eliminating tape handling problems frequently associated with large, expensive 1/2" reel-to-reel transports.

In addition, the cartridge combines plug-in convenience, foolproof operation with a single

motor drive, a built-in File Protect, 4-track read-write capability.

A typical writing error rate approaching one part in 100 million.

The Brush 6000's typical error rate which approaches 1 part per 10⁸ translates to only one writing error for every 12 tape cartridges used.

Connect up to 128 inputs to the Brush 6000 and you won't miss a thing.

The Brush 6000 can be used just about anywhere to monitor just about anything. It's being used for pollution monitoring, chemical processing and refining, weather and seismic recording, product testing, and applied research in various fields.

The Brush 6000's light-weight (under 36 pounds), easy to use controls and rugged construction make it a natural for portable, as well as on-site data acquisition jobs.

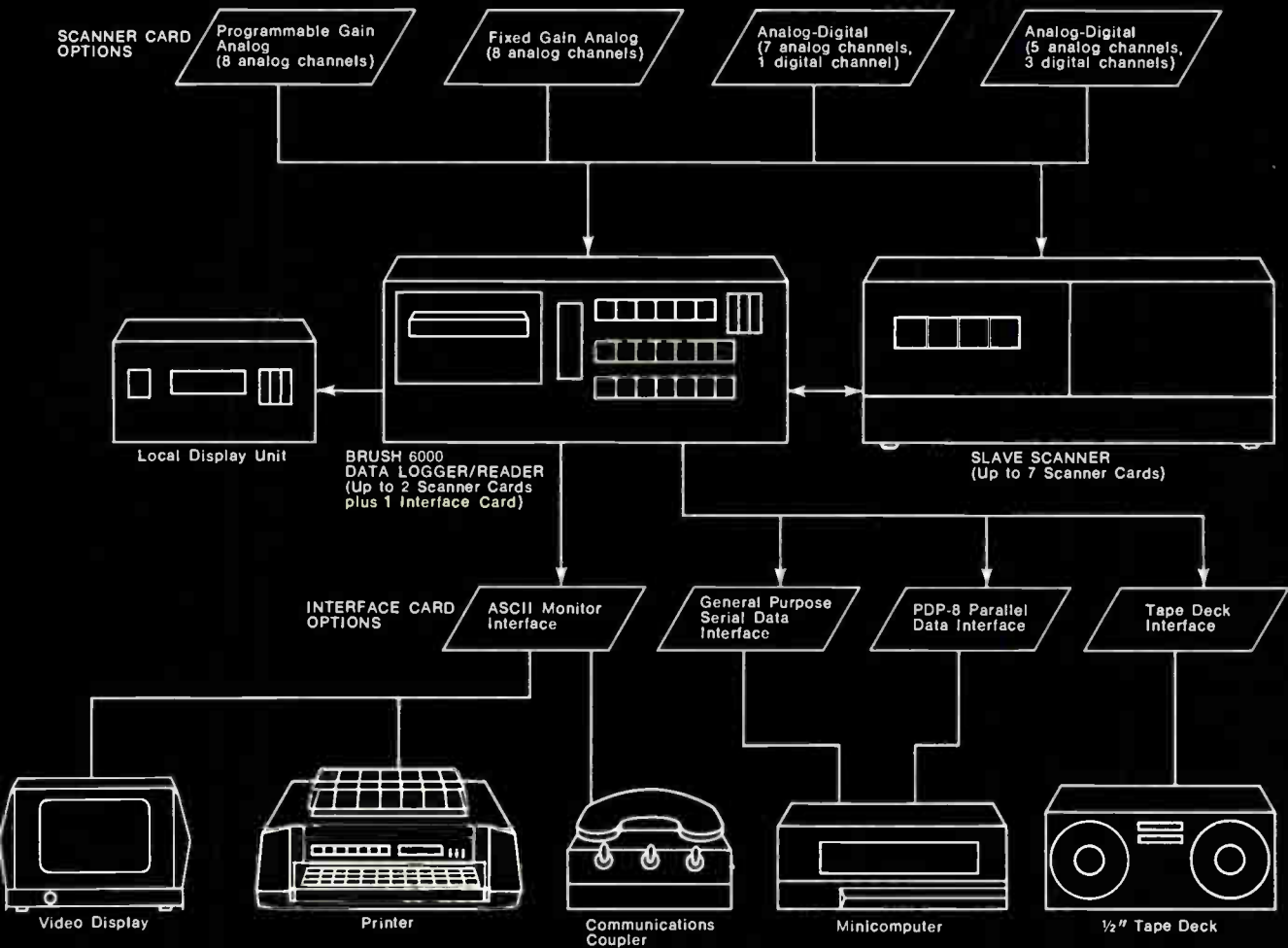

The complete data acquisition system.

The Brush 6000 is truly an operational definition of what a high performance data logger-reader should be. If your research requires an instrument of this quality, contact your nearest Gould

Sales Engineer or Representative. Or write us for detailed performance information and specifications. Gould Inc., Instrument Systems Division, 3631 Perkins Avenue, Cleveland, Ohio 44114 or Kouterveldstraat Z/N, B 1920, Diegem, Belgium.



Circle 143 on reader service card

Our Data Com Team: Champions of the MOS/LSI League.

More and more systems engineers are picking the winners—Western Digital MOS/LSI. That's why we have more devices working in more data com applications than any team in the league. Look at our lineup of outstanding players:

The Rookie of the Year is our FR1502E FIFO (First-In First-Out) buffer memory. It's in a formation 9 bits wide to match your data. Features like tri-state data lines, master reset and status flags, optional 500 kHz or 1 MHz asynchronous input/output, and easy expansion with no external hardware make you stand up and cheer. It's the most cost effective method of data speed buffering available.

If speed is your data com game, try our Programmable Synchronous/Asynchronous Transmitter P/SAT (PT1482B) and Receiver P/SAR (PR1472B). Whatever data transmission play you are calling, this programmable duo upgrades systems with speeds to 100 kilobits/second or more. And you call signals in synchro-



nous, asynchronous or even isochronous modes.



Our old pro is calling new plays. We've added 1.5 stop bits capability to our seasoned favorite TR1402A MOS/LSI Asynchronous Receiver/Transmitter and come up with a new league standard



—the TR1602 series. You have the option of ceramic or hermetic plastic cavity packages (TR1602B). These



(TR1602A)

compatible, double-buffered devices are programmable, and pass and receive simultaneously.



Start and stop bit generation is automatic. Delivery is as fast as you can call it.



Free NFL Pennant

Our data com devices are champions of the MOS/LSI League. Find out why.



Write us on your letterhead and tell us the name of your favorite National Football League team.

Write before January 5, 1974,

and we'll send you an NFL pennant for your favorite, along with literature on our winning team.

Write Western Digital Corporation, 19242 Redhill Ave., Newport Beach, California



92663. Tel: 714/557-3550.
TWX: 910-595-1139.



Go with the action...Go Western Digital!

Digital meters in wide variety hit market

Attracted by the huge sales volume of the analog VOM field, makers of DMMs offer novel measurement capabilities, low prices

by Michael J. Riezenman, Instrumentation Editor

No one can doubt the power of competition as a force for innovation after looking at the digital-multimeter marketplace. Low-cost digital multimeters—typically 3½-digit units priced at about \$250 to \$300—are currently selling at a rate of about 25,000 to 40,000 units per year, corresponding to a dollar volume in the \$5 million to \$10 million area. However, the analog VOM market, which has prices in the \$70 to \$180 range and is estimated at perhaps 150,000 units per year in the U. S. plus another 100,000 units per year in Europe, has a \$20 million to \$30 million volume that the digital-meter manufacturers see as their big chance to get into a really high-volume business.

So far, no digital instrument has been able to match the \$70 price of the bottom-of-the-line analog VOMs. The manufacturers, however, are counting on users being willing to pay a premium for the advantages of digital instruments. In the case of portable multimeters, these include light weight, improved ruggedness, greater accuracy, and, perhaps most important, elimination of the errors caused by misreading the complex, multi-scaled readouts of the analog meters.

The differences in the various manufacturers' approaches, accordingly, seem to reflect differing appraisals of just how much extra the users are willing to pay for just how much extra capability. Some companies, like Data Precision of Wakefield, Mass., and Schneider Electronique of Rungis, France, maintain relatively high prices while offering more capability than the user would normally expect for the money. Data Precision's model 245

multimeter, for example, is a compact 4½-digit (20,000-count) instrument. At \$295, it is about \$100 cheaper than its closest 4½-digit competitor and is reasonably priced when compared with 3½-digit units.

At \$440, Schneider's Digitest 610 sounds like even less of a competitor than the Data Precision unit. However, the 610 is not only a 4½-digit (11,000-count) instrument, it measures temperature in addition to the usual parameters of voltage, current, and resistance. And, since malfunctioning circuits often contain components that are running at abnormally high temperatures, a thermometer can be a very useful tool for both field service and laboratory troubleshooters.

The opposing school of thought holds that only such essential features as overload protection, ruggedness, and the maintenance of long-term accuracy should be allowed to prevail over cost in any cost-performance tradeoff. Reflecting this type of thinking are the new Danameter by Dana Laboratories of Irvine, Calif., and the model 3/24 digital multimeter by Ballantine Laboratories of Boonton, N. J. Both of these instruments sell for \$195, and both of them are powered exclusively by cheap, disposable batteries.

Somewhere between these two schools of thought lies the idea that minimizing cost is important, but that it is equally important to offer the customer something a little different. Data Technology of Santa Ana, Calif., for example, has a 3½-digit (2,000-count) multimeter that measures ac and dc volts, ohms, and capacitance. The capacitance-measuring capability, like the tempera-

ture-measuring capability of the Schneider unit, is not a common multimeter feature, and Data Technology feels that this useful function will give its \$269 model 20 an important competitive edge.

While some of the preceding instruments are unusual, one that is unique is the H-P model 970—a \$275 multimeter entirely contained inside its probe. Designed to require only one hand for its use, the 970 is a completely autoranging instrument with a single three-position function switch that is easily operated by the operator's thumb. An

Compact. Because readout of H-P 970 is close to probe tip, operator can see display without moving his eyes from test circuit.

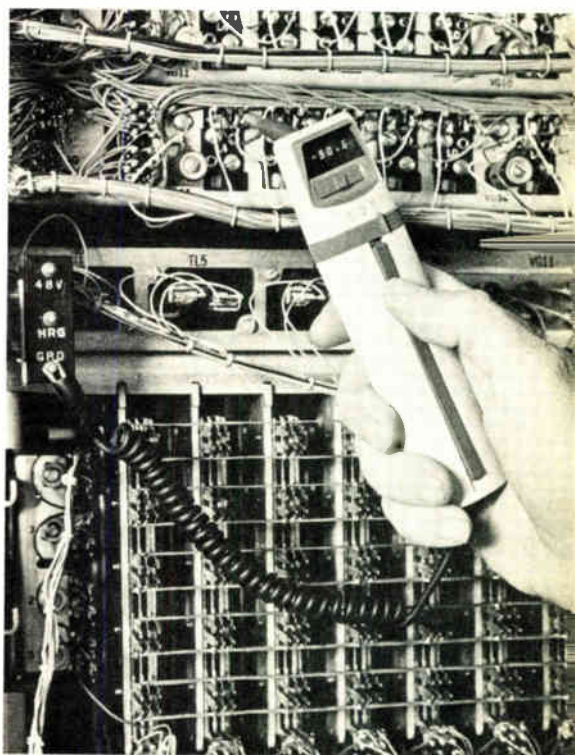

the ultimate
phasemeter
looks like
this...



MODEL 305

works
like this...

Mainframe handles 2 Hz to 700 kHz signals, measures phase angles from -180° to 360° . With or without analog and BCD readouts and digital displays. Resolutions to 0.01° . Then there's a magnificent selection of standard plug-ins, such as...

PA-3001. Automatically selects gain in each channel, for $\pm 0.1^\circ$ accuracy over 60 dB dynamic range (50 mV-50 V).

PA-3002. For $\pm 0.1^\circ$ accuracy with independent input signal levels from 50 mV to 500 mV.

PA-3005. High accuracy out to 11 Megahertz. 1 mV - 3 V input range in either channel.

PA-3008. For precision calibration ($\pm 0.1^\circ$) of wattmeters, watt-hour meters, etc. V-I, V-V, and I-I phase measurements; 50, 60, or 400 Hz.

PA-3009. Provides direct measurements of the voltage amplitude of each signal, and their amplitude ratio, as well as their phase difference.



has these
exclusive
features...

- "No Hands" Operation - fully automatic, with provisions for remote control over-ride.
- Analog/Digital Accuracy to $\pm 0.1^\circ$, resolution to 0.01° , linearity to 0.02° , repeatability to 0.03° , stability to $0.1^\circ/30$ days.
- Auto-Sensing and Selection of AC gains (for highest accuracy), output time constants (for fast response), and angle ranging.
- Navy-Approved for standards laboratories.

For full details and specifications, send for the new Dranetz catalog, or call (201) 755-7080 for a quote.



and bears
this name...

DRANETZ

Engineering Laboratories, Inc.
2385 South Clinton Avenue
South Plainfield, New Jersey 07080

New products

additional switch, operable by the same thumb, inverts the display for easy reading when the meter is used in an inverted position. Like the Data Technology meter, the H-P 970 measures ac and dc voltage and resistance but not current.

One of the most striking features of the H-P 970 is the fact that its display is up near the front of the probe, where the user can read it while keeping an eye on the exact location of the probe tip. The only other meter that puts its display in its probe (although at the rear, not up front) is the model 167 multimeter by Keithley Instruments of Cleveland, Ohio. Like the H-P instrument, the \$325 Keithley 167 is autoranging and does not measure current.

A Keithley instrument that does measure current is the model 165—an autoranging instrument that measures ac and dc voltage and current, and resistances up to 200 megohms. At \$495 this meter is not exactly low-cost, but Keithley's vice president for sales, Anthony Oliverio, says that a new version with lower cost and improved performance will be put on the market in January.

Meanwhile, back in Newark, N. J., Weston Instruments—the people who started the low-cost digital multimeter business in the first place—have been expanding their line so as to have a catalog item to satisfy just about any customer need. In addition to their basic

4440—a 3½-digit (2,000-count) instrument with a basic dc accuracy within 0.3% of reading and a price of \$250—they have a model 4442 with a price of \$275 and an improved accuracy spec of within 0.05%. Both of these instruments contain internal rechargeable batteries and can be line-operated through the battery charger. For the user who wants the accuracy of the 4442 and only wants to pay for a 4440, Weston has two additional low-cost meters: the 4443, a dc-only version of the 4442; and the 4449, a line-operation-only version of the same instrument.

Despite all of this low-priced competition, the \$299 model 8000A by the John Fluke Manufacturing Co. of Seattle, Wash., is still one of the best-selling meters around. The success of this 3½-digit-instrument, which has no autoranging capability, no special functions, and no gimmicks, is, however, no puzzle to the people who use it and the others who compete against it. It succeeds, they all say, because of its ruggedness, reliability, and long-term electrical stability.

Some makers of analog VOMs regard the digital meters as complementary rather than competitive. Says an official at Triplett Corp., Bluffton, Ohio, which sells both types: "The key here is to offer people a choice. The market is that broad. Some people will prefer to stay with analog meters; others will opt for the digital multimeter." □

What's a half-digit? Both the Weston 4442 (right) and the Data Technology 30 are 3½-digit meters. But Weston's is a 2,000-count unit and the model 30 has 5,000 counts.

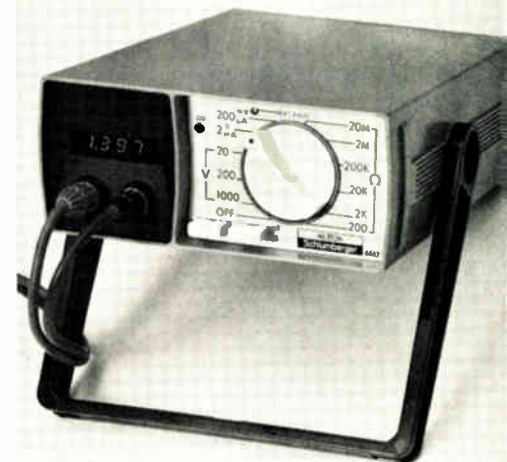

6560/ 3101A

64 BIT RAM

The 3101A now has a real second source. The new 6560/3101A 64-bit RAM is just one of an expanding family of Random Access Memories from MMI.

You know the 3101A; now meet the 6560N/3101A. 35ns access time. Plastic package. And a new, lower price. \$4.50 (100-999).

Also meet the new 6561N, a 3101A with three-state logic outputs. This commercial part (0°-70°C), with 35ns access time, also comes to you at the same low price. \$4.50 (100-999).

And mil versions of the 3101A, too: the 5560D open collector and 5561D three-state version. Both feature a ceramic package, 50ns access time and the same low price: \$8.00 (100-999).

Call your nearest MMI field sales office, rep or franchised distributor and give him your P.O. number. If you don't remember 6560, just ask for it by its last name. Monolithic Memories, Inc., 1165 East Arques Avenue, Sunnyvale, California 94086, (408) 739-3535/TWX 910-339-9229.

Monolithic Memories, Inc.

EASTERN AREA SALES OFFICE: (617) 653-3158 • NEW ENGLAND REGION: (617) 475-9883 • NEW YORK REGION: (607) 748-3211 • CENTRAL AREA SALES OFFICE: (317) 844-3241 • WESTERN AREA SALES OFFICE: (714) 556-1216
Representing your best buy in memories: ALABAMA, Huntsville (205) 539-1771; ARIZONA, Phoenix (602) 264-7971; CALIFORNIA, San Diego (714) 743-3015; Palo Alto (415) 369-4671; COLORADO, Denver (303) 623-8713; CONNECTICUT, North Haven (203) 239-9762; FLORIDA, Orlando (305) 423-7615; ILLINOIS, Chicago (312) 593-0200; INDIANA, Ft. Wayne (219) 744-4331; IOWA, Cedar Rapids (319) 393-8703; KANSAS, Kansas City (913) 236-4646; KENTUCKY, Louisville (502) 893-7303; MARYLAND, Baltimore (301) 825-3330; MASSACHUSETTS, Boston (617) 444-2484; MICHIGAN, Detroit (313) 358-2020; Grand Rapids (616) 451-8901; MINNESOTA, Minneapolis (612) 929-6721; MISSOURI, St. Louis (314) 432-2830; NEW JERSEY, Teaneck (201) 692-0200; NEW YORK, N.Y.C./L.I. (201) 692-0200; NORTH CAROLINA, Raleigh (919) 834-6591; OHIO, Cincinnati (513) 521-2290; Dayton (513) 298-9546; Cleveland (216) 228-7525; PENNSYLVANIA, Willow Grove (215) 674-3850; Pittsburgh (412) 242-0100; TEXAS, Dallas (214) 239-9148; Houston (713) 721-1054; WISCONSIN, Waukesha (414) 786-6330.

Fluxless soldering of exotic metals and glass easy with Ultrasound



An ultrasonic soldering machine is now available for fluxless soldering of regular metals as well as exotics and glass.

It consists of a Model G-35 generator and T-35 soldering iron. The generator delivers 35 watts of ultrasonic heated power into the soldering iron. Power levels are controlled by easy-operating push buttons providing a selection of heat and sound energy. Other features include solid state circuitry; and feedback, power tracking.

The titanium driver/coupler and 400° C piezocrystal vibrating elements eliminate the possibility of mechanical or heat failure.

The complete unit weighs only 2.7 kgs. (six pounds) and the iron weighs less than 340 gms. (12 oz.). It is a "metrified" design with all parts except the threads at the end of the tool in metric measurements.



Several types of replaceable soldering and welding tips are available.

Write or call the Director of Research for complete information.

FIBRA-SONICS, INC.

4626 North Lamon Avenue • Chicago, Illinois 60630 • (312) 286-7377

ECL, TTL get together on same board

Socket panels designed for wire-wrap interconnections have power planes for both logic families; applications seen in computers, peripherals, testers

by Stephen E. Grossman, Packaging & Production Editor

Combining emitter-coupled and transistor-transistor logic families becomes a relatively simple matter with an ECL socket panel developed by Augat as part of a series designed for wire-wrap interconnections. Both ECL and TTL devices can be mounted on the same circuit board because Augat has provided power planes for both types. The company expects the panels to be useful in design of computers, peripherals, test equipment, and digital-communications systems.

The skeptic may raise an eyebrow at the thought of wire-wrapping devices operating at ECL data rates. "But wire-wrapping works out fine," says William Blood, manager of the Systems Logic Development section at Motorola Semiconductor Products. "What's more, packaging ECL and TTL on a single board enables a circuit designer to perform his operations at ECL speeds, yet interface with TTL-compatible systems by employing the Motorola series of translators." These include the MC10124,

which translates TTL to ECL, and the MC10125, which translates ECL to TTL and has a fanout capability of 10 TTL loads.

Leonard A. Doucet, engineering manager, ECL products at Augat, says that point-to-point interconnection wrapped with No. 30 wire can provide less than a 10% undershoot for a pulse signal with a 3-nanosecond rise time. (Digital designers usually consider 12% or less as acceptable.) This performance is achieved by terminating the point-to-point wire at the second-level wrap position 0.370 inch above the board. Doucet reports that the impedance is between 100 and 120 ohms so that a 1/8-watt load resistor of 120 ohms at the far end provides a satisfactory termination. These resistors can be wire-wrapped in place. Source matching is unimportant to achieve the necessary wave-shape performance. A general rule when working with ECL is to terminate ECL interconnections that are 5 inches or longer.

Although designed for the Motorola transistor series, the 8136-ECL-6 panel can also be employed for other devices in the ECL and TTL families. The panel is supplied in multiples of 30 patterns (or sockets), with each group of 30 having 10 sockets committed to TTL and 20 patterns committed to ECL. The panels are glass-epoxy, the conductive foils are 2-ounce copper (2.8 mils thick), and the sockets for the IC pins are beryllium-copper with gold-over-nickel plating.

Augat has also announced another version of its ECL panel series, known as the 8136-ECL-5, which can mount 12 24-pin devices such as Motorola's ECL10181 arithmetic units in addition to 150 standard 16-lead ECL ICs. These devices are capable of performing 16 logic and 16 arithmetic operations on two 4-bit words. Prices of the ECL panels range from \$1.50 to \$2.50 per IC pattern, depending on style and quantity.

Augat Inc., Attleboro, Mass. 02703 [339]

Matchmaker. Upper portion of translator panel (right) is designed for translator ICs that can interface high-speed ECL devices (lower part) with TTL-compatible peripherals. As shown below, power required by each device family is applied to distinct bus systems.

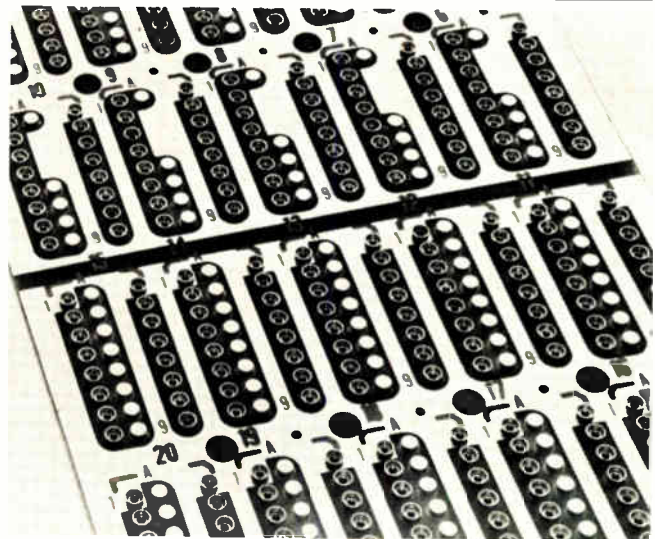
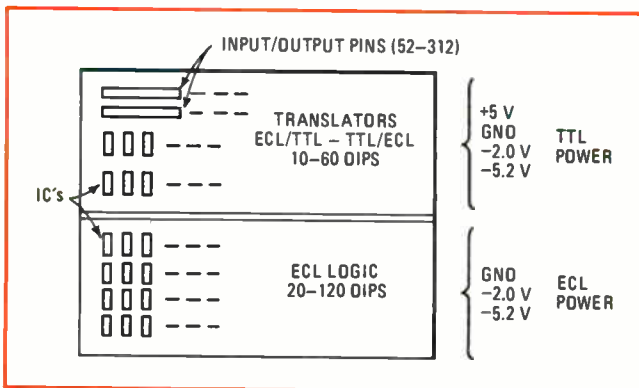

More than 6,000,000 good reasons...

To insist on RCA Rectifiers and SCR's for your fast-switching applications.

If you have an immediate need for fast-switching devices, come to RCA where large quantity production of quality products is a way of life.

We produced over six million fast-switching thyristors for TV production during the past twelve months ... and millions of fast-switching rectifiers and SCR's for other industry needs during the same period.

These low cost dependable devices represent a lot of good reasons why you should insist on RCA Thyristors and Rectifiers.

Want more good reasons?

RCA offers a large selection of fast-switching devices for your most demanding applications. High-speed inverters, choppers, high-current pulse circuits, or "free-wheeling" diode circuits... whatever your needs

are... you'll find the right SCR or rectifier to match your circuit design.

RCA's all-diffused SCR's bring you the best combination of features...

- fast turn-off time
- high di/dt and dv/dt
- high peak current capability
- exceptional uniformity and stability of characteristics

Match this combination with RCA's fast recovery rectifier features...

- low reverse-recovery current
- low forward-voltage drop
- low thermal-resistance design... and you can rest assured that your equipment is backed by the industry's leader in fast-switching technology.

No need to be concerned about quantity, availability, or cost. RCA fast-switching devices are available in quantity... at prices you can afford.

Want more information? Write: RCA Solid State, Section 70L-6, Box 3200, Somerville, N.J. 08876. Or phone: (201) 722-3200,

Fast Switching SCR's		40555	S3704	S5210	2N3653	2N3658
Package		TO-66	TO-66	¼" stud	TO-48	TO-48
I _{RMS}		5 amps	5 amps	10 amps	35 amps	35 amps
T _{OFF} (Microseconds)		2-6	6-10	5-10	10-15	6-10
1K Price:	200V	1.67	.90	3.00	7.24	7.89
	600V	2.89	1.30	12.20	15.60	17.20

Fast Recovery Rectifiers		TA7895	44938	43884	43894	43904	40960
Package		DO-26	DO-15	DO-4	DO-4	DO-5	DO-5
I _{AV}		1 amp	1 amp	6 amps	12 amps	20 amps	40 amps
T _{RR} (Nanoseconds)		50-500	150-500	150-350	150-350	150-350	150-350
1K Price:	200V	.44	.42	1.79	2.42	3.20	3.40
	600V	.72	.66	3.13	4.37	6.00	6.70

RCA Solid State
products that make products pay off

International: RCA, Sunbury-on-Thames, U.K., or Fuji Building, 7-4 Kasumigaseki, 3-Chome, Chiyoda-Ku, Tokyo, Japan. In Canada: RCA Limited, Ste. Anne de Bellevue 810, Canada.

New products

Instruments

Analyzer has 120-dB range

Spectrum measurement unit offers interchangeable analyzer heads

Despite a hefty price disadvantage caused by successive dollar devaluations, a small French company is bidding to break into the U.S. market with a high-performance spectrum analyzer selling at about \$11,600. Adret Electronique will turn out the instrument in a plant near Paris and will sell it in the U.S. market soon through its Lancaster, Pa., subsidiary, Adret Corp.

The main feature of the analyzer, designated the model 6303, is its wide dynamic range—up to 120 decibels. The unit comes in modular form for installation in an existing Adret mainframe. In addition, there are two interchangeable analyzer heads—the first for measurements in the range from 0 to 11 megahertz, and the second from 1 to 110 MHz.

Adret says it has overcome two principal restrictions of some spectrum analyzers—poor short-term stability in the first voltage-controlled oscillator and the low dynamic range of the entry mixer. The answer was to use the high spectral purity that is characteristic of modern synthesizers by linking a synthesized local oscillator to a quartz oscillator, instead of using a voltage-controlled oscillator alone. The arrangement solves the frequency-stability problem and also allows precise frequency measurement

because of the use of the quartz component.

The dynamic range was widened through development of a new type of signal-entry mixer. Adret engineers say the mixer was designed to operate at a high level and to be free from nonlinear characteristics. A new field-effect-transistor integrated circuit was developed to change the frequencies, but the number of active circuits in the measuring system was reduced to a minimum to cut down noise levels.

The synthesizer and oscillator unit, together with the entry mixer, feeds the signal through the eight-element quartz filter with a narrow 10-hertz bandwidth. The shape factor is 10 at 100 dB attenuation. The central frequency of this filter is 84.08 gigahertz to a five-stage logarithmic amplifier that uses very-low-noise field-effect transistors.

To get optimum dynamic range, the unit is fitted with an interchangeable "analyzer head" that incorporates the entry mixer and, in one mode, includes a device to reduce the synthesizer frequency by a factor of 10. The effect is to reduce phase interference of the synthesizer to 10% and, as a result, to raise the maximum dynamic range. At the same time, the frequency range is also divided by 10.

Since the instrument shows its best paces in measurements beyond 80 dB, it is best suited to analysis of very low modulated signals, which can be up to 110 or 120 dB below and as far as 100 Hz away from the carrier.

Depending on the dispersion selected, ranging from 200 Hz to 100 kHz, analysis duration ranges between 100 and 2,000 seconds, and frequency accuracy is within ± 5 Hz. The measured level is displayed on

a galvanometer, and the spectrogram is plotted on an X-Y table.

Adret Corporation, 1887 Lititz Pike, Lancaster, Pa. 17601 [351]

Calibrator covers six thermocouple ranges

A portable thermocouple-control calibrator, designated the model 900, can measure the output of a thermocouple or other transducer or it can simulate the output of a thermocouple to calibrate a thermocouple instrument. These instruments can be either the potentiometer type that draws no current or the power-consuming fixed-input-resist-



ance type. The model 900 handles all six commonly used thermocouples (J,K,T,E,R, and S). It also offers three millivolt scales, from 0 to 75 mv, for other, less commonly used thermocouples, and for load cells, strain gages, and other transducers that produce low voltages. Price is \$398.

Victory Engineering Corp., Victory Rd., Springfield, N.J. 07081 [353]

Panel-meter plug-ins can change ranges

The model 253 digital panel meter with a 20-millivolt full-scale basic range also offers 10-microvolt sensitivity. Four additional dc voltage ranges and seven dc current ranges are selected by changing one internal plug-in 16-pin DIP. The model 253 is also offered without the range-change module, handling

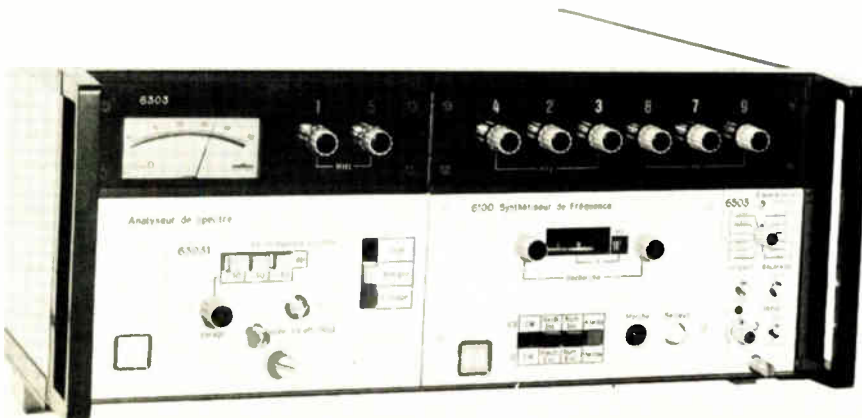

**For Capacitance
at High Voltage
and
High Current**

With low loss, stability of capacitance, easy variability and puncture-proof dielectric, Lapp Gas-Filled Capacitors provide for high-voltage application the same operating advantages as open-air plate capacitors—in compact design.

From the earliest days of high-power radio transmission, Lapp gas-filled capacitors have provided a high order of reliability. Available for broadcast or industrial RF generator use to 85kv peak, at current ratings to 390 amps at 1 MHz, and capacitances to 22,000 pf.

Write for Bulletin 302. Lapp Insulator Division, Interpace Corporation, LeRoy, N.Y. 14482.



**Gas-filled
Capacitors by
Lapp**

INTERPACE
CORPORATION

New products

range and function as necessary, thus reducing the required inventory. Standard features of the



253 include parallel BCD outputs, 3-wire ratio measurement, and read-out-blanking. Price is \$120.

Newport Laboratories Inc., 630 E. Young St., Santa Ana, Calif. 92705 [354]

Measuring bridge is battery-operated

Working from ordinary batteries, a measuring bridge checks resistance, capacitance, and inductance. The resistance-measuring range is 1 mil-



liohm to 1 megohm and can be performed with either a dc Wheatstone-bridge configuration or an ac Kohlrausch bridge. Inductance range is from 0.01 microhenry to 11 henries, and capacitance range is from 0.1 picofarad to 1,100 microfarads.

Tettex A.G., CH-8042 Zurich, Switzerland [355]

Active filters can be used in pass or reject mode

General-purpose two-pole active filters are for use in either bandpass or band-reject configurations. Center

Your power supply...

**if you build it
it might work**

**if we build it
it will work**



Building your own power supply can be costly, especially if you don't have a history of successful power supply design experience under your belt. You'll gamble many man-hours and thousands of dollars and you may well lose.

But if you come to Scott Electronics, you *know* you'll get a power supply that fits your needs. When we say we can custom design and mass-produce a power supply that meets your specs, we back it with past performance. Scott Electronics has built thousands of reliable, custom-designed power supplies. And yours, like those, will be delivered on schedule, at a fixed, predetermined cost.

So put your engineers' time to better use and your money where you know you'll get results. Bring your custom design needs to the specialists. Scott Electronics.



ELECTRONICS CORPORATION

P.O. Box 7637
2525 Shader Rd. • Orlando, Fla. 32804
Phone (305) 295-5850

**This Christmas give your car
a Mark Ten B Capacitive
Discharge Ignition. You and
your car will enjoy it all year.**



The Mark Ten B keeps your car in tune. That means increased mileage, less maintenance and a better running car. A well-tuned car also decreases emission contaminants. All this adds up to more driving enjoyment for you. Mark Ten B, the perfect gift—for cars—and their owners.

New products

frequency is tunable from 1 hertz to 10,000 Hz, and bandwidth at any frequency is controllable over a two-decade range. Bandwidth and center-frequency adjustments are independent and noninteracting. The

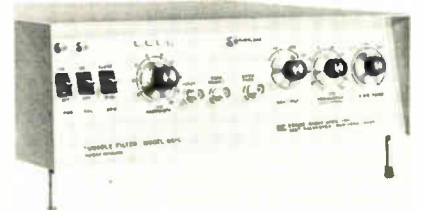

model 8010 filter offers circuit Qs to 1,000, while the 8020 is available with Qs to 10,000. Price starts at \$750.

Edmac Associates Inc., 333 W. Commercial St., E. Rochester, N.Y. 14445 [357]

Multimeter delivers 20 readings a second

Up to 20 readings per second with 60 decibels of noise rejection can be delivered by the model Cimron DMM-50 multimeter. The full auto-



ranging autozero meter provides a 5½-digit readout and combines successive-approximation and integration logics (the former for high speed, the latter for inherent noise rejection). Five ranges of dc voltage are offered from 100 millivolts to 1,000 mv full scale. Price is \$1,195.

California Instruments Co., 5150 Convoy St., San Diego, Calif. 92111 [358]

Digitizer offers built-in computation

Designed for use by OEM firms in measurement and process-control systems, a digitizer called the

Price Card

DELTA PRODUCTS, INC.

P.O. Box 1147, Dept. E
Grand Junction, Colo. 81501
(303) 242-9000

Here's my Christmas order. Please rush!

Please send me free literature.

Enclosed is \$ _____ Ship ppd. Ship C.O.D.

Please send: _____ Mark Ten B assembled @ \$59.95 ppd. _____ Mark Ten B Kit @ \$44.95

ppd. 12 volt negative ground only • _____ Standard Mark Ten, assembled, @ \$44.95 ppd.

_____ 6 Volt: Neg. Ground Only _____ 12 Volt: Specify _____ Pos. Ground _____ Neg.

Ground • _____ Standard Mark Ten Deltakit* @ \$29.95 ppd. (12 Volt Positive or Negative Ground Only)

Car Year _____ Make _____

Name _____

Address _____

City/State _____ Zip _____

Circle 154 on reader service card

PUBLIC SERVICE



SALON INTERNATIONAL DES

**composants
électroniques**
PARIS 1-6 / 4 / 74

COMPONENTS - MEASURING
MATERIALS - EQUIPMENT

Organisation S.D.S.A. - 14, rue de Presles 75740 Paris Cedex 15

FRENCH TRADE SHOWS 1350 Avenue of The Americas
NEW YORK, N.Y. 10019 Tel.: (212) 582-4960, 1

154 Circle 241 on reader service card

Electronics/December 6, 1973

If you've got the timepiece, we've got the electronics.

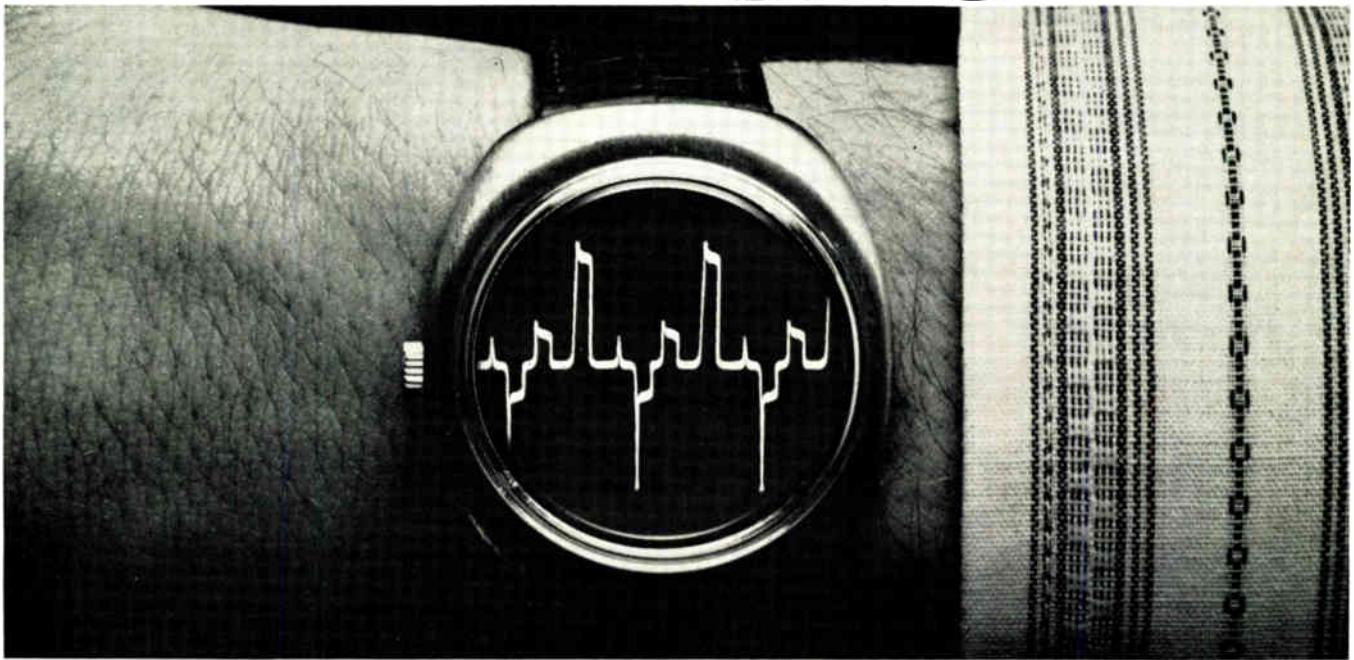

We've got CMOS integrated circuits.

quartz crystals.

liquid crystals.

micro stepping motors.

digital systems.

analog systems.

We help solve your problems by being a single, reliable source for virtually all of your electronic timepiece needs. Please call or write : Marketing Director, Motorola Timepiece Electronics, 3102 North 56th Street, Phoenix, Arizona 85036. (602) 244-4406.

MOTOROLA
Timepiece Electronics

*Bringing more than 45 years of
electronic experience to
the world's watch makers.*



The Real Time Spectrum Analyzer you've needed...



is now within your budget!

If you've been "making do" with sound level meters, tracking filters, wave analyzers or other limited frequency analysis techniques — we've got exciting news for you.

For only \$5000 you can now buy all the advantages of real time narrow band spectrum analysis with our 200-line Saicor 51B Real Time Analyzer/Digital Integrator... and get built-in spectrum averaging and linear, peak hold and exponential averaging modes. A superior frequency analysis technique for thousands of dollars less than ever before. Can you afford not to find out more? Call for a demonstration or write today for our free "25 Ideas" brochure.



Honeywell

Signal Analysis Operation/Test Instruments Division
595 Old Willets Path/Hauppauge, New York 11787/(516) 234-5700

Circle 156 on reader service card

New products

AN7000 P(C)³ incorporates an analog-to-digital converter, a fully preprogrammed processor, random-



access and read-only memories, and an input-output bus, so that it is capable of built-in computation. The digitizer is about 6 inches high, 8 in. wide, and 10 in. deep. The compact unit also offers a resolution of 1 part in $\pm 40,000$ and an error of $\pm 0.01\%$. Price in quantity is \$600.

Analogic, Audubon Rd., Wakefield, Mass. 01880 [356]

Minicounters replace electromechanical units

Designed for the direct replacement of electromechanical counters, the 500M miniature preset counter is suitable where a high count rate and repetitive reset would wear out or degrade an electromechanical version. Available in both count-up and count-down models, the solid-state instrument has a 10-kilohertz count rate.

Dynapar Corp., 1675 Delany Rd., Gurnee, Ill. 60031 [359]



DIP REED RELAYS

Available in all standard configurations
From distributor stock

Elec-Trol's totally encapsulated DIP REED RELAYS can be driven directly by TTL logic. Available in 1 and 2 Pole Form A, 1 Form B, 1 Form C with 5 through 24 VDC standard coil voltages. Contact ratings up to 10 watts. Available in .225" and .275" heights. Clamping diode and electrostatic shielding optional.

Phone, wire or write.

ELEC-TROL, INC.

26477 N. Golden Valley Road
Saugus, California 91350
(213) 788-7292
TWX 910-336-1556



1973-74
eem
VOL. TWO

156 Circle 101 on reader service card

Electronics/December 6, 1973

THE SUPER 70

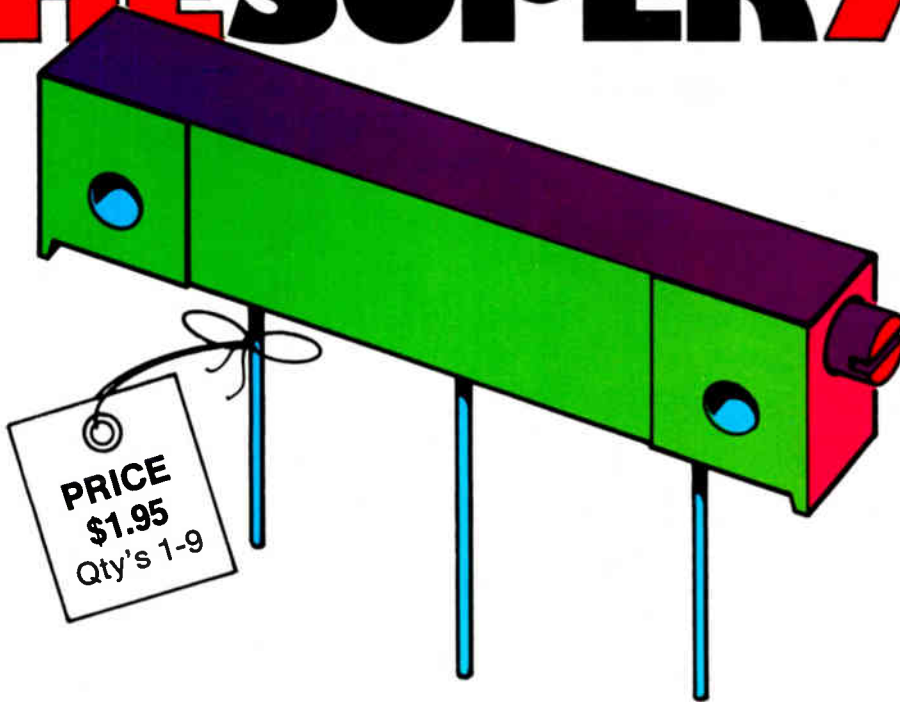

**The new 1-1/4-inch cermet trimmer
that replaces all these...**

55	215	949	3051	AB-MH
56	235	993	3052	AB-NP
58	272	995	3059	AB-NX
78	276	2855	6011	AB-RP
140	450	3011	6022	AB-RH
185	650	3012	AB-MP	ET-12

...with the most advanced features, too!

- Improved wiper and unique slider block design
- Excellent setability and stability
- TEMPCO of 100 PPM/°C
- 1 W @ 85°C
- Five configurations
- Conforms to MIL-R-22097.

Send for data sheet and quantity price information, or contact your local Spectrol representative or distributor.



SPECTROL ELECTRONICS GROUP

UNITED STATES Spectrol Electronics Corporation 17070 E. Gale Avenue, City of Industry, Calif. 91745, U.S.A. • (213) 964-6565 • TWX (910) 584-1314

UNITED KINGDOM Spectrol Reliance Ltd. Drakes Way, Swindon, Wiltshire, England • Swindon 21351 • TELEX: 44692

ITALY SP Elettronica spa Via Carlo Pisacane 7, 20016 Pero (Milan) Italy • 35 30 241 • TELEX: 32242

“Scotchflex” Flat Cable Connector System makes 50 connections at a time.



“SCOTCHFLEX” IS A REGISTERED TRADEMARK OF 3M CO.

Build assembly cost savings into your electronics package with “Scotchflex” flat cable and connectors. These fast, simple systems make simultaneous multiple connections in seconds without stripping or soldering. Equipment investment is minimal; there’s no need for special training. The inexpensive assembly press, shown above, crimps connections tightly, operates easily and assures error free wiring.

Reliability is built in, too, with “Scotchflex” interconnects. Inside of connector bodies, unique U-contacts strip through flat cable insulation, grip each conductor for dependable gas-tight connections.

“Scotchflex” offers you design freedom, with a wide choice of cable and connectors. From off-the-shelf stock you can choose: 14 to 50-conductor cables. Connectors to interface with standard DIP sockets, wrap posts on standard grid patterns, printed circuit boards. Headers for de-pluggable connection between cable jumpers and PCB. Custom assemblies are also available on request.

For more information, write Dept. EAH-1, 3M Center, St. Paul, Minn. 55101.

3M COMPANY **“Scotchflex”.**
Your systems approach to circuitry.

Components**Process guards chip capacitors**

Multilayered terminations protect ceramic from stress during thermal cycling

While working on a contract for high-reliability components, engineers at AVX Corp., Braintree, Mass., realized that the difference between the expansion coefficients of palladium-silver terminations and ceramic-chip capacitors could lead to stress and cracking of the ceramic during thermal cycling. After working on the problem for several years, AVX has made commercially available a termination that consists of layers of silver, nickel, and gold. The company says the termination, called NiGuard, withstands thermal cycling better than does a palladium-silver alloy.

Silver is first fired onto the capacitor in a layer from 0.2 to 2 mils thick. Fully annealed silver is soft enough not to cause cracking; it conforms to the shape of the ceramic. Silver's expansion coefficient of 10.9×10^{-6} at 25°C is closer to ceramic's 7 or 8×10^{-6} than palladium's 11.6×10^{-6} at 25°C and 14×10^{-6} at 500°C .

In the next step, nickel, which has an expansion coefficient of 9.2×10^{-6} at 25°C , is electroplated onto the silver in a layer 50 to 100 micrometers thick. This nickel barrier ties up any free silver, prevents leaching, and adds toughness to the termination.

Finally, a thin layer of gold is plated on. "Its thickness is adequate to maintain solderability and bondability," AVX engineers say. "This is the trick; it took us four and a half years to find the right thickness." The company says that applying the elements in layers divides the stress evenly in the termination area.

NiGuard terminations are available on a variety of multilayered ceramic chip capacitors in a wide

range of sizes, and they meet EIA and MIL-C-55681A specifications. Cost is slightly higher than the cost of palladium-silver alloys, says AVX. Delivery time is about normal now for components—about 30 weeks [*Electronics*, Oct. 25, p. 32].

AVX Ceramics, P.O. Box 867, Myrtle Beach, S.C. 29577 [341]

Piezoelectric transducer offers wide range

A miniature piezoelectric pressure transducer, P200 series, offers a sensing element that is said to show negligible response to spurious vibration, heat transients, body strains and other adverse conditions. Pressure range is from 0.01 to 4,000 pounds per square inch. Alternating variations of 0.01 psi can be detected in a static pressure field of 4,000 psi. Price ranges from \$155 to \$195.

Columbia Research Laboratories Inc., MacDade Blvd. & Bullens Lane, Woodlyn, Pa. 19094 [410]

Miniature switch is easy to mount

A threaded bushing facilitates panel-mounting of the model E-34-00J miniature snap-action switch. The unit also offers a nylon push button $\frac{3}{8}$ -inch in diameter, in addition to a coil-spring mechanism. The switch is intended for use at 15

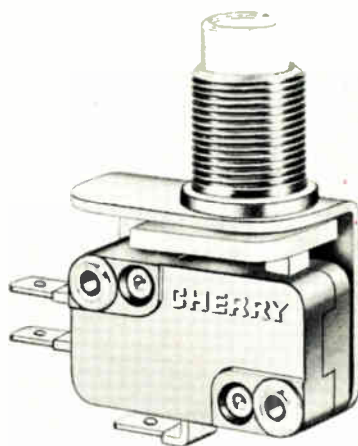

amperes, 125/250 volts ac, and is available with screw, solder, or quick-connect terminals. Price is \$1.35.

Cherry Electrical Products Corp., 3600 Sunset Ave., Waukegan, Ill. 60085 [409]

Reflective transducers combine emitter, detector

A series of optical-pair reflective transducers combines an emitter and detector in a single compact package. Each device also incorporates an infrared bandpass filter over the phototransistor detector to assure operation under adverse ambient conditions caused by stray fluorescent or other short-wave-

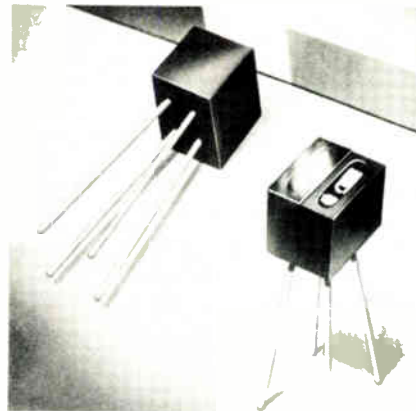

length lights. The transducers are designed for beginning- and end-of-tape sensing, character recognition, mark sensing, and similar applications. The STRT-850 series offers a typical photocurrent output of 125 microamperes.

Sensor Technology Inc., 21012 Lassen St., Chatworth, Calif. 91311 [343]

LEDs are resistant to shock and vibration

Both wide and narrow high-intensity light sources are featured in a family of miniature light-emitting-diode lamps, which are resistant to shock and vibration. Easily read over a wide viewing angle, the LEDs are designed for fiber-optic and imaging systems or front-panel status indication. The units are also

Dialight sees a need:

(Need: The right switch for the right price.)

See Dialight.

For the switch buyer, choice of function and esthetics, reliability, ease of mounting, and low cost are his prime concerns. He may need a pushbutton switch for panel, sub-panel or snap-in mounting. He may need a choice of bezels with or without barriers in black, gray, dark gray or white. He may need a legend that's positive, negative, or hidden until energized... one that's white when "off" and red, green, amber, blue or light yellow when "on"... or colored both "on" and "off." He may need a highly



reliable switch proven in thousands of installations... available in momentary or alternate action... N.O., N.C. or two circuit (one N.O., one N.C.) or for low level, low voltage and current applications... that accommodates a T-1 1/2 bulb with midget flanged base, incandescent, in voltages from 6 to 28 V. Matching indicators with same front-of-panel appearance are also available. These are some custom needs he may face, and these switches are some off-the-shelf answers from Dialight.



Conservatively speaking, Dialight offers well over 1,879,698 switch possibilities. Dialight is a company that looks for needs... and develops solutions. That's how we developed the industry's broadest line of switches, indicator lights and readouts. No other company offers you one-stop shopping in these product areas. And no one has more experience in the visual display field. Dialight can help you do more with switches than anyone else because we have done more with them. Talk to the specialists at Dialight first. You won't have to talk to anyone else.

Here are a few products in this family: **1.** Thumbwheel switches—miniature and standard sizes **2.** Contactless solid state switch **3.** Keyboard reed switch **4.** Double pole, double throw snap action switch **5.** LED lighted momentary action switch **6.** Matching indicators **7.** Momentary snap, nonsnap, and alternate action switches **8.** Transistorized indicator with momentary switch **9.** Incandescent or neon lighted switch.

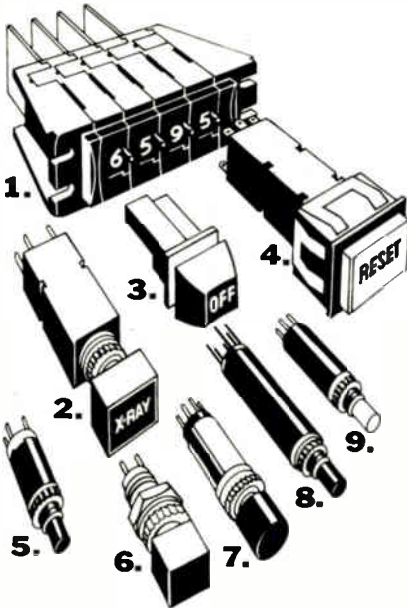

Please send data on your switches.

NAME _____
 TITLE _____
 COMPANY _____
 ADDRESS _____
 CITY _____ STATE _____

DIALIGHT

Dialight Corporation, A North American Philips Company
 60 Stewart Avenue, Brooklyn, N.Y. 11237 (212) 497-7600

Circle 161 on reader service card

New products

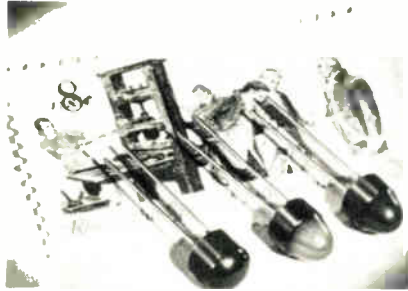

compatible with digital integrated circuits and can be driven directly from low-level digital IC outputs.

Eldema division, Genisco Technology Corp.,
 18435 Susana Rd., Compton, Calif. 90221
 [344]

Power transformer includes printed-circuit pins

A power transformer with printed-circuit pins for fast, economical mounting is of laminated construction. Designated the model IPL-1029-4, the unit is rated at 1.5 watts, and it will transform an input of 100

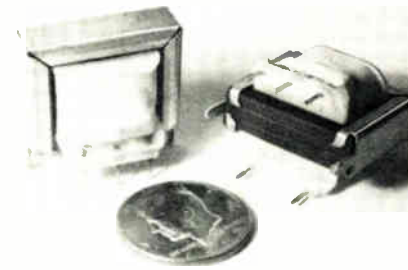

volts at 60 hertz to 35 v minimum at 50 milliamperes and 45 v maximum at 25 mA. Price in quantity is \$1.25 each.

Dale Electronics Inc., East Highway 50,
 Yankton, S.D. 57078 [345]

Ceramic capacitors are glass-enclosed

The CG series of glass-enclosed ceramic capacitors is offered in sub-miniature sizes with capacitances of 10 picofarads through 10,000 pF and 2,200 pF to 100,000 pF. Ceramic dielectric materials available are NPO and W5R in 25, 50, and 100

volts. The devices conform to military standards. Lead taping for automatic equipment is available on request.

Elpac Components, 3131 S. Standard Ave.,
 Santa Ana, Calif. 92705 [346]

Rf power capacitors have Q of 5,000 at 1 MHz

A line of rf ceramic capacitors are general-purpose types designated the MJ series. The devices exhibit a Q of 5,000 when measured at 1 megahertz, and stability over a temperature range of -55 to +125°C is +90 ppm/°C. The capacitors are available in chip, stripline and cased axial and radial configurations. In the chip configuration, 13 case sizes are offered.

ITT Jennings Monrovia Plant, 1960 Walker Ave., Monrovia, Calif. 91016 [347]

Miniature opto-isolator aimed at hybrid work

An opto-isolator in a miniature package can eliminate groundloop feedthrough and isolate floating grounds, voltage transients, and logic signals. The model MCT10 is a gallium-arsenide LED, coupled to a silicon planar transistor mounted in a four-lead clear-epoxy package. The unit is compatible with hybrid circuits where reflow soldering is used and with TTL logic without additional interface circuitry. Price is

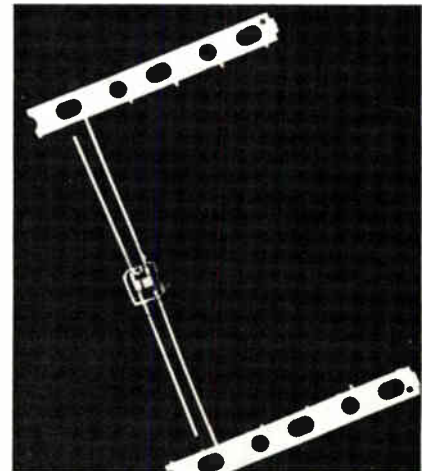

Look what \$450 buys!

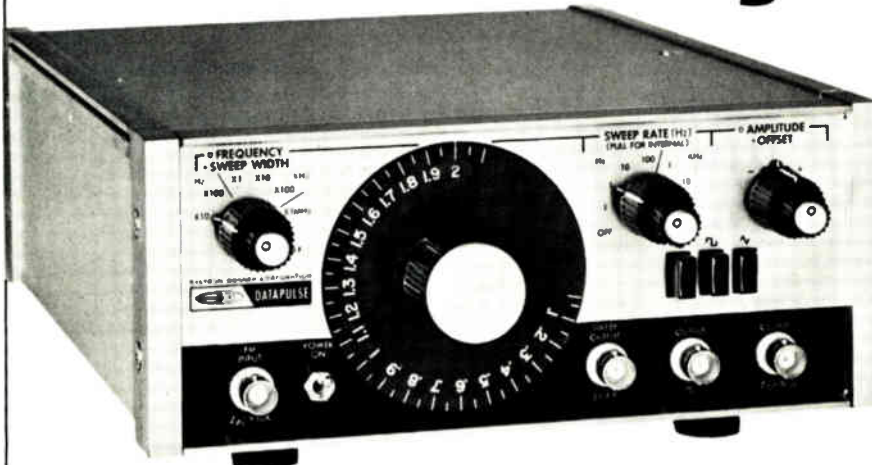

New 2 MHz sweep function generator

It's the only one at that price... Systron-Donner's Model 411 sweep function generator. Check these features: **Frequency** in 6 decade ranges from 0.02 Hz to 2 MHz—Dial accuracy 2% of full scale typical—**Waveform outputs:** sine, square, triangle, ramp and a T2L compatible sync pulse square wave. **Plus:** Model 411 is the only low cost sweep function generator which allows the operator to set the upper frequency limit to dial accuracy. **Contact:** your nearest Scientific Devices office or Systron-Donner Datapulse Division, 10150 W. Jefferson Blvd., Culver City, CA 90230. Phone (213) 836-6100.

SYSTRON  **DONNER**

Circle 162 on reader service card

20MHz ... and small enough to fit in your brief case!

- Mini-portable Oscilloscope • Battery or AC powered
- DC-20 MHz bandwidth • 10 mV/div sensitivity
- Recharging circuitry • Rack mountable • Laboratory Quality

The PS900's are the first mini-portable scopes to bring lab-quality to "on-site" DC to 20 MHz test and measurement applications. These are "true" portables, since they are of rugged construction, small size (will fit into your tool kit or brief case) and light weight (only 7 pounds with batteries), and since they will operate from internal batteries for up to 5 hours. Recharging circuitry is included, and standard "C" size cells can be used... nickel-cadmium, alkaline or in a pinch, even common flashlight batteries!

• Interested? Call Bill Kraus at (714) 279-6572, or write us at 7170 Convoy Court, San Diego, California 92111.



PS920A
"STACK-
PACK"

Two configurations are available...
"FLAT-PACK"—
1 3/4" H x 8 1/2" W x 12" D
"STACK-PACK"—
3 1/2" H x 4 1/4" W x 12" D

AVAILABLE NOW FROM

\$595

From the leader in Multi-Channel Monitor Oscilloscopes

VU-DATA
CORPORATION 

New products

about \$3.15 to \$5.40 each, depending on quantity.

Monsanto Commercial Products Co., 3400 Hillview Ave., Palo Alto, Calif. 94304 [348]

Longitudinal-shaft motion provides switching functions

A series of printed-circuit-board switches, called the 2439, provides standard and modified coded outputs and novel functions that are switched by longitudinal shaft movements. The shaft switches have momentary-spring-return or de-



tented contact positions and are actuated by pulling on the shaft. The unit measures 0.675 inch in diameter; length depends on circuitry desired.

Janco Corp., 3111 Winona Ave., Burbank, Calif. 91504 [349]

Interference filters are rated at 440 volts

A series of general-purpose interference filters is rated for operation at 440 volts at 50 to 60 hertz. The filters are designed for application in office, data-processing, and computer-peripheral equipment. The series JX5500 provides a minimum insertion loss of 60 decibels at 150 kilohertz and 80 dB over the range from 0.5 megahertz to 1 gigahertz.

Sprague Electric Co., 35 Marshall St., North Adams, Mass. 01247 [350]



Improve your hybrid yields with **SINGLE-CHIP TC ZENER CHIPS** from **DICKSON**

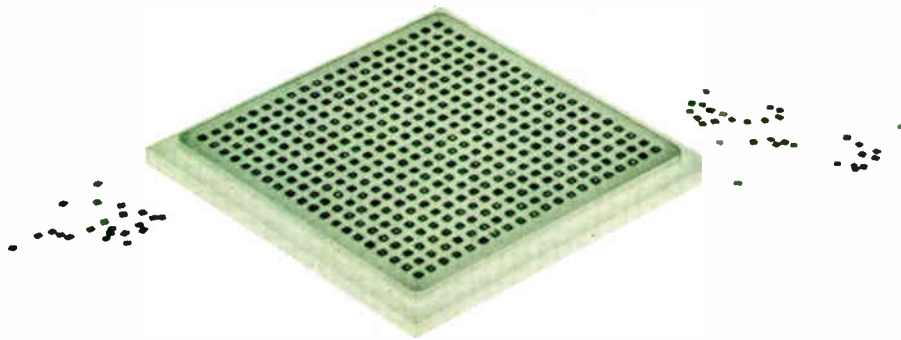

You can now design temperature compensated voltage reference diodes in your hybrid circuits with assurance that temperature coefficients will meet your design requirements. Dickson provides them on a single-chip, 100% tested, to help save time, simplify circuit fabrication and improve your yields.

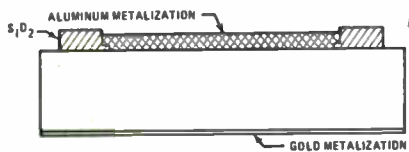

CROSS SECTION OF SINGLE CHIP TC ZENER

Each 37 mil square Dickson chip contains two totally passivated junctions with a 6.2 Volt or 6.4 Volt temperature compensated reference. Temperature coefficients to 0.0005%/°C are available. The chips are electrically equivalent to the JEDEC 1N821-829 and 1N4565A-4584A series.

The Dickson chips have gold metalization on the back, compatible with all common die bonding and soldering

techniques. Aluminum metalization on upper surface is compatible with ultrasonic and thermocompression wire bonding.

FOR COMPLETE TECHNICAL INFORMATION contact your local Dickson Sales Representative, or write to Dickson.

AVAILABLE IN ASSEMBLIES, TOO!



Dickson "single-chip" TC diodes are also available bonded in a ceramic channel for ease of handling and testing. These *LID's* are available with solder coated runners for reflow mounting or with gold runners for wire bonding. In addition, Dickson supplies a wide variety of components in chip assembly form to hybrid manufacturers. Ask for details.



DICKSON
 ELECTRONICS CORPORATION

PHONE (602) 947-2231 TWX 910-950-1292 TELEX 667-406
 P.O. BOX 1390 • SCOTTSDALE, ARIZONA 85252

"Where Quality Makes the Difference"

Semiconductors

Huge SCR handles 2,500 A

Hockey-puck type for industrial applications uses 60-millimeter wafer

The unexpected popularity of a 1,600-ampere silicon-controlled rectifier introduced last year has prompted its maker, International Rectifier, to develop a family of SCRs with still higher current and voltage ratings—2,500A rms (1,600 A average) and up to 1,200 volts, and future versions are planned to reach 2,000 v. Comments David Cooper, IR vice president of sales and engineering, "It is apparent that there is a widespread need, through many segments of industry, for SCRs at power levels that were unheard of only a few years ago."

Believed to be the largest in production, the hockey-puck SCRs replace earlier assemblies of paralleled, smaller devices. This reduces manufacturing costs since fewer parts have to be assembled, and it also eliminates the cost of multiple-firing circuitry. Moreover, the parts' high surge capacity (35,000 A for a half cycle of 60-hertz current) can simplify protective circuitry, sometimes even doing away with the need for fuses.

Major uses for the large device are in chemical processing and furnace controls, in dc motor drives for such applications as rapid transit, ships, earth-moving machinery, and drilling rigs, and in power supplies for welding and radio transmission.

As might be expected, new technology was needed to make a device able to handle this level of power. The semiconductor "chip" is a whole wafer more than 60 millimeters (2.4 inches) in diameter. Cooper says this part, to the best of his knowledge, is the largest chip ever used in a semiconductor device. IR uses an epitaxial, rather than alloy or diffused, process for high voltage

rating and consistent performance. The hermetic ceramic package is a new one, 3.875 inches in diameter and 1.38 inch thick. The part has a thermal resistance of 0.02°C per watt, with heat-sinking very important for full power rating. Laurence R. Carver, manager of applications engineering, says that this level is about the limit for air-cooling, but liquid-cooling offers advantages. The company also sells heat dissipators and will supply the SCR mounted in an assembly.

Other parameters include maximum "on" voltage drop of 1.65 v at 1,600 A average current (the average rating of 1,600 A is more relevant in hockey-puck SCRs than the rms rating, which is better for stud-mounted parts affected more by package limitations). Maximum di/dt is 800 A/s, and dv/dt is 200 v/microsecond. The part typically requires a 60-milliampere drive current at 1.6 v, comparable to the smaller 1,600-A rms part.

The device is rated at an I²t of 5,100,000 square-ampere-seconds for fusing purposes. Maximum holding current required is 500 mA, typical delay time is 1 μs, and typical turn-off time is 120 μs. Junction operating-temperature range is -40°C to +125°C.

Mounting force is 8,000 pounds, and the newly developed device weighs 36 ounces.

The 1,200-v part, 1600 PA120, is priced at \$805 in small quantities.

International Rectifier Semiconductor Division, 233 Kansas St., El Segundo, Calif. 90245 [411]

Power transistor is rated at 50 watts

Two hermetically sealed broadband radio-frequency power transistors offer internal matching and are specifically designed for pulsed and continuous-wave service in the Taccan/DME and phased-array-radar bands. The PH-1114-50 is rated at 50 watts broadband under long pulse conditions of 1 millisecond, 20% duty, or at 50 watts cw for narrowband applications. Power gain is



6 decibels minimum. Ratings are at 28 volts. Price is \$350.

Power Hybrids Inc., 7231 Garden Grove Blvd., Garden Grove, Calif. 92641 [407]

Quad driver, receivers are for data transmission

A series of quad devices consists of two line receivers and a line driver. The MC3450 receiver offers active pull-up, TTL-compatible outputs, and a three-state strobe input. The

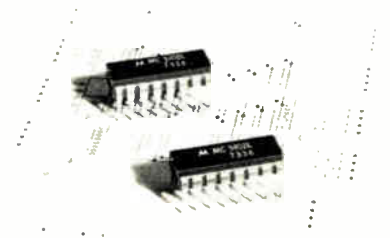

MC3452 is a similar receiver but with open collector outputs which facilitate the implied AND connection. The MC3453 is a 12-milliampere current driver. Designed for data-transmission applications, the devices are priced from \$4.20 to \$5 in 100-lots.

Motorola Semiconductor Products Inc., P.O. Box 20912, Phoenix, Ariz. 85036 [413]

RAM can be used as scratch pad, file or buffer

A random-access memory, called the model 10145, is designed for use as a scratch pad memory, a register

Twelve new answers for the display designer



MAN 51

Common Anode;
Right Hand
Decimal



MAN 52

Common Anode;
Left Hand
Decimal



MAN 53

Common Anode;
Overflow (± 1)



MAN 54

Common Cathode;
Right Hand
Decimal



MAN 71

Common Anode;
Right Hand
Decimal



MAN 72

Common Anode;
Left Hand
Decimal



MAN 73

Common Anode;
Overflow (± 1)



MAN 74

Common Cathode;
Right Hand
Decimal



MAN 81

Common Anode;
Right Hand
Decimal



MAN 82

Common Anode;
Left Hand
Decimal



MAN 83

Common Anode;
Overflow (± 1)



MAN 84

Common Cathode;
Right Hand
Decimal

Introducing twelve new .3" displays: sharp looking readouts in narrower packages; common cathode or common anode; right hand or left hand decimal; red, yellow and green. All from Monsanto, where light-emitting diode displays got started, and all priced at \$2.70 (suggested distributor price for 1,000-lot OEM orders.) Get in touch with any of our distributors: Alta, Elmar, Hamilton/Avnet, Hammond, Kierulff, Kierulff/Schley, Liberty, Schweber, Semiconductor Specialists, Wesco; Cesco in Canada; and Havulina Oy, Helsinki;

Neye-Enatechnik, Hamburg; Nordisk Elektronik, Stockholm; Omni Ray, Switzerland; RTF, Paris; Scansupply, Copenhagen; Silverstar Ltd., Milano; Techmation, Brussels; A.F. Ulrichenson, Oslo; New Metals and Chemicals Ltd., Tokyo; Takachiho, Tokyo.

Monsanto Commercial Products Co.,
Electronic Special Products,
3400 Hillview Avenue,
Palo Alto, CA 94304,
(415) 493-3300/TWX 910-373-1767.

Putting innovation to work.

Monsanto

a new STANDARD for JUMPERS

FLAT

ROUND

from
Ansley

Ansley's new patented FLEXSTRIP® Jumpers have flat conductors laminated between high performance insulating materials and are available from stock in thousands of part numbers. The flatness gives them flexibility where it's needed ... the round contacts insert easily into p.c. board holes or sockets. This combination of flat/round provides a generous radius when flexed, thus eliminating stress from the contacts.

Here's what this means to you ... no broken conductors ... easy insertion of ready to solder contacts ... no fault

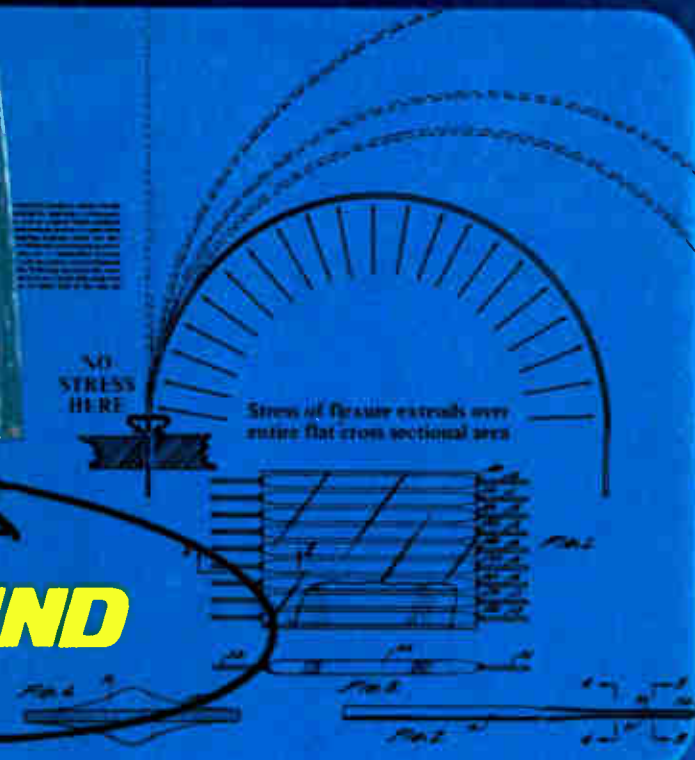

U.S. PATENT NO. 3,601,755

assemblies ... reliable interface ... lower installed cost ... available from stock.

Specify FLEXSTRIP® Jumpers. Flex them a hundred or a thousand times and there'll be no failures.

Ansley's FLEXSTRIP® Jumpers come in standard lengths; four options of insulation; 2 to 60 conductors; .050, .100, .125, .150 or .200 conductor center distances and four pin configuration options. Specials, too, of course.

Contact your Ansley representative.



Conventional wiring

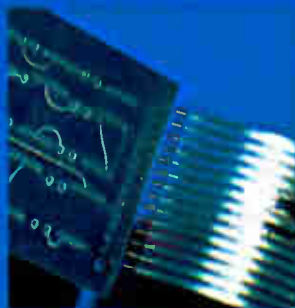

Photo courtesy of Computec Corp.

Ansley

ANSLEY ELECTRONICS CORP.

Subsidiary of Thomas & Beta Corporation

3208 Humboldt St., Los Angeles, Ca. 90031

Tel. (213)223-2331, TWX 910-321-3938

New products

file, a buffer memory, or control storage in mainframe computers, data communications systems, and high-speed test equipment. The device is organized into 16 words of four bits each and is fully compatible with the 10,000 series of emitter-coupled-logic circuits. For memory systems larger than 16 words, the 10145 offers a chip-enable input and open emitter outputs, which allow corresponding bits from different words to be directly tied together in wired-OR configurations with a minimum of additional circuitry.

Signetics, 811 E. Arques Ave., Sunnyvale, Calif. 94086

Monolithic counter-timer generates long time delays

A monolithic counter-timer that generates time delays of from 1 microsecond to 5 days by means of an external setting, combines an analog time-base oscillator with a programmable eight-bit counter on the same chip. Designated the model XR-2240, the device is accurate to within 0.5% and has a temperature stability of 40 ppm/°C. And because of the binary counting method, it is possible to cascade two units to generate programmable time delays of up to three years. Price is \$3 each in 100-lots.

Exar Integrated Systems Inc., 750 Palomar, Sunnyvale, Calif. 94086
[415]



TTL-compatible timing module offers six fixed-delay periods

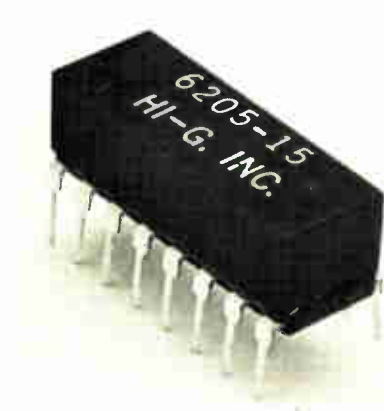

A timing module that is compatible with TTL devices is offered in a 16-pin dual in-line package. The device does not depend on external components for normal operation. Two models are offered: the Inter-



Ansley

Blue Streak™

CABLE/CONNECTOR SYSTEM



Here's Ansley's new cable for your wiring needs. It's rated for 105°C . . . flame retardant . . . 50 conductors or less050" centers . . . choice of 28 AWG stranded or solid or 30 AWG solid . . . cable on 100' reels from stock! Want more features? It's color coded every fifth conductor . . . separates by hand for breakouts . . . connectors to match from stock. And there's more . . . plus a SHURE-STAKE® hand tool for the field installation.

Write for complete brochure and sample.



Ansley

ANSLEY ELECTRONICS CORP.

Subsidiary of Thomas & Betts Corporation 
3208 Humboldt St., Los Angeles, Ca. 90031
Tel. (213)223-2331, TWX 910-321-3938

WHEN THE CHIPS ARE DOWN WE DELIVER!



**CAPACITORS
THAT IS**

We said it and we meant it. We're USCC/Centralab and we said we were preparing to meet the capacitor delivery crisis by substantial commitment to automated production machinery and facilities expansion.

We did it, and we've got the chips to prove it — ELEVEN MILLION in stock, most in the following popular sizes:

- BC - $.080 \pm .010$ x $.050 \pm .010$.045 T MAX
- BF - $.100 \pm .010$ x $.050 \pm .010$.060 T MAX
- BI - $.150 \pm .010$ x $.050 \pm .010$.060 T MAX
- DJ - $.180 \pm .010$ x $.080 \pm .010$.065 T MAX
- FH - $.125 \pm .010$ x $.095 \pm .010$.065 T MAX

We'll also deliver non stock and custom chips in not more than 8 to 12 weeks A.R.O.

Whether it's an immediate or future requirement, contact our applications engineering department now at (213) 843-4222, or our local representative.



USCC/Centralab

Electronics Division ■ Globe-Union, Inc.



2151 North Lincoln Street ■ Burbank, California 91504

New products

val-On, in which output becomes low on application of power and high following delay period; and the Delay-On, in which output remains high for the delay period and then becomes low. Each model is available in six fixed-delay periods. Price of the modules start at \$9.95, and delivery is from stock.

Hi-G Inc., Spring St. and Rte. 75, Windsor Locks, Conn. 06096 [417]

Microprocessors built as prototyping aids

Two general-purpose 16-bit microprocessors, called the IMP-16L and IMP-16P, are intended as prototyping and development aids for systems designers. The model 16L offers a microprogramed 60-instruction set, while the 16P offers 43 instructions. With these units, the OEM can debug a program assembled in software, using either a cross-assembler or the company's self-assembler. The 16L is priced at \$3,950 and the 16P at \$3,850. Accessories are available at additional cost.

National Semiconductor Corp., 2900 Semiconductor Dr., Santa Clara, Calif. 95051

Power Schottky diode is rated for 125°C

A power Schottky diode rated for a junction temperature of 125°C is called the SD-51. The device is also rated at 50-ampere average forward current with a forward voltage of 0.5 volts at the junction temperature. Blocking voltage is 35 volts, and maximum reverse current is 200 milliamperes at a case temperature

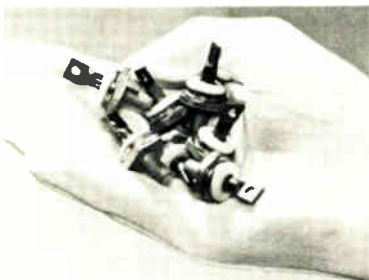

When PRD makes frequency synthesizers, the performance is high...



not the price.

Our 7828 Frequency Synthesizer is offered with 1 kHz phase-locked steps from 1 kHz to 80 MHz. An optional vernier provides 1 Hz resolution. It's fully programmable with contact closures, RTL, DTL, or TTL logic; 1 part in 10⁶/mo stability; up to 1.0 volt output into 50 ohms.

Our 7808 Signal Generator/Frequency Synthesizer-Sweeper has digital synthesizer performance, yet retains the manual and vernier tuning and low spurious output of conventional signal generators. Its frequency range is 0.05 to 80 MHz. Key functions are programmable.

Best of all, these synthesizers cost little more than half the price of comparable instruments. For literature, write:



PRD Electronics, Inc.
A subsidiary of Harris-Intertype Corporation
1200 Prospect Avenue
Westbury, N.Y. 11590 Tel: (516) 334-7810

Circle 169 on reader service card

IMMEDIATE DELIVERY! IN STOCK



THE ONLY SOURCE OF
FLAT
PLUG-IN POWER
TRANSFORMERS UP TO
6VA IS SIGNAL

Flat Plug-In Power Transformers

- Maximum Height of 0.850 Inches Allows Stacking PC Boards on 1 Inch Centers.
- 6VA Rating at 50/60 Hz.
- HUM--Bucking Construction—Reduces Magnetic Field-Balanced Windings.
- Dual Primaries 115/230 V, 50/60 Hz.
- Ratings from 5 to 230 Volts.

**Signal
transformer co. inc.**

1 Junius St., Brooklyn, N.Y. 11212
Telephone (212) 498-5111

Send for Free Catalog also listing extensive lines of PC Plug-In to 24VA, Rectifier Power Transformers and Chokes, and Constant Voltage Transformers.

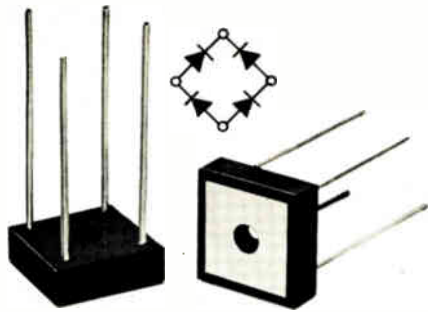

- Low cost, high reliability
- 10 Amp (I_o)
- Electrically isolated case
- Low thermal impedance for longer life and greater operational reliability

New Series

E B R

EPOXY BRIDGE RECTIFIERS

A bonded metal-to-ceramic substrate achieves electrical isolation with an exposed copper mounting pad resulting in low circuit-junction-to-heat-sink thermal impedance.

The VJ series is available in 200 V, 400 V, 600 V, and 800 V PRV ratings in controlled avalanche series. Non-controlled avalanche series also available.

VJ248, \$1.65 ea., 200 V, 1000 qty.

Design us in; we'll stay there



VARO

VARO SEMICONDUCTOR, INC.

P.O. BOX 676, 1000 N. SHILOH, GARLAND, TEX. 75040, 214/272-4551, TWX 910-860-5178

Distributed by:

ALLIED ELECTRONICS, Chicago, Ill. 312/421-2400. THE ALTAIR CO., Houston, Tex. 713/781-5300; Richardson, Tex. 214/231-5166. BELL INDUSTRIES, Menlo Park, Cal. 415/323-9431; Skokie, Ill. 312/965-7500; Bellevue, Wash. 206/747-1515. BLUFF CITY DIST. CO., Memphis, Tenn. 901/725-9500. BRIDGEFIELD SUPPLY, Chesterland, Ohio 216/729-9451. CRAMER ELECTRONICS, Nationwide; Newton, Mass. 617/969-7700; ELECTRONIC PARTS CO., Denver, Colo. 303/744-1992. MILGRAY ELECTRONICS, Freeport, N. Y. 516/546-6000; Hyattsville, Md. 301/864-1111; Cherry Hill, N. J., 609/424-1300. WESTATES ELECTRONICS, Chatsworth, Calif. 213/341-4411.

In Canada:

ELECTRO SONIC, Toronto, Ont. 416/924-9301. R.A.E. IND. ELECTRONICS, Vancouver, B. C. 604/687-2621. PRELCO ELECTRONICS, LTD., Montreal, Quebec 514/389-8051. WESTERN RADIO SUPPLY, Hamilton, Ont. 416/528-0151.

Circle 170 on reader service card

New products

of 125° at 35 volts. In addition, reverse recovery time in inverter circuits is less than 10 nanoseconds. Price ranges from \$9.91 to \$11.20, depending on quantity.

TRW Semiconductors, 14520 Aviation Blvd., Lawndale, Calif. 90260 [418]

Photon-coupled isolators

handle 3,500-V peak

Three high-isolation-voltage photon-coupled isolators, the 4N35, 36 and 37 series, consist of gallium-ar-

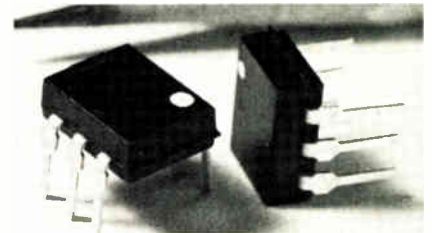

senide lamps optically coupled to silicon phototransistors in dual in-line packages. The model 35 offers an isolated voltage of 3,500 v peak and a 100% current-transfer ratio. Price of this model is \$1.85 in 1,000-lots.

General Electric Co., Electronics Park, Building 7, Mail Drop 49, Syracuse, N.Y. 13201 [419]

Capacitive memory

aimed at disk controllers

A factory-alterable capacitive read-only memory organized as 1,000 words by 48 bits is designated the model CR-0244. It is particularly suited for use in disk controllers. Specifications include an access time of 150 nanoseconds and a cycle time of 400 ns. Higher speeds can be obtained with a minor change in timing, and more than one module can be connected to an interface board, with pin connectors, to form a larger system. OEM purchase price is \$568 for a full system, but parts of the system can be purchased at a reduced price.

Integrated Memories, 495 Andover Industrial Center, Andover, Mass. 01810 [420]

Our single-chip concept:

Copper grid distributes current most efficiently for lowest $V_{CE(sat)}$.

Integral solid copper leads and heat sink make pre-bond chip test and inventory possible.

Meet stringent MIL requirements best with the NPN silicon transistor that's single-minded about performance.

The concept: a unique single-chip design that packs the highest current rating in its class... keeps saturation voltage low and eliminates second breakdown problems. $V_{CE(sat)}$ is .75V max. @ 70 Amps, and guaranteed at 120 Amps. $E_{S/b}$ is 6 joules. And because its very simplicity allows pre-rating

One bigger, beefier chip.

and pre-testing, you can order our JAN & JAN-TX-2N5927 device off-the-shelf for switching regulators, motor controls and other hi-rel power circuits.

For tech. data and application assistance, write or call, PowerTech, Inc., 9 Baker Ct., Clifton, N.J. 07011; (201) 478-6205

Void-free bonding techniques eliminates hot spots.

PowerTech
BIG IDEAS IN
BIG POWER

Top of its class.

120v @ 120A transistor

JAN & JAN-TX

170 Circle 244 on reader service card

Electronics/December 6, 1973

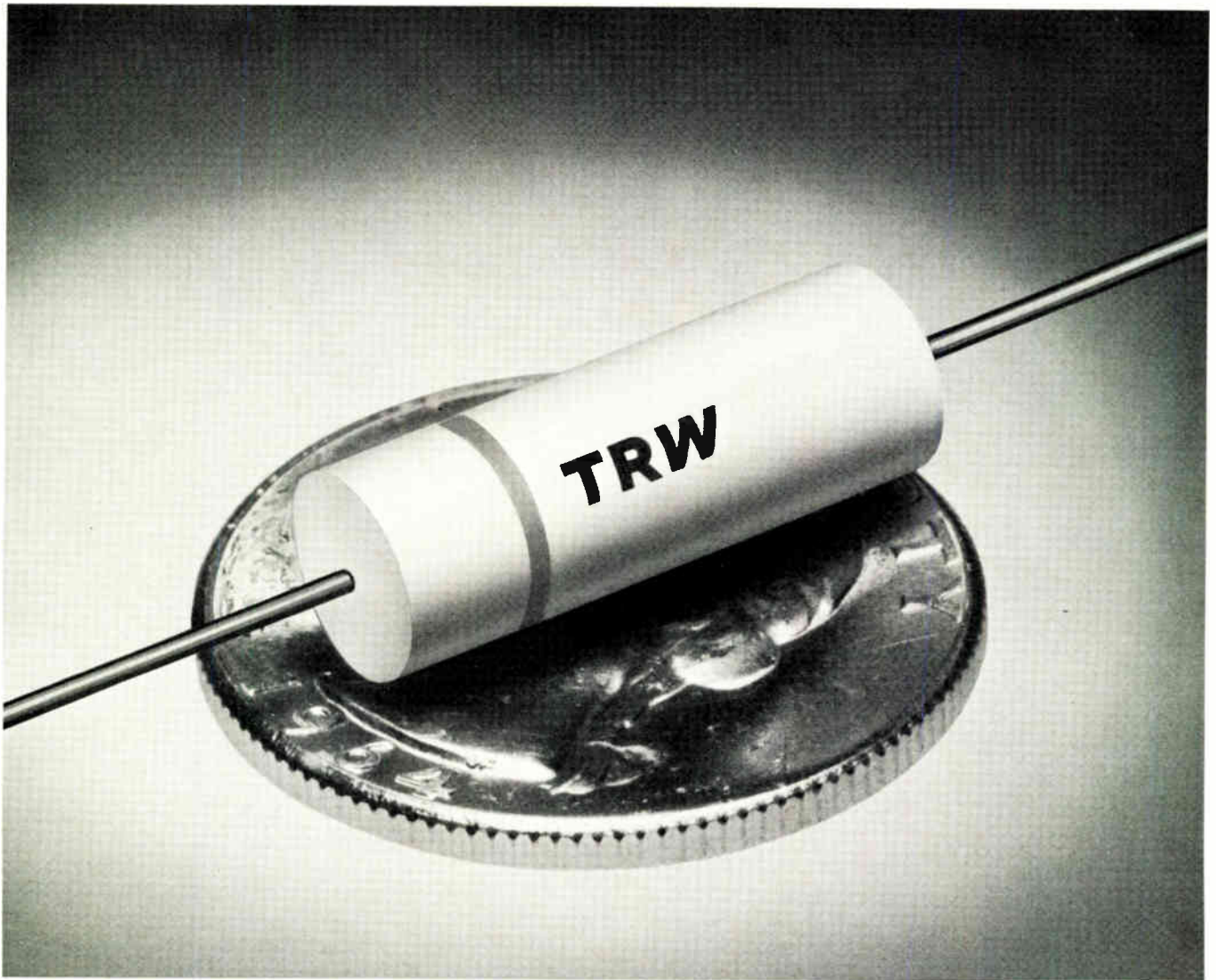

Pay a little more for our products. Get more for yours.

In wound film and solid tantalum capacitors, TRW offers you a capability second to none. For one simple reason.

We figure you can't make quality capacitors and me-too capacitors under the same roof. Because sooner or later, one operation will foul the other one up. So we take the quality route. Count on it.

Count, too, on some shirt-sleeve-minded guys who can understand what *you're* talking about when you have a capacitance problem. R&D, design, QC, application engineering, packaging... they've *been there*. No blue sky.

All this will cost you a little more per capacitor. In return, it can help *your* product earn a reputation for "no headaches, no surprises." What better edge in today's marketplace?



TRW Capacitors, an Electronic Components Division of TRW, Inc., Box 1000, Ogallala, Nebraska 69153.

TRW CAPACITORS

TO-5's WE CAN COOL 'em



1.7¢*

1129-U Press on
May be stacked
Typical R_{θ} , 56° C/W



5.1¢*

2226-U Press-on
Clears adjacent compo-
nents
Typical R_{θ} , 59° C/W



8.2¢*

2230-B5, 3/4" Press-on
gear type, screw mount
Typical R_{θ} , 51° C/W



8.5¢*

2257-R 1/2" Press-on
gear type
Typical R_{θ} , 68° C/W

Popular, easy-to-use economy coolers for PC board components. Thermalloy offers the most complete line of heat sinks in the industry: over 100 designs for cooling all types of packages including DIP's, plastics, TO-3's, TO-66's, and power transistors.

*Prices for 5000 quantity
 R_{θ} values for natural convection @ 1 W

Free Samples
and Catalog
Write Today



Thermalloy Inc.

P.O. BOX 34829
2021 W. VALLEY VIEW LANE, DALLAS, TEXAS 75234
PHONE 214-243-4321/TWX 910-960-5542

New products

Data handling

Program eases design task

General-purpose software system provides interactive circuit-analysis tool

Written for engineers who have little or no experience with computer-aided-design, another powerful circuit-analysis computer program is now available on an interactive basis. Called I/Spice (Interactive/Simulated Program Integrated Circuit Emphasis), the program was originally developed at the University of California at Berkeley, where it is available on a batch basis. It was converted by National CSS Inc., a computer services company, into a user-oriented interactive package.

With I/Spice, the user can treat his simulated design as though it were breadboarded and being checked out with an oscilloscope. As a matter of fact, if the user's communications terminal includes a CRT display, the program output duplicates what would be seen on a scope screen.

I/Spice can perform nonlinear dc analysis, small-signal ac sinusoidal steady-state analysis, and nonlinear transient analysis. Additionally, any parameter in the circuit description can be varied, and the temperature dependence of passive as well as active elements can be described with functions for performing thermal analysis.

Circuits can consist of linear elements (resistors, capacitors, inductors, independent voltage and current sources, and voltage-controlled current sources) and nonlinear elements (regular diodes, Schottky diodes, zener diodes, bipolar transistors, junction field-effect transistors, MOS transistors, or a voltage-controlled current source that is described by a polynomial function). The program also provides built-in models of commonly used transis-

tors and operational amplifiers.

The user does not have to describe circuit elements. He merely indicates where they are used, and I/Spice automatically inserts them. The designer can even create and store models of circuits for use as standard devices in describing other circuits. Also, there is no restriction on the number of levels of model nesting.

Another convenience provided by I/Spice is its save/restore feature. The status of output-node voltages and voltage-source currents is automatically stored so that this data can be referred to later without re-running the entire simulation.

Since I/Spice incorporates many of the latest numerical-analysis techniques, it minimizes computer time and maximizes execution speed. Nodal analysis is used to formulate network equations, and sparse-matrix techniques are used to find the solutions. The program generates a set of internal node numbers and optimally orders the matrix so that the user need not consecutively number the nodes. Circuit size depends on how much storage space is available at the computer facility; the National CSS system provides up to 2 million bytes of storage.

National CSS Inc., 300 Westport Ave., Norwalk, Conn. 06851 [361]

Low-profile keyboards use flip-chip process

Taking aim at the keyboard needs of 1975, a low-profile line of keyboards, called series SD, will be available in 1975 at a price of about 40% below that of current models and will sell for approximately \$50 each in quantity. The keyboards will





The whole works on one single PC board with every chip a plug-in!

LOWEST COST
LOWEST COST
LOWEST COST
HIGHEST UPTIME
HIGHEST UPTIME

Large, double-size characters available for super-readability!



Plug in to a TTY or any RS232 printer for hard copy when you need it!

OUR CRT HAS LESS GUTS ... AND FEWER BELLYACHES

Teleray users call it the **Uptime Terminal** because it rarely gets sick. If it ever does, the cure is simple. We replace *one single plug-in board* that contains **ALL** logic, character generation, drives, interface, the works. Just about anything that can go wrong is on that board and is plug-in replaceable, *right down to every chip*. Teleray is so quickly and easily repaired, you can do it yourself with our easy-to-understand service manual — or we'll do it for you. MSI circuitry and top-grade components have drastically

cut down the number of Teleray parts that can go wrong, and that brings down your cost, too. Our price is competitive, but we're different on the inside . . . we're "healthier."

FEATURES

- RS232-C, TTL, 20 ma current loop signal connections
- ASCII coding; 98 characters generated, 64 displayed
- Data rates to 2400 baud
- Displays of 960, 1728 or 1920 characters
- Full or half duplex, switch selectable
- Local or remote modes, switch selectable

- Non-contacting solid-state keyboard (read-only if you want)
- Direct TTY replacement without interface or software changes

OPTIONS

- Switchable baud rates
- Switchable line formats
- Numeric keypad adapter
- RS232 output to any printer
- 50/60 Hz, 115/230 VAC power
- Remote keyboard
- Slave up to 5 video repeaters

Call collect (612) 941-3300 and ask for Teleray! It's a "gutless wonder"! (We have a warranty that's different, too!)

TELERAY 3300



RESEARCH INC

BOX 24084 MINNEAPOLIS MINNESOTA USA 55424

**Cut your
hot design problems
down to size.**

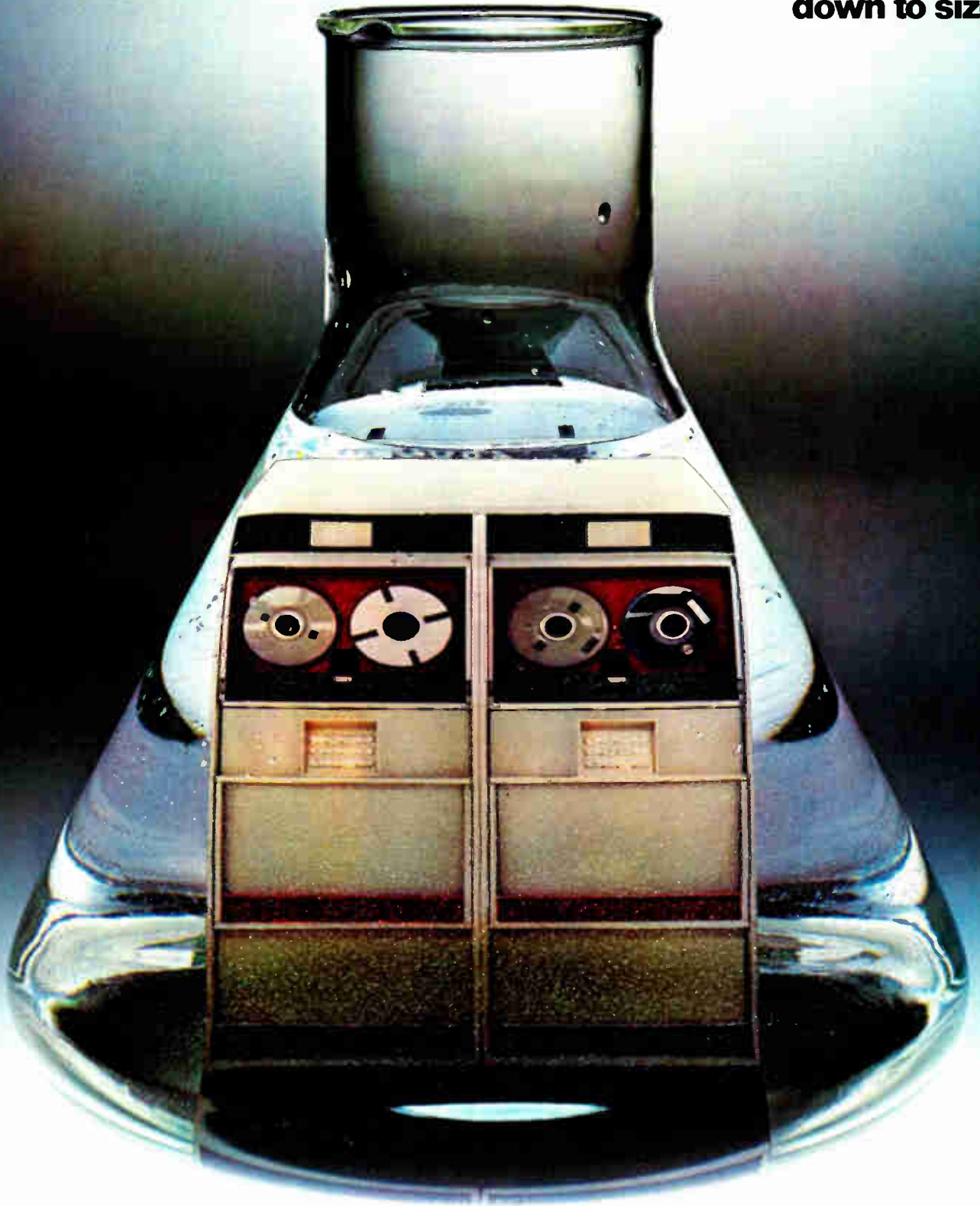

New products

Use Dow Corning dielectric coolants.



A UHF amplifier, for airborne equipment (right), was reduced in size and weight by using Dow Corning® 200 fluid. Only this unit produced full power over full frequency at an altitude of 100,000 ft.

If you're stuck with a hot electronic apparatus that you want to pack away in a snug place somewhere, relax. Silicone dielectric fluids from Dow Corning could be your answer.

The thermal stability of silicone fluids, combined with excellent physical and dielectric properties, solves the critical problem of high performance in smaller equipment. Specifically, rapid heat dissipation, superior dielectric strength, and low losses over the temperature range —40 to 200 C are primary reasons why closer spacing or size reductions in electronic apparatus are possible. Available in a wide viscosity range, they can be used for cooling power tubes, damping meter indicators, insulating high-voltage power supplies, or filling dashpots.

Non-sludging and essentially non-toxic, silicone fluids deliver long life at a competitive price where conventional organic liquids fail rapidly.

For specific information on our complete line of fluids, write Dow Corning Corporation, Dept. C-3336, Midland, Michigan 48640.

Silicones; simply the best way to protect electronic equipment

DOW CORNING

DOW CORNING

use a flip-chip process to package Hall-effect integrated circuits and, instead of wire bonding, will employ the batch process of solder reflow to a ceramic substrate. Moreover, module panel-mount metal plates will replace the mounting rails that hold present key modules. The modules of the SD line will be inserted into the mounting plate automatically. Applications of the key-boards are in traditional batch-data-entry as well as point-of-sale terminals and word-processors.

Micro Switch, Division of Honeywell Inc., Chicago & Spring Sts., Freeport, Ill. 61032 [363]

Point-of-sale keyboards are programable

A 256-bit PROM coupled with a standard TTL scanning circuit provides the means to program any or all of



the 25 keys located on a point-of-sale keyboard with any eight-bit code specified by the user. Also included are an error-free two-key roll-over and two-shot molded key-tops with legends to be specified by the user.

Key Tronic Corp., Building 14, Spokane Industrial Park, Spokane, Wash. 99216 [366]

Bus expander is designed for PDP-8/E computers

A bus expander, designed for use with PDP-8/E computer systems, provides 20 plug-in slots and is compatible with the computer's Omnibus. The unit, which is shipped with power cable and bus-signal jumper boards, is made with two pc

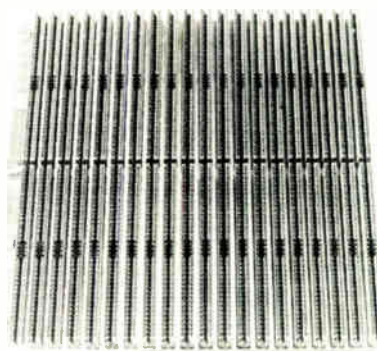

boards of FR-4 glass epoxy. Price of a 20-slot board is \$450. A 10-slot expander board is also available.

Douglas Electronics Inc., 718 Marina Blvd., San Leandro, Calif. 94577 [364]

Process computer system's memory is doubled

A medium-size computer system for process management and control is available with memory capacity of the original system doubled to 65,536 words. The enlarged memory capability allows the FOX I system to support larger tasks and new



communications modules and software packages. A variety of remote CRT terminals, teleprinters, and video monitors are also available. Price starts at \$200,000.

The Foxboro Co., Foxboro, Mass. 02035 [367]

Memory module packages 16,000 16-bit words

A core-memory module packaging 16,000 16-bit words on a single printed-circuit board is for use with

Carpenter controlled-expansion alloys. Uniform. Optimum fabricability. Every time.



Carpenter Kovar® is the most widely used glass-sealing alloy.

Stamp, deep-draw, etch, form, or coin. Many grades are available tailored for the process you use. You get the best possible fabricability.



You get a broad selection of low and high expansion, as well as glass- or ceramic-sealing grades. In every form and size. For every job.



A call to your Carpenter Service Center will bring some of the finest technical assistance in the industry.

The quality is always consistent. Always uniform. So production stays uniform.



Call your Carpenter Service Center today. For prompt and complete information on all Carpenter controlled-expansion alloys. And ask for our free, informative booklet. Carpenter Steel Division, Carpenter Technology Corporation, Reading, Pa. 19603. European Office: 51, Square Vergote, 1040 Brussels, Belgium.

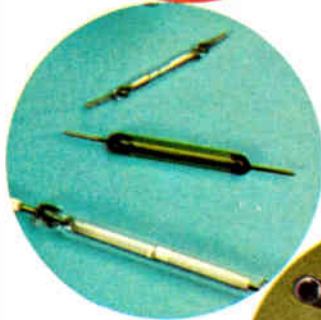

High-quality surfaces, uniform temper, minimum orange peel, and camber.



CARTECH CARPENTER
TECHNOLOGY
CARPENTER STEEL DIVISION

New products

Computer Automation's Naked Mini/LSI and Alpha/LSI mini-computers. The memory is designed to allow users of those computers to expand memory capacity in the mainframe with significant cost savings; the module is priced at \$2,750. It can also be intermixed with MOS or other core memories of various capacities. First deliveries of the module will be made during the first quarter of 1974.

Computer Automation Inc., 18651 Von Karman, Irvine, Calif. 92664 [365]

Audio cassette transport is tamper-proof

The model CAS-4 audio cassette tape transport is a three-motor, unidirectional device that is capstan-driven. The transport features key-slot loading that makes it impossible to insert the cassette in-

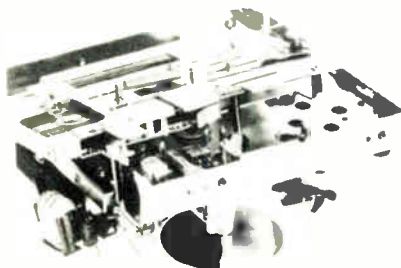

correctly. In addition, the cassette mechanism is interlocked and tamper-proof to prevent damage from misuse. The CAS-4 provides a two-channel, two-track record/play head and uses no mechanical controls. Price is \$90 each in quantities of 1,000.

Conrac Corp., Mill Rock Rd., Old Saybrook, Conn. 06475 [368]

Desktop unit erases IBM magnetic cards

To simplify reuse of IBM Selectric typewriter magnetic cards, a magnetic card eraser restores any cards passed through it to blank condition. Cards can be passed through



the eraser as often as required without scratching or harm to the magnetic surface. Price is \$75.

Western Telematic Inc., 3001 Red Hill Ave., Costa Mesa, Calif. 92626 [369]

Disk memory system has access time of 8.4 ms

A 3,600-rpm disk memory system for Honeywell 316/516 mini-computers, called the model 1747, is a head-per-track peripheral with capacity available in five levels from 32,000 to 524,000 words. Average access time is 8.4 milliseconds, and average data-transfer rate is selectable at the time of purchase in four increments from 8 to 64 microseconds per word. Track advance is automatic so that variable-length records may be written. Price is less than \$7,600 for OEM applications.

Data Disc Inc., 686 W. Maude Ave., Sunnyvale, Calif. 94086 [370]

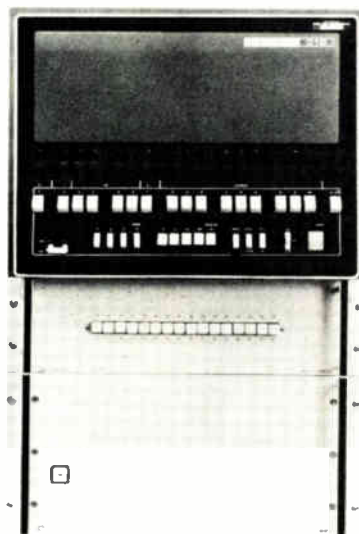

NEW SHORTER CASE! SCHAUER 1-WATT ZENERS

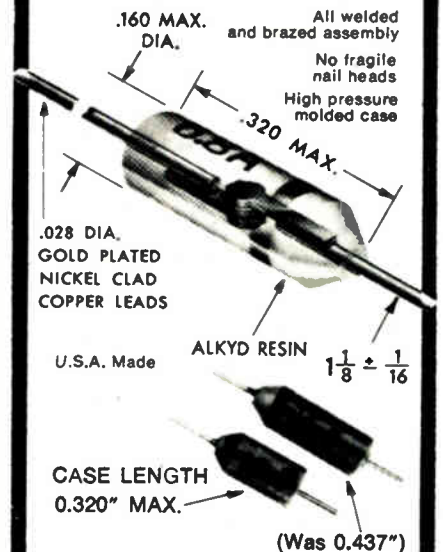

SAME LOW PRICES FOR 1% TOLERANCE ZENERS ANY VOLTAGE FROM 2.0 TO 18.0

Quantity	Price Each
1-99	\$1.07
100-499	.97
500-999	.91
1000-4999	.86
5000 up	.82

IMMEDIATE SHIPMENT

Send for rating data and 20%, 10%, 5% and 2% tolerance prices.

Semiconductor Division

SCHAUER

MANUFACTURING CORP.

4514 Alpine Ave., Cincinnati, Ohio 45242
Telephone 513/791-3030

Introducing \$13,117.

Our 21-inch PDP-11/35 minicomputer for OEMs. All the big-system power of our PDP-11/40 at a much lower price.

With 32K words of our newly designed high-density 980ns memory.

And memory management capability is standard.

Plus the ability to run high-level operating systems like RSTS/E and RSX-11D. And ANSI-standard FORTRAN. CAPS 11. BASIC. BATCH. RT 11. And much more, from the world's largest library of minicomputer software.

There's plenty of room for system expansion. Up to 128K of memory. Floating point. Interfaces, controllers, communications devices. And over 60 PDP-11 family peripherals.

Cabinet and power supplies included. All in a 21-inch chassis.

And all for only \$13,117.*





Introducing \$6,077.

Our 10½-inch PDP-11/35 minicomputer with 8K of memory.

For the OEM who needs 11/35 power and expansion, but in a smaller package at a lower price.

Memory expands to 32K within the chassis. And memory management is available.

Plus all those options. And peripherals. And software.

It comes in a rack-mountable chassis for packaging convenience and flexibility. And includes power supplies, programmer console, and pre-wired connector slots for floating point and memory management. \$6,077.*

It's a small price to pay.

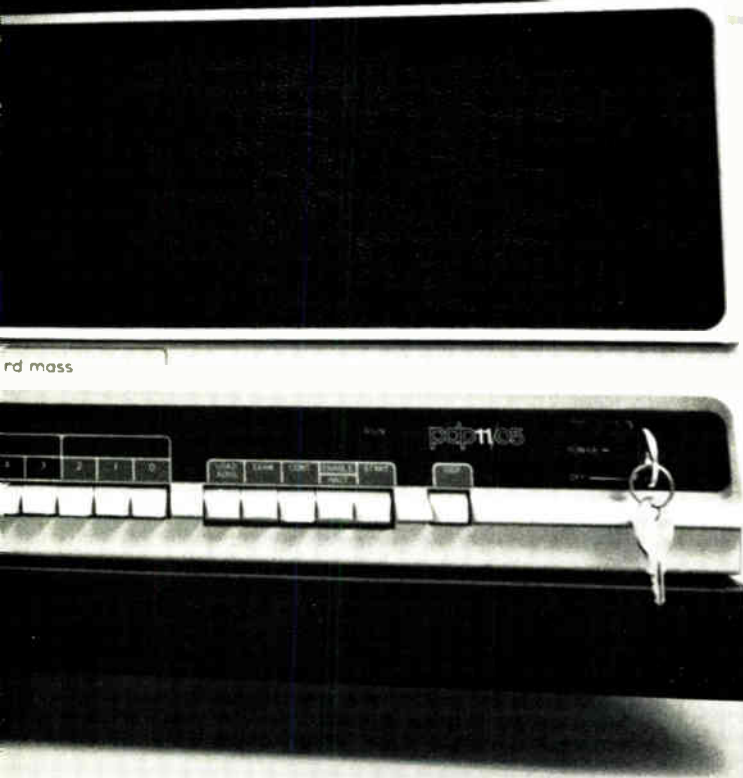

Introducing \$4,156.

Our 10½-inch PDP-11/05 minicomputer. The new big box version of Digital's famous 5¼-inch model, but for OEMs who need greater expansion and flexibility.

Memory starts at 8K and grows to 28K.

Standard features include four-level automatic priority interrupt, direct memory access, power fail/restart, line frequency clock, serial communication line interface, and programmer's console.

Plus, again, all those 11-family options, peripherals and software. At only \$4,156.*

No wonder the PDP-11 outsells all other 16-bit computers on the market.

digital

Contact your local Digital office. Or write: OEM Products Group, Digital Equipment Corporation, Maynard, Mass. 01754 (617) 897-5111. Ext. 3115. European headquarters: 81 route de l'Aire, 1211 Geneva 26. Tel: 42 79 50. Digital Equipment of Canada Ltd., P.O. Box 11500, Ottawa, Ontario K2H 8K8. (613) 592-5111.

Circle 179 on reader service card *QUANTITIES OF 100.

NEW FROM TRW

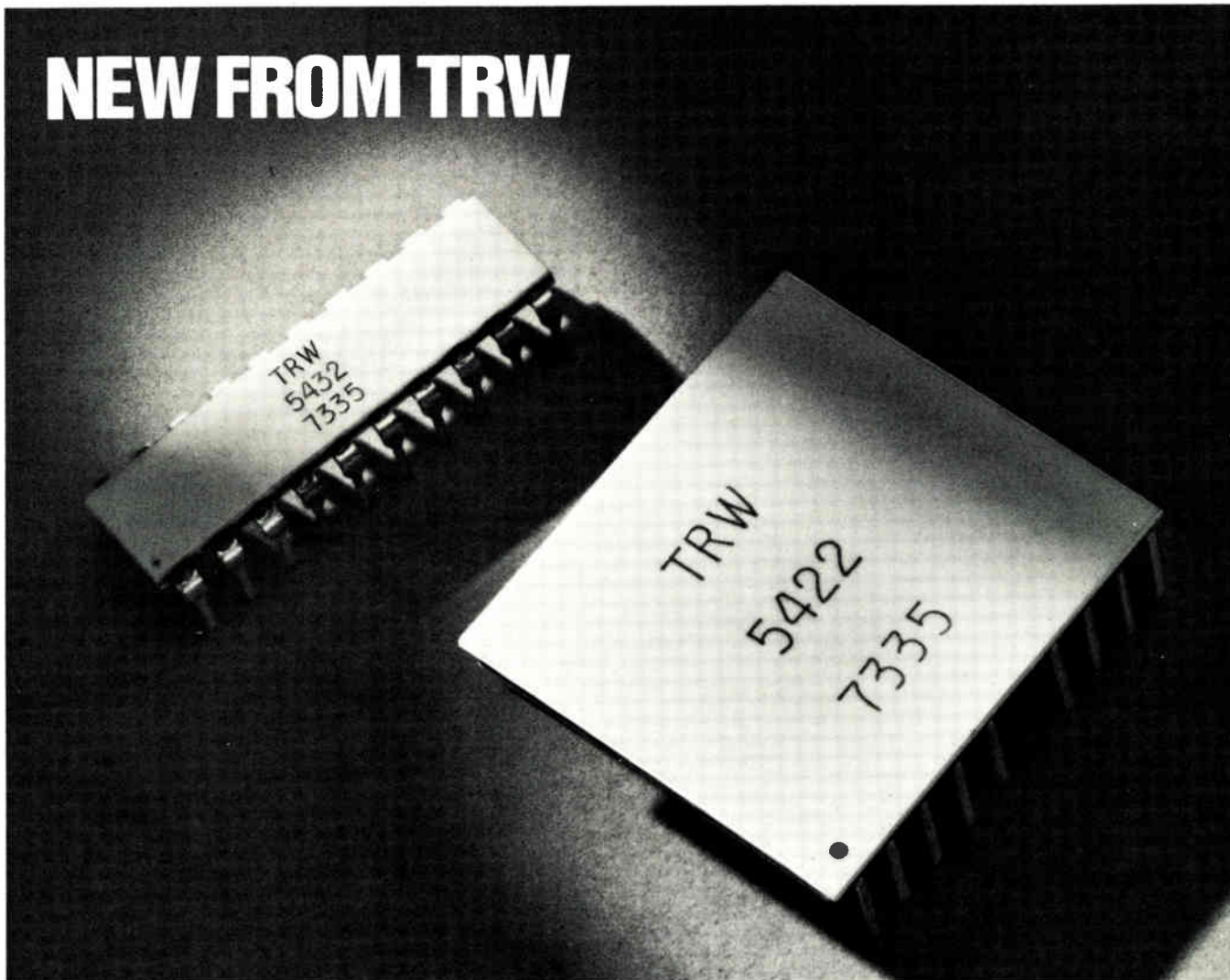

12-Bit TaNFilm® Binary Ladder Networks

These networks—representative of TRW/IRC's tantalum nitride film capability—are now available in standard DIP configurations in 12-bit accuracies. They are also available in a larger version that is pin compatible with an earlier, popular design.

TaNFilm networks—designed for digital-to-analog and analog-to-digital conversion—offer excellent stability, high accuracy, low noise, fast switching and fast settling time. Due to the inherent passivation of TaNFilm, they provide hermetic performance *without* hermetic cost. They retain half LSB accuracy over the entire operating temperature range and after extended operating life.

TaNFilm R-2R ladder networks include application resistors, permitting use of a variety of circuit con-

Performance Characteristics

Ladder resistance values (R)5K, 10K, 20K, 25K ohms
Ladder resistance tolerance	±1%
Absolute temp. coeff.	-75 to -125 PPM/°C
Maximum input voltage	20 volts
Operating temperature	-55 to +125°C
Storage temperature	-65 to +150°C
Conversion accuracy*	½ least significant bit (122 ppm)
Switch compensation	to 5 ohms
Settling time	to 20nSec.

*Ladder voltage ratio accuracy is the maximum voltage ratio error expressed in ppm of full scale with any combination of bits activated.

figurations. Compensation to -5% can be provided in both input and application resistors.

Also available in special configurations—to meet your needs. Request new bulletin detailing performance, cost savings, mechanical characteristics. TRW/IRC Precision Network Operations, an Electronic Components Division of TRW, Inc., 2850 Mt. Pleasant St., Burlington, Iowa 52601. (319) 754-8491.

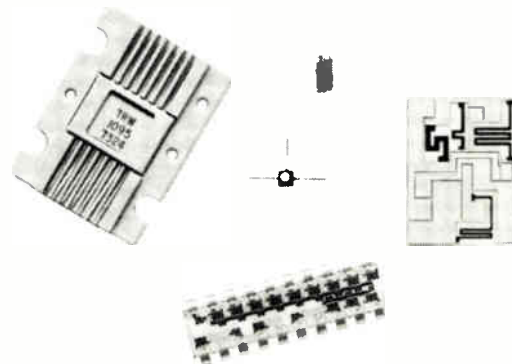

TRW® IRC RESISTORS

Measuring flow rates, draw ratio, rpm, rates, totals, speeds or time periods?

The DigiTec Model 810 Digital Process Indicator can be used to measure an infinite variety of parameters through the use of state of the art design.

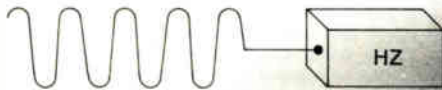

Featuring programmable normalization for direct reading in engineering units, the 810 uses an internal crystal clock for precise, measurement.



Available in models with 3, 4 or 5 digit non-blinking, LED displays, they have a basic input sensitivity of 10mV RMS for use with the outputs of magnetic pickups, photo cells, shaft encoders or any other pulse generating transducers.

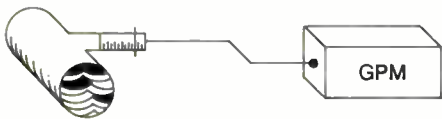

1.89"H x 4.39"W x 4.50"D

The 810 has an input frequency range beyond 100KHz.

Although sensitive, the input can withstand up to 500V peak to peak without damage.



Once programmed for normalization and input sensitivity (both on a rear connector) the Model 810 Indicator becomes a "Hands off" readout, usable by non-technical personnel.

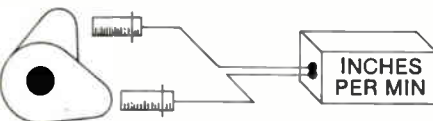

Optional stored BCD output for use with limit detector, recording peripherals and computer interface is also available.

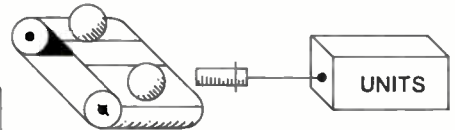

To see a DigiTec Model 810 Digital Process Indicator and obtain quantity prices, contact your nearest DigiTec or Monsanto Representative or write United Systems Corporation.

Prices start at \$234.

United Systems Corporation
918 Woodley Road, Dayton, Ohio 45403
Ph. (513) 254-6251 Twx: (810) 459-1728
a subsidiary of

Monsanto



Packaging & production

Boards handle all ECL circuits

Modular wire-wrap panels can be combined, using busing, special hardware

New wire-wrap boards for emitter-coupled-logic circuits may simplify a problem that has discouraged some users from trying ECL in their systems. Augat has been making boards for 18K ECL, and Standard Logic has now developed panels suitable for all ECL, even 500-MHZ MECL III. Don Nash, designer of the Standard Logic systems says, "We wanted a wire-wrap system that a customer can use for all ECL without problems." He adds that many users want to mix the families.

The boards are compatible with the company's earlier CASH (computer-automated systems hardware) TTL boards, and, like them, are suitable for computer layout and simple wire routing. Nash says that the boards permit full 10K and MECL

II speed with minimal restrictions, run connecting lines in series, terminate with proper resistor values, and keep connections under 10 or 12 inches in length.

The Standard Logic system is modular; small cards hold 16 16-pin sockets (or three 24-pin plus eight 16-pin sockets or other combinations). These are combined into larger panels using special busing and grounding hardware designed for low impedances (The ground bus is 3/16-inch by 1-inch bar stock, for example).

An important consideration in using ECL is the requirement for large quantities of terminating and pull-up resistors. One approach to this in standard hardware is the use of DIP-resistor networks, but Nash points out that a resistor package is required for each two to three ICs, since only eight can be used per package in high-speed circuits. This cuts density by one-third. Another approach is to hang resistors from wire-wrap pins—obviously an expensive approach, since it interferes with high-speed wire-wrapping. Standard Logic's approach is to have small plug-in resistor cards available between each row of ICs. Each card can hold up to 43 resistors, and no input or output pin is

more than one-half inch from a resistor, he says. Each row is equal to about six plug-in packages. He adds that the resistors must be optimized for best results.

Using ECL requires careful attention to bypassing and low-impedance power connections. Standard Logic uses a ceramic disk bypass capacitor for each IC socket and four tantalum capacitors per board. In addition, thin-circuit laminate provides a significant distributed capacitance for high-frequency bypassing. Low-impedance power uses are also laminated with the ground plane. The company incorporates a ground plane on the pin-side of the board, rather than on the top of the board, which permits the interconnection wires to be right against it for constant low impedance.

The cards have extra ground pins for use with twisted pairs, and all power and ground pins are shorter than socket pins for ease of identification. Socket pins are higher for testing and troubleshooting, the company points out.

Standard Logic finds that, for optimum use of ECL, it's best to group logic into small subsystems, then connect them. This requires extra receivers, but minimizes long interconnections. And, says Nash, it "is the price for playing the high-speed game and winning."

The ECL cards are priced at \$46 each, with accessories and variations available. Delivery is from stock for small quantities.

Standard Logic Inc., 2215 S. Standard Ave., Santa Ana, Calif. 92707 [391]

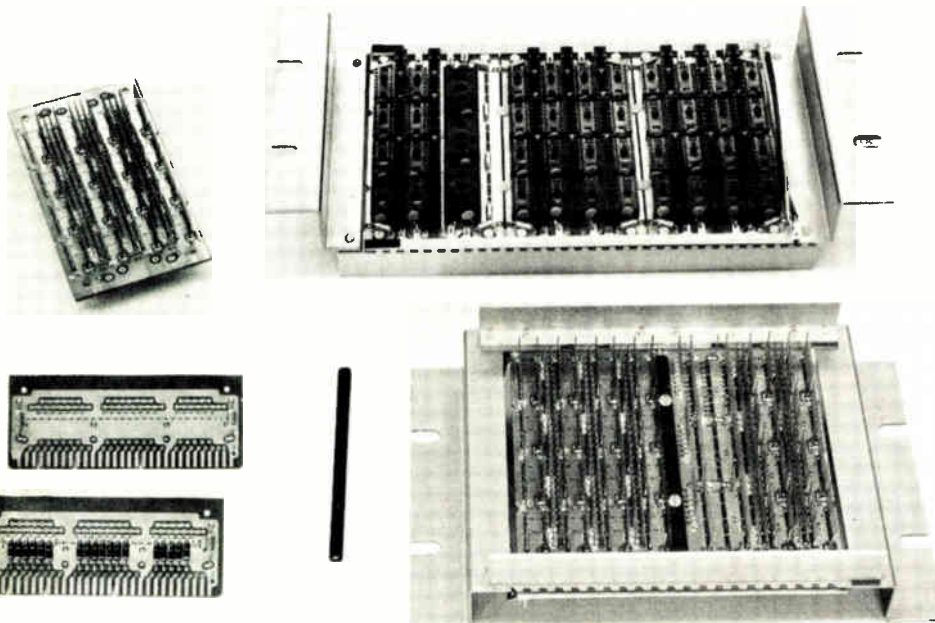

Reflow soldering system handles ceramic hybrids

The model AR-7 automated reflow soldering system is designed for high-speed production soldering of ceramic hybrid circuits. The system features a free-standing solder station and add-on belt extensions that connect work stations directly to the solder-reflow area. Also provided is bottom-side heating, which offers the advantage of absolute tempera-

Our tester is a big name-dropper.



When it comes to programming ease.

Our Hustler 44 — the IC tester that's bought by people who really understand automatic testing — is KO'ing our big competitors time after time.

And for good reason. Ours does more, yet costs less.

Take programming. Our software is designed so that your techs & engineers can generate programs to test any kind of IC after a few hours of training in *your* plant. On the other hand, our worthy competitors require a week or more of training at the factory.

Why the difference? Because our simple English language programming is designed for the typical test operator — not a computer programmer. Programs can be generated, edited, listed & debugged even while testing is in progress.

New programs can be generated in far less time, too. And with our unique parallel test concept, the Hustler 44

can DC & functionally test from 5 to 10 times more IC's per hour than Teradyne's SLOT or Fairchild's Sentry series.

That's why such knowledgeable companies as Bell Labs, Control Data, Fairchild Semiconductors, Honeywell,

ITT Semiconductors, Motorola, RCA, Stewart Warner & Western Electric (just to name-drop a few) have chosen our tester. And many are repeat customers.

Here's an offer you can't refuse. If you're really serious about testing, we'll get you and a Hustler together so you can prove to yourself how easy it is to program our tester.

EASE OF PROGRAMMING BOX SCORE

Job Classification	Datatron Hustler 44	Teradyne SLOT	Fairchild Sentry Series
Technician	Yes with just a few hours of training in your facility	Doubtful. Might take a semester of training at factory	A long shot. Could botch things up
Production Engineer	No problem after a few hours of training in your facility	Possible, but only after weeks of training at factory	"Ditto"
Computer Programmer	Not required but could learn in couple of hours	Recommended. But would still need weeks at factory	"Likewise"

PROGRAM GENERATE & DEBUG TIME BOX SCORE

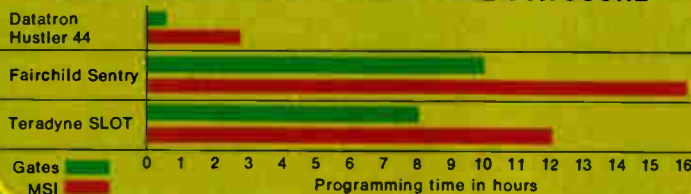

Datatron Hustler 44

datatron inc.

1562 REYNOLDS AVENUE • SANTA ANA, CALIFORNIA 92711 • (714) 540-9330

Circle 183 on reader service card

Our new low-profile keyboard is solid-state. Our new low price is mechanical.



We've expanded your keyboard options dramatically with our new SD low-profile keyboard.

It makes MICRO SWITCH solid-state prices (based on 1975 delivery) competitive with less reliable mechanical-contact keyboards.

So price is no barrier. No matter what your need. Be it word processing, point-of-sale or other data entry applications.

We've coupled our unique Hall effect switch with an advanced "flip chip" ceramic mounting technique to further increase the reliability of our solid-state keyboards.

And our new low-profile design is ideal for modern

compact terminal needs.

Picture a MICRO SWITCH keyboard in your system design.

We're ready to talk prototypes now, with production in late 1974. Contact a MICRO SWITCH Branch Office for complete information.

It's the change you've really been looking for.

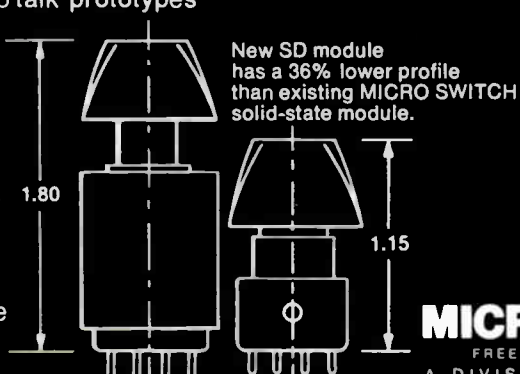

MICRO SWITCH products are available worldwide through Honeywell International.

Circle 184 on reader service card

MICRO SWITCH
FREEPORT ILLINOIS 61032
A DIVISION OF HONEYWELL

New products

ture control for substrates and heat-sensitive components.

Browne Corp., 212 E. Gutierrez St., Santa Barbara, Calif. 93101 [405]

Mask-aligner station minimizes vibration

A laminar-flow mask-aligner station provides a work surface that is independent of the overhead blower-filter module. This prevents transmission of vibration from that source. The mask aligners can be serviced from the rear, and the Plexiglass panels of the blower-filter frame slide out to enable work to be passed to an adjoining work station. The new model operates at very low noise levels.

Agnew-Higgins Inc., 7091 Belgrave Ave., Box 857, Garden Grove, Calif. 92642 [406]

Test system handles semiconductor memories

A computer-operated test system designed for semiconductor memories with capacities of up to 4,096 4-bit words is designated the model

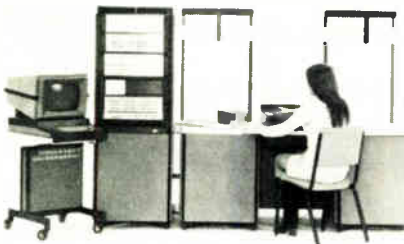

J384. It performs functional and parametric tests on static and dynamic MOS and fast bipolar memories. The instrument features vector-list autocalibration that automatically compensates for time delays inherent in the system and ensures accurate timing, either closed- or open-loop, at each test station. Thus, once the test plan is prepared, it may be used thereafter at any test station without modification. Price starts at \$85,000.

Teradyne Inc., 183 Essex St., Boston, Mass. 02111 [393]

Baking unit processes 450 wafers per hour

During a typical 19-minute cycle, which includes the time required for loading and unloading, an automatic baking machine develops, rinses, dries, and bakes 150 3-inch wafers. The system offers process control and includes a five-stage ex-



plosion-proof developer, forced-nitrogen ducted heater, pressure gages, two tanks and all the necessary controls.

Corotek Corp., 2812 Knott Ave., Garden Grove, Calif. 92640 [394]

Dual-view comparator speeds board inspection

A dual-view comparator for inspecting printed-circuit boards is designed to replace blink- or flicker-type machines. The unit provides a comparison of the new board with a master board and shows a limited area of both boards side by side on a lighted ground-glass screen. Images are magnified to more than double the original size, and addi-



Stripped or loaded, more prints/\$



Model 5103A, \$595. A very reliable, low cost OEM printer. Small size is well suited for panel mounting. Choice of 6, 12, or 18 columns. Prices begin at \$595 (even less in quantity).

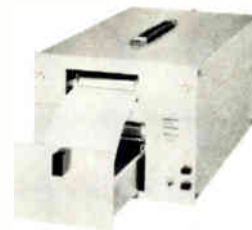

Model 5103B, \$650. Designed for system and OEM users who need reliable, day-in day-out performance. Choice of 7, 14, 21 columns. IC compatible inputs; normal or inverted logic. Grounded or floating inputs. 2-color printing. Power supply optional. Prices start at \$650 (even less in quantity).



Model 5103, \$945. A low cost medium speed printer with many features found only on higher priced instruments. Will accept almost any input with a minimum of options. Up to 21 columns. Plug-in boards, field expandability. Dual-source operation. Internal clock. Programmable zero suppression. Base price \$945.

Find out more about the industry's best printer buys. Contact your Scientific Devices office or S-D at 10 Systron Drive, Concord, CA 94518. Phone (415) 682-6161.

SYSTRON  CONNER

The long-billed heat sucker would like you to meet her family.

Our good friend, the Heat Sucker (better known as a Hughes heat pipe), is now the proud mother of an entire flock: round and flat bills, flexible round bills and the cold mounted plate bill. Each variant feels right at home in electronic, chemical and mechanical equipment; industrial processing; and medical applications. Anywhere you might need thermal control.

Heat Suckers come in various sizes: 3/16" to 1" diameter, 6" and 12" lengths. They have thermal transport capabilities of 10 to 2,000 watts covering temperature ranges from: -90°C to +200°C.

Since the birds have mass migrated to our shelves, you can order right off the shelf for as little as \$37.00 (less in quantity).

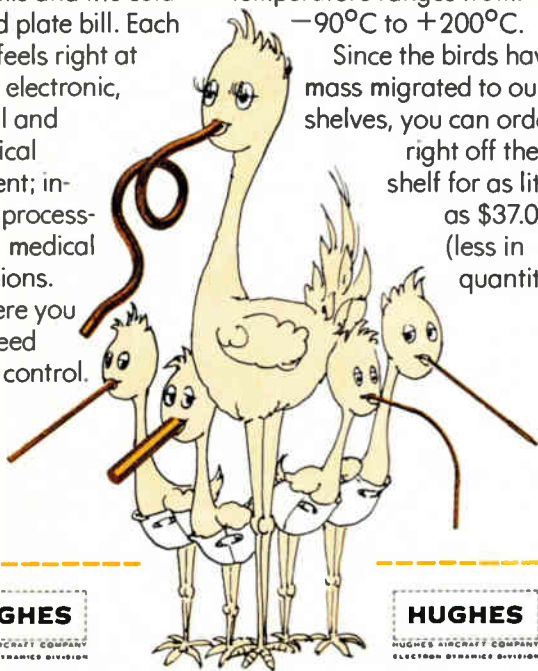

HUGHES

HUGHES AIRCRAFT COMPANY
ELECTRON DYNAMICS DIVISION

HUGHES

HUGHES AIRCRAFT COMPANY
ELECTRON DYNAMICS DIVISION

Celebrate along with us. Send the coupon and get a cigar and literature. Hughes Electron Dynamics Division, Advertising Dept., 3100 W. Lomito Blvd., Torrance, California 90509. Or call (213) 534-2121, Ext. 451.



1350H Series — stainless steel and methanol.



1370H Series — copper and water.



1333H — stainless steel and ammonia.

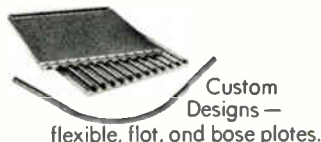

Custom Designs — flexible, flat, and base plates.

Name _____

Company _____

Address _____

City _____ State _____

Zip _____ Telephone _____

E 12

THE LITTLE DEVICES THAT CAN...

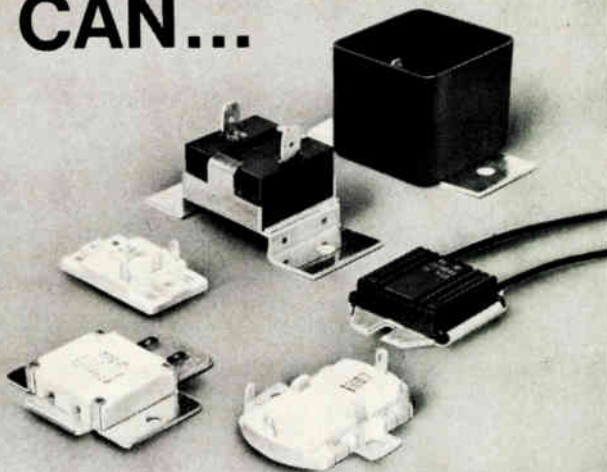

- Start Motors
- Heat Appliances and Ovens
- Control Temperature

MURATA'S NEW POSISTORS!®

What's more, Murata's new Posistors can perform all of these functions with pure, solid state reliability. No contacts. No bi-metal strips. No centrifugal switches. No complex semiconductor circuitry.

Posistors are powerful positive temperature coefficient devices that can switch motor starting windings in and out at up to 12 amps. They can generate enough heat for small appliances and ovens while precisely controlling temperature at the same time. All without moving parts or exotic expensive circuitry.

And, we're sure that you will find applications that we've never dreamed of. Why not find out exactly what Posistors can do for you. Write for complete technical information today.

Murata

MURATA CORPORATION OF AMERICA

2 Westchester Plaza, Elmsford, New York 10523

Telex: MURATA EMFD 137332

Phone: 914/592-9180

A Subsidiary of
Murata Mfg. Co., Ltd., Japan

How to ship small packages in a big hurry.

DELTA'S DASH
DELTA AIRLINES SPECIAL HANDLING

Delta guarantees delivery on the flight or routing you specify between most Delta cities.

Packages accepted up to 50 lbs. with length plus width plus height not to exceed 90" total, with only one dimension exceeding 30".

Delivery to Delta's passenger counter or air freight terminal at the airport at least 30 minutes prior to scheduled departure time.

Pick-up at DASH Claim Area next to airport baggage claim area 30 minutes after flight arrival at destination.

Charges for DASH shipments are nominal. Delta reservations will be pleased to quote actual charges between specific points.

Payments accepted in cash, by company check, most general-purpose credit cards, special credit arrangements or on government shipments by GBL. **DELTA**
The airline run by professionals

Rate examples (Tax included)

Atlanta-Washington	\$21.00
Boston-Miami	\$26.25
Cincinnati-Louisville	\$21.00
Cleveland-Phoenix	\$26.25
Los Angeles-New Orleans	\$31.50
Dallas-Los Angeles	\$26.25
San Francisco-Atlanta	\$31.50
Philadelphia-Houston	\$26.25
New York-Tampa	\$26.25

For full details, call Delta reservations.



Delta is ready when you are!

New products

tional magnification of a limited scanning area is available.

Metron Optics, P.O. Box 690, Solana Beach, Calif. 92075 [396]

Assembly stations load printed-circuit boards

A line of assembly stations for printed-circuit-board production is designated Para-Trak. The stations, which are portable, can be coupled

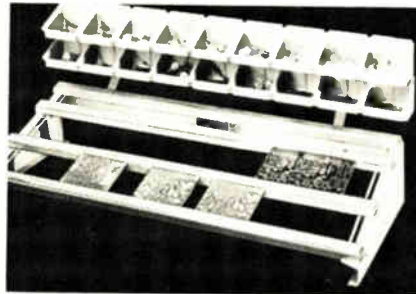

together in a continuous assembly line for sequential board-loading operations. Other features include adjustable tracks and a variety of accessories.

Production Systems Inc., 2021 Via Burton, Anaheim, Calif. 92806 [395]

BNC connector is molded into place

A BNC bayonet cable assembly is part of the Molded-On connector product line of Component Manufacturing Service Inc. Every connection is soldered and meets military specifications. Molding is a process in which a high-impact plastic body is formed in place so that each contact solder joint and wire is permanently embedded. Several types

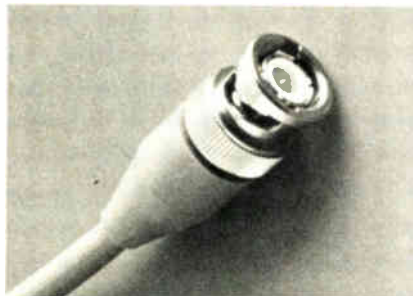

CONTINENTAL TESTING LABS ANNOUNCES

The First

COMPREHENSIVE SEMICONDUCTOR SCREENING GUIDE

The guide compares all the major aerospace, industrial and commercial semiconductor screening programs now in use.

Get your copy

quick!

Write or call

Bob Schuster (201) 347-2030

Floyd Kinney (305) 831-2700



783 U. S. HIGHWAY 17-92
 FERN PARK, FLA. 32730

The pollution problem.

Maybe your engineers deserve a little help.

The engineers will be the ones to find the technical solutions to pollution problems. There's no doubt about it.

But pollution is a people problem, too. And the engineers' technological approach to pollution isn't going to solve people problems.

Maybe this booklet can help. It lists some of the things all people can do to fight pollution. And with all the people supporting your engineers we'll have a better chance of winning the fight.

For a free copy or a list of bulk rates write to Keep America Beautiful, Inc., Box 1771, Radio City Station, New York, New York 10020.

Keep America Beautiful

Advertising contributed for the public good



People start pollution.
People can stop it.

New products

of termination are available.

Component Manufacturing Service Inc., 1 Component Park, W. Bridgewater, Mass. 02379 [397]

Flat-cable latch connector offers multiple terminations

A latch connector provides multiple terminations for flat cable having round conductors on 0.050-inch centers, as well as for woven flat cable. The conductors can be #28 AWG stranded or #30 AWG solid wire, and all terminations are made simultaneously without the need for prestripping or insulation. Connectors can be applied at the end of the cable or anywhere in its length.

AMP Inc., Harrisburg, Pa. 17105 [398]

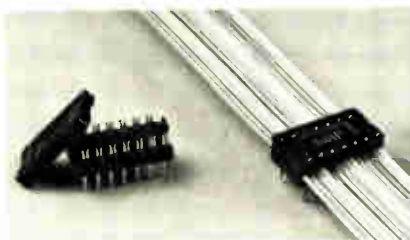

Wafer-washing system reduces operations costs

Called the Hydronic system, a wafer-washing unit is said to reduce costs in three ways. One way, point-of-use polishing, ensures high-quality rinse water, thus avoiding variable yields caused by sporadic contamination. Another way is selective recirculation and repurification, which can conserve as much as 80% of the high-purity water that is often wasted. And the third cost-saver is a downstream resistivity meter, which shortens rinse cycles by eliminating arbitrary elapsed-time criteria for wafer-rinsing. The design of the system is modular, so that the user can tailor an installation to the particular need or add to an existing system. The Hydronic produces particle-free water of 18 megohm-cm resistivity and uses cylindrical wash tanks.

Millipore Corp., Bedford, Mass. 01730 [399]

Here's that dense, static CMOS RAM.

Our S2222 is a 512 word by one-bit RAM, constructed with silicon gate CMOS devices integrated on a monolithic array. Fully decoded on the chip, this memory uses DC stable (static) storage elements and needs no refresh to operate. The memory matrix is organized as 32 rows by 16 columns. High-speed operation and micropower supply requirements make our new RAM ideal for applications where you have to conserve electricity or use a battery.

You can't beat its performance, either. It has a 200 ns access time and 420 ns cycle time, with power dissipation of only 1 μ w/bit and typical stand-by power of just 200 nW/bit. Since it is static, the data can be read without interruption. Maximum power dissipates only when the inputs change.

The unique circuit design lets the chip select precharge the internal nodes which minimize the power dissipation and maximize the performance. And for greater density, we designed in five transistors per cell. All in all, it's the densest, lowest powered CMOS RAM ever produced.

S2222 Specifications

- Access time: 200 ns at room temperature.
300 ns at military temperature range.
- Cycle time: 420 ns
- Power dissipation: typically 1 μ w/bit.
- Stand-by power: 200 nW/bit.
- Power supply: single +10 volt.
- Current sink output with "OR" tie capability.

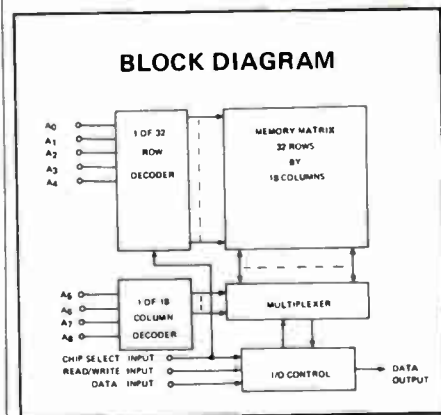

AMI

Circle 188 on reader service card



**“You’ve gotta be kidding.
A battery-powered design like that
would need a dense, static CMOS RAM
with a 200 nanosecond access time
and around 500 microwatt
power dissipation.**

**“No way you’re going to find
an outfit that can hack that.”**

**Give him
the good news:
AMI**

AMERICAN MICROSYSTEMS, INC.

Our new S2222 512x1 CMOS RAM does it all.
It combines the highest density and
performance with the lowest power
requirements on the market — three more
firsts from Number One. For complete
information, write AMI, 3800 Homestead Road,
Santa Clara, CA 95051. Phone: (408) 246-0330.
Or call your distributor.

Another fine OEM product from C. Itoh.

Model AN-101F

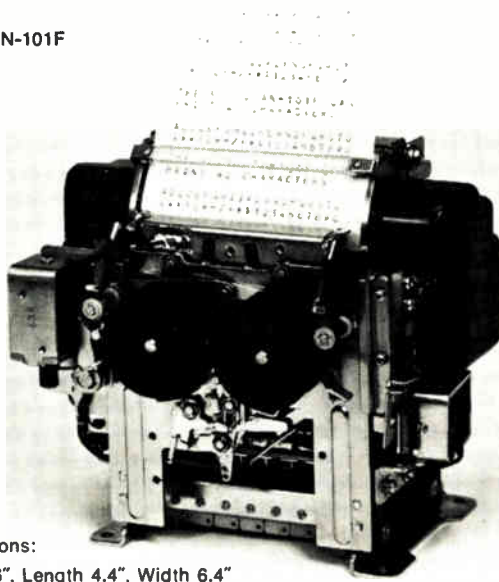

Dimensions:
Height 6", Length 4.4", Width 6.4"

**Alpha-Numeric
Printing Mechanism.**

Designed for the computer peripheral market, this model AN-101F has a capability of printing all 26 alphabetic characters and 10 numeric characters. It can handle up to 21 columns with 42 characters per column, including six special symbols, at a speed of up to 1.2 lines per second.

The Model AN-101F provides a permanent printed record of management information, hospital information, order processing, production scheduling and warehouse inventory. Other features include two-color printing, low electrical power consumption and compact design.

There are 10 additional models available to serve various applications, each ready for immediate delivery at a most attractive C. Itoh price.

Send in the coupon for more information.

C. Itoh & Co. (America) Inc.

270 Park Avenue, New York, N.Y. 10017 • (212) 953-5452/5447

West Coast office: 555 S. Flower Street, Los Angeles, Calif. 90071
(213) 687-0610

New Jersey office: (201) 347-7997 Ohio office: (513) 492-1159

Canadian office: Suite 4181, Commerce Court West Bldg.
Commerce Court Postal Station, Toronto, Ontario • (416) 868-0011

Attention: Industrial Electronics Div. E-126
C. Itoh & Co. (America) Inc.
270 Park Avenue, New York, N.Y. 10017

Please send me more information on your Alpha-Numeric Printing Mechanism.

Name _____ Title _____

Company _____ Telephone No. _____

Street _____

City _____ State _____ Zip _____

Specific Application _____

Flameless Compressed-Air Heat Torches — Lightweight and portable for pinpoint intense heat performance.

Heat Blowers — Built for continuous 24-hour duty.

New! Mite Heat Gun — Lightweight versatility with three interchangeable nozzles and heat ranges.

Standard Heat Gun — Compact and economical, die-cast aluminum housing.

250° to 1,000° F.

Chrome Heat Gun — Designed for labs, R & D, and professional use.

**A flameless
heat tool for
every need:
Master
makes them all**

Master offers you the world's most complete line of flameless heat tools. Each one is precision built for rugged dependability and versatile performance. And every Master heat tool features a complete line of attachments for every production need.

Heat Guns and Blowers are available in U.L. and L.A. approved models. CSA approved in Canada. In Canada, contact Martin Industrial Sales, P.O. Box 576, 4445 Harvest Road, Burlington, Ontario.

Send for your free 12-page catalog and price list on the world's most complete line of flameless heat tools.

MASTER
appliance corporation
Racine, Wisconsin 53403

Spending too much time debugging wide band hi-slew op-amp circuits?

Try RCA's CA3100! Virtually free from Ringing.

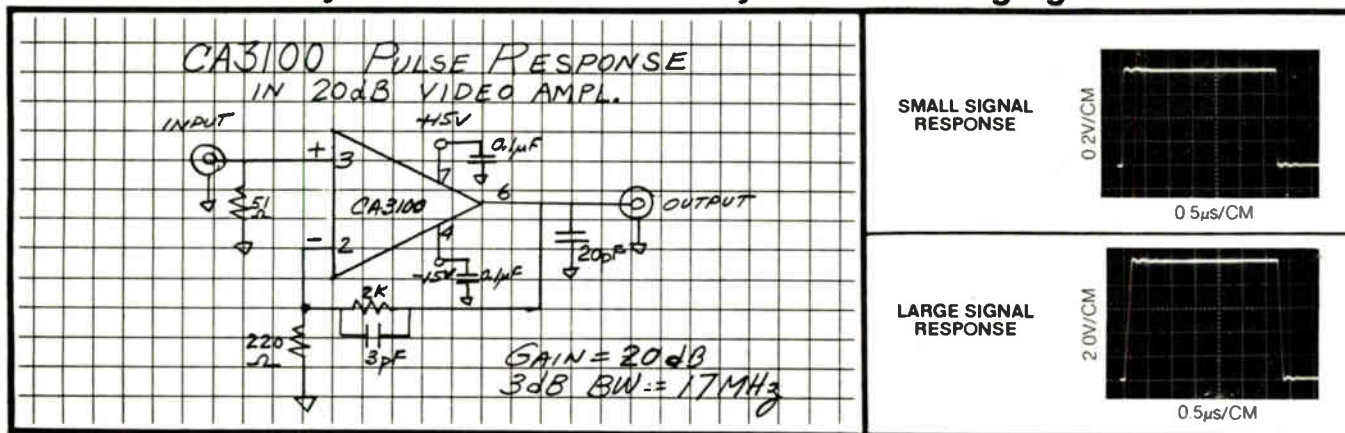

That's because we've combined all of the following features in a single device:

- High open-loop gain at video frequencies—42 dB at 1 MHz.
- High slew rate—70 V/usec (unity-gain, voltage follower, input compensated).
- High slew rate—25 V/usec (unity-gain, voltage follower, single capacitor compensated).
- Fast settling time—0.6 usec.
- High output current— ± 15 mA (min.).

These features are achieved with simpler circuitry because we've combined P-MOS and bipolar transistors on a single chip.

Compare the CA3100 with other wideband op-amps. You'll see the difference. Large signal or small... output waveforms are true reproductions of the input—virtually free from ringing and distortion. Also, compare open loop gain at Video Frequencies—22 dB at 10 MHz.

The CA3100 features dc offset adjust terminals for applications requiring offset null. It can be compensated with a single external capacitor and is pin compatible with other op-amps such as the LM118, LM307, and UA748.

Whatever your applications... high-speed comparators, instrumentation, video... take advantage of the CA3100's characteristics. You get all these features and more... with no tradeoff in price—\$3.50 for 1000 unit quantities.

The CA3100 is available in the standard TO-5 hermetic package, CA3100T, or the dual-in-line version, CA3100S. You can get them in production quantities from your local distributor or direct from RCA.

Interested? Let us send you the complete DATA SHEET! Write: RCA Solid State, Section 70L-6 Box 3200, Somerville, N.J. 08876. Or phone: (201) 722-3200.

RCA Solid State
products that make products pay off

ELECTRONICS

Major programs at Lockheed Missiles & Space Company have created a number of positions for engineers possessing an unusually high level of ability in the following areas:

Analog Circuit Design Engineers: To develop solid-state designs for linear and non-linear circuit synthesis and analysis. BSEE and two years' experience.

Analog Circuit Design Engineers: To develop circuit designs on missile-destruct system electronic packages. BSEE and two years' experience.

Communications Systems Engineers: For communication systems and satellite transponder design. BSEE and strong knowledge of communication theory and microwave hardware from S-Band to K-Band.

Senior Communications Systems Engineers: To analyze wideband transmission systems for voice, video and digital data, including non-linear and linear distortion effects; to be responsible for selecting subcontractors for transponder development. MS or PhD and eight years' experience.

Control Systems Equipment Development Engineers: To design inertial components and handle electronic interface; to function as Responsible Equipment Engineers interfacing with subcontractors. BSEE and two to six years' experience.

Electronic Engineers: To handle design fabrication and testing of electro-mechanical and solid-state relays; to document and to negotiate with vendors. BSEE and three to five years' experience.

Flight Control Systems Engineers: To perform digital autopilot functional design analysis and simulation. BSEE and four years' experience.

Guidance and Control Systems Engineers: To design, analyze, test and evaluate guidance and control systems for advanced missile systems. BSEE and at least three years' experience in automatic control systems.

Microelectronic Hybrid Parts and Components Specialists: With at least three years' experience and detailed knowledge of microelectronic active and passive chips and other electronic parts in general; knowledge of related materials.

Microwave Engineers: To design microwave components such as tunnel diode amplifiers, mixers, upconverters, filters and equalizers. BSEE and four years' experience.

Missile Destruct Specialists: To provide technical direction in application of missile command and automatic destruct systems. BSEE and several years of experience in design or application of RF command systems and negotiation and interpretation of flight test range safety requirements.

Packaging Engineers: To perform layout and packaging of microelectronic hybrids. BSEE with six years' experience, including automatic drafting equipment or computer graphics.

Semiconductor Engineers: To document, negotiate and develop semiconductor devices and associate passive components for missile programs. BSEE with strong solid-state physics and electronic design background plus some computer operation experience.

Those wishing to participate in large programs offering severe technical challenge are invited to write Professional Placement Manager, 1184 North Mathilda, Sunnyvale, CA 94088. Lockheed is an equal opportunity F/M employer.

LOCKHEED
Missiles & Space Company, Inc.

INTRODUCING THE TWO-FACED SWITCH

EECO introduces the Stripswitch™—a versatile, low cost printed circuit switch that's available in strips of one to eleven stations, for ease of handling and installation.

Because it's two-faced, you can mount



it either horizontally or vertically.

And you can wave-solder it directly to the printed circuit board.

Saves you money

Stripswitch is inexpensive to begin with—less than \$1 per station in quantity.

And, because you can wave-solder it directly to the printed circuit board, the need for rivetting, eyeletting, mounting hardware, switch-to-board wiring or expensive special plating is normally eliminated.

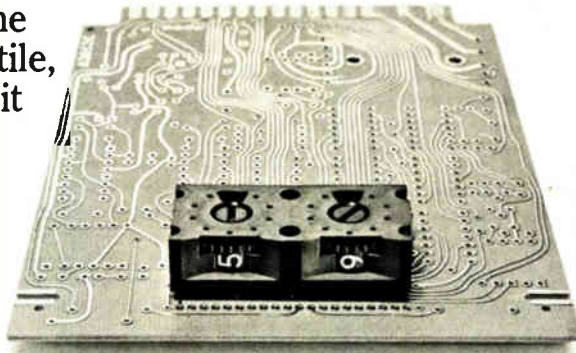

Actuates three ways

You can actuate Stripswitch by means of

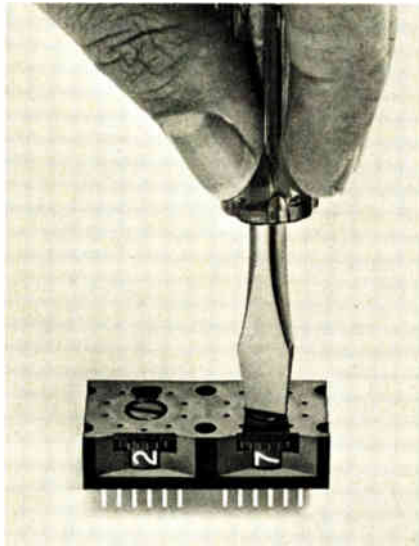

knurled wheels. Or, if you mount it behind a panel, you can actuate Stripswitch by means of a screwdriver or shaft

extension and knobs.

Guaranteed rugged

The Stripswitch is a simple, rugged design available in a variety of

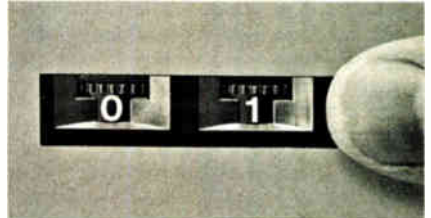

codes and switching functions, backed by an exclusive two-year warranty. And it's constructed from materials that can withstand caustic cleaning solutions.

That's the straightforward story of our two-faced switch.

For more information write to Electronic Engineering Company of California, 1441 East Chestnut Ave., Santa Ana, California 92701. Or phone (714) 835-6000.

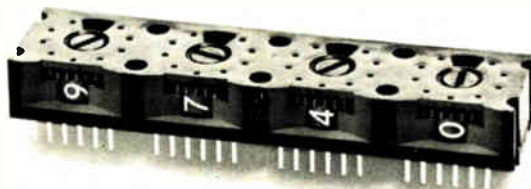

Stripswitch by EECO

Distributed by Schweber, Hall • Mark and G.S. Marshall

New products/materials



Ink-jet printing systems are among the applications for magnetic fluids, a new class of materials that are said to solve ink-settling and clogging problems in traditional, as well as new, printing techniques. Magnetic fluids are available in a wide range of carrier liquids, allowing printing on various surfaces. Signal output from magnetic-ink characters meet American Banking Association standards. The material, also called Ferrofluids, is suited to ink-jet printing systems because these systems require passage of the ink through tiny orifices and the printing jets are magnetically controlled.

Ferrofluidics Corp., 144 Middlesex Turnpike, Burlington, Mass. 01803 [476]

A clear encapsulating resin designed specifically for use with discrete and display-type light-emitting diodes is designated Epocast 2013 A/B. The line consists of four products for specific applications, but all four types of resin are two-component systems with long working life, fast-cure properties, good light transmission, and high heat-distortion temperatures.

Furane Plastics Inc., 5121 San Fernando Rd. West, Los Angeles, Calif. 90039 [477]

Epitaxial gallium-arsenide-phosphide for visible LEDs provides ranges of about 650 nanometers, with wavelength and layer thickness to meet customer specifications. Over-all composition thickness is held constant.

Texas Materials Laboratories, 2716 National Circle, Garland, Texas 75041 [478]

An epoxy powder called DK16 is said to exhibit good moisture resist-

ance on film and ceramic capacitors. The coating powders of the D16 series gel in seconds, cure in minutes, and coat at low temperatures without pinholing. They also offer good heat resistance and self-extinguishing properties. Red powder is available from stock, but other colors can be formulated.

Hysol Division, The Dexter Corp., 211 Franklin St., Olean, N.Y. 14760 [479]

A gold process with high deposition rate for plating connectors, switches, and other electronic parts, is called Autronex CC. The acid-type formulation for gold electroplating produces deposits with a purity of 99.8% and a hardness range of 140 to 190 knoop. The gold is deposited at about twice the rate of other processes, the company says. Coatings are bright and exhibit constant electrical resistivity.

The Sel-Rex Co., 75 River Rd., Nutley, N.J. 07110 [480]

Screen-printable thick-film pastes are being offered in sample packets for evaluation and include a range of resistor, conductor and dielectric materials for hybrid microcircuit and discrete component applications. Each of the three basic packets contains five one-ounce containers of different pastes, processing data, and engineering test property information. In addition, a number of combinations of packets can be selected from the company's full line of thick-film pastes. Prices are \$150, \$200, and \$295 for the evaluation packets.

Thick Film Systems Inc., 324 Palm Ave., Santa Barbara, Calif. 93101 [401]

For use in potting electronic components and circuits, and as an electrical surface coating, Eccofoam VIP is a urethane resin supplied as two components, that are mixed, cast and cured into a unicellular material. The resin has low density and a low dielectric constant of 2.1 at 1 megahertz. Dissipation factor at the same frequency is 0.03. The material is priced at \$24.15 for a 1-gallon kit.

Emerson & Cuming Inc., Canton, Mass. 02021 [402]

CANNON DISTRIBUTORS ARE INNOVATIVE, TOO. CALL THEM.

ALABAMA
Hall-Mark Electronics
Corp.
Huntsville
205/539-0891

ARIZONA
Liberty Electronics/
Arizona
Phoenix
602/284-4438

CALIFORNIA
Kierulff Electronics, Inc.
Los Angeles
213/885-5511
Kierulff Electronics, Inc.
Palo Alto
415/968-8292
Liberty Electronics
El Segundo
213/322-8100

Richey Electronics, Inc.
Sun Valley
213/875-2862
Time Electronics
West, Inc.
Inglewood
213/673-5900
Western Radio/
Liberty
San Diego
714/235-6571

COLORADO
Cramer Electronics, Inc.
Denver
303/758-2100

CONNECTICUT
A.S.I./Connector
Corporation of
America
New Haven
203/624-0127

FLORIDA
Hall-Mark Electronics
Corp.
Orlando
305/855-4020

GEORGIA
Electro Air Corp.
Atlanta
404/351-3545

ILLINOIS
Cramer Electronics, Inc.
Mt. Prospect
312/593-0290
Radio Distributing
Company, Inc.
Chicago
312/237-1105

INDIANA
Radio Distributing
Company, Inc.
South Bend
219/287-2911

KANSAS
Hall-Mark Electronics
Corp.
Lenexa
913/888-4747

MARYLAND
Schweber Electronics
Rockville
301/881-2970

MASSACHUSETTS
Cramer Electronics, Inc.
Newton
617/969-7700
Schweber Electronics
Waltham
617/891-8484
Time Electronics/
New England
Woburn
617/935-8080

MINNESOTA
Cramer/Bonn
Minneapolis
612/941-2770
Hall-Mark Electronics
Corp.
Minneapolis
612/925-2944

MISSOURI
Hall-Mark Electronics
Corp.
St. Louis
314/521-3800

NEW JERSEY
A.S.I./Resco
Electronics
Pennsauken
609/662-4000

NEW MEXICO
Cramer Electronics, Inc.
Albuquerque
505/265-5767

NEW YORK
A.S.I./Progress
Electronics Co., Inc.
Plainview, L.I.
516/433-1700
Schweber Electronics
Westbury, L.I.
516/334-7474
Summit Distributors, Inc.
Buffalo
716/884-3450
Time Electronic Sales
Hauppauge, L.I.
516/273-0100

OHIO
Radio Distributing
Company, Inc.
Cleveland
216/461-9090

OKLAHOMA
Hall-Mark Electronics
Corp.
Tulsa
918/835-8458

PENNSYLVANIA
Aercon, Inc.
Clifton Heights
215/622-2500
Philadelphia
Electronics, Inc.
Philadelphia
215/568-7444

TEXAS
Hall-Mark Electronics
Corp.
Dallas
214/231-5101
Hall-Mark Electronics
Corp.
Houston
715/781-8100
Harrison Equipment
Co., Inc.
Houston
713/224-9131
Kierulff - Dallas
Garland
214/271-2471

UTAH
Cramer Electronics, Inc.
Salt Lake City
801/487-3681

WASHINGTON
Kierulff Electronics, Inc.
Seattle
206/763-1550

WISCONSIN
Cramer Electronics, Inc.
Milwaukee
414/462-8300

CANNON IIT

SMITH DESIGNS IN CANNON® BACKPLANES. CITES FAST DELIVERY, LOW COST. PROJECT TEAM REACTS.



"FOR AIRPLANES YES, COMPUTERS NO," they exclaim.

That ticked Smith off: "Don't keep bringing up Cannon's old MIL-SPEC reputation. Hell, they're one of the biggest backplane makers and they can deliver in six weeks normally, with three weeks turnaround on prototypes. That's pretty damn good."

Then they brought up cost. Smith was ready: "All right, let's talk cost. Cannon can either deliver conventional backplane assemblies, and save us a lot of bread, or deliver them with rack and panel connectors like their zero-force DL or CL; Adapta-Con crimp for connect-

ing to 0.025" square posts; or the snap-in Burgun-D. They can handle the whole assembly. Again, that should save us money in the long run."

Now he went for the jugular: "You know, for a long time I've felt that our performance requirements have just outgrown our present suppliers' capability to satisfy them. Maybe now we need the performance and quality that Cannon can provide. What do you think?"



Well, what they mainly thought was why hadn't they thought of Cannon first.

Now, we can't claim that designing in Cannon backplanes can do as much for anybody else. You, for example. But, on the other hand, it couldn't hurt.

Write for our free catalog today.

ITT Cannon Electric,
International Telephone and Telegraph Corporation, 666
E. Dyer Road,
Santa Ana,
CA 92702.
Telephone
(714)
557-4700.



STAY

with

erc

electronic research co. • a  div.

THE PEOPLE DOING
THINGS THAT MATTER...
IMAGINATIVELY

IN FREQUENCY CONTROL PRODUCTS:
Quartz Crystals, TCXO's, VCXO's,
TCVCXO's, Hybrid Oscillators,
and Frequency Standards •

DIGITAL INSTRUMENTS: Clocks, Timers,
Comparators, Counters, Panel
Meters, Thermometers, Scanners,
and Systems Components •

IN FACT: For anything concerned with
time, temperature or frequency... CALL,
WRITE, or TWX your SOUL SOURCE at:

Telephone (913) 631-6700

7618 Wedd
Overland Park, Kansas 66204

Mail to: P.O. Box 913, Dept. 127
Shawnee Mission • Kansas 66201

TWX: (910) 749-6477

2-WAY



POWER DIVIDER

MODEL MTV-50

- 40-400 MHz Frequency Range
- High Isolation-30dB Min.
- TO-5 Subminiature Size
- \$40/Stock Availability

anzac
ELECTRONICS



39 Green Street, Waltham, Mass.

(617) 899-1900 • TWX 710-324-6484

Circle 247 on reader service card

DIACON'S AUTOMATIC ENVIRONMENTAL STORAGE HANDLER:

- 200 DEVICES IN 029 CARRIERS
- RELIABLE • SIMPLE
- EASY TO MAINTAIN

Fewer moving parts inside
the environment (two bushings
only) provide long,
maintenance-free operation.
The Diakon storage handler is
quiet and mechanically
uncomplicated. Which helps
eliminate down-time. Operates
on 120 or 240 V.



For complete information
and specs, write:

DIACON, Inc.

4812 Kearny Mesa Rd.
San Diego, Calif. U.S.A.
(714) 279-6992

Circle 196 on reader service card

New literature

Resistors. An eight-page brochure is available from the Stackpole Carbon Co., Electronic Components division, Kane, Pa. 16735, describing fixed-composition resistors. Performance characteristics and applications information are given. Circle 421 on reader service card.

Microwave amplifiers. Singer Instrumentation, 3176 Porter Dr., Palo Alto, Calif. 94304. Unattended, remote-control operation such as that required for remote microwave links and CATV distribution is discussed in a brochure on the series 5000 microwave amplifiers. [422]

Relays. A line of medium-duty ac or dc general-purpose, 10-ampere relays is described in a two-page bulletin available from North American Philips Controls Corp., Frederick, Md. 21701 [423]

A brochure describing miniaturized traveling-wave tubes for phased arrays and other airborne applications is being offered by RCA Electronic Components, 415 S. 5th St., Harrison, N.J. 07029 [424]

Rectifiers. International Rectifier Corp., Semiconductor division, 233 Kansas St., El Segundo, Calif. 90245. A series of 300-ampere high-voltage rectifiers, called the 301U series, is described in a data sheet that contains specifications and ratings. [425]

Circuit packages. Tekform Products Co., 2770 Coronado Ave., Anaheim, Calif. 92806, is offering a 10-page bulletin describing and illustrating the company's line of Dihedral microelectronic circuit cases, in which the terminals enter the case at an angle of 45°. [426]

White noise. A four-page data sheet providing information on a white-noise generator is available from Codi Semiconductor division, Codi Corp., Pollit Dr. South, Fairlawn, N.J. 07410 [427]

Hardware catalog. Seventy-eight types of panels, socket boards, connectors, and special boards incorpo-



There are times when sealing is critical

Whether 20,000 leagues under the sea. Umpteen million miles in space. Or at sea level...there are all kinds of critical environments requiring perfect sealing against air, moisture and contaminants.

If your system is nudging the critical level, look to Deutsch. We manufacture a full range of hermetic connectors that are not just at the State of the Art... they are a step ahead of it.

For absolute sealing against critical environments, Deutsch hermetic connectors are your answer. For speed of assembly, ease of maintenance and reliability, the connectors have solderless rear/insertion rear/removable contacts.

Fighting for solutions to critical environments? Keep your head above water (air or contaminants)...look to Deutsch to keep you a step ahead.

A copy of our new hermetic catalog can be yours. Drop us a note. The catalog illustrates and describes every configuration, mil specification and type of connector available for your critical environments. Better yet, if you've got an immediate problem, give us a call and we'll send a Deutschman to your door.



DEUTSCH

ELECTRONIC COMPONENTS DIVISION

Municipal Airport • Banning, California 92220
Telephone (714) 849-6701 • TWX 910-332-1361

“A Step Ahead.”

World's smallest



power supply for op amps...\$14

This 2.3 x 1.8 x 1-inch module has tracking outputs of ± 15 V @ 25 ma with regulation of $\pm 0.1\%$ and ripple of 1 mv. It costs \$14.00 in 1,000 lots and only \$24.00 for one. Requisition Model D15-03. (For ± 12 V @ 25 ma, order Model D12-03.) Three-day shipment guaranteed.



Acopian Corp., Easton, Pa. 18042
Telephone: (215) 258-5441

Circle 198 on reader service card

**DON'T BE FOOLED BY APPEARANCES...
THESE 5 SWITCHES ARE NOT
THE SAME! THEIR SIMILARITY
STOPS AT THE PANEL!**

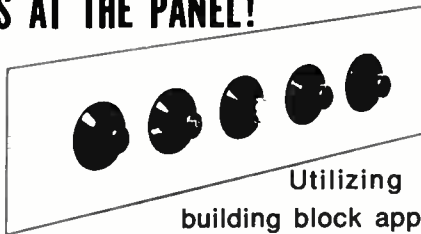

Utilizing CSI's building block approach, you can present a uniform panel appearance even though your switches have different ratings, actions, and circuits. Choose Moistureproof, Single pole, Double pole, Normally open, Normally closed, and other operating functions without sacrificing aesthetic panel layouts.

Write for portfolio of pushbutton-application bulletins.

CONTROL SWITCH INC.

A SUBSIDIARY OF CUTLER-HAMMER INC.
1420 DELMAR DRIVE • FOLCROFT, PA. 19032 (215) LU 6-7500
Representatives and stocking distributors throughout the United States, Canada, and Europe

New literature

rating decoupling capacitors are described in a 28-page catalog now available from Tekmar Electronics Ltd., 102 High St., Harrow-on-the-Hill, Middlesex, England [428]

Pc connector. A zero-insertion-force printed-circuit connector, designed to eliminate high engagement forces and to permit dense packaging, is described in a bulletin being offered by Amphenol Industrial division, Bunker Ramo Corp., 1830 S. 54th Ave., Chicago, Ill. 60650 [429]

Potentiometer. A four-page brochure from West Instrument division, Gulton Industries Inc., 3860 N. River Rd., Schiller Park, Ill. 60176, describes the Pyrotest, a direct-reading-scale potentiometer used to check and calibrate all types of industrial and laboratory thermocouple pyrometers. [430]

Silicon rectifiers. Edal Industries Inc., 4 Short Beach Rd., East Haven, Conn. 06512. Bulletin 133 provides information on miniature high-voltage rectifiers for commercial and industrial applications. [431]

Screening guide. Continental Testing Laboratories Inc., 763 U.S. Highway 17-92, Fern Park, Fla., has prepared a guide to screening for users of integrated circuits and discrete semiconductors. The guide compares various screening programs and test methods. [432]

Digital tape recorders. Digi-Data Corp., 4315 Baltimore Ave., Bladensburg, Md., has published a six-page catalog describing incremental and synchronous tape transports for generating IBM-compatible magnetic tape. Specifications are set in tabular form. Formatters, mini-computer interfaces and dual buffers are included in the short-form catalog. [433]

Computer solutions. Hewlett-Packard Co., 1501 Page Mill Rd., Palo Alto, Calif. 94304. A 32-page bulletin describes a variety of computer solutions for instructional, administrative and research problems of colleges and universities. [434]

When it comes to a wire bundle . . .

Gudebrod's harness room accessories can tie it up, hold it down or cut it off!

Choose the items you need and call now.

Gudebrod Lacing Tape

Gudebrod's complete line of lacing tapes is backed by over 100 years of manufacturing know-how. Many types and styles meet or exceed military specifications and are guaranteed the finest quality available.

Gudebrod makes tapes from nylon, dacron*, nomex*, glass, teflon* and other fibers that cover all harness lacing requirements, plus a research and development department that is continually working to improve or develop new tapes.

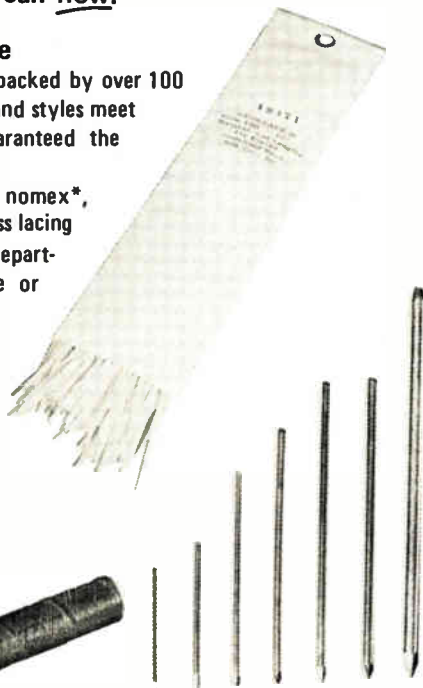

Gudebrod Wire Holding Pins

No need to use nails, cotter pins, etc. and gamble on cutting the harness wire or maybe your hand. Gude-pins are made of case hardened blued steel with rounded heads. They resist bending and can be used over and over again. Gude-pins are available in seven sizes ranging from 1.18 to 4.0 inches in length and various diameters.

Gude-snips

A real time saver. Unique design eliminates the need for picking up scissors every time the tape has to be cut. Gude-snips are held in the palm of your hand while allowing use of fingers at the same time. Fine cutlery steel and hot drop forged construction maintains sharpness a long time. They can be resharpened.

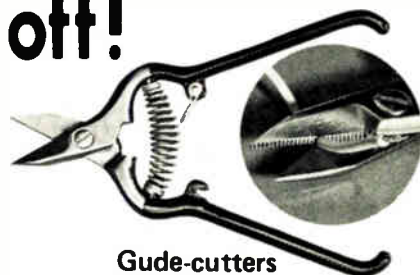

Gude-cutters

Heavy Duty all-purpose tape and wire cutters. Compact in size - easy to use. Drop forged construction with special serrated cutting edge prevents wire from slipping during cut.

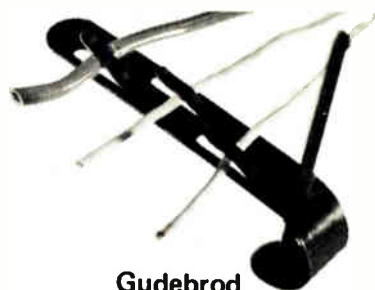

Gudebrod Wire Holding Objects

Branch-off wires can be held in place with lightweight, inexpensive WHOTM clips. Only one pin is required to securely hold 3 to 5 wires in place, either stripped or insulation covered. WHOTM clips are made from steel, are reusable and have low initial cost.

Gudebrod Cable-Lacer

The Cable-Lacer is precision made and designed to speed many production jobs. Light in weight and handy to use, the Cable-Lacer produces tighter knots and makes lacing easier.

Self-contained bobbin holds and feeds tape as required to increase worker efficiency and reduces the strain to the worker's hands.

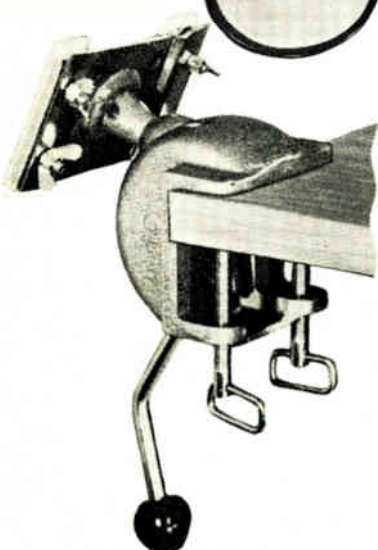

Gudebrod Swivel-Tilt Harness Board Mount

Gudebrod Swivel-Tilt mounts reduce fatigue, eliminate stretching and bending and increase production.

Portable mount swivels and locks securely in any position with a single lever. Handles boards up to 3 ft. by 3 ft. and clamps to any sturdy table or bench. Larger sizes also available.

*DuPont Registered TM



Call or write for facts now.



Gudebrod Bros. Silk Co., Inc. Dept. E612, 12 South 12th Street, Phila., Pa. 19107 Phone: (215) WA2-1122

New York, N. Y. (212) LA4-5858

Boston, Mass. (617) HA6-5347

Branch Offices
Chicago, Ill. (312) DE7-3025

Burbank, Ca. (213) 848-3962

Charlotte, N. C. (704) 333-9591

NEW PANDUIT™ Pneumatic Cable Tie Installation Tool

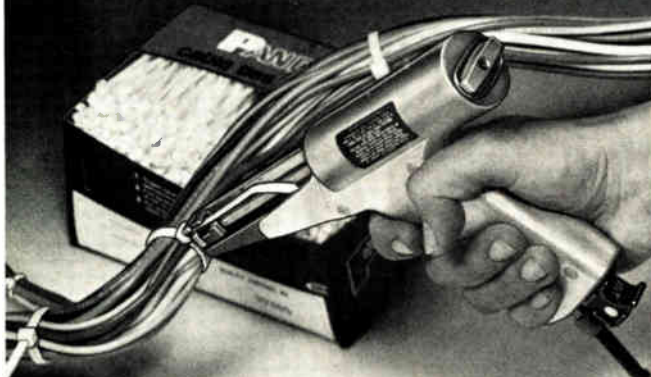

Hand-operated PPTS air tool for fast, continuous, high-volume production ■ Lightweight tool requires minimum force, reduces fatigue ■ No training required ■ One tool installs all miniature, intermediate and standard cross-section PAN-TY® and STA-STRAP® cable tie products—36 different sizes, bundles to 4" dia. ■ Uses standard 70 to 80 lb. psi air to automatically tighten ties to pre-set tension and cut flush ■ No sharp edges; no metal barbs; no twisting.

Ask for free bulletin, demonstration, lease arrangements

PANDUIT

CORP.
Tinley Park, Ill. 60477 Phone: (312) 532-1800
In Canada: Panduit (Canada) Limited

Circle 200 on reader service card

Why mess around when you can have the **ELECTRONICS BOXER** clean up your copies—keep them in top condition.

And, it's easy and

inexpensive to keep the **ELECTRONICS BOXER** in your corner. Just complete the coupon and mail. Your order will be processed immediately, postpaid.

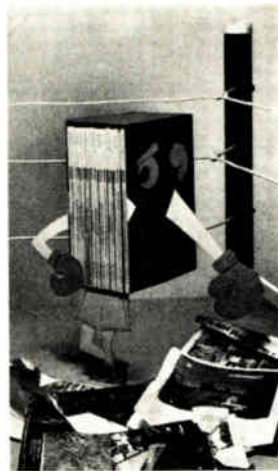

ELECTRONICS BOXER

Jesse Jones Box Corporation

2250 E. Butler St., Philadelphia, Pa. 19137

Please send me: boxes @ \$4.25 each;
 3 boxes @ \$12.00; 6 boxes @ \$22.00

My check or money order is enclosed.

Name _____

Address _____

City _____ State _____ Zip _____

PUBL-SERVICE

SALON INTERNATIONAL DES

composants électroniques

PARIS 1-6 / 4 / 74

COMPONENTS - MEASURING
MATERIALS - EQUIPMENT

Organisation S.D.S.A. - 14, rue de Presles 75740 Paris Cedex 15

FRENCH TRADE SHOWS 1350 Avenue of The Americas
NEW YORK, N.Y. 10019 Tel.: (212) 582-4960, 1

New Books

IBM System 370 Medium Systems, An Auerbach Computer Technology Report, Auerbach Publishers Inc., Philadelphia, 51 pp., \$25.00.

Auerbach, a Philadelphia market-consulting and publishing firm, has put together a good collection of unbiased information about the middle seven of the 13 models in IBM's System 370 series. The report, intended for computer users, is expensive, but it is also comprehensive and apparently accurate.

The book—actually a collection of loose-leaf pages in a semipermanent plastic binder—summarizes the principal features of the entire line of System 370 computers, then gives more detail on the seven middle models. There are brief discussions of four kinds of input-output attachments (all different from the System 360), four kinds of operating systems, virtual memory, and the differences between core and semiconductor memory.

There is a generally laudatory description of the reliability and maintainability of the machines, but the section dealing with applications software contains some unwarranted assumptions about what the reader already knows. For example, the book says, "VSAM, or virtual storage access method, is a functional replacement for ISAM." ISAM, which actually stands for indexed sequential access method, isn't defined in the book, as it should be.

After these introductory remarks, the report gets into a detailed evaluation of the various models. It discusses the levels of compatibility, considers domestic and foreign competition, and takes an occasional swing at the competitive equipment, as well as at IBM. It also looks at the independent manufacturers of plug-compatible peripheral equipment, software houses, and third-party lessors, and reports two users' divergent reactions.

The differences between the various mainframe models are discussed. There are accounts of such features as reloadable control storage, two-level storage (cache memory), storage protection, addressing facilities, and the three principal kinds of input-output

Important new books on now subjects from McGraw-Hill

Applications of Operational Amplifiers

Third-Generation
Techniques

By Jerald G. Graeme



Now the experts at Burr-Brown Corporation have prepared a new reference for circuit designers and users of operational amplifiers explaining those applications which have evolved since the publication of their classic companion volume *Operational Amplifiers: Design and Applications*. (See below) This storehouse of detailed practical information shows you how to modify a wide variety of general circuits to meet your specific needs.

Special Features Include: • A wide range of applications for newly-evolved circuits—many never before published, and • numerous circuit diagrams, circuit valves, pertinent design equations, error sources, and test-based comments on efficiency.

CONTENTS: 1. OPTIMIZING OPERATIONAL AMPLIFIER PERFORMANCE • 2. AMPLIFIERS • 3. SIGNAL CONDITIONERS • 4. SIGNAL PROCESSORS • 5. SIGNAL GENERATORS • 6. SPECIAL PURPOSE CIRCUITS.

256 pages, \$14.00

Semiconductor Memory Design and Application

By Gerald Luecke,
Jack P. Mize, and
William N. Carr



How to use semiconductor storage elements for larger memory systems, that's the essence of this comprehensive book, an indispensable reference for the systems engineer or circuit designer who must keep abreast of important developments in computer memory implementation. Emphasis is on those fundamentals essential to working with future developments in the field.

CONTENTS: 1. MEMORY FUNCTIONS and ECONOMICS 2. SEMICONDUCTOR TECHNOLOGY ARSENAL for STORAGE ELEMENTS • 3. SEQUENTIALLY ACCESSED DESIGN • 4. BIPOLAR RANDOM ACCESS MEMORY DESIGN • 5. MOS RANDOM ACCESS MEMORY DESIGN 6. FIXED PROGRAM SEMICONDUCTOR MEMORY DESIGN • 7. SEMICONDUCTOR STORAGE ELEMENT RELIABILITY • 8. FIXED PROGRAM SEQUENTIALLY ADDRESSED MEMORY APPLICATIONS • 9. BIPOLAR RANDOM ACCESS MEMORY APPLICATIONS • 10. MOS RANDOM ACCESS MEMORY APPLICATIONS • 11. LARGE MAINFRAME MEMORIES. 320 pages, \$18.50

OTHER NEW BOOKS OF IMMEDIATE INTEREST

MANUAL OF ACTIVE FILTER DESIGN

By John J. Hilburn and David E. Johnson

This practical, easy-to-use design aid will help you build an active filter more quickly than by doing your own calculations or even by using a computer. 132 unique rapid-design graphs present an infinite number of clearly labeled designs for low-pass, high-pass, band-pass, band-reject, phase-shift, and time-delay filters, using standard circuit elements, requiring no computations whatsoever. The design procedures are summarized at the end of each chapter and a theoretical discussion of each filter is given in a separate chapter.

208 pages, \$12.50

ADVANCED INDUSTRIAL ELECTRONICS

By N. M. Morris

Originally published in England, this progressive work presents the latest developments in electronics, including digital and linear integrated circuits (bipolar and FET). Conventional circuit design is also covered with many worked examples. Contents include: Closed-Loop Control Systems; Power Supplies; High Power Electronics; Counting and Timing Circuits; Logic Circuits; Non-Sinusoidal Oscillators and Sweep Generators; Multivibrators; Pulse Shaping and Switching Circuits, and much more.

312 pages, \$12.50

AVAILABLE AT YOUR BOOKSELLER
OR USE THIS HANDY COUPON

And in case you missed these best-sellers from *Texas Instruments and Burr-Brown*...

MOS/LSI DESIGN AND APPLICATION

By William N. Carr and Jack P. Mize

A comprehensive working guide on the many time and money saving advances in the integrated MOS/LSI package, plus related application circuitry. Fully illustrated.

320 pages, \$18.50

OPERATIONAL AMPLIFIERS

Design and Applications

Edited by Gene E. Tobey, Lawrence P. Huelsman and Jerald G. Graeme, Burr-Brown Research Corp.

The only available book devoted completely to every aspect of selection, use and design, from basic theory to specific applications. A comprehensive working manual and reference.

474 pages, \$15.00



McGRAW-HILL BOOK COMPANY
1221 Avenue of the Americas, New York, N.Y. 10020

McGRAW-HILL BOOK COMPANY

1221 Avenue of the Americas, New York, N.Y. 10020

Please send me the book(s) checked below for 10 days' free examination. At the end of that time I will remit the price of the book(s) plus local tax, postage, and handling or return the book(s) without further obligation. I understand that if I remit in full, plus local tax, with this order McGraw-Hill will pay all postage and handling and that return privileges still apply.

- Applications of Operational Amplifiers: Third Generation Techniques (023890-1) \$14.00
- Semiconductor Memory Design and Application (038975-6) \$18.50
- Manual of Active Filter Design (028759-7) \$12.50
- Advanced Industrial Electronics (094290-0) \$12.50
- MOS/LSI Design and Application (010081-0) \$18.50
- Operational Amplifiers (064917-0) \$15.00

Name _____

Address _____

City _____

State _____ Zip _____

23-A-489-4000-3

This offer good only in U.S. and subject to approval by McGraw-Hill.

The HS-200S...a wire memory offering speed, capacity, cost and reliability of ample proportions.

This is our latest wire memory. It gives you access time of 180 ns and cycle time of 250 ns. Memory elements, of course, consist of our own special development, magnetic wires. Non-destructive read-out is featured. HS-200S means maximum reliability at minimum cost. In fact, you get a 65 kilo-byte assembly with an MTBF figure of 10,000 hours. HS-200S is a component precisely matched to computers of the new age.

Wire Memory System HS-200S Specifications

1. **Memory elements** Non-destructive read-out
2. **Storage capacity** 8 kwords/80 bits, 16 kwords/40 bits, 32 kwords/20 bits
3. **Access time** 180 nanoseconds
4. **Cycle time** Write-in Read-out 250 nanoseconds
5. **Interface levels** TTL logic . . . H +2.4—+5V L —0.5—+0.5V
6. **Dimensions** 500×300×112mm (Basic unit capacity is 65 Kbytes. Expansion to one megabyte is possible.)
7. **Required power** +30V, +15V, +5V, —15V

Please contact our sales department if you have special requirements.

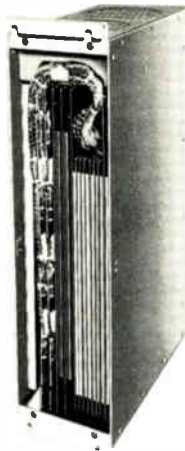

TOKO, INC.

Head Office: 1-17, 2-chome, Higashi-Yukigaya, Ohta-ku, Tokyo, Japan
 New York: Toko New York Inc.
 350 Fifth Avenue, New York, N.Y. 10001 U.S.A. Tel: 565-3767
 Los Angeles: Toko, Inc. Los Angeles Liaison Office
 3440 Wilshire Blvd., Tishman Building, Suite 1106 Los Angeles, Calif.
 90010, U.S.A. Tel: 380-0417
 Düsseldorf: Toko, Inc. Europe Liaison Office
 4 Dusseldorf, Kolner Straße 246, Düsseldorf, W. Germany Tel: 78-7064

Circle 202 on reader service card

JACKS, PINS & TERMINALS

SHIPMENTS FROM STOCK

TEFLON/MICRO MINI/SUB MINI/STANDARD/
 PRINTED CIRCUIT/BRASS SOLDER

Hundreds of configurations in stock

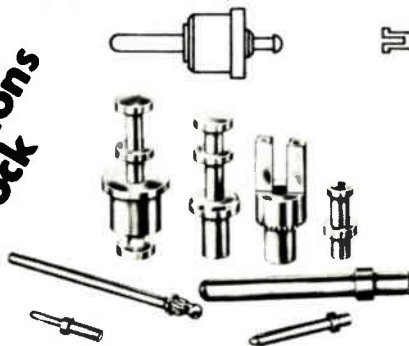

P.C. JACKS

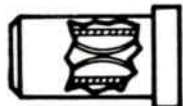

BERYLLIUM COPPER CAGES

WE PRECISION-MANUFACTURE AND PLATE TO MIL SPEC IN GOLD, SILVER, TIN, SOLDER, AND OTHERS TO ORDER.
 FREE CATALOG AVAILABLE.

CONCORD ELECTRONICS CORPORATION

37 GREAT JONES STREET, NEW YORK, N. Y. 10012
 (212) 777-6571 TWX 710-581-4930

New books

channels. Also, there is a list of available peripheral devices with specifications, communications equipment, and terminals.

Finally, a section on software gives program classifications and definitions, more on operating systems and virtual memory, and descriptions of system-support and data-communications software, and applications programs.

Maverick Inventor, My Turbulent Years at CBS, Peter Goldmark, Saturday Review Press, 222 pp., \$7.95.

Goldmark's book is one man's entertaining inside view of what it's like to be head of a corporate research facility, CBS Laboratories, in which, Goldmark relates, the mandate was: "Go forth and make money." For the EE in management, there may be lessons to be learned from it, especially if he's curious about what happened to electronic video recorders.

EVR was invented by Goldmark, the man who brought us the long-playing audio record. It was one of those developments that had a lot going for it, but the project seemed to head down-hill from the day it was finally let out of its box by CBS Laboratories. Behind the whole project was CBS, a giant in TV programming. Yet, EVR was all but dead by 1972, when CBS shut down U.S. EVR operations and left its development to European and Japanese "partners."

How did this happen, and who is to blame? Well, for one readable and colorful side of the issue (and this may be the only side ever to see print), there is Goldmark's new book issued last month in which he covers this phase of his career in a chapter called, "The Great EVR Sleighride." This title will give a pretty good indication of how he assesses EVR's failure. In short, Goldmark points the finger at top management for the lack of consistency in pushing the development, and not at any intrinsic technical weakness in the EVR system. Specifically, he cites CBS chairman William Paley's fear that EVR would invade the corporation's television-broadcasting market.



10 MHz to 18 GHz

MCL is now a leader in solving your high power r-f and microwave testing problems.

Many customers remember us for the "extras" engineered and built into our microwave cavities, e.g., our potted anode bypass assembly.

But some may not be aware that MCL currently offers one of the industry's largest and most diverse power oscillator, amplifier and systems lines.

The same extra margin of reliability and performance customers have learned to expect from our cavities is also a feature of our instrumentation products.

For a recommended solution to your high power testing problem—without obligation—write us today. MCL, Inc., 10 North Beach Avenue, La Grange, Illinois 60525. Or call (312) 354-4350.



See us in EEM-Vol. 1 pp. 551-566

Circle 203 on reader service card

Have only 5VDC available?

... you can now get Baldwin accuracy and dependability in single voltage Optical Encoders!



- Absolute, in 8 through 14-bit resolutions
- Incremental, in 60 — 48,000 counts per turn
- Extended life light source, field replaceable without re-calibration
- TTL internal electronics

Special codes are no problem for the Baldwin Divided Circle Machine. Write for literature or phone today about your encoder application.

BALDWIN® ELECTRONICS, INC.

1101 McAlmont St., Little Rock, Arkansas 72203
Phone (501) 375-7351 TWX 910-722-7384

Circle 251 on reader service card

FREE '74 Heathkit catalog

... fully describes the new Heathkit IB-1103 Counter featuring phase-locked multiplier, extremely high resolution with 8½-digit readout and 180 MHz capability. Pushbuttons permit multiplication by 1 (direct), 10, 100 or 1000. Also, it has temperature compensated crystal oscillator (TCXO) and pushbutton selection of 1 msec., 100 msec. and 1 sec. gate times. Input sensitivity is 50 mV to 120 MHz and 100 mV to 180 MHz. Includes lighted indicators for MHz, kHz, Hz, Gate, Overrange and unlocked conditions. Kit utilizes plug-in circuit boards for fast assembly. Mail order price, \$379.95*. Shipping weight, 12 lbs. ... there are more than 350 other Heathkit products for '74. Including assembled and kit-form automotive and lab test instruments. Kits for every interest — marine, ham, color TV, stereo hi-fi, automotive, home appliances, educational, etc.



Send for your **FREE** Heathkit catalog, **NOW**

HEATH COMPANY, Dept. 53-12
Benton Harbor, Michigan 49022

Please send FREE Heathkit Catalog.
 Please send IB-1103. Enclosed is \$379.95, plus shipping.

Name _____
Address _____
City _____ State _____ Zip _____

*Mail order prices; F.O.B. factory. TE-297R

Circle 252 on reader service card 203

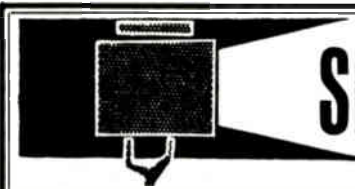

SEARCHLIGHT SECTION

- CLASSIFIED ADVERTISING
- BUSINESS OPPORTUNITIES
- USED OR SURPLUS EQUIPMENT

AUTOTRACK MOUNT

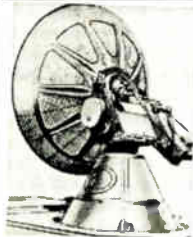

AUTOTRACK SCR-584 RADARS
360 degree azimuth, 210 degree elevation sweep with better than 1 mil. accuracy. Missile velocity acceleration and slewing rates. Amplidyne and servo control. Will handle up to 20 ft. dish. Supplied complete with control chassis. ALSO in stock 10 cm. van mounted radar system. Conical scan. PPI. 6 ft. dish. Ideal for S band telemetry, weather, balloon trk., missile trk., rocket trk., ECM range. Write for complete data. 600 pg. instr. bk. avail. at \$25 ea.

1 MEV LINEAR ACCELERATOR

Dual Mode, Ion or Electron, RF Drive, 300 KHZ at 45 KW. Includes control console, RF unit, accelerator, etc.

MOD IV HIGH RESOLUTION TRACKER

Instrumentation radar; freq. 8.5-9.6 GHz, Pwr: 250 KW, .1 mil tracking accuracy, 6' Fresnel lens antenna with 4 horn monopulse feed. Tracking range 50 or 200 miles. Formerly used as range safety radar at Cape Kennedy.

PULSE MODULATORS

- 245 KW LINE PULSER Output 16 KV at 16 amp. .25 μ s at 4000 PPS.
- 405 KW FLOATING DECK PULSER Output 20 KV at 20 amp. 1 μ s to 10 milisecond pulse.
- 500 KW LINE PULSER Output 22 KV at 28 amp. 4/1.75/2.25 μ s at 2500/550/300 PPS.
- 1 MW HARDTUBE MIT MODEL 9 Output 25 KV at 40 amp. .25-2 μ s at .002 D.C.
- 2.0 MW LINE PULSER Output 30 KV at 70 amp. 1/2 μ s at 600/300 PPS.
- 3 MW LINE PULSER Output 39 KV at 75 amp. .25/1 μ s at 500 PPS.
- 10 MW LINE PULSER Output 76 KV at 135 amp. 2.5 μ s at 350 PPS.
- 17 MW LINE PULSER Output 17 KV at 1000 amp. 2-5 μ s at 150-2000 PPS.

HV POWER SUPPLIES

- 6.3 KV @ 5 Amp; 20KV @ 1.3 Amps; 35KV @ 1.5 Amps; 28KV, 70MA; 12KV @ 800MA; 18KV @ 2.25 Amps; 17.5KV @ 1.8 Amps.

Radio-Research Instrument Co. INC.

3 Quincy St., Norwalk, Conn. 06850 • 203-853-2600

CIRCLE 951 ON READER SERVICE CARD

RECON DRONE CONTROL RADARS

X Band systems autotrack and search complete with plotting boards. Fully mobile van mounted. Gives PPI, slant range, altitude data. Ground to air control links and beacons also in stock. AN/MPQ-29 & AN/TPW-1

RADAR DATA MICROWAVE LINK

Freq. 7.1-7.9 GHz, Pwr. 100 mw., 4 channels. Transmits video, pulse, synchro, and voice information. Mfr: Motorola.

SPARE PARTS IN STOCK

Nike Ajax, Nike Hercules, M-33, MPS-19, TPS-ID, TPS-10D, FPS-6, SPS-8, SCR-584, HIPAR

RADAR & RF PKGS.

- 34ghz 40kw Pulse RF pkg
- 24ghz 40kw Pulse bomb toss system
- 16ghz 130 kw Pulse B-58 search radar system
- X BAND SEARCH 40 KW PULSE WEATHER RADAR
- X BAND AUTO TRACK 250KW PULSE M-33 compl w / plot boards
- X BAND BEACON 400 W PULSE AN/DPN-62
- X BAND AUTOTRACK 50KW PULSE B-47 fire control complete
- C BAND WEATHER RADAR 250 KW PULSE
- C BAND HEIGHT FINDER AN/FPS-26.5 megawatt output AN/TPS-37, 1 megawatt output.
- C BAND 1 MEGAWATT AUTOTRACK 10ft dish mortar locator MPQ-31
- C BAND 285KW PULSE Search AN / SPS-5
- S BAND AUTOTRACK 500 KW PULSE 10' DISH
- S BAND 1 MEGAWATT COHERENT AN / FPS-18
- S BAND 1 MEGAWATT PULSE NIKE ACQ.
- S BAND 5 MEGAWATT HEIGHT FINDER AN/FPS-6
- S BAND BEACON 1 KW PULSE
- L BAND 500KW PULSE AN / TPS-ID / E
- L BAND 5 to 20KW PULSE 400mhz 1KW CW AN / FPS-23

HUNDREDS MORE IN STOCK
LARGEST RADAR INVENTORY IN WORLD.
WRITE FOR CATALOG ON YOUR LETTERHEAD

225mhz 1 MEGAWATT PULSE AN/TPS 28
2-30mhz 100KW PULSE
CW 950-5ghz 150 WATTS
CW 1.5mhz-10.5ghz 5 WATTS
CW 7.4 GHZ 2 KW
AN / GPG-1 SKYSWEEP TRACKER
3 cm. auto tracking radar system. Comp. pkg. w / indicator sys. Full target acquisition & auto tracking. Input 115v 60 cy. new. In stock for immed. del. Entire sys. 6' x 3' x 10' Ideal for infrared tracker, drone tracker, missile tracker. R & D.

FREE ALARM CATALOG

Full line of professional burglar and fire alarm systems and supplies. 80 pages, 400 items. Off-the shelf delivery, quantity prices.



mountain west alarm
4215 n. 16th st., phoenix, az. 85016

CIRCLE 955 ON READER SERVICE CARD

free catalog

POTTING APPLICATORS
MANUAL OR AIR OPERATED
2 1/2cc 6cc 12cc 30cc
FOR POTTING, ENCAPSULATING ETC.

PHILIP FISHMAN CO., INC.
7 CAMERON ST. WELLESLEY, MASS. 02181

CIRCLE 956 ON READER SERVICE CARD

HELP!

Q. How do I reply to a box number ad?

A. Address an envelope with the box number indicated in the ad, c/o Electronics, Class. Adv. Dept., P.O. Box 900, NY, NY 10020

Q. Whom do I contact or call to renew my classified ad or make corrections?

A. Write Electronics, Class. Adv. Dept., P.O. Box 900, NY, NY 10020 or call: (212) 997-6585 or 6586. Give full company name, size of ad, & date or dates it is scheduled to appear.

EUROPE

We are specialists in helping you to get established on the European Market, thru our services tailored to your requirement:

MARKET ANALYSIS, defining your products' potential, competition and Market trends.

MARKETING PLAN, providing you with detailed recommendations on Sales methods and channels to be used to sell your products effectively.

DISTRIBUTION, selecting and setting-up complete Distribution Network, giving optimum coverage and results.

REPRESENTATION, monitoring, coordinating and supervising your established distributors.

Please write for further details to:

FURRER MARKETING
P.O. Box 99
CH-6300 Zug 2, Switzerland

CIRCLE 952 ON READER SERVICE CARD

FREE CATALOG

HARD-TO-FIND PRECISION TOOLS

Lists more than 1700 items—pliers, tweezers, wire strippers, vacuum systems, relay tools, optical equipment, tool kits and cases. Also includes four pages of useful "Tool Tips" to aid in tool selection.



TENSEN TOOLS
4117 N. 44th Street, Phoenix, Ariz 85018

CIRCLE 953 ON READER SERVICE CARD

IMMEDIATE DELIVERY

Minis & Peripherals
DEC—HIS—NOVA
SEL—HP—MOHAWK

CPU, Card, Printer, Tape, Disk

NEW • MOHAWK 4320 PRINTERS
• DATA PRINTER V132

PDP 8 CPU \$1500

\$750 Minis

TELETYPE 35 & 37
DEC & HONEYWELL Modules
617/261-1100

Send for Free Report "Maintenance of Computers"
AMERICAN USED COMPUTER CORP.
P.O. Box 68, Kenmore Sta., Boston, MA 02215

CIRCLE 954 ON READER SERVICE CARD

FREE

new Heath/ Schlumberger Electronic Instruments Catalog



12 New
Test Instruments
New \$335,
10mV-10V, 10 Speed
Chart Recorder
New \$325, auto-ranging
110MHz Counter

from Heath/
Schlumberger

Schlumberger
Copyright Heath Company 1973
Chicago, Ill. 60618



Gives complete details and specifications on hundreds of high performance, budget-conscious instruments for research and industrial applications. Here are just a few examples:

NEW High performance strip chart recorder...4 switch-selected input ranges from 10 mV to 10 V full scale... 10 chart speeds...accuracy within 1%...complete remote control capability...switchable input filtering...easy paper loading...disposable nylon-tip pen. Only \$335*.

NEW 110 MHz frequency counter...5 Hz - 110 MHz guaranteed, 2 Hz - 130 MHz typical...15 mV input sensitivity guaranteed, 3-10 mV typical...input sensitivity control...autoranging with four automatically selected ranges...1 MHz time base w/1 part in 10⁶/mo stability...7-digit LED readout. \$325*.

Dual trace oscilloscope...DC-15 MHz bandwidth w/ 24 nsec risetime...50 mV/cm sensitivity...200 nsec to 0.5 sec/cm sweep rates...triggered sweep...X-Y capability. \$595*.

For your free copy, mail coupon or use reader service number.

HEATH
Schlumberger
Heath/Schlumberger Instruments Dept. 531-282 Benton Harbor, Michigan 49022
Please send new electronic instruments catalog.
Name _____
Title _____
Company/Institution _____
Address _____
City _____ State _____ Zip _____
*Mail order prices; FOB factory. EK-407

Acoplan Corp. Mort Barish Associates, Inc.	198	Dickson Electronics Corp. N.A. Winter Advertising Agency	163	ITT Cannon D'Arcy-MacManus & Masius, Inc.	194-195
Acme Electric Hutchins/Darcy, Inc.	58	Digital Equipment Corp. Creamer, Trowbridge, Case & Basford, Inc.	178-179	Keithley Instruments, Inc. Chagrin Valley Marketing Associates	67
Alexandria Industrial Estate Brunning Advertising & Marketing	77	Dow Corning Industrial Ketchum, MacLeod & Grove, Inc.	174-175	Krohn-Hite Corporation Impact Advertising, Inc.	5
Allen-Bradley Company Hoffman, York, Baker & Johnson, Inc.	34	Dranetz Engineering Labs., Inc. T.C. Gams & Associates, Inc.	146	Kurz-Kasch, Inc. David K. Burnap Advertising	82
American Microsystems, Inc. Wilton, Coombs & Colnett, Inc. Advertising	188-189	Dumont Labs. Mohrs Co.	71	Lapp Insulator Div., Intertec Corp. Wolf Associates, Inc.	152
Anisley Electronics Corp. Richard L. Renner Industrial Advertising	166-167	Dynascan Corp. (B & K Division) HWH Associates, Inc.	70	Lockhead Electronics Company McCann-Erickson, Inc.	94-95 53, 192
Anzac Electronics Ken Puleo Advertising	196	E.I.P., Inc. Dailey & Associates	1	McGraw-Hill Book Company	201
Baldwin Electronics, Inc. Baer, Kemble & Spicer, Inc.	203	E-H Research Laboratories, Inc. Hal Lawrence, Inc.	72	Master Appliance Klau-Van Pietersom-Dunlap, Inc.	190
Bayer A.G. Werbeagentur	2E-3E	Elec-Trol, Inc. S. Michelson Advertising	156	M C L, Inc. Carr Liggett Advertising, Inc.	203
Beckman Instruments, Inc., Hellpot Div. N.W. Ayer/Jorgensen/MacDonald, Inc.	28-29	Electro Scientific Industries Com/Mark Communications Group	14E	Micro Switch Division of Honeywell N.W. Ayer & Son, Inc.	184
Blomation, Inc. Paul Pease Advertising, Inc.	90	Electronic Engineering Company of Calif., Electronic Prod. Div. Mealer & Emerson, Inc.	193	3M Electro Products Division Batten, Barton, Durstine & Osborn, Inc.	165
Bourne, Inc. Marlborough Assoc., Inc.	32-33	Electronic Measurements, Inc. Hill Advertising Agency	2	Monolithic Memories, Inc. Paul Pease Advertising, Inc.	147
Buckbee Mears Europe GmbH Team 23	18 E	Electronic Navigation Industries Hart Conway Co., Inc.	14	Monsanto Commercial Products Co., Electronic Special Prod. Advertising Promotion Services	165
Bulova Watch Co., Inc., Electronics Division E.E. Henkel and Associates, Inc.	88	Electronic Research Co. Eric Advertising	196	MOS Technology, Inc. Henry S. Goodsett Advertising, Inc.	138-139
Busmann Mfg. Division of McGraw-Edison Co. Henderson Advertising Company	126	Erie Technological Products Co., Inc. Altman Hall Associates Advertising	31	Mostek Corporation David W. Evans, Inc./Texas	15
Canon Amsterdam N.V. Euro Advertising B.V.	9E	Ferroxcube Black-Russell-Morris	91	Motorola Semiconductor Products, Inc. E B Lane & Associates, Inc.	85
Carpenter Technology Corp. Beaumont, Heller & Sperling, Inc.	176	Fibra Sonics, Inc., Division of C.E. Niehoff The Griswold + Eshleman Company	148	Motorola Timepiece Electronics Unit Bozell & Jacobs, Inc.	155
Cerme Cerme	10E	Fluke Manufacturing Co., John Bonfield Associates	137	Murata Corp. of America Kenmarc Advertising, Inc.	186
Cherry Electrical Products Corp. Kolb/Tookey and Assoc., Inc.	96-97	Function Modules, Inc. Leon Richman Design, Inc.	21E	National Connector Division Visual-Media, Incorporated	207
Chicago Dynamic Industries, Inc. Burton Browne Advertising	207	GAF Corporation Michel-Cather, Inc.	83	National Semiconductor Corp. Chiat/Day, Inc., Advertising	56-57
Circuit-Silk, Inc. Haaga Advertising	208	General Automation Chiat/Day, Inc., Advertising	110-111	Nelson Ross Electronics, Div. Polarad Electronics McCarthy-Sceiba-DeBiasi Advertising Agency, Inc.	210
CIT Alcatel Promotion Industrielle	12E, 23E	General Electric Co., Miniature Lamp Div. Carr Liggett Advertising, Inc.	92-93	Oscilloquartz SA, Neuchatel M.R. Hofer Werbeagentur BSR/EAAA Bern	13E
Colorado Video O'Connell Words & Pictures	207	General Electric Co., Semiconductor Products Department Advertising & Sales Promotion Syracuse Operation	12-13	Panduit Corp. Donald L. Arends, Inc.	200
Communications Transistor Corp. Hall Butler Blatherwick, Inc.	10	General Instrument Corp., Semiconductor Comp. Div. Norman Allen Associates, Inc.	89	Phillips Elcoma Tag Intermarco	18E
Computer Components, Inc.	24E	Gould, Inc./Instrument Systems Div. Carr Liggett Adv., Inc.	142-143	Phillips N.V. PR/T & M Division Marsteller International S.A.	64
Concord Electronics Corp. Sound Advertising	202	Gudebrod Bros. Silk Co. Electronics Division Coastline Advertising	199	Pico Electronics Roif Johnsen, Inc.	6
Continental Testing Laboratories, Inc.	187	Harris Semiconductor Tucker Wayne & Company	98	Plastics Engineering Company Kuttner & Kuttner, Inc.	16
Control Switch, Inc., Sub. of Cutler-Hammer, Inc. The Larwin Agency	198	Heath/Schlumberger Scientific Instruments Advance Advertising Services	202, 203	Plessey, Inc. Materials Div. T.C.I. Adv.	11E
Dale Electronics, Inc., A Sub. of the Lionel Corp. Swanson, Sinky, Ellis, Inc., Advertising	4th Cov.	Hewlett-Packard, Electronics Products Group Corporate Marketing Communications	17-26	Portescap IVA AG	4E
Data General Corp. Scali, McCabe, Stoves, Inc.	140-141	Hickok Electrical Instrument Co. Carr Liggett Advertising, Inc.	84	PowerTech, Inc. The Sommer Agency, Inc.	170
Datascan, Inc. McCarthy, Sceiba, and DeBiasi Advertising Agency, Inc.	210	Honeywell Test Instrument Division Campbell Mithun, Inc.	156	PRD Electronics, Inc. Caroe Marketing, Inc.	169
Datron, Inc. Larry Courtney Co.	183	Hughes Aircraft Company Foote, Cone & Belding	50-51 73, 186	Precision Monolithics, Inc. Marlborough Associates, Inc.	77
Datel Systems, Inc. John Dolan Advertising	3rd Cov.	Hybrid Systems Corp. Susan E. Schur	30	Radiometer Copenhagen	33
Delta Air Lines Burke Dowling Adams, Inc.	187	ILC Data Device Corporation Marchin Weltman Advertising, Inc.	7	Raytheon Company, Industrial Components Operation Provandie Eastwood & Lombardi, Inc.	38
Delta Products, Inc. The William Loughran Co.	154	Intel Corporation Regis McKenna, Inc.	86	Raytheon Semiconductor Durel Advertising	130-131
Derwent Publications Rumml-Hoyt, Inc.	64	Intronics Impact Advertising Inc.	6	RCA Electronic Components Al Paul Lefton Company, Inc.	38
Deutsch Electronics Smith & Hemmings Advertising	197	C. Itoh & Co. (America) Inc. AC & R Advertising, Inc.	190	RCA Electronic Components Al Paul Lefton Company, Inc.	209
Diacon Grant Rogondino Millard, Inc.	196			RCA Solid State Division Al Paul Lefton Company, Inc.	150, 191
Dialight Corporation Michel-Cather, Inc.	160-161			Research, Inc. Pederson, Herzog & Nee, Inc.	173

TELEPHONE CONNECTORS

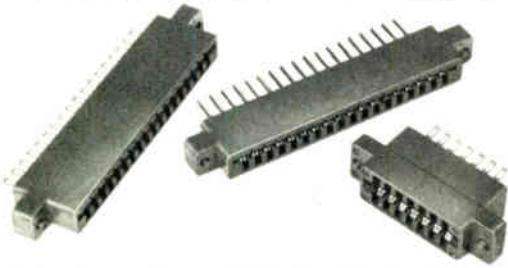

For PBX and Central Office Switching Equipment, Transmission Systems, Etc.

No. 200271 has 18 wrap contacts, .045 tails on .150 centers, accepts 400D K.T.U. (Key Telephone Units) mounted in No. 584 panels. For single-sided PC boards.

No. 2343 has same configuration but has solder eyelet tails.

No. 2342 has 7 dual contacts for double-sided boards, .150 centers, solder eyelet terminations.

Write for information today:

NATIONAL CONNECTOR

5901 South County Road 18 • Minneapolis, Minnesota 55436 • (612) 935-0133

DIVISION OF  **FABRI-TEK INC.**

Circle 253 on reader service card

MINI-THUMBWHEEL SWITCH

FOR COMPUTERS. NUMERIC CONTROLS. IN-FLIGHT GEAR. MANY OTHER SMALL-SPACE INPUT SWITCHING OPERATIONS.

RETROFITS MOST MINIATURE THUMBWHEEL SWITCH PANEL OPENINGS.

CDI Series TSM mini-thumbwheel switches mount on 1/2-inch centers . . . can be furnished with decimal, binary, or binary with complement output—or with specified code characters. Available with extended PC boards for mounting additional components if desired. Large, easily-read numerals . . . positive detent . . . 8, 10 and 12 positions. Completely O-ring sealed against hostile operating environments.

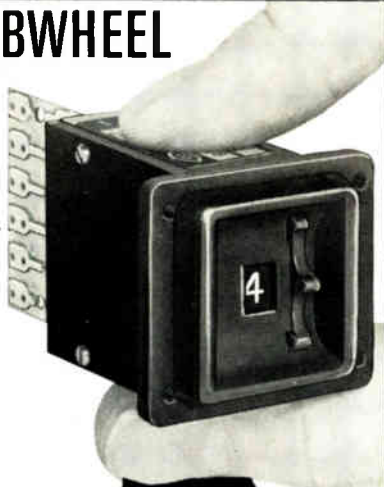

**.900" x .980"
FRONT PANEL SIZE
FOR SINGLE
MODULE ASSEMBLY.**

 **CHICAGO DYNAMIC INDUSTRIES, INC.**
PRECISION PRODUCTS DIVISION
1725 Diversey Blvd., Chicago, Illinois 60614
Phone (312) 935-4600

Circle 254 on reader service card

Need to know where it's at?

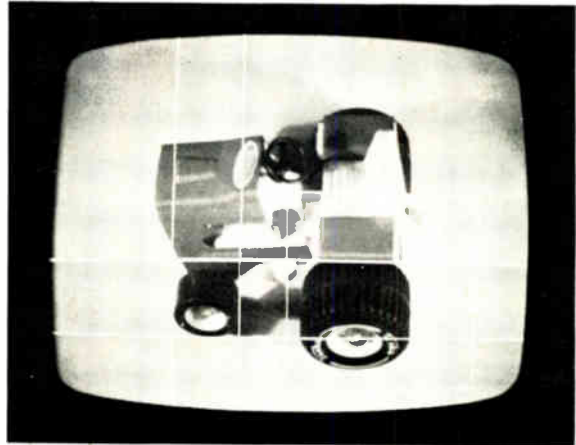

CVI video instruments provide X-Y coordinate information from TV signals — produce boresight reticules — digitize target location — analyse scenes — and more. If you use television and need to reduce data, add special markers, or perform other operations, please call us.

We make things like:

- 304 Motion Detector
- 321 Video Analyser
- 603 Data Insertion Generator
- 610 Video Pointer
- 621 X-Y Indicator
- 622 X-Y Digitizer
- 630 Anomaly Detector

CVI Colorado Video, Incorporated
P.O. Box 928
Boulder, Colorado 80302
(303) 444-3972

Video instruments for data acquisition, processing, Transmission, and display.

Circle 207 on reader service card 207

CIRCUIT-STIK introduces

GP BOARDS

**GENERAL PURPOSE
CIRCUIT BOARDS
Plug-in & Chassis Mounting
and ELECTRONIC
PACKAGING MATERIALS**

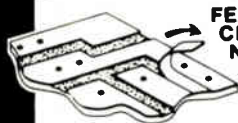
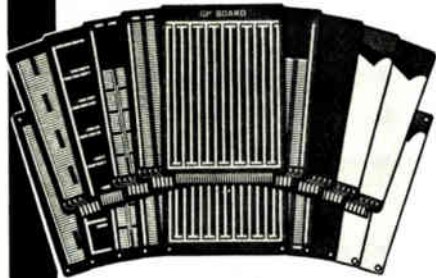

**FEATURING
CIRCUIT-STIK'S
NEW CUT &
PEEL BOARDS**

GP CIRCUIT BOARDS

HIGH QUALITY

- FR-4 Blue Epoxy Glass
- Computer "DRILLED", High Accuracy Holes (not punched)
- Mil-Spec Plating
- Precision Routed Edges

VERSATILITY

- Mix All Types of DIP Sockets (8 to 40 Leads)
- Low, Medium and High Profile Interconnections
- Hybrid Designs for Mixing Discretes and Sockets
- Designed for Edge Connector "Plug-In" or Chassis Mounting
- RFI Shielding

HIGHEST DENSITY

- Up to 50 DIP's on one 4½" x 6½" Plug-In Card
- Plus Space for 50 Decoupling Capacitors

COMPLETENESS of STANDARD DESIGNS

- Choose from 74 Off-the-Shelf Boards
- 4 Sizes of Boards available

APPEARANCE

- Beautiful Gold, Blue and Bright Tin

FULL LINE of ACCESSORIES (HIGH QUANTITY PRICING AVAILABLE)

- Sockets - Low and Standard Profile, P.C. and Wire Wrap
- Molded Nylon and Highest Quality Gold Contacts
- Adapterplugs
- Connectors
- Card Pull Handles

EPOXY GLASS BOARD MATERIALS

- 76 Standard off-the-Shelf Boards
- Including Unclad, Copper Clad, Cut & Peel Copper Clad, Pre-etched "X-Y" Pattern and Plated thru Hole Copper Clad
- .100" Grid Hole Pattern or Undrilled

SEND FOR YOUR FREE CATALOG



P.O. BOX 3396
Torrance, California 90510
Phone (213) 530-5530

• Rohde & Schwarz	1E
Schauer Manufacturing Corp. Noian, Keelor & Sites	177
• Schlumberger Scott MacTaggart Advertising	16E-17E
Scott Electronics, Inc. Chapman & Castello Advertising, Inc.	153
S.D.S.A. Public Service	154,200
■ Signal Transformer Russell Technical Services, Inc.	169
Siliconix Robertson West, Inc.	115
■ Spectrol Electronics Corp. J M R, Inc.	157
■ Sprague Electric Company Harry P. Bridge Company	8, 52
Systron Donner Concord Instruments Fred Schott & Associates	9, 209, 185
Systron Donner Corp. Datapulse Div. Fred Schott & Associates	162
• Tekelec Airtronic S.P.F.D.	7E
Tektronix Inc. McCann Erickson, Inc.	43, 45, 47, 49
■ Teledyne Philbrick Ingalls Associates, Inc., Advertising	2nd. Cov.
• Teledyne Relays S. Michelson Advertising	29
Teradyne, Inc. Quinn & Johnson, Inc.	74
■ Texas Instruments Incorporated Kenyon & Eckhardt Advertising, Inc.	54-55
Thermalloy Warren-Guild	172
‡ Thomas & Betts Company McCarthy, Scelba, DeBiasi Advertising Agency, Inc.	68-69
Toko, Inc. Hakuhodo, Inc.	202
■ TRW/IRC Precision Resistor Networks Gray & Rogers, Inc., Advertising	171, 180
Union Carbide Corp. J.J. Lane, Inc.	27
United Systems Corp., A Sub. of Monsanto Co. Advertising & Merchandising, Inc.	181
■ Unitrode Corporation Impact Advertising	37
U.S. Capacitor Corp. S. Michelson Advertising	168
■ Varo Semiconductor, Inc. Warren-Guild	170
Vu-Data Manning/Bowen and Associates	162
Waveltek San Diego Chapman Michetti Advertising	61
• Wayne Kerr Co., Ltd. Dennis & Garland Ltd.	13E
Western Digital Corporation W D C Advertising	144
■ Winchester Electronics Renaccio Advertising & Marketing, Inc.	81

Classified & Employment Advertising

F.J. Eberte, Manager 212-971-2557

EQUIPMENT (Used or Surplus New) For Sale	
American Used Computer Corp.....	204
Philip Fishman Co., Inc.....	204
Furrer Marketing.....	204
Jensen Tool.....	204
Mountain West Alarm.....	204
Radio Research Instrument Co., Inc.....	204

- For more information on complete product line see advertisement in the latest Electronics Buyer's Guide
- Advertisers in Electronics International
- ‡ Advertisers in Electronics domestic edition

Advertising Sales Staff

Pierre N. Braudé [212] 997-3485
Advertising Sales Manager

Atlanta, Ga. 30309: Joseph Lane
100 Colony Square, 1175 Peachtree St., N.E.
[404] 892-2868

Boston, Mass. 02116: James R. Pierce
607 Boylston St. [617] 262-1160

Chicago, Ill. 60611:
645 North Michigan Avenue
Robert W. Bartlett (312) 751-3739
Paul L. Reiss (312) 751-3738

Cleveland, Ohio 44113: William J. Boyle
[716] 586-5040

Dallas, Texas 75201: Charles G. Hubbard
2001 Bryant Tower, Suite 1070
[214] 742-1747

Denver, Colo. 80202: Harry B. Doyle, Jr.
Tower Bldg., 1700 Broadway
[303] 266-3863

Detroit, Michigan 48202: Robert W. Bartlett
1400 Fisher Bldg.
[313] 873-7410

Houston, Texas 77002: Charles G. Hubbard
2270 Humble Bldg. [713] CA 4-8381

Los Angeles, Calif. 90010: Robert J. Rielly
Bradley K. Jones, 3200 Wilshire Blvd., South Tower
[213] 487-1160

New York, N.Y. 10020
1221 Avenue of the Americas
Warren H. Gardner [212] 997-3617
Michael J. Stoller [212] 997-3616

Philadelphia, Pa. 19102: Warren H. Gardner
Three Parkway,
[215] 997-3617

Pittsburgh, Pa. 15222: Warren H. Gardner
4 Gateway Center. [212] 997-3617

Rochester, N.Y. 14534: William J. Boyle
9 Greylock Ridge, Pittsford, N.Y.
[716] 586-5040

San Francisco, Calif. 94111: Don Farris
Robert J. Rielly, 425 Battery Street,
[415] 362-4600

Paris: Alain Offergeld
17 Rue-Georges Bizet, 75 Paris 16, France
Tel: 720-73-01

Geneva: Alain Offergeld
1 rue du Temple, Geneva, Switzerland
Tel: 32-35-63

United Kingdom & Scandinavia: Keith Mantle
Tel: 01-493-1451, 34 Dover Street, London W1

Milan: Robert Sadel
1 via Baracchini, Italy Phone 87-90-656

Brussels: Alain Offergeld
23 Chaussee de Wavre
Brussels 1040, Belgium
Tel: 13-73-95

Frankfurt/Main: Fritz Krusebecker
Liebigstrasse 27c, Germany
Phone 72 01 81

Tokyo: Tatsumi Katagiri, McGraw-Hill
Publications Overseas Corporation,
Kasumigaseki Building 2-5, 3-chome,
Kasumigaseki, Chiyoda-Ku, Tokyo, Japan
[581] 9811

Osaka: Ryji Kobayashi, McGraw-Hill
Publications Overseas Corporation, Kondo
Bldg., 163, Umegae-cho Kita-ku, Japan [362] 8771

Australasia: Warren E. Ball, ITO Box 5106,
Tokyo, Japan

Business Department

Stephen R. Weiss, Manager
[212] 997-2044

Thomas M. Egan,
Production Manager [212] 997-3140

Carol Gallagher
Assistant Production Manager [212] 997-2045

Dorothy Carter, Contracts and Billings
[212] 997-2908

Frances Vallone, Reader Service Manager
[212] 997-6057

Electronics Buyers' Guide

George F. Werner, Associate Publisher
[212] 997-3139

Regina Hera, Directory Manager
[212] 997-2544

Now two RCA 5-inch scopes... DC to 10 MHz response

The Triggered/Recurrent
Sweep WO-535A . . .
\$349.00 (Optional Price)
including probe



The Recurrent
Sweep WO-505A . . .
\$329.00 (Optional Price)
including probe

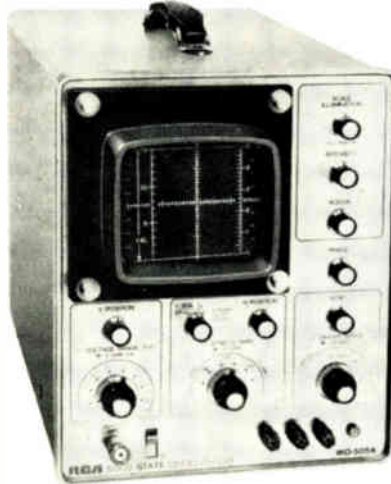

To buy:
order from any one of the more
than 1,000 Authorized RCA
Distributors worldwide, or through
RCA Electronic Instruments
Headquarters, Harrison, N.J. 07029
(RCA will forward your order
to the distributor of your choice.)
Also ask for your copy of the
new full-line Electronic Instruments
1Q1218F catalog.

RCA Electronic
Instruments

Circle 209 on reader service card

Is it a time code generator? Reader? Tape search unit?

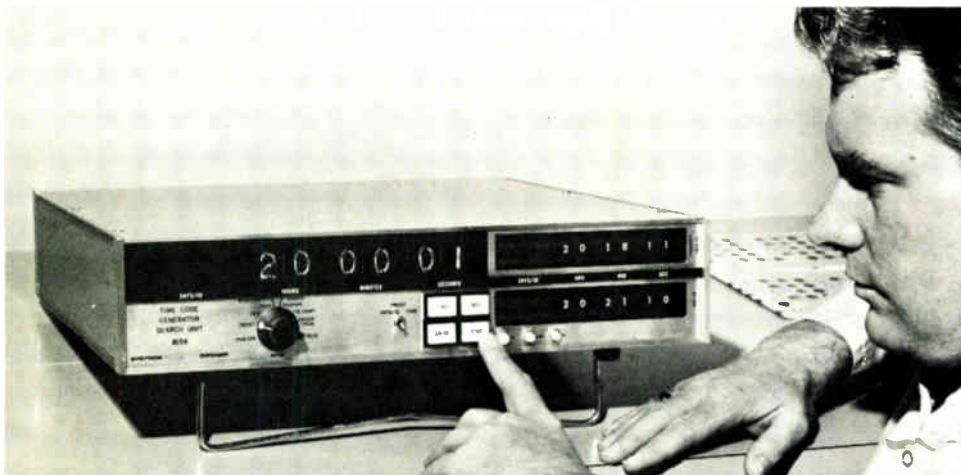

**No.
It's
all
three!**

Systron-Donner's new Model 8154 is a complete time code generator and tape search system, compactly combined into one 3½" high instrument. Savings in packaging costs—without sacrifice of desirable features—results in a delightfully low price of \$3,500 complete. Now, what will the Model 8154 do?

As a time code generator, the standard Model 8154 generates a modified IRIG B format in BCD hours, minutes and seconds. As a time code reader, the unit decodes the incoming code during data playback in both forward and reverse directions. Used for tape search

and control, Model 8154 accepts a serial time code input, searches the recorded data, and controls the tape transport during a preset time interval.

The 8154's wide range input makes it compatible with almost any analog-recording equipment. Options include: parallel BCD outputs; 11-position bandpass filters for both playback and search speeds; slow code rates for graphic recording or visual display; and switch selectable IRIG A or B codes.

For full details contact S-D at 10 Systron Drive, Concord, CA 94518. Phone (415) 682-6161.

SYSTRON  DONNER

The Heavyweight says
**reduce
system costs**



There are hundreds of pages in our new I.C. Logic Card Handbook to help you lower costs — not just card costs but *total system costs*. As an example — there are probably more function-cards illustrated and all with Dynamic Decoupling*, than in any other single logic card source. Function cards means less cards, less back plane wiring, less testing — and *less system costs*.

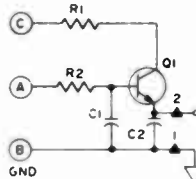

*Dynamic Decoupling™ is a Datascan exclusive — it's a circuit right on the card which eliminates high and low frequency noise for extremely reliable system operation. You get a clean 5V DC power bus on each card — reducing system costs by eliminating system debugging.

Our many services to reduce costs start with letting you know what we have to offer — *get your own copy of Datascan's new Logic Card Handbook* — and see all the DTL, HTL (for high noise environment) and TTL circuits you don't have to design.



P.O. Box 785
1111 Paulison Ave.
Clifton, N.J. 07013
Telephone: (201) 478-2800

Datascan

Datascan
Electronic
Products

925

Circle 218 on reader service card

Value Packed **SPECTRUM ANALYZERS**

0.5 Hz — 6.5 GHz

The Specs You NEED at the Price You Want

... You choose from the largest selection of complete Spectrum Analyzers and plug-ins.* Get specifications you need at lowest cost. Our analyzers cover Sub-Audio, Audio, Ultrasonic, Video, Telemetry Subcarrier, RF/SSB, RF/UHF, CATV, and Microwave applications. And, Nelson-Ross' reliability has been proven by thousands of users for more than a decade.

Get your Nelson-Ross Spectrum Analyzer Catalog; phone, write or circle the reader service number.

* For HP 140/141 series, Tektronix 530/540/550/580 "Letter" series and 560 series scopes.

**nelson • ross
electronics**

A DIVISION OF POLARAD ELECTRONICS CORP.

5 Delaware Drive/Lake Success, N.Y. 11040
516-328-1100 • TWX: 510-223-0414

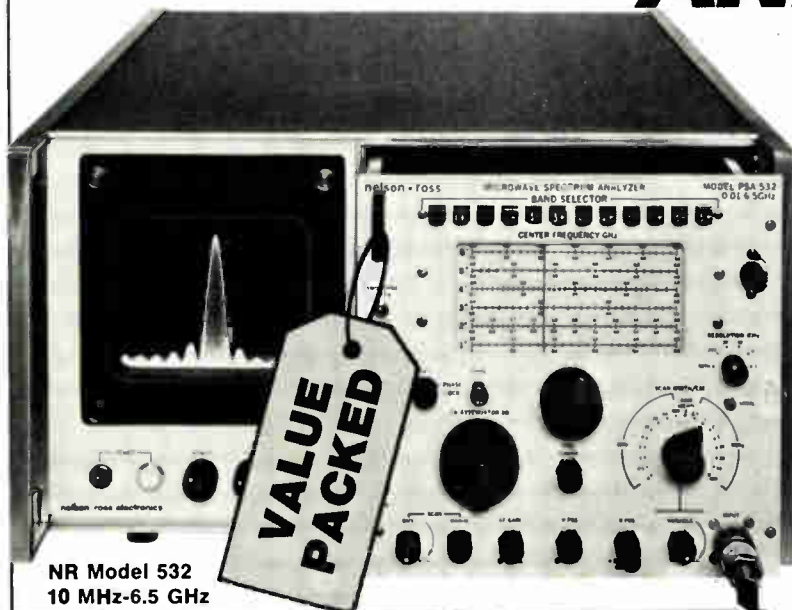

NR Model 532
10 MHz-6.5 GHz

210 Circle 219 on reader service card

Electronics/December 6, 1973

Imagine a Solid-State LED 3½ digit Digital Panel Meter for only **\$99** Single Quantity

On second thought, don't imagine it!
See the Datel System DM-2000 Series



- ± 199.9mV or ±1.999V Full Scale Inputs True Floating Bipolar Differential Input – 100 Megohms Input Impedance
- Automatic Polarity and Overflow Display
- Up to 200 Readings per Second Using Internal or External Clocking
- Operates From Single +5VDC Supply
- Solid State LED Display
- BCD/TTL Digital Outputs

D **DATEL**
SYSTEMS, INC.

1020 Turnpike Street, Canton, Mass. 02021
• TEL. (617) 828-8000 • TELEX 924461 • TWX 710-348-0135
DATELEK SYSTEMS GMBH/DATEN ELECTRONIK
8 Munchen 71, Becker-Gundahl-Strasse 1
Telefon 089/ *784045

FIELD SALES REPRESENTATIVES

(201)944-1800, Fort Lee, N.J.
(205)837-1601, Huntsville, Ala.
(206)285-2525, Seattle, Wash.
(213)476-2251, Los Angeles, Ca.
(214)231-9489, Richardson, Texas
(215)265-3211, King of Prussia, Pa.
(216)486-0782, Cleveland, O.
(303)437-5299, Westminster, Colo.
(305)943-3876, Lighthouse Pt., Fla.
(312)585-5485, Chicago, Ill.
(313)564-6323, Berkeley, Mich.

(314)426-3656, St. Louis, Mo.
(315)622-2350, Liverpool, N.Y.
(317)293-8686, Indianapolis, Ind.
(319)377-6313, Marion, La.
(412)243-1111, Pittsburg, Pa.
(414)464-5555, Milwaukee, Wis.
(415)941-4080, Los Altos Hills, N.C.
(416)678-9241, Rexdale, Ont.
(505)281-5602, Sandia Park, N. Mex.
(513)294-2838, Dayton, O.
(514)388-8951, Montreal, Quebec
Circle 901 on reader service card

(612)544-9393, Minneapolis, Minn.
(613)237-6150, Ottawa, Ont.
(616)327-8390, Portage, Mich.
(703)522-6666, Arlington, Va.
(713)777-4477, Houston, Texas
(714)461-1033, San Diego, Ca.
(801)571-0129, Draper, Utah
(808)946-1533, Honolulu, Hawaii
(913)631-4259, Overland Park, Ks.
(918)622-0321, Tulsa, Oklahoma
(919)722-1783, Winston-Salem, N.C.

Technology Marketing Inc. asked us to prove our network capability.

Now it's your turn.

Respected computer systems developers like Technology Marketing Incorporated are making good use of Dale's thick film network capabilities. The network above is used to set threshold voltage and provide termination for two sense windings in a P.C. layout compatible with 7500 Series memory sense amplifiers. It has been used effectively in high volume production memory and computer systems developed by Technology Marketing Inc. Standard or Special, Dale can provide the resistance function you need...in the quantities and at the price you require. Make us prove it.

Models immediately available for these and many other standard functions:

- MOS/ROM pull-up/pull-down
- Open collector pull-up
- "Wired OR" pull-up
- Power driver pull-up
- High speed parallel pull-up
- TTL unused gate pull-up
- TTL input pull-down
- Digital pulse squaring
- Line termination
- Long line impedance balancing
- LED current limiting
- ECL output pull-down resistors
- TTL input

Power Rating: 1/8 watt max./resistor; 2 watts/package (single in-line); 1-1/2 watts/package (DIP).

Resistance Range: 10 ohms to 1 Meg., depending on tolerance.

Tolerance: 1%, 2%, 5%, 10%, 20%.
T.C.: ± 200 ppm/ $^{\circ}$ C.

Packaging: Flame retardant epoxy coating or sandwich-type ceramic construction.

Double width and discrete networks also available in standard or special designs.

For complete information, call your Dale representative or phone 402-371-0080.

DALE ELECTRONICS, INC., 1300 28th Avenue, Columbus, Nebraska 68601
A subsidiary of The Lionel Corporation • In Canada: Dale Electronics Canada Ltd.

Circle 902 on reader service card

