

- 65 Crucial test nears for closed-flux memories
- 109 Modules simplify industrial data acquisition
- 120 Minis in action: monitoring system temperatures

Electronics®

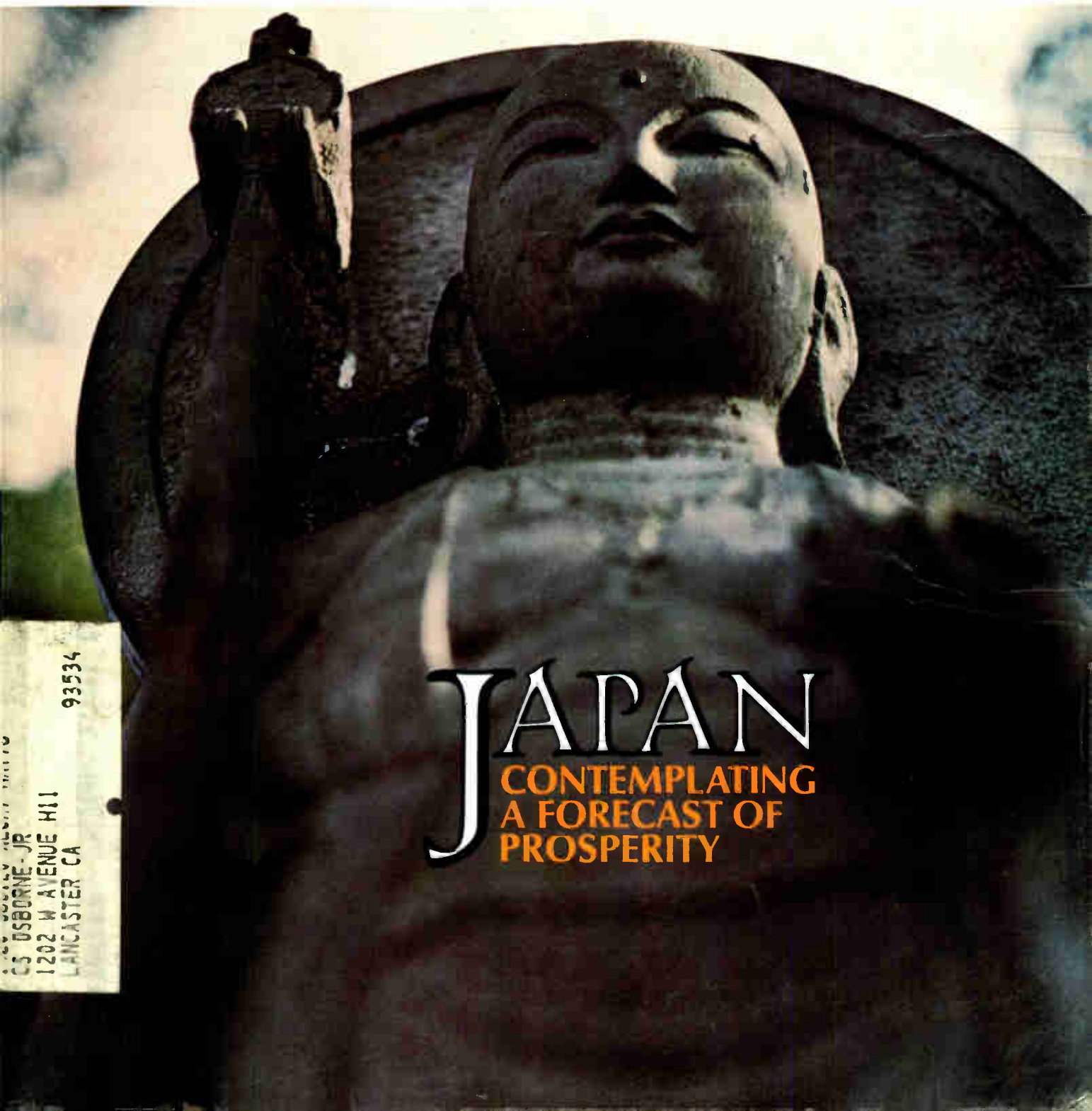

JAPAN
CONTEMPLATING
A FORECAST OF
PROSPERITY

93534
C.S. OSBORNE, JR.
1202 W AVENUE H11
LANCASTER CA

Burroughs panel displays help you sell your products

"The SELF-SCAN panel display provides a *CompuWriter*® feature never before available. . . now an average typist can set quality typography with ease because the SELF-SCAN panel displays each character and function as she keyboards so that she can verify or make corrections by individual character, word, or complete line. Burroughs panel displays DO help you sell your product." — *Mr. John Peterson, Vice President, Domestic Marketing, for Compugraphic Corporation, 80 Industrial Way, Wilmington, Massachusetts 01887.*

Helping you to sell your product helps us sell our product. That's why Burroughs family of panel displays is designed to provide the most pleasing, most readable character available today. Whether your application is for 8, 16, 32, 80, or 256 alphanumeric characters, Burroughs SELF-SCAN panel displays provide an economical approach to your readout requirement plus offer the extra advantage of adding aesthetic quality to your product.

Ask a Burroughs salesman to drop by and demonstrate his terminal in a briefcase. His SELF-SCAN panel display demonstrator is our best salesman.

*Write or call
Burroughs Corporation,
Electronic Components
Division, Box 1226,
Plainfield, N.J. 07061
(201) 757-3400*



SELF-SCAN PANEL

Burroughs



Only Burroughs manufactures NIXIE® tubes, SELF-SCAN® panel displays and PANAPLEX™ numeric panel displays.

Circle 900 on reader service card

SURPRISE!

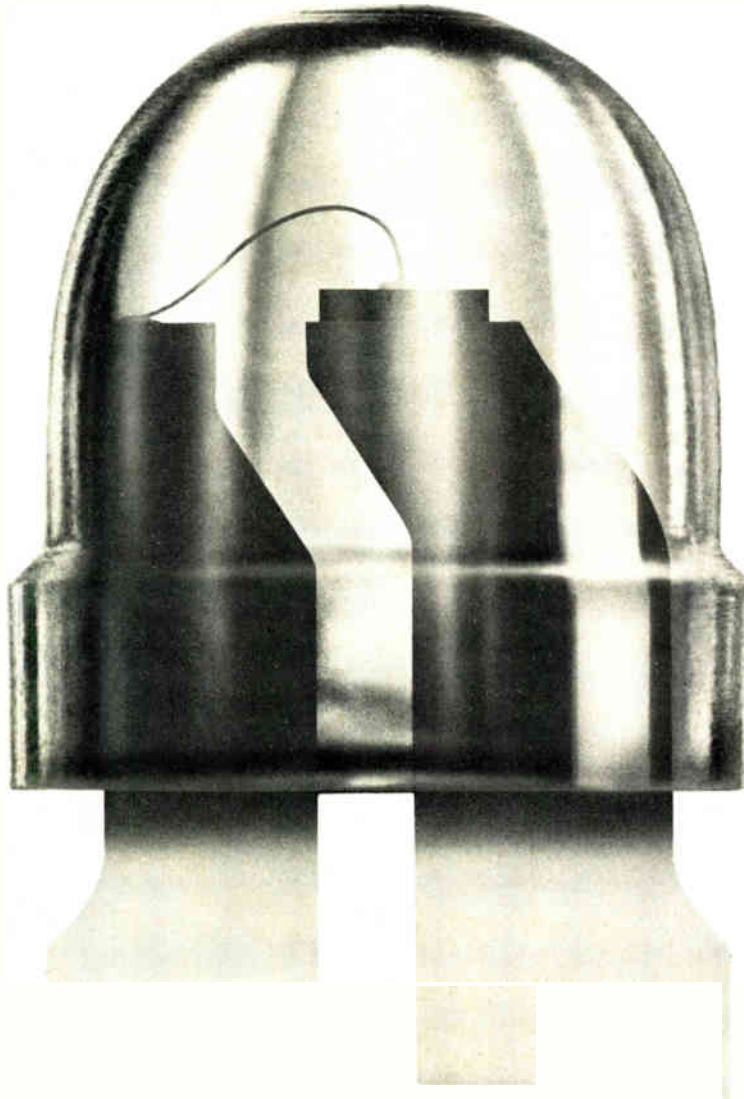

A quality LED for just 9¢*.

Now you can get HP quality in an LED lamp for only 9¢*
That's your price when you order one million. If you only need
one thousand, the price is a low 17¢*. And HP is ready to
deliver that kind of volume to meet your schedule.

This T-1 size lamp features a new low profile lens for
high density application in calculators, cameras, computers, appliances
and automobiles. The 5082-4487 and 5082-4488 both
have a clear lens and a 0.8 mcd at 20 mA typical light output.
Get the full story from your nearby HP distributor
or, write Hewlett-Packard directly.

*US Domestic only.

HEWLETT  PACKARD

Sales, service and support in 172 centers in 65 countries.
Palo Alto, California 94304. Offices in principal cities throughout the U.S.

3 WIRE SYNCHRO TO LINEAR D.C. CONVERTER

ACCURACY 1/2 %



#MAC 1422-1

Provides a linear conversion of
a synchro angle to a DC Voltage

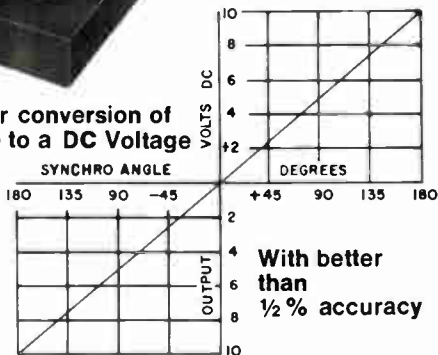

Specifications

Accuracy: $\pm 1\%$ over temperature range
 Input: 11.8V, 400 HZ line to line 3 wire synchro voltage
 Output Impedance: less than 10 Ohms
 Input Impedance: 10K minimum line to line
 Reference: 26V $\pm 10\%$ 400HZ (Unit can be altered to accommodate 115V if available at no extra cost)
 Operating temp. range: -25°C to $+85^{\circ}\text{C}$
 Storage temp. range: -55°C to $+100^{\circ}\text{C}$
 DC power: $\pm 15\text{V} \pm 1\%$ @ 75ma (approx.)
 Case material: High permeability Nickel Alloy
 Weight: 6 Ozs. Size: 3.6" x 2.5" x 0.6"

SOLID STATE SINE-COSINE SYNCHRO CONVERTER - NON VARIANT

This new encapsulated circuit converts a 3 wire synchro input to a pair of dc outputs proportional to the sine and cosine of the synchro angle independent of a-c line fluctuations.

- Complete solid state construction.
- Operates over a wide temperature range.
- Independent of reference line fluctuations.
- Conversion accuracy — 6 minutes.
- Reference and synchro inputs isolated from ground.

Specifications DMD1508-2

Accuracy: Overall conversion accuracy 6 minutes. Absolute value of sine and cosine outputs accurate to $\pm 30\text{mV}$
 Temperature Range:
 Operating -40°C to $+85^{\circ}\text{C}$
 Storage -55°C to $+125^{\circ}\text{C}$
 Synchro Input: 90V RMS $\pm 5\%$ LL 400Hz $\pm 5\%$
 DC Power: $\pm 15\text{V DC} \pm 10\%$ @ 50MA
 Reference: 115VRMS $\pm 5\%$ 400Hz $\pm 5\%$
 Output: 10V DC full scale output on either channel @ 5ma load
 Temperature coefficient of accuracy:
 ± 15 seconds/ $^{\circ}\text{C}$ avg. on conversion accuracy
 ± 1 MV/ $^{\circ}\text{C}$ on absolute output voltages
 Size: 2.0" x 1.5" x 2.5"
 Units are available with wider temperature ranges and 11.8V LL, 26V reference synchro inputs. Information will be supplied upon request.

A.C. LINE REGULATION

A new method has been developed which allows us to provide a low distortion highly regulated AC waveform without using tuned circuits or solid state active filters of any kind.

The result is a frequency independent AC output regulated to 0.1% for line and load with greater than 20% line variations over a wide temperature range.

Features:

- 0.1% total line and load regulation
- Independent of $\pm 20\%$ frequency fluctuation.
- 1 watt output
- Extremely small size
- Isolation between input and output

Specifications: MLR 1471-1

AC Line Voltage: 26V $\pm 20\%$ @ 400Hz $\pm 20\%$
 Output: 26V $\pm 1\%$
 Load: 0 to 40ma
 Total Regulation: $\pm 0.1\%$
 Distortion: 1% maximum rms
 Temperature Range: Operating -40°C to $+85^{\circ}\text{C}$
 Storage -55°C to $+125^{\circ}\text{C}$
 Size: 2.25" x 2.0" x 1.4"
 Other units are available at different power and voltage levels as well as wider temperature ranges. Information will be furnished upon request.

4 QUADRANT MAGNETIC ANALOG MULTIPLIER DC x AC = AC OUTPUT

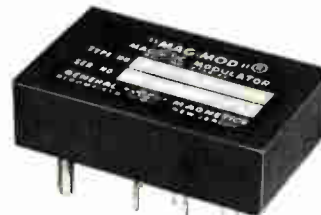

#MCM 1351-2

Product Accuracy
is $\pm 1/2\%$ of all
readings Over Full
Temperature Range
of -55°C to $+125^{\circ}\text{C}$

Specifications Include:

Transfer equation: $E = XY/3$
 X & Y Input signal ranges: 0 to $\pm 3\text{V}$ Peak
 Maximum static and dynamic product error: $1/2\%$ of point or 2 MVRMS, whichever is greater, over entire temperature range
 Input impedance: X = 10K; Y = 10K
 Full scale output: 3 VRMS
 Minimum load resistance for full scale output: 2000 ohms
 Output impedance: Less than 50 ohms
 X input bandwidth: $\pm 0.5\text{db}$, 0 to 200 Hz
 Y input bandwidth: $\pm 0.5\text{db}$, 20 to 1000 Hz
 DC power: $\pm 15\text{V}$ unless otherwise required @ 20 ma
 Size: 1.8" x 1.1" x 0.5"

There is No Substitute for Reliability



GENERAL MAGNETICS • INC

135 Bloomfield Ave., Bloomfield, New Jersey 07003 - Tel. (201) 743-2700

29 Electronics Review

COMMERCIAL ELECTRONICS: Video player costs cut via a-m, 29
SOLID STATE: V-ATE is a potent process at Raytheon, 30
V-notch boosts MOS performance, 31
MATERIALS: Plastics shortage worsens for electronics, 31
MEDICAL ELECTRONICS: Sound to measure blood-vessel walls, 34
DISPLAYS: Liquid crystals make flat TV display, 34
COMPUTERS: Has Justice damaged its suit against IBM? 36
LASERS: Agency to develop goggle safety specs, 36
MICROWAVE: DSCS controls intermodulation over wide band, 38
NEWS BRIEFS: 40
GOVERNMENT ELECTRONICS: HEW plans tests on remote treatment, 41

52 Electronics International

JAPAN: A high-density color display for computers, 52
GREAT BRITAIN: Computer measures hide area, 52
AROUND THE WORLD: 52

65 Probing the News

MEMORIES: Navy to try closed-flux memory, 65
SPACE ELECTRONICS: Low-flying bird to explore atmosphere, 68
COMMUNICATIONS: Interconnect battle goes to court, 71
ELECTRONICS ABROAD: Common Market vs Japan, 76

89 Special Report

JAPAN'S ELECTRONICS MARKETS
Consumer, 91
Semiconductors, 94
Computers, 96
Communications, 100
Industrial, 102
Space, 103

109 Technical Articles

COMMUNICATIONS: Acquiring plant data over 2-wire link, 109
DESIGNER'S CASEBOOK: Register-addressing system is quick, 117
Narrowband digital filter achieves high Qs, 118
Gate threshold difference produces initializing pulse, 119
COMPUTERS: Minicomputer controls temperature-sampling system, 120
ENGINEER'S NOTEBOOK: Circuit lets scope monitor 8 inputs, 131
Displaying gray-scale images on bistable storage tubes, 132
Flashing lamp reminds you to turn off equipment, 133

141 New Products

IN THE SPOTLIGHT: TV integration takes giant step, 141
Synthesizers geared to systems users, 145
Digital VOM challenges analog meters, 146
SEMICONDUCTORS: 4,096-bit RAM has fast access, 148
INSTRUMENTS: Test system built around calculator, 157
PACKAGING & PRODUCTION: Board tester has 1-MHz bit rate, 164
COMMUNICATIONS: System monitors data networks, 175
MATERIALS: 188

Departments

Publisher's letter, 4
Readers comment, 6
40 years ago, 8
People, 14
Meetings, 20
Electronics newsletter, 25
Washington newsletter, 49
Washington commentary, 50
International newsletter, 55
Engineer's newsletter, 134
New literature, 190

Highlights

The cover: Japan faces prosperous future, 89

All sectors of the Japanese electronics industries expect next year to be as good overall as 1973, when sales of audio equipment, microwave ovens, minicomputers, calculators, and test equipment were outstanding. But prosperity created materials shortages, and full employment strengthened interest in automation. Cover photograph by Associate Editor Gerald M. Walker, a coauthor of this report, was taken near a Buddhist temple in Tokyo.

Must AT&T help competing carriers? 68

A specialized common carrier has gone to court to compel AT&T to interconnect local phones to the specialized carrier's intercity microwave links.

Mini improves thermal analysis of equipment, 109

When a computerized recording system handles data from several hundred thermistors distributed throughout the equipment under test, changes in rates of temperature variation are automatically tracked, and the data automatically printed out in useful form. This is Part 7 of the series, "Minicomputers in action."

Data communications aids process control, 120

Complex cable networks required in centralized digital process control systems can be radically simplified by the techniques of data communications. The same techniques make the interfaces of the process measurements code-compatible with commercially available computers and terminals.

And in the next issue . . .

Applications of a new four-amplifier IC . . . Part 3 of the "Thermal design" series: keeping power semiconductors cool. . . NAND gate models, first in a series on IC models for computer-aided design.

EDITOR-IN-CHIEF: Kemp Anderson

EXECUTIVE EDITOR: Samuel Weber

MANAGING EDITORS: Lawrence Curran, *News*;
Arthur Erikson, *International*

SENIOR EDITORS: John Johnsrud,
H. Thomas Maguire, Laurence Altman
Ray Connolly

ART DIRECTOR: Fred Sklenar

ASSOCIATE EDITORS: John N. Kessler,
Howard Wolff, Gerald M. Walker

DEPARTMENT EDITORS

Aerospace: William F. Arnold
Circuit Design: Lucinda Mattera
Communications & Microwave:

Lyman J. Hardeman

Components: Joel DuBow

Computers: Wallace B. Riley

Consumer: Gerald M. Walker

Industrial: Alfred Rosenblatt

Instrumentation: Michael J. Riezenman

Military: Ray Connolly

New Products: H. Thomas Maguire

Packaging & Production: Stephen E. Grossman

Solid State: Laurence Altman

Special Issues: Harry R. Karp

COPY EDITORS: Margaret Eastman,
Everett C. Terry

ASSISTANT EDITOR: Marilyn Offenheiser

ART: Charles D. Ciatto, *Associate Director*
Patricia Cybulski, *Assistant Director*

PRODUCTION EDITOR: Arthur C. Miller

EDITORIAL SECRETARIES: Janet Annunziata,
Julie Gorgoglione, Penny Roberts

FIELD EDITORS

Boston: Gail Farrell

Los Angeles: Paul Franson (Mgr.)

Midwest: Larry Armstrong (Mgr.)

New York: Alfred Rosenblatt (Mgr.)

San Francisco: George Sideris (Mgr.),

Judith Curtis

Washington: Ray Connolly (Mgr.),

William F. Arnold

Frankfurt: John Gosch

London: Michael Payne

Paris: Arthur Erikson

Tokyo: Charles Cohen

McGRAW-HILL WORLD NEWS

Director: Walter A. Stanbury

Bonn: Robert Ingersoll;

Brussels: James Smith;

London: Marvin Petal;

Milan: Peter Hoffmann, Andrew Heath;

Moscow: Axel Krause;

Paris: Michael Johnson, Richard Shepherd;

Stockholm: Robert Skole;

Tokyo: Mike Mealey

PUBLISHER: Dan McMillan

ADVERTISING SALES MANAGER: Pierre J. Braudé

ADVERTISING SALES SERVICE MANAGER:
Wallis Clarke

BUSINESS MANAGER: Stephen R. Weiss

CIRCULATION MANAGER: George F. Werner

MARKETING SERVICES MANAGER:
Tomlinson Howland

This year's Japan market report (p. 89) reflects both the country's optimism gained from a healthy 1973 and the uneasiness left over from a period of ever-worsening shortages. As the statistics reveal, it's been a good year in Japan and there's enough momentum to carry prosperity into 1974. However, shortages of components and materials has hurt, and labor shortages could compound the situation.

If the Japanese economists are right, the economy is in for a cooling off but many an electronics executive may actually look forward to any easing of demand as they contemplate red hot prosperity crippled by shortages.

And news of a cooling off in Japan might make the electronics industries of the Common Market countries breathe a bit easier. In the Probing the News on page 76, Jim Smith, our correspondent in Brussels, recounts the problems faced by the Common Market as a whole and some of its members as individuals in trying to keep Japanese consumer electronics goods from smothering local industry. The catch is that some members have gone ahead on their own and slapped quota restrictions on Japanese goods, while the Common Market frowns on such unilateral frontier-closing. The situation is still fluid, with negotiations going on with the Japanese all across Europe.

Behind the leg work and analysis for the Japan market report provided by staffers Jerry Walker and Charlie Cohen was considerable effort put in by members of McGraw-Hill's Tokyo News Bureau staff, Wakako Ishibashi and Sachiko Ki-

mura. In fact, the report could not fly without them. Wakako put in long hours collecting and collating the data from the market questionnaires sent out to Japanese manufacturers. Her patient, bilingual efforts made possible the chart that appears with the report.

Sachiko, meanwhile, played an important role as chief programmer for Walker's "guided missile" shots aimed at reaching his interviews at the right time and place. Getting around in Tokyo and Osaka is not easy even for the Japanese, so Walker's problem—finding the offices of the electronics company executives on his schedule—was monumental.

Tokyo does not have a street and building number system which means that going from point A to point B by taxi requires a full set of instructions using land marks, mileage estimates and neighborhood names to guide the driver. Each week Sachiko armed Walker with a set of programs to launch him toward the appointed targets.

"It became a running joke around the office," he relates. "First Charlie started referring to me as the guided missile and before long we were all treating the instructions as space documents. Most times splashdown was perfect, but a few landings were either one building short or long. In one case, I ended up entering the building through the rear delivery dock, much to the surprise of my hosts who were waiting in the main lobby."



November 22, 1973 Volume 46, Number 24
92,454 copies of this issue printed

Published every other Thursday by McGraw-Hill, Inc. Founder: James H. McGraw 1860-1948. Publication office 1221 Avenue of the Americas, N.Y., N.Y. 10020; second class postage paid at New York, N.Y. and additional mailing offices.

Executive, editorial, circulation and advertising addresses: Electronics, McGraw-Hill Building, 1221 Avenue of the Americas, New York, N.Y. 10020. Telephone (212) 997-1221. Teletype TWX N.Y. 710-581-5234. Cable address MCGRAWHILL N.Y.

Subscriptions limited to persons with active, professional, functional responsibility in electronics technology. Publisher reserves the right to reject non-qualified requests. No subscriptions accepted without complete identification of subscriber name, title, or job function, company or organization, including product manufactured or services performed. Subscription rates, qualified subscribers in the United States and possessions, Canada, and Mexico \$8.00 one year, \$12.00 two years, \$16.00 three years; all other countries \$25.00 per year, except Japan \$50.00 per year and Brazil \$40.00 per year, including air freight. Limited quota of subscriptions available at higher-than-basic rate for persons outside of field served, as follows: U.S. and possessions and Canada, \$25.00 one year; all other countries \$50.00. Single copies: United States and possessions and Canada 1.00; all other countries, \$1.75.

Officers of the McGraw-Hill Publications Company: John R. Emery, President; J. Elton Tuohy, Executive Vice President-Administration; Gene W. Simpson, Group Publisher-Vice President; Senior Vice Presidents Ralph Blackburn, Circulation, Walter A. Stanbury, Editorial; John B. Hoglund, Controller; David G. Jensen, Manufacturing; Gordon L. Jones, Marketing; Jerome D. Luntz, Planning & Development.

Officers of the Corporation: Shelton Fisher, President; Wallace F. Traudt, Group President, McGraw-Hill Publications Company and McGraw-Hill Information Systems Company; John J. Cooke, Senior Vice President and Secretary; Ralph J. Webb, Treasurer.

Title registered in U.S. Patent Office; Copyright © 1973 by McGraw-Hill, Inc. All rights reserved. The contents of this publication may not be reproduced either in whole or in part without the consent of copyright owner.

Subscribers: The publisher, upon written request to our New York office from any subscriber, agrees to refund that part of the subscription price applying to copies not yet mailed. Please send change of address notices or complaints to Fulfillment Manager, subscription orders to Circulation Manager, Electronics, at address below. Change of address notices should provide old as well as new address, including postal zip code number. If possible, attach address label from recent issue. Allow one month for change to become effective.

Postmaster: Please send form 3579 to Fulfillment Manager, Electronics, P.O. Box 430, Hightstown, N.J. 08520

**If you want high voltage,
programmable power supplies
that don't depend on delicate
low voltage transistors
to stabilize high voltage,
look into**

KEPCO

BHK

**Hybrid power supplies
that control voltage to 2000 volts
linearly and directly with rugged,
forgiving vacuum tubes!**

BHK power supplies are one of several high voltage designs by Kepco that combine modern I-C and transistor small signal processing (for stability and accuracy) with hard-vacuum, high-voltage pass tubes (for reliability and linearity). The result is a happy partnership with each part of the power supply operating in a favorable environment.

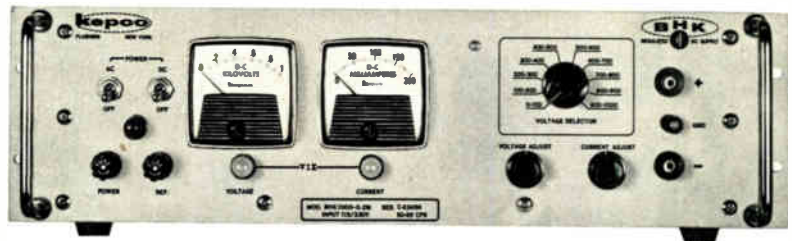

BHK offer 0-500 volts at 0-400 milliamperes, 0-1000 volts at 0-200 milliamperes and 0-2000 volts at 0-100 milliamperes with multiturn voltage and current controls, full metering and automatic crossover voltage/current mode lights.

Ask your Kepco man for details about the Kepco high voltage Hybrids. If you don't know who he is, call (212) 461-7000 collect, or write Dept. AM-14 and we will be glad to direct you to the most exciting power supplies on the scene.

KEPCO®

KEPCO, INC. • 131-38 SANFORD AVENUE • FLUSHING, N.Y. 11352 • (212) 461-7000 • TWX #710-582-2631 • Cable: KEPCOPOWER NEWYORK

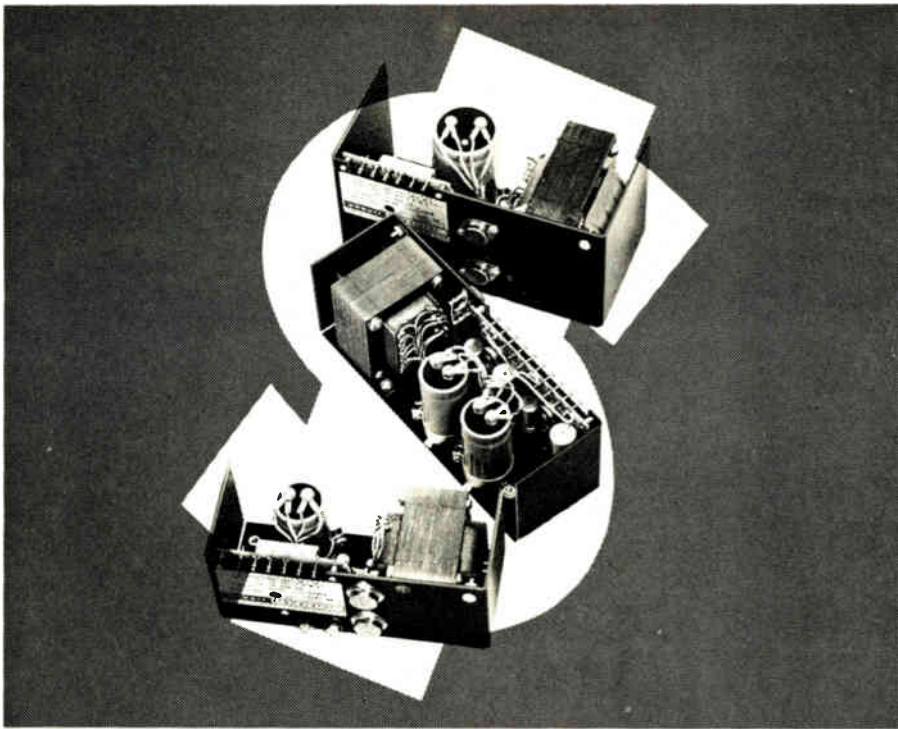

Start Getting Your Money's Worth Out of Power Modules

Now, you can really start getting your moneysworth out of power modules with Abbott's new LOW COST series. Designed to give you 100,000 hours of trouble-free operation (that's 11½ years), these reliable units meet the needs of OEM engineers. Their purchase price is about \$7 per year of service. The model LC series feature:

- 47-420 Hz Input Frequency
- 0.1% Regulation
- +50°C. Ambient Operation
- Single and Dual Outputs
- 1 Day Stock Delivery

These units provide more quality per dollar compared to similar items on the market. See table below for prices on some of our LC models. Many other LC models are listed in our catalog.

If analyzing the many similar power supplies on the market is confusing; if you are concerned about the long-term reliability of those units, then decide on an Abbott power supply for your system. Your best buy in OEM power modules is ABBOTT.

Abbott also manufactures 3,000 other models of power supplies with output voltages from 5 to 740 VDC and with output currents from 2 milliamps to 20 amps. They are all listed with prices in the new Abbott Catalog with various inputs:

- 60 to DC
- 400 to DC
- 28 VDC to DC
- 28 VDC to 400
- 12-24 VDC to 60

5V @ 6 Amps	5V @ 10 Amps	12V @ 10 Amps	15V @ 4 Amps	28V @ 1 Amp	±12V @ 1.2 Amps	±15V @ 4 Amps
LC5T6	LC5T10	LC12T10	LC15T4	LC28T1	LLC12T1.2	LLC15T4
\$72	\$81	\$99	\$81	\$72	\$99	\$135

Please see pages 581-593 of your 1973-74 EEM (ELECTRONIC ENGINEERS MASTER Catalog) for complete information on Abbott Modules.

Send for our new 56 page FREE catalog.

abbott transistor

LABORATORIES, INCORPORATED
 general offices eastern office
 5200 W. Jefferson Blvd./Los Angeles 90016 1224 Anderson Ave./Fort Lee, N.J. 07024
 (213) 936-8185 Telex: 69-1398 (201) 224-6900 Telex: 13-5332

Readers comment

Trimming networks

To the Editor: I would like to note a few corrections for my article, "Impedance-sensitivity nomograph aids design of trimming networks" [Sept. 27, p. 100].

The maximum value of the sensitivity function of Eq. 1 can be found by differentiating that equation with respect to impedance ratio k and then equating the differential to zero. Also, the alternate form for maximum sensitivity (Eq. 3) should be:

$$\hat{S}(Z_T, Z_V) = 1 - \frac{2}{(1 + Z_{F2}/Z_{F1})^{1/2} + 1}$$

Also, the equation following Eq. 5 should read:

$$\frac{Z_{Tmax}/Z_{Tmin}}{= [Z_{F1} + Z_{F2}Z_V / (Z_{F2} + Z_V)] / Z_{F1}}$$

And the maximum sensitivity for the resistive network should be designated as \hat{S}_R :

$$\hat{S}_R = (\hat{k}^2 - 1) / [(\hat{k}^2 - 1) + (1 + n)]$$

$$\hat{S}_R = (\hat{k} - 1)(\hat{k} + 1) / (\hat{k}^2 + n)$$

Similarly, the sensitivity ratio of \hat{S}_R/\hat{S}_Z is expressed in terms of the \hat{k} value of the impedance ratio:

$$\hat{S}_R/\hat{S}_Z = (\hat{k} + 1)^2 / (\hat{k}^2 + n)$$

Finally, in the last equation of the article, quantity Z_P should be defined as the parallel combination of impedances Z_{F1} , Z_{F2} , and Z_V .

Lawrence R. Odess
 Motorola Israel Ltd.
 Tel-Aviv, Israel

Casebook corrected

To the Editor: Some minor corrections are needed for my Designer's Casebook, "Helping a 709-type op amp to outperform itself" [Electronics, Oct. 25, p. 207]. A closing bracket was omitted from the equation for small-signal bandwidth:

$$f_i = 1/[2\pi R_3(C_{C1} + C_{C2})]$$

And the value of one of the upper resistors should be 5.6 kilohms, like the corresponding lower resistor.

Jiří Dostál
 Research Institute for Mathematical
 Machines
 Prague, Czechoslovakia

TRW LVA diode... the sharpest knee below 10 Volts.

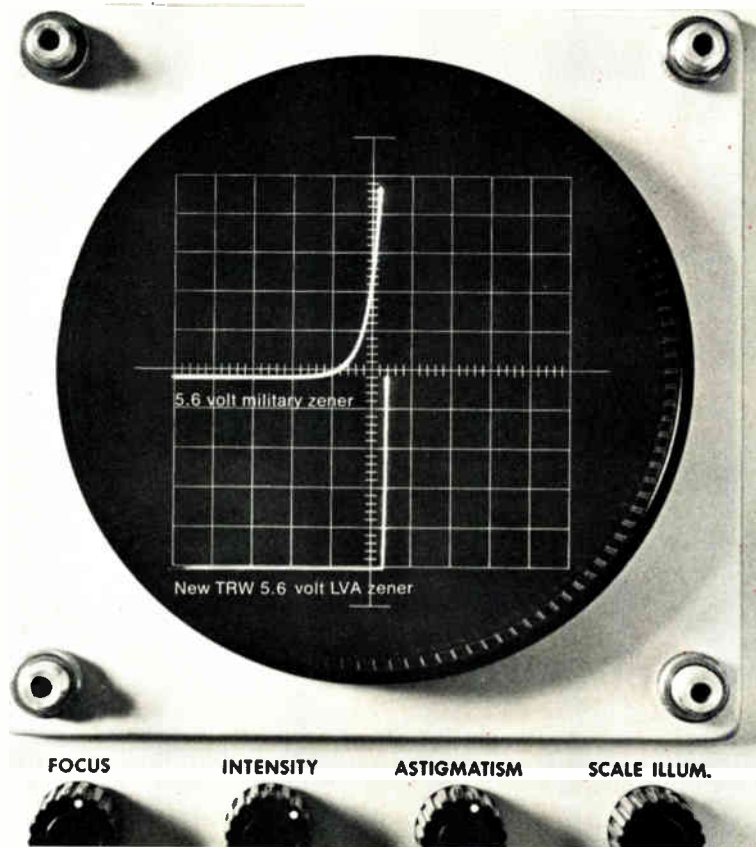

The current saver.

No other zener can approach TRW's LVA performance below 10 volts. Available for operation down to 4.3 volts, TRW LVA diodes minimize power consumption in portable-battery operated equipment. They're also ideal for instrumentation, where, as reference elements, they draw as little as 50 μ Amps.

TRW LVA's are available in various package configurations, including passivated chip form for hybrid-

compatible packages. If you have a need for a low current voltage regulator or any other product that demands low current consumption, you should check out TRW LVA zeners. When it comes to current, they're really misers!

For product information and applications assistance write TRW Semiconductors, an Electronic Component Division of TRW Inc., 14520 Aviation Boulevard, Lawndale, California 90260. Phone (213) 679-4561.

These products are available through the following authorized distributors:

Almo Electronics
Bell Industries
Cramer Electronics Inc.
De Mambro Electronics

Eastern Radio Corp.
Electronics Marketing Corp.
Elmar Electronics Inc.
Hall-Mark Electronics Corp.

Harvey-Michigan Inc.
Liberty Electronics
Powell Electronics
Pyltronics

Semiconductor Concepts Inc.
Summit Distributor
R. V. Weatherford Co.
Westates Electronics Corp.

TRW SEMICONDUCTORS

40 years ago

From the pages of *Electronics*, November 1933

Armstrong's court victory

The latest development in the Armstrong-DeForest regenerative circuit litigation establishes as a *prima facie* case that there is something seriously wrong with our judicial procedure in patent cases.

Entirely aside from the question of whether the present decision is the correct one, it is clear that a system which in a series of proceedings from 1917 to 1924 finds Armstrong to be the inventor, which in another series of proceedings lasting from 1924 to 1933 finds DeForest to be the inventor, and which then determines in 1933 that it was right the first time in holding Armstrong to be first, has many explanations to make to industry.

Uncertainty is a burden which the business executive must forever carry. But what can be more disastrous to his plans than to have litigation in which he is clearly proceeding in his rights appear to terminate favorably, to go forward on the basis of these decisions, and to then, years later, encounter a reversal which places his opponent in control of the situation.

More radio on the farm

More people live on American farms today than ever before in the nation's history. Not only has the drift of farm boys and girls to the city been stopped, after thirty years of continuous growth of the city population at the expense of the countryside, but for three years past the movement of the rural migration has been just the opposite—it now is from city to country. In fact, in these past three years the replacement of farm population has more than equalled the total population withdrawn from rural districts in the preceding third of a century, so that now more people are living in farm homes than ever before.

Most of these 6,000,000 farm houses are without electricity for lighting. Their radios must be battery operated. It is time the radio industry gave more attention to sets designed for this vast market.

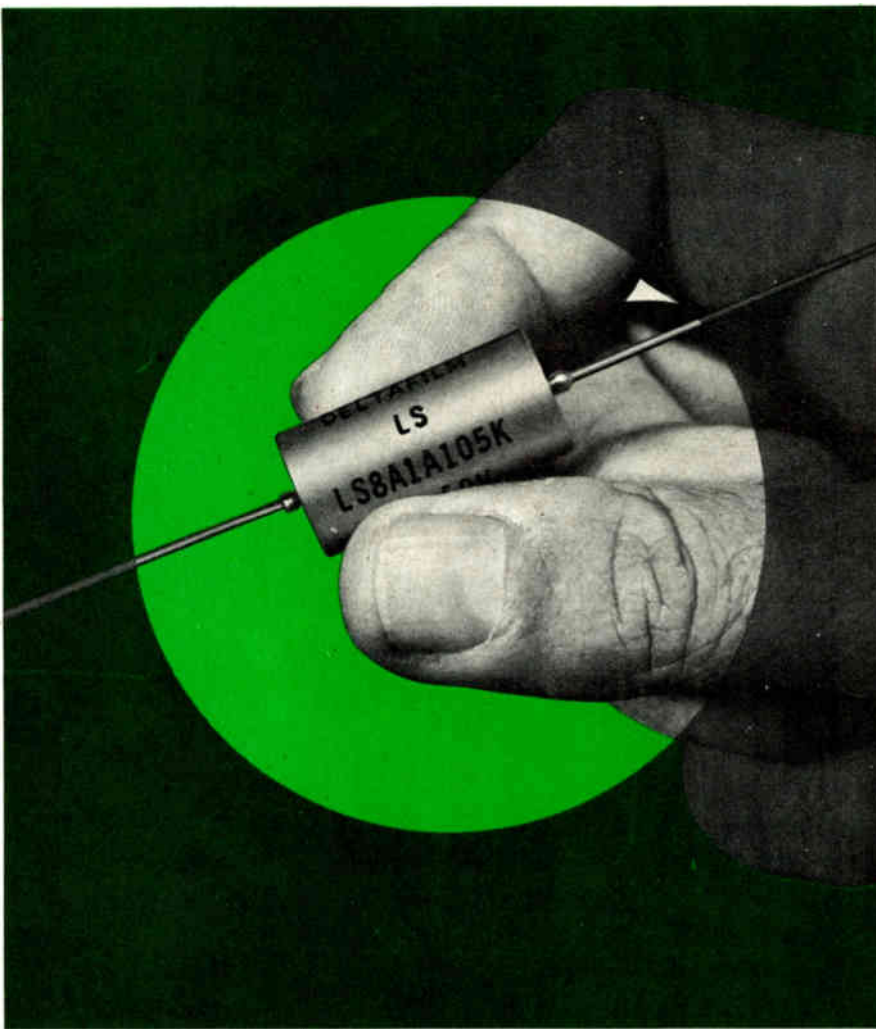

Type LS8 Metalized Polystyrene Capacitors are Smaller and Lighter with No Sacrifice in Performance

Dearborn® Type LS8 Metalized Polystyrene Capacitors are $\frac{1}{3}$ the size and $\frac{1}{4}$ the weight of their "non-metalized" foil-electrode counterparts. Yet their performance characteristics (low negative temperature coefficient of capacitance, extremely high insulation resistance, freedom from dielectric absorption) are every bit as good, making them ideally suited for applications such as low-frequency tuned circuits, an-

alog and digital computer reference, timing and integrating circuits, and high-Q tuned circuits.

Capacitance values range from .0027 μ F to 2.2 μ F. Voltage ratings are 50, 100, and 150 WVDC. Capacitance tolerances as close as $\pm 1\%$ are available. Operating temperature range is -65°C to $+85^{\circ}\text{C}$.

For complete data, write for Engineering Bulletin 401.

SPRAGUE ELECTRIC COMPANY

Dearborn electronics division

P.O. BOX 1076, LONGWOOD, FLORIDA 32750



ENI

The world's leader in solid state rf power amplifiers

Once upon a time if you wanted broadband RF power, you had to settle for bulky tube-type power amplifiers. No more. Because ENI has developed a full line of all-solid-state Class A power amplifiers, covering the frequency spectrum of 10 kHz to 560 MHz, with power outputs ranging from 300 milliwatts to over 1000 watts. And there's more to come.

Driven by any signal generator, frequency synthesizer or sweeper, ENI's compact portable amplifiers, like the ones shown below, are versatile sources of power for general laboratory work, RFI/EMI testing, signal distribution, RF transmission, laser modulation, data transmission, NMR, ENDOR, ultrasonics and more.

Completely broadband and untuned, our highly linear units will amplify inputs of AM, FM, SSB, TV and pulse modulations with minimum

distortion. Although all power amplifiers deliver their rated power output to a matched load, only ENI power amplifiers will deliver their rated power to any load regardless of match.

We also designed our amplifiers to be unconditionally stable and failsafe—you need never fear damage or oscillation due to severe load conditions (including open or short circuit loads).

ENI instrumentation amplifiers come complete with an integral AC power supply and an RF output meter. Ruggedized amplifiers capable of operating under severe environmental conditions are available.

For a **complete** catalog of power amplifiers and multicouplers, write: ENI, 3000 Winton Road South, Rochester, New York 14623. Call 716-473-6900. TELEX 97-8283 ENI ROC.



40 WATT/ MODEL 240L

- 20KHz to 10MHz coverage
- More than 40w linear power output
- Up to 150w CW & pulse output
- Works into any load impedance
- Metered output

Extraordinary performance in a wide range of transducer drive applications. Deliver up to 150w into any load regardless of its impedance. Compatible with all signal and function generators, the 240L is a high quality laboratory instrument for ultrasonics, biological research & electro-optic modulation.

100 WATT/ MODEL 3100L

- 250 KHz to 105MHz coverage
- More than 100w linear output
- Up to 180w CW & pulse
- Works into any load
- Unconditionally stable

Designed to replace bulkier and less efficient tube type amplifiers, the Model 3100L will provide reliable and maintenance free operation. NMR, ENDOR, ultrasonics and laser modulation are just a few of the applications for this versatile source of RF energy.

20 WATT/ MODEL 420L

- 150KHz to 250MHz coverage
- 20 Watts power output
- Low noise figure
- 45dB \pm 1.5dB gain
- Class A linearity

The widest band solid state power amplifier available at its 20w power level, the ENI 420L is a truly state-of-the-art instrument. As a drive source for high resolution acousto-optic modulators and deflectors the Model 420L is invaluable. Its Class A linearity will amplify AM, FM, TV and pulse signals with minimum distortion.

.3 WATT/ MODEL 500L

- Flat 27dB gain 2MHz to 500 MHz
- 1.7MHz to 560MHz usable coverage
- Thin film construction
- 8dB noise figure
- Failsafe

This compact unit can deliver more than 300 milliwatts from 1.7MHz to 560MHz at low distortion. A thin film microelectronic circuit is the heart of this general utility laboratory amplifier. Extremely wide band response at a very modest price.

If you're doing digital signal or special purpose arithmetic processing and you can't use one of these babies,

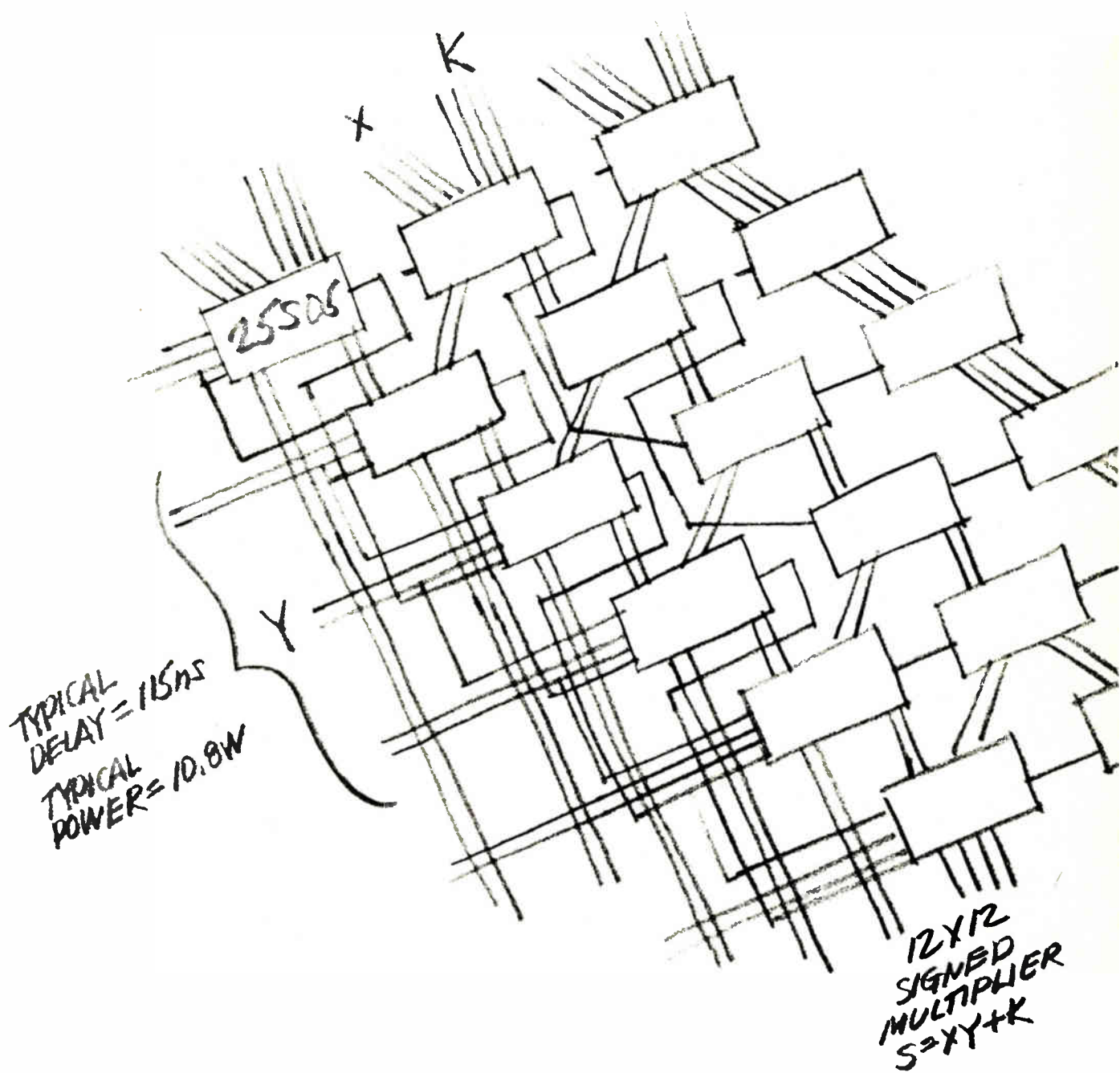

call Clive Ghest and tell him why.



The new Am25S05. A super high-speed, four-bit by two-bit 2's complement digital multiplier that multiplies positive or negative numbers without correction.

A Schottky version of our Am2505, an industry standard since 1972.

A 12x12 array using our new Am25S05's will typically have a delay of 115ns and use 10.8W of power.

For you low-power fans, the same array using our new Am25L05's will typically use just 2.7W of power with a 335ns delay.

All of which means you really have no excuse not to use one of our multipliers. If you do, please call Clive Ghest collect at (408) 732-2400. He'd really like to talk to you about it.

Cornering the high-speed digital multiplier market is just one of the reasons why we're going to be the sixth largest maker of integrated circuits in the U.S. by 1975.



Advanced Micro Devices, Inc.

(#15, going on #6.)

Advanced Micro Devices, Inc. 901 Thompson Place, Sunnyvale, California 94086 / TWX 910-339-9280 / TLX 346306. For product or sales information, call the AMD sales representative nearest you. In Sunnyvale, Shel Schumaker at (800) 538-7904 (toll-free from outside California) or (408) 732-2400. In the eastern United States, Steve Marks or Bill Seifert at (516) 484-4990; in Washington/Baltimore, Ken Smyth at (301) 744-8233; in Boston, Paul Macdonald at (617) 861-0606. In Mid-America, Chuck Keough at (312) 297-4115. In the Los Angeles area, Steve Zelencik or Russ Almand at (213) 278-9700 or Larry Strong at (213) 870-9191. In the United Kingdom, Des Candy at Herne Bay (Kent) 61611; and in Germany, Hermann Lichotka at (0811) 594-680.

Advanced Micro Devices is distributed nationally by Cramer and Hamilton/Avnet Electronics.

**INTERDATA
ANNOUNCES
THE INDUSTRY'S
FIRST \$3200
MINICOMPUTER
TO CHALLENGE
THE NOVA.**

PDP-11 PERFORMANCE AT A NOVA 2 PRICE.

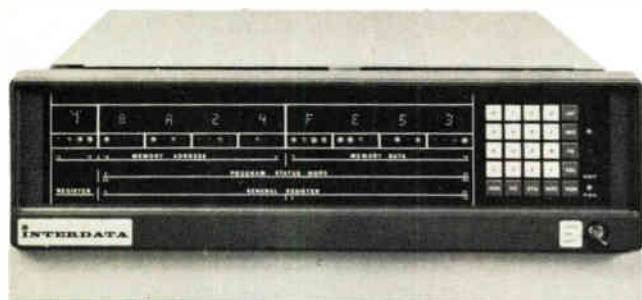

Minicomputer myths you can live without:

1. There is no such thing as a high-performance, low-cost minicomputer.
2. You have to choose between two extremes – pay a ton for a machine like the PDP-11 and save on software costs, or buy a cheapie like the Nova 2 and pay the price later.

All wrong.

Because now there's the Interdata 7/16 – an extremely flexible 16-bit OEM minicomputer that combines the best of both worlds.

It's easier to program than the PDP-11 because it has 16 hardware registers, up to 64K bytes of directly addressable main memory, 255 I/O interrupts with automatic vectoring to service routines and a comprehensive set of more than 100 instructions. That's a lot of muscle.

It's completely modular in design – plug-in options can be installed in the field to meet your specific application requirements.

Options like multiply/divide, programmers' console with hexidecimal display, power fail/auto restart, memory protect and a high-speed Arithmetic Logic Unit that includes floating point hardware. In fact, you can expand the low-cost 7/16 all the way up to the 32-bit Interdata 7/32.

Yet it costs as little as \$3200. Just like the machines that give you the barest minimum. And quantity discounts can reduce that low price by as much as 40%.

Performance	7/16	Nova 2/4	PDP-11/05
Data word length (bits)	4, 8, 16	16	1, 8, 16
Instruction word length (bits)	16, 32	16	16, 32, 48
General-purpose registers	16	4	8
Hardware index registers	15	2	8
Maximum memory available (K-bytes)	64	64	64
Directly addressable memory (K-bytes)	64	2	64
Automatic interrupt vectoring	Standard	Not available	Standard
Parity	Optional	Not available	Special order
Cycle time (usec.)	1.0 or 0.75	1.0 or 0.8	0.9
Available I/O slots	4	2	2

Price	7/16	Nova 2/4	PDP-11/05
8 KB processor	\$3,200	\$3,200	\$4,795
16 KB processor	3,700	3,700	6,495
32 KB processor	5,300	5,300	10,895
Multiply/Divide option	\$950	\$1,600	\$1,800
Floating Point option	\$4,900	\$4,000 plus \$1,000 for 2/10 configuration	Not available

Source: Data General Price List, Copyright 1973, and addendum dated 5/15/73. Nova 2/4 bulletin 012-000060, 1973. DEC OEM & Product Services Catalog, 1972. Auerbach Minicomputer Characteristic Digest, June, 1973. "How to use Nova Computers", 1973.

So you no longer have to make the painful choice between good performance and good price. Or between hardware economy and software efficiency. Now you have a minicomputer that gives you both.

The Interdata 7/16.

We put our muscle where their myth is.

INTERDATA®

2 Crescent Place, Oceanport, New Jersey 07757 (201) 229-4040.
 Boston – (617) 890-0557. Washington – (703) 525-4806. Philadelphia – (215) 436-5579.
 Orlando – (305) 851-6962. Chicago – (312) 437-5120. Detroit – (313) 356-5515.
 Dayton – (513) 434-4193. Kansas City – (913) 384-1606. Houston – (713) 783-3060.
 Dallas – (214) 238-9656. Denver – (303) 758-0474. Los Angeles – (213) 640-0451.
 Phoenix – (602) 968-2477. San Diego – (714) 565-0602. San Francisco – (415) 969-1180.
 Seattle – (206) 455-0680. Toronto – (416) 677-8990. Tokyo – (270) 7711.
 Sydney – 439-8400. London – Uxbridge 52441. Munich – 0811-8543887.

Cast moulded WIMA® capacitors



**Encapsulated
in cast resin under
vacuum to eliminate
air inclusions.**

**Advantages:
Small physical size;
high resistance to
moisture, favourable
a. c. characteristics.
Voltage ratings
up to 1000 V d. c.**

**For stringent
requirements.**

*Please send for
our latest
catalogue.*



Types:

WIMA MKS 3 Metallized polyester capacitors for 100 and 250 V d. c. 0.022 μ F ... 0.47 μ F.

WIMA FKS 3 Polyester film and metal foil capacitors for 160 and 400 V d.c. 1000 pF ... 0.1 μ F.

WIMA FKC 3 Polycarbonate film and metal foil capacitors suitable for frequency divider circuits. Close tolerances available. 160, 400, 630 and 1000 V d. c. 100 pF ... 0.1 μ F.

WIMA FKS 2 min. Polyester film and metal foil capacitors, subminiature, suitable for very small equipment. 100 V d. c. from 100 pF ... 0.047 μ F.

WILHELM WESTERMANN

Spezialfabrik
für Kondensatoren
Augusta-Anlage 56
P.O. Box 2345
D-68 Mannheim 1
Fed. Rep. of Germany
Tel.: (621) 40 8012

People

classified defense projects at the Electronic Systems Center in Owego, N.Y., and software systems at the Federal Systems Center in Gaithersburg, Md. As it completes one big civilian job—the automated en route portion of the FAA's upgrade of the air-traffic-control system [*Electronics*, April 24, 1972, p. 74]—the division looks forward to the possible new civilian jobs: supplying advanced optical character readers for the U.S. Postal Service and selling air-traffic-control systems to the USSR [*Electronics*, Oct. 25, p. 49].

The optical reader is "a unique device for an electronics house," the 41-year-old executive comments, because it has "a heavy dependency on mechanics." Since the Postal Service is deliberating further before deciding what to buy, O'Malley says his group is taking a broader look at applications to help sell its optical readers instead of trying to get into new areas. Commenting that the possible Russian ATC sale would be "an exciting job," O'Malley says the system would take about four years to complete.

In a list that sounds like what every successful marketing director should strive for, O'Malley says that his second challenge "is to try and sell the right things." With IBM's full-employment policy, profits and sales are balanced with manpower levels. To keep the current levels, "we have to increase 9% a year," meaning hiring almost no one while bringing sales up.

Holder of BS and MS degrees in physics from the Universities of Scranton and Delaware, respectively, O'Malley joined IBM in 1960 as a senior associate engineer. A succession of advances led him through radar, computer, and sonar programs to his previous post as assistant general manager of ship-board systems. There he also was responsible for development, engineering, production, and sales of antisubmarine-warfare programs. Before joining IBM, the prematurely gray-haired O'Malley worked on antenna design at Sperry Gyroscope and taught physics courses at the University of Scranton.

556: A real IC two-timer.

The timer of 1001 uses.

(Priced so low it's measured in cents.)

All 556 A true standard IC timer with almost universal applications. The new one-cost 556 7-pin package makes it easier.

And the most extraordinary advantage of 556 is its versatility and its ability to use itself wherever a "hardbody" that's never been matched equal for speed. 556 functions interchangeably as a timer, oscillator, pulse detector or power modulator. Timing never compromises through one hour. Both uses always completely reversible.

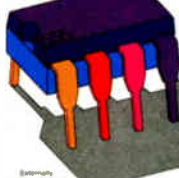

Stability
Temperature stability: 556 will deliver free run or latch on industrial duty cycles from 50% to 99%. Timing can be changed 10:1 with control. Operating from 5 to 15 volts with only a 1% change in timing. Output can source or sink 100mA. Temperature stability: 0.005%/°C.

And getting the accurate 556 is getting any kind of job of the job done faster, cheaper. Requires only a resistor and capacitor to do the job. Works at kinds of options for timing the timing action. And you can operate 556 from just a single power supply.

Get the one-stop package to get dual timer product. Available at the retail store from your distributor at



rock-bottom cost. The 556 up price is only the per dollar and the high level of quality of our 556 better scores you still allow on the parts you no longer need to 556's.

556's up to be assured not to be missed. Counting just 17 years probably makes 556 100% a complete dual timer IC timer.

See the standard 556 suggests apply phone, untimed. If you need technology in the hardware applications. Meet existing functions for board, cable, hardware. Start thinking. And you can take a team shape.

Signetics's new
556 7-pin timer
Sunnyvale, California 94086

Send on the "retailer" spec's and data sheet. Free samples for the great 556 timer package.

Name _____
Title _____
Company _____
Address _____
City _____ State _____ Zip _____
Telephone _____

signetics

Man, did you inundate us with applications for the 555 single timer.

You used it for every possible function from light switches to audio generators to RF outputs. And then, you often used a second 555 to control the function you'd generated with the first one.

We got the message: put two of these babies on one chip. Here it is — the 556 dual timer. Two 555's on a chip. Twice the product at less than twice the cost. 100 up: \$1.25. How's that for responsiveness?

Think of what you can do. Each timer on the 556 chip is independent, and needs only the appropriate values of C and R to function as a time delay,

duty cycles are adjustable from 50% down to 0.01%. If you're a knob twirler, enjoy yourself by changing timing at will on a 10:1 ratio.

No sweat on power, either. Anywhere from 5 to 15 volts does the job, with only 1% maximum timing change from bottom to top. And what you get out will source or sink 100mA. Temperature stability is instrumentation grade, 0.005%/°C.

Intrigued? Curious? Want to try one for yourself? For our own amazement, send us any application diagram you can think up for the 556 dual timer. We'll reward you with a FREE sample to tinker with. In timely fashion.

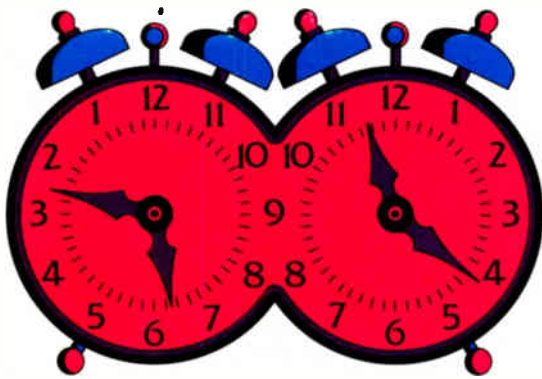

oscillator, pulse detector, power modulator, or what have you. Any kind of output you can dream up from one side, and the control from the other side. Go wild—it can become anything from a toy to a household appliance to a communications breakthrough.

Run free or latch with external triggering. You've got a time span from microseconds to an hour, and

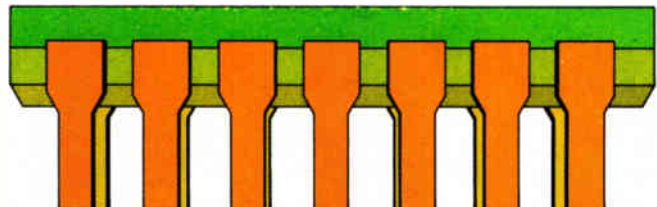

CLIP THIS TO YOUR LETTERHEAD FOR FAST REPLY.

Signetics Linear—Dual Timer

811 East Arques Avenue

Sunnyvale, California 94086 (408) 739-7700

- Here it is, my application suggestion for the 556 universal dual IC timer. Shoot me out my FREE sample unit.
- Just send me the specs and data on the 556, please.
- Somehow, I never got the word on the 555 single timer—throw in some poop on that dealie, too, please.

Name	Title	
Company		
Address		
City	State	Zip

Signetics Corporation. A subsidiary of Corning Glass Works

signetics

Tektronix TM 500 Series puts it all together

Tektronix has taken a new approach to test and measurement instruments. The TM 500 Series is modular, multifunctional, synergistic, cost effective, and more. It includes the features you've been looking for.

Presently, the TM 500 Series includes 24 general purpose plug-in test instruments. All new ways to think of Tektronix. Digital counters to 550 MHz. Signal sources ranging from below 1 millihertz to above 1 GHz. Pulse generators to 250 MHz. Digital multimeters with 4½ digit LED readout and temperature measurements from -55° C to +150° C. Plus signal processors, power supplies, and CRT monitors.

All the modules are interchangeable. So you can make combina-

tions of instruments to meet your particular needs. When new instruments are introduced (and many will be soon), you simply plug them into the power unit. You can use a single compartment (TM 501), a triple compartment power unit (TM 503), or two 503's combined for a standard rackmount installation.

Connections between modules and/or external equipment are made through the power unit rear interface board and optional rear panel connectors. Approximately 30 input-output lines are available in each compartment for special set-ups you might want to make. This intracompartment interface feature also permits multifunction applications resulting in a synergistic effect. Instruments working

together perform more functions than the same instruments working independently. Many modules include serial BCD so information can be transferred directly to a computer or calculator.

The TM 500 is compact too. A three-compartment power unit is only 6"x8.7"x15.3". That means the TM 500 is two to six times smaller than comparable instruments. So you save bench space. And it's light weight, easy to carry. A package including a general purpose counter, multimeter, and power supply weighs 14 to 18 pounds!

Cost? All TM 500 plug-in modules are competitively priced with instruments of comparable capabilities. Because TM 500 instruments share the fixed costs of

Modular, compact, synergistic, multifunctional, versatile, cost effective and more.

Circle 18 on reader service card

For a demonstration circle 19 on reader service card

power supplies, cabinets, etc., they consistently provide the lowest cost per test/measurement function. And, because the instruments are modular, cost of maintenance is lower too.

For complete details, contact your Tektronix Field Engineer. Or write or phone for our new 12 page, full color brochure and 24 data sheets. They show why the TM 500 is the finest test and measurement series available today. Tektronix, Inc. P.O. Box 500, Beaverton, Oregon 97005. In Europe, write Tektronix Ltd., Guernsey, C. I., U.K.

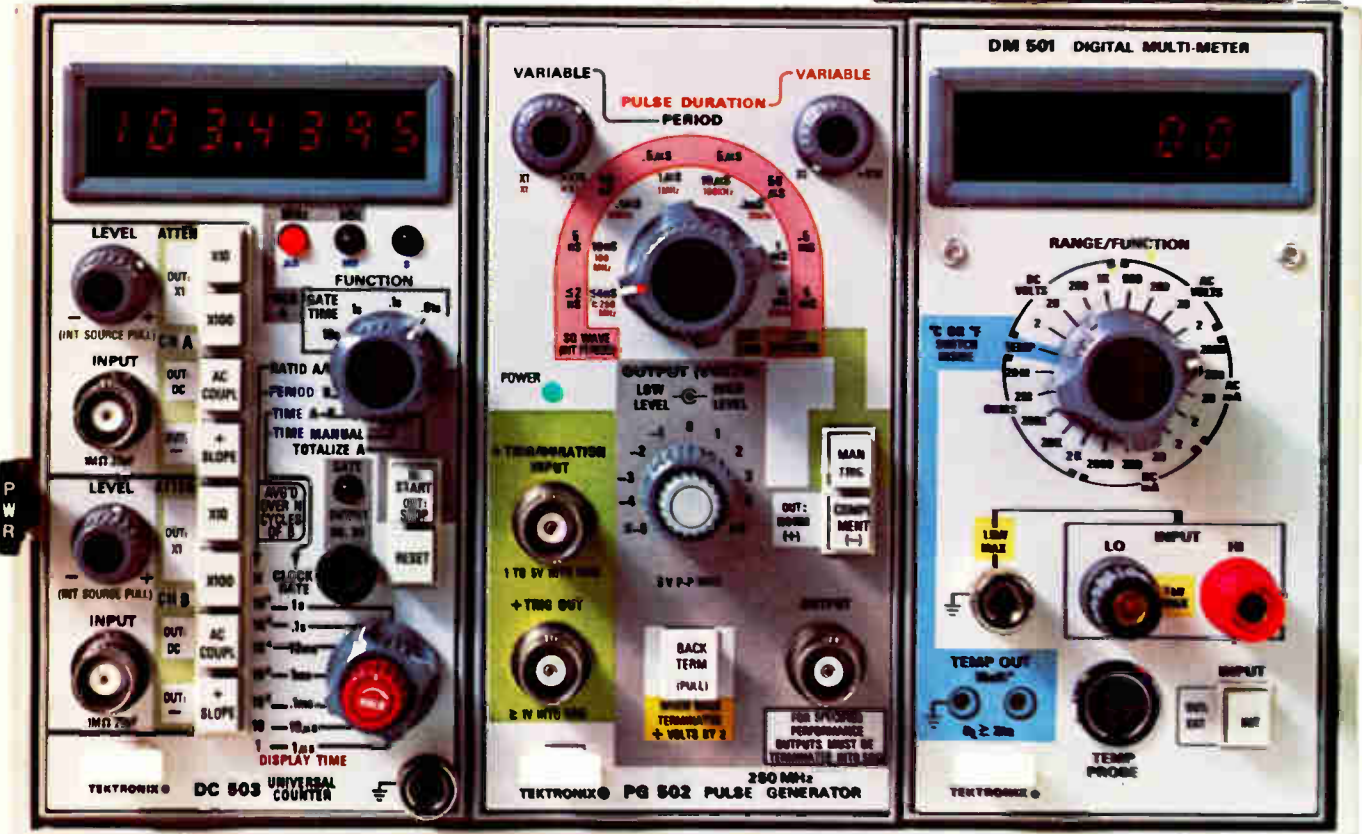
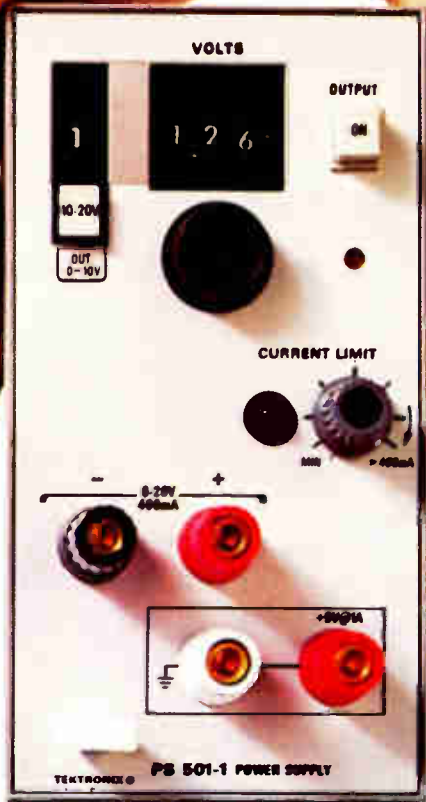

FIRST

AGAIN IN SOLID STATE IMAGE SENSING

Our new *RL-1024* self-scanned array contains 1024 photodiodes on 1 mil centers and offers aperture widths from 1 mil to 24 mils. Contained within the same monolithic chip are the shift registers and multiplex switches to allow serial readout. Standard two-phase clock drive will generate data rates up to 40 MHz. The high speed, low power (4 mW) on-chip shift register is just one of the many new outstanding features.



The *RL-512*, another first of nearly two years ago, is still only surpassed by the *RL-1024*. Both arrays are designed for OCR, facsimile, page/document reader, point-of-sale terminal, real time spectroscopy and non-contact industrial measurement applications. Both devices are in gold/ceramic packages sealed with optical quality quartz windows. They fit into standard DIP sockets.



The *RA-50x50A*, introduced about a year ago, is still the only 2500 element commercially available area array. Here the 50x50 matrix of photodiodes are spaced on 4 mil centers. Designed for optical memories, guidance, surveillance applications, it also is self-scanned and operates in the charge storage mode for high sensitivity.

These and more than a dozen other photodiode array types are available from inventory.

RETICON®

450 E. Middlefield Road
Mountain View, CA 94040
(415) 964-6800 TWX: 910-379-6552

NOTE: All products are shown actual size

Meetings

National Telecommunications Conference: IEEE, Hyatt Regency Hotel, Atlanta, Nov. 26-28.

International Symposium on Computers: MMG, Fair Grounds, Munich, West Germany, Nov. 27-30.

International Electron Devices Meeting: IEEE, Washington Hilton, Washington, D.C., Dec. 2-5.

Fall Conference on Broadcast and TV Receivers: IEEE, O'Hare Inn, Chicago, Dec. 3-4.

Vehicular Technology Conference: IEEE, Sheraton Cleveland, Cleveland, Dec. 4-5.

Joint Conference on Sensing of Environmental Pollutants: ISA, IEEE *et al*, Sheraton Park, Washington, D.C., Dec. 10-12.

Winter Consumer Electronics Show: EIA Consumer Electronics Group, Conrad Hilton Hotel, Chicago, Ill., Jan. 10-13.

Reliability and Maintainability Symposium: IEEE, Biltmore, Los Angeles, Calif., Jan. 29-31.

International Solid State Circuits Conference: IEEE, University of Pennsylvania, Marriott Hotel, Philadelphia, Feb. 13-15.

Computer Conference (Comcon): IEEE, Jack Tarr Hotel, San Francisco, Feb. 26-28.

Aerospace and Electronics Systems Winter Convention (Wincon): IEEE, Marriott Hotel, Los Angeles, March 12-14.

Zurich Digital Communications International Seminar: IEEE, Swiss Federal Institute of Technology, Zurich, Switzerland, March 12-15.

International Convention (Intercon): IEEE, Coliseum and Statler Hilton Hotel, New York, N. Y. March 25-29.

Carnahan Conference on Electronic Crime Countermeasures: IEEE, Univ. of Kentucky, Lexington, April.

Fluke problem solvers

Plug in true rms... at the lowest price available!



These new Fluke plug-in options let you add true rms capability to Fluke 8200A and 8400A DVMs. Take the measure of non-sinusoidal waveforms in 500 ms. Get accurate readings from 1 mv to 1000V rms.

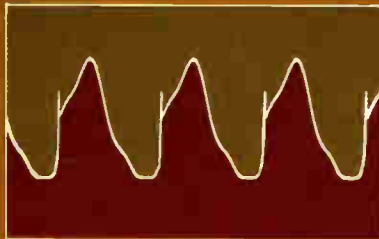

Now you can put true rms to work in your Fluke 8200A for just \$595, and for only \$750 in the 8400A. These are the lowest prices offered for true rms in 4½ and 5½ digit DVMs. But price is only part of our story. Even at an unexcused low price, we offer performance the others don't even begin to match... for instance, ac or ac plus dc coupled measurement capability.

Now look at low level accuracy. We measure low levels that competitive units can't touch. Why? because we use an exclusive converter technique which doesn't have square law response limitations of thermal rms converters.

This same technique allows us to measure waveforms that quasi-rms or distortion insensitive converters can't handle. And, we can do it up to five times faster than thermal converters. Mid-band accuracy (50 Hz to 10 kHz) is 0.1%.

A crest factor of seven takes care of waveforms with a duty cycle as low as 2%. Common mode rejection from DC to 60 Hz is greater than 120 dB.

These options are field installable. All other features and specs are those of the respective instrument. The Model 8200A is a high-speed 0.01% 4½ digit voltmeter with 60% overranging, auto polarity, and auto ranging on all functions. It features switched input filter, full 1000 volt guarding. Full multimeter and systems options are available. Base price is \$995.

Fluke's Model 8400A is the ultimate bench and systems DVM. It features an accuracy of 0.002%, 1 microvolt resolution, resistance measurements down to 100 micro ohms, auto polarity and auto ranging. For \$2450 you get five ranges of DC from 0.1V full scale to 1000 volts with 20% overrange. The switched filter provides better than 65 dB noise rejection for DC, AC, resistance and ratio.

Both DVMs feature 1500V peak overload protection and the ability to meet tough environmental specs.

For full details, call your nearby Fluke sales engineer or contact us directly.

For details call your local Fluke sales engineer. In the continental U.S., dial our toll free number, 800-426-6387 for his name and address. Abroad and in Canada, call or write the office nearest you (shown below): John Fluke Mfg. Co., Inc., P.O. Box 7428, Seattle, Washington 98133, Phone (206) 774-3211, TWX: 910-449-2800. In Europe, address Fluke Nederland (B.V.), P.O. Box 5063, Tilburg, Holland, Phone (0) 674373, Telex: 844-62337. In the U.K. address Fluke International Corp., Garrett Close, Watford, WD2 4TT, Phone, Watford, 30168, Telex: 804500. In Canada, address ACA, Ltd., 6437 Northern Drive, Mississauga, Ontario, Phone 416-678-1590, TWX: 610-492-2179.



If you had to interface two labs like this to a computer across the hall, where would you start?

Rockefeller University started at Digital.



When the neuro-physiology and electronics groups decided to compu-

terize two central nervous system research labs, they faced a staggering challenge. There was the extremely technical nature of the interface. Plus strict budget and time limitations, too.

Deciding to go with Digital, they designed an interface consisting of 2 separate 4-channel multiplexers routing analog signals into 2 high-speed bipolar A/D converters. Additional interface signals included 4 separate D/A outputs for X and Y axis oscilloscope control, 18 TTL pulse input signals, 32 TTL level input signals, 2 TTL intensification pulses for oscilloscope control, and 16 additional TTL levels for controlling experiments.

From Digital's Logic Products Handbook, they ordered a series of standard M modules, which implemented the various interfacing requirements in-

cluding interrupts, interrupt enables and non-processor data transfers. They also ordered the hardware that allowed them to mount their entire interface in a rack that was only 19 inches long and which had the 80 connector slots they required.

Your interfacing problems may not be as intricate as Rockefeller University's. But that doesn't matter. Digital understands the entire range and scope of interfacing, from simple to complex, from common to unique. And we've devoted a whole group to solving the problems people encounter in interfacing. Both by the manufacture and design of standard solutions. Which you'll find listed in the Logic Products Handbook and the System Design Handbook. And with custom design assistance. Which is as near as your phone.

Nobody else can say nearly as much.

Which is why you'll probably want to get in touch with Digital next time you have an interfacing problem.

digital

We think interfacing is so important we've devoted an entire department to it.

We're Logic Products Group, Digital Equipment Corporation, Maynard, Mass. 01754 (617) 897-5111, Extension 2785.
In Canada: P.O. Box 11500, Ottawa, Ontario, K2H 8K8, (613) 592-5111.
In Europe: 81 Route de l'Aire, 1211 Geneva 26, Telephone: 42 79 50.



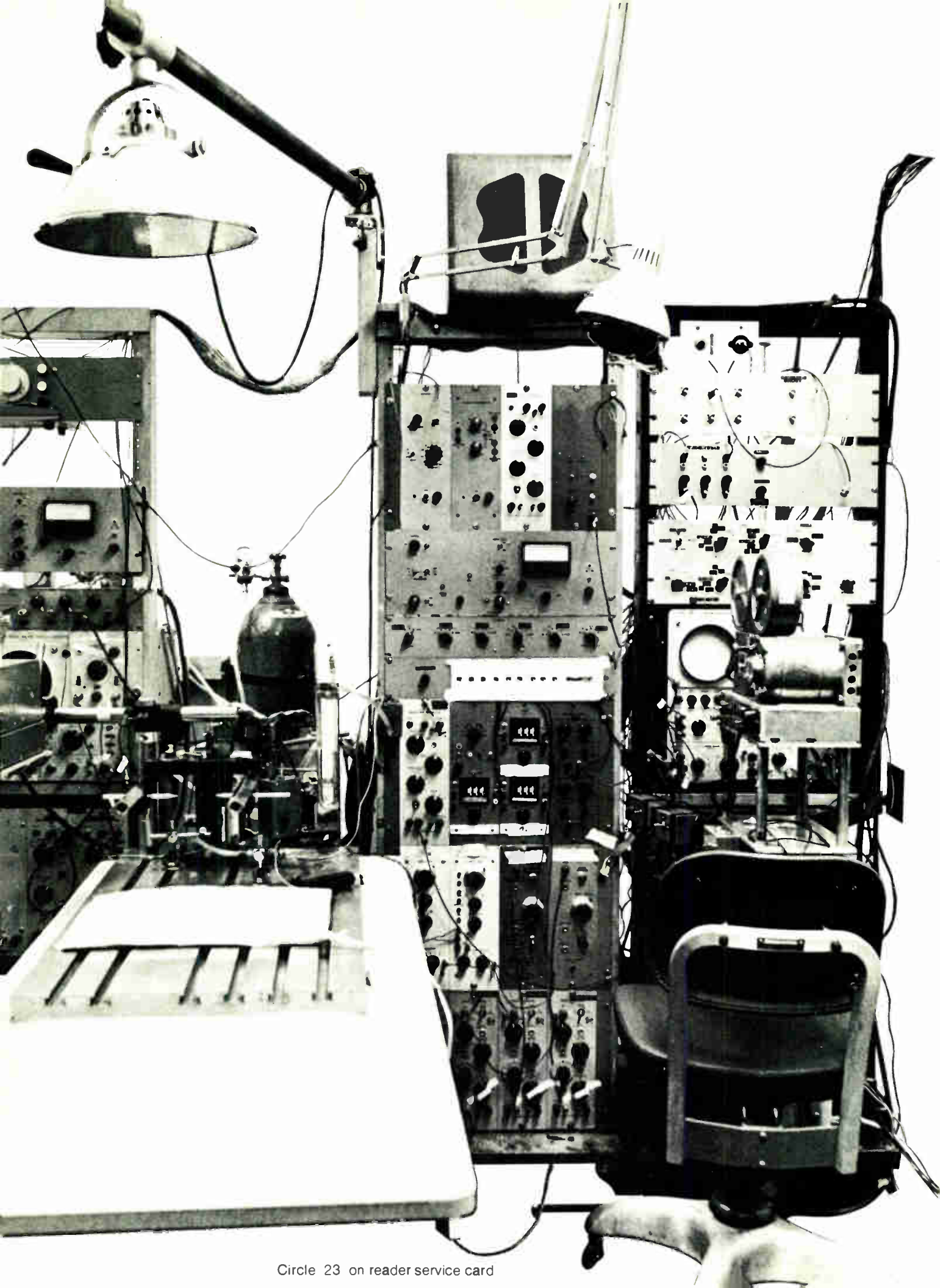

There's more to resistors than resistance

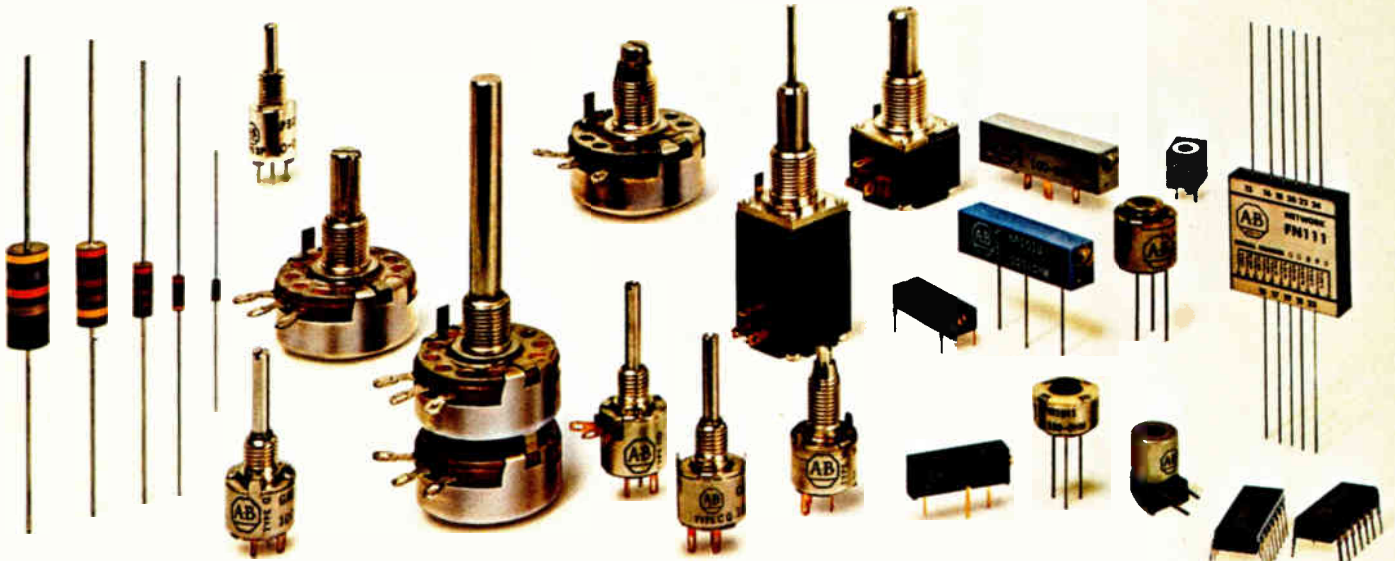

If you're really serious about cost, be serious about quality.

If you think all resistive components are the same, listen to what these users have to say about Allen-Bradley fixed composition resistors:
Buyer—"A-B has shipped nearly four million parts without a single reject or problem. The quality is superb. I've spent 12 years in production control and purchasing. I've seen the amount of down-time, rework and field retrofit caused by others:"

President—"We have used many millions of Allen-Bradley hot-molded resistors. The uniformity of quality from one shipment to the next is truly outstanding."
Engineer—"When we use A-B resistors instead of some other make, it's one less component we have to worry about."
"We learned the hard way. The subtle things make the difference. They all

add up to the top quality we want in our products."
Purchasing Agent—"We wish we had more Allen-Bradleys!"
Write for Publication RD. Allen-Bradley Electronics Division, 1201 South Second Street, Milwaukee, WI 53204. Export: Bloomfield, NJ 07003. Canada: Allen-Bradley Canada Limited, Cambridge, Ontario. United Kingdom: Jarrow, Co. Durham NE32 3EN.



CCD memories are moving into hardware fast

Charge-coupled memory devices are rapidly moving from the laboratory into memory-system hardware. **Bell Northern Research has already incorporated its 8,196-bit CCD shift registers [*Electronics*, June 21, p. 28] into a 1-megabit memory that is compatible with the Digital Equipment Corp. PDP-11 computer system.** The 1-MHz shift-register chip, which will soon be available for general memory applications, has been designed specifically for the fast-disk replacement market. The chip has 32 tracks of 256 bits of serial memory per track.

More color added to some displays more dots to others

Continued research into gas-discharge displays by Burroughs Corp.'s Electronic Components division, Plainfield, N.J., may add variety to present orange-only displays. At the International Electron Devices meeting in Washington, D.C. next month, researchers will talk about **noble-gas and phosphor combinations for producing colors like blue, green and white.**

They will also discuss Burroughs' **flat imaging display panel, which now incorporates 49,000 dots at a density of 1,600 per square inch.** Organized in a 140-by-350 dot matrix measuring 3½ by 8¾ inches, the panel can produce 16 shades of "gray." **Also in the works: a bar-graph display based on the self-scanning gas-discharge approach already in use in Burroughs' Self-Scan alphanumeric panels and thick-film production techniques.**

Industry awaits Army decision on Hellfire missile

The schedule of requests for proposals to build the Army's Hellfire antitank missile, the planned successor to the TOW system, has slipped from six months to a year. Industry sources were expecting the RFP next February, but Army uncertainty about the type of system it wants surfaced late last month. **The indecision centers around whether the service wants a true "fire-and-forget" missile or one that would depend on laser illumination of the target from an observer vehicle that is independent of the weapon carrier.** The laser-illuminator approach would be cheaper, but it would expose the observer until the target is hit. **The alternative is to put a sophisticated—and expensive—seeker system using infrared or television sensors inside the missile itself.**

Monolithic a-d comparator is fast and simple

National Semiconductor Corp. has developed a fast monolithic comparator without having to use expensive gold-doping or complicated Schottky clamping. According to William Fowler, manager of interface circuit design at the Santa Clara, Calif. company, the input bias currents have been halved as well. **The new comparators—the LM360 and LM361—have typical response times of 13 nanoseconds (100-mV step, 5-mV overdrive) and input bias currents of 5 microamperes.**

What simplifies the process, Fowler says, is an annealing technique which shrinks transistor-base width. Storage time of the digital output stages is cut by using ordinary diodes to clamp the outputs and keep them from saturating. The base-width reduction raises transistor beta and provides a gain-bandwidth product of 1.5 gigahertz compared with the normal gain-bandwidth range of 300 to 500 megahertz in high-speed comparators. **The two new comparators, which have pinouts identical to Fairchild's gold-doped UA760 and Signetics Schottky-clamped**

NE 529, will go into production soon. National plans to price the comparators competitively with the older designs. For example, the LM360 will cost \$3 and LM361 will cost \$1.75 in plastic packages in 100-up quantity.

Beam-lead carrier aids testing and may spark sales

"The biggest 'turn-on' for beam-lead sales in five years," is what Raytheon Semiconductor division calls its new chip-testing and shipping carrier. The Mountain View, Calif., firm is committed to more than doubling beam-lead production capacity and increasing the breadth of its beam-lead product line by about 50%.

Designed with test contacts that hold the tiny beam leads, the new carrier allows the chips to be tested as though they were packaged components. Chip tests have usually been restricted to wafer-probing at room temperature. **Now, they can be burned in for high-reliability applications, tested over the operating-temperature range, and, after shipment, put through incoming-inspection tests by the hybrid-IC manufacturer before being bonded to the IC.**

Two minicomputers readied for market

Two fast new minicomputers for specialized applications will soon appear on the market. From Computer Signal Processors Inc., Burlington, Mass., comes the CSP-125, **with a large bipolar semiconductor memory having a capacity of 32,768 16-bit words.** Its cycle time is 125 nanoseconds. This high speed and large capacity make it suitable for many more real-time operations than other machines, or—like CSPI's previous model, the CSP-30, introduced in 1970— for on-line analysis of unusually wide frequency bands. All of this high performance, however, comes at a rather dear price—\$50,000. Conventional minicomputers have cycle times of 500 ns to 1 μ s or even more, and use either MOS semiconductor memories or ferrite-core memories.

Meanwhile, Sanders Associates Inc., Nashua, N.H., is preparing to announce its MIP-16, **with 8,192 16-bit words. It cycles at a relatively slow 1 μ s, but it is, nevertheless, capable of executing a blazing 5 million instructions per second, thanks to its pipeline organization.** With pipelining, while one instruction is being executed, the computer can initiate up to three more in sequence. Among the applications visualized are signal processing and communications. Packaging is available to meet military specifications. Price is \$15,000 to \$30,000.

FCC approves new service

The FCC's approval of Packet Communications Inc.'s application to start a data-communications value-added network breaks the ground for a new service. The Waltham, Mass., firm **will lease lines from AT&T, add equipment, and resell service to third-party subscribers.**

Addenda

National Semiconductor has cut the price of its NS600 six-digit calculator from \$39.95 to \$29.95, and the company plans to come out with an eight-digit calculator with an automatic battery-saver for \$39.95 . . . Look for a lengthy IEEE report soon that contains results of a survey of EE jobs in the U.S. A follow-up of a previous employment survey, this report is intended to give engineering students a handle on the illusive decision of what job categories will be open after graduation and what specialties are overloaded.

C-LINE INDUSTRIAL POWER SWITCHING TRANSISTORS

100 ways to get more switching performance for your money



Unitrode's UPT Power Switching Transistor series offers the optimum combinations of price and performance from 0.5A to 20A, and up to 400V in 3 package types. Choose from 100 different transistor types for more efficient and simplified circuit design in power supplies, switching regulators, inverters, converters, solenoids, stepper motors and other inductive load driving applications. They're available off-the-shelf from your local Unitrode distributor or representative.

For the name of your nearest Unitrode distributor dial (800) 645-9200 toll free, or in New York State (516) 294-0990 collect. For specific data sheets, containing full characteristics of devices, check the appropriate reader service numbers listed in this ad. Unitrode Corporation, Dept. 21Y, 580 Pleasant Street, Watertown, Mass., U.S.A. 02172. (617) 926-0404.

Reader Service No.	I_C	V_{CER}	SERIES/ PACKAGE	t_{on}	t_{off}	100 Qty. prices each
95	0.5ADC	up to 400V	UPT011 -T05	50ns	400ns	\$1.07 to 2.42
			UPT021 -T066			
	1ADC	up to 150V	UPT111 -T05	100ns	250ns	0.87 to 1.95
			UPT121 -T066			
	2ADC	up to 150V	UPT211 -T05	130ns	300ns	1.13 to 2.54
		up to 400V	UPT221 -T066			
96	3ADC	up to 400V	UPT311 -T05	200ns	800ns	1.31 to 2.87
			UPT321 -T066			
	5ADC	up to 150V	UPT611 -T05	250ns	550ns	1.31 to 2.86
		up to 400V	UPT621 -T066			
97	10ADC	up to 400V	UPT721 -T066	250ns	800ns	3.73 to 5.70
			UPT731 -T03			
	15ADC	up to 150V	UPT821 -T066	250ns	550ns	3.30 to 5.30
			UPT831 -T03			
98	20ADC	up to 400V	UPT931 -T03	500ns	1200ns	8.05 to 14.62
			UPT1021 -T066			
	15ADC	up to 150V	UPT1031 -T03	450ns	350ns	3.87 to 6.23
			UPT1131 -T03			
	20ADC	up to 150V	UPT1131 -T03	300ns	600ns	4.75 to 7.26

See EEM Section 4800 and EBG Semiconductors Section for more complete product listing.



UNITRODE quality takes the worry out of paying less.

Unitrode Sales Representatives: ALA., Huntsville, 20TH CENTURY MARKETING INC. (205) 772-9237; ARIZ., Scottsdale, FRED BOARD, ASSOC. (602) 994-9388; CAL., Burlingame, BROOKS TECHNICAL GROUP (415) 347-5411, Escondido, ANDREW ELECTRONICS SALES (714) 743-3015, Sherman Oaks, UNITRODE CORP. (213) 783-1301; CDL., Littleton, SIMPSON ASSOC., INC. (303) 794-8381; CDNN., Hamden, COMPAR NEW ENGLAND (203) 288-9276; FLA., Boca Raton, CONLEY & ASSOC. INC. (305) 395-6108, Oviedo, CONLEY & ASSOC. INC. (305) 365-3283, Tampa, CONLEY & ASSOC. INC. (813) 933-3183; ILL., Chicago, CARLSON ELECTRONICS SALES CO. (312) 774-0277; MD., Baltimore, DANIEL & COMPANY (301) 825-3330; MASS., Newton Highlands, COMPAR NEW ENGLAND (617) 969-7140; MICH., Detroit, RATHSBURG ASSOCIATES, INC. (313) 882-1717; MINN., Minneapolis, CHARLES E. BOHLIG CO. (612) 922-7011; MO., St. Louis, CARLSON ELECTRONICS SALES CO. (314) 991-0262; N.Y., Clifton, N.J., COMPAR NEW YORK, INC. (201) 546-3360, Albany, COMPAR ALBANY, INC. (518) 489-7408, Endwell, COMPAR ALBANY, INC. (607) 723-8743, Fairport, COMPAR ALBANY, INC. (716) 271-2230, Liverpool, COMPAR ALBANY, INC. (315) 471-3356; N.C., Burlington, P. J. NAHSE, INC. (919) 226-8053; OHIO, Cincinnati, BAEHR, GREENLEAF & ASSOC., INC. (513) 891-3826, Cleveland, BAEHR, GREENLEAF & ASSOC., INC. (216) 221-9030, Columbus, BAEHR, GREENLEAF & ASSOC., INC. (614) 486-4046, Dayton, BAEHR, GREENLEAF & ASSOC., INC. (513) 426-5485; PENN., Willow Grove, DANIEL & COMPANY (215) 674-3850, Pittsburgh, COVERT & NEWMAN CO. (412) 563-0303; TEX., Houston, SEMICONDUCTOR SALES ASSOC. (713) 461-4197, Richardson, SEMICONDUCTOR SALES ASSOC. (214) 231-6181; UTAH, Salt Lake City, SIMPSON ASSOC., INC. (801) 521-3622; WASH., Bellevue, N.E.M.C.O. (206) 747-6863; CANADA, Downsview, Ontario, KAYTRONICS LTD. (416) 638-5511, Montreal 267, Quebec, KAYTRONICS LTD. (514) 487-3434.

3,500 VOLT ISOLATION 100% CURRENT TRANSFER OPTO COUPLER

HOW GENERAL ELECTRIC DOES IT

General Electric's unique glass isolation produces precise alignment and controlled spacing between the LED and the silicon detector thus optimizing photon coupling...minimizing the effect of the inverse relationship of isolation voltage and current transfer ratio...and yielding optoelectronic couplers with BOTH high isolation voltage and high current transfer ratios.

3 new models 4N35, 36, 37 are characterized for high isolation voltage and high current transfer ratios. 4N35 offers 3,500 volts (peak) and 100% transfer ratio for \$1.85 each in 1,000 lot quantities.

Available now from any authorized GE Semiconductor distributor or GE Electronic Components Sales Office.

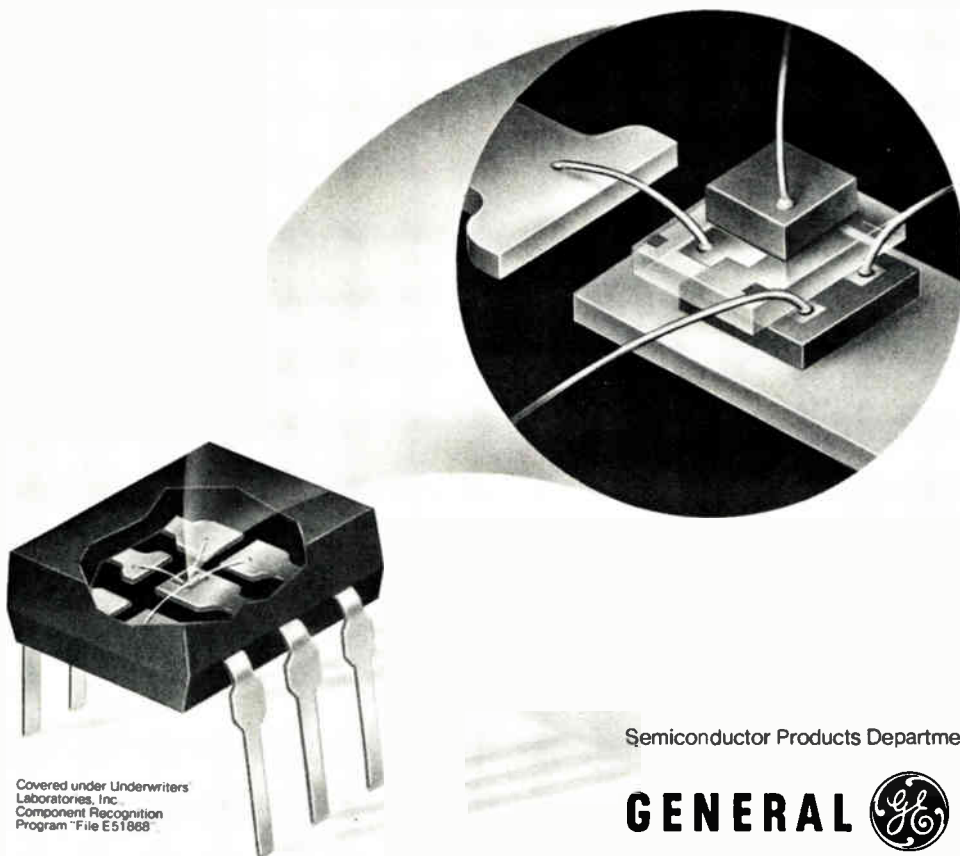

Covered under Underwriters
Laboratories, Inc.
Component Recognition
Program "File E51868"

Semiconductor Products Department, Syracuse, New York.

GENERAL  **ELECTRIC**

Video player costs cut via a-m system and light-bulb playback

The i/o Metrics design could shake up the half dozen or so disk systems now under development

A 25-watt light bulb, which eliminates a laser, and \$75 worth of off-the-shelf parts are the basis for a video record player that could send several major recording markets—home video, audio-visual, mass memories and industrial control—into a spin.

The player, built by i/o Metrics Corp., uses high-density a-m recording and playback techniques on 12-inch records, which carry an hour of color or monochrome TV programs. The Sunnyvale, Calif., company, until now, has specialized in digitizing aerial-photo information.

Although it is only a workbench prototype now, the player tolerates what Peter G. Wohlmüt, i/o Metrics president, calls "slop in the mechanical parts and cookie crumbs on the record." Wohlmüt says that home video players can be manufactured inexpensively with loose-tolerance parts, as in phonographs. What's more, inexpensively made records can be used—and misused—without affecting playback quality. This kind of tolerance and the long playing time result from using amplitude-modulation signal processing rather than a frequency-modulation system as in optical recorders.

Wohlmüt estimates that the players can be produced for about \$100 and retailed for less than \$300. The records can be contact-printed for about 20 cents each on conventional photographic film and sold for the

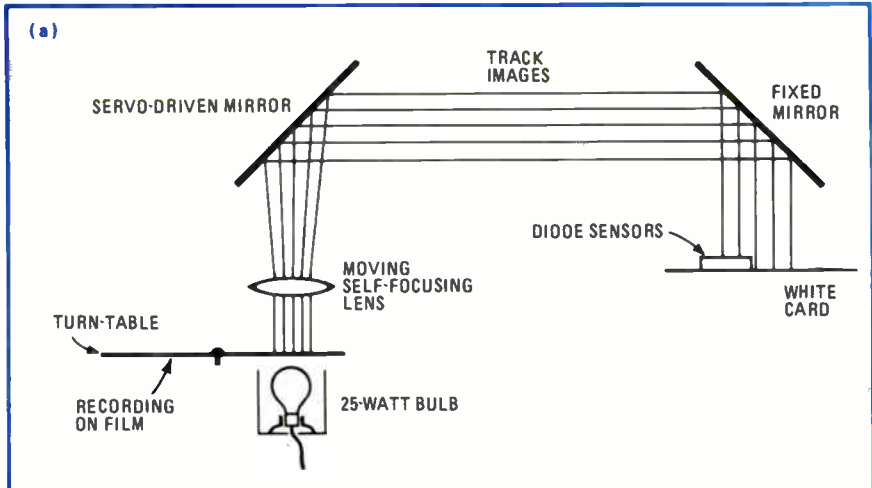

Playback system. Light from bulb projects an image on the track through lens and mirrors to white card. Two diodes control position of mirror and third reads the dot stream.

price of phonograph records. The masters would be recorded in studios with an i/o Metrics laser recorder.

The player was designed and built in two months. The firm has applied for patents on its signal processing system and plans to license consumer-electronics manufacturers to produce the player.

Will play combinations. Experiments have convinced i/o Metrics that its approach is also suitable for audio, analog, and digital recordings. At frequencies to 50 kilohertz, the range of quadrasonic stereo recordings, a 12-in. disk will carry up to 500 hours of audio alone. Or, at the 6-megahertz bandwidth currently used for video recording, Wohlmüt estimates, some 100 billion bits of data can be stored and retrieved from a disk at a rate of 6 million bits a second per channel.

Since combinations of analog and

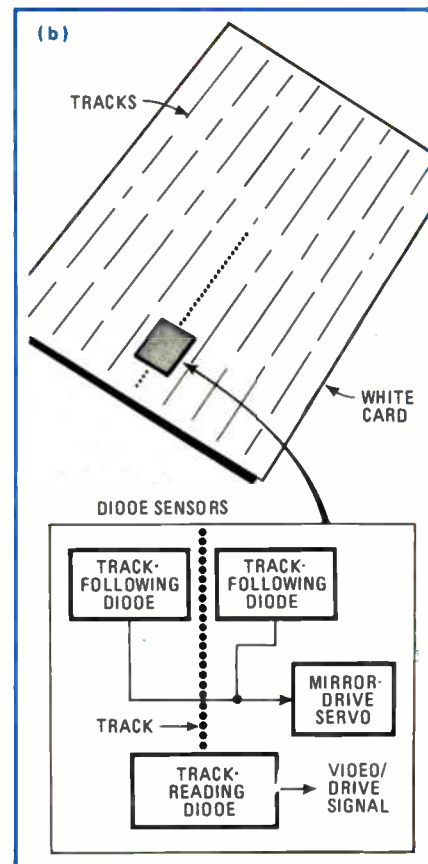

digital information are feasible, the techniques might also be useful in information storage and retrieval systems and in industrial control, where operators could be shown and told what to do via a closed-circuit TV monitor while the digital portions of the recording could be used to operate machines.

Wohlmut and i/o Metrics vice president, Frank Neu, discovered the a-m signal-processing technique about a year ago and spent most of the year refining it and selecting the right recording film. "The experts said it wouldn't work, but we never tried anything but a-m," Wohlmut says. They stuck with a-m because that mode allows the output of a TV camera or signals taken from a TV set to modulate the laser recorder directly.

A breakthrough of sorts in optical transmission is made in the prototype, but it is likely to be short-lived. The off-the-shelf optics relay 20 parallel segments of track to the detector. Wohlmut thinks it is the first system to transmit 60 MHz of information on a beam of white light. Production models, however, will probably carry the light to the record through a fiber-optics light pipe. Track image will be relayed to

a single-chip diode cluster through small, inexpensive plastic optical components. □

Solid state

V-ATE is a potent process at Raytheon

V-ATE is alive and well in Mountain View, Calif. The air-isolation process for high-speed bipolar RAMs went into production and then into limbo at Raytheon Semiconductor division, Mountain View, Calif., more than a year ago. Now it's being used in producing a 256-bit TTL and in pilot production of a 1,024-bit RAM that will be announced in January.

The 1,024-bit device is similar to the first V-ATE RAMs that Raytheon began making in 1972 [*Electronics*, July 17, 1972, p. 65], and development of 300-gate LSI logic arrays has begun. One such array is the central-processing unit for a microcomputer that is expected to be as fast as conventional minicomputers, claims Willard Booth, manager of product planning and applications

in Raytheon's Digital and Memory Products department.

The V-groove isolation structure (V-ATE stands for vertical anisotropic etch) had nothing to do with the production problems, says David Conrad, the department's marketing manager. As sometimes happens in semiconductor plants, "we lost the formula" for a critical process cycle—in this case, the two-layer metalization process—Conrad explains. For some inexplicable reason, the two layers of metal didn't adhere well, so the process had to be redeveloped.

Raytheon is so sure that the problem is solved that Conrad is getting set to quote volume prices on the 256-bit RAM. It lists at \$25, but Conrad is considering prices from \$10 to as low as \$7 in volume.

Cost and yield. "We don't have to take less than \$10. The part has an access time around 35 nanoseconds and a fantastic speed-power product because it dissipates only 250 milliwatts." If yields reach the 15% range expected in January, he calculates that Raytheon could make a good profit at \$7.

The isolation structure cuts chip size down to only 6,400 square mils and 850 chips fit on a wafer. Thus, a 15% yield would produce 100 good chips per wafer. Conventional bipolar RAMs cost only \$4 at 256 bits, but they have twice the access time and power dissipation, Conrad points out.

He won't project a volume price for the 1,024-bit RAM, however, Conrad expects it to be competitive with Fairchild Camera & Instrument Corp.'s 1,024-bit ECL RAM. The Raytheon chip (11,000 square mils) is half the size of a conventional TTL RAM, its access time is 50 nanoseconds, and its power dissipation is 400 milliwatts. It will probably list at around \$80.

Raytheon calls both devices TTL RAMs because they have TTL input and output levels. However, the TTL I/O stages are but a skin added to an ECL memory array to make the devices directly compatible with TTL. If demand for ECL memories builds up, versions with ECL inputs and outputs can be made, Conrad says.

Recording and playback techniques

Master recordings are made on holographic film, which costs about \$1 a disk. They are not holograms, however. Holographic film was chosen because it has a wider bandwidth (10 MHz) than the 6 MHz needed. Studio recorders will cost less than \$30,000 Wohlmut says.

The a-m input signal modulates a helium-neon laser beam so that the beam prints a train of dots on the film. Variations in the diameter and density (blackness) of the dots represent signal amplitudes. As the film spins on a turntable at 30 revolutions a second, the laser beam exposes a spiral track through a lens that moves along the radius of the turntable. The analog signal is compacted 6 to 1 in the dot trains, providing 60 minutes—rather than 10 minutes—of playing time.

To play it back, the record is placed on a transparent turntable illuminated from below by the 25-W bulb. The light projects an image of the track through a magnifying lens and two mirrors to a white card viewed by three photodiodes.

Two of these diodes follow a track and the outputs control the position of a servo-driven mirror that looks at the lens as it moves across the turntable. The third diode reads the stream of dots on the tracks. As the dots vary, the diode integrates the light energy and regenerates the a-m signal.

The signal is converted to TV broadcast frequency, amplified to 100 milliwatts, and fed into the TV set's antenna leads. Although the player simulates a broadband transmitter, the radiated signal is too weak to interfere with other receivers, Wohlmut says.

Now that the V-ATE formula has been found, Raytheon's designers have also resumed work on large-scale logic arrays. They stopped at 60 gates in all-TTL designs because of chip size and power problems. However, the V-ATE process makes 300-gate arrays practical, Booth says.

Communications and control. One such array will be a 16-bit micro-computer central processor with a cycle time of 200 nanoseconds. It will have a set of 32 instructions. Booth expects the principal applications to be communications and control systems.

Like the RAMs in the micro-computer, the CPU will have ECL insides and TTL outsides. That will enable the CPU to meet the cycle-time requirement either with the V-ATE memories or with less expensive TTL read-only and random-access memories, Booth adds. □

V-notch boosts MOS performance

The latest performance-enhancing technique for MOS circuits rests mainly on a device fabrication borrowed from bipolar technology: a preferentially etched V-shaped notch. The new process, called V-MOS, promises to increase device performance and, at the same time, reduce the number of critical process steps.

V-MOS, which is being developed at the University of Toronto's Department of Electrical Engineering, can be used to produce integrated MOS transistors with cutoff frequencies typically as high as 0.5 gigahertz. This value is as good as any achievable with most discrete MOS transistors and points to digital MOS LSI circuits that operate at speeds several times faster than today's circuits. Already, the V-MOS technique has been used to fabricate MOS transistors and logic circuits, as well as charge-coupled devices and bucket-brigade shift registers, according to C.A.T. Salama and F.E. Holmes who are directing the work at the

University of Toronto.

What's more, since V-MOS devices are directly compatible with the V-groove bipolar process, npn bipolar transistors and high-speed p-channel MOS transistors can be made on the same chip.

The key to this improved performance is very short (down to 2 micrometers) channels and low (0.1 picofarad) capacitance. These characteristics are available from V-MOS using a simple three- or four-mask process that requires only non-critical alignment tolerances (12 micrometers compared to the 5-10 μ m tolerances of today's LSI circuits).

The three-step process (see figure) starts with an n-n⁺ epitaxial silicon slice into which boron has been diffused without a mask. The first mask opens windows in the oxide covering the p⁺ diffusion, simultaneously defining the channel and the source-drain regions.

At this point, V-groove channels, which separate the source and drain regions, are defined by anisotropic etch down to the N⁺ substrate. This etch isolates the individual devices. The gate oxide is then grown thermally over the channel, source-drain contact holes are opened in the oxide, aluminum is deposited on the slice, and the metalization pattern is defined. □

Materials

Cutbacks in petroleum worsen shortage of plastics for electronic equipment

The ongoing U.S. boom in the manufacture and delivery of virtually everything electronic—from the smallest circuit to the largest computer mainframe—faces a threat more serious than declining consumer confidence in the national economy. It is the threat of materials shortages developing from America's newest crisis over petroleum.

For the short term, the problem involves plastics—varieties of which are crucial to the encapsulation of components, insulation of wire and

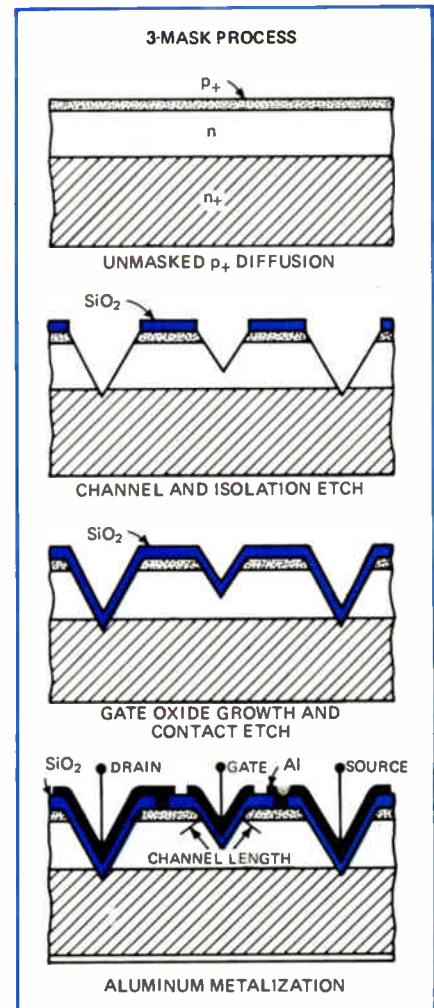

V-MOS process. Short channels result from precise control of V-notch.

ation. SPI, citing an Arthur D. Little Inc., study, contends that "A 15% cutback in petroleum feedstocks reaching plastics producers would have a "domino effect" on the many industries that utilize plastic components. The net result could be a lay-off of more than 560,000 workers and a loss of in domestic production value approaching \$23 billion" over the course of a year.

Out of stock. No firm admits to being hurt by the plastics shortages. But William B. Hewlett, president of Hewlett Packard, Palo Alto, Calif., says: "We aren't sure where we'll get the plastic we need to make calculator cases."

Harold Goldberg, president of Data Precision Corp., Wakefield, Mass., says that last year his company had to delay introduction of its model 245 digital multimeter by six months because it couldn't get the high-impact plastic for the case. Goldberg thinks the high-impact plastic market was "cornered" by the hand-calculator manufacturers.

Injunctronics Inc., Clinton, Mass., is one supplier of plastics to calculator maker Bowmar/Ali, Acton, Mass. Larry McDonald, sales manager, says that the plastics industry is facing a crisis situation with the current shortage. There is not enough ABS, the standard high-impact grade of plastic that is used in hand calculators.

"The situation is very tight, and will require careful planning and purchasing," says a spokesman for Texas Instruments' Calculator Products division. "But at this time we do not project any production disruption."

Belden Corp., Geneva, Ill., a wire and cable manufacturer, is on allocation by most of its suppliers of plastics—especially vinyls—says Arlo Carney, director of purchasing. "It's a worldwide shortage tied into the petrochemical industry, which is tied into the energy crisis." Although he won't go into specifics, Carney admits that Belden's production has been affected, and that

it has had production-line interruptions because of plastics shortages. "We're all very leery about what 1974 is going to bring."

The Connecting Devices division of Hughes Aircraft Co., Newport Beach, Calif., a spokesman says, is encountering a shortage of the plastic film used to laminate flat cable. He adds, however: "We had made large buys earlier, so that production hasn't been interrupted."

Ablestik Laboratories, Gardena, Calif., makes adhesives for microelectronics, principally for lid sealing, chip bonding, and substrate attachment. Its president, Herbert S. Kraus, reports: "There is an extreme shortage of epoxy resins. Many specialty resins are being discontinued by their producers, but we haven't had a problem."

At keyboard and calculator manufacturer Controls Research Corp., Santa Ana, Calif., engineering vice president, Angelo Medici, says: "The plastics situation is tight, but has not affected us so far. We have plastic in stock." He's more concerned about the future. "I think we're in for trouble."

And there are other ramifications of the oil shortage. Obviously keeping the plant running requires power (see "Out in the cold," p. 32). What's more, assume that manufacturers do get their potting compounds, knobs, insulation, and molded cabinets needed to complete their products," says an SPI officer. "Then what do they ship them in? Toasters are packed in styrofoam. Big computers are wrapped in sheet vinyl. They cannot turn back to paper or corrugated cardboard. There isn't enough of that either."

Domino effect. Some Federal economists and other officials pondering the long-term outlook believe the "domino effect" has serious implications for the economy. The "mini-recession" being increasingly forecast for 1974 "may no longer be so 'mini,'" says one economist. Government economic indicators have reflected a cooling economy for two consecutive months now. That downturn has been viewed as desirable by Federal economists disturbed by a soaring inflation that

Out in the cold

On a level even more fundamental than the plastics shortage, electronics manufacturers "are concerned about heating their factories this winter," says an Electronic Industries Association official.

Hewlett-Packard has reset thermostats to 68°F in all of its U.S. plants. While H-P has no plans at this time to curtail night operations existing in some of the plants, the company has installed tanks with 10 to 15 days' supply of butane at plants dependent on heating gas.

Joseph Lauren, director of materials at UniCom Systems Inc., Cupertino, Calif., says his company will be thoroughly investigating the alternatives available and the possible repercussions of any fuel shortage. He says, too, that soon there will be a "cascading effect" caused by the various shortages, and adds that each shortage affects another. "There is a definite tie between the plastics and fuel shortages."

Fairchild Camera & Instrument Corp., Mountain View, Calif., doesn't know exactly what the energy crisis will entail for them. Says a spokesman: "We have come up with contingency plans" if it becomes necessary to cut down on energy consumption. They involve such schemes as moving workers into an already occupied building from another, thus cutting down on heating and lighting two different buildings.

Curtailing shifts is not in the plan. The company can't turn its furnaces off, since temperatures for baking have to stabilize. Fairchild will still have three shifts and run the furnaces 24 hours a day. Other more standard uses of electricity, such as bright office lights, says the company, could be reduced.

Data General Corp., Southboro, Mass., uses gas to keep its plant heated and isn't anticipating any trouble getting enough to keep it going. The company has only a small second shift in some of its operations, so a spokesman says the shift would be no great loss if it has to be discontinued. "We worry more that the energy crisis might force companies to go on a four-day week if it gets bad enough."

And what a beautiful team!

Recently Tektronix introduced to you two new time saving products, the Digital Processing Oscilloscope and the Type 31 Programmable Calculator. Now, we have married them. Meet the Digital Processing Oscilloscope/31 Calculator (DPO 3100-Series).

How did we do it? First from our 7000 Oscilloscope family we took the 7704A 200 MHz mainframe, added a processor to digitize waveforms, and interfaced the processor with our Type 31 Programmable Calculator. The complete assembly can be programmed to perform waveform calculations and measurements with the stroke of just a few keys.

Calculator programming is easy because Tektronix removed the language barrier making it possible for you to communicate with the machine in the math language you grew up with. 24 user definable keys enable you to customize the calculator to meet your own specific needs.

Now, you can stop making waveform measurements by plotting or photographing and then doing your calculations point by point. Computations which presently take hours can be performed in just minutes.

By the way, there is no requirement to keep the components of the DPO 3100-Series together. The calculator can be used all by itself as a scientific programmable calculator. Use the Digital Processing Oscilloscope as a stand alone unit to measure, store and playback waveforms. The DPO 3100-Series adapts to you and your requirements.

Price depends on options and plug-ins chosen. A complete operating DPO 3101 can be as low as \$10,650. For all the details on this versatile new package, use the reader service card, contact your field engineer or write Box 500A, Beaverton, Oregon 97005. In Europe: TEKTRONIX LTD., Guernsey, C.I., U.K.

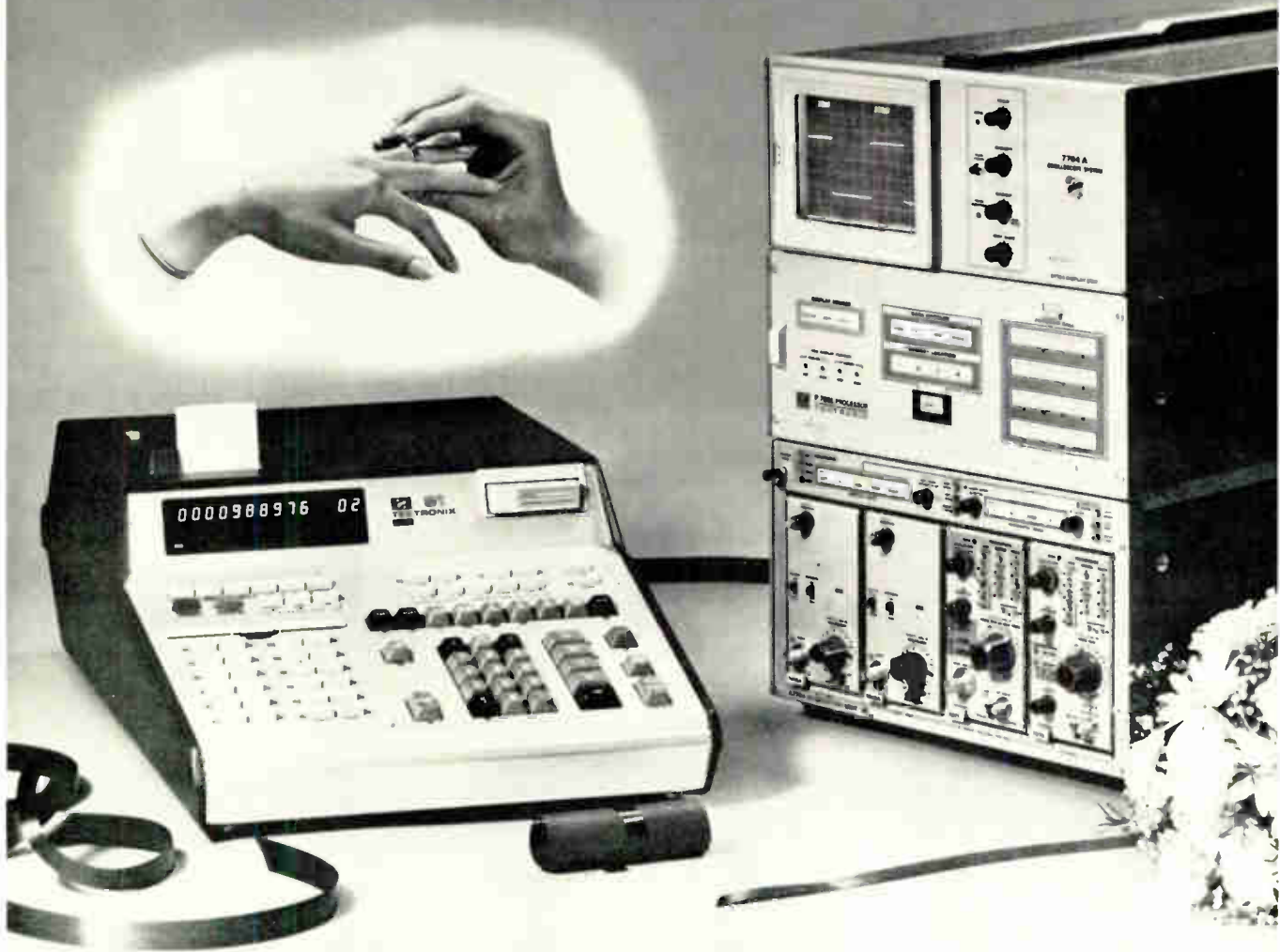

JUST MARRIED

Status of silicon

Reports of a silicon shortage keep cropping up. However, one of the major silicon suppliers to the industry, Dow-Corning—while seeing silicon supply as being “tight,”—says “nobody will have to shut down.” Another big supplier, Wacker Chemical, Corp., says it is meeting all commitments.

There is some concern among semiconductor houses for the future for semicustom wafers. But there is no dire shortage in the offing.

is unmatched by a comparable growth in economic output.

However, the nature of the decline disturbs some officials, “The rate of decline in the indicators is accelerating gradually,” explains one Treasury Department analyst. “If it were flat, I wouldn’t mind. But if it continues to go down faster in December, there could be trouble.”

The energy crisis—apparently unresolvable in the near future—is expected to provide that acceleration to the decline in national economic indicators. “Couple the rationing of gasoline and a heating-fuel shortage to the consumer uncertainty that is reflected in the decline in purchases, and you have problems,” the Treasury official noted. “Watergate and what it is doing to confidence in Government doesn’t help.” □

Medical electronics

Sound to measure blood-vessel walls

The thickness of blood-vessel walls and other body tissues is being measured ultrasonically in tests at Massachusetts General Hospital in Boston. The system, based on ultrasound interferometry, measures the interference of sound echoes from materials of different densities.

The interferometer was developed by Theodore L. Rhyne, a doctoral candidate at the Massachusetts Institute of Technology in Cam-

bridge. Dr. Jason C. Birnholz, a radiologist, is investigating applications at the hospital’s non-invasive diagnostics laboratory. Rhyne says the ultrasonic system is analogous to radar communications. In radar, the shape of a returning wave is analyzed in order to identify the kind of plane “sighted.”

As with sound interferometry, the bigger the density difference between two materials, the greater the interference. Applying this principle, Rhyne and Birnholz are able to measure the thickness of tissues from the differences between two successive interfaces between materials of differing density.

Birnholz notes that even small density differences can be detected—one quarter of a wavelength is the theoretical limit of the unit. Since the velocity of sound in tissue is 1,500 meters per second, a frequency of 2.25 megahertz results in a wavelength of 0.67 millimeter, giving the unit a resolution of about 0.17 millimeters. The interferometer operates over a range of 1.5 to 8 megahertz. Most ultrasonic instruments, he says, have a resolution of only 3 to 10 hertz, or 3½ millimeters.

To apply the techniques, Rhyne developed a new transducer. He says ordinary crystals do not provide enough control of the waveform. “Most of this is in literature over the past 10 or 20 years,” he says. “What I’ve done differently is put greater stress on certain parameters, like sensitivity and bandwidth. Just a slight variation in design makes a highly controlled device.”

Rhyne also designed the circuit of his ultrasonic receiver to maintain linearity of the transducer and receiver. Other ultrasonic transducers use a shock technique that may drive the transducer in a nonlinear fashion. The crystal is treated as an antenna—the characteristics of the crystal are carefully matched to those of the transmitter.

The interferometer is still in the research stage, but the two men feel they are now ready to measure blood-vessel wall thickness in patients. They have already used it to measure chest-wall thickness and to measure the pleura—the membrane

between the chest cavity and the lung. And Birnholz is interested in seeing if the system can differentiate tumors from surrounding tissues. □

Displays

Liquid crystals make graphic display

Liquid-crystal technology, until now just another contender for the mushrooming digital-display market, may get a crack at displacing the cathode-ray tube for graphic display applications.

Researchers at Hughes Aircraft Co. have designed and built a discrete-element liquid-crystal panel, measuring 1 inch by 1 in., that displays good-quality off-the-air television images. The panel consists of 10,000 active liquid-crystal elements, or cells, arranged in 100-by-100 array.

The display is fabricated by sandwiching a thin layer of nematic liquid-crystal material between a transparent conductive electrode and a large silicon wafer on which are formed—using large-scale-integration techniques—an array of elemental cells.

Each cell contains an MOS transistor-capacitor sample-and-hold circuit and a reflective electrode. The circuit acts to stretch the incoming analog video signals, which must be long enough to excite the liquid-crystal. The cell changes from black at 0 volts to degrees of “white,” depending on the applied voltage.

The display is addressed a line at

Flat-screen TV? The Hughes imaging LCS is now 1 inch square.

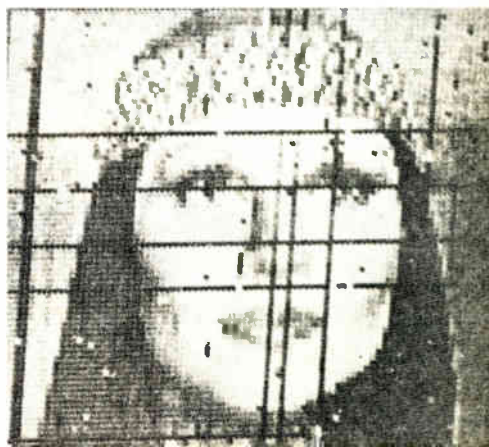

CTC delivers twice the power from DC to daylight.

Which leaves our competitors caught in a power struggle.

We won the battle a long time ago. And what a power trip. Hundreds of watts. Marching bands from 2 MHz to 1 GHz. CTC has captured the market with over 500 transistors. Operating up through 50 watts at 1 GHz, 100 watts in the 225-400 megahertz band, and up to 200 w at the low end of the mobile-communications spectrum.

But the real unsung heroes are CTC's radio engineers. A unique group of pros who know better than leaving an engineer strictly to his own devices. Men who can see things from your side, from in-depth experience.

Unlike some semiconductor designers who'll oscillate an amplifier for a small power gain, our guys have put us in the chips with triumphs like Huge Huey. A hefty 180 x 266 mil chip that puts out up to 200 w at 28 v. Designed like all CTC assemblies—with infinite VSWR. Which is another reason CTC is such a powerhouse.

But just because we command the field, don't be afraid to give us orders.

CTC: The power in RF power.



a time. As the result, the video data must be presented in a parallel format. To work with conventional TV standards, a serial/parallel analog converter is required. This conversion is accomplished by a dual converter circuit, which, together with the sweep circuitry, is now implemented with discrete medium-scale-integration components. However, the Hughes researchers say the sweep and video circuits can be integrated with the display by LSI.

According to the developers—M.N. Ernstoff, A.M. Leupp, M.J. Little and H.T. Peterson—the display promises to be superior to the

CRT for applications requiring presentation of symbolic, graphic, and pictorial images in real time. Advantages of the panel include good visibility that doesn't wash out in sunlight, high contrast and high resolution over the entire display surface, and low weight and power consumption. The Hughes team, which will report details of the development at the International Electron Devices Conference in Washington next month, says its experimental panel provides good contrast under ambient illumination conditions of several thousand foot-candles. □

Computers

Justice Department solicited joint view of IBM competitors

Has the Justice Department damaged its own antitrust case against IBM? That possibility is being raised in the wake of the disclosure that the department "four or five months ago" solicited the individual views of at least five of the computer maker's key competitors—and later acceded to a request that the competition present a joint statement.

It is that joint statement that is raising eyebrows—and questions—by Washington attorneys experienced in antitrust matters. "It almost seems that Justice wants to screw itself up by letting these people get together. Eliciting individual company views is one thing; this is another," says one observer.

Four of the five respondents—Control Data Corp., Honeywell Inc., National Cash Register Co., and Sperry Rand Corp.—asked that their four top officers present a joint statement at the close of October to Thomas Kauper, assistant attorney general for antitrust [*Electronics*, Nov. 8, p. 26]. The fifth company, Burroughs Corp., declined to participate in the action.

The extraordinary Justice Department move, confirmed by officials at two of the four companies that took part, remains unexplained. The

agency's firm "no comment" stance, a spokesman said, was determined by a Federal court order that neither the Government nor International Business Machines Corp. comment on any aspect of the proceeding under threat of contempt charges. Officials at Burroughs's Detroit headquarters would neither confirm nor deny the reports of its decision to stand aloof from the joint industry position. Nevertheless, Burroughs sources elsewhere confirmed that "we were approached and we said 'no.'"

Questions and comments about the move were not surprising in view of the background of the Government suit—one started, not by the Nixon Administration, but by President Lyndon Johnson's Attorney General Ramsey Clark literally hours before LBJ's term expired in January 1969. Reportedly, even Johnson and his top advisers were startled by the action.

Among those opposed to the monopoly suit then, Government sources point out, were the Secretaries of Treasury and Commerce; this was because of IBM's large positive contributions to a diminishing U.S. trade balance. Through its dominant world market position, IBM is

still a major U.S. exporter, although its percentage share of exports has reportedly declined as it has expanded overseas manufacturing.

"Nevertheless," points out one trade official, "no one concerned with our trade balance wants to see IBM broken up now either." In their presentation to Justice, IBM's four competitors also backed away from calling for the breakup of IBM.

Sperry Rand was represented by its president Robert E. McDonald, and the other three by their respective board chairmen—Honeywell's James H. Binger, CDC's William Norris, and NCR's William Anderson. The four observed that even if IBM were dismembered into five to eight companies, "the successor companies will be substantially larger than the non-IBM mainframe companies and will have the further advantage, which could prove decisive, of a very sizable lease base, coupled with a compatible product line among themselves." The competitors made clear that they view the resultant "shared monopoly" as at least as threatening to their futures as the existing situation.

The four computer companies indicate that a decision on breaking up IBM might well be postponed for as long as the rest of this decade while other issues are resolved. They urged, however, that if interim legal proceedings determine that IBM is a monopoly in violation of antitrust laws, the divestiture of parts of IBM and other forms of relief for its competitors be implemented on a worldwide basis. □

Lasers

Agency to develop goggle safety specs

In developing safety standards for protective eyewear for lasers, the Bureau of Radiological Health this month has asked the electronics industry for its comments and information. "As soon as possible" the bureau hopes to work out with manufacturers and other affected groups

CTC delivers over 95% to customer schedules and requests.

Which leaves our competitors with some explaining to do.

It's unheard of in the semiconductor industry, but we'll tell you about it anyway.

When a customer orders from CTC, his shipment is usually received in less than two weeks from date of receipt.

How come? Well, for one thing, you've got to be on your toes when RF power is your only business. For another, there's no hang-up waiting for packages because we make our own. And, with only a 1% return rate, we can spend less time answering complaints and more time expediting your deliveries.

However, no story we can come up with explaining why we ship so fast would be half as interesting as the ones our competition have to tell explaining why they can't keep up with us.

CTC: The power in RF power.

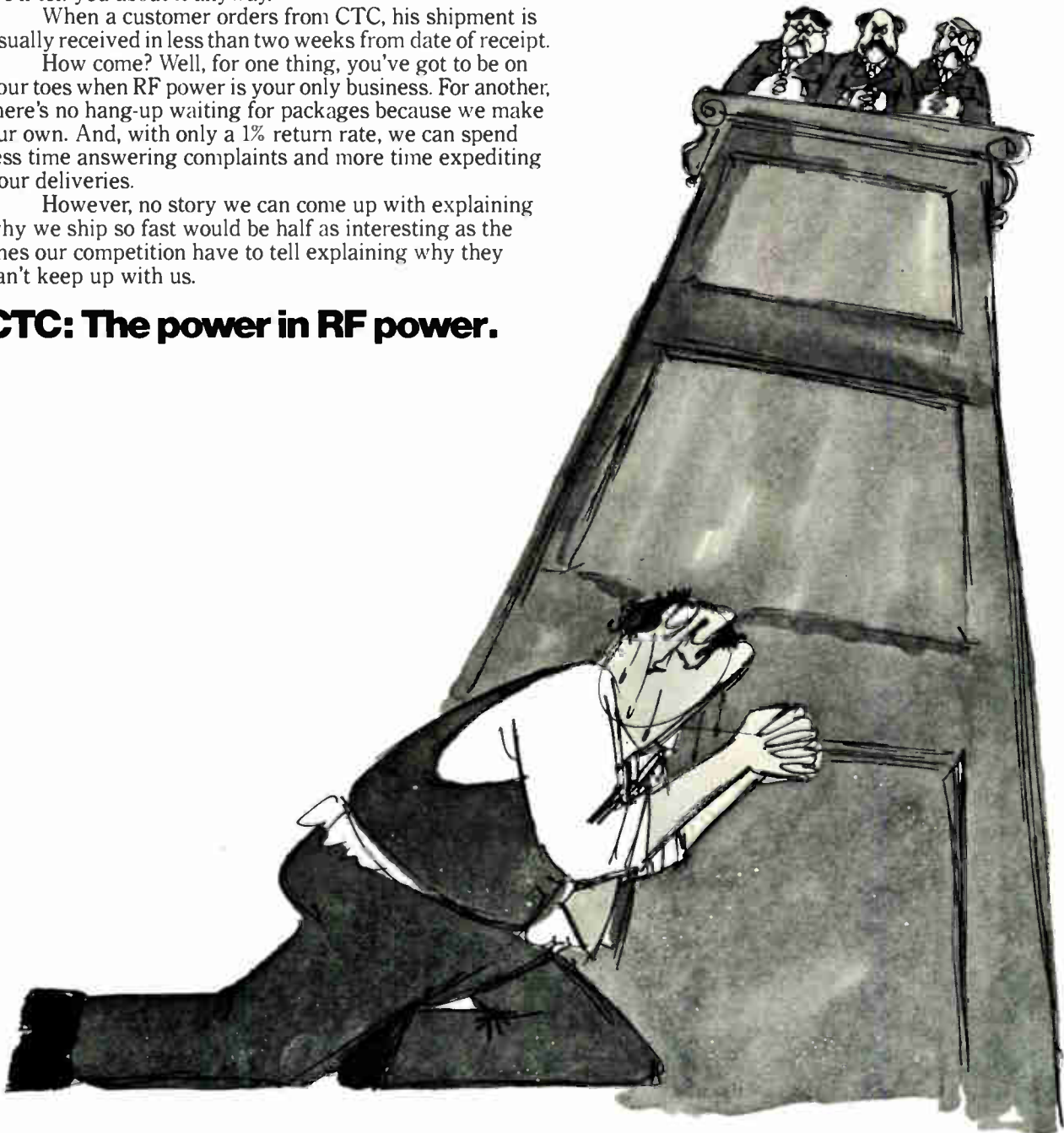

the safety criteria for selling and using protective goggles, according to Robert L. Elder, deputy director of the agency.

The bureau's concern stems from the finding that some laser goggles may fail when exposed to a laser beam, and the wearer, not realizing it, may suffer eye damage, Elder says. Bureau laboratory tests show that some goggles may melt, lose their color, bubble, or even shatter when exposed to sufficiently high laser power. Some products will fail after several seconds' exposure to laser beams of about 1 watt or power density of about 6 to 12 W per square centimeter, he reports.

Evaluation needed. What the bureau would like to work out with industry is a method whereby products for protecting the eyes could be uniformly evaluated and appropriately labeled, and the information disseminated to users. Fortunately, no one apparently has been injured yet from eyewear failure, but some manufacturers have been notified that their products failed during bureau testing, Elder says.

"Since the chance of eyewear failure increases as laser power and energy rise," Elder says, he advises that persons "buying a laser product be urged to make certain that the presently-owned eye-protective equipment will accommodate the power of the new product." All eyewear should be inspected before each use, he adds.

People who use protective goggles around high-power lasers should ask the manufacturer for the failure point, Elder says. If that can't be determined, they should test the goggles at their highest intended power and then carefully inspect them. Should the eyewear fail, then the laser should not be used until alternate effective protection can be provided, he says.

Multiwatt lasers are mostly found in academic, research or medical uses where servicing or alignment procedures may subject the wearer to direct exposure to the beam. The bureau notes that protective goggles that didn't fail were those for helium-neon lasers, which normally have an output of a few milliwatts.

But, Elder says, all users should continue to wear goggles. The BRH reports that cooperation so far has been excellent and, although it has the authority, it is not planning to issue actual safety regulations for goggles.

The Bureau has already met with manufacturers and professional groups to discuss how safety goggles could be uniformly evaluated and

appropriately labelled, Elder says. That information, laboratory experience and suggestions from industry will be used to develop safety criteria.

Elder invited comments or suggestions, which can be addressed to Director, Bureau of Radiological Health, Food and Drug Administration, 5600 Fishers Lane, Rockville, Md. 20852. □

Microwaves

Satellite system cuts interference and aims at zero downtime

In designing a space communication system, Philco-Ford engineers have come up with one of the broadest bandwidth systems yet developed and the first to really control transmitter-receiver intermodulation. And, on top of that, the system, for the second-phase Defense Satellite Communication System (DSCS-2), was built to meet a design demand of zero downtime for 15 years.

For years, microwave system designers have known that waveguide imperfections, known as "diodes," generate harmonics of the microwave signals and cause intermodulation between the transmitter and receiver. But engineers have skirted the problem in communications systems by keeping the transmit and receive frequencies so widely separated that only the weakest harmonics of the signal create intermodulation products—a practice called "frequency management." However, when Philco-Ford engineers began designing ground terminals more than two years ago for the DSCS-2, frequency management was ruled out.

To match the satellites' multiple-access capacities, the DSCS-2 terminal must transmit kilowatts of radio-frequency power at frequencies from 7.9 to 8.4 gigahertz and receive lowpower satellite transmissions across the 7.25 to 7.75 GHz band with sensitive, liquid-helium-cooled parametric preamplifiers.

Meanwhile, the U.S. Army Sat-

ellite Communications Agency, Fort Monmouth, N.J., managing the terminal project, wanted the full bandwidth to be usable so that frequency-division, time-division, and spread-spectrum multiple-access techniques could service many satellite users simultaneously.

In contrast, earlier space terminals and commercial microwave-relay systems have had separations of 1 GHz between channels. Some space terminals have such wide frequency separation that receivers see only the extremely weak 32nd harmonic of the transmitter frequencies, and even those have been worrisome, says Clifford E. Ray, systems engineering manager for the terminals at Philco-Ford's Western Development Laboratories, Palo Alto, Calif.

Philco-Ford had a better idea. In the DSCS terminals, rf power from dual transmitters is piped through waveguide to one input leg of a Y-shaped orthomode transducer coupled to the feed horn of a 60-foot parabolic antenna. The signals received by the big dish go through the other leg of the transducer's hybrid junction to twin parametric amplifiers. Both the transmitter and the receiver are dual-redundant designs to meet another landmark specification—zero downtime for some 15 years. All previous terminals have been specified with less than 100% "availability," meaning they can be shut down periodically

CTC has less than 1% return rate.

Which leaves the competition with many unhappy returns.

When you consider the average return rate for the industry, you suddenly realize CTC has something special going for us. And you, too. The most complete die attach, the most reliable wire bonding and cap sealing techniques, 100% RF, D.C., load pull tested—to boot.

When you consider further that no one else around is qualified to make this claim, you can believe what our customers tell us is true.

We've got the lowest field failure record in the industry. And that's a powerful help when you need it.

CTC: The power in RF power.

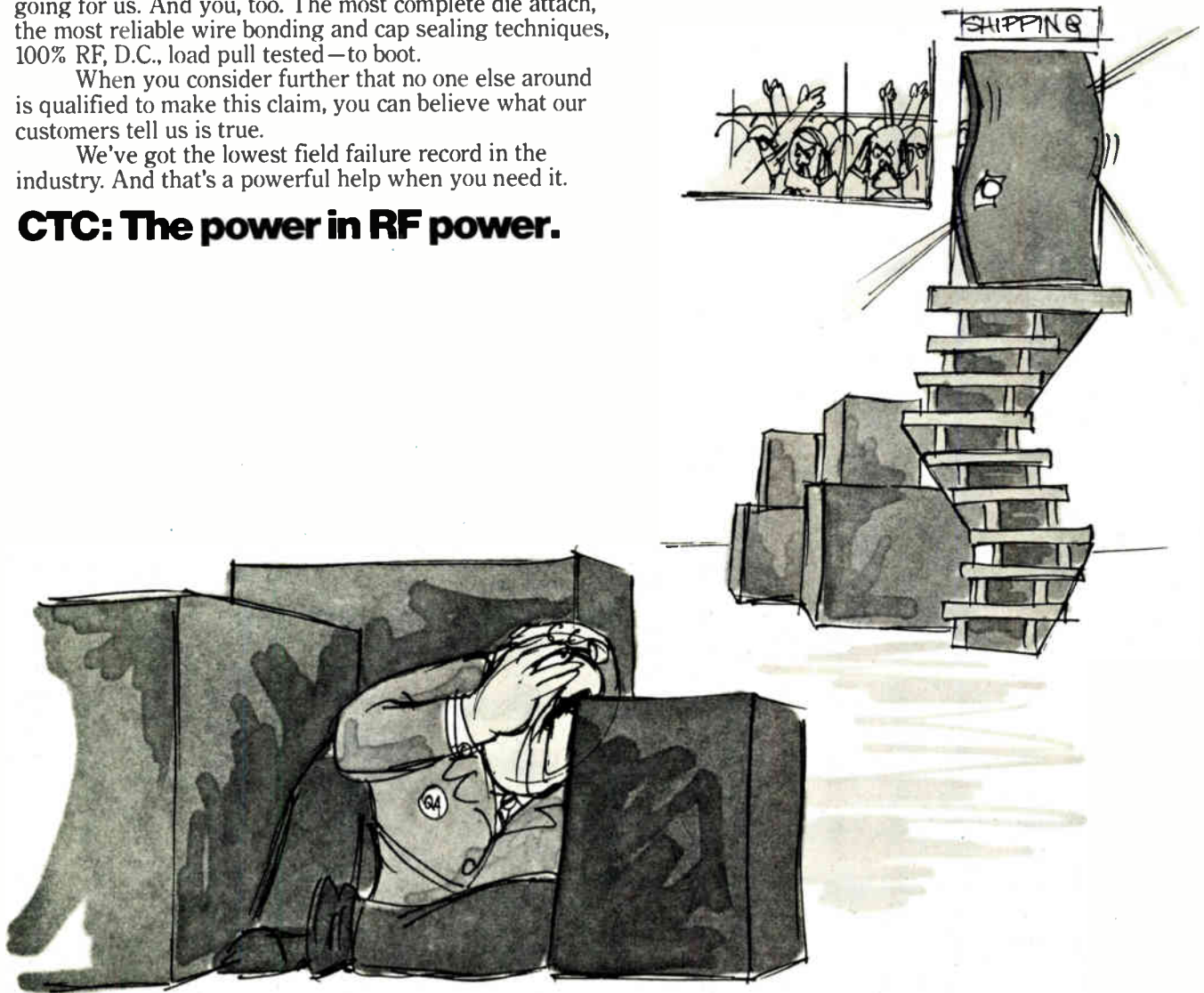

for preventive maintenance.

The system prototype—being operated at WDL for classified Air Force Satellite Communications—has an 8-kw klystron amplifier with a bandwidth of 170 MHz and a 3-kilowatt traveling-wave-tube amplifier with a bandwidth of 500 MHz. A later model being constructed at Fort Detrick, Md., for DSCS-2 will probably have two 5-kw traveling-wave-tube amplifiers with 500-MHz bandwidth and a combiner that will allow the terminal to transmit at up to 10 kw of rf power. Philco Ford hopes that Usascom will order a score of similar terminals for the DSCS-2 ground network.

“When we started,” Ray recalls, “two signals at 10 watts in the transmitter waveguide resulted in signals at 80 dBm on the receive side” of the prototype waveguide assembly. “We were getting intermodulation products from the first harmonics.” And 10 w was a far cry from the design power levels.

In recent tests, Ray says, two signals of 2 kw showed up as 135-dBm interference on the receive side of the waveguide junction. The intermodulation-noise figure is an approximation. “We cut the noise by many orders of magnitude. It was difficult to check with instruments,” he adds. “That’s an over-all improvement of over 70 dB, compared with the first tests.”

To get harmonic sources out of the system, Philco-Ford engineers concentrated on the orthomode transducer. Here, they inserted filters to isolate the transmit and receive legs. And they fabricated waveguide parts using electroforming techniques and pure chemical solutions. □

Government electronics

HEW plans tests on remote treatment

With successful tests of laser, microwave, and cable communications for the remote diagnosis and monitoring of patients in urban clinics

News briefs

Aerosat may fly at last

At its Dec. 6 meeting, the governing council of the European Satellite Research Organization is expected to approve U.S. demands that vhf communications, along with L-band experiments, be included aboard the proposed Aeronautical Services Satellite for airline communications over the Atlantic. This would clear the way for the U.S., Canada, and ESRO to begin organizing the \$100 million program. If Congress approves the arrangement, either Comsat or RCA Globcom will be chosen U.S. co-owner early next year, and the consortium will issue bids for spacecraft soon thereafter. ESRO has informed the FAA that it now approves vhf operation, apparently ending an ESRO-U.S. airlines dispute that had slowed the program for two years.

No additional microwave oven tests

An advisory committee of the Bureau of Radiological Health has turned down a petition by Consumers Union Inc. to impose more stringent safety tests on microwave ovens, but it will consider the consumer group’s requests for warning labeling on the front of the ovens. Representatives of Consumers Union, the microwave-oven industry, and the Bureau’s Technical Electronic Product Radiation Safety Standards Committee are due to meet soon to thrash out what might be done about the warning instructions.

RCA developing postal coder

RCA’s Advanced Technology Laboratories, Camden, N.J., has received a U.S. Postal Service contract for an undisclosed sum to build an engineering model of a parcel-post coding unit, to be part of the automated system for handling bulk mail. Based on the company’s Bullseye supermarket system, the model will combine laser scanners and photo detectors to code as many as 40 packages or read 80 packages an hour.

Pitney Bowes-Alpex closes shop

Pitney Bowes-Alpex, Danbury, Conn. has become the first major casualty in the point-of-sale terminal business. The company, number three in the market and operating at a loss of \$37 million, was closed out by majority owner Pitney Bowes, who claims the investment needed to boost the POS firm into the black would be excessive. Pitney Bowes owns 64% of the POS company’s stock, and the remaining shares are held by the Alpex Computer Co., Danbury.

Guarrera new IEEE president

IEEE members have elected a new president—John J. Guarrera, president of SaCom, Sun Valley, Calif. The membership also voted to maintain the status quo by defeating a referendum to reorganize the society [*Electronics*, Nov. 8, p. 36]. Outgoing president Harold Chestnut, reports that the members voted five to one against a proposal to set up a separate corporation to administer the Institute’s technical activities.

E-H Research acquires Digimetrics

In a move to obtain the capital it needs to put its Digiscope logic-analyzing instrument into production [*Electronics*, Aug. 16, p. 30] Digimetrics Inc., Dublin, Calif., has arranged to be acquired by E-H Research Laboratories Inc., Oakland, Calif. Although the two companies have thus far only signed an agreement in principle, officials at both firms are enthusiastic about the merger and express confidence that the deal will be consummated very soon.

Sprague invests in liquid crystals

After recently selling two of its divisions [*Electronics*, Oct. 25, p.38], the Sprague Electric Co., North Adams, Mass., has bought 40% of Princeton Materials Science Inc. for convertible notes. The New Jersey company is a maker of liquid-crystal displays and modules for solid-state watches. The company is also developing a new dry-film technology for use in duplicating microfilm, microfiche, industrial X rays, and graphic-arts proofing paper.

Think we're bragging? Then call our bluff—even if it's collect.

(415) 591-8921

Ask for Mike Mallinger, Marketing/Sales

or

Tom Moutoux, Engineering

or

Bob Reber, Manufacturing

or

Tom Ciochetti, President

or

if you're the silent type, send for our free brochure.

Name		Title	
Company		Address	
City	State	Zip	
Frequency range of interest		MHz @	V.

 Communications Transistor Corporation
301 Industrial Way
San Carlos, California 94070

CTC: The power in RF power.

Try the New EMR Real-Time Spectrum Analyzer Brochure FREE For 90 days... No Obligation

We're so confident that you will find it the most exciting Real-Time Spectrum Analyzer Brochure yet . . . filled with intriguing facts . . . and figures . . . that we dare to make this offer.

Within its pages, you'll find the "real" story about the Model 1510. . . unique and incredible things like:

It works! . . . Switch it on — no calibration — ready to go

It repeats itself! . . . Analyze a signal once . . . and again and again, and always get the same answer

It doesn't cheat! . . . 60 dB at the input with no gimmickry

It can be carried (by humans)! . . . Fully portable with CRT, Fourier Analyzer and Digital Averager in one 8 $\frac{3}{4}$ " high case

It can be used by (almost) anyone! . . . Foolproof LED display of signal amplitude, frequency and averaging time

It gets along well with photographers! . . . Control setting status appears on graphic for a permanent photographic record

It has plenty of options! . . . Peak Hold, Total Spectrum, 3-D Display, Computer Interface, Low Frequency Sync, Any window, etc.

Remember to order your Model 1510 Brochure Today! Satisfaction Guaranteed! If you love it . . . ask for a demo. If you don't . . . no obligation — or hard feelings.

EMR EMR
Schlumberger

EMR Telemetry
Weston Instruments, Inc.
Box 3041, Sarasota, Florida 33578
813-958-0811



Electronics review

[*Electronics*, Aug. 14, 1972, p. 41] behind it, the Department of Health, Education, and Welfare has revealed plans for testing a similar capability in rural areas.

"This next set of experiments will put people and technology out in 10 remote areas," says Maxine L. Rockoff, logistics chief, health care technology division, in HEW's Health Services and Mental Health Administration. Still in the planning stage, the rural test probably will begin in fiscal 1975 and use telephone links in combination with loudspeaker-equipped phones, electrocardiogram units, pulse-transmission devices, and slow-scan television, she says.

HEW's aim is to find out when clinics and hospitals will need broadband interactive visual communications and when cheaper narrowband, such as telephone and radio, will do. "Is broadband really necessary?" Ms. Rockoff asks. "Won't telephone do just as well?"

HEW's next-phase test will try to set up links to clinics in communities of 300 to 500 persons, to a traveling nurse or paramedical person, and to a doctor, she says. The trick, she says, is to find the level of technology that will be needed to support the paramedical personnel at a remote site being supervised by a doctor at a central hospital.

Urban tests, says Ms. Rockoff, showed that medical-electronics communications allowed doctors to increase the number of critical cases they could evaluate—thus spreading out a scarce resource. Communications has also improved hospital administrative procedures, such as stocking and ordering. A Picture-phone experiment in Chicago, for example, produced unexpected dividends, she notes. It allowed orderlies to use sign language to surmount language differences, and operating-room attendants could consult directly with specialists on an on-the-spot basis. Nurses could order supplies more precisely by showing the stock clerk exact labels. Similar benefits may be in the offing when electronic technology for medical communications branches out to rural areas. □

Beam-Fired* SCRs. A Faster Turn-On.

Faster than any other SCR:
in 3 μs , dynamic forward drop is down
to 3 volts, switching up to 150 amps†
Typical di/dt of 1,000 $\text{A}/\mu\text{s}$.

Speed from leading edge technology:
optimum cathode shunt placement...
integrated gate cascade driver
stages... simultaneous, large area,
multi-gate turn-on.

Patent applied for.

Vastly improved reliability
from low switching losses.
 dv/dt : 200 $\text{V}/\mu\text{s}$ minimum
critical... 200-plus $\text{V}/\mu\text{s}$
reapplied, if you need it.

Evaluate a faster
high-current 235 to
800A SCR from 100-1,300
volts. Brochure and data
sheets through Box 20912,
Phoenix 85036. Take the
lead in high-frequency
inverters, choppers,
PWM, cycloconverters,
induction heating.

Quickly.

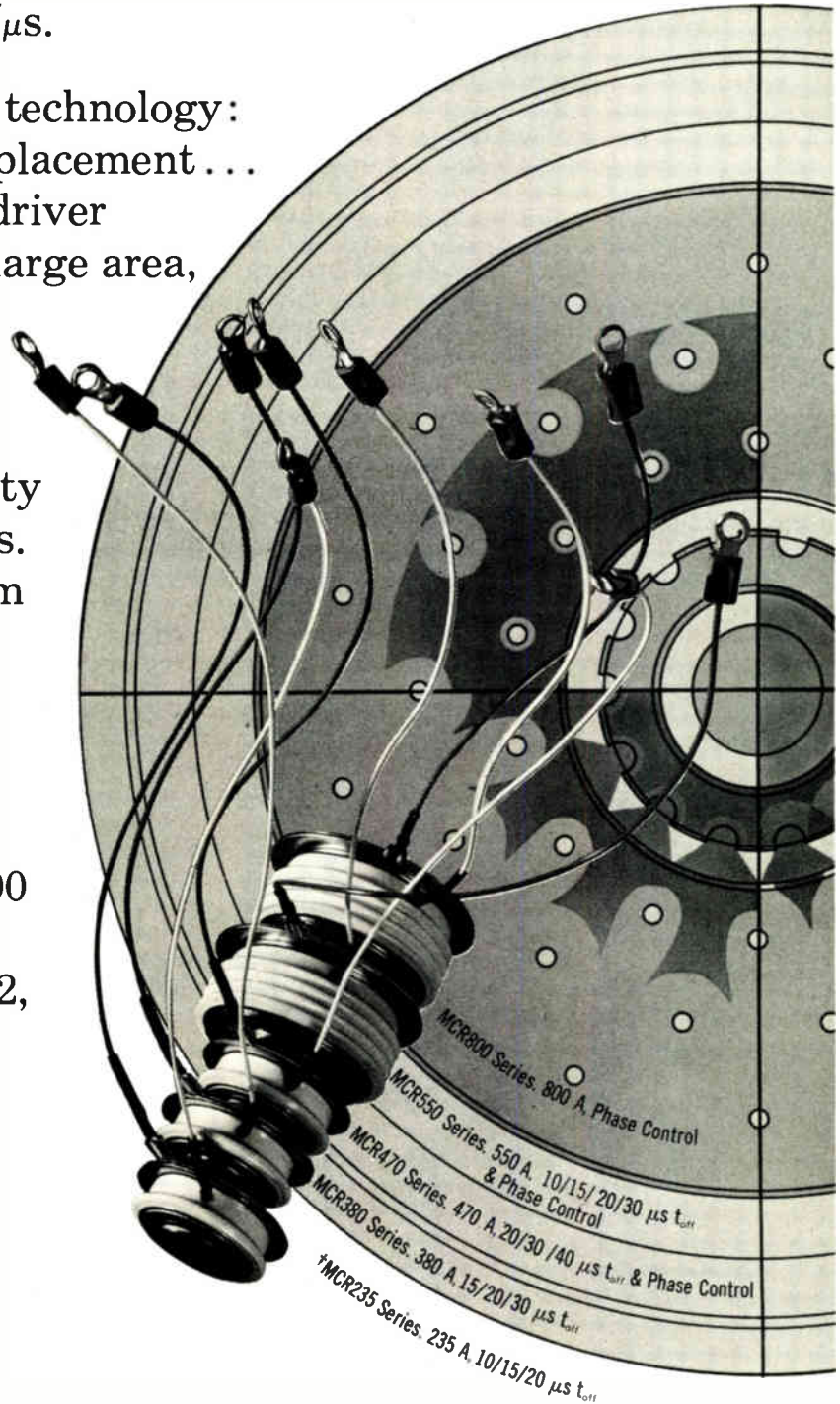

fast moving
From Motorola, The Thyristor Producer

*Trademark Motorola Inc.

FROM DELCO, THREE POWER TRANSISTORS.

	TYPE	V _{CEO}	V _{CEV}
	DTS-708	900V	900V
	DTS-709	900V	900V
	DTS-710	900V	—

We'd like to simplify your life while you simplify your high energy circuits. These three new devices are all NPN,

triple diffused and packaged in Delco's solid copper TO-204MA packages (TO-3 to you old-timers) for man-sized power handling.

DTS-708 and 709 are designed for use in high voltage switching applications—where inductive loads or fault conditions may be giving you problems now. The DTS-710 is ideal for linear regulators and power amplifiers.

Safe Operating Curves on the data sheets let you know where it's at. And our applications engineering assistance is available, too.

You probably know about our reputation for making really tough transistors—for high peak energy handling. You'll find we can deliver, too.

All of the Delco distributors listed have the DTS-700 series in stock.

Give yours a call now for the prices you'll like and the data you'll need.

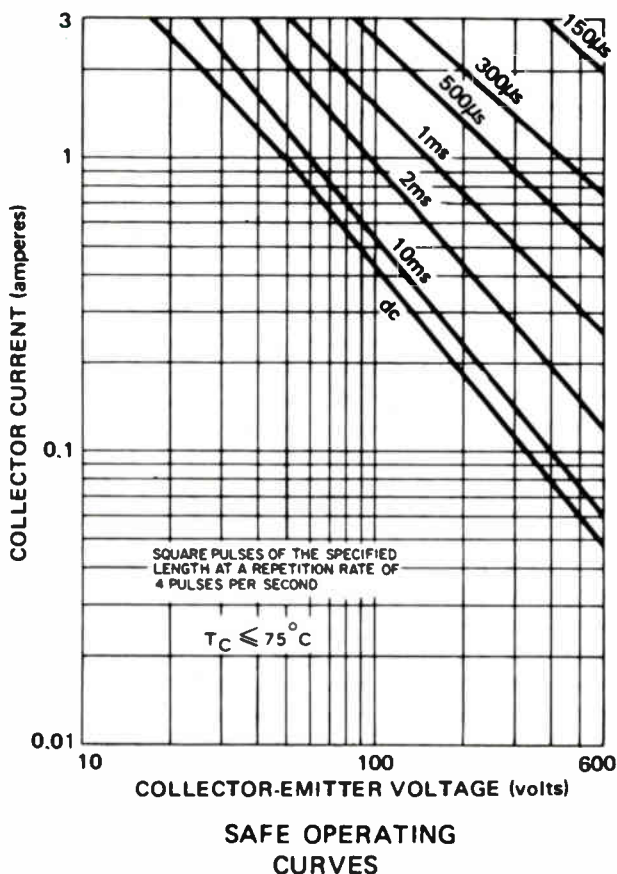

NOW AVAILABLE FROM THESE DISTRIBUTORS IN PRODUCTION QUANTITIES.

ALABAMA, Birmingham
Forbes Distributing Co., Inc.
(205) 251-4104

ALABAMA, Huntsville
Powell Electronics
(205) 539-2731

ARIZONA, Phoenix
Sterling Electronics, Inc.
(602) 258-4531

CALIFORNIA, Goleta
R.P.S. Electronics, Inc.
(805) 964-4764

CALIFORNIA, Los Angeles
Kierulff Electronics, Inc.
(213) 685-5511

CALIFORNIA, Los Angeles
R.P.S. Electronics, Inc.
(213) 748-1271

NEW 900-VOLT SILICON

VCEO(sus) IC = 1A	VCE(sat)	hFE Min/Max	IC
600V	2.0V (IC = 1A, IB = 250mA)	—	3A
600V	1.0V (IC = 2A, IB = 800mA)	—	3A
600V	—	10/50	3A

CALIFORNIA, Palo Alto
Kierulff Electronics, Inc.
(415) 968-6292

CALIFORNIA, Sunnyvale
Cramer/San Francisco
(408) 739-3011

CALIFORNIA, San Diego
Kierulff Electronics, Inc.
(714) 278-2112

CALIFORNIA, San Diego
R.P.S. Electronics, Inc.
(714) 292-5611

COLORADO, Denver
Cramer/Denver
(303) 758-2100

CONNECTICUT, Norwalk
Harvey/Connecticut
(203) 853-1515

FLORIDA, Miami Springs
Powell Electronics/Florida
(305) 592-3260

FLORIDA, Orlando
Powell Electronics/Florida
(305) 859-1450

ILLINOIS, Rosemont
Kierulff Electronics, Inc.
(312) 678-8560

ILLINOIS, Skokie
Bell Industries
Electronics Distributors Div.
(312) 282-5400

INDIANA, Indianapolis
Graham Electronics Supply, Inc.
(317) 634-8202

MARYLAND, Baltimore
Radio Electric Service Co.
(301) 823-0070

MASSACHUSETTS, Needham Heights
Kierulff Electronics, Inc.
(617) 449-3600

MASSACHUSETTS, Newton
The Greene-Shaw Co., Inc.
(617) 969-8900

MICHIGAN, Farmington
Harvey/Michigan
(313) 477-1650

MINNESOTA, Minneapolis
Stark Electronics Supply Co.
(612) 332-1325

MISSOURI, Kansas City
Walters Radio Supply, Inc.
(816) 531-7015

MISSOURI, North Kansas City
LCOMP-Kansas City
(816) 221-2400

MISSOURI, St. Louis
LCOMP-St. Louis
(314) 647-5505

NEW JERSEY, Clifton
Wilshire Electronics/New Jersey
(201) 365-2600 (212) 244-8930

NEW YORK, Binghamton
Harvey/Federal
(607) 748-8211

NEW YORK, East Syracuse
Cramer/Syracuse
(315) 437-6671

NEW YORK, Rochester
Cramer/Rochester
(716) 275-0300

NEW YORK, Woodbury
Harvey/New York
(516) 921-8700 (212) 895-9260

OHIO, Cincinnati
United Radio, Inc.
(513) 761-4030

OHIO, Cleveland
Pattison Supply Co.
Industrial Electronics Division
(216) 441-3000

OHIO, Dayton
Kierulff Electronics, Inc.
(513) 278-9411

PENNSYLVANIA, Philadelphia
Almo Electronics
(215) 676-6000

PENNSYLVANIA, Pittsburgh
RPC Electronics
(412) 782-3770

SOUTH CAROLINA, Columbia
Dixie Radio Supply Co., Inc.
(803) 253-5333

TEXAS, Dallas
Adleta Electronics Company
(214) 741-3151

TEXAS, Fort Worth
Adleta Electronics Company
(817) 336-7446

TEXAS, Garland
Kierulff Electronics, Inc.
(214) 271-2471

TEXAS, Houston
Harrison Equipment Co., Inc.
(713) 224-9131

UTAH, Salt Lake City
Cramer/Utah
(801) 487-3681

VIRGINIA, Richmond
Meridian Electronics, Inc.
(703) 353-6648

WASHINGTON, Seattle
Kierulff Electronics, Inc.
(206) 763-1550

IN CANADA
ONTARIO, Scarborough
Lake Engineering Co., Ltd.
(416) 751-5980

ALL OVERSEAS INQUIRIES:
General Motors Overseas Operations
Power and Industrial Products Dept.,
767 Fifth Avenue, New York, N.Y.
10022. Phone: (212)-486-3723.

Delco Electronics
Regional Sales Offices

Union, New Jersey 07083
Box 1018 Chestnut Station
(201) 687-3770

El Segundo, California 90245
354 Coral Circle
(213) 640-0518

General Sales Office
700 E. Firmin, Kokomo, Ind. 46901
(317) 459-2175
Operator (317) 457-8461



Delco Electronics, Division of General Motors.

**The most powerful
argument for buying
a Nova 840 is what
you don't pay for.**



Nobody's ever going to beat our prices for the Nova 840 software.

It's free.

Which is particularly shocking when you consider that it's some of the most powerful software you can get with any computer at anywhere near the price.

You get an incredibly versatile Real Time Disc Operating System that does double duty as a powerful program development tool and as a run time support system that can handle two modes of operation at the same time.

You get Fortran 5. So fast, you can use it for fussy real-time or computation applications. So comprehensive, the diagnostics tell you exactly what's wrong and where. In English.

Then there's Batch that lets you pick your peripherals, load your job and go do something else.

And Extended Algol. Extended so far it can develop the kind of complex programs you used to need big expensive computers to do.

And Extended Timesharing Basic. It'll take on up to 32 users at the same time and distribute all the system resources to all those users.

And our Remote Synchronous Terminal Control Program that lets the Nova 840 become a programmable remote job entry terminal.

Finally, there's our utility programs: Macro - assembler, Editor, Symbolic Debugger that let you work in assembly language.

All in all, a most remarkable library of software.

But before you get the bright idea of circling the bingo card and asking for it all, please be advised: you get the software free when you get the required hardware from us. And with that software, you're going to be able to use a lot of hardware.

You see, we write software to sell hardware.

The Nova 840 DATAGEN LTD.

190 Edmonton Street, Hull, Quebec (819) 770-2030



Program over 1200 N/C drilling commands an hour.

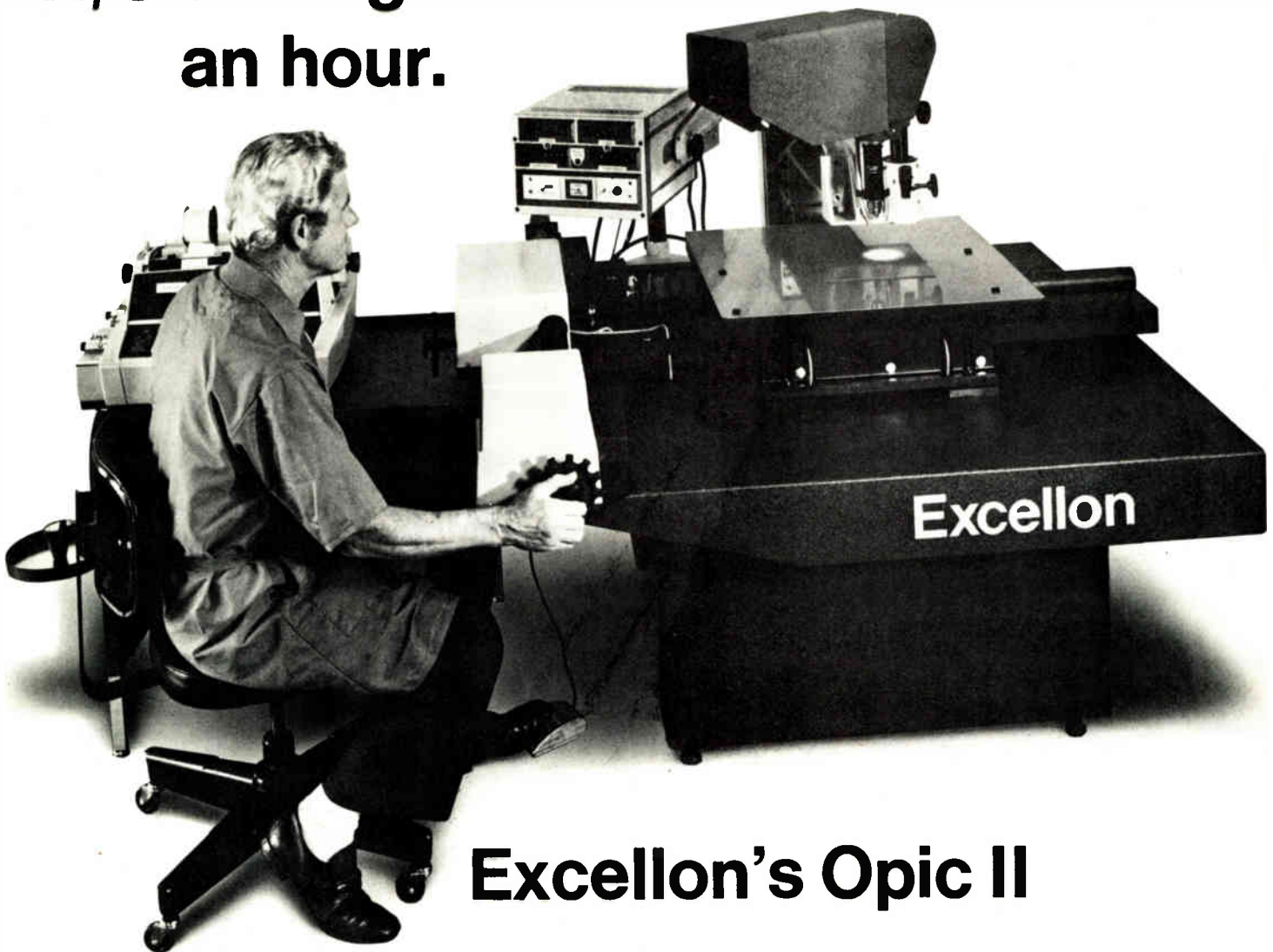

Excellon's Opic II

You're looking at the best way we know of to produce printed circuit board programs for any EIA standard N/C drilling machine. This includes our own Excellon Mark III, the Monomat® 7 and the Quadramatics.

Excellon's Opic II.

It's fast and accurate. And it's uncomplicated.

Simply place your art, negatives or boards on the 25" x 25" work table.

Then control X-Y axis table travel either electrically (at 120-inches a minute), or by manually operating the fine-adjustment hand-wheels. Air bearings virtually eliminate friction, and ball nut lead-screws prevent backlash.

When the pad is centered on the 10-power, 6-inch scope, press the footswitch and the X-Y coordinates are entered on the tape.

Then you're ready to proceed to the next hole. (And you can proceed in inches or millimeters, whichever you prefer.)

In addition, the Opic II, with

± 0.0001 " resolution, can be used to inspect art work or p.c. boards.

There's much more you should know about this outstanding optical programming/inspection center. And you'll find it all in our Opic II brochure.

Call or write Dick Hogan, Sales Manager, today. His number is (213) 325-8000.

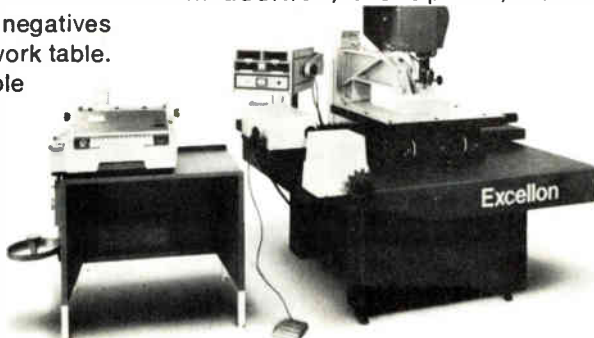

Excellon Automation

A Division of Excellon Industries
23915 Garnier Street,
Torrance, California 90505
Phone: (213) 325-8000

Telex: 67.45.62 Cable: Excellon Torrance

Excellon Sales and Service in ENGLAND • FRANCE
SCANDINAVIA • W. GERMANY • SPAIN • HOLLAND
ITALY • ARGENTINA • ISRAEL • AUSTRALIA • HONG
KONG • TAIWAN • JAPAN

FCC's Hinchman to propose a regional spectrum

A new series of proposals to the Federal Communications Commission suggests **reallocating some frequencies in the U.S. on the basis of regional variations in demand.** Being drafted as an evolutionary plan by Walter Hinchman, influential head of the commission's Office of Plans and Policy, **these proposals would take account of economic considerations** in determining assignments and allow spectrum users to buy each other out.

Hinchman's goal is to **give a regional flexibility to spectrum usage, since the communications industry is too well developed for a nationwide reallocation like Japan's.** Nevertheless, manufacturers would have to switch to making modular equipment with plug-in front-ends to accommodate different channels in different areas, he points out.

"Every other resource in the country is managed on an economic basis, except the spectrum," he observes. He believes that, for example, the "selective sharing" he proposes would **allow land mobile to make use of unused TV spectrum without reducing the number of active TV channels.**

Customs sets RFPs for automated import system

The U.S. Customs Service plans to issue requests for proposals during the spring of 1974 for the next and major phase of its Automated Merchandise Processing System, **a national computerized import clearinghouse that could cost up to \$80 million and use 2,000 terminals when it goes fully operational in 1980.** Preliminary plans call for contractors to bid wholly or piecemeal for the gradual implementation slated to begin in fiscal 1975. Using cathode-ray-tube and line-printer terminals teamed with a computer complex, **the system will speed the processing of imported products, now increasing at a rate of 9% a year.**

Instead of testing the network extensively [*Electronics*, March 13, 1972, p. 42], Customs now intends to install it modularly and leave sizing it until after the first phase is operating. That phase, called the Early Implementation System, is to be installed in Philadelphia in March, then in Chicago, Houston, San Francisco, and New York. TCI Inc., Raleigh, N.C., will supply its 30 terminals, with options for 80 more, to work with the Treasury Department's Honeywell 6064 computer in Washington, D.C.

Consumer imports continue to soar; Taiwan share grows

More than \$500 million in third quarter U.S. imports of home entertainment electronics pushed the total for the first nine months of 1973 to **a record-breaking \$1.39 billion—a 13.3% increase over 1972 figures for January-September.** Japan generated 63% of the total, according to new Commerce Department figures, although its share reflected only a nominal 2.2% rise in value from the first nine months of 1972. That compares with a 30% increase a year ago from the same period in 1971.

Taiwan shipments in the first nine months increased by 43% to \$236.3 million, boosting its share of home entertainment imports to 17%. That compares with its 7.4% share in the same period in 1971, according to Commerce, which noted that Taiwan is "continuing the accelerated growth pattern which began subsequent to the international currency adjustments of August 1971 and February 1973."

The sayings of chairman Ibuka

Beginning with the magnetic-tape recorder and then the transistor radio, Sony Corp. has gone on to become one of the world's leaders in developing and marketing new consumer electronic products. One of those markets—the United States—imported a record-setting \$876 million in Japanese consumer electronics in the first nine months of 1973. Chairman Masaru Ibuka recently offered some intriguing insights into Sony management and marketing philosophies in a talk he gave before the IEEE of Canada. Several quotations from that October lecture in Toronto follow.

—Ray Connolly

On Sony's beginnings

The wire recorder had existed in Japan before the war; therefore, we could fairly easily guess the mechanism and the method of manufacture of the tape recorder. At that time it was virtually impossible for us to obtain thin plastic films for the tape base in Japan, so we had to use a paper-tape base, which easily snapped off. Later, a famous American tape manufacturing company [Ampex] proposed to us the establishment of a joint venture company for the manufacture of magnetic tapes in Japan. We were almost dying to obtain their technical know-how, but we had to refuse the proposal because it was made on the condition that we should not manufacture tape recorders.

While we were still in the development stage in the tape-recorder and tape field, we believed we would automatically make a fortune if we succeeded in putting them on sale for the first time in Japan. But we were not as lucky as we had expected to be. And we learned a valuable lesson: the importance of marketing.

Fortunately, the American Occupation Forces were very eager to promote the spread of audio-visual education, so before long our tape recorder became a very popular device for education in schools all over Japan. . . . This tape-recorder business contributed a great deal to the establishment of the financial foundation of our company.

On other early lessons

As we manufactured more transistor radios [starting in 1955], the yield of applied transistors improved considerably in the following few years, in fact, much more than I had expected. Since then, I have been thoroughly convinced that a good opportunity to introduce a new product should not be missed only on account of a high rejection rate. . . .

If we had not attempted to make small transistor radios, and if either European or Ameri-

can electronics companies had succeeded in making such a tiny radio before Sony, I would imagine that Japanese manufacturers would have followed such foreign manufacturers as happened in other fields . . . and Japan's electronics industry would not be as competitive in the world market as it is now.

On creating markets

I think we were the only ones who thought at the time that it would be feasible to manufacture home-use TV with the application of silicon transistors because they cost \$5 to \$15 apiece. A bigger problem was that, although larger-screen-size televisions were becoming more and more popular then, we could only make 5-inch- or 8-inch-screen-size TVs because of the power limitation of silicon transistors.

When we asked marketing specialists in the U.S. about the possibility of sales of such small TVs before the announcement, they seemed convinced that such small TVs would definitely not sell. However, we dared to challenge the commonly shared view—our first shipment of 6,700 sets intended for the Christmas market was sold out in that October, and we had to send additional shipments in similar numbers in November and December by air cargo . . . With the success of this micro TV, I came to believe that a truly new product will create a new market.

On employing resources

A marked characteristic [of the development of the Trinitron one-gun color TV] was that the inventors . . . also participated in the development or designing of equipment for the manufacturing process. They were actually playing two or three roles simultaneously. . . .

In our experience, most friction or resistance occurs when a development which was made in one section is transferred to another section, thus wasting a considerable length of time during the transfer. In order to avoid that, we effected a system in which the same people were engaged in the whole project from the beginning to the end. . . .

In our company, we tried to avoid expecting fruitful results from basic research, although we were well aware [of its importance]. As our policy, we did not take the road of allowing each researcher to choose his own theme at his own discretion. Rather, we would see a clear target after many heated discussions, then would aim our all-out efforts in technical development toward the target. . . . In short, we look for needs before seeds.

S-D puts the accuracy back into high speed DVMs



FILTER FOR EMERGENCY ONLY

Make 30 accurate readings a second... even with noisy inputs

Most DVM's offer no noise rejection without using input filters—and that limits them to 2 or 3 readings/second. But Systron-Donner's Model 7110A makes 30 readings/second with 60 dB of normal mode noise rejection **without** using filters. DC accuracy in the presence of noise? Typically $\pm 0.005\%$. That's because the 7110A uses dual slope integration which provides built-in noise rejection without filters. Fully-guarded construction and isolated inputs/outputs also help to kill noise. Only the presence of extremely noisy signals requires a filter; it's there if you need it.

Other Model 7110A features:

- true rms or averaging AC • adapts to many systems interfaces
- DC voltage resolution to ± 1 microvolt • $\pm 1,000$ volt overload protection on all functions and ranges • true 4-wire DC ratio system in basic unit • field or factory expandable •

At \$1995 for the basic unit or \$3,400 fully-loaded, Model 7110A outperforms DVMs costing much more. For immediate details, call collect on our Quick Reaction Line: (415) 682-6471, or contact your Scientific Devices office or Systron-Donner at 10 Systron Drive, Concord, CA 94518. **Europe:** Munich, W. Germany; Leamington Spa, U.K.; Paris (Le Port Marly) France. **Australia:** Melbourne.

SYSTRON  DONNER

Albuquerque, (505) 268-6729; Baltimore, (301) 788-6611; Boston, (617) 894-5637; Burlington, NC (919) 228-6279; Chicago, (312) 297-5240; Cleveland, (216) 261-2000; Denver, (303) 573-9466; Dayton, (513) 298-9904; Dallas, (214) 231-8106; Detroit, (313) 363-2282; Ft. Lauderdale, (305) 721-4260; Hamden CT (203) 248-9361; Huntsville, AL (205) 536-1969; Houston, (713) 623-4250; Indianapolis, (317) 783-2111; Kansas City, KS (913) 631-3818; Los Angeles, (213) 641-4800; Minneapolis, (612) 544-1616; New York City area (201) 871-3916; Norfolk, (804) 499-8133; Orlando, (305) 841-8180; Philadelphia, (215) 825-9515; Phoenix, (602) 834-1682; Rochester, NY (716) 334-2445; San Antonio, (512) 694-6251; San Diego, (714) 249-6642; San Francisco area (415) 964-4230; Seattle, (206) 454-0900; St. Louis, (314) 842-2535; Syracuse, (315) 457-7420; Washington, DC area (703) 451-6500.

Matsushita develops high-density color display for computers

Efforts by Japan's Matsushita Electronics Corp. to increase the sharpness of future color-television pictures are expected to pay off almost immediately in improved alphanumeric displays for computers. Furthermore, the technique may short-circuit efforts by many others to produce color tubes that do not need shadow masks but instead enable a limited number of colors to be selected by switching the accelerating voltage of the electron beams.

The high-resolution color-TV tubes, originally developed by Matsushita as part of a joint study with the technical research laboratories of NHK for the evaluation of color broadcasts, will soon be used in computer displays. However, it may be much longer before these tubes are developed to their full potential for color TV because the experimental system in which they were first used has 1,125 lines and a 30-megahertz bandwidth, compared with 525 lines and 6-MHz bandwidth for the NTSC commercial TV used in Japan and the U.S.

NHK is Japan's public-service broadcasting system, and its technical-research laboratories perform much of the basic research for broadcasting in Japan. Matsushita is a subsidiary of Matsushita Electric Industrial Co., Japan's largest manufacturer of television and a joint venture with Philips Gloeilampenfabrieken of the Netherlands.

The key to Matsushita's fabrication of these high-resolution tubes is a process that the company developed to manufacture black-surround—often called black-matrix—color-picture tubes for its standard commercial color sets. In Matsushita's process, the photosensitized screen of the tube is exposed during screen fabrication directly through holes in the completed shadow mask to the ultraviolet-light source.

Others, including Zenith, which

originated the black-surround process, expose the screen through the small holes that have been initially etched in the shadow mask. A post-etch then produces the larger holes required in the shadow mask for the finished tube.

Production is slated to start in February on the first tube developed by Matsushita, which has a 22-inch rectangular shape with a 90° deflection angle. It has two million holes—five times the number usually used for conventional tubes of this size. Since each hole in the mask lies behind one dot trio on the screen, a total of six million phosphor dots on the faceplate form the picture. Even close up, the individual dots are not visible, and the effect is similar to a rear-projection color slide.

The computer display. The new tube can display about 120 lines of about 150 characters each of computer output for a total of about 18,000 characters. In contrast, the usual large color tube can display about 40 characters on one line, although the commonly used IBM punched card contains 80 characters, and computer-output printers print about 120 characters per line.

However, the focus of the usual color-television electron gun is not sharp enough for this fine detail. But Matsushita has developed improved electron guns, which give much better focus and consequently maintain brightness at 80% of the usual value, despite the much finer

shadow-mask pattern being used.

The spot on the faceplate of the cathode-ray tube is illuminated by the electron-beam crossover between the first and second grids of the electron gun, which is imaged on the faceplate by the electron-gun lens. To reduce the size of the crossover diameter and so obtain a finer spot, Matsushita engineers have decreased the diameter of the grid opening from 0.9 to 0.4 millimeter. But this decreases the active area of the cathode by a factor of five. To maintain the same electron-beam current, five times the emission per unit area of the active cathode region is required.

To achieve the required high value of emission, the cathodes are operated at a temperature of 1,000°C, rather than the 800°C of most picture tubes. And since the usual oxide cathode would not last long when operated with this high current, Matsushita engineers are using a dispenser-type cathode, originally developed by Philips for use in microwave tubes. The dispenser cathode consists of porous tungsten, impregnated with a mixture of aluminum and barium oxides, which gradually diffuse to the surface and emit electrons. The tubes can be fabricated with high precision because the dispenser cathode has a relatively smooth metallic emitting surface, instead of the rough surface of the usual oxide-coated cathode. □

West Germany

Half a dozen computers monitor rail nets in Bavaria

Total automation of West Germany's railroad operations is still some time away, but a new com-

puter-based system to monitor rail traffic in the state of Bavaria is a big step toward that goal. The system,

Around the world

Computer transfers textile patterns

Paul Gunold, a small firm in Stockstadt, near Frankfurt, Germany, is using a process computer to aid in transferring patterns to program cards that control jacquard embroidery machines. For about 60 years, these machines have been controlled by program cards, similar to a computer's punched cards, to make repetitive patterns that were designed and coded by hand.

Gunold, an established producer of programs for automatic embroidery machines, explains that only certain aspects of the pattern-transfer process are adaptable to computer programming. To save time and costs, the company has combined the best conventional methods with the advantages of the process computer to get the program to the cards. This eliminates much of the drudgery, and the company claims that it is at least 500% faster than manual methods, depending on the complexity of the pattern.

CCTV system measures hides

A closed-circuit TV system has been turned into an instrument to measure the area of irregular hides, which are awkward to measure by conventional methods. The Shoe & Allied Trades Research Association of Kettering, England, designed the system. The association does not manufacture, but licenses the system to others.

To operate, a CCTV camera scans the hide, which has been flattened on a framework. The measurement is based on the constant speed of the camera's scan across the target, and the scan time is proportional to the scan distance. To turn a proportional measurement into absolute units, the camera is calibrated by focusing it on a rectangular card of known area in the same plane that the hides occupy. The hide area is proportional to the card area as the scan time for the hide is to the time for the card. The device reads out in desired units of measure.

built by Siemens AG around a battery of six computers at a control center in Munich, keeps tabs on the whereabouts of hundreds of trains simultaneously. The trains' positions at any time are shown on CRT displays and on a huge monitoring board at the center. What's more, personnel at rail stations who dial the computers to request certain train information receive the answers in spoken form.

The computers monitor more than 250 miles of rail lines of the Greater Munich rapid-transit system. In addition, they monitor all passenger and freight traffic along hundreds of miles of federal railway track radiating in all directions from the Bavarian capital and extending as far as Salzburg, Austria. The system now in use is the first stage of a project aimed not only at monitoring trains but at controlling them, as well. Second-stage work is already under way, Siemens says.

Computers control. The heart of the setup is the control center with six Siemens 304 process computers hooked into three duplex configurations to enhance system reliability. Messages concerning train movements are fed to the computers over 10 data channels from the more than 100 rail stations in the monitored area.

The incoming messages contain

train number, track number, and other pertinent data that has been punched into keyboards by personnel at the rail station a train starts from and all the subsequent stations it enters. The computers process the keyboard-derived train-movement data together with the status of traffic on the tracks, which comes from automatic track-side contact sensors. The combined data is continuously updated as each train moves from station to station and across the track-status contacts.

In the Munich metropolitan area, however, the system is more sophisticated. Here the train-movement information, instead of being keyboard punched, is fed to the computers by automatic train-number signaling equipment that has been in service there for a number of years.

By comparing the real-time incoming data with stored train timetables, the computers provide all information needed for train-monitoring. In subsequent stages of system development, that information will also be used for actual control of trains.

The geographical area covered by the Munich control center is divided into five regions. The dispatcher responsible for each region, who has CRT displays, can switch a 30-mile section of train routes from the com-

puter onto his display. It shows not only all possible train routes in that section, but also all tracks at rail stations in the region. Superimposed upon that picture are train numbers and time information.

Dispatchers can query. Should any irregularities in train operation occur—for example, late arrival time at a certain station—the dispatcher can either set up a radiotelephone connection between that station and the train operator, or he can himself tell the train operator to try to make up for lost time. The display allows the dispatcher to also make certain other decisions in conflict situations. He can, for example, tell a freight-train crew to wait and give a passenger train on the same route the right of way.

The display is large enough to show a 30-mile section of rail lines outside the Munich area. However, it is too small to display the relatively dense network of rapid-transit lines within the city and all 36 tracks in Munich's main rail terminal.

To handle all that data, the control center has a board measuring 6 by 22 feet that has 400 optical indicators to show the position of any train within the city area. Position information for the board comes from the automatic signaling equipment along the tracks that transmits train numbers. □

★ SIMPLIFY PROCUREMENT ★

BOURNS
NOW OFFERS

16 MIL SPEC

Save paperwork, money and time by ordering all your Mil Spec potentiometers from Bourns, the most complete single source in the industry. It's sound logistics — one purchase order, one approved source. At the same time you're protected by Bourns tradition of excellence. Each Bourns potentiometer is designed and manufactured to consistently exceed Mil Spec requirements.

FOR INSTANT
INFORMATION
DIAL E E M
800-645-9200



POTENTIOMETERS/VARIABLE RESISTORS

★ NON-WIREWOUND - MIL-R-22097



*RJ12 C-F



*RJ22 C-F



*RJ24 C-F



*RJ26 C-F



*RJ50 C-F

★ WIREWOUND - MIL-R-27208



RT10



*RT12

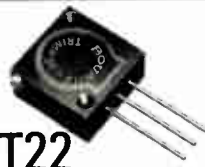

*RT22



*RT24



*RT26

★ ESTABLISHED RELIABILITY - MIL-R-39015

MIL-R-39035 ★



RTR12



RTR22



RTR24 (NEW)



RJR12 C-F (NEW)

★ MIL-R-94

MIL-R-23285 ★



*RV6

BOURNS HAS MORE
POTENTIOMETERS
ON QPL THAN ANY
OTHER MANUFACTURER!



RVC6 (NEW)



BOURNS, INC., TRIMPOT PRODUCTS DIVISION • 1200 COLUMBIA AVE., RIVERSIDE, CALIF. 92507

* AVAILABLE FROM STOCK AT YOUR LOCAL BOURNS DISTRIBUTOR

British plan tropo-scatter link to North Sea wells

The British Post Office will build tropospheric-scatter radio links for communication between the east coast of Scotland and the scores of oil and gas rigs that will be operating in the North Sea by 1975. **Two shore stations with 40-foot diameter dishes will communicate with, initially, two master platforms.** Some 150 to 200 miles out at sea, these platforms will have 25-foot diameter dishes. The individual drilling rigs will be connected with the master platforms via a conventional line-of-sight microwave network.

All tropospheric antennas will be inclined upwards 1° from the horizon. The 2-gigahertz, 1° -wide transmission beams will hit the troposphere slightly nearer the sea stations than the land stations, because the latter are higher above sea level. Attenuation over either link will normally be about 210 decibels.

To safeguard against complete signal loss due to turbulence, there are four antennas for each link at each end—two transmitters and two receivers. One transmission beam is circularly polarized, the other horizontally polarized. Both receiving antennas accept both signals and the most powerful of the four at any instant is selected and amplified for further transmission. British Post Office officials believe that this approach will provide acceptable telephone speech for 99.9% of the time and normal error rates on telegraph transmissions for 99.98% of the time.

Spain looks abroad, sees Motorola

Spain is continuing its efforts to build a domestic electronics industry by tapping foreign expertise in electronics. In the latest development, **the country's telephone company—Compania Telefonica Nacional de Espana—is holding talks with Motorola Inc.** Earlier, Motorola began negotiations for entry into the Spanish market with the state industrial holding agency, Instituto Nacional de Industria.

Then, INI was seeking a technological alliance with a foreign electronics company as the first step in a program to form a government-dominated electronics operation. In the meantime, however, INI shifted its goals and is now looking to form a domestic computer venture in partnership with a foreign group.

Telefonica has already formed three joint ventures with foreign partners—General Cable Corp., Italy's Telettra, and Sweden's L M Ericsson—with the goal of reducing its dependence on ITT as its sole equipment supplier. **Now, Telefonica wants to go further into electronics** and sees an arrangement with Motorola as helping the Spanish electronics industry expand its capabilities.

Bulgaria to build numerical controls under Fujitsu license

Fujitsu Fanuc Ltd., a wholly owned subsidiary of Fujitsu Ltd., specializing in numerical controls for machine tools, says it is near agreement with Bulgaria on a license to build Fujitsu numerical controls. **Bulgaria would be able to use the controls it builds for its own machine tools and would also be able to export the controls as separate components to other countries in the East Bloc countries.**

A Fujitsu official says, though, that computer-controlled numerical

controls are not included in the agreement because they are proscribed by Cocom regulations. Included in the license would be the other electronic numerical controls, pulse motors, and layout and design of production plants. A company spokesman expects the license to be signed later this month.

Siemens expands line of traffic-control computers

Siemens AG is adding two new models to its **VSR 16000—work-horse traffic-control computer system—of which more than 100 have been ordered or installed throughout Europe and parts of South America.** The new models, designated VSR 16020 and VSR 16030, differ from the others in the family mainly because of higher speed and greater traffic-data collection and processing capability. While the 20 works with 144 machine commands, the 30 uses a total of 202 commands. Both have a maximum core store capacity of 63 kilowords, with each word being 16 bits long.

Using an extensive program library, the new equipment satisfies virtually all requirements imposed by traffic situations, Siemens says. The two models work as traffic-flow-dependent systems and collect data on, for example, speed and number of vehicles along specific road sections, the time it takes vehicles to cover certain distances, and similar detailed information.

The data is then processed and used to select one of many traffic light control programs stored in the computer. Depending on the traffic situation, green-light cycles are either prolonged, shortened, or delayed to insure an even vehicle flow. Other programs recognize changing trends in traffic volume in selected streets or even in entire road networks in a city.

Ferranti computer picked for sea-search radar

The long-range, airborne, maritime-search radar being developed by EMI Electronics Ltd. **for installation in the Royal Air Force's 48 Nimrod ocean patrol aircraft** will use an airborne version of Ferranti's FM-1600-D military computer for information processing. This computer is already used in Royal Navy ships for fire control and action information processing.

Initially, Ferranti will provide nine systems, each with a core memory of 32,000 26-bit words. The complete radar will start to get into the Nimrod aircraft in about two or three years from now. **The radar is designed to have very high performance in detecting periscopes and snorkels in rough seas.**

Hungary to enter magnetic-tape making via BASF deal

West Germany's BASF, a large chemical producer known for its expertise in magnetic tape, has signed an agreement with Hungary's Polimer cooperative on audio-tape production. **Under the terms of the agreement, BASF supplies the machines and the starting materials to Polimer,** which will then produce in Budapest audio tape for disk-type and cassette tape recorders for Hungarian consumption. BASF has also agreed to buy back from Polimer any finished material after Hungary's demand is satisfied.

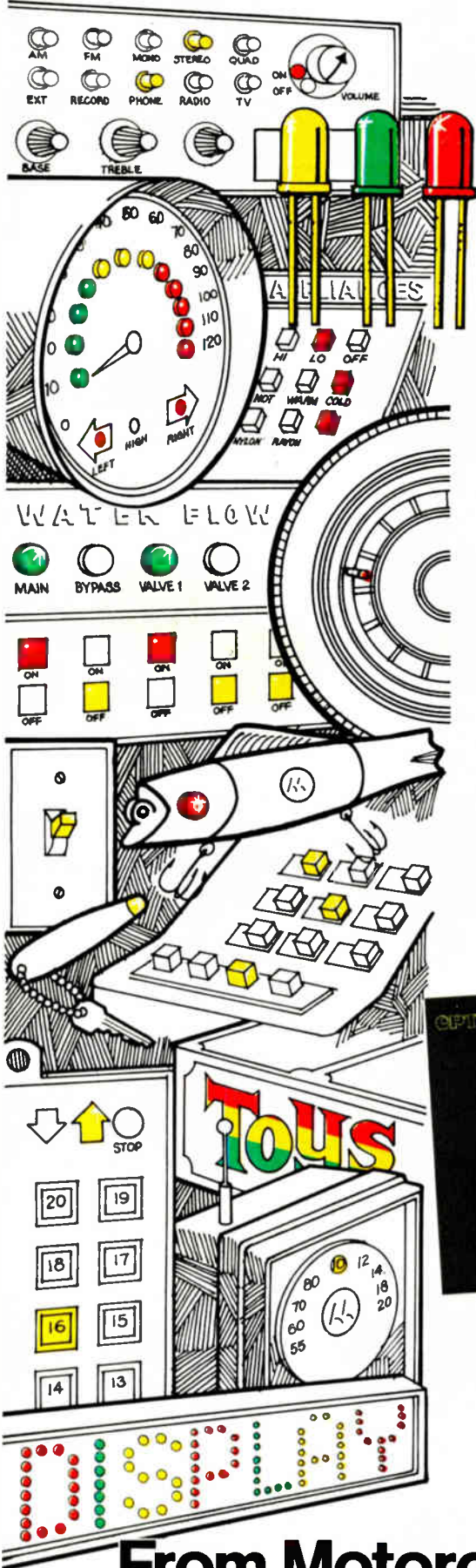

We'll Be Seeing You In All The Old Familiar Places

The LED creative design ball is rolling. Light emitting diodes are being designed in everywhere.

Red. Yellow. Green.

Motorola is a leader in volume production of standard LEDs. Because Motorola is the leader in volume-produced semiconductors.

You have a choice of 20 different visible and IR LEDs in 7 plastic and metal packages from Motorola. With more on the way.

All offer long-term performance incandescents can't.

Like the new MLED850 yellow LED: a 90° field-of-view, 0.5-typical-mcd-intensity unit going for a 100-up of just 89¢.

To get you started in the right LED direction, a new brochure is available. It furnishes selection and cross-reference data, parameter, characteristic and terminology discussion, basic design considerations and application note references.

Send for it. Box 20912, Phoenix 85036.

You may not have a place for LEDs now.

But you know they're always available...



Popular
From Motorola, the LED Producer.

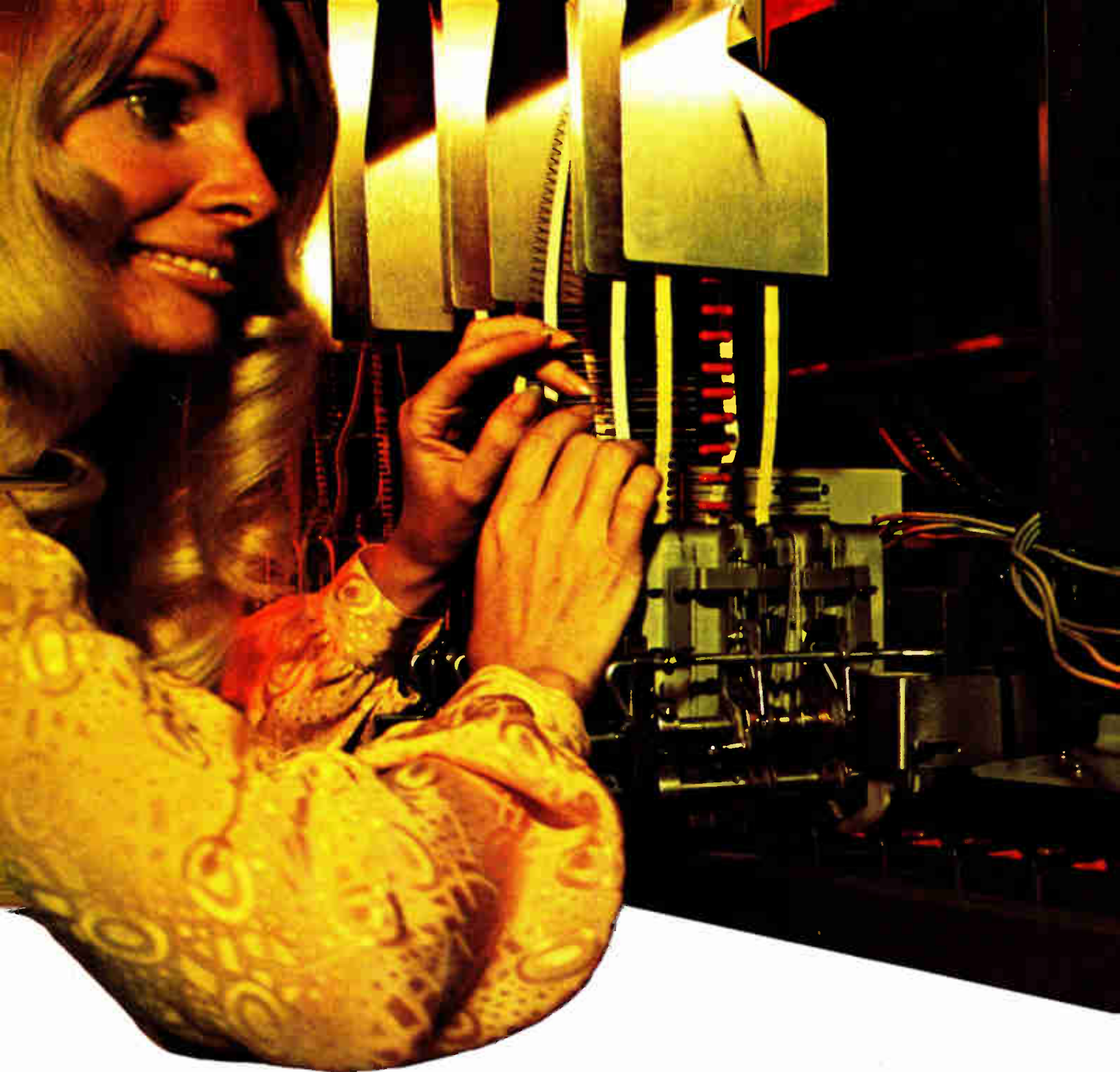

Component Orders Up? Shipments Down?

HP's new LCR meter helps you get your orders out fast. If you're testing diodes, capacitors—or trimming IC capacitors or resistors—you need fast, precise, automatic LCR and loss measurements. You need the most *reliable* LCR meter you can get—one with solid state circuits and LED display. Now you can have it for only \$4295*—less than you've had to pay for this kind of capability. When you plug our new Model 4271A 1 MHz Digital LCR Meter into your system you get fast-reading digital measurements, 10,000 an hour or more. You get four-pair measurement and offset adjustments that eliminate most fixture problems. And you get an instrument that's compatible with many HP programmable calculators and computers.

But the 4271A's accuracy and versatility make it just as great an asset to your design lab as to your pro-

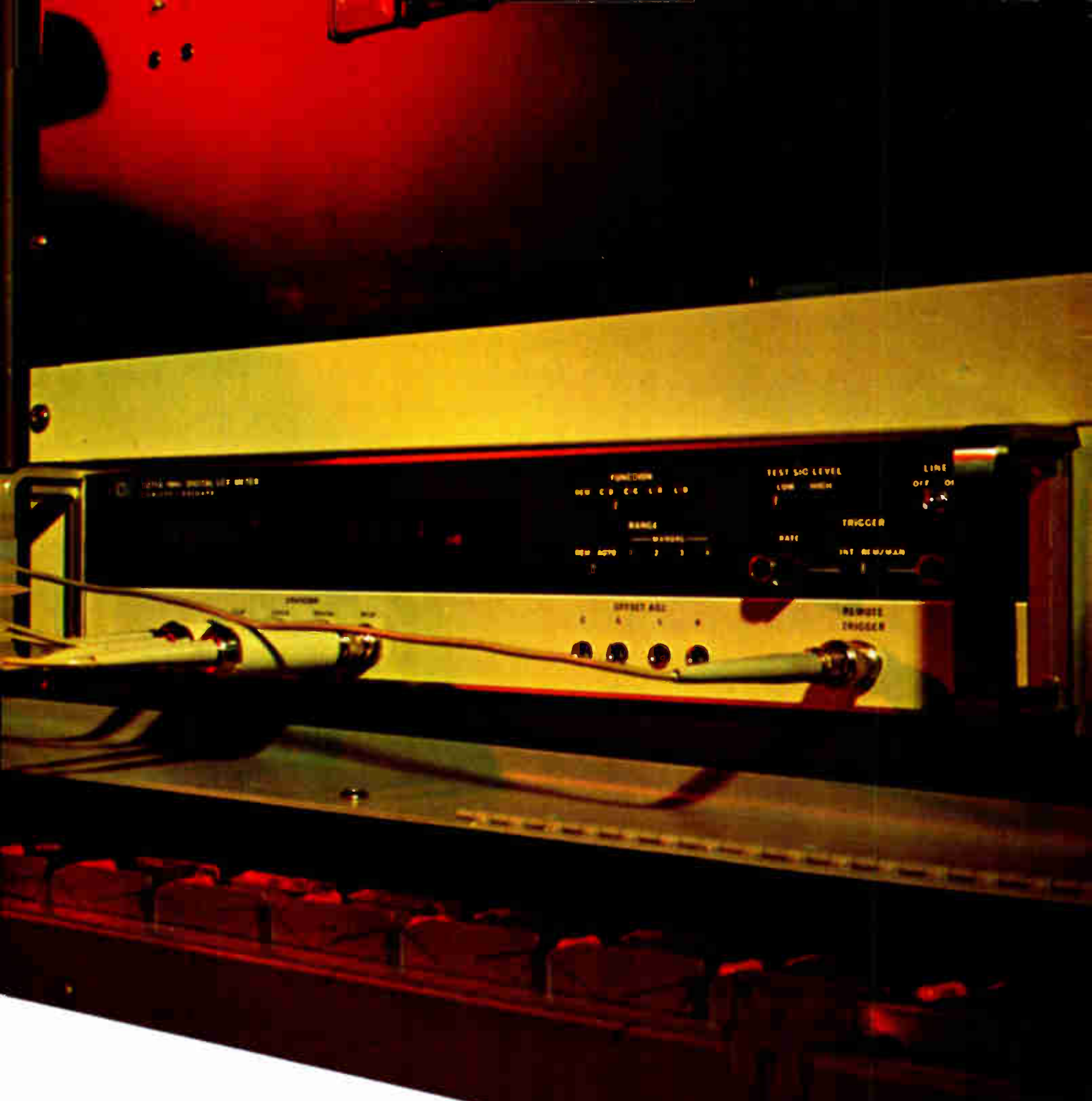

duction line. It's a snap to measure capacitance from 10.000 pF to 19.000 nF, and to measure inductance from 1000.0 nH to 1900.0 μ H. You'll also find that you can greatly simplify varicap diode testing and other kinds of micro-circuit design measurements with the 4271A and its optional DC Bias Controller. This lets you vary DC bias from 00.0V to 39.9V in 0.1V increments.

Remember that this new addition comes to you at a new low price, \$4295*. Inexpensive options are also available: Program Code for Calculator/Computer Interface or BCD Output, DC Bias Controller —and DC Power Supply. And they're all backed by HP's time-tested reputation for reliability and service.

For more information contact your local HP field engineer.

*Domestic USA prices only.

The Useables — new standards in component testing.



Universal Bridge, High Resistance Meter, LCR Meter, Analog Comparator
Universal Bridge, Milliohmmeter, Q Meter, Automatic Capacitance Bridge, High-Capacitance Meter

HEWLETT  PACKARD

Sales, service and support in 172 centers in 65 countries.
Palo Alto, California 94303. Offices in principal cities throughout the U.S.

093/53

Circle 59 on reader service card

“We subjected the Augat plug-in socket panel to an accelerated-life test in order to induce contact failure.

“We failed.”

Dave Fillio
Principal Engineer, Component & Materials Engineering
Honeywell Information Systems

"We needed an interconnection system for controllers on the H716 minicomputer that could help us meet four basic requirements:

"High density to get as much as possible into a small package and still meet the increasing customer demand for a broad range of peripherals, each requiring a separate controller.

"The capability of automatically wiring, with a minimum of two-levels.

"Flexibility to permit anticipated design changes and still allow us to meet a very tight schedule.

"And finally, all these features had to be available in a standard product.

"The most logical approach seemed to be printed wiring boards. But to accommodate all our controllers could have required as many as eight boards. And we couldn't afford the room. Also, when recycling changes are taken into consideration, the design cycle of printed wiring boards becomes too long and, consequently, too costly.

"Multi-layering offered a minimum of flexibility, and it, too, was rejected.

"The only practical solution was the plug-in socket panel. And of all the vendors, Augat was the only manufacturer that could provide a completely uniform, broad range of standardized products, the lowest possible profile and maximum reliability.

"The reliability tests we conducted on the Augat machined sockets included environmental exposures, accelerated-life, vibration, thermal shock, and durability. All tests with the Augat system were positive.

"From a field service standpoint, a key consideration with increasingly complex and flexible systems like the H716 is keeping them on the air at all times. Because of the reliability of the Augat interconnection system, we've had no reports of machine down-time associated with the Augat product since the introduction of the H716 eight months ago."



Dave Fillio

More and more companies like Honeywell are realizing that Augat socket-panels are an economical, reliable and totally flexible solution to interconnection problems, including development, production and field service requirements.

Augat's precision-machined tapered entry contact has made Augat the reliability standard for the industry. As the world's leading manufacturer of socket panels and other IC interconnection products, Augat is ready to help you solve your interconnection problems.

Call or write today for a free brochure and complete product information. Augat, Inc., 33 Perry Avenue, Attleboro, Massachusetts 02703. Represented and distributed internationally.



The H716

Plug into Augat®. Honeywell did.

Growing with the

Amphenol's new telephone connector system saves space, saves time, saves material.

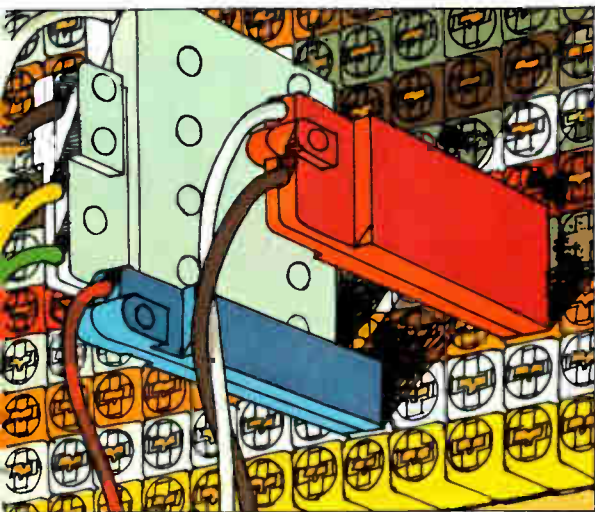

It's called Circuit Concentration Bay (CCB) and was first used to alleviate the problem of overcrowded distributing frames in a major Colorado telephone company central office. More than five miles of cable were actually eliminated in this installation. Floor space requirements were reduced by 80 per cent.

As more and more phone companies gain experience with CCB, it is also becoming clear that the savings in labor are at least as great as the space savings. Instead of the tedious, time-consuming job of hand soldering each connection, the craftsman uses color-coded miniature patchcords to complete circuits in about one-twentieth the time. And circuit interruptions found in normal distributing frames are virtually eliminated.

The savings in space, materials and labor due to Amphenol's CCB system are adding up to tremendous cost reductions and improved service for phone companies across the country.

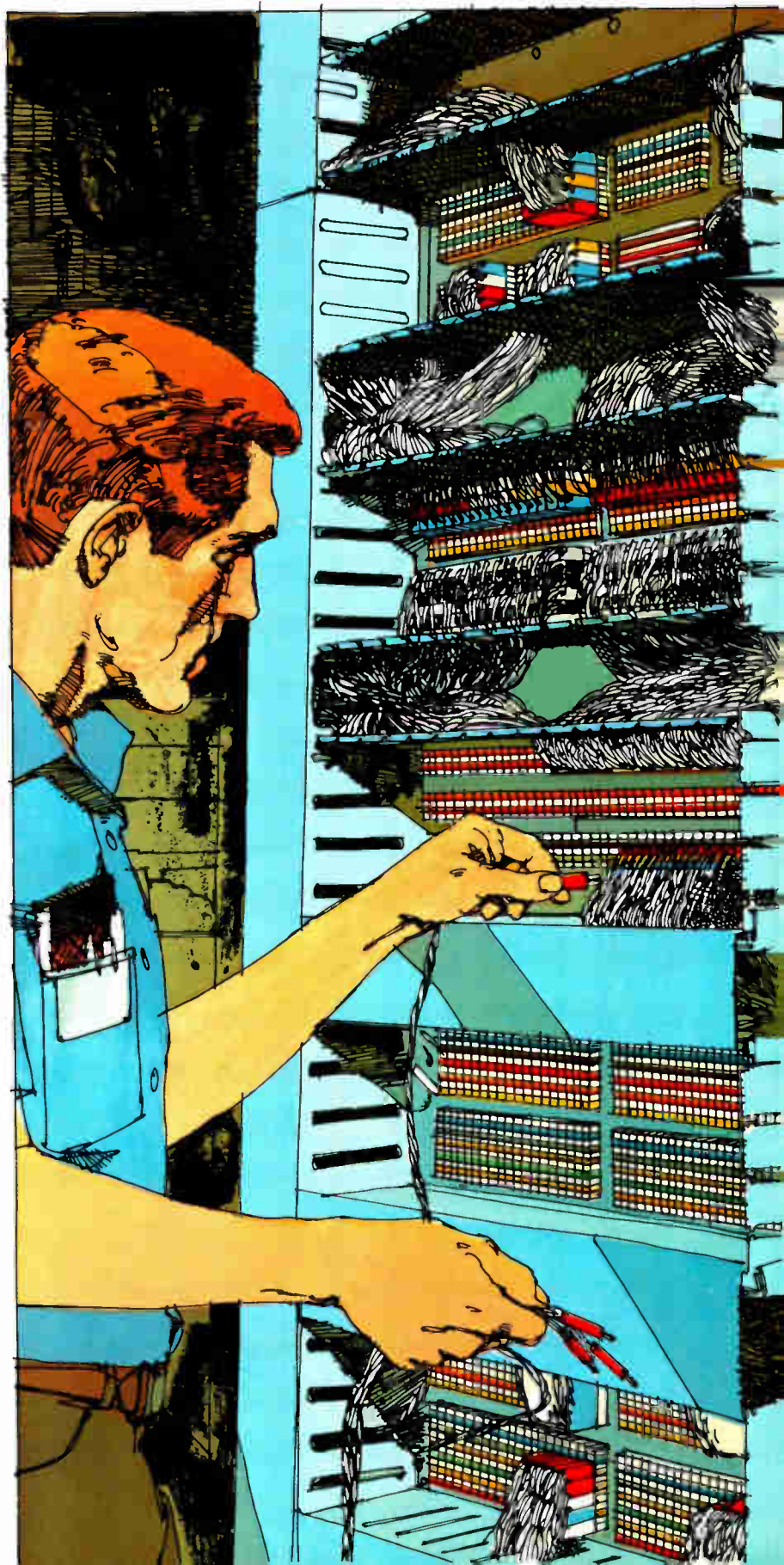

new electronics

Amphenol connectors help a mini-computer control a 70,000 vehicle intersection.



A sophisticated traffic control computer was installed last year to tame an unusually busy intersection in Campbell, California.

Environmental problems are tough because the controller is located right at the intersection. It must remain unaffected by temperature variations between 0 and 120°F. and by voltage variations of plus or minus 10 per cent. It must perform faithfully for years to come.

That's why Amphenol's 5015 series connectors were selected. Our "Old Vet" has a service record in tough environmental conditions that no one can match. Some "Old Vets" are in service after over 30 years on the job.

That's important to Campbell, California because their traffic controller has a lot of work ahead of it.



Amphenol digital turns-counting dials help load a ship by computer.

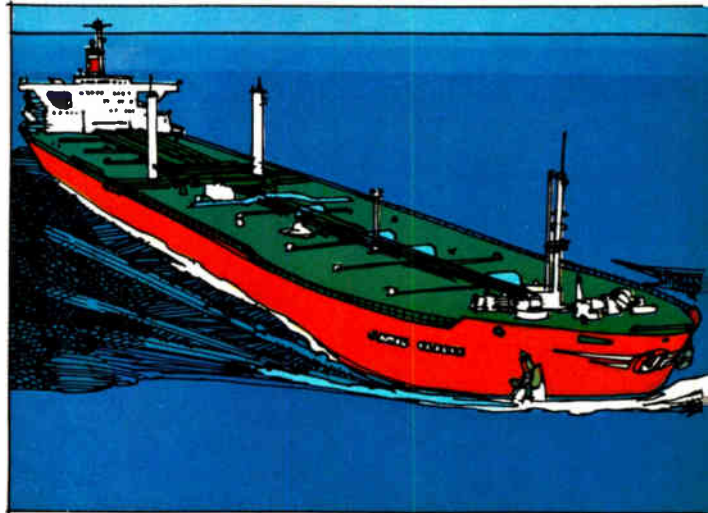

Unless a ship's cargo is distributed just right, stresses can cause extensive hull damage. So proper load distribution is critical. That's why one of the world's largest shipbuilders has developed an electronic cargo distribution computer. It presents cargo placement and hull stress information continuously.



The Swedish manufacturer selected Amphenol dials for this computer because they're so easy to read. A magnifying window significantly enlarges the numerals and vernier scale, and digital readout is angled to the perpendicular for easy viewing from all positions.

Easy readability of the computer input devices is essential because a misread digit, when fed into the computer, could cause a disastrous error in loading.

BUNKER RAMO AMPHENOL

For more information, contact these manufacturing/sales facilities. United States: Amphenol Sales Division, 2875 S. 25th Av., Broadview, IL 60153 Canada: Amphenol Canada Ltd., 44 Metropolitan Rd., Scarborough, Ont. Great Britain: Amphenol Ltd., Thanet Way, Tankerton, Whitstable, Kent, England West Germany: Amphenol-Tuchel Electronics GmbH, 8024 Deisenhofen bei Munchen, West Germany France: Usine Metallurgique Doloise, 92a98 Avenue de Gray, 39100—Dole, France Australia: Amphenol Tyree Pty. Ltd., 10-16 Charles St., Redfern, N.S.W. 2016, Australia India: Amphetronix Ltd., 105 Bhosari Industrial Area, Box 1, Poona 26, India Japan: Daiichi Denshi Kogyo K.K., 20, 3-Chome, Yoyogi, Shibuya-ku, Tokyo, Japan 151

Circle 63 on reader service card

You're O.K., we're O.K.

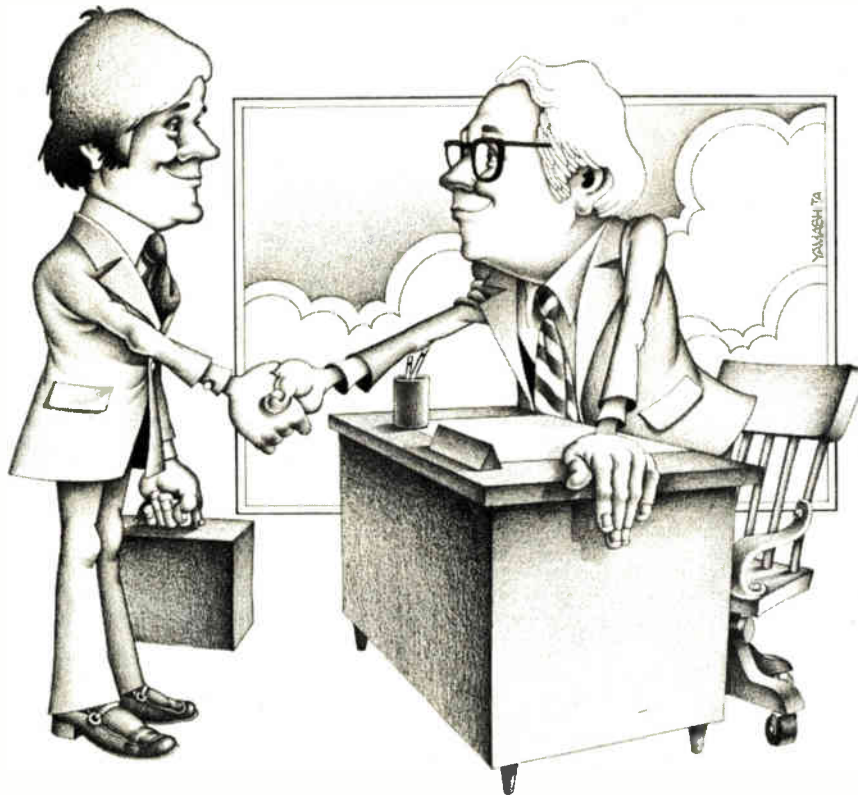

You're O.K.—if you're abreast of latest developments in one of the vital technologies of the aerospace/electronics industry—electro-optics—and if you want a wide open opportunity to exercise your capacity to create and grow.

We're O.K.—if we offer you a challenging assignment, a congenial ambience, an attractive salary, and a promising, long term future.

We believe we do.

We're at work on some 550 projects and programs in 80 major areas. We're a friendly stimulating outfit that recognizes ability and rewards it. We're proud of our pioneering new technologies and building sophisticated systems of superb reliability. We believe it's the reason our sales and backlogs are steadily growing.

HUGHES
HUGHES AIRCRAFT COMPANY
U.S. citizenship required.
Equal opportunity M/F employer.

We especially need *senior staff engineers* to perform conceptual design, analysis, and test of integrated infrared focal planes using charge couple devices for readouts and signal processing, and *packaging engineers* who have a working knowledge of hybrid and LSI technology, high density packaging techniques, and micro-miniaturization for space-qualified units and subsystems. And we always have openings for good airborne weapons *systems engineers* and creative *conceptual design engineers*. While these positions offer opportunity for advancement, they are *not* managerial.

So if we sound O.K. to you, please airmail us your resume. It could be the best 11¢ you ever spent.

Write: Mr. Robert A. Martin, Head of Employment, Dept. 42, Hughes Aircraft Company, Equipment Engineering Divisions, 11940 W. Jefferson Blvd., Culver City, CA 90230.

Navy to try closed-flux memories

Lab tests show they're small, fast, reliable enough to compete if they can be produced in quantity with sufficient yield

by George Sideris, San Francisco bureau manager

Closed-flux memories—the planar counterparts of plated-wire memories—shape up in the laboratory as a technology to be reckoned with in future computer designs. Tests of lab models indicate that CFMs will be as fast as bipolar semiconductor memories and smaller, more reliable, and less power-hungry than any other class of memory. And since the basic planes—each only 3 inches square but capable of storing 4,096 computer words—are batch-fabricated through metalizing, etching, and plating processes, CFMs could be inexpensive in mass production.

There's the rub, though. CFMs have not been produced or tested in sufficient quantity to determine whether manufacturing yields are high enough to justify mass production of the planes and development of the integrated circuits that will be needed to operate them. That crucial step will be taken soon at the research and advanced technology division of Ampex Corp., Redwood City, Calif., which has been experimenting with CFMs for three years under contracts from the Naval Air Development Center at Warminster, Pa.

The Navy has given Ampex a total of \$190,000 in 1970, 1971, and 1972 to make and test lab models. Now, armed with a new award of \$500,000, Ampex is setting up a pilot plant with a capacity of 500 planes a year. For that sum, NADC next July will receive 50 fully tested planes and a statistical study of process yields. The planes are to store 2,048 words of 32 bits each, with each bit stored redundantly in three storage sites—a total of nearly 250,000 sites, counting spare bits, in a module a fraction of an inch high and 9 square inches in area.

By next summer, Ampex hopes the Navy also will have started IC development. To capitalize on the planes' high storage density, drive and sense circuits are to be mounted along the edges of the planes. The lab models use discrete components, emitter-coupled logic, and amplifiers in assemblies about 100 times larger than the planes.

If closed-flux memories are produceable, they will provide the extremely compact and fast memory stacks the Navy wants to put into the all-applications digital computer. As its name implies, the AADC (formerly called the advanced

airborne digital computer) would go into many avionics systems in the next decade. Ever since the project began, the Navy has viewed the closed-flux memory as a leading contender for the AADC [*Electronics*, Aug. 3, 1970, p. 89]. An advanced development model of the computer is expected to be ready in 1976.

A clean room. Herman A. Ferrier, Ampex program manager during the previous lab studies, is confident that the CFM will pass muster. However, he has not been able to prove it in the lab. Nor has he had the data for a production-cost estimate.

"We couldn't test a fully populated plane," he points out. The R&D awards didn't include funds for a system to test all the cells on the prototype planes. Instead, small groups of cells were operated to analyze performance. And if 100% tests had been made, the yield figures would not have been valid because the planes were virtually hand-made in the contaminated environment of lab benches.

Part of the new \$500,000 contract will pay for a clean room and a \$50,000 test system. The room will provide an environment comparable to that of an IC plant. A tester

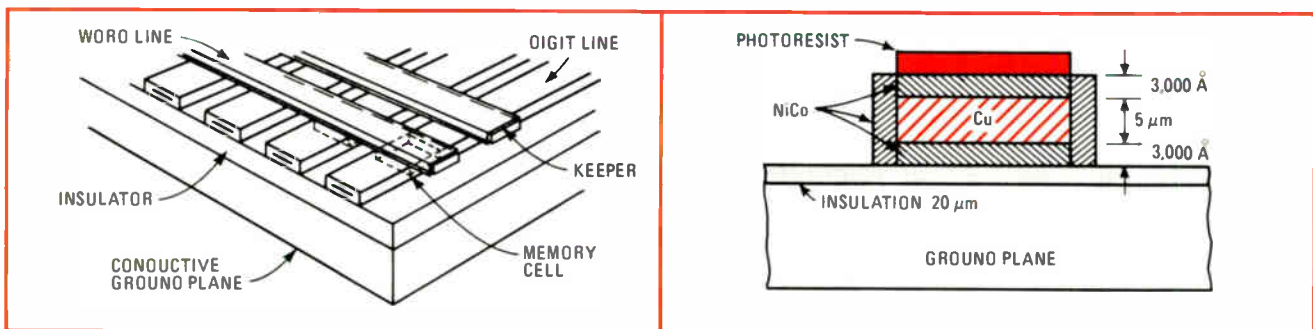

Closed-flux memories. Digit lines are made by plating a magnetic alloy to an insulating film laminated to an aluminum ground plane, etching the alloy into narrow strips, plating on copper, then plating magnetic alloy around the copper. Word lines are plated copper.

Probing the news

similar to a system for probing IC wafers is needed because a plane's word and digit lines end at pads spaced 10 mils apart, the spacing of bonding pads on IC chips.

Pilot production will be managed by John E. Keenan, who has replaced Ferrier because of his experience in developing production and test systems. (Ferrier has been made responsible for one of Ampex's proprietary R&D projects.) At the end of November, Keenan started equipping the clean room. He hopes to start producing planes this winter and have a preliminary estimate of yields by spring.

Clean-room processing and tests after each major production step should indicate whether the process can be controlled to keep the number of flawed cells low and reveal the distribution of the flaws. For instance, large numbers of tiny scattered flaws can be tolerated if each flaw affects only one of the redundant sites in a bit cell. If the flaws spread over groups of adjacent sites, they can be bypassed by wiring the drive and sense chips to spare bits on the plane or by programing the computer to avoid bad bits.

How much? Keenan is willing to predict only that CFMs should cost much less than conventional plated-wire memories (30 to 60 cents a bit) used in hardened military systems. That prediction is based on Ferrier's estimate that the lab models cost about 10 cents a bit to make and on the assumption that production will involve a fraction of the lab costs.

Given acceptable yields, CFMs may compete with cores and semiconductors in the military market, since they are 10 times faster than cores and do not pose the volatility problems of semiconductors. But commercial core memories are down around 0.1 cent a bit and high-speed semiconductor memories are approaching 1 cent a bit. Even to attempt to get into the range of core-memory costs "would take a multimillion-dollar plant and huge volume," Keenan says.

One development that could cut the cost of the planes nearly in half would be a single-input IC sense amplifier able to recover from a 4-volt

overload within 50 ns and then sense a 1-millivolt pulse. The overload is the read-drive signal, and the millivolt signal is the response of the bit-storage cells.

For lack of such ICs, Ampex will probably have to depend initially on complementary drive circuits and differential amplifiers. Such circuits cancel out common-mode noise so that the amplifiers need only detect the millivolt signals.

However, it will necessitate using two planes instead of one to store the 2,048 32-bit words that could be stored in one plane if single-input amplifiers were used. It will also require assembly to the planes of a small, etched-wiring matrix to provide hundreds of electrical cross-overs.

A set of drive and sense circuits will be needed for each pair of word and digit lines. The word lines are etched copper traces about 5 mils wide atop the plane; the digit lines are copper traces enclosed in plated magnetic alloy "wires" 1.6 mils wide. Each digit line is formed in a lazy-S pattern the width of the plane so that each digit line is crossed three times by each word line, giving triple redundancy.

Plans are to produce an array of 274 by 274 triple cells on each plane. Of these, only 256 by 256 cells would be connected to the circuits to form the 2,048 by 32-bit working plane. That leaves 18 spare bits in each 256-bit segment for use

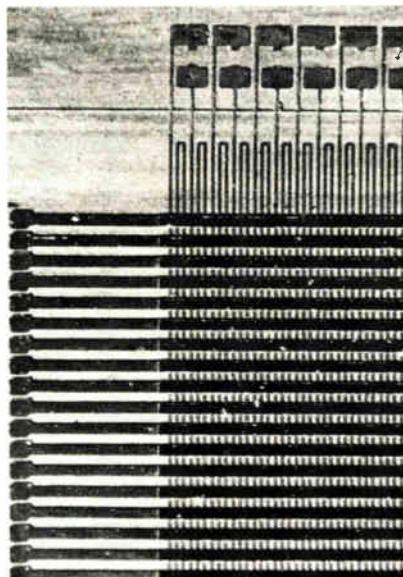

Sharp turns. Digit lines go under word lines, return, then go to other end again.

in flaw-avoidance schemes. In 1970, when the CFM concept was more a gleam in the eyes of Ampex researchers than a reality, the estimated cost per bit was 0.5 cent, including electronic circuits. That figure would have made CFMs competitive with core memories and would have swamped the infant semiconductor-memory market.

Ferrier disclaims the estimate as "before my time" and predicated on extremely high-volume production. Also, CFM complexity has risen in the past few years. Extra processing steps, new materials developments, and the redundant design have been found necessary to satisfy reliability requirements and overcome the limitations of IC sense amplifiers.

Early experimental cells were relatively simple structures, fabricated by plating and etching layers of permalloy (nickel-iron alloy) and copper on an epoxy-coated aluminum ground plane [*Electronics*, Sept. 28, 1970, p. 39]. More recent R&D has shown that military reliability specs require the use of a magnetic (cobalt-nickel) alloy with high coercive force, nickel-phosphor depositions to keep the alloy from crystallizing, laminated Kapton films to insulate the ground plane and wiring layers, and dual planes with pairs of differentially connected triple sites.

Ampex test reports to the Navy show this structure operates reliably at temperatures from -55°C to $+150^{\circ}\text{C}$. It will retain data through 1,000 worst-case disturb cycles, and it can be read out nondestructively at least 100 million times. Accelerated life tests indicate an operating life of more than 30 years at 100°C . And despite the high coercive force of the cobalt-nickel alloy, a plane storing 2,048 32-bit words can operate at IC voltage and current levels on average drive power of about 250 milliwatts.

The triple-cell structure reduces the needed drive current by two-thirds. The ICs themselves are expected to dissipate several watts. Keenan and Ferrier expect the memories to hit an access time of about 60 nanoseconds. The lab models meet Navy specs: 80-ns read-only access time, 100-ns read cycle, and 150-ns read-write cycle. Those speeds were demonstrated by a 16-by-16 model. □

We clamp all the way down
on voltage drain, current
drain, and heat emission...
give you a single-plane
phosphorescent display
you can see across the room.



We clamp down fully
on the disadvantages of other displays.

Our digital readouts,
including the extremely lightweight,
mini-size Multi-Numerical Indicator
with 8, 10, and 12 digit readout,
offer low-voltage,
low-current drain,
and stability advantages over
conventional displays.

All have eye-easy phosphorescent
segments with digits on a single-plane
for optimal visibility
under ambient light.

It's a natural green glow,
so soft and clear you can see
it across the room.

But the best comes last:
They're competitively priced
for all modern applications
in calculators,
digital clocks, voltmeters and counters,
and a host of others.
Count on us.



DP89A

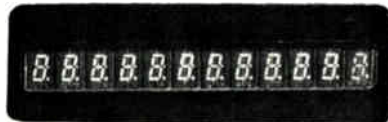

DP127F

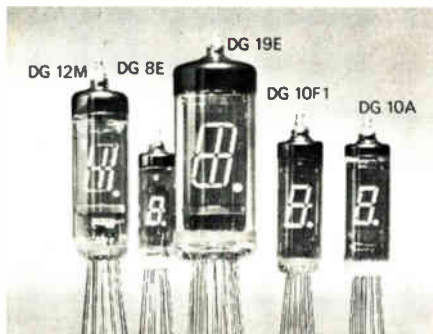

The Brighter Side of Electronics



ISE ELECTRONICS CORP.

P.O. Box 46 Ise City, Mie, Japan Tel: 05963-5-2121

International Div.

ISE INTERNATIONAL CORP.

Shinbashi Kokusai Bldg.
No. 7-7-2, Higashi Shinbashi Minato-ku, Tokyo, Japan
Tel: 433-6618 Cable: Iseworldrep
Telex: J26546 Iseinter

Representative:

ISE CORP. OF AMERICA

(The former LEGI ELECTRONICS CORP.)
1472 West 178th Street, Gardena California 90248
Tel: (213) 532-0470, 0471

Space electronics

Atmosphere Explorer: a low flyer

Craft will dip to within 120 kilometers of earth as its 14 experiments check solar radiation effect on thermosphere and ionosphere

by Alfred Rosenblatt, New York bureau manager

The lowest-flying earth satellite ever to be orbited is set for launch at about Christmas time. The satellite is designed to make a broad range of measurements of the physical processes in the lower thermosphere and ionosphere that are caused by intense radiation from the sun. Designed and built at RCA's Astro-Electronics division, Princeton, N.J., the 1,450-pound satellite, aptly named Atmosphere Explorer C, will fly a highly elliptical orbit. Its low point, or perigee, will be only some 120 kilometers above the earth's surface. At its high point, or apogee,

One to make ready. The Atmosphere Explorer satellite is ready to go. Louvers on underside are designed to cool the craft.

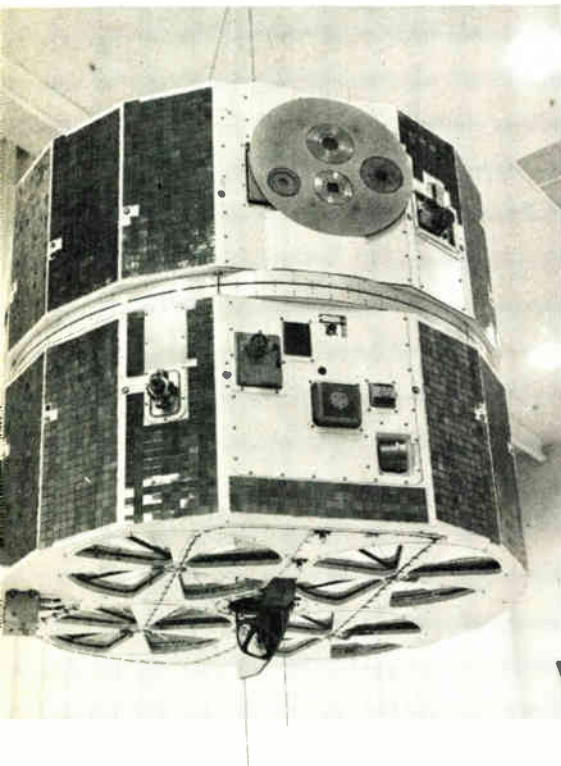

the satellite and its 14 scientific experiments will sweep out to 4,000 kilometers.

The drum-shaped Atmosphere Explorer provides a stabilized platform for 14 experiments and the support systems for handling power, command, control, and data communications, as well as tape-recording, attitude control, and orbit-adjust propulsion. Two previous spacecraft—more probes than satellites—for studying the earth's atmosphere were much smaller. Explorer 32, for example, launched in May 1966, weighed only one-third as much and carried only six experiments.

The new craft is a 16-sided polyhedron that is 53.5 inches in diameter and 45 inches high. Most of the scientific instruments are mounted along the outer edges of upper and lower base plates so that they can "look" out into the environment. The instruments will examine the chemical and physical processes associated with the absorption of the sun's ultraviolet radiation in the upper atmosphere and thermosphere, or lower layer, of the upper atmosphere. These processes alter the composition of the atmosphere, and scientists have long believed that this affects global weather conditions and the earth's ecological balance. Sensors will include an electron-temperature probe, photometers, and spectrometers. The instruments will gather data on charged and neutral particles; the solar spectrum and atmospheric absorption; electronic, ionic, and neutral gas temperatures; and thermal and photo electrons.

The orbit period for a revolution around earth will be 129 minutes,

and inclination of the orbit will be 68°. The primary data-gathering period for the satellite will be at its perigee. A propulsion system aboard the craft will be fired about five times during the spacecraft's mission to alter the perigee from 150 kilometers down to only 120 kilometers, bringing the craft into the thermosphere.

As the spacecraft nears the low point of its orbit, an on-board propulsion system will be fired to restore the orbit and to compensate for the energy lost because of the drag of the atmosphere. The Explorer will also gather information as it swings away from the earth to its apogee of 4,000 kilometers. All data will be recorded aboard the craft for later telemetering at a rate of 16,384 bits per second to earth. Signals will be received by NASA's worldwide tracking network. Later phases of the mission, which is to last a year, will include low-orbit circular flights of the satellite.

Knowledge. The Atmosphere Explorer will produce as much knowledge about the upper atmosphere as all the experiments that have been performed since the first Sputnik went up, predicts physicist W.B. Hanson of the University of Texas at Dallas. In addition, the satellite itself is the first spacecraft to be committed almost totally to using complementary metal-oxide semiconductors, even in equipment for the experiments, points out David W. Grimes, program manager for Atmosphere Explorer at NASA's Goddard Space Flight Center, Greenbelt, Md.

Other noteworthy aspects of the program include a computer-controlled checkout system for the

spacecraft prior to launch and a control center at Goddard to process data received from the satellite in real time so that it is almost immediately available to researchers. The researchers, in turn, are tied into the data at the Goddard center via telephone lines.

Quick data. There's almost a real-time link between the satellite and the researchers, says Brian Stewart, RCA's manager of speciality engineering. "It only takes about a day for data coming in from the satellite to be processed and sent out across the country to the experimenters," he says. In the past, scientists had to wait two or three months for the data to be sent on a magnetic tape. The advantage of such one-day service makes it possible for experiments to be quickly adjusted to take advantage of observations.

The automated checkout system was developed by NASA uniquely for the Atmosphere Explorer, Grimes says, but it could be used, with modifications, for other spacecraft as well. Similar techniques have been used in the past by the Air Force to check out classified satellites, he points out.

Equipment can be tested much more rapidly than it could be with manual or semiautomated techniques, and "there's a tendency to test more functions more thoroughly," points out an RCA engineer on the program. In addition, the checkout system keeps a tape recording of all data coming from the spacecraft so that if there is a malfunction, a test sequence can be carried through to its conclusion. When the sequence is completed, the data pertaining to the fault can be read back to aid in diagnosing the trouble.

At the center of the system is a Xerox Sigma 5 computer with 48,000 words of core memory containing the resident program for interpreting a high-level test-oriented language specially developed for the Atmosphere Explorer. Also included is a Xerox 3-megabyte random-access disk device, three tape drives containing test programs for exercising the experiments and spacecraft subsystems, two high-speed line printers, an operator's console, and four cathode-ray-tube displays with keyboards for bringing

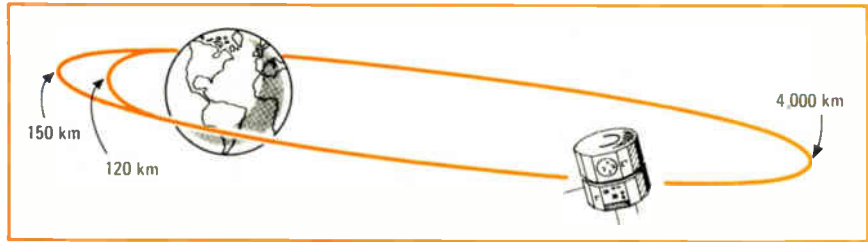

Lows and highs. The Atmosphere Explorer will swing out as far as 4,000 kilometers and come as close to earth as only 120 kilometers as it sniffs the planet's thermosphere and ionosphere and transmits almost real-time data back to Goddard Space Flight Center.

up test and program information.

Xerox Sigma computers—Sigma 5 for control and preprocessing, and a combination Sigma 3 and Sigma 9 for processing data—are also in a separate facility at Goddard that controls the spacecraft while it is in orbit. Data, which is handled as it's received from the craft, is processed and made available to any of the experimenters who desire it. With previous scientific satellites, each experimenter was limited to the data for his own equipment.

C-MOS circuitry. Low power drain—lower than transistor-transistor logic circuits would require—is, of course, one of the prime reasons available for going to C-MOS. But another important factor is that C-MOS componentry provides a larger scale of integration than TTL does. This contributes weight reduction and also enabled an approximately 3% "overbuild" in circuitry, says George Martch, manager of test and manufacturing technology. This overbuilding was included so that any design mistakes discovered as launch time approaches can be easily corrected by wiring around the problem. "A change in a wire and a different software command is all that's required," Martch says.

All told, more than 2,200 off-the-shelf C-MOS parts are used in the command, data-handling and attitude-control subsystems. In addition, another 500 C-MOS devices are packaged in the experimental instruments.

Welded-wired construction is used instead of multilayer printed-circuit boards. "The welded wire gives us a quick turnaround and repair cycle," Martch points out. The approach also makes for greater component density, and he estimates that the standard 6-by-6-inch board used can accommodate 40% to 50% more components than mul-

tilayer pc boards would be able to handle.

A dual-mode system for three-axis attitude-control or spin stabilization with selectable rates of one to 10 revolutions per minute was designed by RCA. It employs magnetic torqueing for roll and yaw; pitch is controlled by a momentum wheel similar to one used aboard the ITOS weather satellite launched in 1970. Wherever possible, off-the-shelf units are used for the communications and tracking functions.

An exception is the S-band resonant cavity slot-type belt antenna built by Ball Brothers Research Corp., Boulder, Colo., which is mounted around the 4½-foot diameter of the craft's equator. Other systems include a vhf beacon/telemetry transmitter, and dual S-band fm transponders. Primary communications are transmitted in the S band. Power is obtained from about 10,000 2-by-2 centimeter n-on-p silicon solar cells connected in series and parallel. They produce 160 watts of power that is stored in three nickel-cadmium batteries aboard the craft.

Two more. Altogether, three satellites are to be built by RCA and launched between now and 1975 at a cost, including R&D, launch, and post-launch support of about \$50 million. Discounting the 580-pound weight of the liquid propellant needed to adjust the orbit and the 14 experiments, each satellite bus will cost \$7,000 per pound, an exceptionally low price for a satellite, asserts RCA's program manager J.J. Newman.

He also says RCA is considering proposing the Atmosphere Explorer as a sub-package for NASA's Space Shuttle because, with "its orbital flexibility, it (the Explorer) could be readily launched and recovered by the shuttle." □

THE FIRST OF THE BIG COUNT TIMERS

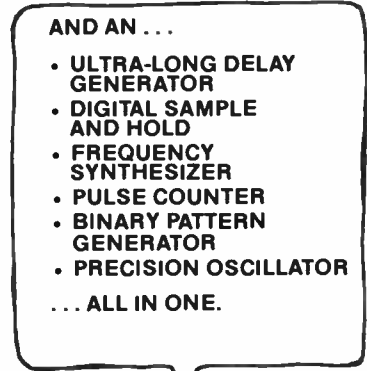
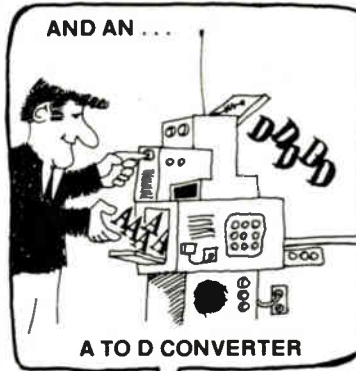
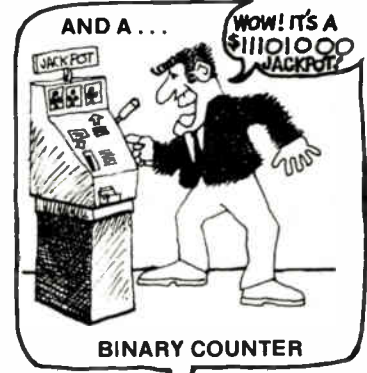
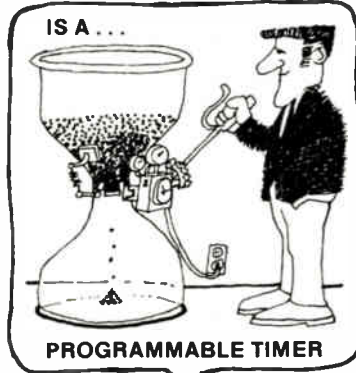
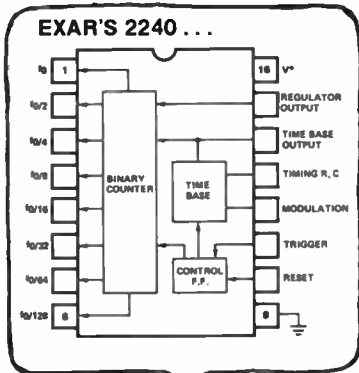

Exar's new XR-2240 counter/programmable timer solves so many tough problems that designers will unanimously agree that it's really the universal timer.

With its unique combination of analog and digital timing methods, you can now replace inadequate and complex assemblages of monolithic and electromechanical timers with the much simpler XR-2240. As a bonus, you get greater flexibility, precision operation, and a reduction in components and costs for most applications.

Because of built-in programmability, you can also use the XR-2240 for frequency synthesis, electronic music synthesis, digital sample and hold, A to D conversion, binary counting and pattern generation, and more.

With a single XR-2240 you can now generate pre-

cision time delays programmable from 1RC to 255RC, a range of microseconds to 5 days. By cascading only two XR-2240 timers, you can extend the maximum delay by a factor of 2^N , where $N = 16$ bits, resulting in a total delay of 3 years!

The XR-2240 operates over a 4V to 15V supply range with an accuracy of 0.5% and a 50 ppm/°C temperature stability. It's available in either a 16-pin ceramic or plastic dual-in-line package for military or commercial applications. Prices start at \$3.00 in 100 piece quantities.

For the more conventional timing applications, look to our other timers: the XR-220/230 timing circuit and the XR-2556 dual timers. Call or write Exar, the timer leader, for complete information.

EXAR SPEAKS YOUR LANGUAGE



EXAR INTEGRATED SYSTEMS

750 Palomar Sunnyvale, California 94086 (408) 732-7970 TWX 910-339-9233

EXAR DISTRIBUTORS Semiconductor Concepts: Woodland Hills: (213) 884-4560 Hauppauge, L. I.: (516) 273-1234 EEP Corporation: Culver City (213) 838-1912 Intermark Electronics: Sunnyvale: (408) 738-1111 San Diego: (714) 279-5200 Santa Ana: (714) 540-1322 Denver: (303) 963-8284 Seattle: (206) 767-3180 Graham Electronics: Indianapolis: (317) 834-8202 Lafayette: (317) 742-4006 Ft. Wayne: (219) 742-4346 Cincinnati: (513) 733-1661 Radio Electric Service Co.: Baltimore: (301) 823-0070 Gerber Electronics: Dedham: (617) 329-2400 Yankee Electronics Supply: Londonderry: (603) 625-9746

Interconnect battle goes to court

MCI files Federal action asking that AT&T be forced to provide links for private-line service of specialized common carriers

by Harry R. Karp, Special Issues Editor

After fighting a long, hard, and expensive battle to win the right to provide leased-circuit services—the Federal Communications Commission gave its approval in 1971—MCI Telecommunications Corp. now has gone to court to try to win its war for success, or maybe even survival. The company has started action in the U.S. District Court in Philadelphia against the Bell Telephone Co. of Pennsylvania and its parent, AT&T. The suit is the latest in a series of actions, interactions, and counteractions involving the Federal Communications Commission, American Telephone & Telegraph Co., Bell System operating companies, state regulatory commissions, and MCI (see “Heading toward a hearing”).

MCI's position is illustrated by a letter from MCI chairman and chief executive officer William G. McGowan, dated Oct. 30, to its 2,000 customers and prospects which, among other things, accuses AT&T of waging an illegal campaign against the FCC's 1971 specialized-carrier ruling. One element in this campaign, says McGowan, was a directive from AT&T to its Bell System companies instructing them to refuse interconnection arrangements for certain types of MCI services.

And, in another letter, dated Nov. 2, MCI says that the Bell System's intransigence in supplying local interconnection facilities between MCI's customer sites and its long-haul microwave links—either not at all, as in Pennsylvania, or too slowly in other areas—has decreased expected revenues well below those it would have enjoyed if all customer requests could have been honored. This reduced flow of cash will force MCI to



slow its expansion plans, says McGowan, and require the company to seek additional debt or equity capital. MCI has already cut 47 employees, 7% of its manpower.

Thus, it appears that an issue raised years ago about the benefits of lower price and improved technology that would accrue to American business by the introduction of competitive communications carriers may not rest at all, in the near term, on price or technology, but rather on the ability of the specialized carriers to generate enough cash to do business and expand.

An immediate victim of the inability to generate revenue at a fast enough rate is another specialized carrier, the Nebraska Consolidated Communications Corp. (NCCC), which services the Midwest. Last month, NCCC president Clifford E. Thompson said: “Unfortunately, our experience with the Bell System and other local telephone companies has not been good. In many instances, they have not been willing to cooperate in the provision of local distribution facilities, as required by the 1971 FCC decision.” The result: NCCC and MCI have

Dialight sees a need:

(**Need:** Find a very small fault in a very large system.)

See Dialight.

All printed-circuit boards need a fault indicator; that's why Dialight has developed such a broad family. These tiny LED devices signal where and when a fault occurs in a complex electronic circuit—and this can reduce downtime to a minimum. With some Dialight fault indicators, you can get as many as 10 units in just 1" of space. These devices, which come in a variety of sizes, are designed to operate from 1.6 to 14 volts and are available with both axial and right angle leads.

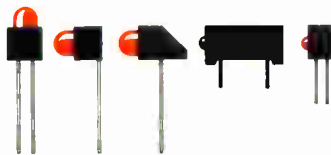

can be driven directly from DTL or TTL logic and can also serve as logic-state indicators, binary data displays, or just as indicators, as in this p-c board furnished by Struthers-Dunn, Inc.* But Dialight's fault finders are only a small part of their fast growing family of light-emitting diodes. Additional opto-electronic devices are extensively used in cartridges, lighted push-button switches, optoisolators, and readouts, all supplied by Dialight. A wide variety of discrete LEDs further adds to the broad family.

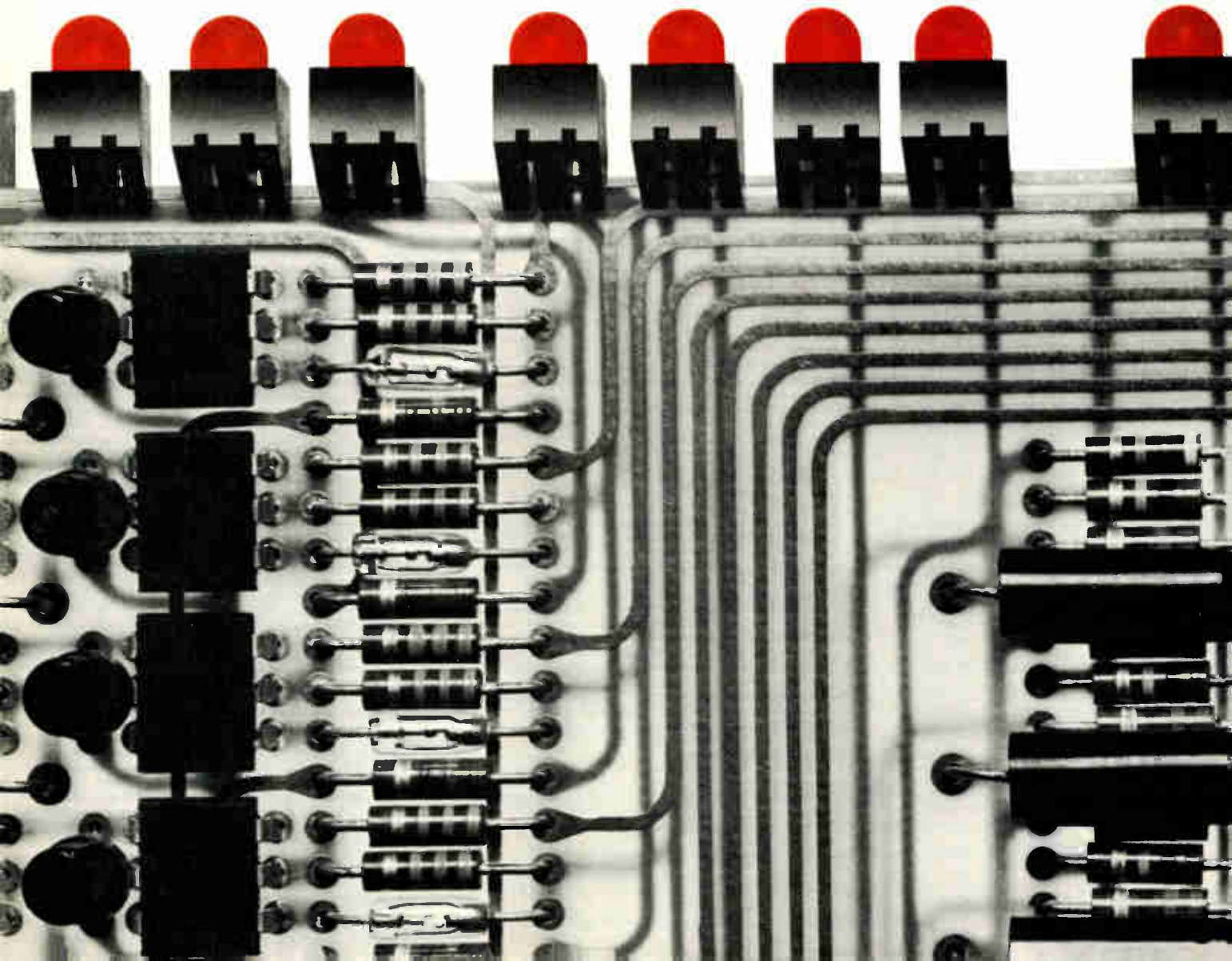

Dialight is a company that looks for needs . . . and develops solutions. That's why we developed the industry's broadest line of switches, indicator lights and readouts using LEDs. No other company offers you one-stop shopping in all these product areas. And no one has more experience in the visual display field. Dialight can help you do more with them. Talk to the specialists at Dialight first. You won't have to talk to anyone else. We can help you do more with LEDs than anyone else because we've done more with them.

Here are a few products in this family: **1.** Ultra-miniature indicator lights **2.** Datalamp cartridges **3.** Bi-pin LED lamp **4.** Opto-isolators **5.** LED solid state lamps **6.** Logic state fault indicators

*Used in their VIP Programmable Controller

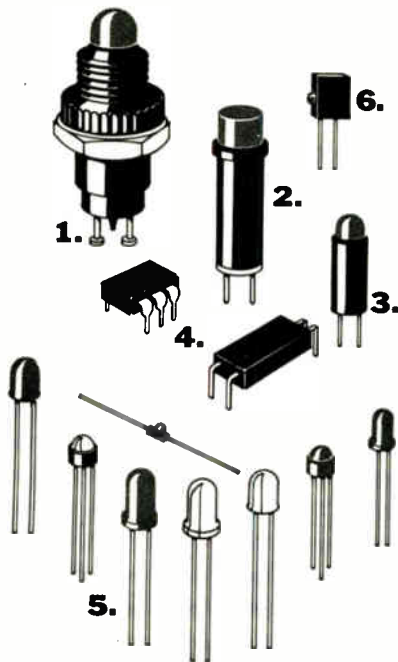

Please send data on your LED products.

NAME _____
 TITLE _____
 COMPANY _____
 ADDRESS _____
 CITY _____ STATE _____

DIALIGHT

Dialight Corporation, A North American Philips Company
 60 Stewart Avenue, Brooklyn, N.Y. 11237 (212) 497-7600

Circle 73 on reader service card

Probing the news

agreed to merge, subject to necessary shareholder and FCC approvals, with MCI as the surviving company. An MCI official called the arrangement a "bailout for NCCC."

Why has MCI had to go to court to seek relief when the issues were decided several years ago by the FCC? The answer is neither simple nor direct. Basically, the action is a revival of a larger conflict between two seemingly contradictory principles that have coexisted in this country for about 100 years. One is the principle of regulated, privately owned monopoly. The other principle is simply that of free and open competition.

A viable détente between these

two principles was supposedly set by the FCC in two momentous interconnection decisions. The 1968 Carterfone decision permitted the attachment of "foreign"—that is, non-Bell—devices to the lines supplied by local telephone companies. And the 1971 specialized-carrier decision authorized new carriers to provide interstate private-line links in competition with the long-haul links of AT&T.

So an economic threat to AT&T has grown in two arenas: one is loss of its revenue at the local level from customer-owned (voice) private branch-exchange systems and telephone instruments, as well as from terminals and modems of all sorts for its data customers, resulting from the Carterfone decision; and the other is loss of revenue on its in-

Heading toward a hearing

- 1968. The Federal Communications Commission issues its Carterfone decision, which permits the interconnection of non-Bell equipment to local Bell lines, but Bell insists on the installation of a tariffed data-access arrangement to protect its network.
- 1971. The FCC issues its specialized-carrier decision, and MCI and other carriers are granted authority to construct microwave transmission links for interstate traffic. Implicit in this decision is the requirement for Bell operating companies to supply interconnections between the specialized carrier and its business customers. MCI builds a link between Chicago and St. Louis.
- Sept. 28, 1973. AT&T responds to a request from FCC for interconnection-tariff information by stating, "it now appears desirable to file tariffs regarding the provision of local-distribution facilities by Bell System companies to other carriers. Tariffs are being filed with state commissions."
- Oct. 4, 1973. Following a unanimous FCC decision, Chairman Dean Burch takes issue with AT&T's position by stating that "such action [to file tariffs with state commissions] would appear to be in direct conflict with the statutory scheme of the Communications Act . . . and, in particular, the policies and objectives of the Commission, as set forth in our MCI, specialized-carrier, and domsat decision." Furthermore, says Burch, "we are of the view that effective implementation of our policy objectives and the statutory scheme of the Communications Act require that you promptly file tariff schedules with this commission . . . which tariff schedules will provide the interconnection facilities essential to the rendition by the specialized carriers of all their authorized services on terms and conditions which are just, reasonable, and nondiscriminatory."
- Oct. 15, 1973. MCI requests specific clarification from the FCC for its entitlement to four particular services from Bell Companies as a result of the FCC's letter of Oct. 4 to AT&T.
- Oct. 19, 1973. The FCC responds to MCI's letter by stating, "we confirm that MCI and/or its customers are authorized to secure from the telephone company serving the area the various types of local interconnection required for all of the services enumerated in your letter that are presently or hereafter offered in your tariffs."
- November 1973. In an attempt to obtain the services to which, by FCC ruling, it is entitled from AT&T-affiliated companies, MCI asks for a writ of mandamus from the U.S. District Court in Philadelphia to force AT&T and affiliates to abide by the FCC's rulings.

Probing the news

terstate transmission links, resulting from the specialized-carrier one.

In retrospect, it seems that both AT&T and the specialized carriers underestimated the intentions of the other party. For example, one of the strong arguments put forth by the specialized carriers in asking for FCC authorization was that they

could provide better-quality service for data communications than could AT&T, primarily because they would have the advantage of newer microwave technology and equipment.

But once MCI has entered the marketplace, its major business has been for voice circuits substantially similar to those supplied by AT&T. MCI has reportedly taken away 70% to 80% of AT&T's private-line business between Chicago and St. Louis.

In effect, though, this specialized carrier is not particularly "specialized" at this time, but its prices are lower.

And the specialized carriers underestimated AT&T's initial acquiescence to the FCC's earlier decision when they expected docile cooperation from the Bell System's operating companies.

Within the past two months, though, there have been signs of a strong stand by AT&T against further intrusion into its business in any arena. Furthermore, AT&T chairman John D. deButts suggests that regulatory commissions declare "a moratorium on further experiments in economics" until the impact on network performance of present interconnect installations can be evaluated. He was concerned about the increased number of service calls and implied a degradation of network performance. DeButts appears to be talking about voice, but data-communications gear suppliers are included.

Any trouble calls on data links, say representatives of two independent modem makers, may be more the phone company's doing than because "foreign" equipment has been attached to the line. Their point is that, although the phone company requires a data-access arrangement (DAA) to protect the network and charges the customer for it, phone-company personnel aren't adequately trained to "strap" and adjust DAAs to meet the customer's applications.

One big company. Whichever way the courts rule on MCI's action, the structure of communications is probably headed for change. One prospect: most of the regional specialized carriers will merge gradually into one major company, competing nationwide with AT&T's Long Lines Department. There are predictions that International Telephone & Telegraph Co.—which until recently has not been involved in domestic communications—will own this second network. ITT already controls a regional specialized carrier, the U.S. Transmission Corp. If MCI faces a long and financially debilitating legal battle with AT&T, observers believe, that ITT cash might make being acquired an inviting prospect. □

You should know about the real cost advantages of custom CMOS.

Most discussions concerning the use of custom CMOS/LSI circuits acknowledge the obvious technical advantages of this approach to implementing complex systems—things like low power requirements, high noise immunity and fanout, good transfer characteristics and the ease of logic simulation.

What many people overlook, however, is the dramatic cost saving often realized by employing custom CMOS in place of multiple-package systems using conventional logic circuits. The fact is this: one of the most significant advantages of custom CMOS/LSI is its ability to shrink system costs—even in moderate production volumes.

We've just published a Cost Analysis File on just this subject. In it are four detailed examples of specific systems in which dramatic savings resulted from the use of CMOS/LSI. One example explains how a single CMOS circuit replaced a 21-package logic system and saved the customer over \$200,000 on a run of only 4500 units. Another shows why CMOS/LSI is competitive even with today's very low TTL prices.

A copy of this publication may help you understand more about the very real cost advantages of the technology. To get one, circle reader service number 245.

We can help.

MICRO POWER SYSTEMS

3100 Alfred Street, Santa Clara, California 95050 Telephone (408) 247-5350

TECHNICAL REPRESENTATIVES IN EUROPE AND THE FAR EAST

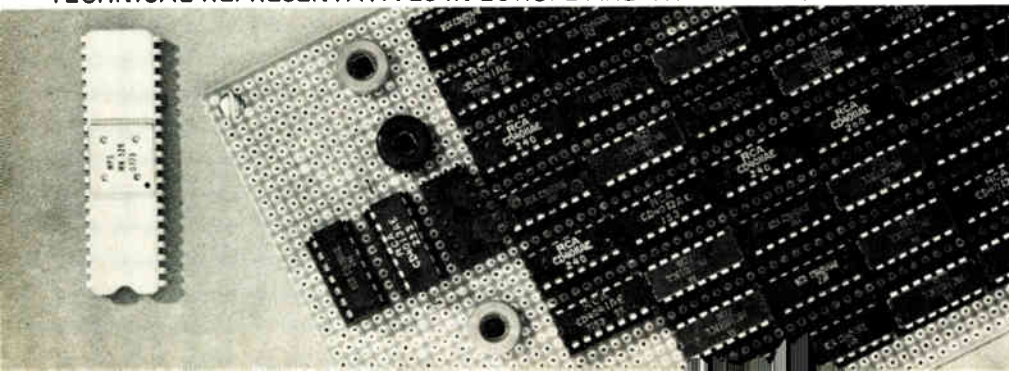

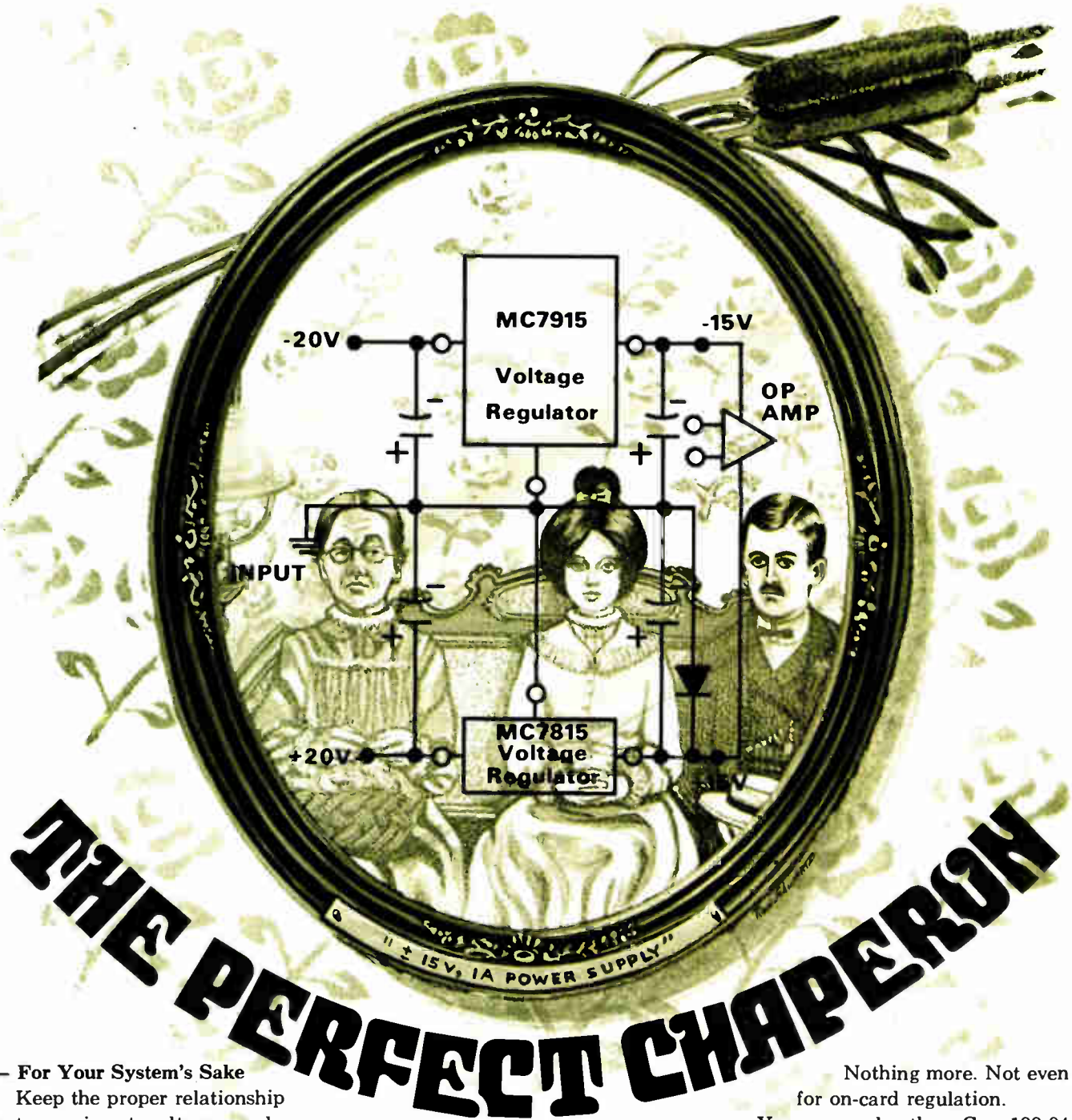

THE PERFECT CHAPERON

— For Your System's Sake

Keep the proper relationship between input voltages and your systems with nine new ICs.

The MC7900CP series three-terminal negative voltage regulators have a rating for all reasons. Besides the -5.0, -6.0, -8.0, -12, -15, -18, and -24 V complements to our MC7800 series, new -2.0 and -5.2 V versions offer superb MECL² system compatibility.

It's difficult to foil these fast paced protectors. Their rated output current is a strong 1.0 A plus; even up to 1.5 A with the proper heat sink and input voltage.

No matter how delicate the situation, these single monolithic chip

devices put voltage in its place. Internal short-circuit current limiting, internal thermal overload protection, and safe-area compensation make them uncorruptible in nearly any operating condition.

Line and load regulation are well controlled, too, with output voltage tolerances of less than $\pm 5\%$.

And these guardians come fully prepared for the job. In most applications, only a capacitor is necessary.

Nothing more. Not even for on-card regulation.

You can employ these Case 199-04 Thermopad[®] packaged escorts for an economical \$2.75 (100-up) for any of the voltage ratings. They're waiting at your local Motorola sales office or franchised distributor. For your peace of mind, post us at Box 20912, Phoenix, Arizona, 85036, to get further information.

The MC7900 series IC voltage regulators.

Upholding the virtues of your system. [®]Trademark of Motorola Inc.



MOTOROLA LINEAR
—practical innovations for systems design!

Common Market tackles Japan

By setting own quotas or making own deals to combat Japanese electronic imports, members are acting against spirit of European community's treaty

by James Smith, McGraw-Hill World News

The Japanese electronic invasion of Europe is creating political, as well as economic, disturbances in the Common Market. The reason: counterattacks in the shape of restrictive quotas imposed unilaterally by individual members and therefore contrary to the Common Market's treaty goal of opening internal frontiers.

In efforts to settle both problems, the Japanese are involved in a round of negotiations with European governments and with the Common Market Commission.

The latest talks opened last month between the Japanese and Italian governments; their object is to lift Italian restrictions on Japanese tape recorders. A new round is also starting in a two-year series of bargaining sessions between the Japanese and Benelux (Belgium, Netherlands, and Luxemburg) governments concerning Benelux quotas on radios, television sets, and tape recorders imposed last April. Also, the legality of efforts to prolong a four-year voluntary restrictive agreement worked out by French and Japanese industries is being examined by the commission. In London, industry talks have been scheduled on voluntary Japanese restraints on television set exports for 1974. Finally, the commission just began examining 1973 restraints on television sets worked out between British and Japanese industry groups.

The controls on Japanese electronic products include both official quotas imposed by European governments and voluntary restraints on exports agreed to by the Japanese themselves. The situation varies from nation to nation.

The Japanese are expected to try to work out voluntary cutbacks on their exports of electronic products to Italy and the Benelux in return for removal of quotas, which the Japanese feel are discriminatory. But all these negotiations may lead only to more conflict. The Common Market's antitrust department has said that so-called "voluntary" restrictions agreed to by the Japanese may violate the Common Market's restraint-of-trade rules, and may have the further effect of raising prices for consumers.

The problem of quotas has existed since 1971, when concern over rising imports of Japanese television sets, radios, tape recorders, and electronic desk calculators first was voiced in the Benelux. Such concern was largely the result of the Dutch giant Philips Gloeilampenfabriek's nervousness about Japanese penetration of its home market.

Benelux industry representatives—mainly Dutch—first attempted to work out voluntary re-

strictions with the Japanese. Subsequently, talks moved to an intergovernmental level but failed last February to achieve agreement on acceptable export levels.

Action taken. Then, on April 25, the Benelux quietly slapped a series of quotas on Japanese television sets, radios, and tape recorders, limiting imports to levels of the period from April 1971 to March 1972, plus an increase of 5%. Restrictions on calculators apparently were dropped, reportedly after Philips moved out of the business.

The argument over imports turned on the amount of penetration of Japanese products in the Benelux market and on the question of injury to local industry—which, in fact, "was never proved to us," says a Japanese trade association spokesman. Some industry sources say Japanese color set penetration was never more than 2%, not enough to permit the Common Market Commission to restrict imports. Counters a Dutch industry spokesman: "This

An unsympathetic America

American views of the European Common Market's efforts to counter rising imports of Japanese consumer electronics have many facets and but one point in common. They are all unsympathetic. European descriptions of increased TV receiver and other Japanese appliance sales as a flood "tells me that they don't know what a flood is," says one U.S. trade official bitterly, noting that Japan accounted for two-thirds of the more than \$1 billion in U.S. consumer electronics imports in the first half of 1973.

Nevertheless, there are a number of U.S. industry lobbyists who privately confess grudging admiration for European policies of self-interest that have protected their domestic manufacturers from Japanese competition. "If we had reacted to imports long ago the way Europe is doing now, we wouldn't be in the bind we are in now," opines one manufacturer's agent.

The Common Market's future effectiveness, Americans agree, could depend on how well it succeeds where the U. S. failed—the adoption of a policy that protects domestic interests without freezing out Japan.

CINCH CONNECTORS

IRC RESISTORS

UTC TRANSFORMERS

GLOBE MOTORS

HOLYOKE WIRE & CABLE

CINCH-GRAPHIK

IRC POTENTIOMETERS

SEMICONDUCTORS

SUPERMET PRODUCTS

CINCH-MONADNOCK

CAPACITORS

ELECTRONIC FUNCTIONS

CONSUMER INTERNATIONAL

You know us well enough to call us by our first name...

Finally!
A filter so precise,
filter characteristics
for every setting
are printed
on top.



We've built a variable electronic filter that's so precise, it has enabled us to print the cutoff frequencies, center frequency, bandwidth, noise bandwidth and filter gain, for every setting, *on top of the instrument*. Besides being the easiest-to-use filters on the market, our 4200 series filters are twice as accurate, have less than half the self-noise, and provide 10 dB greater outband rejection than any other filters. Frequency coverage is .01 Hz to 1 MHz. Built-in selectable post-filter gain and remote preamplifiers are optional. A Butterworth response is used in the NORMAL mode and a Bessel response in the PULSE mode (transient response is superior to conventional "RC" or "Low Q" modes of other filters).

The price? \$695.

For complete specifications and your free copies of our variable electronic filter application notes, write to: Ithaco, Inc., Box 818-7R, Ithaca, New York 14850. For immediate response, call Don Chandler at 607-272-7640 or TWX 510-255-9307.

ITHACO

Probing the news

is a new market—and in a new market penetration statistics don't have much significance." By contrast, tape recorders had the highest penetration, some 40%.

The Japanese also have contended that their color set exports are mainly on the small-screen portable end, while Benelux production was centered on large-screen units.

Last September, the Benelux took a further step and obtained a decision from the European commission permitting the blocking of Japanese electronic products at the German frontier, thus enabling them to check the flow of products coming from Germany, mainly through the port of Hamburg. The frontier closing, provided for under article 115 of the Common Market treaty, applies only when the quotas imposed directly on Japanese imports have been exhausted, and therefore could be upset by the commission if it decides the economic situation does not justify the action.

To expire. Both the Benelux quotas and the article 115 closing expire at the end of this year. Although the frontier closing was protested by the German government, it is not clear whether the Common Market's council of ministers will actually look into the situation. Of course, all this could be avoided if the parties worked out voluntary restrictions among themselves. But should voluntary restrictions be agreed upon in return for lifting of the quotas, the commission would be legally required to unblock imports at the German border. This in itself poses a problem for Benelux negotiators, who would like to keep the frontier restriction.

In Italy, quotas on the imports of Japanese tape recorders, which also expire at the end of this year, are also the subject of government-to-government talks. In contrast to the Benelux situation, the Italian quotas were set last June by the commission after it determined that Japanese imports were disrupting the Italian market.

Japanese industry spokesmen in Brussels appear satisfied with voluntary arrangements worked out with French industry to replace a four-

TRW. CINCH CONNECTORS

TRW. IRC RESISTORS

TRW. UTC TRANSFORMERS

TRW. GLOBE MOTORS

TRW. HOLYOKE WIRE & CABLE

TRW. CINCH-GRAFIK

TRW. IRC POTENTIOMETERS

TRW. SEMICONDUCTORS

TRW. SUPERMET PRODUCTS

TRW. CINCH-MONADNOCK

TRW. CAPACITORS

TRW. ELECTRONIC FUNCTIONS

TRW. CONSUMER INTERNATIONAL

We all have the same first name.

More important, we all operate under the same philosophy, with the same standard of quality, reliability and service. Each of us specializes in a particular area of manufacturing. But not as separate companies. As the operating units of one entity. TRW Electronic Components.

That means you can enjoy all the unarguable advantages of having a single, reliable source for your electronic needs.

Between us, we make over 300 different kinds

of electronic components. And, among us, we have the ability to make whatever you want. High-technology, high-volume—or both. It's all in the family. Or can be.

So it will pay you to get familiar with us, to think of us on a first name basis. In this case familiarity breeds...contentment. With TRW reliability, quality, and service for the components you need. Because we can supply them.

And because we are TRW.

TRW. ELECTRONIC COMPONENTS

10880 Wilshire Blvd., Los Angeles, CA. 90024

LOW COST LOW PROFILE FULL KEYBOARD

AKB-3000 SERIES



ALPS Electronic Alpha-Numeric Keyboard, AKB-3000 Series, has been developed specially for computer related data entry equipment. Experience gained in the manufacture of ALPS' outstanding keyboard switches for desk-top calculators has been applied for top performance.

FEATURES

1. Using coil spring contact mechanism.
2. Low cost.
3. Long-life high reliability.
4. Low profile (1.17in.) and light weight.
5. Easy to replace.

SPECIFICATIONS

1. Mechanical
 - (1) Travel: 0.138 ± 0.02 in. (3.5 ± 0.5 mm)
 - (2) Actuating Force: 2.6 ± 0.65 oz (60 ± 15 g)
2. Electrical
 - (1) Rating: DC12V-0.1A
 - (2) Contact Resistance: $500m\Omega$ Max.
 - (3) Bouncing: 2m sec Max.
3. Circuit
 - (1) Power supply: DC+5V \pm 5%
 - (2) Code: USASCII EBCDIC, JIS, ISO.
 - (3) Output: TTL/DTL Compatible.
 - (4) Parity: Odd or Even.
4. Operating Temperature: 23~'122° F
5. Operating Life: 5,000,000 cycles.



ALPS

ALPS ELECTRIC CO., LTD.

145 HEAD OFFICE: 1-7, YUKIGAYAOTSUKA-CHO, OHTA-KU, TOKYO, JAPAN
 222 YOKOHAMA FACTORY: 1-187, NIPPA-CHO, KOHOKU-KU, YOKOHAMA, JAPAN
 559 OSAKA BRANCH: 28, 3-CHOME, AWAZANAKADORI, NISHI-KU, OSAKA, JAPAN
 NEW YORK OFFICE: ONE WHITE HALL ST. NEW YORK, N.Y. U.S.A.
 DUSSELDORF OFFICE: DUSSELDORF KLOSTERSTRASSE 112 GERMANY

Probing the news

year-old interprofessional agreement that expired last March. The agreement has been extended to March 1974. Commission officials say they are looking into the legality of the extension.

Similarly, the commission will examine limits on television exports worked out between Japanese and British industry for 1973. These restrict sales to 220,000 monochrome sets and 275,000 color sets for the year. Further talks on 1974 arrangements are expected in London later this month.

From the commission's standpoint, voluntary arrangements lessen the chances of obtaining a uniform Common Market commercial policy regarding Japanese electronic imports. Getting such a policy in the electronics sector is extremely delicate since member governments jealously guard the interest of national industries against outsiders. If the commission had its way, it would like first to single out electronic products most suitable for production in Europe. Still, the commission would prefer "a common line" on quotas and restrictions, ruling out a trigger policy.

Secondly, it would like to make the restrictions between countries more even, by preventing countries that permit a high share of Japanese imports on their market from reducing that share, and encouraging countries with heavy restrictions, such as France, to increase imports. Then Common Market funds could be made available to industries hurt by the shift toward uniform quotas. Also, the move toward a single policy would be gradual, to provide time to determine whether some electronics industries could remain competitive.

One problem is to distinguish between production in Europe and third countries. "Companies, such as Philips, which invest in countries with low labor costs and then export back into the community may be important factors in lowering prices for the consumer and in combatting inflation," says a Brussels expert. "But they may also harm weaker national firms, which then cry for protection against the stronger." □

The custom MOS.

If you haven't been able to turn up an off-the-shelf MOS device for a high volume application from us—or anybody else—come back to us. Because you could be in a good position to take advantage of custom MOS.

We'd like to point out a couple of things. First, custom design doesn't have to cost you an arm and a leg. That may be true at some companies, but not at AMI. As long as your volume requirements are high enough, we'll bring in your custom circuit at a competitive price. We've designed more than a thousand in the past seven years, so we know how to get where you want to be in the fastest, most economical way possible.

And second, designing a custom MOS doesn't take forever. At AMI, it's normally less than a year from start to full production.

And production is where dealing with AMI really pays off. As the world's largest producer of MOS, we're way ahead of the others, with a monthly volume in excess of one million LSI devices—and climbing.

We're the only company to design

in seven MOS processes—from P Channel to N Channel, I², Si Gate and CMOS. So we can choose the design that fits your application exactly—whether it's a calculator, dishwasher, musical instrument, car dashboard control, watch, clock or whatever.

Although we're a large supplier of standard MOS products, we got our start as a custom MOS company and we're not about to forget it.

That's worth remembering when you're looking for a proprietary circuit that will give you the jump on your competitors.

We've just published a brochure that outlines our custom

It can put you miles ahead of the competition.

capabilities. It's yours for the asking. And if you want to get right down to business, why don't you tell us your MOS problems at the same time? That way, you'll be another lap ahead. Phone or write our Custom Marketing Department.

American Microsystems, Inc.,
3800 Homestead Road, Santa Clara,
Ca. 95051. Phone: (408) 246-0330.

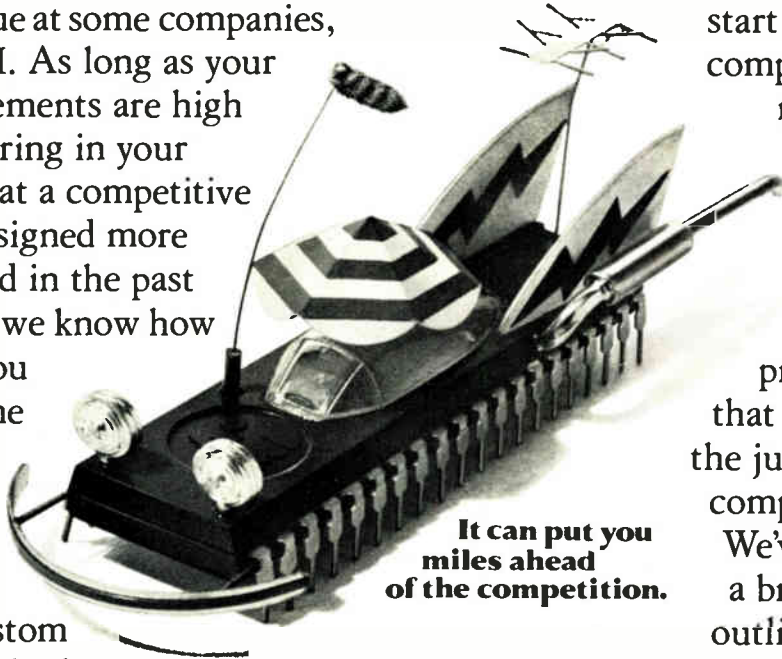

AMI
AMERICAN MICROSYSTEMS, INC.

First with the MOS.

It's either
HALF THE PRICE
or
TWICE AS MUCH
for your money...

OmniScribe™

10" Strip Chart

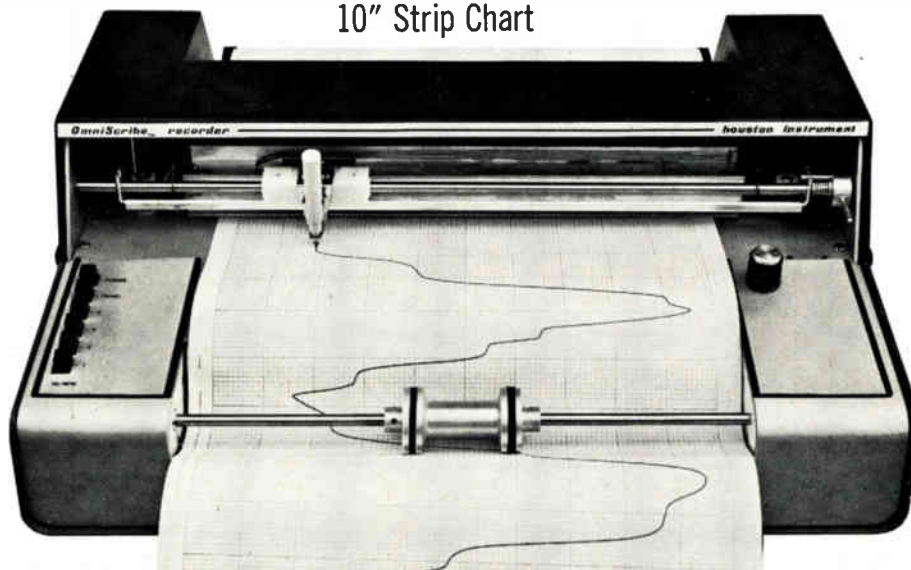

LOOK CLOSELY & DECIDE

1.

The multi-speed chart drive is the equal of any competitor on the market today. Further, the **OmniScribe™** is field adjustable, precisely for English/Metric scaling. Quick, fast, convenient.

2.

Houston Instrument has perfected sprocketless paper drive. It's accurate. It's self-aligning. It works!

3.

A unique operating feature is the non-contact re-balance potentiometer. It eliminates cleaning and trace "glitches" forever. It's beautiful!

4.

Did we mention the price? Just \$395 for single pen; \$595 for dual pen. With options to \$1400.

THE FULL PRICE IS \$39500

*For single pen model

Write today for your complete brochure or contact your nearest stocking distributor listed on the facing page. The **OmniScribe™** is either half the cost or twice as much for your money. You decide.

**houston
instrument**

4950 TERMINAL AVENUE, BELLAIRE, TEXAS 77401
(713) 667-7403 TWX 910-881-5782

European Office
Rochesterlaan 6
8240 Gistel
Belgium
Telephone 059-27445
Telex BAUSCH 19399B

If your application includes industrial, scientific, engineering, pollution or analytical instrumentation,

ORDER
YOUR

OmniScribe™

RECORDER

FROM YOUR NEAREST DISTRIBUTOR

- ALABAMA**
J.L. Highsmith & Co.
3322 S. Memorial Parkway
Suite 36, Holiday Office Ctr.
Huntsville, Ala. 35801
(205) 881-3294
- ARIZONA**
Aztec Enterprises
829 Pennsylvania N.E.
Albuquerque, N. M. 87110
(505) 265-2440
- ARKANSAS**
Comspec, Inc.
13777 N.C. Exway
Suite 416
Dallas, Texas 75231
(214) 234-4137

Industrial Scientific, Inc.
10653 Allyson
Baton Rouge, La. 70815
(504) 921-9282
- CALIFORNIA**
Dayton Associates, Inc.
P.O. Box 1461
San Mateo, Calif. 94401
(415) 347-9419

Measurement Associates
2955B Harbor Boulevard
Costa Mesa, Calif. 92626
(714) 540-7160
- COLORADO**
Aztec Enterprises
1449 W. Littleton Blvd.
Suite 106
Littleton, Col. 80120
(303) 795-0250
- CONNECTICUT**
J.M. Lancaster Co.
147 Concord Street
Frammingham, Mass. 01701
(617) 873-8893
- DELAWARE**
Nine Associates
Dendridge House
10680 Main St.
Fairfax, Va. 22030
- FLORIDA**
J.L. Highsmith & Co.
2543 Industrial Blvd.
Orlando, Florida 32804
(305) 293-5202
- GEORGIA**
J.L. Highsmith & Co.
3733 Monroe Road
Charlotte, N. C. 28205
(704) 333-7743
- IDAHO**
Rush S. Drake Assoc.
6133 Maynard Ave., So.
Seattle, Wash. 98108
(206) 763-2756

Aztec Enterprises
1449 W. Littleton Blvd.
Suite 106
Littleton, Colo. 80120
(303) 795-0250
- ILLINOIS**
Data Devices, Inc.
1148 Barberrry
Downers Grove, Ill. 60515
(312) 887-8480

Adelphi, Inc.
12015 Manchester Drive
Suite 165
St. Louis, Missouri 63131
(314) 821-1232
- INDIANA**
Data Devices, Inc.
1148 Barberrry
Downers Grove, Ill. 60515
(312) 887-8480
- IOWA**
Data Devices, Inc.
1148 Barberrry
Downers Grove, Ill. 60515
(312) 887-8480
- KANSAS**
Adelphi, Inc.
12015 Manchester Drive
Suite 165
St. Louis, Mo. 63131
(314) 821-1232
- KENTUCKY**
Ridgway East, Inc.
P.O. Box 88
1185 Cosmos Drive
Loveland, Ohio 45140
(513) 683-4350
- LOUISIANA**
Comspec, Inc.
13777 N.C. Exway
Suite 416
Dallas, Texas 75231
(214) 234-4137

Industrial Scientific, Inc.
10653 Allyson
Baton Rouge, La. 70815
(504) 921-9282
- MAINE**
J.M. Lancaster Co.
147 Concord Street
Frammingham, Mass. 01701
(617) 873-8893
- MARYLAND**
Nine Associates
Dendridge House
10680 Main St.
Fairfax, Va. 22030
- MASSACHUSETTS**
J.M. Lancaster Co.
147 Concord Street
Frammingham, Mass. 01701
(617) 873-8893
- MICHIGAN**
Ridgway East, Inc.
25210 Five Mile Road
Detroit, Mich. 48239
(313) 538-3940
- MISSISSIPPI**
J.L. Highsmith & Co.
3322 S. Memorial Parkway
Suite 36, Holiday Office Ctr.
Huntsville, Alabama 35801
(205) 881-3294
- MISSOURI**
Adelphi, Inc.
12015 Manchester Drive
Suite 165
St. Louis, Missouri 63131
(314) 821-1232
- NEBRASKA**
Adelphi, Inc.
12015 Manchester Drive
Suite 165
St. Louis, Missouri 63131
(314) 821-1232
- NEVADA**
Dayton Associates, Inc.
P.O. Box 1461
San Mateo, Calif. 94401
(415) 347-9419

Aztec Enterprises
829 Pennsylvania N.E.
Albuquerque, N. M. 87110
(505) 265-2440
- NEW HAMPSHIRE**
J.M. Lancaster Co.
147 Concord Street
Frammingham, Mass. 01701
(617) 873-8893
- NEW JERSEY**
S&S Associates
Boro Line Road
King of Prussia, Pa. 19406
(215) 265-3450

Scientific Devices—East
71 Grand Ave.
Palisades Park, N. J. 07650
(201) 871-3916
- NEW MEXICO**
Aztec Enterprises
829 Pennsylvania N.E.
Albuquerque, N. M. 87110
(505) 265-2440
- NEW YORK**
Doolittle Electronics Corp.
100 Valerie Drive
Fayetteville, N. Y. 13066
(315) 637-3222

Scientific Devices—East
71 Grand Avenue
Palisades Park, N. J. 07650
(201) 871-3916
- NORTH CAROLINA**
J.L. Highsmith & Co.
3733 Monroe Road
Charlotte, N. C. 28205
(704) 333-7743
- OHIO**
Ridgway East Inc.
173 Hawthorne
Chagrin Falls, Oh. 44022
(216) 247-4845

Ridgway East, Inc.
P.O. Box 88
1185 Cosmos Drive
Loveland, Ohio 45140
(513) 683-4350
- OKLAHOMA**
Industrial Scientific, Inc.
10653 Allyson
Baton Rouge, La. 70815
(504) 921-9282

Comspec, Inc.
13777 N.C. Exway
Suite 416
Dallas, Texas 75231
(214) 234-4137
- OREGON**
Rush S. Drake Associates
6133 Maynard Avenue, S.
Seattle, Washington 98108
(206) 763-2755
- PENNSYLVANIA**
Ridgway East Inc.
173 Hawthorne
Chagrin Falls, Ohio 44022
(216) 247-4845

S&S Associates
Boro Line Road
King of Prussia, Pa. 19406
(215) 265-3450
- RHODE ISLAND**
J.M. Lancaster Company
147 Concord Street
Frammingham, Mass. 01701
(617) 873-8893
- SOUTH CAROLINA**
J.L. Highsmith & Company
3733 Monroe Road
Charlotte, N. C. 28205
(704) 333-7743
- TENNESSEE**
J.L. Highsmith & Company
3322 S. Memorial Parkway
Suite 36, Holiday Office Ctr.
Huntsville, Alabama 35801
(205) 881-3294
- TEXAS**
Comspec, Inc.
9821 Katy Freeway
P.O. Box 22572
Houston, Texas 77027
(713) 461-4487

Comspec, Inc.
13777 N.C. Exway
Suite 416
Dallas, Texas 75231
(214) 234-4137

Industrial Scientific, Inc.
1826 Richmond Street
P.O. Box 60002
Houston, Texas 77060
(713) 528-1258
- UTAH**
Aztec Enterprises
1449 W. Littleton Blvd.
Suite 106
Littleton, Colo. 80120
(303) 795-0250
- VERMONT**
J.M. Lancaster Company
147 Concord Street
Frammingham, Mass. 01701
(617) 873-8893
- VIRGINIA**
Nine Associates
Dandridge House
10680 Main St.
Fairfax, Va. 22030

J.L. Highsmith & Company
2604-D Buford Road
Richmond, Virginia 23235
(703) 272-5888
- WASHINGTON**
Rush S. Drake Associates
6133 Maynard Avenue, S.
Seattle, Wash. 98108
(206) 763-2755
- WEST VIRGINIA**
Ridgway East, Inc.
P.O. Box 88
1185 Cosmos Drive
Loveland, Ohio 45140
(513) 683-4350
- WISCONSIN**
Data Devices, Inc.
1148 Barberrry
Downers Grove, Ill. 60515
(312) 887-8480
- WYOMING**
Aztec Enterprises
1449 W. Littleton Blvd.
Suite 106
Littleton, Colorado 80120
(303) 795-0250

For analytical instruments applications call your local Fisher Scientific Company Office:

Atlanta 30324
690 Miami Circle, N.E.
(404) 261-4120

Boston
461 Riverside Ave.
Medford, Mass. 02155
(617) 391-6110

Chicago 60651
1458 N. Lamon Ave.
(312) 379-9300

Cincinnati 45242
5481 Creek Road
(513) 793-5100

Cleveland 44128
28401 Miles Ave.
(Warrensville Heights)
(216) 292-7900

Detroit
34401 Industrial Road
Livonia, Michigan 48150
(313) 261-3320

Houston 77001
4102 Greenbriar Dr.
P.O. Box 1307
(713) 521-9351

New York
52 Fadem Rd.
Springfield, N.J. 07081
(201) 379-1400

Philadelphia
191 South Gulph Road
King of Prussia, Pa. 19406
(215) 265-0300

Pittsburgh 15238
585 Alpha Drive
(412) 781-3400

Raleigh 27604
3315 Winton Rd.
(919) 876-2351

Richmond 23230
Seaboard Bldg. - Room 443
3600 W. Broad Street
(703) 359-1301
(703) 359-1302

Rochester 14624
15 Jet View Drive
(716) 464-8900

San Francisco
3382 Edward Avenue
Santa Clara,
California 95050
(408) 249-0660

St. Louis 63132
1241 Ambassador Blvd.
(314) 991-2400

Washington
7722 Fenton St.
Silver Spring, Md. 20910
(301) 587-7000

In Canada, call

Fisher Scientific:
Montreal 307, Quebec
8505 Devonshire Rd.
(514) 735-5261

**THE
RECORDER
COMPANY**

**houston
instrument**

4950 TERMINAL AVENUE, BELLAIRE, TEXAS 77401
(713) 667-7403 TWX 910-881-5782 CABLE HOINCO
European Office Rochesterlaan 6, 8240 Gistel, Belgium
Telephone 059-27445 Telex BAUSCH 19399B

The Prime Computer

A totally new way to buy, use and upgrade computer systems.

The Plan introduces the first two-year guaranteed trade-in schedule. This program fully protects your computer investment when it's time to expand. Grow as much and as fast as you wish. The Plan will back you up all the way.

The Plan protects your budget by eliminating arbitrary system packaging. You only buy what you need. With 3 discount schedules, you need pay as little as possible.

The Plan also protects your software investment. Only Prime offers upward *and* downward system compatibility. Without modification.

The Plan offers a whole new maintenance procedure, too. Built-in integrity checks can isolate a fault to a circuit board and maintenance is as simple as replacing the board.

There's even a program called Air Spare. It's fast delivery of a backup board and low-cost repair of the defective one.

Everything we offer at Prime, hardware, software and support, works together as a logical system, be it large or small. You can put together a powerful, reliable, easy-to-use computer system at a better total system price than ever before possible. The Plan shows you how.

Read on.



Plan on a guaranteed trade-in

You can start your system with any Prime Computer. If, for any reason it isn't the best one to handle expanding applications, trade it in. Trade all of it or

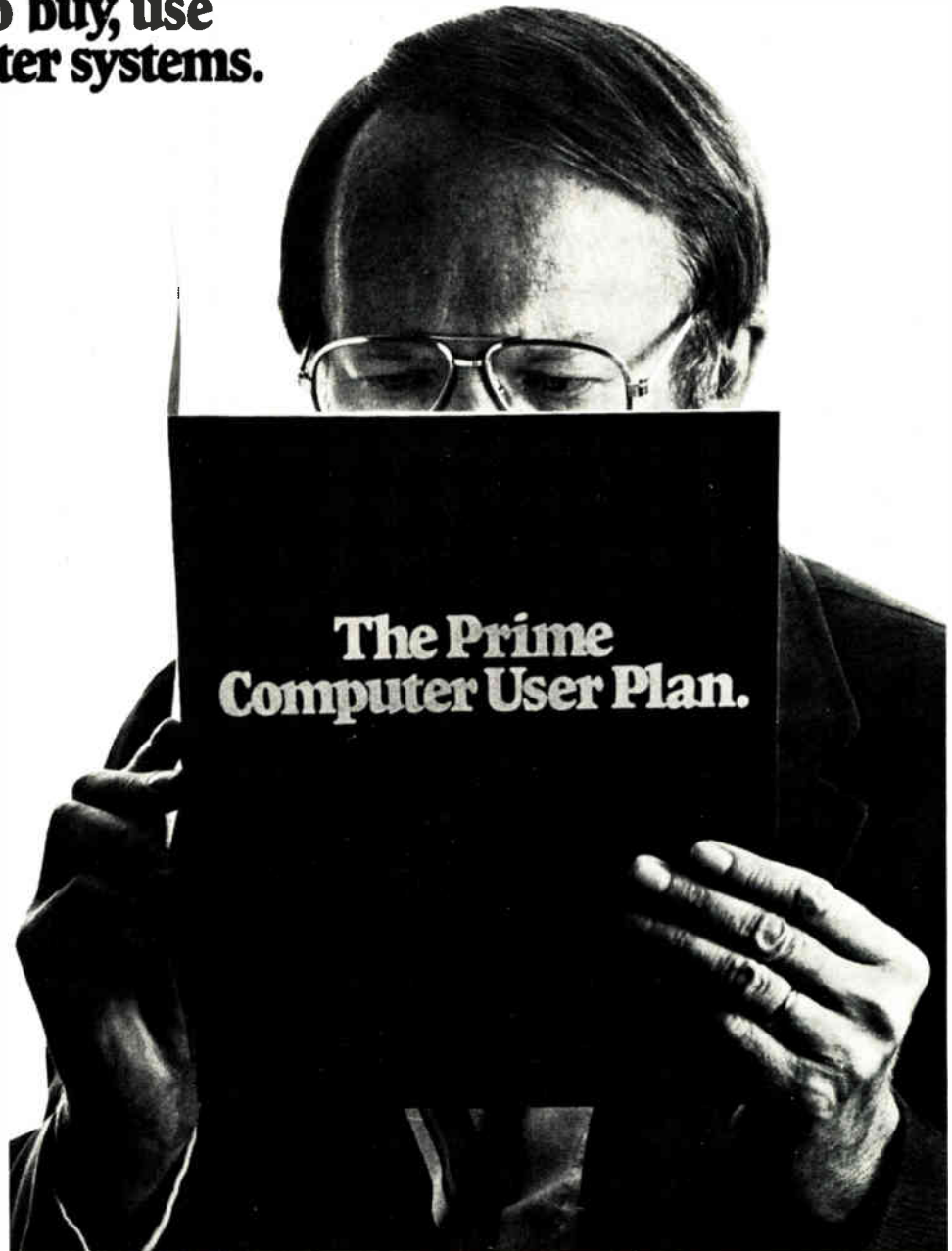

parts of it. Trade whatever is standing between you and better performance.

For instance, to upgrade from a Prime 200 to a 300 processor, simply trade in the original processor board. You can then plug in a fully equipped* Prime 300 for \$5000 (less a 50% trade-in credit for certain optional features on the

original processor).

You can also elect to keep the original processor as a spare. The cost is only \$1000. Keep your original power supply, memory and chassis, too. Or selectively upgrade any of them under similar trade-in arrangements.

Of course, all the software written on the original system

*Standard features include: virtual memory, restricted execution mode, memory protection, byte parity, extended direct addressing, integer multiply/divide, direct memory access system, automatic program loaders and microverification.

User Plan.

will run on the new one without modification. Only Prime makes this possible. Only the Prime Plan guarantees it.

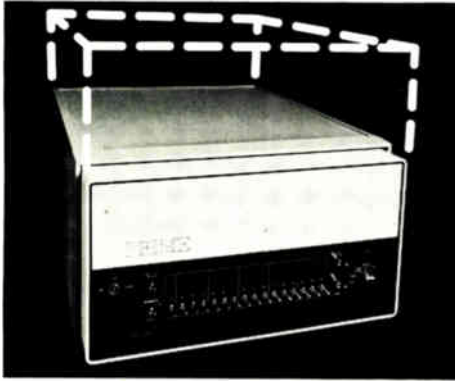

Plan on unheard of compatibility

On any Prime processor, you can write real-time and time independent programs in any language, under the control of any development system with its associated support packages. What's more, you can execute them on any Prime processor under the control of any operating system without modification (time, peripheral and memory size dependency aside).

Choose Any Processor*	Choose Any Development System	Choose From Support Packages
100 200 300	DOS DOS (VM) (Virtual Memory) Stand-Alone	File System Library Utilities IOCS
Choose Any Language	Choose Any Operating System*	
Macro Assembler FORTRAN BASIC	DOS DOS (VM) RTOS RTOS (VM) Stand-Alone	

*Software utilizing unique Prime 300 hardware features may require modification to execute on the Prime 100 or 200. Software dependent on unique RTOS features does not run under control of DOS or DOS (VM).

Plan it right, right off

The right combination of computer resources are all here and they're yours to select.

Pick a processor. Enhance it with options if you wish. Select memory size and speed. Add peripherals and controller.

		PROCESSOR					
		100		200		300	
Memory	First Increment	4K	8K	4K	8K	8K	8K
	Cycle Time	1 μ sec	1 μ sec	750 nsec	750 nsec	750 nsec	600 nsec
	Parity	no	no	yes	yes	yes	yes
Chassis	5 Slot	x	x	x	x		
	10 Slot	x	x	x	x	x	x
	17 Slot	x	x	x	x	x	x
Features	Battery Backup		x		x		x
	Automatic Prog. Load		x		x		x
	Direct Mem. Access		x		x		x
	Integer MUL/DIV		x		x		x
	Extended Direct Addressing				x		x
	Microverification				x		x
	Single Precision Floating Point Arith.				x		x
	Double Precision Floating Point Arith.				x		x
	Writeable Control Store						x
	Virtual Memory						x

Then package the electronics in the right size chassis and you're done. We'll provide the right power supply to handle whatever you put together.

There are no arbitrary restrictions. No surprises, either. With the chart above you could start planning now.

Plan on running full time

Prime service is every bit as sound as its technology. It's just as inventive, too. For instance, you can pick a full service contract or choose to use our services only when required. In either case we maintain a nationwide network of service and customer service representatives. They're ready to help.

We even have a way to hold maintenance costs to an absolute minimum. We call our idea Air Spare. For \$200 we'll loan you a spare (processor, memory or controller). We'll then repair the faulty unit while you keep on running. And better than running, the whole replacement is handled by air express.

Read more about it in the Plan.

One more thing to plan on

The Prime Computer User Plan is a unique and remarkably logical document. You've just been treated to a sampling here. For the first time you'll know everything to expect in a computer system. Read the Plan. Send for it today.

To: Prime Computer Inc.
23 Strathmore Rd.
Natick, Ma. 01760

- Send the Plan
 Send Planner
(He'll call for an appointment.)

Name _____

Title _____

Company _____

Address _____

City _____

State _____

Zip _____

PRIME

Now you can design a *true* shirt-pocket size calculator. Or handheld calculator with 30 or more functions. All with the same snap-through feel and sound that have made Klixon® low profile keyboards the number one sellers.

The new 3KS keyboards retain all the characteristics of the original 1KS model. They are available with selectively gold plated disc construction or TI's new lower cost Alloy A material system. TI engineered snap-acting discs provide uniform feel and over 1 million reliable operations. But the new discs are 25% smaller.

The design of the switch array provides complete flexibility for custom configurations. The entire switch area is sealed with Mylar™, so contacts are both lint-proof and spill-proof. The keyboards are available with or without keytops.

If your plans include shirt-pocket size or advanced-function handheld calculator models, be sure to look over our new literature. Which you can get by sending us the coupon.

Texas Instruments expands your keyboard options:

ORIGINAL 1KS LOW PROFILE KEYBOARD
used on most pocket calculators, only .150" thick.
(Complete 6KS keyboard shown.)

more functions...

NEW 3KS KEYBOARD design can provide
up to 30 switching functions in the same
2½" x 3" areas as the 6KS.

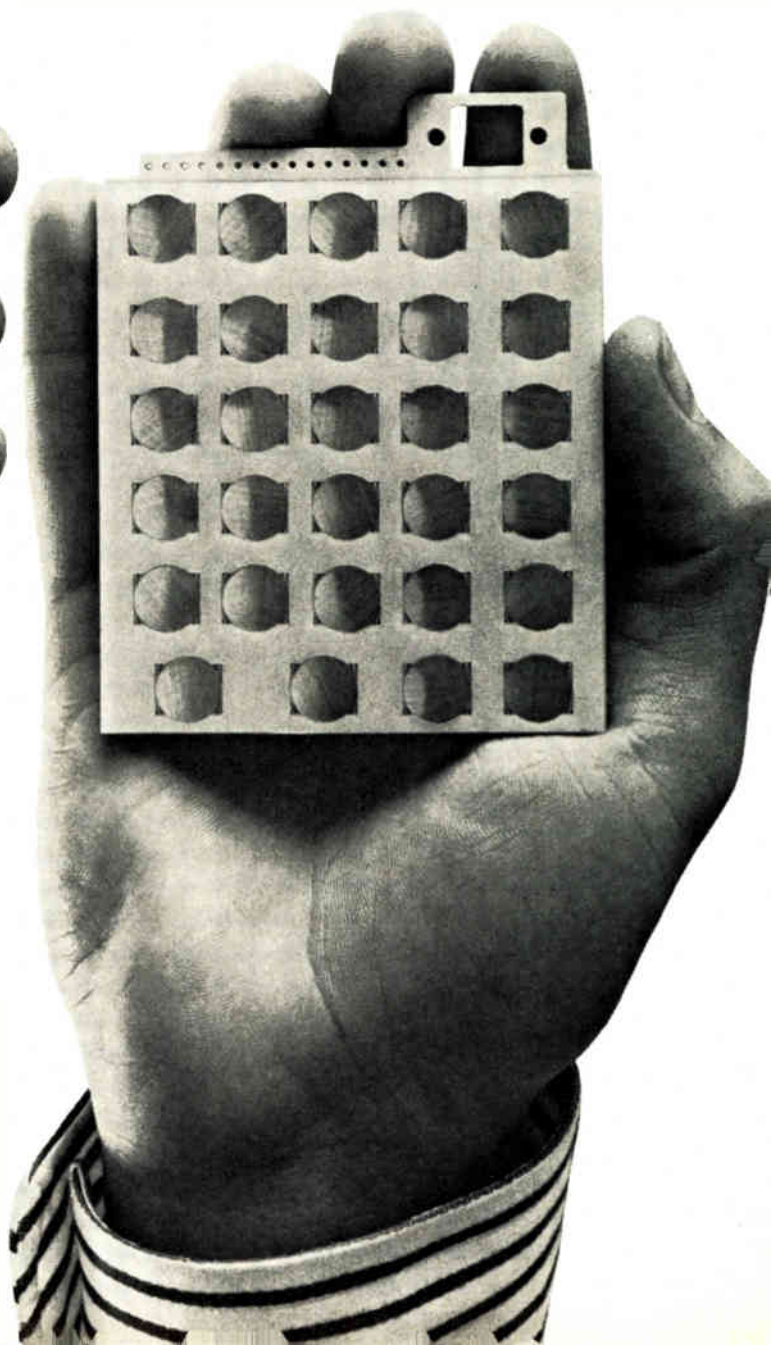

Texas Instruments Incorporated
Keyboard Products Marketing
MS 12-33
Attleboro, Mass. 02703

Name _____

Title _____

Company _____

Address _____

City _____ State _____ Zip _____

Keyboard application:

- Pocket Calculator Computer Terminal
 Desk-top Calculator TV Controls

Other _____

Application is new or existing

Approx. annual usage _____ units

Application requires:

- Basic 1KS or 3KS keyboard array
 Complete keyboard assembly
 Please have a TI Sales Engineer call



TEXAS INSTRUMENTS
INCORPORATED

smaller size...

OR 3KS KEYBOARDS can shrink
20 switching functions into $2\frac{1}{4}'' \times 2\frac{1}{2}''$
shirt-pocket size array.

thinner.

NEW 2KS KEYBOARD
is only .050" thick.

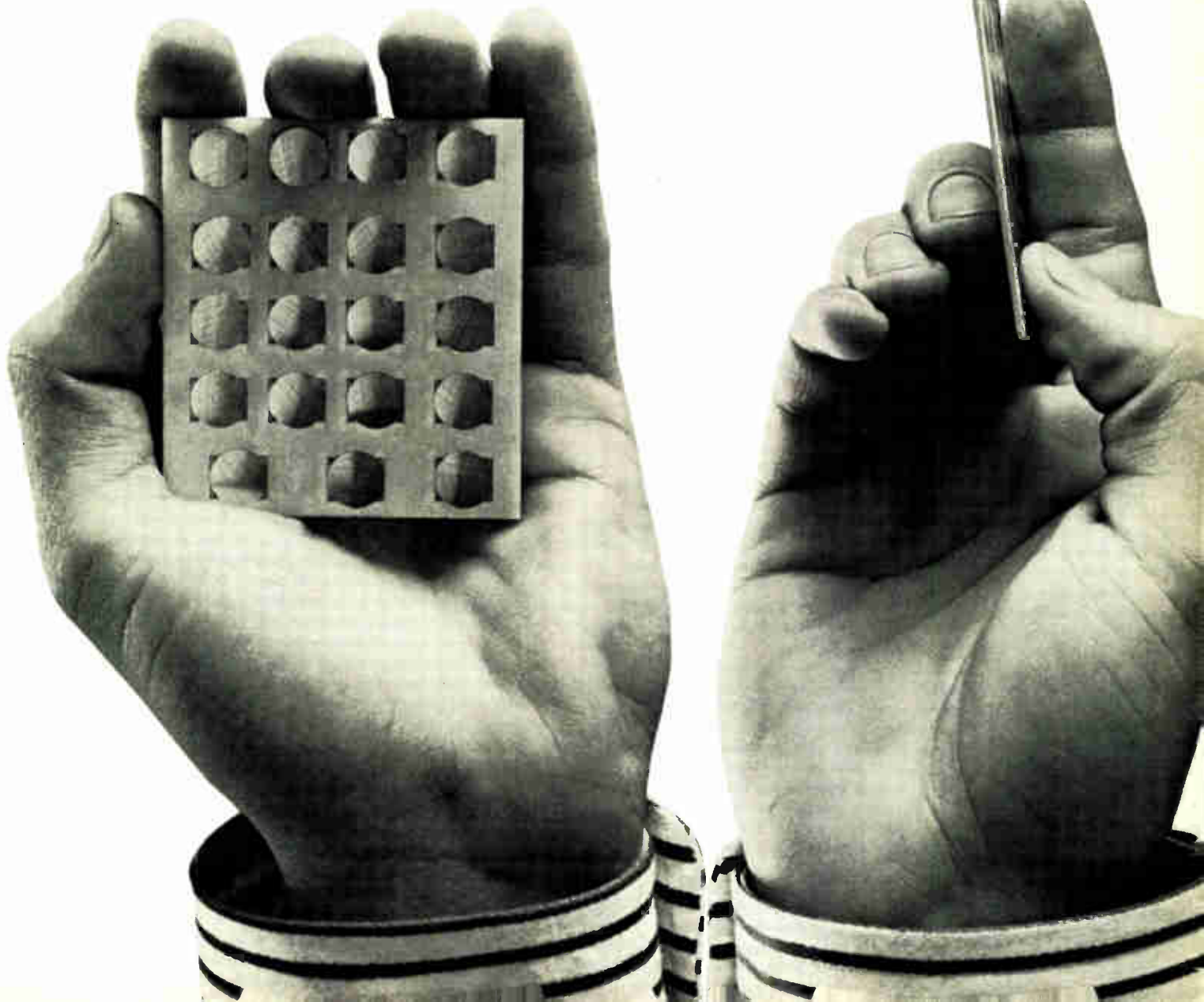

Soft hearted? Sure. With the most complete software package for an interactive system. All the software necessary to produce any electronic engineering drawing or master artwork. Every symbol. Every shape. At your fingertips.

The IDS: Gerber's new Interactive Design System. The system that integrates your engineering creativity with the productivity of the computer. To eliminate drafting drudgery. Slash lead time. And make your engineering profit center even more profitable and productive.

All designed, built and serviced by Gerber Scientific, the international pioneering leader of the computer graphics industry. The soft hearted Gerber Interactive Design System can produce profits for you. Call or write for details. The Gerber Scientific Instrument Company, Hartford, Connecticut 06101. (203) 644-1551.



GERBER SCIENTIFIC

Circle 88 on reader service card

Soft Hearted IDS.



JAPAN

Electronics industries resume vigorous growth in a superheated economy

by Gerald M. Walker, Associate Editor, and Charles L. Cohen, Tokyo bureau manager



But the good year was marred by severe shortages of labor, components, and materials; electricians even demonstrated (above) at MITI to dramatize their need for plastic insulation

Consumer electronics makers hymn 1973 audio results, but anxiously wait out sagging sales of color TV. p. 91

Semiconductors can't be made fast enough for Japanese demand, particularly in MOS integrated-circuit market. p. 94

Computer sales are growing, but the best-sellers are calculators and minicomputers, while point-of-sale gear waits in the wings. p. 96

Communications, as always, had a solid year satisfying the electronic exchange needs of Nippon Telegraph and Telephone. p. 100

Industrial electronics fared better than expected, but credit restrictions may cramp growth in 1974. p. 102

Space projects are getting more money, and thanks to help from NASA, communications satellites should fly on time. p. 103

Defense is pronounced unconstitutional by a district court, confronting Japan's military with a long, legal battle. p. 104

JAPAN

Japan's economy heated up again this year, and the electronics business temperature rose right along with it. Sales ranged from satisfactory to exceptional in virtually all product categories. In short, the cloudy years of adversity seemed to have turned into hot sunshine.

But this boom, unlike previous growth spurts, has developed from increases in government expenditures, personal consumption and housing investment, rather than from exports and expanded investment in private equipment. Such a boom is not healthy, say the economists, and they fret that it may burst easily.

Both wholesale and consumer prices have skyrocketed. Many electronics firms, for instance, have simply raised prices on current products, breaking with the tradition of introducing new improved models with higher price tags. Moreover, recent government efforts to slow down inflation by restraining credit and postponing public works appear to have had little effect. The financial analysts therefore believe that the economy has got to cool off sometime in 1974. Nevertheless, most electronics company executives expect to roar into 1974 with enough momentum to rack up another good sales year—it's 1975 that has them worried.

Every boom creates shortages, and this year electronics companies suffered a dearth of materials, particularly plastics. Components, such as semiconductors, and copper wire were stretched out in some cases as long as 15 to 16 months between order and delivery.

The large conglomerates that are the foundation of the electronics industries did not actually have to slow down production. But, as one executive remarked, "Our purchasing agents have been working very hard."

Smaller companies fared worse. One had to cut back production by 20% because of difficulty in obtaining ICs. Another suffered the agony of receiving components for a day's production only 24 hours before they were needed, and it might easily have been 24 hours after they were needed. A number of consumer electronics manufacturers had to trim the colors offered in radios and microwave ovens because of the plastics shortage. A calculator manufacturer has negotiated purchase of plastic for its cases three years in advance.

Labor is also in short supply. According to a recent estimate, unemployment in Japan is one quarter of one percent, which is practically total employment. In interviews conducted for this report, more electronics company officials complained about the labor supply than about the materials supply. As a result, automation is getting more attention these days from the Japanese, who have been experiencing what American manufacturers did some years ago with the rising cost of labor and the need to hold down production costs.

Because of the 35% upvaluation of the yen over the last two years and the higher disposable income of

Japanese families, competitive conditions now favor imports of consumer products from the U.S. Some American companies have been aggressive enough to take advantage of this change, and their success or failure will undoubtedly influence others. Needless to say, Japanese manufacturers will fight hard to hang on to their domestic markets.

This is vital because export markets have been problems for Japan, too. Toshio Takai, executive vice president of the Electronic Industries Association of Japan, explains, "From here America is to the east and Europe is to the west. Because of currency changes, all's quiet on the eastern front. But all's not quiet on the western front, for Europeans fear the growth of Japanese products."

Where the action is

The heating up pattern runs right through the individual segments of the industry. To start with the consumer electronics sector, stereo consoles (separates) and microwave ovens did much better than expected. Conversely, color television sales have shown rather less than their usual brilliance, but this, though a cause for concern, was expected since saturation of Japanese households has passed the 80% mark.

In semiconductors, large backlogs are the rule for just about every type of device. To reduce them, Japanese manufacturers and U.S. joint-venture operations have announced extensive expansion plans, and conditions should improve next year.

Computer companies are wrapping up a good year, too. Minicomputers are multiplying fast, and calculators have continued their spectacular growth domestically and overseas. The Japanese computer firms are concerned, however, over their condition after liberalization of foreign imports.

With a big spender like Nippon Telegraph and Telephone Public Corp. around, communications equipment suppliers have not had to worry about much, except how big the next order is going to be. Electronic telephone exchanges are the hottest items.

Industrial electronics and test equipment producers

Toshio Takai, executive vice president for EIA-J, observes that Japan's economy has been so hot that yen revaluation and inflation have not dampened electronics business. Labor shortages have hastened use of automated production and increased interest in establishing offshore production facilities. There's enough momentum for another good year in 1974.



had an unusual experience in 1973—prices went up. The increases were necessary to counter the rising costs of components and materials, yet at the same time American imports enjoyed the equivalent of a price reduction created by the yen revaluations.

Consumer

Color TV slumps but audio booms

Color television receivers, star performers in Japan's consumer electronics sales, have entered a difficult period. Over 80% of Japanese households now have color sets, which means a nearly saturated market and a flat domestic sales record. U.S. export markets have sagged as a result of yen revaluation. And Western Europe, in attempting to protect its domestic producers, has blocked any easy penetration by the Japanese there.

Meanwhile, labor and material costs have increased, pushing up production costs and straining profits. In addition, the hoped-for boost expected from consumer-priced video players, both tape and disks, is still a few years from realization. The situation leaves the Japanese TV manufacturers facing unaccustomed lag in growth, referred to as the "post color" problem.

This year's *Electronics* chart, which is based on market reports from Japanese manufacturers, indicates that yen sales this year could be down slightly more than 5% compared to 1972, and off another 4.6% next year.

In contrast, sales of microwave ovens jumped some 60% in terms of yen this year in Japan and should enjoy a climb of almost 40% next year. Hi-fi equipment gained nearly 47% this year and should increase by another third in '74, according to the chart. Audio tape equipment also measured up: about 30% in '73 over '72, and 21% growth or better anticipated for '74.

Yet spokesmen for all the major Japanese TV manufacturers agree that the answer to what follows color TV is color TV. They are counting on the strength of second-set and replacement sales to tide the industry over until 1975, when sets purchased during the boom of the mid '60s will begin to be replaced in large numbers. By 1976 home video players should begin to make a mark.

1973 was another year of the picture tube. Previously Japanese manufacturers had vied over brightness and the competitive merits of slotted, slit, and dot matrix masks, a tussle that eventually made its way to America as well. Then came the push to space saving with 110° deflection tubes. Sony Corp. one-upped everyone else by introducing a 114° model touted as "that 4° difference." More recently Tokyo Shibaura Electric Co. (Toshiba) announced development of a 118° tube to be produced for its 16-inch-diagonal receiver. Not to let the "4° difference" race end there, Sony has said that it could have a 122° tube in an upcoming 20-in.-diagonal set. Other companies concede that the wide-angle race has some promotional value, but will generally stay with 110° models for economic reasons.

Japan's present interest in reducing consumption of

electricity has also influenced the race. According to Tatsuya Inamiya, chief engineer for Toshiba's TV Receiver division, the 118° tube has accounted for significant power saving. By cutting the tube neck's diameter from 36.5 millimeters to 29.1 mm and using a rectangular funnel cross section, Toshiba was able to reduce the power needed to drive it by 30 watts, down to 95 w.

Off with 'instant on'

The desire to save a watt has focused attention on the so-called instant-on circuit in color TV sets—the one that enables sound and picture to come on immediately after the set is switched on. This feature is very popular in Japan and became practical because of the manufacturers' early conversion to the all-solid-state chassis.

Of course, no one wants to take out a selling point. Matsushita Electric Co., for example, has always left the save-a-watt decision to the consumer by giving him a front-panel switch that deactivates the instant-on circuit. Recently, however, Sanyo Electric bravely put out a 14-in.-diagonal, 90°-deflection-tube color TV without the instant-on feature—and Masayuki Yoshioka, Sanyo's domestic sales manager, reports that consumer reaction was favorable. In announcing the set, Sanyo pointed out that it consumes over 20% less power and future models will be designed to save 30 to 40 w.

Shigeru Noguchi, manager of consumer products marketing department for Mitsubishi Electric Corp., favors the elimination of instant-on. In his opinion, this feature not only wastes electricity but is unnecessary.

Matsushita, for its part, is interested in the possibilities of manufacturing under license a new CRT that warms up in just seconds. The tube, developed in Europe, could provide the advantage of instant-on without wasteful standby power.

Japan's TV makers have never put much effort into big-screen sets, believing that large receivers are not suitable for the small Japanese home. However, they became concerned when Motorola's Consumer Prod-

Yasumasa Noda, Sales manager for VTR division of JVC, believes that home video players will succeed at 10% saturation.

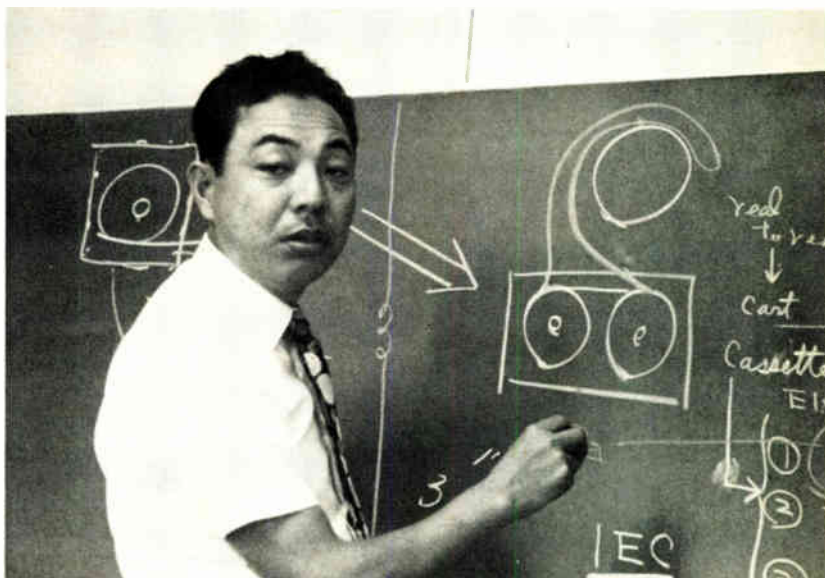

JAPAN

ucts division last summer announced its intention to market 25-in., premium-priced models in Japan through Aiwa Co. Ltd., a member of Sony's consumer products family. Even though the demand for large-screen sets is rather small, Motorola's entry is an attempt to exploit the fact that the yen revaluation now makes U.S. goods more competitive in Japan, particularly in the high-priced categories.

There is some question over how well Aiwa, which produces only audio products, will do in marketing Motorola's TV sets. Kazuo Iwama, Sony's vice president, is confident of success because Aiwa also has had past experience in marketing black-and-white TV. He adds that an important factor will be Sony's assistance in setting up a service network for the U.S.-made units that Aiwa will eventually take over.

While Japanese manufacturers wonder how consumers will take to foreign goods, they are also concerned about keeping customers happy with Japanese-made products. One result has been the formation within the last year of consumer affairs departments to deal with complaints, keep service organizations on their toes, and feed back failure data to engineering for design changes or production line alterations if needed.

Audio hits high notes

Japan's audio sales this year outperformed all the predictions, and the high returns in hi-fi, phono consoles, tape recorders/players, radios, and tape-radio combinations have counteracted the so-so performance of television.

As the year began, console stereos, usually called sep-

Consumer satisfaction. Kazuo Iwama, Sony vice president (below), sees good opportunity for U.S. makers of color TV consoles in the Japanese market. Tsuneo Kudo, director of market planning for Pioneer, expects boom in audio to continue due to four-channel.



arates, seemed to have matured into decline. But instead of fading along a predictable extinction curve, they made a comeback.

The reason was four-channel, says Tsuneo Kudo, director of the marketing planning department for Pioneer Electronic Corp. Unlike the U.S., where four-channel is being promoted to audiophiles in individual components, in Japan what's selling is quadraphonics built into consoles—in fact, 85% of the models sold have this feature.

Consoles started their unexpected growth in the first six months, increasing by 29% in value over the same 1972 period. Modular stereo, or compacts, showed a gain in yen value of 34% in the first half. At the same time, individual components, especially speakers and amplifiers, increased in sales as expected. Now Kudo is wondering if the separates with built-in four-channel (CD-4 discrete, SQ matrix, and regular matrix) have begun a new product life cycle.

Concurring that the separates featuring four-channel sound will increase about 30% this year, Hisashi Kusugami, general manager for Matsushita Electric's stereo department, believes that growth of 20% to 30% will occur next year and very likely continue for one or two more years. However, individual components are the hot items in the long run.

It's estimated that audio saturation in Japan in March, 1973, had reached 40.6%. Potential total is 70% for all Japanese households.

Tape-recorder sales continue to baffle manufacturers. Consumers seem unable to get enough of them, for once again this year promises to be a big one, reaching sales of about 5 million sets of all types.

The leader this year has been radio/tape combinations with step-up features, such as mikes for singing along and a short-wave band to go along with a-m and fm tuning, designed to appeal to opulent Japanese youth. Next year, manufacturers expect to sell 5.5 million to 6 million tape units of all kinds domestically, with total saturation estimated to reach 50%. Only the record producers view the acceptance of radio-tape



combos unhappily. They're complaining that it's now easier than ever for kids to record music off the air rather than buying the disks.

Radio sales are almost all in portables (80%) with the largest yen share going to a-m/fm models. Again the youth market is essential to success, particularly for the multi-band, high end of the product line. Manufacturers estimate that 4.3 million portable radios will be sold in Japan this year and a similar number next year.

The interesting thing about these sales is that saturation was supposed to have been reached long ago, but consumption continues strong, with growing interest in expensive, quality units. For example, this year Matsushita introduced the Cougar series of a-m/fm radios featuring rugged, studio-instrument-type control knobs, a solid 16-centimeter-diameter speaker cone, and 2.6-watts continuous output at 10% distortion. One model line starts at 18,900 yen (about \$72) and another at 13,500 yen (about \$51).

Microwave ranges sell well

Several factors made conditions just right for sales of microwave ovens in Japan this year. For one thing, years of promoting these ranges to the public finally paid off. For another, consumers had money to spend and the price was right. In addition, the save-a-watt campaign meshed with the idea that cooking is a lot faster with the electronic range and therefore uses less electricity. Gas prices also rose. And the growing popularity of large refrigerators with freezers made the microwave ovens attractive for defrosting. (Japanese housewives have traditionally purchased food one day at a time, but with the steep increase in prices, stocking up in a freezer is now more prevalent.) Finally, the government removed a requirement for all microwave range buyers to register the purchase, eliminating a bit of annoying red tape that inhibited sales.

It all added up to almost a doubling of unit sales in 1973, with an estimated total of 800,000 to 1 million ranges sold. Next year looks to be just as good, reaching an estimated 1.8 million units.

The best-selling units were in the 600-w category, priced at about \$260 to \$320. Japan's total potential for microwave ovens could be 18 million homes, or about 60% of today's households, says Yasuhiro Fujiwara, manager, engineering section, microwave oven department for Sharp.

To supplement its retail outlets, and to counter new competition from private brand labels being sold in supermarkets, Sharp this year started a door-to-door sales campaign targeted at carefully selected homes. At present, domestic sales are so good that there is room for all the competitors.

Faith and a camera for VTRs

The turn of the home video player still has not come in Japan, but none of the competitors in this tough market is ready to give up just yet. Despite the collapse of Cartrivision in the U.S., Japanese manufacturers retain their confidence that the patience and yen already spent, together with the development of a consumer-priced color camera, may yet nurse a worthwhile consumer market into existence by 1975. If all this sounds

familiar, that's because similar predictions have been tossed about for over three years.

This year, however, there is some basis in the sales statistics. Right now, according to Sanyo's manager of domestic VTR sales planning, Toshiharu Oku, 55% of the VTR market is in educational and institutional uses; 30% to 35% is in industrial; and 10% to 15% is in personal use. The latter is divided into stationary units and portable, outdoor units. Oku figures that in the coming year half of color TV sales, or about 3 million units, will be for second-set purchases and of these around 10%, or about 250,000 to 300,000 units, will include VTR recorder/players in the package.

Kunio Yarita, national sales manager for Akai Electric Co., has a different gauge. He estimates that 2,200 video cassette recorders a month were turned out in the

Monochrome half-life. Although sales of black-and-white TV have been declining, designs like Matsushita's "military look" still sell.



Camera work. Development by Toshiba (left) of an inexpensive, one-tube color camera should spur home VTR sales by 1975. In the meantime, Sanyo's camera (right) is selling for black and white.



JAPAN

six months ended in August, and of these 30% were for the consumer. Some 800 portable reel-to-reel machines a month were produced in the same period, 70% for consumer use. And about 600 stationary reel-to-reel units a month came off the line exclusively for institutional and educational uses. Yarita figures that a total of 40,000 to 50,000 VTRs will be manufactured in Japan in 1973. Akai, which is in the portable business, wants to reach a consumer market equal to 8-mm-camera owners, or about 20% of Japanese households.

On the other hand, Yasumasa Noda, manager sales department, Video Tape Recorder division, Victor Co. of Japan, believes that an opening target of just 10% of Japanese households would spell success.

None of these estimates includes the possible debut of video disk players. But every Japanese manufacturer with an interest in tape players is also deeply involved in investigating disks, and Sanyo recently announced a license from Teldec for the TED disk system. Because video disk software will be less expensive to produce, this product may actually get off to a faster start by 1975 than tape machines, despite the fact that VTRs offer recording capability. All agree that disks and tapes will coexist.

The Japanese have still not sorted out the competitive and incompatible VTR formats and may not do so until the consumers decide between three-quarter inch, half-inch, and one-quarter inch, and between reel-to-reel, cartridge, and cassette. As of now, the ¾-in. cassette seems to have the edge. Manufacturers have agreed not to introduce any new format in VTR.

Despite the still unsettled condition of the products, there is considerable cause for optimism on the VTR's future among consumers if Toshiba delivers its newly developed, one-tube color camera at the low price it promised [*Electronics*, Sept. 13, p. 62]. This development, coupled with the competing low-cost models that

Console comeback. High-end audio equipment with built-in four-channel, like this Pioneer unit, sold well in Japan this year.



are bound to follow from Sony, Hitachi, and Matsushita, could be the cog that gets the consumer market into second gear.

As for the player/recorder, Masakazu Hara, VTR marketing manager for Hitachi, states that both technical innovations and volume production will be needed to bring down the selling price. For example, he suggests that a fixed playing head would be more economical than a revolving head.

Commenting on the big question of when explosive growth will occur, Sony's Iwama smiles, "It will be in another five years—as always."

Semiconductors

Users, get in line— it's boom time again

This is a year of great shortages in the Japanese semiconductor industry, which only two years ago was worried about dumping by U.S. manufacturers. There is even a lack of engineers to churn out designs for new products for the ever-shifting demands. Hiroe Osafune, general manager of Nippon Electric Co., semiconductor division, doesn't think growth can continue at its present pace through next year. But Gerald Lynch of TDK Fairchild says that his company is getting long-term orders for 12 and 18 months so he doesn't see a return to a surplus condition any time in the near future. The Japanese, incidentally, do not practice double ordering to the extent Americans do.

Relief may be at hand, however, to judge from announcements of new capital investment, which include 5 billion yen (\$19.0 million) by Toshiba and Nippon Electric, 6 billion yen (\$22.8 million) by Hitachi, 4 billion yen (\$15.2 million) to 5 billion yen (\$19.0 million) by Fujitsu, 4 billion yen (\$15.2 million) by Mitsubishi, and 5 billion yen (\$19.0 million) by Matsushita. (One company executive says they all tend to overstate investments, and the correct value is probably closer to 80% of the announced value.) These investments are partly for replacement of obsolete equipment but also for new plant and equipment for increased production, including larger diffusion furnaces and accelerators for ion implantation.

Products with the most rapid growth this year are MOS memories for computers, and MOS or C-MOS devices for new applications such as electronic watches and automotive electronics.

Toshiba claims to be the only Japanese company producing a MOS driver for fluorescent displays for calculators. The company expects these fluorescent displays to keep 60% of the market for next year or two, with 30% LEDs and 10% liquid crystal.

Saturation may be the fate of calculator chips, even though Japan has just caught up with U.S. technology and reliance on imported chips is rapidly decreasing. Toshio Inoue, deputy general manager for Hitachi's Electronic Devices group, thinks it will be necessary to add functions and convert 3- and 6-digit calculators to 8

digits. Hitachi calculator devices include p-channel metal-gate types with enhancement/enhancement inverters and p-channel silicon-gate with enhancement/depletion inverters. On the other hand, William Sick, president of Texas Instruments Asia, says that, as

Toshio Inoue, deputy general manager for Hitachi's electron devices group, expects production to catch up to demand next year.



Sumio Imaoka, semiconductor sales manager for Toshiba, complains that latest U.S.-made, IC-production equipment is unreliable.

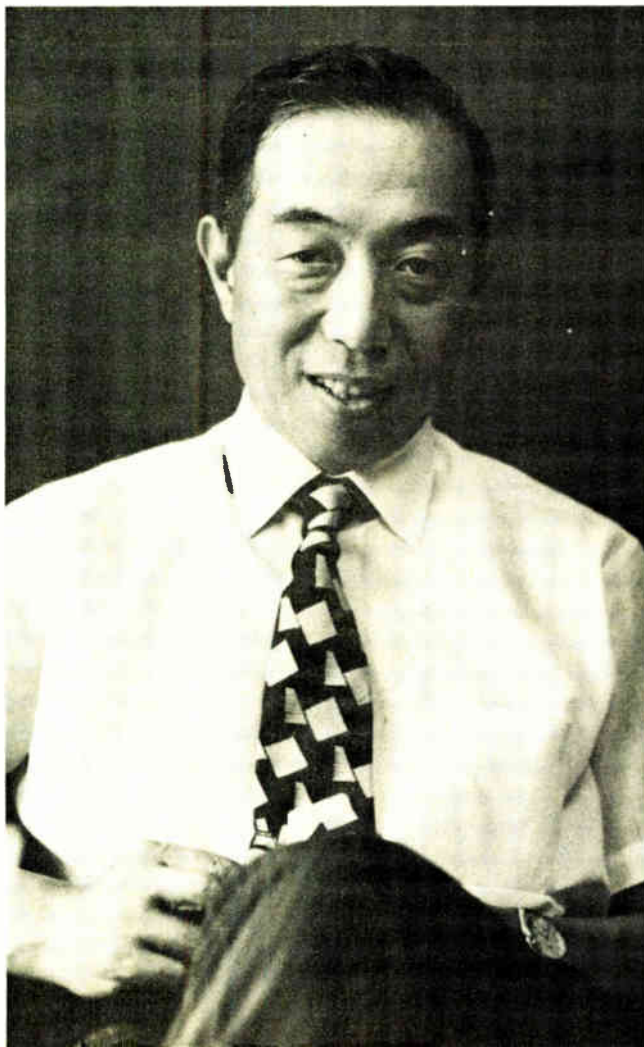

capacity pulls into line with demand next year, there will be strong competition.

Bipolar computer memories have been selling in ever-larger numbers, because they were the only types fast enough for use in large computers. But MOS memories will make up the bulk of the market in the future, and some sources, such as Osafune of Nippon Electric, say they will double in sales each year for the next few years. Nippon Electric is mainly selling p-channel 1,024-bit RAMs, has 2,048-bit units for in-house use, but wants to jump to 4,096 bits for standard devices. Mitsubishi has a 1,024-bit p-channel RAM, and by year-end expects to complete development of 1- and 4-kilobit n-channel RAMs.

TI's Sick points out that the semiconductor memory market has been slower in developing than in the U.S. but this gives Japanese manufacturers a better opportunity to design in the latest devices, like fast 1-kilobit RAMs and workhorse 4-kilobit RAMs. It could make the Japanese market richer than the U.S. in mass memory.

Here come the microprocessors

Several other new products may take off in the next few years to replace some that are saturating or will fall by the wayside. These include microprocessors, C-MOS functional replacements of TTL, and power FETs.

Only two microprocessors have been announced, but others are on their way. Toshiba has a 12-bit microprocessor built on a 5.5-by-5.9-millimeter chip. It is Toshiba's first product using p-channel silicon-gate MOS devices with enhancement/depletion inverters. Channel length has been held to 6 micrometers by use of doped polysilicon diffusion techniques, which also decrease series resistance. Sales are not expected to become large until the second half of next year.

Nippon Electric has developed a 4-bit microprocessor for a requirement within the company, and for larger capacity will develop an 8- to 16-bit type. It expects sales to start next year. Hitachi, says Inoue, will come up from behind by developing a better device. Mitsubishi meanwhile expects to have an 8- or 16-bit type next year as well as a minicomputer on a chip later.

Companies developing C-MOS functional replacements for TTL devices include Toshiba, Nippon Electric, and Motorola. Toshiba started with a 7400 type, but has switched to an RCA version. Initially Toshiba will only develop 25 types because its capacity is limited.

Sumio Imaoka, manager of Toshiba's semiconductor sales, admits the correctness of competitors' statements that its calculator C-MOS has not been profitable, but adds that it is reworking for smaller chips and expects the line to be profitable within six months.

Last year Japanese companies reported that one of the reasons they were behind the U.S. in MOS marketing was lack of production equipment and one of the reasons they were able to catch up was recent availability of ion implantation equipment. But that did not settle matters because a new problem has been unreliability of ion accelerators. Imaoka states that this is the first advance in semiconductor production for which proven equipment has not been available from the U.S. An accelerator purchased for around-the-clock operation broke down after only 30 continuous hours, he com-

JAPAN

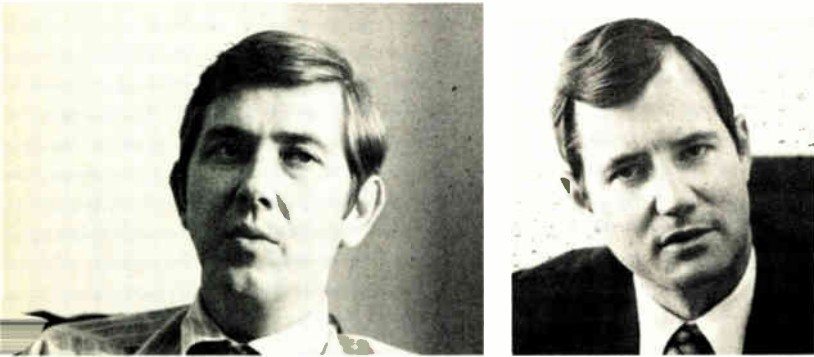

American opportunities. Gerald A. Lynch, marketing manager for TDK Fairchild (left), says orders are strong enough to carry semiconductor sales through '74. William Sick, president of TI Asia (right), thinks semiconductor memory market in Japan could be very big.

plains. Osafune of Nippon Electric is also unhappy with accelerators, but Kazuaki Harada, assistant to the manager, engineering department of Mitsubishi semiconductors, says his company hasn't experienced any difficulties so far, perhaps because of constant maintenance.

C-MOS for automobile electronics will probably be a big item in not too many years, but the only product announced so far is a seat-belt interlock built by Mitsubishi for Toyo Kogyo. (Potentially, there's also a need for up to 100 power transistors in automobiles as relay replacements in lamp, wiper, and other circuits.)

Watches are another very promising C-MOS market. Seiko is now getting units made to its specs from several companies, including Intel, Mitsubishi, Toshiba, Hitachi, and its own production. From 1976 through 1980, about 20% to 30% of watches produced in Japan will probably be electronic, and after that at least half will be electronic. However, Michael L. Jablow of Motorola feels that the market might only support a few manufacturers because the number of watch manufacturers is limited. Nevertheless, consumer electronics firms are ready to put electronic clocks into radios, TV sets, and tape recorders when they become competitive with electromechanical clocks.

Mitsubishi's semiconductor works, which is in the same industrial group as Nikon, is enjoying brisk sales of semiconductors for cameras, according to Toshimi Okubo, deputy manager. Besides Nikon, Minolta and Yashica are using Mitsubishi ICs for electronic shutters. Mitsubishi claims to be the leading manufacturer in Japan of thyristors for a new generation of automatic strobes, in which the thyristor turns off the discharge tube when the desired exposure has been reached while retaining unused energy in a capacitor.

Another type of thyristor that's doing well is a small 200-milliampere plastic-packaged unit. It suits a variety of applications such as printers and vending machines.

Despite the emphasis on C-MOS, simple MOS and even junction FETs haven't lost out. Nippon Electric, for instance, is making diffusion self-aligned transistors originally developed at the government's Electro-Technical Laboratory for use in the first stage of 400-megahertz mobile radios. The main advantages are high gain and low cross modulation, and in future these devices will be used at even higher frequencies.

At the other end of the spectrum Sony has developed complementary symmetry junction FETs with output of 30 watts a pair. On the low-level side, Mitsubishi will soon add a TV linear IC with Schottky picture detector as a second source for a Motorola-developed chip.

A major problem in custom design for new products in Osafune's view is that oriental peoples—including Japanese, Koreans, and Chinese—won't pay for design. "They ask technical questions, say thank you, and go home. Perhaps the only professionals who get paid for conferences in Japan are doctors," he comments. "Even computer manufacturers must offer software as a service to sell hardware."

Tubes are cooling off

Although Japanese manufacturers are locked in combat to produce more and better color picture tubes, most segments of the tube business are no longer growing. Both color picture tubes and black-and-white picture tubes are past their peak in Japan. Receiving tubes have followed a steady path to extinction as Hitachi in August phased out production in favor of supply from an affiliated company in Taiwan. This leaves only Toshiba and Matsushita as producers.

Another tube market that may turn sharply downward during the next few years is the multidigit fluorescent and gas-filled display tubes for calculators, which will be increasingly replaced by liquid-crystal and light-emitting-diode displays.

Microwave ovens continue to increase, but small magnetrons with output of 400 w now have a factory price of less than 5,000 yen (\$19) which does not produce big profits.

In happy contrast, sales of cathode-ray tubes for computer terminals and other non-television displays have continued to increase. And potentially the brightest spot in the tube market is the vidicon in its many variations.

Computers

Small units earn big money— but can the Six beat the 370?

This year the Japanese Six, the domestic computer manufacturers under the wing of the Ministry of International Trade and Industry, continued their chase of IBM. Minicomputers, both Japanese- and U.S.-made, enjoyed booming growth. Calculators did their usual thing—explode.

Business data processing and industrial controls systems both thrived during 1973. Banking terminals came alive, thanks to a change in regulations permitting cash

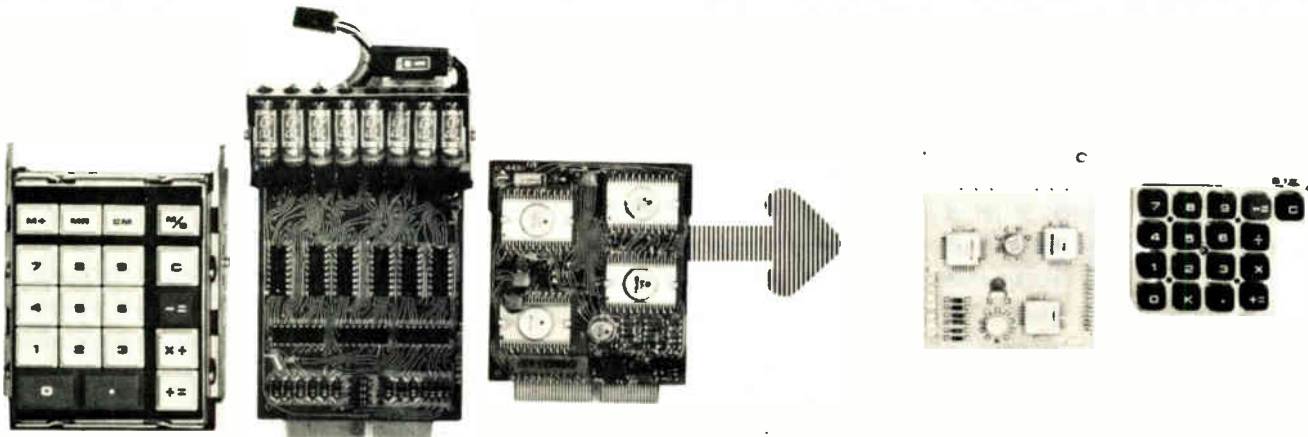

Calculator change. Sharp's Calculator on Substrate, which combines the LSI chips, keyboard, and liquid-crystal display on a single glass board, has radically changed economics of calculator production. Next step will be to put rechargeable battery on substrate.

dispensers outside bank premises, and point-of-sale applications showed good potential, although the field of contenders is already overcrowded. All told, it was a good year that could be matched in 1974, if the economy does not come untracked.

Calculators are now truly international products for business and personal use. Japanese manufacturers will export close to 60% of their production this year, unhindered by the language or import barriers that limit sales of computer systems and TV receivers. What is inhibiting the Japanese, however, is the fear of overdoing it, that is, flooding foreign countries with calculators to the point that trade blockades are raised. As a consequence, even though the opportunities are so good, 15 Japanese calculator producers have, with MITI's blessing, gotten together and imposed export quotas on themselves that affect both U.S. and European markets. The insiders, as this group is called, do not control shipments from another group of producers, called the outsiders.

Production of calculators for 1973 is about 8.64 million from the 15 insiders and around 2 million for the outsiders, for a total of over 10 million calculators. Of these some 85% or 7.4 million were personal models, and the rest were regular business machines. In 1974, estimates are for a 50% increase in production of personal calculators and 30% increase for office versions. The 15 insiders will manufacture somewhere in the vicinity of 12.72 million units in 1974, out of a probable total of 15.2 million.

While last year the preoccupation in Japan was how low the price could go, with Casio, Busicom, and later even Sharp leading the downward trail, this year there has been more serious concern with quality machines. Even though low-priced units have been profitable in Japan, manufacturers began to sense that many consumers would want to upgrade.

For this reason, Sharp's announcement of the Calculator on Substrate EL-805 was greeted with immediate orders from dealers. Using a highly automated assembly and test line, Sharp has got production up to 300,000 units a month now.

Integration inside and outside

Tadashi Sasaki, corporate executive director and Industrial Instruments Group general manager for Sharp,

sees calculator technology taking two paths. The first path, integration inside, aims at a linear decline in price, weight, and power consumption. Packing the calculator circuits onto four, then two, and finally one chip realizes all three reductions. This kind of machine, says Sasaki, can and should be assembled in developing countries, because the technology is easily transferable.

Integration outside, the second path, involves high technology, for the objective is to get the calculator chip, the keyboard, the liquid-crystal display, and eventually the power source on a single substrate. That's what the calculator-on-a-substrate is all about.

The calculator industry is taking off in yet another direction, in the opinion of Hajime Kikuchi, president of Ise Industrial Instrument Co., one of the outsiders. Displeased with the reputation of the outsiders as cheap and dirty, fast-buck assemblers, Kikuchi believes he can angle his firm toward upgraded machines that will be in effect home computers. In his view, survival in this rough market will depend on controlling the design and/or manufacture of all the elements—chip, keyboard, and display. His goal is to match these parts in the design stage and so make automation economical.

Minicomputers showing up

While attention was focused on the battle for the medium- and large-scale computer market backed by the financial aid of MITI, minicomputers have been quietly selling up a storm in Japan. Unit sales of minicomputers in Japan have had an annual increase of 50% a year since 1969, and the 1973 total is estimated at 3,200 to 3,500 central processing units. (It is difficult to translate these units into dollar figures because many are buried in systems, some of which are exported.)

Among those who profited has been Fujitsu Ltd. with its U-200. In addition, the company has recently entered into a joint effort with Matsushita, another minicomputer maker, to produce minicomputer-based systems that will probably have commercial/consumer orientation. Pana-Facom, as the joint system is called, will get under way with a computerized facsimile system.

Digital Equipment Corp. has also increased its business in Japan by concentrating on OEM systems. According to Yu Hata, DEC's Japan district manager, its business is up 80% in Japan this year. Starting in strictly

JAPAN

scientific and engineering applications, DEC has now moved into OEM systems built for commercial operations like typesetting, banking, and communications.

Nippon Minicomputer Corp., which builds Data General's Nova line on license as the result of a Japanese joint venture, has done well sticking to the OEM market, even though this business is a small percentage of total minicomputer sales. While DEC has tended to spread out into general applications, Nippon Minicomputer has concentrated on special applications to fit into the systems designed by mainframe manufacturers.

As for the future, Tohru Kazamaki, executive director marketing for Nippon Minicomputer, has great hopes for the results of a government-sponsored program to develop a pattern-recognition system by 1975. The eight-year-long project, run by Japan's Electro-Technical Laboratory, is to develop direct input and output technology for written characters, design symbols, and voice and involves most Japanese computer and LSI producers. The result could revolutionize the minicomputer market by development of LSI microprocessors as part of large pattern-recognition systems, says Kazamaki.

All of Japan's domestic computer manufacturers can find something in the 1973 sales picture in which to be pleased. For one thing, it appears that the three joint ventures arranged by MITI, which pair off Fujitsu with Hitachi, Nippon Electric with Toshiba, and Mitsubishi with Oki, are on course toward development of a family of domestic computers and peripherals competitive with U.S. imports. For another, each manufacturer found worthwhile sales in areas that have become more or less individual specialities.

Worth cheering about

Most manufacturers have been disappointed with the results of the telephone company's liberalization this year of its policy and rates on lines, which for the first time made it possible to operate computer networks among different companies. A year ago it was thought this change would encourage sales of communications control computers and terminals, yet there hasn't been much action. However, Nippon Electric is quite satisfied with the situation, because of the acceptance of its new NEAC 100, a middle-sized system especially suited to communications uses.

Hitachi, on the other hand, has had success with its new smaller machines—the HITAC 8150 series—and minicomputers—HITAC 10—primarily with new customers in transportation and hospitals, and in schools using computers for the first time.

Fujitsu, holder of the largest market share among the Six, has done well in the medium to large range, as its old customers, such as financial institutions and govern-

On their own. One change coming into Japanese factories is greater independence of test personnel. At this Sanyo plant, employees work unsupervised.





Upgrading. Increased automation is reducing number of employees required at Matsushita audio plant (left) and at Matsushita microwave-oven plant (right). But to give assembly workers feeling of higher status than in the past, they now wear the same uniforms as front-office employees.



Another change. Matsushita has each worker do a series of tasks rather than keep up with a monotonous moving belt.

Fun and games. Matsushita's consumer electronics plant broke with tradition by opening its streets (left) for lunch-hour games like netless volleyball.

JAPAN

ment agencies, upgraded or shifted to on-line processing, and in minis and terminals with new customers.

Mitsubishi's forte is industrial process controls, an area that did not look too promising because of the hindrance to plant expansion created by tightened credit and demands for pollution control. However, pollution control actually increased the need for process-control computers as industrialists were forced to upgrade their plants with new, more efficient systems.

Meanwhile, Nippon Telegraph and Telephone Public Corp. (NTT) has provided continued business for its DIPS network (Dendenkosha information processing system), a pair of time-shared systems. DIPS I machines were of one type, using core main memory. DIPS II will be a family of three machines, all using semiconductor memories, although software will be compatible among the three and with DIPS I. The smallest of the three will be equivalent to the present DIPS I.

On the face of it, then, the Japan Six look to be in good shape, despite the presence of IBM as well as Nippon Univac, National Cash Register, and other U.S. competitors. Fujitsu, Hitachi, and Nippon Electric have their individual sales efforts, joint programs funded by MITI, and NTT business with which to spread out their risks. But this is threatened by liberalization.

After the fence is down

As a result of the economic arm twisting done by the U.S. to help its balance of payments, Japan agreed to remove barriers on foreign computers and completely open its doors to them by 1975. This was a political decision, for once out of MITI's hands, but in order to prepare domestic manufacturers, the ministry set up a subsidy program in 1972 to cover mainframes and peripherals. The goal for this funding is to enable the Japan Six in joint efforts to come up with computers by 1975 that are superior to the IBM System 370 of today.

All of the Japanese companies are worried about what will happen after liberalization, but they are not ready to concede the domestic market to IBM. Says Taiyu Kobayashi, executive director for Fujitsu, "There should be no major changes in the industry overall. There will probably be considerably more competition from American manufacturers of terminal equipment for a share of the Japanese market."

Application of electronic cash registers and point-of-sale systems, however, is one area in which everyone starts even. At the moment, only trial systems have been installed, but the field is filling up with competitors. Fujitsu, Toshiba, Matsushita, Nippon Electric, Sharp, Hitachi, and others are in various stages of entering either the department store, discount store, or supermarket POS field. Added to these are IBM, NCR, Singer (through a joint venture with Hitachi), and other U.S. entries.

Department stores in Japan differ from those in the U.S., so the fact that American companies have a headstart in this country will not necessarily affect their acceptance in Japan. Supermarkets, on the other hand, are much more like those in America and may be easier to automate than department stores.

Another important factor in Japan is the banks, which are not only creating a demand for cash-dispensing terminals and electronic funds transfer systems of their own but are pushing to link up with retail stores.

Communications

Telephone exchanges offer profits, facsimile doesn't

Of all the sectors of the communications business, the electronics telephone exchanges are growing fastest. The number sold is doubling each fiscal year, from 10 in fiscal 1972, to 20 in fiscal '73, to 40 in fiscal '74. But cable and microwave equipment are also doing well. Facsimile equipment and the video telephone have yet to create any kind of a demand.

The electronic exchanges are supplied to Nippon Telegraph and Telephone Public Corp. by Nippon Electric Co., Fujitsu Ltd., Hitachi Ltd., and Oki Electric Industry Co. At full capacity, they could handle up to 40,000 terminals but at present they are being built for fewer. (For areas with lower population densities than the major cities, NTT is also developing smaller exchanges.)

Because of the subsidies for research included in the tags on early units and because of economy of scale since then, the exchanges have been declining in price each year. This year they cost on the order of 10,000 yen (\$38) per terminal—something like three times as much as currently popular crossbar exchanges, which, however, include fewer functions and are rising in cost.

Demand for electronic exchanges could remain strong for a long time. About a third of Japan's 25 million telephones are switched by step-by-step exchanges, most of them in downtown areas of large cities where they occupy high-rent space. But electronic exchanges require just 10% of the space of a step-by-step exchange, and therefore are attractive as replacements to save on rent.

Another advantage of the electronic exchanges could present a problem initially: they require far less maintenance than step-by-step exchanges. Consequently, strikes by maintenance crews protesting present or future transfer of duty could slow down conversion.

The present cost of electronic exchanges, though acceptable for telephone systems, is still too high for other applications. Takeo Kurokawa, executive vice president and director of Nippon Electric, says that with reduced costs it will be good for data communications and TV switching. Once this happens, electronic exchanges should bring about a change in subscriber terminals, such as a faster move to push-button phones (which have electronic tone dialing).

For defense and for automatic private telephone exchanges (PABX) made for export, Japanese companies are producing small electronic exchanges with 500 to 1,000 lines. These cost about 50% more than the crossbar type, but are less than half the size and have more functions. Companies are not selling them domestically because NTT insists that domestic PABX have the same components as domestic utility exchanges, making the price prohibitive. If there were no restrictions, it is conceivable that economy of scale could bring the price of these smaller exchanges down to that of crossbar.

On this point an executive at one of the NTT's major suppliers charges that, despite liberalization of telephone lines, NTT still imposes all types of "administrative guidance." Precedents, perhaps a Japanese version of the U.S. Carterphone case, may be needed for true freedom in installing vendor-designed equipment. But none of the six major suppliers can be expected to fight with an important customer, and it probably will be up to an outsider or importer to attack NTT's requirements. This same executive adds that freedom from these restrictions often makes export markets more attractive than the home market.

Plans for installation of a 60-megahertz coaxial-cable transmission system between Tokyo and Osaka, perhaps in 1975, are going ahead. Development is also under way on a 200-MHz system, but it may not be practical just yet because repeater distances will be something like half that on the 60-MHz system. The 200-MHz cable would require 400 repeaters between Tokyo and Osaka. A thick cable with reduced loss that would permit repeater spans to be increased to 1.5 kilometer is being developed, but it too may not be economical.

Thus the emphasis in cable transmission in the future may shift to pulse-code-modulation systems, and a PCM cable system that would operate at 97 MHz per second is being developed with longer repeater spacings.

This year a 30-MHz submarine cable will be installed across the ocean channel between the Japanese islands of Honshu and Hokkaido. Nippon Electric has already supplied repeaters for a similar 30-MHz submarine cable with 12-MHz bandwidth and for a 12-MHz submarine cable with 960 channels each way in a 4-MHz band-

Communicators. Takeo Kurokawa, executive vice president for Nippon Electric (left), is pleased with growth of electronic exchanges. But Yuichi Makino, director for Toshiba (right), is disappointed with facsimile equipment sales since NTT liberalized line use.

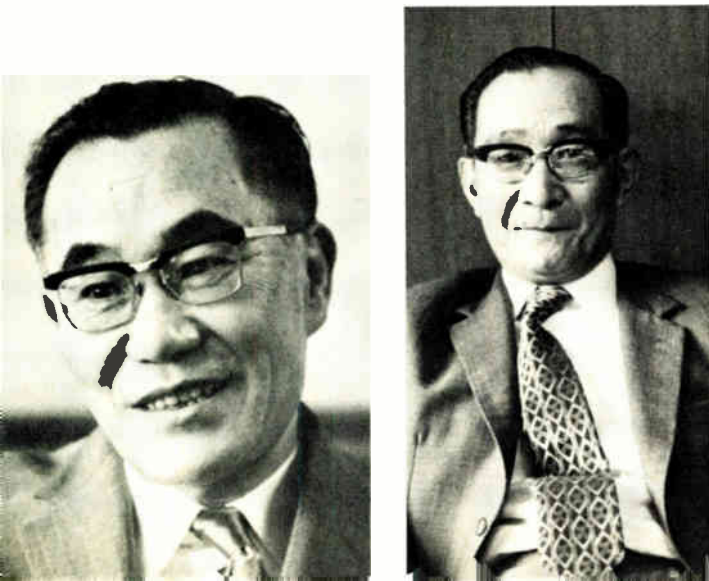

width. By the end of this year or next, a 400-kilometer ocean span of cable will be installed between NTT electrical communication laboratories at Yokosuka and Ibaraki. At present all communications lines converge on Tokyo, and this would provide a bypass around Tokyo to be used in event of an emergency. Total cost of repeaters would be in the \$10 billion range.

The microwave message

Demand for microwave equipment is increasing by more than 10% a year among gas companies, the Japanese National Railways, telephone, and other users.

Last year Nippon Electric shipped a 2,700-telephone channel, 5-gigahertz system for the Tokyo-Nagoya-Osaka route with five radio carriers and one spare in each direction. It also shipped similar systems with three radio carriers and one spare for the Hiroshima-Fukuoka route. Since there are three routes between Tokyo and Osaka, there is still possible demand for two more systems between these cities.

This year Nippon Electric again broke new ground when it shipped 15-GHz systems, also with a capacity of 2,700 channels per radio carrier, to be used between 5-GHz terminals at the edges of cities and exchanges in the center of cities. The standard procedure had been to use 12-MHz coaxial cables for this application, but the 15-GHz microwave systems were installed to provide an alternate transmission method for the long-distance lines in the event of destructive earthquakes or typhoons. Nippon Electric claims to be the only company in the world with a 2,700-channel-per-carrier system at this frequency. It is also working on 2,700-channel-per-carrier systems at 11 GHz, and says that in the future it may develop frequency-division-multiplex/frequency-modulation systems with more than 2,700 channels.

This year a 13-hop experimental system, with an average hop of 5 km and a 6.5-km maximum hop, went into operation between two of NTT's laboratories. It is the only dedicated connection between the laboratories. Operation during the first few months has been good with little trouble either from equipment or from attenuation by rainfall, according to Nippon Electric engineers. They had been worried because all the equipment is in small enclosures at the top of towers, but everything worked well through the past hot summer.

At still higher frequencies all problems in the design of millimeter-wave repeaters for the 40-80-GHz band have been solved, and a 22.7-km line with one repeater in the middle has been installed between the NTT Ibaraki electrical communication laboratory and the Mito telegraph office.

This system has a data rate of 806 megabits per radio carrier, with a capacity of up to 12 carriers and one spare each way. Standard repeater distance is 20 km, but this depends on the number of bends in the waveguide.

As for the very highest frequencies, Nippon Electric has exported to a power company in Bulgaria an optical transmission system of six telephone channels over a light beam in the atmosphere for distances of up to 3 km. The transmitter is a light-emitting diode, and data rate is 300 kilobits per second. The company has also developed a system using a pulsed laser with 4-milliwatt

JAPAN

output that can transmit a 4-MHz bandwidth TV signal up to 200 meters.

On a much smaller scale, there is a more conventional wireless technique that is enjoying a quiet boom, and another that promises to produce business in the very near future. Yuiohi Makino, director and general manager for the Telecommunications division of Toshiba, says that a pocket telephone paging service is very popular, and the 12,000 units made each month by Toshiba and two other companies are insufficient to meet demand. Rental is only 1,500 yen (\$5.70) a month.

Toshiba has also developed a cordless, wireless telephone set that NTT wants to use at exhibition halls so it won't have to install new telephone circuits for each new exhibition every few days. A loop radiating around the periphery of the hall would pick up signals. In the future, a similar scheme might be used for offices to eliminate rewiring as desks and people move.

Conversely, the video telephone has not caught on, though it seemed all set to become an important new market. That prospect helped trigger the vast amount of work now being done on digital communications systems, it being much simpler to multiplex and to maintain the quality of digital TV signals than analog signals. But both Bunichi Oguchi, director, engineering bureau, NTT, and Taichiro Atarashi, executive director and manager of communications, industry division, Fujitsu, say that nobody is clamoring for video telephones.

Similarly, manufacturers of wire communications equipment have for years looked forward to the availability of Japan's switched telephone network for transmission of data, including simple facsimile and electrocardiograms. It only seemed to need NTT to convert lo-

Towering. The 20-gigahertz-band repeater towers on a line between two NTT labs have all equipment mounted on the platforms.

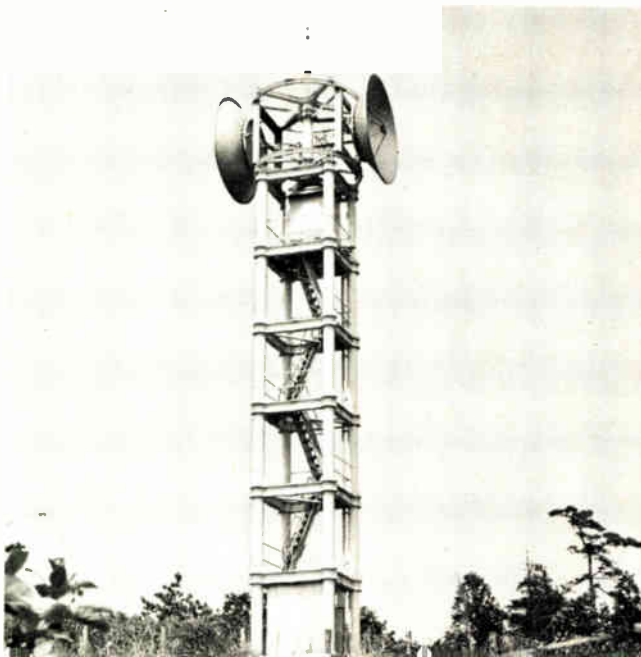

cal calls to a timed message unit rate, which finally occurred this year. But there were no noisy celebrations when the Okinawa prefecture, the last in the country, was cut over to the new message unit system in August.

Sales of computer terminals did increase to take advantage of the new service, but many other applications were expected to take off. Some years ago it seemed that there would be explosive demand in Japan for facsimile, and products were announced by about 10 companies—both communications and other manufacturers. But company executives now agree that there won't be too much demand unless cost problems are solved.

This situation persists despite the large potential demand. Basically, facsimile is much better than teleprinters in the Orient because of the large variety of characters required compared with Western countries, where a Roman alphabet keyboard is sufficient. The line charge for facsimile, however, is expensive because it takes four to six minutes to transmit one page over a 3-kHz-bandwidth telephone line. It isn't possible to double bandwidth, and bandwidth compression with present technology would probably double the cost from the present 400,000 yen (\$1,521).

Industrial

Capital investment lifts instruments to new peak

Before the anti-inflation clamp on credit went into effect late this summer, capital investment in Japan ran high enough to boost sales of electronic instruments. Now money is tight, but since spending for industrial instruments usually lags behind declines in capital budgets by at least a half-year, instrument sales should remain high at least through the first half of 1974.

A year ago, instrument houses were not too optimistic about the recovery of Japanese industry. But the increase in business has been surprising. Masahiro Shimizu, president of Hokushin Electric Works and one of those who were only mildly hopeful last year, enthusiastically reports that sales are 40% higher than in 1972. In fact, it appears that industrial instrumentation will hit a new peak, thanks to a lift provided by increased government spending on pollution control.

Business was so good for Yokogawa Electric Works that it was unable to fill all orders and may have lost some customers to competitors. Yokogawa claims to have about 23% of the instrumentation market, perhaps twice the share held by either Yamatake Honeywell or Hokushin. However, Yamatake Honeywell expects its position will benefit from increased interest in and spending on climate controls for buildings. This trend should also favor Tokyo Keiki Co.

Computer combos

Analog instruments still dominate almost the entire marketplace. This year Yokogawa introduced to Japan the Foxboro SPEC 200 analog system, built under license, that interfaces with computer controllers. Hoku-

shin has also brought out a new analog line for backup of direct digital control. However, the company has deemphasized its own computer production in favor of computers assembled with special modules.

For Hokushin, the liberalization of computer imports will be a benefit because the company will be able to buy modules at better price breaks. Hokushin has already installed 20 systems with DEC modules.

In the opinion of Tohru Kanemitsu, product manager, marketing section of Yokogawa's industrial instruments division, one-chip processors are viable for direct digital control. Each chip would provide local control of one or several loops, with only important signals sent to the larger central processor.

Price declines end for test gear

Test and measuring instruments' prices actually increased this year and will probably continue upward in 1974. In fact, setting the pace for the industry, Takeda Riken has said it expects to raise prices in the near future by an average of 30%. This trend is all the more significant because foreign competitors got an automatic price cut as a result of the up-valuations.

Instrumentation companies also are burdened by the Japanese refusal to pay for engineering services. The dearth of Japanese engineering companies often forces equipment suppliers to provide engineering in a purchase contract as a sort of discount extra or "omake," as the Japanese call it. However, the long-standing ability to "swallow" engineering costs may also make the Japanese more competitive in exports.

Indeed, with the economy as good as it's been, this year they may get away altogether unscathed by the unfavorable price situation. For instance, Morio Ono, assistant manager of Yokogawa's instrumentation marketing section, reports that the company boosted prices of analog instruments and direct-current measuring devices by 15% to 20% in July, but sales during September increased 20% over the previous period and should increase 15% during the coming six months. Matsushita and Iwatsu Electric Co. have had similar experiences.

The reason for the price hikes is the higher cost of virtually every component and material used to produce test instruments, particularly ICs and copper wire. Small companies are being hurt by it, according to Takeda Ri-

Masahiro Shimizu, president of Hokushin, was surprised by strong sales in industrial sector, despite construction cutback.



ken, and some small manufacturers may go bankrupt in the midst of overflowing order books because they are missing some parts and are unable to deliver.

Nevertheless, increases in sales came across the board and included oscilloscopes, multimeters, and even expensive test systems, Japanese manufacturers report. Among new products, Matsushita recently introduced two new types of scopes. One is a miniscope for computer servicing that fits into an attache case. Another is a programmable oscilloscope.

"Japanese manufacturers can no longer compete by trying to undercut price of imports with a dead copy," comments Hajime Karatsu, managing director of Matsushita Communication Industrial Co.'s systems development department, "but must produce unique products such as these oscilloscopes in order to survive."

Space

NASA to help Japanese loft larger satellites

Investment in space is climbing, states Yasuhiro Kuroda, director of the systems planning department of the National Space Development Agency. In the Japanese government's 1974 budget, Nasda hopes to get about 39.3 billion yen (\$148 million) up from 29.3 billion yen in 1973 and 18.3 billion in 1972. This is about 70% of the space budget, the remainder of which goes to the University of Tokyo, the Ministry of Posts and Telecommunications, and the Transportation Ministry.

In 1976 Japan plans to launch two geostationary satellites weighing more than 300 kilograms apiece—a medium-capacity one for communications experiments and a medium-power one for meteorological experiments. Since it will be many years before Japan will have rockets big enough to launch the two, it expects to ask the U.S. space agency to undertake the job, thus getting around one threatened delay.

Nasda officials foresee no problems in this respect from NASA, which has already launched satellites for other countries, but cannot start negotiations with NASA until the Japanese Diet, either late this year or early next, gives its approval in the budget for fiscal 1974. Also, Nasda would actually prefer to approach NASA later than sooner, after Japan has had some success in its own independent space development program and so could offer the U.S. something other than just the ability to foot the bill, explains Kuroda.

At the Ministry of Posts and Telecommunications, communications and broadcast satellites have reached the conceptual design phase, with the definition phase soon to follow.

Progress is further along on those satellites to be put into orbit by the "n" rocket starting in 1975. The first stage of the "n" rocket is an improved four-digit-series Thor-Delta with three strap-on boosters; the second stage is a liquid-fuel rocket developed in Japan, and the third stage will be a solid-fuel rocket.

Present plans call for an engineering test satellite

JAPAN

(ETS-I) weighing 85 kgm to be launched in August, 1975. In February, 1976, an ionospheric sounding satellite (ISS) weighing 135 kgm is to be launched. In February, 1977, ETS-II, weighing 130 kgm, is to be launched. And in February, 1978, an experimental communications satellite (ECS) is to be launched.

Only the first two of these satellites are completed. The prototype and flight model of the ETS-I were produced by Nippon Electric, and the prototype and flight model of the ISS by Mitsubishi.

As Japan jumps into the space age, there is much maneuvering for the many commercial contracts that probably will be forthcoming in the next few years. Most is by the three Japanese companies that will probably get the biggest share of the business and the U.S. space electronics companies with which they have technical agreements—Nippon Electric and Hughes, Mitsubishi and TRW, and Toshiba and General Electric.

Toshiba is developing ground-station transmitter techniques for communications satellites in a joint project with NTT. The result could be major orders for equipment as functional alternatives to microwave stations during disasters like earthquakes.

Nippon Electric has two study contracts from Intelsat. One is for increasing the utility of transmission used for space communications by simultaneous vertical and horizontal polarization of the transmitted signal. The other is for a 1-gigabit PSK modem for time-division multiple-access with burst-mode operation that Nippon Electric says has the highest speed in the world.

Nippon Electric also has developed an 4-gigahertz parametric amplifier that achieves an unusually low-noise temperature of 55 Kelvin despite being uncooled. This amplifier uses a two-stage solid-state Gunn oscillator pumping source and does not require the periodic maintenance needed on the usual helium-cooled amplifier. (Nippon Electric, incidentally, has sold two of these to the Soviet Union.)

By using Peltier-effect cooling to -40°C the company has developed a similar maintenance-free amplifier with a noise temperature of 45 Kelvin.

Defense

District court's decision delays, could halt the military

The Japanese Defense Agency was surprised to find this year that locating a Nike base on land released from a government forest reservation can lead to trouble. In fact, this situation started a major controversy when a

group of citizens brought suit charging that it is improper for such land to be converted to unconstitutional purposes, meaning military use, and a Sapporo district judge agreed with their contention. Suddenly the Japanese self-defense forces were declared unconstitutional.

Final determination, though, may be years in the future. The government wanted to bypass the Sapporo higher court and take its case directly to the Supreme Court, but in Japan this procedure is permissible in a civil case only if the plaintiffs agree, which they did not. The plaintiffs appear to be more interested in the propaganda value of their victory than a definitive decision, which may not come for something like 10 years.

Meanwhile, nothing much has changed. The fourth five-year defense plan, which started in 1972, continues steadily on its course within the confines of the budget of 4.63 trillion yen (\$17.6 billion) over five years. Although the fourth defense plan budget is far larger than any previous one, much of it simply covers inflation. Thus the defense agency expects to buy about the same amount of hardware as before.

One project that is going ahead is Mitsubishi Electric Corp.'s three-dimensional radar. In the 1972 and 1973 budgets two of these units were bought for about 2 billion yen (\$7.6 million) each. Another will be requested in the budget for the coming year. A Nippon Electric transportable three-dimensional radar, which costs about 1.6 billion yen (\$6.1 million), was purchased in 1972. Another was requested in the 1973 budget, but turned down by the Ministry of Finance. A try for a second unit will be made again in the upcoming budget. Another radar under development is a unit in the 9-gigahertz band for an anti-aircraft gun.

R&D and prototype fabrication of a command operations field computer for the ground self-defense force should be finished by next year. The display was completed last year. This computer, being built by Toshiba, will be mounted in vans and two units furnished to each division—one at command headquarters and one to artillery. Estimated cost of the pair for each division is 2.6 billion yen (\$9.98 million).

At present the defense agency relies on Nippon Telegraph and Telephone for about 70% of its telephone long lines. It planned to switch over to its own microwave system during the fourth defense plan, but funds are inadequate, and now it says it will be lucky to be able to complete the installation by 1981. The Defense Agency is working on an fm random-access discrete-address (RADA, a frequency-time matrix scheme) communications system. However, it has not been able to obtain frequencies for operation of this system from the radio regulatory bureau of the Ministry of Posts and Telecommunications.

Some of the airborne electronics under development is for new planes designed in Japan, and this includes a fire-control system costing as much as 0.8 billion yen (\$3.04 million) for the close support version of the T-2 trainer. Most of the airborne electronics in production is domestic production under license for the domestically produced version of the F4-J Phantom, 128 of which have been scheduled to be procured. □

Reprints will be available at \$2.00 each. Write to Electronics Reprint Dept., P.O. Box 669, Highstown, N.J. Copyright 1973 Electronics, a McGraw-Hill publication.

JAPAN

ELECTRONIC MARKETS

1972-1974

COMPONENTS

	1972	1973	1974
COMPONENTS, PASSIVE AND ELECTROMECHANICAL			
Antennas and antenna hardware	50.5	52.3	53.9
Capacitors, fixed	364.4	419.8	481.0
Capacitors, variable	31.4	33.3	42.9
Connectors, plugs, and sockets	60.6	71.0	82.0
Crystals and crystal filters	19.8	21.7	26.8
Delay lines	1.1	1.1	1.7
Displays (except solid state devices)	23.2	26.6	30.5
Ferrite devices (except TV yokes and flybacks)	30.5	31.1	32.0
Loudspeakers (OEM type, for assembly into equipment)	97.1	133.2	144.9
Magnetic tape	73.1	84.8	91.6
Microphones (OEM type for incorporation into equipment)	28.9	33.8	40.6
Microwave components (except tubes and semiconductors)	35.6	42.6	51.0
Potentiometers, composition	126.6	143.8	154.6
Potentiometers, wire wound	20.6	23.5	25.9
Power supplies (OEM type, for assembly into equipment)	29.3	33.7	38.8
Printed circuit boards	146.4	168.0	193.2
Relays	114.1	125.5	136.9
Resistors, fixed (including wire wound)	124.9	155.2	155.6
Servos, synchros, and resolvers	20.0	25.7	27.6
Switches (for communications and electronics)	72.0	95.9	111.5
Transformers, chokes, and coils	436.1	529.7	551.1
Total	1,906.2	2,252.3	2,474.1
SEMICONDUCTORS, DISCRETE			
Microwave diodes, all types	6.8	8.7	10.5
Rectifiers (including diodes rated more than 100 mA)	126.6	158.1	173.5
Signal diodes (rated less than 100 mA, including arrays)	70.4	78.4	85.3
Thyristors (SCR's, four-layer diodes, etc.)	28.1	40.7	48.7
Transistors, power (more than 1-watt dissipation)	162.7	206.6	247.1
Transistors, small signal (including FET's and duals)	188.2	231.9	229.9
Zener diodes	14.1	18.9	20.8
Total	596.9	743.3	815.8
SEMICONDUCTORS, INTEGRATED CIRCUITS			
Hybrid IC's, all types	50.2	63.0	78.2
Digital logic circuits, bipolar	81.1	106.5	131.7
Digital logic circuits, MOS and CMOS	97.7	144.5	207.9
Digital memory circuits, bipolar	3.0	4.2	8.4
Digital memory circuits, MOS and CMOS	14.6	17.5	29.5
Linear IC's, (except op amps)	72.8	92.7	110.9
Op amps, monolithic only	4.5	9.7	11.7
Total	323.9	438.1	578.3
SEMICONDUCTORS, OPTOELECTRONIC			
Total	9.9	14.1	20.9
TUBES			
Tubes, cathode ray (except for TV)	4.9	5.3	5.7
Tubes, receiving	27.8	18.0	13.3
TV picture tubes, black and white	70.2	60.8	55.8
TV picture tubes, color	437.8	433.5	404.3
Total	540.7	517.6	479.1
TOTAL COMPONENTS CONSUMPTION	2,377.6	3,965.4	4,368.2
	(millions of dollars)		

Note: Dollar amounts are based on a conversion rate of \$ 1 = 263 yen

	1972	1973	1974
CONSUMER PRODUCTS			
Audio tape recorders and players (except car stereo)	414.7	538.5	653.8
Citizen band transceivers	7.0	6.3	6.4
Electronic ranges	101.6	162.5	225.7
Hi-fi component equipment	111.4	163.7	218.1
Musical instruments (organs, electric guitars, etc.)	51.3	53.9	56.5
Phonographs and phonoradio combinations	363.0	431.8	483.9
Radios (including car radios)	182.9	192.1	199.0
Video tape recorders (for consumer use)	17.7	31.7	49.4
TV sets, black and white	124.0	109.1	100.2
TV sets, color	2,335.1	2,203.0	2,102.7
Total	3,708.7	3,892.6	4,095.7
MEDICAL			
Diagnostic equipment, except X-ray	35.3	37.0	38.8
Patient monitoring equipment	8.4	10.1	12.6
Prosthetic equipment (hearing aids, pacemakers, etc.)	11.4	13.1	14.4
Therapeutic equipment, (except X-ray)	10.5	11.2	14.4
X-ray equipment, diagnostic and therapeutic	90.7	97.3	104.2
Total	156.3	168.7	184.4
AUTOMOTIVE			
Alternator diode assemblies	53.2	60.8	68.4
Fuel-injection controls	3.8	7.6	22.8
Ignition controls	0.4	0.8	3.8
Electronic voltage regulators	0.4	0.8	1.1
Total	57.8	70.0	96.1
COMMUNICATIONS			
Broadcast equipment (includes transmitters, and studio equipment for radio and TV, but not CATV)	63.3	67.3	75.1
CATV (studio and distribution)	3.0	3.6	4.0
Closed circuit TV	11.4	15.2	20.9
Intercoms and intercom systems	16.7	18.6	20.0
Microwave relay systems	94.4	114.1	146.4
Navigation aids, except radar	89.6	98.7	108.7
Radar (airborne, ground, and marine)	70.0	77.9	91.3
Radio communications, except broadcast	189.7	225.0	247.1
Telephone switching, electronic or semielectronic (except PABX)	33.1	68.4	115.0
Video recorders and playback equipment (non consumer)	38.0	57.0	68.4
Wire message equipment	144.1	180.7	207.3
Wire carrier equipment (includes fdm and pcm)	234.5	264.9	323.2
Total	987.8	1,191.4	1,427.4
COMPUTERS			
Analog and hybrid computers (except process control)	8.4	10.0	12.5
Converters, analog/digital and digital/analog	126.2	164.3	213.5
Digital computers, CPU (except minicomputers)	743.7	901.1	1,161.2
Digital minicomputers, CPU	20.2	30.2	45.2
Data storage devices (core, disk, drum, and tape)	561.2	715.0	930.9
Data entry equipment	102.7	150.2	182.5
Output equipment	76.0	152.1	190.1
Remote terminal equipment	30.2	45.2	67.9
Electronic calculators	199.0	318.1	403.0
Total	1,867.6	2,486.2	3,206.8
INDUSTRIAL EQUIPMENT			
Machine tool controls	32.6	51.9	58.6
Motor speed controls	85.6	105.5	115.0
Power electronics equipment	106.5	136.9	163.5
Process controls and related equipment	372.6	494.3	456.3
Ultrasonic cleaning and inspection equipment	9.5	12.3	13.1
Total	606.8	800.9	806.5
TEST EQUIPMENT			
Amplifiers, laboratory type	16.2	17.5	18.9
Calibrators and standards, active and passive	11.4	13.7	17.3
Components testers (capacitor, IC, transistor, tube, etc.)	18.7	18.7	20.5
Counters and timers	9.3	11.2	13.2
Electronic meters, analog	7.7	9.0	10.6
Electronic meters, digital	6.4	7.9	8.8
Electronic meters, analog panel types	24.3	31.6	33.1
Electronic meters, digital panel types	3.8	4.6	5.7
Generators and synthesizers (pulse, signal, sweep—to 1 GHz)	9.3	12.2	13.7
Lasers, all types	3.4	3.6	3.8
Microwave test and measuring instruments (above 1 GHz)	14.8	15.3	16.1
Oscillators	8.8	8.9	9.1
Oscilloscopes and accessories	29.6	37.1	40.3
Power supplies, laboratory type	5.7	7.4	9.1
Recorders (analog and digital, includes chart, magnetic tape, and X-Y types)	16.6	21.5	24.9
Total	186.0	220.2	245.1
TOTAL EQUIPMENT CONSUMPTION	7,571.0	8,830.0	10,002.0

Nation-wide consumption in Japan in millions of dollars

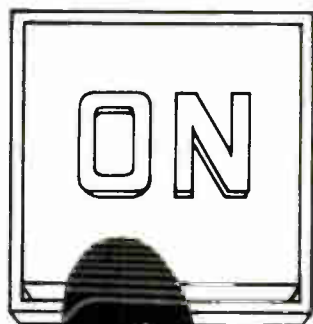

Norplex...your reliable hand for multilayer circuits from prepreg preparation to push button performance

Thin-clad laminates or prepreg materials. Whatever your application calls for, it's the Norplex team reliability that can mean the difference at start-up time.

In thin-clad laminates, it's the reliability of optimum dimensional stability. Plus Norplex's ability to adhere to the many precise tolerances demanded by today's sophisticated multilayer circuits.

And in prepreg materials, it's the Norplex team effort to maintain quantity production under the strictest hygienic conditions... conditions that assure you prepreg which is clean, free of foreign particles and available in many varieties.

Finally, it's the pride of every plant worker, office employee and field representative... a team that serves every customer with 100% effort through Norplex's Quality Assurance program.

All together, this Norplex reliability spells out satisfaction for all your thin-clad laminates and prepreg needs... from plants in both La Crosse and Franklin, Indiana. Start the Norplex team working for you by writing or phoning for catalogs. Norplex Division, UOP (Universal Oil Products Company), Norplex Drive, La Crosse, Wisconsin 54601. Telephone: 608/784-6070.

**Norplex[®] laminates
by UOP**

Distributors

Arizona: Hamilton/Avnet, Phoenix (602) 269-1391
Kierulff, Phoenix (602) 273-7331
California: Hamilton/Avnet, Mountain View (415) 961-7000
San Diego (714) 279-2421
Hamilton Electro, Culver City (213) 870-7171
Kierulff, Palo Alto (415) 968-6292
San Diego (714) 278-2112
Wesco Electronics, Los Angeles (213) 685-9525
Colorado: Hamilton/Avnet, Denver (303) 534-1212
Kierulff, Denver (303) 343-7090
Florida: Hamilton/Avnet, Hollywood (305) 925-5401
Georgia: Hamilton/Avnet, Norcross (404) 448-0800
Illinois: Allied, Chicago (312) 421-2400
Hamilton/Avnet, Schiller Park (Chicago) (312) 678-6310
Kierulff, Rosemont (Chicago) (312) 678-8560
Kansas: Hamilton/Avnet, Prairie Village (Kansas City) (913) 362-3250
Maryland: Hamilton/Avnet, Hanover (Baltimore) (301) 796-5000
Pioneer, Rockville (301) 427-3300
Massachusetts: Electrical Supply, Cambridge (617) 491-3300
Gerber, Dedham (617) 329-2400
Hamilton/Avnet, Burlington (617) 273-2120
Kierulff, Needham Heights (617) 449-3600
Michigan: Hamilton/Avnet, Livonia (313) 522-4700
Minnesota: Hamilton/Avnet, Bloomington (612) 854-4800
Missouri: Hamilton/Avnet, Hazelwood (St. Louis) (314) 731-1144
New Jersey: Arrow, Saddlebrook (201) 256-7331
Hamilton/Avnet, Cherry Hill (609) 662-9337
Cedar Grove (201) 239-0800
Haddonfield (609) 429-1526
New Mexico: Century, Albuquerque (505) 265-7837
Kierulff, Albuquerque (505) 247-1055
New York: Semiconductor Concepts, Hauppauge (516) 273-1234
Hamilton/Avnet, Syracuse (315) 437-2642
Westbury, L.I. (516) 333-5812
Arrow, Farmingdale (516) 694-6800
Summit, Buffalo (716) 884-3450
North Carolina: Pioneer, Greensboro (919) 273-4441
Ohio: Arrow, Dayton (513) 253-9176
Kierulff, Dayton (513) 278-9411
Texas: Hamilton/Avnet, Dallas (214) 638-2850
Houston (713) 526-4661
Kierulff, Garland (Dallas) (214) 271-2471
Utah: Hamilton/Avnet, Salt Lake City (801) 262-8451
Washington: Hamilton/Avnet, Seattle (206) 624-5930
Kierulff, Seattle (206) 763-1550
Canada: Prelco, Montreal (514) 389-8051
Ottawa (613) 237-6150
Electro Sonic Ind. Sales, Toronto (416) 924-9301
Hamilton/Avnet, Montreal (514) 735-6393
Toronto (416) 677-7432
Ottawa (613) 725-3071
L. A. Varah, Vancouver, B.C. (604) 736-6411
Future Electronics, Montreal (514) 735-5775
Ottawa (613) 232-7757
Toronto (416) 677-7820

ANOTHER INNOVATION FROM LITRONIX

THE IRRESISTIBLE LEDS



Our new Red-Lit C200 series constant brightness LED lamps are irresistible because they eliminate the need for external current limiting resistors—saving you time, space and money.

We've accomplished this by packaging a bipolar current regulating IC with the LED. This provides a constant current supply to the LED chip, ensuring a constant brightness over a supply range of 4.5 to 12.5 volts. In addition, the combination of the IC and the LED saves you both board area and

additional component costs. And because there's no need for individual drive circuits, your circuit design job is simplified. This all means that the Bright Guys have come up with another industry first. (Sometimes we feel we're pretty irresistible ourselves.)

There's an irresistible choice of package styles, too. The RLC-200 and RLC-201 are T 1 3/4 size lamps for panel mounting. They're only 50¢ in 1K quantities. The RLC-210 comes in a miniature T 1 size for small tight spaces. And it's priced at 60¢ in 1K quantities.

Want more information on our irresistible LEDs? Call or write the Bright Guys.

the bright guys

litronix

Litronix, Inc. • 19000 Homestead Road • Cupertino, California 95014 • (408) 257-7910 FAX 910-338-0022
European Headquarters Litronix, Inc. • Bevan House, Bancroft Court
Hitchin, Hertfordshire SG5 1EW England • Tel Hitchin 2676 Telex 825 497

Technical articles

Acquiring multipoint plant data over a single two-wire link

ASCII-code interfaces use data-communications technology to permit a digital terminal in a control room to select and control hundreds of distant analog process measurements

by Ivar Wold and Michael Lindheimer, Analog Devices Inc., Norwood, Mass

□ The capability of off-the-shelf electronic modules to perform such functions as signal amplification, analog-to-digital conversion, and multiplexing has had a salutary effect on centralized monitoring and control operations during the past 10 years in process and production plants. The next major advance in making centralized systems more effective and less costly will stem from new special-purpose electronic equipment that will, in effect, bring the benefits of data-communications technology into industrial plants. This equipment will provide compatible interfaces of the process measurements with the operator terminals and digital computers that supervise and control the production operations.

In present centralized systems using the most advanced technology, each analog process signal—the millivolts from a thermocouple measuring temperature, for example—is first amplified and digitized close to its measurement site, and all such digital (parallel-coded) signals are then transmitted, usually via a complex multiplexer, to one central location.

At this central site, which often is thousands of feet from the measurement locations because a plant may occupy several acres of land, an operator maintains constant surveillance and control of plant operation through information (measurements) displayed to him on any one of a variety of digital terminals. Or, at the central site, a digital computer may analyze the input signals and initiate any necessary supervisory or control (actuation) signals that must be returned.

Despite the cost and operational advantages of such centralized control, it entails two major problems. First, the digitized measurement and actuation signals are neither code-compatible nor electrically compatible with commercial digital terminals and computers. Second, because of the numerous measurements and because parallel-coded data requires many wires for its transmission, a separate run of multiconductor cable may be required from each cluster of measurement and actuation signals to the central site. The true installed

ASCII CODE SUBSET FOR DATA ACQUISITION				
DECIMAL NUMERICS	ASCII CODE			
0	0 1 1	0 0 0 0		
1	0 1 1	0 0 0 1		
2	0 1 1	0 0 1 0		
3	0 1 1	0 0 1 1		
4	0 1 1	0 1 0 0		
5	0 1 1	0 1 0 1		
6	0 1 1	0 1 1 0		
7	0 1 1	0 1 1 1		
8	0 1 1	1 0 0 0		
9	0 1 1	1 0 0 1		
	MSB		LSB	
	3 HIGHER SIGNIFICANCE BITS DO NOT CHANGE FOR THESE NUMERALS			4 LOWER SIGNIFICANCE BITS VARY FOR EACH NUMERAL

Assigned control characters	ASCII code	Transmitter response	Receiver response	Controller/multiplexer response
?	0 1 1 1 1 1 1	Convert A-O, transmit result	On - off	Ignored
/	0 1 0 1 1 1 1	Transmit test message	On - off	Ignored
S	0 1 0 0 1 0 0	On - off	End of message	Ignored
=	0 1 1 1 1 0 1	On - off	Clear registers	Ignored
=	0 1 0 0 0 1 1	Ignored	Ignored	Address alert
Unassigned control characters	ASCII code	Transmitter response	Receiver response	Controller/multiplexer response
!	0 1 0 0 0 0 1	On - off	On - off	Ignored
%	0 1 0 0 1 0 1	On - off	On - off	Ignored
*	0 1 0 0 1 1 1	On - off	On - off	Ignored
*	0 1 0 1 0 1 0	On - off	On - off	Ignored

Closing the loop

Readers interested in discussing this article with the authors may call Ivar Wold or Michael Lindheimer during business hours, Nov. 26-30, at (617) 329-5791.

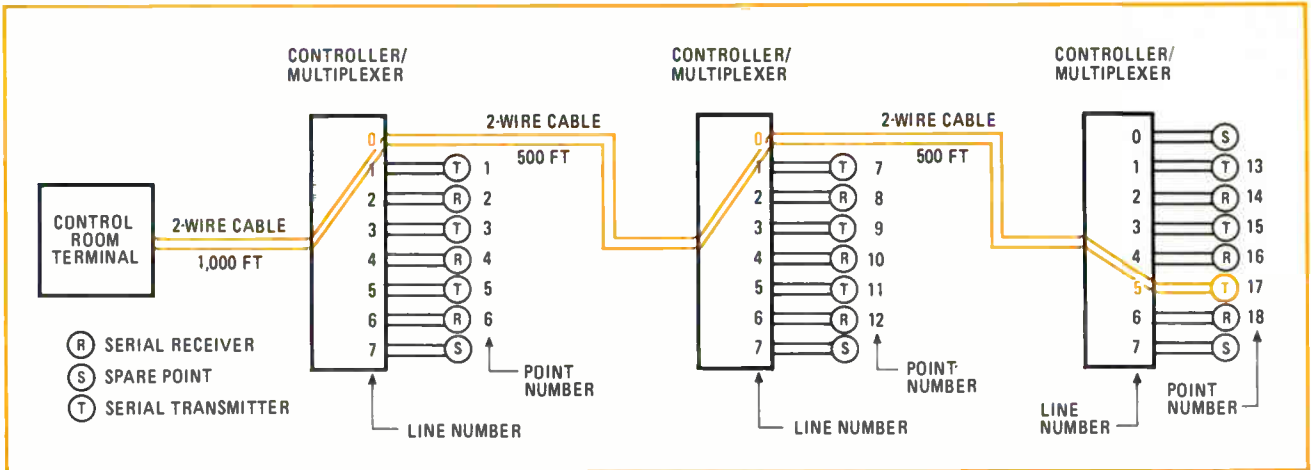

1. **Distributed data.** Controller/multiplexers can be cascaded along one two-wire link to connect dispersed measurement and actuation points to one central terminal or computer, with the communications using 19 serialized ASCII-coded data and control characters.

cost of such wiring may often exceed \$2 a running foot because of the conduits and seals required to meet reliability and hazard-code specifications.

One way to remove the incompatibilities and to reduce the cost of wiring is to adapt some of the common data-communications technology to the requirements of digital process control. Most digital terminals and computers employ or can be adapted to the ASCII (American Standard Code for Information Interchange) code. For data-communications purposes, the bits making up an ASCII character are transmitted serially—that is, a bit at a time.

Furthermore, most terminals and computers have been electrically “standardized” so that they can exchange data via a current loop that uses a 20-milliampere dc level to represent a binary 1 and a 0-mA level for binary 0. Such 20-mA pulse trains, timed by clock signals, can be carried long distances, perhaps as much as 10,000 feet, over ordinary unshielded twisted-pair copper wire. A key factor in the new approach is using an old technique known as half-duplex transmission: the same two-wire link can carry coded measurement signals from a remote site to the central location and coded actuation signals from the central location back to a remote site—but transmission can go only in one direction at any instant.

This two-wire data-communications technique for multimeasurement process-control systems has been made possible by the development of three modules: a serial transmitter, a serial receiver, and a controller/multiplexer. A generalized configuration for a distributed multipoint system is shown in Fig. 1.

The serial transmitter accepts parallel-coded digital data, such as binary-coded-decimal (BCD) levels from an analog-to-digital converter, translates one of the decimal numerics representing the measured value into its corresponding ASCII character, and then it serially transmits the character bits to a remote serial receiver. Each digit of the measured value is transmitted in turn.

The serial receiver accepts the serial-ASCII actuation character transmitted from a distant site and translates the character into a parallel-coded signal, which in turn is then changed, through a digital-to-analog converter, into an analog signal that can be used to adjust the

value of a process variable—pump speed, for example.

In a sense, then, serial receivers and transmitters behave as ASCII terminals, so they can readily communicate with the digital terminal used by a plant operator or the supervisory digital computer.

The third special module, the serial controller/-multiplexer, functions as an addressable multipoint switch. Through the controller/multiplexer, the terminal or computer selects (addresses) any distant measurement or actuation point. A serial transmitter will send back the present value of the measured variable assigned to any one of eight addressable multiplexer channels, or the selected serial receiver will accept new digital data from the terminal or computer to adjust the analog signal to a desired value.

Subset eases electronics

The standard module handles 19 of the 128 characters defined in the full ASCII set. This 19-character subset, shown in the table, can itself be divided into three groups: 10 decimal numerics (0 to 9), five partially assigned control characters, and four completely unassigned control characters. This 19-character subset of ASCII fulfills the requirements for most process, production, and testing applications, simplifies the electronic implementation for parallel/series encoding and decod-

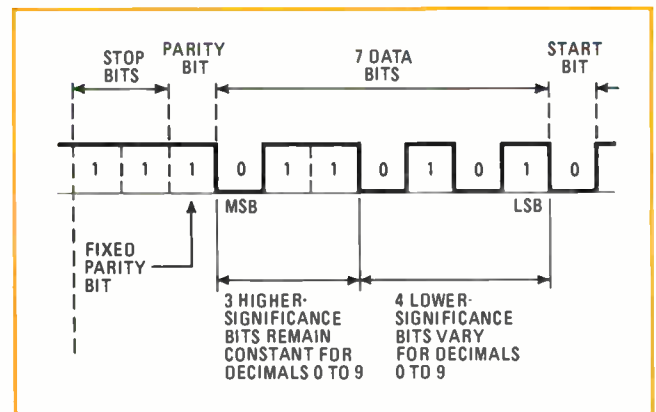

2. **Four bits change.** In the subset of ASCII used in the data-exchange system, only four data bits are changed from 0s to 1s, while the other seven bits are electrically stuffed around the data bits.

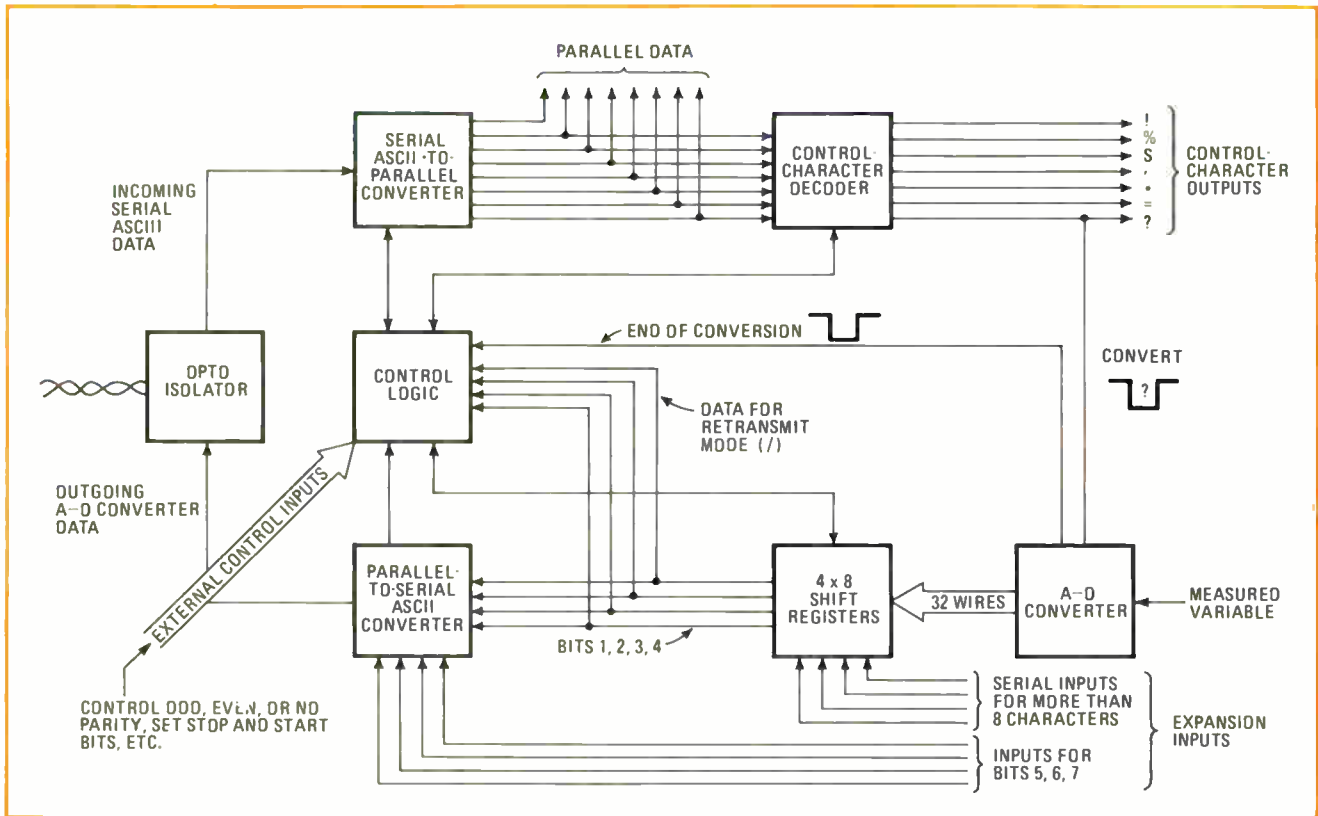

3. Serial transmitter. Incoming measured variable, at left, is converted to digits, translated to serial ASCII, then sent out over the line through the optical isolator (left); but first incoming control characters must be decoded, for example, to start a-d conversion.

ing, and yet is completely communicative with the many commercial terminals and computers that employ the full ASCII set. But the subset can be expanded when necessary.

The five assigned control characters exercise the receiver, transmitter, or controller/multiplexer, as detailed in the table. These control characters first establish a connection and then assure that data passes accurately between connected stations. The four unassigned control characters establish on-off logic levels at connector pins. The on-off signals can be used, as examples, to ring an alarm at a remote location or to open a relief valve if an unsafe pressure develops in a vessel.

Taking measurements remotely

Suppose a plant operator uses a keyboard/printer terminal located in the control room to communicate with all the remote process points. Suppose, also, that the process points occur in clusters of six, with the first cluster about 1,000 feet from the control room and with each succeeding cluster about 500 more feet from the control room. Also, suppose that each cluster involves three measurements (three serial transmitters) and three actuations (three serial receivers). A controller/multiplexer (C/M), which normally handles eight channels but can be expanded to 16, is assigned to each cluster. Such a distribution of points is shown in Fig. 1.

Using the keyboard on his terminal, the operator can obtain a reading at measurement point 6 in this distributed process simply by typing

#6?

which selects line 6 and then tells the analog-to-digital

converter associated with that measurement to start its update conversion and the serial transmitter to send back for example

276

meaning 276° Fahrenheit. Thus, the operator/measurement dialog will appear as

#6?276

on the terminal's printer or display unit.

If however, the operator wants to reach point 17, he needs only to type

#005

Figure 1 shows the connections through the controller/multiplexers for address 005. How the C/Ms do this will be explained later.

The system stays on the last-addressed point until a new ADDRESS ALERT character is transmitted from the central site, so that an operator may at will take a series of readings from the same point without refreshing the address or waiting for a polling cycle to come around to the same point.

Because this in-plant data communications method, dubbed Serdex for serial data exchange, is predicated on the ASCII character set, the use of ASCII in communications will be reviewed before the modules and their application are discussed in more detail.

The full ASCII code uses seven bit positions, resulting in 2^7 , or 128, different bit patterns or characters. The transmission of an ASCII character over two wires requires that the bits be placed in time sequence, or serialized. In addition, one start bit and two stop bits are appended to "frame" the seven-bit data character. Furthermore, one bit is allocated for a parity bit, should

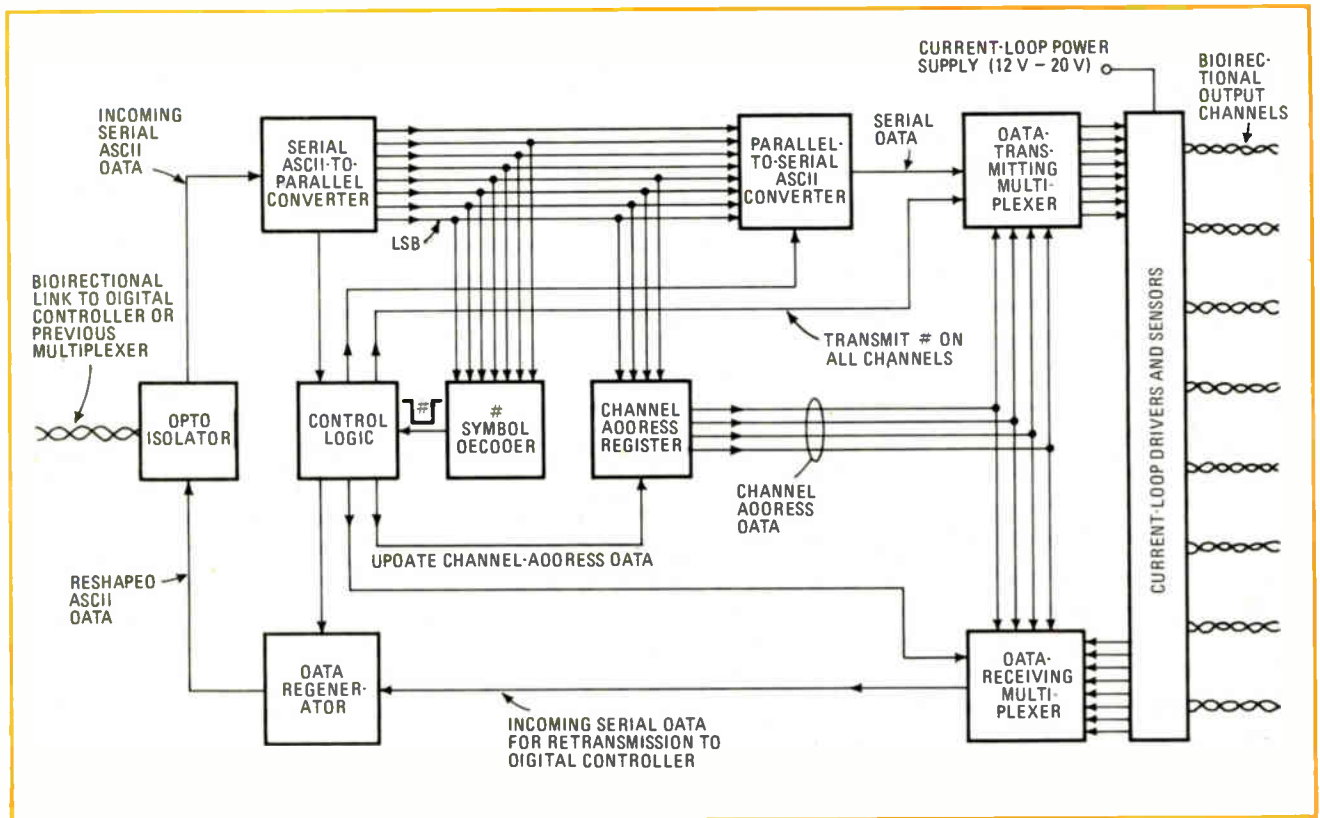

4. Controller/multiplexer. This unit uses a transmitted address to select desired output line for measurement or actuation; symbol alerts C/M to the address and may be used to select another controller/multiplexer connected to other transmitters and receivers in the link.

such an error-checking method be used during transmission. Thus, to send each ASCII character requires the transmission of 11 bits (Fig. 2). The arrangement shown in this figure is known as serial start-stop (but loosely called asynchronous) transmission. The time duration of each bit depends on the clocking rate.

Stuffing the ASCII character

The full 128-character ASCII set requires that each of the seven data bits must be able to take on a 0 to 1 status: from 0000000 to 1111111. The situation is much simpler for transmitting only decimal 0 through 9 in the serial receivers and transmitters. Note, from the table, that 0 through 9 can be defined by only 4 bits taking on either binary 1 or 0 values. This situation is emphasized by the colored bar in the table. The electronic logic and registers required to encode and decode four bit positions is much simpler than for encoding and decoding seven bit positions.

Fixed logic provides the unchanging three bits of the 7-bit ASCII character, as well as the fixed start, stop, and parity bits. These fixed bits are then electrically "stuffed" around the 4 variable data bits, to result in the assembly and transmission of an 11-bit ASCII character, as required for these modules to be code-compatible with those digital terminals and computers that have ports designed to receive and asynchronously transmit 11-bit ASCII characters.

Transmitting a bit at a time

Figure 3 details the serial transmitter. Although primarily for transmission, the transmitter is also equipped

with a control-receiving function to let the transmitter know what it is supposed to do. Control signals, consisting of a 20-mA pulse train, enter the transmitter via an optical isolator connected to the two-wire transmission line (left). The measured-variable value to be transmitted to the distant terminal or computer is shown at the lower right. It feeds an analog-to-digital converter, which is not part of the transmitter but wired to it.

When a transmitter has been selected, the control data coming in through the optical isolator goes through the serial ASCII-to-parallel converter (top of Fig. 3). The control-character decoder (upper right) decodes the seven control characters associated with the transmitter, but ignores all data characters. For example, if the operator wants a transmission of the present value of the measured variable, he depresses the ? key on his terminal. The corresponding ASCII-character pattern (0111111) goes into the control-character decoder and raises the logic level of the ? output line. This CONVERT signal requests the external a-d converter to translate the analog measured value into its decimal representation.

Each of these decimal values appears at the converter's output in BCD format. That is, each decimal numeric is also represented by a 4-bit word. (It turns out that the BCD-code format for each numeric, 0 through 9, is exactly the same as the 4-bit code format representing 0 through 9 in ASCII). The 4-by-8 shift registers in the serial transmitter can accept an 8-digit BCD numeric from the a-d converter. Once the a-d converter has loaded its results into these registers, then clock pulses will shift the most-significant digit of the measured

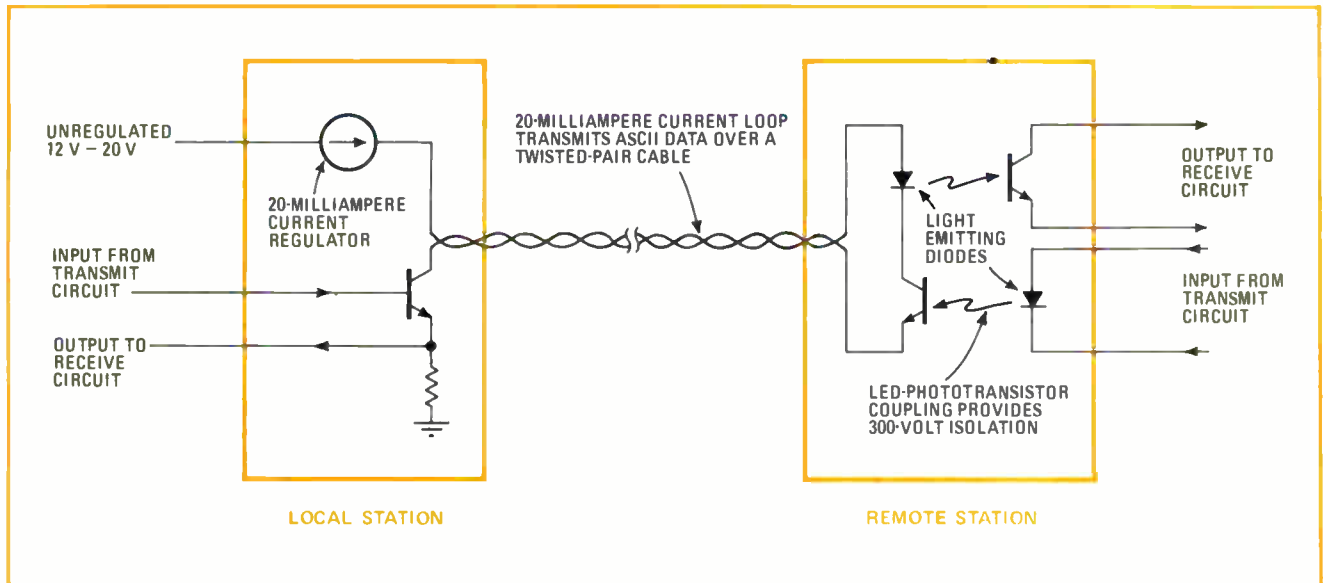

5. **Isolation.** Inputs and outputs of serial-data units are coupled by optical isolators, which prevents noise and also develops 20-mA pulses.

value (a parallel-coded BCD word) into the parallel-to-serial ASCII converter, the necessary appended bits will be stuffed by the control logic, and the resulting 11-bit ASCII character will be transmitted through the optical isolator down the wires to the remote receiving station. Then the next lower significant BCD digit stored in the 4-by-8 shift register is converted, stuffed, and transmitted—and so on, up to eight BCD words.

Transmitting the most-significant digit of the measured value first in the reading sequence is consistent with the way a terminal operates: It types the first digit received at the left and succeeding digits to the right of the preceding digits.

When necessary, external shift registers can handle inputs more than eight characters long, or vary bits 5, 6, and 7 in the ASCII pattern and thus provide for a fuller portion of the total 128-character ASCII set. In this way, a transmitter can send such additional control functions as carriage return and line feed.

Receiving a bit at a time.

The serial receiver operates in much the same way as the transmitter—but in reverse. Its input is a serial ASCII character, which is decoded for data or control characters. The data characters feed into a digital-to-analog converter which in turn develops an analog output signal. The receiver will not be described further, except to say that it must first receive an = control character to clear its registers, then the data characters, and then a \$ control character that informs the d-a converter that the data message has ended so that it can perform its conversion.

Remote addressing

The controller/multiplexer allows any one of a multitude of remote points to be selected by an address sent from the central station (Fig. 4). Incoming data, in a serial format, is converted to parallel format, and the parallel bits are then decoded or converted, depending on whether an ASCII character is a control character (# for ADDRESS ALERT), a channel (point) address, or numeric

data that can flow in either direction through the controller/multiplexer.

The # symbol goes through the control logic and out to all lines through the C/M's data-transmitting multiplexer. The next character sent by the terminal is the channel address, which is decoded to set the logic levels in the data-transmitting multiplexer to select its corresponding output line. Since this multiplexer receives four 0 or 1 logic levels, it can select 16 lines. For eight lines, the multiplexer responds to address characters 0 through 7, and for 16 output lines it also responds to transmitted ASCII characters P through W.

Passing the address along

If the address is a single character, meaning that only one controller/multiplexer is used in the system, then the next character sent is a ?, which causes the a-d converter in the serial transmitter to update and transmit its value back through the C/M's data-receiving multiplexer and on to the distant requesting terminal.

However, if, for example, there are three multiplexers cascaded in the link, as shown in Fig. 1, then the address will require three digits following the #, but preceding the ?. For point 17, the address is 005. The # alerts the first multiplexer in the link, and the first 0 selects output line 0.

The controller/multiplexer retransmits the # to the next C/M, but inhibits the first 0. The second 0 in the address then passes through the first C/M and selects output 0 of the second C/M; meanwhile, the # is retransmitted by the second C/M to the third one, but inhibits the second 0. Now the 5 in the address selects line 5 of the third C/M. The desired address has been reached and the ? updates the a-d converter of the addressed transmitter.

Interface with immunity

As has been mentioned, the electrical interface at each of the three modules in an optoelectronic isolator circuit, which generates and receives the required 20-mA dc current pulses (Fig. 5). This interface also pro-

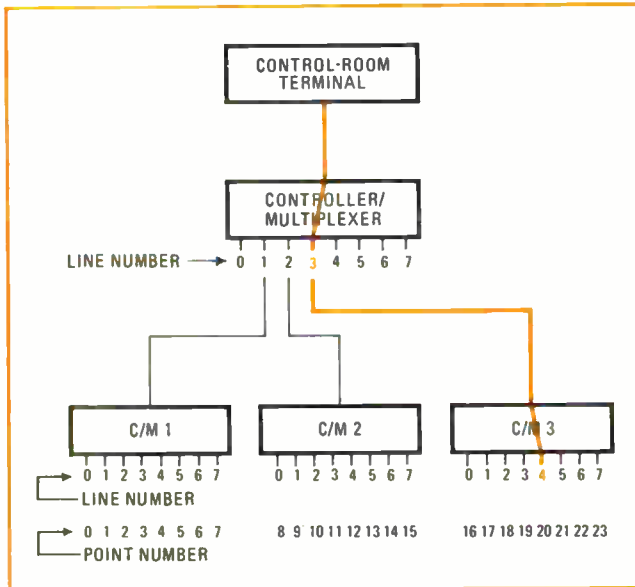

6. Clustered data. When data points are clustered near each other, several C/Ms can be tiered and addressed through another C/M.

vides immunity to line noise and isolates against ground-loop voltages, which may often exceed 100 v between distant locations.

The three basic modules—the serial receiver, the serial transmitter, and the controller/multiplexer—can provide a variety of data-acquisition and control configurations. Figure 1, for example, typifies the kind of installation called for when the measurement and actuation points are distributed over a wide area.

Acquiring clustered measurements.

Sometimes, though, numerous measurements are acquired from points that are close together, and which may be in an environment alien to and unsafe for a human operator. An example is the testing of equipment, or sets of equipment, in an altitude-test chamber that's subject to extremes of vacuum, pressure, temperature, and humidity. For this situation, all the measurement points can be brought to clustered controller/multiplexers in the test chamber, but only a two-wire cable is required to go through the chamber itself for automatic "remote" acquisition of test values.

Here, tiers of C/Ms could be used (Fig. 6). To select point 20 and get a reading would merely require the operator to type #34?

Remote control, too

Figure 7 shows an application that not only permits the remote reading of a temperature, but also allows the operator to manually adjust the temperature from his terminal. The process has a large time constant and is therefore so "slow" it can be controlled easily and safely by a human operator. (Not shown, though, is the controller/multiplexer used to make the connection to the serial transmitter.) The process is to be maintained in the 245°–250°F band.

The dialog following, shown in bold-face, between the operator and the measured point, would consist of the following control characters and temperature reading, as it might appear on a teleprinter. Control charac-

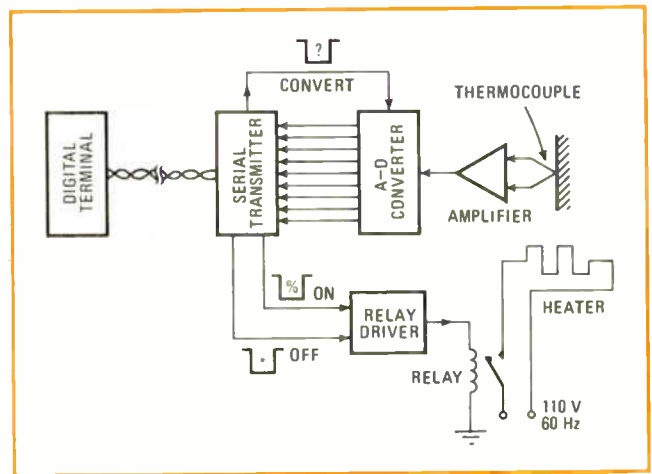

7. Remote control. Heated process can be interrogated remotely by operator at terminal, who can also send control characters to turn the heat on or off as required by process specifications.

ter * is assigned to turn off the heater and character % to turn on the heater.

The sequential actions of the operator and their responses are contained in the parentheses:

- ?247 (247° is okay; operator decides to take new reading in 10 minutes.)
- ?255 (10 minutes later, he finds the 255° too high, so he must turn off heater.)
- * (Control character latches relay driver to turn off heater, and process starts to cool.)
- ?251 (10 minutes later, temperature still too high; take another reading in five minutes.)
- ?249 (Temperature okay, within 245°–250° band; take new reading in 10 minutes.)
- ?242 (Too low; turn on heater.)
- % (Latches heater on.)
- and so on.

The bit rate matches needs

The usable transmission speed of the ASCII characters is determined by several factors, among them the speed at which the digital terminal itself can accept and type the characters and the maximum length of the two-wire cable run. The distributed inductance and capacitance of the cable causes pulse distortion, which can lead to transmission errors. And although the impact of distortion increases with the length of wire and transmission speed, it is easy to transmit a 20-mA pulse train over a 10,000 feet run at least as fast as 110 bits per second, equal to 10 characters a second. An available clock module develops 16 different bit rates, ranging in all common values from 110 to 19,200 bits per second. The actual rate is selectable by pin jumpers on the module.

When data authentication is important for system operation, the modules can be optionally wired to send back acknowledgment signals. To check a transmitter, the operator sends a / control character, followed by eight decimal digits, and the echoes back the eight digits. If both sets of digits are the same, then the operator knows the link is working properly. The receiver can be optionally wired to provide a parity check for each character. If the parity check is correct, it sends back an ACK control character to the remote station. □

COS/MOS

COMPLEMENTARY MOS PRODUCT GUIDE

BEST SELLERS

It's Complementary MOS - and SGS-ATES is firmly committed.

It's the SGS-ATES 4000A series, the first true* second source of this popular COS/MOS family available in plastic dual in-line.

Ask now for a free copy of our "COS/MOS Product Guide"

Available Now		Available Soon		
4001A	4020A	4002A	4019A	4042A
4007A	4025A	4008A	4021A	4045A
4011A	4027A	4009A	4022A	4047A
4017A	4028A	4010A	4023A	4048A
	4029A	4012A	4024A	4051A
	4035A	4013A	4030A	4052A
		4014A		
		4015A		
		4016A		

*Made with RCA license and know-how

B Communications



SGS-ATES Group of Companies



Circle 114 on reader service card

Meet our new series of
high-frequency problem solvers . . .

High-Performance VHF/UHF FET Family

Remember the U310? Some people call it the SuperFET. We introduced it a year ago: worst-case 75Ω input match VSWR of 1.25:1. Figure of merit 2.35×10^9 typical. Third order intercept point of +29 dBm.

Now we've extended the U310 technology to produce an entire family of high-performance N-channel junction FETs. They're ideal for VHF/UHF applications such as the two circuits shown below:

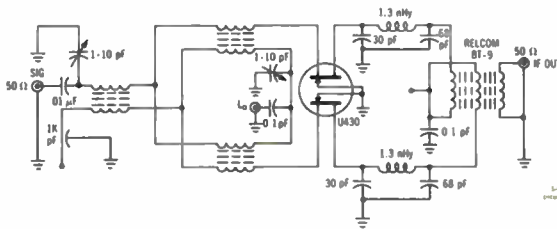

Single-balanced active mixer — 100 dB dynamic range,
+ 2.5 dB conversion gain, + 32 dBm intercept point, 50-250 MHz.

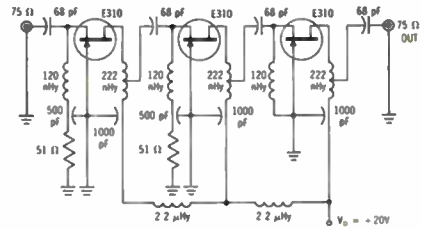

Wideband amplifier — 225 MHz center frequency,
1 dB bandwidth of 50 MHz, 24 dB gain.

U310 family characteristics include:

- High power gain (common gate) — 16 dB at 100 MHz, 11 dB at 450 MHz.
- Noise figure = 3 dB typical at 450 MHz.
- High transconductance = 10,000 to 20,000 μ mhos.

Select the right FET for your application from this array:

Type	Package	Feature	Application	Price (1K units)
E308	Epoxy TO-106	$V_p = -1.0$ to -6.0 V $I_{DSS} = 12$ to 60 mA	High-frequency, small signal VHF- or UHF source followers, amplifiers, mixers, or oscillators	\$ 0.57
U308	Metal TO-52			\$ 3.70
F309	Epoxy TO-106	$V_p = 1.0$ to -4.0 V $I_{DSS} = 12$ to 30 mA		\$ 0.75
U309	Metal TO-52			\$ 4.45
E310	Epoxy TO-106	$V_p = -2.0$ to -6.0 V $I_{DSS} = 24$ to 60 mA		\$ 0.75
U310	Metal TO-52			\$ 4.45
U310 family dual FETs have V_p , I_{DSS} , and g_m parameters matched to 10%. Packages designed for easy insertion into printed circuit boards				
E430	Dual Epoxy Ss-105	$V_p = -1.0$ to -4.0 V $I_{DSS} = 12$ to 30 mA $g_m = 10$ to 20 mmho	VHF/UHF balanced mixers and cascode amplifiers	\$ 1.70
U430	Dual Metal TO-99			\$ 9.95
E431	Dual Epoxy Ss-105	$V_p = -2.0$ to -6.0 V $I_{DSS} = 24$ to 60 mA $g_m = 10$ to 20 mmho		\$ 1.70
U431	Dual Metal TO-99			\$ 9.95

Get the complete story on this advanced high-frequency FET family.
For application notes and technical information

write for data

Applications Engineering: (408) 246-8000 Ext. 802



Siliconix incorporated

2201 Laurelwood Road, Santa Clara, California 95054

Register-addressing system accesses within nanoseconds

by C.A.N. Conde, C.A. Correia, and A.D. Figueiredo
University of Coimbra, Portugal

Addressing systems for shift registers with circulating memories need not be slow and complex. A system containing synchronous binary counters and exclusive-OR gates can considerably speed up clock rate while reducing circuit complexity. For an eight-bit system, propagation delay can be reduced to only 37 nanoseconds.

Generally, shift-register-addressing systems are slow because they compare the address of a counter that is triggered by the clock pulse with the address of a reference register. Instead, it is faster to use up/down synchronous counters in their down-counting mode, as shown in the diagram for an eight-bit system.

When the eight-bit binary counter, which is formed

by the two four-bit counter packages, is in its down-counting mode, it generates successive output clock pulses (1111 1110, 1111 1101, . . . , 0000 0001, 0000 0000, 1111 1111). If, for example, the address register is storing the number 3 (binary equivalent 0000 0011) as the address to be referenced, the counter, after three clock pulses, will contain the binary number 1111 1100, which is the complement of the binary equivalent of number 3.

All the outputs of the exclusive-OR gates will then be logic 1, producing a logic 0 output at the NAND gate to the control logic. This logic 0 output can now be used to gain access to the shift-register bit given by the reference address.

For any address, a logic 0 exists at the output of the NAND gate only when the address is the complement of the binary counter state. And this condition will occur only after the counter generates a number of pulses equal to the contents of the address register.

Although quite fast, this system does have a drawback—it works for binary-coded data but not for binary-coded-decimal data. □

Gaining access. High-speed eight-bit addressing system for shift register cuts propagation delay to only 37 nanoseconds. Exclusive-OR gates compare the outputs of the address register to the outputs of the synchronous binary counter. When these outputs are complementary, the output of the NAND gate becomes logic 0, providing access to the control logic for the system's shift register.

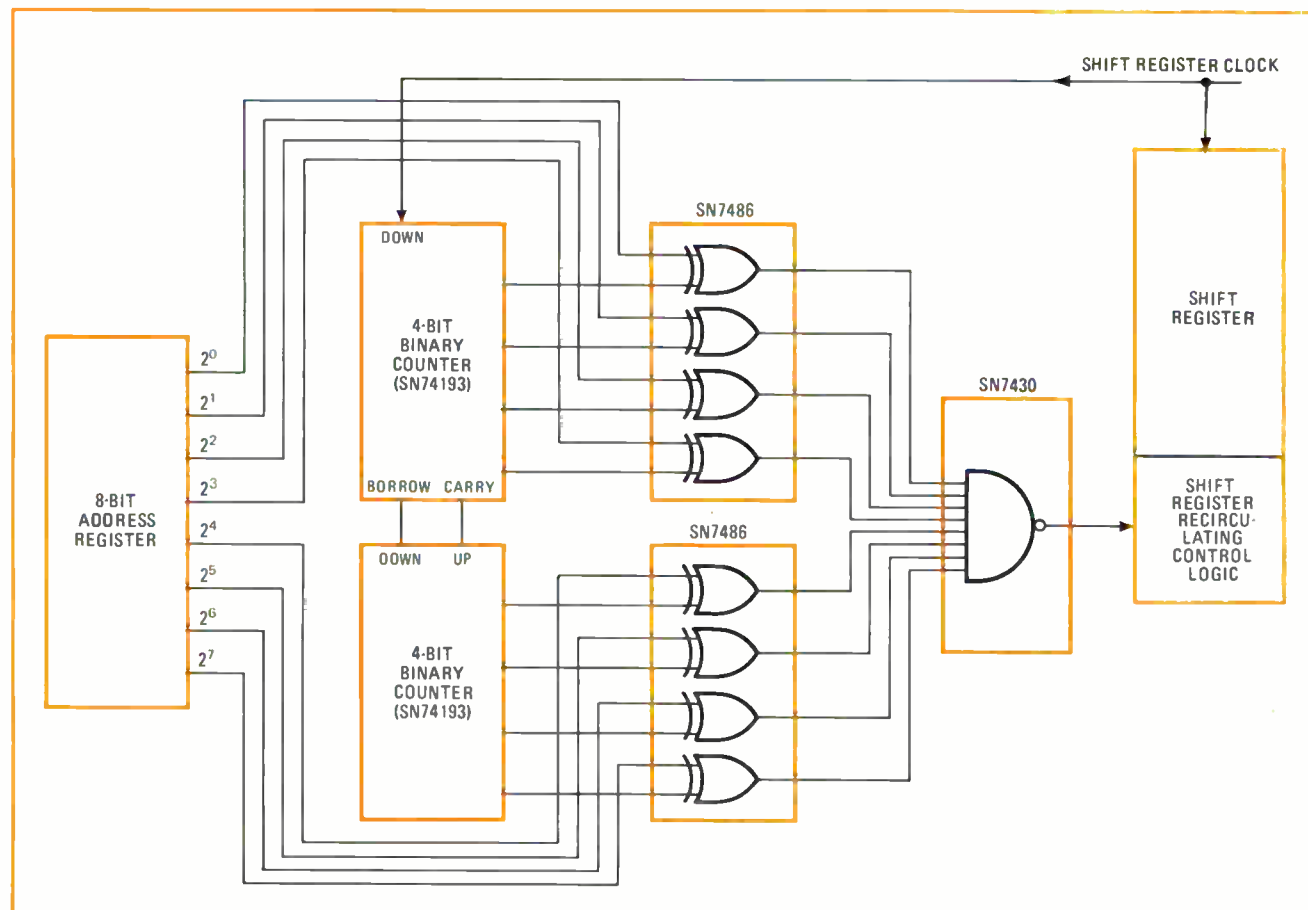

Narrowband digital filter achieves high Qs

by Thomas A. Visel
University of Illinois, Urbana, Ill.

A digital filter that is built with conventional logic ICs permits Qs of 2,000 to 10,000 to be readily achieved. Additionally, the filter's bandwidth is entirely independent of its operating frequency. And, as with other active filters, this circuit's upper frequency is primarily limited by the maximum bandwidth of the operational amplifiers used.

The operating frequency (f_0) is determined by the rate at which flip-flop FF₁ is clocked. Flip-flops FF₁ and FF₂ form an N-stage counter (N = 2 here), and the applied clock rate is Nf_0 . The decoder functions as an N-line-to- 2^N -line open-collector decoder, dividing the incoming signal into 2^N time periods at resonance. For the circuit shown, when f_0 is 1 kilohertz, each of these periods (T_k) is 250 microseconds long.

At resonance, each of the four decoder outputs turns on successively for a quarter period of the incoming signal. This successively charges each of the decoder's output capacitors to:

$$V_c = \int_{T_k}^{T_{k+1}} \frac{Ae_i \exp(-t/R_1C) dt}{R_1C}$$

where A is the gain of the input operational amplifier. At resonance, each capacitor reaches an equilibrium charge, drawing very little current through resistor R₁.

When the filter is not at resonance, each T_k period falls during random times of the input signal. This means that up to three of the decoder's external output capacitors may discharge through the collector-base

Simple digital filter. Flip-flops FF₁ and FF₂ function as an N-stage counter (N = 2) whose clock rate determines the filter's resonant frequency (clock = Nf_0). The decoder divides the input signal period into 2^N time periods so that the input is continuously sampled. At resonance, the output voltage is maximum because the charge across the decoder capacitors (C) does not change between input cycles.

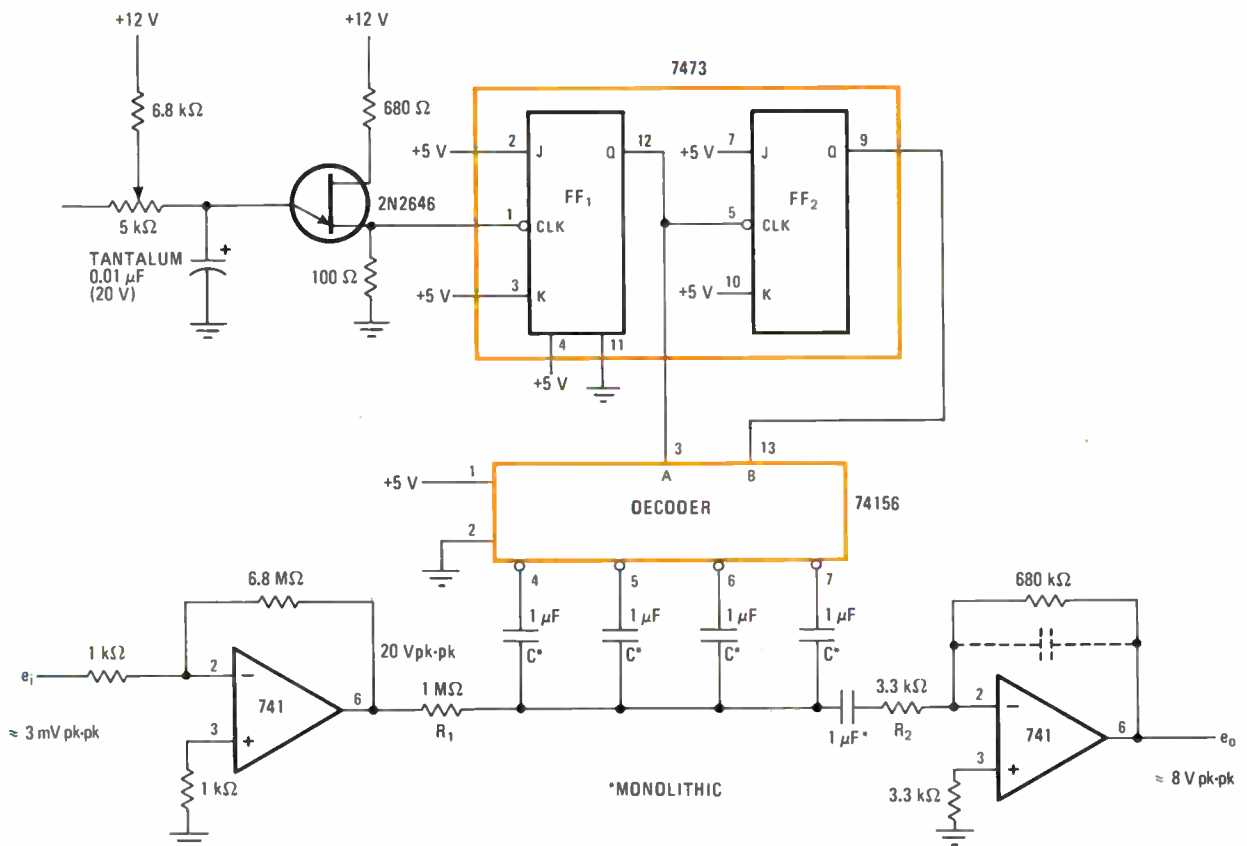
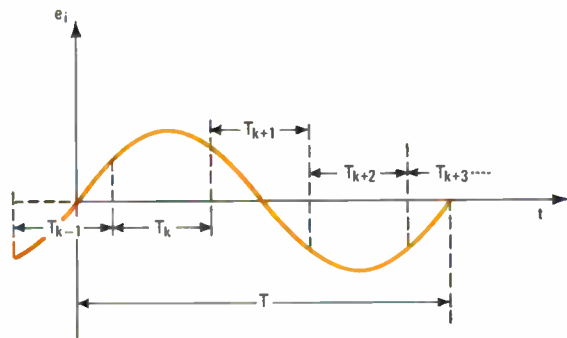

junctions of the decoder's internal output transistors, while the selected capacitor charges, or vice versa. A rather large net current will then be drawn through resistor R_1 , diminishing the output voltage.

The output waveform, therefore, appears as a sampled version of the input signal. The more counter and decoder stages there are, the more exact will be the output waveform sample. A two-stage counter, like the one used here, is sufficient for such applications as synchronous tone detection in audio spectrum analyzers. Criti-

cal filtering applications will require additional stages.

For the components given, the filter's operating frequency is limited to 2.5 megahertz, and its 3-dB bandwidth is 12 hertz set at an f_0 of 20 kHz. When resistor R_2 is a large value, the filter's bandwidth is:

$$BW = 1/(4\pi R_1 C)$$

For a 500-Hz step in frequency, the output response envelope is about 8 milliseconds from its 10% to 90% points. □

Gate threshold difference produces initializing pulse

by Jose Souto Martins
GTE Automatic Electric Inc., Northlake, Ill.

Often it is necessary to have a digital circuit assume a predetermined logic state when the supply is turned on. This is not always easy to do, particularly when the digital circuit contains storage devices such as flip-flops and latches. But a simple two-gate circuit, consisting of a standard TTL NAND gate and a Schmitt-trigger TTL NAND gate, can solve this initialization problem without the need of integrating circuits or external reset leads.

The circuit makes use of the difference between operating threshold voltage levels of the two gates to produce an initializing pulse. When the power supply is switched on, the voltage at points A, B, and C rises at the same rate as the applied supply voltage. Neither gate will sink any current until its operating threshold is reached.

Because the operating threshold of the standard gate is lower than that of the Schmitt-trigger gate, the standard gate will respond first. When this gate's threshold is reached, its output goes to logic 0, clearing the storage element. And when the supply voltage reaches the higher operating threshold of the Schmitt trigger, this gate's output goes to logic 0, causing the standard gate to return to its normal operating state so that its output is again logic 1. The circuit, therefore, generates a pulse that can be used to initialize a logic system.

The width of the initializing pulse depends mainly on the power-supply rise time and the voltage difference between the operating thresholds of the two gates. Clearly, if the power-supply rise time is instantaneous, no pulse is generated. This undesirable situation can be avoided by adding an integrating circuit at point A, thereby guaranteeing a minimum width for the initializing pulse. Needless to say, the slower the power-supply rise time, the longer is the initializing pulse. (It should be noted that another pulse is generated when the power supply is turned off.) □

Designer's casebook is a regular feature in Electronics. We invite readers to submit original and unpublished circuit ideas and solutions to design problems. Explain briefly but thoroughly the circuit's operating principle and purpose. We'll pay \$50 for each item published.

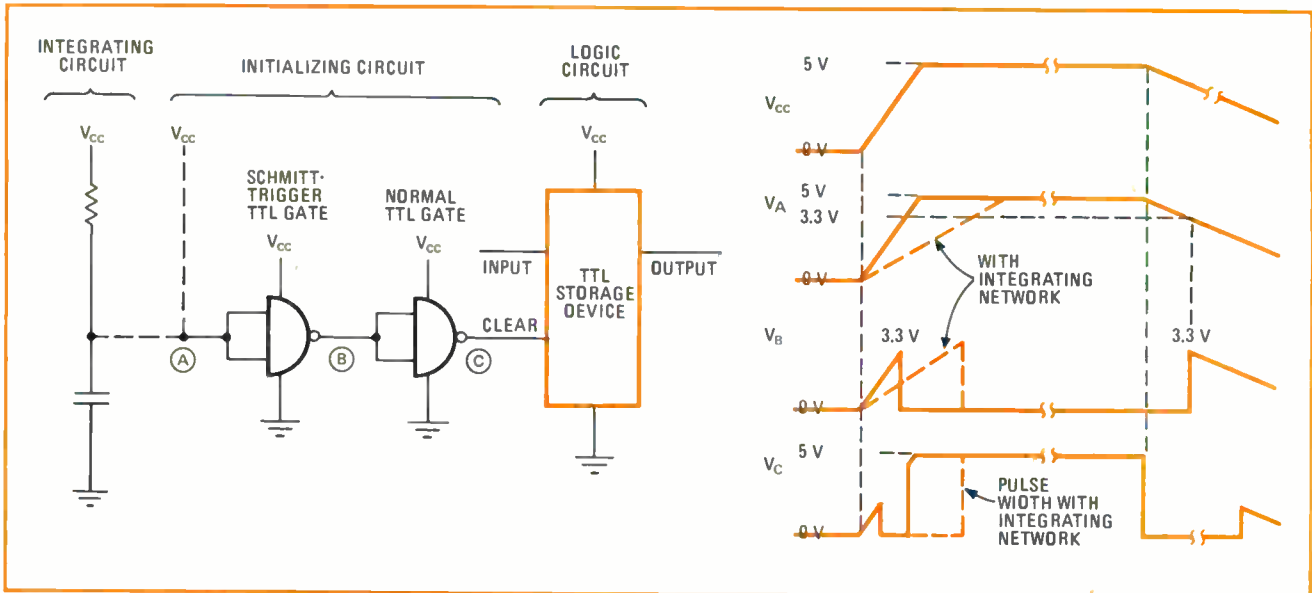

A free pulse. The threshold voltage difference between a regular TTL NAND gate and a Schmitt-trigger TTL NAND gate permits a pulse to be generated for initializing a TTL storage device. As the supply voltage rises, the regular gate changes state twice, producing an output pulse whose duration depends on power-supply rise time. The integrating circuit assures a certain minimum pulse width for the output.

Minicomputer controls temperature- sampling system

When a new design's temperature gradients must be monitored to assure compliance with specifications that may change, a computer provides the needed flexibility, and a multiplexer built in-house keeps costs low

by J.G. Hurt and H.G. Riekers, *Westinghouse Electric Corp., Baltimore, Md.*

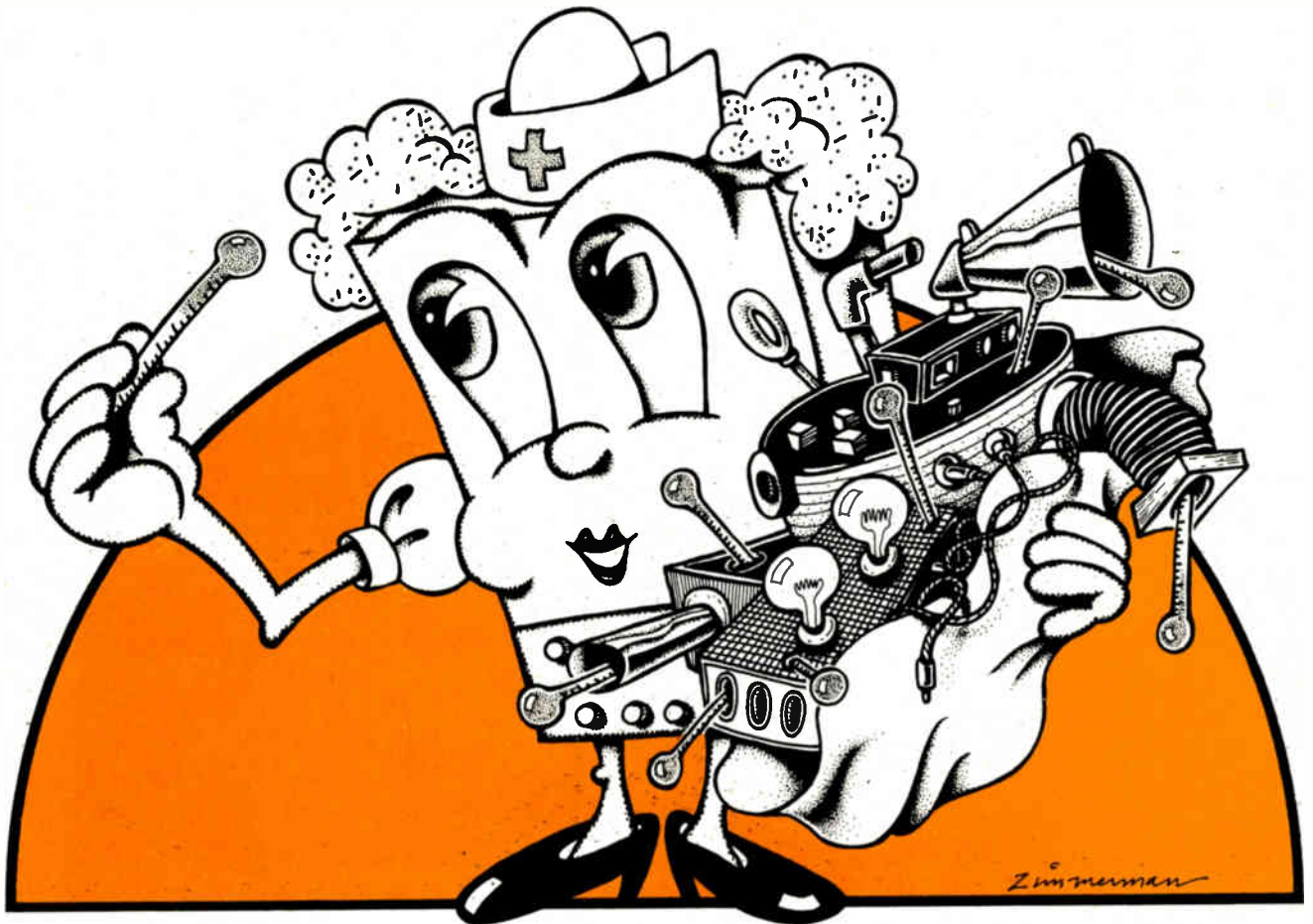

□ For a detailed thermal analysis of classified military equipment, a computerized data collection system can be more efficient than conventional recording and instrumentation systems. One system now in use gathers analog data from 300 thermistors at sampling rates that vary with the rates of change of the individual temperatures, and then converts the data into binary numbers for processing and storage in a small computer (Fig. 1).

The measurement of thermal responses in equipment built of many different materials is important because small temperature gradients across the interface between two materials may create serious mechanical stresses. These stresses may even cause localized failure if the equipment is built to the -65° to $+125^{\circ}\text{C}$ range of military specifications. In planning a manufacturing process, also, detailed thermal response information is useful because some materials used in the process may be permanently degraded if certain critical temperatures are exceeded.

Noncomputerized instrumentation and recording systems, however, have a number of disadvantages. For instance, although the sampling rate for individual thermistors may be variable, the rate can be changed only manually—whereas, if necessary, a computer can adjust the rate quickly on-line, and thus track changes in the rate of temperature variation. Also, conventional systems typically produce intermediate results that the user must look up manually in a table of values to convert them to the quantity of interest, whereas a computer can store the table, from which it can produce the re-

1. Temperature-measuring system. Bank of precision resistors, connected to thermistors in unit under test, is at right. In the rack, top to bottom, are an analog-to-digital converter, a multiplexer, and the power supplies they need for their operation. Controlling the entire system is a PDP-11/15 computer, at left.

Please, more I/O and firmware

The lack of inexpensive peripheral equipment is one of the major stumbling blocks in developing a cost-effective computer-based system. The first requirement is a better man-machine interface. Closely behind it come cheaper bulk storage units, main storage, better built-in routines, and diagnostics.

Teletypewriters are generally accepted as the standard input-output device for small computers—especially when they have a paper-tape punch and reader attached. But other input-output devices would also be very helpful, such as a keyboard-display unit that could show six to eight lines of 80 characters each and transmit them over a communication channel in ASCII. A device like this, if not too expensive, would be very useful for checking data and making selective modifications to programs.

Magnetic-tape cartridges and readers could replace tape transports to provide expensive—although more limited—storage capability. Inexpensive disk memories would significantly lower the cost of on-line storage. Main memories could be more cost-effective.

While these devices are being developed, mini-computer manufacturers could spend more time working out ways to perform certain functions with microprograms, or "firmware," that now require complex software—number conversions, difficult arithmetic computations, and so on. Putting these functions in microprograms is made even more attractive by the limited storage capacity of many minicomputers, and the user's reluctance to commit much of it to software for executing these functions. And microprogramed diagnostics would be very useful; the user wants to know that the computer is working properly of course, but when it's not, he wants to know what's wrong, to reduce his maintenance costs and downtime.

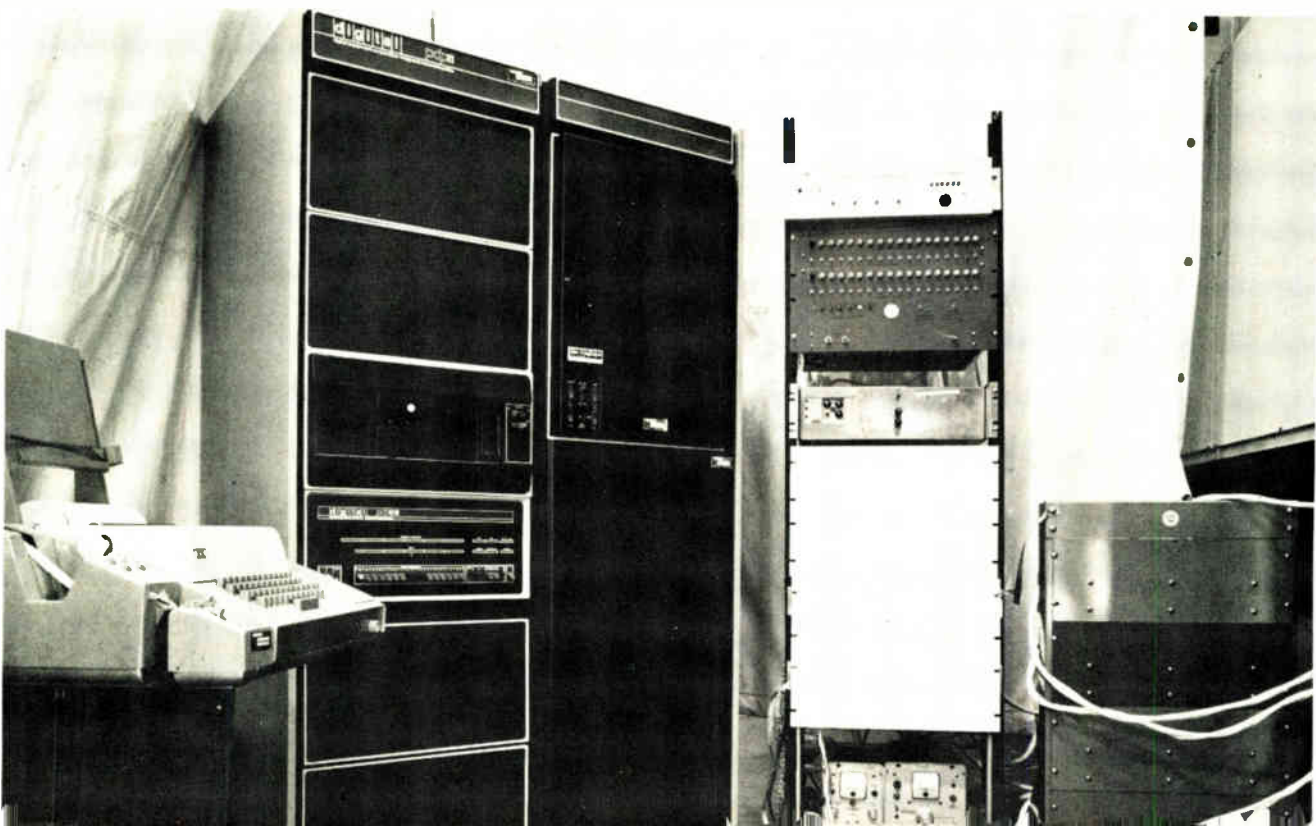

sults in the desired form directly.

When the design of this computerized measurement system was begun, the specifications for the equipment to be measured were only partly determined. Consequently, to cope with possible variations, the versatility of a software-controlled measurement system seemed desirable.

Since 300 points had to be sampled, the data had to be picked up through a multiplexer. Electromechanical crossbar scanners were too slow for the application. Commercially available electronic multiplexers were fast enough but too expensive, costing as much as or more than the computer system. Therefore Westinghouse engineers developed a multiplexer of their own. The combination of the minicomputer and the custom-designed multiplexer provided a cost-effective solution to the problem of designing the measurement and data-recording system.

Temperature-measurement requirements

Most metals have positive temperature characteristics and resistivities that vary less than 10 to 1 over a temperature range of, say, -100 degrees Celsius to +400°C. In a thermistor, however, the higher the temperature, the lower the resistance. This negative temperature characteristic of -4%/°C to -5%/°C produces a variation of perhaps 10 million to 1 in resistance over the same temperature range.

In the equipment that had to be measured in this case, the temperature range was 0° to 90°C, over which thermistor resistance varies about 50 to 1. The temperatures were determined with the aid of a lookup table and by interpolations of 0.05°, corresponding to resistance steps of less than 0.25%. Consequently, to avoid ambiguity, the thermistors themselves had to be accurate within 0.1% or so.

Two kinds of thermistors were chosen for the measurement system. Those for the channels that required the highest accuracy have a resistance of 4,002 ohms and a characteristic of about -4%/°C at 25°C. Those for less demanding channels have a 5,000-ohm resistance and a -4½%/°C characteristic. (Because thermistors in general have exponential characteristics, both the percentage characteristic figure and the resistance are substantially different for other temperatures.)

The temperature in the vicinity of each thermistor is determined by table lookup from its resistance, and its resistance is indicated by the voltage at the junction between it and the series resistor that together form a simple voltage divider (Fig. 2). For optimum resolution and in order to maximize its sensitivity to any changes in temperature, the series resistance is made equal to the thermistor's resistance at the center of the temperature range.

Thermistors are often used in bridge circuits. But this approach was not used here because bridges would have required three times as many expensive precision resistors. Also, a double-ended multiplexer would have been needed for the two bridge junctions—to no good purpose, since singly-multiplexed instrumentation of-

fers just as much precision when used in this particular configuration.

The voltage-divider method of measuring temperature has three sources of error, caused by uncertainties in the reference voltage, the series resistor, and the thermistor itself. The first two of these uncertainties can be expressed as an equivalent error in the resistance of the thermistor, which is the sum of the errors due to each of the sources:

$$\Delta R_t = (\Delta V_{ref}/V_{ref})(R + R_t) + R_t(\Delta R/R)$$

(Technically, the series resistor and the reference voltage themselves have temperature coefficients that could introduce errors, but these errors are not important because the two elements are kept at an essentially constant temperature.)

Accuracy retention

To maintain the high accuracy and resolution that the measurement system requires, the reference voltage is regularly measured and adjusted to keep it within 1 millivolt of its nominal value. The tolerance of the series resistors is within 0.1% of nominal value. Therefore, with a nominal reference voltage of 5 volts, a series resistance of 5,000 ohms at 25°C, the error ΔR_t is shown by the above equation to be 7 ohms, corresponding to a temperature error of 0.035°C.

Errors in the thermistor arise from two sources. First, there's self-heating caused by the passage of current through the thermistor, with consequent power dissipation and temperature rise. Second, an individual thermistor characteristic may depart from its nominal value.

Self-heating is minimized by dividing the 300 thermistors into four groups of 75 and applying power to each group only when a member of that group is being measured, and only for as long as it takes to carry out the multiplexing and analog-to-digital conversion. This power switching is done by electromechanical reed switches controlled by the computer. Provision is included for dividing the thermistors into as many as eight groups.

The only way to verify the thermistor characteristic is to measure a sample of the components. This measurement must also insure that linear interpolation between temperature increments in the lookup table will give readings within the accuracy and resolution limits specified for the system. For the Westinghouse system the

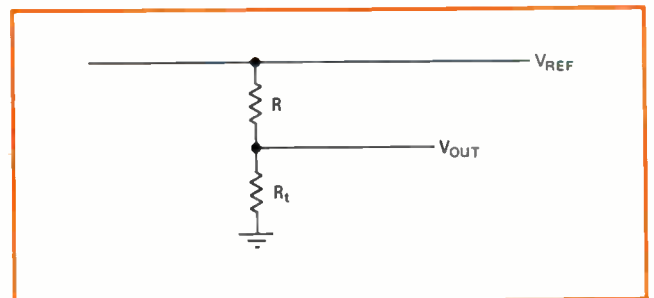

2. Sensor. As temperature increases, resistance of thermistor R_t decreases and output voltage approaches ground level. Therefore continuously monitoring voltage indicates temperature.

company's standards laboratory made the verifying measurements.

The thermistors, of course, are mounted in the equipment being tested. But the series resistors for the voltage dividers of which the thermistors are part are mounted in a separate thermal junction unit, to which the switched reference voltage is supplied, and from which a cable connects these precision resistors with the thermistors. Data passes from this unit by way of the multiplexer/converter into the computer system.

In control

The computer system comprises a Digital Equipment Corp. PDP-11/15 computer, a teletypewriter and magnetic tape unit, a fast paper-tape reader/punch, and a device interface unit, the DEC DR11A, that transfers data between the multiplexer/converter and the computer over 16 input lines, 16 output lines, two interrupt lines and two control lines. An external real-time clock interrupts the computer 25 times per second, corresponding to the frequency of sampling the thermistors—once every 40 milliseconds or all 300 in 12 seconds.

On the teletypewriter's keyboard, the test run identification is entered, along with the channels to be printed out, and the order in which samples are to be taken. The temperature in the selected channels are printed on the teletypewriter, and the temperatures in all channels are recorded on magnetic tape for off-line processing in another computer. The frequency of printing the selected data is determined by the real-time clock and by

a set of console switches on the computer. A block diagram of the complete system is shown in Fig. 3.

The paper-tape unit loads assembly-language or binary-coded programs into the computer. It also punches new tapes as an output of assembly and editing programs.

Details of the interface between the computer and the multiplexer/converter are shown in Fig. 4.

The multiplexer/converter

The analog multiplexer can handle up to 320 single-ended analog channels, each of which carries a signal ranging from 0 to +5 v. Of these, 300 were used in the immediate application for which the system was built. It decodes nine binary-address lines received from the computer to select one of these 320 channels, whose signal is transmitted to an amplifier, and thence to the analog-to-digital converter. The amplifier also shifts the signal range to -5-to-+5 v. For testing, the nine-bit address can also be generated manually from the multiplexer's front panel.

The multiplexer, built from standard off-the-shelf transistor-transistor-logic circuits and TTL-compatible MOS analog multiplexing circuits, works directly with the 0-to-+5-v range that was applied to the thermistors. This is one of the principal reasons the unit was less expensive than commercial multiplexers, which worked with wider voltage ranges—doubtless for a wider range of applications—but still required additional circuitry to shift into the bipolar range for the analog-to-digital

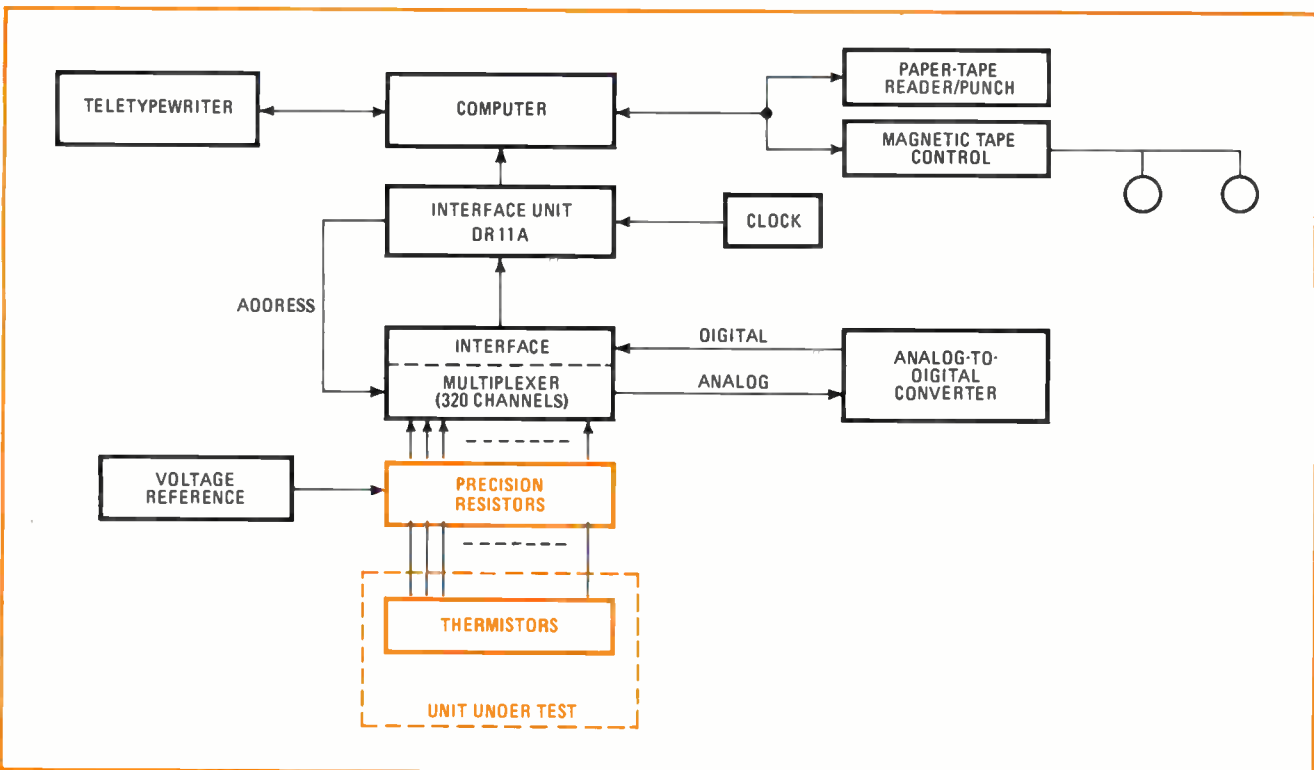

3. System components. Three hundred voltage dividers (Fig. 2), shown in color, measure temperature in unit under test. Multiplexer samples their output as addressed by computer; voltage reading is digitized, transmitted to computer, converted to temperature, and stored on magnetic tape. Selected channel measurements can be printed on the teletypewriter; they are chosen at the beginning of the test run.

converter. Another cost factor was that commercial multiplexers available at the time this system was built came in the form of a chassis to which a maximum of 256 channels could be connected. For a requirement of 320 channels, a whole second chassis would have been required, and the need to interconnect the two chassis would have further complicated the design.

In the Westinghouse system, on the other hand, the multiplexing and decoding for up to 64 channels is packaged on one printed-circuit board. Five of these boards make up the full complement of 320 channels. However, for applications requiring fewer channels, only the appropriate number of boards need be used, without wiring changes. Other boards include lamp drivers, line drivers, line receivers, and random logic.

The analog-to-digital converter is a commercially available unit, the model MD51 made by Scientific Data Systems Inc. (now part of Xerox Corp.). (It also contains a multiplexer, which is not used because its channel capacity is much less than this application requires.) Its output is a two's-complement 15-bit digital word, which can be produced in less than 10 microseconds but is needed in this application only once every 40 milliseconds, or with a 25-hertz repetition rate. It was chosen because its speed would probably be necessary in future applications.

The 15-bit digital output of the converter is returned to the multiplexer, which also contains an interface unit—essentially a battery of line drivers—to transmit the digital data to the computer.

Data enters the computer through the DR11A interface. This unit also transmits the nine-bit multiplexer

address, the three-bit thermistor group identification, and two bits for the thermistor characteristic.

Within the computer memory, a table of temperatures is arranged in groups of three words. In one word is the 15-bit voltage measurement corresponding to an integer value of temperature. In the next word is that integer value. In the third word is a voltage increment corresponding to a temperature increment of 0.05°C.

In the temperature determination for a selected channel, the input from the analog-to-digital converter is compared successively with stored integral-temperature voltages (the first word in the group) to find the largest value less than the measured value. This table value is then incremented by steps equal to the value in the third word, while the temperature is simultaneously incremented by steps of 0.05°C, until the tabular voltage exceeds the measured voltage. The resulting measured temperature is printed in real time.

Benefits of this design

Designing the multiplexer in-house permitted cost-performance tradeoffs that resulted in a low cost of only \$12.50 per channel. Some commercially available multiplexers cost \$19 to over \$100 per channel, and less expensive models are slower and also not programmable.

Commercially available sampling systems were considered, but lacked the voltage range and bit capacity needed, and weren't flexible enough. For example, the Westinghouse system can print the results from certain critical channels, selected in advance, while recording the results from all channels for later analysis—a capability that greatly enhances the system's effectiveness.

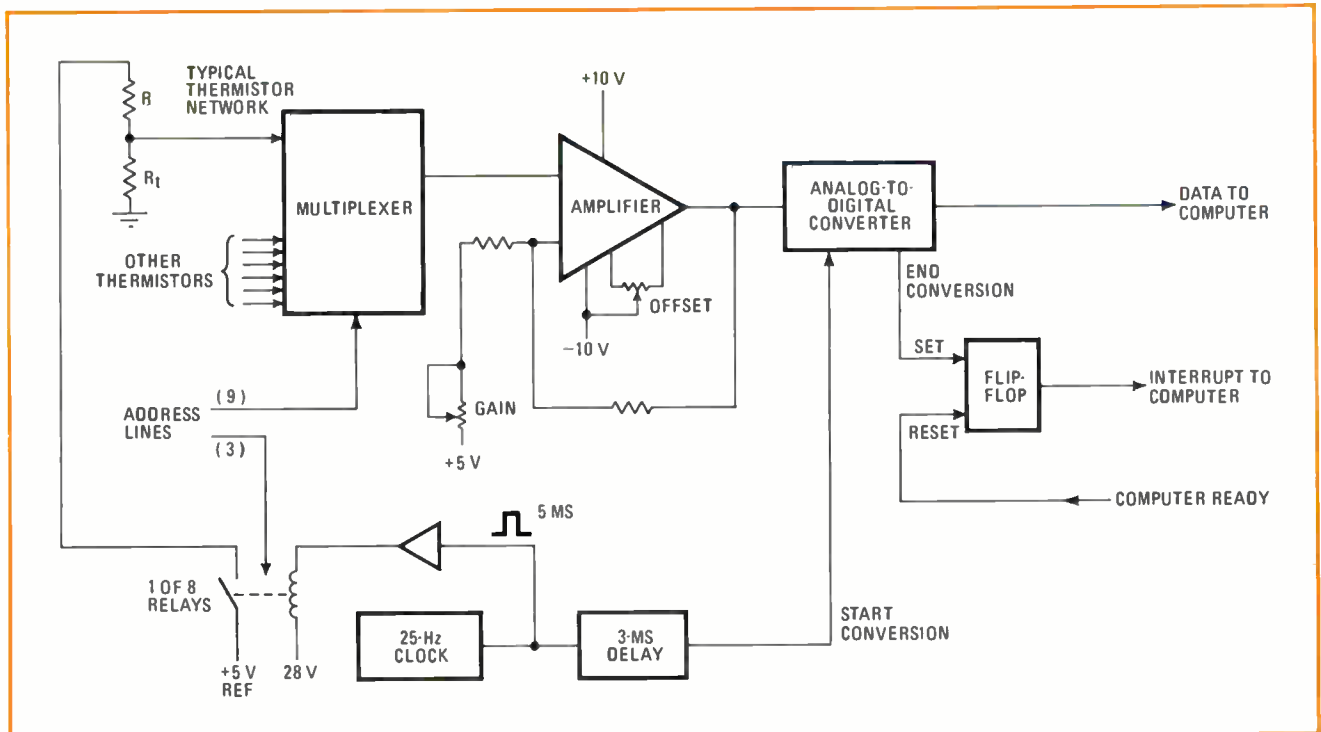

4. Interface. Every 40 milliseconds the clock applies power to a bank of 75 voltage dividers, each of which includes a thermistor. After transients have settled, the output of each divider in turn is amplified, digitized, and sent to the computer for translation to temperature.

Flexibility is very important in research and development applications. For example, the system allows the evaluation engineer to change both the rate and sequence of channel sampling through software, without rewiring the system. Thus he can shape the sampling system to fit his needs exactly—even when those needs are not completely defined at the start of the project, but evolve through trial and error.

Why this particular computer?

For the Westinghouse system, one requirement was the use of assembly language for programing. Then the programs would occupy less memory and be faster to execute than if written in a higher-level language like Fortran or one of the numerous special test-oriented languages. This requirement called for a computer with a powerful instruction set and with an assembly program included in its software complement. Also, a byte-oriented computer was preferable, since data is transferred to the teletypewriter in bytes.

Software was to be developed on the measurement system itself. Though this could have been done with only the teletypewriter and its associated tape unit, the process would have been very slow. Thus the high-speed paper-tape reader and punch was justified.

Since the system's goal was data collection, a high-density bulk storage device was required, and since the stored data was to be processed off-line, the storage device has to be removable. These requirements indicate a standard magnetic-tape unit using 2,400-foot reels of half-inch tape. On one such reel about six million 16-bit words can be stored, corresponding to about 40 hours of testing. Since tests were expected to last no more than 24 hours, the data from a whole test run would occupy less than one reel of tape.

High-performance peripheral equipment, however, such as a disk storage unit or a fast printer, was not needed in this application—particularly since such devices require about 4,000 extra bytes of memory. But conceivably these units might be required for a later application, and if so, they could easily be added.

Any failure of power during a test—even a momentary transient—wipes out data stored in the memory. To avoid such loss, a power-failure restart option monitors the primary power source, and in the event of a failure it shuts down the system in an orderly way to preserve the contents of the memory.

Test data is accumulated in the computer memory for all 300 data points, and then written on the tape in a single record that includes the date, the time of day, and the channels specified for printing, as well as two words—the channel number and the measured voltage—for each data point (Fig. 5). The word containing the channel number also contains information about the thermistor group and the thermistor characteristic—the increment value for interpolation—for that data point.

Two magnetic-tape buffer areas are used in the memory. One holds data as it is transferred to the tape, while the other is being filled by the data acquisition program. Because magnetic tape is used most efficiently when long records are written, one buffer area is big enough to hold several passes through the 300 data points.

From the configuration of the measurement system described above, the most important parameter—memory capacity—was derived. The two magnetic-tape buffers required 4,000 words. Three different lookup tables for different thermistor characteristics, with 1°C increments and 0.05°C interpolations, required a total of 810 words. Another 600 were needed to store the sequence of sampling the channels. A pair of teletypewriter buffers required 450 words. These add up to 5,860 words. The next larger standard increment of memory size is 8,192; this capacity leaves 2,332 words for the program—more than ample.

The speed of the computer is related to the system's sampling rate—25 per second, or 40 milliseconds per sample. During this interval the sample data must be brought into the memory, the elapsed time from the beginning of the test determined from the real-time clock, and the table searched for the temperature corresponding to the data (a voltage) from selected channels. The time and sample data are loaded into the magnetic-tape buffer for all channels, and if the channel is one that has been specified for printing, the temperature is loaded into the teletypewriter output buffer as well.

Complex as this sounds, it requires only about 5 ms, of which 3 ms is a delay to permit the group-switching relay points and other power transients to die away. Thus, the sampling could have been performed eight times as fast before exceeding the processor's capacity. However, the temperatures in the temperature-monitoring tests don't change fast enough for such high-speed sampling to produce useful data. □

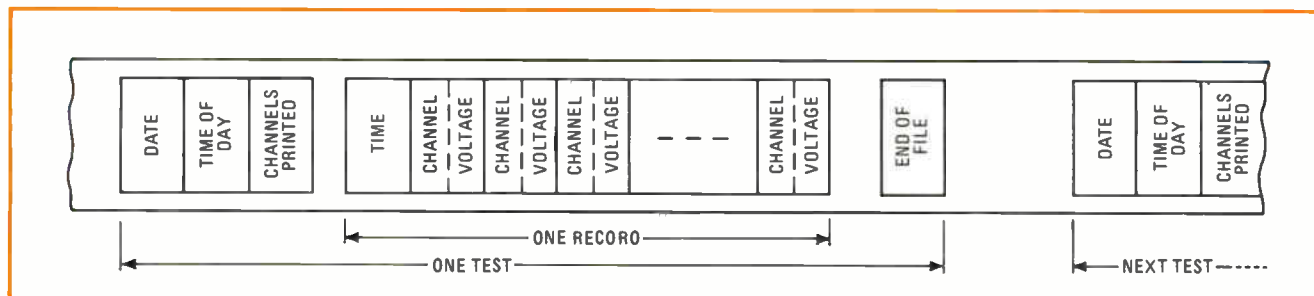

5. Recording. Successive temperature determinations from the unit under test are kept in computer's memory until all 300 of the channels monitored by the measurement system have been read. Then the collected readings are stored on magnetic tape in this format.

Get what you want, when you want it.

Get absolute reliability, wide selection and quick delivery with Hitachi glass-sealed silicon diodes.

Hitachi quick deliveries are as reliable as Hitachi glass-sealed silicon diodes. And that's as reliable as diodes can get.

We make our diodes using a machine we designed, the world's only successful machine for mass-producing glass-sealed silicon diodes of uniform high reliability.

Our selection — always big — now includes many new types for specialized applications requiring fast recovery and high voltage. And our quality control is exacting.

Get what you want, when you want it. From Hitachi. You can count on us for quick delivery of any types of diodes.

And, you can count on them.

Rating of glass-sealed silicon diodes

HITACHI TYPE	V _{RRM} (V)	I _{T(AV)} (A)	I _{TSM} (A)	T _J (°C)	REMARKS
W06 RECTIFIER DIODE	100	0.75 (T _A = 40°C)	20		
	200				
V03 RECTIFIER DIODE	200	1.3 (T _A = 25°C)	30		
	400				
	600				
V06 RECTIFIER DIODE	200	1.1 (T _A = 20°C)	25		
	400				
	600				
V07 AVALANCHE RECTIFIER DIODE	400	1.3 (T _A = 25°C)	30	-40 +165	AVALANCHE POWER 40W
	600				
	800				
V08 AVALANCHE RECTIFIER DIODE	400	1.1 (T _A = 20°C)	25		AVALANCHE POWER 40W
	600				
	800				
V09 FAST RECOVERY RECTIFIER DIODE	200	0.8 (T _A = 40°C)	25		T _{rr} ≤ 0.5 μs sec
	400				
	600				
V11 HIGH VOLTAGE & FAST RECOVERY RECTIFIER DIODE	800	0.4 (T _A = 20°C)	25	-40 +125	T _{rr} ≤ 0.4 μs sec
	1000				
	1300				
	1500				

HITACHI TYPE	V _{RRM} (V)	I _{T(AV)} (A)	I _{TSM} (A)	T _J (°C)	REMARKS
U05 RECTIFIER DIODE	100	2.5 (T _L = 80°C)	100	-40 +175	
	200				
	400				
	600				
	800				
U06 FAST RECOVERY RECTIFIER DIODE	200	2.0 (T _A = 40°C)	100	-40 +150	T _{rr} ≤ 0.6 μs sec
	400				
	600				
	800				
U07 HIGH VOLTAGE & FAST RECOVERY RECTIFIER DIODE	800	1.0 (T _A = 40°C)	100	-40 +140	T _{rr} ≤ 0.8 μs sec
	1000				
	1300				
	1500				
Y16 HIGH VOLTAGE & FAST RECOVERY RECTIFIER DIODE	12000	0.002 15.75KHz PULSE C-Load	1.5	-40 +100	Recovery Current I _{rp} = 2m A peak
AW01 ZENER DIODE	ZENER VOLT. 6-33V	PERMISSIBLE LOSS 1W		-40 +150	
AW03 ZENER DIODE	ZENER VOLT. 2-5V	PERMISSIBLE LOSS 1W			



For further information, please contact:
 Head Office (Section XME): 6-2, 2-chome, Otamachi, Chiyoda-ku, Tokyo 100
 Argentina: Av. de Mayo 666, Piso 12, Buenos Aires Tel. 33-3201
 Brazil: Av. Rio Branco 151, Grupo 1505, Rio de Janeiro GB Tel. 231-1321
 England: 2nd Fl., 11/12 Flinsburg Sq., London E.C.2 Tel. 588-3275
 West Germany: 4000 Düsseldorf, Graf-Adolf-Strasse 37 Tel. 10846
 Hitachi America, Ltd.: New York: 437 Madison Av., New York, N.Y. 10022 Tel. (212) 758-5420
 San Francisco: 100 California St., San Francisco, Calif. 94111 Tel. (415) 981-7871
 Nissei Sangyo GmbH (Deutschland): 4000 Düsseldorf, Am Wehrhahn 41 Tel. 36 09 03
 Nissei Sangyo Co., Ltd., Taipei Office: Nanking Bldg., No. 165, Sec. 2, Nanking East Rd., Taipei 104 Tel. 570704
 Nissei Sangyo Co., Ltd., Hong Kong Branch Office: Watson's Industrial Estate Room No. 603 Block A 6th Floor, Watson Road, North Point, Hong Kong Tel. 5-784021-4, 5-784121
 Nissei Sangyo do Brasil Ltda: Edificio Estrela, Av. Rio Branco 211, 9º Andar Salas 96/99 São Paulo, Brasil Tel. 221-3011, 3805

We celebrate our 1,000th shipment with a 20% reduction in price.



Our 600 LPM Electrostatic Printer/Plotter. Now just \$5,900.00

Your turn to celebrate.

For over three years we've been producing Matrix Printers, Plotters and Printer/Plotters like there's no tomorrow. One after the other. Sending them to hundreds of U.S. companies. To 18 countries. To four continents.

To some places—far from our service reps—where an MTBF of 3,300 hours is a godsend.

To work with 29 midi and mini-computers.

Shipping them as fast as we could make them.

And in three years our Matrix units have become the industry standard.

This has put us in a position to do what no one else in the industry can do.

Thanks to plummeting electronic costs (remember, Matrix has only three moving parts) . . . and manufacturing processes that have matured . . . we are making the price of our plotters and

printer/plotters more competitive than any comparable units.

Starting at only \$5,100 for the Model 200 Plotter.

Consider the price. And consider that these are no ordinary output devices.

Profile of the "standard of the industry."

Matrix units have the highest reliability in the business.

A yearly maintenance contract **50% less** than anyone else's.

A warranty for parts and labor **four times longer** than anyone else's. (One year vs. 90 days.)

Unbeatable price/performance ratios in 8½, 11, and 20-inch-wide Matrix units.

More proven controllers and more powerful software.

And better paper-handling capabilities than anyone else's. Matrix units alone use our MEWT™ writing—a true electrostatic writing technique with

outstanding legibility.

A choice of resolutions—up to 160 points per inch. No one comes close to that.

No wonder that everybody in the electrostatic business uses us as the standard of comparison.

So celebrate with us. Our success affects you right where it feels best . . . in the pocketbook.

This good news is brought to you by Versatec. Electrostatic specialists with the broadest line of electrostatic devices anywhere. Leading the silent generation.

Versatec Inc., 10100 Bubb Road, Cupertino, California 95014 (408) 257-9900

 **VERSATEC**



After three years, Matrix is still the industry standard.

Circle 127 on reader service card



NEC around the corner

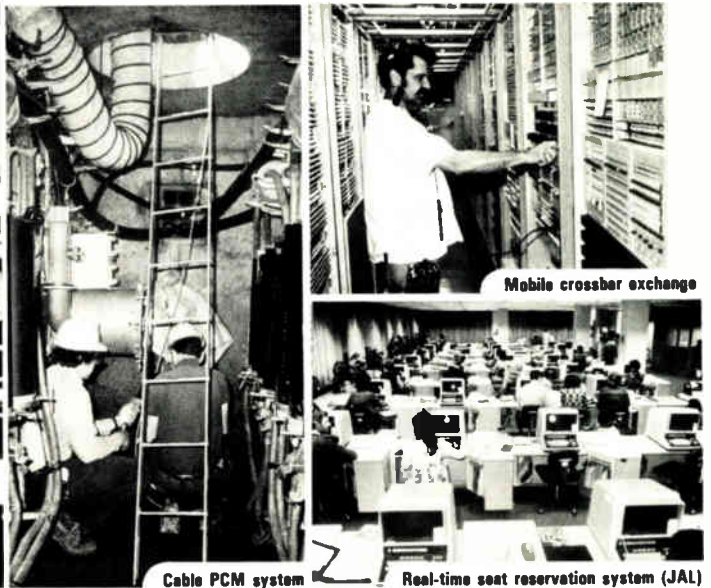

Efficient PBX's in offices.
Mobile exchanges and cable PCM
in telephone companies.
And microwave PCM.
Terminals for the SPADE* system utilize
orbiting satellites more economically.
Postal automation equipment
in a Manhattan Post Office.

All are backed by our unique technology in-
tegration. Few companies produce a com-
parably vast product range. From switching,
transmission, radio to computer mainframes.



Postal automation equipment

NEC products are always near. Filling gaps
and solving urgent problems. Call, telex
or write NEC America Inc. in New York,
Washington D.C., Chicago and Los Angeles.

*Single channel per carrier PCM multiple Access Demand assignment Equipment

NEC America, Inc. Suite 4321, Pan Am Bldg. 200 Park Avenue, New York, N.Y. 10017 Tel. 212-661-3420 TWX 710-581-3376 TLX NECAUR 234936
Washington, D.C. Office: 2990 Telestar Ct., Suite 212, Falls Church, Va. 22042 Tel. 703-560-2010 TWX 710-831-0639
Chicago Office: 500 North Michigan Avenue, Chicago, Ill. 60611 Tel. 312-828-9494 TWX 910-221-2101
Los Angeles Office: Airport Century Bldg., Suite 924, 9841, Airport Boulevard, Los Angeles, California 90045 Tel. 213-776-5923 TWX 910-328-6574

NEC
Nippon Electric Co. Ltd.
Tokyo, Japan

Trace circuit faults easily with TRAC™



With the Data Test user-proven transition count (TRAC) fault-diagnosis method, you can do complete functional logic testing and trouble-shooting of all types of circuit faults, in the plant and in the field.

Today there's a proven, low cost, method of handling all your testing problems at the least expensive level. It's as fast and easy as 1, 2, 3.

It's called Transition Count (TRAC) testing. It's common to every Datatester circuit board test system, and it's being proved daily by hundreds of DATATESTERS in use around the world.

Every logic circuit can be defined by its own truth table. So if an exact number of input transitions is applied to a logic circuit, an exact number of logic transitions will occur at each output pin and internal node.

This TRAC number is unique for every output and node for a specific test. Instead of storing all I/O patterns, we remove the *redundant* information and store *only* the transitions. This reduces your data storage needs. For ex-

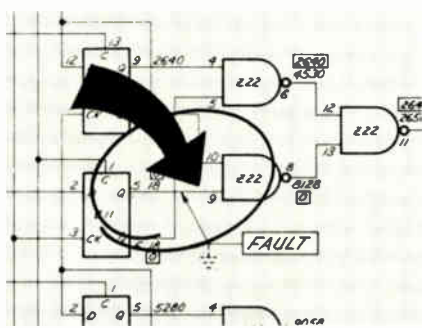

ample, a single TRAC number can store the results of a 1,000,000 pattern test. In addition, a fault anywhere in the network will cause a change in one or more TRAC numbers. Simply trace the fault by comparing

TRAC numbers directly to the faulty function, board, or component.

That's why Data Test can offer you a complete family of test equipment designed to handle every testing job . . . in the factory or in the field.

In the factory you can use our high-volume,

fully automatic test stations for production testing. Our low-cost, semi-automatic systems can be used for limited production or as trouble-shooting and repair stations. High-volume, multiple station systems can be set up for a fraction of the cost of other test methods.

In the field, service personnel can maintain and repair the product on the spot without having to return circuit boards to the factory, reducing board inventory in the field.

Data Test TRAC permits fast, low-cost set-up. It lets you trouble-shoot to the component level easily, quickly, and accurately. And it's backed by a complete, proven family of DATATESTERS for factory-through-field testing.

If circuit board testing and repair costs are eating into your profits, maybe you better try Data Test's TRAC. It's the one that will really save you money.

Get more information on TRAC today. Write Data Test Corporation, 2450 Whitman Road, Concord, California 94518. Or call (415) 689-3583.

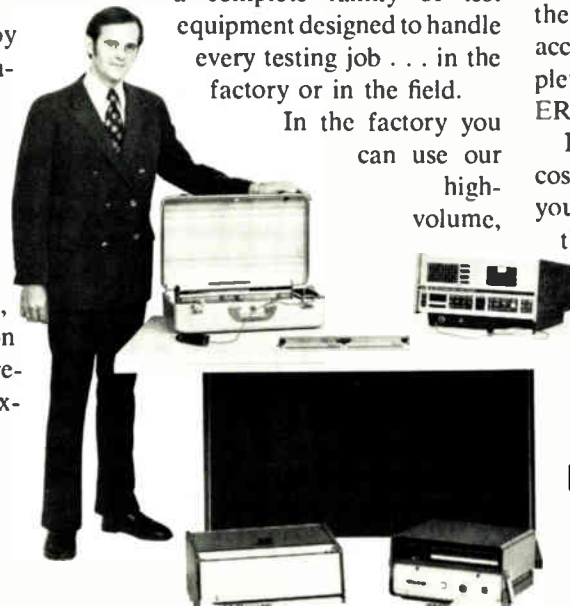

DATA  TEST CORPORATION

Circle 129 on reader service card

The new TH361 tetrode is designed to fulfill the most important features of your FM transmitter. A high gain of 27dB permits operating this tube and reaching 10kW with just a solid state driver; an output power rating significantly lower than the upper limit insures easy operation and long life. The accompanying cavity TH18106

is specially designed to match the outstanding capability of the tetrode and to offer a compact and reliable package. Both the TH361 tetrode and TH18106 cavity combination are available for immediate delivery.

For more information please circle the Reader Service card or contact us directly. *All losses included.

Typical operating points. Class B—FM Amplifier

Anode Voltage	7kV	DC Anode Current	2A
DC Grid 2 Voltage	500V	DC Grid 2 Current	125mA
DC Grid 1 Voltage	-100V	DC Grid 1 Current	10mA
Driving Power	25W*	Load Output Power	10kW

New FM transmitter tetrode/cavity combination boosts 25W to 10kW.



THOMSON-CSF

THOMSON-CSF ELECTRON TUBES, INC. / 50 ROCKEFELLER PLAZA / NEW YORK, N.Y. / TEL. (212) 489-0400

France - THOMSON-CSF Groupement Tubes Electroniques/8, rue Chasseloup-Laubat/75737 PARIS CEDEX 15 / Tel. 566 70.04

Germany - THOMSON-CSF Elektrohenröhren GmbH/Am Leonhardsbrunn 10/6 FRANKFURT/MAIN/Tel. 70 20.99

Italy - THOMSON-CSF Tubi Elettronici SRL/Viale degli Ammiragli 71/ROMA/Tel. 638 14.58

Japan - THOMSON-CSF Japan K.K./Kyosho Bulding/1-9-3 Hirakawa-cho/Chiyoda-ku/TOKYO/TEL. (03) 264.6341

Sweden - THOMSON-CSF Elektronrör AB/Box 27080/S 10251 STOCKHOLM 27 / Tel. (08) 22 58.15

United Kingdom - THOMSON-CSF Electronic Tubes Ltd./Bilton House, Uxbridge Road, Ealing/LONDON W 5 2TT/Tel. (01) 579 55.11/Telex: 25 659

Circuit lets regular scope monitor eight logic inputs

by P.V.H.M.L. Narasimham
Indian Institute of Technology, Kanpur, India

Checking the logic levels of digital circuits can be greatly simplified if both their inputs and outputs can be observed simultaneously. Here is a multiplexing circuit that allows an ordinary oscilloscope to accept up to eight logic inputs at the same time, thereby considerably easing digital-circuit testing. Furthermore, with this scope-input expander, actual signal-voltage levels, instead of just their logic states, can be observed, or any one of the signal waveforms can be displayed for some time.

The logic levels to be checked are applied to the eight-channel analog multiplexer, which also contains a three-line-to-eight-line decoder. The multiplexer's output goes directly to the Y-input of the scope. The three-bit counter drives the three channel-selector inputs of the multiplexer. The counter determines which of the logic inputs is displayed on the scope screen. Its output also drives the three-bit digital-to-analog converter that produces eight discrete voltage levels corresponding (in ascending order) to the eight input channels.

For example, when the state of the channel counter is 110, the logic input on channel 7 is connected to the Y-input of the scope. And the converter's output for this

operating condition will be at its level 7 (assuming that the level corresponding to 000 of the channel counter is taken as level 1).

The circuit has two switch-selectable operating modes. In the MULTIPLEX mode, the channel counter logs clock pulses continuously. In the MANUAL mode, the counter can be set to any one of eight binary counts (from 000 to 111) with the thumbwheel switch (or with a set of three individual switches).

In the MULTIPLEX mode, there is a continuous clock input, and the signals on input channels 1 through 8 are sequentially applied to the scope's Y-input. Since the converter's output drives the scope's X-input, the scope sweep is disabled. When the signal on channel n is applied to the Y-input, the converter's output, which is at level n , horizontally displaces the scope beam by $(n - 1)$ steps to the n th position. Therefore, the actual signal voltage levels, not merely the logic states, of all eight channels can be read directly from the scope screen. Clock frequency can be 1 to 5 kilohertz so that the display remains stable.

For dynamic testing, when a single signal must be studied, the circuit is operated in its MANUAL mode. The desired input is selected by loading the channel counter with the appropriate channel number. The signal waveform can then be observed at length—an advantage that many logic testing devices do not offer.

This scope input-expander circuit can be easily extended to cover 16 inputs by using a 16-channel multiplexer, a four-bit counter, and a four-bit converter. For convenient handling, the 16 signal wires can be terminated with a dual in-line clip. □

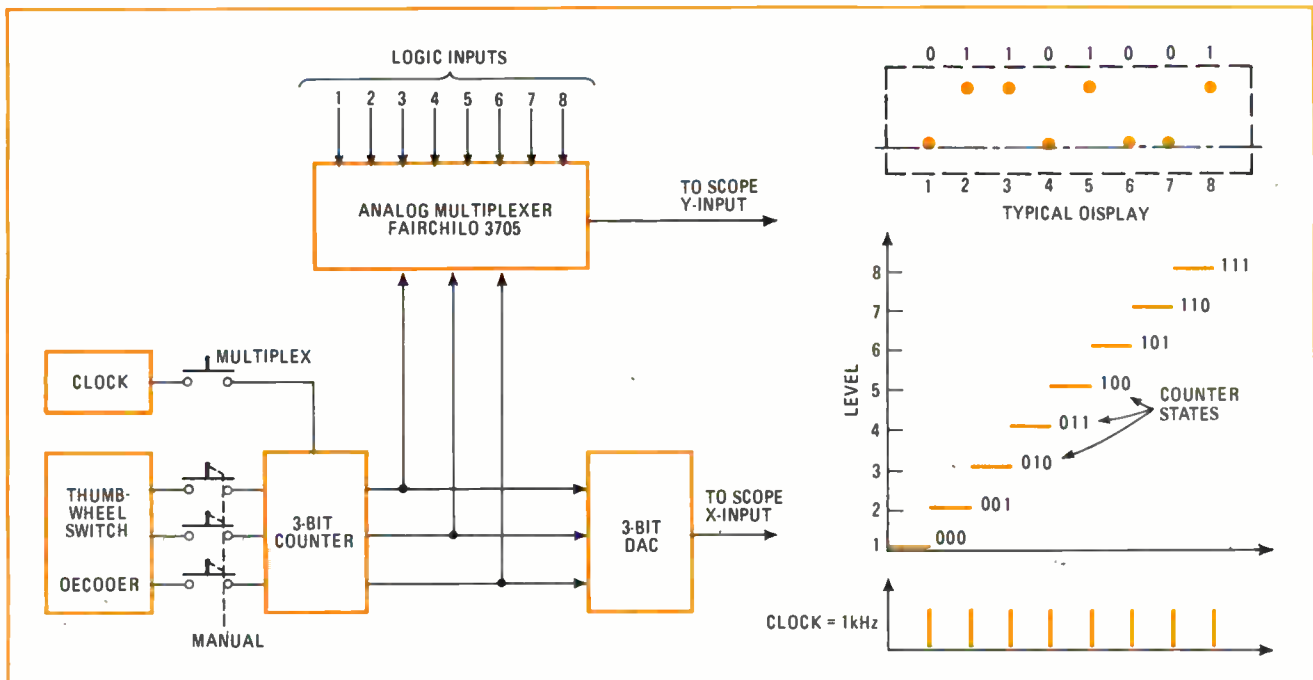

Scope input expander. Multiplexing circuit speeds up digital-circuit monitoring by enabling any scope to display up to eight logic inputs at the same time. With the circuit in its MULTIPLEX mode, the scope displays the actual signal-voltage levels, rather than only the logic levels, of all eight logic inputs. In the MANUAL mode, a single signal waveform can be selected with the thumbwheel switch and studied at length.

Displaying gray-scale images on bistable storage tubes

by J. Karman and N. Kroese
Delft University of Technology, Delft, The Netherlands

With relative ease, the bistable storage cathode-ray tube can be adapted to display halftone photograph-like images. Although it is reliable, rugged, and inexpensive, the bistable storage CRT cannot normally produce the varying intensity levels needed for gray-scale information. This is because its phosphor can be in only one of two states—either written or unwritten.

However, an intensity-varying signal can be simulated by the halftone generator shown in the diagram.

Taking pictures. Halftone generator circuitry enables bistable storage display units to produce gray-scale images. The generator provides a duty-cycle-modulated square-wave output that effectively varies CRT beam intensity, storing a picture on the tube face. The photograph of a satellite weather picture made with this technique shows that resolution is fairly good although the beam dot structure is visible.

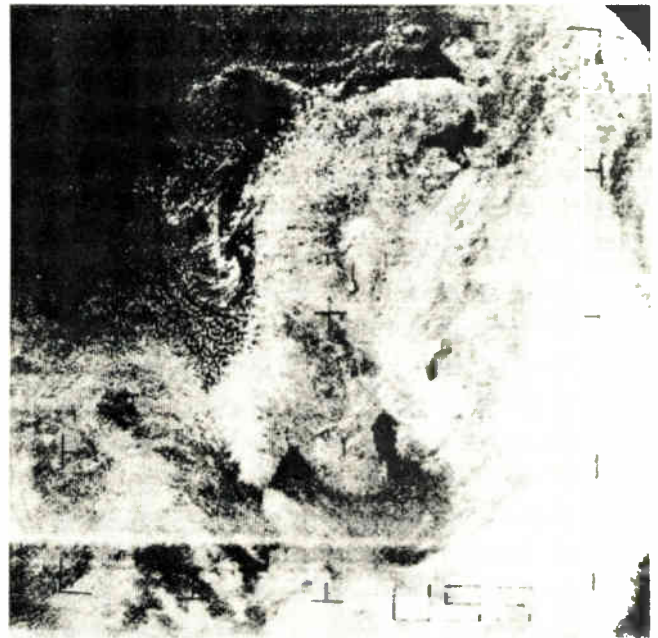
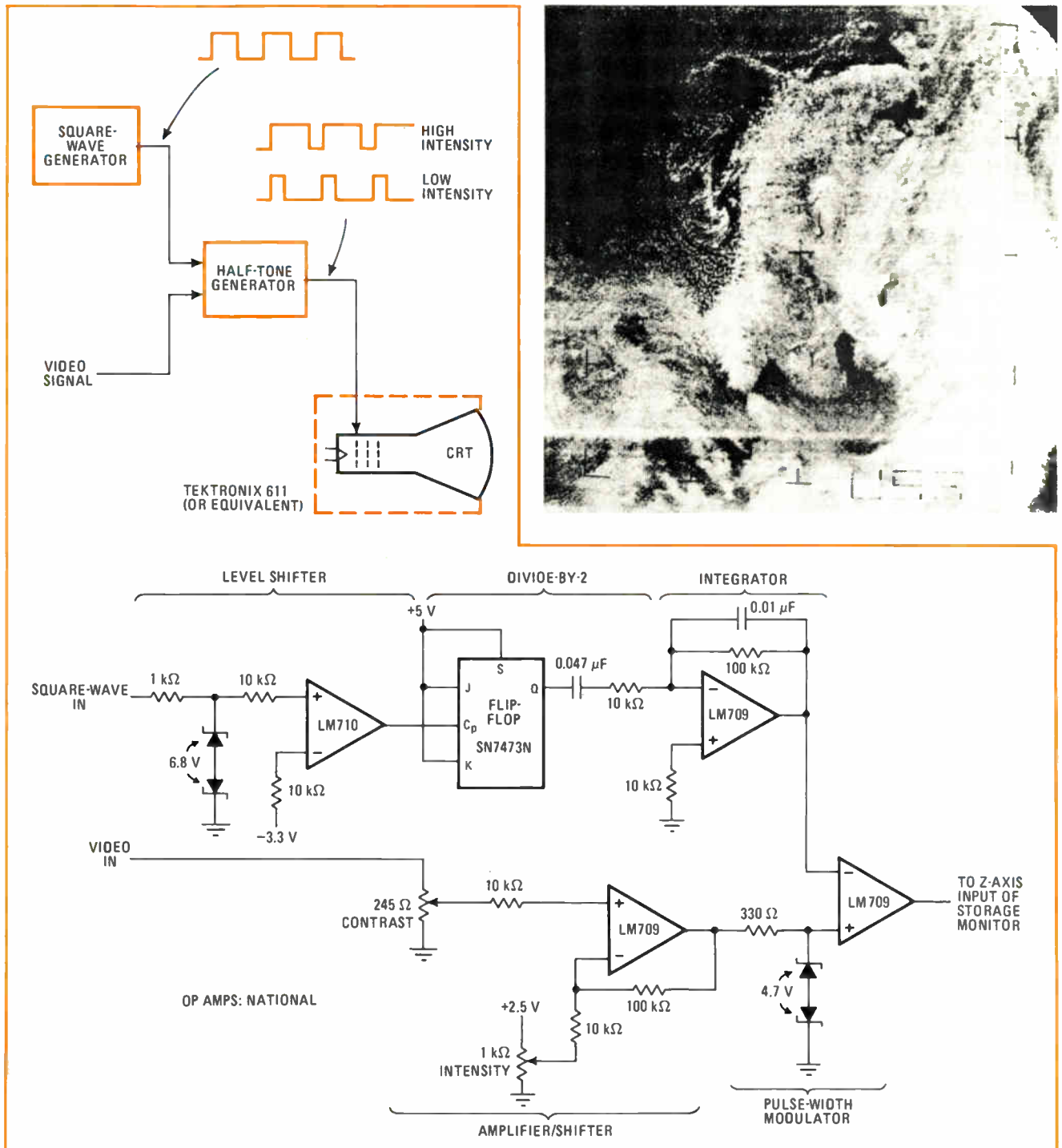

This circuit enables the many oscilloscopes and monitors containing a bistable CRT to be easily adapted for displaying gray-scale images. Also, new applications, such as facsimile and long-term display of X-ray pictures, become feasible.

The circuitry for the halftone generator in the figure is intended to store and display satellite weather pictures, which are transmitted line by line at a rate of four lines per second. The intensity level of each portion of a line is controlled by the video signal.

Since the only control that can be exercised over the storage monitor is to turn the CRT beam on and off, the impression of a changing intensity can be achieved by varying the time that the beam is on as the video level varies. In this way, a halftone display can be produced. The inputs to the halftone generator are a symmetrical square wave and the video signal. The generator output is a nonsymmetrical square wave with a duty cycle that varies with the video level.

The square-wave input to the generator first passes through a level-shifter stage so that the signal logic levels are correct for the rest of the circuit. The divide-by-2 stage is included for added stability. Its output is converted to a triangular wave by the integrator.

The video signal is processed for intensity and contrast by being put through the level-shifter/amplifier stage, which is followed by the pulse-width modulator containing an open-loop amplifier. Each time the triangular wave from the integrator crosses zero, this amplifier's output jumps to its maximum positive or negative level (depending on the triangle's level), producing a square wave at the output of the circuit.

ducing a square wave at the output of the circuit.

The video level signal, which is applied to the non-inverting amplifier input, determines the symmetry of this output square wave. When the video level is minimum, the square-wave duty cycle is also at its minimum; likewise, when the video level is maximum, the duty cycle is maximum. This duty-cycle-modulated square-wave output is applied to the storage monitor's Z-axis input.

To get the best picture resolution, each line displayed on the CRT must contain as many dots as possible. Maximum resolution is controlled by the specifications of the storage display unit. For the Tektronix 611 storage display used here, the specified horizontal resolution is 300 line pairs or 300 dots per line. Since the weather pictures are being broadcast at a rate of 4 hertz (4 lines per second), a square-wave frequency of 1,200 Hz allows a resolution of 300 dots per line to be achieved.

The signal broadcast from the weather satellite contains a 2,400-Hz reference; the line and frame signals are derived from this signal. Increasing the square-wave frequency to 2,400 Hz permits the line, frame, and dot rates to be synchronized so that interference patterns in the picture can be eliminated. (The square wave is returned to 1,200 Hz by the divide-by-2 stage.)

The photograph shows a typical weather picture made using this technique. Although the dot structure is visible, the weather patterns are clearly recognizable. □

Engineer's Notebook is a regular feature in Electronics. We invite readers to submit original design shortcuts, calculation aids, measurement and test techniques, and other ideas for saving engineering time or cost. We'll pay \$50 for each item published.

Flashing lamp reminds you to turn off equipment

by John Gibson
University of California, Berkeley, Calif.

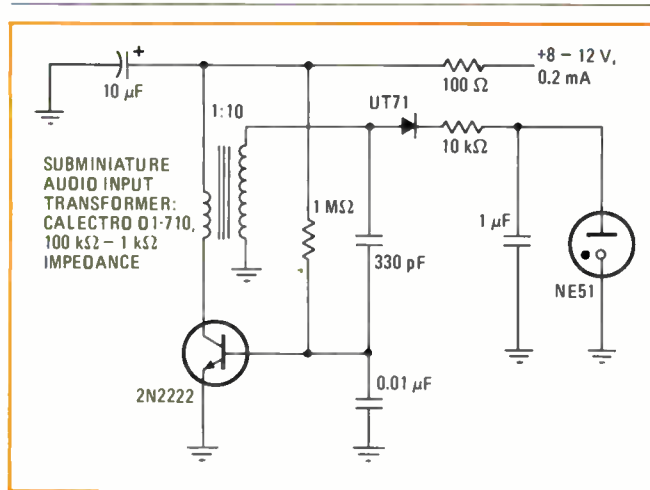

Warning light. Neon panel lamp flashes about every 5 seconds for as long as equipment is on. The circuit, which is intended for battery-operated units, keeps current drain to a low 200 microamperes.

Most battery-operated equipment lacks an indicator light to remind you to turn the unit off. Forgetting to flick the off switch can be an expensive oversight. For instance, if a dry-battery supply is left on so that it discharges completely, the highly corrosive fluid that oozes out of the cells may damage expensive components. Frequent replacement of run-down batteries can also be quite costly.

As a solution, you can easily install an incandescent indicator, but even the lowest-drain (and therefore dimmest) incandescent lamp requires appreciable power, often more than the rest of the equipment needs. On the other hand, the neon-lamp circuit in the figure holds current drain to a mere 200 microamperes. Moreover, the neon lamp flashes approximately every 5 seconds for a better warning indication.

The circuit employs a blocking oscillator whose output pulses are rectified and then used to pump-up the 1-microfarad capacitor in a staircase-generator fashion. When this capacitor's voltage reaches the firing voltage of the neon bulb, the bulb fires and discharges the capacitor. The cycle can now repeat.

Any neon bulb having a firing voltage of less than 90 volts can be used. Both the diode and the "firing" capacitor must be low-leakage devices. Correct transformer phasing is essential for proper circuit operation. The transformer is wired in reverse—that is, its secondary is used as the primary and vice versa. □

At last, a possible statistical solution to IC yield problems

To the IC manufacturer, few subjects have greater economic significance than yield, and yet yield statistics have so far resisted theoretical analysis. R.M. Warner, Jr., of the department of electrical engineering at the University of Minnesota, Minneapolis, Minn., thinks he may have the answer.

From a mathematical analysis of sample slices, he has observed that **defect densities may actually fit the simplest possible statistical model—the well-known Poisson distribution**—provided it is recognized that one slice can contain more than one population of defects. In other words, **the area of a slice often can be divided into two or three sub-areas, each with its own defect density.** Each area's distribution may differ widely, and each has its own probability-density function.

The trick, of course, is to optimize a production run around the optimum density distribution function. Warner's complete treatment and some examples can be gotten from a soon-to-be-published paper, obtainable from the author.

Service updates sets of standards every 90 days

Here's a microfilm service you should check out. Information Handling Services, Englewood, Colo., the company that runs the well-known VSMF (Visual Search Microfilm File), is now offering a series of commercial standards in compact microfilm form. Starting with the **complete family of standards promulgated by the American Society for Testing Materials**, IHS has gone on to **include the standards of the EIA, ANSI, SAE, NPPA, NEMA, and the ASME.** The service, which will shortly be expanded to encompass even more organizations, includes updating of all files at 90-day intervals, **except for the ASTM standards, which are updated every 60 days.**

A clean splice

Cable-splicing jobs are made much less messy than usual by a new kit. The contents include **flexible polyethylene sheathing that can be zipped up as an inner lining**, foam for end seals, a reusable polyvinylchloride for an outer jacket, and **a final seal of polyurethane foam that hardens in 20 minutes.** Maker is Zippertubing Co., Los Angeles, Calif. 90061.

How to get better switching from diodes, transistors

With a diode or transistor, **you can get faster and cleaner switching by biasing the device close to its threshold level.** A simple voltage divider between the switch and an existing supply voltage will generally do the job. J.R. Laughlin, an instructor at San Jacinto College in Pasadena, Texas, discovered the technique while using a diode switch to eliminate the waveform distortion that often results from operating an op-amp half-wave rectifier at high frequencies.

Inputs welcomed

Got any design tips or nifty solutions to knotty design problems you'd like to share? Or for that matter problems you've been puzzling over that you think other designers may want to wrestle with? Send them in to the attention of Senior Editor Laurence Altman. We'll credit you and your affiliation with any item we use.

Looking for Metal Glaze™ resistors?

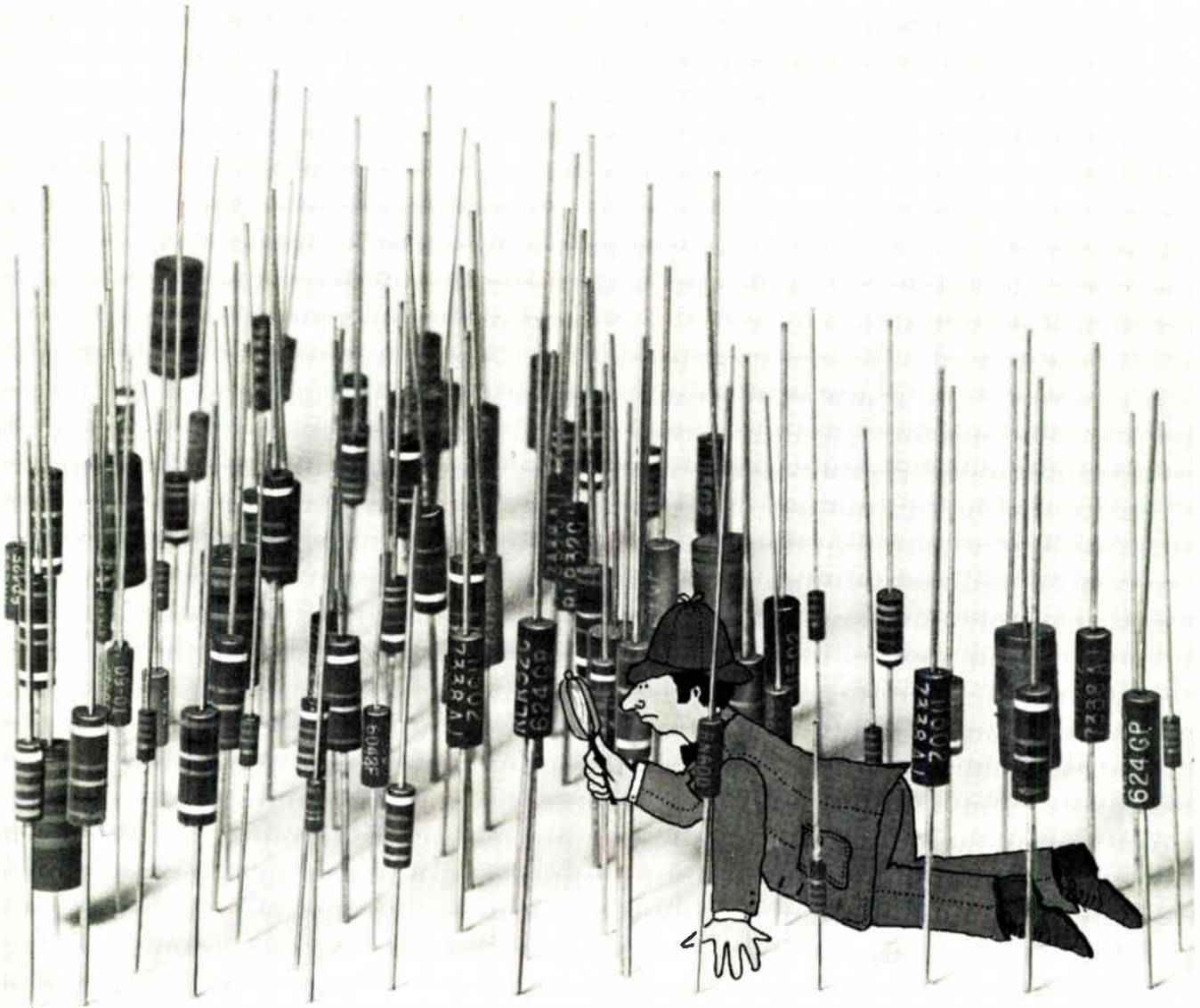

Don't overlook your TRW distributor.

If it's Metal Glaze you're after, you already know *why*. Things like mechanical strength, load-life stability, low $TC\Delta R$, ability to double-rate. For almost any low-power circuitry, TRW/IRC Metal Glaze resistors are hard to beat.

And like a lot of components these days, they're in short supply, right?

One suggestion. Make sure to check your local TRW/IRC *distributor*. We can't *promise* it, but he may just have enough Metal Glaze, or TRW thin-film resistors, on hand to help you out of a bind.

Complete resistor choice. TRW offers a total resistor capability—carbon composi-

tion, thin-film, Metal Glaze, wirewound and other types. For information, contact Distributor Operation, TRW/IRC Resistors, an Electronic Components Division of TRW, Inc., 401 N. Broad St., Philadelphia, Pa. 19108. (215) 923-8230.

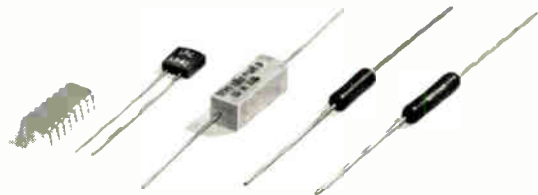

TRW IRC RESISTORS

GOING TO EXTREMES TO INSURE QUALITY

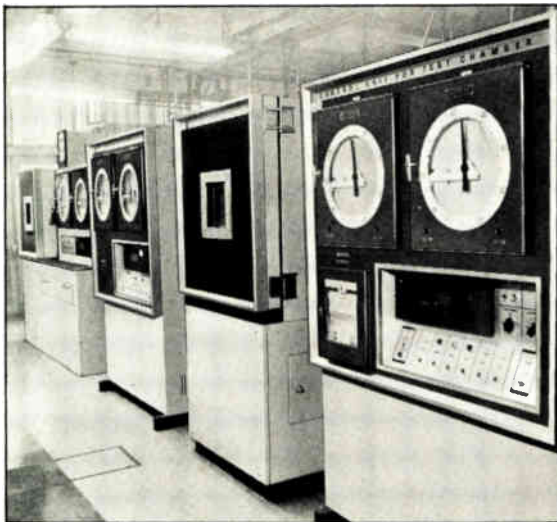

If you could take an express trip from the North Pole to the equator, you'd experience roughly the same effect as our special environmental testing has on the fingertip-size "Toko Pulse Transformer." More than a thousand hours of exhaustive testing in temperatures ranging from -55°C to $+85^{\circ}\text{C}$ and humidity increasing from zero to 98% allow no rest for these electronic machine parts. In addition, anti-vibration and anti-shock tests are repeatedly performed to satisfy uncompromising Toko standards.

Only after repeated and severe testing can we determine if the quality of each piece of circuitry is acceptable. From the radio and TV components that brighten our everyday lives to the electronic miracles that will enable man's exploration of the universe, even a single flaw in the smallest electronic part could spell failure . . . even disaster.

No wonder, then, we strive to maintain such strict standards for all Toko products. Achievements like the development of the Pulse Transformer, Delay Lines, Wire Memories, Super-Miniature Coil and other innovative Toko products require this conscientious attitude, combined with a pioneering spirit, ready to meet every demand placed on the Toko brand wherever it appears in the world.



EXCELLENT SET WITH TOKO PARTS
TOKO, INC.

For further information, just call or write:

Head Office: 1-17, 2-chome, Higashi-Yukigaya, Ohta-ku, Tokyo, Japan

Toko New York Inc.: 350- Fifth Avenue, New York, N.Y. 10001 U.S.A. Tel: 565-3767

Toko, Inc. Los Angeles Liaison Office: 1830 West Olympic Blvd., Los Angeles, 90006 Cal. U.S.A. Tel: 380-0417

Toko Elektronik GmbH: 4 Düsseldorf, Lakronstrasse 77, W. Germany Tel: 0211-284211

Toko (U.K.) Limited: 59-67 Gresham Street. London

yes,
yes,
no,
yes,
no.

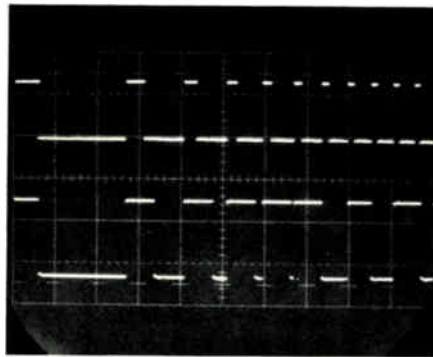

Upper trace: Constant Duty Cycle pulses over a 10:1 frequency range.
Lower trace: Normal pulses over same range.

"Standard pulses with predetermined width are fine for most requirements, but when I'm changing repetition rates I have to fiddle with the width control to make sure that I don't lose the pulse. Does your 'Constant Duty Cycle' mode let me set width as a percent of pulse period so I can change rep rates *without* tweaking the other controls?" (YES)

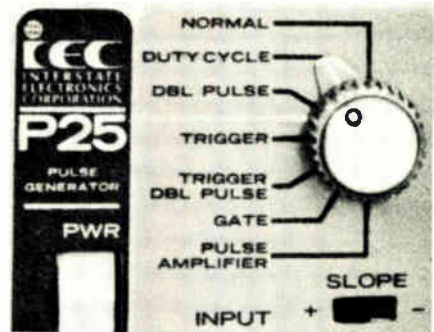

A single control selects all 7 modes.

"That Duty Cycle mode could come in handy, but I also want the regular pulses that I'm used to, and double pulses, and 50% squarewaves to 50 MHz. How about trigger, gate, triggered double pulse, and pulse shaping? (And all of these modes better be easy to set!)" (YES)

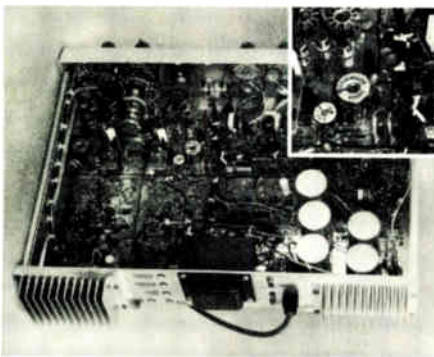

All components are fully accessible.

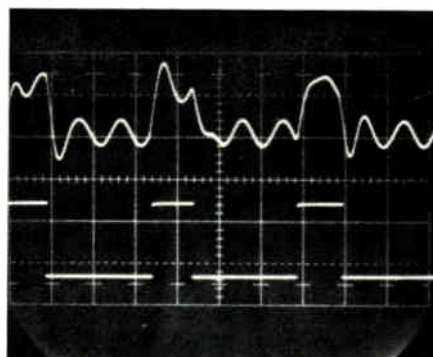

Upper trace: distorted, noisy input.
Lower trace: pulse generator output (Pulse Amplifier Mode).

"My application calls for pure pulses with a bare minimum of overshoot and squiggles. And I need to clean up distorted signals — you know, send in a crummy pulse train and get out a nice squared-up pulse with the offset, amplitude, and rise/fall times I've set up on the generator. Can do?" (YES)

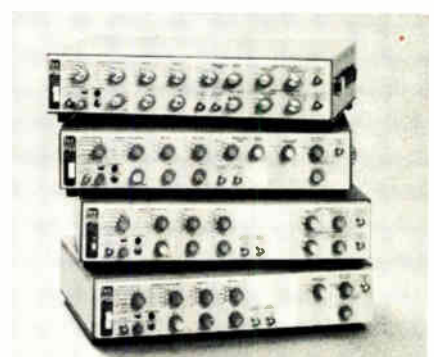

Four SERIES 20 models are available from \$575.

"Your \$1095 P25 Pulse Generator has it all, including simultaneous positive and negative outputs, each with adjustable d-c offset and variable rise/fall times from 5 nanoseconds. But if I only need a single output or faster, fixed rise times, am I out of luck?" (NO)

ask a 50-MHz pulse generator these 5 questions if the answers are yes, yes, no, yes, no, it's INTERSTATE

the Interstate man with all the answers is John Norburg—call collect (714) 772-2811



INTERSTATE ELECTRONICS CORPORATION
Subsidiary of A-T-O Inc.

U.S. HEADQUARTERS: Dept. 7000, Box 3117, Anaheim, CA. 92803; OVERSEAS SALES OFFICES: AUSTRALIA, Parameters Pty., Ltd.; BELGIUM-LUXEMBOURG, Regulation-Mesure S.P.R.L.; FINLAND, Havulinno Oy; FRANCE, Tekelec Airtronic, S.A.; ITALY, Tekelec Airtronic; ISRAEL, Radat International Company Ltd.; JAPAN, Asahi & Co., Ltd.; NETHERLANDS, Tekelec Airtronic, N.V.; NEW ZEALAND, David J. Reid, Ltd.; REPUBLIC OF CHINA, Bons International Co., Ltd.; SPAIN, Telco, S.L.; SWEDEN, M. Stenhardt AB.; SWITZERLAND, Traco Trading Co., Ltd.; UNITED KINGDOM, Euro Electronic Instruments, Ltd.; WEST GERMANY, Tekelec Airtronic GMBH; CANADA, Radionics, Limited. TWX U.S.A. 910-591-1197 TELEX U.S.A. 655443 & 655419

Get an original for the price of a copy.

A lot of imitations have come along since MICRO SWITCH introduced its low-cost line of DM pushbuttons.

Our price is still tough to beat. And so is our package of features.

There's ease of installation.

Snap-in mounting eliminates the use of tools. Quick-connect terminals simplify wiring.

There's versatility.

A wide choice of circuitry. Buttons in several styles and colors. Lighted or unlighted displays. Colored faceplates. Momentary, push-pull maintained, pull-to-cheat and a two-level alternate action (visually tells what mode you're in).

There's reliability.

Rugged construction plus a corrosion-resistant plunger and case. Our time-proven snap-action switch. A high electrical capacity (UL and CSA listed at 10 amps., $\frac{1}{3}$ hp; 125 or 250 vac).

For more information, contact your MICRO SWITCH Branch Office or Authorized Distributor (Yellow Pages, "Switches, Electric"). The help they can provide is another feature our imitators have never been able to beat.

MICRO SWITCH makes your ideas work.

MICRO SWITCH

FREEMONT, ILLINOIS 61032
A DIVISION OF HONEYWELL



The CRT display
isn't really obsolete.
DIGIVUE® just makes
it look that way.

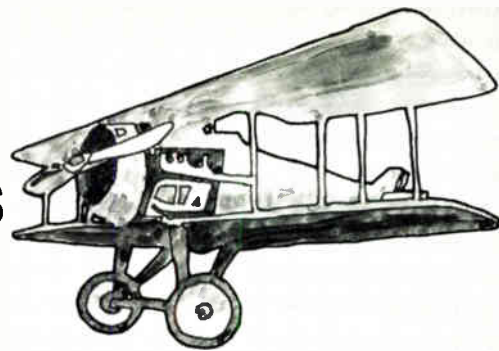

**And Rear Projection Capability
Is One Reason Why . . .**

Digivue is the plasma display device from Owens-Illinois that delivers computer-generated alphanumeric and graphic displays at microsecond speeds. Digivue provides drift-free images, selective write/erase, inherent memory, hard copy printout potential. And rear-projection capability.

You get coordinated computer-driven displays and optically projected images. Rear project a blank graph, chart, table, blueprint or cutaway drawing, for example, while computer-generated data fills in the blanks. Theoretically, anything that can be photographed can be rear-projected through a Digivue screen. From maps to the Mona Lisa.

Try that with a CRT.

If you'd like to know more about the next generation in display systems, take a look at tomorrow—take a look at Digivue.

Call or write:
Electro/Optical Display Business
Owens-Illinois, Inc.
P.O. Box 1035, Toledo, Ohio 43666
(419) 242-6543 Ext. 66-415

Circle 139 on reader service card

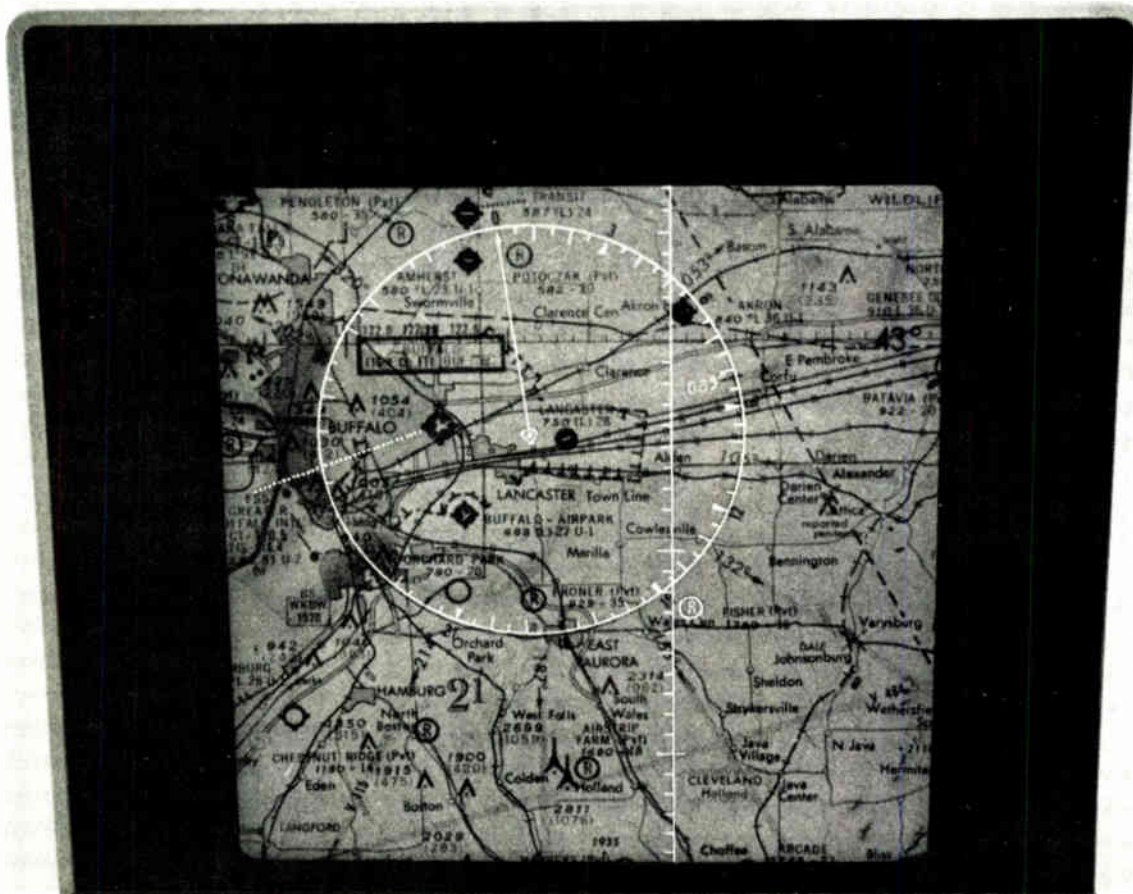

Simulation of rear projection on screen.

SORRY IBM WE DON'T WANT YOUR BUSINESS

Stewart-Warner Microcircuits is better at serving companies our own size.

With due respect to mighty IBM, if they wanted to give us all their business we'd have to turn them down. We're geared to serve small and medium-size companies best. We know their problems because they're just like ours. But although we're not set up to feed the

hungry giants of the industry, when it comes to product quality, service, and customer loyalty—we really deliver.

Speaking of delivery, if you order your 7400 TTL's now, you'll be getting products in '74 instead of promises. Remember, we've got 77 circuits in the 7400 TTL

line, plus the 9601 and 9602, as well as a complete line of 930 DTL's.



STEWART-WARNER MICROCIRCUITS DIVISION
STEWART-WARNER CORPORATION
730 E. Evelyn Ave. • Sunnyvale, Ca 94086 • (408) 245 9200

Get your quote on our out-of-state toll-free line—(800) 538-7906, or contact our nearest representative.

WESTERN STATES
Washington, Oregon, Idaho, Montana,
British Columbia, Alaska
SD IR²
Bellevue, Wash. (206) 747 9424

Northern California
P.M. SALES
Cupertino, Calif. (408) 255 1771

Southern California and Southern Nevada
OHION SALES
Tustin, Calif. (714) 832-7687
Cimarron, Calif. (714) 240 3151
San Diego, Calif. (714) 566 0360

Arizona
DE ANGELO, ROTHMAN & CHEEVER, INC.
Scottsdale, Ariz. (602) 948 2240

Utah, Colorado, New Mexico, and Wyoming
WAUGHAN ASSOCIATES, INC.
Wheatridge, Colo. (303) 423 1020
Albuquerque, New Mexico (505) 265 4097

MID WESTERN STATES
Minnesota, North Dakota, South Dakota,
and Western Wisconsin
S & R SALES
Minneapolis, Minn. (612) 544 3027
Michigan and Northeastern Wisconsin
J.C. HOFSTETTER COMPANY
Birmingham, Mich. (313) 643-7203
Grand Rapids, Mich. (616) 942 0650
Illinois and Southern Wisconsin
L.T.E.C., INC.
Chicago, Ill. (312) 286 1500
Indiana and Kentucky
G & D ELECTRONIC SALES INC.
Fort Wayne, Ind. (219) 432 5680/6
Texas, Oklahoma, Arkansas, and Louisiana
EVANS & DOWELL ASSOCIATES
Dallas, Texas (214) 238 7157
Houston, Texas (713) 777 1282
Kansas, Nebraska, Missouri,
and Iowa
STEWART-WARNER MICROCIRCUITS
Sunnyvale, Calif. (408) 245 9200

EASTERN STATES
Metropolitan New York and
Northern New Jersey
MAXIMO INTERNATIONAL EXPORTS
New York, N.Y. (516) 538 3844
S.J. SALES ASSOCIATES, INC.
Jamaica, N.Y. (212) 791 3232

Upstate New York
MARTIN P. ANDREWS, INC.
Fayetteville, N.Y. (315) 637 3144

Eastern Pennsylvania, and Southern
New Jersey
WALT STEMLER ASSOCIATES
Cherry Hill, N.J. (609) 566-4010
Barrington, N.J. (215) 644 3477

Florida, Georgia and Western
Tennessee
STEWART-WARNER MICROCIRCUITS
Sunnyvale, Calif. (408) 245 9200

Maine, New Hampshire, Vermont,
Massachusetts, Rhode Island,
and Connecticut
COMSALE
Waltham, Mass. (617) 890-0011
Meriden, Conn. (203) 634-0179

Maryland, Washington, D.C. and
Virginia
WALT STEMLER ASSOCIATES
Alexandria, Va. (703) 548-7818
Baltimore, Md. (301) 944-8262/8246

CANADA
Canada
SPACE ELECTRONICS SALES
CORPORATION
Montreal 302, Quebec, Can. (514) 735 5775
Reading, Ontario, Can. (416) 741 6362
Ottawa 7, Ontario, Can. (613) 745 6300

OVERSEAS
Great Britain
BEAM Components
Rochester, Kent, England Telex 851 965166
Sweden, Norway, Denmark, Finland
ELEKTRO MEKANISK KOMBINATION
Dansk Vagn 84 D
416 59 Göteborg, Sweden
Germany, Austria, and Switzerland
INTERNATIONAL MICRO ELECTRONICS
5021 Koenigswaldstr.
Lutherstr., 9 Germany
Belgium and The Netherlands
N.V. NIJCKERK S.A.
Brussels 2, Belgium
Telephone (02) 78 70 70 (2L)

France
RADIO TELEVISION FRANCAISE
Paris, France, Telephone 722 70 40
PANTRONICS, INC.
Fairfield, N.J. Telephone (201) 575 1177
Italy
ELEDRA 3S
20122 Milano, Italy
Telephone 86 03 07 or 86 90 616
Japan
S. KIMURA AND COMPANY, LTD.
Tokyo, Japan Telephone (03) 212 4841
Israel
TELSYS LTD.
Ramat Gan, Israel
Telephone: 739605 = 722362
India
ZENITH ELECTRONICS
Bombay, India Telephone 367717
Palo Alto, Calif.
Telephone (415) 493 1788

TV integration takes giant step

Family of seven ICs developed by Italian company covers most of PAL system; first four to be produced can be used in pre-chroma stages of U.S. color sets

by Andrew Heath, McGraw-Hill World News, Milan

The human eye leaves little scope for miniaturizing the front of the television tube. But in the back of the set, a revolution in miniaturization is taking place throughout the industry and points to significant technological and economic gains.

The Italian state-controlled company, SGS-ATES, is already offering samples of what will be an almost-complete family of TV circuit functions in IC form. By the latter half of 1974, SGS-ATES expects to be manufacturing a total of seven devices that will integrate virtually all stages of the PAL color-TV system from input signal to TV tube. The only functions not covered will be the uhf-vhf tuner, the horizontal power deflection stage, and the final stages of video amplification.

In carrying out the integration, SGS-ATES engineers were able considerably to improve performance and lower costs of many functions normally handled by discretes or lower levels of integration. Moreover, the complete system offers the TV manufacturer the potential for modular construction, with obvious production cost advantages and avoidance of interface problems. The number of passive components required by the system is reportedly 30% to 40% less than in conventional color TV sets.

The first four of the seven devices to be put into production can, in addition, be used in the pre-chroma stages of the American NTSC color system, or both the complete black-and-white systems. Circuits suitable for U.S. sets will be introduced Dec. 3-4 at the IEEE Fall Conference on Broadcast and TV Receivers at O'Hare Inn, Chicago.

The four pre-chroma devices that also cover the functions required in black-and-white TV receivers are: the TDA 440 video i-f amplifier, a device first developed by Telefunken, the TDA 1170 complete vertical deflection system, the TDA 1180 line processor and sync separator, and the TDA 1190 complete sound and audio channel.

The three specifically designed for the PAL color system are the TDA 1140 reference signal processor, the TDA 1150 luminance and chrominance amplifier, and the TDA 1160 chroma demodulator and red-green-blue matrix.

Some of the functions have been integrated before by other manufac-

turers, and in at least one case, more functions were integrated on one chip. SGS-ATES, however, considers that excessive integration on a chip confronts the TV manufacturer with a less flexible choice in second-sourcing decisions and also complicates diffusion techniques, leading to higher rejection rates. Moreover, larger than standard 16-pin packages are costly to install, the company says.

Two of the four pre-chroma devices—the TDA 440 and TDA 1180—are in standard 16-pin form, while the other two—TDA 1170 and TDA 1190—are in Fin DIP packages developed by SGS-ATES. The TDA 1170, for example, has 12 pins plus

Getting smaller. Circuit assemblies shown with deflection yoke include new ICs that will help miniaturize more stages of TV sets and reduce the number of passive components.

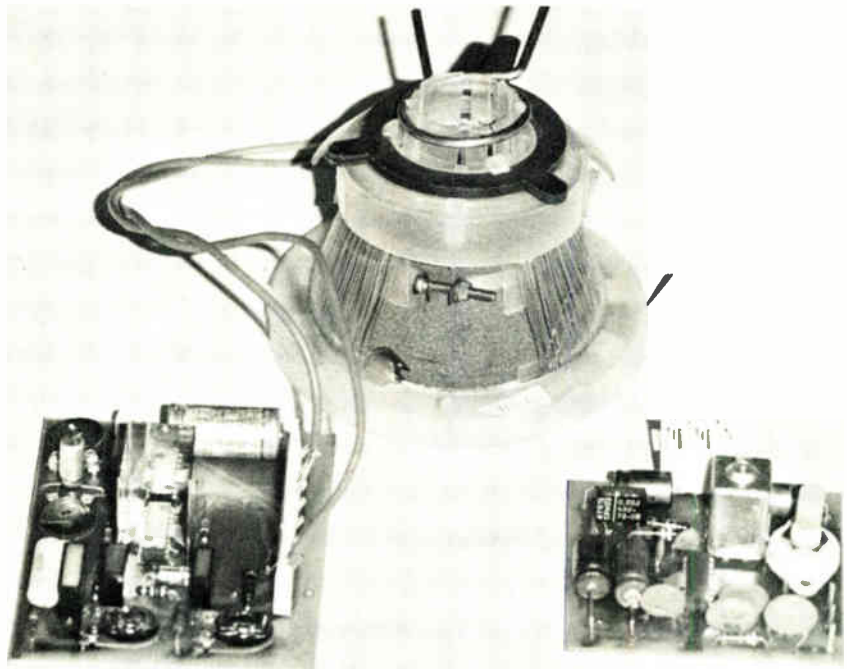

New products

LEAVE THE DRIVERS TO US!



...If we can't
make stepper
motor drivers better
than you can, faster
than you can, and
for less than you
can...PLEASE call
US immediately.
We'd like to know
how you do it.

Model D100 is a 4-phase, unipolar, 8 amp-per-phase driver for 200 step/rev, 5-10,000 step/sec motors. For details about this and other drivers available, write or call collect. Today!

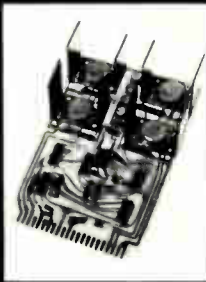

DBE
DAHMEN BURNETT
ELECTRONICS
Grenier Industrial Village
Londonderry, N.H. 03053
Tel: 603-668-2777

Circle 142 on reader service card

two large external cooling tabs that are soldered into the printed-circuit board. The three chroma devices are in 16-pin form.

The choice of 16-pin packages was one decisive factor in splitting up the functions the way SGS-ATES has. But the main motivation behind the company's partitioning philosophy is to achieve homogeneity of function for each IC. "It allowed us to fully exploit the technology we have available in each area," says Aldo Romano, who heads linear IC development for SGS-ATES at the Castelletto plant to the west of Milan, "as well as provide a modular kit approach for the TV manufacturer."

Homogeneity also enabled the company to develop *ad hoc* technologies for each device. As an example, for the TDA 1170, which contains all the functions of a vertical deflection system—frame oscillator, ramp generator, power output amplifier, fly-back generator, and voltage regulator—the company used high-voltage and high-power technology. Integration required raising the voltage to more than 35 volts from the conventional rating of about 18–20 v (in-house technology runs to 70 v). Also, output current was raised to 1.6 amperes. Optimal geometry of the power-stage transistors enables the device to support this current on the reduced silicon area.

For another, the complete audio channel—TDA 1190—has been put on one chip. The device uses high-

power and medium-frequency technologies to integrate an i-f amplifier, fm detector, active filter, dc volume control, power amplifier, and voltage regulator. To accommodate the high power and medium frequency on the same chip without power dissipation and feedback problems, SGS-ATES attenuated the sound carrier at input threshold to 33.4 megahertz, which notably improves the amplitude modulation rejection. The device also carries a dc volume control of 100 decibels (typical) on output power of 4.5 watts and a-m rejection of 55 dB and an input limiting voltage of 30 microvolts.

Similarly, the video i-f amplifier—TDA 440—uses a technology that has a cutoff frequency of 650 MHz, well above the usual levels. The application of such *ad hoc* technologies to each device in turn allowed more intensive integration. For example, in this device the detector contains 14 transistors, two diodes, and 10 resistors. Discrete technology in the same area would have only, as a basic system, say SGS-ATES applications engineers, a diode, a resistor and a capacitor. Romano explains, "We handled it this way rather than by just integrating the discrete system because our solution overcomes the problems of linearity and intermodulation between the sound and chroma carriers inherent in the discrete system."

SGS-ATES Componenti Elettronici S.p.A, Via C. Olivetti 1, 20041 Agrate Brianza (Mi), Italy [338]

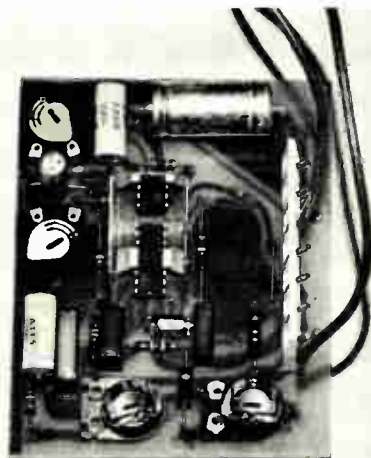

Deflection and sound. On board at left is TDA 1170, an IC that performs functions of vertical-deflection system. On board below is the 1190, a complete audio channel.



if it's a meter or meter relay,

Stock or Special...

Simpson

makes it.

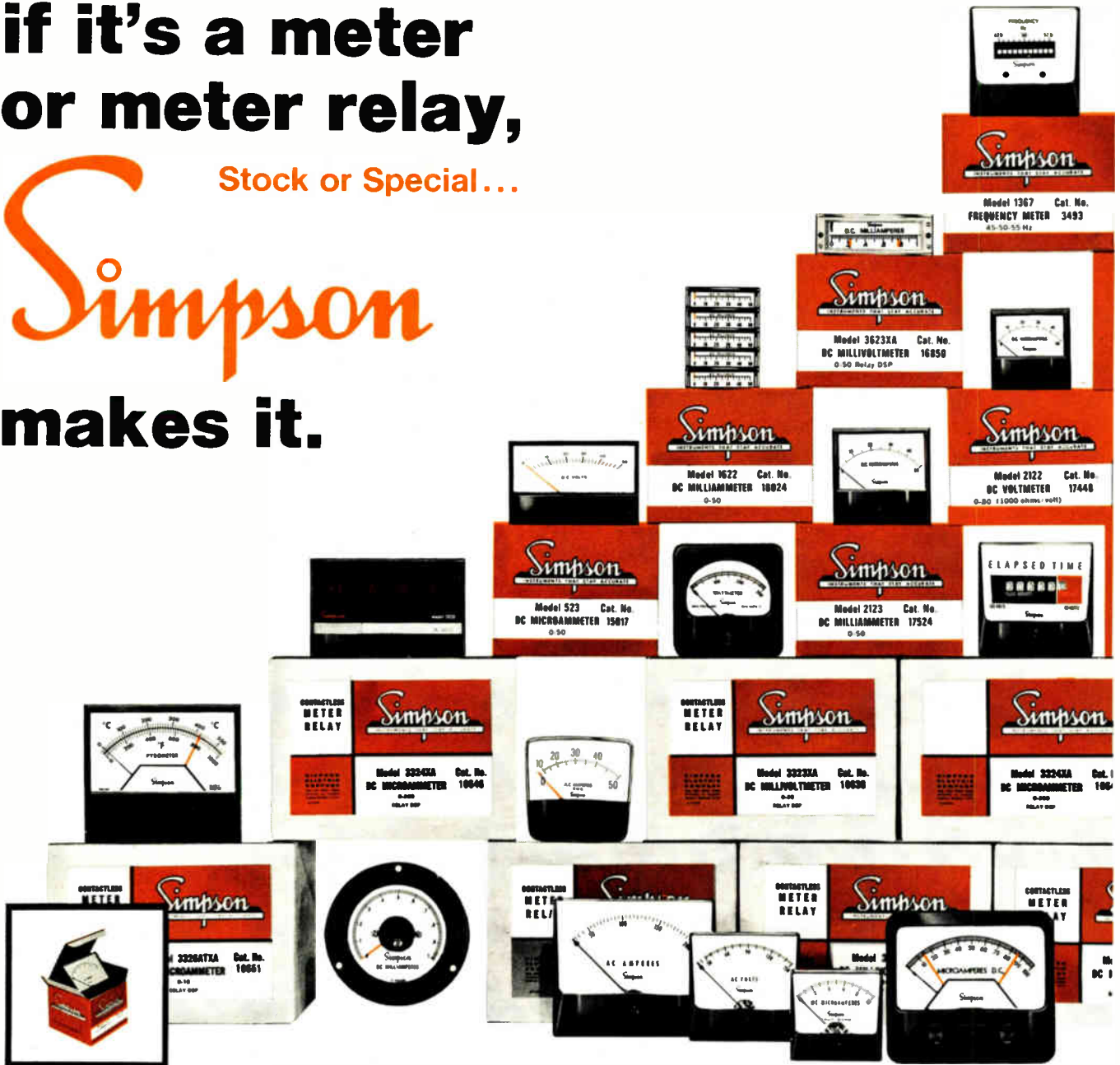

Stock:

Simpson distributors nationwide stock over 1,500 types, ranges, styles and sizes of panel meters, relays and controllers. They're all listed in Catalog 4200. Write for your free copy.

Special:

Need a special or unusual meter? Let Simpson help you custom design it. Send us your specs and we'll send you a quote. But check our catalog first—that "special" may be a standard Simpson stock item.

Get off-the-shelf delivery from your local electronics distributor.



SIMPSON ELECTRIC COMPANY
853 Dundee Avenue, Elgin, Illinois 60120
(312) 695-1121 • Cable: SIMELCO • Telex: 72-2416

IN CANADA: Bach-Simpson, Ltd., London, Ontario
IN ENGLAND: Bach-Simpson (U.K.) Limited, Wadebridge, Cornwall
IN INDIA: Ruttonsha-Simpson Private, Ltd., Vikhroli, Bombay

KATY INDUSTRIES



ELECTRICAL EQUIPMENT
GROUP

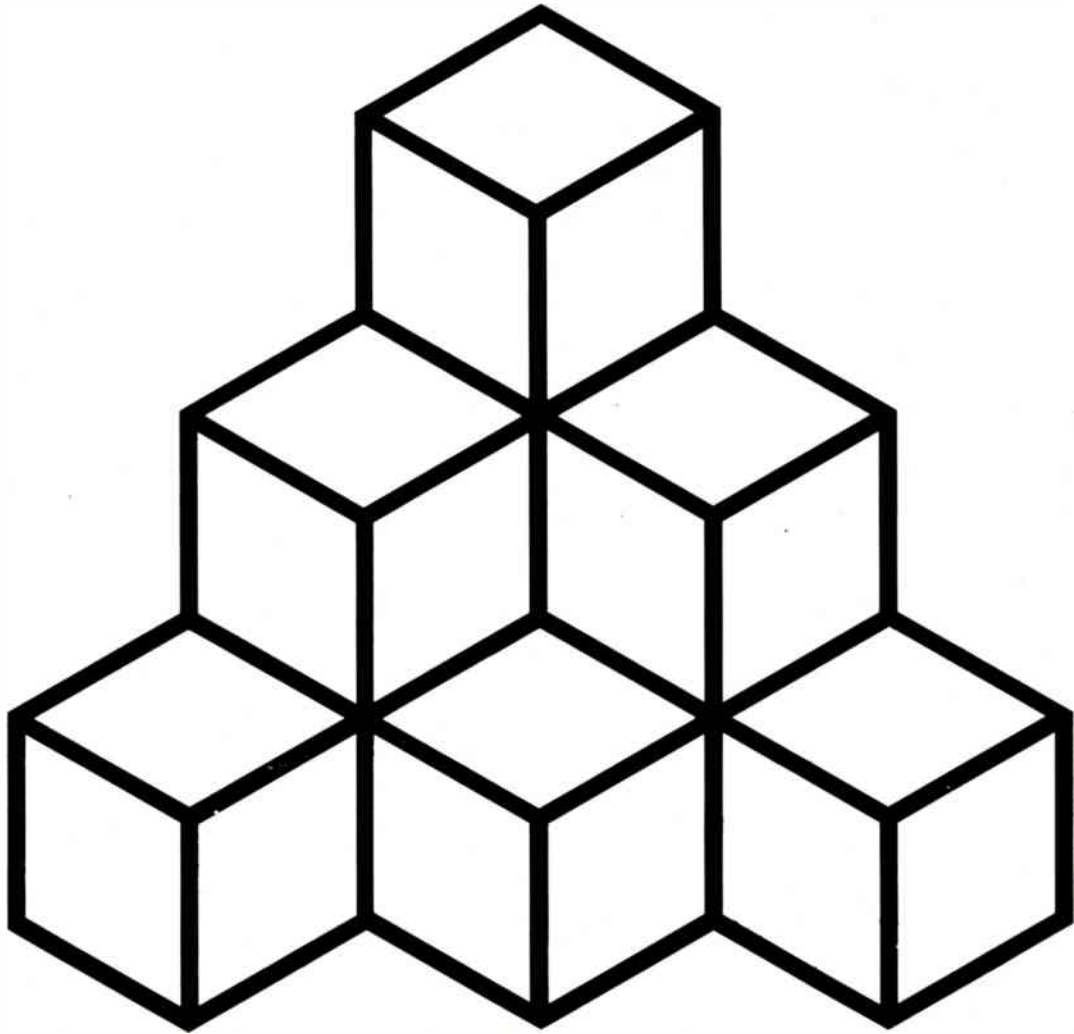

E-H PULSE GENERATORS

Building the solution to your measurement problem.

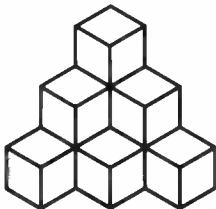

Fast, accurate pulses from E-H, the company that supplies over one-third of the world's pulse generators. A line so complete that you will find exactly the specs you need.

Take the 129, for example. It's used in more sophisticated R&D applications than any other pulse generator. It's capable of 500 MHz — with a transition time specification of 500 psec.

Or the versatile 135A with all the capability you would ever need as a workhorse for your production line.

\$395 is the cost of our 50 MHz Model 710. For this you get a pulse generator that gives you all the basic testing capabilities and a clean pulse.

All these and more — a line of 20 of the world's best pulse generators.

For complete specifications, including a convenient selection chart, use the bingo card, or call us direct.

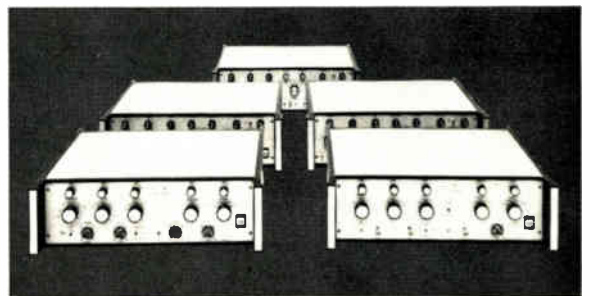

**E-H Research
Laboratories, Inc.**

515-11th Street, Box 1289
Oakland, California 94604
(415) 834-3030



Synthesizers geared to systems users

Low-priced special-purpose units have excellent phase-noise characteristics, along with optional alarm monitors and fault-location circuitry

Lyman J. Hardeman, *Communications and Microwaves Editor*

Vhf-uhf frequency synthesizers have been available for some time to meet a wide variety of general-purpose applications—from instruments in standards and engineering laboratories to automatic test gear. These units, available from several manufacturers, usually have outputs over a broad range of frequencies from a few kilohertz to well into the uhf part of the spectrum.

But Frank J. Sposato, executive vice president at LogiMetrics Inc., points out that 75% to 80% of all synthesizer requirements are for narrow-band systems applications. And because LogiMetrics can produce narrow-band units at prices roughly 25% below the price of wide-band counterparts, his company is introducing a line of narrow-band synthesizers especially designed for the user of special-purpose systems.

Model 510 and model 512, the first of the series, span the ranges from 95 to 115 MHz and 125 to 160 MHz respectively. These synthesizers use the indirect-synthesis method to generate the output power. Each has 1-kHz resolution, with options for resolution down to 1-Hz. Frequency is selected manually by front-panel thumbwheel switches, and remote programming of output frequency is optional.

Maximum phase noise for the model 510 is 110 dB below the carrier in a 1-Hz bandwidth, offset 300 Hz from the carrier frequency. The corresponding phase-noise specification for the model 512 is 107 dB below the carrier. These excellent phase-noise characteristics are generally achieved more readily than in previous units because of the narrower bandwidths over which the



Special-purpose. Narrow-band vhf synthesizers shown above are part of new line from LogiMetrics. The instrument at top includes optional alarm monitor and fault-isolation switch.

new synthesizers operate, Sposato says.

Harmonically related spurious outputs are 30 dB below carrier for both units, while non-harmonically related outputs are maintained at 80 dB below the carrier and lower. Radio-frequency output for both models is variable from +3 dBm to +13 dBm when used to drive a 50-ohm load. Output leveling is kept to within ± 1 dB over the band.

Typical systems applications for the new synthesizers include satellite communications, frequency-agile radar, electronic countermeasure systems, programable local oscillators for surveillance receivers, and microwave common-carrier systems. The synthesizers are also well suited for special-purpose automatic test systems.

Optional alarm monitors and fault-location circuitry have been provided especially for the systems

user. Among the parameters monitored are a check for frequency-standard input, the presence of an output signal, proper operation of all phase-locked loops, and power-supply voltages. Failure of one of these parameters will light a front-panel indicator and close a relay for remote indication. In addition, an 11-position front-panel switch and meter will isolate faults to the removable-module level.

Price for the model 510 is \$3,485 each in quantities of 10. Model 512 is priced at \$4,585 in the same quantity. Delivery time is about four months in both cases.

Higher-frequency models are being prepared for shipment by mid-1974. An example is the model 522, a synthesizer operating from 2,150 to 2,575 MHz with +10 dBm output. It will sell for about \$7,000.

LogiMetrics, Inc., 100 Forest Drive, Greenvale, N.Y. 11548 [339]

Digital VOM challenges analog meters

Drawing less than a milliwatt, rugged 3½-digit unit for \$195 can operate for more than a year on a single 9-volt battery

by Michael J. Riezenman, Instrumentation Editor

Although digital multimeters are widely accepted as laboratory and service tools, they have not made a serious dent in the analog volt-ohm-milliammeter market. And this is despite their unambiguity of reading and their greater accuracy.

The reason for their failure, according to the planners at Dana Laboratories, is twofold: relative inconvenience and relatively high price. To compete successfully with analog meters, Dana says, a digital instrument must be capable of being banged around in the field for at least a year without requiring any recalibration, battery changes, or battery-charging. And it must be comparable in cost with the entrenched analog competition.

Dana's answer to this challenge—

the Danameter—is probably the first instrument that truly rivals analog types on both these counts. Featuring a 3½-digit field-effect liquid-crystal display, the instrument consumes less than a milliwatt of power, so that it can operate for more than a year on a single 9-volt transistor radio battery. The instrument's front panel contains only a single switch, two holes, and the display, so that users of the popular analog VOMs should have no trouble understanding how to use the meter.

Priced at \$195, the Danameter costs about the same as the better analog VOMs—those with FET-input circuitry and good overload protection. The cheaper VOMs—those with input resistances of 20 kilohms per volt and little or no overload protec-

tion—still are less than half the price of the Danameter.

Like the instruments it seeks to replace, the Danameter measures ac and dc volts, dc current, and ohms. Unlike these instruments, however, it has automatic polarity detection and display, automatic zero-adjust, and no need for a special adjustment on the ohms scale. The instrument is conservatively rated to have a maximum error of 1% of full scale on the dc voltage scales, 1.5% on the ac voltage scales, and 2% on the ohms and current ranges.

Input impedance is 10 megohms on the dc voltage ranges and 2 megohms on the ac voltage ranges. For both ac and dc voltage the Danameter has four ranges: 2, 20, 200, and 1,000 v. For current the ranges are 20 microamperes, 2 milliamperes, 200 mA, and 2 amperes. For resistance they are 200 ohms, 20 kilohms, 2 megohms, and 200 megohms.

To further differentiate the Danameter from its analog competition, it has been designed to survive a drop from a workbench to a hard floor without damage. The outer case is made of Cylolac, an ABS plastic of the type used in football helmets. Also, the all-important range switch uses a "music box" cam construction that selectively shorts together various pairs of conductor pads by pushing down on a movable spring contact arm riveted to a single printed-circuit board.

While not completely watertight, the meter was designed to withstand a brief rainshower. Its outside dimensions are 4 inches by 7 in. by 2 in., and weight is 1 pound.

Dana Laboratories, Inc., 2401 Campus Drive, Irvine, Calif. 92664 [340]

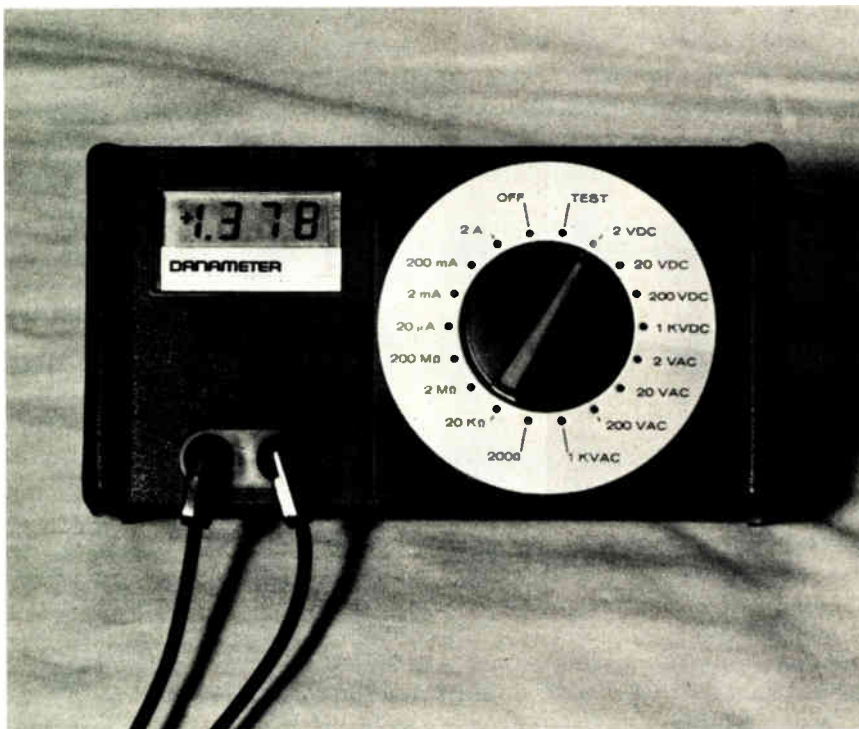

We think of our enclosures as silent salesmen. The first ten seconds of display for an electronics unit focus simply on the package. Its color (and the other colors available), its finish and style. It won't *break* a sale—the equipment inside does that. But it sure can help *make* one. Our award winning designs and

total color range have proved it.

Does a client need a ventilating grille? A blower? What about writing surfaces, drawers, casters? We have them in production, on line and ready to go—offering the access, flexibility and mobility your clients require. We even paint our units inside and out, and assemble

them for final inspection—including most options and accessories—at the plant.

We're ready with all this, and more. Ready right now.

Write Optima Enclosures, 2166 Mountain Industrial Blvd., Tucker, Georgia 30084 or call (404) 939-6340.

OPTIMA

Before you choose your next enclosure, show this ad to your salesmen.



Other Scientific-Atlanta Inc. Divisions are • Cable Communications • Instrumentation • Electro-Systems • Southern Tool and Machine • Security

Semiconductors

4,096-bit RAM has fast access

3-transistor cell from
Motorola and AMI
challenges mainframe cores

Despite its predicted early death, the core memory remains the workhorse of the mainframe computer industry. But new challengers continue to emerge [*Electronics*, Aug. 30, p. 143], and among the most recent is a 4,096-bit random-access memory developed jointly by Motorola and American Microsystems Inc.

Motorola is now sampling one version of its RAM, and this will be available in production quantities in the first quarter of 1974. Another model will be offered in production quantities in the second quarter. AMI is also in production, and its products are expected to be available in large quantities in the first quarter of 1974.

The two companies share the same masks and processes. "That's the only way to have real interchangeability," says Durrell Hillis, manager of MOS marketing at Motorola. The company's 4-kilobit RAM, designated the MCM6605/6, comes in two versions, one for emitter-coupled-logic output with a 190-nanosecond maximum access time and the other for transistor-transistor-logic output, slightly slower at 230 ns. Read-cycle times are 430 and 470 ns, and write times 310 and 350 ns. Both versions are otherwise identical. They have MOS/TTL inputs and are made with n-channel silicon-gate technology, which contributes to the high speed of the devices.

The MCM6605/6 uses three-transistor cells rather than the single-transistor versions now being marketed or developed by several companies. The single-transistor cells require less silicon area than those with three, suggesting lower produc-

tion costs. But Ronald Komatz, manager of MOS strategic planning at Motorola, points out that the actual savings in area is small, and may easily be overshadowed by sensing problems, since the sense amplifiers have to be larger. The Motorola/AMI devices measure 168 by 195 mils. And Hillis thinks that second-sourcing a single-transistor version will be even more difficult than for a triple one.

A number of companies are adopting the single-cell pinouts, but not Motorola and AMI: "Our pinouts were selected for systems reasons," says Komatz. "The power pins are in the corners, eliminating false signals generated from having power around input pins. And though common pinouts help some, the pattern and clock levels are different."

Along with the speed and instant second-source, Motorola feels the MCM6605/6 has an advantage in needing extremely low standby power of only 5 nanowatts per bit. "Ninety percent of the parts are in standby typically, and for a 100-million-bit extended main memory, this represents a large power savings," says Hillis. Active power required is 70 microwatts per bit. Only one low-capacitance clock is needed, with a refresh period of 2 milliseconds, and refresh every 20 cycles instead of 64.

Power required is +12 volts, -5 V, and for the TTL version, +5 v. A-m tolerances are $\pm 10\%$. The package is a 22-pin ceramic DIP, with plastic to be added when volume justifies it. The TTL version is now being sampled, with production in first quarter of 1974, and the ECL version is due for production in the second quarter. Production of this and other 4-kilobit RAMs have been much slower than many semiconductor firms originally anticipated. Komatz says, "I believe that the magnitude of processing a really large dense LSI chip using the n-channel, silicon-gate process was underestimated by the industry."

Present price is about $\frac{3}{4}$ cent per bit in quantities of 100, expected to drop to 0.25 cent by 1975 and 0.15 cent by 1976. At these levels, Motorola is expecting the memory to find

wide use in mainframes and new minicomputers.

Motorola Inc., Semiconductor Products Division, Box 20924, Phoenix, Ariz. 85036 [411]

ROM is electrically
alterable, nonvolatile

Designated as part of the NC7000 series, an M-NOS read-only memory is electrically alterable. It is available in 64-bit and 1,024-bit configurations and is a nonvolatile device requiring a low operating power, some as low as 3 microwatts per bit. The memories will hold the pattern written into them when no power is on. Programing is accomplished as for RAMs—after the clear pulse resets the memory to the zero state. For reprogramming, the ROM need not be removed from the printed-circuit board, nor are ultraviolet irradiation or fusible links required. In addition, the device offers a read-cycle speed of 10 to 20 microseconds and a write time of 1 millisecond. Applications are, for example, in battery-operated digital systems, program and buffer storage, preset radio tuning systems, point-of-sale terminals, telephone autodialing, numerical control, and communications-systems encoding.

Nitron Corp., 10420 Bubb Rd., Cupertino, Calif. 95014 [381]

Solid-state timer produces
delays from 1 μ s to 1 hour

A dual timer in monolithic integrated-circuit form is designed for a wide range of uses including replacement of time-delay relays. Called the model NE/SE 556, the unit produces controllable time delays between 1 microsecond and one hour, adjustable over a ratio of 10 to one. Both halves of the timer can operate independently, as well as together, and it can also be set to run

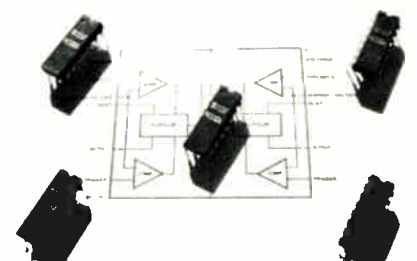



A whole new light on
Advanced System Design...

Winchester Electronics Back Panel Packaging.

Before another dawn comes up, before you put another design on the docket, look into Winchester Electronics Back Panel Packaging. You'll see that it's not one, but **three kinds** of systems. Metal Frame, Metal Plate and Printed Circuit Back Panels. So you can choose the one that fits your objectives best. Your design freedom goes on from there. With the variety of printed circuit, input/output and other discrete connectors you want. With wide choices in terminations, grid spacing, contact types and more. All this to adapt to the design ideas in your completed systems loop.

Winchester Electronics Back Panel Packaging. It'll take you out of the Dark Ages of package design. You'll see how it eliminates spec-by-spec, technological tangles. How it ends the eye-straining drudgery of comparing specifications from one thick catalog to another. You'll see how it frees neat, fast efficient imagination to give your design its place in the sun.

Winchester Electronics Back Panel Packaging. It puts you ahead with Winchester Electronic's comprehensive,

in-depth experience. And with applications-oriented engineers. People with ideas, capabilities, assembly savvy and facilities to help you **design-by-specifying** . . . and get what you need. From custom back panels alone . . . to complete, packaged systems with assembled panels, interconnections, components, wiring, card cages — the whole system, if that's what you specify, according to the cost/performance target you require.

Winchester Electronics Back Panel Packaging. A bright, new light to speed your designs, your production . . . and increase your competitive edge. Before another dawn, write for our new Back Panel Handbook — it tells the full story. Winchester Electronics Division, Main Street & Hillside Avenue, Oakville, Connecticut 06779 (203) 274-8891.



WINCHESTER ELECTRONICS

Circle 149 on reader service card

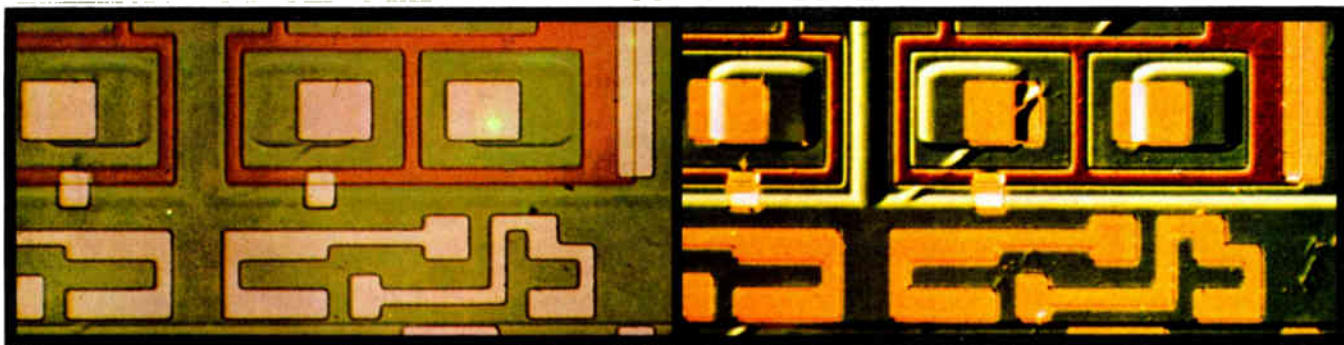

If this is all you're seeing, this is what you're missing.

The AO DICV Series 10 Differential Interference Contrast Microscope can make a big difference. A standard brightfield microscope reveals only what is shown in the specimen on the left.

Now look at the specimen on the right. With this ability to reveal significant detail in outstanding relief in black and white or color, the AO DICV Series 10 can help you spot surface irregularities, inclusions and faults.

By using incident light, after Nomarski, it provides contrast enhancement of opaque

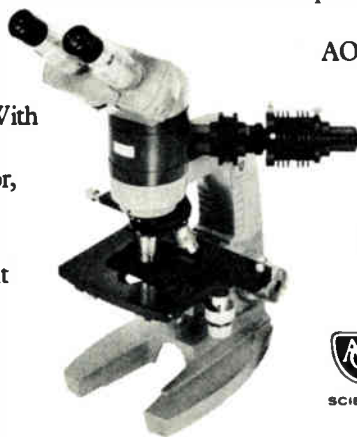

and semi-opaque materials. Helps you make critical quality control checks of semi-conductors, integrated circuits and metallurgical samples.

AO DICV Microscopes convert quickly from interference contrast to brightfield.

So if you can't afford to miss something, you can't afford to overlook the AO

DICV Microscope. For details, write American Optical Corporation, Scientific Instrument Division, Buffalo, N.Y. 14215.



AMERICAN OPTICAL CORPORATION

SCIENTIFIC INSTRUMENT DIVISION • BUFFALO, N.Y. 14215

Circle 150 on reader service card



CELCO
*makes CRT
Camera
Systems
that will
make
YOU Smile!*

Address inquiries to CELCO:
70 Constantine Drive, Mahwah, NJ 07430
1150 E. Eighth Street, Upland, CA 91786

Introducing **CELCO COF/FIC: Computer-On-Film/Film-Into-Computer**

- CELCO DSC I: to 1000 TV lines, 16mm Camera • Low-Cost & Compact
- CELCO DSC II: to 2000 TV lines, 35mm Camera • Ultra-High Stability
- CELCO DSC III: to 4000 TV lines, 70mm Camera • Ultra-Low Distortion to 0.05%



CONSTANTINE ENGINEERING LABORATORIES COMPANY

150 Circle 207 on reader service card

Electronics/November 22, 1973

New products

free, in which case each half can be set to oscillate at any frequency between 300 kilohertz and less than one pulse per hour. Duty cycles are adjustable from 50% to 0.01%. The unit is guaranteed over the temperature range from -55° to $+125^{\circ}\text{C}$ and is priced at \$1.25.

Signetics Corp., 811 E. Arques Ave., Sunnyvale, Calif. 94086 [413]

Static 1,096-bit RAM
accesses in 450 ns

By combining its silicon-gate n-channel and ion-implantation depletion-load technologies, Mostek Corp. has developed a static 1,096-bit random-access memory with a worst-case access time of 450 nanoseconds. Designated the MK 4102-1P, the MOS LSI RAM is a pin-for-pin replacement for the Intel 2102-1, the Signetics 2602-1, and the Intersil 7552-1.

Other features include direct TTL compatibility, a three-state output buffer, and single +5-volt-supply operation. The high impedance "off" state and chip-select input allow a minimum of additional components for large memory arrays, and the fully static operation cuts system overhead for small and medium-size memory applications.

Cycle time is also 450 ns maximum, and chip-select and -deselect require a maximum of 200 ns. Input capacitance is 5 picofarads maximum; output is 10 pF.

The 4102 is available from stock in standard 16-pin ceramic DIPs at \$24 each in 100-unit quantities.

Mostek Corp., 1215 West Crosby Rd., Carrollton, Texas 75006 [414]

Quad register operates
from dc to 5 megahertz

An n-channel, metal-gate MOS shift register, designated the model MC6567L, is a quad device with four monolithic registers on a single chip. It is directly compatible with TTL and uses a single TTL-level clock input; recirculate logic is on the



SPIN-OUT

ITS CAUSE AND CURE

Mercury Spin-Out in mercury displacement load relays, due to high and persistent inrush currents, can impair the function of your circuit.

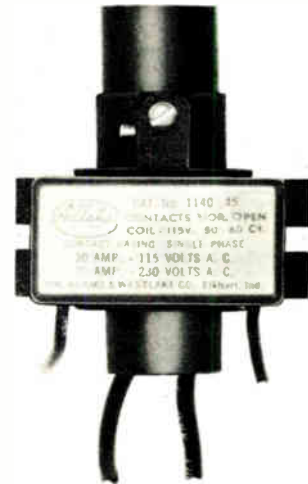

Type 1140-45

Inrush current (up to 8K) will not damage Adlake's Mercury Displacement Load Relays with unique, built-in "Anti-Spin-Out" protection.

Choose SPST to 3PST (N.O. or N.C.) for loads up to 35 amps in street lighting, stage lighting, radio-microwave, mining machinery, railroad equipment, and other demanding applications where high and persistent inrush currents are a problem.

For complete specifying data and a comprehensive, free technical brochure on "Spin-Out", its cause and cure, use reader-service number below.

THE ADAMS & WESTLAKE COMPANY



ELKHART, INDIANA 46514
219 - 264 1141
TELEX 25 8458
CABLE ADLAKE

General Electric has all the Solid State Lamps (LED's) you may need, ready for off-shelf delivery.

GE has a complete line of competitively priced infrared and visible SSL's now available for immediate delivery from your GE distributor or your local GE representative. We have a new plant on-stream ready to serve you, devoted exclusively to manufacturing solid state lamps.

New small infrared SSL.

With the addition of our new SSL-65, GE can now offer an infrared SSL as small as .050". It's the ideal lamp to specify where package size is critical. With GE's line of infrared SSL's, you can now choose lamps

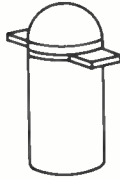

from .25" to .050" in diameter; select beam distance up to 1 mile with proper external optics and specify power output from a maximum of 7.5 mW @ 100 mA down to .1 mW.

Bright visible SSL's.

You'll have to see our visible SSL's to appreciate their brightness. They feature high efficiency GaP pellet material and

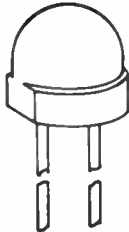

the GE-patented light reflector. GE's GaP pellet gives you bright uniform light.

Exclusive GE guarantees.

As a result of GE's design and construction features, we can offer these exclusive guarantees: Power output to be within published min-max range. 100% lamp inspection at rated current for power output and forward voltage; reverse current @ 10 μ A is 2 volts or greater.

In addition to this blanket guarantee, GE also guarantees every SSL-55B, SSL-

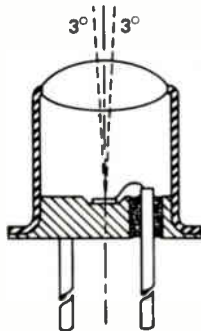

55C, and SSL-56 infrared lamp for precision beam alignment to within 3 degrees of the mechanical axis of the lamp. Power output of each of these lamps is within the less than 2 to 1 range, as published. GE will refund your purchase price or provide replacements for returned lamps not meeting published specifications.

Send today for information.

For a free copy of our Solid State Lamps catalog (3-3358), prices and delivery details, write or phone your GE electronic distributor today.

Or call GE collect. Ask for John Hall at (216) 266-2400 for further details and technical information. General Electric, Miniature Lamp Products Department, Nela Park, Cleveland, Ohio 44112.

GENERAL  **ELECTRIC**

New products

chip. The device, with a capacity of 80 bits, operates from dc to 5 megahertz and is suitable for a wide range of applications, including use as a refresh store. Power dissipation is 650 milliwatts, and voltage requirements are +12 and -3 volts.

Motorola Semiconductor Products Inc., Box 20926, Phoenix, Aviz. 85036 [416]

C-MOS hex inverter

said to cut costs

A C-MOS hex inverter, called the SCL 4449A, is intended as an in-socket replacement for the 4009- and 4049-type hex inverters. The new device is said to cut the cost for that function by more than half, with a reduced current level as the only tradeoff. Features include 2-mA typical sink and source currents at a supply voltage of 10 v. The device is useful for simple digital-logic inversion and for linear applications such as oscillators. Price is 75 cents each for 1,000-lots.

Solid State Scientific Inc., Montgomeryville, Pa. 18936 [417]

Rf power transistors

are rated at 100 watts

Rated at 100 watts for continuous wave and peak envelope power, an rf power transistor is designated the PT5788 in a stud-mounted version or the PT6665A in a flange-mounted version. The devices are primarily intended for single-sideband high-frequency radio applications, particularly for marine off-shore radios. Intermodulation distortion is specified at 32 decibels,



Can a DIVA Disc System really maximize my mini and save me a cool million?

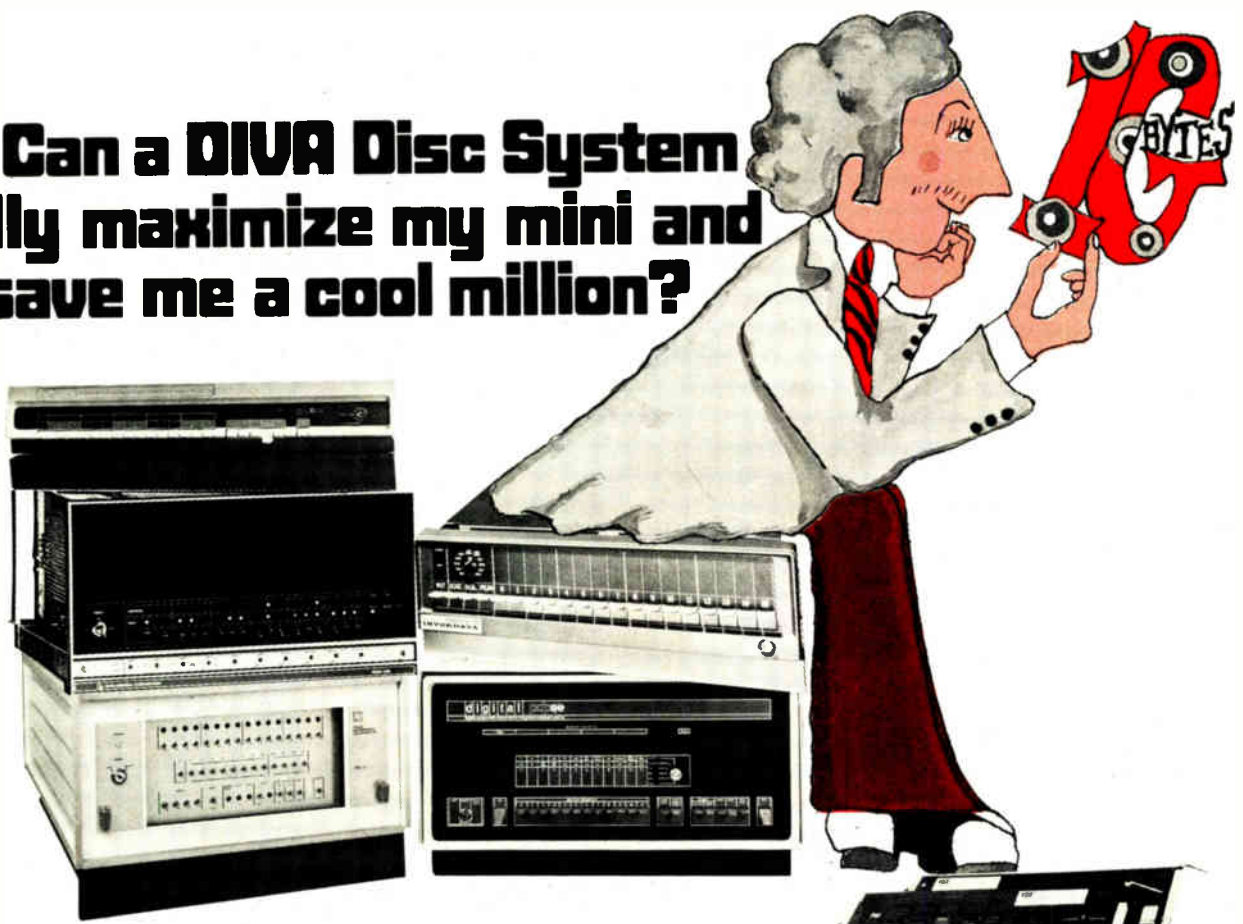

It sure can. Say you own or use one or more of the mini-computers George is sitting on. You can select, according to your particular needs, any one of eight standard mini-maximizer disc systems. George happens to be contemplating a mass memory system with a capacity of approximately 1 gigabyte.

That's a lot of data storage capacity.

But you might be thinking smaller: 7.5 million bytes, or somewhere in between. We can make you both happy. DIVA makes a disc system that will let you or George segment and store your number-crunching, time-consuming calculations and make short shrift of them. These systems are high-performance units: 624 K bytes/sec transfer, 32-msec avg access, 11 sec stop that cut running costs to a few bucks/hr.

That's maximizing your mini.

Now, about the cool million. You don't need a mini for this calculation. DIVA's top-of-the-line disc system with 8 spindles tags out at \$111,900. Add the cost of your mini. Subtract the total from \$1 to \$4 million: the cost of a comparable maxi.

That's saving a cool million, or more.

Obviously, there's more to mini-maximizing than is written here. Options like IBM compatible formatting, an exclusive DIVA feature, and psuedo-sectoring for efficient disc use. Features like overlap seek and removable packs. The rest is in our free brochure. Send for your copy. Read the specs on all the systems. Talk with George Roessler about costs or any unanswered questions on software, training, application, etc.

Then maximize your mini. She's got a lot of potential.

DIVA, Inc./607 Industrial Way West/Eatontown, N. J. 07724/
Phone: 201-544-9000/TWX 710-722-6645.



Mini maximizer systems

FUJI

16K BYTES MEMORY CARD

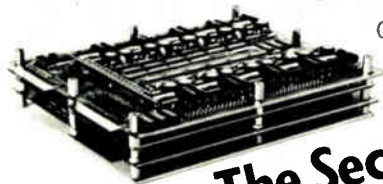

CMS2803

The Second Best Seller
Doesn't necessarily imply second best



CMS2802

CMS 2802: EMM micro 3000
CMS 2803: AMPEX 1800 series

Plug-to-plug compatible.

A clear system using our own hybrid circuit ICs.

	Access time	Cycle time	Temp. range	Power supply voltage
CMS2802	300 ns.	650 ns.	0°~+50°C	+5V ±3%. 4.0A max. +15V ±3%. 4.0A max. -15V ±3%. 0.9A max.
CMS2803	340 ns.	850 ns.	0°~+55°C	+5V ±5%. 3.5A max. -15V ±3%. 4.5A max.

FUJI ELECTROCHEMICAL CO., LTD.

Head Office: Hamagomu Bldg., 5-36-11, Shinbashi, Minato-ku, Tokyo, Japan. TEL: 434-1271

Overseas Office:

New York, TEL: (212) 532-5630/Los Angeles, TEL: (213) 620-1640/Düsseldorf, TEL: (211) 89031

Circle 154 on reader service card

Our single-chip concept:

Copper grid distributes current most efficiently for lowest $V_{CE(sat)}$.

Integral solid copper leads and heat sink make pre-bond chip test and inventory possible.

Meet stringent MIL requirements best with the NPN silicon transistor that's single-minded about performance.

The concept: a unique single-chip design that packs the highest current rating in its class... keeps saturation voltage low and eliminates second breakdown problems. $V_{CE(sat)}$ is .60V max. @ 50 Amps, and guaranteed at 90 Amps. $E_{S/b}$ is 6 joules. And because its very simplicity allows pre-rating

Void-free bonding techniques eliminates hot spots.

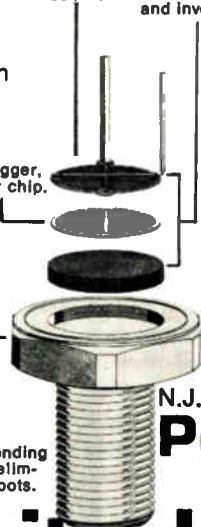

and pre-testing, you can order our PT 7511 device off-the-shelf for switching regulators, motor controls and other hi-rel power circuits.

For tech. data and application assistance, write or call, PowerTech, Inc., 9 Baker Ct., Clifton, N.J. 07011; (201) 478-6205

PowerTech
BIG IDEAS IN
BIG POWER

Top of its class. 200v, 90A silicon transistor

154 Circle 208 on reader service card

New products

minimum power gain is 14 dB, and frequency range is 1.5 to 30 megahertz.

TRW Semiconductors, 14520 Aviation Blvd., Lawndale, Calif. 90260 [419]

Phase-locked loop consumes little power

The CD4046A COS/MOS phase-locked loop consists of a low-power linear voltage-controlled oscillator and two different phase comparators having a common signal input amplifier and a common comparator input. A 5.2-volt zener diode is also provided for supply regulation if necessary. Power consumption is typically 70 microwatts when the supply voltage is 5 v and the operating frequency of the VCO is 10 kilohertz. Price ranges from \$2.50 to \$6.50 each, depending on configuration.

RCA Solid State division, Rte. 202, Somerville, N.J. 08876 [418]

Npn phototransistor offers irradiance of 20 mW/cm²

A fast switching npn phototransistor, featuring a hemispheric lens, provides a high degree of collima-

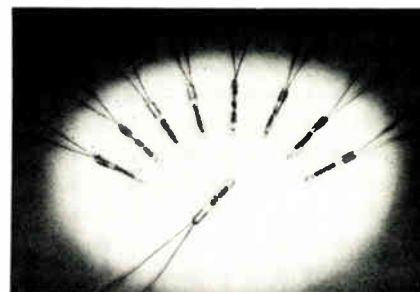

tion and uniform sensitivity with rotation. Called the OP 400, the unit has a collector-to-emitter breakdown voltage of 50 v, dark current of 25 nA, and typical photo-current of 3 mA with an irradiance of 20 mW/cm². Typical applications include punched-tape and card readers and optical encoders.

Optron Inc., 1201 Tappan Circle, Carrollton, Texas 75006 [420]

Electronics/November 22, 1973

Aren't you the guy who says he's always looking for a new way to improve the product?

Here's your chance.

Have you thought about lasers?

A Hughes helium-neon laser is a light source for devices that measure, align, level, detect, record... or even provide a wireless communications link.

There may be a way to incorporate a laser into your product to make it lighter, smaller, faster, more accurate or more versatile.

First, let's make sure we're talking about the same kind of laser. He-Ne lasers are low-cost, low-power, and safe. (They cost as little as \$80 and can operate on either AC or DC.) They send out a visible beam of parallel light waves that can travel for hundreds of feet with very little divergence.

He-Ne lasers don't cut, weld, or perform brain surgery. Those are other lasers.

He-Ne lasers have revolutionized surveying and construction engineering equipment.

They shoot a perfect straight line for building bridges. Digging tunnels. Laying pipes and cables. Or leveling road beds.

But there are many other kinds of equipment that incorporate lasers.

Equipment to: Align car wheels. Tell auto repair shops when a damaged body is

straight. Detect surface blemishes as products pass down a production line. Measure flow rates and machine-tool distances. Gauge thickness. Position automated machines. Inspect large prisms and lenses.

Scan production lines to keep quantitative records. Read bar-code patterns — adding totals and keeping inventory count.

They can even be used in systems that carry large amounts of audio and video information over short distances. (Like transporting TV signals from a football stadium to a transmitter van.)

Video playback systems. Non-contact printing. Security systems. Computer readout. Holographic recording for checking filed data. Particle counting in pollution monitors.

A Hughes He-Ne laser may be the answer to your product im-

provement, too. After all, Hughes made the first working laser. And we pioneered the use of He-Ne lasers in many of the fields we've listed. We can anticipate many of your interface problems. And opportunities.

If you're serious about improving your product, give us a call.

Call Hughes (213) 534-2121

If you're an OEM interested in incorporating a He-Ne laser into your product, call this number. Ask for Bob Weiner, extension 445. Or write 3100 W. Lomita Blvd., Torrance, Calif. 90509.

HUGHES

HUGHES AIRCRAFT COMPANY
ELECTRON DYNAMICS DIVISION

To design engineers, she's
a great mini-solution for
instrument & system
requirements.

To purchasing agents
she's a small blessing
for big money savings.



*Duncan's
little
sweetheart
has something
for
everyone.*



PIXIEPOT®

For complete information, specs, prices
or evaluation samples, call or write:

DUNCAN ELECTRONICS
SUBSIDIARY

SYSTRON  **DONNER**

2865 FAIRVIEW ROAD • COSTA MESA, CALIFORNIA 92626
PHONE: (714) 545-8261 TWX 910-595-1128

Circle 156 on reader service card

Instruments

Test system built around calculator

Programs, hardware interface make unit the control center for automatic checkouts

However easy it may be for an engineer to program the new programmable calculators, Julie Research Laboratories Inc., New York, believes many don't really get that good at it and, in fact, would rather not have to do it at all. "It takes skill



to do a good programming job," asserts Julie, "and to flow-chart the job, type it in the Basic language, and then edit and debug it, takes time and costs money."

With an eye on automated testing, Julie has therefore developed a group of programs, as well as a hardware interface, that allows a Hewlett-Packard 9830 programmable calculator to function as the control center for a system that not only performs measurements but logs and manipulates the resulting data as well. In addition, the system encourages the user to apply any signal sources and measuring instruments he has already on hand in his laboratory or production facility. This is because the hardware interface is flexible enough for Julie to be able to supply it in a form that accommodates whatever test instruments the customer specifies. The

only proviso, according to Loeb Julie, president, is that the instruments be digitally programmable and have digital outputs.

So far, Julie has a library of about 10 master programs contained on the tape cassettes required by the 9830 calculator. These programs deal with the testing of a variety of instruments and components, including resistors, zener diodes, power supplies, panel meters, multimeters, and digital voltmeters. Parameters and permissible limits for the units to be tested are merely typed in by the user at the calculator keyboard in response to instructions presented on the calculator's display panel. In effect, then, the master program is used to create, in about 10 minutes, according to Julie, the sub-program needed to test each model of a particular device.

In testing digital multimeters, for example, the master program will generate the specific test parameters for the particular instrument. Then after the user has typed in information on voltage ranges, number of digits, accuracies, and so on, the program is ready to check out the instrument.

And once the test data is obtained, the software package will also carry out the routine calculations that are usual in an automated test facility. This includes calculating averages and standard deviations, as well as developing the data for generating various types of curves and histograms.

The systems come in a range of configurations, made possible by the interface's universal bus structure. For \$9,900, Julie includes in its Datacal 30 system a 9830 calculator, which Hewlett-Packard lists for almost \$6,000, the hardware interface and its system engineering, and at least one of the master program packages. This price, Loeb Julie feels, is low enough to justify the computerization of small and medium-size laboratories, which would ordinarily resort to slow manual test methods. And it should also be attractive for production-line testing applications.

For \$15,900, Julie includes its own model DM-1060 digital mul-

timeter—a 6½-digit unit with an accuracy within one part per million. This arrangement, shown in photo in first column, is called the Locost-106 data-acquisition system.

In addition, Julie is also trying to do business with those who already own the H-P calculator. For \$3,990, the company will provide only the hardware interface and a master program cassette so that the user can go to automated testing for a minimum extra cost. For those who need them, however, Julie also provides a range of voltage and current sources, pulse and function generators, and meters.

Processed data can be output to the usual devices that interface with the 9830 calculator. These include a teletypewriter, typewriter, and plotter. Also available at additional cost are the Hewlett-Packard plug-in read-only memory function blocks supplied for the calculator.

Julie Research Laboratories, Inc., 211 W. 61 St., New York, N.Y. 10023 [351]

Strip-chart recorder is portable, rugged

A 5-inch strip-chart recorder for field or industrial use is protected against adverse environments and operates up to nine hours on internal rechargeable batteries. Called the model 7155A, the recorder can also operate on external dc power, which can be unregulated at any voltage between 10.5 and 36 v. Timing accuracy is to within 1% at any



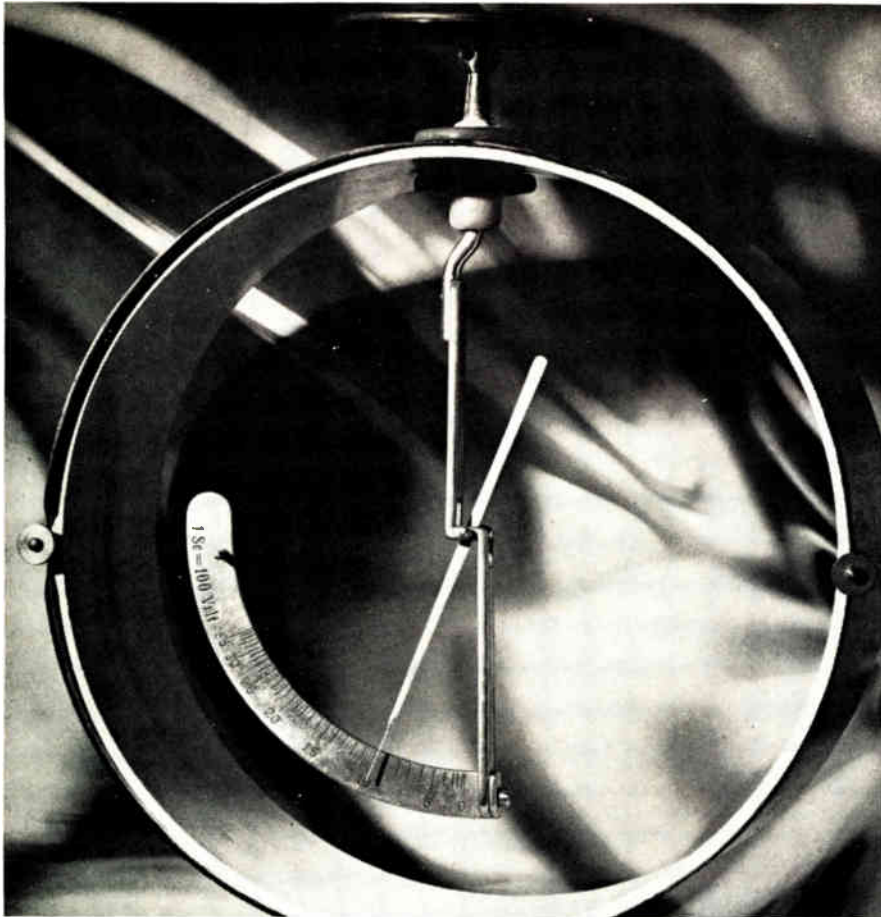

How would you get a measureable signal from only 6,000 electrons per second?

Most people do it Victoreen's way

With just 6,000 electrons, our 10^{12} RX-1 will give you a good clean one millivolt signal . . .

We've been making hi-meg resistors for over 30 years, making it possible for engineers like you to make big things out of little things. And with Victoreen RX-1 resistors, hi resistance is just one of the nice things you get . . . how about accuracy to $\pm 1\%$, good stability, and ranges from 10^7 to 10^{14} ohms . . .

Victoreen . . . where else can you get so many accurate ohms for your money?



VICTOREEN
INSTRUMENT DIVISION
10101 Woodland Avenue
Cleveland, Ohio 44104

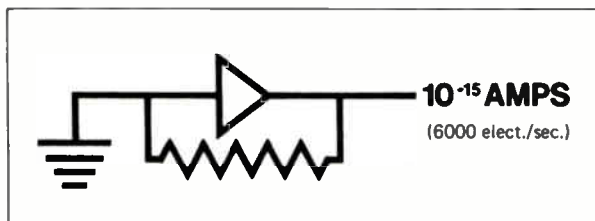

DMA 722

New products

range to 300 to 500 nanometers. Optical probes include tuned filter/detector systems, which are corrected spectrally to measure ultraviolet energy within the sensitive regions of most commonly used photoresist materials and high-resolution plates. Price is \$350.

Optical Associates Inc., 220-F Red Oak Dr. West, Sunnyvale, Calif. 94086 [356]

Testing system handles MOS and bipolar devices

An LSI test system has the capability of handling both MOS and bipolar devices. Called the Spartan 770, the unit offers functional and dc parametric testing of p-channel and n-channel MOS and C-MOS devices, as well as all bipolar devices. The basic model features a mainframe to which memory-channel test heads



and other options may be added. The 770 is expandable to three 48-pin, 40-data-channel test stations with a Digital Equipment Corp. PDP-11 computer and peripheral options, including magnetic-tape and CRT displays. Price is \$55,500.

Western Digital Corp., 19242 Red Hill Ave., Newport Beach, Calif. 92663 [357]

Digital VOM is aimed at production-line uses

The model 360 digital volt-ohm-milliammeter, intended primarily for field use, has a 9.33-inch, $3\frac{1}{2}$ -digit nonblinking light-emitting-diode display that can be read at 15 feet in daylight. Priced at \$275, the instrument includes automatic polarity-selection, a current range to 10 am-

Take Me Along!

- 25 Range DMM includes AC & DC **Current Ranges**
- 3½ Digit **.05%** Accuracy
- Rugged **All Metal** Construction
- **Rechargeable Battery & Line** Operation Standard
- Large Solid-state **LED** Display

New Model 262C



NEW LOW PRICE

\$325.

This price includes rechargeable batteries.

United Systems Corporation
918 Woodley Road, Dayton, Ohio 45403
Ph. (513) 254-6251 Twx: (810) 459-1728
a subsidiary of **Monsanto**

DigiTec

Circle 161 on reader service card

New

MICRO-VECTORBORD AND D.I.P. PLUGBORDS ARE HERE!

Save time — Save work — Save money

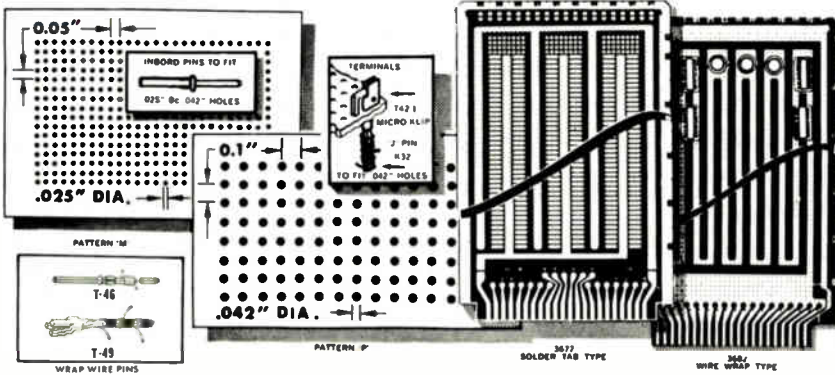

WIDE SELECTION OF SIZES AND MATERIALS

MICRO-VECTORBORD "P" .042" holes match D.I.P. leads. Epoxy glass or paper, cop. cld. also 1/64" to 1/16" thk.

MICRO-VECTORBORD "M" .025" holes match Flat-Paks, 1/32" Epoxy glass, cop. cld. also or .007" Mylar.

NEW SOLDER-PAD D.I.P. PLUGBORDS — 3677 Series Epoxy glass, "P" pat., 1/16" thick with 44 etched plug contacts (2 side total) power, ground

busses, pads for up to 24 D.I.P.'s (14's). Also 21 units 16-leads D.I.P.'s, T-O's and discretes.

NEW WRAP WIRE D.I.P. PLUGBORDS — 3682 Series Similar to above but closely spaced bus lines for higher density. Up to 48 D.I.P. 14 lead wrap wire sockets mountable or T-O's and discretes.

TERMINALS — Micro-Klips, Mini-Wire-Wraps, Rd. Pins, Patch Cords, etc., available.

Send for complete literature

Vector ELECTRONIC CO., INC.

12460 Gladstone Ave., Sylmar, California 91342
Phone (213) 365-9661 • TWX (910) 496-1539

Circle 162 on reader service card

DIRECT DRIVE TO Counters, Stepping Motors, Printers, Relays

A SHAFT ENCODER FOR \$35.00*

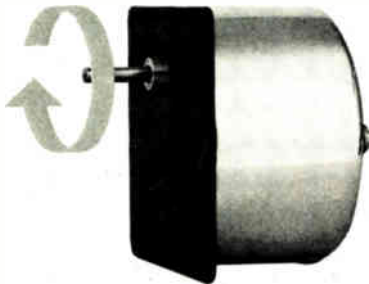

Model 111 ROTASWITCH®
Shaft Encoder



DISC Instruments, Inc.
102 E. Baker St., Costa Mesa, Calif. 92626
Phone (714) 979-5300

Disc Instruments Division
Finnigan GmbH
Dachauer Strasse 511, 8 Munchen 50, Germany
Phone: (0811) 142291 (2)

Disc Instruments Division
Finnigan Instruments Ltd.
Paradise, Hemel Hempstead, Herts, England
Phone: (0442) 57261

No power supply or logic required — The Model 111 ROTASWITCH® Pulser is a unique shaft position encoder using a mercury wetted, no-bounce switch with a service life of 1 billion closures. Since it can handle 100 volt-ampere loads and its output is pulsed, the Model 111 can drive a variety of electronic and electromechanical devices without the need for extra power supplies, amplifiers, or logic circuits—a real plus benefit where design costs must be kept minimal.

The Model 111 is available in various gear ratios to provide from 1 to 360 pulses per revolution to a maximum of 6000 pulses per minute. (For higher rates inquire about our photoelectric encoders). It may also be specified without a housing for direct installation.

Complete details and price list available. Write for Bulletin 100.

* In quantity

162 Circle 209 on reader service card

New products

peres, power from nickel-cadmium batteries or ac, and automatic flashing overrange indication, linear to 250 counts beyond maximum. The model 360 is also equipped with an analog indicator for scanning nulls and peaks, as well as a front-panel analog-output jack for interface to other instruments. The 4½-pound unit includes 29 popular ranges measuring ac/dc voltage, current, and resistance, including two "low-power-ohms" ranges at 200 ohms and 2 kilohms.

Simpson Electric Co., 853 Dundee Ave., Elgin, Ill. 60120 [358]

Frequency synthesizer spans dc-to-2 megahertz range

A frequency synthesizer intended for OEM use offers direct digital synthesis and a frequency range from dc to 2 megahertz. Other specifications include 0.001-hertz resolution, remote binary or BCD programability with integral buffer storage, and a programing speed of less than 1.5 microseconds. The model 5110 also provides transient-free switching and phase and amplitude continuity. Price is \$1,880 in OEM quantities.

Rockland Systems Corp., 230 W. Nyack Rd., W. Nyack, N.Y. 10994 [359]

Digital noise monitor gives continuous readout

The model 7350 digital noise monitor provides a continuous on-line LED readout of the noise figure or noise temperature of an operating receiver system. A wide range of applications is possible, including satellite terminals, microwave relays, CATV systems. Several available options permit, for example, synchronous operation with an operating radar. Price is \$2,180.

Ailtech, Farmingdale, N.Y. 11735 [360]



Still the best and most versatile low-cost multiturn pot available!



THE SPECTROL MODEL 534

Standard, 10-turn, wirewound Model 534 — 100-piece price, \$4.75. Also offered as standard, 5 and 3-turn models. Send for a data sheet, or call for a quote.

Spectrol

SPECTROL ELECTRONICS GROUP

UNITED STATES Spectrol Electronics Corporation 17070 E. Gale Avenue, City of Industry, Calif. 91745, U.S.A. • (213) 964-6565 • TWX (910) 584-1314

UNITED KINGDOM Spectrol Reliance Ltd. Drakes Way, Swindon, Wilshire, England • Swindon 21351 • TELEX: 44692

ITALY SP Elettronica spa Via Carlo Pisacane 7, 20016 Pero (Milan) Italy • 35 30 241 • TELEX: 36091

Circle 163 on reader service card

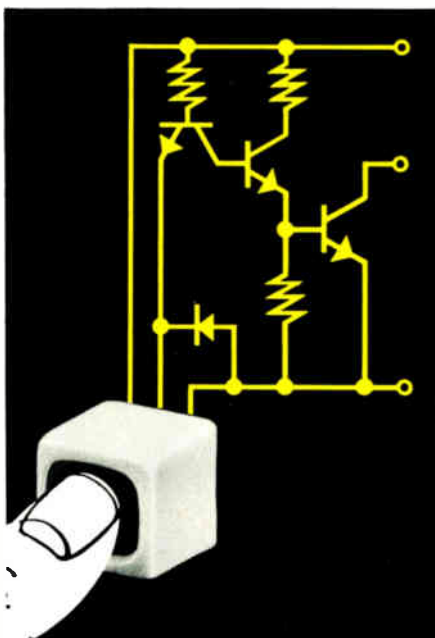

one touch turns on a TTL gate!

Magic Dot's 200 Series solid-state touch-operable switches interface directly with TTL, DTL and HTL, ECL and MOS logic circuits. As with other Magic Dot switches, they operate on a unique capacitance principle and have NO MOVING PARTS to stick, jam, stretch, pit, corrode or bounce because hybrid integrated circuits make them unnecessary. LED's provide reliable visual indication.

The Magic Dot line includes 300 Series switches for remote applications; 400 Series switches for MOS gate switching; industry's only touch-operable, solid-state keyboard and custom capability to meet the full range of special applications.

Write or call today for complete technical and applications information on industry's most reliable switches.

magic dotTM

MAGIC DOT, INC.
3361 Republic Avenue
Minneapolis, Minnesota 55426
Tel: (612) 925-4410

New products

Packaging & production

Board tester has 1-MHz bit rate

Price reduced by using off-line programs instead of computer routines

The usual tester for circuit boards, like an IC tester, consists of a mini-computer plus associated drivers and detectors; but, unlike ICs, boards usually require specialized off-line programs, rather than computer-generated routines. Taking advantage of this, an English company, Membrain Ltd., has developed a modular board-tester without a computer that uses U.S.-type ICs and other components.

First sold in Europe, the tester is being introduced in the U.S. by Mirco Inc. as its first hardware product. The company has been developing software for board testing by users and manufacturers of test systems. Mirco is now developing its own system, which will complement the Membrain tester, to be sold as the Mirco MB1001.

By omission of the minicomputer, the price is significantly reduced. A typically equipped 1001 sells for about \$40,000—\$10,000 less than the average board-test system, says project manager Robert E. Owen. A basic system is priced at \$25,000. Owen says that the MB1001 is 20 to 50 times faster than a system based on a minicomputer. It tests at a 1-megahertz bit rate, while 30 to 40 microseconds are required for each word change in a minicomputer system. He says that the bit rate permits the 1001 to test boards containing certain dynamic memories that can't be tested on slower machines. The system will also test individual components, but it doesn't operate at the 10-MHz rate of memory testers.

The Mirco tester uses a high-speed semiconductor memory loaded from paper tape. Combining the hard-wired processor with a

microprogram means the memory can be fully utilized for board-test programs. The program tape can be developed manually or by computer. Mirco produces these programs, sells a software program suitable for use with a large computer, and will shortly announce a new system based on a minicomputer.

The 1101 can be configured solely for the popular TTL. Adaptations for ECL, HTL, or MOS can be added in the field. A fully programable system is also available. Programs can be generated through a CRT or teletypewriter terminal plus \$1,400 of optional memory, and these programs can also be edited on line. A tape cassette containing 30 8,192-word programs, plus other peripherals, are options.

The normal test configuration is 200 pins, but as many as 1,000 can



be handled. All board terminals are available through shorting plugs so that optional programable analog generators or meters can be used with the system. The only adapter required for a specific board is a simple pin-to-pin jumper; Owen says that the extensive circuitry of some board testers is not required.

Patterns applied to the board are displayed in an indicator matrix of light-emitting diodes on the front panel. If an error occurs, the relevant lamp flashes.

Mirco Inc., 2116 W. Peoria Ave., Phoenix, Ariz. 85029 [391]

Insertion machine handles 25 posts at one stroke

A manually operated insertion machine handles 0.025-inch-square posts and can insert up to 25 of

**Need an LSI/IC maskmaker...
or a complete design system?**



The "Midas" MD-180 is both!

You probably already know about those limited-function maskmakers with design-system price tags. And maybe you've heard about that all-purpose mechanical drafting system that's going to save you \$150,000 a year. Now, standby for something really new, something different!

Just check the features and performance of the new Macrodata Interactive Design Aid System — the MIDAS MD-180! Use the basic system as a simple LSI/IC maskmaker, or build on it with Macrodata's optional modules until you have the most powerful LSI design system available.

MIDAS introduces the dynamic new concept of Interactive Graphics — which permits data entry and editing

directly through the CRT station, but also offers the option of a digitizer and comprehensive design analysis.

MIDAS has already proved itself by solving complex digitizing and editing problems 2½ times faster than other systems, doing in 4½ hours what the leading competitive system took 10½ hours to accomplish.

MIDAS offers Macrodata back-up — the full resources of a company that maintains its technological edge by concentrating exclusively on LSI/IC design and test systems.

For the full story, send for your free copy of the new full-color MIDAS brochure. Just use the reader service card, or call us directly.

Macrodata



Macrodata Corporation, 8203 Varial Avenue, Woodland Hills, California 91364, Phone: (213) 887-5550, Telex: 65-1345

**Sales Offices: Northern California Area Tel. (408) 735-6500 • Southwestern Area Tel. (213) 844-3611 • West/Central Area — Denver Tel. (303) 894-0505 •
Scottsdale Tel. (602) 947-7941 • Albuquerque Tel. (505) 298-7658 • Dallas Tel. (214) 231-2573 • Houston Tel. (713) 821-0040 • Minneapolis Area Tel. (612)
936-1770 • Chicago Area Tel. (312) 455-5100 • Cleveland Area Tel. (216) 481-8333 • New York and New England Area Tel. (212) 962-7787 • Southeast Area
Tel. (205) 883-5142 • International: West Germany — Munich Tel. (089) 34 95 00 Telex: (841) 521-5808 • Milan, Italy Tel. 021-885/800-248 Telex: (842)
34314 • Sweden and Norway — Stockholm Tel. (08) 580-370 • Switzerland and Austria — Bern Tel. (031) 22 44 81 Telex: (845) 33172 • Tel Aviv, Israel Tel.
25 35 68 • Tokyo, Japan Tel. (03) 985-8266 Telex: (781) 272-2171 • Buckinghamshire, England Tel. High Wycombe (0494) 36 3 81 Telex: (881)837236**

Circle 165 on reader service card

Pistoncap™ TUBULAR TRIMMER Capacitors

NOW AVAILABLE IN
Sealed Designs



Sprague-Goodman PISTONCAPs are now available in sealed designs that offer heightened protection against adverse environmental conditions.

Sealed PISTONCAP trimmers are available in panel mounting and in printed circuit board mounting styles in 14 standard capacitance ratings from 0.8–4.5 pF to 1.0–38.0 pF in your choice of glass or quartz dielectrics.

These highly stable capacitors all have a multi-lobed seal ring at the adjust end coupled with the new Sprague-Goodman simplified and highly reliable adjust mechanism.

All meet or exceed MIL-C-14409C requirements.

For full technical information, call the Sprague Electric district office or sales representative nearest you.

PISTONCAP trimmer capacitors are available for immediate delivery from stocking Sprague distributors.

**SPRAGUE
GOODMAN**

**Sprague-Goodman
Electronics, Inc.**

(An Affiliate of the Sprague Electric Company)

371 Willis Ave., Mineola, N.Y. 11501
516/746-1385

New products

20°C to 150°C, and a 6-inch long DIP heat pipe will handle 18 watts at 100°C. Price for a single six-inch

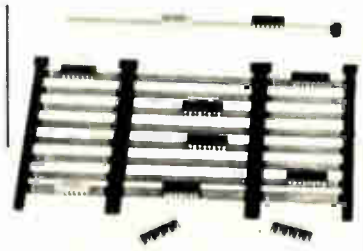

model is \$30, or \$21.50 each for 10 units.

Jermyn, 712 Montgomery St., San Francisco, Calif. 94111 [397]

IC test clips designed for 18- and 22-pin DIPs

Two new integrated-circuit test clips, added to AP Products' TC series, are called the models TC-18, PN923703 and the TC 22,

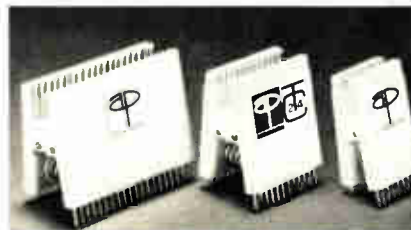

PN923705. The TC 18 is for testing 18-pin, 0.3-inch DIPs, and the TC 22 is for testing 22-pin, 0.4-inch packages. The devices have a spring-controlled grip to provide positive contact on DIP leads, and contact pins extend beyond the clip body to provide accessibility for attaching test probes and connectors directly to the DIPs.

AP Products Inc., Box 110, 72 Corwin Dr., Painesville, Ohio 44077 [398]

Lamp jacks are built with wire-wrapping terminals

Designed to speed jack-panel-assembly wiring by reducing wiring and soldering processing time, Lamp-Jax provide wire-wrapping

NEW SHORTER CASE! SCHAUER 1-WATT ZENERS

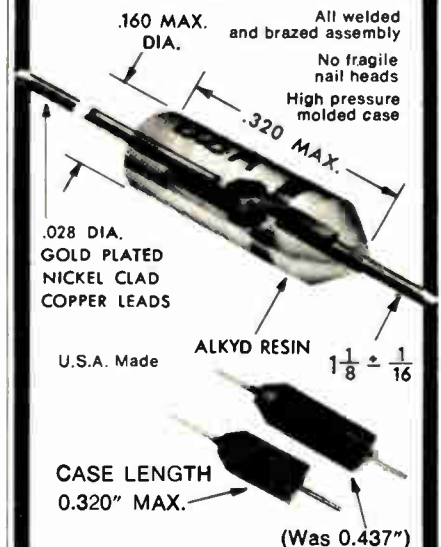

**SAME LOW PRICES FOR
1% TOLERANCE ZENERS**

**ANY VOLTAGE
FROM 2.0 TO 18.0**

Quantity	Price Each
1-99	\$1.07
100-499	.97
500-999	.91
1000-4999	.86
5000 up	.82

IMMEDIATE SHIPMENT

Send for rating data and 20%, 10%, 5% and 2% tolerance prices.

Semiconductor Division

SCHAUER

MANUFACTURING CORP.

4514 Alpine Ave., Cincinnati, Ohio 45242
Telephone 513/791-3030

a great new way to "pick" CHERRYS



**this new 72-page
Cherry Products Handbook is actually
five catalogs in one.**

Packed in a unique new "tell-all" format is everything you could possibly want to know about Cherry's: 1. Unique Snap Switch Selector-Locator that lets you choose—in seconds!—the right switch for any application. 2. Thumbwheel and Leverwheel Switches in nine basic series available in hundreds of variations and specials. 3. Keyboards . . . Keyboard Switches . . . and unique new Matrix Keyboards. 4. Matrix Selector Switches for rapid circuit selection and programming. 5. Gold "Crosspoint" Contact Switches for low energy circuits.

. . . and it's yours for the asking: Just TWX 910-235-1572 . . .

. . . or PHONE 312-689-7702 and ask for Frank

CHERRY



CHERRY ELECTRICAL PRODUCTS CORP.
3600 Sunset Ave., Waukegan, Ill. 60085



Cherry affiliates worldwide • Hirose Cherry Precision Co., Ltd., Tokyo • G. W. Engineering Pty. Ltd., Sydney
Cherry Electrical Products (U.K.) Ltd., St. Albans, Herts • Cherry Mikroschalter GmbH, Bayreuth, Germany

Circle 171 on reader service card

NEED CRYSTAL OSCILLATORS



BULOVA OFFERS A FULL LINE

for Prototypes or Large Run
Industrial or MIL Spec

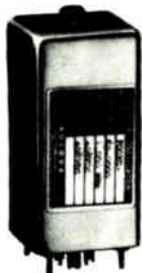

PCOXO's HIGH STABILITY

Highest Stability — achieved by housing a high precision oscillator and an AGC circuit in a stable D.C. proportionally controlled oven.



TCXO'S

TEMPERATURE COMPENSATED

Highly Stable—temperature compensated by a voltage variable capacitance diode and a thermister network.



COMPUTER CLOCK

Compatible with DTL or TTL loads
—for P.C. board mounting.

We've a set of Technical Bulletins and Application Notes waiting for you. To get yours call or write:

BULOVA

Electronics Division
Bulova Watch Company, Inc.
61-10 Woodside Avenue
Woodside, N.Y. 11377

In a rush? Call 212 335-6000, Ext. 632

New products

terminals; the lamp jacks mount into most jack panels, eliminating soldering operations. The units are suitable for applications in telephone, TV and radio broadcasting,



and other telecommunications equipment requiring solderless terminals.

Switchcraft Inc., 5555 N. Elston Ave., Chicago, Ill. 60630 [399]

Sputtering systems are
for cold deposition

Three products based on a cold, high-rate, sputter deposition source include: a self-contained single-target sputtering system, a cold coater system, and special systems with single and multiple round and elongated rectangular cathodes. The single-target system includes an electrode, power supply and chamber and is designed for six-inch targets. The cold coater unit is for scanning electron-microscopy samples.

Vacuum Technology Associates Inc., 1912 Pearl St., Boulder, Colo. 80302 [400]



FREE

1973 Edition . . .
General Electric's
condensed reference
guide to industry's
broadest line of
microwave devices

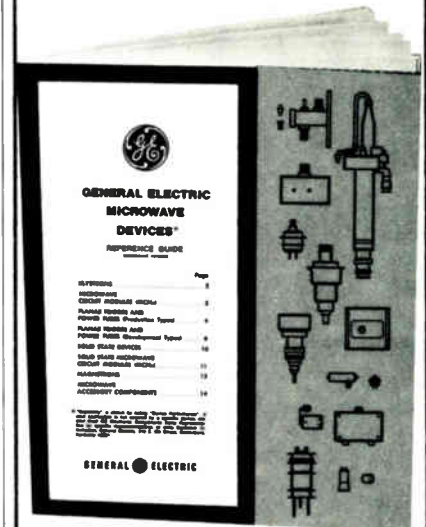

You can "one-stop shop" with this new catalog of microwave devices from General Electric . . . your source for the most complete line of microwave devices. The new microwave guide is clearly indexed to give fast, easy reference to devices for all popular microwave applications. To get your free copy, use the reader service card or write: General Electric Company, 316 East 9th Street, Owensboro, Kentucky 42301.



GENERAL ELECTRIC

360-08



Are you into red, yellow & green?

We hope so. Because we are definitely into Gallium Arsenide Phosphide, Gallium Phosphide and Gallium Arsenide. And, as we all know by now, these are the materials that LED colors are made of.

If your game is LED's, be it discreet, display or array, Monsanto has the material for you.

We've been making III-V Intermetallics since 1956, and with that background and experience we know materials.

Our production facilities are among the most efficient and technically advanced in the world and we are ready to meet your every need.

To get the full story on Monsanto's colorful line of intermetallics, please write or call:

Monsanto Commercial Products Co. Electronic Materials
P.O. Box 8, St. Peters, Missouri 63376 (314) 272-6281
A unit of Monsanto Company

Monsanto

Looking after the details

Tripod microscope
by Ed. Culpeper,
mid 18th. century

Philips mini-computers are built to a standard. Using components we know are good (we make them ourselves). To the requirements of our most exacting OEM customer (ourselves).

With software that's been proved (in our systems).

On top of that there's the backing of a worldwide organisation that's there wherever your systems go.

On price, too, we've something to interest you. There's a lot to be said for a mini-computer company that isn't just a mini-computer company. Full details are at the end of your phone.

Philips P800 M series plus points

Memory capacity from 0.5k to 32k 16 bit words

Cycle time down to 840 nanoseconds

16 Hardware registers for efficient processing

Multiplex channel with 15 subchannels, plus DMA

Up to 63 interrupt lines on 48 hardware levels

Easy interfacing

OEM quantity discounts up to 41%



Mini-computer by Philips, 1973.

* Amsterdam 020 30123 • Brussels 02 493900 • Copenhagen 01 22 27 77 • Essen 01 77 01 01
• Helsinki 09 27 271 • London 01 730 3416 • Milan 02 643 22 22 • New York 021 271 8111 • Oslo
02 67 63 80 • Paris 01 702 7991 / 01 734 7700 • Stockholm 08 63 50 00 • Tokyo 03 435 52 11 • Zürich
01 6 75 2 10 80 • Zürich 01 44 22 11

Philips considers your reputation



Data
Systems

PHILIPS

Communications

System monitors data networks

User can switch equipment in case of failure or for load-leveling

As data communications networks grow in both complexity and quantity, the need for equipment to monitor and manage these systems

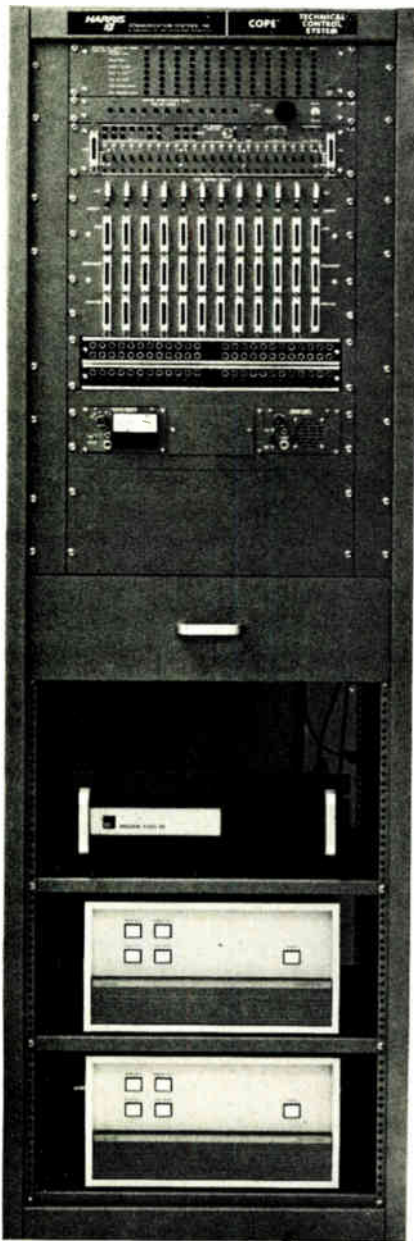

is also increasing. With this in mind, a computer/communications-network-control system has been developed by Harris Communication Systems Inc., a subsidiary of Harris-Intertype Corp.

The control system, designated COPE, enables the large-scale user of computers to switch and manage various types of communications circuits in his system. COPE includes circuit-monitor panels with visual indication of critical control signals for computer-communications interfaces, modems, limited-distance adapters, and telephone and cable communications lines. Also, circuit failures are audibly monitored by the system.

Patchfield and jackfield panels are available for rapid switching of communications interfaces, modems, and lines. On-line monitoring test equipment is available for rapid diagnosis of suspected problems in the communications system. All monitor logic is parallel, and does not affect the signal path.

"COPE gives the data-processing manager the capability of fault-isolation and a convenient mechanism to switch in alternate pieces of equipment in case of failure, or of a load-leveling capability that he doesn't generally have today," says Royce Pipes, manager of product planning for Harris Communication Systems. "It gives the computer-installation manager, for the first time, an equipment means that enables him to manage his computer/communications facility."

First customers, after the system is introduced, will probably be Government agencies and private service bureaus, says Lewis Nixon, vice president for technical marketing at Harris.

Pricing depends on the size of the totally modular, expandable system. "For 12 circuits or less, the purchase price would be \$6,000 to \$7,000," he says. Nixon admits that customers with less than eight circuits wouldn't find the system cost-effective. "The exception would be the installation of a new system," he says. "COPE would be extremely helpful in debugging a system."

Delivery time is approximately

60 days after receipt of order.

Harris Communication Systems Inc., P.O. Box 44076, Dallas, Texas 75234 [371]

Multidrop network controller works with remote computer

The model LDS 2000 multidrop network controller is for use with the Gandalf 200C range of local data sets. The controller is designed for location on a central computer site and can also communicate via standard channels to remote com-

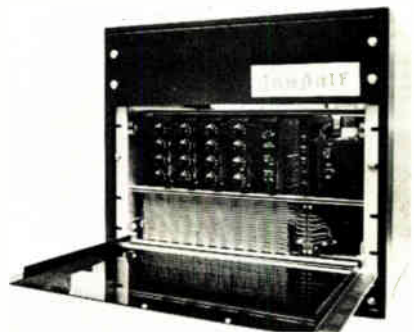

puters. According to the company, the unit eliminates bridging, either in central offices or on customer sites, and permits the use of straight point-to-point lines to the computer room. Various configurations can be tailored to user requirements.

Gandalf Data Communications Ltd., 15 Grenfell Crescent, Ottawa, Ontario, Canada [341]

Line switch interconnects private message networks

Private message networks can automatically interconnect different terminals using the model 5500 line switch. The model 5500 works in real time and is for small- to medium-sized teletypewriter networks. It has a capacity of up to eight full- or half-duplex channels in its basic configuration or up to 16 channels using an expander tray. Up to four or eight simultaneous conversations can be established, depending on the number of channels used. Operation is with any five-, six-, seven- or

INTRODUCING...

adam



**MAN, WHAT A BEGINNING
FOR YOUR
CIRCUIT DESIGN LAB!**



E&I INSTRUMENTS, INC.
61 First Street, Derby, Conn. 06418
Phone (203) 735-8774 Telex No. 963536

If you are doing any circuit design work, somewhere along the way you're going to have to breadboard a working unit. ADAM is a new modular breadboarding system that takes you from circuit concept to working hardware in minutes. The heart of the system is the Mainframe with 5 power supplies, for all your digital and analog work. Solderless circuit design and testing is easy on the Socket Module.

Other modules include a Function/Pulse Generator, a Signal Source Module, a Readout Module, and Blank Modules for "in-house" construction. All modules are interchangeable, providing flexibility for development and growth at all levels of technology.

As pictured, The ADAM system sells for \$395 (less the apple). Write today for full details.

Circle 176 on reader service card

The Brush XY recorder. You get your money's worth.

You'll have a hard time finding another XY recorder that offers you so much for so little. Like pressurized ink writing that assures crisp clear traces at pen speeds to 40 in/sec. Our Metrisite[®] servo-loop feedback system that assures 99.85% linearity. Built-in preamps, and electrostatic paper holddown.

Write Gould Inc., Instrument Systems Division, 3631 Perkins Avenue, Cleveland, Ohio 44114. Or Kouterveldstraat Z/N, B 1920 Diegem, Belgium.



 **GOULD**

176 Circle 214 on reader service card

New products

eight-level code at speeds up to 1,200 baud.

Plantronics Inc., 385 Reed St., Santa Clara, Calif. 95050 [342]

Frequency counter measures carriers in mobile bands

The model 6252 is a 512-megahertz frequency counter designed for monitoring and measuring carriers in the mobile communications bands. The portable instrument provides a level meter coupled to the input for indication of signal level, an overload relay circuit to prevent damage to the input when overloads occur, and a frequency multiplier for making direct measurements of tone and low-frequency inputs. In addition, a choice of five optional oscillators is offered. Input sensitivity of the model 6252 is 25 mv rms to 50 megahertz and 50 mv rms for inputs above 50 MHz. Price is \$1,095.

Systron-Donner Corp., 10 Systron Dr., Concord, Calif. 94518 [343]

Voice-response terminal includes input display

A portable, buffered voice-response terminal is able to store up to 256 characters of numeric data for subsequent transmission to a computer. The terminal uses LEDs in verifying the input data. A memory address



register automatically increments as data is entered, and function keys can move the memory address forward or backward so that previously entered data can be checked or changed. Once the appropriate data has been entered and telephone connection has been made to the

Electronics/November 22, 1973

Modern Production Calls For Modern Manufacturing Equipment

If you need technological equipment for electrical and electronic components production, you will naturally want the best and most advanced. In this sector VEB Elektromat Dresden is the partner you're looking for.

Our equipment program includes

Complete systems and automatic machines for applications in semiconductor fabrication and stator-winding technology

Varnished-wire production equipment

Fabrication equipment for dry-reed contacts

Automatic cable forming and laying machines

Automatic grinding machines for film resistors

Equipment from VEB Elektromat Dresden is efficient of high technical perfection always up-to-date

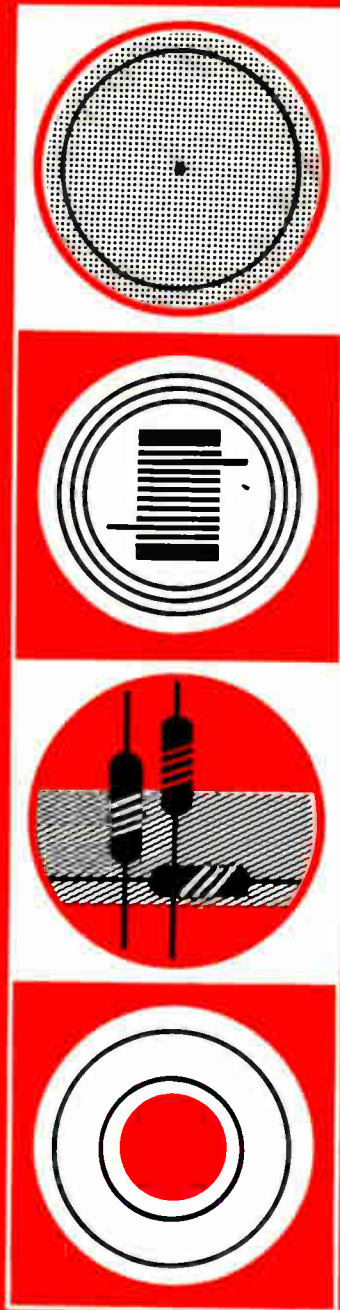

VEB ELEKTROMAT DRESDEN

Betrieb für Projektierung, Automatisierung
und Rationalisierung der elektronischen Industrie
DDR-808 Dresden, Karl-Marx-Straße



JINVEST EXPORT

Volkseigener Außenhandelsbetrieb der
Deutschen Demokratischen Republik
DDR-108 Berlin, Johannes-Dieckmann-Straße 7/9

KITAKAMI HARNESSES & CABLE



ASSEMBLIES

Tailored to Your Needs
Each and every Kitakami harness and cable assembly is especially tailored to meet your specific requirements.

LOW COST

Fabricated at our associated factory in Korea.

- * Main Products:
- Lead Wire & Assemblies
 - Shielded Wire & Assemblies
 - Wiring Harness Assemblies



• Exporters & Manufacturers:

KITAKAMI DENKI CO., LTD.

1407 HIYOSHI-CHO, KOUHOKU-KU, YOKOHAMA, JAPAN.

TEL: 044-61-0175

Cable Address: "KDenco YOKO" Telex: 03842527 KDenco J

Circle 178 on reader service card

SOLDERING + DESOLDERING + RESOLDERING =

SOLDERABILITY

ELEMENTARY TO ELITE
 WORLD'S MOST PRACTICAL SOLDER HANDLING TOOLS

meets industries demands.....

with a COMPLETELY PORTABLE SOLDERING/DESOLDERING/RESOLDERING SYSTEM



EDSYN

15954 ARMINTA STREET
 VAN NUYS, CALIFORNIA 91406
 PHONE (213) 989-2324
 TELEX NO. 65-1469 EDSYNEX VAN

Ads in EEM, MAS, EBG,
 AE, TR, and EPAC Catalogs

Send for our FREE 16 page
SOLDERABILITY
 manual

178 Circle 217 on reader service card

New products

computer by means of a built-in acoustic coupler, a high-speed scanner transmits Touch-Tone signals to the computer. Price is \$795.

Computone Systems Inc., 361 E. Paces Ferry Rd., NE Atlanta, Ga. 30305 [373]

Tube and cavity produce more than 150 W

A tube and cavity combination in the Cermolox series produces more than 150 watts of power in the uhf spectrum. Called the models A2965A and Y1261 (tube and cavity respectively), the system is specifically designed for 150-w base-station transmitters. It is said to en-



able equipment manufacturers to move into the 900-megahertz area without prototype engineering and testing, since the tube operates over 806 to 906 MHz. Price of the tube is \$290 and of the cavity, \$366.

RCA Electronic Components, 415 S. Fifth St., Harrison, N.J. 07029 [374]

Echo generator simulates telephone channels

The model 1755A delay (echo) generator, for communications-channel users, simulates the characteristics and impairments found on Bell and

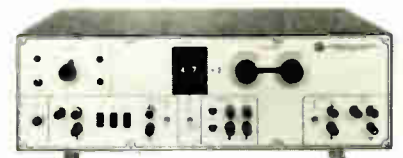

Electronics/November 22, 1973



What has EMR Telemetry been doing lately?

Ask Boeing

about their new EMR Aircraft Flight Test Data System, using our newest dual PDP-11/45 Telemetry/Computer System.

Ask The Latter Day Saints Hospital

about their EMR Phone Line Compatible FM System for coast-to-coast transmission of EEG data over voice grade lines.

Ask John Deere

about their EMR industrial telemetry equipment for farm tractor development testing.

Ask the U.S. Navy

about their EMR PAM and FM demultiplexing equipment for monitoring Point Defense missile firing. Also let them tell you about their special EMR FM multiplexing/demultiplexing equipment for underwater sound data and general data communications.

Ask Cessna

about their EMR Mini-Telemetry/Computer System designed to process flight test data from small aircraft.

EMR-Telemetry . . . innovators of systems that provide you with reliable quality data. The kind of data you need to make important decisions . . . decisions that could have lasting effects on the success of your program.

Ask us . . . about our hardware, our systems, our breadth of technical expertise and accumulated practical skill.

Write for our new condensed catalog.

Now... what are we going to do for you?

EMR EMR
Schlumberger

EMR Telemetry
Weston Instruments, Inc.
Box 3041, Sarasota, Florida 33578
813-958-0811

encapsulated snap-mount LEDs in red or green!



SoLiCo solid state GAP light emitting diodes are designed for low-voltage applications where panel space and speed of installation are important. Light output is exceptional: 3 milli-candellas at 20 milli-amps. Molded nylon bodies snap-fit into panel front with no tools required. Model D-503 provides a resistor in series, and forward voltages 5-6V, 12-14V, 18V or 28V can apply directly. Color-coded 6" insulated leads save valuable assembly time. Write: SORENSON LIGHTED CONTROLS, INC., Suite 810, 1428 Brickell Ave., Miami, Florida 33131. Tel. (305) 358-6112.

SoLiCo

Circle 180 on reader service card



Up electrical yields with low-temperature hermetic sealing.

The Diacon 8 to 32 lead package systems for surface-sensitive devices saves assembly time and other packaging costs.

For information, call or write...

DIACON, INC.

4812 Kearny Mesa Road
San Diego, California 92111
(714) 279-6992



New products

other leased lines. The instrument is suited to applications in developing and manufacturing equipment such as modems and facsimile systems, and wherever it is necessary to evaluate equipment performance under repeatable, calibrated line conditions. Price is \$2,975.

SEG Electronics, 120-30 Jamaica Ave., Richmond Hill, N.Y. 11418 [375]

Rf module doubles monitor range to 1.3 GHz

A plug-in rf module is designed to increase the maximum frequency capability of Singer's model FM-10C communications service monitor from 512 megahertz to 1.3 gigahertz. This allows the monitor to service transmitters and receivers in the following bands: common carrier, Tacan/DME, control links, and traffic-control-radar beacons. Price is \$1,295.

Singer Instrumentation, 3211 S. La Cienega Blvd., Los Angeles, Calif. 90016 [376]

Multi-output decoder is aimed at remote control

Designed for remote-control applications, the model 527 Touch-Tone decoder performs multiple functions. The unit allows specific sites to be individually addressed and up to 15 functions to be performed at any fixed or mobile site. The decoder is offered with momentary, latched, and interlocking outputs

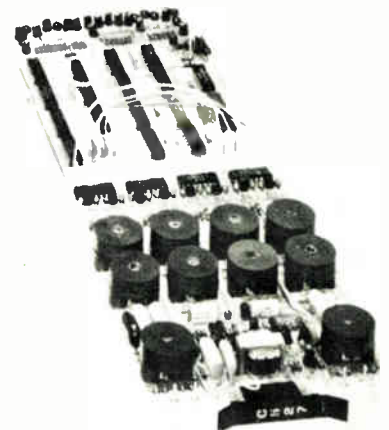

Complete Trimmer Satisfaction

One design...9 pin styles

Still the industry's best trimmer value
... Less than **50¢** each in production quantities

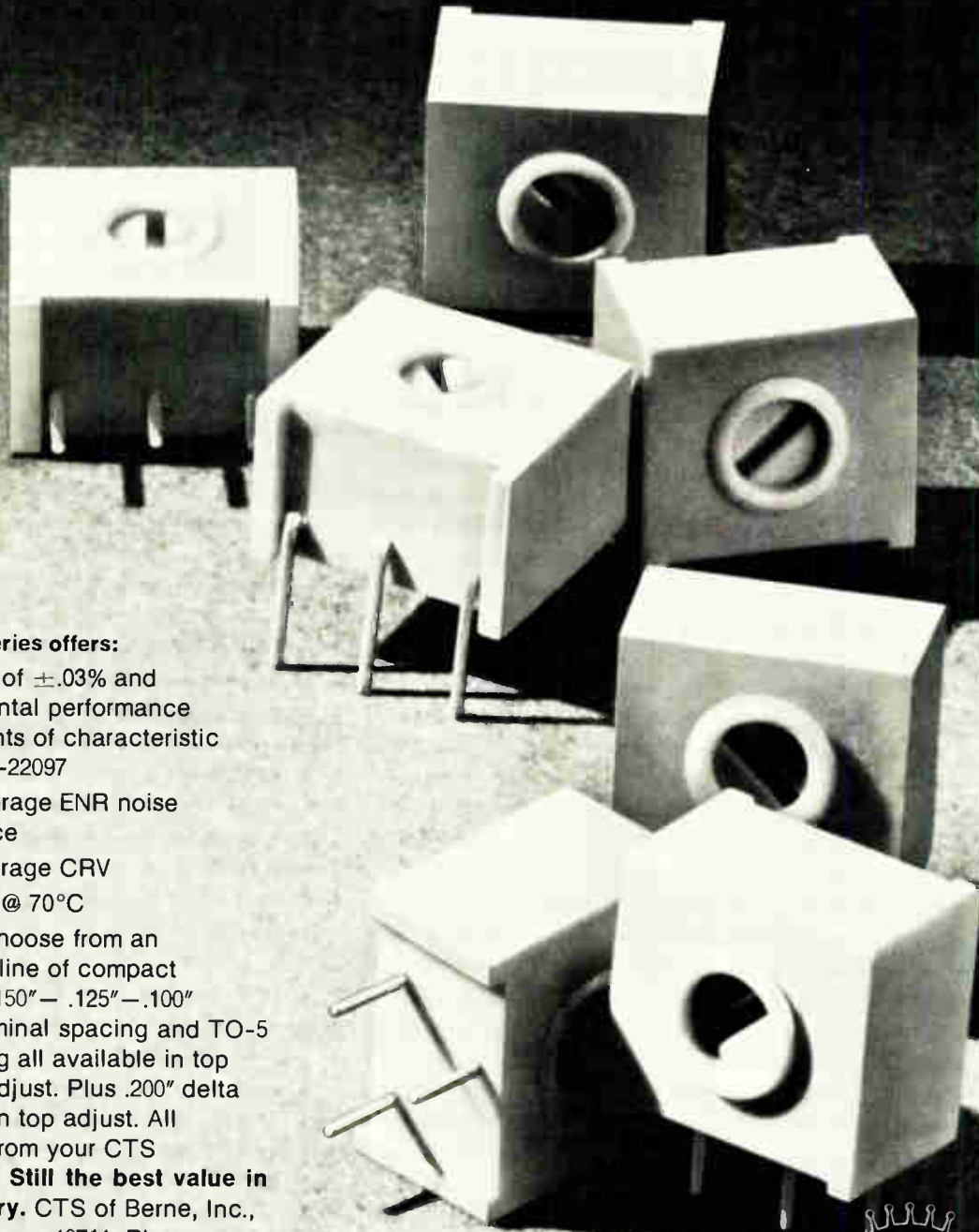

CTS 360 Series offers:

Stability of $\pm .03\%$ and environmental performance requirements of characteristic C of Mil-R-22097

- 1.5% average ENR noise resistance
- 0.5% average CRV
- 1/2 watt @ 70°C

You can choose from an expanded line of compact trimmers. .150" — .125" — .100" in-line terminal spacing and TO-5 pin spacing all available in top and side adjust. Plus .200" delta (.100 grid) in top adjust. All available from your CTS Distributor. **Still the best value in the industry.** CTS of Berne, Inc., Berne, Indiana 46711. Phone: (219) 589-3111.

CTS CORPORATION
Elkhart, Indiana



A world leader in cermet and variable resistor technology
Circle 181 on reader service card

Another fine OEM product from C. Itoh

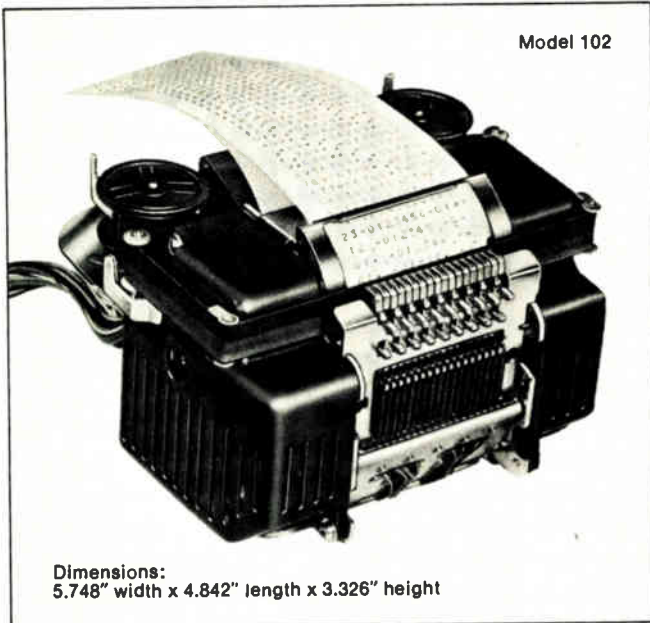

Compact Digital Printing Mechanism

The Model 102 is a sophisticated printer especially developed for use by OEMs in top-quality electronic equipment. It is designed so that only the minimum essential elements are incorporated, using 18 columns x 13 characters, and with a print-out speed of 3 lines per second.

Other features include low consumption of electrical power (160mA max. at 15 V-DC) and a transistorized motor of long-life design.

The Model 102 Printing Mechanism is quite compact yet extremely reliable, which makes it ideal for electronic applications such as calculators, volt meters, measuring equipment and control terminals.

Furthermore, its attractive price makes it a "must" that you consider the Model 102 next time you are looking for a printer. Send in the coupon for full information on this fine product manufactured by the Shinshu Seiki Company.

C. Itoh & Co. (America) Inc.

270 Park Avenue, New York, N.Y. 10017 • (212) 953-5452/5447

West Coast Office: 555 So. Flower Street, Los Angeles, Calif. 90071
(213) 687-0610

New Jersey Office: (201) 347-7997 • Ohio Office: (513) 492-1159

Canadian Office: Suite 4181, Commerce Court West Bldg.,
Commerce Court Postal Station, Toronto Ontario. (416) 868-0011

Attention: Industrial Electronics Div.
C. Itoh & Co. (America) Inc.
270 Park Avenue, New York, N.Y. 10017

Please send me more information on your
Printing Mechanism Model 102.

Name _____ Title _____

Company _____ Telephone No. _____

Street _____

City _____ State (Prov.) _____ Zip _____

Specific Application _____

A Tough Capacitor For A Tough Environment

At Nippon Chemical Condenser Co., Ltd., we have devoted a lot of time and energy to improve the various characteristics of miniature scale electrolytic capacitors. Our goal was a product that would withstand problems created by a tough environment; a capacitor that would give top performance in both high and low temperature extremes. The result of our research is a capacitor that will function smoothly at temperatures above 85°C, as well as in bone-chilling conditions that send the mercury to -40°C.

What this means to you is a capacitor that you can rely on, in either the arid Sahara or the freezing Arctic. A capacitor that gives you greater diversity with regard to operating conditions. Moreover, our products are manufactured on one of the world's most highly automated assembly lines, and under quality control techniques that insure precision and uniformity.



OUR PRODUCTS

Aluminium Electrolytic Capacitors
Foil Tantalum Electrolytic Capacitors
Solid Tantalum Electrolytic Capacitors
Electret Condenser Microphone



NIPPON CHEMICAL CONDENSER CO., LTD.

7-8, 2-chome, Yutaka-cho, Shinagawa-ku, Tokyo,
Japan Tel: 785-1251 Cable Add: NICHEMICON
TOKYO Telex: TK-4618

UNITEO CHEMI-CON, INC.
1128 Lexington Ave., Rochester N.Y. 14606,
U.S.A. Tel.: (716) 647-1050 Telex: 230978325

New products

and is addressable by up to four digits.

Speedcall Corp., 2020 National Ave., Hayward, Calif. 94545 [377]

Tone module for radios covers 20 to 3,000 hertz

A miniature thick-film hybrid sub-audible tone module is designed for direct plug-in retrofit of E.F. Johnson model two-way radio units. Called the model SS-80J-176, the continuous-tone encoder and/or encoder-decoder provides one or more tone frequencies in the range from

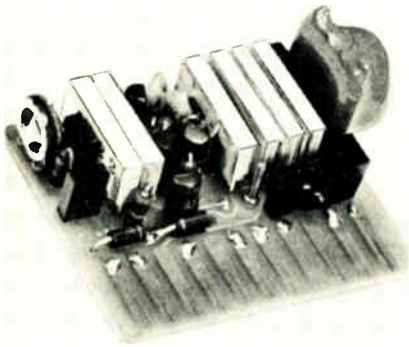

20 hertz to 3,000 Hz. Multiple-frequency, sub-audible tone operation makes multiple repeater systems possible, increasing the range and other capabilities of communications systems.

Alpha Electronic Services Inc., 8431 Monroe Ave., Stanton, Calif. 90680 [378]

Modem transmits at 4,800 bits/second

A Bell-compatible transmitter-receiver modem provides 4,800-bit-per-second transmission over basic unconditioned voice-grade private-line channels. Designated the model 208A, the unit is equipped with an automatic equalizer that corrects for variations in the transmission channel. The modem is also designed for continuous-carrier or switched-carrier applications. Price is \$2,650.

I.I. Communications Corp., 139 Terwood Rd., Willow Grove, Pa. 19090 [379]

The long-billed heat sucker would like you to meet her family.

Our good friend, the Heat Sucker (better known as a Hughes heat pipe), is now the proud mother of an entire flock: round and flat bills, flexible round bills and the cold mounted plate bill. Each variant feels right at home in electronic, chemical and mechanical equipment; industrial processing; and medical applications. Anywhere you might need thermal control.

Heat Suckers come in various sizes: 3/16" to 1" diameter, 6" and 12" lengths. They have thermal transport capabilities of 10 to 2,000 watts covering temperature ranges from: -90°C to +200°C.

Since the birds have mass migrated to our shelves, you can order right off the shelf for as little as \$37.00 (less in quantity).

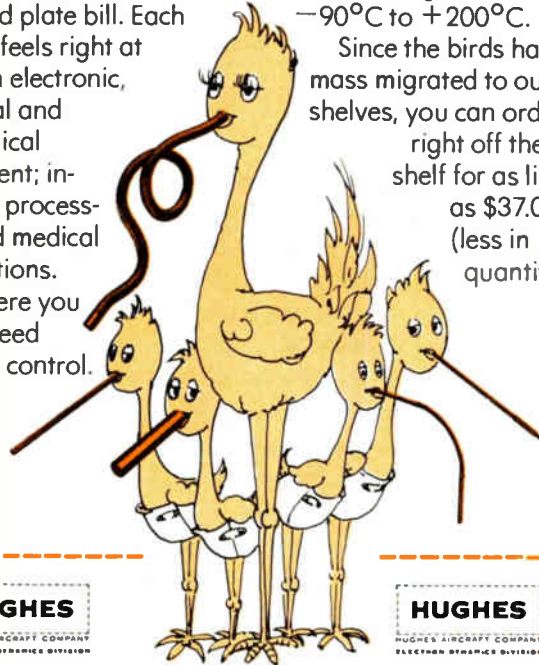

HUGHES

HUGHES AIRCRAFT COMPANY
ELECTRON DYNAMICS DIVISION

HUGHES

HUGHES AIRCRAFT COMPANY
ELECTRON DYNAMICS DIVISION

Celebrate along with us. Send the coupon and get a cigar and literature. Hughes Electron Dynamics Division, Advertising Dept., 3100 W. Lomito Blvd., Torrance, California 90509. Or call (213) 534-2121, Ext. 451.



1350H Series — stainless steel and methanol.



1370H Series — copper and water.



1333H — stainless steel and ammonia.



Custom Designs — flexible, flat, and base plates.

Name _____

Company _____

Address _____

City _____ State _____

Zip _____ Telephone _____

E 11

LET'S FACE IT. IF YOU WANT TO GET AHEAD, YOU'VE GOT TO MAKE CONNECTIONS.

Connections with customers. Distributors. Suppliers. Resources. And with new or expanding markets.

Where can you make these connections? In Georgia—the transportation and distribution center of the Southeast.

Georgia has 500 motor carriers that travel one of the longest interstate highway networks in the nation.

Our smaller towns offer room to expand your plant. And your market. They're near the nation's second busiest airport. Near the two major rail systems in the Southeast, with 5,558 miles of track.

In Georgia, you'll have two deepwater ports. Including the South Atlantic's largest general cargo port and the nation's largest container crane.

Access to market is enough reason for locating your plant in Georgia. But the fact is, you could move tomorrow. Into facilities ready for immediate occupancy.

It all adds up to a better life. For business. And for your people. Our smaller towns are close to year 'round recreation and entertainment. Close to cultural centers and big-league cities.

Mail the coupon today for more detailed information on how your company can get ahead in Georgia.



GEORGIA

GOOD FOR BUSINESS. GOOD FOR PEOPLE.

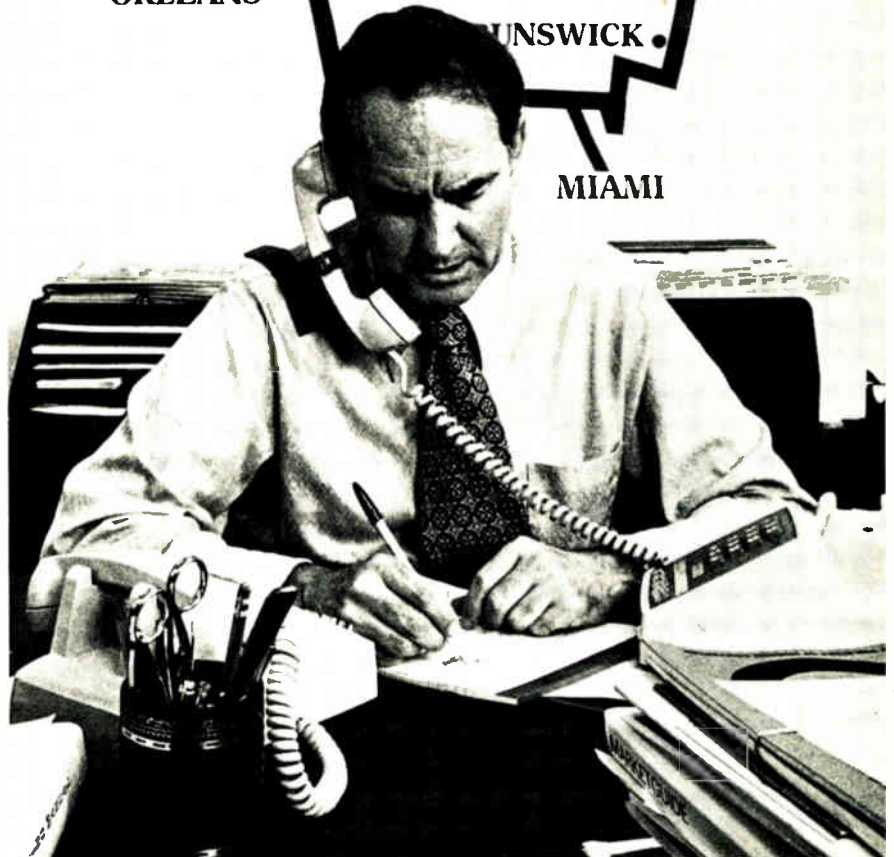

Georgia Department of Community Development
Industry Division, Dept. EL-43
Box 38097
Atlanta, Georgia 30334

IT
DIVISION OF
INDUSTRY AND TRADE

Please send me information on
Georgia's industrial opportunities,
including your new transportation study.

Name _____ Title _____

Company _____

Address _____

City _____ State _____ Zip _____

If you knew what we know about subminiature lamps, you'd specify Chicago Miniature.

The smaller the lamp the tougher the job.

First, subminiature lamps are usually applied in critical situations where a lot more than light is demanded. Where reliability is essential. Like system warning lights. Or status signals. Or critical instructions. And that's why you find Chicago Miniature lamps in tough jobs like the manned space flights.

Second, subminiature lamps are a lot tougher to make. They have all the same components as larger lamps, but everything's reduced to almost impossible manufacturing dimensions. The filaments, complicated assembly, critical material and atmosphere control—all are magnified problems when you work in the subminiature range.

Chicago Miniature specializes in subminiature lamps.

We're expert when it comes to doing tiny things in a big way. For example, we have a special method for coiling the filament to precisely the right fraction of a turn to give you exactly the light output for your application. We also know the importance of precise filament mounting. Our filament mounting process is automated to eliminate the human variable. Both mean you get lamps with uniformity of brightness, and significantly longer life under typical operating conditions. All this and more, and within the subminiature range.



(ACTUAL SIZE)

We invest in flexibility.

It takes a lot of skill and imagination to consistently make dependable subminiature lamps. And Chicago Miniature invests in skilled people and special automated systems no other company can provide. It means that whether you need a standard lamp or a special component, Chicago Miniature has the capability to support you. Right now. Even special requirements are handled systematically and quickly.

Quality control comes naturally. It has to.

We're addicted to detail. All along the line. And that's the best kind of quality control. Chicago Miniature practices "controlled quality"—carefully monitoring key processes all the time. You get only those lamps that measure up. Nothing is left to chance.



CHICAGO MINIATURE
LAMP WORKS
4433 N. Ravenswood Ave.
Chicago, Illinois 60640
(312) 784-1020

a GENERAL INSTRUMENT company

THE LIGHTING BUGS

We help you avoid costly specials.

Chicago Miniature already has more subminiature lamps than any other manufacturer. Immediately available are the T-¾, T-1, T-1¼, T-1½ and T-1¾ sizes. We offer standard wire terminals, flanged and bi-pin bases and a variety of other configurations.

As much service as you need.

For problem solving application assistance, call your Chicago Miniature Sales Representative. Or call us directly for applications engineering assistance. Phone 312/784-1020. For off-the-shelf delivery, call your local Chicago Miniature Electronic Distributor.

Chicago Miniature also publishes technical data on subminiature lamp performance, under various operating and environmental conditions. This document represents over 9 million lamp hours of test data. Send the coupon for your free copy.

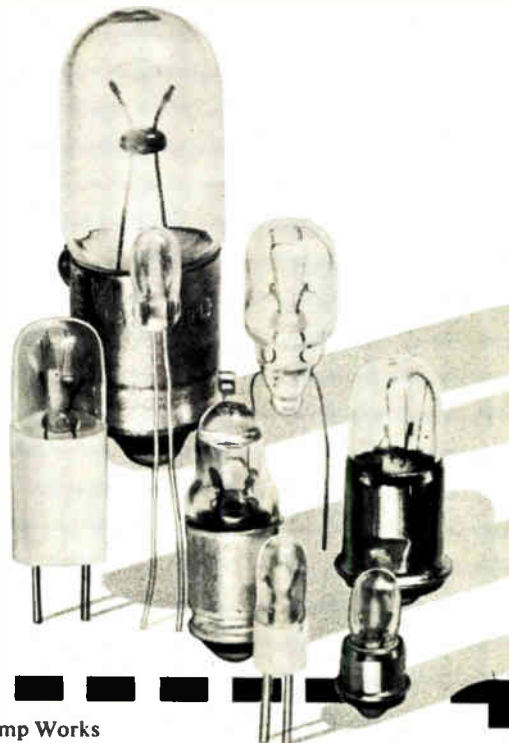

Chicago Miniature Lamp Works
4433 N. Ravenswood Ave., Chicago, Illinois 60640

- Please send me your free booklet on Subminiature Lamp Performance, including 9 million hours of test data.
- Please send me your catalog.

Name _____

Title _____

Company _____

Address _____

City _____ State _____ ZIP _____

Comments: _____

CLASSIFIED ADVERTISING
 **SEARCHLIGHT SECTION**
 BUSINESS OPPORTUNITIES
 USED OR SURPLUS EQUIPMENT

IMMEDIATE DELIVERY
 Minis & Peripherals
DEC—HIS—NOVA
SEL—HP—MOHAWK

CPU, Card, Printer, Tape, Disk
NEW • MOHAWK 4320 PRINTERS
• DATA PRINTER V132

PDP 8 CPU \$1500

\$750 Minis

TELETYPE 35 & 37
DEC & HONEYWELL Modules
617/261-1100

Send for Free Report "Maintenance of Computers"
AMERICAN USED COMPUTER CORP.
 P.O. Box 68, Kenmore Sta., Boston, MA 02215

CIRCLE 956 ON READER SERVICE CARD

PERFORMANCE AND RELIABILITY
WITH ECONOMY

We Can Fulfill Your Needs!

**Electronics and Electro-
 Optics For Laboratory
 Prototype, Production &
 Field Including**

- RF Multimeters and Accessories
- RF Detectors
- Reflection Coefficient Bridges and Sets
- Terminations and Calibrated Mismatches
- Broadband RF Amplifiers and
 Multicouplers (2MHz to 1GHz)
- L-C and Crystal Filters
- Voltage Controlled RF Attenuators
- Opto-Electronic Detector/Amplifiers
- Active Probes and Adapters
- Peak-N-Notch Tunable Active Filters
- "500" Series Analog Modules (To 1MHz)
- Custom Engineered RF Signal Processing
 Subsystems

Call ● Write ● Circle-The-Number ● Now
 For Data and Application Info

Radiation Devices Co.
 P.O. Box 8450
 Baltimore, Maryland 21234, U.S.A.
 Telephone (301) 665-2764



CIRCLE 951 ON READER SERVICE CARD

**RADAR SYSTEMS GROUND AND AIRBORNE. AUTOMATIC
 TRACKING ANTENNA SYSTEMS. NIKE AJAX. NIKE HER-
 CULES. M-33. MSO-1A. MPS-19. MPS-9. SCR 584. TPS-1D.
 TPS-28. FAA-ASR-2. AIRBORNE SYSTEMS. APN-84. APN-102.
 APS-20. APS-27. APS-45. DPN-19. DIGITAL COMPUTERS.
 IBM 650. IBM 704.**



**LARGEST INVENTORY OF RADAR AND
 MICROWAVE EQUIPMENT IN THE WORLD.**
RADIO RESEARCH INSTRUMENT CO.
 3 QUINCY ST., NORWALK, CONN. 06850 (203) 853-2600

CIRCLE 953 ON READER SERVICE CARD

free catalog
POTTING APPLICATORS
MANUAL OR AIR OPERATED
 2½cc 6cc 12cc 30cc
FOR POTTING, ENCAPSULATING ETC.
PHILIP FISHMAN CO., INC.
 7 CAMERON ST. WELLESLEY, MASS. 02181

CIRCLE 954 ON READER SERVICE CARD

BOEING

Electronics Engineers.

**Career opportunities are great
 in Washington State.**

Boeing Aerospace Company has career opportunities for qualified Electronics Engineers in the Seattle area . . . where clean air is abundant. And you may work only minutes from your home.

These positions require three or more years of experience either in the activities described below or related fields. An engineering degree also is required, preferably a B.S., M.S. or Ph.D. in Electrical Engineering. These openings are for U.S. citizens only.

Present opportunities are in the following areas:

Process Automation

Experienced engineers for assignments in Industrial Instrumentation and Control for *commercial product applications*. Experience is required in communications/multiplexer systems, instrumentation, computer interface design, panel/console design, systems integration test simulators, and diagnostics/maintenance design. Applications software experience desired.

Electronic Parts/Components

Engineers with experience in electrical and/or electronic parts test evaluation, specifications, selection and technical parts control are needed. Emphasis is on semiconductor component—transistors, hybrids, LSI arrays, diodes and microwave devices. A knowledge of military and/or NASA specifications would be helpful. Capability to interface effectively with circuit designers and device suppliers is required. The function provides support to major Boeing DOD, NASA and commercial programs. Experience in planning, estimating and implementing support to such programs would be useful.

Computer Software

Real Time operational computing systems requirements analysis and design. Includes definition of computer software requirements, developing plans and specifications, performance of trade and design studies of hardware / software systems.

Real Time operational systems computational analysis and algorithm development. Develop and evaluate numerical algorithms to satisfy specific requirements for aerospace systems.

Real Time operational systems computer program development and implementation. Development and implementation of computer programs for operational systems, simulators and other Real Time applications and for programs to assist in debugging and testing of operational software systems.

Communications

Radio and telecommunications, both narrow and wide-band transmissions.

Definition and evaluation of communications performance, interface, integration, modulation techniques, modem, multiplexers, encryption, teletype or high-quality audio distribution systems.

Computer/Displays

Real Time operational systems requirements, analysis, design and checkout. Includes definition of computer and display hardware requirements, developing plans and specifications, performance of design, and trade studies of hardware/software systems.

Design, development and integration of computer systems, subsystems and components for both general purposes and special purpose applications.

Definition of functional and physical interfaces between the computer systems and all interacting display, sensor and communication systems.

These openings exist in several of the Boeing Aerospace Company's projects. Primarily they're in the following product areas: information and avionics systems, strategic and technical systems, personal rapid transit, and commercial hydrofoils.

You'll enjoy the Pacific Northwest. Living is relaxed. Outdoor sports are plentiful. It's great family country!

Please send your résumé to The Boeing Company, Box 3707-EDB, Seattle, WA 98124. An equal opportunity employer.

BOEING
 Getting people together.

COMBINATION ETCH-STRIP PLASMA SYSTEMS

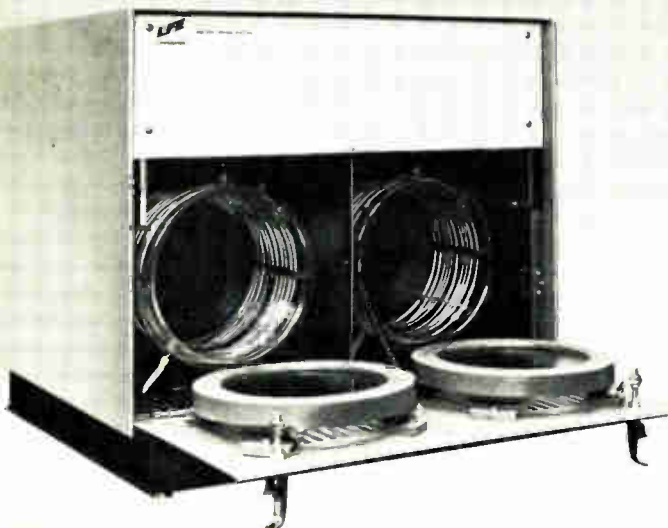
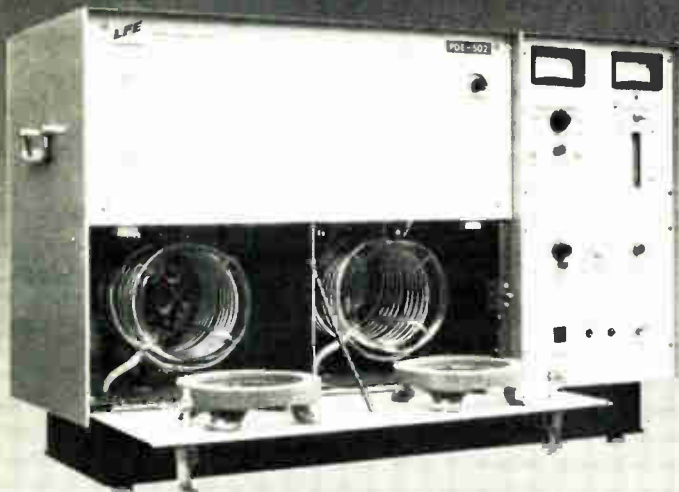

For Semiconductor Wafer Fabrication

The **ultimate** way of increasing productivity and reducing the use of hazardous chemicals by employing gas phase reactions.

The **rapid** means of etching Si_3N_4 employing only a photoresist mask.

The **selective** etching of SiO_2 openings down to the aluminum substrate for making lead contacts or connections in multi-level metallization schemes.

The **precision** etching of microwave geometry and high resolution openings without excessive undercutting.

The **choice** of systems offered have:

1. **Production capacity** of either 25, 50 or 100 three-inch diameter wafers per load using modified IMS carriers.
2. A **variety** of dry etching gases specially designed for etching SiO_2 , Si and such metals as Tantalum, Titanium, Tungsten, Molybdenum, etc.
3. **Selective** synchronous or asynchronous operation (1002 Model, only).

All systems available have:

1. Three modes of operation: etch, strip and etch/strip.
2. Patented gas diffusion process and RF power coupling to achieve uniform etching across the wafer, as well as, from front-to-back of reaction chambers.
3. RF shielding that meets with FCC type-approval.

For further information or a demonstration to prove it on your own process, contact:

In **USA & Canada**: LFE Corp., Process Control Division
1601 Trapelo Road, Waltham, Massachusetts 02154
Telephone: (617) 890-2000 X438.

In **Japan**: Nissei Sangyo Co. Ltd., C.P.O. Box 1316,
Tokyo 100-91, Japan Telephone: Tokyo 501-5311

In **Europe**: George Kent Electronic Products Ltd., 3
Hunting Gate, Wilbury Way, Hitchin, Hertfordshire,
England. Telephone: Hitchin 54001



CORPORATION

Process Control Division

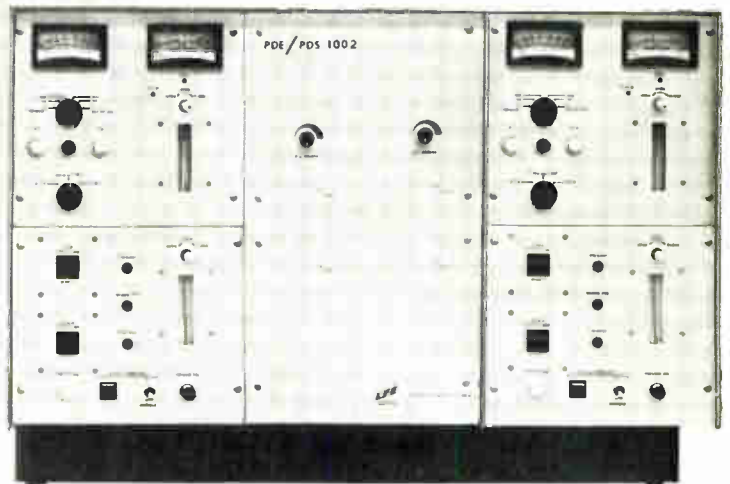

GO with
THE PEOPLE DOING
THINGS THAT MATTER...
IMAGINATIVELY

electronic research co. • **ERC**

In
Hermetically Sealed
.200 Inch High
Crystal Oscillators



Actual Size

- 30 KHz to 15 MHz
- Ambient Range: up to -50°C to $+105^{\circ}\text{C}$
- Ambient Stability: as good as $\pm .002\%$

Telephone (913) 631-6700
7618 Wedd
Overland Park, Kansas 66204
Mail to: P.O. Box 913, Dept. 133
Shawnee Mission • Kansas 66201
TWX: (910) 749-6477

FLATPACK

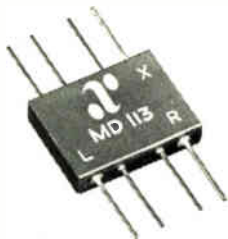

BALANCED MIXER

MODEL MD-113

- DC-1 GHz
- 7.5dB Conversion Loss
- $1/2'' \times 3/8'' \times 1/8''$
- \$29/Stock Availability



39 Green Street, Waltham, Mass.
(617) 899-1900 • TWX 710-324-6484

New products/materials

Ceramacoat 512 is a ceramic material that can be used at temperatures up to $2,500^{\circ}\text{F}$. It is available in a premixed paste, which can be brushed or sprayed on metals and ceramics to form a hard, dense coating that is resistant to oils and most acids. After curing, the silica-based compound has a dielectric strength of 40 volts per mil at 400°F . Price is \$34 for a quart.

Aremco Products Inc., P.O. Box 429, Ossining, N.Y. 10562 [476]

A **silver-palladium** screenable conductor paste is intended for general use with thick-film hybrid micro-electronic devices. By screen-printing the material, it is possible to produce terminations for resistor compositions as well as solderable conductive paths with good bonding characteristics. Wire can be bonded directly to the palladium-silver, which will withstand rigid temperature-cycling. Price is \$23 per ounce in quantity lots, and delivery is from stock.

Transene Co. Inc., Rte. 1, Rowley, Mass. 01969 [477]

A new type of **semiconducting** material, called **Kocite**, is an organic ceramic material whose electrical resistivity can be controlled by varying the conditions under which it is produced. It can therefore be used to control the electrical properties of resin composites, and its applications include thick-film resistors and photographic electronics.

Universal Oil Products Co., 10 UOP Plaza, Algonquin and Mount Prospect Rds., Des Plaines, Iowa 60016 [478]

Electrically conductive transparent coated windows are custom-designed optical display panels used in equipment where the viewing panel must also reduce the radiated electromagnetic energy entering or leaving the device. The windows are produced by dispensing a conductive transparent coating directly onto the surface of various substrate materials, which may be of glass, acrylic, polycarbonate, or fluorocarbon plastics.

Technical Wire Products Inc., 129 Dermody St., Cranford, N.J. 07016 [479]

For bonding metal- to-metal- to-glass- to-glass-to- plastics- to-plastics- to-rubber-to- rubber-to- metal-to-etc- to-etc.

One drop goes a long way in fastening almost anything to almost anything.

Eastman 910[®] adhesive bonds fast, too. Almost instantaneously. With only contact pressure.

Tensile strength? Up to 5000 psi at room temperature.

New Eastman 910 MHT and THT/Grades hold when the heat's on. Even over 400°F .

For further data and technical literature, write: Eastman Chemical Products, Inc., Kingsport, Tennessee 37662.



More than 6,000,000 good reasons...

To insist on RCA Rectifiers and SCR's for your fast-switching applications.

If you have an immediate need for fast-switching devices, come to RCA where large quantity production of quality products is a way of life.

We produced over six million fast-switching thyristors for TV production during the past twelve months ... and millions of fast-switching rectifiers and SCR's for other industry needs during the same period.

These low cost dependable devices represent a lot of good reasons why you should insist on RCA Thyristors and Rectifiers.

Want more good reasons?

RCA offers a large selection of fast-switching devices for your most demanding applications. High-speed inverters, choppers, high-current pulse circuits, or "free-wheeling" diode circuits ... whatever your needs

are ... you'll find the right SCR or rectifier to match your circuit design.

RCA's all-diffused SCR's bring you the best combination of features ...

- fast turn-off time
- high di/dt and dv/dt
- high peak current capability
- exceptional uniformity and stability of characteristics

Match this combination with RCA's fast recovery rectifier features ...

- low reverse-recovery current
- low forward-voltage drop
- low thermal-resistance design ... and you can rest assured that your equipment is backed by the industry's leader in fast-switching technology.

No need to be concerned about quantity, availability, or cost. RCA fast-switching devices are available in quantity ... at prices you can afford.

Want more information? Write: RCA Solid State, Section 70K-22, Box 3200, Somerville, N.J. 08876. Or phone: (201) 722-3200,

Fast Switching SCR's		40555	S3704	S5210	2N3653	2N3658
Package		TO-66	TO-66	¼" stud	TO-48	TO-48
I _{RMS}		5 amps	5 amps	10 amps	35 amps	35 amps
T _{OFF} (Microseconds)		2-6	6-10	5-10	10-15	6-10
1K Price:	200V	1.67	.90	3.00	7.24	7.89
	600V	2.89	1.30	12.20	15.60	17.20

Fast Recovery Rectifiers		TA7895	44938	43884	43894	43904	40960
Package		DO-26	DO-15	DO-4	DO-4	DO-5	DO-5
I _{AV}		1 amp	1 amp	6 amps	12 amps	20 amps	40 amps
T _{RR} (Nanoseconds)		50-500	150-500	150-350	150-350	150-350	150-350
1K Price:	200V	.44	.42	1.79	2.42	3.20	3.40
	600V	.72	.66	3.13	4.37	6.00	6.70

RCA Solid State
products that make products pay off

International: RCA, Sunbury-on-Thames, U.K., or Fuji Building, 7-4 Kasumigaseki, 3-Chome, Chiyoda-Ku, Tokyo, Japan. In Canada: RCA Limited, Ste. Anne de Bellevue B10, Canada.

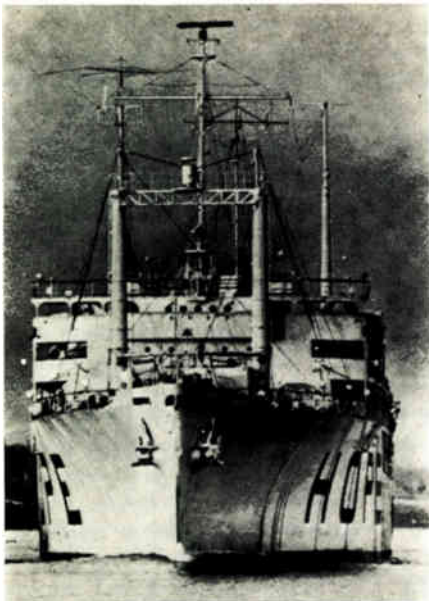

S.S. HOPE, M.D.

Doctor . . . teacher . . . friend to millions on four continents—this floating hospital is a symbol of America's concern for the world's disadvantaged. Keep HOPE sailing.

PROJECT HOPE

Dept. A, Washington, D.C. 20007

\$500*

BALANCED



MIXER

MODEL MD-108

- DC - 500 MHz
- 7dB Conversion Loss
- 30dB Isolation
- 8 - Pin Relay Header

* 500 piece qty. 1-49 pieces (\$7.00)
50-499 pieces (\$5.75).



39 Green Street, Waltham, Mass.
(617) 899-1900 • TWX 710-324-6484

New literature

Components. Catalog #794 from Keystone Electronics Corp., 49 Bleeker St., New York, N.Y. 10012, provides information on the company's line of standardized components. The 48-page brochure describes terminal boards, fuse boards, spacers and standoffs, and transistor sockets. Circle 421 on reader service card.

Power meter. General Microwave Corp., 155 Marine St., Farmingdale, N.Y. 11735. Bulletin 467A describes a low-priced digital microwave power meter, which is designed to operate in conjunction with the company's 420 series of thin-film thermoelectric power heads. [422]

Pc layout system. Bishop Graphics Inc., 7300 Radford Ave., N. Hollywood, Calif. 91605, in its bulletin #1015R, provides information on the Puppets series of individually die-cut transparent layout patterns that represent commonly used electronic devices. Puppets are said to reduce the time it takes a draftsman or pc board designer to go from schematic to final layout. [423]

Circuit hardware. AP Products Inc., Box 110, 72 Corwin Dr., Painesville, Ohio. A 20-page catalog contains technical data and prices on 72 circuit design and breadboarding hardware items, including test probes, terminals, IC test clips, and pins and sockets. [424]

Broadband devices. A four-page catalog from E & M Laboratories, 5388 Sterling Center Dr., Westlake Village, Calif. 91361, gives information on broadband devices for use in the 100-megahertz to 40-gigahertz range. [425]

Transmission measurement. Three product sheets from Cushman Electronics Inc., 830 Stewart Dr., Sunnyvale, Calif. 94086, describe the CE-26A frequency-synthesized signal generator, the CE-23A 1800 channel spectrum display, and the CE-21A frequency-selective levelmeter. [426]

Variable transformer. Superior Electric Co., Bristol, Conn. 06010. A 56-

Primo



CMU-506B

Uni-directional
Condenser
Microphone (With wind screen, tone switch)

The CMU-506B is a condenser microphone powered from a self-contained 9V battery, a quality microphone offering response found in professional microphones along with high stability, extended serviceability, and a good signal-to-noise ratio. Design provides for the needs of semi-professionals and amateurs alike.

- Frequency response: 20—20,000Hz; ±4dB Voice: -12dB at 100Hz
- Output impedance: 600 ohms (balanced)
- Sensitivity: -72dB (1/2 bar, 1kHz)
- Signal-to-noise ratio: More than 50dB.

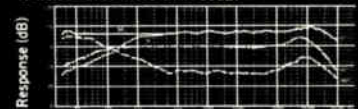

• For catalog, write to:
PRIMO COMPANY LTD.

HEAD OFFICE:
25-1, 6-CHOME, MURE, MITAKA-SHI, TOKYO, JAPAN.
TEL: 0422-43-3120~9
CABLE: "PRIMO MUSASHINO MITAKA"
TELEX: 2822-326 PRIMO J
PRIMO MICROPHONE INC.
SUITE 2207
111 EAST WACKER DRIVE, CHICAGO, ILLINOIS 60601.
U.S.A. TEL: (312) 585-0220, 0221
TELEX: 25-4225 PRIMO MJ5 CGO

Circle 221 on reader service card

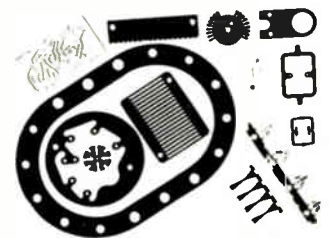

QUALITY METAL PARTS WITH LOW COST PERMANENT TOOLING

WHATEVER YOUR DESIGN MAY BE—HIGH RESOLUTION, CLOSE TOLERANCE, FORMED, PLATED OR HEAT TREATED—WE ARE COMPLETE, FROM "PRINT TO PART". SEE OUR HANDY METALS GUIDE

222 North 2nd St.,
Minneapolis, Minn. 55401
Tel. 612-335-6739

micro parts, inc.

Spending too much time debugging wide band hi-slew op-amp circuits?

Try RCA's CA3100! Virtually free from Ringing.

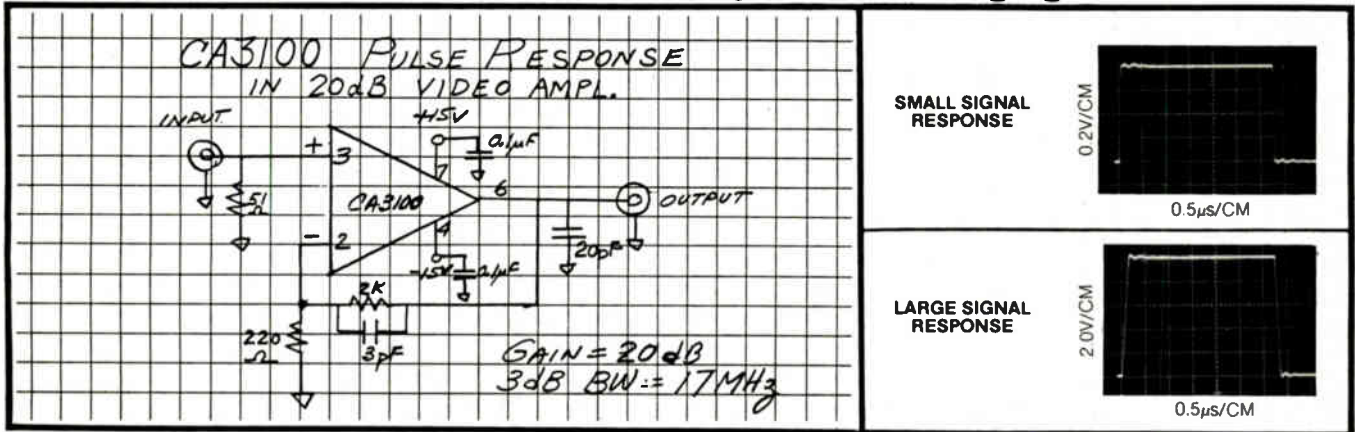

That's because we've combined all of the following features in a single device:

- High open-loop gain at video frequencies—42 dB at 1 MHz.
- High slew rate—70 V/usec (unity-gain, voltage follower, input compensated).
- High slew rate—25 V/usec (unity-gain, voltage follower, single capacitor compensated).
- Fast settling time—0.6 usec.
- High output current— ± 15 mA (min.).

These features are achieved with simpler circuitry because we've combined P-MOS and bipolar transistors on a single chip.

Compare the CA3100 with other wideband op-amps. You'll see the difference. Large signal or small... output waveforms are true reproductions of the input—virtually free from ringing and distortion. Also, compare open loop gain at Video Frequencies—22 dB at 10 MHz.

The CA3100 features dc offset adjust terminals for applications requiring offset null. It can be compensated with a single external capacitor and is pin compatible with other op-amps such as the LM118, LM307, and UA748.

Whatever your applications... high-speed comparators, instrumentation, video... take advantage of the CA3100's characteristics. You get all these features and more... with no tradeoff in price—\$3.50 for 1000 unit quantities.

The CA3100 is available in the standard TO-5 hermetic package, CA3100T, or the dual-in-line version, CA3100S. You can get them in production quantities from your local distributor or direct from RCA.

Interested? Let us send you the complete DATA SHEET! Write: RCA Solid State, Section Box 3200, Somerville, N.J. 08876. Or phone: (201) 722-3200.

RCA Solid State
products that make products pay off



**Ready-to-go
for
immediate
sampling . . .**



**28 standard
axial,
centrifugal
and
transverse-
flow
blowers.**



**(And the
price
is light.)**



No test-sample delays if one of our standard blowers meets your spec demands. We have 28 models on the shelf, ready to be sent to you at once. (Your production orders will go out speedily, too.)



Save time. Write or call now for our catalog with complete performance and spec data. Everything you need to know.



Torin Corporation,
Kennedy Drive,
Torrington, Con-
necticut 06790.
(203) 482-4422; or
16300 Roscoe
Blvd., Van Nuys,
California 91401.
(213) 892-0741



Torin



Torin Corporation
United States: Torrington, Ct.
Van Nuys, Calif.
Rochester, Ind., Elgin, Ill.
Canada: Oakville, Ont.
England: Swindon, Wilts.
Belgium: Nivelles
Australia: Sydney

New literature

page catalog #P773 presents descriptive and technical data on variable transformers. [427]

Digital equipment. The Dynapar Corp., 1675 Delany Rd., Gurnee, Ill. 60031, has published a 16-page bulletin about the company's digital equipment products. [428]

Angle encoder. A report entitled "High Accuracy Angle Encoding using the Farrand Inductosyn Read-out" has been issued by Farrand Controls Inc., 99 Wall St., Valhalla, N.Y. 10595. [429]

Diode switch drivers. A four-page bulletin describes eight models of integrated p-i-n diode switch drivers. Available from Micro-Dynamics Inc., 10 Sonar Dr., Woburn, Mass. 01801, the bulletin contains functional and applications data and other specifications. [430]

Miniature switches. Single- through four-pole miniature switches are illustrated and described in a product selection guide from Alco Electronic Products Inc., 1551 Osgood St., N. Andover, Mass. 01845. [431]

Fault locator. A brochure is available from Hipotronics Inc., Brewster, N.Y. 10509, that describes the model CF25-3 continuously adjustable capacitor impulse fault locator. Design features, specifications, operating instructions, and safety features are given. [432]

Circuit packages. Packaging Unlimited Inc., 10 Railroad St., Lawrence, Mass. 01841. A bulletin describes standard-sized DIP cases for hybrid-circuit applications, including 14-, 16- and 18-pin single- and double-width devices. [433]

Data logging. Kaye Instruments Inc., 15 DeAngelo Dr., Bedford, Mass. 01730, has issued a 12-page catalog describing the 8000 data logging system for measuring and recording temperature, strain, flow, voltage, and current. [434]

Thermocouple assemblies. Weed Instrument Co. Inc., P.O. Box 549, El-

NEW PR/1



COMPONENTS BENDING TOOL
Bending Length: min. mm. 12 max mm. 50

CUT AND BEND TOOL

NEW TP/2



Cuts lead wires from \varnothing 0.3 to 1.5 mm

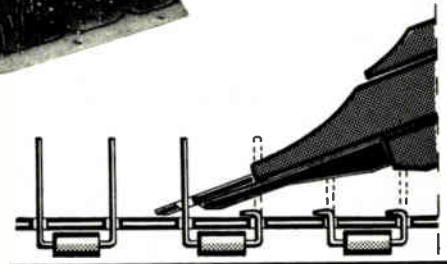

PRINTED CIRCUIT HOLDER

NEW PCSS



- PCSS-1** Dimensions of max use mm. 270x220 (with central bar inserted mm. 270 x 110 + 270 x 100)
- PCSS-2** Dimensions of max use mm. 500x220 (with central bar inserted mm. 500 x 110 + 500 x 100)
- PCSS-3** Dimensions of max use mm. 750x220 (with central bar inserted mm. 750 x 110 + 750 x 100)

ELMEC SASSO MARCONI - (Italy)
P.O. BOX N. 1750
40100 BOLOGNA

AGENTS AND DEALERS REQUIRED

When it comes to data/video receivers, come to us.

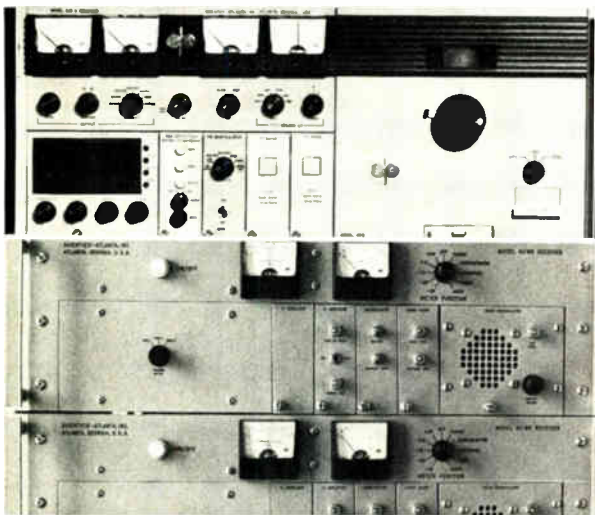

We've engineered in the answers to most data/video receiver problems. The Scientific-Atlanta 410 data receiver, offers plug-in RF tuners covering 65 MHz-6.5 GHz. IF bandwidths range from 2.0 GHz-10 MHz, IF frequencies of 60, 70 and 105 MHz. These units are available with AM, FM, PM, PSK demodulators, along with complete line of accessories for predetection recording, playback, spectrum displays, etc.

For video applications, the Scientific-Atlanta Series 411 wide-band receivers, which are presently being utilized on the ERTS and other satellite communications programs, has demodulators for high data rates and T.V. Input frequencies range from 1.0 GHz-14 GHz with IF

bandwidths from 10.0 MHz-50 MHz. All units have modular construction and standard rack mounting.

Let us know about your particular requirements. We've prepared a receiver application packet that might give you some answers before you can think of the questions. For full details phone or write, Scientific-Atlanta, Inc., P.O. Box 13654, Atlanta, Georgia 30324 (404) 938-2930. Or call one of our regional offices in the following cities: Atlanta, Ga. (404) 938-2930 Belleville, Ill. (618) 397-9251 Bladensburg, Md. (301) 779-1515 Burlington, Mass. (617) 272-1256 Dallas, Tex. (214) 357-1855 Denver, Colo. (303) 321-2483 Leonia, N.J. (201) 461-5340 Long Beach, Cal. (213) 428-7515

**Scientific
Atlanta**
We're systematic.



The U. S. Government does not pay for this advertisement. It is presented as a public service in cooperation with The Department of the Treasury and The Advertising Council.

How to dream with your eyes wide open.



Everybody likes to dream. But the chances of seeing a dream become reality are pretty slim. Unless you're crafty enough to figure out a smart way to save. One that's practical and painless. One that won't eat up your paycheck but will still give you a chance to salt something away.

If you're smart, you'll decide on U.S. Savings Bonds. They're one of the easiest ways to save. Just sign up for the Payroll Savings Plan where you work. Then an amount you specify will be automatically set aside from your paycheck and used to buy Bonds.

So, if you're not satisfied with just dreaming, buy U.S. Savings Bonds. Then you'll find out there's no such thing as an impossible dream.



Now E Bonds pay 5 1/2% interest when held to maturity of 5 years, 10 months (4% the first year). Bonds are replaced if lost, stolen, or destroyed. When needed they can be cashed at your bank. Interest is not subject to state or local income taxes, and federal tax may be deferred until redemption.



Take stock in America.

Now Bonds mature in less than six years.

New literature

gin, Texas 78621. A short-form catalog on thermocouple assemblies offers information on the devices most commonly used in this application. [435]

Telemetry. EMR Telemetry division, Weston Instruments Inc., Box 3041, Sarasota, Fla. 33578. A condensed catalog covers telemetry equipment as well as industrial monitoring and control products and other instruments. In addition, sections discuss frequency- and time-division multiplex systems, applications, and specifications. [434]

Graphics system. A data sheet discussing the model 9300 graphics system for laying out integrated-circuit designs is being offered by GCA/Hampshire Engineering, 204 Second Ave., Waltham, Mass. [435]

Multiresistor chips. A data sheet is available from Airco Speer Electronics, 47th and Packard Rd., Niagara Falls, N.Y. 14302, that provides information on the company's capabilities in custom-designing precision thin-film multiresistor chip arrays for hybrid applications. The two-page publication is illustrated with sample chip designs. [436]

Fourier transform system. Federal Scientific Corp., 615 W. 131st St., New York, N.Y. 10027. Report #23 discusses fast fourier transform systems and provides comparisons of speed, dynamic range, resolution, and price. [437]

Tape transport. A 15-page applications note from Ross Controls Corp., 257 Crescent St., Waltham, Mass. 02154, provides information on the firm's model 1000 digital cassette recording tape transport, which is designed to provide 1,500,000-bit data storage on the conventional Philips-type cassette. [438]

Instrumentation. A 40-page catalog describes the line of test and measurement devices available from Simpson Electric Co., 5200 W. Kinzie St., Chicago, Ill. Included are panel meters, meter relays, and oscilloscopes. [439]

JAPAN ELECTRONICS SHOW '74

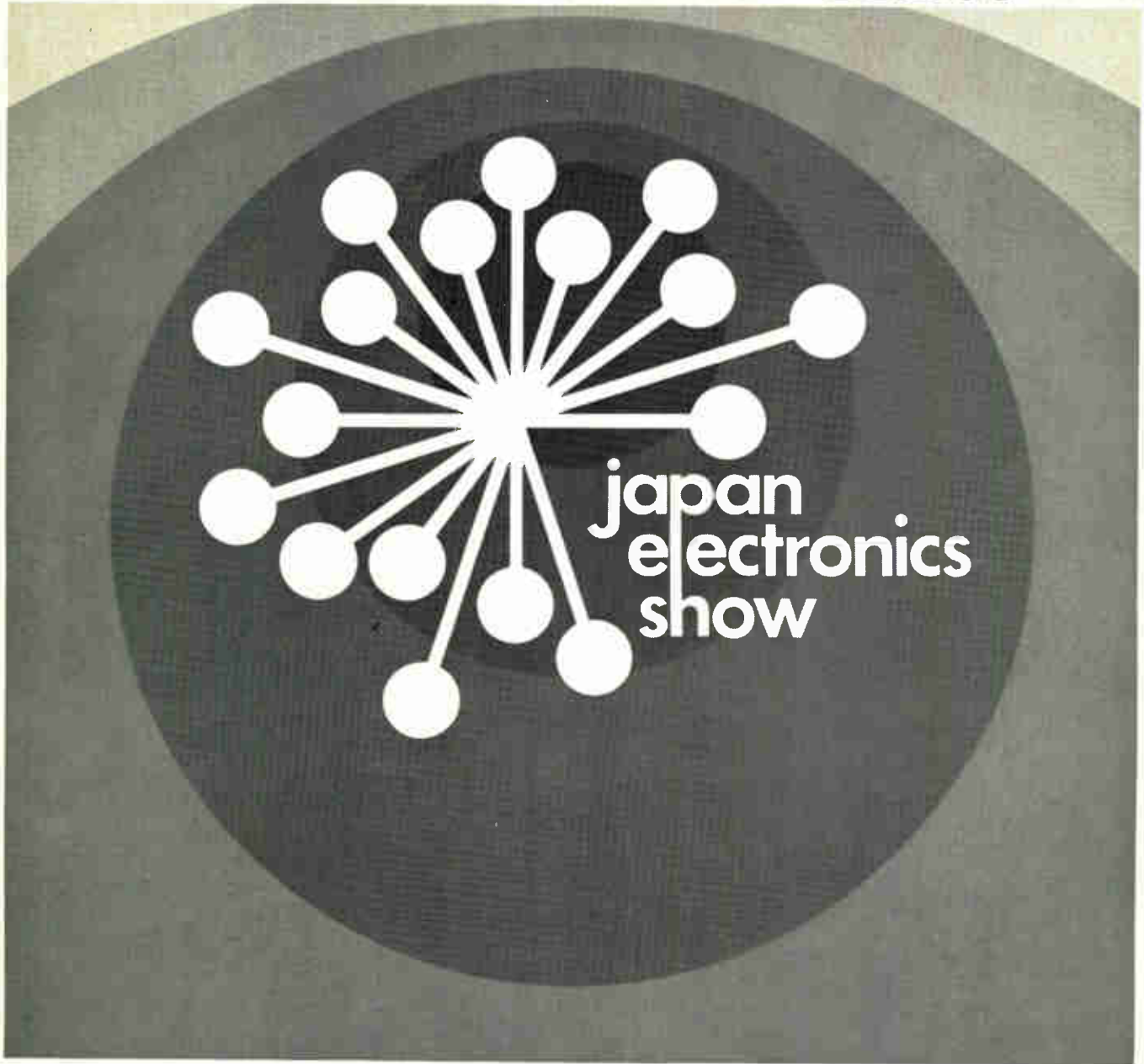

Put Your Products in the Asian Spotlight

The Japan Electronics Show (JES) is the largest international electronics show held in Asia. It's an annual event alternately hosted by Tokyo and Osaka.

Previous shows have welcomed buyers and related personnel from more than 60 countries. The 1974 JES, which will again be held in Tokyo, marks the 13th anniversary, and we again look forward to world wide participation.

JES assures direct contact with buyers for your products as well as a first hand opportunity to learn of the latest advances in the electronics industry, new products and applications.

SEPT. 18-24, TOKYO

Closing date for application: End of March

For details of the '74 JES (13th), please write to

JAPAN ELECTRONICS SHOW ASSOCIATION

(Show management for the Electronic Industries Association of Japan) 2-2, Marunouchi 3-chome, Chiyoda-ku, Tokyo, Japan

**Flameless
Compressed-Air
Heat Torches** —
Lightweight and
portable for
pinpoint
intense heat
performance.

Heat Blowers — Built for
continuous 24-hour duty.

New! Mite Heat Gun
— Lightweight
versatility
with three
interchangeable
nozzles and
heat ranges.

**Standard
Heat Gun**
— Compact
and
economical,
die-cast
aluminum
housing.

250° to 1,000°F.

Chrome Heat Gun — Designed for
labs, R & D, and professional use.

A flameless heat tool for every need: Master makes them all

Master offers you the world's most complete line of flameless heat tools. Each one is precision built for rugged dependability and versatile performance. And every Master heat tool features a complete line of attachments for every production need.

Heat Guns and Blowers are available in U.L. and L.A. approved models. CSA approved in Canada. In Canada, contact Martin Industrial Sales, P.O. Box 576, 4445 Harvest Road, Burlington, Ontario.

Send for your free 12-page catalog and price list on the world's most complete line of flameless heat tools.

MASTER
appliance corporation

Racine, Wisconsin 53403

Need to know where it's at?

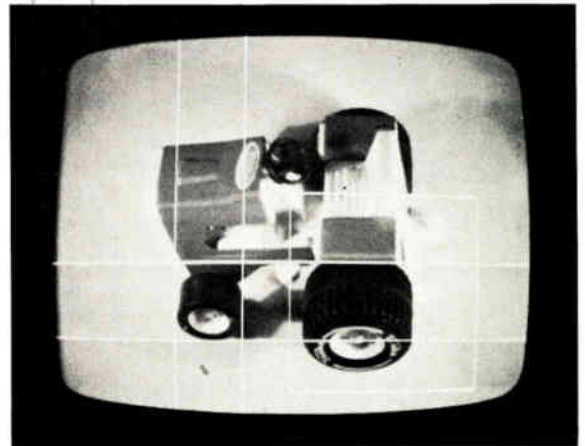

CVI video instruments provide X-Y coordinate information from TV signals — produce boresight reticules — digitize target location — analyse scenes — and more. If you use television and need to reduce data, add special markers, or perform other operations, please call us.

We make things like:

- 304 Motion Detector
- 321 Video Analyser
- 603 Data Insertion Generator
- 610 Video Pointer
- 621 X-Y Indicator
- 622 X-Y Digitizer
- 630 Anomaly Detector

cvi

Colorado Video, Incorporated
P.O. Box 928
Boulder, Colorado 80302
(303) 444-3972

Video instruments for data acquisition, processing, Transmission, and display.

FREE CATALOG

GUIDES
PULLERS
EJECTORS
for PC Boards

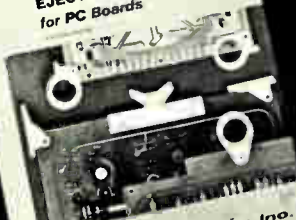

Thermalloy Inc.

WRITE
TODAY
FOR
YOUR
COPY

NEW GUIDES PULLERS AND EJECTORS for PC Boards

FREE Samples
of new designs from Thermalloy:



new easy-to-use ring puller, unique combination ejector-puller. Catalog also includes standard ejectors, pullers, and guides. Guides are black nylon. Pullers and ejectors are white nylon with color coding available.



Thermalloy Inc.

P.O. BOX 34829

2021 VALLEY VIEW LANE/DALLAS, TEXAS 75234
TELEPHONE (214) 343-4321/TWX 910-860-5542

Advertising Sales Staff

Pierre N. Braudé [212] 997-3485
Advertising Sales Manager

Atlanta, Ga. 30309: Joseph Lane
100 Colony Square, 1175 Peachtree St., N.E.
[404] 892-2868

Boston, Mass. 02116: James R. Pierce
607 Boylston St. [617] 262-1160

Chicago, Ill. 60611:
645 North Michigan Avenue
Robert W. Bartlett (312) 751-3739
Paul L. Reiss (312) 751-3738

Cleveland, Ohio 44113: William J. Boyle
[716] 586-5040

Dallas, Texas 75201: Charles G. Hubbard
2001 Bryant Tower, Suite 1070
[214] 742-1747

Denver, Colo. 80202: Harry B. Doyle, Jr.
Tower Bldg., 1700 Broadway
[303] 266-3863

Detroit, Michigan 48202: Robert W. Bartlett
1400 Fisher Bldg.
[313] 873-7410

Houston, Texas 77002: Charles G. Hubbard
2270 Humble Bldg. [713] CA 4-8381

Los Angeles, Calif. 90010: Robert J. Rielly
Bradley K. Jones, 3200 Wilshire Blvd., South Tower
[213] 487-1160

New York, N.Y. 10020
1221 Avenue of the Americas
Warren H. Gardner [212] 997-3617
Michael J. Stoller [212] 997-3616

Philadelphia, Pa. 19102: Warren H. Gardner
Three Parkway,
[212] 997-3617

Pittsburgh, Pa. 15222: Warren H. Gardner
4 Gateway Center [212] 997-3617

Rochester, N.Y. 14534: William J. Boyle
9 Greylock Ridge, Pittsford, N.Y.
[716] 586-5040

San Francisco, Calif. 94111: Don Farris
Robert J. Rielly, 425 Battery Street,
[415] 362-4600

Paris: Alain Offergeld
17 Rue-Georges Bizet, 75 Paris 16, France
Tel 720-73-01

Geneva: Alain Offergeld
1 rue du Temple, Geneva, Switzerland
Tel 32-35-63

United Kingdom & Scandinavia: Keith Mantle
Tel 01-493-1451, 34 Dover Street, London W1

Milan: Robert Saidel
1 via Baracchini, Italy Phone 87-90-656

Brussels: Alain Offergeld
23 Chaussee de Wavre
Brussels 1040, Belgium
Tel 13-73-95

Frankfurt/Main: Fntz Krusebecker
Liebigstrasse 27c, Germany
Phone 72 01 81

Tokyo: Tatsumi Katagin, McGraw-Hill
Publications Overseas Corporation,
Kasumigaseki Building 2-5, 3-chome,
Kasumigaseki, Chiyoda-Ku, Tokyo, Japan
[581] 9811

Osaka: Ryji Kobayashi, McGraw-Hill
Publications Overseas Corporation, Kondo
Bldg. 163, Ume-gae-cho Kita-ku, Japan [362] 8771

Australasia: Warren E. Ball, ITO Box 5106,
Tokyo, Japan

Business Department

Stephen R. Weiss, Manager
[212] 997-2044

Thomas M. Egan,
Production Manager [212] 997-3140

Carol Gallagher
Assistant Production Manager [212] 997-2045

Dorothy Carter, Contracts and Billings
[212] 997-2908

Frances Vallone, Reader Service Manager
[212] 997-6057

Electronics Buyers' Guide

George F. Werner, Associate Publisher
[212] 997-3139

Regina Hera, Directory Manager
[212] 997-2544

\$125



it's so easy to take . . .

You can replace your thermopile with a
SBN PYROELECTRIC DETECTOR.

- BROADBAND RESPONSE—
UV to microwaves
- HIGH SENSITIVITY—
> to 125 V/W
- FAST RESPONSE—
better than 5ns
- NO CRYOGENICS—
operates from -40°C to 90°C
- RUGGED AND
NONHYGROSCOPIC

This package includes a sensing element
plus a integral FET and fits a standard 9
pin miniature tube socket. Available from
stock for only \$125.00.

Call us at 216/248-7400 with your IR
detection and measurement problems.



HARSHAW

THE HARSHAW CHEMICAL COMPANY
DIVISION OF KEWANEE OIL COMPANY

Crystal & Electronic Products Department
6801 Cochran Road • Solon, Ohio 44139
(216) 248-7400

Abbott Transistor Labs, Inc. Technical Adv. Agency	6	Fluke Manufacturing Company, John Bonfield Associates	21	RCA Electronic Components Al Paul Lefton Company, Inc.	11E
Adams & Westlake Company Relay Division Adwest Advertising	151	Fluke TRENDAR Lincoln Associates, Inc.	3rd Cover	RCA Ltd. Marsteller Ltd.	24E-25E 189,191
Adret Electronics P. Raman	37E	Fuji Electrochemical Co., Ltd. General Advertising Agency, Inc.	154	RCA Solid State Division Al Paul Lefton Company, Inc.	14
Advance Electronics Ltd. Evan Steadman (Services) Ltd.	7E	General Electric Co., Miniature Lamp Div. Carr Liggett Advertising, Inc.	152	RCL Electronics, Inc. Morvay Advertising Agency	20
Advanced Micro Devices Keye/Donna/Pearlstein	10-11	General Electric Co., Semiconductor Products Department Advertising & Sales Promotion Syracuse Operation	28	Reticon Corporation Kassler Noble Advertising	1E 170
Advanced Micro Devices Keye/Donna/Pearlstein	40E	General Electric Company, Tube Products Department Robert S. Cragin, Inc.	172	Rohde & Schwarz Schauer Manufacturing Corp.	4E-5E
Allen-Bradley Company Hoffman, York, Baker & Johnson, Inc.	24	General Instrument Europe S. P. A. Studio Hedy	16E	Schneider Electric Intermedia	18E
Alps Electric Co., Ltd. Nihon Keizasha Advertising Ltd.	80	General Magnetics McCarthy/Scelba/DeBiasi Adv. Agcy., Inc.	2	Scientific Atlanta/Electro Systems Mohr & Co., Inc.	193
American Microsystems, Inc. Wilton, Coombs & Cornett, Inc. Advertising	81	General Radio Grad Associates	33E-34E	Scientific Atlanta/Optima Mohr & Co., Inc.	147
American Optical—Scientific Instrument Division Wilson, Haight & Welch, Inc.	150	Georgia Department of Community Development Gerald Raishoon Advertising, Inc.	184	S. E. Laboratories Ltd. Graphic Publicity Ltd.	20E-21E
Amphenol Components Group—Bunker Ramo Corp. Marsteller, Inc.	62-63	The Gerber Scientific Instrument Co. Charles Palm & Co., Inc.	88	Sescosom Perez Publicite	19E,30E
AMP Italia Studio Dolci	14E	Gould, Inc./Instrument Systems Div. Carr Liggett Adv., Inc.	176	SGS-ATES Studio B Communications	115
Anritsu Electric Co. Ltd. Diamond Agency Co. Ltd.	42E	Harris Semiconductor Tucker Wayne & Company	159	Showa Musen Kogyo Co., Ltd. General Advertising Agency, Ltd.	166
Anzac Electronics Ken Puleo Advertising	188,190	Harshaw Chemical Company Industry Advertising Company	197	Siemens Aktiengesellschaft Linder Presse Union GmbH	52
Augat Creamer, Trowbridge, Case & Basford, Inc.	60-61	Heath/Schlumberger Scientific Instruments Advance Advertising Services	199	Signetics Corp.—Sub. of Corning Glass Works Hall Butler Blatherwick, Inc.	17
Bausch & Lomb, Inc. Wolff Assoc., Inc.	200	Hewlett-Packard Richardson, Seigle, Rolfs & McCoy, Inc.	1	Sillconix Robertson West, Inc.	116
Bourns, Inc. Marlborough Assoc., Inc.	54	Hewlett-Packard Tallant Yates Advertising, Inc.	58-59	Simpson Electric Co. Amerad Advertising Services, Inc.	143
Buckbee Mears Europe GmbH Team 23	48	Hitachi, Ltd. Dentsu Advertising Ltd.	126	Solltron Devices, Inc. Tobias Associates, Inc.	168
Bulova Watch Co., Inc., Electronics Division E. E. Henkel & Associates, Inc.	172	Houston Instrument Ray Cooley & Associates, Inc.	82-83	Sorenson Lighted Controls, Inc. Selwyn/Conway Advertising, Inc.	180
Burndy Intermarco Publicem	39E	Hughes Aircraft Company Foote, Cone & Belding	64,155,183	Spectrol Electronics Corp. J M R, Inc.	163
Burrughs Corp. Confi Advertising Agency, Inc.	2nd Cover	Industrie Bitossi S.A.S C. E. T. I.	35E	Sprague Electric Company Harry P. Bridge Company	8
Cario Erbe Studio Dema	41E	Interdata Shaw Elliott, Inc.	12-13	Sprague-Goodman Electronics, Inc. Herbert Lindauer Associates	170
CELCO Stano Advertising	150	Interstate Electronics Corporation Chris Art Studio, Inc.	137	Stewart-Warner Microcircuits JMR Advertising	140
Cherry Electrical Products Corp. Kolb/Tookey and Assoc., Inc.	171	Invest Export Interwerbung	177	Syatron Donner Concord Instruments Fred Schott & Associates	51
Chicago Miniature Lamp Works Buti-Roberts Advertising	184	Ise Electronics Corp. Shinwa International, Inc.	67	Takeda Riken	28E
Circuit-Stik, Inc. Haaga Advertising	166	Ithaco, Inc. Siahtka/Faller, Inc.	78	TEAC Corp. Dentsu Advertising Ltd.	15
CIT Alcatel Promotion Industrielle	36E	C. Itoh & Co. (America) Inc. AC&R Advertising, Inc.	182	Tektronix, Inc. McCann Erickson, Inc.	18-19,33
Clairex Corporation Black-Russell-Morns	4th Cover	Japan Electronics Show Association Asan Advertising, Inc.	195	Teklynne Philbrick Ingalls Associates, Inc. Advertising	12E-13E
Colorado Video O'Connell Words & Pictures	196	Keppo Incorporated Weiss Advertising	5	Teledyne Semiconductor Regis McKenna, Inc.	169
Communications Transistor Corp. Hall Butler Blatherwick, Inc.	35,37,39,41	Kitagami Electric	178	Texas Instruments Incorporated Kenyon & Eckhardt Advertising, Inc.	86-87
CTS Corporation Reincke, Meyer & Finn, Inc.	181	LFE Corporation, Process Control Division LFE Advertising	187	Thermalloy Warren-Guild	197
Constantine Engineering Laboratory Co. Stano Advertising	150	Litronix, Inc. Regis McKenna, Inc.	108	Thomson CSF Electron Tubes, Inc. Mohr & Co.	130
Dahmen Burnett Electronics Weston Associates, Inc.	142	LTT Pubibiel	46E	Toko, Inc. Hakuhodo, Inc.	136
Data General Corporation Scali, McCabe, Sloves, Inc.	46-47	Macrodata Company JMR Advertising	165	Tokyo Electric Co., Ltd. PAL, Inc./Export Advertising	168
Data Test Corporation Hal Lawrence Incorporated	129	Magi Dot, Inc. Allan & Alan, Inc.	164	Tokyo Sokuhan Co., Ltd. Snowa Advertising Service, Inc.	44E
Delco Electronics Division, General Motors Corp. Campbell-Ewald Company	44-45	Magnell Marrell S.p.A. Publicor	50E	Torin Corporation Viscom International, Inc.	192
Delta Products, Inc. The William Loughran Company	158	Master Appliance Klau-Van Pietersom-Dunlap, Inc.	196	TRW Electronics Components Division The Bowes Company	77,79
Diacon Grant Rogondino Millard, Inc.	180	Micro Parts/Inc.	190	TRW/IRC Resistors Gray & Rogers, Inc.	135
Dialight Corporation Michel-Cather, Inc.	72-73	Micro Power Systems Associated Ad Ventures, Inc.	74	TRW Electronics, Semiconductor Division The Bowes Company	7
Diotechnik Wolfgang Fitchner	47E	Micro Switch Division of Honeywell N. W. Ayer & Son, Inc.	138	United Systems Corp., A Sub. of Monsanto Co. Advertising & Merchandising, Inc.	161
Digital Equipment Corporation Schneider Parker Guy, Inc.	22-23	Miyama Electric Co., Ltd. Sanko Tsushinsha Ltd.	200	Unitrode Corporation Impact Advertising	27
Disc Instruments, Inc. Jansen Associates, Inc.	162	Monsanto Company The Advertising Promotion Services	173	Universal Oil Products, Norplex Div. Campbell Mithun, Inc.	107
Divi, Inc. Hallolf & Caine	153	Motorola Semiconductor Products, Inc. E B Lane & Associates, Inc.	43,57,75	Vector Electronic Company, Inc. Communications Management Company	162
Duncan Electronics, Inc., Sub of Systron Donner Corp. Enyart & Ross Advertising, Inc.	156	Mullard Ltd. Roles & Parker Ltd.	38E	Versatec, Inc. Hal Lawrence, Inc.	127
Eastman Chemical Products, Inc., Industrial Chemicals J. Walter Thompson Company	188	Nippon Chemical Condenser Co., Ltd. Daichi-Tsushin Co., Ltd.	182	Victoreen Instrument Division Dix & Eaton, Inc.	16
Eastman Kodak Company, Business Systems Markets Div. J. Walter Thompson Company	15	Nippon Electric Co., Ltd. Hakuhodo, Inc.	128	Wima, Westermann Renaccio Advertising & Marketing, Inc.	16 149
Edayn, Inc. Adsyn Agency	178	Nippon Kokogaku K.K. K & L Advertising Agency	45E	Winchester Electronics	43E
E-H Research Laboratories, Inc. Hal Lawrence, Inc.	174	Oiltronix AB Inter-Media AB	31E	Yokogawa Electric Works Ltd. General Advertising Agency, Inc.	49E
EL Instruments, Inc. Langeier-Stevens, Incorporated	9	Oscilloquartz SA, Neuchatel M. R. Hofer Werbeagentur BSR/EAAA Bern	8E	La Zinco-Lere S.p.A. Studio Dr. Giuliano Bisi	
Electronic Navigation Industries Hart Conway Co., Inc.	146	Owens-Illinois, Inc.—Digivue Howard Swink Advertising	139		
Electronic Research Co. ERC Advertising	188	Philips Elcoma Philips Electrologica	2E-3E 174		
Electro Scientific Industries Com/Mark Communications Group	6E	Philips N. V. PIT/T & M Division Marsteller International S. A.	54		
ELMEC s.n.c. TECNOSTAMPA	192	Pignone Sud Linea Spn	17E		
Emr-Telemetry Carol Marketing Associates	42,179	PowerTech, Inc. The Sommer Agency, Inc.	154		
Exar Integrated Systems Regis McKenna, Inc.	70	Prime Computer, Inc. Wilson, Haight & Welch, Inc.	84-85		
Excellon Industries Graham & Sparkman Advertising etcetera	48	Primo Co., Ltd. General Advertising Agency, Inc.	190		
Figaro Engineering, Inc. Daiyusha, Inc. Advertising	167	Procond S.p.A. Quadrangolo	32E 22E-23E		
		R 2E Sagha			

Classified & Employment Advertising

F. J. Eberle, Manager 212-971-2557

EQUIPMENT (Used or Surplus New) For Sale	
American Used Computer Corp.	186
Boeing Company	186
Philip Fishman Company	186
Radiation Devices	186
Radio Research Instrument Co., Inc.	186

For more information on complete product line see advertisement in the latest Electronics Buyer's Guide
 Advertisers in Electronics International
 Advertisers in Electronics domestic edition

**Two new autoranging
110 MHz counters**

Introducing the new Heath/Schlumberger SM-128A and SM-128B... a pair of very high performance counters at very reasonable prices. The 128s deliver guaranteed performance to 110 MHz with 15 mV sensitivity. Typical performance is even better: 140 MHz at 2-10 mV sensitivity. A front panel sensitivity control allows you to adjust the input amplifier trigger level both above and below the zero-crossing point... a very handy feature to help minimize the effect of noise on the signal. Two preset gate intervals of 1

second and 10 milliseconds are switch-selectable... or use the autoranging function, which automatically determines the correct range for maximum resolution without overranging. Two time-base versions are available: the SM-128A uses a standard clock stable to ± 10 ppm over 0-40° C. For applications requiring very high precision, choose the SM-128B, with temperature stability of ± 1 ppm. Additional features of both versions include 7-digit LED readout with leading zero blanking... high impedance 1 megohm/15 pf input for minimum circuit loading... external time base oscillator input for very high accuracy measurements or frequency ratio work... dual primary power supply... rugged, compact design.

Find out all the details on the new 128s and the rest of our counter line. Use the coupon to get your FREE Heath/Schlumberger catalog.

Factory assembled & calibrated SM-128A,
standard timebase,
10 lbs... **\$325.00***

Factory assembled & calibrated SM-128B,
high stability timebase,
10 lbs... **\$395.00***

**The new SR-255B...
the industry's most
extraordinary value
in a strip chart recorder**

Compare the SR-255B against the others. While other recorders in this price range provide only one input span, the 255B gives you pushbutton selection of four: 10 mV, 100 mV, 1 V & 10 V. Plus a built-in Variable span capability to allow expansion to 100 V FS. Other manufacturers are shouting about a "new concept"... the digitally-driven stepper motor chart drive. We pioneered this idea years ago, and it eliminates the backlash and adjustment problems of mechanical systems. The 255B provides switch-selection of 10 speeds: 10, 5, 2, 1, 0.5, 0.2, 0.1, 0.05, 0.02 and 0.01 inches or centimeters per minute. The high impedance floating input provides better than 10^7 ohms input impedance with less than 10 nA bias current on 10 mV, 100 mV and 100 V ranges. Impedance on the 10 V range is 1 megohm. Switchable input filtering enhances the recorder's ability to reject line frequency noise by 20 dB in both normal and common mode. Complete remote control capability by TTL signals is standard. Other standard features include easy conversion to metric system work... easy paper loading... electric pen lift... pushbutton chart advance... rackmount design.

To get complete details on our complete line of strip chart recorders, use the coupon now.

Factory assembled & calibrated SR-255B, 20 lbs. \$335.00*

**Three new
high performance,
low cost design
instruments from
Heath/Schlumberger**

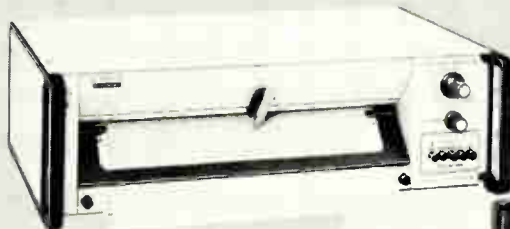

SR-255B 10" recorder, \$335*

SM-128A 110 MHz counter, \$325*



Get your FREE copy of the latest Heath/Schlumberger Electronic Instruments catalog. Use coupon now!



HEATH	
Schlumberger	
Heath/Schlumberger Instruments Dept. 531-281 Benton Harbor, Michigan 49022	
<input type="checkbox"/> Please send latest Electronic Instruments catalog	
Name _____	
Title _____	
Company/Institution _____	
Address _____	
City _____	State _____ Zip _____
*Mail order prices; FOB factory EK-401R	

THE CHAMP

...PICTURE TAKER



Visual images are fleeting—so, for the record, ...you need pictures. No telling when or how often they can prove invaluable.

That's why so many of your peers are routinely snapping pictures while looking at specimens and samples with Bausch & Lomb's StereoZoom 7 visual-photographic system. The Champ's superb optical system which gives unbeatable visuals will put the images on film right while you're looking. And they will be

available as often as you want to refresh your memory, make comparisons, prove points.

There's a choice of most camera formats with the new Integrated Cameras, Series II with optional exposure meter. They're integral, but do not interfere with the optical system and interchange to fit varying needs.

Be ready. Write for our new Stereomicroscope catalog 31-15 and our free demonstration offer.

BAUSCH & LOMB 

SCIENTIFIC OPTICAL
PRODUCTS DIVISION

61423 Bausch Street, Rochester, N.Y. 14602

StereoZoom, Reg. T.M.
Bausch & Lomb.

For Literature Circle #200 on Reader Service Card.
For Demonstration Circle #201 on Reader Service Card.



MIYAMA PARTS NEW PRODUCTS

Smaller than the smallest you need,
You can have now, indeed.



MIDGET TOGGLE SWITCH 3 AMP 125 VAC

MS-172 2P
MS-173 3P
MS-174 6P

MS-175 2P
MS-176 3P
MS-177 6P

MS-184 2P
MS-185 3P
MS-186 6P



Toggle
Chrome plated brass with
plastic colour top (Red/White/
Black/Yellow/Blue)



Toggle Plastic
(Red/White/Black/Yellow/
Blue)



Toggle
Anodized aluminum

Ultra sub-miniature toggle switches.
The future will bring no smaller switch.
Housing consists of a plastic molded case with a chrome plated steel cover.
Contacts and solder terminals are of silver plated copper.
Mounting hole diameter 6 mm.

*MAIN PRODUCTS

Switches Lampholders Minomushi Clips IC Clips Receptacles Fuseholders, etc.

MIYAMA ELECTRIC CO., LTD.

Main Office No 7-1, 4-chome, Kami-kedai, Ohta-ku, Tokyo 145, Japan
Phone (03) 720-5151

Electronics

READER SERVICE

For additional information on products advertised, new products or new literature, use the adjacent business reply cards.

Complete entire card. Please print or type.

Circle the number on the Reader Service postcard that corresponds to the number at the bottom of the advertisement, new product item, or new literature in which you are interested.

To aid the manufacturer in filling your request, please check the appropriate industry classification box.

Postage is prepaid in U.S. Correct amount of postage must be affixed for all mailings from outside the U.S.

All inquiries from outside the U.S. that cannot reach Electronics before the expiration dates noted on the Reader Service postcard must be mailed directly to the manufacturer. The manufacturer assumes all responsibilities for responding to inquiries.

Subscriptions & Renewals

Fill in the subscription card adjoining this card. Electronics will bill you at the address indicated on the card.

ELECTRONICS November 22, 1973 card expires February 4, 1974

NAME _____ TITLE _____

COMPANY _____

STREET _____

CITY _____ STATE _____ ZIP _____

Industry Classification (check one)

a Computer & Related Equip. f Consumer Products
 b Communications Equip. & Systems g Industrial Controls & Equip.
 c Navigation, Guidance or Control Systems h Components & Subassemblies
 d Aerospace, Underseas Ground Support j Independent R&D Organizations
 e Test & Measuring Equip. k Government

1	21	41	61	81	101	121	141	161	181	201	221	241	261	343	363	383	403	423	443	463	483	503	713
2	22	42	62	82	102	122	142	162	182	202	222	242	262	344	364	384	404	424	444	464	484	504	714
3	23	43	63	83	103	123	143	163	183	203	223	243	263	345	365	385	405	425	445	465	485	505	715
4	24	44	64	84	104	124	144	164	184	204	224	244	264	346	366	386	406	426	446	466	486	506	716
5	25	45	65	85	105	125	145	165	185	205	225	245	265	347	367	387	407	427	447	467	487	507	717
6	26	46	66	86	106	126	146	166	186	206	226	246	266	348	368	388	408	428	448	468	488	508	718
7	27	47	67	87	107	127	147	167	187	207	227	247	267	349	369	389	409	429	449	469	489	509	719
8	28	48	68	88	108	128	148	168	188	208	228	248	268	350	370	390	410	430	450	470	490	510	720
9	29	49	69	89	109	129	149	169	189	209	229	249	269	351	371	391	411	431	451	471	491	510	900
10	30	50	70	90	110	130	150	170	190	210	230	250	270	352	372	392	412	432	452	472	492	510	901
11	31	51	71	91	111	131	151	171	191	211	231	251	271	353	373	393	413	433	453	473	493	510	902
12	32	52	72	92	112	132	152	172	192	212	232	252	272	354	374	394	414	434	454	474	494	510	951
13	33	53	73	93	113	133	153	173	193	213	233	253	273	355	375	395	415	435	455	475	495	510	952
14	34	54	74	94	114	134	154	174	194	214	234	254	274	356	376	396	416	436	456	476	496	510	953
15	35	55	75	95	115	135	155	175	195	215	235	255	275	357	377	397	417	437	457	477	497	510	954
16	36	56	76	96	116	136	156	176	196	216	236	256	338	358	378	398	418	438	458	478	498	510	956
17	37	57	77	97	117	137	157	177	197	217	237	257	339	359	379	399	419	439	459	479	499	510	957
18	38	58	78	98	118	138	158	178	198	218	238	258	340	360	380	400	420	440	460	480	500	510	958
19	39	59	79	99	119	139	159	179	199	219	239	259	341	361	381	401	421	441	461	481	501	510	959
20	40	60	80	100	120	140	160	180	200	220	240	260	342	362	382	402	422	442	462	482	502	510	960

ELECTRONICS November 22, 1973 card expires February 4, 1974

NAME _____ TITLE _____

COMPANY _____

STREET _____

CITY _____ STATE _____ ZIP _____

Industry Classification (check one)

a Computer & Related Equip. f Consumer Products
 b Communications Equip. & Systems g Industrial Controls & Equip.
 c Navigation, Guidance or Control Systems h Components & Subassemblies
 d Aerospace, Underseas Ground Support j Independent R&D Organizations
 e Test & Measuring Equip. k Government

1	21	41	61	81	101	121	141	161	181	201	221	241	261	343	363	383	403	423	443	463	483	503	713
2	22	42	62	82	102	122	142	162	182	202	222	242	262	344	364	384	404	424	444	464	484	504	714
3	23	43	63	83	103	123	143	163	183	203	223	243	263	345	365	385	405	425	445	465	485	505	715
4	24	44	64	84	104	124	144	164	184	204	224	244	264	346	366	386	406	426	446	466	486	506	716
5	25	45	65	85	105	125	145	165	185	205	225	245	265	347	367	387	407	427	447	467	487	507	717
6	26	46	66	86	106	126	146	166	186	206	226	246	266	348	368	388	408	428	448	468	488	508	718
7	27	47	67	87	107	127	147	167	187	207	227	247	267	349	369	389	409	429	449	469	489	509	719
8	28	48	68	88	108	128	148	168	188	208	228	248	268	350	370	390	410	430	450	470	490	510	720
9	29	49	69	89	109	129	149	169	189	209	229	249	269	351	371	391	411	431	451	471	491	510	900
10	30	50	70	90	110	130	150	170	190	210	230	250	270	352	372	392	412	432	452	472	492	510	901
11	31	51	71	91	111	131	151	171	191	211	231	251	271	353	373	393	413	433	453	473	493	510	902
12	32	52	72	92	112	132	152	172	192	212	232	252	272	354	374	394	414	434	454	474	494	510	951
13	33	53	73	93	113	133	153	173	193	213	233	253	273	355	375	395	415	435	455	475	495	510	952
14	34	54	74	94	114	134	154	174	194	214	234	254	274	356	376	396	416	436	456	476	496	510	953
15	35	55	75	95	115	135	155	175	195	215	235	255	275	357	377	397	417	437	457	477	497	510	954
16	36	56	76	96	116	136	156	176	196	216	236	256	338	358	378	398	418	438	458	478	498	510	956
17	37	57	77	97	117	137	157	177	197	217	237	257	339	359	379	399	419	439	459	479	499	510	957
18	38	58	78	98	118	138	158	178	198	218	238	258	340	360	380	400	420	440	460	480	500	510	958
19	39	59	79	99	119	139	159	179	199	219	239	259	341	361	381	401	421	441	461	481	501	510	959
20	40	60	80	100	120	140	160	180	200	220	240	260	342	362	382	402	422	442	462	482	502	510	960

If the cards below have already been used, you may obtain the needed information by writing directly to the manufacturer, or by sending your name and address, plus the Reader Service number, to Electronics Reader Service Department, Box 2530, Clinton, Iowa 52732.

First Class
Permit No. 217
Clinton, Iowa

BUSINESS REPLY MAIL

No Postage Stamp Necessary if Mailed in the United States

Postage will be paid by

Electronics

P.O. Box No. 2530
Clinton, Iowa 52732

First Class
Permit No. 217
Clinton, Iowa

BUSINESS REPLY MAIL

No Postage Stamp Necessary if Mailed in the United States

Postage will be paid by

Electronics

P.O. Box No. 2530
Clinton, Iowa 52732

Electronics Reprint Service

Bulk reprints of editorial matter can be ordered from current or past issues. The minimum quantity is 500 copies. Prices quoted on request; call 609-448-1700 Ext. 5494, or write to address below.

The Pervasiveness of Electronics
Complete issue 284 pages \$2.00
Key no. R-328

The Optical Spectrum
\$2.00 Key no. R-326

Semiconductor Memory Systems
16 pages \$3.00 Key no. R-324

New Electronic Displays
10 pages \$2.00 Key no. R-322

Planar Interconnection Techniques
13 pages \$3.00 Key no. R-320

Automotive Electronics
16 pages \$3.00 Key no. R-318

Hybrid Circuit Technology
16 pages \$3.00 Key no. R-316

Leadless, Pluggable IC Packages Reduce Costs 7 pages \$2.00
Key no. R-312

Penetration Color Tubes are Enhancing Information Displays 6 pages \$2.00
Key no. R-310

Program for Transition from Non Linear to Linear Transistor Model
6 pages \$2.00 Key no. R-308

Charge Coupling Improves Its Image
8 pages \$2.00 Key no. R-306

U.S. Market Report
28 pages \$2.00 Key no. R-304

European Market Report
24 pages \$2.00 Key no. R-302

Japan Market Report
16 pages \$2.00 Key no. R-300

Electromagnetic Spectrum Chart
Key no. R-213 \$2.00

Electromagnetic Spectrum Report
16 pages plus Wall Chart \$4.00
Key no. R-211

Semiconductor Rams Mature
15 pages \$2.00 Key no. R-209

Computer Peripherals
16 pages \$3.00 Key no. R-207

Active Filters
96 pages \$4.00 Key no. R-032

Circuit Designer's Casebook
162 pages \$4.00 Key no. R-031

To order reprints or for further information, please write to:

Electronics Reprint Department
P.O. Box 669
Hightstown, N.J. 08520

Only orders with cash, check, or money order will be accepted. No invoicing will be done.

Pocket logic tester

\$395

Logic misbehaving? Forget old-fashioned scope-and-probe, hunt-and-peck methods. The

TRENDAR 200 IC TESTCLIP™ finds and displays logic defects. It pinpoints faults ten times faster: component faults . . . solder faults . . . board defects. And TESTCLIP finds the culprit where loops or multiple faults defy the most sophisticated test systems. The reference IC plugs in the side and TESTCLIP does the rest. A universal troubleshooting procedure, FAULTRACK®, can be quickly learned. Your test technicians can now turn out more finished product. Your service technicians can now fix boards on site. Your R&D group can cut prototype checkout time.

The result: inventory is saved, productivity zooms, and customers admire your fast, reliable field service. All for only \$395. Your Fluke TRENDAR representative has TESTCLIP in stock for immediate delivery and will show you the secret of FAULTRACK. Ask him.

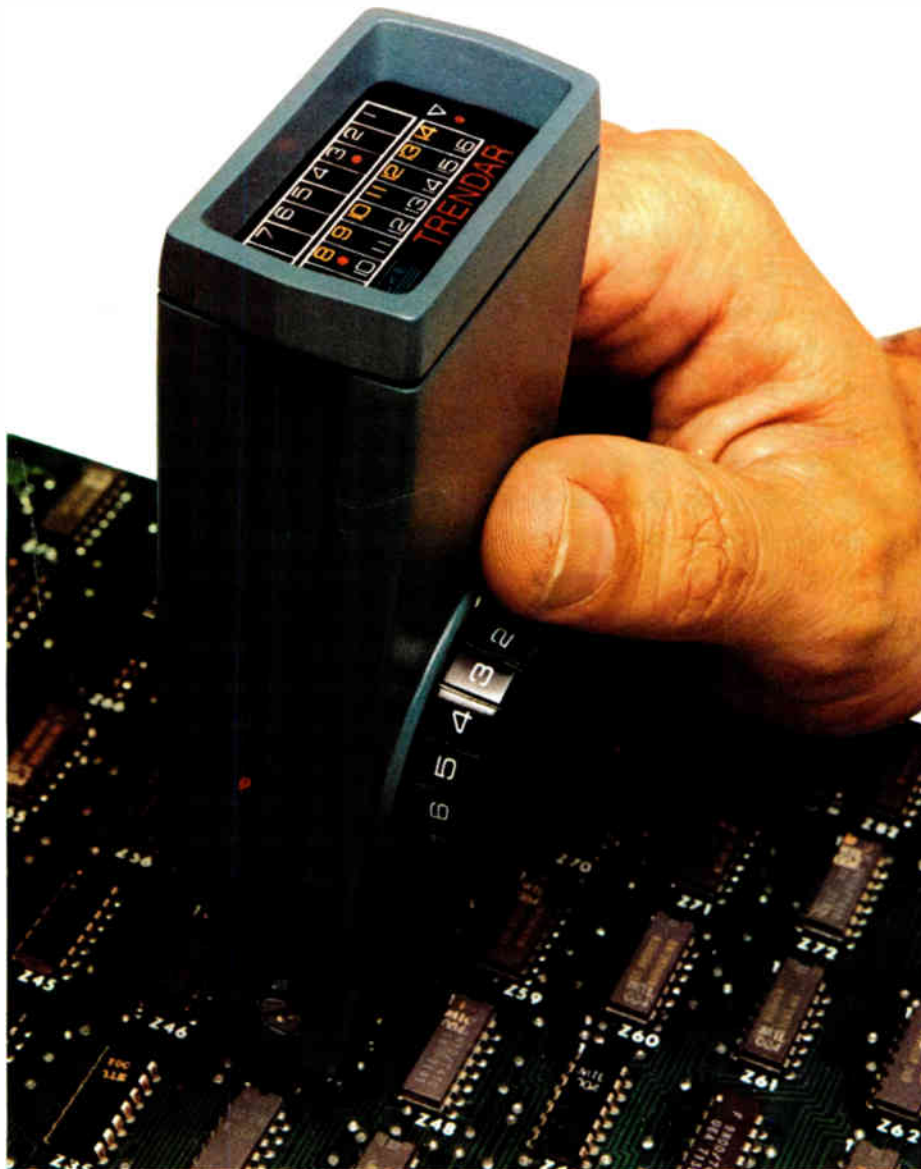

Sales and Service

U.S. AND CANADA

Albuquerque, NM (505) 299-7658
Cleveland, OH (216) 264-0445
Dayton, OH (513) 434-7500
Denver, CO (303) 934-5505
Des Plaines, IL (312) 298-3600
Detroit, MI (313) 892-2500
Glastonbury, CT (203) 633-0777
Glendale, CA (213) 245-9404
Greensboro, NC (919) 273-1918
Houston, TX (713) 621-0040
Huntsville, AL (205) 881-8220
Indianapolis, IN (317) 244-2458
Kensington, MD (301) 881-5300
King of Prussia, PA (215) 265-1600
Lexington, MA (617) 881-8620
Minneapolis, MN (612) 884-4336
Orlando, FL (305) 896-4881
Pittsburgh, PA (412) 892-2953
Pleasantville, NY (914) 769-1811
Richardson, TX (214) 231-2573
Rochester, NY (716) 266-1400
San Diego, CA (714) 565-2555
Santa Clara, CA (408) 244-1505
San Juan, PR (305) 869-4881
Scottsdale, AZ (602) 947-7841
St. Louis, MO (314) 423-1234
Seattle, WA (206) 624-9020
Vancouver, WA (503) 283-3287
Union, NJ (201) 687-8737
Calgary, Alta (403) 261-0780
Montreal, Que (514) 670-1212
Ottawa, Ont (613) 829-9651
Toronto, Ont (416) 678-1500
Vancouver, BC (604) 253-7136

INTERNATIONAL

Athens, Marlos Dalleggio Rep. 710-669
Auckland, David J. Reid, (N.Z.) Ltd.
Bangkok, G. Simon Radio, Ltd. 30991-3
Bogota, Marones Ltda 36 47 31
Bombay, Hinditron Services Pvt. Ltd. 365344
Brookvale, (Australia)
Elmeasco Instruments Pty. Ltd. 939-7944
Brussels, C. N. Rood S.A. 352135
Buenos Aires, Coasin S.A. 523185
Caracas, Coasin C.A. 72 23 11
Copenhagen, Tage Olsen A/S 294800
Helsinki, OY Findip AB 717799
Hong Kong, Gilman & Co., Ltd. 227011
Johannesburg, Elairco, (Pty.) Ltd. 20272
Karachi, Pak International Operations
Kota Kinabalu, O'Connor's (Pte) Ltd.
Lagos, Deemtee Electrotechnics, Ltd.
Lima, Importaciones Y Rep Elect 272078
Lisbon, Equip. De Laboratorio Ltda 976551
Madrid, Atalo Ingenieros S.A. 2153543
Mexico, Mexitek, S.A. 5-36-09-10
Montevideo, Coasin Uruguay S.A.
Munich, Fey Elektronische Messgeraete 184041
Oslo, Morgenstjerne & Co. A/S 372940
Paris,
(Suresnes) M. B. Electronique, S.A. 7723108
Quito, Proteco Coasin CIA, Ltda 526-759
Rijswijk, C. N. Rood B. V. 996360
Rio de Janeiro, Ambrlex, S.A. 264-7406
Rome, Sistel SpA 500-1860
Santiago, Coasin Chile Ltd. 396713
Sao Paulo, Ambrlex, S.A. 52-7806
Selangor, O'Connor's (Pte) Ltd.
Seoul, Asia Science & Co. 24-1431
Singapore, O'Connor's (Pte) Ltd. 637944
Taipei, Heighten Trading Co. Ltd. 518324
Tehran, Berkeh Company Ltd. 628294
Tel Aviv, R. D. T. Electronics Engrg. Ltd. 456181
Tilburg, Fluke (Nederland) B.V. 013-673973
Tokyo, Toyo Trading Co. Ltd. (03) 279-0771
Vallinby, Telinstrument AB 380370
Vienna, Kontron GmbH & Co. KG 420202
Watford, U.K., Fluke International Corp. 33066
Zurich, Kontron Electronic AG 628282
Caribbean, West Indies Sales Co.
(San Juan) (809) 723-3743
Peoples Rep. of China,
May Lee Industries (N.Y.) (212) 532-9200
U.S.S.R., Codevintec Pacific, Inc.
(L.A.) (213) 348-1719



TRENDAR

subsidiary of John Fluke Mfg. Co. Inc.

500 Clyde Avenue, Mountain View, California 94043 • 415/965-0350 TWX 910-379-6573

Europe, Fluke (Nederland) B.V., P.O. Box 5053, Tilburg, Netherlands, Tel. 013-673973. Telex. 52273

U.K., Fluke International Corp., Garnett Close, Watford, WD2, Tel. Watford 33066, Telex. 934583



New Photoconductive Material Rock Stable... Less Light Memory

New Type 9 photoconductive material is now available in three photocell packages from Clairex — TO-5, TO-8, TO-18. Type 9 material is more stable at high temperatures and has less light memory than normal CdS materials. Type 9 material also has improved linearity and broader spectral response. Try Type 9 material if you have photocell stability problems.

Call (914) 664-6602 or write Clairex[®], 560 South Third Avenue, Mount Vernon, New York 10550.

CLAIREX ELECTRONICS
A DIVISION OF CLAIREX CORPORATION