

- 91 Video applications for silicon-target storage tubes
- 108 A new IC component: the binary capacitor
- 112 Cutting digital detector costs with read-only memories

STATIONER  
 1470 ICHS98 MCSA1 JUN73  
 ST TECHNICAL INST  
 LIBRY  
 002 MACON COVE

# Electronics®

**MAKING  
 MINICOMPUTER  
 PROGRAMING  
 SIMPLE**

PUSH A  
 PUSH B  
 ADD  
 PUSH C  
 PUSH D  
 SUB  
 DIV  
 X = (A + B) / (C - D)  
 POP X



1470 ICHS98 MCSA1 JUN73  
 ST TECHNICAL INST  
 LIBRY  
 002 MACON COVE

# 3 Wire Synchro to Linear D.C. Converter

ACCURACY 1/2 %



#MAC 1422-1

Provides a linear conversion of a synchro angle to a DC Voltage

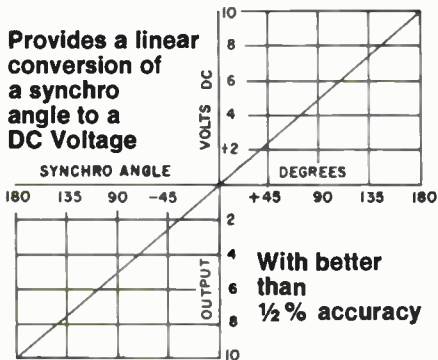

- Scaled for  $\pm 10V$  DC output
- Operates from  $\pm 15V$  supplies
- No external adjustments
- Hermetically sealed
- Output short circuit protected
- Units can be altered to operate with different L-L Voltages or frequency

## Specifications

Accuracy:  $\pm 1\%$  over temperature range

Input: 11.8V, 400HZ line to line 3 wire synchro voltage

Output impedance: less than 10 Ohms

Input impedance: 10K minimum line to line

Reference:  $26V \pm 10\%$  400HZ (Unit can be altered to accommodate 115V if available at no extra cost)

Operating temperature range:  $-25^\circ C$  to  $+85^\circ C$

Storage temperature range:  $-55^\circ C$  to  $+100^\circ C$

DC power:  $\pm 15V \pm 1\%$  @ 75ma (approx.)

Case material: High permeability Nickel Alloy

Weight: 6 Ozs.

Size: 3.6" x 2.5" x 0.6"

## Precision Analog Components for Signal Manipulation and Function Generation

- Radiation Hardened Analog Multipliers and Modulators
- Linear DC to Synchro Converter
- Sine-Cosine to 3 Wire Converter
- 3 Wire to Linear DC Converter
- 3 Wire to Sine-Cosine Converter
- Sine-Cosine Generators
- Precision Modulators
- Precision Analog Multipliers
- Squaring/Square Root Modules
- Precision Analog Divider
- Precision A.C. Regulators
- Demodulators
- Transformers

## Analog Computing Applications

- Trigonometric Manipulations
- Multiplying
- Dividing
- Squaring
- Modulating
- Automatic Gain Control
- Demodulation
- RMS Computation
- Phase Measurement
- AC Amplitude Regulation and Modulation
- Linearizing
- Square Rooting
- Power Measurement
- Ratio Measurement

# 4 Quadrant Magnetic Analog Multiplier

DC x AC = AC Output

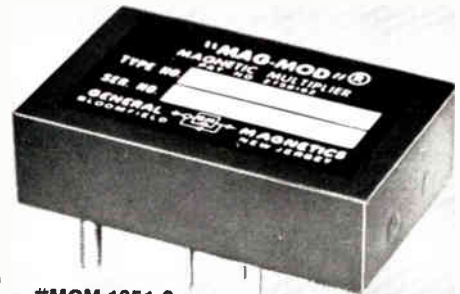

#MCM 1351-2

**Product Accuracy is  $\pm 1/2\%$  of all readings Over Full Temperature Range of  $-55^\circ C$  to  $+125^\circ C$**

- Product accuracy is specified in % of reading for all output analog voltage product points over the full military temperature range instead of % of full scale error giving superior results for small values.
- Linearity, product accuracy, and zero point virtually unaffected by temperature changes.
- All units are hermetically sealed and completely shielded from external electric or magnetic fields.

## Specifications Include:

Transfer equation:  $E = XY/3$

X & Y input signal ranges: 0 to  $\pm 3V$  Peak

Maximum static and dynamic product error:  $1/2\%$  of point or 2 MVRMS, whichever is greater, over entire temperature range

Input impedance:  $X = 10K; Y = 10K$

Full scale output: 3 VRMS

Minimum load resistance for full scale output: 2000 ohms

Output impedance: Less than 50 ohms

X input bandwidth:  $\pm 0.5db, 0$  to 200 hertz

Y input bandwidth:  $\pm 0.5db, 20$  hertz to 1000 hertz

DC power:  $\pm 15V$  unless otherwise required @ 20 ma

Size: 1.8" x 1.1" x 0.5"

There is No Substitute for Reliability



**GENERAL MAGNETICS, INC.**

135 Bloomfield Avenue  
Bloomfield, New Jersey 07003  
(201) 743-2700

There is No Substitute for Reliability



**GENERAL MAGNETICS, INC.**

135 Bloomfield Avenue  
Bloomfield, New Jersey 07003  
(201) 743-2700

# Here's a good reason to buy HP Modular Power Supplies

**Value Plus** . . . at HP that means selection, performance, reliability, price! HP value plus starts with a broad selection of models and ratings in our 62000 Series. Performance? It's yours with 0.01% line and load regulation, 1mV rms/2mV p-p ripple and noise. Long a leader in the field, HP reliability means trouble-free design utilizing conservatively rated, quality components, plus built-in protective features. All this . . . and they're competitively priced (with quantity and OEM discounts).



## and another

Just as important . . . HP assures you of total program support, now and later. We have accessories to make your system designing easy, like: rack mounting trays, panels, slides and a compatible cooling unit. In fact, HP will build your entire system right to the custom front and rear panels.

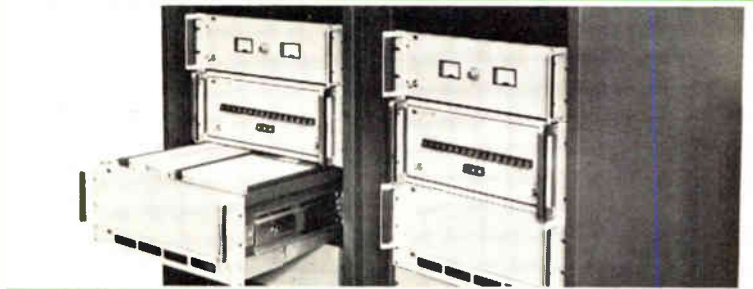

## and another

### New! Switching Regulated Supplies

. . . with advanced transistor switching design and up to 80% efficiency . . . which means a lot more power in a smaller, cooler operating package, with overvoltage, overcurrent, overtemp. reverse voltage and protected remote sensing standard . . . 4V to 28V; with up to 300 Watts output.



## and another

Confidence . . . HP confidence is one feature you don't see, but it's reflected in every HP Laboratory, Modular, Industrial and Digitally Programmable Power Supply. This leadership is backed by the most comprehensive service manuals, a selection guide and catalog, a 140-page power supply handbook, application assistance and a world-wide network of 172 sales and service offices in 65 countries . . . now that's confidence . . . that's Hewlett-Packard.

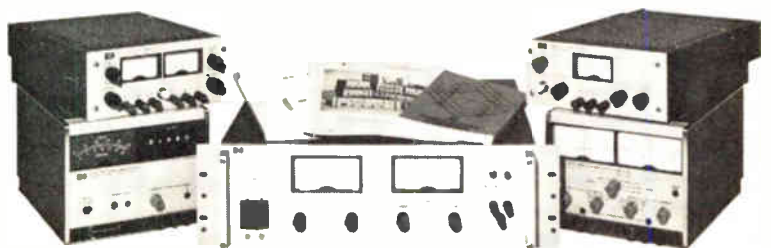

For detailed information, contact your local HP field engineer.  
Or, write: Hewlett Packard, Palo Alto, California 94304  
In Europe: Post Office Box 85, CH-1217 Meyrin 2, Geneva, Switzerland

HEWLETT  PACKARD  
21302

# Fill out this coupon:

Mail to: Hewlett-Packard,  
1501 Page Mill Road,  
Palo Alto, California 94304



Name \_\_\_\_\_

Company \_\_\_\_\_

Title \_\_\_\_\_

Address \_\_\_\_\_

City \_\_\_\_\_ State \_\_\_\_\_ Zip \_\_\_\_\_

## and we'll throw the book at you.



**We'd like to send you our new booklet on how HP's high-precision universal counters can help you make better time interval and frequency measurements.**

HP's 5326/5327 Series of counters offer you unmatched flexibility and versatility for a wide variety of applications. But best of all, you can get the exact counter you need without paying for a lot of extras.

For example, you can get frequency ranges to 50 MHz or to 550 MHz. You

can get a counter with or without time interval averaging which can let you measure short time intervals faster and cheaper than ever before.

Or you can get a counter with or without a built-in DVM for more accurate and more convenient time interval measurements. And these counters feature a higher input sensitivity and high-accuracy time bases that have FCC-type approval.

And that's not all. HP gives you the most complete systems interface at the lowest cost. That means you can have the most ideal systems counter available anywhere. In fact, these counters are so versatile you can get almost any combination you need. Prices start as low as \$995.

Fill out the coupon and we'll rush you a copy of our new brochure which spells out the story in more detail. Or write: Hewlett-Packard, 1501 Page Mill Road, Palo Alto, California 94304; Europe: P.O. Box 85, CH-1217 Meyrin 2, Geneva, Switzerland; Japan: Yokogawa — Hewlett-Packard, 1-59 1, Yoyogi, Shibuya-ku, Tokyo, 151.

02209

**HEWLETT  PACKARD**

## 31 Electronics Review

**INSTRUMENTATION:** CCD cameras may outshine vidicons, 31  
**MATERIALS:** IBM develops amorphous material for bubbles, 32  
**COMMUNICATIONS:** Arpanet engineers plan computer utility, 32  
**COMPUTERS:** The new Ruggednova comes on strong, 33  
**COMPUTERS:** Will IBM's Diskette KO punched cards? 33  
**GOVERNMENT ELECTRONICS:** Proposed laser standards irk industry, 34  
**AUDIO ELECTRONICS:** Varispeech systems could aid blind, 34  
**COMMERCIAL ELECTRONICS:** Computer tells blind what they write, 36  
**COMMERCIAL ELECTRONICS:** Digital thermometer uses DVM chip, 36  
**PACKAGING:** DIPs challenged by film-strip package, 38  
**MARINE ELECTRONICS:** Echo triggers LEDs in depthfinder, 38  
**SOLID STATE:** Plating the way to inexpensive masks, 41  
**SOLID STATE:** Fairchild advances bipolar technique, 41  
**SOLID STATE:** Hearing aid IC cuts battery drain, 43  
**NEWS BRIEFS:** 43  
**DISPLAYS:** Silicon display tested by Air Force, 44  
**MEDICAL ELECTRONICS:** The MODS look in computerized medicine, 46  
**MEDICAL ELECTRONICS:** Electron imaging alleviates X-ray ills, 46  
**MEDICAL ELECTRONICS:** Digital spirometer priced under \$1,000, 48

## 55 Electronics International

**JAPAN:** Tuner uses MAOS memory for tuning, 55  
**WEST GERMANY:** Scale uses MOS, optical techniques, 55

## 68 Probing the News

**THE 1974 BUDGET:** Nixon, Congress battle over purse strings, 68  
**DEFENSE:** No electronics windfall, 70  
**COMMUNICATIONS:** Emphasis on cable TV, 72  
**NASA:** Cupboard almost bare, 73  
**TRANSPORTATION:** Take a flier on the FAA, 74  
**SCIENCE POLICY:** NSF takes the hand-off, 78  
**SOCIAL PROGRAMS:** Money is spread out, 78

## 91 Technical Articles

**DISPLAYS:** Silicon-target tubes outdo direct-view types, 91  
**COMPUTERS:** Microprogramming and architecture aid programmer, 95  
**DESIGNER'S CASEBOOK:** Generating negative resistance, 102  
Low-distortion modulator tests hi-fi a-m tuners, 104  
Programmable multivibrator is four-in-one circuit, 105  
Two-IC digital filter varies passband easily, 106  
**COMPONENTS:** Dual-polarity IC regulators aid design, 108  
**DATA COMMUNICATIONS:** ROMs cut cost of m-out-of-N detectors, 112  
**SOLID STATE:** Two-level capacitor improves MOS memory, 115  
**ENGINEER'S NOTEBOOK:** Voltmeter measures small currents, 118  
Three-step shortcut for finding square roots, 118  
Using pocket calculators to square numbers directly, 119  
Adding numeric readout to logic-probe displays, 119

## 123 New Products

**IN THE SPOTLIGHT:** Inter-bus modules fashion mini arrays, 123  
**SUBASSEMBLIES:** Sample-hold amplifier covers all bases, 127  
**INSTRUMENTS:** Multimeter specs rise, price stays low, 135  
**PACKAGING & PRODUCTION:** Hermetic package is low-priced, 143  
**SEMICONDUCTORS:** Darlington transistor delivers 20 A at 400 V, 153  
**MATERIALS:** 161

## Departments

Publisher's letter, 4	Washington newsletter, 51
Readers comment, 6	Washington commentary, 52
40 years ago, 8	International newsletter, 57
People, 14	Engineer's newsletter, 120
Meetings, 22	New literature, 168
Electronics newsletter, 27	New books, 174

## Highlights

### The battle of the budget, 68

Nixon and Congress are struggling over who controls the purse strings, and some Federal electronics programs could get shot down. The outcome is unlikely to be cut-backs in existing contracts, but "if you are looking for big new starts, forget it," sums up one corporate analyst.

### Storage tube with silicon target has many uses, 91

Dividing the functions of a direct-view storage tube between a CRT display and a silicon-target tube results in a storage tube of greater ruggedness and resolution and smaller size. It performs better in existing applications and attracts new applications.

### Minicomputer programing at minimal cost, 95

Working in machine language may make the most of a minicomputer's performance, but it also maximizes programming costs. A microprogramed minicomputer has therefore been designed from the ground up to talk a high-level language efficiently.

### Build your own multiprocessor, 123

Bus-interconnection modules for the PDP-11 minicomputers let the user design his own computer hierarchy, network, or multiprocessor array. Such arrangements are often more economical—and more reliable—than medium-scale machines of the same capability.

### And in the next issue . . .

The right oscilloscope probe . . . interfacing MOS chips with a gas-discharge display . . . computer decimal operation.

### The cover

Stack architecture enables the Microdata 32/S minicomputer to translate instructions in a high-level language with unusual simplicity and speed.

EDITOR-IN-CHIEF: Kemp Anderson

EXECUTIVE EDITOR: Samuel Weber

MANAGING EDITORS: Lawrence Curran, *News*;  
Arthur Erikson, *International*

SENIOR EDITORS: John Johnsrud,  
H. Thomas Maguire, Laurence Altman

ART DIRECTOR: Fred Sklenar

ASSOCIATE EDITORS: John N. Kessler,  
Howard Wolff, Gerald M. Walker

### DEPARTMENT EDITORS

*Aerospace*: William F. Arnold  
*Circuit Design*: Lucinda Matterna  
*Communications & Microwave*:  
Lyman J. Hardean  
*Computers*: Wallace B. Riley  
*Consumer*: Gerald M. Walker  
*Industrial*: Alfred Rosenblatt  
*Instrumentation*: Michael J. Riezenman  
*Military*: Ray Connolly  
*New Products*: H. Thomas Maguire  
*Packaging & Production*: Stephen E. Grossman  
*Solid State*: Laurence Altman  
*Special Issues*: Harry R. Karp

COPY EDITORS: Margaret Eastman,  
Everett C. Terry

ASSISTANT EDITOR: Marilyn Offenheiser

ART: Charles D. Ciatto, *Associate Director*

PRODUCTION EDITORS:  
Patricia Cybulski, Arthur C. Miller

EDITORIAL SECRETARIES: Janet Annunziata,  
Julie Gorgoglione, Penny Roberts

### FIELD EDITORS

*Boston*: James Brinton (Mgr.), Gail Farrell  
*Los Angeles*: Paul Franson (Mgr.)  
*Midwest*: Larry Armstrong (Mgr.)  
*New York*: Alfred Rosenblatt (Mgr.)  
*San Francisco*: George Sideris (Mgr.),  
Judith Curtis  
*Washington*: Ray Connolly (Mgr.),  
William F. Arnold  
*Frankfurt*: John Gosch  
*London*: Michael Payne  
*Paris*: Arthur Erikson  
*Tokyo*: Charles Cohen

### McGRAW-HILL WORLD NEWS

*Director*: Walter A. Stanbury  
*Bonn*: Robert Ingersoll;  
*Brussels*: James Smith;  
*London*: Marvin Petal;  
*Milan*: Peter Hoffmann, Andrew Heath;  
*Moscow*: Axel Krause;  
*Paris*: Stewart Toy, Michael Johnson;  
*Stockholm*: Robert Skole;  
*Tokyo*: Mike Mealey

PUBLISHER: Dan McMillan

ADVERTISING SALES MANAGER: Pierre J. Braudé

ADVERTISING SALES SERVICE MANAGER:  
Wallis Clarke

BUSINESS MANAGER: Stephen R. Weiss

CIRCULATION MANAGER: George F. Werner

MARKETING SERVICES MANAGER:  
Tomlinson Howland

In Washington, this time of year, the Government stages the annual ritual called "Announcing the Federal Budget." At best, it's a ritual guaranteed to keep journalists up late poring over the huge budget volumes that the Government generates, as well as the special supporting documents put out by the various agencies, to extract the nuggets of information to pass on to their readers.

But, especially with this year's "austerity" budget threatening the chances for new business, it's an important story for us to cover and bring to all segments of the electronics industries. And, as in previous years, we had a team of *Electronics* editors on the spot to get it, both from the pages of the budget volumes and from the mouths of agency spokesmen, Government observers, and industry officials (see *Probing the News*, p. 68).

Ray Connolly, our Washington bureau chief, assisted by Bill Arnold, who covers the Washington aerospace beat, directed the coverage. In addition, Larry Curran, managing editor for news, headed a four-man New York contingent that trekked to the Capital for a concentrated week-end of work. The New York reporting team was rounded out by Howard Wolff, associate editor; Al Rosenblatt, New York bureau manager; and Lyman Hardean, communications and microwave editor.

"The one big difference this year from previous budget expeditions," says Curran, "came in the tone of frugality set at some of the briefings given by agency spokesmen and in the combative mood perceived in Washington. That tone and that

mood suggest this: despite the Administration's attempts to show economies, President Nixon's fiscal 1974 budget is probably in for more flak on Capitol Hill than any in recent memory.

"Congress is angry because many in that Democrat-controlled body think the President is trying to usurp what they regard as their most powerful constitutional weapon—the power of the purse. And the President is challenging that prerogative by refusing to spend some \$8.7 billion in fiscal 1973 money appropriated by Congress.

"An adversary mood tends to surface in budget hearings on Capitol Hill. This year that mood will be sharpened by the Administration's attempt to impound funds approved by Congress last year. Also, many influential senators and congressmen regard the new budget as too lean on butter and too fat on guns, even though a hike in defense spending reflects mainly wage and price increases.

"With all this uncertainty, electronics company officials are hoping that their chances to pick up new business, albeit slim with the tight-belt budget, won't get bludgeoned as the budget items thread their way through the appropriation process."

Supporting our editorial team in presenting its findings was Fred Sklenar, our art director, who enlivened the pages with illustrations of key Administration and congressional spokesmen.



February 15, 1973 - Volume 46, Number 4  
90,264 copies of this issue printed

Published every other Thursday by McGraw-Hill, Inc. Founder James H. McGraw 1860-1948. Publication office 1221 Avenue of the Americas, N.Y., N.Y. 10020. Second class postage paid at New York, N.Y. and additional mailing offices.

Executive, editorial, circulation and advertising addresses: Electronics, McGraw-Hill Building, 1221 Avenue of the Americas, New York, N.Y. 10020. Telephone (212) 997-1221. Teletype TWX N.Y. 710-581-5234. Cable address: MCGRAW HILL N.Y.

Subscriptions limited to persons with active, professional, functional responsibility in electronics technology. Publisher reserves the right to reject non-qualified requests. No subscriptions accepted without complete identification of subscriber name, title, or job function, company or organization including product manufactured or services performed. Subscription rates: qualified subscribers in the United States and possessions: Canada and Mexico \$8.00 one year, \$12.00 two years, \$16.00 three years; all other countries \$25.00 one year except Japan \$50.00 per year including air freight. Limited quota of subscriptions available at higher-than-basic rate for persons outside of field served as follows: U.S. and possessions and Canada, \$25.00 one year; all other countries \$50.00. Single copies: United States and possessions and Canada, \$1.00; all other countries, \$1.75.

Officers of the McGraw-Hill Publications Company: John R. Emery, President; J. Elton Tuohy, Senior Vice President—Services; Donald B. Gindley, Group Vice President, Vice Presidents: Ralph Blackburn, Circulation; John R. Callahan, Editorial; John B. Hoglund, Controller; David G. Jensen, Manufacturing; Jerome D. Luntz, Planning & Development; Joseph C. Page, Marketing.

Officers of the Corporation: Shelton Fisher, President; Wallace F. Traudly, Group President, McGraw-Hill Publications Company and McGraw-Hill Informations Systems Company; John J. Cooke, Senior Vice President and Secretary; Ralph J. Webb, Treasurer. Title registered in U.S. Patent Office; Copyright © 1972 by McGraw-Hill, Inc. All rights reserved. The contents of this publication may not be reproduced either in whole or in part without the consent of copyright owner.

Subscribers: The publisher, upon written request to our New York office from any subscriber, agrees to refund that part of the subscription price applying to copies not yet mailed. Please send change of address notices or complaints to Fulfillment Manager, subscription orders to Circulation Manager, Electronics, at address below. Change of address notices should provide old as well as new address, including postal zip code number. If possible, attach address label from recent issue. Allow one month for change to become effective.

Postmaster: Please send form 3579 to Fulfillment Manager, Electronics, P.O. Box 430, Hightstown, N.J. 08520.

# a superior power supply

# FOR YOUR SYSTEM FROM KEPCO

## introducing the **PTR** automatic crossover power supply module

PTR is an exceptionally stable power supply module offering the convenience of automatic crossover operation for the stabilization of either voltage or current. It offers fully operational programming control of both channels—with a "flag" to tell your system which mode the combination of control and load has selected. PTR's are well built, in the Kepco tradition. All I-C's and transistors (including the power transistors) are socketed for easy maintenance. The entire circuit is contained on a plug-in printed circuit card.

A compact 13 $\frac{7}{8}$ " x 5" x 3 $\frac{1}{32}$ " convection-cooled package that will deliver its full current in any environment—up to 71°C. There is no derating requirement.

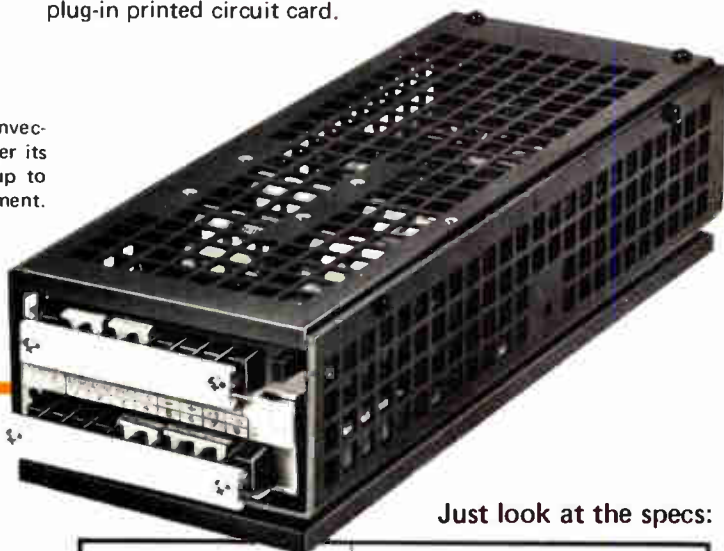

Just look at the specs:

INFLUENCE QUANTITY	OUTPUT EFFECTS	
	VOLTAGE MODE	CURRENT MODE
SOURCE: 105–125/210–250V a.c.	<0.001%	<0.005%
LOAD: No load – full load	<0.005% or 0.1 mV <sup>(1)</sup>	<3.0 mA
TIME: 8-hour [drit]	<0.01% or 0.2 mV <sup>(1)</sup>	<0.05% or 0.1 mA <sup>(1)</sup>
TEMPERATURE: Per °C	<0.01%	<0.05% or 0.1 mA <sup>(1)</sup>
RIPPLE: [rms]	<0.1 mV	<0.5 mA
RIPPLE: P-P [20 Hz–10 MHz]	2.0 mV	2.0 mA

<sup>(1)</sup> whichever is greater.

Choose from six compact models:

MODEL	d-c OUTPUT RANGE		PRICE <sup>(2)</sup>	SHIP WGT.	
	VOLTS	AMPS		lbs.	kg.
PTR 7–5.5	0–7	0–5.5	\$225.00	12	5.5
PTR 15–3.3	0–15	0–3.3	225.00	12	5.5
PTR 21–2.5	0–21	0–2.5	225.00	12	5.5
PTR 40–1.4	0–40	0–1.4	225.00	12	5.5
PTR 72–0.8	0–72	0–0.8	225.00	12	5.5
PTR 100–0.6	0–100	0–0.6	225.00	12	5.5

<sup>(2)</sup> Optional overvoltage crowbar: \$25.00.

Three PTR modules will mount conveniently behind a 3 $\frac{1}{2}$ " x 19" panel, 4 units behind a 5 $\frac{1}{4}$ " x 19" panel.

all KEPCO products are backed by a firm  
**5-Year Warranty**

*with* **KEPCO**  
*you're in control!*

For complete specifications and applications notes, write Dept. EL-14

KEPCO, INC. • 131-38 SANFORD AVENUE • FLUSHING, N.Y. 11352 • (212) 461-7000 • TWX #710-582-2631 • Cable: KEPCOPOWER NEWYORK

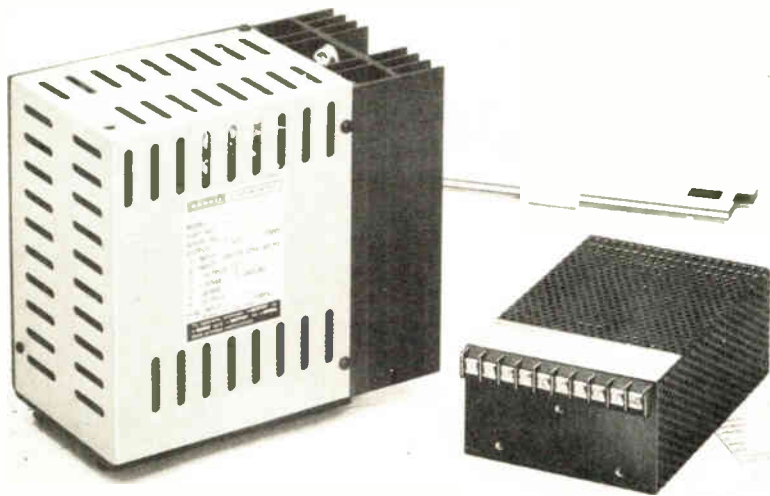

## Reduce Your Power Supply Size and Weight By 70% for \$49

A new way has been found to substantially reduce power supply size and weight. Consider the large power supply shown at left in the above photo — it uses an input transformer, into a bridge rectifier, to convert 60 Hz to 5 volts DC at 5 amperes. This unit measures 6½" x 4" x 7½" and weighs 13 pounds. It sells for \$170 in small quantities. For just \$49.00 more, Abbott's new model Z5T10, shown at right, provides the same performance with 70% less weight and volume. It measures only 2½" x 4" x 6" and weighs just 3 pounds.

This size reduction in the Model Z5T10 is primarily accomplished by eliminating the large input transformer and instead using high voltage, high efficiency, DC to DC conversion circuits. Abbott engineers have been able to control the output ripple to less than 0.02% RMS or 50 millivolts peak-to-peak

maximum. This design approach also allows the unit to operate from 100 to 132 Volts RMS and 47 to 440 Hertz. Close regulation of 0.15% and a typical temperature coefficient of 0.01% per degree Centigrade are some of its many outstanding features. This new Model "Z" series is available in output voltages of 2.7 to 31 VDC in 9 days from receipt of order.

Abbott also manufactures 3,000 other models of power supplies with output voltages from 5 to 740 VDC and with output currents from 2 milliamps to 20 amps. They are all listed with prices in the new Abbott catalog with various inputs:

- 60  $\text{A}$  to DC, Regulated
- 400  $\text{A}$  to DC, Regulated
- 28 VDC to DC, Regulated
- 28 VDC to 400  $\text{A}$ , 1 $\phi$
- 24 VDC to 60  $\text{A}$ , 1 $\phi$

Please see pages 618 to 632 of your 1971-72 EEM (ELECTRONIC ENGINEERS MASTER Catalog) for complete information on Abbott modules.

Send for our new 56 page FREE catalog.

**abbott transistor**

**LABORATORIES, INCORPORATED**  
general offices eastern office

5200 W. Jefferson Blvd./Los Angeles 90016  
(213) 936-8185 Telex: 69-1398

1224 Anderson Ave./Fort Lee, N.J. 07024  
(201) 224-6900 Telex: 13-5332

## Readers comment

### Microwave TV OK was earlier

To the Editor: Your "Electronics review section" [Dec. 4, 1972, p.44] states that "Varian Associates is presently the only manufacturer of microwave transmitters and receivers that have been type-accepted" for multipoint distribution service.

Emcee equipment has been type-accepted by the FCC for this service since Aug. 2, 1972. We are now producing transmitters for such major cities as Washington, D. C., Philadelphia, and Pittsburgh.

Steve Koppelman  
Electronics, Missiles and Communications Inc.  
White Haven, Pa.

### ICs on the track

To the Editor: Your article, "ICs help control diesel locomotive," [Electronics, Nov. 20, 1972, p.32], implies that Genisco's solid-state control is a first on locomotives. General Railway Signal Co. has had ICs on locomotives in a radio remote-control system since June 1968, and in 1953, we first used transistors on a New Haven Railroad locomotive. This, incidentally, was the first use of a transistor outside the communications industry.

We certainly agree that EMI is formidable, but we have worked with electric-propulsion rapid transit and mainline railroads for many years.

M. H. Sluis  
General Railway Signal Co.  
Rochester, N. Y.

### Clarifying meter supply

To the Editor: The story stating that our model AD2004 digital panel meter runs off a "5-volt unregulated supply" [Electronics, Jan. 4, p.125] may prove misleading because an unregulated supply may contain a large amount of ripple and have too high a source resistance. Besides, "unregulated" usually means that the supply voltage can vary by as much as 10% from its nominal value, while our meter can only tolerate variations of up to 5%—its power-supply voltage must be between 4.75 and 5.25 v dc.

Thomas Mealey  
Analog Devices, Inc.  
Norwood, Mass.



# TRW RF Power Modules. The power, the glory — and the gain!

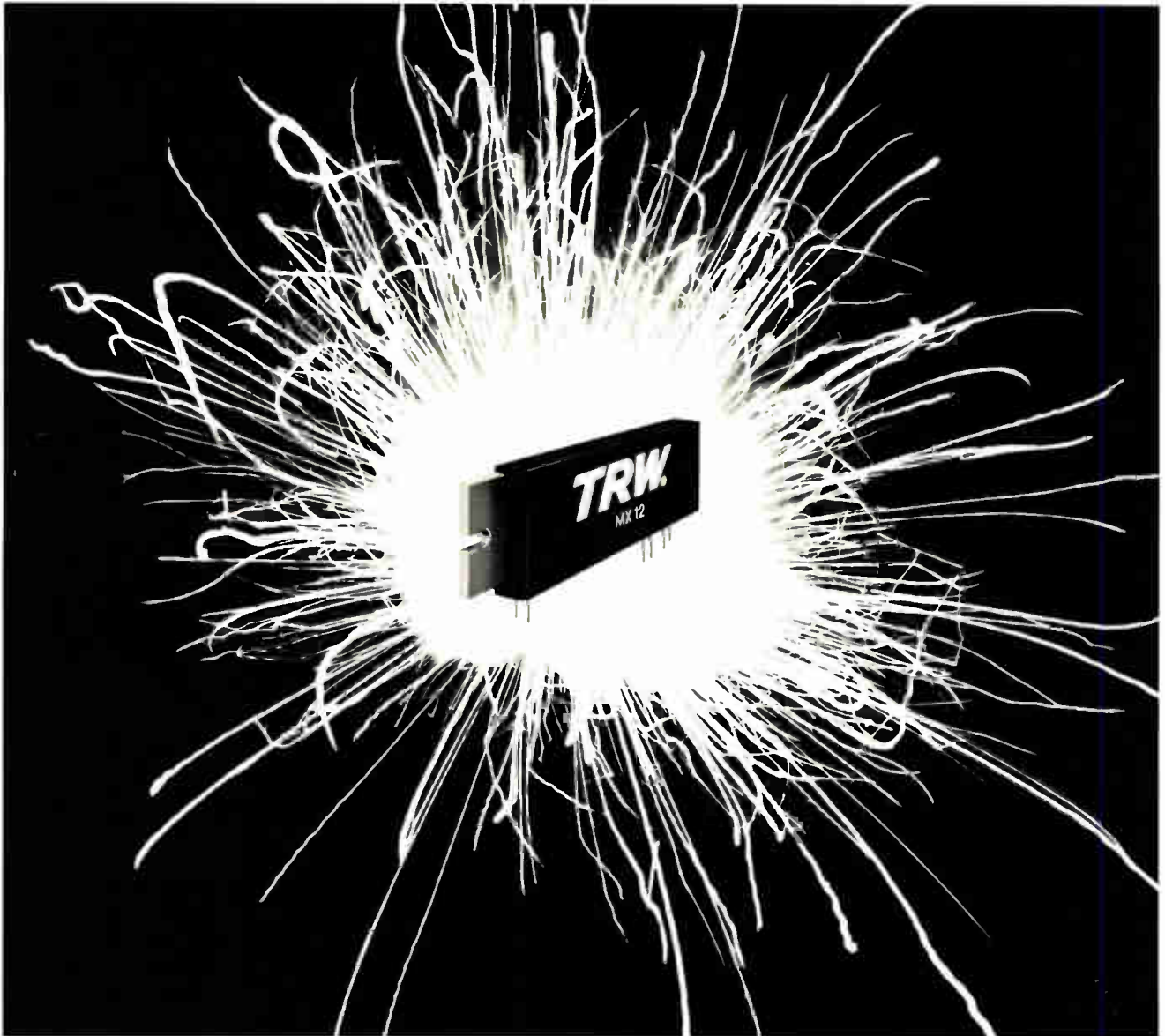

All three are yours — with TRW RF Power Modules at work for you. You get all the gain you want, all the power you need — and at 12V. For any UHF broadband transmitter, or mobile transceiver. From 403-512 MHz. A mere 150 mW in the MX12 — and you get 12 watts out. With the help of a few TRW JØs, 125 mW into an MX7.5 can be stepped up to 160W.

The glory comes your way when your colleagues see the ease of broadband design and manufacture, the quality and reliability of your finished product.

TRW is famous for the ruggedness of its parts, their stability and long life. These RF Power Modules give you the added assurance of knowing only TRW offers such parts with an established history of volume production.

So decide how much power, gain — and glory — you want. Then call or write Sales Manager, TRW Semiconductors, an Electronic Components Division of TRW Inc., 14520 Aviation Blvd., Lawndale, California 90260. Phone (213) 679-4561, ext. 451.

## **TRW** SEMICONDUCTORS

# New



**Increase equipment utilization  
... maintain system integrity  
with 5700 Series  
RS 232 EIA/TELCO Switches!**

**COMPUTER PORT MODEM  
INTERFACE ... only \$97.10**

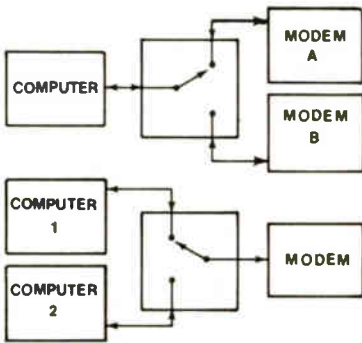

**SPARE MODEM SWITCH  
... only \$175.00**

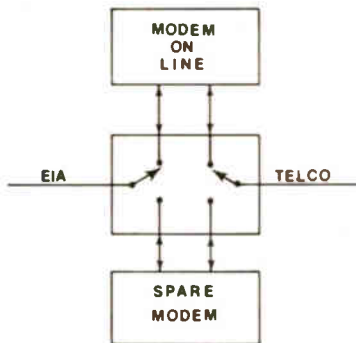

**4 SEPARATE CHANNELS OF  
DIAL-UP BACK UP  
... all for \$98.50**

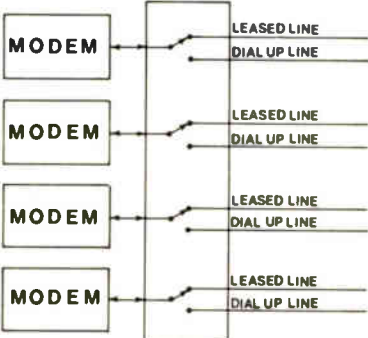

**16-CHANNEL REMOTE  
PUSH BUTTON  
SWITCHING AND CONTROL  
FOR SYSTEM  
RECONFIGURATION  
... only \$160/CHANNEL**



... Plus many many more ...  
all using T-Bar's exclusive  
high reliability DATA-RITE™  
switching devices.

These T-Bar® EIA/TELCO DATACOMM Switches now provide the Communications Systems Engineer and the Communications Manager with a system cost effectiveness that really works. Write or phone today for complete literature ...

**T-Bar**  
**INCORPORATED**  
SWITCHING TECHNOLOGY

141 Danbury Rd., Wilton, Connecticut 06897 Telephone: 203/762-8351

## 40 years ago

From the pages of Electronics, February 1933

The ventilating system of the Roxy Theater in Radio City [New York] is distinguished by an innovation consisting of six ionization machines which provide the equivalent of mountain air in purity and vitality.

The machine consists of a series of special discharge tubes made of transparent vitreous material, containing an inner and outer electrode. These tubes are energized with a high potential electric current, supplied from a step-up transformer. Within these tubes a luminous discharge, rich in ultra-violet, is set up, while outside of the tube an intense electric field is produced and a non-luminous electric discharge takes place in the air surrounding the tube. Solarization, with ultra-violet light, of somewhat shorter wave length than is normally present in sunlight at the earth's surface, is accomplished by both the discharges within and without the tube.

Dr. Karl Compton, of Massachusetts Institute of Technology, did well to coin a new phrase "electrostatic engineering" as defining the new technique that is rapidly being built up employing electrostatic rather than the electro-magnetic effects that have concerned electrical engineers almost wholly so far.

Many examples of this new "electrostatic engineering" are already in evidence.

The 15,000,000-volt electrostatic generator now nearing completion at South Dartmouth, Mass., may wring new secrets from the atom and from the X-ray spectrum. Piezo-crystals are now being used as relays by direct mechanical action on contacts, providing relays that "hold in" with no current expenditure, merely shelf-loss battery charge. Condenser microphones are already familiar; condenser loudspeakers may yet fulfill the promise they inspire. Radio condensers are revising small-motor design.

Electrostatic electricity was the cynosure of Benjamin Franklin's day. It seems destined to a new ascendancy 150 years later, in the post-depression 1930's.

# New Low Cost AM / FM Function Generator Has Built In Modulation Source

EXACT'S NEW Model 129 AM/FM Function Generator lets you do it all with one box. AM internal or external. FM internal or external. Simultaneous AM-FM, sweep, single shot, tone burst. The Model 129 contains two independent function generators. One provides the carrier, while the second provides AM or FM modulating signals plus trig and gating signals in the pulse and burst modes. The two generators provide Sine, Square, Triangle and pulse waveforms. The carrier generator has a frequency range of 0.1Hz to



**Model 129 AM / FM Function Generator**

5MHz and the AM/FM generator 1 Hz to 1 MHz. Up to 100% modulation and double sideband suppressed carrier is provided. FM deviation up to 500:1 around a center frequency is possible. The outputs have precision attenuators, variable d-c offset and all the capabilities to make this the most versatile signal source ever offered at anywhere near the low price tag of \$795. F.O.B. Hillsboro, Oregon. Circle the bingo number and we'll send you more information, or better yet, call the nearest sales office listed below and we'll rush a Model 129 over.



Box 160 Hillsboro, Oregon  
97123 Tel. (503) 648-6661  
TWX 910-460-8811  
**electronics, inc.**

A subsidiary of Danalab, Inc

An Affiliate of **DANA** Laboratories, Inc.

Albuquerque, New Mexico 87112 — Barnhill Three, Inc. — (505) 299-7658  
Brookfield, Wisconsin 53005 — Pivan Engineering, Inc. — (414) 786-1940  
Chicago, Illinois 60645 — Pivan Engineering, Inc. — (312) 539-4838  
Cleveland, Ohio 44126 — Carter, McCormic and Peirce, Inc. — (216) 333-5650  
Dayton, Ohio 45414 — Carter, McCormic and Peirce, Inc. — (513) 278-5873  
Denver, Colorado 80226 — Barnhill Three, Inc. — (303) 934-5505  
Farmington, Michigan 48024 — Carter, McCormic and Peirce, Inc. — (313) 477-7700  
Great Neck, N.Y. 11020 — Measurement Technology, Inc. — (516) 482-3500  
Greensboro, North Carolina 27405 — 8CS Associates, Inc. — (919) 273-1918  
Hamden, Conn. 16518 — Pat Jenks Associates, Inc. — (203) 281-0810  
Houston, Texas — Barnhill Two, Inc. — (713) 621-0040  
Huntsville, Alabama — 8SC Associates, Inc. — (205) 881-6220  
Indianapolis, Indiana 46260 — Pivan Engineering, Inc. — (317) 253-1681  
Kensington, Md. 20795 — Electronic Marketing Associates — (301) 744-7700 (Balt. area)  
Kensington, Md. 20795 — Electronic Marketing Associates — (301) 881-5300 (Wash. area)  
King of Prussia, Pa. — Electronic Marketing Associates — (215) 265-1600 (King of P. area)  
King of Prussia, Pa. — Electronic Marketing Associates — (215) 248-5050 (Phila. area)  
Manchester, Mo. 63011 — Pivan Engineering, Inc. — (314) 227-3501

Minneapolis, Minn. 55422 — Pivan Engineering, Inc. — (612) 537-4501  
Montreal, Quebec, Canada — Atlas Elec Corp — (514) 489-8495  
New Hartford, N.Y. 13413 — KLM Associates — (315) 735-8525  
Newport Beach, Calif. 92660 — Feeger, Lucas, Wolfe, Inc. — (714) 540-4412  
North Hollywood, Calif. 91601 — Feeger, Lucas, Wolfe, Inc. — (213) 877-5518  
No. Syracuse, N.Y. 13212 — KLM Associates — (315) 458-6214  
Orlando, Florida 32803 — 8CS Associates, Inc. — (305) 896-4881  
Palo Alto, California 94303 — Coherent Marketing Associates — (415) 327-2217  
Pittsburgh, Pa. 15235 — Carter, McCormic and Peirce, Inc. — (412) 824-3760  
Richardson, Texas 75080 — Barnhill Two, Inc. — (214) 231-2573  
Rochester, N.Y. 14600 — KLM Associates — (716) 442-0820  
San Diego, Calif. 92117 — Feeger, Lucas, Wolfe, Inc. — (714) 277-0993  
Scottsdale, Arizona 85251 — Barnhill Three, Inc. — (602) 947-7841  
Seattle, Washington 98103 — Hayes Technical — (206) 763-2210  
Shawnee Mission, Kansas 66202 — Pivan Engineering, Inc. — (913) 772-1030  
Toronto, Ontario, Canada — Atlas Elec. Corp — (416) 781-6174  
Wakefield, Mass. 01880 — Pat Jenks Associates, Inc. — (617) 246-1590

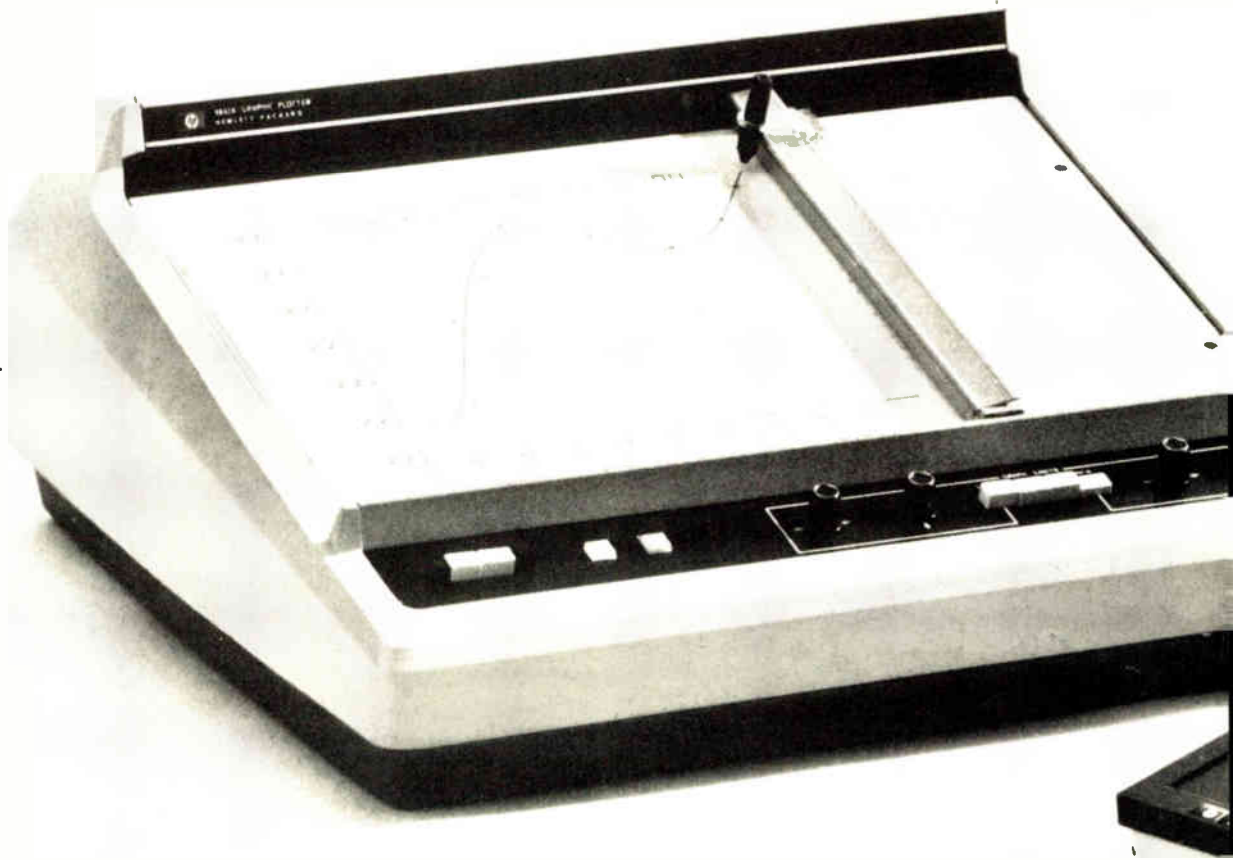

# Hewlett-Packard Series 9800 Model 30. The Name And Number Bridge The Computing Gap.

Building power into a computer isn't much trouble, these days. The task is to make that power respond to the demands of you scientists and engineers who don't pretend to be computer experts. That's a feat we've accomplished with our new Series 9800/Model 30.

It joins the accessibility and easy operation of a programmable calculator with the power and overall capability of a minicomputer. The result? Significantly reduced turn-around time for those complex research and design problems you're now sending to a programmer or outside computing service.

**Conversation guides you to the best solution.** The secret to the Model 30's problem-solving efficiency is its ability to communicate with you on a very human level. Its language is BASIC, a standard language that gives you simple, straightforward programming.

In practice, you solve a problem by setting up a dialogue with the Model 30. You talk to it through the typewriter keyboard. It talks to you through the alphanumeric display.

Once you've entered your instructions in English words and Algebraic formulas, the Model 30 does all the rest, under the automatic control of its hard-wired executive system. It'll even



show you where you've made a mistake—so you can quickly correct anything from one character to an entire block of text with just a few quick strokes on the editing keys.

**Powerful memory for solutions to big problems.** Despite its apparent simplicity and small size, the Model 30 is an extremely powerful computing tool. Significant features include the executive system software implemented by built-in ROM (read-only-memory); the large MOS-LSI read/write memory for programs and data, and the built-in tape cassette operating system for mass storage. Adding it all up, the *basic* Model 30 gives you problem-solving power equivalent to a minicomputer system with 10K sixteen-bit words of memory. And that's just for starters, because the Model 30's modular design lets you add capacity any time your usage demands.

You can add programming and systems versatility with plug-in ROMs.

You can increase your data and program storage with read/write memory modules. And you can plug in up to nine additional tape cassettes for whopping mass storage.

**New Series 9800 Line Printer gives you fast formatted output.** If your work calls for formatted hard copy, you'll be happy to know you no longer need suffer the tedium and noise of slow, mechanical output writers. Our new Series 9800/Model 66 Line Printer mounts atop your Model 30 to give you a fast output of 250 lines per minute. (That's equivalent to typing 3,600 words per minute.)

**Series 9800 Peripherals let you handle data in any format.** As a member of the Series 9800, the Model 30 is fully compatible with all 15 of the

Series 9800 Peripherals—ranging from high-speed Tape Readers to Instrument Interfaces. Illustrated above is our unique X-Y Plotter that not only draws histograms, linear, log-log, semi-log, or polar plots—but writes alphanumeric characters as well.

Put the Series 9800/Model 30 through its paces on some of your problems. We're already shipping production units. Prices start at \$5,975 for the basic Model 30. Add \$2,975 for the Model 66 Line Printer.

For more information or a hands-on demonstration, call one of our 172 worldwide sales offices. Or write: Hewlett-Packard, P.O. Box 301, Loveland, Colorado 80537.

093/2

HEWLETT  PACKARD

HP Sales, Services, and Support in 172 Cities in 65 Countries

# You'll find Lockheed's 417 Most of

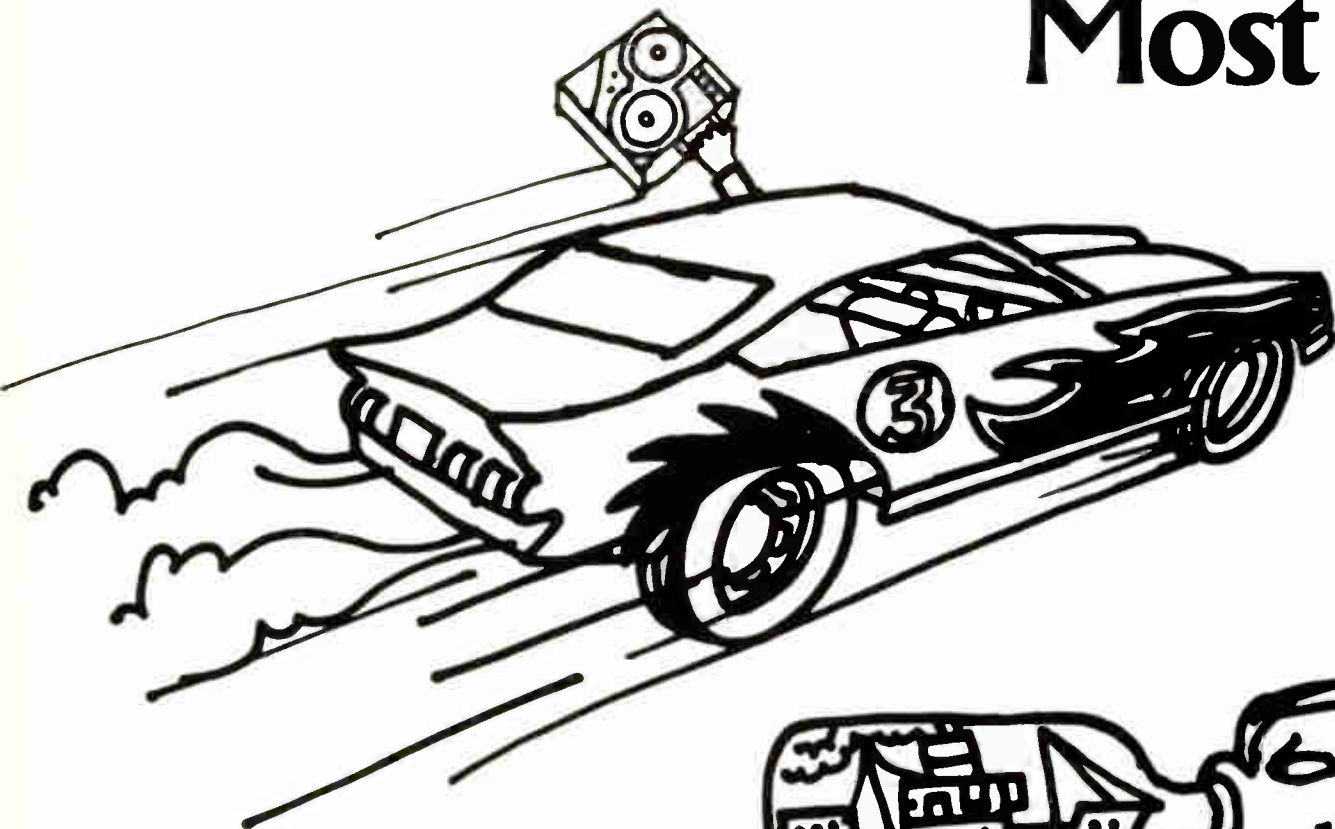

**Tough roads.**  
The 417 shines in  
torture testing of autos  
around the world.

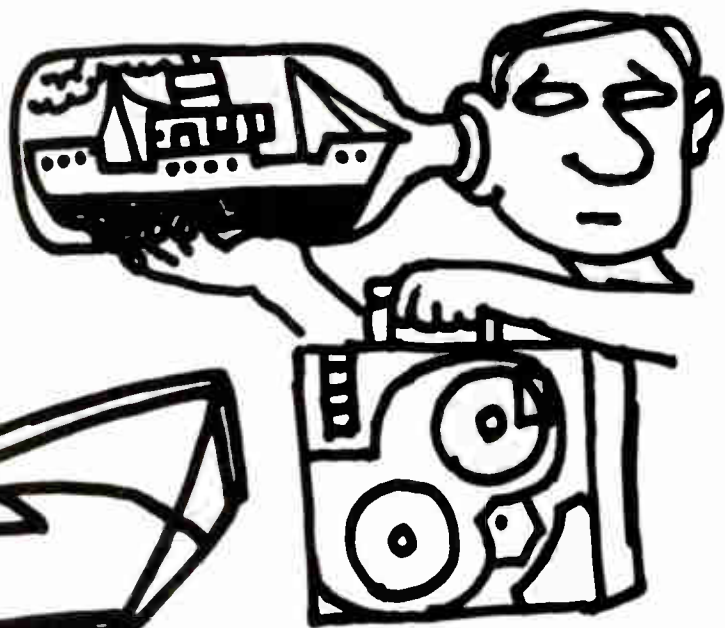

**Down deep.**  
You can take the  
handy 417 to where  
the noise is, deep in  
the heart of ships.

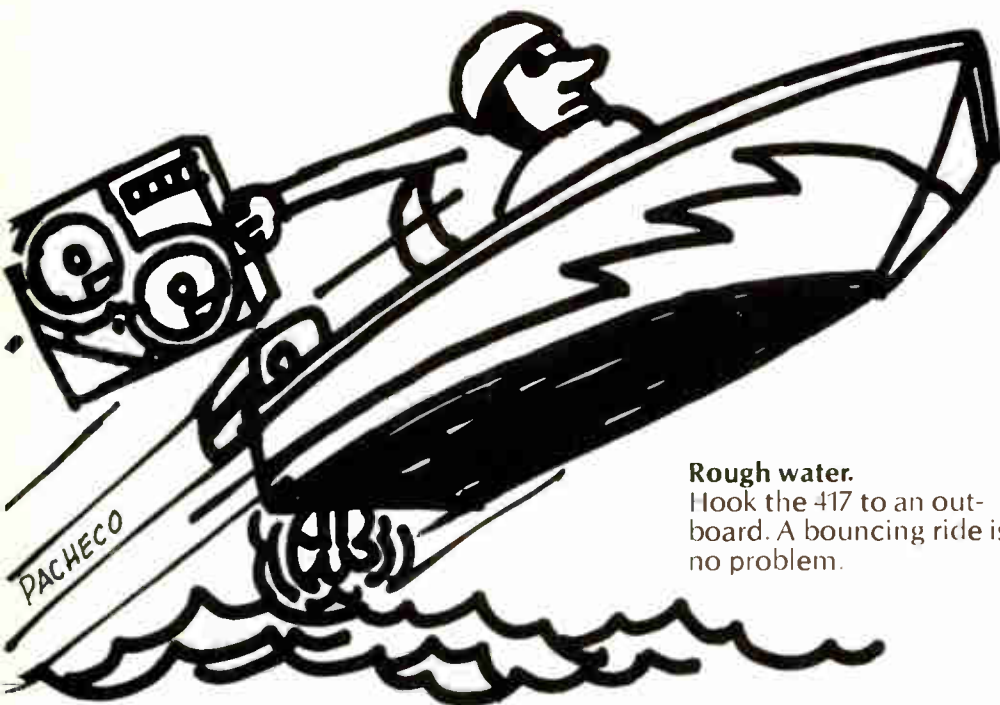

**Rough water.**  
Hook the 417 to an out-  
board. A bouncing ride is  
no problem.

Some people bring data sources to the recorder. That makes life easy for the recorder. But if you have to take the recorder to data sources, consider the 417. It makes life easy for you. Weighs only 28 pounds, fits under an airplane seat. Wide or intermediate band, the rugged 417

# Recorder in many places. them hostile.



**Jittery earth.**  
Seismic measurements are only one of the 417's rough terrain chores.

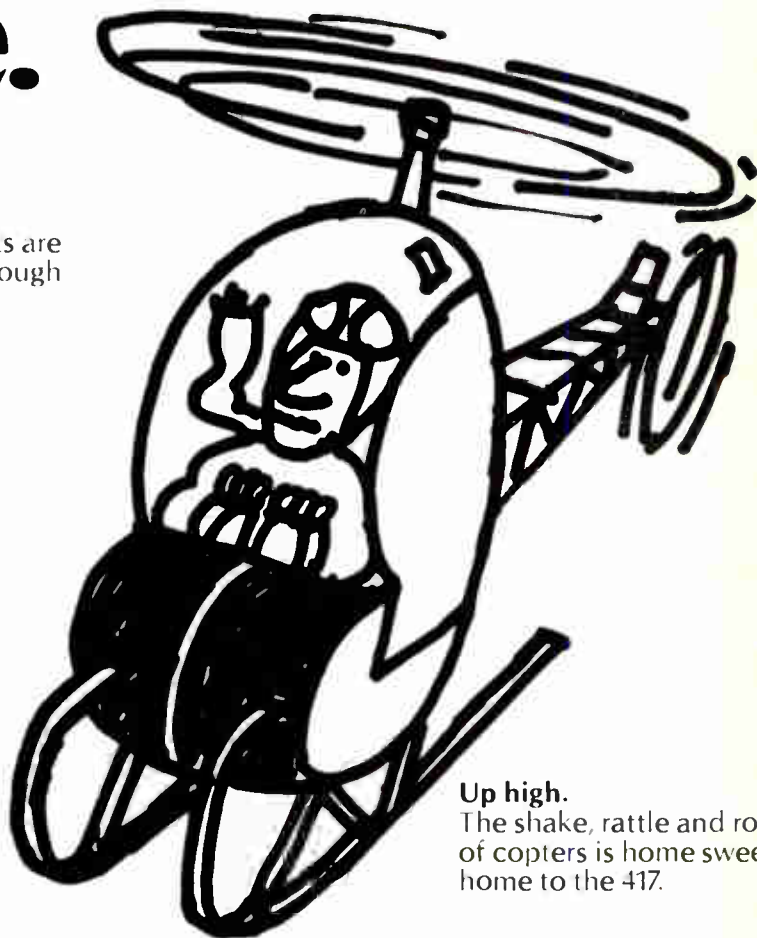

**Up high.**  
The shake, rattle and rattle of copters is home sweet home to the 417.

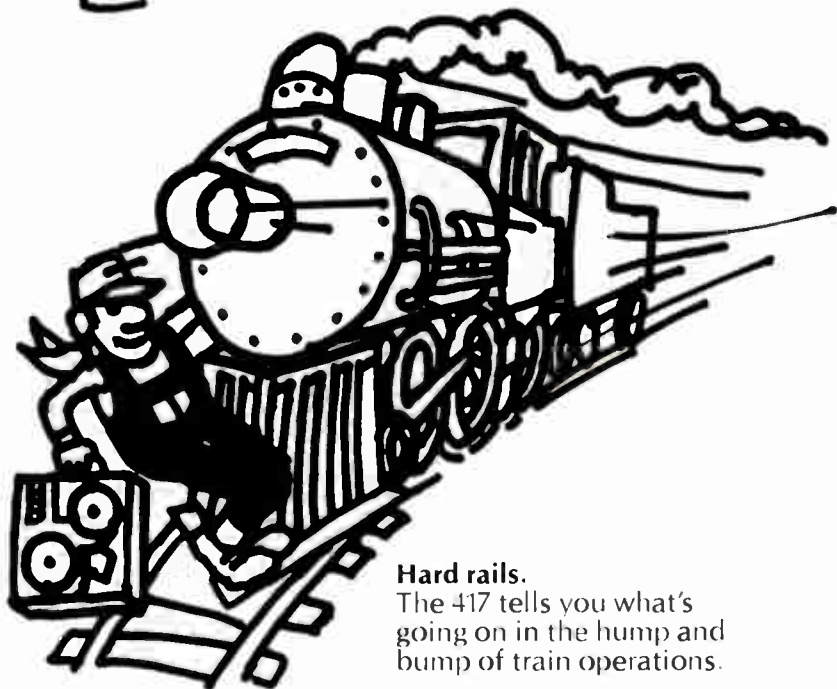

**Hard rails.**  
The 417 tells you what's going on in the hump and bump of train operations.

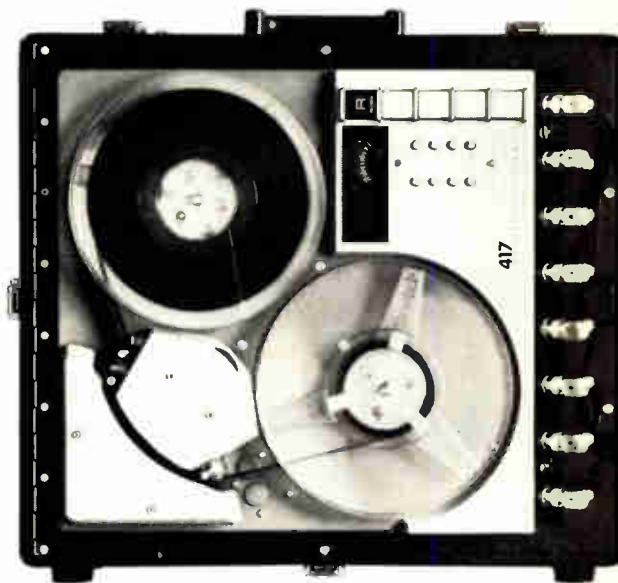

Seven channels, IRIG compatible.  
Frequency response: 100 kHz direct,  
10 kHz FM or 375 kHz to 100 kHz FM.

operates in any position. And is as accurate as large rack machines. Prices as low as \$7,000. Write Earl Nadeau for specs and a free analysis of the 417, for your application, Dept. 413-206, Lockheed Electronics, Plainfield, N.J. 07061. Or call him collect at (201) 757-1600.

**LOCKHEED  
ELECTRONICS**

A Subsidiary of Lockheed Aircraft Corporation

Circle 13 on reader service card

# INDUSTRY'S BEST DELIVERY!

## MINIATURE ROTARY SWITCHES

Any catalog item  
ONE WEEK (ARO)  
(up to 1,000  
pieces!)

## WIRE-WOUND RESISTORS

### PRECISION

Tolerances through  
± .01%  
3 WEEK DE-  
LIVERY!  
(up to 1,000  
pieces per line  
item!)

### POWER

6-8 WEEKS DE-  
LIVERY (up to  
10,000 pieces  
per line item!)

WRITE, WIRE OR PHONE  
FOR IMMEDIATE ATTENTION

# RCL

ELECTRONICS, INC.  
700 South 21st Street  
Irvington, New Jersey 07111

Telephone:  
(201) 374-3311

TWX:  
(710) 999-5511

## People

### GE's Perry on top of the video boom

The new chairman of EIA's Consumer Electronics group and general manager of the General Electric Home Entertainment Business division, soft-spoken Donald E. Perry is enjoying success in both the consumer-products industry and in his own division.

Perry is satisfied with the outcome of the Consumer Electronics group's first attempt at a wintertime products show last month in Chicago. He is also pleased with the EIA's internationalization of reporting industry statistics—instead of tracking only U.S. brands, the association is now going to include total-market sales in this country.

**Four-channel push.** As for the booming consumer sales, Perry believes that U.S. manufacturers can repeat the 1972 success this year "if we can maintain the momentum into the first months." He estimates that the mid-1972 TV-replacement market accounted for 15% of all sales, and that it will increase this year. On the audio side, Perry strongly supports the sales attraction of four-channel sound, despite grumbling by some audio-equipment manufacturers that quadraphonics has caused more confusion than purchases.

Perry is also bullish about the performance of General Electric and expects his division to out-perform the industry average in television sales. On the horizon for GE is a new set with a 25-inch, 110° deflection, in-line-gun tube. (GE's TV Components department has just completed the prototype tube.) Perry expects that the 110° tube will gain acceptance in this country in large-screen sets because the space saving from the tube's shorter neck is more noticeable than with small-screen units.

**Appraisal.** General Electric has also begun market research on home video players to get a "detailed appraisal of the hardware and its sales potential." Until this study is evaluated, GE will make no moves in this volatile field and probably

will not be in any rush to enter the consumer videotape recorder and video-disk market.

Concerning consumer calculators, "we've got zero interest," comments Perry. "We've never tried to pick off



Don Perry presides over the "internationalization" of EIA's CEG.

one end of a market. Unless we can have a full line, from hand-held to office machines, it's not worth it. Besides, our business is home entertainment."

### Afips chief sees

### big show in New York

The world's biggest computer show will be in New York the first week in June, declares Gerard (Jerry) Van Dijk, the first full-time conference manager of the American Federation of Information Processing Societies, which is sponsoring the National Computer Conference and Exposition. "I expect a total sell-out," he affirms.

Some may call this an unusually optimistic position, considering how poorly the large, omnibus technical show—including Afips' own Fall and Spring Joint Computer Conferences—has fared in the past few years. In fact, the June 4-8 conference, to be held annually on a rotating basis in New York, Chicago and on the West Coast, replaces the two that Afips has until now sponsored



# The PHILIPS PM 3200 doesn't look like a \$395 double scope...

## It doesn't perform like one, either.

Developed and manufactured by N. V. Philips of Holland, the PM3200 looks... and performs... like an expensive, laboratory-quality instrument.

Yet it costs only \$395, weighs less than 12 pounds, operates 5½ hours on its optional battery pack, is rugged enough for any kind of field work you can name and offers a wide range of professional performance capabilities, including:

- Freq response flat (-3 db) to 10 MHz
- Sensitivity of 2 mV/div
- 21 calibrated sweeps from 100 nsec/div to 0.5 sec/div
- Vertical amplifier dynamic range allows any signal to be expanded to 24 divisions, with any 8 displayed to 1 MHz
- Negligible DC drift: ¼ div/day

And the PM3200 is simple to operate; even semi-skilled factory workers find it easy to use it for precision test procedures. Most tests require only Y AMPL and TIME/div settings; other functions are automatic.

For instance, the PM3200 has no need for trigger-stability or continuous-level controls. Choose a time base... and you see a stable display. Even for pulses with low duty cycles. And for TV work, a modified version of the PM3200, the PM3200X, adds automatic selection of TV frame or line sync for triggering.

PM3200 needs no DC balance control; a unique feedback circuit reduces trace drift to only ¼ div/day @ 2mV/div and automatically compensates for DC offsets caused by attenuator tracking and by differences in AC and DC coupling.

Try the PM3200 (or the PM3200X) with no obligation. We are convinced that at \$395, considering its portability, ruggedness, precision, flexibility, simplicity of operation and its Philips-of-Holland professional performance—you'll agree that it's the optimum general purpose scope for all kinds of field service organizations, production and QC departments, schools and engineering laboratories.

For details of our no-obligation, 15-day free trial offer and for complete descriptive literature on the PM3200 and the PM3200X, write: Test & Measuring Instruments Inc., 224 Duffy Avenue, Hicksville, N.Y. 11802. Tel: 516-433-8800.

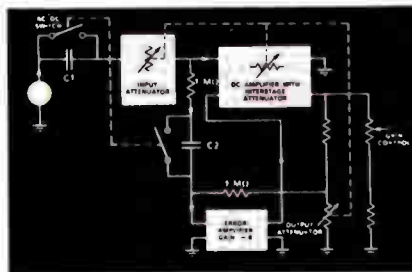

**PM3200 IS DRIFT-FREE AND INHERENTLY DC BALANCED**

Sensitivity and DC drift are both on the order of the noise voltage. The active drift compensation loop compares vertical amplifier input to output and provides feedback to attenuate any drift voltage by a factor of  $1 + \frac{1}{2}B$ , where B is the feedback amplifier gain (approx. 30).

DC offsets are automatically compensated when interstage attenuators are switched, when the Y AMPL gain setting is changed, and when there is leakage around the AC coupling capacitor. Need for a DC balance control, even at 2 mV/div sensitivity is totally eliminated.

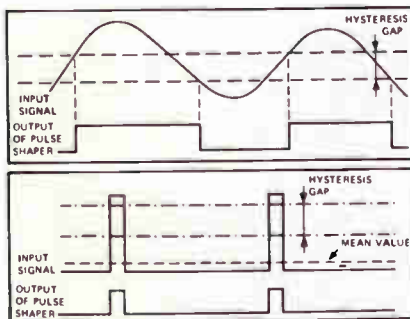

**THREE AUTOMATIC TRIGGER MODES IN PHILIPS PM3200**

Trigger mode selection allows triggering on the mean value of the AC signal, on the peak value of the signal, or on the AM component of an HF signal. Mode switches select DC level of "hysteresis gap" of pulse shaper relative to mean signal value to determine shape of switching pulses applied to time base and auto-trigger controls.



**PM3200X FOR TV SERVICE**

PM3200X offers automatic TV frame/line sync selection for convenience in TV service work. With TRIGGERING switch in TV position, setting the TIME/div control to any sweep speed up to 50 μsec/div produces frame-synchronized displays. Setting the TIME/div control to any sweep speed of 20 μsec/div or faster results in a perfectly stable TV line-synchronized display.

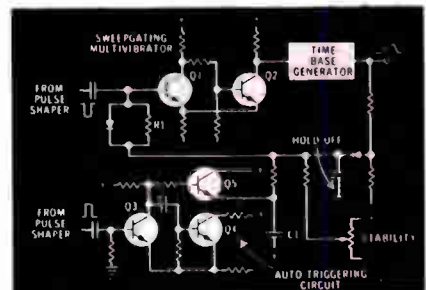

**PHILIPS PM3200 OFFERS AUTOMATIC TRIGGERING TO 10 MHz WITHOUT STABILITY OR CONTINUOUS-LEVEL CONTROLS.**

Time base generator is free running at TIME/div setting. Any signal produces simultaneous pulse-shaped inputs to time base control Q1, Q2 and to auto-trigger control Q3, Q4. The time base control switches the time base generator off and the auto-trigger control switches Q5 to charge C1 to the mode-set trigger level and starts the time base generator via Q3, Q4 in sync with the signal.

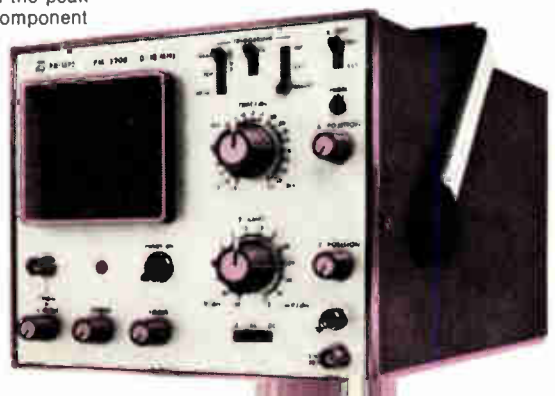

**TEST + MEASURING INSTRUMENTS INC.**

# Cast moulded WIMA® capacitors

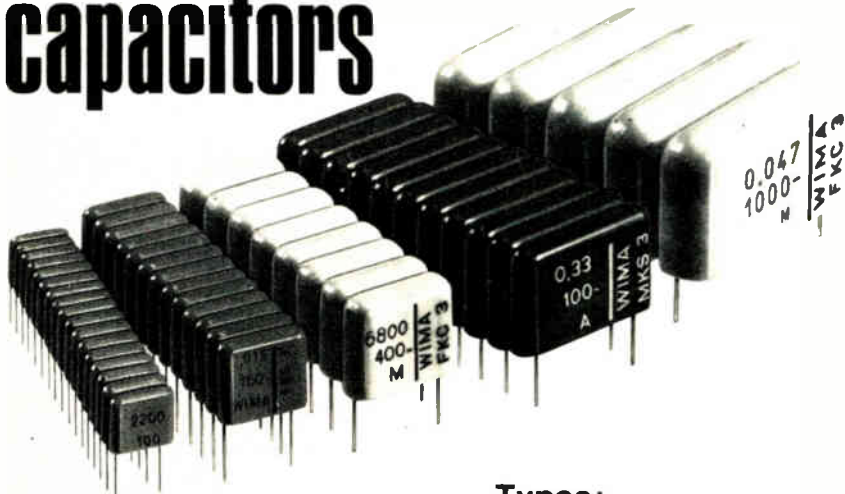

**Encapsulated  
in cast resin under  
vacuum to eliminate  
air inclusions.**

**Patents applied for.**

**Advantages:  
Small physical size;  
high resistance to  
moisture, favourable  
a. c. characteristics.  
Voltage ratings  
up to 1000 V d. c.**

**For stringent  
requirements.**

## Types:

**WIMA MKS 3** Metallized polyester capacitors for 100 and 250 V d. c. 0.022  $\mu$ F ... 0.47  $\mu$ F.

**WIMA FKS 3** Polyester film and metal foil capacitors for 160 and 400 V d. c. 1000 pF ... 0.1  $\mu$ F.

**WIMA FKS 3** Polycarbonate film and metal foil capacitors suitable for frequency divider circuits. Close tolerances available. 160, 400, 630 and 1000 V d. c. 100 pF ... 0.1  $\mu$ F.

**WIMA FKS 2 min.** Polyester film and metal foil capacitors, subminiature, suitable for very small equipment. 100 V d. c. from 100 pF ... 0.047  $\mu$ F.

## WILHELM WESTERMANN

Spezialfabrik  
für Kondensatoren  
Augusta-Anlage 56  
P.O. Box 2345  
D-68 Mannheim 1  
Fed. Rep. of Germany  
Tel.: (621) 40 80 12

*Please send for  
our latest  
catalogue.*



on the East <sup>people</sup>

But since the number and with le. to go, the Dutch (pronounced Van dent. He has 127 exhib up and is more than 70% way to selling all of his square feet of exhibit space goal of attracting up to 40,000 visitors is buttressed by a technical program that has been doubled in size and geared, for the first time, Van Dijk says, to both the computer user and the high-level computer design specialist the Afips meetings generally catered to. Helping also, he admits, is the upturn in the economy and the conference's "highly visible location" in New York.

Van Dijk, 42, sees the business of organizing this conference, close to a \$1 million operation, an easy extension of his 17 years of sales and marketing experience in the computer industry. Ten of those years were spent with IBM.

Tall and lanky and with a long-haired youthfulness, Van Dijk keeps in shape playing paddle tennis in winter and sailing in summer. Right now, he's building a power boat with the help of his nine-year-old son Christopher in the basement of his Larchmont, N.Y., home. (Yes, he says, it will get through the door when it's finished.) "We're sort of eyeballing it, without any plans, doing whatever we think looks good," he says and adds with a smile, "That's about the same way we're building the conference."

**Showman.** Jerry Van Dijk hopes Afips' now-annual conference will be robust.

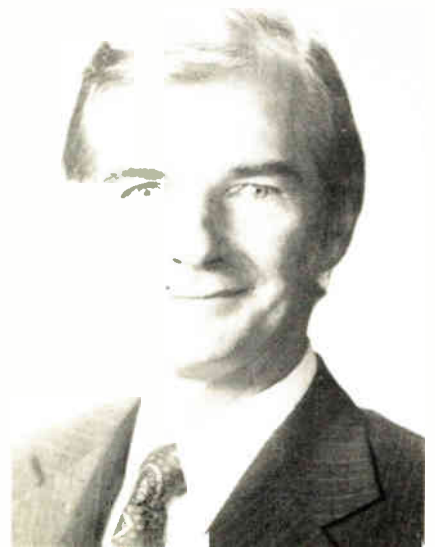

# New Tool New Board New Method

**it's part of the TY-RAP<sup>®</sup> System**

**Now tie quicker than ever before...**

Our new high speed tool does it all . . . feeds a TY-RAP tie around bundle, cinches to a preset tension, locks securely and trims evenly . . . all in  $\frac{1}{10}$  of a second. There is no tool adjustment needed regardless of bundle diameter from  $\frac{1}{2}$ " to  $\frac{3}{8}$ ".

The off-the-board harnessing method allows the tool optimum use. This technique utilizes our new harness board and harnessing aids. The board is reusable and reversible. It's modular too . . . snaps together for larger work areas. It's constructed of poly-ethene foam sandwiched between two metal screens — nails are pushed in by hand. It's all part of the TY-RAP System to lower your costs of harness fabrication.

Write for new catalog, The Thomas & Betts Company, Elizabeth, New Jersey 07207 (201) 345-4321. In Canada, Thomas & Betts Ltd., P. Q.

**Sold Only Through Authorized T&B Distributors**



**THOMAS & BETTS**

Division of Thomas & Betts Corporation

517

Circle 19 on reader service card

**Packaging  
versatility  
unlimited.**

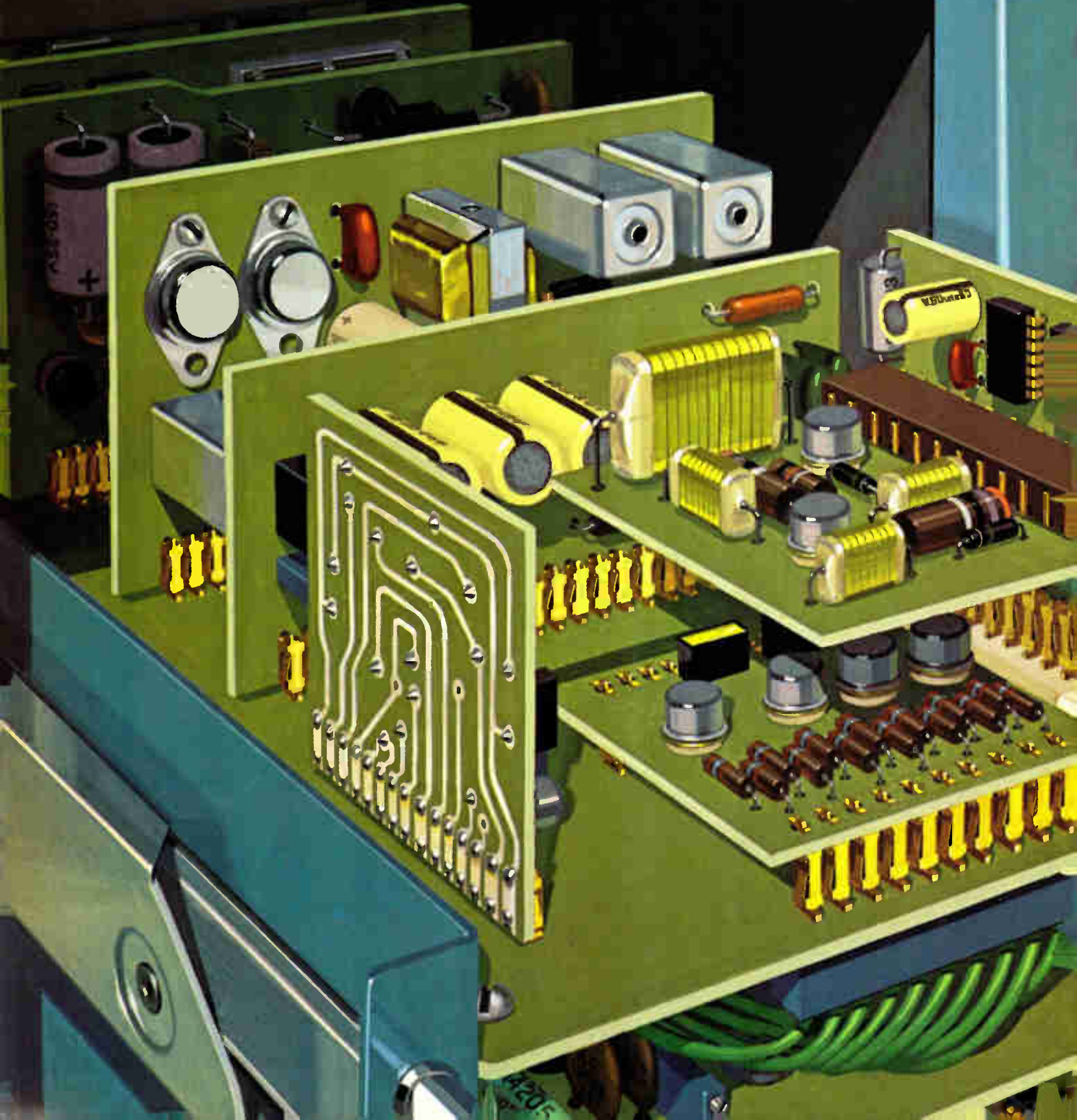

As electronic subassemblies become more sophisticated, the advantages of a single interconnection system to meet diverse packaging needs become more evident. If you're looking for interconnection versatility—with proven reliability—look into our AMPMODU interconnection system. Here's why.

### Unique design permits repeated post/receptacle matings.

AMPMODU contacts are designed with dual cantilever spring beams in the receptacles. These spring members ensure uniform, positive electrical contact with mating posts, every time. This same design feature also compensates for misalignment of staked posts and receptacles, and allows for greater assembly tolerances.



### Wide range of types and sizes.

Four basic AMPMODU contact types provide post and receptacle size selection to meet specific packaging requirements. Mod I types, for example, combine .031 x .062-inch rectangular posts and mating receptacles for a wide variety of applications where spacing between contacts from .125 to .156-inch is required. Mod II types offer miniature .025<sup>2</sup> post and receptacles, permit mounting clearances as close as .100-inch. Mod III types provide high-pressure receptacles for use with .025<sup>2</sup> posts. For special applications, shorter receptacle lengths are available to mate with .025<sup>2</sup> posts in a selection of Mod IV sizes. Each is a complete electromechanical module, designed to give almost unlimited positioning versatility and circuit flexibility.



### Board-to-board, board-to-wire versatility.

Receptacles can be staked up, down or sideways, to module boards or grid panels. Receptacle designs are also available for crimping onto individual wires or for staking into flat flexible cable conductors. Others can be used to connect coaxial wires. Terminated receptacles may also be housed in a wide range of multiple-position connector blocks for both 90° and parallel connections to

boards or grid panels. AMPMODU connector posts are preassembled in insulating nylon blocks or in strip form for machine insertion. They can be wired automatically by AMP's TERMI-POINT clip point-to-point method, or by wrap-type techniques.



### Staking speeds to 12,000 posts or receptacles an hour.

Our new strip-fed multi-head pantograph matches post and receptacle staking speeds to your high-volume production needs. Each applicator head stakes up to 4,000 insertions an hour, either horizontally or vertically, into pc boards from .062-inch up. Any pattern can be staked into 5 x 13-inch to 16 x 13-inch boards. AMP automatic tooling is unequalled for reducing applied interconnection costs.

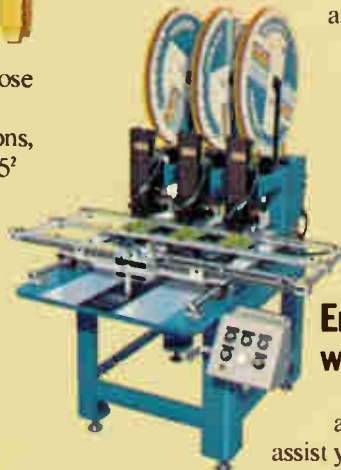

### Engineering backup... worldwide.

At AMP Incorporated, more than 700 application, service and sales engineers are prepared to assist you with every design and production application involving AMPMODU interconnection systems. At your domestic manufacturing plant or wherever you use AMP products and machines throughout the world. You'll find AMP manufacturing and service facilities in 16 major international markets. In the United States, district offices are located in California, Georgia, Illinois, Massachusetts, Michigan, Minnesota, New Jersey, Ohio, Texas, and the District of Columbia.

For more information on AMPMODU connector system products, circle bingo number 10, or write AMP Industrial Division, Harrisburg, Pa. 17105.

# AMP

INCORPORATED

Dear Gabby

**"My Boyfriend Says  
Three is a Crowd  
Unless It's A Datatron  
Time Search Unit..."**



**Datatron's Girl Gabby**

**DEAR GABBY.** My boyfriend from the missile range says that 3 is a crowd on my front porch, unless it's a Datatron Time Search Unit. Is he trying to tell me something? **TIME ON MY HANDS**

**DEAR TIME:** No doubt he wants to get you alone for devious purposes. Gabby knows men! However, he's right about Datatron's new 3030 which combines a time code generator, a translator AND a tape search unit in a single compact 7" rack mount cabinet. It's certainly not a crowd, offering versatility, economy and a big saving in rack space.

who correlate time and events with computers. **GABBY**

★ ★ ★  
**DEAR GABBY:** My husband is all thumbs. He keeps setting up the wrong start and stop times on his tape search unit. Pleeze help us before he gets fired. **FOND OF EATING**

**DEAR FOND:** Again Datatron's new 3030 to the rescue! Instead of using conventional thumb-wheel switches, Model 3030 features a unique keyboard entry of start and stop times. Even a chimpanzee with gloves could enter data accurately. **GABBY**

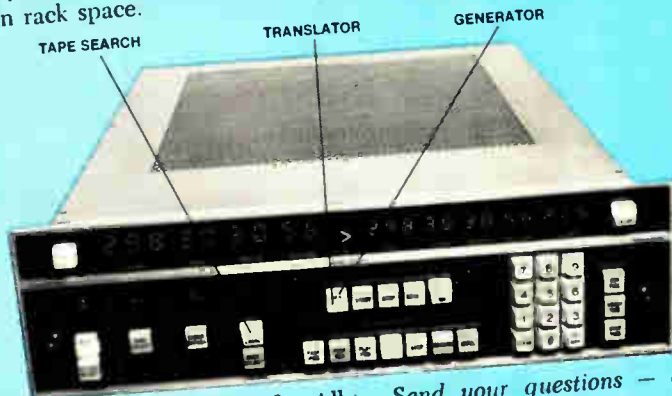

Another important benefit. All key functions such as tape motion control, filter and code selection, and error by-pass can be computer controlled. Which makes the 3030 ideal for data reduction centers

Send your questions — either straight or humorous — to Gabby. We'll mail a Flair pen for all received and pay \$100 if we use question in future ad.

**datatron inc.**

1562 Reynolds Ave / Santa Ana, Calif. 92711  
(714) 540-9330

**moving up fast in...**



## Meetings

**Aerospace and Electronic Systems (Wincon):** IEEE, Biltmore, Los Angeles, Feb. 13-15.

**Annual Meeting, Association for Advancement of Medical Instrumentation:** AAMI, Washington Hilton, Washington, D.C., March 21-24.

**IEEE International Convention (Intercon):** IEEE, Coliseum and New York Hilton, March 26-29.

**Reliability Physics Symposium:** IEEE, Dunes, Las Vegas, April 3-5.

**Southwestern IEEE Conference and Exhibition (Swieeco):** IEEE, Houston, Texas, April 4-6.

**International Symposium on Circuit Theory:** IEEE, Four Seasons Sheraton, Toronto, Canada, April 9-11.

**International Magnetics Conference (Intermag):** IEEE, Washington Hilton Hotel, Washington, D.C., April 24-27.

**Carnahan Conference on Electronic Crime Countermeasures:** IEEE, U. of Kentucky, Carnahan House, Lexington, Ky., April 25-27.

**Electron Device Techniques Conference:** IEEE, United Engineering Center, New York, May 1-2.

**National Relay Conference:** NARM, Oklahoma State U., Stillwater, Okla., May 1-2.

**Electronic Components Conference:** IEEE, EIA, Statler-Hilton, Washington, D.C., May 14-16.

**Naecon:** IEEE, Sheraton, Dayton, Ohio, May 14-16.

**International Symposium:** SID, Statler-Hilton, New York, May 15-17.

**Measurement and Test Instrument Conference:** IEEE, Skyline Hotel, Ottawa, Ont., Canada, May 15-17.

**Electron, Ion, and Laser Beam Technology:** MIT and IEEE, MIT, Cambridge, Mass., May 21-23.

*Continued on p. 180*

# ECL 10K: Now easy as ABC

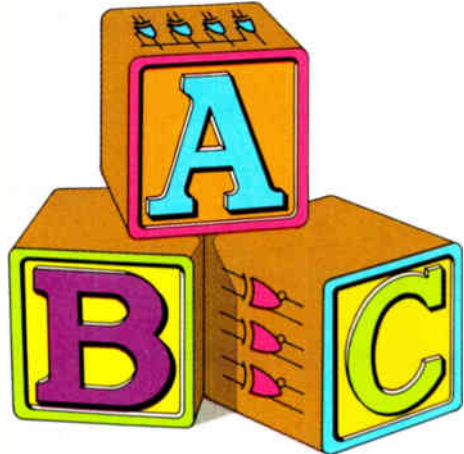

The big three basics come first at Signetics.

**Availability.** The fastest turnaround anywhere in 2ns high speed logic. What you see here, is what you can get from Signetics. Now. No delays, no alibis, no fooling around for months. Standard parts straight from proven, line-ready stock. MIL STD 883 Class B takes just a little longer.

**Broad line.** Twelve new memory, MSI and interface ECL 10K devices join the logic functions we're already shipping in volume world-wide. One-call access to the full range of part types and parameters, packaged in plastic DIP, Cerdip, or chips. A complete high speed logic family, from one single source: for greater design flexibility, plus significant cost advantages on a mixed buy.

ALTERNATE SOURCED FUNCTIONS					
10101	10106	10110	10116	10119	10131
10102	10107	10111	10117	10121	10161
10105	10109	10115	10118	10130	10162
SIGNETICS ORIGINATED FUNCTIONS					
10112	Dual 3-Input 1 OR/2 NOR Gate				
10113	Quad Exclusive OR with enable				
10171	Dual 1-of-4 Demux/Decoder (Low)				
10172	Dual 1-of-4 Demux/Decoder (High)				

**Compatibility.** Pin-for-pin identical with Motorola MECL 10,000, with industry-accepted temperature coefficients and ranges (-30° to +85°C). Two in-depth, production-proven sources insure service and delivery. You can use Signetics ECL 10K in mixed systems without the subtle penalties or noise immunity reductions that occur with compensated 10K families. Switching rise/fall times are compatible with conventional system layouts.

**FREE ECL 10K PARTS KIT**  
To introduce our new ECL 10,000 products, we're offering an Evaluation Kit: six free parts to give you first-hand experience with Signetics optimized ECL 10K.

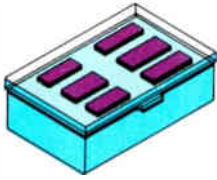

**NEW ECL 10,000 FUNCTIONS:**

- Supergate**  
10100 Quad 3-input gate. Most useful 10K function, most reasonably priced.
- Interface**  
10124/10125 Quad differential line drivers/receivers, ECL-TTL translators. 5ns high-performance delivers density and flexibility, below the cost of any other similar devices.
- Multiplexers**  
10132/10134/10173 Logically powerful, 2.5ns high speed Mux-latches.  
10164/10174 8 to 1/dual 4 to 1. Large fan-in multiplexers, operating at 3.5ns.
- Parity**  
10170 9-plus-2 input expandable parity circuit.
- Storage**  
10133 Quad D-type latch, with gated outputs.
- Memory**  
10139\* Extremely fast 17ns PROM, 32x8 organization.  
10145\* Extremely fast 9ns RAM, 16x4 organization.

\*In characterization now. Coming soon.

Please rush us your free sample ECL 10K Evaluation Kit. Our design/production application is \_\_\_\_\_

Send complete specs, data and application notes on your complete ECL 10K line.

Name \_\_\_\_\_

Title \_\_\_\_\_

Attach this coupon to your company letterhead, and mail to:  
Signetics-ECL  
811 East Arques Avenue  
Sunnyvale, California 94086  
(408) 739-7700

Signetica Corporation. A subsidiary of Corning Glass Works.



# Once you've seen PDP-11/45's to look at other medium

The system you see here has a 1200 CPM card reader. A 1200 LPM 132 column line printer. 20 million word disk drive. They're big peripherals because PDP-11/45 is a big computer.

Big in performance. With 300 nano-second instruction execution. 300 nano-

second solid state memory. 64 bit multi-accumulator floating point hardware. Memory expansion to 248K bytes. Dual ported memory. Sixteen general purpose registers.

That's medium-scale capability. But

at prices you could never buy medium-scale systems for. We've already delivered hundreds of systems. Some as small as \$25,000, many as big as \$250,000.

It's still very much a PDP-11. You can hook up any of the 60 PDP-11 peripherals, use any of the huge PDP-11 soft-





# peripherals, you'll never be able scale systems the same way.

ware library, and do whatever you want done. Communications. Time-sharing. Batch. Real time. You name it.

Now you have some idea of why PDP-11/45 is quickly becoming the hottest selling computer we've ever made.

Get the literature and you'll want to get the computer. Write Digital Equip-

ment Corporation, Maynard, Mass. 01754. (617) 897-5111. European headquarters: 81 route de l'Aire, 1211 Geneva 26. Tel: 42 79 50. Digital Equipment of Canada Ltd., P.O. Box 11500, Ottawa, Ontario K2H 8K8. (613) 592-5111.

**digital**

PDP is a registered trademark of Digital Equipment Corporation.



**Quality  
resistor networks  
now available  
off-the-shelf.**

**Pull ups or  
terminators,  
in popular  
values.**

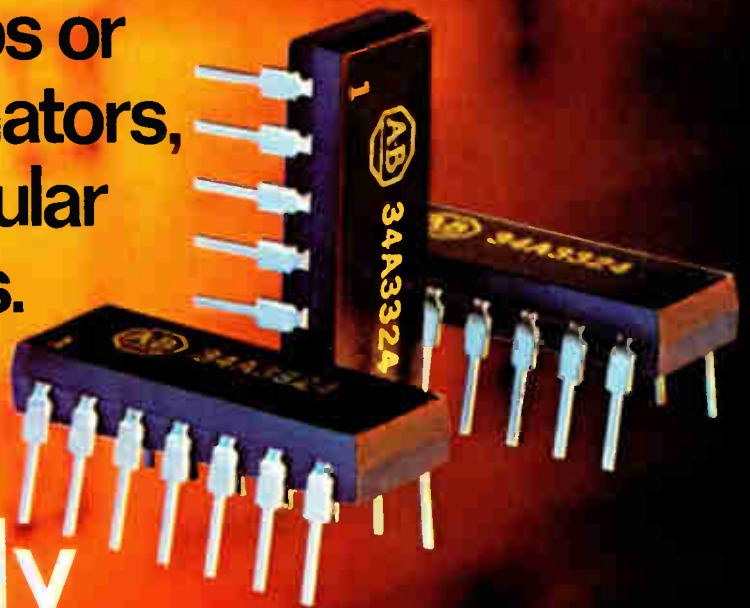

**If you're really  
serious about cost,  
be serious about quality.**

Now our most popular thick-film resistor networks are ready and waiting, in quantity, at your A-B electronics distributor. Pull-up networks and terminator networks with tolerances of  $\pm 2\%$  in popular values from 68 ohms to 22K ohms. All in compatible

14 lead .300 series DIP's. Or if you need something special we'll quickly custom design any circuit that'll fit into a 14 or 16 lead DIP. And we mean quickly. Overall specs include: absolute tolerances to  $\pm .5\%$ . Tracking  $\pm 50$  ppm/ $^{\circ}\text{C}$  (and lower). TCR to

$\pm 100$  ppm/ $^{\circ}\text{C}$ . Write for free technical publications 5850 and 5851. Allen-Bradley Electronics Div., 1201 S. 2nd St., Milwaukee, WI 53204. Export: Bloomfield, NJ 07003. Canada: Allen-Bradley Canada Limited, Galt, Ont. U. K.: Jarrow, Co. Durham NE32 3EN.



Actual Size



## **Motorola move deflates EIA's statistics bag**

The Electronic Industries Association's semiconductor sales-statistics program has been dealt the coup de grace by the cessation of reporting from Motorola's Semiconductor Products division. Motorola, still an EIA member, quit supplying sales statistics to EIA Jan. 1—the last of the top three U. S. semiconductor houses to do so. Previously, Texas Instruments and Fairchild Semiconductor resigned from EIA, taking with them a huge chunk of the association's Solid State Products division's statistical base [*Electronics*, Jan. 4, p. 36].

**A Motorola source says that while he regrets the move, the division "had too much visibility as the only large company left reporting."** He adds that Motorola has proposed alternate and broader reporting categories to the EIA, suggesting that major classifications such as digital and linear ICs, silicon and germanium transistors, be broken out, rather than the scheme EIA has been using. Under the EIA plan, specific product categories have been detailed, such as TTL, ECL, p-channel MOS, and complementary MOS.

## **Goldmark unveils Star Pak cable TV system**

The first units of Goldmark Communications Corp.'s Star Pak, an electronic videotape cassette system for showing full-length movies on cable television [*Electronics*, Jan. 4, p. 34], have been installed in Reston, Va., Olean, N.Y., and Pottsville and Clearfield, Pa. Expected to cost less than \$15,000 per unit, **the system is designed to provide programming for an entire cable-TV network by using four video cassette players to feed movies, programs, and special messages through automatically controlled preset timing.** A solid-state skew-correction device prevents picture distortion and interference, the company says. Goldmark foresees a \$20 million-plus market for program-origination systems.

## **IEEE Intercon threatens move to Boston**

Troubled by high costs and labor problems in mounting its annual show at New York's Coliseum, IEEE has given serious thought to moving Intercon to Boston on an alternating basis. However, Donald Larson, general manager, has stated that the institute wants first "to see if we can't make New York work." **He says that threat of the move has elicited a promise of complete cooperation from the Coliseum's labor force.** But before such a move could be made, several years would be required to complete arrangements.

## **Commercial LED lamp has built-in resistor**

Hewlett-Packard has solved a nagging problem for users of light-emitting diodes—the need to select and assemble circuit-limiting resistors. And H-P's new LED will also save customers the bother of matching light intensity in order to get a row of LEDs with uniform brightness on a panel.

**The Palo Alto, Calif., firm has two LED lamps—one red and one with a clear diffused lens—with a built-in silicon resistor connected to the LED by a bonded wire.** The LEDs cost 60 cents each in lots of 1,000, about 25 cents more than LEDs without resistors. An H-P spokesman says that the run-of-the-mill resistor-LEDs are well-matched in intensity and that matched sets can be ordered.

## **Military to devise test to qualify epoxy bonds**

The difficulty in qualifying for military applications IC devices using epoxy to attach the chips to the substrates will probably be eased soon, thanks to a study grant awarded to Martin Marietta, Denver, Colo. The contract from Rome Air Development Center, Rome, N.Y., requires Martin to develop tests that can quickly eliminate defective devices headed for military procurement.

Up to now, epoxy has been governed by MIL-M-38510, which says that no organic materials are to be used unless specifically authorized in a contract. In effect, a manufacturer has had to obtain nonstandard approval based on test data that he submits to the Air Force.

**Epoxy is particularly attractive in hybrid fabrication because the temperature required for cure (125°C) is less than that required (370°C) in metallurgical die-attachment methods.** And degradation of devices during fabrication is accelerated by time-temperature exposure.

## **Gunn diode is fastest laser switch**

The Gunn diode promises to be the fastest means of switching lasers. Researchers at Bell Telephone Laboratories, Murray Hill, N.J., have used it to switch a GaAs laser with output times as fast as 200 picoseconds and fall times of 400 ps. **This is two to three times faster than such silicon devices as p-i-n diodes previously used for applications needing extremely fast switching.** The technique will be described this week at the International Solid State Circuits Conference in Philadelphia.

The Gunn device is identical to ones used for generating microwave signals. When used as a high-speed light switch, however, the Gunn diode is resistively loaded to prevent microwave oscillation and placed in series with a double heterojunction GaAs laser.

## **Soviets to unveil awaited RJAD line of computers**

The Soviet Union is about to reveal to the world the fruits of its long-standing effort to produce, with its Comecon partners, a line of computers ranging in size from the mini to one as large as IBM's 360/50. The series, called RJAD [*Electronics*, Sept. 25, 1972, p. 72], is to be shown May 3-June 10 at Moscow's Permanent Exhibit of Economic Achievements.

**There are to be seven models in the line, the ES-1010, 1021, 1020, 1030, 1040, 1050, and the 1060, the biggest. Memory capacity of the machines is scheduled to range from 8,000 bytes for the ES-1010 up to 256,000 to 2,048,000 for the ES-1060.**

## **Swedes break into the U. S. bank terminal market**

Saab-Scania has broken into the U.S. computer terminal market with an order, worth \$500,000, for 50 Datasaab teller terminals for the Central Savings Bank of New York City. The terminals—which include Datasaab D5/20 minicomputers, cassette tape storage, CRT displays, indicator panels, keyboards, and printout units—are similar to those the company is delivering to Nordic Savings Banks.

**This is the first bank terminal order outside Scandinavia for Datasaab, and company officials say they are aiming at at least three additional bank customers in the U.S. this year.** Saab-Scania has just named Trivex Inc., of Los Angeles as its North American agent. A maker of CRT displays, Trivex has sales and service facilities throughout the U.S.

# Putting innovation to work.



## The 40-foot-away GaAsLITE display.

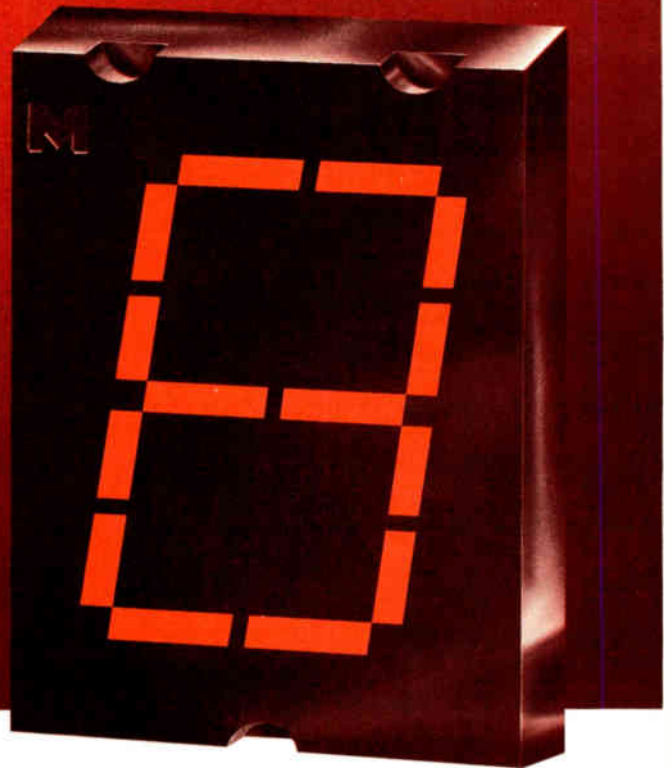

Here's the MAN66A—.6" high and readable from a forty foot distance. There's also the .4-inch MAN64A. Both give you the reliability of GaAsP and both plug into an ordinary 14-pin DIP socket. You can get either in a module containing driving circuitry, too. Whether you buy components or modules, in whatever volume, you can count on Monsanto's tight process and quality controls.

Where to plug them in? Up to 40 feet away. Usually that's not necessary. The optimum design distance is 17 feet, which ordinarily

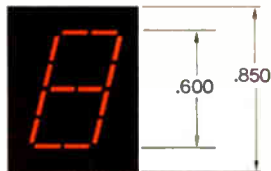

MAN66A—.6-inch high

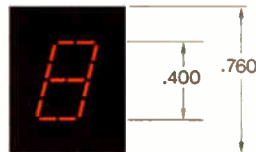

MAN64A—.4-inch high

fills the need. In electronic cash registers, elevators, process controls, communications gear... you take it from there. And take this from us.

Of course, we've also got GaAsLITE displays in digit sizes from  $\frac{1}{8}$ -inch to  $\frac{5}{16}$ -inch, and in colors—red, yellow, green. Get the information you need by writing **Monsanto Commercial Products Co.** Electronic Special Products 10131 Bubb Road Cupertino, California 95014 (408) 257-2140

Distributed by: Alta Electronics, Elmar Electronics, Hammond Electronics, Kierulff Electronics, Kierulff/Schley, Liberty Electronics, Schweber Electronics, Semiconductor Specialists, Wesco Electronics, Western Radio; Canada: Canadian Dynamics, Ltd., Cesco Electronics, Ltd.

## Monsanto

# “Competing abroad helps keep our electronic components competitive worldwide.”

It helps us spread our fixed costs over a broader market base — providing more competitive prices for all our customers.

Worldwide competition enables us not only to find new customers, but also to continue serving established customers located in either the U.S.A. or offshore. General Electric has gone multinational in its electronic components business by providing “local presence” in key markets around the world. And by building “local content” into our product lines manufactured outside the U.S.A.

This is why we continue to set up new overseas sales operations, such as our most recent new facilities in Taiwan and in Amsterdam. To go where our markets are. And be competitive there.

We believe, as do many other U. S. companies, that the best way to offer our domestic customers the best components in terms of price, quality and delivery, is to maintain healthy competition worldwide. 690-14

**GE won't leave you alone.**

*James M. McDonald  
General Manager  
Electronic Components  
Sales Department  
General Electric Company*



OUR NO. 1 GOAL  
TO MAKE  
GENERAL ELECTRIC  
YOUR BEST BUY



**GENERAL  ELECTRIC**

## CCD image sensors outshine vidicons, Fairchild states

Newly developed CCD cameras are moving from the laboratory into practical applications

The charge-coupled device has surpassed the vidicon tube in dynamic performance range—the ability to generate a clear video picture at widely varying levels of illumination. So say the CCD project leaders at Fairchild Camera & Instrument Corp., who see CCD image sensors moving from research into practical video camera design.

“We now have a full order of magnitude improvement over vidicons and hope for a wider dynamic range in the future,” says Michael Harris, electro-optics engineering manager at Fairchild’s Space and Defense Systems division in Syosset, N.Y. His statement refers to line-scanning arrays, which Fairchild’s Semiconductor R&D Laboratory, Palo Alto, Calif., is making and which Harris’ group has used in two mechanically scanned video cameras.

One camera, a feasibility model demonstrated to Fairchild’s board of directors last fall, has generated test pictures illuminated by infrared as well as visible light. It measures about 2 by 4 by 3 inches and consumes about 2½ watts. The linear CCD array is self-scanning in the X direction and has a 625-line scan in the Y direction of about 1 second. A

**CCD eyeball.** Fairchild engineers demonstrate the first charged-coupled-device camera, which operates on 2½ watts of power and measures about 2 by 4 by 3 inches.

prototype of a military version of this camera is now being evaluated.

Moreover, Fairchild also plans to upgrade its F708 airborne reconnaissance camera with a CCD array. The F708 uses a line of 1,024 silicon photodiodes to scan lines in the X direction and aircraft forward motion for Y scanning, a mode that produces a panoramic strip picture. The company is seeking a contract from the Environmental Protection Agency to build the CCD version into an airborne camera system that would find oil spills on bodies of water.

All these camera projects are the

result of progress made in buried-channel array development at the Palo Alto lab. A 500-element design, used as a test bed [*Electronics*, May 22, 1972, p. 29] has been operated successfully over a 1,000-to-1 illumination range, according to James Early, director of research. (Vidicons have about a 100-to-1 range.) In addition to operational advantages, Early emphasizes, the wide range means that much larger arrays will be practical.

The most recent tests will be exhibited at the International Solid State Circuits Conference, Philadelphia, Pa. They will consist of



television test pictures made by scanning a photo mounted on a revolving drum at 2,000 lines a second (1-MHz bit rate) and feeding the signals to a conventional television monitor. The photo shows a fair-haired boy dressed in black and white—a subject that tests a sensor's ability to simultaneously detect highlights and dark shadows without washouts and loss of resolution.

**Steps.** After each scan, neutral-density filters—broadband optical attenuators—step down the image intensity from 30 to 3, 0.3 and 0.03 foot-candles. At the lowest figure, the optical energy input per line is only 15 microfoot-candle seconds. The sensors are almost saturated at 30 foot-candles. At 0.03 foot-candles, they generate about 0.1% of charge saturation. As the intensity drops, the picture on the monitor screen fades somewhat but remains clear, indicating that the buried channels can transfer very small amounts of charge with little loss.

Buried channels are ion-implanted donor layers in a silicon substrate. They provide charges with a relatively trap-free passage under surface traps. Bell Telephone Laboratories, Murray Hill, N.J., which first reported the technique, has used them in linear arrays up to 1,500 elements long, but researchers consider their use in X-Y area arrays problematical [*Electronics*, Jan. 18, p. 162]. □

## Materials

### Magnetic bubbles don't need crystals

Scientists at IBM's Research center, Yorktown Heights, N.Y., have found a way to make magnetic bubble memories out of a film of amorphous material. With the new material, many of the difficulties that now beset development of bubble memories seem to have been bypassed.

IBM researchers have demonstrated a 100-bit shift register, made of amorphous film 2 micrometers

### Arpanet's engineers plan civil data network

A nascent computer utility from Waltham, Mass., styles itself a new kind of carrier offering a new kind of service. Called Packet Communications Inc., the company wants to set up a national network using leased common-carrier lines. It will offer a national message-switching service that it describes as "conceptually similar" to the network of the Pentagon's Advanced Research Projects Agency (ARPA). The Arpanet now interconnects more than 40 independent computers at more than 30 sites throughout the U.S.

The alumni of that system who have founded PCI want to build a commercial network servicing "manufacturing, banking, insurance, brokerage, and real-estate industries; credit-check systems; airline reservation systems; universities; and the commercial remote-access computer industry." Those who left Bolt, Beranek and Newman, the Boston area operator of Arpanet, to form PCI include the new company's president Lee R. Talbert, operations vice president Ralph Alter, and engineering vice president Stephen B. Russell.

If PCI can obtain FCC approval of its application, it could become the first successful computer utility. PCI's illustrative tariff schedule in its filing with the commission cites monthly rates of four-tenths of a cent per 1,000-bit packet for the first 1.5 million transmitted during the day from a computer interface, scaling down to two-tenths of a cent each after the first 9 million. Night rates would be half that. PCI's application contends that in point-of-sale transactions, for example, its "value-added network" would charge \$5 a day for services that Datran, Vienna, Va., a specialized common carrier, proposes to offer at \$40. Moreover, Packet predicts lower error rates than Datran's.

**Issues.** In its application to the FCC, PCI points out it plans no construction of interstate or intercity exchange lines. Instead, PCI proposes leasing "existing wideband interchange lines from established carriers." The FCC must decide

whether PCI requires regulation or treatment as a carrier and what to do about the apparent conflict of PCI's application with FCC rules prohibiting the resale of communications services. To preclude any disputes with the FCC, the company says it will offer a message-switching service as defined by the commission, not data-processing services such as storing, retrieving, sorting, merging, and calculating.

PCI will permit interconnection over the network of any one computer with another using specially modified minicomputers called packet-switching processors, or PSPs. Access from terminals to the computers of various customers will be by means of terminal access processors, or TAPs. Each TAP will be connected to the network through a PSP, with terminals able to access the TAP through the local direct-dial network. PCI says its network would use two network operations centers, "one in the Boston area and a second in the western part of the U.S."

**How it works.** The PSPs will subdivide and reformat messages from customer computers into 1,000-bit packets, and route them to PSPs serving the destination computer. On the receiving end, the PSPs will verify error-free transmission, remove routing and transmission codes, and pass the message on to the appropriate computers. Average round-trip communications delay for PCI users, says the company, will average about half a second for including end-to-end transmission, including store-and-forward functions of the several PSPs. Arpanet works in much the same way.

If PCI can get what it calls "reasonably prompt" FCC action, it forecasts starting service by mid-1974; developing a 20-city net by the end of 1975, and expanding that to 57 cities by 1978. And, if ARPA gets out of the network business—as it expects to—then PCI may find itself with an established business base on which to build, provided it can compete successfully in the bidding to take over Arpanet as a commercial service. □





**Bubbly model.** An "atom" is dropped into an amorphous "film" to show how the evaporation process stops at a point that creates a vertical field so that bubbles can be formed.

thick, which operates at a data rate of 100 kilohertz. And in thinner films, bubbles as small as 1,000 angstroms (0.1  $\mu\text{m}$ ) in diameter have been observed with the help of an electron microscope. This suggests that a shift register is feasible with a data rate well up into the megahertz range, and with bubbles packed as closely as a billion per square inch.

**Deposited on window glass.** Under the direction of Praveen Chaudhari, Jerome J. Cuomo, and Richard J. Gambino, films have been deposited on substrates as diverse as window glass and flexible plastic, at room temperature and without extensive advance preparation.

Until now, magnetic bubbles have generally been formed in films of single-crystal garnet materials grown epitaxially on a single-crystal substrate. Although a great deal has been learned in the few years since the inception of the technology, the single-crystal approach has not been easy.

IBM's goal was to prepare a bubble memory by evaporating the film onto an arbitrary substrate of arbitrary size, cheaply, at room temperature. They did this with an amorphous film of gadolinium-cobalt and gadolinium-iron—materials they had tried to use, without success, in crystalline form. Evaporation is a much simpler process than epitaxial growth. Surprisingly, the necessary magnetic properties, which the researchers didn't think they'd find in an amorphous mate-

rial, were present at levels that, although low, were sufficient to create bubbles.

One of the most important properties is magnetic anisotropy. In an amorphous material made of two components, one would think that the axes of pairs of atoms would be aligned at random, because crystal structure is lacking. But they're not. The IBM researchers discovered that the probability that a pair axis has a component perpendicular to the film is about 1% more than the probability that it has a component parallel to the film, because of the nature of the energy relationships between the atoms. This isn't much of a difference, but it's enough to provide the anisotropy required in a bubble memory. □

## New Ruggednova comes on strong

When the first Ruggednova computers came out, that's exactly what they were—Data General Nova minicomputers repackaged by the Rolm Corp. to withstand military environments [*Electronics*, March 1, 1971, p. 61].

Rolm's new model 1602 Ruggednova is a dozen times faster than its predecessor, the model 1601, and as much as 30% faster than the Data General machines. It is Rolm's own design, a microprocessor run by instructions stored in a 4,096-word

bipolar read-only memory. That memory runs at a 5-megahertz rate—five times the input rate of the basic software and five times as fast as the basic core memory.

The main-memory cycle is asynchronous, which allows semiconductor main memories to replace cores to redouble the processing speed. Another memory feature is direct addressing, which can be used to double the original memory capacity of 32,768 words to 65,536 by employing all 16, rather than 15, bits of the main instruction words. The model 1602 processes 16-bit words. The microinstruction ROM, however, uses 32-bit words to handle the program extensions.

The main reason for these and other innovations is that it opens up new military applications for off-the-shelf computers: electronic intelligence and countermeasures, priority communications-network control, and Omega and Loran.

The price with an 8,192-word core memory is \$18,000. □

## Will IBM's diskette KO punched cards?

IBM's recent announcement of the 3740 data entry system—similar to but not identical with the company's European keyboard-to-disk system—could mean the beginning of the end of punched cards. An IBM spokesman insists, however, that the company is not abandoning the punched card.

The product itself uses a small magnetic "diskette" as the recording medium. (The diskette is similar to the "floppy disk" introduced by IBM in 1970 to load programs into a reloadable control memory, now available on several of the newer IBM computers.)

Each diskette can hold as much information as 3,000 standard 80-column punched cards. Data can be transferred from the diskettes directly into a computer at a rate of 3,600 records per minute—much faster than with punched-card equipment and without a significant



**Data entry.** IBM's 3740 system performs the same job as punched cards, but it's faster.

price differential between the 3740 and high-speed IBM card readers.

The system also uses a serial printer and units for transferring data from the diskettes onto computer-compatible magnetic tape, or directly into a System 370 or System 3 computer. Communications capability is also available so that the diskettes can be used remotely.

Up to now, IBM has carefully stayed out of the keyboard-to-disk and keyboard-to-tape market which

was directly competitive with its punched-card mainstay. Its only nod in that direction was the model 50 magnetic-data inscriber, the performance of which is almost identical to that of an ordinary punched-card machine. Only IBM's optical character recognition machines have had a performance level significantly greater than that of punched-card equipment; and according to the International Data Corp., although IBM has maybe 60% of the installed base in OCR equipment, OCR has provided only a minor part of IBM's income. Thus the 3740 represents a significant step forward in IBM's approach to the data-entry market.

An IBM spokesman said the major market for the 3740 would be in applications that up to now have used punched cards in high volume. But small users, and in particular users of the System 3 and its 96-column punched card, will continue to find the older technology economical. □

## Communications

### Proposed safety standards for lasers draw ire of industry

Representatives of laser manufacturers and the Bureau of Radiological Health will meet Feb. 20 in a showdown over proposed laser safety standards, which, if approved, would "deal a large segment of the market a crippling blow," says one laser manufacturer. The meeting is a hearing before BRH submits the proposed standards March 26 to an advisory committee on radiation safety standards for electronic products. If that committee agrees, the proposals would be on their way to becoming law. Congress is to hold hearings on radiation problems.

At issue is the maximum power levels for class 2 lower-power continuous-wave lasers used in classrooms, demonstrations, construction, and surveying. BRH wants to limit those lasers to 1 milliwatt of power output, but the industry

claims that 5 mw is safe and that the lower limit would wipe out use of lasers in classrooms and construction. If approved, the BRH standard would prohibit the sale of new class 2 lasers above 1 mw, but it will not stop the use of existing ones, assures BRH's Richard W. Peterson, electro-optics branch chief.

The BRH proposals, based on "threshold curves agreed to by ANSI (American National Standards Institute, New York City), and the bio-effects people," are needed to ensure complete safety, Peterson says. Not so, counters C. Harry Knowles, president of Metrologic Inc., Bellmawr, N.J., who argues that the dangerous levels are many times higher. The Electronics Industries Association's position is that 5 mw is a safe level," concurs Allen M. Wilson, engineering department chief. BRH would divide lasers into

four classes. Class 1, those below 1 mw, would automatically be adjudged safe. The disputed class 2 would emit no more than 1 mw and carry warnings against looking at the beam. Class 3 would include all those above 1 mw, those deemed potentially dangerous to the eyes. Class 4 would endanger the eyes and skin. Both classes 3 and 4 would require use of eye shielding.

The new standard wouldn't recall lasers now in use, but EIA's Wilson says, "as we read the present standard, about 60% of existing lasers would be declared dangerous." □

## Audio electronics

### Varispeech system could aid blind

People normally speak at 100 words per minute and read three to five times that fast. Now with a technique called Varispeech, the visually handicapped have a chance to listen as quickly as some people read.

Varispeech uses digital signal-processing techniques to play back recordings with their original pitch and tonal content but at half to 2½ times the speed of the original. Thus, an hour's speech can be heard in 24 minutes, and the blind could increase their learning speeds proportionately.

Other applications might include continuing education of engineers and executives, as well as dictation. Speeches and commercial announcements could be squeezed to fit tight time spots exactly. Moreover, synchronization of film and video sound tracks would be simplified with the system's variable speed control.

There are low-speed applications, too. Short-hand instruction might begin with slow speech, and the rate steadily increased as students improve. Varispeech can also reconstitute so-called "helium speech"—the high-pitched speech, peculiar to high-pressure environments, that is a problem in undersea exploration.

Varispeech is the brainchild of

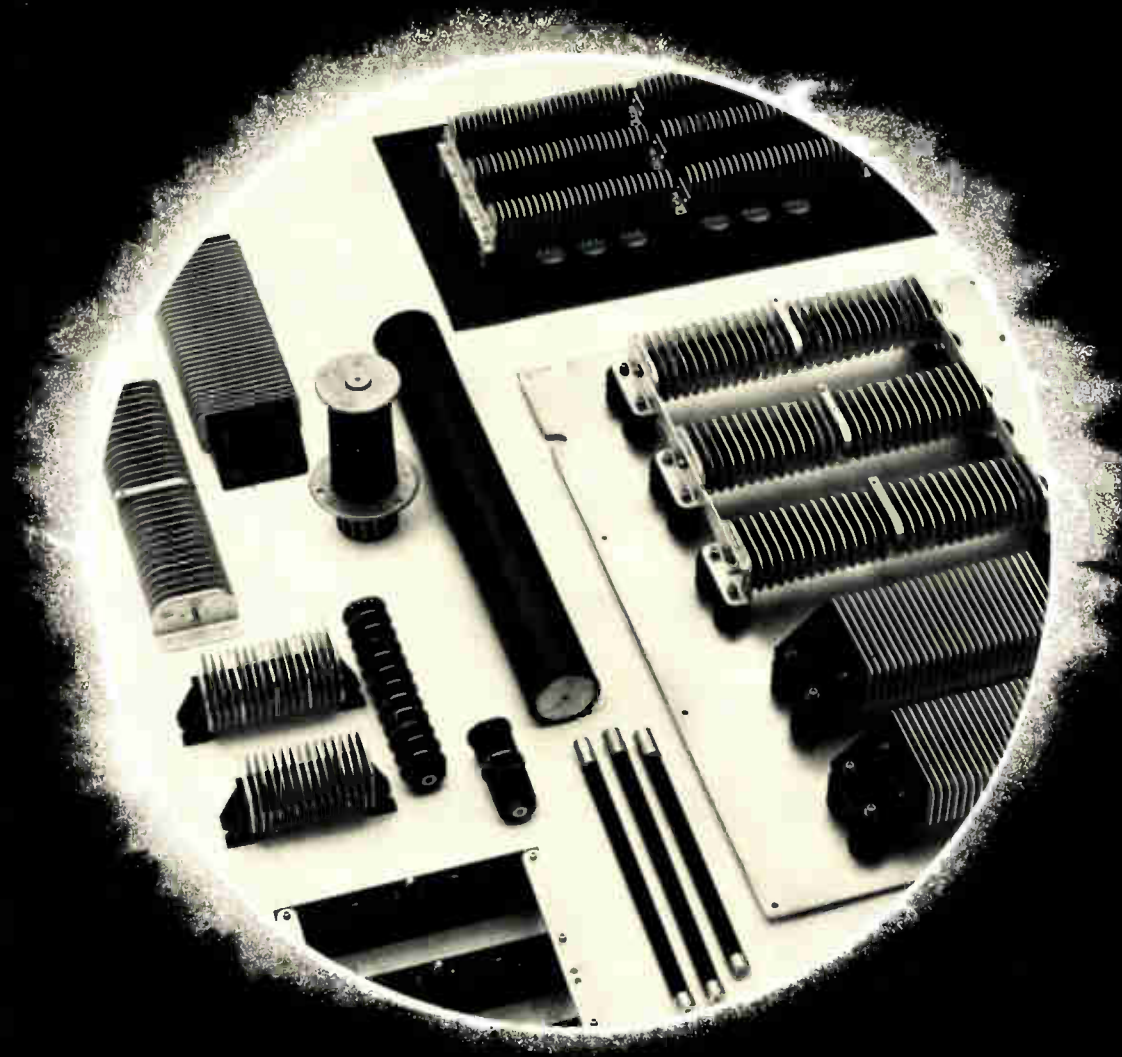

# POWER UNLIMITED

**Efficient, Reliable High Voltage - High Current Rectifiers**

*Semtech's high current-high voltage devices efficiently solve the most sophisticated rectification, clamping, damping or switching problems. Proprietary design concepts allow Semtech to offer assemblies with unlimited voltage-current handling capabilities.*

*Although Semtech offers many standard catalog high voltage power components, it fully understands that these components can seldom be treated independently. Semtech has successfully supplied over 6,000 "specials" completely integrated into unique applications. Semtech engineers are continually concerned with the special problem of high voltage applications. Our modular design concept, in depth stocks of sub-components and Application Engineering Department enable us to supply your particular needs reliably, efficiently and competitively.*

*Call the Semtech representative nearest you and ask about Semtech's unlimited power. We have immediate capacity to handle your specifications.*

820,000 volt  
fast recovery  
device.



**SEMTECH**  
CORPORATION

652 Mitchell Road, Newbury Park, California 91320  
(805) 498-2111, (213) 628-5392 / TWX: 910-336-1264

Chicago: (312) 352-3227  
Dallas: (214) 253-7644  
Florida: (305) 644-5404

New Jersey: (201) 654-4884  
San Francisco: (415) 328-8025  
European Sales: (042) 232-242

Francis F. Lee, professor of electrical engineering at the Massachusetts Institute of Technology, Cambridge, Mass. He is selling it through his company, Lexicon Inc., Waltham, Mass.

Lee's doctoral thesis concerned text-to-audio conversion for the blind, and it earned him a faculty appointment. But construction of the hardware involved optical character-recognition techniques and multi-processors, and it would have cost several hundred thousand dollars to reproduce. "Obviously, I wasn't helping the blind with this," he says, "so I took a new approach." The new system costs \$1,500.

While the Varispeech unit looks much like a standard cassette tape deck, the large variable-speed control knob atop its 13-by-14-inch case sets it apart in appearance. Playback speed is infinitely variable, and both signal processing and other key parameters are controlled through this single knob. The electronics package in the machine samples the output at the playback head, temporarily stores it in a 4,096-bit MOS random-access memory, and then reads out each sample consecutively, playing back the tape without loss of its original tonal content.

Varispeech is simpler and could prove more reliable than systems with television-like rotating multigap heads, tape loops, and other analog solutions. The system requires no more moving parts than a tape recorder and obviates the need to match the output levels of the various gaps in multigap heads.

Lee hopes eventually to be able to sell the electronics package separately for a few hundred dollars, thus broadening his sales potential into OEM markets. □



## Commercial electronics

### Computer tells blind what they've written

An audio-response time-shared computer service (ARTS) is helping the blind to type correspondence, proofread manuscripts, solve book-keeping problems, and even write computer programs. The system was developed by Kenneth Ingram, president of American Systems Inc. Watertown, Mass.

The first ARTS system was recently installed at the Protestant Guild for the Blind in Watertown. It takes only a few hours for a blind person to learn to use the system. When the bureau is telephoned, information is transmitted to the computer via the console; each key pressed generates a touch-tone sound that the computer recognizes. The computer responds in words, telling the user what he has typed or giving the results of commands or computations. The user receives a voice recording, braille copy, or ink-print copy of the typed information, and in addition he receives memory space to store information so he can recall it later for more changes or additional copies.

A student might use ARTS to prepare homework and type papers, and a secretary could type letters or other material, proofread them, and request printed copies on a letterhead. A programmer might type in a program, using the voice to find errors. New lines could be inserted or statements corrected by typing in simple commands and then the changes. The computer would provide a punched card or printed copy of the completed program.

There are two interconnected digital computers in the ARTS bureau. An audio response unit receives the information from 16 telephone lines, transforming it into voice to be played back to the user. Speech information is stored on a magnetic

**Machine speaks fast.** Varispeech unit maintains tone, but speeds up speech.

disk. The audio response unit transmits information from the user to an applications computer which contains and operates the service bureau programs. Included in the applications system is a Data General Nova 800 with 16,384 words of memory, a high-speed swapping disk with 512,000 words of memory, and a moving-head disk for storage. The charge is \$450 for a console with either a standard or a braille keyboard, and computer time costs an additional \$1.50 an hour.

Sixteen users can now be handled simultaneously, and American Systems hopes to expand this capacity. The state of Kentucky has contracted for an ARTS system, and inquiries have come from overseas. □

### Digital thermometer uses DVM chip

One of the least likely applications for a complex one-chip digital voltmeter might seem to be replacing a simple glass thermometer, but Ivac Corp. has done just that. The San Diego company, which has been making digital-readout medical thermometers, has introduced a small portable version using a Mostek DVM chip, plus a three- or four-digit light-emitting-diode readout.

Although priced at \$395, the unit is particularly useful for hospitals because readings take only 3 to 7 seconds, and sterilization is unnecessary because the probe uses disposable covers. Another bonus is the elimination of breakage, which reportedly results in 60 tons of deadly mercury pollution being washed into the environment each year.

The thermometer emits an audible signal when the reading is ready. It also stores the temperature automatically until the probe is inserted for storage.

Models are available for both fahrenheit (49.0 to 108.0 F) and celsius (34.0 to 44.0°C). Resolution for both models is 0.1°, with fahrenheit accuracy to  $\pm 0.2^\circ$ , and celsius to  $\pm 0.1^\circ$ . The unit also includes self-test

# Stable.

**Our phase-locked loops offer you greater V.C.O. stability, frequency range and functional capability.**

**HA-2800 for guaranteed frequencies up to 25 MHz.**

For use in frequency synthesizers. As an I.F. amplifier detector for F.M. Or phase modulation receivers. Operation guaranteed up to 25 MHz. V.C.O. output: compatible with both TTL and ECL and provides improved temperature coefficient and supply regulation. Supply voltage range: 12V to 30 V.

Supplied: 16-pin 100-999 units hermetic DIP

HA-2800 -55°C to +125°C \$22.65  
HA-2805 0°C to +75°C \$ 9.85

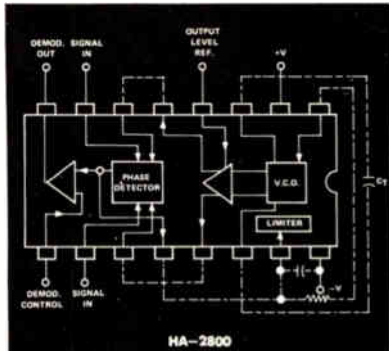

**NO OTHER PHASE-LOCKED LOOPS COMBINE THESE FEATURES.**

**In addition to greater stability, frequency range and application versatility both devices feature:**

**Independent phase detector and voltage controlled oscillator in the same package.**

**Broken loop between the phase detector and the V.C.O., permitting inclusion within the loop of amplifiers, active filters, sweep circuits and other acquisition aids.**

**Isolated phase detector output, which allows adjustment of demodulated output gain and filtering without affecting the loop's characteristics.**

**For details see your Harris distributor, representative, or write direct.**

**HA-2820 for frequencies from 0.1 Hz to 3 MHz.**

For use as amplifier/detectors, audio tone generators/detectors, and precision motor speed controls. V.C.O. output drives DTL/TTL and provides greatly improved stability. Supply voltage: ± 6V to ± 12V.

Supplied: 14-pin 100-999 units hermetic DIP

HA-2820 -55°C to +125°C \$13.35  
HA-2825 0°C to +75°C \$ 6.35

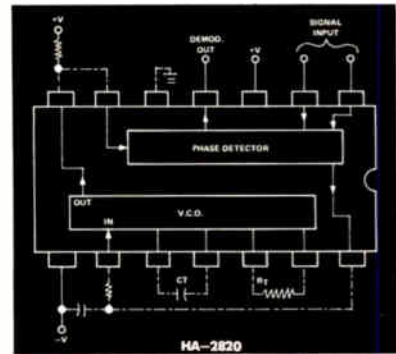

# Harris



**HARRIS**  
**SEMICONDUCTOR**  
A DIVISION OF HARRIS-INTERTYPE CORPORATION

P.O. Box 883, Melbourne, Florida 32901  
(305) 727-5430

**WHERE TO BUY THEM:** ARIZONA: Phoenix—Liberty, Weatherford, Scottsdale—HAR (602) 946-3556 CALIFORNIA: Anaheim—Weatherford, El Segundo—Liberty, Glendale—Weatherford, Long Beach—HAR (213) 426-7887, Mountain View—Elmar, Palo Alto—Weatherford, HAR (415) 321-2280, Pomona—Weatherford, San Diego—Weatherford, Western COLORADO: Denver—Elmar, Weatherford WASHINGTON, D.C.: HAR (202) 337-3170 FLORIDA: Hollywood—Schweber, Melbourne—HAR (305) 727-5430 GEORGIA: Atlanta—Schweber ILLINOIS: Chicago—Semi-Specs, Schweber, Palos Heights—HAR (312) 597-7510 INDIANA: Indianapolis—Semi-Specs MARYLAND: Rockville—Schweber MASSACHUSETTS: Lexington—R&D, Waltham—Schweber, Wellesley—HAR (617) 237-5430 MICHIGAN: Detroit—Semi-Specs MINNESOTA: Minneapolis—Semi-Specs MISSOURI: Kansas City—Semi-Specs, St. Louis—Semi-Specs NEW MEXICO: Albuquerque—Weatherford NEW YORK: Melville—HAR (516) 249-4500, Syracuse—HAR (315) 463-3373, Rochester—Schweber, Westbury—Schweber OHIO: Beachwood—Schweber, Dayton—Semi-Specs PENNSYLVANIA: Pittsburgh—Semi-Specs, Wayne—HAR (215) 687-6680 TEXAS: Dallas—Weatherford, Semi-Specs, HAR (214) 231-9031 WASHINGTON: Seattle—Liberty, Weatherford WISCONSIN: Wauwatosa—Semi-Specs

**LEGEND FOR HARRIS SALES OFFICES & DISTRIBUTORS:** Harris Semiconductor (HAR), Elmar Electronics (Elmar), Harvey/R&D Electronics (R&D), Liberty Electronics (Liberty), Schweber Electronics (Schweber), Semiconductor Specialists, Inc. (Semi-Specs), R V Weatherford Co (Weatherford), Western Radio (Western)

capability. Power comes from rechargeable nickel-cadmium batteries, giving a battery life of eight to 10 hours between charges. The thermometer, which is  $3\frac{3}{8}$  in. wide by  $5\frac{1}{8}$  in. deep by  $2\frac{3}{8}$  in. high, weighs 12 ounces. □

---

**Packaging**

---

## DIPs challenged by film-strip package

A new IC packaging technique that challenges the dual in-line package for reliability, low cost, and ease of test and assembly has been announced by AMP Inc., Harrisburg, Pa. Said to be far less expensive than ceramic packaging, the technique is similar to the MiniMod approach originated by GE, but since sold to Texas Instruments [*Electronics*, Feb. 1, 1971, p. 41]. It uses various widths of Kapton film to support plated-on lead patterns. Although some assemblies can use film strips several inches wide, most common applications would make use of films 16, 35, or 70 millimeters wide, frequently with sprocket holes like movie film for easy indexing and movement.

**Narrower.** Semiconductor chips are bonded facedown to the leads, and the film is spooled up. It can be unreeled later for test and circuit-board assembly. The technique adapts to LSI devices, discrete semiconductors, and multichip arrays; as many as 80 leads can be laid down on the Kapton with spacing between leads as small as 2 mils. According to AMP, this spacing is narrower than that possible with the MiniMod technique.

AMP spokesmen claim high potential reliability for this system, especially compared to wire-bonding techniques. First, there are no wires to bend or break, and one bonding step is completely eliminated. In addition, unlike most other facedown bonding schemes, the active area of the chip can be inspected through the transparent Kapton.

The technique is inexpensive

## Echo triggers LEDs in depth-finder

A readout composed of a quantized linear array of 100 light-emitting diodes is featured in an all-solid-state depth-finder from a new marine electronics company. The 10-inch-wide diode array is sequentially addressed by counter-decoder combinations after transmission of a sound probe into the water. The arrival of an echo from the bottom turns on the diode addressed at that instant.

Developed by Osborne-Hoffman Inc., Point Pleasant Beach, N.J., the Quantiline Sounder distinguishes between actual sea bottom and secondary echos from objects, such as fish, between the boat hull and the bottom. It operates over three ranges, 0-20 feet, 0-100 ft, and 0-500 ft. Resolutions are  $\pm 0.1$  ft,

$\pm 0.5$  ft, and  $\pm 2.5$  ft, respectively. For added safety in shallow water, the unit eliminates spurious echos on the 0-20-ft range and displays only the first signal received.

According to co-founder Edwin Hoffman, production units will be available in April at a suggested retail price of \$150. The prototype demonstrated at the recent New York Boat Show measures 12 in.  $\times$  6 in.  $\times$  2.5 in. □

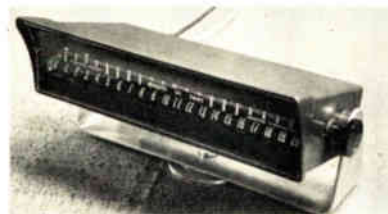

enough that chips can be bonded to the lead patterns before electrical tests, thus removing a source of mechanical damage to chips that often cuts yields during probe tests. Also, lead and chip tests can be combined into a single step.

Packaging could be as simple as allowing a drop of epoxy to cover the chip, sealing it to the Kapton. This could simplify automated packaging, and it might cut packaging costs enough to allow competition with inexpensive offshore labor. Also, since chips so packaged have a very low profile, high component density is possible.

The system is compatible with edge-connection IC-mounting techniques and with other so-called leadless systems. But eventually, printed-circuit-board assembly of ICs using the AMP packaging technique might use reels of chips, laying down each circuit and bonding its leads to attachment points, rather like plastic postage stamps.

Unlike the MiniMod approach and Motorola's spider bonding, the technique is for sale to all comers, and the firm already claims that at least two major firms are about

ready to sign. Thus the technique's challenge to the DIP could become a reality. □

---

**Production**

---

## Plating the way to inexpensive masks

Borrowing from an old technology—chemical plating—RCA's Research Laboratories, Princeton, N.J., is working on a new and inexpensive method for making the photomasks used in the manufacture of semiconductor devices. The masks are made with a cuprous oxide ( $\text{Cu}_2\text{O}$ ) film plated on a glass substrate. Results so far are extremely encouraging, according to the project's manager, Nathan Feldstein, and should the process be used in manufacture, cost savings could be its greatest advantage. "We use a beakerful of chemicals costing only pennies," says Feldstein.

Line widths are down in the 1.5-2-micrometer region, or as good as any obtained with the silver ha-

# Near and far-sighted Spectrum Analyzer.

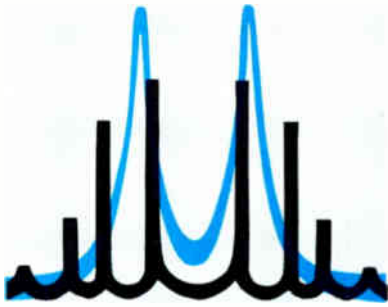

levels down to  $-121$  dBm!

This instrument offers a unique combination of per-

formance, ease of operation, and low cost: Whether you need a bay-window scan or a microscopic display of two very closely spaced signals, the SA-70 series provides near-perfect vision between 500 kHz and 1300 MHz. And it does it over a 141

dB range with signal

- Phase lock for stable displays; indicator light for unambiguous amplitude measurement; 300 Hz resolution for close-in side-by-side signal analysis.
- Internal markers every 100 MHz for precise frequency determination.
- Additional plug-ins for frequency coverage over 20 Hz to 27.5 MHz range.
- Priced to make others seem expensive.

If you need variable persistence and display storage, ask for the SA-71A, otherwise, select the SA-70A. Both are described in our data bulletin. Send for one. It's the far-sighted thing to do.



Spectrum Analyzer Model SA-71A

**SINGER**  
INSTRUMENTATION

The Singer Company, Palo Alto Operation • 3176 Porter Drive, Palo Alto, Calif. 94304 • Telephone (415) 493-3231

# Why we think the Brush 500 is your best choice in an XY recorder.



**RELIABILITY.** It's guaranteed by our exclusive Metrisite® non-contact servo-loop feedback system. You get 99.85% linearity. But you don't get noise, slide wire troubles, dirty pots, wear and the maintenance problems of potentiometric feedback systems.

**CRISP TRACES.** We don't believe in smear tactics. But we must say others don't give you traces as crisp as ours. Reason: we have pressurized inking that forces ink into the paper, instead of simply laying it on the surface. Our pen never needs priming, even

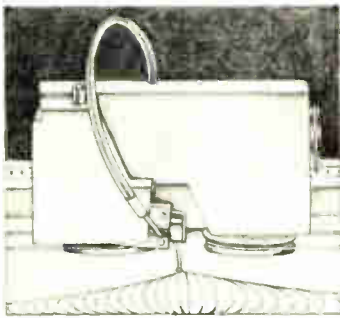

after long periods of not being used.

**SPEED.** The 500 does a fast 40 inches a second. Which makes it 50% or 100% faster than most anyone else's. And it

accelerates at 1650 in/sec<sup>2</sup>. It's a mover.

**MORE FEATURES.** Like electrostatic holddown. Easy rack mounting. Electronic limiters that eliminate collisions between pen and frame. And a price we think will please you.

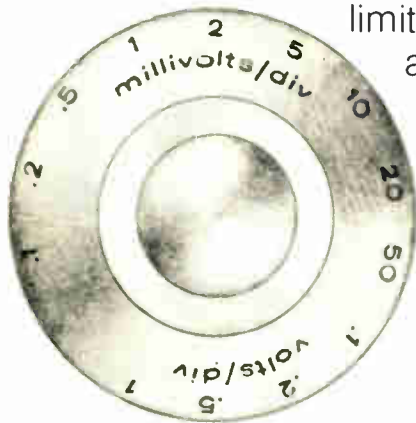
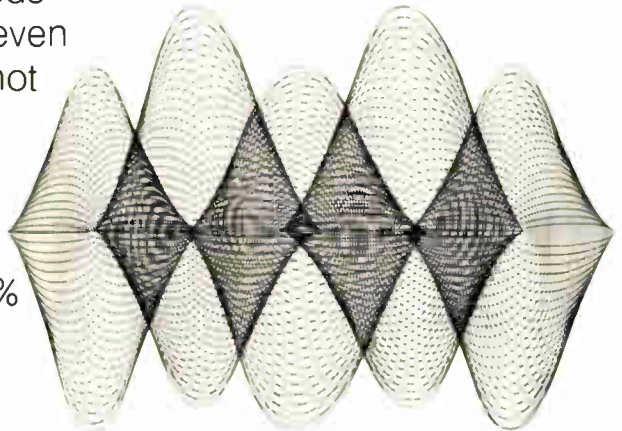

For information on this excellent XY recorder with built-in preamps with a sensitivity range of 100 $\mu$ V/div. to 1.0 V/div., write Gould Inc., Instrument Systems Division, 3631 Perkins Avenue, Cleveland, Ohio 44114. Or Rue Van Boeckel 38, Brussels 1140, Belgium.

BRUSH INSTRUMENTS

 **GOULD**



lide emulsion on glass most commonly used. And while the cuprous oxide film is opaque to the ultraviolet, the region of greatest photoresist sensitivity, it is transparent to visible light. This latter characteristic means that, unlike an emulsion mask, the new mask can be readily aligned on a semiconductor wafer by purely visual means.

Originally, the silver halide emulsions were developed to meet the precise dimensional requirements of semiconductor photomasks. Then other materials, deposited on glass substrates, were introduced that were more durable, like chromium, and also semitransparent, like iron oxide. Mask-making here requires sophisticated and expensive vapor deposition and sputtering machines, eliminated in RCA's process.

The cuprous oxide is plated on the glass strictly with wet chemical methods, and he believes it's the first time this material is handled in this manner. Initially, the glass surface is sensitized with acidic stannous solutions, then activated with acidic palladium chloride. Following this, the cuprous oxide is plated on out of an electroless plating bath of copper sulfate.

As with so many happenings in research laboratories, Feldstein hit upon the cuprous oxide material by accident. He was originally working on printing copper for printed-circuit applications and often found a deposit of an undesirable yellow material he thought "was good for nothing." Fortunately, he decided one day to run a check of its optical properties and found it would be ideal for photomasks. □

## Fairchild advances bipolar technology

While most semiconductor manufacturers are still struggling to get their first high-density bipolar processes on stream, Fairchild Semiconductor already has on tap a powerful second-generation process that promises even more speed and higher packing density than earlier

bipolar memory and logic products. The new method of building digital bipolar integrated circuits is called Isoplanar II—an extension of Fairchild's original cell-shrinking Isoplanar technique that was responsible for putting high-density bipolar memories on the map.

But Isoplanar II does more. Tom Longo, vice president and general manager of Fairchild's Digital Products division, explains that the new process "reduces the silicon area of integrated-circuit transistors by 70% over conventional planar-transistor technology and 40% over the Isoplanar-transistor technology introduced by Fairchild in 1971." Not only does the new process further improve packing density, but Longo claims that Isoplanar II also provides a major reduction in junction capacitors, so that memory and logic circuits will operate faster and consume less power than those built with conventional or other passive isolation techniques.

In terms of random-access memories, using tighter line geometries could mean 2,000 bits and more on a single chip operating at access times of about 50 nanoseconds with power dissipation no greater than today's smaller bipolar RAMs. In logic, it would mean tighter ECL circuits operating at subnanosecond speeds and reduced powers per gate. Indeed, the first product Fairchild has built with Isoplanar II is an ECL circuit—a dual 5/4-input gate with current-switch inputs and emitter-follower outputs—which has typical propagation delays of 650 picoseconds for the five-input gate and 600 picoseconds for the four-input gate at 57 milliwatts per gate.

The new structure, which reduces the transistor collector-base junction area to 60% compared to that attainable by either conventional planar or the previous Isoplanar technologies, is built with an oxide walled-emitter structure. The emitter-base junction terminates at the same silicon-dioxide wall that provides isolation between adjacent transistors in the earlier Isoplanar technology.

As a result, Isoplanar II transistors not only save space, but they

# NEW SHORTER CASE! SCHAUER 1-WATT ZENERS

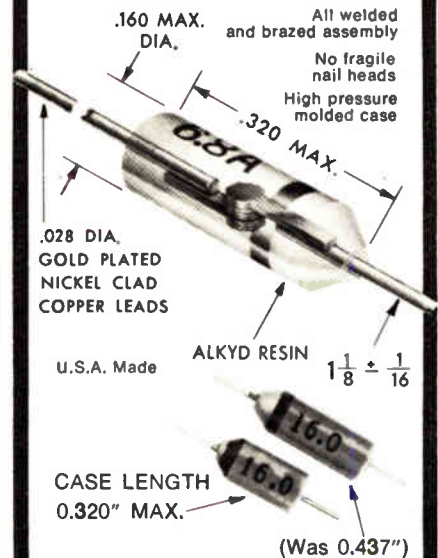

**SAME LOW PRICES FOR 1% TOLERANCE ZENERS**

**ANY VOLTAGE FROM 2.0 TO 18.0**

Quantity	Price Each
1-99	\$1.07
100-499	.97
500-999	.91
1000-4999	.86
5000 up	.82

**IMMEDIATE SHIPMENT**

Send for rating data and 20%, 10%, 5% and 2% tolerance prices.

Semiconductor Division

**SCHAUER**

MANUFACTURING CORP.

4514 Alpine Ave., Cincinnati, Ohio 45242  
Telephone 513/791-3030

# Dialight sees a need:

(**Need:** Find a very small fault in a very large system.)

# See Dialight.

All printed circuit boards need a fault indicator; that's why Dialight has developed such a broad family. These tiny LED devices signal where and when a fault occurs in a complex electronic circuit — and this can reduce downtime to a minimum. With some Dialight fault indicators, you can get as many as 10 units in just 1" of space. These devices, which come in a variety of sizes, are designed to operate from 1.6 to 14 volts and are available with both axial and right angle leads. They



can be driven directly from DTL or TTL logic and can also serve as logic-state indicators, binary data displays, or just as indicators, as in this p-c board furnished by Struthers-Dunn, Inc. But Dialight's fault finders are only a small part of their fast growing family of light-emitting diodes. Additional opto-electronic devices are extensively used in cartridges, lighted push-button switches, opto-isolators, and readouts, all supplied by Dialight. A wide variety of discrete LEDs further adds to the broad family.

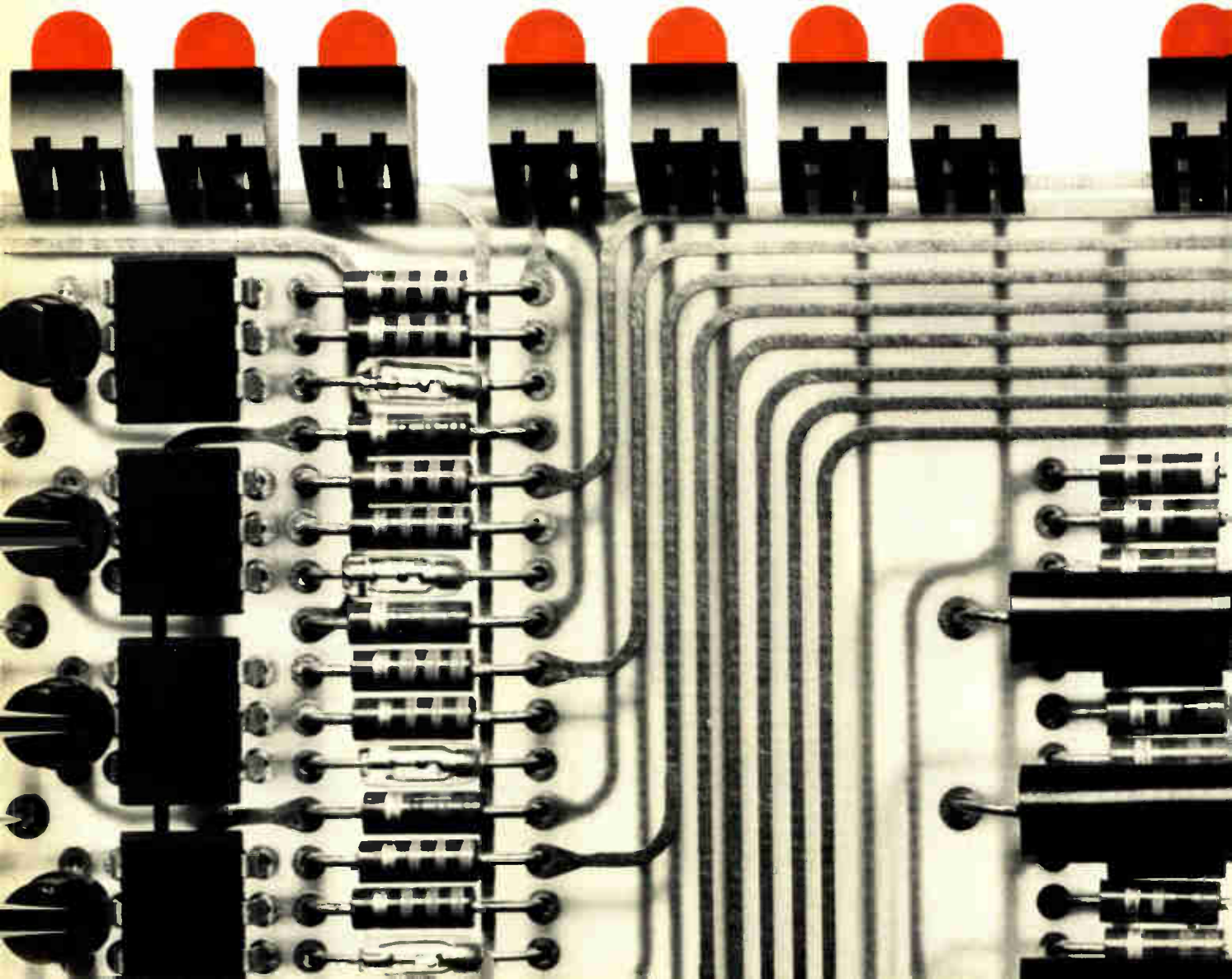

Dialight is a company that looks for needs . . . and develops solutions. That's why we developed the industry's broadest line of switches, indicator lights and readouts using LEDs. No other company offers you one-stop shopping in all these product areas. And no one has more experience in the visual display field. Dialight can help you do more with them. Talk to the specialists at Dialight first. You won't have to talk to anyone else. We can help you do more with LEDs than anyone else because we've done more with them.

- Here are a few products in this family: **1.** Ultra-miniature indicator lights **2.** Datalamp cartridges **3.** Bi-pin LED lamp **4.** Opto-isolators **5.** LED solid state lamps **6.** Logic state fault indicators

\*Used in their VIP Programmable Controller

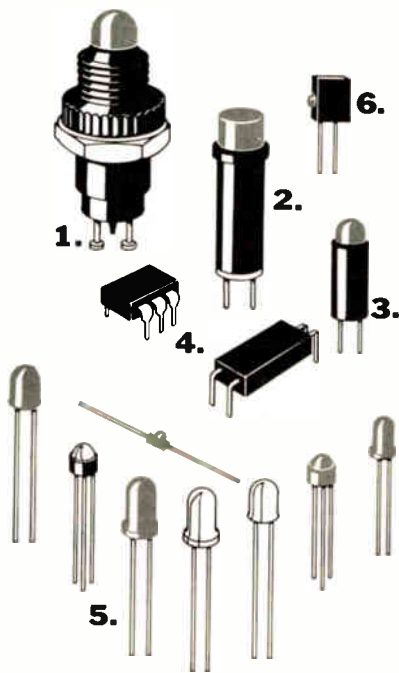

Please send data on your LED products.

NAME \_\_\_\_\_  
 TITLE \_\_\_\_\_  
 COMPANY \_\_\_\_\_  
 ADDRESS \_\_\_\_\_  
 CITY \_\_\_\_\_ STATE \_\_\_\_\_

**DIALIGHT**

Dialight Corporation, A North American Philips Company  
 60 Stewart Avenue, Brooklyn, N.Y. 11237 (212) 497-7600

## Electronics review

have lower collector and isolation capacitances, and their dc breakdown voltages, beta, and open-base voltages are identical to those of conventional transistors made with the same diffusion levels. □

## Hearing aid IC cuts battery drain

A new linear integrated circuit that doubles battery life in hearing aids is going into production at the Raytheon Co. Semiconductor division, Mountain View, Calif. The chip, the

RM8341, also cuts the RC network by more than half and provides automatic gain control. While standard hearing-aid chips, based on the Westinghouse 183 design, pull about 1 milliampere from the battery cell when quiescent, the RM8341 takes only 0.5 mA on standby. This is expected to extend battery life from a range of 60 to 100 hours to almost twice that range.

The only external components required by the RM8341 are two capacitors, a resistor, and a variable resistor with adjustable gain control or three capacitors and two fixed resistors with automatic gain control.

## News briefs

### Sapphire output to triple

The Saphikon division of Tyco Laboratories Inc., Waltham, Mass., a major producer of sapphire substrates, has started an expansion program designed to increase the company's output from 15,000 square inches of sapphire per month to 40,000 per month by early fall. "We've made a decision to target on the electronics market, especially microelectronics," says marketing manager Frank Reed. "We have confidence that this business will take off this year." As it expands its capacity, Saphikon hopes to halve its prices from \$20 for a polished 2-in. square or circle 2-in. in diameter between 10 and 15 mils thick, to sell at about \$10.

Saphikon's new method of growing sapphire, a modification of the Czochralski techniques, is also a factor in its ability to lower prices. The company now can grow sapphire in ribbons, filaments, and tubes. Liquid sapphire is drawn up through capillary tubes to a predetermined shape; it spills over the shape, and crystals are grown from there in a predetermined crystal orientation.

### More test gear for Air Force avionics

The Honeywell Inc. Government and Aeronautical Products division, Minneapolis, has won a \$5.6 million award from McDonnell Douglas Corp. to build depot-level automated test equipment for the avionics aboard the Air Force's F-15 fighter. This is the second military-connected award in about a month for Honeywell's minicomputer-directed H-2600 series of test equipment, sold originally for testing avionics on commercial aircraft. [*Electronics*, Jan. 18, p. 112]. Emerson Electric Co., St. Louis, will supply the rf test equipment; Honeywell itself will build the analog, digital, and intermediate-frequency test stations. In time, and depending on how many aircraft are built, Honeywell estimates sales of the test equipment could reach \$20 million.

### IBM doubles maximum memory

Memory capacity of the multiprocessing versions of IBM's System 370 models 158, 168, and 145 have been doubled—even before the first two machines were shipped to customers. In the 158 and 168, IBM has substituted 2,048-bit MOS chips for the 1,024-bit chips that were originally specified for both machines [*Electronics*, Aug. 14, 1972, p. 40]. Memory size is increased in the model 145, announced two-and-a-half years ago as the first IBM computer with a semiconductor memory, by adding bipolar memory chips of 1,024 bits each to the 128-bit chips used previously.

# MORE!

new

## V-PAC\* POWER SOURCES

for

- Op amps
- Line receivers
- Comparators



Now, use standard +5v source to power your linear IC's. Simplify design, reduce system volume, eliminate extra power supplies, reduce manufacturing costs, with V-PAC power sources.

Operate from 7 to as many as 35 of these types from a single V-PAC source: 709, 741, 710, 711, 720.

Less than a third cubic inch, standard DIP pin configuration, V-PAC sources can be mounted on half-inch center cards with other components.

TYPE:	VA 12-12	VA 15-15	VA 12-6
VOLTAGES:	+12 -12	+15 -15	+12 -6

Write or call for full specifications.

<b>WEST:</b>	<b>EAST:</b>
213-843-5200	513-761-5432
214-233-4489	201-992-2505
505-298-1875	803-288-4450
312-654-8645	416-743-9130
415-593-2189	617-272-7655
206-747-9424	305-941-5544



**Reliability, Inc.**

5325 Glenmont, Houston, Texas  
77036 • 713-666-3261

Europe and the Far East: TISCO (TI Supply Co.)

TWX: 910-881-1739 \*TM, Reliability, Inc.

To cut battery current drain, Raytheon borrowed some techniques from the operational amplifier designers. Chiefly, the company substituted pnp current sources for the passive resistors used in previous hearing aid chips, such as the Westinghouse 183.

There are four gain stages in the RM8341—three in the signal path and one in the feedback path—and an automatic gain control on the chip. The agc can be replaced by an external volume control if the agc stage is grounded. The over-all gain is 70 db, and the acoustic power output is 150 microwatts.

The 183 has a much higher power output—3 milliwatts. However, Alan Borken, manager of linear interface marketing at Raytheon, says that about 60% of the hearing aids made today need only 150  $\mu$ w. For the higher-power market, Raytheon plans to produce a 1-mw version of the RM8341.

Because of the sales appeal of longer battery life, Borken expects IC sales to climb. He estimates the total American market has been some 125,000 chips a year, which amounts to about \$1 million at the typical Westinghouse 183 amplifier list price of \$8, but it is actually less at the volume price of \$5.

With fewer components required, Borken predicts that the RM8341 will cut into hybrid and discrete-circuit markets. He calculates that hearing-aid manufacturers now buy more than 60,000 hybrid ICs and make another 150,000 hybrids in-house. That means about one-third of all aids are still being assembled with discrete components. □

### Displays

## Silicon display being tested by AF

The first reported storage-tube refresh memory for an Eidophor projection color display is undergoing evaluation at the Rome Air Development Center, N.Y.

The color scan-converter system,

developed by Princeton Electronic Products Inc., Princeton, N.J., changes a computer's digital output into a TV-type scan for Eidophor projection. The digital output is converted into three pairs of analog X-Y signals suitable for driving the deflection plates of a CRT. Each X-Y signal pair corresponds to one of the primary colors of a color-TV picture. The random X-Y scans are used to write messages onto the targets of three silicon-target, electrical-output storage tubes known as Lithocons—a trademark of Princeton Electronic Products Inc. (see p. 91). The messages are then read in a conventional TV scan mode to generate red, green, and blue video for display.

The major advantage of the storage-tube approach is cost—a three times saving over previous all-digital methods for refreshing color displays. Also, the system is a quarter the volume of previous units. □

### Solid state

## Electronic watch ICs cut size and costs

Electronic watches are beginning to replace expensive mechanical time pieces for men. However, women's watches have not benefited until now because the electronic components, although tiny, have not been tiny enough for the dainty watch size. Now, Statek Corp. has demonstrated a technique that dramatically reduces the size of the electronic timing circuit, opening the way for a significant decrease in the size of today's electronic watches. Better yet, the circuitry promises to cut costs enough for finished watches to sell for \$25 each, although they won't meet the highest accuracy specifications that the watch industry guarantees for its very expensive watches.

Statek combines miniature tuning-fork crystals with a complementary MOS divider chip inside a 1/4-inch-square IC flatpack. The size of this assembly can be reduced even more by mounting the chip under-

# 256-Bit RAMs.

MAX. ACCESS ACROSS TEMP. AND  $V_{CC}$

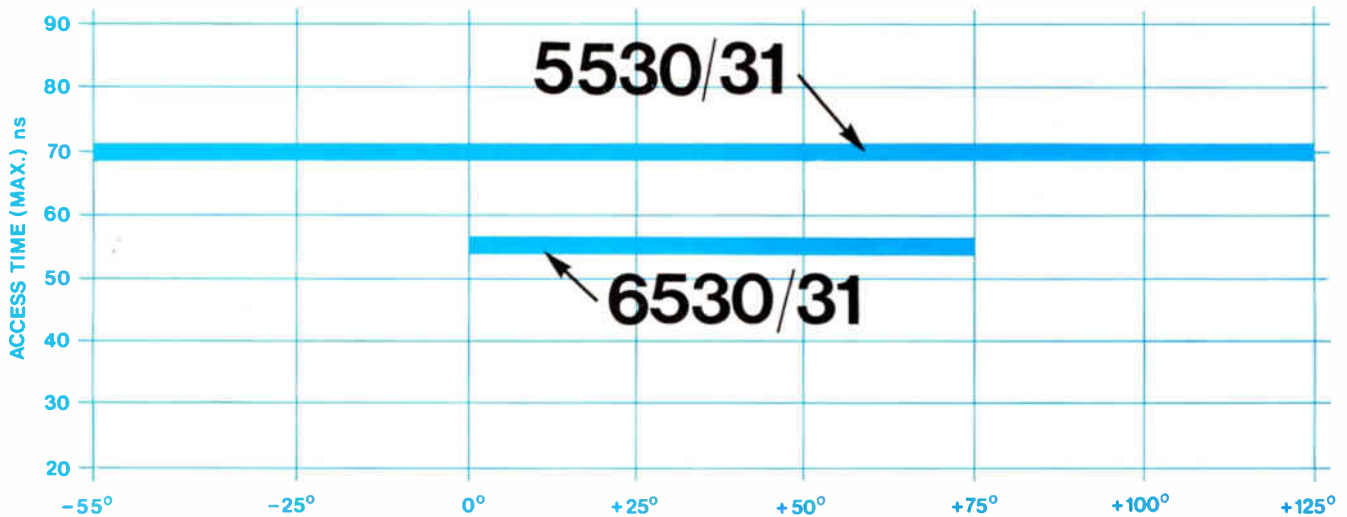

## Guaranteed fastest. Across temp and $V_{CC}$ .

### 256-Bit RAM sources:

Monolithic Memories could have chosen to be your first supplier for 256-bit bipolar RAMs. Instead, we chose to be better. The chart tells how we're better. No gimmicks. No specsmanship. No fooling. The data sheet tells the rest of the story. Get it from our rep or distributor.

If semiconductor memories are your thing, you'll want to know what MMI's up to.

And if delivery's your problem, solve it by looking on our distributors' shelves. Look to MMI for leadership. First with 2K bipolar PROMs. First with 8K, 9K, and 10K bipolar ROMs. Now first with the fastest 256-bit RAMs.

#### FASTEST—55 ns. (256 x 1) guaranteed across temp & $V_{CC}$ range

Manufacturer	Part No.	Open Collector Tri-State	Guaranteed Max. Access @ Conditions	Price (100's)
Monolithic Memories	6530/31	OC/TS	55 ns @ 0° to 75°C, 5.0 $V_{CC}$ ±5%	\$27

#### Alternate source—60 ns. device (256 x 1)

Intel	3107A/06A	TS/OC	60 ns @ 0° to 75°C, 5.0 $V_{CC}$ ±5%	—
-------	-----------	-------	--------------------------------------	---

#### FASTEST—Mil Spec 70 ns. (256 x 1) guaranteed across temp & $V_{CC}$ range

Monolithic Memories	5530/31	OC/TS	70 ns @ -55 to +125°C, 5.0 $V_{CC}$ ±10%	\$52
---------------------	---------	-------	--	------

(Note: The TI 54200 and Intersil IM5533M are specified at 80 ns., but only @ +25°C, 5.0 V.)

#### Alternate sources—80 ns. devices (256 x 1)

Monolithic Memories	6523/33	TS/OC	80 ns @ 25°C, 5.0 $V_{CC}$	\$17
Texas Instruments	74200	OC	80 ns @ 25°C, 5.0 $V_{CC}$	—
Intersil	IM5523/33	TS/OC	80 ns @ 25°C, 5.0 $V_{CC}$	—

If you need parts, call, TWX, or write Dale Williams today.

## Monolithic Memories, Inc.

1165 East Arques Avenue, Sunnyvale, CA 94086 • (408) 739-3535 • TWX: 910-339-9229

Monolithic  
Memories

Representing your best buy in memories: ALABAMA, Huntsville (205) 539-1771; ARIZONA, Phoenix (602) 264-7971; CALIFORNIA, Los Angeles (213) 398-6239; San Diego (714) 747-3015; Palo Alto (415) 369-4671; COLORADO, Denver (303) 623-8713; CONNECTICUT, North Haven (203) 239-9762; FLORIDA, Orlando (305) 423-7615; ILLINOIS, Chicago (312) 455-5100; INDIANA, Ft. Wayne (219) 744-4331; Indianapolis (317) 844-3241; IOWA, Cedar Rapids (319) 362-8155; KENTUCKY, Louisville (502) 893-7303; MARYLAND, Baltimore (301) 825-3330; MASSACHUSETTS, Boston (617) 653-3158; Needham (617) 444-2484; MICHIGAN, Detroit (313) 358-2020; Grand Rapids (616) 451-8901; MINNESOTA, Minneapolis (612) 929-6721; NEW JERSEY, Teaneck (201) 692-0200; NEW YORK, N.Y.C./L.I. (201) 692-0200; Utica (315) 735-5566; NORTH CAROLINA, Raleigh (919) 834-6591; OHIO, Cincinnati (513) 521-2290; Dayton (513) 298-9546; Columbus (614) 888-9396; Cleveland (216) 228-7525; OKLAHOMA, Tulsa (918) 627-4159; OREGON, Portland (503) 292-5656; PENNSYLVANIA, Willow Grove (215) 674-3850; Pittsburgh (412) 242-0100; WASHINGTON, Bellevue (206) 455-2778.

For product information, circle number 220 For evaluation units, circle number 221

# the NSL 2565 tape reader array



## has an impressive list of qualifications

- 9 high sensitivity photo-transistors aligned on 100mil centers.
- Packaged in popular 18 lead DIP configuration.
- Standard lead spacing allows mounting in IC sockets or on PC boards.
- 2 mounting/locating holes for precise registration between the detector head, light source and punched tape.
- Use of a ceramic substrate base has increased power dissipation over its plastic counterparts.
- Optional smooth glass surface for direct tape contact.
- Ease of assembly with guaranteed reliable mounting alignment.

Matching, Companion LED arrays, Emitter/Detector Card Reader arrays and Photodiode arrays with logic level outputs are also available from NSL.

**NATIONAL  
SEMICONDUCTORS  
LTD.**

331 Cornelia St., Plattsburgh, N.Y. 12901  
(518) 581-3160  
West Coast: Call TREPCO (213) 641-7411  
2150 Ward St., Montreal 378, Quebec,  
(514) 744-5507

## Electronics review

neath the crystal. Chip size is 85 by 90 mils, and crystal size is 25 by 180 mils. The watch also requires a trimmer, a battery, and stepping motor or digital display.

The biggest factor in reducing the size is the 32-kilohertz quartz crystal, made by batch photolithographic techniques similar to those for fabricating ICs. Statek puts a clear glass cover on the package so that the tuning fork crystal can be trimmed with a laser after air evacuation and aging.

The Orange, Calif., company is now using a standard Motorola C-MOS watch chip for demonstration purposes. □

## Mini system handles five clinical functions

Computerized medicine moved a step closer this month with the introduction, by Hewlett-Packard's Medical Electronics division, Waltham, Mass., of a multi-functional computer system called MODS, for medically oriented data system. Unlike earlier, dedicated, medical-computer equipment, MODS allows several different clinical functions to be served simultaneously by a single minicomputer, the HP2100. And, since it's a modular system, hospitals can start off small and add functions as needed. The result is lower over-all cost.

Although exact numbers are tough to nail down because no two installations are likely to be the same, Robert J. Sanzo, multi-function computer systems manager at H-P, estimates the cost of a single eight-patient monitoring station at \$45,000, while a MOD system capable of handling four such stations would cost about \$100,000.

The key to MODS is an operating system common to all five clinical functions it handles—electrocardiogram analysis, cardiac catheterization analysis, pulmonary testing, angiogram analysis, and patient-monitoring. A MODS accommodates up to four stations and two of these five functions simultaneously. □

## Medical electronics

### Electron imaging cures X-ray ills

X-ray techniques have significantly improved medical diagnosis and treatment since the phenomenon was discovered 77 years ago. But the technology has been seriously hampered by high incident radiation, relatively high cost, and low resolution of images because film is a poor medium for recording X rays. However, by applying a method analogous to that of electrostatic copying, a small California company has developed a technique that promises to alleviate most present flaws by merely adding a device to existing X-ray equipment.

Called electron radiography (ERG), the technique "produces sharper images at lower radiation," says Robert Carangi, assistant professor of radiology at the University of Southern California, which soon will begin two-year clinical demonstrations of the system. "We expect even better results" than those obtained through prototype testing in the last two years, he adds. Xonics Inc., Van Nuys, Calif., which began work on the process in 1970, plans to exhibit a fully automated ERG table unit later this year.

Essentially, the proprietary process converts the latent X-ray image into a latent image of electrons, and the density of the electronic charge is proportional to the incidence of X rays, explains William F. Hooker, Xonics executive vice president. The totally dry, self-contained process uses a toner to neutralize and make visible within 90 seconds the electron image on Mylar instead of X-ray film.

Unlike the conventional technique, the radiation passing through the body creates a flux of electrons in an imaging chamber. The flux is in ratio to tissue density, and it forms an image directly on plastic or paper sheet.

Xonics says that the process reduces exposure of radiation to

# Ours is one of the broadest 54/74 TTL lines in the world

In the past 18 months we've developed 151 new IC's and put them into production. 53 of them were 54/74 series types. Our total in the standard family (not including the H, L or S series) is now 95 types, each of which is available in two temperature ranges and your choice of dual-in-line or flat package.

## We're doers, not talkers!

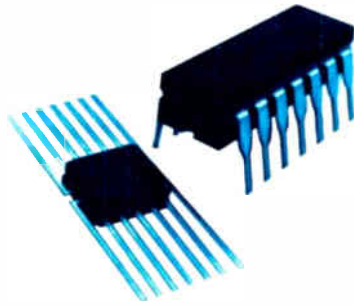

# semiconductors

ITT Semiconductors is a division of International Telephone and Telegraph Corporation, 3301 Electronics Way, West Palm Beach, Florida 33407. Phone 305/842-2411. Factories in West Palm Beach, Florida • Lawrence, Massachusetts • Footscray, England • Colmar, France • Freiburg, Germany • Cascais, Portugal • Sydney, Australia.

# ITT

Here is a

# SUPERIOR 0-1800 MHz SPECTRUM ANALYZER

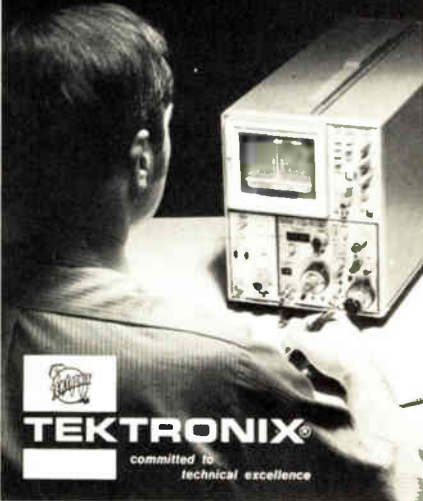

**TEKTRONIX**  
committed to  
technical excellence

... one with intermodulation distortion products more than 70 dB down, even with full screen signals.

... one with absolutely calibrated, spurious-free displays that consistently produce better measurements. This analyzer is the TEKTRONIX 7L12, part of the TEKTRONIX 7000 Series of CRT-based measurement products. System prices start at \$5800.

We will send you a detailed booklet about the 7L12. Just complete the coupon and mail to

**Tektronix, Inc., Box 500A  
Beaverton, Oregon 97005**

Please send me the booklet

Please arrange a demonstration

256 Phone \_\_\_\_\_

Name \_\_\_\_\_

Position \_\_\_\_\_

Company \_\_\_\_\_

Address \_\_\_\_\_

ZIP \_\_\_\_\_

## Electronics review

patients by 50%, and image resolution is doubled. There is also a saving of two-thirds in processing costs because plastic film is cheaper, and darkroom development is unnecessary. Carangi estimates that 20% to 30% of current radiology—especially chest X rays—could be recorded by the ERG process, which he says could replace 50% of the conventional X-ray film market within five years.

Because resolution is proportional to radiation levels, Xonics is trying to achieve the optimum balance between them. Final design of the ERG system will be determined after the clinical trial. Basic work on the idea behind the system began in the early 1960s at Siemens Research Laboratories. □

## Digital spirometer priced below \$1,000

Proprietary sensing and hybrid-computer techniques have made possible a \$995 respiratory-function tester with direct digital readout of eight key pulmonary signs. The spirometer, to be announced by Life Support Medical Systems Corp., has a built-in data processor.

The Woburn, Mass., firm expects to enter markets as diverse as the doctor's office, multiphasic testing, and industry—where the instrument might help spot the onset of such diseases as miner's blacklung. A back-panel BCD output also suits it to high-throughput computerized clinical applications.

The briefcase-size unit is said to be comparable with systems several times as expensive. For example, its semiconductor strain-gage transducer is accurate to 2.5% over a flow-rate range of 40 cubic centimeters per second to more than 10 liters per second, a linearity achieved only by systems priced higher than the entire life-support spirometer, the company says. Also, instead of displaying analog data, which must be interpreted, the spirometer uses a 2½-digit array to display key data in real time. □

## for more information on Microsystems' linears contact:

### microsystems sales offices

#### U.S.A.

<b>CALIFORNIA,</b>	
Palo Alto.....	(415)493-0848
Santa Ana.....	(714)979-6522
PA., Huntingdon Valley.....	(215)W7-5641/2
MINNESOTA, New Hope.....	(612)554-1802
ILLINOIS, Schaumburg.....	(312)894-7860
NEW HAMPSHIRE, Nashua.....	(617)762-8298

#### CANADA

<b>ONTARIO,</b>	
Ottawa.....	(613)828-9191
Toronto.....	(416)279-1358
QUEBEC, Montreal.....	(514)875-2814

### sales representatives

#### U.S.A.

ALABAMA, Huntsville Tech-Rep Associates.....	(205)881-5925
ARIZONA, Scottsdale Barnhill Five Inc.....	(602)947-7841
<b>CALIFORNIA,</b>	
Los Altos, W.W. Posey.....	(415)948-7771
Santa Ana Rical Associates.....	(714)557-6543
COLORADO, Denver Barnhill Five Inc.....	(303)934-5505
CONNECTICUT, New Canaan Stan Pierce Inc.....	(203)986-4630
<b>FLORIDA,</b>	
Indianatic Tech-Rep Associates.....	(305)723-9140
Largo Tech-Rep Associates.....	(813)595-2834
ILLINOIS, Chicago L-Tec Inc.....	(312)286-1500
INDIANA, Indianapolis R.E. Marquart & Associates.....	(317)253-3997
MARYLAND, Baltimore L.H. Kolman Co.....	(301)752-8756
MASSACHUSETTS, Norwood Stan Pierce Inc.....	(617)762-3164
MISSOURI, Kansas Florence & Meyer Inc.....	(913)722-5210
NEW JERSEY, Tenafly ABC Electronic Sales.....	(201)568-2354
<b>NEW YORK,</b>	
Cicero Advanced Components Inc.....	(315)699-2671
New York ABC Electronic Sales.....	(516)747-6610
North White Plains ABC Electronic Sales.....	(914)946-3001
NEW MEXICO, Albuquerque Barnhill Five Inc.....	(505)299-7658
OHIO, Columbus Tom Mulligan & Associates.....	(614)457-2242
PA., Huntingdon Valley ABC Electronic Sales.....	(215)W7-5641/2
TEXAS, Addison Champion Sales.....	(214)239-9196
UTAH, Salt Lake City Barnhill Five Inc.....	(801)487-1327
WASHINGTON, Seattle Carlyle Technical Sales.....	(206)832-4290

### distributors

#### U.S.A.

ARIZONA, Phoenix Kierulff Electronics.....	(602)273-7331
<b>CALIFORNIA,</b>	
Carson Hi-Rel Distributor Sales.....	(213)537-6500
Los Angeles Wesco Electronics.....	(213)685-9525
Menlo Park Bell Electronic Corp.....	(415)323-9431
Riverside Electronic Supply.....	(714)683-5591
San Carlos Sterling Electronics Corp.....	(415)592-2353
San Diego Kierulff Electronics.....	(714)278-2112
COLORADO, Denver Kierulff Electronics.....	(303)343-7090
FLORIDA, Clearwater Southland Electronics.....	(813)443-4514
<b>LONG ISLAND,</b>	
Farmingdale Arrow Electronics Inc.....	(415)323-9431
Freeport Milgray Electronics Inc.....	(516)546-8000
MARYLAND, Baltimore Arrow Electronics Inc.....	(301)247-5200
<b>MASSACHUSETTS,</b>	
Boston DeMambo Electronics.....	(617)787-1200
Dedham Gerber Electronics.....	(617)329-2400
Watertown Sterling Electronics Corp.....	(617)926-9720
NEW JERSEY, Haddonfield Mid-Atlantic Electronics.....	(609)428-8288
<b>NEW YORK,</b>	
Plainview Newark Electronics Corp.....	(516)822-5000
Rochester Simcona Electronics.....	(716)328-3230
Rome, Rome Electronics Inc.....	(315)337-5400
NEW MEXICO, Albuquerque Kierulff Electronics.....	(505)247-1055
TEXAS, Dallas Semiconductor Specialists Inc.....	(214)358-5211
WASHINGTON, Seattle Kierulff Electronics.....	(206)763-1550

#### CANADA

B.C., Vancouver R.A.E. Industrial Electronics Ltd.....	(604)687-2621
<b>ONTARIO, Malton</b>	
Semiconductor Specialists (Canada) Ltd.....	(416)678-1444
QUEBEC, Montreal Cesco Electronics Ltd.....	(514)735-5511

Also throughout Europe, Japan, Asia and Australasia





# Microsystems International... **Big in Linears!**

You know us as a major producer of memory products. But did you know that we're also big in linears?

Big in linears means a carefully selected product line that fulfils more than 80% of market requirements. It means industry standard Op Amps: general purpose, dual, precision, high voltage, micropower and high slew rate. It also means voltage regulators, transistor arrays, voltage references and comparators, line drivers and receivers. Our linears are available in industry standard packages, with selections according to your

needs—to commercial, industrial or military specifications including MIL std. 883 class A and B.

We're big in linears because we're big in R & D, in manufacturing capacity, and in Q.C. Our operating base is a modern 340,000 square foot plant and capitalization in excess of \$100 million, all exclusively devoted to the production of semiconductor products.

When considering your next linear order remember the selected linears from Microsystems International—they're available.



**selected linears from  
the performance leader**

microsystems international limited, box 3529 station c, ottawa, canada K1Y4J1



# NATIONAL ENTERS THE NUMBERS RACKET.

We've got a lot of awfully nice numbers for sale.

Some 2's. 7's. A bunch of swell 6's.

And when you put them together you can get nice numbers like 276.

Or 672.

Or 897146.19.

Our numbers racket is otherwise known as the LEDs business.

Otherwise known as light emitting diodes.

So now you electronic calculator people have another source. Which is kind of nice to know for something in as short supply as LEDs are today.

We're making a three-digit LED (NSN 33, a pin-for-pin compatible second source for the Litronix DL 33).

Also an eight-digit LED with a minus sign, NSN 199, and a nine-digit LED, NSN 299, both in matched brightness sets of guaranteed light uniformity.

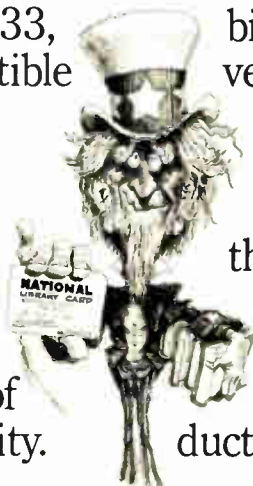
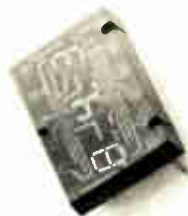
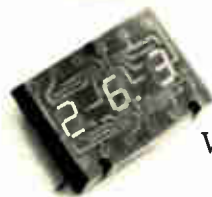

In addition, we're now producing a line of lamps.

NSL 5020 series, compatible with Monsanto's MV 5020 series. And

NSL 100 series, compatible with Fairchild's FLV 100 series.

We're into LEDs in a big way. An all-out effort on our part to supply this important market. With a new LEDs plant just completed in Malacca, Malaysia.

Our people have a little motto tacked on their gym lockers: "If you can't make 'em first...make 'em best."



## Join the National Library

Ask for your official National Library Card and current selection bibliography. Your passport to a veritable wealth of Digital, Linear, MOS and Transistor/FET design information from a single source. We'll selflessly throw in a LED Lamp Cross Reference Guide and Data Sheets. Write: National Semiconductor, 2900 Semiconductor Dr., Santa Clara, Ca. 95051.

# National

## Design changes in Awacs attract critics in Congress

A major design change in the Airborne Warning and Control System to **cut an estimated \$20 million from projected program cost totals** for 42 planes has caught, to the dismay of the Air Force, the attention of congressional budget-cutters. **Congress previously has challenged the need for Awacs**, the modified B-707 capped by a 30-foot-diameter "mushroom" housing a Westinghouse Electric radar. Now the Air Force says it is switching from eight GE engines with long-loiter capability for next-generation air defense to four more powerful Pratt & Whitney engines. Also, it is cutting back its test-bed aircraft program and pushing for more development avionics in the new fiscal year beginning July 1.

The changes would drop the fiscal 1974 program costs to just under \$210 million, most of it for RDT&E, from \$233 million this year. Congressional critics, say sources on both the Senate and House Armed Services Committees, are less impressed by the proposed economies than **the engine changes, which they suspect indicate Air Force uncertainty** about what it really wants or can achieve in the long-delayed program.

## DOT to spend millions on urban transport

The Department of Transportation plans to start a three-phase, multi-year program to provide towns and cities with transportation systems that **combine the features of communications-linked buses and automated personal rapid transit**. It intends to award **up to three \$500,000 first-phase contracts in April**, when responses to its requests for proposals are due. The dual-mode systems are to use rubber-tired vehicles for 10 to 40 passengers that either ride on automated guideways or operated as buses as in DOT's experimental dial-a-ride concept.

Up to two companies would be selected for the 30-month second phase to build and test operational systems at DOT's Pueblo, Colo., test center. Phase three would use Urban Mass Transit Administration grants to enable municipalities to install working systems. Exact funding for the project is being worked out, but **a fiscal 1973 appropriation of \$4 million was reduced**, says a knowledgeable source.

## AF's A-10 award to Fairchild contested; GAO investigating

A General Accounting Office investigation of **charges that political pressure influenced the selection of Fairchild Industries Inc.** to build the A-10 close-support aircraft has not affected the contract award, according to the Air Force. Nevertheless, the service **admits the contract is still "in negotiation,"** but has yet to be signed. Avco Corp.'s Lycoming division at Stratford, Conn., which made the engines in the losing Northrop Corp.'s A-9 prototype, protested the choice of Fairchild's Republic division at Farmingdale, N.Y., on grounds that New York business and political interests had been involved. Aerospace business in the Long Island area is depressed, and the A-10 represents a potential buy of 600 or more planes at \$1.4 million apiece.

Interestingly, the party remaining **silent in the challenge to the Air Force is the Californian Northrop**, which is still in competition with General Dynamics for another major Air Force buy—the Lightweight Fighter, budgeted for \$46.5 million in R&D for fiscal 1974, compared to \$40 million this year.

## Nixonomics, Congress, and Cresco

The evidence is overwhelming that Richard Nixon holds the high cards in the developing dispute between the White House and Congress over who controls the Federal purse. One of the more important and often overlooked reasons why he does can be illustrated by relating the events that took place on April 5, 1968, at Cresco, Iowa.

Cresco is a city of about 5,000 in the north-west corner of the state not far from the Turkey River. About 50 miles to the northwest is Austin, Minn., the nearest city of any size. The business of Cresco is farming, as it is with the other communities of the region. One son of Cresco, now with an aerospace conglomerate in the Capital, recalls visiting his hometown on April 5, 1968—the day following the assassination in Memphis of civil rights leader Martin Luther King in Memphis.

"It was in the morning, about 9:30, and everyone had come to the restaurant for his 'second breakfast,' a little coffee and something to eat after the first few hours' work. The news of King's death and the riots that had broken out in Washington was on the television behind the counter, but you couldn't hear a thing. The conversation in the place was too loud." No one was paying much attention to the news from Washington and Memphis, it turns out, because the local news was overriding: the new line of John Deere tractors was being introduced to Cresco.

### Priorities and perspectives

There is a lesson there for electronics and the other industries who track events in the Capital. It is a lesson dealing with peoples' priorities and perspectives; it is a lesson that Richard Nixon knows well. How well he knows it was demonstrated when he delivered his tough \$268 billion budget for fiscal 1974 to the 93rd Congress at the end of January with the message that it "fulfills my pledge to hold down Federal spending so that there will be no need for a tax increase."

President Nixon knows that "no tax increase" is as much as Cresco heard or wanted to hear. He also knows that there are literally thousands of Crescos throughout the United States. Even in the ostensibly more sophisticated urban centers of the nation, the citizenry finds the stuff of Federal budgets to be dull and undramatic. But, like the residents of Cresco, they too are taxpayers and are caught by the words "no tax increase," rather than by the reordering of specific Federal priorities

through which tax stability is achieved. To its chagrin, Congress knows it, too: for every congressional district, like Iowa's 3rd in which Cresco falls, there are local considerations of far greater importance than the specifics of the Federal budget. Whether the Department of Defense gets more money next year and the Department of Health, Education, and Welfare gets less is not important as long as taxes don't go up and there is money for a new tractor, television or student tuition.

### Congressional backlash

Military and aerospace electronics contractors concerned with specific programs contemplate the congressional reaction to such cold realities with discomfort. Aware that the White House holds the upper hand in the fight to control Federal spending, an increasing number of industrialists suspect that the Democratic majority in the Congress will be unable to carry the day against the President on the fundamental issue of determining national priorities through the appropriations process. Should this be the case, Government contractors fear that a frustrated Congress will then retaliate by turning on specific military budget programs—line item by line item—and cut them back sharply.

Disturbing to both contractors and military project offices is that the President's baiting of Congress on the issue of fiscal responsibility, calling it "not responsible," appears to be asking for program cuts. One defense official, for example, noting the Navy and DOD effort to work out a satisfactory compromise with Grumman Aerospace Corp. on the stalled F-14 fighter contract, sees it this way: "We have enough problems without the President waving red flags in front of some of those bulls on the Hill. All Congress has to say is 'Oh, yes, we are responsible, Mr. President, and to prove it we're going to make the Navy hold Grumman to that contract. Period.'" And there are other programs, as well, for which the Pentagon wants more money for the post-Vietnam period, ranging from the big Trident missile submarine down to the Army's growing R&D effort to develop its Advanced Attack Helicopter.

What the Pentagon sees is that Congress perceives the lesson of Cresco, Iowa, too—the lesson that most citizens are indifferent to budgetary line items as long as the total of those items doesn't cost them. It is a lesson that is casting long shadows in Washington, unsettling shadows that are clouding some corporate futures.

—Ray Connolly

# ac, dc, volts, amps, ohms

## 25 ranges

## \$595 complete

## 5-day delivery



**INTRODUCING** Systron-Donner's all-function 7004A Digital Multimeter  Measures dc and ac voltage, dc and ac current and resistance  New improved circuitry expands AC response to 100 KHz  New color-coded pushbuttons help distinguish functions  New carry case option  New simplified calibration  Optional battery pack with recharger (\$95) mounts internally  1,000 megohm input impedance on 3 lowest ranges  0.01% dc accuracy. For lab, field or systems use (with DTL/TTL compatible BCD outputs, \$45 additional).

Contact your local Scientific Devices office for more 7004A details or: Concord Instruments Division, 10 Systron Drive, Concord, CA 94518. In **Europe**: Systron-Donner GmbH Munich W. Germany; Systron-Donner Ltd., Leamington Spa, U.K.; Systron-Donner S.A. Paris (Port Marly) France. In **Australia**: Systron-Donner Pty. Ltd. Melbourne.

*We made a good DVM better!*

SYSTRON  DONNER

The Systron-Donner Instruments Group:

Concord Instruments  Computer Systems  Datapulse  Kruse Electronics  Microwave  Trygon Electronics

# Raytheon opto's.



## More than a couple of couplers.

We're probably best known for our top quality optical couplers — the RAYSISTOR™ line. But we offer a great deal more in high performance, special purpose commercial optoelectronics.

Almost 50 standard discrete photocells, for example. Or custom-designed photoconductive arrays with an almost limitless number of cells per substrate. Or the fact that, as a major supplier of high reliability military microelectronics,

we put this experience and sophisticated production technology into our high performance commercial opto line.

Raytheon optoelectronics. A broad line of standards. An almost endless variety of specials. Packaging to fit any requirement, from the largest to the smallest. Try us. Raytheon Company, Industrial Components Operation,

465 Centre Street,  
Quincy, Mass. 02169.  
Telephone

617 479-5300.



## Tuner uses non-volatile MAOS memory to control automatic tuning

Digital technology has come to radio with an fm spectrum-scanner stereo tuner developed by Sony Corp. At first glance, the tuner looks more like a minicomputer mainframe, and it uses metal-alumina-oxide semiconductor integrated circuits and transistors for its read-mostly memory, as well as simple IC registers. The MAOS memory devices are used to store electronic display and tuning information for prolonged periods, and to maintain the information even when the power is turned off.

**Display.** One reason why the receiver resembles a minicomputer is an array of lighted front-panel buttons that replaces the dial. There are 100 buttons corresponding to the 100 U.S. fm channels, which are located at 200-kilohertz intervals in the range between 88.1 megahertz and 107.9 MHz. The buttons control the frequency-synthesizer-type local oscillator, which can tune the receiver to any one of these 100 channels only. The accuracy of the frequency setting is to 4 kHz, about one order of magnitude better than the average hi-fi tuner.

The set's new modes of operation include an automatic 5-second sweep of the fm band, after which the buttons—containing green neon bulbs—for those channels on which stations were received remain illuminated. The tabulation of channels on which stations were received is stored in a 100-bit MAOS memory and is retained until the user wishes to rewrite the information.

It is also possible to program the tuner to light buttons only for selected channels among those on which stations were received. This information is stored in a second 100-bit memory. The user can select either of the above two readouts by depressing panel buttons. A button marked "Next" causes the radio to retune to the next among the chan-

nels shown on either of the two readouts.

In line with the digital nature of the tuner panel, the signal strength indicator is also a lamp display—Sony designers thought a meter would look out of place. Other tuners often have two meters—one to balance at zero when correctly tuned to a station and the other to indicate signal strength. The new tuner has no need for tuning indication because the buttons set it almost perfectly on station frequency. Signal strength is shown on a horizontal, thermometer-type indicator with from one to five bulbs aglow according to signal strength.

The actual setting of the tuner frequency is done with a synthesizer-type local oscillator that is based mainly on frequency division. In this synthesizer, the receiver local oscillator frequency is heterodyned against a fixed crystal oscillator to translate it into a convenient lower-frequency range.

The translated lower-frequency signal then passes into a frequency divider, the output of which is compared with the frequency of a second fixed-crystal oscillator in a phase comparator. Output from the comparator is a dc voltage that is impressed on a varactor diode in the local oscillator to set it at the programmed frequency. □

---

### West Germany

---

## Scale uses MOS, optical techniques

Electronic techniques have lately found a niche in the small scales used in groceries, butcher shops, and delicatessens. With these scales, the clerk still has to enter the price of a pound of liverwurst, potato

salad, and other custom-measured items, but the calculation of the selling price is handled by electronic components inside.

A new scale just introduced by a West German weighing-equipment maker combines optical and MOS techniques—the latter for the first time in a scale, the company says—to do the job more elegantly and with a lot fewer components (only two MOS ICs) than are used in the electronic scales offered thus far. This new scale system, dubbed Op Electronic 1000 comes from Bizerba-Werke Wilhelm Kraut KG, a 107-year-old family-owned enterprise in Balingen, near Stuttgart, and Europe's largest weighing-systems producer.

Mechanically, the Bizerba scale is an inclination-balance scale system. The item on the scale plate causes a glass disk to rotate. The disk carries the weight coding as a combination of dots arranged in 12 tracks. With the disk illuminated from one side, the code is detected by an array of phototransistors, the output signals of which are applied to the memory circuit for temporary storage. At the same time the item's weight is shown in viewing windows to both the customer and the clerk.

After placing the item on the scale plate, the clerk punches the unit price—in Germany, the per-kilogram price—into a 10-digit keyboard. The unit price appears for both the customer and the clerk to see. The keyboard output is combined with the weight data, a process carried out about 10 times a second to insure error-free pricing. Such redundancy is one requirement of West Germany's weights and measures regulatory agency. Another requirement is that the calculator IC incorporate a parity and self-checking feature so that in case of circuit malfunction a series of zeroes is displayed. □

# Microdata unwraps a bold, new communications package.

We've combined microprogramming with communications and created a system which outperforms them all at a price no one else can match. It's the new Microdata 1600/60. And it features our Twin Mini, a processor with two microprogrammed CPU's each having separate high speed control memories and I/O facilities. The Microdata 1600/60 handles up to 256 asynchronous lines, up to 32 synchronous lines or any combination of the two at the rate of 40,000 characters per second. Find out why our entry into the communications market is the finest package available today. Write for details. Microdata Corporation, 17481 Red Hill Avenue, Irvine, California 92705. (714) 540-6730.



from the bold guys at

**Microdata**<sup>TM</sup>



## **British companies, eyeing good market, go to Peking**

Forty electronics manufacturers are among 350 British technology-oriented companies exhibiting in Peking from March 26 to April 7 in an effort to get a toe-hold in what could become a valuable market. The electronics companies feel that in the foreseeable future the Chinese are most likely to buy radio-frequency communications equipment, including TV, ground and airborne avionics and avionics servicing systems for China's growing air-transport system, and specialized instruments and components. However, instrument and component makers also hope to sell many standard items while Chinese production falls short of demand.

In communications, several companies will push TV studio and transmission equipment in the belief that **the Chinese want to expand their localized monochrome network but can't make much of the equipment themselves.** They are expected to go for large-screen communal receivers, particularly if they develop color, with which they're experimenting. They already buy high-frequency, vhf, uhf, and microwave-link equipment, and it's thought they'll buy much more. Instrument purchases have been sophisticated items like dynamic performance analyzers, spectrometers, and high-quality voltmeters, apparently for use in research and design. Similarly component purchases include highly specialized items like photomultipliers—probably used in nuclear research— but also standard CRTs that probably end up in oscilloscopes and radar displays.

## **No progress yet in Franco-Japanese import quota talks. . .**

Japan and France are deadlocked in their efforts to set terms for a new **industry-to-industry quota agreement limiting importation** of Japanese consumer electronics products into France. The quota talks, which have dragged on in Paris since last September and included two trips of French officials to Tokyo, are aimed at updating import limitations fixed in the original Franco-Japanese agreement in 1969. That accord expires March 31. French sources say that the Japanese want to free radio and television imports entirely this time around—but the French are insisting on strict limits. **If a compromise is not forced by the expiration date, the Japanese will be freed altogether from the special French restraints.**

## **. . . but Japanese companies search for French factory sites**

Meanwhile two Japanese consumer electronics companies are scouting the French provinces for industrial terrain. **Matsushita Electric Industrial Co. Ltd. wants to build television sets, and Pioneer Electric Co. would make high-fidelity equipment.** Insiders say that the Japanese are being cooperative with the French provincial development agency, Datar, offering to go anywhere in the country where new industry is needed to absorb surplus manpower. Sony also has said it wants to get into manufacturing in France, probably to produce its Trinitron color-TV tube, but this is not yet an active project. French officials say that Matsushita will have trouble winning government approval for TV production, for competitive reasons, but that Pioneer should have little problem getting the go-ahead for its hi-fi plant. Both companies would be obliged to export a large portion of their production.

## **Philips prepares DVM price drops**

Watch for Philips Gloeilampenfabrieken to announce shortly sizeable price cuts in its standard line of digital voltmeters. The reductions, to be made known around the middle of this month, will amount to between 15% and 20%, depending on the model and on the country where it is marketed. For example, in the Netherlands, the PM2423, one model in the Philips DVM range, will go for about \$310 instead of the \$390 at which it is now selling. **The reductions are made possible, Philips officials say, by the use of LSI chips in the instruments and the favorable market response to the company's DVM line.** The price cuts are seen as part of the Dutch firm's efforts to increase its already large share of the test and measuring equipment market, a market in which Philips can claim to be the world's third largest supplier, trailing only Hewlett-Packard and Tektronix.

## **Yet another pocket calculator, this from West Germany, bows**

Unperturbed by foreign competition, a West German company has ventured into the hotly contested pocket-calculator field with a mini-calculator that the firm says stands up well against models from Japanese and U.S. manufacturers. A product of Hamburg-based Aristo-Werke, the calculator is claimed to be the smallest ever made by a domestic company. **It is no larger than a pack of cigarettes, yet can be finger-operated,** as opposed to calculators with keys so small that some kind of peg must be used for key depression.

The aristo M-27 sells for about \$145 on the German market. It can handle all standard mathematical operations, plus power-raising, and features constant-factor multiplication and a floating decimal point. Its MOS chip and eight-digit indicator are supplied by U.S. companies. The calculator is powered by five standard 1.5-volt cells, but provisions are made to incorporate yet-to-be-perfected zinc-air batteries, which will greatly extend the instrument's operating life. **What makes Aristo optimistic about strong sales of its calculators is the company's big distributor network.** Primarily a maker of slide rules and drafting equipment, Aristo has a sales outlet in nearly every large stationery store in the country and elsewhere in Europe.

## **High-frequency-input ICs pay off for Plessey**

**Plessey claims it has notched up sales worth half a million dollars—80% from the U.S.—for its integrated bipolar high-input-frequency divide-down devices** in the year they have been in production. Buyers are makers of frequency counters and radio-frequency synthesizers. John Hayden, commercial manager, claims that Plessey has effectively cornered the market for integrated dividers, doing so by going all out for high input frequencies—currently up to 1 gigahertz, divided internally by four, with 1.2 GHz being sampled—while U.S. makers stopped short at 500 megahertz. In fact, users want the highest frequencies possible up to about 2 GHz. In England, Racal Instruments Ltd. has just announced an eight-digit, 1-GHz counter with a Plessey chip on the input.

In Plessey's bipolar process, the epitaxial layer has been pushed down to 4 micrometers, the emitter diffusion to about 0.3 micrometers and the base diffusion to about 0.5 micrometers. Diffusion temperature is 900°C—about 150° cooler than usual—and time no more than 30 minutes. **Circuitry is emitter-coupled logic, and by year-end the company plans to second-source the full range of MECL-III circuits, but with increased performance, using the same technology.**

Now . . .

# MEASURE ANTENNA CHARACTERISTICS Even in presence of strong interfering signals.

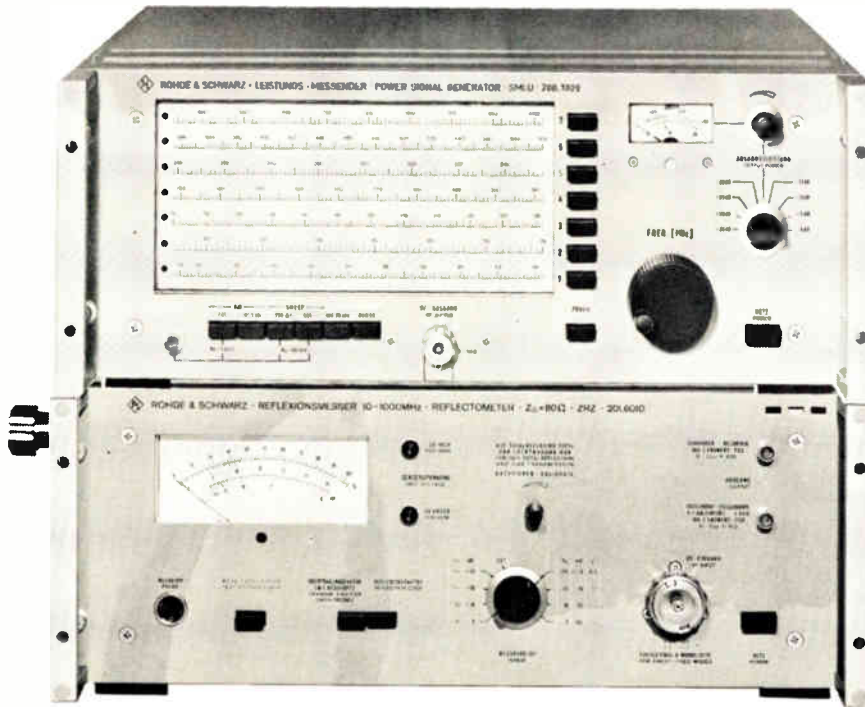

Type SMLU  
(2 Watts Output)

Type ZRZ

## PROGRAMMABLE - SWEEPABLE - DIRECT READING REFLECTION & TRANSMISSION TEST SYSTEM

### FEATURES

- Covers 25 – 1000 MHz Freq. Range
- Measure Reflection Coefficient 0.5% – 100%
- Directivity > 50 dB
- Measure Attenuation 0 – 70 dB
- ZRZ available in 50 Ω, 60 Ω or 75 Ω
- Recorder & Oscilloscope Outputs
- BCD Programmable
- Up to 2 Watts output with ALC from SMLU
- AM Modulation provided

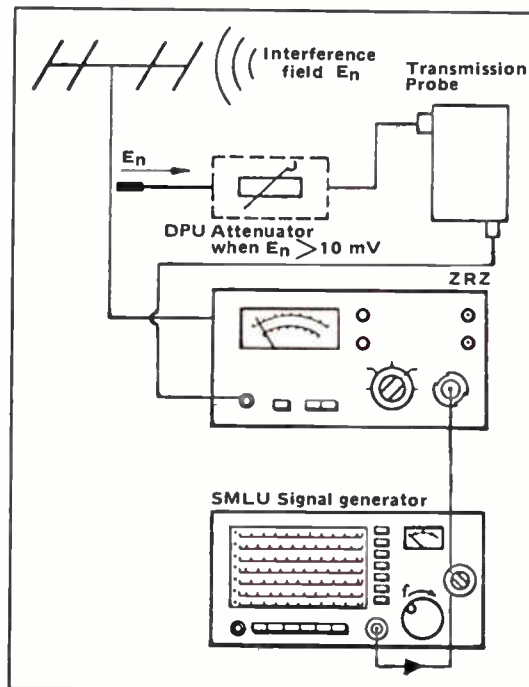

### APPLICATIONS

- Check two & four terminal networks
- Measure & adjust filters, duplexers, attenuators, & couplers
- Low test voltage (1 mV) on active components such as transistors, tuners & amplifiers
- Higher test voltage (1 V) for antenna measurement in presence of interference
- Ideal for production testing on cables & CATV installations

Get The Extra Capability,  
Greater Reliability, and  
Longer Useful Life Of . . .



## ROHDE & SCHWARZ

111 LEXINGTON AVENUE, PASSAIC, N. J. 07055 • (201) 773-8010  
Western Office: 510 S. Mathilda Avenue, Sunnyvale, Calif. 94086 (408) 736-1122

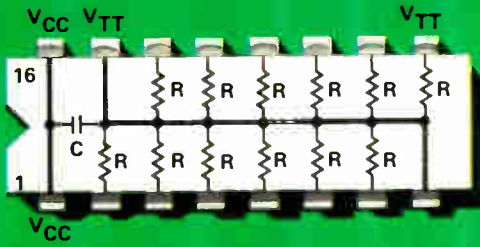

**SERIES 898-41 -2.0 VOLT TERMINATORS** contain eleven resistors for ECL line termination to a -2.0 volt bus. Each unit includes a 0.01  $\mu$ F decoupling capacitor to bypass the -2.0 volt bus. Standard R values of 50, 75, and 100 ohms are available and are designated 898-41-R50, 898-41-R75, and 898-41-R100. Price (1,000-4,999) \$1.25

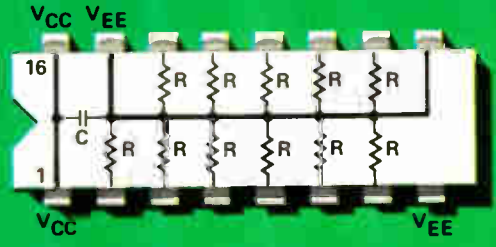

**SERIES 898-42 -5.2 VOLT TERMINATORS** contain twelve resistors for pull-down to the -5.2 volt bus. Each unit contains a 0.01  $\mu$ F decoupling capacitor to bypass the -5.2 volt bus. Price (1,000-4,999) \$1.25

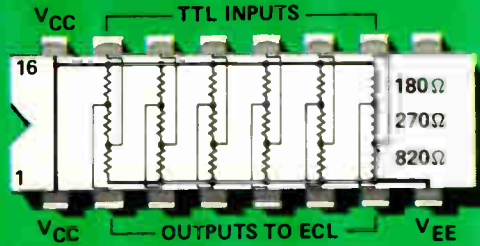

**SERIES 898-45 TTL TO ECL TRANSLATOR** contains six identical three-resistor sections for direct translation from TTL to ECL, both operating between a +5 volt supply and ground. Price (1,000-4,999) \$1.25



**Butterfly**  
Diurnal insect of the order *Lepidoptera*, characterized by clubbed antenna, a slender body, and large, broad, often conspicuously marked wings. Often found fluttering about the design engineer's stomach.

# Our Bugs will get rid of your Butterflies

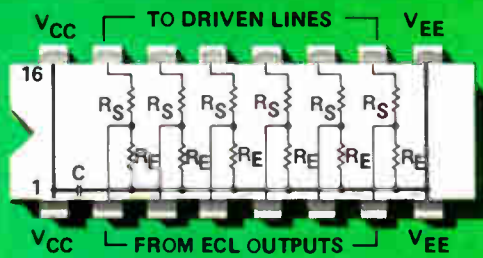
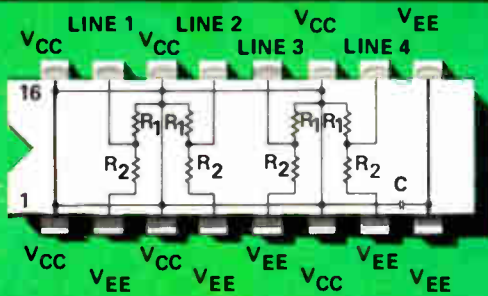

**SERIES 898-43 THEVENIN EQUIVALENT TERMINATORS** contain four Thevenin equivalent terminator sections. Each terminator section consists of two resistors connected as a divider from the ground bus to the  $-5.2$  volt bus providing a Thevenin equivalent voltage of  $-2.0$  volts. Each unit contains a  $0.01 \mu\text{F}$  decoupling capacitor to bypass the  $-5.2$  volt bus. Series 898-43 units are available with Thevenin equivalent impedances of 50, 75, and 100 ohms.

Series 898-43  $R_1$  and  $R_2$  Values

Model	$R_1$	$R_2$
898-43-Z50	81 $\Omega$	130 $\Omega$
898-43-Z75	121 $\Omega$	195 $\Omega$
898-43-Z100	162 $\Omega$	260 $\Omega$

Price (1,000-4,999) \$1.25

**SERIES 898-44 SERIES LINE TERMINATORS** contain six series terminator sections. Each section is designed for terminating a line at the driven end with a series resistor value equal to the line impedance minus the 7 ohm output impedance for 10,000 series ECL. The second resistor in each section is a pull-down resistor to the  $-5.2$  volt bus. Each unit contains a  $0.01 \mu\text{F}$  decoupling capacitor to bypass the  $-5.2$  volt bus.

Series 898-44  $R_S$  and  $R_E$  Values

Model	$R_S$	$R_E$
898-44-S43	43 $\Omega$	47 $\Omega$
898-44-S75	69 $\Omega$	69 $\Omega$
898-44-S100	93 $\Omega$	97 $\Omega$

Price (1,000-4,999) \$1.25

## ECL Terminator Collection

Dependable Beckman ECL terminator networks are specifically designed for, and compatible with, the following Emitter Coupled Logic families:

- Motorola MECL 10,000 Series
- Signetics 10,000 Series ECL
- Fairchild 95K and F10K Series ECL
- Texas Instruments Series SN10000 ECL
- National Semiconductor 10,000 Series ECL

Each Beckman ECL terminator network utilizes thick film resistor materials

with layouts specifically designed for low inductance and the high speed requirements of ECL systems. Where possible, the terminator networks include  $0.01 \mu\text{F}$  decoupling capacitors.

Each network is capable of operating in a  $+85^\circ\text{C}$  still air environment at standard ECL voltage levels and tolerances without heat sinking.

For complete technical data, contact your local Beckman/Helipot representative or write to Beckman Instruments, Inc., Helipot Division, 2500 Harbor Blvd., Fullerton, Calif. 92634.

**Beckman®**

HELIPOT DIVISION



# From start to finish



No licence agreements, no sub-contract work. From start to finish we are in control of every product that goes out to you, the customer, bearing the name Piher. We take a pride in the name. We take a pride in our products. That's why we are now a world leader in component technology.

Don't take our word for it. Let the facts speak for themselves.

We produce over 7 million carbon film resistors per day to meet world demand and have the largest variety of quality preformed resistors available anywhere.

We also provide the best range of quality, low-cost encapsulated trim-

mer pots on the market for every type of application - custom built to your own specific requirement where the need arises.





# - Piher technology

And these components are only the beginning.

Piher is a company that works in professional electronics, developing the best in closed circuit and professional TV, radio-telephones, etc.

And with our ferrites we are in the forefront of magnetic ceramic technology.

We are a high technology company with 6 manufacturing centres employing over 3000 people. And our world-wide distribution network is backed by 5 Piher companies in the U.S.A., Germany, U.K., France and Italy.

That's why our exports have increased by 75% in the past three

years. That's why, when people think components, they should think Piher.

*Find out more about us. It pays.*



**USA** - 1239, Rand Road, Des Plaines - Illinois, 60016.  
Tel: (312) 297-1560. Telex: 0282514.

**GERMANY** - 85 Nuremberg, Westtorgraben, 5.  
Tel: (0911) 260469. Telex: 623354.

**UK** - Romar House, The Causeway, Staines, Middlesex. Tel: 56157. Telex: 934167.

**FRANCE** - 83 Rue Etienne Dolet, 94230 Cachan, France. Tel: 6562607. Telex: 27107.

**ITALY** - Via Soldati, 16, 20154 Milano.  
Tel: 314.532/316.213.



# PIHER

**Head Office - SPAIN**

Riera Canado, s/n. Apartado de Correos, 53 Badalona (Barcelona), Spain. Tel: 389 03 00. Telex: 59521.

**“When Foxboro changed from P.C. boards to Augat panels for FOX 2 process computer systems, we had some doubts about how much development time we would actually save.**

**“6,000 man-hours convinced us.”**

Ben Franklin, Manager, Equipment Product Engineering,  
Systems Operations Division, The Foxboro Company



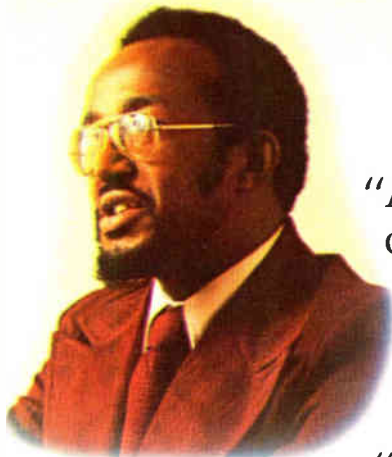

Ben Franklin

"Augat panels provided significant savings in our overall development time, and helped us bring our new FOX 2 process computer systems to the market-place faster. And Augat's precision-machined socket contacts helped us maintain our high standards of reliability.

"Why the change from P.C. boards? P.C. boards inherently have a long development cycle, high development cost and lower initial hardware cost. In the development of the FOX 2 System, the timing was critical to get the system designed and released to the market. By selecting the Augat packaging approach, we shortened the development cycle significantly and minimized the cost of rework with no overall effect on hardware cost.

"But no one likes to gamble with new methods, so our initial evaluation of the Augat system was unusually thorough. We liked what we saw — a good, quality product and a company with lots of experience and a positive attitude towards customer service. Since our past experience with other, less-precision sockets had been comparatively unsatisfactory, we decided to try their wire-wrapped plug-in panels. The results far exceeded our expectations.

"With Augat, we achieved superior modularity, minimum downtime, easier field service, and a system that allows our logic to evolve with the technology. And all this while saving 6,000 man-hours of engineering time. That's not bad."

As you can see, Augat® offers you plug-in flexibility allowing component and wiring changes to be made in minutes (saving precious and expensive man-hours), plus tapered-entry sockets and machined contacts that offer unsurpassed reliability.

All of which just might tell you why Augat has become the world's leading producer of wire-wrapped panels and other IC interconnection products. But Augat has more to offer than just hardware. Augat's technical experience is ready to help solve your interconnection requirements.

Call or write to us today. We'll send you our free brochure and complete product information. Augat, Inc., 33 Perry Avenue, Attleboro, Massachusetts 02703. Represented and distributed internationally.

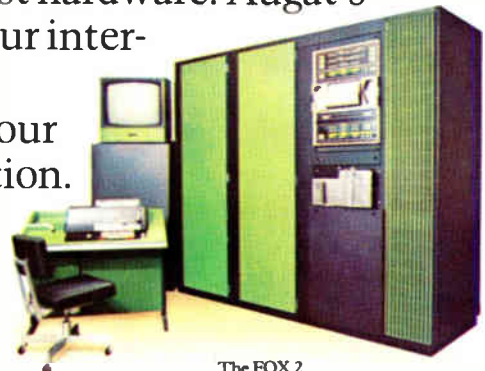

The FOX 2

**Plug into Augat. Foxboro did.**



# Think Twice:

## When is a portable really portable?

### HP's 1700 Series Portable Scopes Always Are...

They're tough go-anywhere scopes: weatherproof, dustproof, completely self-contained. Not the kind of "portable" that's gently moved from bench to bench, trailing a power cord. With a 1700 Series scope you don't worry about the rain. Or the rough ride. Or whether, when you get there, you'll find ac or dc power—or no line power.

An HP portable gives you features you'd expect only in a big lab scope. Like a large, bright CRT that lets you see even difficult signals in high ambient lighting, ECL trigger circuits and a trigger hold-off control, and sweep linearity over the full 10 divisions of horizontal display—ideal for maximum resolution in making those critical timing measurements.

But that's just the beginning. Then the 1700 Series allows you to pick the specific features you need for your field service application: conventional or variable-persistence storage CRT; bandwidths of 35, 75, or 150 MHz; sweep speeds as fast as 2 ns/div; delayed or non-delayed sweep; selectable input impedance; bright-scan viewing mode; and a built-in rechargeable bat-

tery pack for complete measurement independence.

And we're just as proud of the things you don't get with a 1700 Series portable. No heat sinks. No fans. No ventilation holes to let in dust and moisture. That's because our circuits are designed for very low power consumption—and for long, trouble-free operation. And there's no challenge in servicing our portables. In fact, you can completely recalibrate some models in an hour or less, even if all the internal adjustments are misaligned. It's not very sporting, but this ease of servicing quickly adds up to impressive savings.

So before you choose a scope, check your requirements. Then think twice about costs and benefits. Remember, Hewlett-Packard portables let you make any measurement you need—and they cost from \$100 to \$250 less than comparable scopes. These 1700 Series portables are priced from \$1475 to \$2300 for non-storage models and from \$2375 to \$2725 for models with variable-persistence storage. For help in choosing the HP portable that's best for you, send for a free copy of our "No-Nonsense Guide to Oscilloscope Selection." Or contact your local HP field engineer. Hewlett-Packard, Palo Alto, California 94304. In Japan:

Yokogawa—Hewlett-Packard, 1-59-1, Yoyogi, Shibuya-Ku, Tokyo 151, Japan. In Europe: HPSA, P.O. Box 85, CH-1217 Meyrin 2, Geneva, Switzerland.

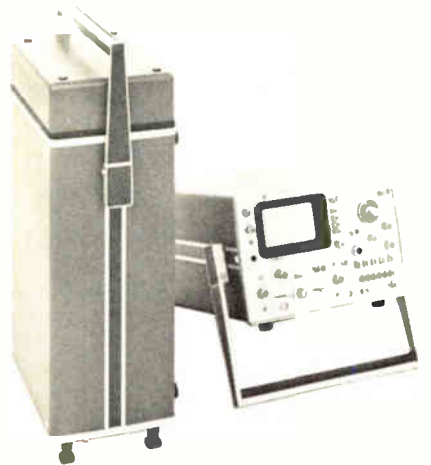

**Scopes Are Changing;  
Think Twice.**

083/1

**HEWLETT  PACKARD**

**OSCILLOSCOPE SYSTEMS**

Circle 67 on reader service card



Probing the news

# Nixon, Congress battle over purse strings

Although ongoing efforts appear to be home free, big new programs are scarce for electronics companies

With Vietnam off his back and flushed with one of America's great political victories, a tough, confident Richard Nixon has delivered his austere fiscal 1974 budget to the 93rd Congress and guaranteed himself another battle.

Spending proposals totaling \$268.7 billion for the fiscal year beginning July 1, coupled to a new \$249.8 billion ceiling on outlays in the current fiscal year, promise a Federal electronics market in the coming year that will remain unchanged at best, or shrink slightly,

at worst. Either way, industry forecasters in Washington see few opportunities for new business of significance, except for some new strategic military systems.

The President's proposals "suggest to me that companies with ongoing programs in-house are safe." summarizes one corporate analyst. "They will continue to get funded. But if you are looking for big new starts, forget it."

Nixon's battle with the Congress has already begun on the spending issue, specifically over the White House impoundment of \$8.7 billion in appropriations for this fiscal year, ending June 30, to hold outlays to less than \$250 billion. Compounding that Constitutional issue of the power of the purse are White House plans to cut back sharply on social programs started under earlier

Democratic administrations to achieve economies of \$17 billion and \$22 billion in fiscal 1974 and 1975, respectively. Beyond these major areas of dispute, the Democratic leadership differs sharply with the President in other areas, several of which impact electronics. Among them:

■ **Authority.** Roy L. Ash, director of the increasingly powerful Office of Management and Budget, is the focal point of this dispute. As OMB's role expands to the point where it can and does decide program requests from the various agencies, Congress wants its director to be subject to Senate confirmation and available to testify in the same way as other cabinet officers. The controversy surrounding selection of the former Litton Industries chief executive for the OMB job and Lit-

ton's claims against the Navy on ship contracts only serve to cloud the issue.

Ash, an advocate of impounding, has already clashed once with Sen. Sam J. Ervin (D., N.C.), the Senate's foremost Constitutionalist, over constitutional strictures on the spending issue. Ironically, both men supported their opposing arguments with the same constitutional language, which requires the President to "take care to see that the laws are faithfully executed." Ervin, asserting that an appropriation is a law, believes Nixon must spend all of it. Ash notes that the debt ceiling passed by Congress is another law, forbidding the President to borrow—and spend—above a set limit. Impounding, he argues, is therefore "consistent with the President's constitutional duties."

Until the conflict is resolved, electronics manufacturers are edgy about the prospect that Federal funds for their contracts could become political footballs, subject to being impounded on the one hand or retaliatory cancellation by Congress on the other, particularly for military programs.

■ **Accounting.** Nixon Administration efforts to put the best public face on its budget by showing spending "increases" where it can, is at least confusing to budget readers, both in and out of Government. Its critics call the increases misleading, as in the case of the Commerce Department National Oceanic and Atmospheric Administration.

Although NOAA's electronics outlays are not seriously hurt, its overall fiscal 1974 spending plan takes a beating. Programed outlays appear to rise \$55.3 million, but this is largely a paper exercise in view of OMB's refusal to spend \$53.8 million in the fiscal 1973 appropriation. The "increase" shown in the new fiscal year is based on the current year's reduced level. It adds up to a net loss, since, NOAA officials say, a significant portion of the funds must be used to cover Federal pay hikes that become effective in March. Where will the money come from? "Out of the programs," says NOAA administrator Bob White. Retorts one angry and frustrated Senate staff man: "There's a lot of Mickey Mouse throughout this whole

budget—more of it than you normally expect." Industry analysts tend to agree.

■ **Controllables.** This bite—funds the Government is not locked into spending by prior legislation and contract commitments—continues to get smaller. Of \$268.7 billion requested for fiscal 1974, the White House estimates that only \$75.2 billion—less than 28%—is controllable. This amount is \$600 million below the figure for this fiscal year, when controllables accounted for 30% of a lower spending level [*Electronics*, Jan. 4, p. 70]. The uncontrollable costs of social insurance, trust funds, interest, and other open-ended programs, plus fixed costs, leave few legislative target areas for cuts.

■ **Defense.** One of those reduction

areas—and the one with the largest profile by far—is defense and its associated hardware. Except for such juicy programs as the General Dynamics Corp. Trident nuclear submarine and its long-range nuclear missile under development at Lockheed—both of which are down for whopping increases—the Nixon Administration appears to have left little for a vindictive Congress to cut by way of hardware.

Beyond such highly visible programs as North American Rockwell's B-1 strategic bomber, Grumman's controversial F-14 fighter for the Navy, and the McDonnell Douglas F-15 for the Air Force, members of Congress anxious to crusade against the rising costs of the defense establishment may have

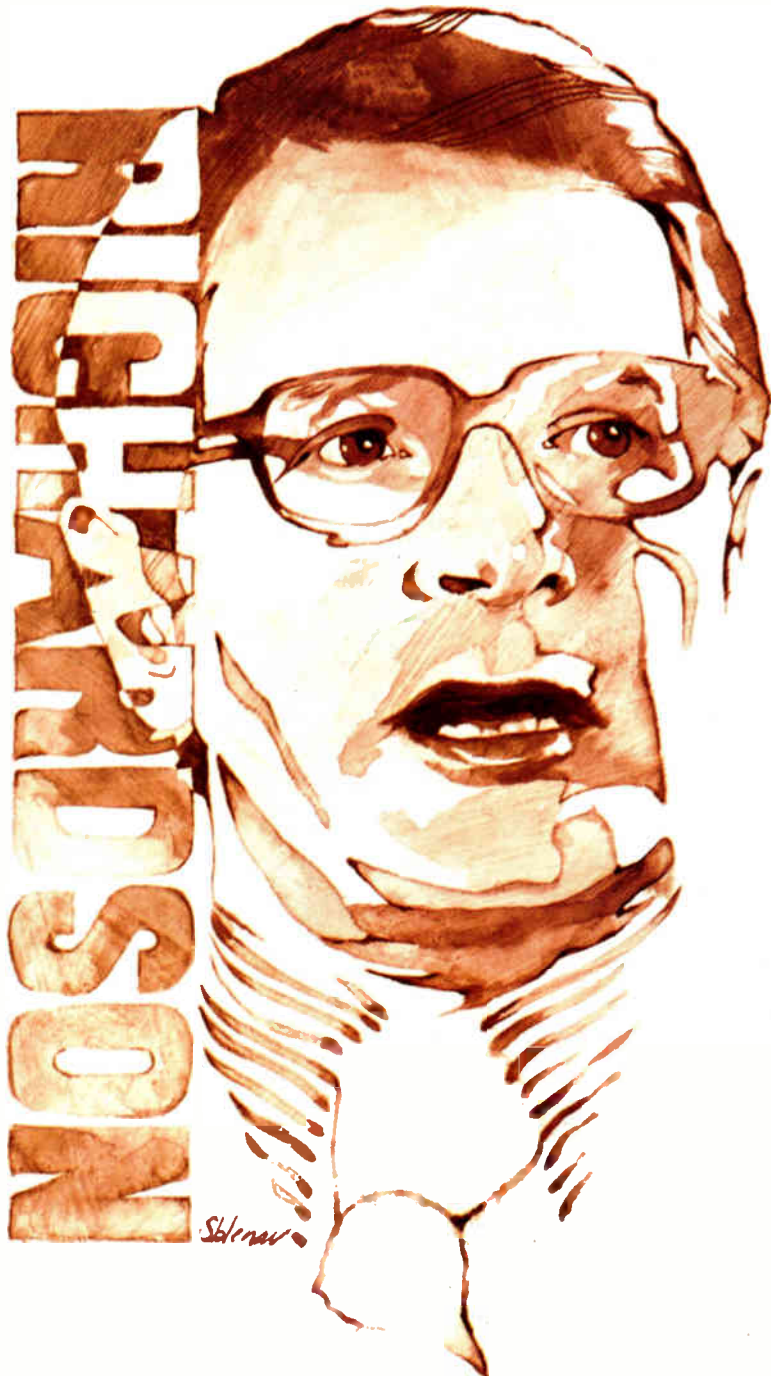

## Probing the news

to bend their efforts to the less dramatic issue of military personnel costs—the rising ratio of support to combat troops and military pension and benefit programs—which now account for 56% of the defense budget.

Of the \$4.1 billion increase proposed for the fiscal 1974 defense budget authority of \$85 billion, Pentagon officials attribute \$3.2 billion, or 78%, to pay increases for military, civilian, and retired personnel. The balance, they say, is “largely accounted for by inflation on material and services purchased.”

Nevertheless, the consensus in and out of Government in Washington is that the defense appropriation could take its biggest beating in Congress since Richard Nixon took office. Though Congress is expected to try to comply with the Administration’s ceiling on Federal spending in order to avoid the political responsibility for a tax increase, the 93rd is almost guaranteed also to try to juggle the Government’s spending priorities by restoring social programs or creating new ones and cutting outlays for defense.

Sen. Edward M. Kennedy (D.,

Mass.) sounded an expected warning, calling the budget “good news for the big defense contractors and bad news for the average citizen.” House Speaker Carl Albert (D., Okla.) was even more critical, calling it “a big-business budget that leaves the common man out.”

The imponderable is whether or not the Democratic majority in the Congress can deliver anything more than strong statements in its struggle to reassert its power. “They couldn’t do it on Vietnam when some tried to cut off funds,” recalls one corporate vice-president in the capital. “I’m not sure they can do it now, especially the way the Congress is structured, with all those overlapping and ineffective committees they have.”

Adds one Democrat: “If we can’t pin him now, we never will.”

### Defense: No electronics windfall

As Secretary of Defense, Melvin Laird met with the press 194 times. Just before turning that job over to Elliot Richardson, Laird received from the press corps a “game ball” marked: “Laird—194; Press—0.”

Laird’s relationship with the Congress was not much different. The lawmakers never dropped the Con-

gressman-turned-cabinet-secretary for a loss.

Whether or not Elliot Richardson can do the same is open to question. In Richardson’s favor is a fiscal 1974 budget request prepared and supported by the Congress-wise Laird. The \$85.2 billion budget request, up \$4.1 billion over fiscal 1973, calls for \$79 billion in spending. The requested increase of \$4.2 billion is almost matched by increases in pay and inflationary price increases laid out in the document.

While some significant increases are requested for big new strategic programs to match the Administration move toward a “hi-lo force mix.” [*Electronics*, Aug. 28, 1972, p. 25], most of the money sought for new hardware is in ongoing programs. Electronics procurement essentially will be flat, with research and development outlays up fractionally from a year ago, say Defense officials.

The new Nixon budget contains a defense procurement request that’s up only slightly—\$184 million—over last year’s figure; the new total is \$18.8 billion. But substantial funds are available to avionics suppliers in a number of aircraft programs scheduled for big buys. For R&D, the President is asking for \$8.5 bil-



DEPARTMENT OF DEFENSE: WHERE RESEARCH DOLLARS GO  
(millions of dollars)

	Defense total		Army	Navy	Air Force	Agencies
	FY 1973	FY 1974	Fiscal Year 1974			
Military sciences .....	488	518	187	139	135	57
Aircraft .....	1,836	1,780	301	253	1,226	—
Missiles .....	2,095	2,254	967	922	292	73
Military astronautics .....	408	603	18	56	529	—
Ships and small craft .....	583	620	—	620	—	—
Ordnance, vehicles, and related equipment .....	350	414	241	50	123	—
Other equipment .....	1,630	1,730	336	524	517	354
Programwide management and support .....	629	636	58	146	390	42
<b>Total research, development, testing, and evaluation .....</b>	<b>8,020</b>	<b>8,555</b>	<b>2,109</b>	<b>2,709</b>	<b>3,213</b>	<b>525</b>

lion in fiscal 1974, a boost of half a billion over last year's level. Both strategic and tactical systems with electronics potential are lumped in the R&D category, such as the site-defense program for Minuteman III protection and the Air Force's A-10 close-air-support plane, for which \$142.4 million is sought.

The A-10 procurement money is the first requested, moving the program out of R&D. Other pivotal programs with big procurement or R&D tickets include the Navy Trident nuclear submarine and its long-range missile, the controversial Litton-built DD-963, plus the service's cost-override F-14 fighter under contract to Grumman Aerospace Corp. Money is also sought to complete the USS Nimitz, as well as five more nuclear attack submarines.

For the Air Force, the more significant items are the North American Rockwell B-1 bomber and the McDonnell Douglas F-15 fighter. The Army runs the site-defense effort. It also wants to split with the Marine Corps a big buy of M-60A1 tanks, as well as \$139 million more for Improved Hawk air-defense missiles from Raytheon. That company's SAM-D Hawk follow-on is down for an R&D increase to \$194 million.

In a variety of big and little ways, the Pentagon is trying to cultivate the Congress and its increasingly critical Democratic leadership on key committees. Although Louisiana's F. Edward Hébert, chairman of the House Armed Services Committee, has been relatively uncritical of military programs, the role of his Senate counterpart, Missouri's Stuart Symington, is different.

Both Symington and, to a lesser

degree, the man he's filling in for, Mississippi's John Stennis, had been prodding the Defense Department to bring weapons systems costs under better control. So have crusty John McClellan, of Arkansas, who takes over the chairmanship of the Senate Appropriations Committee, and George Mahon, the tough and wiry Texan who chairs the House Appropriations Committee.

The Pentagon plans to score at least a small economic point with its accession to last year's congressional consensus that a Safeguard ABM site to defend Washington is not required. No money is requested for the site in the fiscal 1974 program, although Safeguard is down for \$401.5 million to complete the Grand Forks, N.D., site to protect the Minuteman ICBM fields, plus another \$170.1 million for continued R&D on the site-defense option for smaller radars and missiles.

The Navy's Trident program, follow-on to the Poseidon, is down for the biggest single defense budget increase, some \$917 million over the figure for this fiscal year. Of the \$1.712 billion total sought, \$867.8 million is budgeted for procurement of the first General Dynamics boat, plus \$126 million more for RDT&E, and \$536.7 million for continued RDT&E on the Lockheed missile.

The request is in for \$590.9 million to buy seven more DD-963s, a dollar total more than double last year's appropriation.

That mood will also be reflected in the continuing probe of the Navy's F-14 fighter contract with Grumman, on which the contractor has refused to perform without a new and costlier contract. Although the Navy was scheduled to buy 81

of the planes in the new fiscal year under the sixth lot in the program, the service's request is for 48, the allowable minimum under the pact, at a cost of \$572 million, less \$40.4 million for RDT&E.

Money for the new Sea Control Ship (SCS)—a minicarrier for helicopters and V/STOL aircraft—is limited to \$29.3 million for advance-procurement items, although electronics suppliers are tracking the program for potential. It is one of the few ship programs that offers any promise for the long term. Since disclosure of the new budget, the Navy has awarded the first two SCS design contracts. One for \$7.5 million went to National Steel and Shipbuilding, San Diego, Calif., for system-contract design support and detail design; the other, for design support, was awarded to Lockheed Shipbuilding for \$1.5 million.

Although the Pentagon highlights



## Probing the news

its new start on a submarine-launched cruise missile (SLCM) among its programs, Navy sources indicate that the effort is still a small one being carried out in-house at the conceptual-design level. There is speculation that the SLCM program could turn to an encapsulated version of the McDonnell Douglas Harpoon antiship missile, but both programs are carried as separate line items, with Harpoon down for \$85.6 million, including \$19 million in the program's first procurement request.

Even though the Congress termed efforts to begin Harpoon procurement a year ago as "premature," the Navy believes the lawmakers will be ready in fiscal 1974.

Two other opportunities for avionics suppliers are embodied in the Navy's request to buy 34 more planes for the Marines. The service is seeking 24 more A-4M attack aircraft at a cost of \$68.6 million, plus 10 F-4J fighters. No A-4s were bought in fiscal 1973, and the F-4J is a new version of the aircraft, for which \$130.7 million is requested.

The F-15, the Air Force successor to the F-4, carries that service's biggest single procurement request—\$1.14 billion to buy 77 more of the air-superiority fighters. That's 47 more planes and \$240 million more money than was in last year's request, including RDT&E funds. Still in development, but also getting an increase, is the B-1 bomber: the Air Force request of \$473.5 million is \$29 million more than it was last year.

Tactical aircraft for close support are certain to get tough congress-

## Communications: Emphasis on cable TV

At a 1974 level of about \$40 million, funding for the nation's communications managers—the Federal Communications Commission and the Office of Telecommunications Policy—is only a footnote in a \$268 billion Federal outlay.

Nonetheless, small shifts in program activities within the FCC and OTP, which gets its technical support from the Commerce Department's Office of Telecommunications, can have major impact on the communications industry and its suppliers. The largest buildup in funding within the FCC is in the Cable Television Bureau, from \$1.1 million in fiscal 1973 to \$1.8 million in 1974. A bureau spokesman says that the entire increase will be used to pay for processing and licensing of cable systems under new rulings requiring certification of all cable systems by 1977. In the six years prior to the March 1972 ruling, only 600 applications were processed. However, the bureau has received 1,850 applications since then.

Most other activities at the FCC are funded in fiscal 1974 at approximately the same level or a little higher than they were this year. Appropriations for research and planning in communications technology, after a 40% gain in fiscal 1973, have leveled off in 1974 at \$4.5 million. With part of these 1974 funds, the commission hopes to expand its spectrum-management task force to include a second regional center in San Francisco.

A \$287,000 increase in the FCC Common Carrier Bureau's 1974 budget to \$4.87 million will do "little more than maintain present levels of activity," asserts Charles Cowan, assistant bureau chief. Roughly \$1 million of the new budget will go to carry on the bureau's investigation of AT&T pricing policies. Also, a small shift within the bureau staff will increase emphasis on analysis of the proposed domestic communications-satellite programs.

An increase of \$280,000 in the OTP budget to \$3.3 million in 1974 reflects primarily additions to outside study contracts, especially since the permanent employment positions authorized in that office are being reduced from 65 to 52 in the next fiscal year. One such study the OTP hopes to get under way is for a major hardware-demonstration program to take a look at possible new uses and cost-effectiveness for cable television. The resulting trial system is to allow an evaluation of an operating system to include both private and public users. Under present plans, the OTP would perform system management and coordination functions, with primary funding from other Government agencies and the cable-television industry. Project definition, estimated to cost up to \$1 million, is expected to be carried out early in fiscal 1974, with funding from OTP in the neighborhood of several hundred thousand dollars.

sional scrutiny. While the Air Force is proceeding with the Fairchild A-10—an award already being investigated by the General Accounting Office, the Army wants \$49.3 million for RDT&E for its Advanced Attack Helicopter, more than double

this year's \$20 million. The AAH, a scrubbed-down version of the canceled Cheyenne, is budgeted for a design-to-cost goal of \$1.4–1.6 million each in flyaway costs and a total life cycle cost of \$3.2 million each.

DEPARTMENT OF DEFENSE: WHAT PROCUREMENT DOLLARS BUY  
(millions of dollars)

	Defense total		Army	Navy	Air Force	Agencies
	FY 1973	FY 1974				
			Fiscal Year 1974			
Aircraft .....	5,750	6,052	181	2,958	2,913	—
Missiles .....	3,104	2,885	600	712	1,573	—
Ships .....	2,970	3,902	—	3,902	—	—
Combat vehicles, weapons, and torpedoes .....	561	562	253	309	—	—
Ordnance, vehicles, and related equipment .....	2,805	1,946	1,060	234	651	1
Electronics and communications .....	973	1,060	220	451	337	52
Other procurement .....	2,460	2,400	553	812	1,017	18
<b>Total procurement .....</b>	<b>18,622</b>	<b>18,806</b>	<b>2,867</b>	<b>9,378</b>	<b>6,491</b>	<b>71</b>



## NASA's cupboard almost bare

Although the National Aeronautics and Space Administration has managed to keep its head just above the \$3-billion-budget level for the 1974 fiscal year, the true state of its funding plans is illustrated by the fact that it will start only two new programs: the Nimbus-G environmental satellite, costing approximately \$50 million, and a small \$2 million Lageos laser-reflector satellite.

Thus, electronics contractors looking for rays of light will find NASA emphasizing three dark themes: continuing selected large programs, slipping smaller ones, and cutting back others entirely. Even the Nimbus-G program probably will go to the Nimbus series builder, General Electric Co.

There is some sunshine amid the gloom, however. NASA expects to issue requests for proposals in six to nine months for the delayed Tiros-N, a new-generation weather satellite [*Electronics*, Jan. 31, 1972, p. 79] that will cost under \$50 million, says Charles W. Mathews, associate administrator for applications. But the launch date slips a year to 1977.

RFPs for some space-shuttle avionics should be out in the spring and summer with work underway by fall, predicts Dale D. Myers, associate administrator for manned space flight. March is the date for guidance and navigation equipment RFPs, and those for communications equipment are due in the summer, he says, under a philosophy of giving equipment of greater complexity longer lead times. One contract will be for an estimated \$30 million central-data-processing complex of four computers sharing a central mass memory, Myers says.

Overall, NASA plans to spend \$3.1 billion, including carry-over money, with manned-space operations—this year's Skylab flights, the 1975 U.S.-Russian space docking, and the later space shuttle—taking a third. Manned space is down \$100 million from last year to \$1.057 billion.

Space science, which falls by \$95 million to \$584 million, and applications, which drops \$35.7 million to \$153 million, show the effects of cuts NASA announced in January [*Electronics*, Jan. 18, p. 119]. For ex-

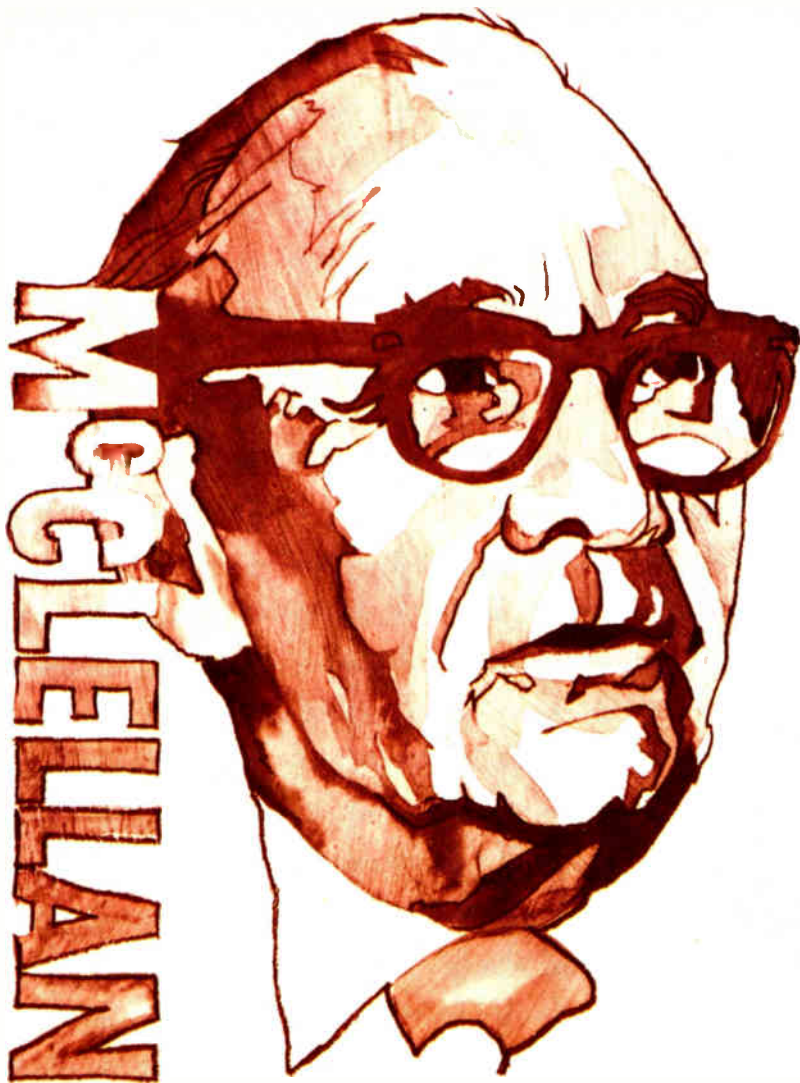

ample, the High-Energy Astronomical Observatory (HEAO) with its \$200 million potential under contract to TRW Inc. was scrubbed. The same fate befell Applied Technology Satellite ATS-G, the follow on to ATS-F that Fairchild industries is building. The reason: NASA has decided to leave the communications-satellite business to private industry. Administrator James C. Fletcher, saying that X-ray astronomy is of the "highest priority," announces that a new HEAO plan, probably reduced, will be ready in the "next month or two."

From past history, NASA's budget should receive a good reception from the two congressional watchdog committees, even though they are headed by new chairmen. Olin E. (Tiger) Teague (D., Texas), a space booster, leads the House Science and Astronautics Committee. Frank E. Moss (D., Utah), a freshman to the Senate Aeronautical and

Space Sciences Committee, which he chairs, is promising a vigorous look at NASA operations.

Stretchouts affect Earth-Resources Technology Satellite ERTS-B, which will be delayed three years to a 1976 launch, even though ERTS-1, built by General Electric and launched last year, has been highly successful. The Orbiting Solar Observatories J and K, deferred last year, are perhaps not scrapped but deferred indefinitely.

The \$5 billion space shuttle is being slipped a little to spread manpower costs, Fletcher says. Even so, shuttle costs for fiscal 1974 will more than double to \$475 million as the program begins to consume more of NASA's tight money.

Funding requests for aeronautics and space technology (AST) and tracking and data acquisition remain about the same at \$240 million and \$250 million, respectively. AST's projects include an advanced

## Probing the news

digital fly-by-wire system for which an RFP is expected "at the start of fiscal 1974," says Roy P. Jackson, associate administrator for AST.

Another AST project will be flight demonstration aboard a Boeing-737 of flight-control and director systems originally developed for the aborted supersonic transport "to demonstrate how these advanced flight-control systems could be used in conventional aircraft," Jackson says. A joint program with the Federal Aviation Administration, the work includes hardware installation during the next fiscal year and test flights the following year against "early models" of the FAA's upcom-

ing microwave instrument-landing system, he says.

NASA also will choose a contractor for a \$5 million remotely piloted vehicle (RPV). It's scheduled to reach the hardware stage in two years.

Downstream, the space agency promises, there are some new programs. Fletcher assures space scientists that a proposed Venus Pioneer 1977 mission is "an important new start," and that "we plan to go ahead next fiscal year, if feasible." The projected heavyweight earth observation satellite [*Electronics*, Dec. 18, 1972, p. 34] and the family of lightweight Small Applications-Technology Satellites (SATS) still are under study.

Onstream, NASA insists, is a raft of programs, many of them reaching

peak funding. Among these are the second Pioneer-Jupiter (built by TRW Systems Inc.) and Mariner Venus-Mercury (Jet Propulsion Laboratory-Boeing Co.) launches slated for this year, the 1975 Viking Mars (JPL-Martin Marietta Corp.) mission, and the 1977 Mariner Jupiter-Saturn (JPL) mission. Also on target are the 1974 launches of Hughes Aircraft Co.'s Orbiting Solar Observatory OSO-I, General Electric's Nimbus-F, Fairchild Industries' ATS-F, and the 1973 and 1974 launches of Philco-Ford Corp.'s Synchronous Meteorological Satellites A and B.

### DOT: Take a flier on the FAA

Companies looking for potentially large electronics programs in the Department of Transportation requested fiscal 1974 outlays of \$8.1 billion should take to the air—only the Federal Aviation Administration will spend money on major electronics projects. But sharp reconnaissance will be needed to track important programs on the FAA's projected \$1.8 billion spending list.

Of that sum, the FAA plans to spend \$280 million in the Airport Development Aid Program (ADAP), which will allow airport operators to buy such navigation aids as radars and instrument-landing systems along with new runways and landing lights. Another \$250 million is routed for continuing improvement in the terminal and en-route traffic control systems, with a good portion charted to complete the automation upgrading already contracted for.

Despite the large FAA budget, industry reaction is that contracts for new projects will be scarce and hard to come by. "It doesn't look good," observes an executive with an electronics contractor doing business with the agency. "In air-traffic control, for example, there's so much to do, but the FAA is having a tough time finding the money to do it." He adds that "we were counting on money" for new development work, but "it doesn't look like we're going to get it."

Several awards could open new markets. The FAA will soon select up to four of the six teams competing for the second phase of the microwave instrument-landing system





## From the Datacraft DC-38 Building Block... Comes a Memory You Can't Afford To Forget

**The DC-38-S.** You can't afford to forget it because we didn't forget anything in its design. We built it complete...and it is a complete magnetic core memory with the timing and control functions all on a single printed circuit board.

It is reliable. Datacraft's ideas on reliability in a memory system are: 1) Don't try to design around those techniques that can inherently fight reliability in traditional memories. 2) Do away with those potential pockets of failure entirely.

That's what happened. In Datacraft memories we wiped out such things as core stack risers, hard backpanel wiring, plus linear transformers and their accompanying problems. The design is a little unorthodox. It's modern and modular to satisfy current needs and adapt to fit future ones...you can forget about obsolescence.

Can you afford it? Pricewise, it's less than most. Combine low cost with the DC-38-S's reliability and performance...we think you can't afford not to.

### Expandability

The DC-38-S is a complete memory with timing and control all on a single card. Using the 5¼" chassis and expansion in 4K X 18 increments, you can go to 20K X 18 or 40K X 9; expanding in 8K X 18 increments you can get a bank of 40K X 18 or 80K X 9.

**For more information, write to the address below. If your application demands larger storage capacity, ask for our brochure on the two-card memory system, the DC-38-D.**

**The DC-38-S**  
Datacraft Corporation  
P. O. Box 23550  
Fort Lauderdale, Fla. 33307

# *Datacraft*

## Probing the news

(MLS) to become universal later this decade [*Electronics*, Feb. 1, p. 73]. By this summer, the agency plans to select a standard for an interim MLS, which will allow airport operators to purchase the systems with ADAP funds [*Electronics*, Jan. 4, p. 53]. Companies competing in this market include Boeing, Cutler-Hammer's AIL division, Singer-Kearfott, and Tull Aviation.

Lockheed Electronics Co. is expecting to sell its ARTS 2 advanced radar terminal systems for medium-size airports. The FAA is now evaluating the system at Wilkes-Barre/Scranton Airport. Philco-Ford could sell up to 21 electronic voice-switch systems for \$78 million if the agency likes the prototype under construction [*Electronics*, Jan. 18, p. 114].

The FAA will spend some \$123 million on research and development, about as much as in the

previous fiscal year. Electronic projects include developing methods for transferring and processing data received from tracking radars, pilot-filed flight plans, airline dispatchers, flight-service stations, and en-route control centers. New computerized airport traffic-control systems will be developed to enable more efficient metering and spacing of terminal traffic under all weather conditions. New omnirange navigation stations also are included in the development budget.

Overall, the DOT will be operating with effectively less money in fiscal 1974, since the modest \$97 million increase over the previous year's amount is more than offset by inflation and salary increases. Most of the money is for asphalt and vehicle items, such as highways and buses, in which electronics only plays a supporting role.

For example, more than half of DOT's budget will go to the Federal Highway Administration, which intends to lay out nearly all of it for the Federal-aid highway program. Electronics companies could get a piece of this action if proposals pass to tap the highway trust fund for urban mass-transit projects, which would need computerized management, signaling, fare-collection, and operations systems.

At the Urban Mass Transit Administration (UMTA), whose request rose \$20 million to an even \$1 billion, capital outlays for new buses, commuter rail cars, and rapid-transit cars will be up slightly from the fiscal 1973 level. The new budget requests \$872 million for an estimated 291 projects, up from an estimated \$864 million in grants for 229 projects.

Research, development, and demonstration grants may well end up ahead of those for last year. Some \$80 million is being requested, an increase of \$6.7 million. However, UMTA originally requested \$115 million, which Congress severely slashed. Allocation of the \$80 million will be revealed when UMTA presents its exact proposals to Congress in a month or two.

Particular emphasis is being placed on developing the "state-of-the-art" commuter railroad car, now under contract to Boeing Co. The car is to include the latest innova-

# What you don't know about custom CMOS can hurt you.

What we know about it could revolutionize your product.

At Micro Power, custom CMOS means proven production processes, a service approach that lets us perform as an extension of your own design and manufacturing departments, and a way to make your product smaller, less expensive and easier to build.

It also means advanced technology like High-Density CMOS (example below), a technique employing two-layer metallization for interconnecting circuit elements. HD/CMOS saves chip real estate, lowers power needs, and slashes costs.

Learn more about these very real possibilities. You can start by learning more about us—just circle reader service number 245.

We can help.

## MICRO POWER SYSTEMS

3100 Alfred Street, Santa Clara, California 95050 Telephone (408) 247-5350

TECHNICAL REPRESENTATIVES IN EUROPE AND THE FAR EAST

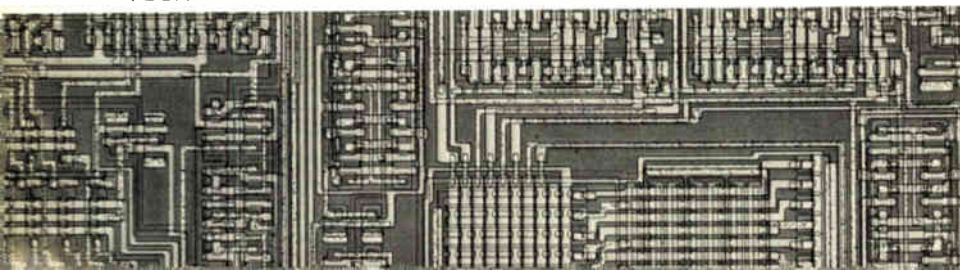

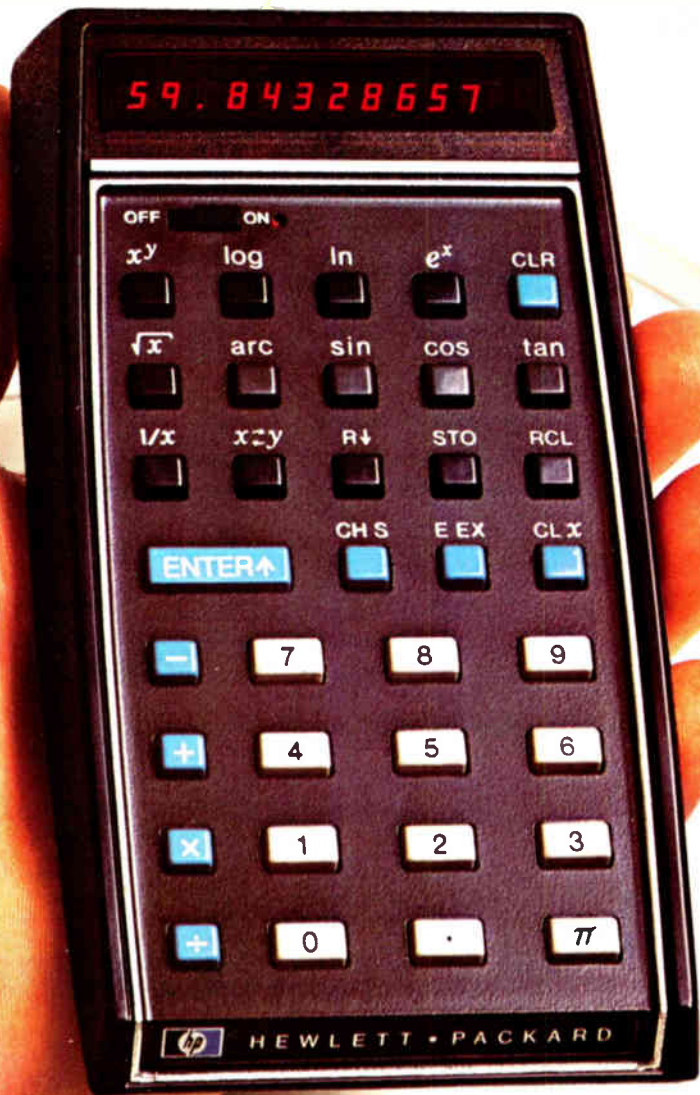

The HP-35—  
A small tribute  
to great American  
ingenuity. Made in U.S.A.  
Don't settle for less.

# Hewlett-Packard presents the world's first pocket calculator that challenges a computer

Slide-rule portability and computer-like power for just \$395

Hewlett-Packard's HP-35 is a time-and-money saver for every engineer, scientist, and decision-maker on your staff. This cordless wonder is just a bit larger than a pack of king-size cigarettes and weighs a mere 9 ounces. Yet it *challenges a computer* in handling problems ranging from simple arithmetic to complex mathematics. Best of all, it solves these problems on the spot—whenever and wherever they arise. All this highly sophisticated, highly portable calculating power results from Hewlett-Packard breakthroughs in research, development, and production. It's really a small tribute to great American ingenuity. So why settle for less? For a mere \$395, our professional time-saver will pay for itself many times over. Find out now what the HP-35 can do for the problem-solvers on your payroll. Just write today for your free copy of our in-depth Capability Report.

Mail to:  
HEWLETT-PACKARD  
Advanced Products Division • Dept. 214A  
10900 Wolfe Road, Cupertino, Calif. 95014

Please mail me a free copy of your  
in-depth Capability Report on the  
HP-35 Pocket Calculator.

NAME \_\_\_\_\_

TITLE \_\_\_\_\_

FIRM NAME \_\_\_\_\_

ADDRESS \_\_\_\_\_

CITY \_\_\_\_\_

STATE \_\_\_\_\_

ZIP \_\_\_\_\_

HEWLETT  PACKARD

Circle 77 on reader service card

## Probing the news

tions in electronic control systems, as well as those of suspension, ride quality, and comfort. Also, requests for proposals are to go out before June to develop a complete advanced train aimed at achieving what Boeing is doing for a single car.

However, any new funding for the type of personal rapid-transit system being constructed at Morgantown, W. Va., may be held off until fiscal 1975. UMTA wants to get some operating experience with the Morgantown system before it goes ahead elsewhere, explains James M. Beggs, outgoing DOT undersecretary. The department needs "to have a handle" on the installation, operating, and maintenance costs of such a system, he says, as well as "whether the public will ride it."

Work is also continuing on the Grumman Corp. tracked air-cushion vehicle (TACV), the 300-mph levitation machine sponsored by the Federal Railroad Administration, and on UMTA's 150-mph urban tracked air-cushion vehicle. But budgeting for the so-called dual-mode transportation vehicle—one that could ride equally well on both highways and rails—has, as one UMTA spokesman put it, "faded from sight."

The Coast Guard will be looking for some new electronics. Close to \$7 million is budgeted for vessel-traffic systems to be installed in the harbors at New York, New Orleans, and Puget Sound. The final configurations of the systems will depend upon the conclusions of a study due by March.

### Social money spread out

More will be spent this year than last on social programs. As ever, just how much will go to electronics is difficult to ferret out from the budget document. And just where to find the money is harder than ever, since this year the Administration is determinedly spreading fiscal power among the state capitals and county seats, as well as Washington.

Still, law enforcement would appear to be the richest vein to be tapped this year. Other major

spenders will include the Department of Health, Education, and Welfare, the Department of Commerce—especially its National Oceanic and Atmospheric Administration—and the newly prominent National Science Foundation.

At the Law Enforcement Assistance Administration (LEAA), "electronics continues to be a high-priority item" notes outgoing LEAA administrator Jerris Leonard. And makers of police-communications equipment should do particularly well. The rich agency uses about half of the Justice Department's budget, or \$891.1 million, up \$35.8 million from fiscal 1973, to help state and local law-enforcement agencies upgrade their crime-fight-

ing and crime-information systems.

How big a share in these funds will go to electronics depends on what individual states request as well as what LEAA finally approves. The states will receive most of their funds through revenue-sharing provisions instead of direct grants as before. But the agency has so much money that its outlays "cut across fiscal years and aren't directly related to appropriations figures," comments associate administrator Richard W. Velde. To keep better track of its 34,000 funding grants, LEAA has just opened a computerized grants-management information system, he says.

LEAA's big Project Search may find that political considerations

## NSF takes the hand-off

The people who run the National Science Foundation, shoved suddenly stage center when President Nixon closed the White House Office of Science and Technology, manfully insist that they're ready to take on the OST's responsibilities. But some in the scientific community and the Congress aren't so sure.

H. Guyford Stever, director of the NSF and now the top scientific adviser in the Federal hierarchy, insists: "It is not the intent of the President and his staff to downgrade science, and I have the feeling we may be very effective." Stever concedes, however, that he learned of his new role only around the middle of January, even though he had discussed the possibility with former White House Science Adviser Edward E. David Jr., who resigned last month.

Under the reorganization plan, not only is the OST gone, but the post of White House science adviser has been downgraded, and the President's Science Advisory Committee has been eliminated. It leaves Stever, the very picture of a smiling, optimistic college president—which he used to be—reporting to Secretary of the Treasury George P. Shultz. His predecessor reported to the President.

What does the new setup mean? "All we can do now is conjecture how it will turn out," says Daniel W. DeSimone, a former top aide of David's. "Stever is well aware that he must develop a strong relationship with Shultz and Ash [Roy Ash, former president of Litton Industries and director of the President's Office of Management and Budget]. Working with them he can be more effective with the White House than Ed David was. If Stever can get leverage with Shultz, he'll have clout."

But that's the rub. The 4,700-member Federation of American Scientists fears that Stever won't be able to get close enough to Shultz to apply any leverage. Jeremy Stone, director of the federation, maintains that Stever will be reporting to Shultz mainly through a White House deputy, moving Stever possibly two levels away from the President.

Congressman John W. Davis (D., Ga.), a high-ranking member of the House Science and Astronautics Committee and chairman of the subcommittee that oversees the NSF, is upset by the reorganization. He says that it will, in effect, "pull the rug from under the feet of our scientists and technicians." Davis says that the NSF will have new responsibility, but it will not get more personnel. Stever confirms this, but he says that some 20 new posts will be added in the fiscal 1974 budget. These were originally planned for other purposes, but "we have very flexible bodies," says Stever.

It all boils down to whether or not Stever's flexible bodies, up to now running the NSF mainly as a mild-mannered, university-oriented agency in charge of parceling out research grants, can get in there and swing in the name of the scientific community.

# AVX

## makes another bold move

AVX meets the needs of the industry head-on with a pledge to deliver the best quality ceramic capacitors in larger quantities than any other manufacturer.

Automated lines, continuous process controls, plant expansion and an unexcelled distributor network make AVX the best (and the biggest) single source for ceramic capacitors in the world today.

In July AVX will have its new Myrtle Beach plant in full production. This additional 45,000 sq. ft. will bring AVX's total manufacturing floor space to over 250,000



sq. ft. of which 25,000 sq. ft. are "clean room" facilities devoted exclusively to the manufacture of high reliability capacitors for the electronics industry.

AVX's wide product line includes multi-layer capacitors, ceramic discs, tubular feed-thrus, chips, ceramic filters and other similar products in all sizes and ranges.

For complete information, write

AVX Ceramics Corporation,  
P.O. Box 867, Myrtle Beach, S.C. 29577.  
Telephone: (803) 448-3191.

# AVX

## CERAMICS CORPORATION

Braintree, Massachusetts

# Reduce Car Maintenance Increase Engine Performance.

Put a Mark Ten Capacitive Discharge Ignition (CDI) System On Your Car.

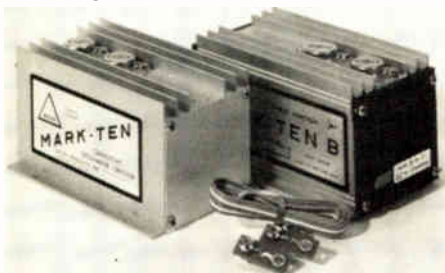

Even Detroit finally recognizes that electronic ignition systems dramatically increase engine performance. Chrysler is now putting them on their new models. The Mark Ten CDI, the original electronic ignition system, has been giving increased performance with lower maintenance to hundreds of thousands of satisfied customers for over eight years. Install a Mark Ten CDI on your car, boat or truck and eliminate 3 out of 4 tune-ups. Increase gasoline mileage up to 20%. Enjoy improved engine performance. Or put a Mark Ten B on your car. It was especially designed for engines with smog control devices. By reducing combustion contaminants, the Mark Ten B restores power losses caused by these devices. Equipped with a convenient switch for instant return to standard ignition, the Mark Ten B is applicable to ANY 12 volt negative ground engine. Both systems install in 10 minutes with no rewiring. Order a Mark Ten or Mark Ten B CDI today.

Mark Ten (Assembled) \$44.95 ppd.

Mark Ten (DeltaKit) \$29.95 ppd.  
(Kit available in 12 volt only, positive or negative ground.)

Mark Ten B \$59.95 ppd.  
(12 volt negative ground only)

Superior Products at Sensible Prices  
Mfg. in U.S.A.



Dept. E  
**DELTA PRODUCTS, INC.**

P.O. Box 1147 / Grand Junction, Colo. 81501  
(303) 242-9000

Please send me free literature.

Enclosed is \$ \_\_\_\_\_  Ship ppd.  Ship C.O.D.

Please send:

\_\_\_ Mark Ten B @ \$59.95 ppd.

\_\_\_ Standard Mark Ten (Assembled)  
@ \$44.95 ppd.

\_\_\_ 6 Volt: Neg. Ground Only

\_\_\_ 12 Volt: Specify

\_\_\_ Positive Ground \_\_\_ Negative Ground

\_\_\_ Standard Mark Ten (Deltakit) @  
\$29.95 ppd.

(12 Volt Positive Or Negative Ground Only)

Car Year \_\_\_\_\_ Make \_\_\_\_\_

Name \_\_\_\_\_

Address \_\_\_\_\_

City/State \_\_\_\_\_ Zip \_\_\_\_\_

## Probing the news

have a bigger impact than budgetary ones as "the issue of dedicated computers is slowing up" the program for establishing the crime-information system, asserts Leonard. Too many local law-enforcement people want their own computers because they confuse security with dedicated computers, he charges. "That's nonsense," he snorts. "We'll never have a nationwide system if that happens." Leonard, who says the agency is firmly behind time-shared multi-use computers among intrastate agencies, adds that some governors, in lining up behind LEAA, have told law officials to forget about wanting their own computers. Fiscal 1974 funding requests for Project Search are up \$250,000 to \$2 million. The funds are tagged for some other uses, such as helping states develop information systems, but just how the pot will be divided has not been decided. LEAA says.

Over at the FBI, \$9,042,000 will be spent to automate fingerprint classification and matching operations. The bureau, which says it gets 24,000 sets of prints each day, will put out requests for proposals on production-model print-reading scanner equipment and related gear—including construction of a special processor to match the prints. The budget earmarks \$4,478,000 for the project. North American Rockwell and Calspan Corp. (formerly Cornell Aeronautical Labs) did parallel research on such equipment, but Calspan was chosen to design and build a prototype fingerprint-identification system.

The rest of the money—some \$4,564,000—will be used to rent computers to support the automation project.

As usual, the markets for electronics at the Department of Health, Education, and Welfare are scattered throughout the mazelike HEW structure. Contract awards appear to be tapering off on at least one front—computer and related equipment, called automated data processing (ADP) in Government. Following style for other Federal departments, "there's a lid on ADP expenditures this year [fiscal 1973],"

says Edward A. Diephaus, director of office-management systems for HEW. "Fiscal 1974 looks worse," he adds. The fiscal 1974 ceiling, in turn, is only \$124 million. This means that in recent years the growth rate in funds is decreasing to where it actually stops between 1973 and 1974, he says.

Diephaus explains that HEW originally estimated it would spend \$137 million for fiscal 1973, but that the Office of Management and Budget knocked it down to \$125 million. Partially "a problem of definition," he says that "there's no decision yet on how this will be spread" among hardware, support, and personnel throughout the Food and Drug Administration, Social Security Administration, and other parts of HEW.

Things look better at the National Oceanic and Atmospheric Administration and in the parent Department of Commerce, where electronics programs come out relatively well.

Under the fiscal 1974 NOAA budget request, administrator Bob White identified these changes affecting electronics:

- A \$16.2 million increase in the environmental-satellite services program to \$53.4 million will permit operation to begin for the two geostationary orbiting environmental-satellite systems, in addition to continuing the polar-orbiting Improved Tiros Operational Satellite (ITOS).
- An \$8 million increase sought in Basic Environmental Service to \$95.8 million is, in effect, a net loss, since the "increase" is achieved ad-





# You supply the transducers and the computer...



## System 620 takes care of the rest

### A WORD FROM OUR AMPLIFIER-PER-CHANNEL

There's one of us for each channel. We isolate transducer signals right at the source. This means lower noise, less crosstalk, higher CMR, high input impedance, and continuous analog outputs for each channel. If one of us gets zapped by a tidal wave input, the rest don't feel a thing. You can set our gain from 0.1 to 1,000 in the field with our plug-in gain modules.

### OUR HIGH LEVEL MUX CHIMES IN

I'm FET & fast. I'm addressed sequentially or at random. Then I zip data to our programmable gain amplifier. It's your turn, amp.

### OUR ADC SPEAKS HIS MIND

I'm responsible for the 50KHz throughput with 12 bit digital output while my slower brother can output 14 bits at 20KHz. And my sample & hold amplifier insures accuracy with dynamic signals.

### OUR CONTROL LOGIC DEMANDS EQUAL TIME

Using DTL/TTL logic, I'm the one that makes it so easy to interface *your* computer with System 620.

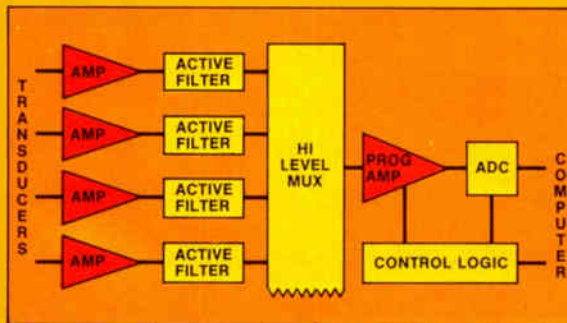

### OUR ACTIVE FILTER SPEAKS UP

Anyone in the know will tell you that the place to filter is *after* amplifying the signal. No wonder I'm so active. I limit the signal bandwidth, which reduces noise and eliminates signal components which produce aliasing errors. It's easy to set my bandwidth from 1Hz to 1KHz in the field with my little plug-in module. System 620 puts the cart (that's me) after the horse, where it belongs.

### LET'S HEAR FROM OUR PROGRAMMABLE AMP

I'm fast too. And my gain is also under computer control. I can increase the input sensitivity of System 620 by 1, 2, 4, 10, 20 or 40. This allows our input amplifiers to accommodate maximum signal levels, while your computer programs me for best signal to noise ratio.

### IN UNISON !!!

Imagine, 64 amps & filters, a MUX, a programmable amp, an ADC & control logic in a 7-inch rack cabinet for less than \$150/channel. And expandable to 256 or 2048 channels. No wonder we're multiplying like rabbits in installations everywhere.

**NEFF**  
INSTRUMENT CORPORATION

1088 E. Hamilton Rd., Duarte, Calif. 91010  
Tel. (213) 357-2281 TWX 910-585-1833

Circle 81 on reader service card

ministratively by taking the national data-buoy program, originally scheduled to get \$9.5 million, cutting it to \$8 million, and transferring it to this account. The program calls for upgrading NOAA's disaster-warning system through improving use of satellite data and providing better materials for the guidance of users.

■ An increase of nearly \$9 million in the weather-modification program to a \$12.8 million level reflects what White calls "the high priority on severe-storm modification," notably in the Pacific area.

■ A \$1.3 million increase in the mapping, charting, and surveying program, boosting it to the \$40.2 million budget level, produces another, if smaller, opportunity for electronic instrumentation as more emphasis is put on ways to automate production of nautical charts for public, industrial, and government needs.

The National Science Foundation, which suddenly finds itself the loudest science and technology voice in the Federal Government (see "NSF takes the hand-off," p. 78), gets a total of \$641.5 million. It's moving ahead with at least one big electronics program, the VLA—for very large array—a \$60 million multi-antenna astronomical instrument. The Y-shaped system, to be built in the New Mexico desert, will measure 13 miles along each arm. It's destined, once partial operation starts in 1976, to be the world's most sophisticated radio-astronomy system. Funded for \$3 million in this year's budget, the VLA is earmarked for \$7 million in fiscal '74. The big jump is attributed to start-up cost.

Another area of interest to NSF is computer-assisted instruction (CAI), an area in which growth has been disappointing after all the hoopla of only five years ago. NSF's director, H. Guyford Stever, says his agency intends to strengthen CAI. Toward this end, adds Keith R. Kelson, acting assistant director for education, NSF will be looking at CAI matters other than computers—how to link the computers and terminals, or the advantages of interactive terminals and closed-circuit TV.



# Good Listeners maintain a low profile

Even in the solitude of the forest depths, from rooftops, arctic tundra, swamps to sweltering tropics, 'neath snow, sand or ice, the Hermes Loop antenna keeps an ear to the sky. The amazing aperiodic antenna does away with vast log periodic and rhombic arrays - those towering antenna farms.

In rosette configuration, the Hermes loop antenna provides an omnidirectional broadband receiving array in space merely 1/100th that of the traditional antenna farm.

More than 53 government agencies around the world have pressed the loop antenna into service.

A new, even more compact version is available. Only Hermes Electronics makes it.

2-32MHz  
BROADBAND

## ASK US Send for our Brochure

Hermes Electronics Limited  
Suite 315  
2020 F Street NW  
Washington, DC 20006 USA  
202-296 2978  
TWX 710 822 1106





## “Putting a minicomputer inside your new product? You’ve got problems.”

1. You’ve got to get your product on the market as fast and economically as possible.
2. You want lots of money left over for profit.
3. Your product (and all components) must be reliable.
4. You have to deliver on time.
5. You have to start out and stay price competitive.
6. You don’t want any surprise problems when Version II is ready.
7. You want the right internal hardware, software, and all the rest.
8. You have to have good technical service back-up when you need it.
9. You’re getting into bed with your major suppliers and want to play it as safe as possible.
10. You need all the help you can get from your vendor.
11. You don’t want suppliers who end up competing with you.

Big problems. And we have some unique solutions proven by some of the biggest minicomputer buyers in the country. Our customers ran us through some of the toughest competitive bidding you ever saw. Against every name competitor you can mention.

We solved their problems. Partly, because we’re not newcomers. Five years and thousands of minicomputers later, we’re still solving problems. Successfully. And economically. How about yours?

Call or write me personally. I’ll answer by phone or by airplane.

Dave Methvin  
President



**COMPUTER AUTOMATION, INC.**  
**the naked mini™ company**

18651 Von Karman, Irvine, California 92664, (714) 833-8830, TWX 910-595-1767

# The Same Technology Instruments Makes Them

## Take signal sources for example...

You can't see the automated testing and the other manufacturing advances that help lower the price of HP's quality signal sources. But you sure can see the versatility and extra performance you get for your money. From the simplest function generator to the most capable synthesizer, HP technology has brought the price of quality way down.



**Brand New Function Generator 3311A** shows what a performance plus you get from this technology in action. Priced at only \$249, it adds sweep capability and a separate high-power pulse output to the usual sine, square and triangular wave outputs. Sweep it over any 10 to 1 span within its 0.1 Hz to 1 MHz range. The pulse output drives up to

20 TTL loads. Note that price again. It's 15% lower than its nearest major competition.

**Wide Range Function Generators 3310A/B** deliver general-purpose waveforms with extended low-frequency response. These 0.0005 Hz to 5 MHz instruments equip you with a linear very-low-frequency ramp, in addition to sine, square, triangle and pulse waveforms. Prices are a modest \$595 for the 3310A, and \$735 for the 3310B that also provides free-run, single-cycle and multiple-cycle operating modes.



# HP That Makes Better... Now Cost Less



**Lowest Cost Frequency Synthesizers 3320A/B** bring you synthesizer quality for as little as \$1,900. You get 1 part in  $10^6$  frequency resolution over the entire 0.01 Hz to 13 MHz range. Also, on the 3320B, HP's thermopile control of amplitude level gives 0.01 dB level resolution. If precise amplitude setting and calibration aren't required, get the 3320A for \$1,900. Or, get *both* frequency and amplitude precision in the 3320B for \$2,550 (add \$595 for full ASCII programmability). How's that for a blend of quality, performance and low price!

**Top-of-the-line Automatic Synthesizers 3330A/B** have a built-in "brain" that lets you avoid tying up a computer. They're like the 3320A/B, only these can be programmed to automatically sweep their frequency spectrum (and, on the 3330B, its precision amplitude level). With the 3330B you're getting a synthesizer, a sweeper, a marker generator, a counter, a programmable attenuator, a built-in controller and a precision level generator—in other words a lab-in-a-box—for just \$6,000. Or, cut that to \$5,100 for the manual-amplitude-control 3330A

Whatever your needs in signal sources, satisfy them with one of HP's technology-leader instruments. They're packed with more capability than ever before—and priced lower, too. For more information on the entire family of HP signal sources, contact your local HP field engineer. Or, write



Hewlett-Packard, Palo Alto, California 94304. In Europe: HPSA, P.O. Box 85, CH-1217 Meyrin 2, Geneva, Switzerland. In Japan: Yokogawa—Hewlett-Packard, 1-59-1, Yoyogi, Shibuya-Ku, Tokyo, 151.

093/43

HEWLETT  PACKARD  
SIGNAL SOURCES

If he's not one of our computer salesmen, that's the one thing he probably won't bring up.

Because he probably can't bring anybody over to do it for you.

But we can.  
And we will.

And we'll bring over all the modules (including special modules), labs, wire wrap service, cabinets, hardware, assembled logic arrays, terminals and technicians it takes to

do the job.

For us it's easy, because our Logic Products Group makes it all themselves, or gets what they need from one of our other groups, so it all fits together when it gets there.

## When you buy a computer the hooker in the deal can be "Who's going to hook it up?"

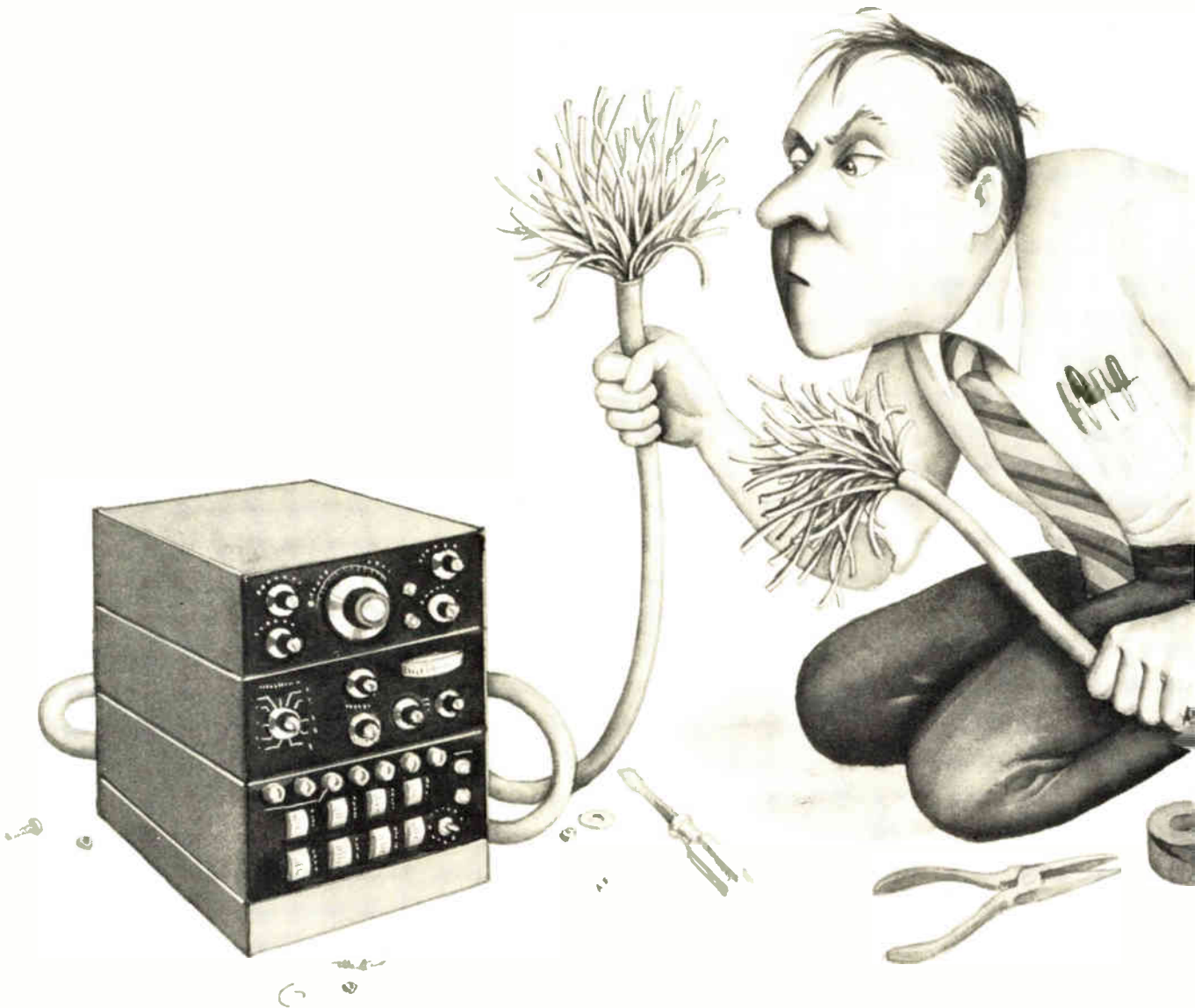

We can do it because we've had, we've got, and we keep getting the kind of designers, engineers and logic people it takes to make and market more kinds of computers, and everything it takes to make a com-

puter work right, right from the start, than any other computer company in the world.

We're the Logic Products Group, Digital Equipment Corporation, Maynard, Massachusetts 01754/(617)897-5111 (Ext: 2785) in the U.S.

81 route de l'Aire, 1211 Geneva 26/(022) 42 79 50 in Europe.

**digital**

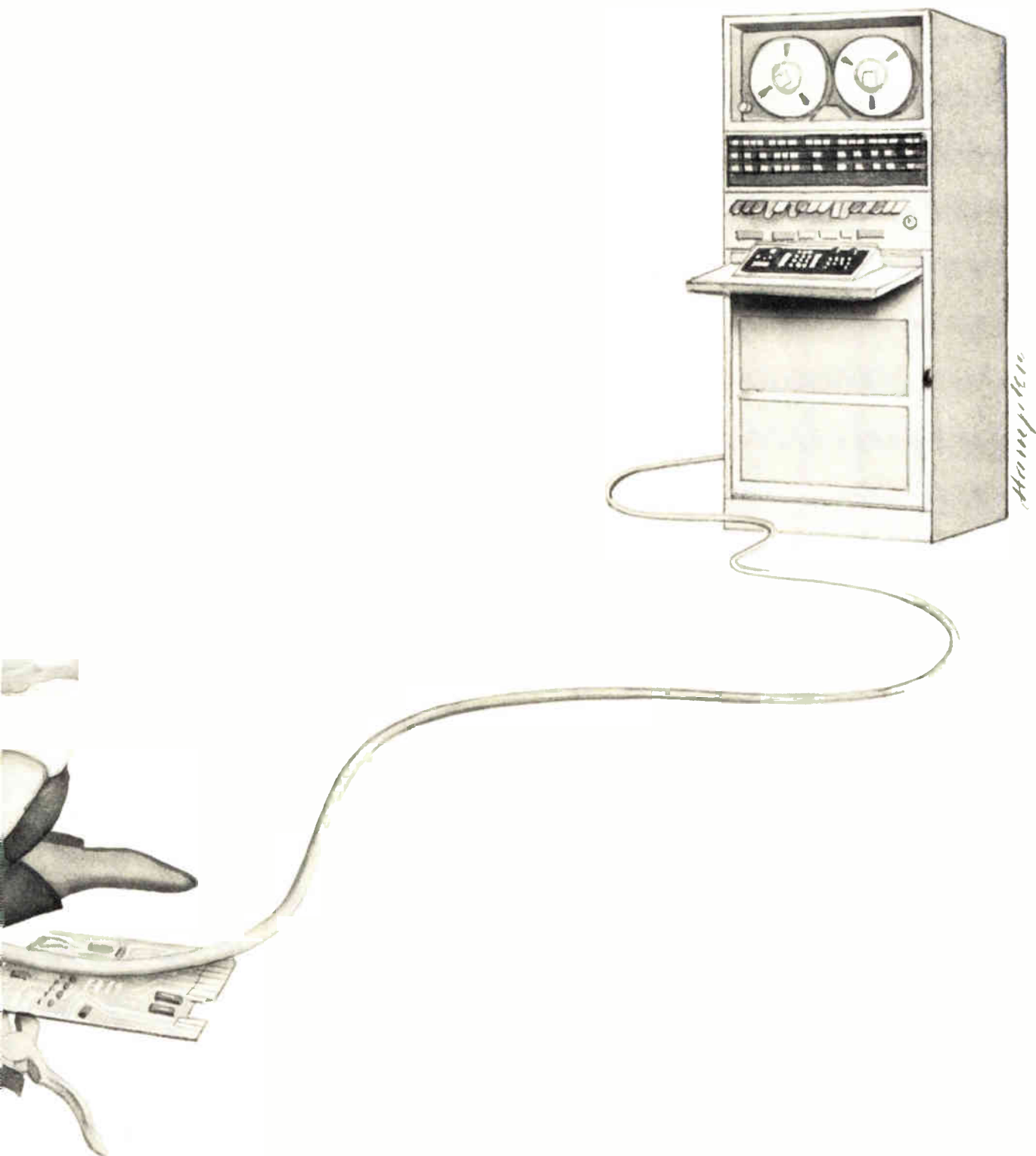

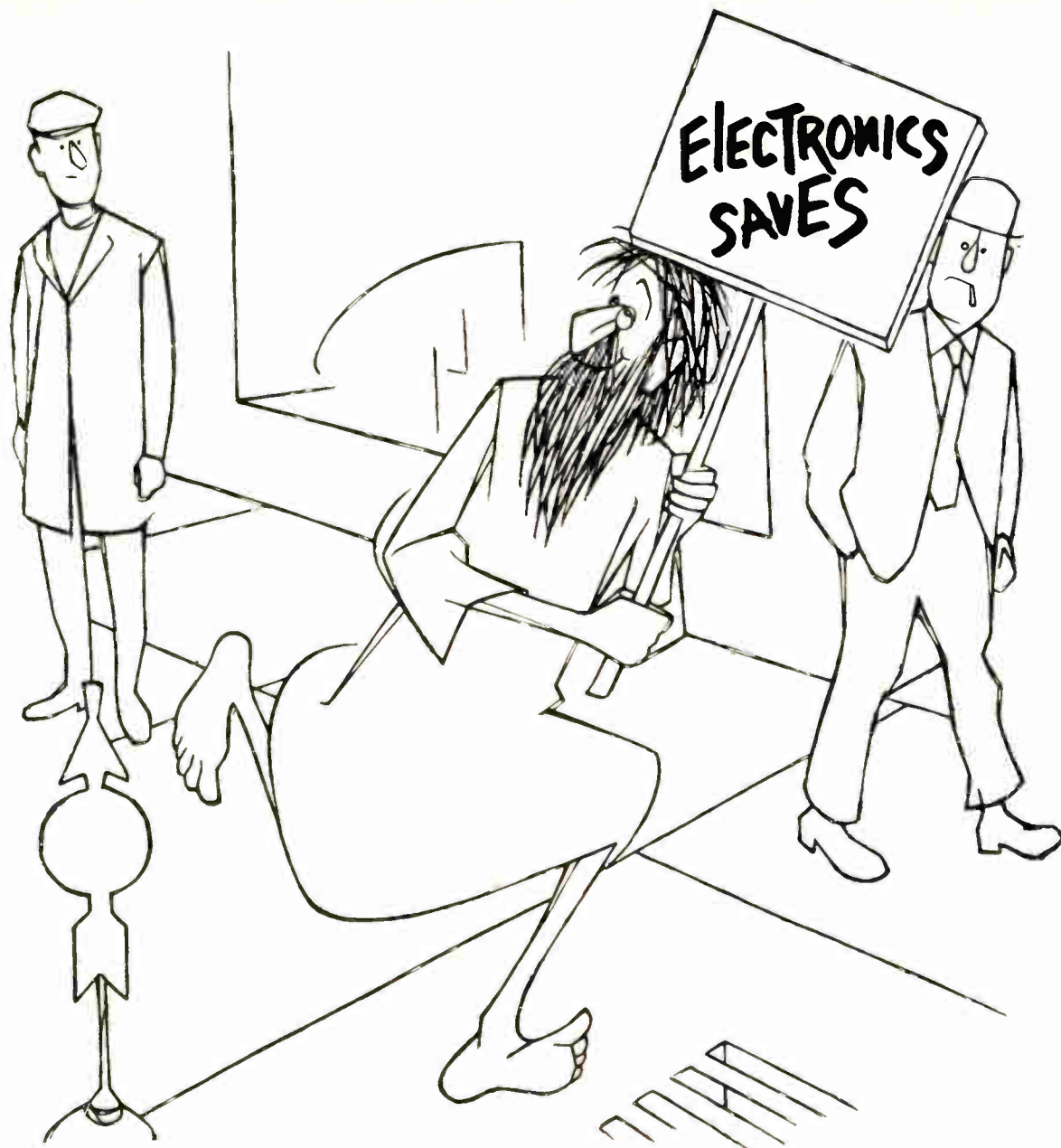

# 1973: The Year of the Advertiser

Beginning January 1, Electronics is dropping all bleed charges! And there'll be no full-run rate increase in 1973. Actually, Electronics hasn't had a rate increase since January, 1970. While in the same period, circulation is up nearly 10% and will continue to rise in 1973.

What does this mean to you?

- You can now reach an Electronics reader at nearly 10% less than you paid in 1970. You save!
- If you use bleed, you save an additional 15% on the cost of a full page ad. 25% savings in all!
- Free bleed allows you to be even more creative by using the additional 29% area available!

Why are we setting a precedent by lowering your advertising costs? Because we want 1973 to be the year of the advertiser. How can we do this? By

giving you an extra return on your investment. And, speaking of investments, leading advertisers have already increased our ad revenue by 22% over last year.

What else does Electronics give you? Only the most authoritative editorial in the technical publishing business, delivering the most involved readers in your markets.

**Electronics is THE SOURCE for advertiser benefits in 1973—the year of the advertiser. Because Electronics saves ad dollars!**

**Electronics**   
**THE SOURCE.**

Electronics/February 15, 1973



# CTS puts the squeeze on space wasters

## CTS Cermet "Saver Pac" Resistor Networks Increase Circuit Density ... At Economical Prices

Space comes *high*! So you'll like how much a CTS 750 Series "SAVER PAC" network can save you, and your circuit. Less space ... fewer components ... greater system reliability ... quicker, easier installation ... reduced handling costs ... and faster inspection. Consolidate up to 13 discrete resistors into one compact in-line resistor module. CTS can do it easily

with twenty standard packages ... available in .100", .125", or .150" lead centers. High power capabilities to 4.3 watts @ 70°C per module.

CTS 750 series cermet thick-film resistors assure proven performance—ultra high stability and reliability—backed by over 700,000,000 hours of test data. Hand install or use automatic assembly equipment...they're designed for either. Pick a SAVER PAC today. Large or small orders welcome. CTS of Berne, Inc., 406 Parr Road, Berne, Indiana 46711. Phone: (219) 589-3111.



**CTS CORPORATION**

A world leader in cermet resistor technology.

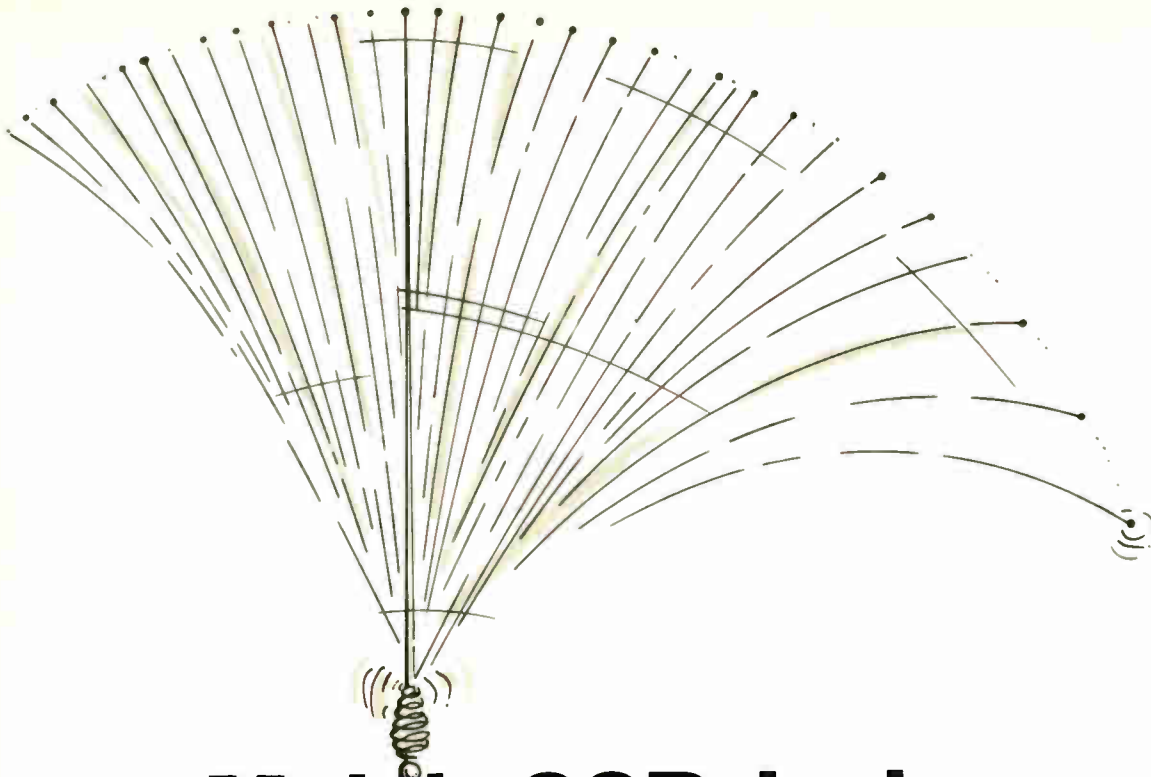

# Mobile SSB designs... whip 'em out fast.

Simply. Easily. Economically.  
... with just 4 linear devices, a  
temperature-sensing diode and a few



passive components for stable biasing — all that's necessary now for rugged, reliable, single-sideband amplifiers, distortion-free over the 2-30 MHz transmission range.

Traditionally, linear power amplifiers have been tough to design without complex schemes necessary to overcome spurious signals generated by system non-linearities. Motorola changed all that ... and we've just changed the approach to linear SSB with new device chains that provide intermod distortion ratios low enough to transmit far, wide ... and clean.

You send the right signals ... simplified, power-conserving, even-harmonic SSB that goes anywhere — and performs like this:

Power Gain ..... 40 dB  
IMD Ratio ..... -34 dB  
Collector Efficiency .. 40%

Engineering models of these designs were open and short circuit mismatched at full power — with no apparent device damage.

## ... one if by land

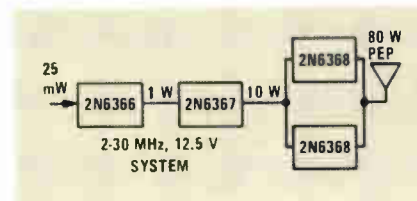

All it takes to obtain 80 W PEP from a 25 mW input in a 12 V lineup is two 2N6368's in push-pull with an intermediate 2N6367 and a 2N6366 predriver. Easier one-side assembly and better thermal contact are inherent in the studless flange cases.

## ... two if by sea

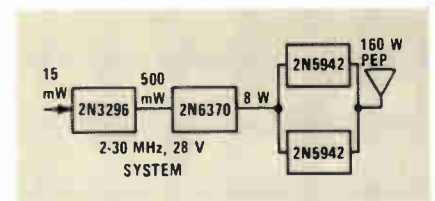

The 28 V hookup outputs 160 W from a 15 mW input ... courtesy of a pair of 2N5942's, a 2N6367 and a 2N3296. Cooling fans aren't required since with speech operation the average power dissipation is 15 dB below peak levels.

If you're serious about finding out how just a few parts can line things up for you in SSB, write for AN-546, "Solid-State Linear Power Amplifier Design" and AN-593, "Broadband Linear Power Amplifiers Using Push-Pull Designs." We'll also dash off data sheets on Motorola's complete family of SSB/linear amplifiers. Box 20912, Phoenix, AZ 85036.

Write today. Simplify tomorrow.

# Silicon-target storage tubes outdo direct-view types in versatility

Tubes that store images on a silicon target instead of a wire-mesh screen and that display them on a separate CRT achieve high resolution, ruggedness, and a good gray scale; new applications are multiplying

by Steven R. Hofstein, *Princeton Electronic Products Inc., North Brunswick, N.J.*, and William A. Rudisill, *Columbia University, N.Y., N.Y.*

□ Imaging systems today are abandoning the old-style direct-view storage tubes in favor of silicon-target tubes for storage and standard cathode-ray tubes for viewing. From the standpoint of tube design, the requirements of storing images and displaying them are better served by separate devices. Economically, too, there is no longer any reason to double up the two functions, now that ICs have reduced the cost of the external control circuitry.

Consequently, the popularity of the image-storage tube is growing rapidly. Its most recent and commercially important application is in low-dosage X-ray systems for inspecting luggage at airports. Then, too, it has great potential in television image storage, frame-snatching, ultrasound imaging, and microfilm and microfiche retrieval.

It has several advantages over the storage/display tube. It is smaller and more rugged, storing information on a solid silicon/silicon-dioxide target instead of on a fragile wire mesh. It has higher resolution (up to 3,000 lines per diagonal), can store and display up to 10 logarithmic shades of gray, and requires lower operating voltage (700 volts or less). It can provide electronic "zoom" ratios as high as 36:1 (compared with 4:1 for conventional mesh-target tubes of the same size), and its life will typically exceed 10,000 hours.

Fundamentally, the silicon storage tube consists of a triode assembly, a focus system, a deflection system, and a silicon/silicon-dioxide target (Fig. 1a). An electron beam, formed by the triode section, is focused onto

the target by a focusing coil. Depending on its energy, which is controlled by the voltage of the target, the beam can write, read, or erase all or part of the image on the target.

Unlike the direct-view storage tube, which displays its output visually, the silicon-target tube has an electrical output only. This output—the beam current—is determined by the information stored on its target.

In most other storage tubes, a fine wire mesh onto which a dielectric material has been evaporated serves as the storage structure. Because it is impossible to prevent the dielectric material from being deposited across some of the grid spaces, nonuniformities occur in the mesh transmission ratio (the ratio of the open area in a given target region to the total area of that region). These nonuniformities are amplified in most cases by over an order of magnitude by the storage process, and they show up on the stored image as noise or graininess. To minimize the variation in transmission ratios, a fairly coarse mesh must be used, so that large targets have to be used for even modest levels of resolution.

By contrast, the stripes of silicon dioxide on the silicon tube target are so thin that they have virtually no

**Closing the loop.** Readers wanting to discuss this device further with one of the authors can call Steven Hofstein any time during business hours on Feb. 26 or 27 at (201) 297-4448.

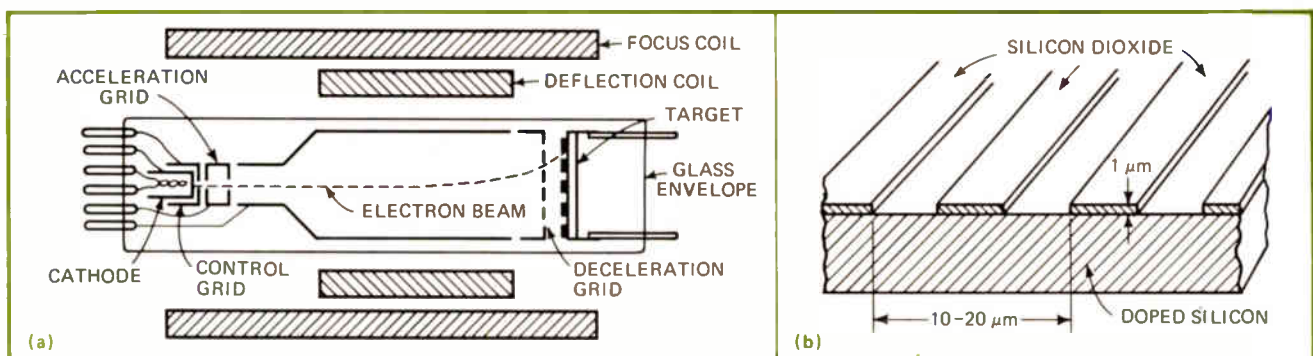

**1. The Lithocon.** The world's first commercial silicon storage tube (a) is a single-ended device that uses magnetic focusing and magnetic deflection. Its target (b) consists of a heavily doped silicon substrate partially covered by stripes of a silicon dioxide dielectric.

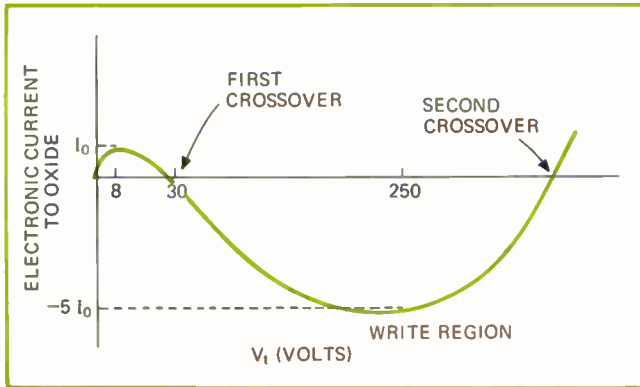

**2. Secondary emission.** For voltages well above the first crossover point, approximately 200 V, the silicon-dioxide layer has a secondary emission ratio of about 6:1. At this energy level, an impinging beam knocks out six electrons for every one that arrives so the target charges up to a positive level and stores an image element.

effect on image resolution (Fig. 1b). Moreover, the silicon/silicon-dioxide unit has a rigidity that wire mesh lacks, plus a solidity that the mesh and screen combination cannot approach.

### Secondary emission

The storage mechanism for a silicon-target tube is based on secondary emission from the silicon dioxide. Figure 2 shows beam current entering the oxide as a function of target voltage. At the crossover points the secondary emission ratio is unity so that the net electronic current to the oxide is zero. This means that for every electron that impinges on the silicon dioxide another electron is knocked out and captured by the deceleration mesh.

The net direction of current flow may be changed by changing the target voltage ( $V_t$ ). In the range between  $V_t = 0$  and the first crossover voltage ( $V_t$  about equal to 30 volts), the secondary emission ratio is less than unity. In this operating range, the number of primary electrons arriving at the target exceeds the number of secondary electrons leaving it, causing the storage surface to be charged in a negative direction.

If the beam energy level is increased to well above the first crossover point ( $V_t$  about equal to 200 v), the storage surface exhibits a secondary emission ratio which is approximately six to one. In this region six times as many secondary electrons leave the oxide surface as impinge on it, so that the surface charges in the positive direction. For higher target voltages, the sec-

ondary emission ratio decreases because secondary electrons are formed deep in the oxide surface and have difficulty escaping. Eventually, beyond the second crossover point, most of the electrons impinging upon the silicon dioxide remain imbedded deeply in the layer, again charging it negatively.

Information is stored when the oxide is charged to some positive level, which still is less positive than the silicon base. For intensity modulation, a video signal is superimposed on the control-grid bias level. The resultant variation in beam current is linearly related to the amount of positive charge deposited onto the target.

During the read cycle, the silicon base of the target is returned to a potential that sets the entire surface of the oxide negative with respect to the cathode. Unwritten sections of the silicon dioxide, corresponding to the "black" or most negative storage regions, divert the scanning beam from the surrounding silicon areas toward the deceleration mesh. Partially written sections—that is, the halftone or "gray" level, where the storage element potential is less negative than in the previous "black" condition—allow some current to flow to the silicon and return the remainder toward the deceleration mesh. Virtually all beam electrons succeed in landing in matrix sectors which are written as "white" (least negative), allowing a significant amount of current flow to the silicon. The number of beam electrons going to the target is proportional to the amount of positive charge stored during the write cycle. The point here is that the highly doped silicon is always positive and the silicon dioxide is always below cathode potential, so no electrons land on the oxide to neutralize the stored image.

To erase the stored charges, the target is raised to a positive voltage, and maximum beam current is used to charge the surface of the silicon dioxide to cathode potential. After erase, the oxide surface is below cathode potential, and the completely erased target appears black on a kinescope. No electronic current can flow to the silicon then because the oxide sends all incoming electrons back to the deceleration grid.

In addition to the fineness of target structure, the deceleration grid potential and the diameter of the electron beam are important determinants of image resolution in most video storage tubes. Insufficient bias of the deceleration grid reduces resolution by letting electrons repelled by a "black" or cutoff target region return to the more positive target regions instead of to the grid. The result is loss of contrast and a washed-out image.

**3. Bomb detection.** Lithocon-based X-ray inspection system uses pulses only 40 nanoseconds long, resulting in radiation dosages so low that they can detect guns or grenades without fogging photographic film or endangering nearby personnel.



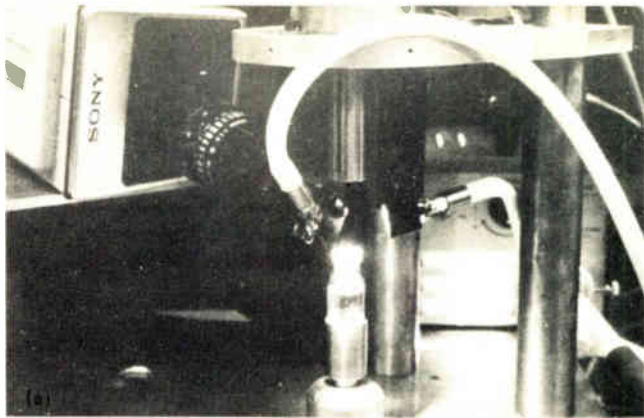

**4. Keep It clean.** Video image differentiator checks transparent pharmaceutical preparations for visible impurities (a). By subtracting the TV image of the bottle containing moving particles (b) from a second image of the same bottle, the nonmoving background is deleted (c).

For the Lithocon storage tube that effect does not become noticeable until the deceleration grid is biased below 600 V, and so presents no problem.

In fact, electron beam diameter is the one factor that limits the silicon tube's resolution. But since it can be made quite small, the resolution of a silicon storage tube still turns out to be about four times better than that of a metal mesh device.

The techniques used to fabricate a large-resolution target produce an extremely smooth surface. Such a surface has very little target noise (caused by small random variations in the oxide spacing) and little or no shading caused by large-area target variations.

#### The enduring signal

There are three other important features of a storage tube's performance. They are its reading time, storage time, and erase time.

Reading time is the maximum time over which a usable output signal is obtained during continuous read-out—that is, while the beam is on. A "usable output signal" is usually defined as one in which a normally "white" level has not decreased by more than 50% (or in which the normal "black" level has not increased to more than 50% of the "white" level).

During read-out of a silicon storage tube, the "white" charges on the target are slowly discharged by two mechanisms. First, some positive ions are generated in the region between the deceleration grid and the target and accelerated toward the more negative target, where they land and neutralize the excess electrons. The degree to which this process occurs is roughly proportional to the tube's residual gas pressure and to the reading beam current.

The second mechanism is harder to detect. Apparently, electrons are discharged throughout the silicon-dioxide layer by carriers generated in the oxide by soft X rays (of about 650 V) emitted from the grid during the read cycle. This discharge mechanism is proportional only to the reading beam current and limits the reading time in a practical system to 10 to 30 minutes.

Storage time is the maximum time during which a usable output signal may be stored without being read. For the silicon tube, it is determined by the dielectric relaxation time of silicon dioxide, which is typically greater than one month.

Erase time is the minimum time taken to reduce a fully written "white" level to 5% of its original value. It can be decreased if inter-electrode capacitances are decreased or if the oxide layer thickness is increased.

All three specifications vary depending upon the method used to store the information, potentials on the tube elements during various modes of operation, and pre-storage and post-read signal processing. Shorter writing times may be obtained with some sacrifice in resolution. Reading and storage times may be extended if only bilevel (binary) signals are recorded.

#### Two new uses

The potential applications of video storage tubes in general, and the silicon-target storage tube in particular, are many and varied, ranging through ultrasound and sonar imaging, waveform monitoring, electron microscopy, and computer graphics. Two rather different examples will give a feeling for the tubes' capabilities: X-ray imaging, and the detection of visible contaminants in pharmaceutical preparations.

Pan Am's recent announcement that it will install X-ray inspection equipment at its major air terminals around the country highlights a very promising application of the silicon-target storage tube. The inspection system being bought by Pan Am is built by the Aerospace Systems division of the Bendix Corp. in Ann Arbor, Mich., and incorporates a modified version of the PEP-400, an image storage and scan conversion terminal manufactured by Princeton Electronic Products Inc., North Brunswick, N.J. The heart of the PEP-400 is a silicon-target tube called the Lithocon—a trademark of Princeton Electronic Products Inc.

The terminal operates in combination with a pulsed X-ray source and a phosphorescent screen. The X-ray pulses travel through passenger luggage to the screen, producing an image of the metal contents for a vidicon to pick up and transmit to a Lithocon. There the image is stored, scan-converted, and relayed to a standard video monitor for detailed viewing by an inspector (Fig. 3). The image can be held without loss of gray scale for up to 15 minutes. The 40-nanosecond pulses are so short they will not fog film. Also, luggage throughput is fast, for new luggage can be put in place while the inspectors are still studying the previous bag.

The other application is a novel, fully automatic sys-

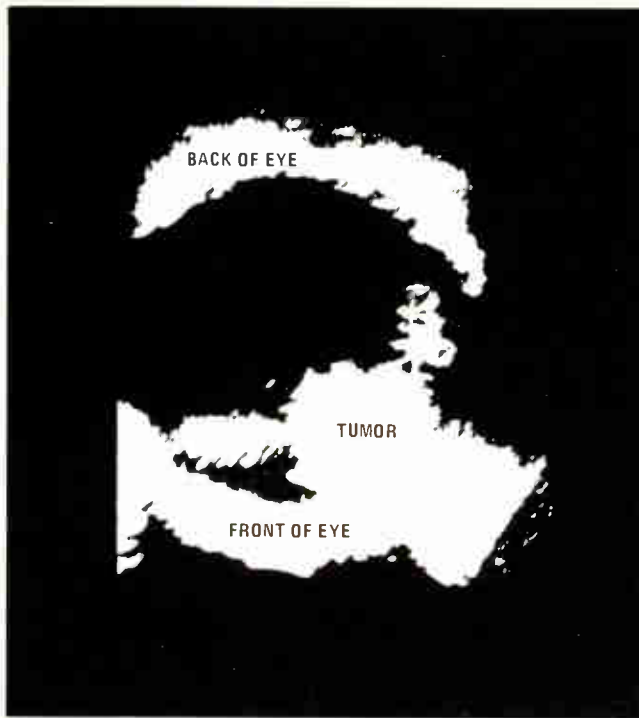

5. **Tumor detector.** This ultrasonographic display of an eye shows a tumor in the front of the eye, just behind the lens. (Photo courtesy of D. Jackson Coleman, M. D., Edward S. Harkness Eye Institute, Columbia Presbyterian Hospital, New York, N.Y.)

tem being developed by a major pharmaceutical manufacturer. Prior to the advent of the Lithocon, this manufacturer employed a line of inspectors to check transparent vials for contaminants. The vials were filled with various liquids, and an inspector would take one, hold it to a bright light for a visual check, shake it, and hold it to the light again. If he could see anything moving, or swirling around, the vial was assumed to be contaminated and was rejected. A major problem with this method, however, was eye fatigue.

The new equipment, employing special-purpose Lithocons, greatly simplifies and speeds up this process. Now, when the vial comes in, it is placed into a rotatable chuck where it is illuminated by a bright light and viewed by a vidicon (Fig. 4a). The chuck is spun for a brief period and then stopped. The image seen by the vidicon is then sent to the special-purpose Lithocon, which has the ability to subtract successive images from each other and feed only the difference between the images to a video monitor. If the liquid in the vial is clear, the successive images are identical and the differential output signal is zero. If, however, there are any visible contaminants swirling around in the vial (Fig. 4b), the successive signals are different, and the differential output shows the moving particles as white dots moving on a black background (Fig. 4c). At present, a human inspector looks at the monitor, but probably he too will ultimately be replaced by a photomultiplier system or some such electronic particle counter.

This device can be thought of as a video image differentiator. It may someday be used to detect intruders in banks and other sensitive installations.

The silicon-target tube is also particularly appropriate for ultrasound imaging, probably one of the most

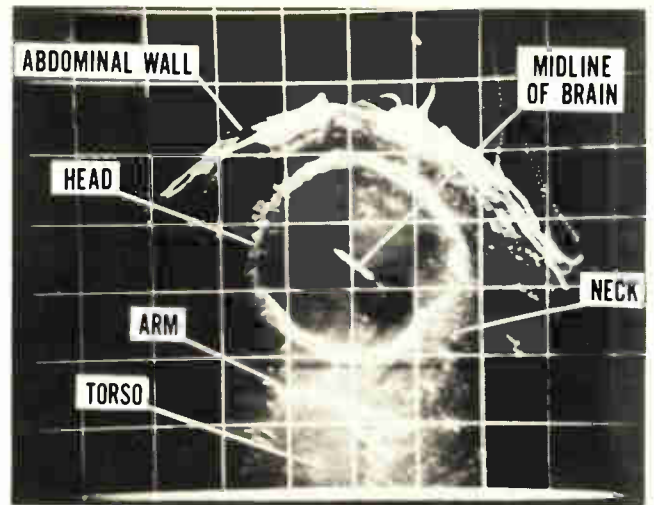

6. **Safety.** This prenatal sonogram clearly shows the midline ridge of an unborn baby's brain along with the mother's abdominal wall without exposing either baby or mother to the possible hazards of X radiation. (Photo courtesy of Zenith Corp., Chicago, Ill.)

exciting applications of technology to medicine being developed today. Unlike X-ray imaging, which is better suited to high-contrast applications such as forming images of bones, ultrasound is good at producing high-contrast images within soft tissues and can carry out highly detailed examinations of such organs as the heart, liver, and kidney.

### Sound medicine

Basically, the technique is an extension of sonar—a pulse of sound energy is sent into the body, and an image is formed from the sound waves that are reflected back. In systems that use this technique, the storage tube has two functions. First, it accepts the information, which takes several minutes to be generated, and accumulates it into a clear, concise, single image. Second, it acts as an image computer, enhancing and bringing out detail from signals that would otherwise be lost in the noise from spurious echoes.

A limitation of previous imaging techniques, however, has been their inability to provide a gray scale. The images they produced were strictly black and white, and, unfortunately, much essential information needed for a diagnosis is contained within the gray scale. Thus, although ultrasound was of some value, physicians used to working with gray-scale images, such as those produced by X rays, have been hesitant about accepting the new technique.

The introduction of the Lithocon storage tube with its ability to record a full range of grays while maintaining high resolution has greatly expanded the diagnostic capabilities of the technique. According to those physicians and companies who are using silicon-target tubes in their systems, the tube may play a key role in getting ultrasound fully accepted by radiologists as a standard diagnostic tool.

The sample sonograms shown in Figs. 5 and 6 give some idea of the potential medical applications of the Lithocon in ultrasound imaging alone. Other medical uses include electrocardiogram monitoring and infrared mammography. □

# Microprogramming, stack architecture ease minicomputer programmer's burden

To meet the requirements of a high-level language and its compiler, a microprogrammable minicomputer has been built that can adopt a stack architecture; as a result, it's inexpensive to program

by Rod Burns and Don Savitt, *Microdata Corp., Irvine, Calif.*

□ The soaring cost of programming minicomputers could be cut by as much as 80% if high-level languages like Fortran or PL/I could be used efficiently on them. Unfortunately, most experienced programmers prefer to work directly in a minicomputer's machine language, despite the much greater time that it takes, because the available software compilers that translate high-level languages into minicomputer machine language are cumbersome and degrade performance.

The fault has lain in the architecture of minicomputers, which have not been designed with the problems of compiling a high-level language in mind. An architectural concept that does take those problems into account is the "push-down stack." This concept is at the heart of a new minicomputer, the Microdata 32/S, a firmware enhancement of the equally new 3200 microprogrammable minicomputer.

The 3200 is a general-purpose machine, microprogrammable by the user to meet his own requirements. With the 32/S firmware added, the 3200 becomes a stack-architecture machine optimized to compile and execute programs written in a version of the PL/I high-level language. The result is a low-cost, high-perform-

ance machine that is also inexpensive to program.

Microprogramming was first proposed 20 years ago. For the past eight years, it has been used extensively in large computers to provide a common architecture in machines covering a wide range of cost and capability. More recently it has been used in minicomputers to customize an instruction set to a particular application.

## Neither hard nor soft

Writing a microprogram is very similar to writing a problem program. But the microprogram is like the hardware control logic that would be required in a non-microprogrammed computer, in that it is usually implemented in a read-only memory and is not altered after the machine has been built. Thus microprograms are sometimes called "firmware," because they are designed like software and built like hardware.

With firmware, the orientation of the minicomputer architecture can be shifted away from the constraints of hardware and toward meeting the needs of software, in two ways. First, firmware can be exploited to make minicomputers easier to program. For example, sophisticated instructions are simpler and less expensive to

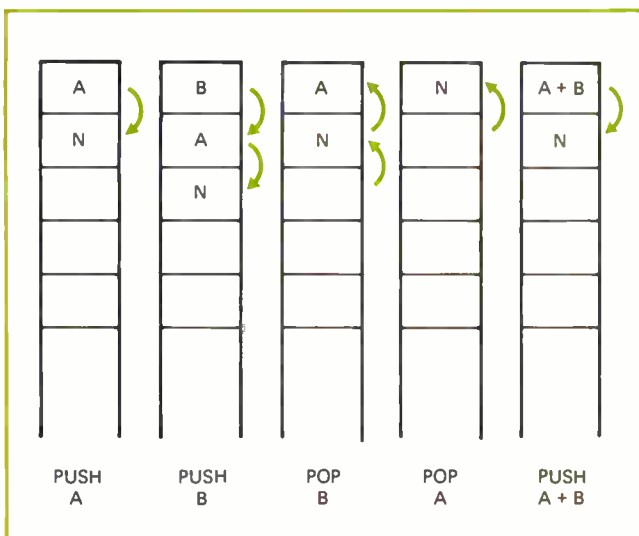

**1. Push-down stack concept.** All data, shown here algebraically as A, B, N, enters stack at one end and is removed at same end. As new data enters, previously loaded data ripples downward into successive positions; as data is removed in reverse order, remaining items ripple upward until last item (first loaded) is gone.

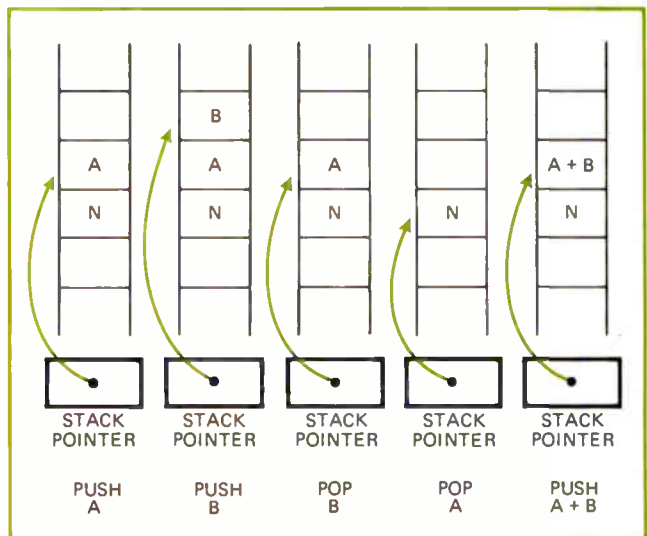

**2. Stack implementation.** Since register-to-register rippling is physically impractical, actual stacks use an external counter as "pointer" to indicate "top" of the stack at any moment. Counter's contents always show the most recently loaded register. Registers are loaded sequentially and unloaded in the reverse sequence.

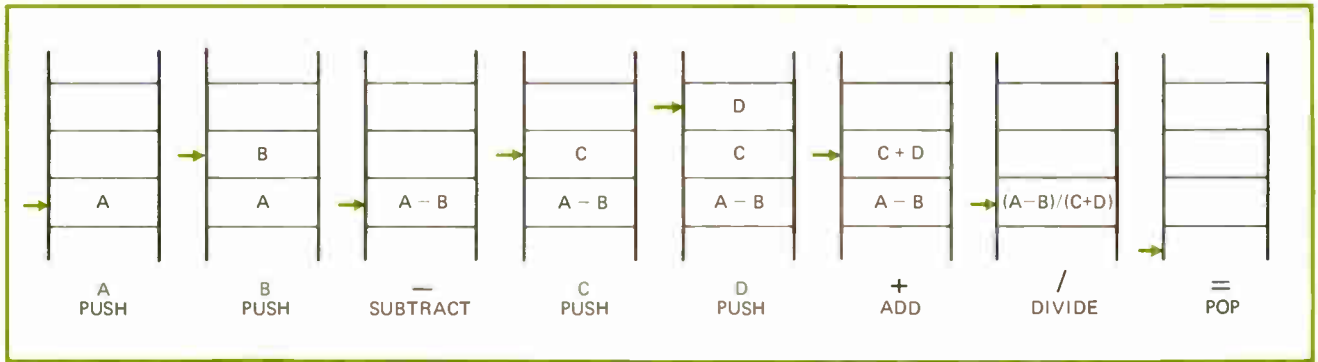

**3. Stack evaluation.** As the equation  $X = (A - B) / (C + D)$ , expressed in Polish notation as  $A B - C D + / X =$ , is evaluated in a stack, the stack takes on these successive appearances. Colored arrow represents the stack pointer indicating the top of the stack.

implement in a microprogramed computer than in its hard-wired equivalent. Second, the dual nature of firmware as described in the preceding paragraph tends to shorten the traditional distance between the programmer and the engineer—to get them to talk with each other.

### Language versus architecture

The standard approach to programming large computers, in both data-processing and scientific applications, is with high-level languages. These computers, having large main memories and plenty of mass storage and being heavily backed by development money, can afford multipass compilers—those which run through the input program several times, to make the best possible translation.

With minicomputers, however, it has been more efficient to use assembly language instead. (Assembly language replaces the numerical machine-language 1s-and-0s code with alphanumeric instruction and address codes one-for-one; while high-level languages, in general, replace many assembly-language instructions and their addresses with one statement.) A compiled program normally occupies just too much of the minicomputer's limited memory capacity and inserts an excessive number of extra instructions.

One reason for this inefficiency is that most minicomputer architectures minimize the execution time of common operations such as addition, or minimize the number or cost of components, without regard to the problems of compilers and high-level languages. Since high-level languages are very different from machine languages, the cost of bridging the difference is paid by the compiler, and the cost is usually very high. The solution is not to force-fit the language to the computer architecture, but to tailor the architecture to the language and its compiler.

### Push and pop

Compilers can work efficiently with computers that are designed with a "push-down stack" architecture. Conceptually, a push-down stack is a set of registers of which only one is externally accessible. Data is loaded or "pushed" into the stack through this one register; when additional data is loaded, previously loaded data moves sequentially "down" from one register to the next in the set (Fig. 1). Data is retrieved or "popped" from the same register used for loading; each such retrieval causes other data to move "up" sequentially

from other registers. All data is retrieved in the reverse order from that in which it was loaded, so that the push-down stack is sometimes called a "last-in-first-out" (LIFO) buffer.

This push-down-stack concept has been used successfully in large-scale processors, notably the Burroughs 5500 and 6500. Furthermore, it is readily implemented in firmware. It's much simpler for a compiler to generate efficient programs for a push-down stack architecture than for the conventional multiregister architecture—for the simple reason that the human programmer, shuttling data from register to register in a minicomputer of conventional design, can visualize what is going on, whereas the compiler can only count and catalog and sort. Therefore the compiler is likely to use the registers in a very constrained way, with many needless transfers to and from the main memory.

In addition, the stack concept is convenient for writing the compiler. Proof is that compiler writers using conventional computers create stack environments in software. Thus, from the standpoint of any user, the availability of a minicomputer with a stack architecture makes it cheaper to obtain a compiler for the particular high-level language that suits his application.

No actual push-down stack works like the conceptual model described previously. Instead, in the simplest configuration, a set of successive locations in the computer's main memory is set aside for use as a stack. Instead of data actually moving from location to location during a push or a pop, the address of the next empty location is stored in a stack pointer. This pointer is a register that can be incremented or decremented by 1 (Fig. 2), and points to the location that is currently the top of the stack.

A similar but faster-operating stack uses high-speed registers with a separate counter for the top several locations of the stack, and a stack pointer and main memory locations for lower portions. The highest register is tied directly to one input of the computer's arithmetic unit. Since most of the traffic in and out of the stack involves only the top few locations, the hardware registers reduce the number of accesses to the main memory and speed up the whole system's operation.

In an architecture based on the push-down stack, the instructions that concern the stack automatically transfer data as needed between the register stack and its extension in the main memory, so that the programmer or



the compiler need not be concerned with what or how much data is in the stack. Thus a push into the register stack when it is already full is automatically preceded by a transfer of the word in the bottom register into the main memory. But, for maximum performance, the reverse is not necessarily true; a pop from the register stack is not accompanied by a transfer from the main memory stack. Only when the register stack is empty does a pop fetch data from the main memory.

### Example of stack usage

The simplest example of stack usage is the evaluation of an arithmetic expression. Working in a high-level language, a programmer writes an assignment statement such as:

$$X = (A - B)/(C + D)$$

The compiler translates this into the format known as "reverse Polish notation," after Jan Lukasiewicz, a Polish logician:

$$A B - C D + / X =$$

This notation eliminates parentheses because each mathematical operator refers not to the two operands between which it stands, but to the two operands preceding it—or, in the case of unary operators, such as logic complementing, to only the first preceding operand.

Translating from algebraic to Polish notation is very simple, given a push-down stack to do it in. Basically, it involves juggling the variables in accordance with the notion of precedence of mathematical operations. For example, in the expression  $AB + CD$ , the sum of two products, multiplication takes precedence over addition.

Carrying out the computation after translation is also simple, because the computer can perform each mathematical operation as it encounters the operators, without backing up to see what went before or waiting to see what comes next.

To evaluate an expression in Polish notation, a compiler produces a LOAD instruction (a "push") for each variable, a mathematical instruction (such as ADD) for

each operator in the expression, and a STORE instruction (or "pop") for the = sign. Mathematical instructions operate on the top one or two items in the stack and replace them with the result. The pop instruction uses the address of the dependent variable X as the location in main memory for storing the result of the evaluation. This sequence is illustrated in Fig. 3.

In comparison, if a push-down stack is not available, the compiler must create a sequence of LOAD and STORE instructions, moving data into and out of main memory or temporary registers, interspersed with the mathematical operations. The result, for a computer with a single accumulator register, and using the same example as previously, is given in Fig. 4, which also

### Hardware versus firmware

Basically, a microprogrammed computer is a computer within a computer. At the hardware level, or "micro-level," is the inner computer, designed by the engineer and consisting of an arithmetic and logic unit, several registers, the main memory, and input-output buses. This computer's instruction set controls the transfer of data among these subassemblies and is stored in a control memory. These microinstructions are executed in sequence, just as in the outer computer and, also as in the outer computer, may jump out of sequence under the control of an external condition, such as the operation code of a "macroinstruction" or the occurrence of an interrupt.

Around this inner computer the microprogrammer builds the outer computer, or "target-level" computer. He writes a set of routines to adapt the micro-level computer to the intended end use. Essentially he prepares one routine for each target-level instruction code, each addressing mode, and each type of interrupt. He may also prepare a routine to control the sequence of data and control transfers on the input-output buses. Since many of these routines share subroutines, the microprogrammer minimizes the amount of control memory he needs by branching in and out of subroutines just like the target-level programmer. The microprogram is called the computer's "firmware."

To debug firmware, the control memory may at first be implemented in a read-write memory, in which changes can easily be made. But often, when the firmware has been checked out, it will be built into a high-speed read-only memory to prevent any accidental changes.

The microprogrammer must appreciate logic design far more than is required of a software programmer, and he must understand the hardware engineer's constraints of circuit delays and race conditions. Conversely, the hardware engineer must understand the nature of the microprogram sequences that will control his machine; he must know the main-memory fields that will significantly affect the microprogrammer's ability to design optimum data paths; and he must provide the necessary test condition signals and enough general-purpose registers for the microprogrammer's work.

#### Bibliography

S.S. Husson, "Microprogramming. Principles and Practices," Prentice-Hall, 1970.  
"Microprogramming Handbook," Microdata Corp., 1971

LOAD	A	PUSH	A
SUBTRACT	B	PUSH	B
STORE	TEMPORARY 1	SUBTRACT	
LOAD	C	PUSH	C
ADD	D	PUSH	D
STORE	TEMPORARY 2	ADD	
LOAD	TEMPORARY 1	DIVIDE	
DIVIDE	TEMPORARY 2	POP	X
STORE	X		

CONVENTIONAL SINGLE REGISTER MACHINE                      STACK MACHINE

**4. Stack economy.** Simple sequence of operations and operands using stack occupies 38% less space in memory than does step-by-step sequence of conventional single-accumulator machine program, not counting two temporary storage locations.



**5. Microdata 3200.** New minicomputer uses firmware-controlled stack concept to run efficiently on PL/1-like high-level language.

shows the listing for a program in a stack machine. In this example, the single-accumulator computer requires 18 instructions compared to 13, or 38% more memory space. If two entire programs were compared instead of a pair of steps, and if a multi-accumulator machine were used, the stack machine might enjoy a smaller advantage in terms of the memory space the program occupies, but the task of compiling the program to an optimum level without the help of the stack would be more difficult.

Allocating registers and temporary locations in memory, a problem in conventional compiler design, is automatically solved when a stack is available. Running out of space when the stack isn't deep enough at first might seem as bad, but it's much less critical, being handled automatically by the firmware with only a time penalty—whereas the register-allocation problem must be solved with great effort ahead of time by properly designing the compiler.

#### **Microdata 3200**

A microprogram that implements a stack-oriented computer is available in the Microdata 32/S. This is one firmware enhancement of the basic 3200 micro-programmable computer.

The 3200 (Fig. 5) is a machine with a 16-bit data word length. It has a 135-nanosecond control memory for the firmware, and a main memory—an MOS semiconductor array—that cycles in 300 ns and holds 4,096 to 131,072 words of 16 bits each, addressable by 8-bit byte. The processor, the main memory, and the input-output controllers share an interface along a common asynchronous bus, the Monobus, which provides a 16-bit data path among the system components.

The processor contains three working registers, a program pointer register, and a register file of 16 general-purpose registers, optionally expandable to 32. Instruc-

tions at the machine-language level are fetched by look-ahead logic (the microprogram could perform this function, but the logic offers a substantial speed advantage). All logic in the 3200 is TTL, a small proportion being Schottky TTL.

Words in the control memory are 32 bits long and are divided into eight 4-bit encoded fields that specify various functions in the machine control. Up to 4,096 words of control memory are available.

The processor and all or part of the control memory fit on three circuit boards (Fig. 6). They are a data board, a Monobus interface board, and a control board.

The data board contains the three 16-bit working registers, which receive inputs from the F bus and drive the 16-bit arithmetic and logic unit. This unit, in turn, drives the F bus and stores machine status in the status register. The F bus also transfers data directly from the Monobus and to and from the 16 or 32 general-purpose file registers that are also on the data board. The top four file registers and one of the three working registers together form the top five locations of the 32/S push-down stack.

The Monobus interface board contains the 16-bit Monobus data register, the 18-bit Monobus address register, the 18-bit program pointer register, and the 16-bit instruction register. The two 18-bit registers require two-step loading, since only 16 bits are available in a single machine cycle; however, the Monobus address register's two high-order bits may be retained in a separate two-bit register that helps keep track of the current base address for the stack.

The processor control board holds the first 2,048 words of control memory, which must be read-only, the 32-bit control-word data register, which holds the control memory's output, and the logic for generating the control memory address. Additional control memory goes on extra boards; it can be read-only, programmable read-only, or read-write memory mixed in any proportions. Inputs to the address logic come from the F bus, from fields of the current control memory word, and from external or internal interrupts; its output is the address for the control memory, whether it be entirely on the same card or partially on other cards. If additional control memory cards are used, their outputs drive the data register on the processor control board through another bus.

Each main memory board contains up to 8,192 words, of which the first 4,096 are contained on the board itself and the remainder on a secondary board that plugs into the main board (Fig. 7). The combined module fits into one connector on the backplane.

On each 8,192-word memory module are 128 dynamic MOS packages—Advanced Memory Systems' type 6002—of 1,024 bits each. Since the maximum size memory contains 131,072 words (262,144 bytes), up to 16 of the basic modules may be required; each is manually set to respond to its particular group of addresses with a 4-bit switch.

The module also contains its own timing logic, including that required for automatic refreshing. The MOS devices are refreshed every 30 microseconds during normal operation and, to conserve power, every 2 milliseconds during standby—a condition entered upon

automatically by the power supply if the primary power source is interrupted for more than 100 ms (six cycles). Standby mode can also be entered manually for idle periods or for computer servicing. Power to the processor and input-output controllers is lost during standby, and a battery provides the 21-volt level required to preserve data in the memory.

The module also contains an oscillator-rectifier circuit, which generates a 3-v bias on top of the main 21-v supply for biasing the MOS substrates—without which the memory circuits would fail. The on-card bias generator permits the module to be removed from the backplane while system power is on.

An address block of 4,096 words (8,192 bytes) is reserved for input-output controllers plugged into the Monobus; these are the highest byte addresses in the range 0 to 262,144. This range requires an 18-bit binary address, and the memory modules, with the aid of the 4-bit switch already mentioned, decode all 18 bits. Requiring the input-output controllers to decode so many bits would, however, unnecessarily complicate their logic design. They are therefore designed to decode only the 13 low-order bits, while the upper five bits are decoded in the processor and produce a separate control signal that identifies the 13 bits to the controllers as applying to them and not to a memory module.

Standard input-output controllers fit on one circuit board. Controllers for complex devices that require more than one board can be accommodated, with interconnections between boards through a flexible cable between the tops of the boards.

All boards measure 9 by 14 inches and plug vertically into a printed-circuit backplane that is the chassis floor (Fig. 8). The Monobus and five other buses are on this backplane. As a result, any board may be plugged into any backplane connector. Ordinarily the board containing logic related to the external maintenance panel plugs into the first connector, but the panel can be relocated, its board moved to another connector, and any other board plugged into its place. Thus any board can be serviced in the chassis without an extender, and with maximum cooling.

### Microdata 32/S

Although the 3200 is a general-purpose micro-programmable machine, its logic design was optimized for a microprogram that defines a stack machine. When the 32/S firmware is installed, the machine becomes a general-purpose stack-oriented computer optimized to execute machine code compiled from a derivative of the PL/I high-level language. Variations of the 32/S firmware can be designed to optimize the machine for other

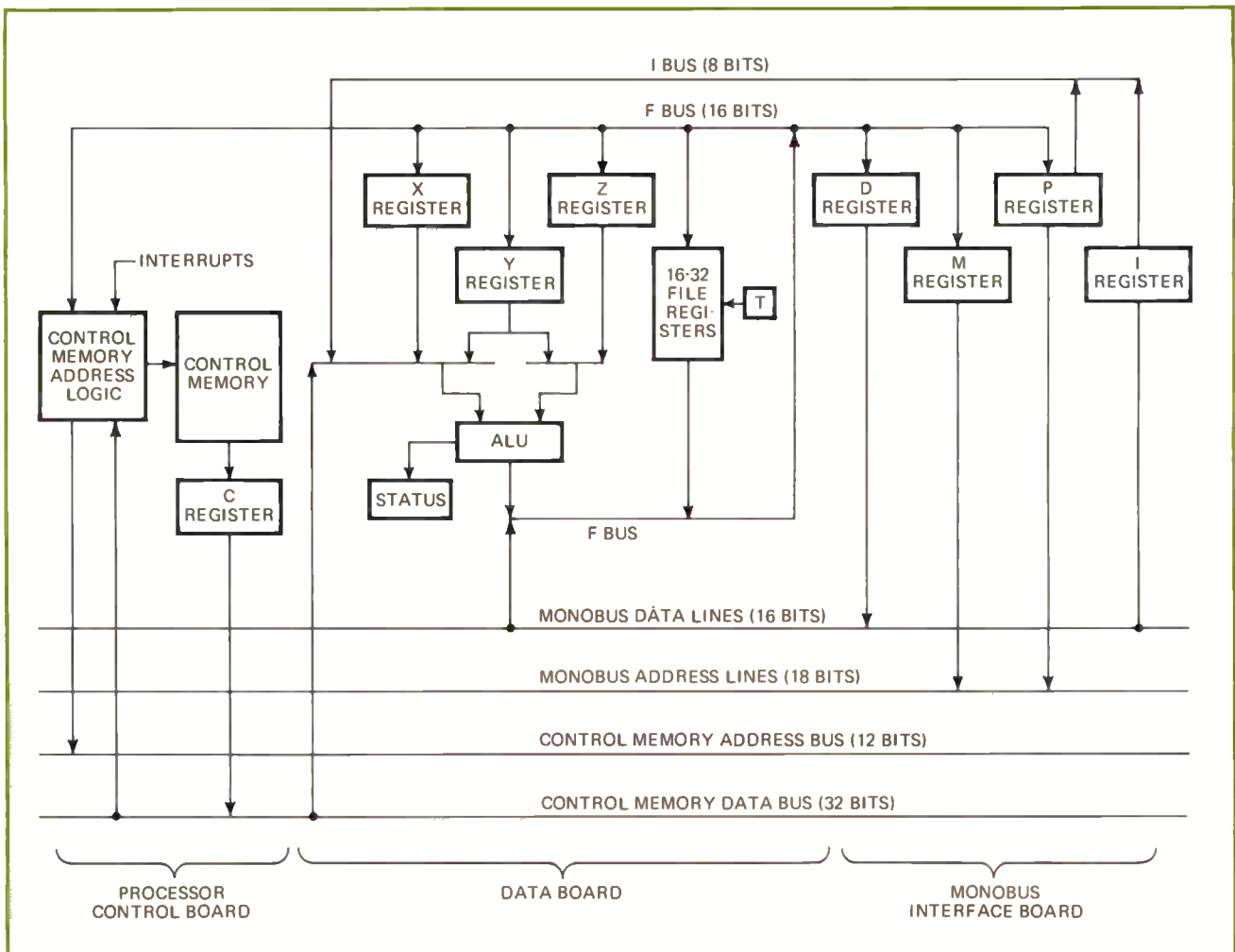

6. **Three boards.** The Y register and four of the file registers form the top of the stack in the Microdata 3200; register T is the stack pointer. Lower stack positions are in main memory, reached along the Monobus. Controlling firmware (microprogram) is in control memory.

languages, such as RPG, Cobol, Basic, Fortran, or the full PL/1.

The goal in designing the 32/S was a machine in which machine-language programming would never be necessary. Accordingly, the development program began with a high-level source language and a compiler, but no assembler. This language was designed concurrently with the 32/S firmware and the 3200 hardware. The architecture of the 32/S is the result of tradeoffs between the requirements of the compiler and the cost of the control memory, containing the firmware. No 32/S instructions were included that the compiler would not use when generating machine code from the source language. With this restriction, architectural changes could be made without affecting the 3200 hardware design.

The choice of high-level language, PL/1, as a target for optimizing the 32/S firmware, is based on the belief that this language will eventually become the industry standard. A derivative of this language, designated MPL for Microdata Programming Language, was defined as the first language for which a compiler would be designed in this project.

MPL is meant to satisfy the needs of assembly-language programmers who are familiar with hands-on control of the computer, while at the same time providing the advantages of a high-level language that is suitable for system and real-time programming. Since it was designed to utilize all the capabilities of the 32/S, MPL, unlike PL/1 or Fortran, is not intended to be machine-independent.

As with most high-level languages, the Microdata Programming Language employs sentence-like statements. There are two general types: assignment statements, which express arithmetic and logical operations and look like equations; and control statements, which specify branching and looping within the program. Both kinds occur in blocks, each of which defines its own variables and therefore allocates the necessary space in memory. Blocks can be nested within blocks.

MPL is a simple language. Its power arises from the ways of combining its elements, be they arithmetic, logical, or comparison operators, symbolic data references, constants, functions, conditional expressions, and so on. Expressions may take on either an arithmetic value or a logical (true/false) value, depending on context. Compound statements—groups of simple statements—are also usable.

MPL contains no explicit input-output statements. Rather, the processor communicates with I/O controllers as if it were transferring data to or from locations in the memory. Different memory locations correspond to the registers within different controllers. The programmer assigns symbolic names to these locations, and transfers data and commands to peripheral devices and tests their status by using these names in conventional MPL statements.

Such capabilities are in keeping with the role of MPL as a replacement for the typical minicomputer assembler language. A simple program in MPL that calculates the first 1,000 prime numbers is shown in Fig. 9, together with its flow chart.

### Extending the 32/S

One of the outstanding advantages of a microprogrammed computer is its ability to extend its instruction repertoire simply by extending its firmware—that is, simply by plugging in more control memory. MPL allows for this contingency by including provision for a statement that can cause the computer to take its next microinstruction from a specified location in the control

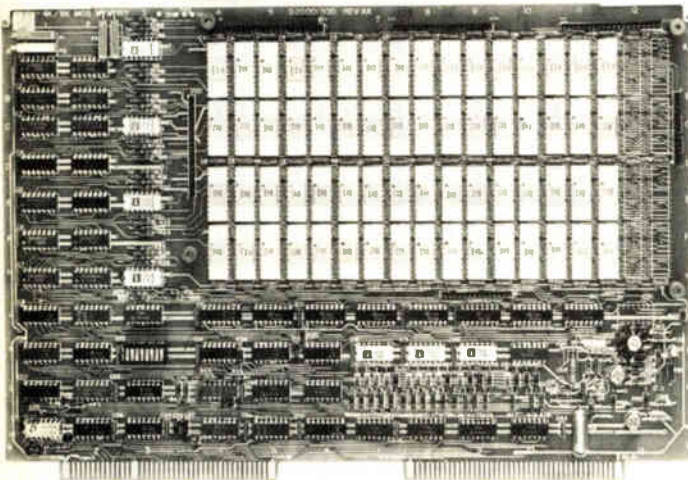
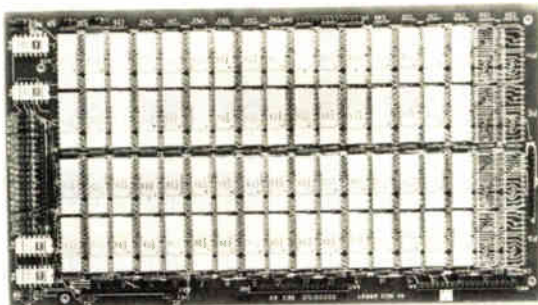

7. **Piggyback.** Main memory comes in 8,192-bit modules. Half the bits in each module are on a secondary board that plugs into the main board containing the other half and peripheral circuits.

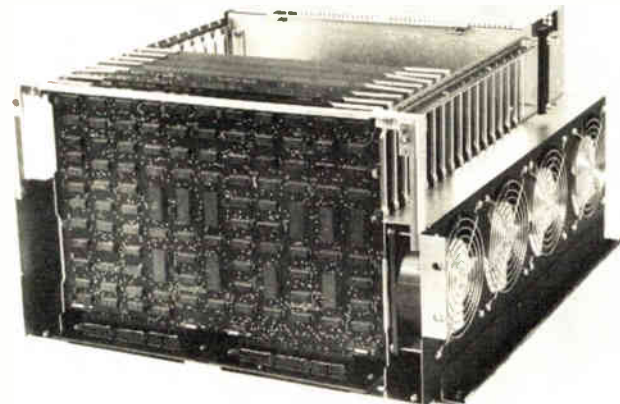

8. **Easy access.** Because any board plugs into any connector, it can be brought up to the front connector for servicing. Normally the front board serves the front panel, removed in this photo.

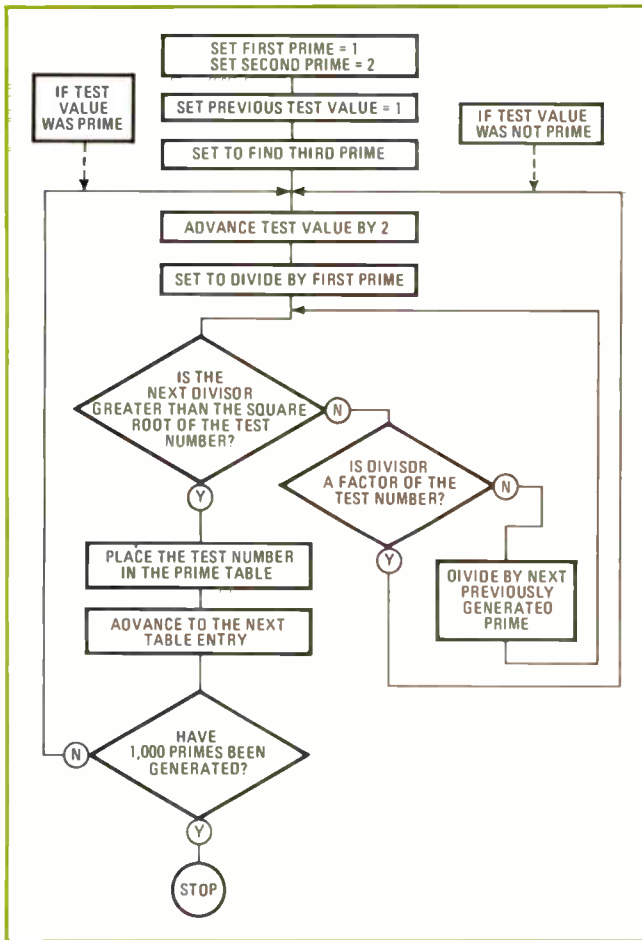

```

PRIME:
PROCEDURE; /* A PROCEDURE TO CALCULATE THE
FIRST 1000 PRIME NUMBERS */

DECLARE
P(1000) WORD, /* THE ARRAY OF PRIMES */
TEST WORD, /* THE VALUE BEING TESTED */
(I, J) WORD; /* INDICES */
P(1)=TEST:=1; P(2)=2; /* SET INITIAL VALUES */
DO I=3 TO 1000; /* MAIN LOOP TO FILL THE TABLE */
TEST += 2; /* INCREMENT THE TEST VALUE */
J = 1; /* INDEX FOR TRIAL DIVISORS */
DO WHILE TEST/P(J) >= P(J);
/* THIS LOOP USES ALL DIVISORS <= SORT( TEST) */
IF TEST MOD P(J) = 0 THEN /* NOT PRIME, SO */
GO TO LI; /* FOR NEXT TRIAL VALUE */
J += 1;
END;
P(I) = TEST; /* TEST IS PRIME, SO STORE IT IN TABLE */
END; /* END OF LOOP FOR 1000 PRIMES */
END; /* OF PROCEDURE PRIME */

/* NOTE ***
1. THE OPERATOR ':=' SPECIFIES AN IMBEDDED
ASSIGNMENT (WITHIN ANOTHER ASSIGNMENT STATEMENT).
THE LEFT-HAND VALUE OF THE IMBEDDED ASSIGNMENT
IS USED IN COMPUTING THE VALUE OF THE CONTAINING
ASSIGNMENT STATEMENT.
2. THE OPERATOR '++' SPECIFIES AN INCREMENT OPERATION.
THAT IS, THE VARIABLE ON THE LEFT OF '++' IS
INCREMENTED BY THE VALUE ON THE RIGHT.
3. THE OPERATOR 'MOD' IS THE MODULO OPERATOR. IT IS
SIMILAR TO THE DIVIDE OPERATION EXCEPT THAT THE
RESULTANT VALUE IS THE REMAINDER OF THE OPERATION
AND NOT THE QUOTIENT. */

```

**9. Simplicity.** Only six instructions in the MPL language are required in this simple program for generating prime numbers. Though a more efficient program would apply several tests to each trial number and thus spend less time dividing, this example illustrates the power of MPL. Other languages, in contrast, might require one or more instructions per box in the flow chart, especially at branches.

memory—what might be called a software-controlled firmware branch. Thus, as new instructions are added to the 32/S architecture, the compiler need not be modified.

To provide for a range of computers with different performance levels and corresponding prices, the 3200 computer branches to a software routine if the firmware addresses a nonexistent location. This permits the system designer to execute some functions in firmware in a higher-performance version of a machine, and in software in the lower-cost versions.

### 32/S architecture

In the architectural scheme of the 32/S, the main memory is divided into two parts: a push-down stack area, which stores program variables and maintains temporary storage as needed during program execution; and a program segment area, which stores the coded instruction sequence for one or more blocks of statements. All instructions refer to operands in the stack and leave results in the stack. Some relatively complex instructions “mark” the stack with pointer and status information when the computer enters a new block during execution of a program, and remove the mark and re-establish the previous machine environment when the computer leaves that block.

Some instructions can also retrieve data from the program area; but no instruction can modify the program area. This eliminates the possibility of designing a program that modifies itself, either deliberately or acciden-

tally. It also reduces the number of bits required for addressing data, since the latter has its own section of memory that is smaller than the total data-plus-program memory.

When a new program segment is called into the memory from bulk storage or from an input peripheral unit, executive software decides, on the basis of the segment size and a table it keeps of available memory, where within memory it can load the segment. Having made this decision, the software assigns a base value to the segment, and stores the base address (the address of the beginning of the segment) and the length in a program library table. Then, when the execution of the segment begins, the firmware automatically refers to the program library table to obtain the base address and the length. These are placed in registers for use during the execution.

Memory locations in the data stack area are also addressed relative to individual base and stack-length registers. This makes both the program segment and data stack areas relocatable—that is, either area may be loaded or moved around without modifying the program code. The length of the program segment determines when a memory reference to the program segment has erroneously reached beyond its end into some other program—a capability required in time-sharing and sometimes referred to as memory protection. These features are conveniences for single users, and almost indispensable for multiple users in time-sharing applications. □

# Designer's casebook

## Negative-resistance generator has controllable response

by Samuel E. Bigbie  
IBM General Systems Division, Boca Raton, Fla.

A negative-resistance generator, consisting of three matched transistors, has a current-voltage characteristic that varies with feedback resistance, but not with frequency. When driven by a current source and loaded by an LC resonant circuit, the generator can be operated as a self-starting sinusoidal oscillator. It also can be used for monostable, bistable, or astable pulse generation, as well as oscillator stabilization and switching networks.

The maximum collector current of transistor  $Q_1$  depends on the amount of bias current available at its base terminal. Feedback resistor  $R_f$ , along with transistors  $Q_2$  and  $Q_3$ , make up a voltage-to-current converter that decreases the base drive of transistor  $Q_1$  when this

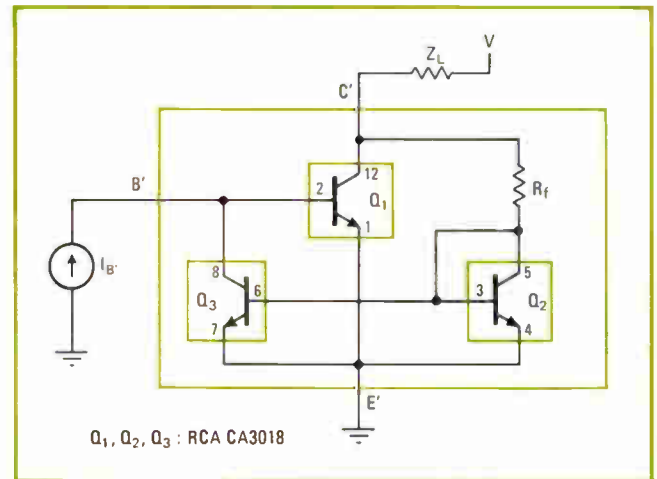

**Positively negative.** Three matched transistors form negative-resistance generator with stable, predictable operating characteristics. Circuit can be treated as transistor that develops negative impedance at terminal  $C'$ . Transistors  $Q_2$  and  $Q_3$  and resistor  $R_f$  decrease base current of transistor  $Q_1$  whenever  $Q_1$ 's collector voltage increases. Circuit makes dependable oscillator or pulse generator.

COLLECTOR CHARACTERISTICS

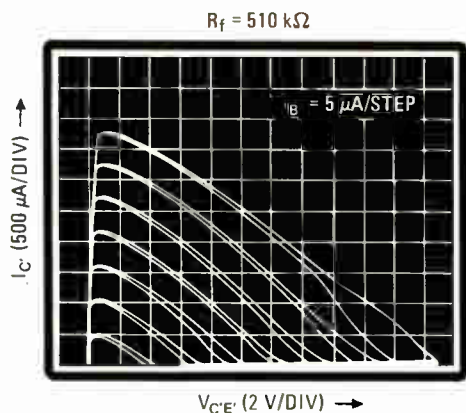
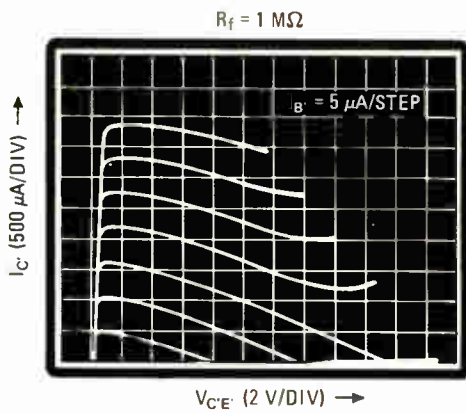

FIXED CHARACTERISTICS

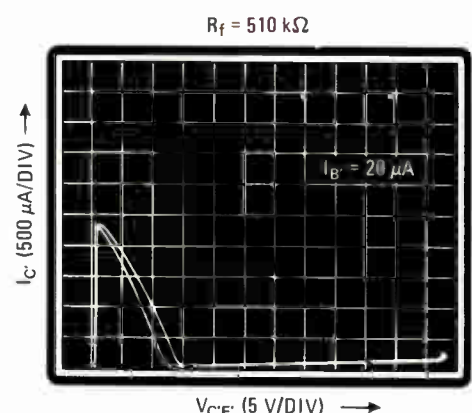
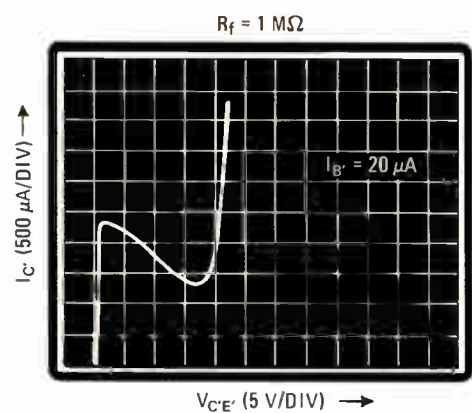

### SINUSOIDAL OSCILLATOR

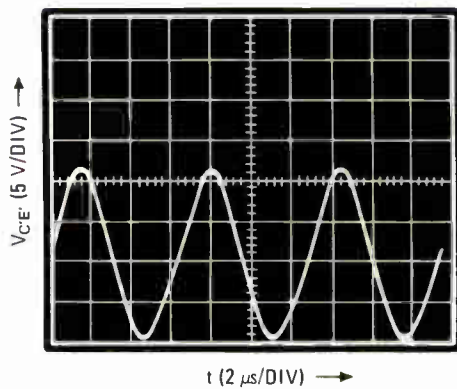
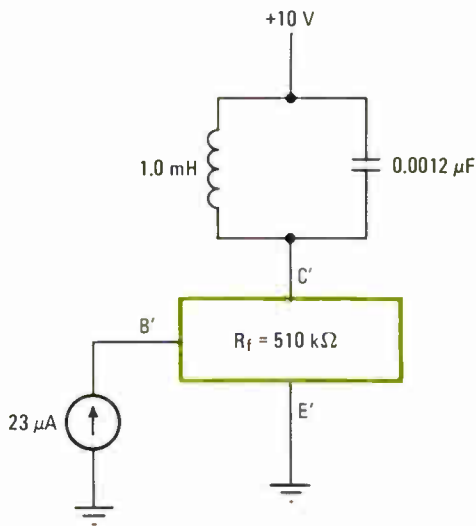

### ASTABLE PULSE GENERATOR

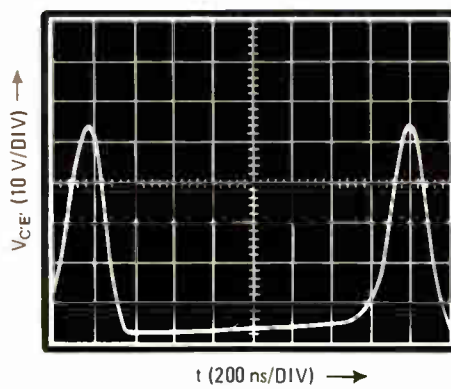
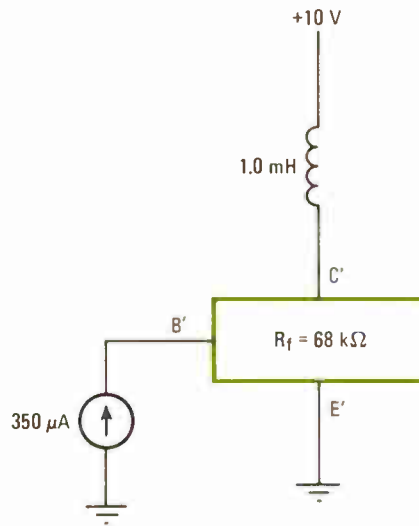

device's collector voltage is increasing.

The negative resistance appearing at  $Q_1$ 's collector is present at frequencies from dc to several megahertz. The upper frequency limit is determined by the frequency response of both transistor  $Q_1$  and the voltage-to-current converter.

The generator circuit is effectively a three-terminal transistor (with pins labeled B', C', and E'). An input current source provides the base current for transistor  $Q_1$ , while resistor  $R_f$  determines the amount of current fed back to  $Q_1$ 's base. Because transistors  $Q_2$  and  $Q_3$  are a matched pair and their bases are connected in common, their collector currents will be nearly equal.

As the base current supplied to transistor  $Q_1$  increases, the voltage drop across load impedance  $Z_L$  also increases, lowering the potential at  $Q_1$ 's collector. This lowered potential decreases the collector current through transistors  $Q_2$  and  $Q_3$ . The reduced collector current through transistor  $Q_3$  represents an increased

impedance at  $Q_1$ 's base terminal. (A decrease in  $Q_1$ 's base current has the opposite effect, since  $Q_3$ 's collector current will be reduced.)

The circuit's operating characteristics are illustrated by the scope traces showing generator performance for two different values of resistor  $R_f$ , and for both a fixed and changing bias current. As can be seen, the negative-resistance slope becomes steeper as the value of  $R_f$  decreases, from 1 megohm to 510 kilohms, in this instance.

When the load impedance is a parallel LC tank circuit, the negative resistance generator acts as a sinusoidal oscillator, as shown in the figure. Using only an inductor as the load impedance yields an astable pulse generator, which has an output pulse amplitude that equals the breakdown voltage of the combined transistors between terminals C' and E'. □

#### BIBLIOGRAPHY

Millman, Jacob, and Taub, Herbert. *Pulse, Digital and Switching Waveforms*. McGraw-Hill Book Co., New York, 1965, pp 452-512

# Low-distortion modulator tests hi-fi a-m tuners

by M.J. Salvati  
Sony Corp. of America, Long Island City, N.Y.

Most commercially available signal generators do not hold distortion to a level that is low enough to test the frequency response and distortion characteristics of the a-m tuners found in today's high-fidelity equipment. The amplitude modulator shown, however, supplies amplitude-modulated rf signals at a distortion level of less than 0.15%.

As indicated in the block diagram (a), the modulator (b) is used in conjunction with standard radio-frequency and audio-frequency signal sources. The output level of the over-all test system can be adjusted exactly with the step attenuator that follows the modulator and the vernier level control that is generally included on the rf generator. Also, the modulator gain (for the low-impedance output) can be set at 0 decibels into a matched load, allowing the absolute value of the system's output level to be easily read out from the step attenuator setting and the rf-generator setting.

The rf carrier, which has a root-mean-square amplitude of 35 to 50 millivolts, is applied to the differential input of the IC differential cascode amplifier. And the af signal drives the current-source transistor for this IC's differential transistor pair. Since the current-source transistor controls the gain of the differential pair, the af signal can vary the instantaneous gain of these two transistors, producing up to 100% amplitude modulation of the carrier signal.

The modulated carrier is coupled to the source-follower/emitter-follower combination through a high-pass filter, so that just the carrier and sidebands appear at the circuit's output. The source-follower/emitter-follower combination is essentially an impedance transformer that provides a large current gain for driving low-impedance loads.

The modulator's low output has an impedance of 75 ohms, which can easily be changed to 50 ohms. The circuit's input impedance can also be either 50 or 75 ohms, depending on the value chosen for the input resistor. The high output can drive a low-distortion detector for adjusting or evaluating modulator performance.

Output percent modulation can be indicated by the output-level setting of the af generator (a Krohn-Hite 4100A, in this case) by calibrating the circuit. Although the IC amplifier requires only a 400-mV input for 100% modulation, the modulator can be calibrated with the

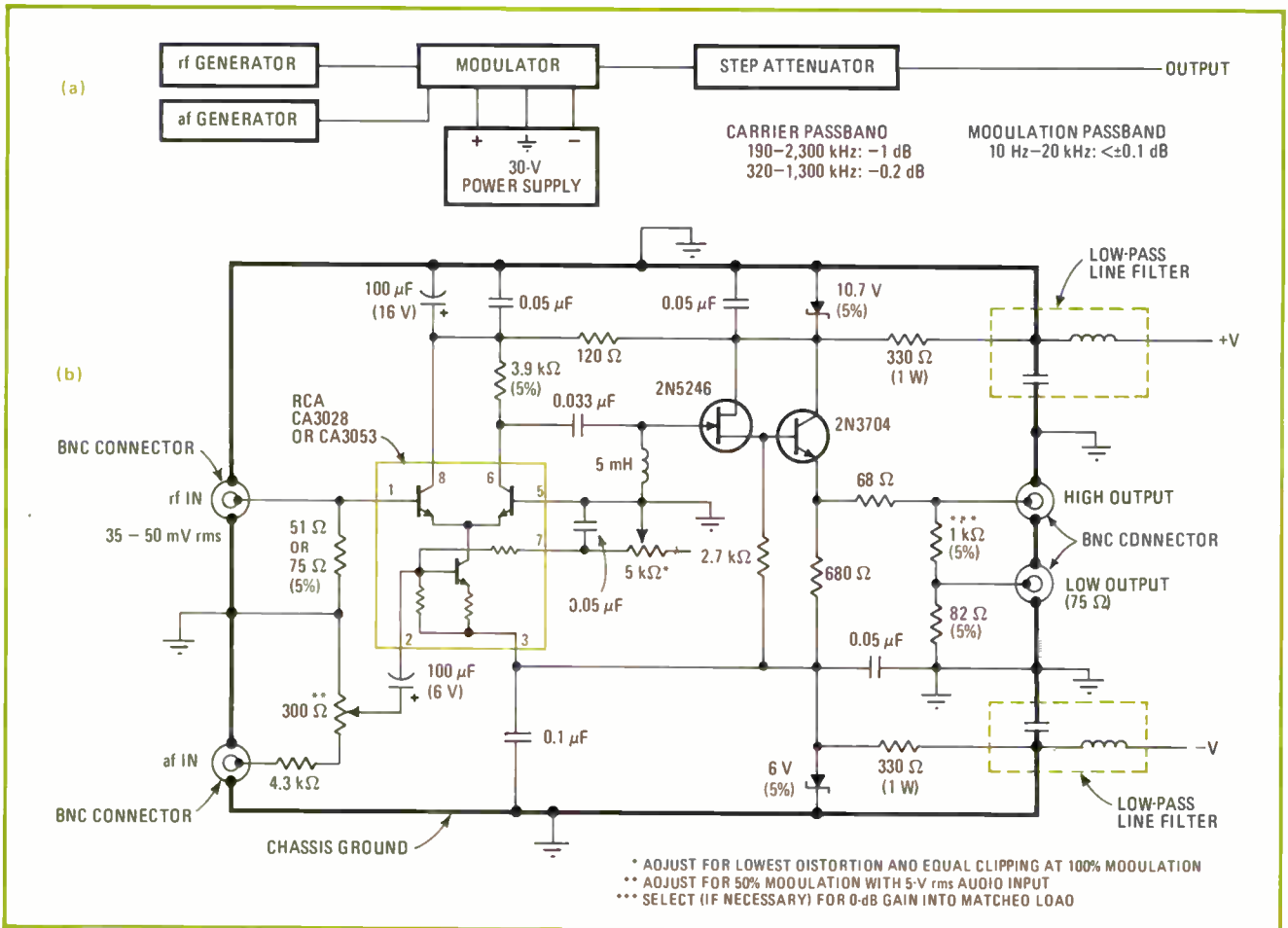

**Checking out a-m tuners.** Amplitude modulator produces less than 0.15% total harmonic distortion. Equipment setup (a) shows that modulator (b) requires only one power supply. Integrated differential cascode amplifier accepts rf carrier input, as well as af modulation input, giving modulated carrier at its output. Combination source-follower/emitter-follower provides high current gain for driving low-impedance loads.



300-ohm potentiometer. Here, the circuit produces 10% modulation per volt rms of the af input.

The modulator exhibits only 0.11% total harmonic distortion when providing 30% modulation for a 400-

hertz af input and a 1-megahertz rf carrier having an amplitude of 50-mv rms. Only a single 30-volt power supply is needed—neither its positive nor negative terminals is grounded. □

## Programable multivibrator is four-in-one circuit

by Edward Beach

McGraw-Hill Continuing Education Co., Washington, D.C.

One inexpensive transistor-transistor-logic quad dual-input NAND gate and a few other components make up a multivibrator that can be programmed for four functions—a simple latch, a monostable multivibrator, an astable multivibrator, or a retriggerable monostable multivibrator. The circuit employs a discrete timing circuit, rather than a conventional TTL timer, to allow a wide range of values to be used for timing components.

The table summarizes the operation of the circuit. With input A held low (to ground), gate  $G_1$  shorts out timing capacitor  $C_t$  through diode  $D_1$ , and gates  $G_2$  and  $G_3$  operate as a simple reset-set latch. When input A is held high, the circuit becomes a monostable multivibrator. A negative-going trigger (B) sets the latch, removing the short from the capacitor. Now capacitor  $C_t$  charges toward the supply voltage (5 v) through resistor  $R_t$  until point 1 reaches approximately 3.2 v. The regenerative switch formed by transistors  $Q_1$  and  $Q_2$  then rapidly discharges capacitor  $C_t$ , resetting the latch.

The circuit's output pulse duration (T), which equals approximately  $1.3R_tC_t$ , can be adjusted from about 280 nanoseconds to well over several hours in length. For the longest period, requiring timing component values of 10 megohms and 1,000 microfarads, a very low-leak-

age capacitor must be used.

Input C acts as a direct clear for all circuit functions. Bringing C to ground potential clears the monostable by discharging capacitor  $C_t$  so that the circuit is ready for another input signal.

Tying inputs A and B together produces the retriggerable monostable multivibrator. Its timing period begins at the end of a negative-going trigger input. If the circuit has not timed out before the arrival of another trigger, capacitor  $C_t$  is discharged, and the timing cycle is started again.

Grounding input B while holding inputs A and C high allows the circuit to act as an astable multivibrator, producing positive pulses at its  $\bar{Q}$  output. Negative-going pulses could be taken from point 2, if desired.

A programmable unijunction transistor (PUT) can be used instead of transistors  $Q_1$  and  $Q_2$ . It is connected as shown in the schematic. □

Designer's casebook is a regular feature in Electronics. We invite readers to submit original and unpublished circuit ideas and solutions to design problems. Explain briefly but thoroughly the circuit's operating principle and purpose. We'll pay \$50 for each item published.

CIRCUIT FUNCTION			
A	B	C	OPERATING MODE
LOW	SET	RESET	R-S LATCH: B = SET, C = CLEAR
HIGH		HIGH	MONOSTABLE: $T = 1.3 R_t C_t$ , C = CLEAR
HIGH	LOW	HIGH	ASTABLE: $\bar{Q}$ = OUTPUT, C = CONTROL
A TIED TO B		HIGH	RETRIGGERABLE MONOSTABLE: C = CLEAR

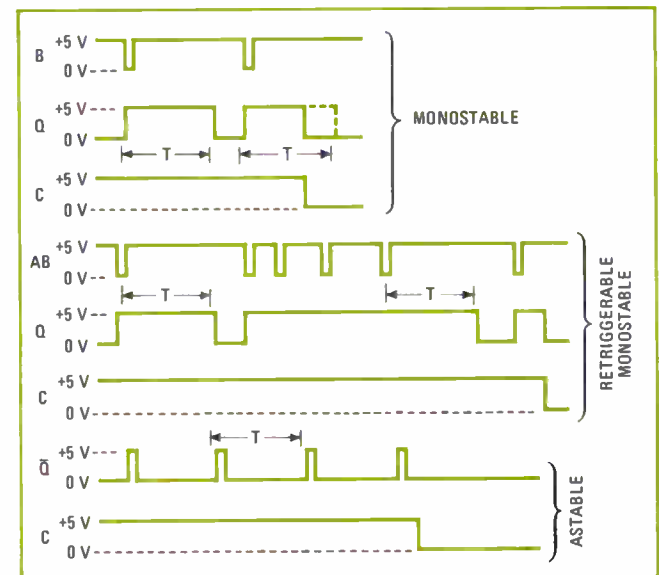
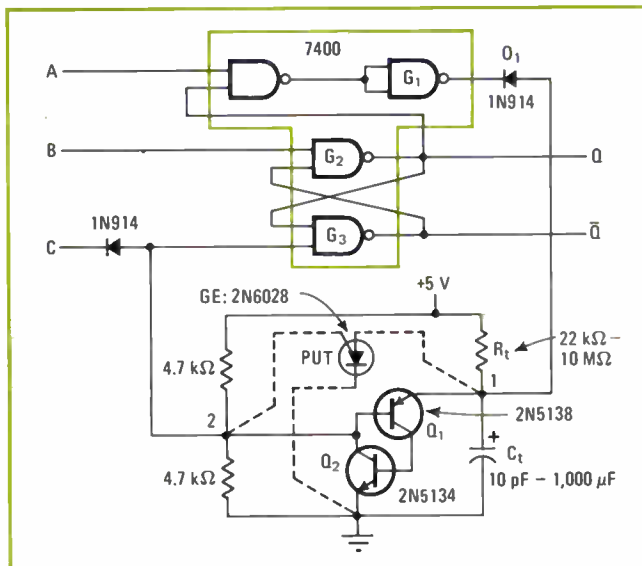

**Versatile multivibrator.** Input signals determine operating mode of four-function multivibrator, which can be a reset-set latch, a monostable multi, an astable multi, or a retriggerable one-shot. Discrete devices in the timing network permit output pulse period to range from 280 nanoseconds to more than several hours. The programmable unijunction transistor (PUT) can be used to replace transistors  $Q_1$  and  $Q_2$ .

# Two-IC digital filter varies passband easily

by Andrew M. Volk  
University of Wisconsin, Madison, Wis.

Only two integrated circuits—a dual monostable and a three-input NAND gate—are needed to build a digital filter that offers completely adjustable cutoff frequencies as well as excellent frequency stability. The bandpass filter is also independent of the duty cycle of the input waveform. It can be used in a variety of circuits, for instance, in tone-controlled devices or for fm demodulation of digital codes.

The input RC differentiator makes the filter independent of the duty cycle of the input. In (a), the lower and upper cutoff frequencies of the filter's passband are determined by the retriggerable monostable multivibrators. The output pulse length of the first monostable (MONO<sub>1</sub>) is set to the period of the highest frequency of interest, while the output pulse length of the second

(MONO<sub>2</sub>) is set for the lowest frequency wanted.

If an input pulse appears after MONO<sub>1</sub> times out but while MONO<sub>2</sub> is still high, there will be a pulse at the output of gate G<sub>1</sub>. When the input frequency exceeds the upper cutoff, MONO<sub>1</sub> stays triggered (its Q output remains low). When the input frequency is below the lower cutoff, MONO<sub>2</sub> times out (its Q output goes low). This prevents input pulses from passing through the output gate.

For the circuit in (b), MONO<sub>1</sub> sets the high-frequency cutoff, and MONO<sub>2</sub> sets the filter bandwidth. As in circuit (a), the input pulse reaches the output when MONO<sub>1</sub> has timed out and MONO<sub>2</sub> is high.

To obtain a constant output level when the input frequency is within the filter's passband, a retriggerable monostable that has its pulse length set for  $1/f_{\min}$  can be placed at the output. The monostable will remain triggered as long as there are output pulses from gate G<sub>1</sub>. However, there will be a time lag in the filter's response of  $1/f_{\text{in}}$  for pickup and  $1/f_{\min}$  for dropout.

For particularly critical applications or for high-speed operation, the input differentiator, made up of the passive RC network, should be replaced with a regular monostable, like a 74121-type or a 9603-type. □

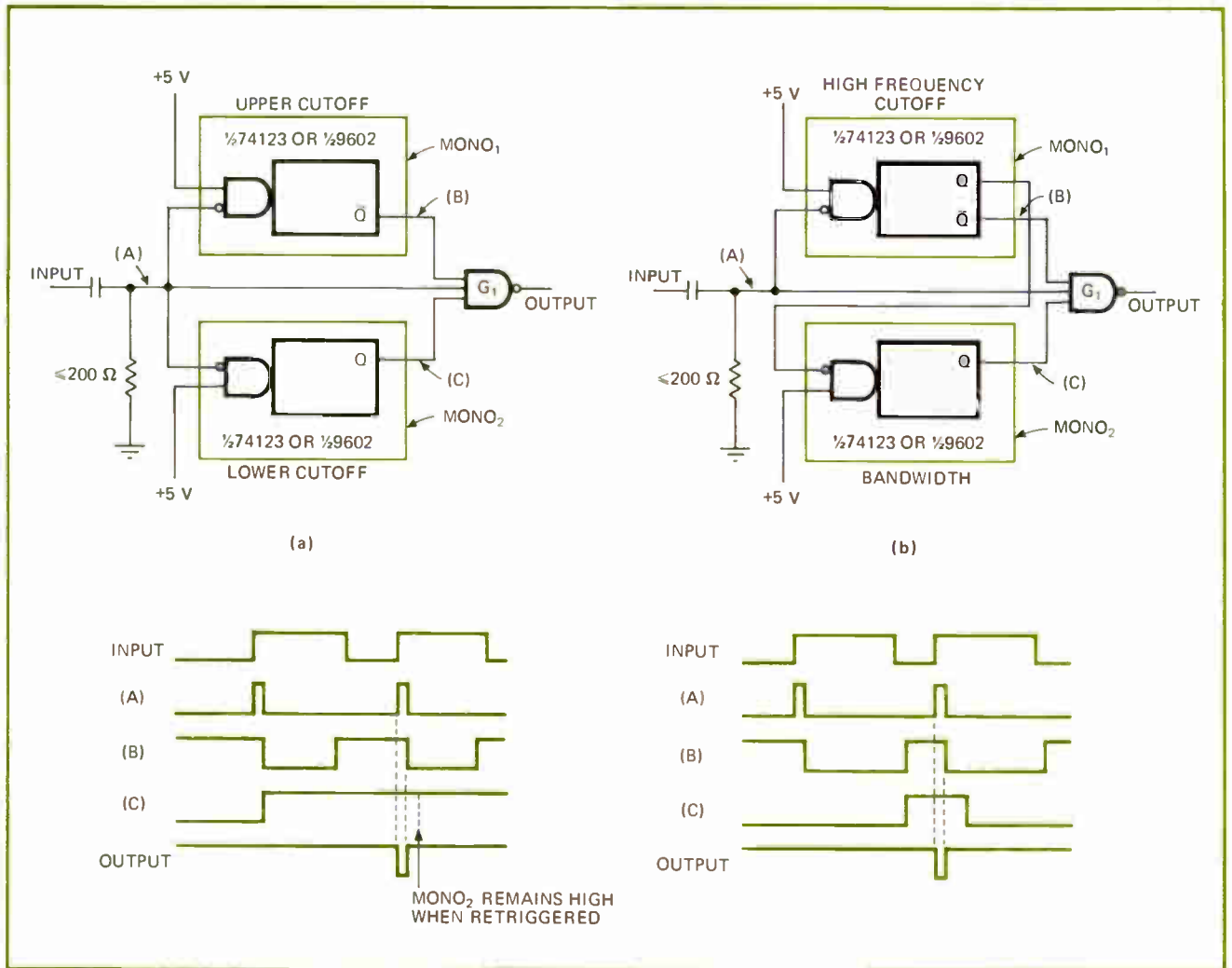

**Digital frequency selection.** Bandpass digital filter built with two ICs is easily adjusted for lower and upper passband cutoffs. In (a), output pulse width of retriggerable monostable MONO<sub>1</sub> sets high-frequency cutoff, while MONO<sub>2</sub>'s output pulse width sets low-frequency cutoff. In (b), MONO<sub>1</sub> determines upper cutoff frequency and MONO<sub>2</sub> determines bandwidth. The RC network differentiates all input waveforms.

Here's a versatile new IC for  
portable or battery-powered instrumentation

# 150 $\mu$ Watts powers Triple Op Amp

The Siliconix L144 is a *low-power* monolithic IC with three complete op amps and a common bias network on the same substrate. The circuit operates over a power supply range of  $\pm 1.5$  to  $\pm 15$  V, with a supply current set by an external bias resistor. With a  $\pm 1.5$  V battery, only  $50 \mu\text{A}$  is required for all three op amps!

Other features:

- Internal compensation provides stable operation for any feedback circuit—including capacitive loads  $> 1000$  pF
- 80 dB gain with  $20\text{K}\Omega$  load
- Typical slew rate  $0.4 \text{ V}/\mu\text{sec}$
- Military or commercial versions available

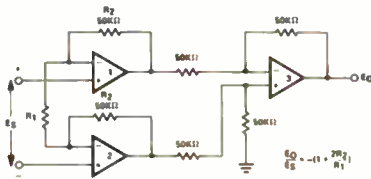

Instrumentation amplifier for high input impedance with differential operation.

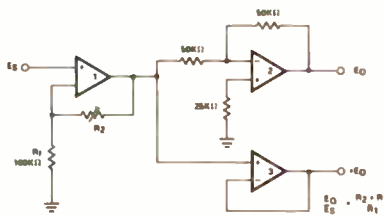

Precision phase splitter with good gain, high input impedance, low output impedance.

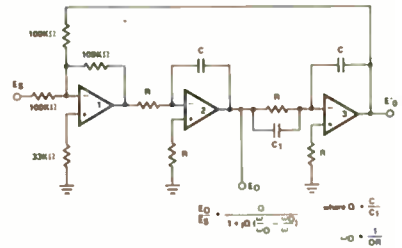

Active filter with high Q and excellent stability.

Applications? Above are three suggestions. There are more: Low-drift sample-and-hold, inverting amplifiers, voltage comparators, and so on. Call us if you have a specific design problem.

## write for data

Applications Engineering: (408) 246-8905



**Siliconix incorporated**

2201 Laurelwood Road, Santa Clara, California 95054

# Dual-polarity IC regulators aid design and packaging

Mounted in cans or dual in-line packages, voltage regulators that provide both positive and negative outputs from single monolithic chips use little pc-board area, yet they give many electrical options

by Robert A. Mammano, *Silicon General Inc., Westminster, Calif.*

□ Electronic systems using analog integrated circuits have been considerably enhanced by dual-polarity voltage regulators, now available as single monolithic chips. In addition to mounting handily on the printed-circuit boards along with the ICs they are to control, several regulators can be driven from a single remote unregulated power supply. The dual-polarity regulator provides simultaneous positive and negative voltages, with one of the two regulated voltages automatically compensating for fluctuations in the other.

When linear integrated-circuit packages first became available, they permitted the designer to build rather large and complex analog functions on one small printed-circuit board. But energizing several pc boards from one central, but remote, voltage-regulated power supply can create operational problems because of lead inductance and decoupling, and particularly from the voltage drop through leads and connectors. To eliminate these problems, an on-board IC voltage regulator was fed from a separate unregulated power supply. In this way, regulation occurred close to the load.

Initially, these IC regulators could handle voltages of only one polarity, either positive or negative, but two regulators could not be fabricated on the same monolithic chip. However, since most analog circuits require simultaneous positive and negative voltages, single-polarity regulators seemed to beg the question, since each board needed two regulators. Furthermore, two independent regulators still did not meet another basic requirement—that the two regulated voltages match, or track, each other.

Thus, the increasing use of linear integrated circuits created a demand for a dual-polarity voltage regulator built on one monolithic chip so that the adjustment of the voltage of one polarity could automatically adjust the other polarity by the same amount. This tracking capability was achieved by incorporating a single reference diode to regulate one polarity and using that output for the other polarity.

The available dual-polarity voltage regulators are Silicon General's SG1501, SG1501A, and SG1502, Motorola's MC1568, and—recently—Raytheon's RC4195. The SG1501, the first such device, features 100-milliampere output current,  $\pm 30$ -v input, factory-set output of  $\pm 15$  v, and a sensitivity to full-range load or line variations of typically less than 2 mV. Although the output voltages can be adjusted over a range of  $\pm 8$  v

to  $\pm 23$  v, this is done with some degradation in temperature stability.

Motorola's MC1568 and Raytheon's RC4195 are substantially the same as the SG1501. All such regulators can be combined with external pass transistors to regulate currents to about 2 A.

The SG1501A handles up to 200 mA of load current, and also it includes a circuit for automatic shutdown when the chip junction temperature exceeds a safe limit. The input voltage has been increased to  $\pm 35$  v.

The SG1502 employs the same basic circuit as the SG1501, but it includes two additional features. User-supplied external voltage-setting resistors with small temperature coefficients permit output levels to be adjusted from  $\pm 8$  v to  $\pm 28$  v while maintaining excellent temperature stability. And instead of limiting the current to some maximum value, the SG1502 includes the capability for foldback circuitry, which actually reduces the short-circuit current to less than the maximum rated load current, thereby limiting internal power dissipation of the pass transistors to a safe value.

Successful applications of these dual-polarity regulators is in the hands of designers, since it is up to them to make sure that the devices do not dissipate enough power to raise internal temperature above allowable limits. The panels that follow discuss regulator operation and detail power-dissipation control by heat-sinking, by current-limiting, and by foldback circuitry.



In this basic circuit for all dual-polarity regulators on single monolithic chips, the constant voltage developed by a zener diode is applied to one input of the negative error amplifier. The other input comes from the tap between  $R_1$  and  $R_2$ , the negative voltage divider, which thus sets the negative output voltage. Because of the closed-loop connection, the output voltage will remain fixed over a wide range of load currents and input voltages.

The reference input to the positive error amplifier is grounded, or zero. Two equal resistances span the negative and positive outputs. The tap between these two resistors goes to the other input of the positive error amplifier. In the steady state, the tap must have a potential equal to zero volts. If it does not, the positive output

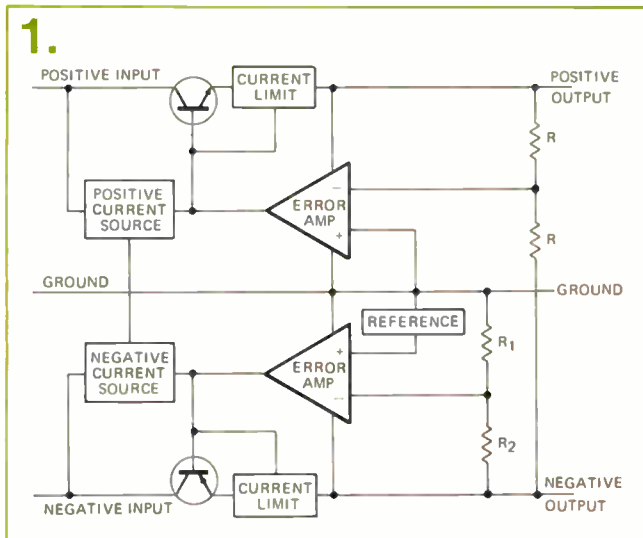

voltage will increase or decrease until the input is zero. When this happens, the positive output is equal in magnitude but opposite in polarity to the negative output voltage. (Motorola's MC1568 operates similarly, except the zener reference controls the positive side.)

Any change in the setting of the negative voltage divider will provide exactly the same percentage of change in the positive output voltage. This tracking will hold within 0.5% from slightly above the reference voltage, which is 6.2 v, to about 2 v less than the input supply voltage.

**2.** Power dissipation

In maintaining a constant output voltage, despite changes in input voltage and output current, the regulator acts like an automatically variable resistance. The power dissipated by this

"resistance" is the product of the voltage drop across the regulator and the load current, plus standby power. Standby power, about 10% of maximum power, is dissipated, even when no load current flows.

The maximum total dissipated power cannot allow the junction temperature of any of the many transistors on the chip to exceed 170°C. For maximum reliability, this temperature is usually derated to 150°C.

Determining the maximum power-handling capability and the resulting maximum current is a function of the difference between input and output voltages. The allowable maximum junction temperature rise,  $\Delta T_j$ , is:

$$\Delta T_j = 150^\circ\text{C} - T_{a(\text{max})}$$

where  $T_{a(\text{max})}$  is the maximum ambient temperature. The power that can be dissipated,  $P_d$ , is:

$$P_d = T_j / \Theta_{ja}$$

where  $\Theta_{ja}$  is the thermal resistance between the junction and the ambient. The thermal resistance depends on the amount of cooling provided by convection currents, forced air, or heat-sinking. As examples, for a regulator mounted in a TO-100 metal can in open, still air, the thermal resistance is 185°C/w; for a TO-116 ceramic dual in-line package, it's 125°C/w. A heat radiator will

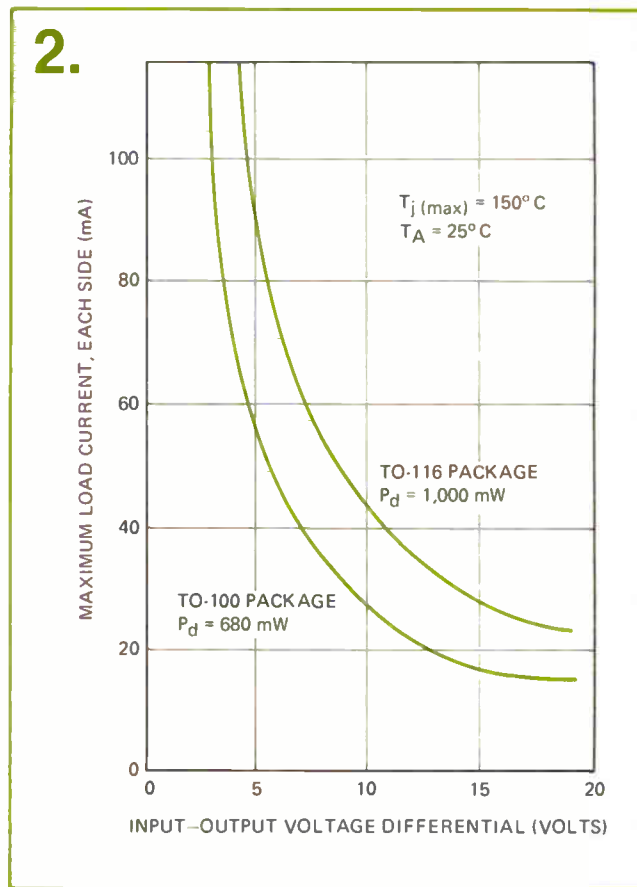

significantly reduce these values. For example, an IERC model TXFB-032-025 top-hat radiator mounted on a TO-100 can brings the thermal resistance down to 130°C/w. A model LIC-214A-2B radiator on the TO-116 reduces the thermal resistance to 50°C/w.

The standby power,  $P_{sb}$ , is then subtracted from  $P_d$ . The remainder is the amount of power due to the product of load current and input-output voltage differential, for each side, that can be safely dissipated in the regulator. The illustration shows the maximum load current for each side, as a function of a symmetrical voltage differential, for two typical regulator packages.

**3.** Current limiting

In this simple application of an SG1501 dual-polarity regulator, the device delivers  $\pm 15$  v at the output. For the designer, the main concern is to limit the maximum load current to a value

that will not raise junction temperatures above a safe value. Heat-sinking can increase dissipation and hence allowable maximum current.

Each side of the regulator contains a series transistor, through which the load current passes. Current limiting is obtained by diverting, at some prescribed value of load current, the drive signal from the pass transistor. This is accomplished by another transistor which is normally held off, or nonconducting, by an external base-to-emitter resistance, shown as  $R_{sc}$  in this circuit. To turn on the current-limit transistor requires a voltage between its base and emitter of about 0.6 v at a junction

### 3.

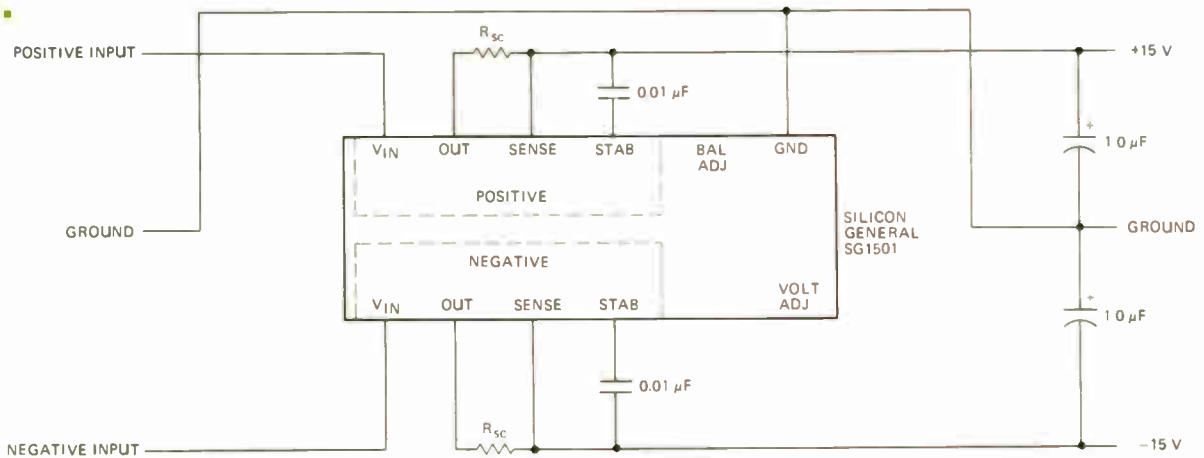

temperature of 25°C, decreasing to about 0.4 v at 125°C. The load current flowing through  $R_{sc}$  develops the sense voltage. Normally, the allowable short-circuit current—the limit—is taken as 150% of maximum operating load current.

Thus the value of the sense resistance is:

$$R_{sc} = \frac{\text{Sense voltage at maximum } T_j}{\text{Allowable short-circuit current}}$$

Because the sense voltage depends on junction temperature, increasing the dissipation within the regulator lowers the value of current at which limiting occurs.

### 4.

Adding extra power

When the regulator itself cannot handle the required load current, external power transistors can be added on either or both sides. These transistors are selected basically on current and voltage

capability and on mechanical requirements for heat-sinking. However, low-frequency transistors are preferred to reduce risk of oscillation. Capacitors marked by an \* should be of solid tantalum because they have lower equivalent series resistance, particularly at high frequencies, than do common electrolytic

capacitors. The 75-ohm base-to-emitter resistors provide a path for the dual-polarity regulator standby current under no-load conditions.

The power dissipated in these external pass transistors under short-circuit conditions can be two or three times more than normal maximum operating levels. Thus, these external transistors may need high-capacity heat sinking. Even the SG1501A, which has an internal circuit for thermal shutdown, cannot help these external pass transistors, since the thermal-shutdown circuit senses internal temperature of the chip, rather than the temperature of the power transistors. To eliminate the need for excessive short-circuit heat-sinking, the SG1502, with its foldback current capability can be used, as discussed in the next panel.

### 5.

Foldback current limiting

An important added feature in dual-polarity regulators is the inclusion of foldback, the ability to reduce the output current due to a short, to less than normal or maximum operating level. That is, as the output voltage goes to zero with a short circuit—which maximizes input-output voltage differential—the output current is reduced to decrease

### 4.

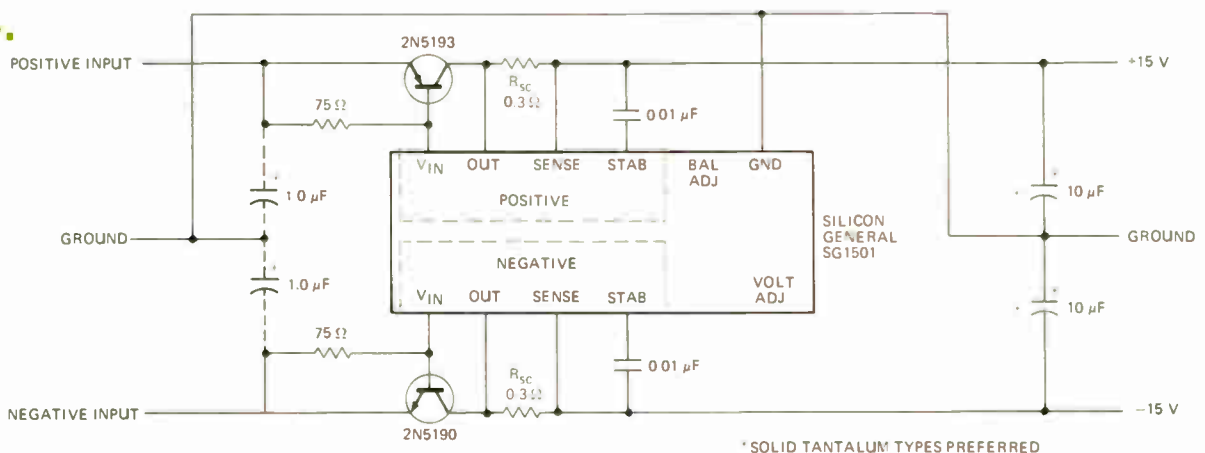

\* SOLID TANTALUM TYPES PREFERRED

5.

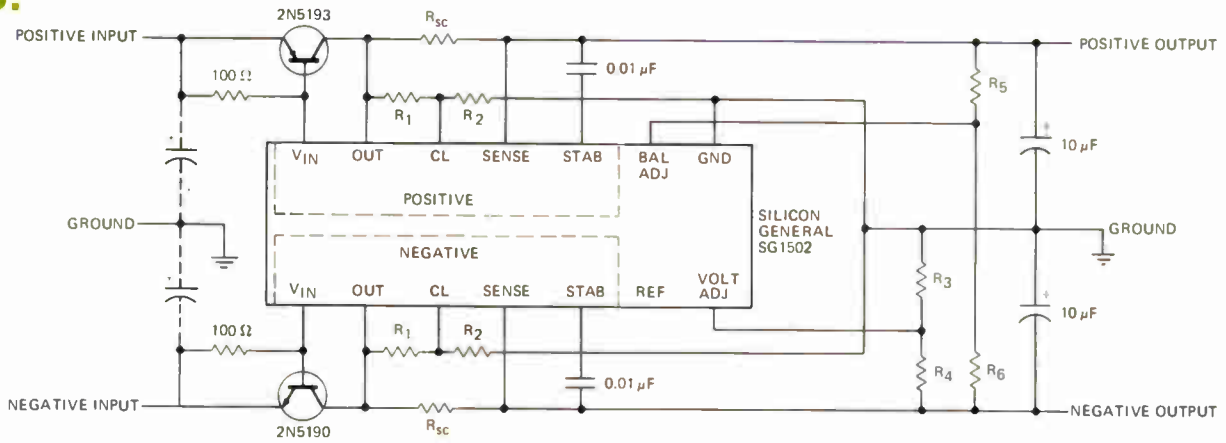

power consumption.

Therefore, the use of additional heat-sinking capacity to handle current overloads is not required. Using the SG1502, resistances  $R_1$  and  $R_2$  divide the output voltage,  $V_o$ , to essentially increase, or bias, the amount of sense voltage required to turn on the current-limiting transistor.

The values of  $R_1$  and  $R_2$  are determined approximately from an iterative solution of the equations for computing the maximum load current and the short-circuit current;

$$\text{Max load current} = [\text{Sense voltage} + (R_1 V_o / R_2)] / R_{sc}$$

$$\text{Short-circuit current} = \text{Sense voltage} / R_{sc}$$

Inspection of the first equation for normal operation shows that when a short circuit occurs,  $V_o$  drops to zero, resulting in the second equation. Hence, foldback reduces the short-circuit current to less than maximum operating current. The larger the voltage drop across the sense resistance,  $R_{sc}$ , the larger is the amount of foldback.

Besides limiting foldback current, the SG1502 can also provide output voltages that differ substantially from the normal  $\pm 15$  v. Two resistance-divider circuits on the outputs of the regulator allow each side to be set to its own value.

$$\text{Negative } V_o = 6.2(R_3 + R_4) / R_3$$

$$\text{Positive } V_o = R_5 (\text{Negative } V_o) / R_6$$

The 6.2 in the first equation is the voltage of the zener reference, which means that, to retain good tracking, the minimum output is limited to about 8 v.

## 6. Voltage offset

The 710 and 711 IC voltage comparators are widely used in analog circuits. They require +12 v and -6 v for operation. Although 6 v is below the minimum output range of the SG1501,

a more reasonable approach is to reduce the -15 v to -12 v, using the 1,800- and 2,000-ohm divider network. Because of the tracking feature, the +15 v drops to +12 v, as required. Then the -12-v output is reduced to the required -6 v by inserting a 6-v 1N4735 zener diode in the negative-output line.

Since the diode is outside the feedback loop, minor variations in the -6-v output may occur because of changes in temperature and dynamic impedance. However, since the negative voltage is used merely to bias high-impedance current sources in the voltage comparator, these variations will have a negligible effect on comparator operation. □

6.

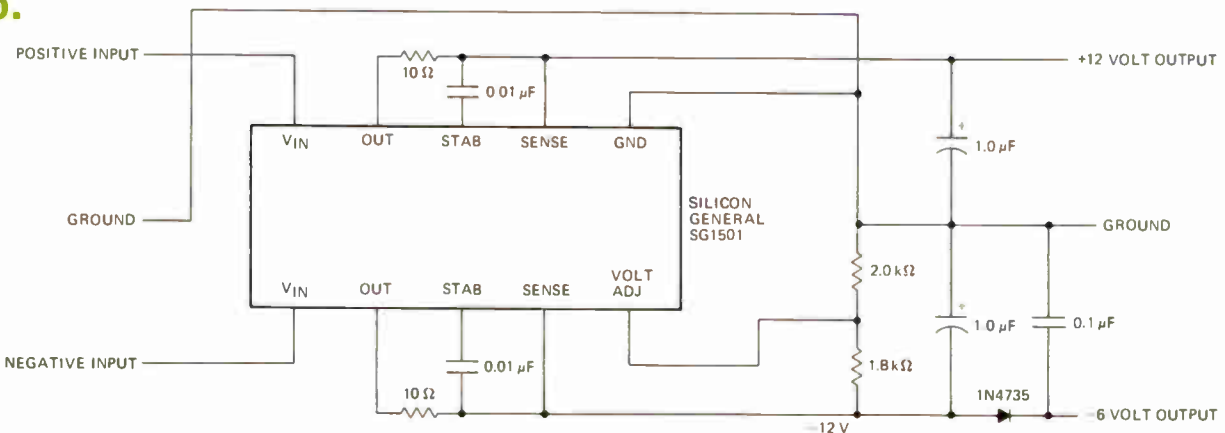

# ROMs cut cost, response time of m-out-of-N detectors

For computer and data-communications applications, the new technique using read-only memories operates faster than present shift register-counter designs and uses fewer ICs than conventional decoding-gate approaches

by A.W. Kobylar, R.L. Lindsay, and S.G. Pitroda, *GTE Automatic Electric Labs., Northlake, Ill.*

□ It is often necessary to examine groups of independent signal leads in large digital systems to determine if a prescribed number of them carry true binary levels. Such a test circuit, which is useful for a variety of functions in computer and data-communications systems, is called an m-out-of-N (m/N) detector. It indicates if m-out-of-N leads carry the true output.

In previous approaches to building m/N detectors, a tradeoff was necessary between high component count and speed. But with the ready availability of monolithic read-only memories, this important function tester can be fabricated with a relatively small number of components and a response time on the order of 150 ns.

A design often used to implement m/N detecting circuitry utilizes decoding gates like those shown in the example of Fig. 1a. With decoding gates, however, a total of  $\binom{N}{m}$ \* gates are required. Thus, when N exceeds about 15 or 20, the amount of needed hardware becomes unmanageable.

Another common approach that requires less hardware uses a shift register (Fig. 1b). Here, information on each of N parallel lines is stored in an N-bit register. The contents of the register are then counted bit-by-bit as the N-bit word in the register is serially clocked out. The counter is then checked to determine if only m 1s are contained in the N-bit word. This scheme requires

considerably less hardware but, for large values of N, results in a very slow response time because of the serial counting operation.

A simplified special version of the m/N ROM detector—the 1/N decoder—serves to introduce the technique. The 1/N decoder has broad application in testing for one and only one valid signal from a group of parallel lines at any given instant.

In general, a 1/N decoder requires  $2^N$  bits of binary storage in a ROM. The memory is addressed by the N leads to be checked. The permanently stored information in the ROM contains one “true” state corresponding to all the addresses with a single 1 in the N-bit input word. For the remaining addresses—those containing all 0s, two 1s, and more than two 1s—a “false” is stored.

However, for a large number of inputs, N, the storage capacity for such a single-unit ROM is impractical. For a more versatile system, which uses more easily produced ROMs, a modular design approach has been taken (Fig. 2). For modularity, a large number of input leads, N, are subdivided into smaller groups of n leads. Therefore, a 1/n decoder can be built from commercially available ROMs. The outputs of each smaller ROM are then cascaded to achieve the desired composite output.

In such a decoder design, where N is divided into a smaller group of n inputs, three states can be distinguished at the output of each ROM module. These states are all 0s, a single 1, and two or more 1s.

Since the all-0s state can be decoded from knowledge of the other two states, only two output lines for each

\*This is notation for  $N!/[m!(N-m)!]$ , or the number of possible combinations of N dissimilar elements taken in groups of m at a time.

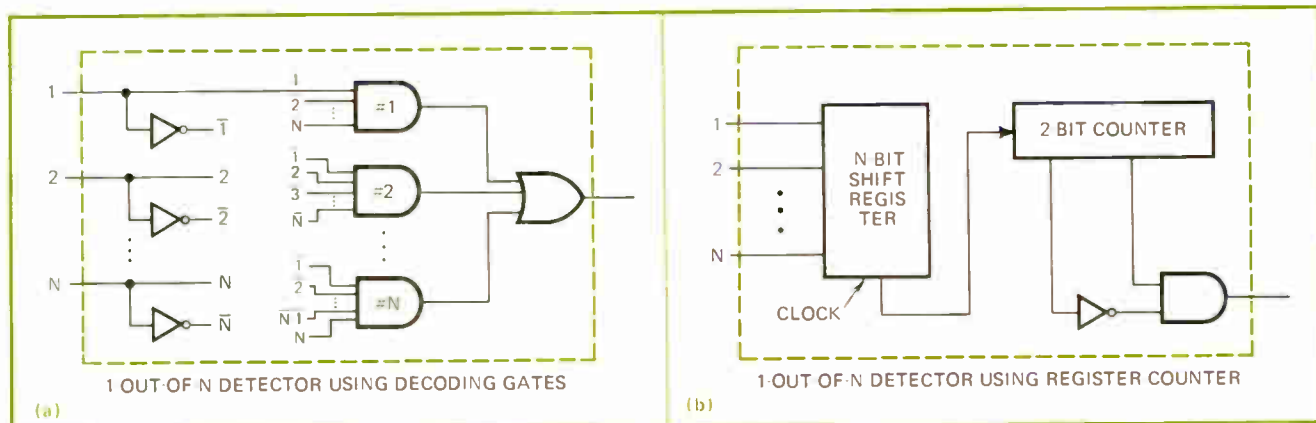

**1. Speed-size tradeoff.** For a large value of N, the decoding gate scheme (a) promises rapid response time, but it requires considerable hardware. The technique using shift registers and counters (b) requires less hardware, but it produces a slow response time.



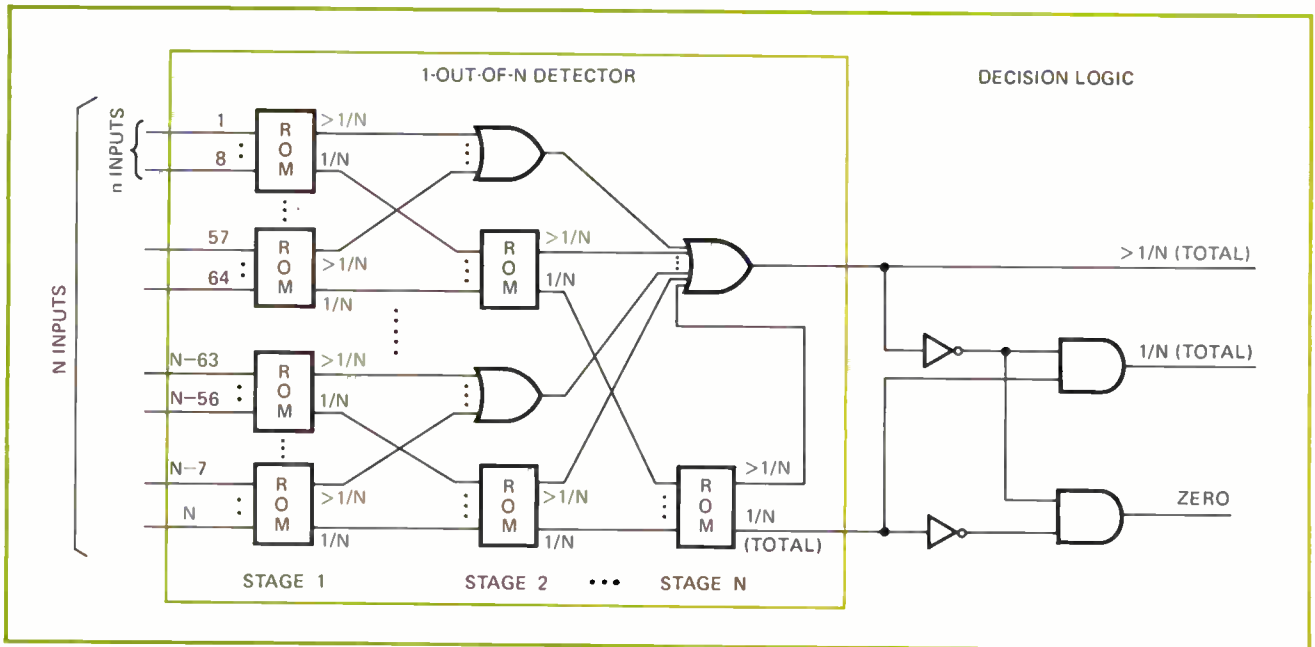

**2. Best of both worlds.** A modular design using read-only memories offers a minimum response time with fewer ICs than competing approaches. Here, all 8-input modules are identical. By simply adding modules, 1-out-of-N detection is achieved for any desired value of N.

ROM are needed—one indicating a 1/N condition, one indicating that greater than 1/N input lines are true.

An input word size of 8 bits has been chosen to illustrate the modular design approach shown in Fig. 2. Thus, a 512-bit ROM ( $2^8$  bits for an 8-line input)  $\times$  2 (for the 2-line output) is needed as the basic building block. Multiple stages can then be cascaded to derive a 1-out-of-N detector for any value of N.

The first stage is a set of 8-input ROMs, from which  $\lfloor N/8 \rfloor$  sets of outputs are generated. (Note that throughout this article the symbol  $\lfloor \dots \rfloor$  indicates the next largest integer value.) The  $\lfloor N/8 \rfloor$  outputs, representing greater-than-1/N inputs for each ROM, are Ored together in groups of eight. Then  $\lfloor N/8 \rfloor$  outputs representing inputs from stage 1 become the input for the second stage, and so on.

In the second stage, the greater-than-1/N output lines are Ored together and the 1/N outputs form the inputs for the third stage so that  $\lfloor N/512 \rfloor$  ROMs are required for this stage. Thus, a detector to decode one input out of as many as 512 can be made with only one ROM in the third stage.

The greater-than-1/N output generated in stage N is Ored with the greater-than-1/N Ored outputs from preceding stages to form a greater-than-1/N (total) output. Likewise, the 1/N line out of the final stage is applied to decision logic to form a 1/N (total) output.

In general, the number of n-bit ROMs required for a 1/N detector can be calculated from

$$\sum_{\alpha=1}^{\lfloor \log_n N \rfloor} \lfloor N/n^\alpha \rfloor$$

A comparison of the number of integrated circuits and the response times required for detectors using individual decoding gates, shift registers, and the ROM decoder are compared in the table for varying values of

N. The advantages of ROM techniques are evident.

The modular concept can be extended to the more general case where any number, m, lines out of a set, N, can be checked for true conditions. As in the 1/N detector, N is divided into smaller groups of n lines for each module. For such an m-out-of-N detector, the basic module is configured so that its output consists of m leads where (1) if zero out of n inputs is true, then all outputs are 0, (2) if 1-out-of-n inputs is true, then a single output is true, and so on until (3) if m-out-of-n inputs are true, then all m outputs leads are true. An additional output lead for each module indicates that the m-out-of-N condition has already been surpassed (greater than m/N) in that module.

In arranging the ROM truth table in this way, each output lead carries independent information and can be used as an input to any of the memories in the following stage. Notice that, for this modular scheme, m must always be less than n.

The size of the ROM depends on the values of m and n. The total storage required is  $2^n(m+1)$  bits, broken down as follows:

IC REQUIREMENTS AND RESPONSE TIMES FOR 1/N DETECTOR						
N	Decoding gates		Shift-register counter		Read-only memory	
	$T_r$ (ns)*	IC Packs**	$T_r$ (ns)*	IC Packs**	$T_r$ (ns)*	IC Packs**
10	0.10	11	0.5	2	0.1	4
50	0.10	255	2.5	6	0.1	10
80	0.10	648	4.0	9	0.15	16
800	0.10	64,080	40	81	0.2	130
5,000	0.10	2,500,500	250	501	0.3	808

\* A response time of 50 ns per level of logic or shift pulse is assumed.  
 \*\* Assumes a 10 input AND gate, 10-input OR gate, 10-bit shift register, or a single counter for each IC package.

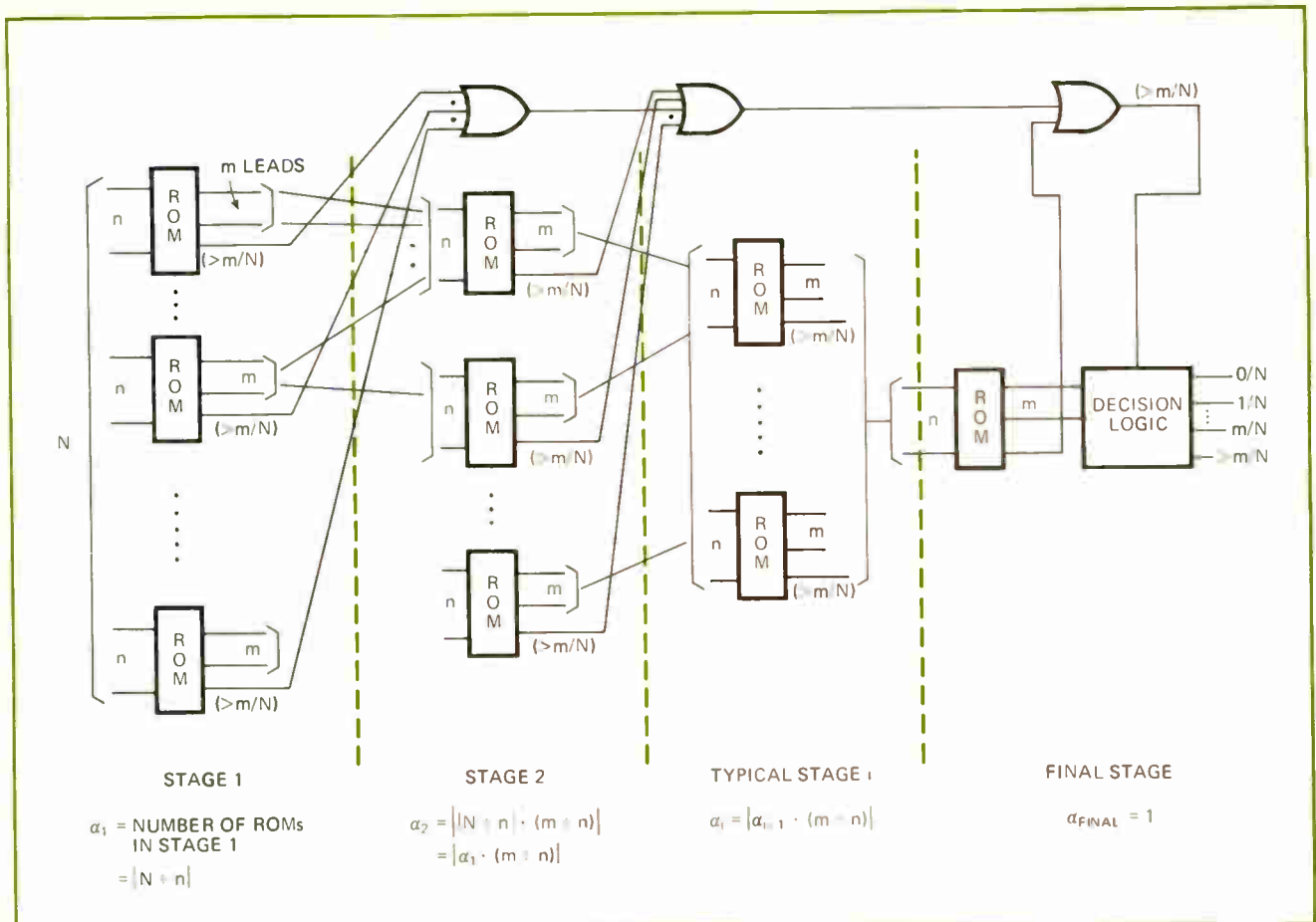

**3. Flexible.** The general  $m$ -out-of- $N$  detector is built with ROMs that are all identical. Each building block is designed for  $n$  inputs and  $m + 1$  output leads. Simple decoding logic, which derives the desired outputs, follows the final read-only-memory stage

## Applications

The concept of checking for  $m$  conditions on  $N$  parallel lines is useful for a number of applications. One specific installation at Automatic Electric Co. is in a data multiplexing system where 90 terminals are time-division multiplexed onto a single transmission line.

A fault in the control circuitry that multiplexes the data terminals would result in invalid transmissions because more than one terminal is connected at any time. Thus, a 1-out-of-90 detector was designed with ROMs, and with a minimum of hardware, it provides a real-time fault indication.

The communications industry also requires  $m$ -out-of- $N$  detectors routinely for other applications. To transmit each digit through standard tone-keyed format, for example, one tone from each of two sets of 4 tones is combined to address the central office; thus, two 1-out-of-4 detectors are required at the central office to locate faulty dialers.

Likewise, signaling between central switching offices is often effected by tone sets that can be checked for errors with a 2-out-of-6 detector.

For the general computing industry, the 2-out-of-5 decimal code (where five binary digits represent values of 0, 1, 2, 4 and 7) is commonly used when simple transmission-error checking is to be implemented. In these and many other applications in the expanding computer and communications fields,  $m$ -out-of- $N$  detectors are sure to find greater usage.

- 1 address corresponds to all 0s at the input
- $\binom{n}{1}$  addresses correspond to a single 1 at the input
- $\binom{n}{2}$  addresses correspond to two 1s at the input
- ⋮
- $\binom{n}{m}$  addresses correspond to  $m$  1s at the input
- $\sum_{i=1}^n \binom{n}{i}$  addresses correspond to greater-than- $m$  1s at the input.

The first stage of the  $m/N$  detector divides the  $N$  input leads into groups of  $n$ . The intermediate outputs up to  $m/n$  are necessary, since usually more than one stage is involved in the checking process, and it is essential to know exactly how many input 1s have been detected. The greater-than- $m$ -out-of- $n$  leads are simply ORED together, since any such output, no matter where it is generated, makes the input fail the  $m/N$  check.

Each successive stage uses the  $m$  outputs from the preceding stages as inputs and further concentrates the detecting process by a factor of  $m/n$ . The concentration process continues until the final stage when only one ROM is reached.

The outputs of the final stage then feed simple decoding gates to derive the desired information—usually  $m/N$  or  $0/N$ . However, all intermediate values—from  $1/N$  through  $(m-1)/N$  are available if the correct decoding logic is provided. □

# Two-level capacitor boosts MOS memory performance

Capacitor with two capacitance levels, above and below a MOS circuit's threshold voltage, is easy to build with silicon-gate technology; it can bootstrap logic swings and could help realize the single-transistor cell

by Luciano Talamonti, SGS-ATES, Milan, Italy

□ The best days of metal-oxide-semiconductor memories are yet to come, now that a new type of high-value capacitor has been developed for MOS ICs. The component, which is like a gated diode in configuration, is called a binary capacitor (Bicap) because it has two distinctly different values of capacitance above and below the operating threshold voltage of the circuit.

Storing charge in a memory with Bicaps in place of conventional MOS capacitors will greatly enhance the logic output voltages. As a result, it will be possible to

use cheaper and less sensitive circuits to sense logic swings. Moreover, Bicap memories can be operated faster because the response time of a MOS memory cell is directly proportional to the voltage stored on the capacitor (RC time constant). Equally significant is the fact that binary capacitors can be built with either the standard metal-gate MOS process or a self-aligned process such as the silicon-gate technology. It is usually difficult and expensive to create a standard high-value gate capacitor between a polysilicon gate and the p<sup>+</sup> region beneath it.

In existing memory designs, the immediate usefulness of the Bicap will lie in bootstrapping logic swings—enlarging them so that the circuits become faster. More important, however, is the prospect of a workable, single-transistor memory cell, pointing to memories with 4,000 to 8,000 bits on a chip.

The key to the design of a good single-transistor cell, till now an interesting but elusive concept, is the ability to build a large-value integrated capacitance in a small area. In such a cell, all of the stored charge must be confined to one external capacitor, instead of spread out

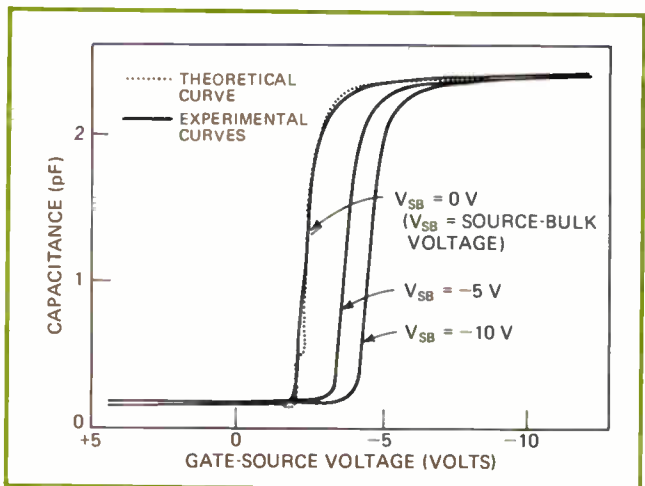
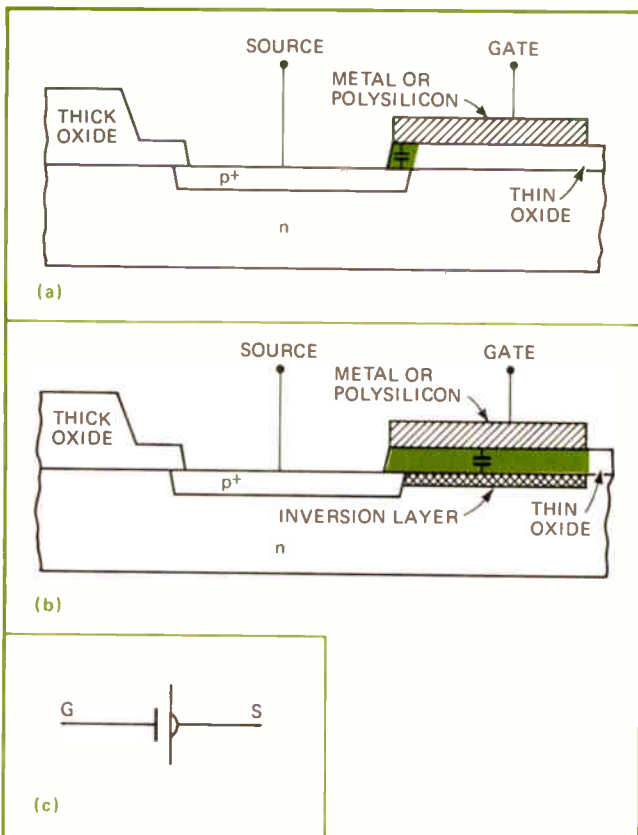

**1. The Bicap.** Binary capacitor is made by partly overlapping the metal or polysilicon gate with the p<sup>+</sup> diffusion. Below threshold (a), no inversion region exists under the gate, and the capacitance is small. Above threshold, a high-capacitance inversion layer is formed under the gate that communicates with the p<sup>+</sup> region, forming a large-value capacitor between source and gate. Since only a gate and source electrode are used, the Bicap component is in effect an MOS transistor without a drain, symbolized in (c)

**2. It's nonlinear.** These theoretical and experimental curves of capacitance characteristics show the nonlinear nature of the Bicap device. Data for three values of substrate bias (source-to-bulk voltage) are given. Below threshold Bicap has a capacitance of less than 0.2 pF. Above threshold (say about 2 volts) Bicap shows a sharp increase in capacitance, about 2.5 pF. Threshold is determined by the source-to-bulk voltage. Note that Bicap is already saturated at -5-V levels and is therefore TTL-compatible.

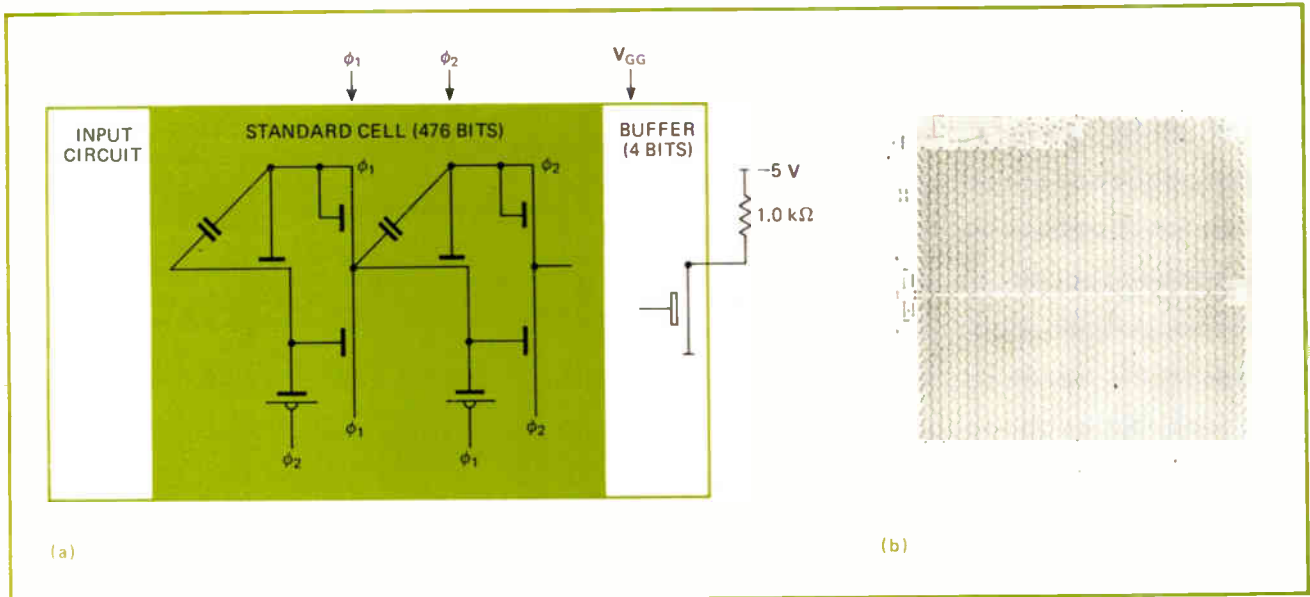

**3. Logic boosts.** In a shift-register circuit, bootstrapping increases logic-one levels, as in cell shown in (a). With this cell design, a 2-by-480 dynamic shift register (b) has been built with an active area of only 133 by 133 mils. An operation frequency of 20 MHz can be predicted.

## The beginnings of Bicap

Though silicon-gate technology has from the beginning had certain obvious advantages over other standard processes, its usefulness has been limited by the impossibility of realizing capacitive coupling of the type that occurs between p<sup>+</sup> material and thin silicon oxide. Circuits nearly always require capacitors, especially to achieve bootstrapping. But in such self-aligned processes as silicon-gate, a p<sup>+</sup> region cannot in fact be placed under the gate electrode, since it is the gate electrode itself which fixes the boundaries of p<sup>+</sup> regions.

Work on this problem was begun at the Agrate Laboratory in late 1970. Once the solution was found in the Bicap, moreover, the device's special characteristics proved applicable to quite other uses. For instance, the Bicap can be made with any process, self-aligned or not. Also, its high capacitance region allows it to replace ordinary capacitors wherever they are used. Finally, its transition region makes it suitable for such novel applications as large-scale integrated MOS logic chips.

among three or four transistors as in conventional cell designs; yet for measurable logic swings the single capacitor must be large because of losses on the bus lines. That requirement appears well satisfied by the high capacitance and small size of the Bicap component.

### What's in a Bicap?

In p-channel MOS technology, the Bicap starts with a p<sup>2</sup> region, the edge of which is overlapped by thin oxide topped by a metal gate. (For silicon-gate technology, a polysilicon gate is used.) When the gate voltage is lower than the threshold voltage (with body effect taken into account), the capacitance between the gate and the source is governed only by the small overlap of the metal on the p<sup>+</sup> region. This capacitance is very low. When the gate voltage is higher than the threshold volt-

age, an inversion layer is formed beneath the thin oxide (Fig. 1b). Highly capacitive with respect to the gate, this layer in effect extends the p<sup>+</sup> region. Now a highly capacitive path exists between source and gate. This is the high-capacitance mode of the Bicap.

Only gate and source electrodes are utilized. The Bicap therefore amounts to an MOS transistor without drain; its symbol is shown in Fig. 1c.

It should be noted that the Bicap's capacitance is highly nonlinear. At the threshold voltage it switches from a very low value of about 0.2 picofarads, involving only the small metal-p<sup>+</sup> overlap, to a high value of 2 to 3 pF, involving the entire gate area. This nonlinearity is crucial to the behavior of Bicap in circuit applications. Since it presents two values completely independent of each other, the Bicap allows an increase of the logic 1 level without disturbing the logic 0 level.

The nonlinear nature of the Bicap capacitor is illustrated in Fig. 2. Here the theoretical and measured values of capacitance as a function of gate-source voltage are shown for a silicon-gate Bicap with a 4-by-4-mil area. Below threshold the capacitance is about 0.2 pF, above threshold about 2.5 pF. Capacitance values are shown for two operating voltages:  $V_{SB} = -5$  volts and  $V_{SB} = -10$  v. Significantly, because saturation occurs at just over -5 volts, very little is gained by going to higher drive voltages. Thus the Bicap's efficiency is as good at TTL's 5-v level as at the 10-v MOS levels. Of course, the theory applies equally to n-channel technology.

### Bootstrapping

One immediate application of the Bicap structure is to bootstrapping—producing an extra voltage for a gate, boosting it to levels which may be higher than the supply voltage itself. Usually this is done by inserting a capacitor between gate and source, and so establishing positive feedback between the two points. When the nonlinear Bicap replaces the conventional capacitor, it is possible to operate the circuit at a higher speed. And as far as output buffers or internal clock generators are

**4. Good forms.** Typical output waveforms of a memory cell containing a Bicap show its high speed. In (a), the output waveform of the 2-by-480-bit register at 6 MHz closely resembles the input. In (b), an experimental 8-bit register is being driven to above 11 MHz. Blowing up this trace (c) shows a pulse width of less than 20 ns, indicating a theoretical phase repetition frequency above 20 MHz.

concerned, bootstrapping with the Bicap makes it possible to raise voltage levels up to the supply voltage.

To prove the viability of this technique, an experimental p-channel shift register with a Bicap bootstrap cell has been built and operated at high frequencies. The cell, diagramed in Fig. 3a, consists of six transistors, two capacitors, and two Bicaps. Two-by-480 of these cells make up the dynamic shift register, a photomicrograph of which appears in Fig. 3b. The low-voltage Planox process was used to build the circuit.

Since the introduction of the Bicap in the memory requires no extra contact, the extra area required is very small. The cell measures 133 by 131 mils, well within the cell size of conventional 1,024-bit registers. The speed characteristics of the circuit are excellent as well. Figure 4a shows the typical output waveform at a frequency of about 6.0 megahertz (most MOS shift registers of this capacity operate at less than 5 MHz).

#### How fast can it get?

Six megahertz is not the upper limit of cell frequency, although it is rather difficult to drive this shift register correctly at higher frequencies because of the high value of the phase capacitance. To evaluate the maximum repetition frequency of the cell, therefore, a small eight-bit shift register was constructed. At about 12 MHz the output buffer began to fail—but not the memory cell. Figure 4b gives the output waveform at a repetition frequency of approximately 11.0 MHz.

When the waveforms are studied in detail (Fig. 4c), the minimum pulse width is seen to be less than 20 nanoseconds. With proper high-speed buffers, this implies a theoretical phase repetition frequency higher than 20 MHz. It should be remembered that this high frequency is from a p-channel device. When Bicap is applied to n-channel devices, still faster operation will surely result.

Following these results, a new two-phase cell is being developed. It has two capacitors, two Bicaps, and only four transistors. As a result, its area is very small, and the maximum repetition frequency is not very different from that of the cell in Fig. 3a. The main characteristic of this cell, apart from smaller area, is the lower value of phase capacitances. This makes it far easier to drive, especially when internally generated clocks must be used.

Other applications that will exploit the Bicap's unique nonlinear characteristics include the single-transistor cell for random-access memories and a self-refreshing dynamic RAM that requires no external refresh cycle. Work here is attempting to improve speed, increase output levels, and decrease power dissipation.

Also promising are Bicap logic applications, in which the transition region of the capacitance/gate-source-voltage curve of Fig. 2 is used to implement a high-speed logic function. This will be the first real attempt to build useful MOS logic circuits. □

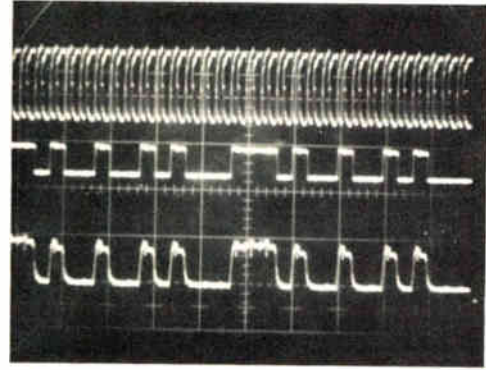

CLOCK TRACES (top) : 10 V/DIV.  
 INPUT TRACE (middle) : 5 V/DIV.  
 OUTPUT TRACE (bottom) : 5 V/DIV.  
 TIME SCALE : 500 ns/DIV.

(a)

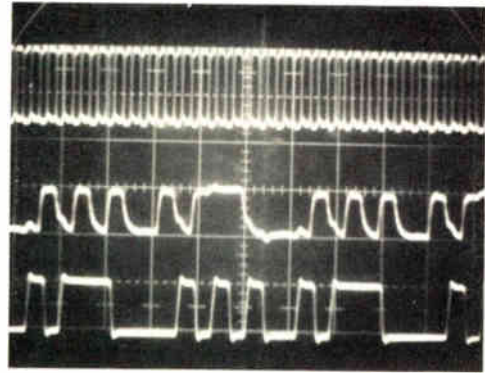

CLOCK TRACES (top) : 10 V/DIV.  
 OUTPUT TRACE (middle) : 5 V/DIV.  
 INPUT TRACE (bottom) : 10 V/DIV.  
 TIME SCALE : 250 ns/DIV.

(b)

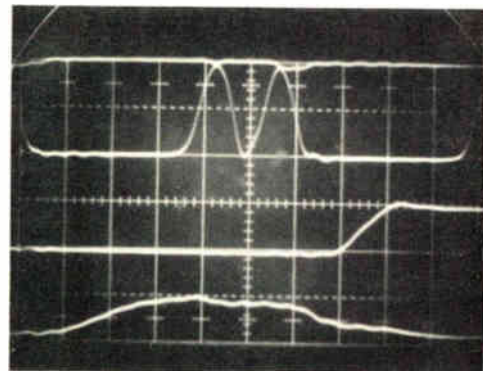

CLOCK TRACES (top) : 10 V/DIV.  
 INPUT TRACE (middle) : 10 V/DIV.  
 OUTPUT TRACE (bottom) : 5 V/DIV.  
 TIME SCALE : 20 ns/DIV.

(c)

## Measuring small currents with an ordinary voltmeter

by Robert J. Battes  
Quantic Industries, San Carlos, Calif.

If it is necessary to measure extremely small currents only occasionally, the expense of a specialized instrument like an electrometer probably can't be justified economically. However, even semiconductor leakage currents and the input bias currents of FET-input operational amplifiers—on the order of nanoamperes and picoamperes—can be measured by a standard voltmeter, to within better than 5%. The meter should have a moderately high input impedance (approximately 10 megohms) and a reasonably good sensitivity rating (around 100 to 200 millivolts full scale).

The trick is to use the voltmeter's input attenuator as a calibrated current shunt, as shown in the figure. Then, only a single calculation is necessary to read nanoamperes or picoamperes directly from the voltmeter scale, since:

$$I_{\text{test}} = V_m / R_{\text{in}}$$

where  $I_{\text{test}}$  is the current being measured,  $V_m$  is the displayed voltage measurement, and  $R_{\text{in}}$  is the voltmeter's

input resistance. The current is measured accurately, because voltmeter input attenuators are usually specified within  $\pm 5\%$  of their nominal value.

As an example, assume the voltmeter being used is a standard economy-priced 3 $\frac{1}{2}$ -digit multimeter. The most sensitive multimeter current-measuring range usually found on such an instrument is 2.000 milliamperes full scale, providing a resolution of 0.001 mA, or  $10^{-6}$  amperes. The voltmeter section of this type of multimeter usually has a sensitivity of 0.2000 volt full scale and an input impedance of 10 megohms. With the meter connected as shown, each 0.0001 V displayed on the meter will represent a current as small as 10 pA, or  $10^{-11}$  A. When the meter is used this way, its current-measuring sensitivity is increased by five orders of magnitude. □

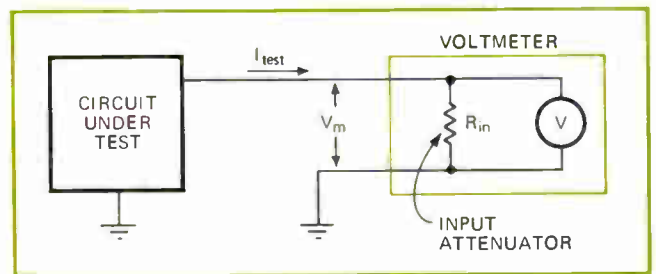

**Applying Ohm's law.** Nanoampere or picoampere currents can be measured accurately with a standard voltmeter by taking advantage of the tight tolerances of input attenuators of today's instruments.

## Three-step shortcut for finding square roots

by James R. Whitmore  
Whitmore Electronics Co., Miami, Fla.

Although a very useful tool, the popular four-function calculator is intended primarily for home use, and therefore, it cannot directly perform such sophisticated mathematical functions as finding square roots. However, here is a three-step technique that uses only the three functions of addition, subtraction, and division, which are always available on the home calculator, to determine square roots accurately.

Each step involves four mathematical operations, and the number of steps can be increased if greater accuracy is desired. With this technique, an initial approximate answer must be estimated—the closer this first approximation, the fewer steps are needed to compute a square root with at least four significant digits.

An example, in this case finding the square root of 624, will illustrate how to use the method. The approxi-

mate answer could be 20, 25, or 30. While the estimate of 30 is not too close to the correct answer, it is still within the range of this three-step technique. Here are the steps for obtaining the square root of 624 when the first approximation is 30:

- Step 1: ■  $624/30 = 20.8$  (divide by 30)  
■  $20.8 - 30 = -9.2$  (subtract 30)  
■  $-9.2/2 = -4.6$  (divide by 2)  
■  $-4.6 + 30 = 25.4$  (add 30)
- Step 2: ■  $624/25.4 = 24.566929$   
■  $24.566929 - 25.4 = -0.833071$   
■  $-0.833071/2 = -0.4165355$   
■  $-0.4165355 + 25.4 = 24.983465$
- Step 3: ■  $624/24.98 = 24.979983$   
■  $24.979983 - 24.98 = -0.000017$   
■  $-0.000017/2 = -0.0000085$   
■  $-0.0000085 + 24.98 = 24.979992$  (answer)

(If the estimate of 25 had been chosen as the first approximation, then only two steps would have been required to reach an accurate final answer.)

For an eight-digit calculator, the last step should contain at least four most significant digits in the divisor (24.98 in the example). If the calculator has a constant register, the answer can be easily verified without losing the data. □

## Using pocket calculators to square numbers directly

by Paul B. Wesling  
Intel Corp./ISS Division, Cupertino, Calif.

The inexpensive four-function calculator with the constant register, which is now available for less than \$100, can do addition, subtraction, multiplication, and division, as well as chain and mixed calculations. But, with a little know-how, it can be made to take reciprocals [*Electronics*, "Finding reciprocals easily with pocket calculators," Jan. 18, 1973, p. 186] and to square a number or raise a number to some integer power, without clearing or re-entering any of the data.

To square a number, especially a long one, the user usually writes it down, presses the multiply ( $\times$ ) key, re-enters the number, and then presses the add/equal ( $+/=$ ) key. An easier way is to load the number to be squared into the constant (K) register, then multiply the constant and display registers to get the answer. The steps are:

- Enter the number to be squared
- Press and hold down the K key
- Press and release the  $\times$  key
- Release the K key

CALCULATOR OPERATIONS				
Calculation	Entry Operation	Display Register	K Register	K Operation
$n^2$	Enter number	n	Clear	—
	Hold K button [ $\times$	n	n	Multiply
	$+/=$	$n^2$	Clear	—
$n^3$	Enter number	n	Clear	—
	Hold K button [ $\times$	n	n	Multiply
	$+/=$	$n^2$	n	Multiply
	$+/=$	$n^3$	Clear	—

- Press and release the  $+/=$

The square of the original number is now in the display register and can be used for additional computations.

To cube a number, hold the constant key down through both the multiply and add/equal operations, then release the constant key and press the add/equal once more. Again, the answer is in the display register. Any integer power of any number can be calculated by simply extending this method.

The table summarizes the operations required for squaring and cubing. □

Engineer's notebook is a regular feature in *Electronics*. We invite readers to submit original design shortcuts, calculation aids, measurement and test techniques, and other ideas for saving engineering time or cost. We'll pay \$50 for each item published.

## Adding numeric readout to logic probe displays

by Kai Lanz  
Stanford University, Stanford, Calif.

Not too long ago, logic probes were little more than a light bulb, plus the necessary driver circuitry. Nowadays, however, they are more likely to consist of three light-emitting diodes, indicating the three possible logic states—logic 1, logic 0, and high impedance. And with three flashing displays crowded into the narrow probe body, it is not uncommon to have to pause and check which legend is actually illuminated. A simple way to build a compact probe readout that is unambiguous and easy to decipher is to substitute a solid-state numeric readout for the three discrete LEDs.

The figure shows a seven-segment readout connected to display 0, 1, and H (for high impedance). The two right-hand segments are on at all times since they are tied directly to the 5-volt supply. A pair of diodes serves as a simple decoding network to prevent undesired segments from lighting. Any good general-purpose silicon diodes should be adequate, but devices having a low forward voltage drop will help to equalize segment brightness.

The cost of building a logic probe this way is less than the cost of building one with three discrete LEDs. With the numeric readout connected as shown, the sense and drive circuitry for displaying a logic 1 can be eliminated because the 1 is always lit.

The readout's power requirement averages about 10 milliamperes per segment. Miniature readouts, such as Monsanto's MAN-3A, are slim enough to mount without difficulty in the end of the probe body, where they will be readily visible. □

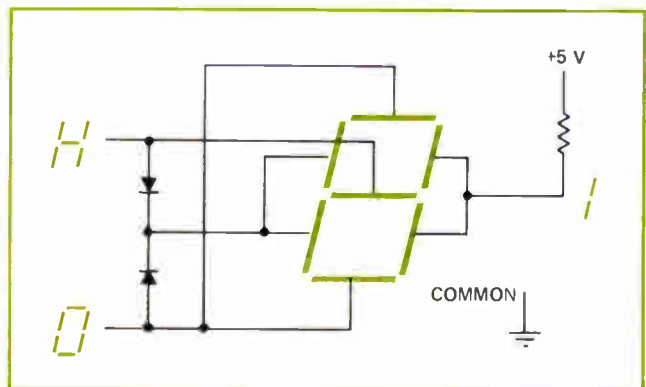

**Deluxe display.** Solid-state numeric readout shows three possible logic states—1, 0, or H (high impedance)—for logic-probe display. Since the two right-hand segments are always illuminated, only two standard diodes are needed for decoding. The sense and drive circuitry for displaying a logic 1 can then be eliminated.

## Take a signal's complement for a free logic 1

Designers buying the new displays that have built-in decoders are delighted with the saving in board space that's the result of not needing a separate decoding package. **Still more space could be saved by making double use of the decoding logic that's needed to interface the display.** For example, using a simple inverter or gate to take the complement of the blanking signal **often produces a useful function—such as a logic 1—** and it comes practically for free. In a DPM display this logic 1 is then available to get a half digit, say, or the inverted signal could act as a control pulse to sync the display to other parts of the system.

## Test DACs the easy way

Testing digital-to-analog converters has generally meant building your own special test setup each time. —But no more. Sitek Inc., 1078 W. Evelyn Ave., Sunnyvale, Calif. 94086, has an automatic bench-top DAC tester that can evaluate the accuracy of any modular or monolithic converter. The tester, which compares the accuracy of your DAC with a reference device, can accommodate converters of up to 12 bits in all standard packages. It's fast, too—it tests a typical 10-bit device in four seconds flat.

## Bit count of core mats quadruples

Still want to use cores in your minis? Some minicomputer manufacturers are planning to build machines this year with **core mats of 8,000 and 16,000 bits.** Previously, core mats larger than 4,000 bits were considered impractical because the sense line mismatch became formidable with planes of this complexity.

## Get flexible with expandable C-MOS

Logic designers can get more flexibility out of circuits by being smart about the new expandable-type C-MOS circuits. For example, Solid State Scientific's 4402A dual four-input expandable NOR will give you **direct TTL outputs as well as the NOR function.** Connect the n-channel output of the device to an external pull-up resistor. Since the n-channel transistor current capability is typically 3 milliamperes with a 10-volt gate drive, **a TTL fanout of two can be accommodated.** If the p-channel transistor output is used with the same pull-down resistor, the device acts as a positive-to-negative level shifter. In either case, the pull-resistor could be connected to a negative supply of up to -30 v.

## Glossary explains new terms

**Stumbling over some of the new jargon** that's piling up around the electronics industries? A handy glossary of electronic terms, costing \$1.50 from Henry Lavin Associates, P.O. Box 921, Meriden, Conn. 06450, will straighten you out. It'll teach you, for example, **what a KISS means to a programmer.** An acronym for keep it simple, stupid, KISS refers to a method for reducing the complexity of information that's to be fed into a computer.

## P-i-n point

Many microwave designers are finding that **the best way to get a low-loss resistance (up to 50 kilohms) at high radio frequencies** is to use a p-i-n diode—it appears as an almost pure resistance in the rf range.



# Complete RF Network Analysis — IMPEDANCE

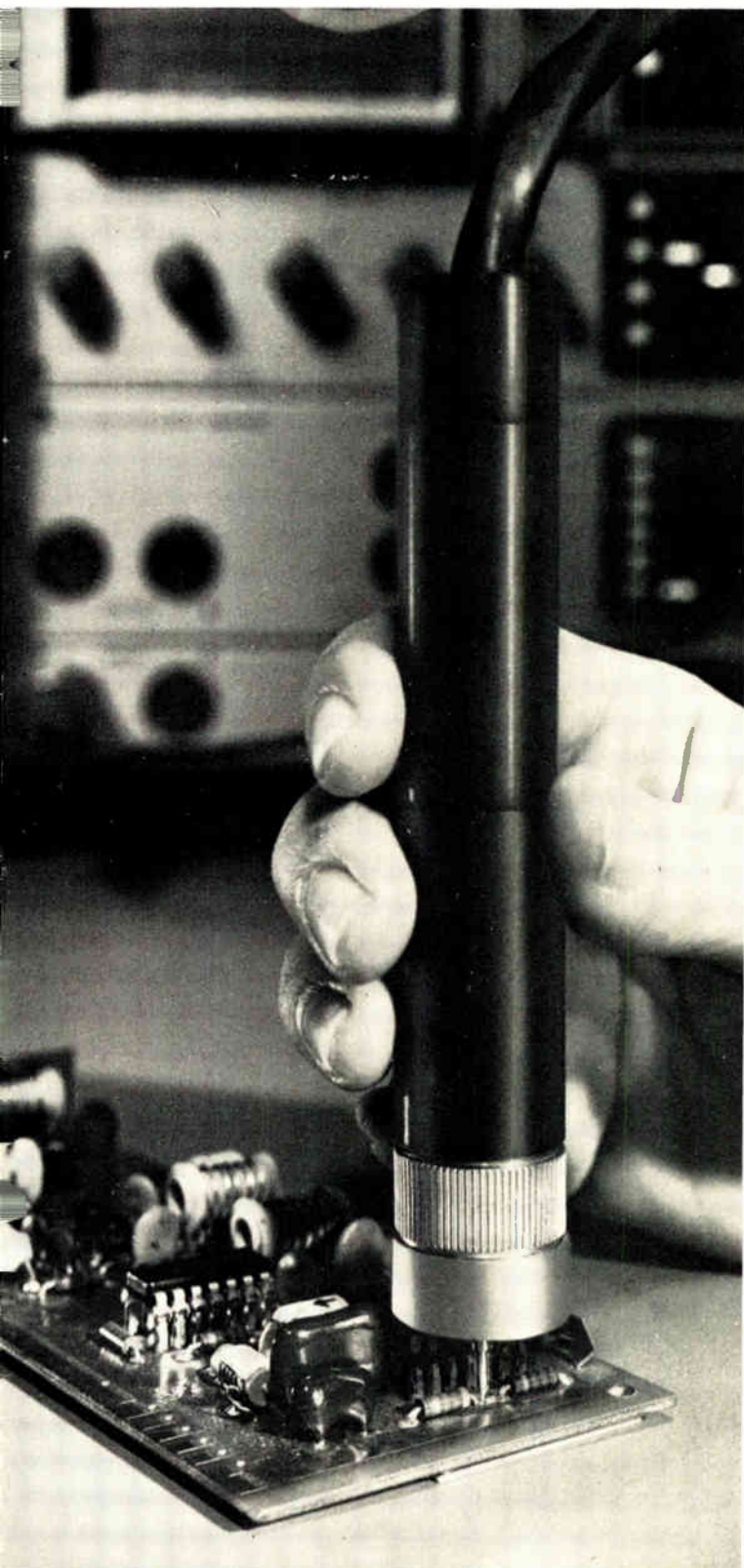

**NEED** to make high-frequency measurements of dielectric materials? To determine transistor  $Y_{22}$  parameters? To match a network to nearly any impedance over a broad frequency range?

**NEED** to study the frequency behavior of resistors, capacitors, and inductors, or to make high-resolution measurements of coaxial standards and components?

**NEED** to determine impedance from  $0.5 \Omega$  to  $1 M\Omega$  or admittances from  $1 \mu\Omega$  to  $2 \Omega$ ? Need a pushbutton choice of a phasor display ( $Z \angle \theta$  or  $Y \angle \theta$ ) or a Cartesian/polar display ( $R + jX$  or  $G + jB$ ) — from 400 kHz to 500 MHz?

**NEED** all this for \$595? Then order a GR 1710-P5 Immittance Probe for your 1710 RF Network Analyzer. The 1710-P5 is the latest engineering achievement to expand the versatility of the basic 1710 and to improve **your** high-frequency measurements.

**NEED** a 1710 also? That's only \$6850 for sweep-frequency measurements from 400 kHz to 500 MHz with 115-dB dynamic range and 0.005-dB resolution. In addition to measurements of impedance, the 1710 also provides measurements of transmission and reflection properties in both 50-ohm and 75-ohm systems and measurements of group delay and s-parameters.

**INDEED**, the 1710!

 **General Radio**

NEW YORK (N.Y.) 212 964-2722, (N.J.) 201 791-8990 • BOSTON 617 646-0550 • DAYTON 513 294-1500  
CHICAGO 312 992-0800 • WASHINGTON, D. C. 301 948-7071 • ATLANTA 404 457-2485  
DALLAS 214 234-3357 • LOS ANGELES 714 540-9830 • SAN FRANCISCO 415 948-8233  
TORONTO 416 252-3395 • ZURICH (01) 55 24 20

GR COMPANIES • Grason-Stadler • Time/Data • Techware Computing Corp.  
GR ASSOCIATE • Micronetic Systems Inc.

# The most complete line of sweepers between here and 1.4 GHz.

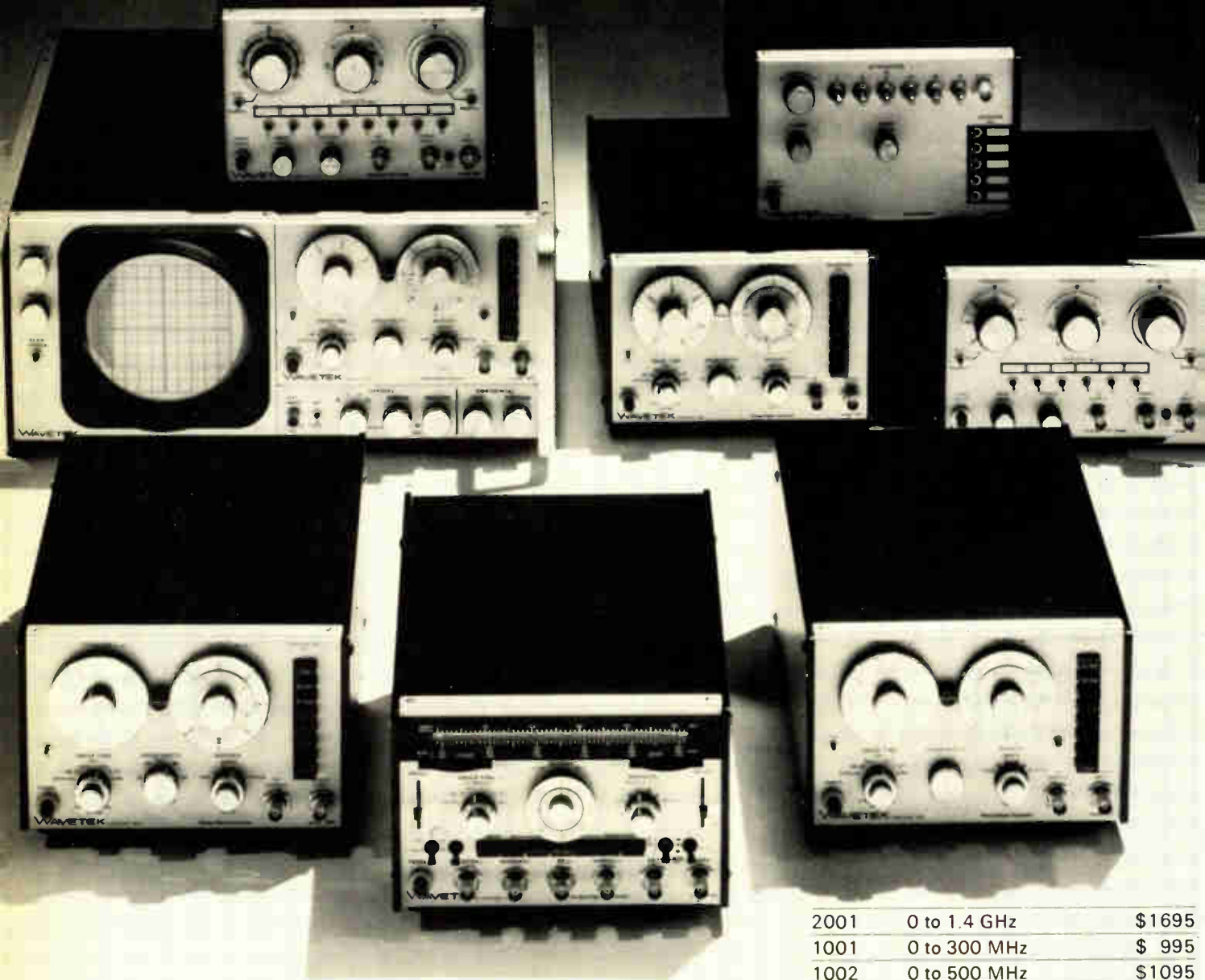

2001	0 to 1.4 GHz	\$1695
1001	0 to 300 MHz	\$ 995
1002	0 to 500 MHz	\$1095
1003	350 MHz to 650 MHz	\$ 995
1004	500 MHz to 1 GHz	\$ 995
1005	700 MHz to 1.4 GHz	\$ 995

No matter what your frequency range or your price range, there's a Wavetek Sweep/Signal Generator to fit it. All have laboratory and production capabilities in a rugged solid-state design. They include such features as pin diode internal or external leveling, front panel crystal-controlled markers with amplitude, width and tilt controls, and up to 90db attenuation. And the frequency, amplitude and sweep width may be remotely programmed. So take your pick.

Circle 122 on reader service card

## WAVETEK®

INDIANA INCORPORATED  
P. O. Box 190, 66 North 1st Ave.  
Beech Grove, Ind. 46107

## Inter-bus modules fashion mini arrays

User of PDP-11 can build his own multiprocessors, networks, and computer hierarchies; unified bus architecture is the key

by James Brinton, Boston bureau manager

**Spokesmen** for the Digital Equipment Corp. say that DEC's introduction of three bus-interconnection modules for its PDP-11 computers could be that firm's most important move of 1973. For the first time, a major computer maker is offering its customers the capability to construct multiprocessor arrays, computer hierarchies, and networks—and all with minimal need for manufacturer support.

With this approach, a user can start out with a single processor system and add processing power as needed. Users with high-reliability applications now can easily construct redundant processor systems. Others with costly peripherals can profit from DEC's modules. With the lower cost of integrated circuitry, central processors have become one of the least costly parts of any computer system—computer power is inexpensive, compared to peripheral and interfacing equipment.

**Thrifty.** But as yet, "men specifying systems don't tend to think of multiprocessors as money-savers," says a DEC engineer. "We figure that a third or more of the tasks now reserved for medium-scale machines could be performed more economically with multiprocessor mini-computers, and now we are giving users the tools needed to put them together without the cost penalties associated with custom-multiprocessor installations."

The new tools are made possible by the PDP-11's unified bus architecture. The so called Unibus scheme is democratic in the sense that every part of the computer can be addressed as if it were a location in memory. This approach can now make possible complex gross archi-

tectures as DEC's new interconnecting modules address other buses and devices on them as if they were at addresses on the host computer's buses.

**A trio.** DEC is offering three types of interconnection modules—the switch (DT-03), the link (DA-11-B), and the window (DA-11-F). The switch, the simplest of the three, is expected to sell into applications where computer reliability is at a premium. A typical installation might consist of a 100% redundant processor system expected to run an industrial process with a minimum of downtime. One processor would be in operation with the other on standby. Should the running computer fail, the switch would place the other computer on line either manually or automatically. Switching time is less than 1 microsecond, and during that time, the two computers' buses are synchronized.

In shared peripheral applications, the switch's latency time becomes an important specification; in this case, bus cycles that pass through the switch are lengthened by 450 nanoseconds. The switch is all-solid-state, not only for speed, but also to maintain the impedance character-

istics of the extended bus structure. In its various uses, the switch can be more than merely a single-throw, double-pole device; switches can be arranged to form matrixes that allow communication among several bus structures. The constraints are the imagination of the user and a 100-foot limit on the length of any combination of buses.

**On guard.** The switch includes a so-called watchdog timer, which allows a back-up computer to take peripheral control away from a failed processor—one that doesn't respond to a request signal within 10 milliseconds.

Power-isolation circuitry is also included in the switch to prevent its loading down a mainframe power supply and also to remove its dependence on mainframe power. Obviously, in a high-reliability application, the switch must not depend on power from a computer that might fail, nor can such an application allow failed peripheral equipment to drain off mainframe power. Failed peripherals also are disconnected automatically.

**Linking up.** Where a system demands greater interaction between connected computers, the link is the

**Reliability.** One PDP-11 interconnection module—the DT-03 switch—makes possible a dual redundant system complete with peripherals and memories as well as processors.

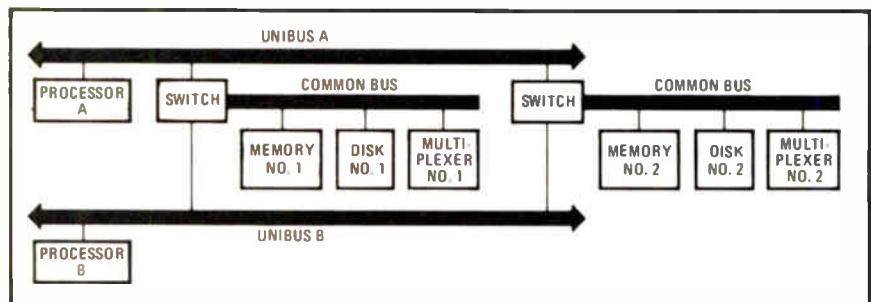

## New products

**50 watts  
from your  
signal  
generator.**



The ENI Model 350L RF power amplifier provides more than 50 watts of linear power and up to 90 watts of pulse power, from 250 KHz to 105 MHz. This all-solid-state unit will supply more than 30 watts at frequencies up to 120 MHz and down to 120 KHz. With a flat 50 dB gain, the amplifier can be driven to full power by a wide variety of signal sources and signal generators. AM, FM, SSB, TV and pulse modulations are faithfully reproduced by the highly linear output circuitry. The 350L is immune to damage due to load mismatch or overdrive, and constant forward power can be delivered to loads ranging from an open to a short circuit. This compact, portable instrument is complete with an integral AC power supply and RF power output meter.

Write for complete information:  
ENI, 3000 Winton Road South,  
Rochester, New York 14623  
Call (716) - 473-6900, TELEX 97-8283.

**ENI ELECTRONIC  
NAVIGATION  
INDUSTRIES**

**ENI . . . The world's leader  
in solid-state power amplifiers.**

choice. This is a parallel transfer channel between computer buses 16 bits wide and capable of operation at memory speeds. Two or more computers can talk to one another via their memories and the half-duplex transmission capability provided by the link, which effectively offers shared access to memory.

The link can transmit blocks of data up to 32,000 words long at up to 8 megabits per second. Each computer processor programs its end of the link; to transmit, it sends to the link an interrupt signal, a status header, control word, and an answer request. Communications protocols are justified at the link, and system balancing is a matter of presetting the appropriate transfer rate. The CPUs don't need to waste computer power on this.

The link might find itself, for example in laboratory instrumentation dual-processor systems. The foreground and background tasks of data acquisition and data analysis would be divided between the two processors, each of which is dedicated. The foreground CPU would occupy itself with acquisition while the background machine would be processing the acquired information. Both phases would be closely coordinated, but with software interaction at a minimum.

**Networking.** DEC spokesmen expect the link to be used in combination with the company's communications equipment to construct networks of computers. "In the past, an EDP designer would look at the total amount of work to be done in an organization, then pick a machine large enough to take it all on," says an engineer. "Now, distributed nets of smaller computers often will cost less than single larger machines and would also simplify programming. Just as there would be nodes of computer power, there would be specific programs for each node and very little need to consider software interaction as it would occur in a single large mainframe."

But it is through the bus window that DEC expects to compete most directly with large computers. The window makes the bus of a connected computer appear like an ex-

ension of its own to a host processor, and because it operates synchronously with bus cycles, the window's actions appear instantaneous to the host processor.

Unlike the link, the window is full-duplex and allows simultaneous multiple-CPU operations with fewer interrupts than the link. At its input port, the window looks like a memory, and at its output it looks like a direct-memory-access channel. Memory may be dynamically shared or not, in real-time under programed control of the memory's host processor. A host CPU can be programed to allow no access, partial access, or read-only or read-write access to its memory. Once this is done, the window makes the proper connections between bus and memory locations, and future memory requests are handled on a completely transparent basis—hence the term "window." And since all peripherals have memory-like addresses, full peripheral sharing comes along as a matter of course.

**Mixable.** And there is no rule against mix and match. The switch, link, and window could appear in the same complex system. Also, because each member of the PDP-11 family is program- and hardware-compatible, users can mix slower machines with faster ones.

A large-scale data-acquisition and handling system might use four processors. At the first level, a processor would interact with a process or experiment through sensors and analog-to-digital converters. After some quick preprocessing, the data would be passed on—perhaps by a link system—to two other machines, which would split the analysis and reduction tasks. These two machines might be linked together themselves, or use a window, depending on the desired throughput. A final processor, probably on a link, would handle files and input-output control. And such a multiprocessor array might be only one node in a larger network.

The switch is priced at \$8,400, the link at \$3,500, and the window at \$5,950.

Digital Equipment Corp., 146 Main St., Maynard, Mass. 01754 [338]

Computer malfunctions cause incalculable chaos in split seconds. That's why you need multi-layer laminates made by the finicky folks at Norplex Division of UOP.

They're such sticklers for high standards they had to design much of their own quality-control equipment. That's how they can guarantee to meet or exceed NEMA, MIL-P and customer specifications.

And their clean rooms with precisely controlled temperature and humidity provide an extra measure of inclusion-free dependability. Norplex multi-layer laminates are without equal for stress-free uniform quality and dimensional stability.

Your Norplex representative is unique, too. He's a laminate engineer, a problem-solving consultant, offering you the widest line of laminates in the business. And he's backed by a

customer-service team assigned to each account for complete follow-through.

For process predictability in computer laminates, call on the Lint-Pickers. Norplex Division, UOP (Universal Oil Products Company).

Main Office and Plant  
Norplex Drive  
LaCrosse, Wisconsin  
54601  
608/784-6070

Franklin Office and Plant  
P.O. Box 186—  
Route 31 North  
Franklin, Indiana 46131  
317/736-6106

## How the Lint-Pickers keep the numbers game clean.

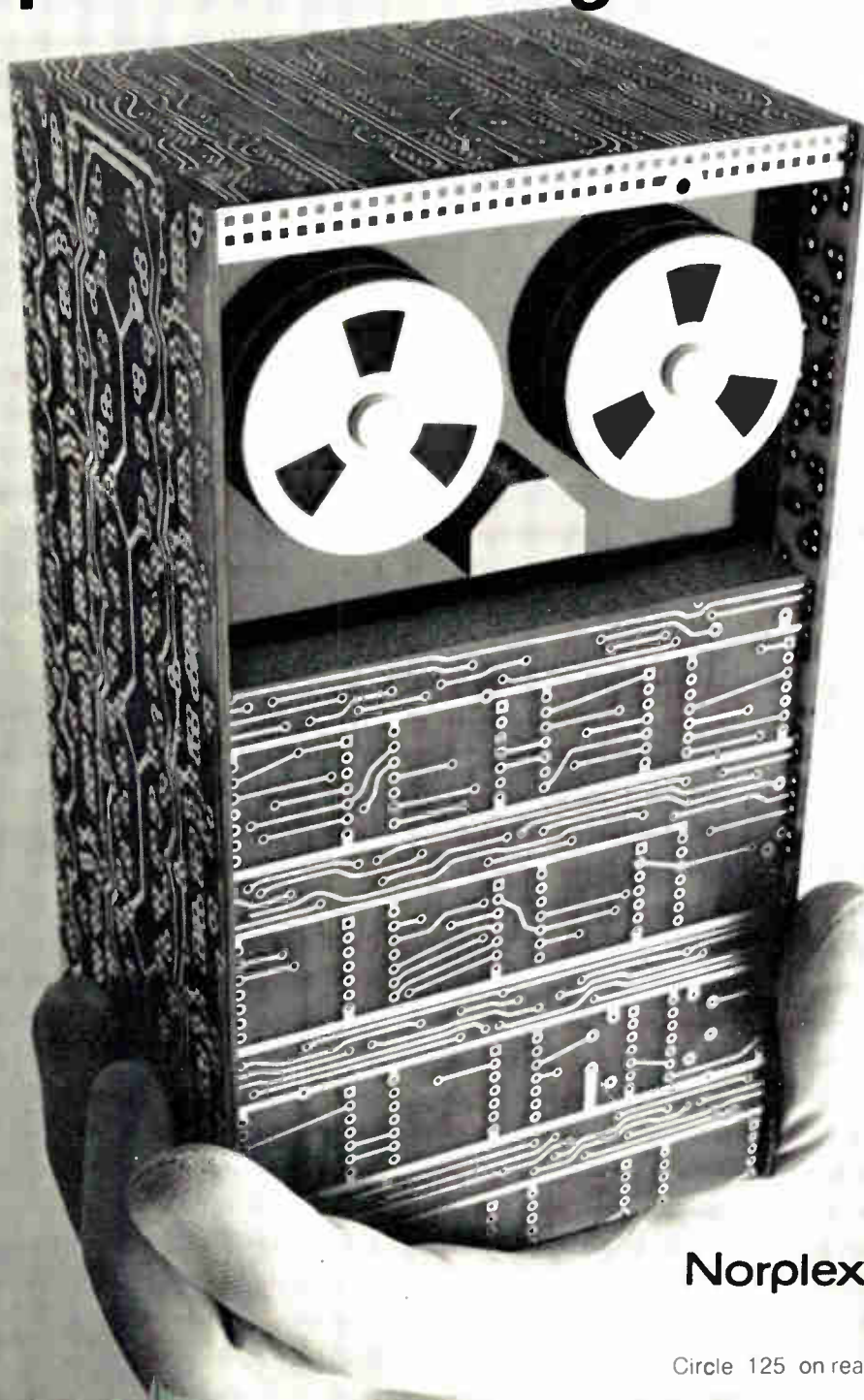

**Norplex<sup>®</sup> laminates**  
by **UOP**

Circle 125 on reader service card

# The 5 fastest ways to make better inverters.

## ① The new 81RM — fastest 125 Amp inverter SCR around.

It has  $20\mu\text{S}$  turn-off, through 1000V, with efficiency that cuts filtering, commutating and snubbing costs up to 30% in new designs. Plugged into existing circuits, it can increase overload capability or power rating by 50%. Its 30% lower switching losses let you operate efficiently at 10KHz. And for today's circuits, a guaranteed turn-off time of  $25\mu\text{S}$  with an antiparallel diode gives unequalled speed. The best "soft recovery" in the business assures the lowest RFI generation, minimizes false triggering and improves reliability. Voltage ratings from 100-1000V.  $dv/dt$  is  $200\text{V}/\mu\text{S}$ , and  $di/dt$  is  $800\text{A}/\mu\text{S}$ .

## ② New 35 Amp IR140/141's. None faster. Lowest switching losses.

At  $15\mu\text{S}$  and  $10\mu\text{S}$  turn-off, there are no faster SCRs in their range. But what really sets them apart is the 30% lower switching loss for unequalled efficiency at high frequencies. No derating to 4KHz, and 50% of the rated current at 20KHz. Excellent as commutating SCRs. Conforms to JEDEC 2N3649-58. Reapplied  $dv/dt$  is  $200\text{V}/\mu\text{S}$ , and  $di/dt$  is  $400\text{A}/\mu\text{S}$ . Voltage ratings: 50-400V.

To get our Inverter SCR "Data pack" fast, write Dept. E

International Rectifier  
233 Kansas Street  
El Segundo, CA 90245

## New — The fastest Turn-Off ( $10\mu\text{S}$ ) high-current inverter SCRs available!

These low-frequency inverter SCRs turn off four times faster than others at their power level. You can reduce commutating component size and cost  $\frac{1}{3}$  and still increase inverter ratings with greater reliability. Higher surge ratings give you bigger safety margins, easier fuse selection. To top it off, you can choose from three package types in 50-600V ratings to optimize your design.

③ New 430 Amp (RMS), 275RF Series. The only stud-mounted 430 Amp (RMS) inverter SCR available. 7000 Amp surge rating.  $200,000\text{A}^2\text{Sec}$ .  $I^2t$  rating.

④ New 710 Amp (RMS), 450PF Series. Rated 710 Amp (RMS), this ceramic "Hockey Puk" has a surge rating of 9000 Amps and  $I^2t$  of  $340,000\text{A}^2\text{Sec}$ .

⑤ New 710 Amp (RMS), 451PF Series. For maximum economy, the first and only plastic encapsulated 710 Amp (RMS) "Hockey Puk" SCR. Surge rating: 9000 Amps.  $I^2t$  is  $340,000\text{A}^2\text{Sec}$ .



# International Rectifier

the innovative power people 

## Subassemblies

**Amplifier built to cover all bases**

---

Speedy sample-and-hold unit is designed for a variety of data handling tasks

---

In the new sample-and-hold amplifier from Teledyne-Philbrick, a promise of fast performance is to be expected. What's unexpected is the improved and more thorough specifications. Often, users buy seemingly good sample-and-hold devices, only to find them faulty in some key aspect. T-P spokesmen say this usually results from insufficient or misunderstood specifications, and with its new 4853 the company is trying to cover all the bases, whether the device is to be used in data acquisition, analog-to-digital or digital-to-analog conversion systems, pulse stretchers, process control, or "de-glitching" circuits.

The 4853's usual specifications are respectable. Acquisition time is 1 microsecond to  $\pm 0.01\%$  for a 10-volt input step signal. Its bandwidth can extend to 20 kilohertz within  $\pm 0.01\%$ . Settling-time to 0.01% is 1.4  $\mu\text{s}$  for a 20-v input, and 1  $\mu\text{s}$  for a 10-v step. The network slews at 30 V/ $\mu\text{s}$ , and accuracy is nominally to within  $-0, +0.05\%$ , with linearity to within 0.005%.

But other specifications often are missing, or misapplied. Examples are aperture-time uncertainty and feedthrough.

The 4853's aperture time can be 0 to 10 nanoseconds. Aperture time uncertainty—the time variation between a hold command and its actuation—is  $\pm 1$  ns. When combined with an application's required accuracy, uncertainty time can give the useful bandwidth of a sample-and-hold amplifier and the ultimate magnitude of any output error—factors an engineer often needs, but sometimes may not have, for choosing the right device.

And according to T-P spokesmen,

the importance of feedthrough, if not misunderstood, is often underestimated. T-P designed it as the effect of an input signal on the output signal when the amplifier is in the hold mode. Normally this varies with input level and frequency, but T-P uses a proprietary circuit to cut feedthrough to 1 millivolt at most, regardless of frequency and at inputs of up to 10 v. Not only does low feedthrough improve accuracy, but it also allows higher throughput. Multiplexing can continue during analog-to-digital conversion—there is no need to synchronize conversion to sampling time.

Small quantities of the 4853 are available within two weeks at \$125 each. Lots of 100 or more are priced at \$99.50 each.

Teledyne-Philbrick, Allied Dr. at Rte. 128, Dedham, Mass. 02026 [381]

---

**Oscillators tunable over three decades**

Three new tunable quadrature-output sine-wave oscillators are finding ready application in testers, demodulation filters, synchros and servos, resolvers, and other equipment, in addition to the usual fixed or swept-output applications. The modules, which measure 2 by 3 inches, can be tuned over three decades. Made by Frequency Devices Inc. of Haverhill, Mass., the model 444 is tunable from 20 kilohertz to 20 Hz, the 442 from 500 Hz to 0.5 Hz, and the 440 from 50 Hz to 0.5 Hz.

The quadrature outputs from each of the modules are kept in phase to within  $0.1^\circ$  over its full frequency range, accounting in part for their acceptance in synchro/servo applications. Distortion is low, with 0.27% total harmonic distortion at the sine output and 0.087% at the cosine output. Spurious response is 85 decibels below 10 volts peak-to-peak output, and output, which is adjustable over a peak-to-peak range of 2 – 20 v, can be either controlled resistively or by voltage. Amplitude/temperature drift is only 0.0008 dB/ $^\circ\text{C}$ .

With addition of associated elec-

tronics, the devices become part of systems to test harmonic or inter-modulation distortion in audio equipment, modulator/demodulator pairs, transmitters and receivers, and even spectrum analyzers. Frequency synthesizers normally trade their frequency accuracy for distortion figures in the order of 1%. Few available commercial testers have distortion below 0.1%, and these usually include precision RC oscillators that are costlier than the frequency technology modules.

Prices for the 440 and 444 range from \$113 each in single quantities to \$66 each in lots larger than 100; the 442 costs \$99 and \$56.

Frequency Devices Inc., a subsidiary of Frequency Technology Inc., 25 Locust St., Haverhill, Mass. 01830 [382]

---

**Supply delivers 250 watts in 10-pound package**

High power levels in space-restricted systems are provided by the 662 series of power supplies, which deliver 250 watts. Model 662A05 delivers 5 volts at 50 amperes over the range of  $-20^\circ\text{C}$  to  $+40^\circ\text{C}$  with no moving air required. Efficiency is reported to be 70%, and combined line and load regulation is  $\pm 0.2\%$ . Model 662 accepts either 102–130 v ac or 198–256 v ac input with no circuitry changes required. Output noise and ripple are only 50 mv peak-to-peak measured differentially. The 662A05 weighs approximately 10 pounds.

Trio Laboratories Inc., 80 Dupont St., Plainview, L.I., N.Y. 11803 [384]

---

**Low-priced digital-analog converter resolves 12 bits**

Designed for such large-quantity applications as data-distribution, process-control, and instrumentation systems, a 12-bit modular digital-to-analog converter provides typical settling times (to within  $\frac{1}{2}$  the least-significant bit) of 5 microseconds, linearity to within 0.012%, and a typical temperature coeffi-

**Finally!**  
**A filter so precise,**  
**filter characteristics**  
**for every setting**  
**are printed**  
**on top.**



We've built a variable electronic filter that's so precise, it has enabled us to print the cutoff frequencies, center frequency, bandwidth, noise bandwidth and filter gain, for every setting, *on top of the instrument*. Besides being the easiest-to-use filters on the market, our 4200 series filters are twice as accurate, have less than half the self-noise, and provide 10 dB greater outband rejection than any other filters. Frequency coverage is .01 Hz to 1 MHz. Built-in selectable post-filter gain and remote preamplifiers are optional. A Butterworth response is used in the NORMAL mode and a Bessel response in the PULSE mode (transient response is superior to conventional "RC" or "Low Q" modes of other filters).

The price? \$695.

For complete specifications and your free copies of our variable electronic filter application notes, write to: Ithaco, Inc., Box 818-7R, Ithaca, New York 14850. For immediate response, call Don Chandler at 607-272-7640 or TWX 510-255-9307.

**ITHACO**

**New products**

cient of 15 ppm/°C. The units are priced at \$39 each in quantities of 100. They make extensive use of medium-scale integration to keep the parts count down to 27 components, with a resulting mean-time-between-failure reported by the company as 500,000 hours. The MP1412 is self-contained, with an

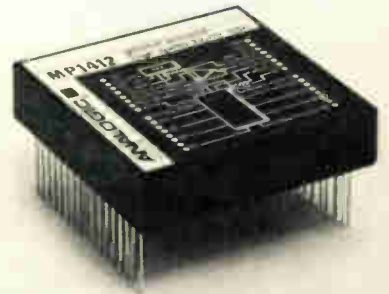

internal precision reference supply, ladder network and output amplifier. Full-scale analog outputs of -10 to +10 volts, 0 to +10 v, -5 to +5 v, and 0 to +5 v are pin-selectable to match nearly all DAC applications. The MP1412 accepts standard TTL-logic-level inputs and can be interfaced directly with computers.

Analogic, Audubon Rd., Wakefield, Mass. 01880 [383]

**Two-digit LED module**  
**built for multiplex jobs**

A two-digit LED module with 0.19-inch characters is designed to add economy to multiplex-drive applications. The DL-44 is designed for use where displays have multiple

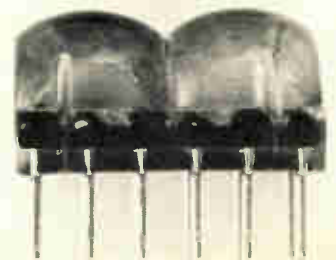



# PTM DUALS.

## A powerful addition to the Sorensen modular line.



Nine new dual output supplies are everything you expect from Sorensen's compact PTM line. Unmatched power density and built-in overvoltage protection on every model. Plus a unique +5, -12 volt output for MOS applications.

The PTM duals are packed with performance for OEM requirements. Like adjustable tracking accuracy to 0.2%. Regulation of 0.02%. Transient response of 50  $\mu$ sec.

PTM duals. First in performance, first in reliability. Send for complete data. Write Sorensen Company, a unit of the Raytheon Company, 676 Island Pond Rd., Manchester, N.H. 03103. Telephone (603) 668-4500. Or TWX 710-220-1339.

# Sorensen

## POWER SUPPLIES

SPECIFICATIONS							
Package size I: 3 <sup>5</sup> / <sub>16</sub> x 3 <sup>7</sup> / <sub>8</sub> x 6 <sup>1</sup> / <sub>2</sub>							
Model	Adjust. Range (VDC)		Current Rating (A)				Price*
	Min.	Max.	40°C	50°C	60°C	71°C	
PTM-12-1D	11	13	1.0	0.9	0.7	0.4	\$130
	11	13	1.0	0.9	0.7	0.4	
PTM-15-8D	14	16	0.8	0.72	0.56	0.32	\$125
	14	16	0.8	0.72	0.56	0.32	
PTM-5/12D1	4.75	5.5	2.0	1.8	1.4	0.8	\$135
	11	13	0.5	0.45	0.35	0.2	
Package size II: 3 <sup>5</sup> / <sub>16</sub> x 5 <sup>1</sup> / <sub>8</sub> x 6 <sup>1</sup> / <sub>2</sub>							
PTM-12-1.6D	11	13	1.6	1.44	1.12	0.64	\$155
	11	13	1.6	1.44	1.12	0.64	
PTM-15-1.5D	14	16	1.5	1.35	1.05	0.6	\$150
	14	16	1.5	1.35	1.05	0.6	
PTM-5/12DII	4.75	5.5	3.5	3.15	2.45	1.4	\$160
	11	13	1.0	0.9	0.7	0.4	
Package size III: 3 <sup>5</sup> / <sub>16</sub> x 5 <sup>1</sup> / <sub>8</sub> x 9 <sup>1</sup> / <sub>2</sub>							
PTM-12-3D	11	13	3.0	2.7	2.1	1.2	\$180
	11	13	3.0	2.7	2.1	1.2	
PTM-15-2.8D	14	16	2.8	2.52	1.96	1.12	\$175
	14	16	2.8	2.52	1.96	1.12	
PTM-5/12DIII	4.75	5.5	6.0	5.4	4.2	2.4	\$185
	11	13	1.5	1.35	1.05	0.6	

\*U.S.A. list.

**An Important Public Service Message**

**HyComp Addresses the Problem of Inflation**

**Q** What is better than two for the price of one?

**A** Using one instead of two for the price of one!

IF YOU NEED PRECISION THIN FILM RESISTOR LADDER NETWORKS TO USE WITH CURRENT SWITCHES (such as Intersil's 8018A thru 8020A and Fairchild's  $\mu$ A9650) FOR A/D AND D/A CONVERSION AND WANT LOWER COST, SMALLER SIZE AND A CHOICE OF PACKAGING . . . DIP, FLAT PACK OR CHIP, READ ON! ACQUAINT YOURSELF WITH AN EXTRAORDINARY SOURCE OF THIN FILM MICROCIRCUITS AND HYBRID DEVICES

HC-130 and HC-135 SERIES . . . OFFERS A 12 BIT WEIGHTED RESISTOR LADDER NETWORK ON A SINGLE CHIP . . . REPLACING THE STANDARD TWO CHIPS . . . PROVIDING SUPERIOR T.C. TRACKING AND OTHER CHARACTERISTICS . . . ONLY \$24.00 (1-99) and \$17.00 (1K).

SPECIFICATIONS INCLUDE: T.C. TRACKING: <1 ppm/°C. RATIO ACCURACY: 0.01%. MAX. ACCUMULATED POSITIVE OR NEGATIVE ERROR: 0.012% F.S. PACKAGING: 24 LEAD DIP OR FLAT PACK. HERMETIC OR NON-HERMETIC. ALSO 110 x 190mm. CHIP. 10 and 8 BIT MODELS ARE ALSO AVAILABLE

THE HC-130 SERIES IS USED WITH INTERSIL'S SWITCHES AND THE HC-135\* SERIES WITH THE FAIRCHILD  $\mu$ A9650.

HC-130A and HC-135A SERIES . . . THE 3 DECADE BCD WEIGHTED LADDER COUNTERPARTS OF THE HC-130 and HC-135 SERIES . . . WITH THE SAME CHARACTERISTICS EXCEPT: RATIO ACCURACY: 0.05%. MAX. ACCUMULATED POSITIVE OR NEGATIVE ERROR: 0.05% F.S.

IF THE OLD STANDARD TWO PACKAGES HAVE ALREADY BEEN FROZEN INTO THE DESIGN, HYCOMP ALSO PROVIDES MODELS HC-420 and HC-430 . . . in 14 LEAD DIP OR FLAT PACK WITH THE SAME ESSENTIAL PERFORMANCE AS MODEL HC-130 . . . FOR USE WITH INTERSIL SWITCHES. MODELS HC-425 and HC-435 FOR FAIRCHILD'S  $\mu$ A9650.

AND IF YOU NEED PRECISION THIN FILM R-2R LADDER NETWORKS . . . ON THE SMALLEST SINGLE CHIPS AND AT THE LOWEST LIST PRICES:

HC-1000 SERIES . . . 12 BIT NETWORK WITH STANDARD RESISTANCE VALUES OF 5K, 10K, AND 25K. . . ONLY \$23.20 (1-99).

SPECIFICATIONS INCLUDE: T.C. TRACKING: <1ppm/°C. RATIO ACCURACY: 0.01%. MAX. ACCUMULATED POSITIVE OR NEGATIVE ERROR: 0.012% F.S. PACKAGING: 16 LEAD DIP OR FLAT PACK. HERMETIC OR NON-HERMETIC. ALSO 100 x 150mm. CHIP. 10 and 8 BIT MODELS ARE ALSO AVAILABLE.

HC-210 SERIES . . . offers a 12 BIT LADDER NETWORK WITH A RESISTANCE VALUE OF 50K for MOS OR ANY ANALOG SWITCH WITH A HIGH SATURATION RESISTANCE . . . ONLY \$25.00 (1-99).

SPECIFICATIONS INCLUDE: T.C. TRACKING: <1ppm/°C. RATIO ACCURACY: 0.01%. MAX. ACCUMULATED POSITIVE OR NEGATIVE ERROR: 0.012% F.S. PACKAGING: 16 LEAD DIP OR FLAT PACK. HERMETIC OR NON-HERMETIC. ALSO 100 x 190mm. CHIP. 10 and 8 BIT MODELS ARE ALSO AVAILABLE

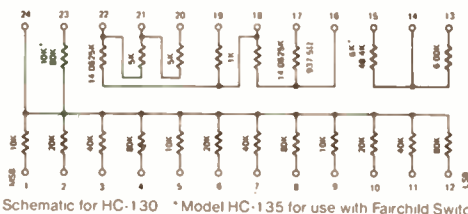

Schematic for HC-130 \* Model HC-135 for use with Fairchild Switch

HyComp's expertise and facilities embrace thin film microcircuits and hybridized fabrication as well as analog/digital functions. In addition to supplying many standard resistor networks and D/A converters with a normal delivery time of 2 weeks, we are pleased to consider modifications and specials whenever economically feasible.



146 Main Street, Box 250 Maynard, Mass. 01754 (617) 897-4578

**New products**

minimum of  $\pm 20$  milliamperes at  $\pm 20$  v. The unit also has a 25-nanoampere bias current, 1-megahertz bandwidth, 6-v/microsecond slew rate, and 86-dB minimum common-mode rejection ratio. Housed in a low-profile module, the 1034 is



priced a \$30 each in lots of 100. For critical applications, the model 103401, which offers  $\pm 5 \mu\text{V}/^\circ\text{C}$  maximum offset voltage drift, is priced at \$37 each in quantities of 100.

Teledyne Philbrick, Allied Drive at Route 128, Dedham, Mass. 02026 [387]

**A-d converters offer**

conversion time to 2  $\mu\text{s}$

A series of high-speed analog-to-digital converters providing binary resolution from 8 through 14 bits offer total conversion time as short as 2 microseconds. All units in the 800 series are complete, fully assembled, tested, and calibrated, system-ready, plug-in modules incorporating all of the functions except power supplies, necessary to perform conversions. No external reference-voltage

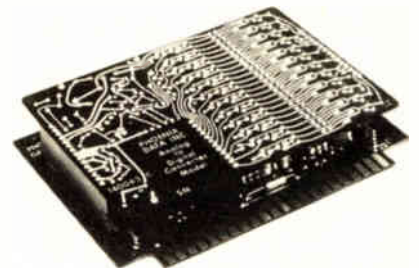

source, amplifiers, or trimming potentiometers are required.

Conversion times for specific units are as follows: 10  $\mu\text{s}$  for 14 bits, 4  $\mu\text{s}$  for 12 bits, 3  $\mu\text{s}$  for 10 bits, and 2  $\mu\text{s}$  for 8 bits.

Single-unit prices are: 8 bits, \$295; 10 bits, \$380; 12 bits, \$515; 14 bits, \$695.

Phoenix Data Inc., 3384 West Osborn Rd., Phoenix, Ariz. 85017 [384]

# For built-in reliability, design with "Scotchflex" Flat Cable/Connector Systems.

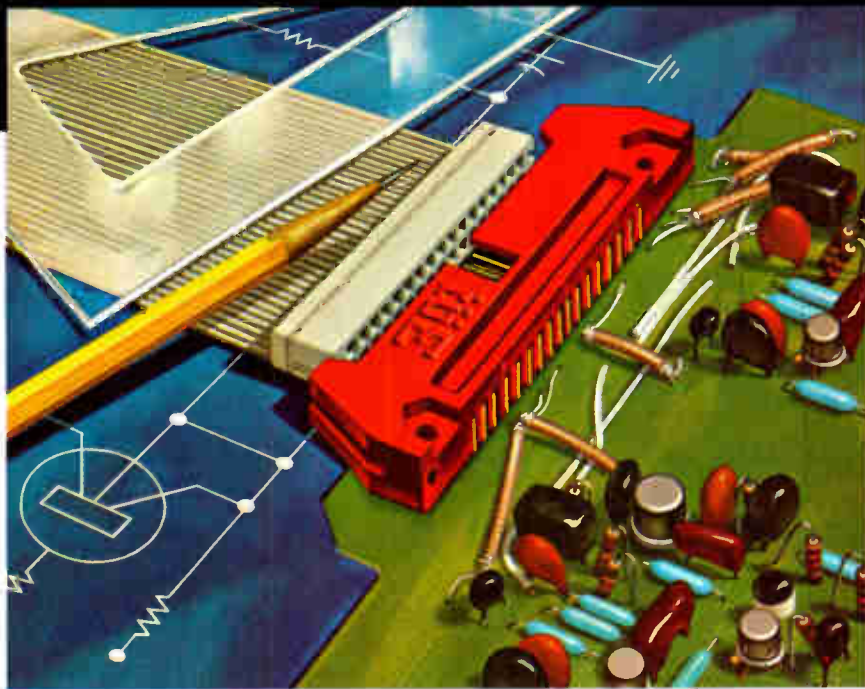

"SCOTCHFLEX" IS A REGISTERED TRADEMARK OF 3M CO.

"Scotchflex" Flat Cable and Connectors can offer you trouble-free packaging for your next generation equipment.

There's built-in reliability for your circuit inter-connects. Our flat, flexible PVC Cable has up to 50 precisely spaced conductors. The gold plated U-contacts are set into a plastic body to provide positive alignment. They strip through the insulation, capture the conductor, and provide a gas-tight pressure connection.

Assembly cost reductions are built-in, too. "Scotchflex" Connectors make up to 50 simultaneous connections without stripping or soldering. No special training or

costly assembly equipment is needed.

Off-the-shelf stock offers you flat cable in a choice of lengths and number of conductors from 14 to 50. Connector models interface with standard DIP sockets, wrap posts on .100 x .100 in. grid, or printed circuit boards. Headers are available to provide a de-pluggable inter-connection between cable jumpers and printed circuit boards (as shown). Custom assemblies are also available on request.

For full information on the "Scotchflex" systems approach to circuitry, write to Dept. EAH-1, 3M Center, St. Paul, Minn. 55101.

**3M**  
COMPANY

**This problem should take you  
about 42 minutes to solve.**

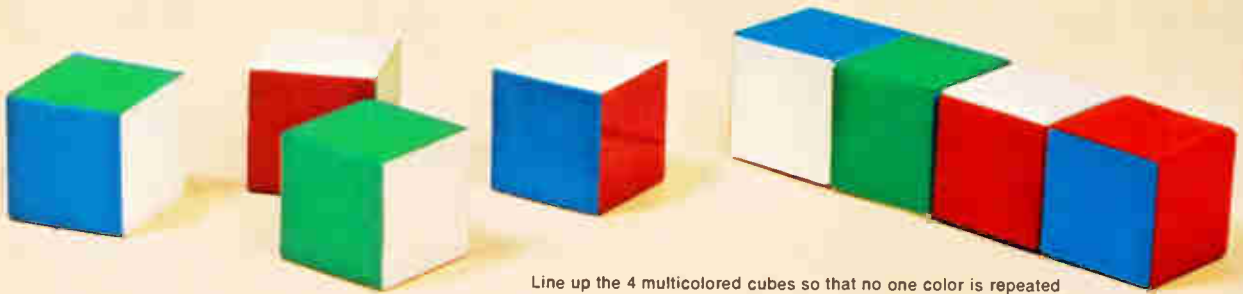

Line up the 4 multicolored cubes so that no one color is repeated on any side.† As an engineer you should do this in 42 minutes.\*

**With P & B's four new time delay relays  
you solve cost, accuracy and size problems.  
Immediately.**



R12

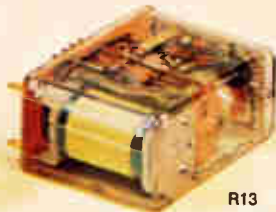

R13

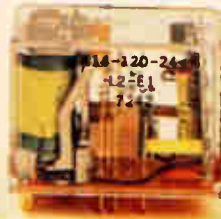

R14



R15

These new solid state time delays—each designed to solve different design problems—are built around our compact, widely accepted R10 relay. Each is available in 2 or 4 Form C contact arrangements and may be mounted directly to a chassis, printed circuit board, special mounting strip or in sockets having solder or printed circuit terminals.

**R12 Series.** A high resolution, 15-turn potentiometer provides delay on operate timing variations within ranges of 0.1 to 2.0, 1.0 to 30 and 5.0 to 120 seconds. Coils are for 12, 24 or 48V DC. Six contact styles cover a load range from dry circuit to 10 amperes.

**R13 Series.** These fixed, delay on operate time delays are available in 10 timing ranges from 1 to 300 seconds. They require less than 240 milliwatts of DC to operate. Operating voltages are 12, 24 and 48V DC. Contact ratings: dry circuit to 5 amperes.

**R14 Series.** Seven timing ranges provide delay on operate (R14) or interval timing (R14A) from .025 to 600 seconds. Available fixed or externally adjustable with coil voltages of 6, 12, 24 and 48V DC. Contacts may be specified from dry circuit to 10 amperes.

**R15 Series.** AC operated from 12, 24, 48 and 115V power sources,

these compact time delays may be ordered fixed or externally adjustable in seven timing ranges from .025 to 300 seconds. Delay on operate (R15) or interval timer (R15A) modes are available.

Get complete specifications from your local P&B representative or call Potter & Brumfield Division AMF Incorporated, Princeton, Indiana 47670. 812-385-5251.

*\*Think you can readily solve the puzzle shown above? Ask your P&B representative for one.*

**Solving switching problems is what we're all about.**



## New products

### Instruments

## DMM specs rise, price stays low

4½-digit unit has five ac and dc voltage ranges, offers 3-year warranty, \$595 price

The purchaser of a 4½-digit multimeter today is in an enviable position—at least eight major manufacturers are competing for his business. And they are offering him more value for his money than ever before. At least one company is trying to beat the industry leader by offering equivalent performance at a much lower price, while several others are offering substantially improved performance at a slightly higher price. Hickok, however, is pursuing a different route: its new model 3400 offers substantially improved performance at exactly the same price as the older model—\$595.

The 3400 has five ac and dc voltage ranges, instead of the usual four; six resistance ranges instead of five; and a three-year warranty, instead of the usual one year, or, for a few instruments, 90-day guarantee. Furthermore, the 3400 has 100% overranging as a standard feature (some units have only 20%), and it has a \$100 option that provides 300% overranging on the dc scales. The extra ac and dc voltage ranges provided by the 3400 are 100 millivolts full scale; the instrument, therefore, has a resolution of 10 microvolts. Both ac and dc current can also be measured in five ranges from 100 microamperes full scale to 1 A full scale. The current-measuring resolution is therefore 100 nanoamperes. And the six resistance ranges span 100 ohms full scale to 10 megohms full scale, giving the meter a resolution of 0.01 ohm on its lowest range.

Behind the 3400's long warranty period is the manufacturer's belief that its low parts count will make it one of the most reliable meters in

the field. Although it uses more ICs than its principal competitor (11 vs five), it uses fewer capacitors, diodes, transistors, and resistors—for a total parts count of 245 vs 502 for the other unit.

The meter has a segmented fluorescent display with automatic polarity indication, and an automatically positioned decimal point. Overrange is indicated by blinking of the display.

A rechargeable nickel-cadmium battery pack, which is available as an option for \$200, provides eight hours of continuous operation and has a maximum recharge time of 16 hours. Its lifetime is at least 1,000 recharge cycles.

The Hickok Electrical Instrument Co., 10514 DuPont Ave., Cleveland, Ohio 44108 [351]

### Laboratory tape recorder provides 28 channels

Advances in microcircuit logic during the past several years contributed significantly to development of a high-performance, laboratory-type magnetic tape recording system introduced this month by Honeywell Instruments Division. The ICs were used, not so much to reduce the size of the instrument as to pack more capability into the same space.

The analog recorder/reproducer, designated the model Ninety-Six, provides 28 channels, expandable to 42; nine selectable speeds from 15/16 to 240 inches per second, up to 16-inch reel capacity, solid ferrite heads with a 3,000-hour warranty, and all-solid-state modular construction.

In addition to features of earlier Honeywell models, the new system offers all-band data electronics, electronic shuttle programing, intermediate and wideband direct-phase equalization, digital ratio comparator end-of-tape sensing, and an LED electronic footage counter.

Of special interest to those interested in very-narrow-band analysis, Honeywell points out, the Ninety-Six achieves a high degree of spectral purity.

The system offers both inter-



Prescribe instant relief from head worries by specifying HDC shieldless magnetic recording heads. Choose from the broadest production-proved line in the industry. The pioneer of shieldless heads is first again, now covering the range from 6–250 ips.

## DUAL-GAP WRITE/READ HEADS

## NO EXTERNAL CROSSFEED SHIELD

## 6 TO 250 IPS



HAMILTON DIGITAL CONTROLS, Inc.  
2118 Beechgrove Place, Utica, N.Y. 13501  
(315) 797-2370

# Guess the price. Win the box.

**Hint: Your first guess will probably be  
five or six hundred dollars high.**

What we have here is our new 4700A. A full multimeter with 5 DC ranges (10 microvolt resolution), 4 AC ranges, and 6 ohm ranges.

What would you think that would cost?

Well, add to that *.01% DC accuracy for 90 days.* Sounds expensive.

Next, you have full autoranging or manual selection of range in every function. And *100% overranging* in all functions.

Finally, the standard digital output and remote programming in every one of these units is fully isolated. This is a true systems box, with 100,000-to-1 reduction of errors caused by ground



loops and power line hum.

Surely by now we've convinced you we have here a very expensive multimeter.

Well, that's the whole idea. Because the first

person to guess the price of this new unit exactly, (F.O.B. Irvine, California), is going to win one.

Write your guess down and mail it to Cliff Hamilton at Dana Laboratories, Inc., 2401 Campus Drive, Irvine, California 92664. The correct guess with the earliest postmark wins. The contest closes March 15, 1973.

One more hint. The closest comparable box isn't even close.

**DANA**®

**Others measure by us.**

## New products

mediate band (0.6 MHz at 120 ips) and wideband (2.0 MHz at 120 ips) capabilities. An average system costs \$25,000-\$40,000

Test Instruments Division, Honeywell Inc., 4800 East Dry Creek Rd., P.O. Box 5227, Denver, Colo. 80217 [352]

## Sweep/function generator goes to 20 megahertz

The model 421 function/sweep generator provides a 20-MHz maximum frequency, an internal sweep generator with calibrated sweep limits, and 80-dB attenuation of a 20-volt peak-to-peak output. It provides 10-V dc offset, trigger and gate modes, and a distortion indicator when the combination of offset and output exceed  $\pm 10$  v. Applications are in communications systems, amplifiers, phase-lock loops, and frequency discriminators. The unit handles sine, square, and triangle waveforms. Price is \$895.

Systron-Donner Corp., Datapulse Division, 10150 W. Jefferson Blvd., Culver City, Calif. 90230 [353]

## LCR meter makes up to 10 readings per second

A meter that measures resistance, capacitance, and inductance checks low-value components, semiconductors, delay lines, and pulse transformers. The 1-megahertz unit uses



a four-pair measurement technique—four wires with individual shields—to reduce errors caused by stray capacitance, residual inductance, and noise. The instrument can make as many as 10 measurements per second. Error is a maximum of 0.1%. The model 4271A includes a four-digit light-emitting-diode display with 90% overrange,

# The Iron That Revolutionized Desoldering

The PACE SODR-X-TRACTOR was designed from scratch for power desoldering. Unlike jury-rigged, piggy-back desoldering irons which are top heavy and Unwieldy, the PACE design is well balanced and easy to operate at any angle. PACE SODR-X-TRACTORS feel, weigh, and handle just like your small soldering iron. Plus, consider these other benefits:

1. **POWER VACUUM/PRESSURE CONNECTIONS** keep cords away from your hands and work area.
2. **QUICK DISCONNECT OF SOLDER CHAMBER** permits safe, easy, rapid cleaning.
3. **INSULATED MOLTEN SOLDER RECEIVING CHAMBER** located within handle to protect your hands. Accepts wire-wrap pins and clipped leads.
4. **COAXIAL IN-LINE DESIGN** for balance, feel and use just like a soldering iron.
5. **TIP-TO-GRIP LENGTH** the same as a small soldering iron—for precise manipulation and control.
6. **TIP TEMPERATURE** infinitely controllable from 300°F to 1000°F. Provides automatic control of top (safe) limit while allowing quick cool-down during vacuum sequence.

### JUST PICK A SYSTEM TO SUIT YOUR REQUIREMENTS . . .

We realize that everyone does not have the same desoldering problems so we've built a complete series of power sources to give you the choice of matching your desoldering needs with a system suited to your specific applications. Whether you have in-house vacuum, in-house pressure or want the advantage of a truly portable system. PACE offers many systems for you to choose from. To learn more or get a Free in-house demonstration, just write or call:



**PACE** 9329 Fraser Street  
Silver Spring, Maryland 20910  
(301) 587-1696  
**INCORPORATED**

Circle 137 on reader service card

Why mess around when you can have the **ELECTRONICS BOXER** clean up your copies—keep them in top condition.

And, it's easy and

inexpensive to keep the **ELECTRONICS BOXER** in your corner. Just complete the coupon and mail. Your order will be processed immediately, postpaid.

### ELECTRONICS BOXER

#### Jesse Jones Box Corporation

2250 E. Butler St., Philadelphia, Pa. 19137

Please send me:  boxes @ \$4.25 each;  
 3 boxes @ \$12.00;  6 boxes @ \$22.00

My check or money order is enclosed.

Name \_\_\_\_\_

Address \_\_\_\_\_

City \_\_\_\_\_ State \_\_\_\_\_ Zip \_\_\_\_\_

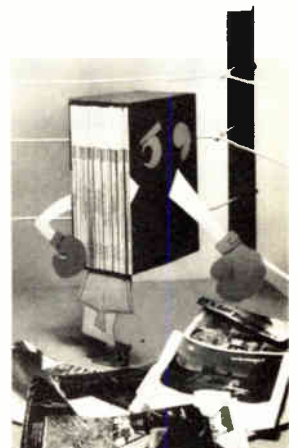

# Frame Up

## with NATIONAL POWER PRODUCTS Open Frame Power Supplies

When your Power Supply requirements include high currents, tight regulation and small size, take a look at National Power's RF Series. What you will find are power supplies that will give you the best electrical parameters, plus a no derating output at operating temperatures from  $-25^{\circ}$  to  $+71^{\circ}\text{C}$

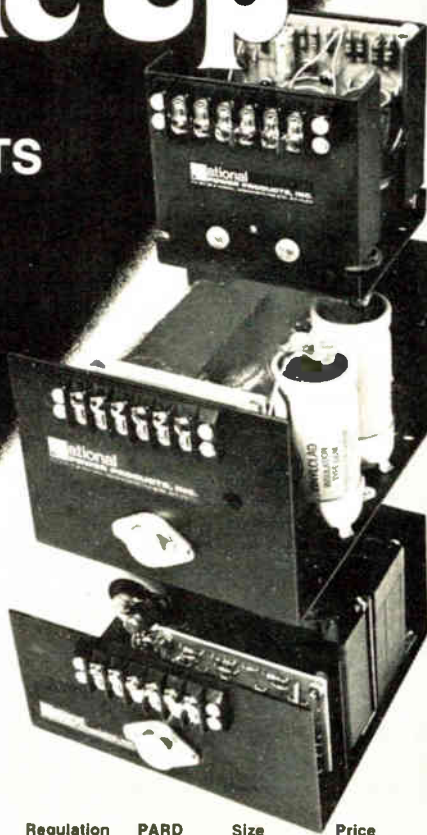

MODEL	Output Vdc @ A	Regulation Line	Load	PAR rms	Size (in.)	Price (1-9)
RF5S3000	5 3	↑	↑	↑	3.5 CUBE	\$ 48.50
RF5S5000	5 5				6x6.2x3	58.50
RF5S7000	5 7	↓	↓	↓	6x6.2x3	68.50
RF5S12000	5 12				6x6.2x3	98.95
RF12D1000	$\pm 12$ 1				6x6.2x3	88.50
RF15D1000	$\pm 15$ 1	↓	↓	↓	6x6.2x3	88.50
RF12D2000	$\pm 12$ 2				5x7x4	119.95
RF15D2000	$\pm 15$ 2				5x7x4	119.95

Many other standard single, dual and triple output power supplies are available

**National** Formerly **SERVOTRON**  
**POWER PRODUCTS, INC.**

P.O. BOX 292 ■ HAVERHILL, MASSACHUSETTS 01830 ■ TEL. (617) 374-0777

Continental Europe, Contact Myrra Div. of HI-G 112 bis, rue du Chemin-Vert des Mâches 94 - Créteil • France  
Tél. 207.66.83 • TELEX 68843-MYRRAHIG

Circle 138 on reader service card

## New products

and the price is below \$4,000. Inquiries Manager, Hewlett-Packard Co., 1501 Page Mill Rd., Palo Alto, Calif. 94304 [354]

### Impulse generator gives flat output to 35 megahertz

An impulse generator with output that is flat to within  $\pm 1$  dB from 500 hertz to 35 megahertz is designated the model 93453-1. The output is useful from dc to 400 MHz. The output level is adjustable in 0.25-dB steps from 0 dB above  $1 \mu\text{V}/\text{MHz}$  to 121 dB above  $1 \mu\text{V}/\text{MHz}$ . Pulse repetition rate is variable from 2 to 100 pulses per second. A single pulse can also be obtained from a manual switch. Pulse width is 10 nanoseconds. The generator is intended for making receiver bandwidth mea-



surements, rapid checking of tuner gain, testing noise-suppression receivers, and receiver alignment.

Singer Instrumentation, Los Angeles Operation, 3211 So. LaCienega Blvd., Los Angeles, Calif. 90016 [355]

### Active FET probe for scopes has 220-MHz bandwidth

Designed for wideband oscilloscopes, an active field-effect-transistor probe, designated the PM9353, measures low-amplitude, high-frequency signals without appreciable circuit loading. The probe's bandwidth is 220 megahertz, making it suitable for scopes with intrinsic bandwidths to 150 MHz with no adverse effect on the scope rise time.

Input impedance of the PM9353 is 3.5 picofarads in parallel with 1 megohm; its unity-gain FET amplifier eliminates the 10:1 attenuation

**birth defects are forever.**

**March of Dimes**

**unless you help.**

THIS SPACE CONTRIBUTED BY THE PUBLISHER



# HP's new LEDs

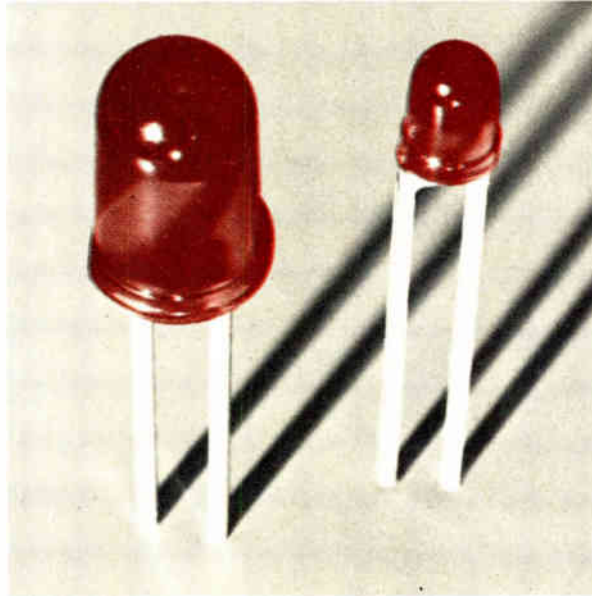

## Only 17¢

The low cost LED is here today! Only 17¢ in 100K quantities; even less in higher volumes. Advanced design and high volume production make these new low prices possible. So now you can use an LED for any application requiring an indicator light.

Two sizes of lamps are available: a T-1 and a T-1¾ size package. These long-life LEDs are ideal for housewares, appliances, automobiles — anywhere you need a

brilliant long-life solid-state lamp.

To get a free sample, call your nearest HP distributor.

For application information, call or write Hewlett-Packard, 620 Page Mill Road, Palo Alto, Calif.

In Europe: P.O. Box 85, CH-1217 Meyrin 2, Geneva, Switzerland;

In Japan: Yokogawa—Hewlett-Packard, 1-59-1, Yoyogi, Shubuya-ku, Tokyo, 151.

HEWLETT  PACKARD  
COMPONENTS

## CALL ONE OF OUR DISTRIBUTORS FOR A FREE SAMPLE

### Distributor Stocking Locations:

#### SCHWEBER ELECTRONICS

Hollywood, Florida  
(305) 927-0511  
Rockville, Maryland  
(301) 881-2970  
Waltham, Massachusetts  
(617) 890-8484  
Rochester, New York  
(716) 328-4180  
Westbury, New York  
(516) 334-7474  
Beachwood, Ohio  
(216) 464-2970

#### WYLE DISTRIBUTION GROUP

Liberty Electronics/Arizona  
Phoenix, Arizona (602) 264-4438  
Liberty Electronics  
El Segundo, California (213) 322-8100  
Elmar Electronics  
Mt. View, California (415) 961-3611  
Western Radio  
San Diego, California (714) 235-6571  
Elmar Electronics  
Commerce City, Colorado (303) 287-9611  
Liberty Electronics/Northwest  
Seattle, Washington (206) 763-8200

#### HALL-MARK ELECTRONICS

Huntsville, Alabama  
(205) 539-0691  
Lenexa, Kansas  
(913) 888-4747  
St. Louis, Missouri  
(314) 521-3800  
Raleigh, North Carolina  
(919) 832-4465  
Tulsa, Oklahoma  
(918) 835-8458  
Dallas, Texas  
(214) 231-6111  
Houston, Texas  
(713) 781-6100

#### EUROPE

Celdis Ltd.  
37-39 Loverock Road, READING, Berks, England  
Tel.: READING 58 22 11  
I.S.C. France  
20, rue Gambetta, 92-Boulogne, France  
Tel.: 604.52.75  
Ingenieurbüro Dreyer  
238 Schleswig, Flensburger Strasse 3, Germany  
Tel.: (04621) 2 31 21  
EBV Elektronik  
8 Munich 2, Augustenstrasse 79, Germany  
Tel.: (0811) 52 43 40/48  
6 Frankfurt 1, Myliusstrasse 54, Germany  
Tel.: (0611) 72 04 16/8

# Celco

## for CRT DISPLAYS

**DEFLECTION YOKES**

**FOCUS COILS**



For the CRT Display Designer who NEEDS everything, CELCO makes everything you need. CELCO serves you in a unique capacity; we are the only

**DEFLECTION DRIVERS • CIRCUIT CARDS**



single source for all the most sophisticated precision display components you'll need for building your

**RAMP GENERATORS**



entire display system. All CELCO components are designed to perform exactly according to the requirements of your particular display, are fully compatible

**POSITIONERS CRT SPOT ANALYZER**

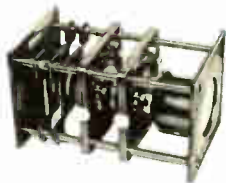

with each other, and create a harmoniously performing system.

**CRT CAMERA DISPLAY SYSTEMS**

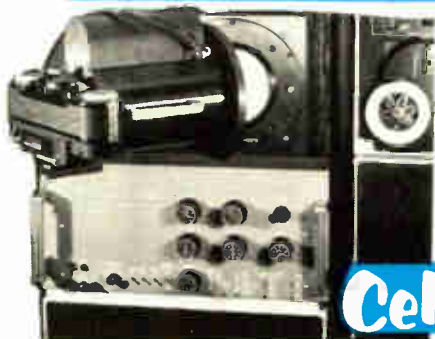

# Celco

CONSTANTINE ENGINEERING LABORATORIES COMPANY  
UPLAND, CALIF. 91786

MAHWAH, N. J. 07430

## New products

on conventional probes. Dynamic range of input signals for the PM9353 is  $\pm 1$  volt, approximately triple the range of some earlier FET probes. This dynamic range is independent of the  $\pm 1$  volt dc offset range of the probe. Priced at \$325,

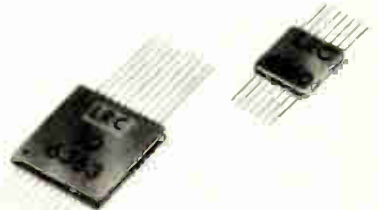

the probe is supplied in a carrying case that also contains a set of 26 accessories.

Test and Measuring Instruments Inc., a North American Philips Co., 224 Duffy Ave., Hicksville, N.Y. 11802 [356]

Miniature decade counters  
plug in side-by-side

Operating from a single 5-volt power supply, a line of miniature high-speed modular decade counters offers a side-by-side plug-in feature that allows fast assembly of any number of digits with no unit-to-unit wiring for main-sequence operations. The DEC-100 series of Decaplug uses miniature seven-segment incandescent readouts that are



available in several styles. Full use of the company's 7447 decoder can be obtained from both the DEC-100 up-down and DEC-101 up counter. Single-unit prices for these modules, including readouts, are \$29.50 for the DEC-100 and \$26.90 for the DEC-101.

Compton Electronics, P.O. Box 5326, Compton, Calif. 90224 [357]

Would the engineer who asked us to design a marking system to imprint electronic anti-hazard golf balls please call (603) 352-1130.

It's ready.

If for some strange reason you're not making electronic golf balls, how about your semiconductors, switches, bulbs, circuit breakers, motors, generators, connectors, circuit boards or whatever? Markem can handle those, too. We've got the marking systems, printing elements, foils, inks, supplies and services to mark whatever you make, and mark it right. Plus do-it-yourself pressure-sensitive labelmakers.

If you want a better way to solve your marking problems, write to us now. Markem Corp., 305 Congress St., Keene, N.H. 03431. We'd like to help you avoid a few hazards.

**MARKEM**



Sales Offices:  
Cleveland

Chicago      New York  
Kitchener, Ontario

Boston  
Dorval, Quebec

Los Angeles

Charlotte  
Rugby, England

Dallas

Schipol Oost, Holland

# Are you getting static?

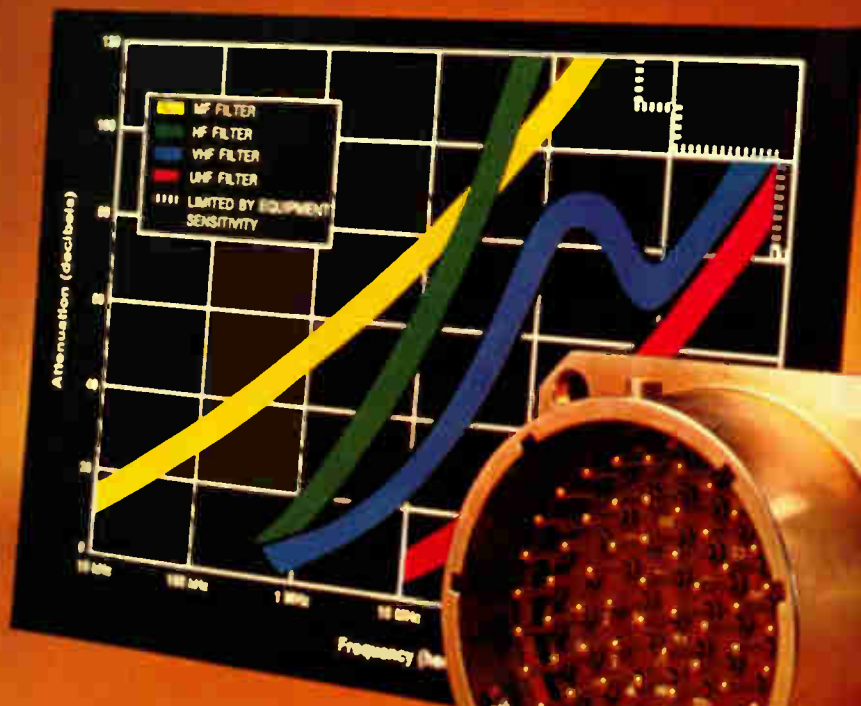

Our filter connectors are designed to eliminate interference from your circuits. See those attenuation curves? They are just a part of our selection. We can mix and match filters to solve your low pass filtering requirements. Small wonder Bendix filter connectors are first choice in the fight against electronic noise pollution.

Bendix filters come packaged in connectors intermateable with MIL-C-26482, MIL-C-83723, MIL-C-38999 and

Circle 142 on reader service card

MIL-C-5015 connectors. In addition, filter contacts can be packaged to mate with other popular connector types including rectangular in military, industrial and commercial applications. There's sure to be one to meet your attenuation and frequency requirements.

You'll like the price, too.

Delivery? We won't give you any static there, either. Write for our brochure. The Bendix Corporation, Electrical Components Division, Sidney, New York 13838.

**Bendix**

## New products

### Packaging & production

# Hermetic pack is low-priced

Ceramic cavity is sealed, but bulk of 40-pin package is low-cost plastic

A plastic-ceramic package developed by Space Ordnance Systems may satisfy requirements for lower-cost MOS LSI packaging without the need to change packaging techniques. The company's Glass Seal division, which has been supplying hermetic flatpacks, has a new package called Ultrapak that uses a sealed ceramic cavity, and the bulk of the 40-pin package consists of low-cost plastic supporting the leads. C.A. Registro, general manager, says that a semiconductor manufacturer can bond and seal the package just as he has been doing with conventional ceramic packages. However, the part sells for only 55 to 60 cents each in 100,000 quantities, compared to 85 to 90 cents for an equivalent 40-pin package plated with gold 40 microinches thick.

In addition to cost savings, the company claims that the package offers more impact resistance than ceramic, and it has several advantages over the even less-expensive all-plastic packages. Registro says that a big advantage over user-molded packages is improved yield because the delicate wire bonds aren't subjected to the stresses of molding, then curing, which he says typically cause a large yield loss in expensive LSI dice. Also, no conformal coating or special—and very expensive—encapsulating equipment is required.

The ceramic insert cavity also permits conventional die attach-

ment, instead of specialized approaches required for premolded-cavity plastic packages. The loaded glass (25% alumina) has better thermal characteristics than plastic.

Registro says that the cavity can be sealed with the usual gold-tin eutectic, or with Malon Meg-165, a thermosetting plastic that is becoming increasingly popular for sealing. The Meg-165 is supplied as a preform attached to the lid; for eutectic sealing, either metal or ceramic lids can be used.

The package meets MIL STD 883, Registro says, and he has heated the package to 450°C (100°C over the usual die-attach temperature) for a number of minutes with no problems. He says there is no apparent movement between the ceramic and plastic, and the Kovar lead frame is chosen to match the thermal movement of the ceramic.

Space Ordnance will have 40-pin packages with 250-mil cavities available in late April. And smaller 24- and 28-pin versions may become available later. But Registro says the main call is for 40 pins. "They contain the most expensive dice and provide the most problems in encapsulation."

Space Ordnance Systems, Glass Seal Division, 25977 Sand Canyon Rd., Saugus, Calif. 91350 [391]

### System tests diodes, zeners, rectifiers simultaneously

The model Z337 computer-operated test system for diodes, rectifiers, and zeners tests all three types of components simultaneously. At \$49,000, it costs less than some systems which can test only one type, and for manufacturers who must classify these three components, the Z337 costs less than three separate classification systems.

The Z337's wide range of analog

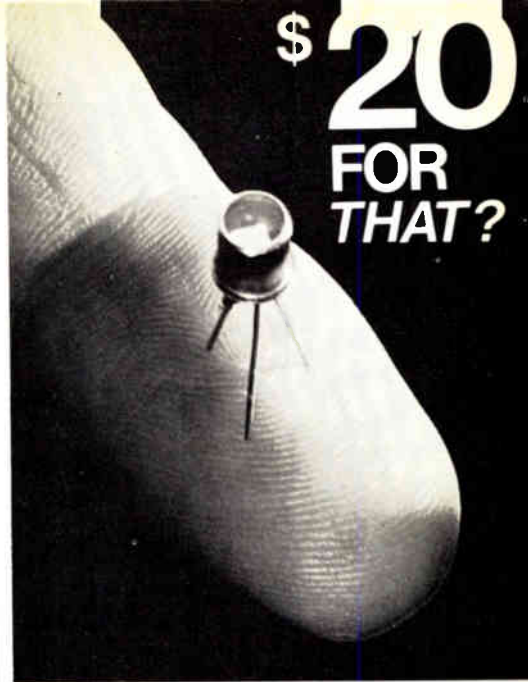
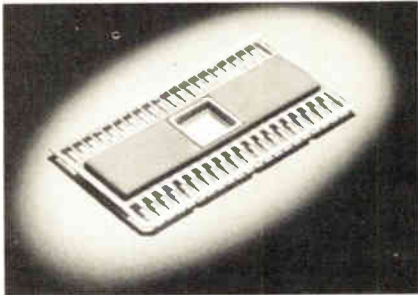

# yes, but look at the performance it buys you!

## A SUPERIOR IR DETECTOR!

Size • 0.010 x 0.044 in.

Responsivity @ 0.9  $\mu\text{m}$  •  $\geq 0.62 \mu\text{A}/\mu\text{W}$

Dark Current •  $< 0.005 \mu\text{A}$

$D^*$  (0.9  $\mu\text{m}$ ,  $10^3$ , 1) •  $0.25 \times 10^{12} \text{ cmHz}^{1/2}\text{W}^{-1}$

NEP (0.9  $\mu\text{m}$ ,  $10^3$ , 1) •  $0.21 \times 10^{-12} \text{ WHz}^{-1/2}$

Risetime (10%–90%) •  $< 20\text{ns}$

Noise Current ( $10^3\text{Hz}$ , 1Hz) •  $< 0.13\text{pA Hz}^{-1/2}$

Capacitance •  $< 2\text{pF}$

Package • T0-18 Series

Single or multiple active areas available in large sizes.

Better prices for quantities of 1,000, 50,000 or 100,000 units.



# HARSHAW

THE HARSHAW CHEMICAL COMPANY  
DIVISION OF KEWANEE OIL COMPANY

Crystal & Electronic Products Department  
6801 Cochran Road • Solon, Ohio 44139  
(216) 248-7400



## seal of improval

Improved reliability through the use of a glass-to-tantalum true hermetic anode seal is the prime feature of new Type 138D gelled-electrolyte sintered-anode Tantalum<sup>®</sup> Capacitors. This new construction eliminates all internal lead welds while retaining the strength of conventional internal lead-welded parts. In addition, the new construction offers outstanding resistance to extensive temperature cycling.

Type 138D Tantalum Capacitors are designed to meet or exceed

the environmental and life test requirements of MIL-C-39006. The gelled-electrolyte employed in these new capacitors gives premium performance for all capacitor parameters with respect to frequency and temperature variations.

Originally developed for use in aerospace applications, this capacitor design is now available for general industrial and aviation use where the utmost in component performance and reliability are primary necessities.

For complete technical data, write for Engineering Bulletin 3704A to: Technical Literature Service, Sprague Electric Co., 35 Marshall St., North Adams, Mass. 01247.



THE BROAD-LINE PRODUCER OF ELECTRONIC PARTS

144 Circle 144 on reader service card

capability allows it to supply forward current to 10 amperes and voltage up to 1,200 volts for testing diodes and rectifiers. For zeners, it can handle a 1-kilohertz impedance measurement and up to 200 V zener voltage.

A voltage-sensing capability controlled by software allows the Z337 to measure the squareness of the voltage change at zener breakdown voltage or on a controlled avalanche rectifier. The system offers a test time up to three times faster than in previous generations of test equipment, a faster computer testing sequence than the industry standard, and an automatic recording of test values.

As many as 50 tests may be stored in the computer, and the number performed can be limited to only those necessary for the device being tested. The Z337 can accept up to 10 test stations, although the average is five stations, or the unit can multiplex two handlers that are processing 10,000 components an hour each, and it still has time for one manual station.

Applications also include data recording directly on magnetic tape, burn-in, and data processing, as well as classification. Richard J. Lucey, manager of discrete-component test systems at Teradyne, points out that software packages allow data to be processed in two ways: the end-of-life application compares present with previous readings, and the automatic distribution curve takes all standard statistical points, such as median, mean, and sigma, from the data. This is essential for process control feedback, the test systems manager points out.

Teradyne, Inc., 183 Essex St., Boston, Mass. 02111 [392]

Abrasive resistor trimmer provides to 1,000 trims/hour

The model RT-10SA abrasive resistor trimmer is designed to meet accuracy requirements in thick- and thin-film printed circuits, and the unit is capable of trimming up to 0.1% of the desired value. Produc-

# Caught in the old cassette vs. 1/2"-drive, price vs. performance crunch?

With a choice like that you pay the price no matter what you do.

So we've come up with the first real alternative you've ever had.

The "Scotch" Brand Data Cartridge.

It's a unique approach to digital tape storage that's priced like a cassette but performs like a 1/2"-compatible drive.

It operates at speeds up to 90 ips, starts/stops with accelerations up to 2000 in/sec<sup>2</sup> and offers transfer rates up to 48,000 bps.

It uses 1/4" tape and records at up to 3200 frpi, so it stores up to 5.5 million bits of data per track on 1 to 4 tracks.

It needs only a single point drive and no external tape guidance, so tape can never cinch, spill, stretch or break and each cartridge has a life expectancy in excess of 5000 passes.

Because the "Scotch" Data Cartridge functions as its own transport, tape handling is fast, accurate and precise at all



times. It's ideal for: Word processors and terminals. Point-of-sale data capture and computer data entry. Minicomputer I/O and paper tape replacement.

And if you need more information, you've got a choice there, too.

Just contact any of the major peripheral manufacturers or Data Products, 3M Company, 300 South Lewis Road, Camarillo, Calif.

93010. Telephone:

(805) 482-1911. TWX:

910-336-1676.

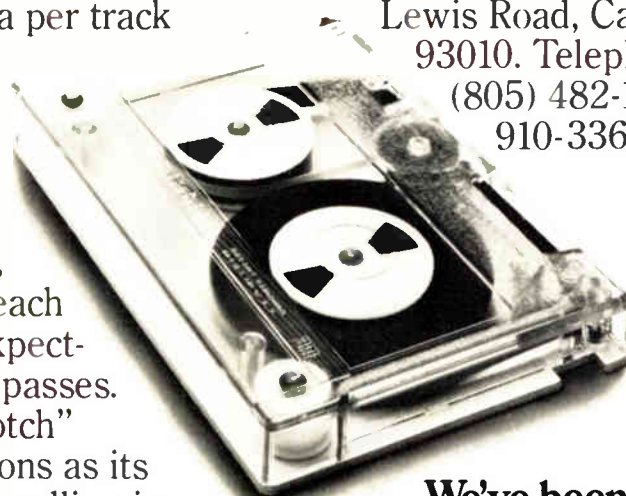

**We've been there.  
And brought the answers back.**

**3M**  
COMPANY

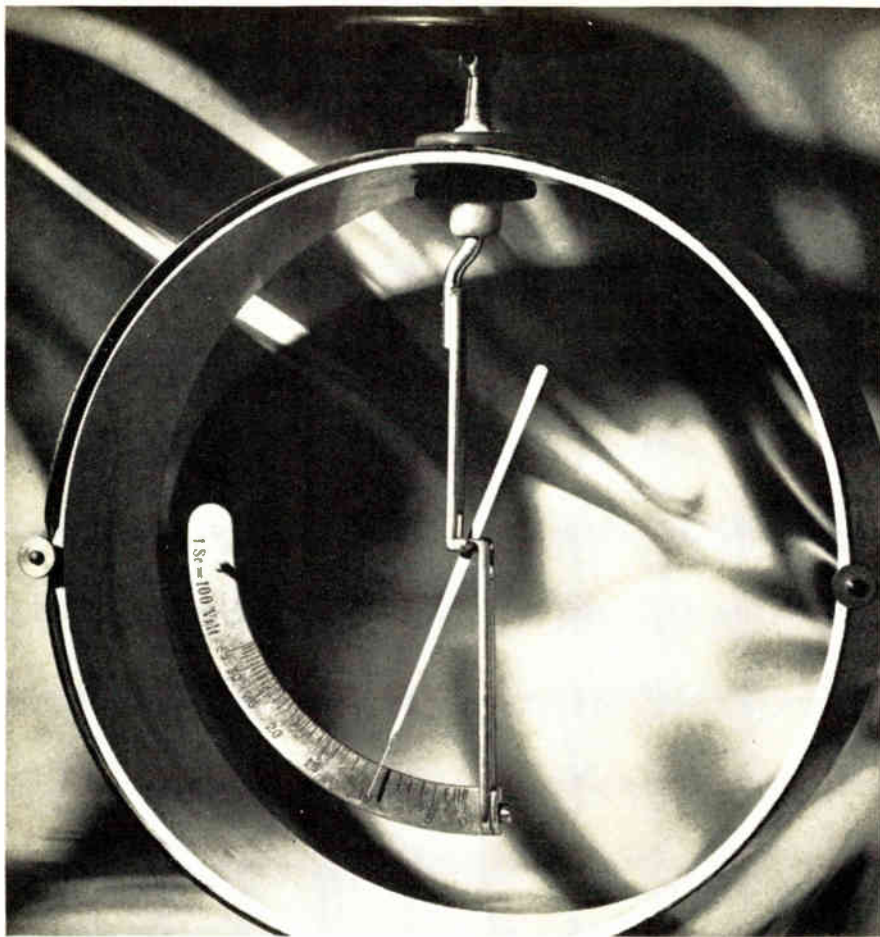

# How would you get a measureable signal from only 6,000 electrons per second?

Most people do it Victoreen's way

With just 6,000 electrons, our  $10^{12}$  RX-1 will give you a good clean one millivolt signal . . .

We've been making hi-meg resistors for over 30 years, making it possible for engineers like you to make big things out of little things. And with Victoreen RX-1 resistors, hi resistance is just one of the nice things you get . . . how about accuracy to  $\pm 1\%$ , good stability, and ranges from  $10^7$  to  $10^{14}$  ohms . . .

Victoreen . . . where else can you get so many accurate ohms for your money?

DMA 722



VICTOREEN  
INSTRUMENT DIVISION  
10101 Woodland Avenue  
Cleveland, Ohio 44104

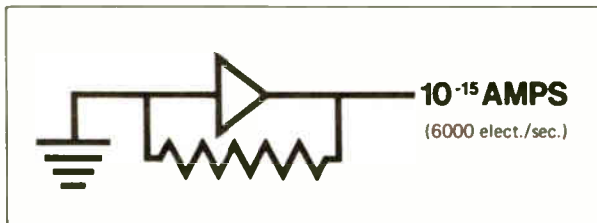

## New products

tion rates are up to 800 to 1,000 trims per hour at a range from 0.1 ohm to 11 megohms with a maximum power dissipation of 12 milliwatts. The unit has a shuttle mechanism that allows loading and unloading of a substrate during a

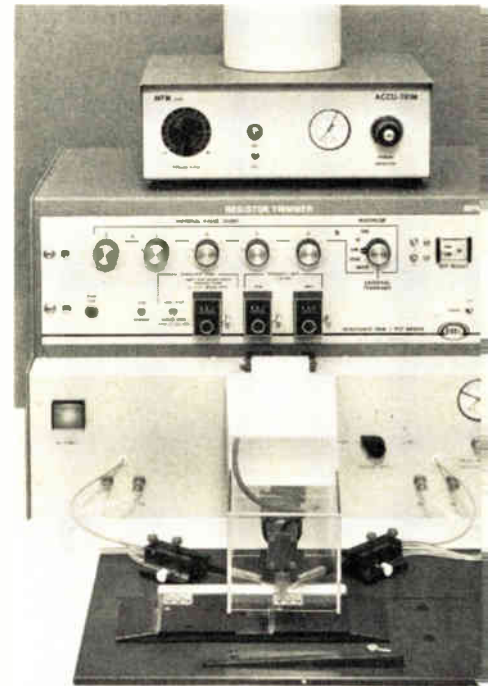

trim cycle, which is said to double the trim capability on a single-station abrasive trimmer. Price is \$6,500.

M.P.M. Corp., 2225 Massachusetts Ave.,  
Cambridge, Mass. 02140 [393]

Contact printer offers  
precision to within  $\pm 0.5 \mu\text{m}$

A manual loading and unloading contact printer called the CP-551, an automatic cycling device, dupli-





*whatever your computer says...*

# SELF-SCAN® SAYS IT BEST

PANEL DISPLAYS



16 18 Character Position Panel, 5 x 7 Dot Matrix. Characters 0.4" High. Available as numeric only or alphanumeric panel with 64-character format.



32 37, 80 Character Position Panel, 5 x 7 Dot Matrix. Characters 0.2" High. Alphanumeric panel with 64-character format.



SELF-SCAN Panel Display Subsystem, 256 Character Capacity, 5 x 7 Dot Matrix. Characters 0.25" High. 64-character format, available with all drive electronics including memory, character generator, and timing.



(1)

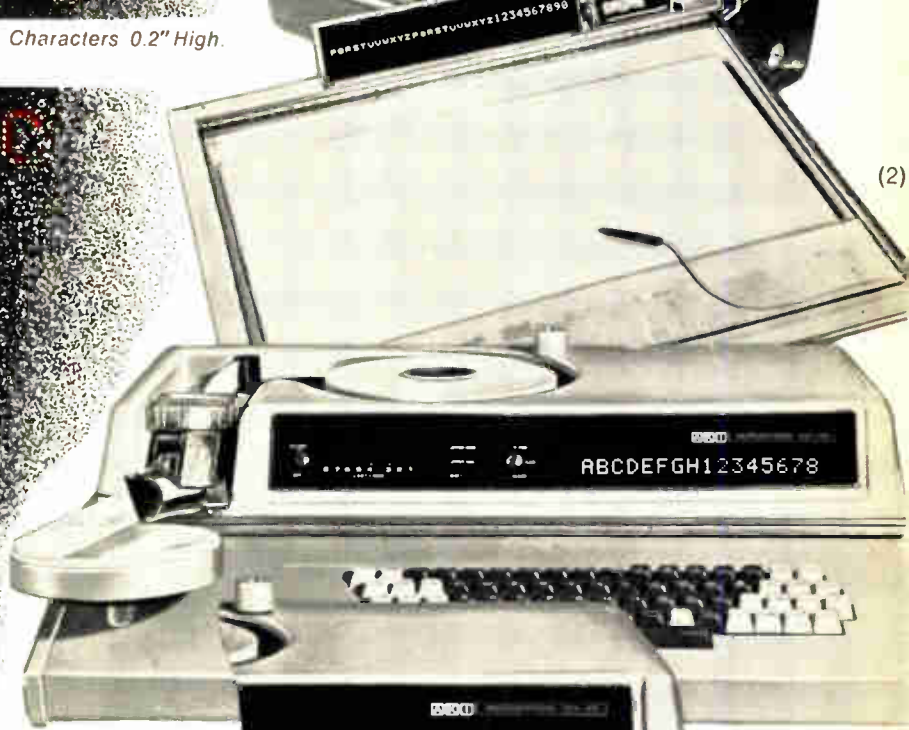

(2)



(3)

Whether it's a police officer in a patrol car requesting information on a suspect, an architect specifying coordinates for plumbing fixtures in a new building, or a type setter verifying type for a mail-order catalog, SELF-SCAN panel displays guarantee the most accurate transfer of data between the operator and the computer. If you need a computer display and demand error-free communications, follow the lead of Kustom Electronics (1) in Chanute, Kansas; Science Accessories Corporation (2) in Southport, Connecticut; Automix Keyboards (3) in Bellevue, Washington, and the many other SELF-SCAN panel display users. Have a Burroughs salesman demonstrate his "terminal in a briefcase." You'll see why the SELF-SCAN panel display is the most effective man/machine interface device available today.

Burroughs Corporation, Electronic Components Division, Plainfield, New Jersey 07061. (201) 757-3400.

**Burroughs**

Circle 147 on reader service card

# OSHA OVERCURRENT PROTECTION REQUIREMENTS

... could render your  
equipment substandard  
for industrial use!

## AIRPAX™ CIRCUIT PROTECTORS



# PROVIDE THE PROTECTION REQUIRED!

(and save you money)

Contact the factory for literature and/or assistance in selecting the proper protection for your application.

### AIRPAX ELECTRONICS CAMBRIDGE DIVISION

Cambridge, Maryland 21613  
Phone (301) 228-4600

# AIRPAX™

25 YEARS OF PROGRESS

#### § 1910.312 Overcurrent protection.

(a) *Protection of equipment.* Equipment shall be protected against over current.

(b) *Interrupting capacity.* Devices intended to break current shall have an interrupting capacity sufficient for the voltage employed and for the current which must be interrupted.

(c) *Circuit impedance and other characteristics.* The overcurrent protective devices, the total impedance, and other characteristics of the circuit to be protected shall be so selected and coordinated as to permit the circuit protective devices used to clear a fault without the occurrence of extensive damage to the electrical components of the circuit. This fault may be assumed to be between two or more of the circuit conductors; or between any circuit conductor and the grounding conductor or enclosing metal raceway.

(d) *Location in premises.* Overcurrent devices shall be located where they will be not exposed to physical damage and not in the vicinity of easily ignitable material.

(e) *Enclosures for overcurrent devices—(1) General.* Overcurrent devices shall be enclosed in cutout boxes or cabinets, unless a part of a specially approved assembly which affords equivalent protection, or unless mounted on switchboards, panelboards or controllers located in rooms or enclosures free from easily ignitable material and dampness. The operating handle of a circuit breaker may be accessible without opening a door or cover.

(2) *Damp or wet locations.* Enclosures for overcurrent devices in damp or wet locations shall be of a type approved for such locations and shall be mounted so there is at least one-fourth inch air space between the enclosure and the wall or other supporting surface.

### How AIRPAX Circuit Protectors help you meet OSHA requirements:

(a) *Protection of equipment.* Airpax magnetic circuit protectors offer the most effective equipment overcurrent protection available. Fuses and thermal breakers are not as reliable.

(b) *Interrupting capacity.* Airpax magnetic circuit protectors have U.L. recognized interrupting capacities for voltage ranges up to 480 volts—sufficient for most equipment applications.

(c) *Circuit Impedance and other characteristics.* Airpax magnetic protectors operate more accurately than thermal breakers and ordinary fuses. This factor, plus close coordination with load conditions, possible only with a magnetic device, provide fault clearing without excessive damage to components and associated circuitry.

(d) *Location on premises.* Airpax protectors are also designed for front panel mounting for maximum accessibility. Front panel mounting permits use of the breaker as a power switch, as well as the protective device.

(e) *Enclosures—(1)* Airpax protectors are also designed for internal mounting.

(2) Airpax UP Series protectors are U.L. approved sealed magnetic circuit protectors designed for use in adverse environments. Other Airpax protectors (UPL, UPG, 205, 203) are constructed using inherently corrosion-proof and moisture resistant materials. Airpax manufactures special circuit breakers for Panel Seal (watertight integrity) as well as for dust and explosive environments.

### New products

ates photomasks. It is designed to handle any combination of master and copy plates from 2 by 2 by 0.06 inch to 5 by 5 by 0.25 inch. Illumination of  $\pm 5\%$  is provided over a 5.6-inch diameter, permitting printing of a 4-inch-square format. Precision is to within  $\pm 0.5$  micrometer from the master over a 3.5-inch diameter for most applications. Price begins at \$13,900 for a basic unit without options. Delivery time is 60 to 90 days.

The Jade Corp., 3063 Philmont Ave., Huntingdon Valley, Pa. 19006 [394]

Screen printing system is fully automated

Magazine feed and magazine reload are features of an on-contact/off-contact screen printer designed for hybrid-circuit production. The unit maintains an accuracy to within  $\pm 0.001$  inch in printing at rates up to 1,000 pieces per hour. The model SPS-1 is equipped with an electric-motor-driven print head, a walking-



beam part-transfer system, a collocator, and infrared dryer. Magazines can be changed while the printer is running and each magazine holds up to 800 0.025-inch-thick substrates measuring 3 by 3 inches in size. Price is \$24,200.

Wells Electronics Inc., 1701 S. Main St., South Bend, Ind. 46623 [395]

Pluggable sockets built for disconnect system

The series 741 individual pluggable sockets on plastic carrier strips can be used with the company's printed-circuit-board jumpers to provide a

# The inside story on Spectrol trimmers...

**(p.s. they're a bargain!)**

## High quality/low prices

Don't let the high quality of our Spectrol trimmers fool you . . . check our prices — they're competitive!

## Broad line/all types

Rectangular, square, round, cubic, or TO-9 packages, wirewound or cermet elements, industrial or MIL-Approved models — we've got them all!

## Local stock/off-the-shelf

Looking for products in a hurry? Try your local Spectrol distributor . . . there are over 75

authorized outlets in the United States and Canada, and we have factories in England and Europe as well.

## Get a Spectrol quote before you buy!

Break that careless habit of sole-sourcing your trimmer buys — or that dangerous habit of buying on price alone . . . demand high quality as well as low prices — get a Spectrol quote before you buy! Contact our local distributor or call us directly. (The reader service card will get you our Short Form Catalog.)

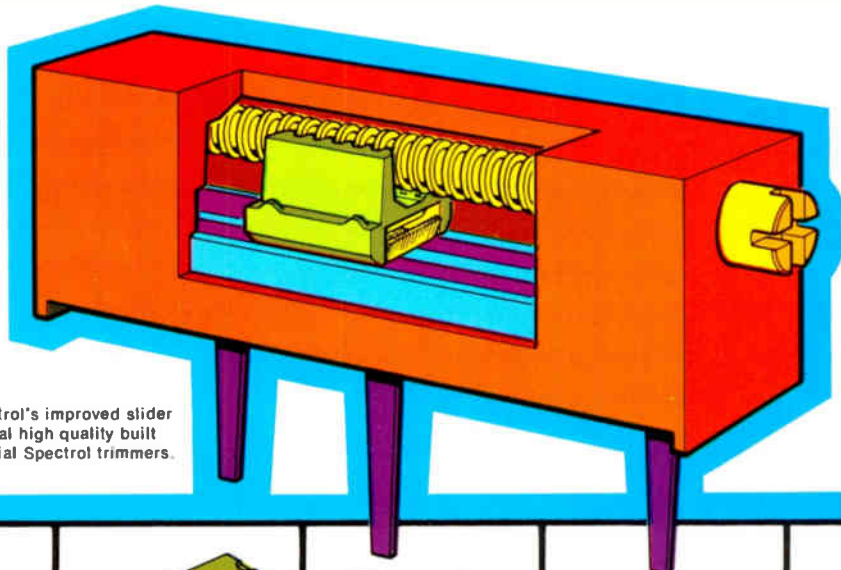

Model 43, 3/4" cermet trimmer

Cut-away drawing shows Spectrol's improved slider block design, illustrating typical high quality built in to even the low-cost industrial Spectrol trimmers.

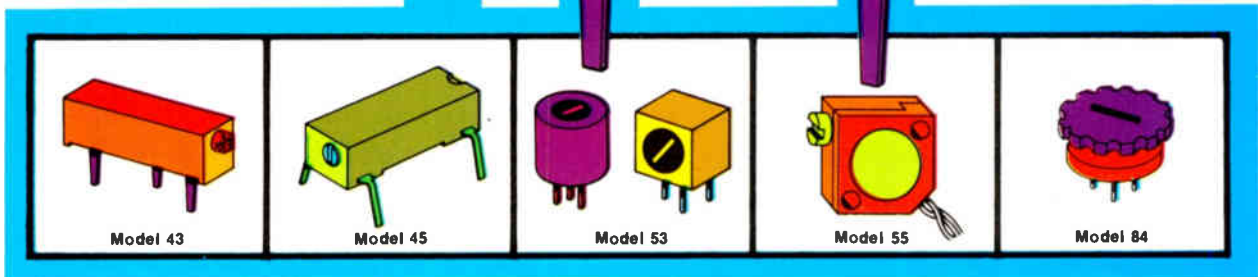

**SPECTROL ELECTRONICS GROUP**

**UNITED STATES** Spectrol Electronics Corporation 17070 E. Gale Avenue, City of Industry, Calif. 91745, U.S.A. • (213) 964-6565 • TWX (910) 584-1314

**UNITED KINGDOM** Spectrol Reliance Ltd. Drakes Way, Swindon, Wiltshire, England • Swindon 21351 • TELEX: 44692

**ITALY** SP Elettronica spa Via Carlo Pisacane 7, 20016 Pero (Milan) Italy • 35 30 241 • TELEX: 32242

# WHY CHOOSE RENTAL ELECTRONICS WHEN YOU RENT, LEASE, OR RENTAL-PURCHASE?

Because REI is the recognized leader when it comes to supplying you the most complete selection of electronic/scientific test equipment—to rent, to lease, or to rental-purchase—at the most attractive costs.

Now, more than ever, you must expand along with the pace of economic and technological development. To avoid the handicap of obsolete equipment, to help you maintain a flexible budget, to keep abreast of the competition, to assure growth with increased production and sales—Rental Electronics offers you the instruments you need, when you need them, for as long as you need them.

REI offers you precisely the right instruments—everything from amplifiers to oscilloscopes to synthesizers—with a plan custom-designed to meet your specific requirements!

Our staff of sophisticated financial planners is ready to help you choose the rental, lease, or rental-purchase package that best fits your situation.

And your needed equipment is ready for almost instantaneous delivery, direct from one of nine strategically-located "Instant Inventory" Centers across the U.S. and Canada.

Every Rental Electronics customer is our *very special* customer, receiving the service he needs under a rental, lease, or rental-purchase plan custom-tailored especially for him. The results are increased **PROFITS** for you!

Ask for our full catalog today! Write or call:



## Rental Electronics, Inc.

A **PEPSICO** LEASING COMPANY

99 Hartwell Avenue, P. O. Box 223  
Lexington, Massachusetts 02173 Tel. 617/862-6905

Gaithersburg, Maryland 301/948-0620 / Lexington, Massachusetts 617/861-0667 / Anaheim, California 714/879-0561 / Rosemont, Illinois 312/671-2464 / Fort Lauderdale, Florida 305/771-3500 / Dallas, Texas 214/638-4180 / Oakland, New Jersey 201/337-3757 / Ontario, Canada 416/677-7513 / Palo Alto, California 415/328-4525

## New products

connect/disconnect system. The sockets fit a range of board hole sizes from 0.050 to 0.058 inch in diameter and provide positive retention in the board prior to soldering. Installation may be made by hand or semiautomatic tooling. The use

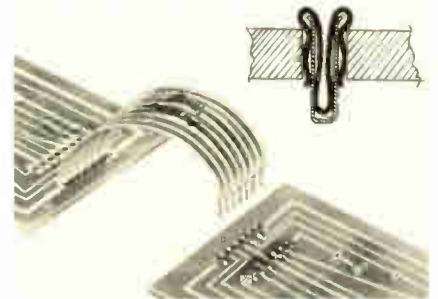

of the sockets allows the jumper to be used as a direct connect/disconnect interconnection between two printed-circuit boards, eliminating the use of conventional connectors. Price is 5 cents per socket, depending on quantity.

Ansley Electronics Corp., Old Easton Rd., Doylestown, Pa. 18901 [396]

## Test jacks, points facilitate circuit test readings

A line of test jacks and test points are designed for use in high-density electronic assemblies where test readings are desirable or necessary at certain circuitry points. This not only facilitates circuit test readings, but the miniature points can also be used as receptacles for jack-in connections between components or chassis. Other test points can be used with molded insulators or as feed-through test points in thick housings. The printed-circuit test jacks are designed to receive 0.080-inch-diameter probes.

Sealectro Corp., Circuits Hardware Division, Mamaroneck, N.Y. 10543 [397]



# We can solve your IC Packaging problems...

**We  
do it  
better**



#### Socket Card Files

Ruggedly constructed, precise card/connector fit, holds up to 14 socket cards in standard EIA racks. Standard sizes for all socket cards—customs also available. Standard I/O systems include connectors, optional mother board and I/O panel.

#### Socket Cards

40 and 60 position cards that mount 14 and 16 pin devices. universal cards that mount any device 6 to 40 pins, Kit Cards for those special customs. Cards have 72 or 122 I/O connections. All have decoupling capacitor provisions. Prices about \$1.00/position.

#### Socket Panels

14 and 16 pin models provide 30 to 180 sockets in zones of 30; Universal model for 6 to 40 pin devices with 9 to 54 pin rows in 9 row zones. All have decoupling capacitor provisions and female or feed-thru pin I/O systems. Prices about \$35.00 per zone.

#### Socket Panel Drawers

Single and Double page drawers with 14, 16 and universal patterns. Singles from 30 to 510 positions. Doubles up to 1120 positions. I/O connections from 120 to 1200—customs readily available.

We really know how to solve your I.C. packaging problems. We do it with cards, panels, drawers and complete systems. We do it with decoupling capacitor provisions on all cards and panels. We do it with high reliability contacts which insures positive I.C. connections. So give Scanbe a call or send us your requirements and we'll prove that when it comes to solving I.C. packaging problems we can help you do it better.



"The Packaging People"

Scanbe Manufacturing Corporation  
3445 Fletcher Avenue  
El Monte, California 91731  
(213) 579-2300/686-1202  
TWX: 910-587-3437

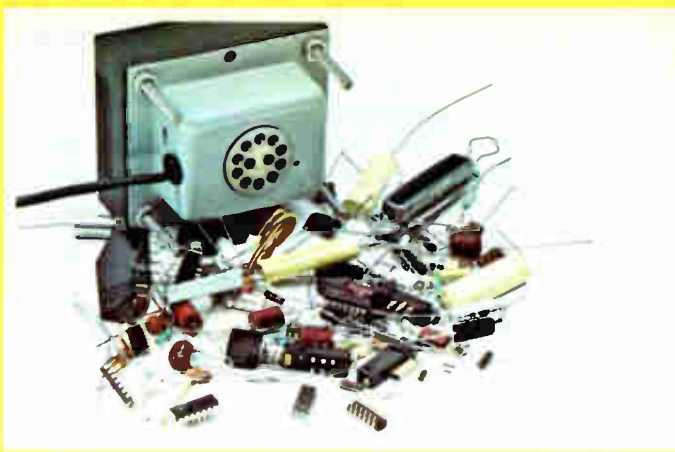

all DVM's  
start  
like this

...but only **CIMRON**  
puts it all together  
like this...

and like this



**HAVE YOU HEARD ABOUT THE CIMRON SAINT LOGIC?**

Do you need a 5½ digit systems DMM with optical coupled programming, parallel and serial BCD outputs? Do you need high noise rejection coupled with high speed and accuracy? The DMM 50 does it all. Would you like to know more? Then, there's the DMM 40. Do you need 5 ranges of AC and DC. 6 ranges of ohms plus internal AC and DC current shunts and complete autoranging ... all with 140% overrange? How about battery operation and isolated data outputs? The DMM 40 does it all at an extremely attractive price. For more information about these and other Cimron multimeters or to arrange for a demonstration of these state-of-the-art instruments, write or call Lear Siegler, Inc., Cimron Instruments, 714 North Brookhurst Street, Anaheim, California 92803, (714) 774-1010, or circle the number below.



LEAR SIEGLER, INC.

ELECTRONIC INSTRUMENTATION DIVISION  
CIMRON INSTRUMENTS

## New products

Semiconductors

### C-MOS ROM has 1,024 bits

Power, noise benefits of complementary units are extended to ROMs

Read-only memories have become vital to the modern digital logic system, but until now, designers of complementary MOS systems have had to be content with p-MOS or even bipolar ROMs because no C-MOS versions were available. That inconvenience has now been corrected by Motorola's introduction of a 1,024-bit C-MOS ROM, which extends the low power and high noise advantages of C-MOS to ROMs. The Motorola part, the latest in the company's line, will be almost doubled in size to 90 functions by the end of the year, says Ron Komatz, manager of Motorola's C-MOS product planning.

The new part, the MCM14524, is arranged 256 by 4 bits. Like other C-MOS parts, it can operate from 3 to 15 volts, and quiescent power is only 11 nanowatts. Actual operating power depends on operating frequency, as well as supply voltage; it's about 100 microwatts at 5 v and 10 kilohertz.

The ROM's clock-access time varies significantly with supply voltage. At 5 v, compatible with TTL circuits, the value is 1,800 ns; at 10 v, 825 ns; and at 15 v, 530 ns. These times indicate an operating frequency of approximately 1.5 MHz at 10 v.

Komatz expects that the major use of the part will be in industry, where the low power consumption, simple power supplies and high noise-immunity of C-MOS make it especially attractive for controls, communications, and micro-programming storage.

The new ROM is triggered on the negative edge of the clock, and internal latches store output data. The inputs to the device are protected by

diodes. A chip-enable permits simple expansion for applications that require more than 1,024 bits. The part is mask-programmed. Turn-around time is about 10 weeks. Programs can be supplied in either truth-table form or on IBM cards.

The 16-pin package is ceramic, with the military (MCM14524AL) version priced at \$24.70, and commercial (MCM14524CL), at \$13.75. Both prices are for more than 500 pieces. Mask charge for 100 to 500 parts is \$700.

Motorola Semiconductor Products Inc., Technical Information Center, Box 20924, Phoenix, Ariz. 85036 [411]

### Darlington transistor delivers 20 A at 400 V

Building on its recently introduced line of monolithic Darlington power transistors TRW Semiconductor has added a device capable of switching 20 amperes at 400 volts. Richard Seinfeld, product-line manager, points out that power transistors generally have been limited to about 5 A at 300 v. The devices offer fast switching as well as high voltage-current capability.

TRW is already providing the 20-A Darlington in quantity for a variety of control applications, including 5- to 10-horsepower motor drives. Other applications for the new high-current, high-voltage units in the series include off-line switching of power supplies and such consumer equipment as TV sweep circuits. Seinfeld says the 20-A version is particularly well suited for application where SCRs or a multitude of transistors were formerly used in parallel. The company also has 5- and 10-A versions; all are of triple-diffused mesa construction.

The Darlington is, in effect, two transistors, one driving the other, and they have common collectors. The device provides higher gain than a single transistor, in this case a forced beta of over 10 at a collector current of 20 A compared to 1 or 2, or a fractional value, for conventional transistors of this rating.

The device can be used in power-



## NEW METAL OXIDE FILM RESISTORS...

## DOUBLE THE POWER IN THE SAME PACKAGE

Type	Wattage	Volt	Range	A
ROH-3/4	3.8	7.5K	100-1.0G	.80
ROH-1	5.0	10K	100-2.0G	1.05
ROH-1-1/2	7.5	15K	150-3.0G	1.55
ROH-2	10.0	20K	200-4.0G	2.05
ROH-2-1/2	12.5	25K	250-5.0G	2.55
ROH-3	15.0	30K	300-6.0G	3.05
ROH-3-1/2	17.5	35K	350-7.0G	3.55
ROH-4	20.0	40K	400-8.0G	4.05

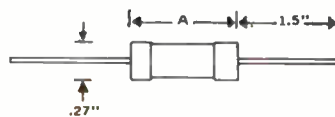

*that's why  
resistance  
is part of  
our name*

**RPC Resistance  
Products Co.**  
914 SOUTH 13TH STREET  
HARRISBURG, PENNSYLVANIA 17104  
PHONE 717-236-5081

Export Address: 2200 Shames Dr., Westbury, N.Y. 11590  
Cable Churchin, Westbury, N. Y.

## New products

supply design instead of conventional power transistors to permit elimination of the 60-hertz power transformer. The switching techniques permit significant reductions in size and power dissipation when used in power supplies and similar applications. The units are housed in standard TO-3 packages. The fast switching time of 300 nanoseconds allows operation of the devices to 40 or 50 kHz.

The TRW 20-A Darlingtons have sustaining breakdown voltage ratings (collector-to-emitter) of 300 v (type SVT 6060), 350 v (SVT 6061), and 400 v (SVT 6062). An unusual

feature of the Darlington construction is self-compensating collector-emitter saturation voltage. It typically changes from only 1.15 v at  $-40^{\circ}\text{C}$  to 1.09 v at  $+150^{\circ}\text{C}$ , rather than the usual large increase with temperature change. This effect is caused by the base-emitter voltage of one transistor cancelling the collector-emitter voltage of another. Maximum saturation voltage is 2 v at 20 A.

Price for the SVT 6060 Darlington transistor in 100-unit quantities is \$15.54 each.

TRW Semiconductor Operations, 14520 Aviation Blvd., Lawndale, Calif., 90260 [412]

Analog-to-digital converter operates in 1 microsecond

Packaged in an 18-pin dual in-line case, the model MN500 analog-to-digital converter is an eight-bit successive-approximation device. It is

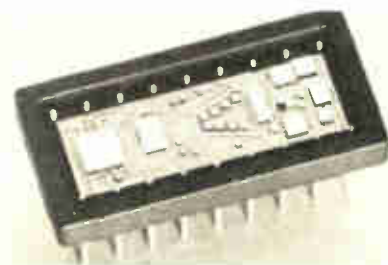

# THE CHAMP

...PICTURE TAKER



Visual images are fleeting—so, for the record, ... you need pictures. No telling when or how often they can prove invaluable.

That's why so many of your peers are routinely snapping pictures while looking at specimens and samples with Bausch & Lomb's StereoZoom 7 visual-photographic system. The Champ's superb optical system which gives unbeatable visuals will put the images on film right while you're looking. And they will be

available as often as you want to refresh your memory, make comparisons, prove points.

There's a choice of most camera formats with the new Integrated Cameras, Series II with optional exposure meter. They're integral, but do not interfere with the optical system and interchange to fit varying needs.

**Be ready. Write for our new Stereomicroscope catalog 31-15 and our free demonstration offer.**

**BAUSCH & LOMB** 

SCIENTIFIC OPTICAL  
PRODUCTS DIVISION

61414 Bausch Street, Rochester, N.Y. 14602

StereoZoom, Reg. T.M.  
Bausch & Lomb.



# MONSANTO LAUNCHES NEW 50MHz COUNTER ATTACK



## New Model 100C

- 6 digit display
- Full-function to 50 MHz
- Priced at only \$565
- 7 digit option \$605



## New Model 101C with BCD

- 6 digit display
- 2 parts in  $10^8$  stability
- Priced at only \$695
- 7 digit option \$735

**When Monsanto first introduced these full-function 50MHz Counter-Timers we established the standards for the industry and caught our competition with their guard down.**

But our offensive couldn't be maintained by sitting on past successes. So, our NEW counter attack is again in your behalf, with new, realistic features and functional improvements. Contact your nearest Monsanto representative for a demonstration of our battle plan. Your reward will be a look at the best value on the market today.

For complete specifications request new brochure.

## United Systems Corp.

918 Woodley Rd.  
Dayton, Ohio 45403  
(513) 254-6251  
Subsidiary of

# Monsanto

**Monsanto: precision measurements to count on.**

All Monsanto instruments are available for rental or lease through Rental Electronics, Inc.

Models 606 and 603

## Photoelectric Paper Tape Transmitters with interface and power supply

Serial (RS232 compatible) or parallel (buffered)

Contains power supply and clock

Selectible 10, 15, 30, 60 or 120-character per second asynchronous

Weighs only 8 pounds

Rack mounted or self-contained case

Completely interfaced — just plug it in!

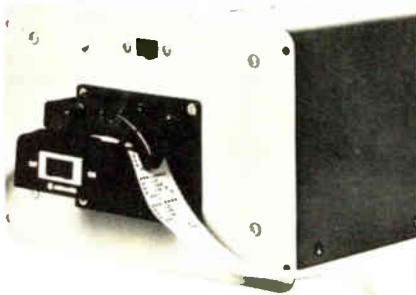

**ADDMASTER**

Addmaster Corporation

416 Junipero Serra Drive, San Gabriel, California 91776

Circle 158 on reader service card

## Megohmmeter and Hipot?

**YES!** For true integrity in HV bench-testing of electrical or electronic equipment — you need both! Megohmmeter to test insulation resistance (IR) . . . Hipot to test dielectric strength.

### HIPOTRONICS OFFERS

a full line of high resistance megohmmeters — sixteen models with ranges to 20,000,000 megohms and high current capability for testing insulation resistance to ASTM specification D-257, MIL, and UL standards.

### HIPOTRONICS ALSO OFFERS

a full line of AC/DC hipots — twenty-seven models with ranges to 10KV AC and 25 KV DC for non-destructive measurement of leakage current, corona discharge, AC and DC insulation strength.

### HIPOTRONICS GUARANTEES

complete high voltage — high resistance capability for thorough testing of switches . . . motors . . . coils . . . chokes . . . insulation . . . transformers . . . cables . . . electrical/electronic assemblies . . . harnesses . . . and more.

For more information write or call our marketing department for brochures HP7101 and HP7107.

**HIPOTRONICS**®

BREWSTER, N. Y. 10509  
Phone: (914) 279-8091



## New products

both is by two control lines that determine the operational mode of the counter. Lines S1 and S2 control one of four operations: preset, increment, decrement, or hold. A third terminal allows cascading of multiple units. Price is \$14.23 to \$17.79 depending on quantity.

Motorola Semiconductor Products Inc., P.O. Box 20912, Phoenix, Ariz. [416]

Receiver-transmitter is programmed for 1.5 stop bits

An MOS LSI asynchronous receiver-transmitter is capable of half-duplex or full-duplex operation. The device is TTL- and DTL-compatible and can be programmed to transmit 1.5 stop bits. The internal control, programmable from the device terminals, is a static control register. The programmable transmitter portion of the TR1602A links variable-length parallel-input data to a serial channel and converts parallel characters into a serial data stream with a format compatible with all standard, asynchronous data-communications media. Price is \$8.80 in quantities.

Western Digital Corp., 19242 Red Hill Ave., Newport Beach, Calif. 92663 [417]

Hybrid voltage regulators supply 5 amperes

A line of high-power, 5-ampere dc voltage regulator has three circuits in each series for both positive and negative applications. The positive circuits are identified as CJCA001.

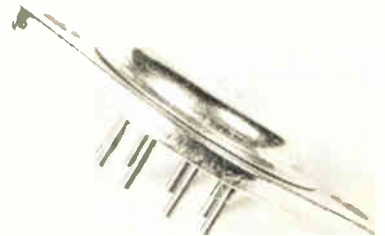

CJCA003, and CJCA005. The negative circuits are the CJCA002, CJCA004, and CJCA006. The series is available with a FET internal current source and a current limiter.



# RECTIFIERS

## Hard-boiled hermetics... TI's rugged 1-amp glass rectifiers.

TI's 1-amp glass rectifiers are tough, high-performance units you can depend on.

They're proven through extensive high-reliability testing—like 168 hours in a pressure cooker at 15psi, 120°C (no failures). This high reliability is achieved by combining the best processing, construction and packaging technologies.

The silicon mesa oxide-passivated structure has additional nitride and glass passivation over the junction. Double-plug construction provides highest mechanical integrity. Matched coefficients of expansion of the glass case and dumet leads provide hermeticity under widely varying temperatures (–65° to 175°C max operating range).

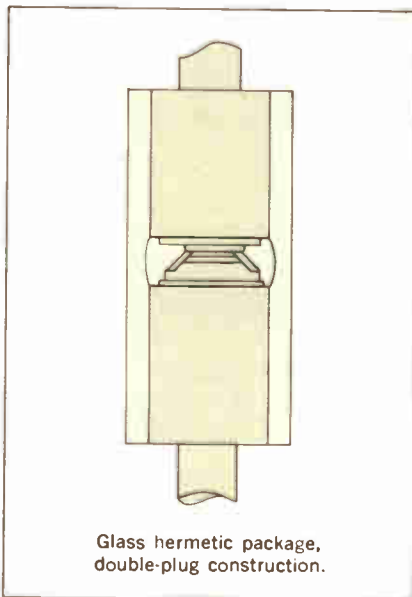

Glass hermetic package,  
double-plug construction.

Designated 1N4001 through 1N4006, the 1-amp devices offer a reverse voltage range of 50 to 800V. Repetitive peak forward current (10 cycles, 75°C or below) is 10 amps. Peak surge current is 30 amps. Static reverse current is 10 microamps at 25°C and 50 microamps at 100°C.

**For more information**  
For price and delivery, call your local TI sales office or authorized TI distributor. For complete data sheet covering the 1N4001-1N4006 1-amp glass series, circle 243 on the reader service card. Or write Texas Instruments Incorporated, P.O. Box 5012, MS 308, Dallas, Texas 75222.



TEXAS INSTRUMENTS

INCORPORATED

# LAY YOUR CARDS on the table ...



Don't "throw-in" a potentially winning circuit design just because you need a special timing or current switching component. Adlake offers mercury wetted contact relays, dry reed relays, and load relays . . . custom motor start-winding timers, fault grounding switches, pulse start dual time delays, and bistable AC/DC switches as standard catalog items . . . or how about a full line of hybrid timers, transfer timers, pulse latches, and power pulse latches for special applications.

You need **RELIABLE, PRACTICAL, and ECONOMICAL** special components. And Adlake's design engineers, with decades of experience, can tell you if a special current or timer device can be built reliably, practically, and at reasonable cost — 24 to 48 hour turn-around time is not unusual.

**Before you decide to  
"reshuffle" your circuit design  
... CONTACT ADLAKE ...**

**our innovative engineers can design  
and build the special  
component  
you need.**

### PULSE START DUAL TIME DELAY

Provides two preset time delay functions to a common load. A momentary "switch-closure (or pulse)" to the selected timing terminal starts the output circuit (120 VAC, 5A). At the pre-selected time, the circuit switches off.



### POWER PULSE LATCHES, SERIES HR-1000

Power Pulse Latches are designed for main power switching control of machine tools, assembly line systems, display sign flasher/control systems, and other power switching applications requiring long life, highly reliable, heavy current switching. With rated positive "gate" voltage applied to the all solid state input circuit, successive control pulses will alternately switch the load contacts "on" and "off". Output is DPST (N.O. or N.C.) high current mercury displacement switch contacts which will switch up to 100 amps per pole at 120 VAC.

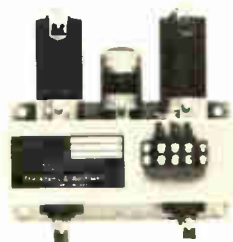

### MOTOR START WINDING TIMER

Dependable silent delay timing of start winding contactor. Same unit operates on voltage input from 120 to 460 V.A.C. Output capable of controlling up to 220 V.A.C. contactor coil. All solid state output insensitive to shock, dirt and most other environmental influences.



**ADLAKE CAN GIVE YOU AN UNBEATABLE HAND!**

## THE ADAMS & WESTLAKE COMPANY



ELMHART INDIANA 46513  
219 264 1141  
TELEX 25 8458  
CABLE ADLAKE

## New products/materials

electronic circuits. The material is formulated to be screened on, and is fired to develop interdiffusion bonding, which results from the formation of the eutectic phases during the firing process. Price is \$45 per pound.

Transene Co. Inc., Rte. 1, Rowley, Mass [478]

**A high-temperature alumina ceramic coating** for thermocouple protection tubes is called Pyro-Clad, and provides heat resistance to 3,000°F. The process matches the thermal rate of the alumina ceramic coating to the base metal in the thermocouple protection tube, and the responsiveness of the tube is not impaired because the coating acts as a thermal conductor. Price is from \$10 per unit depending on quantity and size of tubes to be coated.

Aremco Products Inc., Box 145, Briarcliff Manor, N.Y. [479]

**A series of alloys** consists of alloy 194, a copper alloy for contacts and lead frames; alloy 195, a high performance material for terminals, lead frames and springs; alloy 688, a cobalt aluminum modified brass material for contacts, terminals and connectors; and alloy 638, a cobalt-modified aluminum silicon bronze material used as a replacement for phosphor bronzes and nickel silvers in spring applications, and as a glass-to-metal seal in semiconductor packages.

Olin Corp., 460 Park Ave., New York, N.Y. 10022 [480]

**Stycast HiHiK** is a material that has an isotropic dielectric constant and is offered in rod, bar and sheet stock. The dielectric constant range is 3.5 to 30, and the dielectric constant increments are one with inter-



# Another introductory offer to new members of the ELECTRONICS AND CONTROL ENGINEERS' BOOK CLUB

	404/445 <b>ELECTRONIC CIRCUITS MANUAL</b> by J. Markus Pub. price, \$19.75 Club price, \$15.75		286/515 <b>INTEGRATED CIRCUITS: A Basic Course for Engineers and Technicians</b> by R. G. Hibberd Pub. price, \$9.95 Club price, \$8.45
	637/458 <b>DESIGNING WITH TTL INTEGRATED CIRCUITS</b> by Texas Instruments Inc. Pub. price, \$18.50 Club price, \$13.50		162/212 <b>INTEGRATED CIRCUITS &amp; SEMI-CONDUCTOR DEVICES</b> by Deboo & Burrous Pub. price, \$13.95 Club price, \$10.50
	404/437 <b>SOURCEBOOK OF ELECTRONIC CIRCUITS</b> by J. Markus Pub. price, \$19.75 Club price, \$14.75		313/059 <b>HANDBOOK OF SEMI-CONDUCTOR ELECTRONICS, 3/e</b> by P. Hunter Pub. price, \$27.50 Club price, \$21.50
	259/607 <b>COMMUNICATION SYSTEM ENGINEERING HANDBOOK</b> by D. H. Hamsher Pub. price, \$29.50 Club price, \$22.50		287/341 <b>STANDARD HANDBOOK OF ENGINEERING CALCULATIONS</b> by T. G. Hicks Pub. Price, \$18.50 Club Price, \$14.25
	388/458 <b>MAGNETIC RECORDING</b> by C. E. Lowman Pub. Price, \$14.50 Club Price, \$9.75		124/035 <b>HANDBOOK OF PHYSICS, 2/e</b> by Condon and Odishaw Pub. price, \$34.75 Club price, \$14.95
			283/672 <b>INSTRUMENTS &amp; MEASUREMENTS FOR ELECTRONICS</b> by C. N. Herrick Pub. price, \$13.95 Club price, \$10.50
			649/170 <b>OPERATIONAL AMPLIFIERS</b> by Tobey, Graeme & Huelsman Pub. price, \$15.00 Club price, \$11.50
			349/428 <b>TRANSISTOR AND INTEGRATED ELECTRONICS, 4/e</b> by M. S. Kiver Pub. Price, \$12.50 Club Price, \$9.75
			209/731 <b>STANDARD HANDBOOK FOR ELECTRICAL ENGINEERS, 10/e</b> by Fink and Carroll Pub. price, \$32.50 Club price, \$24.95

**ANY ONE**  
of these great professional books  
for only \$ **1.00**

VALUES FROM \$9.95 to \$34.75

Special \$1.00 bonus book comes to you with your first club selection

Save time and money by joining the  
Electronics and Control Engineers' Book Club



HERE is a professional club designed specifically to meet your day-to-day engineering needs by providing practical books in your field on a regular basis at below publisher prices.

How the Club operates: Basic to the Club's service is its publication, the *Electronics and Control Engineers' Book Club Bulletin*, which brings you news of books in your field. Sent to members without cost, it announces and describes in detail the Club's featured book of the month as well as alternate selections which are available at special members' prices.

When you want to examine the Club's feature of the month, you do nothing. The book will be mailed to you as a regular part of your Club service. If you prefer one of the alternate selections—or if you want no book at all for that month—you notify the Club by returning the convenient card enclosed with each *Bulletin*.

As a Club member, you agree only to the purchase of four books over a two-year period. Considering the many books published annually in your field, there will surely be at least four that you would want to own anyway. By joining the Club, you save both money and the trouble of searching for the best books.

**MAIL ATTACHED POSTPAID CARD**  
(If card removed, send coupon below)

**ELECTRONICS AND CONTROL ENGINEERS' BOOK CLUB**  
582 Princeton Road, Hightstown, N.J. 08520

Please enroll me as a member of the Electronics and Control Engineers' Book Club and send me the two books indicated below. I am to receive the bonus for just \$1.00, and my first selection at the special Club price shown. These books are to be shipped on approval, and I may return them both without cost or further obligation. If I decide to keep the books, I agree to purchase as few as four books during the next two years at special Club prices (at least 15% below list).

Write Code No. of bonus book here

Write Code No. of first selection here

Name \_\_\_\_\_

Address \_\_\_\_\_

City \_\_\_\_\_

State \_\_\_\_\_ Zip \_\_\_\_\_

E 33204

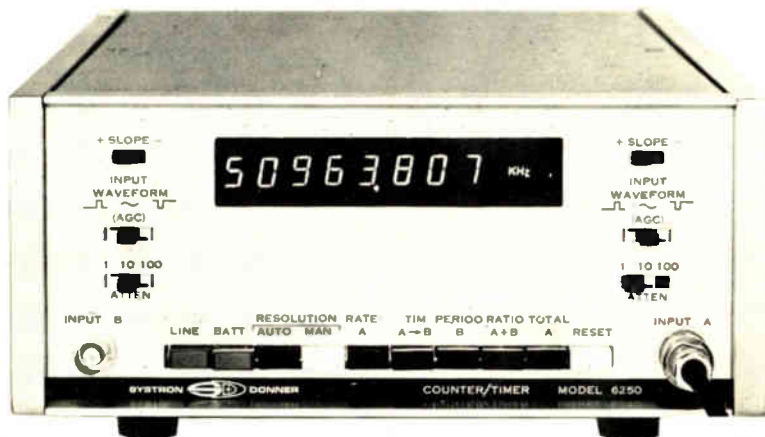

## 50 MHz automatic counter/timer

Frequency, TIM, period, ratio, totalize  
 Automatic gain control  
 Autoranging  
 Leading zero suppression  
 8-digit readout (standard)  
 25 mV input sensitivity  
 BCD output

### Model 6250 Options include:

Choice of 5 higher oscillator stabilities  
 Internal battery pack

Contact your Scientific Devices office or Concord Instruments Division,  
 10 Systron Drive, Concord, CA 94518. (415) 682-6161  
 Europe: Munich, W. Germany, Leamington Spa, U.K.

**SYSTRON**  **DONNER**

Circle 166 on reader service card

### SIR SEIBERLING IS AN IMPECCABLY CLEAN FIGHTER

Yes, when Sir Seiberling is armed with the absolutely dust free, seamless Sensiflex® glove, he can do battle in any "white room" in the world.

These comfortable, ambi-fit PVC's from Seiberling Latex Products fit snugly enough, even at the fingertips, for the most intricate of tasks.

Seiberling's Sensiflex gloves are strong enough to be reused, yet inexpensive enough to be thrown away. They come in three models — the dust-free 3004, the powdered 3003, and the 3006 with a little larger gauge.

For a free sample of any or all models, write or call Seiberling Latex Products today.

SEIBERLING LATEX PRODUCTS, 4500 SE 59th Street  
 Oklahoma City, Oklahoma 73135 405/672-2301



166 Circle 234 on reader service card

## New products/materials

mediate values available on special order. Loss tangent is below 0.0015 from low frequencies through microwave. Price is in the \$15 to \$20 per pound range.

Emerson & Cuming Inc., Canton, Mass. 02021 [403]

A polyester film with flame retardant properties is for applications in transformers, flat cables, and other uses of polyester film. Use of the material eliminates the need to encapsulate television flyback transformers in silicone rubber, and the material is self-extinguishing. The Scotchpar film has a minimum oxygen index of 28.

3M Co., Box 33600, Dept. Fi3-1, St. Paul, Minn. [401]

The custom packaging of most multicomponent resins into one packet allows the packaged materials to be compatible with most epoxies, urethanes, and RTV silicones used as adhesives, sealants, potting compounds, and electronic filler materials. The Acu-Paks are filled with materials to customer specifications, and the package is a transparent

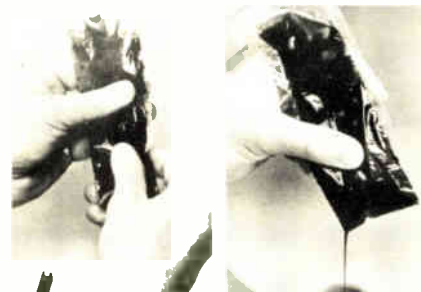

pouch separated into compartments. Allied Resin Corp., Weymouth Industrial Park, East Weymouth, Mass. 02189 [404]

A release agent called Exxit-II offers release quality for any type of polyurethane, compression-molded epoxy-resin, and other types of materials. It does not permit buildup of molds on steel, aluminum, epoxy or polyester resins, ceramics, and glass. The material applies with a fine mist spray and will provide instant release of clean pieces with good surface finish and without sticking or tearing thin sections.

Contour Chemical Co. Inc., 4 Draper St., Woburn, Mass. [405]

Electronics/February 15, 1973

# If you thought our first I.C. multiplier solved a lot of your problems, take a look at this one.

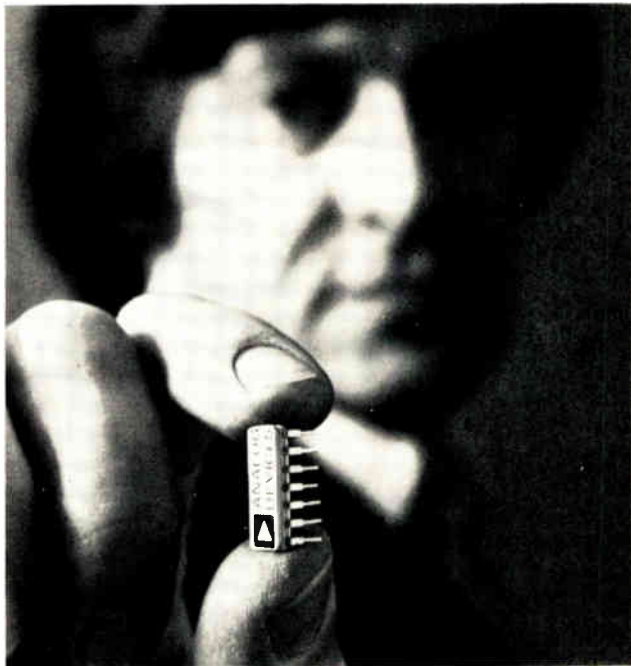

## **AD531. The first programmable XY/Z Multiplier/Divider. From \$20 in 100's.**

If you have anything to do with I.C. multipliers, you know our two-year-old AD530 line of monolithic multiplier/dividers has become the industry standard.

That kind of reputation we like. And we know our new AD531 will keep it going nicely.

The AD531 has our proven high performance design of a differential transconductance multiplying element, stable reference, and output amplifier combined on a

single chip. And we've added a variable scale factor which allows you to set any fixed value of a Z by an external resistor, or to dynamically vary the value of Z by an externally controlled simple reference circuit.

Plus a differential  $V_x$  input with 75dB of common mode rejection. All this makes a lot of complex applications very simple. Like automatic gain control.

True RMS-to-DC conversion. Absolute value. Vector summation.

You can use the instrumentation amplifier input to reject common mode noise. Or to subtract two input signals prior to further processing.

Or you can use the AD531 just to multiply, divide, square, or square root.

The AD531 will help you do all of this and more with an error guaranteed to be less than 0.5%.

The package is the TO-116 14-pin ceramic DIL for high reliability and handling ease. You can choose from three accuracy versions (J,K,L) for operation over the 0°C to +70°C temperature range, and one for -55°C to +125°C operation (S).

For the next 60 days we're offering five evaluation samples of any version of the AD531 at the 100-piece price.

Call for complete applications and price information. We'll also tell you about two other additions to our I.C. multiplier line. The AD530L, the highest accuracy addition to our AD530 line: 0.5% maximum error. And the availability of the AD530 in a ceramic 14-pin DIL package.

I.C. multipliers are just another of the unique solutions we bring to more of your problems.

Analog Devices, Inc., Norwood, Massachusetts 02062.



**Call 617-329-4700**  
for everything you need to know about multipliers.

# Save Cost Enjoy Quality with TOKO INC.

Announcing a new cost saving plan on PCB assembly with transfermolded Dual-In-Line PULSE TRANSFORMERS and DELAY LINES by thick film approach.

Offering a wide range of custom-designed features which meet your requirements.

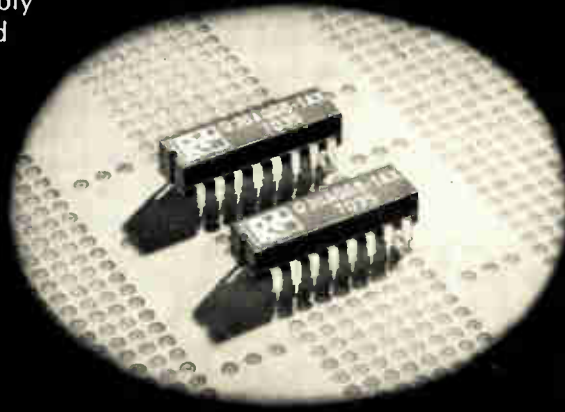

For further information, just call or write:



## TOKO, INC.

Head Office: 1-17, 2-chome, Higashi Yukigaya, Ohta-ku, Tokyo, Japan

New York: ToKo New York, Inc.

350 Fifth Avenue, New York, N.Y. 10001 U.S.A. Tel: 565-3767

Los Angeles: Toko, Inc. Los Angeles Liaison Office

1830 West Olympic Blvd., Los Angeles, 90006 Cal. U.S.A. Tel: 380-0417

Düsseldorf: Toko Elektronik GmbH:

4 Düsseldorf, Lakronstrasse 77, W. Germany Tel: 0221-284211

Circle 168 on reader service card

# JACKS, PINS & TERMINALS

## SHIPMENTS FROM STOCK

TEFLON/MICRO MINI/SUB MINI/STANDARD/  
PRINTED CIRCUIT/BRASS SOLDER

Hundreds of  
configurations  
in stock

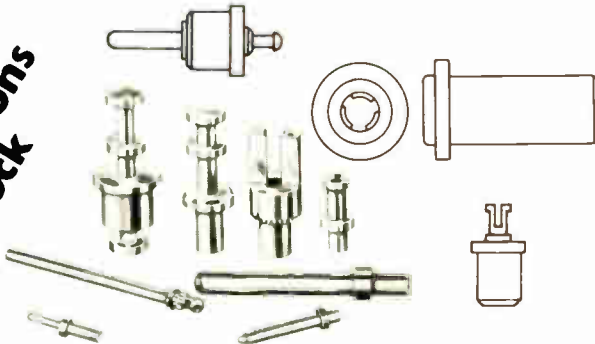

WE PRECISION-MANUFACTURE AND PLATE TO MIL SPEC  
IN GOLD, SILVER, TIN, SOLDER, AND OTHERS TO ORDER.  
FREE CATALOG AVAILABLE.

## CONCORD ELECTRONICS CORPORATION

37 GREAT JONES STREET, NEW YORK, N. Y. 10012  
(212) 777-6571 TWX 710-581-4930

168 Circle 201 on reader service card

## New literature

**Capacitors.** ITT Jennings, 970 McLaughlin Ave., San Jose, Calif. 95116, has published a catalog on its line of fixed and variable vacuum capacitors. The 52-page bulletin can assist the designer of high-power radio-frequency equipment to select a specific unit for a particular application. Circle 421 on reader service card.

**Automatic testers.** A 12-page brochure from Datatron Inc., 1562 Reynolds Ave., Santa Ana, Calif., describes a line of automatic testers. The brochure provides technical details and applications data. [422]

**Conversion devices.** Datel Systems Inc., 1020 Turnpike St., Canton, Mass. 02021. A three-ring binder catalog contains detailed electrical and mechanical information on a line of data-conversion modules, systems, and subsystems. The prod-



ucts described include a-d converters, d-a converters, sample-and-hold modules, digital panel meters, dc power supplies, and data acquisition systems. [423]

**Display modules.** A six-page catalog from Optical Electronics Inc., P.O. Box 11140, Tucson, Ariz., describes a line of analog three-dimensional display-generation modules. [424]

**Power supplies.** A two-page data sheet from Spellman High Voltage



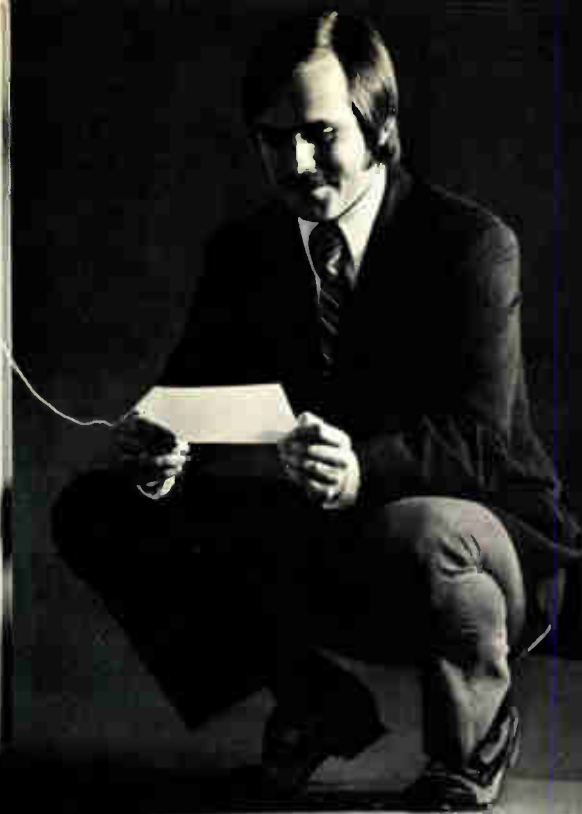
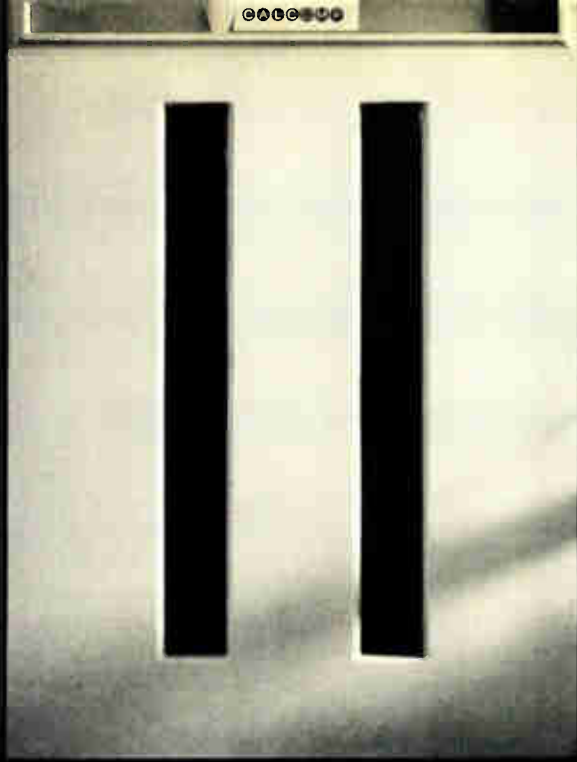

# Buy your own tape drive.

## Can you afford to? Can you afford not to?

We have a set of figures worked out by one of our accountants that shows you a savings of 20% over a three year period if you *buy* instead of lease.

But your figures will be different from his. They always are.

Here's what you positively *can* afford to do. You can call (714) 821-2011 collect, and talk to Rod Murray. Get together

with him or one of his people and your accountant.

Find out if you really can save something by buying instead of leasing.

But if you prefer to lease, check to see if you're leasing from us. If not, you're still spending too much.

Call your local CalComp office, or contact California Computer Products, Inc., EM-M2-73,

2411 West La Palma Avenue,  
Anaheim, California 92801.  
(714) 821-2011.



# CALCOMP

# Clean Up Signal Pollution



**multimetrics**  
INDUSTRIES

Division of DAYSAM Corp.

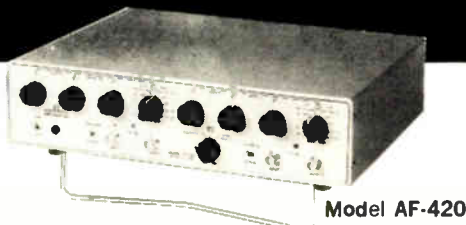

Model AF-420

## ACTIVE FILTERS

Our "clean-up" team of tunable active filters offers unsurpassed precision, versatility and reliability. Like our digitally tuned **SERIES AF-400**: cutoff frequencies from .001Hz to 99.9KHz • 2% accuracy • high pass, low pass, band pass, band reject, by-pass • Butterworth and Time Domain responses • 24 and 48db/octave slopes • 115/230v/battery operation • 2° phase tracking. Other Multimetrics signal "cleaners" include:

- SERIES AF-100** — 20Hz to 2MHz
- SERIES AF-200** — 0.2Hz to 20KHz
- SERIES AF-300** — 0.001Hz to 100KHz  
Mini-sized fixed frequency modules
- MODEL AF-520A** — 0.2Hz to 20KHz  
Push button — low cost
- SERIES AF-600** — to 100KHz  
Remotely programmable
- SERIES AF-800** — 0.2Hz to 20KHz  
Tunable sharp spikes and notches

Most instruments available on GSA Contract — write for details.

**CLEANER SIGNALS ARE UP TO YOU — SPECIFY MULTIMETRICS!**

**MULTIMETRICS INDUSTRIES • 120-30 Jamaica Ave., Richmond Hill, N.Y. 11418 • 212-441-4240**

Circle 170 on reader service card

# The Electronic Slide Rule

Here's the most exciting scientific/engineering tool since we introduced the log-log slide rule in 1884. It does everything your slide rule does, and then some. Hyperbolics, for example. It's fast, convenient, and has large, bright, 12-digit readout.

Direct entry makes complex calculations easy. Automatic sine of a number by entering the number and pressing **sin**. Convert degrees, minutes, seconds to decimal equivalent by entering angle and pressing **d**. Calculate the natural log of a number by entering the number and pressing **ln**. Read hyperbolic, trigonometric and exponential functions; convert radians to degrees or degrees to radians; all with a single function key that really fits your finger.

Put this slim, trim, 16-function electronic slide rule on your desk, right at your fingertips, and make life easy. From Dietzgen, the slide rule people. Who else? See it at your Dietzgen dealer today.

**Use just the CD scale on your slide rule? (+, -, X, ÷)** Get a Dietzgen CD-1. Dietzgen Corporation, 2425 North Sheffield Avenue, Chicago 60614

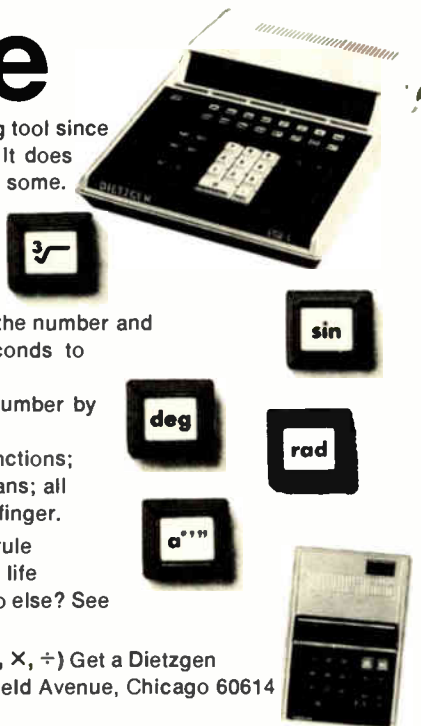

# DIETZGEN

170 Circle 202 on reader service card

## New literature

Electronics Corp., 1930 Adee Ave., Bronx, N.Y., details the Mini-Module RMX series of regulated high-voltage dc power supplies. [425]

**Process controller.** Leslie Co., Parsippany, N.J. The model 2610 process controller for temperature, pressure, power, and other applications is discussed in a two-page data sheet. [426]

**Thin-film measuring.** Bulletin 203-72 from Gaertner Scientific Corp., 1201 Wrightwood Ave., Chicago, Ill., describes equipment and accessories for thin-film measuring. [427]

**Capacitors.** A four-page variable capacitor-selection guide is available from Codi Semiconductor, Pollitt Dr., Fairlawn, N.J. 07410. [428]

**Oscillograph.** The series 870 portable test oscillograph is the subject of a brochure from Hathaway Instruments Inc., 5250 E. Evans Ave., Denver, Colo. 80222 [429]

**Instruments.** A 52-page catalog from Heath/Schlumberger Scientific Instruments, Benton Harbor, Mich. 49022, provides descriptions and specifications for a line of design and laboratory instruments, including a series of vhf counters that can provide capability to 600 MHz. [430]

**Switches.** An eight-page brochure being offered by Micro Switch, a division of Honeywell Inc., 11 W. Spring St., Freeport, Ill., describes the company's mercury-switch development, engineering and manufacturing capabilities. [431]

**Test sockets.** K-Tech Inc., 885 Waverly St., Framingham, Mass., has published a six-page brochure describing electrical and burn-in test sockets and carrier contact systems for semiconductor devices. [435]

**Memories.** A brochure available from Data Disc Inc., 686 W. Maude Ave., Sunnyvale, Calif., describes plug-in disk memories for most minicomputers, including those made by DEC, Honeywell, Interdata,

# Two decisive differences!

## The aperture-time uncertainty. The feed-thru.



*Aperture-Time Uncertainty—the tolerance of the delay between a hold command and the actual opening of the hold switch, i.e., the repeatability of the aperture time.*  
*Feed-thru—the effect of input on output when in the hold mode, usually a function of input signal level and frequency.*

Our Model 4853 high speed sample-hold amplifier boasts a low aperture-time uncertainty ( $\pm 1$  nsec) to ensure high accuracy in data acquisition systems even with rapidly changing input signals. And the 4853's exceptionally low feed-thru (1 mV for a 20V step) means you can multiplex during conversion, increasing thru-put.

Other features provided by our proprietary circuit design include an exceptionally fast settling time with minimum sample-to-hold offsets and "glitches", excellent linearity, low acquisition time, and low cost. All in a low profile module.

Ask your local Philbrick representative for the 4853 data sheet. It tells the *whole* story. Or write, Teledyne Philbrick, Allied Drive at Route 128, Dedham, Massachusetts 02026. For toll-free ready data, dial (800) 225-7883. In Massachusetts (617) 329-1600.

## Philbrick Circuit Modules. The best makes the difference.



## SECOND ARRESTING OFFER...

One MOS Encoded ASR-33 Keyboard with N-Key Rollover for \$59.00

Why \$59.00? For the same reasons the \$98.00 ANSI keyboard was offered at \$49.00.

First. Because of the quality and features offered by the fully assembled ASR-33 compatible keyboards • MOS reliability • N-key rollover • 25c BI-PAC switches featuring dual gold spring contacts (used in most all U.S. made electronic calculators) • less than 200 mA power consumption • standard ASCII encoding • tri-state or TTL output compatible • full repeat function, and more.

Second. The keyboard is \$59.00 because that's the cost for 5,000 (\$125 for 1-25). Your first is from stock. Quantities in 6-8 weeks.

Like to try one? See your local CRC rep's keyboards. He'll arrange for you to take the first or second arresting offer.



**Controls Research Corporation**

2100 South Fairview, Santa Ana, California 92704

Phone: (714) 557-7161 • TWX-910-595-1106

Circle 172 on reader service card

The new  
**ROTASWITCH®**  
**820 Encoder**  
is so small it  
fits in a space  
this size.



**See!**

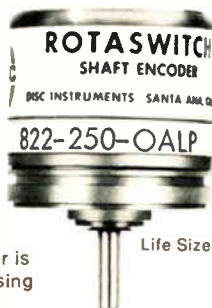
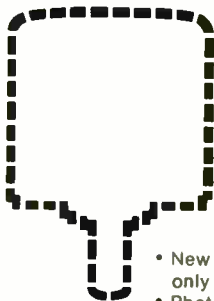

- New 820 Series ROTASWITCH Encoder is only 1" in diameter; size 11 servo housing
- Photoelectric type, uses LED sources
- Single or quadrature, sine or TTL compatible  output
- Up to 500 pulses per revolution
- High quality components for top dependability
- Low cost (\$150.00 in single quantities)

Complete specifications in Bulletin 820. Write or call

**DISC Instruments, Inc.** 2701 S. Halladay St., Santa Ana, Calif. 92705, Phone (714) 549-0343

**Disc Instruments Division**

Finnigan GmbH, Dachauer Strasse 511, 8 Munchen 50, Germany. Phone: (0811) 142291 (2)

**Disc Instruments Division**

Finnigan Instruments Ltd., Paradise, Hemel Hempstead, Herts, England, Phone: (0442) 57261

## New literature

Hewlett-Packard, Varian, and Data General. [432]

**Panel meters.** LFE Corp., Process Control division, 1601 Trapelo Rd., Waltham, Mass. 02154. A six-page bulletin describes the company's line of analog panel meters. [433]

**Data conversion.** An eight-page selection and evaluation guide on data conversion from Data Device Corp., 100 Tec St., Hicksville, N.Y., covers a-d, d-a, and multiplying converters, plus sample-and-hold modules. Included are applications notes and approaches available to the systems engineer. [434]

**Switches.** Cherry Electrical Products Corp., 3600 Sunset Ave., Wauke-



PRECISION  
SNAP-ACTION  
SWITCHES..

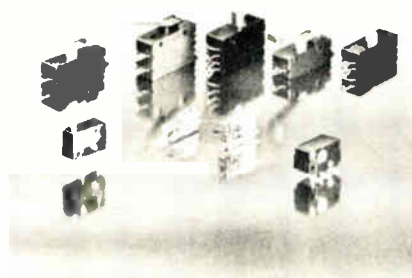

gan, Ill., has published a 30-page guide to 12 series of snap-action switches. [437]

**Lasers.** International Laser Systems Inc., 3404 North Orange Blossom Trail, Orlando, Fla. A four-page brochure provides information on high-energy, high-repetition-rate, neodymium YAG laser systems. [436]

**Panel meters.** A 28-page catalog, available from Triplett Corp., Bluffton, Ohio 45817, covers panel meters and accessories plus a customized panel meter service for use in industrial process control, electronic instrumentation, communications equipment, and computer and data processing systems. [438]

# Major breakthrough in advanced power tube technology

THOMSON-CSF announces a revolutionary new invention from their power tube laboratories...

We call it the **Pyrobloc\* Grid** and it surpasses all earlier grid designs.

With the Pyrobloc Grid, we can offer an entirely new generation of high power and compact Triodes and Tetrodes with remarkable improvement in performance.

These new grids offer:

- Single piece construction
- Enhanced mechanical strength
- High precision assembly
- Low expansion coefficient
- Optimum heat dissipation.

With our Pyrobloc Grids, and **Hypervapotron\*** cooling techniques, our new generation of tubes gives the designer of broadcasting, television, telecommunications, radar, nuclear and industrial equipments, a powerful tool for long-life, low-cost and reliable operation. For more information on our Pyrobloc Grid Tubes, please circle the appropriate number on the Reader Service Card, or contact us directly.

\* Registered Trade Mark  
and THOMSON-CSF patents.

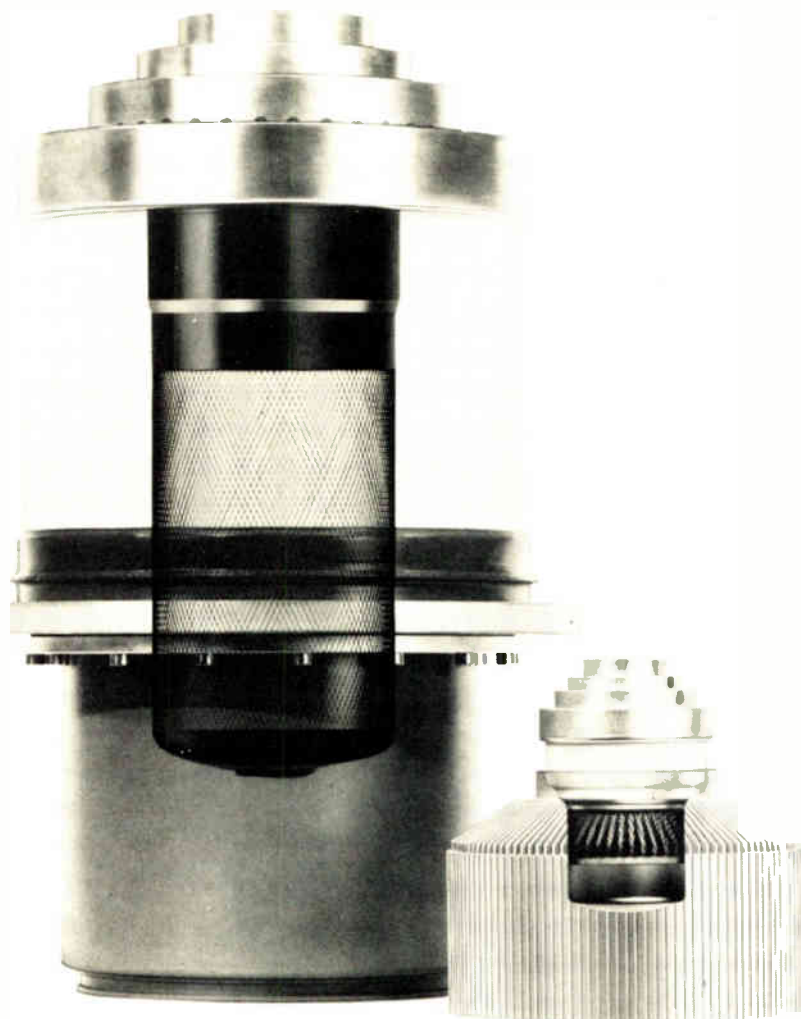

**THOMSON-CSF**

THOMSON-CSF ELECTRON TUBES, INC. / 50 ROCKEFELLER PLAZA / NEW YORK, N.Y. 10020 / TEL (212) 489-0400

France - THOMSON-CSF Groupement Tubes Electroniques / 8, rue Chasseloup-Laubat / 75015 PARIS / Tel. 566.70.04

Germany - THOMSON-CSF Elektronenröhren GmbH / Am Leonhardsbrunn 10 / 6 FRANKFURT/MAIN / Tel. 70 20 99

Italy - THOMSON-CSF Tubi Elettronici SRL / Viale degli Ammiragli 71 / ROMA / Tel. 63 80 143

Japan - THOMSON-CSF JAPAN K.K. / Kyosho Building / 1-9-3 Hirakawa-cho / Chiyoda-ku / TOKYO / T. 102 / Tel. 03 264-6341

Sweden - THOMSON-CSF Elektronrör AB / Box 27080 / S 10251 STOCKHOLM 27 / Tel. 08/22 58 15

United Kingdom - THOMSON-CSF Electronic Tubes Ltd / Bilton House, Uxbridge Road, Ealing / LONDON W5 2TT / Tel. 01-579 1857 / Telex: 25 659

1659

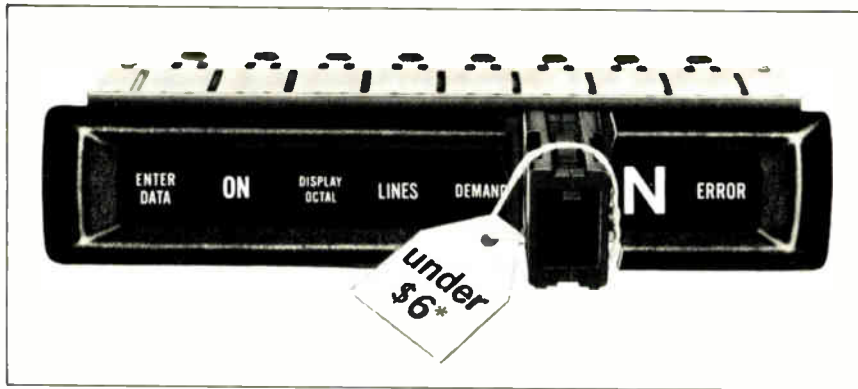

## NOW! A REAR-PROJECTION DISPLAY FOR UNDER \$6

IEE introduces the Series 1100 Readout, the first Rear-Projection display under \$6. Series 1100 costs far less than equivalent Rear-Projection models, yet packs all the similar features. We're talking of a .6" character displaying bright, crisp messages, numerals, symbols or colors, easily read from 20 feet. The total plug-in package (12 positions per readout) offers quick front panel removal for lamp and film servicing. Series 1100 accepts 5, 14 or 28 volt lamps compatible with DTL/TTL input

with a light output of 100 ft-L. Equally inexpensive is the mating Driver Decoder, the long life Series 7800. The Series 1100, low cost . . . high reliability . . . from the world leader in Rear-Projection displays. Give us a call. Industrial Electronic Engineers, Inc., 7740 Lemona Ave., Van Nuys, Ca. 91405, Telephone: (213) 787-0311. TWX 910-495-1707. Our European Office: 6707 Schifferstadt, Eichendorff-Allee 19, Germany, Phone: 06235-662.



\*In quantities of 1000

Circle 174 on reader service card

## Houdaille's versatile new n/c systems offer pluggable circuits, countless options -- and unbelievably low cost!

2- or 3-axis systems. Options include computer-assisted tape preparation, sophisticated contouring capability. The low cost is standard. So is Houdaille's nationwide factory service. Request information, and learn how to custom-automate economically with Houdaille. Electronics Division, Houdaille Industries Inc. 9023 Wehrle Drive/Clarence, N.Y. 14031/716-632-8412.

ELECTRONICS  HOU DAILLE

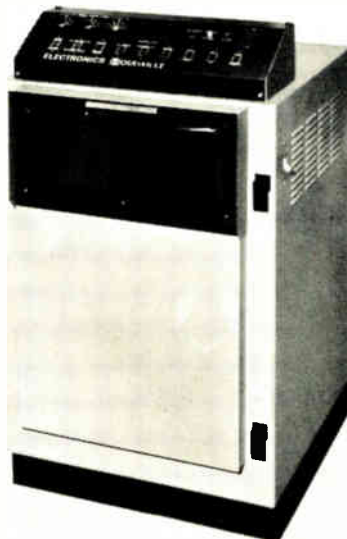

## New books

**Handbook of Wiring, Cabling, and Interconnecting for Electronics**, Charles A. Harper, editor-in-chief, McGraw-Hill Book Co., 1,142 pp., 1,034 illustrations, \$29.50.

Although many design engineers probably have one or more sources of basic data on wire and cable, be they handbooks or wire and cable catalogs, this book provides an exhaustive source of data that is probably not available elsewhere in a single volume. Most of the material was prepared two years ago, but the book is nonetheless quite up-to-date. Moreover, a dividend of owning this volume is the large bibliography included.

Charles Harper has assembled a volume with a great wealth of materials in diverse interconnection fields. The book discusses such traditional technologies as magnet wire and coaxial cable, as well as newer techniques such as printed circuits, flat cable, and microelectronic interconnections.

One strength of this book is its coverage of competing techniques, and much of this data is tabulated so that the reader may, for example, compare the reliability of soldered, welded, and wrapped connections with respect to their abilities to endure such environmental hardships as vibration, shock, and humidity.

**Organization.** Preparing such a handbook is an extremely ambitious undertaking, and this volume incorporates detailed inputs by knowledgeable people in the industry. It is hoped, however, that this volume will be revised from time to time—not only to update it as technology progresses, but also to reorganize material. The volume is organized in a chapter format, and it appears that the chapters have been printed as they were submitted by the various authors. This results in a good deal of redundancy. For example, the information on printed circuits appears in at least two chapters and flat wiring in three.

Frank Keister, in his chapter on soldered, welded, and mechanical terminating systems, begins with a comparison of termination techniques from the standpoint of reliability, design, ease of manufacture,

# For reliability, we stick to the basics.

You're looking at a cut-a-way of one of our least expensive lighted pushbuttons. The Series 4.

Inside, you can see what also makes it one of our most reliable: a precision SM snap-action basic switch. The time-proven SM assures you of mechanical and electrical dependability throughout the long life of the Series 4.

See those two mounting clips? They allow you to snap the Series 4 into the front of your panel. In seconds. Notice too, that the terminals are quick connect for ease of wiring.

Relamping is just as fast and simple. Pull out the display screen and the lamp is automatically extracted. The display screens themselves are bright, vivid rectangles of color that do wonders for the front of your panel.

Something we can't show here are all our options: low energy (1 amp, 125 VAC max.) and power load (5 or 10 amp, 250 VAC max.) all UL listed, bezel and barrier housings, matching indicators and a wide variety of display techniques.

For the complete list of options, contact your MICRO SWITCH Branch Office or Authorized Distributor (Yellow Pages, "Switches, Electric"). They're reliable, too. You'll see.

MICRO SWITCH makes your ideas work.

**MICRO SWITCH**  
FREEPORT ILLINOIS 61032  
A DIVISION OF HONEYWELL



Shown 2½ times actual size.

MICRO SWITCH products are available worldwide through Honeywell International.



## Liquid Crystal Readouts in Stock

Samples of LIQUID CRYSTAL READOUTS available for engineering evaluation

3-1/2 Digit (with colon) LIQUID CRYSTAL DISPLAY

Sample price: (\$30.00) each

Electrical connector and CMOS clock-timing, decoder-driver chip also available if you need it.

**OPTEL**

Send order directly to Peter Stearns  
Box 2215, Princeton, N.J. 08540 609 • 452-9250

Circle 176 on reader service card

## THE MITE<sup>T.M.</sup> NEW HEAT GUN FROM MASTER



Rugged, Anodized,  
Air Cooled Barrel

Safety Light - Easy to see...  
indicates unit is "on."

One Hand Control -  
Three-way switch operated  
with simple finger movement.

Now bring a new dimension to heat shrinking as well as countless other industrial applications. Easier to handle... only two pounds with nozzle... perfectly balanced.

Three easily interchangeable color-coded nozzles to speed specific jobs. Silver (standard)... used for most shrinkables (475°F.). Blue nozzle for Mylar\* (500°F.)... and Black for Teflon\* (800°F.) both optional equipment. Nozzles can be changed in seconds.

Draws only 5.4 amps. High impact housing withstands hard knocks of shop use. For information on the new MITE Heat Gun or the full line of Master Heat tools, contact your distributor or write:

\*Reg. Trade Name of DuPont

**MASTER**  
appliance corporation

Racine, Wisconsin 53403  
Phone 414/633-7791

and maintainability. His section on wire-wrap is brief, but it contains important data on the reliability of this technique, including the effects of various environmental factors—important because of the relatively recent arrival of wire-wrapping on the electronic production scene.

The chapter on connector systems provides the designer with significant information for connector selection. A table compares the characteristics of 21 plastics used as insert materials. Another valuable section provides working formulas that enable the reader to calculate failure rates based on the following: insert material, current load through the contact, size of contact, insert-temperature rise, ambient temperature, maximum operating temperature, number of active contacts, and mating and unmating cycles.

Elmer Goodwin's chapter on hookup wire, multiconductor cable, and terminating devices describes alloys used in conductors, and it contains data on insulating and jacket materials. There is a section on thermocouples and thermocouple leads.

**Coax.** As for coaxial cable and connectors, the material by Jack Spergel on this topic alone is worth the price of the book. Spergel goes beyond the usual domain of a handbook. Beginning with Maxwell's field equations, he develops the formulas governing electric and magnetic-field propagation down transmission lines. The additional topics are too voluminous to list, other than to note that they include power handling, voltage-standing-wave ratio and attenuation, and their variations with just about any line or load condition.

There are chapters on telephone cable, together with high-voltage-, magnet-, and flat-wire.

There has been little written on telephone cable technology (outside of telephone publications), and the chapter on telephone cable will probably be useful to engineers on the outside who wish to know something of telephone cabling techniques. It covers cable used for inside and outside plant, and splicing techniques, and discusses wideband



# The New Threedom.

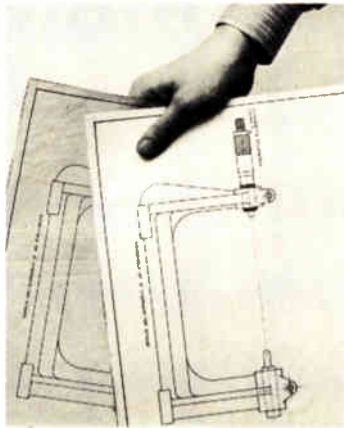

1. Pos. to pos.



2. Small to big.



3. Contact.

---

Kodak now has three KODAGRAPH Wash-Off Films that can save you hours of redrawing time.

---

**1.** Now you can enjoy the benefits of KODAGRAPH Wash-Off Films for more of your drafting room work. With the new KODAGRAPH Wash-Off AUTOPOSITIVE Film, you get a positive reproduction from a positive original. Like all KODAGRAPH Films, it gives you high-contrast prints that make excellent second originals.

**2.** When you need a size-change of a drawing, or an enlargement from an aperture card, just ask for it on the new KODAGRAPH Wash-Off Projection Film. You can count on getting a sharp, positive reproduction. And, as with other

KODAGRAPH Wash-Off Films, you'll like its wet-erasable photo lines and excellent dimensional stability.

**3.** You probably know already what KODAGRAPH Wash-Off Contact Film can do for your designs. You may even be specifying it regularly to obtain high-quality, positive reproductions from intermediate negatives of your drawings. It produces intense black lines on an outstanding drafting surface that takes either pencil or ink, just like the other KODAGRAPH Wash-Off Products.

---

Get the facts.

---

For additional information on The New Threedom, write Eastman Kodak Company, Business Systems Markets Division, Dept. DP823, Rochester, N. Y. 14650.



**Products for engineering data systems**

# Introducing the expensive curve tracer that doesn't cost a lot.

The B&K Model 501A.

It hooks up to any scope, old or new. (Like our Model 1460 triggered-sweep scope.)

And it analyzes all semi-conductors including J-FET's, MOS-FET's, signal and power bipolar transistors, SCR's, UJT's and diodes. Fast and easy.

Constant current and voltage steps with 3% accuracy make the Model 501A an exceptional value. In fact, it performs like \$2,000 units. Yet you can afford one on each engineer's bench. And another for incoming quality control.

Call your B&K distributor. Or write Dynascan Corporation.

In stock at your parts distributor.



## \$129<sup>95</sup>



Product of Dynascan Corporation  
1801 West Belle Plaine Avenue, Chicago, Illinois 60613

Circle 178 on reader service card

**Cambion  
Catalog 119:  
72 pages of good news**

Our new Catalog 119 offers 72 illustrated pages of advanced digital components and IC accessories. It gives you all specifications and dimensions, fresh ideas, sensible solutions.

Card files, IC socket cards, integrated arrays, test devices, interface hardware, production and breadboarding aids for using ICs . . . nobody recognizes your growing product needs like Cambion. The best news in the market is still our Double "QQ" approach, repeatable Quality in any Quantity. Get the whole story by ordering your free copy of Catalog 119. Cambridge Thermionic Corporation, 445ED Concord Avenue, Cambridge, Mass. 02138. Phone (617) 491-5400. In Los Angeles, 8703 La Tijera Blvd. Phone (213) 776-0472.

Standardize on

**CAMBION**  
the guaranteed digital products

## New books

signal distribution, such as that used in CATV applications.

The chapter on printed-circuit boards considers their fabrication and electrical and thermal characteristics, besides throwing in some historical tidbits, such as the fact that pc boards date back to a British invention of 1903. Pc connector design is also dealt with, and the section on reliability, though brief, is important in view of the low confidence many engineers have in the one-piece pc connector.

In a well-written chapter on formed high-frequency circuits, Joseph Marshall discusses the electrical properties of strip line and microstrip. He explains how some semi-lumped circuit components can be formed on a pc board to behave as inductive and capacitive reactances, the equivalent of inductors and capacitors. He also describes the basis of strip-line resonant-circuit design.

**Performance.** Burton Gerpheide has written a concise but satisfactory evaluation of flexible, flat-printed wiring. He discusses the electrical and mechanical characteristics of flat wire along with its performance at radio frequencies.

John McCormick of the Air Force's Rome Air Development Center was chosen to prepare a chapter on microelectronics. The RADC has been deeply involved in the reliability of technology processes, and excellent samples of its investigations are presented in this chapter. McCormick presents concise discussions of many of the technologies employed in microelectronics such as thin- and thick-film fabrication processes. Some scanning-electron-microscope photographs, along with some good text discussion, provide excellent insight into these metalization techniques. The chapter goes into chip bonding and wire bonding, along with some detailed reliability data.

The glossary lists many of the terms used in the book, and an index is well-structured. Unfortunately, not all terms contained in the glossary appear in the index.

—Stephen E. Grossman,  
Packaging & Production Editor

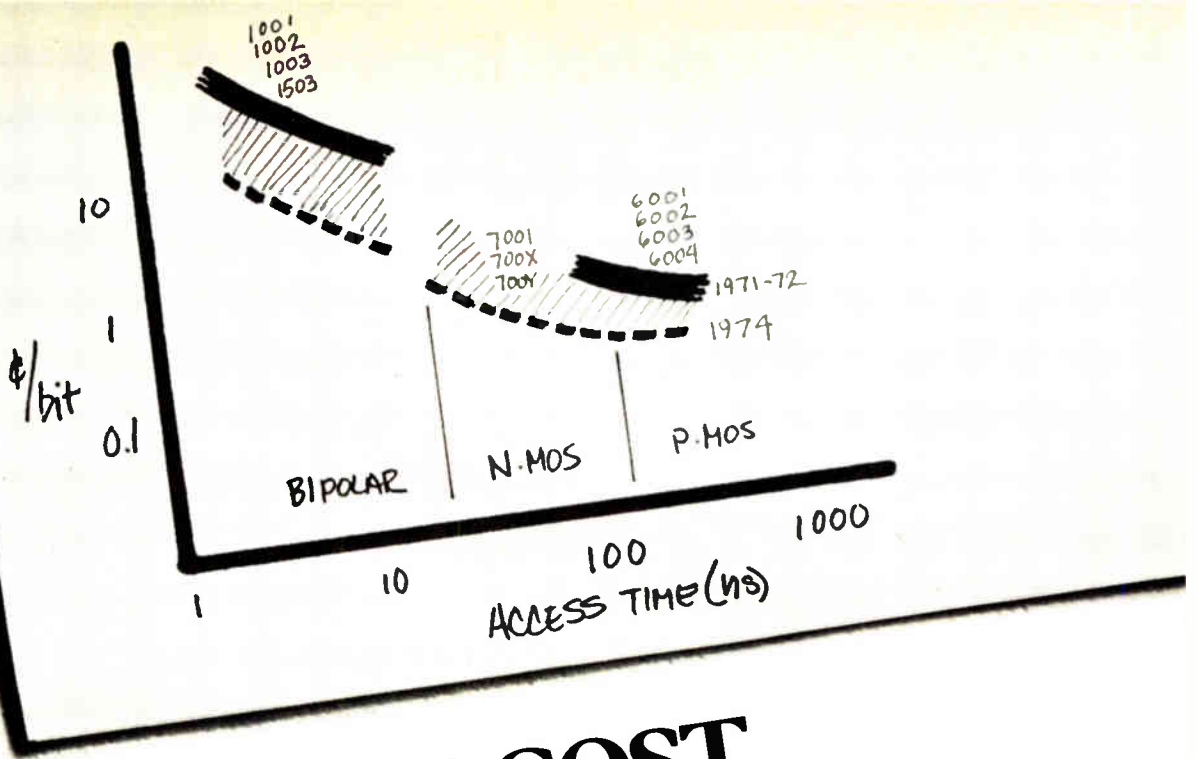

# RAM COST

Devices are the critical path...AMS knows!

Count the full cost of monolithic main memory: include not just devices, but boards, back panels, power supplies, cabinetry, diagnostics, final test. You'll discover, as main memory capacities rise in every class of machine, that the component is an *increasing* proportion of solid-state memory cost, even though individual device costs are declining (see historical chart above). Conclusion: select the RAM supplier at the cutting edge of the cost curve in every class of RAM—bipolar, N-channel, P-channel. The supplier: AMS.

Solid-state computer memory is now superior to every other main memory technology in performance and price. Only one independent semiconductor

memory company has always gone all the way from silicon to systems: AMS. Result: we have delivered more monolithic memory, installed and operating worldwide, than all the other suppliers put together.

Ask for the facts. We've got them. Facts on AMS semiconductor memories: cost, performance, reliability, our process technologies. Facts on how to get AMS memory when you need it, who is using our memory, what they think about it. Proof that we do the whole job, from silicon to systems, and do it right.

We've got it all together, to give you better memories. In this business, if you haven't got it all together, you haven't got it.

**Advanced Memory Systems, Inc.**  
1276 Hammerwood Avenue  
Sunnyvale, California 94086

AMS means advanced memories. From silicon to systems



ADVANCED MEMORY SYSTEMS • ADVANCED MEMORY SYSTEMS • ADVANCED MEMORY SYSTEMS

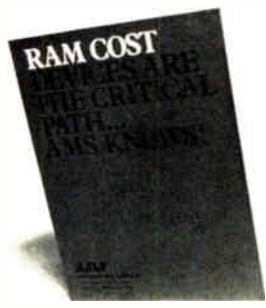

Name \_\_\_\_\_

Title \_\_\_\_\_

Company \_\_\_\_\_

Address \_\_\_\_\_

City \_\_\_\_\_ Zip \_\_\_\_\_

State \_\_\_\_\_

Tel. ( ) \_\_\_\_\_

ADVANCED MEMORY SYSTEMS

ADVANCED MEMORY SYSTEMS

ADVANCED MEMORY SYSTEMS • ADVANCED MEMORY SYSTEMS • ADVANCED MEMORY SYSTEMS

Clip and mail to us

CLASSIFIED ADVERTISING  
**SEARCHLIGHT SECTION**  
 BUSINESS OPPORTUNITIES  
 USED OR SURPLUS EQUIPMENT

RADAR SYSTEMS GROUND AND AIRBORNE. AUTOMATIC TRACKING ANTENNA SYSTEMS. NIKE AJAX. NIKE HERCULES. M-33. MSO-1A. MPS-19. MPS-9. SCR 584. TPS-1D. TPS-28. FAA-ASR-2. AIRBORNE SYSTEMS. APN-84. APN-102. APS-20. APS-27. APS-45. DPN-19. DIGITAL COMPUTERS. IBM 650. IBM 704.  
 LARGEST INVENTORY OF RADAR AND MICROWAVE EQUIPMENT IN THE WORLD.  
**RADIO RESEARCH INSTRUMENT CO.**  
 3 QUINCY ST., NORWALK, CONN. 06850 (203) 853-2600

CIRCLE 951 ON READER SERVICE CARD

**Radiation Devices Co.**



**BROADBAND AMPLIFIERS**  
 Our Economical Line of Broadband RF Amplifiers Covers The Frequency Region From 3 MHz. to 800 MHz. With Noise Figures As Low As 3.0 dB. Remotely Powered Versions Are Available. Brochures and Application Notes Are Available Upon Your Request  
 RADIATION DEVICES CO. BOX 8450. BALTO. MD 21234

CIRCLE 952 ON READER SERVICE CARD

**20,000 sq. ft.**  
**to 72,000 sq. ft.**  
**BERGEN COUNTY, N.J.**  
 Modern plant on 6½ fenced acres; at Routes 17, 46, 80; sprinklered; heavy power; high ceilings, concrete floors; easy public transp; A/C offices; Competitive rentals.

Exclusive Broker  
**J. I. KISLAK REALTY CORP.**  
 Real Estate Services  
 of The Kislak Organization  
 581 BROAD STREET / NEWARK, N.J.  
 (201) 624-8000 (212) 962-3600

CIRCLE 953 ON READER SERVICE CARD

**SOLID TANTALUM CAPACITORS**  
**FIRST QUALITY AT SURPLUS PRICES. WIDE VARIETY, immediate shipment**  
**GREEN TECH**  
 Box 6805, Greenville, S. C. 29606  
 (803) 277-3537

CIRCLE 954 ON READER SERVICE CARD

**Somebody—  
 Somewhere**  
 needs your idle equipment! Reach that buyer quickly and economically thru the  
**"SEARCHLIGHT SECTION"**  
 The meeting place of  
**Used Equipment Buyers and Sellers**

 **EMPLOYMENT OPPORTUNITIES**

# Engineers

Do you couple  
*creativity*  
 with solid  
 skills?

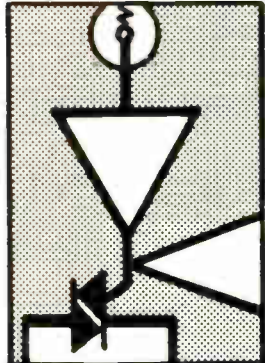

A leading designer/producer of business machines, we are pioneering a new generation of equipment to meet expanding commercial needs. The engineering challenges are enormous, offering wide latitude for application of your talent. If you qualify, you'll find excellent salaries, scaled to experience, a comprehensive benefit package, and opportunity to increase your professional stature. Your active pursuit of higher academic achievement is expected. Familiarity with computers and scientific programming is necessary.

**PROJECT**

**ELECTRONIC AND/OR ELECTRO-MECHANICAL ENGINEERS**  
 Technical and Management Experience. BSEE or BSME. 5-10 years' experience

You'll need to have worked in design and development of electronic or electro-mechanical products using digital logic. It is imperative that you have the ability and experience to determine the effects that the methods of manufacture and fabrication have on product design and function.

**ADVANCED DEVELOPMENT**

**ELECTRONICS ENGINEERS/BSEE**

Up to 10 years' broad technical experience applicable to business machines. You must possess a solid background in the areas of electronic systems involving circuit design using linear ICs and logic and digital systems design incorporating various families of digital ICs.

**MECHANICAL ENGINEERS/MSME or BSME** working toward Master's  
 You'll need at least 3 years' experience in design and analysis covering areas of stress, vibration and dynamics. The successful candidate can expect to assume project responsibilities.

**ELECTRONIC PACKAGING**

**ELECTRONICS ENGINEERS/MSEE** preferred

5 years' experience in solid state controls and ICs.

You'll be converting existing relay logic to state-of-the-art design. You must know harness layouts, be able to work from schematics, and develop logic drawings into production blueprints. An understanding of design limitations imposed by production is needed. Within that framework, you'll be required to develop techniques to improve manufacturability and servicability.

Your resume is invited. Please forward it with salary requirements, in confidence, to:

D. SCHOLEFIELD

 **Pitney Bowes**  
 An Equal Opportunity Employer

Walnut and Pacific Streets, Stamford, Connecticut 06904

# VIDEO COMPRESSOR



## FOR LAB AND COMMUNICATION SYSTEMS

The CVI Model 260 Video Compressor samples conventional "real time" television signals to achieve a large reduction in bandwidth. The compressor also digitizes the signals for computer input and image analysis. A special 260 feature incorporates a "real time" video output which allows users to monitor the sampling process.

### TYPICAL APPLICATIONS INCLUDE:

- Computer data input, linear or semi-random scanning
- Communications: transmission of TV images over voice grade circuits for conference or data distribution purposes
- Environmental monitoring: transmission of TV signals for remote observation and computer analysis
- Data recording: utilization of conventional audio cassette or reel-to-reel tape recorders for image storage
- Biomedical image analysis
- Industrial control
- Computer image enhancement

Video instruments for data acquisition, processing, transmission, and display.

**cv****i**

Colorado Video, Inc.  
P.O. Box 928 Boulder, Colorado 80302 (303) 444-3972

Circle 208 on reader service card

# MONO-KAPS<sup>TM</sup>

## Unique in Availability, Price and Quality

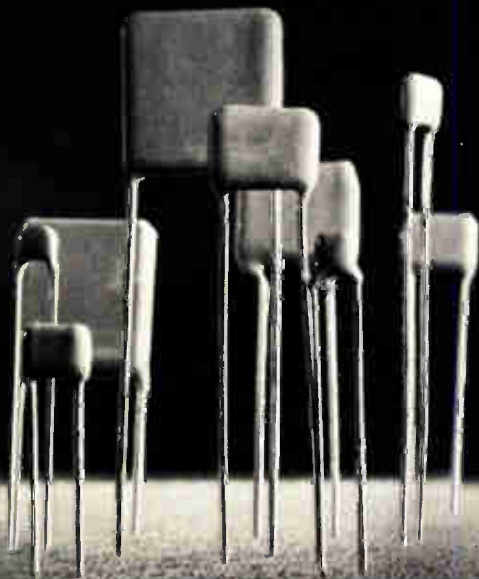

### \* FREE Samples

USCC/Centralab Mono-Kap Ceramic Capacitors have availability, price and quality inherent in every part.

**AVAILABILITY.** Immediately available from over 150 distributors are stock units in six sizes from .100 x .100 to .500 x .500. Our four dielectrics are NPO, W5R, Z5U and Y5V, with capacitance values from 4.7 pF to 10 Mfd in 50, 100 and 200 VDC ratings.

**PRICE.** \$.09 average in production quantities. This low price is due to USCC's development of highly automated assembly techniques resulting in large volume production of Mono-Kaps.

**QUALITY.** USCC is currently under contract to produce chip capacitors (the heart of Mono-Kaps) at the rate of 25,000 per hour, with a failure rate level of only .001% per 1000 hrs.



\*Want FREE evaluation samples? Write on company letterhead to USCC/Centralab. For complete technical data on MONO-KAPS and other quality USCC components, circle the information retrieval number below.

**USCC**

**USCC/Centralab**

Electronics Division • Globe-Union, Inc.

2151 North Lincoln Street • Burbank, California 91504  
(213) 843-4222 • TWX: 910-498-2222



Circle 183 on reader service card

# Electronics advertisers

February 15, 1973

■ <b>Abott Transistor Labs Inc.</b> Technical Adv. Agency	6	<b>General Magnetics</b> McCarthy/Scelba/DeBiasi Adv. Agcy., Inc.	2nd Cover	<b>Piher International</b> Scott MacTaggart Advertising	62-63
■ <b>Acoplan Corp.</b> Mort Barish Associates, Inc.	188	■ <b>General Radio Co.</b> GRAD Associates	121	● <b>Plessey Arco</b> A. & E. Bologna	11E
■ <b>Adams &amp; Westlake Company Relay Division</b> Adwest Advertising	162	● <b>General Radio</b> GRAD Associates	7E	‡ <b>Raytheon Company, Industrial Components Operation</b> Provandie Eastwood & Lombardi, Inc.	54
■ <b>Addmaster Corporation</b> Mich Associates	158	■ <b>Gould, Inc./Instrument Systems Div.</b> Carr Liggett Adv., Inc.	40	● <b>RCA Ltd.</b> Marsteller Ltd.	2E-3E
■ <b>Advanced Memory Systems</b> Writing Unlimited	179	■ <b>Grayhill, Incorporated</b> Carr Liggett Advertising, Inc.	188	■ <b>RCL Electronics, Inc.</b> Norway Advertising Agency	14
■ <b>Airpax Electronics</b> Welch, Mirabile & Co., Inc.	148	■ <b>Hamilton Digital Controls, Inc.</b> Graystone and Ramsey, Inc.	135	■ <b>Reliability, Inc.</b> Marketing Services Management	44
■ <b>Allen-Bradley Company</b> Hoffman, York Baker & Johnson, Inc.	26	■ <b>Harris Semiconductor</b> Tucker Wayne & Company	37	■ <b>Rental Electronics, Inc.</b> Communications Unlimited, Inc.	150
■ <b>AMF/Potter &amp; Brumfield Division</b> Fuller & Smith & Ross Inc.	134	■ <b>Harshaw Chemical Company</b> Industry Advertising Company	143	■ <b>Resistance Products Co.</b> Romano Associates, Inc.	153
■ <b>American Electronic Laboratories Inc.</b> Ernest Williams Greenfield Inc	156	■ <b>Heath/Schlumberger Scientific Instruments</b> Advance Advertising Services	17-18	‡ <b>Rohde &amp; Schwarz, Inc.</b> R & S Sales Company	59
■ <b>AMP Incorporated</b> Atkin-Kynett Co. Inc.	20-21	■ <b>Hermes Electronics Ltd.</b> Public & Industrial Relations Limited	82	● <b>Rohde &amp; Schwarz</b> Perez Publicite	1E 151
● <b>AMP Italia</b> Studio Dolci	15E	■ <b>Hewlett-Packard</b> Stone & Adler Incorporated	77	● <b>Scanbe Manufacturing Corp.</b> Warren C. Wilson & Associates	41
■ <b>Analogue Devices Inc.</b> Schneider Parker Guy Inc	167	■ <b>Hewlett-Packard</b> Richardson, Seigle, Rolfs & McCoy, Inc.	139	■ <b>Schauer Manufacturing Corp.</b> Nolan, Keefer & Sittes	166
■ <b>Augat</b> Creamer, Trowbridge, Case & Basford Inc	64-65	■ <b>Hewlett-Packard</b> Tallant Yates Adv., Inc.	66-67	■ <b>Seiberling Latex Products</b> Kenray Advertising, Inc.	35
■ <b>AVX Ceramics</b> Allied Advertising Agency, Inc	79	■ <b>Hewlett-Packard</b> Tallant/Yates Advertising, Inc.	10-11	■ <b>Semtech Corporation</b> Burruss/Advertising	12E
■ <b>BAFCO, Inc.</b> Designex Company	180	■ <b>Hewlett-Packard</b> Tallant/Yates Advertising, Inc.	84-85	● <b>Sescosom</b> Perez Publicite	54
■ <b>Bausch &amp; Lomb, Inc.</b> Wolff Assoc., Inc.	154	■ <b>Hewlett-Packard</b> McCarthy, Scelba, and DeBiasi Adv. Agency, Inc.	1	● <b>Siemens Aktiengesellschaft</b> Linder Presse Union GmbH	23
‡ <b>Beckman Instruments, Inc., Helipot Div.</b> N. W. Ayer/Jorgensen/MacDonald, Inc	60-61	■ <b>Hewlett-Packard</b> Phillips Ramsey Advertising & Public Relations	157	■ <b>Signetics Corp., Sub. of Corning Glass Works</b> Hall Butler Blatherwick, Inc	107
■ <b>Bendix Corporation, Electrical Components Div.</b> D'Arcy-MacManus-Intermarco, Inc.	142	■ <b>Hewlett-Packard</b> Richardson, Seigle, Rolfs & McCoy, Inc.	2	■ <b>Siliconix</b> Robertson West, Inc.	161
■ <b>Bulova/Electronics Division</b> Caroe Marketing, Inc.	130	■ <b>Hipotonics, Inc.</b> Kenmarc Advertising, Inc.	158	■ <b>Simpson Electric Co.</b> Amerad Advertising Services, Inc.	39
■ <b>Burroughs Corp.</b> Conti Advertising Agency, Inc.	147	■ <b>Houdaille Inds., Inc., Electronics Div.</b> John E. Hayes Co., Inc.	174	■ <b>Singer Instrumentation—Alfred Div.</b> N. W. Ayer/Jorgensen/MacDonald, Inc.	129
■ <b>Cambridge Thermionic Corporation</b> Chrurg & Cairns, Inc.	178	■ <b>Hycorp</b> Industrial Electronics Engineers, Inc.	132 174	‡ <b>Sorensen Operation Raytheon Company</b> Provandie Eastwood & Lombardi, Inc.	149
■ <b>CELCO (Constantine Engineering Laboratory Co.)</b> Stano Advertising	140	■ <b>Industrial Electronics Engineers, Inc.</b> S. Michelson Advertising	188	■ <b>Spectral Electronics Corp.</b> J. M. R., Inc.	144
■ <b>California Computer Products</b> Dailey & Associates Advertising	169	■ <b>Information Terminals</b> Lincoln Associates Inc	131	■ <b>Sprague Electric Company</b> Harry P. Bridge Company	53, 166
■ <b>Cherry Electrical Products Corp.</b> Kolb/Tookey and Assoc., Inc.	185	■ <b>Inselek</b> Insel Advertising Agency	181	■ <b>Sytron Donner Concord Instruments</b> Bonfield Associates	8
■ <b>Chicago Dynamic Industries, Inc.</b> Burton Browne Advertising	187	■ <b>International Electronic Research Corporation</b> Van Der Boom McCarron Inc Advertising	126	■ <b>T-Bar Incorporated</b> The Robert A. Paul Advertising Agency, Inc.	59
■ <b>Clairex Corporation</b> Black-Russell-Morris	4th Cover	‡ <b>International Rectifier Corp., Semiconductor Division</b> William E. Wilson Company	128	● <b>TEAC Corp.</b> Dentsu Advertising Ltd	78, T1-T8
■ <b>Colorado, State of Commerce and Development Division</b> Frye-Sills, Inc.	186	■ <b>Ithaco Inc.</b> Hart Conway Co., Inc.	47	■ <b>Tektronix, Inc.</b> Dawson, Inc.	171
■ <b>Colorado Video, Inc.</b> O'Connell-Colburn Inc Creative Business Communications	183	■ <b>ITT Semiconductors</b> Hall & McKenzie Advertising	5	● <b>Teledyne Philbrick</b> Ingalls Associates, Inc. Advertising	9E
■ <b>Computer Automation</b> Cochrane Chase & Company, Inc	83	■ <b>Kepec Incorporated</b> Weiss Advertising	3rd Cover	■ <b>Teledyne Relays</b> S. Michelson Advertising	15
■ <b>Concord Electronics Corp.</b> Sound Advertising	168	■ <b>Lambda Electronics Corporation</b> Michel Cather, Inc	152	■ <b>Test &amp; Measuring Instruments, Inc.</b> Sam Groden, Incorporated	159
■ <b>Controlled KW Products, A Division of Miller Electric Mfg. Co.</b> M & M Advertising, Inc.	187	■ <b>Lear, Siegler/Cimron Instruments</b> Manning/Bowen and Associates	12-13	‡ <b>Texas Instruments Incorporated, Semiconductor Group</b> Tracy-Locke Advertising, Inc.	19
■ <b>Controls Research Corp.</b> Ron Jenner & Company	172	■ <b>Lockheed Electronics Company</b> McCann-Erickson Inc.	16E	■ <b>Thomas &amp; Betts Company</b> McCarthy, Scelba, DeBiasi Advertising Agency, Inc.	173
■ <b>CTS Corporation</b> Reincke, Meyer & Finn, Inc.	89	● <b>LTT</b> Publibel	60-61	■ <b>Thomson CSF</b> Bazaine Publicite	168
■ <b>Dana Laboratories</b> Dailey & Associates	136	■ <b>McGraw-Hill Magazines</b> Markem Corp.	141	■ <b>Toko, Inc.</b> Hakuhodo, Inc.	7
■ <b>Datacraft Corporation</b> The Communicator	75	■ <b>Master Appliance</b> Klau-Van Peltersom-Dunlap, Inc	176	■ <b>TRW Electronics, Semiconductor Division</b> The Bowes Company	155
■ <b>Datron, Inc.</b> Larry Courtney Company	22	‡ <b>Microdata Corporation</b> James Brunton Advertising	56	■ <b>United Systems Corp., A Sub. of Monsanto Co.</b> Michel-Cather, Inc.	125
■ <b>Delevan Division, American Precision Industries, Inc.</b> Comstock Advertising, Inc.	160	■ <b>Micro Power Systems</b> Associated Adventures	175	■ <b>Universal Oil Products, Norplex Div.</b> Campbell Mithun, Inc.	183
■ <b>Delta Air Lines</b> Burke Dowling Adams Inc.	186	■ <b>Micro Switch Division of Honeywell</b> N. W. Ayer & Son, Inc	48-49	■ <b>U. S. Capacitor Corp.</b> S. Michelson Advertising	180
■ <b>Delta Products, Inc.</b> The William Loughran Company	80	■ <b>Microsystems International Ltd.</b> Media Advertising Ltd.	133	■ <b>U. S. Comp</b> Harold Marshall	146
■ <b>Dialight Corporation</b> Michel-Cather, Inc.	42-43	■ <b>3M Electro Products Division</b> Batten, Barton, Durstine & Osborn Inc.	145	■ <b>Victoreen Instrument Division</b> Dix & Eaton, Inc.	122
■ <b>Dietzgen Corp.</b> Midland Associates, Inc.	170	■ <b>3M Company—Mincom Division</b> D'Arcy-MacManus & Masius, Inc	45	■ <b>Wavetek Indiana</b> Chapman Michetti Advertising	16
■ <b>Digital Equipment Corporation</b> Creamer, Trowbridge, Case & Basford, Inc	24-25	■ <b>Monolithic Memories, Inc.</b> Paul Pease Advertising, Inc.	29	● <b>Wima, Westermann</b> General Advertising Agency, Inc.	19
■ <b>Digital Equipment Corporation</b> Schneider Parker Guy, Inc.	86-87	■ <b>Monsanto Commercial Products Co., Electronic Special Products</b> Advertising Promotion Services	90		
■ <b>Disc Instruments, Inc.</b> Jansen Associates, Inc.	172	■ <b>Motorola Semiconductor Products, Inc.</b> E. B. Lane & Associates, Inc	170		
■ <b>Dynascan Corporation (Industrial IP Products Division)</b> Albert Jay Rosenthal & Company Advertising	178	■ <b>Multimetrix</b> National Power Products, Inc. (Servotron)	138		
■ <b>Eastman Kodak Company, Business Systems Markets Div.</b> J. Walter Thompson Co.	177	■ <b>National Semiconductor Corp.</b> Chai/Day, Inc Advertising	50		
■ <b>Electronic Navigation Industries</b> Hart Conway Co., Inc.	124	■ <b>National Semiconductors Limited</b> Gnener Harries Maclean Ltd	46		
■ <b>Electronics &amp; Control Engineers Book Club</b> Exact Electronics	163-165	■ <b>Neft Instruments Corp.</b> Larry Courtney Company	126		
■ <b>Exact Electronics</b> Exact Advertising Agency	9	● <b>Nippon Kogaku K.K.</b> K & L Advertising Agency	176		
● <b>Ferranti Ltd.—Dundee</b> Rowlinson Broughton Ltd	10E	■ <b>Optel</b> Black-Russell-Morris, Inc.	137		
■ <b>Fluke Manufacturing Co., John</b> Bonfield Associates	180	■ <b>Pace, Inc.</b> Communications Unlimited Inc.	4E		
■ <b>General Electric Electronic Components</b> Robert S. Cragin, Inc.	30	■ <b>Phillips Elcoma</b>	56		
		■ <b>Phillips N. V. Pit/T &amp; M Division</b> Marsteller International S. A.			

## Classified & Employment Advertising

F. J. Eberle, Manager 212-971-2557

<b>EQUIPMENT (Used or Surplus New) For Sale</b>	
Greentron, Inc. ....	182
J. I. Kisliak .....	182
Pitney Bowes .....	182

■ For more information on complete product line see advertisement in the latest Electronics Buyer's Guide  
 ● Advertisers in Electronics International  
 ‡ Advertisers in Electronics domestic edition

# My how our "GOLDIE" has grown



If you remember our "Goldie" as a single gold crosspoint contact switch for low energy switching . . . it's time to take another look. Because our "Goldie" has grown to a complete line of switches capable of solving just about any low energy switching problem you can name. The same crossed knife-edge contact configuration that made the original Cherry "Goldie" the belle of the ball has now been applied to virtually every type of Cherry snap-action switch—more than a dozen basic snap-switch configurations and thousands of variations . . . plus new keyboard switches for electronic desk top calculators and data entry keyboards.

## TAKE A NEW LOOK AT OUR "GOLDIE"

Send for a copy of the just-published 72-page Cherry Switches & Keyboards catalog. Just TWX 910-235-1572 . . . or PHONE 312-689-7702 . . . or WRITE CHERRY.



**E78-00A**  
Double Pole  
Push Button

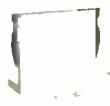

**E68-00A**  
Single Pole  
Push Button



**E21-00A**  
Miniature



**E63-00K**  
Subminiature



**E21-50K**  
Miniature



**M61**  
Keyboard Switch



**G18-01A**  
Enclosed  
Single Throw



**E53-00B**  
Low Torque



**G13-00E**  
General Purpose



**S31-20P**  
Miniature Open

# CHERRY



**CHERRY ELECTRICAL PRODUCTS CORP.**  
3608 Sunset Avenue, Waukegan, Illinois 60085

Cherry affiliates worldwide: Cherry Mikroschalter GmbH, 8580 Bayreuth, Bavaria...  
Cherry Electrical Products (U.K.) Ltd., St. Albans, Herts...G. W. Engineering Pty. Ltd., Sydney

# How to ship small packages in a big hurry.

## DELTA'S DASH

DELTA AIRLINES SPECIAL HANDLING

Delta guarantees delivery on the flight or routing you specify between most Delta cities.

Packages accepted up to 50 lbs. with length plus width plus height not to exceed 90" total, with only one dimension exceeding 30"

Delivery to Delta's passenger counter or air freight terminal at the airport at least 30 minutes prior to scheduled departure time.

Pick-up at DASH Claim Area next to airport baggage claim area 30 minutes after flight arrival at destination.

Charges for DASH shipments are nominal. Delta reservations will be pleased to quote actual charges between specific points.

Payments accepted in cash, by company check, most general-purpose credit cards, special credit arrangements or on government shipments by GBL. **DELTA**  
The airline run by professionals

### Rate examples (Tax included)

Atlanta-Washington . . . . .	\$21.00
Boston-Miami . . . . .	\$26.25
Cincinnati-Louisville . . . . .	\$21.00
Cleveland-Phoenix . . . . .	\$26.25
Los Angeles-New Orleans . . . . .	\$31.50
Dallas-Los Angeles . . . . .	\$26.25
San Francisco-Atlanta . . . . .	\$31.50
Philadelphia-Houston . . . . .	\$26.25
New York-Tampa . . . . .	\$26.25

For full details, call Delta reservations.



## Delta is ready when you are!

### Advertising Sales Staff

**Pierre J. Braudé** [212] 997-3485  
Advertising Sales Manager

**Atlanta, Ga. 30309:** Joseph Lane  
100 Colony Square, 1175 Peachtree St., N E  
[404] 892-2868

**Boston, Mass. 02116:** James R. Pierce  
607 Boylston St. [617] 262-1160

**Chicago, Ill. 60611:**  
645 North Michigan Avenue  
Robert W. Bartlett (312) 751-3739  
Paul L. Reiss (312) 751-3738

**Cleveland, Ohio 44113:** William J. Boyle  
[716] 586-5040

**Dallas, Texas 75201:** Charles G. Hubbard  
2001 Bryant Tower, Suite 1070  
[214] 742-1747

**Denver, Colo. 80202:** Harry B. Doyle, Jr.  
Tower Bldg., 1700 Broadway  
[303] 266-3863

**Detroit, Michigan 48202:** Robert W. Bartlett  
1400 Fisher Bldg  
[313] 873-7410

**Houston, Texas 77002:** Charles G. Hubbard  
2270 Humble Bldg [713] CA 4-8381

**Los Angeles, Calif. 90010:** Robert J. Rielly  
Bradley K. Jones, 3200 Wilshire Blvd., South Tower  
[213] 487-1160

**New York, N.Y. 10020**  
1221 Avenue of the Americas  
Warren H. Gardner [212] 997-3617  
Michael J. Stoller [212] 997-3616

**Philadelphia, Pa. 19103:** Warren H. Gardner  
6 Penn Center Plaza.  
[212] 971-3617

**Pittsburgh, Pa. 15222:** Warren H. Gardner  
4 Gateway Center. [212] 971-3617

**Rochester, N.Y. 14534:** William J. Boyle  
9 Greylock Ridge, Pittsford, N Y  
[716] 586-5040

**San Francisco, Calif. 94111:** Don Farris  
Robert J. Rielly, 425 Battery Street,  
[415] 362-4600

**Paris:** Alain Offergeld  
17 Rue-Georges Bizet, 75 Pans 16, France  
Tel: 720-73-01

**Geneva:** Alain Offergeld  
1 rue du Temple, Geneva, Switzerland  
Tel: 32-35-63

**United Kingdom:** Keith Mantle  
Tel: 01-493-1451, 34 Dover Street, London W1

**Milan:** Robert Saldel  
1 via Baracchini Phone 86-90-656

**Brussels:** Alain Offergeld  
23 Chaussee de Wavre  
Brussels 1040, Belgium  
Tel: 13-65-03

**Stockholm:** Brian Bowes  
Office 17, Kontor-Center AB, Hagagarten 29,  
113 47 Stockholm Tel 24 72 00

**Frankfurt/Main:** Fritz Krusebecker  
Liebigstrasse 27c  
Phone 72 01 81

**Tokyo:** Masaru Wakeshima, McGraw-Hill  
Publications Overseas Corporation,  
Kasumigaseki Building 2-5, 3-chome,  
Kasumigaseki, Chiyoda-Ku, Tokyo, Japan  
[581] 9811

**Osaka:** Ryji Kobayashi, McGraw-Hill  
Publications Overseas Corporation, Kondo  
Bldg., 163, Ume-gae-cho Kita-ku [362] 8771

**Australia:** Warren E. Ball, IPO Box 5106,  
Tokyo, Japan

### Business Department

**Stephen R. Weiss, Manager**  
[212] 997-2044

**Thomas M. Egan,**  
Production Manager [212] 997-3140

**Carol Gallagher**  
Assistant Production Manager [212] 997-2045

**Dorothy Carter,** Contracts and Billings  
[212] 997-2908

**Frances Vallone,** Reader Service Manager  
[212] 997-6057

### Electronics Buyers' Guide

**George F. Werner,** Associate Publisher  
[212] 997-3139

**Regina Hera,** Directory Manager  
[212] 997-2544

# ACT FAST — YOURS COULD BE THE FIRST ELECTRONICS FIRM IN RANGELY, COLORADO.

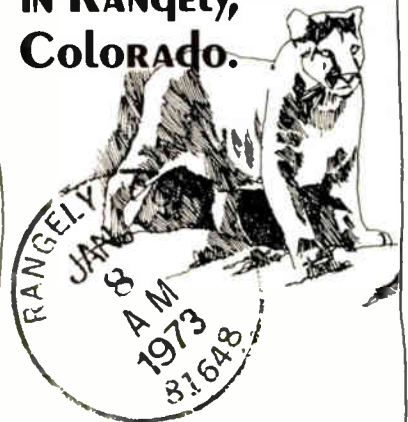

More than 100 electronics firms have located in Colorado in the past decade. None has looked seriously at Rangely. Perhaps the map scared them off. There's a clean, clear water stream running through the heart of town which some old-timer misnamed Stinking Creek. And there are peaceful little towns nearby called Dinosaur and Dragon.

But maps don't tell you the important things about Rangely and other Colorado communities: About the low prices for the unspoiled land, and for power and water; about the good, fresh air and the great hunting and fishing; or about the educated, productive workers who sincerely want your firm to move to their town.

Learn about 127 Colorado communities — including Rangely — that have prime industrial sites to suit your business. Send for our free, 83-page Executive Portfolio. Write William C. Hacker, Colorado Division of Commerce and Development, 1342 State Capitol Annex, Denver, Colorado 80203.

# COLORADO

where there's room to live and breathe



look at a  
**SPECIALIZED  
 POWER SOURCE**  
 this way...

**FREE** brochure from the company that custom builds power units at low cost per KW output.

Specialized power sources WITH PROVED INGREDIENTS FOR PRODUCT SUCCESS come from *controlled KW products*, a division of Miller Electric Manufacturing Company . . . known for technological and design excellence in power sources, for over 40 years.

**Wide Range of OEM Requirements**

*controlled KW products* custom builds power units for lowest cost per KW output in environmental testing . . . motion picture projection and lighting . . . solar simulation . . . plasma arc heaters . . . induction furnaces . . . desalination . . . high temperature furnace melting . . . vacuum plating . . . and countless other applications. We move quickly in design, engineering and manufacture. We join our technological competence with yours, creating controlled KW power to fit your needs. Ask for brochure #FLDEM.

P.O. Box 1087 • APPLETON, WISCONSIN 54911

A Division of Miller Electric Manufacturing Company



**controlled KW products**

Circle 187 on reader service card

**INNOVATIVE  
 SWITCHES by CDI**



**Sealed Switch Module.** Completely sealed and/or RFI shielded.



**Series TSM Mini Thumb-wheel switch** mounts on 1/2" centers. Retrofits most miniature thumb-wheel switch panel openings.

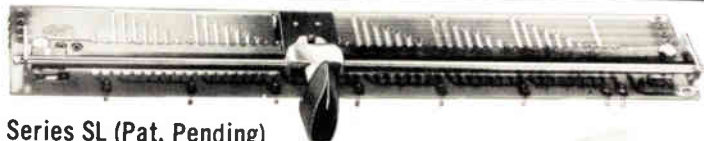

**Series SL (Pat. Pending) Linear Slide Switch.** Up to 100 or more positions. Mounts EITHER left/right OR up/down. Single or multiple position selectors.

**No Down-Time Rotary Switch.** 5-Second wafer replacement. Mfd. under Tabet U.S. Patent 2,956,131 & others.

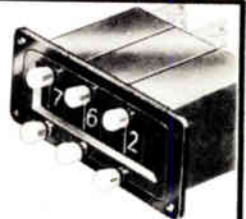
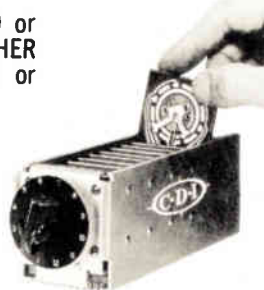

**Miniature Add/Subtract Pushbutton units** retrofit most mini-thumb-wheel switch panel openings. Pat. #3,435,167.



**Series SP Rotary Switch.** Economical, flexible, compact. More options on one wafer than previously available.

CDI earns its reputation every day for Consistently High Quality, Consistently Good Delivery. Request catalog.



**CHICAGO DYNAMIC INDUSTRIES, INC.**  
 PRECISION PRODUCTS DIVISION

1725 Diversey Blvd., Chicago, Illinois 60614 Phone (312) 935-4600, TELEX 25-4689

## T300: the cassette designed for data



Fully complies with **ANSI** and **ECMA** standards for digital data recording. It's the ultimate in cassettes — the only one with *performance* specifications:

- Zero dropouts — certified *after final assembly* to ANSI and ECMA specifications
- Off-center slot for use in drives built to ANSI and ECMA specifications
- Hinged record-lockout tabs can't be removed . . . and misplaced
- Fiberglass-reinforced screwed case dissipates static charges — doesn't attract dust

### Immediate Delivery from Stocks in Key Cities — World-Wide

#### FRANCE/BELGIUM/SWITZERLAND

Paris — BFI Electronique S.A.R.L. Tel. KLE 6969

#### WEST GERMANY/WEST BERLIN/AUSTRIA/HOLLAND

Frankfurt — BFI Elektronik, GmbH Tel. 617099

#### ENGLAND/SCOTLAND/IRELAND

London — BFI Electronics Ltd. Tel. 01-998-2113

#### ITALY Milan — BFI Electronica SPA Tel. 316716

#### ISRAEL

Tel Aviv — TALVITON Electronics Ltd. Tel. 444572

#### FINLAND

Helsinki — KONTVA Tel. 90-713621

#### SWEDEN (Helsingfors, Finland) — KONTVA

Tel. Helsingfors 90-713621

#### CANADA Rexdale, Ont. — DASCO Data Products Ltd. (416) 677-9373

#### BOSTON

A. W. Mayer Co., Inc.  
West Newton  
(617) 965-1111

#### NEW YORK CITY AREA

Technical Electronic Dist.  
Bergenfield, NJ  
(201) 384-3643

#### ROCHESTER, NY

Elcom Sales, Inc.  
(716) 385-1400

#### BALTIMORE

Robert L. Wilkinson, Inc.  
(301) 377-7800

#### CHARLESTON, SC

Wholesale Radio  
Supply Co.  
(803) 722-2634

#### ATLANTA

Lykes Electronics Corp.  
(404) 355-2223

#### MIAMI

Lykes Electronics Corp.  
(305) 633-8535

#### TAMPA

Lykes Electronics Corp.  
(813) 229-1911

#### CHICAGO

Magnuson Associates,  
Mt. Prospect  
(312) 956-0700

#### CINCINNATI

Sheridan Associates, Inc.  
(513) 761-5432

#### MORGAN CITY, LA

Photo Mart  
(504) 384-2485

#### HOUSTON

Lenert Company  
(713) 225-1465  
Dataquip Inc.  
(713) 526-5531

#### DALLAS

Wholesale Electronics  
(214) 824-3001

#### LOS ANGELES

F.S.I.  
(213) 651-4411

#### SEATTLE

Almac/Stroum  
(206) 763-2300

#### HONOLULU

Hole Enterprises, Inc.  
(808) 946-3185

Send for more data

**INFORMATION TERMINALS**  
323 Soquel Way, Sunnyvale, California 94086  
(408) 245-4400

## This is not the end of the line

### FOR GRAYHILL TERMINATION HARDWARE.

We currently make over one hundred different items of termination hardware. And we're constantly adding to the line so there's no end to it.

But that's not the termination of our hardware story either. What we really make are quality features our customers couldn't find in existing hardware products. Like firm positive contacts the first time and every time a connection is made with a push post. Or rapid test clip connections without having to open and close jaws manually. Plus caps that resist melting at soldering temperatures, exceptional dielectric strength and better insulation.

Want to learn more about our hardware and miniature switch lines? Write today for our newest Engineering Catalog. Grayhill, Inc., 523 Hillgrove Avenue, La Grange, Illinois 60525. (312) 354-1040.



Circle 214 on reader service card

## Best buy power module for op amps



**± 15 V (tracking) @ 400 ma...\$85**

Line/load regulation of  $\pm 0.1\%$  and ripple of 1.5 mv. 3.4"Hx5.1"Wx5.1"D. Order Model TD 15-40. For 1.0 amp outputs, specify TD 15-100. Price \$125. Other great buys are available to power balanced loads drawing from 25 ma to 8.5 amps.

Three day shipment guaranteed. Five year warranty.



Acopian Corp., Easton, Pa. 18042  
Telephone: (215) 258-5441

Circle 215 on reader service card

Circle 188 on reader service card