

Can technology eliminate U.S. trade deficit? 65
Special report: n-channel MOS technology 106
What engineers need to know about patents 118

Electronics®



TWO-WAY CABLE TV
SNARLED ON THE WAY
TO THE WIRED CITY

1428 N. 1002 BQW7 NOV 72
MATT NEILL
3022 NE BROADWAY
PORTLAND OR



Choose. Don't compromise.

The most experienced maker of storage tubes offers you a choice: the broadest selection of devices in a wide range of sizes to meet most any display requirement you may have. There's no need to compromise. If you don't see what you need in our long line of standard models, we'll design one for you.

Write for new brochure: 2020
Oceanside Blvd., Oceanside, CA
92054. Or call (714) 757-1200.

HUGHES

HUGHES AIRCRAFT COMPANY
INDUSTRIAL PRODUCTS DIV.

Introducing the working man's signal generator.

It works in Production.

It works in the Lab.

It works in the Field.

It works in the Service Shop.

In fact it works just about everywhere.

That's because our new 8654A Signal Generator delivers big performance but is small in size — and price. It weighs just 16 pounds and costs only \$1135. Yet you get all the functions you'd expect from higher priced instruments.

The 8654A is a 10 to 512 MHz VHF solid-state signal generator with leveled, calibrated output adjustable from +3 to -130 dBm. CW stability is 20 ppm/5 minutes, and you can AM or FM, internally or externally. A look at the front panel will give you an idea of just how easy it is to use.

For more information about this high-value RF signal generator, call your HP field engineer. Or write to Hewlett-Packard, Palo Alto, California 94304; Europe: 1217 Meyrin-Geneva, Switzerland.

HEWLETT  PACKARD
SIGNAL GENERATORS



*New
from HP...
Modular
Power Supplies*

today

*for those who
think about
tomorrow!*

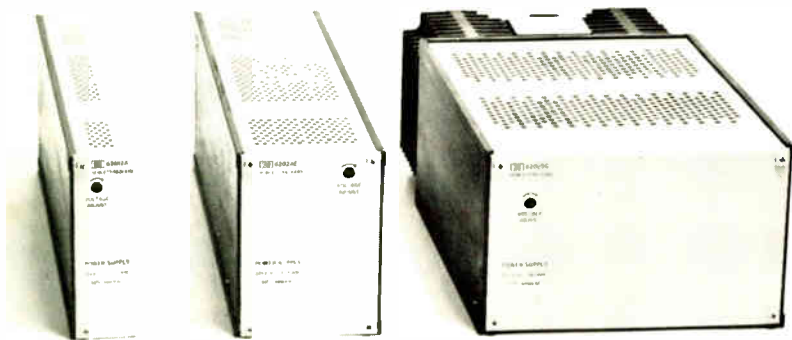

HEWLETT **hp** PACKARD

POWER SUPPLIES

21201

Value has always been synonymous with HP power supplies, and these new 62000-series modular power supplies are no exception. They're competitively priced (with quantity and OEM discounts), reliable, systems compatible, and available now. Coverage is from 3 to 48 volts, at up to 200 watts, with performance assured to specifications. Best of all, HP offers applications assistance and service support before and after the sale. It's all backed up with an international network of 220 offices to serve you. For detailed information, contact your local HP field engineer. Or, write: Hewlett-Packard, Palo Alto, California 94304. In Europe: 1217 Meyrin-Geneva, Switzerland.

29 Electronics Review

ELECTRONICS ABROAD: Japan shifts emphasis, 29
ELECTRONICS ABROAD: French electronic anesthesia system, 30
COMMUNICATIONS: Comsat silences phone echoes, 31
CONSUMER ELECTRONICS: TV tuner rule strains capacity, 31
MATERIALS: Hunt for space leads to magnets, 32
SATELLITES: Intelsat dilemma: more or bigger? 32
SOLID STATE: TI weighs in on 10K end of scale, 34
MEDICAL ELECTRONICS: Dorsal stimulator jams pain signals, 39
GOVERNMENT: Challenges seen delaying domsat, 39
INDEX OF ACTIVITY: 40
FOR THE RECORD: 42

53 Electronics International

THE NETHERLANDS: A 1-cent-per-bit core memory, 53
SWITZERLAND: Slide-and-liquid-crystal sandwich display, 53
JAPAN: Bubble shift register rotates patterns, 53

65 Probing the News

GOVERNMENT: Electronics: the fulcrum of U. S. trade, 65
DISPLAYS: Liquid crystals begin to turn on, 73
MANAGEMENT: Vidar's team takes time off for growth, 78

91 Technical Articles

SPECIAL REPORT: CATV's path to the wired city is tangled, 91
DESIGNER'S CASEBOOK: Control one-shot divides frequency, 102
Pulsed standby battery saves MOS memory data, 102
Triangular-wave generator spans eight decades, 104
SPECIAL REPORT: Improved n-channel process used for RAMs, 106
Putting n-channel to work with TTL, 107
Coplamos keeps n-channels in line, 111
YOU AND YOUR CAREER: What EEs should know about patent law, 118
ENGINEER'S NOTEBOOK: Low-cost IC timer handles many jobs, 127
Reducing IC FET op amp input bias currents, 128

141 New Products

SJCC PRODUCT PREVIEW: 141
INSTRUMENTS: Analyzer price tailored to job, 151
DATA HANDLING: Monitor traps 30 data link codes, 159;
Circuit-analysis software eases designer's task, 159
SEMICONDUCTORS: Monolithic DAC resolves 10 bits, 167

Departments

Publisher's letter, 4
Readers comment, 6
People, 14
Meetings, 20
Electronics Newsletter, 25
Washington Newsletter, 49
Washington Commentary, 50
International Newsletter, 55
Engineer's Newsletter, 127
New Books, 172
New Literature, 174

Highlights

U.S. tries to boost technology export, 65

Government agencies have ambitious plans to stimulate electronics exports. But they are being frustrated by the mixed reactions of industry and outright opposition of labor.

Special report: tangled path to wired city, 91

That return link necessary to achieve two-way operation for the wired city creates a snarl of troubles, but solutions are being found in suburban experiments.

Special Report: n-channel races to market, 106

Development of practical fabrication processes has started makers off on a race to produce high-speed, high-density, low-cost n-channel RAMs for a market that may reach \$200 million by 1975. Also:

■ Intel begins production of two dynamic shift registers and a static RAM—all TTL-compatible, 107.

■ Coplamos process by Standard Microsystems controls parasitic currents through oxide-isolated MOS, 111.

SJCC to highlight peripherals, 141

Computer show exhibitors will also demonstrate how to get the most out of data processing systems, especially through use of communications techniques.

And in the next issue . . .

Prospects for trade with Eastern Europe . . . putting EEs back to work . . . packaging LSIs in plastic . . . computer-aided design of C/MOS logic.

The cover

Tangle of wires symbolizes the obstacles that lie between the promise and the payoff for the many services that two-way CATV could bring to the wired city.

Electronics

EDITOR-IN-CHIEF: Kemp Anderson

EXECUTIVE EDITOR: Samuel Weber

MANAGING EDITORS: Lawrence Curran, *News*;
Arthur Erikson, *International*

SENIOR EDITORS: John Johnsrud,
H. Thomas Maguire, Stephen E. Scrupski

ART DIRECTOR: Fred Sklenar

ASSOCIATE EDITORS: Richard Gundlach,
John N. Kessler, Howard Wolff

DEPARTMENT EDITORS

Aerospace: William F. Arnold
Circuit Design: Lucinda Mattern
Communications & Microwave:

Lyman J. Hardeman

Computers: Wallace B. Riley
Consumer: Gerald M. Walker

Industrial: Alfred Rosenblatt

Instrumentation: Michael J. Riezenman

Military: Ray Connolly

New Products: H. Thomas Maguire

Packaging & Production:

Stephen E. Scrupski

Solid State: Laurence Altman

Special Issues: Harry R. Karp

COPY EDITORS: Margaret Eastman,
Everett C. Terry

ASSISTANT EDITOR: Marilyn Offenheiser

ART: Charles D. Ciatto, *Associate Director*

PRODUCTION EDITORS:

Patricia Cybulski, Arthur C. Miller

EDITORIAL SECRETARIES: Vickie Green,
Nancy Baldasare, Julie Gorgoglione

FIELD EDITORS

Boston: James Brinton (Mgr.), Gail Farrell

Dallas: Larry Armstrong (Mgr.)

Los Angeles: Paul Franson (Mgr.)

New York: Alfred Rosenblatt (Mgr.)

San Francisco: Stephen Wm. Fields (Mgr.),
Roberta Schwartz

Washington: Ray Connolly (Mgr.),
William F. Arnold

Frankfurt: John Gosch

London: Michael Payne

Paris: Arthur Erikson

Tokyo: Charles Cohen

McGRAW-HILL WORLD NEWS

Director: Walter A. Stanbury; *Atlanta*: Stan

Fisher; *Chicago*: Mike Sheldrick; *Cleveland*:

Arthur Zimmerman; *Detroit*: James Wargo;

Houston: Robert E. Lee; *Los Angeles*: Michael

Murphy; *Gerald Parkinson*; *San Francisco*:

Margaret Drossel; *Seattle*: Ray Bloomberg;

Washington: James Canan, Herbert W.

Cheshire, Seth Payne, Warren Burkett, William

D. Hickman; *Bonn*: Robert Ingersoll; *Brussels*:

James Smith; *London*: Marvin Petal; *Milan*:

Peter Hoffmann, Andrew Heath; *Moscow*: Axel

Krause; *Paris*: Stewart Toy, Michael Johnson;

Stockholm: Robert Skole; *Tokyo*: Mike Mealey

PUBLISHER: Dan McMillan

ADVERTISING SALES MANAGER: Pierre J. Braudet

ADVERTISING SALES SERVICE MANAGER:
Wallis Clarke

BUSINESS MANAGER: Stephen R. Weiss

CIRCULATION MANAGER: George F. Werner

RESEARCH MANAGER: David Strassler

MARKETING SERVICES MANAGER:

Tomlinson Howland

Publisher's letter

The wired city—the not-so-fanciful description of a community transacting its business, organizing its entertainment, even alerting its security personnel to disasters via two-way cable links—is now being tested in several communities. Our special report on page 91 details the advances—and pitfalls—on the road to the wired city.

“There are some who say that two-way CATV systems will revolutionize the use of television,” says Jerry Walker, our consumer electronics editor. “But not many people talk about what could be one of its most lasting effects: the ability to find out instantly what all subscribers are watching and for how long. That information could bring about a whole new era in programming experimentation, especially where an economically significant audience segment, even though not a majority, could be identified.”

Although it will not be until the 1980's that this all-encompassing preference research will be available, the implications for program producers and sponsors is clear. As Jerry, who prepared the report, observes: “While watching a demonstration of a polling technique, I realized that I couldn't wait for the day when I'd know that turning off my set registers one vote against a show I dislike, even though this is a kind of passive complaining. Unfortunately, when the set is on, the broadcaster will not be able to know if anyone is actually paying attention to it. Falling asleep will still be the big undocumented passive protest for many viewers.”

The sudden blooming of n-channel metal-oxide semiconductor

May 8, 1972 Volume 45 Number 10
90 016 copies of this issue printed

Published every other Monday by McGraw-Hill, Inc. Founder: James H. McGraw 1860-1948. Publication office: 330 West 42nd Street, N.Y. N.Y. 10036. Telephone (212) 971-3333. Teletype TWX N.Y. 710-581-4235. Cable address: MCGRAW-HILL N.Y.

Subscriptions limited to persons with active, professional, functional responsibility in electronics technology. Publisher reserves the right to reject non-qualified requests. No subscriptions accepted without complete identification of subscriber name, title, or job function, company or organization, including product manufactured or services performed. Subscription rates: qualified subscribers in the United States and possessions and Canada: \$8.00 one year, \$12.00 two years, \$16.00 three years, all other countries: \$25.00 one year except Japan: \$50.00 per year including air freight. Limited quota of subscriptions available at higher-than-basic rate for persons outside of field served, as follows: U.S. and possessions and Canada, \$25.00 one year; all other countries: \$50.00. Single copies: United States and possessions and Canada, \$1.00; all other countries, \$1.75.

processes—and products, such as random access memories—at half a dozen companies in the same year (see special report starting on p.106) is more than a coincidence. It's more like proof that n-channel has come of age, after being on the scene, albeit on the sidelines, since the inception of MOS a decade ago.

Indeed, the activity in n-channel R&D is making this the year of the RAM, the big product area that will be impacted by all the current n-channel advances.

“That's because n-channel techniques add a whole new dimension to MOS memory technology, opening up a sizeable market—large computer mainframes—that was largely closed to p-channel products,” says Larry Altman, our solid state editor, who handled the report. Industry experts estimate that semiconductor RAMS will have sales measured in the hundreds of millions of dollars by 1975.

Larry observes that “some companies that were pioneers in n-channel five years ago still have not announced any memory products.” And, he points out, other companies, not yet active in the field, will be jumping in soon. One semiconductor manager interviewed by Larry describes his management strategy this way: “I'll just buy it—the people, the equipment—and convert as n-channel technology matures. It'll be cheaper than trying to start n-channel R&D from scratch now.”



Officers of the McGraw-Hill Publications Company: John R. Emery, President; J. Elton Tuohy, Senior Vice President—Services; Donald B. Gridley, Group Vice President; Vice Presidents: Ralph Blackburn, Circulation; John R. Callahan, Editorial; John B. Hoglund, Controller; David G. Jensen, Manufacturing; Jerome D. Luntz, Planning & Development; Joseph C. Page, Marketing.

Officers of the Corporation: Shelton Fisher, President; Joseph H. Allen, President Publications and Business Services Group; John J. Cooke, Senior Vice President and Secretary; Ralph J. Webb, Treasurer. Title registered in U.S. Patent Office. Copyright 1972 by McGraw-Hill, Inc. All rights reserved. The contents of this publication may not be reproduced in whole or in part without the consent of copyright owner.

Subscribers: The publisher, upon written request to our New York office from any subscriber, agrees to refund that part of the subscription price applying to copies not yet mailed. Please send change of address notices or complaints to Fulfillment Manager, subscription orders to Circulation Manager, Electronics, at address below. Change of address notices should provide old as well as new address, including postal zip code number. If possible, attach address label from recent issue. Allow one month for change to become effective.

Postmaster: Please send form 3579 to Fulfillment Manager, Electronics, P.O. Box 430, Hightstown, N.J. 08520.

a superior power supply for your system



...introducing the JMK design from **KEPCO**

- Automatic voltage and current crossover; functions as a current-limited voltage stabilizer or a voltage-limited current stabilizer.
- Panel-mounted lamps tell you whether JMK is controlling voltage or current; an electrical "flag" tells your system.
- Ten-turn controls for exceptional resolution of both the voltage and the current adjustment. They're very stable, too!
- Programming (remote control) and sensing functions are accessed through rear-mounted plug connectors. You don't fuss with wired lugs to get on line.
- Multirange (10:1) metering for easy readability.
- Built-in voltage-sensing crowbar can be set from the panel, and checked, *without* actually shorting the output and upsetting your system.
- Self-contained, sealed-bearing blower exhausts the heat, keeping JMK cool for exceptional reliability. You can use them without derating inside hot equipment cabinets, up to 71°C (160°F).
- "Quarter-rack" shape allows you to mount up to 4 units across in a standard 19-inch equipment bay.

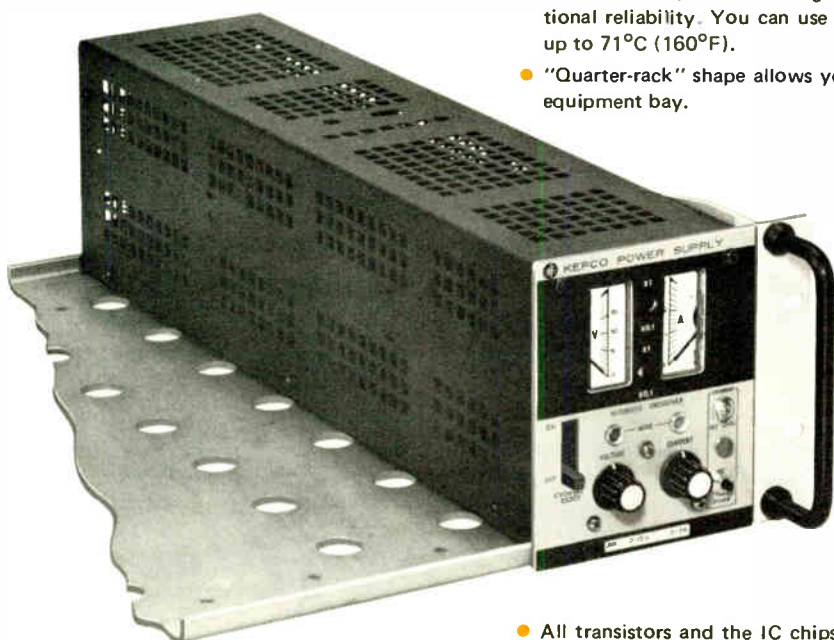

MODEL	VOLTS	AMPS	PRICE
JMK 6-5M	0-6	0-5	\$395.00
JMK 6-10M	0-6	0-10	465.00
JMK 15-3M	0-15	0-3	395.00
JMK 15-6M	0-15	0-6	465.00
JMK 25-2M	0-25	0-2	395.00
JMK 25-4M	0-25	0-4	465.00
JMK 36-1.5M	0-36	0-1.5	395.00
JMK 36-3M	0-36	0-3	465.00
JMK 55-1M	0-55	0-1	395.00
JMK 55-2M	0-55	0-2	465.00
JMK 75-0.7M	0-75	0-0.7	395.00
JMK 75-1.5M	0-75	0-1.5	465.00
JMK 100-0.5M	0-100	0-0.5	395.00
JMK 100-1M	0-100	0-1	465.00

- All transistors and the IC chips that control the voltage and current stabilizing channels are plug-in for easy maintenance. Even the *power transistors* plug-in.
- Digital control. Interface with the Kepco "SN" programmers (2-, 3-digit BCD up to 12-bit binary) and let your system control its own voltage or current.
- Exceptional immunity from the effect of your wildly varying power source. A 105-125V ac variation (50-65 Hz) produces less than 0.0005% change in the stabilized voltage. Less than 0.005% change in the stabilized current.
- JMK power supplies can be loaded with impunity. A 100% current swing disturbs the voltage less than 0.005% (or 0.2 mV, whichever is greater). When you stabilize current with the internal control channel, a 100% load voltage change produces less than 5 mA effect on the current.
- Excellent temperature immunity, using the controls supplied (no need to substitute "more stable" ones, JMK's are as good as you can get) 0.005% per °C typical; 0.01% per °C guaranteed for the voltage channel. A small extra charge will buy a rigorous test and certified report guaranteeing the 0.005% figure.

JMK, the superior voltage or current stabilizer for your system.

KEPCO®

Ask your Kepco-man for the new JMK specification folder,
or write: DEPT. EK-14

KEPCO, INC. • 131-38 SANFORD AVENUE • FLUSHING, N.Y. 11352 • (212) 461-7000 • TWX #710-582-2631 • Telex: 12-6055 • Cable: KEPCOPOWER NEWYORK



How to Buy a Good Power Supply Without Spending a Bundle...

Take a long look at the Abbott line of over three thousand standard models **with their prices listed**. The unit shown above, for instance, is the Abbott Model R5S, a 60 Hz to DC converter which puts out 5 volts of regulated DC at 0.15 amps and sells for only \$83. Other power outputs from 2 to 240 watts are available with **any output voltage from 5 volts to 3,650 volts**, all listed as standard models in our catalog. These power supplies feature close regulation, short circuit protection, and the latest state of the art specifications for solid state modules.

If you really want to save money in buying your power supply, why spend many hours writing a complicated specification? And why order a special custom-built unit which will cost a bundle—and may

bring a bundle of headaches. As soon as your power requirements are firmed up, check the Abbott Catalog or EEM (see below) and you may be pleasantly surprised to find that Abbott already has standard power supplies to meet your requirements — **and the prices are listed**. Merely phone, wire, or write to Abbott for an immediate delivery quotation. Many units are carried in stock.

Abbott manufactures a wide variety of different types of power supply modules including:

- 60A to DC, Regulated
- 400A to DC, Regulated
- 28 VDC to DC, Regulated
- 28 VDC to 400A, 1ϕ or 3ϕ
- 24 VDC to 60A, 1ϕ

Please see pages 618 to 632 of your 1971-72 EEM (ELECTRONIC ENGINEERS MASTER Catalog) for complete information on Abbott modules.

Send for our new 56 page FREE catalog.

abbott transistor

LABORATORIES, INCORPORATED
 5200 W. Jefferson Blvd./Los Angeles 90016
 (213) 936-8185 Cable ABTLABS
 1224 Anderson Ave./Fort Lee, N.J. 07024
 (201) 224-6900

6 Circle 6 on reader service card

Readers comment

Straightening the record

To the Editor: Your report [*Electronics*, Feb. 28, Electronics International] of Ferranti's experience with the liquid crystal test technique is not correct. I know of no particular reason why the liquid crystal compound material should be suspected of causing cancer, and I have never at any time advised that the compound in question might cause cancer. Neither I nor any other Ferranti chemist has at any time recommended stricter precautions than those maintained by John Keen of the Royal Radar Establishment. In fact, Ferranti Ltd. uses VL-1047N liquid crystal supplied by RRE and operates identical precautionary measures to those used at RRE. These are the precautions we normally take when handling a new and unknown material. Further, since we adopted the technique some months ago we have continued to use it without a break.

T.L. Houghton
 Chief Chemist, Ferranti Ltd.
 Hollinwood, England.

■ *We are happy to set the record straight in this matter. Electronics erred in attributing to the chief chemist the statements about possible danger from using the liquid crystal. However, the notes made by our London editor during telephone interviews with two Ferranti semiconductor engineers concerned with using the technique include references to the dangers mentioned.*

On d-a converters

To the Editor: Your article "Digital-to-analog converters: trading off bits and bucks" [Mar. 13, p.84] is outstanding for presenting and clarifying the many DAC performance characteristics that must now be considered by the electronics engineers. Too often the engineer is misled by headlines of low price. It is most misleading to the industry to advertise a DAC as a 10-bit model when its linearity drops off to 7 or 8 bits at 70°C.

Robert R. Jay
 Micro Networks Corp.
 Worcester, Mass.

To the Editor: We welcome your ar-

Free! The profile chart that takes all the compromise (and gamble) out of fixed resistor selection



Don't settle for a resistor that is "almost" what you need. This chart provides complete electrical and physical characteristics for *all* popular fixed resistor types—with relative prices. See exactly what the trade-offs are and match up your needs just as if you were using custom parts.

Only TRW could (or would) offer you a chart like this. Because only TRW makes every popular type of fixed resistor. We never have to push one type over another. The choice is strictly up to you. In fact, buying from TRW gives you the variety and selection of 22 companies, with all the convenience of one source.

To prove this even more dramatically, we've prepared another chart—an industry-wide fixed resistor cross-reference. It covers every popular resistor type and every major manufacturer. Tells you who makes what, and what their competitive part numbers are.

To get either or both of these unique charts, just fill in the attached coupon and mail it today to TRW Fixed Resistors, an Operation of TRW Electronic Components. Or contact your local TRW Distributor.

TRW Fixed Resistors / Distributor Marketing
P. O. Box 12867
Philadelphia, Penn. 19108 (Phone 215/923-8230)

This I've got to see. Please send me a free copy of your fixed resistor profile and cross-reference charts.

Name _____

Company _____

Address _____

City _____

State _____

Zip _____

TRW
IRC FIXED RESISTORS

New! ONE Relay that compacts 21,600 switch points with modular ease... at \$1 per pole!*

Meet the T-BAR[®] "PLUGGABLE"[®]

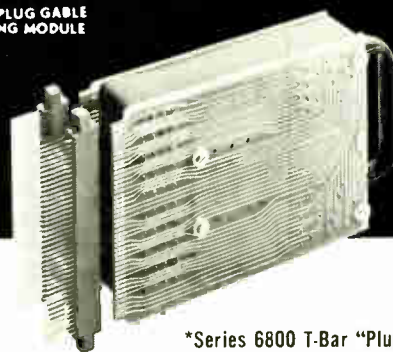
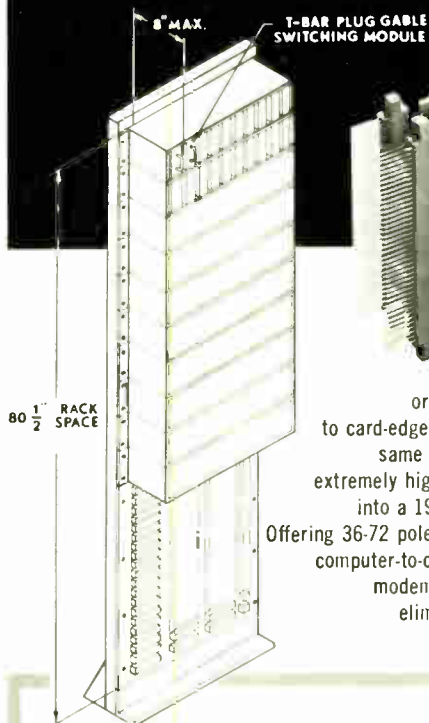

*Series 6800 T-Bar "Pluggable" Relays... new T-Bar Switch/Relays mounted on or between printed circuit boards for direct plug-in to card-edge connectors in a standard card frame... with the same mounting ease as any solid-state module... with extremely high density of up to 21,600 switch points packaged into a 19" rack, 7" high... for as little as \$1.00 per pole. Offering 36-72 poles, the "Pluggables" are ideal to interface switch computer-to-computer, computer-to-peripheral, or computer-to-modem... while cutting packaging and hardware costs, eliminating component wiring, simplifying component scheduling and easing incoming inspection.

Features new Data-Rite™ T-Bars with unique EDGE-TO-DOME™ Bifurcated Contacts...

Wipes in two directions across a dome shaped contact that is as effective as a SOLID GOLD Contact Set.

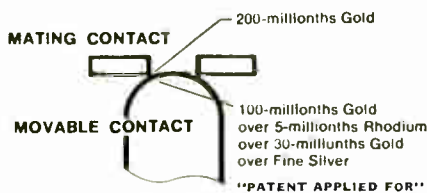

Want more facts on the "Pluggables"? Write or phone today for complete literature and prices on 6800 Series and other T-Bars...

T-Bar
INCORPORATED
SWITCHING TECHNOLOGY

141 Danbury Road, Wilton, CT 06897
phone: 203/762-8351

Readers comment

ticle "Digital-to-analog converters: trading off bits for bucks." It should assist in improving the understanding of a complex product, offered in an unbelievable variety.

However, we must take issue with the paragraph that talks about the possibility of building a 16-bit converter with 10-bit "accuracy" to attempt cost savings. It is, of course, possible to build a 16-bit converter with 16-bit linearity but with scale factor, or gain, accuracy of only 0.1%, as would be considered appropriate for an 8- or 10-bit converter. All that is saved is the cost of a good zener reference. The real cost of building the 16-bit converter lies in giving it 16-bit linearity. We doubt that there is a practical use, in instrumentation or control, for any DAC with linearity errors not at least commensurate with the LSB value. On the other hand, we are frequently asked to provide converters with linearity errors appreciably smaller than the LSB value.

Your caption for the oscillograms of Fig. 6, "photos, courtesy Analog Devices, have been retouched," implies that the pictured characteristics may have been altered before they were given to Electronics. In fact, our original oscillograms were retouched by Electronics to improve printing quality.

Your graphic description of a non-monotonic DAC (shown in Fig. 9) qualitatively depicts the reversal of direction in the transfer function. The actual non-monotonic transfer function shown could not occur in a real device.

Cyril H. Brown
Analog Devices Inc.
Norwood, Mass.

■ Differences of opinion exist between makers on the first point raised by Mr. Brown. A 16-bit DAC with a 10-bit accuracy to save cost was a concept suggested by one maker interviewed for the article. Sixteen bits implies a wide dynamic range and often the user is more interested in the shape and trends of the variable being plotted than absolute accuracy. In the figure referred to, retouching was necessary to show the glitch or very fast transient, which was very faint on the original.

some black and white facts about our new, blue sky cap™ ceramic capacitors



- Meet or exceed MIL-C-11015 or MIL-C-20 specifications
- Low cost!
- Available in 3 temperature characteristics: NPO, X7R and Z5U
- Available in 50, 100 and 200 VDC
- Capacity range between 2.2 pf and 4.7 mf
- Solder coated copper leads
- Epoxy dipped, monolithic construction

Want more information?
Send for our latest
technical data sheet.

AVX AEROVOX®

AEROVOX CORPORATION, NEW BEDFORD, MASSACHUSETTS 02741 • TEL. 617-994-9661
PLANTS IN: NEW BEDFORD, MA., OLEAN & FRANKLINVILLE, N.Y., MYRTLE BEACH, S.C. AND HAMILTON, ONT., CANADA

Two Years Ago, Almost

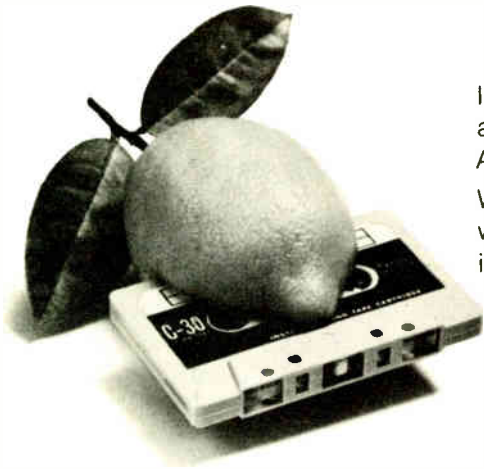

Including us. A digital cassette recorder. Seemed like a great idea at the time. But there was too much garbled info. And lousy reliability. A bumper crop of real lemons.

Well, we licked our wounds along with everyone else. But we also went back to the drawing board because we still thought the basic idea was sound. And we came up with a unit that really works.

A Whole New Concept

To get super reliability, we reasoned, you have to control that tape. So, we started from scratch. Got rid of the traditional pinch rollers, belts, solenoids, levers and mechanical linkages from the transport. Took out the head guide forks.

Eliminated the need for pressure pads. Those were the main cause of head and tape wear, oxide shed and dropout.

Then, instead of just pushing the head up to the tape as it rolls by, we decided to get the tape out of the cassette. (That way the cassette is just a tape holder.) So we designed two little fingers that pull the tape down past the head, over a precision guide and around a capstan. That maintains optimum head wrap angle – critical for read-after-write operation. And it's all done automatically as you load. (We've got a patent pending, in case you're interested.)

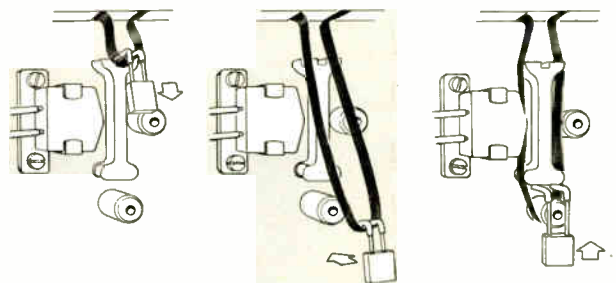

The Insides

Next, we put in three DC motors. One for the capstan and one for each reel. Servos positively control tape tension on both sides of the capstan. And tension sensors confirm proper loading to BOT – no writing on tape leader. There's no drag on the tape. Ever.

So now we have high bi-directional tape speed, fast start/stop times, precise start/stop distances.

Reel motor torque is automatically reduced when EOT or BOT is sensed to prevent pulling tape from cassette reel hubs or other possible tape damage.

All modular electronics. Plug in PC boards. Logic and interface that're TTL compatible.

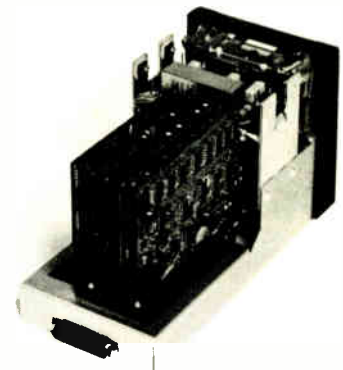

Everybody Brought One Out

The Outsides

All these components are mounted in a cast aluminum frame. Very, very rugged. So it works for any number of EDP OEM applications. And we supply it for users in a handsome case with straightforward, push-button controls.



Real Reel to Reel Performance

Our basic Model 240 has 2 tracks, selectable data rates from 2 to 20 ips, with start/stop times of 15-30 msec. Same start/stop times for 50 ips search or fast forward/reverse. It operates in incremental and/or continuous modes, and in several combinations of recording codes/data channel selections. Test data indicates: calculated MTBF in excess of 2,000 hours. Thousands of passes without tape damage.

Options

All sorts of options. Like two selectable read/write speeds. Dual gap read-after-write head. Separate read-after-write heads. Power supply. Rack mount kit. Automatic tape cleaner. Etcetera.

Don't Wait. Order Now

Now that we've really licked performance and reliability problems, we figure our recorder's a natural for business machine manufacturers, terminal makers, mini computer builders.

And users. A great replacement for punched paper tape. Even some reel to reel mag tape applications. Especially at the price. About \$500 to \$600 in bunches.

Bell & Howell & a Digital Cassette Recorder That Works

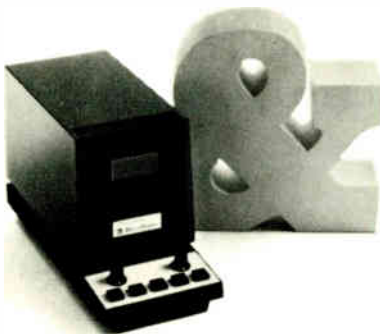

- Send me all the specs.
- Send a guy around for a demo.
- Here's my P.O. You fill in the blanks.

Name _____

Title _____

Company _____

Address _____

City _____ State _____ Zip _____

Bell & Howell—Electronics & Instruments Group,
360 Sierra Madre Villa, Pasadena, California 91109

See us at the SJCC, Booths 1803-1805.

ELECTRONICS & INSTRUMENTS GROUP

 **BELL & HOWELL**

© COPYRIGHT 1972 BELL & HOWELL

We regretfully announce that we were system into our old calculator box.

All we could get in were 52 times as many memory registers plus 16 times as many programming steps, a lot more logic, and a magnetic card reader. The rest of the stuff we had to leave outside.

Our box still weighs 22½ pounds, but it now holds

Up to 522 memory registers, in increments of 64. There's 4-rule arithmetic and special key functions into and out of all registers, and you won't destroy the contents when you turn off the machine.

Up to 4,096 steps of programming, in increments of 512. You can do an entire program from the keyboard and see all your steps printed out for debugging. Symbolic addressing makes branching and jumping very simple. You can backspace, correct errors, and insert steps without having to re-enter the program. You can program the decimal-point printing format, do 16-level nesting.

A magnetic card reader/writer that lets you input programs, write programs, put data into memory, save programs and memory contents.

Fully algebraic keyboard arithmetic, with nesting of parentheses. You enter equations the way you write them, not the way the machine wants them.

Multiple key interlock and rollover, with buffering so you can enter data while the machine is calculating.

Labeled keys for logs, antilogs, a^x , and all common mathematical and trigonometric functions including hyperbolics, and also input/output in degrees-minutes-seconds, full 4-quadrant coordinate conversion, statistical summation (n , x , x^2), standard deviation and mean, factorial, sum-square backout (correction of summations), plus optional user-definable function keys.

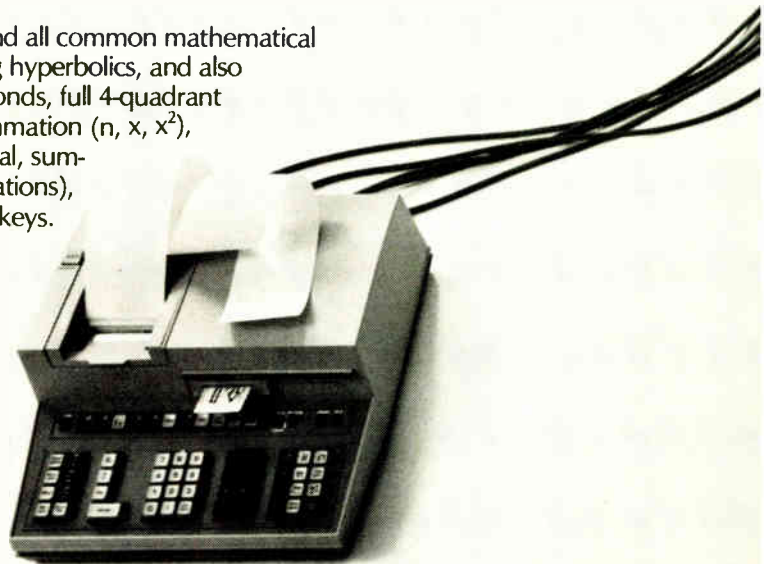

Compucorp®

unable to cram all of our new computer

It doesn't hold

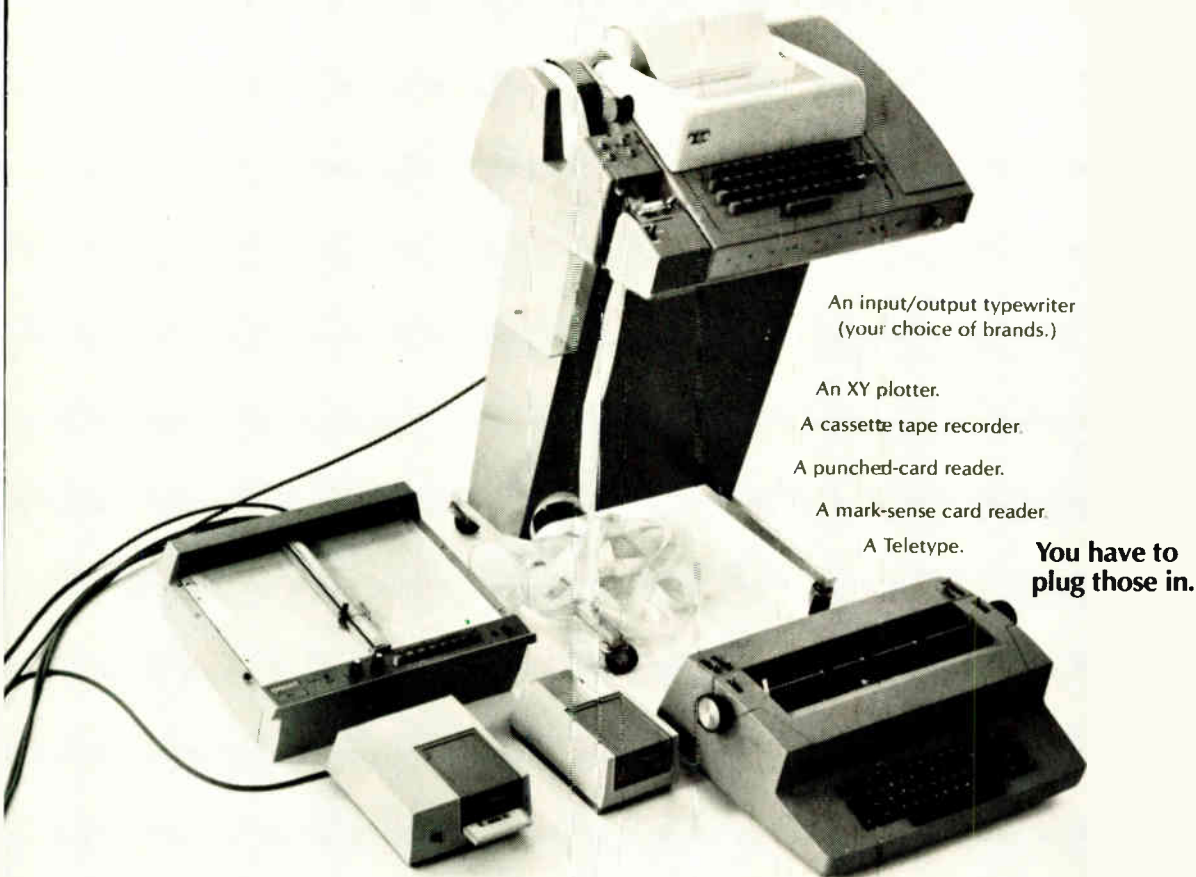

An input/output typewriter
(your choice of brands.)

An XY plotter.

A cassette tape recorder.

A punched-card reader.

A mark-sense card reader.

A Teletype.

**You have to
plug those in.**

We're talking about the new 400 Series of desktop computers that complements and extends our Compucorp calculator line. The Model 425 is for engineers, scientists and surveyors, the 445 is for statistical folks.

We've made more than 30,000 of our other models in the last couple of years. They come in little boxes that sit on a corner of your desk. Each one has an array of powerful one-punch keys that solve the problems of a particular kind of user. They have up to 20 storage registers and 256 steps of programming.

There's a wide range of prices so you can buy enough power to do your job without having to pay for more than you need.

But many customers have said, "That's not enough machine for me." Hence the 400's.

The 400's are as easy to operate as our other models (easier, in fact.) They're enormously powerful and versatile, they interface with an array of peripherals, and they come in the same little box.

The 400's start at \$3,750, our other models a lot lower.

Write down what you need on your letterhead. We'll show you a calculator or a desktop computer that fits your problems and your pocketbook.

JUST OFF THE PRESS!



RCL's NEW 1972 RESISTOR ENGINEERING GUIDE

the industry's most extensive and most accurate compilation of engineering information on wire-wound resistors

PRECISION/HI-SPEED POWER/WIRE-WOUND RESISTORS

including: beryllium oxide core power resistors . . . 22 special temperature coefficients from -50 PPM to +6000 PPM . . . sub-miniature precision resistors . . . ladder and summing networks.

Write for your free copy today!

RCL

ELECTRONICS, INC.
700 South 21st Street
Irvington, New Jersey 07111

People

Katzmann's formula
for success: continuity

What is the secret of success in instrumentation? After 20 years in the business, Fred L. Katzmann believes he has the answer. In one word it's "continuity"—continuity of management and continuity of goals.

The former vice president of



Katzmann: Putting his money on continuity.

Singer's Instrumentation division and ex-director of Monsanto's Electronic Instruments division is certainly in a position to know. He has seen, first-hand, how changes in the thinking of management can have disastrous consequences—often because of the short-term goal of a healthy appearing profit-and-loss statement. He has also observed the success of such companies as Hewlett-Packard and Tektronix and feels that it's no coincidence that these companies are still under the direct control of their founders.

Plan to stay. Last August, Fred Katzmann put his money where his mouth is and, with two partners, bought Ballantine Laboratories in Boonton, N.J., from Singer. The three partners—Katzmann, Milton J. Lichtenstein, and Louis V. Foundos—have decided to conduct their business as if they're going to be around for a long time, because they intend to be. They have developed a long-term business plan, and they intend to stick by it.

One part of their plan is simply the realization that instrumentation

is a mature industry. "We're no longer selling technology," Katzmann says. "The problems of mass production are behind us. Now we must sell solutions to measurement problems. Whatever makes money for the customer, that's what we want to make—at a profit." Lichtenstein agrees. "Benefits, not features, are what sell instruments today," he points out.

Katzmann and company don't deny that innovation is still needed. But they're against innovation for its own sake. "The pioneer," says Katzmann, "is the guy with all the arrows in his backside."

A concerned citizen, Katzmann believes that engineering has made a real economic contribution to society. But he feels it could do a lot better. Part of the problem, as he sees it, is the Government. Too large a fraction of the electronics industries has adapted its entire method of operation to the Government and its nonprofit-oriented goals. "IBM and the Japanese have done things differently," he observes, "and with notable success."

Witmer says the key
is cutting labor cost

"At our yield rate and high unit value, we could afford to hire the president of General Motors to turn out chips, provided, of course, he had the right technical background," says Warner H. Witmer, president of Mosfet Micro Labs, a high-technology-sounding mouthful in Quakertown, Pa. MML was formed in 1969 and is in the business of fabricating MOS chips and wafers. And it plans to do so with the best-trained people it can find, coupled with a minimum of investment.

"Labor costs are no longer a major consideration in the manufacture of these devices," asserts Witmer. One wafer, he points out, will yield a multiplicity of products. "It pays to make the wafer as carefully as possible and use the best people because they have the best chance of making good devices."

Custom credo.

Our custom philosophy is pretty simple. Sometimes you need a custom MOS/LSI or hybrid circuit to get the job done.

We want your custom business too.

So, we've expanded our very complete standard circuit design and volume production capability to include a very complete *custom* circuit design and production capability.

CUSTOM MOS/LSI We have all the processes (metal gate, silicon gate, ion implantation and C-MOS), so we can use whichever is most cost-effective for your program. We've also got the best designers, computer-aided graphics system and LSI testers available.

CUSTOM HYBRID You name it (Digital, Linear, MOS, Transistors and FETs), we've got the die capability in-house, in

addition to custom chips specially designed for hybrid applications. Plus computer-controlled laser trimming of resistors and capacitors and computer-controlled final test equipment.

From us, you'll get a great custom circuit.

And you'll get it fast. For specifics (including a copy of our new Custom MOS/LSI or Hybrid Capability Brochures), write on

your letterhead to: National Semiconductor Corporation, 2900 Semiconductor Drive, Santa Clara, California 95051.

JOIN THE NATIONAL LIBRARY. Ask for your official National Library Card and current-selection bibliography. Your passport to a veritable wealth of Digital, Linear, MOS and Transistor/FET product, application and design information from a single source.



National

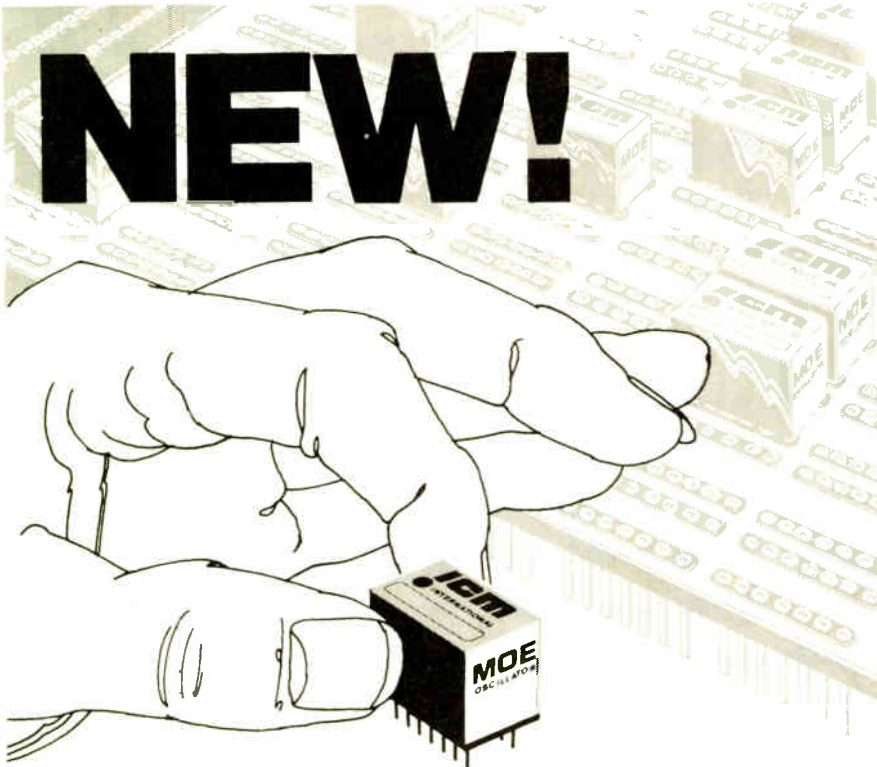

NEW!

INTERNATIONAL'S MOE Crystal Oscillator Elements provide a complete controlled signal source from 6000 KHz to 60 MHz

The MOE series is designed for direct plug-in to a standard dip socket. The miniature oscillator element is a complete source, crystal controlled, in an integrated circuit 14 pin dual-in-line package with a height of 1/2 inch.

Oscillators are grouped by frequency and temperature stability thus giving the user a selection of the overall accuracy desired. Operating voltage 3 vdc to 9 vdc.



TYPE	CRYSTAL RANGE	OVERALL ACCURACY	25°C TOLERANCE	PRICE
MOE-5	6000KHz to 60MHz	+ .002% -10° to +60°C	Zero Trimmer	\$35.00
MOE-10	6000KHz to 60MHz	+ .0005% -10° to +60°C	Zero Trimmer	\$50.00

With this philosophy, Witmer eschews the usual approach of partitioned production with specially trained but relatively low-skilled people responsible for different parts of the process. If the technology should change, such technicians are difficult to retrain, he says. And with responsibility shared, it's difficult to pin down the source of a problem, should one crop up. Witmer says, basing this opinion on his 15 years of experience in the development of electronic components and solid state devices at RCA, Western Electric, and United Aircraft.

Teamwork. Instead, Witmer is setting up two-man teams of a highly trained engineer and a technician to be responsible for the entire wafer production process, including diffusion, photolithography, and metalization. And MML will have such teams for each of the MOS processes it is perfecting. "It gives flexibility for our customers, and no excuse for not delivering," declares Witmer. The processes include standard, complementary silicon gate MOS, as well as the newer oxide-nitride processes. MML also has developed a power FET of the overlay type that's compatible with MOS processing. And in addition, Witmer asserts he has a pinhole-free process. This increases yields markedly, and is a key to making his production team profitable.

Coupled with this approach to fabrication, Witmer has also taken a close look at the production line itself. "We've thrown out all the witchcraft," he asserts, and with it has gone the expensive vertical laminar-flow rooms—"We use hoods instead"—and careful control of humidity—"We don't need it." The result, Witmer claims, is that he can set up a production line for under \$50,000. He obtains substrates and masks from outside suppliers and produces custom-designed chips and wafers in as little as two weeks time. Assembly is done by local jobbers. And because the initial equipment investment is low, MML can handle custom work in exceptionally small quantities—as few as 10 wafers looks reasonable, says Witmer.

it's Dana again

with a new DMM that out-classes all competition



\$650. That's the full price for complete multimeter capability: 5 DC ranges, 4 AC ranges, 5 ohm ranges.



4-DIGIT LED. 5th digit for 100% overrange, with leading zero suppression. Easy reading, reliable, cooler.



BATTERY CHECK. Shows operating hours remaining. When battery is low, automatic shut-off prevents wrong reading or battery damage.



AUTOMATIC BRIGHTNESS. The LED self-adjusts intensity to ambient light conditions.



RUGGED. Virtually unbreakable case. Weatherproof. Reliable for roughest field use. Won't quit.



ONLY 7½ LBS., with self-contained battery pack. Compact and lightweight for easy use . . . anywhere.



GOOF-PROOF. Exclusive cam-interlock absolutely prevents mis-matching of range and function.



EASY ACCESS. Just loosen 2 screws to remove case. Display and battery pack plug-ins for easy, fast replacement or repair.



SPARE FUSE. Fuse box has no-shock safety interlock. Never leaves you dead in the field.



NO CREEP. Non-slip-grip feet won't let this DMM slide away.

So, before you buy any old standard DMM, check out this new Dana Model 4300 Multimeter. It has all the performance specs you need . . . plus all these features designed to make your job easier and safer. Write for literature on Dana Model 4300 today. Or phone: (714) 833-1234 Collect.

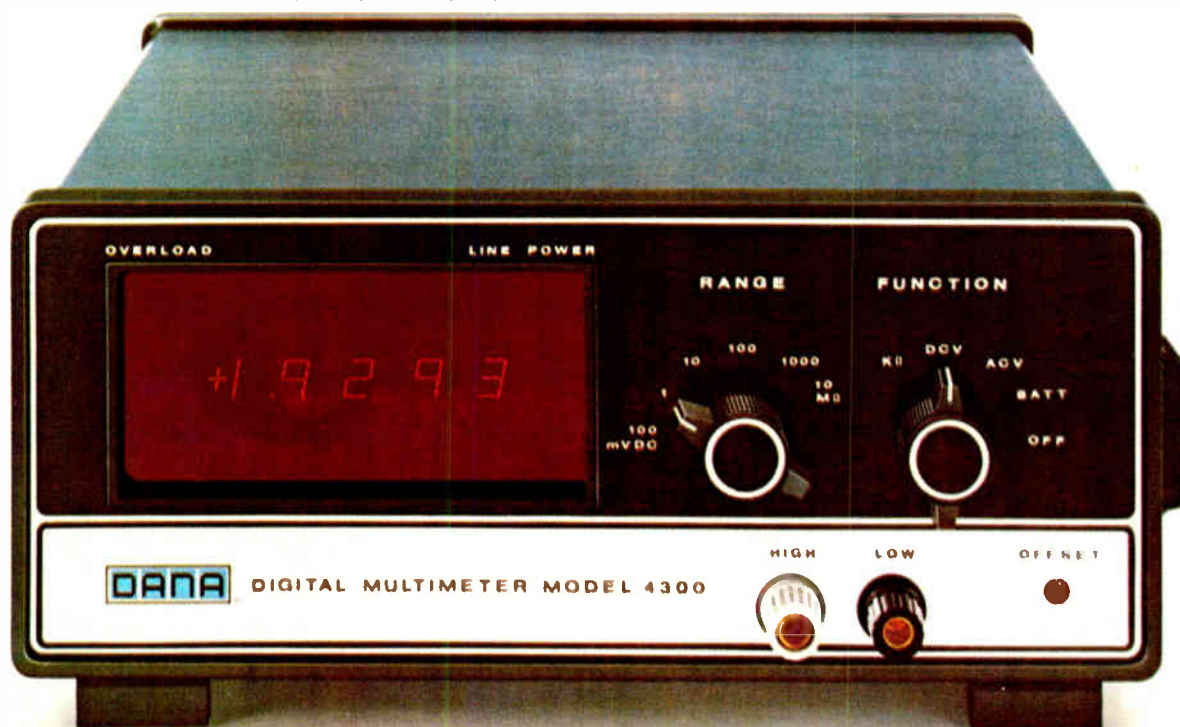

DANA®

Dana Laboratories, Inc. 2401 Campus Drive, Irvine, California 92664

Pick-a-Panel

D1000 Series Socket Panels

- 14 or 16 pin socket patterns
- Modular construction—up to 6 modules per panel
- 30 functions per module
- Standard ground and power pin commitment or uncommitted for custom design
- Optional feed-through pins or 14 pin input/output sockets
- 4 lb. min. strip force
- 14 standard designs

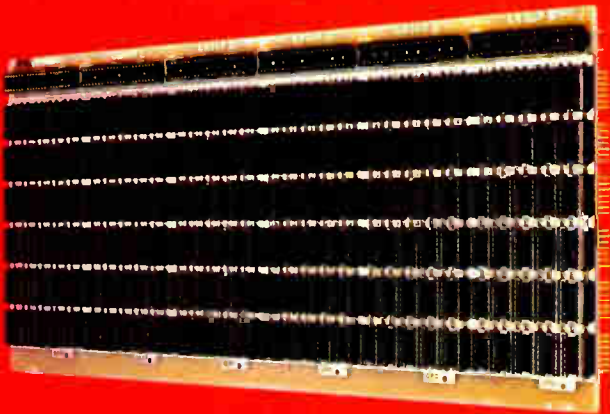

D2000 Series Pin Panels

- Low profile, high density
- Modular construction—up to 6 modules per panel
- 30 IC patterns per module—14 or 16 pin patterns
- 4 lb. min. strip force
- 10 lb. min. pin push-out force
- Optional I/O interface—cable plug receptacle or feed-through pins
- 4 leaf contact construction
- Pin lengths for 2 and 0 level wiring

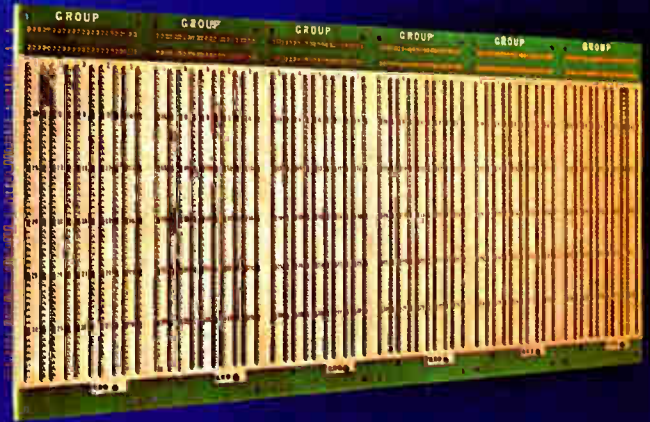

D3000 Series Multi-purpose Panels

- Technical features of either D1000 Socket Panels or D2000 Pin Panels
- Pins on continuous .100" centers within rows, .300" between rows
- Accepts 8, 14, 16, 18, 24, 28, 38 and 40 pin dual-in-line packages, discrete component platforms, and interfacing plugs
- Any pin may be soldered to power or ground

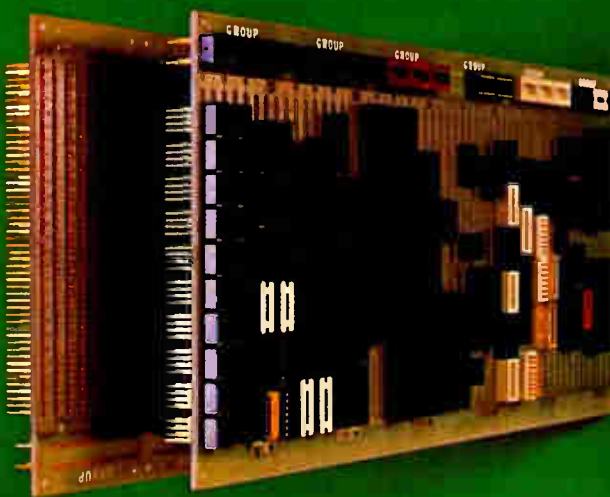

Select-A-Wrap® Plug-In Panels

- Low cost
- No tooling
- Any combination of 14 or 16 pin sockets
- Any pin soldered to GRD or VCC
- Optional feed-through pins
- Assembled to custom designs using standard off-the-shelf components

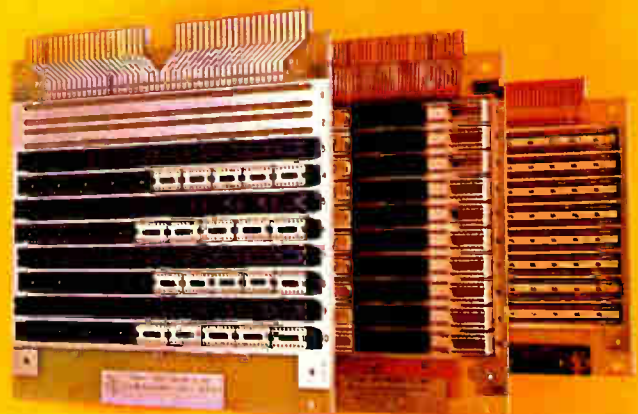

TI announces one of the industry's broadest lines of off-the-shelf IC panels.

From the company with the industry's broadest line of IC sockets comes one of the widest selections of standard off-the-shelf panels. Pick and choose from pin-in-board panels, socket-on-board panels, Select-A-Wrap® prototype panels, and multi-purpose panels.

Every socket panel we make is available with TI's exclusive gold stripe contacts. We metallurgically bond gold at the contact point, where it does the most good. No wasted gold. Reduced cost. More reliable contacts.

Select-A-Wrap, available on all panels, is a unique ground/power system. It gives you great design flexibility since you can solder any pin to ground and power planes — before, during and after production. And you can get Select-A-Wrap committed, or uncommitted for custom design.

TI pin-in-board systems are high in reliability, low in profile. Contacts have low contact resistance and high retention. That means they stand up to vibration and rough use. And, thanks to a multi-purpose pin grid, you can easily mount almost any component — including capacitors, resistors and other discrete components.

Socket-on-board panels offer a choice of literally hundreds of low-cost standard designs. Take your pick of copper/nickel alloy with gold clad contacts or phosphor bronze with gold or tin plating. From 30 to 180 functions per panel. A variety of I/O designs. Black or white sockets.

Select-A-Wrap prototype panels feature the unique opposed ground and power system. They can handle any combination of 14 or 16 pin sockets. Yet all you pay for is the number of functions you need. Three basic panel sizes of 40, 70, or 100 functions, maximum. All prototype panels mate with standard-size edgeboard connectors.

See what we mean by a broad line? Add TI's sockets, custom design capability, and wire wrapping to the mix, and you've got the most complete off-the-shelf line of interconnection systems and components available in the industry.

Send for free TI Pick-a-Panel Pak

Each Pick-a-Panel Pak includes all the detailed information you need to choose from TI's broad line of standard panel products. Plus a handy pocket tool kit, as shown, with

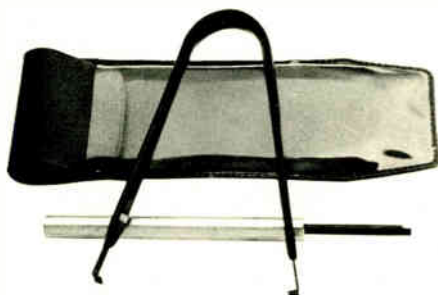

both an IC extractor and a unique Change-a-Wrap tool for manually wrapping or unwrapping connections. And for a limited time we'll also send along a special discount certificate good on your first order of TI panels.

Gentlemen:

Please send me free Pick-a-Panel Pak. Don't forget my bonus tool kit and discount certificate. I am most interested in:

- Pin-in-board panels
- Socket-on-board panels
- Select-A-Wrap panels
- Multi-purpose panels
- Custom panels (specify) _____

- I'm also interested in knowing more about the industry's broadest line of IC sockets.

My need for the products checked is:

- Immediate
- Within 90 days
- Long-range

Name _____

Title _____

Company _____

Address _____

Job description _____

Currently working on _____

Send coupon to: Texas Instruments Incorporated
Connector Products Marketing, Mail Station 11-1,
Attleboro, Mass. 02703



TEXAS INSTRUMENTS
INCORPORATED

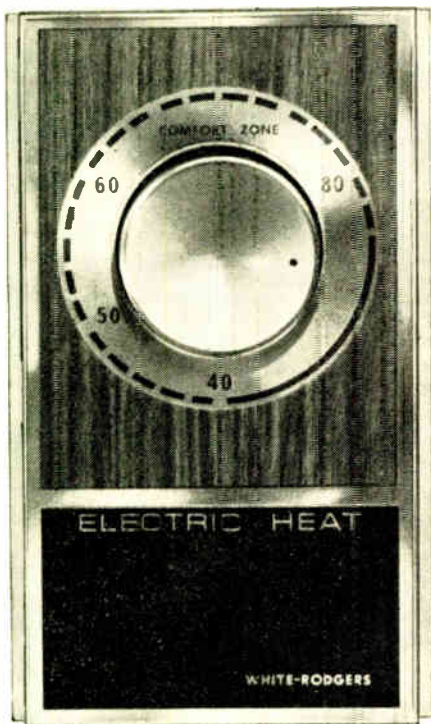

How to make
a thermostat
of extra sensitivity
stand up:
White-Rodgers'
answer includes
Plenco.
Plenco 755.

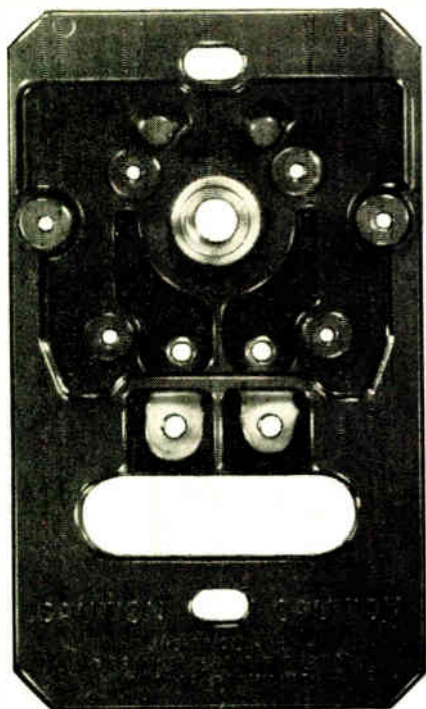

An electrical-grade melamine-phenolic of excellent arc resistance, both ASTM and wet-arc tracking. Important? It is to White-Rodgers Division, Emerson Electric Co., St. Louis, producers of line voltage electric heat controls for baseboards, cable heat, floor and duct insert heaters, wall and ceiling units, and portable heaters.

The exposed control knob has the ability to sense radiant heat as well as ambient air temperature and, through the hydraulic-action switch, controls room temperatures within $\frac{1}{2}^{\circ}\text{F}$. What does Plenco do? The sturdy base, injection-molded of Plenco 755 Brown, helps provide for reliable operation in millions of heating installations.

We're pleased to be part of this White-Rodgers "sensitivity team" and believe we have what it takes to be part of yours. You've only to call.



PLASTICS ENGINEERING COMPANY
Sheboygan, Wisconsin 53081

Through Plenco research... a wide range of ready-made or custom-formulated phenolic melamine, epoxy and alkyd thermoset molding compounds, and industrial resins.

Meetings

Spring Joint Computer Conf.: IEEE, Convention Center, Atlantic City, N.J., May 15-18.

Aerospace Electronics Conf.: IEEE, Sheraton Dayton Hotel, Dayton, Ohio, May 15-17.

Electronic Components Conference: Electronic Industries Assn., IEEE, Statler-Hilton Hotel, Washington, D.C., May 15-17.

International Microwave Symposium: IEEE, Arlington Park Towers Hotel, Chicago, May 22-25.

Power Sources Symposium: Army Electronics Command, Shelburne, Atlantic City, N.J., May 23-25.

Microwave Power Symposium: IMPI, Govt. Conf. Centre, Ottawa, Canada, May 23-26.

Photo-Optical Applications in Security, Surveillance, and Law Enforcement: SPIE, Conrad Hilton, Chicago, May 24-26.

International Transportation Exposition/Congress of Transportation Conferences: FAA, SAE, IEEE, etc., Dulles Airport/Sheraton Park, Washington, May 27-June 4.

International Switching Symposium: IEEE, MIT, Cambridge, Mass., June 6-9.

Spring Conference on Broadcast & Television Receivers: IEEE, Marriott Motor Hotel, Chicago, June 12-13.

Air Pollution Control Assn. 65th Annual Meeting: APCA, Fontainebleau, Miami Beach, June 18-22.

International Conference on Communications: IEEE, Marriott Motor Hotel, Philadelphia, June 19-21.

Joint Measurement Conf.: ASQC, IEEE, ISA, NBS, et. al., U. of Colorado, Boulder, June 21-23.

Conf. on Precision Electromagnetic Measurements: IEEE, NBS, U. of Colorado, Boulder, June 21-23.

our new High-Current power supplies pack a big jolt.



A 100 amp, 5 volt power supply for only \$315. That's the big one. The little one is 16 amps at 28 volts for \$245. In between, there are eight other models. All have comparable high current and shockingly low prices. Plus a bonus. All ten models have passed the cool operation and safety tests to earn a UL listing.

Of course, if you don't need all the power we've packed into this HCM Series, there are about 300 other models

to choose from. Single and dual output; from 2 to 400 volts; from .26 to 100 amps. Miniature versions, card types and our UL listed OEM Series. They all carry ACDC's "guaranteed forever" warranty and most are ready for off-the-shelf delivery at lightning speed.

So, next time your power supply requirements have you swimming upstream against the current, give us a call. Collect. (714) 757-1880.

acdc electronics inc.

Oceanside Industrial Center, Oceanside, California 92054, (714) 757-1880

Circle 21 on reader service card

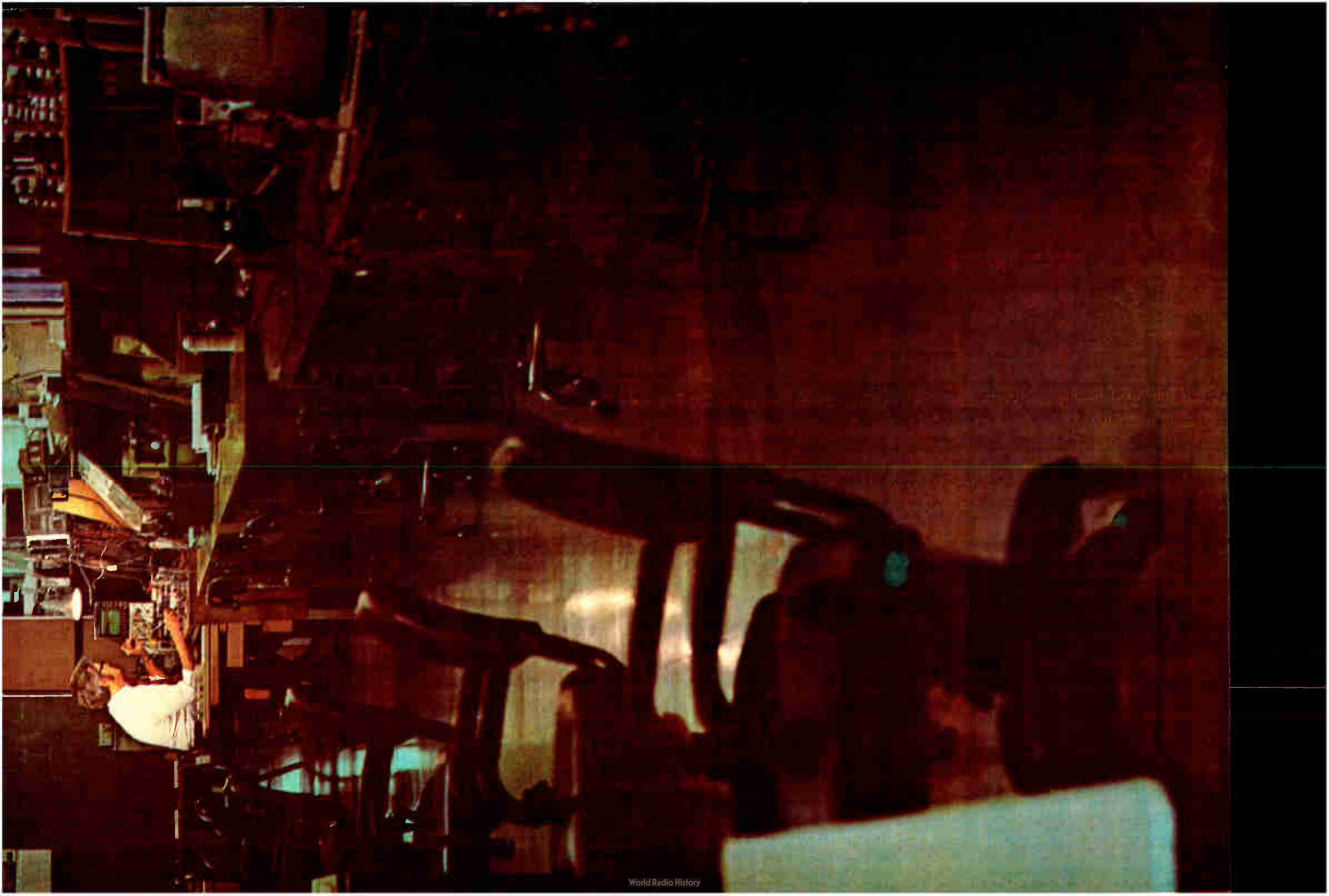

Think Twice:

Extra contribution is one way to the top. Specifying HP scopes will help you, too.

Here's why.

You're an engineer on the way up. Your ideas, your designs, your work all reflect the extra contribution you're making. (You might even slip back to "the shop" after dinner and on weekends.) Rewards won't be long in coming.

There's one more thing you can do for yourself and your management. Show them a way to cut operating expenses and boost profits. How? By being critical and downright hardnosed in making your cost/performance comparisons on instrument purchases.

Scopes Have Changed.

Take laboratory oscilloscopes for instance. In the past several years, scope design and performance have changed—for the better. Many companies, maybe yours, are in the process of replacing older scopes, to take advantage of the extra capability these new models offer. To get the best buy now, you're going to have to do more than look at the name tag and spec sheet. Plug-ins are not compatible. Calibration is completely different. Controls and operations have changed radically. It's a whole new ball game. *Little* that you learned or used on older scopes—*whether theirs or ours*—can be transferred to the new models. You need new techniques, new training materials, new parts. Here are three specific reasons why you should investigate the HP 180 Series... why you should think twice.

HP Scopes Cost Less To Buy

Analyze your total measurement needs, then ask both manufacturers to submit prices. On latest model plug-in lab scopes, you'll find that HP can consistently save you money—lots of it. For example on a 75 MHz non-delayed sweep, plug-in system, ours is 24% less (with delayed sweep, 18% less); at 100 MHz, ours is 16% less; for 1 GHz sampling, you'll pay 54% less if you buy ours.

HP Scopes Cost Significantly Less To Operate

Because scopes have changed, training, operation, calibration, and repair are expenses that you'll have to contend with—no matter which make you buy. HP's new scopes are supported by simplified operation and live or videotaped training and repair sessions that can substantially cut your start-up and overall operating costs.

Calibration? We've cut the number of adjustments by 50%—and eliminated interactive adjustments. Therefore, when you're comparing oscilloscopes be sure to include in that comparison the cost of calibrating each manufacturer's unit.

Our users are reporting shorter training periods, faster, surer measurements, and savings up to 50% on calibration time and costs. Some companies buying Hewlett-Packard, cite this as the main reason.

HP Technological Leadership. More Performance. Fewer Problems.

HP innovations in general purpose lab scopes include: the first scope with a real time bandwidth of >250 MHz; the first 18 GHz sampling scope; the first 100 MHz variable persistence and storage scope; and the first and only 100 MHz scope with a "big-picture" CRT (8x10 div, 1.3 cm/div). These are meaningful, functional innovations that boost your performance, not your costs.

Think twice! Once you make the comparison, we're certain you'll choose HP. Many engineers like yourself—engineers on the way up—have already made the switch. For more information on how you can help your company boost profits and how you can help yourself make faster, more positive measurements, write for our free "No Nonsense Guide To Oscilloscope Selection."

Hewlett-Packard, Palo Alto, California 94304. In Europe: 1217 Meyrin-Geneva, Switzerland.

Scopes Are Changing; Think Twice!

HEWLETT  PACKARD

O S C I L L O S C O P E S

Circle 23 on reader service card 082/6

Why invest in wire-wrapping facilities,



when you can use ours?

We can handle your complete back-panel wire-wrapping including all inventories right up to and including final inspection. You just have to bolt it in. And you can be sure of a completely tested, 100%-error-free back panel.

All your back panels can be tested with an Omnitester 900 Wiring Analyzer. This unit, pictured here in the center, has forward scan capabilities to determine, for example, whether a missing wire went to some other point. It then identifies that point.

The unit further tests for continuity resistance,



insulation resistance, DC hipot, and features programmable dwell time.

All this at a price less than in-house fabrication. No costly inventories, no capital tied to costly equipment. You can furnish the back panels or we can supply our own.

Delivery? Just 2 to 8 weeks, depending on the job and material availability. And we have two locations: Longmont, Colorado or Endicott, New York. For more details just call your nearest Amphenol sales office or write us direct. Amphenol Cadre Division, Bunker Ramo Corporation, 20 Valley St., Endicott, N.Y. 13760.

BUNKER RAMO AMPHENOL

Circle 24 on reader service card

Laser system eliminates mask, clean room

Engineers at Bell Laboratories in Murray Hill, N.J., are using a computer-controlled laser beam to machine circuit patterns **directly onto ceramic substrates**. Conventionally, such patterns must be fabricated under clean-room conditions involving several process steps, including mask-making, photoresist applications, and chemical etching. With the new technique, **masks are eliminated because patterns are stored in the computer memory, and a "clean room" atmosphere is unnecessary.**

As many as 48 substrates, 1 by 3 inches each and coated with a thin film of conductive metal, are mounted on the outside of a drum. As the drum rotates, each substrate is successively exposed at a rate of 25 inches per second to a 35-micrometer-diameter beam from a neodymium-yttrium-aluminum-garnet laser. A movable lens keeps the beam in focus over the substrate's length. Metalization is either vaporized or left intact as the laser beam is pulsed at 960 watts for 250 nanoseconds. After a complete revolution of the drum, a reflecting mirror steps the beam to the next line to be machined.

Within the next six months, the still-experimental system **will be tried out at Western Electric's manufacturing facility in Allentown, Pa.**

Buried channels hold out hope of faster CCDs

Buried channels, a new technology stirring up excitement in some major laboratories, **could result in step-function increase in semiconductor device performance.** Buried channels are being used in charge-coupled devices to boost operating speed dramatically.

Normally, charge is transferred at the oxide-substrate interface of a CCD; consequently, some charge is trapped in "surface states" during each transfer—the condition worsens at higher transfer rates. This means that operating speeds around 20 megahertz appeared to be the limit for serial memories—until buried channels came along.

By implanting a lightly doped channel just under the surface of the silicon substrate—say, 1 micrometer—CCD designers can confine the charge to the bulk silicon, where it can't be trapped easily. The result: **laboratory shift registers operating at hundreds of megahertz, with the possibility of speed in the gigahertz.** What's more, in random-access-memory configuration, buried-channel CCD structures could mean access time of **less than a nanosecond for RAM chips containing tens of thousands of bits.**

Who's doing buried-channel work? Bell Labs published first, and Fairchild Semiconductor isn't far behind.

DuPont to offer thick-film switch

Thick-film compositions can do more than produce dielectrics, conductors, and resistors—they **also can produce active switching elements**, says a team of researchers at the duPont Co., Wilmington, Del. Their work could lead to a cheap control element for appliances and for power-control circuits.

On May 15, at the Electronic Components Conference in Washington, D.C., Stephen C. Thayer of duPont will report on new compositions that perform as threshold switches. They can be triggered by external heat or by electric current that induces self-heating. When triggered electrically, the switch provides a change in resistance of three orders of magnitude within 1 microsecond. Threshold voltages

Electronics newsletter

range from 5 to 20,000 volts. The compositions, based on a reversible phase-transition phenomenon, **will be marketed soon under the trade name Tyox.**

Disk drive bids to change limits on mini systems

The development of a new disk drive at Omron Systems Inc., Mountain View, Calif., is **expected to change disk-based minicomputer systems drastically.** The new disk drive will offer 7.5 megabits of storage on a 6-inch-diameter disk with a worst-case access time of only 10 milliseconds. Data transfer rate is 7.5 megabits per second, and the cost will be about 0.05 cent per bit in OEM quantities. This compares with access time of 30 to 75 milliseconds and data rates of 1.2 megabits to 5 megabits per second for large, IBM-type disk drives.

In many disk-based minicomputer systems, the disk, which is typically slower than the IBM type, is the limiting factor in total system performance. **But with the high-density, high-speed Omron unit, to be ready in the fall, the computer may become the limiting factor.**

Hermetic package holds 3-in. wafer

A hermetic package capable of handling a **complete 3-inch-diameter LSI wafer or hybrid multichip substrates** will be the basic module in the All-Application Digital Computer (the AADC, formerly Advanced Avionic Digital Computer), says the Naval Air Systems Command. Singer Kearfott division, Little Falls, N.J., and Westinghouse Aerospace division, Baltimore, each developed a package. **The hermetically sealed region could be as much as twice as large as previous packages,** according to Plessey Ceramic, Frenchtown, N.J., which worked with Singer on the package.

It consists of a 4-inch substrate with a 3-inch-diameter hermetic enclosure that's sealed either with solder or is laser welded; 300 leads are taken out of the enclosure, 75 on each edge on both sides. A cam-actuated zero-insertion-force connector makes contact to each edge of the substrate. The module can dissipate up to 50 watts.

Honeywell adds eight minis

Honeywell Information Systems Inc. has added eight minicomputer systems to its line. The newcomers collectively are termed the System 700; **six use a new processor and two use a previously announced one.** All are for communications-oriented information-processing networks made up of a larger host processor and several of the new minis.

Statistics for the new processor are a 775-nanosecond cycle time, 16-bit word length, and compatibility with Honeywell's existing Series 16 computers. The minimum system will sell for \$30,000 or rent for \$1,000 a month, minimum; delivery will begin this July.

Union aims at N.J. Lockheed engineers

The 500 or so engineers and scientists at Lockheed Electronics Corp. are the object of a labor association organizing effort. **An organizing committee is seeking affiliation with the Association of Scientists and Professional Engineering Personnel (ASPEP)** located in Camden, N.J. According to the association, the committee has informed the company of its action, and that it can be certified as an official bargaining unit if more than half of the engineers join. The company says it is watching the situation.

Φ-LINE PLASTIC PUTs

24¢

more of the best for less
for more types of timing circuits

The Programmable Unijunction Transistor (PUT) has superseded conventional Unijunctions. It has become the preferred device for low-cost timing circuits, oscillators, sensing circuits, and many other variable voltage level threshold applications. Now with the addition of 4 new plastic PUTs, Unitrode has the broadest line available — 15 standard types including hermetically sealed. And we will select to meet your specific needs. Unitrode also offers the highest voltage PUTs and the first with better than 1% oscillator timing accuracy guaranteed from -55°C to $+125^{\circ}\text{C}$. Φ-Line plastic PUTs are available off-the-shelf for as low as 24¢ ea. in quantity, and they come complete with the services of a strong applications engineering staff. For fast action and the name of your nearest Unitrode distributor, call Sales Engineering collect at (617) 926-0404. Unitrode Corporation, Dept. 5Y
580 Pleasant Street, Watertown, Mass. 02172



UNITRODE quality takes the worry out of paying less.

Unitrode Corporation

Dept. 5Y, 580 Pleasant St., Watertown, Mass. 02172

Please send free samples of Φ-Line plastic PUTs

P13T1 for general purpose, P13T2 for long interval timing

2N6027 2N6028

Please send PUT information folder, complete with data sheets and application notes.

NAME _____ TITLE _____

COMPANY _____

ADDRESS _____

CITY _____ STATE _____ ZIP _____

TRAKATRON

The World's First Paging Eliminator

Today we can track astronauts all the way to the moon, but we can't locate them instantly in a building on earth. Trakatron closes this communications gap.

Trakatron stands for "tracking people electronically." Trakatron is available in three modes — manual (Trakapen), semiautomatic (Trakascan) and fully automatic (Trakafone).

With the basic manual Trakapen system, operation is manual through a standard touchtone keyboard which indicates on a readout the location of any person at any instant.

The semiautomatic Trakascan system automatically and continuously scans multiple numbers of people and displays their whereabouts on a TV-like (CRT) terminal.

Trakafone is a completely automatic mode in which the room sensors and other interface equipment are incorporated in the telephone system. This system automatically "searches" and rings the phone nearest to where a person being called may be at a particular moment. Trakafone also has a built-in memory which indicates when a person being called is not available, and notifies the caller automatically when the party becomes available.

Here's how one mode, Trakascan, works: a processor holds a list (see diagram) of all people tracked by the

system and their Trakatron pen numbers. At specific time intervals, the processor sends a coded message, on private or telephone wires, to all ultrasonic transmitter-receivers (sensors) installed throughout a building, or buildings. In the room, or designated areas of this building, the pen code addressed by the processor will respond with its own coded signal to the receiving sensor in that particular room, or area.

That receiver will then send a coded message to the processor which identifies the area of the coded pen. The processor now places the room number, phone extension, or other code opposite the name of the person in the list and then moves on to locate the next coded person. By scanning the list, a complete directory of people is ultimately built up and is kept current by constant repetition of the scanning process.

TV monitors placed at strategic locations throughout the building can display the contents of the list continuously, thus making the current information immediately available to interested parties.

As people move from one area to another, the Trakascan system locates and displays their present location. If a person is unavailable, or has left the building, it will also report that fact. Personnel may be added, or deleted

at any time.

Trakatron systems are designed to incorporate a number of options; digital synchronized clocks in any room sensor; after hours intrusion alarm; fire detection; provision for Trakavision internal video picture phone interface (the same screen can scan and display data on location of personnel and display actual live pictures of the person talking on the phone).

The versatility of the Trakatron system makes it possible to incorporate other features such as Penlock access control which permits a doorlock to "recognize" the pen of an individual without any conscious personal human involvement, insuring access only by cleared personnel.

Trakatron — automated locating systems for medium and large corporations, institutions, terminal facilities, etc.

For more information on licensing, write:

R.W. Lester, President
Recognition Devices, Inc.
101 Park Avenue, New York, N.Y. 10017

Trakatron patents and trademarks pending.

 **Recognition Devices Inc.**

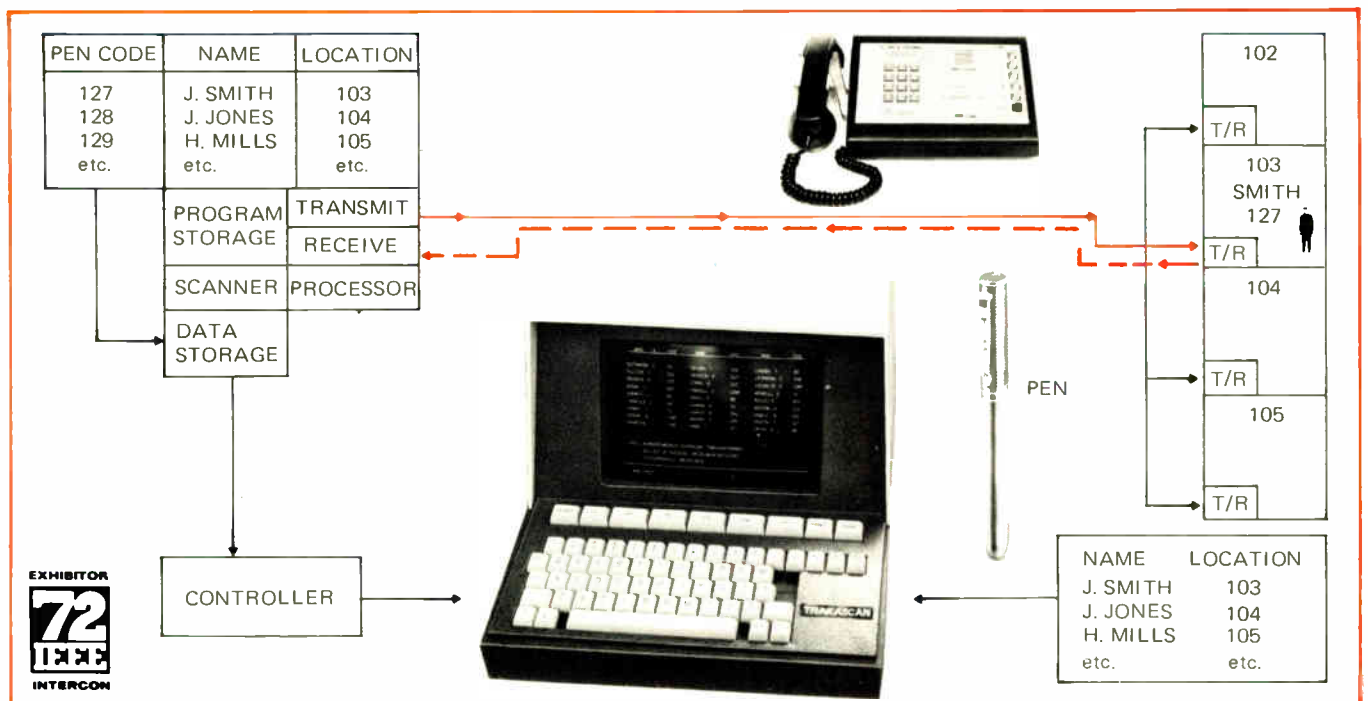

Japan shifts emphasis toward commercial sectors

New law seeks to restructure nation's industry as rest of world continues to do battle in consumer arena

The Japanese government is driving to restructure its electronics industry with new emphasis on commercial and industrial systems. While the United States and the nations of the Common Market continue to develop positions to grapple with the tide of consumer electronics exports from Japan, that government has been quietly working for more than a year under a new law to develop and expand 20 categories of products and materials for systems applications ranging from avionics and space to education, medicine, factory automation, and controls.

Staying up. A ranking official at the Commerce Department observes that the law "sounds typical of the Japanese—keeping several jumps ahead us," confirming the view of lower echelon State and Commerce Department sources who believe the Japanese action represents a serious threat to the strong U.S. position in world commercial and industrial electronics markets—a threat that they claim "no one seems to be doing anything about."

Popularly known as Law 17, the statute gives the Ministry of International Trade and Industry "overall policy direction" for the promotional development program. In addition, MITI gets funds to support it with awards to companies.

Law 17, formally titled the Speci-

fied Electronic Industry and Specified Machinery Industry Promotion Temporary Measures Law, went into effect April 1, 1971, succeeding the similar electronics Temporary Measures Law of 1957, that expired the day before and under which Japan rose to become a leading producer of consumer products. State Department records show that the U.S. Embassy at Tokyo first wired a translation of Law 17 and a list of products covered on Aug. 12, 1971—

more than four months after it went into effect.

A sampling late last month of U.S. Government, industry, and congressional sources showed that most were ignorant of the Japanese action. Those who were not were either uncertain of Law 17's contents or unconcerned about its implications. The Commerce Department's director of international trade policy, for example, said he is "unfamiliar with the law; it has not

Japan's 20 varieties

Under Law 17, MITI has been empowered:

To develop technology and experimentally manufacture:

1. High-performance radiation measuring instruments;
2. High-performance medical electronics;
3. Communications equipment, gear using ultrasonics and lasers;
4. High-performance avionics;
5. Missile and satellite electronics;
6. High-energy particle accelerators;
7. Ultrasonic measuring, detection, and applied processing equipment;
8. High-performance digital computers;
9. High-performance automatic control systems;
10. High-performance "load-beam-applied" hardware for chemical reactors, industrial processing, and melting;
11. Teaching and training aids;
12. Printed circuits, structures, and circuit parts;
13. Tubes ranging from vhf, uhf, and millimeter-wave tubes "for large power use," plus high performance CRTs, imagers, storage, display, electrostatic memory, and gas laser tubes;
14. High-performance silicon and chemical compound semiconductors;
15. ICs stressing large-scale, low-noise, low-power operation, high-speed, and ability to withstand high powers and voltages;
16. Materials ranging to low-loss dielectrics.

To push industrialization and mass production of:

1. Facsimile equipment, including color systems;
2. Video recorders and tapes;
3. Laser-applied equipment;
4. Magnetic disks and disk packs;
5. ICs, excluding MOS, of less than 1,500 elements, insulated by silicon oxide and using aluminum internal wiring;
6. Semiconductor chemical compounds.

crossed my desk." The Electronic Industries Association mailed copies of the State Department translation of Law 17 to some members of its Communications and Industrial division.

Under Law 17, the MITI director is instituting an "upgrading plan" for the 37 electronics categories to develop technology and experimentally manufacture 17 new products; move six others into mass production, and improve quality and performance while cutting costs in all categories already in production (see table). Though the measure is defined as "temporary," it does not expire until March 31, 1978.

To achieve Japan's targets for its electronics "upgrading" drive, MITI is given broad, almost dictatorial, powers to impose on companies "re-

strictions on the kind of goods," they may make; where and from whom they will buy parts and raw materials, and how they will use their plants, including directing joint corporate efforts.

Make change. At the same time, MITI is given authority to control and alter product standards in the categories under Law 17, when a company "holds a considerably high ratio to the total amount of production" in a product category; when a manufacturer's "business activities" are deemed "a considerable obstacle" to goals of the upgrading plan, and "when there is a fear that the continuation" of a company's activities "will produce a seriously adverse effect on the improvement of the production formula."

U.S. officials contend that Japan's

move implies recognition that it not only has a significant share of the world consumer electronics market, but also that its share is likely to diminish in years ahead. The reasons: the country's rising labor costs make it increasingly noncompetitive with operations such as U.S.-controlled TV receiver offshore assembly plants in places like Taiwan, other nations continue to restrict Japanese consumer product exports, and the nation's manufacturers move to exploit the higher profit margins in commercial and industrial electronics of its own manufacture while continuing to contract for production of consumer lines of manufacturers in other countries. On the other hand, sources in Japan say the law is merely the next logical step in the development of electronics. □

French electronic anesthesia system used successfully in 20 operations

The first feasible electronic anesthetic system has been developed by a French dental surgeon, Aimé Limoge, and used on more than 20 patients at Necker Hospital in Paris. It consists of a signal generator, three electrodes, a potentiometer, and an oscilloscope to monitor the signal.

The system produces a deep sleep with 2-milliampere pulses when the electrodes are positioned in a special pattern that won't cause muscle spasms and variations in blood pressure. The cathode is placed between the eyebrows and two anodes are placed in the back of the ears behind the mastoids. The main flow of current passes through the sides of the brain instead of through the center.

Limoge says that his method was developed by trial and error. After experimenting with hundreds of variations of pulses, Limoge settled on a single-polarity current at 77 cycles per second, supplemented by the injection of 3-millisecond hf pulses at 130 kilohertz. These additional pulses are of 10-microsecond duration with 30-second intervals. There is a 10-ms interval between

each of the three groups of hf pulses.

Three prototypes are being built by the French firm Sirel, and Limoge says that the U.S. Army has used his plans for construction of its own system. He says the Army is interested because of the simplicity of the system and its convenience for field hospitals. In France, the government-backed patent agency is negotiating with several electronics firms to commercialize the Limoge device. And at least one U.S.

pharmaceutical and medical equipment house is considering purchase of U.S. rights.

Opinion at the American Medical Association is conservative, if not skeptical. The AMA says it has not heard of the Limoge system, but that electronic anesthesia is not new and not without risks. Says a spokesman, "We would want to look very carefully at the device, and make tests on animals ourselves before sanctioning its use on human beings." □

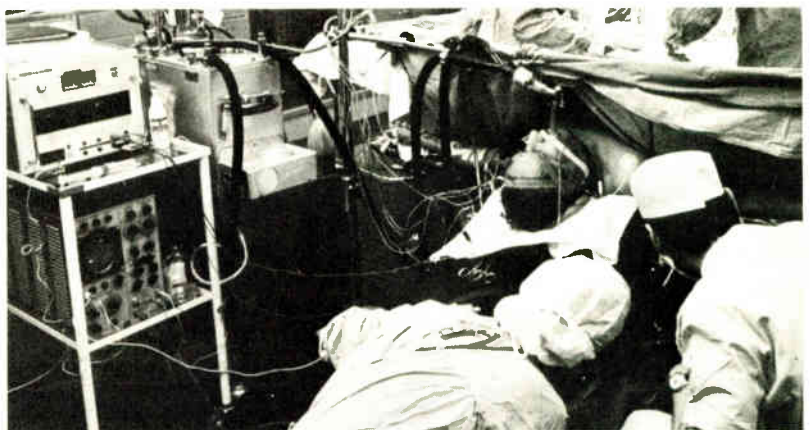

In use. Elastic bands around patient's head contain electrodes of anesthesia system.

Communications

Comsat silences telephone echoes

The problem of echoes in long-distance telephone conversations is handled by echo-suppression devices that switch high losses into the send path upon detecting speech signals in the receive path. But too often when both parties try to speak at once, the switch falters so that part of the conversation is lost and some of the echo sneaks by.

In satellite communications, the problem is magnified because propagation delays reach 270 milliseconds, compared to about 70 for long-lines cable. By substituting a minicomputer for a switch, communications Satellite Corp. Laboratories has developed what it calls an echo canceler. Comsat says the new digital processing scheme not only suppresses echoes but cancels them without weakening the voice signals.

Trials set. The device, introduced in late April at the American Institute of Aeronautics and Astronautics Conference on Satellite Communications Systems in Washington, D.C., will undergo field trials this year, says S.J. Campanella, broadband processing manager.

Campanella predicts a vast market for the devices because "you would need two for every channel in the telephone system." Mass production would lower costs to about \$1,000 each, he says, compared with \$600 to \$800 for echo suppressors now in use. Essentially, the echo canceler consists of two memories, a multiplier, and an accumulator that combine to sample the line continuously to eliminate echo.

The heart of the device is a self-adaptive feedback control loop that generates a mathematical model that describes the echo path. The model's output is fed to a subtractor 180° out of phase that eliminates the echo from the incoming line, explains Michael Onufry, technical staff member.

"If the mathematical model isn't

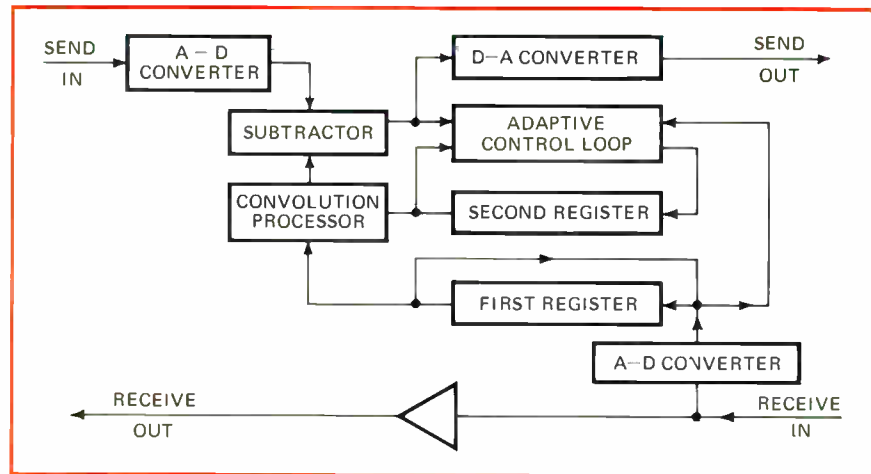

Quiet look. In this echo canceler, developed by Comsat Labs, digital signal processing is used to effectively cancel echoes often found in long-distance telephone conversations.

accurate enough (the echo has changed), we send an error signal above a threshold in to correct the model," he says. The conversation is sampled 8,000 times a second so that the canceler is continuously self-correcting. The canceler doesn't actually eliminate all echoes, Onufry admits. But since the ones that do get through are about 46 decibels below the signals—at the noise level of the phone system—they can't be heard anyway.

Basic system elements are two 256-bit shift registers, a convolution processor, a subtractor, and the adaptive control loop containing a correction sensor and an echo update. The convolution processor, consisting of a multiplier and a summer, multiplies the stored segment of conversation from one register and updated data from the model in the second register, sums the products, and feeds the result to the subtractor.

Messenger. If the sum is wrong, the difference is sent through the adaptive control loop, which adjusts the model, based on inputs from the first register, and sends the new data to the second register for resubmission. The system continuously samples by cross-correlating values from received speech and the error signal from the subtractor.

An echo canceler would be needed at each end of a telephone circuit, which is a four-wire, two-way transmission system. This is because a canceler at A's end only

stops B's echoes and vice versa. Onufry says. Because the amplitude and phase of echo paths vary between phone calls, the echo canceler employs an impulse response storage to record the differences.

The canceler converts real speech to digital mode to process it and converts the signals back to analog mode to reconstruct the echoless conversation, says Campanella. □

Consumer electronics

TV tuner rule strains capacity

Television-tuner manufacturer Sarkes Tarzian Inc. has become a victim of its own success. The Bloomington, Ind., company can't deliver enough 70-channel detent ultra high-frequency tuners to enable set makers to meet Federal Communications Commission parity requirements [*Electronics* Feb. 28, p.95]. The Tarzian company is the major supplier for most makers using the 70-channel device, and the FCC has ruled that by July 1, 1972, 40% of the models in a TV maker's line must have the new tuner.

"We're swamped with orders," cheerfully states company president Sarkes Tarzian. "We have a back-order of about 450,000 tuners and the TV makers want delivery at the rate of about 25,000 a week." Tar-

Electronics review

zian also points out that the company still has to maintain production of its regular line of tuners. And although assembly time on the device is nominal, precise alignment of the new tuner takes more time.

Tarzian's solution has been to train additional people on the company's own assembly lines and to help its biggest customers—RCA, Zenith, and Admiral—train their own personnel in alignment technology. "It takes about eight weeks to train a good aligner," says Tarzian, "but we fully expect to be out of the crunch by June."

The FCC has been lending a hand, too. It has granted waivers to two companies, Philco-Ford and GTE Sylvania, to extend the compliance date. Admiral has also petitioned for a waiver. However, the FCC says waivers would be granted only where danger of a production line shutdown exists. □

Materials

Hunt for space leads to magnets

The need for a new traveling-wave tube for airborne phased-array electronic countermeasures systems has drawn designers at Varian Associates to new magnetic materials—and a new product line.

The motivating problem was size: the beam-focusing magnets inside the tubes took up too much space, so the tubes couldn't be stacked as closely together as was required by the array spacing. As a result, says Louis R. Falce, techniques and materials engineering manager at the Palo Alto, Calif., firm, "we devel-

oped our own rare-earth cobalt magnet materials."

Rare-earth materials such as samarium-cobalt (SmCo) have magnetic energy levels that, says Falce, are "two to six times higher than those of Alnico magnets and are 20 to 50 times more resistant to demagnetization." For instance, a magnet with flux density equivalent to an Alnico magnet's is only a fifth its size. And now that Varian's space problem is solved, the company has decided to market the material to outsiders.

Equal flux. Martin M. Seldon, product sales manager, points out that while the SmCo magnets are more expensive, pound for pound, than Alnico, "the cost of equivalent magnets is about the same—the flux per buck is about equal." The large flux density in SmCo magnets results from the way they are made. Conventional magnets are made by placing the material in a strong magnetic field to align their internal domains. When the field is removed, the magnetization that remains is a function of the lattice structure of the material. If the magnet is then placed in a strong opposing field, it will demagnetize.

Rare-earth magnets, however, are made by a powder metallurgy technique. A SmCo powder is pressed into the desired shape in a mold surrounded by a strong magnetic field so that the powder granules orient themselves at the same time. This pressed powder is then sintered in an inert atmosphere and charged a second time to reach the precise magnetization desired.

The result is an extremely powerful magnet, which also is not easily demagnetized. It could be used in watch tuning forks, very small permanent-magnet motors, and

medical transducers. According to Seldon, one potential customer is looking at a transportation system based on magnetic levitation. □

Satellites

Intelsat dilemma: more or bigger?

Members of the International Telecommunications Satellite Consortium (Intelsat) are arguing over how to handle the large traffic increases forecast by 1980: build a few bigger and better satellites (next generation Intelsat 5 birds) or crank out more modified Intelsat 4 craft, or "4.5," as they are called. While it may seem logical to develop high-capacity satellites, strong sentiment within the 83-member consortium favors more small ones.

This thinking holds that using many smaller satellites will give system flexibility, lower cost to small users, and adequate redundancy in case one fails. Putting all one's eggs in one basket, the argument goes, is expensive, benefits the large users, and isn't as reliable. Smaller countries, which constitute most of Intelsat's membership, also are worried about added earth terminal cost for bigger systems. Compounding the issue are national priorities and jealousies.

One basket. "We think it is unwise to put the whole ocean traffic into one satellite," says a spokesman from the United Kingdom's post office, which reportedly wants alternative routes through five satellites for reliability and flexibility. "In 1985, the system (using bigger birds) might be okay, but in 1986 it busts," he says. The UK also thinks it "unwise for an organization that has many separate countries using it" to go for big systems, he says.

Disagreeing are some big users, notably the U.S. planners from Lockheed Missiles and Space Co., Sunnyvale, Calif., and Comsat, which operates the Intelsat network, who believe they have the answer for the 1980s: satellites using new

Drawing power. The need to save space in this traveling-wave tube for airborne ECM system led Varian Associates to new rare-earth cobalt magnet materials and new product line.

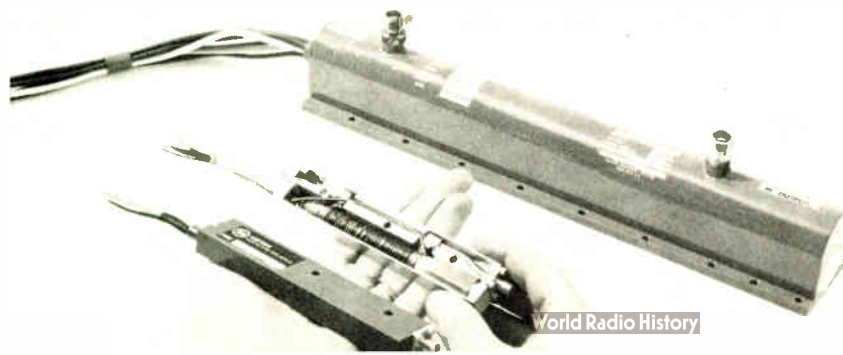

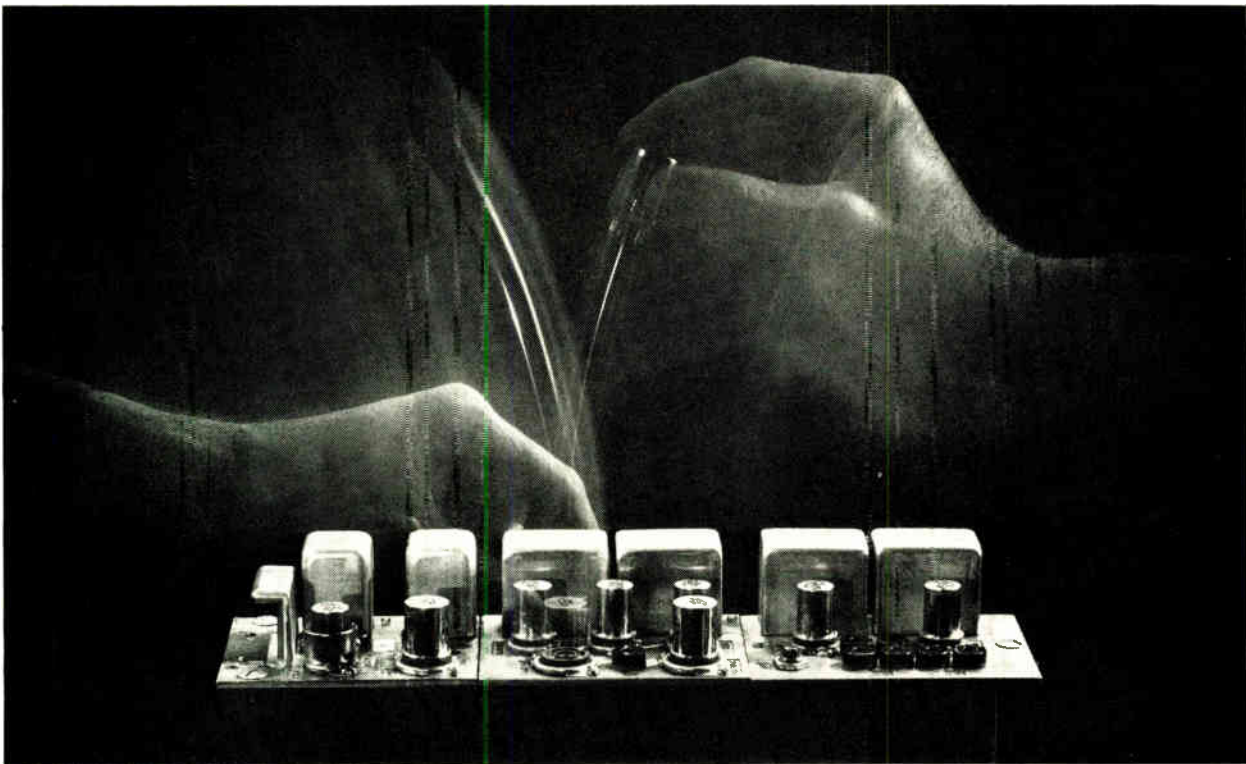

Out go the old tubes, in go the FETRONS™*

Teledyne's new FETRONS are pin for pin solid state application replacements for pentode and double triode glass tubes. The all new solid state FETRONS run for years and years and years without replacement, improve your equipment's S/N about 4dB, and use very little power. Because they are solid state, there are no air conditioning troubles. And they just won't drift.

Teledyne's first FETRON, the pentode TS6AK5, is designed for RF and IF amplifiers with wide band capability up to 500MHz. We have a TS6AK5AMP1 for amplifier applications and a TS6AK5OSC1 for oscillator applications.

The dual triode FETRON, TS12AT7AMP1, can be used for push-pull cathode-drive amplifiers and frequency converters in the FM range. A version is also available for oscillator (TS12AT7OSC1) applications. These are the first. Others will follow.

To get the details on the new FETRON, rush the coupon, or facsimile thereof, to us today for details on FETRON, the no-glass tube from Teledyne.

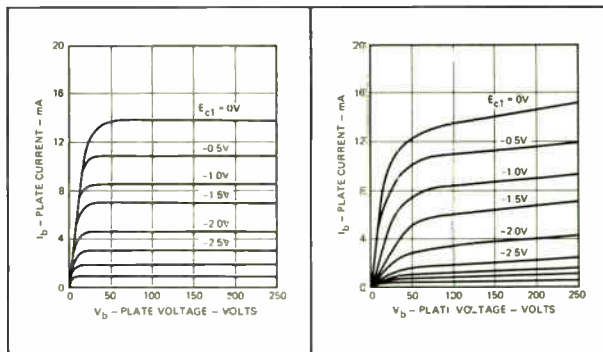

TS6AK5 Solid State Tube

6AK5 Vacuum Tube

* FETRON is a trademark of Teledyne Semiconductor.

Send me full details on the new solid state FETRON.

My Application is _____

Name _____ Title _____

Company _____

Address _____

City _____ State _____ Zip _____

TELEDYNE SEMICONDUCTOR

1300 Terra Bella Avenue Mountain View, California 94040 (415) 968-9241 TWX: 910-379-6494 Telex: 34-8416

communications techniques with capacities up to 135,000 circuits.

The new communications techniques that would be needed include multiple beam-steerable antennas, wideband digital transmission, and higher frequency bands. To handle these, the spacecraft would need better pointing accuracies for its antennas, plus more efficient means of generating power, storing energy, and using onboard propellants. Included in these projections are 10-year satellite lifetimes, redundancy to reduce failures, a standardized modular "bus" that could be changed as needed, and judicious use of the new 11- and 14-gigahertz bands allocated to satellite communications.

TDMA key. Satellite-switched time-domain multiple access is a key to high-capacity, large communications satellites. That's the view of John D. Kiesling, branch manager with Comsat Laboratories in Clarksburg, Md. The satellite switch, which is TDMA-controlled, connects the appropriate receivers and transmitters efficiently. The system's advantages are that the switches weigh little, the trans-

mitters can operate at peak efficiency, and the system instantaneously adapts to any network modifications. The frequency-domain multiple-access system is less efficient and requires too large a share of satellite weight and power because of filter weight.

"Actually, there are many ways to

skin a cat," Kiesling acknowledges, in order to achieve Intelsat goals of efficiency and economy. One alternative is to use FDMA on the 4- and 6-GHz, frequencies and TDMA on 11 and 14 GHz. Another is to take the model 4 satellites, change them to cross-polarization, and add spot beams. □

Solid state

TI weighs in on 10K end of scale with second-source MECL line

"The heavies are now all on one end of the ECL seesaw."

That comment from one industry insider sums up the effect of Texas Instruments' announcement that it is second-sourcing the MECL 10,000 line of emitter-coupled logic made by Motorola Semiconductor. And TI agrees. "We intend to supply the full 10,000 family and to have an impact on what that family might eventually be," says David Davies, new-product marketing manager at the Sherman, Tex., facility that TI

has dedicated to ECL standard and custom services.

The announcement was by no means unexpected. TI's initial offering of 16 devices from the new SN 10,000 series is a full complement of dual, triple, and quad gates and line receivers, as well as several complex and MSI functions. Eight SSI parts and a dual D-type latch are now available from distributors, with production quantities available in six weeks. In early June, TI will begin sending out samples of four more SSI chips, plus a dual D-type master-slave flip-flop device, a carry/lookahead adder, and an ECL version of its TTL 54/74 four-bit arithmetic logic unit/function generator, the SN 10181J. Those seven parts will be available from distributors late in June.

Lucky number? Davies indicated that TI would announce 13 devices in the third and fourth quarters—seven SSI and six complex and MSI functions, including some proprietary part numbers—plus several memory products in the family.

"When you're going after form, fit, and function, the ability to deviate and still stay in the box is not that great," observes Larry Regis, manager of TI's advanced-circuits department. But the TI officials detailed these differences between their SN 10,000 family and MECL 10,000:

- 100% hermetic packaging: the announced parts are in 16-pin, ceramic dual in-line packages, except for the SN 10181, which, unlike other man-

Thinking big

Strongly backing the idea of going to bigger Intelsat communications satellites are Lockheed Missiles & Space Co. and Comsat.

Assuming a 25% annual traffic growth rate, Lockheed proposes to build a 3,800-pound satellite. It would be dc-powered by 2,870-watt, sun-oriented, flexible-substrate solar arrays, recommends J.J. Knopow, communications satellite program manager. This craft would have 24 transmission channels in each frequency band, with 84,000 one-way voice channels at the 11- and 14-gigahertz frequencies, and 68,000 at 4- and 6-GHz, with multiple-spot beam antennas.

Lockheed's satellite would achieve operational flexibility and future growth by use of steerable antenna spot beams and onboard transponder and antenna switching, Knopow says. The antennas would use multifeed and unfurlable reflector techniques. Lockheed's projection is based on the three-year-old programs for the smaller development test satellite it is managing for 15 companies from nine countries. The engineering prototype will begin thermal and vacuum testing shortly, he says.

Comsat's projected body-stabilized Intelsat 5 satellite could come in several sizes, depending on technology, according to John D. Kiesling of Comsat Laboratories. Model 1, a simple extension of Intelsat 4, would use multiple spot beams, 40-megahertz transponder bandwidths, require more than 15 kilowatts of power, and weigh 37,000 lbs. to get its 270,000 channels, he says. A more efficient model 2 would have a wider transponder bandwidth and, by using fuel cells, ion engines, and better solar arrays, could drop its weight to 3,240 lbs. With a satellite-switched time-domain multiple-access system, model 3 would need only 1.3 kW and weigh 1,100 lb.

Whether you're designing for military applications or for police radar, your microwave need is total. And RCA's capability is equal to it — extending from the fabrication of our own gallium arsenide diodes all the way up to complex subsystems, incorporating features such as octave-band coverage, Ku-band VCO's and high-speed linear electronic tuning.

RCA's line of TEO's is among the industry's leaders. Ideal for systems designers, these versatile devices operate over a wide temperature range. RCA TEO's include low-cost, fixed-frequency industrial types, tuned to your specified frequency, as well as

types with narrow-range mechanical or electronic tuning.

Since RCA makes its own diodes, they are characterized specifically for use in its solid-state devices and subsystems so that you may be assured of the performance characteristics you require. Furthermore, RCA will design VCO's into your subsystems employing a choice of functions which include dc voltage regulation, linearization, bandswitching, isolation, and temperature control.

For more information, see your local RCA representative. For technical data, write: RCA Microwave Marketing, 1000 South Second St., Harrison,

Representative RCA TEO's

RCA Type	Center Frequency Range (GHz)	Min. Power Out (mW)	Comment
S293V1	8.8-9.8	20	Electronically Tunable, 0.5% stability
S494	2.0-4.0	10	Electronically Tunable, ± 40 MHz Linearity
S495	4.0-7.0	10	Electronically Tunable, ± 40 MHz Linearity
S496	7.0-11.0	10	Electronically Tunable, ± 40 MHz Linearity
S433	8.0-10.0	1-7 W Peak	Mechanically Tunable, ± 250 MHz
S437	10.0-12.0	10-120	Mechanically Tunable, ± 250 MHz
S479	12.0-14.0	20	Mechanically Tunable, ± 250 MHz

Other types are also available in the 2.0 to 16.0 GHz range

N.J. 07029. International: RCA, 2-4 rue du Lièvre, 1227 Geneva, Switzerland, or Sunbury-on-Thames, U.K., or P.O. Box 112, Hong Kong.

Get all the pieces from RCA from simple fixed-frequency TEO's to complex frequency determining subsystems



RCA

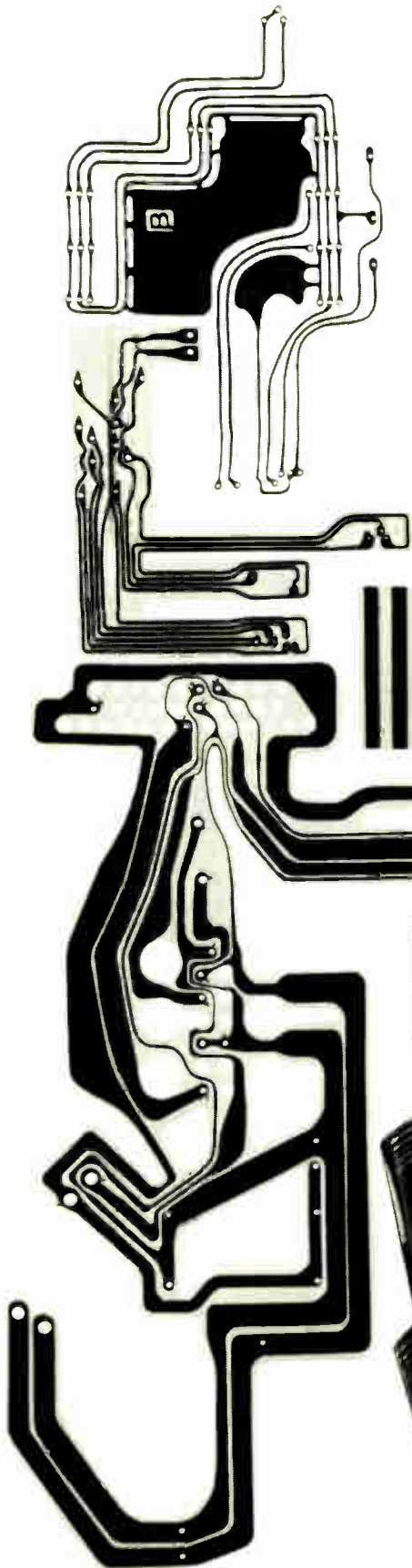

We started something in flexible cable 13 years ago when we pioneered Contour™ Cable for the Surveyor moon probes, Minuteman missiles and for the special needs of new high-speed computers.

And we can terminate it, too. We've everything you need to interconnect your circuits. Flat flexible continuous cable, flexible etched circuits — and 19 different types of connectors.

We're the only one offering a total interconnection systems approach, with the experience and on-going production to give you the benefit of all three (cables, circuits and connectors) now.

Want to make something of it?

We'll show you how. Write for our new 6-page Contour™ Cable catalog: 500 Superior Avenue, Newport Beach, California 92663.



TM—Contour Cable is a trademark of Hughes Aircraft Company.

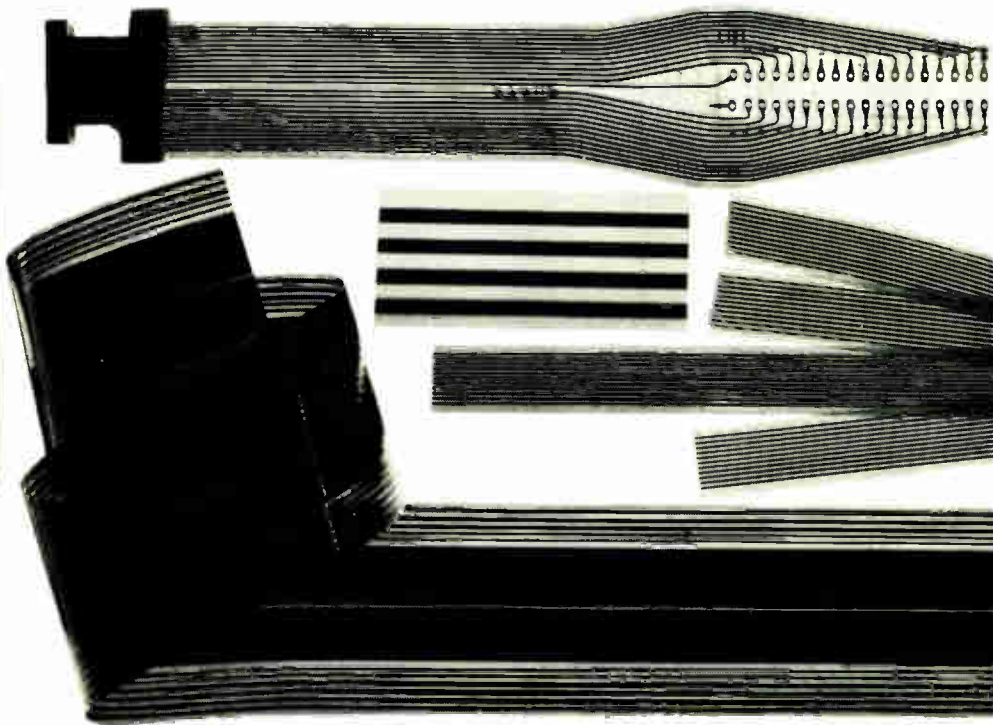

**If it's happening in interconnections,
it probably started at Hughes.**

Circle 36 on reader service card

Electronics review

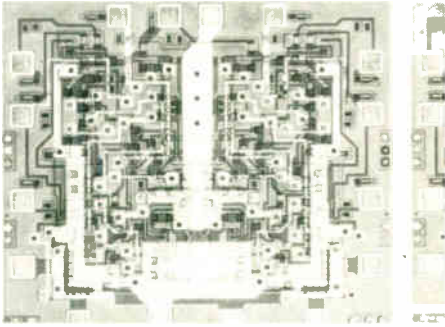

ECL echo. This is Texas Instruments' dual D-type master-slave flip-flop in new line.

ufacturers' 16-pin plastic packages, is available in a 24-pin C-DIP.

■ The industrial temperature range, 0° to 75°C, instead of Motorola's and Signetics' -30° to 851°C range: "We just haven't found a market for the extended temperature range." Regis explains.

■ An improved internal-reference generator to relax power supply tolerance and distribution requirements.

■ An active current source in the gate, rather than a resistive source.

It's no secret that, through its experience in custom ECL based on the earlier 2500 line, TI controls perhaps 50% of the ECL business. Indeed, some sources estimate that the com-

pany sells twice as much ECL as its nearest competitor, Motorola. Yet the firm apparently wanted to wait until it had standard parts available through distributors and TI sales offices before it dropped its other shoe.

"Our assessment of the situation from a competitive standpoint was that a standard family should have the benefit of multiple sources, that Motorola probably offered the best choice for multiple sources, and that market acceptance of the 10K family was far greater than that of the Fairchild 9500," Davies says.

What price pride? "When we weighed the alternatives, our choice was to second-source the existing family, rather than to try to splinter the ECL market with yet another choice," he explains, "that would not necessarily be enough of an improvement to make its own way." Adds Regis: "Kicking in a TI proprietary family, just for the sake of pride and emotional gratification, financially would not add enough leverage to the ECL market."

That market last year was about \$50 million worldwide, and \$36 million domestically, estimates Eugene McFarland, TI's marketing man-

View from Phoenix

Officials at Motorola Semiconductor in Phoenix have adopted a sanguine attitude toward Texas Instruments' entry into the 10K emitter-coupled logic business. It could be due partly to the fact that Motorola has cut prices on its MECL 10,000 line an average of 15%—not, says the company, in response to competition. Rather, officials say, the lower prices are the result of natural progress along the production learning curve, plus increased user acceptance.

As for competition from TI, here's the reaction of Douglas Powell, Motorola's outspoken manager of computer industry marketing: "We aren't worried; it'll take them a while to get into the saddle. What can they do that we haven't already worked on? In fact, I'm surprised it took them so long."

Powell points out that MECL 10,000 is strong in Europe. "Motorola's guys in Europe have done a much better job than we have here in the U.S. They've sewed up the whole continent—and we may have Russia yet!"

Asked why he thinks TI chose MECL rather than Fairchild's 9500, Powell replies: "It only makes sense to follow a line that has gotten wide acceptance."

Meanwhile, back at Fairchild Semiconductor in Mountain View, Calif., Cliff Vaughan, ECL product marketing manager, says: "Some 10K people are designing in 9500 series parts. And now that 95100 is available, we expect to see more of this." He points out that at least three companies are now using 9500 in peripherals and mainframes. What's more, Vaughan doesn't expect an ECL version of the 7400 TTL price war. But prices are now lower than for Schottky TTL, he says.

Hughes is more than electronic components and systems.

It's equipment, too.

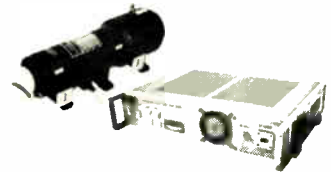

Microwave TWTs, TWTAs and solid state products (RS 228)



Displays (RS 229)

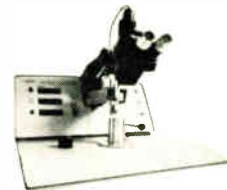

Microcircuit production equipment (RS 232)



Gas lasers (RS 231)

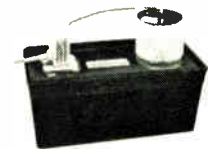

Thermal energy transfer (RS 237)

For complete information, write Bldg. 100, Mail Station C-512, Culver City, CA 90230. Or request by Reader Service (RS) numbers.

HUGHES
HUGHES AIRCRAFT COMPANY

Industrial Electronic Products

NEW! A/D ENCODER CIRCUIT.

Contains all the digital circuitry necessary to build an 8-bit successive approximation A/D converter.

HI-0180

This new device replaces three conventional TTL MSI packages, resulting in significant space and cost savings.

Features:

Both serial and parallel output data compatible with DTL/TTL.

"Data Ready" output pin indicates when conversion is complete and can be used for serial word synchronization, gating of parallel data, or actuating an analog sampling circuit.

"Reset" and "Enable" inputs which allow the device to convert continuously or stop on completion of a conversion until externally restarted.

Applications:

The HI-0180 can be used with the HI-1080, 8-bit D/A converter, the HA-2111 comparator, and a reference voltage source to implement a complete 8-bit A/D system capable of converting unipolar or bipolar signals with 1/2 L.S.B. accuracy at up to 40,000 conversions per second.

Other applications include:

Point of measure A/D converters in data acquisition systems.

Encoders and decoders for digitally multiplexed audio, instrumentation, or control transmission systems.

Supplied:

16-pin ceramic DIP 100-999 units

HI-1-0180-2 (-55°C to +125°C) **\$17.70**

HI-1-0185-5 (0°C to +75°C) **\$ 8.85**

CFO-0185-6 (Chips) **\$ 5.35**

For details see your Harris distributor, representative or write direct.

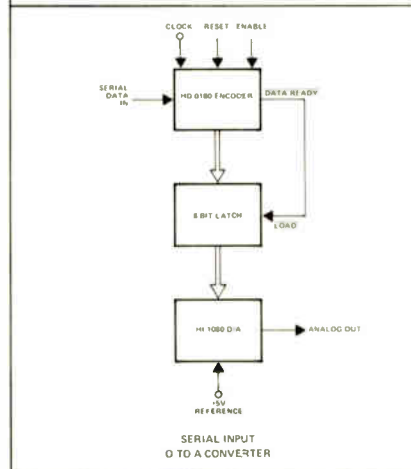
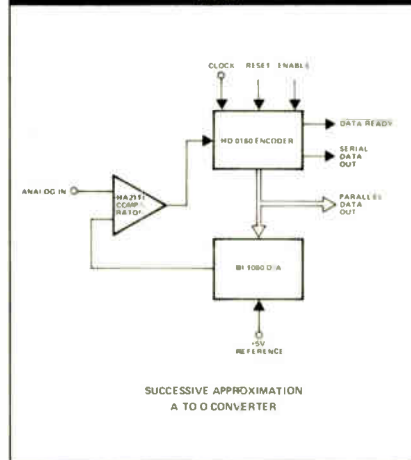
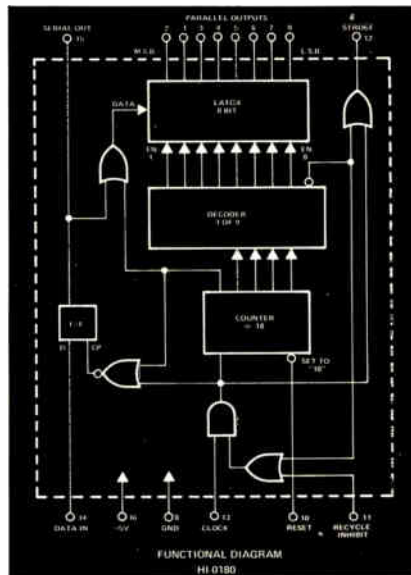

Special Introductory Offer! Complete 8-bit A/D Converter System Kit

For a limited time we are making available a complete 8-bit A/D converter system in kit form for both commercial and military applications. Kits also contain a prewired PC card and information package. Both versions may be ordered only through your Harris distributor, but be sure to place your order early because quantities are limited.

The military version consists of our new HI-0180 encoder, the HI-1080 D/A converter, the HA-2111 voltage comparator. **\$65.00** in 1-99 quantities.

The commercial kit contains our HI-0185 A/D encoder, the HI-1085 D/A converter, and the HA-2311 voltage comparator.

\$36.80 in 1-99 quantities.



HARRIS
SEMICONDUCTOR
A DIVISION OF HARRIS-INTERTYPE CORPORATION

P.O. Box 883, Melbourne, Florida 32901
(305) 727-5430

DISTRIBUTORS: Schwaber Electronics; Westbury, New York (516) 334-7474; Rockville, Maryland (301) 881-2970; Hollywood, Florida (305) 927-0511 / Harvey/R & D Electronics; Lexington, Massachusetts (617) 861-9200 / Semiconductor Specialists, Inc.; Chicago (312) 279-1000; Detroit (313) 255-0300; Minneapolis (612) 884-8132; Kansas City (816) 452-3900; St. Louis (314) 428-6100; Dallas (214) 358-5211; Indianapolis (317) 243-8271; Pittsburgh (412) 781-8120; Dayton (513) 278-9455 / R.V. Weatherford Co.; Albuquerque (505) 265-5671; Anaheim (714) 547-0891; Austin (512) Enterprise 1443; Dallas (214) 231-6051; Denver (303) 427-3736; Glendale (213) 849-3451; Houston (713) Enterprise 1443; Palo Alto (415) 321-5373; Phoenix (602) 272-7144; Pomona (714) 623-1261; San Diego (714) 278-7400; Seattle (206) 762-4200. HARRIS SALES OFFICES: Wellesley, Massachusetts (617) 237-5430; Wayne, Pennsylvania (215) 687-6680; Palos Heights, Illinois (312) 597-7500; Melbourne, Florida (305) 727-5430; Palo Alto, California (415) 321-2280; Melville, New York (516) 249-4500; Syracuse, New York (315) 463-3373; Washington, D.C. (202) 337-4914; Dallas, Texas (214) 231-9031; Scottsdale, Arizona (602) 946-3556; Long Beach, California (213) 426-7687.

Electronics review

ager, and is currently running about 70% custom. He foresees no increase in ECL business until the fourth quarter, and then not enough to increase over-all 1972 figures. "From the standpoint of the TTL market," he says, "the ECL market will remain small for some time; in the mid-1970s, it will remain about one-fifth of TTL worldwide." □

Medical electronics

Dorsal stimulator jams pain signals

Medical researchers are using military electronic countermeasure technology—against pain. The device they've come up with is the Myelostat, a dorsal column stimulator developed at Medtronics Inc., Minneapolis, Minn., to jam pain signals. It consists of an externally worn rf transmitter and antenna, plus a surgically implanted rf receiver. So far, about 300 persons are using the \$915 device, principally through the University of Minnesota Hospitals.

Pain is sensed only when it reaches the brain via the spine. However, only a limited number of pain signals can be transmitted at one time. The impulses continuously transmitted by the Myelostat keep the pain "gates" full, blocking

Pain killer. Patient-controlled device is surgically implanted, jams pain signals.

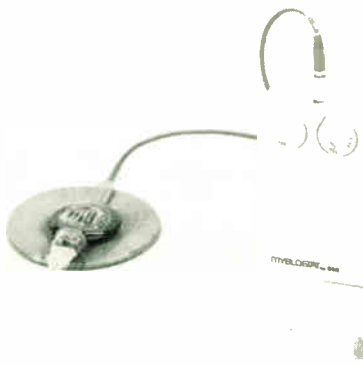

the entrance of signals to the brain. To relieve pain, the patient simply presses an "on" button.

In order to implant the receiver, the surgeon opens the spinal column at shoulder level and attaches an inch-long electrode with three platinum prongs to the spine. The electrode is connected by a pair of wires to the receiver, which is implanted in the chest just beneath the skin. The signal travels through a demodulator and filter, and is passed on to a tuned coil through an ac coupling device. Then it is sent to the brain.

The transmitter, worn at the waist, is connected to an antenna that is taped on the skin directly over the embedded receiver. The transmitter is about the size of a cigarette pack, and contains a single printed-circuit card. Frequency is on the order of 460 kilohertz, and voltage level is 30 volts maximum peak-to-peak at 8 milliamperes.

Variable. Besides three transistors, the card contains an air-coupled transformer and a rate generator that uses a programable uni-junction transistor. This permits nine to 250 pulses per second to feed into a monostable vibrator. The vibrator uses this output for the rf signal.

The battery-operated device has two sets of controls. One, which is hidden beneath the battery pack, is for the physician, who sets the maximum amplitude allowable for his patient. The patient, however, can adjust rate and amplitude beneath that upper limit on his own set of controls. Another built-in safety feature eliminates any chance of intermittent stimulation. □

Government

Challenges seen delaying domsat

The Federal Communications Commission is unlikely to meet the mid-May deadline set by Chairman Dean Burch on the dragged-out domestic satellite case. Timely decision

29¢

FET SALE

2N 3970	2N 4857
2N 3971	2N 4858
2N 3972	2N 4859
2N 4091	2N 4860
2N 4092	2N 4861
2N 4093	UC 250
2N 4856	UC 251

SOLITRON high quality N-channel FETS are sale-priced at 29¢ each in 1,000-piece lots (limited time only). Further price reductions on larger quantities. All available from stock. Call your Distributor listed below:

EAST	Texas, Dallas
Florida, Orlando	Component Spec.
Hallmark Electronics	(214) 357-4576
(305) 855-4020	Houston
Maryland, Baltimore	Component Spec.
Radio Electric Service	(713) 772-5127
(301) 823-0070	WEST
Savage	Arizona, Phoenix
Pytronics, Inc.	Kierulff (602) 273-7331
(301) 792-7000	California, Culver City
Massachusetts, Boston	Avnet (213) 836-7200
DeMambo Electronics	JSH Elec. (213) 837-0177
(617) 787-1200	Los Angeles
Needham Heights	Kierulff (213) 685-5511
Kierulff/Schley	Menlo Park
(617) 449-3600	Bell (415) 323-9431
New Jersey, Pennsauken	San Carlos
Resco (609) 662-4000	Intermark Electronics
New York, Binghamton	(415) 592-1641
Federal (607) 748-8211	San Diego
Farmingdale, Long Island	Intermark Electronics
Arrow (516) 694-6800	(714) 279-5200
Hauppauge	Kierulff (714) 278-2112
Semiconductor Concepts	Santa Ana
(516) 273-1234	Intermark Electronics
Hicksville	(714) 540-1322
Kierulff/FJR	Van Nuys
(516) 433-5530	Intermark Electronics
Pennsylvania, Trevese	(213) 782-0362
Hallmark (215) 355-7300	Washington, Bellevue
MIDWEST	Farwest (206) 747-1515
Colorado, Denver	Seattle
Intermark Electronics	Intermark Electronics
(303) 936-8284	(206) 767-3160
Kierulff (303) 343-7090	Kierulff (206) 763-1550
Illinois,	CANADA
Elk Grove Village	Quebec, Montreal
Lakeland (312) 595-1000	Prelco Electronics, Ltd.
Ohio, Dayton	(514) 389-8051
Kierulff (513) 278-9411	
Kettering	
Arrow (513) 253-9176	

Solitron DEVICES, INC.

Give us a quick call today, and test our producibility. We also excel in RAMS, ROMS, LIC's, and Custom Circuits. Solitron Devices, Inc., P.O. Box 23157, San Diego, California 92123. Telephone (714) 278-8780 TWX 910-335-1221

on the oral arguments scheduled for the first week in May is threatened by the mostly negative reactions that have been expressed by 31 affected parties to the FCC's staff recommendations for "limited open entry" into the potentially lucrative satellite market [*Electronics*, March 27, p. 34].

Seeking open approach. Crying for "unlimited open entry" are AT&T, Communications Satellite Corp., Western Union Telegraph Co., Departments of Defense and Justice, and the White House Office of Telecommunications Policy—among others. In fact, OTP threatens to take the matter to Congress if the commission turns down the "open skies" concept.

Opponents are questioning the economic practicality, the functional logic, and the legality of the staff's proposal to group proposed applications into four classes based on the status of technology and cus-

tomers. In calling for "open skies," AT&T and Comsat blast the staff's recommendations that Comsat should either serve only AT&T or lease to other users, with AT&T limited to message toll telephone and WATS traffic.

AT&T says that it is "illogical" and "imposes restrictions and unnecessary constraints on the applicants that could well prove unworkable for reasons which neither the staff, nor the commission, nor even the applicants now foresee." Comsat argues that the staff's position would okay the same satellite capacity as the individual applicants seek totally, without preventing the "market fragmentation" the staff fears. Hughes Aircraft Co. supports AT&T and Comsat.

Western Union says, "It would be arbitrary and unreasonable for the FCC to order some applicants to enter into consortiums when consortium arrangements promise so

many serious problems in negotiations and day-to-day administration." The Defense Department argues that restricting AT&T would be "to the detriment of the national defense," while the Justice Department says, "Limited entry would also increase the commission's regulatory burdens."

Grouping up. Essentially, the FCC Common Carrier Bureau has proposed to put Western Union, Hughes, General Telephone & Electric, RCA Corp., and Western Tele-Communications Inc. in one applicant group; American Telephone & Telegraph and Comsat in group two; the Microwave Communications Inc. and Lockheed Satellite Corp. team in group three; and Fairchild Industries in the last group.

Using this approach, the staff seeks a fair balance between markets, competitors and technology. Western Tele-Communications,

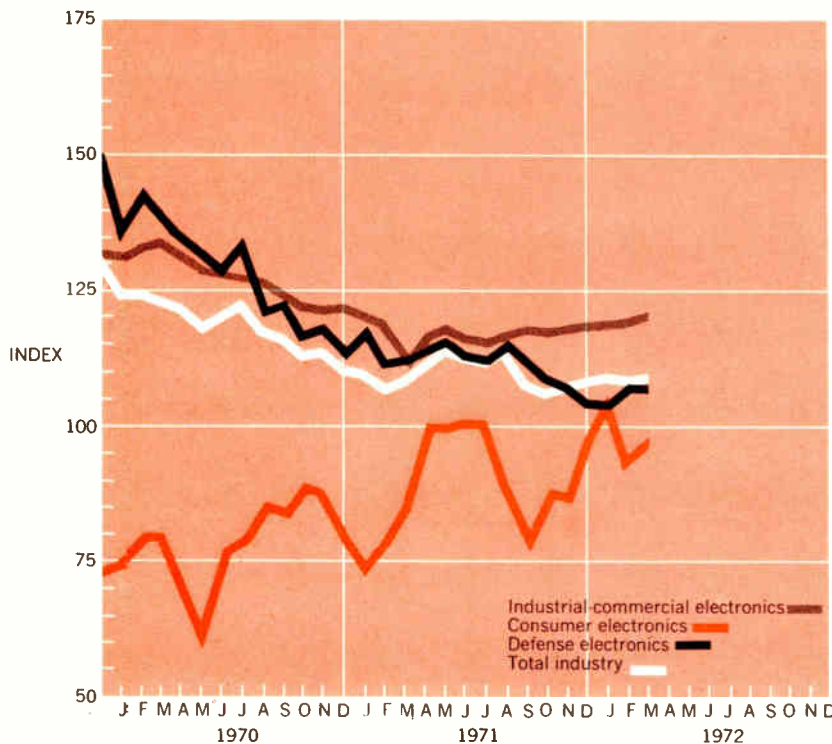

Segment of Industry	Mar. '72	Feb. '72*	Mar. '71
Consumer electronics	97.9	94.9	86.4
Defense electronics	107.5	107.6	113.3
Industrial-commercial electronics	120.8	119.6	118.4
Total industry	109.9	109.1	109.9

Electronics Index of Activity

May 8, 1972

The index for March showed a month-to-month increase of 0.7%, but there was no change from the March 1971 total. Major contributor to the slight rise was consumer electronics, with a 3.2% increase. Industrial-commercial moved up 1.0% while defense was off 0.1%.

On a year-to-year basis, consumer was 13.3% ahead of its March 1971 level, industrial-commercial was up 2.0%, and defense was down 5.1%.

Indexes chart pace of production volume for total industry and each segment. The base period, equal to 100, is the average of 1965 monthly output for each of the three parts of the industry. Index numbers are expressed as a percentage of the base period. Data is seasonally adjusted.
Revised.

Computer malfunctions cause incalculable chaos in split seconds. That's why you need multi-layer laminates made by the finicky folks at Norplex Division of UOP.

They're such sticklers for high standards they had to design much of their own quality-control equipment. That's how they can guarantee to meet or exceed NEMA, MIL-P and customer specifications.

And their clean rooms with precisely controlled temperature and humidity provide an extra measure of inclusion-free dependability. Norplex multi-layer laminates are without equal for stress-free uniform quality and dimensional stability.

Your Norplex representative is unique, too. He's a laminate engineer, a problem-solving consultant, offering you the widest line of laminates in the business. And he's backed by a

customer-service team assigned to each account for complete follow-through.

For process predictability in computer laminates, call on the Lint-Pickers. Norplex Division, UOP (Universal Oil Products Company).

Main Office and Plant
Norplex Drive
LaCrosse, Wisconsin
54601
608/784-6070

Franklin Office and Plant
P.O. Box 186—
Route 31 North
Franklin, Indiana 46131
317/736-6106

How the Lint-Pickers keep the numbers game clean.

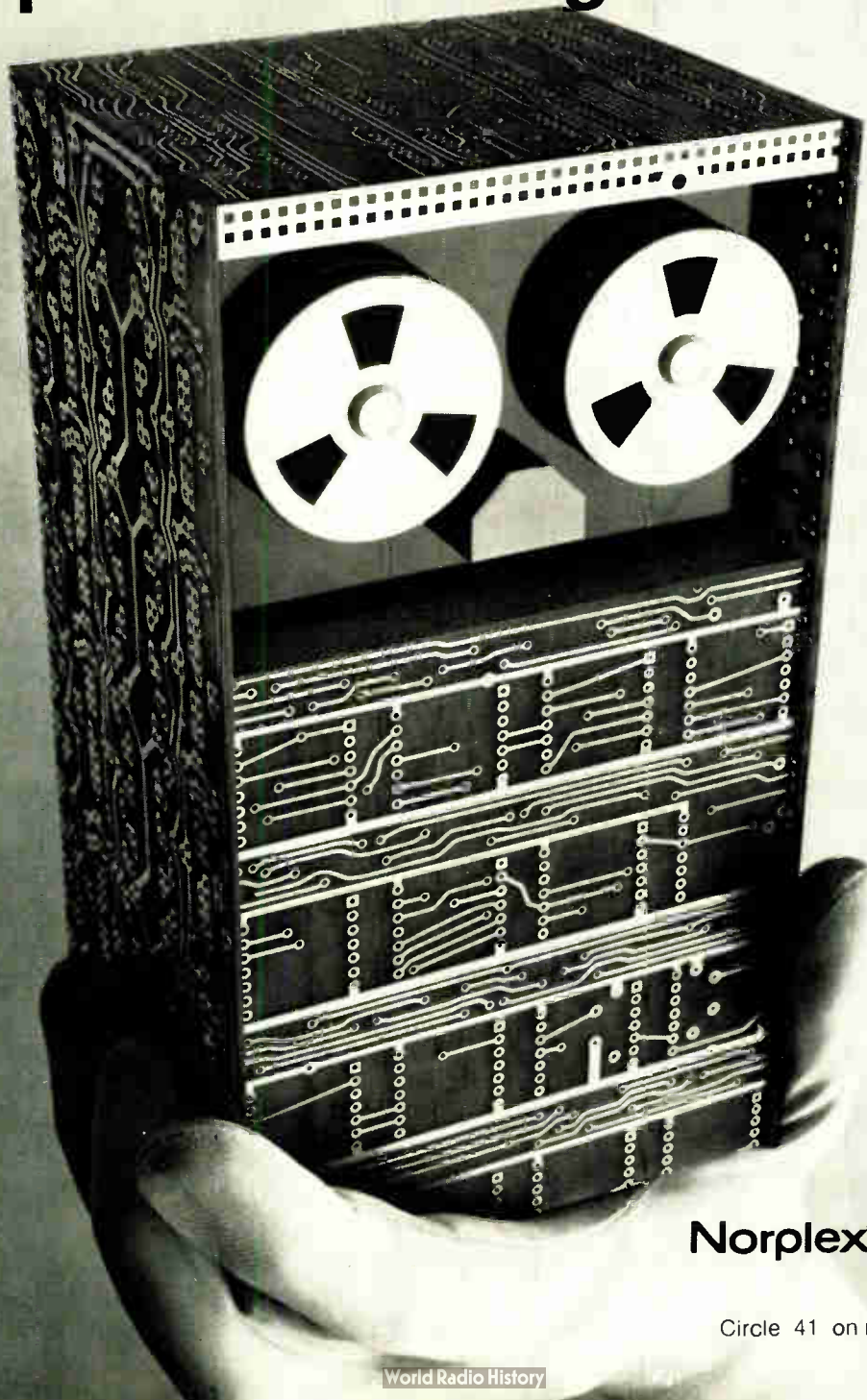

Norplex® laminates
by UOP

Circle 41 on reader service card

RCA and AT&T-Comsat would be given options, with restrictions, to go it alone.

Among the other applicants, Fairchild, RCA, Western Tele-Communications, and MCI-Lockheed, approve the staff's plan, but GT&E objects to sharing in a joint venture. Unlike satellite builder Hughes, General Electric also is in favor of limited entry.

Potential microwave and cable network customers find the plan to their liking. The National Cable Television Association expresses "general agreement," as does Data Transmission Co. (Datran). CPI Telecommunications Inc., arguing for several other microwave service

Waiting. It looks as though that's what Dean Burch, FCC chairman, will be doing as the dragged-out domsat case is delayed. The reason this time is that most of the 31 affected parties have reacted negatively to "limited open entry" to the market.



companies, wants to own receive-only earth stations without having adjunct satellite operations. The educational broadcasters are asking for free or reduced fee service. □

For the record

Status. The U.S. retains a slim world profit lead only in industrial electronics with a 7% return on total assets, compared to 6.8% for Japan, says a private study of world electronics by Stanford Research Institute, Menlo Park, Calif. But in total equipment and components output in the 1965-1969 period, Japan recorded the greatest growth in both sales and profits, followed by Western Europe and the U.S., according to the 2,500-page analysis SRI has completed for an estimated 50 companies over a 27-month period.

The recently delivered study says that equipment and component sales, respectively, increased by 13% and 32% in Japan over the period; by 13% in both U.S. categories, and by 10% and 11% in Western Europe. However, return on assets in the four-year period for the respective categories were 7.6% and 9.0% for Japan; 6.5% and 2.8% for the U.S., and 4.6% and 6.4% for Europe.

Down to \$75. A hand-held, four-function calculator to retail for less than \$75 will be introduced late this summer by Master Calculator Co., of Dallas. The machine features a one-chip calculator circuit from

Electronic Arrays with a contractual maximum price of \$8, and it uses a Burroughs Corp. Panaplex 2 gas-discharge display with eight 0.25-inch digits. Master's price to mass merchandisers will be about \$50.

Master is now shipping about 8,000 calculators a month, including an earlier hand-held model with an Electronic Arrays four-chip circuit for under \$150, the same four-chip calculator in a desk model for around \$85, and a 12-digit desktop calculator with memory using a Mostek two-chip circuit.

Rockets. Honeywell Inc. will develop a computer-based system for controlling the reusable liquid-fuel engines being developed by North American Rockwell's Rocketdyne division for the manned orbiter stage of the space shuttle. Honeywell's contract is for \$35 million; estimated total cost of the engines is \$450 million.

W.J. Brennan, Rocketdyne president, says that the three liquid-fuel engines used in each orbiter will be the most advanced ever designed in the U.S. He added that the Honeywell master control system is a significant step forward in rocket systems technology:

"This will be the first time that a digital electronic assembly has been developed as an integral part of a liquid rocket engine."

The system will contain dual sets of input/output electronics and two small digital computers to provide

Sales to rise

Electronics producers expect 1972 sales to rise by 7% over the level of 1971, while outlays for new plant and equipment will show no increase at all, according to the latest annual McGraw-Hill survey of capital spending plans. By 1975, sales will be 29% higher than in 1972, with about a quarter of the total attributed to new products now in planning, the survey shows.

Furthermore, it won't be until 1973 that capital equipment spending by the electronics industries steps out smartly—a 17% increase is predicted, followed by a mere 3% bump in 1974 and even a 1% decline in 1975.

Overall, American business plans to spend a total of \$92.9 billion for new plants and equipment this year, a booming 14% jump over 1971, the McGraw-Hill survey predicts. Between 1973 and 1975, preliminary plans indicate an average of \$100 billion will be spent each year. This year's Gross National Product (the total dollar value of goods and services produced in the nation) is expected to hit the \$1,148 billion mark this year, up about 9.6% over 1971. □



TRY 'EM...YOU'LL LIKE 'EM

Instant relief for design congestion: Cherry Subminiature snap-action switches.

When your design is afflicted with circuit congestion brought on by acute lack of space, here's the prescribed cure: Cherry 5 and 10 amp subminiature switches! Compact, easy-to-take size . . . refreshingly dependable coil spring action . . . plus long overtravel to combat assembly line headaches. You get Speedy snap-action relief in the dosage you prescribe: Either individual switches or space-saving multiple switch modules. Consultation available if design distress persists . . . Cherry diagnoses proven in over 160 million cases.



E61-00A
Standard Force Basic 10 amp.
Circle Reader Service No. 121

E63-00A

"Goldie" Low Energy 0.1 amp.
Circle Reader Service No. 120



Try 'em: Send for free sample switch.
You'll like it.



E62-50K
Roller Actuator 10 amp.
Circle Reader Service No. 122

CHERRY



TWX 910-235-1572 . . . or PHONE (312) 689-7600 . . . or WRITE:

CHERRY ELECTRICAL PRODUCTS CORP.
3608 Sunset Avenue, Waukegan, Illinois 60085

Makers of patented Leverwheel/Thumbwheel Switches, Matrix Selector Switches, Snap-Action Switches and Keyboards.

**STOP
ELECTRICAL
POLLUTION**

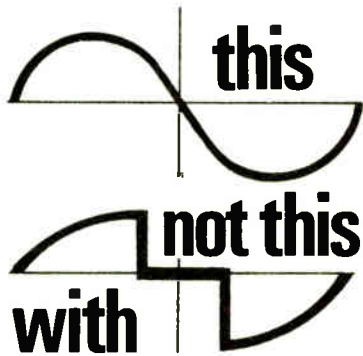

Jewell
GOLD LINE
SOLID STATE RELAYS



ZERO
CROSSING
TYPES

- 8 amp.
- 15 and 30 amp.
- miniature 2, 3 & 4 amp.

FOR APPLICATIONS
WHERE RELIABLE
TROUBLE-FREE SWITCHING IS
REQUIRED IN CONTAMINATED
ENVIRONMENTS

EXCLUSIVE FEATURES: Zero crossing switching. No noise. Highest inrush capability. Input-output isolation. Fully encapsulated. All solid state. No moving parts for maintenance-free operation and long life.

- PROPORTIONAL CONTROLLER/RELAY TYPES ALSO AVAILABLE
- VARIATIONS TO ORDER

*Write for pricing and
technical information.*

Jewell

JEWELL ELECTRICAL INSTRUMENTS, INC.
Grenier Field, Manchester, NH 03105
Phone: (603) 669-6400 • Telex: 94-3435

Electronics review

redundancy in the case of failure of one unit. Honeywell will build most of the electronics at headquarters in Minneapolis, with the computers supplied by its Aerospace division, in St. Petersburg, Fla.

Honeywell is scheduled to deliver the first developmental control units to Rocketdyne next year, and the first flight engines will be delivered to NASA in 1977.

Insurance. Cartridge Television Inc. has licensed Magnavox, already an RCA licensee, to use CTI's Cartrivision.

This word came with another CTI announcement: formation of a rental-cartridge distribution company, Cartridge Rental Network, jointly owned by CTI and Columbia Pictures Industries. However, says the new firm's president, Larry Hilford, "Since we are a profit-making center, we won't preclude distribution of cartridges for other systems also."

Acceptance. A 2-gigahertz digital radio built by Avantek Inc., Santa Clara, Calif., has received type acceptance from the Federal Communications Commission. The unit, designed for use in commercial microwave relay systems, uses a four-level phase-shift-keyed modulation scheme. According to the manufacturer, it is the first American-manufactured PSK system to be type-accepted.

The radio is compatible with the Bell System T-1 PCM wire-line carrier. The new unit (model DR2A-T1) will accept two non-synchronized Bell T-1 carrier bit streams (1.544 megabits per second each) and transmit them over a single 2-GHz rf channel. Two DR2A-T1 radios, using a cross-polarized feed on the antenna, will carry four T-1 streams (a total of 96 voice channels) on the same radio frequency, or the equivalent of over 6 megabits of data per second.

Package cost. Ceramic dual in-line IC packages cost just about the same as molded plastic packages. But when costs of maintenance and replacement are considered, the eco-

nomics swing overwhelmingly to ceramic. That, says Owens Illinois Inc., of Toledo, Ohio, is what an 18-month study shows.

The study was made by Sakari Jutila, chairman of University of Toledo's Department of Operations Analysis. Jutila says that for a 14-lead DIP, Cerdip-type packages cost out to about \$118 per thousand, while plastics come out to about \$100 per thousand. But if the cost is, say, \$30 per repair in a small system, the buyer is spending twice as much for the glass ceramic package as for the plastic package.

And, at \$300 per repair for a large computer system, the glass-ceramic package could cost 10 times as much and still be more economical.

Polaroid clicks. Lifting its traditional veil of secrecy long enough to wow stockholders at its annual meeting, Polaroid Corp. has demonstrated a small IC-controlled camera that produces already-dry color pictures in a little over a second each. The IC, which controls the top-secret developing procedure and automatically adjusts the exposure, is to be supplied by both Texas Instruments and Fairchild. Each chip has 300 transistors.

Breakthrough. Fairchild Camera & Instrument Corp. has announced its first profitable quarter in two years. Net income for the period ending April 2 is \$1,114,000, or 25 cents per share, on sales of \$51,020,000. This includes a tax-loss carry-forward of \$356,000, or 8 cents per share. For the comparable period last year, Fairchild incurred a loss of \$1,614,000, or 37 cents per common share, on sales of \$48,188,000.

Quits Italy. Phileo-Ford Italiana, which was acquired some eight years ago by Ford in hopes of cashing in on the then booming European appliance and TV market, has given up the struggle against the European giants and has decided to join their ranks instead.

The company has been sold for an undisclosed amount to Robert Bosch GmbH, of Stuttgart, Germany. □



BUILDING FOR THE FUTURE

"The foundation upon which the future will be built was laid in the past."
 That is the real significance of our fiftieth anniversary.
 A half-century of experience in electrical insulations gives us
 a sound base for anticipating and meeting the requirements of industry
 and science in the future. We invite you to bring your insulation
 problems to us. If we don't have the solutions, we'll find them.

L. FRANK MARKEL & SONS, INC., NORRISTOWN, PA. 19404

Pioneers in Electrical Insulations Since 1922



World Radio History

Circle 45 on reader service card



STRAIGHT TALK

Our New Model 20 Programmable Calculator. Latest In the Series 9800.

It speaks and understands English. It speaks and understands Algebra. It really understands your problems. It was designed for instant programming right at your desk. The Model 20 will take you from concept to final solution of your problems

faster than any other system on the market.

Incredibly Natural Language.

You'll quickly grasp the operating concepts of the Model 20, because it uses a natural but powerful language that lets you work with algebraic symbols, formulas, and English language instructions. And, if you already know how to program, you'll

appreciate features that once were exclusive to languages like FORTRAN or BASIC: Enter and Format statements, function subroutines, and callable subroutines with parameter passing.

Talk out a problem with your Model 20. Key in your problem exactly as you would write it on paper. Press EXECUTE and there's your answer. It's deceptively simple.

With the Model 20 you always know where you stand. Its alphanumeric display and printer give you operating instructions, show your formula as you key it in, and



completely label your input and output data.

Easy To Get Along With.

One of the nicest things about the Model 20 is that it doesn't bite. If you make a mistake, your display not only tells you there's an error — but precisely what and where the error is. Then it's a simple matter to insert, delete, or replace anything from one symbol to an entire line with just a few quick strokes on the editing keys. It adds up to this: You don't have to be an expert to operate the Model 20. Because of its error detecting and correcting techniques,

the Model 20 is the fastest and easiest programmable calculator available.

A Word About Power.

What really counts is not that our calculator will solve up to 36 simultaneous equations, but what you can do with that power. With the Model 20 you'll spend less time getting answers and more time building ideas. Another thing. Our keyboard is modular. So if you don't like our setup, you can build your own.

The Model 20 can be plugged into our hardworking Series 9800 Peripherals: X-Y Plotter, Type-

writer, and Card Reader, to name a few. An added plus — it interfaces with test instruments. The basic unit, including our built-in alphanumeric display and printer is \$5,475, with immediate delivery.

For more information or a "hands-on" demonstration, write: Hewlett-Packard, P.O. Box 301, Loveland, Colorado 80537. In Europe: 1217 Meyrin-Geneva, Switzerland.

C092/2

HEWLETT  PACKARD

CALCULATOR PRODUCTS

For literature, circle 218 on reader service card
For demonstration, circle 219 on reader service card

Carter Semiconductor wants you to know about its quality...

You'll be impressed!

Quality and reliability go together like Carter and Semiconductors. We judge a product's reliability by its long-term performance to spec.

You can judge Carter by its performance to your critical needs, whether it be on-time delivery or design.

Try us and be impressed!

We can deliver whatever you need when you need it. Linear IC's, TO-92, Metal can transistors, epoxy transistors, germanium diodes, silicon diodes and rectifiers.

Our pledge to you is quality devices, reliability of operation and fast and efficient service and delivery.

Be impressed! Write or call today for our catalog of products.



CARTER SEMICONDUCTOR, INC.

State Facility • 351 Aiken St., Lowell, Mass. 01853 (617) 454-5147
Main Office & Eastern Region • 374 Bayview Ave., Amherst, N.Y. 11701 (516) 842-6666
Western Region • (415) 947-7056 Midwest Region • (312) 438-4282

Circle 48 on reader service card

World Radio History

ASK YOUR DISTRIBUTOR FOR CARTER SEMICONDUCTORS

Air Force faces sharp Awacs cuts by Senate alone . . .

The Air Force is getting little support from the Secretary of Defense and none from the White House in its effort to get the Senate to restore the \$227 million slashed from the Airborne Warning and Control System by the Armed Services Committee. The nearly 50% cut drops two of three planes sought for procurement in fiscal 1973, and reduces the program, long politically chancy, to R&D status. Though the Senate authorization cannot be exceeded in the subsequent appropriation, **the Air Force may get some money restored in a final Senate-House conference committee**, since the more militant House membership is less likely to cut the program back. In a time of tight national budgets, top administration leaders appear to be listening to the arguments of Awacs opponents that **42 of the big command post radars will probably never be required** to counter a manned bomber attack on the U.S.

. . . Army loses \$\$ for Cheyenne, Marines for VTOL

The Army lost its battle with Congress to get \$58.6 million in fiscal 1973 funds for its AH-56 Cheyenne helicopter gunship built by Lockheed Aircraft, as was anticipated. The Senate Armed Services Committee's deletion for the second year is **unlikely to be restored until the Army comes forward with results of competitive performance results from tests of Cheyenne as well as Bell Helicopter's KingCobra and Sikorsky's Blackhawk.**

Also reduced on economy grounds was the Marine Corps plan to increase its fleet of Hawker Siddeley AV-8 vertical-takeoff-and-landing fighter from 60 to 90. All \$115 million for the 30 extra planes, to be produced under license, are **pending a judgment on the need for two distinct close air support weapons—the VTOL and the helicopter gunship.**

DOT ponders deterrents against truck hijacking

A sizeable market in electronic devices that will stop truck hijacking is a possible outcome of a Federal interagency committee on transportation security. Led by the Transportation Department, the group is coordinating research information among several Federal agencies, and is expected to **recommend safety procedures and security equipment for truckers and other transportation businesses.** Simultaneously, DOT's Transportation Systems Center, Cambridge, Mass., is looking into several electronic techniques, including a method of automatically shutting off a truck's ignition if it strays off a predetermined course.

Avionics imports from Canada, UK, are surging

A rising tide of imported navigational aids and aircraft flight instruments—mostly from Canada and the United Kingdom—will continue to threaten U.S. manufacturers, according to new Commerce Department data. Comparing 1971 with 1970, the department finds that **imports of navigational instruments and parts more than doubled in value, aircraft flight instruments and parts jumped two-thirds, and electronic ship logs and depth-sounding devices rose by almost half.**

Canada had the biggest gain, tripling its shipments of aircraft instruments to \$6.2 million and doubling those in navigation to \$5.8 million while the UK showed less steep but still significant, gains. **Significantly, U.S. exports of aircraft flight instruments, including automatic pilots, fell sharply from \$57.6 million to \$44.7 million during the same period.**

Making it in world trade

After a long string of technological and marketing victories at home, the American electronics industry has dropped the ball overseas competing for exports. That is the impression given by Export-Import Bank chairman Henry Kearns and Secretary of Commerce Peter Peterson. Nevertheless, any assessment of U.S. world competitiveness must include its multinational electronics corporations—companies that are running hard with a firm grip on the ball.

Kearns, an accomplished globetrotter who has hit 10 countries so far this year for a total of 47 since 1970, says foreign industry and government officials have a high regard for U.S. technology but invariably ask: "When will American business present its products to us?" Americans, Kearns asserts, "simply are not competing with anything like the vigor of our Japanese, German, British, Italian, and French friends."

Peterson's principles

The view from the Commerce Department is similar, although Secretary Peterson puts it in a somewhat different perspective, suggesting that too many U.S. corporations for too long have taken a short-term view of their businesses—one that fails to extend beyond the next fiscal year's profit and loss statement. There is truth in that.

There is also truth in the contention of General Electric Co. chairman Fred Borch that "it boils down to the fact that other countries have placed international trade as a top national priority." The United States, of course, never has.

As America's deficit continues to mount, foreign trade is belatedly surfacing as a national issue in the capital to join such controversies of longer standing as the Vietnam war, tax reform, and environmental pollution. First quarter figures put out by Commerce at the end of April put the red ink at a record \$1.5 billion—an astonishing figure in view of the figure of slightly more than \$2 billion for all of 1971, when the country recorded its first deficit since 1893. Now the question is which way to go.

Several Federal programs are in varying stages of development, including authorization for industry formation of special domestic international sales corporations, or DISCs, as a means of spurring exports through deferral of taxes on half of a DISC's income [see p. 66].

But the Administration has rejected industry proposals for a 25% tax allowance against R&D expenditures, says Secretary Peterson, "as too expensive at this time" of tight national budgets. That spur to U.S. competitiveness could

cost up to \$3 billion a year in Federal revenues. Instead, Peterson favors "a program which would permit broad, joint research efforts by a number of companies with common goals," efforts now precluded by antitrust statutes.

Such joint efforts—uncomfortably reminiscent of what Japan's Ministry of International Trade and Industry has been doing for some time—would be carried out with "general Government oversight to guard against restrictive practices," explains Peterson. "Any patents resulting from such efforts would be privately owned but broadly shared—free of charge to all participants and at a reasonable royalty to other American companies."

Looking at MNCs

No one in the electronics industry has publicly opposed the proposal, but no one is heard promoting it either. Some of the more successful manufacturers suggest they prefer to continue down the road they are going—multinational. Popularly known as MNCs, multinationals abound in electronics. While the Commerce Department, in an internal study not yet released, concludes that MNCs in electronics and other high-technology industries are a powerful and positive world force, the leadership of the Congress is not so sure. Arkansas Democrat William J. Fulbright, for one, says his Senate Foreign Relations Committee is building up a special investigative staff prior to an extended examination of the role of multinationals.

When all is said and done, many of these investigations, studies, reports, and analyses by both the executive branch and Congress will have a shorter editorial life span than this commentary. That seems to be the American way of government, unfortunately. While too many people continue to make haste slowly, the balance of electronics trade shows no signs of turning up, much less of improvement.

It may be that the giant multinational corporations will prove the ultimate survivors of what shapes up as a worldwide technological shakeout. And that may be the way for American electronics manufacturers to make it in the international marketplace.

This is especially likely, given the slow U.S. Government response to the threat, and given also the truth of ExIm's Henry Kearns that too many U.S. corporations exhibit no enterprise, the truth of Peter Peterson that others have become shortsighted, and the truth of Fred Borch that foreign countries make trade a top national priority.

—Ray Connolly

Why more people are buying DVM's from S-D:

Jerry Hartman, DVM Sales Manager

3½ digit, 17,000 units sold. High performance at lowest cost. Unequaled customer acceptance. Good noise rejection and long-term stability resulting from Dual-Slope integration design. Ideal for production, test and design areas. (Model 7050, \$279 and up)

4½ digit, AC, DC, volts, amps, ohms. 25 ranges of dc and ac volts, dc and ac current, and resistance. Full 4-digit display with 10 microvolt resolution. Dual-Slope design and a fully guarded input assure highest noise rejection. Lightweight, with optional battery pack and protective cover, for operate-anywhere convenience. (Model 7004, \$650)

5½ digit bench. Best price/performance. Full 5-digit accuracy and resolution at lowest cost. Use in any area where critical measurements must be made. Fast response readings. High input impedance: lowest 'kickback' noise. Plug-in card expandability-dc volts, dc millivolts, current, ac volts, resistance, auto-range, digital outputs. (Model 7005A, \$1295)

5½ digit systems. Fast and Accurate. 30 readings/second and high noise rejection. Fully isolated programming and digital outputs in a variety of optional formats. DC volts and ratio standard. Plug-in card options for ac volts, 4-wire ohms, system interface. (Model 7110, \$1695)

For full details, contact your Scientific Devices office or Concord Instruments Division, 888 Galindo Street, Concord, CA 94520. Phone (415) 682-6161.

In Europe: 8 München 60, Haidelweg 20, Germany. Telex: 841-529-615.

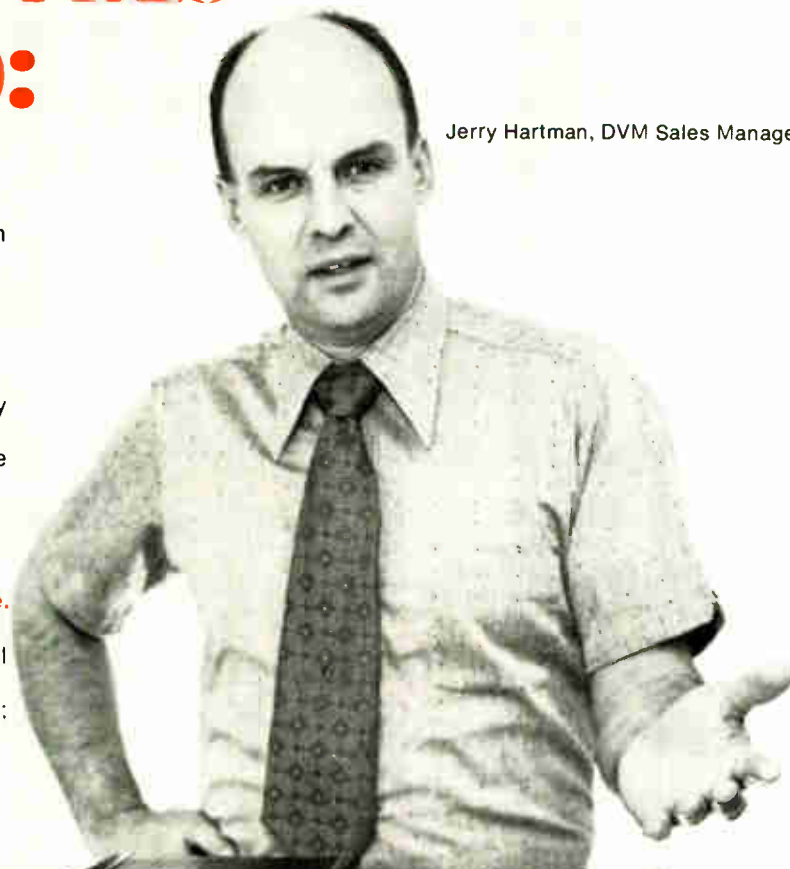

SYSTRON  DONNER

The Systron-Donner Instruments Group:

Alpha Scientific Computer Systems Concord Instruments Datapulse Kruse Electronics Microwave Trygon Electronics

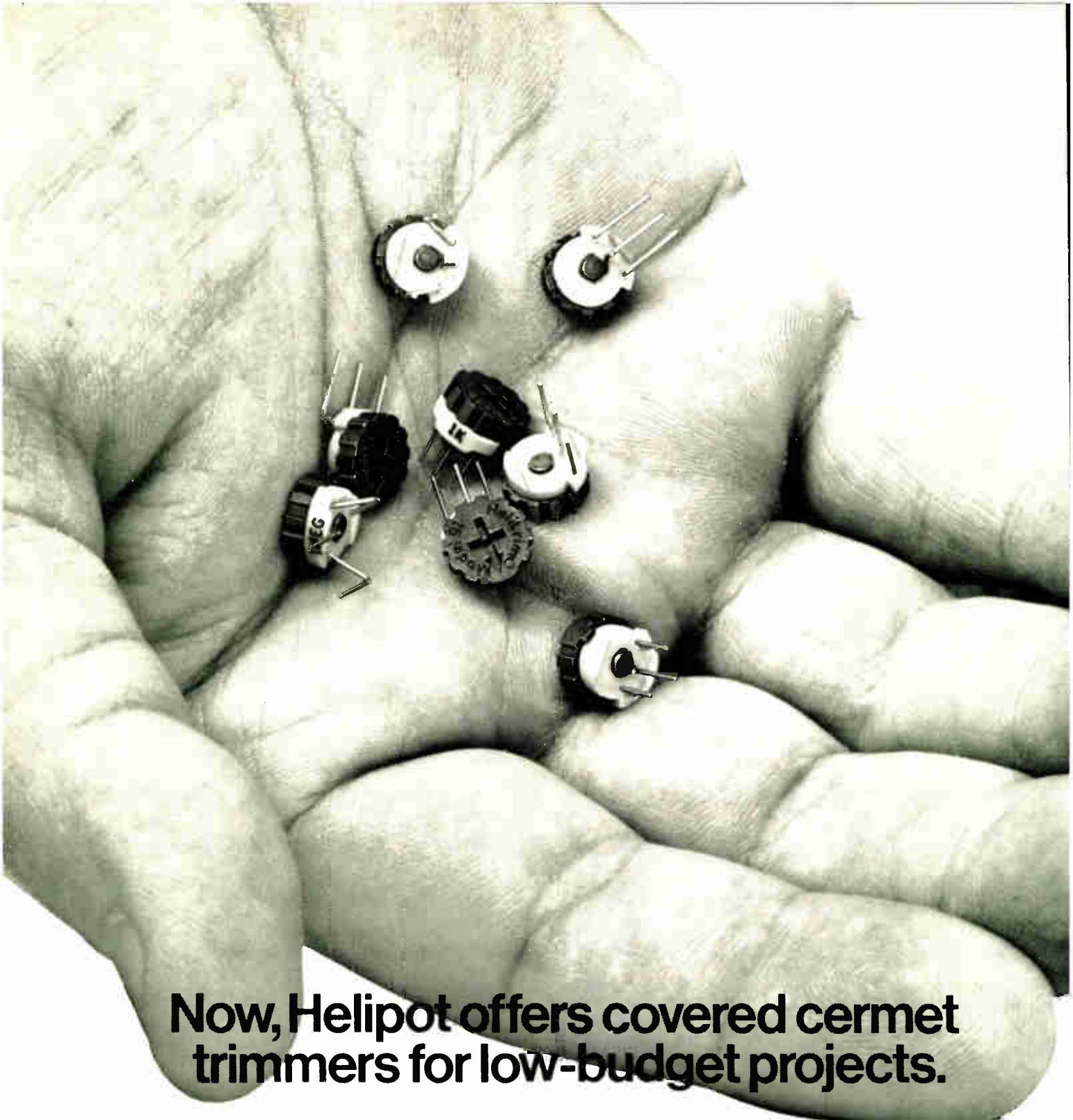

Now, Helipot offers covered cermet trimmers for low-budget projects.

There's not much sense in using cheap wirewound or carbon trimmers anymore. Not when the new Helipot Series 91 Cermet Trimmers are available *off-the-shelf* for a few cents more.

These single-turn, $\frac{3}{8}$ " , covered trimmers come in 10 different mounting styles and 19 standard resistance values from 10 ohms to 2 megohms. Covered construction helps protect against moisture, corrosive atmospheres, dust, oil and other

contamination. Which means, in addition to cermet stability and better resolution, you get long-term dependable performance.

The breakthrough price is just 35¢ each in the 50,000 piece quantity, and they're equally well-priced in other quantities.

Send now for complete data on the Series 91 Trimmers... the finest of their class. We've made them for your projects where the budget may be tight, but you don't want to compromise performance.

Beckman

INSTRUMENTS, INC.
HELIPOT DIVISION
Fullerton, California

HELPING SCIENCE AND INDUSTRY IMPROVE THE QUALITY OF LIFE

INTERNATIONAL HEADQUARTERS: AMSTERDAM, GERMANY: DUISBURG, ITALY: MILAN, JAPAN: TOKYO, MEXICO: MEXICO CITY, SWITZERLAND: BASEL, U.S.A.: FULLERTON, CALIF., U.S.A.: TORONTO, CANADA: TORONTO, ONTARIO

Philips researchers get cost of core down to a penny a bit

Memory designers at Philips Gloeilampenfabrieken in the Netherlands, using improved fabrication techniques, have managed to get costs down to less than a penny per bit for a ferrite core memory with a capacity of 16 kilowords of 36 bits each.

The new techniques also make for a considerable savings in memory volume, with the basic 16 kiloword unit taking up no more than 11.5 by 14.4 by 2 inches—about the dimensions of a telephone book.

In Taiwan. The high packing density and small bit price are the prime features of the new ferrite core memory designated Q-14, of which first samples are now being offered to potential customers. Volume production, at the company's facilities in Taiwan, is expected to start next year.

To suit individual applications, the basic memory unit can easily be expanded.

Cost/performance. What will probably appeal most to prospective users is the Q-14's low cost. The penny-per-bit figure, elusive so far, has been the industry's goal because a fast-access memory at that price level would be competitive with low-cost storage devices, such as drums and disks, with access times in the millisecond range. With its fast access time—600 nanoseconds—the Q-14, Philips says, provides a cost-effective substitute for memory drums in, for example, mini-computers and office systems.

Ted Holtwijk, marketing manager for memory products, attributes the Q-14's low bit price/small volume combination to three factors. One is the use of continuous-wiring techniques possible with an in-house-designed machine that can wire up to 64 rows of ferrite cores in one strike. Another is the use of relatively large printed-circuit boards for core ar-

rays and the associated electronic circuitry—boards that Holtwijk says his company can fabricate with high yield. The third factor, one that's responsible for the Q-14's compactness, is the special memory construction based on board-folding techniques. □

Switzerland

Slide sandwich varies display

In their search for new variable-data display techniques, scientists at Switzerland's Brown, Boveri and Cie. have hit upon a method that looks like a winner over other display schemes, at least as far as costs and simplicity are concerned. The BBC technique combines the electro-optical effects of liquid crystals with conventional slide projection to avoid the problems normally encountered in presenting variable and non-variable information on a common display screen.

Displays with variable data superimposed on static information are often found in control rooms monitoring industrial processes. They are also used as display boards in such diverse applications as traffic control centers and military command posts. In most of these jobs, the data that remains unchanged occupies the display's major portion, while the section with variable data is relatively small.

Sandwich. The Swiss display technique, devised at BBC's Research Center at Baden, near Zurich, does not need a computing system. All it uses are a slide frame in which a photographic transparency containing the static picture is combined with a liquid crystal cell and a mat-

rix drive circuit for controlling the varying information on the display.

The system's key element is the two-slide frame, which consists of two 5-by-5 centimeter glass plates spaced about 0.1 millimeter apart. A thin layer of nematic liquid crystal is sandwiched between them. Attached to one plate is the transparency, and deposited onto the other are the electrodes for liquid crystal operation. A conventional keyboard drives the matrix. □

Japan

Bubble device gives rotation

Two-dimensional shift arrays built with bubble devices may simplify computer-aided pattern recognition. One register of this type is being investigated by researchers at the Central Research Laboratory of Hitachi Ltd. for use as a pattern rotation device for data preprocessing in optical character recognition.

Hitachi's experimental 10-by-10 T-bar arrays are fabricated on 52-micrometer thick TmFe O₃ orthoferrite, with a permalloy pattern that is 1.2 micrometers thick.

How they work. Rotation is obtained by skewing bubble detectors arranged along the left-hand or bottom margin of the array. The lag between the first bubbles in a given column or row to reach the detectors and the following ones causes rotation of the pattern. Two shift arrays, one with detectors arranged at a small angle along the right-hand side, can be used to rotate vertical lines in the character. Another array, with similar detectors along the bottom, can be used to rotate horizontal features in the pattern. □

before you specify your next minicomputer you should know this about minicomputer applications

Cincinnati Milacron offers complete adaptive aid in applying minicomputers to your product or process. Cincinnati has helped to design and apply minicomputers to such operations as machine controls, inventory control, chemical processing, electric power generation, commercial scale and batching, insurance data handling, medical data processing, radio and television communications, fast food business operation, commercial printing, and scientific education.

A full line of minicomputers is available from Cincinnati to fit your particular application requirements. A new "Strippable CIP" minimum hardware unit is also available for about \$1600.00. You can custom-tailor your own if you like. Full software is available for standard and special applications. Call (513) 494-5444 and ask for Minicomputer Applications Support . . . we'll help you get the most for your minicomputer dollar. Or send for our brochure, MINICOMPUTERS AND THEIR APPLICATIONS. Cincinnati Milacron, Process Controls Division, Lebanon, Ohio 45036.



Cincinnati Milacron's CIP/2200 minicomputer is the high-speed reliable heart of this concrete batching system.



minicomputers



**CINCINNATI
MILACRON**

Machine Tools
Process Controls
Chemicals
Plastics
Plastics Processing Machinery
Abrasives

Japan exports technology: N/C to Russia . . .

The Soviet Union has reached a basic agreement to import technology for the production of numerical control equipment from Fujitsu. A 5-man team headed by B.A. Matkin, a Russian deputy minister, reached this agreement during their late April visit to Japan. Technology will include both numerical control electronics and pulse motors used for machine tool table and tool drive, but probably will not include computing control electronics.

In an unrelated move, Fujitsu is also preparing to send a team to mainland China to discuss exports of telephone transmission gear, including cable, microwave carrier equipment, and exchange equipment. Last year, the company sent a similar team to the mainland to discuss computers, but Fujitsu says the trip has not resulted in any equipment or knowhow sales.

. . . and consumer electronic plant to Poland

Poland has bought a whole plant from the Japanese for video and audio equipment—including black and white TV, radios, and tape recorders—plus knowhow. Sanyo Electric Co. is supplying the equipment to the Polish Unitra concern. The plant, which will be loaded on ships this autumn, costs \$5.5 million. Sanyo's price for knowhow is \$1.1 million. Unitra will pay 25% down for the plant and remainder in semiannual payments over six years, starting when it is loaded on ships.

Chinese technology shoppers view wares in Paris

China's increasing interest in Western products had the French electronics industry on pins and needles last month as a seven-man delegation from Peking made a three-week window-shopping tour of high-technology companies, beginning with booths at the Paris Components Show. Despite their follow-up visits to eight French companies after the show, the Chinese bought nothing on this round. **Particular areas of interest to the Chinese were lasers, microwave measuring devices, crt manufacturing equipment, and a variety of components for use in telecommunications.** One firm got the impression that the Chinese were sizing up French technology, especially in comparison with what they knew about German technology. "If the orders come at all, we expect a long interval," remarked one realistic-minded commercial man.

British microwave landing system set for 1975 . . .

The standard landing aid for tactical aircraft and helicopters in Britain's armed services starting in 1975, will be the system known as Madge, for microwave aircraft digital guidance equipment, developed by Mullard Ltd., and its associate MEL Equipment Co. The Ministry of Defence plans to equip about 1,000 planes and have about 90 two-man-portable ground units in use or in reserve. The system is likely to be used on all airfields from short temporary strips on up.

In Madge, **microwave interferometers on the ground use a pulsed 5-gigahertz transmission from the aircraft to measure azimuth and elevation approach angles.** The data is radioed to the plane in digital form in response to regular, automatic interrogations. The pilot's display indicates the error from a pre-selected path. Three ground boxes measure elevation, azimuth, and overshoot azimuth. Each box contains at least six antennas spaced at increasing ratios of two-to-one to form the inter-

ferometer. MEL says **this system eliminates all interference and multipath effects down to zero elevation.**

. . . as maker hopes for NATO sales

The ministry intends to buy Madge Mark 1, which is an approach aid providing assistance to instrument landing system category two standards through an elevation arc from 1° to 25°, and 45° either side of a datum reference point out to 15 nautical miles and 65° either side out to 2 miles. Angular accuracy is better than 0.04°. MEL, which is doing the operational system development, **is working on a civil version of similar performance and an automatic landing version incorporating a ground computer.**

The company hopes to sell it to other NATO countries, particularly the U.S., now that the Pentagon is buying proven foreign equipment abroad; there is no similar, developed U.S. equipment. **Basic cost of a ground set up is about \$60,000, an airborne one about \$10,000.**

West Germany's components outlook brightens

For West German components makers, hard hit by lackluster markets during the past year and a half, business is beginning to take a turn for the better. That's the word from producers returning from the just-ended Hanover Fair. **AEG-Telefunken, for example, expects a 6% to 8% increase in sales for this year.** A similarly optimistic forecast comes from Valvo GmbH, the Philips subsidiary. **The reason for the livelier components activity is stepped-up sales of entertainment electronic equipment, particularly of color receivers.** There are also indications, some companies say, that during the course of this year additional boosts will come from the industrial electronics sector, mainly from producers of automation equipment and test and measuring gear.

Hitachi plans TV set assembly in Canada

Add Hitachi Sales of Canada, in Montreal, to the list of Japanese subsidiaries making television sets in Canada. Its parent, **Hitachi Ltd., in Tokyo, says it is assembling 26- and 22-inch sets, with completed chassis coming from Japan—and picture tube and cabinet made locally.** Initial production will be several hundred sets per month. Hitachi gives several reasons for move into Canada, which it considers a trial. One reason is that these large size sets are not made in Japan. Another is that Hitachi's president, Hirokichi Yoshiyama, says that his **company must become a multinational company, not depending on just expanding exports to keep it healthy in overseas markets.**

From West Germany, a liquid-crystal quartz watch

A group of five West German watch makers, which last year teamed up to form the Deutsche Uhren-Kooperation, have announced the first result of their joint development efforts: a quartz-controlled wristwatch featuring liquid-crystal time indication. The watch, tradenamed Pallas, has a strong American accent, however. **The complete works—integrated circuit, liquid crystals and all—comes from Optel Corp. in Princeton, N.J.** The Pallas watch will go into serial production soon and, retailing for around \$287, will hit the German market by September or October—about the same time that a 13-firm group in Switzerland will start marketing a similar watch using Optel-made works [*Electronics*, Apr. 24, p. 42].

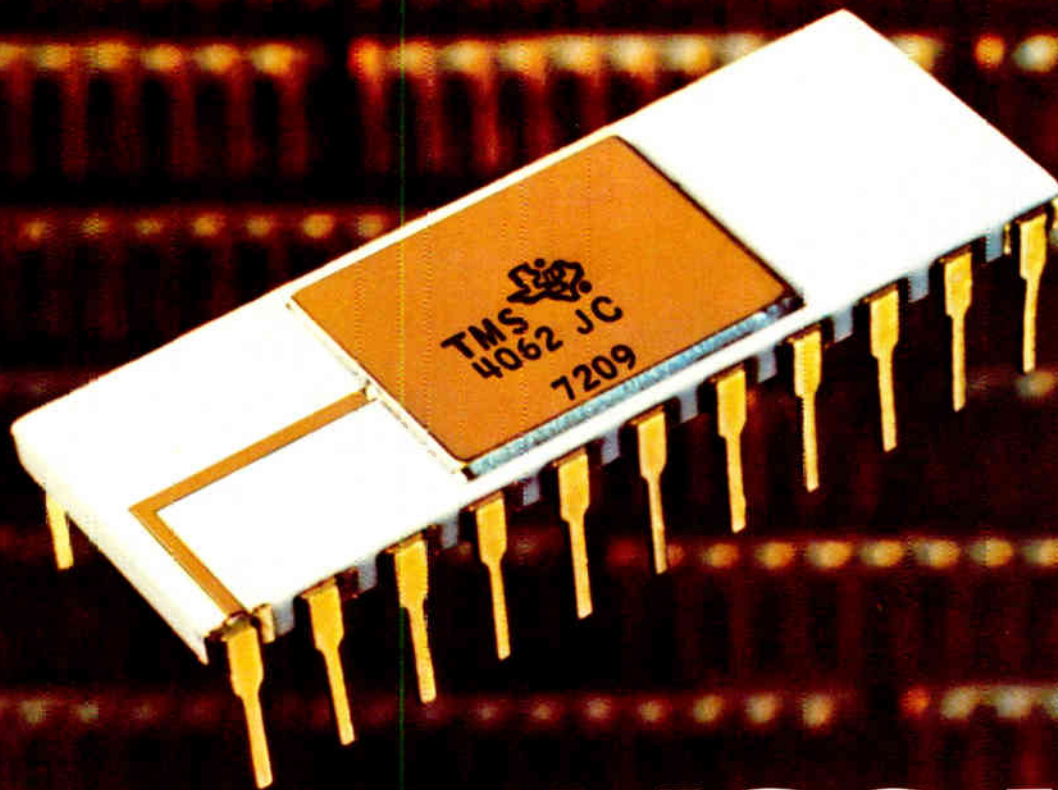

MOS/LSI

You can get 150-ns, 1024-bit MOS/LSI RAMs in volume from TI.

You can get fast delivery from TI in large quantities on one of the fastest 1024-bit MOS/LSI RAMs available today.

TI's new TMS4062JC has 150-ns access and 290-ns cycle times—and is a pin-for-pin equivalent to the AMS6002.

At 180 mW operating and 2 mW standby, the TMS4062JC requires less power than most other MOS devices—and it is easier to use. Used with the SN75370 sense amp/digit driver, fewer peripheral components are required and there are no critical clock overlap requirements. Differential outputs reduce noise sensitivity while low capacitance inputs ease drive requirements.

Field-proven reliability

Produced by the standard (111) P-channel process, this circuit has

established more than 176 million device hours of field performance in more than 90 installations. Typical users have experienced a mean-time-between-failure of 8.5×10^6 hours (at 95% confidence level).

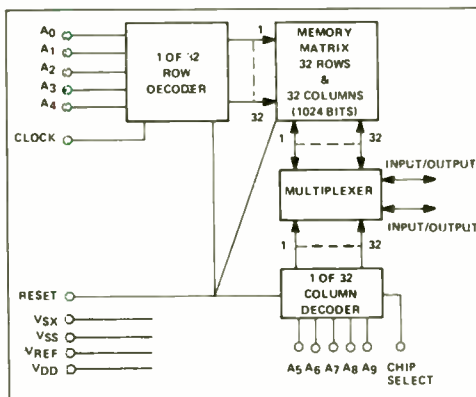

Delivery: One week, off-the-shelf.

Up to 5000 units can be delivered one week after receipt of order. Larger quantity orders can be filled by TI three weeks ARO. Priced at \$10.50 in 1000-piece quantities, the TMS4062JC is available either from TI stock or from authorized TI distributors.

For data sheets on TI's new TMS-4062JC MOS/LSI RAM, circle 92 on Service Card. Or write Texas Instruments Incorporated, P.O. Box 5012, M/S 308, Dallas, Texas 75222.



TEXAS INSTRUMENTS
INCORPORATED

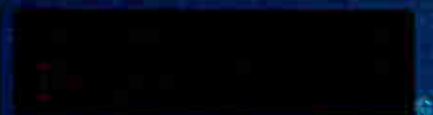
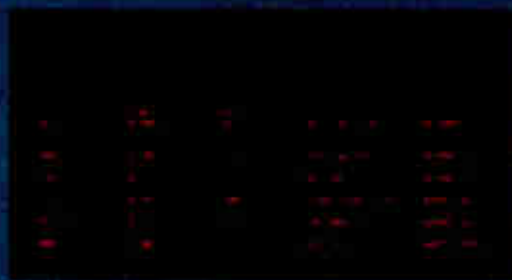
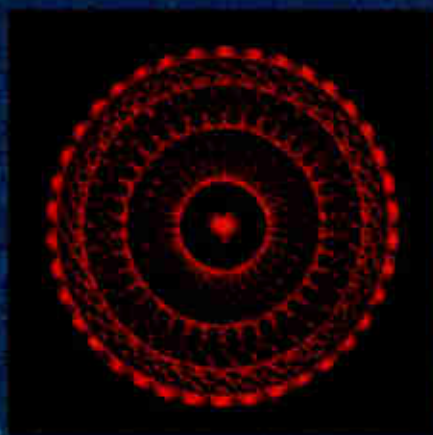

A. Display 515-80 Display/Memory Unit. An 8 1/2" x 8 1/2" inside panel of 540 x 512 lines at 60 lines per inch resolution.

B. Display 258-30 Display/Memory Unit. A 8 1/2" x 10 1/2" panel of 408 x 512 lines at 30 lines per inch resolution.

C. Display 84-30 Display/Memory Unit. A 2' x 8" panel of 84 x 224 lines at 33.3 lines per inch resolution.

Digivue[®] Display/Memory Units.

Take a look at tomorrow. You can have it today.

Take a look at Digivue display/memory units from Owens-Illinois. With the kind of visual impact needed in the new age of communication. And then consider this combination of features never before available in any other single display panel:

Inherent Memory—Flicker-free display without refresh requirements. Your computer is, in effect, free to perform other operations after addressing Digivue display/memory units.

Selective Write/Erase—Digivue display/memory units are digital display devices, with no digital-to-analog conversion necessary. You directly address Digivue display/memory units at individual display points on the panel matrix for selective write or erase at micro-second speeds.

Drift-Free Images—The intersections of thin, narrow electrodes imbedded in the panel positively define all elements of the images.

Rear-Projection—Because Digivue display/memory units are transparent they are ideally suited for rear-projection. You have drift-free registration between computer-generated displays and optically-projected images.

Design Adaptability—Digivue display/memory units are flat, not curved. As a result, information at the edges is just as sharp and accurate as in the center. And a Digivue display/memory unit is uncommonly slim—regardless of display area—allowing for a variety of installation possibilities . . . in desks, walls, drawers, consoles.

Hard-Copy Potential—The resolution of a Digivue display/memory panel allows for integration with standard office duplicating processes to produce page at a time hard-copy printouts of excellent quality.

Digivue display/memory units are available from Owens-Illinois in sizes ranging from 80 by 256 display lines at a resolution of 33 electrode lines per

inch to a 512 by 512 display lines panel with a resolution of 60 lines per inch and a display capability of up to 4000 characters. One of them just has to be right for your system.

Think what these Digivue display/memory units can do for time-sharing applications, management information systems, computer-aided instruction . . . and dozens more including airline reservations displays, aircraft cockpit displays, financial data terminals . . . in fact any display terminal for direct readout from digital computers or data systems.

WHO IS OWENS-ILLINOIS? O-I is a multi-product, multi-national manufacturing and marketing organization with 140 major facilities and sales in excess of \$1.5 billion a year. You may think of us as a packaging products company, but we also manufacture and market a diversified product line that includes everything from laboratory glassware to inertial guidance test systems for deep-space vehicles.

AND WHY ARE WE MAKING DISPLAY UNITS? As a natural extension of our already broad-based capabilities—in television bulbs, microelectronic products, ground glasses, new generation materials for technical, commercial and industrial use, and elements necessary for laser technology. We're committed to change, to the future, and to Digivue display/memory units.

If you and your organization are also committed to the future and to opening new and more effective communications systems, we'd like to hear from you. We'll send you technical data on Digivue display/memory units and a copy of our new full-color brochure.

Call or write: Jon Klotz, Marketing Manager,
Electro/Optical Display Business Operations B,
Owens-Illinois, Inc., P. O. Box 1035
Toledo, Ohio 43601 • (419) 242-6543.

OWENS-ILLINOIS

Toledo, Ohio 43601



Westinghouse Scores!

We helped the Baylor Company sink a long putt

The real payoff in any technological breakthrough is the ultimate score. Westinghouse scored big with the Baylor Company, manufacturer of THYRIG* power-conversion systems for offshore oil rigs.

It all started when we conducted tests at Youngwood with Baylor's applications engineer. These were based on customer heat-sink specifications and proved that our device was applicable. We then invited Baylor's customer to the plant to show him the exactness of our processing. He and Baylor were delighted with the test results and the way we manufacture and test our products. Westinghouse, as the result, has now supplied Baylor's needs for very-high-voltage rectifiers and thyristors for over a year.

The Baylor Company is a good example of our product quality. Ours have to be good, day and night, under extreme weather and climate conditions. A missed delivery schedule or a failure would cost Baylor customers thousands because of the remoteness and virtual inaccessibility of the regions where rigs are installed. Places like the North Sea.

At Westinghouse, when we say we've made a breakthrough, we mean it. We have broken through many technological barriers. Passivating the semiconductor element, compression-bonded encapsulation, special testing and computer-model characterization, and a pace-conveyor assembly system are all part of the exciting Westinghouse breakthrough story. It means that we can deliver high-power semiconductors faster than anyone else in the industry. And it proves a point. We can meet the needs of companies like Baylor and help them score with their customers. That's where the payoff is in any breakthrough.

Our breakthrough in high-power rectifiers and thyristors is just the start. For more information, call 412-925-7272, or write Paul E. Lego, General Manager, Westinghouse Semiconductor Division, Youngwood, Pa. 15697.

*Trademark of the Baylor Company

You can be sure...if it's Westinghouse





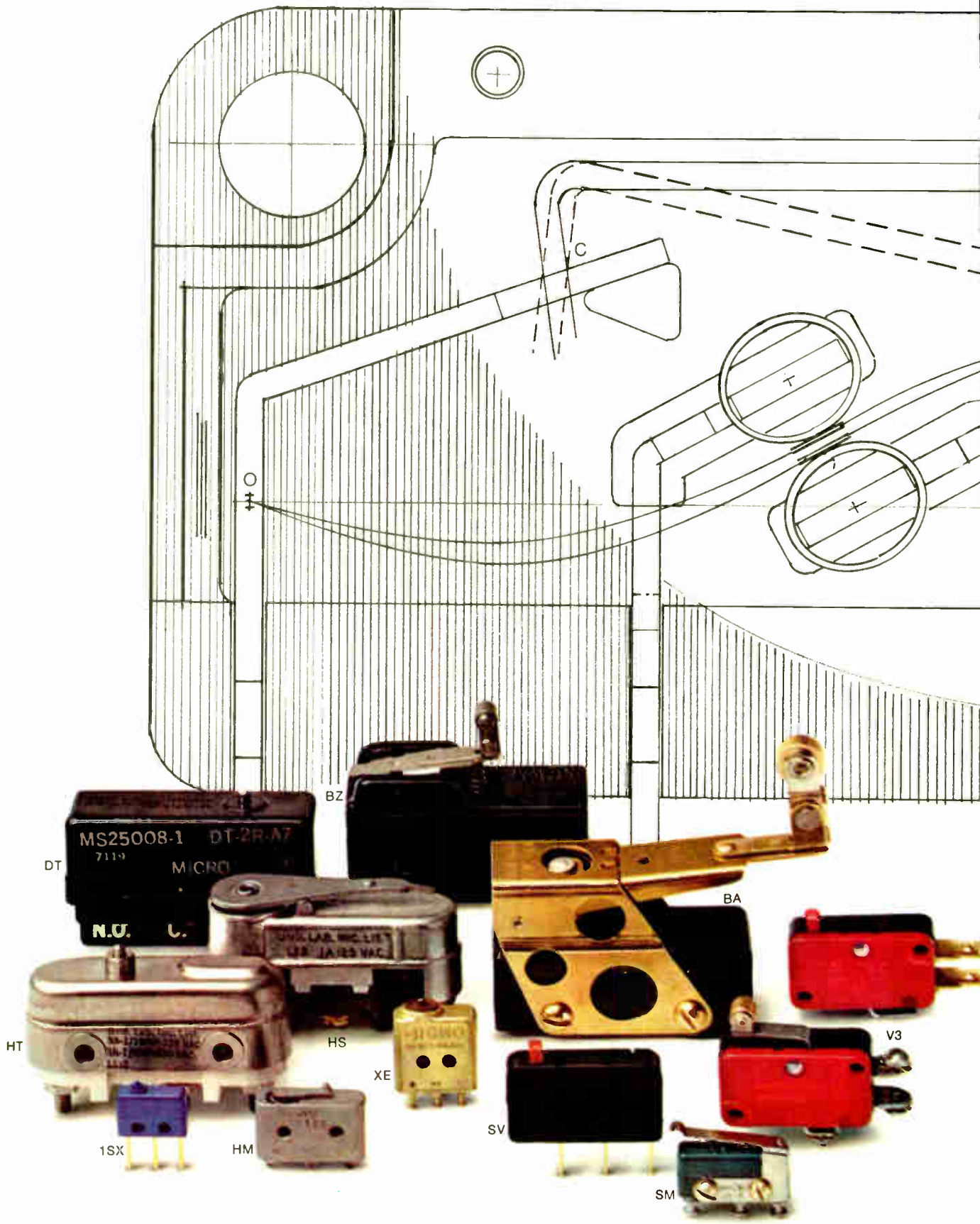

MICRO SWITCH products are available worldwide through Honeywell International.

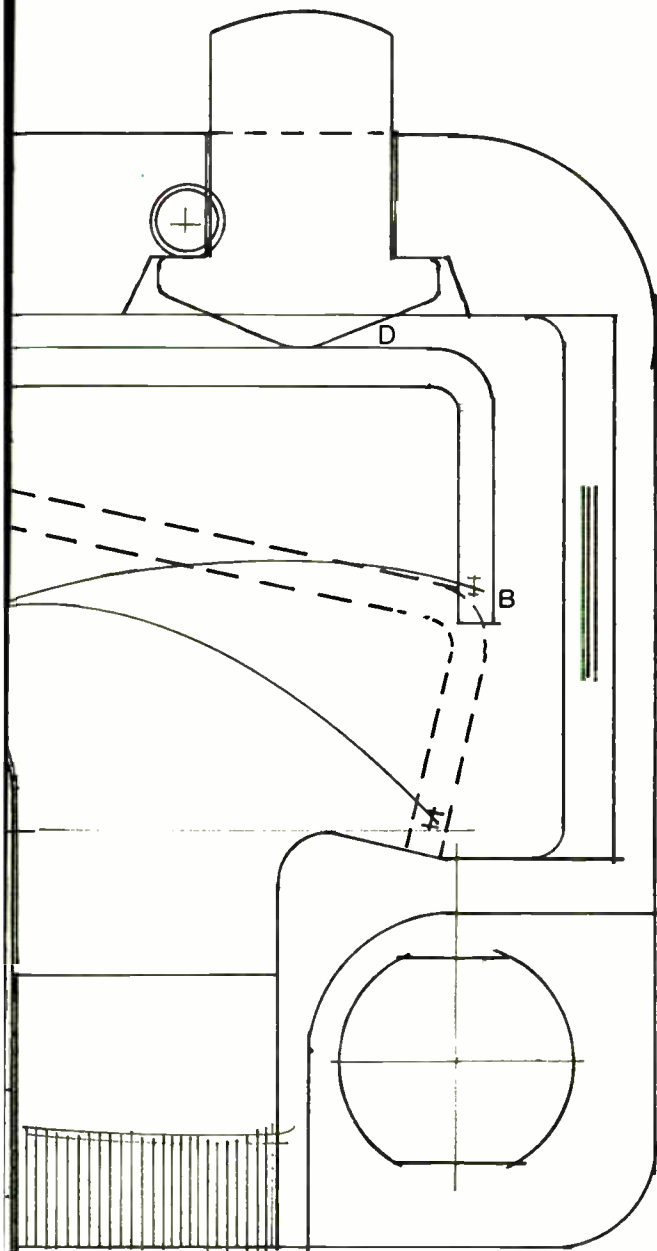

We're big in basics.

We invented the basic switch. So it's no wonder we offer more of them than anyone else in the world.

THE WAVE OF THE FUTURE.

The SV is our newest basic. It uses a revolutionary spring concept to provide reliability unique to a miniature snap-action switch.

BACK TO THE BASICS.

When space and weight are critical, a snap-action subminiature such as the SM (up to 10 amps AC) or the smaller 1SX (up to 7 amps AC) more than likely will be perfect. When cost is also critical, the small, versatile V3 (up to 15 amps AC) is ideal.

For maximum dependability and repeatability, there are our thousands of standard-size switches. The BZ and BA are among the most popular (up to 20 amps AC).

DOWN TO THE SPECIFICS.

For special situations, we have special basics. The DT (DPDT) and the HT, a high-temperature basic, (up to +1000° F) are good examples. SE and XE are small switches offering environmental protection (MIL-S-8805). While HM and HS offer true hermetic sealing (MIL-S-8805).

Actually, these are only a few members of our basic family. To meet the rest, contact your MICRO SWITCH Branch Office or Authorized Distributor (Yellow Pages, "Switches, Electric"). Or write for our complete literature.

MICRO SWITCH makes your ideas work.

MICRO SWITCH

FREEPORT, ILLINOIS 61032
A DIVISION OF HONEYWELL

If you buy transistors, find out what you're buying. Data doesn't cost that much anymore.

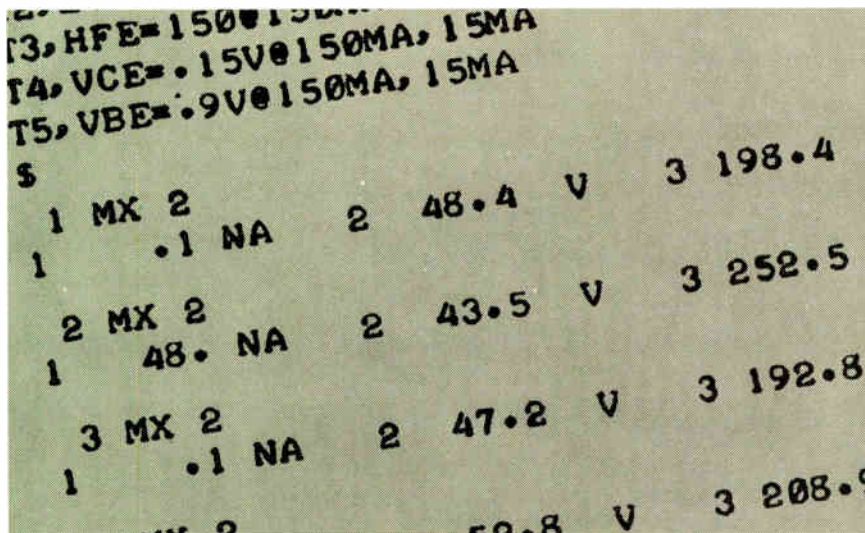

at different stations, simultaneously.

The system that gives you all this is our T241, the most widely accepted, thoroughly field-proven system of its kind. More than 150 T241s are at work the world over, most of

Maybe the basic go/no-go type of transistor tester is all you really need. Fine. We can sell you the best there is, for as little as \$12,500.

But know this. The computer-operated system that cost maybe \$50,000 last time you looked is now yours for \$29,000.

What can computer control give you?

Data. Measured values and lot summary statistics. In hard copy.

Fast setup. Test programs that automatically flow into memory at the flick of a switch.

Multiplexing. Testing different types of transistors

them on production lines.

Now we have packaged an incoming-inspection version of the T241, complete with special software. Program writing couldn't be easier. In T241 talk, I_{CBO} is ICBO. H_{FE} is HFE.

Like all Teradyne test equipment, the T241 carries a 10-year warranty and is built to work without worry at least that long.

And it costs only \$29,000.

Learn more.

Write Teradyne, 183 Essex St., Boston, Mass. 02111.



TERADYNE

Electronics faces tough, new world

Government attempts to enlist technology's aid in righting the U.S. trade deficit meet with mixed industry reactions, labor opposition

by Ray Connolly, Washington bureau manager

Squeezed between the continuing "economic miracle" of Japan and expanding competition from Western Europe's economic community, the United States is calling on electronics and other high technology industries to erase the red ink from its trade balance ledger. But restoring trade in electronics to a surplus position in 1972 is viewed by both industry and Government as unusually difficult.

Last year, when total U.S. trade moved from a surplus position of roughly \$2 billion at the end of 1970 to a comparable deficit—the first since 1893—the electronics industry recorded its first trade deficit in history. New figures for 1971 show that electronics, a leading contributor to U.S. exports, plummeted from a peak surplus of more than \$1,334 million in 1970 to a loss of more than \$174 million last year. Most of the \$1,508 million electronics turnaround is attributable to a sharp decline in exports. They dropped by more than \$1,475 million, while total imports rose by only \$33.5 million (see table, p. 67).

One gloomy but hardnosed economic analysis circulating in Washington suggests that America's 1972 electronics trade balance will decline even further, despite an upturn in the domestic economy. Authored by the U.S.-Japan Trade Council, a non-profit association of more than 700 companies that draws substantial support from the Japan Trade Promotion Office and is registered as a foreign lobby, it concludes that "an optimistic forecast, in fact, would call for no sizable deterioration in last year's deficit."

The Council's arguments are all

too persuasive. "The effects of a currency realignment will require many months to be felt," it maintains. "Even then, a reduction in the price of U.S. technology-intensive products, such as computers and aircraft, will probably not result in any major expansion of exports. In many of these products, the U.S. has no real international competition, and a price decrease will not by itself generate any increased foreign buying."

Programs. Moreover, a varied package of projects put together by the U.S. to spur electronics exports has only succeeded in generating mixed feelings within industry, opposition from organized labor, and no enthusiasm for the short term.

The substance of the Treasury's programs affect U.S. trade agreements with Europe, and, it is hoped, other nations' tariffs.

The General Agreement on Tariffs and Trade (GATT) is set to be updated in 1973 as a result of pressure put on the European Community by Treasury Secretary John B. Connally. In addition, although the full impact of rewriting and expanding the agreement won't come until after negotiations, the U.S. plans to get after member nations now for current violations. France, for instance, has quotas on American semiconductors, the Netherlands slapped a quota on Japanese consumer electronics, and there are

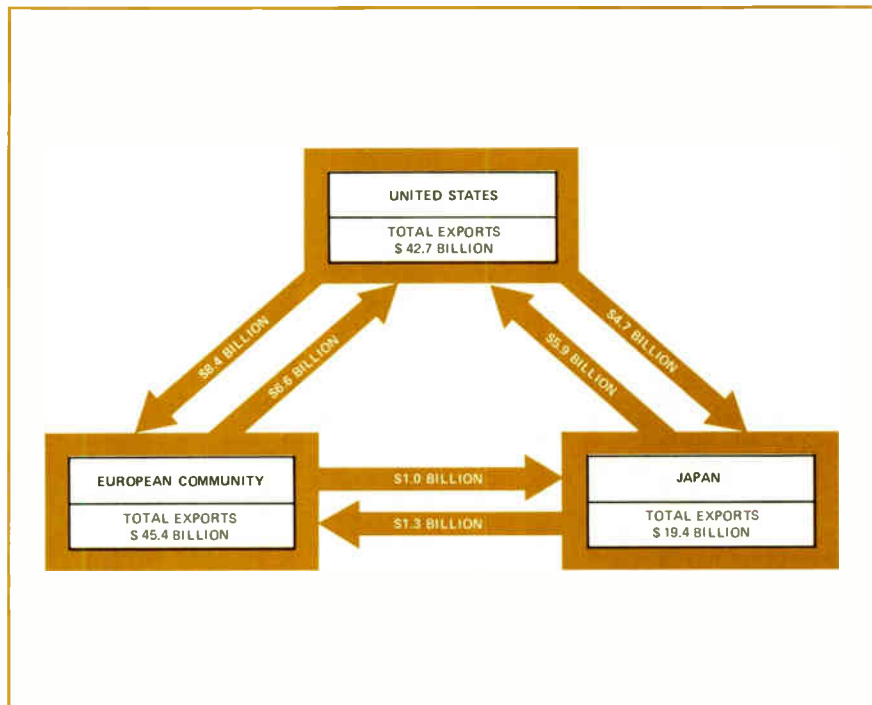



Trade balancer. Commerce chief Peter Peterson faces labor and industry opposition.

multiple bilateral agreements on specific items between the European communities members that produce import tax breaks and handicap U.S. competition.

Besides opposing European quotas limiting U.S. exports, the Administration is pushing the European community to drop its stiff quotas against Japanese electronics. This is expected to take some pressure off the U.S., which now takes 30% of Japan's shipments. In addition, the U.S. plans simultaneously to press Japan to liberalize opportunity for direct U.S. industry investment and to accelerate reduction of its quotas of electronics.

DISCs. The value of the controversial congressional action: last year permitting U.S. companies to create Domestic International Sales Corporations (DISCs) as a spur to exports still must be measured. Industry, of course, favors the Nixon plan that allows a company to create a DISC provided at least 95% of its revenues are derived from export sales. In return, the DISC is not liable for taxes on 50% of its export income until it is returned to this

Can Peterson right the trade balance?

Peter G. Peterson, the 46-year-old former boss of Bell & Howell Corp., is the man whom President Nixon has charged with the job of spurring America's industrial technologists to new competitive heights in the world marketplace. It is a tough assignment, despite the fact that Peterson, as Secretary of Commerce, will be working in tandem with Treasury Secretary John B. Connally, the Cabinet's most accomplished international trader. But whereas Connally has shown his mettle thus far in negotiating international money matters, Peterson is still an unknown quantity.

However, he's known to hold the belief that U.S. labor's declining productivity is in large measure responsible for America's trade problem. This opinion puts him in conflict with the views of at least one major top executive, GE board chairman Fred Borch. As Borch put it: the 1964-70 jump of 20% in U.S. labor costs is not the real reason for America's trade problem. The GE leader—who didn't make his reputation by arguing on the side of organized labor—notes that America's main trading partners have experienced comparable increases: "Italy is close to our 20% increase in costs; France is lower at 6% . . . Germany 26% and Britain, almost 33%."

The problem, in Borch's view, "boiled down to the fact that other countries have placed international trade as a top national priority and have adopted structural policies to promote their trade balances and their balance of payments." The U.S., he indicates, has not followed a like policy and must bargain hard to break down foreign barriers to equal competition.

Can Peterson meet that challenge? Since he took over the department in February on Maurice Stans' departure to raise funds for President Nixon's re-election, Peterson has given few signals as to how he will perform. Some electronics industry executives in the capital believe he has a better understanding of their particular problems than Stans did. But several other executives hear his proposals as inevitably leading to a bigger bureaucracy at Commerce, already long criticized for its lackluster operation.

country. Since a DISC may extend loans to the parent corporation instead of adding it as income, and, critics say, "roll this money over and over" by regularly granting new loans, opponents of the plan have dubbed it "a corporate tax dodge." Moreover, they contend the effectiveness of DISCs may never be accurately measured, since it will not be possible to determine how much of the export sales they generate would have been sold abroad anyway. The reaction of U.S. industry: the Treasury department which is responsible for DISCs, has over 1,000 applications from companies that want to set one up.

Whatever the consequences for Federal tax revenues, the Nixon Administration believes U.S. industry requires new incentives to compete. Export-Import Bank chairman Henry Kearns summed up this view at the end of April: "America's reputation for technology is world-wide . . . but I find American salesmanship in most places at a low ebb.

However, these Treasury Department efforts on the international

front, coupled with reported plans to accelerate anti-dumping actions, will not ease the pressures on U.S. manufacturers for a year or more—to judge by recent history. American TV-receiver makers, for example, were still waiting in April for the Customs Bureau to determine penalties to be assessed against Japanese monochrome receivers, though it was 1970 when the U.S. Tariff Commission ruled that dumping was taking place. And although Magnavox Corp. sought relief in March under countervailing duty statutes against alleged Japanese export subsidies on TV receivers, Zenith Radio Corp. is still awaiting a Treasury decision on a similar complaint filed in 1970.

Promotions. At the Commerce Department, Secretary Peter G. Peterson is still getting his arms around the job he took on in February after he left his prestigious White House assignment as Chairman of the Council on International Economic Policy. He plans to revitalize the department, having a Nixon mandate to keep U.S. industry competitive in increasingly tough world

markets. Specific proposals of his include:

- A computerized market intelligence service to be created within the Department on worldwide market opportunities for industry. But his proposal to sell the service to companies has arched more than one industrial eyebrow—"First, it would have to be far better than anything Commerce has ever done before we'd pay a dime for it," comments one Washington vice president of a multinational electronics manufacturer, "and second, any idea he may have that industry will contribute significant input is out of the question. We gather a lot of market data abroad, but it is intelligence; we consider it proprietary, and we are not about to share it." Those sentiments reflect the view of most multinationals.

- Development of the first Federal statistical analysis of the competitive strengths and weaknesses of America's main trading rivals. The assessment of comparative technological strengths, tax structures, subsidies, export and import policies and practices, antitrust statutes, and trends in market shares for products is expected to weigh heavily in the next round of GATT negotiations, if it can be readied in time. Once completed, the global assessment would be continuously updated for Government and industry usage.

- Takeover of the State Department's network of commercial attachés. Both Peterson and Secretary Connally believe the present organization is largely ineffective and unresponsive to industry's needs, and electronics industry executives agree. If Peterson takes over the International Commercial Services, he will put larger staffs in key foreign trade centers. Sure to appeal to electronics exporters is the prospect of expanded staffs and centers in the East Europe block of nations.

- Cooperation with Science Adviser Edward David in developing the New Technological Opportunities Program that will increase the spin-off from the \$17 billion-plus annual Federal investment in R&D [*Electronics*, Sept. 27, 1971, p. 33; Jan. 31, 1972, p. 42]. Although this effort has less Federal money behind it than originally planned because of the tight deficit budget, Peterson be-

lieves it can be made to work. (While the U.S. dollar outlay on R&D far exceeds that of any other nation, Peterson's Assistant Secretary for Science and Technology, James Wakelin, points out that the U.S. investment on the civilian side is less than that of West Germany and Japan in terms of gross national product. The U.S. figure represents 1.2% of the GNP, Germany's investment was 2.9%, Japan's 2.8%. "Each plows back into commercial technology more than twice as much," Wakelin notes.)

Increased Federal support of civilian R&D however, has drawn a suspicious response in many quarters of the electronics industry, which in the past has drawn much of its R&D support from the defense and space programs that account for the bulk of Federal spending. "Rather than build up another Government superstructure that will drain off money into the bureaucracy," complains one communications company executive, "I would much rather see a system of tax credits for increasing our own investment."

Whatever evolves from Peterson's policies, many foreign governments are already doing a lot more for their industries. So says Robert C.

Wilson, president of Collins Radio Co., Dallas, who points to support in the form of outright cash grants to offset capital plant and equipment costs, cash grants for R&D, long-term tax forgiveness, relaxed antitrust laws, and protection from foreign competition. America, on the other hand, "seems determined to give foreign industry a competitive advantage," he says, citing enforcement of vaguely worded antitrust laws, legal interpretations that discourage innovation, and condonement of monopolistic labor practices that cripple productivity.

"As somebody put it," he says, "our foreign competitors are lucky. They have two Governments working for them—theirs and ours." Wilson's view of Washington is that of "the central stronghold of a deadening bureaucracy," that has caused many to fail.

John Boyle, international vice president of Collins, points to two specific areas where the electronics industries could use more help from their Government. "Financing is probably the biggest aid you can give a man. The Japanese give very fine financing. The Canadians give very fine financing. The French give very fine financing. Of course, we deal with the Export-Import Bank,

U. S. EXPORTS/IMPORTS OF ELECTRONIC PRODUCTS
(in millions of dollars)

CATEGORY	1971	1970	1969	1968
COMMUNICATIONS & INDUSTRIAL				
Exports	1,170,252	2,438,855	1,896,857	1,495,917
Imports	346,684	514,319	437,917	341,584
CONSUMER				
Exports	95,009	76,946	106,587	85,223
Imports	1,333,600	1,152,498	995,952	711,732
SOLID STATE				
Exports	370,527	419,734	345,714	204,379
Imports	179,091	157,158	104,330	71,543
ELECTRON TUBES				
Exports	108,715	125,776	91,862	78,529
Imports	34,416	37,745	43,147	55,560
OTHER COMPONENTS				
Exports	304,837	463,004	423,862	337,116
Imports	329,583	328,138	243,888	176,783
TOTALS				
Exports	2,049,341	3,524,315	2,864,882	2,201,164
Imports	2,223,374	2,189,858	1,825,234	1,357,202

Source: EIA from Commerce Department data.

Probing the news

and they are getting better: we can now get up to eight or nine years on Eximbank. They're improving, but there's a helluva lot more that they could do."

On the issue of Government assistance in overseas sales, Boyle concedes that "we have civil and military attachés in our embassies, but they don't treat the American industry like, say, a Japanese embassy does. To the Japanese, the embassy is part of the sales team."

Where to look? While industry and Government officials agree that a fair international marketplace will undoubtedly take years to evolve, American manufacturers are being urged to move more rapidly on their own. The International Bank for Reconstruction and Development—the organization more popularly known as the World Bank (WB) and headed by former Defense Secretary Robert McNamara—sees a major telecommunications market evolving in the less developed countries.

"Typically, the developing countries are devoting about 3% of their total public investment" to telecommunications systems expansion, the bank says. In its analysis of telecommunications potential in underdeveloped nations, the bank says it "contemplates an increase of about 50% in the level of lending attained through fiscal 1971"—a level that reaches \$592 million under 34 bank loans. But, though the Washington-based bank's study details the potential fully, including an outline of an enlarged program of research and technical assistance, one Federal official sees the opportunities in less developed nations as "small potatoes" when stacked beside the electronics opportunities for export expansion in Eastern Europe and the Soviet Union.

In Eastern Bloc nations, Hewlett-Packard Co.'s manager of international trade relations, Thomas A. Christiansen, sees a great instrument market potential. H-P has boosted its sales "from approximately \$100,000 in 1967 to \$3.5 million, or about 3% to 4% of our European business in 1971," he says. Though Christiansen says his com-

U. S. DIRECT INVESTMENT ABROAD
INCOME AND OUTFLOWS

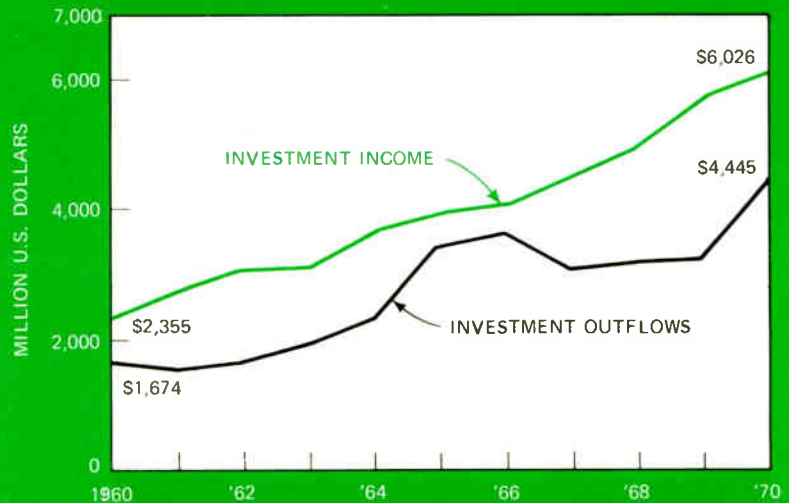

The multinationals, technology and labor

The electronics industry sees a threat to the multinational corporation stemming from a rising protectionist tide in the country. The most visible challenge is the "foreign trade and investment act" (H.R. 10914 and S.2592), popularly known as the Burke-Hartke bill, and strongly supported by the AFL-CIO. Though massive industry opposition to the bill has diminished the prospects of its passage, there is still industry concern that Burke-Hartke advocates will push to slip some of the bill's individual sections through as riders on other legislation.

On the labor side, Nathaniel Goldfinger, AFL-CIO research chief, charges that American multinationals, including electronics companies, "have been exporting American technology and this is technology frequently developed at the cost of the American taxpayer." And, he says, American companies have been exporting American capital—building plants in foreign countries and displacing U.S. production in high technology and sophisticated products. "Multinationals," he argues, "should not be determining the basic economic policies of the U.S. government or of the American people."

Organized labor also leaps on former deputy Defense Secretary David Packard's turning the Pentagon on to foreign R&D for its programs, now being pursued as a cost-cutting device [*Electronics*, March 27, p. 31]. They cite figures from the U.S. Tariff Commission that some \$430 million worth of foreign components—more than 2% of DoD's 1970 procurement spending—were imported, many of them allegedly from overseas subsidiaries of U.S. multinationals.

DoD, nevertheless, argues that it must import to survive, largely because of rapidly escalating U.S. contract costs, but also because European technology in some areas is good as well as cheaper. "Engineering R&D in France or West Germany costs half of what it does here," a Defense official points out, "so we buy that when we can and then license a U.S. manufacturer for production to keep Congress off our back."

Computers are another area of concern. While first 1971 trade figures don't break out precisely where U.S. exports of solid-state products and communications and industrial electronics declined, labor and some Government sources suspect much of the drop in industrial products stems from U.S.-owned computer plants abroad—like IBM's West German operations—which are now cutting the large dollar shipments of EDP hardware. These sources also contend that the declining U.S. dollar advantage in the world semiconductor market (exports slipped almost \$50 million in 1971 and imports rose \$22 million) stems from heavy licensing by U.S. firms overseas and a 20th century communications system that makes corporate secrecy increasingly vulnerable.

$\pm 10 \mu\text{V}/\text{mo.}$ (max)

AD508 CHOPPERLESS.

No one else gives you this kind of long term drift performance. In fact, there's only one other I.C. you can call "chopperless." It's also ours.

Our AD508 series are extremely stable and highly accurate monolithic I.C. operational amplifiers.

They feature all the precision performance of our AD504 series along with superbeta processing. Which means you get bias currents of 10nA. Offset Voltage Drift of $0.3 \mu\text{V}/^\circ\text{C}$. Common Mode Rejection of 120dB. Open Loop Gain of 140dB. And fully protected inputs and outputs.

And you get all this along with guaranteed low drift with time. We do this by burning in all our AD508's—the AD508L for almost a month—and monitoring their performance. So you can be certain of their accuracy.

You can now achieve circuit precision on the order of a few parts per million in a hermetically sealed package. Along with the economy advan-

tages of using an integrated circuit.

Our 508 is perfect for high precision analog computing and data acquisition. Instrumentation amplifiers. Ultra stable voltage references. High accuracy bridge measurements. Or wherever your error budget demands guaranteed excellent stability with temperature and time.

The AD508J, AD508K and AD508L are ready now. And we can send you an evaluation package of five at our hundred piece price. As well as our 1972 Product Guide which shows all the things we make to solve more of your problems better than anyone else.

Analog Devices, Inc.,
Norwood, Mass. 02062.
(617) 329-4700.

 **ANALOG
DEVICES**

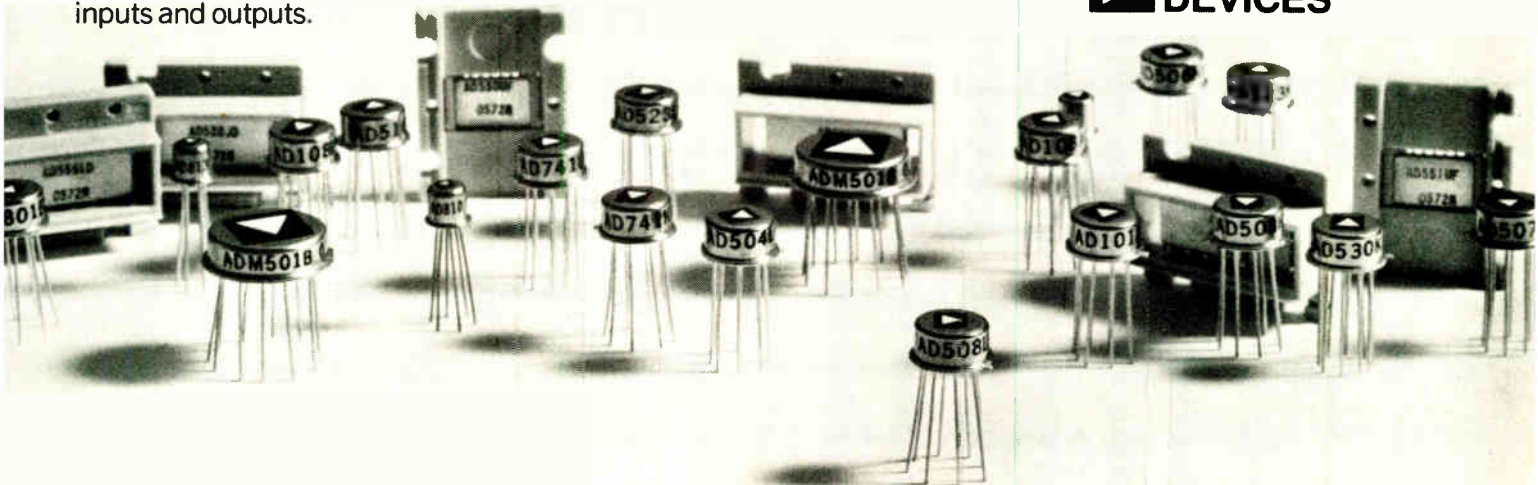

Circle 69 on reader service card

It's your lead



...when you deal with MICRO-i®

A winning combination often depends on the selection of the right lead. You can make that selection when you specify MICRO-i.

Choose your leads from standard .100 inch grid styles of gold plated beryllium copper ribbon for welding; tin coated for standard applications; plated pads for reflow soldering or wire bonding; and leads that are internally bonded to withstand high temperature processing . . . or one that's just right for your circuit design.

MICRO-i inductors are inherently self-shielding, moisture resistant and have negligible core saturation effects within rated current values. These miniature inductors are available in four basic sizes from .100 to .250 inch square. Their profile is a scant .065 or .075 inches with "L" values from .015 μ H to 1.0 mH.

Perhaps your unique requirements demand special materials and configuration; a miniature discrete transformer or a tuned resonant circuit. Special designs, values or tolerances can be matched to your needs.

Find out exactly how Delevan can transform its MICRO-i to fit your application and make your next selection a winner. Phone or write.

Delevan
Division



**AMERICAN
PRECISION
INDUSTRIES INC.**

270 QUAKER RD./EAST AURORA, N.Y. 14052
TELEPHONE 716/852-3800 TELEX 091-293

OTHER DIVISIONS OF AMERICAN PRECISION INDUSTRIES INC.:
BASCO • DUSTEX • MOELLER INSTRUMENT CO. • OXFORD CORP.

MICRO-i is covered
by U. S. Patent
No. 3,493,909.

Probing the news

pany's total international sales could nearly double to \$300 million by 1976, he adds that H-P doesn't foresee "great increases in our sales volume in the USSR and the Socialist countries of Eastern Europe" because of "various export controls which limit the products we can sell" and a market limited by lower technical sophistication.

Hangups. But, in urging the Congress to extend the Export Administration Act of 1969, Christiansen believes the U.S. should further limit the authority of the Office of Export Control to unilaterally turn down U.S. manufacturers' export requests. This authority—designed to protect against exports of technology with potential military value—is sometimes exercised too cautiously at the Pentagon, complain numerous manufacturers and some Federal officials. As one of them summed it up: "No one at the Pentagon ever got into trouble by saying 'no'."

However, the position of most instrument and computer makers anxious to open up the East European market was perhaps best expressed by the then H-P chairman David Packard in 1968, when he supported the first passage of the Export Administration Act: "The controls, in effect, serve to push East European purchasers into the hands of our West European and Japanese competitors."

And though some improvements have come since 1968, H-P's Christiansen makes clear that Secretary Peterson's Commerce Department still has much red tape to cut.

It involves the time tangle "required to make formal license applications and the delays encountered in obtaining licensing decisions." Such delays, he explains, "were not so important years ago when the U.S. had little interest in developing the market, and, in addition, enjoyed a near monopoly of the products of high technology. This, however, is no longer the case." The real loss, in Christiansen's view, "is in those orders which are placed with West European and Japanese firms, rather than U.S. suppliers, because delays for U.S. soul-searching cannot be tolerated." □

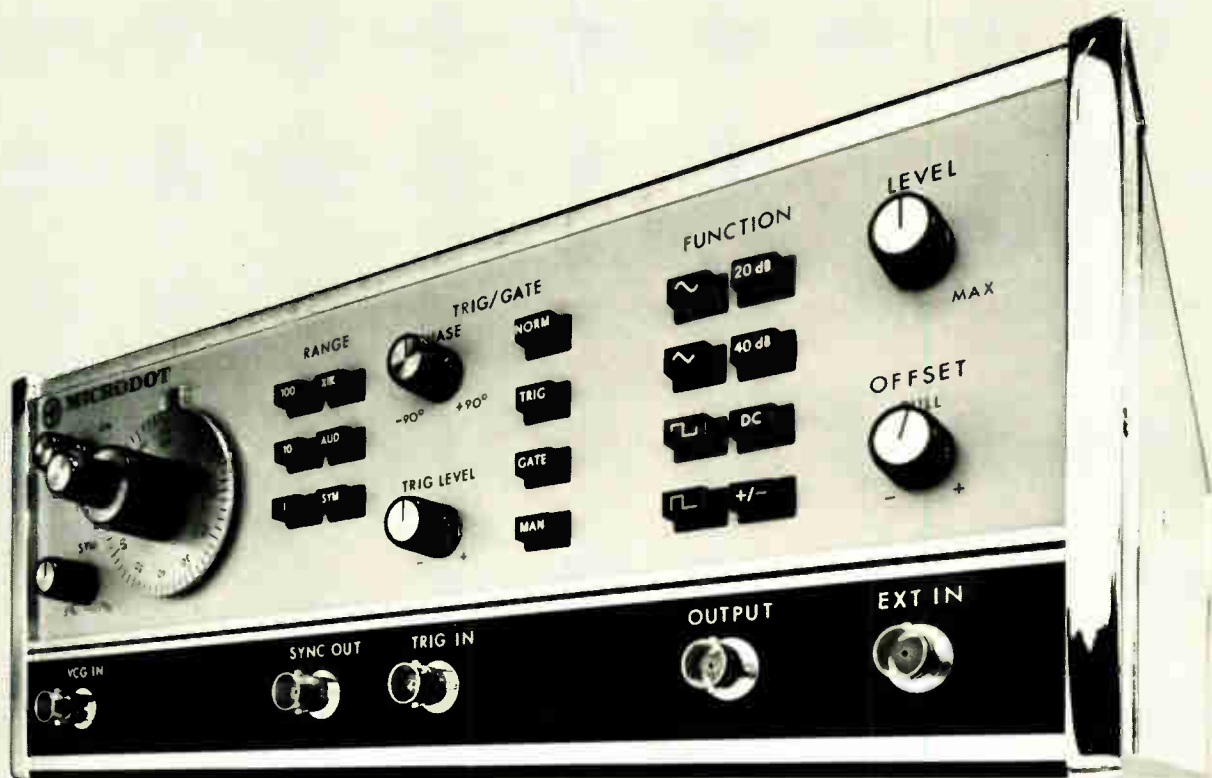

Super-performer!

A new series of exceptionally versatile Microdot waveform generators . . . at prices you won't believe.

Each Microdot Series 500 Function Generator offers the greatest performance, easiest operation, and lowest price in its class.

Like the 10MHz Model 510, for only \$495. This instrument utilizes a unique, 1000:1 voltage-control-generator with exclusive "ECL" switching, and a super-fast bipolar output amplifier. The design assures an extremely clean signal through the broad 10MHz frequency spectrum. This advanced instrument engineering permits <10ns rise and fall response, and offers variable pulses from 50ns.

Model 511 adds variable start/stop triggering to the features of the Model 510. And for lower frequency applications, the 5MHz Model 501 provides burst, gating, and special mode operation for only \$395. All Series 500 generators offer six versatile operating modes including fixed and variable DC offset, full audio range, and 5% - 95% variable symmetry control.

But these features and instruments are just the beginning. Ask about the Series 500 higher frequency and sweep models.

Contact Microdot today for complete details on how the Series 500 Waveform Generators can solve your most demanding measurement problems. You get more than your money's worth from Microdot instrumentation . . . the Super-performers.



MICRODOT INC.
INSTRUMENTATION DIVISION

19535 East Walnut Drive ■ City of Industry, California 91748
(213) 965-4911 ■ EUROPE: 102 High Street ■ North Church
Berkhamsted, Hertfordshire, England ■ 04427-71138

From Monsanto... something new for people who count.

We build counters for just about every requirement, but a lot of people who count asked for a mix of capabilities we hadn't yet packaged in a single unit. Now, here it is—the Model 113A Counter/Timer, newest addition to the Monsanto line.

Take a quick look at some of its outstanding features... **Frequency range: DC to 80 MHz... 8 operating modes: frequency, totalize, ratio, period, period average, time interval A to B, positive pulse width, negative pulse width... Monsanto LED display.** All Monsanto instruments are available for rental or lease through Rental Electronics, Inc.

The Model 113A gives you automatic selection of slope when measuring positive or negative pulse widths, so you have one less mental calculation to make, one less knob to turn. And you get Monsanto's two-year warranty. What other major instrument manufacturer offers you that? All this versatility, all this four-figure performance, sells for just \$895 for 5-digit display. For complete data or a demonstration, write United Systems Corp., a subsidiary of Monsanto Co., 918 Woodley Road, Dayton, Ohio 45403

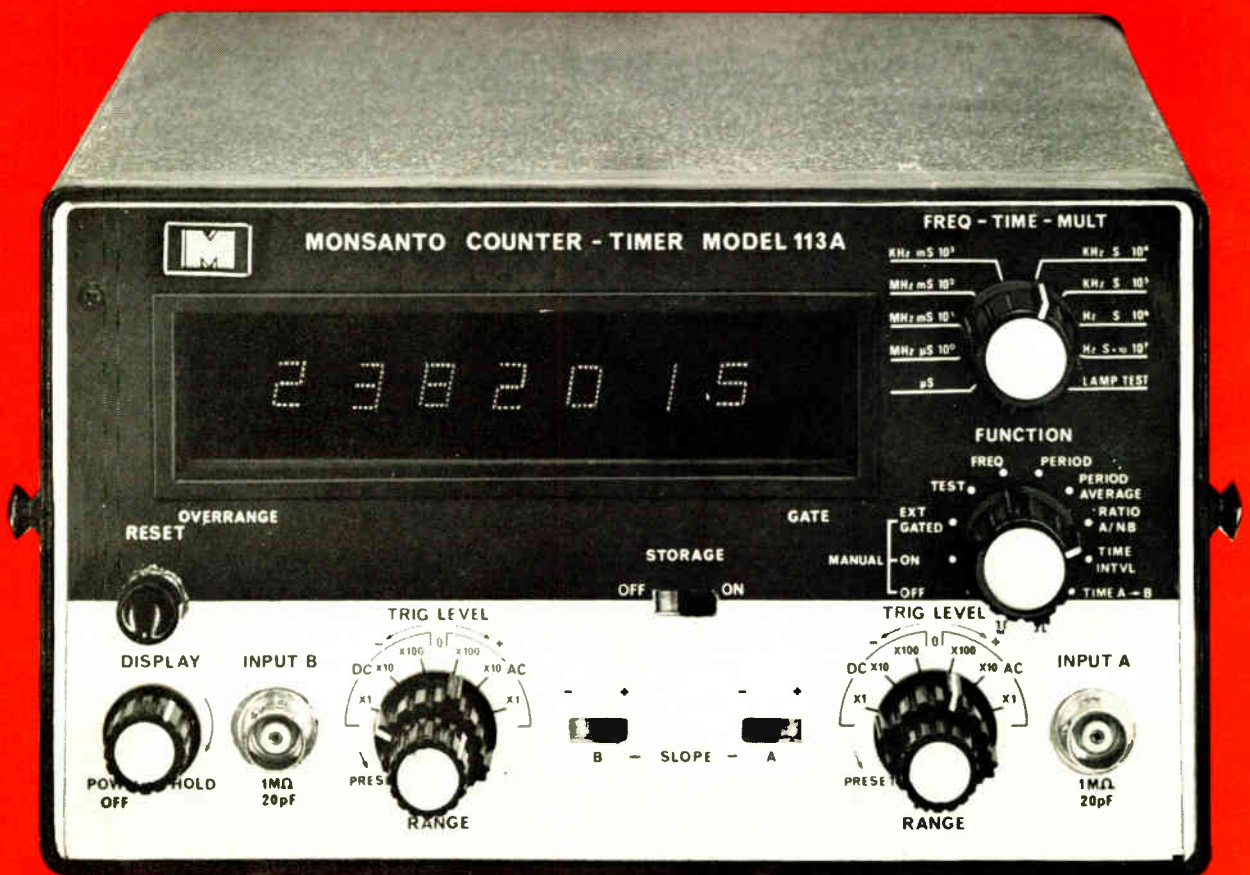

Monsanto

Displays

Liquid crystals begin to turn on

Markets for the devices are maturing faster than expected as makers find ways to take advantage of LCD's low prices, low power and MOS compatibility

by Paul Franson, Los Angeles bureau manager

Electronic watches, consumer calculators, digital panel meters are just a few of the products in which liquid crystal displays (LCDs) are cropping up much sooner than most observers in the industry anticipated. And display makers are tooling up for what is expected to be more than the trickle of LCDs that have characterized pilot operations in the U. S., Japan, and Europe.

As recently as January, an official at Sperry Information Displays, Scottsdale, Ariz., said that his operation was still about two years away from production, but now it is gearing a pilot production line for later this year. Obstacles are being overcome and many companies are bringing to fruition the benefits of LCDs—low cost, low power consumption, direct compatibility with metal-oxide semiconductor technology, and thin displays, both large and small.

American Micro-systems Inc., Santa Clara, Calif., is producing 1,000 displays per month and expects the figure to rise to 20,000 per month by September. Optel Inc., Princeton, N.J., expects to sell 100,000 watch displays in 1972. North American Rockwell Microelectronics Co. (NRMEC), in Anaheim, Calif., will deliver over 200,000 units in the next 15 months as parts for calculators. Texas Instruments is engaged in pilot production of custom watch displays with standard units to follow.

Other U.S. firms in or about to enter the market include General Electric, old-time display house Industrial Electronics Engineers Inc., and newcomers International Liquid Xtal Corp. (Ilixco), and Riker-Maxson.

There's considerable activity in Europe and Japan in LCDs, but the only companies that seem to be close to production are Electrova in Vienna and, in West Germany, Siemens AG in Munich and AEG-Telefunken in Frankfurt. Siemens will offer standard four-digit, seven-segment displays starting in August, with production to start a few months later. AEG-Telefunken will have samples of black-and-white displays available in six weeks. AEG-Telefunken expects to be able to handle orders for custom displays by the end of the year and will have standard types on the market next year.

In Japan, Busicom Corp., will make LCDs for its calculators, as will Seiko for watches. Toshiba and Sharp Corp. are now making samples, and ISE Electronics is expecting to begin late this year or early in 1973. They're all after a slice of

what could become a large business, but those who have estimates of its size are hesitant to let possible competitors know.

But Harry Weisberg, MOS product manager at RCA Solid State division, Somerville, N. J., is willing to stick his neck out: "There's no question in my mind that liquid crystals will be the dominant display by 1975 and beyond." He estimates that sales in 1975 could go as high as \$20 million in a total alphanumeric display market amounting to five times that figure.

RCA is apparently nearing large-scale production; an imminent cut in LCD prices should bring four-digit panels, in quantities of 1,000, down to about \$12 from the \$75 level at which they were offered last summer.

New uses. Much of the market will come in applications where electronic displays aren't used now

On time? A technician in one of NRMEC's laboratories checks the clock for an LCD. NRMEC will deliver 200,000 LCDs in the next 15 months as calculator displays.

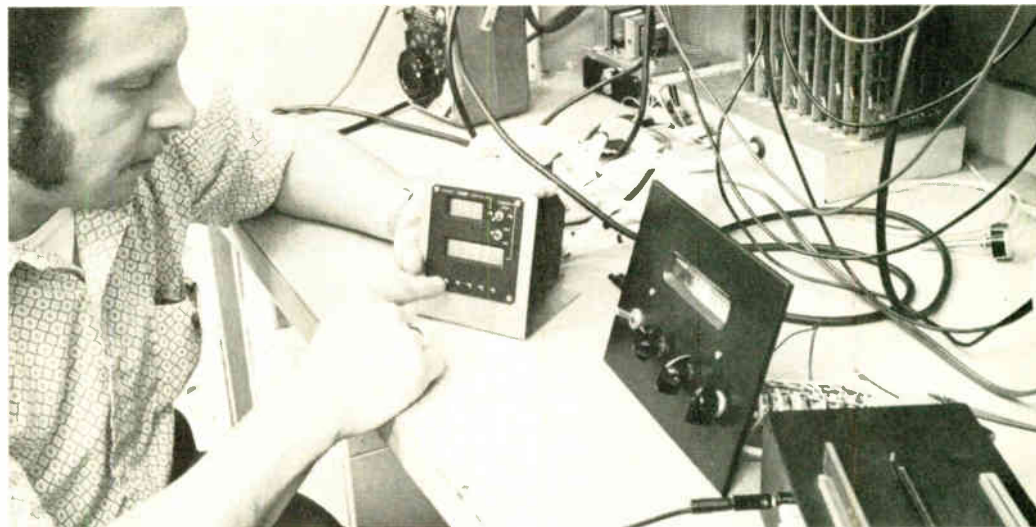

Probing the news

at all, such as wrist watches, clocks, gasoline pumps, odometers and speedometers, airport and sporting displays, and road signs. Other uses will come in such mushrooming products as consumer calculators and digital panel meters. Digilin, Inc. in Glendale, Calif., for example, has introduced a panel digital voltmeter with 3½ digits of LCD. Sales manager Stan Ericsson says that it's already the lowest priced DVM on the market at \$125 in unit quantities and \$55 in large quantities. Delivery is slated for May.

Liquid-crystal production has attracted a diversity of firms—some with related technology and some who see the potential. MOS houses AMI and NRMEC, for example, note the importance of compatibility of LCD surfaces for interfacing the displays with MOS. Sperry Information Displays, for another example, makes a gas display using flat glass plates and transparent conductive coatings such as those used in LCDs. IEE, Van Nuys, Calif., which has a joint venture with Japanese materials manufacturer Dai Nippon Toryo, will introduce a 5½-digit display in July. Efforts at Motorola's Semiconductor Products division in liquid crystals are confined to the laboratory, and Fairchild Semiconductor isn't working with them. Burroughs Corp.'s Electronic Components div., Plainfield, N.J., evaluated LCDs and decided to put its money on its Panaplex gas discharge display.

LCDs are simple in theory and structure. They consist of certain nematic organic compounds that change from a normally transparent state to opaque when placed in an

Display makes a point. AMI's 8-digit calculator display with decimal and polarity sign.



electric field. Two types of operation are possible, reflective and transmissive. A thin film of liquid crystal material is sandwiched between two transparent conductive plates (generally glass with tin or indium oxide coating on the inside). When the material is energized, it becomes opaque and scatters light that is either reflected or transmitted through the display. Digits are formed by etching one coating into segments, and each segment usually has an individual electrical connection.

Transmissive displays require backlighting, usually by incandescent bulbs, but even here, the tiny amount of power required by the liquid panels can be supplied by low-level MOS logic.

LCDs offer a number of advantages over conventional displays in many applications. The primary features are extremely low power consumption and cost. NRMEC's eight-digit LCD with ½-in figures requires less than 2 milliwatts: Optel's watch displays require only about 15 microwatts, and a new field-effect reflective display developed by Ilixco in Cleveland, Ohio, requires only 0.01 μw per digit with all segments on and operates at 10 v. This power level is a low power record for LCDs; and the price of the displays is equally low—under \$2.50 per digit, claims company president James Ferguson. The low leakage current of the LCD is a result of the material "and the way we make it," Ferguson says, declining to describe its formulation.

How much? Present small quantity pricing is not too relevant, since most applications are for custom displays and large quantities. NRMEC is apparently figuring prices at about \$1 per digit in the large quantities it is supplying in calculators. Ian McCrae, optoelectronics marketing manager at Texas Instruments, Dallas, feels that \$1.50 per digit will be required to have much impact in the market place.

Once underway, volume production costs should be minimal. The most expensive material used is the glass. Only about a drop of liquid crystal material is used in each display, and its cost is not significant. Recent Kodak prices were typically \$1 per gram in kilogram quantities,

but many users either make or mix their own materials.

Problem solving. But all isn't rosy for LCDs. A major problem for many users is their limited temperature range. The maximum range, James S. Carlyle, head of the Information Presentation Products division at AMI, points out, is a 90°C window in the -30 to +130°C range: "We can move the window, but we cannot broaden it yet with different formulations." Optel says the range is 0°-50°, but Edward Kornstein, vice president, display marketing, says that wrist watches stay close to body temperature of the wearer even at low temperatures. RCA says that its 5°-55°C range is adequate for indoor use, and a small heater can be used for lower temperatures, such as for gasoline pumps outdoors.

Most manufacturers are trying to find materials that can tolerate lower temperatures, and L.E. Tannas Jr., supervisor, advanced techniques, for North American Rockwell's Research & Technology division, a sister division to NRMEC, says that the solution may lie in a class of suspended crystal materials that aren't liquid crystals, but could be used in a similar way in displays of the same type.

Another area of controversy and confused specifications is response time. Most LCDs have a noticeable time delay when switched. E.T. Fitzgibbons of NRMEC's processing engineering operation, is annoyed at the specsmanship in this area: "The rate at which the data can be changed and recognized is the important figure. Three character changes per second is nice and crisp to the eye, and this is about what we get." Rise times quoted vary from 20 to 80 milliseconds and from 50 to 200 ms

Experimental. TI's new LCD is ½-in. high and ¼-in. wide. Display is driven by TTL.



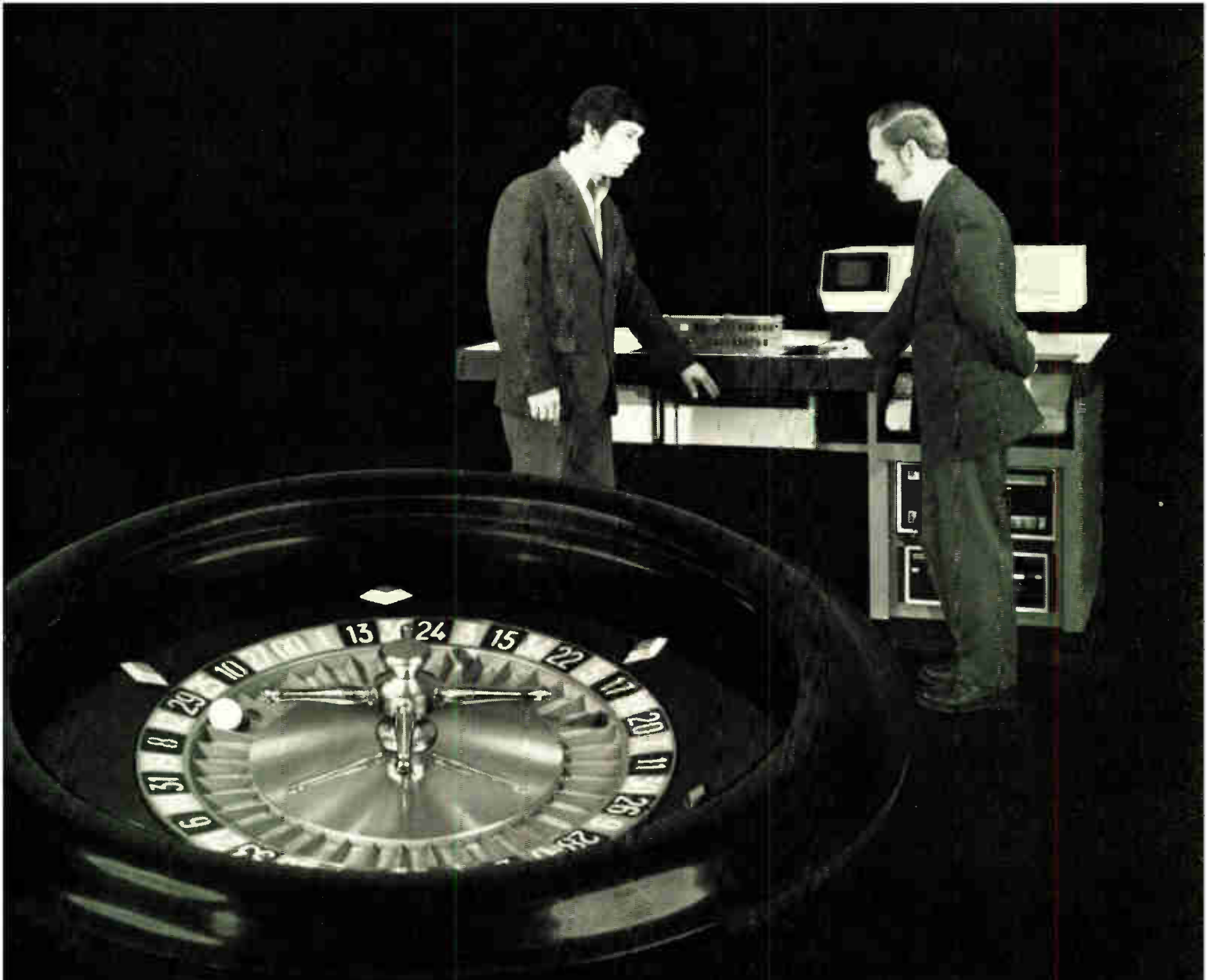

Take the risk out of buying a Logic-Circuit Tester

Buying a tester can be risky. You know it all depends on the supplier, but who can you trust? Your own staff, for one, of course. They know what you need and may find the time to design and build your system. So why not them?

Because General Radio has already done it for you — solved the design and programming problems that your staff has yet to face. In three years, GR has sold twice as many logic-circuit testers as our three closest competitors. Our designs and test programs are proven in 100 years of field operating time, yet you'll pay only a small

fraction of their cost. And, GR assumes full system responsibility. Honestly, now, can you do the job for \$20,000? We can.

Special Needs?

Our modular subsystems and programs are easy to add later as you need them. Let present needs dictate initial specs and cost with the assurance that later expansion will be both possible and economical.

So, who can you count on for a logic-circuit analyzer at least as good as you could make yourself? GR, of course.

Try Us

Our 1790, 1792, or 1793 can do your job. Outline your requirements or ask for a demonstration from the GR office nearest you or from GR in Concord, Mass. In Europe, write Postfach, CH 8034, Zurich, Switzerland.



General Radio

NEW YORK (N.Y.) 212 964-2722 (N.J.) 201 797-8996 • BOSTON 617 646-0550
CHICAGO 312 992-0800 • WASHINGTON, D.C. 301 681-5333 • LOS ANGELES 714 540-9830
TORONTO 416 252-3395 • ZÜRICH (01) 55 24 20

GRASON-STADLER 617 369-3787 • TIME DATA 415 327-8322

Circle 75 on reader service card

New SOLID-STATE FET-INPUT MULTIMETER



from
SIMPSON
of course

**Model
2795**
**PORTABLE,
LABORATORY
ACCURACY,
SOLID-STATE
ELECTRONIC
MULTIMETER**

- 68 Switch Selectable Functions:
 - 13 AC and DC Voltage Ranges (as low as 1 MV, full scale)
 - 14 AC and DC Current Ranges (as low as 1 μ A, full scale)
 - 6 low power (IC compatible) Resistance Ranges
 - 6 completely self-contained Capacitance Ranges
- Plus 12 Output Ranges
- Circuit Breaker Overload Protection
- High FET-Input Impedance
- $\pm 1\%$ Accuracy for AC and DC
- Negligible Voltage Drop
- Simple, Straight-Forward Operation
- Size: 8.07" High, 5.04" Wide, 3.94" Deep. Only 3.3 lbs.

2795 MULTIMETER supplied complete with batteries, test leads and operator's manual. Complete accessories available.

\$250⁰⁰

WRITE FOR BULLETIN L-1010 . . . OR CONTACT YOUR SIMPSON INSTRUMENTATION PRODUCTS DISTRIBUTOR FOR OFF-THE-SHELF DELIVERY

Simpson
INSTRUMENTS THAT STAY ACCURATE

SIMPSON ELECTRIC COMPANY

5200 W. Kinzie Street, Chicago, Illinois 60644

Phone (312) 379-1121

EXPORT DEPT.: 400 W. Madison St, Chicago, Ill 60606. Cable Simelco

IN CANADA: Bach-Simpson Ltd., London, Ontario

IN INDIA: Ruttonsha-Simpson Private Ltd., International House, Bombay-Agra Road, Vikhroli, Bombay



Probing the news

for decay time.

LCDs are so new as products that life data isn't very complete. A number of manufacturers are claiming 10,000 hours of life, while Kornstein of Optel and Weisberg of RCA estimate that five years of operation is reasonable. NRMEC's Fitzgibbons points out a number of destructive modes for the liquid crystals: Excessive voltage can tear the molecules apart, and the cell can be attacked by contaminants.

A controversial failure is attributed to ion migration under dc operation. The mechanism isn't clear, according to a number of sources, but the solution is simple for some uses: don't use a drive with any dc component. "The answer is to apply an ac signal with no dc component at all," says Carlyle, "and AMI's MOS driving circuits do just that."

Togetherness. The display and its drivers must be considered together. For this reason, NRMEC says that it is interested only in systems business where it can make sure everything works together. AMI, which supplies the LCD to Digilin for its digital panel meter, also furnishes the MOS large-scale integration used in the product. North American Rockwell's Tannas adds that ac operation works so well and is so easy to do with MOS that there's no real advantage to dc." For watch use, though, dc is needed.

Another problem is how to make connections to all the segments in a display, which may have as many as 16 digits. The connections on the LCD panel itself aren't usually a great problem, but the connector into which it plugs can be a headache, says Fitzgibbons. The plug-in connectors usually cost about 1 cent per connection. Volume production will reduce the cost, as will the integration of the logic and drivers into the display panel, but great attention is now being paid to multiplexing to eliminate connections.

As these problems are being solved, the future seems to hold great promise for liquid crystal displays, with improved materials, and likely integration of displays and logic into one package being the next step. □

The most versatile multicolor CRT's on display

Special multicolor screens with different color renditions provided by changing voltages make these up-to-the-minute CRT's especially useful in the latest display applications. Air traffic control systems, electronic test equipment, computer displays and many other applications are possible for these tubes. You can get any of our CRT's (from 4.5" to 25" diagonal) with bicolor or multicolor display screens, a monicolor screen with different persistence phosphor layers, or multicolor screens with variable persistence phosphor layers.

You'll also specially appreciate the high brightness and picture contrast. And you'll like the high resolution, a major feature with THOMSON-CSF cathode ray tubes.

Moreover, your circuit engineer will have the benefit of the low voltage swing required to switch from one color to the other. For complete information on these and all the tubes in our wide CRT line, circle the Reader Service Card or contact us direct.



See us at IEEE, booth 2232



THOMSON-CSF

THOMSON-CSF ELECTRON TUBES, INC. / 50 ROCKEFELLER PLAZA / NEW YORK, N.Y. 10020 / (212) 489-0400

France - THOMSON-CSF Groupement Tubes Electroniques / 8, rue Chasseloup-Laubat / 75 PARIS 15^e / Tél. 566.70.04

Germany - THOMSON-CSF Elektronenröhren GmbH / Am Leonhardsbrunn 10 / 6 FRANKFURT/Main / Tel. 70 20 99

Italy - THOMSON-CSF Tubi Elettronici SRL / Viale degli Ammiragli 69 / ROMA / Tel. 63 80 143

Sweden - THOMSON-CSF Elektronrör AB / Box 27080 / S 10 251 STOCKHOLM 27 / Tel. 08/22 58 15

United Kingdom - THOMSON-CSF Electronic Tubes Ltd / Bilton House, Uxbridge Road, Ealing / LONDON W5 2TT/Tel. 01-579 1857

Management

Vidar team takes time off for growth

To uncover new markets itself, top management at a California firm moved aside in favor of the next level—with marked success on both counts

by Stephen Wm. Fields, San Francisco bureau manager

"Who's gonna mind the store?" is the basic question that Vidar Inc. faced when growth stalled in the 1970 recession and its top brass decided to quit their regular jobs in order to dig up the much needed new business. The usual approach is to take a few bright MBAs and PhDs from the ranks and get them to brainstorm products that may break new ground.

But according to Vidar's Ted Keane, "you really should let your experienced executives do the investigating and give the MBAs and PhDs the experience of running a going organization." Keane has tried it and says it more than doubled the sales of his company in under one year with a single innovative product developed by a "phantom squad" of top executives.

Vidar is a 12-year-old Mountain View, Calif., manufacturer split about equally between an instrumentation division, which designs and manufactures sophisticated data acquisition systems, and its Vicom division, which makes telecommunications equipment. The former division, which Keane managed in 1970, was hit by the recession in Government business; the latter was doing well—but needed to do much better if the company as a whole was to grow.

Plan for profits. At that time, it had become obvious to Vidar's president, Vernon Anderson, that 1970 was a sad contrast to 1969—"a banner year," when the company earned about \$15 per share on sales of \$11 million. Together with the other corporate executives, Anderson put together a three-part plan which included: setting new profit targets for existing product lines so

as to increase revenues by \$5 million by 1975; looking into new market areas and new products, again to increase company sales by \$5 million; and developing a program of acquisition to take place in 1973, and to add another \$4 million in sales.

The most ambitious of these goals was the search for new markets, and Vidar put its most experienced people to work on it: Anderson, Keane, Dalton Martin, vice president of finance, and John McDonald, director of R&D. "We dubbed ourselves the phantom squad," says Keane.

Meantime, Richard Grey, who had been division manager of Vicom, was named acting head of the corporation, while Anderson retained responsibility for over-all profitability. Grey in his turn was replaced by L.R. Schultz, who was Vicom's marketing manager. R&D ceased to exist. Finance was handled by Gordon Hammond, who came from the management information services department, while Lew Jordan was brought from the

sales manager slot to become acting general manager of the instrumentation division.

By August, 1971, the "phantom squad" had developed an electronic metering system to replace mechanical counters in telephone central offices. They had a contract with the Bell System for more than \$20 million. The internship of the acting corporate staff was over—they had proven themselves capable of handling the organization. An unorthodox management maneuver had paid off.

Phantoms seek business. When the phantom squad set out to find new market areas, they picked on the telecommunications industry as their first choice. Eight potential product areas were picked out, then narrowed to three by asking what the production load on the company would be, what the cost of getting into the new business would be, and whether specific customers could be identified.

The marketing aspects were handled by Anderson and Keane. Product design was McDonald's job, and

In conference. Vidar's R&D vp Jack McDonald, vp Ted Keane, president Richard Grey, former president Vernon Anderson, and finance vp Dalton Martin consult on their new product.

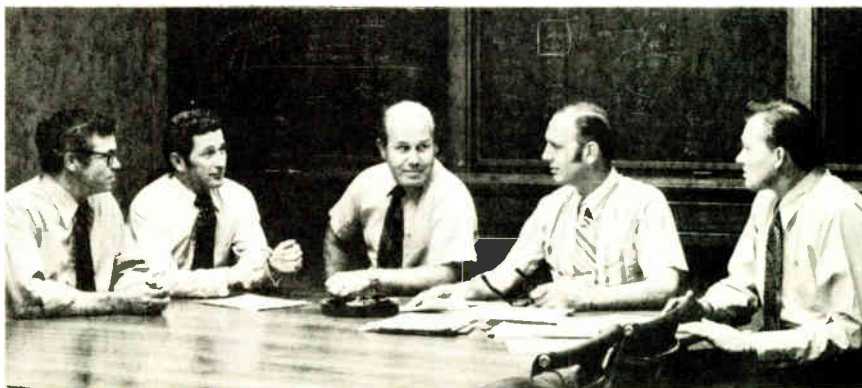



Get help...free.

Is your PDP-11 running short of memory? Get help. Look into our new fully compatible semiconductor Add-On Memory.

Let us show you how to expand working storage. Easily. Efficiently. With our MTI-311 Add-On Memory. High performance characteristics include 600 nanoseconds Read cycle; 800 nanoseconds Write cycle. Reliability? Monolithic semiconductor technology cuts component and inter-connection count for a fivefold improvement in reliability over core memory. And, costs are lower. Capacities up to 28K words in a single module. Field expandable with 4K-word plug-in cards.

Get help . . . free. We'll share full details. Including easy interface of the MTI-311 with your PDP-11. Write Memory Technology, Inc., 83 Boston Post Road, Sudbury, Massachusetts 01776. Or call Roger Marino. (617) 443-9911.

Memory Technology
Incorporated

Circle 79 on reader service card

OUR ADC DELIVERS 12 BITS + SIGN IN 0.5 μ SEC

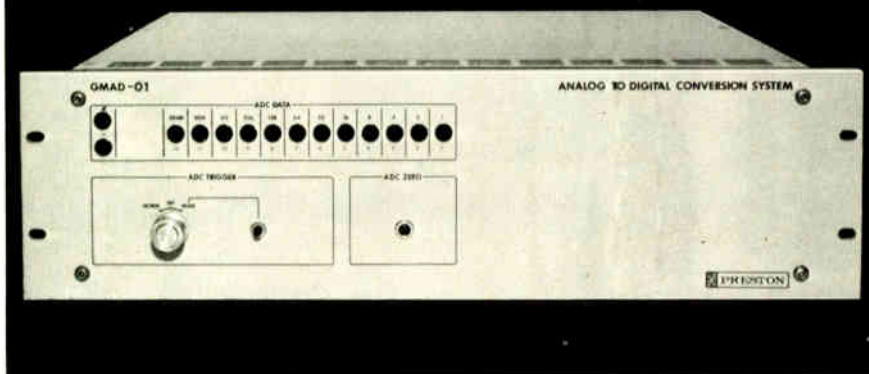

Preston's GMAD-01 A/D converter is the fastest, high-precision digitizer you can buy . . . designed for the most exacting analog data processing tasks. Jobs that were previously limited to processing off-line can be accelerated, or performed in real time, with the GMAD-01.

SOPHISTICATED APPLICATIONS

Its outstanding speed and accuracy make the GMAD-01 a leading candidate for such applications as radar and acoustic signature recognition; digital data communications; high-precision instrument data reduction; analog waveform, spectrum, and correlation analyses; and digital enhancement of high-resolution video and optical data.

UNUSUAL FLEXIBILITY

Preston's GMAD-01 is the only high-speed A/D converter that covers the resolution range from 7 to 13 bits! If your application requires only 7 or 8 bits plus sign, the GMAD-01 will get it for you in a spectacular 100 nanoseconds, with aperture error less than one nanosecond.

QUALITY AND RELIABILITY

You can have implicit confidence in Preston. Meticulous attention to every detail of design and construction makes Preston's GM-Series the hallmark of quality in digitizer instrumentation.

Contact Preston today for complete data and prices on the GMAD-01 — The A/D converter that delivers high-speed and precision.



SCIENTIFIC INCORPORATED

805 East Cerritos Avenue • Anaheim, California 92805 • Phone: (714) 776-6400
REPRESENTATIVES IN MAJOR CITIES THROUGHOUT THE WORLD

Probing the news

Martin was the operations man.

"By our June deadline, we had a proposal for a field trial," in which American Telephone & Telegraph was interested. Keane says.

The Vidar electronic metering system was to be installed in the phone company's central offices to record the number of message units used by each customer. The present system uses mechanical counters. Each month a photo is taken of the counter bank and the numbers are compared to those on last month's photo. The system, dubbed LMMS for local message metering system, uses an electronic scanner bank that monitors each subscriber's line and records the phone number, duration of call, and the time of day. This information is stored on magnetic tape and played back to the accounting machine for billing.

Interns promoted. At this stage in the game, November 1971, Grey, Jordan, Schultz, and Hammond had shown that they could run the corporation, and so they were promoted officially to the position they occupied on a temporary basis. And the phantom squad was able to work on the LMMS project full time.

By January, the field trial was completed, and last month Vidar and the Bell System announced the outcome. The New York Telephone Company purchased an electronic metering system that will handle approximately 3.6 million telephones. The contract was worth over \$20 million.

Since—to say the least—this overshoot Keane's plan of increasing sales by \$5 million, the acquisition plan was scratched, and a new division was formed to manufacture the LMMS. It will be headed by James Conklin who had been managing the company's other manufacturing facilities. And, boasts Keane, "we did it all with existing people, and were able to use experience where it would do the most good."

As for the phantom squad, Anderson is taking a leave of absence from Vidar, and Grey has been named president, at the same time joining the squad. The squad, meanwhile, will draw a breath and then take a look at the future. □

RCA engineers wrote the books!

Comprehensive library of solid state theory and applications.

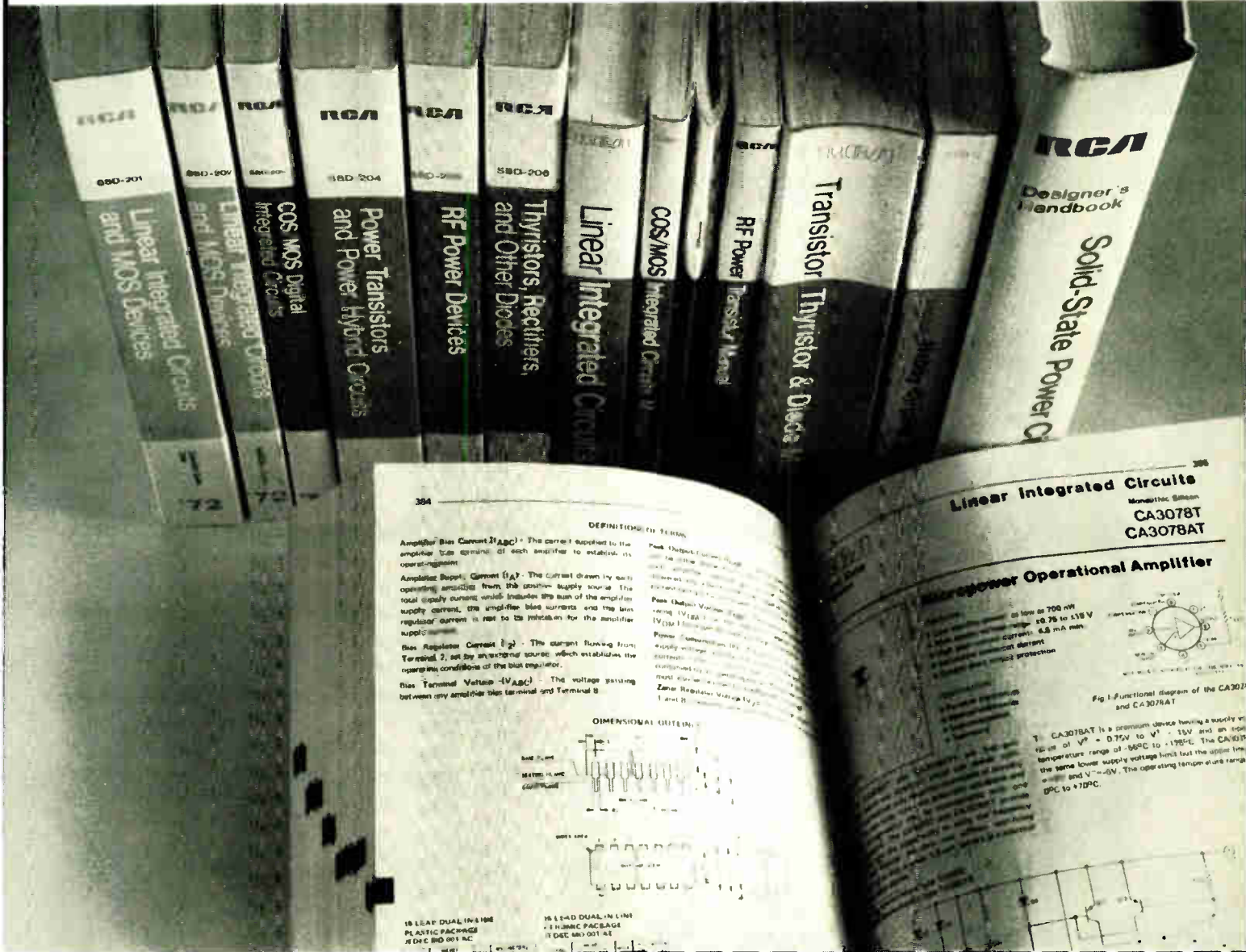

An extensive library of solid state theory and applications from the men who know the field best. RCA design engineers. RCA application experts. And RCA research scientists.

Get the entire library of 13 volumes — 5,600 pages of information — or just the books you need.

The seven technical manuals and six DATABOOKS are available from RCA distributors or directly from RCA.

Act now. See your RCA Distributor, or mail coupon with check, money order, or purchase order to: RCA Corporation, Solid State Division, Section E-1 Box 3200, Somerville, New Jersey 08876.

DATABOOKS

- Linear Integrated Circuits and MOS Devices (Data and Selection Guide) ... SSD-201 \$2.50
- Linear Integrated Circuits and MOS Devices (Application Notes) ... SSD-202 \$1.50
- COS/MOS Digital Integrated Circuits ... SSD-203 \$3.00
- Power Transistors and Power Hybrid Circuits ... SSD-204 \$2.00
- RF Power Devices ... SS-205 \$2.00
- Thyristors, Rectifiers and Other Devices ... SSD-206 \$2.00
- All six DATABOOKS ... \$13.00

Technical Manuals

- Linear Integrated Circuits ... IC-42 \$2.50
- COS/MOS Integrated Circuits Manual ... CMS-270 \$2.50
- High-Speed, High-Voltage, High-Current Power Transistors ... PM-81 \$2.00
- RF Power Transistor Manual ... RFM-430 \$2.50
- Transistor, Thyristor, & Diode Manual ... SC-15 \$2.50
- Solid-State Hobby Circuits Manual ... HM-91 \$1.95
- Solid-State Power Circuits (Designer's Handbook) ... SP-52 \$7.50

Complete library of six DATABOOKS and seven technical manuals ... \$34.45

RCA Solid State, Box 3200, Somerville, New Jersey 08876.

Please send books as indicated on this coupon. Check, money order, or purchase order enclosed. Payable to RCA Corporation.

Name _____

Address _____

City _____

State _____ Zip _____

Payment by: Check ; Money Order ; Purchase Order .

World Radio History

RCA Solid State

products that make products pay off
Circle 81 on reader service card

12 years ago.



Our fledgling data products company, forerunner of today's LEC, joyously received its first order ... for 40,000 50 mil ferrite cores.

Today.

Exploring the Moon. In Houston, our Aerospace Systems Division performs myriad engineering and scientific duties as part of NASA's Apollo Support Network.



Mariner '71 Spacecraft. One of our space travelers along with others including ESRO, NIMBUS, SIS, Mariner '69 and '73 and the Viking Lander.

SUE. The System User Engineered minicomputer with unequalled flexibility. SUE will be available in a galaxy of configurations.

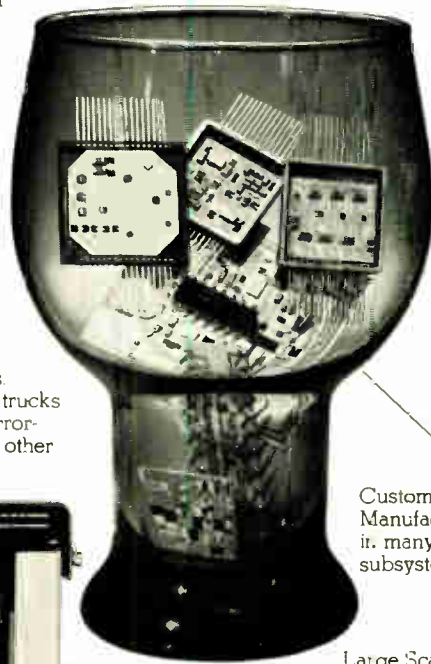

Custom-built Microcircuits. Manufactured by us for use in many of our systems and subsystems.

840 Centinel Fuel Registers. These ride on tank delivery trucks and produce on-the-spot, error-free invoices for fuel oil and other liquid deliveries.



Large Scale Memory. Built to "simple spares logistics" demands. Highly rated components can withstand extreme vibration and humidity.



MADAR recorder. Now being manufactured for the Air Force C-5 Galaxy's in-flight performance, analysis and recording system.

417 Data Recorder. Now in the hands of scientific and industrial users throughout the world.



MAC 16. The Multi-Application Computer. Many are at work now. Many more are awaited by expectant customers.

Electromagnetic Program. We're conducting a major engineering and technical support program in connection with the Army's electromagnetic test facility in Arizona.

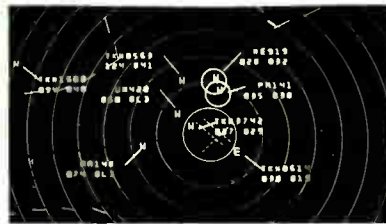

Air Traffic Control Systems. We're marketing this new ATC system on a worldwide basis. It's a unique, low-cost solution to traffic control at low-density airports.

Transaction Systems. Our LTS is the most technologically advanced self-service gas station pay system in the country.



Continuous Strung Planar Array. New, high-speed memory planes with closely packed low-drive cores offer speed, cost and space savings.

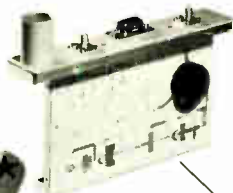

Advanced Design Radar. These high-power modules transmit at either of two frequencies. They're forerunners to multi-frequency, phased-array radar systems that will scan via electronic beam steering.

CB-65 memory system. A compact, core memory system which combines high-speed with low-cost. It can be used for minicomputers or expanded for use in large-scale mass storage units.



Mk 86 Gunfire Control System. We're producing these for the Navy. This computerized system gives Navy guns pinpoint accuracy against surface and air targets.

Growing through merger, acquisition, blood, sweat, and tears, Lockheed Electronics is five profitable divisions, accounting for over \$100,000,000 in sales from a remarkable diversity of electronic products and services.

Lockheed Electronics

A Subsidiary of Lockheed Aircraft Corporation
Circle 83 on reader service card

CTS *has the answer in*

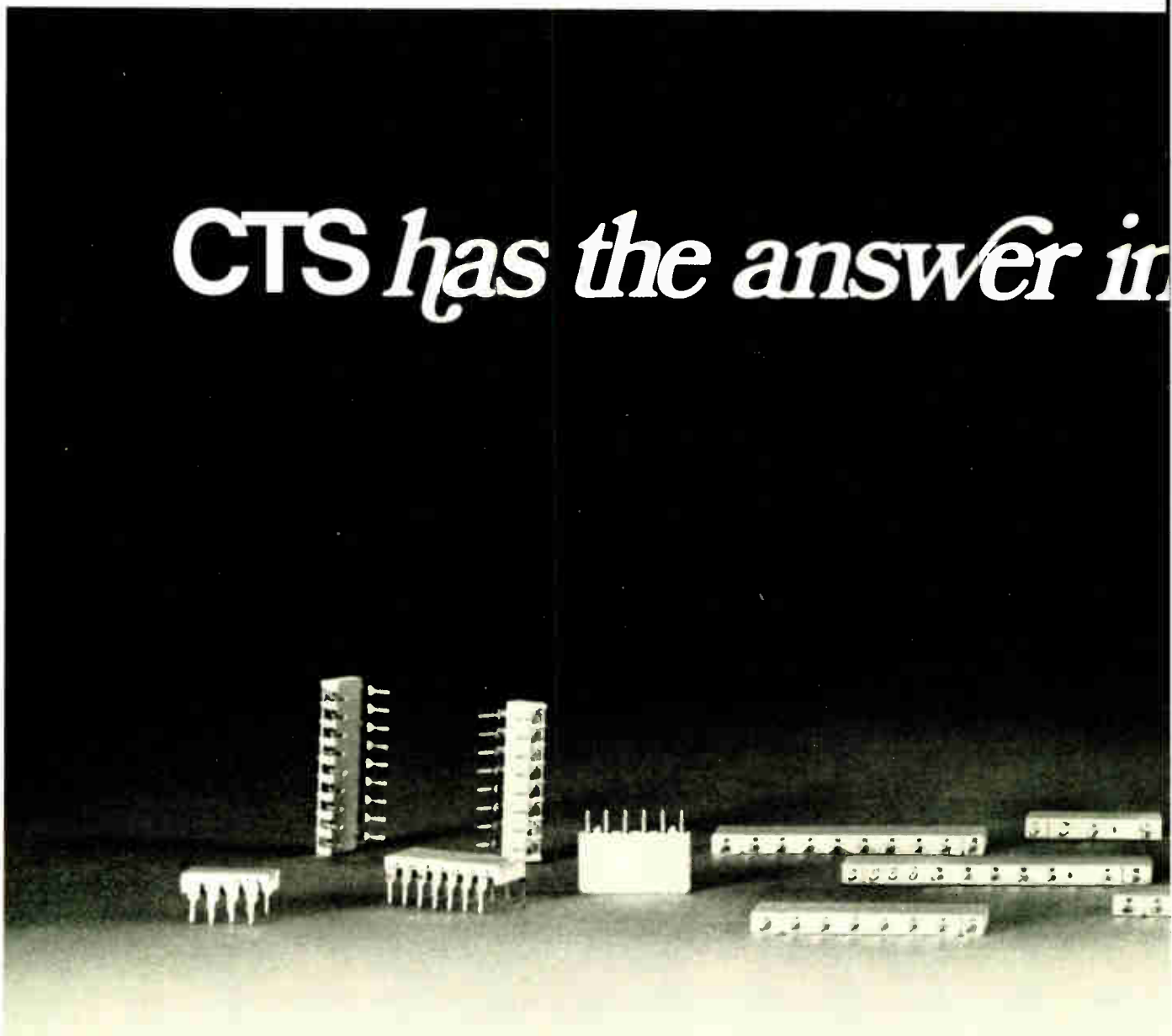

You name it—we have the exact cermet resistor network size and characteristics you need. Here's the choice you get right now: our 750 line includes: .100" centers with 4, 6 & 8 pins; .125" centers with 2, 4, 6 & 8 pins; and .150" centers with 4 through 13 pins. And we're working on new designs right now!

All compact, extremely stable and highly reliable. Recently we packed even more circuitry into our 760 series, giving you a choice of four popular space-saver packages: 8, 14, 16 and 18 flat lead styles. Packed with up to 17 resistors per module with flat leads standard (round leads on request).

cermet resistor networks. So ask us!

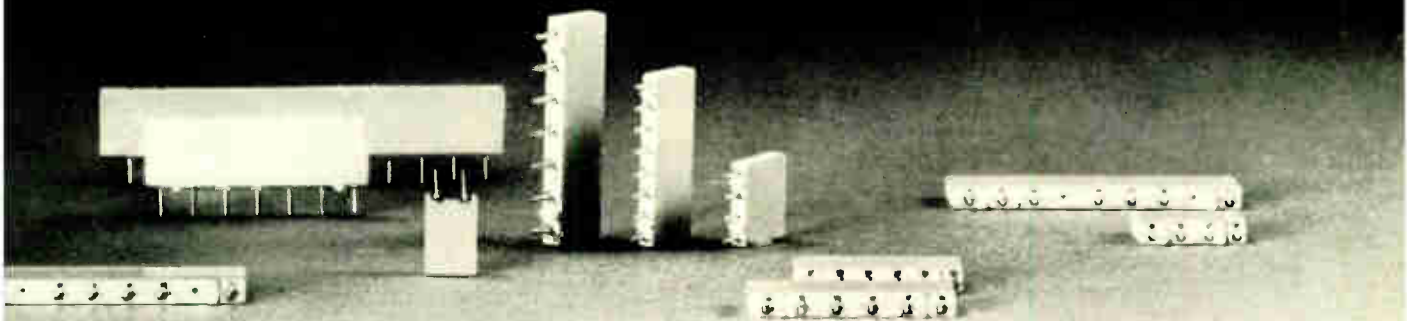

Our broad line provides an infinite number of circuit combinations, all with excellent TC, load and temperature characteristics supported by millions of hours of reliability testing. Ask your CTS sales engineer for data. Or write CTS of Berne, Inc., Berne, Indiana 46711. Phone (219) 589-3111.



ACTUAL SIZE



CTS CORPORATION *Elkhart, Indiana*

A world leader in cermet and variable resistor technology.



Reads credit cards.

Read all about them.

The innovation you see at the left is our new electronic card reader. It scans and helps verify credit in seconds. It may be used by itself, or as part of a complete point-of-sale transaction terminal. In fact, we have technology for all types of card or tag readers. And we have electronic sub systems for digital data processing and

transmission including modems, and liquid crystal displays.

In the musical department, we've developed the "brain" of an electronic organ. Mounted on an 11" x 17" board, we built a musical mini-computer that converts sound waves into digital signals, stores them in memory, then recalls them as sound waves. Truer than any other electric organ in the world.

And at a fraction of what it would cost with conventional electronics.

You'll find us in textiles as well. With an electronically controlled knitting machine that changes fabric patterns faster than the fashion industry can change its mind (or a girl can change her outfit). A computer tape does it. In seconds.

Impressed? Keep reading.
We work in the automotive



Reads music.

field, too. For example, our automatic braking system (known as Skid-Trol™) prevents big rigs from jackknifing, even under the worst road conditions.

Another field is utilities. The dispatch control center that we built for the Philadelphia Electric Company gives an instantaneous picture of the entire bulk power complex. Plus a forecast of load factors during the

next 15 minutes.

And, of course, we're suppliers to the business machine manufacturers—we're the world's leading supplier of MOS/LSI devices for electronic calculators.

These—and many more. When it comes to processing,

Reads fashion news.

storing, sensing, displaying or transmitting data, nobody can match our experience.

Or capabilities. Write us in Anaheim, California 92803. Or phone 714/632-4195.

Maybe we can improve your reading habits and save you money besides.



**North American Rockwell
Electronics Group**



PDP-8. PDP-11. For OEM's

A few months ago, we came out with new low cost versions of our PDP-8 and PDP-11 families for the OEM.

With prices as low as \$2436. In quantities of 50.

We made sure they'd have the features, architecture and compatibility that make PDP-11 and PDP-8 the most popular, most imitated minis ever.

We must have hit on the right combination. We've been mixing it up with some of the toughest OEM's around. And coming away with their business.

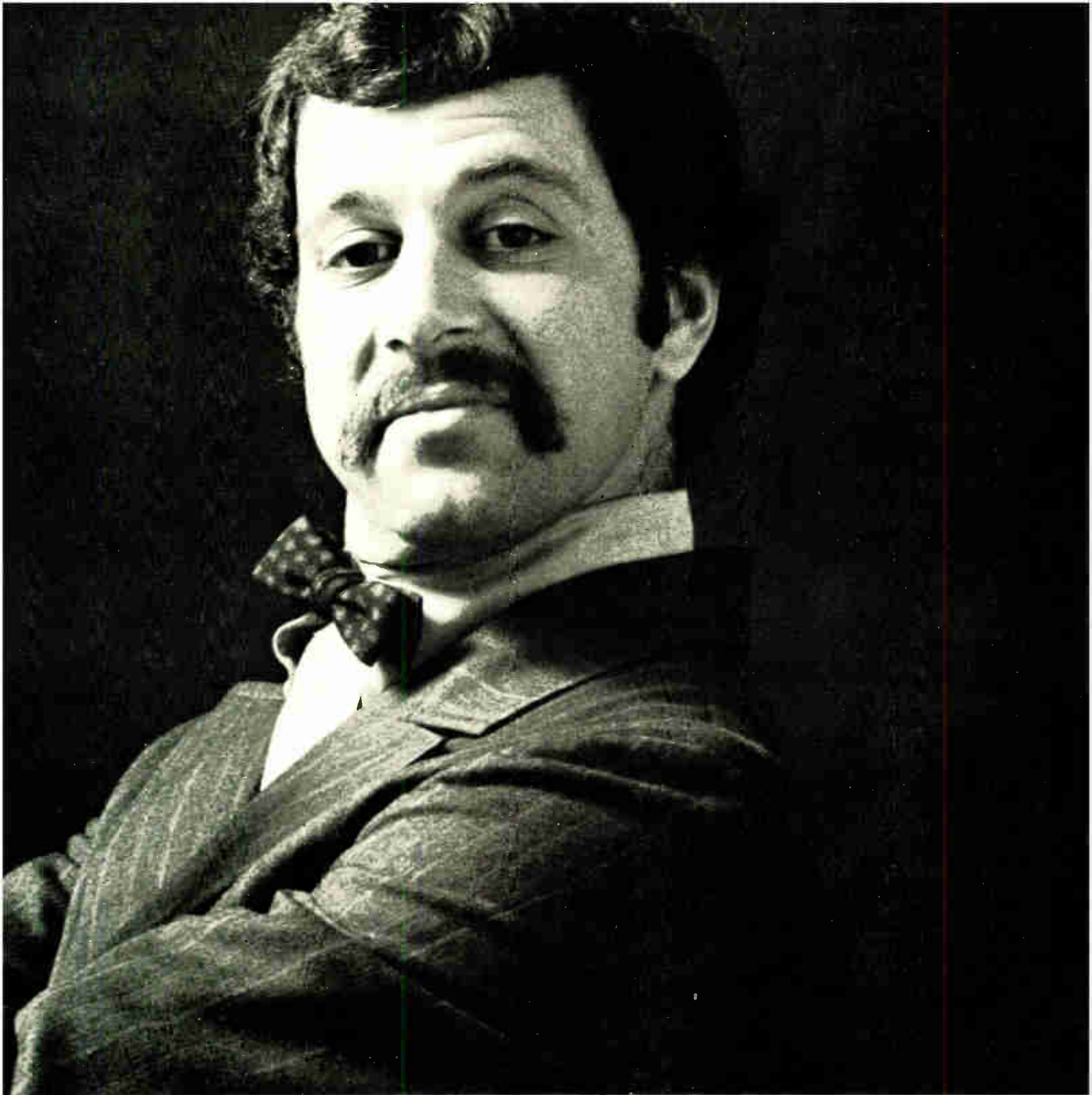

who hate to spend money.

We're after your business, too.
Because now we have the right
computers. At the right prices.
From the right company.
Come and get 'em.

Digital Equipment Corporation,
146 Main Street, Maynard, Mass.
01754. (617) 897-5111.

digital

Centralab Potentiometers... in line with your design requirements

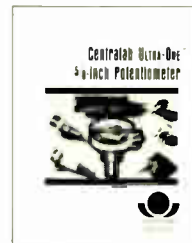

Write
Centralab
for
Bulletin
No. 1526P2

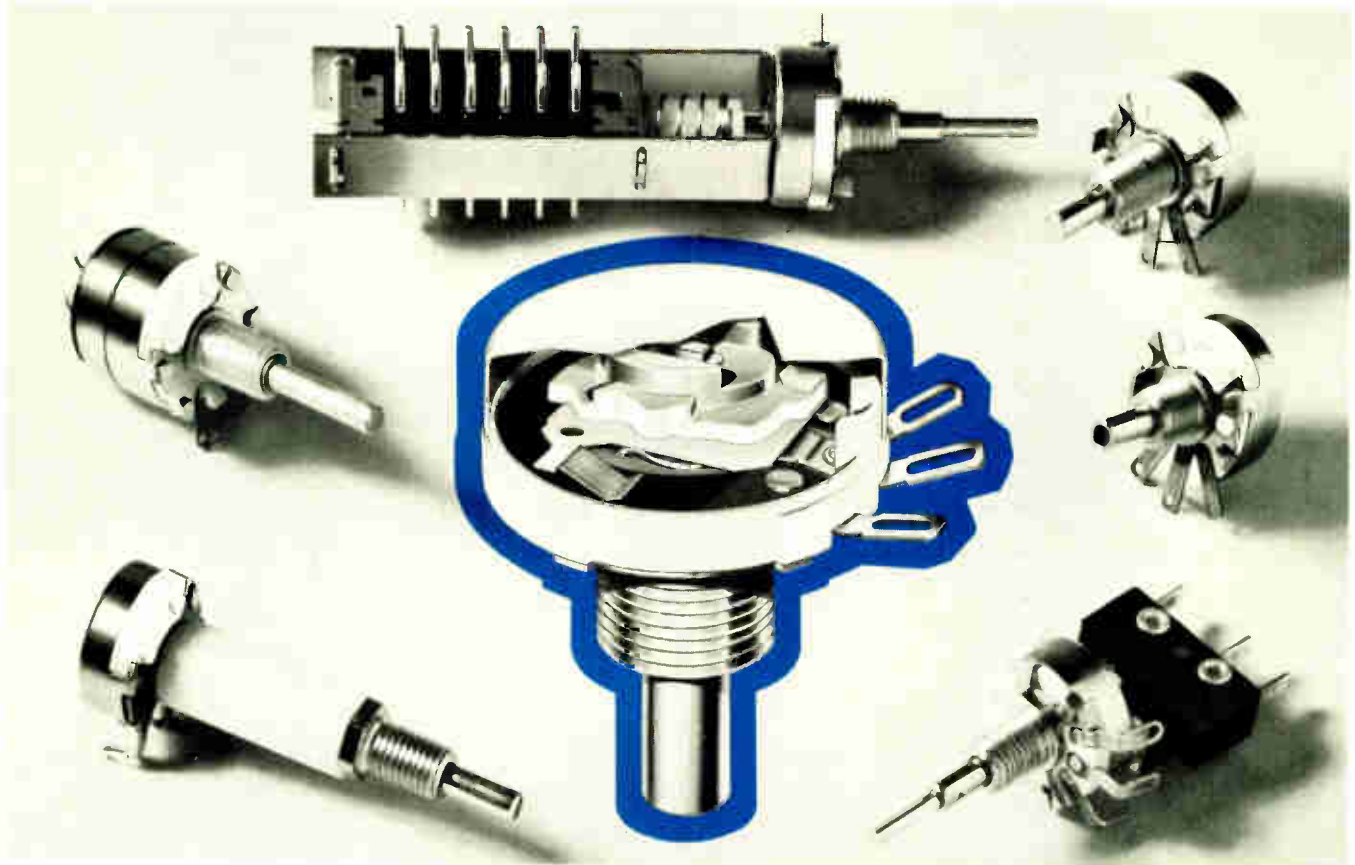

You can't tell a pot by its cover

You have to look inside to see how a potentiometer is made. Centralab's new ULTRA-ONE™ 1/8-inch potentiometer simply has more quality under its gold finished cover.

The extremely quiet ULTRA-ONE operates within 0.5% maximum CRV (contact resistance variation) for linear tapers—*not just initially—but through 100,000 cycles!*

We did it by an improved resistor system and by using a new contact. This quiet combination is a smooth conductive plastic element and a ten-fingered contact. The result is that

CRV is almost unmeasurable throughout the life of the potentiometer.

For versatility, the ULTRA-ONE can be coupled with snap-action, line and push button switches. It's available with a high-voltage bushing and shaft—with hollow shaft—and a high-torque feature.

ULTRA-ONE is the industrial potentiometer line that gives you more design flexibility . . . low noise operation, component add-ons, long life, and high-quality . . . in an extremely attractive package.

For complete specs, write Potentiometer Sales Manager, Centralab.

GET CENTRALAB THE "IN" LINE FOR YOUR DESIGN

Hybrid Microcircuits
Pushbutton & Rotary Switches
Capacitors
Potentiometers
Technical Ceramics
Ceramic Packages
Semiconductor Devices



CENTRALAB

Electronics Division
GLOBE-UNION INC.

5757 NORTH GREEN BAY AVENUE
MILWAUKEE, WISCONSIN 53201

ULTRA-ONE features

- 0.5% maximum noise through 100,000 \sim
- Multi-fingered contact
- Conductive plastic element
- ± 250 PPM/ $^{\circ}$ C
- 1/2 watt at 40 $^{\circ}$ C
- 500 volts DC
- $\Delta R < 10\%$ after load life
- $\Delta R < 10\%$ after 100,000 \sim

Special report: Cable's path to the wired city is tangled

CATV pioneers, inspired by the potential benefits and profits of interactive television, are finding in suburban experiments that many financial and technical problems remain to be solved

by Gerald M. Walker, *Consumer Editor*

□ Wiring our cities with reliable broadband communications networks has long been a dream of cable television operators. Turning the home television set into a communications terminal hooked to central computers to provide a variety of interactive services is part of this dream. It's a far cry from CATV's original objective 20 years ago of bringing programs to communities in fringe TV viewing areas.

Today the multiple system operators (MSOs) attracted to the big cities are still a long way from the payoff of the wired city. The key to providing such new services as a choice of first-run movies, customized college courses, shopping services, and fire and burglar protection, is two-way television capability. But adding a return channel for bidirectional communication requires much more than plugging in two-way amplifiers and some crossover filters.

It is possible to retrofit existing systems to make them bidirectional, but it is not as easy as hardware manufacturers had thought. It costs more than the relatively small CATV manufacturers have been able to raise in the past. And the Government—rather than advancing money for predicted benefits in such public activities as education—appears to be waiting for results before committing funds.

Meanwhile, private foundations have sponsored enough think-tanking on the wired city to raise expectations and impatience, but raising the necessary money is more germane at this point. A two-way system mul-

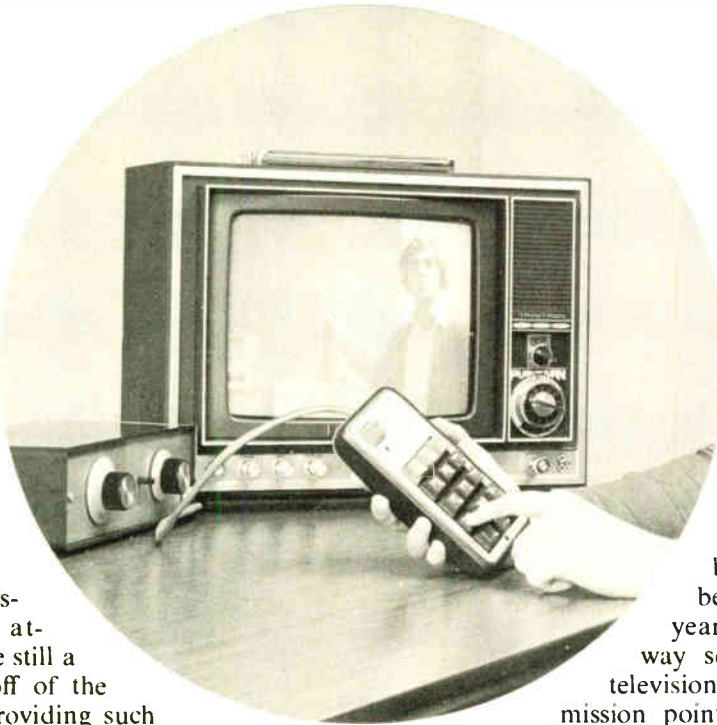

tiplies many times the costs and risks inherent in a simple one-way cable operation delivering off-the-air signals (Table 1). The problems involve system design, hardware and cable reliability, software development, marketing new services, and of course, financing the investment. Put it all together and you've got trouble on the way to the wired city.

What form two-way systems will take is yet to be decided and may not be ironed out for another year or two. Essentially, two-way service means wiring the television set to a central transmission point, sending signals downstream to the receiver, where a terminal

makes it possible to return signals upstream to the sending point (Figs. 1 and 2). Such a cable system is like an audio/video/digital party line.

The technical approaches to bidirectional operation are varied and controversial. First of all, the upstream channels must be multiplexed to distinguish what signals come from each subscriber. At the same time, downstream and upstream channels must be separated to avoid interference. This task can be done by frequency-division multiplexing, time-division multiplexing, or space-division multiplexing. An operator can combine these three techniques within one system, depending on the amount of information to be transmitted. The bandwidth available with present-day amplifiers is approaching 300 megahertz, though requirements vary according to the type of signals transmitted. A digital response in an opinion poll, for

1. **Interactive.** This hand-held alphanumeric keyboard unit with a built-in microphone and push-to-talk switch makes two-way audio communication possible by cable. The Vicom Manufacturing Co. design has transmitter, receiver, and control electronics in a separate unit.

example, would require just 100 hertz per subscriber sent upstream. Audio return would be in the 3-to-4-kilohertz bandwidth, while color video transmission uses 6 MHz.

One-way cable television systems use frequency-division multiplexing for 12 or more video channels, each with a bandwidth of 6 MHz, sent downstream on a single cable. The technique that will probably be accepted by most cablecasters, it is the basis for the figures presented in Table 1.

However, there is controversy over whether or not frequency-division multiplexing is more or less expensive than time-division multiplexing. The latter divides a channel into separate time slots for each signal, then these slots are interleaved together. Computer data and other digital messages are handled via time-division multiplexing. The most expensive way to go, but the most secure from interference is to transmit signals physically separated by space—that is, over separate lines.

Return information, whether video, audio, or digital, is transmitted to the cablecaster's head-end in the bands between 5 MHz and 30 MHz. It is also possible to use the

bands between 30 MHz and 50 MHz. These are also the bands used for ham, fixed-terrestrial, and citizens' band operation.

A computer can poll terminals and control services to subscribers. However, the operator has to decide whether the computer is to perform as an interrogator, addressing each terminal in sequence, or as a responsive slave, handling subscriber-initiated requests at random. The former is less costly to install, program, and maintain than the latter. However, the time will come when subscriber-initiated interactive programming will be necessary for complete development of the two-way potential.

The receiver for any two-way system, of course, is the television set. However, the subscriber also needs a terminal attached to the TV receiver to accept interrogation from the head-end computer and transmit responses upstream (Fig. 2). The terminal consists of a control logic and buffer storage module, a keyboard, and a modulator/transmitter. To date, keyboards have been designed with three to 15 keys, depending on the amount of response data required by the subscriber. The simplest three-key unit is basically for responding to polls with "yes," "no," or "no opinion." At its most elaborate, the terminal can send complete alphanumeric, audio, and visual signals.

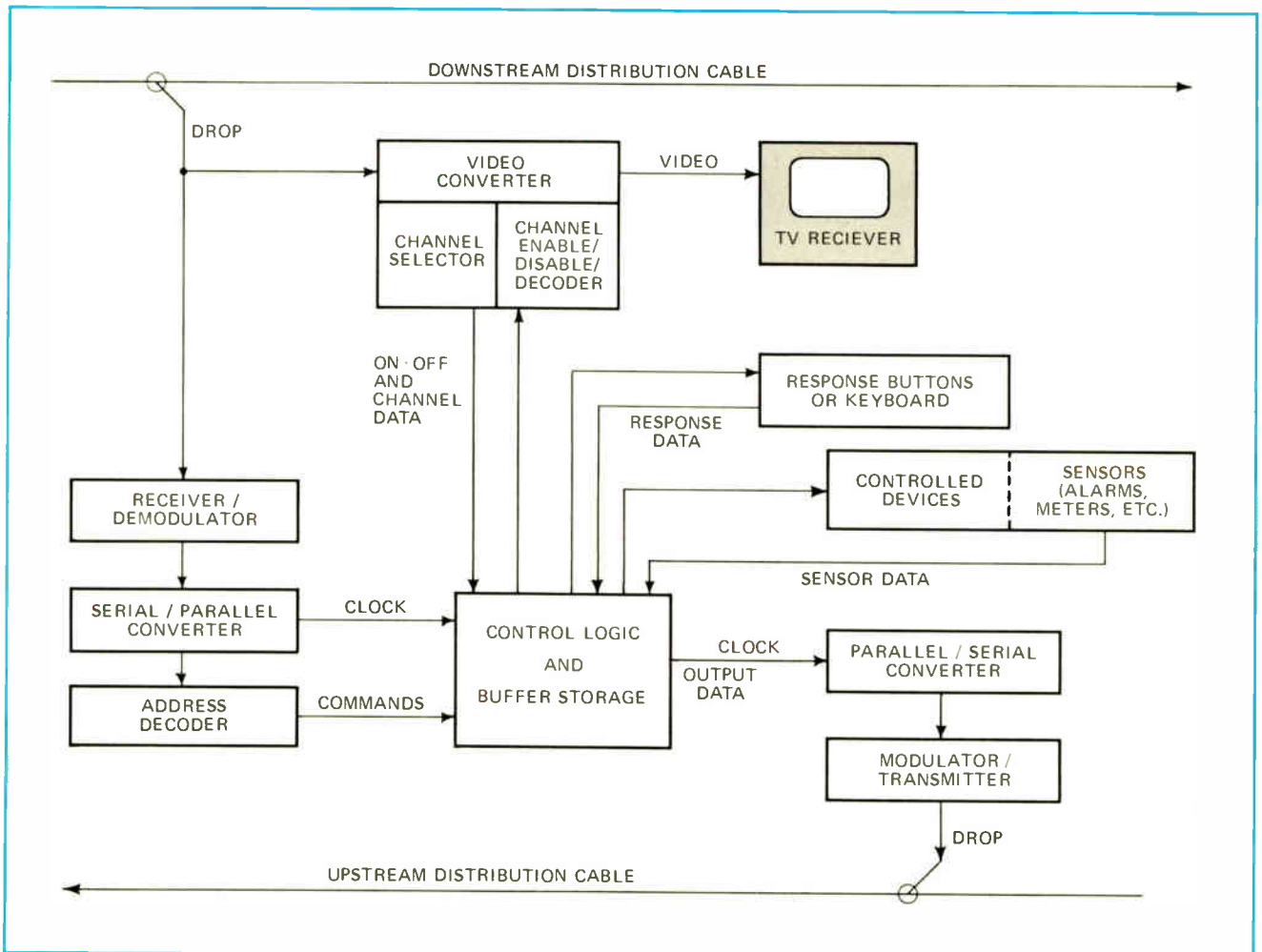

2. Terminal functions. A subscriber-response system requires a home terminal to perform the tasks above—by way of either a separate return transmission line or a single cable used for transmission in both directions, according to a Rand Corp. report, "Interactive Television."

Overseas cable

While CATV supporters have long complained of unfavorable controls in this country and decried the lack of Federal support of the wired city, Europe is a veritable Siberia, by comparison.

The plight of would-be cable entrepreneurs overseas centers around government control of the entire communications network. To date, bidirectional cable systems are but distant dreams in Europe, since there is not much of a cable industry to start with.

In Britain, the government announced last January that it will allow half a dozen new channels for local cable-casting and invited applications for four-year licenses. No advertising will be permitted, and content must be entirely local. Only one company has taken out a license, although powerful Rediffusion has said it will also apply. Rediffusion has not seen fit to try out two-way services on its Dial-a-Program concept outside of its own laboratory—mainly because there are not enough channels available in Britain.

In France, operators and hardware suppliers have

cried for liberty and equality with the government-run communications system, but thus far they have not even been told to eat cake. At a recent international conference on cable in Cannes, France, Henri Weill, director of the Television division of Compteurs Schlumberger, declared that his firm has decided it is "useless" for a French company to start developing a cable system at this time. "We hope that in the coming years the laws will become more flexible, and the development of equipment will become possible."

The French have recently created a company, jointly operated by the Post and Telecommunications Authority and the radio-television monopoly ORTF, to study the possibility of developing cable TV. Observers feel little of substance will come of it.

Belgium remains the Continent's leader in cable, mainly because the country is bilingual and has laws flexible enough to permit importation of foreign signals. Coditel, the largest operator, has more than 100,000 subscribers.

Several two-way CATV experiments have been set up to develop operating techniques. In suburban communities, local experimenters hope to learn if the equipment works, if the services perform as expected, and finally, what services are popular. Suburban communities were chosen largely because the costs of installation and equipment access are much lower than in the cities.

Experiments underway

The Hughes Aircraft Co. Theta-Com division has teamed with TelePrompTer, the largest CATV operator in the U.S., to install its Subscriber Response System (SRS) at El Segundo, Calif. Another duo, composed of American Television & Communications Corp. (ATC), Denver, and Electronic Industrial Engineering Inc. (EIE), North Hollywood, Calif., a recent RCA Corp. acquisition, is installing a similar two-way system in Orlando, Fla.

On the drawing board is an experiment being put together by Community Information Systems Inc. (CIS), using General Electric Co. terminal technology and patents, in Jonathan, a new town under construction near Minneapolis. TeleCable Corp., Norfolk, Va., is a comparative old-timer with its bidirectional video experiment—begun in mid-1971 at Overland Park, Kan., a suburb of Kansas City. Its main thrust is toward education.

Mitre Corp., a Government think tank that has diversified into CATV, is testing a system in Reston, Va., an upper-income community near Washington, D.C. Tocom, Dallas, will install a system, jointly sponsored by a consortium of CATV operators, in a prime TV reception area in Irving, Texas. Tocom will collect fees only for pay TV and home retailing, but this income is intended to support the experiment and pay the franchise license fee.

LVO Cable Inc. has set up a system to provide burglary and fire detection services in two communities outside of Chicago—Carpentersville and Crystal Lake, Ill. Rediffusion International Ltd., the British communi-

cations conglomerate, is trying a different approach with its Dial-a-Program switched network at Dennis Port, Mass.

Problems encountered

These experimenters have encountered a number of problems. On the transmission side, two-way broadband nets are feasible, as engineers have been saying for some time, but a technically feasible system is not always operationally reliable. Unfortunately, a bidirectional system picks up noise from the cable converter, the TV receiver, and outside rf signals.

In a sense, a coaxial cable layout with inadequate shielding and mismatched connections is a huge antenna able to pick up enough outside signals to garble data flowing in the sub-band frequencies from the subscriber to the head-end. At its worst, every home on a two-way net funnels noise and interference into a cumulative stream roaring back to the transmission point.

Until now, installation practices could be fairly lax, so long as the downstream subscriber received a clear picture; therefore, there has been little need to be concerned about noise and interference on one-way hook-ups. But two-way systems cannot live with mismatched, leaky installations.

The Overland Park operators have discovered that there is no such thing as a plug-in bidirectional cable system. Noise and interference caused a nightmare from the beginning—until every dropline was adjusted for rf integrity. "No matter how much testing you do, you get operational problems," James Dixon, TeleCable engineering director, comments.

"When dealing with interference, there appears to be a different mechanism in the sub-bands than in standard television bands. Conditions causing interference one day may not occur on another. In the future, we may want to avoid the ham radio band for return channels, or else get up into the television bands.

"The biggest problem with noise is that every receiver and converter contributes; so the time will come when



3. Two-way environment. A technician inside a Theta-Com temperature test chamber checks a two-way cascade of 15 upstream and 15 downstream amplifiers made by Jerrold Electronics Corp. before they are installed in El Segundo, Calif. Amplifiers are interconnected by a reel of cable to provide normal amount of cable attenuation experienced in the actual system.

we will want television sets in which we can bypass the front end and connect directly into the i-f. We will also probably need a separate maintenance crew for two-way equipment, because the average technician is lost with this system.”

Despite criticism that audio/video is too expensive and invites troublesome noise, TeleCable officials are satisfied with over-all equipment performance.

ATC battles rf

ATC has also been struggling to improve the integrity of the cable layout. “To anybody who tells me that bidirectional cable is a bolt-on option,” Edward J. Callahan, Jr., director of engineering and development for ATC, complains, “I say, ‘no way.’ No one in the industry was really prepared to handle rf interference in the 5-to-35-MHz region.”

But after transmission trials for almost a year, ATC is now ready to deal with rfi. Callahan has installed high-pass filters at the television receivers, gone to 90% mesh in cable shielding, put double-braided copper coaxial cable into the home “drops,” shielded the body and flanges of the pole taps with rfi gaskets, and installed silver-impregnated “O” rings in the cable connectors.

He has also discovered that the connectors, when clamped on the aluminum cable shielding, developed rf leaks caused by discontinuities that resulted from cold flow of the aluminum. Now ATC has a collar installed under the aluminum shielding at each connector point to prevent cold flow.

Rf integrity is more crucial upstream because a small amount of interference can wipe out a return channel, Callahan points out. ATC learned in Orlando to limit

the size of a return area so that the accumulated noise of, say, 10,000 receivers doesn’t come upstream. Instead, the total system is divided into return areas, each assigned a separate three-channel return path. Callahan estimates that a community with 300,000 TV sets on the cable would require 17 return areas. With three channels per area, 51 return channels would be required. However, if rf integrity were lost in one sector, it would not be necessary to shut down the entire two-way system while repairing the one offending sector.

Area control will become more important to ATC as it expands. Ultimately the PolyCom system, as ATC calls its two-way network, will interconnect with other nearby ATC cable systems so that many services can be shared.

“The industry is conditioned to put up anything and hope for the best, but the investment is too high and the need for secure lines too big to be careless,” Callahan emphasizes. “We’re not building a traditional cable hook-up, but a broadband communications system.”

Theta-Com tests amplifiers

To be on the safe side, Theta-Com is putting some of its aerospace know-how to use by testing the amplifiers destined for El Segundo in environmental chambers. A dual-cable two-way cascade, consisting of 15 upstream amplifiers and an equal number of downstream amplifiers interconnected by a reel of cable to provide the normal amount of cable attenuation, has been put under extreme temperature conditions before installation, scheduled to begin this month (Fig. 3). The firm also runs SRS subscriber terminal modems through electro-magnetic susceptibility and radio-interference tests in

an interference-free environment (Fig. 4). These tests should help weed out two-way noise prior to installation.

The first transmission trials of Theta-Com's SRS were run last year in Los Gatos, Calif.; the El Segundo system is a follow-up. Robert W. Behringer, president and general manager, says that the firm is committed to build 1,000 terminals now and is expected to begin paying back on the original investment by the end of 1973. SRS is a computer-interrogated system with the capacity to poll up to 10,000 terminals in 2 seconds. There will be three home terminal models—a three-key unit for simple yes/no/no-opinion replies, another 10-key numeric version, and later a full alphanumeric keyboard. According to Theta-Com, these terminals should sell for \$150 to \$300 in quantity.

Downstream signals are transmitted at 110 MHz and upstream at 23 MHz. Error rate measured at the Los Gatos experiment is 1 in 10^{-6} . Since the single-cable layout in Los Gatos experienced impedance-matching problems at the amplifiers, the El Segundo plan calls for a dual cable. A Digital Equipment Corp. PDP-11 computer, plus a communications interface unit from Hughes, control SRS. While Los Gatos proved out the transmission concept, Richard T. Callais, SRS division manager, observes, El Segundo will test software and cable service operations.

TelePromPTer plans to offer a few services at a time during the early going, including premium TV, security alarm, and remote meter reading. After all of the first 30 units are in place—15 three-key and 15 10-key terminals—Theta-Com plans to move them around to various homes to find out how different locations on the cable affect performance.

Educational TV tried

One of the first interactive experiments to transmit both data and video was begun by TeleCable in mid-1971 to six terminals in Overland Park, Kan. This trial attracted much attention because it went all the way to audio/video/digital, and featured education by TV for two shut-in children. Other services offered were opinion polling and shopping by television, operated for two months in cooperation with the local Sears branch.

Amplification equipment came from EIE, and the home terminals were developed by Vicom, Dexter, Mich., which had the only proven two-way terminal at the time, according to Gordon Herring, director of research at TeleCable.

The system uses the bands between 30 and 50 MHz for return information. A teacher in the TeleCable studio interrogates students from a control console and receives digital responses via the Vicom keyboard. However, if a student wants to make audio/visual contact, he requests permission from the teacher, who can then open the two-way channel. A camera and microphone in the home picks up signals for transmission to the studio, where they are modulated for downstream transmission, thus putting the child on all the home screens.

TeleCable's Herring was frustrated by the piecemeal approach to services that economics forced on the experiment. Recognizing that the best two-way system would be one that offers many services from the begin-

ning, he contends that a lone operator cannot foot the bill.

However, TeleCable is going to expand services, anyway. Later this year Herring hopes to hook up a network to enable physicians at the Kansas University medical center to counsel nurses in Overland Park's schools. A microwave hop from the medical center to the head-end will be extended by cable to the schools so that a doctor can see patients and advise the nurses.

Mitre tries frame-grabber

Another year-old veteran in interactive TV, Mitre has installed its showplace in Reston, Va. To the Mitre planners who set up the experiment, the IBM 360/50 computer, the TouchTone telephone for return information, and the Sony reel-to-reel tape recorder used to capture and hold a single TV frame selectively seem primitive, compared to what a refined system would now entail [*Electronics*, Sept. 27, 1971, p.44].

The IBM computer and a Honeywell 516 process controller were used because they were available at Mitre's office in nearby McLean. (Data is transmitted by microwave to and from Reston and McLean.) The latest plans call for a pair of Data General minicomputers for control and memory retrieval. The Reston cable was not capable of two-way operation; thus the telephone link to the computer was necessary. However, a bidirectional link is to be installed soon. The phone set will be replaced by an alphanumeric keyboard that Mitre has designed to interface with the TV receiver. In light of the slow takeoff of home TV player/recorders, Mitre has scrapped the idea that most American homes would have inexpensive video tape-recorders to double as frame-grabbers to hold static images.

The silicon storage tube, an alternate means for

4. Terminal check. One of the subscriber terminals to be installed by Theta-Com in a home undergoes electromagnetic susceptibility and rf tests in an interference-free chamber to weed out potential noise problems before turning over the unit for field trial.

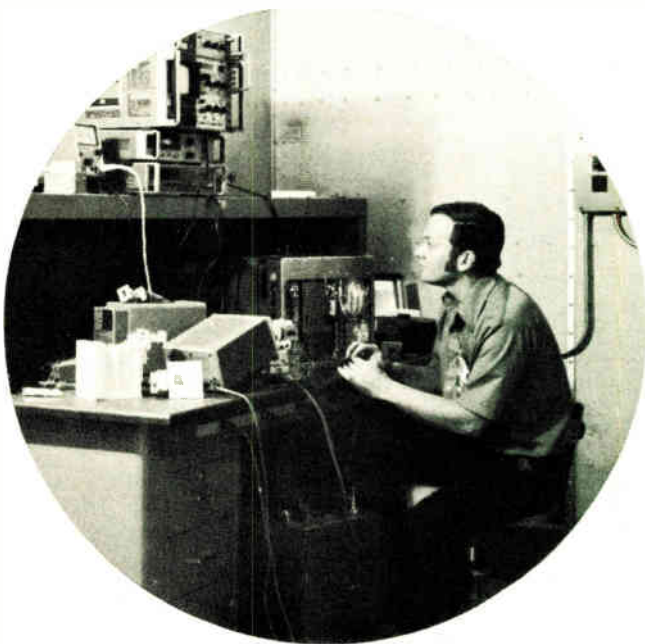

frame-grabbing, is being evaluated. It offers the possibility of cost reduction down to \$10 a unit in large quantities, rather than \$300 estimated for production-quantity VTRS.

The Reston system is weighted toward education, providing the subscriber with the option to order computer-aided instruction through the telephone keyboard for alphanumeric responses. Users can also order the computer as a calculator and use its random-access memory to store and forward figures as needed. A third service brings in directory listings and community activity reports stored in computer memory, demonstrating the ability to search files and present catalogued data.

The next step at Reston, says William Mason, director of Mitre's Systems Development division, will probably be demonstration of what he calls "pop" entertainment. This would include games with the computer, as well as shopping by TV.

Credit verification test set

In Florida, ATC and EIE are also set to install an interrogate-response system with 24 terminals in Orlando homes. The terminal has a 10-character numeric keyboard and a key-actuated switch to authorize pay TV reception. One terminal in a gasoline station is to test credit verification by cable. The minicomputer controlling the system can send 32 bits to each terminal at 42 kilobits a second and get back 128 at 675 kilobits a second.

By early 1973, EIE expects to have installed 3,000 to 5,000 terminals along dual cable lines. Then marketing surveys of the services—pay TV, security alarm, emergency alarm, and shopping, as well as the gas station credit verification—will be possible. As C. Edward Harmon, EIE program manager, observes, "We know how

much it costs; now we have to find out how much it's worth."

What may be cable's most untraditional installation is taking shape this summer in Irving, Texas, under the banner of Tocom, formerly CAS Manufacturing Co. The plan calls for a consortium of eight to 10 operators to support an experimental two-way program in a limited section of Irving. A special two-year franchise has been approved to permit this plan. To hold up its side, Tocom, a turn-key hardware company, will be part of the joint venture. Four MSOs had prepared to join as of last month, and two others are seriously thinking it over.

The Irving plan is designed to test two-way under fire, since potential subscribers already enjoy excellent TV reception of three networks, local channels, and an education station. So if the public goes for the Tocom concept, it will be solely because of the appeal of the extra services that cable can provide. The objective is to reach 100% penetration with an 18.1-mile aerial plant passing 1,234 homes, 1,150 apartment units, and about 40 businesses, plus two high schools. A line is planned to the Dallas Cowboys' new stadium, but how and when games will be broadcast to subscribers will be worked out after the team's owners have completed selling all the seats, which in Dallas shouldn't be long.

Tocom polls subscribers

Like the California and Florida trials, Tocom is a computer-interrogated system (Fig. 5) of polling 60,000 subscriber sets at a rate of 60 in 6 milliseconds. By the end of the year, Tocom expects to have installed about 1,500 terminals.

The transmission system will have a capability of 26 channels downstream at 40 to 250 MHz and an upstream capability at 5 to 25 MHz. The subscriber-response terminal has a five-key keyboard of one to four digits and a clear button, plus a key switch to authorize pay TV. All peripheral devices—such as burglar alarm,

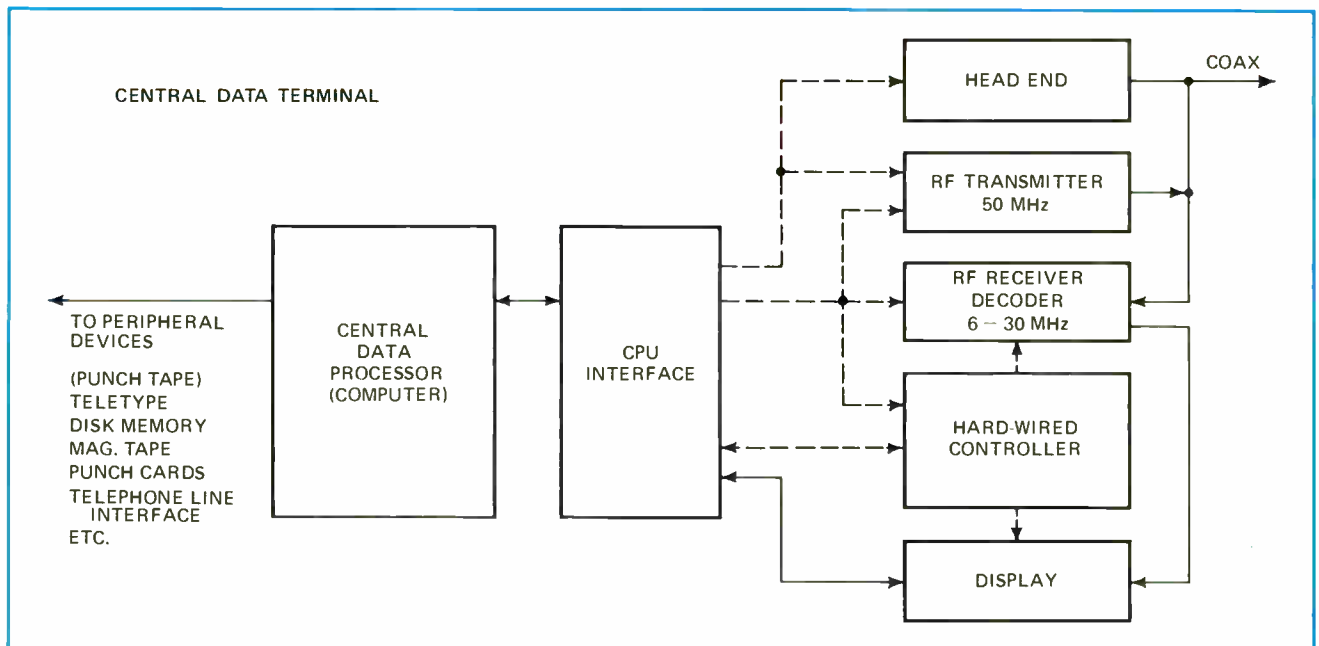

5. TV computer. A central data processor, designed for the Tocom system to be installed in Irving, Texas, controls terminal interrogations and responses to returning data, such as fire and burglar alarms. The computer has the capacity to interrogate up to 60,000 terminals.

Table 1
ADDED COST OF TWO-WAY TRANSMISSION FOR A 200-MILE CABLE SYSTEM

Two-way Option	Added Cost			Total Cost	Cost per Mile
	Trunk	Feeder	Taps and Drops		
1. Wire pairs	\$ 17,000	\$ 36,000	\$ 25,000	\$ 78,000	\$ 390
2. Single cable FDM	\$ 41,000	\$ 125,000	0	\$ 166,000	\$ 830
3. Separate cables	\$ 84,000	\$ 191,000	\$ 50,000	\$ 325,000	\$ 1,625
4. Separate trunks, FDM on feeders	\$ 84,000	\$ 125,000	0	\$ 209,000	\$ 1,045
5. Switched distribution system	—	—	—	\$ 425,000 – 900,000	

Source: Rand Corporation

fire alarm, emergency assistance request button, and utility meter—are connected to the terminal via a multi-conductor connector in the rear.

Each remote unit is identified by a separate group and identification number and, upon interrogation by the central data terminal, will respond in the form of five 16-bit words indicating its condition.

The advantage of the interrogation speed is most apparent in alarm situations, Brian Belcher, Tocom engineering head, points out. When a remote unit responds to the computer with an alarm bit, the computer will interrogate that unit 100 consecutive times in 0.6 second. If, during the 100 interrogations, the computer accumulates 90 alarm bits, it assumes that an alarm condition exists. This triggers a display panel at the operator's console to show the location, and a bell rings to attract attention.

A Teletype then prints out the group number, identification number, date, time, and type of alarm. This system will also be able to interface with an optional automatic telephone dialer to notify the fire or police department, or a protection agency.

The subscriber Response Unit (SRU), to be tested at Jonathan, Minn., was developed jointly by CIS and GE. The SRU has a 12-key keyboard and a Nixie-tube display screen (Fig. 6) to show the codes being transmitted upstream. After a period of showing the system's capability, which will feature six interactive services, including video retrieval, installation will begin this fall in 50 to 100 buildings, launching a year-and-a-half trial. CSI estimates that it will cost about \$4 million to wire 1,000 to 1,500 buildings in the new town. The LVO cable program near Chicago will use digital terminals developed by Scientific-Atlanta Inc., Atlanta, Ga. Oak Security Inc., a subsidiary of Oak Electro/netics Corp., will provide burglary and fire detection sensors, and operate the system's security portion.

An interrogation-type, time-division-multiplexed, single-cable net, the LVO/Scientific-Atlanta plan uses 12.5 MHz for downstream transmission and 5.5 MHz for upstream. Originally designed to be a security system only, the Scientific-Atlanta operation will include opinion polling and limited-access channels for pay TV, starting sometime this summer.

Rediffusion International has tested its Dial-a-Program concept for the last year and a half at Dennis Port, Mass. Dial-a-Program operates on a switched network, using multipair cables. Instead of each separate pair being dedicated to the distribution of an individual program, each pair is dedicated to connecting a specific subscriber to a program exchange, from which that subscriber may select a channel by means of a telephone-type dial.

Dial-a-Program tested

Rediffusion transmits all programs on the same carrier at 7.94 MHz, with the upper sideband suppressed. With all programs in the same carrier, it means that there can be no crosstalk between the carrier of one program and the carriers of programs on neighboring cable pairs; therefore, separation of about 45 decibels, or about the same as between two video-frequency circuits, is required.

At first glance, the Rediffusion home equipment looks like the offspring of mating a telephone and television set. Instead of a tuner and converter, the user has a dial selector to send his channel selection to a switching station, which connects the receiver to the proper channel (Fig. 7). An inverter at the receiving end converts the 7.94-MHz signals from the switching station to the high band for viewing on the home screen.

The exchange net requires four wires in matched pairs and has a 36-channel capacity, although Dennis Port subscribers have only six entertainment channels. At program exchanges, buses in banks arranged by switching level handle a maximum of 336 subscribers. These exchanges are connected to others by trunk lines.

There aren't any amplifiers between the program exchange and the TV receiver, which means that cable lengths are limited by the attenuation and the tolerable level of crosstalk from adjacent pairs carrying different programs.

The limit set by these two considerations is about 1,200 feet. Because of this, the Rediffusion concept may find early acceptance for internal systems with a limited number of users. Dial-a-Program has recently been accepted for a student-participation, random-dial-access, audio-visual setup at Case Western Reserve University

SPECIAL REPORT

in Cleveland. A student will be able to dial a request for a video tape stored in a library and remotely control the tape recorder from his Dial-a-Program receiver.

Software is need

Cable integrity is a problem involving basic practice—tedious, but possible to solve with high-pass filtering and careful shielding. Software development, on the other hand, is a bed of quicksand comparable to the first applications of computers, when users invariably underestimated their complexity and costs of programming.

In cable television, software has two meanings—the programs transmitted to subscribers and the programs required for the computer to control this transmitted material. Thus, the MSOs must have programmers. The importance of software in the cabled metropolis cannot be overstated; yet until more experiments get under way, it's impossible to judge whether or not standard software for multiple system use will be possible or if each CATV franchise will have to provide its own computer programs.

Vicom president Harold Katz says that software must be written so that generalized computer programs can be used. It should be possible for the various operators to use the same software, as well as the same hardware, he says.

Katz also points out that the technical trial at Overland Park underscores the need for a “generalized ter-

minal,” that is, a home unit capable of handling a number of services. Dr. Walter Baer, a consultant for Rand Corp. and author of a Markle foundation study on interactive TV, supports the total two-way service approach, pointing out that though terminals may represent a significant capital expense now, prices should come down when manufacturers go to large-scale integration. A two-way terminal in the \$150 range is possible in large enough production quantities.

In a sense, operators and hardware designers seem to be saying, “We don't know where we're going, but we know how to get there.” Like all innovators, the systems planners are open to criticism—most of it from each other. The MSOs are knocking competing systems as hand-tooled, gold-plated, under-designed, show-boating, impractical, short-sighted, and one-shot deals.

The two-way problems suggest the need for more engineers, particularly systems-oriented, development-thinking EEs. Operators and suppliers say they need engineers badly, but admit that the cable industry cannot afford fancy salaries.

While the engineers puzzle over the system design, cable integrity, and computer programming, the marketing side of CATV has yet to establish which of the 100 or so potential services made possible through interactive television will actually sell. And no one is sure how much the public is willing to spend for added features.

Will the public buy it?

While the two-way contenders sort themselves out, another potential detour has developed because of pay TV on one-way cable. Some observers contend that pro-

6. Double check. The keyboard, designed jointly by Community Information Systems Inc. and General Electric Co., features a four-digit tube display to show the subscriber the codes being sent upstream. This response confirmation eventually will appear on the TV receiver.



viding first-run movies via single-cable will whet the public's taste for cable and provide quick profits for operators. And Rand's Dr. Baer suggests that, once attached to the subscription movie business, operators may be slow to reinvest in wider two-way services requiring more sophisticated terminals.

Among the results the experimenters hope to ascertain later is what services are popular. Potential weaknesses in these trial efforts are an almost complete absence of business or industrial users because CATV is a home-oriented industry. Secondly, these affluent test communities may not reflect what services economically and socially diverse core-city residents will want from cable. On the other hand, since the primary goal is engineering shakedown, these early installations must be considered test tubes rather than full-fledged operations.

Mitre's Mason observes that none of the experiments will break out into the real world until cable operators are shown the commercial benefits of two-way investments. "The social benefits are so great that the U.S. Government will have to be involved—at least to the point of providing seed money. System operators do not want 'blue-sky' services. They won't be motivated until they are shown that the rate of return is better on two-way than on a typical one-way transmission."

While the FCC has provided mild encouragement, other Federal agencies that might reasonably be expected to support education, transportation, and law enforcement experiments via two-way cable have not provided much funding.

Small Government grants received

One encouraging move is a grant of more than \$2 million by the National Science Foundation to Mitre for an experimental program to provide instruction over TV in mathematics and English at two junior colleges. And CSI has obtained a \$175,000 grant from the Department of Housing and Urban Development to aid the experiment at Jonathan, Minn.

The FCC has provided an entry into the major cities with the agreement hammered out with the White House Office of Telecommunications, broadcasters, cable operators, and entertainment producers on rules for importing distant signals, along with the ruling on bidirectional capability. As in most compromises, operators did not get all they wanted. The MSOs contended that in order to earn enough income to finance bidirectional services, they had to be able to import signals from other cities. They received authority to import signals from only a limited number of sources.

Because of this restriction, cablecasters may have to grab pay TV first, says a Rand Corp. investigator, Nathaniel E. Feldman, since the FCC has not given cable a wide enough entry into the 100 top markets.

"On the issue of importing distant signals, the FCC's ruling was like putting a man on 800 calories a day," Feldman contends. "It's enough to stay alive, but not enough to prosper." Consequently, there will be less income available to support two-way investment, and the Government seems reluctant to spend more money until the benefits are more fully demonstrated.

As for the hardware suppliers, Feldman chides,

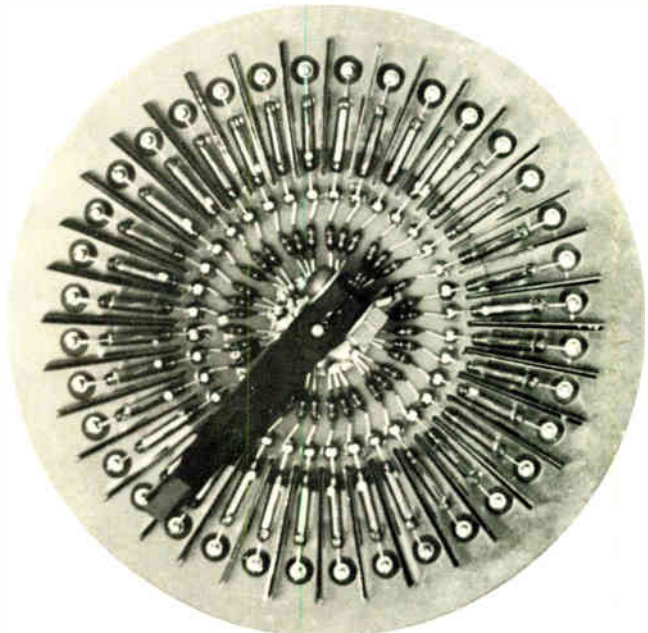

7. Switching channels. Selector switches used by Rediffusion International Ltd. have reed relays operated by a magnet mounted on a rotating arm. It is stepped by subscriber-dialed impulses.

"There has been more distortion and baloney about two-way cable than any other subject. To date, manufacturers have sold more stock than hardware."

But the big boys on the block are moving in. Hughes has entered with Theta-Com, and RCA's acquisition, EIE, is a partner in the ATC system. GE is entering with its technology in the CIS experiments, and more companies are sure to follow. Their help will provide a big boost to the risky business of CATV financing.

The investment necessary to get a wired city is much higher than MSOs have ever known, however. A recent study conducted by Mitre for the Markle foundation on bringing two-way CATV to Washington, D.C., indicated just how risky this move can be. Mitre estimated that in a 10-year period, total expenditures to provide all the bells and whistles could amount to \$192.98 million. Income from this period is estimated at \$199.70 million, which is too close for comfort. The largest MSO in America, TelePrompTer, grossed \$50 million in 1971 with about \$156 million in total assets.

Of the capital expenditures, estimated to be \$61.21 million, terminals would account for \$40 million, according to Mitre. And this projection assumes a high percentage of penetration which CATV does not yet have in this country. Multiply these figures by 100 cities, and the risks take on enormous proportions.

With these technical, software, marketing, and financial obstacles, the wired city may be seen as far away as Camelot, rather than a practical communications plan. Yet experimental programs continue to take shape and show promise. The potential of bringing new life to TV—which has become to many a dull, repetitious medium—serves to make CATV's immediate problems more frustrating for those who are involved. For the extra, interactive services possible in the wired city will not only make new fortunes for CATV, but in all likelihood revitalize television viewing. □

The 90% time-saver.

New Burndy One-Piece Contact
for Coax and Twisted Pair.

We took five pieces and combined them into one. The result? A one-piece contact, so much easier to handle that it takes only 15-30 seconds to install. Not the usual 4-5 minutes. A solid 90% timesaving.

Just four simple steps are required. Insert the coax or twisted pair. Crimp the inner conductor. Crimp the outer conductor. Heat to reflow the solder.

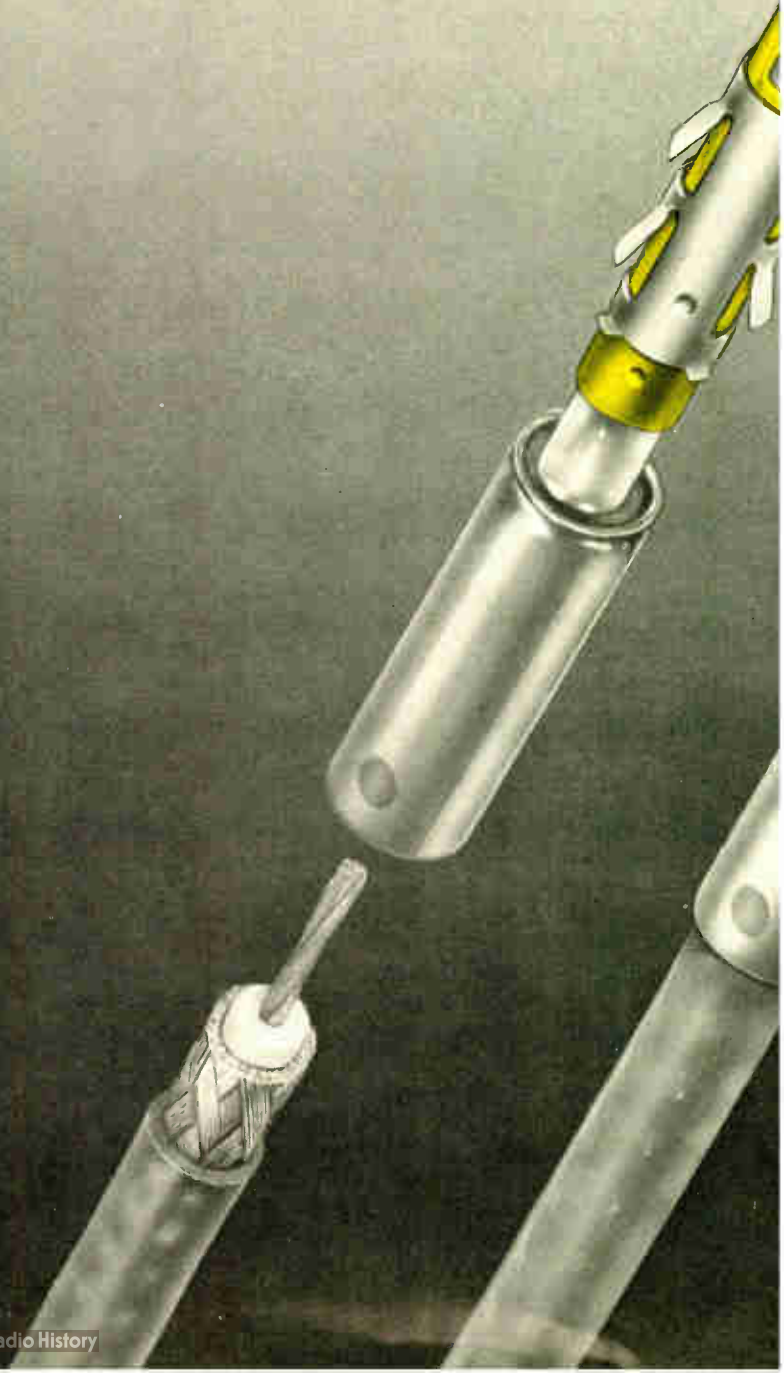

See it at NEPCON EAST, June 13-15, booth 5101

World Radio History

You can expect fewer rejects and more reliable connections because quality control is improved along the line. There are tiny inspection holes to permit a visual check before each crimp is made. A Burndy exclusive is the small black dot that appears when the soldering is completed. It's a heat-sensitive paint on the outer ferrule that changes color to indicate proper heat has been applied for sufficient time.



A range of Burndy tooling is available to let you match your job needs and production rates precisely. For high production, our bench mount CATS machine can crimp and reflow solder up to 240 contacts an hour. If you want a portable system that works in limited access areas, use our MINI-CATS machine (pictured left).

The new Burndy One-Piece Contact is designed to work with our Trim Trio System. It's interchangeable with power contacts in round or rectangular connectors. And it can intermate with existing multi-piece, sub-min contacts. So, in addition to saving time you save on inventory. And you open up design options at the same time.



Norwalk, Connecticut 06856

INTERNATIONAL SALES HEADQUARTERS & MANUFACTURING FACILITIES:
CANADA/ENGLAND/BELGIUM/MEXICO/BRAZIL/JAPAN/Sales Offices in Major Cities



BURNDY  **CONNECTS**

World Radio History

Circle 101 on reader service card

Control one-shot divides frequency by up to 30

by Jerome Snaper
Leach Corp., Controls Div., Azusa, Calif.

A three-gate control allows precision frequency divisions of up to 30 merely by changing a resistance. A crystal oscillator acts as the frequency source so that all subharmonics of the reference frequency have crystal stability.

NAND gates G_1 and G_2 and the crystal comprise the oscillator that generates the reference frequency. The one-shot, consisting of NAND gates G_3 and G_4 , controls

gate G_5 , which is synchronized by the oscillator.

After one pulse of the reference frequency passes to the output, the one-shot locks out gate G_5 for a period of time determined by the setting of potentiometer R_1 . When the one-shot resets, another single pulse reaches the output, and the cycle repeats.

The input frequency, f_{in} , is simply a multiple of the output frequency, f_{out} :

$$f_{in} = N f_{out}$$

where N is the division factor. N can have any integral value between 2 and 30. The circuit shown divides a 1.1-megahertz reference frequency by 11 to yield an output frequency of 100 kilohertz.

Additional versatility is possible by substituting a field-effect transistor or voltage-variable resistor for the potentiometer. Then, frequency divisions can be electronically swept over a wide range. □

Precision division. Crystal oscillator supplies reference frequency for three-gate divider scheme. NAND gates G_3 and G_4 form one-shot that controls gate G_5 . After G_5 passes single reference pulse, one-shot inhibits this gate for period selected by adjustment of potentiometer R_1 . When one-shot resets, another reference pulse passes to output. Crystal frequency can be divided by up to 30 without loss of stability.

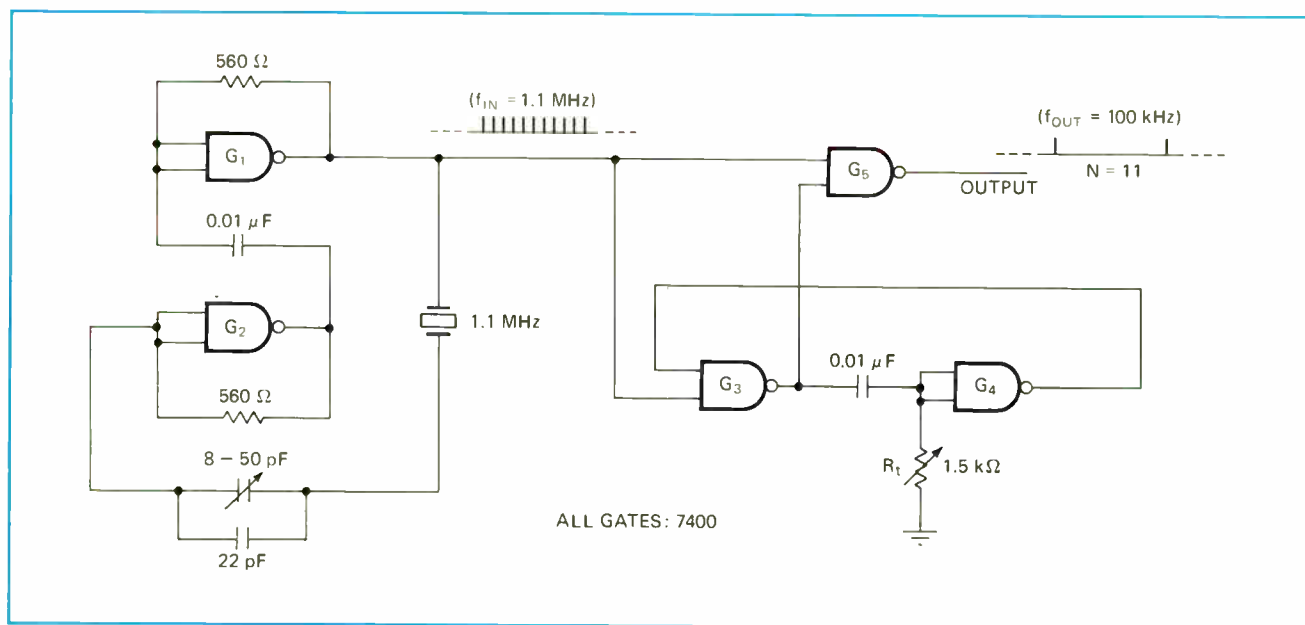

Pulsed standby battery saves MOS memory data

by K. C. Herrick
Fisher Berkeley Corp., Emeryville, Calif.

A simple pulsed battery supply can reduce standby power necessary for MOS random-access memories to

one-thousandth of the operational requirement. In many systems, this power-saving scheme allows inexpensive batteries to be used with essentially shelf-life longevity. In some cases, merely a capacitor can supply enough standby power to sustain memory until an auxiliary power source can come on-line.

A typical RAM cell consists of a cross-coupled multivibrator with active MOS transistor loads. When there is a power failure, the potential across the multivibrator declines toward zero. As long as its inputs are kept off, the cell is isolated from external influence, except for

leakages, when the MOS transistors cease conducting.

The charges remaining on the gates of the cross-coupled transistors then begin to leak off exponentially. If power is reapplied within a short period of time, however, sufficient differential charge levels remain on the gates to re-establish flip-flop conduction in the same state as when power failed.

It is this cell characteristic that can be exploited to save standby power. The potential across the multivibrator must be reapplied periodically, at a rate fast enough to replenish the MOS gate charges before they decline below threshold levels and for long enough to re-establish fully the charge levels. Usually, a sufficient rate is 1,000 hertz with a pulse width of 1 microsecond. For any given type of memory and upper temperature limit (leakages increase with temperature), the required duty cycle may vary.

Of course, the potential needed must be reapplied within the maximum period of time that is allowable (for example, 1 millisecond). The little-used series multivibrator and a 14-volt battery (a) will do the job. The nominal memory cell potential is 15 v, less one diode drop, or about 14.3 v.

When power fails, diode D_1 disconnects the RAM's V_{DD} line from the main supply. The memory potential of $V_{CC} - V_{DD}$ declines in magnitude until the voltage of $14 - (V_{CC} - V_{DD})$ is large enough to start the series multivibrator. Oscillations usually begin when the voltage across the multivibrator becomes about 0.75 v. The components shown yield a pulse width of about 1 μ s and a pulse interval of about 500 μ s.

If a rechargeable battery is used, the diode and resistor connected with dashed lines may be added to allow the battery to charge while the main power is ap-

plied. The memory's peripheral-circuit supply voltage V_D can become zero and remain zero during the loss of main power, without any effect on data retention.

While the memory supply voltage is decreasing, the memory's chip-select input must be held FALSE at the V_{CC} (+5 v) potential. TTL devices or other elements driving this line may change state erratically when the 5-v logic supply loses voltage. The presence of these stray signals may cause a RAM cell to change state.

A circuit for maintaining the chip-select line at the instantaneous V_{CC} level is shown in (b). Since the 14-v (in this case) semi-regulated supply is the power source for the 5-v regulated logic supply, in the event of power failure the 14-v source will lose voltage before the logic supply.

Transistor Q_1 is normally kept on by base current from the 14-v supply via zener diode D_1 . Collector current from Q_1 biases Q_2 on. Base current from Q_2 causes only a negligible drop below 5 v in the FALSE voltage level of the memory chip-select line, due to the high resistance ratio of R_1 to R_2 . Whenever a zero chip-select voltage is applied to Q_2 's collector from the control logic, Q_2 conducts, and its emitter voltage changes to the TRUE level (0 v).

Upon power failure, the 14-v and 10-v supplies begin to lose voltage. Transistor Q_1 's base current will become zero when resistor R_3 's voltage drops below about 0.7 v. At this time, voltage V equals 10.7 v—20.7 v above -10 v or 5.7 v more positive than V_{CC} —a value that still maintains the 5-v V_{CC} level. When Q_1 stops conducting, Q_2 is cut off, and the memory's chip-select input line is connected only to V_{CC} via resistor R_2 . Therefore, even if V_{CC} decreases in value, the chip-select line remains at the V_{CC} potential. \square

Preserving memory contents. Series multivibrator and battery (a) allow MOS random-access memory to retain data when power fails. Circuit takes advantage of MOS charge retention property so that pulsed voltage is sufficient to refresh memory. Dashed components let battery recharge when main power is restored. Protection circuit (b) for chip-select line prevents erratic logic signals from changing memory state.

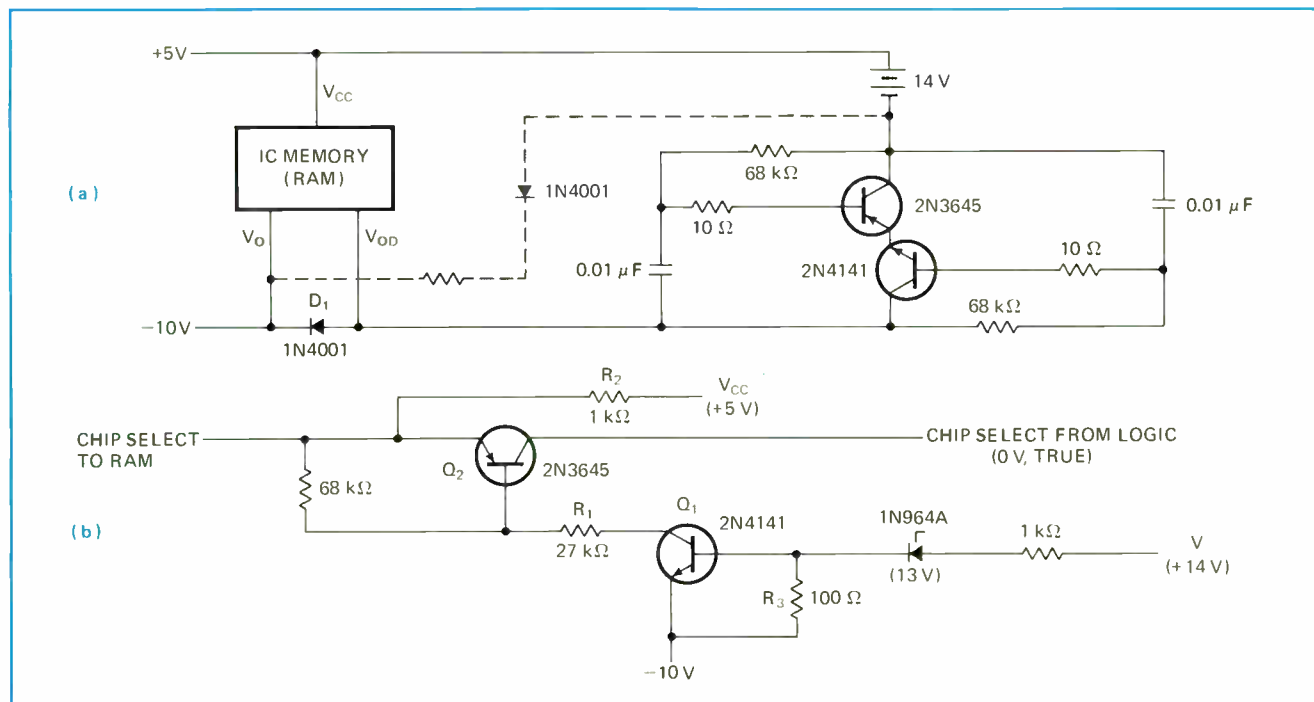

Triangular-wave generator spans eight decades

by William S. Shaw
University of Texas, Applied Research Laboratories, Austin, Texas.

Because of its nonsaturating design, a triangular-wave generator can cover eight decades of frequency—from 0.01 hertz to 2 megahertz. Lower and upper frequency limits are set by resistance adjustment. Circuit layout is not critical, and complementary circuitry assures output symmetry and amplitude stability, as well as the absence of dc offset. By decreasing output voltage swing and increasing current, the generator's frequency range can be made to span 1 to 20 MHz.

Transistors Q_1 and Q_2 are constant-current sources whose outputs are switched to produce the charging and discharging currents for the output capacitor. Transistor pairs Q_3 - Q_4 and Q_5 - Q_6 are differential amplifiers that function as comparators; Q_3 and Q_6 conduct whenever Q_4 and Q_5 switch off, and vice versa.

The series string of diodes D_1 and D_2 and resistors R_1 , R_2 , R_3 , and R_4 set comparator voltages V_1 and V_2 . Diodes D_1 through D_4 compensate the four-transistor integrated-circuit array so that the generator maintains its frequency stability with changing temperature. Comparator input and output currents are:

$$i_1 = 28.7R_1 / (R_1 + R_2 + R_3 + R_4)R_5$$

$$i_2 = R_7 i_1 / R_6$$

When Q_4 and Q_5 are on, Q_3 and Q_6 are off, and output capacitor C_1 charges at a constant rate (since i_2 is a

constant) until the upper trigger level (V_U) is reached:

$$V_U = V_{E1} + V_{BE1} + V_{D5}$$

where V_{E1} is the voltage at Q_1 's emitter, V_{BE1} is Q_1 's base-emitter voltage, and V_{D5} is the voltage across diode D_5 . Once output voltage equals V_U , transistor Q_1 conducts and Q_2 switches off, turning Q_3 and Q_6 on. Since R_7 is larger than R_6 , Q_4 and Q_5 will switch off.

Due to the symmetry of the circuit, capacitor C_1 is discharged by transistor Q_6 at the same constant rate as it was charged and by the same current, i_2 . The capacitor discharges to the lower trigger level (V_L):

$$V_L = V_{E2} - V_{BE2} - V_{D6}$$

where V_{E2} is Q_2 's emitter voltage, V_{BE2} is Q_2 's base-emitter voltage, and V_{D6} is the voltage across diode D_6 . When V_L is reached, Q_1 turns off, Q_2 turns on, and V_2 becomes larger than V_4 . This switches on Q_4 and Q_5 , causing Q_3 and Q_6 to switch off by feedback through capacitor C_2 . The cycle can now repeat.

Diodes D_5 and D_6 allow the output to slew above and below the limits imposed by the emitter-base breakdown voltage (about 6 v) of Q_1 and Q_2 . The generator will oscillate without latch-up as long as V_{E1} is less than V_1 and V_{E2} is greater than V_2 .

For a 20-v peak-to-peak output, the frequency is:

$$f_{out} = 0.0425i_1 / C_1$$

Capacitor C_1 determines nominal output frequency, while resistor R_3 sets the lower frequency limit and potentiometer R_2 sets the upper limit in addition to providing a linear frequency span of 20:1. When $R_2 = 500$ kilohms and $C_1 = 1,000$ microfarads, $f_{out} = 0.01$ Hz; when $R_2 = 0$ and $C_1 = 100$ picofarads, $f_{out} = 2$ MHz. □

Designer's casebook is a regular feature in Electronics. We invite readers to submit original and unpublished circuit ideas and solutions to design problems. Explain briefly but thoroughly the circuit's operating principle and purpose. We'll pay \$50 for each item published.

High-frequency triangles. Complementary nonsaturating circuitry permits triangular-wave generator to provide 20-volt output at frequencies as high as 2 megahertz. Output triangle is obtained by charging and discharging C_1 . Current from Q_2 charges C_1 until output voltage reaches threshold V_U , then Q_3 - Q_4 and Q_5 - Q_6 comparators switch, and Q_1 supplies discharge current until threshold V_L is reached.

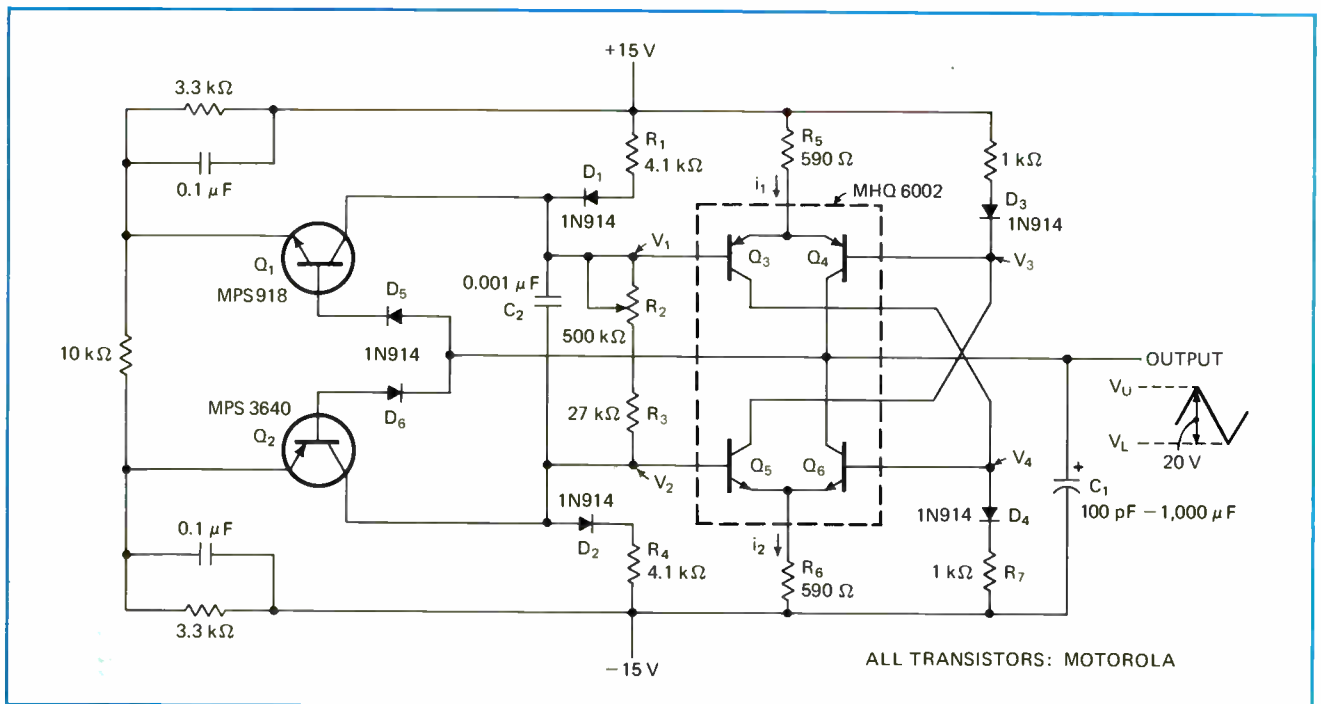

The amplifier-per-channel
Neff system 620

Like buying a Porsche at Volkswagen prices!



At long last. A high speed-amplifier-per-channel data acquisition system at the price of a low level multiplexer.

At under \$150 per channel, that's like buying a new 911 Porsche at the price of a Beetle.

Everyone agrees that for performance, the amplifier-per-channel approach wins hands down. With isolation right at the signal source, higher CMR, less crosstalk, lower noise, higher speed, greater accuracy, continuous analog output, active low pass filter, protection against loss of data on other channels if one is overloaded. And that's just for openers.

Take a good look at System 620. Behind that handsome front panel are 64 field-proven Neff amplifiers and active filters - one for each input channel. Plus a high level multiplexer, gain programmable amplifier, 50KHz ADC and TTL logic to easily mate with your computer. And in the remote mode, your computer has complete control over addressing and gain programming.

Expandable? Just add 3 more boxes and you have a 256 channel system that takes up just 28 inches of rack space. And prices out at under \$40K. Or, System 620 can be configured to handle up to 2048 channels.

System 620 is possibly the most important development in data acquisition since the differential amplifier itself. And we were the people that invented the differential amplifier. Send for the whole System 620 story today.

NEFF
INSTRUMENT CORPORATION



1088 East Hamilton Rd., Duarte, California 91010
Telephone (213) 357-2281 TWX 910-585-1833

World Radio History

Circle 105 on reader service card

SPECIAL REPORT

Improved n-channel processes make their move in memories

Adding silicon gate to n-channel structure gives a new look to semiconductor memories: faster, denser, and ultimately cheaper

by Laurence Altman, *Solid State Editor*

□ With the silicon-gate n-channel process finally under control at many semiconductor houses, builders of MOS random-access memories are out to conquer the world.

The designers say that n-channel devices give them the performance edge they need over p-channel devices for large RAMs. As proof, they point out that:

- n-MOS memories will be two to three times faster than most p-MOS memories (100-nanosecond or even shorter access times for n-MOS, typically 200 to 300 ns for p-MOS).

- n-MOS is two to four times denser (four to eight thousands bits per chip for n-MOS, one to two thousand for p-MOS).

- n-MOS is potentially cheaper per chip function than p-MOS memories (perhaps settling at 1 cent per 100 bits of memory for n-MOS as against 1 cent per 10 bits for today's p-MOS).

- n-MOS is generally lower-threshold than p-MOS (2 to 5 volts for n-MOS, 10 v for p-MOS).

What got the n-channel process on stream is a new ability to make reliable n-impurity diffusions in p silicon—long a vexing problem to IC manufacturers. Anxious to get MOS products on the market, they at first stuck with the easier p-channel process. But as the designers gained more n-channel experience from their complementary MOS efforts (C/MOS has both n and p devices on the same chip), they turned again to n-MOS. Adapting silicon-gate techniques to n-channel structures was the clincher: n-channel MOS was a going thing.

Several properties of the silicon-gate n-channel process are responsible for better device performance and increased bit packing density: carrier mobility, electrical characteristics, and device geometry. Because n carriers have higher mobility than p carriers, n-channel devices are from two to four times faster, depending on clock voltage. And because of reduced parasitic conduction, reduced spacing between memory elements, narrower line widths, and smaller contact holes, memory elements are smaller and can be placed closer together—typically 0.2 mil

widths and spacings for n-MOS, as against 0.6 mils for p-MOS.

By now, just about everyone has an n-channel process—from the large across-the-board manufacturers like TI, Motorola, and Fairchild, to tiny new companies like Cogar, Ragen, Standard Microsystems, Electronic Arrays, and others that are putting a large share of their resources into exploiting the technology. Then there are the memory-oriented companies like Intel, which pioneered the silicon-gate process and is now adapting it to n-channel memories.

Surprisingly, there may be more to n-channel than memory, for n-channel logic is in the wind. Because of its high speed, delays of better than 20 ns are in the offing with n-MOS logic circuits—speeds that are comparable to TTL gate performance. An entire logic and memory technology could be built with one n-channel process, resulting in a truly homogeneous LSI technology (see panel, p. 113).

There is competition, however. New bipolar techniques threaten to crowd n-MOS in the memory field. High-bit (1,024) RAM processes, such as Isoplanar from Fairchild, Oxium II from Bell Labs, V-ATE from Raytheon, CDI from Ferranti, and compose masking from TI are all on the breadboard. And new bipolar circuit techniques, such as dynamic memory operation (Bell Labs), the all-transistor cell that eliminates resistors with lateral pnps (IBM, Germany), and ion-implanted high-resistivity resistors, all promise to reduce bipolar cell size even further, and lower power dissipation to levels even below those of n-MOS circuits.

The two articles that follow explore the two ends of the n-channel performance range. First, designers at Intel discuss a production reality: a moderately fast, moderately dense, recirculating dynamic shift register that is directly TTL-compatible and needs only a single +5-v power supply. The second article describes a promising but more exploratory process that puts the n-channel technique through all its paces: 4,096-bit RAMs with access speeds of 200 ns.

N-channel goes to work with TTL

Two dynamic shift registers and a static RAM operate from a single 5-V supply, have 1-V thresholds

by R. Abbott, H. Gopen, T. Rowe and D. Bryson,
Intel Corp., Mountain View, Calif.

□ Nearly ten years of increasing success with p-channel devices have brought MOS technology to the point where it can tackle the much harder job of n-channel processing. With the addition of silicon gates, such devices can outdo their p-channel forerunners in speed, packing density, and low threshold voltage. They also offer direct compatibility with transistor-transistor logic.

For instance, a family of dynamic recirculating shift registers now being built with a silicon-gate n-channel process has speeds typically of 2 megahertz and threshold voltages of less than a volt, and is TTL-compatible; it enables an entire memory subsystem to operate from a single +5-v power supply. The same process is being used to build a static 1,024-bit random-access memory, which also operates off a single +5-v supply.

A different n-channel process is being developed that will yield a 4,096-bit dynamic RAM. Like most MOS devices, this will require both positive and negative supply voltages.

An alternate approach to designing n-channel devices is to forego compatibility with TTL and instead go all out for speed. This requires the device to be operated like its p-channel equivalent, at drive voltages of 10 to 17 v. But for this initial family of circuits, TTL compatibility was preferred, in order to promote its use in existing systems.

How to make n-channel devices

The processing steps used in building the shift registers and the static RAM are much the same as those for p-channel silicon-gate structures. The difference is that with n-channel devices the starting wafer is boron-doped, p-type silicon. The device threshold is then maintained at less than 1 v by controlling the impurity of the boron and the thickness of the gate dielectric.

Fabrication starts with the p-type wafers being thermally oxidized to a thickness of about 1 micrometer, and parts of the oxide being removed to define the diffusion and gate regions in the first of five photomasking steps. Then a gate dielectric and a polycrystalline silicon are deposited, and areas defining the gate regions of the transistors and the deposited silicon undercrossing are etched out, again by photomasking.

Next comes a diffusion operation, in which n-type impurities form the source and drain regions and the dif-

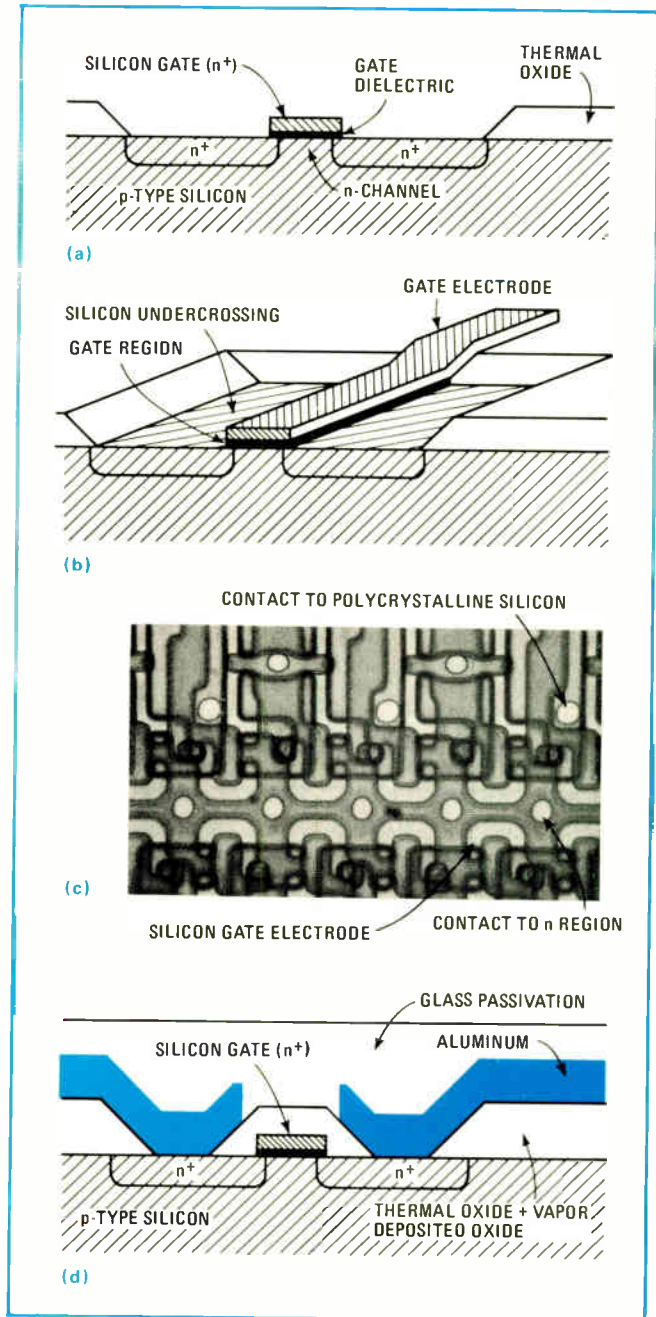

1. Making n-channels. Fabricating n-channels requires the deposition of a gate dielectric and polycrystalline silicon (a), after which an etching step defines the gate regions and the silicon undercrossing (b). Next, contact holes are etched through the glass to the polysilicon and diffused regions (c). The finished device has the usual aluminum interconnection and glass passivation (d).

fused undercrossing (see Figs. 1a and b). Glass formed by the oxidation of silane is then deposited on the wafers at low temperature, and contact holes are etched through it to the polycrystalline silicon and the diffused regions (see Fig. 1c).

Aluminum is evaporated onto this surface, and a fourth photomasking step forms interconnection patterns. Finally, the wafers are heated (alloyed) to insure ohmic contact between the aluminum and silicon, and a glass passivation layer is vapor-deposited over the surface. The fifth photomasking step removes the glass

SPECIAL REPORT

from the bonding pad area and the scribe line.

A cross section of the completed device is shown in Fig. 1d. For some more complex n-channel arrays, a buried contact may be desirable to save silicon space. The price is an additional photomasking step, used to etch contact windows before the polycrystalline silicon is deposited, so that the polysilicon may make direct contact with the diffused regions.

Low voltage payoff: greater density

There's more to this low-voltage n-channel silicon-gate process than just the convenience of its compatibility with TTL. The size of a given chip layout is a function of the voltages applied to the various junctions, and since the low-voltage device requires only a +5-volt supply, and since the internal nodes are at even lower voltages, diffusions may be placed close together (0.4 mils) and channels may be short (0.25 mils). Indeed, tighter and smaller layouts are possible without the expense of tight alignment tolerances.

The resulting high packing density permits larger arrays at a lower cost per bit. Table 1 lists the area savings it makes possible, and Fig. 2 shows the photomicrographs of the cells for the devices listed in the table. For a RAM, the n-channel array needs a memory cell less than half the size of a comparable p-channel device cell, enabling a chip that could handle only 256 bits as a p-channel RAM to accommodate 1,024 bits as an n-channel RAM. A similar density advantage applies to shift registers.

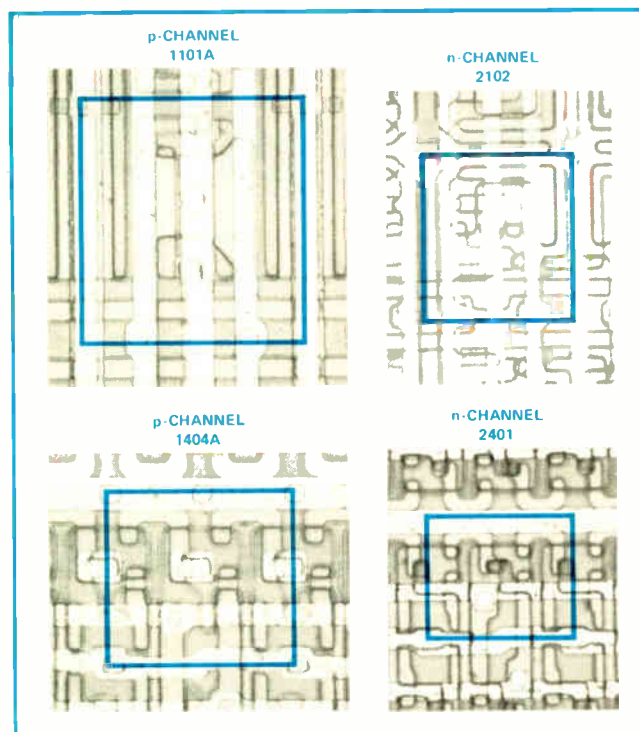

2. Making room. Photomicrographs of RAMs and shift registers made with p- and n-channel technology show higher device density achieved by the n-channel devices. Compared here are static RAMs and a dynamic shift register, all units that are in production.

Table 1:
Comparison of p- and n-channel static RAMs and shift-registers

Product		Process	
		p-channel	n-channel
Static RAM	Device #	1101A	2102*
	Size	256 bits	1,024 bits
	Organization	256 x 1	1,024 x 1
	Cell size	17.2 mil ²	7.9 mil ²
Dynamic shift register	Device #	1404A	2401
	Size	1,024 bits	2,048 bits
	Organization	1,024 x 1	1,024 x 2
	Cell size	10.0 mil ²	5.6 mil ²

Table 2:
Comparison of p- and n-channel products

Parameters	Products	
	p channel dynamic shift register	n-channel recirculating shift register
Size	1,024 bits	2,048 bits
Organization	1,024 x 1	1,024 x 2
Chip size	118 x 136 mils ²	125 x 151 mils ²
Cell size	10.0 mils ²	5.6 mils ²
Power supply or supplier	+5/-5/-12 V	+5 V/ground
Data levels	V _{CC} -2 / V _{CC} -4.2	2.2 V/0.65 V (TTL)
Clock levels	+5/-12 V	2.2 V/0.65 V (TTL)
Number of clocks	2	1
Clock capacitance	140 pF	7 pF
Maximum power dissipation at 25 °C, maximum frequency	500 mW (not including clock generator)	350 mW (including clock generator)
Maximum frequency (over temperature range)	5 MHz	1 MHz
Minimum frequency	10 kHz @ T _A = 70 °C	25 kHz @ T _A = 70 °C
Output requirement	External R _L needed	No external R _L needed
Other features	None	Recirculating and chip select

Another advantage of the low-voltage technology is the reduction of parasitic device interactions, which are caused by interconnection levels that have higher threshold voltages than the voltages used for the operation of the circuit. This eliminates both large leakage paths and high capacitance caused by field inversion—problems that needed solving before n-channel devices could be implemented.

The reliability of n-channel silicon-gate technology is dependent on the stability of the threshold voltages of the MOS transistors and the two levels of interconnects used in the array. In addition, the stability of dynamic storage circuits will be determined by the change in junction leakage, since it is this leakage that determines the retention time of the memory cell.

The basis for the inherent high reliability of silicon-gate n-channel devices is the way the layers are arranged. In the cross section of an n-channel MOS transistor and the interconnects used in the silicon-gate process shown in Fig. 3, three parts of the device are

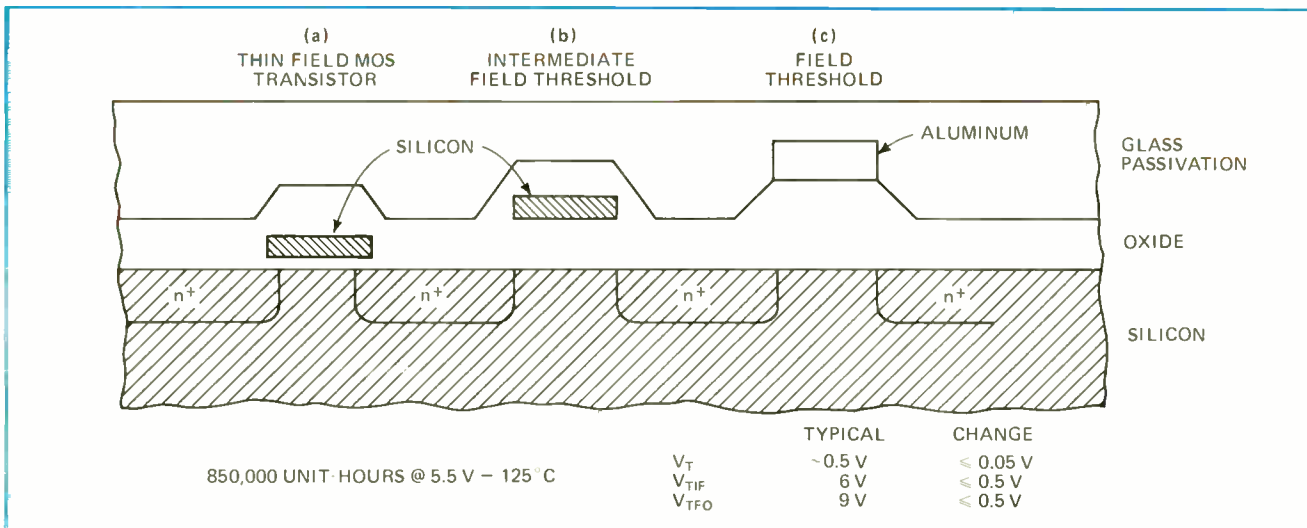

3. Reliable. With the low-threshold silicon-gate process reliability is maintained in all parts of the n-channel device. In region labeled (a), the glass passivation insures against contamination, just as in p-channel fabrication. The silicon interconnects and the metal lines—regions (b) and (c)—are also well protected because of the thick oxide step surrounding the silicon gate and aluminum electrode.

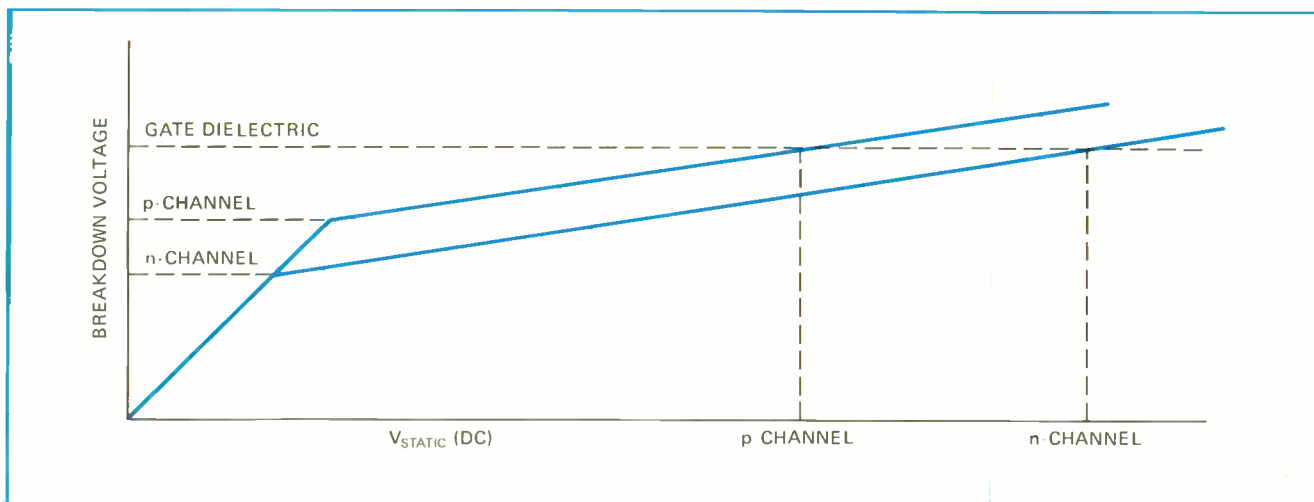

4. Extra protection. Devices made with n-channel technology have better gate protection than p-channel structures made with conventional fabricating techniques. The low n-channel breakdown voltage curve means that these n-channel structures operate at voltages substantially lower than those causing gate breakdown. This extra gate protection, compared to p-channel devices, adds to device reliability.

identified: the thin field segment (a), the intermediate field with the silicon line interconnects (b), and the thick field segment with metal line interconnects (c).

In (a) the MOS transistor is well protected from the external environment by a glass passivation barrier impervious to contamination. The resistance of this barrier to contamination (Na^+) has been well established in p-channel technology. The interconnects of (b) and (c) are also fabricated as in the p-channel technology process, and so are also well protected from external contamination.

Included in Fig. 3 are the results obtained after 800,000 unit-hours of stress on test devices. It shows that virtually no shifts in any of the threshold voltages were observed. The stress condition on these units was 5.5 volts (maximum value for the TTL circuits) at 125 C. The junction leakages of these devices were also monitored, and no increases observed.

An additional reliability feature of the n-channel technology is improved gate protection of the input de-

vices—resulting in the lower breakdown voltage of the diode. Figure 4 compares the dc behavior of the same gate protection device for both n-channel and p-channel processes as a function of the static charge applied. If the same dynamic impedance is assumed for the two diodes, the breakdown voltage in the n-channel version is consistently lower than in the p-channel device, requiring a large static charge to break down the gate dielectric.

The real thing

The n-channel 2,048- and 1,024-bit dynamic recirculating shift registers, the Intel 2401 and 2405, are examples of products using this new technology. Both are directly TTL-compatible in all respects: inputs, outputs, clock line, and power supply. Table 2 compares a typical p-channel silicon-gate 1,024-bit shift register (1404A) with the n-channel silicon-gate 2,048-bit recirculating shift register (2401). A photomicrograph of the latter die is shown in Fig. 5.

SPECIAL REPORT

Even though the n-channel device has twice as many bits as the p-channel version, it is only 20% larger in area. This is because the cell size of the 2401 is also nearly half the cell size of the 1404A, thanks primarily to the closer spacing allowed by the low voltage. Doubling the bit capacity in each package results in considerable savings for the user in printed-circuit board area, of course. The increase in bits per chip on 2401 will far outweigh the loss in yield on the slightly larger chip and result in a much lower cost per bit.

Additionally the input levels are all referenced to ground, unlike the p-channel MOS levels that are referenced to the positive power supply voltage V_{CC} . Nearly 50% of the user problems with p-channel MOS shift registers are related to the clock levels. Incidentally, these are 16-V clock swings, and require either a voltage multiplying stage between the 5-V TTL supply or a separate negative voltage supply. Since the 2401 has a TTL level clock and the clock capacitance is only 7 picofarads

(worst case) over the full temperature range, as compared to over 100 pF for p-channel MOS clock inputs, system design is greatly simplified.

The maximum power dissipation of the 2401 is less than the 1404A in system configurations. The 400-milliwatt worst-case power dissipation over the temperature range at maximum frequency of operation includes the clock generator power of the 2401, which is about 40% of the total.

Since ease of use and TTL compatibility were emphasized for this n-channel silicon gate design, the maximum data rate of the 2401 is actually slower than that of the 1404A. This is due to the large load presented to the internal drivers. But even under these circumstances the device is capable of operating at 2 MHz.

Finally, the 2401 saves the user some expense in external parts. Many p-MOS shift registers must have separate circuits to recirculate the data and to address the bit lines. With the 2401, on the other hand, recirculation, and two chip selects for X-Y matrix selection are supplied on chip. Also included is an internal load resistor, removing the user's need for external matching. □

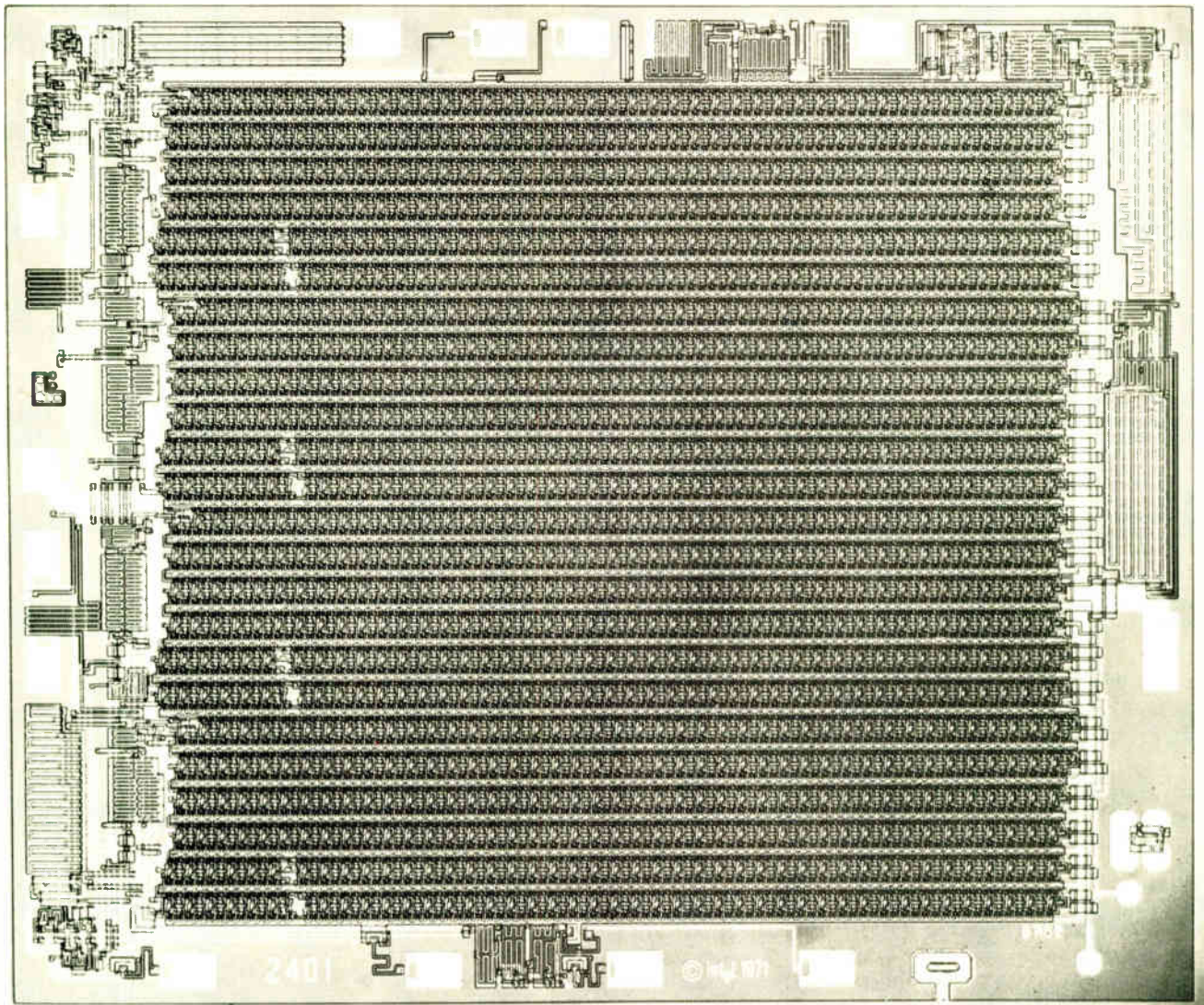

5. Close fit. Unlike most p-channel memory devices, this 2,048-bit dynamic shift register made with n-channel technology is directly compatible with TTL interface circuits in input, output, and clock lines; most significantly, it can operate from a single 5-V supply.

Coplamos keeps n-channels in line

Oxide-isolated MOS structure controls parasitic currents that plagued past n-channel devices

by Paul Richman and James A. Hayes,
Standard Microsystems Corp., Hauppauge, N.Y.

□ Although inherently faster than p-channel MOS integrated circuits, the n-channel configuration has made no significant impact on the semiconductor scene so far. What has held it back from fulfilling its promise for high-speed random-access memories is a fundamental problem that is only now being solved: parasitic conduction.

Parasitic currents, a major contributor to failures in n-channel circuit operation, can arise in two ways. The first occurs wherever a metal interconnection in an n-channel IC passes over a thick layer of silicon dioxide and crosses two non-related, heavily diffused n⁺ regions. At a high enough positive voltage level, inversion of the silicon surface can occur directly under the metal, and undesired current flows between the two diffused regions.

The second arises when so-called "punch-through" occurs between two closely spaced, unrelated diffused regions. This can happen when the doping concentration near the surface of the p-type silicon substrate is low enough, and the distance between the two n⁺ regions is small enough, for space-charge-limited current

to flow when a potential difference exists between the n⁺ regions and a positive voltage is applied to the overlying metal. This kind of parasitic current can occur at even lower voltages than the silicon inversion level.

In general, these parasitic conduction mechanisms occur at much lower voltage levels in conventional n-channel structures than in p-channel configurations. But both are virtually eliminated by new n-channel process, called Coplamos. Additionally, Coplamos makes it possible to attain much greater packing densities than p-channel devices achieve.

The solution

The new process solves the parasitic problem with an oxide-isolated monolithic structure that takes advantage of the fact that silicon nitride can mask against both oxidation and diffusion. It is fundamentally an extension of the Planox process developed by Morandi at SGS, Milan, Italy [*Electronics*, Dec. 20, 1971, p. 44] and of the work on the local oxidation of silicon reported by Appels, Kooi, and others at Philips in the Netherlands. The new technology is equally applicable to n-channel aluminum-gate and n-channel silicon-gate structures.

A cross section of an active n-channel silicon-gate MOS transistor along with an n⁺ diffused silicon interconnection, fabricated with the Coplamos process, is given in Fig. 1. As in the Planox process, all active silicon regions—drains, sources, channels, and diffused interconnections—are located on mesas which are surrounded by silicon dioxide and rise well above the recessed parasitic (nonactive) area. But in the Coplamos technique, a double dielectric layer, consisting of silicon nitride on top of silicon dioxide, covers the active mesa regions and protects them from the effects of the subsequent low-level p-type diffusion and localized thick-field oxidation. These thick-field p-doped regions are consequently self-aligned with respect to the active mesas. The mesa formation, the thermal oxidation, and the selective doping of the thick-field regions all require

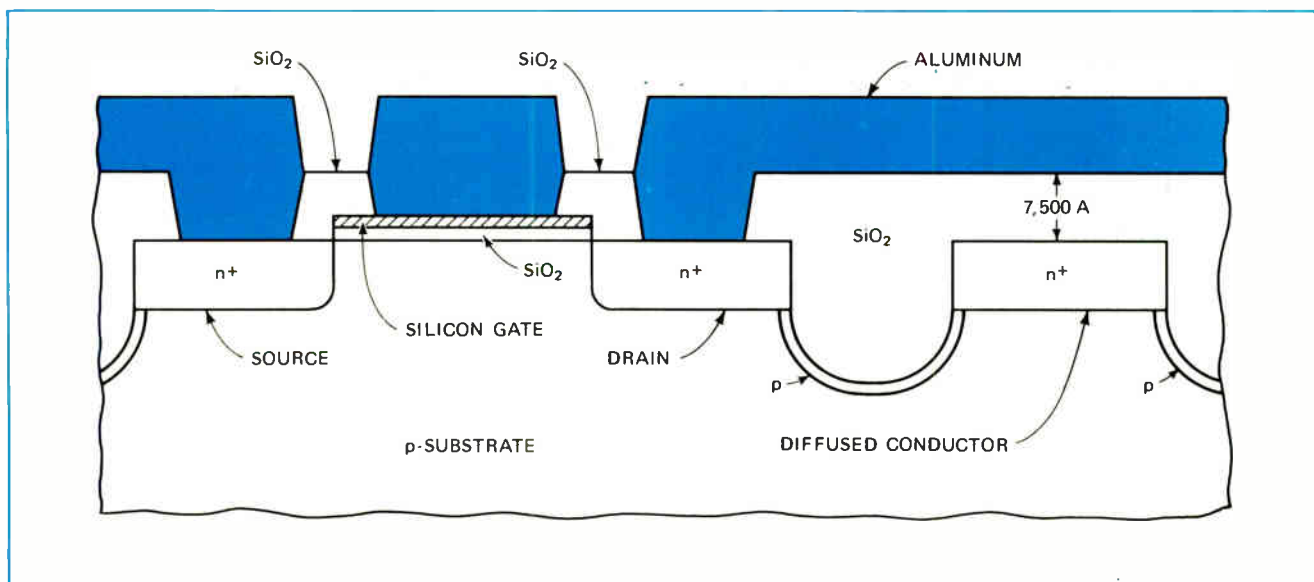

1. Above all. Source, drain and diffused interconnections all are located on raised mesas, isolated from the surrounding silicon by SiO₂. The formation of the mesa, along with the thermal oxidation and selective thick-field doping, takes only one mask step. The process greatly reduces parasitic conduction, and results in closer memory-cell spacing, high circuit density and high speeds.

SPECIAL REPORT

only the one photolithographic operation.

A key feature of the Coplamos process is the use of substrate bias to permit the desired active device threshold voltage to be achieved on a moderately doped substrate, while also maintaining high electron mobility and low junction capacitances to substrate. Typically, with a -5-V substrate bias, the threshold voltages of the active n-channel devices are on the order of $+1.7\text{ V}$. The selective doping of the silicon surface in the thick-field regions increases the surface depletion region charge density there, and hence increases the parasitic field-inversion voltage.

The source-body effect (change in threshold voltage with applied substrate bias) is directly proportional both to the thickness of the gate insulator of an MOS device and to the maximum value of the surface depletion region charge density. The latter quantity is much greater in the thick-field regions than in the active areas because of the selective doping, and the thickness of the silicon dioxide in the thick-field regions is approximately 18,000 angstroms as compared with an active gate insulator thickness on the order of 1,000 angstroms.

It follows that the source-body effect associated with parasitic devices is many times greater than for active devices. Consequently, while the selective doping of the parasitic regions results in typical field-inversion voltages of $+10$ to $+20\text{ V}$, the application of a small negative substrate bias further increases the field-inversion voltage to values in excess of $+70\text{ V}$.

In addition, the selective doping of the silicon surface in the thick-field regions increases the acceptor doping concentration at the surface such that the punch-through voltage is much greater than typical operating supply voltages. This is the case even for drawn separations of nonrelated diffused regions as small as 0.2 mil.

On the level

As Fig. 1 shows, the surface of the Coplamos structure is relatively flat, since the thick oxide regions are recessed into the silicon. Indeed, when the polycrystalline silicon layer is deposited, the surface of the wafer is almost perfectly flat; thus, the polycrystalline silicon can be kept quite thin. In addition, any aluminum interconnection which crosses a polysilicon region will only encounter at most a 4,000-angstrom step. This virtually eliminates the step-coverage problems associated with double-metalization structures.

In practice, the largest step the metalization layer is required to climb is about 7,500 angstroms, and this occurs only at contact hole locations, where aluminum surrounds all four sides of the contact hole. All other steps in the structure are considerably lower. The result is very uniform deposition and etching of the metalization layer, so that it's easy to use 0.2-mil-wide aluminum interconnections spaced 0.2 mil apart.

Since all diffused interconnection mesas in this type of n-channel structure are surrounded by silicon dioxide, the area required to make contact to a diffused region can be greatly reduced. In a conventional planar silicon structure (Fig. 2a), a contact hole to a diffused

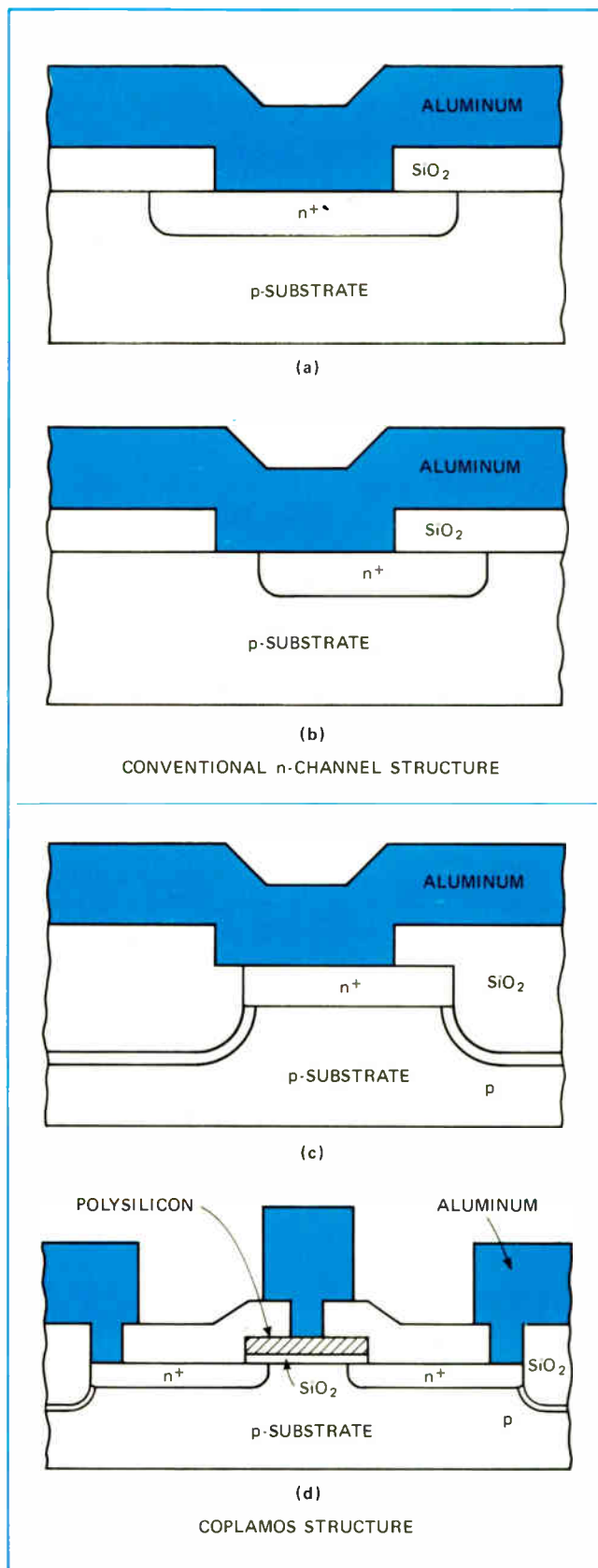

2. Better contacts. Comparison of standard planar structure (a) and (b) with the Coplamos structure (c) shows that in the former misalignment can cause contact between aluminum electrode and substrate—but that the p-diffusion in the Coplamos process eliminates this problem by resulting automatically in self-alignment. In (d) the complete structure is shown.

region has to be at some distance from the edge of the diffused region. Otherwise, any misalignment during the photolithographic process could cause the aluminum to contact the p-type substrate (Fig. 2b), and produce considerable metal-to-substrate current flow. In a Coplamos device, however, it's conceivable that a contact hole can actually extend beyond a diffusion region (Fig. 2c), and if misalignment occurs, the aluminum will still not make contact to the p-substrate, which lies well below the mesa.

A further advantage of this n-channel structure is that the p-diffusion surrounding the active area of the device forms a diode that can be used to protect thin oxide layers very effectively against static charge rupture. Since the acceptor doping concentration near the surface in the p-doped parasitic regions is high enough to achieve a sharp breakdown voltage in the +20- to +30-V range, this diode can function as a protection device without needing a grounded gate electrode to be placed over the periphery of a diffused junction, as is commonly done in conventional MOS integrated circuits.

Electrical parameters

Typical values for the more important electrical characteristics of the Coplamos process are listed in Table 1. The threshold voltage of the device is only 1.7 v, enabling Coplamos structures to interface easily with bipolar ICs. In addition, the high field-inversion voltage and drain-to-source-substrate breakdown voltages (+75 and +25 v respectively) insure reliable operation over a wide range of operating voltages.

The high electron mobility, μ_e , is evident in the gain factor K' (given in the table and derived from gain measurements made when the device was biased both in and out of current saturation). It indicates a surface electron mobility μ_e of approximately 575 cm²/volt-second, typically more than twice the hole mobility associated with conventional p-channel MOS devices.

Another point is that the silicon gates in the Coplamos process reduce the overlap Miller capacitance, thus increasing the circuit operating speed. This high speed enables the designer to achieve a higher fanout limit for his logic, as well as increasing the frequency range over which the device can operate.

Figures 3 and 4 show the high degree of threshold voltage stability typically associated with the process. The capacitance-voltage curve of Fig. 3 shows almost no degradation after stressing at 300°C. with 15 v. The threshold voltage, V_T , and field-inversion voltage of Fig. 4 had similar high marks in stability after 500 hours of high-temperature operation at 125°C.

Figure 5 compares the active device areas of Coplamos and conventional p-channel aluminum and silicon-gate processes. Because of the reduced spacing between active devices, the narrower aluminum linewidths and spacing, the smaller area required for contact hole location, and the reduction of device area, a better-than-twofold density advantage over p-channel silicon-gate processes results, and about a fivefold advantage over the more widespread aluminum-gate p-channel technology can be realized.

The increased density provides a much lower cost per

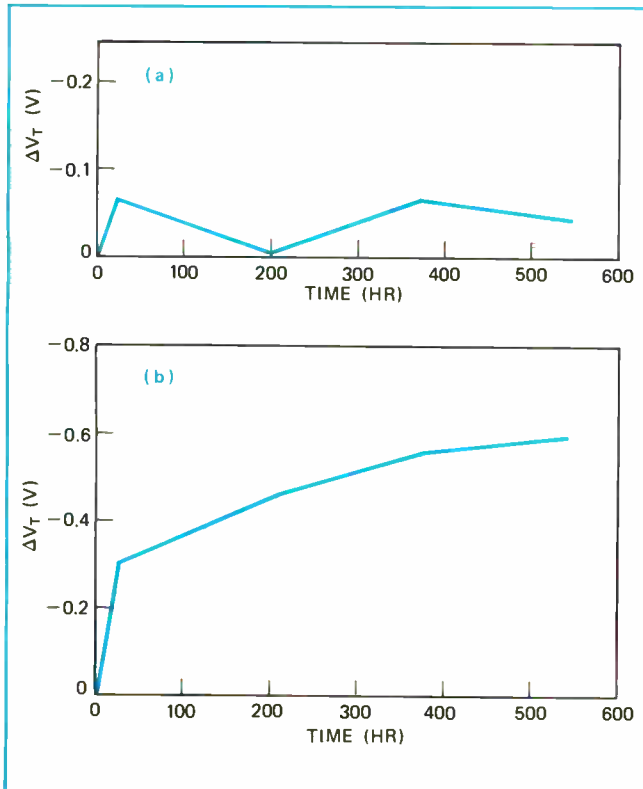

3. Steady under pressure. The Coplamos structure shows a nearly perfect ability to hold its capacitance-voltage relationship. Consequently there is no degradation of logic levels when the device is operated at normal gate voltage ($V_g = 2$ volts).

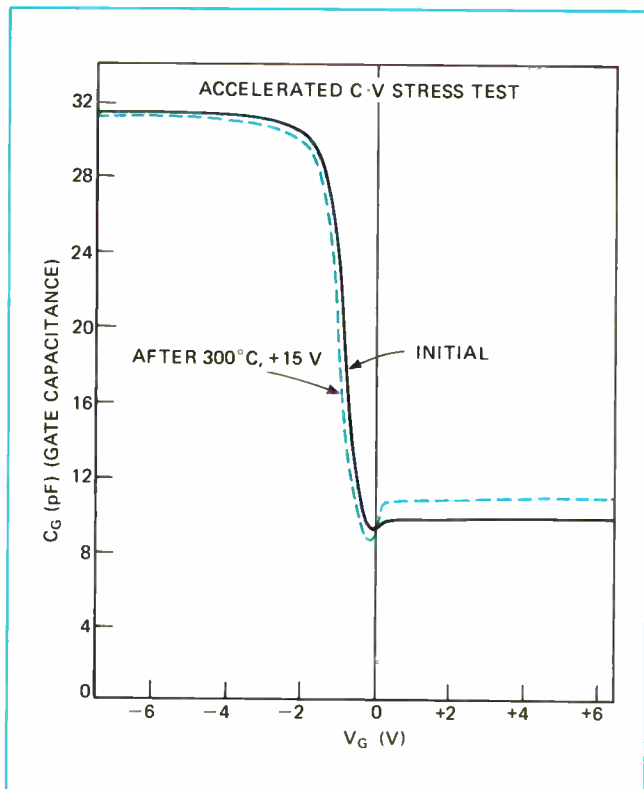

4. Stable thresholds. After being operated for 500 hours at 125°C, the Coplamos device shows a high degree of both threshold voltage stability and field inversion voltage stability. Tests were also successfully run under a severe bias stress (-17 volts).

It's logical, too

By adding another dimension to MOS LSI standard logic cells, the n-channel process opens up a new vista for LSI. First, n-channel allows speeds comparable to TTL speeds (e.g., 20-ns pair delays). Second, the system voltage requirements and power requirements are identical with those already existing in most systems (+12 V, -12 V and +5 V). Third, the process allows direct TTL input/output compatibility (noise margin, levels, speed).

To take advantage of these characteristics, a set of standard logic cells could be developed that were identical in all respects to the present TTL. Then MOS LSI would no longer be an arduous re-engineering of a working TTL design, and the logic design could be implemented directly on the memory chip. This would reduce the custom MOS LSI circuit design to the level of laying out a single printed-circuit board, containing both logic and memory, and so would lessen considerably the cost of implementing equipment in MOS LSI.

Laurence Altman

logic function because logic requiring two, three and four chips can be reduced to one chip, thus lowering packaging costs. Now a designer can use the Coplamos process and put about 250 logic equations corresponding to a "bare bones" 8-digit calculator on a chip 100 mils square, or about 1,000 equations on a chip 160 mils square. Under development is a single calculator chip with 12 digits and memory, not considered feasible with the older p-channel process.

Long memory

One of Coplamos first entries into the random-access-memory market will be a 4,096-bit, fully decoded, dynamic memory. To fit into existing solid-state memory systems with a minimum of new peripheral design and testing development, the basic cell and memory cycle timing chosen are similar to the standard 1103. The cell area is 3.2 mils square, resulting in a chip size of only 167 by 167 mils.

The memory is organized in a 64-by-64 array, requiring 64 read cycles every 2 milliseconds for refresh. Although containing four times the bits of a present-day 1-kilobit RAM, the access time and read cycle times are 250 ns and 400 ns (read/write cycle time 500 ns), compared to the standard 350 ns and 500 ns for the 1103.

The 4,096-bit memory requires three high-level clocks—precharge, chip enable, and read/write. However, the input, output and all addresses are TTL-compatible, dramatically reducing system interface circuit complexity, cost, and power dissipation.

A more advanced 4,096-bit RAM being developed will have cells approximately 2 square mils in size, and allow a 200-ns access time and 250-ns cycle time. In addition, the device will have clock voltages generated on the chip, and will be fully TTL-compatible, reducing the user's peripheral circuitry. □

Table 1
COPLAMOS ELECTRICAL PARAMETERS

PARAMETER	TYPICAL VALUE
Threshold voltage (with applied substrate bias)	+1.7 V
Field inversion voltage (with applied substrate bias)	+75 V
Gain factor, $K' = \mu_e \epsilon_{ox} / T_{ox}$	$22 \times 10^{-6} \text{ A/V}$
Drain to substrate breakdown voltage	+25 V
n ⁺ silicon sheet resistivity	17 Ω /square
n ⁺ polycrystalline silicon sheet resistivity	50 Ω /square

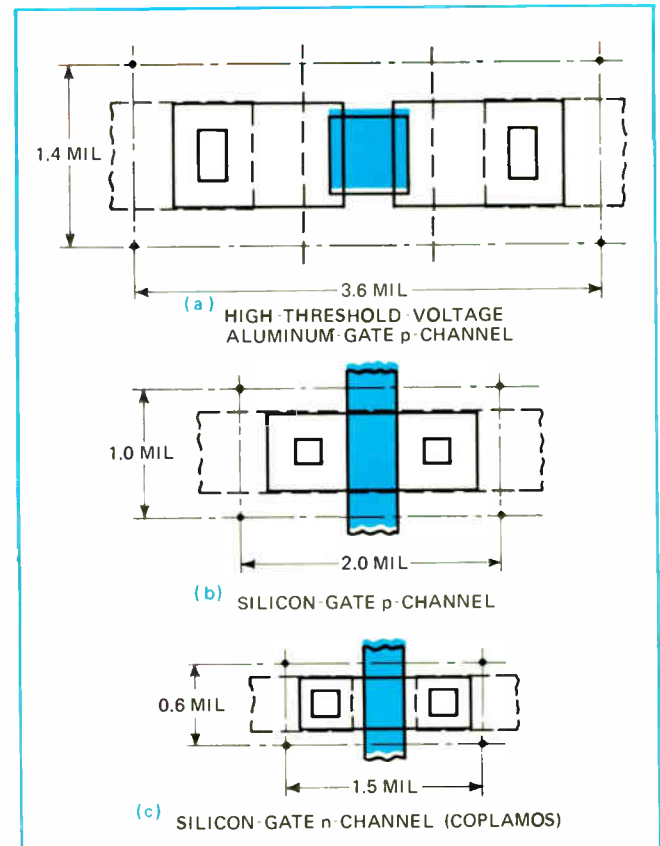

5. Sizing up. Coplamos memory cells are far smaller (0.9 mil²) when compared to aluminum p-channel cells (5 mil²), and the best silicon-gate p-channel cells (2.0 mil²). RAMs with 4,000 to 8,000 bits can fit on chips that measure only 180 by 180 mils.

BIBLIOGRAPHY

- C. T. Sah and H. C. Pao, "The Effects of Fixed Bulk Charge on the Characteristics of Metal Oxide Semiconductor Transistors," *IEEE Transactions on Electron Devices*, Vol. ED-13, No. 4, April, 1966, pp. 393-409.
- E. M. Wilder, "Source Bias and the Large-Signal MOS Transistor Switch," *Electro-Technology*, Sept. 1967, pp. 46-48.
- P. R. Chman, "Modification of Space Charge Limited Current Flow in Insulated-Gate Field Effect Tetrodes," *IEEE Transactions on Electron Devices*, Vol. ED-16, No. 9, September, 1969, pp. 759-766.
- F. Morandi, "The MOS Planox Process," presented at the 1969 International Electron Device Meeting, Washington, D.C., October, 1969.
- J. A. Appels, E. Kooi, M. M. Paffen, J. J. H. Schatorje, and W. H. C. G. Verkuylen, "Local Oxidation of Silicon and Its Application in Semiconductor Technology," *Philips Research Reports*, Vol. 25, 1970, pp. 118-132.



From The Datacraft DC-38 Building Block
Comes A True Planar Design 8K Single Card Memory

Today at Datacraft you can buy an 8K X 18 magnetic core single card memory in a true planar design... all electronic components and core plane array connected to the single plane of a printed circuit card.

This is a design with no compromise. There are no stacked components...no qualifications. Like our 4K single card memory, the 8K single card is also available two ways. The 8K single card can be expanded up to 64K X 18. Take the two card approach and you can get one timing and control card to drive eight 8K X 18 digital stack boards. Then you can expand even further in banks of 64K.

But a big bonus is that the 4K and 8K digital stack boards are interchangeable in the same chassis with no internal wiring. Both the 4K and 8K DSB use the same timing and control board. Or, if your application calls for it, the 8K single board memory is also interchangeable with the 4K single board memory with no internal wiring.

The 8K single board memory is about 25 per cent less than two 4K printed circuit boards. Here is truly a memory system you can get in just the right combination of price and performance to match your exact specification.

The 8K single board memory is simply another example of how we use the modular design of the DC-38 as a basic building block.

Just clip the coupon for more information on any Datacraft memory. And if you don't see the configuration you need, then just give us a call...we're probably working on it.

Datacraft Corporation
 Post Office Box 23550
 Fort Lauderdale, Fla. 33307

Please send me specifications for the configuration I have checked

- 4K X 18 Single Card Memory
- 4K X 18 digital stack boards with separate timing and control card
- 8K X 18 Single Card Memory
- 8K X 18 digital stack boards with separate timing and control card
- Call me about another configuration

NAME _____
 TITLE _____
 COMPANY _____
 CITY _____ STATE _____ ZIP _____

Datacraft

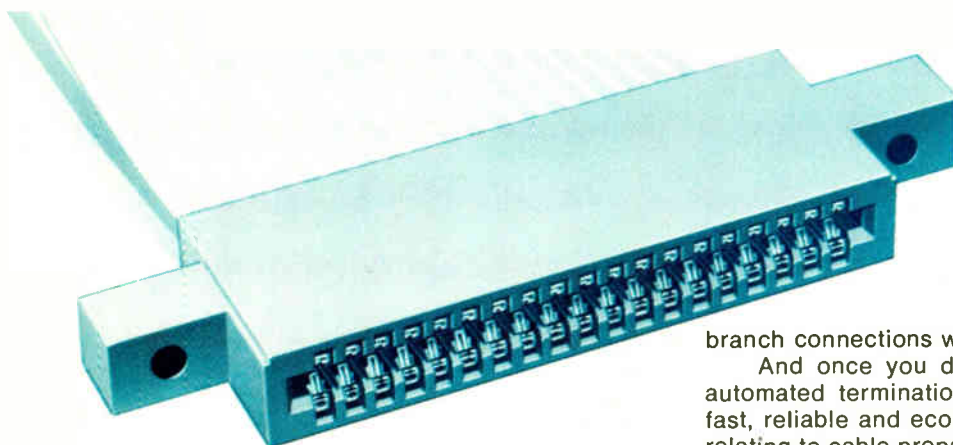

New AMP connector for flat flexible cable

The one-piece printed circuit board-edge connector, with bifurcated contacts on .100" centers, that we've just added to our line further expands the scope of AMP connectors for flat flexible cable applications. It's the

Dualatch connectors reliably sustain more than 10,000 make-break cycles.

Here's the multi-position connector with the long make-break life... 10,000 cycles and beyond.

It has unique hermaphroditic contacts—reduces your inventory—requires 70% less make-break force. Housings are designed with positive polarization to prevent mismatching.

DUALATCH connectors are available with 7.5 amp or 15 amp crimp contacts that can be applied manually. Or with automatic AMP machines for economical, reliable production in your plant at rates up to 3000 terminations per hour.

Also available with posts for automatic wiring, compatible with AMP TERMI-POINT* clip wiring. Or with manual, semiautomatic and automatic wrap methods. A variety of contact gold plating thicknesses are available for customer selection.

CIRCLE 96 ON READER SERVICE CARD

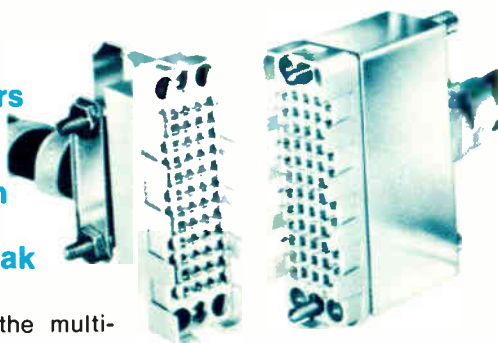

New thumbwheel switches for manual programming.

Use these long-life, compact, 10-position thumbwheel switches for data entry, control or programming applications. Decimal and BCD outputs are standard, plus a number of optional coded formats. They're ideal for both matrix and individual outputs.

We have human-engineered these switches to make them thoroughly effective as a man-machine interface. White numerals, 0.180" high, are readable even in dim lighting. Available in both matte and gloss finishes. In ganged units, readout numerals appear in accurate horizontal alignment for goof-proof legibility. Rated for 115 VAC or 28 VDC. Contact current rating: nonswitching—3 amps, switching—125 milliamps. Tested life expectancy: 1 million detent operations.

Thumbwheel switch terminals adapt to solderless interconnection methods, including standard AMP card edge connectors.

CIRCLE 97 ON READER SERVICE CARD



broadest line on the market. And it makes it practical for you to capitalize on the weight and space savings, strength and flexibility of flat cable in just about any application you might imagine.

AMP connectors let you go cable-to-cable, cable-to-post, flat cable-to-round wire, and cable-to-board. They let you make "daisy chain" or

branch connections without cutting the cable.

And once you decide on how to go, our unique automated termination technique makes getting there fast, reliable and economical. It works with zero effort, relating to cable preparation. No stripping, no soldering. Just cut cable to length and feed it into our machine, which dependably completes up to 3400 connections per hour. Our exclusive insulation displacement crimp technique produces positive, multiple-area contact between cable conductor and terminal, assuring top reliability.

CIRCLE 95 ON READER SERVICE CARD

Insertion rates for AMPMODU posts and receptacles reach 12,000 per hour.

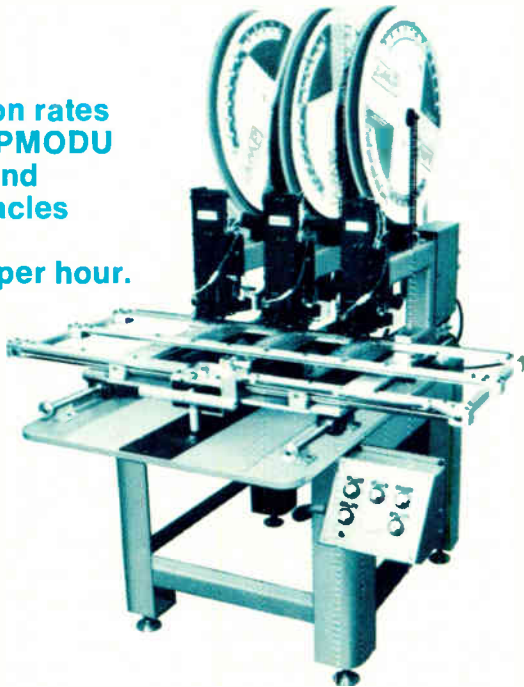

AMPMODU*, our post-receptacle interconnection system, now offers you even higher production capabilities than ever before. It's the ideal technique for modular-designed consumer or industrial electronics.

The secret is the AMP triple-head pantograph machine, which can insert AMPMODU contacts into three of your printed circuit boards at a time. Your operator uses a positioning pin and template . . . the three heads each move simultaneously, accurately. Rates up to 12,000 insertions per hour are readily achieved.

The machine will handle boards from .062" x .125" thick, with dimensions from 5" x 13" to 16" x 13".

And that all means simplified staking with maximum reliability and versatility at the lowest overall applied cost . . . AMPeconomation.

CIRCLE 98 ON READER SERVICE CARD

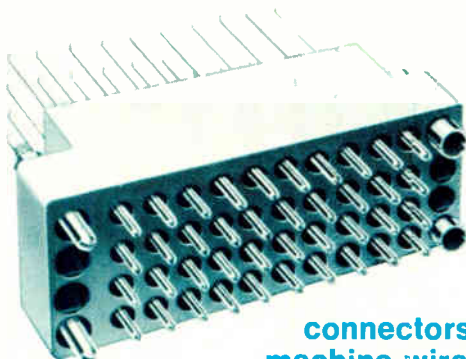

M-Series connectors now with machine-wirable posts.

The latest addition to our M-Series connectors gives you real production economy. They have posts for automatic machine wiring . . . four sizes: .022" x .036"; .031" x .062"; .025" square; .045" square.

Post sizes are compatible with AMP TERMI-POINT*

clip wiring. Or with manual, semiautomatic and automatic wrap methods.

These new post-type contacts are designed for AMP's standard M-Series housings, and will intermate with all M-Series connectors.

The posts also come in 1, 2 and 3 contact heights, and with all our standard platings.

CIRCLE 99 ON READER SERVICE CARD

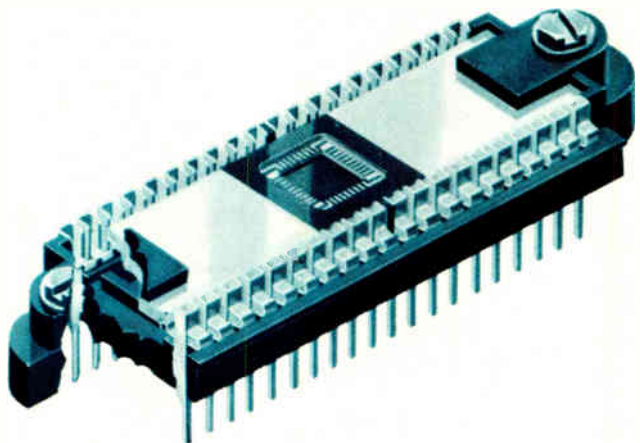

Now—practical pluggability for leadless LSI packages

New leadless substrate LSI packages eliminate the problems of handling and inserting many delicate leads, and simplify field replacement.

AMP now has a line of special connectors designed to make pluggability of these leadless substrates practical and reliable. Our connectors feature zero entry force insertion, a contact design with stored spring energy to maintain reliable contact, and a low profile.

Two types are available for leadless LSI; one mates with top or bottom surface metallization, the other accepts packages with contact pads on the edge of the substrate.

CIRCLE 100 ON READER SERVICE CARD

For additional information on any of the above products write: **Industrial Division, AMP Incorporated, Harrisburg, Pa. 17105.**

*Trademark of AMP Incorporated.

AMP
INCORPORATED

Manufacturing and direct sales facilities worldwide: Barcelona, Brussels, Buenos Aires, Frankfurt, London, Mexico City, Paris, Puerto Rico, Sao Paulo, s'Hertogenbosch (Holland), Sydney, Stockholm, Tokyo, Toronto, Turin, Vienna.

What EEs should know about patent law

The EE's specialized knowledge is vital to the patent attorney who has to define what is new in an invention

by Michael I. Rackman, *Gottlieb, Rackman & Reisman, N.Y., N.Y.*

□ Of all the potential clients a patent lawyer encounters, electrical engineers are the most skeptical. They are the most prone to question how a valid patent can issue on anything electrical, except perhaps the pioneering inventions in radar, transistor technology, or xerography. Then, even if satisfied on that count, they tend to deprecate the whole process by saying, "But why apply for a patent, when I can design around anything?"

A glance at any issue of the Patent Office's Official Gazette, to which many companies and libraries subscribe, will settle many doubts on the first point. Each week this publication lists brief descriptions of over a thousand patents. Hundreds of these are electrical, some being directed towards new or improved circuits and devices, others towards new systems.

The companies that own these patents are not only in a position to protect themselves against the copying of their products—they can also horse-trade with their competitors for an exchange of rights.

What is a patent?

The effectiveness with which any patent protects its owner depends on its language. In theory, a patent bestows on its owner the exclusive right to make, use and sell an invention for 17 years. The problem is to define just what it is that has been invented. The engineer will want to claim proprietorship not only of a particular circuit or system, but of all circuits or systems based on the same principles of operation. He will also need the definition to be drawn broadly enough to cover any inventions that are made after his, and that are derived from his. At the same time, it has to be narrow enough to differentiate his invention from what has gone before.

Consequently, a U.S. patent includes, besides a patent drawing and a patent description, a set of numbered paragraphs, called claims, which are found at the end of the document. Each claim is a short definition of the invention, and infringement is established when an alleged infringer is shown to be making, using or selling something defined by at least one of the patent claims. Although some countries do not require the invention to be precisely defined in one or more claims, in the United States the claims determine the extent of protection.

Engineers frequently ask why so many claims use the word "means" to define a component in a circuit or a

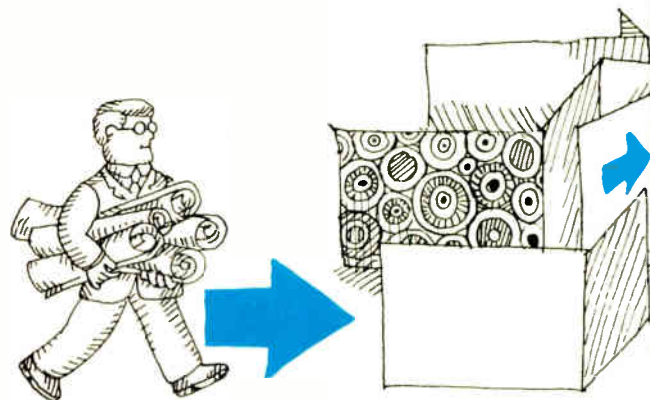

block of a system. The answer is that this is the way the lawyer generalizes the claim to equivalent circuits or systems. The patent statute specifically authorizes the use of a "means plus function" clause for the definition of an element in a claim for a combination of elements. (Almost every electrical invention is a combination of standard elements—resistors, capacitors, transistors, in circuits, or amplifiers, power supplies, converters, modulators, in systems.)

For example, consider any system—an optical character reader, integrated-circuit chip tester, patient monitor and so on—which includes a core memory. While the patent disclosure might describe a core memory as one block of the over-all system, the applicant will usually want to cover semiconductor, optical, and other newer types of memory, and even as yet uninvented types that could be used in the system. He can do this in the claims, by defining the memory block and its read/write circuits as "means for representing data, means for writing data in the representing means, and means for reading data represented in the representing means." If the system includes a read-only memory, the phrase "means for writing data in the representing means" would be omitted in claims referring to it.

Another question that often bothers the engineer is why there are several claims in a patent. Since each patent covers only one invention, why should it not be possible to define the invention in a single claim? By drafting several claims, the lawyer is essentially attempting to cope with the unknown. In the nature of things, he and his client cannot know what other inventors and their lawyers have recently done and are doing. And both are unavoidably ignorant of what is likely to happen in the next 17 years.

Scope of claims

A good hypothetical example to illustrate the need for several claims of differing scopes is frequency modulation. Assume that amplitude-modulated transmission and reception have already been invented but that most of the engineering profession is still unaware of it. This is not an unreasonable assumption, since a patent application is kept secret until a patent is issued, and since publication of the invention is often withheld pending its commercialization.

The patent application on fm might completely de-

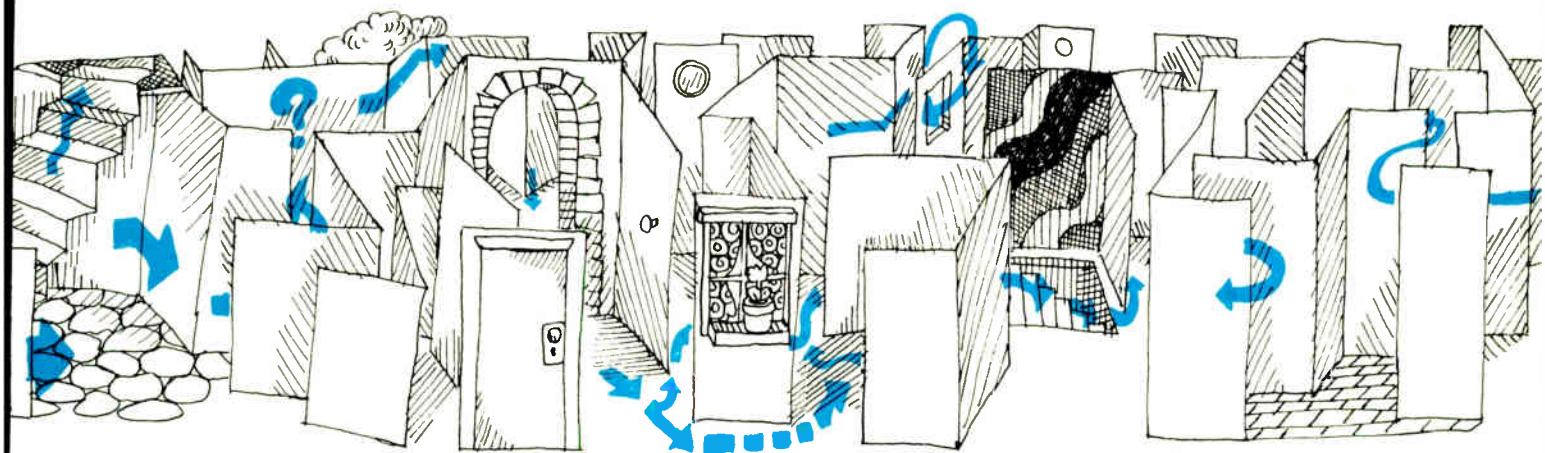

scribe fm transmitters and detectors, without the inventor recognizing that amplitude modulation is possible. He may also be unaware that by modulating the phase of the carrier rather than its frequency, a nearly identical modulated carrier can be produced.

A patent application might include the following claim:

"A system for communicating an information signal at frequencies higher than the frequencies which characterize the information signal, comprising: (a) means for generating a carrier signal at a frequency higher than the frequencies which characterize the information signal, (b) means for modulating the generated carrier signal in accordance with the information signal, and (c) means for transmitting the modulated carrier signal."

The patent application should also include claims about receivers and transmitter-receiver pairs, but the claim quoted is representative enough. (For a variety of reasons, the above claim and those to follow are less than ideal, but they make the point under consideration.)

A future shock

The patent attorney and his client who included only this claim in the application might be in for a rude awakening. The patent might be issued, and only years later might someone discover that a-m was actually invented before fm. For example, an application on a-m that was filed first might take longer to be issued as a patent than the fm application. When the a-m patent was issued, the world would suddenly learn that a-m had existed before fm. Alternatively, an a-m patent application might not have been filed at all; the technique might simply have been described in an obscure professional journal. Technically, either the a-m patent or the journal now counts as "prior art"—that is, a record of an earlier, pertinent discovery.

Unquestionably the above claim covers the prior art as embodied in the a-m patent or article—that is, it defines something that was old when the fm invention was made. Thus it is a broad claim in that it attempts to cover all modulation schemes—even those which are presently unknown. If the claim were valid, it would offer the broadest possible protection. Unfortunately, its breadth is its own undoing, because it covers many alternate schemes, one of which happens to be prior art.

A claim, to be valid, must define only something new.

But instead of writing the claim in the application as above, substitute the following for clause (b):

"(b) means for varying the instantaneous frequency of the generated carrier signal by an amount which is proportional to the amplitude of the information signal and at a rate equal to the frequency of the information signal to derive a modulated carrier, and"

Because this claim does not characterize a-m, it is much narrower than the first claim and is therefore valid (assuming that no other prior art is pertinent). But it is so narrow that when phase modulation is invented in the future, the inventor may have no control over it. That is because, even though the forms of the fm and pm transmitted signals are the same, the pm circuit varies the instantaneous phase of the carrier rather than its frequency, and the claim defines a circuit "means" whose function is different. Thus, while the revised claim quite fortuitously does not define amplitude modulation, neither does it cover the yet-to-be-invented phase modulation. (Actually, the claim could be interpreted to cover phase modulation, especially since it deals with a pioneering invention; nevertheless, a claim that leaves no doubt is better.)

But now consider a third claim—which substitutes a new clause (b) but otherwise is the same as the other two:

"(b) means for deriving from the generated carrier signal a modulated carrier signal whose amplitude is constant and whose frequency varies in accordance with the information signal, and"

This claim clearly covers fm and pm, and yet because of its constant-amplitude limitation does not cover the prior art a-m. Therefore it is valid, and affords maximum protection because it covers both the new and the as yet un-invented forms of modulation.

The claim preferred

The choice of the third claim is predicated on the attorney's and the inventor's knowledge of the state of the art: a-m is old, fm has just been invented, and they suspect that some variations of fm are possible even though they are not quite sure what these variations might be. But usually neither the inventor nor his attorney knows the true state of the art, even though the at-

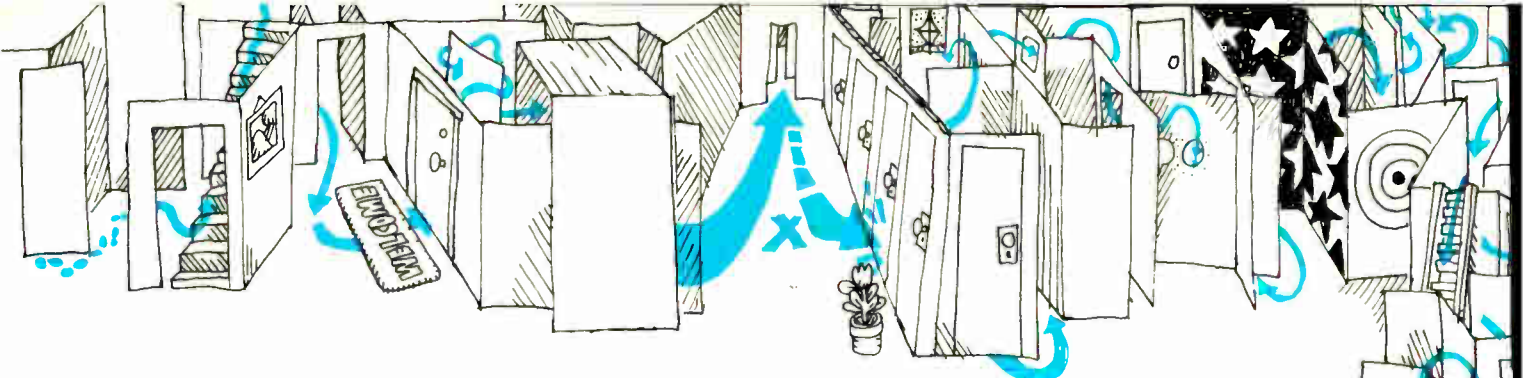

torney may make a patent search to determine it. If a patent search does not turn up a-m—which is likely if the a-m application is still pending—the attorney should include all three claims in the application. If he is aware of a-m, he would omit the first claim.

In general, even if the Patent Office rejects some of the broadest claims, and still others are invalidated in litigation, the remaining claims may still be broad enough to cover not only the specific embodiment of the invention disclosed in the application, but also the more important future variations of it.

Circuits and systems

The sorts of devices that can be patented are many. A typical recent issue of the Patent Office Gazette summarizes 309 electrical patents, ranging through memory array testers, adders, variable-gain circuits using field-effect transistors, error detectors, burglar alarm switches, electroluminescent displays, television deflection systems, insulated-gate field-effect transistors, time-interval-averaging circuits, electrical connectors, data processors, magnetic-domain propagation arrangements, optical mass memories and analog-to-digital converters.

Many of the patents that are issued each week describe new or improved circuits and devices for achieving standard functions, such as switching regulators, sample and hold circuits,

and adders. Such patents are valuable not only in themselves, but especially when they are part of a larger group. A company with dozens of patents pertaining to analog-to-digital converters, for example, usually has a patent position strong enough to pose a threat to any competitor who tries to assert one of his own patents against it.

But more important, many basic patents are issued each week. Usually these cover systems rather than circuit improvements. Actually designing a system, especially if the design is only on paper, is often not too difficult after the system function has been decided. When a system is the first one to perform a new function, it can often be covered by very broad claims, for no really pertinent prior art can exist if the function is new. Simply producing prior art of blocks of equipment that could have been combined to build the system is not enough to invalidate the patent. What must be shown for invalidation is how the prior art suggested that the blocks be combined—it must include something that makes the new combination obvious.

The first inventor to do a particular job often gets patent protection that covers subsequently invented and different ways of doing the same thing. For example, the inventor of the first version of each system listed in the table—even though his design may not have been particularly elegant or efficacious—could have been (and maybe was) granted a patent. Very broad claims in that patent would have covered much more sophisticated and better systems developed during succeeding 17 years.

An actual case

An example of broad claims in a non-esoteric area is a patent application made for a weighing machine for retail stores that would audibly announce weights. Several years ago, an engineer was grocery shopping for his wife. As he was straining to see the scale reading while some fruit was being weighed, it occurred to him that such an audio-output scale would have many advantages. He thought of providing a tape loop, with successive weight announcements, which would make one revolution after each weighing, and would announce only the correct weight. However, a scale with a 10-pound limit that announces weights in 1-ounce increments requires 160 announcements to be recorded on the tape.

To reduce the number of recordings, the en-

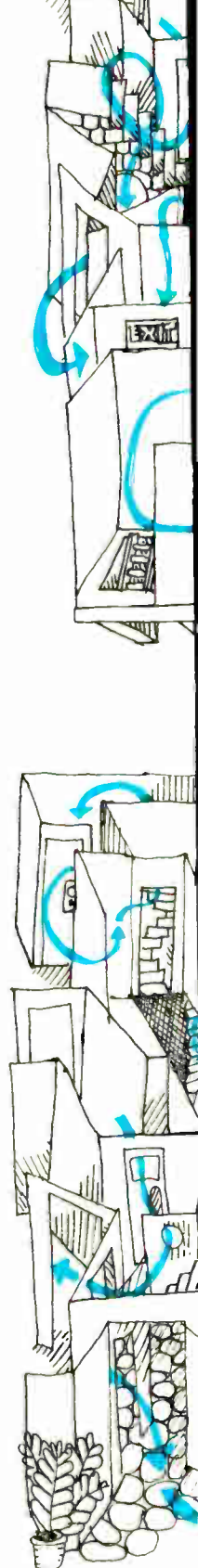

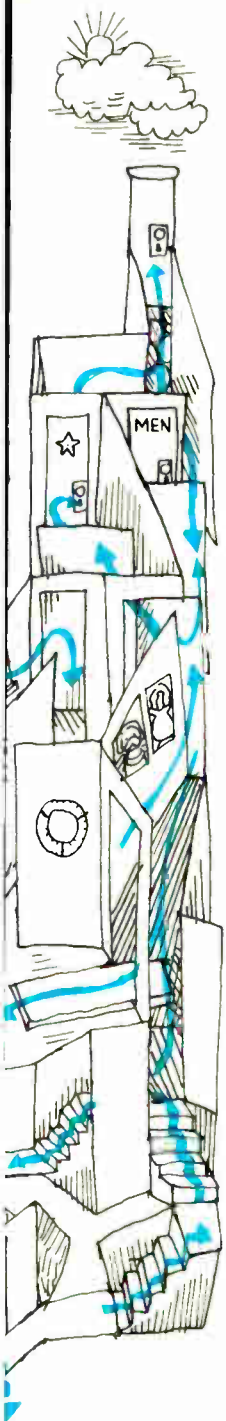

gineer decided to record only 10 successive pound announcements, from "no pounds" up to "nine pounds" inclusive, followed by 16 ounce announcements, beginning with "and no ounces," and continuing through "and 15 ounces." The proper pound and ounce announcements would be registered during each weighing, and the tape would begin moving at high speed. It would slow down only when the two registered announcements came beneath the read head, and only at these two times would the speaker amplifier turn on. After the weights had been announced, the tape loop would continue at high speed to its starting point.

The patent on this device includes two claims:

"An announcement machine comprising recording means containing thereon a plurality of announcements, read-out means for reading out said announcements, means for registering selected ones of said announcements, means for controlling the read-out of said registered announcements at a first speed, and means for controlling the read-out of the others of said announcements at a second speed.

"An announcement machine comprising recording means containing thereon a plurality of announcements, read-out means for reading out all of said announcements during each operation of said announcement machine, means for selectively registering which of said announcements are to be audible, and means for rendering audible only the registered announcements."

Neither of these claims is limited to scales. The first claim broadly covers a two-speed machine that moves at one of these speeds while reading certain registered announcements from a recording, and at the other speed while reading the other announcements. It says nothing about the speaker system through which the announcements are read. The second claim covers a system that reads all announcements on a recording during each cycle, but that renders audible only registered announcements. It ignores the speeds of these readings.

The claims, on their face, certainly provide broad protection—especially since they are not limited either to tape loops or scales—despite the fact that the actual system built was in a particular field and was relatively simple.



It isn't just the individual inventor who applies for a patent in the hopes of striking it rich. Nor is it just the newer and smaller company, for whom a strong patent may be the only way to protect a proprietary product and to establish its position in an emerging technology.

Why patents?

Many large companies, who do not generally assert patents against each other or against their smaller competitors, are often the most patent-conscious—they file dozens of patent applications each year. A company which is in a position to assert many patents against a competitor is often left alone when it uses a particular one of the competitor's inventions. Frequently, large companies exchange royalty-free cross-licenses so that each can utilize the inventions of the other. The stronger a company's patent portfolio, the stronger its bargaining position.

The classic example of the need for cross-licenses is that of Fleming and DeForest, inventors of the diode and triode respectively. DeForest could not manufacture triodes because each triode had a cathode and a plate, and necessarily infringed Fleming's diode patent. Fleming, while he could make diodes, could not add a grid to his diodes; that would make them triodes, which would have infringed DeForest's patent. By cross-licensing each other, they were both in the triode business.

Even if he's employed by a large company, however, the individual engineer plays an important part in securing a patent. (And even if he has assigned any direct pecuniary benefit he might get from it to his employer, the prestige that comes from having his name on the patent

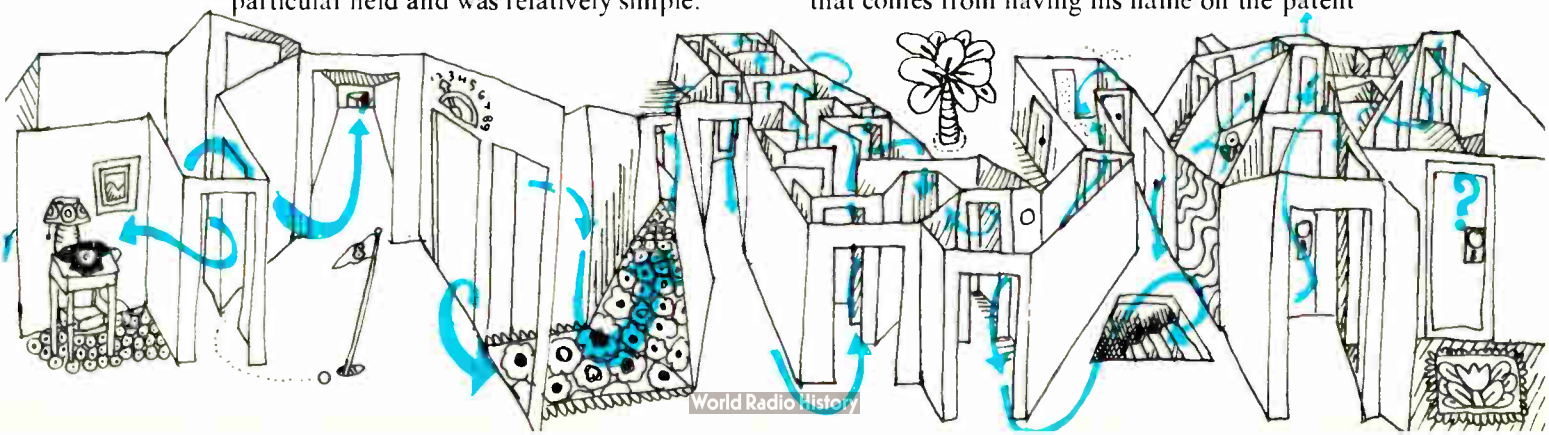

Broad-claim systems

Integrated-circuit chip tester

Light pen

System which "learns" certain data patterns during a learning interval and thereafter monitors incoming data to detect deviations from the previously learned patterns

Optical character reader

System for electronically converting black-and-white films to color films

Time and/or frequency division multiplexer

Data processor with priority-interrupt structure

Data processor with microprogramming features

Data processor with store and fetch protection

System for computing fast Fourier transforms

Data processor with cache or virtual memory

Vertical, longitudinal redundancy check characters

often earns salary raises and promotions.)

The engineer's role

In patent affairs, record-keeping is perhaps the engineer's most important contribution. A summary of each chronologically important development, experiment, theoretical analysis, and other landmarks of a project should be entered in a laboratory notebook—preferably a bound book with pre-numbered pages, successive pages of which are "witnessed and understood," and dated, by coworkers who are not co-inventors.

This industry standard practice is not arbitrary. Often, engineers of different companies make the same invention, and file patent applications, at about the same time. In such a case, the Patent Office sets up an interference proceeding by which a patent is awarded to the first inventor. Determining who was first depends on establishing the date the invention was first thought of, and the dates on which it was built and tested. Diligence in building and testing the invention following conception is also a factor in interference proceedings; because laboratory notebook entries can show diligence, the engineer should not limit them solely to the initial conception and final testing of the invention.

Laboratory notebook entries can also be important if the Patent Office rejects an application. When the Pat-

ent Office's rejection is based on the ground that the claimed invention is old or is at least obvious in view of the prior art, the inventor can overcome the rejection by demonstrating that the invention was actually made before the date of the prior art.

The engineer also is usually most aware of the first commercial use or publication of his invention, and he is responsible for preventing his attorney from making what could be a very expensive mistake. For if a patent application is not filed within one year of the first commercial use of the invention—including an offer for sale—or the first publication of the invention, any patent issued on the application will be invalid. Furthermore, if the patent was procured fraudulently by withholding use and publication information from the Patent Office, and is then asserted against an alleged infringer, not only will the court hold the patent invalid but in all likelihood it will also award attorney fees to the alleged infringer.

The need for precision

One of the engineer's primary roles vis-à-vis the patent attorney is to advise him of the nature of the invention. The attorney must fully understand what the invention really is, not only the details of a specific embodiment of it. This understanding, which is crucial, allows the attorney to characterize the invention properly, attributing to it the advantages that it has without any unnecessary exaggeration. When the Patent Office examiner rejects excessively broad claims, it is often difficult to argue that some specific arrangement or feature is patentable. As a matter of advocacy, accurately describing the prior art in the application is far better; then, in an offensive posture, the application can claim invention in the feature or features that are really new.

The engineer also must provide the patent attorney with the best embodiment of the invention, since the patent statute requires that this be disclosed in the application. Some patents contain a defect that may be fatal—the systems which are disclosed are not even operative. This is especially true in a block-diagram case—prepared expressly for the purposes of a patent application—in which one block or function is omitted. If this renders the disclosed system inoperative, the patent will often be held invalid.

For example, consider the disclosure of a priority interrupt structure in a data processor. Such a structure

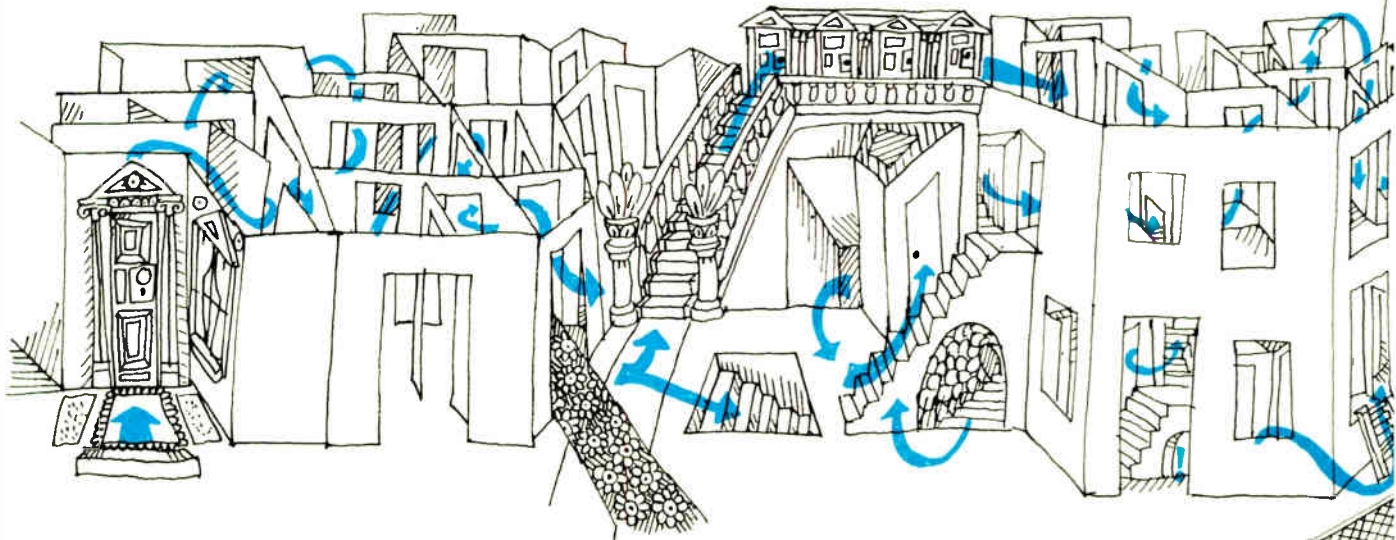

typically requires a way to store a base address in a register when an interrupt occurs, to call in a new program. Yet in preparing the block diagram drawing, directed primarily to what the engineer feels are more important aspects of the invention, the "initialization" detail might be inadvertently omitted. The engineer is less likely than his attorney to omit such a detail; therefore, he should constantly bear operativeness in mind when working with his attorney.

While processing the application, the patent examiner cites prior art as the basis for rejecting some or all of the claims. Very often the attorney will ask the inventor to review the prior art and to distinguish his invention from it. The inventor should, of course, work with the attorney in amending the claims so they do not describe the prior art, while at the same time insuring that the broadest protection yet available is secured.

When a patent gets into litigation, an engineer may find himself devoting a considerable portion of his time to helping the lawyer. When aiding the plaintiff, the engineer may be called upon to analyze both the defendant's infringing product and the prior art cited as defense by the defendant. Or when aiding the defendant,

the engineer may spend weeks reviewing old periodicals and texts, looking for prior art that invalidates the plaintiff's patent.

The important point is that both in litigation and in normal Patent Office proceedings, it does not matter whether the inventor actually knew of the prior art which is alleged to anticipate the invention. Knowledge of the prior art is irrebuttably presumed as long as it was publicly available somewhere. If prior art is uncovered showing that the claimed invention was used or published more than one year before the application was filed or making the invention obvious in view of it, then the patent is invalid even if the inventor was totally unaware of the earlier work.

Some bad luck just cannot be avoided. In general, however, engineers can do a lot to improve the chances of their patent applications, and the protection these afford to their companies, if they will take the trouble to understand the principles on which patent law is based. Patent matters cannot be left entirely to the attorney—the engineer's knowledge and experience are almost as vital to the protection of his design as they are to its conception in the first place. □

The position on software patents

The controversy over the patentability of software is now before the Supreme Court. Since the early 1960s, the Patent Office has been opposed to it, on the grounds that it would be improper to grant protection to the "mental steps" of a program, and that the search procedures for processing program applications would be too burdensome. But the Court of Customs and Patent Appeals has consistently overruled the office. In about a half-dozen cases, this court has held that methods or processes carried out by a computer can be patented provided that, as in other inventions, they are new and unobvious. The claims usually cover the steps of a method, rather than a combination of elements. Consequently, the Patent Office is now in the process of asking the Supreme Court to review and reverse one of the court's decisions.

What is most disturbing about the Patent Office's position is that it is not clear where to draw the line distinguishing hardware from software. In fact, before the present spate of CCPA decisions allowed them to be more forthright, patent attorneys often prepared block

diagrams of special-purpose machines which executed the steps of a computer program. And they were quite successful, because the Patent Office could not determine whether the invention was made by an engineer or a programmer—i.e. whether the disclosed machine was real or created just for that patent application.

But more important than the stratagems of lawyers is the fundamental question of how the Supreme Court can possibly differentiate between hardware and software.

The distinction in terms of function is difficult even for engineers to make. The term "firmware" was coined because microprogramming fell between the two categories. Trade-offs between hardware and software are constantly made in the design process. A hardware design can be simulated by software. If the boundary between the two wavers even for those most familiar with them, the difficulties and dangers in having jurists draft an applicable legal definition are obviously great. The decisions of the Court of Customs and Patent Appeals thus far are logical and consistent; it is to be hoped that they will remain the law.

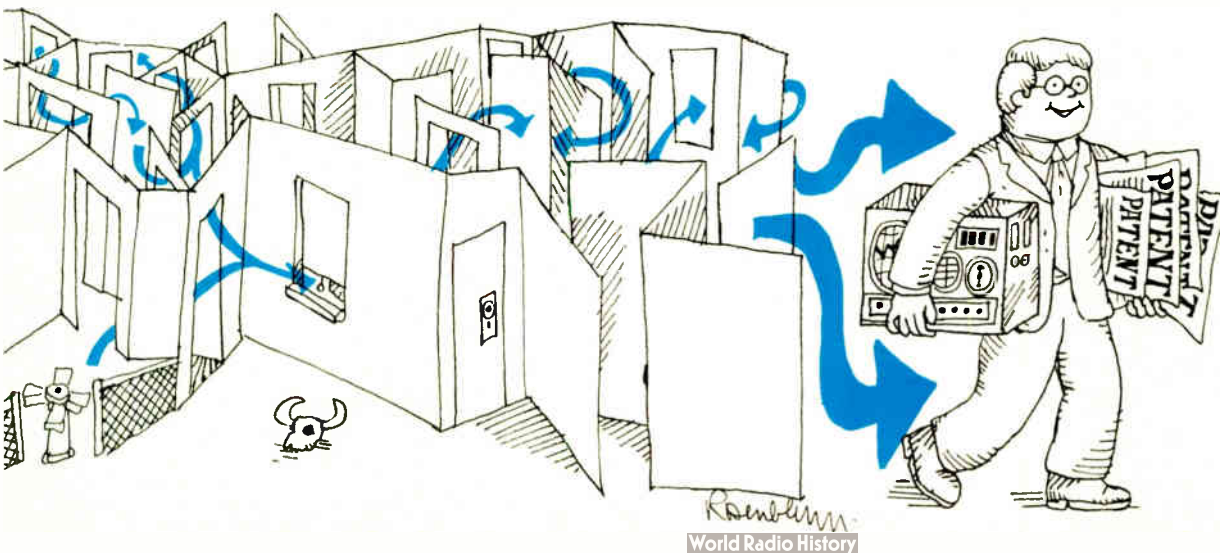

DATA GENERAL ENTERS THE MINIPERIPHERAL WAR.

Data General, the world's number 2 minicomputer company, is in the peripheral business.

We've just introduced a new line of compact, fixed-head discs — the Novadiscs.

They're the ruggedest, most reliable mini discs on the market.

When we designed the Novadiscs, we recognized that the critical requirement — beyond price, speed, size, and capacity — was reliability.

Most minicomputer discs simply can't stand up to the kind of hard use that minicomputer mainframes take.

So we made sure the Novadiscs have the guts to go anywhere our computers go — including the tough on-line industrial applications in which modern minicomputers work.

Plug a Novadisc into a Nova-line computer, and you get a dramatically extended mainframe, with up to 800,000 16-bit words of high-speed memory in a single tough, compact package.

We built reliability right into the guts of the Novadiscs.

Instead of trying to fly the read-write heads on a fragile 30- or 40-gram air bearing, we designed an air bearing that exerts 2 pounds of force on the head, and can stand up to 4 pounds. So the heads aren't disturbed by the bumps and jolts that make other discs crash.

When they're not flying, the heads are secured, outside the disc pack cylinder. So you don't risk a crash every time you move the unit across the room — or across the country.

The Novadisc recording medium is an industry-standard, 10-surface disc pack. The motor, drive spindle, drive belt, and air filters are the same ones used on big, mass-produced disc drives.

Some of those parts are over-engineered for our requirements. They're also a lot less expensive and more reliable than anything else on the market.

Of course, the Novadiscs have all the other right specs, too.

Price. A Novadisc with storage capacity of 128K 16-bit words costs \$5,200,

ROUND 1: A NEW DISC WITH GUTS.

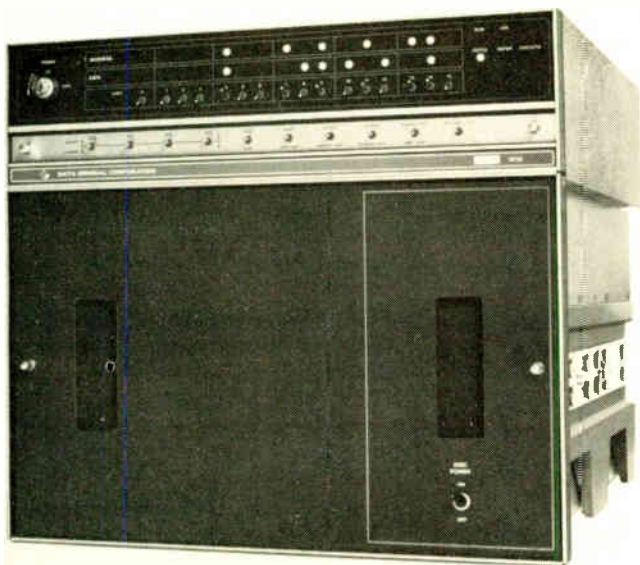

256K is \$6,750, 512K is \$9,250, and the 768K Novadisc costs \$12,560. Quantity discounts are available.

Size. Including power supply, the Novadiscs are only 12¼ inches high in a 19-inch rack.

Speed. Average latency time is 8.4 milliseconds, and data transfer rate is 2 million bits per second.

Software. Novadiscs are compatible with our device-independent Disc Operating System, which handles user I/O and provides interrupt-driven buffered service for peripherals.

DOS in turn supports a relocatable assembler, editor, linking loader, Extended ALGOL, Extended FORTRAN, and Extended Timesharing BASIC.

Peripherals. You can add mag tape, other DOS-compatible discs, A/D and D/A, communications equipment, CRT's, plotters, printers, card readers, paper tape equipment.

In the last three years, we've shipped over 2,500 Nova-line minicomputers and systems.

We've made a reputation for making some pretty pushy claims — and for living up to them.

Now we're in the peripheral business. And just as pushy as ever.

 **DATA GENERAL**

Southboro, Massachusetts 01772, Tel. (617) 485-9100

No physical checkup required.

You might well assume that a very small (19.7 cubic inches) and very inexpensive (\$95 in 100's) DPM would soon fall prey to some dread disease. Like heat prostration, or severe irregularity. Even cardiac arrest.

We worried about reliability beginning in the design phase. For example we reduced the number of components in this AN2532 self-powered meter, which cut down the power requirement and the heat dissipation and did wonders for MTBF. We isolated the analog return from the digital return with true differential inputs. We made the converter immune to line transients. We did a lot of other things to design reliability into it.

Then came vibration tests, 3-day burn-ins, baking, and computer-controlled testing of every performance specification. We did these things because we are pretty sure you care more about reliability than the latest development in the DPM size-price war.

Sample specifications of the AN2532 line-powered meter

Accuracy 0.05%

Stability 50ppm/°C

Bipolar, floating differential inputs

Input impedance 1000 megohms min.

Power requirement 3.5 watts

BCD output standard

Separate analog and digital grounds

Dimensions: 2" h x 3.5" w x 2.8" d (mounting surfaces)

There's a lot more to it, of course, and other meters to choose from. So send for complete specifications and our helpful 28-page booklet explaining the theory, operation, and applications of DPM's in general. Very little hard sell. Analogic Corp., Wakefield, Mass. 01880, (617) 246-0300, manufacturers of the largest line of DPM's in the world.

ANALOGIC ■



Northeast

617-235-2330
203-966-2580
315-446-0220

Mid Atlantic

201-652-7055
212-947-0379
215-272-1444
301-587-3910

Midwest

314-837-0597
216-267-0445
513-434-7500
313-892-2500

South

312-283-0713
913-648-4173
412-892-2953
713-785-0581
817-268-3505
305-647-3498

205-881-5031
404-351-3654
803-576-7462

West

303-744-3301
505-523-0601
602-946-4215
505-296-8303

714-540-7160
408-374-5220
206-762-7664
503-646-6064

Canada

613-836-4411
604-688-2619
514-491-9111
514-811-1775

Worldwide 800-622-8709

Low-cost IC timer handles a lot of jobs

by Hans R. Camenzind
Interdesign Inc., Sunnyvale, Calif.

If you're in the market for a low-cost compact timer, try a new commercial integrated circuit—you may like it. This adaptable IC, internally compensated for component tolerances and temperature drifts, requires only an external resistor and capacitor for time delays ranging from a microsecond to an hour with maximum deviation of only 1%.

Designed by Interdesign Inc., the IC is available from Signetics Corp., in either an 8-pin plastic package (NE555) or an 8-pin metal package (SE555). The plastic version costs 75¢ in quantities of 100 and has a timing accuracy within 5%. The temperature coefficient of both circuits is typically only 25 ppm/°C.

In addition to one-shot timing chores, the IC can be converted simply into a free-running pulse generator. The IC can be used for simple time delay, missing-pulse detection, frequency-division, pulse-width and pulse-position modulation, and test sequencing.

The output of the IC can supply about 200 milliam-

peres to a load, which can be connected either to V_{CC} or ground. This is achieved by using two high-current transistors in an inverting output stage, which allows the load to be connected for either normally on or normally off operations. At load currents less than 50 ma, the IC delivers a pulse with a maximum rise and fall time of 50 nanoseconds at any time setting, and the voltage levels are TTL-compatible.

When connected as a one-shot the timing cycle of the IC starts when the trigger voltage drops below $1/3V_{CC}$

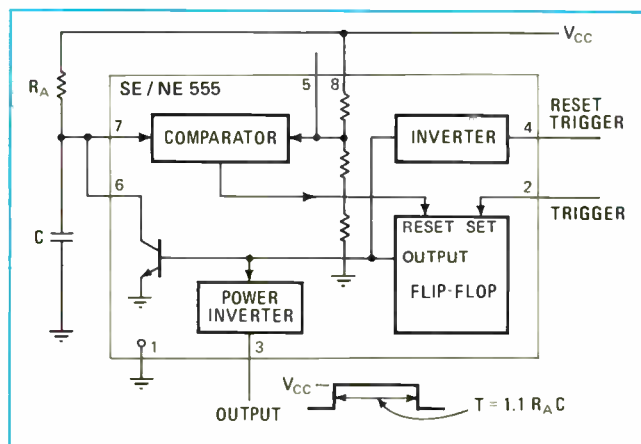

Functional diagram shows setup for one-shot operation; adding another resistor between pins 6 and 7 makes it astable.

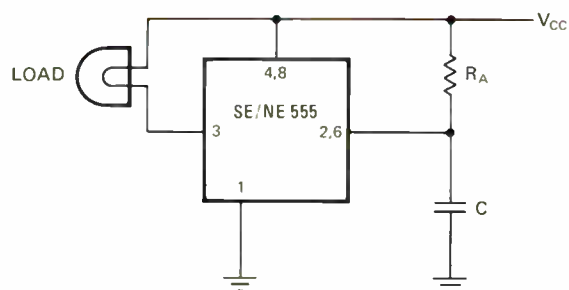

(a) BASIC TIMER. Circuit provides an initial time delay in which the lamp will turn on $1.1 R_A C$ seconds after the supply voltage is applied. Circuit resets every time the power is turned off.

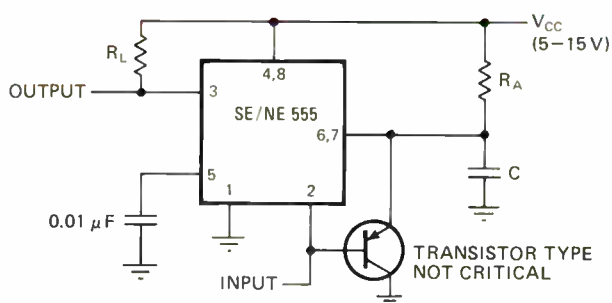

(b) MISSING PULSE DETECTOR. A change in frequency or a missing pulse shifts the output level. For proper operation, the time delay should be slightly longer than one expected pulse spacing.

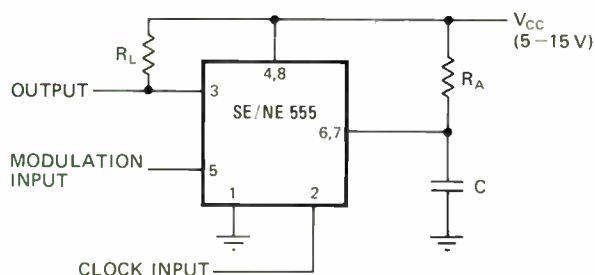

(c) PULSE-WIDTH MODULATOR. Modulating the control voltage terminal (pin 5) and triggering the timer with a continuous pulse train produces an output of different pulse widths.

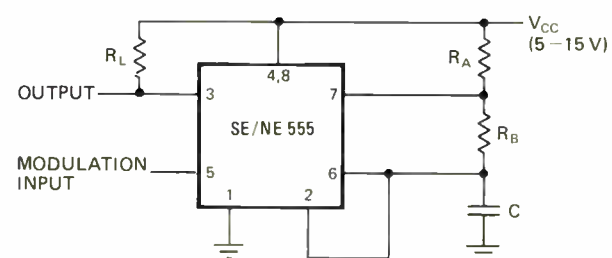

(d) PULSE-POSITION MODULATOR. With the modulating signal applied to the control voltage terminal and the timer free-running, the output pulse positions can be varied depending on the modulating signal.

and continues undisturbed, even if the circuit is triggered repeatedly. This eliminates contact bounce or can serve as a pulse stretcher.

Initially, the external capacitor is discharged by the transistor from pin 6 to ground. The negative trigger sets the flip-flop output to zero, which removes the short-circuit from across the capacitor and raises the IC output (pin 3) to V_{CC} . The capacitor then starts charging toward V_{CC} at a rate proportional to the time constant established by $R_A C$. The cycle ends when the capacitor is charged to $2/3 V_{CC}$. The time that the IC remains in the high state is given by: $T = 1.1 R_A C$.

The circuit incorporates a high-input impedance comparator so that large timing resistors (several megohms) can be used. The comparator is referenced to $2/3 V_{CC}$ by three resistors of equal value. When the voltage across the external timing capacitor reaches this level, the flip-flop is reset, and the capacitor is discharged. The IC output level is then in the low state.

Both the charging current and the end-of-cycle voltage ($2/3 V_{CC}$) are proportional to the supply voltage, which makes the timing accuracy independent of that voltage. The circuit operates from 4.5 V to 15 V, with less than 1% long-term drift in timing accuracy.

Timing can be adjusted in any of three different ways: resistor R_A provides a four-decade range; capacitor C offers more than an eight-decade coverage, and applying an external control voltage to terminal 5 produces a 3:1 timing variation. This terminal also provides an ideal point in which to add filtering to reduce

noise on the supply-voltage line.

The basic one-shot circuit is easily triggered manually by a switch that connects the trigger input (pin 2) to ground to initiate the timing cycle. For example, using a 10-microfarad capacitor and a 91-kilohm fixed resistor in series with a 5-megohm variable resistor can provide preset timing from a second to an hour.

In addition to monostable operation, the IC timer can be made to trigger itself and free-run. An extra terminal (pin 6) is provided so that a second resistor (R_B) can be used to help set the duty cycle. The timing capacitor charges through both resistors, but discharges only through R_B . The total period, $T = 1.46 / (R_A + 2R_B) C$, is the sum of the charge time (output high), $0.685(R_A + R_B) C$, and discharge time (output low), $0.685 R_B C$. The duty cycle, however depends only on the timing resistors: it is the ratio of either the charge or discharge time to the sum of both.

A quite different triggering mode is possible by connecting pin 4 and pin 2 (trigger input). In this arrangement, the timer is reset each time a trigger pulse is present, and the output will only go low if the circuit is not retriggered within the set time. Such a configuration could be used as a missing-pulse detector or a pulse-width discriminator. Other applications requiring any sort of a timing cycle can be easily accommodated by the IC timer. Frequency dividers, pulse-position modulators, and pulse generators with a frequency from 0.00001 hertz to 500 kHz and a duty cycle from 0.1% to 50% are possible. □

Reducing IC FET op amp input bias currents

by Richard G. Jewell
Nova Devices Inc., Wilmington, Mass.

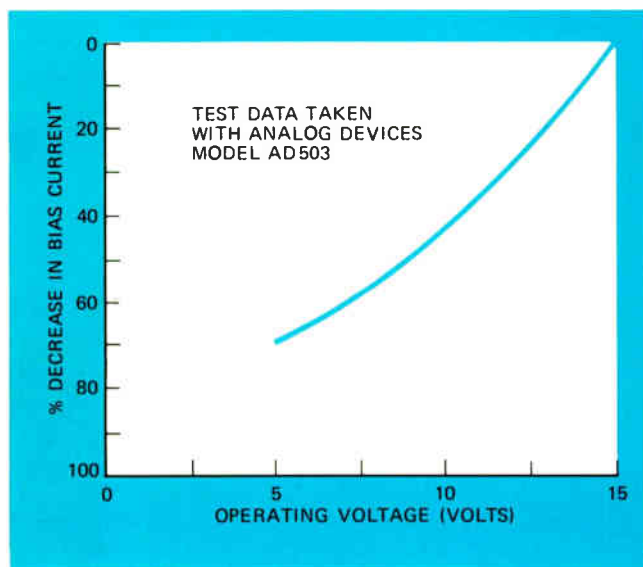

Adding a simple heat sink or operating at reduced voltage can significantly improve a field-effect transistor operational amplifier's input bias current over what the spec sheet says. Actually, both methods merely reduce the IC's junction temperature, but this is of great importance since FET input bias current doubles with every 10°C rise in temperature.

Either method of reducing the temperature requires the user to sacrifice very little. A heat sink isn't very expensive, if there's room for it; lowering the operating voltage has only a small effect on such parameters as input offset, slew rate, and gain. However, the maximum output-voltage swing will be limited to the operating voltage chosen.

Using a Wakefield model 209 or an equivalent heat sink can reduce the warmed-up bias current of an AD503 by 60%, typically to 1 picoampere. The model 205 reduces the bias current by 40%, and the model 204 provides a 10% decrease. Or reducing the operating voltage to ± 5 volts would drop the AD503's warmed-up bias current by as much as 70%—to about 0.75 pA.

Although both methods can be used simultaneously to obtain subpicoampere bias currents, there is a practical lower limit of about 0.5 pA because of the finite leakage inherent in the IC's glass header. □

Engineer's Notebook is a regular feature in Electronics. We invite readers to submit original and unpublished design, applications, and measurement ideas.

Trading larger output-voltage swings for lower input bias currents

Off the Shelf

RCA RF Tubes/Cavities
for VHF/UHF Translator/ Transposer
Service world-wide.

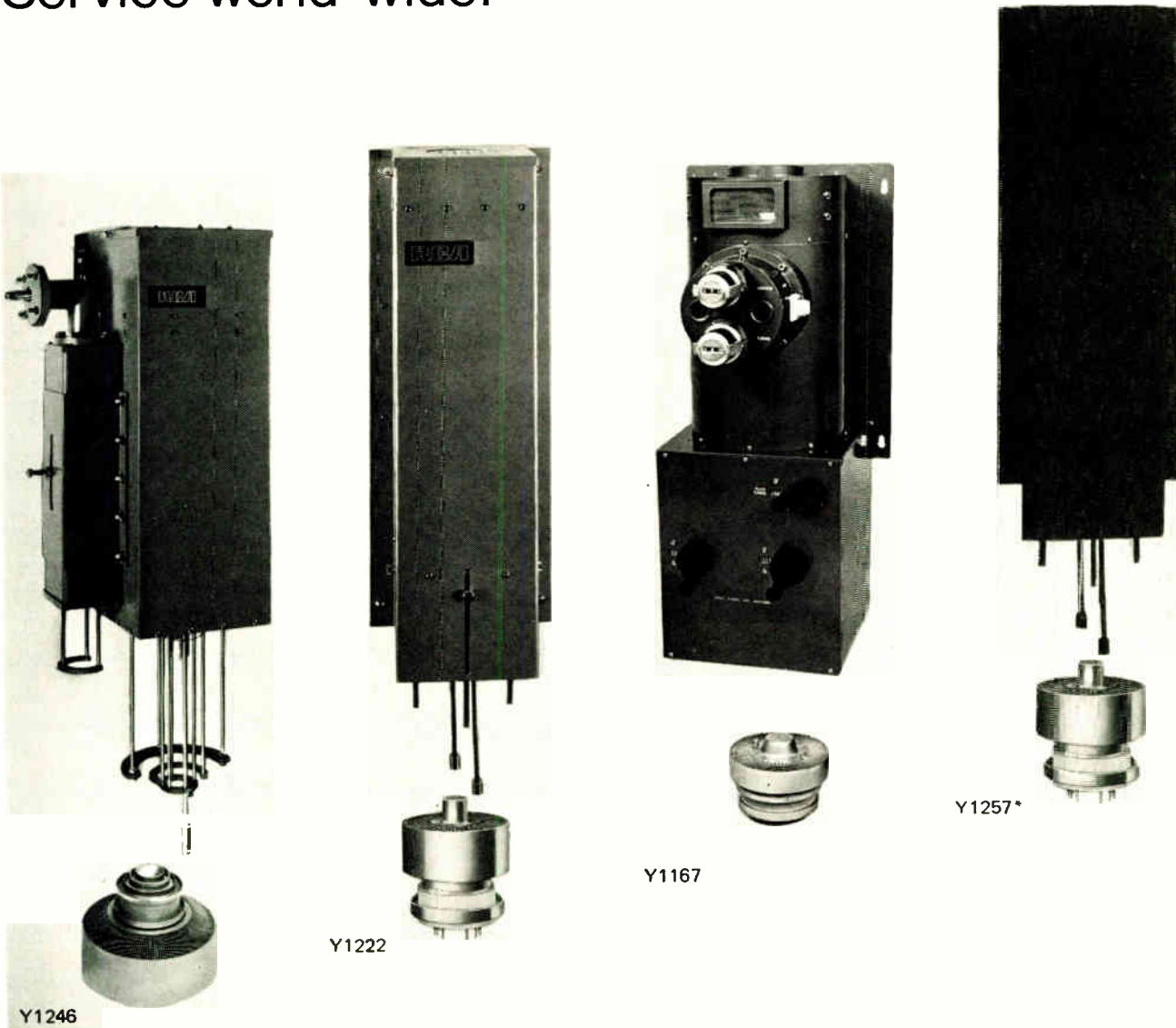

From 100 W to 1 kW. For VHF and UHF. That's RCA's range of RF tubes and cavities for translator/transposer service — world-wide!

From RCA the leading U.S. supplier of these combinations, you get as much as a 4-to-1 savings in plate dissipation. All the audio/visual RF circuitry is provided in each tube/cavity combination, and it can be tuned to any band now allocated to TV service anywhere in the world.

Ask your RCA Representative about the attractive costs and special advantages of RCA tube/cavity combinations. For more information, write: RCA, Power Tube Marketing, Section 70E8 /ZR7, Lancaster, Pa. 17064. International: RCA, 2-4 rue du Lièvre, 1227 Geneva, Switzerland, or Sunbury-on-Thames, U.K., or P.O. Box 112, Hong Kong. In Canada: RCA Limited, Ste. Anne de Bellevue 810, Quebec.

Tube/- Cavity	Peak of Sync	Gain (Typ.)	Linearity (Typ.)
8122/Y1222	100 W VHF	15 dB	-52 dB
8792/Y1167	1 kW VHF	12 dB	-50 dB
4628/Y1246	1 kW UHF	12 dB	-52 dB
8226/Y1257*	100 W UHF	12 dB	-52 dB

*Objective

MOS Memories

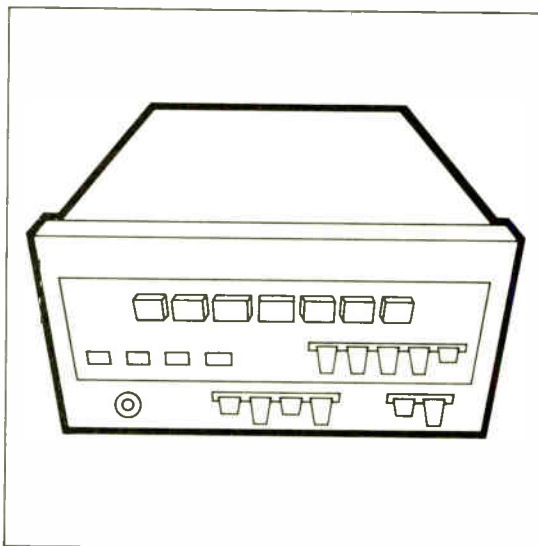
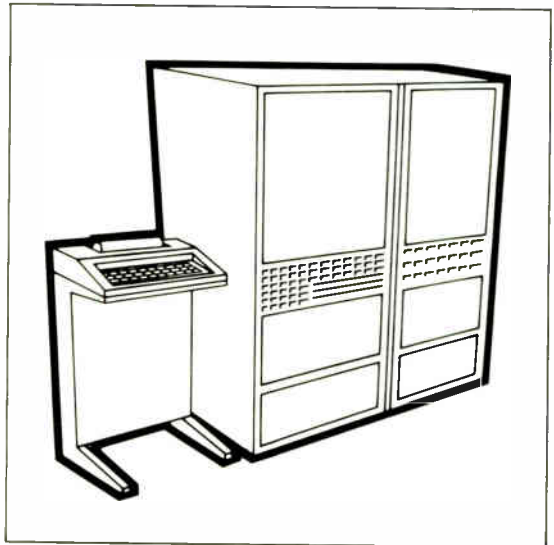
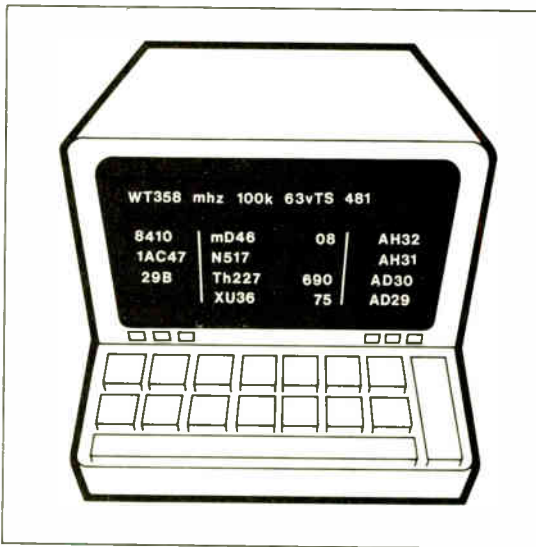

The FIRST source for standard RAM's is AMI. Production quantities of the following are available at prices that are hard to beat, try us.

Description	Model #	Replaces
1024 x 1, 500 nsec	S4008	MK4008
1024 x 1, 400 nsec	S4006	MK4006
1024 x 1, 300 nsec	S2103	1103
1024 x 1, 150 nsec	S3103	1103-1
1024 x 1, 100 nsec	S5103	
COMING — 512 x 4, 4096 x 1, and 1024 x 4		

Whatever your memory requirements, from scratch pads to main frames, contact AMI. The company that shipped over 1 billion bits of memory in 1971.

Send today for current specifications, price list and memory application work sheet.

STANDARD
MASTERS OF MOS
^

AMI Micro-Products
A DIVISION OF AMERICAN MICRO-SYSTEMS, INC.
© 3800 Homestead Rd. Santa Clara, CA 95051 (408) 246-0330 TWX (910) 338-0018

CAD programs optimize designs

Don't toss out the soldering iron and lab oscilloscope just yet, but computer-aided-design programs are coming closer to validating the cliché about the computer's eliminating the circuit breadboard. **New programs, such as Optinet, Magic, and Recal II, all have optimization features.** You specify a certain characteristic to be maximized or minimized, give the computer weighting factors for the various circuit parameters, and you get the design that comes the closest to the desired performance. The operating cost is coming down because language has been simplified and computer time is used more efficiently.

Custom connectors come in 5 modules

Another do-it-yourself kit: Amphenol Industrial division of Bunker Ramo is ready to announce a set of connector insert modules for a 57-series shell size that will allow you to assemble your own customized rack-and-panel connectors. For lab use and small production runs, you could find it a lot cheaper and faster than entering into custom-design programs. **The shell holds five modules, and five different modules will be available from distributors:** a blank, a shielded coax or size 12 contact, four size 16 contacts, eight size 20 contacts, and 21 size 24 contacts.

What happened to the nanofarad?

We get letters: "Let's hear it for the nanofarad," writes Brock Dew of MIT's Charles Stark Draper Labs. He points out that nanosecond and nanoampere have come into common use, but not nanofarad. **Using nF would avoid keeping track of leading and trailing zeros such as in 0.001 μ F and 2,700 pF.** About the only reason we can think of for the nF lag is that in most cases the numerical value itself suggests whether it's μ F or pF and thus is more convenient. What's your opinion?

Effort was worth it, say IBM authors

Why don't engineers write more about their work? According to a survey of IBM professionals taken by IBM's Mason Southworth, about **two-thirds of the survey respondents who had never written an article or delivered a conference paper cited lack of time or motivation.** On the other hand, Southworth, reporting at the March IEEE show, pointed out that about **80% of the respondents who had written said it was indeed worth the effort.** They said it made them better known inside and outside the company, it opened up new lines of communication with other professionals working on similar projects, or forced them to analyze their projects closely in order to write about them.

Addenda

If you're planning to use batteries in portable equipment, **watch out for differences in physical size.** Designers at Keithley Instruments have found that D-cells of nickel-cadmium, alkaline, and zinc-carbon vary considerably. This could be critical, especially in large series stacks. For a new multimeter that will accommodate any of the types, Keithley engineers laid out six D-cells in three stacks of two each. . . . Motorola Semiconductor Products, 5005 E. McDowell Rd., Phoenix, Ariz. 85008, has put together a comprehensive book on beam leads. **It covers such aspects as thermal capabilities, reliability, and bonding.** You can get a copy by writing to Paul White, of beam-lead marketing.

A Complete 40 MHz to 40 GHz DIRECTION-FINDING ANTENNA SYSTEM

**ANTENNA
AND
PEDESTAL**



All the equipment you'll need for fast threat analysis and identification is here: . . . antenna . . . pedestal . . . antenna control and amplifier . . . receiver . . . displays. Available in a versatile modular configuration, this multi-service D.F. system consists of rugged, field-proven equipment for air-borne, ship-board or ground usage.

The 40 MHz to 40 GHz frequency range is covered by three distinct antenna and receiver combinations:

Frequency	Antenna	Receiver
40 to 550 MHz	L4/A	RS-160
550 MHz to 12.4 GHz	L3/A	WJ-1140
12 GHz to 40 GHz	L5/A	WJ-1140

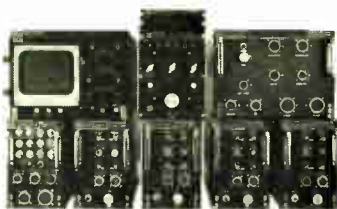

W-J 1140 RECEIVER



**INDICATOR
CONTROL
ASSEMBLY**

Frequency or spectrum coverage can be computer programmed by synchronizing the antenna spin rate and the receiver sweep rate.

If desired, the antenna can be manually slewed in azimuth to any position, and the receiver can be manually tuned across the spectrum. System analysis capability may be expanded through the use of optional equipment, including RF spectrum displays, IF pan displays, and time base analysis displays. Computer interfacing and software programs are also available.

By merging the antenna system and the receiver into a single integrated package, Watkins-Johnson solves a critical interface problem. May we do the same for you?



3333 HILLVIEW AVE., STANFORD INDUSTRIAL PARK, PALO ALTO, CALIF. 94304 (415) 493-4141

These new IC op amps have the lowest drift yet!

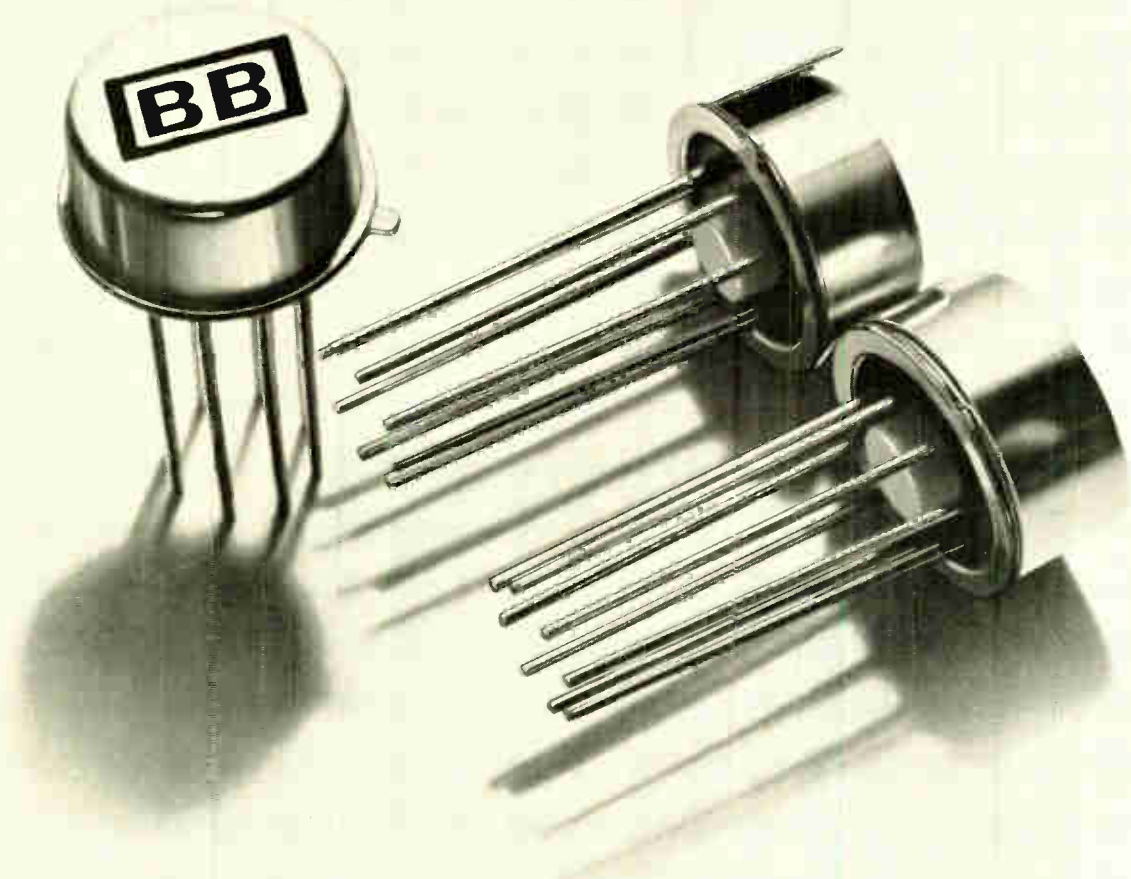

1 μ V/ $^{\circ}$ C, in solo or duet!

Now you have a monolithic op amp that has a maximum voltage drift of just 1 μ V/ $^{\circ}$ C with **no external compensation**. What's more, this performance is also available in drift-matched pairs, computer-matched to obtain 1 μ V/ $^{\circ}$ C tracking.

As good as it is, low voltage drift isn't the only outstanding feature of these Burr-Brown units. Offset voltage is just 500 μ V, maximum (200 μ V for matched pair), without external trimming. In addition, they have extremely low noise, low bias current over temperature and common mode voltage ranges, high input impedance, and are internally current limited to provide short circuit protection.

Designed for low input current while maintaining a respectable slew rate (1.0V/ μ sec) and bandwidth (1.5MHz), the 3500E (single) and 3500MP (matched pair) are ideal for a wide variety of applications. Burr-Brown quality is assured

since all units are 100% tested to all min/max specifications including voltage and current drift vs. temperature.

HIGHLIGHT SPECIFICATIONS

	3500E	3500MP (matched pair)
Voltage Drift	1.0 μ V/ $^{\circ}$ C, max.	1.0 μ V/ $^{\circ}$ C, max. (Tracking) 5.0 μ V/ $^{\circ}$ C, max. (Each unit)
Input Offset Voltage	\pm 500 μ V, max.	\pm 200 μ V, max. (Match)
Open Loop Gain	100dB, min.	100dB, min.
Input Bias Current	\pm 50nA, max.	\pm 50nA, max.
Slew Rate	1.0V/ μ sec, min.	1.0V/ μ sec, min.
Price, 1-24	\$30.00 each	\$25.00 per pair

For complete technical information and applications suggestions, use this publication's reader service card or contact your Burr-Brown Representative.

NEW BURR-BROWN BOOK

"Operational Amplifiers — Design and Applications", over 470 pages, 300 illustrations. Written by Burr-Brown application-engineering staff, published by McGraw-Hill. U.S. price, 15.00 dollars. Order from Burr-Brown.



BURR-BROWN

RESEARCH CORPORATION

International Airport Industrial Park • Tucson, Arizona 85706
TEL: 602-294-1431 • TWX: 910-952-1111 • CABLE: BBRCORP

How to stuff a lot of hot semiconductors into a small space and not get burned.

We've developed an ingenious new printed circuit board that conducts heat, radiates heat, and offers an effective area for convection of heat to the surrounding air, just like heat sinks and dissipators do.

So now you can mount concentrations of heat-producing devices directly on our new circuit board and save the space, weight, and cost of heat sinks, heat dissipators, blowers, and conduction planes while you operate your circuit at high power densities and let our circuit board keep junction and case temperatures at safe, comfortable levels.

Simple secret ingredient

Our new circuit boards permit these power densities—from 4 to 13 times those possible using G-10 epoxy boards—because they are made out of aluminum.

So that our metal circuit board can function like normal circuit boards do, we coat it—all over and through the holes—with an electrically insulating material on which we plate the circuit and plate through the holes.

The difference that makes the difference

But here's where our 15 years of working with heat sink coatings makes heat dissipating metal circuit boards possible. Our exclusive new coating—tough, hard, resistant to solder, solvents and thermal shock, and displaying high dielectric strength plus high surface and insulation resistance—has excellent thermal qualities.

That means you can take one of our

circuit boards—called "MCCB" for Metal Core Circuit Board—and put circuitry on it developing four times the power that a circuit on a G-10 board of the same size and weight can handle while both hold case and junction temperatures to the same, safe levels.

can thermally ground it. And when you do, it will dissipate up to 13 times the power of a simple epoxy board while maintaining recommended temperatures.

That kind of ratio means you're replacing big blowers moving strong air flows over bulky heat sinks—maybe even liquid systems—with a printed circuit board.

Missing link found

And in a thermally grounded system, MCCB supplies a heretofore nonexistent link between the heat generating semiconductor—or resistor or whatever—and the natural conduction path from metal board retainers through the chassis to the outside world. Another MCCB advantage you won't want to overlook is high conductor current carrying capacity. For instance, a .033" wide conductor printed on our MCCB will carry over three times the current as the same conductor on G-10 with the same conductor tem-

perature rise above ambient.

Original fit or retrofit

Our new metal circuit boards can revolutionize your next packaging design, and they can clear out hot spots in existing designs as well. Write, phone, or circle for all the details. Or send us your artwork for a quotation. International Electronic Research Corporation, a corporate division of Dynamics Corporation of America, 135 West Magnolia Blvd., Burbank, Calif. 91502. (213) 849-2481.

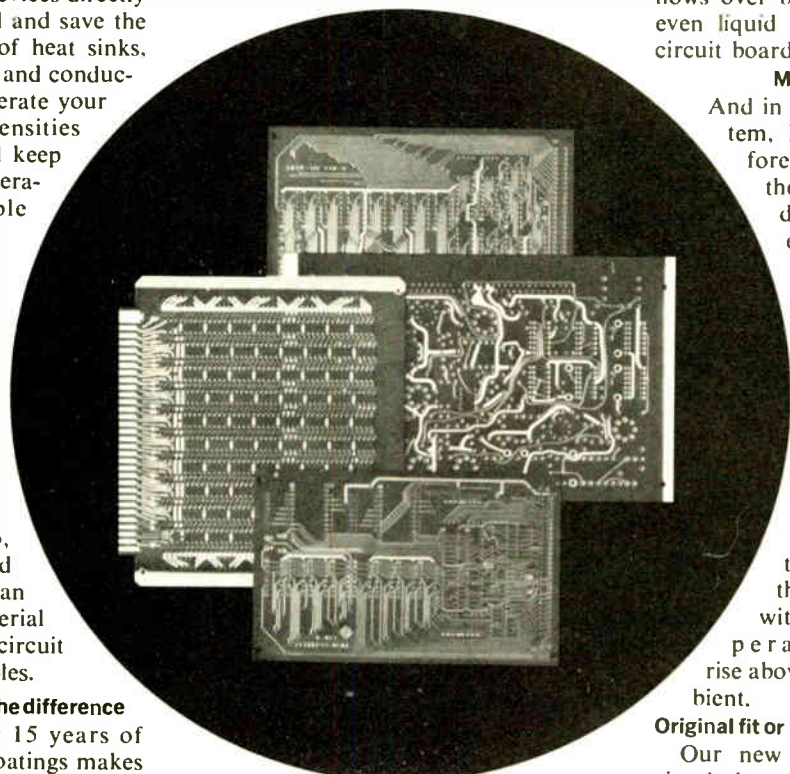

When you're hot, you're hot

Looking at it the other way, if you're stuck with a hot circuit and you'd like to tuck it away in a nook somewhere, loading it on an MCCB will let you put it in about half the space you could get away with using an epoxy board plus the required heat dissipators and other thermal management devices. And it will weigh about half as much to boot.

But here's where our MCCB really gets unfair to the G-10 competition: You

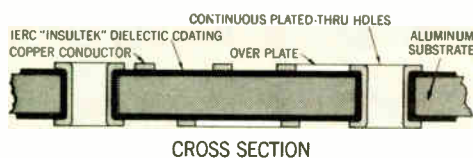
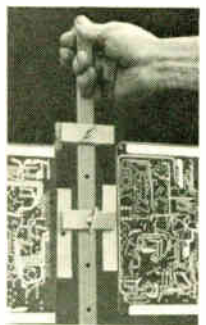

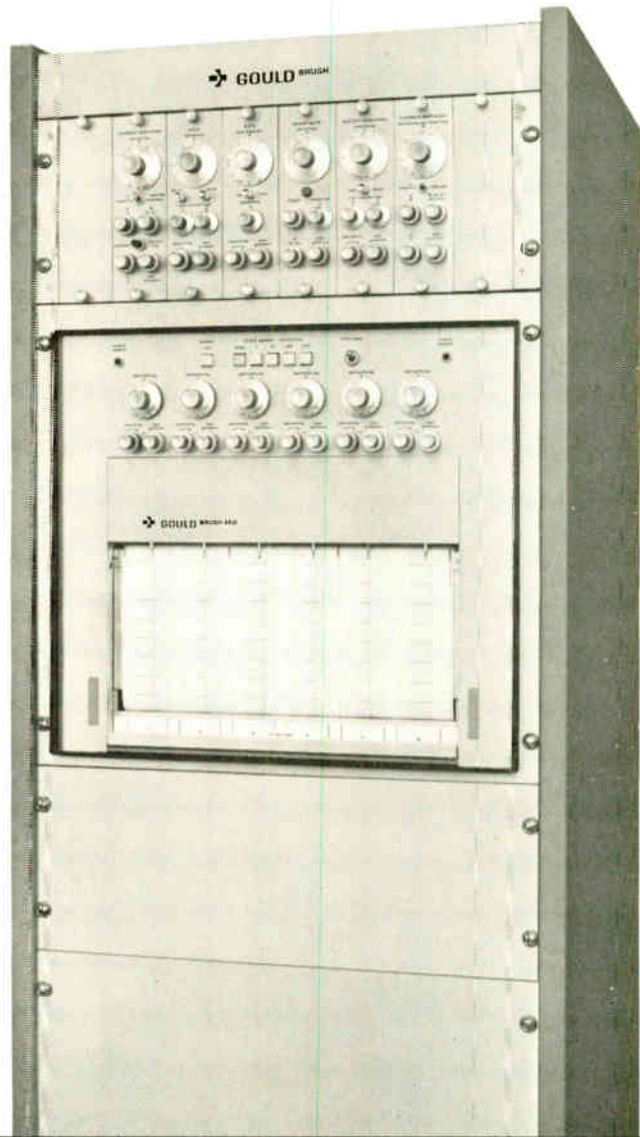
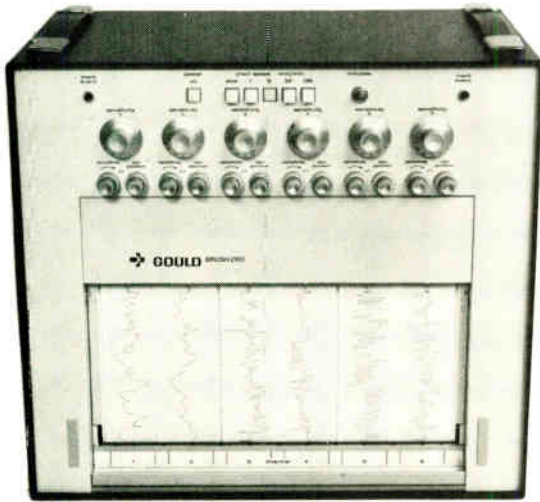

FREQUENCY RESPONSE AND AMPLITUDE

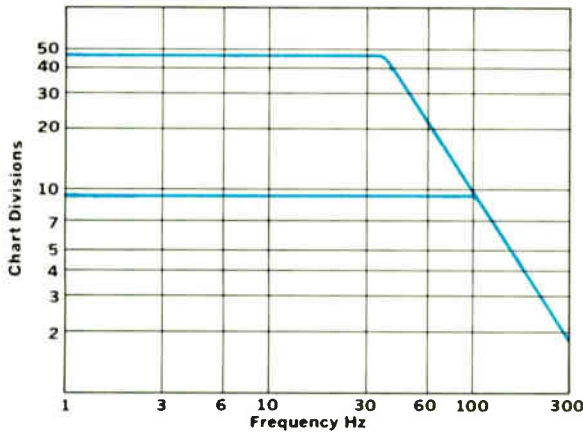

The Brush 260 is one of the few bargains left.

Because the Brush 260 6-channel recorder gives you the most accurate, reliable data at the lowest cost per channel.

The 260 also gives you all the important Brush exclusives. Like a pressurized ink system. Which eliminates smudging, puddling, and priming. So traces are always crisp, clear, and uniform. And a throw-away plastic cartridge which holds a year's supply of ink.

Another Brush exclusive is our Metrisite® non-contact servo-loop feedback device. The Metrisite makes the 260 so accurate we guarantee 99½% linearity.

And the 260 has built-in preamps which provide a

measurement range from 1mV/div. to 500V full scale. Frequency response for the 260 at 50 divisions is flat within ± 2% of full scale from d-c to 40Hz.

Add in six 40mm analog channels and four event markers. Plus eight pushbutton chart speeds from 1.0 to 125mm/second and mm/min. And you can use the 260 as a portable unit, rack mount it or put it in a roll-around cart.

The Brush 260. It's a good way to get the most for your money. For more information, write: Gould Inc., Instrument Systems Division, 3631 Perkins Avenue, Cleveland, Ohio 44114. Or Rue Van Boeckel 38, Brussels 1140, Belgium.

BRUSH INSTRUMENTS

 **GOULD**

It took us years to develop the best stereo microscope.

Now give us a few minutes to prove it.

Let us compare our StereoStar/ZOOM to any stereoscopic microscope in your lab.

Our microscope offers high resolution, larger fields of view, greater working distance. We have as wide a magnification range as you're likely to need: a full 6 to 1 zoom range with magnifications from 3.5 X through 210 X. The zoom control knob is coupled—so that it's conveniently located on both sides, for either left or right-hand operation. And the entire head is easily rotatable through 360°.

135 years of optical excellence went into the AO StereoStar/ZOOM. Let us compare it to any stereo microscope in your lab. After all, if it's worth your money, it's worth your time.

Call your AO Representative. Or write for our convincing 24-page brochure.



**AMERICAN OPTICAL
CORPORATION**

SCIENTIFIC INSTRUMENT DIVISION • BUFFALO, N.Y. 14215

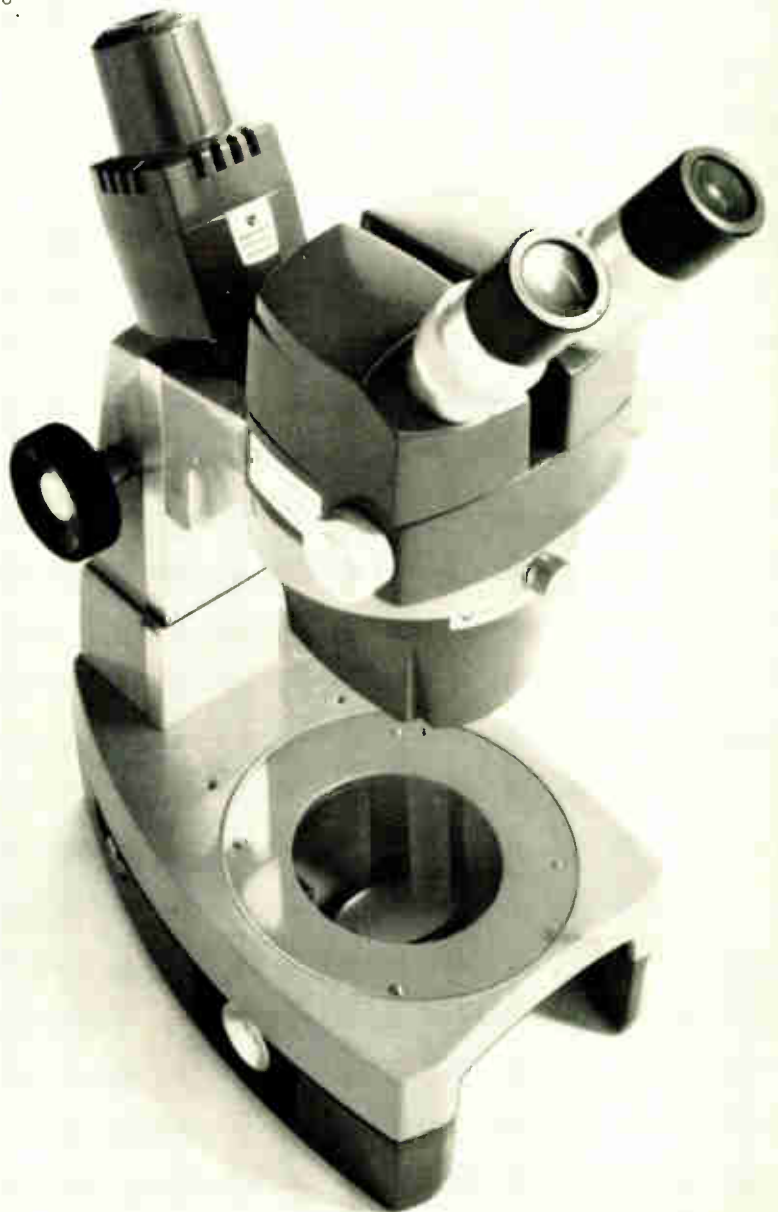

Stackpole's phenomenal
Ceramag® ferrite bead

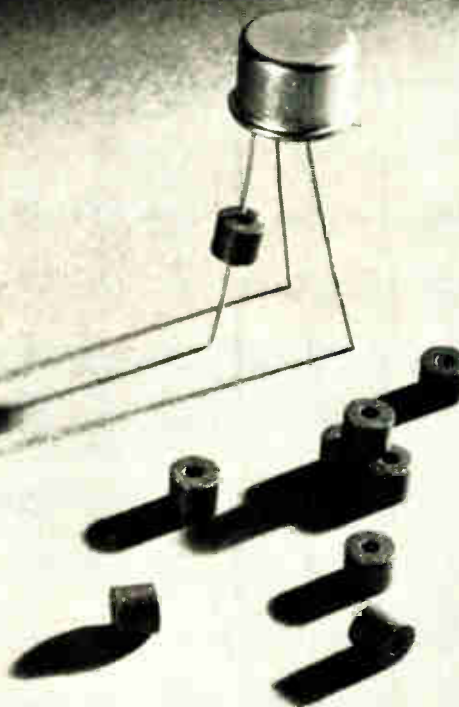

The Silencers

Ceramag® Beads Do Away with Noise

Stackpole ferrite beads offer a simple, yet effective means of suppressing spurious RF signals to prevent them from entering areas susceptible to such "noise." No other filtering method is as inexpensive as a ferrite bead.

How can you use a bead? Consider it as a frequency-sensitive impedance (Z) element. Beads are available in a variety of

Stackpole Ceramag® materials. Depending upon the material selected, beads can provide increasing impedances. From 1 MHz to over 200 MHz. Keep in mind, the higher the permeability, the lower the frequency at which the bead becomes effective.

Should a ferrite bead be small? Not necessarily. The unique, giant bead shown below is used by IBM to eliminate the effect of transient noise.

The impedance of Stackpole ferrite beads can be changed by simply varying the length or the O.D.-I.D. ratio.

Installation of Stackpole beads is easy. And inexpensive. Simply slip one (or several) over the appropriate conductor(s) for the desired noise suppression or high frequency isolation.

Additional savings in production time and labor costs are possible by utilizing automatic insertion equipment to install ferrite beads *with leads* in printed circuit boards.

CERAMAG® FERRITE BEAD CHARACTERISTICS

	24	7D	5N	11
Initial Permeability	2500	850	500	125
Volume Resistivity @ 25°C	1.0x10 ²	1.4x10 ⁵	1.0x10 ³	2.0x10 ⁷
Effective Suppression At:	1 MHz.	20 MHz.	50 MHz.	100 MHz.
Curie Temperature	205	140	200	385

Beads are available in sleeve form in a range of sizes starting at .020 I.D., .038 O.D., and .050 long. For special compact filtering applications, beads can be supplied to tight mechanical tolerances.

Sample quantities of beads and beads with leads are available upon request. Send your requirements to: Stackpole Carbon Company, Electronic Components Division, St. Marys, Pa. 15857. Phone: 814-781-8521. TWX: 510-693-4511.

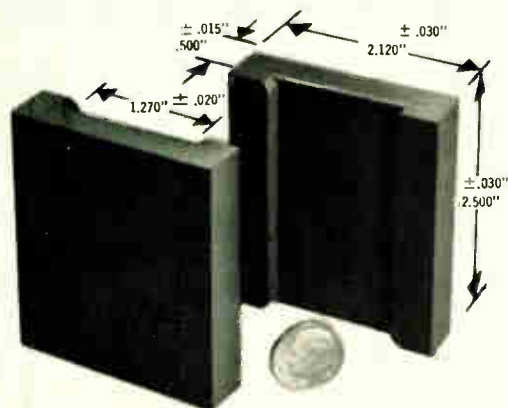

Circle 137 on reader service card

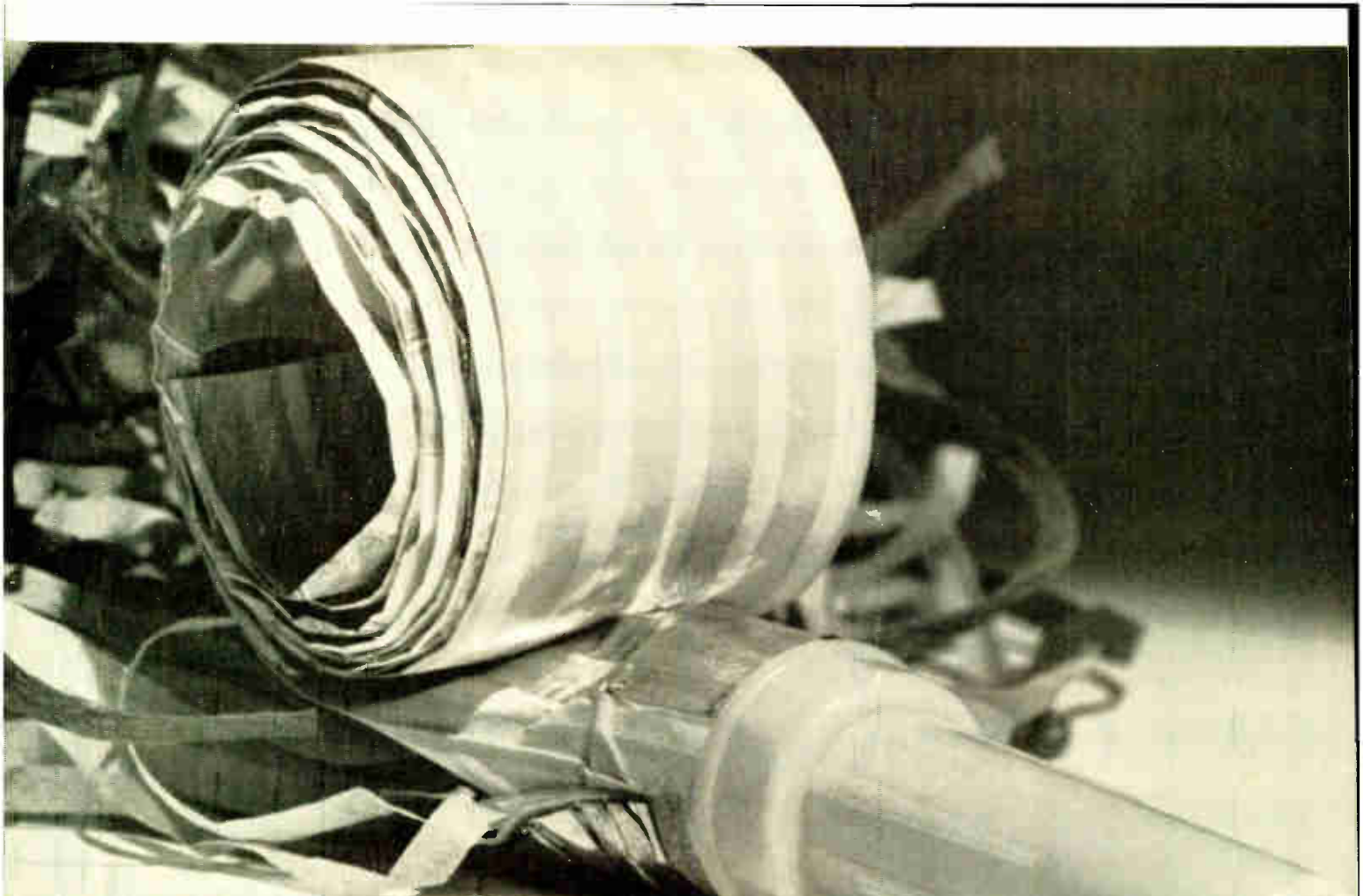

Free with every Model 132 Function Generator.*

We've always designed Wavetek generators to produce as clean an output as possible. The result is that we've neglected all you guys that need to check a system's capacity to handle noise. Our new Model 132 changes all that because it contains a pseudo-random noise generator. Now you can generate precise, calibrated outputs of digital or analog noise. And you can dial in calibrated signal-to-noise ratios. Naturally, the Model 132 still puts out super-pure sine, square and triangle waveforms—from 0.2Hz to 2MHz. And for just \$795, you can also make all the noise you want.



WAVETEK®

P.O. BOX 651, SAN DIEGO, CALIFORNIA 92112
TELEPHONE (714) 279-2200, TWX 910-335-2007

*(While supply lasts.)

Circle 140 on reader service board

New Products

Computer show focuses on peripherals

There won't be as many mainframes on display at the 1972 Spring Joint Computer Conference as there were at previous shows. But visitors to the Convention Hall in Atlantic City May 16-18 will see plenty of peripheral equipment and witness demonstrations of computer applications in a variety of industrial and commercial environments.

"It's like what happened to the steam engine," says a marketing manager. "After the novelty wore off, people became concerned with how to use it." Visitors to the SJCC this year will find a broad range of equipment demonstrating applications and capabilities of computer power, as well as techniques for getting the most out of data processing systems through communications and for enhancing mainframe capabilities. The rapidly growing field of data communications will be one of the principal themes of the exhibition.

In the pages that follow, *Electronics* previews some of the more significant products from around the country that will be on display at 1972 SJCC.

Domain-tip propagation memory goes to market

When a new electronic technology is dreamed up, it either makes its way into the commercial world within a year or two, or disappears. But a variation from this pattern is the domain-tip propagation memory, which was first developed some six years ago [*Electronics*, May 2, 1966, p.25, March 20, 1967, p.48], but is only now emerging as the technology behind two new products that will be introduced at SJCC.

The products are the DOTram-4 and the DOTram-16, both block-oriented random-access memories developed by Cambridge Memories Inc. The model 4, designed for terminals and peripheral equipment, can be thought of as a four-bit-by-16,384-word memory, although the word length can be as long as 36 bits, and the total storage capacity can range from 40,000 to 320,000 bits. The model 16 is intended to be a replacement for magnetic disk and drum storage units; basically it is a 16-bit-by-65,536-word memory, although again the word length can be eight to 36 bits and the total storage capacity can range from 65,000 to 16 million bits—and perhaps later it will be possible to increase capacity up to 128 million.

A block-oriented random-access memory (Boram) is one in which the

beginning of any block of data can be addressed independently of every other block, but in which data in successive locations in the block can be obtained rapidly after the beginning has been located. In both DOTram models, any block is accessible in a maximum of 1 microsecond, and once started, words in a block come out at 1 μ s intervals, but the average word access time is 1.75 milliseconds. Here, the DOTrams have an advantage over most Borams in that they suffer no time penalty in reaching the beginning of the block: the magnetic drum, another

form of Boram, must wait until the drum rotates an average of half a revolution under the read/write head before data transfer can begin. Another advantage is that the DOTram can be stopped dead in its track for an indefinite time. A drum can't be stopped or even appreciably slowed down, and metal-oxide semiconductor dynamic shift registers, which can read data at a megahertz clock rate and stand by at a few kilohertz, can't quite come to a stop.

The DOTram consists of a narrow strip of magnetic film deposited in a serpentine pattern on a substrate

Memory path. In a domain-tip propagation memory, a strip of magnetic film is deposited in a serpentine pattern. Magnetic domains are set up in the film and moved along it.

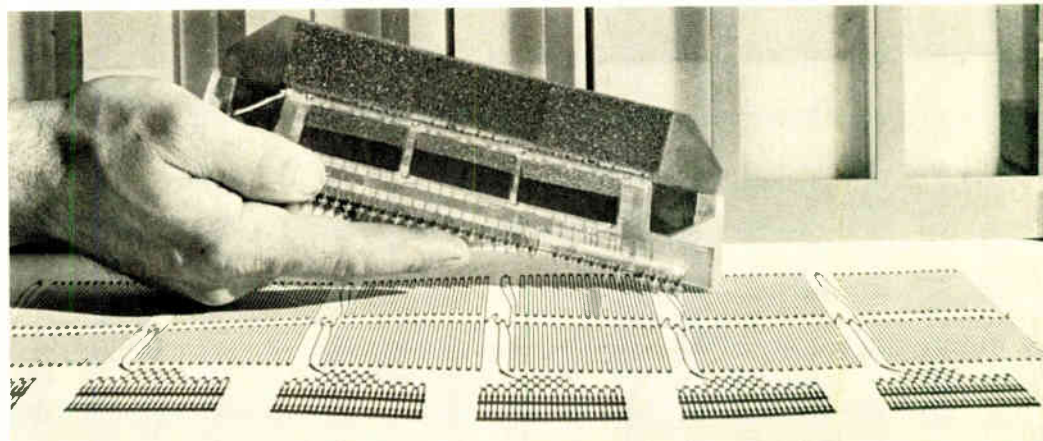

New products

over a pair of windings that carry a two-phase drive current. Magnetic domains are set up in the serpentine film and made to move along it, propelled by the field associated with the drive current. The phase relationship of these currents, together with the shape of the corners in the serpentine pattern, keep the domains from moving backward. They can move backward if the drive current phases are reversed; this is another advantage of DOTrams over drums and semiconductor

shift registers, neither of which can be reversed.

DOTram-4 memories cost about 0.4 to 0.5 cent per bit, compared to the 1 cent per bit and up that ferrite core and MOS memories cost today. DOTram-16, because of its larger capacity, costs even less, and achieves storage densities of up to 10,000 bits per square inch—five times that of core memories.

Domain-tip propagation technology superficially resembles bubble technology. In the DOT

memory, the domains are in the serpentine film and move along it under control of drive currents in windings close to the film. In the bubble memory, the domains are in the substrate and move freely through it, constrained by the magnetic properties of metal patterns deposited on the substrate; they are driven by a magnetic field perpendicular to the substrate and rotating in a plane parallel to the substrate.

Cambridge Memories, Inc., 285 Newtonville Ave., Newtonville, Mass. 02160 [371]

Modular design cuts cost of disk memory system

Designed for point-of-sale and other systems requiring mass storage of data for minicomputer processing, a disk memory developed by Data General Corp. is available in capacities from 128,000 16-bit words to 768,000. The Novadisc is the first peripheral designed and made in-house by the Southboro, Mass., minicomputer manufacturer. Prices range from \$5,200 to \$12,500.

DG uses the same modular concept it employs in its computers—electronic subsystems are plugged together, rather than soldered like the mechanical assemblies, thus reducing costs. The head retracts from the disk when not in use. If the disk drops 10% below its speed of 3,600 rpm during power brownouts, the head automatically swings away to avoid surface wear.

An air bearing exerts 2 pounds of force on the Novadisc head; since it can tolerate up to 4 pounds, the head will not hit the disk if it is jarred during operation. This feature should enable the disk to operate in moderately rugged environments, as on ships and planes.

The head module is held by a single bolt to the loading and retracting post so that if it is damaged it can be replaced in about five minutes. Instead of using thin magnetic wires to connect the head to the electronics, DG uses Flexprint, which reduces to two 16-wire harnesses at the edge connector.

Three-frequency recording, such as that used on the IBM 3330 disk system, reduces the number of signal reversals required to enter data on the Novadisc. The operating speed of 3,600 rpm gives an average latency period of 8.4 milliseconds and a data transfer rate of 2 million bits per second. DG's 4019 disk control can handle as many as eight disks containing a total of 2,048 million words, has a track lock-out to protect disk tracks against overwriting by a program, and two buffer registers that give the data channel almost two words to respond to a request by the channel.

Along with the Novadisc, DG is offering a new real-time disk operating system that can handle single or multiple tasks and allows the user

to access information randomly, continuously, or sequentially.

The Novadisc will be discounted at the same rate as Nova minicomputers—as much as 40% on quantities of 200.

Data General Corp., Route 9, Southboro, Mass. 01772 [372]

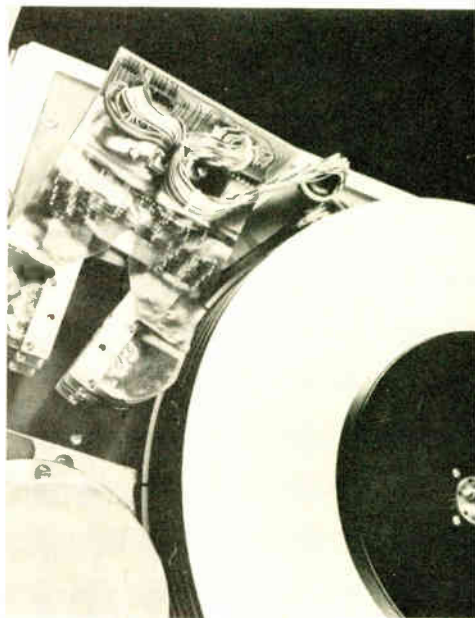

Graphics display stores, erases data selectively

A graphics display terminal developed for specialized scientific research at the Lawrence-Livermore Laboratory will now be marketed commercially. It is expected to have broad industrial applications as a

designer's aid for products ranging from aircraft to integrated circuits.

The model 801, built by Princeton Electronic Products Inc., stores information on a silicon-target storage tube and can erase it selectively.

The 801 interacts directly with a computer through a typewriter-like keyboard. On a 17-inch cathode-ray tube screen, it displays alphanumeric characters, vectors, or points at a writing speed as fast as 5,000

characters or 20,000 vectors per second. As many as 32 different shades of gray can be displayed.

Providing 50 foot-lamberts of brightness, it can be easily viewed in daylight, according to the company. And with an 8,192-character storage capability in the Lithocon storage tube—developed by Princeton about two years ago—the 801 is faster, 12 times brighter, and stores almost three times as much graphics information as other available units, asserts president Steven R. Hofstein.

The terminal is compatible with ordinary television systems—resolution is 550 line pairs—and one terminal will drive up to six TV moni-

tors directly, or any number if a distribution amplifier is added. Altogether, the unit can address a matrix of 4,096 by 4,096 points, of which 1,024 by 1,024 are viewable. The model 801 character generator uses the ASCII 8-bit character set and can provide three character sizes. The unit will operate in full-or half-duplex mode.

Because of the Lithocon storage tube characteristics, the terminal can be equipped with an electronic “zoom-in” feature that allows a magnified portion of the generated image to be displayed. The zoom control consists of a joystick for manual positioning of the image

center in the X and Y directions, and a size-control switch providing several different area magnifications. The terminal can also drive a Princeton electrostatic printer to produce hard copies of the display.

Hofstein says the terminal will appeal strongly to the scientific and engineering communities that use computer graphics displays to aid the design of aircraft, automotive parts, buildings, and integrated circuits. Price of the terminal is \$7,200, plus \$750 for the circuitry needed to provide an interface with a computer.

Princeton Electronic Products Inc., P.O. Box 101, North Brunswick, N.J. 08902 [373]

Plotter is accurate within 0.005% at 750 in./min

Two main types of plotters are available: small, low-priced units such as strip-chart recorders, used mainly in the laboratory, and high-speed closed-loop feedback units priced at \$25,000 and up. But now Data Technology of Watertown, Mass., is marketing a plotter that combines the accuracy and speed of higher priced units for only \$15,000.

Data Tech gains economies by supporting the pen from only one side of the drafting area instead of two—the more usual gantry approach. Experience in making coordinate digitizer systems also enables the company to cut manufacturing costs. And it uses state-of-the-art technology, such as transistor-transistor logic. The plotter is inexpensive enough to make it practical for the drafting room. Data Tech is aiming first at companies with in-house computer-assisted-design facilities.

The plotter has a flat bed measuring 22 in. by 34 in., a size that the company says will become more

popular in the future and can fulfill 95% of most people's needs. Drafting paper is held down electrostatically, instead of with the usual vacuum method. Accuracy of the unit is guaranteed to within 0.005% and has reached 0.002%—equal to high-priced plotters—at a velocity of 750 in. per minute.

To attain this accuracy, Data Tech has developed an analog approach. Since there cannot be an instantaneous change in velocity, speed must come up on a ramp and then down. With digital plotters, the computer itself must speed and slow the pulse rate, an expensive procedure. Data Tech's plotter is able to accept pulses at a continuous speed of 5 kilohertz, which go into an up-down counter. Its output is converted to an analog signal, put through a low-pass linear filter, and then sent to a voltage-controlled oscillator (VCO) that subtracts counts from the up-down counter.

Thus, the analog input to the VCO is the velocity signal, and that can

be used in an analog loop to control velocity with a tachometer feedback sensor. VCO pulses step the motor, and are behind the input pulses in time. Position of the pen is controlled by the VCO and velocity signal. Pulse resolution of 0.0025 enables the plotter to draw smooth curves and do lettering faster than usual, since there is no need to slow down at intersections.

At first, Data Tech will offer interfaces to PDP-8, PDP-11, and Nova minicomputers, and within a year it says it will have interfaces for most other minis, as well as Univacs and IBM 1130s. The first one will be a pulse-stream interface, which requires only a small amount of logic on the computer side. Later a word interface will be offered. Future plotters will be built to accept magnetic and paper-tape input. A read-out, multiple pens, and a scribe for cutting rubyolith will be offered as options.

Data Technology, 65 Grove St., Watertown, Mass. 02172 [374]

Cassette recorder challenges paper-tape equipment

A magnetic-tape cassette recorder that is aimed at the high-speed paper-tape market will read and write data at speeds from zero to 350

characters per second incrementally. This enables the operator to stop on a character to edit and correct data without duplication to a new cas-

sette. In addition, in the continuous-tape read mode, fast tape access is available in any one of four digitally selected speeds up to 800 characters

New products

per second. The recorder, the PI-72, was developed by International Computer Products Inc.

Data organization in the Philips 0.15-inch tape cassette is adapted to paper tape. While bits are recorded serially on both channels, the deck reads and writes from a register to provide compatibility to the parallel-by-bit, serial-by-character paper-tape equipment. It also stops from full speed in four characters, which are stored in a short buffer to give the device the stop-on-character capability common to paper tape.

"The PI-72 was designed to do all the things magnetic tape does well—including correction and silent operation," says ICP vice president Robert N. Miller. Since the deck can be hooked up directly to paper devices, ICP hopes to capture its share of the market from the industries now relying on paper-tape punches and readers: communications, printing, minicomputers, business and accounting machines, and numerical

machine-tool operations.

ICP uses a bit-mark-sequence recording format to get the deck's incremental capability in both read and write modes. Nine-bit bytes are bracketed by two-channel start and stop bits, and a nine-bit interbyte gap is inserted to allow the deck to increment in the read as well as the write mode without restricting data format or record length.

Bits are spaced at 0.002 inch, yielding 25 characters per inch, counting the interbyte gaps. Miller estimates that the PI-72 can write 55,000 characters on the standard Philips cassette. The recorder, using a spindle mechanism to drive both reels, can maintain some drive in both directions for fast braking and to maintain tape tension. The deck can reach its maximum read/write speed of 350 characters per second, or 14 inches per second, in 20 milliseconds. Specified error rate is one bit in 10^7 bytes.

One of the few machines compet-

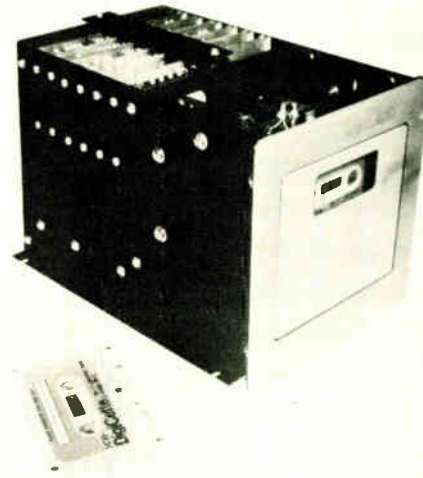

ing in the high-speed, expensive end of the cassette deck market, ICP's PI-72 offers size, price, and power requirement advantages over conventional high-speed paper tape devices. It is priced at \$1,015 in quantities of one to 10.

International Computer Products Inc., P.O. Box 34484, Dallas, Texas 75234 [375]

Graphics display system eases load on processor

Using a minicomputer as a dedicated graphics processor has enabled Data Disc Inc. of Sunnyvale, Calif., to introduce Anagraph, its multichannel graphics display system for only \$5,000 to \$10,000 per terminal. The mini handles many tasks ordinarily assigned to the host processor, says Andrew O'Sullivan, president, adding that other graphics systems can run as high as \$100,000 a terminal.

The Anagraph, said to be a plug-to-plug replacement for the IBM 2250 with most of the capability of the 2250, consists of a Data Disc

6600 cathode-ray tube display system, an Interdata 70 minicomputer, a Data Disc 7200 disk memory, and up to 16 Data Disc 6612/6611 display monitors and keyboards. Not only does Anagraph incorporate the minicomputer as a graphics processor, but because it is not necessary to communicate with the central processing unit to edit or format information, the system reduces the load on the CPU. The clustered system, similar to that of the IBM 2260, allows users to share the disk memory for the display, which further cuts costs. And the ease of

graphic programming means more economies.

The Anagraph will drive as many as 16 display terminals. It can display 3,840 standard characters simultaneously in 300 milliseconds. Four character sizes are available. More than 300,000 points are possible in the graphic display with a 640 by 480 format. A complex graph of 1,000 random vectors can be generated in 2 seconds, the company says. Any rectangular area of the screen may be erased, and each graphic point is individually addressable. Channels may be combined for color or gray-scale displays. Seven colors plus black are available from three channels.

Process control and management information systems are probably Anagraph's chief applications. The first Anagraph management information system is already operating at the First National Bank of Chicago. But Anagraph can also be used in financial and securities analysis, and scientific/engineering ap-

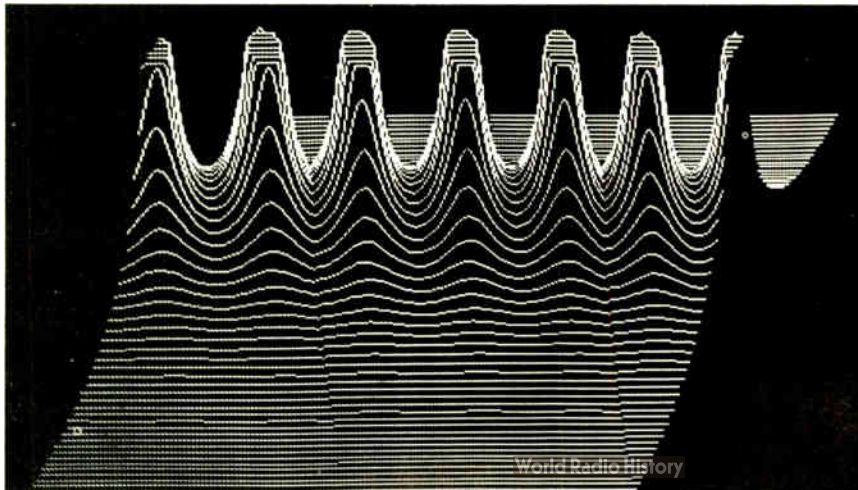

38% OFF

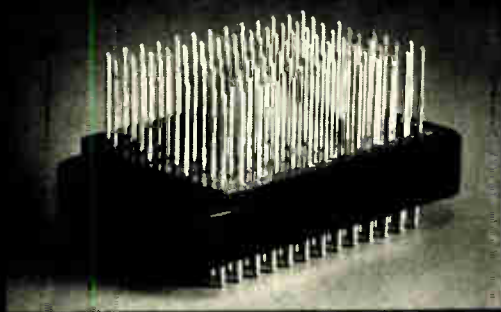

This isn't a discount sale on rack and panel connectors and it's not just a way of getting rid of old inventory.

It's just a plain and simple fact that you can save money by using our P108 rack and panel connector.

And as an even bigger advantage, the savings come on your end of the line, not ours.

You can save on installation cost, because the P108 comes completely assembled. All you need is someone to snap it into place.

In one installation, using fifty-four of our 104-pin P108 connectors, the customer was able to reduce assembly time by 18.6 hours using a combination of automatic and semiautomatic wire wrapping techniques.

This resulted in a 38% reduction in overall assembly labor.

He also got an extra measure of assured reliability, because on any GTE Sylvania connector everything is made by GTE Sylvania—from plastic body to gold-plated contacts.

The standard P108 connector comes with 104 pins. We also have a 50-pin version.

On the 50-pin version, your savings will be a little bit less than on the 104-pin design.

Sorry about that. In any event, why not contact Marv Gustafson at 814-723-2000. He'll tell you all about the P108 and our complete custom facility. GTE Sylvania, Precision Materials Group, Parts Division, Warren, Penn. 16365.

GTE SYLVANIA

Circle 145 on reader service card

Circle 147 on reader service card

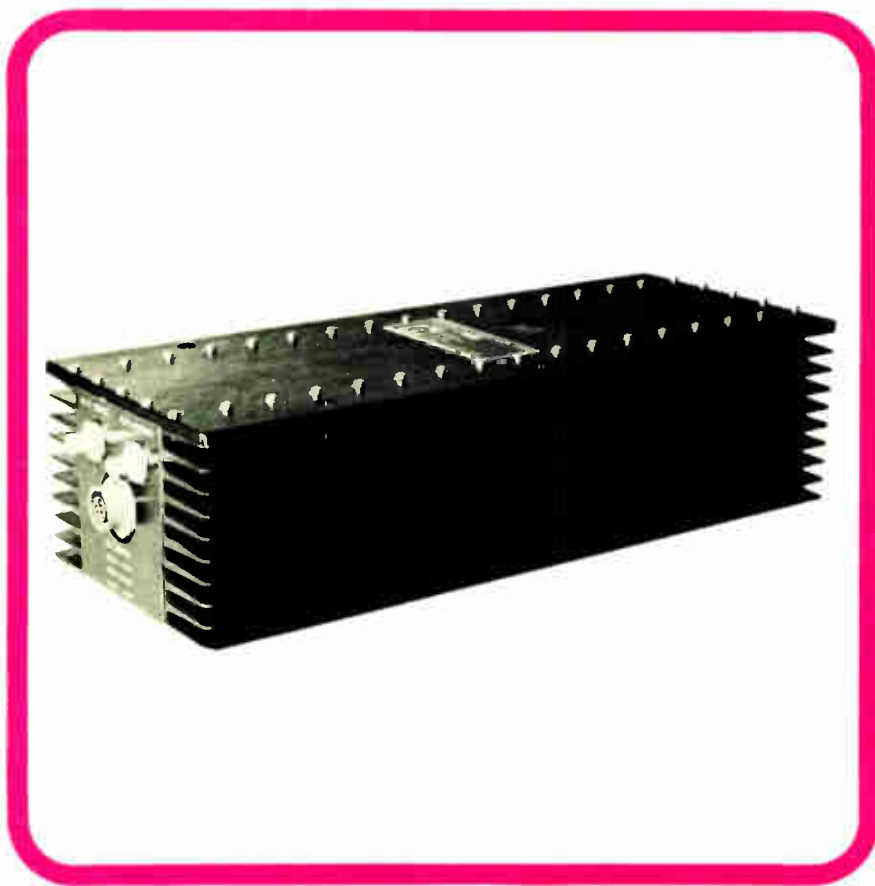

KEEP PLUGGING

A highly reliable solid state high frequency transmitter — 'build it in the field'.

Hermes Electronics Limited manufactures a 100W Broadband linear amplifier which replaces tubes in power output stages.

The 100W modules may be used singly or in groups to provide power output levels from 100 watts to many kilowatts. The amplifier has interface compatibility with the transmitter used in the majority of MANPACK systems, and with most mobile, airborne and fixed ground transmitter exciters.

It covers the frequency range 2MHz to 32 MHz and in combination can achieve power outputs to 5KW.

- ★ unique cooling system gives high reliability under adverse conditions
- ★ constructed for vehicular use
- ★ embodies overload protection

Hermes Electronics Limited can plug you into a wide range of HF equipment.

ASK US



Hermes Electronics Limited
 Suite 315
 2020 F. St., N.W.
 Washington, D.C. 20006
 Telephone 202 296 2978
 TWX 710 822 1106

New products

models of Complot digital plotters having DTL/TTL compatible inputs, at the control system market.

Software for driving the plotter can be as small as 30 locations of memory for specialized applications, says the company; the complete package, including alpha-numeric symbol generation, array plotting and axis generation for graphs, requires about 1,000 locations. Delivery time is 60 days.

Houston Instrument Div., Bausch & Lomb Inc., 4950 Terminal Ave., Bellaire, Texas 77410 [378]

Tiny disk drive

What's the smallest disk cartridge support drive ever offered? Caelus Memories Inc. of San Jose, Calif., says that its new model 103, which stands 5.25 inches high and weighs in at 35 pounds, takes the prize. Compared with previous models, which Caelus says are at least 8.75 in. high and weigh 75 lbs. the 103 represents quite a saving in rack space—its length is 25.75 in., and it occupies 26.75 in. of rack.

Capable of being mounted in a standard RETMA rack, the unit consists of the enclosure, head-positioning servo system, spindle, disk, spindle motor, read/write electronics, option/interface board, and power supply. It interfaces with and provides on-line peripheral storage capabilities for small general-purpose digital computers and intelligent terminals. With a fixed disk drive, it is especially applicable to process control, where it must be completely sealed.

Available in a single-disk configuration, the model 103 has a 24-megabit capacity. There are 204 tracks per surface, divided into 24 sectors. The recording medium is a double-sided, magnetic-oxide-coated disk that is fixed within the drive. Density is 2,200 bits per inch. Transfer rate is 1.38 megahertz at 1,500 rpm.

The model 103 is priced below \$2,000.

Caelus Memories Inc., 967 Mabury Rd. San Jose, Calif. 95133 [379]

Fluke problem solvers

At .002% guaranteed accuracy, our 8400A is the ultimate bench and systems DVM



Built with an accuracy for all seasons, every season.

With a guaranteed accuracy of 0.002%, true RMS AC, 1 microvolt resolution, resistance measurements down to 100 micro ohms, auto polarity and ranging, you will find it's the top DVM in the field. And, in the Fluke tradition, you'll find this member of your measurement team won't be technically obsolete or out of style next year or the year after, because of its wide choice of systems and measurement options.

It's built to last. It's built to use.

It's the DVM to use for low-level, high speed measurement of distorted AC waveforms, physiological measurements, transducer calibration and virtually every other laboratory or field application demanding "state-of-the-art" digital measurement.

Here's what you get for \$2450: Five ranges of DC

from 0.1v full scale to 1,000v with up to 0.002% accuracy. 5½ digits with 20% overrange. Recirculating remainder A-to-D conversion for low power consumption and high reliability. 1500v peak overload resistance and the ability to meet tough environmental specs. Switched filter for DC, AC, resistance and ratio with better than 65 dB noise rejection.

Wide choice of options: Fluke uses single main frame construction with all options field installable. Get them when you buy or anytime later.

Choose from seven ranges of 4-terminal resistance. Four ranges of true RMS AC from 1 to 1,000 volts. Well isolated and buffered serial or parallel data outputs. Multiplexing of analog input, data output or remote control. Automatically adaptive time-outs with status flags.

For more information, call your nearby Fluke sales engineer or contact us directly.

Fluke, Box 7428, Seattle, Washington 98133. Phone: (206) 774-2211. TWX: 910-449-2850/In Europe, address Fluke Nederland (N.V.), P.O. Box 5053, Tilburg, Holland. Phone: (04250) 70130. Telex: 884-52337/In the U.K., address Fluke International Corp., Garnett Close, Watford, WD2, 4TT. Phone: Watford, 33066. Telex: 934583.



Signetics chooses 10,000

Two years from now you'll wonder why you waited.



Take the time for a good hard look into ECL 10,000's high speed/performance advantages. And engineer your own head-start into tomorrow's optimized logic. Available today—and tomorrow—from the major new source for ECL series 10,000. Signetics.

Because Signetics never settles for less than total IC capability, we researched your future requirements in high speed logic. And cut through the claims of existing ECL alternatives without mercy. All the know-how, the back-up, the all-out commitment you expect in Signetics linear, digital and MOS, stands behind our development and production of proven, line-ready ECL 10,000 devices.

What's in it for you? A constant reliable supply of the best high speed/low power trade-off yet. Typical speed level: 2.0 ns propagation delay per gate. Low power dissipation of 25mW—with no special cooling required in any environment, still air or forced. Switching rise and fall times compatible with conventional system layouts (3.0 ns edge speed).

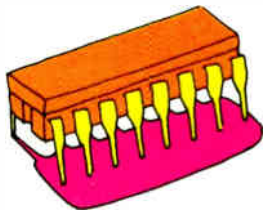

ECL 10,000 delivers outstanding design/function flexibility. Multi-

level gating on a single chip, through open emitter outputs and high impedance inputs, means a significant savings in gate and package count. Plus a free choice of terminating schemes and logic interconnects.

Packaged in plastic Silicone DIP or Cerdip, Signetics ECL 10,000 line will provide a complete high speed logic family—some already on-shelf in factory or distributor stock, the remainder due by summer.

Signetics DUAL 3-INPUT 1 OR/2 NOR OUTPUT GATE 10112
—10112, 10112*—10112, 10112*

DESCRIPTION
The 10112 is a dual in-line package (DIP) 3-Input OR/NOR Gate. It is designed to provide high speed performance and low power dissipation. The package contains all the devices necessary for the gate and its output. The package is available in both plastic and ceramic packages. The package is available in both plastic and ceramic packages. The package is available in both plastic and ceramic packages.

PACKAGE TYPES
1 Plastic DIP
2 Ceramic DIP

TEMPERATURE RANGE
0° to 70°C (Commercial)
-55° to 125°C (Military)

RECOMMENDED OPERATING VOLTAGE
V_{CC} = 5.0V ± 0.2V
V_{EE} = 0V ± 0.2V

CIRCUIT SCHEMATIC

Contact your Signetics salesman, rep or distributor for availability information. He will also rush you our informative ECL 10,000 booklet, free upon request. Or write Signetics/ECL directly, 811 E. Arques Avenue, Sunnyvale, California 94086.

SIGNETICS ECL 10,000 SERIES

10101 Quad 1-Input OR/NOR Gate	10112 Dual 3-Input 1-OR/2-NOR Gate	10130 Dual D-Type Clocked Latch
10102 Quad 2-Input NOR Gate	10113* Quad Exclusive -OR Gate/Comparator	10131* Dual D-Type Master-Slave Flip-Flop
10105* Triple 2,3,2-Input OR/NOR Gate	10115* Quad Differential Line Receiver	10161 1 of 8 Demultiplexer/Decoder (Low)
10106* Triple 4,3,3-Input NOR Gate	10116 Triple Differential OR/NOR Line Receiver	10162 1 of 8 Demultiplexer/Decoder (High)
10107 Triple 2-Input Exclusive OR/NOR Gate	10117 Dual 2-wide 2,3-Input OR-AND/OA Invert Gate	10170* 9 + 2-Input Parity Circuit
10109 Dual 4 5-Input OR/NOR Gate	10118 Dual 2-wide 3,3-Input OR-AND Gate	10171* Dual 1 of 4 Demultiplexer/Decoder (Low)
10110 Dual 3-Input 3-Output OR Gate	10119* 4-wide 4,3,3,3-Input OR-AND Gate	10172* Dual 1 of 4 Demultiplexer/Decoder (High)
10111 Dual 3-Input 3-Output NOR Gate	10121* 4-wide 3,3,3,3-Input OR-AND/OA Invert Gate	

*Coming soon.

Signetics

New products

Instruments

Analyzer price tailored to job

Modular design of pulse and transient tester handles variety of waveforms

Carefully analyzing transient waveforms such as laser pulses and shock-test results can be a very expensive proposition. Typically, a high-speed a-d converter is used in this application. And since the cost of a converter goes up with both speed and accuracy, a precision tester can be a pretty expensive piece of gear.

If, however, the time between transient events is long, compared with the events themselves, there is a cheaper way out. A bank of sample-and-hold modules can sample the signal very rapidly, and then feed the samples into a relatively slow a-d converter during the inter-pulse interval.

By using this approach where it is appropriate, Inter-Computer Electronics Inc., is able to offer its pulse and transient analyzer at prices that go as low as \$2,500. When the inter-pulse interval is short, it becomes necessary to use either a faster converter or even one converter per channel, driving the price up considerably.

A more representative price for the pulse and transient analyzer is about \$8,000, according to Inter-Computer President James J. Connolly. Such a system would have 16 channels of sample-and-hold circuitry, a 16-channel multiplexer, a 10-bit/1-megahertz a-d converter, 2,048 words of 10-bit digital memory storage, and the necessary power supplies, interfacing circuits, control circuitry, etc. If a particular application really needs a high-speed converter, the system can be provided with a 10-MHz/8-bit unit, but the price then goes up to \$12,000. Clearly the analyzer's chief attraction is its flexibility: It can be con-

sidered a customized off-the-shelf instrument.

The analyzer can accommodate up to 16 channels of sample-and-hold input, each of which has an aperture time of less than 100 picoseconds. The maximum sampling rate is 200 MHz, corresponding to a sampling interval of 5 nanoseconds. Over-all system accuracy can be within $\pm 0.15\%$ of full scale (when a 10-bit converter is used). Analog input range is 10 mv to 10 v.

A key feature of the pulse and transient analyzer is its packaging in standard nuclear instrumentation modules. These modules can be arranged, with all required power supplies, in a single 19-inch rack measuring 17 in. deep and 8 3/4 in high.

Delivery time of the pulse and transient analyzer, designated the ISA-1310/1024, is 90 days after receipt of order.

Inter-Computer Electronics Inc., a subsidiary of American Electronic Laboratories Inc., P.O. Box 507, Lansdale, Pa. 19446 [351]

'Goof-proof' multimeter is portable, priced at \$700

Portability, protection from incorrect use, and low price are the key features of the model 4300 digital multimeter. The four-digit unit, with one digit for over-range, has a carrying strap built into the instrument's case, and provides eight hours of continuous battery operation for use at remote sites. A digital readout of the battery voltage is featured; with this readout and the conversion chart supplied, users can compute how many hours of operation to full specifications the unit will provide.

The model 4300's light-emitting diode display is blanked if battery power is too low to operate to full specifications. Further protection against erroneous readings or instrument damage is provided by means of interlocking cams that prevent the user from setting improper combinations of ranges and functions and by having the readout go blank when the instrument is overloaded.



Five dc ranges can be measured, from 100 millivolts to 1,000 volts. In ac, four ranges from 1 to 1,000 volts are offered. The kilohm function provides five ranges, from 1,000 ohms to 10 megohms. Price is less than \$700, not including the nickel-cadmium battery pack; delivery time is 30 days.

Dana Laboratories Inc., 2401 Campus Dr., Irvine, Calif. 92664 [352]

Line of digital clocks uses diode readouts

A family of digital clocks, designated the series 2400, has light-emitting diode displays and includes remote-control features. Standard models are available with three methods of time reference: power line, internal crystal oscillator, or external input. Price of model 2411, with 60-Hz time base, 24-hour display, is \$353.

Electronic Research Co., 10,000 W. 75th St., Overland Park, Kansas 66204 [359]

Low-cost prescaler extends counter's frequency range

Frequency prescaler model 6300 can extend the frequency range of any counter of 5 megahertz or higher to 512 megahertz. The 6300





- Accepts Hollerith cards or badges.
- Extremely reliable, compact.
- Easy to operate.
- Uses diode-isolated light sensors.
- Available from 10x10 to 12x80 matrix.
- Prevents improper card insertion.
- Plugs into standard connectors.
- Horizontal or vertical card insert.
- Optional solenoid card ejector.

For further information contact
Ken Terasaki, Panasonic Industrial Division,
200 Park Avenue, New York, N.Y. 10017 (212) 973-8907

Panasonic®

just slightly ahead of our time
"See our card reader at SJCC, booth 2316"

Circle 152 on reader service card

**Join
now**

Eastman 910™ adhesive joins virtually any combination of smooth, clean materials instantaneously, with shear strengths up to 5000 p.s.i.



For details, call or write:
Eastman Chemical Products, Inc.
Kingsport, Tenn. 37662



152 Circle 188 on reader service card

New products

is a system component, in addition to being an instrument accessory. For example, it may be used as a countdown for high-frequency phase-lock loops. Sensitivity is adjustable from 5 volts peak-to-peak to 100 millivolts peak-to-peak. Output is 1 v into a 50-ohm load, and the price is \$485.

Newport Laboratories Inc., 630 E. Young St., Santa Ana, Calif. 92705 [353]

Analog signal processor has one amplifier per channel

An analog signal processor, designated the model 620, provides individual amplifiers and filters for up to 64 input channels. The chassis also contains a high-level multiplexer, gain-programable amplifier, high-speed analog-to-digital converter with sample and hold, and DTL/TTL-compatible levels. The system can be expanded to 256 chan-



nels by plugging additional 64-channel units into the basic 620. The high-level multiplexer reduces cross talk to less than 0.005%, and there is no degradation from common-mode voltage channel-to-channel. Price is \$12,000, and additional 64-channel expansion units are \$8,500.

Neff Instruments Corp., 1088 East Hamilton Rd., Duarte, Calif. 91010 [354]

Voltmeter's input impedance is greater than 10^{14} ohms

An electrostatic voltmeter that offers input impedance greater than 10^{14} ohms measures up to 100,000 volts ac or dc. Many models are available, with a choice of frequency range, single or multirange scales, and accuracy to within 0.5% or 1%. Highest operating frequency

Distributors

Arizona: Hamilton, Phoenix (602) 269-1391
 Compar, Scottsdale (602) 947-4336

California: Hamilton, Mountain View (415) 961-7000
 Culver City (213) 870-7171
 San Diego (714) 279-2421
 Compar, Burlingame (415) 347-5411
 Burbank (213) 843-1772

Colorado: Hamilton, Denver (303) 433-8551
 Intermark Electronics, Denver (303) 936-8284
 Compar, Littleton (303) 798-5919

Florida: Hamilton, Hollywood (305) 925-5401
 Compar, St. Petersburg (813) 342-8741

Illinois: Hamilton, Schiller Park (Chicago) (312) 678-6310
 Compar, Des Plaines (312) 824-0104

Kansas: Hamilton, Prairie Village (Kansas City) (913) 362-3250

Maryland: Hamilton, Hanover (Baltimore) (301) 796-5000
 Pioneer, Rockville (301) 427-3300
 Compar, Baltimore (301) 484-5400

Massachusetts: Electrical Supply, Cambridge (617) 491-3300
 Hamilton, Burlington (617) 273-2120
 Compar, Newton Highlands (617) 969-7140

Michigan: Hamilton, Livonia (313) 522-4700
 Compar, Utica (313) 781-3900

Minnesota: Hamilton, Bloomington (612) 854-4800
 Compar, Minneapolis (612) 922-7011

Missouri: Hamilton, Hazelwood (St. Louis) (314) 731-1144
 Compar, St. Louis (314) 567-3399

New Jersey: Hamilton, Cherry Hill (609) 662-9137
 Cedar Grove (201) 239-0800
 Compar, Clifton (201) 546-3660
 Haddonfield (609) 429-1526

New Mexico: Compar, Albuquerque (505) 242-3631
 Century Electronics, Albuquerque (505) 265-7837

New York: Semiconductor Concepts, Inc., Hauppauge (516) 273-1234
 Hamilton, Syracuse (315) 437-2642
 Westbury, L.I. (516) 333-5812
 Compar, Albany (518) 489-7408
 Arrow, Farmingdale (516) 694-6800

North Carolina: Compar, Winston-Salem (919) 723-1002
 Pioneer, Greensboro (919) 273-4441

Ohio: Arrow, Compar, Dayton (513) 253-9176
 Fairview Park (216) 333-4120

Texas: Compar, Dallas (214) 363-1526
 Hamilton, Dallas (214) 638-2850
 Houston (713) 526-4661

Washington: Hamilton, Seattle (206) 624-5930
 Compar, Kirkland (206) 822-4191

Canada: Prelio Electronics, Montreal (514) 389-8051
 Ottawa (613) 237-6150
 Electro Sonic Ind. Sales, Toronto (416) 924-9301
 Hamilton, Montreal (514) 381-9127
 Toronto (416) 789-1848
 Toronto (416) 789-1338

Representatives

Alabama: Twentieth Century Marketing, Huntsville (205) 772-9237

Arizona: Erskine Associates, Scottsdale (602) 263-7654

California: Bertrand-Zoolalan, Downey (213) 927-4006
 Celtec, Inc., San Diego (714) 279-7961
 Trident Assoc., Mountain View (415) 967-7031

Colorado: R. G. Enterprises, Denver (303) 744-2464

Florida: W. M. & M. Assoc., Allamonte Springs (305) 831-4645
 Clearwater (813) 446-0075
 Pompano Beach (305) 943-3091
 West Palm Beach (305) 848-9042

Illinois: Compar, Des Plaines (312) 824-0104

Maryland: Burgin-Kreh Assoc., Baltimore (410) 288-5300

Massachusetts: Contact Sales, Inc., Lexington (617) 861-1550

Michigan: Greiner Assoc., Grosse Pointe Park (313) 499-0188

Minnesota: Comstrand Inc., Minneapolis (612) 560-5300

Missouri: Compar, St. Louis (314) 567-3399

New Mexico: Electronic Marketing, Albuquerque (505) 265-7837

New York: Win-Cure Electronics, Manhattan (516) 622-9474
 Tritech, DeWitt (315) 446-2881

North Carolina: Burgin-Kreh Assoc., Winston-Salem (919) 768-4174

Ohio: T.M.A., Inc., Centerville (Dayton) (513) 433-3841
 Aurora (Cleveland) (216) 247-4488

Pennsylvania: G. C. M., Ampler (215) 646-7537

Texas: Semiconductor Sales, Richardson (214) 231-6187

Virginia: Burgin-Kreh Assoc., Lynchburg (703) 845-5600

Washington: Compar, Kirkland (206) 822-4191

Canada: Contronics, Montreal (514) 733-0749
 Ontario (416) 636-8311

BRIGHTEST RED LIGHTS IN THE DISTRICT

The Litronix' line of LED panel and indicator lites sport some of the brightest, most economical and efficient solid state lamps around. Select from a broad line of devices with red diffused, clear, water clear or white diffused lens. Our LEDs have wide angle viewing, high brightness, low power, sturdy construction and a competitive price tag. We repeat, "competitive price tag." We have a lamp to fit your application. Here are just a few of our most popular:

GREAT FROM ANY ANGLE

RL-21. 180° of full, bright viewing. Great for panel mounting, with lovable, wire wrappable leads. Available with black or clear mounting clip. Replaces HP 5082-4403, 65¢ in 1,000 quantities.

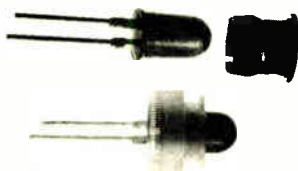

EASY MOUNTING

RL-2. Maximum brightness and spot size, comes with panel mounting clip and four lens options. 65¢ in 1,000 quantities.



BIG RED

RL-20. Extra bright, big boomin' 200 mil spot. Ideal for head-on viewing. Has panel mounting clip and two lens options. 65¢ in 1,000 quantities.



LITTLE ANTE

RL-50. Economy model with high brightness at low current. Its small size and low price make it ideal for general purpose applications. Comes in four lens options. The new diffused types provide a large 80 mil spot with full 140° viewing. Only 39¢ in 1,000 quantities.



We'll send you lots of free literature and you can smooth talk one of our distributors out of a sample any day

the bright guys
litronix

NEW

VECTOR-PAK SYSTEM SOLVES PACKAGING PROBLEMS

- CAGES NOW AVAILABLE FULLY OR PARTIALLY ASSEMBLED.
- NEW EASY-TO-ORDER NUMBERING SYSTEM.
- BUILT IN ADJUSTABILITY AND FLEXIBILITY TO SOLVE YOUR PACKAGING PROBLEMS.

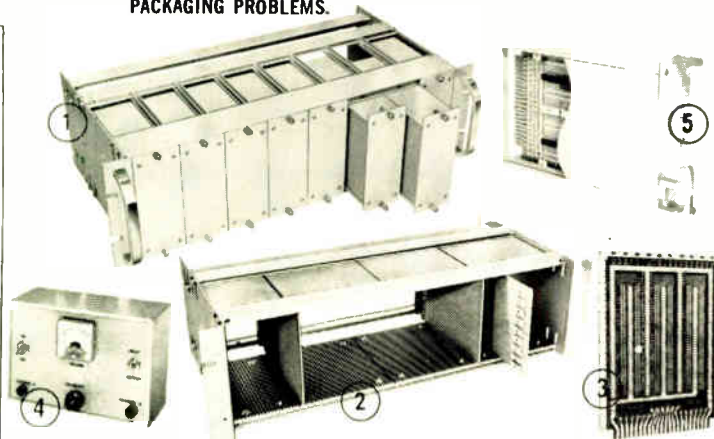

- ① Rack mountable cage and module systems available in 3½", 5¼", 8¼" heights and 9", 12", 15" depths. Immediate availability - assembled or multi purpose kit versions.
- ② Rugged Vector Pak Card Cages with extruded ABS or aluminum guides located on .15", .25", or .3" multiples.
- ③ Dozens of new Plugboards for building Plug-In Cards - IC and discrete types.
- ④ Multi-Mod Cases - sleek functional aluminum cases for instruments and other circuitry. 4 slotted interior surfaces for cards, mounting plates.
- ⑤ EFP modules in 1.6", 2", 3", or 4½" widths have slots for cards 4½" x 6½", 2.7" x 6.5", 8" x 9.6", slide off sides

Send for new specification sheets. NIMS bins and modules also available.

VECTOR ELECTRONIC CO., INC.
 12460 Gladstone Ave., Sylmar, California 91342
 Phone: (213) 365-9661 ■ TWX (910) 496-1539



Circle 154 on reader service card

Minnesota

**"It is a labyrinth of rivers and streams and forest,
 of lakes of wild rice and waterways
 dammed by the beaver."***

Wilderness is good for a man. He goes back to work refreshed, relaxed, more productive. Minnesota, people like it here... and it shows in their work.

**Quoted from an article in "Western's World"*

FACTS IN 48 HOURS

STATE OF MINNESOTA Dept. of Economic Development
 Industrial Development Division, Suite 213
 51 E. 8th Street, St. Paul, Minn. 55101

I'm interested in Minnesota. Send me facts.

NAME _____ TITLE _____
 FIRM _____
 ADDRESS _____
 CITY _____ STATE _____ ZIP _____

All inquiries held in strict confidence.

It's good to be in Minnesota

154 Circle 189 on reader service card

New products

offered is 450 kilohertz. The models ESH and ESD have extremely low loading features and thus have many special applications, such as low-charge measurements associated with ionization chambers. The instrument can measure extremely high voltages used in cathode-ray-tube power supplies.

Singer Instrumentation, Los Angeles Operation, 3211 South LaCienega Blvd., Los Angeles, Calif. 90016 [355]

Function generator can make semilog plots

Nine modes of operation are offered in the model 5300 function generator. The instrument features an exponential ramp function for logarithmic sweeping, in addition to separate waveforms and ramp outputs, pulse, sweep, and burst modes, and external voltage control of main



output frequency. The exponential sweep in conjunction with the linear sawtooth output enables the generator to do semilog plotting. In external and sweep modes, the frequency range of the versatile generator extends from 0.00003 hertz to 3 megahertz. Price is from \$695.

Krohn-Hite Corp., 580 Massachusetts Ave., Cambridge, Mass. 02139 [356]

Versatile signal generators cover L and S bands

A line of signal generators, 7100 series, has a six-digit frequency counter readout for L band, upper L band, and S band. The frequency thus is determined within 10 kilohertz. Wideband frequency modulation is greater than 6

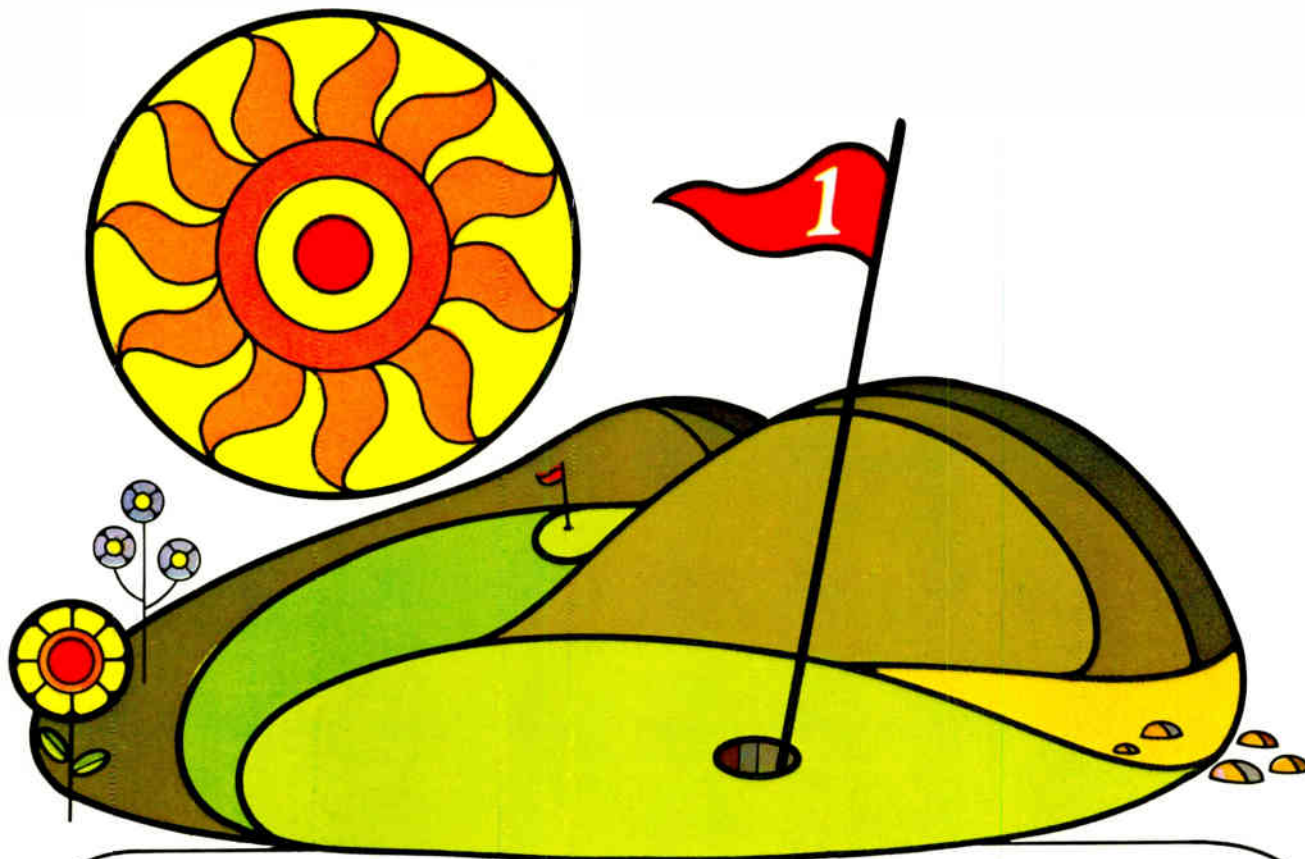

If you'd rather be golfing

Let SAE solve your packaging problems.

Are the problems of component selection, packaging, and systems assembly interfering with your golf game? Then delegate all that to us. You can concentrate on grooving your swing.

Only SAE provides a complete packaging service in your choice of three systems: Plug-in, Planer, and Dipstik™.

We manufacture all the hardware for plug-in systems, including PC cards, card guides, card files, enclosures, connectors, sockets, mounting and bussing.

Prefer planer? We'll provide the logic panels, mounting hardware, sockets, and all peripheral items.

Or investigate our unique Dipstik. It gives twice the IC density as PC methods, and eliminates lots of hardware.

Whichever method you choose, we can supply the components for you to assemble yourself. Or, we'll pick the parts, do the assembly, and let you do the wiring. Or, we'll provide everything: components, assembly, and Wire-Wrap®. So, just call us in . . . and you go out golfing!

Free bumper sticker for your desk. Flaunt your favorite sport. Or, if something else turns you on, tell us. Maybe we can send you a bumper sticker for that, too. We'll also include a brief brochure describing how we can relieve you of systems packaging hang-ups. Write us:

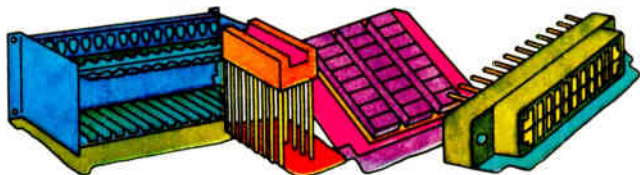

**I'd rather be
golfing**

Stanford Applied Engineering Inc.

340 Martin Avenue, Santa Clara, California 95050 Telephone (408) 243-9200 — (714) 540-9256 — TWX 910-338-0132

New: I.C. Burn-In System

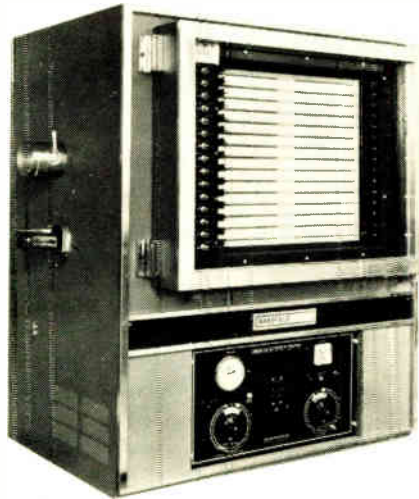

Front and rear doors, allowing programming of power supplies and stimuli on either or both doors, are features of a new oven system for aging IC's and power devices. This standard system permits configurations of 30, 58 or 74 board positions and is designed for either maximum pin usage, maximum density or a mixture of both. The oven system is versatile, so that regardless of the original configuration systems are easily changed over. Send for Bulletin OV-62.

WAKEFIELD ENGINEERING INCORPORATED
 AUDUBON ROAD, WAKEFIELD MASSACHUSETTS 01880
 TELEPHONE (617) 245-5900

Circle 156 on reader service card

A new read/write memory system with ROM capability—by TOKO

Let TOKO bridge the gap between low-performance 0.5 penny per bit memory and 3 pennies per bit memory. TOKO's new NDRO memory system, HS-600E, offers high performance—300NS access time and 600NS cycle time and electrically alterable ROM capability. TOKO's plated wire memories, assure simplified computer architecture.

Basic module size:

- 4K word by 9 bits
- 4K word by 18 bits
- 8K word by 9 bits
- 8K word by 18 bits

8K x 18 configuration consists of five plug-in boards: two memory stack boards, two bit electronics boards and one word electronics and control board. Each board 13" x 8.7" in size.

Various memory systems, stacks, pulse transformers, and delay lines are also available.

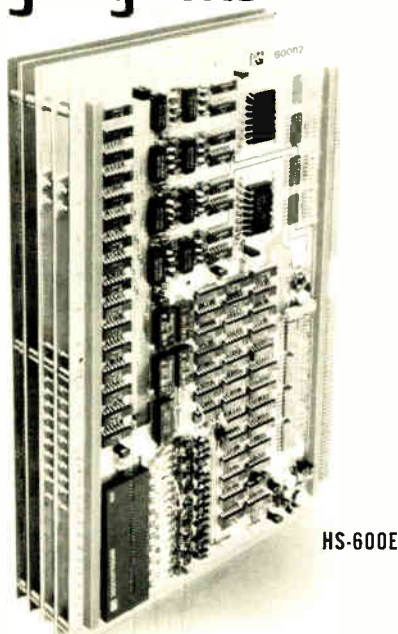

HS-600E

Head Office: 117 W. 42nd St., New York, N.Y. 10011
 New York: Toko New York, Inc. 212-675-1100
 10001 U.S.A. Tel: 56-3707
 Los Angeles: Toko, Inc. 213-740-1100
 Liaison Office: 1830 S. Hollywood Blvd., Los Angeles, CA 90028
 U.S.A. Tel: 330-9511
 Tokyo: Toko Electronic GmbH 1-1-1, 2-2-1, 3-3-1, 4-4-1, 5-5-1, 6-6-1, 7-7-1, 8-8-1, 9-9-1, 10-10-1, 11-11-1, 12-12-1, 13-13-1, 14-14-1, 15-15-1, 16-16-1, 17-17-1, 18-18-1, 19-19-1, 20-20-1, 21-21-1, 22-22-1, 23-23-1, 24-24-1, 25-25-1, 26-26-1, 27-27-1, 28-28-1, 29-29-1, 30-30-1, 31-31-1, 32-32-1, 33-33-1, 34-34-1, 35-35-1, 36-36-1, 37-37-1, 38-38-1, 39-39-1, 40-40-1, 41-41-1, 42-42-1, 43-43-1, 44-44-1, 45-45-1, 46-46-1, 47-47-1, 48-48-1, 49-49-1, 50-50-1, 51-51-1, 52-52-1, 53-53-1, 54-54-1, 55-55-1, 56-56-1, 57-57-1, 58-58-1, 59-59-1, 60-60-1, 61-61-1, 62-62-1, 63-63-1, 64-64-1, 65-65-1, 66-66-1, 67-67-1, 68-68-1, 69-69-1, 70-70-1, 71-71-1, 72-72-1, 73-73-1, 74-74-1, 75-75-1, 76-76-1, 77-77-1, 78-78-1, 79-79-1, 80-80-1, 81-81-1, 82-82-1, 83-83-1, 84-84-1, 85-85-1, 86-86-1, 87-87-1, 88-88-1, 89-89-1, 90-90-1, 91-91-1, 92-92-1, 93-93-1, 94-94-1, 95-95-1, 96-96-1, 97-97-1, 98-98-1, 99-99-1, 100-100-1



For further information, just call or write:

TOKO, INC.

New products

megahertz peak at a 4-MHz rate. Continuous-phase PCM/fm with deviations to 6 MHz peak up to 15

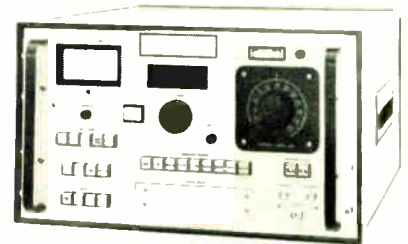

megabits per second, non-return to zero, is also provided. The unit offers continuous-wave, fm, and phase-modulation capability for output signals within the individual frequency ranges.

Microdyne Corp., P.O. Box 1527, Rockville, Md. 20850 [357]

Solid-state sweeper covers

2-18 GHz in one range

A new broadband sweeper, designated model 9530, extends the upper limit of the Narda 9500 series from 12.4 to 18 gigahertz. The 9530 covers 2 to 18 GHz with a leveled output power of 1 milliwatt minimum over the entire range, and up to 20 mw of leveled power can be obtained over narrower ranges at the low end of the spectrum. The



unit can be programmed by an external analog signal; its calibration factor in this mode is 1 GHz per volt. Maximum frequency error in the continuous-wave mode is $\pm 0.5\%$. Sweep-end points and markers keep maximum error within 1%. Price of the 9530 is \$17,000.

The Narda Microwave Corp., Plainview, N.Y. 11803 [358]



**Protection
Plus...colors to
please any designer**

Airpax Type 203 Electromagnetic Circuit Protector with Illuminated Rocker Arm

Airpax circuit protectors have always offered protection, plus. But now there's an added Plus — Type 203 protectors with illuminated rocker handles in a variety of colors that will enhance the appearance (and sales appeal) of any product or panel.

Combining over-current protection with ON-OFF switch and pilot light functions, the 203 is ideal for

use in high quality consumer, commercial, and industrial equipment where accurate, reliable protection and attractive appearance are demanded.

A choice of many mechanical and electrical configurations provide maximum versatility for the designer. Series, shunt, and relay trip internal circuits are available and can be combined in single, two, and

three-pole versions. Current ratings from 0.02 to 20 amperes at 120V AC and 0.02 to 10 amperes at 250V AC. Inverse time delay or instant trip.

Interested? Write for Bulletin 2009. Airpax Electronics, Cambridge Division, Cambridge, Maryland 21613.

AIRPAX™

Protection comes in many colors

Airpax also manufactures many other types of circuit protectors in current ratings up to 100 amperes.



PROBLEM:

establishing plug-to-plug compatibility
within a multi-company Information Display System.



SOLUTION:

the most complete series of "standard" interconnecting
cable constructions available.

Brand-Rex has been solving wire and cable problems for the major main frame and independent peripheral equipment manufacturers for years. Designing and producing special cables for CRT displays, buffer units, modems and teleprinters. All UL listed, with jackets color-matched to equipment finish where required. Suddenly we find ourselves with the most complete series of "standard constructions" in the business. Information Display System

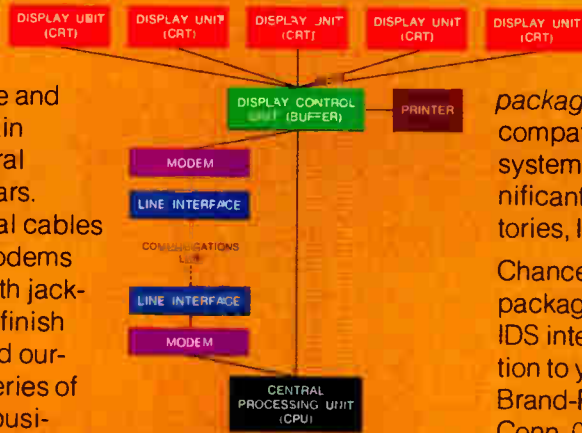

packages that provide plug-to-plug compatibility between multi-company system components. You realize significant savings through reduced inventories, longer lengths, faster deliveries.

Chances are Brand-Rex has the cable package you need for fully integrated IDS interconnections. Ask us for a solution to your particular problem. Write Brand-Rex Company, Willimantic, Conn. 06226. Or call 203/423-7771.

BRAND-REX

4,000 solutions in search of a problem.

Circle 158 on reader service card

Data handling

Monitor traps 30 data link codes

By analyzing sequential line-control characters, user can pinpoint faults

When a data communications user installs his own system, particularly one that interacts on-line with a host computer, he usually deals with many different vendors for terminals, modems, printers, interfaces,

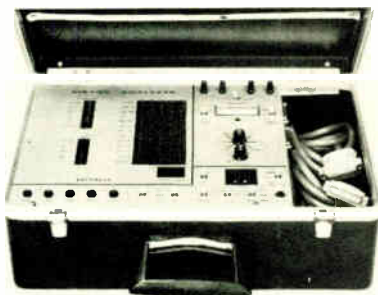

and the like. And when a fault shuts down communications or causes message errors, the user is often frustrated in finding the fault location and determining which vendor, including the telephone company, to hold responsible.

Some faults result from such electrical parameters as line distortion and phase jitter that are out of specification. But another type of serious failure arises from incompatibility in line-control protocols between terminal and computer, terminal and modem, modem and modem, modem and phone-line interface, and software programs.

Paradyne's model 810 Bisync Line Control Monitor aids in rapid diagnosis of faults resulting from inconsistencies in the control dialog for data communications equipment. Compatible with equipment using standard EIA RS-232 connectors, the monitor analyzes the line-control dialog of any single device or devices in tandem, based on the popular IBM binary synchronous communications protocol.

The protocol defines the code, the

control characters and their meaning, the message formats, the reply formats, and the rules for responding to different messages. The 810, though, ignores message characters to simplify diagnosis and recognizes the occurrence of 13 different line-control characters, plus any one thumbwheel-switch-selectable message or control character, and it also displays whether or not a character occurred during transmission or reception.

The analyzer stores up to 30 sequential transmitted and received control characters and displays five of them on a 5-by-15 matrix of light-emitting diodes. A switch permits the operator to shift the other 25 characters into the display window, one at a time, for analysis of the control dialog. The 30 control characters can be trapped in several ways, including stopping the unit on the occurrence of a preselected control character.

In addition to this control character trap, the analyzer also includes functions to test the RS-232 interface, a meter to indicate line dBm and voltage levels, and an audio amplifier and speaker to permit the operator to listen to the line signal. Price is \$2,750. Delivery time is 45 days after receipt of order.

Paradyne Corp., P.O. Box 5144, 2040 Calumet Street, Clearwater, Fla. 33518 [361]

Circuit analysis software eases designer's task

Added versatility and ease of use are built into the revised computer program called Recal II (Rapidata's electronic circuit analysis language). Since all inputs and outputs are specified in engineering terms, Rapidata points out, a user can run the powerful software system after 30 minutes of instruction. A circuit must be described just once, then Recal will add or delete component descriptions as the user analyzes his design for dc, ac, or transient conditions. Because Recal does not have a library of device models, the user is not limited in his design by the program's data base.

Recal's new features include optimization, arriving at the best possible design to maximize or minimize any single output parameter; frequency functions, representing multipoint networks or complex components as a series of parameters that are a function of frequency; modulated sources, ac sources with built-in modulation and dc offset capabilities; and function files, the ability to load nonlinear and frequency functions into the program directly from a file.

Semiautomatic circuit partitioning can be accomplished by breaking a design down into areas or "black boxes." Then, Recal will generate the network terminal characteristics for the areas, and these characteristics can be re-entered into the program to replace the specified circuit area or areas. Also, impedance, admittance, and gain can be specified as functions of frequency in the design or circuit area.

The program's output can assume several forms—tables, graphs, and files. And the complete Recal II package can be called as a sub-routine in any Fortran program when network analysis is required. This allows such sophisticated analysis as multidimensional circuit optimization. Moreover, ac and dc worst-case analysis and sensitivity analysis can be performed on part or all of a circuit for any output parameter.

Recal II is available on a time-shared basis; there is no program fee. Typically, a dc analysis for a 10-node circuit costs less than \$1.

Rapidata Inc., 20 New Dutch Lane, Fairfield, N.J. 07006 [362]

Optical page reader scans 2,000 characters a second

The Laser Vision series 2000 optical page reader incorporates a laser beam, fiber optics, and a type-written font in its design. It reads at speeds above 2,000 characters per second, and a vacuum transport accepts pages up to 9 by 11½ inches in size in a range of thicknesses and weights. A so-called Logic Font, a self-checking code, is typed below



From Advanced
Thyristor Technology

HUTSON'S 30A & 40A TRIACS

with
**GLASS-PASSIVATED
CENTER-GATE CHIPS**

For motor, heating, cooling and lighting controls, the Hutson 30A and 40A triacs feature greatly improved dv/dt ratings and di/dt characteristics for faster turn-on and lower switching losses.

Improved thermal characteristics and current-carrying capabilities allow these triacs to withstand surges of up to 400A.

Di-Mesa* Construction

This patented construction eliminates operational cycling failures resulting from dicing-induced passivation fractures.

Immediate Delivery

Press-fit, stud, and TO-3 outline mounting. 30A & 40A [$I_{T(RMS)}$]; 50V to 600V (V_{DROM}).



3/4" PRESS-FIT SERIES. ELECTRICALLY ISOLATED. GLASS-PASSIVATED, CENTER-GATE



1/2" PRESS-FIT SERIES. GLASS-PASSIVATED, CENTER-GATE

OTHER HUTSON TRIAC'S AND SCR'S FROM 3A SENSITIVE GATE AND IN ALL POPULAR PACKAGE CONFIGURATIONS



*T.M. HUTSON INDUSTRIES

HUTSON INDUSTRIES

BOX 34235 • 2019 W. VALLEY VIEW
DALLAS, TEXAS 75234 (214) 241-3511
TWX 910-860-5537

Distributed by:

BOELLE CO., INC., Chicago, Ill. 312/468-1016
Detroit, Mi. 313/273-6920 ■ NEWARK ELECTRONICS CORP., Inglewood, Cal. 213/678-0441
THOR ELECTRONICS, Elizabeth, N.J. 201/354-2420
Canada: WEBER-SEMAD ELECTRONICS, Downsview, Ont.

European Marketing Director:

30 Rue Pierre Semard, Yerres, 91 France
Tel: Paris 925-8258 TELEX 21-311

Distributed in Europe by:

Switzerland: D. LEITGEB, Dubendorf
Sweden: ELEKTROFLEX, Sundbyberg
Spain: BELPORT, Madrid
Holland: RODELCO, Den Haag

New products

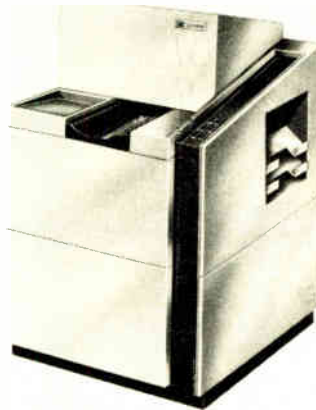

normal alphanumeric upper- and lower-case characters. The reading head of the unit dissects only the Logic Font code and analyzes it for specific recognition features. Price is less than \$20,000; slower units are available for about \$10,000.

Creative Logic Corp., 80 E. Ridgewood Ave., Paramus, N.J. 07652 [369]

Controller operates with most central processors

The model 844 universal controller can interface with any major manufacturer's central processing unit, and operates with a single- or double-track disk double-density, a mix of the two track densities, or other peripheral units such as tape drives, printers, and readers. When used as part of the company's model 844 disk storage system, the controller makes it possible to double or quadruple



existing storage. The system, consisting of eight spindles (four racks) and one spindle mounted in the controller rack, provides a storage capacity of 233 megabytes when using single track and 466 megabytes, using double track. The controller will be displayed at the Spring Joint Computer Conference.

Peripherals General Inc., Cherry Hill Industrial Park, Cherry Hill, N.J. 08003 [366]

Tape transports offer speeds of up to 25 inches/second

Tape transports in the model 1600 Mididek series operate at speeds of 12.5, 18.75, and 25 inches per second. Optional speeds are 6.25 and 37.5 in./s. The single-capstan units have densities of 200, 556, 800, or 1,600 cycles per inch, and accom-

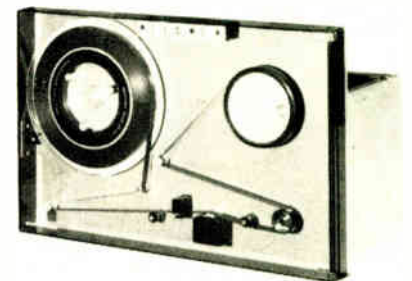

modate 8 1/2-inch reels. They are IBM-compatible, and configurations include read-only, write-only, and read/write with single- or dual-gap heads. Prices in OEM quantities start at \$1,927. The transports will be demonstrated at the Spring Joint Computer Conference.

Digi-Data Corp., 4315 Baltimore Ave., Bladensburg, Md. 20710 [365]

Printer terminals are compact, virtually silent

Three new models in the Silent 700 series of data terminals are compact, virtually silent printers aimed at hard-copy requirements in video terminal display systems, hospital monitors, newswire services, and similar systems. The model 722S, with bit-parallel data interface, is for computer applications supplying

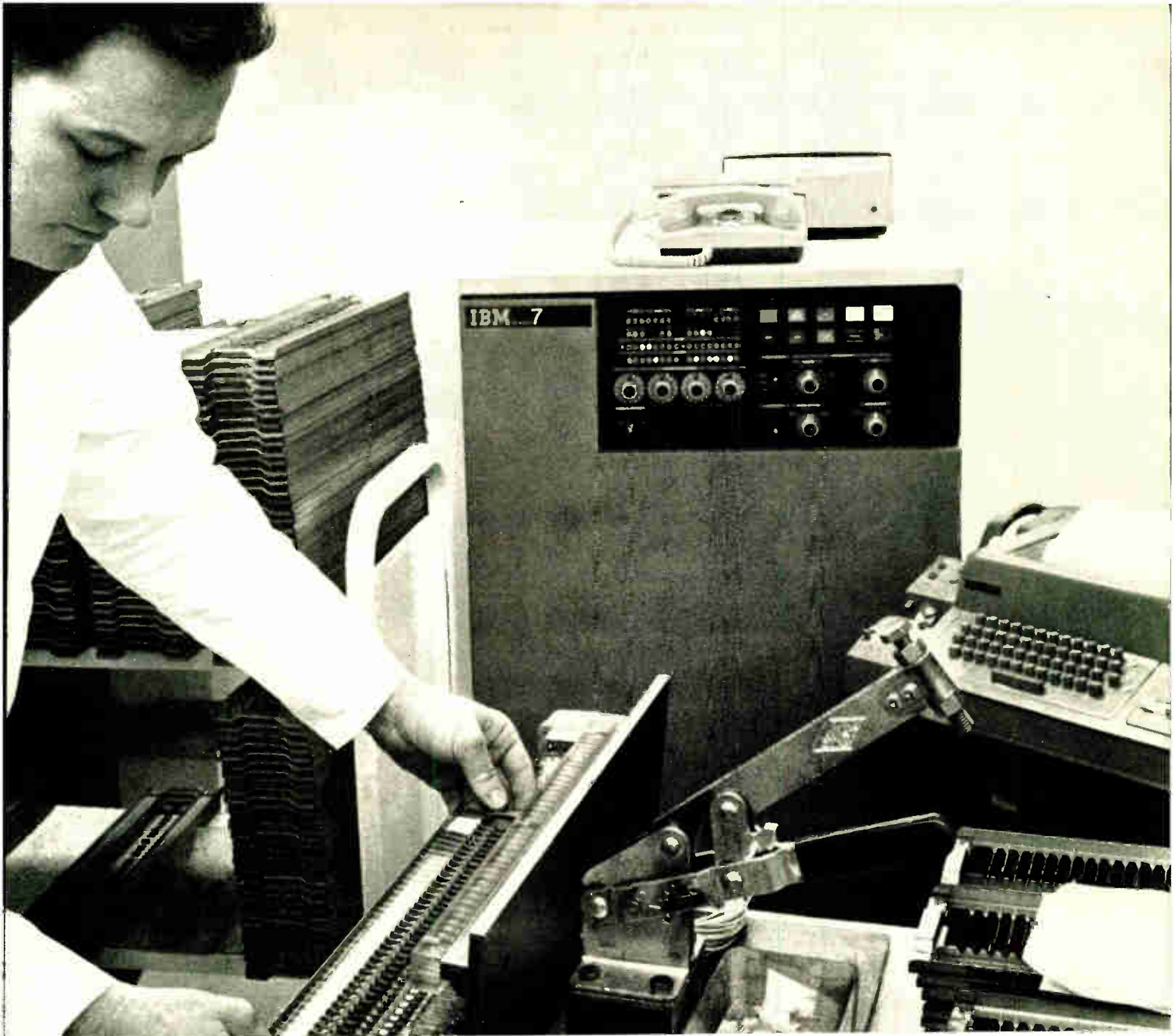

IBM System/7 installed at Dale Electronics to speed production.

A sensor-based IBM System/7 computer has gone into operation at the Norfolk, Nebraska, plant of Dale Electronics, a subsidiary of The Lionel Corporation. Dale expects that use of the System/7 will double its output of high-reliability film resistors.

All such resistors must undergo repeated tests to insure that actual resistances do not deviate more than 1% from rated values. Formerly, differences between pre-test and post-test values were calculated by hand, creating a production bottleneck.

Now, test instrument readings are entered directly into the System/7, which singles out for removal resistors failing to meet specifications. All readings for resistors which meet specifications are then transmitted directly to an IBM system at Dale headquarters

in Columbus, Nebraska.

Upon completion of endurance testing, the resistors are again measured. The system at headquarters computes the differences between readings and transmits a list of resistors which failed to qualify back to the System/7 in Norfolk.

In addition to speeding resistor throughput, Dale plans to use the System/7 for order tracking and monitoring and control of testing and production machinery.

Full information on the System/7 is available through your IBM representative or local office. Or write IBM Data Processing Division, Department 807-E, 1133 Westchester Avenue, White Plains, N.Y. 10604.

IBM

ENGINEERS WHO KNOW TANTALUMS SPEC DICKSON

Because Dickson is a specialist in solid tantalum capacitors! This specialization means more quality in every unit produced from MIL-C-39003 types to low-cost commercial units. With over 4,000 standard catalog items, you can always depend upon Dickson to supply the right tantalum unit at the right price. Try us! Write, today, for our 6-page Tantalum Capacitor Short Form Catalog.

"The Specialists"



"Where Quality Makes The Difference"



DICKSON
ELECTRONICS CORPORATION
PHONE (602) 947-2231 TWX 910-950-1292 TELEX 667-406
P. O. BOX 1390 • SCOTTSDALE, ARIZONA 85252

Circle 162 on reader service card

Dual-in-line Packaging BONANZA

IC PANELS
I/O CONNECTORS
FRAMES • DRAWERS
BREADBOARDING KITS



Break through your present logic packaging limits with new versatility, new economy and new fast delivery. EECO's modular socket boards offer widest range of package sizes and shapes... help you eliminate unnecessary card connectors, connector wiring and power transient problems. Just 4-6 weeks from logic diagram to wired hardware.

NEW 1972 CATALOG

Very wide selection of socket boards, frames, drawers and accessory hardware offers new freedom for logic designers. 28 pages with 122 illustrations and 12 convenient product reference tables.



ELECTRONIC ENGINEERING COMPANY of Calif.
1441 East Chestnut Avenue, Santa Ana, California 92701
Phone (714) 547-5655 • TWX 910-595-1550 • Telex 67-8420

162 Circle 191 on reader service card

New products

transistor-transistor-logic levels; the model 721S, with serial dataset interface, and the 731S, with serial dc signal interface, are compatible with systems requiring EIA, modem, or teletypewriter interfacing. Options



include upper- and lower-case alphabet and a built-in copy lighting kit. Prices are \$2,490 for the 721S, \$2,175 for the 722S, and \$2,415 for the 731S. The terminals will be displayed at the Spring Joint Computer Conference.

Texas Instruments Incorporated, Digital Systems Div., P. O. Box 1444, Houston, Texas 77001, Att. Marketing Services [363]

Digital tape transport
loads, unloads automatically

A digital tape transport offers automatic loading and unloading, vacuum buffering, and a modular capstan assembly that pulls out of the front of the unit and can be replaced without realignment. The model TD 1000 is IBM-compatible, and has bidirectional tape speeds from 25 to 90 inches per second. Bidirectional search speed is 150 inches per second. The unit, housed in a frame measuring 19 by 24 inches, costs less than \$4,000. It will

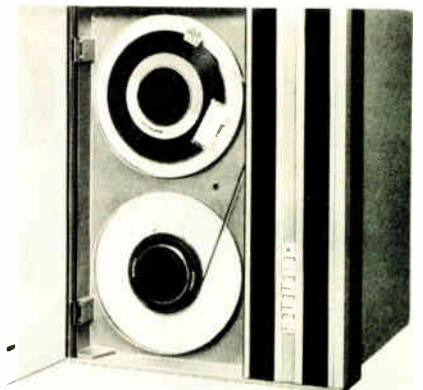

Electronics/May 8, 1972

Bendix printed circuit board connectors put an end to close order drilling.

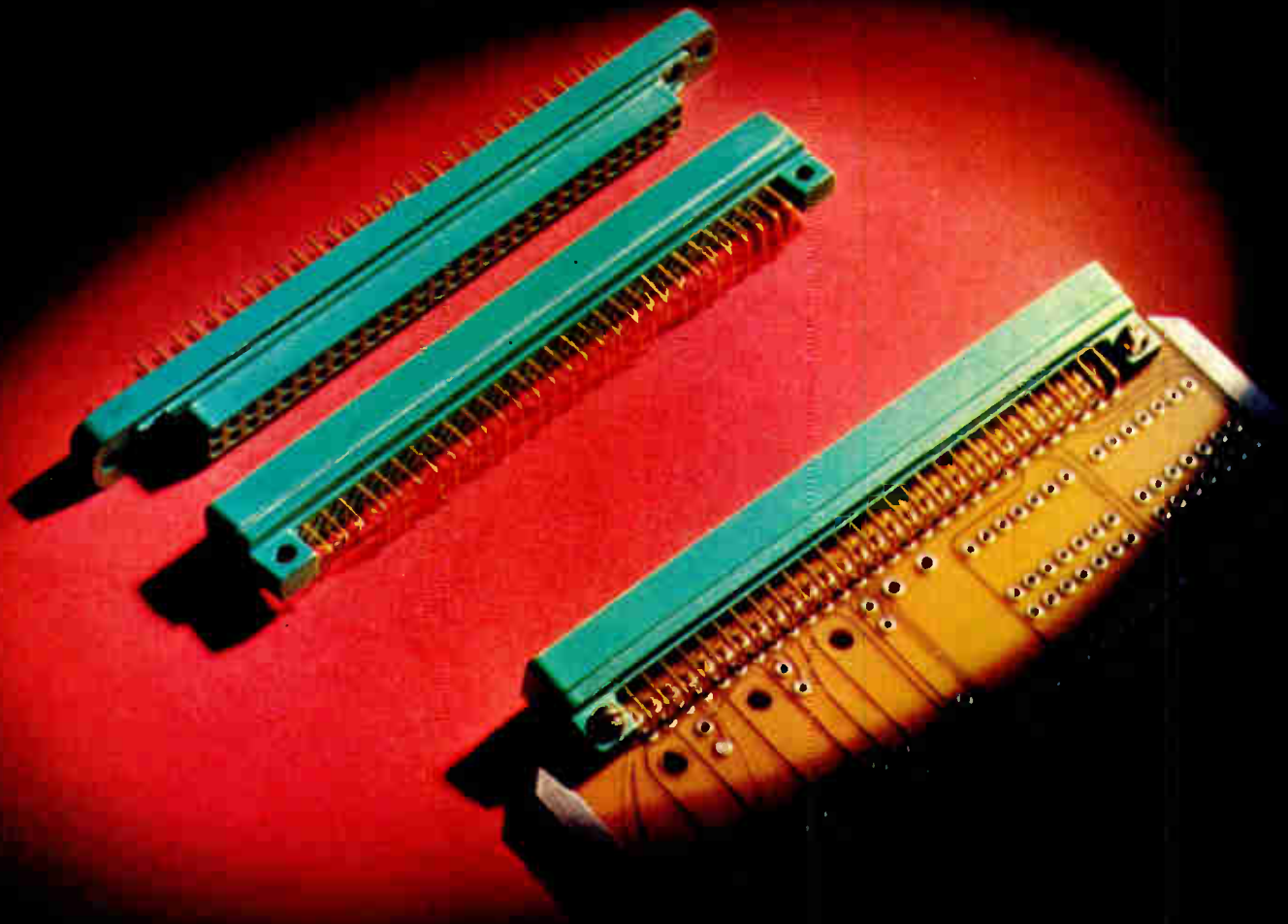

You know close order drilling. It's what's called for to produce ultraprecise hole locations in printed circuit boards. Eliminate this need and you'll cut costs for sure. Bendix P.C.B. connectors help you do precisely that. Their optional floating pin terminations "give" enough to make it easier to align pins with the printed circuit board holes.

Bendix boasts other features, too. Options like wire wrap or solder termina-

tions. Straight or right angle. Insertable crimp contacts.

Applications? Wherever printed circuit boards are used, such as switching circuits, computers, business machines, process controls, etc.

Chances are, Bendix Printed Circuit Board connectors can help you. Why not find out. The Bendix Corporation, Electrical Components Division, Sidney, New York 13838.

Bendix

Circle 163 on reader service card

the only printed circuit Relay

that plugs into your PC board without SOCKETS or SOLDERING

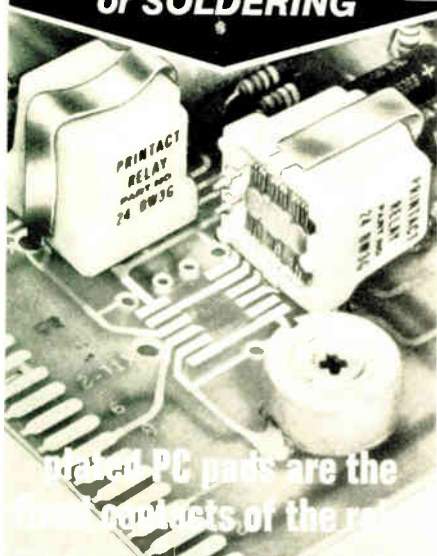

Printed PC pads are the main contacts of the relay

PrintactTM MAGNETIC LATCHING AND NON-LATCHING RELAYS

The only relay designed to make full use of printed circuit technology. Unlike others adapted with terminal pins or sockets for solder mounting, Printact plugs directly into your module. Precious metal plated PC pads mate with shorting bar contacts on the pivoting armature, which is the single moving part. Held by a permanent magnet, it eliminates return springs, pigtailed, electrical and mechanical connections—assuring reliability for millions of cycles.

Inherent Custom Features include: Low Thermal EMF, Low Contact Bounce, Impedance Matching, 45-60 db Isolation, Bifurcated Contacts, and Encapsulated Coil—all at low cost!

Send for Test Sample and PC Board Preparation Aids to simplify design and production of your module.

For action write or call 212—EX 2-4800.

Executone

PRINTACT RELAY DIVISION
P.O. Box 1430E

LONG ISLAND CITY, N.Y. 11101

New products

be on display at the Spring Joint Computer Conference.

Wang Computer Products Inc., 2400 Broadway, Santa Monica, Calif. 90404 [367]

Teletype and magnetic tape serve as remote terminal

An automatic send-receive terminal, to be shown at the Spring Joint Computer Conference, includes a Teletype model 38 with a 15-inch-wide pin-feed platen and a model 4210 magnetic tape data terminal that can handle data distribution and collection at speeds as high as



2,400 words per minute. Matching the two terminals enables remote-batch computer processing applications. The model 38 accepts 14 $\frac{7}{8}$ -inch fan-fold paper and prints a 132-character line at 10 characters per inch in upper and lower case. Price is \$1,400 to \$1,450.

Teletype Corp., 5555 Touhy Ave., Skokie, Ill. 60076 [364]

Printer operates at 120 characters per second

An asynchronous serial impact-printing terminal called the Execuport 1200 operates at a speed of up to 120 characters per second. It prints a full 132-column line from a buffer, and can also print one character at a time. Settings are provided for speeds of 10, 15, 30, or 60 characters per second. Options are available to extend the capability of the terminal to include use as a communications printer, billing printer, computer output lister, and remote-batch terminal. Price for the basic unit is \$4,500. It will be introduced at the Spring Joint Computer Conference.

Computer Transceiver Systems Inc., 317 Route 17, Paramus, N.J. 07652 [368]

Have you met any good sports in Rochester?

We offer you the best of all seasons. Spring: pro baseball, putting and sand-blasting at 20 golf courses. Summer: sailing, skiing, and splashing at 11 lakes (from 45 min. to 2 hours away). Fall: pro soccer, college football, leaf-watching at 12 parks. Winter: pro hockey, skiing (and falling down) at 13 slopes. All this, here in a fertile, dynamic 9-county area of Western New York. Aside from varied recreation, did you know that Rochester has 8 million square feet of plant space available for occupancy now? Would you like some hard data on these plants... or information on any aspect of plant or site selection? If so, call collect or write to Bob Hall, Director of Area Development, Rochester Gas & Electric, 89 East Ave., Rochester, New York 14604 (Telephone: 716-546-2700). Nobody knows more about this area than we do. And because we make money selling energy to industry, we're eager to share our knowledge with you.

Taylor Instrument made it here. How about you?

RGE ROCHESTER GAS AND ELECTRIC



Discover the value of power...

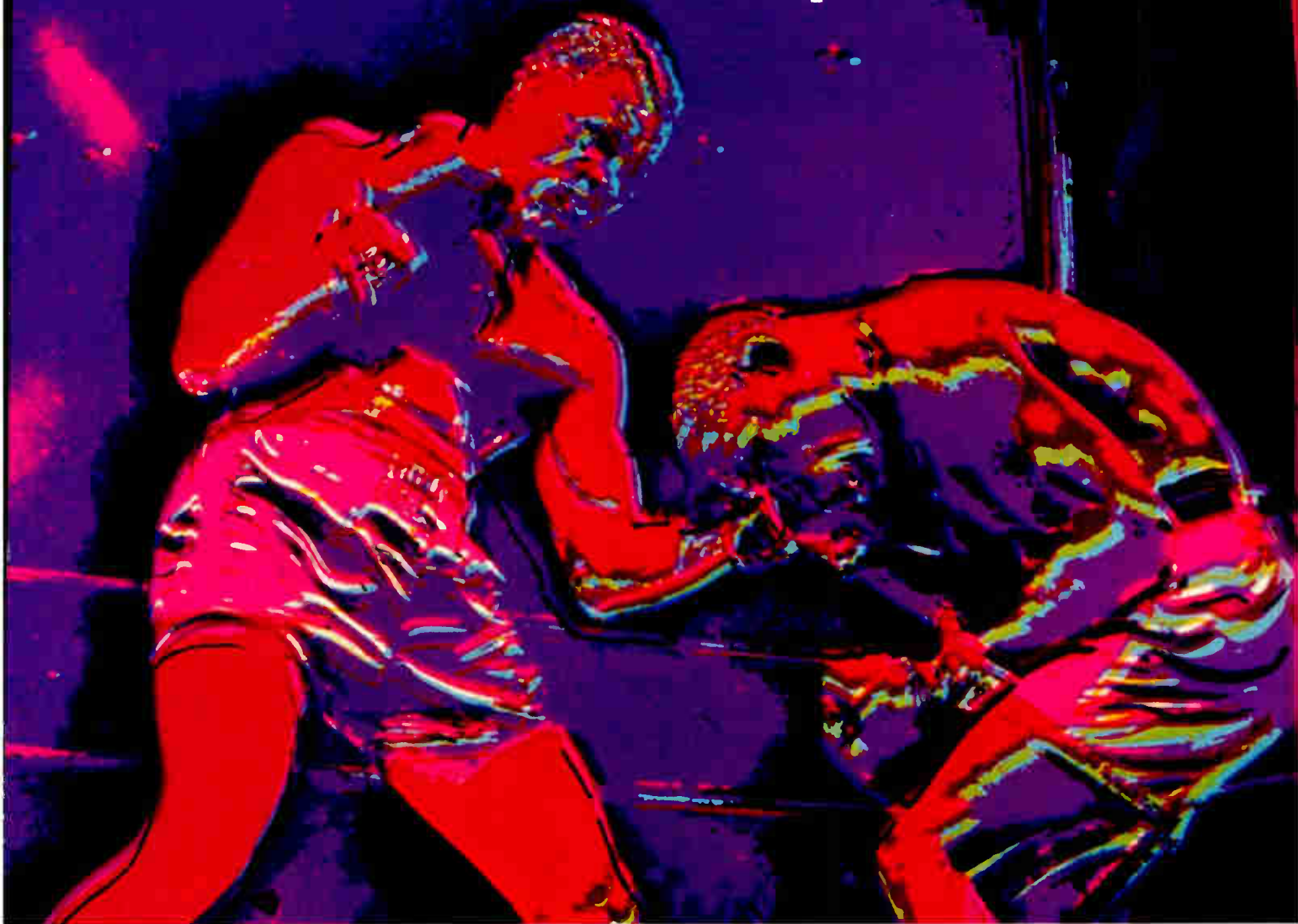

and how it saves you money on your mini.

Discover the all-new SPC-16 family of minicomputers. The first minis to save you substantial money in system implementation. They're from General Automation... the fast-growing, pace-setting mini maker.

For total value, SPC-16's put those other two highly-touted brands of minis to shame. With features like the most powerful instruction set of all. Features like exclusive OR. Compare and bit/byte word instructions. A unique one-word Load All Registers/Store All Registers capability. Eight true (16 optional) general purpose registers that can save you up to 4K (about \$2500) worth of core. Plus programs that let you code your problem in half the time. And a lot more.

Including the right price, the best quantity discounts in the industry and the easiest OEM buying policy of all.

SPC-16's are available as I/O and memory-integrated models for dedicated in-house applications. Or as unbundled versions for OEM users or large system applications requiring up to 65K of memory. Six models in all, in three speeds.

No other minis come close to SPC-16's in giving you so much performance for your money. Give us a benchmark, we'll prove it. Meantime, send today for a detailed brochure.



 **GENERAL AUTOMATION, INC.** 1055 So. East Street, Anaheim, Ca. 92805 (714) 778-4800 TWX 910-591-1695
'Discover The Value Of Power'

Circle 165 on reader service card

Go ahead,
dream
your impossible dream....

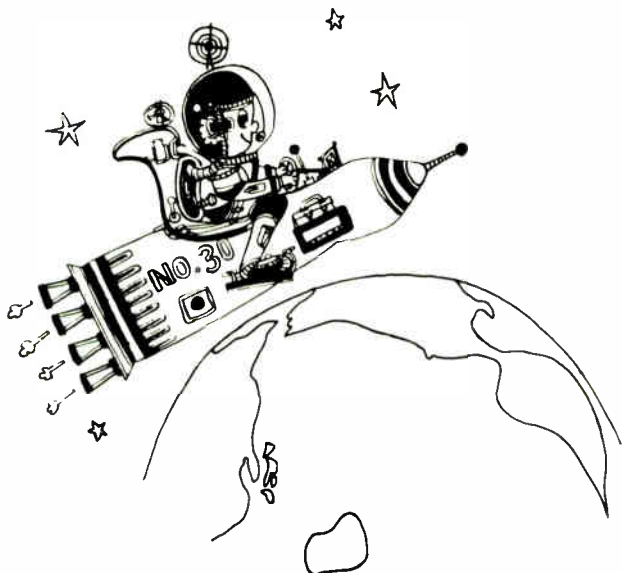

Stopped by the need for a permanent magnet better than any that now exists? Maybe Hitachi Metals can help. At our magnetic and electronic materials research center and other laboratories, our experts are hard at work making magnets do more things than anyone thought possible. Developing new magnetic materials such as rare-earth cobalt, and finding new uses for magnets. No one knows what they'll come up with next. But it just might be the answer to your impossible dream.

Devotion to improvement, added to integrated production backed by years of experience, is behind the quality of Hitachi magnets. Quality that means cast magnets designed and finished to close tolerances. Featuring high coercive force; big energy product; magnetic field uniformity and stability. And cast in any shape—no matter how intricate.

Here are some typical examples.

Type	Residual Induction (Br) gauss	Coercive Force (Hc) oersteds	Energy Product (B×H) max. × 10 ⁻⁶
HI-MAG (ALNICO-5-7)	13,000-14,500	700- 800	6.8- 8.2
YCM-8B (ALNICO-8)	8,800- 9,600	1,380-1,550	4.8- 5.5
YCM-8D (ALNICO-8)	7,500- 8,300	1,700-1,850	5.5- 6.5
YCM-8E (ALNICO-8)	7,500- 8,500	2,000-2,150	5.5- 7.0
YCM-9B (ALNICO-9)	10,000-11,000	1,350-1,500	9.0-11.0

For full details about Hitachi magnets, write.



HITACHI
Hitachi Metals, Ltd.

Head Office: Chiyoda Bldg., Marunouchi, Tokyo, Japan

Hitachi Metals America, Ltd.

New York (Head Office): Magnet Materials Sect., 437 Madison Ave., New York, N.Y. 10022. U.S.A. Tel. 212-758-5255

Chicago: 2200E, Devon Ave., Des Plaines, Ill. 60018. U.S.A. Tel. (312) 299-0031

Detroit: Suite 375, 24300 Southfield Road, Southfield, Michigan 48075. U.S.A. Tel. (313) 557-7142

Los Angeles: Suite 870, 1901 Ave. of the Stars, Los Angeles, Calif., 90067 U.S.A. Tel. (213) 553-6649



\$17²⁵

Use it **FREE** for 5 days!
Test new circuit ideas...I.C.circuits...
discreet components...**FREE!**

All you need are #4 mounting screws ... just plug-in components ... like 1/4 watt resistors, ceramic capacitors, diodes, I.C.s, transistors and more ... and your circuit's built! No special patch cords needed! Components interconnected with any solid No. 22-26 gauge wire.

- Nickel/silver plated terminals — very low contact resistance
- Low insertion force
- Mounts with #4 screws
- Initial contact characteristics beyond 10,000 insertions
- Vertical, horizontal interconnecting matrices
- Accommodates wide range of wire or component leads from .015"-.032"
- Quantity discounts

And you can try it absolutely **FREE** for 5 days! If not satisfied, just return your EL Socket and you won't be billed. Trying is believing. How can you go wrong? Order your EL Socket today!



EL INSTRUMENTS, INCORPORATED
61 First St., Derby, Conn. 06418
Telephone: 203/735-8774

Circle 193 on reader service card

What do you want in a push button switch?

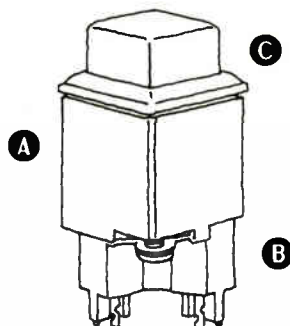

- A Actuation**—Momentary, alternate or snap action.
- B Circuitry**—From single pole, single throw to double pole, double throw; SPDT (2 circuit); make-before-break or break-before-make.
- C Styling**—Square, round, bezel, colors, lighted.

Just a few of the options possible in a wide range of push button switches available from Grayhill. If what you need isn't among them we can design one that is.

For our latest Engineering Catalog write or phone:

Grayhill, Inc., 523 Hillgrove Ave.,
La Grange, Illinois 60525.
(312) 354-1040.



New products

Semiconductors

Monolithic DAC resolves 10 bits

Converter chip includes voltage reference, op amp, and diffused resistors

When Precision Monolithics introduced a 6-bit monolithic digital-to-analog converter two years ago, a horse race of sorts developed among a half-dozen companies interested in developing a one-chip DAC with

inverting amplifier, driving the output op amp, converts the summed currents to a low-impedance output voltage.

Precision Monolithics Inc., 1500 Space Park Dr., Santa Clara, Calif. 95050 [411]

SPECIFICATIONS

Resolution: 10 bits and sign (11 bits)
Linearity options: 0.05%, 0.1%, 0.2% max (0–70°C)
Tempco options: ±15, ±30, ±60 ppm/°C
Output voltage options: +10 v, ±5 v, 0 to ±5 v, 0 to ±10 v, 0 to –5 v, 0 to –10 v
Settling time: 1 μs to 0.1%
Zero offset: 10 mV max
Logic input current: 10 μA max
Bipolar symmetry: 10 mV
Output slew rate: 40 V/μs
Power supplies: +12 v to +18 v
Power supply rejection: 0.1% per %
Power consumption at +15 v: 260 mW max
Logic levels: $V_{IH} = 2.0$ min $V_{IL} = 0.8$ max (can also operate with +15, –5 v CMOS and C²MOS logic)

SOS static shift register

stores up to 256 bits

A static shift register built into a silicon-on-sapphire chip is intended for use in high-performance computers, digital communications systems, and cathode-ray tube displays. The circuit, which is expected to compete with glass delay lines in some applications, stores up to 256 bits of digital data, and processes it at a rate of 20 million bits per second. It is said to be the most complex SOS circuit now commercially available. Operating range is from 0 to 75°C. Built-in control circuitry is also provided for writing in, reading out, and recirculating data, or for stopping. The unit is TTL-compatible, and it is packaged in a 14-pin, hermetically sealed, dual in-line package. Price is \$50 for sample lots of 100 or more. Delivery is from stock.

Inselek Inc., University Park Plaza, 743 Alexander Rd., Princeton, N.J. [413]

LED is interchangeable with incandescent lamp

A light-emitting diode made from gallium arsenide phosphide is designed as a direct replacement for incandescent T-1¾ equivalents. The series, called the 549 Bi-Pin, is available in voltages from 1.4 to 14 v and currents up to 30 milliamperes. The LED, capped by a red diffused lens,

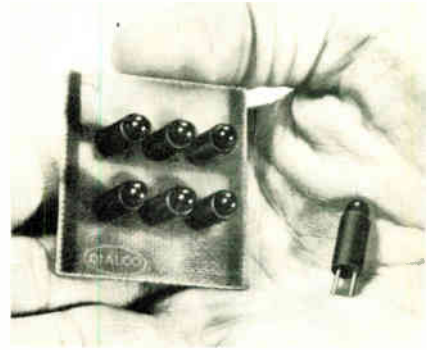

is combined with a built-in current-limiting resistor and pins molded in a plastic case. In quantities of 1,000, the LED is priced at 84 cents. Delivery is from stock.

Dialight Corp., 60 Stewart Ave., Brooklyn, N.Y. 11237 [414]

4-watt IC audio amplifier is designed for television

A 4-watt monolithic integrated circuit called the model LM354 is designed for use in television sets as an audio amplifier. The usable range of the supply voltage is from 6 to 24 v.



Other specifications include a self-centering bias for any operation in the voltage range, a direct-coupled input and high input impedance, high supply voltage rejection ratio, and a minimum number of external components. Price in 100-lots is \$3.

European Electronic Products Corp., 10180 W. Jefferson Blvd., Culver City, Calif. 90230 [415]

7-segment display delivers 500 foot lamberts at 10 mA

A seven-segment alphanumeric display for high ambient light conditions is designated the MAN-10. The 0.27-inch-high display has a typical brightness characteristic of

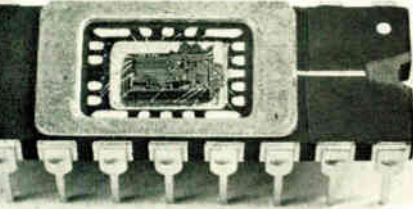

8-, 10-, or 12-bit resolution.

The race has been won by Precision Monolithics with a full 10-bit-plus-sign DAC containing all the required elements on a single chip. These include the voltage reference, an internally compensated operational amplifier that slews at 40 volts per microsecond and requires only 1 μs to settle within 0.1% of the final value, and a diffused R-2R resistor ladder. In its own right, the op amp is a significant advance.

The converter, which is designated the monoDAC-02 and is described by Precision Monolithics as the industry's first true linear large-scale integrated circuit, is built on an 82-by-148-mil chip and housed in an 18-pin dual in-line package.

In operation, the signal from the internal voltage reference drives the bases of 10 constant-current-source transistors. These current sources, with emitters connected to the appropriate taps of the R-2R ladder, provide the required binary-scaled currents, which are switched by current-steering logic either to ground or to an output sum line. Finally, an

What happened when a group of experts teamed up to write this book?

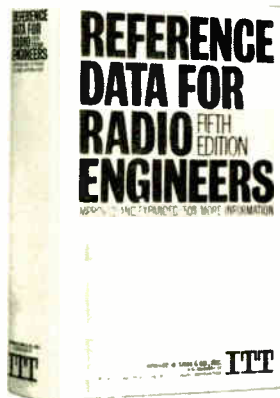

They made it so practical that it's now in its 5th edition!

This completely revised 5th Edition of the world famous Reference Data for Radio Engineers is the result of 5 years work by a broad group of practicing engineers, professors, government experts and the ITT staff. Its 1196 pages and 45 chapters bring you the very latest on transistors, electroacoustics, microminiature electronics, space communication, navigation aids, quantum electronics, reliability and life testing, etc.; information you need in your work. 1350 illustrations, charts, diagrams, tables, etc. Everything cross indexed for ready reference. Practical? Valuable? 400,000 radio engineers think so. Your money back if you don't agree with them.

Reference Data for Radio Engineers
No. 20678 \$20.00



HOWARD W. SAMS & CO., INC.
4300 West 52nd Street
Indianapolis, Indiana 46268

Please send Reference Data for Radio Engineers. Check/money order enclosed for \$_____ for _____ copies @ \$20.00. (Include sales tax where applicable.) Canadian price slightly higher. **E 052**

Name _____
Address _____
City _____
State _____ Zip _____

New products

500 foot lamberts at 10 milliamperes. At 20 mA, it produces 1,000 ft.-l. The display, packaged in a 14-pin dual in-line housing, is capable of displaying all digits from 0 to 9, plus nine distinct alphabetic characters. Price for 1 to 9 displays is \$13. In quantities of 10 to 99, it is \$10.75, and for 100-lots, \$9.

Monsanto Commercial Products Co., 10131
Bubb Rd., Cupertino, Calif. 95014 [416]

Reference diode chips are packaged as LIDs

Temperature-compensated reference diode chips, designated the CZ series, are channel-mounted devices. They feature an average long-term reference voltage drift of less than 10 parts per million per 1,000 hours.

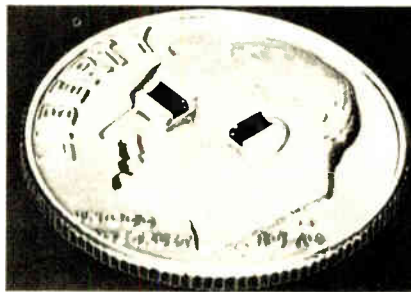

The units are packaged as leadless inverted devices, and they offer precise temperature compensation for reference voltage, with coefficients as low as 0.0005% per °C. Measurements are 0.080 inch maximum in length, 0.082 in. in width, and 0.040 in. in height.

Centralab Semiconductor 4501 N. Arden
Dr., El Monte, Calif. 91713 [417]

MOS memory designed for PDP-8/E computers

A metal-oxide semiconductor plug-compatible memory is designed for the PDP-8/E computer. It plugs directly into the Omnibus chassis and is both electrically and physically compatible with the DEC memory. The unit can be used either as a complete substitute memory or as an add-on to the existing system. Design is modular.

YOU'RE WHISTLING IN THE DARK...



IF YOU THINK THAT HEART DISEASE AND STROKE HIT ONLY THE OTHER FELLOW'S FAMILY.

GIVE... so more will live HEART FUND



Contributed by the Publisher

Evolution and the function generator

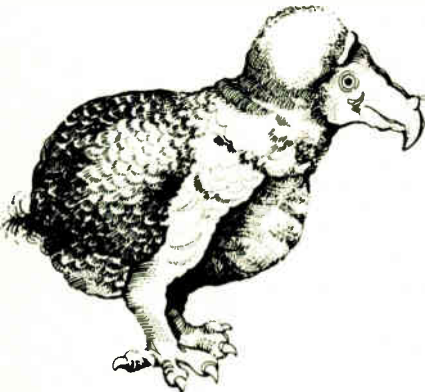

Lessons from the Dodo

IEC, in building its high-quality, low-cost Series 30 Function Generator, learned from the mistakes of others. (Yes, the industry has had its Dodos.) We knew that only a strong, highly reliable unit would survive, so we developed our compact, hard-working 0.3Hz-3MHz Series 30 accordingly.

Performance and quality are built into the unit right from the beginning. Interstate Electronics Corporation's independent QC lab puts every Series 30 semiconductor through a rigorous performance test before production acceptance. Then, after Unit Testing, Calibration, Burn-In, and Stress Cycling, each instrument ticketed for shipment has to pass QC's computerized Assurance Test before it goes to our customer.

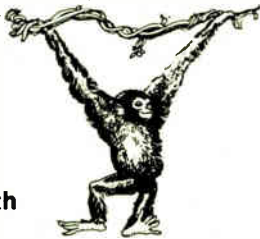

Monkeying with Ontogeny

The Unit Test is the first evaluation to identify and correct operative problems in the working instrument. Each of Series 30's versatile outputs, including variable Width Pulse, Sweep Sawtooth, Adjustable D-C Level, and Sine, Square, and Triangle waveforms are scrutinized for pure, consistent performance up to 20V p-p. In addition, our direct-reading Sweep Limit, 40-db Calibrated Attenuator, and other controls are handled for "feel" as well as accuracy.

During Calibration, Trigger, Gate, Burst, and Sweep Modes are given full play. By such critical inspections, we learn more about the instruments we make, and the product species as a whole is improved.

IEC actually over-calibrates to reach an exceptional quality of performance. While we spec a respectable 0.3% sine distortion, our generators typically achieve 0.18%.

Loss of the Sixth Toe

As part of the stress Cycle, we developed a "Shake 'n Bake" test that jolted and jarred Series 30 prototypes, then operated them in a 70°C. heat chamber. We still burn-in each Series 30 generator, but after extensive Unit Tests without a vibration failure, the "shake" cycle was declared obsolete.



Mutation Elimination

We don't produce to MIL-SPECS, but our procedures are amazingly close to it. During four in-process inspections, a QC team checks everything from each solder joint to screw mounts, rejecting the slightest imperfections. We expect each Series 30 unit to evolve exactly as specified, with absolutely no mutations.



Survival of the Fittest

After calibration, the Series 30 generator undergoes a minimum 120-hour "mileage" test. We turn each instrument on and off at irregular intervals during this stress cycling to simulate real-world strain, and our exclusive Output Limit Indicator glows to confirm that the Generator is operating under stress.

Following this, all instruments are processed by a final automated lab system. At this point the Function Generator *must* continue to perform precisely, with an exacting degree of conformity and predictability. Only by surpassing the highest standards of the species does the Series 30 survive in the field, and enjoy the lowest return in the industry.

We're ready to back up our claims. Go ahead . . . call John Norburg, collect, at (714) 772-2811, and ask for a demo!

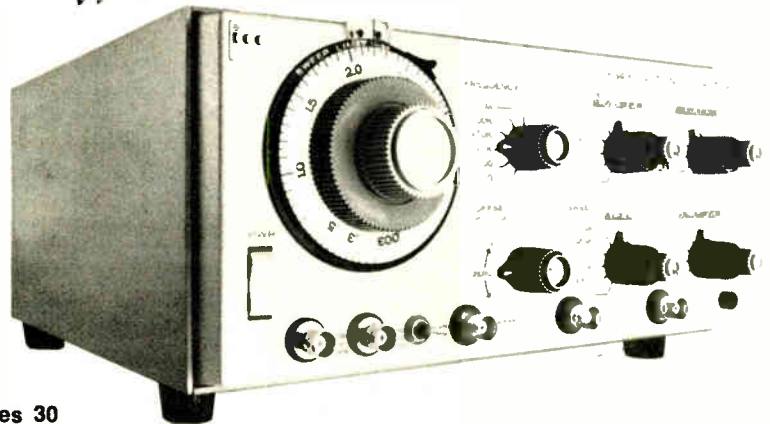

F34 . . . \$495

5 Other Models available in Series 30 From \$295 to \$695



IEC INTERSTATE ELECTRONICS CORPORATION

a subsidiary of A-T-O Inc.
Dept. 7000, Box 3117, Anaheim, Calif. 92803.
TWX 714-776-0280 TELEX 655443 & 655419



Deionized Water Essential To Texas Semiconductor Manufacturer

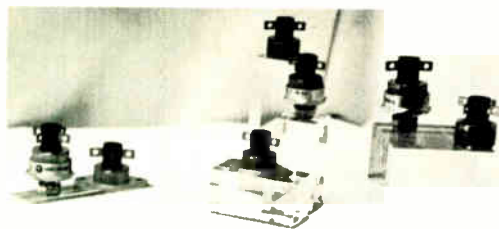

INTEGRATED BRIDGE RECTIFIER



Typical silicon rectifiers made by Varo Incorporated.

Close-up view of cleaning booth, where assembly is being rinsed with deionized water.

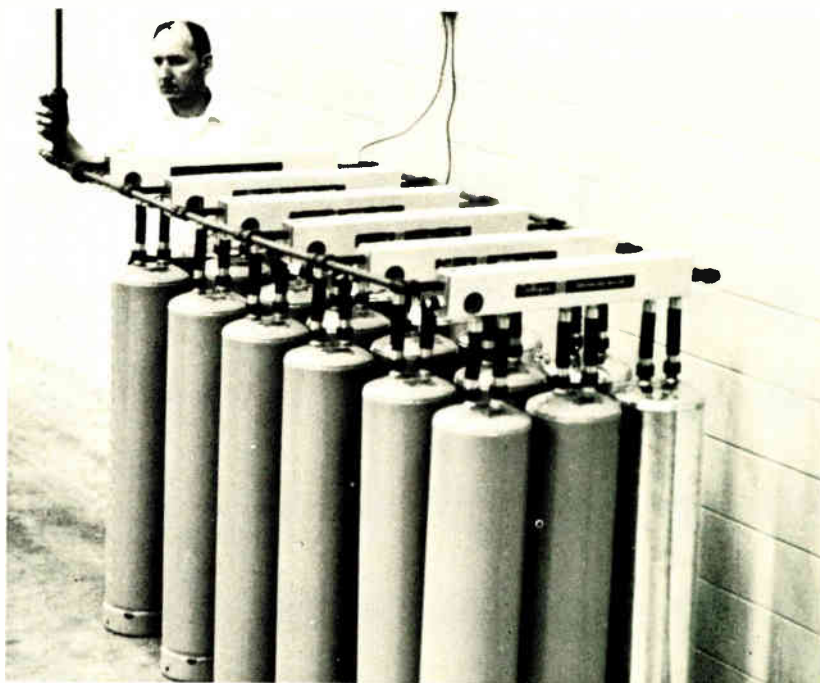

Eighteen-tank Culligan system in use at Varo. System supplies deionized water for use in manufacture of semiconductors.

□ If a manufacturer of semiconductor devices can't get high quality water, then it isn't a matter of product quality—it's a matter of product life or death. "And by very high quality," says Jan Collmer, General Manager of Varo, "we're talking far beyond one or two parts per million; we mean water quality in the 15 to 18 megohm range."

To meet Varo's exacting standards, the local Culligan Man supplied a deionizer system, utilizing 9-inch exchange service tanks. The decision to use portable exchange rather than automatic packaged

deionizers was made for two reasons: economics and convenience.

The Culligan Man put the economics reason this way: "When the flow volume demand is low, you use portable exchange. Naturally, you reach a point in gallonage where you must balance the cost of purchase against the cost of leasing equipment. But you can't make a universal rule about it; each customer's demands are different."

As for convenience, Collmer adds, "We're not interested in becoming water experts. Our main concern is having high quality water available at all times,

and we want to limit our involvement to paying the invoice each month.

We pay only for the water we use. If we have a plant shutdown or if production drops for any reason, we can reduce or cut off the supply of deionized water immediately."

For detailed information and additional case histories, write to Will Sanders for our 4-page Job Reports 103, 119 and 120—or call your local Culligan Man for a consultation. □

Culligan USA, One Culligan Parkway, Northbrook, Illinois 60062.

CUSTOMER: Varo Incorporated

PROBLEM: Need for high quality water for manufacture of semiconductors

SOLUTION: 15-megohm water with exchangeable tanks

EQUIPMENT: Culligan deionizer tanks and carbon filters

New products

and capacity can be expanded from 4,000 to 32,000 words in 4,000-word increments. The MOS device consists

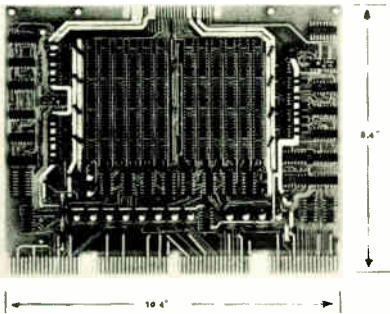

of one timing and control card plus up to eight 4,000-by-12 memory cards.

Signal Galaxies Inc., A subsidiary of The Signal Companies Inc., 6955 Hayvenhurst Ave., Van Nuys, Calif. [418]

Monolithic timer IC provides delays of 1 μ s to 1 hour

A monolithic timing integrated circuit with delay output pulse ranging from 1 microsecond to 1 hour offers typical accuracy to within 0.5%. Temperature drift of the XR-220 is specified as 150 parts per million per $^{\circ}$ C. Only three external components are required: a timing resistor, a timing capacitor, and a simple load resistor, with delay determined

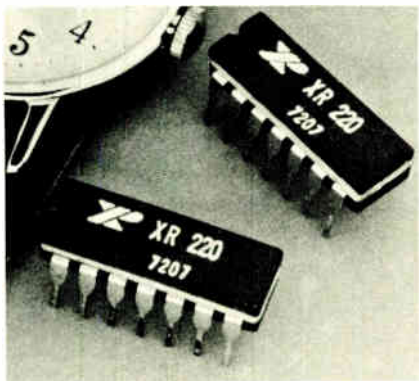

by the value of the timing resistor. Practical values of this resistor range from 3 kilohms to 1 megohm for a 5-volt supply. The XR-220 is available in two guaranteed timing-accuracy ranges. A military version is also available. Prices start at \$4.

Exar Integrated Systems Inc., 733 North Pastoria Ave., Sunnyvale, Calif. 94086 [419]

We'll convert you . . .

Compare our new ADC-N, P, and H series, which are capable of converting analog data at rates of up to 2.5MHz in word lengths of up to 12 binary bits . . . then check this price . . . from \$350. We have faith in where you'll place your order.

- Fast . . . up to 2.5MHz conversion rate
- High Resolution . . . up to 12 binary bits
- Compact . . . 3.2 cubic inches
- Flexible choice of input range and output digital codes
- Economical . . . priced far below competitive units



from just **\$350.00**

D/A's from \$9.95
A/D's from \$22.95

Send for new free 50-page catalog.

DATTEL
SYSTEMS, INC.

1020 TURNPIKE STREET, CANTON, MASS. 02021 / TEL. (617) 828-6395

TWX 710-348-0135

Circle 171 on reader service card

THIS SPACE CONTRIBUTED BY THE PUBLISHER

LISTEN TO YOUR BODY.



If something's going wrong, it'll tell you.

1. Change in bowel or bladder habits.
2. A sore that does not heal.
3. Unusual bleeding or discharge.
4. Thickening or lump in breast or elsewhere.
5. Indigestion or difficulty in swallowing.
6. Obvious change in wart or mole.
7. Nagging cough or hoarseness.

If you have a warning signal, see your doctor. If it's a false alarm, he'll tell you. If it isn't, you can give him time to help. Don't be afraid.

It's what you don't know that can hurt you.

American Cancer Society

TRY SOME FREE SAMPLES OF BY-BUK PROFESSIONAL QUALITY ELECTRONIC CIRCUITRY DRAFTING AIDS.

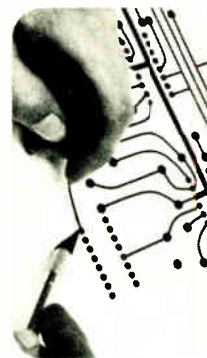

It's our way of proving that artwork layout accuracy can be accomplished in seconds with By-Buk pressure sensitive drafting aids.

We'll also send you our catalog featuring thousands of ideas in individually die cut artwork patterns and conductor line tapes to connect them with.

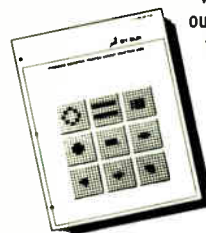

BY-BUK COMPANY
A SUBSIDIARY OF WEBTEK CORPORATION

4326 W. Pico Blvd., Los Angeles, CA 90019
(213) 937-3511

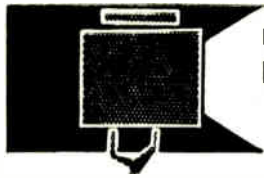

SEARCHLIGHT SECTION

• CLASSIFIED ADVERTISING • BUSINESS OPPORTUNITIES
• USED OR SURPLUS EQUIPMENT

AUTOTRACK MOUNT

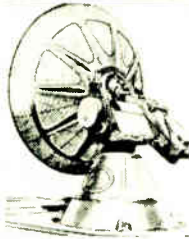

AUTOTRACK SCR-584 RADARS

360 degree azimuth, 210 degree elevation sweep with better than 1 mil accuracy. Missile velocity, acceleration and slewing rates. Amplidyne and servo control. Will handle up to 20 ft. dish. Supplied complete with control charts. **ALSO** in stock: 10 cm. van mounted radar system. Comical scan PPI 6 ft. dish. Ideal for S band telemetry, weather, balloon trk, missile trk, rocket trk, ECM range. Write for complete data. 600 pg instr bk avail at \$25 ea.

HAWK MISSILE DOPPLER RADAR

CW low power illuminator. AN/MPQ-33 Dual antenna on single mount. Van mounted. Complete X band doppler tracker.

PATH LOSS MEAS. FACILITY

Mfg. RFI. For establishing max. xmsn paths for tropo- and microwave links. 2 heli-hut vans. Covers 1-2.5ghz bands. 20 to 120 wats. CW output.

PHOENIX MISSILE SYSTEM

10" PPI, 5" B and C displays, and complete digital computer consoles.

IBM 704 SCIENTIFIC COMPUTER

w/ peripherals & programs. Cost \$2,000,000. Our price \$10,000.

MIT MODEL 9 PULSER 1 MW—HARD TUBE

Output 25kV 40 amp, 30kV 40 amp max. Duty cycle .002 to 2 microsec. Also 5 to 5 microsec. and 1 to 5 microsec. Uses 6C21. Input 115V 60 cycle AC. Mfg. GE. Complete with driver and high voltage power supply. Ref. MIT Rad Lab Series, Vol 5, p. 152.

2 MEGAWATT PULSER

Output 30 kV at 70 amp. Duty cycle 001 Rep. rates, 1 microsec. 600 pps. 1 or 2 msec. 300 pps. Uses 5948 hydrogen thyratron. Input 120/208 VAC 60 cycle. Mfr. GE. Complete with high voltage power supply.

2 MEGAWATT HARD TUBE PULSER

Output 40kV at 50 Amps. Duty cycle 0038. Var. pulse width. Compl. with driver and HV power supply. Input 208V 60hz.

RECON DRONE CONTROL RADARS

X Band systems autotrack and search complete with plotting boards. Fully mobile van mounted. Gives PPI, slant range, altitude data. Ground to air control links and beacons also in stock. AN/MPQ-29 & AN/UPW-1.

AUTOMATIC TRACKING SYSTEM

SCI, ATL, MOD, 3101-J70 Antenna Pedestal. AZ-EI 15 deg per second rated speed. 23 inch dia. bearing. Complete w/ control console & mag amplifiers.

SPARE PARTS IN STOCK

Nike Ajax, Nike Hercules, M-33, MPS-19, TPS-1D, TPS-10D, TPS-6, SPS-8, SCR-584, HIPAR.

RADAR & RF PKGS.

34ghz 40kw Pulse R1 pkg
24ghz 40kw Pulse bomb toss system
16ghz 130kw Pulse B-58 search radar system
X BAND AUTOTRACK 250KW PULSE M-33
compl w/ plot boards

X BAND AUTOTRACK 50KW PULSE B-47
fire control complete

C BAND 5 MEGAWATT PULSED KLYSTRON

AN/TPS-26 Heli Finder

C BAND 1 MEGAWATT AUTOTRACK

10ft dish mortar locator MPQ-21

C BAND 285KW PULSE Search AN/SPS-8/10

S BAND 1 MEGAWATT COHERENT AN/TPS-18

S BAND 1 MEGAWATT PULSE NIKER ACQ.

L BAND 1 MEGAWATT PULSE AN/TPS-1

L BAND 500KW PULSE AN/TPS-1D/1

L BAND 5 to 20KW PULSE

400mhz 1KW CW AN/TPS-23

225mhz 1 MEGAWATT PULSE AN/SPS-28

2-30mhz 100KW PULSE

CW 950-5ghz 150 WATTS

CW 1.5mhz-10 5ghz 5 WATTS

CW S & X BANDS 300-600WATTS

AN/PGP-1 SKYSWEEP TRACKER

3 cm auto tracking radar system. Comp pkg w indicator sys. Full target acquisition & auto tracking. Input 115V 60cy. new. In stock for immed del. Entire sys 6' x 3' x 10'. Ideal for infrared tracker, drone tracker, missile tracker, R & D.

CATV-COLOR MICROWAVE LINKS

Ratheon type KTR-1000. Fullcolor bandwidth as well as studio audio. Rack mounted. Complete trans-receiv tracks in stock.

HUNDREDS MORE IN STOCK
LARGEST RADAR INVENTORY IN WORLD.
WRITE FOR CATALOG ON YOUR LETTERHEAD

Radio-Research Instrument Co. INC.

3 Quincy St., Norwalk, Conn. 06850 • 203-853-2600

CIRCLE 951 ON READER SERVICE CARD

FREE CATALOG

HARD-TO-FIND PRECISION TOOLS

Lists more than 1700 items—pliers, tweezers, wire strippers, vacuum systems, relay tools, optical equipment, tool kits and cases. Also includes four pages of useful "Tool Tips" to aid in tool selection.



JENSEN TOOLS and ALLOYS
4117 N. 44th Street, Phoenix, Arizona 85018

CIRCLE 952 ON READER SERVICE CARD

free catalog

POTTING APPLICATORS MANUAL AND DISPOSABLE

6cc 12cc 30cc

FOR POTTING, ENCAPSULATING, AND SEALING OF MINIATURE COMPONENTS

PHILIP FISHMAN COMPANY
7 CAMERON ST., WELLESLEY 81, MASSACHUSETTS

CIRCLE 953 ON READER SERVICE CARD

Don't forget the

BOX NUMBER

... when answering the classified advertisements in this magazine. It's our only means of identifying the advertisement you are answering.

Somebody— Somewhere

needs your idle equipment! Reach that buyer quickly and economically thru the

"SEARCHLIGHT SECTION"

The meeting place of
Used Equipment Buyers and Sellers

New books

CRC Handbook of Lasers with Selected Data on Optical Technology. Robert J. Pressley, ed., The Chemical Rubber Co., pp. 631, \$27.50

A comprehensive compilation of experimental data, this book consists mainly of charts, graphs, and tables—the text serves simply to explain them. The data is current as of late summer, 1970, the editor says, but he promises future editions.

In 21 chapters, with material from 28 contributors, the book covers such topics as safety, atmospheric transmission, incoherent sources, filters, detectors, laser types, modulator materials, optical storage media, and holographic parameters and materials. Each chapter is well referenced—a necessity, because there is little standardization in many measurements, and the user should have access to the original papers to determine the methods used in making any measurement.

One 20-page section lists more than 2,000 gas lasers by wavelength. Injection lasers are listed in a separate chart, backed up by some 89 references. The book's philosophy of compact treatment is epitomized in the section on injection lasers—in two pages, basic equations and definitions for injection lasers are given, while a third page lists the various materials, wavelengths, bandgaps, and modes of excitation.

Some practical applications of lasers are given in the chapter on holography, but primary emphasis is on materials and properties.

Electronic Engineering Materials and Devices. John Allison, McGraw-Hill Book Co., pp. 303, \$13.50

Calculus for Electronics. (second edition), A. E. Richmond, McGraw-Hill Book Co., pp. 544, \$9.95

Parallelism in Hardware and Software: Real and Apparent Concurrency. Harold Lorin, Prentice-Hall Inc., pp. 508, \$15.00

Instruments and Measurements for Electronics. Clyde N. Herrick, McGraw-Hill Book Co., pp. 560, \$13.95

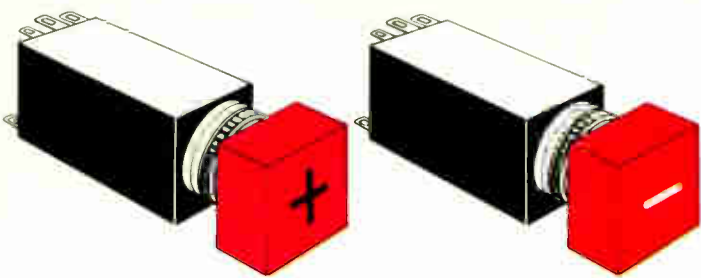

Contactless solid state switches:

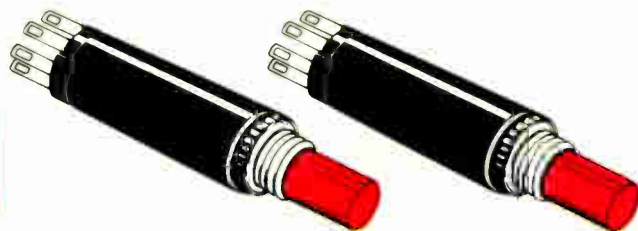

Incandescent or neon lighted switches

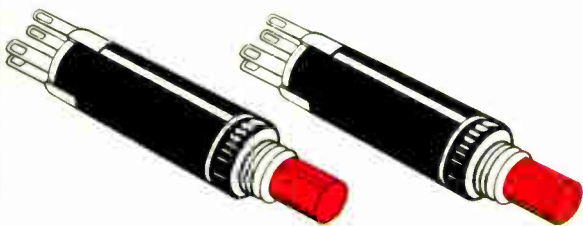

LED lighted switches... panel mounting

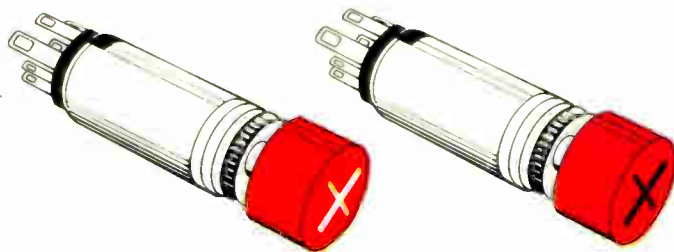

Incandescent lighted switches... panel mounting

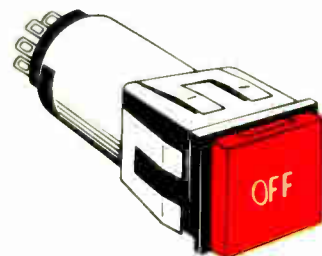
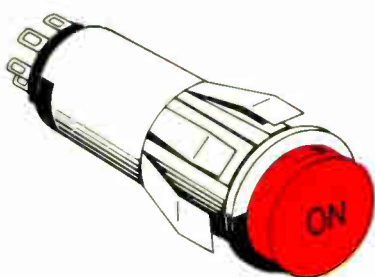
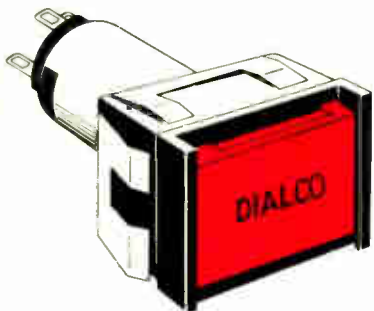

Incandescent lighted switches... snap-in mounting

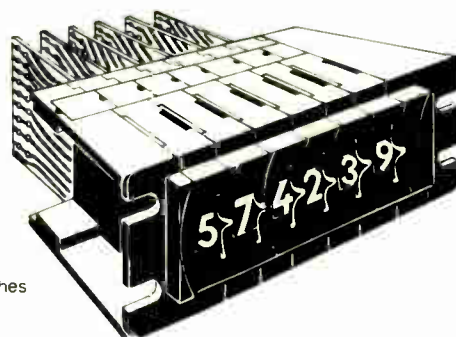
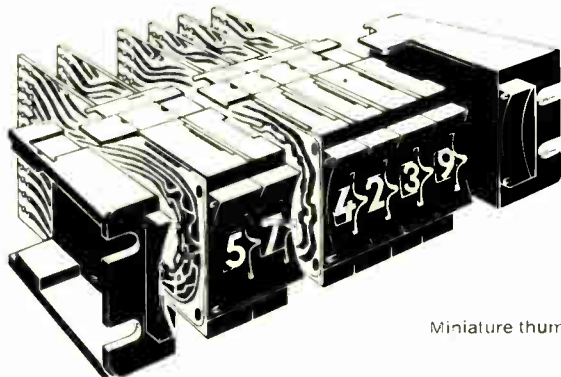

Miniature thumbwheel switches

Switches?

**Talk to the specialists at Dialight first.
You won't have to talk to anyone else.**

Dialight has a switch for virtually any application. That means complete freedom to design for the job without compromising on physical or electrical parameters. Dialight can give you push button switches with unlimited cap and bezel options...solid state switches that eliminate all mechanical switching

problems...LED lighted switches...thumbwheel switches that snap together to provide any number of decades you require... switches with transistorized indicators. If you have a special problem, tell us about it. Chances are, the specialists at Dialight have seen it before. Meanwhile, ask for our switch catalog.

DIALIGHT DIALCO

DIALIGHT CORPORATION, A NORTH AMERICAN PHILIPS COMPANY • 60 STEWART AVENUE, BROOKLYN, N. Y. 11237 • (212) 497-7600

New AO II-80 Illuminator sheds intense, "cold" light on your subject.

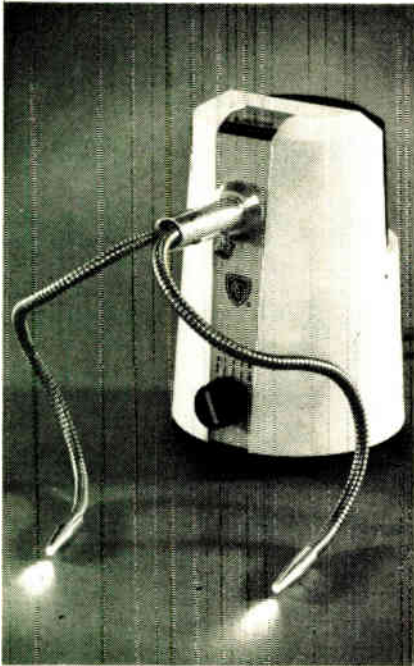

This is the illuminator with 1001 uses. You can use it to provide bright, shadowless light for microscopy. To equally illuminate samples under stereo comparison microscopes. To illuminate miniature components under assembly. Illuminate hazardous areas. And in many other applications.

The AO II-80 uses a quartz iodine light source. Fan-cooled lamp has 50- to 500-hr. life. A 4-level switch controls settings. Unit weighs only 4¾ lbs.

The flexible two-branch gooseneck light guides transmit intense cold light—measure 24". (Other light guides also available.)

AO II-80 Illuminator
price: only \$129.50
Gooseneck Light Guide
(shown) \$75.00

 **AMERICAN OPTICAL CORPORATION**
Fiber Optics • Southbridge, Massachusetts 01550

New literature

Tone-burst generator. Singer Instrumentation, Los Angeles Operation, 3211 S. LaCienega Blvd., Los Angeles, Calif. 90016. A four-page brochure describes the universal tone-burst generator, and lists proprietary call systems with which the instrument can be used. Circle 421 on reader service card.

Time code formats. A reference book of time code formats gives drawings and characteristics of about two dozen of the most commonly used codes, along with a glossary of terms. The manual is available from Datum, Timing Div., 170 E. Liberty Ave., Anaheim, Calif. 92801 [422]

Relays. A 28-page catalog is available from Struthers-Dunn Inc., Pitman, N.J. 08071, that gives condensed specifications, dimensions and prices for relays and motor controls. [423]

Coaxial components. A 36-page brochure from General Radio, 300 Baker Ave., Concord, Mass. 01742, describes components and accessories for high-frequency applications to 9 gigahertz. [424]

Fm tuner. Texas Instruments Incorporated, Components Group, P.O. Box 5012, Dallas, Texas 75222, has published an application report on designing a frequency-modulation tuner using metal-oxide-semiconductor field-effect transistors. Bulletin CA-164 is eight pages long, and provides test data and technical guidelines. [425]

Instrument transformers. An eight-page booklet on how to specify an instrument transformer is available from the Ritz Instrument Transformer Co., 2006 Manhattan Beach Blvd., Redondo Beach, Calif. [426]

Transistor chips. Teledyne Crystallonics, 147 Sherman St., Cambridge, Mass. 02140, has published a catalog of semiconductor chips for use in hybrid circuits. The catalog describes a series of standard components including FETs, pnp and npn

switching transistors, integrated choppers, and monolithic interface circuits. [427]

Transformers. Essex International Inc., Controls Div., Stancor Products, 3501 W. Addison St., Chicago Ill. 60618. Catalog 207 lists more than 1,900 standard transformers for design engineers, and includes technical data and illustrations. [428]

Pc card test systems. A 16-page brochure has been released by Tera-dyne Inc., 183 Essex St., Boston, Mass. 02111, describing the company's L100 family of computer-oriented printed-circuit-board test systems. The brochure discusses both hardware and software aspects of the systems. [429]

Thyristors. A short-form catalog from Hutson Industries Inc., 2019 W. Valley View Rd., Dallas, Texas 75234, lists the line of triacs, SCRs, and diacs available, with data on principal voltage, current ratings and characteristics. [430]

Station coupler. Elgin Electronics Inc., Walnut St., Waterford, Pa. 16441, is offering a two-page data sheet of the ESC-20721 station coupler that connects various types of customer-provided equipment to the switched telecommunications network. [431]

Instruments catalog. Ballantine Laboratories Inc., P.O. Box 97, Boonton, N.J. 07005, has available a 15-page condensed catalog listing the company's line of test and measurement instruments, including automated and programmable equipment. [432]

Photomultipliers. A catalog covering the line of photomultipliers, gas and vacuum photodiodes, electron multipliers, and integrated photodetection assemblies is available from RCA Commercial Engineering, Industrial Tube Div., Harrison, N.J. 07029. The 86-page catalog, PIT-700B, describes developments in photodetector design and manufacture. [434]

SEVENTY ACTIVE YEARS IN RADIO TELECOMMUNICATIONS

1901 . . . using kites and 500 feet of wire Guglielmo Marconi and his assistants, Kemp and Paget, receive the first transatlantic radio message. Faintly, but triumphantly, the three dots, 'S' in Morse Code, span three thousand miles breaking what was then the major communications barrier between continents.

1972 . . . seventy years later, Canadian Marconi Company has set the pace for breaking today's communications barriers using another form of code — pulse code modulation.

If you are in the business of communicating voice or data, find out how you can benefit from seventy years of telecommunications experience.

Write and ask us about our MCS 6900 digital microwave communications system . . . **the better way to communicate.**

CANADIAN MARCONI COMPANY 
TELECOMMUNICATIONS DIVISION · 2442 TRENTON AVE., MONTREAL 301, P.Q., CANADA
TEL.: (514) 343-3411, TELEX NO. 05-267563, TWX NO. 610-421-3564, CABLE: ARCON MONTREAL

Circle 175 on reader service card

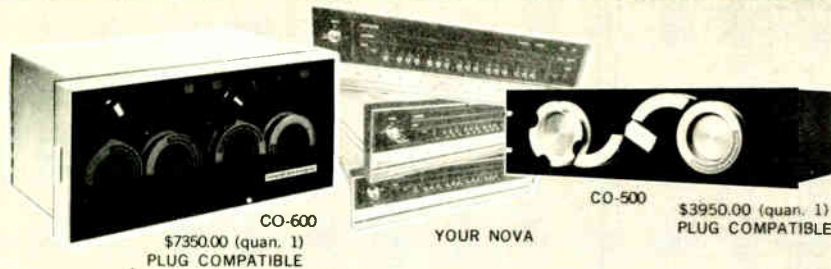

**PLUG A LINC TAPE INTO YOUR NOVA.
HERE'S WHAT YOU GET**

- Most Reliable Tape System in the Industry
- 100,000 Tape Passes Guaranteed
- 8,400 Bytes/Second Transfer Rate
- Block Addressible Disc Format for True Random Access
- 204,800 Bytes/Reel in Blocks of 512

PLUS

A complete operating system to expedite program preparation through a powerful text editor, assembler, two loaders, and 7 file utilities. Completely eliminates paper tape. All files, source, object, and image, are stored on LINC tape. Up to five times improvement in throughput over high speed paper tape.

Send for Reference Manuals.

Computer Operations, Inc.

10774 Tucker St. • Beltsville, Md. 20705 • 301-937-5377

Circle 176 on reader service card

See us at SJCC Booth 1704

Presenting
in your
corner:
**THE
ELECTRONICS
BOXER!**

Why mess around when you can have the **ELECTRONICS BOXER** clean up your copies—keep them in top condition.

And, it's easy and inexpensive to keep the **ELECTRONICS BOXER** in your corner. Just complete the coupon and mail. Your order will be processed immediately, postpaid.



ELECTRONICS BOXER

Jesse Jones Box Corporation

2250 E. Butler St., Philadelphia, Pa. 19137

Please send me: boxes @ \$4.25 each;
 3 boxes @ \$12.00; 6 boxes @ \$22.00

My check or money order is enclosed.

Name _____

Address _____

City _____ State _____ Zip _____

Advertising Sales Staff

Pierre J. Braudé [212] 971-3485
Advertising Sales Manager

Atlanta, Ga. 30309: Joseph Lane
100 Colony Square 1175 Peachtree St., N E
[404] 892-2868

Boston, Mass. 02116: James R. Pierce
607 Boylston St. [617] 262-1160

Chicago, Ill. 60611: Robert W. Bartlett
Kenneth E. Nicklas, 645 North Michigan
Avenue. [312] MO 4-5800

Cleveland, Ohio 44113: William J. Boyle
[716] 586-5040

Dallas, Texas 75201: Richard P. Poole
1340 Republic National Bank Building
[214] RI 7-9721

Denver, Colo. 80202: Harry B. Doyle, Jr.
Tower Bldg. 1700 Broadway
[303] 266-3863

Detroit, Michigan 48226: Robert W. Bartlett
2600 Penobscot Building
[313] 962-1793

Houston, Texas 77002: Richard P. Poole
2270 Humble Bldg. [713] CA 4-8381

Los Angeles, Calif. 90017: Robert J. Rielly
Bradley K. Jones, 1125 W. 6th St.
[213] HU 2-5450

New York, N.Y. 10036
330 W. 42nd St.
Warren H. Gardner [212] 971-3617
Michael J. Stoller [212] 971-3616

Philadelphia, Pa. 19103: Warren H. Gardner
6 Penn Center Plaza
[212] 971-3617

Pittsburgh, Pa. 15222: Warren H. Gardner
4 Gateway Center, [212-971-3617

Rochester, N.Y. 14534: William J. Boyle
9 Greylock Ridge Pittsford N Y
[716] 586-5040

San Francisco, Calif. 94111: Don Farns
Robert J. Rielly 425 Battery Street
[415] 362-4600

Paris: Alain Offergeld
17 Rue-Georges Bizet 75 Paris 16, France
Tel 720-73-01

Geneva: Alain Offergeld
1 rue du Temple, Geneva, Switzerland
Tel 32-35 63

United Kingdom: Keith Mantle
Tel 01-493 1451, 34 Dover Street, London W1

Milan: Robert Saidel
1 via Baracchini Phone 86 90 656

Brussels: Alain Offergeld
23 Chaussee de Wavre
Brussels 1040 Belgium
Tel 13-65 03

Stockholm: Brian Bowes
Office 17 Kontor-Center AB Hagagarten 29
113 47 Stockholm Tel 24 72 00

Frankfurt/Main: Fritz Krusebecker
Liebigstrasse 27c
Phone 72 01 81

Tokyo: Masaru Wakeshima McGraw-Hill
Publications Overseas Corporation,
Kasumigaseki Building 2-5-3 chome
Kasumigaseki Chiyoda Ku Tokyo Japan
[581] 9811

Osaka: Ryji Kobayashi, McGraw-Hill
Publications Overseas Corporation Kondo
Bldg., 163 Umegae-cho Kita ku [362] 8771

Australasia: Warren E. Ball, IPO Box 5106,
Tokyo Japan

Business Department

Stephen R. Weiss, Manager
[212] 971-2044

Thomas M. Egan,
Production Manager [212] 971-3140

Carol Gallagher
Assistant Production Manager [212] 971-2045

Dorothy Carter, Contracts and Billings
[212] 971-2908

Frances Vallone, Reader Service Manager
[212] 971-6057

Electronics Buyers' Guide

George F. Werner, Associate Publisher
[212] 971-3139

Regina Hera, Directory Manager
[212] 971-2544

We sell more magazines than most of our competition can give away free.

When you can sell something that everyone else gives away free, you must have something special. And that's how it is with Electronics.

Our readers find Electronics so valuable, they'd rather pay for it than take a chance on something for nothing.

With every other electronics magazine giving subscriptions away, Electronics, at \$8.00 to \$25.00 a year, has a higher circulation than all but one. And that one doesn't beat us by much.

Ours is the most controlled circulation in the field. Controlled first, because subscribers must qualify to receive Electronics. Controlled again, because our readers have to be willing to pay the price.

Not only is our audience select, it's loyal. In fact, 25,000 of our subscribers never read any of the next six electronics journals.

And that's the kind of audience you have to reach.

58,000 (67%) have management responsibility.

48,000 (56%) are responsible for company profits.

74,000 (86%) do or supervise design work.

73,000 (85%) select vendors.

These important customers believe in Electronics. And they'll believe in you when you advertise in Electronics.

With our kind of reader loyalty, you can't afford not to go to **Electronics** The Source. **THE SOURCE.**

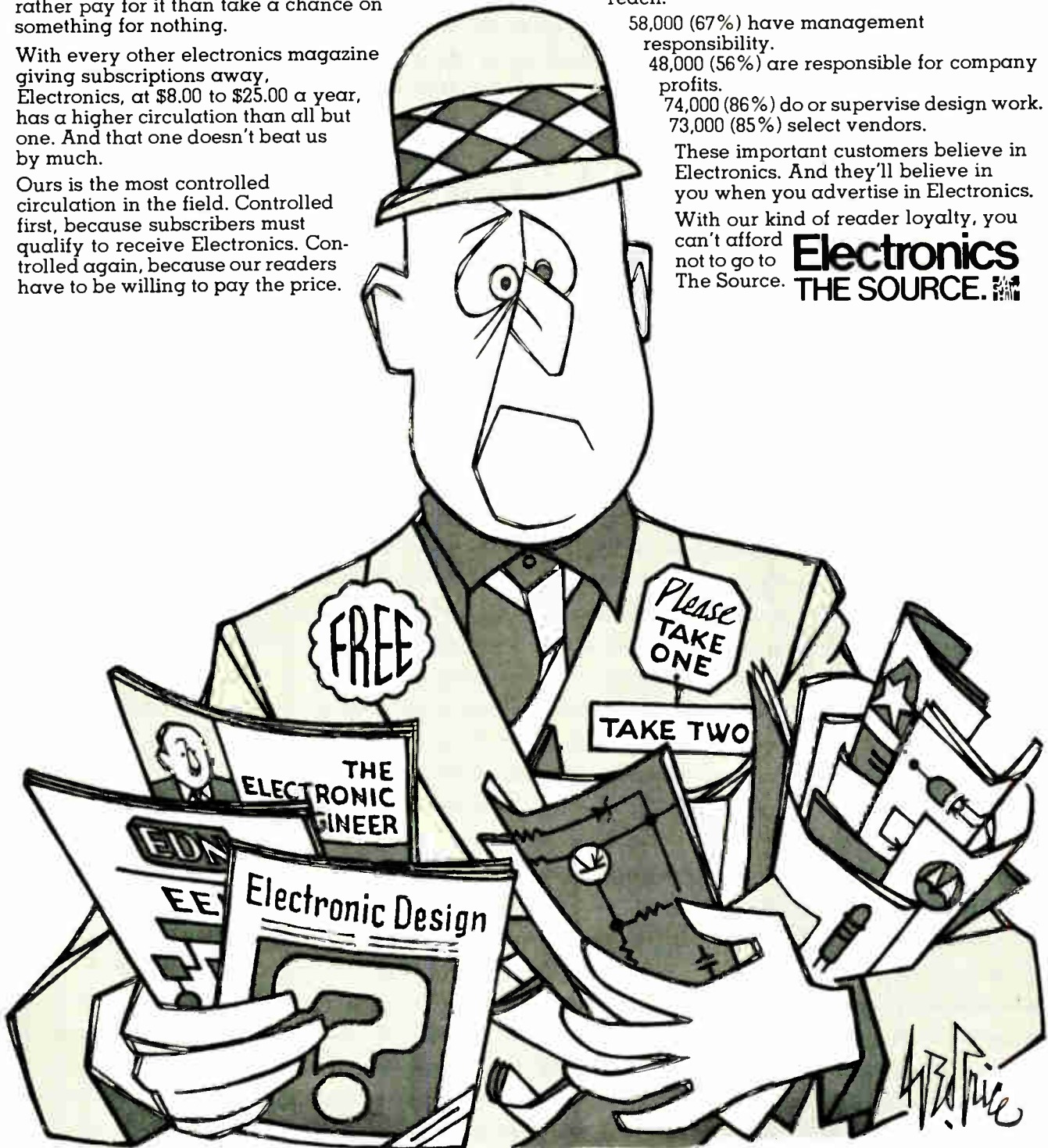



DIGITEC DIGITAL THERMOMETERS

We delivered our first Digital Thermometer in 1963. We were the first to offer these unique, convenient instruments. Today we're still the leader with a broad line of accurate, wide range thermometers to meet the requirements of nearly any application.

DigiTec Thermometers are designed for use with thermistors, platinum resistance and thermocouples. Probes for the thermistor and platinum resistance units are available from stock. The Thermocouple Thermometers are for use with the five most common TC types in both °F and °C.

These instruments are value oriented with many outstanding features, some of which are: optional battery pack, LED displays, guarded input and isolated BCD output. Prices range from \$395 to \$825. Write or call for assistance in selecting the most suitable Thermometer for your application.

Call or write United Systems Corporation, 918 Woodley Road, P. O. Box 458, Dayton, Ohio 45401 (513) 254-6251, TWX (810) 459-1728.



Circle 179 on reader service card

Narrow-Band TV



- If you don't need motion in your TV pictures, but need:
- Low cost, long distance, transmission over standard voice grade phone lines
 - Tape recording on standard 1/4" audio tape
 - Hard copy printout
 - Magnetic disc image storage (multiple pictures or color too)
 - An interconnection to a computer

Investigate our 201 series Video Converters, which compress the bandwidth of standard TV signals to as low as 500 Hertz, and our 220-series Video Converters which utilize a unique disc memory technique to re-convert to conventional 525-line TV format.

CVI

COLORADO VIDEO, INCORPORATED • P. O. Box 928 • Boulder, Colo 80302 • (303) 444-3972 Video Data Acquisition • Processing • Display • Transmission

Electronics/May 8 1972

Circle 196 on reader service card 179

A CAMBION® Double "QQ" Product Line

You decide which plug and patch components are best for your end use design. Whether your concept calls for modular construction to permit ease of assembly and service, or a tightly packaged sophisticated system, CAMBION mounting devices provide the ultimate in flexibility.

From basic breadboarding to production runs of finished equipment, you can use a variety of CAMBION mounting components. You can create your own discrete component mounting configuration with the famous CAMBION cage jacks, design a patchable panel, piggy-back with patch cords, develop special purpose circuit assemblies with a wide selection of CAMBI-CARDS®, and plug finished units into Wire-Wrap® card connectors mounted in multi-purpose card files with optional back planes.

Whichever way you go, the CAMBION plug and patch components you select have two things in common: quality that's built in from design through material selection and finished production, and availability of identical standard parts in quantity. The quality stands up as the quantity goes on. That's the CAMBION Double "QQ" approach.

When you want a sales engineer to show you samples of CAMBION's broad line of mounting devices, write or call us. For a designer's catalog to start now, send us your name and address. Cambridge Thermionic Corporation, 445 Concord Avenue, Cambridge, Massachusetts 02138. Phone: (617) 491-5400. In Los Angeles, 8703 La Tijera Boulevard, 90045. Phone: (213) 776-0472.

Plug and patch components cut design and maintenance costs.



Standardize on

CAMBION®
The Guaranteed Electronic Components

Do you face a make or buy decision on power supplies?

BUY THE NEW LAMBDA LY SERIES

**>50% efficient, 20 KHz switching,
50mV P-P ripple, 0.1% line or load regulation**

SINGLE OUTPUT

\$300

**5 VOLTS 30 AMPS
WITH OVERVOLTAGE
PROTECTION BUILT-IN**

DUAL OUTPUT

\$380

**±15 TO ±12 VOLTS
8.5 AMPS EACH OUTPUT**

TRIPLE OUTPUT

\$395

**5 VOLTS 18 AMPS
DUAL ±15 TO ±12 VOLTS
2 AMPS EACH OUTPUT**

QUADRUPLE OUTPUT

\$450

**5 VOLTS 16 AMPS
DUAL ±15 TO ±12 VOLTS
1.5 AMPS EACH OUTPUT
24 TO 28 VOLTS 1.0 AMPS**

AC input: 105-132 VAC, 47-440 Hz
DC input: 145 VDC ±10%

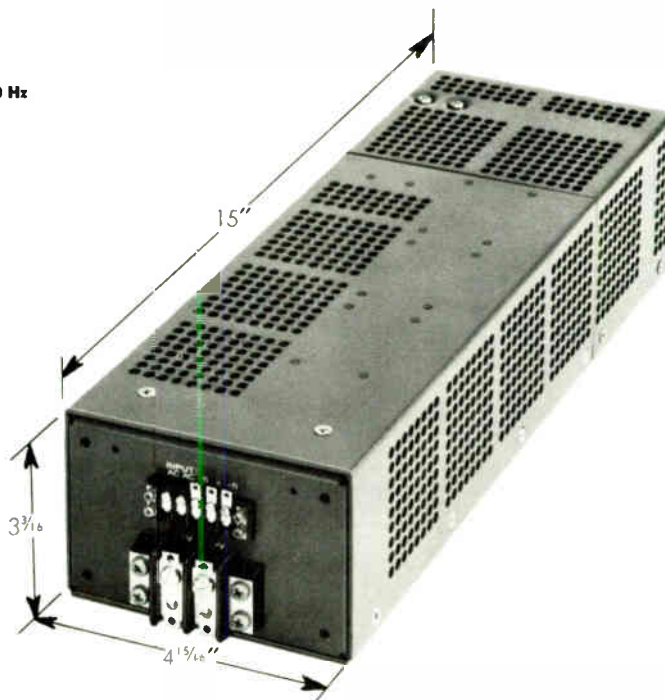

11 standard models in single, dual, triple or quadruple outputs in new "5" package. Triple and quadruple output models incorporate Lambda Power Hybrid Voltage Regulator.

**ALL CARRY LAMBDA'S 5-YEAR GUARANTEE.
ALL IN STOCK FOR 1-DAY DELIVERY.**

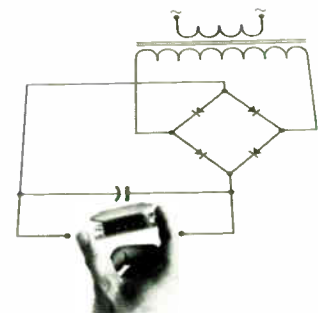

**WHETHER
YOU MAKE
OR BUY...**
△ LAMBDA
ELECTRONICS CORP.
A **Veeco** Company

MELVILLE, NEW YORK 11746 515 Broad Hollow Road Tel. 516-694-4200 ARLINGTON HEIGHTS, (CHICAGO) ILL. 60005 2420 East Oakton St., Unit Q Tel. 312-593-2550
NORTH HOLLYWOOD, CALIF. 91605 7316 Varna Ave. Tel. 213-875-2744 MONTREAL, QUEBEC 100C Hymus Blvd., Pointe-Clair, Quebec-730 Tel. 514-697-6520

Circle 901 on reader service card

Extend the spectrum you control...

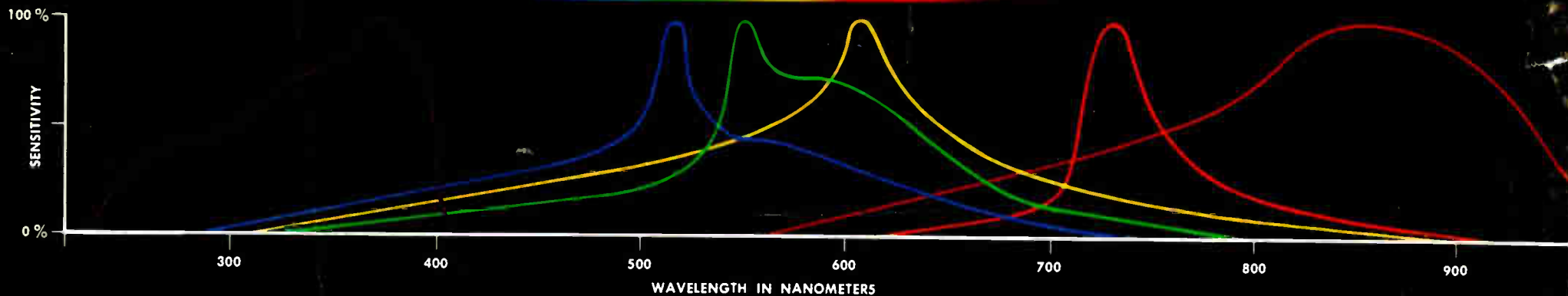

with Clairex Photoconductors and Phototransistors

With Clairex solid-state sensors and opto-isolators you can sense, measure, and control throughout the visible spectrum and beyond—wavelengths from 245 to 1100 nanometers.

For complete specifications or for design assistance with your "light" problems, call (914) 664-6602 or write Clairex®, 560 S. Third Ave., Mount Vernon, N.Y. 10550.

CLAIREX ELECTRONICS®
A DIVISION OF CLAIREX CORPORATION