

Rotating rings: another option for display design 52

Stacked wafers shrink system packaging 62

Designing high-frequency log amplifiers 70

# Electronics®

**For compact communications**

**MONOLITHIC  
CRYSTAL  
FILTERS**



1470 WLL#33 44-JA6  
JW WILLIAMS  
NAVSECGRU  
BOX 33 NAVCOMMSTA  
FPO NEW YORK NY  
09540

When we started a revolution  
in Valley Forge,  
a part of it was to build a new  
customs house!

A customs house—manned, equipped, ready to serve!  
You'll find it at MOS Technology where we've put together  
some of the best brains in the business along with the most  
sophisticated equipment to get your job done! You've got  
specs, need custom LSI's? We've got the personnel and the  
computerized design and computer-controlled testing to  
give you the arrays you want—quality, reliability and  
economy included! After all, if we, at MOS, could start a  
revolution, and turn a technology into a company, you can  
be sure we'd build ourselves an exceptional customs house  
from which to conduct the whole business!

We've Turned  
A Technology  
Into A Company



**MOS TECHNOLOGY, INC.**  
VALLEY FORGE INDUSTRIAL PARK, VALLEY FORGE, PA. 19481 • (215) 666-7950

A Proud Affiliate  
of Allen-Bradley Co.

#### EASTERN REGIONAL OFFICE

REGIONAL SALES DIRECTOR—Mr. William Whitehead, MOS TECHNOLOGY, INCORPORATED, 88 Sunnyside Blvd., Suite 307, Plainview, New York 11803 • Phone: (516) 822-4240 • ALABAMA, FLORIDA, GEORGIA, N. CAROLINA, S. CAROLINA, TENNESSEE, MISSISSIPPI—Currie Aerospace Associates, P.O. Box 1424, Huntsville, Alabama 35807 • Phone: (205) 536-5650 • 2907 McCoy Road, P.O. Box 13229, Orlando, Florida 32809 • Phone: (305) 855-0843 • P.O. Box 5588, Greensboro, North Carolina 27403 • Phone: (919) 273-3040 • NEW ENGLAND STATES—Victor Associates, 179 Union Ave., Framingham, Massachusetts 01701 • Phone: (617) 879-5710 • NORTHERN NEW JERSEY, NEW YORK (WESTCHESTER COUNTY, LONG ISLAND)—Falk Baker Associates, 383 Franklin Avenue, Nutley, New Jersey 07110 • Phone: (201) 661-2430 • E. PENNSYLVANIA, SOUTHERN NEW JERSEY—Rlyzo, P.O. Box 338, King of Prussia, Pennsylvania 19406 • Phone: (215) 265-5211 • DELAWARE, MARYLAND, WASHINGTON, D.C., VIRGINIA, W. VIRGINIA—Bernard White & Company, Inc., 7 Church Lane, Baltimore, Maryland 21208 • Phone: (301) 484-5400.

#### CENTRAL REGIONAL OFFICE

REGIONAL SALES DIRECTOR—Mr. Alan Matatal, MOS TECHNOLOGY, INCORPORATED, 10400 W. Higgins Rd., Suite 651, Rosemont, Illinois 60018 • Phone: (312) 298-2035 • ILLINOIS, INDIANA, WISCONSIN—L-TEC, Incorporated, 5808 West Higgins Rd., Chicago Illinois 60630 • Phone: (312) 286-1500 • OHIO, KENTUCKY, W. PENNSYLVANIA—McShane, Inc., P.O. Box 523, 123 W. Washington, Medina, Ohio 44256 • Phone: (216) 725-4568 • MICHIGAN—R. C. Merchant & Co., 18411 W. McNichols Road, Detroit, Michigan 48219 • Phone: (313) 535-6000 • MISSOURI, KANSAS, NEBRASKA, IOWA—Harlan J. Weisler & Assoc., Inc., 2050 Woodson Road, St. Louis, Missouri 63114 • Phone: (314) 428-3934 • TEXAS, OKLAHOMA, ARKANSAS, LOUISIANA—Norvell Associates, 10210 Monroe Drive, Dallas, Texas 75220 • Phone: (214) 357-6451.

#### WESTERN REGIONAL OFFICE

REGIONAL SALES DIRECTOR—Mr. Jack Turk, MOS TECHNOLOGY, INCORPORATED, 2172 Dupont Drive, Patio Bldg., Suite 221, Newport Beach, California 92660 • Phone: (714) 833-1600 • ARIZONA, NEW MEXICO—Toward Engineering Assoc., P.O. Box 15258, Arcadia Station, Phoenix, Arizona 85018 • Phone: (602) 955-3193 • CALIFORNIA, NEVADA—Bertrand & Zoolallian, Inc., 7340 Florence Avenue, Suite 205, Downey, California 90241 • Phone: (213) 927-4406 • Hunter Associates, 1208 Fox Plaza, San Francisco, California 94102 • Phone: (415) 626-8576 • COLORADO, UTAH, WYOMING—R. G. Enterprises, 1107 South Pearl Street, Denver, Colorado 80210 • Phone: (303) 744-2464 • WASHINGTON, OREGON, IDAHO, MONTANA—J. A. Tudor & Assoc. Inc., 2605 Western Avenue, Seattle, Washington 98121 • Phone: (206) 682-7444.

#### INTERNATIONAL SALES REPRESENTATIVES

ARGENTINA—T. R. C. Electronica, S.A.C.I.e.l., Cangallo 4450, Buenos Aires, Argentina • Phone: 88-4044/5/6, Mr. M. Lissin • ENGLAND, WALES, SCOTLAND, IRELAND—Impectron Limited, Impectron House, 21-31 King Street, London W3 9LJ, England • Phone: 01-992-5388 • FRANCE—Bureau de Liaison, 113 Rue de L'Université, Paris VII, France • Phone: 551.9920 • GERMANY, NETHERLANDS—International Micro Electronics, Inc., Arabellhaus 1838, Arabellastr. 5, 8000 Munich 81, Germany • Phone: 92-321 • INDIA—Electronic Enterprises, 46 Karani Building New Charni Road, Bombay 4, India • Phone: 375375 • ISRAEL—Eastronics, Ltd., 75 Haifa Road, P.O. Box 21029, Tel-Aviv, Israel • Phone: 38352 • ITALY—Special-Ind. Corporation, Piazza Spotorno, 20159 Milano, Italy • Phone: 632-435 • JAPAN, HONG KONG, KOREA, TAIWAN—Takachiho Koheki Company Ltd., 1-7, Chome Kohjimachi, Chiyoda-Ku, Tokyo 102, Japan • Phone: 263-3211 • SWEDEN, DENMARK, FINLAND, NORWAY—Thru F. Forsberg, Forshagatan 58, P.O. Box 79, Farsta 1, Sweden • Phone: 647040 • SWITZERLAND—Ernst M. Egli, Ingenieur—Bureau Ag, Witikonstrasse 295, Zurich (CH 8053), Switzerland • Phone: 53.38.11.

# 14 NEW Lowest Cost Spectrum Analyzers

From Sub-Audio to Microwave

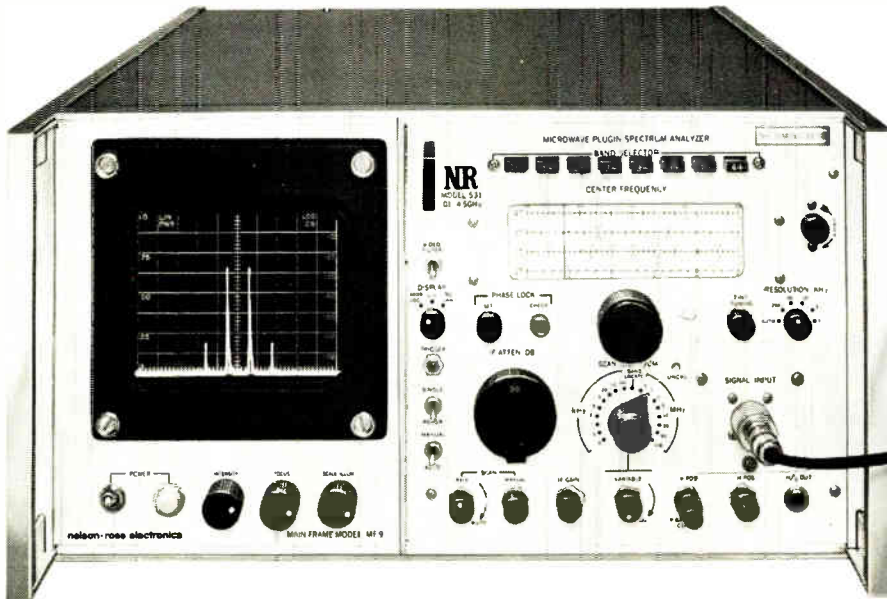

## Nelson Ross Spectrum Analyzer Model 531

10 MHz to 4.5 GHz  
Dispersion 0-1 GHz  
Phase locked 1 KHz resolution  
Price: \$3,000

Nelson Ross, the specialist in Spectrum Analyzers, has the **Biggest Selection, Most Versatile Specifications and Proven Reliability . . . All This For The Lowest Prices.**

Now you can select a Spectrum Analyzer from 0.5 Hz to 6.5 GHz which is just right for your application. And, with Nelson Ross you'll save 50% or more by not paying for unnecessary extras that you'll probably never use.

The versatile Spectrum Analyzers illustrated here are typical of 14 complete analyzers and more than 30 plug-in analyzers available from Nelson Ross.

The complete instruments include the new MF-9 Calibrated Display Main Frame which provides bright, long persistence

8x10cm readouts, adjustable scale illumination and camera mount facility.

Our plug-in analyzers come in 3 complete series: • for the Tektronix "540/550 letter" series scopes • for the Tektronix 560 series scopes • for the HP 140/141 series scopes and the Nelson Ross MF-9 Display Main Frame.

Compare specifications, quality, ease of use and price. We're sure you'll join the thousands who have been selecting Nelson Ross Spectrum Analyzers for more than a decade.

Call, write or circle the Reader Service Number to get your new 44-page Nelson Ross Spectrum Analyzer Catalog. Then you can compare and save.

### Typical Plug-In Spectrum Analyzers for Nelson Ross MF-9 Display Main Frame or HP 140/141 series scopes.

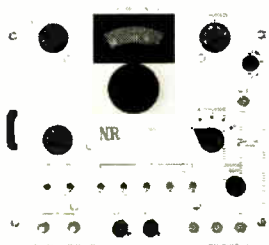

**Sub-Audio: Model PSA-036**  
0.5 Hz - 2 KHz  
0.5 Hz Resolution  
Plug-In: \$1,100  
With MF-9: \$2,100

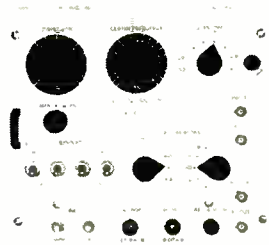

**Broadband: Model PSA-235**  
1 KHz - 25 MHz  
200 Hz Resolution  
Plug-In: \$1,600  
With MF-9: \$2,600

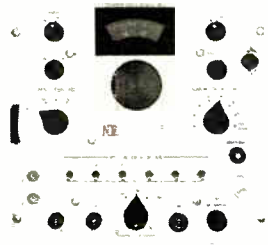

**Audio: Model PSA-031**  
10 Hz - 20 KHz  
10 Hz Resolution  
Plug-In: \$ 800  
With MF-9: \$1,800

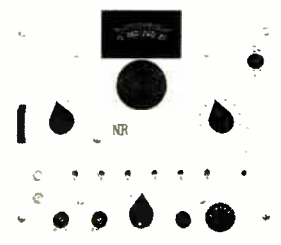

**RF-TV: Model CATV**  
1 MHz - 300 MHz  
Plug-In: \$1,500  
With MF-9: \$2,500

### Typical of more than 25 Plug-In Analyzers for use with Tektronix scopes.

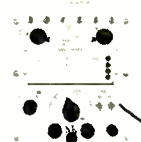

**For "540/550 letter" series**  
**SSB Narrow-Band RF**  
**Model PSA-201**  
0.6 - 36 MHz  
10 Hz Resolution  
\$1,600

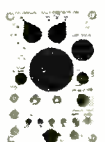

**For 560 Series**  
**Ultrasonic**  
**Model PSA-023**  
0.15 - 500 KHz  
150 Hz Resolution  
\$800

## nelson • ross electronics

A DIVISION OF POLARAD ELECTRONICS CORP.

5 Delaware Drive  
Lake Success, New York 11040  
516 - 328-1100 • TWX: 510 - 223-0414

Another calculator first... from MOSTEK

NEG 501350145015 MEM  
OVF

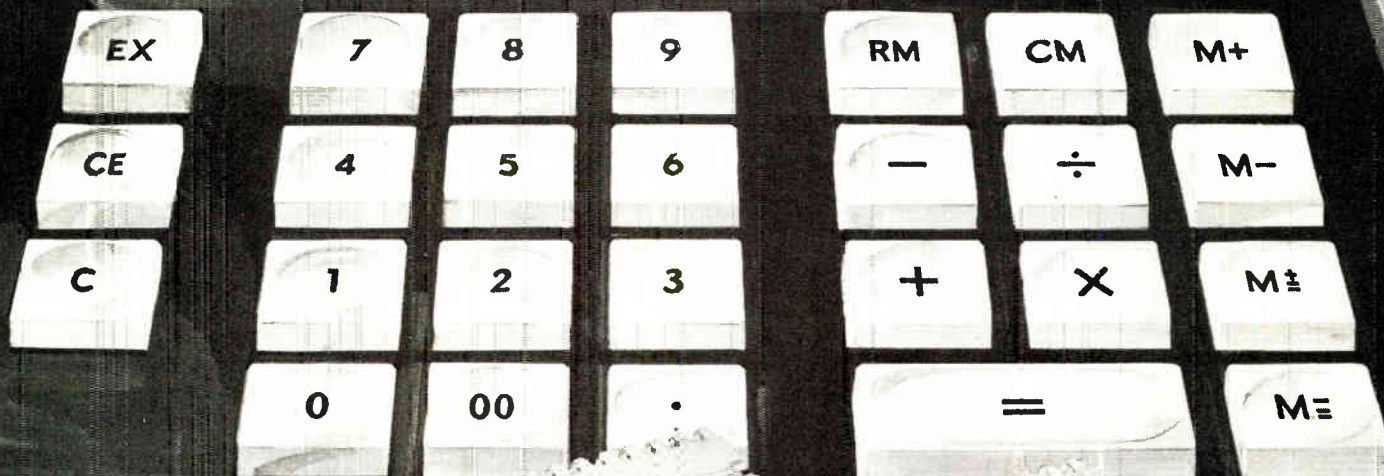

## NOW -- a 12-digit, 4-function calculator with memory ... on 2 CHIPS!

MOSTEK, the company that gave you the first single-chip electronic calculator, has done it again! Now we're offering the MK 5013/5014 P, the first two-chip calculator with memory. And look at the other features:

Four functions (+ - × ÷); 12 digits; four registers including memory and constant (allowing for automatic constant); selectable 5/4 roundoff or truncate; full floating decimal on intermediate multiply/divide calculations and fixed point selectable to any of 12 places on final results; indicators for overflow, memory usage and negative sign, giving true credit balance.

All this—in just two economical, easy to use MOS packages. In addition, of course, the 5013/5014 offers leading-zero blanking, chain calculations and fully decoded seven or

eight-segment outputs with multiplexing circuitry provided.

What's more, the new pair will give you interconnection with a third chip for direct interfacing with a printer (to be available soon); power-up clearing of all registers including memory; double-zero input key and a register exchange function.

Take a close look at the overflow protection feature. The 5013/5014 maintains last stored data in all registers and locks out further keyboard entries except clear or clear entry. And there are other advantages: our automatic constant allows chain calculations to be intermixed with fixed constant calculations. And our memory register provides storage of 12-digits with decimal point. It may be displayed, added to, subtracted from or erased (cleared) on command of the appropriate key inputs.

If you don't need memory, then consider our single chips: the MK 5010 P (low voltage, 10 digits); or the MK 5012 P (low voltage, 12 digits). Whether you need single or two-chip calculators, MOSTEK is your logical choice. After all, we started it all! For information and immediate delivery call your nearest MOSTEK representative or distributor listed below.



1400 Upfield Drive  
Carrollton, Texas 75006

**Regional Sales Offices:** West: 12870 Panama Street, Los Angeles, Calif. 90066 (213) 391-2746 East: 60 Turner Street, Waltham, Mass. 02154 (617) 899-9107 Midwest/Southeast: 515 S W Avenue, Jackson, Michigan 49203 (517) 787-0508

**Representatives:** HMR Inc., Minneapolis, Minn. (612) 920-8200; W. J. Purdy Co., Burlingame, Calif. (415) 347-7701; Littleton, Colo. (303) 794-4225; KCE Corp., San Diego, Calif. (714) 278-7640; Los Angeles, Calif. (213) 391-0586; Sheridan Associates, Inc., Cincinnati, Ohio (513) 761-5432; Florissant, Missouri (314) 837-5200; Cleveland, Ohio (216) 524-8120; Dayton, Ohio (513) 277-8911; Latrup Village, Mich. (313) 358-3333; Pittsburgh, Pa. (412) 243-6E55; FM Associates Ltd., Greerisboro, N. Carolina (919) 294-2754; Huntsville, Ala. (205) 536-9990; Orlando, Fla. (305) 851-5710; Sprague Electric Co., Wayne, New Jersey (201) 696-8200; Schiller Park, Ill. (312) 678-2262; Richardson, Texas (214) 235-1256; Tempe, Arizona (602) 966-7233; N. Seattle, Wash. (206) 632-7761; Precision Electronics, Inc., Glenside, Pa. (215) M16-8383; The Addem Group, Huntington Station, N.Y. (516) 567-5900.

**Distributors:** Cramer Electronics Inc.—Alabama: Huntsville (205) 539-5772; Arizona: Phoenix (602) 263-1112; California: San Diego (714) 279-6300; Colorado: Denver (303) 758-2100; Connecticut: North Haven (203) 239-5641; Florida: Hollywood (305) 923-8187; Orlando (305) 841-1550; Georgia: Atlanta (404) 451-5421; Illinois: Mt. Prospect (312) 593-0230; Maryland: Baltimore (301) 354-0100; Gaithersburg (301) 354-C100; Massachusetts: Newton (617) 959-7700; Minnesota: Bloomington (612) 881-8678; New Jersey: Union, (201) 587-7870; Pennsauken (215) 923-5950; New Mexico: Albuquerque (505) 265-5767; New York: Hauppauge, L.I. (516) 231-5600; Endwell (607) 754-6661; Rochester (716) 275-0300; East Syracuse (315) 437-6671; North Carolina: Raleigh (919) 876-2371; Winston-Salem (919) 725-8711; Ohio: Cleveland (216) 248-7740; Cincinnati (513) 771-6441; Oklahoma: Tulsa (918) 836-3371; Texas: Dallas (214) 350-1355; Utah: Salt Lake City (801) 487-3681; Wisconsin: Milwaukee (414) 462-8300; Canada: Ontario (416) 530-5023; Brlll Electronics, Oakland, Calif. (415) 834-5888; Eimar Electronics, Mt. View, Calif. (415) 961-3611; Liberty Electronics, Inglewood, Calif. (213) 776-6252; Wesco Electronics, Los Angeles, Calif. (213) 685-9533; Merquip Electronics, Skokie, Ill. (312) 965-7500; Stark Electronics Supply, Minneapolis, Minn. (612) 333-3361; Sheridan Sales Co., Cincinnati, Ohio (513) 751-5432  
**International:** MOSTEK GmbH, 7 Stuttgart 80, Waldburgstrasse 79, West Germany 0711-731305; System Marketing Inc., Center News Bldg., 1-3-11 Sotokanda, Chiyoda-ku, Tokyo, Japan; W G Booth Pty. Ltd., 39 Church Street Hawthorn, Victoria 3122, Australia.

Circle 2 on reader service card

## 29 Electronics Review

---

COLLISION AVOIDANCE: Effort to decide CAS standard mired in committee, 29  
SOCIETIES: IEEE questionnaire seeks mandate for change, 29  
ASSOCIATIVE MEMORIES: Functional approach holds promise for logic, 30  
INTEGRATED ELECTRONICS: Phase-locked loop dissipates less power, 30  
AIR TRAFFIC CONTROL: Color radar tube may mean \$100 million market, 31  
MEMORIES: Optical disk aims at minicomputers, 32  
MATERIALS: Potting compounds fail prematurely in aircraft, 32; Process removes potting and saves component, 33  
COMPUTERS: Honeywell's 2000 designed for sophisticated user, 34  
COMMUNICATIONS: Support grows to reopen FCC inquiry into AT&T, 36  
CONSUMER ELECTRONICS: Motorola readies move into varactor market, 36  
COMMERCIAL ELECTRONICS: Supermarket coding gets closer to checkout, 39  
FOR THE RECORD: 39

## 47 Technical Articles

---

COMMUNICATIONS: Communications systems benefit from monolithic crystal filters, 48  
INSTRUMENTATION: Rotating ring display offers new face for instruments, 52  
CIRCUIT DESIGN: Designer's casebook, 57  
PACKAGING: Three-dimensional IC packaging—with a twist, 62  
CONSUMER: P/MOS chip drives liquid crystal display for digital alarm clock, 66  
CIRCUIT DESIGN: Approximating true log output at high frequencies, 70

## 75 Probing the News

---

NIXON'S 1973 BUDGET: A bid for jobs and votes, 75  
COMMUNICATIONS: More issues than money, 76  
DEFENSE: Technology-oriented jobs—the big fallout in 1973, 77  
SPACE: NASA gets a big-ticket item, but kills Grand Tours, 79  
SOCIAL PROGRAMS: From education to law enforcement, they take largest budget slice, 82  
TRANSPORTATION: Budget fuels mass transport, but throttles back air traffic control 84

## 89 New Products

---

IN THE SPOTLIGHT: MSI multiplexer cuts teleprocessor's cost and complexity, 89  
COMPONENTS: FET op amp is low-priced, 91  
INSTRUMENTS: Generator varies signal-to-noise ratio, 93  
DATA HANDLING: Core memory stack has 8,192 words, 95  
PACKAGING AND PRODUCTION: Digitizer cuts drafting costs, 97  
SEMICONDUCTORS: 1,024-bit static shift register uses only 250 milliwatts, 99  
MATERIALS: 102

## 109 Electronics International

---

JAPAN: In-line guns, vertical slits team up in color tube, 109  
FRANCE: Satellite with experimental solar cells awaits Russian piggyback launch, 110  
THE NETHERLANDS: Sensing low light levels for photography, 111  
GREAT BRITAIN: Ferranti cuts computer size, costs, 111  
GREAT BRITAIN: Microwave data link for computers, 112

## Departments

---

Publisher's letter, 4  
Readers comment, 6  
40 years ago, 8  
People, 12  
Meetings, 16  
Electronics Newsletter, 17  
Washington Newsletter, 41  
Washington Commentary, 42  
New Literature, 103  
Personal Business, PB1  
International Newsletter, 107

# Electronics

EDITOR-IN-CHIEF: Kemp Anderson

EXECUTIVE EDITOR: Samuel Weber

MANAGING EDITORS: Lawrence Curran, *News*;  
Arthur Erikson, *International*

SENIOR EDITORS: John Johnsrud,  
H. Thomas Maguire, Stephen E. Scrupski

ART DIRECTOR: Fred Sklenar

ASSOCIATE EDITORS: Richard Gundlach,  
John N. Kessler, Howard Wolff

## DEPARTMENT EDITORS

*Aerospace*: William F. Arnold

*Circuit Design*: Lucinda Mattera

*Communications & Microwave*:

Lyman J. Hardeman

*Computers*: Wallace B. Riley

*Consumer*: Gerald M. Walker

*Industrial*: Alfred Rosenblatt

*Instrumentation*: Michael J. Riezenman

*Military*: Ray Connolly

*New Products*: H. Thomas Maguire

*Packaging & Production*:

Stephen E. Scrupski

*Solid State*: Laurence Altman

*Special Issues*: Harry R. Karp

COPY EDITORS: Margaret Eastman,  
Everett C. Terry

ART: Charles D. Ciatto, *Associate Director*

PRODUCTION EDITORS:  
Patricia Cybulski, Arthur C. Miller

EDITORIAL ASSISTANT: Marilyn Offenheiser

EDITORIAL SECRETARIES: Vickie Green,  
Nancy Baldasare

## FIELD EDITORS

*Boston*: James Brinton (Mgr.), Gail Farrell

*Dallas*: Larry Armstrong (Mgr.)

*Los Angeles*: Paul Franson (Mgr.)

*New York*: Alfred Rosenblatt (Mgr.)

*San Francisco*: Stephen Wm. Fields (Mgr.),

Roberta Schwartz

*Washington*: Ray Connolly (Mgr.),

William F. Arnold

*Frankfurt*: John Gosch

*London*: Michael Payne

*Paris*: Arthur Erikson

*Tokyo*: Charles Cohen

## McGRAW-HILL WORLD NEWS

*Director*: Walter A. Stanbury; *Atlanta*: Stan

Fisher; *Chicago*: Mike Sheldrick; *Cleveland*:

Arthur Zimmerman; *Detroit*: James Wargo;

*Houston*: Robert E. Lee; *Los Angeles*: Michael

Murphy; *Gerald Parkinson*; *San Francisco*:

Margaret Drossel; *Seattle*: Ray Bloomberg;

*Washington*: James Canan, Herbert W.

Cheshire, Seth Payne, Warren Burkett, William

D. Hickman; *Bonn*: Robert Ingersoll; *Brussels*:

James Smith; *London*: Marvin Petal; *Milan*:

Peter Hoffmann, Andrew Heath; *Moscow*: Axel

Krause; *Paris*: Stewart Toy, Michael Johnson;

*Stockholm*: Robert Skole; *Tokyo*: Mike Mealey

PUBLISHER: Dan McMillan

ADVERTISING SALES MANAGER: Pierre J. Braudé

ADVERTISING SALES SERVICE MANAGER:  
Wallis Clarke

BUSINESS MANAGER: Stephen R. Weiss

CIRCULATION MANAGER: George F. Werner

RESEARCH MANAGER: David Strassel

MARKETING SERVICES MANAGER:  
Tomlinson Howland

## Publisher's letter

The new Nixon budget for fiscal 1973, delivered to the 92nd Congress last Monday, sets a new record for proposed Federal spending, as usual. "As the economy expands through a combination of inflation and true growth, the budgets are guaranteed to be bigger every year," explains our Washington bureau chief, Ray Connolly. Ray directed the six-man editorial task force that put together *Electronics'* analysis of Administration spending plans and their impact on U.S. industry (see page 75).

A record of another sort—speed—was set by the team that wrote, edited, checked and double-checked that story. The team spent three gruelling days in the capital, pulling together the numbers meaningful to *Electronics* readers and pinning down Government executives and program managers on their spending plans. And the team did it in time to make this issue, getting the in-depth story to you while it's hot.

Although the budget was delivered officially to Congress on Monday, advance copies were available to the press late on the preceding Friday. That meant long hours of study between Friday night and Saturday morning, when the Government agencies began a series of briefings for the press. These briefings, of course, start out by presenting the agencies' point of view. Reporters had to do a lot of homework—fast—to ask the right questions at the briefings.

Then industry and Government sources had to be contacted after the briefings to uncover the details of just what impact the announced spending plans will have. Then came the actual writing and edit-

ing—done under the gun to get the copy to New York by Monday morning to meet press deadlines.

"Most of the Federal number jugglers are either accountants or economists and therefore are not equipped to talk knowledgeably about what their figures mean for a given industry," says Connolly. "Dollars for electronics are rarely broken out precisely, so it takes a lot of digging to get the details."

Of course, the budget books are heavy on how much new funding Government agencies want and, if they get it, how much they will have when funds unspent in prior years are added in. But these are indicators at best. It's the actual plans for expenditures in the coming year that interest industry managers. And it's those plans that *Electronics* has sifted from the stack of documents the White House delivered to Capitol Hill on January 24.

One move leads to another. With Larry Curran coming east to take over as managing editor, news, we were left with a hole to fill in Los Angeles, where Larry has been bureau chief. So we decided to move Paul Franson, the packet of energy who has been running our Dallas news bureau for over a year now, into that spot. And just as with hole-electron pairs, reporters move one way and the vacancy moves the other. So we've sent Larry Armstrong, who moved into our Washington office about the time Paul went to Texas, out to Dallas.



January 31, 1972 Volume 45, Number 3  
89,776 copies of this issue printed

Published every other Monday by McGraw-Hill, Inc. Founder James H. McGraw 1860-1948. Publication office 330 West 42nd Street, N.Y., N.Y. 10036; second class postage paid at New York, N.Y. and additional mailing offices.

Executive, editorial, circulation and advertising addresses: *Electronics*, McGraw-Hill Building, 330 West 42nd Street, New York, N.Y. 10036. Telephone (212) 971-3333. Teletype TWX N.Y. 710-581-4235. Cable address: MCGRAWHILL N.Y.

Subscriptions limited to persons with active, professional, functional responsibility in electronics technology. Publisher reserves the right to reject non-qualified requests. No subscriptions accepted without complete identification of subscriber name, title, or job function, company or organization, including product manufactured or services performed. Subscription rates: qualified subscribers in the United States and possessions and Canada, \$8.00 one year, \$12.00 two years, \$16.00 three years, all other countries \$25.00 one year except Japan \$50.00 per year including air freight. Limited quota of subscriptions available at higher-than-basic rate for persons outside of field served, as follows: U.S. and possessions and Canada, \$25.00 one year, all other countries \$50.00. Single copies: United States and possessions and Canada, \$1.00, all other countries, \$1.75.

Officers of the McGraw-Hill Publications Company: John R. Emery, President; J. Elton Tuohig, Senior Vice President—Services; Donald B. Gredley, Group Vice President, Vice Presidents: Ralph Blackburn, Circulation, John R. Callahan, Editorial; David G. Jensen, Manufacturing; Jerome D. Luntz, Planning & Development; Joseph C. Page, Marketing; Robert M. Wilhelm, Finance.

Officers of the Corporation: Shelton Fisher, President; Joseph H. Allen, President Publications and Business Services Group; John J. Cooke, Senior Vice President and Secretary; Ralph J. Webb, Treasurer.

Title registered in U.S. Patent Office, Copyright 1972 by McGraw-Hill, Inc. All rights reserved. The contents of this publication may not be reproduced either in whole or in part without the consent of copyright owner.

Subscribers: The publisher, upon written request to our New York office from any subscriber, agrees to refund that part of the subscription price applying to copies not yet mailed. Please send change of address notices or complaints to Fulfillment Manager, subscription orders to Circulation Manager, *Electronics*, at address below. Change of address notices should provide old as well as new address, including postal zip code number. If possible, attach address label from recent issue. Allow one month for change to become effective.

Postmaster: Please send form 3579 to Fulfillment Manager, *Electronics*, P.O. Box 430, Hightstown, N.J. 08520.

# The filter that stands by itself.

Model 3550 multifunction filter has no competition. For just \$590, this instrument provides band-pass, band-reject, low-pass or high-pass operation — instantly selected by a single front panel switch. The 3550 minimizes circuit loading with high input impedance and overcomes load sensitivity with low output impedance. Cut-off frequency is continuously adjustable from 2Hz to 200kHz — covering the entire

audio range and well beyond. Model 3550 also offers a choice of Butterworth response or Low Q for transient-free performance. It's features like these that leave all other filters without a leg to stand on. For fast action, call The Wavemakers at (617) 491-3211, TWX 710-320-6583 Krohn-Hite Corporation, 580 Mass. Ave., Cambridge, Mass. 02139.



**KH KROHN-HITE  
CORPORATION**

OVERSEAS SALES OFFICES: AUSTRIA, Universal Elektronik Import; AUSTRALIA, Warburton O'Donnell Limited; BELGIUM, C. N. Rood s. a.; DENMARK, SC Metric A/S; ENGLAND, Allied International Limited; FINLAND, INTO O/Y; FRANCE, Antares; GERMANY, Nucletron Vertriebs-GMBH; HOLLAND, C. N. Rood n. v.; INDIA, Bali International Agencies; ISRAEL, R.D.T. Electronics Engineering, Ltd.; ITALY, Vianello S.P.A.; JAPAN, Shoshin Shoji Kaisha, Ltd.; NEW ZEALAND, H.M.Z. Ltd.; SOUTH AFRICA, Protea Physical; SPAIN, Rema Leo Haag, S.A.; SWEDEN, Teleinstrument; SWITZERLAND, Megax Zurich GmbH.

**It does everything a \$2500 rack-mount does. Only it does it for \$2000.**

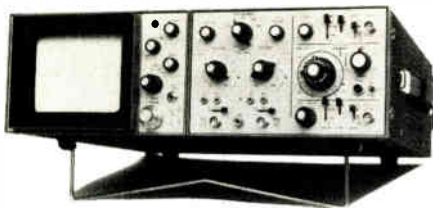

NEW R-1062

Dumont's new 5¼-inch, 60MHz scope costs about \$2000. Or about \$500 less than everybody else's.

The reason? It comes without plug-in drawers, saving you the cost of all that hardware.

So while you *do* sacrifice a little versatility (how often do you change the capability of the rack-mounted scope in your system, really?), you gain a lot monetarily (our racks start at \$1845).

Not that we've compromised performance. Far from it. The full bandwidth triggering system is completely new. With new trigger level control circuits. As well as a new variable hold-off feature that provides synchronous triggering for digital words. All this, plus our exclusive trigger independence that lets you re-position the traces without re-adjusting the trigger level.

There are other advantages. Like full 60MHz bandwidth at 5 mV per division. Exceptional reliability. Off-the-shelf components. And simplified service. Find out all about it. Write for our literature.

DUMONT OSCILLOSCOPE LABORATORIES, INC.  
40 Fairfield Pl., West Caldwell, N.J. 07006  
(201) 575-8666; TWX (710) 734-4308



## Readers comment

### Union vs status quo

**To the Editor:** I found the union/association poll reported in the September 27 issue quite interesting. In particular your conclusion that "radicalism" peaks out in the 31-40 age bracket seems anomalous at first blush. One problem is the straw poll technique. What young engineer affords the "luxury" of a subscription to *Electronics* rather than reading a library or friend's copy? The rugged individualist. Once maturity sets in and the need for breadth becomes apparent, your readership becomes more diverse. Another factor is the outflow of EE's with marginal capability, and the greatest need for "union security," into other endeavors.

The only surprise to me was the one student sample at Illinois. A poll of IEEE student chapter members I recently conducted at an urban university with a rather small EE department showed eleven for union, eight for association, and two for status quo. The three faculty responding were all for a new association. Is there a real push for union-

ism among student engineers? Some more polling is called for.

Anthony D. Robbi  
RCA

David Sarnoff Research Center  
Princeton, N.J.

### P/MOS vs C/MOS

**To the Editor:** After having studied the article "C/MOS unites with silicon gate to yield micropower technology" by R. R. Burgess and R. G. Daniels [*Electronics*, Aug. 30, 1971], I was appalled at the slanted comparison between complementary and standard p-channel MOS performance. The article grossly misstates the ability of P/MOS to operate effectively at low power levels.

My main concern is with the first figure [shown at left with bipolar portions removed] in the article, which shows the speed/power performance curves for P/MOS, C/MOS, and other logic forms. The power for the entire range of "standard" P/MOS technologies is shown to be 3 mW/gate and independent of frequency up to approximately 1.5 MHz maximum frequency.

While it is true that a static-type gate designed for a given speed will dissipate roughly the same power at lower frequencies—assuming a constant duty cycle—I feel that this is an unrealistic analytical scheme that was used to make complementary technology look good. It is absurd to design a 1.5-MHz P/MOS gate, operate it at 10 kHz, and then compare its power to complementary at 10 kHz.

The analysis really required is to design a gate to operate at a frequency of interest and compare its

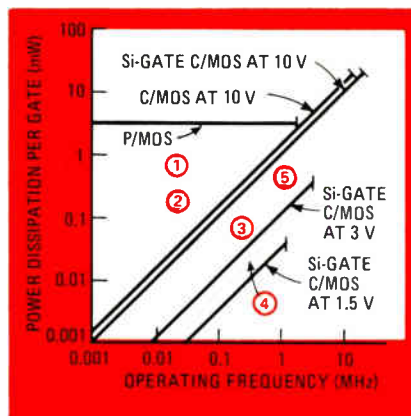

Plotted Data Points	Circuit*	Power	Number of Gates	Operating Speed**	Power/Gate
1	Single chip calculator: high- $V_T$ p-channel enhancement	430 mW	660	20 kHz	650 $\mu$ W/gate
2	Single chip calculator: low- $V_T$ p-channel enhancement	120 mW	660	20 kHz	182 $\mu$ W/gate
3	MK 5002 Counter/Display (Standard product): low- $V_T$ p-channel depletion	10 mW	330	250 kHz	30 $\mu$ W/gate
4	Custom random logic chip: low- $V_T$ p-channel depletion	2.5 mW	163	200 kHz	15.3 $\mu$ W/gate
5	MK 4007 (1101-type RAM): low- $V_T$ p-channel depletion	170 mW	612	1 MHz	280 $\mu$ W/gate

\* These five circuits are in production.

\*\* All five circuits are static, i.e. capable of operating down to dc.



# The Ortec P-554 Ion Implantation Processor:

- It's safer and simpler to operate than the other machines on the market.
- Its price is competitive.
- It can be delivered in 90 days or less.

## Sounds great. But who's Ortec?

performance with complementary at that specific frequency. Those data points which are summarized in the accompanying table represent currently produced high-threshold circuits, low-threshold circuits, and depletion-load circuits. Points 1 and 2 indicate the performance of Mostek's single-chip calculator. At 20 kHz this straightforward p-channel-technology circuit is significantly better in performance than the article's P/MOS curve would indicate—by a good factor of 10 for a low-threshold version. These points represent what can realistically be done with designs tailored to a specific job and using today's P/MOS technology. Significant improvements in the speed/power figure of merit can be achieved through the use of depletion loads as shown by points 3, 4, and 5.

There are many applications where the display or peripheral electronics dissipates significantly more power than the MOS chips. There, battery performance is not appreciably improved even if the MOS power were to go to zero; microwatt complementary circuits would be of no advantage. However, the significantly lower processing cost and the higher functional densities of simple P/MOS depletion-mode circuits would offer a much more cost effective system.

R. H. Crawford  
Manager of engineering  
Mostek Corp.  
Carrollton, Texas

■ *The authors reply: We hope that Mr. Crawford will appreciate the difference in comparing custom-designed and off-the-shelf standard ICs—produced with different technologies. These comparisons made in our article were for truly static operation, as opposed to the clocked "static-dynamic" family of circuits. We are not, however, unfamiliar with this type of design; Motorola also has several custom ICs with performance comparable to those cited.*

### 1971 index available

The index of articles published in *Electronics* in 1971 is now available. For a copy, circle number 340 on the reader service card.

The question is justified. For all you know, we could be a garage operation.

Truth is, we were once just that—about twelve years ago. Now we're one of the leading producers of ion sources, semiconductor detectors, and electronic instrumentation for nuclear physics research. We're into life-sciences instrumentation, too, and x-ray analysis systems.

We're no strangers to vacuum and accelerator technology, for sure. Both are in our normal line of work. And as for semiconductor technology—well, we're the world's largest manufacturer of precision silicon and germanium radiation detectors.

In other words, although you may not have heard of us, we've been toiling in your back yard for quite some time.

And our Ion Implantation Processor shows it. The P-554 is a very practical production machine. Take, for example, its extraordinary simplicity: the

operator has only to load the tray with wafers and push a button to start the implant cycle. After that, the process is completely automatic.

Safety precautions—for both operator and the wafer load—are elaborate. With our system of interlocks, it's nearly impossible for an operator to foul up the works. Or expose himself to high-voltage or radiation hazard.

But perhaps the best proof of performance is for us to implant a few of your wafers. Which we'll be glad to do. Or, if you prefer, we'll send you a copy of our P-554 brochure. Either way, you have only to call or write our systems specialist, George Thoeming. The phone number: (615) 482-4411. The address: Ortec Incorporated, 110 Midland Road, Oak Ridge, Tenn. 37830. In Europe: Ortec Ltd., Dallow Road, Luton, Bedfordshire, England. Phone: LUton 27557. Ortec GmbH, 8 München 13, Frankfurter Ring 81, West Germany. Phone: (0811) 359-1001. In Japan: Toyo Trading Co., Tokyo. Phone: 279-0771.

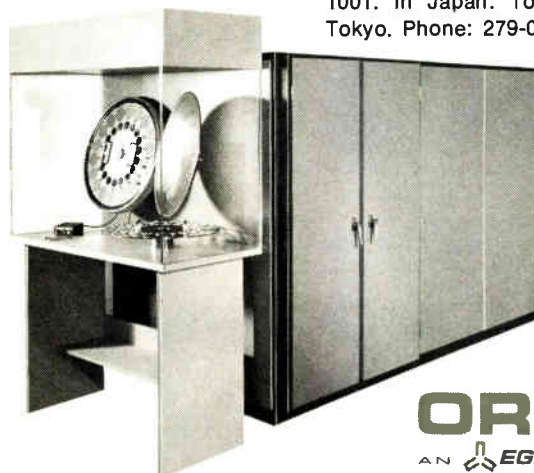

**ORTEC**<sup>®</sup>  
AN EG&G COMPANY

# VOICE YOUR CHOICE

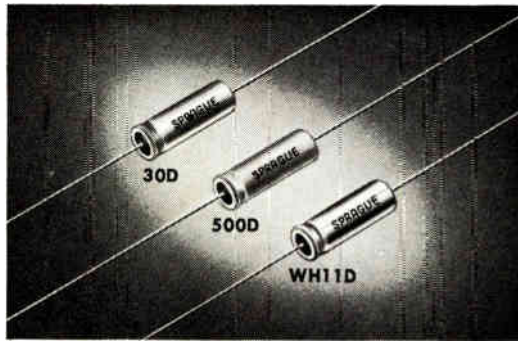

... Sprague makes three!

## SMALL ALUMINUM 'LYTIC CAPACITORS

### TYPE 30D FOR INDUSTRIAL APPLICATIONS

Will withstand 2000 hr. life test at 85C. Excellent stability, dissipation factor, leakage current. Designed for business machines, instrumentation equipment, etc. Write for Engineering Bulletin 3150A or; CIRCLE 157 ON SERVICE CARD.

### TYPE 500D FOR MODERATE-COST APPLICATIONS

Good operating life characteristics, including stability, ESR, leakage current. Will withstand 1000 hr. life test at 85 C. Ideal for radio, TV, and other entertainment applications. Write for Engineering Bulletin 3149 or; CIRCLE 158 ON SERVICE CARD.

### TYPE WH11D FOR ECONOMY APPLICATIONS

Welded construction, similar to higher-priced capacitors. Widely used in solid-state equipment where cost is of prime importance. Made by Sprague World Trade Corp. in Hong Kong. Write for Engineering Bulletin 3148C or; CIRCLE 159 ON SERVICE CARD.

## MORE FROM SPRAGUE ... THE BROAD-LINE PRODUCER OF ELECTRONIC PARTS

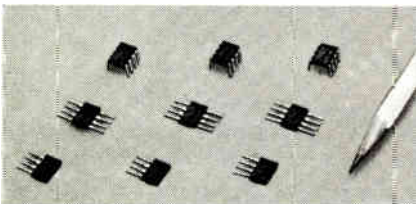

**HALL EFFECT SWITCH ICs.** Actuated magnetically, not mechanically or optically. Hall generator trigger circuit and signal amplification circuit on single silicon chip. Reliable (no moving parts). Easy interfacing with DTL/TTL/MOS logic. High speed. Low cost. Write for Engineering Bulletin 27,402A or;

CIRCLE 160 ON READER SERVICE CARD.



**U.L. LISTED FILTERS.** Series JX5000 for EDP equipment and general-purpose use. Rated 125/250 VAC, 0-60 Hz, 1 thru 50 amps. 60 db @ 150 kHz, 80 db from .5 MHz thru 1 GHz. Special designs and rectangular multi-circuit units also available. Write for Engineering Bulletin 8210 or;

CIRCLE 161 ON READER SERVICE CARD.



**TYPE 36D POWERLYTIC® CAPACITORS.** For use in computer power supplies, control equipment, energy storage, etc. Low impedance construction. Up to 650,000  $\mu$ F at 3 V. Ratings from 3 to 450 V. Can be operated at 85 C. Tapped 10-32 terminals simplify filter bank assembly. Write for Engineering Bulletin 3431C or;

CIRCLE 162 ON READER SERVICE CARD.

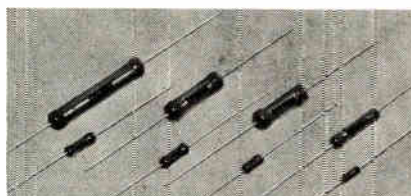

**BLUE JACKET® RESISTORS.** Vitreous-enamel power wirewound. Unique all-welded end-cap construction eliminates moisture paths along leads, anchors leads securely to resistor body. Expansion coefficients of vitreous enamel, ceramic body, and end caps are closely matched. Write for Engineering Bulletin 7410E or;

CIRCLE 163 ON READER SERVICE CARD.



TECHNICAL LITERATURE SERVICE, SPRAGUE ELECTRIC CO., 35 MARSHALL ST., NORTH ADAMS, MASS. 01247

48-1117

## 40 years ago

From the pages of Electronics, January 1932

The year 1931 started off with 10 or more manufacturers having a line of 16-mm. film projectors with sound on accompanying disk. The problem of film distribution and cost to the ultimate consumer has not, however, been satisfactorily worked out, such as to create a large market for this equipment. Some progress in the establishment of film libraries is being made with better coordination promised among the various manufacturers. Sound-on-16-mm. film has not yet been commercially launched, although several public demonstrations have been made.

The industry has been awaiting the 16-mm. equipment developed by RCA Victor, which is expected to be placed on the market early in 1932. Initial efforts in marketing RCA's equipment will probably be concentrated in the advertising and educational fields with introduction into the home looked into later.

In the application of thermionic tubes to control purposes, the past year has recorded gratifying progress. Steel mills, sheet plants, wire mills, rubber factories, paper machines, chemical processes, and many other industrial operations are making wider use of tubes.

With its decision to equip the USS Utah so that it can be completely operated by remote control radio for handling its course and speed in bombing and gunfire tests, the U.S. Navy will have two radio-controlled ships. The destroyer Stoddert is already being used for that purpose. The Utah will be refitted at Hampton Roads for operations on the Atlantic. The Navy also plans to equip two other destroyers.

The radio control of crewless vessels was first tried off Panama in 1923 when the old battleship Iowa was used as a target.

A new hot cathode, indirectly heated, half-wave, high-current density mercury vapor rectifier has been announced. The rectifier is rated at 35 amperes peak anode current and 500 volts inverse peak anode EMF.

# PCM on microwave.

Ten years experience in PCM microwave technology. That's Canadian Marconi Company's record. A record you may not have been aware of — because our major customers don't say too much about their purchases.

But now you, the commercial communications user, can benefit from CMC's experience in PCM-on-radio.

Our MCS 6900 MICROWAVE COMMUNICATIONS SYSTEM\* is an integrated multiplex/radio combination designed to serve your voice and data communications needs — digitally.

Plan now to meet the ever-increasing demands which will be placed on your communications systems in the future. Go digital. With the MCS 6900.

Contact us for more information. Let us tell you about the better way to communicate.

\*The MCS 6900 12.2-12.7GHz model is FCC-type accepted for use under Part 91, Industrial Radio Service.

**CANADIAN MARCONI COMPANY**  
TELECOMMUNICATIONS DIVISION · 2442 TRENTON AVE., MONTREAL 301, P.Q., CANADA  
TEL.: (514) 343-3411, TELEX NO. 05-267563, TWX NO. 610-421-3564, CABLE: ARCON MONTREAL



Circle 9 Readers Service Card

# More power to you!

In fact, our model 320L delivers the most power and widest bandwidth of any solid state instrument amplifier available. Easily mated with a wide variety of signal sources, it amplifies AM, FM, SSB, TV, Pulse and other complex modulations with minimum distortion. Constant forward power is continuously available regardless of load match (from an open to a short). The 320L provides over 20 watts of power from 100 KHz to 125 MHz with useful output all the way to 160 MHz . . . and there's no tuning.

*Applications include:*

- RFI/EMI testing
- NMR Spectroscopy
- Transmitter applications
- Laser modulation
- Signal distribution
- Test equipment calibration
- Cable isolation

For complete information write or call  
Electronic Navigation Industries,  
3000 Winton Road South,  
Rochester, New York 14623.  
(716) 473-6900

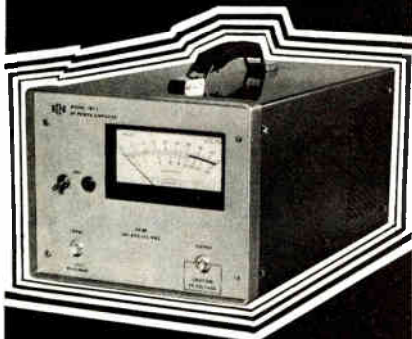

**EN** ELECTRONIC  
NAVIGATION  
INDUSTRIES

## People

Conway: semiconductors and politics in 1972

**American semiconductor** manufacturers, still strong and positive contributors to a national trade balance that turned negative last year, face increasing competition in world markets in 1972. Thus Jim Conway, the industry's official spokesman in Washington, is driving hard to enlist the kind of Federal support that will permit American producers to maintain their competitive advan-



Conway: His sport is named politics.

tage. That advantage permitted manufacturers to raise their export surplus to \$250 million in 1970—a 770% increase during the last seven years.

Conway took charge of the Electronic Industries Association's Solid State Products division in 1970 when it was formed out of separate semiconductor and microelectronics operations. He says his division's 1972 goals include an effort to persuade the Treasury Department to allow import tariff exemptions, under Item 807 of the Tariff Schedules, for epoxy-encapsulated semiconductors assembled offshore from exported U.S. parts.

**Jaycee prize.** The EIA has been his sole employer since Conway joined the organization's marketing services statistical section a decade ago. Nevertheless, his life style fits neatly the semiconductor industry's image of aggressive youth. Tagged in 1968 by the Jaycees of America as one of Maryland's Outstanding Young Men, he went on the following year

to be elected to the Bowie, Md., City Council.

Father of three, Conway is now in his second term on a council that has attracted national attention by banning the sale of soft drinks in nonreturnable containers—an ordinance that is now running the gamut of court tests and appeals by the bottling industry and local merchant groups. While his big frame and modish dress suggest a professional athlete rather than an accountant, Jim Conway's favorite sport is clearly politics.

A recent payoff at EIA came for Conway when he was able to tell semiconductor manufacturers just after Christmas that the Treasury Department had approved use of low-level X rays to identify U.S. components contained in imported semiconductors that would qualify them for duty-free entry.

**Big saving.** That ruling, Conway contends, means an annual saving of some \$5 million in duties on imports of integrated circuits and other devices assembled abroad from exported U.S. parts. Moreover, it may have saved as many as 15,000 of the industry's more than 100,000 domestic jobs that could have been lost by transfer of more operations abroad.

Fougere and ADL find branching out fruitful

**Six years ago,** half the work of the electronics R&D section of Arthur D. Little Inc. was Government-supported. Now, the Cambridge, Mass., consulting firm gets just a quarter of that, yet has maintained an annual growth rate of 17% through the re-

Fougere: Giving advice—and doing it.



# FROM MODULES TO MONUMENTS



DATUM MODEL 9310 TIME CODE GENERATOR/TRANSLATOR

Major integrated Range Timing Systems are monuments to man's ingenuity and skills; to the user for his conception and utilization and to the builder for his design experience.

Whether your timing need be for a module or a monument — a digital clock or a computer-integrated range timing system — it has been designed by DATUM Instrumentation Specialists. Every instrument, from the simplest to the most sophisticated, is a monument to engineering excellence and is performance engineered.

For Time Code Equipment of any type, DATUM is your best bet. Find out for yourself: call us, or send for our complete catalog today.

## DATUM 'TII

TIMING DIVISION

170 E. Liberty • Anaheim, Calif. 92801  
Telephone (714) 879-3070 • TWX (910) 592-1289

# So you're looking for bandpass filters...

## better check Vernitron... (the ceramic filters people)

Miniature, lightweight, stable, fixed-tuned—that's ceramic filters for you. And Vernitron, innovator in piezoelectric technology, has varieties for almost any kind of communications equipment—consumer, commercial, military. If you're looking for size-reduction, cost-reduction—and high performance where it counts—it will pay you to check with Vernitron. A few examples:



**FM-4**  
10.7 MHz monolithic miniature for quality FM's. Only 0.016 cu. in.—replaces four tuned circuits 20 times its size. Bandwidth: 235 kHz @ 3 dB; 825 kHz @ 40 dB. Less than 1/2% distortion. The filter for the best in home entertainment, auto, or commercial FM's. **Data sheet 94033.**



**11-DISC LADDER FILTER**  
Rugged little 455 kHz lump-filter for MIL or commercial. Rejection above 60 dB in less than 0.1 cu. in. Six standard models, 6 to 40 kHz @ 6 dB. Great for hand-helds, mobile or airborne. **Data sheet 94029.**



**17-DISC LADDER FILTER**  
455 kHz. Ultimate in selectivity, stability and ruggedness for MIL-quality AM's or FM's. Ten standard models, shape factors 2.5:1 to 1.4:1. Rejection to above 80 dB. Highest shock and vibration resistance. **Data Sheet 94017.**



**TCF SERIES**  
Low-cost 455 kHz filter with fixed-tuned LC input, for 2-way, landmobile, aircraft, navigation or CB. Choice of standard bandwidths—6, 12, 18, 30 and 35 kHz. Highest selectivity at lowest cost. **Data sheet 94026.**



**LOW FREQUENCY (LF) SERIES**  
9 to 50 kHz. High-performance miniature for LF communications or Omega systems, selective calling, U/W sound, command-destruct. Rejection to 40 dB. Can be cascaded for higher rejections. Cascaded assemblies available; also shock/vibration units to MIL specs. **Data Sheet 94030.**

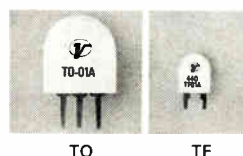

**TRANSFILTERS®**  
Low-cost replacements for inductive or capacitive elements in IF stages or discriminators. TF's contain single resonator, 2 terminals; TO's are complete filters with 3 terminals. Excellent interstage couplers for transistor circuitry. **Data Sheets 94018-20.**

**NEED DESIGN HELP?** Computer-design facilities give us an edge in designing specials for special needs. If it's bandpass filters you're looking for, get in touch.

 **Vernitron Piezoelectric Division**  
232 Forbes Road / Bedford, Ohio 44146 / (216) 232-8600

cession—and even has continued to hire personnel. The reason is that the section has been concentrating on building its industrial and commercial base; insiders attribute a good deal of the success of that effort to Guy L. Fougere, 49, vice president for electronics R&D.

Fougere more modestly ascribes ADL's success to its ability to give clients broad interdisciplinary support for a project, and to produce hardware. "It's one thing to give advice and another thing to do it," says Fougere. "We will continue to give thrust to development and delivery of small quantities of hardware as the ultimate combination of what ADL can offer a client."

**Out looking.** But as companies become more cautious about spending their R&D money, ADL has started to take a more active role in finding clients and assuming risk. "We used to sit like a doctor in his office waiting for someone to be sick," says Fougere, "but more recently we have taken an entrepreneurial role. We have sought to anticipate who might need what kind of new product, and taken on development until we can meet with a prospective client and say, 'Here's a new product, let's insure it reaches the marketplace by sharing the proceeds.'" For instance, ADL is now doing research in the memory field.

Interest in reducing risk is reflected in other aspects of ADL's operation as well. Clients are looking for an identifiable return on investment in a short time. "Previously, six months was a reasonable time to develop a product prototype; three months is demanded now. And one year from product conception to manufacturing is characteristic, whereas it was two years in the '60s," he says.

Fougere thinks another important development will be the "progressive invasion of electronic circuitry into new areas that are the stronghold of the mechanical domain. I'm willing to bet that a significant proportion of typewriters that get into offices in the '70s will have the likes of magnetic tapes and cards."

Another good growth area will be electro-optics, thinks Fougere.

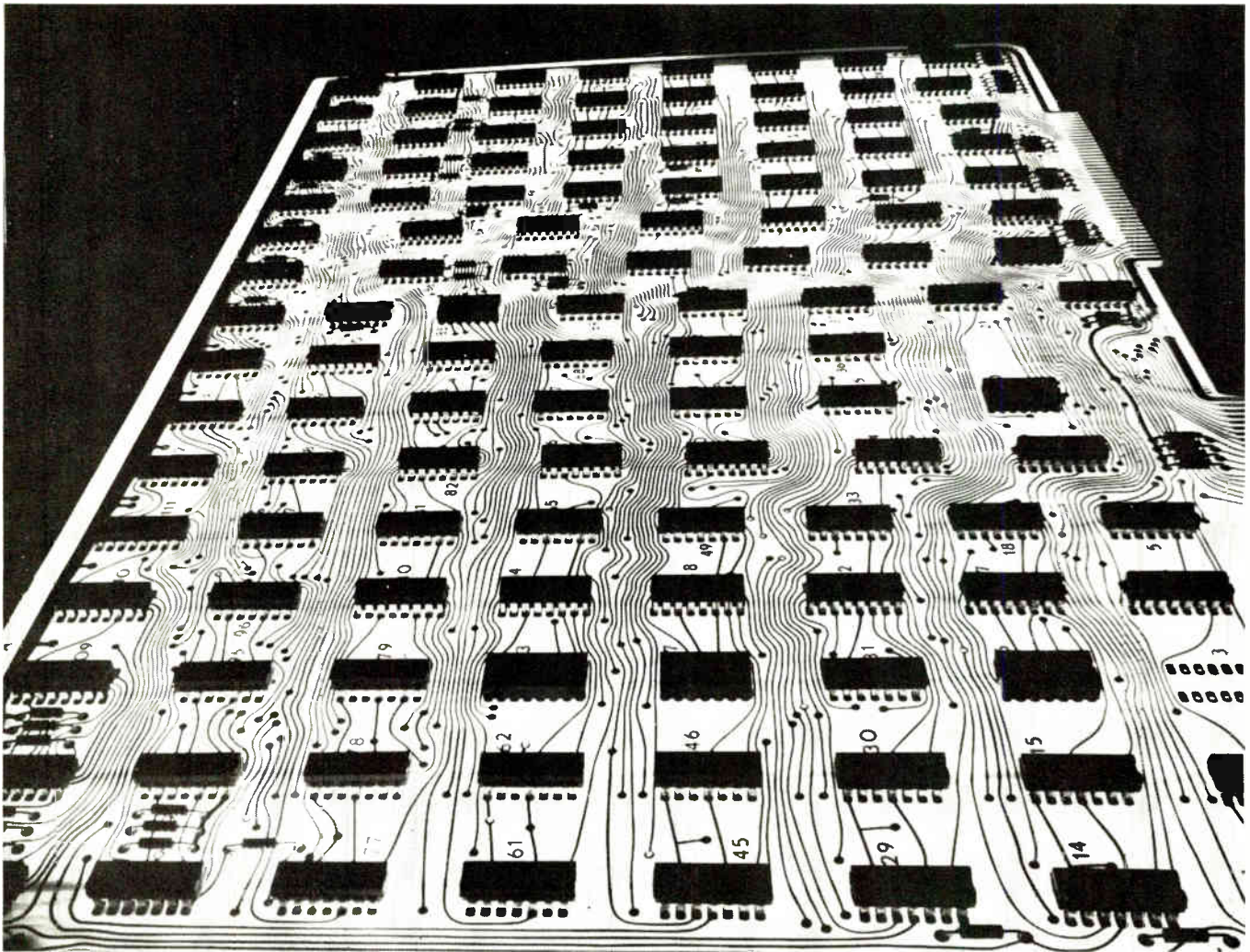

## The under \$20,000 Computer-Controlled Logic-Circuit Tester is here

You can't buy one for less. You can't build one for less. And General Radio hasn't compromised capability for the sake of a low price tag. With this new system you can perform high-speed functional GO/NO-GO and diagnostic tests even on big boards with more than 100 IC's.

GR's new 1793 Logic-Circuit Tester is a full-blown computer-controlled system with a 4k memory minicomputer, paper-tape input, and teleprinter output. Test programming is done in a simplified high-level language. Personnel with little or no previous programming experience can write test programs after only a few hour's training. What's

more, the system design, hardware, and software have been field-proven over the past two years in GR's highly successful 1790 system.

The basic 1793 gives you 96-pin capability. We can furnish more if you need it.

This new system from GR brings high-speed logic-circuit testing into the price range of almost every company. We'd like to tell you the full story on the 1793. Write or call the GR office nearest you or GR in Concord, Mass., (617) 369-4400, for complete information on the low-cost 1793. In Europe write Postfach 124, CH 8034, Zurich, Switzerland.

Photo courtesy of Incoterm Corporation



**General Radio**

NEW YORK (N.Y.) 212 964-2722 (N.J.) 201 791-8990 • BOSTON 617 646-0550  
 CHICAGO 312 992-0800 • WASHINGTON, D.C. 301 881-5333 • LOS ANGELES 714 540-9830  
 TORONTO 416 252-3395 • ZÜRICH (01) 55 24 20  
 GRASON-STADLER 617 369-3787 • TIME/DATA 415 327-8322

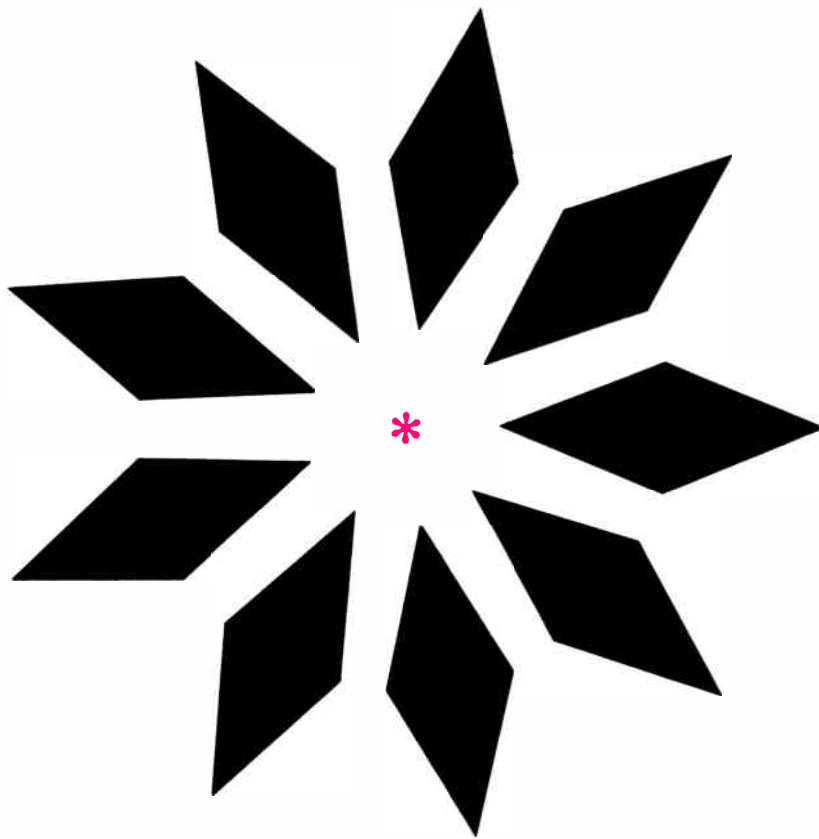

# Complete HF Receive Antenna capability in a 50 meter circle

How Hermes did away with vast rhombic or log-periodic antenna farms. Shoed away by a shrewd array:

Take 1 meter diameter loops, 4 meters apart, and get an omni directional broad-band receiving array.

Covers 2 - 32 MHz.

Optimum beam characteristics for both long and short range communications.

Rosette configuration of linear arrays gives a number of overlapping high gain beams - all available simultaneously.

**\* Using less than one hundredth of traditional real estate.**

Aperiodic Loop Systems are shrewd enough for restricted space, quick set up, roof mountable, or just below ground level. And portable version now available.

From polar icecap to sweltering tropics.

Installed in more than 52 locations for more than ten governments and more than 32 of their agencies.

Give up the antenna farm. ASK US

## Hermes Electronics Limited

Suite 315  
2020 F Street N. W.  
WASHINGTON  
D.C., 20006  
Telephone 202 296-2978  
TWX 710-822-1106

## Meetings

**International Convention & Exhibition:** IEEE, Coliseum and N.Y. Hilton, New York, March 20-23.

**International Electronic Components Exhibition:** FNIE, Parc des Expositions, Porte de Versailles, Paris, April 6-11.

**International Geoscience Electronics Symposium:** IEEE, Marriott Twin Bridges Motor Hotel, Washington, D.C., April 9-14.

**International Conf. on Magnetics (INTERMAG):** IEE, Kyoto International Conference Hall, Kyoto, Japan, April 19-21.

**International Symposium on Circuit Theory:** IEEE, Sheraton-University Hotel, Universal City, Calif., April 19-21.

**Southwestern IEEE Conf. & Exhibition (SWIEECCO):** IEEE, Baker Hotel & Dallas Mem. Aud., Dallas, Texas, April 19-21.

**Conf. on Computer Aided Design:** IEEE, IEE, University of Southampton, Southampton, England, April 25-28.

**National Telemetry Conf.:** IEEE, Houston Shamrock Hilton Hotel, Houston, Texas, May 1-5.

**Electrochemical Society Spring Meeting:** Electrochem. Soc., Shamrock Hilton, Houston, Texas, May 5-12.

**Quantum Electronics:** IEEE, AIP, OSA, APA, Queen Elizabeth Hotel, Montreal, Canada, May 7-11.

**International Semiconductor Power Converter Conf.:** IEEE, Baltimore Hilton Hotel, Baltimore, Md., May 7-10.

**Spring Joint Computer Conf.:** IEEE, Convention Center, Atlantic City, N.J., May 15-18.

**Aerospace Electronics Conf.:** IEEE, Sheraton Dayton Hotel, Dayton, Ohio, May 15-17.



---

# Electronics Newsletter

---

January 31, 1972

## Wired-city study in second phase

Arthur D. Little Inc. has entered Phase 2 of its wired-city study. In the first phase [*Electronics*, July 19, 1971, p. 17], the Cambridge, Mass., consultant did technically oriented market research for an experimental broadband telecommunications system for a city of 10,000 to 20,000. **Phase 2 will lay out ground rules for a prototype operating company.**

The prototype company, funded at \$2 million to \$3 million, would use channels on cable TV nets to bring a variety of services into the home, such as alphanumeric interactive CRT displays for real-time classified advertising, news, encyclopedia services, and education. **One of four types of terminal hardware envisioned, the CRT console would access an 80-million-character data bank.**

"The aim is to prove that these services can be provided by private industry at a profit," says John P. Thompson, a senior research associate. **"There is some bias in favor of Government-owned utilities for this, and we hope to overcome it."**

Bankrolling the \$180,000 study are the Bank of America, the Bell System of Canada, Burlington Industries, Encyclopaedia Britannica, IBM, Magnavox, Million Market Newspapers, Scripps-Howard Newspapers, Westinghouse, Zenith, and Southam Press.

Phase 2 could end by May, says Thompson, who would like to **begin buying hardware for Phase 3—the prototype subscriber net—by late autumn.**

## Warranty timer market opening?

Counting on the growing militancy of consumer groups, Sanyo Electric Co. of Japan will soon introduce to the U.S. market an **inexpensive timer that would keep track of the hours-in-use** of color TV sets, refrigerators, washing machines, and other household appliances to monitor warranty periods. **The largest model will sell for \$1 in quantities of 1,000.** With an electrochemical cell as the basic component, the timer is similar in principle to the Coulombeter of Curtis Instruments, Mt. Kisco, N.Y., which uses a mercury cell.

## Pay TV system uses laser, microwave links

A New York firm has developed a pay TV system for hotels and hospitals that it hopes will avoid the cost and delay of installing special cables. **The system, to be demonstrated within a few weeks by Telebeam Corp., uses both point-to-point microwave and laser beam communications.** Holobeam Inc., Paramus, N.J., is developing the laser links as well as multiplexing and central station equipment.

A patron merely needs to dial the central station on his telephone. Once sent to a customer location, the program will be distributed over the usual wired TV distribution system. Billing and distribution will be controlled by a minicomputer. **Special decoders will be connected to each TV set.**

Also contemplated, especially for hotels, is a room-access control system, also developed by Holobeam. This uses a randomly coded card in conjunction with the mechanical key to unlock a hotel-room door. **The card's code is set when a guest registers and can be changed when he checks out.**

## RCA computers for defense to bow

RCA, which withdrew last September from the general-purpose computer business, **has developed two new computers** for aerospace and defense systems.

The model 195, from RCA's Aerospace Systems division, Burlington, Mass., **is designed for tactical command-and-control systems** such as the Air Force's 485L and the Advanced Airborne National Command Post. With a central

---

# Electronics Newsletter

---

processor about the size of an office desk, the machine has a million-byte main memory with a cycle time of 1.5 microseconds, and a read-only-memory access time of 300 nanoseconds. **It is the first machine, despite its numerical designation, in RCA's new line of series 200 militarized computers.**

The other machine, the R-100, was developed by the Communications Systems division, Camden, N.J., for large military communications networks. The R-100 can be used both for message and circuit switching, **—functions generally performed by separate processors.** Up to 2,500 voice and data circuits can be controlled simultaneously with messages routed directly to their destinations or stored and forwarded later. In addition, the R-100 can interconnect and control multiple voice circuits and provide services for voice communications, including automatic call forwarding.

## Computerized test for keyboards due

The latest technique to make calculator production faster, more efficient, and less expensive is a computer-directed final inspection system for keyboards being built by the Micro Switch division of Honeywell in Freeport, Ill. **The goal is a 100% check of all function switches and circuitry.**

Among parameters to be checked for each key are proper code, rise and fall times, and output levels of voltage and current when the key is depressed or not depressed. Inspection commands and related acceptable parameter values will be stored in a high-speed disk pack storing several million words. **At the test station the inspector keys in the keyboard model number, and the system automatically exercises each key 10 times.** Information for several hundred keyboard models, with an average of 55 keys, is retained in the system, called CAKE for computer Assisted Keyboard Evaluator.

Edward C. Leibig, product/market manager for keyboards, says CAKE will service several inspection stations simultaneously. **A complete test should take only "a few minutes."** CAKE is based on a Honeywell DDP 516 computer with 16,384 words of core. Initial operation is slated for late February.

## Garrett expanding Canadian facility

The Garrett Corp. of Los Angeles, which essentially got out of the MOS/LSI business when it sold its Rancho Bernardo, Calif., production facility to Burroughs Corp., isn't abandoning microelectronics completely. **The firm has decided to add 20,000 square feet to Garrett Manufacturing Ltd., in Rexdale, Ont., Canada, to make thin- and thick-film hybrid microelectronic devices.** Production is expected to start at the new facility by April.

Some \$1.5 million in new equipment is earmarked for hybrid microcircuit production over the next three years. **The Canadian government has helped underwrite a portion of the R&D and production equipment costs.**

Although sales this year are expected to be less than \$1 million, Garrett Manufacturing officials are projecting volume topping \$7 million by 1975.

## Addenda

MOS/LSI is beginning to edge into automobiles—in that widely publicized Phystester ignition interlock system developed by the Delco Electronics division of General Motors Corp. **The experimental device includes a keyboard and display, with MOS/LSI logic and memory array supplied by North American Rockwell Microelectronics Co. . . . To encourage use of its calculator on a chip for scales, meters, cash registers, and other applications, Texas Instruments is reported to have cut the price in half—to the \$12-to-\$14 range. The 230-by-230-mil chip is MOS/LSI, and it is programable [Electronics, Sept. 27, 1971, p. 24].**



**in this issue**

An economical VHF signal generator

HP's new data acquisition system

At last: an X-Y recorder for OEMs

**Counter intelligence for demanding buyers**

These HP counters have so many well-planned features and options that you get out-of-this-world performance at down-to-earth prices.

Select the electronic counter/timer capability that you need without paying for unwanted extras. HP 5300 and 5326/5327 counters fill the bill at bare-bones prices, \$520 to \$2150. That includes capability to 550 MHz and many features you could never get before.

Take the 5300A six-digit main-frame, snap-on any of four function-determining modules in less than 15 seconds, and you have a 10 MHz or 500 MHz counter, 10 MHz/100 ns counter/timer, or 50 MHz multifunction counter. Snap-on a battery pack for portable use with any module. You can hold any 5300A in one hand; it's that compact.

*(Continued on next page)*

# High-performance signal generator: small in size, small in price

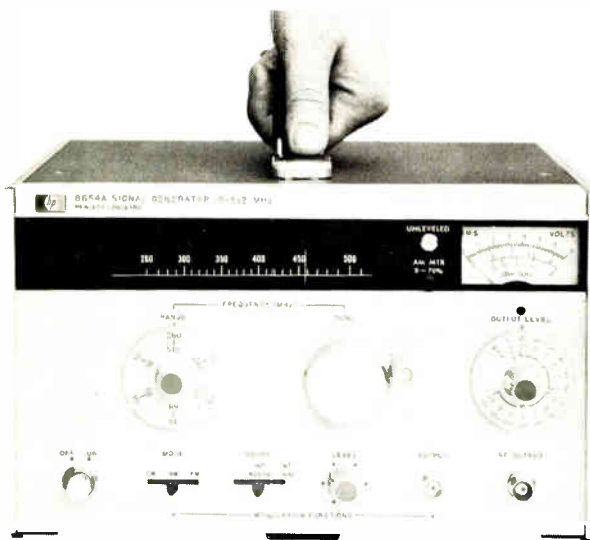

Looking for a small, solid-state calibrated signal generator? One as easy on the budget as it is to operate? The 8654A VHF Signal Generator gives leveled and calibrated output over a 10 to 512 MHz frequency range. Stability is 20 ppm and residual FM is  $5 \times 10^{-7}$ .

The power level is variable from +3 dBm to -120 dBm, calibrated, and is leveled automatically over the whole frequency range. Modulate it externally or internally: continuously variable amplitude modulation, 0 to 80% (metered); and FM peak deviation 0 to 0.1%.

Its compactness fits the 8654A easily into production, mobile,

HP's easy-to-use 10-512 MHz signal generator is versatile enough for almost every job.

airborne, and shipboard test locations. Its rugged solid-state construction recommends the 8654A for field maintenance and service applications. And its economy commends it for use everywhere—testing receivers, amplifiers, antennas, filter networks, etc.

The price? Only \$1,135.

Perhaps you could use a high performance "economy" generator. For more information, return the HP Reply Card.

(continued from page 1)

For more capability, step up to the 5326/5327 Series. Select seven or eight-digit readout, total remote programming, economical computer interface, time-interval averaging down to 150 picoseconds, a built-in DVM for dc voltage, or maximum accuracy time interval measurement via digital trigger level setting, new ultrastable time bases or 10-25 mV sensitivity.

It's a six counter family: 5326 A/B/C (50 MHz) and 5327

A/B/C (550 MHz). The A and B models are universal timer-counters; the B models have a built-in DVM. The C models measure frequency, period, ratio, and totalize input.

For the least costly counters that will serve all your needs, discover the 5300 and 5326/5327 line of electronic counters.

Need more details? Just send the HP Reply Card.

# True RMS goes digital at a reasonable price

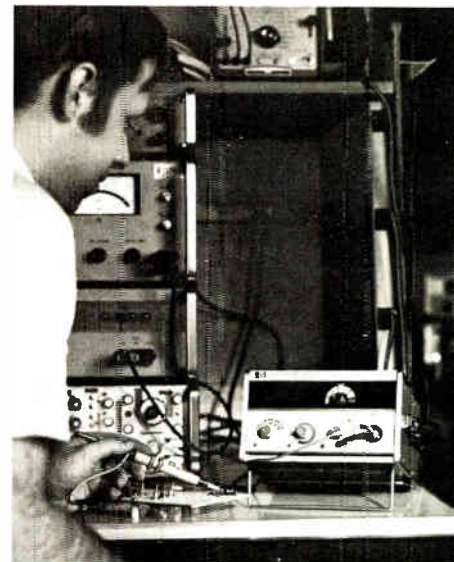

Only 4½ by 7¾ by 9½ inches, the Model 3403A/B fits in any corner of your laboratory. Attach it to a calibration microphone or a semiconductor test system with equal ease.

The new digital 3403A/B True RMS Voltmeters offer combined capabilities never before available in one instrument:

- Wide voltage range—measures ac voltage from 10 mV to 1000 V full scale.
- Wide frequency range—from 1 Hz to 100 MHz.
- True rms accuracy—measures both simple and complex signals  $\pm 0.2\%$  reading  $\pm 0.2\%$  of range.
- Versatility—measures ac, dc, ac and dc, low frequency, RF levels, and complex signals.
- LED display—three digits with fourth digit for overrange.
- Volt or decibel readout—an option automatically converts measurements to decibels and reads dBV from -48 to +60 with a resolution of 0.1 dB.
- Economy—an eight-decade bandwidth and six-decade ac voltage range in one instrument, not two or three.

The 3403A True RMS Voltmeter sells for \$1400 plus options; the 3403B (ac only) version starts at \$1150. Six options, including BCD output, are available.

Interested? For more information, check the HP Reply Card.

# Do IC troubleshooting ten times faster

The new 5010A Logic Troubleshooting Kit saves time, aggravation, and money. Use the Probe separately for pulse activity problems; the Clip, for logic state; and the Comparator, for logic fault. They analyze digital IC problems ten times faster than conventional techniques.

In design applications, the Probe can be a replacement for expensive oscilloscopes; it indicates logic

states or pulses as narrow as 25 ns. The Clip monitors logic states on all 16 IC pins at a time. With the Comparator, the designer can be confident that all ICs are working even if his circuit is not.

These pieces may be purchased separately, or as a complete kit for \$495.

*There's more. Just check the HP Reply Card.*

The 10529A Logic Comparator finds the faulty pin in 5-10 seconds per IC; tests ICs dynamically in the circuit. Price: \$295.

The 10525A Logic Probe detects static logic highs and lows, the presence or absence of pulse activity. Price: \$95.

The 10528A Logic Clip "looks inside" the suspect IC. LEDs on the clip correspond to 16 IC pins so that each one is monitored. Price: \$125.

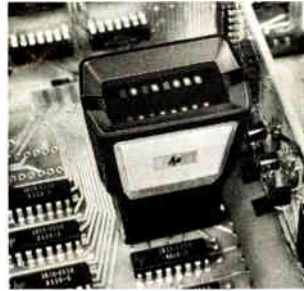
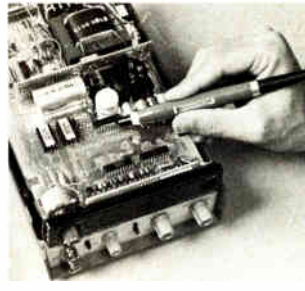

# A digital multimeter with multi-features



The 3469B is a multimeter, milliohmmeter, dc ammeter, and dc voltmeter—all in one low-cost digital instrument.

Now you can choose 26 different combinations of range and function to make *digital* measurements of ac/dc voltage, dc current, and resistance.

The HP 3469B Digital Multimeter gives you five dc voltage ranges, six dc current ranges, seven ac voltage ranges with 10 MHz bandwidth, eight ohm ranges—all for \$595.

The multimeter measures ac from 1 mV full scale to 500 V over a frequency range of 20 Hz to 10 MHz—particularly useful in communications, broadcasting, and audio applications.

On its most sensitive resistance range, it is a milliohmmeter—one ohm full scale. Use it for contact resistance, components, and plated-through circuit board hole resistances.

The digital dc ammeter measures dc current from 1 microampere to 100 mA full scale.

The dc voltmeter measures from 100 mV to 1000 V full scale with an accuracy of  $\pm 0.2\%$  to  $\pm 0.3\%$ , depending on the range.

*For more information, check the HP Reply Card.*

# Microwave power meter for automatic systems



The 432C inputs and outputs are fully compatible with HP computers and digital recorders.

Now the HP 432 Power Meter family has a programmable member. The new 432C is a systems-oriented precision power meter with 1  $\mu$ W to 10 mW range. Frequency coverage is 1 MHz to 40 GHz using HP's temperature-compensated thermistor mounts.

The 432C features include digital readout, autoranging and auto-zeroing (these can be accomplished with remote programming), BCD and analog outputs of measured power, and 0.5% f.s. accuracy. Price of the 432C is \$1375.

*Check the Reply Card for full information about all the 432 series power meters.*

# Three new computer systems for low-cost batch, time-sharing or real time . . .



Dedicating a computer system to a specific processing task is now much easier, and costs less to do, with HP's new family of small disc-based systems. These systems can be applied to:

- Batch processing—for uninterrupted job processing with maximum throughput;
- Time-sharing—for direct man-machine interaction; and
- Real-time processing—for response to and control of external events while executing.

The fundamental system is the versatile new 2100A computer with a fast 7900A five-megabyte disc. Other mass storage devices provide up to 47 million bytes of disc storage. Each HP system interfaces with more than a dozen peripherals and plugs in to more than 50 HP instruments.

The reliable software is fully supported. The 2120 Disc Operating System features program chaining, extended file management, and a job processor that handles assembly language, ALGOL, and FORTRAN IV. It executes machine instructions or complex mathematical and logical operations with equal ease.

Just add 16 terminals, some hardware, and our easy-to-learn conversational programming language, HP BASIC, and you have the new 2000E time-sharing system. It can be expanded further to the new 2000F system with a dual processor and another 16 terminals.

With additional equipment and Real-Time Executive software, the disc system becomes a real-time system with priority interrupt and multi-programming capabilities.

Batch systems begin at \$33,000, time-sharing and real-time from \$50,000.

*To learn more, check the HP Reply Card.*

**Batch, time-sharing, or real-time—HP's disc-based computer systems are particularly suitable when there's a need to access large data banks, and where ease of I/O interface is required.**

# ... And a versatile new HP system family for sensor-based data acquisition

The new 9600 Series of modular data acquisition systems satisfies the need to handle multitudes of analog and digital inputs and outputs, all simultaneously. This new HP family of automated systems is specifically designed for applications in research, development, sensor-monitoring, and industrial control. The 9600 is based on the 2100A computer and features two new "plug-in" analog and digital subsystems, as well as three different software operating systems (RTE, DACE, and BCS).

The new **analog subsystem** is capable of scanning and digitizing both low and high level analog signals, and also outputting analog information, for purposes such as driving graphic displays and plotters. The unique feature is that all functional elements are contained on plug-in cards for greater flexibility with less cost and easier maintenance.

The main component is an analog-digital interface. Functional modules plug into the backplane and communicate with each other via analog and digital busses. The subsystem is controlled from the computer, through a control card in the interface. This card uses micro-programming and ROMs to generate the control and timing signals for various system functions. Depending on system needs, more than one interface can be used.

The **digital subsystem** includes the new HP 6940 multiprogrammer with 15 channels of 12-bit digital I/O and expansion capability up to 240 channels. Various plug-in cards let you monitor TTL, DTL, RTL, or contact-closure logic, and output TTL/DTL logic levels and contact-closures with read-back capability. The digital subsystem can also provide analog outputs (voltages and resistances) for controlling devices, such as power supplies.

Software for 9600 systems includes three different operating systems:

Fully integrated—rather than the all-too-familiar piecemeal assembly of data acquisition systems—is HP's 9600 Series. It features the 2100A computer, 7900A disc drive, 7970 magnetic tape unit, 2440A A-D interface, and the 6940 multiprogrammer.

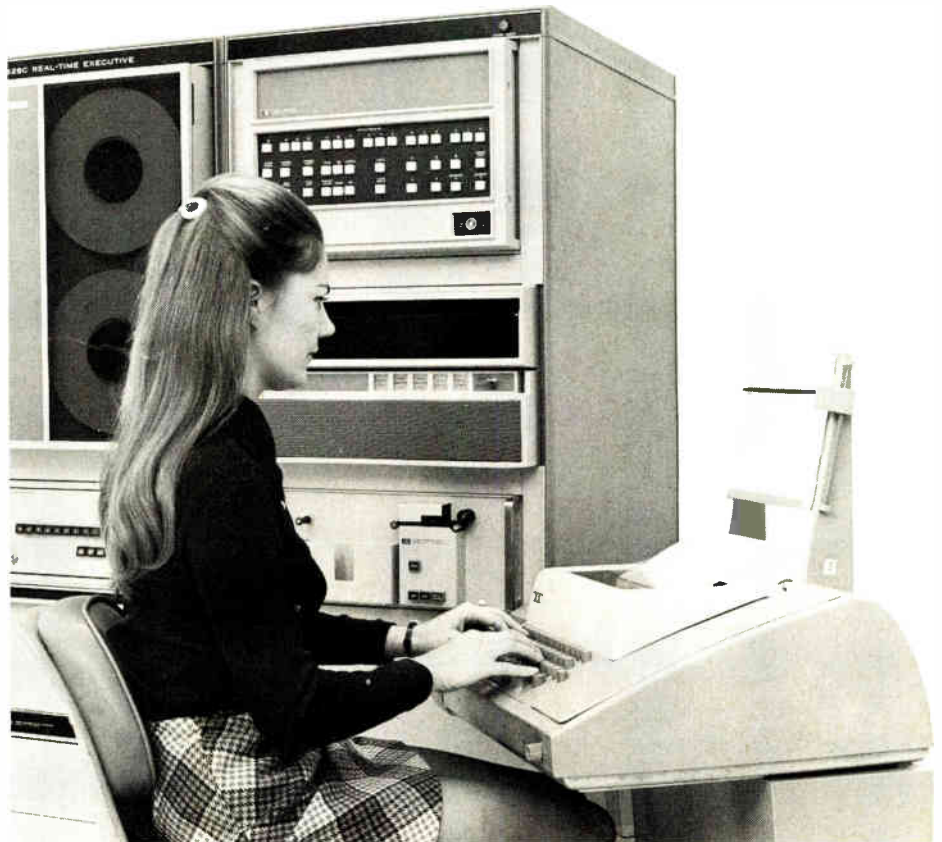

- **Real-Time Executive**—Multi-programming allows real-time programs to run concurrently with general-purpose background programs. Priority scheduling/interrupt controls your programs on the basis of time, event and critical need.
- **Data Acquisition and Control Executive (DACE)**—Schedules multiple tasks (measurement, computation and output) in real-time.
- **Basic Control System**—Features

relocation and linking of user's programs, interrupt processing, input/output control, and a library of arithmetic, logic, and utility subroutines.

Configure a 9600 system to control a single test or experiment, or to automate a whole laboratory or factory. Systems start at approximately \$22,000 and typical systems cost between \$32,000 and \$60,000.

To learn all the facts and features, check the HP Reply Card.

## A laser device for computer or IC guys?

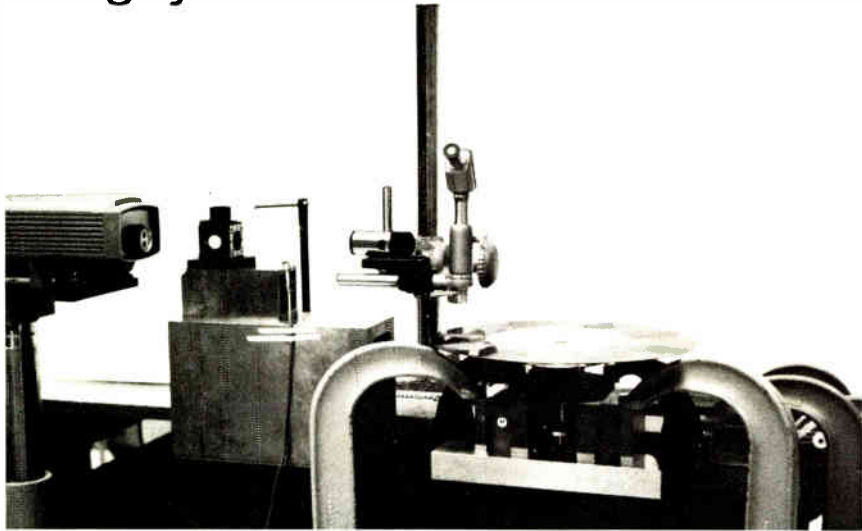

Use lasers in IC production or memory disc positioning? Why not? HP's 5525B Laser Interferometer measures displacements down to one microinch or, with the new K02-5525B Resolution Extender, down to one angstrom. This accessory electronically extends the laser's resolution by a factor of 10. The resolution extension is real-time, giving one microinch resolution at a high update rate, or 0.1 microinch at a lower rate. With two extenders cascaded together, resolution is 0.1 microinch in real-time; or .01 microinch,  $10^{-10}$  meters, or one angstrom with the lower update rate.

The integrated circuit industry uses the Model 5525B both for

This laser interferometer is being used in HP's Gage Lab to measure spacing between the tracks of a memory disc.

calibration and for feedback control of artwork generators, step and repeat cameras, and mask inspection machines. For computer memory discs, the interferometer makes closer track spacing possible—thus improving the disc packing densities. It also calibrates the scales and actuator systems.

The 5525B costs \$11,500. For the K02-5525B Resolution Extender, add \$800.

Interested? Just send the HP Reply Card.

## Fast yet precise RF measurements with high resolution

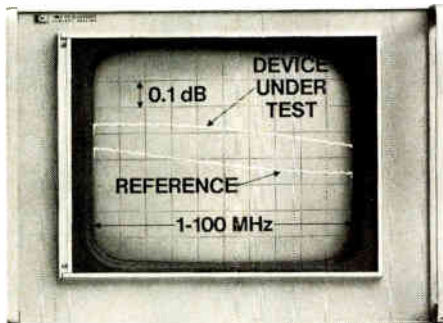

Comparisons over a 100 dB range, differences as small as 0.01 dB and  $0.2^\circ$  can be resolved.

Production-testing RF components normally calls for swept-frequency tests, but high precision and high resolution usually require fixed frequency tests. End the conflict. Use the new HP 8728A Network Comparator with the HP 8407A 0.1 to 110 MHz Network Analyzer, and make quick yet precise swept-frequency comparative measurements.

The 8728A is \$2950. A typical complete system is approximately \$12,000.

Discover many other features; check the HP Reply Card.

## Low-cost displays come with onboard IC

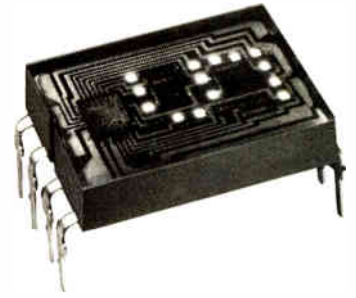

The 5082-7300 numeric display is completely TTL-compatible.

We've built both the decoder/driver and the memory into our new 5082-7300 solid-state numeric display. All you do is address them directly with four-line BCD input. You can store data or have a real-time display at your fingertips.

The characters are .290 in. high for better readability over a wide viewing angle. Yet, it's a compact .6 by .4 inch package.

The displays cost \$10 each in 1 K quantities, and are available from stock.

For more information, please check the HP Reply Card.

## Increased sensitivity for 7100 recorders

One small input module increases the sensitivity of the 7100 Series recorders to 100  $\mu$ V full scale. Just plug in the 17505A High Sensitivity Input Module; it measures input signal variations as low as 1  $\mu$ V at maximum sensitivity. Your strip-chart recorder acquires a variable voltage span from 100  $\mu$ V to 100 V full scale. There is even an optional calibrated offset capability in increments from one to ten, full scale. The 17505A costs \$400.

Interested? Just send your HP Reply Card.

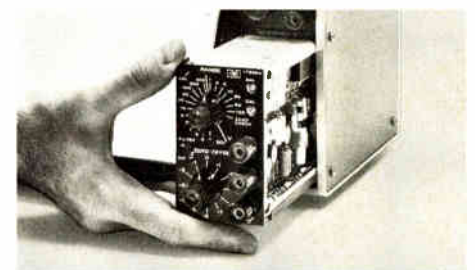

HP 17505A plug-in for 7100 recorders.



# OEM's get an x-y recorder of their very own

Forty OEM options include several X-Y range calibrations, metric scaling, a time base, an event marker that records in the top margin, rear connectors, and TTL logic control.

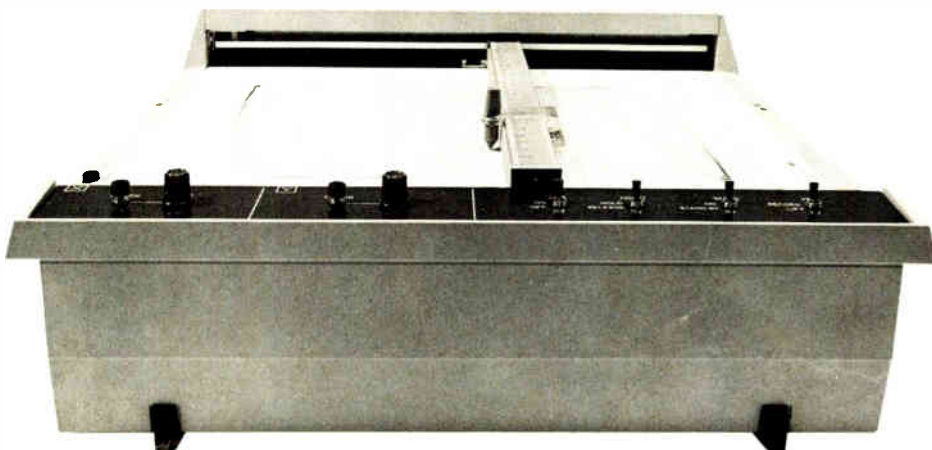

X-Y recorders used to be designed principally for laboratories; now, there is one designed specifically for original equipment manufacturers. The new 7040 does not require any special paper, calibration adjustment, or expensive maintenance.

The one-piece mainframe is die-cast aluminum—durable yet shock-resistant. The circuitry contains only ten hand-soldered connections—reliable and maintenance-free. The writing area is 10 by 15 inches (25 by 38 cm.) with an autogrip that holds 11 by 17 in. or international A3 size paper.

Accuracy is  $\pm 0.2\%$  of full scale; linearity,  $\pm 0.1\%$  of full scale. Standard features include a newly-developed hybrid potentiometer, disposable pens, 1 megohm input resistance, and 20 in./sec. minimum slewing speed. A new motor design on both axes lets the OEM recorder pen be driven offscale for an indefinite period of time without noise or damage.

The price, sans options, is \$890.

For more information, check the HP Reply Card.

# Set scope time bases as easy as 1-2-5



The HP 226A Time Mark Generator

When you need precise timing, the new HP 226A Time Mark Generator makes it easy to calibrate your oscilloscope and recorder time bases. With a room-temperature crystal that needs only  $\frac{1}{2}$ -hour warm-up to give you 20 ppm accuracy (at 25°), the 226A generates one-volt markers (into 50 ohms) at 30 intervals ranging from

2 nanoseconds to 10 seconds and in a 1-2-5 sequence.

It's programmable, too, with an option that makes it operable in automatic systems.

The 226A costs \$670. (For the programming option 003, add \$150.)

To learn more about the 226A, just check the HP Reply Card.

# 18-40 GHz measurements with network analyzer

Now you can measure reflection and transmission coefficients—magnitude and phase—in the 18–26.5 and 26.5–40 GHz bands, using the new K8747A and R8747A waveguide test units for the 8410 Network Analyzer.

For full details on this much-needed high-frequency measurement capability, use the HP Reply Card.

## OOPS!

That was some thermal recorder described in the last issue of MEASUREMENT NEWS. Unfortunately, its impressive specifications resulted from a typographic error. (We should have said 50 Hz and 100 Hz, instead of 50 MHz and 100 MHz.) Meanwhile, the HP 7414A is still a nifty performer.

# "The Portables" add two scopes, including a 75 MHz model with delayed sweep

Two new scopes have been added to HP's 1700 Series of high-performance "portables"—the 1707A, with a 75 MHz bandwidth and delayed sweep; and the 1703A, the first variable persistence/storage oscilloscope operated on batteries.

Both scopes incorporate all the 1700 Series' best features: low power requirements, only 24 lbs. in weight, bright display, no dust-collecting ventilator holes, solid triggering with a minimum of signal, and reliable thermally-stable ECL trigger circuits instead of conventional tunnel diodes.

Both scopes also have a 10 mV/div deflection factor over the full bandwidth, 10 ns/div sweep speed, and a rise time of less than 4.7 ns. There are improved divider probes, delayed sweep, and a large cathode-ray tube display. They can readily measure T<sup>2</sup>L or some ECL pulse timing and propagation delay. The sweep and trigger circuits were designed especially for digital field service applications.

Their low power requirements mean you can use an internal, rechargeable battery pack for up to four hours operation; or use an 11.5 Vdc to 36 Vdc source, or any standard ac outlet.

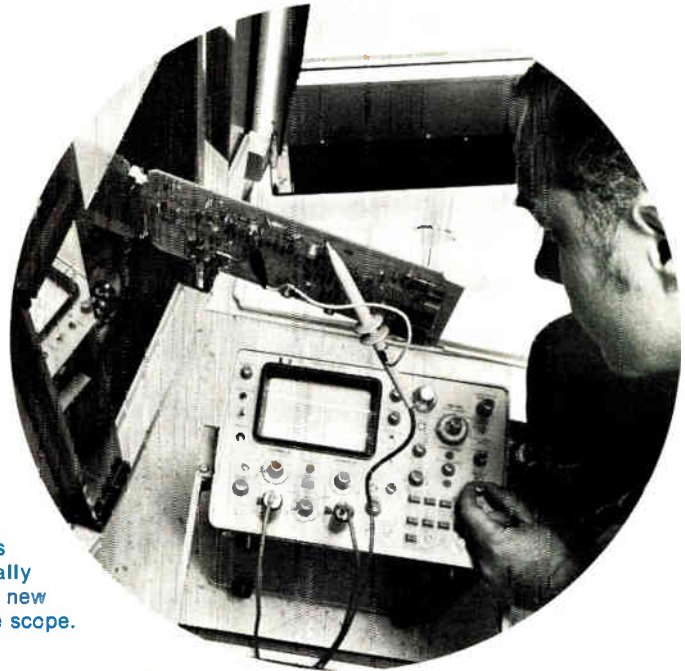

Serviceing computers and peripherals can be less costly, especially if you use HP's new 1707A portable scope.

The new 35 MHz 1703A with delayed sweep is an HP exclusive—the only portable variable persistence/storage oscilloscope that can be battery-powered. Variable persistence allows you to control the rate at which the trace fades; the storage capability lets you hold a particular pattern on the scope.

Actual customer experience verifies that the 1700 Series requires roughly half the calibration time of competitive portables due to the low number of internal adjustments.

This means substantial savings over the lifetime of each instrument.

The 1700 portable scopes begin as low as \$1680 for the nondelayed-sweep, dual-channel 35 MHz version. The 35 MHz variable persistence/storage scopes sell for \$2,725 (1703A, with delayed sweep) and \$2,375 (1702A, nondelayed). The 75 MHz scopes cost \$1,925 (1707A, with delayed sweep) and \$1,775 (1706A, nondelayed).

For more facts and features, please check the HP Reply Card.



Measurement, Analysis, Computation

East—W 120 Century Road, Paramus, N.J. 07652, Ph. (201) 265-5000.  
South—P.O. Box 2834, Atlanta, Ga. 30328, Ph. (404) 436-6181.  
Midwest—5500 Howard Street, Skokie, Ill. 60076, Ph. (312) 677-0400.  
West—3939 Lankershim Boulevard, North Hollywood, Calif. 91604, Ph. (213) 877-1282.  
Europe—Rue du Bois-du-Lan 7, CH-1217 Meyrin 2, Geneva, Switzerland, Ph. (022) 41 54 00.  
Canada—275 Hymus Boulevard, Pointe Claire, Quebec, Canada, Ph. (518) 561-6520.  
Japan—Ohashi Building, 59-1, Yoyogi 1-chrome, Shibuya-ku, Tokyo 151, Japan, Ph. 03-370-2281/92.

I'd like  Literature  Applications assistance on:

- |                                                                                                          |                                                                                           |
|----------------------------------------------------------------------------------------------------------|-------------------------------------------------------------------------------------------|
| <input type="checkbox"/> <input type="checkbox"/> IC Troubleshooters (Logic Probe, Clip, and Comparator) | <input type="checkbox"/> <input type="checkbox"/> 5525B Laser Interferometer              |
| <input type="checkbox"/> <input type="checkbox"/> 226A Time Mark Generator                               | <input type="checkbox"/> <input type="checkbox"/> 7040 X-Y OEM Recorder                   |
| <input type="checkbox"/> <input type="checkbox"/> 432C Power Meter                                       | <input type="checkbox"/> <input type="checkbox"/> 8654A VHF Signal Generator              |
| <input type="checkbox"/> <input type="checkbox"/> 1700 Series Portable Oscilloscopes                     | <input type="checkbox"/> <input type="checkbox"/> 8728A Network Comparator                |
| <input type="checkbox"/> <input type="checkbox"/> 3403A True RMS Voltmeter                               | <input type="checkbox"/> <input type="checkbox"/> 8407 Network Analyzer                   |
| <input type="checkbox"/> <input type="checkbox"/> 3469B Digital Multimeter                               | <input type="checkbox"/> <input type="checkbox"/> 8747A Transmission/Reflection Test Sets |
| <input type="checkbox"/> <input type="checkbox"/> 5082-7300 Solid-State Display                          | <input type="checkbox"/> <input type="checkbox"/> 8410S Network Analyzer                  |
| <input type="checkbox"/> <input type="checkbox"/> 5300A Measurement System                               | <input type="checkbox"/> <input type="checkbox"/> Dedicated Disc-Based Computer Systems   |
| <input type="checkbox"/> <input type="checkbox"/> 5326/5327 Universal Counters                           | <input type="checkbox"/> <input type="checkbox"/> 9600 Data Acquisition Systems           |
|                                                                                                          | <input type="checkbox"/> <input type="checkbox"/> 17505A High-Sensitivity Input Module    |

PLEASE PRINT and include zip code

Name	
Title	
Department, Building, Mail Station, Etc.	
Company	
Post Office Box or Street No.	
City	State Zip
Phone (Area Code) Number	

I'd like  Literature  Applications assistance on:

- |                                                                                                          |                                                                                           |
|----------------------------------------------------------------------------------------------------------|-------------------------------------------------------------------------------------------|
| <input type="checkbox"/> <input type="checkbox"/> IC Troubleshooters (Logic Probe, Clip, and Comparator) | <input type="checkbox"/> <input type="checkbox"/> 5525B Laser Interferometer              |
| <input type="checkbox"/> <input type="checkbox"/> 226A Time Mark Generator                               | <input type="checkbox"/> <input type="checkbox"/> 7040 X-Y OEM Recorder                   |
| <input type="checkbox"/> <input type="checkbox"/> 432C Power Meter                                       | <input type="checkbox"/> <input type="checkbox"/> 8654A VHF Signal Generator              |
| <input type="checkbox"/> <input type="checkbox"/> 1700 Series Portable Oscilloscopes                     | <input type="checkbox"/> <input type="checkbox"/> 8728A Network Comparator                |
| <input type="checkbox"/> <input type="checkbox"/> 3403A True RMS Voltmeter                               | <input type="checkbox"/> <input type="checkbox"/> 8407 Network Analyzer                   |
| <input type="checkbox"/> <input type="checkbox"/> 3469B Digital Multimeter                               | <input type="checkbox"/> <input type="checkbox"/> 8747A Transmission/Reflection Test Sets |
| <input type="checkbox"/> <input type="checkbox"/> 5082-7300 Solid-State Display                          | <input type="checkbox"/> <input type="checkbox"/> 8410S Network Analyzer                  |
| <input type="checkbox"/> <input type="checkbox"/> 5300A Measurement System                               | <input type="checkbox"/> <input type="checkbox"/> Dedicated Disc-Based Computer Systems   |
| <input type="checkbox"/> <input type="checkbox"/> 5326/5327 Universal Counters                           | <input type="checkbox"/> <input type="checkbox"/> 9600 Data Acquisition Systems           |
|                                                                                                          | <input type="checkbox"/> <input type="checkbox"/> 17505A High-Sensitivity Input Module    |

PLEASE PRINT and include zip code

Name	
Title	
Department, Building, Mail Station, Etc.	
Company	
Post Office Box or Street No.	
City	State Zip
Phone (Area Code) Number	



**DIRECT RESPONSE SYSTEM**

For fast response, please use the above Reply Cards to request information on any Hewlett-Packard product described in the foregoing issue of MEASUREMENT NEWS.

Please note that you can choose two types of HP response:

- Literature (You will receive more information on a product, such as data sheets or other relevant literature.)
- Applications Assistance (You will receive product information and a follow-up call by an HP Field Engineer. He'll discuss general or specific applications, answer questions, or provide other information as requested.)

If both the Reply Cards on this page have been used, contact your nearest HP field office or one of the regional offices listed on the preceding page. Or write directly to the Hewlett-Packard Company, 1601 California Avenue, Palo Alto, California 94304.

No Postage Necessary if Mailed in the United States

**BUSINESS REPLY MAIL**

Postage will be paid by

**HEWLETT-PACKARD**  
1601 California Avenue  
Palo Alto, California 94304

First Class  
Permit No. 201  
Palo Alto  
California



No Postage Necessary if Mailed in the United States

**BUSINESS REPLY MAIL**

Postage will be paid by

**HEWLETT-PACKARD**  
1601 California Avenue  
Palo Alto, California 94304

First Class  
Permit No. 201  
Palo Alto  
California

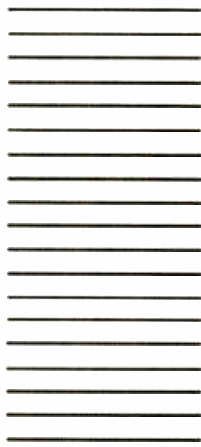

## Effort to decide CAS standard mired in committee

FAA, Pentagon, NASA unit to take more than a year as makers of ground and cockpit systems keep vigil

A common way to avoid taking action on a controversial subject is to form a committee to study the matter. The same thing is done in Washington, except that in the Federal Government, where financial stakes are highest, it takes more agencies to form the committee, and the delay is longer.

That's what has happened to the pending national standard for aircraft collision-avoidance systems that the Federal Aviation Administration has been agonizing over—some industry sources say, “procrastinating over”—for several years. An interdepartmental committee of the FAA, the Defense Department, and NASA is going to study various competing CAS systems in hopes of lowering costs. The committee is headed by the FAA's David R. Israel, director of the Office of Systems Engineering Management.

**Market loss.** While the official word is that the committee will take about a year, one FAA source concedes that the study will last “much more than a year,” and an industry spokesman estimates that a final decision on CAS will be delayed three to five years. Also put off are electronics manufacturers that see a potential market amounting to several hundred million dollars.

The action deals a setback to advocates of time-frequency systems, led by the Air Transport Association, the airlines' trade group.

McDonnell Douglas, Bendix Avionics, Wilcox Electric Inc., and Sierra Research were the largest developers—with McDonnell Douglas, especially, prodding the FAA to decide for the time-frequency technique. Gaining a toehold are newer systems: RCA's Secant and Honeywell's operational proximity-warning indicator systems, which will also be studied. McDonnell Douglas and RCA have been in a fierce competition to get their respective systems FAA-approved.

The study is a “delaying game” by the Defense Department, which thinks that time-frequency systems would be too expensive to install on its planes and wants to look at other systems, says one FAA source. Hard figures are hard to come by, since, for example, time-frequency systems aren't in mass production. But it's known that outfitting the entire military fleet would cost more than \$1 billion.

However, one bitter time-frequency advocate says that “DOD doesn't want a cockpit [airborne] system at all” and is using the study as an excuse to develop further ground-based CAS functions. FAA topside also has voiced a preference for ground-based systems, saying that collision avoidance can be provided better from sophisticated ground radar equipment.

**Interference.** One problem with airborne CAS units is that they are assigned the same L-band frequency as some military altimeters, says an FAA source. Although there aren't any hardware problems with time-frequency units, he adds, agency officials wonder if such an interrogator-transponder system wouldn't have mutual interference

problems when, say, 300 CAS-equipped planes are aloft near one airport.

There also are problems with ground-based systems, says one FAA official, such as achieving adequate coverage and obtaining back-up facilities in case of malfunction. “It's a complicated proposition that we don't want to rush into,” he says. “We want to really study the matter to make sure of the right system before we undertake such a major investment.”

### Societies

IEEE questionnaire seeks mandate for change

“Fifty-fifty is a mandate to do something; even 18-18 is a mandate.” Speaking earlier this month was the IEEE's new president, Robert H. Tanner. He used these numbers to summarize the results of vot-

**Tanner:** IEEE's president sees a mandate for change, but just how strong is it?



ing by IEEE members last November on a proposed amendment to the institute's constitution to redefine its primary purpose to look after the professional and economic well-being of the engineer, rather than stick to its traditional mission only to disseminate technical information [*Electronics*, Jan. 3, p. 25].

Only 36% of IEEE's members voted, but almost half—or 18%—favored the amendment. (The usual institute election attracts votes from 20% to 25% of the membership.)

The IEEE's response has been to send out a questionnaire to members in an attempt to find out what—if any—additional services they want.

In nine categories, the questions ask, for example, if the institute should establish its own pension plan, become more active in political and economic matters, engage in technology forecasting, and expand its continuing education program.

The basic question for the institute is whether or not members would be willing to pay higher dues to get these services.

**Dues going up.** Even if they aren't, dues are already slated to go higher—\$5 to \$10 a year—depending on the board of directors' decision. The reason for this, Tanner says, is a fall-off in income from advertising and exhibits, as well as inflation. Another factor: the growth rate of the 160,000-member organization has slowed.

If anything, the English-born Tanner, who is director of information for Bell-Northern Research in Ottawa, Canada, and the six-member executive committee seem committed to changing the institute's purview.

Says John J. Guarrera, a regional director and president of Guide Scientific Industries Inc., Sun Valley, Calif., "We have already asked members of the committee to consider preparing some amendments to the society's constitution, should the results of the membership questionnaire direct them to."

However, the questionnaire, with its total of 22 yes-no responses, "may not give us clear marching orders," cautions Tanner. The results

will have to be studied carefully so that the will of the membership can be ascertained.

---

### Associative memories

---

Functional approach holds promise for logic

The use of memories to implement control logic in terminals and computers is growing rapidly, especially with the ready availability of MOS/LSI memory circuits. But in some areas, the use of micro-programming with read-only memories has not taken off—primarily because so much ROM is required to duplicate a given logic configuration. For example, in desk calculators, ROMs are employed as look-up tables for trigonometric functions, but not for the logic.

Officials of the Systems division of Varadyne Inc., Cupertino, Calif., think they have solved this problem with a special memory organization that employs a three-state, content-addressable functional memory. Donald E. Farina, vice president and general manager of the division, says, "Two years ago, we started to look for a memory configuration that would enable us to develop LSI circuits for terminals, point-of-sale systems, and scientific calculators. We wanted to get around the problems of designing combinational logic, but micro-programming with ROM wasn't the best solution—too much memory is required." The solution was functional memory.

**Tighter tables.** The concept is fairly new. Last summer, Peter L. Gardner of IBM's United Kingdom Laboratory in England described a functional memory that is based on an associative array, composed of writable storage cells capable of holding three states—0, 1, and "don't care." Used as a logic block, the array's logic is performed by associative table look-up, using the don't-care state to give "significant compression of tables over conventional two-states arrays."

For the same function, a three-

state functional memory would require  $n^2$ -words, instead of the  $2^n$ -words required by a two-state memory. And because the functional memory is basically an array, the circuits can be packed densely. Interconnection between arrays is regular, as opposed to the irregular interconnection pattern of combinational logic chips.

As Farina puts it, functional memory "is not just a stored sequence of events; it's really logic in memory." As a result of work with functional memories, Varadyne engineers have designed a scientific calculator that has logarithmic, trigonometric, exponential, and other special functions on four relatively small chips, each of which is about 150 mils on a side.

Farina points out that because the chips are small, and a great deal of computing power can be packed into them, functional memories are also candidates for the simpler four-function machines. One such design, employing three functional memory chips, is being discussed by Varadyne with calculator makers.

---

### Integrated electronics

---

Phase-locked loop dissipates less power

The phase-locked loop offers frequency accuracy with virtually no drift. But there's a rub: currently available versions require a good deal of power—either 1-milliamperes operating currents or high-voltage supplies. Now, RCA says that it has applied complementary MOS technology to come up with a loop that requires a mere 0.1 mA.

However, while the new chip dissipates 10 times less power than its competitors, its maximum operating frequency is somewhat limited. RCA guarantees an upper limit of 200 kilohertz with a probable extension to 1 megahertz. Competitors generally can reach several times that.

In addition to an on-chip zener diode, the new IC has an exclusive-OR phase comparator, eliminating the need to perform an exclusive-OR

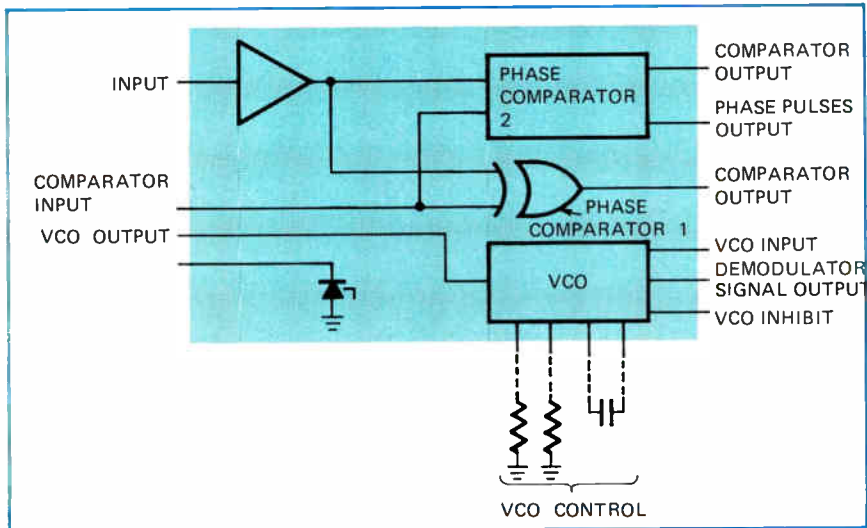

**Savings watts.** Complementary MOS phase-locked loop cuts power consumption by factor of 10. On-chip exclusive-OR phase comparator and zener diode are added features.

function external to the chip. Frequency drift for the unit is expected to be in the order of 0.02% per degree centigrade.

Planned applications include frequency synthesis, frequency modulation and demodulation, frequency multiplication and division, frequency discrimination, signal restoration, and use in frequency-shift-keyed modems. A conservative cost estimate for the new chip fixes the price at \$5 to \$10. Delivery is expected by the third quarter of 1972.

## Air traffic control

Color radar tube may mean \$100 million market

The Federal Aviation Administration plans to choose a contractor in March to produce a testbed for developing color radar scopes for the nation's air traffic control system. Even though the 18-month effort will be part of a small \$750,000 three-year program by the FAA, the color tube development could lead to "a \$100 million market for sure," says one industry source. "What color does is worth it," the source says. "They'll probably replace every scope they have."

Consequently, eight companies are anxiously awaiting the results due by Feb. 1 from the FAA's tight-

lipped technical evaluation committee. Industry sources report that proposals being considered are from the Electro-Magnetic and Aviation Systems division of RCA, Van Nuys, Calif.; Raytheon, Sudbury, Mass.; Sanders Associates, Nashua, N.H.; Tasker Industries, Los Angeles; Government Electronics division of Motorola, Phoenix, Ariz.; the Norden division of United Aircraft Corp.; Norwalk, Conn.; the Aerospace Optical division of ITT Corp., Fort Wayne, Ind.; and tiny (\$1 million annually) CPS Inc., Sunnyvale, Calif. Contract negotiations to select a winner among those deemed technically qualified should begin in February.

**Easier sorting.** The FAA is considering color radar scopes because they would make the controllers' job still easier when the automated alphanumeric tracking system is installed in the terminal and enroute traffic-control systems by 1975, says Ernest N. Storrs, chief of the data display branch. The alphanumeric system basically is black-and-white, he explains, which means it is difficult to pick out a plane from ground or weather clutter—a big problem with radar systems. Also, the alphanumeric tags identifying planes, their altitude, and speed, tend to smear with each sweep.

Adding only one color would do a lot to solve those problems, Storrs says. If more than one color were

added, planes could be colored differently from ground or weather clutter to make them easier to spot, and the alphanumeric tag could change color with each sweep to reduce smear. Moreover, the planes under a controller's surveillance could be color-coded so that a controller could easily keep track of assigned planes. "It's another scheme for filtering information in the busy control room," Storrs says.

The FAA program would test and evaluate the prototype color tube and switching circuits for displays in the enroute and terminal systems, in an oceanic control system for which the specifications are being written now. It is expected to be used to define a military model, as "they're very interested in what we're doing," Storrs says. Program goals are to validate computer instruction requirements, to test controller experience with color, and to determine the life span of a multilayer color tube.

**Moving ahead.** Advances in color phosphor technology make the color concept possible, Storrs says. Using two phosphors with computer-generated radar displays, the FAA can have a long-persistence phosphor for the map and static information and a contrasting short-duration phosphor for the changing information, such as the alphanumeric tags. Colors being considered are yellow with either green or red, and red with either green or orange. "The mixture of the two will give you three," Storrs says. Color TV tubes aren't good enough because they don't have high enough resolution.

Another improvement is in switching technology. "We anticipate voltages for the tubes of between 6 and 15 kilovolts," Storrs says, which means the switches will have to handle from 6 to 12 kV or some other one-to-two proportion up to 15. With tubes of 16, 19, or 21 inches, the range of capacitance can be from 250 to 450 picofarads, he explains. "When you switch at those voltage levels and at that capacity, the switches must handle a lot of power in short periods of time (15-25 microseconds)."

Storrs downplays the number of

---

## Electronics review

---

color displays the FAA may buy eventually by emphasizing that. "We have to see if there are economic benefits and that everyone is satisfied." He also mentions developing modification kits to convert existing displays to color. Even so, he estimates that about 1,000 displays would be candidates for color conversion. The FAA is estimated to have about 4,000 air-traffic-control radar scopes that could be converted to color.

---

### Memories

---

#### Optical disk memory aims at minicomputers

The hot and heavy competition for retail store credit authorization systems has produced a new type of transparent disk memory that is read optically. Moreover, the memory may have applications in minicomputers for simple program updating, process control changes, and other systems requiring inexpensive data access.

A product of New OROM (for optical read-only memory) Inc., San Jose, Calif., the single-disk memory has an access time of 0.2 second. The capacity of the present model is 2 million bits, but an advanced prototype disk with 10-million-bit capacity is being built.

With price to the original equipment manufacturer of well under \$1,000, the disk offers a means of searching a large data file at low cost, according to inventor Thomas D. McLaughlin, general manager of New OROM, which is a subsidiary of Credit Systems Inc. of Colmar, Pa.

"It may be slow in getting there in access time," says McLaughlin, "but when it gets there, it reads data as fast as or faster than magnetic disks, since the entire file can be read in one 0.2-second burst."

**Photo process.** The primary use is for systems requiring many disk files at separate locations. For example, a retail chain store that wants to circulate a file of negative credit accounts would first collect all the information on magnetic tape or disk. Credit Systems would transfer this information to a master disk by high-speed photography. The photographed master would then be used to make acetate disk copies. Placing the data on the disk in a specific pattern allows the information to be read photoelectrically, rather than with a magnetic head.

Each 14-inch acetate disk contains 64 data tracks, two timing tracks, and a once-per-revolution track. A quartz-iodine lamp shines light through a condenser lens system that illuminates an area of the disk. Since the disk is transparent, a relay lens on the opposite side re-images the data pattern onto a photodetector array that is shaped so that only one specific field is intercepted at a time—in the retail store instance, a 16-character credit account. Differential comparators then convert the output of the detector array to compatible digital voltages, though a buffer would be needed for minicomputer interface.

McLaughlin estimates that it would cost a retail store \$25 to prepare the master disk and 35 to 45 cents for each acetate copy. Of the first 15 memory units off the production line next month, 10 will probably go directly into retail use,

and the others will be used to break into the OEM market, which is potentially more lucrative. However, McLaughlin admits that it may be two or three years before OROM will be able to establish a position as an OEM supplier.

---

### Materials

---

#### Potting compounds fail prematurely in aircraft

The Defense Department is going to get stuck with a repair bill of at least \$39 million because of premature failure of potting on electrical connections in 775 of its first-line operational fighters, the McDonnell Douglas F-4 Phantoms. And, according to an investigation by the General Accounting Office, economic watchdog for the Congress, signs of failure by a second sealant used on another 1,575 F-4s could run the tab to nearly \$125 million by 1976 for total replacement.

The Pentagon calls the GAO estimates "much too high" but concedes that there have been problems with potting compounds that have reverted to a liquid state after prolonged exposure to high temperatures and humidity. The DOD also acknowledges that there have been similar reversion problems on connections on some 15 submarines built at Mare Island Naval Shipyard in the five years ended in 1966, as well as some less serious problems on the General Dynamics F-111 interceptor, the B-52 bomber, and Minuteman intercontinental missile.

Despite the split between the GAO and the Pentagon on the severity of

---

**Storekeeper.** OROM components are, left to right, point-of-sale terminals, communications interface, authorization terminal, ROM unit.

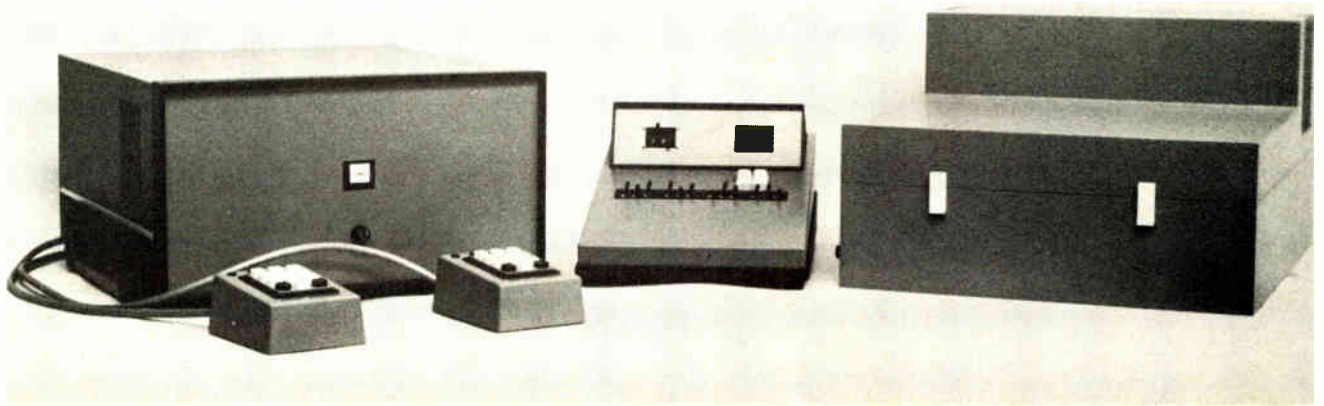



the problem, the Defense Department concurs largely with two recommendations of the civilian investigators. New materials, such as potting compounds, should be tested independently and approved by a military laboratory, GAO adds, and better interservice communication is needed to disseminate reports of deficiencies in materials.

In the case of the F-4, problems arose with a state-of-the-art polyurethane first used in the early 1960s for components to replace reversion-prone polysulfides where temperatures exceeded 200°F. Though the Naval Avionics Facility at Indianapolis—as well as other laboratories—ran a combined high-heat and humidity test in early 1961 that destroyed polyurethane after four days of exposure, the report didn't get outside the facility, and the compound was used in the F-4 for another three and a half years, says the GAO. Then, in August 1964, the report contends, the builder switched to a proprietary compound dubbed EC-2273, described as akin to a polyacrylate. Though the Navy approved, the switch was made on the basis of the manufacturer's recommendations and test data without independent studies.

**Problems end.** EC-2273 was more resistant to humidity than polyurethanes, but the GAO says that the Navy noted the first reversion in March 1967. The use of EC-2273 was discontinued in July 1968, and McDonnell Douglas was asked to use a polysulfide-based compound in low-temperature areas and a silicon-based compound in high-temperature areas. With both compounds conforming to specs, "no serious problems have been encountered," says the report.

It is the EC-2273, says the GAO, that will encounter "general reversion" in the F-4s about 1976, though DOD says it is prepared for this event by replacing it on a "repair-as-required" basis at a far lower cost estimate than the investigators report. But, argues the report, this could result in multiple repairs to the same plane, adding: "Since the major part of the repair cost concerns disassembly and reassembly of

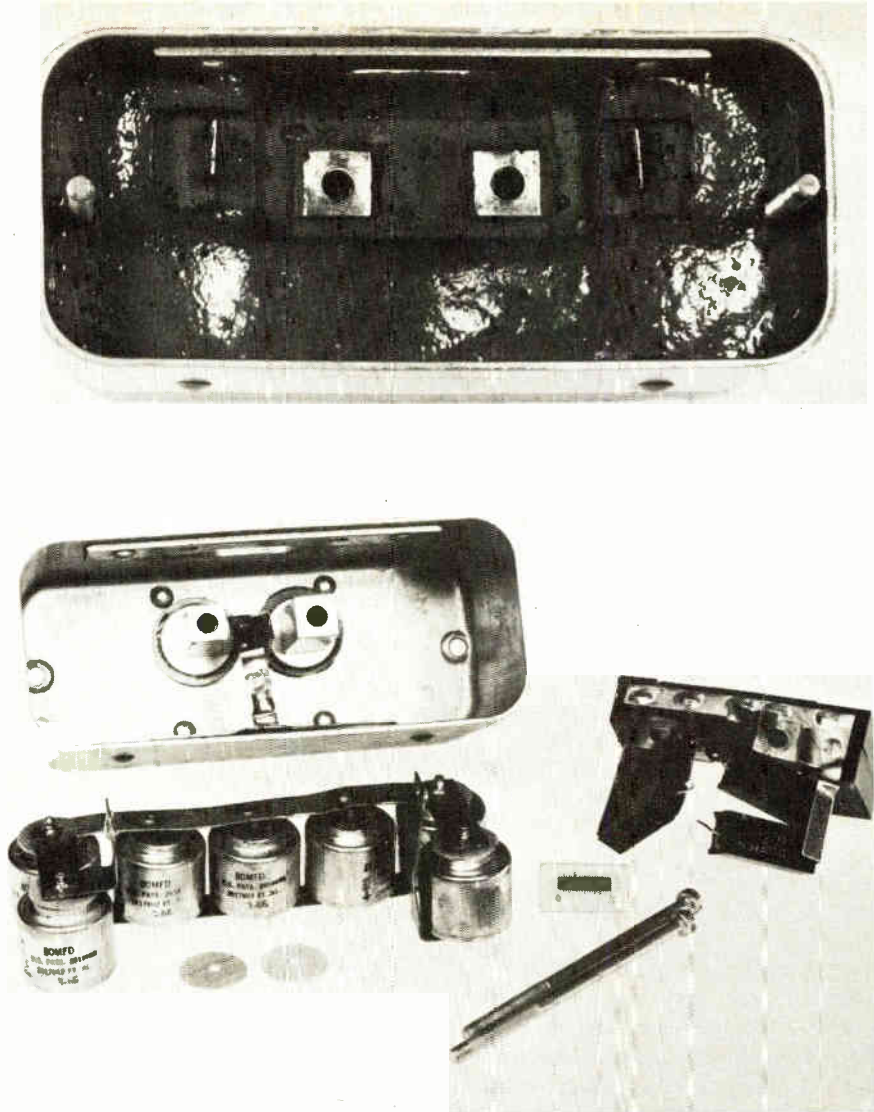

**Before and after.** Top picture shows rf filter from Minuteman missile potted in polyurethane after reversion. Bottom picture shows same component after cleaning by Access process.

the aircraft, it may be more economical to replace all the reversion-prone compound at one time."

As for the submarines, the Defense Department says five have been repaired at an average of 2,500 connectors apiece at a cost of about \$380,000 per boat—a figure that will put total charges in the vicinity of \$6 million, says the Pentagon.

### Process removes potting and saves component

As the Defense Department and General Accounting Office agonize over their failed potting (see story above), at least one connector maker is busily telling the world about a possible way out.

In the words of John Farley, "old connectors don't die; they just get potted once too often." That's the

way Farley, president of Decapsulation Services Inc., Placentia, Calif., highlights the potting problem—a problem that he says he can solve with his process for nondestructively removing potting compound from any electronic assembly at a fraction of the cost of a new assembly. The process, now called Access, was acquired in December by Bunker Ramo Corp.'s Amphenol SAMS division.

Amphenol is keeping details of the process under wraps, but Bennett W. Brachman, SAMS division vice president for marketing, says that Access can remove almost any potting compound—polyurethane, polysulfide, silicone, epoxies, and others, including Union Carbide's parylene. There is no damage to components, wire insulation, or even to the marking on the components, he says.

The problem with potting a con-

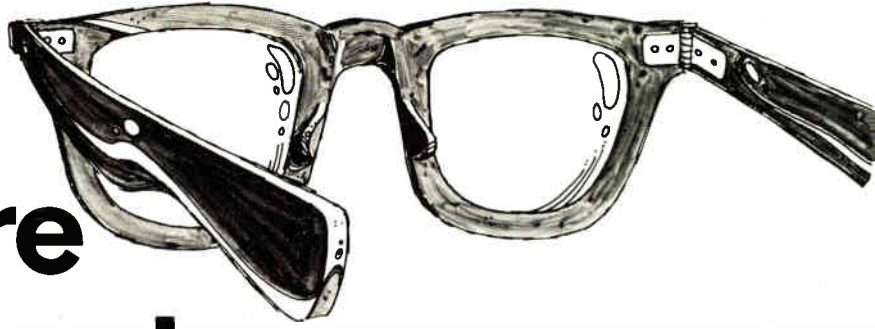

# While you're reading about our new X-band solid-state communications amplifiers, your competitor may be ordering them.

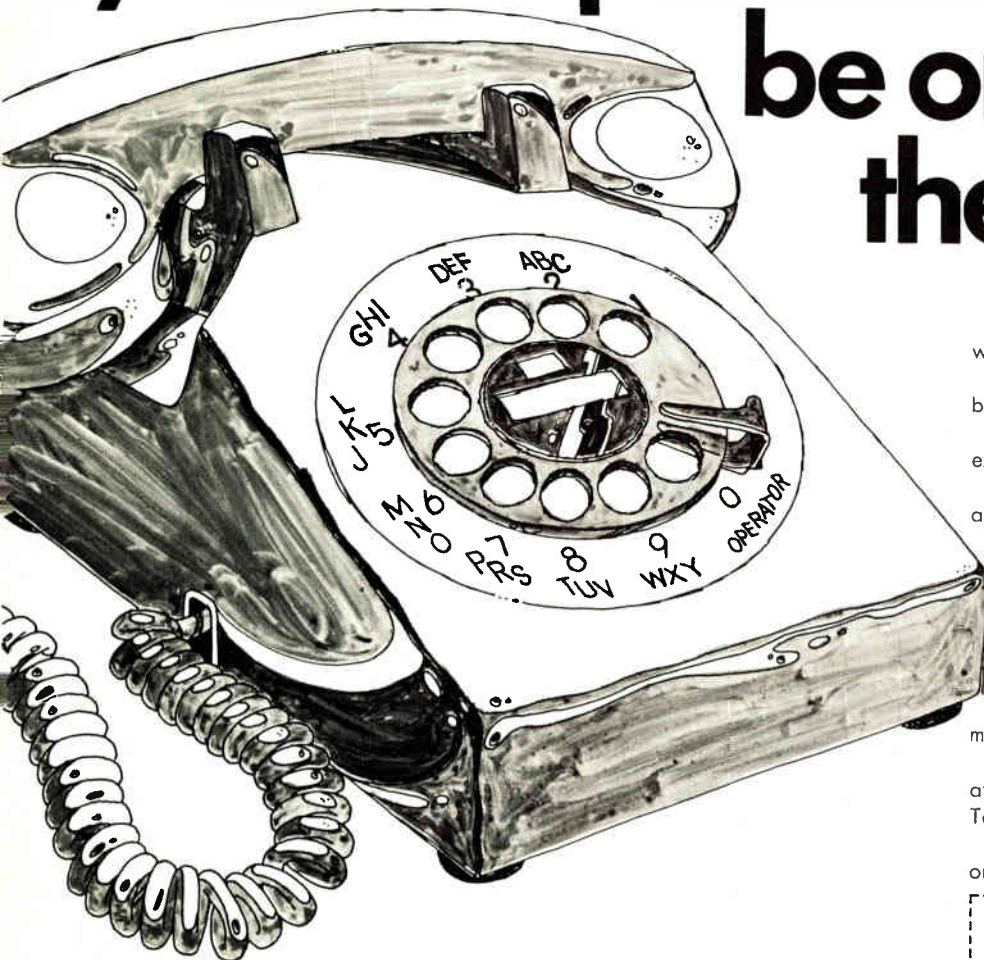

Quick reactions have never hurt anybody. Especially in the microwave amplifier field, where there's a crying need for advanced designs. Because until now, all that's been available has been tubes.

And tubes, you know, can burn out. And they're expensive.

So now, Hughes announces its new solid-state avalanche diode amplifiers.

System-proven in the F-14, F-15, and Phoenix programs.

Superior quality. Low voltage power supply. Less system down time for your customer.

And very, very inexpensive. Right now, we're delivering our solid-state ADAs for 1W systems in C, X, and Ku bands. And for millimeter-wave systems through V-band.

All you have to do is stop reading and write us at: Electron Dynamics Division, 3100 W. Lomita Blvd., Torrance, CA 90509.

Or better still, in case your competition has ordered some, call: (213) 534-2121.

**HUGHES**

HUGHES AIRCRAFT COMPANY  
ELECTRON DYNAMICS DIVISION

Hughes Industrial Electronic Products

## Electronics review

tuning diodes this year—more than any other manufacturer.

The Motorola division makes not only the varactor tuning diodes but also the transistors and switching diodes for tuners. The typical vhf tuner has three transistors, seven switching diodes and possibly an automatic-frequency-control diode, which Motorola also makes. Motorola's tuning diodes cover a vhf range from 54 to 213 megahertz and a uhf range from 470 to 890 MHz.

**Automated.** Besides making all the semiconductor components that go into a varactor tuner, however, Motorola officials are basing their belief that they'll capture a huge chunk of the market on an automated system that matches the varactor diodes. A Control Data Corp. 1700 computer is at the heart of the system, which assures that the diodes are matched to within 1.5% of each other in capacitance at a given voltage.

Whereas other varactor diode suppliers may offer four matched diodes in a bag, Motorola is offering hundreds or thousands. If a lead breaks on one, the four-diode set doesn't have to be discarded; there are hundreds more—all matched to each other by computer selection. That kind of volume is also the key to Markle's conviction that Motorola can sell the diodes at reasonable prices to trigger volume usage.

## Commercial electronics

Supermarket coding gets closer to checkout

Automated point-of-sale control of supermarket products moved a step closer to reality this month when Distribution Number Bank Inc., Washington, D.C., was signed up by a grocery industry group to begin promulgating the 10-digit product identification code established last summer.

The group, Uniform Grocery Products Code Council, authorized DNB to begin contacting some 5,000 manufacturers, wholesalers, and retailers that make and/or package

items sold in supermarkets. These companies will be asked to join the council, a membership corporation. Each member will receive a five-digit identification number and begin marking products with its identification number and a second five-digit code—five for source and five for item.

Meanwhile, companies manufacturing coding and reading equipment have begun trials of tag-reading hardware. Two or more new test systems are expected to be announced soon to join trials being conducted by RCA with Kroger and Swiss manufacturer Zellweger with Stop and Shop stores. According to management consultant McKinsey & Co., there are 13 companies potentially ready to supply terminals and other equipment for supermarket automation.

Their success will depend on the standard machine-readable code technique chosen by the supermarketeters at the end of the trials. This selection is not expected until March 1973.

## For the record

**Job shopping.** Standard Kollsman Components, a division of Standard Kollsman Industries, Melrose Park, Ill., has opened five plants in Mexico. In addition to assembling its own TV tuners, the firm says it will put together anything for anyone.

Says Kollsman marketing manager Jim Marx, "We don't want to be dependent on the ups and downs of the TV industry. We want to diversify and become a job shop, as well."

**Freer trade.** Calling for an end to the "imbalance" between Japanese and U.S. duties and restrictions on trade that favor Japan, executives from five major American manufacturers have organized the Electronic Industry Committee for Fair International Trade. The founders are Corning Glass Works, Zenith Radio Corp., the Magnavox Co., GTE Sylvania Inc., and Stackpole Carbon Co. The chairman is Robert D. Murphy, honorary chairman of Corning International Co.

# Hughes is more than electronic equipment and systems.

## It's components, too.



Microwave diodes (RS 220)



Bipolar and hybrid circuits (RS 221) and MOS integrated circuits (RS 222)



Electrical connectors (RS 223)

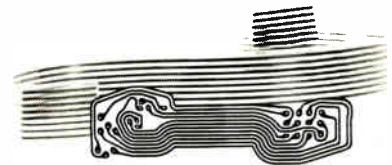

Flat flexible cable and circuit assemblies (RS 224)

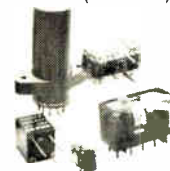

Special assemblies (RS 225)



Direct view and scan converter storage tubes (RS 226)

For complete information, write Bldg. 100, Mail Station C-512, Culver City, CA 90230. Or request by Reader Service (RS) numbers.

**HUGHES**  
HUGHES AIRCRAFT COMPANY

Industrial Electronic Products

# THE WORLD'S FIRST GIRL MINICOMPUTER. SUE.

Here is SUE. The Systems User Engineered minicomputer. We have big plans for SUE. She's going to break the hearts of competitive minicomputer sales types.

She's flexible, responsive, adaptable and nearly ageless. SUE has micro-modularity. All modules...processor cards, memory cards, device controller cards, or whatever...simply attach to the Inifibus of a 24-card frame. SUE can meet your systems needs exactly. You never pay for more than you want or have to take less than you need. If your system requirements change, so does SUE. For example, a switch from core memory

to semiconductor memory, or a mix of both, requires only a card change. Now that's flexibility. And responsiveness.

Speed? SUE has a 5-megacycle bandwidth and inherent direct memory access with submicrosecond memories.

The price is equally exciting. A complete 4 K computer for only \$4,295, dropping to less than \$2,600 a unit for 100. That's neither the least nor most expensive version of SUE.

For more information on SUE, ring us up or drop us a line. Call or write: (213) 722-6810...6201  
E. Randolph St., Los Angeles,  
California 90040

**Lockheed Electronics**  
Data Products Division, A Subsidiary  
of Lockheed Aircraft Corporation

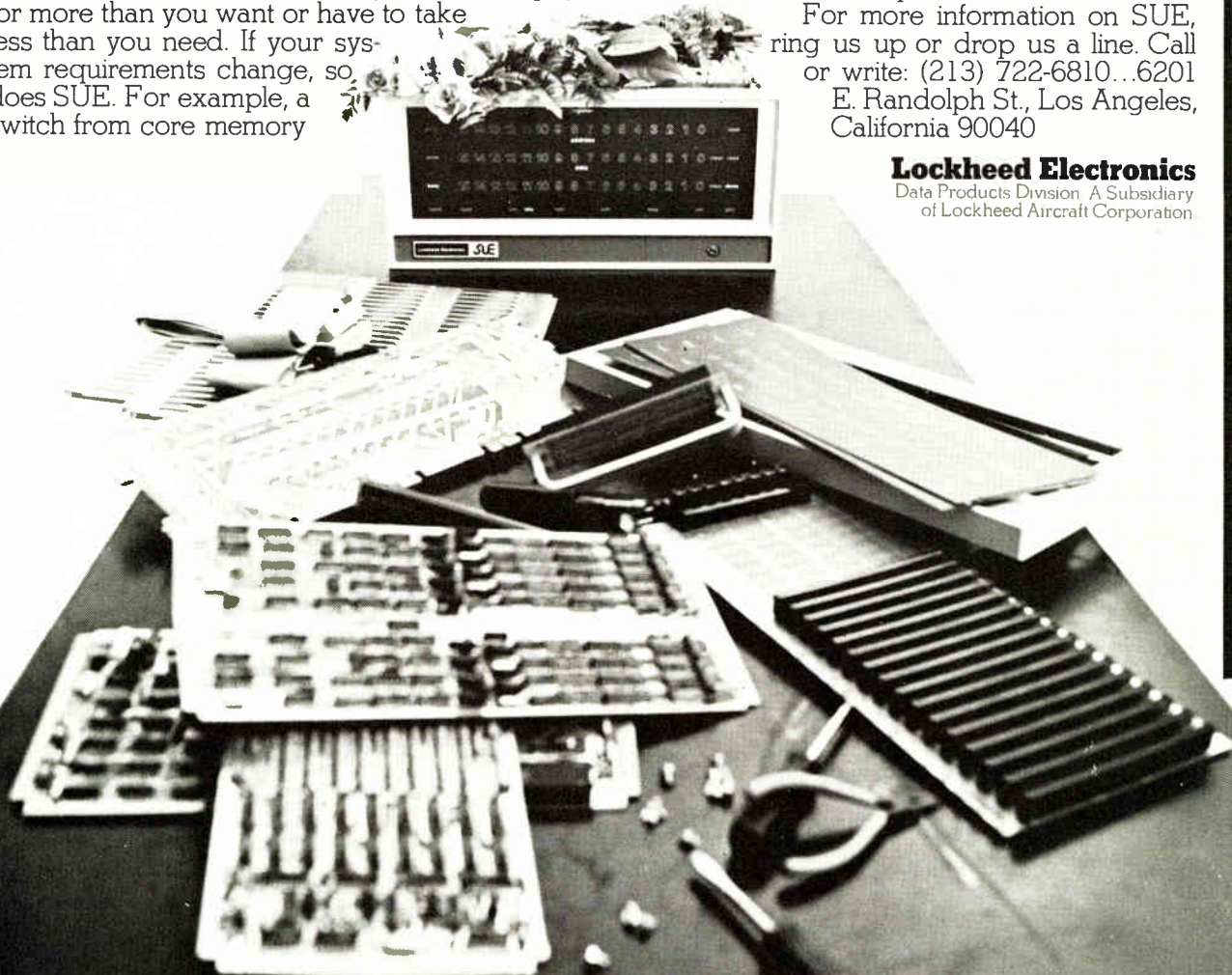

---

# Washington Newsletter

---

January 31, 1972

## **New DOD leaders: Rush, Schlesinger?**

Top candidate for successor to Secretary of Defense Melvin Laird, following his expected resignation later this year, is former Union Carbide chief executive Kenneth Rush. The U.S. ambassador to West Germany, Rush is the President's nominee to succeed David Packard as deputy secretary. But that leaves the question of who would succeed Rush in the Pentagon's No. 2 slot, if he moves up to Laird's job. Sources inside and outside the Administration give first rank to tough-minded Atomic Energy Commission Chairman James R. Schlesinger.

The former Rand Corp. director of strategic studies, Schlesinger is "very much in the David Packard mold without the rough edges," says one Pentagon insider, "and the Administration and Congress liked Packard's way of doing things." Schlesinger would very much like the Pentagon slot, say sources at the AEC, where he is described as one who "does his homework, has opinions of his own, and is forceful in implementing them."

## **Satcom terminal for Nixon China visit to turn on soon**

The first satellite communications between the U.S. and the Peoples Republic of China, in preparation for President Nixon's trip next month, will come "between 14 and 48 hours" after the Feb. 1 arrival of the 24-foot transportable earth station at Peking Airport, according to Louis Greenbaum of Hughes Aircraft. The 60-channel full-duplexed terminal, now leased to Western Union International, was put together by Greenbaum. He heads a team of Hughes technicians that will set up the terminal with WUI personnel and "our opposite numbers from the Peking Long Distance Administration for Telecommunications."

The station will be hard-wired into the Chinese telephone system at the airport and sent to the system's uplink with either an Intelsat 3 or Intelsat 4 satellite for transmission to Communications Satellite Corp.'s 97-foot antenna at Jamesburg, Calif. Color television, voice, and teleprinter signals will be retransmitted over telephone lines to New York.

The terminal, upgraded from 24 channels since its last use in Iran for coverage of the nation's 2,500th anniversary last year, will be transported with a virtually complete set of spare parts on a stretched C-130 transport by Saturn Airways. While Hughes and WUI officials put down speculation that the terminal could be left in China after the visit, Greenbaum said Hughes "would be delighted to build one for them if anybody asks."

## **Lockheed, Univac vie for FAA automated radar**

Industry observers see the opening of a potential domestic market of \$30 million—and up to \$400 million in foreign sales—with the expected award by the Federal Aviation Administration for an engineering model of an automated radar beacon system for medium- and small-traffic airports. Although designed for the smaller U.S. airports that have radar beacons, the automated alphanumeric system has great appeal abroad, where there are many such airports.

The FAA soon will begin bargaining with the two contenders—Lockheed Electronics and the Univac Defense Systems division of Sperry Rand. It plans to announce the winner in March. Lockheed proposes using its MAC-16 minicomputer with an ITT display for its system. Univac's prototype uses its 1616 minicomputer with Burroughs data acquisition and Texas Instruments displays. Initially, the winning prototype will be operationally tested at Wilkes-Barre-Scranton, Pa., airport for six months. If the FAA decides to go ahead, it could buy up to about 200 systems over 10 years.

---

# Washington Commentary

---

**Nixon's "initiatives"  
look good for  
electronics . . .**

*"In reaching the moon, we saw what miracles American technology is capable of achieving. Now the time has come to move more deliberately toward making full use of that technology here on earth, in harnessing the wonders of science to the service of man."*—Richard Nixon, State of the Union Address, Jan. 20, 1972.

When the President formally declared his plans for "a new program of Federal partnership in technological research and development," he was only making public what has been an open secret in the capital for months. **The Administration wants to spur new applications of technology throughout American industry to enhance its declining competitive stature in world markets** [*Electronics*, Sept. 27, 1971, p. 33]. At the same time, the President expects to generate more jobs within the country's hard-hit engineering communities—**aerospace and electronics in particular**—that will help ensure his reelection in November. As one old Government engineering hand puts it: "A happy worker is a happy voter—and happy voters don't vote for change."

What the President is laying before Congress is the New Technology Opportunities Program that his assistant for technology, William Magruder, former manager of the supersonic transport project, has been putting together. Though the Magruder team considered some 400 ideas drawn from virtually every Federal agency for NTOP, it has turned aside many so-called "soft science" projects—in areas such as health care and education concepts. **They opted instead for projects heavy in hardware—like mass transit—that call for high job levels and spending over a comparatively short span.** The President's stated goal for all of this is "full employment in peacetime with . . . more imaginative use of America's great capacity for technological advance."

Yet in moving to guarantee his own job for another four years, the President is giving himself more options than the Magruder plan to cope with what is clearly a hostile Congress [see budget story on page 75]. **He has called for significant increases in defense spending, R&D included, as well as in other technology-oriented areas such as law enforcement.** Then, too, there is NASA's proposed start on the space shuttle—a less controversial program than the SST and one that may very well make it through the Congressional maze.

**. . . but they revive  
basic questions  
of Federal support**

All in all, the fiscal 1973 Nixon program should restore a semblance of a smile to faces of managers and engineers in the electronics community. And, at first glance, it has. Nevertheless, there are lingering suspicions that merely pouring more Federal money in to prime the technological pump may not be the best long term solution—even though that pump badly needs priming.

"What is the Government doing to us?" asks one Washington-based industry executive. Shifting Government spending is unquestionably the quickest way to turn industries like electronics around from a wartime to a peacetime economy, he concedes. "But even though it comes from a different pocket, it is still Federal money. In my book, the best 'initiatives' and the best products are the ones that come when you have to spend your own money. I really wonder if the quickest way is always the best way for us, the country."

Is there an alternative? A growing number of industrial leaders and legislators say there is. They see distinct advantages in finding new incentives—**such as accelerated tax credits for independent R&D investment**—as a step toward restoring management that is independent of government. Cynical students of economics and government say there is not, that questions of direct Federal support for technology were resolved 25 years ago. **Yet industry leaders, chagrined at the increasing number of Federally sponsored technological efforts marred by escalating prices and poor performance, are asking these questions again.**

—Ray Connolly

# AMS

of the semiconductor  
memory systems built  
and operating today use the  
AMS 6002 MOS RAM.

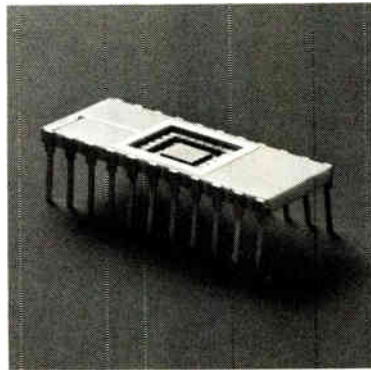

The AMS 6002 MOS RAM has already established more than 16 million hours of field performance in more than 40 installations. Six months after its introduction, the 6002 is still the fastest 1024-bit RAM available with 150 nanosecond access and 250 nanosecond cycle times. It is the only MOS RAM that utilizes field-proven P-channel processing *and* a ceramic package.

That's why most of the systems out there today use the 6002. Shouldn't you?

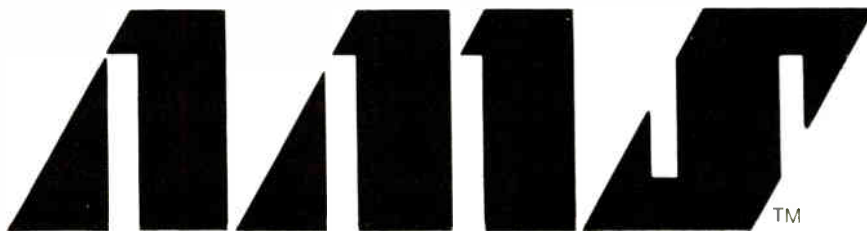

**Advanced Memory Systems, 1276 Hammerwood Avenue, Sunnyvale, Ca 94086 (408) 734-4330**

Powell/Philadelphia  
S. Island Road/Box 8765  
Philadelphia, Pa. 19101  
(215) 724-1900

Powell/Washington  
10728 Hanna Street  
Beltsville, Md. 20705  
(301) 474-1030

Powell/Huntsville  
Box 488, Fayetteville  
Tenn. 37334  
(615) 433-5737

Powell/Florida  
2049 W. Central Blvd.  
Orlando, Fla. 32814  
(305) 423-8586

Powell/California  
411 Fairchild Dr./Box 997  
Mountain View, Ca. 94040  
(415) 964-0820

Powell/California  
Southern California  
(213) 988-3330  
(213) 873 6431

Apollo Electronics, Inc.  
101 Binney Street  
Cambridge, Mass. 02115  
(617) 868-3120

# COMPLETE 3-TERMINAL IC VOLTAGE REGULATORS





## **New 7800 family: first with complete voltage regulation on a single chip.**

Now you can virtually forget about your VR design problems and get on with the rest of your system. Our new 7800 series is the first high quality, sophisticated, versatile, yet simple way of regulating voltage. At a price low enough to inventory in quantity, so you can use them as you need them.

Here's why:

**Simple to use:** Complete and self-contained—one chip in one plastic package. Connect 3 terminals, bolt in place and add the normal line decoupling capacitor. Requires no other external components. You get optimum performance with no calculations.

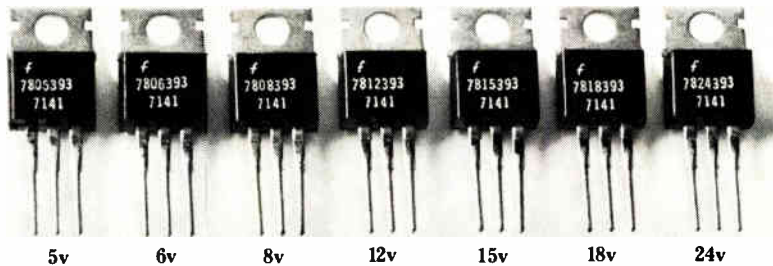

**Superior Performance:** Output voltage tolerance better than  $\pm 5\%$ ; line regulation of 0.01%/volt; output impedance of  $0.03\Omega$ . Output current rated at 1 Amp (usable to 1.5 Amps depending on input voltage and heat sinking considerations).

**Self-Protecting:** Internal current limiting, thermal shut-down and safe area compensation protect device and circuit from current, power, temperature fluctuations. Resets automatically.

**Versatile & Compact:** Use locally...at the power source, on a remote chassis, on PC cards, wherever is most convenient and efficient. Compact; you can miniaturize your design. Result: simpler, smaller, cheaper, easier-to-use power supply and circuitry.

**Low Cost:** 1-24@\$2.20. 25-99@\$2.00. 100-999@\$1.75! (About 1/2 the cost of the elements required in a commonly accepted voltage regulator—and virtually no design cost.)

**Available:** In quantity, from distributor or factory stock. TO-220 package now; TO-3 in first quarter of 1972. There are 7 versions (last 2 digits indicate voltage): 7805, 7806, 7808, 7812, 7815, 7818, 7824.

Write for Data Sheets and application information.

**MADE IN  
FAIRCHILD**

# NOW YOUR MOS/LSI BUILDING BLOCKS CAN LAST FOR GENERATIONS.

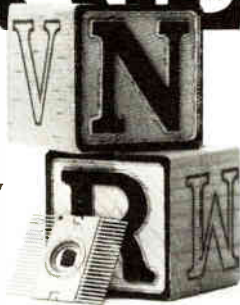

When you know about our advances in the state of the art, you're able to get a continuing return on your design investment in our MOS/LSI electronics.

Over and over again.

Since MOS/LSI circuits embrace so many functions, it's just good business to think of using them in different systems. And, with our unique custom-layout computer-aided design, we give those circuits versatile building-block capabilities.

In a single basic design, for instance, we provide MOS/LSI building blocks for several model generations of calculators, accounting machines, cash registers, appliance timers, automotive controls, or for modem and multiplexing subsystems of data transmission and telecommunication equipment.

## **MOS/LSI beats the high cost of product development.**

Our MOS/LSI building-block circuits can be adapted quickly and inexpensively for use in a succession of different models. You can produce a new model before your salesmen can say "competition"—and go to Petty Cash instead of your Board of Directors to finance the changes.

We can even make it possible to produce a number of different

models of a machine from exactly the same circuits. Wiring changes, that's all. And, of course, circuit costs drop. Because you buy in

quantity for a number of models, instead of buying a few circuits for each model.

## **Lower costs elsewhere, too.**

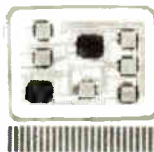

Mastery of MOS/LSI design and of high-volume production has enabled us to produce commercial electronic systems at an all-time low cost. As much as 50% the cost of conventional systems—electromechanical or electronic.

And, our MOS/LSI systems can be packaged so that non-electronic manufacturers can assemble them into their equipment without teaching employees new trades.

For many of the functions performed today by little black boxes selling for around \$20,000, you can buy our MOS/LSI digital filter circuits (in

small quantities) and fabricate a plug-in digital filter for less than \$1,000. Or, you can buy our MOS/LSI modem circuits and save substantially.

We've MOS/LSI memory systems and circuits that cost less per bit than conventional devices—and we're ready with other processes, too. For example, silicon-on-sapphire (SOS) diode arrays that make beautiful ROMs (3,000-plus bits) with 20 ns maximum access times. Within 24 hours we'll custom encode them with our special laser and sell them to you one by one for \$64. Less, much less, in quantity of course.

## **Collaboration made easy.**

As part of NR's Electronics Group, we're ready to share with you the long-term commitment required for new product design, testing and development.

Even more.

We'll join you in product planning, so that you may share in the progress of current research.

Drop us a line on your company letterhead for a copy of our new brochure, "The Economics of Change!"

Write A.B. Chambers, P.O. Box 3669, Anaheim, California 92803.

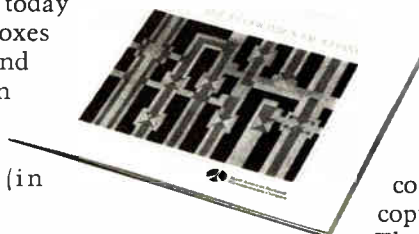

**North American Rockwell  
Microelectronics Company**

# Technical articles

---

## **Using monolithic crystal filters in communications systems: p. 48**

The big advantage of going to monolithic crystal filters is that they can cover bandwidths as broad as several tenths of a percent without the use of inductors. While many monolithic filters are still made to custom order, standard models are now available, which reduces cost. If costs come down even more, their use at intermediate frequencies of 30 MHz and above can be expected.

The cover: Mobile communications systems are becoming even more mobile with monolithic crystal filters, like the 10.7-MHz unit from Piezo Technology, Inc.

## **Rotating rings may run circles around other displays: p. 52**

There's yet another entry in the information display sweepstakes. Its single moving part—a rotating ring—makes it far simpler than most electromechanical displays, and a series of rings can be ganged together for multichannel displays. It is adaptable to both digital and analog outputs. And its pulsed drive consumes power only while the ring is actually moving. Given the same mechanical tolerances as in mechanical watches, say, power consumption would be only one-tenth that of today's electronic watches.

## **3-d interconnection scheme puts devices inside the wiring: p. 62**

There's been such progress in cutting the costs of ICs that, on a per-terminal basis, it costs more to interconnect them than to make them. One answer is to up component density with a three-dimensional wiring system. And one answer to the limits of standard 3-d approaches is to use interconnection wafers, which allow devices to be placed inside a multilevel wiring stack, not just on the surfaces of the layers. A bonus is flexibility; the stack can be taken apart and rearranged.

## **P/MOS and liquid crystals team up for digital clocks: p. 66**

It seems like a natural. Metal oxide semiconductor integrated circuits promise to be a low cost replacement for electromechanical clockworks. Liquid crystals look good as a quiet, solid state display. But there are still a lot of problems in putting them together into a challenger to the proven digital alarm clocks. But a team from American Micro-systems Inc. has built one to show that such an alarm clock is a cost-effective competitor.

## **How to approximate a true log output at high frequencies: p. 70**

When a circuit design analysis calls for displaying signals over a very wide dynamic range, some form of compression has to be used to show even a portion of the range. Converting the signal to a logarithmic function of the signal is the common approach. Even the most sophisticated of the standard compression methods—successive limiting—has drawbacks. A new approximation route, says author Douglas Clifford, eliminates interstage phase shift by using twin-gate amplifier blocks to build the log curve from a series of straight lines.

## **And in the next issue . . .**

Optoelectronics: where it's going . . . bipolar technology steps ahead . . . doubling op amp summing power . . . simplified transistor testing.

# Communications systems benefit from monolithic crystal filters

Bandwidths to several tenths of a percent at frequencies above 5 MHz are achieved without inductors, providing lower cost, smaller size, and performance advantages over discrete-element crystal filters

by Robert C. Smythe, *Piezo Technology Inc., Orlando, Fla.*

□ At first limited to replacing conventional discrete-element crystal filters in existing equipment design, the monolithic crystal filter is now finding applications in a new generation of solid-state communications systems, where its lower cost, smaller size, and performance advantages can be fully realized. Typical equipment using monolithic filters are hand-held very high frequency and ultra high frequency two-way radios, paging receivers, and land and marine mobile radios.

Telephone-frequency multiplex equipment, which for many years has used crystal filters in the 60–108-kilohertz range, is beginning to be replaced by an 8-megahertz system using monolithic crystal channel filters. Also, vhf monolithic crystal filters are being used in hf receivers that use front-end up-conversion.

In the past, conventional crystal filters have been, with few exceptions, custom made. While many monolithic crystal filters are being made to custom specifications, the use of standard models is becoming increasingly common to reduce cost. For narrowband frequency modulation applications, a large variety of standard models are available at 10.7 MHz and 21.4 MHz. There is also considerable market interest in yet higher intermediate frequencies for these applications. If current costs can be brought down, intermediate frequencies of 30 MHz and above are expected to come into use. Table 1 compares parameters of monolithic and discrete element crystal filters.

## No inductors required

The main advantage of monolithic crystal filters is that they can achieve bandwidths as broad as several tenths of a percent without the use of inductors. A few

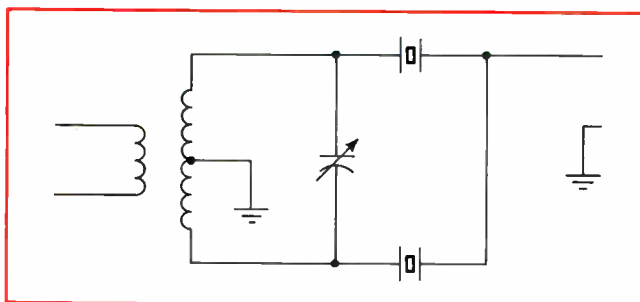

1. **The old way.** The conventional crystal filter section comprises one or more half-lattice sections coupled by a balanced transformer. The design requires bulky circuit elements, which increase costs.

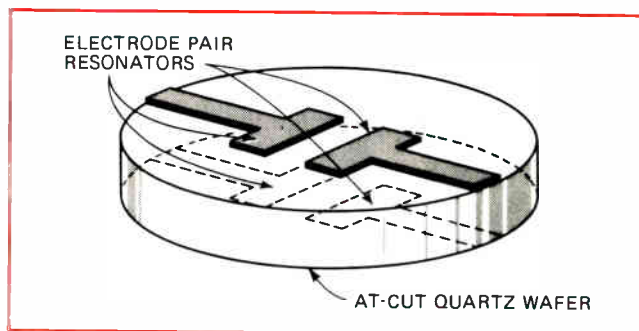

2. **Building blocks.** In its simplest form, the monolithic crystal filter consists of an input and an output resonator, each formed by a pair of thin-film electrodes deposited on opposite sides of a piezoelectric wafer. Rectangular electrodes are shown, but circular and semi-circular electrodes also may be used. Often, the electrodes on the grounded side of the plate are electrically joined.

very narrow bandwidth conventional crystal filters are made without coils. But a typical discrete resonator crystal filter consists of one or more half-lattice sections using balanced transformers (Fig. 1).

It has been known for many years that by dividing the electrodes of a thickness-shear-mode crystal resonator into two electrode pairs, it is possible to form a two-pole bandpass filter. Unfortunately, since the device was not well understood, it was seldom used. Then about 1965, Sykes<sup>1,2</sup> and his co-workers at Bell Telephone Laboratories and Onoe<sup>3,4</sup> and his colleagues in Japan independently recognized that the divided-electrode filter was basically two acoustically coupled resonators. The recognition of this acoustic coupling mechanism led to the development of multiresonator monolithic structures. Multiresonator filters with as many as eight electrode pairs on a single substrate have since undergone intensive development at frequencies from below 5 MHz to above 350 MHz.

In its simplest form, the monolithic crystal filter comprises an input and an output resonator—each formed by a pair of thin film electrodes deposited on opposite sides of a piezoelectric plate—usually an AT-cut quartz wafer (Fig. 2). The electrodes are typically thin films of aluminum, silver, or gold, deposited with carefully controlled thickness. Additional electrode pairs are often added to the same quartz substrate to obtain greater selectivity, but practical fabricating techniques now limit the number of resonators to about four.

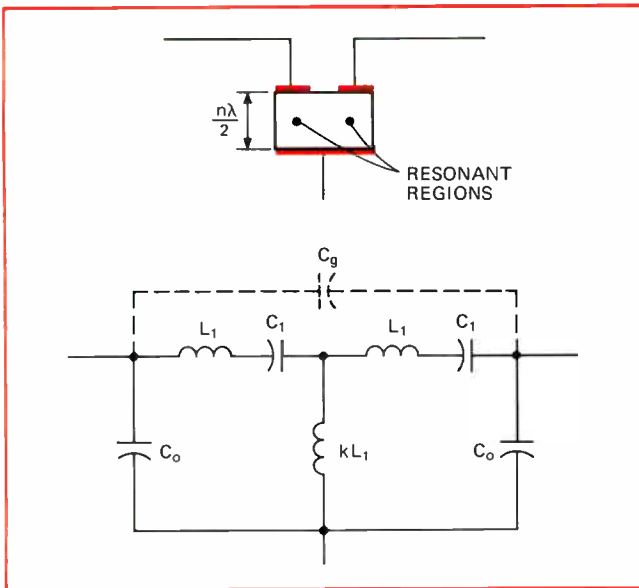

**3. LC equivalent.** The approximate equivalent circuit for a two-resonator monolithic crystal filter divides series capacitance and inductance between the input and output network loops. The thickness of the piezoelectric material is  $n\lambda/2$ , where  $\lambda$  is the operating wavelength and  $n$  is an odd integer.  $C_g$ , the gap capacitance between leads, often limits stop-band attenuation.

The two-resonator monolithic crystal filter shown in Fig. 2 can be considered the acoustic analog of a parallel-plate waveguide with a cutoff frequency inversely proportional to its thickness. Regions of lower cutoff frequency are formed between electrodes on each side of the wafer.

### Basic operation

By properly dimensioning the surface area of the electrodes, a single resonant frequency can be produced. Two resonators placed close together will be acoustically coupled. Input and output electro-acoustical transducer action is provided by piezoelectric effects.

An approximate equivalent circuit of the two-resonator structure (Fig. 3) shows the monolithic filter in the more conventional lumped-constant form. The inter-

resonator coupling is represented by inductance  $kL_1$ , whereas  $L_1$  and  $C_1$  determine the fundamental operating frequency of the filter. A static parasitic capacitance,  $C_o$  exists between the top and bottom electrodes of each resonator.

When possible, the monolithic crystal filter is operated at its fundamental resonant frequency, which is determined by the thickness of the wafer. To excite the fundamental frequency, the wafer thickness is approximately one-half of the acoustic wavelength. A quartz crystal has a practical limit of about 35 MHz. To operate above this frequency, the wafer thickness is adjusted to the proper number of odd half-wavelengths to resonate at the desired overtone frequency.

Parasitic capacitance limits the maximum realizable filter bandwidth. The input-to-output capacitance,  $C_g$ , which exists between electrodes of adjacent resonators, often limits the stop-band attenuation.

As more resonators are added to the monolithic structure, the equivalent circuit is expanded into a ladder

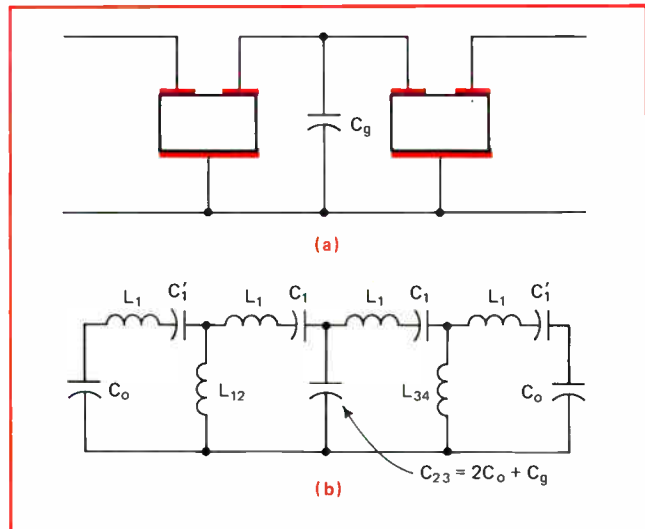

**4. Tandem monolithics.** Two two-pole units connected in tandem yield a four-pole response while reducing manufacturing problems to those of a two-resonator device.  $C_g$  is the capacitance between the common line connecting the two-pole units and ground.

## MONOLITHIC CRYSTAL FILTERS COMPARED WITH CONVENTIONAL DISCRETE ELEMENT TYPES

Configuration	Number of Resonators	Maximum Inductorless Bandwidth <sup>1</sup>	Center Frequency (MHz)	Number of Major Electrical Components		Production cost Per Resonator (\$)
				4-Pole	8-Pole	
<b>Monolithic</b>						
Single-Section	2 - 4	N/A	5 - 350	1	N/A	1 - 10
Two-Section (Acoustically isolated on same wafer)	4	0.4%	20 - 90	1	N/A	3 - 6
<b>Tandem Monolithic</b>	4 - 10	2 - 0.3% <sup>2</sup>	5 - 175	2 - 3	4 - 7	1.25+
<b>Discrete-Element</b>						
Tandem Half-Lattice (Fig. 1)	1 - 12 <sup>3</sup>	Inductors required	0.01 - 175	6 - 9	12 - 18	1.50+
Crystal-Capacitor Ladder	1 - 12	0.05 - 0.1%	2 - 35	8 Typical	16 Typical	1.50+

Notes: 1. 3dB bandwidth expressed as a percentage of center frequency. Applies to fundamental-mode filters only. Inductive terminations may be required in some instances.  
 2. Based on individually packaged monolithic sections.  
 3. Some high-performance single-sideband filters use as many as 30 resonators.

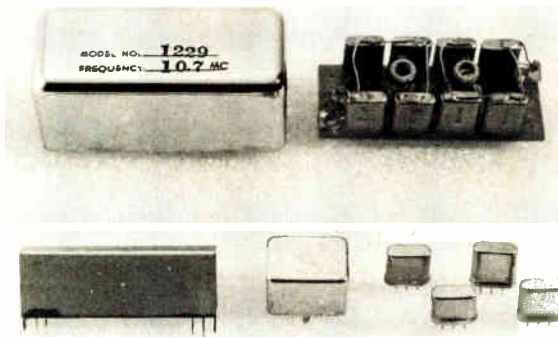

**5. Getting smaller.** The eight-pole, 10.7-MHz discrete-element filter (top, both with and without cover) now can be replaced by smaller monolithic filters. The four two-pole sections (bottom right) are packaged in two configurations (bottom left and bottom center) to give the equivalent eight-pole response.

network. This multiresonator monolithic filter, while elegant in concept, has its share of manufacturing and calibration problems. For example, shaping the passband of an  $n$ -resonator device requires  $2n - 1$  parameters ( $n$  resonator frequencies and  $n - 1$  coupling coefficients). Meeting this requirement, although relatively straightforward for  $n = 2$ , becomes more difficult as the number of resonators increases. One way to achieve greater selectivity without the calibration problems inherent with multiresonator wafers is to connect two or more monolithic devices in tandem (Fig. 4).

The tandem monolithic configuration has another advantage: it enhances the stop-band attenuation by minimizing the affect of unwanted modes. In addition to the desired acoustic path directly along the resonator array in a multiple-resonator filter, there exists a number of indirect paths from input to output, producing spurious responses and degrading the stop-band performance of the filter.

In a tandem filter, the spurious responses of the different monolithic sections may be made to occur at different frequencies and may be thereby largely attenuated. Moreover, electrostatic shielding between input and output can be increased greatly over that of a monolithic device. Generally, each monolithic filter section is packaged in its own holder—usually a modification of a standard crystal can (Fig. 5).

Yet another configuration offers the best of both worlds. The four-resonator two-section monolithic filter combines the lower cost and smaller size of monolithic filters with the performance advantages of sectionalization.

The filter consists of two two-resonator sections connected in tandem on a single plate. The first and second resonators are acoustically coupled; the second and third are acoustically isolated, but electrically coupled; and the third and fourth are again acoustically coupled. The attenuation and selectivity of a 75-MHz third-overtone filter in the two-section, four-resonator configuration, are shown in Fig. 6.

Both minimum and maximum bandwidths can be calculated readily for monolithic crystal filters. The minimum bandwidth is determined primarily by  $Q$  limitations. Normalized to center frequency, minimum

## Specifying monolithics

To keep costs down, it is imperative not to overspecify filter requirements. However, certain minimum standards must be set. The following steps should help formulate practical parameters.

- **Selectivity.** Typically, the passband is determined by the signal information bandwidth, plus system frequency uncertainties. The stop-band boundaries depend on the frequency and strength of unwanted signals (e.g., adjacent and alternate channel signals); double-sided boundaries should be avoided.

- **Center frequency.** In addition to such usual system considerations as image rejection, the inductorless bandwidth limitations should be kept in mind. A good rule of thumb when using an inductorless filter in the 5–35-MHz range is that the 6-dB bandwidth should be less than 0.3% of center frequency.

- **Special requirements.** Define any potentially critical requirements. For example, if unusually high or low power levels are expected, be sure to require that the other parameters be tested at these power levels.

- **Terminating impedances.** If possible, specify the filter's natural impedance as the terminating impedance. External matching usually costs less than building matching networks into the filter. Typically, the natural terminating impedance is:

$$Z = RN^3 (BW/f_0)^2 \Omega,$$

where  $R$  is 1,000 to 2,000,  $N$  is the overtone order,  $BW$  is the 3-dB bandwidth in kHz, and  $f_0$  is the center frequency in MHz.

- **Packaging.** State general requirements, but avoid custom-designed packages, if possible. Keep the number of dimensional tolerances to a minimum.

- **Environment.** State the operating and non-operating environmental requirements.

For an example, consider a monolithic crystal filter that will be used in the 11.5-MHz i-f strips of land mobile narrow-band fm receivers. These receivers operate in the 140–170-MHz band with 30-kHz channel spacings. A specification for this filter might be:

Nominal center frequency, $f_0$	11.5 MHz
Attenuation boundaries	
Passband ( $f_0 \pm 7$ kHz)	6 dB max
Stopband beyond $f_0 \pm 25$ kHz	80 dB min
From $f_0 \pm 60$ kHz to $f_0 \pm 5$ MHz	100 dB min
Insertion flat loss	4 dB max
Passband ripple	2 dB max
Terminating impedance	
(natural filter impedance)	$3k\Omega \pm 10\%$
Operating temperature	$-30^\circ\text{C}$ to $+80^\circ\text{C}$

bandwidth may be expressed approximately as:

$$\frac{BW_{\min}}{f_0} = \frac{6n}{QL}$$

where  $f_0$  is the center operating frequency,  $n$  is the number of resonators with quality factor  $Q$ , and  $L$  is the insertion flat loss (minimum value of insertion loss over the passband) of the filter in decibels. For monolithic filters,  $Q$ s from 25,000 to 100,000 are typical over a fairly wide range of frequencies. The intrinsic  $Q$  of quartz ( $1.6 \times 10^7$  divided by the operating frequency measured in MHz) is approached only in very special cases.

The maximum bandwidth obtainable in a monolithic crystal filter is limited by several barriers. For pure resistive terminations, the approximate normalized maximum bandwidth limit is:

$$\frac{BW_{\max}}{f_0} = 0.0035/N^2$$

where  $N$  is the overtone order. Parasitic capacitance (including case capacitance) must be carefully controlled, however, if this limit is to be approached.

Inductive terminations can increase the filter's bandwidth by tuning out static capacitance. The use of this method can often double bandwidth to about 0.7% of the center frequency when operating in the fundamental mode.

For wider bandwidths, it is necessary to use the terminating inductances as resonators. This wideband design is of limited usefulness in the fundamental frequency mode, where the design can achieve bandwidths from about 0.8% to 2.5% of center frequency.

For tandem monolithics, a second limitation is imposed by junction capacitance—resonator static capacitance plus case and stray capacitance at each junction between monolithic sections. The maximum inductorless bandwidth for typical values of stray capacitance are plotted in Fig. 7. In the absence of parasitics, bandwidth is limited to  $0.0051 f_0/N^2$ , about one and a half times the limit for non-inductive terminations.

Because the maximum inductorless bandwidth (neglecting stray capacitance) varies inversely as the square of the overtone order, while the terminating impedance varies directly as its cube, intense efforts have been aimed at achieving a very high fundamental frequency.

The fundamental frequency limit for AT-cut quartz plates has increased gradually from a few megahertz before World War II to about 35 MHz today. A fundamental frequency of 35 MHz corresponds to a wafer thickness of about 0.0018 inch. Since only odd-order

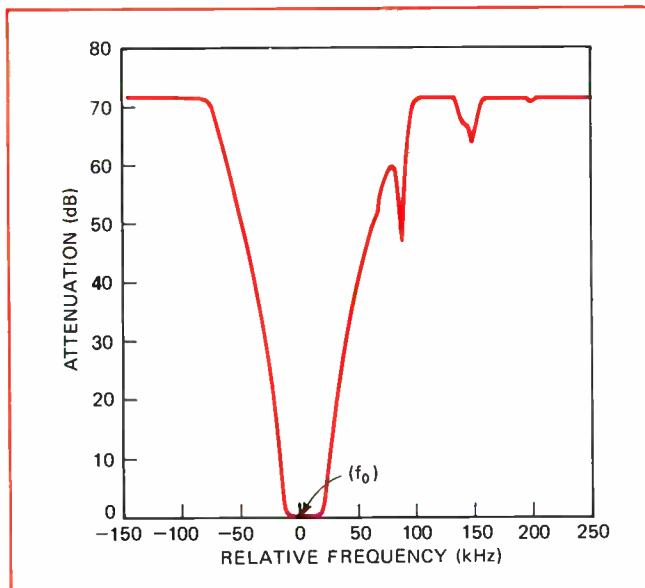

**6. Four-pole response.** Selectivity curve depicts a four-resonator monolithic filter that operates at the third overtone of the crystal's natural resonant frequency. Center frequency is 75 MHz, ripple is 0.7 dB, and the minimum insertion loss over the passband is 2.6 dB.

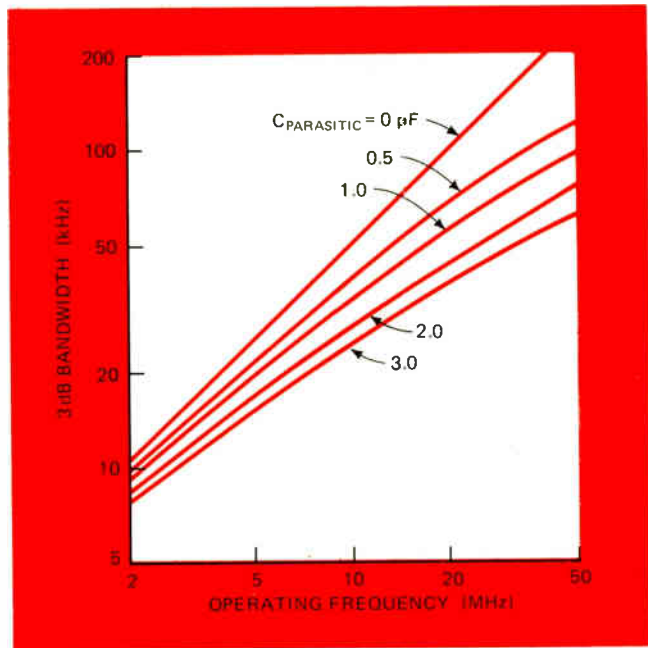

**7. Bandwidth limit.** Design curves illustrate the bandwidth reducing effect for typical values of parasitic capacitances in a filter operating at the fundamental frequency. For overtone filters, the frequency axis must be divided by the overtone order, and the bandwidth must be multiplied by the overtone order.

overtones can be used, a 50-MHz filter, for example, would be fabricated from a third-overtone wafer. For this filter, the maximum inductorless bandwidth, neglecting strays, would be one-ninth the fundamental mode value, while the terminating impedance would be increased.

### A look to the future

There is considerable interest in developing compact, economical, tandem monolithic packages in which two or more monolithic units may be mounted and hermetically sealed, instead of being mounted and sealed in individual holders and then assembled in an outer case. This technique would also provide an attractive means of increasing maximum inductorless bandwidth by reducing parasitic capacitances.

Further refinement of lapping and polishing techniques will continue to raise the maximum usable frequency for monolithic devices. It does not seem likely, however, that a breakthrough will be achieved by extension of present techniques. Wafer thickness reduction by ion etching or by processes combining chemical etching with mechanical polishing offer future technological advances. Also, the use of piezoelectric material other than quartz may prove feasible in future filter designs. These materials include lithium tantalate, lithium niobate, and bismuth germanium oxide.

### REFERENCES

1. R. A. Sykes and W. D. Beaver, "High Frequency Monolithic Crystal Filters with Possible Application to Single Frequency and Single Sideband Use," Proc. 20th Freq. Cont. Symp. pp. 288-308, 1966.
2. R. A. Sykes, W. L. Smith, and W. J. Spencer, "Monolithic Crystal Filters," IEEE Conv. Rec. vol. 15, pt. 11, pp. 78-93, 1967.
3. M. Onoe and H. Jumonji, "Analysis of Piezoelectric Resonators Vibrating in Trapped Energy Modes," J. Inst. Elec. Comm. Eng'rs Japan, vol. 48, No. 9, Sept. 1965.
4. M. Onoe, H. Jumonji, and N. Kobori, "High Frequency Crystal Filters Employing Multiple Mode Resonators Vibrating in Trapped Energy Modes," Proc. 20th Freq. Cont. Symp. pp. 266-287, 1966.

# Rotating ring display offers new face for instruments

Indicator driven by pulsed electromagnetic force promises economical analog or digital display with single moving ring for each channel, providing ruggedness and long life with minimum power requirements

by H. G. Dill, A. M. Leupp, A. T. Robinson, T. N. Toombs, and R. F. Zurcher, *Rotating Ring Display Systems, Costa Mesa, Calif.*

□ A miniature battery can make time go around in concentric circles for at least a year with a new wristwatch display. Electromagnetically driven rings show hours, minutes, seconds, and the date. The display offers an attractive alternative to gear-driven displays with their large numbers of moving parts, light-emitting diodes with their high power consumption, and liquid crystal displays with their limited lifetimes.

The rotating ring display system (RRDS) provides a clearly visible multichannel analog or digital display of a large variety of information. The RRDS can display digital data directly in an analog fashion—without electronic digital-to-analog conversion.

This RRDS seems especially adaptable for wristwatches and multichannel instrument displays, particularly where clusters of varied information must be observed and monitored quickly. The system's pulsed electromagnetic drive consumes power only while the display ring—the only moving part—is rotating. And, because the ring is also sealed, it has inherent long life and immunity to ambient disturbances. Moreover, the display has high shock resistance and, because there is no need for critical alignment, it is quite inexpensive to build in large quantities.

The technology of fabricating today's watches is directly applicable to the rotating ring display, which can be driven by an inexpensive integrated circuit that needs no additional multiplexing or complex decoding. The entire display system operates from a small 1.2-volt battery. If the same mechanical tolerances used in mechanical watches were applied to the RRDS, power consumption of the entire system could be as low as 1 microwatt—about one-tenth the power consumed by today's electronic timepieces.

The low power demand would permit battery size to be reduced considerably, and still power the RRDS for at least a year. A quartz oscillator and countdown system would limit error to within one second a month.

## Only one moving part

The basic idea of the rotating ring display system is that a ring unsupported by a center bearing can be rotated in either direction by supplying a set of electrical pulses to an electromagnetic drive system. Digital information can be displayed through a window; analog information can be shown by a moving band or a pointer on the band. The electronic circuitry necessary to sup-

ply these driving pulses can be integrated on a small chip that uses either bipolar or complementary MOS technology and fits easily into any small package, along with the display mechanism.

Although several clocking methods are possible, the three-phase drive appears to be the least expensive way to provide motion in either direction, as well as good stability. The number of phases in the drive system is not restricted to three, but may be two, four, or more. However, a two-phase system has no provision for reverse stepping and is inefficient. Systems with four or more phases become very complex.

## Moving magnets

A basic rotating ring three-phase system that uses indirect drive is shown in Fig. 1. The ring contains equally spaced magnetic and nonmagnetic areas, called ring poles. The ring functions as a rotor, revolving concentrically between the elements of a corresponding stator that is divided into three equal phases, each having the same number of stator poles.

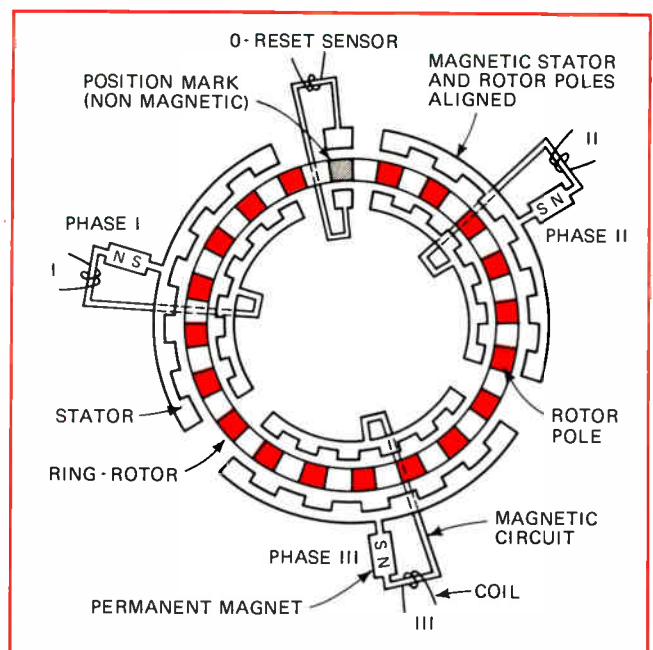

1. **Asymmetric three-phase drive.** Rotating ring of equally spaced magnetic and nonmagnetic areas is held at rest by permanent magnets, but moves a step when stator coil is energized.



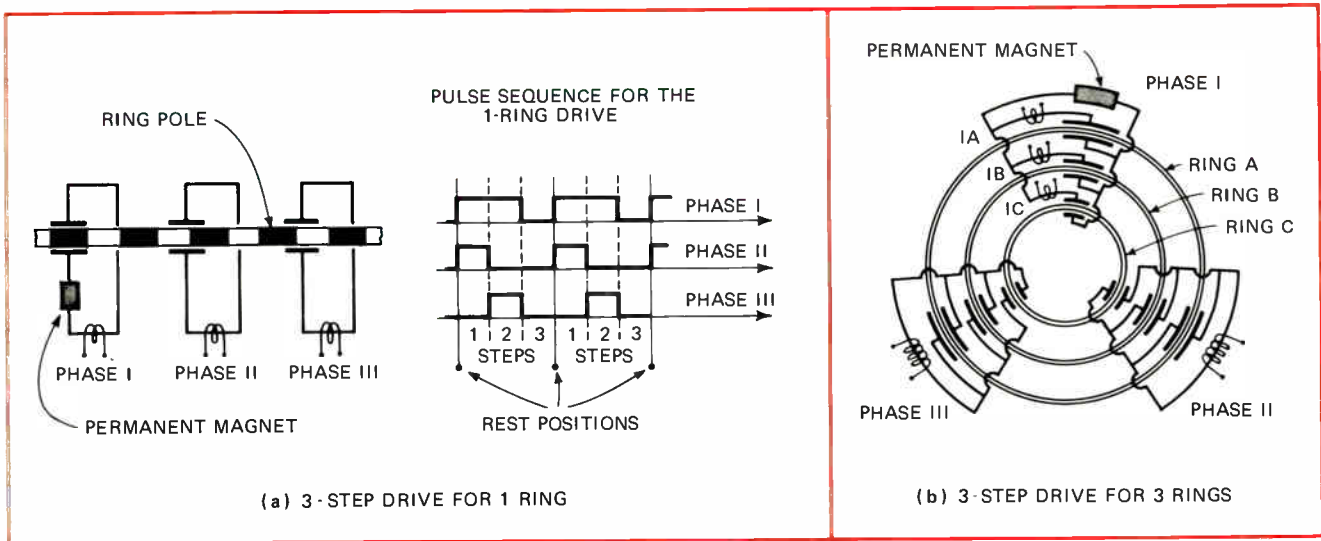

**2. One, two, three.** Three-step drive for a single-ring display (a) uses simple pulse sequence to drive the stator phases so that the ring is stepped from one rest position to the next. Adding two drive coils allows the three-step configuration (b) to handle three rings.

Each stator phase has its own magnetic circuit with a permanent magnet and a coil. In the arrangement of Fig. 1, the stator poles of phase II are aligned with the ring poles. The stator poles of phase I and III overlap the ring poles by one-third, but on opposite sides. The ring consumes no power while it is stabilized in this rest position by the permanent magnets. What does consume power is moving the ring to the next position. Ring movement is initiated by applying an electrical pulse to the coils of phases II and III, thus compensating, or cancelling, the magnetic flux of the permanent magnet in these circuits. As a result, stator phase I exerts a force that aligns the ring poles with the stator poles.

The ring then rotates counterclockwise one step, which is two-thirds the length of a ring pole. Similarly, the ring can be stepped farther by addressing each of the three coils with a suitable pulse train. Clockwise rotation is achieved simply by changing the sequence of the pulses. After each step, the display remains stable, thus consuming no power.

The position of the ring can be monitored by a magnetic or capacitance detector that senses a position mark on the ring. This allows the ring to be reset to its zero position, if desired. The magnetic detector (reset sensor in Fig. 1) comprises a stator pole and sensing coil. The absence of a magnetic pole on the ring is used as a position mark. Since the number of ring poles is quite large, the absence of one pole does not reduce the driving force significantly.

### The 3-step drive

In contrast to the indirect drive, a direct drive without permanent magnets is also possible. For this operation, the ring is held in the stable rest position by friction or by keeping one phase activated. But neither of these situations is very satisfactory. The first provides no insurance against accidental ring displacement, and the second increases considerably the power requirement.

On the other hand, a combination of direct and indirect drive that uses the three-step-drive approach is shown in Fig. 2. Only one permanent magnet is required for this drive, instead of three. As the name indi-

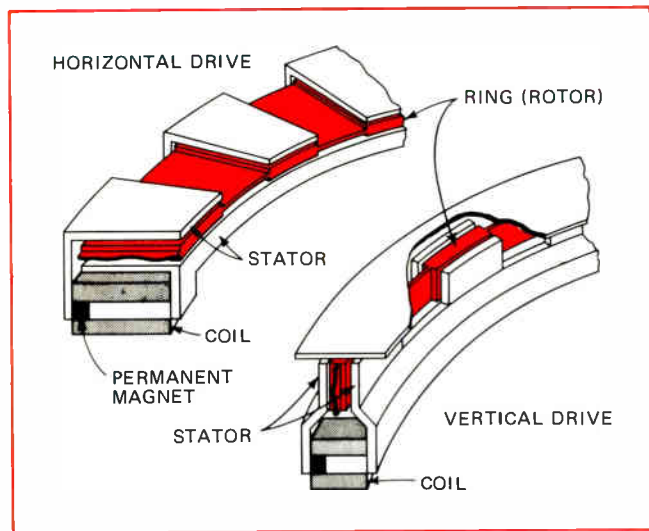

**3. Practical examples.** Of two types of asymmetric ring drives, the horizontal is of simpler construction, however its top stator poles considerably reduce visibility. This problem can be averted with the slightly more complex vertical-drive construction.

cates, the ring moves from one rest position to the next in three consecutive steps. The first step is initiated by compensating the flux of the permanent magnet in phase I and, at the same time, activating the coil in phase II.

The second step follows immediately. At the end of the first step, phase II is deactivated, and phase III is energized while the flux of the permanent magnet of phase I remains compensated. The third step requires no external pulses. The permanent magnet, which is no longer compensated, moves the next magnetic pole on the ring into alignment with the stator of phase I. Since the driving pulses are very short—2 to 5 milliseconds—and the three steps follow in rapid succession, the complete sequence appears as one big step.

The necessary electronic circuitry to drive the three-step drive is relatively simple. The electrical drive pulses can be generated by a logic circuit composed of two monostable flip-flops, three output drivers and an OR

gate. The pulse sequence easily can be triggered from the countdown segment of the timing circuit.

The many advantages of the three-step drive become more apparent with the multiring display. One of the big pluses is that fewer coils and permanent magnets are needed. A three-ring display, for example, requires only one permanent magnet and five stator coils—much less expensive than the indirect drive, which needs nine of each. In addition, the drive power is kept very low with the simple pulse sequence used. And the low demagnetization of the permanent magnet allows a wide choice of materials.

A typical three-ring display is also shown in Fig. 2. Only one drive coil is used for phase II and one drive coil for phase III. Each of these coils is common to all three rings. Phase I, however, uses three coils which are energized separately to select the desired ring. For example, to select ring A, the flux from coil IA compensates the flux of the permanent magnet in the air gap IA, but enhances the flux in the other two air gaps, IB and IC. This, of course, assumes that the reluctance of the permanent magnet is much higher than that of an air gap. Therefore, the demagnetization of the permanent

magnet caused by the compensating field is very small.

A two-phase version of the three-step drive also can be realized, but would provide only unidirectional ring rotation. For this case, a three-ring display would still require one permanent magnet, but only four coils. Its operation, however, would consume more power.

### Different construction techniques

Two practical examples of rotating ring assemblies are detailed in Fig. 3. The horizontal drive configuration is the simplest to construct, but the top stator poles limit visibility of the ring surface. However, as the number of stator poles increases, the size of each decreases, and their masking effect is much less noticeable. A vertical drive configuration, while slightly more complex, has no visibility limitations.

Regardless of construction, the important ring criteria are low mass, mechanical rigidity, and suitable magnetic properties. Since the areas of the ring that are considered magnetic and nonmagnetic are determined only by a difference in ring thickness, the whole ring can be made from the same material. The complete ring could be molded from a magnetic plastic material, or formed

GUIDELINES FOR RRDS APPLICATIONS				
	LOW-POWER APPLICATIONS (20-mm RING, 1-VOLT SUPPLY)		INSTRUMENT APPLICATIONS (80-mm RING, 5-VOLT SUPPLY)	
	HORIZONTAL DRIVE	VERTICAL DRIVE	HORIZONTAL DRIVE	VERTICAL DRIVE
Ring mass (mgr)	10 – 20	15 – 30	100 – 300	200 – 500
Ring acceleration and holding (g)	10 – 100	5 – 80	20 – 200	10 – 150
Number of ring steps	60 – 240	60 – 240	120 – 360	120 – 360
$f_{max}$ (steps/sec)	200	150	1,000	800
Pulse $I_p$ (mA)	0.5 – 2	0.5 – 2	5 – 50	5 – 50
$t_p$ (msec)	2 – 10	2 – 10	1 – 10	1 – 10
Air gap $\ell_A$ ( $\mu\text{m}$ )	25 – 100	25 – 100	50 – 200	50 – 200
H (Oe)	500 – 2,000	500 – 2,000	2,000 – 10,000	2,000 – 10,000
Average power ( $\mu\text{W}$ ) for $10^{-2}$ to $10^{-3}$ duty cycle	0.5 – 10	0.5 – 15	10 – 2,000	10 – 2,000
Coil (ampere-turns)	2 – 6	2 – 6	20 – 100	20 – 100
Size (mm)	2 x 2 x 2 to 3 x 3 x 4	2 x 2 x 2 to 3 x 3 x 4	3 x 3 x 4 to 6 x 6 x 10	3 x 3 x 4 to 6 x 6 x 10

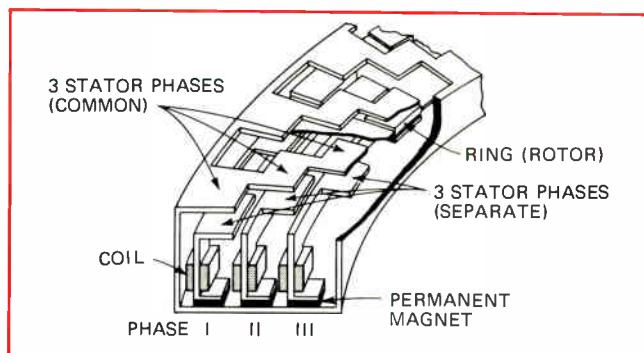

**4. Symmetry pays dividends.** Because the forces are applied simultaneously along the ring's circumference, the symmetric three-phase drive reduces friction and possible ring deformation.

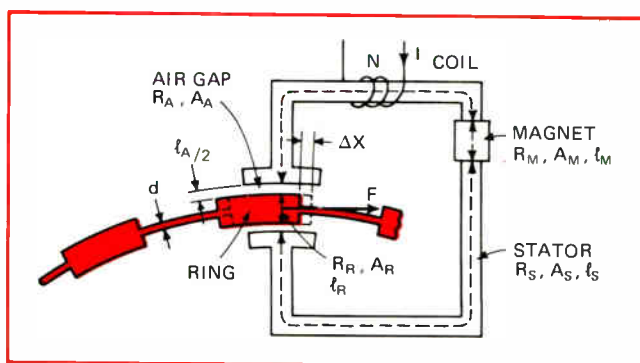

**5. Basic model.** An efficient drive system requires minimum total reluctance. The driving force,  $F$ , depends on volume, magnetic flux density, and the magnetic field strength in the air gap.

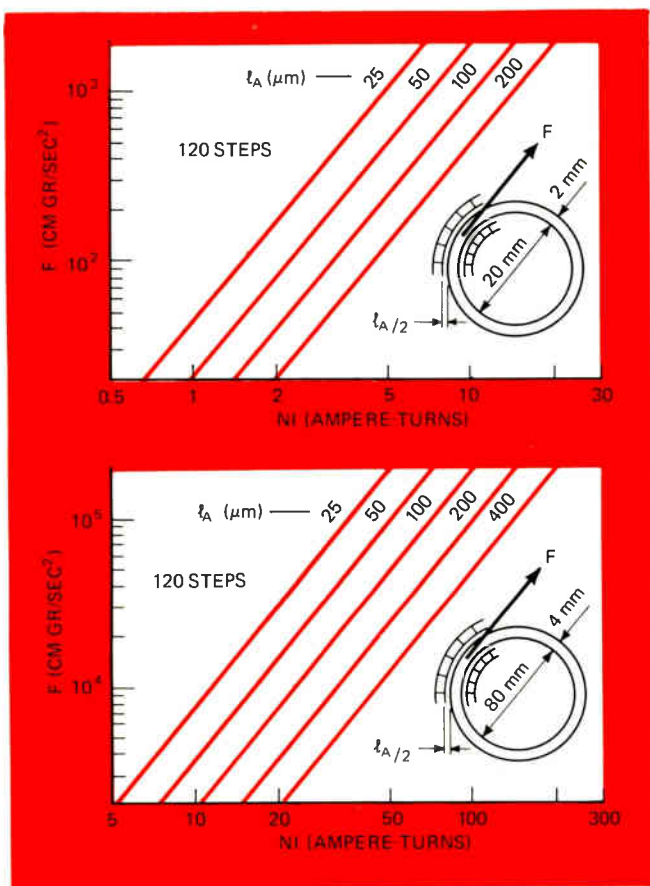

**6. Useful charts.** Ring force as a function of ampere turns is plotted for several values of air-gap widths and two sizes of rings. Direct drive is assumed, and second-order effects from magnetic-field crowding in rotor and stator poles are neglected.

from sheet metal. This type of ring construction would be particularly suitable for mass production.

A practical display unit has three basic parts—the transparent front cover, the main body, and the back cover. The stator poles, which consist of stamped magnetically active sheet metal, are embedded in the main body and in the transparent front cover. The assembly is completed by inserting the coil and the rotating ring, then sealing the main body with the covers.

### Driving forces

During each step of the rotating ring, the drive force is active over less than a third of its circumference. This asymmetry may introduce additional forces and could cause deformation of the ring.

In contrast, the fully symmetric drive shown in Fig. 4 applies the driving forces uniformly. Each phase covers about one-third of the ring circumference. The ring structure is similar to that used for the asymmetric drive, except that the ring poles of each phase are separated by slots to minimize magnetic crosstalk.

The main advantages of the symmetric drive are reductions in friction and ring deformation, thus allowing the use of lighter rings with a higher force-to-mass ratio. However, construction is considerably more complex than that of the asymmetric drive.

The tangential driving force,  $F$ , acting on the ring (Fig. 5), depends on the change of stored magnetic

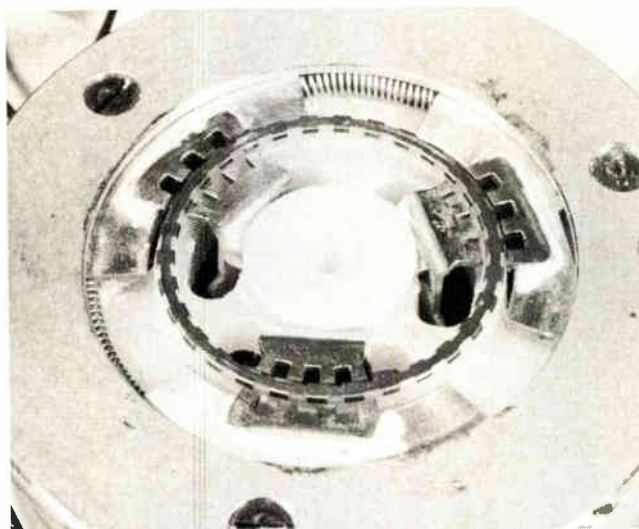

**7. One of the first.** Top view of experimental one-ring display model shows the U-shaped ring which forms the rotor's magnetic poles. Each phase has four stator poles equally spaced about the ring.

energy in the air gap,  $\Delta E$  with the motion of the ring ( $F = \Delta E / \Delta x$ ). The stored energy in the air gap is proportional to the volume, magnetic flux density,  $B_A$ , and the magnetic field strength,  $H_A$ , generated by the permanent magnet.

$$E \approx H_A^2 l_A A_A n$$

where  $A_A$  is the area and  $l_A$  is the width of the air gap, and  $n$  is the number of magnetic stator poles per phase.

Neglecting any loss in the magnetic circuit and assuming the ampere turns required to compensate for the effect of the permanent magnet is given by  $H_A l_A$ , the tangential driving force can then be expressed as:

$$F \approx \frac{(NI)^2 n}{l_A}$$

This equation is valid only if the reluctance of the air gap is the dominant factor in the total reluctance of the magnetic circuit. This property can be achieved by careful design. The graphs of Fig. 6 show the calculated ring force,  $F$ , of the direct drive as a function of ampere turns with the air-gap length as a parameter.

A convenient way to increase the driving force is with a larger number of magnetic poles. The force increases with  $n$  because, although the flux change-per-step remains constant, the stepping distance decreases. Unfortunately, increasing  $n$  also increases the power dissipation and demands tighter fabrication tolerances.

### Pulse duration

A very important parameter relating to power consumption is the duration of the driving pulses. The pulse duration must be just long enough to insure that the ring moves at least one step. If it is much longer, excessive power dissipation will result. The minimum pulse duration usually depends on the ring acceleration, friction, and the time constant of the stator circuit. This time constant typically falls between 0.3 millisecond and 1 ms for a 20-millimeter ring and a 4-ampere-turn coil. The stepping time also depends on the ring's acceleration and friction, and is usually less than 3 ms for a 20-mm ring with 120 steps and 25-g acceleration. Con-

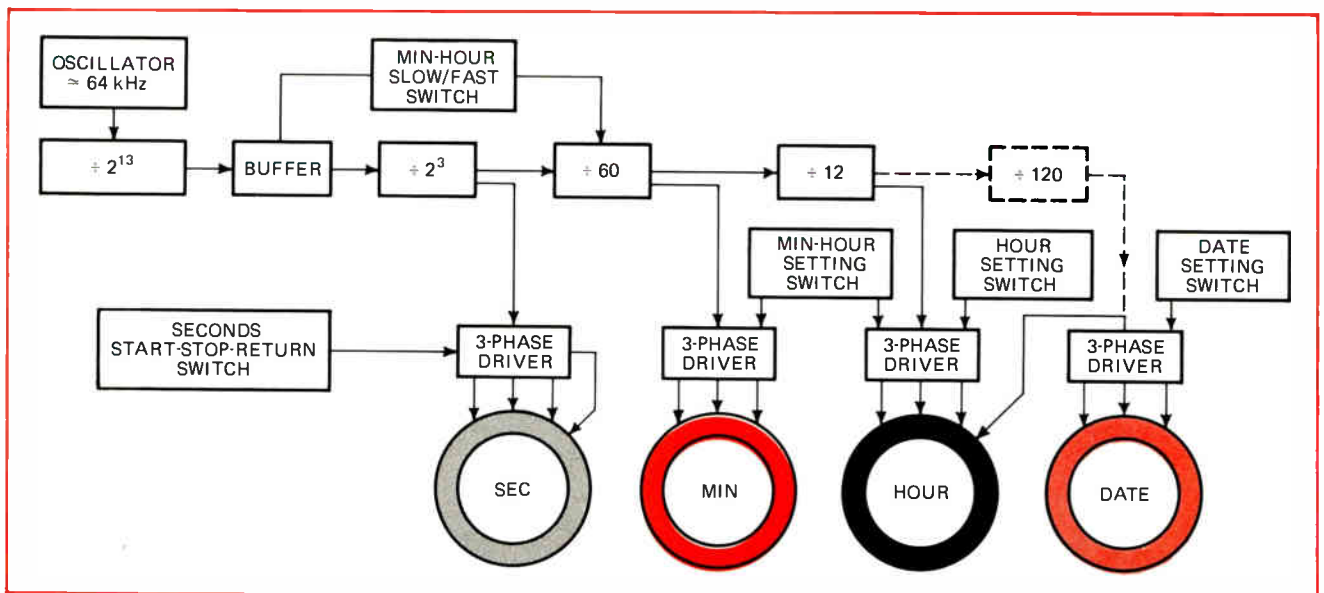

**8. Marking time.** Countdown circuits produce proper timing sequence to step the four rings in a wristwatch display. To conserve power, the seconds ring rotates only on command from the seconds switch. Once initiated, the seconds ring stops within a reasonable amount of time automatically if not stopped manually. The date also can be changed by magnetically sensing directly from the hour ring.

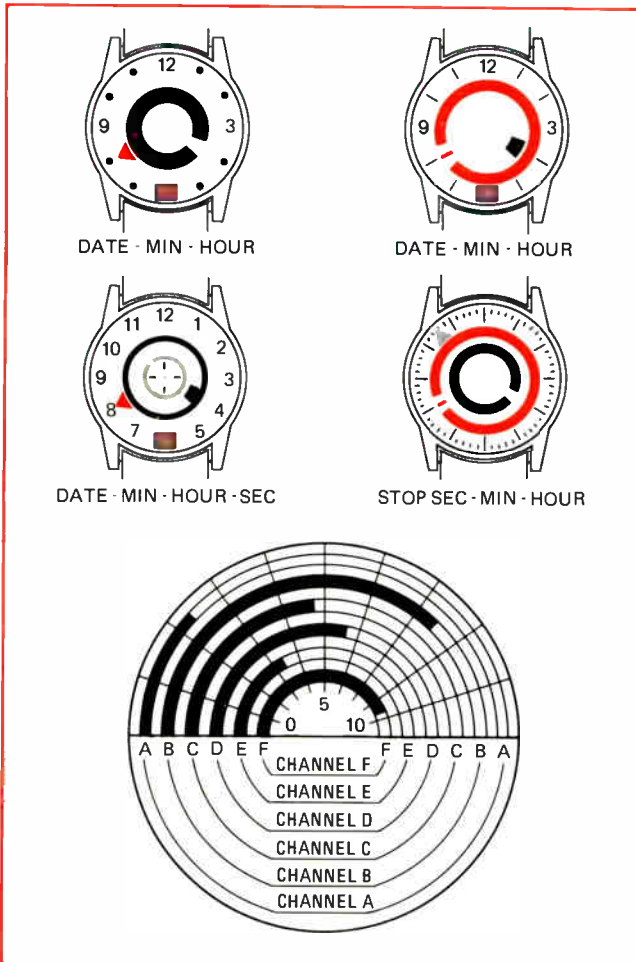

sidering all these factors, 3 – 10-ms driving pulses are practical for the 20-mm ring and 4-ampere-turn coils.

A prototype of a rotating-ring display, having one U-shaped ring that slides on a nylon rail to minimize friction has been built and tested. The top view of an

**9. Versatile display.** In addition to typical wristwatch data, several separate channels can display multiple information simultaneously. Applications include aircraft and process control instrumentation, particularly for comparison-type displays.

actual model is shown in Fig. 7. The coils and the permanent magnets, located under the ring, are not visible. The mu-metal ring, which contains 30 magnetic poles, has a diameter of 30 mm and a mass of 30 milligrams.

### Early results

The prototype configuration provides 90 stable rest positions for direct and indirect three-phase drives, and 30 stable rest positions for the three-step drive. The stator assemblies, with four poles each, can be rotated by loosening the set screws to adjust the phase relation. The total length of the air gap is 500 micrometers—250  $\mu\text{m}$  on each side of the ring. The prototype was not as efficient as the proposed models because it used larger air gaps, fewer stator poles, and larger ring mass than an optimized configuration. However, it could be built with inexpensive tooling.

Additional models with the direct, indirect, and 3-step drive were evaluated with 20-, 40-, and 60-ampere-turn drive pulses. Ring accelerations were calculated by using the highest measured stepping frequency, which is related to the minimum pulse duration. The measured value of ring acceleration was considerably lower than the calculated value for the lower values of ampere turns, but approached the calculated value for the higher values. These results indicate that frictional forces, which were neglected in the calculations, are dominant for low ring accelerations (10 g).

Good agreement between experimental and calculated data proves the validity of the basic assumptions of the RRDS drive and with lighter rings (20 mm) and tighter tolerances, it seems possible easily to achieve the 50–100-g acceleration needed for good stability with low power dissipation—4-ampere-turn 3-ms pulses.  $\square$

# Designer's casebook

## Tunable active filter has controllable high Q

by Max Artusy  
Stanford Electronics Laboratories, Stanford, Calif.

A tunable variable-Q active narrowband filter can be built from a slightly modified Wien-bridge oscillator with a net loop gain of less than unity. Not only can Q be independently controlled, but stable single-frequency Qs as high as 2,000 can be realized. A gain of 600 is achieved with a Q of 2,000. Gain becomes approximately 140 when Q is 30, and Q remains constant within  $\pm 10\%$  over a 10-to-1 tuning range. (Gain, in this case, refers to signal gain, from input to output, rather than amplifier or loop gain.)

Although it is generally known that the effective Q of an oscillating tuned circuit is infinite, it is often forgotten that stable finite Qs can be obtained by reducing the

**Adjustable Q.** Active filter offers Q of up to 2,000 that is stable to within  $\pm 10\%$  for moderate Qs over 10-to-1 tuned frequency range. Actually a modified Wien-bridge oscillator, the circuit operates with a net loop gain of less than 1 so that Q of RC network can be increased. Potentiometers  $R_1$  and  $R_2$  and capacitors  $C_1$  and  $C_2$  determine filter resonant frequency, while potentiometer  $R_3$  is an independent Q adjustment.

net loop gain below unity. In the conventional Wien-bridge oscillator, the gain of the amplifier looking into its non-inverting input is maintained at 3, and the circuit oscillates. For the modified oscillator, however, amplifier gain is less than 3, allowing the Q of the surrounding RC network to be increased. And, as can be seen from the diagram, the value of resistor  $R_1$  is the same as that for resistor  $R_2$ , and the value of capacitor  $C_1$  is identical to the value of capacitor  $C_2$ .

Signal current is introduced into the negative feedback loop by  $R_3$ , which also determines input impedance and circuit Q. For oscillation to occur:

$$1 + R_4/(R_3 + R_s) \text{ must be less than 3.}$$

where  $R_s$  is the source impedance. Resonant frequency becomes:

$$f_0 = 1/2\pi(R_1R_2C_1C_2)^{1/2}$$

Circuit components should be selected carefully for best tuning range and constant Q. In particular, well-matched wirewound potentiometers help maintain uniform Q with changing frequency. All capacitors should be Mylar. Nominal component values shown result in a tuning range of 160 hertz to 1.6 kilohertz for the circuit.

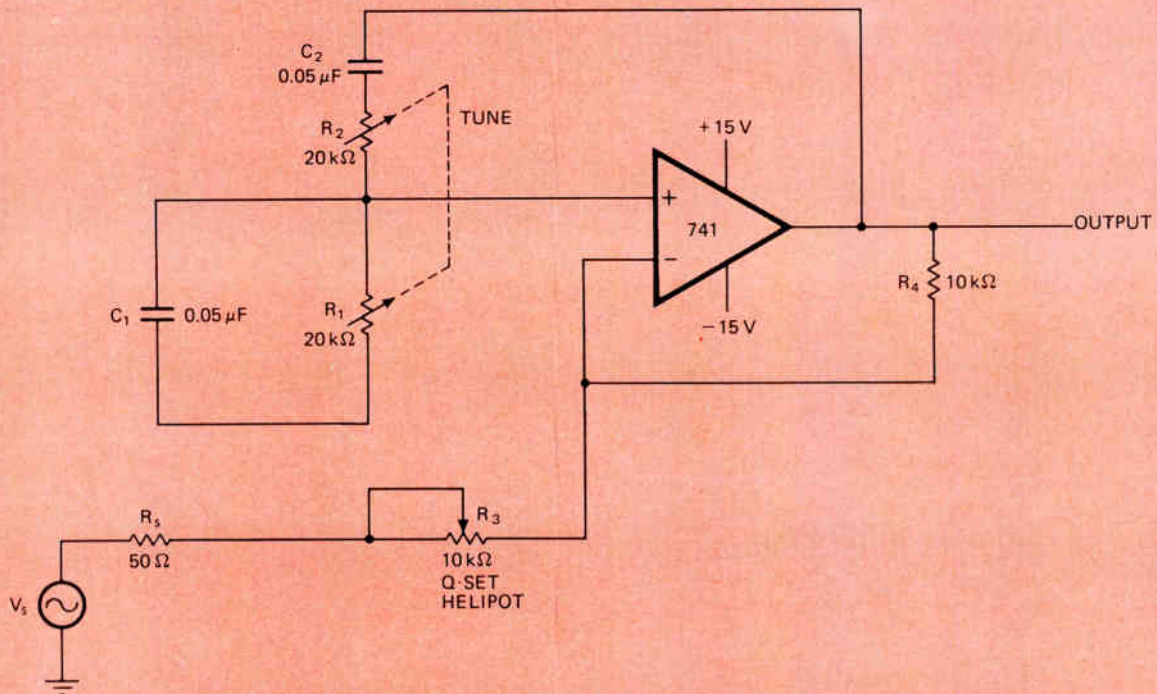

# Op amps generate precision staircase

by Jerald Graeme  
Burr-Brown Research Corp., Tucson, Ariz.

A staircase generator with adequate precision for sequential control and multiple-level testing produces a staircase output by differentiating and then integrating only the negative transitions of a square wave. Although a staircase waveform can be generated precisely by a digital-to-analog converter driven by a clock-controlled counter, a simpler, but sufficient, circuit approach is to use operational amplifiers.

Amplifier  $A_1$  differentiates and rectifies input square wave  $e_i$ , which is applied to capacitor  $C_1$  through resistor  $R_1$ . For positive input transitions, transistors  $Q_1$  and  $Q_2$  are off, and diode  $D_1$  conducts; for negative transitions,  $Q_1$  and  $Q_2$  conduct. From this rectification, only negative-going transitions are transferred to the

second amplifier through  $Q_1$  and  $Q_2$ . Transistor biasing is implemented by connecting one input of  $A_1$  below ground through resistors  $R_2$  and  $R_3$ .

The staircase output is produced by amplifier  $A_2$ , which integrates, through capacitor  $C_2$ , the current supplied by  $Q_1$  and  $Q_2$ . The change in output voltage ( $\Delta e_o$ ) becomes:

$$\Delta e_o = -\frac{I}{C_2} \int i(dt)$$

where:

$$i = C_1 de_i/dt$$

Or, whenever input voltage change ( $\Delta e_i$ ) is less than 0:

$$\Delta e_o = -C_1 \Delta e_i / C_2$$

Each negative transition of the input square wave creates a step in the output voltage, generating a staircase waveform. This stepping continues until the output voltage reaches the trigger level of the reset clamp formed by transistors  $Q_3$  and  $Q_4$ .

The clamp triggers when the emitter-base junction of  $Q_4$  breaks down, limiting the output to a peak voltage ( $V_p$ ) of:

$$V_p = V_{CB} - BV_{EB} + V_{BE} - V_f$$

**Stepping up.** Staircase generator first differentiates and then integrates input square wave to supply precise stepped output.  $A_1$  performs the differentiation, and  $Q_1$  and  $Q_2$  rectify all negative-going inputs, passing them on to integrator  $A_2$ . Positive input transitions are not used. Every negative input steps up the output until  $Q_3$ - $Q_4$  reset clamp triggers when  $Q_4$ 's emitter-base junction breaks down.

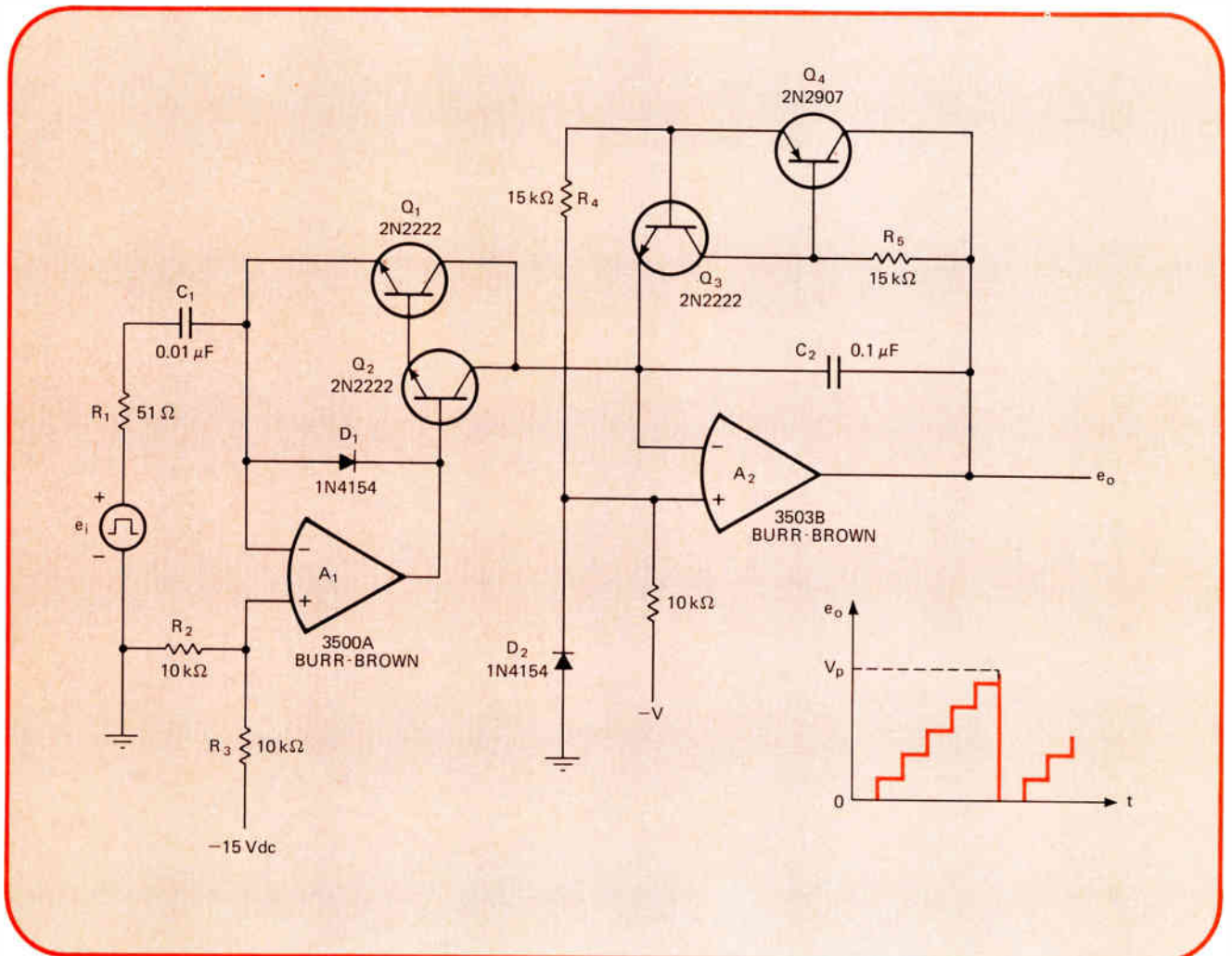

where  $V_{CB}$  is  $Q_4$ 's collector-base voltage,  $BV_{EB}$  is  $Q_4$ 's emitter-base breakdown voltage,  $V_{BE}$  is  $Q_3$ 's base-emitter voltage, and  $V_f$  is the voltage across diode  $D_2$ . Because the collector-base junction of inverted transistor  $Q_4$  is forward-biased, its voltage drop is around that of the diode, and:

$$V_{CB} - V_f = 0$$

—so that  $V_p$  is approximately equal to 7 volts:

$$V_p = V_{BE} - BV_{EB}$$

Since the thermal variations of  $V_{BE}$  and  $BV_{EB}$  approximately cancel,  $V_p$  is quite stable, with a temperature coefficient of around 0.01%/°C.

With  $Q_4$ 's breakdown, base current through  $Q_3$  activates the positive feedback loop formed by  $Q_3$  and inverted transistor  $Q_4$ . Capacitor  $C_2$  is then discharged until its voltage reaches  $V_{BE}$ , the cutoff for clamp conduction. Once output voltage returns to 0 v, the clamp turns off, and a new staircase begins.

Gain error and nonlinearity for this staircase generator vary with operating frequency and component characteristics. Operational amplifier input currents remove some of the derivative current pulses, and they also create output sag by discharging capacitor  $C_2$ . To prevent severe error from being introduced by these op amp input currents, amplifier input protection circuitry must be avoided since such circuitry will draw high current during an input overload.

Slewing rate and overload recovery limit the generator's operating frequency range. Another current transfer error results from the finite betas of transistors  $Q_1$  and  $Q_2$ . However, for the Darlington pair used, the loss is only about 0.002%. Resistors  $R_4$  and  $R_5$  are included to reduce an output nonlinearity that is introduced by leakage of the reset clamp. Circuit gain error is typically about 0.05%, and nonlinearity is commonly around 0.1%.

## Schottky diodes eliminate two-level NAND gating

by Charles J. Huber,  
Westinghouse Electric Corp., Systems Development division, Baltimore, Md.

To eliminate the need for two-level gating with NAND gates, a pull-up resistor and Schottky diodes can perform the AND function at the input of a low-power TTL gate. NAND gating causes an unwanted increase in power consumption and delay time. The diode circuit can be used for decoding sequence-generator outputs, encoding digital signals, and implementing the AND function in counter designs.

Conventional pn junction diodes are not suitable for use with low-power TTL gates since diode forward voltage drop is comparable to the maximum allowable logic 0 gate input voltage—around 0.7 volt. But Schottky-barrier diodes exhibit only half the voltage drop of pn junction diodes, permitting them to satisfy the TTL logic 0 condition.

Moreover, the dynamic change from logic 1 to logic 0 at the output of a TTL gate is limited, since the common-base input stage is not rapidly cut off. Gate response can be improved considerably by placing a resistor from the supply line to the gate's input pin.

The test results in the table show that the worst-case degradation of gate response time from no diodes to three diodes is 35 nanoseconds for five-TTL loads. Since this time factor is comparable to the propagation delay of only one TTL gate, an entire gate delay is saved and the power consumption is due principally to the pull-up resistor. When three diodes are used, the dc level at the diode-resistor junction is approximately 0.5 v.

**Diode gating.** Pull-up resistor and Schottky diodes replace NAND gates at input of low-power TTL circuits, improving gate response time and decreasing power consumption. Since Schottky diode drop is only half that of pn junction diodes, Schottky diodes are compatible with logic 0 condition of TTL gates. Pull-up resistor decreases gate response time by connecting gate input directly to supply.

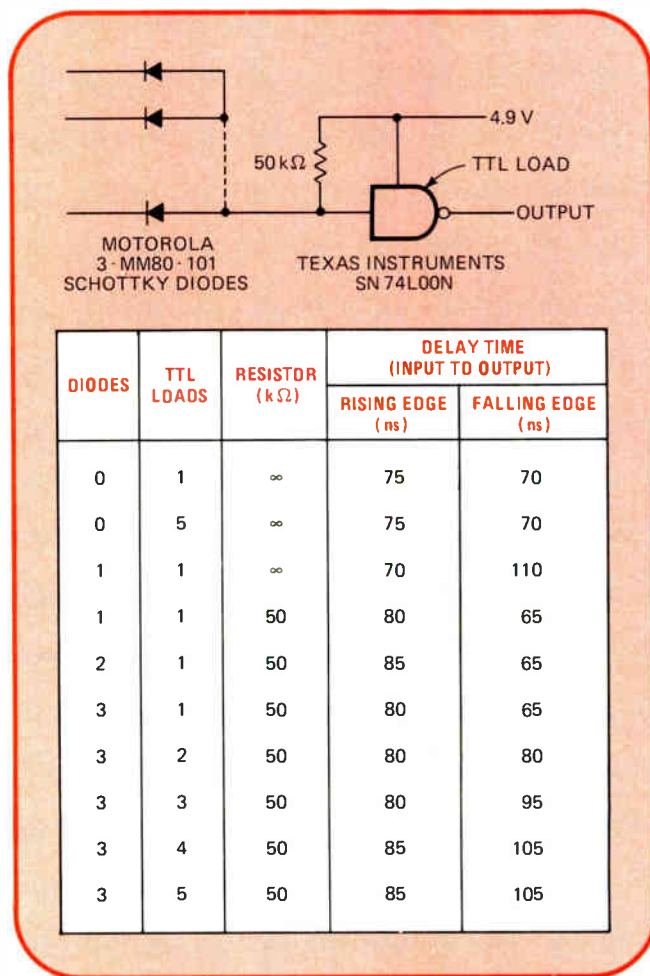

Designer's casebook is a regular feature in Electronics. We invite readers to submit original and unpublished circuit ideas and solutions to design problems. Explain briefly but thoroughly the circuit's operating principle and purpose. We'll pay \$50 for each item published.

# **Signetics has the broadest line-up of ROMs in the industry.**

## **BIPOLAR**

256 Bit Field Programmable ROM (32 x 8) Open Collector Outputs 8223  
256 Bit Mask Programmable ROM (32 x 8) Open Collector Outputs 8224  
4096 Bit Mask Programmable ROM (1024 x 4) Totem Pole Outputs 8228  
2048 Bit Mask Programmable ROM (256 x 8) tri-state Outputs 8204  
4096 Bit Mask Programmable ROM (512 x 8) tri-state Outputs 8205

## **MOS**

### **METAL GATE**

1024 Bit Static ROM (256 x 4) Bare Drain or MOS Pull-Down 2410  
1024 Bit Static ROM (128 x 8 or 256 x 4) Bare Drain or MOS Pull-Down 2420  
2048 Bit Static ROM (256 x 8) Bare Drain or MOS Pull-Down 2430

### **SILICON GATE**

2560 Bit Static Character Generator (64 x 8 x 5) tri-state Outputs 2513  
2560 Bit Static ROM (512 x 5) tri-state Outputs 2514  
3072 Bit Static Character Generator (64 x 6 x 8) tri-state Outputs 2516



# And we make them easy to use.

With our fantastic line-up, we can put you on the air in breadboard and keep you there all the way into production. From design desk to shipping dock your ROM designs will be fully functioning at system operating speeds. In breadboard you'll be using field programmable FROMs or simulators. Through prototype you'll be working on FROMs, ROMs, or simulator. In production you'll be working with FROMs and ROMs—taking advantage of field programming or the Signetics quick turn around ROM mask generation and mask verification capability.

Designs will be de-bugged and into production in weeks or even months less time. And at savings you can measure in thousands of dollars per unit type. No one knows more about ROMs than Signetics. And we help make them easy to use. In addition to what you've already seen, here's the deal we offer.



**5 separate fusers for 3 new FROMs.** 3 new FROMs with 5 separate fusers to custom develop your fused ROMs: for laboratory and prototype use or pre-production through mass production.



**De-bug your design before you build it.** With the fantastic ROM simulator, you can simulate up to sixteen fully operational ROMs simultaneously, each up to 4096 bits either Bipolar or MOS. Each operating completely independent of the others. Or use our FROMs which are designed for both prototyping and production usage. Your choice.



**Support.** Application notes, 2 complete manuals covering both MOS and Bipolar, 2 operating programs and a wealth of descriptive data sheets. We put it in writing. Send for it.

Please send me a full literature package.

Name \_\_\_\_\_

Address \_\_\_\_\_

City \_\_\_\_\_ State \_\_\_\_\_ Zip \_\_\_\_\_

**signetics**

811 E. Arques Ave, Sunnyvale, California 94086  
A subsidiary of Corning Glass Works.

# Three-dimensional IC packaging—with a twist

Active devices can be placed inside a multilayer wiring stack, not just on the surfaces, using interconnection wafers that are held together by mechanical pressure

by Howard L. Parks, *Bunker-Ramo Corp., Westlake Village, Calif.*

□ Prices of integrated circuits have dropped to the point that interconnecting them now costs more than the devices themselves. Since interconnection costs based on ceramic or printed circuit systems are roughly proportional to the substrate area, the obvious approach to lower packaging costs is higher component densities with multilayer, three-dimensional wiring to complete the circuits.

However, low maintainability and inflexibility to change have limited the usefulness of conventional 3-d approaches. During the past year, a new method—which Bunker-Ramo has trademarked Planar Coax—has been refined that avoids the problems of the

previous 3-d methods while reducing interconnection costs to the level of the per-terminal costs of the devices.

High-quality 16-terminal semiconductor devices, for example, commonly sell for about 2 cents per terminal. With conventional packaging methods, cost of the completed system can climb to 10 cents per terminal. With Planar Coax, finished systems can be made with packaging costs of less than 2 cents per terminal, and further refinements are expected to reduce this cost another order of magnitude in the next few years.

Essentially, the method uses a stack of wafers, each typically 2 inches square and 7 mils thick, holding conductor patterns, active devices, and gold buttons that

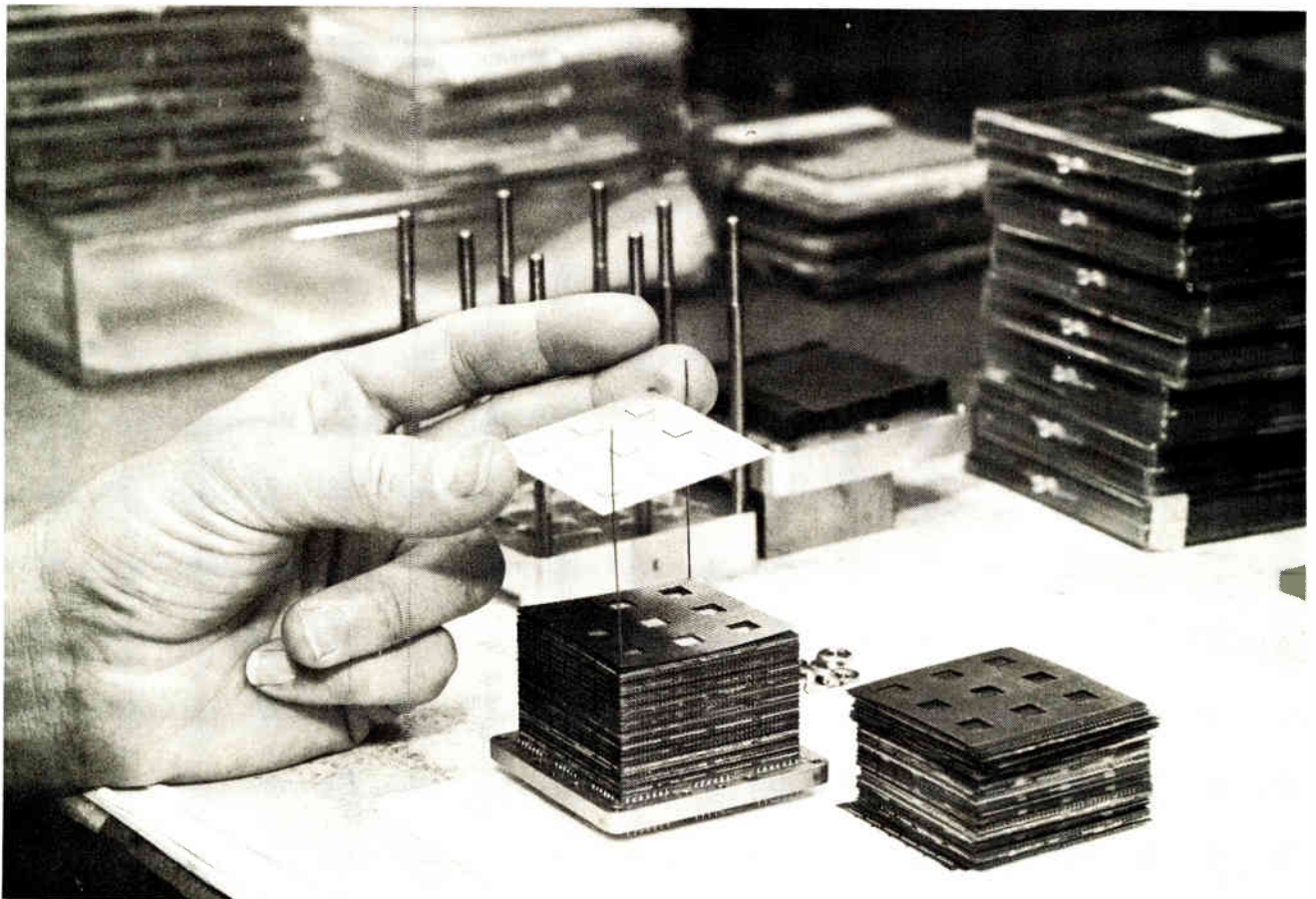

1. **Stack 'em.** System is assembled using alignment rods, which pass through etched registration holes in opposite corners of each wafer. Since each wafer is 7 mils thick, 140 wafers are needed to make a stack 1 inch high. Typical wafers are 2 inches square.

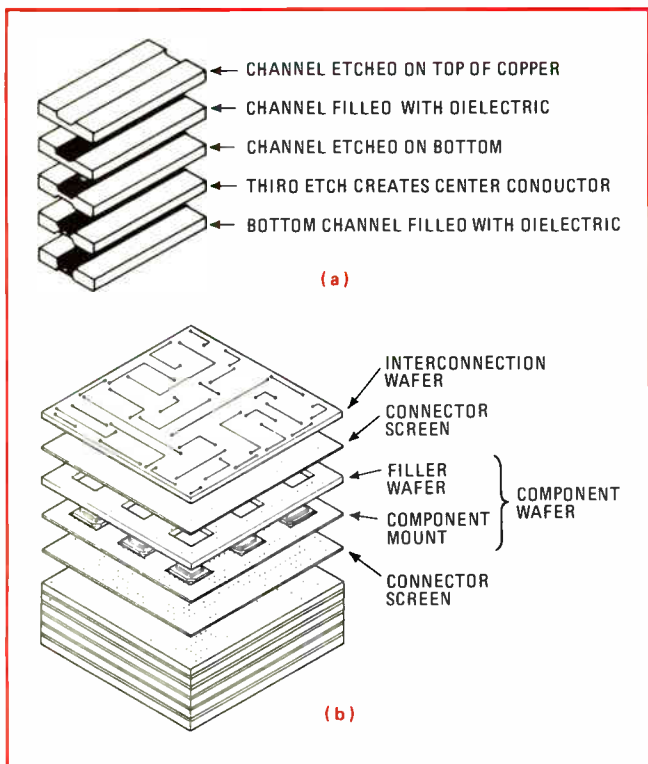

**2. Etch, fill, and stack.** Planar Coax wafers are made by successive etching and filling operations (a) to produce a coaxial structure—a center conductor surrounded by dielectric. Through-slugs for vertical connections are produced similarly, except for different etching masks. The system is assembled (b) by stacking wafers. Note that removable wafers allow active devices on internal layers.

contact other wafers placed immediately above and below (Fig. 1). The stack is held together by high pressure alone, and thus can be opened at any time for maintenance or for replacement of a wafer if the system is redesigned. Only a few of the wafers need be specially designed for each system; the remaining 80% to 90% of the wafers can be designed with a standard format and thus can be made in large quantities and stocked.

The wafers can be made at a cost of about 25 cents per square inch, which is comparable with printed circuit and ceramic costs. However, because active devices can be mounted on internal layers, over-all system costs are much less. The wafers are each only about 7 mils thick, and thus about 140 wafers will make up a stack one inch high; one cubic inch of Planar Coax wafers

### Putting Planar Coax to work

Potential users can obtain test wafers—with or without active devices—to check out the stacks under their own environmental conditions. According to author Parks, Bunker-Ramo will supply, for as little as \$1,200, a Planar Coax stack specially designed for customer evaluation tests. The stack has about 70 1-inch-square wafers. In full production, the packaging costs of less than 2 cents per terminal can easily be met, adds Parks. If a potential user wants to pursue production after testing an environmental vehicle, Bunker-Ramo will negotiate a licensing arrangement.

costs about \$30. In that cubic inch, about 200 devices, each with 14 leads, can be mounted and interconnected. Thus, the 2,800 connections will cost a little more than 1 cent apiece. And the per-terminal cost remains the same, whether simple diodes or complex LSI devices are used.

Planar Coax also makes MSI a more attractive alternative to LSI since much of the incentive to use LSI is to reduce the interconnection costs of several MSI chips. Test costs will also be less with MSI chips, and later new designs to accommodate LSI can be easily made.

### Buttons of gold

In the system, two types of interconnections are used: gold buttons that contact slugs on adjoining wafers for z-axis interconnection and coaxial structures in the plane of the wafers for x-y interconnection. Both are formed by selectively etching the beryllium copper substrate and filling with epoxy dielectric.

To create the x-y coaxial structures, one side of the substrate is covered with photoresist, masked with the desired wiring pattern, exposed, and then etched (Fig. 2a) about half way through the thickness. The etched paths then are filled with dielectric. The other side of the substrate then is similarly prepared and etched, leaving a thin layer of copper covering the underside of the dielectric. A third etch isolates the copper on the dielectric from the substrate copper to form the coaxial center conductor. This conductor then is covered with dielectric, forming an approximate coaxial structure.

The through-slugs for z-axis connections are formed in a similar way, except that the etching process leaves a mesa of copper, the top of which is level with the copper substrate surface. Dielectric filling on one side of the

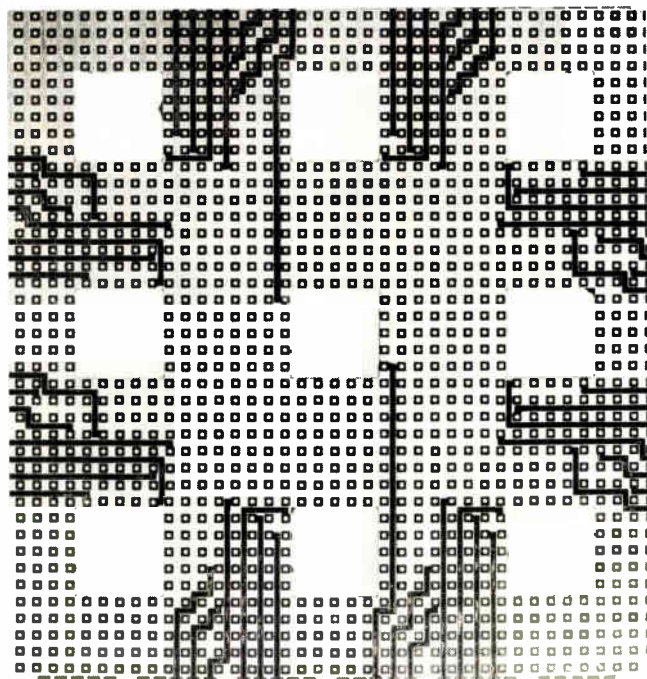

**3. On edge.** A test point wafer, made by bringing any number of device terminals on filler wafer to edge, is the key to Planar Coax's flexibility in testing. Square cutouts accommodate device heights on neighboring wafers in stack. Through-slugs adjacent to cut-outs contact device terminals in z-direction.

## Working on both coasts

Work on Planar Coax at Bunker-Ramo's Westlake Village, Calif., installation is being complemented by work on matching connectors at Bunker-Ramo's Amphenol RF division, Danbury, Conn. The format of Planar Coax is a natural mate for interconnections using flat cable, although individual coaxial cables can also provide system interconnections with matched impedances. The Planar Coax method is also being used to provide matched connections from flat cable to printed circuit boards.

For example, a wafer of Planar Coax can be made with signal lines on 50-mil centers to mate with signal lines in the flat cable, which has its conductors on 25-mil centers, and alternate conductors are used for signal and ground. The flat cable conductors can be soldered or welded to the Planar Coax conductors and ground planes. A Planar Coax connector-screen wafer—an array of through-slugs with gold buttons—then can be used to complete the contact to terminals on a printed circuit board with a pressure pad and clamp providing the needed force. If the flat cable has a ground plane, it easily can be connected to the underside of the Planar Coax structure to provide transmission-line-to-transmission-line interconnections.

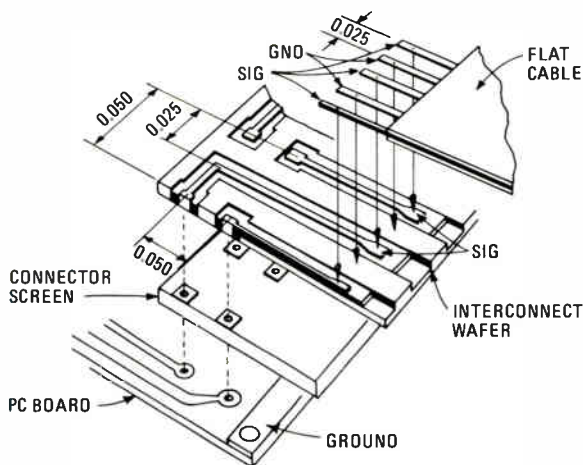

wafer surrounds the mesa. The center slug is isolated from the copper substrate on the other side by etching and filling, thus forming a coaxial structure in the z-direction. The through-slug can also be placed at the end of an x-y interconnection, of course, simply by combining the two processes. Because of the coaxial structure, crosstalk is low, both for the x-y and z-axis connections. The through-slugs, about 12 mils square when completed, are usually placed on 50-mil centers. To interconnect with a neighboring wafer, a gold button is plated on one or both sides of the through-slug. The button is usually about 5 mils square. Gold buttons also are plated directly on the copper substrate to allow ground-plane interconnection in the z-direction.

### Less complex than pc boards

Thus, the photochemical processing used in Planar Coax is the same as is used in printed-circuit board manufacture, except for the steps involving application

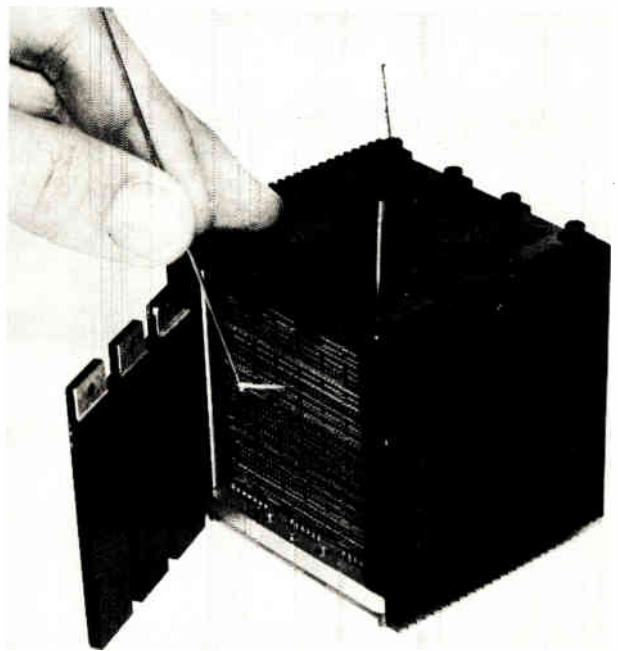

**4. Probe.** When assembled, the system can be tested with a needle probe applied to test points on the edge of the stack. The test points are arranged in groups for easy identification. Note the twelve bolts used to apply pressure to the stacks and the alignment rods projecting out of the top surface. Case is designed with heat-removal fins. Since wafers are copper, heat is easily conducted to case.

of the dielectric. Also, there are no holes drilled in Planar Coax and no through-hole plating is performed. In fact, there are fewer steps in Planar Coax than there are in pc board production: about 21 steps compared with 28 steps for pc boards.

The epoxy dielectric is one of the critical components of the system, and its formulation is proprietary with Bunker-Ramo. A single-component system, the dielectric matches the copper in coefficient of thermal expansion; a filler is used to give it this property. Its dielectric constant is about 4.5, and it withstands all the chemical processing steps. The filler, which has a paste-like consistency, is doctor-bladed across the substrate to fill the etched moats. After curing, the substrates are run through a printed circuit sander to remove the flash of dielectric that remains.

### Mix and match four types

Four types of wafers are used in building a system (Fig. 2b): x-y interconnections, z-axis interconnections, component wafers, and filler wafers.

The x-y interconnection wafers are the only custom-designed parts in the system. With a computer program and an automatic artwork generator, new wafers can be produced in one to two days. In a typical system, two such wafers are needed for each component-bearing wafer. The z-axis interconnection wafers, called connector screens, are simply arrays of through-slugs plated with gold buttons.

The component wafer contains mounting pads for the devices and a matrix of through-slugs. A wide variety of

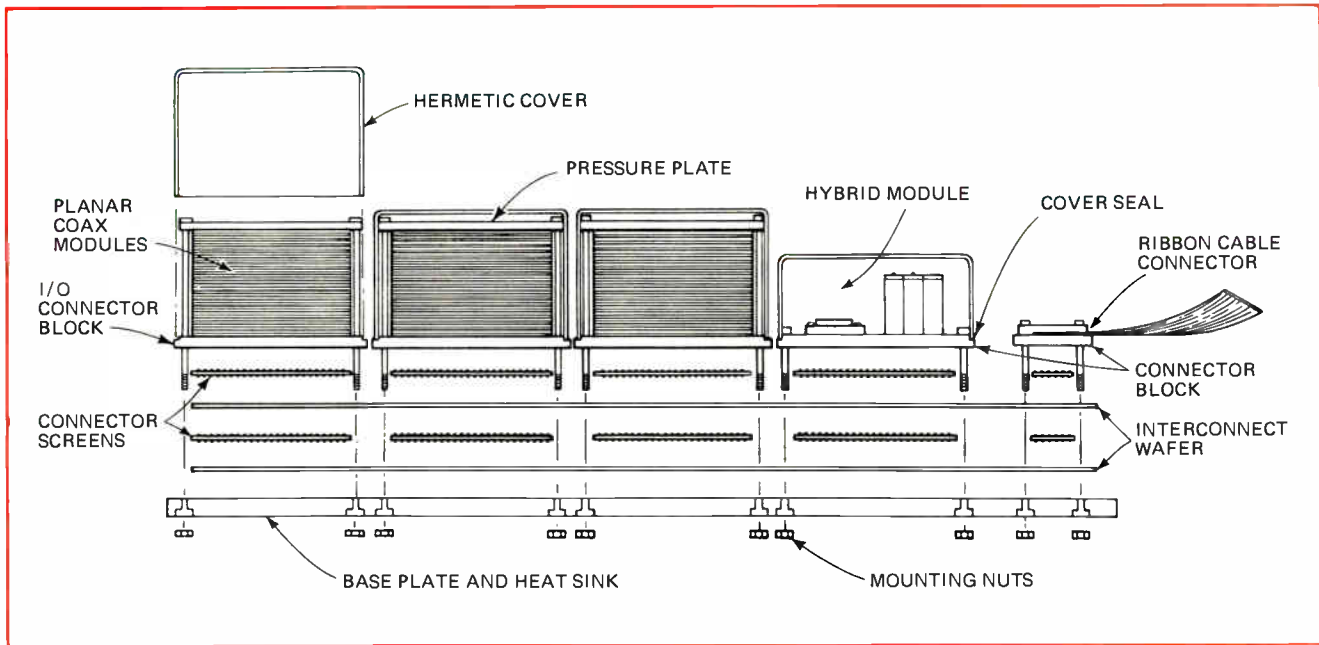

**5. The big picture.** A complete system includes several wafer stacks plus a separate module for discrete components or other hybrid modules that are not adaptable to mounting in Planar Coax stacks. Modules are interconnected by large Planar Coax wafers, and base plate serves as a heat sink. Planar Coax also provides a well-matched connection to flat cable at input and output.

device types can be used—beam-lead chips, leadless inverted devices (LIDs), and flatpacks. The mounting pads are each connected via buried conductors to one of the through-slugs for interconnection to other wafers. To allow greater flexibility and to allow the component wafers to be made as standard parts, no interconnections are included on the component wafers.

Filler wafers (Fig. 3) have cutouts to allow for the height of the active devices and also have x-y interconnections from the slugs that mate with device terminal slugs. These interconnection paths are routed to the outer edges of the wafer to serve as test points for every device used for troubleshooting the system. At the wafer periphery, the edge contacts are about 20 mils wide and about 10 mils deep. Since they are about 7 mils high, there is enough space on the resulting 7 by 20 mil exposed cross-section for making contact with a needle probe (Fig. 4). When the stack is assembled, the filler wafers with edge contacts are arranged to form patterns of test points on the faces of the stack. A tabular listing will assist the troubleshooter in locating terminals.

The concept of pressure interconnections, which is fundamental to the ability to replace individual wafers, is not as unorthodox as it might seem. The gold-button connection can be compared to wire-wrapped connections, which have billions of hours of reliability data behind them. So far, about 50 million button hours have been logged without contact failure.

Since the stack is assembled under a pressure of about 1 to 2 pounds per button, each gold button deforms under a pressure of about 20,000 pounds per square inch. The interface between the button and the through-slug is hermetic. Button heights are uniform; with the uniform field in the plating bath, about 0.3 mil of soft, ductile gold is plated on each button.

In the photo of the computer in Fig. 4, 12 screws are used to bolt the stack together, but fewer could be used.

The computer stack requires about 4,000 pounds and each screw can take up to 900 pounds; thus, only five screws are needed. The placement of the screws could also vary with the design, and even could be placed down the center of the assembled stack.

Alignment problems are avoided by making the gold buttons about 5 mils square and the through-slugs about 12 mils square. Thus, the buttons can be off center by as much as 3 mils before they reach the edge of the slug. Alignment is assured with hardened rods (Fig. 1), about 28 mils in diameter, which pass through etched holes in opposite corners of each wafer. The rods hold the wafers within 1 mil of proper alignment.

### Computer checkout

When stacking the wafers in production, the stack is checked for proper contact as it's being assembled. After inserting a component wafer, a special probe wafer is pressed over the stack to make contact to all through-slugs, and a computer-controlled test set checks out all interconnections. A 4,000-wire stack can be assembled and tested in about half an hour with the computer.

To build a complete system, as shown in Fig. 5, the stacks would form separate modules that are interconnected with a larger Planar Coax interconnection wafer that's made in the same way as the smaller wafers. A separate module can be included to house the discrete components needed to complete the system.

Heat is not much of a problem, even with the high-component density. Since the wafers are almost 80% copper, there's a high thermal conductivity path to the heat sink. Measurements have shown that a heat flux of 50 watts per cubic inch produces worst-case system temperature differentials of 2° to 5°C. The module covers can be designed to have heat fins to dissipate the heat from the sides and top, and wafers can be mounted on a base plate to dissipate heat to the mounting plate. □

# P/MOS chip drives liquid crystal display for digital alarm clock

The unique interface between MOS and liquid crystal technologies makes possible a solid-state household clock that may be priced low enough to compete with electromechanical commercial versions

by Howard Borden, Joseph Mingione, and Paul Nance, *American Micro-systems, Inc., Santa Clara, Calif.*

□ Liquid crystal displays and MOS integrated circuits promise soon to become a valuable combination in digital equipment, and one of the most intriguing from a design viewpoint is the teamwork in clocks. Such a clock has been built to see whether that approach could lead to an alarm clock for the same cost as standard electromechanical models (Fig. 1).

The MOS IC for a clock must be simple, able to handle all the functions performed in competing electromechanical clocks, and—above all—low in price. It is possible to fabricate on a single chip a device to meet all of these demands, despite the varied functions performed by such a digital system. As shown in Fig. 2, the chip must interface with the liquid crystal display and the alarm, plus make allowance for setting the time and for various options such as “snooze” alarm, alarm “clear,” “stopwatch,” and “reset”.

The chip designed to meet these system demands (Fig. 3) has a standard ion-implanted, p-channel monolithic structure and operates from a primary frequency of 60 hertz, derived from a standard ac power line. The device incorporates output circuitry capable of driving directly a liquid crystal display (LCD). Input detection and shaping are also provided internally.

As cost in a consumer clock is an important design

factor, the MOS chip is intended to eliminate as many separate control and display interface components as possible. For that reason, the LCD driver and the 60-Hz amplifier and shaper are contained in the device.

Similarly, p-channel was chosen for cost advantages, though complementary MOS devices might provide power savings. Actually, the low power drain of the C/MOS approach was not essential in this application because the clock operates from an ac power line. The total power required for the P/MOS chip is approximately 75 milliwatts at 5 volts or 300 mW at 20 V, which is not considered high for the application.

In addition, the C/MOS approach would not only use about double the area of the silicon chip needed for P/MOS, but would also require a more complex fabrication process—some 130 handling steps to 36 for P/MOS. The bipolar approach was also rejected for this application because it also would require more fabrication steps. Also, because of the low power drain, the high current capabilities of bipolar do not benefit the design. Furthermore, economical partitioning of a bipolar design would require two or three chips to do the job, rather than only one P/MOS device.

Since size of the P/MOS chip directly affects cost, much effort was made to minimize die size. Unfortu-

**1. No hands.** A liquid crystal display, with an indication for a.m. or p.m., could be built into an alarm clock for the same cost as current electromechanical models, as this clock has proven. Use of a Triac or relay enables it to control other household appliances.

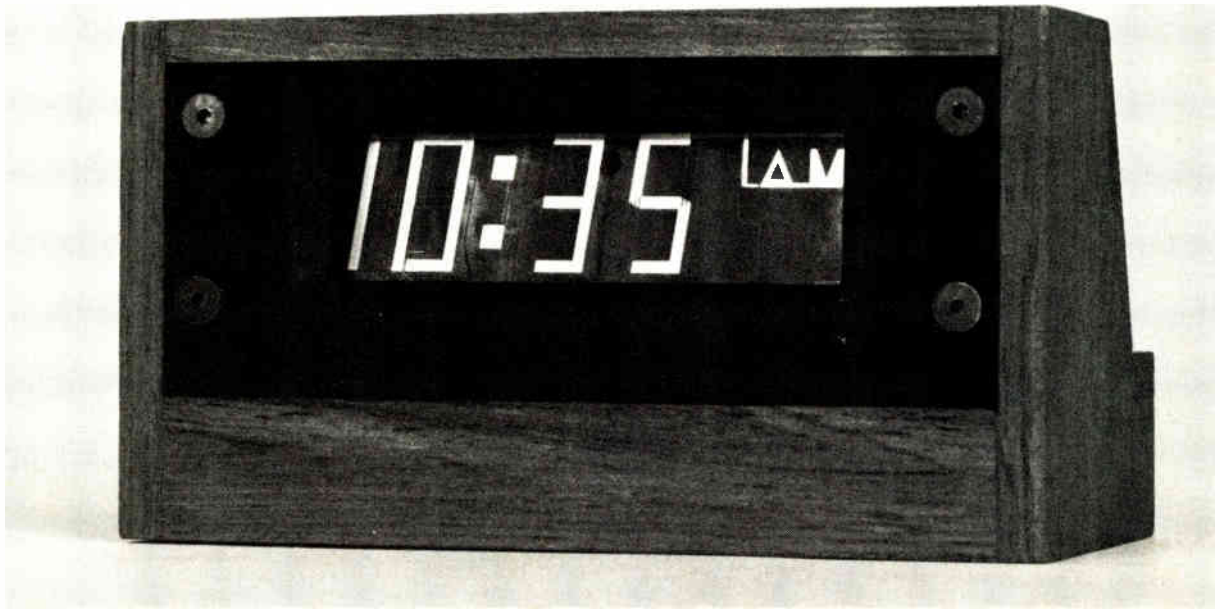

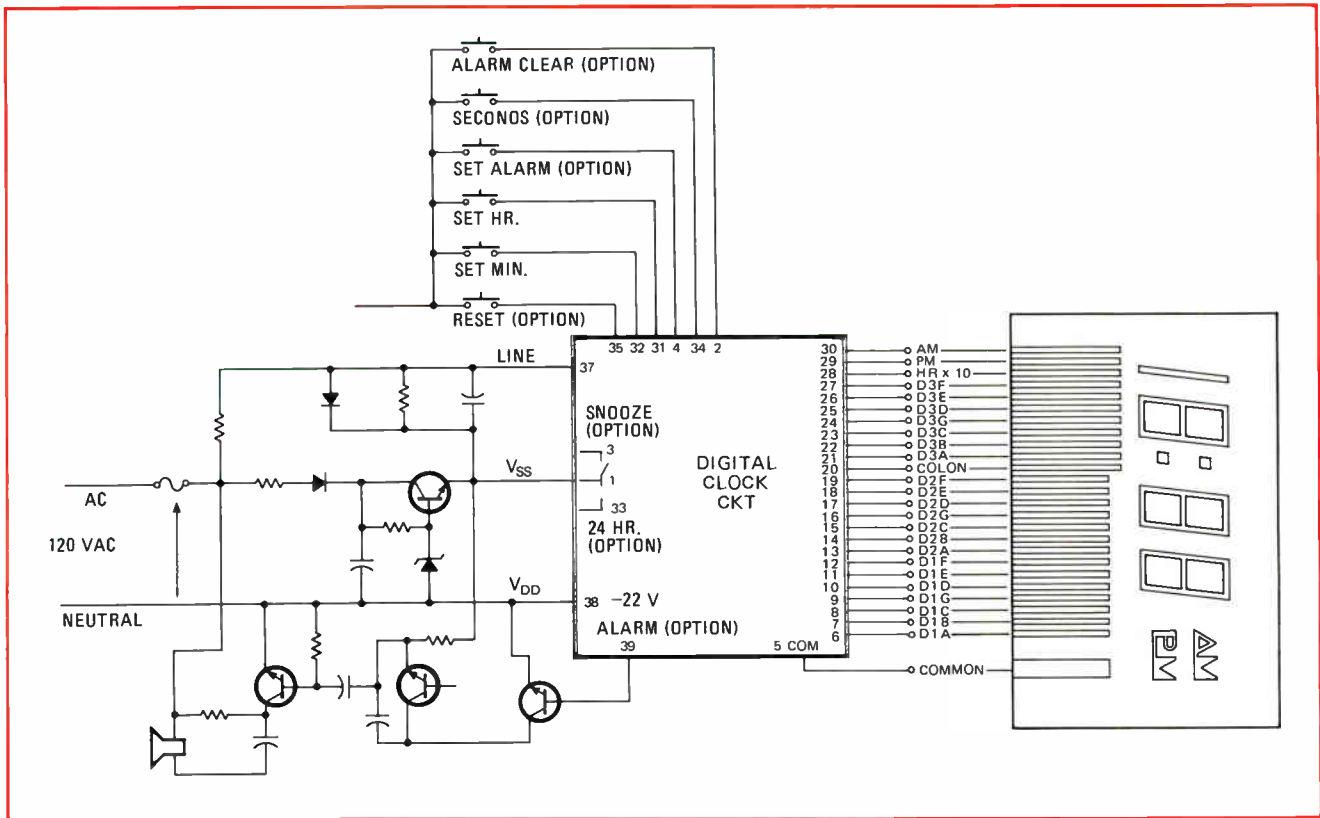

2. **Clock watcher.** The complete system for the single-chip digital clock consists of the clock circuit with outputs to the liquid crystal display and the alarm circuits. There is also allowance for time and alarm "set" and "clear" switches, as well as a "stopwatch" optional feature.

nately, computer-aided design (CAD) layout makes it difficult to spread logic throughout the device real estate. With CAD, logic has to be put in predetermined areas joined by preassigned wire or interconnect paths. Though effective for many designs, this constraint usually results in much larger devices than those attainable by hand layout. In this case the hand-drawn topography achieved a 30%-50% reduction in logic area from what could have been achieved by computer methods.

The complete alarm clock system requires this single MOS device (Fig. 4), plus the liquid crystal display, one diode, two capacitors, two switches, and four resistors for the basic model, which is considerably simpler than the circuit board in a TTL version (Fig. 5). In use, a power supply range ( $V_{DD}$ ) of  $-15V$  to  $-30V$  is acceptable both to the MOS device and the LCD. (Either a reflective or transmissive liquid crystal display may be used.)

### Clock operation

The device circuit, essentially independent of supply variations, has a nominal  $V_{DD}$  current requirement of 6 milliamperes. With these basic electrical requirements met, the clock is ready for action. A 60-Hz input signal is required with the following limits: logic "1"—maximum  $-15V$ ; minimum,  $V_{DD}$ . Logic "0"—maximum  $V_{SS} + 0.3V$ ; minimum,  $V_{SS} - 2V$ . All input control lines have internal pull-up resistors and require a connection to ground to perform the appropriate function.

To set the correct time, two controls are used to cycle the four-digit, seven-segment display to the minutes and hours—one switch for each. At an increment rate of one digit flashing per second, the display numbers are

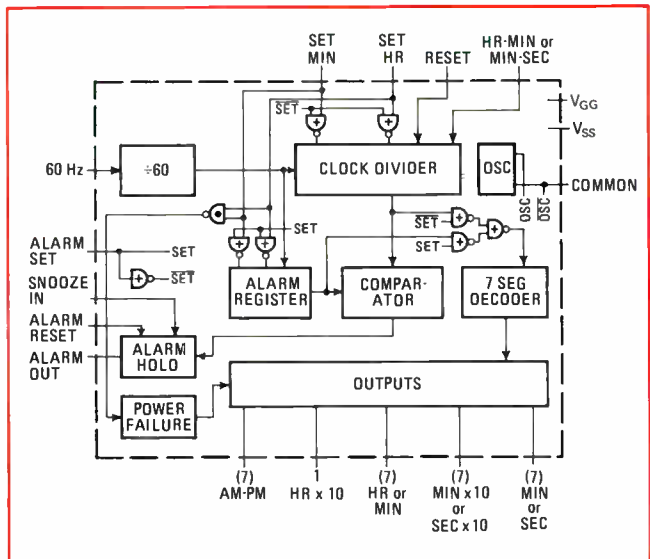

3. **Inside the chip.** The block diagram of the P/MOS chip shows how many functions are located within minimum space. To conserve on die size, hand-drawn layouts were used instead of CAD.

stepped when one or the other controls is switched on. This gives the user enough time to react when the desired digit appears, and he can release the "set" control before the desired number has passed.

These same two controls also can be used to set the alarm. After first activating an alarm "hold", the user runs the display to the exact hour and minute desired for the alarm. When he releases the "set" switches and the alarm "hold," the clock, which has been keeping the

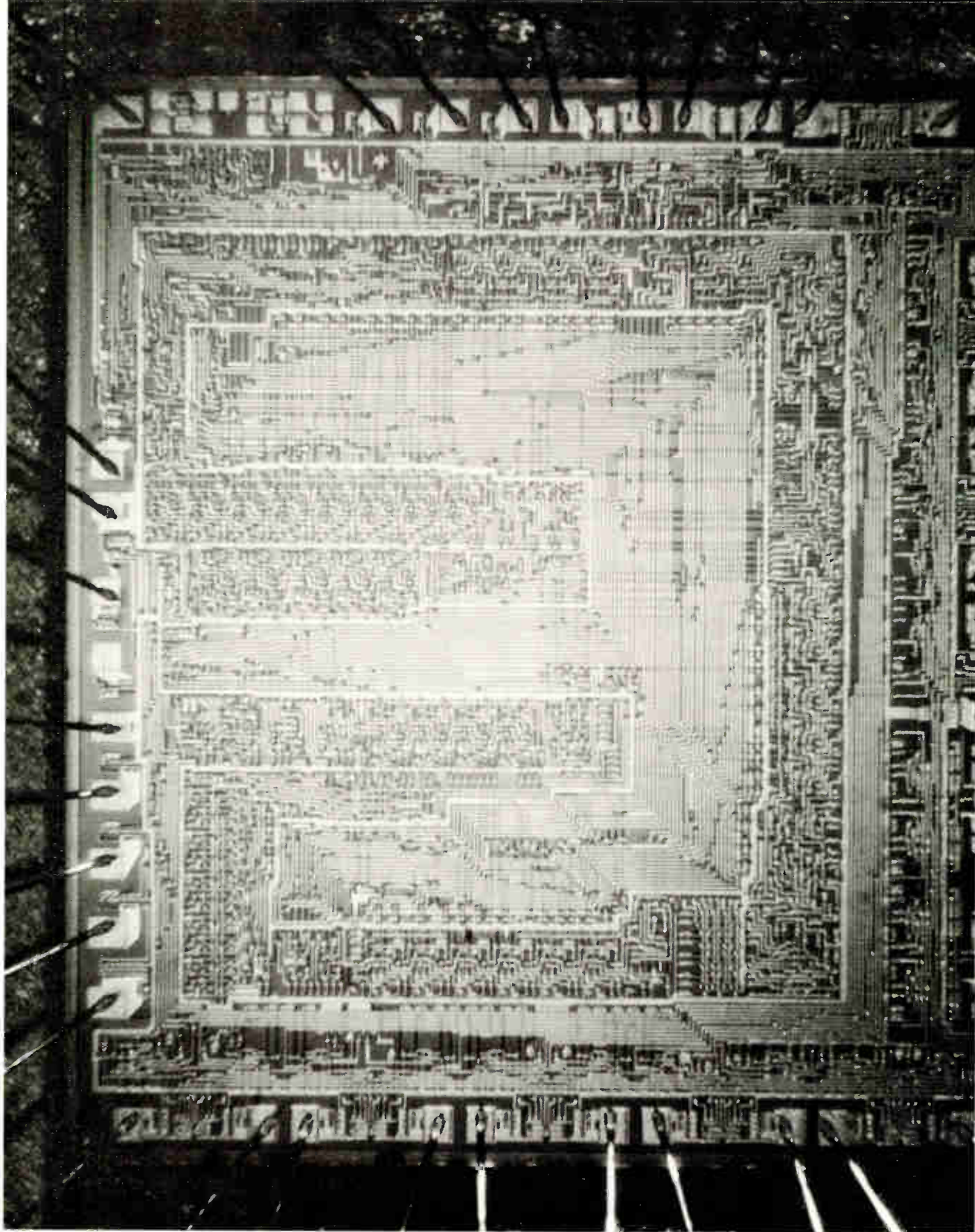

time internally during this interval, resumes the time display. A comparator circuit on the chip will set off the alarm when the time reaches the point set in the alarm register—that is, when the output of the timing counter exactly equals the contents of the alarm counter.

The clock controls a transducer that can generate an audible signal. The alarm "clear" input is the counterpart of the on/off switch on a conventional alarm clock—a ground on this input disables the alarm output. An optional feature, the "snooze" setting, resets the

alarm counter and provides a five-minute interval between rings. If not cut off by the alarm switch, the first ring lasts 12 minutes, and the snooze rings, which may be repeated as often as desired, last seven minutes.

For military or world clock uses, there is a 24-hour display option. Ordinarily, there is an a.m. or p.m. segment on the display that pulses once a second. These are in addition to the four numerals and a colon. Twenty-four hour capability is provided by combining the a.m. and hours times 10 and the p.m. and hours



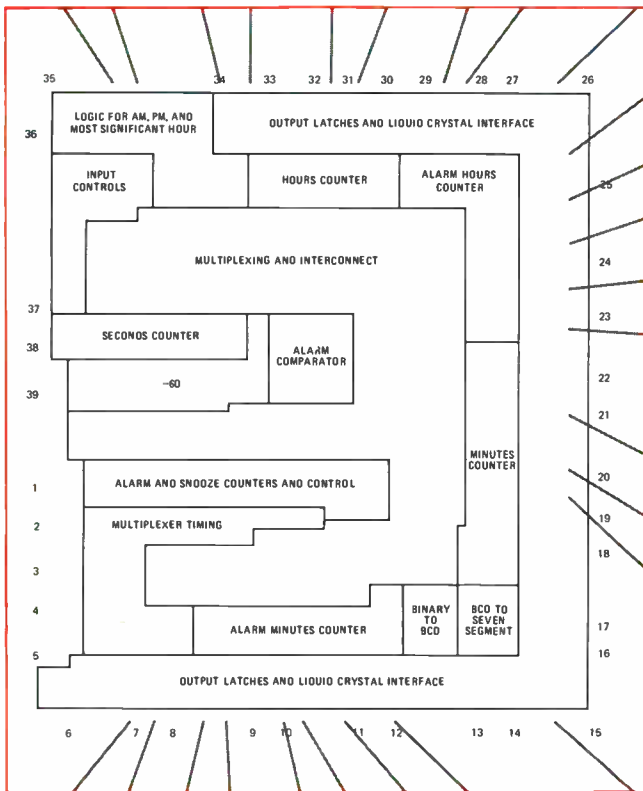

**4. Chip off the old clock.** A single P/MOS chip provides all the electronic functions necessary for a digital readout alarm clock. This circuit is available in both a 40-lead dual in-line and a 40-lead edge-mount package to facilitate connector applications.

times 10 IC outputs to generate a number "1" or a number "2" respectively from the seven segments making up the first numeral on the display, enabling the display to read as high as 2400, or midnight.

It is possible to ground the "seconds" input driving the a.m. and p.m. indicators and transfer the counter and most significant minute digit onto the internal multiplexing lines in order to view a display of the minutes and seconds only. Activating the reset returns the seconds, minutes, and hours counters to 0. By gating the 60-Hz input line in conjunction with the reset function, a "stopwatch" mode is available.

### Warning flashes

Another important consideration for an electric clock is reaction to a temporary power loss. For the P/MOS clock, a failure activates an internal detector, which causes both the a.m. and the p.m. indicators described above to pulse simultaneously, thus alerting the user to the erroneous display. This pulsing stops when the time is reset. For the 24-hour version, since there are no a.m. and p.m. display segments, the chip has been designed to "scramble" the first digit in the four-digit display. The bottom four segments and the top of the seven segments on the first numeral appear, and the top right hand segment may or may not be visible. This results in a 0 with a bar over it, or a reversed six, which is intended to alert the user that something is wrong.

Although the LCD output interface of the circuit is one of the clock's significant features, it is also the simplest in design. It is basically an inverter circuit with a

## Looking at liquid crystal displays

Electrically, each numeral of a liquid crystal display is a resistor shunted by a capacitor. Looking at it another way, the display is two conductive plates, separated by a leaky insulator.

The values of the resistor and shunt capacitor are the result of the display element area, the area of the leads, the spacing between conducting surfaces, the dielectric constant of the liquid material, the operating temperature, and the electrical conductivity of the conducting surfaces.

The range of values can be quite large, but with proper design, the LCD display is ideal for direct interface with MOS drivers. The P/MOS driver-LCD clock (Fig 1), designed and built by American Micro-systems Inc., to demonstrate the capability of this combination, has three-quarter-inch high numbers. Electrical values for this size are a 5-megohm resistor shunted by a 5-picofarad capacitor.

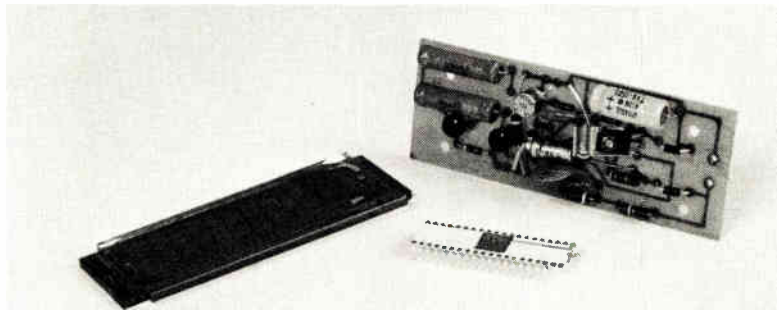

**5. Changing times.** The display and single-chip P/MOS device (foreground) designed for a clock are far more compact than the board with TTL-based components used for the same functions.

depletion-mode FET pull-up resistor. The depletion-mode pull-up causes an offset condition from the  $V_{DD}$  line to the output, thus insuring that there is 0 dc voltage across the liquid crystal display which, in turn, helps prolong the display's life. The LCD is driven in parallel; a different output is provided for each element, which includes each segment of the four digits, the colon, and the a.m./p.m. indicators, when used. In addition, outputs are decoded internally for the display drive.

The outputs of the MOS circuit apply a 60-Hz signal directly to the individual display segments. When the applied signal is in phase with the 60-Hz backplate (LCD common terminal) voltage, no illumination occurs. When the applied signal is 180° out of phase with the backplate voltage, illumination occurs.

The backplate voltage is generated on the chip at 60 Hz by buffering the line input signal, which also generates the primary input frequency. This prevents synchronizing problems or rise and fall time differences that may cause undesirable crystal visibility. The phase of the segment outputs is generated from the contents of data latches and buffer circuits. This provides an active pull-up or pull-down to both ends of the segments, thus eliminating capacitive coupling across the LCD. □

# Approximating true log output at high frequencies

New way to build high-frequency log amplifiers eliminates interstage phase shift by using twin-gain amplifier blocks that consist of a unity-gain non-limiting amplifier and a high-gain limiting amplifier

by Douglas Clifford, Hewlett-Packard Co., Loveland, Colo.

□ Many circuit analysis applications, such as those involving tuned receivers and spectrum analyzers, require displaying signals with a very broad dynamic range. Signal levels can typically vary from -120 to +10 decibels referred to 1 milliwatt. But to display even a portion of such a signal requires some form of compression. Usually the signal is processed by forming a logarithmic function of signal level.

A recently developed technique eliminates the objections of poor frequency response above 5 megahertz that is characteristic of the previously least complicated method, successive limiting. The new design is similar to successive limiting, but it eliminates interstage phase shift by using twin-gain amplifier blocks to approximate the log curve as a series of straight lines.

## Comparing approximation methods

Successive limiting, or linear approximation, is the most sophisticated of three traditional nonlinear methods, which use progressively more complex compensating circuitry to improve accuracy. The new twin-gain amplifier technique achieves accuracy with no compensating circuitry.

The method that requires heaviest compensation employs feedback with a nonlinear element. Generally, a transistor's base-emitter junction is used, since its characteristic is exponential.

The second technique, which can achieve equal accuracy with less compensating circuitry, is also based on an exponential characteristic—that of transistor collector current. A single, simple transistor amplifier can usually provide exponential gain over a range of more than 20 dB. For larger dynamic ranges, transistors must be cascaded with intervening gain blocks to allow each stage to operate within its range.

The third method, successive limiting, has been the most popular at high frequencies because of its simplicity. Successive limiting approximates the logarithmic curve by summing either the rf signal outputs or the detected video signal outputs of a series of linear amplifiers that limit at a predetermined level. Figure 1 illustrates the circuit and its output characteristic.

Poor frequency response is the main limitation of successive limiting. At frequencies above 5 MHz, phase shift between stages causes the rf signal components to be summed out of phase, and the logarithmic response deteriorates unless delay networks are inserted.

In applications where the log of the rf signal must be detected before further processing, detectors can be placed at the output of each amplifier. This solves the phase shift problem, but complicates circuitry and increases over-all thermal sensitivity because the detectors do not track each other as temperature changes.

A recently developed technique eliminates both the

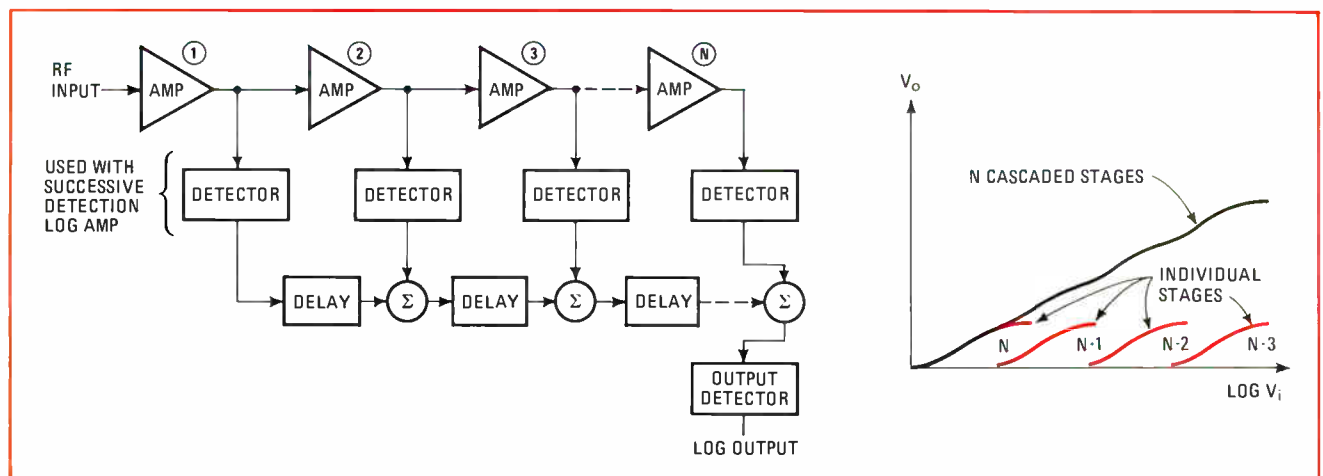

1. **Successive limiting.** Summing the outputs of cascaded limiting amplifiers yields logarithm of input signal. Limited output of each stage is added to that of previous stage to approximate log curve. Delay networks become necessary when operating above 5 megahertz to compensate for phase shift between stages. Optional detectors allow rf signal to be detected before additional processing.

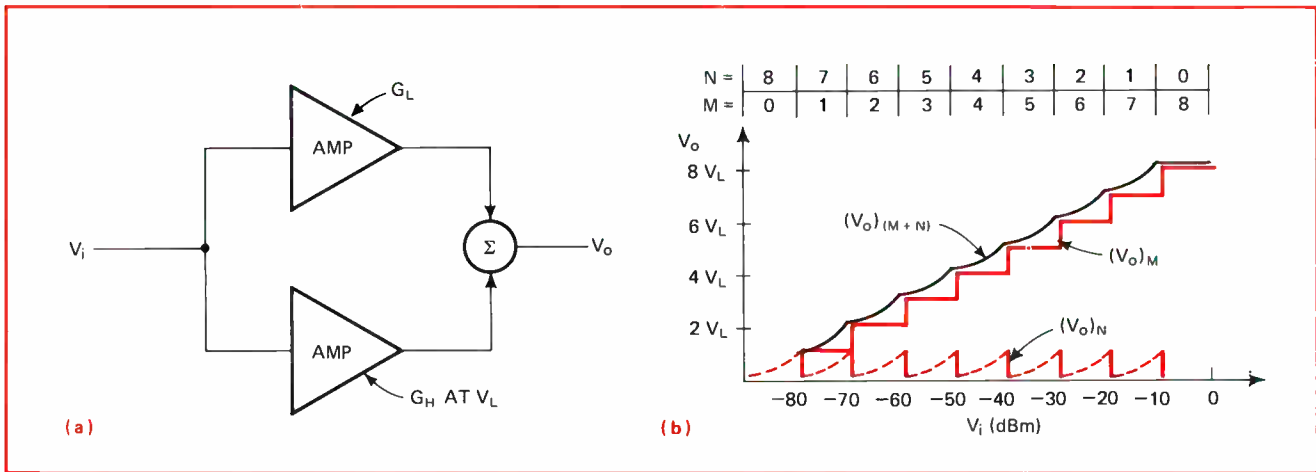

**2. Double-amplifier log stage.** Twin-gain amplifier block (a) can be cascaded to form log amplifier that does not need phase-shift correction. Low-gain ( $G_L$ ) amplifier does not limit input signals, but high-gain ( $G_H$ ) amplifier does, at limit level  $V_L$ . For logarithmic output to result,  $G_L$  must be unity. Plot (b) shows how eight cascaded stages of twin-gain amplifiers approximate log curve. Final output voltage,  $(V_o)_{(M+N)}$ , reflects addition of outputs from both limiting ( $M$ ) and non-limiting ( $N$ ) stages for total signal range of  $-80$  to  $0$  dBm.

need for multiple detectors and rf phase shift problems. The method is similar to successive limiting, because a number of identical blocks are used with output characteristics that approximate the log curve with a series of straight lines.

As shown in Fig. 2(a), the signal is applied simultaneously to two amplifiers that form a twin-gain circuit. The low-gain ( $G_L$ ) amplifier does not limit an input signal, but the high-gain ( $G_H$ ) amplifier does, limiting it at a voltage level of  $V_L$ . The relationship between output voltage ( $V_o$ ) and input voltage ( $V_i$ ) can be written as:

$$V_o = V_i(G_H + G_L)$$

when  $V_i$  is less than  $V_L/G_H$ , and:

$$V_o = V_i G_L + V_L$$

when  $V_i$  is greater than  $V_L/G_H$ .

If  $V_i$  is less than  $V_L/(G_H + G_L)^N$ , the limit level for  $N$  cascaded amplifier blocks, the overall amplifier will be linear. However, when the magnitude of  $V_i$  causes the high-gain amplifiers in each block to limit, the system becomes nonlinear.

When all the stages are limiting, the output of one is still the input drive to the next. For  $M$  stages driven into limiting:

$$(V_o)_M = V_L(1 + G_L^2 + G_L^3 + \dots + G_L^{M-1}) + V_i G_L^M$$

Combining  $N$  stages of non-limiting blocks and  $M$  stages of limiting blocks gives:

$$(V_o)_{(M+N)} = V_L(1 + G_L + G_L^2 + \dots + G_L^{M-1}) + V_i G_L^M (G_H + G_L)^N$$

If  $G_L$  is set to unity, then:

$$(V_o)_{(M+N)} = V_L M + V_i (G_H + 1)^N$$

The maximum non-limiting gain for  $N$  stages is found by setting  $M = 0$  and letting  $V_o = V_L$ :

$$(G_H + 1)^N = V_L / V_i$$

or:

$$N = \log(V_L / V_i) / \log(G_H + 1)$$

Substituting  $T = M + N$ , where  $T$  is the total number of gain blocks:

$$M = T + \log(V_i / V_L) / \log(G_H + 1)$$

If  $G_H$  and  $V_L$  are the same for each block, this equation reduces to:

$$M = K_2 + K_1 \log(V_i)$$

where  $K_1 = 1 / \log(G_H + 1)$

$$\text{and } K_2 = T - K_1 \log(V_L)$$

Since  $V_i (G_H + 1)^N$  is greater than or equal to  $V_L$ :

$$(V_o)_{(M+N)} = V_L M + V_x, \text{ for } V_x \text{ between } 0 \text{ and } V_L.$$

This last equation indicates that  $V_o$  is proportional to  $M$ , which is in turn related to  $\log(V_i)$ , making  $V_o$  proportional to the log of the input. It should also be noted that  $G_L$  must equal unity for the log approximation to hold.

A plot of the two parts of  $(V_o)_{(M+N)}$  illustrates the logarithmic relationship between the output and the input. As an example, the graph of Fig. 2(b) results for cascaded twin-gain blocks when  $M + N = 8$ ,  $G_H + 1 = 10$  dB, and  $V_L = 0$  dB into 50 ohms. Assuming  $G_L = 1$  and  $N = 0$  yields the output of  $M$  limiting blocks:

$$(V_o)_M = V_L M$$

And setting  $M = 0$  and keeping  $G_L = 1$  gives the output voltage for  $N$  non-limiting blocks:

$$(V_o)_N = V_i (G_H + 1)^N$$

The graph shows the contributions of both  $(V_o)_M$  and  $(V_o)_N$  for all combinations of  $M$  and  $N$ . The two outputs are simply added together for a total output voltage. Both output voltage level and input signal range become larger with increasing  $M$  and decreasing  $N$ .

### From theory to hardware

A log amplifier with almost any given dynamic range and log fidelity can be constructed with twin-gain amplifier blocks. The fewer the stages used, the more gain each stage must provide for a given range, and the greater the deviation from the actual log curve.

The computer printout of Fig. 3 compares an eight-stage log amplifier to a five-stage one. For both computations, the maximum and minimum errors (differences) between the calculated values of  $(V_o)_{(M+N)}$  and the actual log of  $V_i$  are printed. Also shown are the computed output voltages for inputs from  $-80$  to  $-10$  dBm. Output voltage figures are normalized to reflect a 1-v output change for a 10-dB input step.

The calculation for the eight-stage log amplifier, in Fig. 3(a), indicates a maximum error of 0.03 v and a minimum error of 0 v when  $G_H = 6.68$  dB and  $V_L = -1$  dBm into 50 ohms. (Here, maximum error represents

(a) GAIN DB, LIMIT ?6.68,-1			
MAX ERROR=	3.12457E-02	MIN ERROR=	0
DB=-80		VOUT=	1.00247
DB=-70		VOUT=	2.00211
DB=-60		VOUT=	3.00176
DB=-50		VOUT=	4.0014
DB=-40		VOUT=	5.00105
DB=-30		VOUT=	6.0007
DB=-20		VOUT=	7.00035
DB=-10		VOUT=	8
(b) GAIN DB, LIMIT ?14,-5			
MAX ERROR=	8.13584E-02	VMAX=	.699427
DB=-80		VOUT=	.979577
DB=-70		VOUT=	2.07618
DB=-60		VOUT=	3.00364
DB=-50		VOUT=	3.92999
DB=-40		VOUT=	5.01443
DB=-30		VOUT=	5.98255
DB=-20		VOUT=	6.91574
DB=-10		VOUT=	8

**3. Computer comparison.** Printouts for eight-stage (a) and five-stage (b) twin-gain log amplifiers list normalized (1 V = 10 dB) output voltage for inputs from -80 to -10 dBm. Maximum and minimum errors across this range are computed as difference between calculated  $(V_o)_{(M+N)}$  and actual log of  $V_i$ . Eight-stage amplifier, whose  $G_H = 6.68$  dB and  $V_L = -1$  dBm, gives maximum error of 0.03 V and minimum error of 0 V. Five-stage amplifier, with  $G_H = 14$  dB and  $V_L = -5$  dBm, provides errors of 0.08 V max and 0.09 V min.

the largest positive deviation from the desired output, and minimum error the largest negative.) Error levels are higher for the five-stage amplifier, as indicated in Fig. 3(b), with  $G_H = 14$  dB and  $V_L = -5$  dBm into 50 ohms. Maximum error becomes 0.08 v, while minimum error is about 0.09 v, bringing the peak-to-peak error to 0.17 v or 1.7 db.

As can be seen from the circuit equations, the critical design parameters are limit level  $V_L$  and high gain  $G_H$ . These quantities are influenced by the desired log range and number of stages. A computer program is generally used to determine them for the dynamic range and log fidelity desired.

One way to implement a twin-gain log amplifier is to use two differential pairs driven in parallel and feeding a common load, as illustrated in Fig. 4(a). Transistors  $Q_1$  and  $Q_2$  form the unity-gain amplifier, while transistors  $Q_3$  and  $Q_4$  provide a high gain of  $G_H$  and limit at  $V_L$ . This design, it should be noted, is completely analogous to the theoretical model. Differential pairs are used because of the excellent limiting they provide when they are overdriven.

The gain of the low-gain amplifier is:  
 $G_L = R_L / (2R_1 + 2r_e) = R_L / (2R_2 + 2r_e) = 1$   
 where  $R_1 = R_2$ , and  $r_e$  is transistor dynamic emitter resistance. High gain  $G_H$  is determined by:  
 $G_H = R_L / (2R_3 + 2r_e) = R_L / (2R_4 + 2r_e)$   
 where  $R_3 = R_4$ . Limit level  $V_L$  is fixed by the peak-to-peak current swing allowed in  $R_L$  due to the high-gain amplifier:  
 $V_L = IR_L$

Usually,  $G_H$  and  $V_L$  are found first from a computer model of the circuit. Actual resistor values can then be determined from the equations. Amplifier bandwidth is established by components  $R_L$ ,  $L$  and  $C$ . Transistors should be chosen so that amplifier input and output ca-

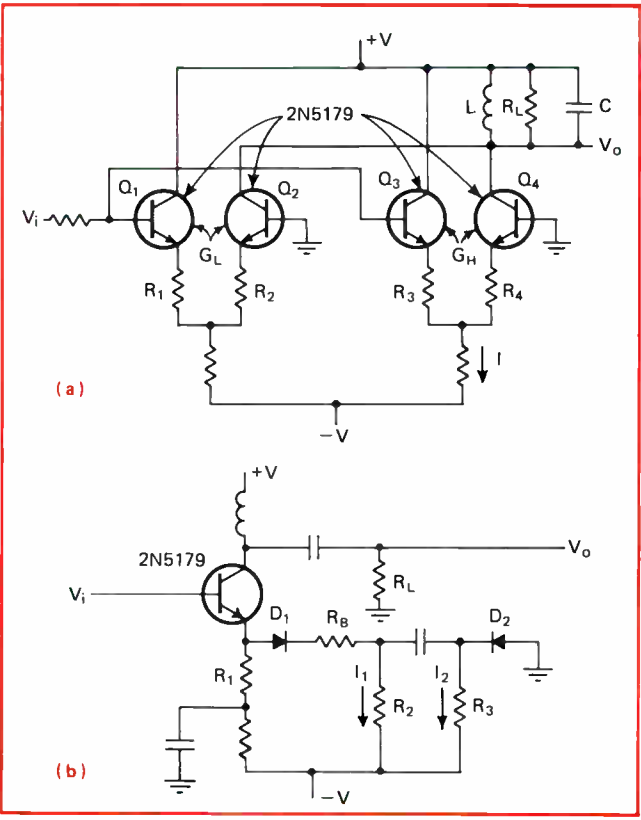

**4. Building a log amp.** Two differential pairs (a) drive common load to realize twin-gain log amplifier. Limit level  $V_L$  of high-gain ( $G_H$ ) pair is determined by allowable peak-to-peak current through  $R_L$ . Single transistor (b) can also be used. When diodes are forward-biased, amplifier gain is  $G_H$ , and limit level is fixed by current flowing in diode limiter. For both circuits, low gain  $G_L$  is unity.

pacitances are small to obtain broadband frequency performance.

Another design method, shown in Fig. 4(b), uses the same amplifier to provide both  $G_L$  and  $G_H$ . Diodes  $D_1$  and  $D_2$  are forward-biased for small signal levels so that:

$G_H = R_1 / (R_B + 2r_b) = R_1 / (R_B + 2r_b)$   
 where  $R_1 = R_L$ , and  $r_b$  is diode resistance. Low gain  $G_L$  is obtained through the emitter resistance path:

$G_L = R_L / R_1 = 1$

The limit level for the high-gain portion of the amplifier is determined by how much current is flowing in the diode limiter:

$V_L = I_1 R_2 + I_2 R_3$

where  $V_L$  is the peak-to-peak voltage of the limit level. When the signal begins to reverse-bias the diodes, turning them off, the effective transistor emitter resistance increases, and gain drops. The final amplifier gain approaches unity.

Test results for this log amplifier configuration verify its predicted performance. An eight-stage amplifier, for example, with a nominal operating frequency of 20 MHz, provides an 80-dB input range for signal levels from -80 to 0 dBm. Moreover, its maximum output deviation from a true log curve is only 0.3 dB. For this tight peak-to-peak ripple performance, the emitter resistors must be adjusted to assure that  $G_L = 1$  when a stage is limited. □

# RCA's thyristor line continues to expand— in plastic.

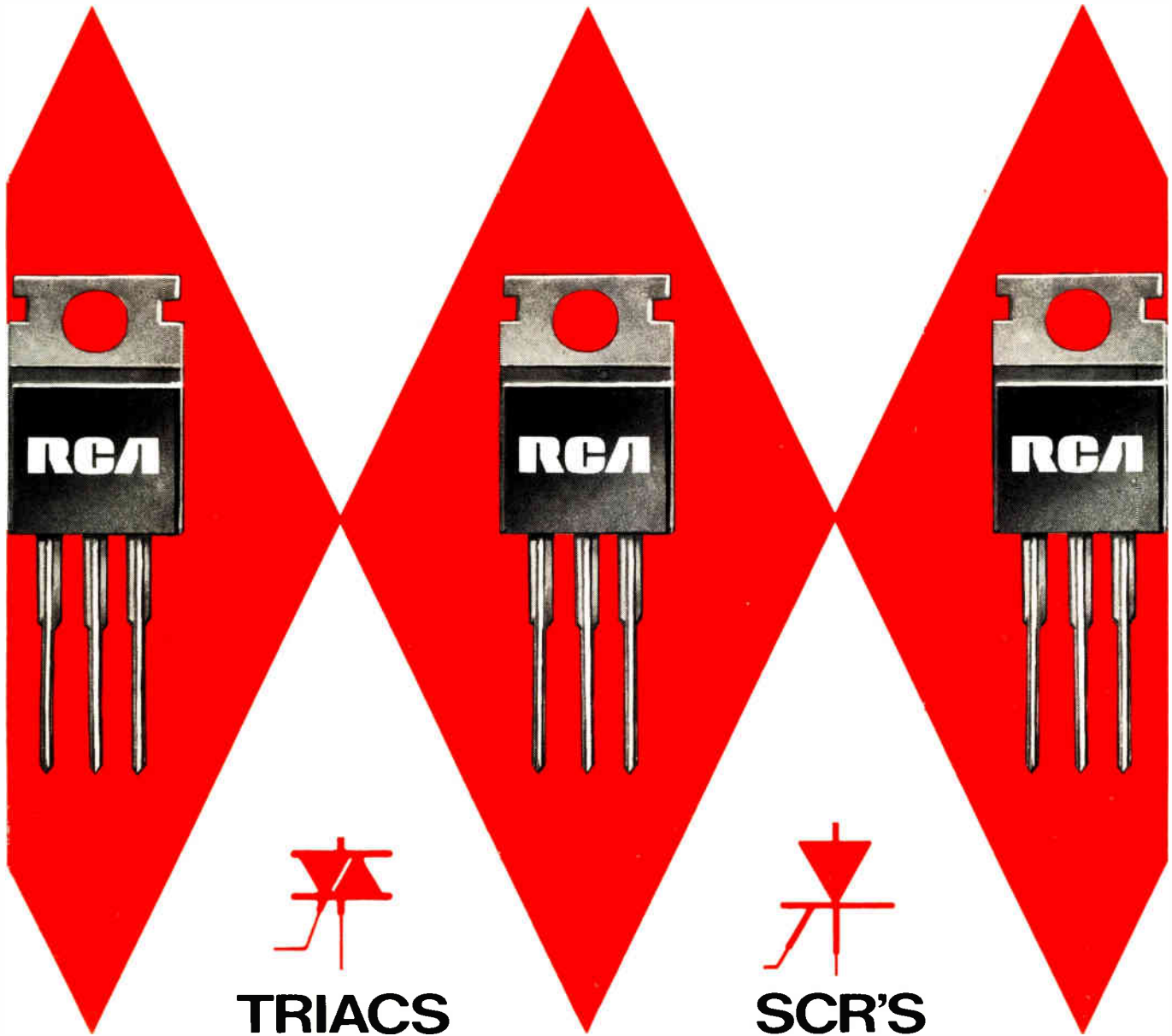

To its popular 40668/40669 triacs and 40868/40869 SCR's, RCA now adds 8 A ISOWATT triacs and 4 A SCR's—all available now—in the industry-accepted VERSAWATT package. Leads are custom-formed to your requirements, of course.

- ISOWATT triacs, 40900, 40901, 40902. These 8 A units are ceramic isolated versions of 40668/40669, providing great flexibility in chassis mounting.

- RCA-106 and 107. Here are 4 A SCR's that fill your needs for low-cost circuit areas that require triggering at 200 and 500  $\mu$ A. These RCA microamp gate SCR's

have extended voltage ratings to 500 V and 600 V.

- 40668/40669. Use these 8 A triacs for control of AC loads for power control and industrial lighting applications.

- 40868/40869. Select these 8 A SCR's for applications in power switching and motor speed controls.

RCA triacs are gate-controlled in all four modes.

RCA VERSAWATT thyristors employ glass-passivated chips for quality performance. When you design circuits using the RCA VERSAWATT thyristor, you get ease of mounting, low thermal impedance

for operation at elevated temperatures, and minimum heat sink requirements—all at excellent cost-effective levels.

With RCA's full plastic capability, you can cover full- and half-wave applications with currents from 1 to 15 A and voltages from 15 to 600 V.

See your local RCA Representative for details. For technical data, write: RCA Solid State Division, Section 70A-31/UR14, Box 3200, Somerville, N.J. 08876. International: RCA, Sunbury-on-Thames, U.K. or P.O. Box 112, Hong Kong. In Canada: RCA Limited, Ste. Anne de Bellevue 810, Quebec.

**RCA** Solid State  
products that make products pay off



The purest place in the world.  
Naturally that's where they make  
the purest maskplate: Millimask

**Millimask**  
the new name in microcircuitry maskplate

Write for full information to:

AGFA-GEVAERT INC. - 175 NORTH STONEY - TETERBORO - NEW JERSEY

AGFA-GEVAERT N.V. - MORTSEL - BELGIUM

**GEVAERT**

**AGFA-GEVAERT**

## Nixon's budget: jobs and votes

It's an election year budget, heavy on spending to boost employment, especially in technology—and that means more electronics jobs

**In this election year,** President Richard Nixon is aiming his new budget to “increase jobs” and produce “a new prosperity for all Americans without the stimulus of war and without the drain of inflation.” But the Democrat-controlled 92nd Congress, which received his budget on January 24, is in no mood to let it go through unchallenged. After all, Congress faces an election year, too.

The \$246.4 billion requested will indeed generate jobs, particularly within the electronics industry, provided a hostile Congress cooperates. And no one is betting on that. Indeed, there are signs that the canny incumbent in the White House is orienting his reelection campaign around the possibility that 1972 may be a carbon copy of 1948. Back then, Harry Truman won after successfully pinning the “do-nothing” label on the Republican-dominated 80th Congress.

**Money for jobs.** Questions also exist about whether the President can achieve his job goal in time to make it count in the polling booths. Though the economic stimulus of the Vietnam war has in fact evaporated, the new budget, with its huge \$25.4 billion deficit, calls for a massive boost in defense spending. A 9% jump, that rise is sure to inflame the Congress.

Economic historians note that the budget rests on the third consecu-

**Money managers.** The future of Richard Nixon, confident of reelection, may rest with key Democratic leaders of Congress, to whom he has submitted another deficit budget. They are (from top) Mike Mansfield, Senate majority leader, and the Appropriations Committee chairmen, Sen. Allan J. Elender and Rep. George H. Mahon.

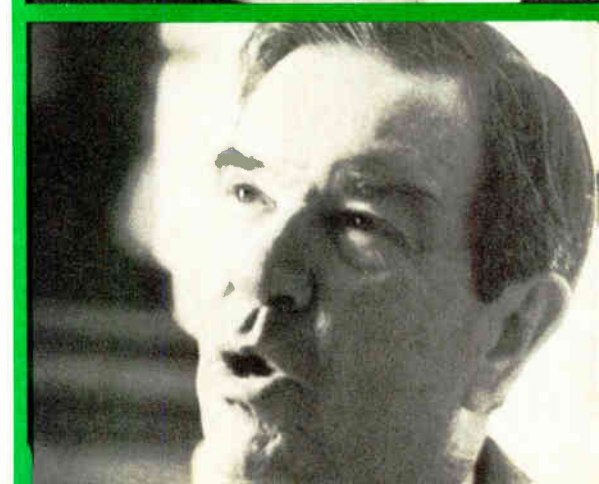
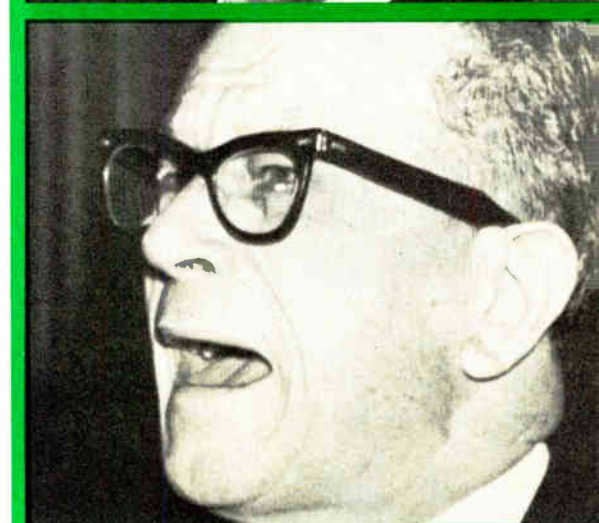
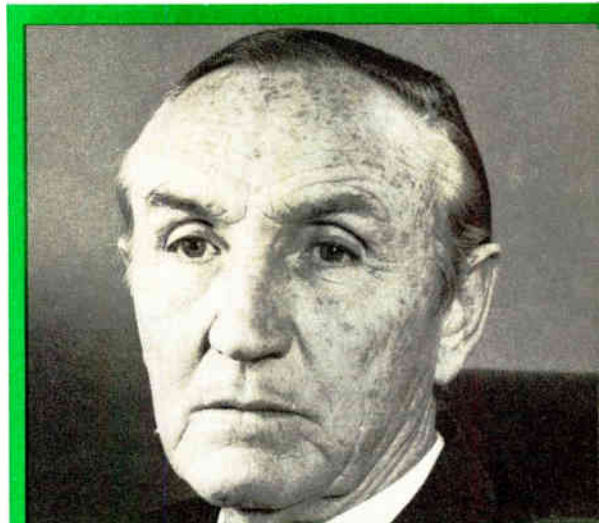
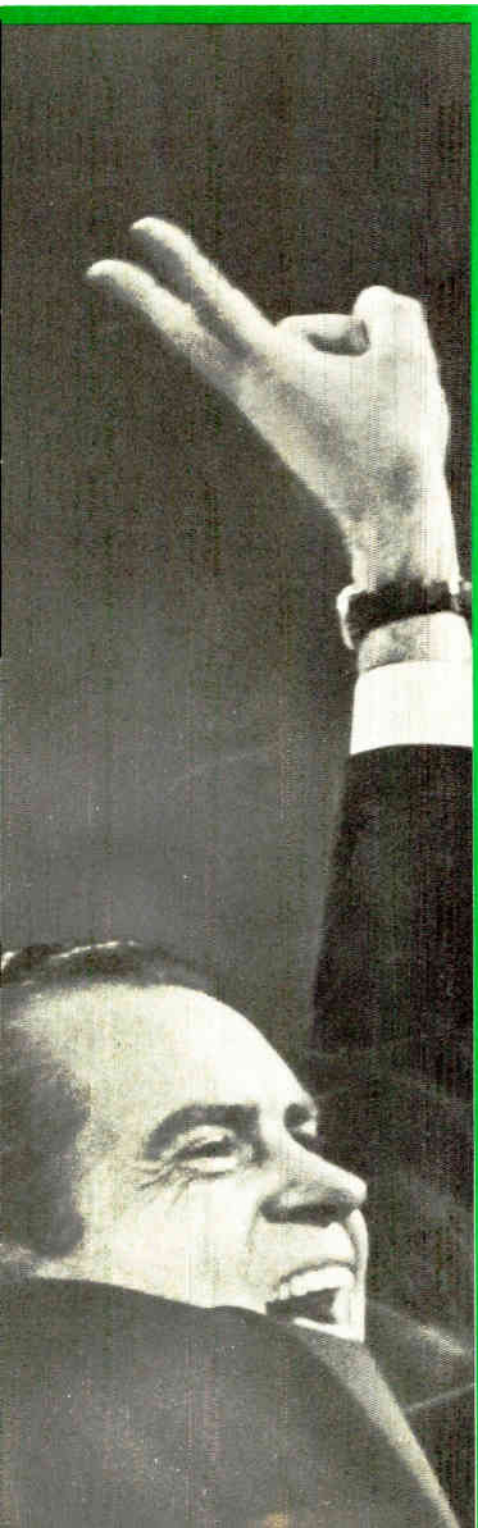

## Probing the news

tive deficit, coming hard on the heels of a \$38.8 billion deficit this year—a blotch of red ink unmatched since the end of World War II. Congress' Democratic leaders view Nixon's proposals as an obvious attempt to generate jobs for unemployed voters, who will than repay him with enough votes to guarantee reelection. Publicly, the Democrats deplore the proposals, of course. Yet they want to increase jobs, too—but with programs geared both to their own advantage and the White House incumbent's disadvantage.

**Priorities.** Electronics engineers—and their employers—see Nixon's budget from a variety of perspectives, depending on their professional biases. Like the economists and politicians on both sides, they welcome the emphasis on high-technology jobs. Yet they can also see there are more jobs for some electronics specialties than others.

Defense contractors, for example, are clearly pleased with the big in-

creases contained in the \$75.9 billion to be spent by the Pentagon. The Defense Department's mix contains avionics, missiles, and shipboard systems. It also includes the communications to interconnect new and improved sensors destined for the new intelligence, surveillance, and warning systems that are needed when hot wars turn cold.

**Grand Tour dead.** Civilian space program suppliers, on the other hand, grumble at an electronics spending level that remains essentially unchanged. The Grand Tour satellites, which were to go to five planets, have been axed in favor of the \$5.5 billion space shuttle. Though the electronics potential of the shuttle—being pushed by James C. Fletcher, head of NASA—could run to hundreds of millions of dollars, that money is all in the future. Cancellation of the unmanned Grand Tour satellites killed an estimated \$500 million in total business, including about \$80 million in fiscal 1973 R&D.

Transportation equipment makers look at the increased funding for



a new mix of programs as an appeal for the urban vote. Emphasis on ground transportation within and between cities is heavy. New air traffic projects, on the other hand, will get smaller bankrolls.

The catch-all package of electronics in social programs—embracing education, environmental protection, law enforcement, and medicine—appears larger this year on first reading. However, the broad distribution of these relatively small efforts in corners of the Departments of Justice and Health, Education, and Welfare and at smaller operations continues to frustrate industry marketing men.

**New initiatives.** Now, of course, the White House believes that it has an alternative solution to that problem with its New Technology Opportunities Program (NTOP). Still an unknown political quantity, that program calls for a \$398 million boost in Federal support for new civilian R&D as the first stage of a \$2 billion, five-year plan to apply U.S. technology to a broad range of social problems at home.

Equally important to NTOP proponents is its proposal to stimulate private industry investment in independent R&D. The goal is to capitalize on areas of technological leadership, improving the nation's declining competitive position in world markets by raising exports of high-technology products. The passage of an NTOP appropriation this

## Communications: more issues than money

The nation's communications managers—the Federal Communications Commission and the Office of Telecommunications Policy—get only nominal increases to oversee the nation's expanding systems in the fiscal 1973 budget.

However, the political sensitivity of a number of pending issues—domestic satellite communications and the controversial probe of American Telephone & Telegraph Co., for examples—could lead the Democrat-controlled Congress to boost appropriations for the Republican-dominated agencies as a device for embarrassing the Nixon Administration. In any event, upcoming actions by the FCC and OTP will continue to impact heavily on the electronics industries in 1972.

The budget request shows that a significant share of the FCC's \$1.5 million increase will be used to "augment the commission's program of surveillance of Bell System operation" by the Common Carrier Bureau. According to Bernard Strassburg, the bureau's chief, his operation's budget increase of about 10%, to a level of approxi-

mately \$350,000, will permit "an additional 15 to 20 man-years" of engineering effort. The FCC has estimated it would take roughly \$1 million and 50 additions to the staff to examine AT&T meaningfully. Since the budget only asks for one-third that investment, a full-scale probe seems unlikely.

Though a domestic satellite ruling by the commissioners, based on the Common Carrier Bureau's recommendation, is probably the FCC's highest priority item, Strassburg acknowledges that the action is not expected to come before "early spring." Initially, the FCC had hoped to act before 1971 ended.

Total FCC budget authority is set at \$32.8 million for the new fiscal year, while OTP, which says it will not get any additions to its 65-man staff, will spend \$3.2 million. The FCC programs receiving the largest budget increases are those involving research and planning in communications technology. An added \$830,000 will boost to \$4.54 million the funds available to conduct broad studies designed to improve the utilization of the radio spectrum.





**Influentials.** Men bearing the President's message that high technology is the key to economic recovery are (from left) William Magruder, who put together a new domestic R&D package, Defense Secretary Melvin Laird, who is pushing for a major spending increase, and space shuttle promoter James C. Fletcher, head of the National Aeronautics and Space Administration.

year would raise civilian R&D funding from all quarters to an estimated \$5.4 billion—up \$700 million.

**New gear.** Typical new domestic applications for technology proposed in the NTOP package include accelerating development of all-weather landing systems for commercial aviation, use of helicopters as flying fire engines and ambulances, and creation of new communications networks and warning systems aimed at avoiding disasters created by fast-developing storms.

The New Technology concept evolved quickly and quietly in the last half of 1971 [*Electronics*, Sept. 27, 1971, p. 33]. Now being marketed politically by former supersonic transport boss William Magruder in his new role as White House special assistant, NTOP got technological guidance and evaluation from the Office of Science and Technology, headed by Edward E. David Jr.

**New incentives.** David says there will be \$40 million available in the new fiscal year alone for corporate tax incentives and other cost-sharing schemes, which will encourage "trials of actual ideas" to foster increased R&D. The National Science Foundation is budgeted for \$25 million of this, with another \$15 million administered by the National Bureau of Standards. Though David is

uncertain how many professional engineering jobs will be generated, he has "no doubt at all that we will see an increase in hiring."

Put down election year 1972 as a battle for the ballot of the American worker, with electronics specialists near the top of the politicians' lists. □

## Technology-oriented jobs will be the big Defense Department fallout in fiscal 1973

Defense electronics jobs "will rise significantly" in fiscal 1973. That's how Pentagon comptroller Robert Moot sees President Nixon's \$75.9 billion defense spending program impacting the electronics industries. And other defense officials agree, believing that Moot's forecast will hold true even after the inevitable election year paring by the Congress. The very size of the President's request—a whopping 9% increase from last year—and its increased emphasis on electronics hardware should ensure that.

Total U.S. employment in defense industries will hold steady at about 1.9 million persons, Moot explains, with the expected sharp rise in technology-oriented jobs offset by declines in industries supplying "soft goods"—uniforms and similar items. Moot says it is too early to estimate precisely how the numbers will fall,

but confirms that big increases in procurement and R&D requests will escalate engineering employment. The President proposes to raise Pentagon procurement authority by \$1.4 billion in fiscal 1973 to \$19.3 billion and boost R&D funds by \$900 million to nearly \$8.5 billion [see tables on next page].

**Supplements, too.** Moreover, Defense Secretary Melvin Laird has begun his drive on Capitol Hill for a \$254.8 million supplemental appropriation for fiscal 1972—nearly all of which involves programs with a heavy electronics content. Two of four new classified development efforts, accounting for \$100 million of the supplemental request, call for new sensors for ocean surveillance [*Electronics*, Jan. 3, p. 75] and an increased level of effort on electronic warfare. Particularly important is development of a system to counter

## Probing the news

the electromagnetic pulses generated by nuclear warhead explosions. Such pulses disrupt electronic circuits within the range of an explosion.

**Command post.** The supplement contains \$6 million that Laird wants to begin procurement of the long-delayed Advanced Airborne National Command Post with the first four Boeing 747s for the Air Force, plus another \$143.8 million to restore funds for a variety of Air Force and Navy plane buys cut by the Congress this year.

The remaining \$35 million, says Moot, is to accelerate R&D on the Undersea Long Range Missile System submarine and the ULMS missile, for which the first R&D award went to Lockheed Missiles and Space late last year. For the new fiscal year, total funds to accelerate efforts on Submarine-Launched Ballistic Missile systems soar to more than \$942 million, including ULMS and the operational Polaris-Poseidon systems, whose missiles continue to be upgraded with multiple warheads. The SLBM package contains a heavy \$520 million for R&D, plus nearly \$395 million for procurement.

**Livable.** Though ULMS and a handful of other programs could get canceled if a successful strategic arms limitation agreement is concluded with the Soviet Union—an agreement the President is pushing strongly—the total defense budget request has pleased industry and military leaders alike. “The Marines can live with the fiscal 1973 budget,” says No. 2 man, Lt. Gen. J. R. Chaisson. Such comments sum

up the typical military reaction in the capital and are legitimately represented as expressions of joy.

There is, however, one cloud on the horizon from the viewpoint of large electronics and other prime contractors. That is DOD’s revised approach on contract progress payments, which will be subject to new limitations in 1972 and require increased capital investment by contractors as a result. To be invoked on new contracts, the progress payment rules will be altered so contractors will only be reimbursed for money paid out to subcontractors and others, rather than for work in progress, and frequency of payments will be cut back.

**Payments.** The concept is one that DOD believes “will make the defense industry more prudent in producing weapons”—if contractors have to buy items with their own funds. Though the proposal is just beginning, some industry sources believe it could cut back on instrument sales to big prime contractors. However, component manufacturers who serve as subcontractors believe that the policy will accelerate their receipt of payments from primes.

Within the military, the Navy, as expected, bags the biggest procurement increment by far, with a \$9.65 billion request—plus \$2.71 billion more for research, development, test, and evaluation. Comparable Air Force totals are nearly \$6.27 billion and \$3.18 billion, while the Army is being held to \$3.32 billion and \$2.05 billion as it winds down and out of the Southeast Asian war.

Though the Navy gets funding for 55 more ships, shipboard electronics buys for these ships are still years down the road—particularly the controversial new CVAN-70 nuclear

attack carrier, for which \$100 million of the estimated \$1 billion total is sought this year. Nevertheless, the Navy is expected to spend heavily in the new fiscal year for new systems to retrofit two antisubmarine warfare (ASW) carriers as the service moves to combine the ASW and attack functions on all its 16 ships in the fleet over the next two years.

**S-3A troubles.** For ASW, the Navy also wants its first production buy of 42 of Lockheed’s S-3A aircraft for \$581.1 million, plus \$46.5 million for initial spare parts, and \$36.7 million more for on-going R&D. However, the S-3A could become the subject of a new Congressional controversy, following growing reports of trouble with the performance of the plane’s electronic submarine detection system, particularly the Difar package, from Sanders Associates Inc.

Also significant in the Navy’s budget is its first proposed buy of Bell Helicopter’s AH-1J Cobra attack model at \$32.9 million for 20 units with initial spares. In the helicopter budget mill, too, is \$53 million for continuing R&D on the controversial Lockheed AH-56 Cheyenne gunship, funds for which were knocked out of the current budget.

**Choppers.** The Army also wants a \$23 million increase next year for R&D on a heavy-lift helicopter, raising funding for the vehicle to \$53 million. At the same time, the service wants to boost spending on its utility tactical transport helicopter, called Uttas, to \$64 million, a \$24 million boost in R&D that could run into Congressional resistance.

As for Air Force plans, new money is limited, following a series of heavy commitments in fiscal 1972. However, besides the airborne

Department of Defense: what procurement dollars buy (millions of dollars)						
	Defense total		Army	Navy	Air Force	Agencies
	FY 1972	FY 1973				
Aircraft .....	6,568	5,849	135	3,102	2,613	—
Missiles .....	3,418	3,717	1,153	792	1,772	—
Ships .....	3,010	3,564	—	3,564	—	—
Combat vehicles, weapons, and torpedoes .....	403	542	259	283	—	—
Ordnance, vehicles, and related equipment .....	3,209	2,580	1,360	567	653	—
Electronics and communications .....	778	953	193	524	236	—
Other procurement .....	1,498	2,108	226	818	994	70
<b>Total procurement .....</b>	<b>18,884</b>	<b>19,313</b>	<b>3,325</b>	<b>9,650</b>	<b>6,268</b>	<b>70</b>

Department of Defense: where research dollars go  
(millions of dollars)

	Defense total		Army	Navy	Air Force	Agencies
	FY 1972	FY 1973				
			Fiscal Year 1973			
Military sciences .....	538	573	202	149	145	77
Aircraft .....	1,984	1,948	243	379	1,325	—
Missiles .....	1,946	2,383	960	958	387	78
Military astronautics .....	405	454	19	90	346	—
Ships and small craft .....	411	429	—	429	—	—
Ordnance, vehicles, and related equipment .....	337	331	187	44	100	—
Other equipment .....	1,515	1,692	383	505	501	303
Programwide management and support .....	576	638	57	157	376	49
Emergency fund .....	50	50	—	—	—	50
<b>Total research, development, testing, and evaluation .....</b>	<b>7,762</b>	<b>8,498</b>	<b>2,051</b>	<b>2,711</b>	<b>3,179</b>	<b>557</b>

national command post, the service wants to proceed with procurement of the long-delayed Airborne Warning and Control System (AWACS), buying the first three Boeing 707s with a fresh bankroll of nearly \$310 million, and another \$160 million for R&D. A selection between the competing Hughes and Westinghouse radars is anticipated later this year, if the project survives the Congressional hurdles.

Missiles come in for heavy funding, with Raytheon Co. systems getting heavy incremental production requests. The Army, for example, wants \$116.8 million for the Bedford, Mass., company's Improved Hawk air defense weapon, while the Marine corps wants \$20.9 million. The Army is also budgeting \$171.1 million for the Hawk follow-on system, the SAM-D, up from \$115.5 million this year.

The Raytheon-produced Sparrow

3 air-to-air missile used on Navy planes accounts for \$118.2 million, up from \$69.3 million. General Dynamics, Pomona, Calif. draws a mixed bag from Navy for its Standard ship missile. The increase sought for the extended-range version was cut to \$15.9 million from \$32.9 million, while money for the medium-range version was hiked to nearly \$45 million from \$30.6 million.

**Safeguard.** And what about the biggest weapons controversy of them all, the Safeguard missile defense system? Secretary Laird says the President is asking for \$390 million for two more sites, plus \$716.6 million for procurement and \$340 million for R&D. But, says one Congressional armed services staffer, "it will never fly—especially with the election this year. If it doesn't get dropped at the SALT talks, it'll get knocked off up here." □

ade at a cost of \$700 million, ■ defer the J and K series of the advanced Orbiting Solar Observatory (OSO), which were to be launched in 1974 and 1976, and

■ reduce its research into nuclear propulsion by dropping the high-thrust Nerva program, looking into smaller-thrust rockets instead.

Also, Tiros N aside, the agency is not committing to any new earth-oriented satellite programs.

**Steady state.** Overall, the budget shows NASA's steady-state condition as it weathers the post-Apollo transition. The agency plans to spend \$3.19 billion, up slightly from last year, but down about \$190 million from fiscal 1971.

NASA's budget, although a disappointment for those electronics manufacturers looking to space programs to pump more money into the marketplace, will at least keep the funding level constant until the big-ticket space shuttle gets under way. The shuttle will mean about 50,000 new jobs, NASA estimates, a compelling reason why the White House approved the program.

**Shuttle.** Breaking the budget down, manned space projects are in for \$1.22 billion, down \$61 million, as Apollo ends with the last two moon shots this year. The space shuttle will begin to pick up the slack in fiscal 1975 through 1977, when it reaches peak funding of over \$1 billion. NASA has about \$300 million to spend in fiscal 1973, counting the \$200 million in the budget, \$80 million unspent from previous years, and other funds now squirreled away in various accounts.

NASA expects to go out for bid on the \$4 billion shuttle orbiter con-

## Space shuttle brings a big-ticket program back to NASA, but Grand Tours are dead

For NASA, the name of the game is long-term survival. Fighting for a good field position so that it can score the big one, the National Aeronautics and Space Administration has had to pass up some short gainers in exchange for some much needed long yardage.

NASA won White House approval for the \$5.5 billion space shuttle program on which the future of the agency's manned space efforts—and present \$3.2 billion size—hinge

[*Electronics*, Jan. 17, p. 36]. It also got a whopping raise for space satellites, a small gain in applications that includes a new start for a Tiros N weather satellite, and an increase in aeronautics research.

But in the fiscal year 1973 game plan, NASA had to:

■ bargain away the unmanned Outer Planets Missions, popularly known as Grand Tours, which were to explore Jupiter, Saturn, Uranus, Neptune, and Pluto later that dec-

## Probing the news

tract in March and award the contract in the summer. Shuttle avionics should cost at least \$600 million. Every major aerospace company is expected to bid, either singly or as part of a team. Currently performing shuttle study contracts are North American Rockwell teamed with General Dynamics, Grumman with Boeing, McDonnell Douglas with Martin Marietta, and Lockheed.

**HEAO.** Despite the loss of the Outer Planets Missions, NASA's unmanned space science programs are up \$116.5 million to \$669.4 million, with increases both for physics and astronomy and for lunar and planetary satellites. Big gainers are the Viking automated Mars probe, with \$229.5 million, and the High-Energy Astronomical Observatory (HEAO) with \$59.6 million. The Martin-Denver division is building the Viking lander, and the Jet Propulsion Laboratory, Pasadena, Calif., is managing the orbiter development for the 1975 launch. TRW Systems Group, Redondo Beach, Calif., has been selected to build the first two HEAOs for launch in 1975. About 13 scientific experiments are to be flown to gather high-resolution data on sources of cosmic, gamma, and X rays.

OSO I, for which Hughes Aircraft Co., Culver City, Calif., is prime contractor, is slated for \$14.5 million, down slightly from last year. Its launch late next year will end the project, although George Low, NASA's deputy administrator, says the agency has only deferred the J and K versions of the sun investigator until later. Even so, deleting the follow-on versions this year only saved the agency about \$7 million.

**Grand Tour.** The Outer Planets Missions were killed, administrator James C. Fletcher says, because the program was getting less than wholehearted support from Congress and the scientific community—even though the agency had lowered the cost to about \$700 million. NASA is looking at a Mariner-type spacecraft for cheaper missions to

**Job transport.** Space shuttle will carry four-man crew and 65,000-pound payload into orbit to launch, repair, or retrieve satellites.

## NASA: Major applications programs (thousands of dollars)

	FY 1971	FY 1972	FY 1973
<b>Earth resources survey:</b>			
Earth resources technology satellites .....	55,750	52,225	35,400
Aircraft program .....	10,985	12,350	13,000
Applications technology satellites .....	23,750	51,800	61,200
Nimbus .....	24,700	18,125	28,300
Synchronous meteorological satellites .....	8,850	15,000	11,500
Cooperative applications satellites .....	75	2,600	3,300
<b>Tiros/TOS improvements:</b>			
TOS improvements .....	2,559	2,048	2,200
Tiros-M .....	641	202	—
Tiros-N .....	—	—	5,800
Geodetic satellites .....	2,806	3,500	5,000
Global atmospheric research program .....	1,000	2,250	4,500
Meteorological soundings .....	3,100	1,500	1,500
Supporting research and technology/advanced studies .....	28,744	23,300	22,000
Earth observatory satellite studies .....	—	1,000	1,000
Radio interference and propagation program .....	1,000	1,600	—
Air traffic control studies .....	3,000	—	—
<b>Total space applications .....</b>	<b>166,960</b>	<b>187,500</b>	<b>194,700</b>

Jupiter and perhaps a fly-by to Saturn in 1977. A decision is due shortly, according to John E. Naugle, associate administrator for space science.

**Applications.** Tiros N is a modest new start at \$5.8 million, but it reflects the agency's slightly increased funding—\$194.7 million—for applications satellites. Just a paper concept at the present, the program is to become an operational prototype development for the National Oceanic and Atmospheric Administration (NOAA), says Charles N. Mathews, applications chief. The meteorological satellite will have new-generation instruments for gathering atmospheric and earth thermal profiles when it is launched in 1976, he says.

Other weather birds, the Nimbus E and F built by General Electric for meteorological research, will get

\$28.3 million. Due to fly this year and in 1974, the satellites will develop instrumentation for operational satellites, such as the Tiros N. A cooperative program with Canada is down for \$3.3 million.

NASA's shift toward applications, exemplified by closer ties with the Department of Transportation, shows up in the sharply higher budget for aeronautics and space technology. At \$163.4 million, that request is up 50% from last year. Budgets in two key areas, short takeoff and landing (STOL) transports and quiet aircraft engines, have doubled, and NASA is coordinating research with DOT.

**Airplanes.** The STOL transport programs will receive \$27.5 million. Late this year, NASA will select a contractor to build two prototype STOL transports to be delivered in 1974-75 for an estimated \$100 mil-

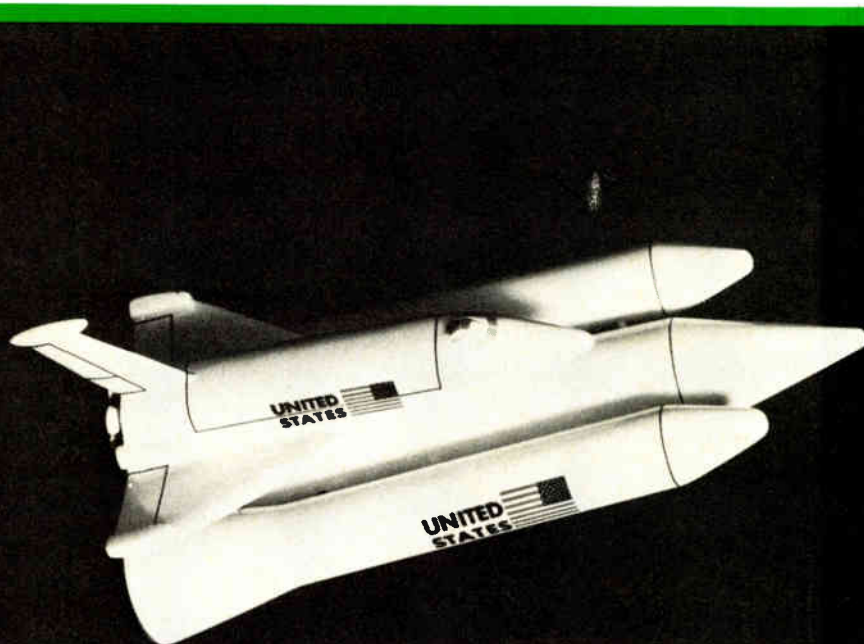

# The most versatile multicolor CRT's on display

Special multicolor screens with different color renditions provided by changing voltages make these up-to-the-minute CRT's especially useful in the latest display applications. Air traffic control systems, electronic test equipment, computer displays and many other applications are possible for these tubes. You can get any of our CRT's (from 4.5" to 25" diagonal) with bicolor or multicolor display screens, a monicolor screen with different persistence phosphor layers, or multicolor screens with variable persistence phosphor layers. You'll also specially appreciate the high brightness and picture contrast. And you'll like the high resolution, a major feature with THOMSON-CSF cathode ray tubes. Moreover, your circuit engineer will have the benefit of the low voltage swing required to switch from one color to the other. For complete information on these and all the tubes in our wide CRT line, circle the Reader Service Card or contact us direct.



**THOMSON-CSF**

THOMSON-CSF Electron Tubes, Inc./50 Rockefeller Plaza/New York, N.Y. 10020/(212) 489-0400

France—THOMSON-CSF Groupement Tubes Electroniques/8, rue Chasseloup-Laubat/75/PARIS 15ème/Tel: 566 70 04

Germany—THOMSON-CSF Elektronenröhren GmbH/Am Leonhardsbrunn 10/6 FRANKFURT/Main/Tel: 0611-70 20 99

Italy—THOMSON-CSF Tubi Elettronici SRL/Viale degli Ammiragli 69/ROMA/Tel: 63 80 143

Sweden—THOMSON-CSF Elektronrör AB/Box 27080/S 10 251 STOCKHOLM 27/Tel: 08/22 58 00

BAZAINE PUBLICITE 1409 E

## Probing the news

lion. Design concepts are being prepared now by McDonnell Douglas, Grumman teamed with Boeing, and Lockheed-Georgia teamed with North American Rockwell and

Cornell Aeronautical Laboratory. The quiet-engine development programs will get \$12 million.

Other major research and technology areas will be in laser communications and in achieving long-life, high-speed components for space electronics systems. □

## Social programs—from education to law enforcement—take biggest budget slice

Funds available for electronics in the broad area of the Government's social services are like buried treasure, difficult to find but of great potential value. Secretary Elliott Richardson's Department of Health, Education, and Welfare is by far the largest of these treasure troves, with its \$78.9 billion budget, up \$7 billion from a year ago.

**Far-flung.** HEW, with its widely scattered organizations dealing with the health and education programs of interest to electronics manufacturers, looks discouraging to some industry marketeers. Nevertheless, the dollars are there and a hungry industry is tracking them anxiously.

At the Social Security Administration, automated systems are helping push the equipment budget from \$6.2 million in fiscal 1972 to \$8.5 million in 1973. "We are planning to purchase one large-scale computer—the size of an IBM

**Peaceable.** HEW Secretary Elliott Richardson gets the biggest budget slice, but his electronics "peace market" is scattered.



360/65—this year," says an agency official. And, if the welfare reform legislation proposed to the Congress is enacted, the agency will be in the market for three or four such computers in the next year or so, he says.

The extent of the Social Security's use of integrated data processing has significantly increased over the past year, according to Sherwin Montell of the agency's budget office. More than 800 district offices throughout the country are linked to the administration's central computer in Baltimore, where claims are processed from stored microfiche records, with copies transmitted to district offices when required.

**TV classrooms.** Educational technology is slated to get a hefty 50% boost—up to \$30 million. The largest part of these funds will be used to apply communications technology to improving instruction in basic, career, and early childhood education. Some vehicles will be communications satellites; closed-circuit, cartridge, and disk television; telephone networks and computer-based systems.

The influence of TV in Federal education programs has just begun. The Administration has proposed legislation that would establish a National Foundation for Higher Education. A major goal of the foundation is to develop new educational formats, such as "TV colleges." To start planning, \$3 million will be requested later this year if Congress enacts the bill. Appropriations for fiscal 1973 are then set to be hiked to \$100 million.

While budget requests for the Environmental Protection Agency are

up from \$168 million to \$179 million in fiscal 1973, the allocation for "equipment"—which would include any electronics for monitoring, sensing, or measuring pollutants—is significantly down, from \$16 million to \$10 million.

**Electronics for police.** The Justice Department's Law Enforcement Assistance Administration proposes raising spending to \$595 million, up \$170 million in two years—and computers and peripheral equipment promise to become the big items. While LEAA continues with its policy of matching state funds for law enforcement equipment, manpower, and construction, a major initiative is the improvement of law enforcement science and technology. This year's budget more than triples the funds for data systems and statistical assistance—\$18.7 million.

LEAA will continue to study improved police communications systems to connect foot patrolmen and radio cars to station houses. LEAA is also working hard toward linking state agencies to regional and national computer banks containing criminal files.

Now that the Postal Service is an independent organization, there is a real push to make it cost effective, and one of the ways is via electronic processing of mail. Research, development, and engineering will grow from \$76 million this year to \$91.4 million next. One must item: to fulfill President Nixon's proposal to develop and demonstrate an electronic system for providing routine overnight mail delivery.

**Earth viewer.** At the Department of Interior, the Earth Resources Observation System (EROS) is up by nearly double the \$5.2 million requested last year. The \$10.6 million program managed by the U.S. Geological Survey will support the Earth Resources Technology Satellite (ERTS), built by General Electric and slated for launch in June.

Among the Nixon programs that Edward David, the Presidential science advisor, classes as "big science"—costly and glamorous projects with high public visibility—there's one aimed at electronics. It's a \$60 million antenna array for radio-astronomy, dubbed the Very-Large Array (VLA) by its sponsor, the National Science Foundation.

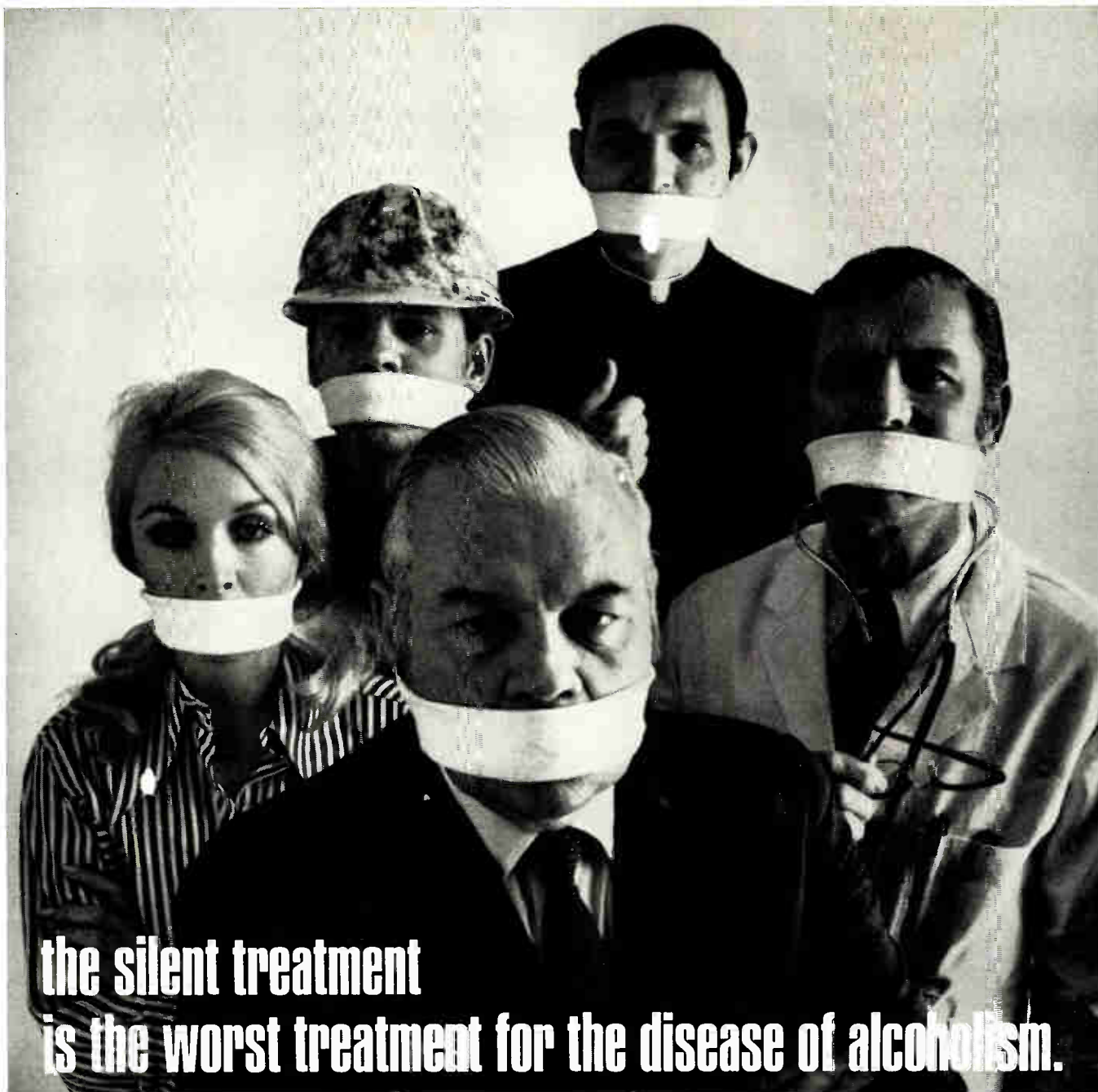

## the silent treatment is the worst treatment for the disease of alcoholism.

When one out of 20 employees in America—including executives—has alcoholism, it's time for some plain talk about alcoholism. The alcoholic's family, friends and employer may mean well, but the silent treatment is no way to treat a disease. And alcoholism is a disease from which recovery is possible, rather than a moral weakness for which the alcoholic should be pitied—or fired. It's a disease which ranks with heart disease, cancer and severe mental disorders as a public health menace.

The National Council on Alcoholism has pioneered in setting up joint union-management alcoholism programs. In these programs, industry is achieving *recovery rates averaging 60 to 70 percent*. Management profits by re-

taining its experienced employees and regaining lost productivity—estimated at six billion dollars. Unions profit by increasing health and welfare protection for members and keeping them in the active work force.

If you think alcoholism is affecting your business, talk it over with the Director of Labor Management Services, National Council on Alcoholism, 2 Park Avenue, New York, N.Y. 10016.

**National  
Council  
on  
Alcoholism, Inc.**

CLASSIFIED ADVERTISING

**SEARCHLIGHT SECTION**

BUSINESS OPPORTUNITIES  
USED OR SURPLUS EQUIPMENT

**Radiation Devices Co.**

OEM'S - BROADCASTERS  
UNIVERSITIES - SERVICE COMPANIES

Review Our Economical Line of Instruments, Accessories, and Signal Processing Components Spanning The Frequency Range From D-C to 2 GHz. To Get Best Value For Your Electronics Dollar. Brochures and Application Notes Are Available Upon Your Request.

RADIATION DEVICES CO., BOX 8450, BALTIMORE, MD. 21234

CIRCLE 951 ON READER SERVICE CARD

**Radio-Research  
Instrument Co.**

3 Quincy Street, Norwalk,  
Connecticut 06850  
Tel: (203) 853-2600

CIRCLE 952 ON READER SERVICE CARD

**"SEARCHLIGHT"**  
is  
**Opportunity  
Advertising**

—to help you get what  
you want—to help you  
sell what you no longer  
need.

**Take Advantage  
Of It**

**"THINK  
SEARCHLIGHT  
FIRST"**

*For Every Business Want*

## Probing the news

The Y-shaped antenna, measuring 13 miles along each arm, will be the world's most sophisticated radio-astronomy system.

Though industry's share in the ar-

ray is not expected to run to more than half of the \$60 million program—\$3 million of which is sought in the new fiscal year—VLA bears watching as a device which could provide fundamental new information about the basic nature of communications. □

## Budget fuels mass transportation projects, but throttles back on air traffic control

Urban mass transportation is picking up speed in the Department of Transportation. The Federal Highway Administration still absorbs nearly 69% of DOT's \$8.6 billion budget for fiscal 1973—which is up only \$150 million from this year. But the President has told the nation that he intends to promote inner city transit systems, and Secretary John Volpe has responded.

These programs may amount to as much as \$1 billion, the budget requested by the Urban Mass Transportation Administration (UMTA). For the electronics industries, outlays here will help offset a \$100-million-plus decrease in expenditures for enroute and terminal air traffic control systems.

**Local help.** The largest percentage increase—65%—for major DOT programs will be at UMTA. Most of the money—\$841.1 million—is earmarked for assisting state and local public bodies to buy new buses and commuter railroad and rapid transit cars. A sizeable \$115 million, compared with only \$62 million this year, is allocated for R&D and demonstration of new systems.

Some \$67 million of this is reserved for "new technology transit systems." Here, personal rapid transit systems—using cars carrying fewer than half a dozen people—are down for \$38 million, double this year's funding. In addition, \$10 million—a giant jump from this year's \$800,000—is to be spent on dual-mode systems, which can be driven manually or guided automatically.

Of particular interest to electronics companies will be a request for proposals for a "new family" of rapid transit vehicles that would apply

the latest control and automation technologies. The request should be out during the first half of the new fiscal year, according to Carlos C. Villarreal, the agency's head.

**Express tracks.** The Federal Railroad Administration will also be sponsoring R&D and demonstrations. The agency has proposed a budget of \$81.2 million, \$38 million more than this year. Of this, \$60.8 million is for R&D in high-speed ground transportation. Programs will be aimed at both upgrading existing railroads systems and exploring new concepts.

Well up on the priority list is the continuing development of an experimental Tracked Air Cushion Research Vehicle that can zoom along at 300 miles per hour. UMTA is also looking at high-speed vehicles, but is aiming at a more sedate, 150-mph train, better suited for shorter hauls. In addition, funds will be spent on improving Metroliner service between New York and Washington and on upgrading the Metroliners' electric propulsion and electronic control systems.

DOT is also beginning work on developing a system—computer based and relying on "simple sensors"—for keeping track of freight cars throughout the nation's railroad system, says Robert H. Cannon, Jr., assistant secretary at DOT for system development and technology.

**Up in the air.** Although the \$1.5 billion budget for the Federal Aviation Administration is about the same as this year, the electronics industries' share may fall off some tens of millions of dollars in fiscal 1973. This is because much of the modernization of terminal and en-



route air traffic control facilities has been completed. Procurement in these categories drops \$103.6 million to \$231.3 million.

At the same time, the next generation of equipment—for such things as microwave-frequency instrument landing systems and digital communications—are still under development. However, R&D funds climb \$10.1 million to \$70.6 million.

**Airports.** Procurement for terminal traffic control towers, such as the ARTS 3 system, will fall off sharpest of all—from \$115.1 million this year to \$48.8 million. Another sharp drop comes in equipment for air route traffic control centers, which sport long-range radar, computers, and automated displays. Funds here drop to \$155.8 million, down from \$181 million in fiscal 1972. In 1971, this figure amounted only to \$22.5 million.

On the research, engineering, and development side, \$50.1 million is budgeted for air traffic control systems—compared with \$49 million last year. The air traffic control funds are to be expended for computerizing airport traffic control systems and for more efficient metering of terminal traffic under all weather conditions. Under the navigation category, which gets \$20.5 million, come the new microwave landing systems, for which study contracts are expected to be awarded any day.

**At sea.** There will also be a rise, albeit modest, in RDT&E funds for the Coast Guard—up to \$13.5 million from \$11 million—for search and rescue, aids to navigation, and marine environmental protection.

More specifically, the Coast Guard wants to improve methods for detecting and locating persons in distress. Major projects include continued development and testing of a prototype distress alerting and location system, and a precision navigation system for use in harbors and confined waterways. The service will also initiate the development of a prototype search-and-rescue helicopter system, as well as work on large-screen displays, improved vessel detection and identification techniques, and shore-to-vessel data links.

This report was prepared by Ray Connolly, William F. Arnold, Lyman J. Hardeman, John Johnsrud, John N. Kessler, and Alfred Rosenblatt.

# Rental wants you to know: The Secret to Greater Profits

Don't Spend Money . . . unless you have to! Remember, not spending it is almost the same as earning it. For example, you can have the best test equipment with no large capital investment by renting what you need . . . for as long as you need. Instead of building test equipment inventories, you build profits. Let us show you how it's done. Call or write Otto Rothfuss.

## Rental Electronics inc.

A PEPSICO LEASING COMPANY

16600 Oakmont Avenue  
Gaithersburg, Maryland 20760  
Telephone (301) 948-0625

Eight Major Service Centers  
Conveniently Located  
Throughout the U.S. and Canada

Circle 130 on reader service card

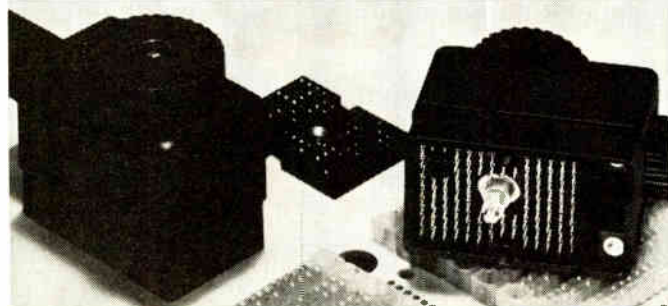

### At last. An I/O connector designed exclusively for back panel assemblies.

Here it is. An input/output connector that features up to 120 crimp-removal contacts on a .100" grid which accepts #22 to #26 gage stranded wire.

The receptacle contacts, fixed to the panel half, can be supplied in numerous .025" wrap post lengths. The receptacle contacts are as precisely located as the rest of the back panel contacts, and automatic wiring presents no problem.

Get all the facts, write for free Bulletin No. I/O 100.

Gentlemen:  
Please send me Bulletin No. I/O 100.

# TERADYNE

Name \_\_\_\_\_

Company \_\_\_\_\_ Street \_\_\_\_\_

City \_\_\_\_\_ State \_\_\_\_\_ Zip \_\_\_\_\_

Teradyne Components, Inc., 900 Lawrence Street, Lowell, Mass. 01852

# meeting ground

# 4



Where Medicine  
and Electronics  
Come Together

**The 4th National Conference on Electronics in Medicine** provides a major forum for the interchange of ideas and information between the men who make and the men who use electronic instrumentation for one overriding purpose—the betterment of world-wide health care. The Conference is sponsored by McGraw-Hill's *Medical World News*.

**For physicians and medical researchers**, the Conference offers an opportunity to become informed of new and significant technological developments that affect not only their specialty, but the entire world of medicine.

**For designers and manufacturers of electronic equipment**, the Conference provides a forum for an interchange of thought with M.D.'s. Only through this valuable exchange can electronics companies make the proper critical R&D, manufacturing and marketing decisions in the growing market of health care.

**The major focus** of this Conference will be on what is now functioning practically at the diagnostic, therapeutic and monitoring phases of medical practice and neither doctor nor engineer can afford to miss this 3-day dialogue of plenary sessions, workshops and demonstrations.

**Dates:** March 27, 28, 29, 1972

**Place:** Chicago, Drake Hotel

## Speakers (Plenary Sessions)

Keynote—**Howard A. Rusk, M.D.**, Director, New York University, Institute of Rehabilitation Medicine  
**Thomas E. Bird**, Manager, Monitoring Systems, General Electric  
**Robert Shaw, M.D.**, Director, Western Research Center, San Francisco  
**William Kerr**, Director, Medical Systems Division, IBM  
**Keith Sehnert, M.D.**, Editor, *Computer Medicine*; Sec./Treas., Society for Computer Medicine  
**Dwight E. Harken, M.D.**, Clinical Professor of Surgery, Emeritus, Harvard Medical School  
**Billy Jack Bass, M.D.**, Bass Clinic, Salem, Mo.  
**R. Hewlett Lee, M.D.**, Department of Surgery, Palo Alto Clinic  
**Ray Brown**, Executive V.P., Northwestern University  
**Will Houde**, Customer Service Manager, Medical Division, Hewlett Packard  
**James O. Wear, Ph.D.**, Chief, Central Research Instrument Program, VA Hospital, Little Rock, Ark.  
**Joel Nobel, M.D.**, Director, Emergency Care Research Institute  
**David Link**, Special Assistant, Medical-Clinical Devices, FDA

## Special Luncheon Speaker

**Merlin K. DuVal, M.D.**, Assistant Secretary HEW for Health and Scientific Affairs

## Moderators (Workshops)

**Gerald L. Looney, M.D.**, Coordinator Emergency Services, Arizona Medical Center  
**Hugo C. Pribor, M.D., Ph.D.**, Director of Laboratories, Perth Amboy (N.J.) General Hospital  
**James T. Richards, Jr.**, Chief, NASA Technological Applications Division  
**Stanley E. Jacobs, Ph.D.**, Director, Division of Hospital Computer Systems American Hospital Association  
**Carl E. Wasmuth, M.D., LL.B.**, Chairman, Board of Governors Cleveland Clinic  
**Thelma Schorr, R.N.**, Editor, *American Journal of Nursing*  
**Louis R. M. Del Guercio, M.D.**, Director of Surgery, St. Barnabas Medical Center, Livingston, N.J.  
**William A. Spencer, M.D.**, Director, Texas Institute for Rehabilitation and Research, Houston

## Plenary Session and Workshop Topics (Plenary)

- Instrumentation—Status, problems, solutions
- Computers—Significant contributions in the delivery of health care
- Government's role in the increasing use of electronics in medicine
- Man and machine—is dehumanization a problem?
- Computerization in private practice
- The Problem-oriented Medical Record—getting ready for the computer
- Equipment obsolescence and related problems of repair, maintenance and cost
- Industry's view of hardware problems and possible solutions
- How doctors can help make medical instruments more reliable
- FDA classification of medical electronic devices and what it will mean to pending device legislation

## (Workshops)

- Emergency care—growing challenge for electronics
- Automating the clinical lab—the best way to do it
- Spinoffs from space—applications of space technology to medicine
- The trend toward minicomputers
- New problems in liability and malpractice—what does the increased use of electronics portend?
- Nurses—Their increasing role in the use of sophisticated equipment
- Cardiac equipment—what exists, what's needed, and what's being developed
- Prosthetic devices—new contributions to rehabilitation medicine

**Demonstrations** at the Conference will include COMPU-GRAM, a computerized system for taking and diagnosing EKGs; multi-testing, an automated physical work-up. A "meet-the-experts" evening session is also planned for interested participants.

The 4th National Conference will offer the most complete discussion available of the state-of-the-art of electronics in medicine. What is practical, not futuristic, will be the thrust of the entire program. Attendance will be limited. Fill out the coupon below today.

## Register Now...

Advance registration fee: \$165; Registration at conference: \$200 (includes all sessions, demonstrations, two luncheons and a digest of technical papers when published). Mail this registration form along with your check payable to: Donald Rubin, Conference Chairman, *Medical World News*, 299 Park Avenue, New York, N.Y. 10017. A block of rooms is being held at the Drake Hotel for registrants. Make your reservations directly with the hotel, identifying yourself as a Conference attendee.

Please pre-register me for meetings, work sessions, and demonstrations. My check for \$165 is enclosed.

Bill me     Check enclosed

Medical World News, 299 Park Avenue, New York, N.Y. 10017



NAME \_\_\_\_\_ TITLE \_\_\_\_\_

COMPANY OR HOSPITAL \_\_\_\_\_

ADDRESS \_\_\_\_\_

CITY \_\_\_\_\_ STATE \_\_\_\_\_ ZIP \_\_\_\_\_



# Two ways to improve your memory

from  
Microsystems  
International

You know us as a great MOS memory house, but that's only half the story. We are in business now with a new line of state-of-the-art bipolar memory products.

Our well-known silicon gate MOS memory capability has recently been complemented by the signing of a Technological Exchange/Alternate Source agreement with Monolithic Memories Inc. recognized leader in the bipolar memory field.

We have memories with bit densities from 64 up to 2048, and access times ranging from 40 to 300 nanoseconds—in fact all you're looking for in semiconductor memories.

For speed—specify our Bipolar. For low power dissipation—specify our MOS.

So, if you want to improve your memory, contact Microsystems International for the most advanced line of RAM's, ROM's, PROMS and Shift Registers in the industry.

## MOS & Bipolar Memories from the performance leader



microsystems international limited, box 3529 station c, ottawa, canada - montreal, ottawa, toronto, brussels, stuttgart, london, palo alto, union.

For further information—call or write your nearest Microsystems sales office or distributor.

### U.S.A.

**Microsystems International Limited,**  
Palo Alto, Calif. 415-493-0848,  
Orange, Calif. 714-637-2330,  
Union, N.J. 201-964-3131,  
Schaumburg, Ill. 312-894-7660,  
Norwood, Mass. 617-762-3164  
**ABC Electronic Sales,**  
Williston Park, N.Y. 516-747-6610,  
Philadelphia, Pa. 215-464-2275.  
**Arrow Electronics Inc.,**  
Farmingdale, L.I. N.Y. 516-694-6800  
Baltimore, Md. 301-247-5200  
**Erskine Associates,**  
Scottsdale, Ariz. 602-263-7654.  
**Gartner Assoc.,**  
Orlando, Fla. 305-229-1000.

Miami Beach, Fla. 305-861-3661.  
**Genesee Radio and Parts Co. Inc.,**  
Buffalo, N.Y. 716-873-9661.  
**Gerber Electronics,**  
Dedham, Mass. 617-329-2400.  
**Hall-Mark Electronics Corp.**  
Dallas, Tex. 214-231-6111  
Minneapolis, Minn. 612-925-2944  
**Intermark Electronics,**  
San Carlos, Calif. 415-592-1614  
**James Semple Assoc.,**  
Rochester, N.Y. 716-342-1413  
Liverpool, N.Y. 315-457-1188.  
**L. H. Kolman,**  
Baltimore, Md. 301-752-8756.  
**Lou Bacher and Associates,**  
Itasca, Ill. 312-773-1810.

**Milgray Electronics Inc.,**  
Freeport, L.I. N.Y. 516-546-6000.  
**Pem Sales Co.,**  
St. Louis, Mo. 314-427-7200,  
Kansas City, Mo. 816-333-6012.  
**R. E. Marquart and Associates,**  
Indianapolis, Ind. 317-253-3997.  
**Rical Associates,**  
Santa Ana, Calif. 714-557-6543.  
**R-J Inc.,**  
Minneapolis, Minn. 612-922-1425.  
**Stan Pierce Inc.,**  
Norwood, Mass. 617-762-3164,  
New Canaan, Conn. 203-966-4630.  
**Sterling Electronics,**  
Waterlooville, Mass. 617-926-9720,  
Houston, Tex. 617-926-9720.

**Tom Mulligan and Associates,**  
Columbus, Ohio 614-457-2242.  
**W. Pat Fralia Co. Inc.,**  
Fort Worth, Tex. 817-738-2394.

### CANADA

**Microsystems International Limited,**  
Montreal, Que. 514-875-2814,  
Ottawa, Ont. 613-828-9191,  
Toronto, Ont. 416-366-7721.  
**A. W. Bleue,**  
Vancouver, B.C. 604-685-7914.  
**Cesco Electronics Ltd.,**  
Montreal, Que. 514-735-5511,  
Ottawa, Ont. 613-729-5118.  
**R. A. E. Industrial Electronics Ltd.,**  
Vancouver, B.C. 604-687-2621.

## New products

# MSI multiplexer cuts teleprocessor's cost and complexity

by Wallace B. Riley, Computers Editor

Minicomputer in terminal uses look-up table in its memory for code conversion, simplifying controllers' jobs

The acquisition route was chosen by the former Bryant Computer Products Co. when it decided to branch out from its base as a leading supplier of rotating magnetic memories. Bryant officials discovered a fledgling company called Cybermation Corp. in Washington Crossing, Pa., with seven employees, an idea for a low-cost data communications terminal, and no money for manufacturing or marketing.

Bryant's parent company, Ex-Cell-O Corp., acquired Cybermation and combined it with Bryant and with another Ex-Cell-O subsidiary, Linnell Electronics, in Cherry Hill, N.J., under the name of XLO Computer Corp. Now, XLO offers two products: the 7700 terminal from Cybermation, and the 3100 series minicomputer, which is the heart of the terminal. Later this year, the company expects to market a more sophisticated data communications terminal, also based on the 3100 minicomputer.

The minicomputer is an eight-bit-byte machine optimized for teleprocessing applications. Its key element is an eight-bit multiplexer, a medium-scale integrated circuit that has become a standard item from several sources relatively recently—Cybermation was one of the first users to pick it up. The multiplexer makes the minicomputer's non-bus organization pay off, an exception to the current trend toward bus-

organized computers, says Richard F. Rohrer, manager of systems engineering at XLO.

Teleprocessing applications normally require numerous input-output controllers to be used with a central processor. To avoid duplication, as many functions of these controllers as possible were put into the 3100 processor, resulting in simplified controllers. For example, the controller for a card reader uses only 26 ICs, all standard off-the-shelf units; the controller for a printer uses 32; and the controller for a paper-tape reader, only eight. A benefit of this design is that the 3100 can be run with many kinds of output devices connected to large mainframes of many manufacturers, using a large variety of communication codes—ASCII, EBCDIC, binary synchronous, and the like—more devices, more mainframes, and more codes than other communications

processors now on the market.

The 3100 achieves such flexibility through a look-up table in the main memory, which makes the necessary code conversions under software control. The bulk of the controller logic is employed for such brute-force purposes as reducing a 12-bit Hollerith code to an eight-bit form for internal use. This approach, of course, requires more than the usual amount of memory. However, the cost of the memory is not increased appreciably because cost of a fairly large increment of memory is minor for small systems.

The 3100 memory includes both read-only and read-write forms. The read-only memory begins with a basic 64-byte programable chip made by Harris Semiconductor [*Electronics*, Jan. 18, 1971, p. 122] and containing a program-loading routine for bringing up the machine from a cold start. Additional read-only

**Key multiplexer.** Eight-bit IC, now a standard, makes XLO 3100 minicomputer's non-bus architecture pay off. Many I/O controller functions are combined in this processor.

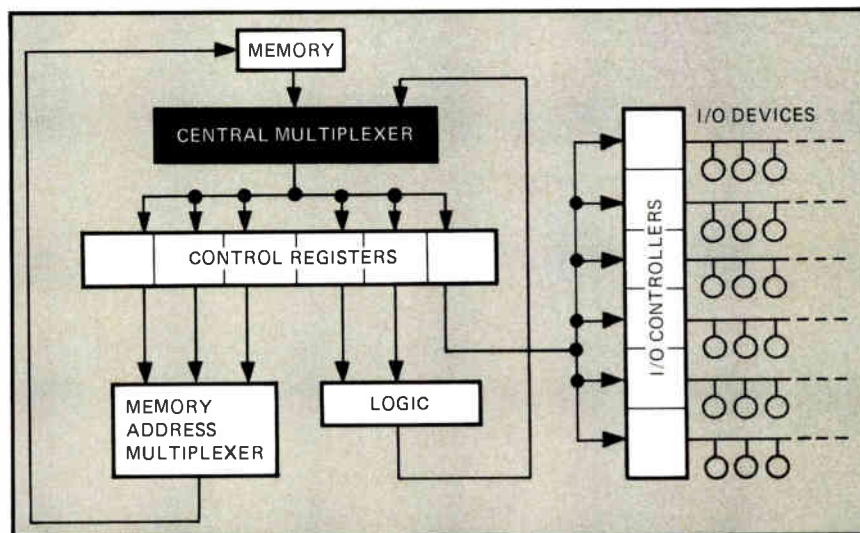

# Rental wants you to know: How to unfreeze Capital Funds

Simply call Rental Electronics and sit back and relax! Because Rental can supply practically all of your test equipment needs for as long as they exist. When the need disappears . . . call us and we'll make the test gear disappear and you'll still have your "frozen" budget in tact. Ask for Otto Rothfuss.

## Rental Electronics inc.

A PEPSICO LEASING COMPANY

16600 Oakmont Avenue  
Gaithersburg, Maryland 20760  
Telephone (301) 948-0625

Eight Major Service Centers  
Conveniently Located  
Throughout the U.S. and Canada

Circle 90 on reader service card

**NO SOCKETS • NO SOLDERING**

**MAGNETIC RELAY**  
with  
**Custom Features**

- Low Thermal EMF
- 45-60db Isolation
- Low Contact Bounce
- Encapsulated Coil
- Bifurcated Contacts

**At No Extra Cost!**

**Printact®**

**Plugs into your PC board . . . mates with plated conductors**

The unique design concept of the Printact magnetic latching and non-latching relays provides <math>5.0\text{uv}</math> thermal EMF, 45-65 db cross talk isolation, <math>0.5\text{ms}</math> contact bounce and other custom features as standard at no extra cost. The single moving part is the pivoting armature with series break contacts held by a permanent magnet eliminating return springs, mechanical linkage and pig-tail connections thus assuring reliable performance for many millions of cycles.

Available with 6, 12 or 24 VDC coils (0.5 watt G series, 1.0 watt LD series) in 2, 3 and 4 pole configuration. Series break swingers permit each pair of fixed contacts to be etched with common (Form C) or isolated (Form A plus Form B) switching between make and break circuits.

Send for catalog, 2X and 4X artwork stick-on contact patterns and Technical Notes PR262-D, which assist in simplifying PC board artwork, fabrication and procurement.

For a sample and/or data, write or call 212-EX 2-4800

Printact Relay Division, Executone, Inc., Box 1430E Long Island City, N.Y. 11101

90 Circle 143 on reader service card

memory capacity is available—up to 32,768 bytes—for other basic routines and complete user programs.

The basic read-write memory is a standard 4,096-byte core unit that is also expandable to 32,768 bytes. The maximum read-only and read-write configurations can be combined in a single machine for a total memory capacity of 65,536 bytes. The machine's address word is 16 bits long, giving it the capability of addressing this large capacity.

How is a 16-bit address squeezed into an eight-bit byte? Most of the instructions are simple and require only one or two bytes in the memory. Of the eight bits in a one-byte instruction, four address one of 16 registers, which are really the first 16 locations in a 256-byte block of the memory. The desired block, one of 16 in a basic 4,096-byte memory, is identified by the instruction counter. Most programs can be written to stay within these 16 registers. But instructions are available in the machine to increment any of the registers directly, to load a new address into the memory address register, and to move data from any location in a block into one of the registers.

**Wait time.** If the 3100 were a general-purpose machine, this pulling and hauling would present a headache to the programmer and seriously impact performance. However, as a communications processor, the machine is input-output bound and has time to juggle instructions while waiting for the peripheral equipment to catch up.

XLO's market for the minicomputer is the manufacturer who incorporates the 3100 in his own equipment and adds logic of his own design if the application calls for it. Rohrer is also aiming at the large end-user. Price of the minicomputer is \$4,500 for one.

To small end-users, the company offers the 7700 terminal, which includes an EIA interface and a standard modem. Synchronizing with whatever pattern appears on communication lines, the terminal passes the data to the processor, which does all the message and communications work in software.

XLO Computer Corp., subsidiary of Ex-Cell-O Corp., 26 Olney Avenue, Cherry Hill, N.J. [338]

Electronics/January 31, 1972

**Components****FET op amp  
is low-priced**

---

Key parameters guaranteed  
for family of devices  
housed in TO-99 package

---

When Alan Liberman, chief analog designer at Teledyne Philbrick, set out to develop a new operational amplifier with a field-effect-transistor front end, he had three goals: a lower price than existing units,

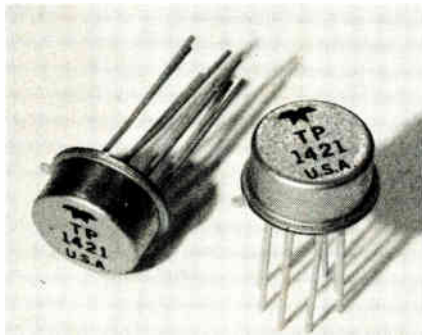

guaranteed—not typical—specifications for the critical parameters, and module-performance characteristics in a TO-99 package.

The result is the 1421, which sells for \$11 each in quantities of one to nine. Comparable op amps on the market are priced from \$14.80 to \$19, says Walter Patstone, product manager. In larger quantities (100-249), the unit price of the 1421 drops to \$8.50. Equivalent performance in a module, including Philbrick's, costs \$20 to \$30, he points out.

The guarantee on critical performance parameters, says Patstone, will allow engineers to design their circuits to have more predictable performance. For the 1421, the key parameters and guaranteed values are: low bias current, 50 picoamperes; high common mode rejection ratio (CMRR), 4,000; high common-mode voltage range,  $\pm 12$  volts; high output current,  $\pm 10$  milliamperes; and 1-megahertz bandwidth at unity gain.

Even higher performance can be guaranteed, says Patstone, though at a price premium. For example, the 1421/02 offers a 10-pA bias current, a CMRR of 10,000, an output offset current of 5 pA, and a voltage offset temperature coefficient of  $\pm 25$  microvolts/ $^{\circ}\text{C}$ . Price is \$14.40 (100-249).

In the 1421 series, chip devices mount directly on the case header, rather than on a ceramic substrate, thus reducing the number of bonds. A monolithic interdigitated dual FET connected to the input of a 741-type amplifier provides an open-loop gain of 100,000—five times more than usual. A booster transistor to drive the output stage helps produce the  $\pm 10$ -mA output current.

For use in integrators, current-to-voltage converters, and high-gain amplifiers, the 1421 is connected inverted; here the key parameter is low bias current, which means high impedance. For pH meters, buffer amplifiers, and other instrumentation applications, the amplifier is non-inverted, with the key parameters being low bias current, high CMRR, and high common mode voltage range.

Teledyne Philbrick, Allied Drive at Rte. 128, Dedham, Mass. 02026 [341]

---

**Low-priced capacitors  
challenge tantalum units**

Intended to fill the gap between high-performance expensive tantalum capacitors and standard-performance low-cost aluminum capacitors, a new line of electrolytic capacitors made by Sanyo Electric of Japan offers a performance profile that is comparable to tantalum units, while keeping price tags very close to those for aluminum units. The new electrolytics use two different dielectrics to cover a broad capacitance range. One dielectric, an aluminum-sintered material called Alsicon, provides capacitances from 0.1 microfarad to 22  $\mu\text{F}$ , and the other, a recently developed proprietary solid dielectric labeled SP-CON, is used for capacitances of 4.7 to 1,000  $\mu\text{F}$ .

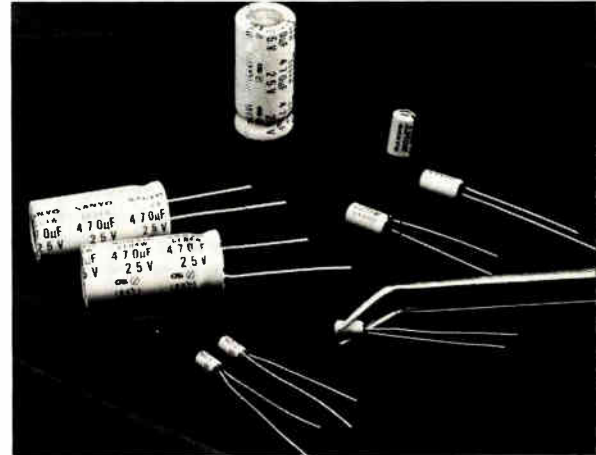

A 1- $\mu\text{F}$  10-volt Alsicon capacitor with a  $\pm 10\%$  tolerance sells for 7½ cents in 1,000-unit lots, while a comparable tantalum unit would sell for about 20 cents.

Both Alsicon and SP-CON capacitors can be used in non-polar circuit designs. And, unlike tantalum devices, the SP-CON units can withstand reverse voltages of up to 1 v without damage.

Standard working voltage ratings for the line range from 3.15 v to more than 25 v, and leakage current is less than 4% of the nominal capacitance value times the working voltage. Dissipation factor is the same as that for tantalum—only 6%—and operating temperature range is  $-55^{\circ}\text{C}$  to  $+85^{\circ}\text{C}$ . Small size and tight capacitance tolerances are other features of the new capacitors. For example, a 2.2- $\mu\text{F}$  Alsicon measures  $\frac{1}{8}$  by  $\frac{1}{4}$  in., and an aluminum one is  $\frac{1}{4}$  by  $\frac{1}{2}$  in.

Expected applications are in computers, peripheral equipment, calculators, instruments, industrial control systems, and entertainment products.

Sakata International, Inc., 208 South LaSalle St., Chicago 60604 [342]

---

**General-purpose counter  
has precision-wound ac coil**

A general-purpose counter, the series 7443, features a precision-wound ac coil and avoids rectifier problems caused by voltage surges. A balanced drive ensures against miscounting due to vibration. The

## New products

unit operates at 600 counts per minute on 115 or 230 volts ac. Options include special voltages.

Veeder-Root, Hartford, Conn. 06102 [349]

Switch built for use with rear-projection displays

The series 0123 readout incorporates a device called the Screen Switch for use with rear-projection displays. The switch is a single-pole momentary contact, consisting of two bonded, copper-laminated Mylar squares separated by a plain Mylar square with a built-in aperture. Finger pressure on any portion

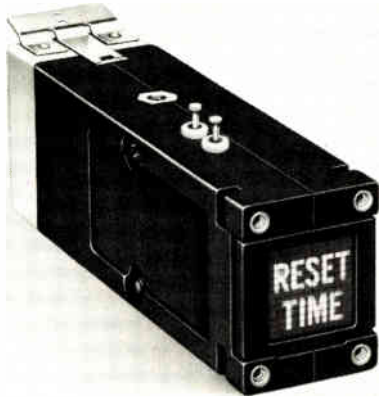

of the screen actuates the device, causing the two copper grids to come into contact. Release of pressure returns the switch to the open-circuit state. The readout can display up to 12 different instructions. Price for one to 49 is \$44.50 each.

Industrial Electronics Engineers Inc., 7720-40 Leona Ave., Van Nuys, Calif. 91405 [343]

Low-profile reed relays are replacements for IBM line

Reed relays with a low profile, 0.350 in. high, are designed to be interchangeable with the entire line of IBM reed relays. The units are supplied with Form A single-pole, single-throw dry reed switches up to six poles; single-pole, single-throw Form A mercury capsules up to six poles; or Form C mercury capsules up to three poles. Price for one to 24

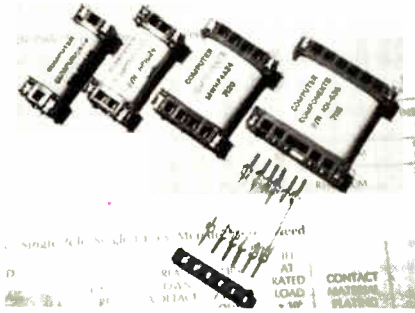

pieces starts at \$2.50 each.

Computer Components Inc., 88-05 Van Wyck Expressway, Jamaica, N.Y. 11418 [344]

Neon lamp replaces tube in alphanumeric displays

A neon lamp for alphanumeric display symbols, designated the model A261, can replace tubes in the over-range position of a digital voltmeter, or the plus and minus displays in other digital-readout equipment. The 14mm-lighted-electrode length is compatible with commonly used readout tubes including multi-character types. Operating life is 2,000 hours, continuous, on a circuit voltage of 150 v dc minimum. The lamp draws 1.5 mA of current.

Signalite, 1933 Heck Ave., Neptune, N.J. 07753 [347]

Tunable capacitors aimed at stripline circuit jobs

A series of tunable capacitors is designed for critical tweaking of micro-stripline circuits in locations where conventional-type capacitors will not fit. The models 7263 and 7283 are for impedance matching in microwave ICs, for hybrid circuits, and for mounting across gaps in stripline circuitry. The capacitors are self-resonant at frequencies up

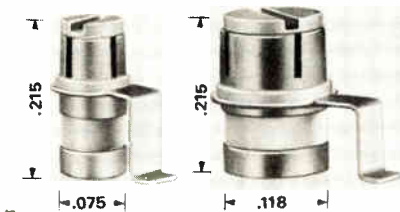

to X band. Capacitance ranges are from 0.3 to 1.3 pF, 0.4 to 2.5 pF, and 0.5 to 4.5 pF, with dielectrics available to increase the capacitance to 12 pF. Price is \$4.25 to \$7.85. Delivery is from stock.

Johanson Manufacturing Corp., 400 Rockaway Valley Rd., Boonton, N.J. 07005 [346]

Pressure transducers deliver up to 125 mV

A family of pressure transducers called Flatline measures both steady-state and dynamic pressure in applications requiring low-profile sensors. The units are 0.040 in. high, have a 0.200-in.-diameter stainless steel sensor diaphragm, and deliver a full-scale output up to 125 mV. The transducers are available in ranges from 5 to 1,000 lb/in.<sup>2</sup>. Dynamic response is from dc to above 8,000 Hz.

Entran Devices Inc., 775 Avenue of the Americas, New York, N.Y. 10001 [345]

Rotary switches include pc terminals to front or rear

One-and-one-eighth-inch rotary switches are being offered with printed-circuit terminals projecting to the front, to the rear, or a combination of both on the same switch.

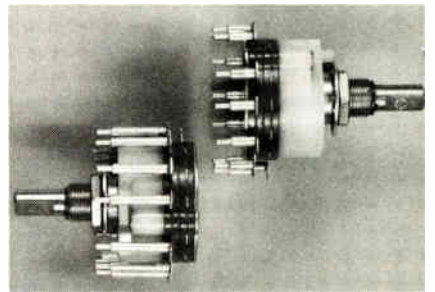

PC boards can be mounted and supported on the pins themselves. A variety of switching configurations is available, including binary codes and special switching sequences. Up to six poles per deck are possible. Called the series 100, the units are priced at less than \$2 each.

Stackpole Components Co., P.O. Box 14466, Raleigh, N.C. 27610 [348]



### Instruments

## Generator varies S/N ratio

2-MHz instrument produces signals, noise, or a mixture of the two

Clean waveforms are all right in their place, but often—in the testing of receivers, phaselock loops, lock-in amplifiers, and the like—what is needed is a test signal with a controllable amount of noise on it. By combining a pseudo-random sequence generator with a 2-MHz function generator, Wavetek has put this test-signal capability into one instrument.

Called the model 132 VCG/Noise Generator, the unit can act as a noise generator, a function generator, or a combination of the two. As a function generator, the 132 produces sine, square and triangle waves from 0.2 Hz to 2 MHz with a maximum amplitude of 10 v peak-to-peak into a 50-ohm load, or 20 v peak-to-peak into an open circuit.

As a noise generator, it produces both digital and analog outputs. The digital noise is actually a pseudo-random sequence of bits, with a clock rate that can be varied from 160 Hz to 1.6 MHz, and a sequence length of either  $2^{10}-1$ ,  $2^{15}-1$ , or  $2^{20}-1$  bits. The analog noise—which is derived from the digital noise generator—is essentially band-limited white noise with an adjustable bandwidth of 10 Hz to 100 kHz. Like the function generator, both noise outputs have a maximum amplitude of 20 v peak-to-peak into an open circuit.

In its S/N and N/S modes of operation, the instrument allows the user to add calibrated amounts of noise to the function-generator output. The S/N or N/S ratios can be adjusted from 0 to -50 dB (corresponding to a S/N ratio range of +50 dB to -50 dB). Since the noise can be added to any one of the function-generator outputs, the instrument is

as useful for measuring the noise immunity of digital logic circuitry as it is for evaluating the noise performance of an fm detector.

In addition to the preceding functions, the generator has an fm mode of operation in which the noise source is used to jitter the output frequency, providing a signal with a random fm.

For all its capability, the instrument weighs only 7 lb, measures 8½ in. by 5¼ in. by 11½ in. and consumes less than 15 watts of power.

The price is \$795, and delivery is from stock to 30 days.

Wavetek, 9045 Balboa Ave., San Diego, Calif. 92123 [351]

## Vhf generator goes to 512 MHz, sells for \$1,135

Featuring automatic output-power leveling, internal and external modes of amplitude and frequency modulation, and a frequency range of 10 to 512 megahertz, the Hewlett-Packard Co. 8654A signal generator has a price tag of \$1,135. That's about 25% less than the company's older 608E vhf signal generator, which is roughly comparable. In addition, the new machine is an all-solid-state unit that weighs only 16 pounds and consumes about 20 watts, in contrast to 62 lb and 220 w for the tube instrument.

The 8654A provides calibrated output levels from a maximum of +3 dBm down to -120 dBm (into a 50-ohm load) over its full frequency range. The output-power calibration is accurate to within  $\pm 1.5$  dB, plus the attenuator error, which is  $\pm 0.5$  dB from 10 to 50 dB and  $\pm 1.5$  dB from 60 to 120 dB.

The generator's frequency accuracy is within  $\pm 2\%$  after a 30-minute warmup, and maximum drift is  $\pm 0.002\%$  (20 ppm) over a five-minute period after a one-hour warmup. Residual fm is less than 5 parts in  $10^7$  peak.

In the internal modulation mode, the generator can amplitude- or frequency-modulate its output either at 400 or 1,000 Hz. A front-panel control allows adjustment of the

depth of the a-m from 0% to 80%, and adjustment of the peak deviation of the fm from 0% to 0.1% of the carrier frequency.

With an external modulating signal, response is dc to 5 kHz for 70% a-m, and dc to 2 kHz for 80% modulation. Nominally, maximum modulation requires 1 v peak.

Hewlett-Packard Co., 1601 California Ave., Palo Alto, Calif. 94304 [352]

## Pulse generator rise time is less than 2 nanoseconds

A pulse generator operates in the range of from 1 Hz to 50 MHz in the single-pulse mode and from 1 Hz to 75 MHz in the double-pulse mode. Rise time is less than 2 ns at 5 v output amplitude, and the unit will operate either in a voltage mode from  $\pm 50$  mV to  $\pm 20$  v from 50 ohms, or in a current mode from  $\pm 10$  mA to  $\pm 400$  mA from 10 kilohms minimum. Repetition rate, delay, duration, dc offset, rise time, fall time, and amplitude are continuously and independently variable over wide dynamic ranges. Called the model PG-14, the unit is priced at \$1,450. Delivery is stock to 30 days.

Chronetics Inc., 500 Nuber Ave., Mt. Vernon, New York, N.Y. 10550 [356]

## Data test set checks bit and block error counts

A data test set, the model DTS-101, measures bit and block error counts and turnaround time of telecommunications equipment. Included



**ONLY  
TUNG-SOL  
PERFORMANCE  
IS  
LARGER**

Tung-Sol single phase and three phase bridge rectifiers come in standard size packages. It's their current ratings and forward surge ratings that are larger. They give you added performance reliability — and at no additional cost!



**B-10 series**

DC rating — 30A @ 55°C. Forward surge rating—400A @ rated load. B-10 series replace similar bridges rated from 8 to 25A and from 50 to 1,000 PRV per leg.



**B-20 series**

DC rating — 35A @ 55°C. Forward surge rating—400A @ rated load. B-20 series replace similar bridges rated up to 25A and from 50 to 1,000 PRV per leg.

**SILICON POWER RECTIFIERS**  
*Tung-Sol makes a complete line of high reliability silicon power rectifiers in the DO-4, 5, 8, 9 and 21 configurations.*

WRITE FOR TECHNICAL INFORMATION. SPECIFY BRIDGES, OR POWER RECTIFIERS.

SILICON PRODUCTS SECTION  
**TUNG-SOL DIVISION**  
**WAGNER ELECTRIC CORPORATION**

630 West Mt. Pleasant Ave. Livingston, N.J. 07039  
TWX: 710-994-4865 PHONE: (201) 992-1100  
(212) 732-5426

Trademark TUNG-SOL Reg. U. S. Pat. Off. and  
Marcas Registradas

**New products**

are four pseudo-random word lengths, reversals, continuous spacing, and continuous marking. A choice of 16 baud rates are selectable from the front-panel control. A light-emitting-diode display gives a readout from 0 to 999, with overflow indication.

Computing Devices of Canada, P.O. Box 8508, Ottawa, Canada K1G 3M9 [355]

**Lock-in voltmeter provides tracking front-end filter**

A lock-in voltmeter, using the heterodyning principle, provides a tracking front-end filter that eliminates harmonics and overloading interference without manual filters. A



floating, guarded input allows differential performance with single-ended connection and eliminates grounding problems. Other features include frequency from 0.1 Hz to 200 kHz in optimized ranges. 100-nanovolt full-scale sensitivity (to 100 picovolts with external preamplifier), and a built-in sine oscillator. Price of the Dynatrac 391 is \$1,595. Delivery is from stock.

Ithaco Inc., 735 W. Clinton St., Ithaca, N.Y. 14850 [353]

**Hands-off phasemeter is accurate to within 0.1°**

Phasemeters in series 305C feature a five-digit direct-reading panel display with a resolution of 0.01° and an accuracy to better than 0.1° over the range of 50 Hz to 50 kHz. The units have no operator controls, and drift of less than 0.1° is guaranteed for 30-day intervals. The 305C is available with rear-panel inputs and both analog and digital outputs. A programable version is compatible with DTL and TTL logic. Price ranges



from \$2,000 to \$3,500, depending on type of plug-in and options. Delivery is from stock, and units are supplied with 19-in. rack adapters.

Dranetz Engineering Laboratories Inc., 1233 North Ave., Plainfield, N.J. 07062 [358]

**Low-priced pulser has repetition rate up to 50 MHz**

A modular pulse generator offers a repetition rate of from 1 Hz to 50 MHz, and has delays and widths adjustable to 1 second. The model 8010 provides an output for TTL and ECL simultaneously and an output for the AEC NIM standard. The instrument may be gated synchronously or asynchronously, and also features double pulse, external trigger, and single-cycle add. Packaging is in an AEC NIM module, and the front panel measures 2.7 in. by 8.7 in. The device may be used independently or connected with other pulsers in a system.

Berkeley Nuclonics Corp., 1198 Tenth St., Berkeley, Calif. 94710 [354]

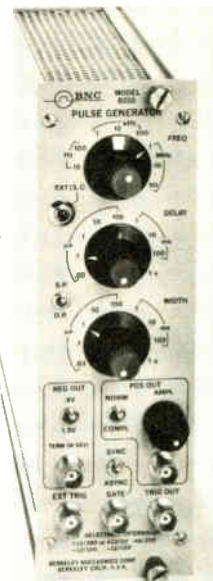

---

## New products

---

Data handling

# Core stack has 8,192 words

---

Folded planar memory for minicomputers, terminals uses 18-mil-diameter cores

---

A little more than a year ago, the Electronic Memories Division of the Electronic Memories & Magnetics Corp. brought out its first standard off-the-shelf core memory stack for use in small systems, such as minicomputers [*Electronics*, Nov. 23, 1970, p. 118]. That was a 4,096-word module, the EM2220; now the industry is shifting from 4,096- to 8,192-word units, according to Dale Sutton, division product manager for commercial magnetics. That's why the division is introducing the EM2230, with a capacity of 8,192 18-bit words. Like the EM2220, the EM2230 is a folded planar stack that is offered as a standard product.

The two principal improvements over the EM2220 are the exclusive use of 18-mil-diameter cores and a wider separation of the drive and sense pins to make the unit more compatible with the system designer's layout requirements, Sutton says. By using 18-mil instead of 20-mil cores, "We've been able to get an 8,000-word sense line on tight densities without increasing area significantly," he adds.

In fact, Electronic Memories is packing twice the capacity of the EM2220 into an area that's only slightly larger: 7½ by 8 inches, compared with 6 by 6½ in. for the EM2220. The EM2230 uses the same double-herringbone core pattern as its predecessor, and requires only about 89 in. of sense line compared with some 61 in. for the EM2220. But, again, the former packs twice as many cores along that sense line. Sutton says that by minimizing the sense-line length, Electronic Memories has been able to minimize phase shift between the first and last cores sensed on the line.

The three-wire, 3-d planar stack has two printed-circuit boards attached to a hinge, and one folds atop the other to minimize the area. The EM2230 has a cycle time of 700 microseconds, and an access time of 350  $\mu$ s. Sutton says the new stack will cost less than \$600 in production quantities.

"The 4,000-word minicomputer was a passing thing," Sutton asserts. "The normal minicomputer today leaves the factory with 12,000 words of memory. With the EM2230, the user can get 16,000 words of memory for what it would cost him to get 12,000 words, using earlier designs, with very little added hardware in the system configuration." Electronic Memories Division, Electronic Memories & Magnetics Corp., 12621 Chardon Ave., Hawthorne, Calif. 90250 [361]

---

## Cassette allows selectable baud rates for record, read

By decreasing overall line-time charges, the 1,200-baud service now being offered by time-sharing computer utilities should save their customers more than its extra initial cost—provided proper use is made of these high-speed data lines.

One way to save is to record data at high speed as it comes over the line, and then play it back slowly for printout. When the program or data is to be sent again, it can be recorded at a slow speed, say 110 baud, and played back for transmission over the line at maybe 1,200 baud. Mobark Instruments Corp. has a new digital cassette unit that does just that.

Mobark's model 400TE is designed specifically for paper-tape replacement and remote data communications terminal applications. The 400TE combines true incremental serial-by-bit and serial-by-character recording and reproduction control with a transport drive system that maintains equalized tension on the tape. A stepper motor moves the tape in precise increments only when data is present.

According to Dick Barton, marketing manager, the recording

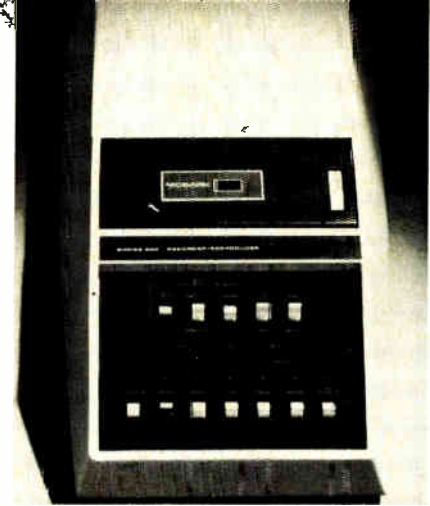

method makes use of a photoetched, slotted disk fixed to the shaft of the stepper motor. This disk, when strobed to advance, photoelectrically transfers each bit, the individual slots timing the transfer to the tape advance. Barton says that 60" of stepper motor travel place a coincidence (synchronization) bit, eight data bits and an end-of-character bit, followed by an inter-character gap, precisely on 0.045-inch tape.

The 400TE records serial format on tape on two tracks using NRZ-mark on one and NRZ-space on the second. The tape is bipolar-saturated at a bit wavelength of 333 bits per inch. Wideband NRZ and complement recording provide insensitivity to poor tape quality and unstable tape motion.

The 400TE is plug-to-plug compatible with EIA RS232C and teletypewriter current loop interfaces. Data rates of 110, 150, 300, 600, and 1,200 baud can be selected with total independence between record and reproduce baud rates. Thus data can be recorded from a high-speed line at 1,200 baud and played back at 110 baud for printout.

Other features include continuous play or incremental play, one character at a time, with backspace for editing. An optional, plug-in digital file-search is available.

The cassette sells for \$1,870. Mobark Instruments Corp., 1080 East Duane Ave., Suite D, Sunnyvale, Calif. 94086 [362]

---

## Signal processors offer 50 preprogramed functions

Two digital signal processors in the CSS-3 series have more than 50 preprogramed functions that can be

## New products

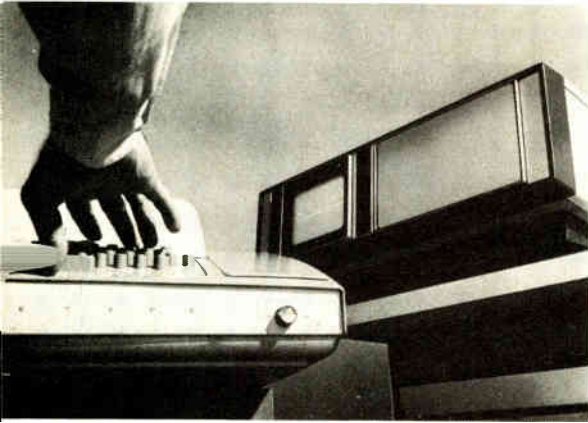

combined to generate other functions, using automatic storage and execution techniques. The new models also feature dual-channel sample and hold, greater sampling interval resolution and arithmetic, as well as more signal processing capabilities than previous models. Conversion accuracy is improved, and a new method of time-domain treatment reduces fast Fourier transform sidelobes and resolution. Prices start at \$25,900.

Computer Signal Processors Inc., 209 Middlesex Turnpike, Burlington, Mass. 01803 [363]

### Computer output microfilm terminal provides 8-s access

A keyboard-controlled, 16-mm computer output microfilm terminal, the model 310, retrieves and displays data in an average access time of 8 seconds. The unit can re-



trieve COM data recorded in cine or comic format or be used as a general-purpose 16-mm microfilm display. It accepts 100-foot rolls of microfilm loaded in Quantor or 3M cartridges. Each cartridge stores up

to 3,000 pages of data. Price is \$2,495.

Quantor Corp., Cupertino, Calif. [365]

### Memory extension systems built for computer users

Two memory extension systems for end-user applications are directed to users of DEC's PDP-8/I and L, Digital Computer Controls' D-112, and Data General's Nova and Supernova minicomputers. Designated the DMS-8 and DMS-16, each system consists of controller, fixed-head-per-track rotating memory, power supply, cabinet, and supporting software. Memory capacity ranges from 64,000 to one million words, and four units can be attached to a controller. Prices start at \$9,000.

Digital Development Corp., 5575 Kearny Villa Rd., San Diego, Calif. 92123 [364]

### Sixteen channels of display can share common computer

A line of raster scan graphic displays with a solid-state memory can stand alone or operate as a clustered system. Sixteen color channels can be clustered and share a common computer interface. The memory meets environmental specifications of temperature of from 0°C to 60°C, and other features include endpoint vector generation, multisize alphanumerics, complex graphics, and one bit of memory for every bit displayed. Price for a four-color system is \$7,500. Additional channels are \$2,000 each. An eight-color system is available at \$8,500, with additional channels priced at \$3,000 each.

Ramtek Corp., 1000 Elwell Court, Palo Alto, Calif. 94303 [367]

### Numeric keyboard increases efficiency of terminal

A numeric keyboard for time-share terminal users operates simultaneously with teletypewriters or other

ASCII terminals for input data. The 16-key pad may be used on-line directly to the data set, or in local mode for generating paper tape. The line-feed command key automatically produces a rubout character, and since the carriage return command key is separate, double



line feed is eliminated during on-line operation. Price of the model ANK-16 is \$224. Delivery is from stock.

TTS Div., Remote Data Terminals Inc., 2928 Nebraska Ave., Santa Monica, Calif. 90404 [366]

### Key-to-disk entry system has full-record CRT display

A shared-processor, key-to-disk data entry system, called the 1302, offers three times the disk capacity of the Inforex model 1301, and is compatible with the earlier system. Capacity is 18,000 records, based on a record length of 125 characters, 36,000 records at 61 characters, or 72,000 records at 29 characters. Features include support of from one to 16 key stations and a full-record CRT display at each station. Options are expanded tape processing, blocking, reformatting, 1,600 bits-per-inch tape drive, and an interval timer. Price is \$3,100 for the control unit, \$1,200 per key station, and \$4,800 for an expansion adapter. Rental is \$710 per month for the control unit, \$50 per key station, and \$100 for the expansion adapter unit.

Inforex, 21 North Ave., Burlington, Mass. 01803 [368]

Packaging and production

## Digitizer cuts drafting costs

---

System goes from rough circuit drawing to final schematic in single step

---

Most digitizing systems provide automatic input to a computer that then drives a plotter to produce a correctly sized and spaced circuit schematic. But Design Aids Inc., Anaheim, Calif., has developed a turnkey system that allows the user to go directly from an engineer's rough drawing to the finished schematic without the need for a draftsman to draw a gridded schematic between the two steps.

Called Drafting System 1, it can cut the time required for generating a finished circuit diagram from 16 hours to one, according to the company. That assumes that the final drawing is done by hand, using rub-ons or templates, but the time saving is still estimated at 10 to one, compared to drawing a gridded layout, digitizing it, and allowing time for input to the computer and plotting. With System 1, a rough drawing can be plotted in an hour.

The system includes a Science Accessories Corp. digitizer plus proprietary software written in Fortran that makes it suitable to run on an IBM 1130 or 360 computer, or on a Data General Nova 1200. With one digitizer, the system will carry a \$17,000 price tag, not including computer and drum plotter.

The user tapes the rough drawing to the upper portion of the digitizer. Below and to the left of it he affixes a "keyboard and control panel" sheet and another containing the symbols required to complete the circuit drawing. Data defining the contents of the panel and the symbol selection sheet must have been previously entered into the computer.

To operate the system, the user touches register marks on the two

lower sheets with the digitizer stylus, automatically entering a cutoff line into the computer. Any coordinate that falls above that line in later entries is automatically translated by the software as being in the rough drawing; any coordinate below that boundary line is treated as being either on the keyboard and control panel or on the symbol selection sheet.

The keyboard and control panel sheet contains a keyboard layout similar to that of a typewriter. The operator selects a symbol by touching it on the symbol selection sheet, then touching the terminals of the symbol in the rough drawing. If the symbol is labeled, he touches with the stylus those points on the keyboard that spell it out, such as 2N1306, for that type of transistor.

As each feature's coordinate is ticked off by the digitizing stylus, a paper tape is being punched simultaneously, containing the coordinates of the rough drawing's features. When the tape is later read, the software automatically finds node points between lines and between symbols and lines, determines symbol orientations, determines labels and label positions, and allows space for symbols and their labels. It also straightens horizontal and vertical lines, moves symbols to allow space for each and to maintain relative symbol positions similar to those on the rough drawing, compresses the drawing to remove excess space, and plots a check drawing or final drawing.

Design Aids Inc., 1748 Woodwind Lane, Anaheim, Calif. 92806 [391]

---

## Cable assemblies mate with standard DIP sockets

Interconnection systems, designated the L series, will mate with standard IC dual in-line package sockets, or directly plug in to boards. A choice of styles includes 22 to 30 AWG cable, 8-, 14-, 16-, 18-, 24-, 28-, 36-, or 40-pin mating plugs, single- or double-ended harness, terminated to ribbon cable, twisted pair ribbon, and single or twisted-pair individual

conductors. Six-inch and one-foot lengths are available from stock, and other lengths may be ordered.

Texas Instruments Inc., Metallurgical Materials Div., Attleboro, Mass. 02703 [393]

---

## Plug-in fuseholder mounts near edge of circuit board

Subminiature, low-profile, plug-in fuseholders are designed for mounting near the edges of printed-circuit boards. This allows for removal of

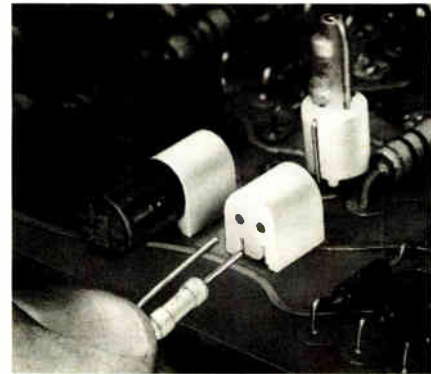

fuses without disturbing other components. The series 281007 units are rectangular and measure 0.260 in. high by 0.244 in. wide by 0.276 in. deep. They accommodate the company's Microfuses and Picofuses. The fuseholders are rated at 5 amperes at 125 volts ac.

Littelfuse Inc., 800 E. Northwest Highway, Des Plaines, Ill. 60016 [395]

---

## Silicon oxide reactor offers uniform deposition to 5%

A silicon oxide deposition reactor assures users of less than  $\pm 5\%$  deposition variation from wafer to wafer and from run to run. The rotat-

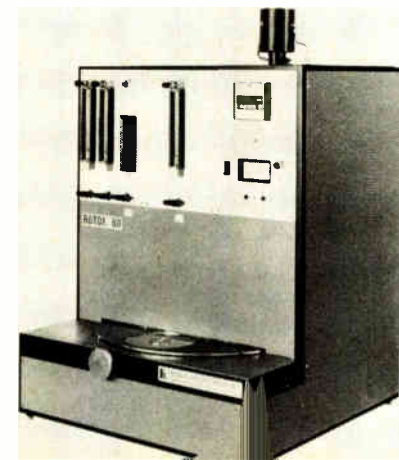

AMERICAN MADE

# Tolerance SCHAUER 1-Watt ZENERS

**Immediate Shipment  
Low Prices**

ANY voltage from 2.0 to 18.0

Quantity	Price each
1-99	\$1.07
100-499	.97
500-999	.91
1000-4999	.86
5000 up	.82



All welded and brazed assembly

No fragile nail heads

Gold plated leads

Write for complete rating data and other tolerance prices.

## Buy the kit- Save a lot



Kit contains a 51-piece assortment of SCHAUER 1% tolerance 1-watt zeners covering the voltage range of 2.7 to 16.0. Three diodes of each voltage packaged in reusable poly bags. Stored in a handy file box. Contact your distributor or order direct.

A \$54.57 value for

# ONLY \$24<sup>50</sup>

Semiconductor Division

## SCHAUER Manufacturing Corp.

4514 Alpine Ave. Cincinnati, Ohio 45242  
Telephone: 513/791-3030

## New products

ing reactor operates semicontinuously, depositing doped or undoped silicon oxide at 350°C to 450°C. The SiO<sub>2</sub> film prepared in the Rotox-60 is used for passivating oxide metal, multilayer metal insulation, doped oxide sources, and field oxide buildup. Applications outside the semiconductor wafer fabrication area include insulation on ceramic hybrid substrates and optical configurations. The basic system sells for \$7,000.

Hugle Industries, 625 N. Pastoria Ave., Sunnyvale, Calif. 94086 [394]



### Semiconductor saw provides accuracy to 0.0004 inch

An automatic inside-diameter saw is for production cutting of semiconductor crystals. Called the Microslice, it is programable. Single crys-

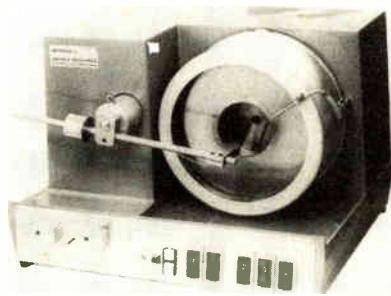

tal ingots up to 3 in. in diameter can be cut to an accuracy of better than 0.0004 in., with a kerf loss of only 0.008 in. These specifications make the saw suitable for expensive or delicate materials where low surface damage and minimum breakage are required. Price is \$11,950.

Imanco-Metals Research, 40 Robert Pitt Dr., Monsey, N.Y. 10952 [396]

ing options, such as card feed, hopper feed, lead and body tape feed, and bowl feed, in addition to a variety of forming configurations. Standard equipment includes an adjustable transport system, a variable-speed, all-electrical drive to regulate output, and a cut-lead bin to collect scraps. Price is \$695.

Heller Industries Inc., 18 Microlab Rd., Livingston, N.J. 07039 [397]

### Wire wrapper has its own 6-volt power source

A portable wire-wrapping tool, model 616, comes with a leather belt, holster and 6-volt power supply, suiting it for field repairs or locations where a power source is not available. The unit also comes with a four-foot retractable coiled cord, and is rechargeable over a 10-to-12-hour period. Operators can make over 1,000 wraps on one charge. Free speed is over 2,500 rpm, and the tool handles wire sizes from 32 to 20 AWG.

Standard Pneumatic Motor Co., P.O. Box 7500, Reno, Nevada 89502 [398]

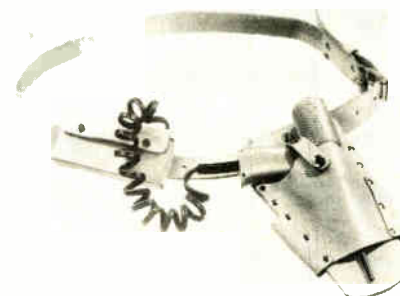

### Component lead former handles 14,000 units/hour

An axial-component lead former called the Leadmaster model LJR-7, can handle up to 14,000 pieces per hour, and can accommodate the complete range of sizes of commonly used axial components. Also offered is interchangeability of feed-

### Semiconductors

# Register uses only 250 mW

Cell geometry cuts power drain of 1,024-bit unit for low-speed applications

As shift registers get longer and faster, designers are finding many new applications, but there is one application area that has been neglected—where a register is being used at slow speeds such as 1 or 2 kilohertz.

Dynamic shift registers, which are available in lengths up to 2,048 bits, can't be used because they lose the data, and static registers have been available only in lengths up to 512 bits. According to Jim Kane, an MOS circuit designer at Signetics Corp., the length limitation in static shift registers is mainly due to power dissipation.

Through some novel circuit design techniques, Kane has designed a 1,024-bit static shift register that dissipates only 250 milliwatts. "Basically," says Kane, "I've adjusted the cell geometry so that it draws almost no power—only 250 microwatts per bit; the rest of the power is drawn by the on-chip clock generator." The new register, designated the 2533, is TTL-compatible at both inputs and the output. Power supply requirements are +5 volts, -12 v, and ground. The 2533 employs an enhancement-mode p-channel silicon gate MOS process and will operate from dc to 2 MHz. Through the use of two data inputs and a "stream select line," an external recirculate function is fairly easy to configure. And a single 5-v TTL-level clock is all that is needed—the three clock phases used by the static register cells are generated internally.

Kane says that all of the inputs have pull-up resistors. The output is push-pull, operating between 0 and +5 v, and it provides a sink current of 1.6 milliamperes for one TTL

fanout. One interesting feature of the 2533 is its pin-outs. They are patterned closely around Intel's 1401 which is a 1,024-bit dynamic register; this will allow a relatively easy substitution where low-frequency operation is critical.

Signetics is also introducing a quad 80-bit static shift register in a 16-pin DIP that employs the same improved cell design. It's called the 2532 and will be priced at \$9.20 each in quantities of 100 to 999. The 2533 will sell for \$15.30.

Both registers will be available from stock by early March.

Signetics Corp., 811 East Arques Ave., Sunnyvale, Calif. 94086 [411]

### Universal programmer also verifies any ROM

More than two dozen semiconductor manufacturers build field-programmable memories of different

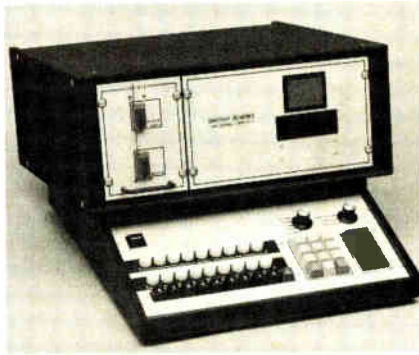

sorts—such as fusible link, charge injection, and avalanche injection. The problem was that no single piece of hardware was available that could program all types, and a memory user either had to jury-rig his own programmer or he had to have on hand three or four different commercial types. But Spectrum Dynamics has now developed a universal memory programmer; it can program every ROM that's commercially available today. In addition, the model 550 can verify a ROM program and test for the program integrity of random-access memories.

Bud Sheesley, president of Spectrum Dynamics, sees field-programmable memories capturing one-third of the total semiconductor

memory market by 1975—reaching a total of \$50 to 100 million. "Servicing that kind of market puts us right on the tail of a galloping lion," says Sheesley.

The 550 can program ROMs of the fusible-link, diode-junction-shortening, electrochemical-fusing, and floating-gate avalanche-injection types. And these can be programmed manually or automatically, depending on the volume.

Features include the ability to verify automatically that a programmable ROM is blank, to program all programmable ROMs using interchangeable personality cards, and to program automatically from a master ROM or (optional) when interfaced with other equipment. An address keyboard permits direct selection of words, with an additional key to increment one word at a time. A data keyboard permits entry of data into a RAM for checkout before programming. Bits to be programmed can be displayed in a data register.

Address capacity is 9,999 words, expandable to 99,999 words. The basic model 550 is priced at \$2,200. Personality modules start at \$380.

Spectrum Dynamics, 2300 East Oakland Park Blvd., Fort Lauderdale, Fla. [412]

### Circuit design kit speeds custom IC development

Custom linear and digital monolithic circuits can be designed with a kit called the XR-C100, that allows a breadboard circuit to be converted into an IC in a few weeks. The kit



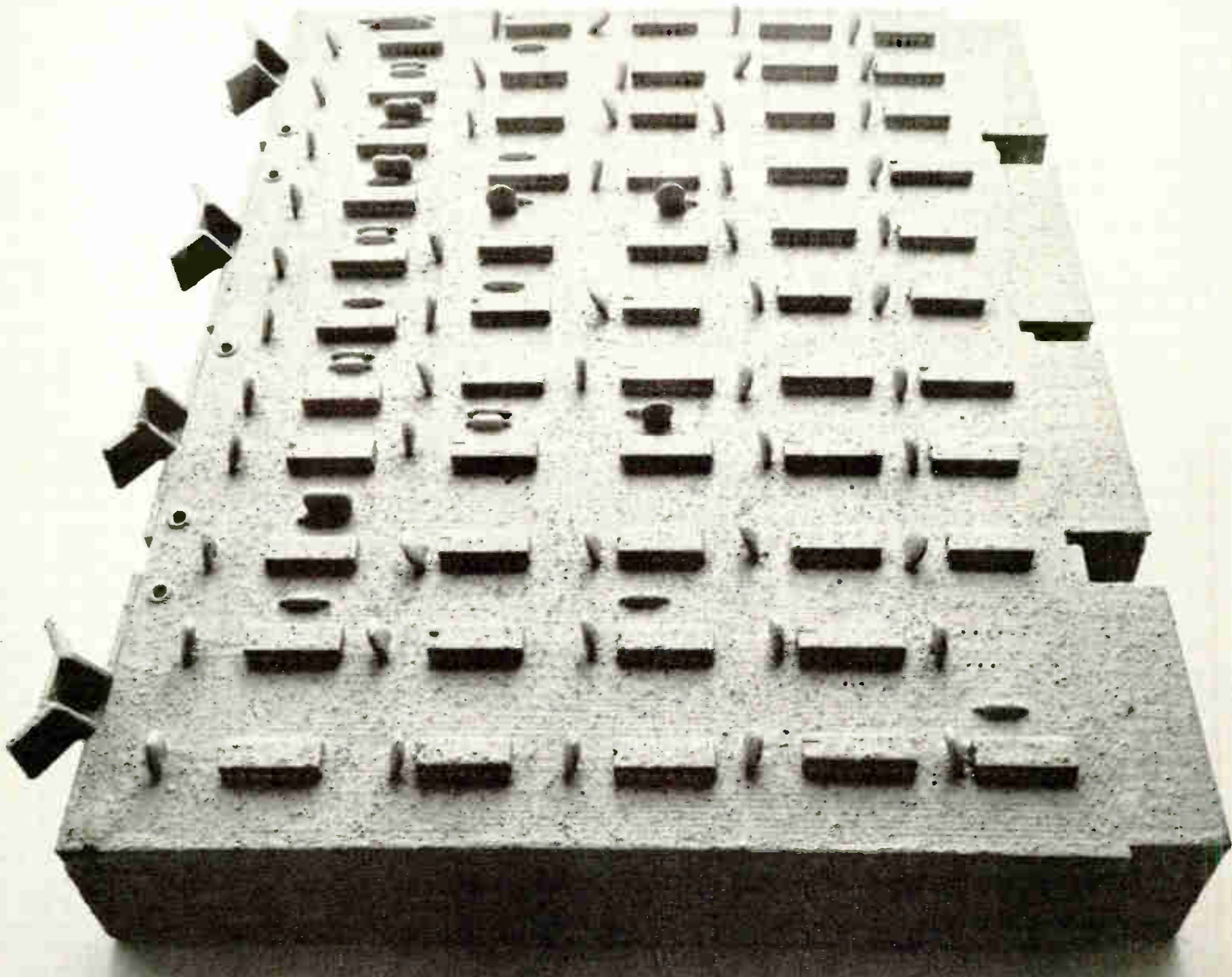

## Augat says you can't afford to bury your circuit in a block of cement.

Ever try making production or in-field component changes in a printed circuit board?

Good luck.

Easier to scrap your board and start again. New artwork.

New etching. New components.

Now you see why there's a revolution going on to replace printed circuits with flexible, plug-in, wire-wrapped packaging. And Augat's high density dual-in-line panels are leading the way.

The Augat panel is your best guarantee of getting your product on the market fast. Because with Augat you can quickly change your circuits at any time—during breadboarding, prototype or production.

It's the most important and competitive new packaging concept in years. You can have low cost interconnections, high reliability, space saving density . . . all with the flexibility to allow in-production or in-field changes in minutes.

Current sales of thousands of panels a week are proof that the Augat approach is already in orbit. We'll be glad to tell you more. Call us today at (617) 222-2202.

Or write for literature showing our complete product line in panels and accessory equipment. Augat Inc., 30 Perry Avenue, Attleboro, Massachusetts 02703. Our representation and distribution is nationwide and international.



## Plug into Augat® instead.

See our New Packaging innovations at the NEPCON West Booth #441.



---

## New products

---

has more than 200 independent components in addition to several subfunctions, such as current sources and doubly balanced modulators in 22 individually packaged ICs. The parts are reusable, and instructions and diagrams are included. Price is \$80.

Exar Integrated Systems, Sunnyvale, Calif. [417]

---

### Transistor chain amplifies 0.2 watt to 200 watts

A series of 50-MHz, 12-v transistors is designed for high-frequency land mobile radio applications. The family includes a 3-w device (the A3-12), a 25-w device (the A25-12), and a 50-w device (the A50-12). When used in a chain of one 3-w, one 25-w and four 50-w units, the transistors deliver 200 w with 200-mW input. Frequency band is 25 to 50

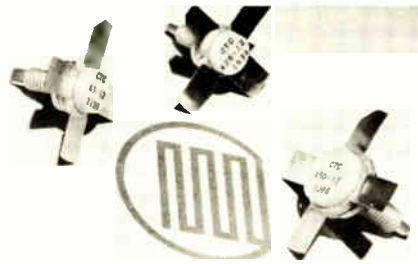

MHz. Construction is single chip, and the transistors are guaranteed to withstand infinite VSWR at all phase angles when operated at rated power and supply voltage.

Communications Transistor Corp., 301 Industrial Way, San Carlos, Calif. 94070 [414]

---

### Shift registers made for odd-length applications

Two mask-programable MOS dual shift registers are designed to fill the need for registers with odd lengths and tap locations, and they also come in standard-length versions. The model MM4007/MM5007 is a 100-bit dynamic register, and each half can be 20 to 100 bits long. Mask options include internal connection as a single register, tap at the junction of the two halves, and

locations of input, output, and tap pins. The model MM4019/MM5019 is a 256-bit register, and each half can be from 40 to 256 bits long. Tap

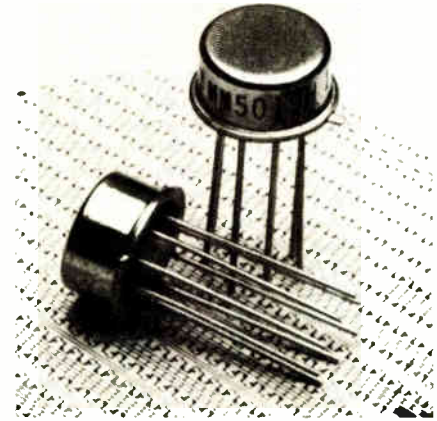

and pin locations are optional. Price ranges from \$8 to \$19.70 in lots of 500.

National Semiconductor Corp., 2900 Semiconductor Dr., Santa Clara, Calif. 95051 [416]

---

### Hybrid circuit aimed at regulator, amplifier jobs

A power hybrid circuit, consisting of two Darlington-pair high-gain current amplifiers with commutating diodes, is designated the HC3000. The circuits are packaged in a hermetic eight-lead TO-3 can. Applications are in regulators and amplifiers and for driving inductive loads such as hammers, solenoids, and stepper motors. Design of the HC3000 features Hometaxial output transistors and thick-film base-emitter resistors. The circuit can be operated from power supplies up to 70 v. Price in 1,000-lots is \$4.25 each.

RCA Solid State Div., Box 3200, Somerville, N.J. 08876 [413]

---

### 4-bit shift registers are direct-coupled

Two dc-coupled TTL integrated-circuit shift registers designated the SN54/74178 and SN54/74179 are functional replacements for the

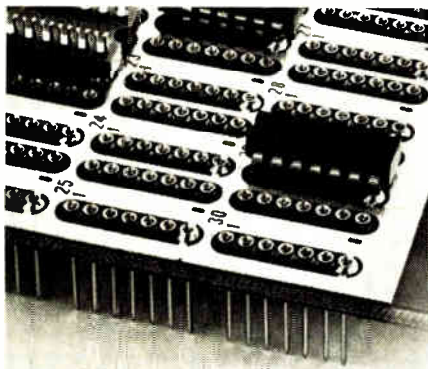

## All plug-in panels are not the same.

It's one thing to want plug-in flexibility in your circuit. It's another to get flexibility plus all the other things you'd like in a dependable point-to-point system.

Like easier IC insertion. Precision-machined contacts. Tighter contact retention. Greater reliability (we'll prove it). Unique tapered entry sockets (patent pending). Lower profile. Plus the versatility to accept 14, 16, 18, 24, 28, 36 or 40 pin IC's in a choice of panel sizes.

And we offer virtually any panel you'll need, in any number of patterns, plane-mounted or edge-connected, off the shelf or custom.

We'll also give you single-source supply for sockets, enclosures and accessories—even automatic wire wrapping whenever you need it.

The Augat way? It's a better way. Call us at (617) 222-2202. Or write for our catalog. Augat Inc., 30 Perry Ave., Attleboro, Mass. 02703. Our representation and distribution is nationwide and international.

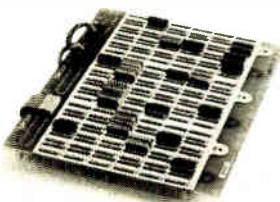

## Plug into Augat\* instead.

Circle 101 on reader service card  
Electronics/January 31, 1972

## New products

models 8270 and 8271. Dc coupling eliminates the need for controlled clock rise and fall times, as well as external clamping of the clock input. Other features include full parallel access, serial input data, and shift and load inputs. The three modes of operation are shift right,

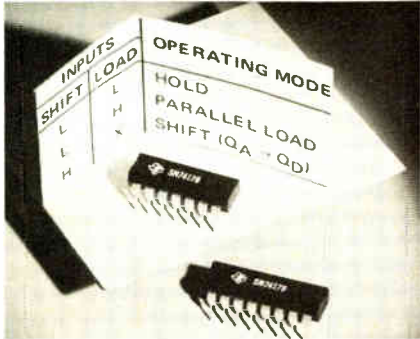

parallel load, and hold. The model 179 has a direct clear input, but the model 178 does not. Price in 100-lots ranges from \$2.20 to \$9.72 each, depending on configuration.

Texas Instruments Inc., Inquiry Answering Service, P.O. Box 5012, MS/308, Dallas, Texas 75222 [415]

## Planar power transistors can switch 250 amperes

A family of npn silicon planar power transistors called the SDT series, are packaged in a 1 1/16-in. stud TO-114 case. The 250-ampere units are for high-current switching applications, such as in motor con-



trols and power supplies. Specifications include a typical  $f_t$  of 15 MHz, saturation voltage of 1.0 v maximum, and a power dissipation of 300 w at 100°C.

Solitron Devices Inc., Semiconductor Div., 1177 Blue Heron Blvd., Riviera Beach, Fla. 33404 [418]

## New products/materials

**Semiconductor encapsulation** compound MC-506 is formulated to give freedom from ionic contaminants. The material, providing heat resistance for environments exceeding 225°C, is designed for all types of semiconductor devices, including integrated circuits.

General Electric Co., Silicone Products Dept., Waterford, N.Y. [477]

**Eleven chemicals** for use in the manufacture of MOS integrated circuits include acetic, hydrochloric, phosphoric, and chromic acids; ammonium hydroxide, hydrogen peroxide, acetone xylene, trichloroethylene, tetrachloroethylene, and butyl acetate. They are designed for etching silicon dioxide.

J.T. Baker Chemical Co., Phillipsburg, N.J. 08865 [478]

**Silicon carbide powder** for cutting silicon wafers into semiconductor chips has an average particle size of 10 micrometers. The powder is designed primarily for use in the Taft-Pierce Mark 111A dicing machine. The grain size allows the kerf loss to be held to 4 mils, and half-dollar-size wafers can be sliced into 1,000 uniform squares in 90 seconds.

Bendix Abrasives Div., The Bendix Corp., Teterboro, N.J. 07608 [479]

**One-part epoxy adhesive**, called Ecobond 144, cures in about two minutes at 350°F and can be cured at temperatures as low as 200°F. Shelf life without refrigeration is greater than three months. The material contains no solvents and requires no additional catalyst. Fast gel time



prevents sag during cure and establishes a preliminary bond. Price is \$2.25 per lb.

Dielectric Materials Div., Emerson & Cuming Inc., Canton, Mass. 02021 [476]

**Gold cermet paste** called S4300C allows a hybrid circuit processor to rework circuits by removing a defective IC, then replacing it with a

working device. Integrity of the completed circuit does not deteriorate, and the material is mainly for chip and wire bonding operations, as well as beam-lead bonding.

Cermalloy Div., Bala Electronics Corp., 14 Fayette St., Conshohocken, Pa. 19428 [480]

**Masking film** called Stabilene Red 44 5524 has a flame resistant 4-mil polyester base, and can re-adhere to base and surface. It is available in rolls and sheets, will not bleed, and can be cut with hand tools. The material has a nonglare surface.

Keuffel & Esser Co., 20 Whippany Rd., Morristown, N.J. 07960 [481]

**Urethane adhesive**, DC 8815, is fabricated for bonding Mylar EL to copper for flexible printed circuits. The material can also be used in bonding iron oxide particles to polyester film.

Daubert Chemical Co., Dept. RM, 4700 South Central Ave., Chicago, Ill. [482]

**A cobalt-modified aluminum silicon bronze** called Alloy 638 Coronze is for hermetic glass-to-metal seals in discrete devices and integrated circuit packages.

Olin Corp., 460 Park Ave., New York, N.Y. 10022 [483]

## New Literature

**Ceramic capacitors.** A 10-page ceramic capacitor conversion chart for MIL-C-39014B and MIL-C-39014A established-reliability capacitors is available from Union Carbide Corp., Components Dept., P.O. Box 5928, Greenville, S.C. 29606. Circle 422 on reader service card.

**Computer services.** Raytheon Co., Lexington, Mass. 02173. A 16-page brochure, intended primarily for computer and peripheral manufacturers, describes available maintenance services with details of cost and obligation. An additional six-page bulletin describes services offered to computer users. [423]

**Spectrum analyzers.** Federal Scientific Corp., 615 W. 131st St., New York, N.Y. 10027, has available a 12-page brochure describing the features, specifications, and applicability of the company's 200-, 400-, and 500-line of spectrum analyzers. [424]

**Computers.** A 28-page brochure features diagrams describing the characteristics of a family of 16-bit Mod-comp computers and system building blocks manufactured by Modular Computer Systems, 2709 N. Dixie Highway, Fort Lauderdale, Fla. 33308 [425]

**Circuit testers.** Microdyne Instruments Inc., 209 Middlesex Turn-

pike, Burlington, Mass. 01803, has published a booklet detailing the 720 series of automatic digital circuit testers. [427]

**Microprogramming.** Microdata Corp., 644 E. Young St., Santa Ana, Calif. 92705, has issued the second edition of the Microprogramming Handbook, which is a sequel to the first edition in an expanded 448 pages. [426]

**Software packages.** A 12-page brochure detailing the operation of software packages offered with the 620 computer family is available from Varian Data Machines, 2722 Michelson Dr., Irvine, Calif. [428]

**Active filters.** Frequency Devices Inc., 25 Locust St., Haverhill, Mass. 01830. A four-page report for systems engineers provides an understanding of voltage-tunable active filters, including methods of optimizing usage and applications. [429]

**Function modules.** Intronic Inc., 57 Chapel St., Newton, Mass. 02158 has available a 16-page product catalog describing a line of analog function modules for applications in control, measurement, display, and computation systems. [430]

**Reed switches.** A guide to the selection and application of reed switches is available from Hamlin Inc., Lake and Grove Sts., Lake Mills, Wis. 53551. Also covered in the guide are various forms of actuation, including proximity switching with permanent magnets, bias switching, and shielding. [431]

**Components.** A 12-page catalog describing the company's line of components for the electronics industry is available from the James Millen Manufacturing Co. Inc., Malden, Mass. 02148 [432]

**Circuit analysis.** SofTech, 391 Totten Pond Rd., Waltham, Mass. 02154. A 16-page brochure illustrates the use of AEDCAP in solving circuit analysis problems. [433]

**Schottky ICs.** Texas Instruments, P.O. Box 5012, M/S 308, Dallas,



Texas 75222, has published a 26-page brochure describing its line of Series 54S/74S Schottky-clamped TTL integrated circuits. The bulletin, CB-147, provides aids for designing the systems. [421]

**Data systems.** Princeton Applied Research Corp., Box 2565, Princeton, N.J. 08540 has published an eight-page bulletin describing a modular system that can automatically receive, record and analyze data from instrumentation and, if desired, control the instrumented system generating the data. Also discussed is the use of the system to interface instruments with computers or calculators. [434]

**Data cassettes.** Information Terminals Corp., 1160 Terra Bella Ave., Mountain View, Calif. 94040, has available a brochure detailing the physical properties and performance specifications of the T300 digital data cassette. [435]

**C-band links.** RHG Electronics Laboratory Inc., 94 Milbar Blvd., Farmingdale, N.Y. 11735. A two-page bulletin describing variable-frequency C-band links for reconnaissance, surveillance, and high-speed data transmission systems contains photos, tables of received signal strength, video signal-to-noise ratio, and a comprehensive block diagram. [437]

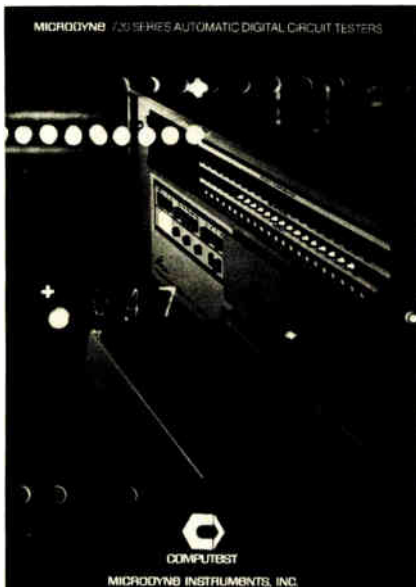

# Only Electronics takes you into all 5 audience dimensions

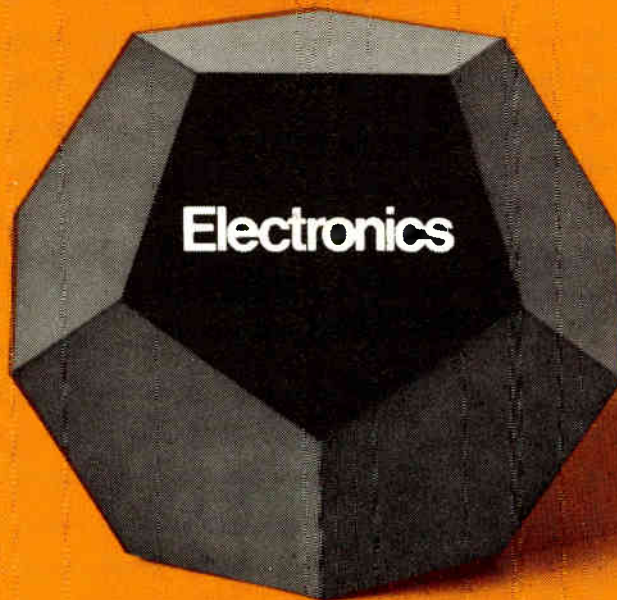

**1. Management Dimension 2. Technical Dimension 3. International Dimension  
4. Purchasing Dimension 5. Reader Involvement Dimension**

New reader profile study highlights the power of *Electronics* readers in five key areas. These are the people you must reach to move a product or a service in the worldwide electronics markets today—and tomorrow.

If you want to know just how powerful a magazine is as an advertising medium, ask its readers. We did. Here's what they said.

**1. *Electronics* subscribers** are vitally important to their companies, and therefore must be important to you: 58,000 (67%) have a management responsibility.

48,000 (56%) are responsible for their companies' profit.  
68,000 (79%) travel on business for their companies — 31% make more than 7 trips per year.

**2. *Electronics* subscribers** are determining the technical and business futures of their companies. They're also determining yours:

70,000 (81%) have engineering job functions.

69,000 (80%) participate in business, product or technology planning.

74,000 (86%) do or supervise design work.

**3. *Electronics* subscribers** are where you need them:

76,000 (88%) work in the worldwide electronics original equipment market.  
7,600 (9%) more, work in vital "user" markets.

44,000 (52%) work in the five major growth markets of the '70's—computers, communications, instrumentation, industrial controls and consumer products.

**4. *Electronics* subscribers** buy your products:

73,000 (85%) select vendors.

23,000 (26%) recommend, approve or

specify purchases in excess of \$100,000 per year.

70,000 (82%) buy passive components.

71,000 (83%) buy control and display components.

77,000 (90%) buy active components.

75,000 (88%) buy instruments and test equipment.

**5. *Electronics* subscribers** depend on *Electronics*:

55,000 (64%) read it at home.

41,000 (48%) spend more than one hour reading each issue.

25,000 (29%) do not read any of the next six publications in the field.

55,000 (64%) do not read the second publication in the field.

68,000 (79%) do not read the third publication in the field.

It all adds up to this one crucial point—a magazine's power is only as great as the power of its readers. Only *Electronics* takes you into all 5 audience dimensions. For complete details on this new reader profile study, contact your nearest *Electronics* advertising district manager.

## Reach the buyers for your product where they're at.

Beginning with the January 3, 1972 issue, *Electronics* offers advertisers four different market-coverage opportunities.

**a. Full-Run.** Advertisers may reach the *Electronics* worldwide audience of 86,000 with one advertising message. Full-run advertising rates are lowest on a cost-per-thousand basis. Full-run space earns frequency discounts for all other options.

**b. Full-Run, Copy Split.** Advertisers may reach *Electronics* worldwide audience with two or more advertising messages. Full-run rates apply, plus split-run charge. A standard domestic-overseas split is available at low charge. Full-run split advertising space earns frequency discounts for other options.

**c. International Advertising.** Advertisers may elect to reach only the *Electronics* overseas audience of 16,000 through the International Advertising Section, which is available in all issues. IAS space earns frequency discounts only for IAS advertising.

**d. Domestic Advertising.** Advertisers may elect to reach only the *Electronics* U.S. and Canadian audience. This option is available every issue but publisher reserves the right to restrict space to 12 pages per issue. Space units of full page or larger only. Domestic advertising space earns frequency discounts for domestic advertising only.

## Electronics offers free proof of advertising effectiveness.

For 1972, *Electronics* offers you a free inquiry follow-up service—Buyer Action Measurement (BAM). It can determine for you just where the buying action is for your product. BAM has a tremendous memory bank which enables you to get unusual and critical information on products you advertise. And, *Electronics* is the only magazine in its field to offer any such service with BAM's capability. Here's how BAM works:

1. When a prospective buyer circles a number on the *Electronics* Reader Service Card, he also checks off his industry classification. When the card is received by BAM, the information is stored in the computer. Questionnaires are then mailed to the requestees to determine the action taken. The response to these questionnaires is also stored in the computer.
2. BAM then produces a printout table

that tells you number of requests for information, number of questionnaires returned from requestees, the percent of response, five types of action taken by respondents, number and percent of sales actions taken—all broken down by *industry classification*.

3. In addition, BAM gives you a comparison report showing the action taken by your customers and prospects on *all similar products* to yours that were advertised in the same issue.

4. And, as a final service, BAM offers a *cumulative comparison report*, by product, of all the issues studied. From this, you can determine where the

sales actions for your type of product come from over a period of time.

*Electronics* offers AD COM—Advertising Communications Evaluation—the most comprehensive advertising readership service available anywhere. It tells you, through 100 personal interviews, the percent of respondents who remembered seeing your ad and remembered reading it. It also tells you whether your message got through and whether it was believable. Finally, it tells you the percentage of readers who took or plan to take action as a result of reading your advertisement.

## 1972 ADVERTISING SCHEDULING GUIDE

Use this convenient advertising scheduling guide to take full advantage of special issues and reports, as well as those issues which are scheduled for BAM and

AD COM. You will be notified well in advance of closing dates of the additional special reports and studies as they become scheduled.

ISSUE	CLOSING	CYCLES	SPECIAL REPORTS	AD COM	BAM
Jan 3	Dec 10	A	Annual U.S. Markets Report	✓	
Jan 17	Dec 24	B			✓
Jan 31	Jan 7	A		✓	
Feb 14	Jan 21	B		✓	
Feb 28	Feb 4	A			✓
Mar 13	Feb 18	B	IEEE Preview		
Mar 27	Mar 3	A		✓	
Apr 10	Mar 17	B			✓
Apr 24	Mar 31	A			
May 8	Apr 14	B		✓	
May 22	Apr 28	A			✓
June 5	May 12	B		✓	
June 19	May 26	A			
Jul 3	June 9	B			✓
Jul 17	June 23	A			
Jul 31	Jul 7	B			
Aug 14	Jul 21	A			✓
Aug 28	Aug 4	B			
Sept 11	Aug 18	A	Wescon Preview		
Sept 25	Sept 1	B			
Oct 9	Sept 15	A			
Oct 23	Sept 29	B			
Nov 6	Oct 13	A			
Nov 20	Oct 27	B	Japan Markets Report		
Dec 4	Nov 10	A			
Dec 18	Nov 24	B	European Markets		

**TOTAL PAGES SCHEDULED** \_\_\_\_\_

## Get the whole picture.

For the total picture of what the five-dimensional audience of *Electronics* can do for you, contact your local *Electronics* district manager.

That's also where you can get a complete copy of our new International Profile Study, as well as the recently-completed European Product Preference Poll and the domestic

Product Preference poll. Plus the 1972 *Electronics* rate card.

You can't sell to the world's electronics markets unless you reach all five audience dimensions.

**Electronics**  
The International Magazine  
of Electronics Technology

# SHOCK

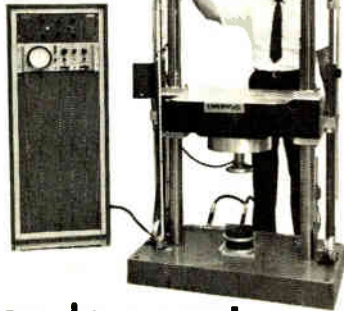

## New low cost SHOCK TESTING SYSTEM

Five sizes (16 to 60-in. table), simple design, rugged; for product fragility, packaging or MIL STD tests.

Free Literature Available — Write Today



**MTS SYSTEMS CORPORATION**  
BOX 24012, MINNEAPOLIS, MN. 55424 (612) 941-3200



Circle 106 on reader service card



**YOU'RE WHISTLING IN THE DARK...**

if you think that heart disease and stroke hit only the other fellow's family.

**GIVE ... so more will live  
HEART FUND**



*Contributed by the Publisher*

# 5 compelling reasons why Electronics is your passport to the world of electronics marketing

- 1 Electronics is the best-read magazine in its field in Europe.
- 2 Electronics contains more marketing information that pertains to Europe than any other magazine in its field.
- 3 Electronics has the highest pass-along readership of any magazine in its field.
- 4 More of the world's leading electronics-equipment manufacturers advertise in Electronics than in any other magazine in its field.
- 5 Advertisers may elect to reach only the Electronics audience of 16,000 outside of the U.S. and Canada through the International Advertising Section, which is available in all issues. You may, of course, also use the full run, which reaches 86,000 Electronics subscribers world-wide.

For more reasons why Electronics is the best place to reach your local markets, ask your Electronics representative. He can provide you with a personal copy of our new Electronics International Profile Study and a copy of the only European Product Preference Poll available.

# Electronics

THE INTERNATIONAL MAGAZINE  
OF ELECTRONICS TECHNOLOGY





Dick Wolters

JANUARY 1972

INVESTMENTS

Tending to the health of your stock portfolio

INSURANCE

Those cherished "valuables"—are they adequately covered?

TAXES

Dollar items in the news

EDUCATION

A parent's guide to the junior year abroad

HEALTHY, WEALTHY AND WISE

**Start 1972 right—make the portfolio check-up a habit**

It is unfortunate that far too many people think seriously about the make-up of their portfolios only once a year, usually in the hectic pre-holiday season. Despite the pressure of Christmas shopping, December is the popular month for portfolio review. Why?—because it is the last time each year that adjustments can be made for tax purposes.

Now, with a new year starting, does it mean that the portfolio can go back in the freezer for the next 10 or 11 months? Not at all.

One's stocks and bonds should be watched all the time, and that means different things to different people. It depends on the time the investor has available and the size and number of his holdings. But for an investor with an ac-

tive portfolio, and at least some time to spare, the minimum should be once a week. In this case, a weekly review is a must whether he takes entire charge of his own investments or depends, in varying degree, on others to manage them.

A simple way to check a list of securities is to write the prices and volumes down at the end of each week. If one issue is noticeably weaker or stronger than the rest, it becomes a case of finding out why. The same thing would hold true for any unusual activity. The investor—like it or not—must attempt to keep up with news developments affecting his specific securities.

This is relatively easy, of course, for the man who reads a paper with extensive financial coverage such as the *New York Times* or *The Wall Street Journal*, plus magazines such as *Business Week*

or even the *London Economist*. The problem is that not every businessman or professional can take the time to thoroughly read a daily financial section, let alone a solid segment of the business press. This is where the value of watching *prices* and *activity* comes in.

Penn Central Co., for example, had a reasonably profitable year in 1968—if one accepts its accounting. The stock, at one time, sold very close to \$90 a share, which proved to be its high. Last year, the same stock sold for under \$5. Many investors, institutional and private, professional and novice, carried it a large part of the way or all the way down before liquidating.

But in this classic case, there were many danger signs for the watchful investor. Beginning with the first quarter of 1969, reported earnings were under those of the year before. The stock was still about \$50 at the time. In the September quarter of 1969, the railroad reported its first loss. The stock was then still above \$30. Those who followed earnings surely should have been alarmed—and should have acted.

There are those who follow prices. In December 1968 and January 1969, Penn Central stock had a poor rally. But

PERSONAL BUSINESS

like all McGraw-Hill publications, is written for a select audience. Prepared each month by the staff of the new monthly magazine *Personal Business*, it is devoted entirely to your own interests and activities. Its theme: Better management of your time and money. This supplement reaches a limited audience, and there is no separate subscription list, or rate.

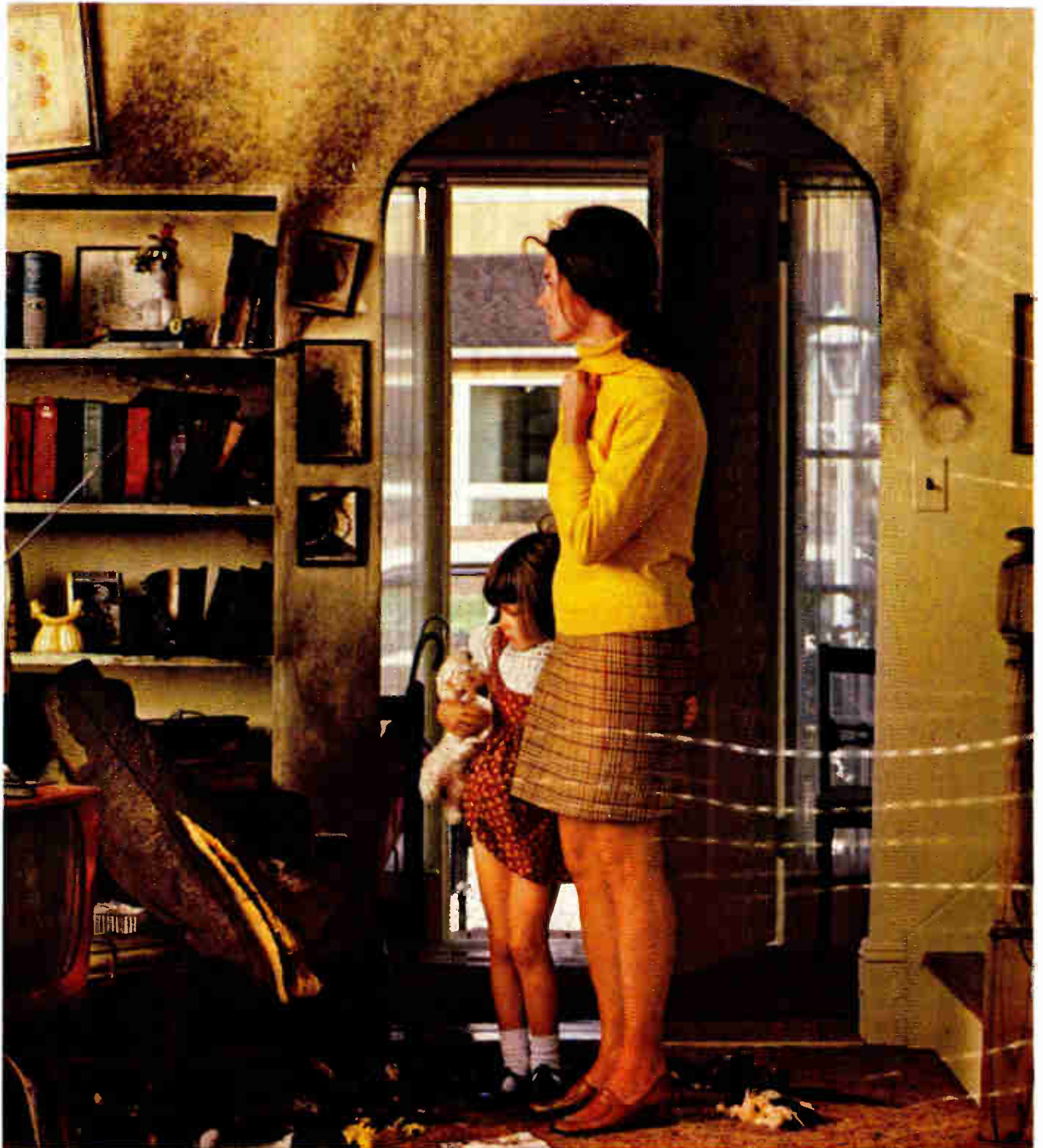

**Would your insurance cover the loss at today's inflated prices?**

*If you haven't increased the value of your homeowners insurance recently, you may be seriously under-insured. Inflation has boosted the cost of just about everything.*

*See a State Farm agent about insuring your home and your possessions for what they're worth today. With no worry about*

*tomorrow, because a special inflation coverage feature automatically increases the amount your policy pays as inflation continues to boost the cost of things.*

*We're the world's largest home insurer. We protect you from loss by fire, tornado, burglary, vandalism*

*and more... at surprisingly low rates.*

*State Farm Fire and Casualty Company. Home Office: Bloomington, Illinois.*

*For your home, your life, your health and your car—State Farm is all you need to know about insurance.*

**State Farm  
inflation-coverage  
Homeowners  
Insurance**





by March '69 it had broken the December '68 low of \$60. In April, it broke the "trendlines" that some investors watch. Weekly awareness would have furnished plenty of warning and saved many investors a great deal of loss.

It almost goes without saying that the more conscientiously an investor follows his portfolio during the year, the less he needs to do at year-end. Tax sales for establishing profits or losses—though most often taken in December—can be taken at any time. And ironically, December is usually the worst time to establish a tax loss. This is because it is probable that in the case of stocks priced near their lows, many investors will be tax-loss conscious and selling out—driving prices down. It is ordinarily more advantageous to establish a loss in November, and hope to *buy back* in December, after a lapse of at least 30 days.

In Wall Street, people speak of the "January investment demand" as a recurring annual event. It is a time when an investor may find it easier than at any other time of the year to set up a portfolio balance sheet. Essentially, this means making a reasonably accurate estimate of net worth. It means totaling income, gains and losses (realized and unrealized), and taxes. The investor will know how he has done during the year and where he is going.

This analysis should go far beyond just security investments. It should involve checking over personal financial goals, plans for the future (such as college financing), as well as life insurance, estate and retirement questions.

From a practical dollar standpoint, people have a tendency to neglect or postpone important decisions. But it is vital to review a portfolio and see whether it has the *balance* that is needed. Here an investor begins with what professionals call the "cash-equity ratio," which simply means how much is in cash or its equivalent, and how much is in securities—mostly stocks—that are subject to fluctuations.

Some prudent people vary this ratio as they appraise the outlook. There is a time when they feel they should have a higher percentage of stocks, and a time when they feel they should have a minimum. The same thing applies to high-grade, long-term bonds that are sensitive to changes in interest rates. Here the swing in price in a 30-year bond, for example, is necessarily very substantial.

There are other investors who concentrate on their personal earning power and invest savings according to formula. This might mean, for example, having 25% of a portfolio in liquid short-term investments such as 90-day Treasury bills, rolled over every three months; another 25% in one- to five-year bonds, tax-

exempt or otherwise, bought for income; 25% more in income stocks or convertible bonds or preferreds that might combine some income with possible appreciation, and the remaining 25% in commons bought for gain.

One well-known Wall Street man, near retirement, says that when he quits he will never again look at any financial news. His solution is to place half of his money in top-quality bonds, spread between issues due a year hence, two years, and so on, up to a maximum of five. The other half he plans to place in conservative, large, high-grade mutual funds that invest in a broad spectrum of blue chips. He does not expect any great profits from this portfolio. He simply hopes that in a prolonged depression—or in case of a decline—his bonds would give him protection. He hopes that in prosperous periods, dividends and prices will improve in the mutual fund portion of his holdings. The point is, of course, that he has a plan—not fool-proof, but carefully devised to suit his needs and his temperament.

There seems to be a tendency for people who inherit property to keep it as is or, at least, to delay consideration of whether it fits into their scheme of things. Very often, fathers and husbands conceal the make-up of their investments from their children and wives. All of a sudden, unexpectedly, the wife becomes a widow and the children come into property. At the outset, they may be forced to liquidate some assets to pay inheritance taxes. But this is not the prime problem. The widow often feels that the portfolio balance should be left alone, invested as her deceased husband left it. But the chances are that his investment plan was related to his ability to make changes, and to his personal earning power and tax bracket. This is all changed by his death, of course, and

the portfolio should be altered to fit the new circumstances.

Thus, in any case—in any family situation—each investment and each security owned should be evaluated as to whether it has a place in one's plans. A useful yardstick is to consider whether the investment would be worth making again. If not, perhaps the security should be sold. Following this line, it should be remembered that the more places an investor has capital, the more time it takes for supervision and portfolio review. So, for most people, it is a mistake to be over-diversified. A good rule is not to own or buy anything unless the investment is sufficiently large to be checked out carefully (and to return a worthwhile profit). Dipping into \$5 flyers for quick profit is fine, but few investors can really afford to put more than 10% or so into out-and-out speculation.

Professionals have a term they call the "risk-reward ratio." It is doubtful whether they can really forecast these ratios based on their own security and market analysis, but everyone needs to try to do this in some manner. The most practical way is to estimate potentials, and arbitrarily cut losses at a preset percentage. If an investor thinks a stock will double, he must decide how much risk he faces. It might be a 10% or 15% risk, but certainly never 50%. A buyer does not make profits investing a dollar with a built-in risk of losing 50% for the chance of doubling. The chance to win must be substantially greater than the chance to lose.

An investor doing a portfolio review and deciding on new buys must be careful of labels. For example, a deflated common stock of lower quality but with promising prospects, selling at an "investment" price can be a safer investment than a prime security quoted at a higher "speculator" price. There are cases where a solid dividend-paying stock selling in the hundreds is a speculation—and a deflated common with a future is an investment. Somebody once said: "Xerox?— what's that?"

—GERALD M. LOEB

Dick Wolters

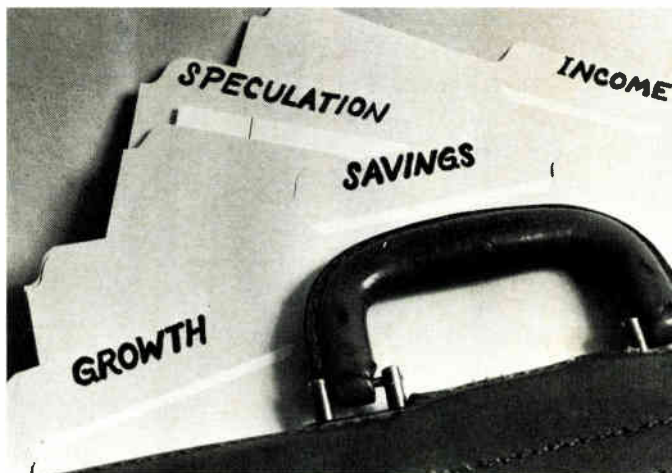

## It's beautiful, it's valuable . . . but is it covered?

The increase in theft and burglary—up 12% on a yearly basis according to the latest Federal Bureau of Investigation report—has sent apartment dwellers and home-owning suburbanites alike scurrying to their insurance brokers for reappraisal of their anti-burglar, anti-loss coverage. Their anxiety is at least part of the reason why the money they put out in homeowners' premiums has soared to \$2.5-billion a year.

The post-holiday, chill dawn of a new year should prompt a lot more to take a hard squint at the small type of their insurance contracts, particularly if Christmas largesse has brought more stealable valuables into the house. Most common of these is the standard homeowners' policy—and it has its limitations. Contents—anything from cooking pans to minks and jewels—are only covered up to 50% of the insured value of the house, with a \$50 deductible on the total of any one claim. Thus, if a house is insured for \$60,000, all the personal property within is worth no more than \$30,000 to any insurance adjuster.

This type of "package" also puts a maximum recovery ceiling of \$500 for all jewels and furs lost in any one theft. In theft-prone New York, the ceiling is even lower—\$250. Therefore, wise home-

owners will check the contents of their homes, have each important item separately appraised and listed under "scheduled articles endorsements" in their homeowners' policies. Many have been doing just that, as insurance industry figures indicate. Premiums on such "floaters," as the endorsements are called, have jumped in recent years to \$16-million annually for furs, and to a whopping \$107-million for jewelry.

Excluding ordinary wear and tear, such "floater" policies cover virtually all risks—with no regard to geographical limits. "Off-the-premises" coverage is automatically included in the endorsement, and that means the insurance company will pay whether the valuables are missed in a London hotel, a restaurant in Tokyo, or a motel on Cape Cod.

Local crime rates, however, are the major determining factor in setting premiums for "scheduled articles endorsements." This means that residents of Los Angeles and New York, the nation's crime leaders, pay the highest rates. Furs, for example, can be insured for about 50-cents a year on each \$100 of value in most places. But they go up to \$1.10 in New York City and \$2.10 in Los Angeles. In Chicago, minks have such a following among thieves that coverage costs 70-cents per \$100 a year; for other furs, the rate is only 30-cents.

Floater categories, besides furs and jewels, include cameras, fine arts, musical instruments, silverware, stamps, coins, and expensive sports and hobby equipment. Because of the inconvenience and extra charges that accompany writing coverage on single or moderately

expensive articles, insurance agents suggest getting floaters only on major valuables. Still, many homeowners insist on "floater" coverage for prized sets of golf clubs, cameras, and such. For this, the owners must pay the minimum \$6 annual premium for \$250 worth of coverage.

Rates for fine arts objects vary widely. The premium for a \$2,500 portrait is \$70 a year in New York City, for instance, but would probably be \$24 a year in Green Bay, Wisconsin.

Because of the high incidence of thefts of certain items, insurance companies are shying away from writing floaters, and private associations are picking up the business. Ski Theft, a policy administered by U. S. Ski Insurance Administrators (11 South LaSalle St., Chicago, Ill., 60603) insures skis and bindings if they are lost or stolen, not broken, up to \$250 with \$10 deductible. The premium to members of the U. S. Ski Assn. is \$8.25 a year (membership is \$7). A similar policy is available on bicycles, which have been hit by a wave of thefts, from the National Bicycle Dealers Assn., Wickliffe, Ohio.

A leading insurance man suggests updating the appraisal of valuables at each renewal date of one's policy. "That's the only way you can be sure that your insurance coverage meets the value of the item," he says. Whether it's diamonds or lithographs, only a reputable dealer should be dealt with for a valuation, industry experts warn. His word will count heavily in any future claim the policyholder may have to make. Experts also suggest photocopying the original bill of sale and appraisal and sending them to the insurance company, keeping the original in a safe deposit box (perhaps along with photographs of the item). A safe deposit box is also the place for an inventory of all household goods.

Another defense against inadequate coverage of valuables is the "inflation guard endorsement," introduced a year or so ago. For an added outlay of 5% of the regular premium, this endorsement provides a graduated increase in coverage that ranges from 1% after the first three months the policy has been in effect, up to 12% after 33 months.

One option open to homeowners who are trying to keep a ceiling on premiums is to increase deductibles from the usual \$50 to \$100, \$250 or \$500. This way they can save up to 20% on basic premium costs—but are also increasing their own out-of-pocket liability in the event of a theft.

Lower insurance rates are also granted if jewelry is kept in a bank vault. Credits are given, too, on stamp and coin collections if they are stored in a fireproof safe or vault with a combination lock. However, there are no deductions given for furs kept in commercial storage, whether it be in a dry-cleaner's

Wayward jewelry ran up a \$60-million tab with insurers last year.



Dick Wolfers



## Pictured above is the most tightfisted, thrifty man in America.

He is Ralph Ginzburg, the New York magazine publisher. No one holds on to money more tenaciously than he. Mr. Ginzburg has made a career of perfecting and implementing ingenious methods of making and saving money. Now he has even launched a publication devoted to that subject. Its name is *Moneysworth*.

*Moneysworth* is more than just a manual of Ralph Ginzburg's personal financial ploys. It is a brash, jolly, authoritative Fagin School in the art and science of shrewd money management. It covers personal finance as well as consumer affairs (including product ratings).

Perhaps the best way to describe *Moneysworth* is to list the kinds of articles it prints:

- The New Japanese Cars: A Rating
- Earn 10½% on Your Savings Account
- How to Collect Social Security from Canada and the United States *Simultaneously*—It's perfectly legal.
- When to Hire a Negligence Lawyer—By Melvin M. Belli.
- The Third Most Expensive Item You'll Ever Buy—It's your funeral, and *Moneysworth* tells how to minimize the grief.
- Earn Interest on Your *Checking* Account
- The Unshrouded Facts About Life Insurance—This article, alone, may save you *hundreds* of dollars.
- Sewing Machines that Seam Fine—Why *Moneysworth* chose a \$40 model as its best buy.
- Living Afloat without Getting Soaked—By novelist Sloan Wilson.
- Freeze-Dried Coffees Rated (and Berated)
- Small Bite—How to get dentures from one of America's top dental clinics for *only \$40*.
- Water Beds Are Making a Big Splash
- How to Hold onto Your Auto Insurance
- Food Fit for King: Best Buys in Dog Food
- A Blast at Aerosol Cans—How they threaten your health and pick your pocketbook.
- "How We Live on Less than \$75 a Month"
- The Wisdom of Maintaining a Secret Swiss Banking Account—Half a million Americans can't be wrong.
- America's 25 Best Free Colleges—As rated by the students themselves.
- The Boom in Going Bust—The growing popularity of personal bankruptcy.
- How to Get a Divorce without a Lawyer
- Air Travel at 50% Off
- Ski Areas without Steep Prices
- Drug Combinations that Can Kill You
- The World's 100 Best Free Catalogs
- Both a Borrower and Lender Be—Shrewd use of your life insurance's little-known loan feature.
- Cut-Rate Stock Brokerage
- The Bitter Truth about Refined Sugar

- How College Students Can Get Food Stamps
- The Cars that Thieves Like Best
- Land Investment in Canada
- Trailers with No Hitches: A Product Rating
- How to Break a Lease
- Heretical Retirement Advice
- Teaching Your Child the Value of Money—Without having him *overvalue* it.
- Undetected Bank Errors—A report on the untold millions of dollars lost each year by consumers who fail to reconcile their monthly bank statements.
- The Most Dangerous Car of All
- Franchising: The Perils of "Being Your Own Boss"
- The Wisdom of Attending College Abroad
- Quadraphonic Hi-Fi: Innovation or Commercial Hype?
- Wheeling and Dealing for a New Bike—Which are the best buys and how to bargain for them.
- Soundproofing Your Home
- How to Contest a Bad Credit Rating
- Indigestion Remedies that Pass the Acid Test—An evaluation by brand name.
- How Two Widows Nearly Got Merrill-Lynched
- How to Sue without a Lawyer
- The Link Between Heart Attack and Coffee—A suppressed report by a member of the President's Commission on Heart Disease.
- The Spirit of '72—A report on the new "light" whiskey that has the industry in ferment.
- The Ugly Facts about Beauty Aids
- Easy-Riding Motorcycles: New Models Rated
- The Best of the Good Book—An evaluation of currently-available editions of *The Bible*.
- Safety Bug—A preview of the Volkswagen model being developed to replace the easily crushed "Beetle."

In sum, *Moneysworth* is your own personal consumer crusader and chancellor of the exchequer—in one. It is a bonanza of uncanny monetary intelligence.

Although launched only a year ago, already *Moneysworth* has become the most widely read newsletter in the world (with a circulation of 400,000 and readership estimated at *one million*).

Every week, *Moneysworth* is inundated with enthusiastic, unsolicited testimonials like the following (which are completely authentic):

•"Thanks to the advice in your article 'Inaccurate Billing by the Phone Company,' my own firm—the Bayard Pump & Tank Company—has just received a \$1,593 refund."—*Armand DiRienzo; Bristol, Pa.*

•"*Moneysworth* is to be commended for the reliability of its merchandise evaluations. I just bought a Canonet 35mm rangefinder camera—which you recommended as 'First Rate'—and have gotten some beautiful shots with it. Moreover, thanks to *Moneysworth's* buying advice, I saved over 30% on its cost."—*Robert D. Goodrich; Tucson, Ariz.*

•"Your article 'How to Fight a Traffic Ticket' saved me a \$200 lawyer's fee and a ticket. I did exactly as you suggested—taking pictures of the scene and double-checking the statute book—and came out the winner in court."—*W.R. Wendel; Hicksville, N.Y.*

•"Thanks to your article 'How to Buy a New Car for \$125 Above Dealer's Cost,' I have just purchased a Malibu Sport Coupe at a saving that I conservatively estimate at \$350."—*Ron Bromert; Anita, Iowa.*

•"I am grateful for your tip on 'Tax Savings for Teachers'—which saved me the cost of a tax accountant and got me a very high income tax refund."—*Charles Bryan; Brooklyn, N.Y.*

•"Your article on low-cost, unadvertised trans-Atlantic air fares enabled me to save \$108 on a vacation to Ireland. In addition, once I was there, I saved \$64 on a car rental, thanks to your advice."—*Bernard Bullon; Bronx, N.Y.*

•"Upon *Moneysworth's* advice, I asked the phone company for an itemized bill. As a result, I discovered that for years I had been paying for a nonexistent extra line. Result: A \$550 refund. My trial subscription has paid for itself 110 times over!"—*George T. Petsche; Washington, D.C.*

•"I want you people to know that because of your article 'Hiring a Lawyer to Avoid the Draft' I am today a free man."—*Tony Schweda; St. Paul, Minn.*

In short, *Moneysworth* has become an absolutely indispensable mentor for many of America's most astute consumers.

The staff of *Moneysworth* consists of several of the most keenly analytical and imaginative minds in the fields of consumer affairs and journalism. At the helm, of course, is Ralph Ginzburg himself, as editor-in-chief. *Moneysworth's* executive editor is Warren Boroson, a former editor of *Medical Economics*. Its articles editor is Dorothy Bates, formerly of *Scientific American*. Herb Lubalin, the world's foremost graphic designer, is *Moneysworth's* art director. Augmenting this team of hard-nosed, experienced editors are reporters, researchers, product-testers, and consultants throughout the United States. Together, they create America's first—and only—financial periodical with *charisma*.

*Moneysworth* is published fortnightly. It is available by subscription only. The average newsletter (according to the Directory of Newsletters) costs well over \$25. But we are offering Special Introductory 32-Week Subscriptions to *Moneysworth* for ONLY \$3.88! This is a MERE FRACTION of the going rate.

Moreover, we are so confident that *Moneysworth* will prove invaluable to you that we are about to make what is probably the most generous subscription offer in publishing history: *We will absolutely and unconditionally guarantee that the tips, techniques, and inside information in Moneysworth will increase the purchasing power of your income by at least 15%—or we'll refund your money IN FULL.* In other words, if you now earn \$10,000 a year, *Moneysworth* guarantees that it will increase the value of your income by at least \$1,500—or you get your money back. And, meanwhile, you will have enjoyed a subscription to *Moneysworth ABSOLUTELY FREE!* As you can see, a subscription to *Moneysworth* is an absolutely fool-proof investment.

To enter your subscription, simply fill out the coupon below and mail it with \$3.88 to *Moneysworth*, 110 West 40th Street, New York 10018.

We urge you to act at once. In this case, especially, time is money.



110 WEST 40TH ST. NEW YORK 10018

I enclose \$3.88 for a Special Introductory 32-Week Subscription to *Moneysworth*, the shrewd, audacious new fortnightly on consumer affairs and personal finance. I understand that this is a MERE FRACTION of the going rate. Moreover, *Moneysworth* guarantees that it will increase the purchasing power of my income by at least 15% or I will get my money back IN FULL!!

NAME \_\_\_\_\_

ADDRESS \_\_\_\_\_

CITY \_\_\_\_\_

STATE \_\_\_\_\_

ZIP \_\_\_\_\_

© MONEYSWORTH 1971 T.M. REG. PEND

93B

# Every Personnel Director should have 540 offices.

## Ours.

From coast to coast.

One call to your local Snelling & Snelling office can accomplish miracles.

Your job specifications may fit people we have immediately available. If not, we'll find them.

Quickly. Efficiently.

And with measurable savings to you in time, aggravation and in another vital area—money.

Look us up in the White Pages. Then pick up your telephone and let a miracle happen.



# Snelling AND Snelling

The World's Largest Employment Service  
with 540 offices coast to coast

shop or fashionable department store. And even though the furs may be stored in locked wardrobes, insurance companies do not consider them as secure as bank vaults and therefore grant no discounts.

Even if a home or apartment dweller can afford the insurance rates, which are increasing at a minimum rate of 5% yearly, he may have trouble buying coverage in some cases. For instance, an insurance company may balk if he asks for coverage on just one or two high-value items, particularly if they are kept in a burglary-ridden area. And no matter how sound a customer's finances or how high his moral character, an insurer will certainly be hesitant about taking on a person who has a record of misplacing or losing articles. Insurance agents and claims adjusters keep tabs on what they consider "irresponsible" policy holders. In addition, insurance companies usually run checks on people who apply for sizable amounts of floater protection, including their forgetful habits.

Despite the current boom in wall safes, alarms and other anti-burglar protection systems, these do not guarantee a lower insurance rate, a fact that this industry often fails to mention. But it should be noted that setting up such gadgetry may make it a bit easier to buy coverage.

Protection against theft from autos should also be examined. Most homeowner's policies cover only items stolen from a car when there is evidence of forcible entry. Coverage on theft from an unlocked auto is usually only guaranteed if the car is on the policyholders property or in a public garage where he surrenders his car keys to an authorized parking attendant. Coverage to include losses from an unlocked auto can be included in the homeowners' policy by a theft coverage extension endorsement—but with an additional premium, of course. However, insurance advisers warn that such coverage may take some shopping to obtain, particularly in New York City and other high crime rate areas.

Finally, most homeowners' insurance policies have a "mysterious disappearance" provision. If a woman leaves a diamond ring in the powder room of a night club, and returns shortly thereafter and finds it gone, the claim examiner reasonably presumes a theft, and coverage is provided. However, if a man loses a ring while gardening on his property, the presumption is that it is lost, not stolen, and therefore he cannot expect to collect on his claim. If he wants to protect himself against his own carelessness, he's going to have to get another floater. His insurer will probably be glad to oblige—at a premium.

—RON W. ANSELMO

## Tax scene: dollar items in the news

**RETURNS.** Coordinating federal and state returns is a way to save time, trouble, maybe cash. Carriage-trade advisors stress the theme. Most states now crosscheck tax-return information with IRS in Washington, and slip-ups by higher-bracket taxpayers have led to more audits by IRS and state collectors. Note that income taxes are now levied by 39 states, and the trend is to the adoption of U. S. rules for computing taxes.

**LOSSES.** The Tax Court in a "small claim" case allowed a deduction of \$200 for a stolen canoe, even though the canoe owner furnished no proof of theft or value. Circumstances and taxpayer's own word apparently were enough. The Tax Court, liberal in such cases, has reversed Internal Revenue and allowed deductions based on reasonable estimates of value. "If a substantial casualty loss is involved," notes a Manhattan attorney, "—it can pay to go the court route." . . . In another recent "loss" case, a taxpayer sold his country club membership for less than it cost and took a deduction for the loss. His claim: that the membership had been an investment. The Tax Court turned him down flat.

**TRENDS.** Use of the limited partnership as a vehicle for real estate investment is getting a sizable play. Investors aim for top tax advantages that arise from the tax code's liberal treatment of residential rental housing. Among the breaks: A partnership's business deductions can be used by the individual investor on his own tax return; and a fast, 200% depreciation is still allowed. "This item is well worth looking at—with a smart pro at your side," says a West Coast consultant. . . . The so-called "tandem stock option" is also becoming well established—a point an executive should know about when relocating or negotiating a new pay package. Here "qualified" and non-qualified options are combined. A report by J.K. Lasser shows that tax breaks for the individual are meaningful—and that 40% of the big companies now offer the tandem. . . . New speeded-up collection of gift taxes has some people confused. A clear explanation is found in *Guide to Federal Estate and Gift Taxation* (Supt. Documents, U.S. Gov. Printing Office, Washington, D.C. 20402; 50¢).

On your first day in business, you'll have all you can do to handle your job, without worrying about your workers handling theirs.

So Georgia's Quick Start training program starts worrying about your workers long before your first day.

We'll find them for you. Screen them for you. Train them for you. And we'll pick up the bill.

Give us a call at 404-656-3599. Or send us the coupon. We'll see that you get started right.

Georgia Department of Industry & Trade  
Industry Division, Dept. MH-4, P.O. Box 38097,  
Atlanta, Georgia 30334.

Please send me details on Georgia's new approach to advance employee training.

Name \_\_\_\_\_ Title \_\_\_\_\_

Company \_\_\_\_\_

Address \_\_\_\_\_

City \_\_\_\_\_ State \_\_\_\_\_ Zip \_\_\_\_\_

**Georgia, the unspoiled.**

**Georgia's technical training program makes your first day in business feel like you've been there awhile.**

## Junior year abroad: Picking a program, a study in itself

College students today really think that all the world is their oyster, and, as anyone who saw their knapsacks dotting the globe last summer knows, they want to explore it. Study abroad may be best for the student majoring, say, in Greek archaeology or French literature, but even the youth who simply has a case of wanderlust can benefit. Since applications for study abroad—typically in the junior year—are due about February (or soon after first semester grades are out), Mid-year vacation may be the best time for a parent to have a serious discussion with his offspring about such plans.

"If they're not all going abroad," says Harold Epstein, vice-president of the Institute of International Education, the organization that administers the Fulbright grants, "they're all thinking about it." In fact, in 1950, there were just 20 formal study-abroad programs; now there are 500 in 70 countries, and about 50,000 students this year have decided to expatriate—temporarily—in their quest for learning.

More students than ever are going beyond what one returnee calls the "elite

watering grounds"—Paris and the other continental capitals—although the vast majority do land in Europe. Right now, students are bearing down on Far Eastern Studies in Singapore in a program sponsored by the State University of New York. Drama majors are following a theater course in London under Tufts University tutelage, and students from any of the 31 colleges that belong to the Pittsburgh-based Regional Council for International Education are soaking up culture in Verona and Basel. Smith College, which pioneered the first such program in Paris back in 1925, now has operations in Madrid, Geneva, Florence and Hamburg as well.

With the proliferation of programs, the idea that only language majors can benefit from foreign exposure is dying. The Institute of European Studies, for instance, has sent 600 students abroad this year in various programs, including one in Nantes, France, which features courses in engineering and physics. Syracuse has 400 students abroad, including groups in the Netherlands working in the fields of human development and social work. Drew University sponsors one group studying the Common Market in Brussels.

For the student attempting to analyse brochures—some of which offer the

mythical wonders of Hemingway's Paris without mentioning that bath water is sometimes rationed and the food less than one-star—there are many things to consider. The best way of finding out about different programs is to ask the directors—or, more important, students who have gone before. "This is the only way that a student can get what he's looking for," says Philip Yasinski, admissions director of the six Institute of European Studies programs. Another good source is the Council on International Educational Exchange, (777 U.N. Plaza, New York 10017) which runs a clearinghouse for 165 colleges.

"You can't just pick up a body and plunk it in a foreign culture without some preparation," warns one director. "They don't adjust automatically." He thus emphasizes that a good program, especially one with classes in a foreign tongue, should offer orientation.

Different programs also have different living arrangements. Some house students together in a pension or rooming house, which means that mingling with "the people" may be difficult. On the other hand, lodging with "families" often turns out to mean joining a widow or retired couple who just need the money, aren't interested in companionship, and have strict ideas about relations between the generations and the sexes.

There are, of course, the academic considerations as well. Programs such as that at Smith demand the quality of student—male or female—that would



qualify for Smith at home. Roughly speaking, the quality of the sponsoring institution indicates the quality of the program. Many study directors maintain that students have enough problems dealing with an alien culture without having to face academic mediocrity.

A foreign language—or more accurately a lack of it—does not necessarily deter a willing student. Some programs, like those of Smith and Sweet Briar, do require good fluency. Other groups demand some ability "to get around" in a foreign tongue. But Harold Vaughn, director of Syracuse's international programs, says of his Florence project, "We'd rather they didn't have Italian. A smattering can just get in the way." Other programs, like those of the Regional Council, were originated precisely for those who are not language-oriented.

The difference in language requirements is just the most obvious variation in foreign study programs themselves. Basically there are two camps. One, typified by Smith, Sweet Briar and the State University of New York, insists that the primary rationale for foreign study is academic. In the words of SUNY's international study director, Ivan Putman, "The student should get something unique from his studies that he couldn't get on the campus."

Others give major weight to the personal experience. "There's nothing wrong with vuituring for culture," says New York University Dean Boyley Winder. "You can't quantify the worth of exposure to another culture."

The personal growth of a student, however, may be the same no matter what the program is. By adapting to an unknown situation any young person cannot escape a new awareness of himself and the manners and mores of his own society.

The problem is to match the right student to the right program. "The range of programs is like the range of colleges," says IES's Yasinski. "They run the gamut from colleges with isolated campuses abroad to those where the student is completely assimilated." Stanford, for instance, has nearly 1,000 students a year in classes on campuses in Austria, England, France, Germany and Italy who study together, often under Stanford professors. Such a program surmounts the hurdles of language fluency. Conversely, Smith, Hamilton and the Institute of European Studies programs in Paris and Madrid have all classes taught in the native language by natives. Going further, the Sweet Briar Paris program integrates its students into French schools.

Most school officials do not recommend—or even tolerate—a student entering a foreign university on his own. For one thing, these schools often offer foreigners watered-down curricula lim-

ited to language and that amorphous commodity, "culture." Not only is the young American likely to be excluded from courses with nationals, he will also find that foreign professors don't show up, reading lists don't exist, and classes are overcrowded. Without a program director, a student can flounder.

A major point of any planning is to make sure that when the student is repatriated, his study credits are repatriated as well. Students should not only get permission from their current college to join a program, but should check its courses with a faculty advisor.

A good alternative to a year abroad is a program that lasts a semester, and hence does not cut into the prescribed

academic pattern of some majors. The student whose school has a January term for independent study can even opt for a month abroad. Headquartered in St. Petersburg, Fla., the 4-1-4 Conference, an organization of schools with such scheduling, lists 19 such projects in London alone this year and 18 in France. Some cost less than \$500, including tuition, travel, room and board.

The price for full-year study goes a bit steeper, but most programs cost roughly the same as a year at a good private college in the states. In fact, Stanford charges the same tuition and even tosses in the cost of travel to Vienna, Cliveden or Florence. Sweet Briar's cost is \$3,500 and Smith's is \$4,070, plus transportation. The Institute of European Studies offers several scholarships, and colleges that sponsor their own groups often continue their scholarship aid.

—BARBARA RADLOFF

Florida Presbyterian College





### What is a true "growth stock", anyway?

What is the real meaning of "growth stock"—and where does one find such a stock? Some definitions get cloudy and miss the mark. A good one is by Richard Carney, mutual fund portfolio manager with Lionel D. Edie & Co. He lists six basics as a criteria for investing in smaller companies with good growth potential: (1) The company must show consistent and superior growth in earnings per share at a rate better than 9% a year, even in the face of depressed business conditions. (2) It should have a steady, year-in year-out demand for its products—one good example is a firm that sells disposables (razor blades, or such). (3) The company should ideally be a leader in a fast growing field. Better to be the number one tropical fish breeder, says Carney, than a little outfit trying to make a better transistor. (4) If it can't meet standard #3, then the company should at least be in some emerging field. (5) It should be well managed, and you should not buy stock in, say, a tiny electronics firm without having met their people. (6) It should have a high return on stockholders' equity. Net profit should be high compared to that earned in the industry generally. To qualify as a true growth stock, it should earn at least 20% in dividends or book value; today, an average stockholder gets 11%.

### Smart tax shelter: a who-why-where "T and E" diary

There is no more neglected item in taxes than the daily "T and E" diary (*Personal Business*, Oct.). It is tedious—you need to outline the details of every meaningful travel-and-entertainment expense that is business-related, if you expect to nail down a tax deduction on the form 1040. Entertainment for business or professional purposes is, of course, what causes most of the flap. Reason is that each diary entry should show not just the routine information but the *why* underlying the entertainment. In a recent Tax Court case, a taxpayer was denied over \$3,000 in T-and-E costs despite the fact that he faithfully kept day-to-day records, as needed. He dutifully entered amounts and dates—but he skipped lightly over people, places, and business purposes. These essentials were hit-or-miss in the diary, and all the demonstrated good faith in the world couldn't salvage the \$3,000 in costs. . . . A sensible New Year's resolution might be to buy a good tax-structured diary; one of the best is the J.K. Lasser Diary (\$6.95).



Soaring, once the sport of a daredevil few, is rapidly becoming a national pastime. Already, 20,000 leisure-time pilots have been caught up in the fun of non-powered flight. It's not so mysterious, expensive or dangerous as you may think. The average man can earn his private license in perhaps three months of weekends, or in \$500 worth of lessons. Sailplanes generally rent for \$16 an hour, including the tow to get you aloft. Buying your own plane may cost between \$5,000 and \$12,000. Financing nowadays is readily available, through banks or such outfits as Aircraft Finance Corp., Inc., Columbus, O. As for the danger, insurance companies now rate sailplaning no more hazardous than conventional small plane flying. An excellent guide to the sport is the new book, *The Art and Technique of Soaring* by Richard A. Wolters (McGraw-Hill \$14.95).

### Black Russian

The barman at the Pierre Marques hotel, on the beach just south of Acapulco, makes a Black Russian this way: 1 part Kahlua (Mexican coffee liqueur), 2 parts vodka. . . . PB's dining-place-of-the-month: Capriccio's, on the Jericho Turnpike, Jericho, Long Island, N.Y. Try linguine with white clam sauce.





"PLAYBOY", Playboy Bunny, and Bunny Costume are marks of Playboy, Reg. U.S. Pat. Off."

## If you'd like to see how beautiful our building products are, just take a look at one of our doors.

In case you haven't noticed there is a door in the picture. It's one of the many C-E aluminum patio doors at the new Playboy Club-Hotel at Great Gorge, McAfee, New Jersey. Doors that were built to show off the clean modern lines of this complex, yet work efficiently year after year.

But this is just one of the many product lines at C-E Glass and C-E Building Products.

Lines that include insulating glass that has a mirror-like, gold coating to reflect sunlight; hermetically-sealed units that have rotating venetian blinds between the glasses; and tempered glass for applications where safety is as important as looks.

Plus windows and sliding glass doors for residential and commercial, store-fronts, curtainwall, shower-tub enclosures, storm windows and doors.

Everything to keep up with the building boom, including the kind of quality service that helps to sell quality products nationally.

And the real beauty of it is that they're all well-built.



**COMBUSTION ENGINEERING, INC.**  
277 Park Avenue, New York, N.Y. 10017

**Our names in the building industry... C-E Glass and C-E Building Products.**

## Let's put the O back in Sonoco.

There's one thing we at Sonoco want to be remembered by: our name.

But people keep spelling it with a U instead of an O. Which is not just another way to spell Sonoco. It's another company.

So to help you remember who we are, we'd like for you to remember, one: we don't pump gas for a living. And, two: our business is making things out of paper and plastics.

Things like cones, cores and spools for textiles. Cores and tubes for paper manufacturers and converters. Cans, containers and folding cartons for packaging. Column forming tubes and underground pipe for construction. And underground vaults for the utility industry.

What's more, each of the thousands of products we make is developed in some of the largest and most complete laboratories in the paper, cone and tube industry: our own. And none of them go to consumers. Because all our products are made to solve specialized industrial problems.

We'd like to tell you more about all the things we do. If you'll write Sonoco Products Company,

Department PB, Hartsville, S.C. 29550, we'll

send you a copy of our capabilities booklet.

Because other than our name, there's at least one product we want to be remembered by.

The one we can make for you.

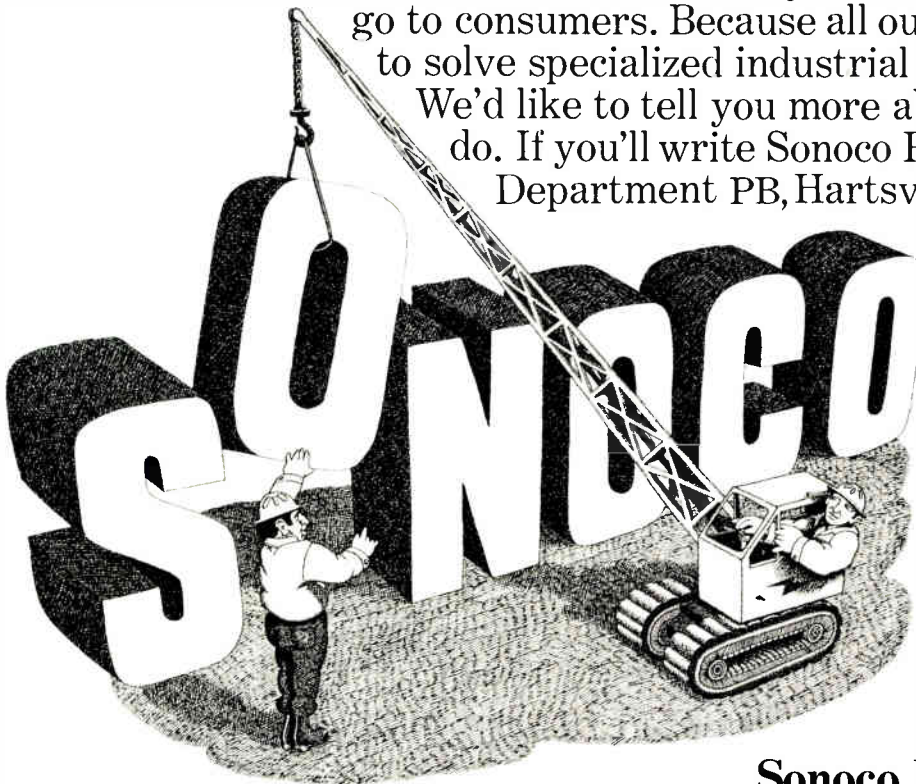

**Sonoco Products Company.**  
**Innovators in paper**  
**and plastics.**



---

# International Newsletter

---

January 31, 1972.

## **3 semiconductor firms in Europe seek entente . . .**

Within the next few months, at least three European semiconductor makers are expected to reach accord on a plan to streamline their overlapping production and to reduce the cut-throat competition that has cost them millions of dollars over the past two years. **Plessey of Britain, AEG-Telefunken of West Germany, and Thomson-CSF of France acknowledge that they are in the first stages of negotiating a cooperation pact, having tried without success to bring Motorola into the deal.**

Details on possible agreements are being kept secret for the moment. But whatever corporate structure evolves, **the three are expected to divide up the market, each specializing in agreed-upon types of semiconductors.** While all are strong in radio-TV ICs, Plessey has been a leader in computer core memories and is shifting to semiconductor memories, Sescosem makes good power transistors and zener diodes, and AEG-Telefunken is important in ECL capability and noise-immunity ICs.

## **. . . as cordial end to price war**

**Thomson-CSF, speaking for its ailing Sescosem semiconductor division, says a "rapid solution" is needed to the price war.** Certainly, the efforts of the three toward a rationalization pact coincide with the abrupt resignation this month of Andre Danzin, head of Thomson-CSF's components and computers operation. Reportedly Danzin lost out in a dispute over how to deal with losses, especially in the components division, which includes Sescosem. Sescosem's losses last year were estimated at \$6 million.

## **Siemens AG also seeks European computer partner**

While Sescosem, AEG-Telefunken and Plessey are considering a deal in semiconductors, West Germany's Siemens AG continues its exploratory talks with a number of companies about a long-term cooperation agreement in computers. **It will have picked and named its partner "within the next few months," the German firm says.** It is widely speculated that, unlike Siemens' former link with RCA, the new partnership won't extend across the Atlantic, because only by tying up with a European firm can Siemens count on a sizeable share of computer-promotion money from the Bonn government. Furthermore, operating within the framework of the European Economic Community is expected to bring certain marketing advantages.

## **Swedish defense cuts won't affect Viggen**

**When the Swedish government presented its 1972/3 budget last week, it proposed what may be its last ever increase in military appropriations.** The extra \$90 million brought proposed defense spending up to almost \$1.4 billion. Of this, the Air Force would get almost \$400 million, including \$75 million for R&D—mostly for the fighter version of the Viggen Jet—and about \$150 million for aircraft and hardware.

A few days after the budget was presented, however, a Royal commission published its long-awaited report on the future of Swedish defense, which **recommended that future military spending be kept at the present level.** Because the Commission's Social-Democratic majority did not even allow for cost hikes or inflation, many newspapers here saw the report as calling for disarmament. Minister of Defense Sven Anderson said it would definitely not mean this, but would probably involve making savings through "rationalizing." One cutback would limit Sweden's naval operating range strictly to coastal operations. **Development of the Viggen in a fighter version would, however, continue.**

---

# International Newsletter

---

## Japanese gov't aids electronics

Japan's fiscal 1972 budget was relatively favorable to the electronics industries. For the fourth five-year defense plan, procurement of the main new hardware involved was authorized, and will include 20 T-2 supersonic trainer and ground support planes, 11 C-1 jet transports, and 14 RF-4 reconnaissance versions of the Phantom. **R&D will also begin on an airborne early warning radar, and on a new patrol plane to search out submarines.**

**The Nippon Telegraph and Telephone Public Corp.'s construction budget rose 22.4% to \$3.27 billion, to cover 2.8 million new telephones and 33 new information processing systems.** Its \$112 million R&D budget includes \$42 million for the Dendenkosha (Japanese for NTT) Information Processing System and \$13 million for electronic exchanges.

Included in the budget for the Ministry of International Trade and Industry is a \$17 million subsidy for Japan's computer manufacturers, first installment of a total of \$111 million to be paid them over the next three fiscal years. **The National Space Development Agency will get \$59 million from the Science and Technology Agency budget.** The new international airport at Narita has been allotted \$8.6 million for control tower and radio equipment.

## British PO asks how microwave data can stand weather

Helped by the government's Radio and Space Research Station, **the British Post Office is building an experimental microwave digital network to study the effects of weather on microwave frequency line-of-sight radio transmissions, carrying pulse-coded digital data.** Experimental links will operate at 11, 20, and 37 gigahertz, and each will be equipped with fast responding weather sensors and telemetry transmitters.

**Specific aims are to check rain attenuation, interference between orthogonally polarized signals using the same path and frequency, and multi-path propagation caused by temperature stratification of the atmosphere.** The frequencies were chosen to tie in with the Post Office's present thinking on likely operational digital microwave links.

## Comsat, ESRO eye joint satellite research

Joint technological programs to develop advanced satellite communications systems are being seriously discussed by the Communications Satellite Corp. and the European Space Research Organization. Among the items being considered are **whether the two sides would share technological development and costs on a joint system or use the joint research to build individual systems.** In the latter case, Comsat would build the proposed Intelsat 5 satellite and ESRO a regional European system.

## Dutch technique more than doubles C/MOS speed

Scientists at the Philips Development Laboratories in Nijmegen, the Netherlands, are now applying their Locos isolation technique to complementary MOS circuits, and expect to come up with the first commercially available devices sometime this year. Compared with conventional C/MOS, **the new Philips ICs using Locos (for local oxidation of silicon) have an area advantage of 1:2, while their internal capacitance is smaller by factors of from three to five.** This, in turn, leads to a comparable improvement in speed, which, at a few nano-seconds, is comparable to that of standard TTL circuits.

With such performance, the Philips experts say, Locos-C/MOS devices should find applications in battery-operated units like desk-top and pocket-type calculators and digital voltmeters; in LSI circuits for memories and minicomputers; and, because of their TTL compatibility, in keyboard encoders for communications terminals.

## In-line guns, vertical slots team up in color tube

Toshiba's new approach, which simplifies convergence circuitry, is already on its way into color sets

An in-line arrangement of picture-tube electron guns and a shadow mask with apertures arranged in the pattern of a brick wall rotated 90° promise to bring a new look to color television. This new geometry simplifies the complex convergence circuits required with the conventional triangular gun and aperture geometry, and gives an apparently sharper color picture.

For starters Tokyo Shibaura Electric Co. (Toshiba) is producing a 10-inch version of the new tube, and will soon follow it with a 13-in. version. A set using the 10-in. tube has already been announced by Sharp Corp., with domestic deliveries to start in February. By the middle of this year, Toshiba expects its other color tube customers to have sets on the market using the new tube. These customers include Toshiba's own set division, Sanyo Electric Co., New Nippon Electric Co., and The General Corp.

**To market.** Some of these companies also buy tubes from Hitachi Ltd., which is rumored to be working on a new design so it can maintain its share of the market. Matsushita Electronics Corp., which supplies color picture tubes only to Matsushita Electric Industrial Co. and to Victor Company of Japan Ltd., is not directly affected at the component level but may have to come along with new designs to hold Matsushita's No. 1 position in

the set market. New Nippon Electric only makes larger size color tubes and won't be affected until the design comes along in larger sizes. Sony Corp. makes solely for its own use a color picture tube that to the average consumer is virtually indistinguishable from Toshiba's.

Instead of the three-color phosphor-dot trios used in conventional color tubes, Toshiba's new tube uses a repeating pattern of vertical stripes of red, green, and blue phosphors. The apertures in the shadow mask are essentially vertical slits centered on the green stripes, with bridges of metal crossing the slits at intervals to maintain the structural integrity of the mask. Bridges across adjacent apertures are staggered by half the pitch of the bridges.

**Slits.** In operation, the green electron gun shoots electrons straight through the apertures to the green phosphor stripes. The red and blue electron guns, which are off to each side, shoot electrons diagonally through the slits to the red and blue phosphor stripes.

Shadows are formed on the phosphor stripes beneath the bridges. But the bridges are narrow enough so that the reduction in brightness is negligible, and staggering the bridges decreases the visibility of the shadow pattern.

With the vertical stripe pattern, the apparent horizontal resolution of the picture is enhanced, because of the sharp cutoff at edges of objects. In the vertical direction, there is no possibility of degradation of purity by mislanding because the phosphor color remains the same along a given vertical phosphor stripe.

Another plus of the tube is the

use of a narrow, 29-millimeter neck rather than the standard 36-mm neck. The narrow neck reduces deflection power requirements and enables set designers to cut costs by using smaller deflection output transistors.

**Neck.** But a narrow neck makes life difficult for the tube designer because with it the in-line gun arrangement forces him to reduce the diameter of the guns. However, the smaller diameter guns are adequate because the resolution-determining green electron beam does not undergo any focus-degrading bending for convergence purposes.

Because the bridges preserve the structural integrity of the shadow mask, it can be formed and fitted to a tube with a spherical faceplate. The only other color picture tube now on the market with a vertical phosphor stripe faceplate is made by Sony. It has vertical slits from top to bottom in its mask, which Sony calls an aperture grille. It can only be bent about its vertical axis. Sony thus uses a cylindrical rather than spherical faceplate in its color tubes. Sony engineers say the cylindrical faceplate is advantageous, because it can be tilted downward to eliminate room reflections. But for the largest sizes, this design is disadvantageous because thicker glass, required in the faceplate to withstand atmospheric pressure, and the heavy frame around the mask make for a very heavy tube.

**Guns.** Aside from the advantages it provides in the picture when teamed with the proper type of shadow mask, the in-line arrangement of guns enables the set designer to simplify design and cut costs. One pair of permanent mag-

nets is sufficient for static vertical convergence, which is maintained over the full height of the tube. Another pair of permanent magnets provides static horizontal convergence. Only a single assembly is needed for static convergence in vertical and horizontal directions and for horizontal dynamic convergence, the correction needed when the beams are out towards the sides of the tube.

### France

#### French solar battery test awaits Russian launch

With an admirable display of patience, French space scientists and solar cell experts are about to enter their eighth month of waiting for the Russians to launch SRET-1. The piggyback launch, when it comes, will mark a new stage in Franco-Soviet space cooperation and, if successful, will provide important new data on the rate of deterioration of cadmium sulfide and cadmium telluride thin film solar batteries.

The French show no sign of concern over the long delay, but they conceded that they are anxious to get SRET into orbit so they can see how their two panels of CdS and two panels of CdTe hold up in space. Their anxiety is doubled by the fact that their last thin-film test project plunged into the sea aboard the ill-fated Diamant-B French rocket launched last December [*Electronics*, International Newsletter, Dec. 20].

**Panels.** SRET, a space experiment agreed upon in 1969 by Soviet and French specialists, is an eight-panel craft, four of which power the coder, converter, and radio transmitter aboard. The other four carry thin film batteries developed by two French firms—CdTe elements from La Radiotechnique-Compelec (RTC) and CdS devices from Sté. Anonyme de Télécommunications (SAT)

The 34-pound satellite was delivered in Moscow last June for launch, under terms of the agree-

ment, as a free ride with a Molniya, which means lightning, communications satellite. Due to the Russians' passion for secrecy, the French had to agree to leave the satellite at the Moscow offices of the Academy of Sciences and trust the Russians to check it out and mount it on a rocket at some unspecified date at an unspecified launch site in the USSR. No French technicians are allowed to help or even witness the launch.

"We have given them a control valise to check out the satellite's electrical systems on a go/no-go basis," says project supervisor Jean-Claude Evrard of CNES the French space agency. "We had to assume that the checkout might be done by a technician who doesn't understand all the workings of the satellite."

**Anxiety.** The electronic interface and weight-size values were worked out in four meetings between French and Soviet experts about a year ago. SRET will be totally inert during the launch, but its nickel cadmium batteries must be charged by the Russians to ensure proper automatic separation once Molniya reaches orbit.

The French are understandably anxious to see whether their halting cooperation with the Russians can work in such a complex piggyback project. Previous Franco-Soviet space efforts have involved only French accessories or subsystems on Russian satellites—such as the French laser reflector on the Lunokhod-1 moon rover and the current stereo solar flare experiment aboard Mars-3. SRET will mark the first time the Russians have launched a satellite for any foreign country.

"We have had to learn to work together," says Evrard. "They just don't think like us." The Russians were sometimes excruciatingly slow in providing the French with technical details necessary to mesh Molniya and SRET. One key element the Russians hung onto until the last moment was the time sequence required for separation of Molniya from its last rocket stage and the separation of SRET from Molniya. "Actually when we finally extracted

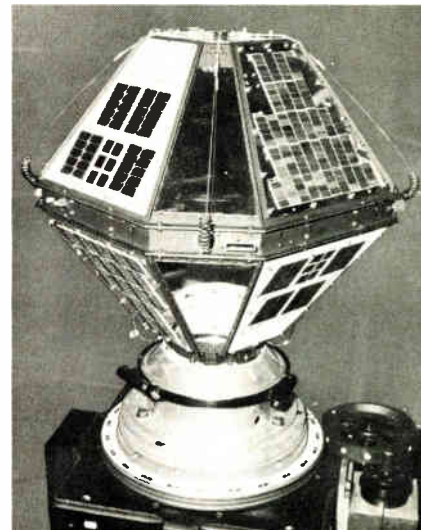

**Up in the air.** France's experiment in CdS and CdTe solar cells awaits flight.

this fact, it was too late, and we had to set our timer quickly as best we could" says Evrard.

The French are using their politically-inspired cooperation program with the Russians to exploit, and hopefully commercialize, the lead they already have in the production of CdTe and especially CdS thin film solar cells. "These batteries will probably be the power source of the future in the new generation of unmanned spacecraft that require three-axis stabilization to keep the panels continuously oriented toward the sun," says Wolfgang Palz, manager of the electric power branch at CNES, just south of Paris. He believes CdS batteries will be suited for any craft, such as communications satellites, that need a kilowatt of power.

**Packing.** Palz says serious research on CdS has been abandoned in most countries, but it has remained a promising energy source in French labs. While CdS batteries produce 30-50% less power per square centimeter than the standard silicon batteries, they put out twice as much per kilogram.

Palz says he is hoping SRET's experimental batteries will only drop from 6% efficiency to 5% after six months. Standard silicon cells, which have about 10% efficiency, also will fall to 5% in the same period—a 50% power loss in silicon compared with expected thin-film

loss of only 17%. SRET's lifespan will be about one year.

CNES' technicians will monitor SRET's phase modulation transmissions coded in pulse shift keying. The results will be shared with the Russians in return for the free piggy-back ride into orbit. The French and Russians already have agreed to go ahead with SRET-2, due tentatively for launching at the end of 1974, and within the next six months negotiations will begin on a possible SRET-3 launch for 1975.

---

## The Netherlands

---

### Philips circuitry opens door for moonlight photography

Imagine an automatic camera with photo circuitry so sensitive that pictures can be taken at a light level much lower than that of the moon. Although the circuit is not yet on the market, a trio of researchers at Philips in the Netherlands has come through with an experimental version that makes moonlight photography a snap.

Developed by Cor Mulder, Leen Willemsen, and Albert ter Riet at the company's Eindhoven Research Labs, the camera circuit is a combination of a silicon photodiode and a silicon chip that contains the measuring circuitry.

**Short circuit.** In contrast to conventional exposure time control devices, which are based on measuring the photodiode's open-circuit voltage, the Philips combination uses the diode's short-circuit current. This design not only accounts for higher light sensitivity, but also for greater temperature stability, a feature which assures reliable circuit operation even when ambient temperatures vary.

For a photodiode to provide sufficient light sensitivity, it must have a surface area several square millimeters in size. Such a relatively large area, however, results in two major drawbacks for a silicon photodiode. For one thing, the leakage current limits the open-circuit voltage produced under illumina-

tion. This, in turn, reduces sensitivity.

In addition, the value of the leakage current, and therefore the value of the open-circuit voltage, is closely related to the ambient temperature, and this hampers consistent circuit operation. In conventional designs, such temperature dependence is largely eliminated by mounting the photodiode and the measuring circuitry on the same substrate. But that puts certain restrictions on circuit layout.

**Short-circuit current.** The new Philips combination overcomes these drawbacks by using the photodiode's short-circuit current as the input to the measuring circuitry. Because the voltage difference across the diode, even under illumination, then becomes negligibly small, reduced sensitivity as a result of leakage current is no longer a problem.

What's more, with the short-circuit current being practically independent of the ambient temperature, the photodiode need not be mounted on the same substrate as the measuring circuitry. This means each circuit portion can be installed at the most suitable spot in the camera.

With a 3-square-millimeter photodiode surface, the minimum light level that the Philips researchers found still usable for circuit operation was 0.01 lux—a level 25 times less than that of a full moon in a clear night sky. Effects of temperature and supply voltage variations are negligible, Philips men say.

In the automatic exposure control circuit, the photocurrent is applied directly to the measuring circuitry, consisting of a converter, a dc amplifier, an integrator capacitor, and a voltage stabilizer. The converter keeps the voltage across the photodiode practically at 0 volt, regardless of the photocurrent value, and feeds a proportional current to the dc amplifier. The gain of this amplifier is adjustable from the outside in 13 steps to a value appropriate for the lens opening chosen and the speed of the film used.

**Exposure timed.** As soon as the shutter opens, the amplified current begins to charge the capacitor.

When it reaches a certain reference value, a trigger circuit energizes the shutter coil and causes the shutter to close again. Thus, the exposure is automatically determined. The entire circuit requires 4 to 6 v. Its total current consumption is about 10 milliamperes.

In more complex reflex cameras, the value of light intensity must be determined by illuminating the photodiode by way of the camera's hinged mirror. This means that light is shut off from the diode while the mirror moves away during exposure. This problem is solved by connecting a memory circuit, built around an external capacitor, to the dc amplifier. Illumination information obtained while focusing is temporarily stored in the memory circuit and fed to the amplifier.

---

## Great Britain

---

### Ferranti redesigns 1600B computer with MSI/TTL

For several years the Digital Systems division of Ferranti Ltd. has built warship fire control and action information systems, which use its own computer. A special architecture has been developed to cope with the special requirements, particularly fast interrupt response in a real time system.

Now the original FM-1600B computer has been joined by the FM-1600D, which uses new technology, particularly MSI/TTL, to rearrange the architecture for better cost effectiveness. Further, with an eye on the avionics and land mobile military systems market, the 1600D has been made more modular so that small versions can be built. The division is also considering a much bigger, more powerful variant using a Schottky TTL processor.

**Interrupts.** A military action control, real-time computer system must respond very quickly to an alarm situation. If a radar picks up a plane or a missile, the computer must work on the extracted data immediately, not 5 seconds later. Thus, the 1600B has a complex interrupt

controller between peripherals and processor. Instead of scanning the peripherals looking for one that wants to come in, the initiative is vested in the peripherals, which signal when they want to come in. They are allowed in immediately or delayed according to a pre-determined priority rating. For instance, radar sensors rate higher than display controllers, which rate higher than teletypewriters. Further, data interrupts always have priority over program interrupts.

**Logic.** To make this system work in the 1600B, each peripheral is controlled directly from the interrupt equipment, so that when the radar control line wakes up, everything else is stopped to let the radar in. Data travels from the peripherals to the processor over a common 25-line parallel highway—24 bits plus parity bit. The interrupt controller has to sort out the channel priorities and the consequent data flows, which involves a lot of logic.

The logic used is Ferranti's own, very fast—9 nanoseconds—DTL, which is not cheap. Ferranti claims the maximum waiting time for data interrupt on the highest priority channel is 2.3 microseconds with a 650-nanosecond store.

To get most of the performance of the 1600B using simpler, cheaper methods, Ferranti has designed the 1600D to make use of MSI/TTL. Instead of a single entry port the store now has multiple ports, built around TTL multi-bit staticizers. This means that peripherals passing large quantities of data at a fairly high rate, for instance display control stations, can have their own dedicated store block and parallel data highway. This reduces the load on the interrupt controller, which can be simpler, and on the remaining data highways which are serial links with TTL serial-parallel registers, multiplexers, and demultiplexers at the ends. The processor uses bipolar stores as working registers, and its controllers make much use of data selectors and multiplexers.

**One third.** The redesign has cut the size of the processor to less than one-third of the 1600B processor. Keith Dixon, a Digital Systems divi-

sion sales executive, says a 1600D system is about the same size as current single-address, 16-bit small computers, but packs three-address instructions into one 24-bit word, with a code of 325 instructions, and very much greater input/output capability.

**Special boards.** For the 1600D, Ferranti has developed the multi-layer epoxy resin boards used in the 1600B so that there are now no interconnects at all on the outer faces on the boards. This is achieved by making through-hole connections on internal layers of the board, subsequently covered over as the outer layers are built on. So far, internal through-holes penetrate only one internal layer, though there are plans to penetrate more. These holes are drilled 15 mils in diameter and plated down to 10 mils. The outside of the board is plain except for holes to take component pins. The thickest board used in the 1600D is a motherboard of 22 layers.

Though Ferranti expects most 1600Ds will be sold for military purposes, a civil version will be offered. All versions will use the same Mil-Spec casing and mountings and multilayer boards, but the components can be military grade or commercial grade.

---

### Microwave data link for nearby computers

Sometimes two computers only a stone's throw apart can't be linked because the cost of building a land line is too high. This can easily happen in a city center, or when a peripheral computer temporarily controlling an experiment might not be on the job long enough to justify building a costly link to a large machine.

To deal with these situations, researchers at the Royal Radar Establishment are developing a portable, short range, line-of-sight microwave data-link system. It works by generating a stable, continuous signal in Q-band and turning it into pulses by passing it or blocking it in a Q-band

Gunn diode, which is switched on and off by the data coder.

In the on state—biased above threshold voltage—the Gunn switch locks onto the input signal and provides about 2.5-decibels amplification. In the off state it gives about 21 dB attenuation. Steve Gibbs, who is in charge of the project, says that this difference is sufficient, using a 100-milliwatt generator and a 5-inch, 5°-beamwidth dish antenna, to produce a 100-megahertz pulse stream that can be received up to 2 miles away in heavy rain with error rates inside standard limits. In good weather, the range of the system extends over 5 miles.

**Absorption.** Q-band was chosen partly to keep antenna size small for easy portability and partly because it contains sectors in which absorption by water vapor and oxygen in the atmosphere is very low. In the prototype, using 33.5 gigahertz one way and 34.5 GHz the other way, atmospheric absorption is low enough to be ignored, though rain absorption is significant.



The prototype transmitter/receiver system is in a cylindrical pod 2 feet long by 11 inches in diameter, weighing about 10 pounds, with the separate transmitting and receiving antennas in one end. Gibbs says it's simpler to use separate antennas than to try to achieve the necessary 90-dB isolation in a single antenna. Hence the need to keep antenna size down. He says future systems will be much smaller, essentially two antenna diameters wide, one antenna diameter high, and 2–3 in. thick. Power consumption is 30 watts.

**Locks.** For 100-mW output, an Impatt diode generator is used. However, if the range required is no more than about 1 mile and low-voltage batteries are essential, a Gunn-diode generator of 5 or 10 mW could be used. The generator is stabilized by locking it onto a crystal-controlled source working at 127 megahertz and multiplied up.

The receiver signal is mixed with a local oscillator signal from a separate stabilized Gunn-diode source, and amplified at a frequency of 100 MHz. Radio frequency noise is 11 dB over the 33–35 GHz band.





# Another introductory offer to new members of the ELECTRONICS AND CONTROL ENGINEERS' BOOK CLUB

	107/971 <b>ELECTRONIC CIRCUITS: PHYSICAL PRINCIPLES, ANALYSIS AND DESIGN</b> by P. M. Chirlian Pub. price, \$15.50 Club price, \$13.25		286/515 <b>INTEGRATED CIRCUITS: A Basic Course for Engineers and Technicians</b> by R. G. Hibberd Pub. price, \$9.95 Club price, \$8.45
	637/458 <b>DESIGNING WITH TTL INTEGRATED CIRCUITS</b> by Texas Instruments Inc. Pub. price, \$18.50 Club price, \$13.50		497/265 <b>ELECTRONIC SWITCHING, TIMING AND PULSE CIRCUITS 2/e</b> by Pettit & McWhorter Pub. price, \$12.50 Club price, \$8.95
	404/437 <b>SOURCEBOOK OF ELECTRONIC CIRCUITS</b> by J. Markus Pub. price, \$19.75 Club price, \$14.75		313/059 <b>HANDBOOK OF SEMI-CONDUCTOR ELECTRONICS, 3/e</b> by P. Hunter Pub. price, \$27.50 Club price, \$21.50
	259/607 <b>COMMUNICATION SYSTEM ENGINEERING HANDBOOK</b> by D. H. Hamsher Pub. price, \$29.50 Club price, \$22.50		308/470 <b>ACTIVE FILTERS: LUMPED, DISTRIBUTED, INTEGRATED, DIGITAL &amp; PARAMETRIC</b> by L. P. Huelsman Pub. price, \$16.50 Club price, \$13.95
	158/215 <b>AN INTRODUCTION TO ELECTRONIC COMPUTERS, 2/e</b> by G. B. Davis Pub. price, \$12.50 Club price, \$9.30		124/035 <b>HANDBOOK OF PHYSICS, 2/e</b> by Condon and Odishaw Pub. price, \$34.75 Club price, \$14.95

**ANY ONE**  
of these great professional books  
for only **\$1.00**  
VALUES FROM \$9.95 to \$34.75

Special \$1.00 bonus book comes to you with your first club selection

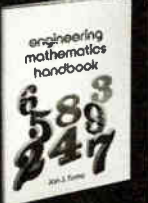
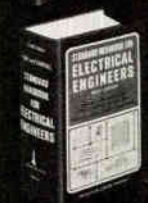
	494/754 <b>ENGINEERING MANUAL, 2/e</b> by R. H. Perry Pub. price, \$12.50 Club price, \$9.95		621/616 <b>WAVE GENERATION AND SHAPING, 2/e</b> by L. Strauss Pub. price, \$16.50 Club price, \$13.95
	654/301 <b>ENGINEERING MATHEMATICS HANDBOOK</b> by J. J. Tuma Pub. price, \$9.95 Club price, \$8.45		209/731 <b>STANDARD HANDBOOK FOR ELECTRICAL ENGINEERS, 10/e</b> by Fink and Carroll Pub. price, \$32.50 Club price, \$24.95

## Save time and money by joining the Electronics and Control Engineers' Book Club



HERE is a professional club designed specifically to meet your day-to-day engineering needs by providing practical books in your field on a regular basis at below publisher prices.

How the Club operates: Basic to the Club's service is its publication, the *Electronics and Control Engineers' Book Club Bulletin*, which brings you news of books in your field. Sent to members without cost, it announces and describes in detail the Club's featured book of the month as well as alternate selections which are available at special members' prices.

When you want to examine the Club's feature of the month, you do nothing. The book will be mailed to you as a regular part of your Club service. If you prefer one of the alternate selections—or if you want no book at all for that month—you notify the Club by returning the convenient card enclosed with each *Bulletin*.

As a Club member, you agree only to the purchase of four books over a two-year period. Considering the many books published annually in your field, there will surely be at least four that you would want to own anyway. By joining the Club, you save both money and the trouble of searching for the best books.

### MAIL ATTACHED POSTPAID CARD (If card removed, send coupon below)

ELECTRONICS AND CONTROL ENGINEERS' BOOK CLUB  
582 Princeton Road, Hightstown, N.J. 08520

Please enroll me as a member of the Electronics and Control Engineers' Book Club and send me the two books indicated below. I am to receive the bonus for just \$1.00, and my first selection at the special Club price shown. These books are to be shipped on approval, and I may return them both without cost or further obligation. If I decide to keep the books, I agree to purchase as few as four books during the next two years at special Club prices (at least 15% below list).

Write Code No. of  
bonus book  
here

Write Code No. of  
first selection  
here

Name \_\_\_\_\_

Address \_\_\_\_\_

City \_\_\_\_\_

State \_\_\_\_\_ Zip \_\_\_\_\_

E 33174

Circle 142 on reader service card

MONOLITHICS:

# THE STATE OF THE ART

## Specifying tips



The next time you order monolithics, here's a helpful hint. It's usually best to specify attenuation boundaries rather than bandwidth, since these are easily related to information transmission and selectivity requirements. We have a sheet filled with all the details that's yours for the asking. We'll also be glad to discuss design trade-offs.

## Our new 21.4's



We've just come up with an off-the-shelf line of low cost monolithic and tandem monolithic crystal filters at 21.4 MHz. Here's the story — twenty-one standard models in 2, 4, 6 and 8 poles with 13, 15 and 30 kHz bandwidths. Available in flatpack or upright packages. We'll be happy to mail you our new data sheets with all the specs.

## The Bare Essentials



A lot for a little — that's the idea behind the do-it-yourself approach to tandem monolithics. Take a set of our tandem monolithics. Mount them on your circuit board. Add two or three fixed capacitors and voila, you've got a 6- or 8-pole filter. Why bother? To save space, save money and gain layout flexibility. Whatever your filter problem, we can help reduce it to the bare essentials. Write us.

Like more information on monolithics? Drop us a line or call us.



**Piezo Technology Inc.**

2400 Diversified Way  
Orlando, Florida 32804  
305-425-1574

The standard in monolithic  
crystal filters.

# Electronics advertisers

January 31, 1972

<b>Advanced Memory Systems</b> Feig and LeBoeuf Adv., Inc.	43	<b>Nelson Ross Electronics, Div. Polarad Electronics</b> McCarthy-Scelba-DeBiasi Advertising Agency, Inc.	1
<b>Agfa Gevaert</b>	74	<b>North American Rockwell, Microelectronics Co.</b> Campbell-Ewald Company	46
■ <b>Augat</b> Creamer, Trowbridge, Case & Bastford, Inc.	100-101	<b>Ortec, Incorporated</b> Thomas R. Sundheim, Inc.	7
■ <b>Bendix Corporation, Electrical Components Division</b> D'Arcy-MacManus-Intermarco, Inc.	3rd cover	■ <b>Oscilloquartz SA, Neuchatel</b> M. R. Hofer Werbeagentur BSR/ EAAA Bern	12E.16E
<b>Canadian Marconi Company, Telecommunications Division</b> Telecommunications Advertising	9	■ <b>Philips GAD</b>	19E-20E
<b>Combustion Engineering</b> Bastford, Inc.	PB11	■ <b>Philips GAD Elcoma</b> Tag-Intermarco de la Mar	2E.6E.11E
■ <b>Dale Electronics, Inc., A Sub. of The Lionel Corporation</b> Swanson, Sinkey, Ellis, Inc. Advertising	4th cover	<b>Piezo Technology, Inc.</b> Shattuck/Roether Advertising, Inc.	D4
<b>Datum, Inc.</b> Data Advertising	13	<b>Plastics Engineering Company</b> Kuttner & Kuttner, Inc.	37
<b>Dumont Oscilloscope Laboratories, Inc.</b> Barbetta Miller Advertising, Inc.	6	<b>RCA Electronic Components</b> Al Paul Leflon Company	73.D6
■ <b>Electronic Navigation Industries</b> Hart Conway Co., Inc.	12	<b>Rental Electronics, Inc.</b> Technical, Industrial & Scientific Marketing, Inc.	85.90
<b>Electronics</b>	104-105	■ <b>Rohde &amp; Schwarz</b>	5E
<b>Electronics &amp; Control Engineers Book Club</b>	D1-D3	<b>Schauer Manufacturing Corp.</b> Nolan, Keelor & Siles	98
<b>Executone, Inc., Printact Relay Div.</b> J. A. Richards	84	<b>Signetics Corp., Sub. of Corning Glass Works</b> Hall Butler Blatherwick, Inc.	60-61
<b>Fairchild Semiconductor, Inc.</b> Carson Roberts, Inc. Advertising	44-45	<b>Snelling &amp; Snelling</b> Evo & Mattern Advertising	PB6
■ <b>General Electric Co., Semiconductor Products Department</b> Advertising & Sales Promotion Syracuse Operation	10-11	<b>Sonoco Products Company</b> Cargill, Wilson and Acree, Inc.	PB12
<b>General Radio Co.</b> GRAD Associates	15	<b>Sprague Electric Company</b> Harry P. Bridge Company	8
<b>Georgia Department of Industry &amp; Trade</b> Cargill, Wilson & Acree, Inc. Advertising	D5.PB7	<b>State Farm Insurance</b> Needham, Harper & Steers, Inc.	PB2
<b>Hermes Electronics Ltd.</b> Public & Industrial Relations Limited	16	■ <b>Tekelec Airtronic</b> Soc. de Publicite de Films et de Documentaires or S.P.F.D.	14E
■ <b>Hewlett-Packard, Electronics Products Group</b> Corporate Marketing Communications	19-28	<b>Teradyne Components</b> Quinn & Johnson, Inc.	85
<b>Hughes Aircraft Company</b> Foote, Cone & Belding	38-39	<b>Thompson CSF Electron Tubes, Inc.</b> Mohr & Co.	81
<b>Krohn-Hite Corporation</b> Impact Advertising, Inc.	5	<b>Tung Sol Division, Wagner Electric Corp.</b> Winus Brandon Company	94
<b>Lockheed Electronics Company</b> McCann-Erickson, Inc.	40	<b>Unitrode Corporation</b> Impact Advertising	35
■ <b>LTT</b> Publibel	17E	<b>Vernitron Piezoelectric Division</b> Cross & Associates, Inc.	14
<b>Medical World News</b> Friedrich Fearon & Strohmeier	86-87		
<b>Microsystems International Ltd.</b> Media Advertising Ltd.	88		
<b>Moneysworth</b> The Ad Agency	PB5		
<b>MOS Technology, Inc.</b> Henry S. Goodsett Advertising, Inc.	2nd cover		
<b>Mostek Corporation</b> Continental Communications, Inc.	2		
<b>MTS Systems Corporation</b> Midland Associates, Inc.	106		

## Classified & Employment Advertising

F. J. Eberle, Manager 212-971-2557

<b>EQUIPMENT (Used or Surplus New) For Sale</b>	
Radio Research	84
Radiation Devices Co.	84

■ For more information on complete product line see advertisement in the latest Electronics Buyer's Guide  
= Advertisers in Electronics International

## Advertising Sales Staff

**Pierre J. Braudé** [212] 971-3485  
Advertising Sales Manager

**Atlanta, Ga. 30309:** Joseph Lane  
1375 Peachtree St., N.E.  
[404] 892-2868

**Boston, Mass. 02116:** James R. Pierce  
607 Boylston St. [617] 262-1160

**Chicago, Ill. 60611:** Robert W. Bartlett  
Kenneth E. Nicklas 645 North Michigan  
Avenue. [312] MO 4-5800

**Cleveland, Ohio 44113:** William J. Boyle  
[716] 586-5040

**Dallas, Texas 75201:** Richard P. Poole  
1340 Republic National Bank Building  
[214] RI 7-9721

**Denver, Colo. 80202:** Harry B. Doyle, Jr.  
Tower Bldg., 1700 Broadway  
[303] 266-3863

**Detroit, Michigan 48226:** Robert W. Bartlett  
2600 Penobscot Building  
[313] 962-1793

**Houston, Texas 77002:** Richard P. Poole  
2270 Humble Bldg. [713] CA 4-8381

**Los Angeles, Calif. 90017:** Robert J. Rielly  
Bradley K. Jones 1125 W. 6th St.  
[213] HU 2-5450

**Minneapolis, Minn. 55402:** Kenneth E. Nicklas  
1104 Northstar Center [612] 332-7425

**New York, N.Y. 10036**  
330 W. 42nd St.  
Warren H. Gardner [212] 971-3617  
Michael J. Stoller [212] 971-3616

**Philadelphia, Pa. 19103:** Warren H. Gardner  
6 Penn Center Plaza  
[212] 971-3617

**Pittsburgh, Pa. 15222:** Warren H. Gardner  
4 Gateway Center. [212-971-3617

**Rochester, N.Y. 14534:** William J. Boyle  
9 Greylock Ridge, Pittsford, N.Y.  
[716] 586-5040

**St. Louis, Mo. 63105:** Kenneth E. Nicklas  
The Clayton Tower, 7751 Carondelet Ave.  
[314] PA 5-7285

**San Francisco, Calif. 94111:** Don Farris  
Robert J. Rielly, 425 Battery Street.  
[415] 362-4600

**Paris:** Alain Offergeld  
17 Rue-Georges Bizet, 75 Paris 16, France  
Tel 720-73-01

**Geneva:** Alain Offergeld  
1 rue du Temple, Geneva, Switzerland  
Tel 32-35-63

**United Kingdom:** Keith Mantle  
Tel 01-493-1451 34 Dover Street, London W1

**Milan:** Robert Saidel, Roberto Laureri  
1 via Baracchini Phone 86-90-656

**Brussels:** Alain Offergeld  
22 Chaussee de Wavre  
Brussels 1040, Belgium  
Tel 13 65-03

**Stockholm:** Brian B. Wines  
Office 17, Kontor-Centier AB, Hagsgården 29,  
113 47 Stockholm Tel 24 72 00

**Frankfurt/Main:** Fritz Krusebecker  
Liebigstrasse 27c  
Phone 7 01 81

**Tokyo:** Masaru Wakeshima, McGraw-Hill  
Publications Overseas Corporation  
Kasumigaseki Building 2-5, 3-chome,  
Kasumigaseki, Chiyoda-Ku, Tokyo, Japan  
[581] 9811

**Osaka:** Ryji Kobayashi, McGraw-Hill  
Publications Overseas Corporation, Kondo  
Bldg 163, Um-gae-cho Kita-ku [362] 8771

**Australasia:** Warren E. Ball, IPO Box 5106  
Tokyo, Japan

## Business Department

**Stephen R. Weiss, Manager**  
[212] 971-2044

**Thomas M. Egan,**  
Production Manager [212] 971-3140

**Carol Gallagher**  
Assistant Production Manager [212] 971 2045

**Dorothy Carter,** Contracts and Billing  
[212] 971-2908

**Frances Vallone,** Reader Service Manager  
[212] 971-6057

## Electronics Buyers' Guide

**George F. Werner,** Associate Publisher  
[212] 971-3139

**Regina Hera,** Directory Manager  
[212] 971-2544

# Six months before Reliance Electric opened in Georgia, 90% of its future employees thought a circuit board was something a telephone operator worked at.

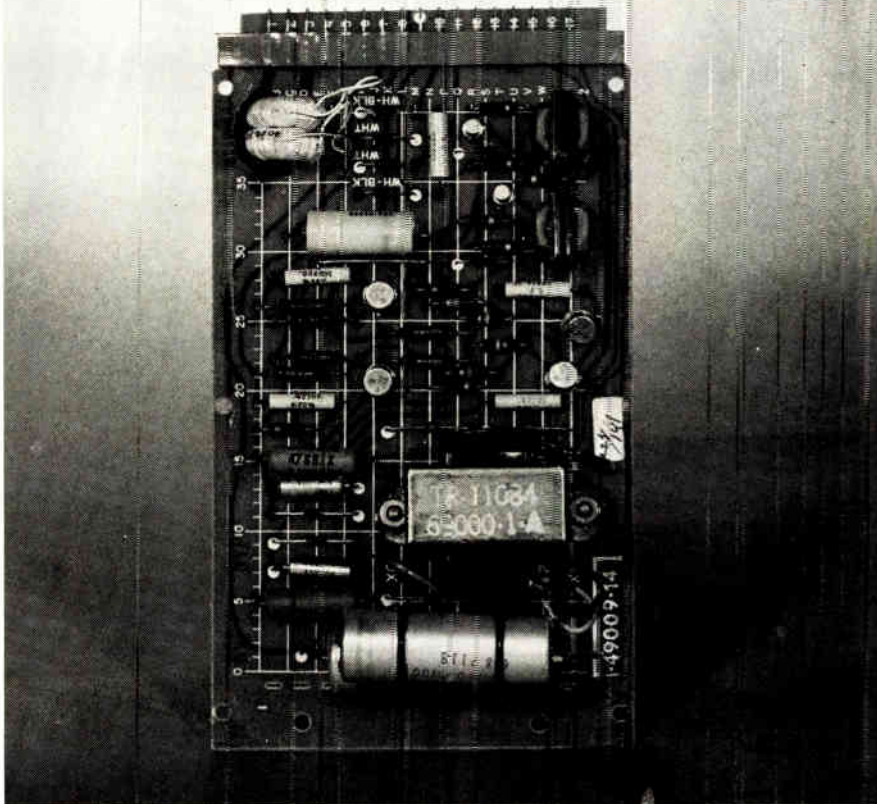

Reliance Electric is a major international manufacturer of automation equipment.

A while back, they decided to build a highly complex operation in Georgia, involving the latest metal-working and electronic assembly equipment available.

"In Georgia?" people said, scratching their heads. They shouldn't have been surprised.

Georgia's technical training program is among the finest anywhere. Students are highly motivated. Dropouts are rare.

According to Reliance's management "The workers have a great ability to learn complex skills. And an outstanding attitude. They couldn't wait to get started."

The Georgia startup was one of the most successful in Reliance's 63 year history.

One of the least expensive, too.

You see, what's really surprising about Georgia's sophisticated technical training program is that Georgia picks up the bill.

Georgia Department of Industry & Trade  
Industry Division, Dept. EL-9, P.O. Box 38097,  
Atlanta, Georgia 30334.

Please send me details on how Georgia will train my employees at no cost to me.

Name \_\_\_\_\_ Title \_\_\_\_\_

Company \_\_\_\_\_

Address \_\_\_\_\_

City \_\_\_\_\_ State \_\_\_\_\_ Zip \_\_\_\_\_

**Georgia, the unspoiled.**

# RCA leads the way— with 8 new emitter-ballasted microwave transistors

Type	Frequency (GHz)	Power Out (W) Min.	Supply Voltage (V)
2N6267	2.0	10.0	28
2N6266	2.0	5.0	28
2N6265	2.0	2.0	28
2N6269	2.3	6.5	22
2N6268	2.3	2.0	22
40898	2.3	2.0	22
40899	2.3	6.0	22
40909*	2.0	2.0	25

\*Oscillator

RCA's microwave transistor line keeps growing! Led by state-of-the-art types spec'd at 2.3 GHz and 22 V, these new transistors broaden a total high-power, high-frequency capability designed to meet expanding individual requirements.

Evaluate these new emitter-site ballasted transistors for your circuit. Their unique structure reduces "hot spots," improves safe operating area, and effectively minimizes transistor failure under high VSWR conditions.

At the same time, look over the full range of other RCA devices by getting the complete RCA microwave story. Write for your copy of RCA's Microwave Data Package, 2L1205, which includes

a new Microwave Transistor Brochure describing major design features, device selection criteria, typical circuit designs, and performance data. The package also includes technical data bulletins and a complete price list on all commercially-available RCA microwave power transistors.

For more information see your local RCA Representative or your RCA Distributor. For a copy of the data package, write: RCA, Solid State Division, Section 70A-31/-UF16, Box 3200, Somerville, N.J. 08876. International: RCA, Sunbury-on-Thames, U.K., or P.O. Box 112, Hong Kong. In Canada: RCA Limited, Ste. Anne de Bellevue, 810 Quebec.

**RCA** Solid State  
products that make products pay off

# Bendix ARINC's join the mating game.



Real togetherness. Now Bendix makes ARINC connectors, too. Completely intermountable. Completely intermateable. And they have all the advantages. Solid aluminum shell. Hard dielectric. Crimp contacts. Rear-removable. Environmental. Non-environmental.

The one-piece aluminum die-cast shell comes in both double- and single-shell configurations. With the standard three polarizing posts. The aluminum shell is designed to give you maximum strength with minimum weight.

Bendix crimp, rear-removable contacts elim-

inate logistic and stocking problems. Utilize standard insertion and removal tools, too. The environmental version prevents moisture creepage along the individual wires and seals around each individual contact.

Other design modifications in shell styles, mounting, plating and contact plating are available. Bendix ARINC connectors. Just the thing you need to help win the mating game. For additional information write: The Bendix Corporation, Electrical Components Division, Sidney, New York 13838.

**Bendix**

# Circuit-Makers.

## New DIP Tools from Dale.

### DIP TRIMMERS

**2600/8600 "Fastpacks".** Wirewound model (2600) rated at 1 watt (40°C) over 10-50K ohm range  $\pm 10\%$ . T.C. 50 ppm/°C. Film model (8600) rated .75 watt (25°C) over 10 $\Omega$ -2 Meg. range  $\pm 10\%$ ,  $\pm 20\%$ . T.C. 150 ppm/°C. Sealed cases, .75" long, machine or hand insertable.

**85/87 "Fastpacks".** Single or multi-turn models rated at .5 watt (25°C) over 10 $\Omega$  to 1 Meg. range  $\pm 20\%$ . T.C. 150 ppm/°. Sealed cases, .265" wide x .28" long. Machine or hand insertable.

### DIP RESISTOR NETWORKS

**TKR.** Molded or coated networks with 14 (T.O. 116) 16, 18 pins. 1/8 watt max. per resistor, 3/4 watt max. at 125°C per package. 10 $\Omega$  to 1 Meg.,  $\pm 2.5\%$ , 200 ppm/°C. Available with DIP or P.C. pins on .3" x .1" or .6" x .1" grid (coated only).

**WDP/FDP.** Film (FDP) networks in 14 and 16 pin packages. Up to 15 elements, .05 watt max. with .5 watt max. per package; 10 $\Omega$  to 1 Meg. per resistor,  $\pm 1\%$ , 10-200 ppm/°C. Wirewound (WDP) networks have up to 7 elements per 14-pin package, .5 watt per element, 3.5 watts max. per package. 1 to 800 $\Omega$  per resistor, .1%-5%,  $\pm 20$ ,  $\pm 50$  ppm/°C.

### DIP PULSE TRANSFORMERS

**PT-14/PT-16** with 3 (14-pin) or 4 (16-pin) pulse transformers per package. Inductance 1  $\mu$ h to 2.0 mh over -55 to +125°C. range. Temperature stability  $\pm 10\%$ , tolerance  $\pm 20\%$ . Sealed cases with pins on .3" x .1" grid. Machine or hand insertable.

In addition to these standard DIP packages, we're ready to quote on custom RC networks and hybrids with active and passive devices to your specification. Fast turnaround on prototypes. Write for new DIP Brochure or phone our Application Engineering Department, 402-564-3131 today!