

Low-cost, programable test systems 71

\$1.00 A McGraw-Hill Publication

Shaping up bandpass filters 80

July 6, 1970

Analog recorder stores digital data 90

Electronics®

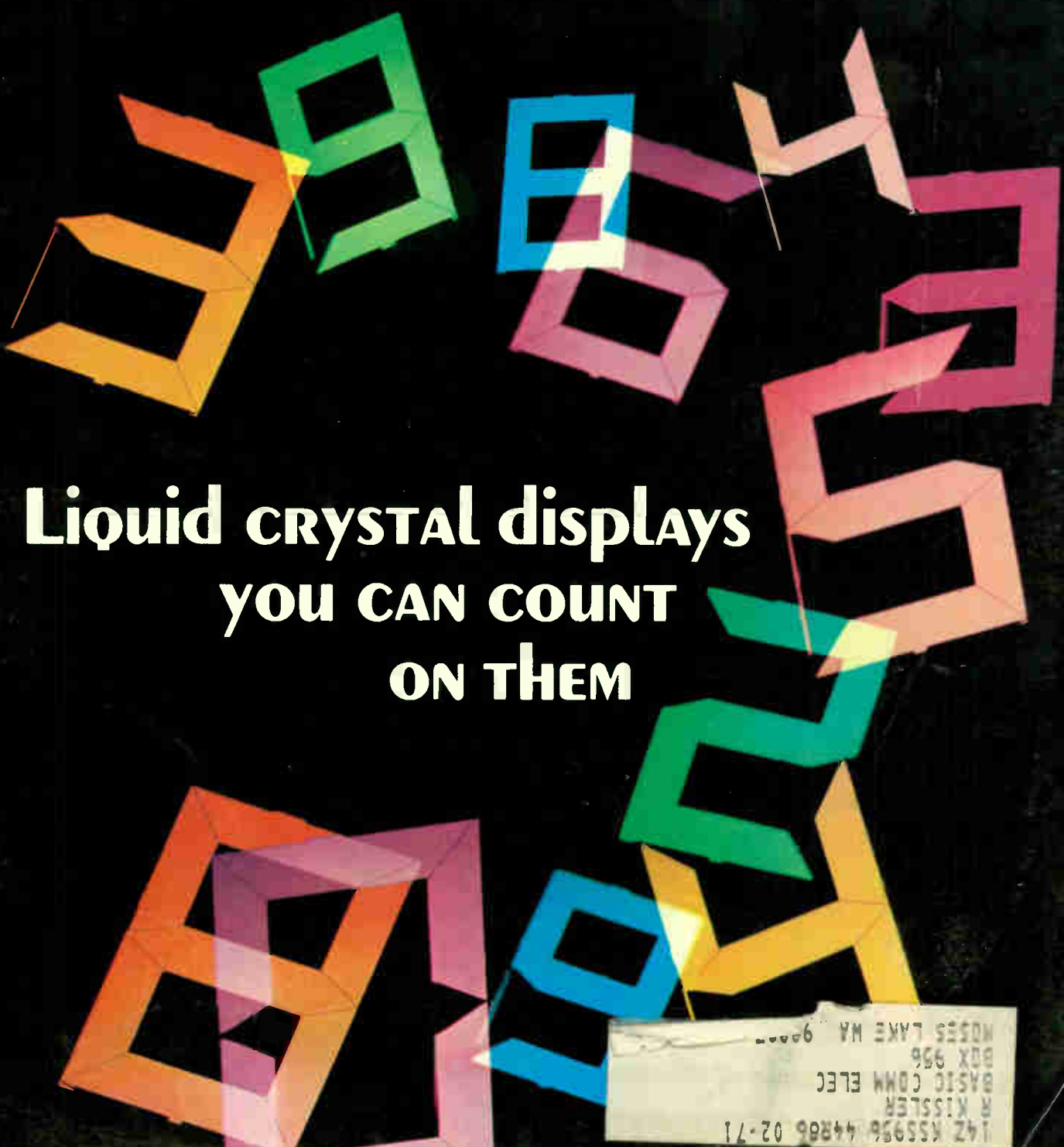

**Liquid crystal displays
YOU CAN COUNT
ON THEM**

142 K55956 4486 02-71
R KISSLER
BASIC COMM ELEC
BOX 996
MOSES LAKE WA 98252

Why 24 firms have chosen GR's 1790 Logic-Circuit Analyzer this year:

"The 1790 has the best software of all the logic testers we surveyed."

"Our 1790 will pay for itself in the first few months of operation."

"GR's 1790 has significantly reduced the time required to debug engineering prototypes."

"LSI circuits are rapidly tested on our 1790."

Still other satisfied customers have told us how much they like the interactive mode of operation, which allows them to prepare and modify test programs on-line, and the tape-cassette memory for quick access to all existing test programs. Some have mentioned the programmable logic levels and power supplies that permit the testing of marginal conditions and boards with mixed logic families, the control panel and alpha-numeric display scope that simplify and speed test procedures, and the universal

device adaptors that allow all pins to be inputs or outputs and permit checking for shorted inputs.

We can stand behind these comments because we, too, have benefitted from using the 1790 in our own development and production efforts. When we decided to build a logic-circuit analyzer, we did it because the system we needed just wasn't available commercially. So we built the best possible analyzer for ourselves, and we've used it for over two years to help manufacture our products with a resulting increase in quality and decrease in price. Now we want you to have the same advantages from your own 1790.

The basic 1790 includes a large I/O capacity (96 input pins and 144 outputs), a high-level test language that technicians can learn in only a few days, computer speed (up to 4000 tests per second), and a simplified GO/NO-GO test mode. The physical contents of the 1790 are a computer with 4096 12-bit words of 1.6- μ s-cycle core memory, teletypewriter, photoelectric tape reader, display scope, control panel, logic probe, and all the needed accessories. And the entire system is priced at only \$32,500 in the U.S.

Some great new options will increase the power of your 1790 many times: programmable logic levels for mixed-logic testing, expanded tape-cassette memory with 150,000 12-bit-word capacity, and universal device adaptors for testing a greater variety of devices.

Complete 1790 specifications and operating information are available from your nearest GR District Office or from 300 Baker Ave., West Concord, Mass. 01781. In Europe write Postfach 124, CH 8034, Zurich, Switzerland.



GENERAL RADIO

ATLANTA 404 633 6183 / BOSTON 617 646 0550 / CHICAGO 312 992 0800 / CLEVELAND 216 886 0150
DALLAS 214 637 2240 / LOS ANGELES 714 540 9830 / NEW YORK IN Y 212 964 2722 IN J1 201 943 3140
PHILADELPHIA 215 646 8030 / SAN FRANCISCO 415 946 8233 / SEATTLE 206 747 9190 / SYRACUSE 315 454 9323
WASHINGTON, D.C. 301 881 5333 / TORONTO 416 252 3395 / ZURICH 10511 47 70 20

Circle 900 on reader service card

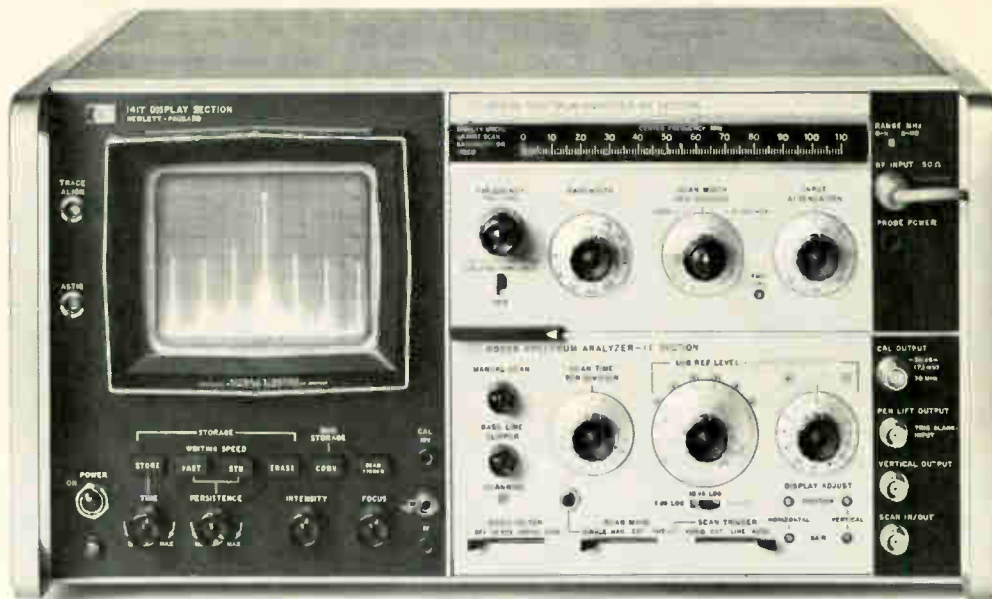

How do you improve the world's best spectrum analyzer?



Add counter accuracy and a tracking signal source.

Combine HP's new 8443A Tracking Generator/Counter with the HP 110 MHz Spectrum Analyzer and you can make the most precise, complete frequency-domain measurements ever. The 8443A produces a visible marker that you can place anywhere on the spectrum analyzer display and immediately get 10 Hz resolution digital measurement of that point. The 8443A is more, too: a precision signal source that will make swept measurements over a 120 dB range and still produce the marker to determine any specific frequency with counter accuracy.

The 8553B 8552B Analyzer itself covers 1 kHz to 110 MHz with scans as wide as 100 MHz and as narrow as 200 Hz. It provides absolute amplitude calibration, better than -130 dBm sensitivity, over 70 dB dynamic range, 10 Hz resolution, plus exceptional stability (<1 Hz FM) and flatness. The 8443A capitalizes on all the qualities of the analyzer to function both as an accurate frequency counter and as a precision source for complete swept frequency measurements.

With the system you can make much more precise design and production

line measurements of filters, mixers, modulators, oscillators, amplifiers and RF systems. For example, you can now:

- measure to 10 Hz the frequency of nanovolt signals in the presence of much larger ones. Use the tunable marker to find the signal and measure its frequency on the 8443A counter readout. You can easily identify IM distortion products, hum sidebands, spurious signals, and the like, because the 8443A is a frequency-selective counter with the analyzer's incredible sensitivity.
- completely characterize devices such as narrowband, high Q devices with simple, quick measurements. Use the tracking generator to sweep the spectrum and measure the frequency of any point on the response curve to 10 Hz. You can precisely measure passband flatness and shape factor on filters as narrow as 20 Hz, and make swept-reflection or return loss measurements. In other words, the tracking generator combines with the analyzer to provide a complete swept test system.

- test and align RF communications systems with unprecedented ease, thoroughness and precision. The high resolution and stability of the analyzer lets you see each and every signal, and the 8443A measures their frequency to 10 Hz. The system is also a natural for surveillance applications since you can scan broad and narrow ranges, resolve all signals of interest and count their frequency.

Call us for a demonstration. The system is easy to set up and you'll find it simple to use as an oscilloscope. If you've already got an HP 110 MHz spectrum analyzer, you can add the tracking generator/counter for \$3500. The high-resolution 8553B 8552B with variable persistence display costs \$6750. Ask your HP field engineer for details. Or write Hewlett-Packard, Palo Alto, California 94304; Europe: 1217 Meyrin-Geneva, Switzerland.

04015

HEWLETT  PACKARD
SIGNAL ANALYZERS

NOW

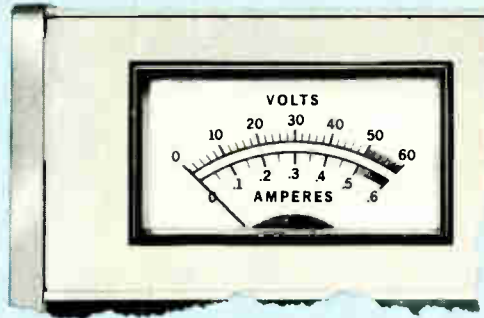

3 MODELS AVAILABLE

Model 6177B
0-500mA, 0-50Vdc

Model 6181B
0-250mA, 0-100Vdc

Model 6186B
0-100mA, 0-300Vdc

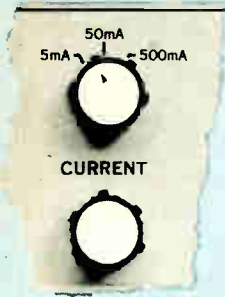

EXCELLENT RESOLUTION

0.02% of range selected

PRECISE REGULATION

25 ppm of output down to 1 μ A using unique guard design.

THAT'S

CONSTANT

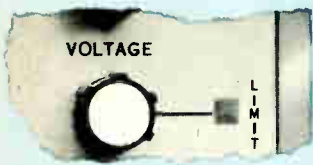

CURRENT

INDEPENDENT VOLTAGE LIMIT

Preset your voltage... light warns when complying voltage limit is reached.



RAPID PROGRAMMING

1ms from 0 to 99% of full range

HIGH OUTPUT IMPEDANCE

100 to 10,000 megohms depending on range

Typical applications for HP Constant Current Sources include: ■ semiconductor testing, e.g., evaluating reverse breakdown and V-I characteristics of p-n junctions ■ measuring dynamic or incremental impedance ■ extremely accurate four-terminal resistance measurements ■ testing and sorting resistors, capacitors, relays, and meters ■ precision electroplating ■ analytical testing ■ operating IMPATT and GUNN Effect diodes ■ supplying accurate currents to Hall Effect devices. Write for Constant Current Application Brochure. Model 6177B and 6181B: \$425. Model 6186B: \$475.

Hewlett-Packard, New Jersey Division, 100 Locust Ave., Berkeley Heights, New Jersey 07922.

HEWLETT  PACKARD

POWER SUPPLIES

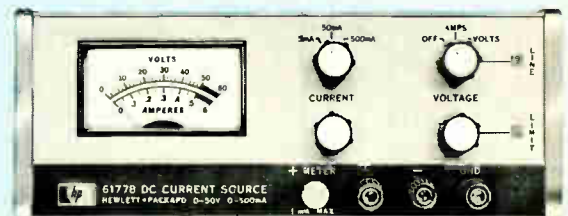

Features

Probing the News

- 97 **Commercial electronics:** Traffic jam spur ERC's revival
99 **Space electronics:** Scientific satellite's subsystems from previous spacecraft
102 **Military electronics:** Destroyer contract means \$600 million for subcontractors

U.S. Reports

- 37 **Microwave:** Fabrication method cuts phase shifter current need
38 **Computers:** Universal black boxes auger changed EDP concepts; Old Minuteman 1 machines gain a new life
40 **Communications:** Picturephone finally makes debut
40 **Air traffic control:** Answer might be associative processors
42 **Solid state:** Air-dropped remote weather stations; transistor thermal-cycle rating chart
44 **Manufacturing:** Infrared p-c board trouble shooter
44 **Materials:** Spinel bids to replace sapphire in SOS
46 **Components:** High capacitance, low voltage in electrolytic capacitor
49 **Memories:** Magnetic-acoustic version less than cent a bit

Electronics International

- 127 **Great Britain:** Generating tv lettering
128 **Switzerland:** Electronic key for gasoline sales
128 **West Germany:** Cemented cores
129 **France:** Handyman's microprogram
130 **Japan:** Repeating at 20 Ghz
130 **Around the world**

New Products

- 105 **In the spotlight**
105 12-bit computer sells for \$2,535
107 Calculator is multipurpose tool
109 **Components review**
109 Op amp has error below 0.01%
111 **Microwave review**
111 Materials promise device gains
112 Hybrid preamp built for radio navigation
115 **Production equipment review**
115 Low-voltage source trims stripper
116 Pcb assembly automated
117 **Semiconductor review**
117 C/MOS register runs at 10 Mhz
119 **Instruments review**
119 Meter compares bcd signals
120 Plug-in boosts resolution
121 **New materials**

Articles

- Advanced technology** 64 **Now that the heat's off, liquid crystals can show their colors everywhere**
Joseph A. Castellano,
RCA Laboratories
- Instrumentation** 71 **Computer, software, p-c cards match up to cut automatic test system costs**
When a computer and simple circuits synthesize costly instruments, many tests can be run cheaply and efficiently
Don Mactaggart,
Canadian Marconi Co.
- Circuit design** 76 **Designer's casebook**
▪ IC oscillation sets up a mini-sized bias supply
▪ Switching regulator drives IC's and Nixies off battery
▪ Switched oscillator controls four-wire resistance checks
- Design theory** 80 **Bandpass filter shapes up from a low-pass network**
Computer program helps determine key design parameters with calculations that start with shape factors
Philip Geffe,
Westinghouse Electric Corp.
- Conference calendar** 85 **Spotlighting major foreign meetings**
Four-page foldout offers a checklist of events through the year-end
- Data handling** 90 **Low-cost stereo recorders can adapt to digital data**
Combining information and clock on one track licks intertrack phase shift and head gap spacing problems
David Newton and Walter Buczek,
U.S. Army Electronics Command

Departments

- | | | | |
|----|--------------------------|--------------------------|-----------------------|
| 4 | Readers Comment | 39 | Index of Activity |
| 6 | Who's Who in this issue | 59 | Washington Newsletter |
| 14 | Who's Who in electronics | 122 | New Books |
| 22 | Meetings | 123 | Technical Abstracts |
| 33 | Electronics Newsletter | 124 | New Literature |
| | 125 | International Newsletter | |

Electronics

EDITOR-IN-CHIEF: Kemp Anderson

EXECUTIVE EDITOR: Samuel Weber

MANAGING EDITORS: Robert Henkel, News;
Arthur Erikson, International

SENIOR EDITORS: H. Thomas Maguire,
Stephen E. Scrupski

ASSOCIATE EDITORS: William Bucci, Richard
Gundlach, John Johnsrud, Howard Wolff

DEPARTMENT EDITORS

Advanced Technology: Laurence Altman;
Communications & Microwave: Leon M. Magill;
Components: Joseph Mittleman; *Computers*:
Wallace B. Riley; *Consumer*: Roger Kenneth
Field; *Industrial Electronics*: Alfred Rosenblatt;
Instrumentation: Owen Doyle; *Military*/
Aerospace: Herman Lowenhar; *New Products*:
H. Thomas Maguire (Mgr.), William P. O'Brien,
George Weiss; *Packaging & Production*:
Stephen E. Scrupski; *Solid State*: George F.
Watson

COPY EDITORS: William S. Weiss, Chief;
Edward Flinn

ART: Charles D. Ciatto, Assistant Director

PRODUCTION EDITORS: Susan Hurlburt,
Arthur C. Miller

EDITORIAL RESEARCH: Virginia Mundt

EDITORIAL SECRETARIES: Barbara
DiBenedetto, Claire Goodlin, Vickie Green,
Terri O'Neill, Bernice Pawlak, Patricia Ritter

BUREAUS

Boston: James Brinton (Mgr.), Gail Farrell;
Los Angeles: Lawrence Curran (Mgr.), Ralph
Selph; *New York*: Peter Schuyten; *San
Francisco*: Stephen Wm. Fields (Mgr.), Marilyn
Howey; *Washington*: Ray Connolly (Mgr.),
James Hardcastle, Lois Vermillion; *Frankfurt*:
John Gosch; *London*: Michael Payne; *Paris*:
Arthur Erikson; *Tokyo*: Charles Cohen

McGRAW-HILL WORLD NEWS

Director: Walter A. Stanbury; *Atlanta*: Fran
Ridgway; *Chicago*: Robert E. Lee; *Cleveland*:
Arthur Zimmerman; *Dallas*: Marvin Reid;
Detroit: James Wargo; *Los Angeles*: Michael
Murphy; *San Francisco*: Margaret Drossel,
Tyler Marshall; *Seattle*: Ray Bloomberg;
Washington: Charles Gardner, James Canan,
Herbert W. Cheshire, Seth Payne, Warren
Burkett, William D. Hickman; *Bonn*: Robert F.
Ingersoll; *Brussels*: James Smith; *London*:
Marvin Petal; *Milan*: Jack Star; *Moscow*:
Axel Krause; *Paris*: Robert E. Farrell, Stewart
Toy; *Tokyo*: Mike Mealey

PUBLISHER: Dan McMillan

ASSISTANT TO THE PUBLISHER: Wallace
Carmichael

PLANNING & DEVELOPMENT MANAGER:
Donald Christiansen

ADVERTISING SALES MANAGER: Pierre Braudé

CIRCULATION MANAGER: John D. Drummond

RESEARCH MANAGER: David Strassler

PROMOTION MANAGER: Tomlinson Howland

ADVERTISING SALES SERVICE MANAGER:
Wallis Clarke

Readers Comment

Silver lining

To the Editor:

Your report on resistor failures caused by the exposure of thick-film resistors containing palladium oxide to hydrogen originating from storage batteries [April 13, p. 52] is accurate. However, without some further details, the overall impression created may be needlessly alarming with regard to the general reliability of thick-film systems.

It is well known that the thick-film circuit modules used in the IBM 360 computer series utilize palladium-silver resistors; the reliability of these resistors has been excellent. Since these modules have been produced and used in large quantities, it is safe to conclude that thick-film resistors containing palladium have accumulated more in-service evidence of reliability than other thick-film resistors, and should also compare favorably in this regard with any type of resistor.

When dealing with the relatively rare cases where exposure to hydrogen can occur, it should be stressed, as your report clearly does, that sensitivity to hydrogen is a characteristic of, and only of, resistor systems containing palladium oxide. Essentially, all suppliers of thick-film compositions can provide exceptionally stable, never resistor systems which do not contain palladium in any form and often have many other useful attributes as well. However, even palladium-bearing resistors can be protected against hydrogen by overglazing.

Historically, overglazing was an accepted step in the preparation of

many early types of cermet resistors. Only after the remarkable immunity of palladium-silver resistors to catastrophic failures in a great variety of exposures (but excluding reducing environments) was clearly proven was the industry emboldened to use unglazed resistors. It should be added in this context that the reducing action of certain curing agents associated with some organic encapsulants can also lead to severe degradation of palladium-silver resistors. Therefore, the manufacturer's recommendations should be followed closely when such encapsulants are selected.

Donald W. Altmaier
Public Relations Department
Dupont
Wilmington, Del.

Unharmonic

To the Editor:

An error appears in one of the equations in your article on third harmonics [April 13, p. 124]. The correct equation is $B = -(b/2) \cos 2\omega t$ and not $B = -(b/2) \cos \omega t$ as it is written.

Lvigi Totaro
Dallas, Tex.

Pioneer work

To the Editor:

I found your article on a stable, field replaceable strapdown gyro in a can [May 25, p. 106] very informative. The MIT Draper Laboratory has been a pioneer in the development of strapdown guidance systems. Our first effort was in 1963,

July 6, 1970 Volume No. 43, Number 14
89,591 copies of this issue printed

Published every other Monday by McGraw-Hill, Inc. Founder: James H. McGraw 1860-1948. Publication office 99 North Broadway, Albany, N.Y. 12202; second class postage paid at Albany, N.Y. and additional mailing offices.

Executive, editorial, circulation and advertising addresses: Electronics, McGraw-Hill Building, 330 W. 42nd Street, New York, N.Y. 10036. Telephone (212) 971-3333. Teletype TWX N.Y. 710-581-4235. Cable address: MCGRAWHILLN.Y.

Subscriptions solicited only from those professionally engaged in electronics technology. Subscription rates: qualified subscribers in the United States and possessions and Canada, \$8.00 one year, \$12.00 two years, \$16.00 three years; all other countries \$25.00 one year. Non-qualified subscribers in the U.S. and possessions and Canada, \$25.00 one year; all other countries \$50.00. Air freight service to Japan \$50.00 one year. Single copies: United States and possessions and Canada, \$1.00; all other countries, \$1.75.

Officers of McGraw-Hill Publications Company: Joseph

H. Allen, President; John R. Emery, J. Elton Tuohig, Senior Vice Presidents; Donald B. Gridley, Group Vice President; Vice Presidents: John R. Callahan, Editorial; John M. Holden, Marketing; David G. Jensen, Manufacturing; Jerome D. Luntz, Planning & Development; Robert F. Marshall, Administration; Robert M. Wilhelmy, Finance; Director of Circulation: Ralph Blackburn.

Officers of the Corporation: Shelton Fisher, President and Chief Executive Officer; John J. Cooke, Senior Vice President and Secretary; Gordon W. McKinley, Vice President and Treasurer.

Title © registered in U.S. Patent Office; © Copyright 1970 by McGraw-Hill, Inc. All rights reserved. The contents of this publication may not be reproduced either in whole or in part without the consent of copyright owner.

Subscribers: The publisher, upon written request to our New York office from any subscriber, agrees to refund that part of the subscription price applying to copies not yet mailed. Please send change of address notices or complaints to Fulfillment Manager; subscription orders to Circulation Manager, Electronics at address below. Change of address notices should provide old as well as new address, including postal zip code number. If possible, attach address label from recent issue. Allow one month for change to become effective.

Postmaster: Please send form 3579 to Fulfillment Manager, Electronics, P.O. Box 430, Hightstown, N.J. 08520.

SOLID TANTALUM CAPACITORS



BOARDABLE & AFFORDABLE

RIGHT ON THE MONEY
FOR PRINTED WIRING BOARDS
IN INDUSTRIAL, COMMERCIAL,
AND ENTERTAINMENT
ELECTRONICS

Sprague Type 196D Dipped Solid-Electrolyte Tantalex® Capacitors cool the performance/budget argument. Newly broadened line—now available in all popular 10% decade values between 0.1 μ F and 330 μ F. Voltage range: 4 to 50 vdc. Hard insulating resin coating is highly resistant to moisture and mechanical damage. Straight or crimped, long or short leads. Operate to 125C with only $\frac{1}{3}$ voltage derating. Write for Engineering Bulletin 3545A.

Technical Literature Service
Sprague Electric Company
35 Marshall Street
North Adams, Mass. 01247



45M-0139

THE BROAD-LINE PRODUCER OF ELECTRONIC PARTS

NOW
HIGH-PERFORMANCE SCRs
TO MEET THE
CRITICAL NEEDS OF...

- Power Inverters
- A.C. Motor Variable Speed Drives
- Induction Heaters
- Pulse Width Modulators



NATIONAL®
DISC PACKAGED
REGENERATIVE GATE* SCRs
provide these plus factors...

- + Voltages to 1000 V
- + dv/dt to 500 V/ μ sec.
- + Turn-off time to 15 μ sec.
- + di/dt to 800 A/ μ sec.
- + Low power gate drive
- + Operation to 20 KHz, with low switching losses
- + 175 and 380 amperes RMS
- + Also available in stud packages to 470 amperes RMS

* A NATIONAL® exclusive.
Patent No. 3,486,088

We welcome requests for detailed data
and application assistance. Contact...

NATIONAL ELECTRONICS, INC.
a varian subsidiary

Geneva, Ill. 60134, phone 312-232-4300

Readers Comment

and we are completing work on a second-generation system.

Our first-generation system, which had components equivalent to United Aircraft's, was extensively tested in the lab and field. Our second-generation system, with the performance of the inertial component improved by an order of magnitude, was delivered to the Naval Weapons Center, China Lake, Calif., in July 1969. We have two modified systems under construction. They include data processing for attitude and are scheduled for completion in the fall. An extensive field test program for the New England area will commence in October. Aircraft testing will be carried out at Holloman Air Force Base, Alamogordo, N.M., starting in May 1971.

John W. Fish

Assistant director,
Charles Stark Draper Laboratory
MIT
Cambridge, Mass.

Notes demotion

To the Editor:

Your description of the effect of layoffs on the job market for electrical engineers [April 13, p. 137] was quite good except for the misinformation regarding the job stability of EE's who work for the Government. I was a GS-13 electronics engineer until recently. I now have a GS-12 rating. As has happened before, at the first hint of a cutback in personnel, the high-priced engineer finds himself in the foreground as a prime candidate for demotion. This is my second demotion in less than five years, while engineers of other classifications are not considered or demoted. I find that this is a common occurrence in the Air Force Civilian Service.

Austin Frank

GS-12 electronics engineer,
U.S. Air Force
Seattle, Wash.

▪ Electronics discussed only layoffs, saying that few engineers in Government service would be affected by the Defense Department's plan to cut back jobs.

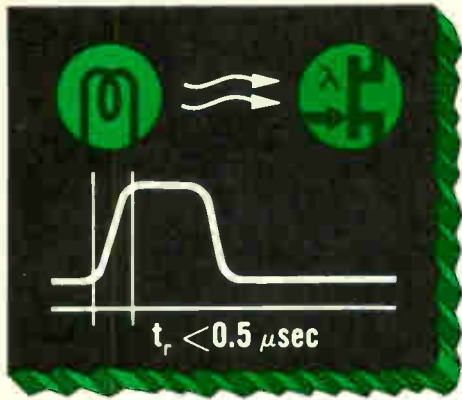

WIDEBAND PHOTOFETS

Need rise time less than one-half μsec , low noise and high sensitivity? You get these with the Siliconix P236! Here's a circuit and a performance table showing what happens with two of our op amps:

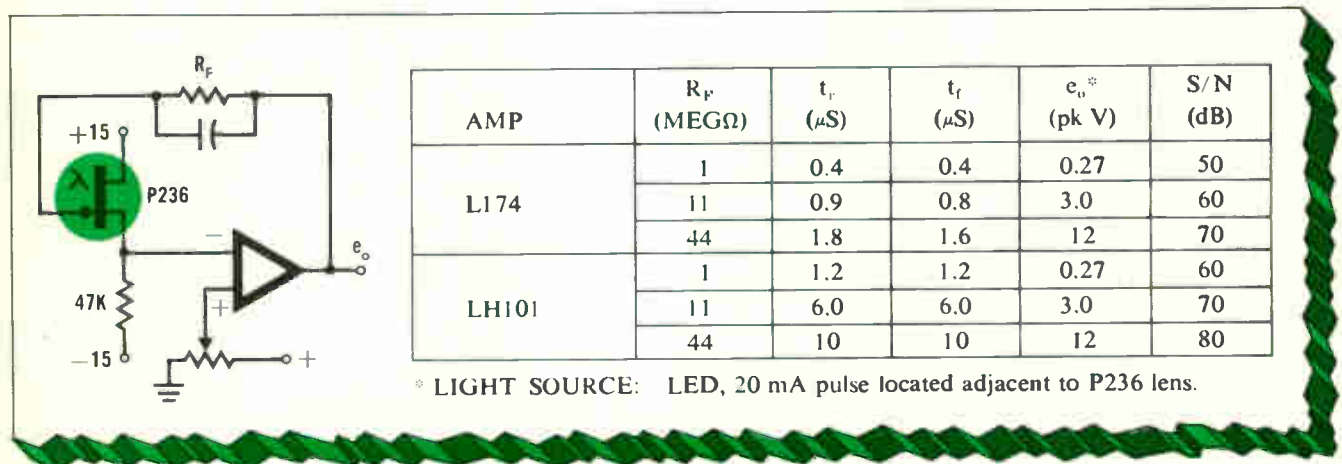

In this wideband photosensor, photocurrent flows from the gate and becomes the input signal at the summing junction (gate terminal). Feedback holds the gate at virtual ground, so the effect of C_{in} is negligible and pulse response is limited largely by the op amp. You can use any op amp, allowing for its response characteristics.

For complete information on the P236-8 Series photofets and the L174 or LH101 op amps write direct or call any of the numbers below.

New York: Sy Levine (516) 796-4680
 New England: Al La Croix (617) 762-8114
 Ft. Worth/Dallas: Charlie Williams (214) 231-8151
 St. Louis: Jim Spicer (314) 291-3616
 Minneapolis: Ed Koelgen (612) 920-4483
 Southern California: Dave Ferran (213) 420-1307
 Northern California: Chuck Brush (408) 246-8000



Siliconix incorporated

2201 Laurelwood Road • Santa Clara • California 95054
 Telephone (408) 246-8000 Extension 201 • TWX: 910-338-0227
 In Europe: Siliconix Limited, Saunders Way, Sketty, Swansea, Great Britain

NO KLYSTRONS



More reliable and using less power than any other equipment type, Farinon microwave is completely solid-state. There is no klystron. Easy to maintain, compact, and versatile systems with capacities of up to 300, 600 or 960 channels meet international standards for performance over distances of more than 1000 miles. They operate in all bands to 7 GHz. Remodulating repeaters provide complete base-band access at each repeater.

With Farinon SS-series microwave, you can have a system that exactly matches your needs. Ask for complete information on performance, terminal arrangements and accessory gear, including fully CCITT-compatible multiplex.

Farinon

Farinon Electric, 935 Washington St., San Carlos, Cal. 94070

Who's Who in this issue



Maciaggart

Curious about Sweden, Don Maciaggart, author of the article on automatic test systems that begins on page 71, spent a year there designing digital controls for an atomic power plant and the Stockholm subway system. A graduate of McGill University with a Bachelor of Engineering degree, Maciaggart went to work for Sperry Canada designing numerical control and sonar gear when he returned from Sweden. He's now a project supervisor with the Canadian Marconi Co.



Newton

A pair of soldiers at the Army's Electronics Command wrote the article on digital recorders that begins on page 90. Walter Buczek, a University of Virginia graduate, has been working on logic circuit and systems design. David Newton, a graduate of the University of Rochester who has worked at the Lawrence Radiation Laboratory, is doing logic and power supply design.



Buczek



Geffe

Mathematic and network synthesis were the major fields of study for Philip R. Geffe, author of the article on active bandpass filters that starts on page 80. A veteran in network theory and filter design, Geffe is now a fellow engineer at Westinghouse Electric's Defense and Space Center.



Castellano

Organic photochemistry, organic semiconductors, and liquid crystals—the subject of the article that starts on page 64—are the stock in trade of Joseph A. Castellano, its author. Castellano, who holds a Ph.D. from Polytechnic Institute of Brooklyn, is a member of the technical staff at RCA Labs.

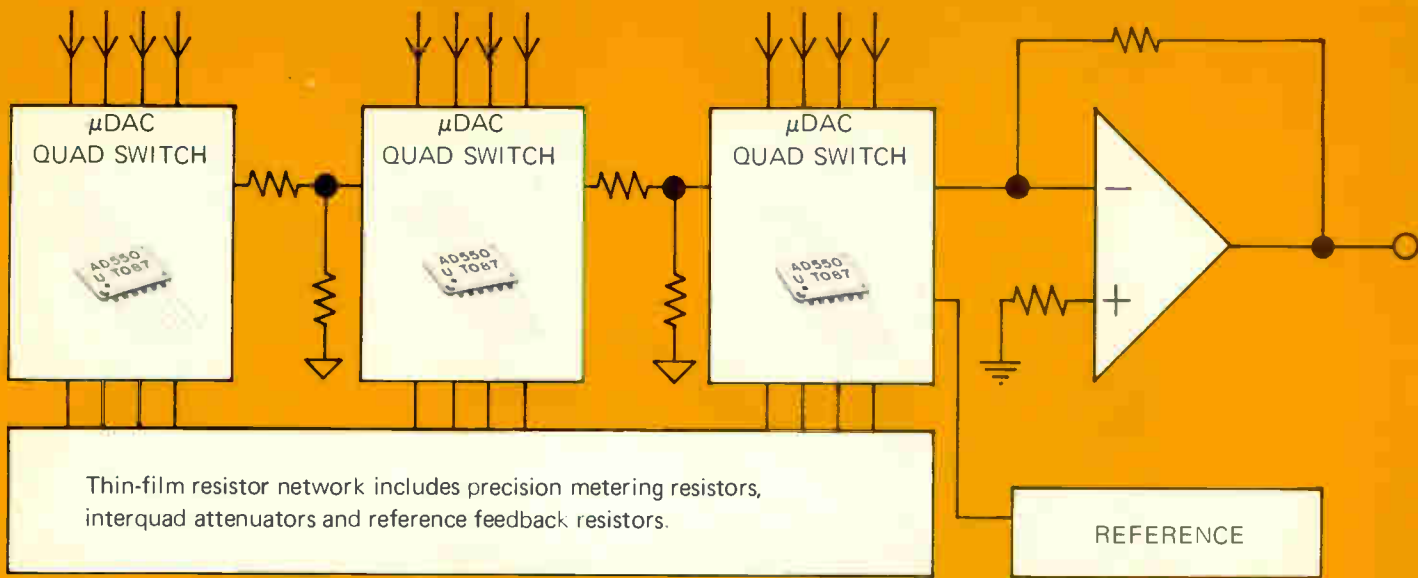

μDAC...The World's First Monolithic IC D/A Converter With 12 Bit ($\pm 1/2$ LSB) Accuracy

- **Monolithic IC Construction**
- **.01% Accuracy with No Trimming**
- **Monotonic From -55 to $+125^{\circ}\text{C}$ with $5\text{ppm}/^{\circ}\text{C}$**
- **Small Size... Hermetic Flatpack or DIP**
- **High Reliability... Meets Mil-Std 883**
- **5,000 Units In Stock For Immediate Delivery**

Input buffers provide DTL, TTL compatibility

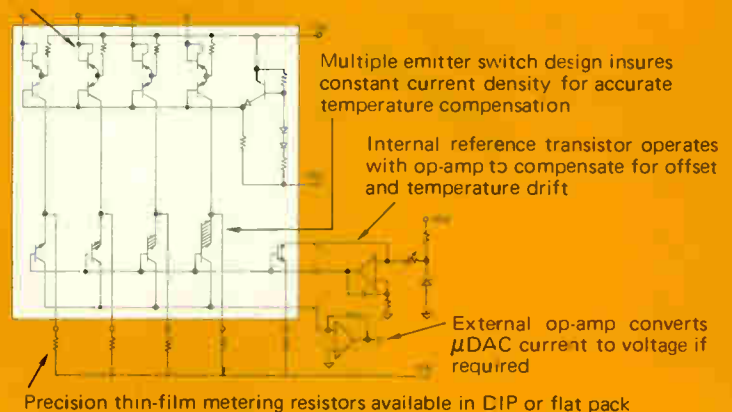

Analog Devices has applied the advantages of monolithic IC design to high accuracy D/A converters. The obvious advantages include high reliability, small size, low power consumption, wide temperature range operation and lower production costs. A more subtle but very important benefit of monolithic design is that multiple emitter switch design insures uniform current density which also contributes to the improved accuracy of the μDAC. Furthermore, a temperature compensating transistor is included on the chip with the bit current switching transistors. As a consequence, temperature drift effects are compensated leaving only $5\text{ppm}/^{\circ}\text{C}$ error (actually better than discretres).

The μDAC is comprised of 4 weighted current switches (and the compensating transistor) driven by logic input buffers compatible with all popular DTL or TTL logic. With the addition of current metering resistors, each μDAC becomes a 4 bit D/A converter. Three such μDAC's may be interconnected by means of simple 16:1 attenuator networks to form a 12 bit converter.

Complementary precision thin-film resistor networks, also available from Analog Devices, include precise metering resistors, reference resistor, gain setting resistor and the 16:1 attenuators. These resistor networks are packaged in

hermetic DIP or flatpacks identical to μDAC packages and reduce construction of 12 bit converters to the simplest possible assembly techniques. μDAC switches and resistors will also be available soon in plastic DIP's for low cost industrial applications.

The μDAC components can be readily assembled on your own PC card to build D/A and A/D converters. No trimming or adjustments are required to obtain up to 12 bit linearity and accuracy. Alternatively you can buy assembled and tested converters using μDAC components directly from Analog Devices.

Send for a free new 20 page applications manual giving specifications and theory of operation. The booklet also describes actual circuits and parts lists for implementing D/A's and A/D's using μDAC components. Write Analog Devices, Inc., 221 Fifth Street, Cambridge, Massachusetts 02142 or call Dick Ferrero collect on our HOT LINE - (617) 969-3661.



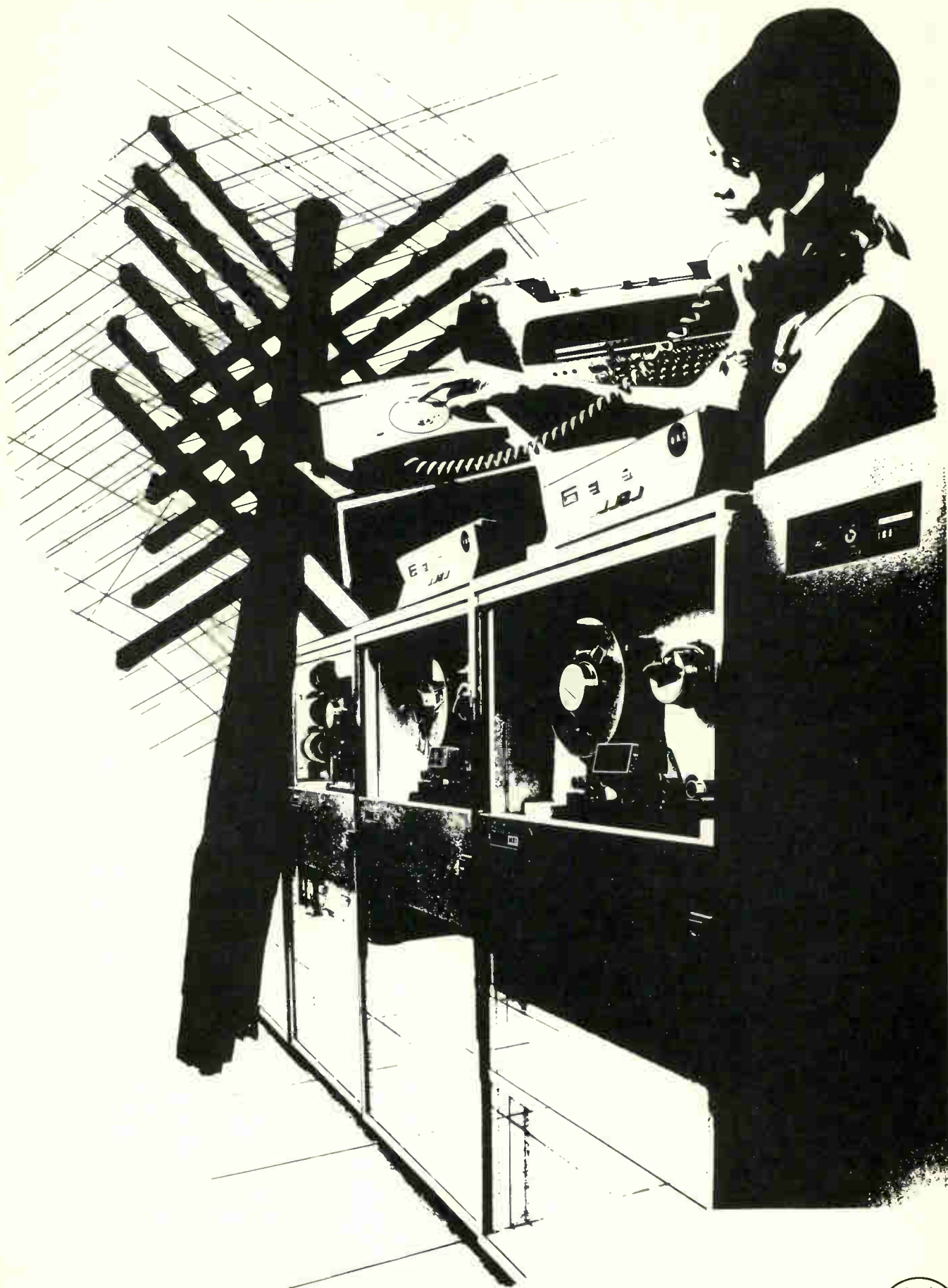

- where the priceless ingredient is care!



The Sweet Heart Of The MODEM System

One call does it all

Dial Motorola for complete data about the industry's most complete line of "Dial-for-Data" MODEM circuits. There's an IC for every stage; and they're all available at cost-saving system prices.

RS-232C Line Drivers and Receivers . . . the first and only monolithic quads in the industry to meet this stringent EIA spec. They're designated MC1488L and MC1489L.

More importantly, because there's four in one package, you get more board space, lower package count. And, they're directly compatible with MDTL and MTTL logic circuits. Both types are available right now in the 14-pin dual in-line ceramic package.

Op Amps for Active Filters . . . to select specific audio tones from telephone lines. A dual op amp is the ideal element; and, your ideal choice would be the MC1437L (a dual MC1709C) or the brand new MC1458G (a dual MC1741C). The latter is internally compensated for frequency response. Both devices cost considerably less than two single-package op amps and compare favorably with mechanical resonators or reed systems . . . and, of course, are much more reliable!

Tone Generators . . . The MC1550G is a high-frequency differential amplifier that makes an ideal, ultra-stable oscillator with built-in bias circuitry at little more than the cost of a transistor.

Digital Logic . . . MDTL or MTTL can be used to control the frequency-shift keyer and to perform other MODEM logic functions. Motorola offers a complete line in both families.

There's a Motorola IC for every MODEM stage; and, they're all available "off-the-shelf" . . . at cost-saving system prices:

Type	Function	Price (100-up)
MC1488L	Quad RS-232C Line Driver	\$7.00
MC1489L	Quad RS-232C Line Receiver	\$6.00
MC1437L	Dual (MC1709-type) Op Amp	\$3.25
MC1458G	Dual (MC1741-type) Op Amp	\$4.00
MC1445G/L	Dual-input F.S.K. Switch	\$3.95
MC1550G	Differential Amplifier	75¢

If you're interested in complete data about integrated circuits for the complete MODEM system, simply Dial-for-Data . . . (602) 962-3161. Or write: P.O. Box 20912, Phoenix, Arizona 85036.

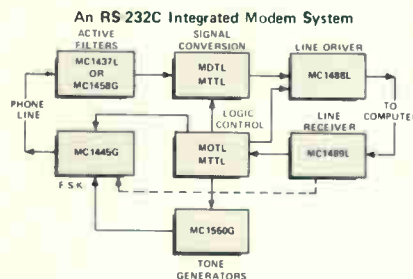

Frequency-Shift Keyer . . . The MC1445G is a dual-input, logic-controlled video switch that can connect either of two tone generators to an output line. It also has a low-impedance emitter-follower output stage.

MDTL, MTTL trademark of Motorola Inc.

Memory Bank.

The information contained in these volumes has taken man thousands of years to develop and compile. And every day more is being added. The storage capacity of this memory system is theoretically unlimited. But what about its access time?

When the ability to retrieve must be measured in nanoseconds, that's where we come in. Memory systems are an important part of our business. And our leadership in this field is measurable through our combined technical knowledge, our production experience—and our reputation for product quality.

Two fast examples:

The cycle time of our Nanomemory® 2600 is 600 ns. Access time is 300 ns. Capacity from 16K words by 18 bits to 8K words by 36 bits. (As usual, K is 1024). Our Nanomemory 3650 has a full cycle time of 650 ns and an access time of 350 ns with capacity of 16K, 32K, 64K and 128K words by 8 to 76 bits.

To evaluate these and other examples of our systems line, you should also know more about such unique features as the field replacement benefits that result from plug-in stacks. And you'll want to be briefed on the low

power and low component-count requirement of our advanced system design concepts.

Or you may want to talk with us about standardized or customized cores for your own systems.

Or stacks for virtually any digital storage application.

The history of EM's experience in memory systems is massive. And you don't need a library card to check it out. Just call or write.

And watch our response time.



Electronic Memories. Worth remembering.

A new commercial version of our MINIATURE ROTARY "E" SWITCH at a MUCH LOWER PRICE



U. S. Pat. #3352979

Single deck 1 pole-24 position
to 3 pole-8 position MBB or BBM

as low as
\$196
each
in quantities of 1,000

For ordering purposes designate series "EC"

DELIVERY FROM STOCK

Completely automated facilities and mass production tooling now makes RCL highly competitive in commercial applications with "obsolete" wafer-type open frame switches!

Equivalent performance at much lower prices than "instrument type" switches.

- The smallest enclosed MINIATURE ROTARY SWITCH available with up to 24 positions shorting or non-shorting on each deck.
- Up to 12 poles per deck.
- As many as 9 decks may be specified.
- Life expectancy - 200,000 mechanical operations.
- Solder terminals will accept two .032 diam. (AWG #20) wires.

Write for complete technical information

RCL

RCL ELECTRONICS, Inc.
700 South 21st Street,
Irvington, New Jersey 07111

Who's Who in electronics

Herman Melville would surely drop his quill on reading the biography of Carl O. Holmquist. The story of the rear admiral who now serves as Chief of Naval Research scarcely fits the mold of a Yankee lad sitting on the ocean's edge pinning for a ship to sail the seas. In fact, the largest body of water young Carl Holmquist saw probably was the Great Salt Lake in his home state of Utah. And the 50-year-old admiral first applied for an appointment to the U.S. Military Academy at West Point.

But at this point, Holmquist clearly has no regrets. He learned to fly. And his enthusiasm proved contagious—two of his four children are Naval Academy midshipmen bent on becoming pilots. "I was very careful to avoid suggesting they go to Annapolis," the Admiral contends with a smile and a wink, "but my youngest is dying to get in." He is 14.

Natural. His assumption of the top Navy research assignment is clearly to his liking as well. It fits his background as a Ph.D., a degree he earned in aeronautics from Cal Tech. Furthermore, it's a logical step up from prior assignments as deputy chief for research, project officer for the new F-14 fleet defense fighter, and executive director for research and technology at the Naval Air Systems Command—three jobs he has held since coming to Washington three years ago.

Holmquist's present command includes what some regard as the most prestigious research operation of any of the military services. Characteristic of ONR's effort to advance the state of electronics technology is its current goal of developing a computer that can sense its surroundings and respond intelligently to spoken commands. Directed by Charles Hendrix at Telluron in Santa Monica, Calif., under an ONR contract, the computer design is patterned on the living nervous system's cells or neurons. Using artificial neurons (or "neuromimes," as ONR calls them), a network of 16 of the circuits is trained by modifying its responses through "punishment" or "reward" signals.



Holmquist

Probably due to his academic background, and because his career has revolved around R&D since 1953, Holmquist places great emphasis on the need for basic research in maintaining the balance of power. He worries out loud about the whipsaw effect of budget cuts and inflation on ONR's programs. He personally thinks that ONR's \$120 million research budget—virtually all of which goes toward basic research, much of it in electronics—should be dramatically increased.

Many military traditions have gone by the boards during the war in Vietnam, so no one around Long Binh, headquarters for the 20,000-man First Signal Brigade, was particularly surprised when the brigade's commanding general and his immediate boss switched jobs.

Moving into the top communications-electronics job out where they're fighting is Maj. Gen. Hugh F. Foster Jr. Leaving the brigade after 22 months in the combat zone is Maj. Gen. Thomas M. Rienzi, who takes over—from Foster—as commanding general of Stratcom-Pac, Signal Corps compression of "Strategic Communications Command—Pacific."

Since the brigade turns up on

What to do about your voltage calibration problems:
 Tell your Fluke Engineer to hurry on out with
 his two new Kelvin-Varley Dividers, new Fluke
 Lead Compensator, and new Fluke Reference Divider.
 Use the Fluke traceable calibration.



Four new pieces of gear are now ready to help you solve voltage calibration problems with little fuss and no muss.

Basic unit is the Model 750A Reference Divider which can be used with either the seven dial Model 720A Kelvin-Varley Voltage Divider or the six dial Model 725A. The Model 721A Lead Compensator is a vital accessory for the precise comparison of voltage dividers.

Model 750A Reference Divider. The Model 750A is an adjustable resistive divider with a ratio accuracy of $\pm 0.001\%$ of output ± 5 volts for one year. Because its accuracy is related to saturated standard cells, the output is considered traceable to the National Bureau of Standards. Calibration can be maintained at better than ± 5 ppm of output. Price: \$1,195.

Model 720A Kelvin-Varley Divider. The Model 720A incorporates an internal Wheatstone bridge and adjustable resistors on the first three decades, making it a "self-calibrating" ratio standard with ± 0.1 ppm absolute linearity. Price: \$1,495.

Model 725A Kelvin-Varley Voltage Divider. A low cost high accuracy 1100 volt divider, the 725A offers four times the linearity of competitively priced models. It essentially has a "zero" power coefficient derating spec. Price: \$390.

Model 721A Lead Compensator. Lead compensation, where ratios between standard and test divider are as great as 4000:1, is possible with the Model 721A. Mode selection for electrically interchanging standard and test divider, as well as voltage ON-OFF for operator protection, is provided. Price: \$295.

Fluke, Box 7428, Seattle, Washington 98133.
 Phone: (206) 774-2211. TWX: 910-449-2850.

In Europe, address Fluke Nederland (N.V.), P. O. Box 5053,
 Tilburg, Holland. Phone: (04250) 70130. Telex: 844-50237.
 In the U.K., address Fluke International Corp., Garnett Close,
 Watford, WD2 4TT. Phone: Watford 27769. Telex: 934583.



Who in electronics

the
a unit
com-Pac,
had suffer
but that's no
and Stratcom-
star Signal Corp
Phone comp
ter's new unit und
cial part electronics
no-front war that's
Vietnam. The First Sig
simply is the Army's la
gade ever. Along with
tactical communications fo
troops tangling with the Viet U
in the jungles or hitting them fro
the air, the brigade runs a nation
wide telecommunications network
that's tied to the U.S. both by radio
and by cable. "We handle a million
phone calls a day and 100,000
messages," says Rienzi, who, until
he headed for Hawaii and Strat-
com-Pac, ranged Vietnam in a heli-
copter.

Foster's big job, as far as the
backbone telecommunications net-
work goes, will be to get a good
part of it turned over to Vietnamese
Army operators and repairmen.
Under the Vietnamization program,
there's an ambitious project to
train enough ARVN (Army of the
Republic of Vietnam) personnel to
run and maintain the system by the
end of 1972. Already, ARVN signal-
ers are working alongside Ameri-
can troopers at a few mountaintop
relay sites. In one of Rienzi's pet
projects, U.S. and ARVN signal
units are paired off under a buddy
system to speed on-the-job training
for the Vietnamese.

Rienzi has seen startling ad-
vances in battlefield hardware.
First, there's digital transmission—
the Autodin network, for example
—and, equally important, digital se-
cure-voice gear for tactical talking.

Next on Rienzi's list is a new
target-acquisition gear and particu-
larly night-vision equipment. One
of Rienzi's last previous Vietnam
assignments, in fact, was as pro-
gram manager for the Army's effort
in surveillance and target-acquisi-
tion hardware. The list is rounded
out by small radars like the PS-4
and PS-5 and the generation of
light avionics gear spawned by the
Army's helicopter war in Vietnam.



no lower
price.
no higher
performance.
anywhere.

Texscan's LA Series Rotary Attenuators.

KEY SPECIFICATIONS

ATTENUATION: Model LA-50, 0 to 10db in 1db steps; Model LA-51, 0 to 70db in 10db steps; Model LA-53, 0 to 1.0db in 0.1db steps; Model LA-54, 0 to 60db in 1db steps

FREQUENCY RANGE: DC-500 MHz

ACCURACY: LA-50, ± 0.3 db; LA-51, ± 0.5 db; LA-53, ± 0.05 db; LA-54, ± 0.5 db

DELIVERY: From Stock for Quantities of 10 or less

PRICES: Models LA-50, 51 and 53 — \$60.00, \$67.50 and \$65.00
Model LA-54 — \$120.00

All four models offer a variety of attenuation steps, connector options. Choice of 50 or 75 ohm impedance. Circle the reader service number below for descriptive literature containing complete technical details.



Texscan CORPORATION

2448 NORTH SHADELAND AVENUE
INDIANAPOLIS, INDIANA 46219
Phone: 317-357-8791 TWX: 810-241-3184

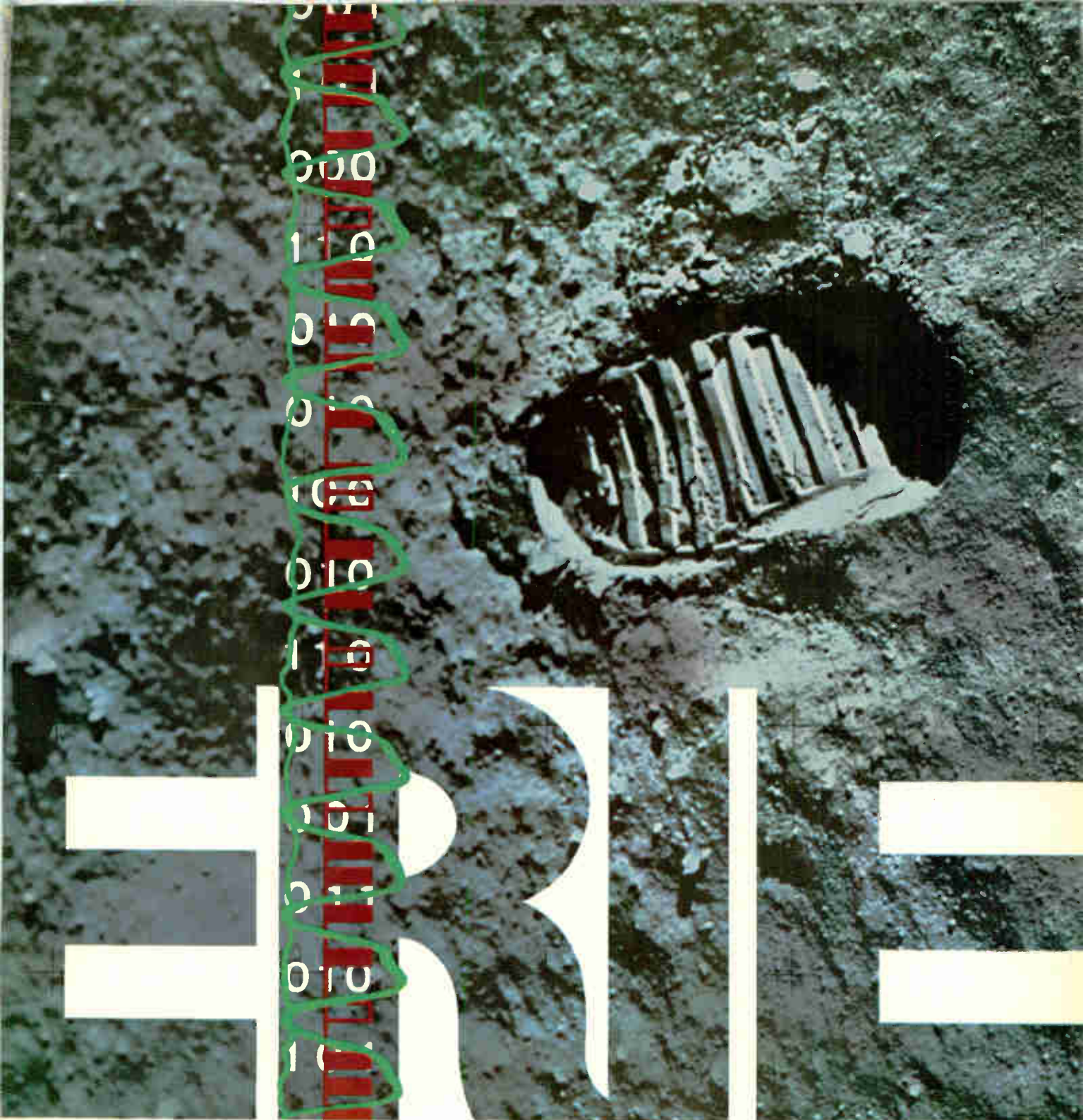

When you can't afford a "wrong number"...

Symbolic representation of the TV, voice, ranging data and biomedical telemetry signals from the moon. Photograph courtesy of NASA.

bring ERIE in early.

Where are they? How are they? What do they see... and say? NASA and the world want to know. And, the only way to find out is over the special Motorola S-band equipment on both the Command and Lunar Modules. Once the Apollo Astronauts are over 30,000 miles out, it's their *only* communications link with Earth. It simply can't fail. That's why Motorola called on ERIE TECHNOLOGICAL to develop the EMI filters and Monobloc capacitors that would help this equipment perform flawlessly on every Apollo mission since Motorola has been involved. Proof, once again, that it pays to bring ERIE in early.

ERIE TECHNOLOGICAL PRODUCTS, INC.
644 West 12th Street, Erie, Pennsylvania 16512
(814) 453-5611



General Electric helps you solve the tough ones

GE has the broadest line of electronic components in the industry. From the tiniest integrated circuits to powerful high performance motors, GE components help you solve your tough problems . . . in design, in performance, in economy. Take a look at these GE problem solvers.

p.s.1 New GE computer-grade capacitor offers 50% greater ripple current capability. GE's new 92F provides 30 to 50% lower ESR for better frequency capability. High efficiency permits reduction in size and weight over conventional units.

This newly-developed GE capacitor has a life expectancy of up to 3000 hours at 85C. Temperature capability up to 120C gives increased reliability or eliminates derating or additional cooling. Get complete specifications on this new GE capacitor. Circle 316

p.s.2 Replace 200 different SCR's with GE's versatile C103. This rugged epoxy encapsulated low-current SCR comes in the TO-18 plastic package and is ideal for tough military and industrial uses as well as many consumer applications.

The C103 is available in peak reverse voltage ratings from 30 to 200 volts. It combines an extremely sensitive gate (200 μ A) with a high surge capability (8 amp) and a low forward blocking current (1 μ A). Get full details. Circle 317

p.s.3 GE Sintered Alnico magnets give you high energy products with superior temperature stability and physical characteristics. And only GE can provide a complete line of Sintered Alnico materials.

Sintered Alnico has its greatest advantage in applications where mechanical work is required in small complex shapes. GE materials offer up to 12000 gauss induction and 1550 oersted coercive forces. For complete data or application help, circle 318

p.s.4 New Hi-TECH ceramic metal components . . . custom-designed problem solvers. GE's Hi-TECH line offers a variety of alumina, forsterite and other special ceramic materials . . . sealed to virtually any metal . . . and custom-engineered to meet your toughest operational requirements.

Use in severe environments, for example, to withstand ultra-high tempera-

tures and hyperactive chemicals. Ideal for vacuum or gas-filled devices, electrical equipment or machine parts. Find out how GE can custom design the ceramic component you need. Circle 319

p.s.5 Get long-life portable power with rechargeable GE nickel-cadmium batteries. Nominal ratings range from 0.1 amp-hours to 4.0 amp-hours in sealed cells and up to 160 amp-hours in vented types at the one-hour rate. And GE batteries are rechargeable for longer operating life.

Get details on how to put longer battery life into your application. Circle 320 for complete information.

p.s.6 Get more magnetic performance per size and weight with GE cast Alnico 5-7 and 9 permanent magnets. GE's columnar grain cast Alnico 5-7 provides high inductions at 7.5 million energy products. Cast Alnico 9 couples high coercive forces with 9 million energy capabilities.

Complete directionality of grain growth permits design freedoms which were impractical before. Check with GE's application experts. Or for complete details, circle 321



with the broadest line of electronic components

p.s.7 Select your indicating instruments from industry's most complete line. For measurement and control of electrical quantities, get GE Panel Meters and Meter Relays in the popular BIG LOOK® and HORIZON LINE® styles. 1½" edgewise instruments are ideal for compact display problems.

And the new BIG LOOK Frequency Meters in three ranges . . . 45-55Hz, 55-65Hz and 380-420Hz . . . are now available for engine generator sets, panel boards and inverters. For complete catalog, circle 322

p.s.8 New complementary power transistors are color coded for easy identification. GE's 4-amp NPN/PNP power transistors (D44C/D45C) are molded in plastic packages to provide tough pellet protection in the most demanding applications. Three round leads fit the standard JEDEC TO-66 configuration.

These color-molded transistors feature low collector saturation voltage, excellent gain linearity and fast switching. Apply them in countless industrial and consumer circuits. For details, circle number 323

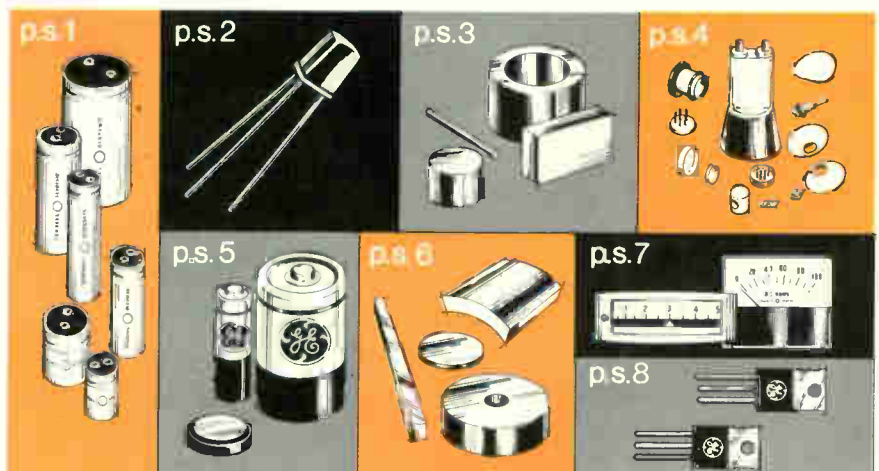

Let General Electric help solve your component problems. Call your nearest Electronic Components Sales Operation Office. Or check with one of the many authorized GE distributors. P.S. Problems? General Electric has solutions. 285-65

GENERAL  **ELECTRIC**

Fight noise pollution



with this quiet family.

Hot Molding with Allen-Bradley's exclusive technique, gives these composition variable resistors an unusually low noise level. And importantly, this low noise level actually decreases in use. Under tremendous heat and pressure the resistance track is molded into place. A solid element with a large cross-section is produced.

This important Allen-Bradley difference means better short-time overload capacity and a long operating life. Control is smooth, resolution almost infinite. These variable resistors are ideal for high frequency circuits. Why should you trust the performance of

your designs or your reputation to anything less than Allen-Bradley quality? Use the most thoroughly "field tested" (over 20 years) variable resistors available today. Quantity stocks of popular types J, G, W and GD available for immediate delivery from your appointed A-B industrial electronics distributor.

For information write: Marketing Department, Electronics Division, Allen-Bradley Co., 1201 South Second Street, Milwaukee, Wisconsin 53204. Export office: 1293 Broad Street, Bloomfield, N. J. 07003, U.S.A. In Canada: Allen-Bradley, Canada Ltd., 135 Dundas Street, Galt, Ontario.

SPECIFICATIONS

	TYPE J— STYLE RV4	TYPE K	TYPE G— STYLE RV6	TYPE L	TYPE W	TYPE GD
CASE DIMENSIONS	5/8" deep x 1-5/32" dia. (single section)	5/8" deep x 1-5/32" dia. (single section)	15/32" deep x 1/2" dia.	15/32" deep x 1/2" dia.	15/32" deep x 1/2" dia.	35/64" deep x 1/2" dia.
POWER at + 70°C	2.25 W	3 W	0.5 W	0.8 W	0.5 W	0.5 W
TEMPERATURE RANGE	-55°C to +120°C	-55°C to +150°C	-55°C to +120°C	-55°C to +150°C	-55°C to +120°C	-55°C to +120°C
RESISTANCE RANGE (Tolerances: ±10 and 20%)	50 ohms to 5.0 megs	50 ohms to 5.0 megs	100 ohms to 5.0 megs	100 ohms to 5.0 megs	100 ohms to 5.0 megs	100 ohms to 5.0 megs
TAPERS	Linear (U), Modified Linear (S), Clockwise Modified Log (A), Counter-Clockwise Modified Log (B), Clockwise Exact Log (DB). (Special tapers available from factory)					
FEATURES (Many electrical and mechanical options available from factory)	Single, dual, and triple versions available. Long rotational life. Ideal for attenuator applications. Snap switches can be attached to single and dual.	Single, dual, and triple versions available. Long rotational life.	Miniature size. Immersion-proof. SPST switch can be attached.	Miniature size. Immersion-proof.	Commercial version of type G. Immersion-proof.	DUAL section version of type G. Ideal for attenuator applications. Immersion-proof.

ALLEN-BRADLEY

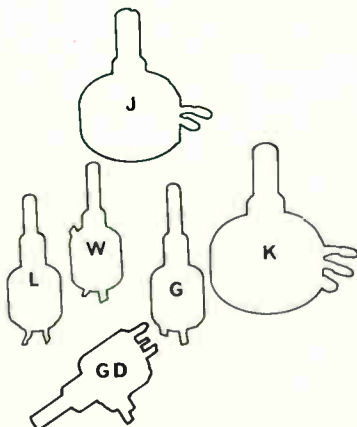

COLLISION AVOIDANCE SYSTEMS

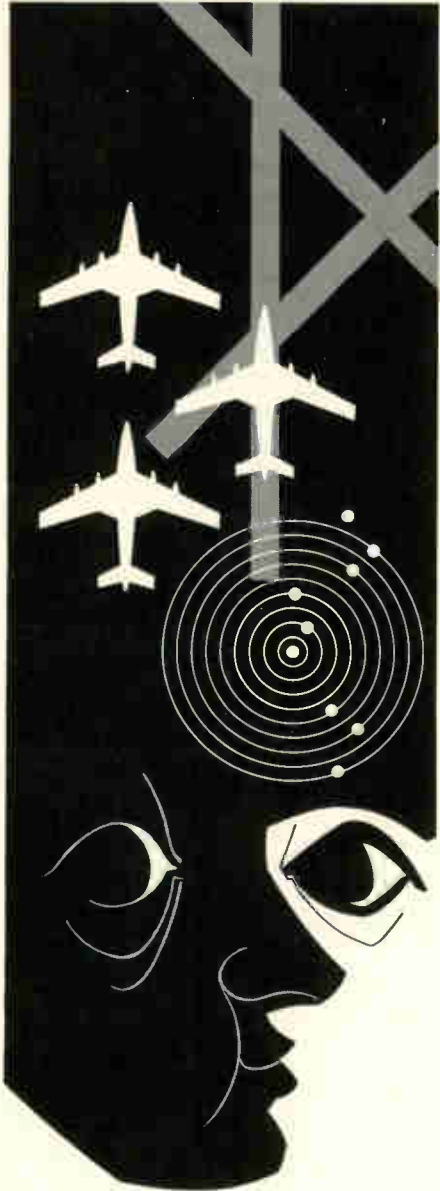

TOTAL ELECTRONIC
SYSTEMS CAPABILITY.
SPECIALISTS IN
TIME/FREQUENCY,
RADAR AND
DATA SYSTEMS
OFFERING RAPID
GROWTH.



P.O. BOX 222, BUFFALO, N.Y. 14225

Meetings

Hard road for circuit designers

With military users increasingly demanding radiation-resistant systems, the task of hardening devices falls mainly to circuit designers. Thus is the July 21-23 IEEE-sponsored Conference on Nuclear and Space Radiation Effects at the University of California at San Diego aimed especially at device and materials physicists, and at engineers involved in circuit analysis.

Of the eight technical sessions and one symposium included in the program, three merit special attention—two because they're new to the traditional program and the third, called "Circuit Analysis and Design: How to Radiation-Harden Circuits," because it's a fundamental approach.

The two new sessions treat "Radiation Effects and Quality Assurance" and "Electromagnetic Pulse—Effects and Modeling." For the quality-assurance session, A.M. Briepohl of Oklahoma State University will deliver the invited

paper, on "Prediction of Post-Irradiation Reliability."

W.J. Karzas of the Rand Corp. has been chosen to give the invited paper on electromagnetic pulses. His topic is "EMP: Approaches to Understanding Systems Effects." The invited paper for the session on circuit analysis and design is the work of R.A. Poll, manager of the Military Systems division of Systems, Science and Software, who will discuss "Approaches to Systems Hardening."

Other sessions are devoted to such topics as displacement effects in materials, charge buildup and surface effects, ionization and displacement effects on devices, and dosimetry and energy deposition. The symposium portion of the conference will consider the future of nuclear power and inertial guidance systems.

For further information contact R.A. Poll, Systems, Science and Software, Box 1620, La Jolla, Calif. 92037.

Calendar

Summer Power Meeting and EHV Conference, IEEE; Biltmore Hotel, Los Angeles, July 12-17.

Conference on Dielectric Materials, Measurements and Applications, IEEE; University of Lancaster, London, July 20-24.

Reliability and Maintainability Conference, Society of Automotive Engineers, the American Society of Mechanical Engineers, and the American Institute of Aeronautics and Astronautics; Sheraton-Cadillac Hotel, Detroit, July 20-22.

Conference on Nuclear and Space Radiation Effects, IEEE; University of California at San Diego, July 21-23.

International Conference and Exhibition on Water Pollution Research, IEEE; San Francisco, July 19-21; Honolulu, Aug. 2-5.

Photovoltaic Specialists Conference, IEEE; Seattle Center, Washington, Aug. 11-13.

International Conference on Microelectronics, Circuits, and Systems Theory, IEEE; University of New South Wales, Kensington, Sydney, Australia, Aug. 18-21.

AFMA National Conference, Armed Forces Management Association; International Hotel, Los Angeles, Aug. 20-21.

Radiation Effects in Semiconductors, Air Force Cambridge Research Labs; State University of New York at Albany, Aug. 24-26.

Western Electronic Show and Convention (WESCON), IEEE; Biltmore Hotel, Sports Arena, Los Angeles, Aug. 25-28.

Preparation and Properties of Electronic and Magnetic Materials for Computers, The Metallurgical Society, Statler-Hilton Hotel, New York, Aug. 30-Sept. 2.

Application of Computers to the Problem of Urban Society, Association for Computing Machinery; New York Hilton Hotel, Aug. 31.

(Continued on p. 24)

Diode Arrays

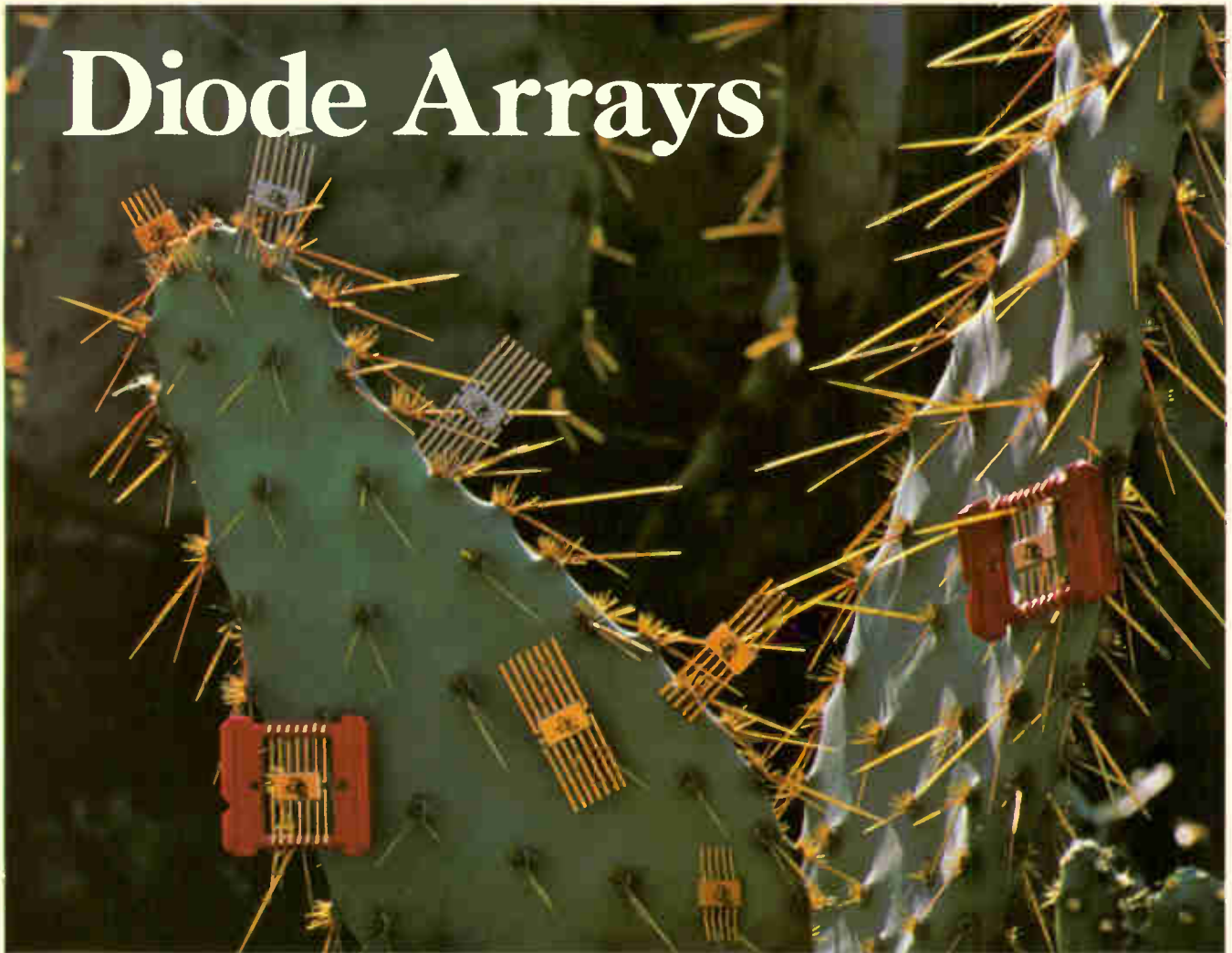

Prickly problem solvers

Solve thorny computer memory problems with diode arrays from TI.

Unbeatable core-drivers, they assemble quickly and cut P-C board space requirements up to 65%! Save time, trouble and costs. And they're smaller, lighter, more reliable, too.

Performance? They're real sticklers for fast recovery, low capacitance, and high forward conductance. With closely matched electrical characteristics through a broad temperature range.

Try them. They're available fast: Through TI distributor and factory stocks. In arrays of 8, 16 and 20 diodes. Common cathode or anode connections. In flat packs with 10 or 14 leads.

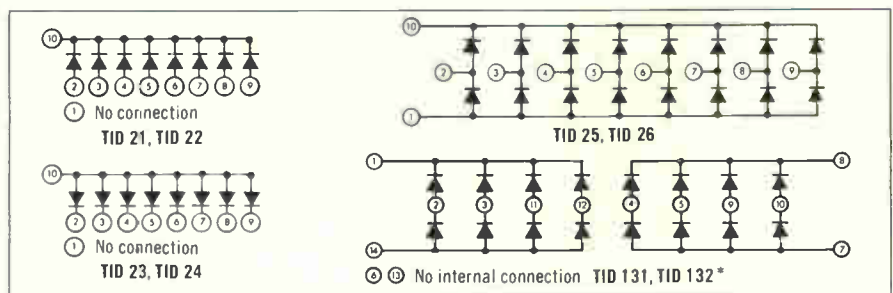

These arrays are part of TI's preferred semiconductor line, selected to save you time and money in specifying discrete components.

If one of these doesn't fill your specific needs, TI makes custom arrays of 2 to 20 diodes in flat packs, 10-lead TO-5 metal-can, and plastic dual-in-line packages.

Write for TI's brand new data sheet covering our complete line of flat pack and dual-in-line plastic diode arrays. Texas Instruments, Incorporated, P. O. Box 5012, MS 308, Dallas, Texas 75222. Or just circle reader service number 122.

*Will become a preferred product in 1971.



TEXAS INSTRUMENTS
INCORPORATED

Meetings

(Continued from p. 22)

Association for Computing Machinery Conference, New York Hilton Hotel, Sept. 1-3.

International Electrical and Electronics Engineering Conference, Korean Institute of Electrical Engineers, Korea Institute of Electronics Engineers, Korea Institute of Science and Technology, IEEE; Korea Institute of Science and Technology, Seoul, Sept. 2-4.

Conference on Microwave and Optical Generation & Amplification, IEEE; Amsterdam, the Netherlands, Sept. 7-11.

International Broadcasting Convention, IEEE; Grosvenor House, Park Lane, London, Sept. 7-11.

Petroleum & Chemical Industry Technical Conference, IEEE; Camelot Inn, Tulsa, Okla., Sept. 14-16.

Annual Technical Symposium, Society of Photo-optical Instrumentation Engineers; Anaheim Convention Center, Calif., Sept. 14-17.

International IEEE/G-AP Symposium and Fall USNC/URSI Meeting, Ohio State University, Columbus, Sept. 14-17.

Conference on Gas Discharges, IEEE; London, Sept. 15-18.

Intersociety Energy Conversion Engineering Conference, IEEE; Frontier Hotel, Las Vegas, Sept. 20-25.

Conference on Engineering in the Ocean Environment, IEEE; City Marina Auditorium, Panama City, Fla., Sept. 21-24.

Conference on Electron Device Techniques, IEEE; United Engineering Center Auditorium, New York, Sept. 23-24.

Fall Broadcast Technical Symposium, IEEE, Washington Hilton, Sept. 23-26.

Joint Power Generation Technical Conference, IEEE; Pittsburgh Hilton Hotel, Sept. 27-30.

Conference on Underground Distribution, IEEE; Hotel Pontchartrain and Cobo Hall, Detroit, Sept. 27-30.

Conference on Trunk Telecommunications by Guided Waves, IEEE; Savoy Place, London, W.C. 2, Sept. 29-Oct. 2.

Mervin J. Kelly Communications Conference, University of Missouri and IEEE; Rolla, Missouri, Oct. 5-7.

(Continued on p. 26)

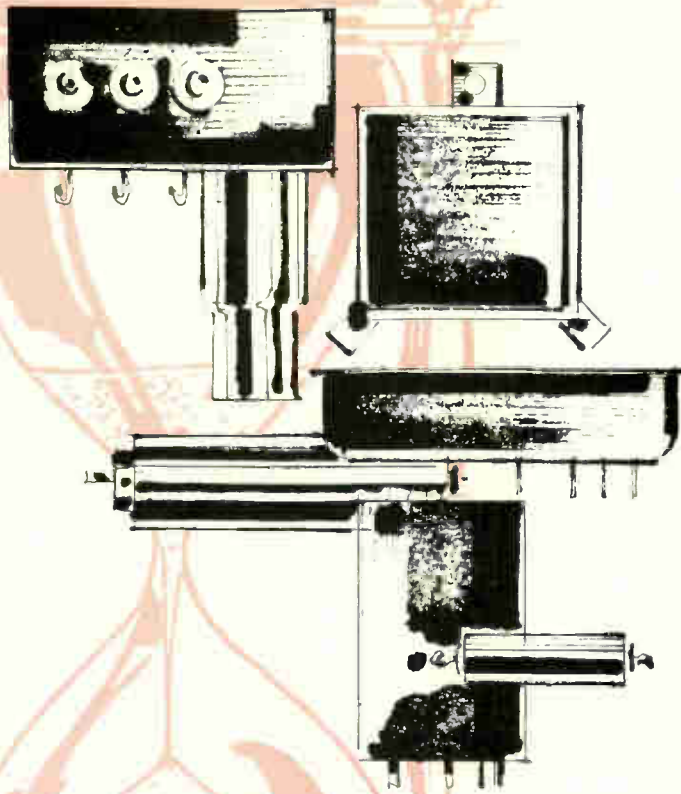

When
time
is filtering
out...

Captor is quicker

Customers tell us our shipments of standard RFI/EMC filters are the fastest in the industry. Captor responds quickly on custom designs, too, with prompt attention given to problem-solving prototypes. One reason for Captor's time saving capability is a new environmentally controlled plant built expressly for the production of such electronic components as miniature EMC filters, communications and security filters, and custom designed filters and assemblies. One section handles large orders numbering into thousands of units; a separate section provides fast action on prototypes and short runs. Beat the clock . . . write for our capabilities brochure today!

 **CAPTOR**
CORPORATION
Electronics Division

5040 Dixie Highway, Tipp City, Ohio 45371, Phone: (513) 667-8484



Winchester Electronics

— their obsession with precision is solving tomorrow's problems today.

Problems—like connectors requiring post true positioning to within a mere .020 of an inch—won't stump Winchester Electronics. They've been making AccurFrame® as close to perfection as modern wire terminating machines demand.

And this fact proves the point: Of the various types of wire terminating connectors, only the HW Series by Winchester Electronics, positioned in AccurFrame,

consistently meets the contact true position tolerances required by automatic wire terminating machines.

Now, if that doesn't say something for Winchester Electronics' AccurFrame, perhaps you have a connector requirement that does. Want to take us up on it? Write or call Winchester Electronics, Main Street and Hillside Avenue, Oakville, Conn. 06779.



**WINCHESTER
ELECTRONICS**

DIVISION OF LITTON INDUSTRIES



Get your FREE power transistors from your authorized GE semiconductor distributor

<p>ALABAMA</p> <p>Birmingham Forbes Distributing Co. (205) 251-4104</p> <p>Huntsville Cramer/Huntsville, Inc. (205) 536-4493 Electronic Wholesalers, Inc. (205) 534-2461</p> <p>ARIZONA</p> <p>Phoenix Hamilton Electro of Arizona (602) 272-2601 Kierulff Electronics, Inc. (602) 273-7331</p> <p>ARKANSAS</p> <p>Little Rock Carlton-Bates Co. (501) 375-5375</p> <p>CALIFORNIA</p> <p>Culver City Hamilton Electro Sales (213) 870-3301</p> <p>El Monte G. S. Marshall Company (203) 886-0141</p> <p>Los Angeles Kierulff Electronics, Inc. (213) 685-5511</p> <p>Mountain View Elmar Electronics (415) 961-3611 Hamilton Electro Sales (415) 961-7000</p> <p>Oakland Grill Electronics (415) 834-5888</p> <p>Palo Alto Kierulff Electronics, Inc. (415) 968-6292</p> <p>Riverside Electronic Supply (213) 683-8110</p> <p>San Diego Hamilton Electro Sales (714) 279-2421 Kierulff Electronics, Inc. (714) 278-2112 G. S. Marshall Company (714) 278-6350 Western Radio & TV Supply (714) 239-0361</p> <p>COLORADO</p> <p>Denver Electronic Parts Co. (303) 286-3755 Hamilton Electro Sales (303) 443-9551 L. B. Walker Radio Co. (303) 935-2401</p> <p>CONNECTICUT</p> <p>North Haven Cramer/Connecticut (203) 239-5641</p> <p>Norwalk Arrow Electronics (203) 838-4851</p> <p>Waterbury Bond Radio Electronics, Inc. (203) 753-1184</p> <p>DELAWARE</p> <p>Wilmington Almo Industrial Electronics (302) 656-9467</p> <p>FLORIDA</p> <p> Ft. Lauderdale Cramer/Florida (305) 566-7511</p> <p>Wetlywood Schweber Electronics (305) 927-0511</p> <p>Miami Electronic Wholesalers, Inc. (305) 696-1620</p> <p>Orlando Electronic Wholesalers, Inc. (305) 841-1550 Hammond Electronics (305) 241-6601</p> <p>GEORGIA</p> <p>Atlanta Jackson Electronics Co. (404) 355-2223</p> <p>ILLINOIS</p> <p> Addison Hamilton Electro Sales (312) 543-8500</p> <p>Chicago Electronic Distributors, Inc. (312) 283-4800 Newark Electronics Corp. (312) 638-4411 Semiconductor Specialists, Inc. (312) 279-1000</p> <p>INDIANA</p> <p>Evansville Ohio Valley Sound (812) 425-6173</p> <p>Indianapolis Graham Electronics, Inc. (317) 634-8486 Semiconductor Specialists, Inc. (317) 243-8271</p> <p>IOWA</p> <p>Cedar Rapids Deeco, Inc. (319) 365-7551</p> <p>KANSAS</p> <p>Wichita Interstate Electronics Supply Corp. (316) 264-5318</p> <p>KENTUCKY</p> <p>Louisville P. I. Burks Co. (502) 583-2871</p> <p>LOUISIANA</p> <p>Lafayette Ralph's of Lafayette (318) 234-4507</p> <p>New Orleans EPCOR (504) 486-7441 Sterling Electronics, Inc. (504) 522-8726</p> <p>MAINE</p> <p>Portland Holmes Distributors, Inc. (207) 774-5901</p>	<p>MARYLAND</p> <p>Baltimore Kann-Eliert Electronics, Inc. (301) 889-4242</p> <p>Hanover Hamilton Electro Sales (301) 796-5000</p> <p>Rockville Cramer/Washington, Inc. (301) 424-2700 Schweber Electronics (301) 427-4977</p> <p>Saltisbury Almo Industrial Electronics (301) 742-1393</p> <p>MASSACHUSETTS</p> <p>Dedham Gerber Electronics (617) 329-2400</p> <p>Newton Cramer Electronics, Inc. (617) 969-7700</p> <p>Springfield T. F. Cushing, Inc. (413) 788-7341</p> <p>Waltham Schweber Electronics (617) 891-8484</p> <p>MICHIGAN</p> <p>Detroit Radio Specialties Co. (313) 491-1012</p> <p>Grand Rapids Newark-Industrial Electronics (616) 452-1411</p> <p>Rochester Semiconductor Specialists, Inc. (313) 255-0300</p> <p>MINNESOTA</p> <p>Edina Lew Bonn Company (612) 941-2770</p> <p>Minneapolis Semiconductor Specialists, Inc. (612) 866-3434</p> <p>St. Paul Gopher Electronics Co. (612) 645-0241</p> <p>MISSISSIPPI</p> <p>Jackson Ellington Electronic Supply, Inc. (601) 355-0561</p> <p>MISSOURI</p> <p>Kansas City Radio Lab, Inc. (816) 421-0171</p> <p>North Kansas City ECI Semiconductors Inc. (816) 421-8400</p> <p>University City Olive Industrial Electronics (314) 863-4051</p> <p>NEBRASKA</p> <p>Lincoln Scott Electronic Supply Corp. (402) 434-8308</p> <p>Omaha Radio Equipment Co. (402) 341-7700</p> <p>NEW JERSEY</p> <p>Camden General Radio Supply Co., Inc. (609) 964-8560</p> <p>Cedar Grove Hamilton Electro Sales (201) 239-0800</p> <p>Mt. Ephraim Hamilton Electro Sales (609) 862-9337</p> <p>Almo Industrial Electronics (609) 933-3800</p> <p>Pennsauken Cramer/Pennsylvania, Inc. (215) 923-5950</p> <p>Totowa Arrow Electronics, Inc. (201) 256-7331</p> <p>NEW MEXICO</p> <p>Albuquerque Kierulff Electronics, Inc. (505) 268-3901 Sterling Electronics, Inc. (505) 247-2486</p> <p>NEW YORK</p> <p>Buffalo Standard Electronics, Inc. (716) 685-4330</p> <p>Endicott Standard Electronics, Inc. (607) 754-3102</p> <p>Farmingdale, L. I. Arrow Electronics, Inc. (516) 694-6800</p> <p>Hempstead Cramer/Long Island (516) 231-5600</p> <p>Rochester Cramer/Rochester (716) 275-0300 Rochester Radio Supply Co. (716) 454-7800</p> <p>Rome Rome Electronics, Inc. (315) 337-5400</p> <p>Syracuse Cramer/Syracuse (315) 437-6671</p> <p>Westbury, L. I. Schweber Electronics (516) 334-7474</p> <p>Yonkers Valley Industrial Electronics, Inc. (315) 736-3393</p> <p>NORTH CAROLINA</p> <p>Charlotte Disle Radio Supply Co. (704) 377-5413</p> <p>Raleigh Southeastern Radio Supply Co., Inc. (919) 828-2311</p> <p>Winston-Salem Electronic Wholesalers, Inc. (919) 725-8711</p>	<p>OHIO</p> <p>Akron Sun Radio Co., Inc. (216) 434-2171</p> <p>Cincinnati Hughes-Peters, Inc. (513) 351-2000</p> <p>Cleveland Pioneer-Standard Electronics, Inc. (216) 432-0010</p> <p>Columbus Electronics Marketing Corp. (614) 299-4161 Hughes-Peters, Inc. (614) 294-5351</p> <p>Dayton Pioneer-Dayton (513) 236-9900</p> <p>Toledo Warren Radio Co. (419) 248-3364</p> <p>OKLAHOMA</p> <p>Oklahoma City Trice Wholesale Electronics (405) 524-4415</p> <p>Tulsa Oil Capitol Electronics Corp. (918) 836-2541</p> <p>OREGON</p> <p>Portland Hamilton Electro Sales (503) 255-8550</p> <p>PENNSYLVANIA</p> <p>Philadelphia Almo Electronics Corp. (215) 676-6000</p> <p>Pittsburgh R.P.C. Electronics (412) 782-3770 Semiconductor Specialists, Inc. (412) 781-8120.</p> <p>York Rosen Electronics Co. (717) 843-3875</p> <p>RHODE ISLAND</p> <p>Providence W. H. Edwards Co. (401) 781-8000</p> <p>SOUTH CAROLINA</p> <p>Columbia Dixie Radio Supply Co., Inc. (803) 253-5333</p> <p>TENNESSEE</p> <p>Chattanooga Harge Electronic Distributors, Inc. (615) 267-2381</p> <p>Kingsport Radio Electric Supply Co. (615) 247-8111</p> <p>Memphis Bluff City Distributing Co. (901) 276-4501</p> <p>Nashville Electra Distributing Co. (615) 255-8444</p> <p>TEXAS</p> <p>Dallas Arco Electronics (214) 239-9123 Hamilton Electro Sales (214) 638-0900 Sterling Electronics (214) 357-8131 Wholesale Electronic Supply (214) 824-3001</p> <p>El Paso McNico, Inc. (915) 566-2936 Midland Specialty Co. (915) 533-9555</p> <p>Houston Hamilton Electro of Houston (713) 526-4661 Sterling Electronics (713) 623-6600</p> <p>Salt Lake City Kimball Electronics (801) 328-2075</p> <p>VIRGINIA</p> <p>Charlottesville Virginia Radio Supply Co. (703) 296-4184</p> <p>Richmond Meridian Electronics, Inc. (703) 353-6648</p> <p>Roanoke Peoples Radio & TV Supply Co. (703) 342-8933</p> <p>WASHINGTON</p> <p>Seattle Almac/Stroum Electronics (206) 763-2300 Hamilton Electro Sales (206) 624-5930 Kierulff Electronics, Inc. (206) 763-1550</p> <p>Tacoma C&G Electronics Co. (206) 272-3185</p> <p>WEST VIRGINIA</p> <p>Charleston Mountain Electronics (804) 342-8151</p> <p>WISCONSIN</p> <p>Milwaukee Electronic Expeditors, Inc. (414) 374-6666</p> <p>West Allis Marsh Radio Supply Co. (414) 545-6500</p> <p>CANADA</p> <p>Toronto Canadian General Electric Co., Ltd. 537-4481</p>
---	--	---

(Continued from p. 24)

Meetings

Symposium on Feature Extraction and Selection in Pattern Recognition, IEEE; Argonne National Laboratory, Argonne, Ill., Oct. 5-7.

Industry & General Applications Group Annual Meeting, IEEE; La Salle Hotel, Chicago, Oct. 5-8.

Short courses

Fundamentals and Applications of Optical Data Processing and Holography, University of Michigan; Chrysler Center, Ann Arbor, July 20-31; \$375 fee.

Principles of Imaging Radars, University of Michigan; Chrysler Center, Ann Arbor, July 20-31; \$375 fee.

Digital Communication Systems, University of Michigan; Chrysler Center, Ann Arbor, July 20-24; \$225 fee.

Minicomputers: their Structure, Characteristics and Applications, University of Michigan, Chrysler Center, Ann Arbor, July 27-31; \$250 fee.

Call for papers

Mexico International Conference on Systems, Networks, and Computers, IEEE; Oaxtepec, Mexico, Jan. 19-21, 1971. Aug. 31 is deadline for submission of abstracts to Dr. Roberto Canales R., Instituto de Ingenieria, Ciudad Universitaria, Mexico 20, D.F.

International Federation of Automatic Control Symposium on Multivariable Control Systems, Duesseldorf, Germany, Oct. 11-13, 1971. Oct. 31 is deadline for submission of abstracts to VDI/VDE—Fachgruppe Regelungs-technaik, P.O. Box 1139, D-4000 Duesseldorf 1, Germany.

International Federation for Information Processing Congress, Ljubljana, Yugoslavia, Aug. 23-28, 1971. Nov. 30 is deadline for submission of papers to academician V.M. Glushkov, chairman, IFIP Congress 71 Program Committee, Institute of Cybernetics, Ukrainian Academy of Sciences, Kiev-28, U.S.R.; or professor C.C. Gotlieb, Vice-Chairman, IFIP Congress 71 Program Committee, Institute of Computer Science, University of Toronto, Toronto, Ontario, Canada; or Professor H. Zemanek, vice-chairman, IFIP Congress 71 Program Committee, IBM Laboratory, Vienna, Parkring 10, A-1010 Wien, 1, Austria.

GENERAL ELECTRIC

221-28

FREE POWER TRANSISTORS

Present (or mail) this coupon to your authorized GE semiconductor distributor
ATTN: INDUSTRIAL SALES MGR. Please furnish 1 or 2 free power transistors shown below.

TYPE	VOLTAGE			H _{FE} (MIN.)		
	low	med	high	low	med	high
<input type="checkbox"/>	<input type="checkbox"/>	<input type="checkbox"/>	<input type="checkbox"/>	<input type="checkbox"/>	<input type="checkbox"/>	<input type="checkbox"/>
<input type="checkbox"/>	<input type="checkbox"/>	<input type="checkbox"/>	<input type="checkbox"/>	<input type="checkbox"/>	<input type="checkbox"/>	<input type="checkbox"/>

NAME _____ FIRM _____
 POSITION _____ STREET _____ CITY _____
 STATE _____ ZIP _____ Distributor Name _____

Offer expires August 31, 1970

Born free

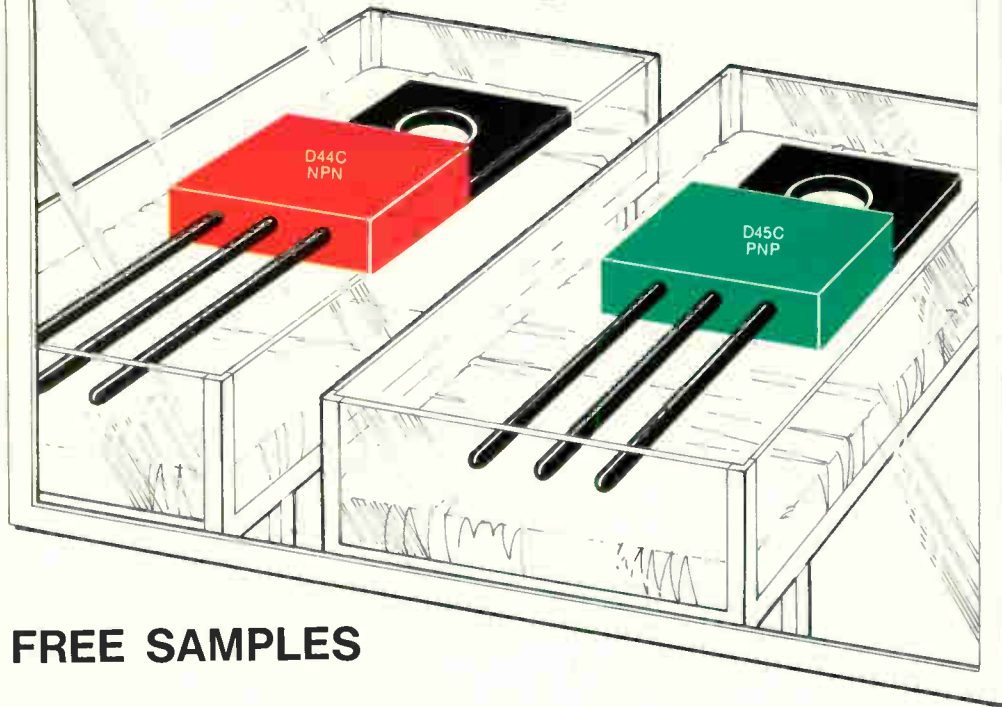

FREE SAMPLES

Celebrate GE's new NPN/PNP transistors with a complimentary pair

We're proud to announce the birth of another complementary pair of power transistors from General Electric. Housed in GE's silicon Power Pac package, these new 4-amp NPN/PNP transistors are color molded so you can tell NPN from PNP. And for a limited time only, you can get a pair free. That's right! To introduce you to GE's new arrivals, we're offering you a pair free. You may choose the new Power Pac types with round

leads or their older brothers in the power tab package (with flat leads). You may even choose two that aren't complementary . . . still with our compliments. General Electric's complementary pairs feature low saturation voltage, excellent gain linearity and fast switching characteristics. They're compatible with either TO-5 or TO-66 mounting and designed for use in amplifiers (dc-1MHz.), regulators (series, shunt and switching), high-frequency inverters and converters and many other general purpose controls.

To get your sample power transistors along with a packet of application information, fill out the coupon on the opposite page and present it (or mail it) to your authorized General Electric semiconductor distributor (also shown on opposite page). Offer expires August 31, 1970.

220-90

Type No.	I _c (cont.) Amps.	P _{tot} (T _c 25°C) Watts	P _{tot} (T _A 25°C) Watts	V _{CE} (sat.) (max.)		V _{CE0} (sus.) Volts			h _{FE} (min. or range)				
				volts	amps	lo	med	hi	bias V _{CE} I _C		lo	med	hi
D40D (NPN) D41D (PNP)	1.0	6.0	1.25	0.5	0.5	30	45	60	2V	0.1A	50-150	120-360	290①
D42C (NPN) D43C (PNP)	3.0	12.5	2.10	0.5	1.0	30	45	60	1V	1.0A	10	20	25②
D44C (NPN) D45C (PNP)	4.0	30.0	1.33	0.5	1.0	30	45	60	1V	1.0A	10	20	25②
D40N (NPN)	0.1	6.25	1.65	—	—	250	—	300	10V	.04A	—	20	—
D40C (NPN) (darlington)	0.5	6.0	1.25	1.5	0.5	30	40	50	5V	.2A	10K- 60K	40K	—

① Available in 30V NPN units only
② Available in 30V and 45V units only

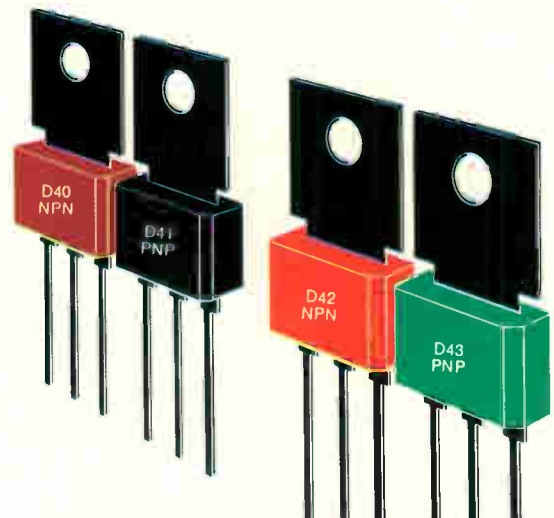

GENERAL  ELECTRIC



**“No one made a
small, quiet, medium-speed
chain printer for \$9500.
So Mohawk did.”**

George C. Hohl, OEM Marketing Director, discusses a new product.

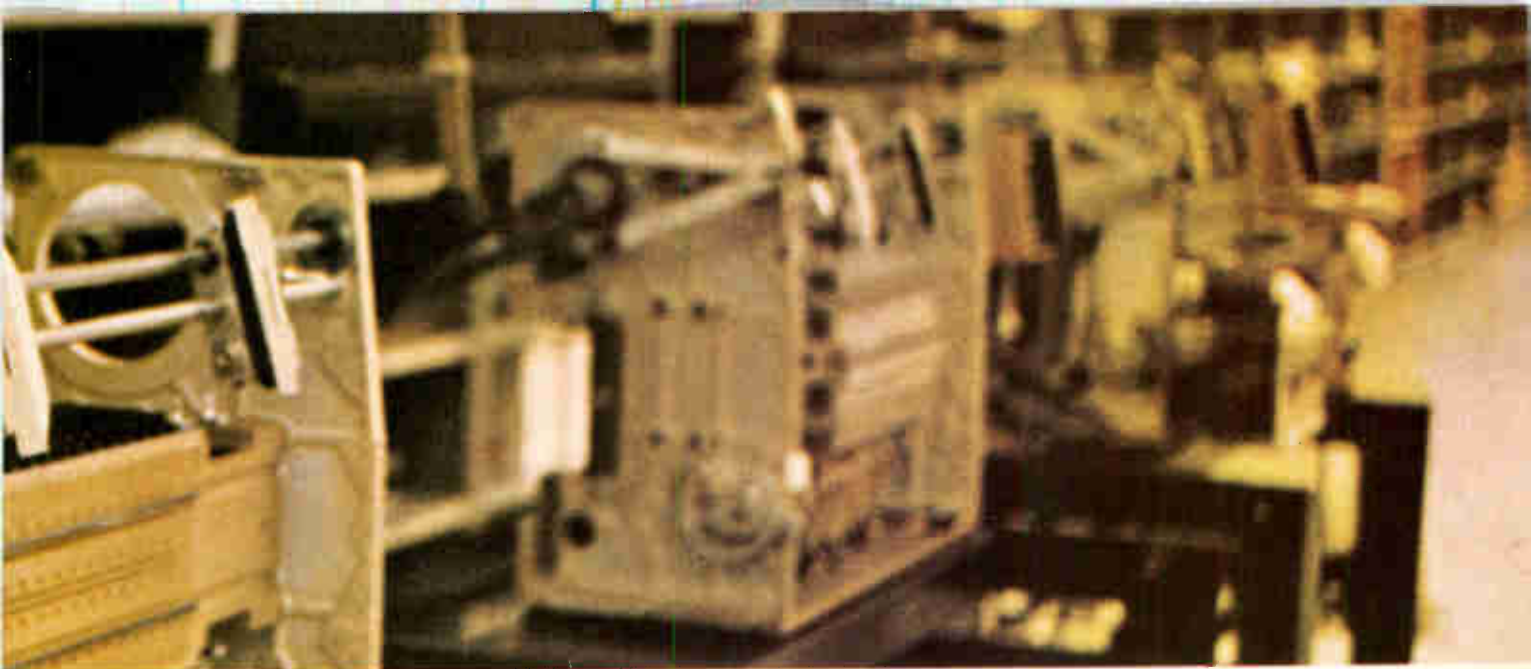

“We saw a gap in the printer field. Either you paid a lot of money to get a lot of speed and sophistication, or you could pay a little and get very little in return. We decided to aim our printer somewhere in between.

“Chain printers are mechanically simpler, easier to maintain, less expensive. Their flat face characters give good print characteristics, too.

“Our design requirements were rough. We wanted 300 lines-per-minute with such niceties as easily changeable fonts, and yet we wanted to sell it for less than \$10K. It had to be small, and yet we couldn't lose accessibility. The design engineers grumbled, but they made it.

“The changeable font cartridge is great—an operator can quickly switch the font chain—and we're offering fonts from 16 to 128 characters.

“We designed a disposable ribbon cartridge to make ribbon

changes quick and clean. Paper handling is enclosed to stay clean, too. And everything that could be modularized, was modularized.

“We considered noise reduction vital—anyone who has worked in a printer room knows why. Well, compared to other printers, you'd hardly know this one was working.

“We're selling the printer for \$9500 in OEM quantities, and some variations cost even less. So you get a lot of performance in a very little printer—for very little money.”

Mohawk Data Sciences Corp.
Herkimer, New York



To make the lowest-cost arithmetic logic unit with carry lookahead built-in,

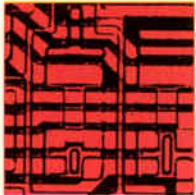

Fairchild's new 9340 is the perfect arithmetic logic unit for almost every application. It's a high-speed device that can perform two arithmetic operations (ADD or SUBTRACT) and any of six logic operations on two 4-bit binary words in parallel. To handle 16 bits, just hook up four 9340s.

And nothing else.

The 9340 can ADD two 4-bit words in 28ns and SUBTRACT two 4-bit words in 33ns. The addition of two 16-bit words takes only 42ns.

The new ALU has full internal carry lookahead, and provides either a ripple carry output or carry lookahead outputs. The speed and flexibility of the 9340 make it ideal for other applications like multipliers, dividers and comparators.

Input clamp diodes are used on all inputs to limit high speed termination effects in the 9340. Input/output characteristics provide easy interfacing with all Fairchild DT μ L, TT μ L and MSI families.

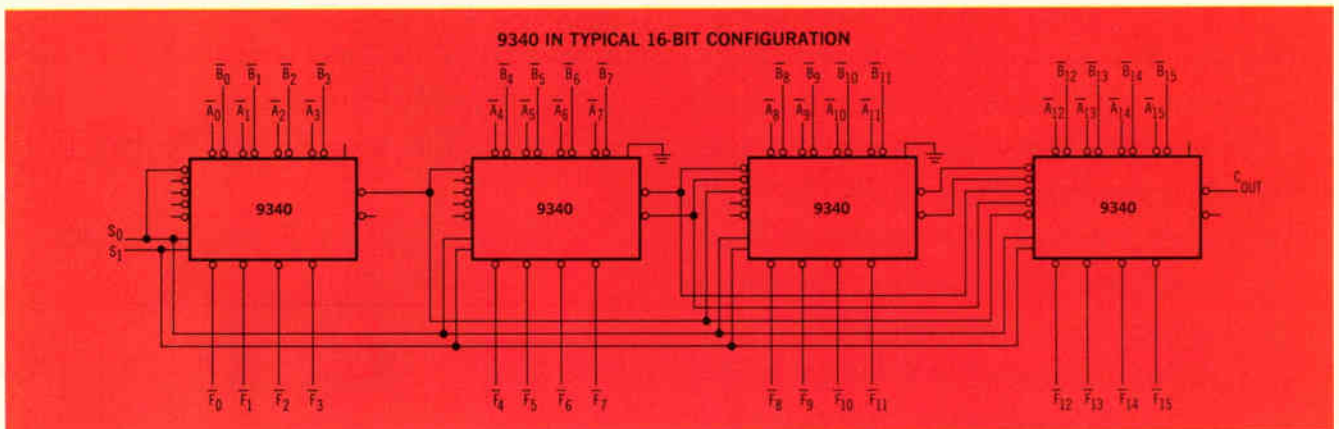

To order the 9340, call your Fairchild Distributor and ask for:

PART NUMBER	PACKAGE	TEMPERATURE RANGE	(1-24)	PRICE (25-99)	(100-999)
U6N934059X	DIP	0°C to + 75°C	\$20.90	\$16.70	\$14.00
U6N934051X	DIP	-55°C to +125°C	41.80	33.40	28.00
U4M934059X	Flat	0°C to + 75°C	23.00	18.40	15.40
U4M934051X	Flat	-55°C to +125°C	46.00	36.80	30.80

you have to get serious about MSI family planning.

We put together a family plan by taking systems apart. All kinds of digital systems. Thousands of them.

First we looked for functional categories. We found them. Time after time, in a clear and recurrent pattern, seven basic categories popped up: Registers. Decoders and demultiplexers. Counters. Multiplexers. Encoders. Operators. Latches.

Inside each of the seven categories, we sifted by application. We wanted to design the minimum number of devices that could do the maximum number of things. That's why, for example, Fairchild MSI registers can be used in storage, in shifting, in counting and in conversion applications. And you'll find this sort of versatility throughout our entire MSI line.

Finally, we studied ancillary logic requirements and packed, wherever possible, our MSI devices with input and output decoding, buffering and complementing functions. That's why Fairchild MSI reduces—in many cases eliminates—the need for additional logic packages.

The Fairchild MSI family plan. A new approach to MSI that's as old as the industrial revolution. It started with functional simplicity, extended through multi-use component parts, and concluded with a sharp reduction in add-ons. Simplicity. Versatility. Compatibility. Available now. In military or industrial temperature ranges. In hermetic DIPs and Flatpaks. From any Fairchild Distributor.



OPERATORS
9304—Dual Full Adder/
Parity Generator
9340—Arithmetic
Logic Unit



LATCHES
9308—Dual 4-Bit Latch
9314—Quad Latch

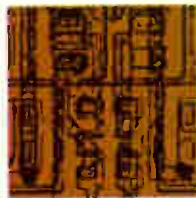

REGISTERS
9300—4-Bit Shift
Register
9328—Dual 8-Bit
Shift Register

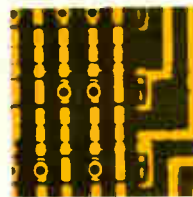

MULTIPLEXERS
9309—Dual 4 Input
Digital
Multiplexer
9312—8-Input Digital
Multiplexer
9322—Quad 2-Input
Digital
Multiplexer

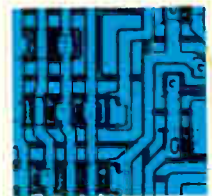

**DECODERS AND
DEMULPLEXERS**
9301—One-Of-Ten
Decoder
9315—One-Of-Ten
Decoder/Driver
9307—Seven-Segment
Decoder
9311—One-Of-16
Decoder
9317—Seven-Segment
Decoder/Driver
9327—Seven-Segment
Decoder/Driver

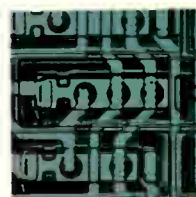

ENCODERS
9318—Priority 8-Input
Encoder

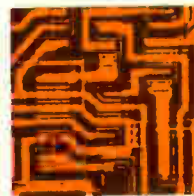

COUNTERS
9306—Decade Up/
Down Counter
9310—Decade Counter
9316—Hexidecimal
Counter

FAIRCHILD
SEMICONDUCTOR

Change your mind at the snap of a cam.



NEW FROM YOUR GUARDIAN ANGEL: LEVER SWITCHES WITH SNAP-IN CAM INSERTS

This latest miracle from your Guardian Angel lets you change switch actuator positions instantly . . . at any time. Any combination of off, momentary or locked actuator positions is as easy as inserting a pair of "programmed" molded plastic cam inserts.

A snappy little chore that takes maybe 20 seconds.

The new Guardian Lever Switches offer more than versatility. They are available in non-illuminated or illuminated with color coding. Up to 4 pole, double throw per station with switches arranged in any desired form to provide needed circuitry. (Now do you believe there's a Guardian Angel watching over Engineers?)

Write for Bulletin No. E-2



NEW FROM GUARDIAN:

Push button switch banks with illuminated color coded buttons. Sleek, compact design with interlock, non-lock, all-lock, push-to-lock/push-to-release or solenoid life? 100,000 operations!

*Talk to your GUARDIAN ANGEL
at the WESCON SHOW*



GUARDIAN ELECTRIC

MANUFACTURING COMPANY
1550 W. Carroll Ave., Chicago, Illinois 60607

Circle 32 on reader service card

Electronics Newsletter

July 6, 1970

IBM's new series less than startling

After all the speculation about what was expected to be IBM's "fourth generation" computer series [*Electronics*, June 22, p. 33], the announcement revealed little to get excited about. **The two machines in the new System 370 family are slower than two models in the six-year-old 360 line.** The 370/155 has a cycle time of 115 nanoseconds, while the 370/165 has 80 nsec. This compares with 80 nsec for the 360/85 and 54 nsec for the 360/195.

Along with the two computers, IBM also announced two peripherals for the machines—a **disk memory** and a **high-speed printer**. The memory—dubbed the 3330—can store up to 800 million bytes with an access time of 30 milliseconds. **The model 3211 chain printer rips along at 2,000 lines per minute, almost twice as fast as previous IBM printers.**

As expected, the new computers have a cache, or high-speed buffer, memory identical to those in the 360/85 and the 360/195. Also available is an optional integrated emulator permitting the machines to use programs developed for the 360 and the older 1400 and 7000 series.

This emulator uses an extension of the 360's read-only memory concept, together with a writable control store introduced in the 360/85. But unlike the 360, it can emulate several different machines at once in a multiprogramming mode.

Typical rental for a 155 with 768,000 bytes of main memory is around \$48,000 a month with an outright purchase price of slightly over \$2.2 million. For the 165 with 1 million bytes of memory, rental runs around \$99,000 a month, with a \$4.7 million purchase price. First deliveries of the 155 will be in February 1971; for the 165 it will be April.

The new input-output gear won't be available until late in 1971; meanwhile, all 360 peripherals will run on the 370.

World pcm group agrees on coding

Now that AT&T no longer insists on the mu law as the standard for international coding, digital communication via global satellite is a step closer. After AT&T relented, members of the multiplex working party of the Consultative Committee for International Telegraph and Telephone (CCITT) agreed that **the companding law will be $A = 87.6$ for satellite communication between countries on different codes.** AT&T had been pressing for $\mu = 255$ [*Electronics*, Dec. 22, 1969, p. 40]. The group also agreed on a standard international bit rate of 6.336 megabits per second. **An eight-bit word length had been approved previously.**

Not only did Bell go along, but, along with the other North American phone companies, it has agreed to recode data from A to μ for North America. Recoding is necessary since the agreement covers international transmission, not each nation's digital net.

Navy faces S-3A cuts as plane costs soar

Defense Department concern over the S-3A antisubmarine warfare plane's escalating costs is making both the Naval Air Systems Command and contractor Lockheed Aircraft jumpy. **The first S-3A has yet to fly.**

When Lockheed was selected a year ago, the Navy told the Pentagon that 154 planes would have a unit cost of \$8.4 million. **The latest estimate is that the larger purchase of 193 planes now planned carries a bigger, rather than a smaller, unit price tag—\$11.8 million—or not much less than the larger and more sophisticated land-based P-3C ASW plane's \$12.2**

Electronics Newsletter

million. The Navy's costs for the program, about the only one on which Lockheed has no problems, have caused Deputy Defense Secretary David Packard to consider cancellation. But program sources say this consideration has been shelved pending resolution of Lockheed's many other fiscal problems. Unit cost of the plane to be replaced, the S-2E, was \$1.1 million for the 238 aircraft bought between 1961 and 1965.

Motorola takes aim at Harpoon radar

Motorola's Government Electronics division will propose a Swedish "frequency agility" radar for the Harpoon missile. Officials have been talking with Hughes Aircraft Co. about a teaming arrangement. Hughes is seeking the prime contract for Harpoon, shipboard weapon for use against other surface vessels.

Motorola is licensed by Philips Teleindustrie of Sweden to manufacture the radar, which gives broadband, random pulse-to-pulse frequency variations. The key component in a frequency agility system is its spin tube magnetron; Motorola will offer tubes that operate at both X and Ku band. A breadboard is being readied for testing.

Meanwhile, flight tests of Motorola's "smart noise" electronic countermeasures equipment should be completed by the first of next month. The jamming gear confuses surface-to-air missile radars homing in on aircraft, because it introduces noise that makes the aircraft's active radar emanations difficult for two or more SAM sites to triangulate. The system is one of several Motorola has proposed to IBM for the B-1 bomber. IBM is one of the principal competitors for B-1 avionics.

Data General offers build-it-yourself multiprocessor kit

The Data General Corp. of Southboro, Mass., has developed a method of combining two to 15 of its 16-bit minicomputers into a single multiprocessor. A marketing official says the scheme aims to combat tight money. "This way, a customer can start with one or two machines and build up to a 15-channel multiprocessor system." The so-called multiprocessor communications adaptor consists of a module with multiplex, transmit, and receive circuitry that plugs into the computers' data channel input-output port. Memory then is common to all machines on the bus, and any processor may communicate with any other at data rates of up to 1 megabyte per second. Word length remains 16 bits.

Addenda

An optical character reader has been married to a computer typesetter by ECRM Inc. of Cambridge, Mass. Key punch or Teletypesetter keyboard operators now supply tape input for a computer at 20 to 30 words a minute; ECRM says its system can produce 500 to 6,700 words a minute with a worst-case error rate of just 0.03%. Built around a PDP-8/L, the system should sell for around \$89,000 with software. Production is to start in October. . . . President Nixon has named one of his special assistants, Clay T. Whitehead, to direct the new Office of Telecommunications Policy. Whitehead was the principal architect of the reorganization plan that led to the formation of the OTP out of the old Office of Telecommunications Management [*Electronics*, Jan. 5, p. 79]. . . . Texas Instruments is trying to sell vending-machine makers a plan that would tie machines to a central computer over phone lines. The advantages would be better inventory control, a burglar alarm system, and a check against dishonest servicemen.

HERE'S HOW THE V-O-M SPECIALISTS GO DIGITAL

The principal problem with digital V-O-M's is that circuitry (rather than readability) limits their accuracy. Triplett has attacked that problem with characteristic thoroughness. The result . . . a totally new circuit (patent pending) in which there is virtually no internally-generated current from the V-O-M input circuit to affect measuring accuracy.

Triplett's Model 8000 digital V-O-M . . . the only V-O-M with this newly-developed circuit . . . offers a true DC accuracy of 0.1% of the reading ± 1 digit and an AC accuracy of 0.2% ± 1 digit. Triplett calls this "true accuracy" because it's the same accuracy you can achieve day-in and day-out, test-after-test, on any kind of circuit.

Quality-minded buyers will appreciate, too, the other job-matching features of Triplett's new digital V-O-M. Like . . . automatic zeroing; AC and DC voltage measurements from 0.1 mV to 1000 V in 5 ranges at 10 megohms input resistance; AC and DC currents from 0.01 μ A to 1000 mA in 6 ranges; 0.1 ohm to 10 megohms in 6 ranges.

Sounds like it was worth waiting for, doesn't it? Available through your local Triplett distributor, the new Model 8000 is priced at only **\$575** suggested USA user net. If you'd like the added convenience of an instant replay circuit that displays a previously-stored reading for on-demand comparison with an existing reading, ask for the Triplett Model 8000-A at **\$630** suggested USA user net. For more information, or for a free, no-obligation demonstration, call your local Triplett distributor or sales representative. Triplett Corporation, Bluffton, Ohio 45817.



The World's most complete line of V-O-M's . . . choose the one that's just right for you

1. True 0.1% DC accuracy. Virtually no kickback current*. Allows voltage measurements in high resistance circuits at stated accuracy.
2. High AC accuracy with nearly perfect AC linearity and 10 megohm input resistance.
3. Low profile design in shielded case with modular construction for ease in use and maintenance.

*There is virtually no internally generated current from the V-O-M input circuit to affect measuring accuracy. (Patent pending on this feature).

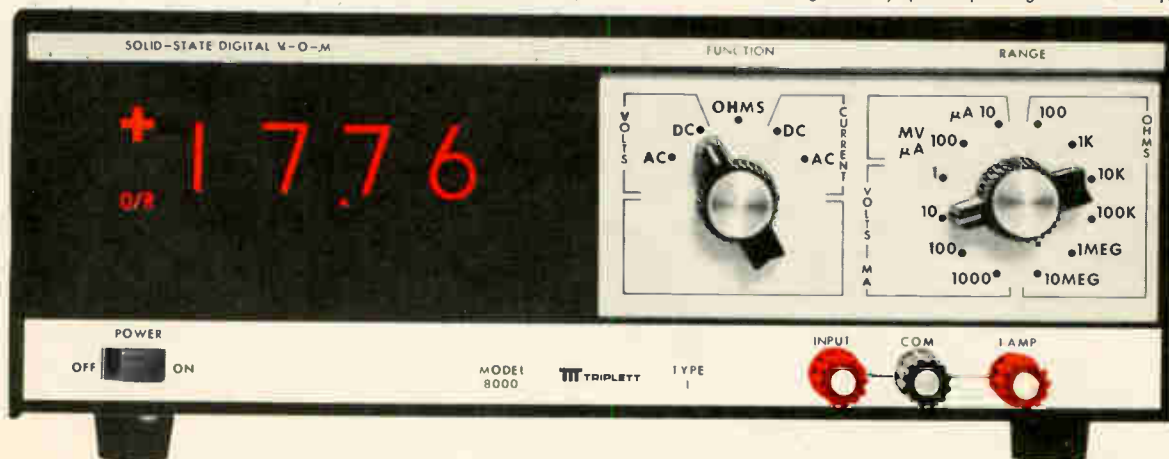

We can't afford to be complacent.

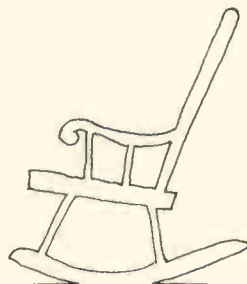

Seven years ago we shook the relay world with the birth of the TO-5 (SPDT) relay. It was quite a breakthrough in the state of the art. Your demands for other configurations in the TO-5 transistor can led to the introduction of magnetic latching and sensitive relays. In 1966, we performed another relay miracle by combining a transistor and a relay in the same TO-5 can. Would wonders never cease? We did it again in 1969 with what we fondly call our "Solid Citizen;" a series of solid state relays for industrial and military applications.

Our competition has increased, we know this, and further

we welcome it; after all, isn't imitation the sincerest form of flattery? We know that as long as there are unsolved switching problems we can't afford to sit on our little cans and watch the world go by. We have other wonders up our sleeves and will let the world know when we're ready.

No, sir, no easy chairs for us. We like it this way. We invite you to write or call and ask for any technical assistance regarding our growing family of little switching devices.



TO-5
Relay



TELEDYNE RELAYS

3155 West El Segundo Boulevard, Hawthorne, California 90250 / Telephone (213) 679-2205

Happy marriage cuts current needs

Hughes researchers combine electron-beam mask exposure, ion-beam machining, and ion implantation techniques in a microwave switch

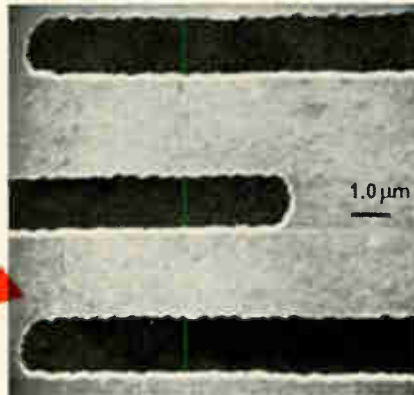
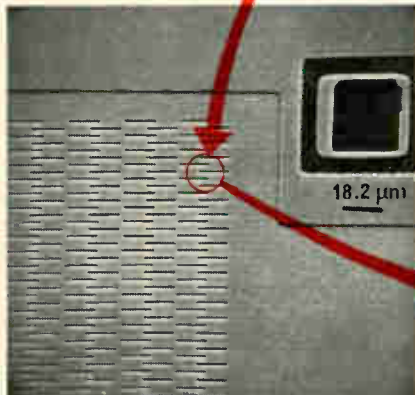
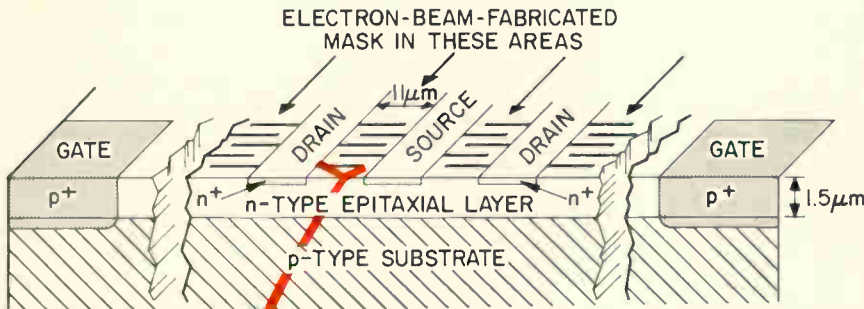

Putting it all together. Drawing shows relationship of diffused source and drain bus bars to interdigitated drain-source structures. Left photo shows implantation windows in gold mask and registration mark for scanning electron microscope. Right photo shows fingers.

P-i-n diode switches often are used in phase shifters for phased-array radars, and while they offer good r-f performance past X band—high cutoff frequencies on the order of 600 to 800 gigahertz—they also require considerable bias power. This dictates cooling of high-current lines in a system, and somewhat expensive solid state drive circuitry. A group at the Hughes Aircraft Co.'s Research Laboratories believes it has come up with a unique technique—the first combination of electron-beam mask exposure, ion-beam machining, and ion implantation—to cut the bias current for a microwave switch by two orders of magnitude

compared to p-i-n switches used for phase shifting. The development promises to lower the current requirements for a 5,000-element phased array from about 50 amperes to less than 2.5 amps.

Family way. The initial device to which Hughes researchers applied the technique is a junction field-effect transistor modified to work as a microwave switch, but they emphasize that they can improve their technology marriage to produce even better devices.

Using the planar process, optical masking, and chemical etching, Hughes researchers would have been limited to resolutions of about 2.5 microns. But they needed

smaller structures than that for a closely spaced, interdigitated drain-source structure they wanted to superimpose between diffused drain and source bus bars. Center-to-center distances between them would be 25 microns, but they would have only 11 microns of channel length. The drain-source structures, placed at right angles to the larger bus bars, have to be extremely small to reduce the resistance of the device, which, in turn, raises cutoff frequency and lowers the current requirements.

The combination of electron-beam mask exposure and ion-beam machining is required to make the mask for the very small fingers. Ranging from 0.5 to 1 micron wide, the fingers are then ion implanted through the mask, cutting the FET's on resistance from 35 ohms to about 2 ohms, while increasing capacitance by no more than 10%.

Luc Bauer, a member of the technical staff in the lab's MOS research department, says that although the switch hasn't been tested at microwave frequencies, he's convinced the cutoff frequency can be hiked to 200 Ghz from 20 Ghz. This is still less than that of p-i-n switches, but Hughes researchers are more interested in lowering the current requirements.

This is how Hughes does it. In his lab at Newport Beach, Calif., Bauer begins with a high-resistivity p-type substrate on which an n-type 1-micron-thick epitaxial layer is grown. Next, a thick oxide is grown conventionally over the wafer, and a deep p+ gate region is diffused in to make substrate contact. Using a phosphorus diffusion, the parallel and alternating large n-type drain-source bus bars are emplaced. This done, the thick oxide is etched away and a thinner

U.S. Reports

layer of 1,500 angstroms is grown.

At this point, Hughes researchers depart from conventional fabrication by coating the wafer with a very thin layer of nichrome, then evaporating a 1,000-Å layer of gold that acts as the implantation mask for high-energy phosphorus ions. Registration marks for the scanning electron microscope work are etched into the four corners of the mask and a positive resist layer is placed over the gold. Edward Wolf, senior staff chemist in the lab's ion physics department at Malibu, points out that proper registration of the wafer at this point is critical. The tiny interdigitated pattern is registered using the bench marks and a scanning electron microscope beam, digitally controlled by a punched paper tape containing the small pattern.

The device is exposed with a 15-kilovolt electron beam, then developed. Ion-beam sputtering is used to micro-machine through the gold layer in those areas that have been exposed in the electron-beam resist. The resist polymethyl methacrylate functions as the sputter mask for the gold layer beneath it. The gold is selectively sputter-removed two or three times faster than the resist with a 3-kilovolt argon ion-flood beam.

Finally, the remaining resist is chemically removed, and Bauer gets the wafer back to implant phosphorus ions through the electron-beam exposed and ion-sputtered mask, creating the tiny source-drain structures. The dosage is 2×10^{15} ions per square centimeter, accelerated by 150 kilovolts. The gold and nichrome are removed after implantation, the wafers are annealed, and devices are metalized and bonded. Finally, the devices are packaged.

Computers

Up the UBB

Imagine a large computer digging into a calculation as casually as an electric drill makes a hole in a piece of wood. That's how Frank J. Langley sees it—the computer

Simple. So-called universal black box computer has four LSI circuits.

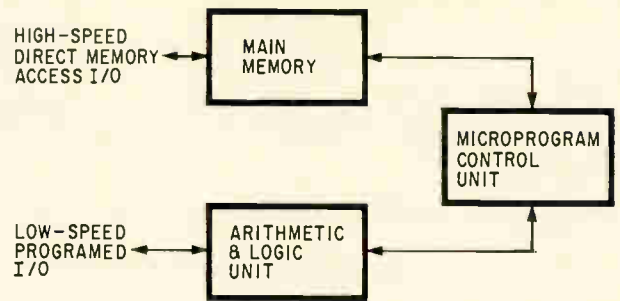

would be treated as a tool, not an awe-inspiring monolith.

Langley, a senior engineer at the Raytheon Co.'s Missile Systems division in Bedford, Mass., has developed a concept he calls the universal black box, or UBB, which an electronic alchemist might call the quintessence of the computer. No one admits it, but a possibility could be the Navy's advanced airborne digital computer system, where the UBB technique could replace up to 35 mainframe types with a single machine possessing multiple capabilities.

The UBB is to computer power as the cell is to complex life forms: if you have a more complex job to do, add more cells—or UBB's. Each UBB might consist of several LSI circuits: a read-write memory, a read-only memory for microprogram storage, a programmable multipurpose register wafer, plus arithmetic and logic devices.

Fast and cheap. Langley points out that his black boxes could be turned out by the carload using LSI batch fabrication techniques, and that cost therefore could be very low. He estimates current parts costs of only \$800 or less in civilian form, and \$2,500 or so for versions meeting military specifications unless quantity production could drop costs.

As Langley describes it, the UBB would be a sort of general-purpose, special-purpose computer. That is, UBB's as a class could do any job they could hold in memory, but as units they would be limited by their ROM-stored microprogram instruction set and the amount of read-write memory storage. However, a plug-in ROM wafer would permit the user to change the instruction set to suit his immediate need.

And his immediate need would be all he would have to fill; with UBB's users would buy only the computer power needed and no more—one, two, or more UBB's. Thus users could avoid the waste in money or computer power present even in the smallest general-purpose machines.

Langley envisions single UBB's applied as LSI testers with a test fixture at one high-speed I/O port and a slower printer output. Here the UBB would match the performance of an LSI wafer against a lookup table in memory and print out the errors. With a different ROM, the same UBB could sample, edit, and format data coming from analog-to-digital converters, acting as a front end for a data storage unit, or process controller.

Data preparation, in fact, might offer a large market for such devices. Today's computerized production lines often depend on a single large computer, and when it goes down, the line can, too. UBB's with contingency microprograms could take over if the big machine quit—and otherwise pay for themselves by acting as peripheral processors predigesting data for the large mainframe under normal conditions.

The Langley UBB also would seem to be a natural for a federated avionic computer, missile guidance computer, or other military application. Instead of building special-purpose computers for each task, the military could build many UBB's and match the ROM-stored instruction set to the application. In fact, avionics houses—including Raytheon—are thinking along those lines. But there's no unity on the federated concept, in which a system is designed as a unit with components that can work indepen-

dently. Some favor larger special-purpose units over the federated unit. They feel that the special mainframe could deliver exactly the performance desired, while a federated approach would automatically mean a tradeoff somewhere even if it were less costly.

Another life

Two years ago, when the Air Force began upgrading its Minuteman 1 missiles to Minuteman 2's, among the first items to be shelved was the Autonetics D-17B guidance computers. And while the D-17B is nothing to write home about in this age of semiconductor memories and MOS circuitry—it's built with discrete components and has a whopping cycle time of 78 microseconds—it has one highly attractive feature: price. Qualified users can get the machines for what it costs

to ship them from Hill Air Force Base, Utah.

With this in mind and because the \$234,000 D-17B's still had plenty of life left in them, Charles H. Beck, a Tulane University professor of electrical engineering, acquired one with official approval and \$40 in freight charges. After a preliminary inspection, Beck decided the machine had an adequate instruction repertoire and disk memory—2,727 24-bit double precision words—and came up with a plan for converting the machines into general-purpose computers. The ultimate result may be that within four years some 1,000 D-17B's will be in laboratories across the country.

Tinkering. Beck, who earlier had converted a Titan 1 computer to general-purpose use, received \$30,000 in National Science Foundation support. He came up with a \$25 black box arrangement fashioned out of a pushbutton that creates the

timing pulse needed to set the flip-flop registers and a row of switches that set binary data words. He also showed how, for \$500, an interface could be built for the also obsolete Friedan Flexowriters which become input/output units complete with punched paper tape capability.

He is now working on the design of circuit cards that would give the machine the hardware divide feature that is now missing.

Last month, 64 members of the Minuteman computer users' group attended the organization's first meeting and formed software, hardware, and spare parts committees. Many more members are expected as Federal agencies and contractors—and, eventually, universities and high schools—get their chance to acquire the 1,000 machines that will eventually be surplused.

In the meantime, Beck is studying Defense Supply Agency surplus bulletins in an attempt to find a cheap source of peripheral units for

Electronics Index of Activity

July 6, 1970

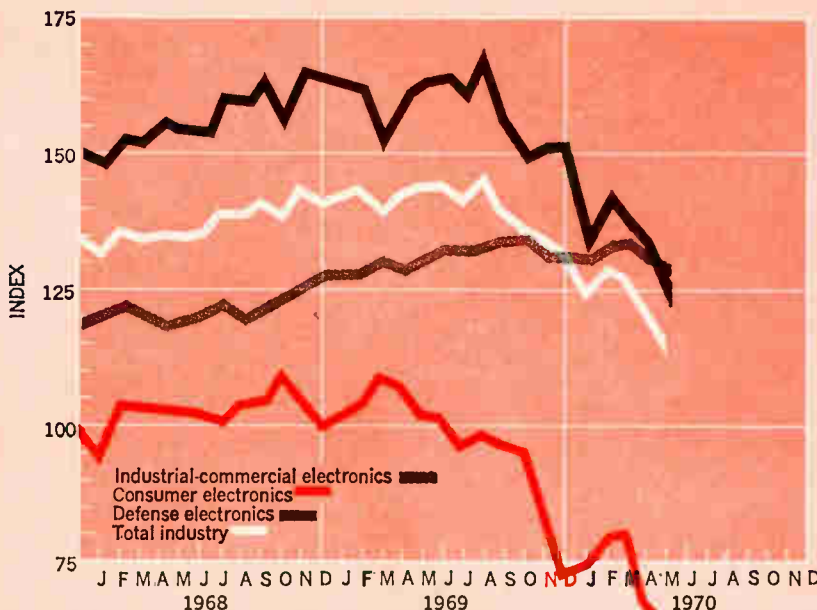

Electronics production in May took its biggest month-to-month drop in five years. The index was down 5.4 points from April's downward revised 122.2, and off a whopping 28.5 points from May 1969.

With all three of the index components contributing to the decline, defense electronics took the worst beating—down 7.5 points. This was its poorest monthly showing since March 1969 when it fell 8.4 points. Consumer electronics sustained its second minus month in a row to slide still farther off the chart with a 4.3-point drop. The industrial-commercial sector, as usual, did better than the other two, dipping only 1.8 index points.

Segment of Industry	May 1970	Apr. 1970*	May 1969
Consumer electronics	63.4	67.7	102.4
Defense electronics	127.1	134.6	166.2
Industrial-commercial electronics	130.1	131.9	132.1
Total industry	116.8	122.2	145.3

Indexes chart pace of production volume for total industry and each segment. The base period, equal to 100, is the average of 1965 monthly output for each of the three parts of the industry. Index numbers are expressed as a percentage of the base period. Data is seasonally adjusted. *Revised.

his low-cost line of minicomputers. He is also casting a covetous glance at another \$750 million in similar computers now aboard Minuteman 2's and 3's.

Communications

Peekaboo

Picturephone's long-awaited commercial debut in Pittsburgh last week was a mixture of the new and the predictable. The central panel on the fewer than 50 sets on line at under 10 companies—12 of them at Westinghouse and six at Alcoa—was redesigned, and, as expected, there were problems.

The control panel is easier to read since the unit was shown at the Pittsburgh-New York trials in 1969. If you want to see yourself, press the "Vu Self" (formerly "Monitor") button; to substitute a bar pattern, hit "Private" (formerly "Disable"); and if you want to cut your voice from the receiver, the "On" switch also has a "Quiet" position.

Woes. The drawbacks are 1969 hangovers. A voice echo suppressor also turns off both voices if the parties try to talk at the same time; the camera can't adjust to bright light—sunshine, for example—and it can't differentiate type smaller than 14 points.

Picturephone is costly. The

monthly charge is \$160—\$110 for the service line and \$50 for the set with additional sets running \$50 a month. And after the allotted free 30 minutes of monthly calling time is used up, charge is 25 cents a minute. However, D.C. Burnham, Westinghouse's chairman, says, "If Picturephone can save me one trip to New York monthly, it will be worth the expense."

The Pittsburgh offering initiates Bell's plans for a nationwide Picturephone network. Plans are for intracity service in Chicago, Cleveland, Detroit, Philadelphia, and Washington in 1971. The number of sets is slated to reach 100,000 in 27 cities by 1975. The goal for 1980 is 1 million sets.

Air traffic control

Associations count

As air traffic around the nation's busiest terminals continues to outpace the development of automated air traffic control systems, FAA officials have been looking for a data processing system capable of keeping up.

Now they think they may have a solution in associative processors, and are readying plans for a test of a system next year at the Minneapolis-St. Paul International Airport. Requests for bids on associative processors, essentially

computers with logic at every word or even bit location in memory, were to go out after July 1, according to Lawrence E. Shoemaker, Chief of the data processing branch of the FAA's systems research and development service.

Look to 1980. Shoemaker notes that with serial data processing equipment now being installed in major airports, the upper limit of aircraft that can be tracked and identified is 300. With associative processors, he says, the 1,500 aircraft expected to be under terminal control in major airports by 1980 could be tracked easily.

Because of the power of associative processor in handling real-time data bases, other tasks also could be turned over to them. The FAA data specialist sees the day when computers will identify which planes are on collision courses, a task now performed by harried air traffic controllers. He also points out that display processing, a function performed by sequential Univac processors in the current ARTS 3 system, could be turned over to associative processors.

Although at least six firms are known to have performed such work, most industry sources agree that the Goodyear Aerospace Corp. and Honeywell's Aerospace division are far ahead. Goodyear will hold a strong hand in the bidding because its Staran 4 processor is already available. Honeywell, however, is working on an LSI machine that promises to be even faster than the Staran 4's 40 million instructions per second, which Goodyear hails as the world's fastest computer.

Besides its availability, the Goodyear machine's \$1.5 million price is low for such a fast machine. Willard C. Meilander, Goodyear Aerospace's data processing chief, says that the cost was made possible through the use of emitter-coupled logic at the end of each of the machine's 256 word locations.

Wired. Plated wire is the storage medium for the 256-bit words, although a breadboard of a machine using a bipolar memory has been built under an Air Force contract. Cycle time for the plated



Getting the picture. Here's a typical Picturephone installation in Pittsburgh. That's the control box at left, speaker behind it.

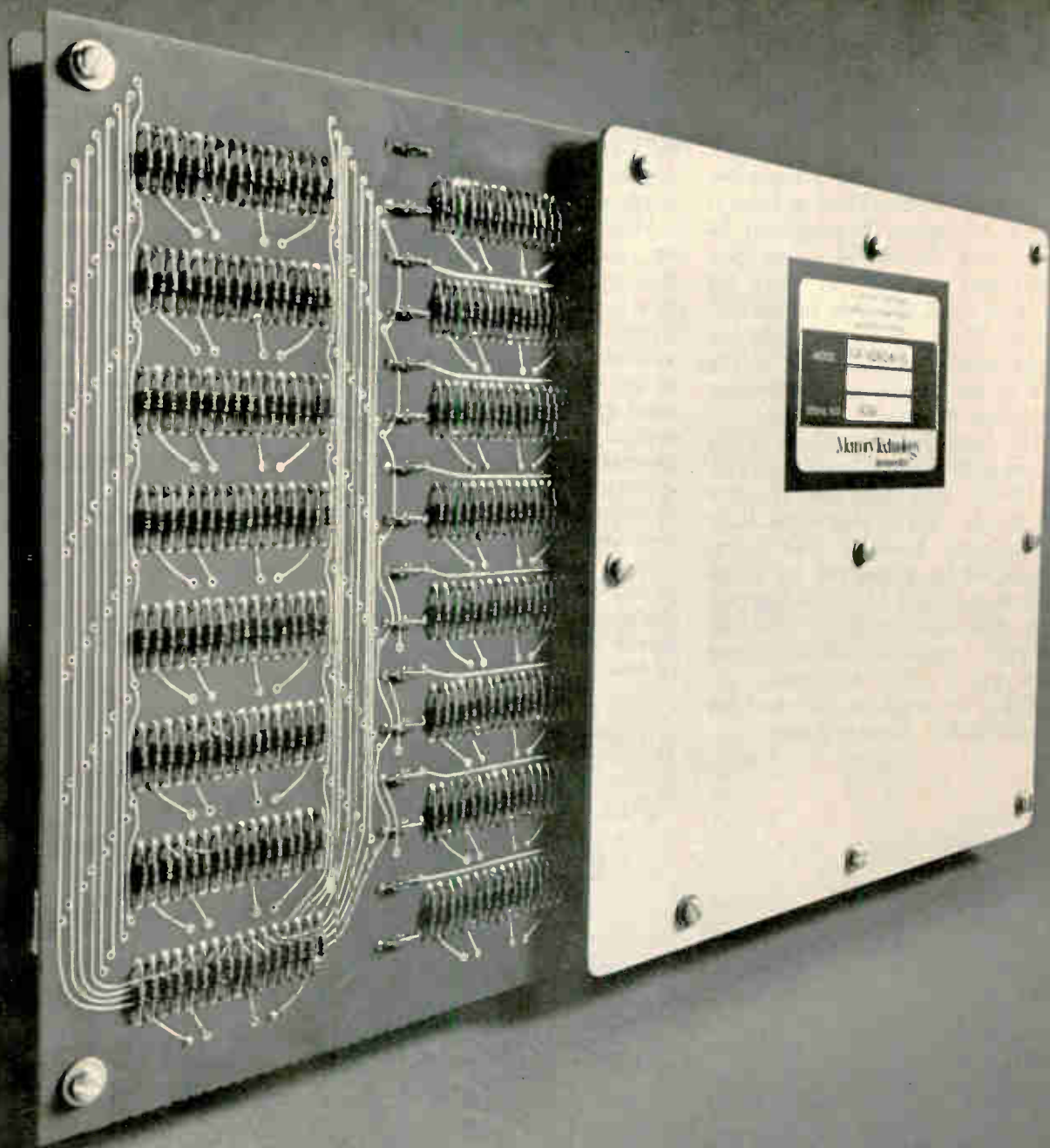

New 90 Nanosecond READ-Only Memory

90 nsec access time. 190 nsec cycle time. 10,240 bits; up to 80 bits per word. Mechanically alterable memory contents—bits, words, or the entire memory may be mechanically modified. TTL compatible.

What's more, NANOROM 90 can be directly compatible—pin for pin, space for space,—with our other standard 300 and 500 nanosecond systems.

Get more details on the NANOROM 90. It's a natural addition to the new Engineering Guide to READ-Only Memory Systems. Ask for it. Write Paul Rosenbaum, Memory Technology, Inc., 83 Boston Post Road, Sudbury, Massachusetts 01776, (617) 443-9911.

Memory Technology
Incorporated

U.S. Reports

wire is 100 nanoseconds, he says.

At this point, Honeywell cannot project the costs of its processor, much of which is still on paper, says Dale Gunderson, a computer technology section chief in Honeywell's Aerospace division. But he notes that the use of dense MOS chips and the logic at every bit position made possible by LSI will permit his machine to make an exact-match search of all of the bits in the processor in 300 nsec, compared to Staran's 100 nsec.

The basic building block of the Honeywell machine will be 110-by-130-mil MOS chips with 16 eight-bit words and exclusive or logic at each bit location. The chips, developed for Honeywell by Texas Instruments, will be wired together into 256-word modules with an external sequential adder serving each word. Once electronics are added to the modules, the modules can be tied to a control unit.

Solid state

Weather drop

The Air Force has asked Honeywell to develop an automatic weather station that can be dropped from an airplane. Known as Erows—for Expendable Remote Operating Weather Station—the eight-foot, spear-shaped system will provide weather data from remote areas that are inaccessible by foot or vehicle.

Honeywell's system, which is being developed by its Aerospace division in St. Petersburg, Fla., measures wind speed and direction, atmospheric pressure, temperature, humidity, precipitation, and cloud cover. And it will do all this with a four-pound solid state sensor package having hardly any moving parts, according to Gene B. Wyatt, technical director of meteorological instrument programs at Honeywell. Without moving parts, corrosion will be less of a problem and the package will be better able to withstand the shock of impact.

Thus, designers at Honeywell will eliminate perhaps the best known of any of the sensors found in a weather station—the rotating

cups commonly used to measure wind speed. Instead of the cups, Honeywell will use a dual-thermistor temperature-sensing unit whose feasibility for the job has only recently been proven.

Wind will blow on one thermistor, while the second, protected from the wind, will be the temperature base. As the wind blows, the thermistor cools so that the power needed to maintain its temperature at the base value is a measure of wind speed. The other types of sensors in the package, including the aneroid barometer for pressure, hygrometer for dew point, and bead thermistor for temperature, have been used before.

Most of the weight in the 55-pound weather station is needed to deploy and slow the unit after it leaves the airplane and to guide its heavy steel tip into near vertical

impact with the ground. Following impact, the sensor package is freed from its supports to rotate and level itself about a two-axis bearing. This leveling can take place if the station is within a $\pm 25^\circ$ angle of the vertical. A small pyrotechnic charge then drives a metal pin into the package to hold it steady. A quarter-wave antenna pops up, a receiver turns on, and that's it.

Under order. The station makes measurements in anywhere from two to five minutes only after being interrogated with a coded address by a master control station in an aircraft or on the ground; the rest of the time the sensors sit passively. Most of the measurement time is needed for the sensors to warm up and stabilize. Data is collected, converted to digital signals, and transmitted via an ultrahigh-frequency carrier in about 10 seconds, using

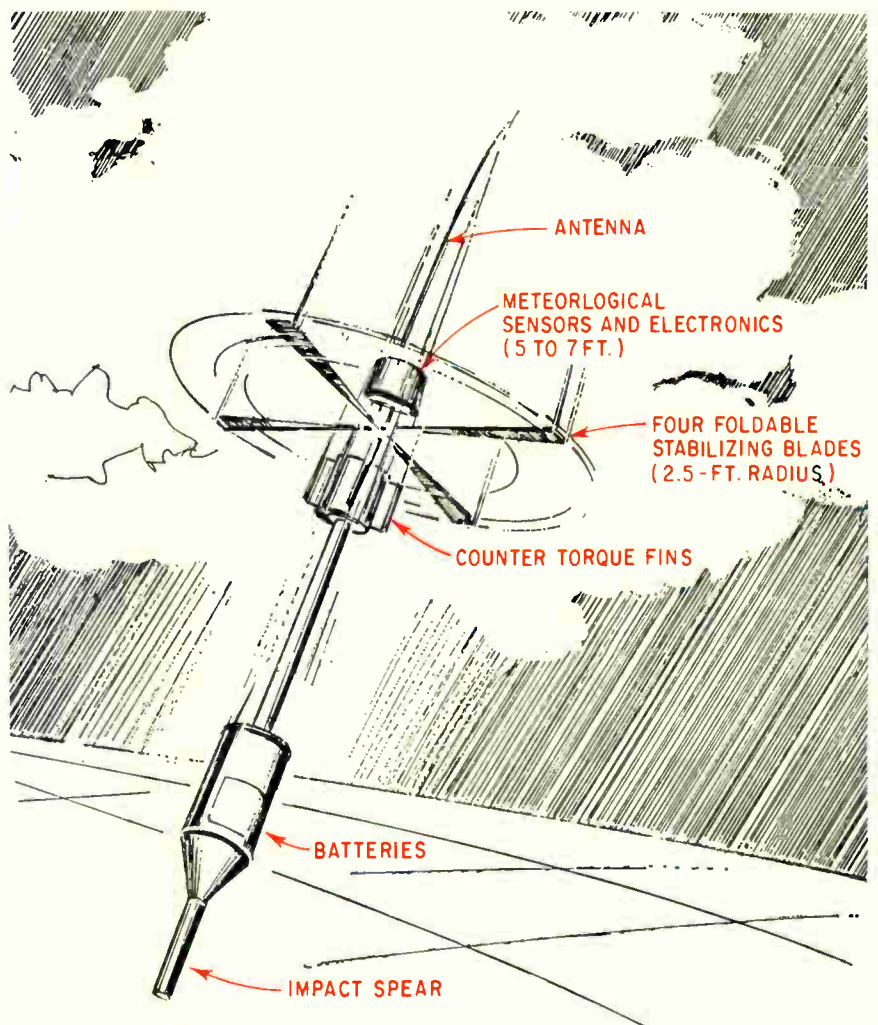

On its way. Artist's conception of air-dropped weather station, called Erows, under development by Honeywell for the Air Force.

PULSE

FIDELITY

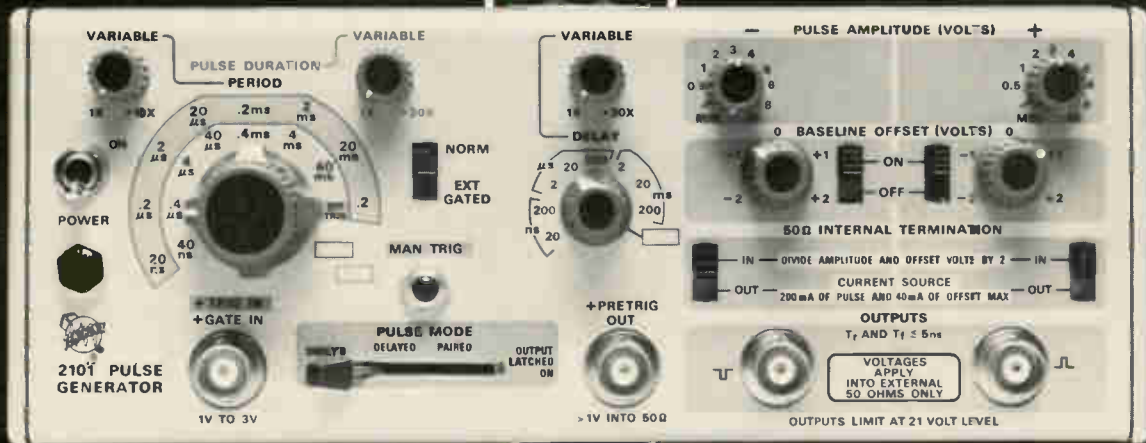

3%

Simultaneous Positive and Negative Pulses

This 25-MHz, 10-volt, general-purpose generator produces exceptionally clean pulses with aberrations not exceeding 3%. Positive and negative-going pulse outputs are simultaneously available and independently variable from 0.5 V to 10 V. (See photo at right.) Each output is provided with a continuously variable baseline offset of +2 V to -2 V.

A choice of paired, delayed and undelayed pulses, as well as a DC output is provided by the four operating modes.

Pulse duration, period and delay are separately variable; pulse duration from 20 ns to 400 ms, period from 40 ns to 400 ms, and delay from 20 ns to 4 s. Mechanical coupling prevents the duration from exceeding the period for all calibrated positions.

Risetime and falltime of 5 ns (2.5 Hz to 25 MHz rep rate), simultaneous positive and negative outputs, with aberrations less than 3%, make the 2101 an ideal pulse source for logic testing or wherever the need for clean pulses exists.

A demo of the 2101 will prove its merits — call your local Tektronix Field Engineer. Have you

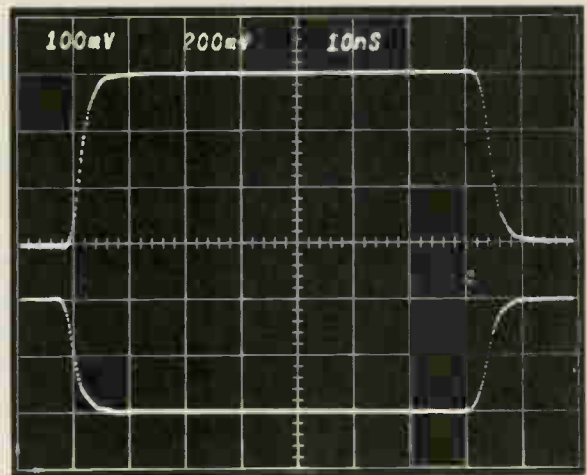

seen the new 7000-Series Oscilloscopes? For complete specifications on these instruments, consult your 1970 Tektronix Catalog, or write P. O. Box 500, Beaverton, Oregon 97005.

All these new instruments are available under our new Leasing Plan.

2101 Pulse Generator \$700

U.S. Sales Price FOB Beaverton, Oregon

Tektronix, Inc.



*committed to progress
in waveform measurement*

U.S. Reports

an f-m, frequency-shift-keying mode.

Maximum power output will be 10 watts peak, supplied by a lead-acid battery. Line-of-sight range of the transmitter is 50 miles.

The Honeywell award, from the Air Force Cambridge Research Laboratories, is for "several hundred thousand dollars," Wyatt says. The company will have a developmental model ready in about a year. An earlier attempt by the Air Force to develop the same type of station is believed to have failed because the unit could not survive the impact.

Another second breakdown

A factor that's often overlooked in power transistor circuits is the number of power cycles—the number of times the circuit is turned on and off. But circuit designers are becoming increasingly aware that when there is an appreciable temperature swing when the circuit is turned on, a transistor failure mechanism—thermal fatigue—can set in and shorten the life expectancy of the equipment. Minute cracks are induced by the rapid change in temperature as the devices goes on and off in even the best-designed power transistors.

These cracks slowly become larger with subsequent cycles until the device is destroyed. An auto radio, for example, is turned on two or three times a day. If the radio has power transistors that can withstand, say, 1,000 such cycles, the radio could fail after less than a year of service. Computer power supplies also are prone to power-cycle-induced failure, since they are turned on and off a few times every day. In fact, a computer power supply is subjected to about 800 power cycles just during fabrication and testing.

Chart. To help design engineers cope with the problem, RCA's Solid State division in Somerville, N.J., has developed a way of specifying a transistor's capacity for repeated power cycles. RCA uses a power thermal-cycle rating chart that Carl R. Turner, manager of power

devices at Somerville, believes will become as important to the power circuit designer as the second-breakdown-free safe-area charts introduced five years ago.

RCA is gathering power-cycle data on all its power transistors, and will publish power thermal-cycle rating charts—which will be unique for each transistor type—on all data sheets by December.

The chart plots the number of power cycles as a function of case temperature change for various power dissipations. The accompanying diagram shows a chart for a typical 175-watt transistor. To use a chart, the designer starts with a set of constraints. Say he's designing an 80-watt power supply that must operate without failure for at least eight years with 1,000 on-and-off cycles per year. Suppose he decides to use two 175-

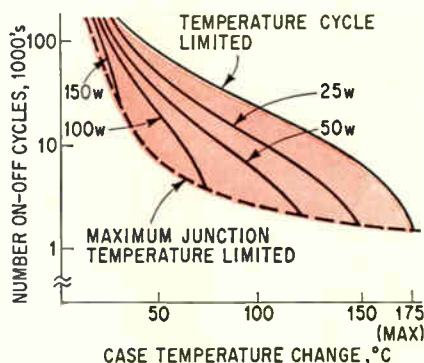

Picture. Here's the RCA power thermal-cycle rating chart.

watt-rated transistors, each dissipating 40 watts. The chart shows that at this dissipation and a life expectancy of 8,000 cycles, a case temperature change no greater than approximately 95°C over the ambient is permissible. The engineer can now design a heat sink for the transistors that will limit the temperature change to this value.

Turner sees the new charts as a way of placing design responsibility where the design authority is—which is the way most power circuit engineers would like to see it. RCA is now seeking approval from JEDEC members so that the power thermal-cycle rating can become standard in the industry.

Materials

Aid for SOIS

If they could, makers of silicon-on-sapphire integrated circuits would gladly substitute the semiprecious crystal spinel for sapphire. At RCA's David Sarnoff Research Center in Princeton, which is doing advanced work on SOS, researchers are convinced that spinel's advantages—ease of polishing, freedom from contamination, and closeness to the silicon crystal structure—would significantly ease fabrication problems. But good-quality spinel has been in short supply and is expensive.

Now, however, the Union Carbide Corp.'s Crystal Products department in San Diego has developed a process for growing synthetic spinel economically and in large quantities. The company adapted the familiar Czochralski process used to grow silicon to growing of spinel. A small seed crystal of spinel is introduced in a molten mass of the material. As the seed is slowly withdrawn, the liquid spinel crystallizes and clings to it, forming a long rod of single-crystal spinel.

Hurdle. One of the problems the developers encountered was finding refractory materials. Spinel has a melting point of 2,150°C, 100° higher than that of sapphire and uncomfortably close to the melting point of the materials used to contain the liquid for processing. The effort was worthwhile, however, because spinel made by the Czochralski technique is cheaper and purer than that made by other processes; it's stoichiometric $MgO \cdot Al_2O_3$.

Union Carbide has been so successful that it is offering wafers of spinel off the shelf in quantities up to 199. Price of a wafer, with a thin film of silicon already deposited on it, is \$28—about half that of an SOS wafer, the manufacturer says, and only 3½ times the price of a bulk-silicon wafer. The wafers are 1¼ inches in diameter, but soon will be available with the 2-inch diameter that IC manufacturers are accustomed to in their bulk silicon wafers.

Availability of silicon on spinel

New! A Unique CRT. 150 MHz Bandwidth... 11.5" Long.



For a long time, oscilloscope designers have been looking for a short-length CRT allowing for high frequency measurements with good sensitivity.

Now, with a breakthrough combination of design and precise assembly technique, we offer the F8071—an 11.5" long CRT operating up to 24 kV for improved visual and photographic writing speed. Thanks to a new patented deflection system featuring two quadrupole lenses and a special "slot" lens, no transmission line technique is required for operation up to 150 MHz. @0.2 dB. A graticule, placed in the same plane as the phosphor, avoids errors caused by parallax.

For the latest information on the CRT state-of-the-art, write or call your nearest Cain & Company representative or contact us directly.

Tube Type	Bandwidth @ 0.2 dB (MHz)	Useful Screen Dimensions (Inches)	Length (Inches)	Average Sensitivity		Typical Operation			
				Horizontal V inch	Vertical V inch	Anode (Kilo-volts)	Grid 2 (Kilo-volts)	Focus Grid (Volts)	Cutoff (Volts)
F 8071P31	150	4 x 2½	11½	29	10	18	2.0	200-500	-30 to -80



THOMSON-CSF

Thomson-CSF Electron Tubes, Inc./50 Rockefeller Plaza/New York, N.Y. 10020/(212) 245-3900

U.S. Reports

in quantity and at reasonable price should be a shot in the arm for SOS—or more generally, silicon on insulating substrate—technology. Although fabrication problems diminished to the point where several major companies, Autonetics, Signetics, RCA, and Plessey, have vague plans to produce SOIS IC's commercially, the cost of the substrate material has been a deterrent [*Electronics*, June 8, p. 88]. Now, the huge potential market for SOIS, estimated at 30% to 40% of the total \$100 million semiconductor memory market in 1970, is that much closer.

Manufacturing

Seeing infrared

Infrared profiling of printed-circuit boards is a proven troubleshooting and fault-location technique, but the market for the specialized radiometers used in this work has never caught fire. Spokesmen for Vanzetti Infrared and Computer Systems of Dedham, Mass., feel that there are two reasons; first, the cost of the equipment available has been too high—about \$100,000—and second, potential users need education before they can become customers.

Now, Vanzetti is trying to correct for both with its so-called Inspect system. The computer-controlled system is pegged at about \$50,000, aimed at broad applications areas, and is being sold with an approach that lets the user educate himself while solving his own problems.

The central part of Inspect is a liquid nitrogen cooled, indium-antimonide diode detector. A rocking mirror scans a spot about 0.020 inch in diameter over the surface of printed circuits as large as 8 by 12 inches in about 30 seconds, reflecting heat-generated i-r into the detector. A computer controls the position of the mirror and, thus, the location of the spot, as well as processing the data coming out of the detector; Vanzetti uses a 12-bit General Automation processor.

Printout. In applications like production control or troubleshooting, Inspect's Teletype printout docu-

ments the i-r profile of each p-c board. Alternately, the printout can include only readings on components that depart from Octal-coded temperatures stored in memory.

These temperature readings can be used to trace chains of hot or cold components back to specific failures. In practice a technician armed with a schematic and a list of hot or cold components can work his way to the faulty component or connection in less than a minute. If nothing else, this cuts down labor time.

According to company president Riccardo Vanzetti, about 3% of printed circuits that pass conventional tests contain hidden defects which will cause failures later. For example, a half-watt resistor may be substituted for a 1-watt resistor, and though it will operate for a time, its limited heat dissipation will eventually burn it out, and the component may carry others with it when it goes. Inspect would have noted the extra i-r emitted by the hotter-than-normal resistor, but electrical tests would have detected nothing.

For \$350 per man-day, Vanzetti engineers train customers on their own Inspect system, and then let them evaluate i-r in their own applications. Usually students bring along troublesome circuits, and the firm allows them to program the computer to trouble-shoot.

Lines. Actually, there is far less training than evaluation. To use Inspect, the component layout of a p-c board is transferred to x-y coordinates, and the amount of i-r expected from each component or location is noted along with normal tolerances.

This information is punched out on tape at the Teletype console and fed into memory. If the emission values aren't known, the Inspect system can measure and record the values from a bogie board, getting absolute figures by comparison with two i-r calibration sources mounted beside the p-c board.

The user then plugs in his board, lets it reach operating temperature, and Inspect scans it. Only the departures from the norm are printed out, and fault isolation is simple afterward.

Components

Well stacked

For years, computer designers have sought high capacitance at low voltage in an electrolytic capacitor. Such a device can filter at low and high frequencies in a computer's power supply and permit high-frequency, high-current a-c and d-c circuit operation.

Now researchers at the Sprague Electric Co. have developed a stacked structure of anode and cathode foils separated by paper spacers. The capacitor has been breadboarded in two- and four-terminal configurations with capacitances up to 157,400 microfarads at 5-volt operation.

The four-lead device passes high currents and continuously filters a-c and interference. The unit is terminated by stripline, which helps assure low inductance while providing a physical and electrical anchoring for the foils. The units have inductances of less than 1 nanohenry.

Eight out. Previously, a bank of eight electrolytic capacitors was required to provide the same impedance-frequency characteristics. Although the parallel units provide the same electrical characteristics as the stacked version, inductance increases when terminations are applied. The stacked capacitor's low inductance does not change when it is properly connected to a bus bar or similar conductor.

The anode material is pure aluminum foil, as are the rolled foil devices. Voltage and capacitance ratings are set by using foils with various oxide-film characteristics. The plates are about 3 inches by 4 inches. The overall unit, which measures approximately 4 inches by 6 inches by 2.5 inches, is impregnated with conventional electrolytes so that it can operate from -20°C to $+85^{\circ}\text{C}$.

Since the development is relatively new, extensive life tests are yet to be performed. However, several tests were done after 3,000 hours of operation and measurements were taken at 120 hertz.

Initial capacitance was 117,000 μf ; after 3,000 hours it dropped

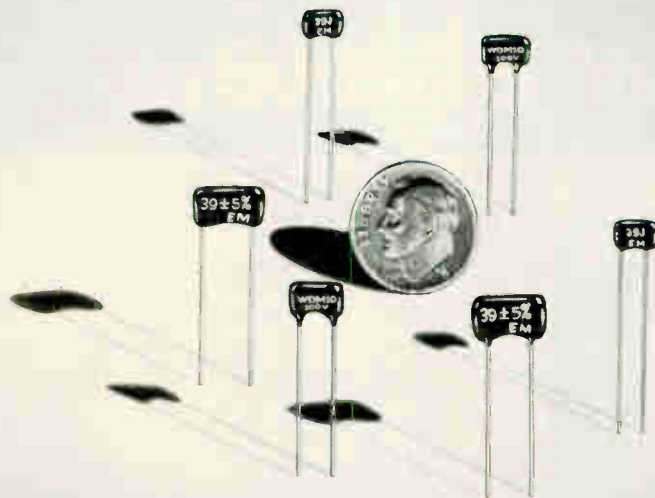

They're Small and Reliable*

EL-MENCO DM5 — DM10 — DM15 — ONE COAT DIPPED MICA CAPACITORS

STYLE	WORKING VOLTAGE	CHARACTERISTIC	CAPACITANCE RANGE
DM5	50VDC	C	1pF thru 400pF
		D, E	27pF thru 400pF
		F	85pF thru 400pF
DM5	100VDC	C	1pF thru 200pF
		D, E	27pF thru 200pF
		F	85pF thru 200pF
DM10	100VDC	C	1pF thru 400pF
		D, E	27pF thru 400pF
		F	85pF thru 400pF
DM15	100VDC	C	1pF thru 1500pF
		D, E	27pF thru 1500pF
		F	85pF thru 1500pF
DM5	300VDC	C	1pF thru 120pF
		D, E	27pF thru 120pF
		F	85pF thru 120pF
DM10	300VDC	C	1pF thru 300pF
		D, E	27pF thru 300pF
		F	85pF thru 300pF
DM15	300VDC	C	1pF thru 1200pF
		D, E	27pF thru 1200pF
		F	85pF thru 1200pF
DM10	500VDC	C	1pF thru 250pF
		D, E	27pF thru 250pF
		F	85pF thru 250pF
DM15	500VDC	C	1pF thru 750pF
		D, E	27pF thru 750pF
		F	85pF thru 750pF

Where space and performance are critical, more and more manufacturers are finding that El-Menco miniaturized dipped mica capacitors are the reliable solution. The single coat is available in three sizes: 1-CRH, 1-CRT and 1-CE.

The 1-CRH DM "space savers" easily meet all the requirements of MIL and EIA specifications, including moisture resistance. The 1-CE and 1-CRT units also meet the requirements of MIL and EIA specifications, except that they have less moisture protection because of their thinner coating; these capacitors, therefore, are ideally suited where potting will be used. Note: DM10 and DM15 units are still available in the standard 4-CR size.

Specify "El-Menco" and be sure . . . the capacitors with proven reliability. Send for complete data and information.

*Normally, El-Menco 39 pF capacitors will yield a failure rate of less than 0.001% per thousand hours at a 90% confidence level when operated with rated voltage and at a temperature of 85°C. Rating for specific applications depends on style, capacitance value, and operating conditions.

THE ELECTRO MOTIVE MFG. CO., INC.

WILLIMANTIC, CONNECTICUT 06226

Dipped Mica • Molded Mica • Silvered Mica Films • Mica Trimmers & Padders
Mylar-Paper Dipped • Paper Dipped • Mylar Dipped • Tubular Paper

West Coast Manufacturers contact: COLLINS & HYDE CO., 900 N. San Antonio Rd., Los Altos, California 94022
5380 Whittier Blvd., Los Angeles, California 90022

ALSO SOLD NATIONALLY THROUGH ELECTRONIC PARTS DISTRIBUTORS

Give our PC connectors an unfair shake.

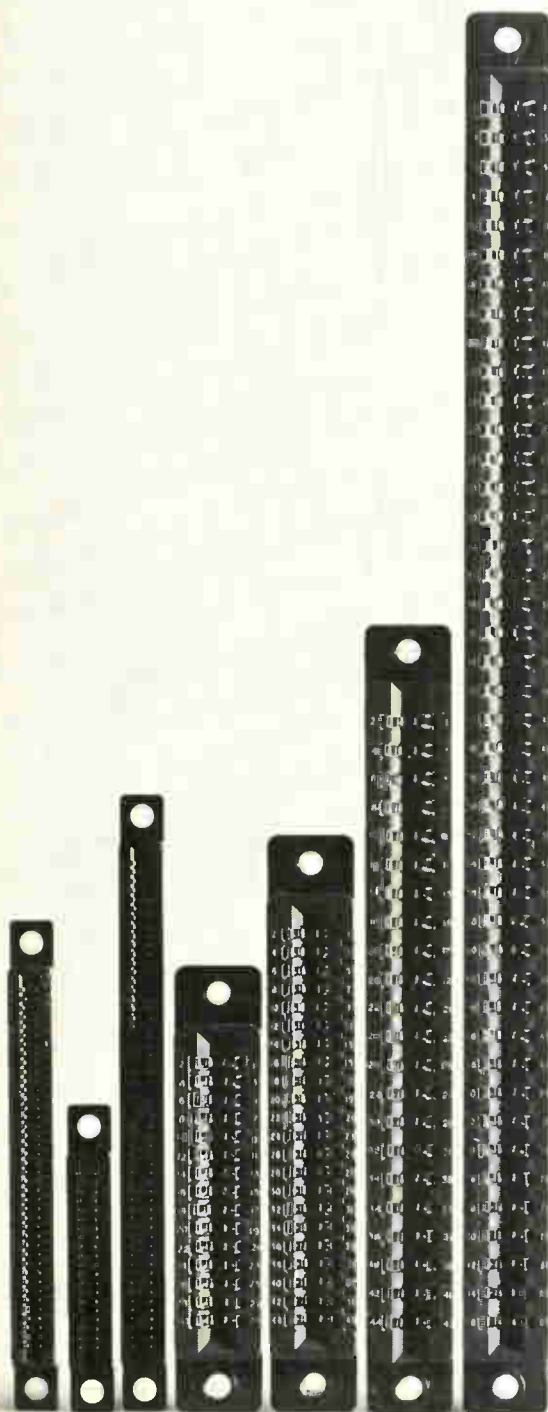

They can take it.

Vibration.
Shock.
Warping.

That's what printed circuit boards have to put up with nowadays.

So we designed PC connectors that can take it.

Not even an unfair shake (or warp) can jar them loose.

In fact, they can withstand shaking no matter how widely deflected the linear direction of the contact force.

The secret's a bifurcated dual-socket contact that uses a double-cantilever principle.

Once contact is made, it stays made unless you want to reposition it. And when you do, Hughes' exclusive JacPin construction lets you do it easily

and quickly.

Hughes PC miniature and subminiature connectors are available off-the-shelf in 10 sizes with 10 to 96 contacts.

Order some. And give 'em an unfair shake.

Write Hughes Aircraft Co., Connecting Devices, 500 Superior Ave., Newport Beach, Calif. 92663. Phone (714) 548-0671. TWX (714) 642-1353.

☐ Connecting Devices, part of Hughes Circuit Technologies. Including: Contour™ Cable; Semiconductors; Flip Chips/Equipment; Frequency Control Devices; Microelectronic Circuits; MOSFETs.

HUGHES

HUGHES AIRCRAFT COMPANY

If it's happening in connectors,
it probably started at Hughes.

7.6% to 108,200 μ f. Equivalent series resistance—largely responsible for the energy loss and heating effects within the capacitor—was kept very low, an important factor if high currents, free from a-c, are to be carried. Initially, the equivalent series resistance measured 0.0023 ohm; after 3,000 hours it dropped 26% to 0.0017 ohm. Initial leakage for the unit was 670 microamperes; it dropped to 250 μ a after 3,000 hours—a change of 62%. Operating voltages for the tests were at 5 volts d-c.

Memories

Magic cent . . .

Demand for cheap mass data storage is one force triggering the surge in semiconductor memories—their makers hope to use batch fabrication to bring down the storage cost per bit. But so far, the users' cry of "penny a bit" only causes the makers to flinch, and disks and drums continue to dominate the bulk storage field.

But now, the Electronic Systems division of Sylvania in Needham, Mass., has developed with some Navy support a new memory that uses a magneto-acoustic effect to store data en masse at a promised cost of only 0.1 to 0.2 cent per bit [*Electronics*, June 22, p. 34].

Sylvania calls the batch-fabricated memory Soniscan and says it packs up to 8 million bits into a one-foot cube, a higher packing density than possible with disks and drums. Its read-write time is a swift 70 to 75 nanoseconds, verging on semiconductor memory territory, and much faster than disk memories. Since the memory is block oriented, access time seems slow at 1 to 2 microseconds, but this still is faster than the multi-millisecond latency time of disks and drums.

Production. Sylvania probably will decide about Soniscan production this month. If the decision is yes, production should be simple. Developmental memory planes have been made by depositing magnetic, insulating, and copper

planes on a 10-mil-thick, inch-wide glass substrate. The structure then is etched into 30 to 40 lines, 10 mils wide on 20-mil centers. This is the only etch step, and because these geometries are very large compared to those of integrated circuits, they should be easy to control, allowing a predicted high yield and low end-product cost.

Lead-zirconium titanate sonic transducers are attached to the underlying substrate ends and leads are connected to them and to the write-sense lines—the deposited copper planes.

The basic storage element is a five-deck sandwich of two magnetostrictive layers separated by an insulated conductive layer. When transducers at the end of the substrate are pulsed, strain waves travel down the glass. They cause changes in coercive force, and in flux from positive to negative in the magnetic materials as they pass.

Change of state. To store data in the memory strips, the transducers and copper strips are pulsed. The combined effect changes the remanent state of the magnetic material where the electronic and acoustic pulses coincide.

To read, the sonic transducers are pulsed and the change from positive to negative magnetism in the films induces current in the copper layer that is sensed as data. After the sonic pulse, the magnetic layers go back to their former positive or negative remanent states, making the read-out process non-destructive.

RCA laboratories in Princeton, N.J., developed a similar system [*Electronics*, April 14, 1969, p. 91] with one magnetostrictive layer. RCA is said to have dropped the effort.

. . . attracts Navy

A magneto-acoustic memory, maybe Sylvania's Soniscan, is said to be the leading candidate for on-line bulk storage in the Navy's advanced airborne digital computer. Navy spokesmen say that cost, reliability, and low weight are major reasons for the tentative

How did Hughes get a reputation for innovation?

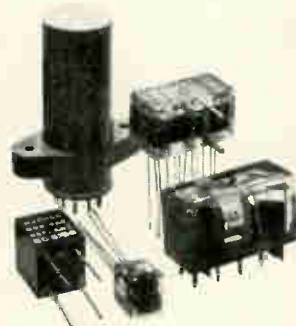
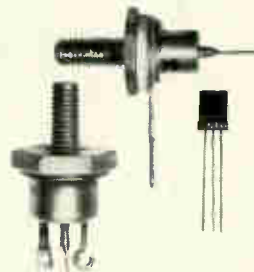
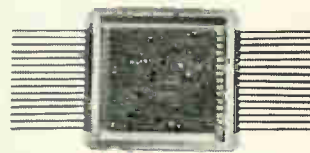

That's how.

A reputation from technical know-how in developing better MOS devices (RS 283), bipolar and hybrid circuits (RS 284), discrete devices and monolithic circuits (RS 282), frequency control devices (RS 285), and special assemblies (RS 286).

HUGHES

HUGHES AIRCRAFT COMPANY
INDUSTRIAL ELECTRONICS GROUP

Circle appropriate Reader Service (RS) number.

the only switch with CHANGEABLE functions

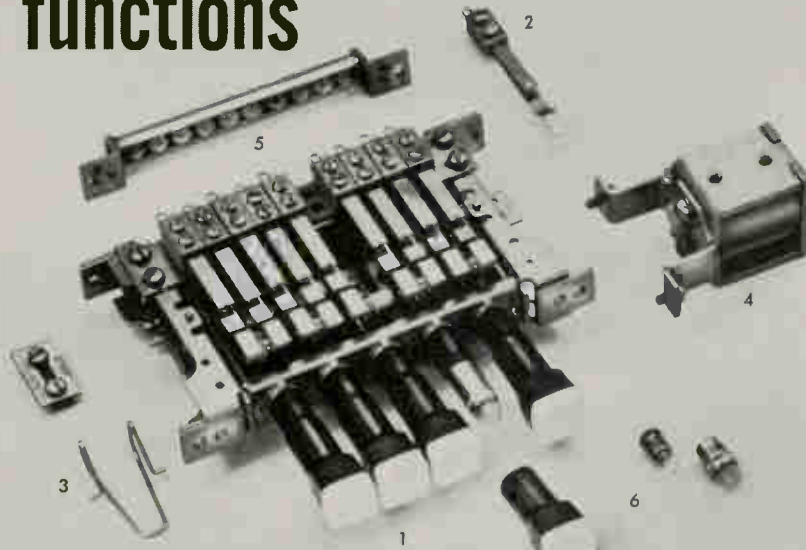

SWITCHCRAFT "MULTI-SWITCH"[®] SWITCHES

Multiple Station Pushbutton Switches

this is all you need!

The ultimate in dependability, simplicity—and versatility. Switchcraft's exclusive Componentized design gives you complete control over functions and operating characteristics . . . switches "grow" with the job, functions can be changed at any time—even in the field. Ideal for prototypes, R & D models . . . unsurpassed for production models whether switch functions are permanent, semi-permanent, expandable, add-on, or where unit should have re-claimable components. Since the multitude of possible functions are too numerous to mention here, such as electronic lock-up, push-lock/push-release, programming of switches, neon lighting, etc., only the basic switch functions are listed below to illustrate how Componentized design works:

1. **BASIC FRAME.** From 1 to 37 stations in one row! Or up to 100 stations or more in ganged assemblies. Rugged; heavy gauge welded steel. Illuminated (6V or 28V) or non-illuminated pushbuttons.
2. **STACK SWITCHES.** Up to 16 switching circuits activated by any one station . . . up to 4 switching stacks per button. Long-life contacts (choice of palladium or gold) . . . famous Switchcraft quality throughout. Completely changeable, too.
3. **LATCH SPRING, STOP PLATE AND PIN.** Enable you to set up switches for 1. Interlock, 2. Non-Lock, 3. All-Lock, 4. Interlock and Non-Lock combinations, 5. All-Lock and Non-Lock combinations. And, all modes of operation are readily changeable. Also available in Push-Lock/ Push-Release.
4. **SOLENOID.** For automatic remote release of depressed buttons.
5. **LOCK-OUT BAR.** Prevents 2 buttons from being depressed simultaneously.
6. **BUTTONS & LAMPS.** Replaceable from front of panel. Square, round; illuminated, white, colors; blank, numbered, lettered—you name it!

Whether you need a multiple pushbutton switch for launching missiles or "automating" drive-ins, investigate Switchcraft Componentized "Multi-Switch"[®] switches—for reliability and versatility.

For complete details write for Engineering Specification Catalog No. S-306 or see your local Switchcraft Authorized Industrial Distributor for immediate delivery at factory prices.

SWITCHCRAFT[®]

5561 Elston Avenue, Chicago, Illinois 60630

Canada: Atlas Radio Corp., Ltd., 50 Wingold Ave., Toronto, Ontario, Canada

U. S. Reports

choice. But since large numbers of AADC's would replace as many as 35 separate mainframe types, the Navy is scouting for a second source and soon may announce a contract for development of another memory similar to Soniscan, or for a Soniscan back-up production capability.

The Navy compared core, plated wire, film, and semiconductor memories with Soniscan. The Sylvania entry, at least in the form wanted by the Navy, led the pack in potential bit storage capacity and in packing density at 5,000 bits per cubic inch.

For the record

Watch your step. Alarmed by reports that microwave oven emissions can disrupt heartbeat-regulating pacemakers, the government has launched a study of the design of the medical devices. The object: to find out from manufacturers how much emission a pacemaker can handle, and at what distance. The study is under the auspices of the Bureau of Radiological Health of the Department of Health, Education, and Welfare.

Market. The recent FCC ruling that cable tv operators originate programming as of Jan. 1, 1971, has spurred at least five set makers to rush inexpensive color cameras to the market. During the past six months, cameras costing from \$6,700 to \$10,000 have been brought out by RCA, Hitachi, the International Video Corp., Sony, and the Shibaden Corp. of America. And RCA has just signed a deal with the TelePrompTer Corp. to deliver \$1 million worth of cameras and other studio equipment to the cable operator.

Big hop. Due to fly this month is an experimental satellite called OFO (for orbiting frog otolith). The principal experiment: to learn how a frog's inner ear nerve mechanism adapts to zero G. It's being managed by the Space General division of the Aerojet General Corp in El Monte, Calif.



Whether you want fast-acting or slow blowing fuses, whether you want signal indicating/alarm activating fuses, subminiature fuses or rectifier fuses, you can meet the requirement with a selection from the complete BUSS Quality line.

If you need fuse-holders, BUSS has in-line, panel-mounted and miniature types, as well as RF in-

terference-shielded, lamp indicating, and space saver varieties. The BUSS Quality line also includes all types of fuseblocks and related mounting hardware.

So, save time and trouble by standardizing on the BUSS Quality line. You'll not only find the right fuse and fuseholder everytime, but you'll simplify stock handling and inventory problems too.

For fuses and fuseholders of unquestioned high quality for every protection need

SUPPLIED THE ECONOMICAL WAY
THRU DISTRIBUTORS

BUSS QUALITY
FUSES

Bussmann Mfg. Division, McGraw-Edison Co., St. Louis, Mo. 63107

Tips on cooling off hot semiconductors

As power levels go up and up and package size shrinks, circuit designers are keeping semiconductors cool with IERC Heat Sinks/Dissipators. Reducing junction temperature gives many benefits: faster rise and fall times, faster switching speed and beta, fewer circuit loading effects and longer transistor life and circuit reliability.

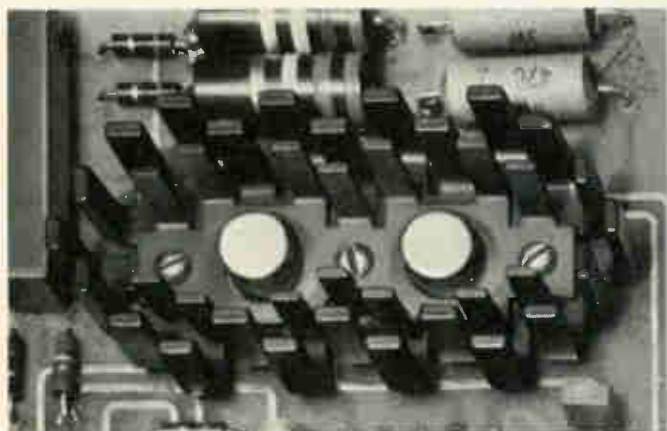

Thermal mating of matched transistors, such as these TO5's shown on a dual LP, maintains matched operating characteristics. The LP's unique multiple staggered-finger design (both single and dual models) maximizes radiation and convection cooling, results in a high efficiency-to-weight and -volume ratio.

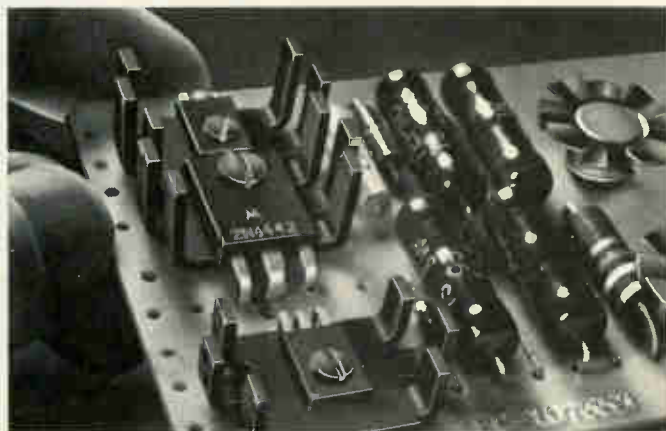

Power levels of plastic power devices such as X58's, MS9's, and M386's can be increased up to 80% in natural convection and 500% in forced air when used with PA and PB Dissipators. PA's need only .65 sq. in. to mount; PB's 1.17 sq. in. Staggered finger design gives these light-weight dissipators their high efficiency.



TO5's and TO18's in high density packages can be cooled off with efficient push-on Fan Tops that cost only pennies. T-shaped, need no board room, let other components snuggle close. Spring fingers accommodate wide case diameter variations. Models for RO97's, RO97A and D-style plastic devices also.

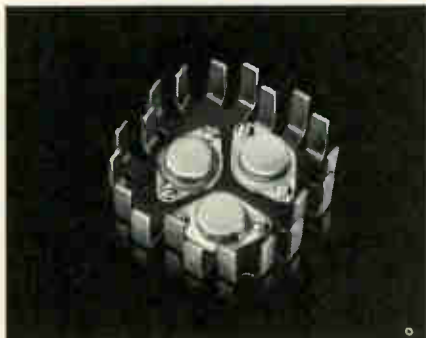

High power TO3's, TO66's, TO6's, TO15's, etc. can be operated with much more power when used with HP's. These compact, light-weight staggered finger devices accommodate from one to four TO3's. Provide the same heat dissipation as an extrusion that's three times heavier and one-third larger.

Heat problems? IERC engineers welcome the opportunity to help solve your heat dissipation problems. As the world's largest manufacturer of heat sinks/dissipators for lead and case mounted semiconductors, they can come up with a practical, low cost solution.

Free
four-page
Short Form
Catalog.
Send for
your copy
today.



Heat Sinks/Dissipators

IERC



Need an 80-db blast?

Actual size



You'll get it from our 1½-ounce Sonalert® electronic audible signal.

With as little as 6 VDC and 3 ma., Sonalert produces a piercing sound that's hard to ignore. Yet it weighs only a couple of ounces because it's all solid state. Even the transducer is a crystal. This makes Sonalert reliable, efficient and long lasting. And because it's solid state, there's no danger of arcing, no RFI or EMI noise, important considerations in computer and other control signal applications.

Standard units vibrate at a fixed frequency of 2900 = 500 Hz or 4500 = 500 Hz depending on model. In

© Registered trademark, P. R. Mallory & Co., Inc.

addition, pulsing, warbling and AC models are available. The penetrating sound covers a wider area than alarm lights and demands instant action. This makes Sonalert ideal where ignoring warnings would be hazardous or cause damage. Examples: aircraft fuel warning, electrical overload, computer error, automobile door ajar or headlights-on warning. Other applications include communications, shipboard, missile and medical electronics alarms.

For an informative 48-page booklet of projects and circuit ideas, write for folder No. 9-406. Address: Mallory Capacitor Company, a division of P. R. Mallory & Co., Inc., Indianapolis, Indiana 46206.

MALLORY

MALLORY CAPACITOR COMPANY

4 Division of P. R. MALLORY & CO., INC.
3000 E. Washington St., Indianapolis, Indiana 46206 Telephone: 317-406-0000

Electrical and electronics components • sequence timers • metallurgical products • batteries

Room for improvement

General Electric's TO-5² transistor-size sealed relays give you more room for increased power, improved performance

We didn't cut any corners on this high-reliability, transistor-size sealed relay. We left them on so there'd be more room for a more powerful magnet—2½ times more powerful.

This added power means this type 3SBS, 2PDT, 1 amp relay gives you higher contact forces, larger contact gaps, and greater overtravel to minimize mechanical shifts. Shifts which usually increase early-in-life failures.

Though there's more room inside to give you all these advantages, the outside dimensions—top-to-bottom (.275") and side-to-side (.370")—are the same as any transistor-size relay.

So don't cut corners on your next transistor-size relay application. Specify GE's square Type 3SBS, now qualified to MIL-R-5757E/40. For full details, write General Electric, Section 792-45, Schenectady, New York 12305.



ACTUAL SIZE

GENERAL  ELECTRIC

Facts.

The Mark 260 delivers more of them...with less fuss, bother and cost...than any other oscillograph you can buy.

Facts start with accuracy.

And the Mark 260 is about as accurate as you can get. We *guarantee* 99½%. So when you're looking at the chart of a Mark 260, what you see, is fact. We owe it all to a fool-proof position feedback system that enforces pen position all the way across the chart. There are no springs, no strings. Or any of the other tricky mechanisms that you'll suffer with in other recorders.

Those traces you see are a lot more than just accurate. They're crisp and clear and reliable from one edge of the chart to the other. They won't smudge or smear. (And you can chalk that up to a patented pressurized ink-

writing system that puts the trace into the paper and not just on it.)

You can forget about recalibration problems, too. We took care of that little nuisance at the factory. So change those settings to your heart's delight. The Mark 260 will keep right up with you. And save you piles of time and piles of chart paper in the bargain.

That's what you get with a Mark 260. It's the go-anywhere, do-anything 6-channel recorder by Brush. At a price per channel that will surprise you.

More facts. Less fuss, bother and cost.

Ask your Brush representative for a demonstration. Or write for Mark 260

Bulletin 942-2: Brush Instruments Division, Gould Inc., 3631 Perkins Avenue, Cleveland, Ohio 44114. We'll include one of the most comprehensive handbooks on signal conditioning you'll ever find.



GOULD BRUSH

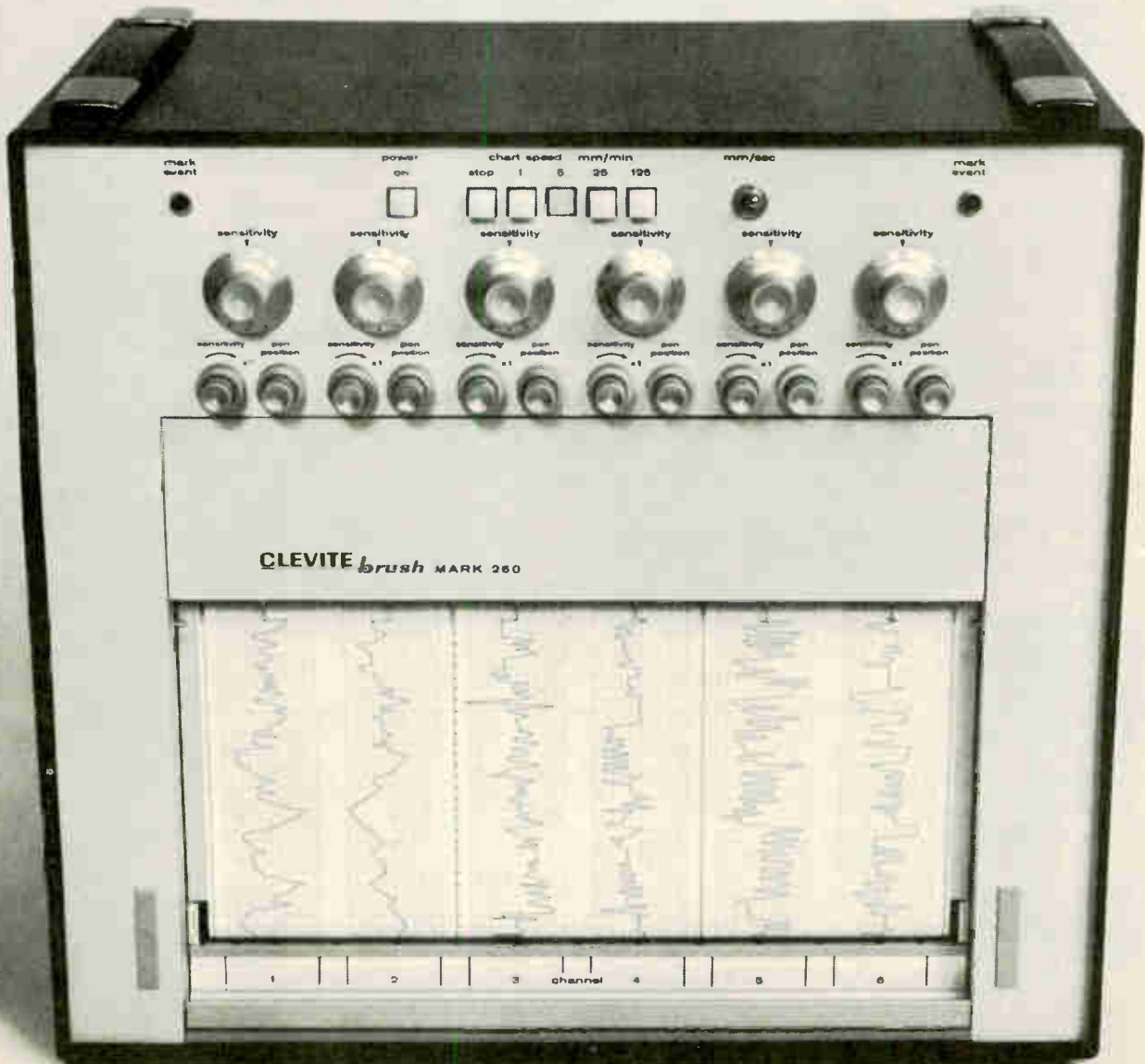

New S. S. White system trims microelectronic hybrid resistors at 1,000 per hour...or more



If you're into hybrid circuitry in a big way, or hope to be, our Model AT-701AR may be just what you need. It offers high capacity, accurate trims, high yield — or, just what you need to keep your customers and your comptroller happy.

Model AT-701AR is similar to our highly successful Model AT-701A, but with the addition of a rotary feeding system which lets operator load and unload substrates during the machine's trimming cycle. Capacity is limited only by the man-

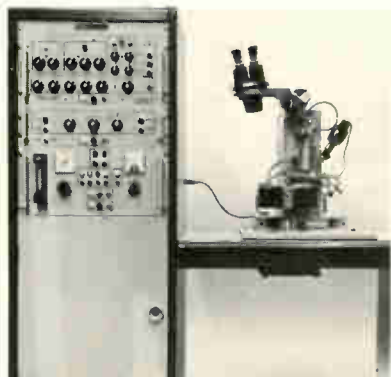

Model AT-701AR

ual dexterity of your operator.

Accuracy of the AT-701AR is guaranteed — within 0.5%. 0.1% is attainable with care and some sacrifice of speed. Trimming is monitored by a precision system of electronics featuring a four-wire Kelvin bridge, and tolerances may be programmed from $\pm 0.1\%$ through $\pm 11\%$. (No use making them better than the specs require!)

But suppose the Model AT-701AR is too big or too small for you?

Call us anyway. If you can get by with something like 600 accurate trims an hour, we can offer you our Model AT-701A, to which you can add the turntable feature later. If you're still experimenting, we have Model LAT-100 for breadboarding. It is accurate to 1% better, takes substrates up to 4 x 4 inches and sells for only \$5,950. If you're *really* big, there's the Model AT-704A, a rotary-feed

machine that trims four resistors simultaneously, monitors, and inspects them at the breathtaking rate of 4,000 per hour. And if *that's* not fast enough for you, buy two.

All the S. S. White resistor trimming systems are based on the proven Airbrasive® method of removing resistance material which produces neither heat nor shock, does not alter the substrate.

Call 212-661-3320 to arrange for a live demonstration. Speak to Hal Skurnick or Nick LaCourt. These same gentlemen will be demonstrating the Model AT-701AR and the Model LAT-100 at major electronics trade shows around the country, and if that's not quick enough for you, we will arrange for you to visit our factory. We have also prepared an extensive technical bulletin on this equipment, called, rather cryptically, the "RT-14", a copy of which is yours for the asking.



RT-14

Write to S.S. White Industrial Division, Pennwalt Corporation, Dept. R, 201 East 42nd Street, N.Y., N.Y. 10017. Tel.: 212-661-3320

PENWALT
S.S. WHITE
INDUSTRIAL PRODUCTS

“a real Joule”

FROM SOLITRON



NEW, LOW COST 2N3055
COMMERCIAL SINGLE-DIFFUSED
NPN SILICON POWER TRANSISTOR SERIES

$E_s/b=1$ Joule minimum

100% TESTED TO 125 WATT/SECOND

TYPE NUMBER TO-3 CASE	h_{FE} @ 4.0V V_{CE}				V_{CE} (sat)	V_{BE} (on)	V_{CEX}	V_{CEO}
	$I_C=3.0A$		$I_C=4.0A$		$I_C=4.0A$	$I_C=4.0A$	VOLTS	VOLTS
	Min	Max	Min	Max	$I_B=4.0V$	$V_{CE}=4.0V$		
2N3055/1	20	—	—	70	1.5V	2.0	40V	30V
2N3055/2	10	—	—	70	1.5V	2.0	40V	30V
2N3055/3	20	70	—	—	1.5V	2.0	100V	60V
2N3055/4	30	—	70	—	1.5V	2.0	30V	20V
2N3055/5	—	—	14	—	1.5V	2.0	30V	20V
2N3055/6	—	—	15	70	1.1V	1.8V	100V	60V
2N3055/7	14	—	—	70	1.1V	1.8V	100V	60V
2N3055/8	—	—	70	—	1.1V	1.8V	100V	60V
2N3055/9	14	—	—	70	1.1V	1.8V	55V	45V
2N3055/10	—	—	70	—	1.1V	1.8V	55V	45V
SDT9201	—	—	20	70	1.1V	1.8V	55V	45V
SDT9202	—	—	20	70	1.1V	1.8V	100V	80V
SDT9203	—	—	20	70	1.1V	1.8V	120V	100V
SDT9204	—	—	20	70	1.1V	1.8V	140V	120V

Solitron's new line of 2N3055 Commercial single-diffused power transistors offer you an inexpensive solution for meeting rugged application requirements. It provides an outstanding secondary breakdown capability for high inductive loads. The TO-3 case is tin plated for easy-wave solder assembly.

Now available from stock in quantities of 10,000 or more for immediate delivery. Contact us today for details and application assistance.

Dial 1-800-327-3243 for a
“No Charge” telephone call
and further information.

Solitron
DEVICES, INC.

1177 BLUE HERON BLVD.
RIVIERA BEACH, FLORIDA
(305) 848-4311 / TWX: (510) 952-6676

HELIAX COAXIAL CABLE...

unique design
and performance



The coaxial cable with the corrugated outer conductor.

Better than braided coax because HELIAX has perfect shielding, precise electrical characteristics, lower attenuation and freedom from age deterioration.

Better than smooth wall coax because HELIAX is more flexible, easier to install, stronger, lighter, free from differential expansion and comes in extremely long continuous lengths.

Available from stock in 35 types and sizes down to 1/4". Foam or air dielectric. Teflon too. Connectors for all standard interfaces.

For full details, communicate with Andrew.



ANDREW

ANDREW CORPORATION, 10500 W. 153RD STREET,
ORLAND PARK, ILLINOIS 60462, PHONE (312) 349-3300

Washington Newsletter

July 6, 1970

**Nixon action on
DOD management
study unlikely . . .**

Little positive action by President Nixon is anticipated following the July 1 delivery to the White House of recommendations for restructuring management of the Department of Defense. Sources close to Secretary Melvin Laird's blue-ribbon defense panel, which coordinated the study, note that Nixon has named some 40 commissions since taking office, but has done little to date with the recommendations contained in their studies.

One panel member, however, was disappointed because the military had a crack at the recommendations before the White House saw them. This led to a watering-down of some potentially controversial points. "Coordinated all out of shape" by the Pentagon was the suggestion that computers should be more widely-used in DOD's decision making process [*Electronics*, Dec. 22, 1969, p. 14].

**. . . but ongoing
decentralization
gets panel's nod**

At the same time, Deputy Defense Secretary David Packard already has moved ahead on his own with programs to decentralize management responsibility while retaining ultimate authority. Some Packard concepts—such as giving program managers longer tours of duty, completing R&D before entering production, and procuring less complex and proven hardware to shorten lead times on operational systems—are apparently supported by the panel, which was headed by insurance executive Gilbert Fitzhugh.

**Separate peripheral
purchases pushed
as EDP money saver**

Independent manufacturers of computer peripherals will get a crack at a new multimillion dollar market some time this month when the General Services Administration asks for bids on replacements for some 2,500 disk and tape units it leases from mainframe computer manufacturers. The massive purchase results from a directive from the Bureau of the Budget authorizing a GSA survey of Federal installations to determine which mainframe maker's units can be economically replaced. Similar action already has been taken by the Air Force and the Navy. A General Accounting Office report last year found that \$5 million could be saved if tape and disk units were leased from independents rather than from mainframe manufacturers. What's more, savings as great as \$23 million could be effected if the units were purchased from independents instead of from mainframe makers.

**DOD zeroes in
on off-campus site
for Illiac 4**

The Pentagon's Advanced Research Projects Agency is invoking the ounce-of-prevention rule in plans to place the giant Illiac 4 computer off the University of Illinois campus when it is delivered later this year. ARPA reportedly has narrowed site selection to four non-campus locations, in order to circumvent the clause precluding classified research on campus as well as protect the machine from antimilitary campus elements.

ARPA officials inevitably talk about worldwide weather modeling when discussing Illiac applications, but estimates are that most of the giant number-cruncher's time will go to the Advanced Ballistic Missile Defense Agency, which has \$4 million invested in the machine: the Air Force Weapons Laboratory, which does extensive nuclear simu-

Washington Newsletter

lation for the Defense Atomic Support Agency, and ARPA contractors concerned with underground weapons tests.

FCC may remove roadblocks to special carriers

A new Federal Communications Commission policy now in the works looks certain to promote competition in data communications by making route applications easier for special service common carriers, such as Microwave Communications Inc., and University Computing's Data Transmission Co. Publication of the policy, being worked on by FCC's Common Carrier Bureau, is expected by the end of the month. **Reportedly slated for elimination is the time-consuming procedure that requires applications to prove the need and demand for new services both in filings and in the subsequent hearings for new routes.** By acknowledging the need in a policy statement, FCC is expected to expedite decisions, which will spur growth of the market for point-to-point equipment.

U.S. artillery to use French-German radar units

What one senior Pentagon official describes as "Dave Packard's fetish for things that work" is allowing the military to buy more hardware overseas. A case in point is the Army's van-mounted field artillery radar developed jointly by the French and West Germans. Known as Ratac, for Radar de Tir l'Artillerie de Campagne, the system is designed to replace the AN/TPS-25. The Army will buy eight of the 330-pound units from ITT Gilfillan at \$500,000 each in fiscal 1971. The system had been successfully operated in Indochina. The Army reprogrammed \$8.3 million in fiscal 1970 money to buy 16 of the sets in February.

According to Brig. Gen. Fred Kornet Jr., assistant deputy chief of staff for logistics, the approval followed Packard's visit to Vietnam, where he saw the gear in action. "By virtue of his trip we were successful with the office of the Secretary of Defense in establishing this early procurement," Kornet notes. Ratac, a standard for the French and German armies since mid-1960, could run to a 180-set purchase if the Army replaces all its AN/TPS-25's. The system, the Army says, could interface with Litton Industries' tactical automatic fire direction unit, which has experienced a development slippage of some 42 weeks.

NAS would give FCC standards role for telephone gear

The biggest threat to coordinated operation of the nation's telephone network is increased message traffic from data communicators, says the National Academy of Sciences. NAS, in a study for the Federal Communications Commission, asserts that giving data users too much of a free hand would degrade network performance for other users.

The remedy, says the academy's report, is to make the FCC responsible for coordinating development of standards for interconnection of user-owner equipment to protect the telephone network. The NAS says the common carriers, suppliers, or users could write standards under FCC supervision. To protect AT&T and other carriers, NAS suggests that standards be set for signal levels, transmission, and network control signaling. The study is an outgrowth of the Carterphone and subsequent court decision concerning user-owned telephone equipment.

Along with the standards the FCC should set up a program of enforced certification of equipment, the report says. This program would include evaluating and monitoring each manufacturer's products. The academy report criticizes self-certification by manufacturers and users as inadequate to protect the network.

We've made our cable line bigger, so you can make things smaller.

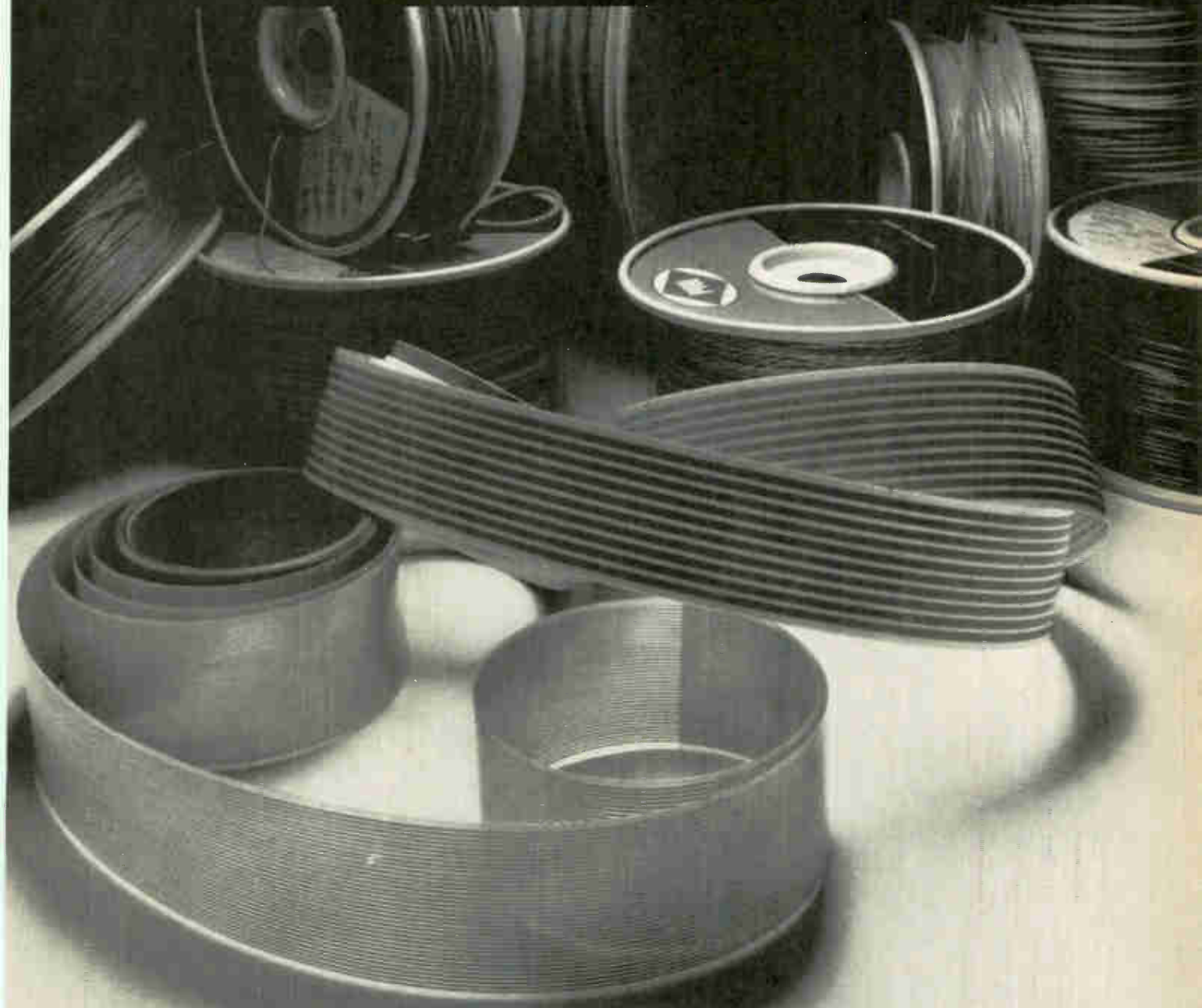

Flat-wire cable can help you make equipment smaller, lighter and lower in cost.

That's nothing new.

What's new is that now you can buy it from Sylvania.

What's more, we've also developed an "instant capability" in flexible insulated wire and cable products.

If you are wondering how we achieved this capability overnight, the answer is simple: We integrated Philadelphia Insulated Wire Co. into our Parts Division.

PIW is one of the oldest wire companies in the country. Although they are old, their capabilities are brand new. Their product line includes wires insulated with Kynar,* and Teflon.†

*-Trademark of Pennwalt Chemical Company.
†-Trademark of DuPont.

Recently, PIW engineers perfected a technique for overcoating Teflon with polyimide enamels to meet the needs of the aircraft industry.

In development operations, they are working with a brand new material, Tefzel.† This resin combines the excellent electrical properties of Teflon with mechanical properties similar to Kynar.

Your Sylvania sales representative now has one of the broadest lines of wire and cable products in the industry. He's the man to talk to when you've got wiring problems.

Sylvania Precision Materials, Parts Division, 12 Second Ave., Warren, Pa. 16365

SYLVANIA
GENERAL TELEPHONE & ELECTRONICS

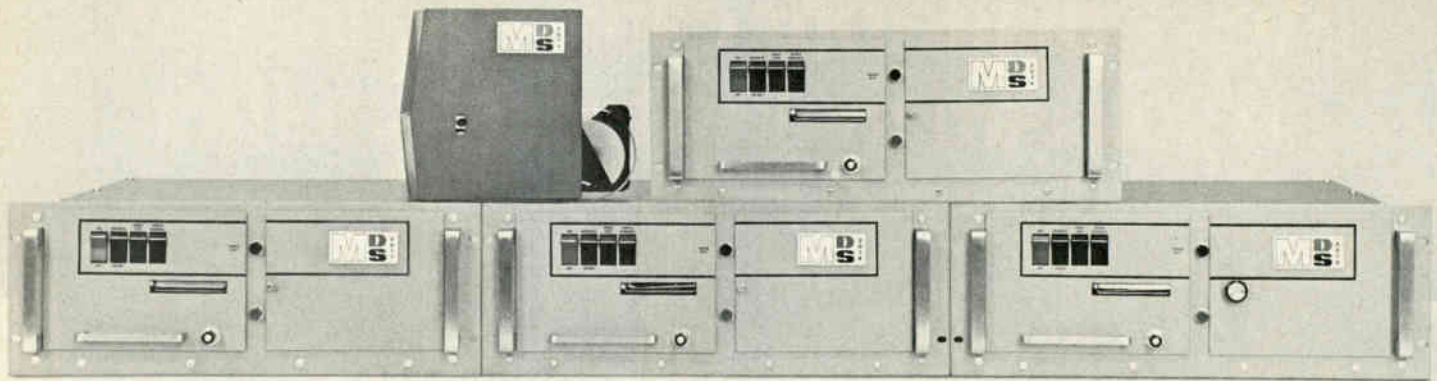

Five new printers from Mohawk.

These 5 new printers plus the 6 original Franklin printers give MDS a product line of strip and lister printers that can fill any requirement.

Our five new printers are the 2015 through the 2019. They're all fully buffered, asynchronous, have ultra-reliable TTL integrated circuits, and can operate on either 50 or 60 cycles. The lister printers range from 8 columns to 20 columns with printing rates from 10 to 20 lines per second. While the 2016 and the 2018 are numeric, the 2017 and 2019 are alpha-numeric. All four have programmable zero suppress and format control. And two of them, the 2018 and 2019, are character-serial. The 2015 strip printer features first character readability and a full 96 character ASCII font.

Our six original Franklin printers, the 800, 1200, 1600, 2200,

and 3200, add more capabilities to our line. Such as speeds up to 40 lines per second, a range of positive and negative interfaces, synchronous operation, and capacities up to 32 columns.

And, of course, all these printers are in production and are available for immediate delivery.

For more information about these MDS/Franklin digital printers, or about special printers like airline ticket printers, boarding pass printers, and card serial printers, call your nearest MDS salesman.

Mohawk Data Sciences Corp.
King of Prussia, Pa.



Article Highlights

**With the heat off,
liquid crystals can
show their colors**
Page 64



Though light-emitting diodes and plasma devices are leading contenders in the advanced display derby, liquid crystals are coming on strong as a potential challenger. The optoelectric properties of liquid crystals could provide the rugged, low-cost display of the future. Advances in materials and fabrication processes have lowered operating temperature requirements that have hindered development of the technology. And with only a low-voltage d-c power source and standard IC counters and drivers required, portable displays may be the first application for liquid crystal devices.

**Computers, software,
p-c cards cut costs
in a test system**
page 71

Building or buying a computer-controlled test system usually is expensive. But it doesn't have to be if a minicomputer, software, and simple circuits are used to synthesize costly instruments. That's the story of Melvin, a system built to check out doppler navigators but now used for a wide variety of functions—in fact, everything from inspecting memories to designing filters.

**Bandpass filter
shapes up from
low-pass network**
page 80

Because of the complexity of designing a bandpass filter, many engineers usually couple a low- and high-pass network to obtain the electrical effect of the bandpass. But this is often tedious, and doesn't work when the bandwidth falls below one octave. Now there's a better way—it starts with any of the multitude of available low-pass designs and uses a simple computer program to speed up calculations.

**Low-cost recorder
can adapt to
digital data**
page 90

At the heart of a new 8-channel digital recording system is a low-cost stereo tape recorder. With complementary MOS integrated circuits and a data format for recording at 15/16 inch per second, the playback speed can vary up to $\pm 20\%$ without any loss of information. And since both clock and data are put on one track, intertrack phase shift does not adversely affect operation.

Coming

**L- and S-band
phased-array module**

A single, electronically steered phased-array module has been developed that provides both L- or S-band outputs. This could herald a new era of multifrequency, as well as multi-function, phased-array systems.

Now that the heat is off, liquid crystals can show their colors everywhere

By Joseph A. Castellano

RCA Laboratories, David Sarnoff Research Center, Princeton, N. J.

● After kicking around laboratories since the turn of the century, a dark horse—liquid crystal—is emerging as a potential challenger to light emitting diodes and plasma arrays in the race for the next generation of displays. Manufacturers for years have been seeking displays with low power consumption, ruggedness, and low cost—and have bypassed the special optoelectric properties of liquid crystals that potentially offer all these advantages.

The old attitude was that liquid crystals were not practical to work with. But this stance is being changed in the face of new materials and fabrication techniques. The older liquid crystalline compounds needed elevated operating temperatures—around 200°F—to be useful. But the liquids synthesized by RCA have the required properties between 20° and 150°F for both black and white and color displays. And it's this development that has turned a curiosity into a display technique of enormous potential.

To demonstrate the versatility of liquid crystals, RCA built an assortment of experimental devices: electronic clocks with no moving parts, electronic window shades, numeric readouts, displays for cockpit panels. Also, with new mixtures of liquid crystal materials, RCA researchers have built display devices that change color electronically, and cells that store data indefinitely. The storage characteristic could potentially be useful in memory

systems. Even low voltage, flat-screen tv is a possibility.

A basically simple structure, a liquid crystal cell consists of two parallel glass plates with a drop of liquid crystal material sandwiched between them. A thin conductive coating, such as tin oxide, on the plate's inside surface ensures a uniform electric field across the cell. Polymeric spacers—Teflon, for example—keep the thickness of the active area within a range of 6 to 25 microns. Electrodes attached to each glass plate complete the fabrication.

Electronically, the liquid crystal cell has the characteristics of a parallel plate capacitor (approximately 200 picofarads per square centimeter) with the liquid crystal material forming the dielectric. With no voltage applied, the material is quiescent and essentially transparent. Applying a d-c voltage or low frequency (60 hertz) signal to the plates turns the material opaque. The magnitude of the applied voltage must be at least on the order of 5×10^3 volts per cm, or about 6 volts for a 0.5 mil thick cell.

This opacity is not a chemical reaction; rather, under the influence of an electric field, the liquid becomes turbulent and scatters light. When the field is removed, the liquid crystal material returns to its original quiescent, transparent condition. This optoelectric switching property, which has been recently characterized by a new concept called dynamic scattering, is at the heart

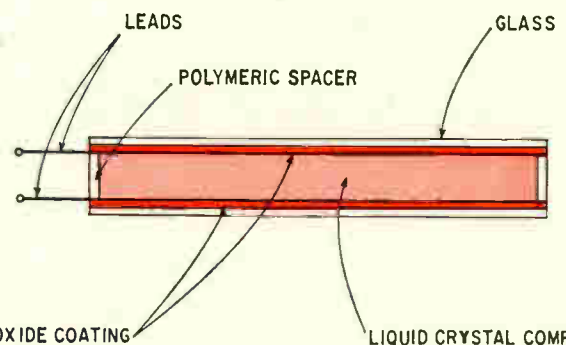

Basic. The basic cell consists of a parallel plate capacitor with liquid crystal material acting as a dielectric. A cell is fabricated by placing a drop of the material on a glass plate which is then covered by another plate. Polymeric spacers control the thickness of the active area.

of many liquid crystal applications.

Dynamic scattering is a condition peculiar only to a special group of materials in the class of liquid crystals called nematic materials. Their molecular arrangement differs significantly from that of ordinary liquids: in nematic materials, the electric dipole moment—the resultant force set up in the molecule by the field—does not lie along the main molecular axis. Instead, nematic molecules, which are long and cylindrically shaped, have an oxygen-carbon appendage that causes the molecular moment to be at an angle with respect to the molecular axis.

Because of this arrangement, the molecules cannot align with their dipole moment in the direction of the field when an electric field is applied to a thin film of this material. Instead, the axes of the molecules remain at some angle with respect to the electric field.

This off-axis alignment of the molecular axis and electric field is an essential condition for the scattering mode. Under the influence of the field, ions traveling in the liquid crystal material disrupt the normal orientation pattern of the molecules. Some molecules are forced to line up in the direction of the local field around the ion, giving rise to regions of discontinuity in the molecular distribution.

Representing a region of changing index of refraction, this discontinuity forms scattering centers for light in-

Key theory. Dynamic scattering is the key to liquid crystal operation. The molecules of some nematic compounds have dipole moments at an angle with respect to an applied electric field. Ions formed by the field cause some of these molecules to align in the direction of ion transit. This alignment generates index of refraction gradients which give rise to 1 to 5 micron-sized scattering centers.

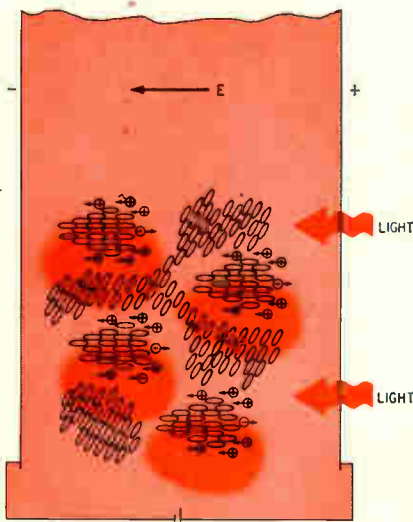

cident on the liquid. Thus, when voltage is applied to the cell, light, which normally would pass through the material, suddenly scatters, rendering the liquid opaque. Moreover, these scattering centers, which have diameters of 1 to 5 microns, are 5 to 10 times larger than the wavelength of the incident light, and so the scattering is essentially independent of the wavelength. In fact, any wavelength can be used with equal success.

In addition, the light scatters in the forward direction, that is, in the same general direction in which the light was traveling initially. This means that for some devices like numeric read-out displays it's necessary to reflect the light back to the viewer. This can be done most simply by replacing one of the glass plates with a chromium or aluminum reflector.

RCA scientists have built both transmissive and reflective experimental devices based on the dynamic scattering mode of liquid crystals. In concept, the simplest of the transmissive types is the electronically controlled window. In this device both glass plates are transparent, and with the absence of a voltage the window is clear. When a voltage is applied across the cell, the window becomes opaque—about 50 volts d-c does the job for a cell approximately 0.5 mil thick.

This frosting effect forms the basis of numerous applications where it's desirable to control automatically the amount of light passing through a window. Since the degree of scattering, and hence the cell's opacity, is directly related to the applied voltage, a grey scale is readily attainable. The contrast varies from a minimum of 7:1 at 6 volts, which is the threshold voltage required for the effect to occur in a cell 0.5 mil thick, to 15:1 at 60 volts, the saturation voltage. A photocell placed next to the window could control the voltage source so that only the desired amount of light can pass. This scheme could be useful in such diverse applications as greenhouse windows, airplane and automobile windshields and camera apertures.

Reflective-type cells can be used in numeric counters. Etched segments—each an independently operating liquid crystal cell—on one composite cell can form a seven-segment numeric indicator to display the numerals 0 through 9 when a voltage is applied to the appropriate segments. The segments are selected by standard commercially available IC's for the clock, counter, and decoder, and discrete transistors for the driver.

Since the addressing circuits do not supply the energy for light emission (liquid crystals use reflected ambient light for display) the power required for operation is considerably less than in other display devices. In fact, liquid crystal displays require less than a milliwatt for each square inch of display area, compared with the several hundred milliwatts needed to drive a single light emitting diode in an array.

A more complex application, based on the seven-segment indicator, is an all-electronic clock with no moving parts. Four basic cells, arranged in succession, display time in hours and minutes; seconds can be displayed by adding two cells. The time reference can be either a crystal oscillator or, as in conventional clocks, the 60-hertz line frequency which is divided by a 60 to 1 counter to produce pulses at 1 hz.

The counter output, which is in standard binary-coded-decimal form, is then decoded by a series of binary gates and applied to the appropriate segment in

Colorful stuff

Though there's a long road ahead before liquid crystals can be used in color displays, intensive experiments by scientists at RCA's Research Laboratories in Princeton confirm the potential of these devices. Researchers also are on the way to maximizing their understanding of liquid crystals.

For example, recent experimental data point the way to better color contrast in display devices. Measurements of optical density (relative absorbance) as a function of applied field strength and dye concentrations, taken on cells prepared with a wide variety of mixtures of dyes and nematic liquids, show that contrast can be optimized by keeping the dye concentration at or below 1%. This level appears to yield the greatest absorption change—it was discovered that the change drops to half its maximum value at 5% dye concentration and above.

As concentration exceeds 1%, the contrast ratio gradually decreases from its maximum of 1.4 optical density units. This indicates that nematic compounds can produce alignment of only a limited number of dye molecules. As the number of dissolved dye molecules increases, unoriented molecules that contribute to absorption of the medium under an electric field reduce optical absorbance, and hence contrast. Significantly, however, the devices have a low excitation requirement. The threshold for switching is only 1 or 2 volts for almost all concentrations. Furthermore, maximum absorbance change occurs in the 0-to-10 volt range, after which saturation rapidly ensues. Thus, fine color tuning is possible at very low voltages—from 2-8 volts for most colors.

It's also possible to construct liquid crystal color switches using photochromic dyes—materials that change their color with different wavelengths of incident light. Both electronic and optical color change combinations are available with these materials. Mixtures of pleochroic and photochromic dyes can be used in the same cell, providing an entire spectrum of color changes, by applica-

tion of an electric field and by irradiation of light of a specific wavelength, or both.

This effect has been demonstrated in the laboratory with a series of combinations of photochromic and pleochroic dyes. These materials exist in two forms, each exhibiting a different absorption spectrum, say at 4600 and 5100 Angstroms, respectively. If a liquid crystal fabricated with these materials is irradiated with light at the right wavelength, it produces a reversible conversion of one form to another. This changes the absorption spectra of the cell and hence its color. These materials also can be electronically switched by applying an electric field in the order of 10 to 40 kilovolts per centimeter.

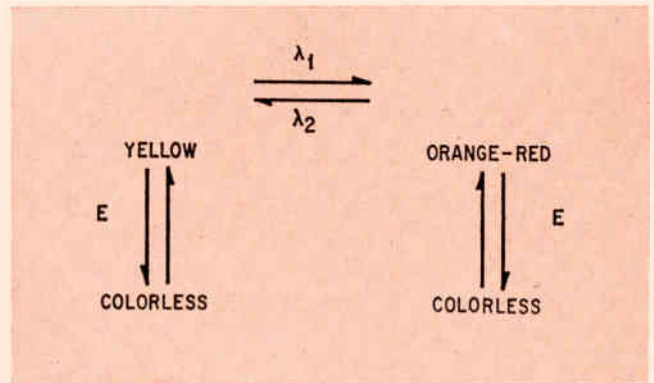

Another dimension. Mixing pleochroic and photochromic dye molecules allows optical as well as voltage color switching. Light of one wavelength (say λ_1) changes the cell from yellow to orange-red while light of wavelength λ_2 reverses the process. An electric field eliminates both colors leaving the cell colorless.

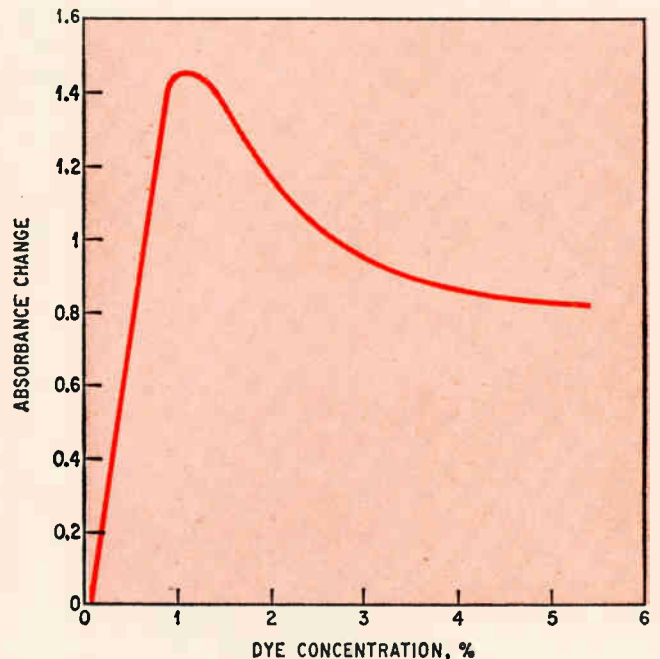
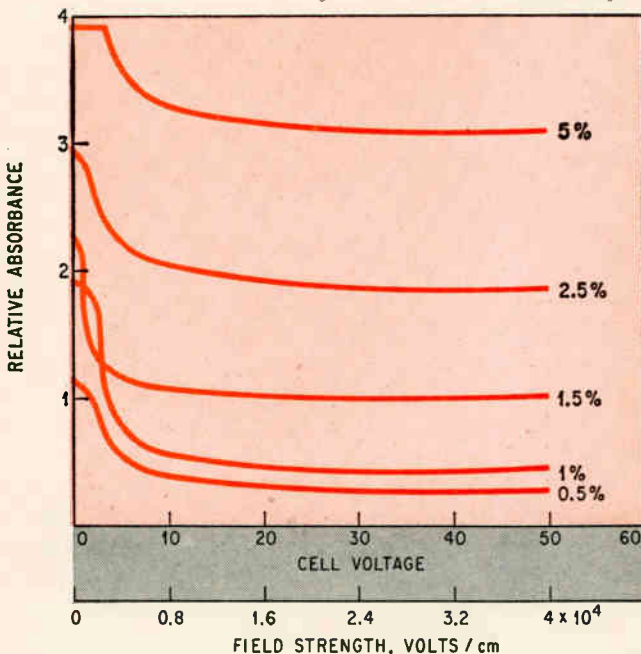

Absorbing data. When dye concentrations range from 0.5 to 5%, the greatest color changes will occur between 2 and 8 volts. However, the most optimum dye concentration is at or below 1%, above which the absorbance-change gradually decreases.

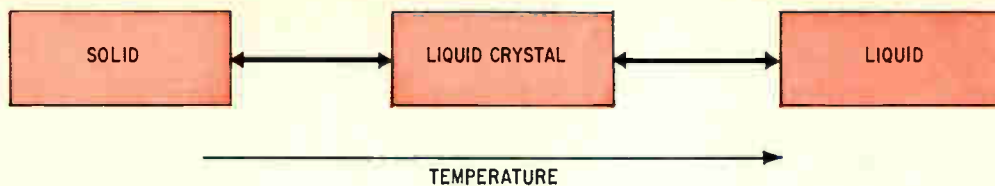

States. Liquid crystal behavior exists within a specific temperature range. Below that materials are solid; above they are normal liquids. An appendage on the molecular structure of some compounds (left) causes an electric dipole pointing away from the molecule's main axis, giving rise to dynamic scattering. However, nematic compounds (right) have a strong dipole moment on the molecule's main axis and orient dye molecules in color switching devices.

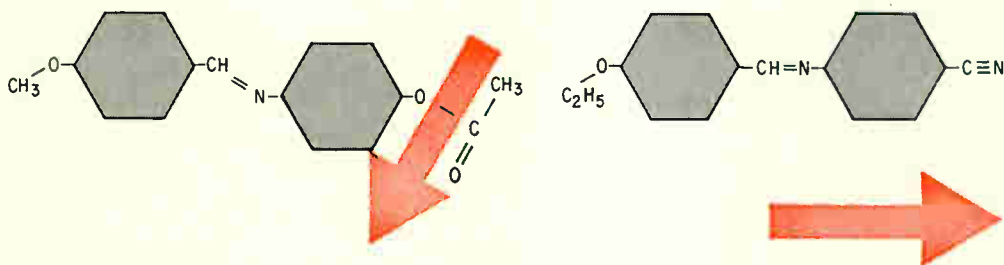

the display. However, logic must be included to reset the hour to 1 when the count reaches 12, upon receipt of the next count pulse. To set the clock, appropriate switches bypass the 1-hz pulses to numerical counters which index the particular numeral at a 1-hz rate until the desired numeral is displayed. Because of the inherently low power requirements and its flat construction, the clock concept could be readily extended to battery-operated electronic wristwatches.

However, some limitations must be considered. Although the addressing time, or the time necessary to impart information to the display, is less than 60 microseconds, the response time of the scattering effect takes from 1 to 5 milliseconds, depending on the current density in the material; thus, the display is useful only where high speed is not required. Worse yet, the natural image decay time, or the period which it takes for the display to revert back to its initial state after the field is removed, varies between 30 milliseconds and one second, depending on the temperature, the liquid crystal material used, and the method of fabrication. At room temperature, typical relaxation time for a cell 6 microns thick is about 50 msec.

Image retention could be a serious problem in fast counting applications at low temperatures—say around 20°F where the material responds sluggishly. At temperatures above 150°F, the liquid crystal reverts into its nor-

mal isotropic state and light scattering properties disappear. Researchers studying these problems hope to develop materials with better temperature behavior.

Liquid crystals also have useful storage properties. Unlike the display cell, which uses pure nematic liquids, the storage cell uses an active material containing a mixture of a nematic compound and another type of liquid crystal material called cholesteric. Just as in the display cell, the initially transparent panel becomes opaque on application of a d-c or low frequency signal (25 to 30 volts for a 6-micron thick active layer). However, in the nematic-cholesteric cell, the scattering remains after the voltage is removed. The reflective contrast ratio falls gradually with time, reaching a value of about 7:1. This value can be considered the storage mode of the device and will remain for hours, days, or even longer, depending on fabrication techniques and the specific material used. Application of an a-c signal in the kilohertz range abruptly (msec) restores transparency and constitutes the erase mode.

Although not completely understood, the mechanism of the storage process apparently involves the formation of scattering centers in which, as in the dynamic scattering mode, the axes of the cholesteric molecules are distributed at angles with respect to the electrode surfaces. However, the centers seem to remain



Now you see it. Liquid crystals could electronically control a window. Since switching from clear to opaque requires power of less than a milliwatt per square inch, a small amount of power could control large areas.





In good time. Electronic clocks with liquid crystal numeric indicators may soon be here. Each numeric panel consists of a glass/liquid crystal/glass sandwich with segmented electrodes etched on one glass plate by photoresist techniques. Flat structure could be adapted to battery-operated wristwatches.

partially fixed even after the field is removed (similar to processes which occur in emulsions) and although some reduction in the number of scattering centers does result in a decrease in the contrast ratio, a sufficient fraction of them remains to maintain the scattering property. On the other hand, the high-frequency erasure field produces molecular alignment of the nematic molecules in the direction of the field and, thus, returns the cell to the transparent state.

This unique property of liquid crystals adds another dimension to their application. Information can be optically stored without requiring maintaining power. Memories that store data in the form of dot patterns are possible. An optical scanner or diode array could be used to read the data. Liquid crystals could also possibly be adapted to holographic storage systems.

In an experimental 20-element storage display panel, data is written into each element with a 60-hz, 50-volt signal, and erased with a 1-khz signal. Since resolution is roughly 500 tv lines per inch (commercial tv is 550 lines/inch) this concept could be extended to storage panels capable of reproducing high-density information patterns.

The addition of certain dyes to the liquid crystal material, a recent development that permits color switching, greatly extends the range of applications. Control indicators can be commanded by a warning signal to change color, and displays can be color-cycled. In addition, photographic lenses and filters with variable absorption characteristics could be designed to respond instantly to changing atmospheric conditions.

Electronic color switching relies on the introduction of dyes composed of pleochroic molecules. The optical absorption spectrum of a pleochroic dye molecule is a function of its molecular orientation with respect to the polarization of the incident light. If the dye molecule is oriented with its long axis parallel to the electric vector of incident polarized light, absorption of the light by the molecule occurs, and an observer sees the characteristic color of the dye. Conversely, if the dye molecules have their long axis perpendicular to the electric vector, little or no absorption occurs and the incident light is transmitted unchanged.

To orient the dye with respect to the field to produce

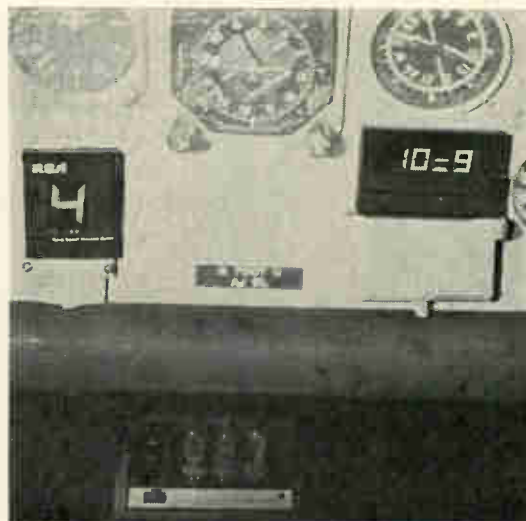
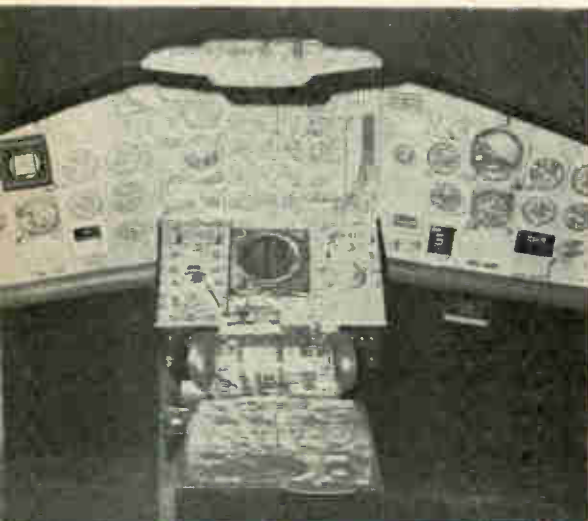

Up, up, and away. Because liquid crystals use ambient light—the more the better—for their operation, they are ideal for cockpit instrument read-out panels. As shown in this mockup, liquid crystal indicators appear bright while a Nixie display washes out.

Japanese 'watch' liquid crystals

Although RCA is by far the most active U.S. company in liquid crystal development, Japan also boasts extensive liquid crystal development programs. But the Japanese frankly admit they're still chasing RCA's results.

Closest to marketable devices is the Seiko group of companies, which manufactures the watches and clocks sold under the Seiko brand. Although Seiko did not begin work in liquid crystals until late 1968, it has already built a prototype liquid crystal display for a clock, which it hopes to bring to market in 1971. Like RCA, Seiko anticipates that the clock application can be simply extended to wristwatches. In fact, Seiko believes that a stop watch made with liquid crystal material, because power consumption is low, would be more practical than the light-emitting diode units frequently proposed.

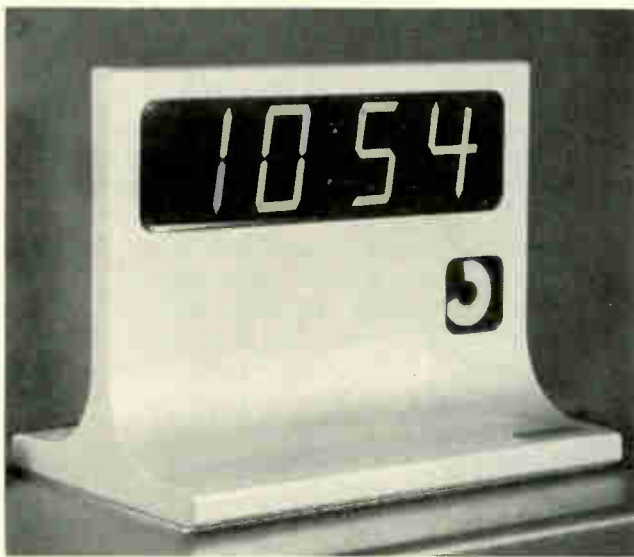

Timely. Seiko's clock is completely sealed to prevent degradation of liquid crystal. The inner surface of the back glass cover plate is nickel, into which cuts are photoetched to separate the segments from the remainder of the nickel-plated sheet. Front electrode is Nesa coated on the inside surface of the glass cover plate.

Seiko also hopes to market large, wall-mounted reflective displays, and transmission type window displays. The company also expects desk calculator readouts to be one of its major applications.

Seiko's numeric display, like RCA's, is addressed by segments. During operation it has a reflectivity of 50 to 60% compared with that of magnesium oxide, the reflectivity standard. The display operates over a range of approximately 10° to 140° Fahrenheit, comparable to the widest temperature ranges reported by others to date. Rise time is 1 to 10 milliseconds, operating voltage 25 to 30 volts, and the panel consumes less than 20 to 30 microwatts per square centimeter.

The liquid crystal material used by Seiko is a mixture of two nematic materials that extends the device's useful temperature range. The high resistivity of these materials reduces the power drain to perhaps one-third to one-tenth that of displays previously reported.

Seiko is attempting to decrease the thickness of the

liquid crystal layer in its devices; a thinner layer would allow lower operating voltages and faster pulse response times. One barrier to thinning the layers, however, is the difficulty in obtaining glass with the required tolerances. Seiko is currently experimenting with a pulsed mode of operation in liquid crystal displays because even further reduction of power consumption and longer life are theoretically possible in this mode. However, these advantages may be outweighed by longer pulse response time under pulsed excitation.

Seiko engineers are also experimenting with memory crystals, primarily for clocks and watches. With that scheme, infrequently changing segments—such as those representing the year, month, day, and hour—could be displayed by memory that requires no maintenance power. When they are required to operate, a voltage can be applied and then removed. Seiko is also studying colored displays, but here the company admits it has a problem: most of the work appears to be already covered by an RCA patent.

The Electrical Communication Laboratory of the Telegraph and Telephone Corp. of Nippon is taking another approach to displays in their liquid crystal prototype: each digit is composed of a five-by-seven dot matrix formed from reflection-type liquid crystals. Dot selection is activated by a coincidence of voltages applied to appropriate x and y transparent electrode elements. Some cross effect occurs between elements because the voltage applied to one set of electrodes makes neighboring dots slightly reflective; but the display operates at the microwatt level.

Electrical Communication Laboratory is opting for the matrix approach over the segment display because it hopes to apply liquid crystals to data terminals and other display applications requiring both alphanumeric and graphic capabilities. ECL engineers say that the low-power requirement meshes perfectly with the power levels of integrated circuits in these applications, although new driving circuit techniques may be needed to compensate for the slow rise time of the displays.—C.L.C., Tokyo Bureau

And the English got color without dye

Marconi Company Ltd, in Chelmsford, Essex, appears to be the only major British company with a program in liquid crystals. One of the more interesting results to fall out of their work is a liquid crystal material that changes color without the use of dye additives. Unlike RCA's color switching materials, the Marconi material produces color changes directly in the material itself. The company has a crystal mix that, for example, changes color from red to green when 150 volts are applied. At lower voltage levels there is a suggestion of yellow as the red is changing to green. Using this system, Marconi men hope to develop liquid crystals that will offer multicolor displays.

Marconi's work, conducted by a small team, is essentially exploratory, and although some laboratory display models have been built, given the current level of liquid crystal technology, Marconi doesn't expect any operational displays for at least a year and probably longer. But since the company is heavily involved in graphic displays through its radar and computer displays division, they hope that liquid crystals will turn out to offer an additional display technique.—M.P., London Bureau

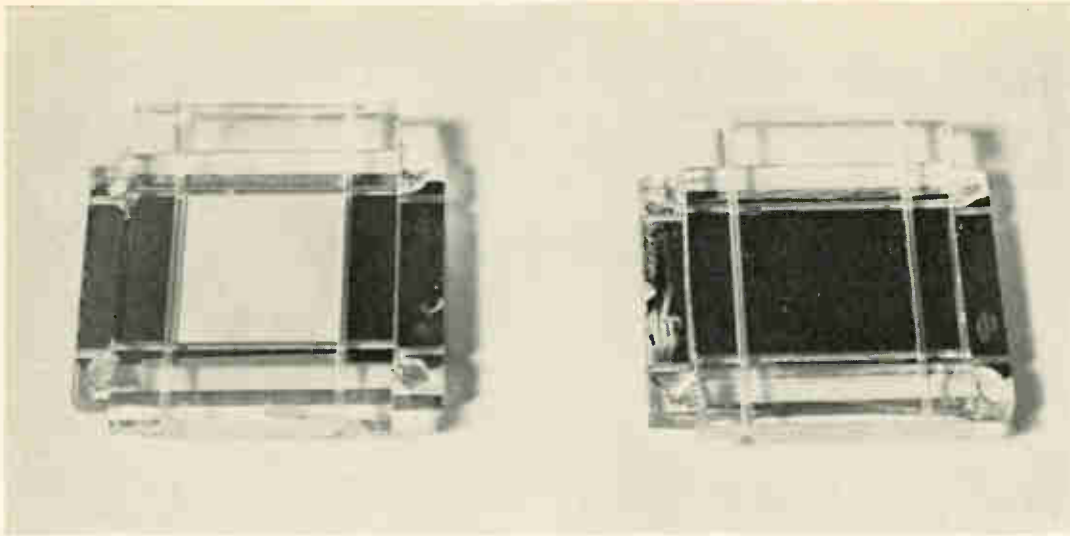

Storage. A clear liquid crystal storage cell turns opaque once voltage is applied. Opaqueness remains after voltage is removed, pointing to systems that could store data without the need for a continuously maintained power source.

the desired color changes requires the use of a nematic liquid crystal that has different properties than the type used for dynamic scattering. The nematic material to which the dye is added must have an extremely strong dipole moment operating along the long axis of the molecules, instead of one operating at an angle with this axis. Now when a voltage is applied, this moment will align with the field. This causes the dye molecules to also align with the field, resulting in the disappearance of the color of the dye. Removal of the voltage collapses the field; the nematic host molecules with their dye guests realign in their original configuration and the cell returns to its original color.

Not only must the dyes be soluble in the nematic materials, they must also be non-ionic, or their introduction will produce irreversible electrochemical processes that will destroy the material. This restriction eliminates from the pleochroic class a large number of known dyes that might otherwise exhibit the desirable optical properties.

Although work is needed to improve the contrast and overcome the temperature-dependence of color switching material, some developmental devices have been fabricated. For example, a series of electronically tuned optical filters were arranged into a word display. The letters are conventional filters superim-

posed on a liquid crystal panel that controls the amount of yellow light transmitted through the cell. A letter that is red, say, with no field, will change to magenta with the application of approximately 25 volts (20 kv/cm). Other letters of the display also change appropriately. The use of different color layers of liquid crystal material allows the fabrication of filters that will electronically control the color of light throughout the visible portion of the spectrum. These filters are expected to be useful also in portable photographic equipment.

A single-digit numeric indicator with colored digits has also been built which has the complete range of numbers. A flat, 2-inch square fluorescent panel capable of continuous operation at 8 to 12 watts provides ample back illumination for viewing the display.

As a future possibility, liquid crystals may yield a practical thin-screen television display. The low voltage and power consumption of these devices are compatible with the integrated circuits that would implement the complex addressing schemes required to replace the conventional kinescope.

A crossgrid pattern could be formed by appropriately designing the top and bottom electrodes. Scanning circuitry would select any given element. Since a high resolution picture requires at least 250,000 elements, the cost and complexity appear to hinder the full development of such a system at the present time. But to evaluate a liquid crystal display operated at full television frame rates, a demountable cathode ray tube was built by J.A. Van Raalte at RCA Laboratories. The front of the demountable unit consists of a 3.75-cm square mosaic centered on a brass faceplate. The mosaic is a piece of 3.1-mm-thick glass in which 25-micron wires on 100-micron centers are embedded and semi-randomly positioned. A liquid crystal layer of the dynamic scattering type is sandwiched between the mosaic and a standard conductive-coated glass slide.

In experimental operation, the electron beam from the cathode ray tube scanned the wire inputs of the mosaic, transferring the live video image onto the mosaic. The resolution achieved was only 150 to 175 lines, approximately half the resolution of commercial tv, due to the limitations imposed by the mosaic. While this experiment was crude, it served to demonstrate the potential of liquid crystals in the area of television displays. ●

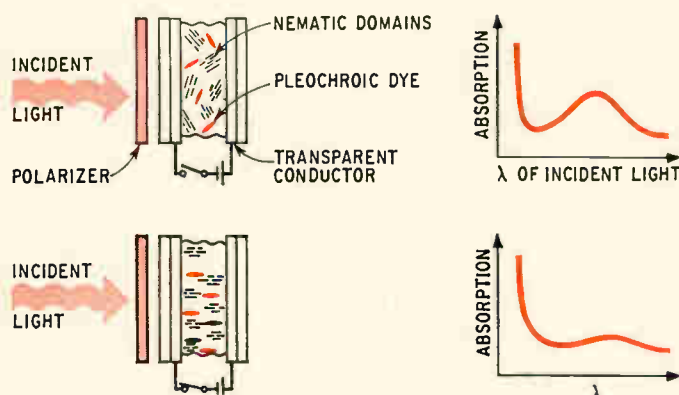

Color switching. With no field, the nematic domains and pleochroic dye molecules align randomly; dye absorbs incident light and colors the cell. An applied voltage lines up the domains and dye; light is not absorbed, and the cell takes the color of the light.

Computer, software, p-c cards match up to cut costs in an automatic test system

When a computer and simple circuits synthesize costly instruments, a wide variety of tests can be run at a fraction of other systems' expenses

By Don Mactaggart, *Canadian Marconi Co., Montreal*

● There's no good reason why computer-controlled automatic test systems should have to cost hundreds of thousands of dollars. But unfortunately, most systems, whether built in house or purchased from manufacturers, are complex and expensive—they're put together with lots of costly programable instruments and a bare minimum of software. Under this approach, computer main-frame extensions, increased complexity, and jungles of patchcords make for soaring prices.

But an engineer building his own system can follow another, less-expensive route. Using widely available analog and digital medium-scale integrated circuits he can duplicate just about any standard instrument with a small, inexpensive circuit and some software. The key to this approach is to reduce the concept of an instrument to its most essential part; build that part with software and circuitry; and either eliminate the other parts or build them once for the whole system.

A digital voltmeter, for example, costs \$1,000 or more if purchased outright. But when a dvm is reduced to its essentials, total hardware cost, excluding the computer, can be less than \$100. Working in a computer-controlled system, the dvm doesn't need a display—the results are printed out. And it doesn't require its own power supply. Only an analog-to-digital converter is required; this can be built with a few integrated circuits plus the computer. The voltage to be measured goes to one input

terminal of a comparator; at the other input is the voltage from a digital-to-analog converter that's driven by the computer. The comparator's output is fed back to the computer, which runs a successive approximation routine, continuously adjusting the converter's voltage until the comparator's output is less than the least-significant bit.

As another example of unnecessary expense, if an a-c signal with a precisely-known yet adjustable frequency is needed, a system maker will put in a synthesizer that costs at least \$5,000. But a minicomputer can do the job with a counter, a voltage-controlled oscillator, and a digital-to-analog converter—all for less than \$250. The d-c output of the converter, driven by the computer, controls the oscillator frequency, which is measured by the counter. The computer adjusts the converter's output until the correct frequency is attained.

When packaging these circuits for a system, it's wise to put only one function on each printed circuit card. It also reduces the number of leads in and out of the computer, because it isn't necessary to have one set of leads coming from each p-c card. Only three sets of leads can do the job for all the cards if each functional circuit has its own local memory on the same card as the circuit. Depending on the nature of the circuit its memory is a command register, which stores



Space saver. Melvin's not the name of the girl, but the system she's running. It's small enough to be built into a single desk, yet it performs almost any analog or functional test.

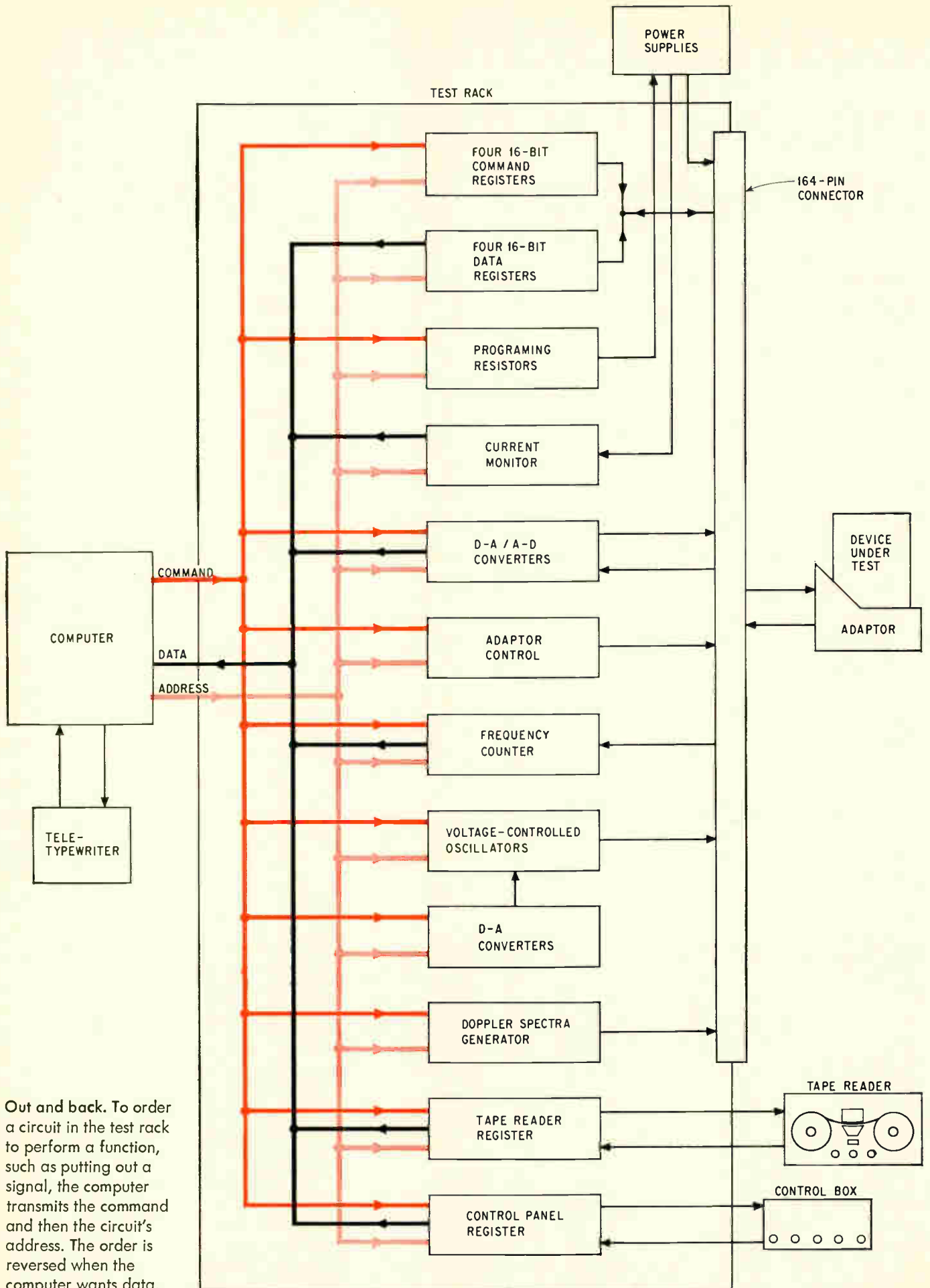

Out and back. To order a circuit in the test rack to perform a function, such as putting out a signal, the computer transmits the command and then the circuit's address. The order is reversed when the computer wants data.

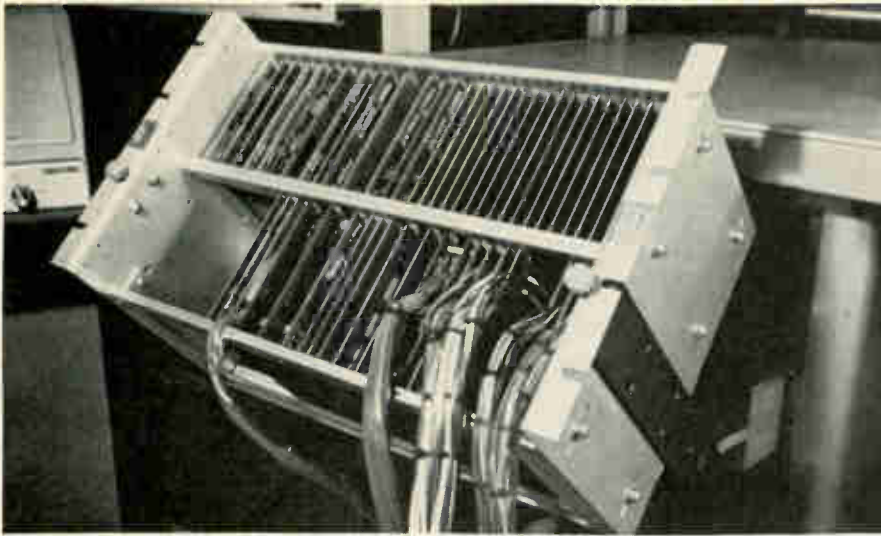

One on one. Melvin's test rack contains two rows of printed circuit cards, each with one functional circuit and a local memory. Thus each voltage-controlled oscillator is on a single card; the programing resistors for the supplies are on another, and so on. The exceptions are the a-d converters, which go two to a card, and the simulator, which takes up five cards.

commands coming from the computer; a data register, which stores measured data that's to be sent back to the computer, or one of each.

All command registers in the system are connected only to the command bus, all the data registers to the data bus, and all the address registers to the address bus. One set of leads from each bus goes to the computer. Thus, for a 16-bit system, a total of only 48 leads joins the computer to the test circuits.

Such a system is exemplified by Melvin, designed and built by engineers at Montreal's Canadian Marconi Co. (Melvin isn't an acronym. A vote was taken on a name for the system, and Melvin won.)

Melvin took two months to design and build. Including its Hewlett-Packard 2114 computer, hardware costs about \$23,500. Melvin does any kind of standard test and can be adapted to many nonstandard routines. It measures d-c voltage; a-c voltage and frequency; exercises 64 logic levels; generates d-c signals with both programable power supplies for high currents and digital-to-analog converters for fast changes in voltage level; and generates sine and square waves.

In addition to these routine jobs, Melvin also can check out doppler navigation radars. With its own simulator Melvin sends a pair of doppler spectra to the radar under test. With these inputs, the radar computes an aircraft's ground speed and drift angle, and sends back signals whose frequencies Melvin measures.

Melvin was created for the AN/APN-189, a doppler ground-speed/sensor destined for the F-111D aircraft. Checking out an AN/APN-189 begins with routine testing—measuring filter bandwidths, running functional tests on logic circuits—which Melvin runs through in two minutes. If everything checks out, Melvin runs the sensor through a simulated 10-mile flight during which the doppler spectra fed to the sensor are varied according to test requirements to simulate the effects of changes in such factors as altitude and the nature of the terrain below the aircraft.

Before Melvin, the AN/APN-189 simply wasn't getting built. The tests were difficult to accomplish manually, and there was no way to weed out bad units before they went through the simulated flight.

A system with the capability of the automatic testers used by the military or by semiconductor manufacturers was required, but the \$250,000 to \$1 million cost was

out of the question. Custom-made systems were priced a little lower but they imposed long delivery times—from six months to two years. Off-the-shelf systems seemed to be priced out of line considering their lack of flexibility. For example, one commercial tester exercises only 32 logic levels, performs no analog functions, and sells for more than \$100,000.

Since Melvin was put on the shop floor in early 1969 it has enabled relatively unskilled workers to make, troubleshoot and certify complex military gear, such as the AN/APN-189, which alone has 5,500 electronic parts.

Melvin's main components are a teletypewriter, a tape reader, the computer, a control panel, the test circuits on 4½-by-6-inch cards mounted in a 19-inch rack, eight small, commercially available power supplies, and an adaptor to link the device under test to the rack.

Three cables connect the test rack to the computer and each cable has 16 leads. Inside the test rack each of these sets of leads goes to one of the three 16-conductor buses—command, sense or address.

The cards with the fewest components are the command and sense registers which run functional tests. On each card are two Fairchild 9308 eight-bit latches, providing 16-bits of memory. Melvin has four cards as command registers and four as sense registers, giving the system a 64-bit capacity.

The memories provide another example of the economy of systems like Melvin. Registers identical to the command and sense units are used throughout Melvin as local memories for other test circuits. Each register has about \$32 worth of parts; two cards are needed for sending and receiving 16 bits, which works out to \$4 a bit. Computer vendors make cards that do the same thing as Melvin's registers, call them interface cards, and sell them for \$750, or \$47 a bit.

Computer vendors also sell tape readers with computer interface circuits. The price is about \$2,000. Melvin has the same reader, but uses a register card as its interface. The combined cost of buying the reader and building the card is \$700.

Digitally programable power supplies are bulky and sell for about \$1,500. However most general-purpose laboratory supplies are analog programable—they can be programed with external resistors. Melvin has a card containing the programing resistors for four supplies. With these small supplies—which cost only \$138 each—

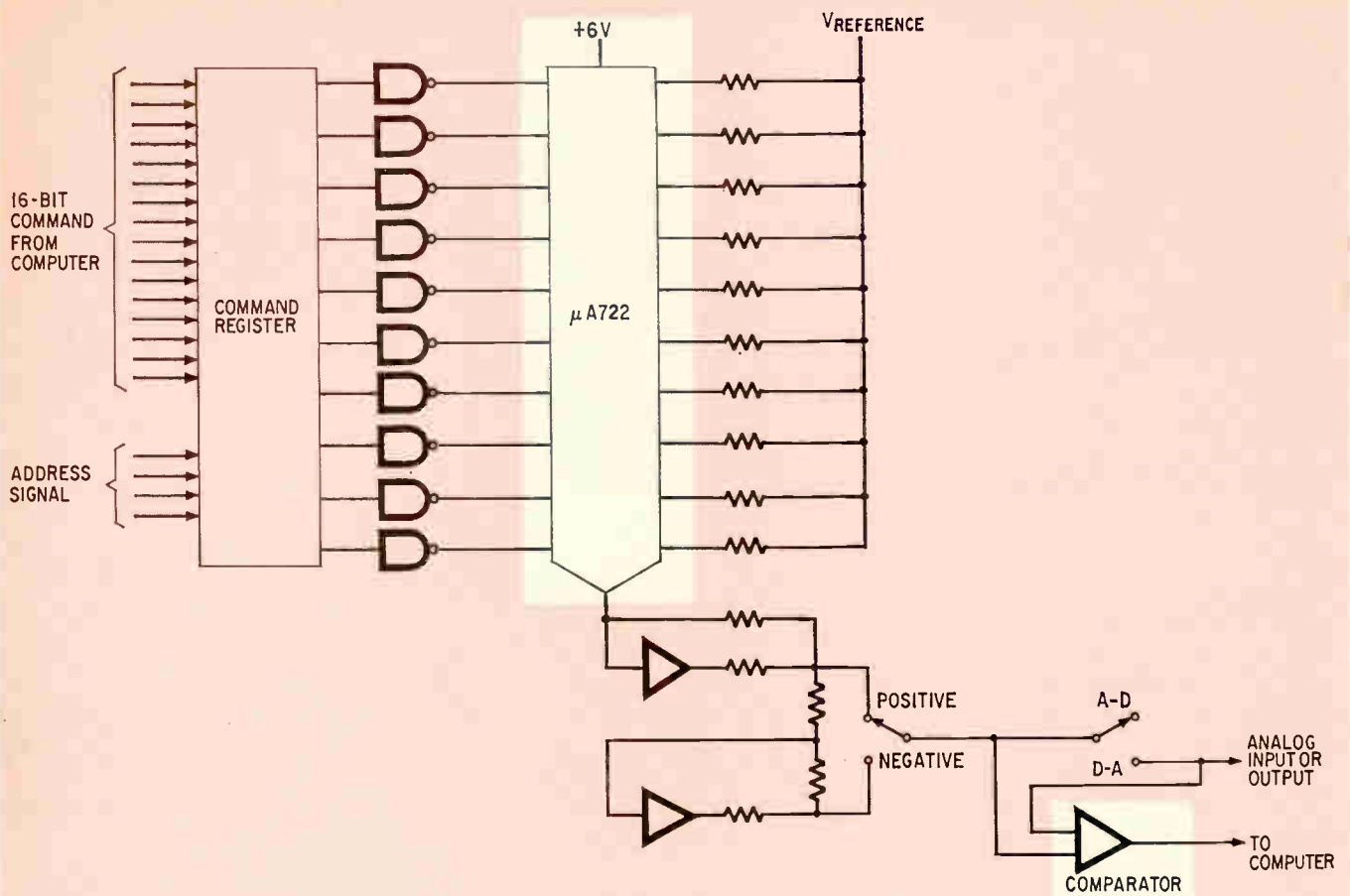

VOLTAGE-CONTROLLED OSCILLATOR

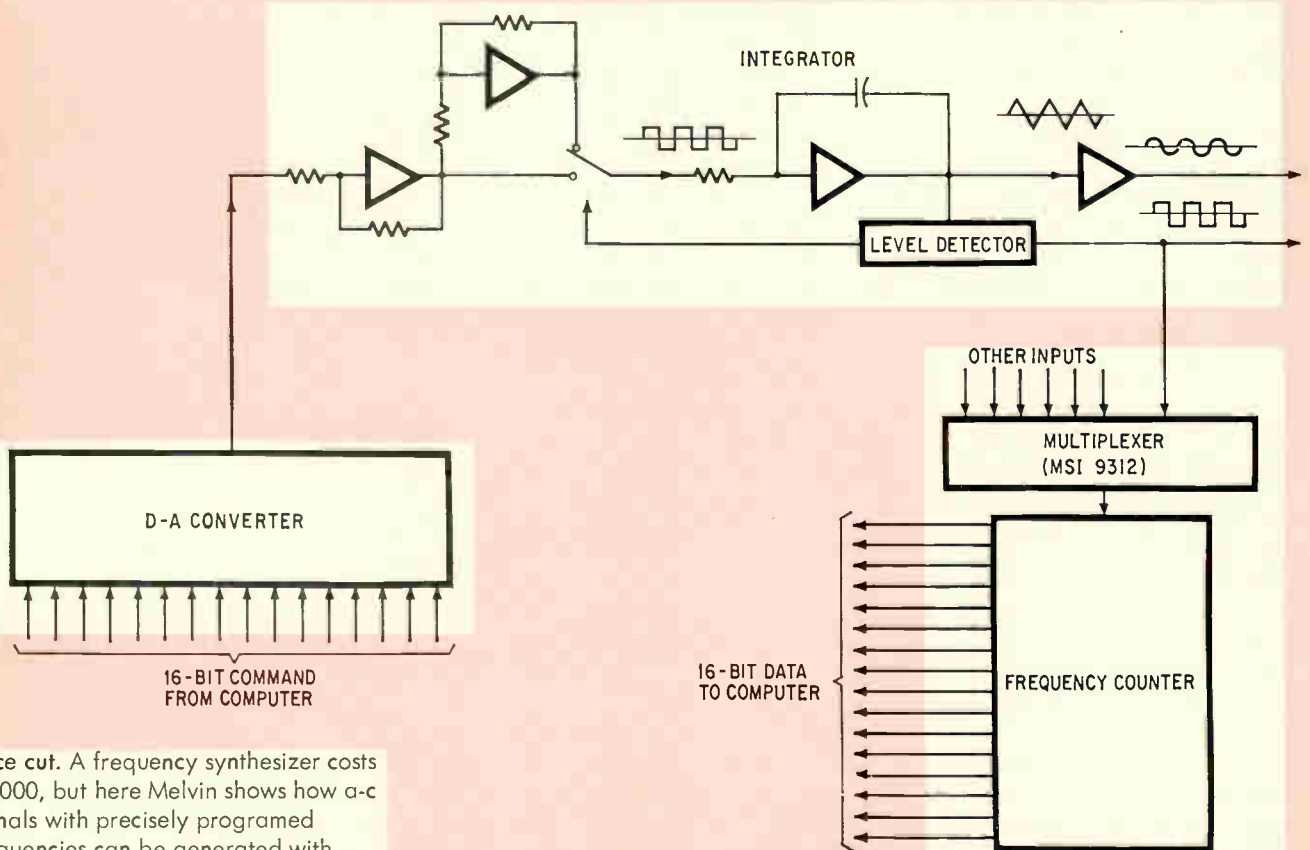

Price cut. A frequency synthesizer costs \$5,000, but here Melvin shows how a-c signals with precisely programmed frequencies can be generated with only \$250 worth of hardware.

One circuit, two jobs. Melvin's a-d converters either can put out a d-c signal or measure it. When a converter is a source, the computer sends a digital command, picks a polarity, and switches the converter to the d-a function. When it's a voltmeter, the converter is switched to a-d so that the output of the μA 722—a 10-bit current source—can be compared with the unknown signal coming from the device under test. Error voltage is fed back to the computer, which adjusts its output to the converter.

the tradeoff is speed. It takes milliseconds, not microseconds, to change the value of an output, but this isn't a limitation in most tests Melvin runs.

Melvin's other circuits are registers that monitor output currents of the system's power supplies, control the adaptor, and run the control panel; six digital-to-analog converters; two voltage-controlled oscillators; and the doppler-spectra generator. Herein lies another advantage of the Melvin approach—it's relatively easy to build unusual test devices as part of the system. It's also economical because some of the basic test circuits often can be used as part of the unusual device.

Commercial doppler-spectra simulators are extremely complicated machines, with as many as 60 controls. And no company makes a programable unit because the demand is small. However, many engineers face test problems that also are unusual and for which they have to build their own test gear or have it custom made.

Melvin's simulator was built with only five additional p-c cards, containing shift registers used as pseudo-random noise generators [*Electronics*, April 28, 1969, p. 82], digital filters, and single-sideband networks.

Melvin's software setup involves permanently storing certain programs in the first 700 words of the computer's 4,096-word memory. These programs include routines for loading, using the teletypewriter, and performing many common routines such as multiplication and supervisory functions.

The test programs are written in assembly language. While higher-level languages with appropriate READ and WRITE statements are fine for devices requiring large numbers of tests on a limited number of pins, the vast majority of electronic assembly tests at Canadian Marconi are in the general area of bit shuffling—detecting logic levels as a function of frequencies, performing pure digital logic, etc. For this class of tests, assembly language produces very efficient codes, and allows easy inclusion of comments on the original program and the test results.

The present language can be characterized as assembler plus library. The extensive use of Melvin's permanently stored routines frees the programmer from worrying about such factors as test-equipment delays and the exact details of input/output formatting. Nevertheless, it leaves him the full power of assembly language.

A typical discrete test operation takes three to 20

lines of code; each line is a statement on paper tape prepared by a standard ASCII teletypewriter. Test programs typically are looped; to simplify coding and to minimize the amount of memory taken up by a given program, the same program is repeated for each desired arrangement of power supply outputs. In testing the AN/APN-189, for example, the program is run through three times—at nominal voltage, at high voltage, and at low voltage.

In the case of almost every test run by Melvin, speed has been limited by the device under test, and not by the computer or any other part of the system.

Just as the design concept behind Melvin isn't limited to this specific system, so Melvin itself also isn't limited to testing doppler gear. In fact, the system now works in four different areas—incoming inspection, research, testing, and development.

Working with a simple timing circuit, Melvin has run acceptance tests on purchased memories long before the computer for which they were purchased was ready.

For research purposes, Melvin can compare the theoretical and actual performance of a filter. When hooked up to work with a special program written in Fortran, Melvin can calculate and plot on an X-Y recorder a theoretical response curve. If the actual device then is connected to the system, Melvin will measure the response, plotting it over the theoretical curve.

Melvin also has been put to work in the development laboratory. Here special test setups formerly were constructed during each new development program. As the device being developed grew, its own test setup grew with it. At the end of the development phase, the setup had to be modified for use on the production floor, and test procedures had to be written. Now engineers write test programs as they go along. When development is over, not only a device but also its test program is handed over to production.

The system also has proven itself indispensable on the production floor, where it has been running 24 hours a day testing a variety of devices and subsystems.

Since it has no instruments per se, Melvin can't be tested and calibrated itself by the methods open to most calibration facilities. Instead, Melvin is checked out with a calibration program, run when the device under test actually is a special circuit containing the necessary voltage and frequency standards. ●

Designer's casebook

Designer's casebook is a regular feature in Electronics. Readers are invited to submit novel circuit ideas and unusual solutions to design problems. Descriptions should be clear. We'll pay \$50 for each item published.

IC oscillation sets up a mini-sized bias supply

By James Kotas

General Electric Co., Daytona, Fla.

Many circuits require a negative bias supply to give higher speeds in the cutoff of a transistor stage. But in small systems, it's often not economical to provide the necessary extra transformer winding and circuitry in the power supply. In a small test unit for checking memory operation, for example, a negative voltage was needed to speed up the clock circuit. With only a single integrated circuit package—a quad NAND gate—and two diodes, and two capacitors, the negative voltage was obtained.

Three of the NAND gates are connected in a loop to form an astable multivibrator, which, with

transistor-transistor logic circuits, will oscillate at about 33 megahertz. The output of the fourth gate applies the square wave, running from about 0.2 volt up to about 4 volts, to the capacitor-diode circuits.

When the output of the gate is high, C_1 charges through D_1 to 4 volts, minus the diode voltage drop, or about 3.3 volts. When the gate output drops, capacitor C_1 is effectively placed across D_1 , cutting it off. In addition C_2 charges through D_2 to the voltage on C_1 , minus the D_2 voltage drop and the 0.2 volt, for the low level. The C_2 voltage, however, is negative with respect to ground, and its net value is about -2.4 volts. A higher negative voltage can be obtained by connecting a pull-up resistor to a higher positive voltage at the output of the fourth gate.

The test unit uses TTL circuitry because of the lower delays. If diode-transistor logic had been used, the oscillator frequency would have been in the 10-Mhz range, introducing more ripple in the d-c output. The value of C_2 is not critical and could be eliminated with high impedance loads.

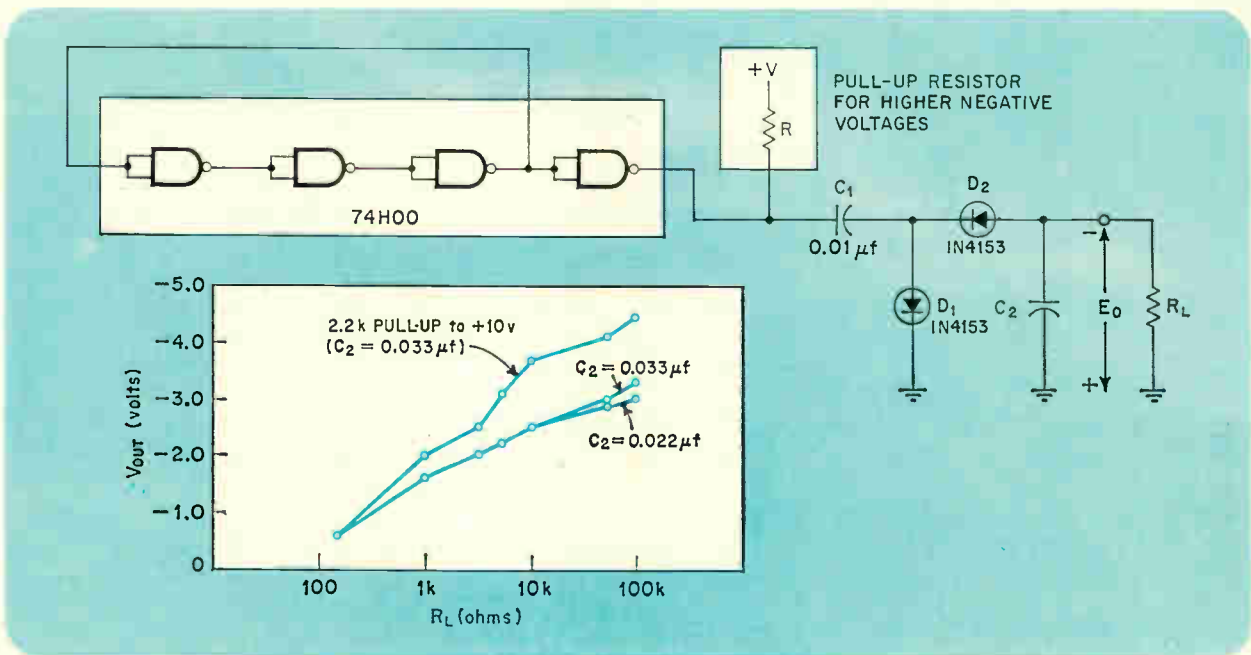

Mini bias. Three NAND gates form an astable multivibrator oscillating at about 33 Mhz, while the fourth gate drives the capacitor-diode network. Capacitor C_1 charges when the gate output is high and transfers its charge to C_2 when the gate output goes low. The output voltage is negative with respect to ground.

Switching regulator drives IC's and Nixies off battery

By David B. Newton

U.S. Army Electronics Command, Fort Monmouth, N.J.

The combination of integrated circuits and Nixie tubes is one that's widely found in digital instruments. Yet the large difference in supply voltages needed for the two can pose a problem when designing a power supply for equipment that must be battery operated for portability. With a battery-operated supply, any voltage converter that's used should have a high efficiency to conserve battery energy. This can be accomplished with a switching regulator built around an integrated regulator circuit, the LM100, and both an extra winding on the smoothing inductor and a voltage doubler to obtain the high voltage for the Nixie tubes.

The basic regulator circuit bears some similarity to one described by the manufacturer in an application note, but in this case, the input and output capacitances have been increased. This increase was found to be necessary to improve the efficiency when the extra winding was added to the smoothing inductor. Without the change in capacitor values, the switching frequency was higher and the extra winding caused the regulator to lose its sharpness in turnon and turnoff. With the 22 microfarads and 100 μf recommended, the switching frequency would be between 30 and 75 kilohertz. With the values shown—32 μf and 350 μf —the frequency drops to about 9.8 khz, and efficiency is in the 78% to 85% range, depending on the low-voltage load.

The circuit produces two separate output voltages for an input voltage of from 10 to 15 volts. The TTL logic circuits are supplied 5.5 volts, regulated to within $\pm 1\%$, for load currents from 0.1 to 2 amperes. Maximum noise voltage is 0.5 volt peak-to-peak. Driving the three Nixie tubes takes from 150 to 210 volts at about 6 millions.

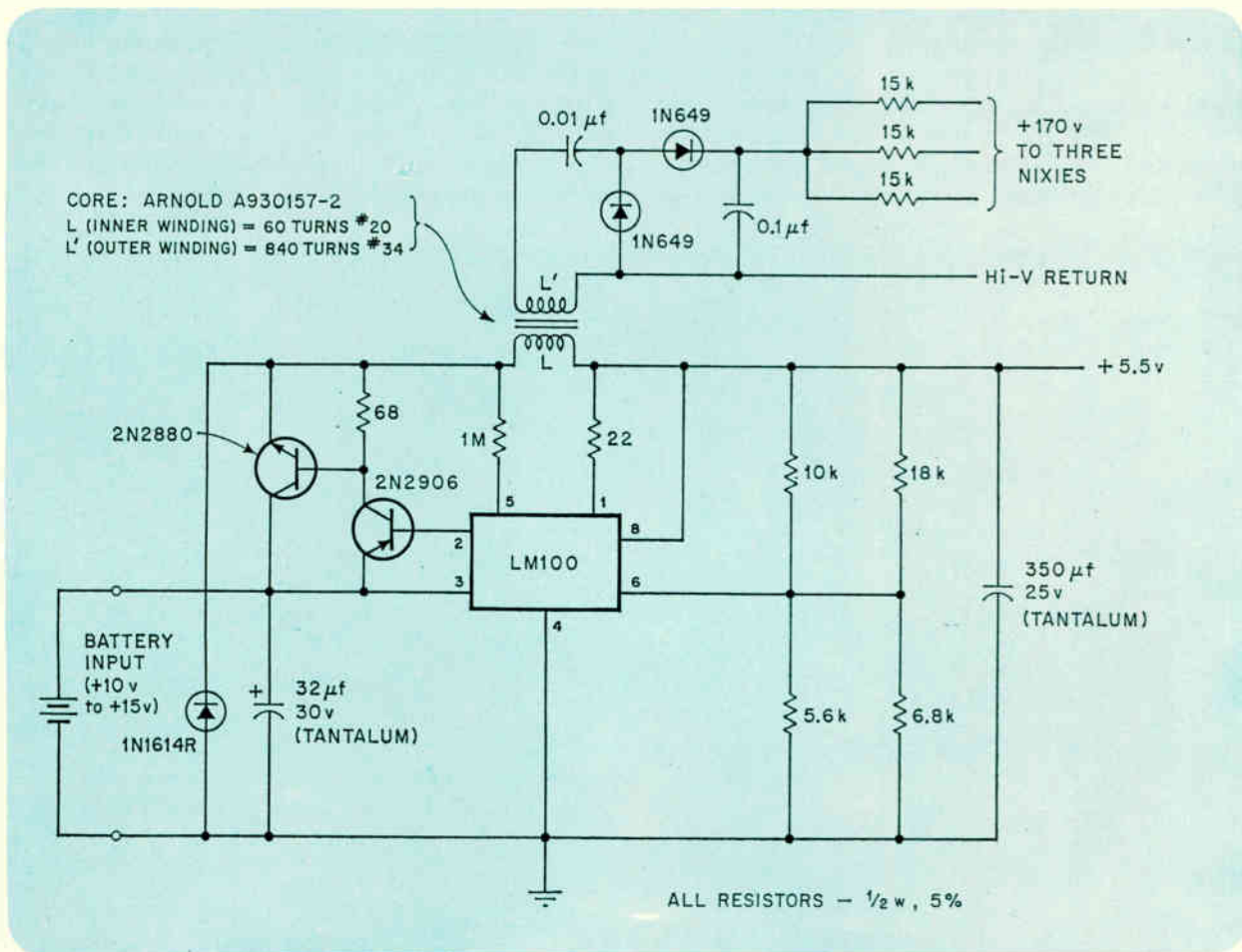

Nixie power. The extra winding on the switching regulator's smoothing inductor drives a voltage doubler to provide the 150 to 210 volts needed for Nixie display tubes. The circuit also produces a low voltage for powering transistor-transistor logic circuits. Overall efficiency is between 78% and 85%.

Switched oscillator controls four-wire resistance checks

By C.H. Ristad

International Business Machines Corp., Endicott, N.Y.

Computer-controlled component testing requires an array of switches that apply a voltage or current drive to the component and also connect an appropriate meter into the circuit. In four-wire resistance measurements, for example, a current source is applied and the voltage is monitored across the component terminals. However, accuracy requires separate grounds for the switching and component measurement circuits. And for high testing rates, the switch should operate at high switching speeds.

This circuit gets the needed isolation from a shielded transformer, which is driven by an oscillator that's switched on by the gate circuit. The current and voltage switches are then turned on by the rectified oscillator signal from the transformer's secondary winding.

To measure the resistor between pins 1 and 2 of the integrated circuit; switches 1A and 2B are turned on. This allows current flow and connects the terminals to the analog-to-digital converter for voltage measurement. To reverse the current—as

in measuring the reverse resistance of a diode—switches 1B and 2A are turned on.

An input signal of zero volt grounds the 2-kilohm resistor in the base circuit of Q_1 , and Q_1 turns off. Transistor Q_2 then turns on, oscillating in the 14-megahertz Hartley circuit. The current and voltage switches then turn on. Turn-on time is about 2 microseconds. A 6-volt input allows base current to flow in Q_1 , Q_2 turns off, and the oscillation ceases, opening the current and voltage switches.

The transformer's primary and secondary windings are on separate bobbins and are physically separated in the cup cores. A thin sheet of copper, sandwiched between the cup cores, acts as an electrostatic shield.

Currents up to 100 milliamperes can flow in the current circuit because the two shunt diodes act to eliminate the need to operate each transistor in the inverse mode, where current-carrying ability is lower than in the normal mode. The 3N76 dual emitter, integrated chopper transistor in the voltage circuit provides lower offset voltage than two separate transistors.

Isolation is good for frequencies below 100 kilohertz, but at the 14-Mhz oscillator frequency, a nearly 1 volt peak-to-peak noise occurs in the output. However, this will be far above the pass-band of the a-d converter; but note that converters that rectify noise inputs would not be suitable in this case.

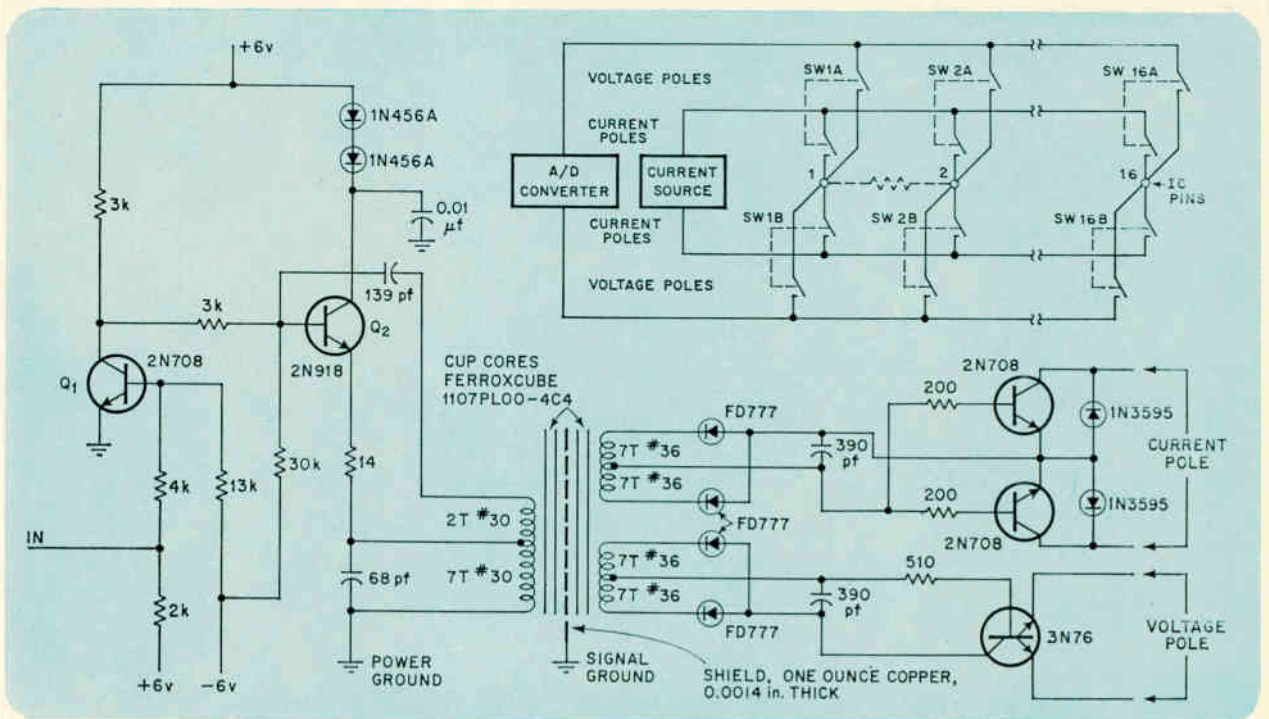

No common ground. The transformer provides isolation between switch control and measurement circuit grounds for four-wire resistance measurements. Transistor Q_2 's circuit oscillates when turned on by Q_1 's turnoff, and the transformer output is rectified to close the voltage and current poles of the switch.

Record all the data you want without touching a tape.

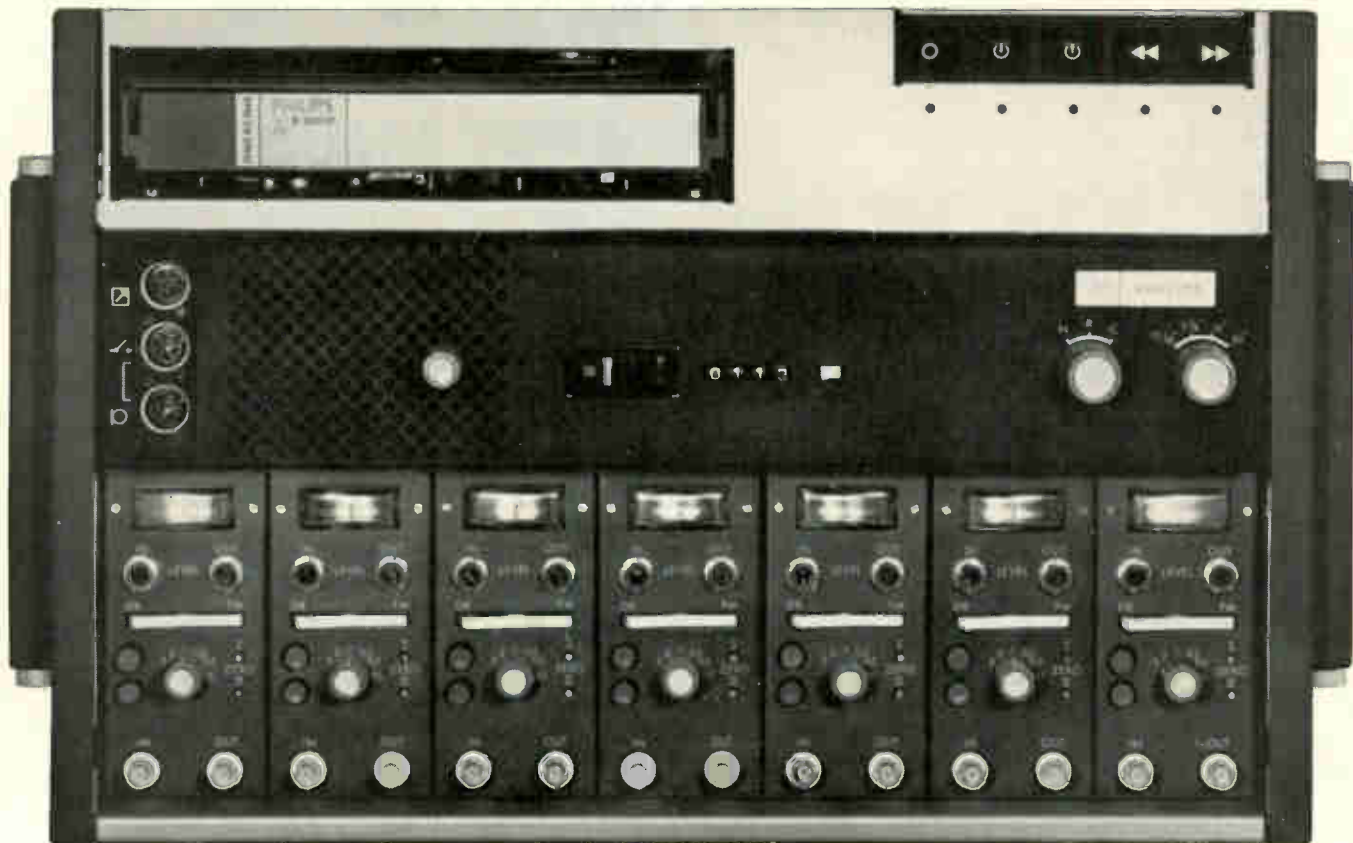

ANA-LOG 7 gives you universal application and portability with cassette convenience. Use it where you like with any AC or DC power supply. For what you like. There's a bandwidth of 100 kHz, a choice of any combination of direct and FM recording, complete IRIG compatibility, and a choice of four tape speeds — ranging from 15/16 to 30 inches per second.

ANA-LOG 7 gives you the technical precision you demand.

It has a dual capstan with crystal-controlled drive for constant tape tension, speed and tape-head contact. The low loss Ferroxcube heads of revolutionary design have small, well-defined gaps and negligible gap scatter.

ANA-LOG 7 gives you the operational convenience you'll appreciate.

A few simple controls in a logical configuration; dust-proof, transparent tape cassettes with easily interchangeable 8-inch reels of 1/2-inch tape; full protection against faulty tape insertion, tape threading and other factors which can cause loss of information; automatic lining up of equipment, without the need for speed filters or re-settings; and facilities for remote control.

ANA-LOG 7 is available at just \$9,875— or about half the cost of comparable equipment.

What's more, no additional electronics are required.

This makes the ANA-LOG 7 an attractive proposition for the scientific, technical and medical users of magnetic data recorders whose budgets are limited.

**PHILIPS
ELECTRONIC
INSTRUMENTS**

750 B. FULTON AVE., MT. VERNON, N.Y. 10550
A DIVISION OF PEPI, INC.

Bandpass filter shapes up from a low-pass network

Computer program helps determine key design parameters through simple calculations that begin with shape factors

By Philip Geffe,

Westinghouse Electric Corp., Defense and Space Center, Baltimore

● Designing a bandpass filter can be a tedious and time-consuming chore. A staggering array of calculations must be performed. The right components must be selected to achieve the desired frequency response shape, and the effect of any component value changes on the others have to be determined. But the designer may be pleasantly surprised to learn that if he starts with a low-pass prototype filter, available in numerous possibilities, a good deal of his work is already done. With this kind of variety available, he can design any number of bandpass filters quickly and simply.

Furthermore, a computer program has been especially developed to determine the filter's design parameters with only a minimum of calculations. The designer starts by finding the required shape factors, then selects a low-pass filter that conforms to this shape, and transforms poles and zeros of the low-pass network to obtain those for the bandpass device.

Top performance bandpass filters without inductors can be fabricated from integrated-circuit operational amplifiers, resistors, and capacitors. In principle, these active filters are simpler than their passive equivalents—instead of a network of passive components interacting with each other, an active filter comprises cascaded isolated resonators.

Each resonator produces a single pair of complex-conjugate poles in the complex frequency plane. Thus there's just a single peak in the plot of each resonator's gain-vs-frequency curve, each corresponding to a single value of Q . This Q is approximately equal to the ratio of the center (peak) frequency to the half-power 3-decibel bandwidth.

In addition to the pole pair, each resonator is characterized by two transfer zeros—frequencies at which attenuation is infinite. In simple Butterworth and Chebyshev bandpass filters, each of the resonators produces a zero at zero frequency; the other zero appears at infinite frequency. More selective filters comprise resonators with zeros at frequencies near the passband.

A simple three-resonator Chebyshev filter is shown on the facing page. The dashed curves are the responses of the individual resonators, and the solid curve—the algebraic sum of the dashed curves—is the filter's overall response.

The critical design parameters here are the tuning frequencies and values of Q . It doesn't matter how the

gain is distributed among the several resonators so long as each has the correct response shape. Any RC amplifier with the right response may be used as a resonator.

The design begins with the required passband width, and minimum attenuations at various frequencies. From these the bandwidths that are needed at the given attenuations are found. Ratios between these bandwidths—known as shape factors—then may be calculated.

Once the required shape factors are ascertained, the designer searches for a normalized low-pass filter with the same, or better, shape factors. This is the low-pass prototype. From readily available data the designer determines the complex poles and zeros of the low-pass prototype.¹

Using formulas or the computer program listed on page 83, the designer next applies a low-pass-to-bandpass transformation procedure to the low-pass poles and zeros of the prototype. This produces the set of Q -values, tuning frequencies, and zero frequencies required for the bandpass design. All that remains is the conventional design of the individual resonators with the appropriate f_0 , Q , and zeros.

Finding the shape factors. The passband's width and flatness are usually specified at the outset. For example, for a passband that is flat within $+0$, -0.5 decibels from 954 hertz to 1,048 hz, the bandwidth is written as

$$B_{0.5} = 1,048 - 954 = 94 \text{ hz}$$

The shape factor calculation depends on the specified requirement. If, in this example, at 42-db attenuation the bandwidth is to be 430 hz maximum, then the shape factor Ω_s , is

$$\Omega_s = \frac{B_{42}}{B_{0.5}} = \frac{430}{94} = 4.57$$

However, if at least 42 db is required at a specific frequency—say, 1,238 hz, the procedure is slightly more complex. Here, the shape factor is calculated by recognizing that the filter has geometric mean symmetry about a center frequency, f_0 . Thus, the geometric mean of any frequency pair at which attenuation is the same can be used for each calculation, regardless of the attenuation used.

A response curve is drawn on semilog paper, with a

logarithmic-frequency axis showing "fold-over symmetry;" that is, both halves of the curve will coincide when the graph is folded at f_0 .

The band-edge frequencies already are known, so that

$$f_0 = \sqrt{(954)(1,048)} = 1,000 \text{ hz}$$

this is the geometric mean of both the band-edge and 42-db frequencies. Therefore, if the 42-db frequencies are, say, f_a and f_b , with $f_b = 1,238$, then

$$f_0 = 1,000 = \sqrt{f_a f_b}$$

from which

$$f_a = \frac{f_0^2}{f_b} = 808 \text{ hz}$$

Subtracting 808 hz from 1,238 hz gives

$$B_{42} = 430 \text{ hz}$$

$$\text{and } \Omega_s = 4.57$$

Hence, in this example, specifying 42 db at 1,238 hz is the same as specifying a 42-db bandwidth of 430 hz.

Finding the low-pass prototype. Poles for the Butterworth and Chebyshev filters are tabulated, in part, directly below. Data on the highly selective elliptic-function filters, including the poles and zeros, are found in references 2 and 3.

For his next step, the designer finds a low-pass filter with a shape factor less than 4.57. Stated another way, the low-pass filter will give at least 42-db attenuation at a frequency which is less than or equal to 4.57, times the frequency at which attenuation is 0.5 db. One suitable filter appears on page 177 of reference 2. It has these characteristics:

$$\alpha_p = \text{passband ripple} = 0.18 \text{ db}$$

$$\alpha_s = \text{stopband attenuation} = 46.87 \text{ db}$$

$$\Omega_s = \text{shape factor (from } \alpha_p \text{ to } \alpha_s = 4.1336$$

Complex poles lie at $-0.86266 \pm j0$ and $-0.40363 \pm j1.13538$. Zeros on the $j\omega$ axis are located at $\pm j4.7552$. These tabulated values are the poles and zeros of a

Cascaded filter. Overall gain for this Chebyshev filter is the algebraic sum of responses for resonators 1, 2, and 3.

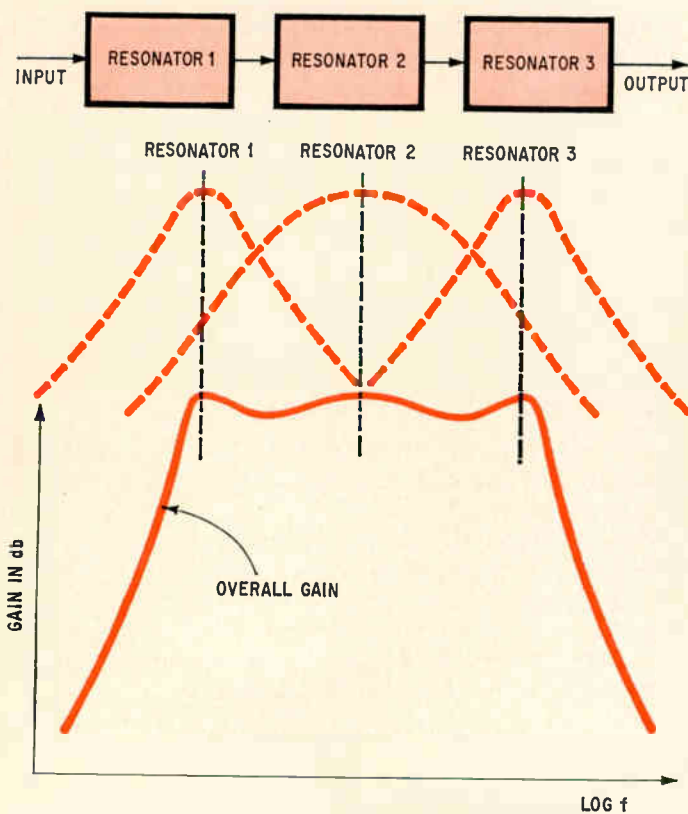

Poles of Chebyshev transfer function

(db)	n = 2	n = 3	n = 4	n = 5	n = 6
0.001		$-1.22315 \pm j 2.28873$ -2.44630	$-0.59185 \pm j 1.70152$ $-1.42885 \pm j 0.70479$	$-0.35194 \pm j 1.44144$ $-0.92139 \pm j 0.89086$ -1.13890	$-0.23457 \pm j 1.30361$ $-0.64086 \pm j 0.95431$ $-0.87543 \pm j 0.34930$
0.01	$-2.22777 \pm j 2.33729$	$-0.79469 \pm j 1.62622$ -1.58937	$-0.41087 \pm j 1.35553$ $-0.99192 \pm j 0.56148$	$-0.25251 \pm j 1.22820$ $-0.66109 \pm j 0.75907$ -0.81715	$-0.17147 \pm j 1.15867$ $-0.46845 \pm j 0.84820$ $-0.63992 \pm j 0.31046$
0.03	$-1.66227 \pm j 1.80642$	$-0.63517 \pm j 1.40011$ -1.27034	$-0.33740 \pm j 1.23169$ $-0.81455 \pm j 0.51018$	$-0.21011 \pm j 1.15007$ $-0.55007 \pm j 0.71078$ -0.67992	$-0.14372 \pm j 1.10486$ $-0.39265 \pm j 0.80881$ $-0.53638 \pm j 0.29605$
0.10	$-1.18618 \pm j 1.38095$	$-0.48470 \pm j 1.20616$ -0.96941	$-0.26416 \pm j 1.12261$ $-0.63773 \pm j 0.46500$	$-0.16653 \pm j 1.08037$ $-0.43599 \pm j 0.66771$ -0.53891	$-0.11469 \pm j 1.05652$ $-0.31335 \pm j 0.77343$ $-0.42804 \pm j 0.28309$
0.30	$-0.84716 \pm j 1.10348$	$-0.36464 \pm j 1.07186$ -0.72928	$-0.20260 \pm j 1.04536$ $-0.48912 \pm j 0.43300$	$-0.12890 \pm j 1.03048$ $-0.33746 \pm j 0.63687$ -0.41713	$-0.08922 \pm j 1.02171$ $-0.24376 \pm j 0.74794$ $-0.33298 \pm j 0.27377$
1.0	$-0.54887 \pm j 0.89513$	$-0.24709 \pm j 0.96600$ -0.49417	$-0.13954 \pm j 0.98338$ $-0.33687 \pm j 0.40733$	$-0.08946 \pm j 0.99011$ $-0.23421 \pm j 0.61192$ -0.28949	$-0.06218 \pm j 0.99341$ $-0.16988 \pm j 0.72723$ $-0.23206 \pm j 0.26618$

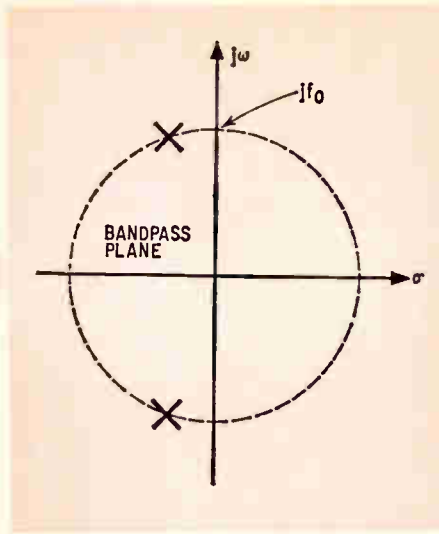
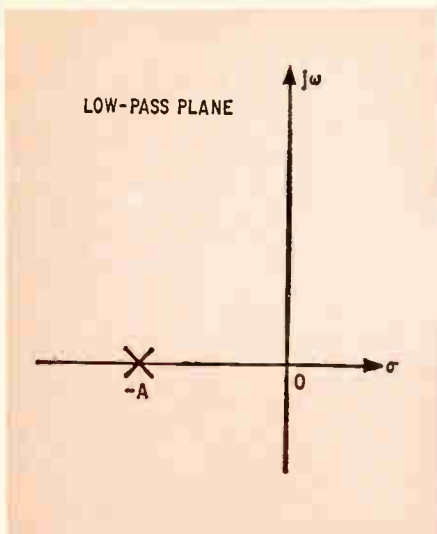

Single real pole. A negative real pole in the low-pass plane is transformed into a complex-conjugate pair of poles in the bandpass plane.

low-pass filter normalized for a unit passband—one radian per second. This normalization is the most common one among published filter tables. The designer is now ready to determine the bandpass filter's design parameters.

Low-pass-to-bandpass transformation. Now the passband's design width is selected. A likely figure for this example is 100 hz, a value sufficiently larger than 94 hz to absorb component tolerances and thermal drifts. And it guarantees bandwidths of at least 94 hz at all times.

Circuit Q is a parameter needed for the transformation

$$Q_c = \frac{f_o}{f_2 - f_1}$$

where f_1 and f_2 are the frequencies at the edge of the passband.

In the example, substituting for Q_c yields

$$Q_c = \frac{1,000 \text{ hz}}{100 \text{ hz}} = 10$$

Some terms should be defined before introducing the low-pass-to-bandpass formulas and computer program. A pole is represented by a complex number, s , or is a

point in the complex-frequency plane. It has both real and imaginary parts and is written

$$s = -A \pm jB$$

The pole-center frequency or tuning frequency is the pole magnitude

$$\omega_o = \sqrt{A^2 + B^2}$$

The value of Q associated with a pole is

$$Q_p = \frac{\omega_o}{2A}$$

In performing the transformation on the poles and zeros of the low-pass prototype, three possible cases must be considered:

Case 1. When the low-pass filter has an odd number of poles, one of them appears on the negative real axis of the low-pass plane. Then $A \neq 0$, and $B = 0$. The single real pole will be transformed into a single pair of poles in the bandpass plane, as shown directly above. The result, after transformation, yields a

$$\text{tuning frequency} = f_o \tag{1}$$

$$\text{pole } Q = Q_p = Q_c/A \tag{2}$$

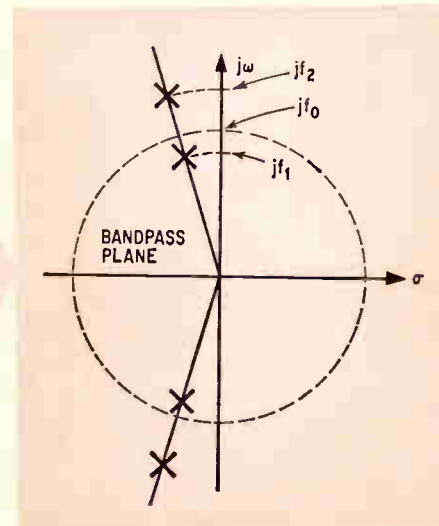
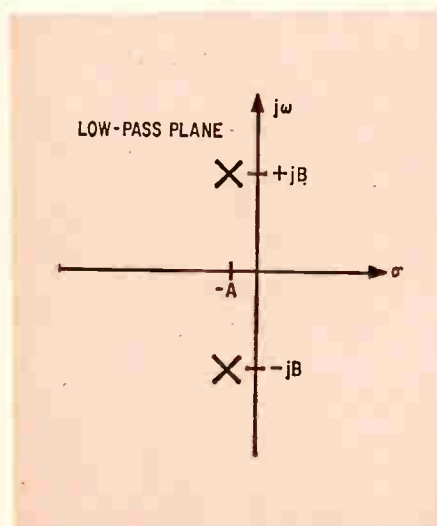

Single pole pair. A complex-conjugate pole pair in the low-pass plane is transformed to a double set of complex conjugate poles in the bandpass plane all having the same pole Q .

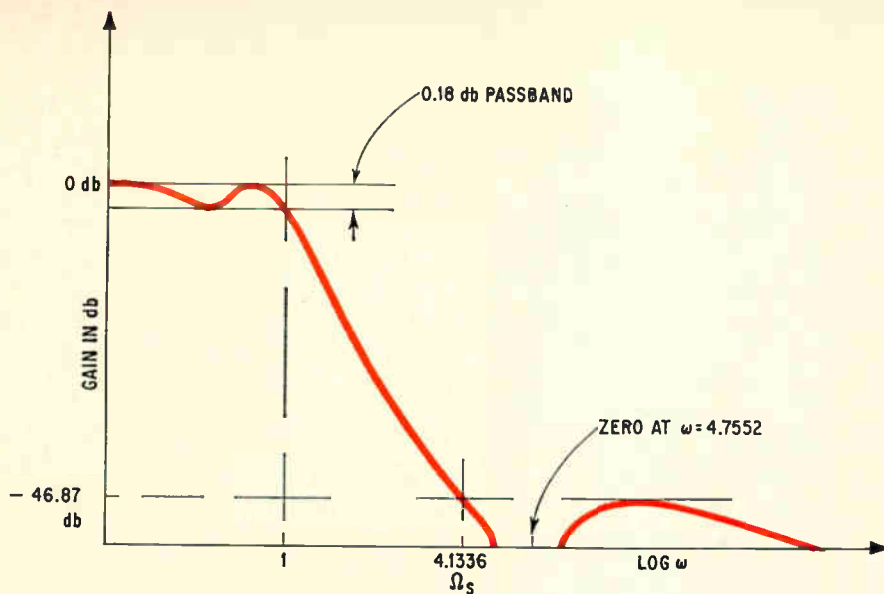

Low-pass filter. First step in the design process for an active bandpass filter is to select a low-pass prototype whose shape factor meets the desired value. Here the filter selected offers attenuation of at least 42 decibels at a frequency of 4.57 times the 0.5-db frequency.

Printout pointers

The computer program devised by the author to implement his filter design procedure is written in the Basic language. The notations in the program correspond to that used in the formula shown in the article. Thus,

Input	Program symbol	Equation symbol
	F	f_o
	Q	Q_c
	A	A
	B	B
	F3	Tuning frequency from real low-power pole
	Q3	Pole Q for F3
	PQ	Pole-Q of bandpass pole pair
Output	F1	First tuning frequency of bandpass pole pairs
	F2	Other tuning frequency of bandpass pole pairs
	Z1	Bandpass zero frequency
	Z2	Bandpass zero frequency

Data statements must enter the input numbers in the following order:

DATA F, Q

DATA A, B, A, B, . . . , in pairs

Note that the A, B information must be complete. If either number is zero, then a zero must be written into the data statement. As many A, B pairs as needed may be entered. Equations 1 to 17 also can be programmed in Fortran, or some other familiar computer language. A typical printout is as follow:

Calculating. The designer starts his program off by instructing the computer to read the values for f_o , Q_c , A, and B. The machine then determines for which of the three cases it is to design the parameter values. To do this it examines the values for the zeros A and B to find out if either has a zero value. Based on this value the program proceeds to the next appropriate step.

LIST

LPT0BP 14:00 CEIR 11/24/69

```

100 READ F,Q
110 READ A,B
120 IF A = 0 THEN 290
130 IF B = 0 THEN 370
140 LET C = A*A+B*B
150 LET D = 2*A/Q
160 LET E = C/(Q*Q)+2
170 LET G = SQR((E+2)*(E+2)-4*D*D)
180 LET Q1 = SQR((E+G+2)/(2*D*D))
190 LET H = A*Q1/Q
200 LET W1 = H+SQR(H*H-1)
210 LET W2 = 1/W1
220 LET F1 = F*W1
230 LET F2 = F*W2
240 PRINT "PQ=";Q1,"W1=";W1,"W2=";W2
250 PRINT
260 PRINT "F1=";F1,"F2=";F2
270 PRINT
280 GOTO 110
290 LET H1 = B*B/(2*Q*Q)+1
300 LET Z1 = SQR(H1+SQR(H1*H1-1))
310 LET Z2 = 1/Z1
320 PRINT "Z1=";Z1,"Z2=";Z2
330 PRINT
340 PRINT "FZ1=";F*Z1,"FZ2=";F*Z2
350 PRINT
360 GOTO 110
370 LET W3 = 1
380 LET Q3 = Q/A
390 PRINT
400 PRINT "W3=";W3,"Q3=";Q3
410 GOTO 110
420 DATA
430 DATA
440 END

```

```

420 DATA 1000, 10
430 DATA 0.86266, 0, 0.40363, 1.13538, 0, 4.7552
RUN

```

LPT0BP 14:04 CEIR 11/24/69

```

W3= 1          Q3 = 11.5921
PQ= 24.8151   W1= 1.05839   W2= .94483
F1= 1058.39   F2= 944.83
Z1= 1.26564   Z2= .790116
FZ1= 1265.64  FZ2= 790.116

```

OUT OF DATA IN 110

TIME: 1 SECS.

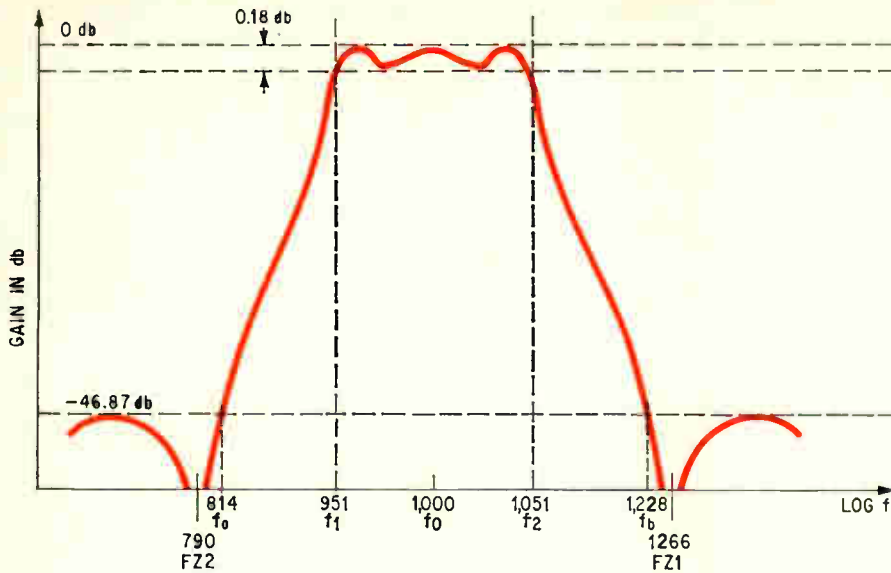

Final design. Response for completed bandpass filter design is symmetrical about the center frequency, 1,000 and meets the shape-factor requirement.

In the example, tuning frequency = 1,000 hz and pole $Q = 10/0.86266 = 11.5921$

Case 2. The low-pass prototype will have at least one pair of complex-conjugate poles for which $A \neq 0$ and $B \neq 0$. In the bandpass plane, each pair transforms into two pairs of complex-conjugate poles. Both bandpass pole pairs have the same value of pole Q . The appropriate formulas are

Input: f_0, Q_c, A, B

Calculate:

$$C = A^2 + B^2 \quad (3)$$

$$D = 2A/Q_c \quad (4)$$

$$E = C/Q_c^2 + 2 \quad (5)$$

$$G = \sqrt{(E + 2)^2 - 4D^2} \quad (6)$$

$$Q_p^2 = (E + G + 2)/(2D^2) \quad (7)$$

$$H = A Q_p / Q_c \quad (8)$$

$$W_1 = H + \sqrt{H^2 - 1} \quad (9)$$

$$W_2 = 1/W_1 \quad (10)$$

$$f_1 = f_0 W_1 \quad (11)$$

$$f_2 = f_0 W_2 \quad (12)$$

Output: Q_p, f_1, f_2

In the example, the inputs are

$$Q_c = 10, f_0 = 1,000, A = 0.40363, B = 1.13538$$

The calculations yield: $C = 1.452, D = 0.080726, E = 2.01452, W_1 = 1.05839, W_2 = 0.94483$. Thus, $Q_p = 24.8151, f_1 = 1,058.39$ hz, and $f_2 = 944.83$ hz.

Case 3. If the low-pass prototype has zeros on the $j\omega$ -axis, then they will occur in pure imaginary conjugate pairs wherein $A = 0$ and $B \neq 0$. The low-pass zeros transform into two conjugate zeros pairs in the bandpass

plane. The formulas are: Input: f_0, Q_c, B

Calculate:

$$H_1 = B^2/2 Q_c^2 + 1 \quad (13)$$

$$Z_1^2 = H_1 + \sqrt{H_1^2 - 1} \quad (14)$$

$$Z_2^2 = 1/Z_1^2 \quad (15)$$

$$f_{1\infty} = f_0 Z_1 \quad (16)$$

$$f_{2\infty} = f_0 Z_2 \quad (17)$$

Output: $f_{1\infty}, f_{2\infty}$

Continuing the example,

$$f_0 = 1,000, Q_c = 10, B = 4.7552.$$

Using equations (13) through (17), $f_{1\infty} = 790.116$ hz, $f_{2\infty} = 1,265.64$ hz. Resonators not required to provide zeros on the $j\omega$ -axis should have one zero at $f = 0$, and one at $f = \infty$.

Now the bandpass filter's numerical calculations are complete, except for the resonator circuit. Since the passband width is set at 100 hz, and $\Omega_s = 4.1336$, the bandwidth at 46.87 db will be 413.6 hz. This value provides plenty of margin beyond the user's requirements. However, it's helpful to ascertain the exact frequencies at the edges of passband and stopbands. These frequencies are calculated from the property of geometric mean symmetry.

If f_1 and f_2 are the passband edges, then $\sqrt{f_1 f_2} = f_0 = 1$ khz, and $f_2 = f_1 + b = 0.1$ khz. Solving for f_2 yields

$$f_2^2 - b f_2 - f_0^2 = 0 \quad (18)$$

In the example, this becomes $f_2^2 - 0.1 f_2 - 1 = 0$ which gives $f_2 = 1,051.25$ and $f_1 = 951.25$ hz. To obtain the stopband frequencies, $b = 0.41336$ is substituted in equation 18, yielding $f_a = 814.4$ hz (46.87 db) and $f_b = 1,227.8$ hz (46.87 db). The overall bandpass response is shown above.

Now all requirements have been met and the shape conforms exactly to the desired response. ●

References

1. ITT Corp., "Reference Data Handbook for Radio Engineers," fourth edition.
2. A.I. Zverev, "Handbook of Filter Synthesis," John Wiley & Sons, 1967.
3. E. Christian and E. Eisenmann, "Filter Design Tables and Graphs," John Wiley & Sons, 1966.

Major European shows and meetings: July-December 1970

July

**Conference on Dielectric
Materials and Applications**
July 20-24
Lancaster University, England

**National Audiovisual Aids
Conference and Exhibition**
July 20-23
Olympia, London

August

**Third Conference on
Magnetic Signal Storage**
August 11-15
Szabadság ter, Budapest

**World Conference
on Computer Education**
August 24-28
International Congress
Center, Amsterdam

Leipzig Fall Fair
August 30-September 6
Fairgrounds, Leipzig,
East Germany

September

**International Broadcasting
Convention**
September 7-11
Grosvenor House, London

**7th International
Components and Measuring
Instruments Salon**
September 7-11
Fairgrounds, Milan

Flying Display and Exhibition
September 7-13
Farnborough Airfield, England

**International Conference
on Magnetism**
September 14-19
University of Grenoble,
France

**Electronic Engineering
in Ocean Technology**
September 21-24
University College of
Swansea, Wales

**Annual Conference,
Association of German
Electrical Engineers**
September 21-26
Liderhalle, Stuttgart

**Trunk Telecommunication
by Guided Waves**
September 29-October 2
IEE, Savoy Place, London

October

Computers 70
October 5-9
Olympia, London

"Modern Electronics" Fair
October 6-11
Fairgrounds, Ljubljana,
Yugoslavia

**Fiarex 70—Components
and Instruments Exposition**
October 12-16
RAI Gebouw, Amsterdam

**Inter/Nepcon Packaging
and Production Conference**
October 13-15
Brighton, England

**3rd International Electronics,
Automation, and
Instruments Fair**
October 13-18
Udstillingshallen Forum,
Copenhagen

**Earth Station Technology
for Satellite Communications**
October 14-16
IEE, Savoy Place, London

**Conference on Network
Analysis and Synthesis**
October 15-16
Technical University,
Stuttgart

November

**Airlines Electronic
Engineering Committee
Fall General Session**
November 3-6
Royal Garden Hotel, London

**Symposium on Protection
from X-ray Emission from
Electronic Products**
November 3-6
University of Toulouse, France

Communications 70
November 4-8
Alexandra Palace, London

Electronica 70
November 5-11
Fairgrounds, Munich

**4th International
Microelectronics Congress**
November 9-11
Fairgrounds, Munich

Laboratory Automation
November 10-12
Middlesex Hospital Medical
School, London

No major meetings or shows
are scheduled for December

December

Details on other side

Major European shows and meetings: July-December 1970

Stopover in London

Every third year the Airlines Electronic Engineering Committee, which is predominantly American, holds its fall meeting in Europe. In 1967 the committee chose Rome; for 1970 it's picked London, in association with British European Airways. The first day is a closed session, but for the other three days there's a chance for all comers to air their views before the committee, which sets specifications for airlines' hardware. European airlines will hold their own electronics meeting in London the week after, November 9-12.

Dutch treat

Between 10,000 and 15,000 people are expected to turn up at Fiarex 70, the Dutch show that covers components, equipment, instruments, and acoustics. Philips' Gloeilampenfabrieken will be on the floor in force, of course, and will also sponsor a technical symposium on the continuing growth of information processing in the industry.

Olympian calculations

Although there's been many a computer at many a show, the organizers of Computers 70 claim theirs is Europe's first major exhibition devoted solely to computers and data-processing services. True or not, all the space at the Olympia Exhibition Halls has been snapped up by some 200 exhibitors.

Fair play in Milan

The early-September components salon in Milan, as usual, figures to be one of the high spots in the year for the Italian electronics industry. But there is plenty of justification for the show's "international" label. Fully 70% of this year's 200-odd exhibitors will be non-Italian. The technical symposium that's traditionally held with the show will feature hybrid circuits this year.

Well-insulated at Lancaster

IEE conferences on dielectrics come rarely (the last was in 1964); so when they do, there's plenty to talk about. This time, there'll be nearly 100 papers from a dozen countries covering both theory and applications. Far and away the farthest out offering: an American report on remote sensing of the dielectric properties of the surface of Mars.

Colorful company in London

Since this year's international broadcasting conference in London will be the first since extensive color tv transmission started in Britain, it's obvious what broadcasters want most to gab about. But color tv isn't all; automation and digital techniques in broadcasting will get a good play, and there will be more on broadcasting sound than has been usual in recent years. About a quarter of the 70 papers are from outside the U.K.

Attracted to Grenoble

Every three years there's a big meeting that draws practically everybody who's anybody in the theory of magnetism, and this year the attraction is to Grenoble. Some 1,500 scientists, mostly physicists, are expected to show up, and they will have 350 papers to contend with. Except for thin-film domains, the field is blanketed. Thin films are getting relatively short shrift at Grenoble because they'll be the main topic at another meeting, in Prague, later this year.

Calendar on reverse side

Massed in Munich

Electronica, the Munich show that got off to such a precarious start six years ago, since has turned into a major attraction for components people around the world. For this year's show, the fourth, more than 700 exhibitors will be on hand, five times the number that signed up for the first Electronica back in 1964. They'll come from some 20 countries, including Israel, the Soviet Union, East Germany, and Czechoslovakia. Emphasis this year will be on three main aspects of componentry: functional modules and sub-systems, production equipment, and test equipment.

Data in Amsterdam

The explosion in information processing has brought with it a new shortage for the world: people skilled in the computer sciences. How to overcome this shortage will be the underlying theme in Amsterdam in August when 400 experts from around the world gather for a conference on computer education. Topics will range from computer training in secondary schools to the design of time-sharing networks. Along with the talk, there'll be an exhibition of hardware.

Novemberfest

For more than 1,000 professionals, it will be microelectronics rather than beer during the international congress covering the field that will run in Munich during the last three days of Electronica. After opening speeches by such luminaries as Fairchild's C. Lester Hogan and AEG-Telefunken's research director Kurt Fraenz, there will be some 35 lectures under four headings: technology, circuit engineering and applications, new components, and mounting and connecting systems. This year for the first time there'll be an international panel discussion each day after the lectures.

On station in Savoy Place

Conferences centered on communications by satellite have become commonplace. To lift its October meeting on ground stations out of the run-of-the-mill category, the IEE will emphasize military, regional, and domestic systems. There will also be papers on planning for Intelsat 4 and reports on experience with existing installations. There should be no lack of ideas: Americans apart, Britons have built more ground stations than anyone.

New waves in London

Trunk telecommunication by guided waves looks like a sure thing for the future, and this September will see the first major conference in the U.K. on the subject. The papers will chart progress, so far, in using millimeter waves and light as carriers. Problems and prospects will be pinned down as well. Among the topics: modulation, multiplexing, repeaters, terminals, and, of course, building and laying the waveguides themselves.

Stampede to Stuttgart

Just about every facet of electronics will get some sort of airing at the mammoth annual conference of the Association of German Electrical Engineers. Topics cover the gamut from components and communications to data processing and industrial control. Of particular note: sessions on electronics in motor vehicles and on the use of radar in air traffic control. All papers will be delivered in German.

Introducing hard software. Soft hardware?

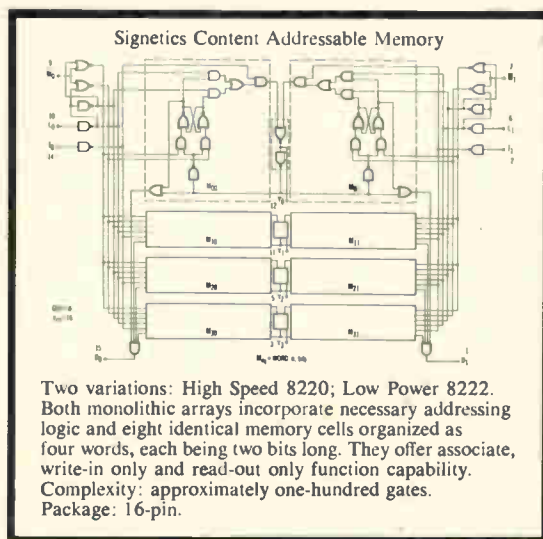

Signetics new memory search devices bridge the gap between hardware and software.

They match input to stored data. They cut the time needed for memory search. And they're available now from our distributors.

Also available for the writing, a copy of the application notes for our new CAM hardware. Soft hardware?

Either way, a new medium for the computer architect.

Signetics

Signetics Corporation / 811 E. Arques Ave., Sunnyvale, California 94086 / A subsidiary of Corning Glass Works

Low-cost stereo recorders can adapt to digital data

Combining information and clock on a single track licks the problem of intertrack phase shift and head gap spacing common to audio machines

By David Newton and Walter Buczek,
U.S. Army Electronics Command, Fort Monmouth, N. J.

● Add to a standard high-quality stereo tape recorder a unique multiplexing and data format scheme and some complementary metal oxide semiconductor integrated circuits. The result of this recipe: a versatile digital recorder and playback unit that offers most of the features of commercial digital recorders—but at a significantly lower cost.

Such a recorder is particularly attractive when data from several sources must be stored simultaneously for later analysis. Although originally designed for military applications, the low cost and portability of the converted unit fill a need in many instrumentation situations, particularly when long recording periods rather than fast data rates are required.

For example, in biomedical applications, the recorder could sample for several hours, perhaps at 5-second intervals, arterial blood flow as measured with an implanted flowmeter. Or it could monitor cardiological parameters such as period and peak amplitude of an electrocardiograph. For industrial applications, the recorder could measure the output of factory piecework over several seconds per datum, or monitor, at 1-second intervals, temperature variations in a furnace. And for military jobs the unit could record battlefield activity from a remote site.

Although a stereo tape recorder is adaptable for digital data recording, certain undesirable characteristics—such

as intertrack phase shift, narrow bandwidth, and large variations in capstan speed—limit its performance.

These liabilities restrict the ability of the stereo tape recorder to store data. Continuous flexing of the magnetic tape as it passes over the recording head causes a time-dependent phase shift between identical signals on concurrent recording tracks. The shift precludes using separate clock and data tracks. This, in turn, imposes a serial format in which both clock and data signals are recorded on the same track, and a playback scheme in which the reference clock signal is derived from the data signal.

Typical bandwidth of an audio tape recorder is from 100 hertz to 5 kilohertz, at a tape speed of $\frac{1}{4}$ inch per second—the speed used for maximum recording time. The upper band limitation is imposed by the physical size of the head gap—the space between the poles of the U-shaped recording head. When the signal wavelength approaches the gap size, gap and eddy current losses become sufficiently large to produce a poor signal-to-noise ratio. Amplifier circuitry defines the lower band edge which is not critical here since the edge is much lower than the lowest usable frequency.

Variations in tape-drive speed during record and playback may be significant on the same or different units. This difference poses a problem when transferring data from one unit to another, or if data is recorded on one



Converted. High-quality stereo recorder stores 11 million bits of digital data over a 6-hour period. The C/MOS conversion circuitry is at the rear and the data input plugs are seen at the left. Microphone permits operator to record audio "notes" on one of the two stereo tracks.

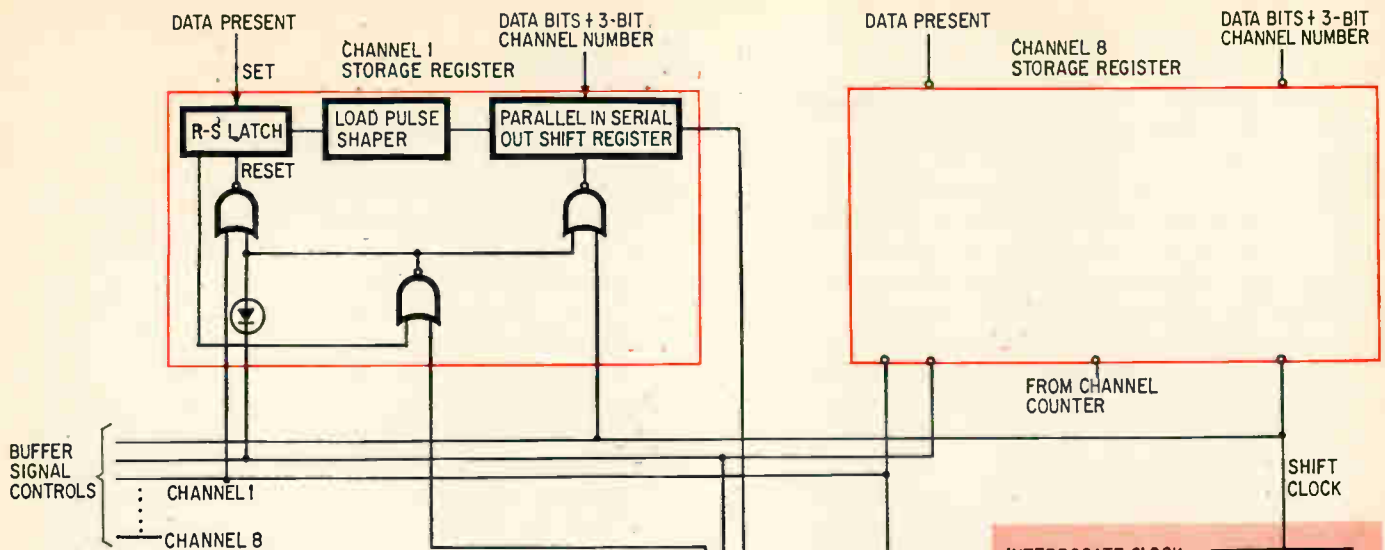

machine and played back to another. However, the data format scheme selected for this digital recorder allows playback speed to fluctuate up to $\pm 20\%$ from the nominal $\frac{1}{8}$ ips before the system fails to differentiate between logic 1's and 0's. This provides enough leeway for even moderately priced tape drives.

The tape recorder selected for conversion was a Uher 4400 stereo machine. It offers two advantages over most other commercially available stereo recorders: it has four tape speeds and 5.5 volt drive motors that can be battery powered.

The four tape speeds make possible data compressions of two, four, and eight when playing back data recorded at $\frac{1}{8}$ ips at either $1\frac{1}{8}$, $3\frac{3}{4}$, or $7\frac{1}{2}$ ips. This form of data compression offers a twofold advantage: it speeds up transfer to another tape, and simplifies operator interpretation of the displayed data.

Other commercial stereo tape recorders possess the required $\frac{1}{8}$ ips record speed and could have been used if portability had not been a prerequisite and a-c line voltage had been available.

Two integrally related square-wave frequencies represent the binary states that the recorded data can assume. A 1-khz square wave denotes a logic 1 while a 500-hz square wave represents the logic 0 state. The 500-hz signal also times the multiplexer.

An astable multivibrator, two bistable multivibrator frequency dividers, and two sampling switches perform the voltage-to-frequency conversion. The astable runs free at 2 khz and drives the bistable chain to produce the 1-khz and 500-hz square-wave signals.

Each single-pole, double-throw sampling switch consists of two field effect transistors driven by a bistable multivibrator. The first switch selects the square-wave frequency corresponding to the binary input to the switch's bistable multivibrator. The second switch, controlled by an end-of-field signal that is sent from the multiplexer and denotes the end of binary word, injects an average d-c level—half the peak voltage of the data waveform, about 0.2 volt—for one bit length into the output bit stream. The end-of-field signal interrupts the otherwise continuous f-m wave that is the data signal. The spdt switches are synchronized by the 500-hz clock signal.

Three operations recover binary data during playback and prior to demultiplexing. First, a Schmitt trigger cir-

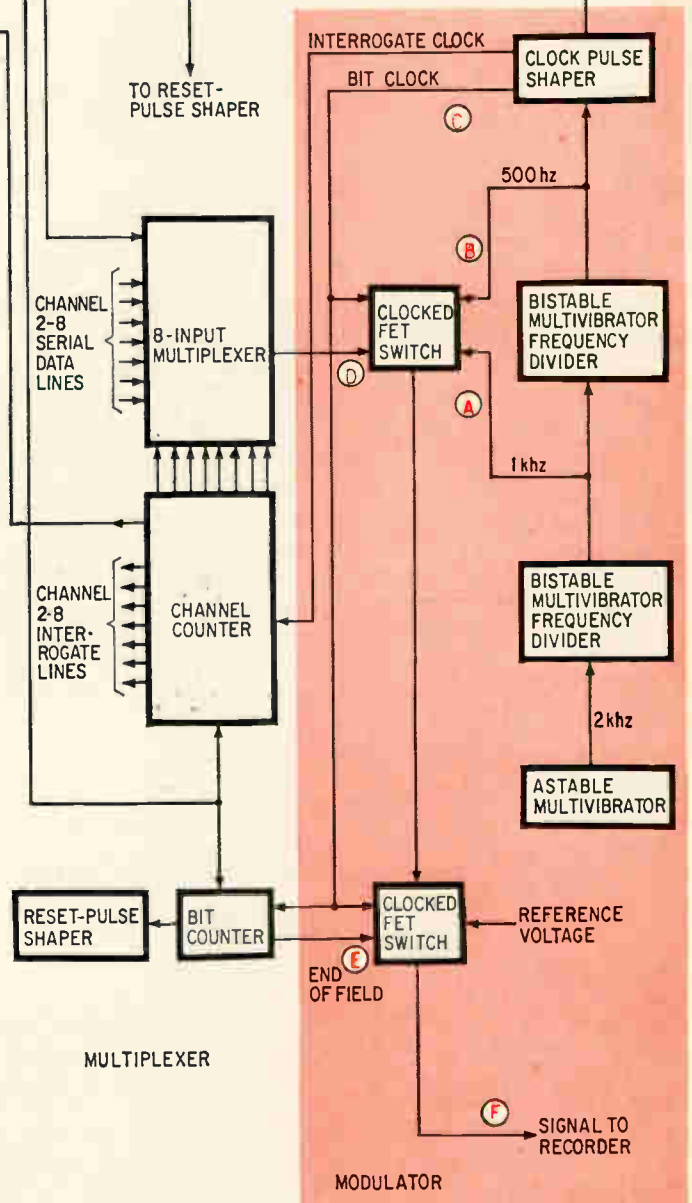

Record. The astable multivibrator in the modulator, shown in color, develops basic 2-kilohertz signal that is then divided in two steps, to form the binary 1 (1-khz), and the binary 0 (500 hertz). The letters in color refer to waveforms shown on page 92.

cuit converts the recorded signal to a square wave restoring the leading and trailing edges, and adjusts the amplitude to the appropriate levels required by the logic circuitry. The pulse train that results contains the original recorded data. Second, the end-of-field signal is recovered by taking the differentiated negative-going edge of the 500-hz locked astable multivibrator waveform and combining this edge with the data signal in an AND gate. This combination will yield an output signal when the edge coincides with the arrival of a low binary state. During the end-of-field no-signal period, the astable multivibrator is forced to run free and generate a negative-going edge unaccompanied by a positive data level—no data is present. The result is a positive end-of-field pulse.

The third recovery step extracts the data's clock signal. Generated by a synchronized astable multivibrator, the 500-hz clock frequency is locked in both phase and frequency with the binary 0 portions of the playback signal. During binary 1 transmission, the reference signal is locked to the playback pulse's leading edge. During end-of-field transmission the astable multivibrator runs free at its natural frequency. To vary playback speed, the appropriate resistor-capacitor network is switched on manually to change the astable's natural frequency.

The eight-channel multiplexer consists of independent buffer storage registers for each data source, a counting and sequence control unit, and signal modulating circuitry. During no-data periods of recording, the one-of-eight counter continuously cycles at the 500-hz rate, interrogating each buffer unit for the presence of data. The serial output of each buffer register is sequentially channeled to the data input of the modulator. During this phase of operation, all circuits that count and shift bits are inhibited, and the input to the recorder is a string of binary 0's—a continuous 500-hz square wave.

When data appears at an input channel, the reset-set latch associated with the channel's buffer is set, and a pulse is formed. This pulse loads the data in parallel with a permanently wired, three-bit code denoting the channel number. The operation is independent of system timing.

The data can now be shifted into the modulator prior to entry into the recorder. First, the channel counter interrogates the channel that takes in the data. An acti-

Digital signals. Recorded signal format, F, is composed of binary 1's (1 kilohertz) binary 0's (500 hertz), and an end-of-field signal which is a one-bit long pulse at the average d-c level of the waveform. A Schmitt trigger circuit restores the recorder's rounded output, G. The combination of the trailing edge of the astable output pulse, I, and the absence of a positive transition in the restored data signal produces the end-of-field signal, K. The demultiplexed data lags the data signal from the recorder by one millisecond.

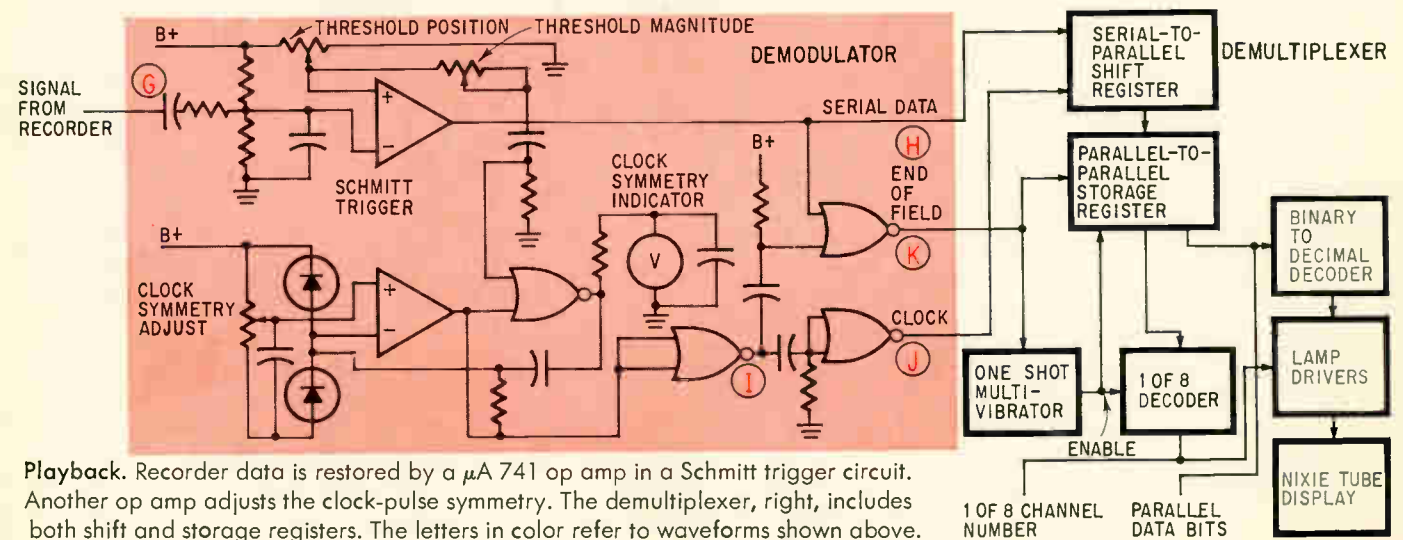
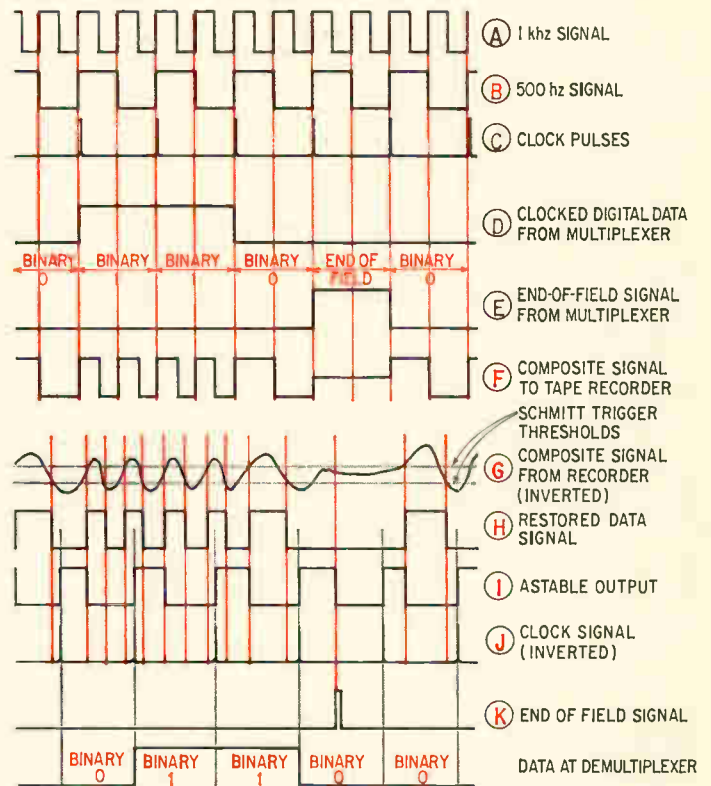

Playback. Recorder data is restored by a μA 741 op amp in a Schmitt trigger circuit. Another op amp adjusts the clock-pulse symmetry. The demultiplexer, right, includes both shift and storage registers. The letters in color refer to waveforms shown above.

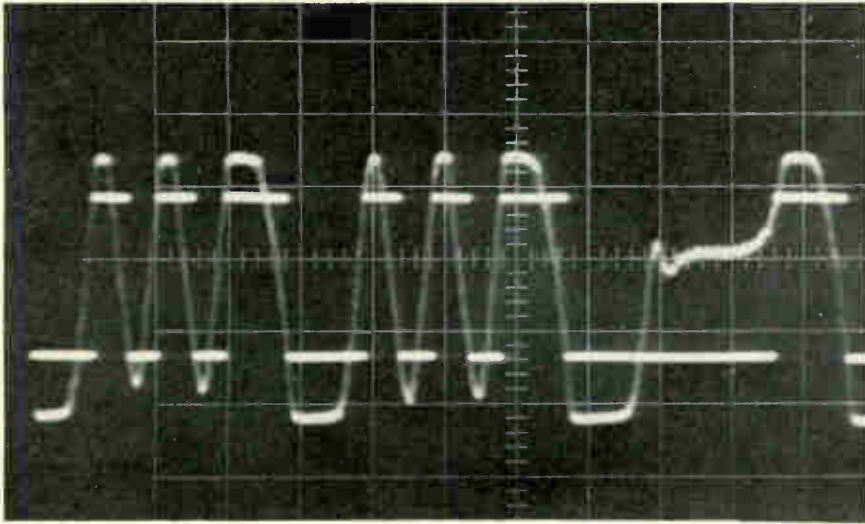

Squaring. Rounded waveform as recorded on the tape is superimposed on the demodulator output. Recorded 2-volt peak-to-peak signal fires a Schmitt trigger when the leading edge reaches the threshold level of the trigger. Result is a square wave, with amplitude of 9 volt pk-pk.

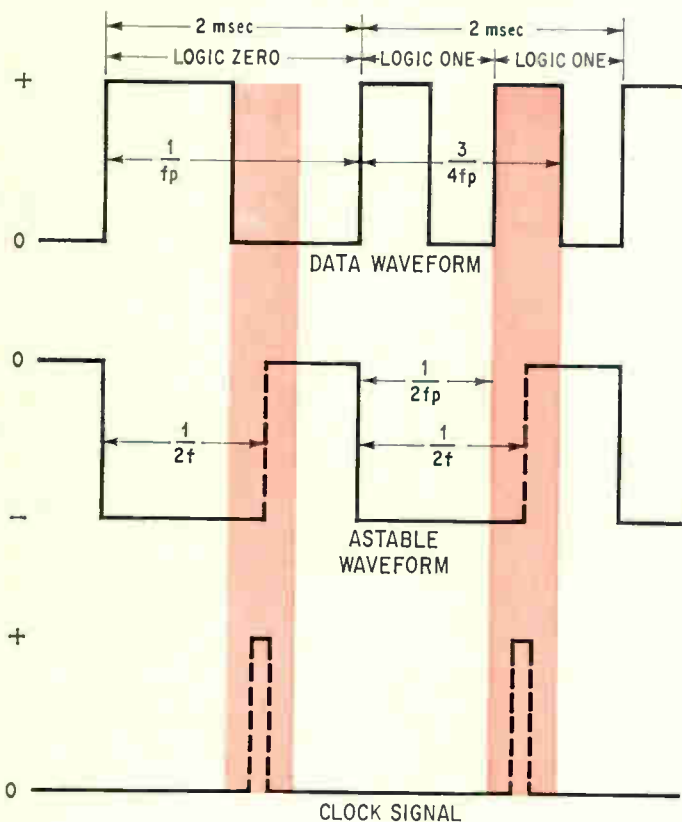

Timing counts. If the equipment is to distinguish between a logic 1 and a logic 0, the clock pulse must occur within the red-tinted regions. To insure this, the leading edge of the astable waveform is synchronized to the leading edge of the data waveform; the trailing edge times the clock-pulse cycle. This scheme permits as much as $\pm 20\%$ variation in recording or playback speed without error. The natural frequency of the astable is f , while the playback frequency of a logical 0 is f_p .

vated sense-line halts the counter at that position; the bit counter is also enabled. At the same time, the shift clock is routed to the channel's buffer register. And data, together with the channel identification code, is shifted to the modulator.

When the bit counter reaches the desired field size, the modulator receives an end-of-field pulse, and the reset-set latch gets a reset pulse. Resetting the latch clears the buffer register, disables the shift clock, and deactivates the data-sense line. The channel can now receive data again, and the interrogation sequence proceeds. All three operations—interrogation, shifting, and counting—are controlled by a three-phase clock signal developed by the modulator's timing circuitry.

In the demultiplexing arrangement, the restored data from the demodulator is serially clocked into a serial-to-parallel shift register. On detecting an end-of-field pulse, the demodulator produces a pulse that allows the data in the shift register to be loaded instantaneously and in parallel into a storage register. The stored data and channel code are decoded and displayed for a length of time determined by a one-shot multivibrator triggered by the demodulator pulse. When the period ends, the storage register empties. The data can also be fed to output connectors for external processing.

The electronics package was designed using C/MOS IC's to prolong battery life and decrease the size of the overall package. The batteries—two AN/PRC-25 compatible dry cells—produce 15 volts. System tests indicate battery life is 70 to 80 hours. The entire package—stereo tape recorder, electronics, and batteries—fits into a 0.9 cubic foot aluminum case and weighs less than 40 pounds.

The first prototype of the military version of the digital recording system cost \$2,300 with \$750 of this for the Uher stereo tape recorder and the military-type connectors. However, a commercial version could be built for substantially less. For example, power restrictions could be eased by using larger batteries or line power. This relaxation would pave the way for the use of transistor-transistor logic instead of the more expensive C/MOS. A breadboard model using TTL and an a-c power supply reduced the cost of the electronics from \$1,550 to \$650. Additional cost reduction hinges on choosing a less expensive audio tape recorder with fewer playback speeds. ●

Pulling the nations
of the world
closer together...

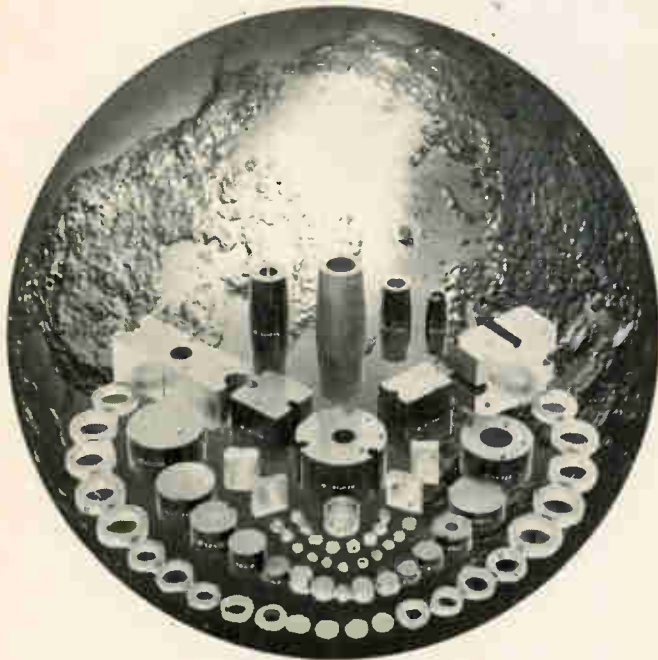

Hitachi Cast Magnets

Today's communications systems could not exist without high-grade permanent magnets. Cast magnets in particular are becoming increasingly important. Hitachi Metals produces some of the best. Cast magnets for microwave communications. Compactly designed and finished to close tolerances. Featuring high coercive force and high energy product plus magnetic field uniformity and stability.

At Hitachi Metals, magnet production is integrated. Backed by decades of experience, and a tradition of quality workmanship. Hitachi Metals makes full use of technology as modern as tomorrow.

The results speak for themselves. In communications equipment around the world.

Typical Hitachi Cast Magnets and Properties

Type	Residual Induction (Br) gauss	Coercive Force (Hc) oersteds	Energy Product (B x H) max. x10 ⁻⁶
HI-MAG I (ALNICO-5-7)	13,500~14,500	700~750	7.0~8.2
HI-MAG II (ALNICO-5-7)	13,000~14,000	680~780	6.8~8.0
YCM-8B (ALNICO-8)	8,800~9,600	1,380~1,500	4.8~5.5

Hitachi cast magnets are also used in meters, generators, motors, telephone equipment, magnetos and many other types of equipment. For further information, please contact:



HITACHI
Hitachi Metals, Ltd.

Head Office
Chiyoda Bldg., Marunouchi, Tokyo, Japan
Hitachi Metals America, Ltd.
Magnet Materials Sect.
437 Madison Ave., New York, N.Y. 10022,
U.S.A. Tel. 212-758-5255



KEPCO TALKS POWER SUPPLY TECHNOLOGY:

HOW TO TEACH AN ANALOG
VOLTAGE, DIGITAL TRICKS

The output of a power supply is an infinite continuum of possible settings limited only by the resolution of the control and your steadiness of hand. To subject such an analog continuum to digital control requires that we divide it into digits of information which can be machine-processed (as opposed to your personal tweaking of a control). The digits must be timed and sequenced correctly—stored if necessary—and then used to select command levels for a programmable power supply.

The device to do all this may take one of several forms. It may be a low level D/A employing semiconductor switching with some sort of capacitive or transformer signal isolation or it might be a high level D/A, operating at the output voltage level, using mechanical means to switch fixed control resistors.

The first method obtains speed at the expense of resolution and stability. The best semiconductor switches exhibit relatively large "on" resistances and a distinctly noninfinite "off" resistance. Moreover, at low levels, noise limits the resolution. Typically, this type of D/A produces a small (under 10V) analog output that must be amplified in a linear manner by the power supply that it controls, noise and all.

Kepco has chosen the second method. Cycle times don't break any speed records but are in line with the speed of the fastest programmable power supplies. We use reed relays arranged in decades of four each, controlling precision, wirewound, low TC resistors scaled 8-4-2-1.

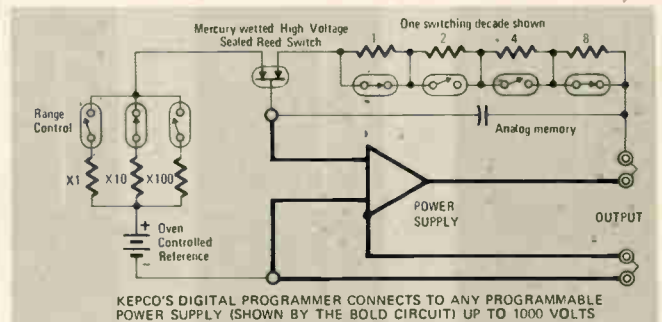

Because the D/A is working right at the output level, controlling voltage 1:1, you can divide voltage into some mighty small pieces. A three-position movable decimal point helps. Model DPD-3, for instance, will control 0-1000.00, 0-100.000 and 10.0000 volts! And, because the reeds firmly connect precision-fixed resistors—with a low "on" resistance—directly to the power supply's control loop, you can leave the setting indefinitely, confident that it will stay right on the nose.

Transients are avoided by a two-stage switching system. A command change is initiated by first opening the mercury-wetted relay to throw the power supply onto an analog memory "hold" capacitor, while the individual decade reed switches open and close in a dry circuit, establishing a new precision command level. The mercury-wetted relay then cycles closed, permitting the supply to slew to its newly established voltage level.

We will discuss this subject in some detail at the Kepco Power Supply Seminars—during WESCON at the Century Plaza Hotel. If you would like to participate in these discussions, please contact Mr. Art Rippeon at Windsor Dynamics, for complimentary tickets. Write to P.O. Box 5500, Sherman Oaks, Cal. 91413, or call (213) 989-3631. We'll see you at WESCON.

KEPCO

For complete specifications
and applications notes,
write Dept. DB-14

KEPCO, INC. • 131-38 SANFORD AVENUE • FLUSHING, N.Y. 11352
(212) 461-7000 • TWX # 710-582-2631

Circle 137 on reader service card

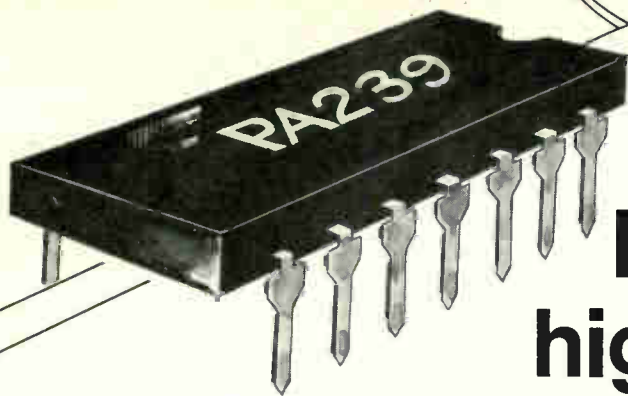

Reliable, high-performance stereo starts here

General Electric's new dual-channel preamp IC teams up with five power amp IC's

General Electric has expanded its line of power amplifier IC's to five and introduced a dual-channel stereo preamp to work with them. The new PA239 preamp contains two identical 68 dB gain amplifiers designed to feed any of the five power amp IC's.

GE's new IC features a high impedance input (typ. 250K ohms) and very low distortion (typ. 0.5%). And the device contains its own power supply filter to help back up its low noise characteristics.

The PA239 preamp requires only a few external frequency-shaping components, and is ideal for many types of consumer stereo equipment for auto, home or portable use.

At the top of GE's power amplifier line is the PA246 — the highest power monolithic amplifier available—providing 5 watts of continuous audio output. Other power amp IC's provide 1, 1.5, 2 and 3.5 watts output (see chart).

Each of these highly-reliable monolithic IC's is housed in a rugged, plastic package and requires much less space than comparable discrete components. All operate over a wide range of supply voltages and load impedances as well, to give you the utmost flexibility in design.

For more information about General Electric integrated circuits, call or write your GE sales representative or distributor, or write General Electric Company, Room C-2, Northern Concourse Office Bldg., North Syracuse, N. Y. 13212. In Canada: Canadian General Electric, 189 Dufferin Street, Toronto, Ont. Export: Electronic Sales, IGE Export Division, 159 Madison Avenue, New York, N. Y. 10016. 220-88

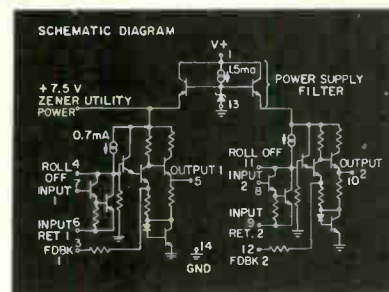

Circuit diagram—PA239

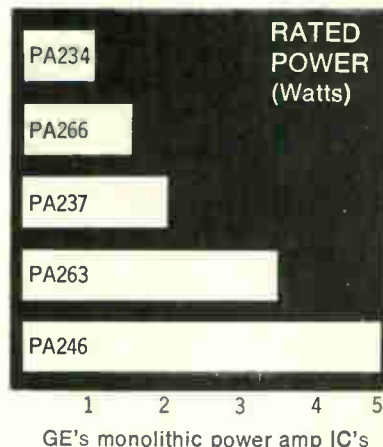

Interactive Graphics

for the Tektronix T4002 Graphic Computer Terminal

With the introduction of the 4901 Interactive Graphic Unit and Joystick accessory, graphic input capability is now available for the Tektronix T4002 Computer Terminal. The Interactive Graphic Unit is a valuable aid wherever graphic analysis of statistical data is fundamental to thorough scientific investigation—effective computer-aided instruction—*informed decision making.*

The 4901 and optional Joystick are *software supported.* The software permits coordinate identification, display rotation and overlaying, menu picking and other frequently repeated functions in graphic formatting.

The new 4901 generates a bright, no parallax, orthogonal crosshair cursor. The cursor is easily and accurately positioned with the desk-top Joystick. You enter data points and instructions through the T4002 keyboard. This means complete graphic interface without removing your hand from the Joystick.

Tektronix Application Engineers, especially trained in the capabilities of Tektronix Information Display Products, will discuss with you the full versatility of the T4002 Graphic Computer Terminal. A T4002 demonstration provides an excellent opportunity to discuss software support, machine compatibility, interface options and maintenance. Contact your Application Engineer through any Tektronix office (57 domestic—48 foreign) or directly by calling (301) 825-9000 Baltimore; (617) 894-4550 Boston; (415) 326-8500 Palo Alto. Or write Tektronix, Inc., P. O. Box 500, Beaverton, Oregon 97005.

T4002 Graphic Computer Terminal	\$8,800
4901 Interactive Graphic Unit	\$ 450
Optional Joystick (015-0175-00)	\$ 250

U.S. Sales Prices FOB Beaverton, Oregon

The new, no parallax crosshair cursor is positioned with the desk-top Joystick.



Tektronix, Inc.
committed to technical excellence

Traffic jams spur ERC's revival

Former NASA research center bounces back as a transportation R&D lab; though funds are limited now, future contract work could be significant

By James Brinton,
Boston bureau manager

Phoenixlike, NASA's former Electronics Research Center has sprung back to become the Department of Transportation's first central electronics and systems laboratory. But it's going to be some time before the Transportation Systems Center, as the Cambridge facility is now called, will have any financial impact on industry.

"We're going to do almost everything in house this year," says a spokesman at the new center. "I can't foresee any contract funding—other than work carried over by NASA—until at least fiscal 1972." But this situation may change as the center begins to help shape such programs as air traffic control. As these programs firm up, the center will be a crucial link in determining industry's role in developing future systems.

Meanwhile, the reorganized center is tackling electronics problems farmed out by DOT's various divisions. It's also trying to generate ideas for new electronics systems to help avoid future transportation snarls. At the same time, other DOT laboratories, such as FAA's National Aviation Facilities Experimental Center in Atlantic City, will continue with their own work. In line with DOT's mandate, the new center has geared up for quick turnarounds and near-term goals.

The new center is organized into three technical directorates. Advanced planning will be carried out by the transportation systems concepts directorate, headed by John D. Hodge [*Electronics*, June 22, p. 14]. Gene Manella, ERC's former director of advanced technology, will head the technology direc-

torate, and another ERC veteran, Robert W. Wedan, is charged with transportation systems development. Wedan formerly directed ERC's technical programs.

Prevention. By charter, the systems concepts directorate will "plan, analyze, and define land, water, and air transportation systems," then identify the feasible ones and analyze their cost, timing, and performance. This puts Hodge's group at the center's input end, where conceptual problems would be recognized and analyzed, providing watershed data for the other two directorates.

"For our efforts to be valuable, we must try to predict how various kinds of transportation are going to work and interact in, say, the year 2000," says Hodge. "If we can reach adequate definitions for these

... and a little bit of luck

While much of the credit for the Transportation Systems Center is given to James C. Elms, its director, it was also fortunate that two Department of Transportation officials knew enough about NASA's Electronics Research Center to define its potential value to DOT. They knew because both were former high-level NASA managers. They are James M. Beggs, Under Secretary of Transportation, and Robert H. Cannon, DOT Assistant Secretary for Systems Development and Technology.

Both men sat on a panel started three years ago by Elms to evaluate ERC's goals and potentials. And when Elms approached them around the New Year, both immediately saw at least a partial match between DOT's needs and ERC's capabilities.

While the sales job was under way, NASA helped by chipping in \$4 to \$7 million to continue ERC programs which would otherwise have been halted just short of completion. Included was work on semiconductor

data, laser propagation, satellite communications, and electronic packaging.

Meanwhile, to turn a partial match with DOT into a better one, the staff was cut to about 425 people, with most leaving from the old research directorate. Simultaneously, DOT's agencies got interested in what the center could do for them: the Coast Guard discussed its data buoy program, small boat communications, and navigation; the Urban Mass Transit Authority talked over computerized transit systems and new approaches to the automobile; the FAA wanted to expand air traffic control work.

Finally, DOT bought the idea, the site, and the talents of about 450 scientists and engineers [*Electronics*, April 13, p. 48]. "DOT is being very good to us," says a staffer at the new center. "Most of our fiscal 1971 money must come from other budgets in DOT, but instead of antagonism, we meet enthusiasm."

. . . Data handling is a common problem among each of the DOT agencies . . .

far-out situations, we can look at today's systems, then figure how to get from here to there efficiently, with the least expense, the minimum ecological upset, and so on."

Meanwhile, Manella's technology directorate is tackling more immediate problems. "Application, not investigation" is his slogan.

"There seems to be a common problem among each of the agencies of DOT, namely information handling," he points out. "Almost all transportation includes a data loop; air traffic control, for example, needs sensors, communications links, computers, displays, and more communications to close the loop in what really amounts to a command and control system. Soon, the Urban Mass Transit Authority is going to need the same thing," Manella asserts.

Fast response. "Our fast response work will occur in the engineering and reliability division," he notes. "This will include a microelectronics design, fabrication, and packaging capability up to the LSI level. E&R will work on everything to a degree: crash sensors for auto testing, systems to spot defective vehicles before they crash, mechanical components and test techniques in general."

The computer division will model transportation systems and requirements; study the handling of sensor inputs; develop new software for command, control and simulation; and research computer displays. Air traffic control probably will be its initial focus.

The biotechnology division will cooperate with the computer division on the man-machine interface, which Manella says needs lots of work—"not just the computer-machine interface," he says, "but everything down to the man-automobile interface. We hope to build a strong human-factors capability here, to wring the most out of non-computer-driven display methods."

The electromagnetics division will be engaged largely in NASA carryover work at first: these tasks include earth resources sensor development, work in laser propagation, and solid state oscillator and

microwave device studies. "DOT has broad sensor needs, mostly in radar," says Manella. "But the Coast Guard needs something to spot oil slicks fast, for example, and there's sensor work to be done before clear-air turbulence studies will become the sole province of Wedan's directorate."

Will it fly? Wedan's transportation systems development directorate has most of its jobs spelled out.

Eight major efforts will come under his four divisions—systems engineering, data systems, guidance/navigation/control, and special projects. Most will be partly funded by NASA and some by the FAA. One, the Coast Guard data buoy [*Electronics*, April 24, p. 46] would be a radio navigation effort.

But almost all others deal in some way with air traffic control (ATC) in the broad sense. The vertical/short takeoff and landing (V/STOL) avionics effort, work on automatic landing systems for conventional aircraft, the anticollision pilot warning indicator (PWI) program, and the job of improving beacon transponders for light planes are examples. Other ATC-type work includes programs on improved inertial navigation sensors, a threat discrimination addition to the PWI, and aeronautical services satellite efforts.

The V/STOL work will be funded by the space agency, but its objectives will change slightly with infusion of some new FAA money. "We'll want to channel ourselves more toward operational V/STOL navigation systems and the certification of their airworthiness," says Wedan. "Thus, there will be a de-emphasis of work on inertial sensors as such—that'll go elsewhere, but we'll keep our expertise and help coordinate V/STOL into the air traffic control environment.

"We'll continue work on a year-old FAA-NASA program on automatic landing for conventional planes," he says. "We're now running flight tests with an FAA aircraft and inertial gear aboard a Convair jet transport at Atlantic City, N. J., and we're trying to coordinate outputs of an inertial navi-

gator from Litton with a Lear-Siegler autopilot and the FAA test facility's various radio nav aids."

NASA will drop out of this effort in July and the FAA will take over and extend it to the field of terminal area guidance, which occurs before final approach and landing. The end result of the studies will stress operational performance standards, certification, and integration with ATC.

The NASA-sponsored PWI now is in flight tests at Wallops Island, Va. "We have made some good progress detecting the xenon lamp flashes from other aircraft," says Wedan, "though there has been some interference from clouds and overcast." When this test cycle is finished in four to six months, NASA will bow out and the program will go on at FAA's Atlantic City site.

Meanwhile, at Cambridge, personnel already are working to improve the PWI with a readout that indicates the direction of approaching planes. There's still some space agency money behind this work, but most comes from the FAA. The plan already has been demonstrated at the Cambridge center.

Modular. The improved beacon transponder, strongly urged in the Alexander report of 1969 [*Electronics*, October 27, 1969, p. 127], also may become a center task. The goal is a low-cost module that could be added to existing transponders, but which would allow ground control to address only those it wants. Now a radar-like beam sweeps the sky and all transponders answer. The new random-access approach is viewed as the first step in development of a data uplink, necessary to close the ATC loop. Also sought after is a way of getting more frequent responses from transponders, and this may involve phased-array antenna studies.

Finally, work will continue at Cambridge on aeronautical services satellites. The FAA, NASA, and the airlines want an end to the fight over both L-band and uhf ranging and communication effectiveness. Leo M. Keane, head of Wedan's special projects division, hopes for a "fly-off" this year using a balloon carrying both uhf and L-band gear, perhaps over the Atlantic, that will yield the data to codify link parameters [*Electronics*, May 25, p. 33].

Something borrowed...

With money drying up, proposals for 10-ton satellite call for using subsystems from previous spacecraft

By Peter Schuyten, *New York bureau*
and Ralph Selph, *Los Angeles bureau*

Designing a new satellite used to mean just that—a new design. But no longer. Engineers at two aerospace companies, now putting together proposals for the Space Agency's planned High Energy Astronomy Observatory (HEAO), are resorting primarily to subsystems previously built for other spacecraft.

In the past, money was spent—sometimes in large quantities—to push the state of the art in developing improved subsystems for new satellites. But this approach—pretty much standard operating procedure during the National Aeronautics and Space Administration's high-flying days at the top of the national priority list—is difficult, if not impossible, to sell to today's budget-minded Congress.

"NASA didn't specifically dictate this approach," says Frank Canning, Grumman HEAO program manager, "but you might say they strongly suggested it."

HEAO, with its 30-foot length and weight of more than 10 tons, would be the biggest scientific satellite orbited by the U.S. Ten-month parallel studies worth \$250,000 each were awarded to Grumman Aerospace Corp., Bethpage, N.Y., and to the TRW Systems Group in Redondo Beach, Calif. "TRW took the approach of maximum use of existing equipment and hit extremely hard on price because the program hasn't been sold yet," declares Richard Silva, applications manager for scientific spacecraft. "We were trying to help NASA sell the program to Congress," he adds, noting that most aerospace companies are taking similar design

approaches under current budgetary constraints. "As it turns out, we can do all the specified functions for the spacecraft with existing hardware," Silva says. Frank Canning, Grumman's HEAO program manager, also feels that the proposed satellite marks the beginning of a new trend. "More and more, we'll see the technology of the '60's being used in the spacecraft of the '70's," he says.

Selling. Space agency officials realize that the only way to get the HEAO program started in the fiscal 1972 budget is to sell Congress not only on the scientific value of the four proposed HEAO missions, but also on their relatively inexpensive price tag; 1972 appropriations are likely to be about \$10 million, while the cost of the first two of the four proposed HEAO craft and their launching is expected to be better than \$125 million. Designing-in proven subsystems reduces the need to build and test costly engineering models and prototypes.

This route also provides additional insurance that the program will stay pretty much on schedule. Overruns are extremely costly—and Congress knows it. Should HEAO get the green light next year, the schedule calls for the first craft, HEAO-A, to rocket into its 200-nautical mile circular orbit in the fall of 1974, reflecting a shorter-than-normal procurement cycle for a satellite of this size and type.

To help meet that schedule, TRW proposes liberal borrowing from past satellite designs. For openers, they specify using the Intelsat-3 communication satellite's conver-

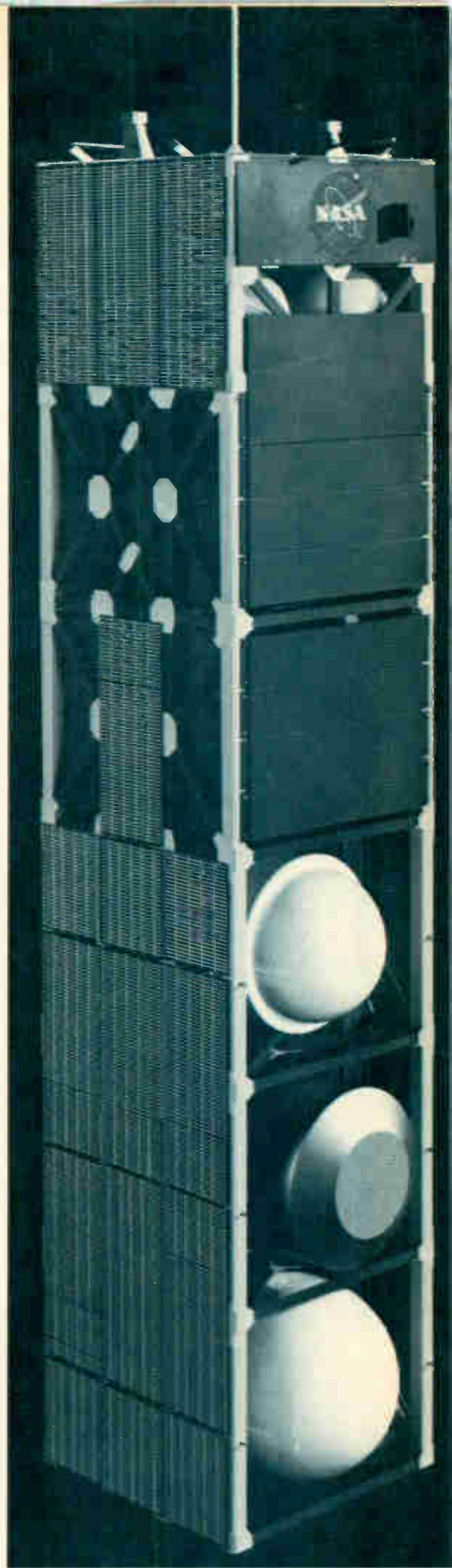

Order the Famous DeltAlert Ultrasonic Burglar Detection System prior to an August 1 price increase.



MADE IN U.S.A.

Last January we introduced our DeltAlert system incorporating the latest in ultrasonic and solid state components to help you protect your homes and property from the ever-increasing threat of burglary and vandalism. We are pleased with DeltAlert's wide acceptance and user response. DeltAlert's silent blanket of ultrasonic beams covers 30 to 50 feet of critical space in your home or business. Designed for easy installation, it plugs into a wall outlet like a lamp. Lights and our DeltaHorn are plugged directly into the DeltAlert which activates them. DeltaHorn provides total intrusion detection and DeltaHorn supplies an intermittent, high-intensity sound so loud and obnoxious that any intruder will make a rapid retreat. The horn, which plugs directly into the back of the DeltAlert, can be placed anywhere and has its own built-in, 20-second delay to enable you to turn it off when you enter the area. Both units are designed in a handsome walnut finish to blend with any decor.

DeltAlert, complete unit ready to use.

Only **\$59⁹⁵** ppd.
through July 31. (Effective August 1 price will be \$69.95)

DeltaHorn, complete with built-in delay

Only **\$24⁹⁵** ppd.

Superior Products Sensibly Priced



DELTA PRODUCTS, INC.

P.O. BOX 1147E • GRAND JUNCTION COLO. 81501
PHONE (303) 242-9000

Please send me literature immediately.

Enclosed is \$ _____

Ship ppd. Ship C.O.D.

Please send _____ DeltAlert(s) _____ DeltaHorn(s)

Name _____

Address _____

City/State _____ Zip _____
DP 70-9

... officials of both companies foresee no major difficulties in subsystem compatibility ...

ter, which supplies power for the instruments. Solar cells, which will provide 1,000 watts of power, are the same as those developed for Skylab, the orbiting workshop. The pulse code modulation encoder, sun sensors, vhf receiver, and telemetry switching unit are borrowed from TRW's Orbiting Geophysical Observatory. The vhf stub antenna is the same as the one for the Vela (earth-oriented advanced nuclear test detection satellite) program, while the vhf transmitter is borrowed from the TETR (Apollo tracking network test and training satellite) series of small test satellites. Still other elements in HEAO, including the S-band antenna and transmitter, are taken from a classified Air Force reconnaissance satellite designed and built by TRW. Finally, the attitude-control gyro package to be assembled by TRW in-house uses gyros purchased off the shelf, while the tape recorders under consideration are flight-proven models from the Kinellogic Corp. in Pasadena, Calif., RCA's Astro-Electronics division in Princeton, N.J., and Borg Warner's Controls division in Santa Ana, Calif. The recorders—up to three may be used—must be able to store 453 million bits of instrument data collected during three orbits. During normal operation, 151 million bits of downlink data would be returned to ground stations during each orbit. Up to 1,024 10-bit commands can be stored in the core memory of the on-board programmer.

Grumman and its associate contractors, Hughes Aircraft's Data Systems division and Bendix's Navigation and Guidance division, are less specific about borrowing from other satellites. But John Purcell, Grumman's assistant program manager for HEAO, admits that the electrical power system is basically similar to Skylab's and that possible flight-proven recorders include units from RCA and Kinellogic. For the rest, it's not hard to guess which spacecraft are likely to be donors, based on previous aerospace contracts. Hughes, for example, will be working primarily in the area of communications and

data handling for the HEAO competition. It was the prime contractor for Intelsat, Tacset, Syncom, ATS, and Surveyor, and was one of the subcontractors for the communications portion of the Orbiting Astronomical Observatory. Grumman was the prime contractor for this program.

Bendix, which will handle the stabilization and control design as well as the experiment interface for the HEAO effort, also can draw on past work. It built the actuator and some of the instruments for the lunar module, for which Grumman again was the prime contractor. Bendix also did the guidance portion of the Saturn rocket, and worked on the experimental equipment in the Apollo Telescope Mount (ATM) experiment planned for Skylab. Regardless of which equipment is borrowed, Purcell says, Grumman and TRW will be pushing essentially the same basic equipment. Officials of both firms foresee no major difficulties in subsystem compatibility.

No sweat. At any rate, no problems have developed so far, according to Herbert A. Lassen, manager of planetary and interplanetary advanced development at TRW, primarily because voltages used aboard most craft are fairly standard—usually 28 volts. "I'm sure that as we get down to the nitty-gritty of designing HEAO some problems will become apparent, but there are none now," Lassen says.

The one major difference between TRW's ideas and the Grumman-Hughes-Bendix team's design approach is structural. Grumman sees the craft as a single structural unit. But TRW proposes that the satellite be built in five six-foot sections—each of which could be built independently of the other. There's also a third alternative: building the craft in two sections, one for the experimental packages and the other for the subsystems.

Trackdown. An HEAO-A mission, launched by a Titan 3-D rocket, will last one or two years; its goal will be to map distant non-solar high-energy gamma-, X-, and cos-

mic-ray sources. To date, only 40 or 50 celestial gamma- and X-ray sources have been identified because instruments have always been carried aloft by balloons and sounding rockets that don't go high enough or stay up long enough. HEAO-A is expected to locate hundreds of new gamma sources and several thousand X-ray sources. Pinpointing origins of cosmic rays is a bit more tricky—they tend to bend over long distances—but it's hoped that their distribution will indicate where they come from.

The experiments to be aboard the first craft haven't been determined yet, although NASA's Marshall Space Flight Center is expected to decide that later this month. But it's known that together the approximately six experiments selected from the roughly 60 under consideration will weigh in at 12,500 pounds. During phase A of the program—a feasibility study of HEAO—NASA listed a hypothetical group of experiments that observers feel are likely to be a good indication of those chosen. These include a large-area X-ray detector; a low-energy gamma-ray detector; a medium-energy gamma-ray detector; a gamma-ray telescope; and a primary cosmic-ray electron detector.

The satellite's orbit, coupled with its 1/10 rpm spin, will permit the instruments to scan and map these sources of radiation during a six-month period. Though pointing accuracy for HEAO-A will be only 1°, subsequent missions—HEAO-B through D—will more than likely require minute-of-arc accuracy.

HEAO-B would be launched a year after the A version—in September 1975. Two later missions, C and D, will be launched later in the 1970's for a more detailed look at the celestial sources mapped by their two predecessors. Experiments under consideration for HEAO-C include a nuclear emulsion spark chamber, a Cerenkov detector, a nuclear gamma-ray spectrometer, a "venetian blind" telescope/spectrometer, and a small Wolter-type I X-ray telescope.

For HEAO-D, NASA is considering a large grazing-incidence reflecting telescope that would collect X-ray images in the same way that an optical telescope picks up visible light images.

It took a new generation to bridge the gap

Delevan's Micro-i® Series 155



A new generation of low-cost, miniaturized inductors that is the long-sought transition between discrete and monolithic IC circuits.

HIGH RELIABILITY AND VERSATILITY

Originally designed to meet the rigorous standards of DOD and NASA specifications, Micro-i Series 155 inductors are perfect for communications applications and the computer field where performance is critical and ownership costs are a consideration. Proven successful for choke and filter applications.

SUPERIOR FEATURES

Ruggedly constructed with internal connections, thermo-compression bonded for high temperature processing.

RF Inductor Epoxy-molded to meet MIL-C-15305, Rev. D, Grade 1, Class A.

Miniaturization and low profile give improved compatibility with hybrid ICs.

Four separate leads are readily adaptable for solder reflow connections. Eliminates costly body tie-down, reduces lead fatigue caused by vibration and is easily adaptable to tuned circuits by means of outboard chip capacitor.

Write for complete technical data.

Delevan

Division



**AMERICAN
PRECISION
INDUSTRIES INC.**

270 QUAKER RD. / EAST AURORA, N. Y. 14052
TELEPHONE 716/852-3800 TELEEX 091-293

OTHER DIVISIONS OF AMERICAN PRECISION INDUSTRIES INC.: BASCO • DUSTEX •
MOELLER INSTRUMENT CO. • OXFORD CORP. • TRUCK EQUIPMENT CO.



Military electronics

Naval destroyer contract will share the wealth

Electronics subcontractors will land a \$600 million slice of the DD-963's \$2.14 billion prime contract

For old Navy hands, it was a clear sign of victory: A clean sweep was signaled by a Litton engineer who marched about, carrying a broom upside down at the announcement this month that his company won the long, hard-fought battle for the Navy's "DX" or DD-963 class destroyer. But it also will be a victory for business-starved military electronics makers who will share in the estimated \$600 million worth of gear going into the program's 30 ships.

Much of the contractor-furnished electronics will be bought competitively. Few suppliers already are locked in. The low bids by Litton's subcontractors were used principally for contract negotiation, says Ellis Gardner, Litton senior vice president. A loser on the earlier bidding rounds could even end up a winner, he notes, since new bids will be solicited wherever possible.

Competition for electronics on the DD-963 could continue throughout the lifetime of the new ship class, because the design approach will enable the Navy to update the electronics subsystems on board with new and improved equipment.

The \$2.14 billion contract was sweet music to Litton's Advanced Marine Technology division, even though the first \$214 million funding increment calls for only three ships instead of the originally planned five. The first of the 7,000-ton ships—as big as a World War II light cruiser—will be delivered in April, 1974. With about \$20 million of the \$83.4 million outlay for each ship going for electronic systems, the Spruance-class vessels will be

the most expensive "tin cans" ever purchased by the Navy.

But even at that price, the Navy feels the new destroyer is a bargain. It is counting on much lower costs by shifting from conventional shipbuilding to a revolutionary approach: an integrated design, by the builder not the Navy, where electronic subsystems are designed in, not added as an afterthought, and an assembly-line method of building the ships.

Litton gambled heavily on landing this contract by going ahead with its \$30 million investment in an automated shipyard at its Ingalls shipbuilding division in Pascagoula, Miss. That state, incidentally is the home of Sen. John Stennis, chairman of the Armed Services Committee.

More than 200 tons of electronics on each ship will aid the destroyer in its primary role, antisubmarine warfare, and secondary mission, shore bombardment.

Although most hardware subcontracting is up for grabs, decisions already are firm on some of the major subsystems. One of these is the Univac AN/UYK-7 computer, the heart of the ship's command and decision network [*Electronics*, Sept. 29, 1969, p. 62]. Applications for the processor include surface and underwater weapons control, navigation, communications, and electronic warfare.

The Navy also has made up its mind on the sonar, a General Electric SQS-26 bow-mounted unit. More than \$165 million already has been spent on the unit in development production for other ships, and the Navy has produced four different versions to date, none of

which met performance requirements. Nevertheless, it's scheduled to go in the DD-963 in a version that the Navy feels will work well on a silent ship. Litton could earn a \$23 million incentive award by satisfying this heavily emphasized requirement.

For its radar complement the ship will use the SPS-55 for surface search, one of the SPS-40 family for two-dimensional air search and a phased array 3-D unit. Also slated is a Lockheed Mark 86 fire control system which includes the SPQ-4 track-while-scan radar with Mark 45 rapid-fire, 5-inch guns mounted fore and aft. The Hughes/Hazeltine SPS-48 radar, a phased array air search system, is not scheduled for use "except as a guide for sizing antenna platforms," Navy officials say. A substitute system, however, has not been selected.

Unknowns. Indeed, aside from the decision to use many of the more than 25 nomenclatured subsystems of the Naval Tactical Data System (NTDS) several selections for the ship's electronic equipment remain to be made during the four years before the first delivery. Though the Hughes/Hazeltine SYA-4 display console, for example, is a firm requirement, sources indicate the total NTDS package is unlikely to make it aboard. A slimmer system likely will be used to keep

total ship costs down—costs that already escalated nearly 30% from a first estimate of about \$65 million per ship, according to the Navy.

Still in the design stage is the ship's electronic warfare package. It will be Government furnished and is not expected to be firmly defined for another year or more. "If the threat or technology changes markedly, it could be longer," adds one official. Electronic warfare and government weapons are certain to raise the 30-ship package price by more than \$400 million. Though the Navy will draw on the technology and some of the components of the classified Samid (ship antimissile integrated defense) program, it will not go aboard as a package. A DD-963 model shows a chaff dispensing system forward of the after stack, possibly Goodyear's ALE-29. Part of the Samid program, the Goodyear system launches tinfoil-filled warheads to a minimum distance of 15 miles to confuse enemy gears.

Other major Samid components include the passive/active location system for homing in on airborne targets while a ship operates in electronic silence. Something along this line is likely to become part of the electronic warfare package, sources say, as is the Target Acquisition System for use with the Basic Point Defense Surface Mis-

On the dotted line

Under the fixed-price incentive contract for the DD-963 destroyer, Litton Industries expects to earn 8% on sales before taxes—but it will have to pick up 85% of all cost overruns. Similarly, Litton will split 85-15 with the government on any money saved by coming in under target cost. The contract also has other incentives—in ship silencing, for example.

As a hedge against inflation, the first \$214 million increment has a 7.5% escalation factor should Federal statistics show costs rising, while the fiscal 1971 appropriation for the new ships contains a 10% inflation booster.

sile and an improved version under study. One of these will comprise a major weapon using the Raytheon Seasparrow vehicle. The DD-963 also will be armed with the Harpoon antiship missile, the Asroc antisubmarine rocket, as well as torpedoes, and two helicopters to be launched from a landing pad amidships. These are expected to be the Light Airborne Multipurpose System if the chopper is produced.

Another strong electronic warfare contender from the Samid package is Shortstop Jr., a small version of the system that identifies and jams enemy radar signals guiding surface-attacking or air-launched missiles. This program has a variety of contractors led by ITT/Federal Laboratories.

Probably the last electronics components to be firmly specified and purchased will be the communications package, because little development is required there. Already identified as part of that package, however, are the SRN-9 satellite communications antenna and receiver and the SRN-14 receiver and antenna for the Omega communications system.

Litton's \$2.14 billion contract—the biggest in the U.S. Navy's history—includes the cost of long-range sonars, and surface search and fire-control radars. Weapons, as well as the electronics warfare and air search radar packages, will be procured under separate government contracts.

Meanwhile, down East . . .

Litton Industries' proud and politic disclosure that it will share more than 60% of its \$2.14 billion wealth on the DD-963 destroyer program brought no joy to Bath, Maine—home of Bath Iron Works Corp., losing bidder. However, Bath may be consoled by a Maine Congressman's rider on the fiscal 1971 military procurement bill requiring the Defense Department to use at least two shipyards for the destroyer contract. Though the amendment passed the House, it was stricken by the Senate Armed Services Committee headed by John Stennis, whose Mississippi bailiwick is home to Litton's new automated shipyard. If the Stennis action gets by the full Senate, the issue will be decided by a House-Senate Conference committee.

Though Bath could get a piece of the DD-963 action if the Navy later decides to buy more than the initial 30 destroyers, Washington observers wonder if Bath stands a chance to share in the present award. At a time when criticism of costly weapons systems is strident, the Navy appears to have a strong case in arguing that splitting the construction sites will increase program costs by more than \$600 million. Moreover, Litton invested \$30 million in modernizing its Pascagoula, Miss., yard. Bath did not. And Naval Ships System Command's Rear Adm. Nathan Sonenshein estimates that \$21-22 million of Bath's price proposal can be ascribed to a modernization program planned if it had won the contract.



a. Find out how an electronic switching & relay equipment company can save \$427,000 a year.*



b. Find out how a character recognition equipment manufacturer can save \$570,000 a year.*



c. Find out how a company making fluorescent lamp ballasts and specialty transformers can save \$434,000 a year.*



d. Find out how a producer of powered industrial hand tools can save \$321,000 a year.*



e. Find out how a mobile home sub-assembly maker can save \$346,000 a year.*



f. Find out how a construction machinery firm can save \$649,000 a year.*

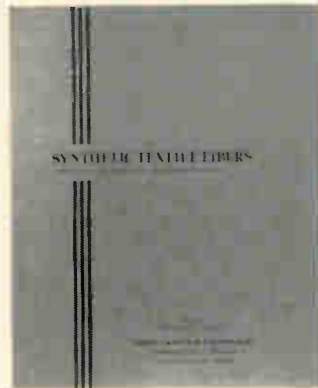

g. Find out how a synthetic textile fiber manufacturer can save \$441,000 a year.*



h. Find out how a producer of plastics and resins can save \$373,000 a year.*



i. Find out how a metal salt and catalyst producer can save \$265,000 a year.*

If you're interested enough in your company to read this magazine, you're probably interested enough in its profits to send for one of these books.

If the Fantus Company says my company can save money and increase profits by locating a plant in Georgia, I want to see the facts. Please send me all the details about the (letter) ___ Fantus Study.

NAME _____ TITLE _____

COMPANY _____

CITY _____ STATE _____ ZIP _____

Georgia's got it.

*As compared to where you may be presently operating.

12-bit computer priced as low as \$2,535

PDP-8/E line, ranging up to \$4,990, is designed to replace other 8's in most applications; volume use of TTL arrays, omnibus architecture, automated production cut costs

By James Brinton

Manager, Boston bureau

The IBM of the minicomputer field, Digital Equipment Corp., is tooling up to produce more than 1,000 high-performance machines per month which it hopes will replace most of its PDP-8 series computers in less than two years.

The Maynard, Mass., firm says its new machine, designated the PDP-8/E, outperforms the 8/I, previously considered DEC's top 12-bit minicomputer, and retains near-total compatibility with all PDP-8 series software.

"The software's already on the shelf for this one," says David Chertkow, PDP-8 engineering manager. Thus, the new machine could become a plug-for-plug replacement for older PDP-8's in some applications that require extra speed or flexibility.

But for many users, price probably will be the clincher. At \$4,990, the PDP-8E not only is said to be the first fully parallel 12-bit machine to break the \$5,000 barrier, but with original-equipment discounts running as high as 22%, it also would break the \$4,000 line at a quantity price of \$3,892.

A 4,096-word core memory and full operator console are standard, but where less memory is needed, DEC offers the PDP-8/EB at \$3,250. It includes a processor, power supply, 256-word ROM, 256-word RAM, and a turnkey console. At 22% off for quantity orders, this means a price tag of \$2,535.

Thus DEC has repeated its approach to the 12-bit computer market—namely, to jump into the field with machines priced below the going rate. That was the route of the PDP-8/L, the first computer to

sell for less than \$20,000, and this was followed with the serial PDP-8/S which broke the \$10,000 price line. Then came the PDP-8/I and the PDP-8/L, both with competitive price/specification ratios—especially the PDP-8/L with an \$8,500 price tag. Now the PDP-8/E is to replace them all.

William H. Long, PDP-8 product line manager, says the shift will begin quickly with "only OEM's locked into specific mainframes continuing to buy earlier models—which DEC will continue to service and produce" for them. Howard O. Painter, PDP-8 marketing manager, says that within 18 months almost all PDP-8 production will have shifted to the 8/E. Only a few other models will be built to satisfy special orders.

But those buying older PDP-8's will be getting less for their money. The PDP-8/E's 3-wire, 3-D memory cycles in 1.2 microseconds versus 1.5 μ sec for the 8/I; add time is 2.6 μ sec with the new machine, including 1.2 μ sec for fetch, but the 8/I needs an additional 0.6 μ sec. And the 8/S and 8/L take even longer.

MSI's the thing. The reason for the cost reductions in the PDP-8/E is the new computer's mechanical and electrical design. DEC has tried to capitalize on medium-scale integrated circuits where possible—there are 50 MSI/TTL arrays in the processor alone.

Basic to the 8/E's physical architecture is its omnibus. It borrows some characteristics from the PDP-11's unibus [*Electronics*, Jan. 5, p. 161]. But while the unibus was made of Flexprint, the omnibus

is an assembly of printed-circuit edge connectors backed up by a printed circuit board with the assembly wave-soldered.

This construction is initially inexpensive and also does away with time consuming back-panel wiring—the familiar and colorful web of wire-wrapped connections is gone from the 8/E and soon may depart from other DEC machines. DEC aims to produce 8/E's at only

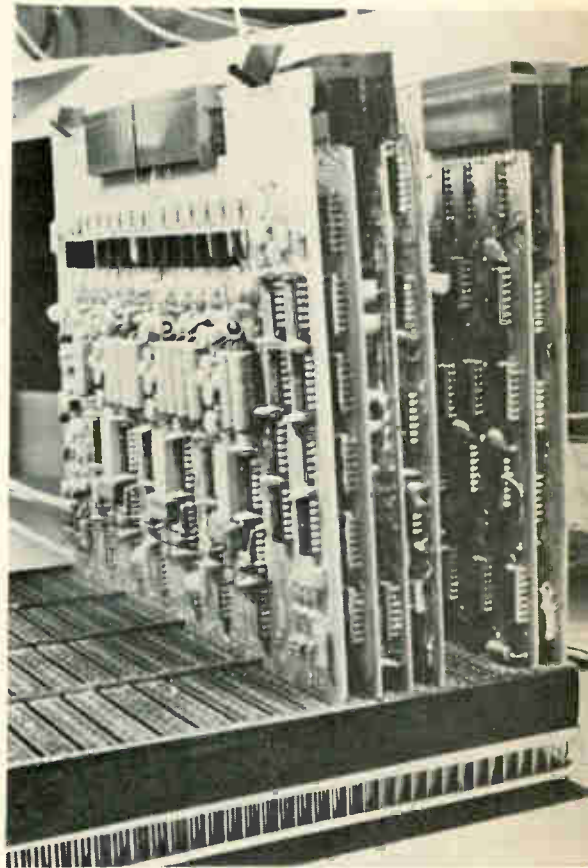

Trunkline. Omnibus, at bottom, interconnects circuit-card modules.

EMC simplified

BY USE OF **ACL**

FI-601

14 KHz to 1.0 GHz



- Electronically swept plug-in RF tuners.
- Complete coverage of 14KHz to 1 GHz with 6 tuners
- Complete solid state circuitry
- Built-in Spectrum Display for IF monitoring
- Selectable IF bandwidth (4 provided)
- Designed for testing in accordance with such specifications as:
MIL-STD-461, 462, 463
MIL-STD-826 MIL-STD-449
FED-STD-222

ACL

ASTRO COMMUNICATION LABORATORY

A Division of Aiken Industries, Inc.

9125 GAITHERS ROAD
GAITHERSBURG, MD. 20760

Phone: (301) 948-5210 TWX 710-828-9706

RF Equipment for The Systems Engineer

a third the man hours needed for 8/I's.

And, where the PDP-11 used wire-wrapped modules, the PDP-8/E's designers managed to get everything onto printed circuit cards. Where this wasn't possible or convenient, they broke parts of the computer into smaller sections. Thus, the central processor is built on four printed circuit boards, plugged into and interconnected by the omnibus. The 4,096-word core memory is divided among three slots, with the core plane in one and read-write electronics in the others.

The omnibus interconnections give the user full freedom in inserting the modules. "Except for the processor and memory, the modules making up the machine are asynchronous," says Chertkow; "a functional unit can go in any slot."

It's possible to build more or less computer into a given box with the omnibus concept. "You can go heavily for processing power or heavily in favor of memory," says Chertkow, indicating that the modularity of the new computer even extends into its gross architecture.

Finally, the compact design of the modules and of the omnibus may make it possible for the 8/E to hold a full 32,768-word memory in one rack location. The omnibus is about 10 by 10 inches and has slots for 20 modules: DEC supplies a jumper that allows omnibuses to be ganged within a single case. With this setup the user can buy a computer with characteristics like these: 32k of memory in 24 slots, a processor in four slots, console input-output card in one slot, teletype I-O card in another, one more slot for the hardware arithmetic unit, a slot for memory extension module (free with the first 4k of core), and seven others open for I-O cards.

I-O operations were a design constraint in the 8/E. There's a hint of similarity between the PDP-8/E and the PDP-11, which used simulated memory addresses to communicate internally. But since the 8/E had to be compatible with earlier PDP-8 computers, it had to use an interrupt/communication scheme with less freedom than that of the PDP-11. Internal communication among the units on the omnibus is through

I-O transfer instructions; such a transfer takes about 1.2 μ sec.

Skip-jump. Although DEC plans to sell a hardware interrupt module, standard operation is through software polling. "It's a skip-jump arrangement," says Chertkow; "it's simple and fairly quick; it polls devices in order and reacts to flag bits."

Unlike earlier PDP-8's which used delay lines to fix machine time, the 8/E has a crystal-controlled clock with $\pm 1\%$ accuracy. It's on one of the computer's four central processor boards. By contrast, PDP-8/I timing was accurate only to $\pm 15\%$, and the PDP-8/L was only good to $\pm 20\%$. The 8/E's clock runs at 20 megahertz and machine time is scaled down from that; real-time clocks—three of them—are offered as options, and one would enable interrupts at rates of 1 Mhz.

With less variation in the PDP-8/E's internal clock, some rewrite of earlier PDP-8 timed routines will be needed. But the alert programmer will take advantage of other features which should offset this according to DEC.

For example, while earlier PDP-8 series computers had to await the end of a current instruction before they could honor a data break or direct memory access request, the new computer can break in after completion of any major "state of processor" instruction such as FETCH, EXECUTE, or DEFER. This allows faster access to memory and to peripheral devices. And the faster memory allows a faster data transfer rate—more than 800 kilohertz at 1.2 μ sec per word.

Direct memory access is easier and cheaper with the 8/E. On the 8/I, a multiplexer was needed to extend DMA from one to four ports; this unit set the user back \$1,500. In the 8/E, DMA for up to 12 channels is built in, thanks to the use of I-O instructions on the omnibus. "This is a real saving for customers using tape or disc memory systems," says marketing manager Painter.

Pre-production machines will reach users this Summer, and production models will be delivered by Jan. 1, 1971.

Digital Equipment Corp., 146 Main St., Maynard, Mass. 01754 [338]

A multipurpose calculator



Engineering problems can include statistics and accounting. Often an engineer has to figure costs in parallel with his engineering solutions such as when he's writing bids or proposals. Complex scientific problems involve side calculations, too—solutions to parts of equations needed before the whole can be solved. Thus, engineers still keep pencil and paper beside their new electronic calculators.

To speed up these side calculations, and automate them to remove a possible source of error, Wang Laboratories, Inc., is offering the 100-series electronic calculators. According to Edward Lesnick, Wang's director of product planning, the 100 series fits into markets ranging from statistical to scientific.

Two features characterize the 100 series; first, its use of large-scale metal oxide semiconductor read-only memories to change the nature of the machine through plug-in microprogramming; and secondly, its six to 14 independent registers which allow not only the main calculation but several side calculations to proceed without interference. Lesnick states that

these and other features make the 100 series unique in the \$1,600 to \$3,000 price range. He says, "It can be almost anything from a business adding machine to a healthy scientific calculator."

The smallest of the 100 series has six registers, costs \$1,595, and is aimed at statistical applications; the top of the line model runs \$2,295, has the full set of 14 registers. For another \$500, the user can add a plug-in microprogram that converts the machine to a powerful scientific calculator.

The series is modular. And while for now only two microprogram plug-ins are offered, the scientific unit, and a statistical model, there is a hint of more to come.

Also, the machines can be card-programmed through one or two Porta-Print card readers. The cards are punched in an eight-bit code and can place from 60 to 120 instructions into a 100's 512- or 1024-word MOS/LSI memory. Card programming allows almost computer-like operations similar to branching subroutines, loops, and decisions.

Each register adds, subtracts, multiplies, divides, stores, recalls or totals. And so through the key-

low cost panel ideas

*Prices shown are single lot. Inquire about quantities.



ELFIN® Readout Neon Indicator

Single plane 7-segment neon for brighter, wider viewing 0.41" dia. Has mount for PC wiring. Displays 0-9 some alpha & decimal. Long-life operation. MG-17 \$4.95 Single
2.99 each, in 1000 lots
 Circle #513



Mini Switch With 1/32" Bushing

Miniature series has standard 1/32" mounting but case has rear panel compactness. Hi-volt barriers inside & out. 1-2-3-4 pole types. 6A @ 125 VAC. SPDT. MSTG-106D.
2.15*

Circle #514

Miniature Display! MTX-250

Small incandescent single plane display operates from 5V source. Decimal input. Compact size. 1/2" x 1".



Combination Price
12.66 in 1000 lots

Circle #515

Magnet Push Button Keyboard Switches

Magnetic repulsion, momentary types use magnets to totally eliminate springs. Metal case, N.O., Reed. MSPM-101C



Circle #516

3.90*

T-1-3/8 Mini Neon Lamps



Unusual ring-electrode glows over entire surface for max. brightness. Unobstructed glass allows the illuminated elements to be placed close to top for better viewing. For DC use only. MNE-4

29.00 per 100

Circle #517

Compact Remote Control Relay

For safe, shock-free remote control circuit operation. Compact plastic case. 115 VAC input 5A capability. FR-105



Circle #518

3.85*

Immediate Deliveries on Above Items

ALCO®

ELECTRONIC PRODUCTS, INC.
 Lawrence, Massachusetts 01843

NEW THERMAL SHOCK BATHS



**(FOR COMMERCIAL USE
AND MIL. STD. 883)**

Although designed to meet Mil.Std. 883, Method 1011, Conditions A to F, these Blue M VERSA-WHIRL Constant Temperature Baths are ideal for precision commercial testing. There are four models, each with its own specific temperature range:

- Ambient to +204°C.
- Ambient to -35°C.
- 0°C. to -75°C.
- 0°C. to -100°C.

A fifth accessory unit extends the capability of any model to -195°C.

Temperature is regulated by solid-state digital setpoint time proportioning control providing virtual straight-line performance. This, combined with uniquely efficient liquid circulation system, affords uniformity and control of $\pm 0.25^\circ\text{C}$. throughout all ranges.

These baths — easily the finest of their kind ever built — complement Blue M's already extensive line of Thermal Cycling and Shock Test Chambers for Mil. Std. and in-house testing requirements. For our latest brochure describing them all, write: Blue M Engineering Company, A Division of Blue M Electric Company, Corporate Headquarters, Blue Island, Illinois 60406.



board, the microprogram or card deck program, each can be made to act almost as an individual calculator.

Calculations are performed most often using the numerical keys directly with the working or "W" register, while the side calculations are done in the other registers. The W register also supplies data to the 100's miniature line printer.

The model 100 keyboard is fairly symmetrical; on either side of a central numerical entry panel are entry keys for the right and left registers. They are called right and left only because of position, though in the simple models of the 100, it's only through the right-hand keyboard that the operator can access the minimum of three extra registers.

Chaining. With the right and left registers, the user can manipulate data in the W register. Taking the right register and its keyboard as an example, the store key copies the content of the W register in the right register, while the recall key does the opposite. The plus key adds the contents of the right and W registers and stores the result in W. The multiplication and division keys allow chained operations because results are stored both in W and right registers. Chaining becomes just a matter of entering a new number in W and pressing the appropriate multiply or divide key. And users can interleave multiplication and division—they can operate on the data in the right register until it's totaled, erased or replaced.

The same operations are possible with the left register, which with the W and right registers make up half of the basic six. Three toggle switches at the upper left corner of the main keyboard activate the zero, one, and two registers. The product accumulator toggle adds the result of multiplication or division in the right register to the contents of register zero. The entry accumulator toggle combines the contents of the W register and register one if multiplication or division is punched in at the right register, but before it takes place. The item count switch adds a one to register two whenever an addition or subtraction takes place in the right register, thus keeping track of the number of calculations.

With these three registers, a user can keep running control of a complex calculation, or its parts, in memory while performing side or subcalculations in the right, left, and W registers.

On the far left side of the keyboard are eight statistically oriented keys. Operating with the W register, they trigger calculations of square root and square, of reciprocals, antilogs, natural log calculations, and others including pi—a key which loads W with the value of pi to 10 significant digits. After these keys have altered the content of W, the right and left registers come into play.

Registers three through 11, on the larger machines, are reached and used through eight tombstone shaped lockdown keys in a row above the larger register selection keys. These function-select keys emulate the right and left register keyboards. For example, pressing down the key marked store, and then punching the key for register seven transplants data in W to register seven. Thus, just one keystroke more is needed to reach the extra registers.

Calculating and getting back out is just as simple: for example, just press the lock down add key, and then the register eight key. Eight's contents are added to those of W and the result is stored in W. Meanwhile, the right or zero register is storing the interim result of the main calculation. Thus, the interplay between the registers makes possible fast and accurate side calculations.

While 14 registers may be more than the average engineer needs, ROM plug-ins offer further flexibility and enhance the statistical and scientific capabilities of the basic machine. By plugging in ROM package 188-1, the user converts the keys which normally would select registers zero through nine into added scientific calculation keys. This \$500 plug-in adds sine, cosine, arc sine, arc tangent, two-way degrees/radians conversion, multiplication and division by constants, and three sigma calculations.

Wang plans deliveries in October and quotes four to six month delivery times.

Wang Laboratories Inc., 836 North St., Tewksbury, Mass. 01876 [339]

Op amps' single element speeds settling

Common-mode rejection ratio of 40,000 keeps error below 0.01%; units designed for a-d and d-a converters in data acquisition systems

Selecting an operational amplifier is more complicated than just picking bandwidth and slew rate. Fast settling time, high input impedance, low input current, and good stability with capacitive loads are equally important. In data acquisition systems, for example, a user wants to get the information from several channels into the analog-to-digital or the d-a converter as

quickly as possible.

A fast settling time in the op amps helps achieve this. In addition, a high input impedance buffer in an a-d converter prevents loading to the source. Fast amplifiers are also useful in high-speed buffers, high-speed integrators, and automatic test systems.

The Dynamic Measurements Corp. is adding to its line two op

amps that the company says combine the fast settling time with desirable specifications for input impedance, input current, and stability.

The units, designated the FST-151A and 151B, are available in a package 1.5 inches square by 0.4 inch high. The design relies on a single passive element to achieve the response shape of the amplifier,



Microminiature relay series T is for high isolation switching and r-f use. The 2 pdt unit is rated at dry circuit through 1 amp resistive, operates from -65° to $+125^{\circ}\text{C}$, and has a life at rated load of 100,000 cycles. Contact bounce is at a low 0.0015 sec maximum, and the unit has a dielectric strength at sea level of 500 v rms. Leach Corp., 5915 Avalon Blvd., Los Angeles [341]

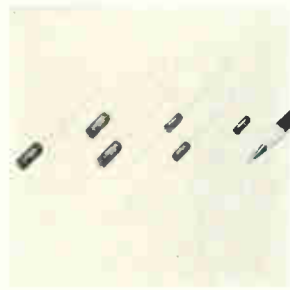

Polyester film capacitors type 417P Filmite E are suited for application under conditions of high humidity in digital computers, transistorized instruments, and electronic entertainment equipment. They are available in standard voltage ratings of 100, 200, 400, and 600 v d-c with capacitance values from 470 pf to 0.1 μf . Sprague Electric Co., North Adams, Mass. [342]



Crystal controlled IC oscillator model MCO-F, which uses thin-film capacitors and resistors on a single substrate, is totally contained within a 4-lead TO-5 Koldweld package. Operating in the 5 Mhz to 25 Mhz frequency range, it offers a frequency stability of $\pm 0.003\%$ from -55° to $+125^{\circ}\text{C}$. TRW Semiconductor Division, 14520 Aviation Blvd., Lawndale, Calif. 90260 [343]

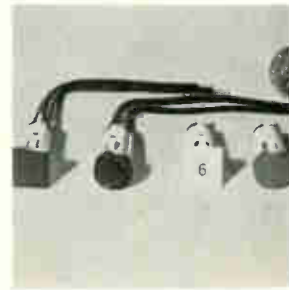

Indicator lights series 1.69507 are for uses requiring $\frac{1}{2}$ in. center-to-center mounting and less than 1.181 in. depth behind the panel. They are molded of Makrolon polycarbonate plastic and come in transparent red, yellow, green, clear or blue, and in opaque red, yellow or white colors. Nucleonic Products Co., 6660 Variel Ave., Canoga Park, Calif. [344]

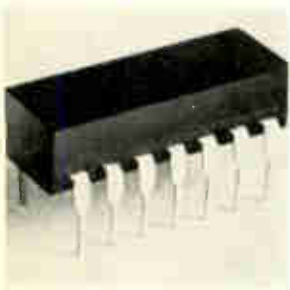

Dual-in-line packaged relay series 9000 is a Logcell mercury-film switch capable of operating in any mounting position without contact bounce. It operates at speeds faster than 2.5 msec. Thermal noise is less than 1 μv ; and a-c noise is below instrumentation levels. Contact life is in excess of 50×10^6 operations. Fifth Dimension Inc., Box 483, Princeton, N.J. [345]

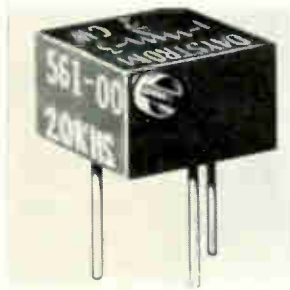

Trimming pots models 561 (base mount) and 562 (edge mount) are 13-turn $\frac{1}{4}$ in. square devices. Features include $\pm 5\%$ resistance tolerance, standard resistance range from 10 ohms through 20 kilohms, and operating temperature range of -55° to $+150^{\circ}\text{C}$. Maximum temperature coefficient is ± 50 ppm/ $^{\circ}\text{C}$. Weston Components Division, Archbald, Pa. [346]



Eight-terminal p-c selector switch wafer series 212 incorporates a molded glass alkyl skirt for greater terminal support and stability. Wafer assemblies are rated $\frac{1}{2}$ amp at 28 v d-c; $\frac{3}{4}$ amp at 115 v a-c. Contact life for standard terminals is a minimum of over 1,100,000 operations or 50,000 cycles through 12 positions. CTS Corp., W. Beardsley Ave., Elkhart, Ind. [347]

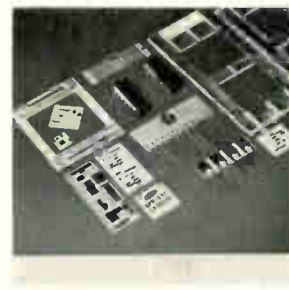

Thick-film IC's, custom designed to application requirements, combine resistors and capacitors in dual in-line packaging, modular packaging, or screened silicone coating. Standard power capabilities are 20 w/in.². Devices offer a surface resistivity per square of 10 ohms to 1 megohm and a capacitance of 10 pf to 100 μf . Dale Electronics Inc., Box 609, Columbus, Neb. [348]

Overshadows All—

The Pan Man SURVEILLANCE RECEIVING SYSTEM

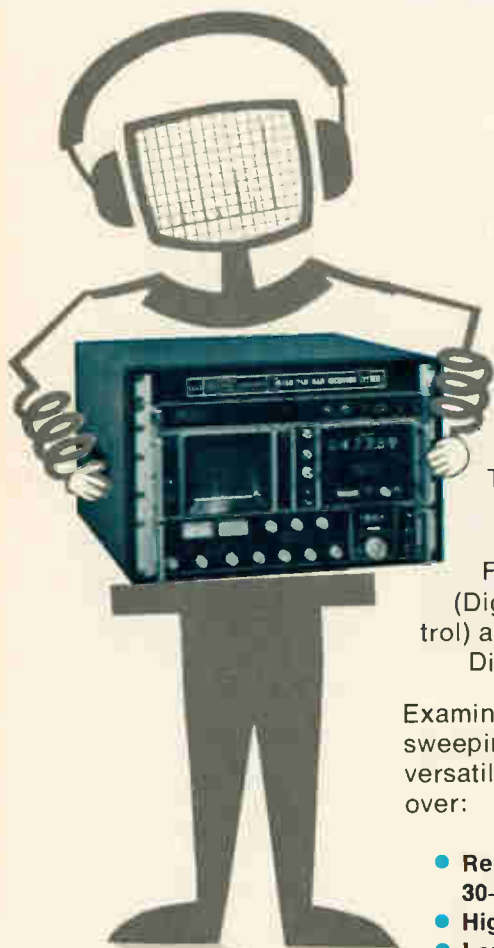

Without the shadow of a doubt, the WJ-RS-160 is unique in the surveillance receiver field. Especially now with the extension of its frequency range to 1000 MHz—covering 30–1000 MHz with six plug-in tuners.

The system consists of the Type 205 Sweeping and Manual Receiver, the DRO-308 six-digit Frequency Readout with DAFC (Digital Automatic Frequency Control) and the SM-7301 five-inch Signal Display with beam intensification.

Examine these attributes for a low-cost sweeping receiver that is compact and versatile, then write, call or hurry on over:

- Receives AM, FM, pulse signals 30–1000 MHz
- High dynamic range
- Low noise
- High spurious signal rejection
- Digital readout of tuned frequency with DAFC
- Versatile for airborne, ship, mobile and fixed site applications
- Compact: only 8¾ inches high by 19 inches wide
- Costs a fraction of what you'd expect

World's Largest Selection of Receiving Equipment for Surveillance, Direction-Finding and Countermeasures

CEI DIVISION



WATKINS-JOHNSON

6006 EXECUTIVE BOULEVARD, ROCKVILLE, MARYLAND 20852 • (301) 881-3300

... design avoids breaks
in settling curves ...

and this element eliminates discontinuities in the settling-time curve regardless of the gain.

Some op amps of this type have discontinuities that are small when observed at unity gain. But the discontinuities become noticeable when measured at closed-loop gains that are greater than unity.

The units also offer input impedances of 10^{11} megohms, a typical common-mode rejection ratio of 40,000, a gain of 250,000, and a minimum slew rate of 100 volts per microseconds. Settling time is 0.4 microsecond.

Factor. Common-mode rejection from d-c to high frequencies is a determining factor for proper operation. The higher the ratio, the faster the performance. A common-mode rejection ratio of less than 10,000 will make the amplifier error

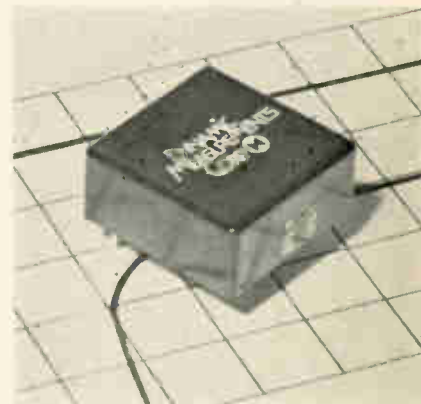

Fast and smooth. Settling time and high CMRR make op amp useful for data system jobs.

exceed 0.01% regardless of how high the gain is. Moreover, an inadequate ratio at high frequencies will limit its noninverting settling speed.

The stability of these units is 35 millivolts/°C for the 151A and 15 mv/°C for the 151B. The input bias current is 0.1 nanoampere for the 151A and 0.05 na for the 151B. The maximum output of the devices is ± 10 volts.

In quantities of 100, the 151A is priced at \$52. For the same quantities, the 151B sells for \$62.

Dynamic Measurements Corp., Arlington, Mass. 02174 [349]

Materials spur device gains

Single-crystal bismuth germanium oxide, beryllium oxide and yig marketed for radar, communications, and high-speed computer components

Advances in signal processing for radar, communications and high-speed data systems are largely attributable to important developments in materials, particularly the growth of single-crystal materials. The Autonetics division of North American Rockwell Corp. will go to market with three types of material developed in its Research and Technology division during

work on surface acoustic and magnetostrictive delay line devices for radar filters [*Electronics*, Jan. 19, p. 110].

Autonetics says it will "test the market" for single-crystal bismuth germanium oxide, beryllium oxide, and low-loss yttrium iron garnet. All are offered at evaluation-quantity prices for device development.

George R. Pulliam, manager of

the R&T division's physical sciences department, stresses two principal features of the bismuth germanium oxide: low acoustic velocity (1.68 kilometers per second for surface waves) and cubic lattice structure. This structure eliminates the variable thermal expansion rates that cause problems with lithium niobate substrates carrying surface acoustic waves. In addition, bis-

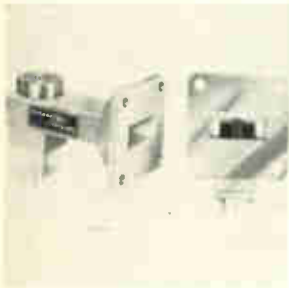

Solid state waveguide noise sources are suited for built-in test, radar jamming and secure communications. Typical are type 8050, a 13.2-13.4 Ghz unit; and type 8050, an 8-10 Ghz unit. The former offers up to 31 db excess noise, flat within 0.25 db over the band; the latter, 31.9 db at 8 Ghz decreasing to 31 db at 10 Ghz. Solitron/Microwave, 37-11 47th Ave., L.I.C. N.Y. [401]



Multiband variable attenuator MBA-124 can handle all signals in the uhf, L, S, C, and X bands with a flat response and a very low insertion loss. Unit is flat to ± 4 db deviation between 0.5 Ghz and 12.4 Ghz for any value of attenuation down to a minimum of 60 db isolation. The compact device will handle 1 watt of c-w power. Nesco Mfg. Co., 28 Osgood St., Methuen, Mass. [402]

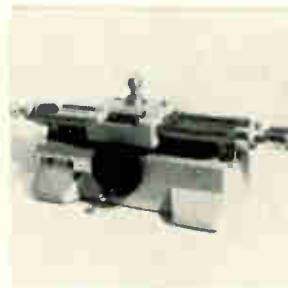

Seven-millimeter coaxial slotted line type 3407 is for both swept line use and laboratory standards application in the range of 1.2 to 18 Ghz. It is equipped with a modified APC-7 connector and has residual error of less than 1.005 to 3 Ghz, less than 1.007 to 6 Ghz, less than 1.011 to 12 Ghz, and less than 1.015 to 18 Ghz. Alford Mfg. Co., 120 Cross St., Winchester, Mass. [403]

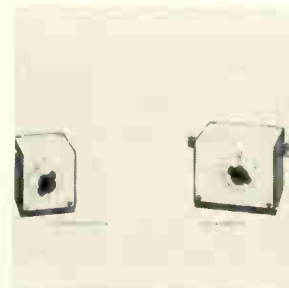

Coaxial step attenuators series 180 are for lab, test, and systems use. Type N units (2 w) cover 0 to 12.4 Ghz, and type SMA units (0.5 w) operate from 0 to 18 Ghz—both with flat frequency response and low vswr. Both come in a 10 db model with 1 db increments, and 60 db and 100 db models with 10 db increments. General Microwave Corp., Farmingdale, N.Y. [404]



R-f repeater FR2000 for point-to-point systems, makes use of microwave IC-type amplifiers to provide 90 db of gain at 2 Ghz. It can be used to reduce the costs of new routes, to replace out-dated heterodyne repeaters, or to eliminate path problems on existing routes. It is small in size and consumes 35 w of power. Farinon Electric, 935 Washington St., San Carlos, Calif. [405]

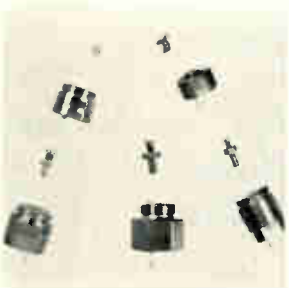

Filter bias networks are designed for stripline or coaxial line shunt mounted diodes. They offer a very closely controlled bias capacitor value to eliminate or utilize the self inductance of the diode, and a low pass filter to allow passage of the diode switching frequency while isolating the transmitting frequency. Corry Micronics Inc., P.O. Box 31, Corry, Pa. 16407 [406]



R-f power leveler model 1805 ensures precision in systems used for transferring calibration factors of primary standards to bolometer standards or secondary power standards and power meters. It has minimum power level control range of 20 db and employs only d-c substituted and bias power to maintain precise power levels. Weinschel Engineering, Gaithersburg, Md. [407]



Amplifier/multiplier system model UHM-3(TX)-4965-3 provides greater than 1.25 w at its output frequency of 4,965 Mhz while achieving a spurious suppression of greater than -50 db. Input power is from 100 to 300 mw at 1,655 Mhz. System will operate into any load without breaking into self-oscillation. Applied Research Inc., 76 S. Bayles Ave., Port Washington, N.Y. [408]

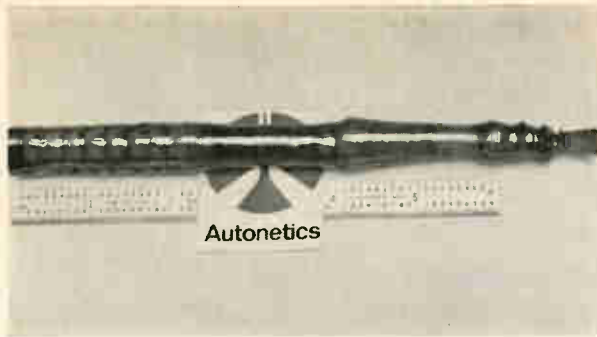

Raw material. For device development work, bismuth germanium is offered in boule (above), slab, or bar form.

muth germanium oxide has about half the acoustic velocity of lithium niobate, yielding twice the delay over a given length. Autonetics readily achieves delays of 100 microseconds over a 7-inch-long bismuth germanium oxide crystal, and has applied them in digital signal correlators for secure communications, tapped delay lines and dispersive delay lines for phased-array radars, and programmable delay lines. Typical insertion loss for most delay line applications is 10 decibels.

The bismuth germanium oxide single crystals are available in limited quantities from stock in boule, slab or bar form. Prices range from \$200 to \$300 for a 2-inch-long raw boule to \$200 for a 2-inch polished bar.

Beryllium oxide is an electrical insulator, but also features some of the best thermal conducting properties. Conductivity for the Autonetics crystals is 3.0 watts per centimeter per °K at 300°K. This combination makes it useful as a substrate material for high-power microwave devices, such as Gunn and impatt devices, because the devices can be electrically isolated from each other but still dissipate the heat typical of microwave operation. Pulliam says the material's heat dissipation could allow continuous operation of Gunn devices at higher power levels.

The Autonetics beryllium oxide single crystals are of the Wurzite type and have a hexagonal lattice structure. They're available as prismatic or irregularly shaped crystals, or as sliced and oriented crystal wafers. Wafers less than 1 cm² will sell for about \$100, and evaluation quantities are available from stock.

The epitaxial yig films, grown on gadolinium gallium garnet substrates by chemical vapor deposi-

tion, are also particularly suited for microwave device applications, Pulliam says. Besides use as band-stop or band-pass radar filters, surface magnetic waves operating up to 18 gigahertz can be obtained with the single-crystal films; surface acoustic wave materials are limited to about 5 Ghz, and the best reported to date is 1.75 Ghz, Pulliam says.

Autonetics is specifying a thickness range of 0.5 to 12 microns for unprocessed yig deposits, or will sell yig films as square or disk etched arrays. The price for a film on a half-inch-diameter gadolinium gallium garnet will be \$500 in evaluation quantities; these will be available from stock by the end of summer. Resonance linewidth of 0.70 to 3 oersteds is specified.

Research and Technology Marketing, Autonetics division, North American Rockwell Corp., 3370 Miraloma Ave., Anaheim, Calif. 92803 [409]

New microwave

Preamp built for radio navigation

Hybrid building block offers 20 decibels of gain between 0.4 and 1.3 Ghz

Since the advent of integrated circuits as building blocks, the designer of data processing equipment no longer has to think about components—such as which transistor is the right one to use in his amplifier. All that is ancient history. Now the building-block approach has spread to the micro-

wave industry, and the impact could be as great as it was for the computer people.

During the past few weeks, two companies—Varian Associates and Avantek—introduced thin-film hybrid IC's for microwave applications. Varian's Solid State division in Copiague, N.Y. announced a series of low noise (8 decibels typically) mixer-preamplifiers covering the frequency range from 10 to 12.5 gigahertz and having a minimum gain of 24 db. Avantek, a small Santa Clara, Calif. company, says its device, packaged in a TO-5 can, offers 15 db of gain and has a seven octave bandwidth—5 to 500 megahertz.

The latest offering in the thin-film hybrid area is from Hewlett-

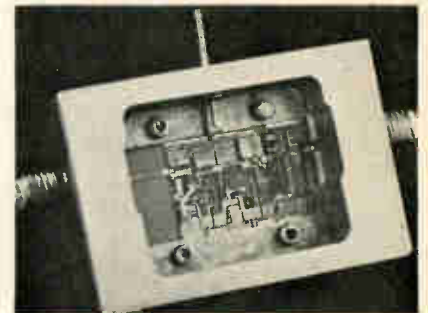

Packard. The H-P 35007 preamp, designed for radio navigation, communications, and radar applications, offers 20 db gain that is flat within 1 db over its operating frequency range from 400 Mhz to 1.3 Ghz. Output at 1 db gain compression is zero dbm minimum.

The preamp was built to serve the needs of the designer so that he can concentrate on system instead of device parameters. As one H-P spokesman says, "The microwave business is changing. Systems designers are looking for building blocks instead of components, and they want to get the blocks off-the-shelf."

Two versions of the preamp are available: the 35007A has a noise figure of 4.5 to 5 db and sells for \$490. And the 35007B, with a noise figure of 6 to 7 db, is priced at \$450. The two devices complement each other and can be used as a cascaded pair, providing 40 db gain with a 5 to 5.5 db noise figure. Delivery is from stock.

Hewlett-Packard Co., 1501 Page Mill Road, Palo Alto, Calif. 94304 [410]

Instant Changes.

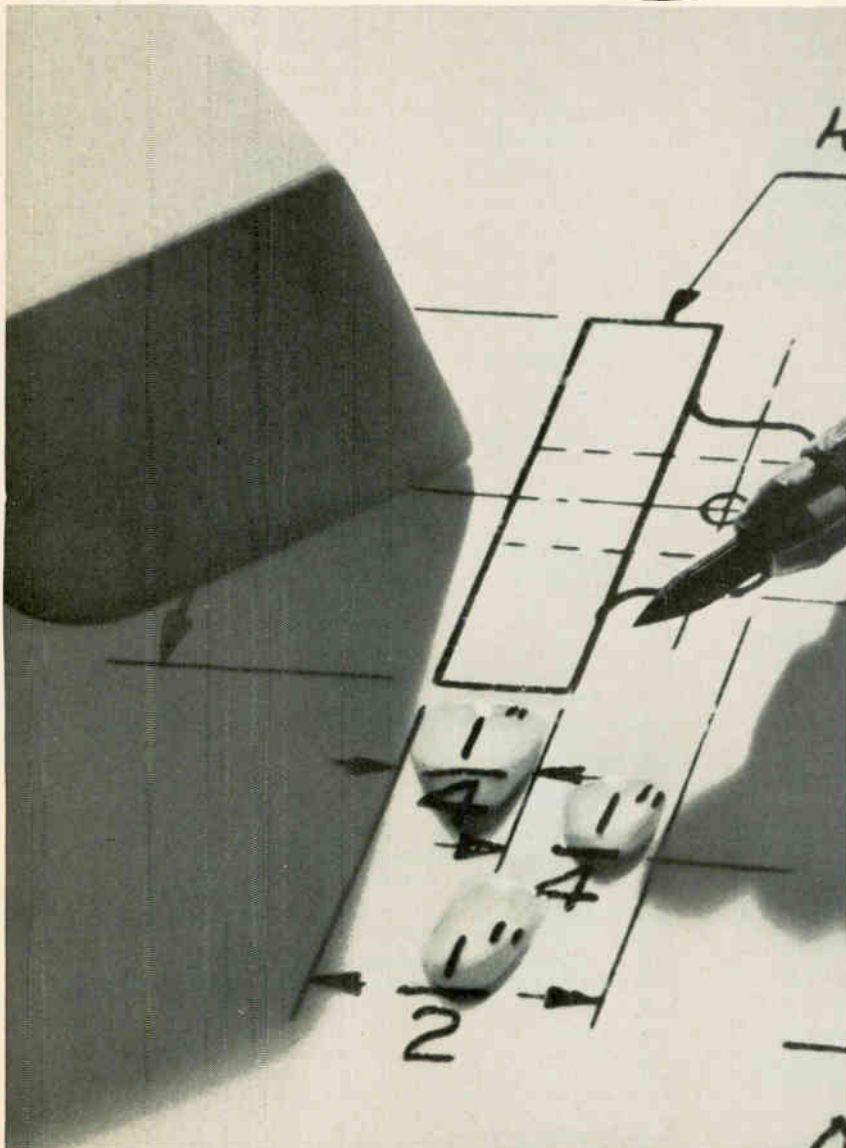

Revisions are easier with KODAGRAPH Wash-Off Films.

Here's a real bonus for draftsmen.

You don't need to retrace an entire drawing that needs only revision. A beautiful reproduction on KODAGRAPH Wash-Off Film can be made that includes only the unchanged areas. You merely draw the new details.

The improved drafting surface on these ESTAR Base Films takes pencil or pen nicely—holds up under repeated erasures. Photographic lines are wet erasable. Resulting diazo prints will be sharp and clean.

Ask your local Kodak Technical Service Representative to show you all the drafting shortcuts possible with Kodak Photo Drawing Systems. Or write Eastman Kodak Company, Business Systems Markets Division, Rochester, New York 14650. Dept. DP 770

DRAWING REPRODUCTION SYSTEMS BY KODAK

Kodak

ANNOUNCING

PLUG-IN DIGITAL MEASURING SYSTEM MODEL 3202



3½ digit. Nine wide range plug-ins for measurement of AC-DC Voltage, DC Current, Resistance, Capacitance, Frequency and Time. Digital Printer and Set Point Controller accessories. Main Frames from \$385.00 Plug-Ins from \$100.00

DIGITAL MULTIMETER MODEL 3300

3½ digit, with internal rechargeable battery pack. 26 ranges for measurement of AC-DC Voltage, AC-DC Current, and Resistance.

\$395.00 including rechargeable battery pack



25 MHz OSCILLOSCOPES MODEL 5000 & 5002

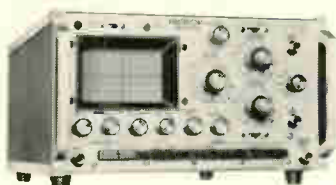

Solid State, high performance single and dual trace models. Simplified, stable triggering to 50 MHz.

Single Trace \$725.00
Dual Trace \$995.00

NEW INSTRUMENTATION CATALOG

A new Catalog describing these instruments and listing your local Hickok Representative is now available. Send for your copy today.



HICKOK INSTRUMENTATION GROUP
10514 Dupont Ave., Cleve., Ohio 44108
Phone (216) 541-8060

STATE OF THE ART SEMINARS FOR ENGINEERS AND SCIENTISTS

Here's an opportunity to engage in short programs that will review many of the latest advances and engineering techniques in your field ... presented by RCA Institutes.

LOGIC DESIGN	Albuquerque	7/27-31
	Montreal	8/24-28
	Detroit	8/31-9/4
	Rochester	9/14-18
	Washington, D.C.	9/21-25
	Huntsville, Ala.	9/21-25
	San Diego	10/5-9
	Boston	10/19-23
DIGITAL SYSTEMS ENGINEERING	San Francisco	7/20-24
	San Diego	7/27-31
	Huntsville, Ala.	8/3-7
	Chicago	8/10-14
	Houston	8/24-28
	Boston	9/14-18
	Philadelphia	9/21-25
	Montreal	10/5-9
	Phoenix	10/19-23
	Rochester	10/26-30
DIGITAL COMMUNICATIONS	Syracuse, N.Y.	7/27-31
	Washington, D.C.	8/10-14
	New York	8/24-28
	St. Louis	9/14-18
	Montreal	10/5-9
	Palm Beach	10/19-23
INTEGRATED CIRCUITS	Pittsburgh	7/27-29
	Clark, N.J.	8/3-5
	San Francisco	8/10-14
	Los Angeles	8/17-19
	Cleveland	9/21-25
	Albuquerque	10/5-9
	Washington, D.C.	10/19-23
	Houston	10/26-30

Partial Schedule—Dates subject to change

RCA

RCA Institutes, Inc. Dept. E-70
Institute for Professional Development
Central & Terminal Avenues, Clark, N. J. 07066

For free descriptive brochure, please check the seminar in which you are interested.

Logic Design Integrated Circuits
 Digital Communications Digital Systems Engineering

Name _____ Title _____

Company _____

Address _____

City _____ State _____ Zip _____

Low-voltage source trims stripper

R-f plasma generator for removal of photoresist reduced in size, weight, and price by high-current supply

In cost and weight, the biggest part of a plasma generator is the r-f power supply. That's the section International Plasma Corp. tackled after deciding to redesign its plasma machine. The equipment, built for semiconductor makers, uses a low-temperature oxygen plasma, instead of an acid bath, to remove photoresist.

"Like any other high power [300

to 1,000 watts] r-f generator, ours used a high-voltage power transformer, power tube, and all the other expensive, high-voltage components," says James Beaudry, chief engineer. So Beaudry redesigned the power supply, and the result is the 1003B, a 300-watt generator that is about half the weight (33 compared to 65 pounds), one-third the size (1,300 versus 3,024

cubic inches), and roughly \$1,000 less expensive than the earlier 1003. Including the generator and a control module that contains the quartz tubes, the system sells for \$4,000.

The new power supply is based on a concept "that is the reverse of conventional thinking," says Beaudry. "High-power r-f supplies have usually employed high volt-

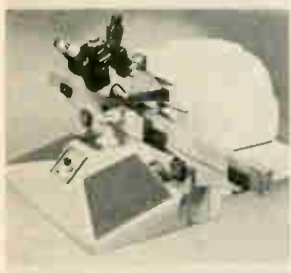

Thermocompression die bonder model DB1000, capable of high-speed automatic or semiautomatic operation, has a capacity of 7,200 cycles or 6,000 parts per hour. Designed for strip bonding of devices up to 1½ in. width, it has a wafer capacity of 3⅓ in. diameter. It also is adaptable to IC strips or carrier belts. Kasper Instruments Inc., 983 Shulman Ave., Santa Clara, Calif. [421]



Electronic counters series MP are for use on coil, capacitor, and other winding equipment. They provide from 4 to 12 preset channels, each containing a separate slow down and a stop setting. This permits 4 to 12 different winding operations to be controlled with precise set points. Each channel handles up to 5 digits. JMR Electronics, 1424 Blondell Ave., Bronx, N.Y. [422]



Spray coater and dryer model 600 is a sleek, modular in-line, high production system. It is fully automated for the application of photoresists, microelectronic materials, conformal coatings, adhesives, luminescent coatings, etc. Coatings may be applied from 4,000 angstroms to over 1 mil thick. Epec Industries Inc., Industrial Park, New Bedford, Mass. [423]

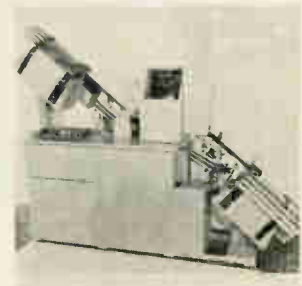

IC printer model U1188 automatically marks DIP integrated circuits. It prints up to 3 lines of identifying data at speeds of about 12,000 an hour. DIP's are loaded into the printer in standard plastic carriers (or sticks). They are fed from the carriers by the machine, marked, cured, and returned to the stick, all automatically. Markem Corp., Congress St., Keene, N.H. [424]

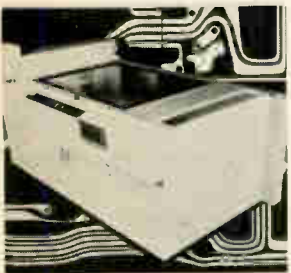

Exposure system called Scanflex automatically registers, exposes and advances flexible, resist coated material. It is a single-sided system that handles flexible, roll-to-roll p-c material up to 24 in. wide. Exposures are made with a 4800 watt supercharged metal additive lamp. Standard model system occupies 29 sq ft. Colight Inc., 123 N. 3rd St., Minneapolis [425]



Manual die bonder model HDB-900 is a self-contained unit that utilizes the eutectic method for bonding semiconductor chips to substrates or headers. It features a work chuck that is a separable but interchangeable part of the heated stage, providing simple change of chucks for hybrids or semiconductors. Hughes Welders, 2020 Oceanside Blvd., Oceanside, Calif. [426]



Laser system model SS-218 is used for trimming thick and thin film resistors, capacitors, and other deposited materials. Units, which operate at a variety of pulse repetition rates and energy levels, are completely shielded for operator safety. Resistor trimming accuracy is better than 0.1% over a range of 1 ohm to 11 megohms. Raytheon Co., Waltham, Mass. 02154 [427]



Single-operator machine can produce a complete motor stator every 30 seconds, depending on winding configurations. It consists of a main winder, auxiliary winder and slot wedge inserter. The machine will wind straight or skewed stators in either single or three phase windings of various poles and winding configurations. Lincoln Tool & Mfg. Co., S. 5th St., Milwaukee. [428]

Pulling down the cost of lighting up an instrument

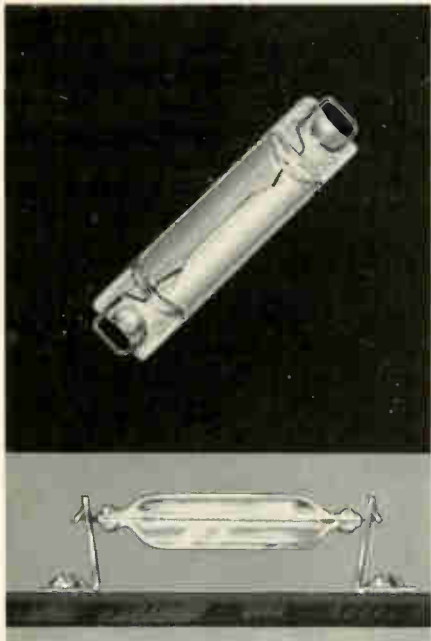

For a high-reliability light source, the Tung-Sol baseless cartridge lamp is about as simple as you can get. Elimination of cemented-on bases removes two potential failure sources while lowering cost. There are no anchors to generate noise and no soldered connections. Design permits use of an inexpensive clip-type mounting bracket which achieves low silhouette. Can be supplied in 6 v. and 12 v. types. Complete information and application assistance available. Write for catalog A-21. Tung-Sol Division, Wagner Electric Corporation, 630 W. Mt. Pleasant Avenue, Livingston, N.J. 07039; TWX: 710-994-4865, Phone: (201) 992-1100; (212) 732-5426.

TUNG-SOL® BASELESS CARTRIDGE LAMP

TUNG-SOL—WHERE BIG THINGS ARE DONE WITH SMALL LAMPS

© Trademark TUNG-SOL Reg. U.S. Pat. Off. and Marcas Registradas

age at low current to produce the required power. But it's the high-voltage components that cost, so why not build a low-voltage, high-current supply?" An immediate advantage is elimination of the power transformer. "In effect," says Beaudry, "we use the utility company's transformer out on the pole. It supplies us with low voltage compared to the thousands of volts used before, and an almost unlimited current supply."

The technique employs a capacitor-diode multiplier chain to triple the line voltage. This is then fed to a high-current r-f amplifier made of six power pentode tubes similar to those used in the horizontal output section of a color television set. The tubes are driven by a 13.5-megahertz oscillator. This raw r-f power then is sent to the control module which contains the quartz tubes that hold the necessary wafers.

One problem encountered in this technique is chassis isolation. Since there is no power transformer to act as an isolator, the chassis of the generator might get connected to the hot side of the a-c line. A phase polarity detection circuit was built in to prevent this. It detects which side of the line cord is grounded and also checks the grounding of the plug's ground pin. If it isn't grounded, or if the wrong side of the line is hot because of a building wiring error, the unit is dead until the plug is turned around.

International Plasma Corp., 25222 Cypress Ave., Hayward, Calif. 94544 [429]

Production equipment

Assembler does all but mount units

Machine specifies

components, their location, polarity, and orientation

Accurately assembling components onto printed circuit boards depends to a large degree on the operator's skill in selecting the right

components and placing them in the correct locations on the board with the proper orientation and polarity. Such positioning by an unskilled operator, however, often leads to errors in the card assembly.

An automatic printed circuit board assembler, PCP-75, from Ragen Precision Industries, Inc., selects the proper components for a given coordinate position on the board, and shows the operator the correct polarity and orientation by a lighted arrow cast from an overhead projector on the assembler. The assembler is programed by punched paper tape which delivers the commands to the machine's numerical control unit for a particular p-c board layout. The system delivers sequentially up to 75 component trays to the operator and can handle several p-c boards of the same layout simultaneously.

In addition to the increasing accuracy, the assembler speeds layout. Assembly charts are no longer needed and the operator need not familiarize himself with the board layout before inserting the components.

Tape commands are translated by the logic circuitry into digital codes which define a component tray, the operation or step number, the x-y coordinate position, one of eight angular positions of orientation, and the size of the component. The coordinate position and orientation are pointed to by an arrow from the overhead projector, and the length of the arrow indicates the size of the component. After each component is inserted into the board, the operator presses a foot-switch and the next instruction is incremented.

The trays are mounted on an elevator shift—15 to a level—and are sequentially rotated into a slot on the console table. Each bag of components is numbered and dumped into the tray by the operator. The operator continues to select components from the same tray until an indicator lamp on the console lights to signify the last component in the series.

The price of the assembler is \$8,000, and delivery time is 4 to 6 weeks.

Ragen Precision Industries, Inc., 9 Porete Avenue, North Arlington N.J. 07032 [430]

C/MOS shift register runs at 10 Mhz

64-bit static device is insensitive to waveform;
IC also can be used as a counter or in flip-flop configuration

In the fast-changing world of semiconductor memory-type circuits, complementary metal oxide semiconductor integrated circuits occupy a special place: with a quiescent power dissipation measured in nanowatts, C/MOS IC's hold power requirements down to economical levels in large memory stores or in portable battery-powered equipment.

A new C/MOS IC from Solid State Scientific Corp. provides just such advantages and also dramatically boosts the modest switching speed of C/MOS circuitry, thanks to an unusual circuit design. The 5130-1 is a 64-bit static shift register that operates at 10 megahertz from a 12-volt supply voltage. The closest competition among C/MOS circuits is a shift register of similar

capacity that shifts at 4 Mhz at 10 volts. The 5130-1 thus offers a factor-of-two improvement in shift rate, and is as fast as a dynamic shift register without the complicated refresh circuitry requirement.

Robert J. Lesniewski, program technical manager at Solid State Scientific, describes the new C/MOS IC as a general-purpose, master-slave flip-flop circuit. In addition

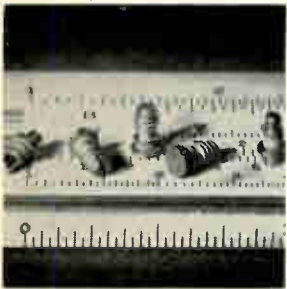

X-band GaAs Gunn diodes operate through bulk negative resistance and feature low f-m/a-m noise characteristics. They achieve a one-step conversion from d-c to microwave energy from a single low voltage supply. Type MA-49107 operates over the 8 to 12.4 Ghz band with output power of 100 mw. Microwave Associates, Burlington, Mass. [436]



Planar epitaxial, pnp power transistors are available up to 100 amps. The SDT3600 comes in the TO-68 case, and the SDT 3900 in the TO-114 case. Features include 50 amp saturation voltage less than 1.5; h_{FE} at 90 amps, 10 typically; less than 10 μ a leakage currents; on and off times less than 2 μ sec at 100 amps. Solitron Devices Inc., Riviera Beach, Fla. [437]

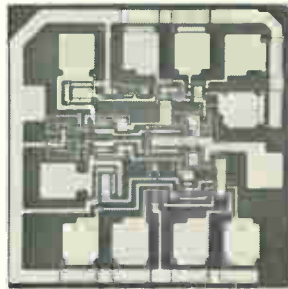

Schottky-clamped TTL IC's designated series 54S/74S offer 3-nsec typical gate propagation delays and power dissipation of only 20 mw per gate. They use Schottky diodes to clamp active transistors, preventing classic saturation and thus permitting extremely fast switching at low power. Supply voltage is 5 v. Texas Instruments Inc., P.O. Box 5012, M/S 308, Dallas [438]

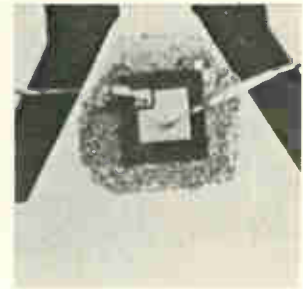

Plastic medium-power scr's series TC106 are rated up to 4 amps rms at 75°C case temperature and packaged in tab-mounted configurations. The units are sensitive gate (200 μ a) devices rated from 15 to 400 v. They are priced in 100 quantities from 55 cents to \$1.20 depending on rating and package option chosen. Transitron Electronic Corp., Wakefield, Mass. 01880 [439]

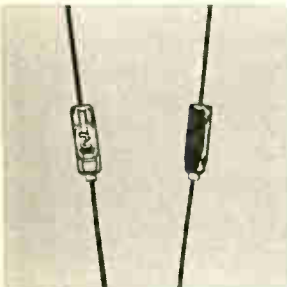

General purpose, glass zener diodes are available in dissipations of 250, 400 and 500 mw. Units are packaged in hermetically sealed glass in accordance with JEDEC DO-7 case outline. Break-down voltages are rated from 2.1 v to 68 v with tolerances of $\pm 20\%$, $\pm 10\%$ and $\pm 5\%$. Electronic Transistors Corp., 153-13 Northern Blvd., Flushing, N.Y. 11354 [440]

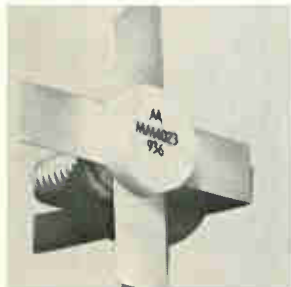

Silicon pnp r-f power transistors feature balanced emitter construction for optimum safe operating area, low lead-inductance stripline packaging, and a choice of four power levels at 12 v d-c, 175 Mhz. Prices for the MM 4020, -1, -2, and -3 are \$6.20, \$15, \$23 and \$38 respectively in lots of 100-999. Motorola Semiconductor Products Inc., Phoenix [441]

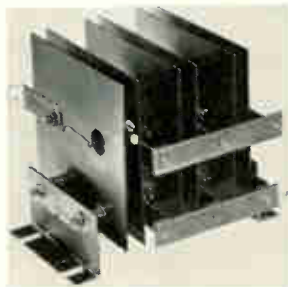

Diode silicon rectifier assemblies series F feature a compact, packaged configuration requiring only electrical connections and mounting bolts for immediate installation. They offer operating and storage temperatures ranging from -65° to 170° C, as well as low forward voltage drop and extremely low leakage. Edal Industries Inc., 4 Short Beach Rd., East Haven, Conn. 06512 [442]



Stud rectifiers are available with the following JAN numbers: 1N1124A, -RA, 1126A, -RA, 1128A, -RA, 3649, -R, 3650, -R. They provide average currents of 1 amp d-c at a case temperature of 150° C, with piv ratings up to 1,000 v, surge capabilities of 100 amps typical, and switching of 1-2 μ sec. Atlantic Semiconductor, 905 Mattison Ave., Asbury Park, N.J. [443]

THE COCKY LITTLE TRANSIENT QUENCHER FROM JOSLYN

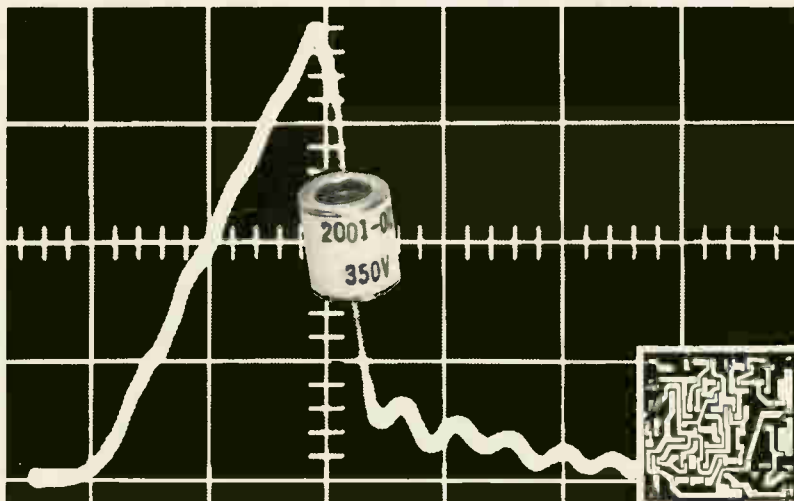

2001-01
350V

Transients have never been able to knock off solid-state electronics when Joslyn precision protection devices are on guard duty. *Never! They quickly extinguish damaging transients with extreme accuracy, nano-second response, and high repeatability over an unequalled period of time. Ideal for protecting AC and DC input lines, RF systems (transmitting or receiving), balanced and unbalanced transmission lines, radar modulators, traveling wave tubes, and cathode ray tubes. Contact Joslyn today for full information and delivery from stock for the field-proven cocky little spark gap that will solve your particular protection problem. Full line includes surge protectors and lightning arresters.

*when properly selected and connected



JOSLYN

ELECTRONIC SYSTEMS

Joslyn Electronic Systems □ Santa Barbara Research Park □
P.O. Box 817 □ Goleta, Calif. 93017 □ Tel. (805) 968-3551

1813

... pulse-shaping circuits
can be simple ...

to shift register tasks, he expects it to find application as a counter, and in various flip-flop configurations.

The IC provides peripheral logic functions at its input. It can operate at supply voltages from 20 volts down to less than 5 volts. Even at 5 volts, the shift rate is a remarkably high 2 Mhz.

Unlike other shift registers, the 5130-1 is insensitive to rate of change of applied waveforms. Whether the rise time of the leading edge, for example, of an input pulse, is 1 nanosecond or 20 milliseconds isn't critical; the circuit operates as well with either risetime.

The circuit is sensitive only to the direction of the waveform. Thus, the front end of the master-slave flip is actuated by a negative-going edge on a pulse, while the back end is actuated by a positive-going pulse. This insensitivity to rate of pulse changes is an advantage for the over-all system: since great demands are not placed on it, the pulse-forming circuitry can be simpler and therefore less expensive. In contrast, other shift registers require precisely maintained edge forms; without them, performance suffers.

Two factors are responsible for the 5130-1's exceptional speed. First, it operates without inverting the single clock input. Thus, it's not necessary to wait until the inverted clock pulse arrives before data is shifted. Secondly, no transmission switches are employed in the special design—called the Todd cell after its inventor at Solid State Scientific—for the basic flip-flop element. In experimenting with the Todd cell, the company found that these transmission switches were a serious deterrent to propagation through the shift register. In the absence of these switches, the circuit essentially is self-clocking.

Price of the 5130-1 is approximately \$65 per unit in quantities of 100 or more. Delivery is off-the-shelf.

Solid-State Scientific Corp., Montgomeryville Industrial Park, Montgomeryville, Pa., 18936 [444]

What's the difference between bcd signals?

Seven-pound instrument finds out by subtracting a preset reference from an unknown; the unit's main job is as a null meter in digital systems

The native tongue of more and more test systems is binary-coded decimal. And any instrument that doesn't talk that language slows a system down and, by making more digital-to-analog and a-d converters necessary, decreases the system's accuracy. Yet one key instrument—the one that compares a measured signal with a reference value—often is some type of null meter, taking

in only analog signals and putting out the same.

To close this section of a test loop, engineers at Israel's Monsel Electronic Instruments Ltd. built the 520A deviation calculator. Available in the U.S. from Monsel's parent, Monsanto Electronic Instruments, the 520A compares any five place bcd signal with some preset reference value, and then

both displays the value of the difference and makes this value available as a bcd output. The time required to complete these operations is 200 microseconds.

With a relay closure, the 520A can also signal when the unknown equals the reference. Thumbwheel switches on the instrument's front panel are for setting the reference, or this value can be adjusted re-



Phase locked oscillator/synthesizer SG602A provides an effective means for reducing measurement errors when analyzing signals from magnetic tape recordings. Used in conjunction with a precision external source, the unit can function independently as a prf synthesizer. Operating temperature is 10° to 40°C. ESL Inc., 495 Java Dr., Sunnyvale, Calif. [361]



Digital tachometer series D9000 displays rpm directly, or any other rate information such as gallons per minute, inches per second, etc. Signal inputs may be obtained from magnetic pickups, photocells, contact closures or shaft encoders, with any number of pulses per revolution or frequency range. Price is \$354. Dynalco Corp., 4107 N.E. 6th Ave., Ft. Lauderdale, Fla. [362]



Digital multimeter UGWD is a compact set for measuring d-c and a-c voltages from 100 μ v to 1,000 v and resistances from 1 ohm to 15 megohms. The stored display gives an accurate three-digit readout with a fourth digit of "1" for overrange indication. Unit can be used in the lab and production. Rohde & Schwarz Sales Co., 111 Livingston Ave., Passaic, N.J. [363]



Impedance bridge model 1656 features 0.1% basic accuracy, ease of balance, portability and low cost. Lever arm switches permit fast balances and easy-to-read answers for measurements of C, L, R, and G. Unit also measures D and Q, using a dial indicating technique. A 1-khz generator is included. Price is \$700. General Radio Co., West Concord, Mass. 01731 [364]



Fully integrated pulse generator model 701 is suited for general lab use such as driving IC's, transistors, and circuitry operating at positive voltages. It features rise and fall times less than 3 nsec over a frequency range from 10 hz to 8 Mhz in six overlapping ranges. Price is \$160 each; availability from stock. Dytech Research Corp., P.O. Box 162, Santa Clara, Calif. [365]



Nondestructive tester model 33 measures the safe operating region of power transistors. Power supplies with various voltage and current ratings are available. Extremes of the available ranges are 60 v at 30 amps and 330 v at 4 amps. Test time can be varied by a front panel control from 10 msec to 10 sec. Test Equipment Corp., 2925 Merrell Rd., Dallas 75220 [366]



Digital synchro display model 1841 accepts two-speed (1:1 and 36:1) synchro position information and provides 5-digit angle display. It is all solid state and uses no rotating mechanisms or optical devices. Two display ranges, 0 to 360° and 0 to \pm 180°, with the same zero reference provide added flexibility. Price is \$2,400. Scientific-Atlanta Inc., Box 13654, Atlanta, Ga. [367]



Tunable, lock-in voltmeter is for a wide range of low-level signal and noise measurement. The instrument is made up of a combination of the company's standard model 132 lock-in signal-to-noise meter and the new model 500 programmer with tunable frequency range from 1 hz to 1 khz. Brower Laboratories Inc., 237 Riverview Ave., Newton, Mass. 02154 [368]

NEW
RF MILLIVOLTMETER

- Solid State
- Programmable
- Accuracy 1% fs + 1% rdg.
- Half Rack Size 5.2" high
- Push Button Ranging
- Linear DC Output
- Many more features

Write for Details

**BOONTON
ELECTRONICS** ||||
CORPORATION

ROUTE 287 PARSIPPANY, N.J. 07054

Telephone: 201-887-5110

TWX: 710-986-8241

motely with bed signals.

Zvi Glaser, Monsel's chief engineer, expects the 520A to be particularly useful in measuring frequency. It's hard to accurately compare frequencies by using analog methods.

Possible customers in this area, says Glaser, are makers of crystals for oscillators. "While grinding a crystal," he explains, "measurements are made with a counter to determine the oscillation frequency of that crystal. The real problem is knowing how far away the crystal's actual frequency is from the reference."

In this type of system, the 520A could both turn off the grinder when the crystal's frequency is within tolerances and order the printing of the value of its deviation from the desired frequency.

Glaser also expects the deviation calculator to see use in monitoring. He cites the hypothetical case of a motor where a record is needed of the deviation of the motor's speed from some nominal value.

The 520A is actually a subtractor that uses an old computer trick—the 9's complement approach. Inside the instrument are five decade counters where the 9's complement of the reference is stored. For example, if the reference were 76352, the numbers 23647 would be in the counters.

When the unknown signal arrives, the counters add it to the number they're already holding. If the sum has six digits (e.g., 106597), the 520A knows that the unknown is greater than the reference. The sum's most significant digit—always a "1"—is dropped (06597), and "1" is added, producing the value of the deviation (06598). This is displayed and made available as an output signal.

On the other hand if the sum has five digits (e.g., 72115), the 520A turns on the display's minus sign, and takes the 9's complement of the sum (27884), which is the absolute value of the deviation.

The 520A uses 5-volt logic and 8-4-2-1 code. Input impedance is 15 kilohms, and power drain is 20 watts.

The instrument weighs 7 pounds, and is 4¼ by 7½ by 11 inches. Price is \$650.

Monsanto Electronic Instruments, 620 Passaic Ave., West Caldwell, N.J. [369]

New instruments

Plug-in boosts resolution

New i-f section retains bandwidth of spectrum analyzer

Better resolution is being plugged into Hewlett-Packard's spectrum analyzer. The analyzer comprises a display and two plug-ins, r-f and i-f. Now H-P engineers have increased resolution from 50 hertz to 10 hertz in a new i-f section, the 8552B. But there's no tradeoff in bandwidth. The new i-f section still has the 1-khz-to-110-Mhz bandwidth and the 200-hz-to-100-Mhz scan width of the older 8552A. The tradeoff is in price; the new 8552B sells for \$2,850 while the model A's price is \$2,050.

With the new plug-in, it's possible to take a look at such things as line-related sidebands that are greater than 60 db below a carrier.

To take full advantage of the 8552B's high resolution, extreme stability is required—and the unit is indeed stable. "If someone wants to see just how stable the instrument is, all he has to do is turn it on and look at the L-O signal," says Lawrence Rayher, product manager. "The noise sidebands are greater than 60 decibels down and 50 hertz or more away from the signal. This is true for any c-w signal viewed through the 10-hz bandwidth window. And typical residual f-m is less than 0.1 hertz peak-to-peak." This stability facilitates measurements on high-Q devices and oscillators.

Other features include a new 2-db-per-division log expand scale that permits discrimination of signals closely spaced in amplitude. Sensitivity has been increased from 130 db in the A version to 140 db in the 8552B, and a 10-hz video filter is provided to average background noise. A 30-Mhz calibration signal also is provided.

Hewlett-Packard Co., 1501 Page Mill Road, Palo Alto, Calif. 94304 [370]

Tubing provides rfi shield

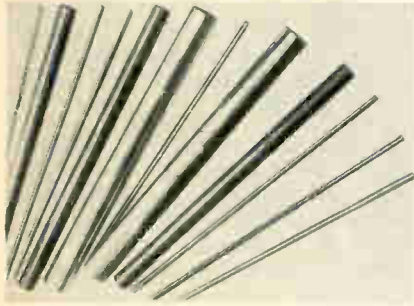

Spirally-wound thin-wall tubing of copper, mu metal, or metal/plastic-film combinations, offers designers and engineers effective, space-saving, cost-saving shielding for reed relays and other applications where radio-frequency or any electromagnetic waves must be contained. It is available with inside diameters from 0.09 inch to 1.0 inch, with wall thicknesses comparable to those of available foils (basically from 1/2 mil up), and in lengths of 36 inches. Niemand Bros. Inc., 43-10 94th St., Elmhurst, N.Y. 11373 [381]

Capacitor-grade polycarbonate film, designated Kimfol, is available in thicknesses down to 0.00008 in. (2 microns), plain or metalized with either aluminum or zinc. The manufacturer claims that capacitors bound with metalized Kimfol polycarbonate film can be made with a temperature coefficient closer to zero than is possible with any other film dielectric. Peter J. Schumtzer Division, Kimberly-Clark Corp., Lee, Mass. 01239 [382]

Epoxy "Wipe-Out" CT325 will disintegrate many thermoset resins including polyester and epoxy but will not attack molded phenolics, nylon, Teflon, linen, Formvar, and metals. Applications are in the semiconductor and hybrid IC industry for the repair and salvage of valuable components in embedded, potted, or encapsulated assemblies. CT325 is available from stock and sells for \$17 per gallon. Four-gallon lots are priced at \$15 per gallon, and a five-gallon bulk container sells for \$65. Starnetics Co., 10639 Riverside Dr., North Hollywood, Calif. 01602 [383]

High-purity germanium is available in both single crystal and polycrystalline forms. Single crystals are offered in diameters from 1/4 in. up in lengths up to 6 in. A typical 1/4 in. diameter x 1 in. long crystal is priced at \$150. Purity ranges as high as 99.99%. Polycrystalline ingot comes in 99.999% purity at \$180 per lb. Polycrystalline germanium powder in a mesh range of -100 to 325, with purity of 99.999%, is available at \$200 per lb. Aremco Products Inc., P.O. Box 145, Briarcliff Manor, N.Y. 10510 [384]

Three fire-retardant, hot-melt insulating resins have been developed. Type R-6027 has a high melting point (295°F) and a low viscosity composition for impregnating various coil windings. Another, R-6041-2, is a medium-melting-point (240°F) impregnant for moisture-proofing phenolic slurry-dip-coated and molded electronic components. Coil anchoring compound R-6040-2 is a high-melting-point (260°F) moisture-proofing coating designed for cementing coil turns in place before removal from winding machines. Mitchell Rand Mfg. Corp., Torne Valley Rd., Hillburn, N.Y. [385]

Low-cost Class H polyester insulating varnish B-515 is a flexible dipping and baking material suited for coating motor, coil, and transformer windings and all electrical insulating applications requiring 180°C temperature resistance. Thermal rating at 25,000 hours is 194°C. The insulating varnish is available from stock in 1-gallon cans, 5-gallon pails, and 55-gallon drums. Westinghouse Electric Corp., Industrial Plastics Division, West Mifflin, Pa. 15122 [386]

Low rate of thermal expansion, extreme hardness, and high resistance to oxidation at elevated temperatures are three major characteristics that make M-120-FT ceramic an ideal material for glass sealing molds. The material also offers good heat shock resistance, and can be fabricated to precise mold tolerances that maintain the excellent dimensional stability that is considered necessary for automation. Duramic Products Inc., 426 Commercial Ave., Palisades Park, N.J. 07650 [387]

Metex PTH9066 is an etch for removing epoxy smear in interconnecting holes for multilayer printed circuits. This chemical treatment provides a method for producing a functionally reliable multilayer interconnection. It replaces vapor honing or the use of 66° Baume sulfuric acid followed by 49% hydrofluoric acid for smear removal. The new material is used at full strength, at a temperature of 150°F, for 2 1/2 to 3 1/2 minutes. MacDermid Inc. 526 Huntingdon Ave., Waterbury, Conn. 06720 [388]

Flame-retardant epoxy and polyester compounds are for insulating electrical components used in manufacturing television sets. Included in the series are impregnating compounds for power transformers, casting compounds for molding flyback coils, dip encapsulant for capacitors and resistors, and conformal coatings for use with printed circuit boards. Sterling Division of Reichold Chemicals Inc., Sewickley, Pa. 15143 [389]

TO BID OR NOT TO BID?



GEM

GOVERNMENT ELECTRONICS MARKET

Every Monday the GEM Report helps solve the bid dilemma.

- New Systems & Programs
- Reviews New IFB's/RFP's
- Current Bid Abstracts
- Trend Information
- Developing Markets Data
- Right of Telephone Inquiry

TRIAL SUBSCRIPTION \$25
8 WEEKLY ISSUES

HALF THE ANNUAL RATE

DMS of McGRAW-HILL
100 Northfield St.
Greenwich, Connecticut 06830

\$25 enclosed Bill me

Name _____

Co. _____

Address _____

City _____

State _____ Zip _____

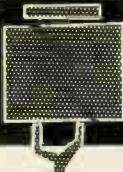

SEARCHLIGHT SECTION

- CLASSIFIED ADVERTISING • BUSINESS OPPORTUNITIES
- USED OR SURPLUS EQUIPMENT

AUTOTRACK MOUNT

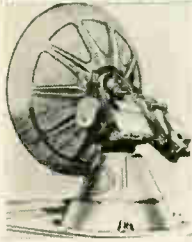

360 degree azimuth, 210 degree elevation sweep with better than 1 mil. accuracy. Missile velocity acceleration and slowing rates. Amplidyne and servo control. Will handle up to 20 ft. dish. Supplied complete with control chassis. In stock—immediate delivery. Used world over by NASA, USAF, MP-61-B. Type SCR-534. Ideal satellite tracking. Large spare parts inventory for back-up.

ANTI-AIRCRAFT GUN MOUNT

Will handle 6,000 lbs. rapid slew through 360° azimuth, 180° elevation. Mobile.

COUNTERMEASURES TRAINER

Covers L-band, S-band, X-band, all radars. Tacan, UHF drone control, VHF drone control, Communications band. All housed in shelter.

FIBERGLASS RADOME will handle 20 foot antenna. Easily erected & shipped. \$4800.

PULSE MODULATORS

250 KW HARD TUBE PULSER

Output 16 kv 16 amp. Duty cycle .002. Pulses can be coded. Uses 5D21, 715C or 4PR60A. Input 115 v 60 cy. AC \$1200 ea.

MIT MODEL 9 PULSER 1 MW—HARD TUBE

Output 25kv 40 amp., 30kv 40 amp. max. Duty cy. .002. .25 to 2 microsec. Also 5 to 5 microsec. and 1 to 5 microsec. Uses 6C21. Input 115v 60 cycle AC. Mfr. GE. Complete with driver and high voltage power supply. Ref: MIT Rad. Lab. Series, Vol. 5, p. 152.

2 MEGAWATT PULSER

Output 30 kv at 70 amp. Duty cycle .001. Rep. rates 1 microsec. 600 pps. 1 or 2 msec. 300 pps. Uses hydrogen thyratron. Input 120/208 VAC 60 cycle. Mfr. GE. Complete with high voltage power supply.

SCR 584 AUTOTRACK RADARS

Our 584s in like new condition ready to go, and in stock for immediate delivery. Ideal for telemetry research and development, missile tracking, satellite tracking. Fully Desc. MIT Rad. Lab. Series, Vol. 1, pps. 207-210, 228, 284-286. Comp. Inst. Bk available \$25.00 each.

AUTOMATIC TRACKING SYSTEM

Sci. Atl. Mod. 3101-J70 Antenna Pedestal. AZ-EL 15 deg. per second rated speed. 23 inch dia. bearing. Complete w/control console & mag. amplifiers.

Also in stock complete Glo-track receiving system for 200-400 MHz telemetry band including 12" square quad. Helix. All part of Atlas missile instrumentation system.

AN/GSS-1 PASSIVE TRACKER

10 cm passive automatic tracking system with 6 foot parabola. Complete, mounted on van. Supplied by GE for Atlas instrumentation system.

MICROWAVE SYSTEMS

SPARE PARTS IN STOCK

Niko Ajax, Nike Hercules, M-33, MPS-19, TFS-ID, TFS-10D, FPS-8 SPS8, SCR-534, MPQ-18. From Largest Inventory in World

200-2400 mc. RF PKG

Continuous coverage. 30 Watts Cw nominal output. Uses 2C39A. Price \$575.

L BAND RF PKG

20 KV peak 990 to 1040 MC. Pulse width .7 to 1.2 micro sec. Rep. rate 180 to 420 pps. Input 115 vac incl. Receiver \$1200

200-225 mc RADAR SYSTEM

1 Megawatt output, 200 nautical mile range for long range detection of medium and high altitude jet aircraft as well as general search. AN/TPS-23.

AN/GMD-1B RAWIN RADAR

L-Band Radiosonde Tracking System. Complete, new cond. in stock for immed. del. AN/GMD-2 computer mfg. Gen'l Mills also in stock.

500 KW L BAND RADAR

500 kw 1220-1359 msc. 160 nautical mile search range P.R.I. and A scopes. MITI. thyratron mod 5326 magnetron. Complete system.

C BAND AUTOTRACK

1 Megawatt 10 ft. Parabola. Sperry.

AN/GPG-1 SKYSWEEP TRACKER

3 cm. auto. tracking radar system. Comp. pkg. w/indicator sys. Full target acquisition & auto. tracking. Input 115v 60 cy. new. in stock for immed. del. Entire sys. 8' x 3' x 10'. Ideal for infrared tracker, drone tracker, missile tracker, R & D

INDICATOR CONSOLES

AN/SPA-4A. PPI 10", range to 300 mi. VJ-1 PPI 12", Range to 200 mi. VL-1 RH1 12" to 200 mi. 60K ft.

HUNDREDS MORE IN STOCK
LARGEST RADAR
INVENTORY
IN WORLD.
WRITE
FOR
CATALOG
ON YOUR
LETTERHEAD

Radio-Research Instrument Co.

45 W. 45th St., New York, N.Y. 10036 • 212-586-4691
CIRCLE 966 ON READER SERVICE CARD

EMHART CORP. GLASS TESTING LABORATORIES

Serving all Industries

Chemical Analysis (Gravimetric, X-Ray),
Physical Measurements of Glass and Ceramics

HARTFORD DIVISION, BOX 1620

Hartford, Ct., 06102. Tel. (203) 242-8551, Ext. 514

CIRCLE 967 ON READER SERVICE CARD

ADDRESS BOX NO. REPLIES TO: Box No.

Classified Adv. Dept. of this publication.

Send to office nearest you.

NEW YORK, N.Y. 10036: P. O. Box 12

CHICAGO, Ill. 60611: 645 N. Michigan Ave.

SAN FRANCISCO, Cal. 94111: 255 California St.

EMPLOYMENT SERVICES

A Small & Truly Professional Fee-Paid employment service for engineers & scientists. Nationwide. Write or call Joseph P. Corcoran Personnel Consultants, 505 Germantown Pike, Lafayette Hill Pa. (215) 825-0848.

The Resume Game: An Insider's Guide How to write & use your successfully. Cover letter/resume samples. \$2. Plymouth Pubs, Box 318A Plymouth Mtg Pa. 19462.

BUSINESS OPPORTUNITY

Capital Contacts—Before you try Public or Private Placements to Underwriters, Investment Banking Houses, write for helpful information to Confidential Consultant, 817 51st St., Brooklyn, N.Y.

How to become a registered engineer.

Send a resume of your experience to the Electronics Manpower Register.

That will make you part of our computerized job opportunity program.

The Electronics Manpower Register will match your profile and experience against every opening in a long list of companies using Manpower's central or affiliated services.

All you have to do to get a confidential look at every appropriate chance to advance is send your resume to:

Electronics Manpower Register

Electronics

330 West 42nd Street
New York, N.Y. 10036

New Books

Recently Published

Introduction to Computer Analysis: ECAP for Electronics Technicians and Engineers, Herman Levin, Prentice Hall, 256 pp., \$14.65

Gives a complete rundown on the use of ECAP for circuit analysis: setting up models, preparing statements, handling signal sources and analyzing computer outputs. Many examples are given and exercises for self-study, with answers, are included.

Materials for Conductive and Resistive Functions, G.W.A. Dummer, Hayden Book Co., 326 pp., \$13.95

Using many materials properties charts, the book covers wire, cable, printed circuit conductors, and films, as well as contacts and resistive elements. Superconductivity and integrated circuit interconnections are also discussed. It's primarily intended as a reference book, giving a short discussion of each aspect of the main subject followed by an extensive bibliography.

Power Sources, D.H. Collins, Pergamon Press, 619 pp., \$28

Contains reprints of the papers presented at the Sixth International Symposium on Power Sources held in Brighton, England, September 1968. The papers, covering some 36 topics, come from leading men in industry, government, and universities where power source projects are in progress.

The Design of Filters Using the Catalogue of Normalized Low-Pass Filters, R. Seal, Telefunken, 381 pp., \$14.95

Written in German, with an accompanying English translation, this tabulated volume details the component values required for conventional Chebyshev and Cauer filters. Tables list circuit element values based on resistive terminations at either end for filters containing from four to nine circuit elements, with 11 different reflection coefficients, and 11 different maximum variations of the insertion loss within the passband. Specific examples are offered to aid in designing a variety of filters with these tables.

Handbook of Semiconductor Electronics, edited by Lloyd P. Hunter, McGraw-Hill, 924 pp., \$27.50

Geared to cover the needs of today's electronics engineer, this revised third edition includes contributions from 17 leading experts. It covers methods and techniques needed to design and evaluate semiconductor circuits: device physics, fabrication techniques, and evaluation measurement methods. Also included is new material on physics and design of integrated circuits.

Technical Abstracts

This Patsy's no dupe

Pulse amplitude transmission system (Patsy)
Neal L. Walters
IBM Corp.
Research Triangle Park, N.C.

Patsy's the name of a new data entry unit developed for transmitting numeric data asynchronously at low rates over short distances—up to 1,000 ft—as by a machine operator in a factory to a central data collection point. It is simple, inexpensive, and easy to install. It's also unique—it requires no internal power or data set.

Patsy is an acronym for pulse amplitude transmission system. It's part of the IBM 2790 data communication system, announced last summer. While the unit doesn't use conventional pulse amplitude modulation, the data does appear on the line in the form of pulses whose amplitude conveys the data.

Each digit or control signal actually is two sequential pulses, one positive, the other negative. The transmitted digit is defined by the amplitudes of these pulses, which are determined by resistor-diode voltage divider networks, connected between the wires carrying the pulses. The rest of the voltage divider is in the receiving station, which provides all the power requirements. Diodes establish resistance connections.

Each data entry unit is connected to a receiver by a single pair of wires; up to 32 units can be connected to one receiver; many receivers can be connected to a single controller as part of a data collection system. The receiver scans the data entry units in rotation, one every 4 milliseconds; if it finds one that is ready to send data, it stops polling, sends out a start signal, and then begins to generate pairs of pulses. The data entry unit switches these pulses among the resistor-diode networks as the pulses arrive, controlling their amplitudes; the receiver detects the entry unit's data by sensing these amplitudes. It converts this data, digit by digit, into another code which is retransmitted to the main controller.

Presented at the Spring Joint Computer Conference, Atlantic City, N.J., May 5-7.

3 REASONS FOR BOURNS LEADERSHIP IN AEROSPACE TRANSDUCERS



PRESSURE



POSITION

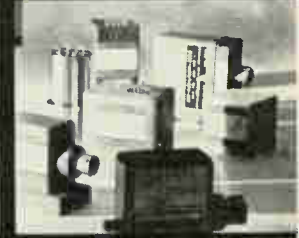

ACCELERATION

Each Bourns **PRESSURE** Transducer is individually calibrated and provides our own designed and fabricated sensor. **POSITION** Transducers offer special features including taps, switching segments, special mounting, shaft connections, cable and plug connectors, turret terminals, etc. **ACCELERATION** Transducers attain a high natural frequency by utilizing a small mass deflection supported by unique suspension designs.

The preceding paragraph contains a statement about each of our Aerospace product lines. There are many other statements; all of them true . . . and tried. Tried by the industry of which you are a part. Can you really continue to experiment with less than our 24 years of experience and capability? Send for new, informative Summary Brochure.

Pioneers in sensing and controlling position and pressure



BOURNS, INC., INSTRUMENT DIVISION, 6135 MAGNOLIA AVE., RIVERSIDE, CALIF. 92506

Circle 139 on reader service card

New

MICRO-VECTORBORD AND D.I.P. PLUGBORDS ARE HERE!

Save time — Save work — Save money

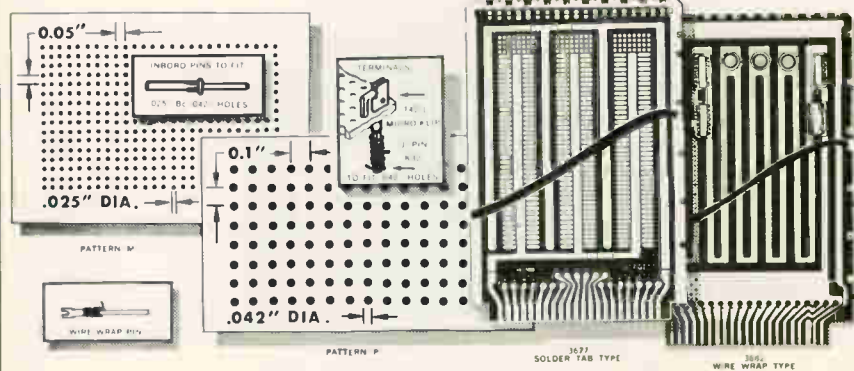

WIDE SELECTION OF SIZES AND MATERIALS

MICRO-VECTORBORD "P" .042" holes match D.I.P. leads. Epoxy glass or paper, cop. cld. also 1/64" to 1/16" thk

MICRO-VECTORBORD "M" .025" holes match Flat Paks. 1/32" Epoxy glass, cop. cld. also or .007" Mylar.

NEW SOLDER-PAD D.I.P. PLUGBORDS — 3677 Series Epoxy glass, "P" pat. 1/16" thick with 44 etched plug contacts (2 side total) power, ground

busses, pads for up to 24 D.I.P.'s (14's). Also 21 units 16 leads D.I.P.'s, T.O's and discretes.

NEW WIRE WRAP D.I.P. PLUGBORDS — 3682 Series Similar to above but closely spaced bus lines for higher density. Up to 48 D.I.P. 14 lead wire wrap sockets mountable or T.O's and discretes.

TERMINALS — Micro-Klips, Mini Wire Wraps, Rd. Pins, Patch Cords, etc., available.

Vector

Send for complete literature

ELECTRONIC CO., INC.
12460 Gladstone Ave., Sylmar, California 91342
Phone (213) 365-9661 • TWX (910) 496-1539



DIGITAL TV



CVI video sampling instruments allow your computer to "look" at practically anything. High accuracy bandwidth compression of conventional television signals opens new doors to data processing in research and industrial applications. Let us tell you about some of our unique video devices.

COLORADO VIDEO, INCORPORATED
P.O. Box 928 • Boulder, Colo. 80302 • Phone (303) 444-3972

cv

Video Data Acquisition • Processing • Display • Transmission

Circle 140 on reader service card

What Memory-System Maker Is Speeding Up the Cycle Time—But Holding Down the Price?

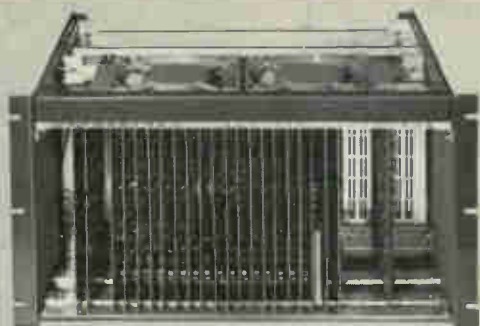

HS500R

Toko. Of course!

Beef up your technology with Toko's 500 nanoseconds Memory System without raising your costs.

Now rolling off the production line, Toko's HS500R Memory System offers the following key features:

- * Access time of 250ns.
- * Memory capacity of 4K words by 18 bits expandable to 16K words by 18 bits, rearrangeable to multiples of 36 and 72 bits.
- * Compact, space-saving advantages—measuring 10" x 19" x 13-1/3".

Toko's advanced electronic technology also enables it to provide computer components, such as memory stacks. Contact Toko today for details.



TOKO, INC.

Head Office: 1-17, 2-chome, Higashi-Yukigaya, Ohta-ku, Tokyo, Japan
TOKO N.Y., INC. 350 Fifth Avenue, New York, New York 10001 Tel: 212-565-3767

New Literature

Rack-and-panel connectors. Elco Corp., Willow Grove, Pa. 19090, has released the revised and expanded 1970 edition of its guide describing a wide range of low-cost rack-and-panel connectors. Circle 446 on reader service card.

Microwave IC's. American Electronic Laboratories Inc., P.D. Box 552, Lansdale, Pa. 19446, offers a four-page brochure describing its product capability and accomplishments in the microwave IC field. [447]

Insulating varnishes. John C. Dolph Co., Monmouth Junction, N.J. 08852, has issued a four-page selection chart for insulating varnishes. [448]

Microwave tubes. Raytheon Co., 190 Willow St., Waltham, Mass. 02154. A 48-page condensed catalog gives specifications on more than 200 microwave tubes operating at various frequency bands and power levels. [449]

Power relays. Babcock Electronics Corp., 3501 Harbor Blvd., Costa Mesa, Calif. 92626, has published a 16-page brochure covering a line of 15-amp MS sealed power relays. [450]

Communications processor. Micro Systems, 644 E. Young St., Santa Ana, Calif. 92705, offers a 20-page brochure describing its Micro 812 communications processor. [451]

Solid state choppers. Solid State Electronics Corp., 15321 Rayen St., Sepulveda, Calif. 91343, has available a 62-page catalog describing its complete line of solid state choppers. [452]

Counter-timer. Itron Corp., 11675 Sorrento Valley Rd., San Diego, Calif. 92121. A six-page folder illustrates and describes the model 680, a 200-Mhz counter-timer. [453]

Reinforced thermoplastics. Dart Industries Inc., Evansville, Ind. 47717. A four-page brochure contains information on a complete line of flame retardant, fiberglass reinforced thermoplastics. [454]

Frequency response tracer. B&K Instruments Inc., 5111 W. 164th St., Cleveland 44142. Model 4712 frequency response tracer is fully described in a new product data bulletin. [455]

Active filters. Polyphase Instrument Co., E. Fourth St., Bridgeport, Pa. 19405, has published a catalog of active filters that are furnished complete, ready to install in circuits. [456]

Current sources. Keithley Instruments Inc., 28775 Aurora Rd., Cleveland 44139, has available an engineering note describing two low-level d-c current sources. [457]

International Newsletter

July 6, 1970

France and Japan may team up for large computers

Japan may give France the technology developed for its large-scale computer project. In return France would offer funds for operating the Japan Electronic Computer Co.—which has been plagued by insufficient money for several years. An official of Japan's Ministry of International Trade and Industry admits there have been unofficial talks between the Japanese and French, but adds that nothing concrete has yet been discussed and any agreement is probably more than a year off.

Initial interest in Japanese-French cooperation in computers came during an on-the-spot study of the European computer industry by a 15-man Japanese group a year ago. Further interest was fanned last October when, during a visit to Japan, a French government group called for cooperation between the two nations' computer industries.

One reason that an agreement may take until the end of next year is that no one knows yet if the large-scale computer will work well. But regardless of the success of the big machine, there will be a tremendous technology fallout. Logic circuits initially developed for the large-scale project are being used in large computers built for the Nippon Telegraph and Telephone Public Corp. And similar circuits will also be used in the next batch of larger commercial computers. If the two countries get together, some of the fallout will go to France.

Viatron farms out its System 21 work in France

Behind on European deliveries of its System 21 data entry and micro-processing machines, Viatron Computer Systems is negotiating with France's Cie. Industrielle des Telecommunications to manufacture the units for France and possibly for the Common Market. Viatron says it has 2,000 orders in France alone but can deliver only about 40 units a month. CIT, a subsidiary of Cie. Generale d'Electricite, could start production by year-end. It would be a temporary arrangement until Viatron can build its own European plant.

Viatron's move will give the company a faster jump on tapping the European market, industry observers note. Company officials admit that right now the European market looks greener than the American market because the business slowdown in the U.S. has not yet had a great dampening effect on West Europe's industry. Viatron initially planned to concentrate on domestic sales, but now officials predict that overseas sales will account for a sizable chunk of total production, probably reaching 50% in a few years.

East Bloc market beckons to France's CII

France is cashing in on Eastern Europe's push to establish electronics industries. Sources close to Compagnie Internationale pour l'Informatique say the state-backed French computer builder is negotiating a computer licensing deal with Poland covering the Iris 50, CII's medium-sized commercial machine.

Earlier this month, CII confirmed a significant package deal with Rumania. French engineers will help the Rumanians build plants to turn out the Iris 50, as well as the integrated circuits and peripherals used with it. Rumania will build several dozen Iris 50's, according to a CII official. Britain's ICL and France's Bull-GE have licensing deals with East Bloc countries, but CII's deal with Rumania is the most sweeping yet. What's more, insiders say CII finally has signed a pact

International Newsletter

to license its small 10010 computer to Hungary, which will export the machines throughout Eastern Europe—including Russia.

The company, which says it had to do enough battling just to overcome NATO countries' resistance to the Rumanian deal, denies rumors that it plans to buck NATO embargo rules against exporting big scientific machines, such as the Iris 80, to the East.

British probe prints out blood velocity spectrum

With its "three-dimensional" view of blood flowing through the heart, a new British medical electronics device not only shows how fast the blood is going, but also the range of velocities following each heartbeat. Hooked up to an ultrasonic probe, which uses Doppler shift sensing for measurement, the device breaks down the returned signal into 18 separate velocity channels. A printout unit, which shows the channels as side-by-side bars, provides the three dimensions. Time is indicated by the printout paper speed; the velocity spectrum, which can indicate a blockage, by the relative length of the bars; and the amount of blood at each velocity by the blackness of the bars. Its developers say the unit is not limited to medical uses, but that the same printer could be used to show, at one time, several variables in any material sensitive to ultrasonic radiation.

East German push in electronics lagging seriously

East Germany's electronics industry apparently hasn't performed according to plan in recent months. Together with some other industrial sectors, the electronics field has lately come under some heavy fire from East Berlin's central party committee for failing to meet production schedules. Even the Dresden-based firm Elektromat, which is generally considered a star performer in East German electronics, has been openly criticized by the government.

The problems seem to be industry wide. In communications, for example, production has fallen behind by more than \$1 million, primarily because production of critical devices has been sluggish. Non-available components also are held responsible for missed production targets in switch and control gear. And in the consumer electronics field, retailers have had to turn back to the industry up to 17% of black-and-white sets and between 7% and 30% of color receivers because of malfunctions.

Irresponsibility and lack of discipline are some of the official charges leveled against plant managers. But Western observers say that one of the prime causes for the setbacks are snafus in switching to automated techniques and processes.

Addenda

The Japanese government has given the green light for Honeywell to participate on a 50-50 basis with the Nippon Electric Co. in a new joint venture. However, NEC-Honeywell Space Systems, specializing in space software, will not be a new company; it was operating as a wholly owned NEC subsidiary. In the future NEC expects to extend cooperation with Honeywell to space hardware . . . Portugal's government has authorized Control Data's Portuguese subsidiary to establish a duty-free zone at its plant in Palmela near Lisbon. There the company will make and assemble electrical and electronic parts and equipment, especially printed circuits for computers. The raw materials will be flown in and assembled by locally trained women. Finished parts will be exported to the U.S.

Electronic letters shape up for tv

BBC-developed character generation technique puts out and selects 50 basic shapes that are clear, distinct, and just like printed forms

On election night, June 18, the British public had its first hint of a new government and its first look at some new, electronically generated tv lettering. All the characters were clear and distinct—and shaped like ordinary printed lettering.

The new technique, developed by the British Broadcasting Corp. depends on electronic generation of about 50 basic line shapes. Parts of each shape are selected and combined to make a letter, number or punctuation mark. So far, 50 characters are available: all the capital letters, all the numbers, and 15 punctuation marks. What's more, the system can generate any character in any one of 350 positions, which fall in a pattern of 14 horizontal rows of 25 positions each.

Anchor. The system was designed for BBC tv, but the corporation plans to license interested equipment manufacturers. Called Anchor, it was invented by Ray Taylor of the BBC's Engineering Designs department. David Kitson, who heads Taylor's section in the department, says the electronic techniques involved are not new in themselves—what's new is their combination and application.

"Electronic character generation has been dominated by the computer display men, who are dedicated to binary techniques. Character shapes have been limited to what is compatible with binary logic," says Kitson. "We started again from scratch, and bothered only about our own requirements. Once we'd dropped the binary tradition, it was not difficult to see what we had to do," he asserts.

In fact, the line shapes are generated by the same basic methods

used to generate line and circle displays in tv special-effects mixers. There are about 20 straight, vertical, and horizontal lines, the same number of straight lines sloping at various angles, and 10 curved line shapes—ellipses and circles. The vertical and horizontal lines are generated by straight voltages, the sloping lines by sawtooth waveforms, and the circles and ellipses by parabolic waves.

The 50 shapes are generated continuously and are fed into a character generator which uses logic to select the right parts of the incoming analog waveforms to make each character; the most complex character is 5, which is comprised of parts of five different shapes. All 50 characters, in turn, are gen-

erated all the time and fed out along 50 different wires.

Sequential. Any given wire has to pass its character information in a form which fits the tv line format and the 25-by-14 character position layout. Each character is 28 tv lines deep and 1.4 microseconds wide. Hence, the letter-A wire, for example, passes in sequence 25 1.4- μ sec lines containing the top line information for a row of A's, followed by 25 1.4- μ sec lines with the second-line information, and so on.

All the output wires are broken at an AND gate. Character information passes the gate only when a second input, controlled by the character selection system, is present. The address logic, which closes the gate at the right times



At the keyboard. The Anchor system accepts commands for generating a character from a computer, from a paper tape reader, or from a keyboard. Overall cost is no more than for dot matrix generators, developers say.

to put a specified letter at a specified position, can be controlled by a computer, by a paper tape input, or by manual input from a keyboard. Kitson says that it was very much simpler to make the selection system control the address logic rather than the character generation system.

The address system operates through a seven-bit, 25-by-14 MOS shift register store. Each seven-bit block in the array corresponds to one position on the screen. A specified letter is converted into a seven-bit word and is addressed, by position information also punched in, to the selected store block. The output from the store block travels to the AND gate of the selected letter wire and activates it in step with the raster scan timing. The binary information recirculates through the store as long as the letter is wanted on the screen.

Switzerland

Key to credit

An ingenious little Swiss company has devised an electronic gasoline dispensing system that is attracting major oil companies like mice to Swiss cheese. With the system, a driver can buy gas at any time without cash. Payment is made at agreed-upon intervals to the filling station owners.

To buy gas the customer inserts a coded, cylindrical key into an electromechanical counting unit on a gas pump and push a button.

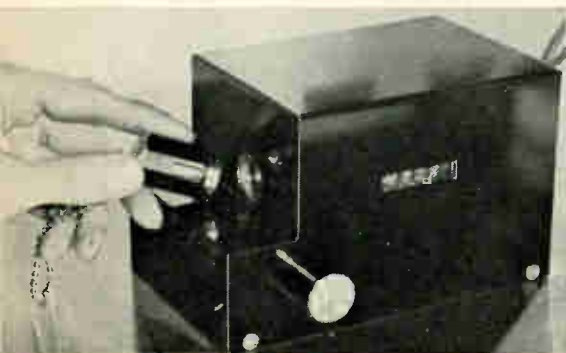

Fill 'er up. To unlock gas pump, holes in key's end must match decoder pins and counter must be free to turn.

This triggers an electronic controller which, in turn, starts the gas pump motor and opens a valve allowing fuel to flow through the hand-held nozzle into the car's gas tank. The value of the gas pumped is indicated on a counter inside the key.

Bandwagon. The self-service, cashless system, dubbed Keystar, is the latest development of Asper und Co. AG, a 15-man firm in Horgen. The system is being used experimentally at some 10 independent filling stations along Swiss highways. Major European oil companies, among them ESSO, ARAL and British Petroleum, already are negotiating with Asper. Migros, a huge Swiss food chain with gasoline stations, also is interested.

The Keystar system is the brainchild of Theodore Asper, a tool maker with about 20 patented inventions in the liquid-measuring field to his credit. Asper and his staff work with all types of fuel pumps for gas stations, but also are engaged to some extent in making liquid pumping apparatus for the Swiss military. Asper sees his Keystar system as the logical extension of self-service, coin-operated gas pumps used in West Germany and elsewhere in Europe.

The keystone of Keystar is the key. Basically, it's hermetically sealed tube about 2 inches long and slightly less than 1 inch in diameter. Inside the key, which is made of a hard plastic, is a counter with four digit drums.

One end of the cylinder is capped by a metal plate whose rim has a series of holes of varying depth. The distance between these holes and their depth is a code that stands for a particular gasoline brand. If the car owner wants to switch to another brand he would have to get another key. The key costs about SF40—roughly \$9—but Asper thinks that once it's mass-produced it would sell for about one-third of that.

Self-destruct. The key is tamper-proof, destroying itself if anyone tries to forcibly open it. Understandably, Asper is reluctant to reveal just how the self-destruction mechanism works. He will only hint that a tiny cartridge inside

the cylinder ignites when air gets in. The heat produced is sufficient to damage the counter's vital parts.

The gas pump's regular counting mechanism is mechanically linked to Asper's counting unit, installed on top of the gas pump. The value of gas pumped is transmitted to the counter drums inside the key through a magnetic coupling, using small ferrite pieces in the key.

The electronic controller, sees to it that the counter in the key and the one in the counting unit work synchronously. It's also an additional safeguard against attempts to fool the system with a home-made rod whose shape and code is the same as that of a real key. If such a rod is used the electronic controller would not be triggered because it would sense non-synchronism and would not initiate the gas pumping operation. It also insures that no gas is pumped when the key's counter has reached its limit. In this case the controller would sense that the key counter isn't moving.

The counter in the key runs down from its upper limit. When zero is reached, the customer pays the filling station owner the money and his key is magnetically turned back up to 999.9.

In a country-spanning Keystar network, the fuel pumps at all gas stations could be hooked up by regular telephone lines to a central data processing center. There, a computer would accept the data coming from the filling stations and process it for the distribution and marketing departments of all oil companies selling gas in Switzerland.

West Germany

Cemented cores

A 12-kilobit ferrite core memory weighing less than half an ounce is one of several new memories to come out of Siemens AG's component development labs at Munich. The Siemens devices, based on an improved fabrication technique, are only 70% the size and weight of comparable memories. Even more important is the struc-

ture of the units. One memory can be made with only 176 solder connections, instead of the 4,400 needed in comparable types.

Siemens builds the memory using its trademarked Stapelblock—or stacked blocks method. In this process, single, frameless matrix planes are stacked and then bonded together with a special adhesive material. The matrix planes are thin plates on which are glued ferrite cores. The X and Y wires are continuously threaded through the cores on all planes.

In conventional ferrite core units, the matrix frames and the supporting elements use up most of the memory's volume; the electrically essential parts take up comparatively little space. Besides, they require many soldered junctions because the wires of each matrix terminate at the frame surrounding that matrix. To be sure, memories with folded matrices reduce both weight and space. But Siemens rejected that approach because the folding process can cause problems that adversely affect output signals.

Stacked. Using its new stacked assembly technique, Siemens has built ferrite core memories with up to 12 64-by-64-bit planes. Density is one bit per cubic millimeter. The company is developing a 32-plane buffer memory with 128 by 128 bits per plane. With a capacity of more than 500,000 bits, the unit, designed for space applications, will weigh less than 1 pound and will measure only 5 by 5 by 1.5 inches.

In a typical Stapelblock memory the carrier plates for the ferrite cores are sandwiched between a base plate at the bottom and a thin cover plate on top which protects the whole stack. The carrier, base, and top plates are made of either a ceramic material or a ceramic-metal combination, depending on how the memory's impedance or heat dissipation characteristics are specified.

For attaching the cores, Siemens uses a silicone rubber that doesn't set up mechanical stress across the entire specified temperature range, eliminating magnetostrictive effects. On the other hand, the ad-

hesive loads the cores just enough so that, under unfavorable conditions, pulses can not set off magnetostrictive oscillations.

France

Handyman's microprogram

France's Thomson-CSF, through its Cofelec subsidiary, is set to market a new read-only waffle-iron memory whose high speed and low cost open new possibilities for computer designers.

What's more, Cofelec will offer a do-it-yourself kit allowing users to build their own microprogram modules with a minimum of equipment in a few days' time and at a cost of only a half-cent to one cent per bit. Custom-made semiconductor ROM modules—the Cofelec unit's only real competitor so far—cost around \$1 per bit and take a well-equipped professional laboratory months to produce, say Cofelec engineers. The French memory thus offers users an opportunity to build large libraries of microprograms, greatly increasing the flexibility of their computers.

Companions. The first new computer designed to accept the memory is on its way. It's a mini-machine developed by another Thomson-CFS subsidiary, Compagnie Internationale pour l'Informatique, and will debut in September.

Aimed primarily at the process control market, the CII computer will have a mainframe memory of 4,096 12-bit words made of ferrite cores. Four interchangeable Cofelec ROM memory modules will give microprogramming capacity of 512 16-bit words.

Another French company is designing a process-control computer with 1,024 12-bit words around the Cofelec memory. Furthermore, a French government agency is working on a machine with 2,048 64-bit word using the new ROM, and a German company is developing a similar machine.

Pierre Meunier, a Cofelec engineer, will tour the U.S. in September, showing the new memory to American computer makers and



Building blocks. Cofelec's ROM is built up of snap-out modules.

looking for a U.S. firm to build it under license. Meunier, with engineer Tran Van Khai, headed a three-year design program that was partly financed by CII.

On the surface the new memory resembles waffle-iron destructive read-and-write units developed by Litton Industries and Standard Telecommunications Laboratories. [*Electronics*, Jan. 19, pp. 102 and 107]. All include a magnetic thick-film layer placed over a slotted ferrite waffle-iron base.

Bare spaces. But instead of a continuous magnetic film, the French memory uses a permalloy layer that has been photo-etched to produce a pattern of rectangles and bare spaces. Each rectangle covers two groove intersections in the waffle iron and represents a binary 1.

The ferrite base contains 0.004-inch grooves spaced 0.011 inch apart. Interlaced in these grooves are word and bit wires, and a common d-c bias wire runs along the bit wires.

When a 70-milliampere bias current is passed through the memory, it magnetizes the permalloy rectangles in the easy axis. During readout a current pulse is sent through the selected word, creating a magnetic field which rotates bit magnetization toward the hard axis. When the word pulse ends, the bias field returns magnetization to the steady state. The memory

thus is mechanically but not electrically alterable. Access time is 70 nanoseconds and its cycle time is 100 nsec.

Kit. The do-it-yourself kit includes a paper grid, 10 times larger than the permalloy film. The user marks an X on squares in the paper grid where he wants a binary 1. He then places a transparent Mylar sheet over the paper grid and puts masking tape over the marked rectangles. By photographic reduction, the pattern is scaled down to size on a glass plate. The rest of the process resembles integrated circuit fabrication.

Japan

Repeating at 20 Ghz

Repeaters working in the 20-gigahertz band are being developed in Japan for use with videotelephone communication links. In another step toward millimeter systems,

engineers at the Electrical Communication Laboratory of the Nippon Telegraph and Telephone Public Corp. have pushed transmission rates to 400 megabits.

The company, which operates Japan's telephone network, needs new transmission methods both to handle the increasing volume of data and video telephone information and to provide alternate routes to prevent a disaster from completely stopping communications.

Channels. NTT already is operating radio repeater systems in the 2-, 4-, 6-, 11-, and 15-Ghz bands. These bands are largely filled by a high-density communications network, and do not have sufficient bandwidth for video telephones, which generally take up more than 100 voice channels. The 400-megabit modulation of the new system yields 5,760 telephone channels, or about 48 video units.

In the 20-Ghz band there is a 3.3-Ghz bandwidth available between 17.7 and 21 gigahertz. This bandwidth is exceeded only by ex-

perimental millimeter waveguide and laser systems, both of which are further from being ready for commercial installation.

NTT engineers split the 20-Ghz band into two parts: 17.7 to 19.3 Ghz for transmission in one way and 19.4 to 21 Ghz the other way. Ten channels in each direction are created by using horizontally and vertically polarized signals at each of five frequencies to carry two separate channels. Each channel in the transmitter is two-phase modulated twice by 200-megabit signals to give 400-megabit four-phase modulation.

Because the transmission span becomes quite short—2 to 3 miles—at these high microwave frequencies, it is uneconomical to build repeaters in the same way as for standard microwave repeaters. Indeed, the steel towers for antennas and the buildings housing repeaters are not required because the high-frequency equipment can be much smaller. For example, the antenna diameter is only 6 feet, half the size of antennas used at commercial microwave frequencies. What's more, lower susceptibility to interference can increase route density because a greater number of parallel systems can be operated. Development work is under way on improved antennas with reduced side and back radiation that can be mounted back to back.

Pole sitting. The repeaters are designed to be attached to the back of the antenna. Thus the entire repeater can be mounted on top of a pole. The new NTT repeaters won't extend present techniques, but will use new semiconductor devices—including Gunn diodes, Impatt diodes, and hybrid microwave and monolithic IC's. For example, typical transmitters use Gunn oscillators operating directly at the carrier frequency. The carrier is four-phase modulated by two two-phase diode modulators, and then is amplified by an Impatt diode device. The Impatt diode operates as an oscillator phase locked to the modulated carrier; it amplifies because its output is at a higher level than, but with precisely the same frequency and phase as, the locking signal.

Around the world

Okinawa. Fairchild Semiconductor has leased about 7 acres of land in central Okinawa and plans to make semiconductor devices there by 1972, when it will employ about 1,000 people in a new plant. The company now employs about 50 people in Okinawa to test semiconductors. The move is a bit of a gamble. It's far from certain that Fairchild will be able to retain 100% ownership of such an operation when Okinawa is returned to Japan.

Great Britain. Varian Associates will use its Scottish plant at Donibristle as computer manufacturing center for the British, European, Middle Eastern, and African markets. Assembly of the Data 620 from U.S.-made components has started, at a five-per-month rate.

Sweden. A sharp sales slowdown and a shortage of components is plaguing color tv receiver makers in Scandinavia. Last year at this

time, Swedes were buying more color sets than any Europeans, and it was estimated that 250,000 color receivers would be sold in 1970. This estimate has been cut back several times—and today's estimate is only 150,000. An increase in value-added taxes as well as tight credit are two reasons for the sales drop. Meanwhile, makers are screaming for components. Philips components sales people in Sweden say that makers last year underestimated their needs by between 30 and 40%.

West Germany. IBM, number one computer maker in Germany, soon will start its fourth production plant there. This fall the company will break ground for a big plant at Hanover for data processing equipment components. Eventually, semiconductors will also be fabricated there. The company's existing production facilities in Germany are located at Sindelfingen, Mainz and West Berlin.

PRETTY FACE FORCE

Sure our women are pretty. But in the Mountain West, they have a little something more going for them. Education.

In Utah the girls go to school longer than anywhere else in the country.* But then, so do the boys.

So when they do get out, they're brighter, better educated. More stable too.

When you add all those together you come up with a labor force that's more than just a pretty face. It's a pretty way to face the future.

If you're looking for a labor pool that promises profit, remember, in Utah, we deliver.

*The average Utah adult has completed 12.2 years of schooling, compared with the national average of 10.5 years. Source: *Rankings of the States in 1969*, published by the National Education Association.



For more information on Utah's Pretty Face Force, write:

Ask for our new 28 page Brochure

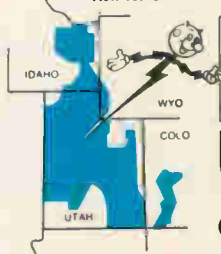

"A Treasure Chest in the Growing West"

Wayne F. Mulcock
Director, Area Development
P.O. Box 899, Dept. E-2a
Utah Power & Light Co.
Salt Lake City, Utah 84110

Utah Power & Light Co.

Circle 141 on reader service card



YOU'RE WHISTLING IN THE DARK...

if you think that heart disease and stroke hit only the other fellow's family.

**GIVE ... so more will live
HEART FUND**



Contributed by the Publisher

CIRCUIT DESIGNERS and MECHANICAL ENGINEERS

We need BSEE's with experience in "on-the-bench" linear circuit design for video, deflection, and pulse circuits. Project level responsibility.

Call collect, or write:
Al Busch, Director of Engineering, Sarkes Tarzian, Inc.,
Bloomington, Ind. 47401.
AC 812/332-7251



Live in Bloomington, Indiana, home of Indiana University, just ten minutes from the largest lake in Indiana. Unsurpassed opportunity for intellectual and leisure time activities.

Advertising Sales Staff

Pierre Braudé [212] 971-3845
Advertising Sales Manager

Atlanta, Ga. 30309: Charlton H. Calhoun, III
1375 Peachtree St., N.E.
[404] 892-2868

Boston, Mass. 02116: William S. Hodgkinson
McGraw-Hill Building, Copley Square
[617] CO 2-1160

Chicago, Ill. 60611: Ralph Hanning,
Kenneth E. Nicklas, 645 North Michigan
Avenue, [312] MO 4-5800

Cleveland, Ohio 44113: William J. Boyle,
55 Public Square, [216] SU 1-7000

Dallas, Texas 75201: Richard P. Poole,
1800 Republic National Bank Tower,
[214] RI 7-9721

Detroit, Michigan 48226: Ralph Hanning,
2600 Penobscot Building
[313] 962-1793

Houston, Texas 77002: Richard P. Poole,
2270 Humble Bldg. [713] CA 4-8381

Minneapolis, Minn. 55402: Kenneth E. Nicklas,
1104 Northstar Center [612] 332-7425

New York, N.Y. 10036
500 Fifth Avenue
James R. Pierce [212] 971-3615
Warren H. Gardner [212] 971-3617
Michael J. Stoller [212] 971-3616

Philadelphia, Pa. 19103:
Jeffrey M. Preston
6 Penn Center Plaza,
[215] LO 8-6161

Pittsburgh, Pa. 15222: Jeffrey M. Preston,
4 Gateway Center, [412] 391-1314

Rochester, N.Y. 14534: William J. Boyle,
9 Greylock Ridge, Pittsford, N.Y.
[716] 586-5040

St. Louis, Mo. 63105: Kenneth E. Nicklas,
The Clayton Tower, 7751 Carondelet Ave.
[314] PA 5-7285

James T. Hauptli [415] DO 2-4600
Western Advertising Sales Manager

Denver, Colo. 80202: David M. Watson,
Richard W. Carpenter
Tower Bldg., 1700 Broadway
[303] 266-3863

Los Angeles, Calif. 90017: Ian C. Hill,
Bradley K. Jones, 1125 W. 6th St.,
[213] HU 2-5450

Portland, Ore. 97204: Don Farris,
James T. Hauptli, 218 Mohawk Building,
222 S.W. Morrison Street,
Phone [503] 223-5118

San Francisco, Calif. 94111: Don Farris,
James T. Hauptli, 255 California Street,
[415] DO 2-4600

Paris: Denis Jacob
17 Rue-Georges Bizet, 75 Paris 16, France
Tel 727 33 42, 727 33 60

United Kingdom and Scandinavia
London: Oliver Ball, Tel: Hyde Park 1451
34 Dover Street, London W1

Milan: Robert Saidel, Roberto Laureri Jr.
1 via Baracchini Phone 86-90-656

Brussels: Denis Jacob
27 Rue Ducale Tel: 136503

Frankfurt/Main: Hans Haller
Elsa-Brandstroem Str. 2
Phone 72 01 81

Tokyo: Noboru Matsumoto, McGraw-Hill
Publications Overseas Corporation,
Kasumigaseki Building 2-5, 3-chome,
Kasumigaseki, Chiyoda-Ku, Tokyo, Japan
[581] 9811

Osaka: Akihiko Kamesaka, McGraw-Hill
Publications Overseas Corporation, Kondo
Bldg., 163, Umegae-cho Kita-ku [362] 8771
Australasia: Warren E. Ball, IPO Box 5106,
Tokyo, Japan

Business Department

Stephen R. Weiss, Manager
[212] 971-2044

Thomas M. Egan,
Production Manager [212] 971-3140

Dorothy Carmesin, Contracts and Billings
[212] 971-2908

Frances Vallone, Reader Service Manager
[212] 971-2865

New! Zenith's colorful two gun CRT

Where precise, high resolution color displays are essential, Zenith Dual Neck, Flat-Face Two Color CRTs offer the best answer. Independent operation of two guns allows different scan formats and rates without the need of complex switching circuits . . . assuring excellent color purity from edge to edge. Details are easily separated by variations of vivid color. For specifications, write for Zenith's new Dual Neck product file.



ZENITH RADIO CORPORATION
THE RAULAND DIVISION

5614 W. JARVIS AVE. • CHICAGO, ILL. 60648 • 312-647-8000

Circle 142 on reader service card

Paris: Denis Jacob
17 Rue-Georges Bizet, 75 Paris 16, France
Tel 727 33 42, 727 33 60

United Kingdom and Scandinavia
London: Oliver Ball, Tel: Hyde Park 1451
34 Dover Street, London W1

Milan: Robert Saidel, Roberto Laureri Jr.
1 via Baracchini Phone 86-90-656

Brussels: Denis Jacob
27 Rue Ducale Tel: 136503

Frankfurt/Main: Hans Haller
Elsa-Brandstroem Str. 2
Phone 72 01 81

Tokyo: Noboru Matsumoto, McGraw-Hill
Publications Overseas Corporation,
Kasumigaseki Building 2-5, 3-chome,
Kasumigaseki, Chiyoda-Ku, Tokyo, Japan
[581] 9811

Osaka: Akihiko Kamesaka, McGraw-Hill
Publications Overseas Corporation, Kondo
Bldg., 163, Umegae-cho Kita-ku [362] 8771
Australasia: Warren E. Ball, IPO Box 5106,
Tokyo, Japan

Business Department

Stephen R. Weiss, Manager
[212] 971-2044

Thomas M. Egan,
Production Manager [212] 971-3140

Dorothy Carmesin, Contracts and Billings
[212] 971-2908

Frances Vallone, Reader Service Manager
[212] 971-2865



NORTON[®]
MAGNETIC
HEADS

MULTITRACK
ERASE
RECORD
PLAY

Send now for complete technical literature.

NORTON
ASSOCIATES, INC.

10 Di Tomas Court, Copiague, N.Y. 11726
Phone: 516 598-1600

WHOLESALE TO ALL

Breadboard Kits—"RF" Kits—
"PC" Kits—Perf. Phenolic
Board—Copper Clad board—
Cowl Type Electronic Cabinets
—Heat Sinks—Solid State
Hobby Kits—Solderless Con-
nectors—Hardware Kits—
Transistor Sockets and many
other items. (Products ap-
proved by the Defense Sup-
ply Agency—Federal Supply
Code number furnished upon
request.) Send for free cata-
log from:

H. M. C. SALES
P.O. Box 276
Santa Susana, Calif. 93063

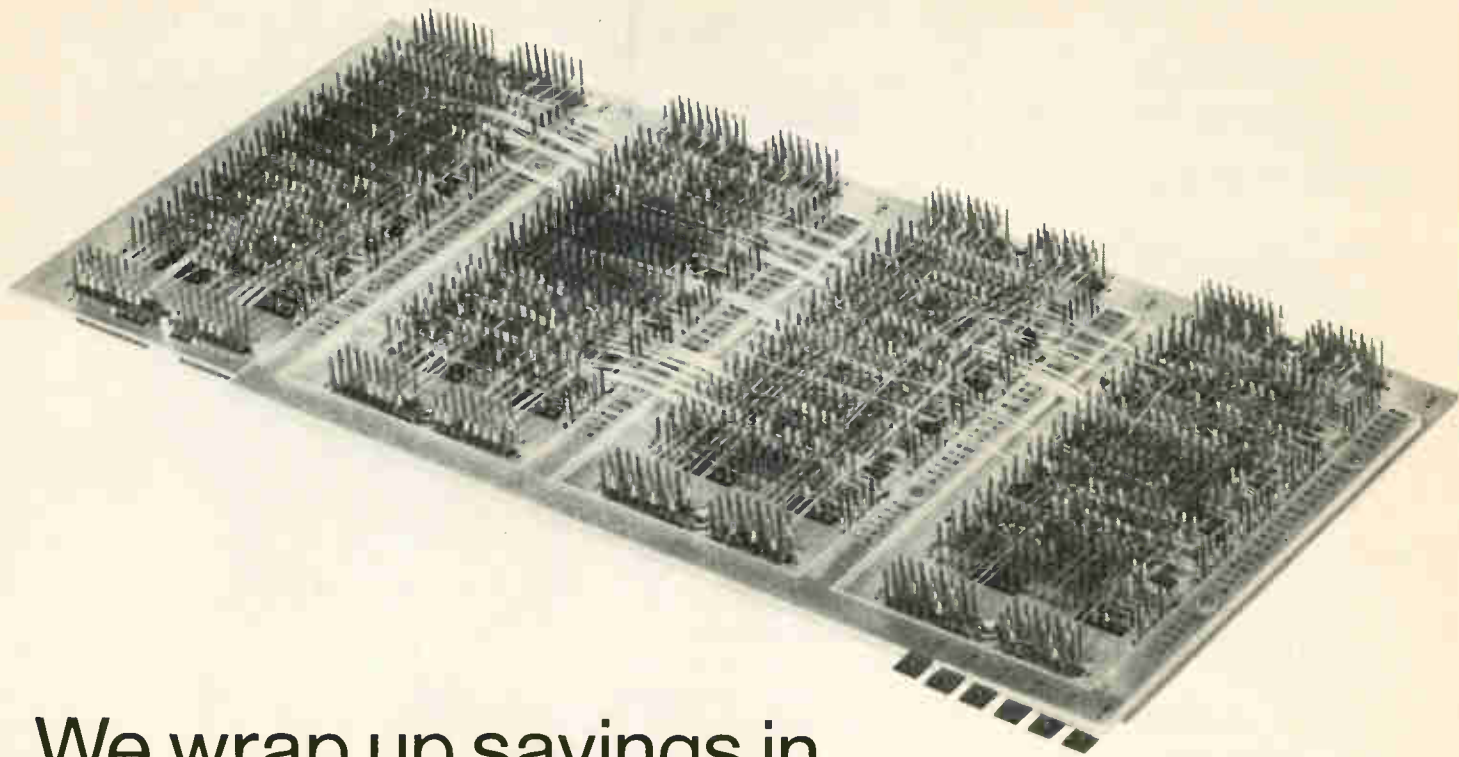

We wrap up savings in interconnection packages three important ways.



Hand wrapping



Semi-automatic machine wrapping



Fully automatic Gardner Denver machine wrapping

Our "Total Packaging Service" has helped a lot of our customers save a lot of time and money. And it's helped make us the largest manufacturer of metal plate back panel interconnection systems.

It's complete interconnection system packaging from design to wire wrap termination.

We deliver in six weeks.

That's it in a nutshell. Now, here's how it works:

You can call us in on the design stage. We'll sit down with you and help design a p.c. board or frame or metal plate back panel system to do exactly what you want it to do. With our experience we can save you problems. And problems cost money.

Next come the connectors. We have all you're likely to require; several hundred thousands of them. All standard. Maybe they used to be special, but now they're standard. You save again. For square or offset grids. On .100", .125", .150", or .200" centers. Or non-standard configurations if you need them.

And, finally, your wire termin-

ations. (You could send us your back panels and your wire list even this late in the game and we could still save you enough money to make it worth your while.)

You have three choices here: hand wrapping, semi-automatic machine wrapping, or fully automatic Gardner Denver machine wrapping. We handle the computer programming for the automatic and semi-automatic wire wrapping so you get not only accuracy, but minimum wire lengths and densities, too. You save again.

Add it up: three important ways you can save on your back panel interconnection systems. And we haven't even mentioned the remote possibility (perish the thought) of something not being quite right with the final package. Single source responsibility can save you all kinds of time and money.

For the rest of the details, call our Interconnections Manager, Jim Scaminaci, at (213) 675-3311, Ext. 235. Collect. Or write Elco Corporation, Willow Grove, Pennsylvania. 19090. (215) 639-7000. TWX 510-665-5573



ELCO Interconnection Systems

New LC Series power package IC regulated Modular Power Supply

The LCS-A is another package in the LC series of 5 package sizes providing single and dual outputs; wide range of d-c voltages, up to 150 volts; wide range of currents, up to 3.0 amps; priced from \$99.00.

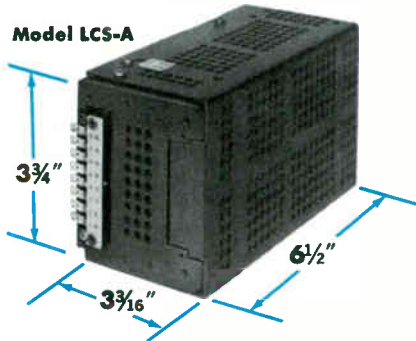

All-silicon DC power supply using integrated circuits to provide regulation system

Convection cooled

no external heat sinking required

Regulation

line or load .01% + 1 mv

Ripple and noise

250 μ v rms; 1 mv p-to-p

Wide input voltage and frequency range

105-132 vac, 47-440Hz

Wide temperature range

-20°C to +71°C

Temperature coefficient

.01% + 300 μ v/°C external programming resistor

.015% + 300 μ v/°C internal programming resistor

Remote programming

1000 ohm/v nominal or volt/volt

Remote sensing

Automatic current limiting

Series/parallel operation

with similar single or dual units

Multi-current-rated

Complete serviceability

Overvoltage protection

available as accessory up to 70 vdc

Other LC models are available with single and dual outputs and these voltage and current ranges:

LCS-1	to 120 vdc,	to 275 ma.,	from \$ 70
LCS-2	to 120 vdc,	to 550 ma.,	from \$ 80
LCS-3	to 60 vdc,	to 1.2 a.,	from \$ 90
LCS-4	to 150 vdc,	to 4.5 a.,	from \$130
LCD-2	to 120 vdc,	to 300 ma.,	from \$125
LCD-3	to 60 vdc,	to 700 ma.,	from \$150
LCD-A	to 120 vdc,	to 1.0 a.,	from \$155
LCD-4	to 120 vdc,	to 1.8 a.,	from \$190

"S" denotes single, "D" denotes dual output.

LCS-A SINGLE OUTPUT MODELS (Fixed Voltage)



3 3/16" x 3 3/4" x 6 1/2"

MODEL	FIXED VOLT. RANGE VDC	MAX. AMPS. AT AMBIENT OF: ¹				PRICE ⁽²⁾
		40°C	50°C	60°C	71°C	
LCS-A-3	3±5%	3.0	2.5	2.0	1.4	\$99
LCS-A-3P6	3.6±5%	2.9	2.4	1.9	1.3	99
LCS-A-4	4±5%	2.9	2.4	1.9	1.3	99
LCS-A-4P5	4.5±5%	2.8	2.3	1.8	1.2	99
LCS-A-5	5±5%	2.7	2.3	1.8	1.2	99
LCS-A-6	6±5%	2.6	2.2	1.8	1.2	99
LCS-A-8	8±5%	2.4	2.0	1.7	1.1	99
LCS-A-10	10±5%	2.1	1.8	1.5	1.0	99
LCS-A-12	12±5%	1.9	1.7	1.3	0.9	99
LCS-A-15	15±5%	1.8	1.5	1.2	0.9	99
LCS-A-18	18±5%	1.6	1.3	1.1	0.8	99
LCS-A-20	20±5%	1.4	1.2	1.0	0.8	99
LCS-A-24	24±5%	1.1	1.0	0.85	0.70	99
LCS-A-28	28±5%	1.0	0.9	0.75	0.60	99
LCS-A-36	36±5%	0.90	0.80	0.70	0.50	99
LCS-A-48	48±5%	0.60	0.55	0.50	0.45	99
LCS-A-100	100±5%	0.18	0.18	0.18	0.18	109
LCS-A-120	120±5%	0.15	0.15	0.15	0.15	109
LCS-A-150	150±5%	0.10	0.10	0.10	0.10	109

LCS-A SINGLE OUTPUT MODELS (Wide Range)



3 3/16" x 3 3/4" x 6 1/2"

MODEL	ADJ. VOLT. RANGE VDC	MAX. AMPS. AT AMBIENT OF ¹				PRICE ⁽²⁾
		40°C	50°C	60°C	71°C	
LCS-A-01	0-7	2.0	1.9	1.6	1.1	\$99
LCS-A-02	0-18	1.1	1.0	0.9	0.7	99
LCS-A-03	0-32	0.69	0.64	0.60	0.45	99
LCS-A-04	0-60	0.37	0.34	0.31	0.25	99
LCS-A-05	0-120	0.10	0.10	0.10	0.10	109

NOTES: (1) For operation at 360-440Hz, consult factory for ratings and specifications.

(2) Prices are USA list prices only, FOB Melville, N.Y.; North Hollywood, Calif.; Montreal, Canada. All prices and specifications are subject to change without notice.

(3) The following charges are applicable for shipment from other than Melville, N.Y.:

Value of Order

up to \$50.00
\$51.00 to \$180.00
\$181.00 to \$300.00
\$301.00 to \$500.00
\$501.00 and over

Handling Charge

\$1.00
\$2.00
\$4.00
\$6.00

FOB Melville, N.Y. only

Lambda's Distributor Division maintains a total inventory of over 10,000 power supply units located in Los Angeles, Montreal and New York for 1-day delivery - 5 year guarantee.

Write for complete Lambda Catalog!

Lambda Electronics Corp., 515 Broad Hollow Road, Melville, Long Island, New York 11746 • Tel. 516-694-4200

RCA DISPLAY TUBES DELIVER CLEAR,

BRIGHT VISUAL INFORMATION ... LOOK!

USE RCA DISPLAY TUBES FOR ALL TYPES OF VISUAL INFORMATION: ALPHA-NUMERIC -- WAVEFORMS -- PICTORIAL -- AND COMBINATIONS. READOUT IN 2-COLORS PLUS IN-BETWEEN SHADES ON 1-GUN CRTS. THEY EXPAND COMMUNICATIONS POSSIBILITIES IN AIR TRAFFIC CONTROL SYSTEMS, MILITARY IFF SYSTEMS, STOCK MARKET QUOTATION DISPLAYS, TRANSPORTATION STATUS BOARDS, TEACHING MACHINES AND ELECTRONIC TEST INSTRUMENTS.

Ask your local RCA Representative or RCA Industrial Tube Distributor for more information on these tubes which add new dimension to computer readout. For technical data, write: RCA Electronic Components, Commercial Engineering, Section 70G-6/ZC-3, Harrison, N.J. 07029. International: RCA, 2-4 rue du Lièvre, 1227 Geneva, Switzerland, or Post Office Box 112, Hong Kong.

RCA