

Shifting more bits faster 84

\$1.00 A McGraw-Hill Publication

IC stabilizes power supply 91

December 8, 1969

Microwave acoustics: materials and circuits 102

Electronics®

F
 INTERDIGITATED
 T R
 S PERFECT
 W
 I
 N
 S

JOHNSON

14Z K55956 44R06 02-71
 R KISSLER
 BASIC COM ELEC
 BOX 956
 MOSES LAKE WA 98827

be a
namedropper...



tell the world your exclusive

MICRO HANDLER®

AUTOMATIC HANDLING SYSTEM FOR SEMICONDUCTOR DICE

comes from

BULOVA



In the Model 85002 MICRO HANDLER® (shown at left) dice are bulk-loaded into a vibratory feeder. They are faced pattern-side down in the feed track and rotated to a known orientation at subsequent stations prior to being placed onto the test probes which are connected to your electronic tester. A simple signal to the MICRO HANDLER® will cause the die to be automatically placed in one of nine (or more) vials for easy removal.

- Thruput rate of up to 7200 devices per hour.
- Accommodates both flip-chip and planar devices.
- Dice ranging in size from 20 to 250 mils (square or rectangular) can be processed.
- Models offering automatic magazing and other features are also available.

For prices and additional information, contact:
AUTOMATION SALES DEPARTMENT

BULOVA
WATCH COMPANY, INC.

SYSTEMS AND INSTRUMENTS DIVISION

GREEN ACRE RD. WEST, VALLEY STREAM, N.Y. 11582 | 516 - 561-2600 | TWX 510 - 225-8409

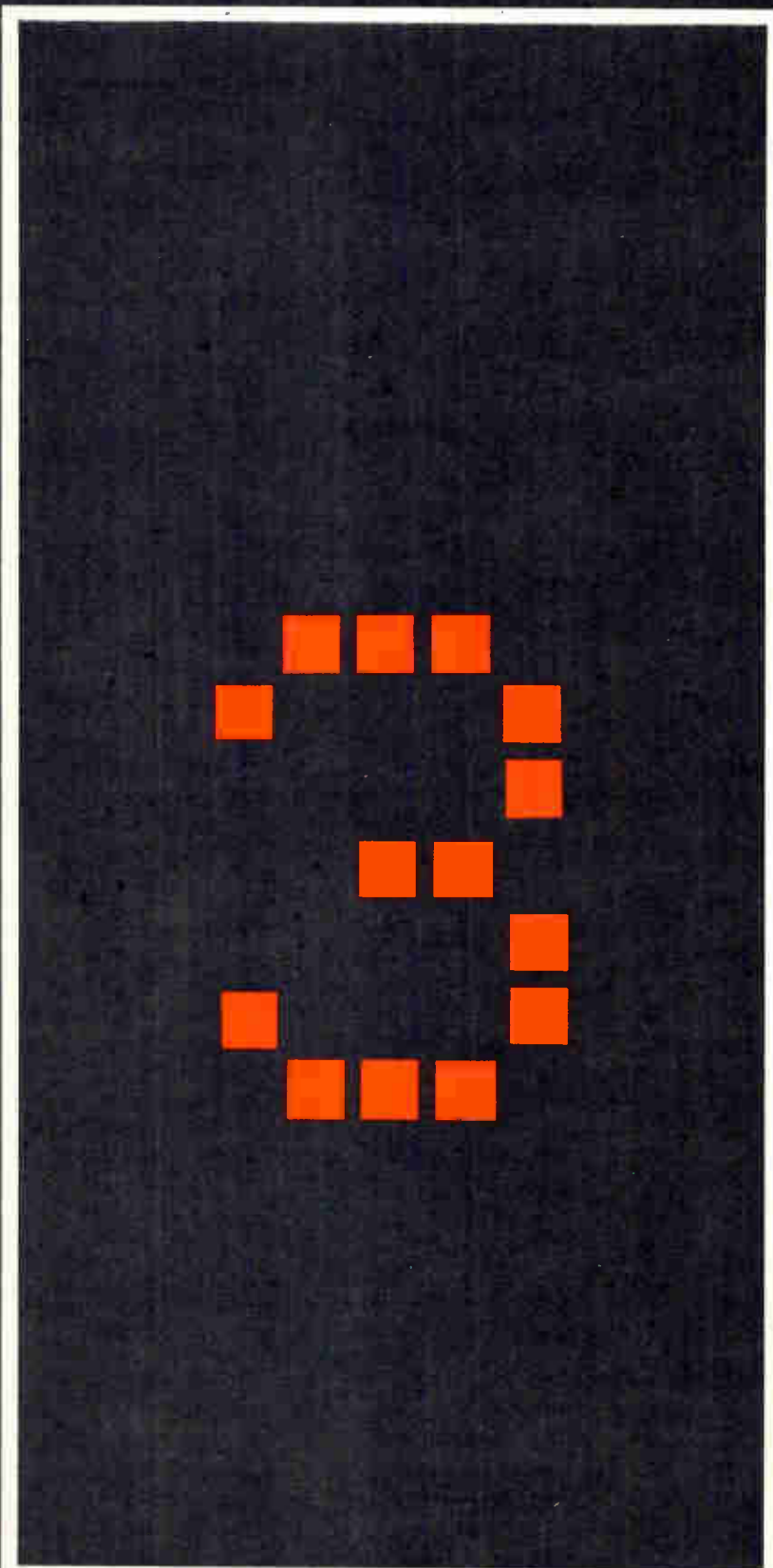

Display of strength

There are several sound reasons to use our solid state numeric displays. One of the most important is this: they're so strong, they won't die of shock. So they can be used in the most demanding applications.

Another decisive factor is size: each display package measures just 1"x 0.5"x 0.16". And that's all there is to it. In this tiny framework, you get everything necessary to display numerals 0-9. The chip includes an IC driver/decoder and gallium arsenide phosphide diodes that make the bright red numerals visible clear across a room, even at an acute angle.

The display needs less than 5 volts to drive it, and takes a straightforward four line 8-4-2-1 BCD input. You can vary the brightness. And, as the modules are IC compatible, no special interfacing is required. You can buy our solid state numeric display in three-character packages, as well as the solo component. And our small displays of strength cost just \$42 each in 1000 quantities.

For all the bright details about this new technology for numeric indicators, call your local HP field engineer. Or write Hewlett-Packard, Palo Alto, California 94304; Europe: 1217 Meyrin-Geneva, Switzerland.

HEWLETT  PACKARD

SOLID STATE DEVICES

Circle 1 on reader service card

Pulse problems change and change and change and change.....and

so does the 1900 pulse system

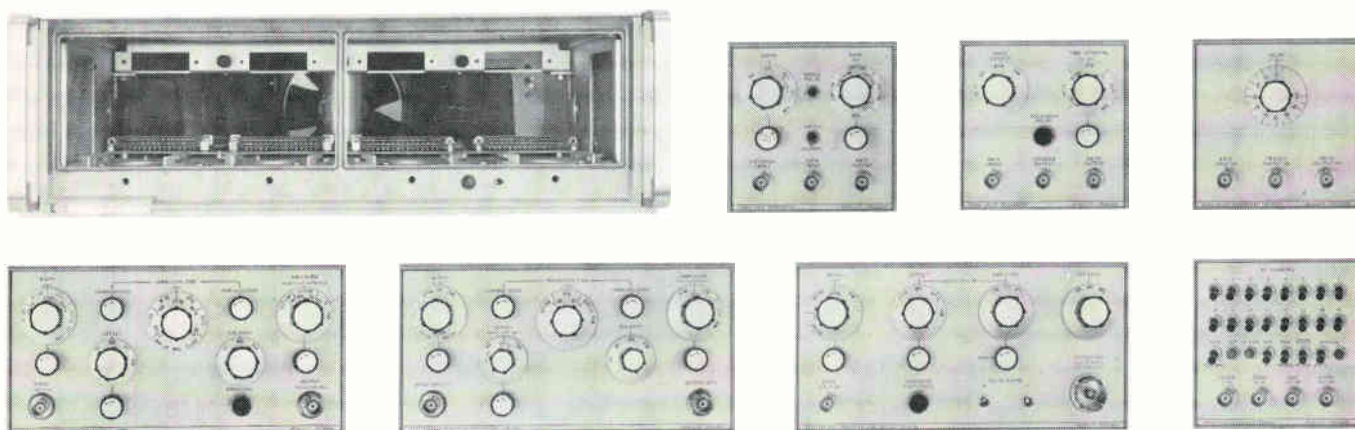

HP's brand new solution for people with pulse problems is a set of multi-purpose building blocks. You put what you want in your pulse generating system. With the HP 1900 Pulse System, you start with a standard mainframe that contains only power supplies and optional programming wiring.

Where do you go from there? That's up to you. HP is currently offering seven different functional plug-ins with more to come later. You can start with a relatively simple system and add to it as your needs change. Even complex pulse systems can be formed easily by using several mainframes and appropriate plug-ins.

Just to give you an idea of the capability of the 1900 system, here is a very brief description of the 7 existing plug-ins and some of their capabilities. And, keep in mind that the optional programming wiring allows you to make the 1900 completely automatic!

HP 1905A Rate Generator—provides output triggers variable in fre-

quency from 25 Hz to 25 MHz; it includes a pushbutton for single pulse triggers. (\$200)

HP 1908A Delay Generator—delays or advances pulses up to 25 MHz over a range of 15 ns to 10 ms and includes a double pulse mode. (\$200)

HP 1910A Delay Generator—pulses up to 125 MHz can be delayed from 5 to 100 ns in 5 ns steps. It has a 3 ns risetime and sufficient output to drive two variable transition time output plug-ins. (\$150)

HP 1915A Variable Transition Time Output—varies pulse risetime and falltimes from 7 ns to 1 ms and output currents from 40 mA to 1A, amplifies RZ or NRZ word formats. (\$1600)

HP 1917A Variable Transition Time Output—varies pulse risetime and falltimes from 7 ns to 500 μ s, amplifies RZ or NRZ word formats, 0.2 to 10 V amplitude at frequencies up to 25 MHz. (\$525)

HP 1920A Pulse Output—provides very fast 350 ps fixed risetime and 400 ps falltime with variable width and 0.5 to 5 V amplitude. Reversible

polarity and offset capability. (\$1750)

HP 1925A Word Generator—provides 2 to 16-bit words, RZ or NRZ format at frequencies to 50 MHz. Has remote programming and pseudo-random noise sequence generation capabilities. (\$850)

Two mainframes—are available to let you select the one that best meets your power requirements. Price: HP 1900A Mainframe, \$750; HP 1901A Mainframe, \$450.

Put together the system that best fits your needs. No other pulse system will do so much, so well—at such an economical cost! For more information, contact your local HP field engineer. Or, write to Hewlett-Packard, Palo Alto, California 94304. Europe: 1217 Meyrin-Geneva, Switzerland.

089/8

HEWLETT  PACKARD
S I G N A L S O U R C E S

News Features

Probing the News

- 137 **Industrial electronics:** Jumble of electronics, instruments keeps pollution monitoring hazy
- 149 **Government:** Practical research gets emphasis at NASA's ERC

U.S. Reports

- 41 **Computers:** Automating Congress is big deal with a catch
- 41 **Contracts:** Drone system worth \$50 million with no R&D
- 43 **Medical electronics:** Measuring blood pressure ultrasonically
- 43 **Components:** Navy's standard hardware to have 2 million items
- 44 **Avionics:** Converting inertial navigators; LSI for Ioran C/D
- 48 **Military electronics:** Field tests for Stano gear
- 50 **Communications:** Opening some spectrum space; application for digital common carrier
- 50 **Space electronics:** Will L-band need new satellite?

Electronics International

- 237 **Western Europe:** Mammoth computer project a step closer
- 238 **Japan:** Television camera adjusts for image motion
- 239 **West Germany:** MOS process takes steps off surface

New Products

- 169 **In the spotlight**
- 169 Liquid laser goes commercial
- 174 Lorgnette for color, 3-D display
- 179 **Components review**
- 179 4-pole relays fit in TO-5 can
- 182 Proximity switch sets new limits
- 187 **Instruments review**
- 187 Making any scope a storage scope
- 188 A-D converter has keyed clock
- 191 **Microwave review**
- 191 Sweeper covers 10 Mhz—18 Ghz
- 192 Log amp has 80 Mhz bandwidth
- 195 Avalanche source puts out 250 mw
- 197 **Production equipment review**
- 197 Relay analyzer tests and tells
- 202 MOS-array tester run by computer
- 207 **Industrial electronics review**
- 207 Spectrometer for fast analysis
- 208 Gage provides digital readout
- 210 **New Materials**

Technical Articles

- Solid state** 84 **At last, a bipolar shift register with the same bit capacity as MOS**
At 1,000 bits per wafer, discretionary wired bipolar IC's not only match MOS circuits in complexity but also surpass them in shift rate with no need for data refreshing; speeds of 40 Mhz are possible
Roger Dunn and Glenn Hartsell, Texas Instruments
- Circuit design** 88 **Designer's casebook**
- Multivibrators separate pulses according to their widths
 - D-a converter switches digital inputs with TTL gates
 - Capacitor discharge sets shape of ramp function
- German IC's** 91 **Multi-emitter IC's stabilize voltages in solid state tuners**
With inherent temperature compensation, monolithic devices eliminate expensive zener diode matching in discrete units and offer better performance characteristics
Dieter Eckstein and Heiner Schmidt, Valvo GmbH
- Materials** 94 **Connecting aluminum wire reliably**
Some termination problems remain to be solved before aluminum can replace copper as the principal source of wiring material
Joseph Mittleman, Electronics staff
- Advanced technology** 102 **Amplifying acoustic surface waves**
Acoustoelectric interactions and acoustic waveguides provide active and passive signal processing devices—all on a chip
J.H. Collins and P.J. Hagon, Autonetics
- 114 **Matching FET's by design is faster and cheaper than by pick and choose**
Interdigitating two transistors on a chip assures a perfect match, thus avoiding testing and pairing of separate chips
Robert Christensen and Donald Wollesen, National Semiconductor Corp.

Departments

- | | | | |
|----|--------------------------------|-----|--------------------------|
| 4 | Readers Comment | 42 | Index to Activity |
| 7 | Who's Who in electronics | 65 | Washington Newsletter |
| 8 | Who's Who in this issue | 218 | Technical Abstracts |
| 22 | Meetings | 212 | New Books |
| 31 | Editorial Comment ^o | 226 | New Literature |
| 33 | Electronics Newsletter | 235 | International Newsletter |

Electronics

Editor-in-Chief: Donald Christiansen

Senior staff editors

Technical: Stephen E. Scrupski

News: Robert Henkel

International: Arthur Erikson

Art director: Gerald Ferguson

Senior associate editors: Joseph Mittleman, Harry R. Karp

Assistant managing editors: H. Thomas Maguire, Howard Wolff,

William Bucci, Richard Gundlach, Frederick Corey

Special projects editor: Roger Kenneth Field; Senior staff writer: John Johnsrud

Department editors

Advanced technology: Laurence Altman

Communications: Leon M. Magill

Computers: Wallace B. Riley, George Weiss

Design theory: Joseph Mittleman

Industrial electronics: Harry R. Karp

Instrumentation: Owen Doyle

Military/Aerospace: Alfred Rosenblatt

New products: William P. O'Brien

Solid state: George Watson, Stephen Wm. Fields

Field bureaus

Boston: James Brinton, manager; Gail Farrell

Los Angeles: Lawrence Curran, manager; Ralph Selph

New York: Peter Schuyten

San Francisco: Stephen Wm. Fields

Washington: Ray Connolly, manager; Robert Westgate, Lois Vermillion

Frankfurt: John Gosch

London: Michael Payne

Paris: Arthur Erikson

Tokyo: Charles Cohen

Copy editors: Edward Flinn, William S. Weiss

Assistant art director: Charles Ciatto

Production editors: Susan Hurlburt, Arthur C. Miller

Editorial research: Virginia Mundt

Editorial secretaries: Lorraine Longo, Claire Goodlin, Barbara Razulis, Vickie Green, Bernice Pawlak

McGraw-Hill News Service

Director: Arthur L. Moore; Atlanta: Fran Ridgway; Chicago: Robert E. Lee

Cleveland: Arthur Zimmerman; Dallas: Marvin Reid

Detroit: James Wargo; Houston: Barbara LaRoux

Los Angeles: Michael Murphy; San Francisco: Margaret Drossel, Tyler Marshall

Seattle: Ray Bloomberg; Washington: Charles Gardner, James Canan,

Herbert W. Cheshire, Seth Payne, Warren Burkett, William D. Hickman

McGraw-Hill World News Service

Bonn: Robert F. Ingersoll; Brussels: James Smith; Hong Kong: Kate Mattock

London: John Shinn; Mexico City: Gerald Parkinson; Milan: Jack Star

Moscow: Jack Winkler; Paris: Robert E. Farrell, Stewart Toy

Tokyo: Marvin Petal

Reprints: Virginia Mundt

Circulation: Isaaca Siegel

Reader communications manager: John Drummond

Publisher: Gordon Jones

Associate Publisher: Dan McMillan

Assistant to the publisher: Wallace C. Carmichael

Electronics: December 8, 1969, Vol. 42, No. 25

Published every other Monday by McGraw-Hill, Inc. Founder: James H. McGraw 1860-1948.

Publication office 99 North Broadway, Albany, N. Y. 12202; second class postage paid at Albany, N. Y. and additional mailing offices.

Executive, editorial, circulation and advertising addresses: Electronics, McGraw-Hill Building, 330 W. 42nd Street, New York, N. Y. 10036. Telephone (212) 971-3333. Teletype TWX, N.Y., 710-581-4235. Cable address: MCGRAW-HILL N.Y.

Subscriptions solicited only from those professionally engaged in electronics technology. Subscription rates: qualified subscribers in the United States and possessions and Canada, \$8.00 one year, \$12.00 two years, \$16.00 three years; all other countries \$25.00 one year. Non-qualified subscribers in the U.S. and possessions and Canada, \$25.00 one year; all other countries \$50.00. Air freight service to Japan \$50.00 one year. Single copies: United States and possessions and Canada, \$1.00; all other countries, \$1.75.

Officers of McGraw-Hill Publications Company: Joseph Allen, President; John R. Emery, J. Elton Tuohig, Senior Vice Presidents; Gordon L. Jones, Jr., Group Vice President; Vice Presidents: John R. Callahan, Editorial; Paul F. Cowie, Circulation; John M. Holden, Marketing; David G. Jensen, Manufacturing; Jerome D. Luntz, Planning & Development; Robert F. Marshall, Administration; Robert M. Wilhelm, Finance.

Officers of the Corporation: Shelton Fisher, President and Chief Executive Officer; John L. McGraw, Chairman; Robert E. Slaughter, Executive Vice President; Daniel F. Crowley, Donald C. McGraw, Jr., Bayard E. Sawyer, Senior Vice Presidents; John J. Cooke, Vice President & Secretary; Gordon W. McKinley, Vice President & Treasurer.

Title © registered in U.S. Patent Office; © Copyright 1969 by McGraw-Hill, Inc. All rights reserved. The contents of this publication may not be reproduced either in whole or in part without the consent of copyright owner.

Subscribers: The publisher, upon written request to our New York office from any subscriber, agrees to refund that part of the subscription price applying to copies not yet mailed.

Please send change of address notices or complaints to Fulfillment Manager; subscription orders to Circulation Manager, Electronics at address below. Change of address notices should provide old as well as new address, including postal zip code number. If possible, attach address label from recent issue. Allow one month for change to become effective.

Postmaster: Please send form 3579 to Fulfillment Manager, Electronics, P.O. Box 430, Hightstown, New Jersey 08520

Readers Comment

Free the market

To the Editor:

If the Government, instead of creating monopolies such as AT&T, refrained from interfering with the free market economy, there would be no need for regulatory agencies and their zealous guardians [Oct. 27, p. 134].

Given the freedom to compete, men would stake their reputations, their futures, and their fortunes on ideas for improving service, not by proposing or imposing them from a government office which is shielded from the full consequences of impractical decisions, but by putting them into operation. The promoters of successful ideas then would receive their well-earned financial rewards.

However, I rather suspect that FCC Commissioner Nicholas Johnson likes to have the governmental power to control and regulate without having to face the practical problems and the economic consequences of his decisions.

Ernst F. Germann

Austin, Texas

Heady experience

To the Editor:

I found the investigation of disk memory units [Oct. 27, p. 88] quite informative. An expanded description of the mechanical problems of shock and vibration would have been helpful. Most computer manufacturers have experienced the problem of crashing heads; the source and remedy of this problem could have been explained in more detail.

Another area of interest to me is the interface. I think that in addition to the anticipation logic, a description of other aspects of interfacing to a computer could have been explained.

Charles Wheelock

President,

Computer Logic Systems Inc.

North Billerica, Mass.

■ Author Boisvert has received many similar requests and is currently summarizing and evaluating them.

Buy resistors with built-in dependability...

Vitreous-enamel **BLUE JACKET[®]** **POWER WIREWOUND RESISTORS**



INFORMATION RETRIEVAL NO. 517

All-welded end-cap construction eliminates moisture along the leads, also anchors leads securely to resistor body. Expansion coefficients of vitreous enamel coating, ceramic core, and end caps are closely matched. Standard wattage ratings include 1, 2, 2.5, 3, 5, 7, 10, and 11 watts. Also available with radial tab terminals in ratings from 8 to 230 watts.

4SR-9145

Stop hunting for a smaller tantalum capacitor!

Zero in on **RED TOP[®]** MINIATURE **SOLID-ELECTROLYTE TANTALEX[®] CAPACITORS**

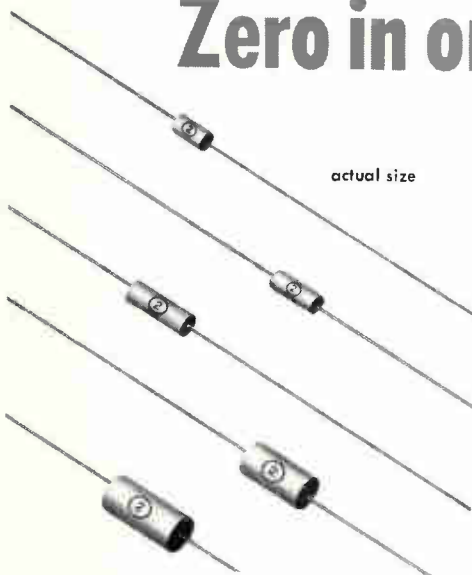

actual size

INFORMATION RETRIEVAL NO. 518

Expressly manufactured to fulfill the need for a micro-size capacitor of high volume efficiency, Red Top Capacitors are used in hybrid circuits and miniature modules where the ultimate in size and electrical performance is required at moderate prices. Red Top Capacitors meet the electrical and mechanical requirements of military, industrial, and commercial applications over the temperature range of -55°C to $+85^{\circ}\text{C}$. Standard working voltage range is from 2 to 100 VDC.

For information on Blue Jacket Resistors, request Engineering Bulletin 7410D. For information on Red Top[®] Miniature Tantalex[®] Capacitors, request Engineering Bulletin 3536A. Write to: Technical Literature Service, Sprague Electric Co., 35 Marshall St., North Adams, Mass. 01247.

4SC-9152



'Sprague' and '®' are registered trademarks of the Sprague Electric Co.

THE BROAD-LINE PRODUCER OF ELECTRONIC PARTS



Help exterminate the QUADRADECAPEDE!

West Concord, Mass. - Doctors here announced a cure for the virus streptocircuitus integratus, transmitted by the fourteen-legged logic bug and prime cause of inflamed logic and many chronic output diseases.

A statement released by the group said in part, "By using the new General Radio 1790 Logic-Circuit Analyzer, with all its active ingredients, we are now in a position to perform 100% functional testing — on even the most complex modules. The computer-controlled 1790 can test devices with as many as 96 inputs and 144 outputs, checking from a simple functional GO/NO-GO test to a detailed step-by-step analysis for the debugging of defective units, and the optional programmable logic levels permit marginal testing!

"For only \$32,500 we can't see why any user of printed-circuit boards or integrated arrays would be without one — especially since extensive programming knowledge isn't

required. The results have been overwhelming! In several thousand test cases we've been able to eliminate defective IC's and modules early in the game, thereby producing harmony, well-being, and great cost savings in production."

Help increase the yield and longevity of logic circuits! Write or phone for more information from General Radio Company, West Concord, Massachusetts 01781; telephone (617) 369-4400. In Europe write Postfach 124, CH 8034 Zurich 34, Switzerland. Price applies in U.S.A.

GENERAL RADIO

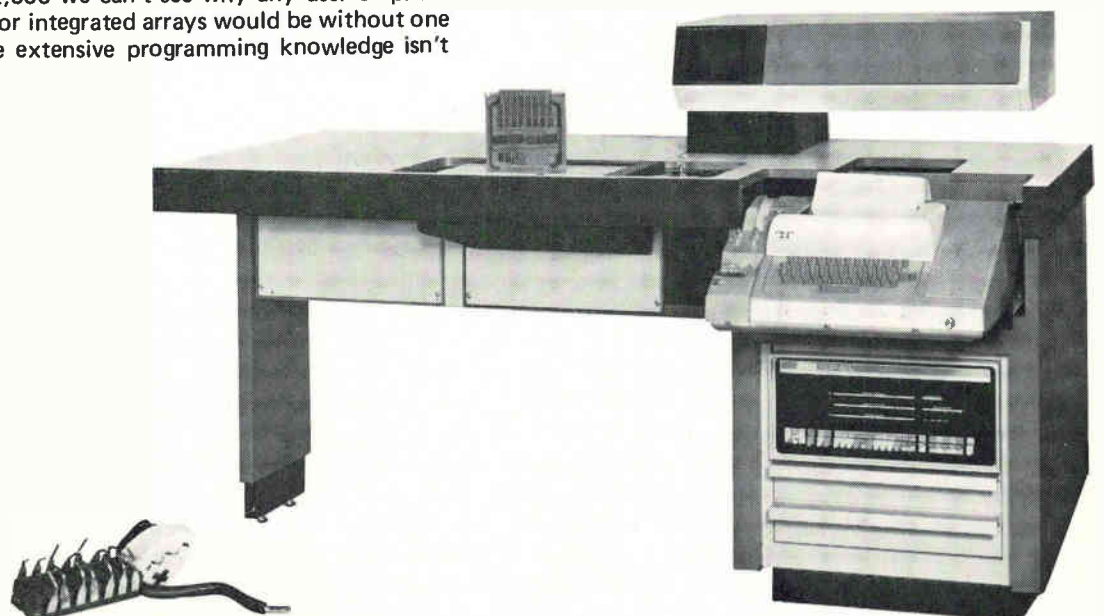



Robert Bower and Jack Hirshon

One man who's probably considering himself pretty lucky these days is Jack Hirshon. He has just been named manager of the Hughes Aircraft Co.'s new metal oxide semiconductor division, and believes a number of the factors that led Hughes to set up the division give it another shot at becoming a significant force in the semiconductor industry. Says the 41-year-old Hirshon, "From about 1956 to 1958 Hughes had a great reputation and a tremendous potential in semiconductors that was never fulfilled." It was the age-old problem of strong technology, weak production. "We have taken steps to change that image," Hirshon says.

No small role was played by George Smith, a vice president and director of the Hughes Research Laboratories at Malibu, Calif., who pressed for establishment of a solid state research department at the Newport Beach division. His objective was closer rapport between the labs, to which the department was assigned, and the semiconductor production operations at Newport Beach.

Together. The man picked to manage that department when it was established in January 1967 was appointed assistant manager of the MOS division at the same time Hirshon became its head. He

is Robert Bower, 33, who has worked on ion implantation in both MOS and microwave devices since 1965. Both Bower and Hirshon are convinced that ion implantation is going to give Hughes a speed advantage over the competition in MOS products [*Electronics*, Oct. 13, p. 52]—be they p-channel, n-channel, or complementary MOS.

The other key factors that Hirshon says contributed to the semiconductor rebirth at Hughes were the acquisition two years ago of Raytheon's MOS field effect transistor product line, some of its key people and MOS production know-how, plus the rapid expansion of the MOS market itself.

Hirshon says his marketing forecasters look for a total integrated circuit business of about \$1 billion by 1973, with \$200 million of that in MOS. "This is the median estimate," he points out, "and IMOS (ion-implanted MOS) could double the MOS share of the IC market. We're looking to be a major factor in this market."

Steps. The bearded Bower foresees this kind of technological evolution in MOS: the "now generation" of devices, as it were, is basically p-channel. The next generation, already gestating, will feature silicon gates, multilayer metal-

(Continued on p. 14)

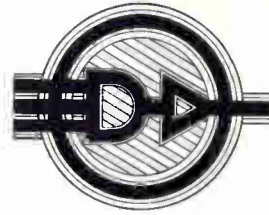

BINARY DECODE DRIVERS

Problem: Decode binary counter output into separate lines to drive indicator lamps or FET switches.

Solution: Siliconix D132L for the lamps, D129L for MOS FET switches. Both drivers provide four output channels, inputs are compatible with most TTL or DTL logic circuits, and outputs are capable of 50 volt switching.

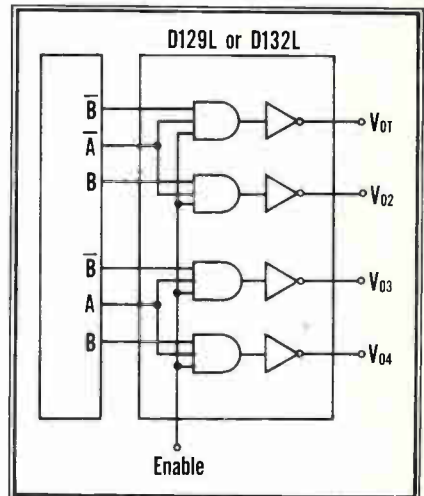

TRUTH TABLE					
Counter State		Output			
A	B	V ₀₁	V ₀₂	V ₀₃	V ₀₄
0	0	0	1	1	1
0	1	1	0	1	1
1	0	1	1	0	1
1	1	1	1	1	0

Write for complete data. For instant information and applications assistance, call the number below.

Siliconix
incorporated

2201 Laurelwood Rd. • Santa Clara, Calif. 95054
(408)-246-8000 Ext. 201 • TWX: 910-338-0227

* Applications Power: Providing the product and service to make your product serve better!

Who's Who in this issue



Christensen

Wollesen

FET vets describes Robert Christensen and Donald Wollesen, the National Semiconductor engineers who wrote the matched-FET story that begins on page 114. Christensen worked with FET's at Union Carbide and Fairchild before joining National; Wollesen was with Motorola and Philco. Christensen has a BSEE from Cornell and an MS in physics from Brigham Young; Wollesen is a California State Polytechnic EE.

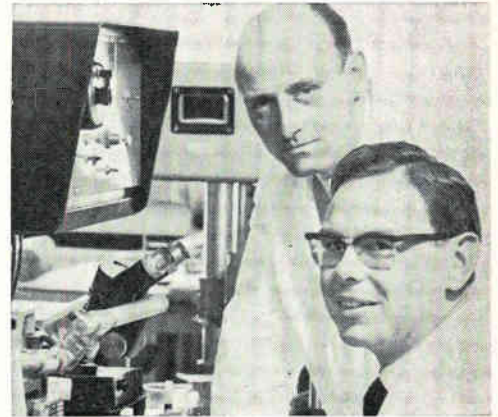

Schmidt

Eckstein

A consumer application is this issue's entry in the German IC series, as related by Dieter Eckstein and Heiner Schmidt of Valvo GmbH in the article beginning on page 91. Schmidt works in mask layout; Eckstein is a group chief.



Mittleman

No stranger to *Electronics'* readers, senior associate editor Joseph Mittleman, who wrote the article on making aluminum wire connections starting on page 94, also has worked on the computer-aided design and active-filter series. Mittleman, who has an MSEE from George Washington University, has been writing for the past eight years.



Collins

Hagon

J. H. Collins and P. J. Hagon of Auto-netics continue the acoustic surface wave series [*Electronics*, Nov. 10, p. 94]. Starting on page 102, they cover materials, amplifiers, and waveguides.



Dunn

Complex IC development has been the major work of Roger Dunn and Glenn Hartsell, who wrote the article starting on page 84. Dunn is manager of custom MSI programs at Texas Instruments; his particular interest is computer-aided of TTL arrays, and he has worked on LSI memories, both main frame and scratch pad, for TI. Hartsell has been in LSI since joining TI in 1966; he helped develop a prototype of the shift register described in the article. He now heads the LSI design section.

Hartsell



Thinking of
programmable calculators?

MATHATRON III

gives multi-user access to computer power at calculator cost.

The new timesharing programmable MATHATRON III . . .

- Simultaneous calculating and programming key-boards (or other ASCII terminals such as Teletypes or CRT's) as needed, to a maximum of 16 terminals.
- Calculates and programs in Algebra (no machine language).
- Handles complex problems (e.g. 11 x 11 Matrix Inversion, Fourier Transforms, Correlation and Least Squares Analysis, Hyperbolic Trig, Chi-Square Statistics, all from MATHATRON III's library of over 400 programs).
- Hard copy (both problem and answer) at no extra cost.
- Cost: UNDER \$3700 per terminal, for a three keyboard system.
UNDER \$2000 per terminal, for an eight keyboard system.
UNDER \$1450 per terminal, for a sixteen keyboard system.

For detailed information about the new MATHATRON III System, write to . . .



MATHATRONICS

MATHATRONICS CORPORATION
241 Crescent St., Waltham, Mass. 02154
(617) 893-1630



754 8367 z temporary
 5 238 848 815 05 y accumulator
 32.50 x keyboard

Dynamic range 10^{-99} to 10^{99} , nearly 200 decades. Observation of math operations on 3 displayed registers. Up to 32 more registers for data storage.



Complex and vector arithmetic simplified with coordinate transformation keys, rectangular-to-polar and vice-versa, in milliseconds.



Trig functions covering all quadrants and any size angle in degrees or radians.

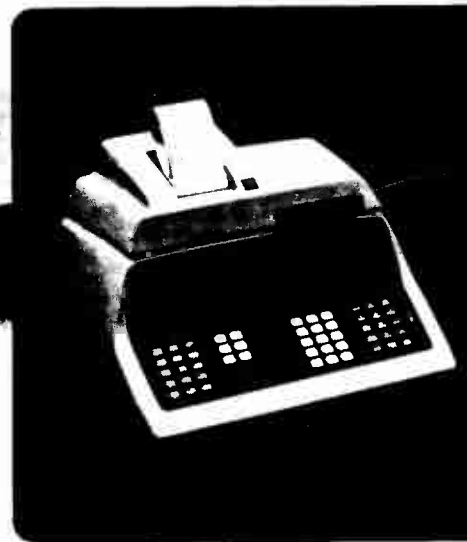

Introducing the HP 9100B to give you a choice of basic calculators. Provides additional internal memory and programming capability.



Program from the keyboard. Record and store up to 392-step programs on credit-card size magnetic cards for repeated use.



Branching and looping flexibility provided by "IF" keys expands programming capability. Single-key direct sub-routine call.



Edit programs easily. Single-step through programs to check and de-bug. Address an individual step and make corrections without re-entering the entire program.

The Emancipator...

start of the small computing system!



It all starts with the HP 9100A calculator... and grows from there. In capability... not in size.

In fact, you can fit the entire HP System 9100 on your desk. It's the personal computing system that puts immediate answers to big computing problems right at your fingertips.

If a picture is worth a thousand numbers, add a plotter. See the solutions being plotted as fast as your problem is being solved.

Need printouts? Get the quiet printer that operates in an office or lab environment without disturbing you, or your neighbors.

You also get an extensive and growing library of applications oriented programs.

But the HP System 9100 is not resting on its laurels. Now you have a choice of basic calculators for your small computing system.

HP is adding the 9100B calculator for those of you who want even more memory and programming power.

The addition of 16 more storage registers doubles the programmable memory to 392 program steps. And, the

ability to call subroutines directly gives you more efficient use of this extra memory.

Just pick the calculator that best suits your needs. Plug in the peripherals and you are ready to go. The computing power of your basic system can continue to grow to meet your changing requirements. Additions, like the upcoming memory extender, will be compatible with either calculator.

Stretch your computing dollar with the personal computing system that has learned to live on a small budget. Put this system to work for you now. Just call your local HP Calculator Salesman, he will have the HP System 9100 on your desk faster than you thought possible.

Or, write to Hewlett-Packard, P.O. Box 301, Loveland, Colorado 80537. In Europe: 1217 Meyrin-Geneva, Switzerland. Prices: HP 9100A Calculator \$4400; HP 9100B Calculator \$4900. Peripherals; HP 9120A Printer \$975; HP 9125A X-Y Plotter \$2475. Lease/rental programs start as low as \$1.50/computing hour, based on average usage.

090/1

HEWLETT  **PACKARD**

HP CALCULATOR SYSTEM 9100

When reliability and performance are essential, Airco Temescal specifies General Electric components



General Electric meters, SCRs, capacitors, selector switches, indicating lights, Volt-Pacs®, gear motors, current transformers and arc pilot devices are used in Airco Temescal's line of Integrated Electron Beam Systems and products such as this Thin-Film Electron Beam Deposition System. (For more information, circle 513.)

Contaminant-free, high quality, thin-film coated substrates are produced by Airco Temescal's Model FC-1100 Thin Film Deposition System with the CV-10 Electron Beam Power Supply. It was designed for either manual or automatic operation for research or production applications.

Systems such as this require hundreds of components — components that are rugged, reliable, capable of top-notch performance.

The complexity of this equipment requires many types of meters which constantly monitor various functions and controls. These meters, designed by General Electric, check such things as voltage, evaporation rates, current emissions, focus current, gun filament current, and others.

Systems designers, such as Airco Temescal's, look to General Electric when they need a certain component to meet specific criteria. They know, for example, GE SCRs are highly sensitive, very versatile . . . and more important, extremely reliable as well as economical.

Capacitors are another of the many GE components used in this equipment. Designers specified General Electric for this application because high capacitance was required in minimum space, and long life was important.

Companies like Airco Temescal specify General Electric components because the name, General Electric, stands for quality, reliability and performance.

LOOK TO GENERAL ELECTRIC — your best source for electronic components.

285-51

GENERAL ELECTRIC



What can GE do for you?



GE's new magnetic material increases magnetic energy 75%

You can have either greater magnetic performance for the same size, or equal performance with less volume and magnet weight with GE's new Alnico 9 magnetic material. It increases the energy product of cast Alnico 8 to a minimum of 8 million gauss-oersteds—a 75% increase in magnetic energy.

Alnico 9 was developed especially for applications requiring superior performance with minimal space and weight, such as focusing of microwave tubes, motor fields and rotors, torque couplings, accelerometers or other "radial gap" designs.

TYPICAL DEMAGNETIZATION CURVE OF CAST ALNICO 9

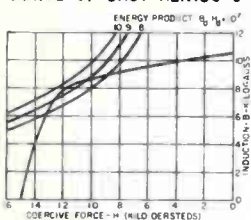

Consult our engineers about designing a Cast Alnico 9 magnet for your application. For details, circle 507.



New "Hi-TECH" ceramics line... top-flight ceramics plus custom engineering

Need a customized ceramic-metal component to do a tough job? General Electric's Hi-TECH line offers a broad variety of alumina, forsterite and other special ceramic materials... sealed to virtually any metal... and custom-designed to your specifications.

End use and operating environment are all our engineers need to know in most cases to design and manufacture the exact component you need.

If your device is one that must operate in a severe environment; or if you need a dimensionally-stable abrasion-resistant machine part; or if you are working on electrical equipment, vacuum or gas-filled devices, or hermetically sealed electronic components... check the Hi-TECH line. Circle number 508.



Now available—3SBV half-size relay for multiple applications

Attention, manufacturers of:

- COMPUTERS
- COMPUTER PERIPHERALS
- AVIONICS
- STUDIO & BROADCAST EQUIPMENT
- VISUAL COMMUNICATION PRODUCTS
- INSTRUMENTATION
- TEST EQUIPMENT
- MICROWAVE & MOBILE COMMUNICATIONS
- MOTOR CONTROLS
- PHOTO-ELECTRIC CONTROLS
- GEOPHYSICAL EQUIPMENT
- SECURITY WARNING EQUIPMENT

Specify the new 3SBV 200-grid half-size relay for those applications where high reliability, top performance and low cost are essential. The 3SBV is an adaptation of the 3SAV type, and has a nylon, heat-sealed metal case. It is ideal for use in environments less severe than aerospace and military applications. For more information on the GE 3SBV, DPDT, relay, circle 509.



Solve unijunction design problems with the new programmable UJT

GE's D13T is a programmable unijunction transistor (PUT) with characteristics (η , R_{BB} , I_p , I_v) that can be selected to fit your circuit. Just two circuit resistors give the D13T1 and T2 programmability which permits the designer to:

- reduce a risk of thermal runaway
- use PUT in battery and other low-voltage circuits
- use base 2 as low impedance pulse output terminal
- use PUT in high volume applications.

Especially suited for long-interval timers, D13T2 features very low leakage and peak point currents. D13T1 is for more general use in high gain phase controls and relaxation oscillators.

Both are 3-terminal planar passivated PNP devices in the low-cost plastic TO-98 case. Circle number 510.

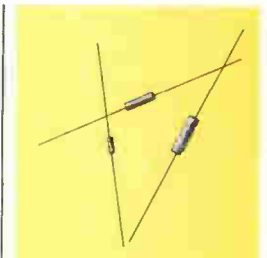

GE 69F900 wet slugs give highest volumetric efficiency

69F900 wet slugs meet high-density application needs with highest volumetric efficiency of any capacitor. We halved the military (CL64) wet slug size, and essentially kept its electrical and performance traits.

The 69F900 has excellent capacitance retention at low temps... can be stored to -65C. Operating range is -55C to +85C. It's tough too—withstands vibration to 2000Hz; 15G acceleration!

GE's capacitor is fully insulated; has low, stable leakage current. Ratings are available from 6 to 60 volts; capacitance ranges from 0.5 to 450 μ f.

RATING	CASE SIZE	VOL. UME
50V, 30 μ f		
solid (CS12)	.341X.750	100%
wet slug (CL64)	.281X.681	58%
69F900	.145X.600	15%
15V, 80 μ f		
solid (CS12)	.341X.750	100%
wet slug (CL64)	.281X.681	58%
69F900	.145X.600	15%
6V, 180 μ f		
solid (CS12)	.279X.650	100%
wet slug (CL64)	.281X.641	100%
69F900	.145X.600	15%

For data, circle 511.



Miniature oil-tight push buttons control almost any function

GE's line of industrial miniature oil-tight push buttons, CR104, is available to control almost any function. They are suitable for use on machine tool control

panels — especially where space is limited. For example, twenty of these units can be easily mounted on a 6" x 5 1/2" panel.

Units are rated 5 amps carry, 115 volts max., 30 amps make and break at 115-125 volts. Double-break

1NO-1NC and 2NO-2NC contact blocks are available for pilot duty control.

Forms include push-buttons, select switches, indicating lights, special forms, and oil-tight enclosures and stations. Color-coding is easy: knobs and rings

come in many colors. Flush and surface-mounted stations make GE's miniature oil-tight push button line the most versatile in the industry.

For detailed information on the entire line of push buttons, circle reader card 512.

Who's Who in electronics

(Continued from p. 7)

ization, and a better understanding of n-channel phenomena (although n-channel parts may not be marketed by Hughes, the technology must be mastered before it can graduate to complementary MOS).

Bower expects the generation after that to be dominated by CMOS technology, and Hughes, licensed by RCA as a second source, is already shipping evaluation quantities of CMOS devices. Speeds will improve in each generation, and Bower and Hirshon believe that with their IMOS treatment, because it lowers parasitic capacitances and because it's here now, they'll have an additional speed advantage in each generation.

Not many engineers can resist the heady lure of management positions. The executive suite is, after all, more comfortable than the laboratory work bench. One who has resisted, to the enduring benefit of the electronics industry, is James L. Buie, a man who thrives on the creative discomfort of attacking knotty problems in microelectronics and integrated circuits.

Buie, who was recently appointed senior scientist in the TRW Systems group microelectronics center, was hardware-oriented from the time he received an EE degree from the University of Southern California in 1949. He went with Pacific Semiconductors, which later became the TRW Electronics group, in 1954. When the microelectronics center was established in 1964, he was a charter member of the staff.

TTL patent. Since then, Buie has received five individual patents and one joint patent, including the basic patent for transistor-transistor logic. "During late 1960 and early 1961 at Pacific Semiconductor, we were looking at advanced technology and trying to come up with digital building blocks," he recalls. "What we came up with was TTL logic, which seemed to be optimum in terms of manufacturability and performance. We came out with the first TTL gates and flip-flops in early 1962," says Buie.

His work at the center is directed now toward improved technology and yield factors for bipolar large scale integration. He says the break-even point has already been reached in yields at the 1,000-device-per-chip level. Yields of 20 chips per wafer at the wafer function test level, with at least one good chip per wafer deliverable to the customer, are being attained, he says. This is expected to result in a \$100-per-unit price—low enough for custom, low-volume applications.

"Next year we plan to work up to 6,000 to 8,000 devices per chip. Better yields are being obtained by looking at things like mask defects and the purity of materials going into the device. We have also minimized the manufacturing steps by reducing the number of masks from eight to five," says Buie.

Here to stay. While emitter-coupled-logic may replace TTL in some ultrahigh-speed applications, Buie believes TTL is superior for things like high-speed shift register correlators, high-speed comparators, and other normal high-speed logic because of its better speed-power product.

The TRW center has a well-established metal oxide semiconductor program, but Buie isn't personally joining the stampede in that direction. He says that bipolar LSI is on a par with MOS in complexity, and with the advantage of speed, will hit the market in 1971. "An early fallacy that bipolar transistors take more space has held up bipolar LSI work; this isn't true any more and we have been able to streamline the processes," Buie says.

"You have no limits on your expansion in the U.S.: it's big, rich, and free," says Erick I. Siwko, 38, who came here in 1960 via Poland (where he was born), Siberia, Iran, Lebanon, England, and Canada. "It's a fascinating country for Europeans; they still have dreams about it carried over from the last century."

Siwko (pronounced Zivko) has been able to realize his own dream by founding Contronautics Inc. in

It's the
era of the
mini-skirt . . .
and electronic
miniaturization!



Now
the newest and smallest
multi-pin connector
puts meaning into
miniaturization!



Meet Navajo: The miniature multi-pin that complements your miniaturization program. This is

the industry's first miniature, circular multi-pin connector series offering 3, 5, 7 and 9 pin-contact versions all in one 1/2" maximum diameter shell size. (Also available are combinations of coaxial and power contacts.) Five key polarization. Shell and contacts gold over nickel plating. Threaded 3/16"-28 THD coupling. Contacts fused into glass or molded into thermosetting compound per MIL-M-24325. Contacts are closed entry design with one amp rating. Seven and nine pin versions' contact solder pots accept 22 gauge wire. Three and five pin versions accept 18 gauge wire. Receptacles available in various mounting configurations. Typical mated parts weigh less than 1/2 oz. These connectors are moisture-proof and extremely resistant to shock, vibration and corrosion.

Navajo was designed for you. So before you finalize your next design, learn more about the miniature multi-pin connectors that really are miniature. Ask about our complete line of coaxial connectors, too. They're not ordinary, either. Contact:



MANUFACTURING CORPORATION
11415 Johnson Drive
Shawnee Mission, Kansas 66203

The Fine Art of ONEUP MANSHIP



ONEUP

4PDT Miniature 3 Ampere Industrial Relay—Type 156

All features of competitive models, *plus* U/L recognition through 240 VAC instead of a mere 125 VAC.



ONEUP

General Purpose 1,2&3PDT Industrial Relay—Type 157

All features of competitive models, with U/L recognition through 240 VAC, potential recognition through 600 VAC. Superior electrical performance.

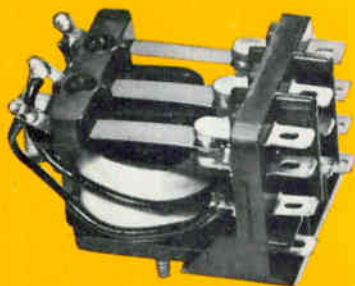

ONEUP

Magnetic Latching, General Purpose, 1,2&3PDT Industrial Relay—Type 157

Same electrical parameters as standard Type 157. Modern approach to magnetic latching does not employ hard permanent magnets.



ONEUP

1&2PDT Coaxial Crystal Can Relay—Type 153

Only Coaxial Crystal Can Relay that will switch above 500 MHz with VSWRs below 1.2. Now improved to switch 2000 MHz with low VSWRs.

Who's ONEUP? MIDTEX/AEMCO . . . and *YOU*, when you get in touch with the MIDTEX/AEMCO distributor in your area. CALL ONE UP!

MIDTEX
INCORPORATED



AEMCO DIVISION

10 STATE STREET
MANKATO, MINNESOTA
56001

PROGRAMMERS/TIME DELAY RELAYS/MINIATURE COAXIAL RELAYS/INDUSTRIAL RELAYS/MERCURY-WETTED CONTACT RELAYS

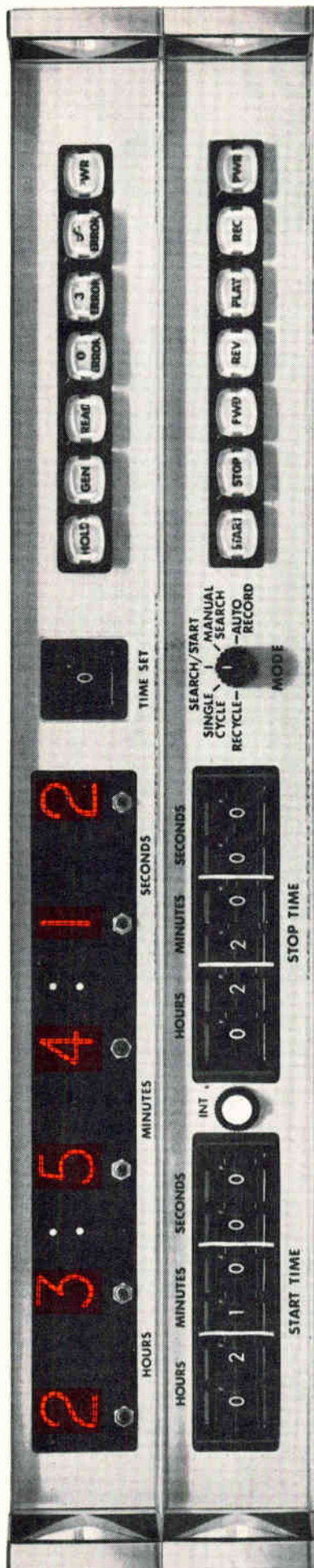

Now: A **True**
Tape Search
and Control
System in
3½ Inches.
\$3695
FOB Anaheim.
Delivery: Two Weeks
(or sooner)

Automatic tape search in *both* directions with this new time code generator and tape search and control system from Datum.

This complete system provides time generation for data acquisition, time reading for data playback, and fully automatic tape search for automatic data reduction — all in 3½ inches.

Modular IC construction permits many optional features, such as slow-code outputs, remote display, remote manual control, and high-accuracy time base.

For complete information about the Datum 9300/9420 Tape Search/Control System, or other timing instrumentation, circle the reader service number below, or write: DATUM, INC., Timing Division, 170 E. Liberty Avenue, Anaheim, California 92801. Telephone Number (714) 879-3070. TWX Number (910) 592-1289.



Who's Who in electronics

(Continued from p. 14)

Waltham, Mass. "I can't really pinpoint the reasons I started my own company," he says. "There is an internal drive that pushes you to more independence. Once you decide to go out on your own you start thinking of the most successful beginning, usually an extension of your field, to assure success in the initial stages. Once you succeed, then diversification is natural."

A former engineering specialist in charge of new product development for the Industrial Controls division of Fenwal Inc., Siwko now puts his experience to use in custom designing control devices. So far his company's work has been mainly in temperature control, but he hopes to develop a manufacturing capability and enter medical electronics.

Quick. Because Contronautics is new, Siwko finds he has an advantage older companies lack. "We watch new trends, mainly in IC technology, and make use of them fast and efficiently," he says. "It may not be economical for older companies to introduce the latest technology because they already have older models on the market that haven't paid for themselves yet. We can select the most suitable IC for an application and make use of it right away because we have no tradition."

Siwko claims that this ability to use the latest technology allows Contronautics to sell its equipment at a lower cost, sometimes half the price of competing units, and "in quite a few cases customers have told us that our equipment performs better than our competitors'," he says. He cites as an example a thermocouple sensor that costs less than \$20 in large quantities; "there is nothing like it at this price," he asserts.

Contronautics also is doing R&D in medical electronics, and is looking for a location where it can do its own manufacturing, which now is subcontracted. But Siwko is cautious about entering any other areas right away. "We are trying to discipline ourselves by staying in the industrial and medical control fields," he says.

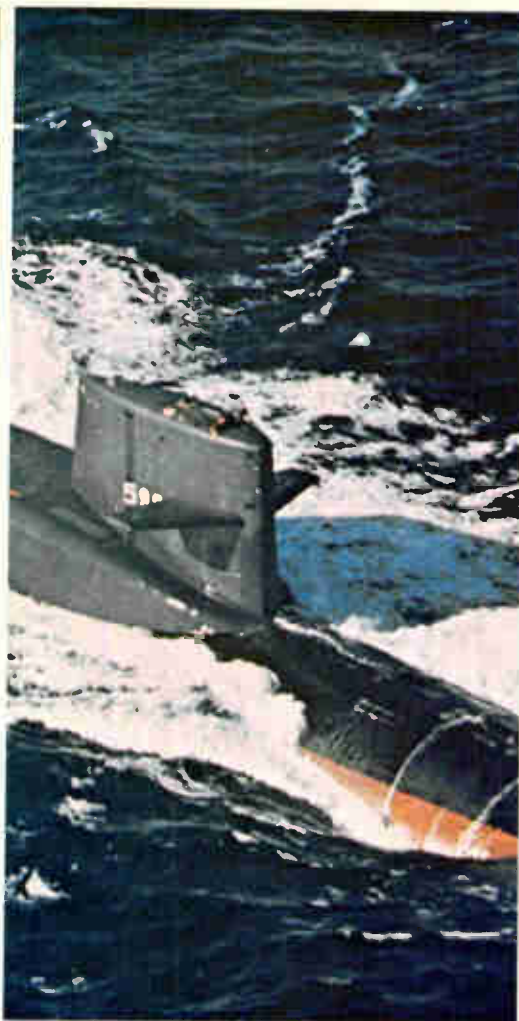

METALS THAT MONITOR, MEASURE AND MAGNIFY...A SPECIAL CAPABILITY OF CARPENTER!

When a life hangs in the balance, an intensive care unit in a local hospital constantly monitors the patient's progress. When a sleek submarine maneuvers silently beneath the surface, sonar devices sound the bottom to measure the water's depth. When a tiny signal cries from outer space, land-based radar systems magnify its whisper to a loud, clear voice. Each of these electronic devices depends on specialty metals for flawless performance. Carpenter produces a full line of electronic alloys that bring a high level of reliability to the electronic industry. Included are: Magnetic Core Irons, High Permeability Alloys, Glass Sealing Alloys, Electrical Resistance Alloys, Temperature Compensator Alloys, and others. What measure of confidence in materials do you need to make a better product? To find out, contact your Carpenter representative. Steel Division, Carpenter Technology Corporation, Reading, Pa. 19603.

*European Office: Emmastraat 39,
Amsterdam-Z, The Netherlands*

CarTech CARPENTER
TECHNOLOGY

Describe the display storage tube you need. Westinghouse will build it.

Commercial airborne radar? Medical monitoring systems? Industrial instrumentation? Military radar and sonar systems?

Name your application. Westinghouse will design and custom package a display storage tube with unmatched resolution, controllable persistence, and high brightness.

Westinghouse has designed and manufactured all types of DSTs for both commercial and ruggedized military applications for more than 15 years. The split screen storage tube is our most recent innovation. It combines storage and cathode ray functions in a single tube.

The Westinghouse display design/application team is ready to assist you. For more information, write Westinghouse Electronic Tube Division, Elmira, New York 14902. Ask for brochure SA-10249.

ET-1009



You can be sure...if it's Westinghouse



Circle 19 on reader service card

Describe your needs in power tubes. Westinghouse can fill them.

We have over 700 tube types from rectification to RF heating to control diodes to fill your power tube needs. Most of them like RF oscillators, RF amplifiers, pulse, ignitrons, thyratrons, rectifiers, ionization gauges, and ion pumps are available from over 200 stocking locations. Two new additions are WL-8170/4CX5000 and WL-8171/4CX10000 tetrodes. They're backed by over 40 years experience in power tube design and manufacturing.

We'd like to help you decide on the right power tube for your application. For more information, write Westinghouse Electronic Tube Division, Elmira, N.Y. 14902.

ET-4-69



You can be sure...if it's Westinghouse



Circle 21 on reader service card

GLASS ENCLOSED

AMPERITE

Thermostatic DELAY RELAYS

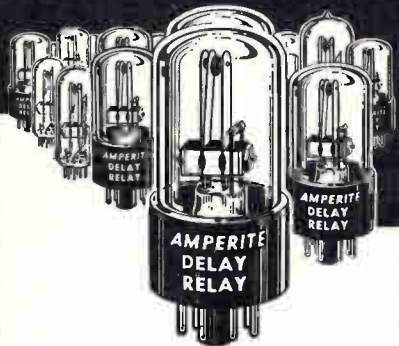

**Offer true hermetic sealing
-assure maximum stability and life!**

Delays: 2 to 180 seconds . . . Actuated by a heater, they operate on A.C., D.C., or Pulsating Current . . . Being hermetically sealed, they are not affected by altitude, moisture, or climate changes . . . SPST only—normally open or normally closed . . . Compensated for ambient temperature changes from -55° to $+80^{\circ}$ C . . . Heaters consume approximately 2 W. and may be operated continuously . . . The units are rugged, explosion-proof, long-lived, and—inexpensive!

TYPES: Standard Radio Octal, and 9-Pin Miniature.
List Price, \$4.00

PROBLEM? Send for Bulletin No. TR-81

AMPERITE

BALLAST REGULATORS

Hermetically sealed, they are not affected by changes in altitude, ambient temperature (-50° to $+70^{\circ}$ C.), or humidity . . . Rugged, light, compact, most inexpensive.

List Price, \$3.00

Write for 4-page Technical
Bulletin No. AB-51

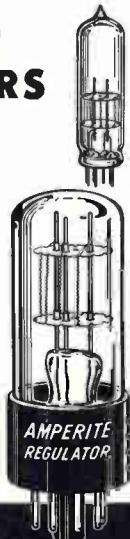
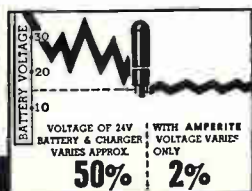

AMPERITE

600 PALISADE AVE., UNION CITY, N.J.
Telephone: 201 UNion 4-9503

In Canada: Atlas Radio Corp., Ltd.,
50 Wingold Ave., Toronto 10

Meetings

Reliability: spread the gospel

The Ralph Nader spirit is abroad in the land—just check the program for the annual symposium on reliability sponsored by the American Society of Quality Control. It will be held Feb. 3-5 at the Biltmore Hotel in Los Angeles.

To an unprecedented degree, the meeting will emphasize the need to apply reliability techniques developed for military and space programs to commercial and industrial products.

The keynote speaker, Rear Admiral Nathan Sonenshein of the Office of Naval Material, will outline what managers, systems designers, and engineers must do in the assurance sciences to meet the competition, complexity, and cost demands of the 1970's. Banquet speaker Robert Six, president of Continental Airlines, will discuss the effects of reliability and maintainability on commercial aviation.

Of particular interest will be a second-day panel session on failure mechanisms in integrated circuits. Ultrasonic aluminum wire bonding of microelectronic applications will be discussed by W.P. Cox and Dr. E.E. Anderson of Lockheed Aircraft, and J.H. Anderson Jr. of the University of Rochester. Metal

bridging under planar oxide will be the subject of J.F. Knudsen of Lockheed, and electromigration in IC's will be the topic of Ilan Blach and E.S. Neiran of Technion University, Haifa, Israel. Surface-related failure mechanisms in IC arrays will be discussed by D.J. Fitzgerald and A.S. Grove of the Intel Corp. Reliability physics investigation of IC failures will be covered by P.H. Eisenberg and C.W. Scott of Autonetics.

A morning session on the final day will cover the latest screening specifications, special testing of IC's, and part parameter drifts. Papers to be presented: Subcontracting for Parts Screening by R.J. Green and H.J. Bailey Jr. of TRW; the Effectiveness of Part Prefailure Analysis by R.C. Aakhus and H.W. Luedthe of the Honeywell Corp.; and Some Practical Parts Criteria by P. W. Fowler and H.J. Bailey Jr. of TRW.

Members of the advisory board of the annual reliability symposium will explore the broad-spectrum potential of the 1970's for reliability engineers in a panel session on the second day.

For additional information contact R.F. Hahn, Sperry Systems Management division, Sperry Rand Corp., 2 Aerial Way, Syosset, N.Y. 11791

Calendar

International IEEE G-AP Symposium,
The University of Texas at Austin,
Dec. 9-11.

**Symposium on Application of
Magnetism in Bioengineering, IEEE,**
Israel Society for Biomedical
Engineering; Rehovot, Israel, Dec. 9-11.

**Asilomar Conference on Circuits and
Systems, Naval Postgraduate School,**
The University of Santa Clara, Stanford
University, and IEEE; Asilomar Hotel
and Conference Grounds, Pacific Grove,
Calif., Dec. 10-12.

**Winter Power Meeting, IEEE; Statler
Hilton Hotel, New York; Jan. 25-30,**
1970.

**Annual Symposium on Reliability,
Group on Reliability of the IEEE, Amer-**

ican Society for Quality Control, Amer-
ican Society for Nondestructive Test-
ing, and the Institute of Environmental
Sciences; Biltmore Hotel, Los Angeles;
Feb. 3-5, 1970.

**International Solid State Circuits
Conference, IEEE, University of**
Pennsylvania; Sheraton Hotel and
University of Pennsylvania,
Philadelphia, Feb. 18-20, 1970.

**Symposium on Management and
Economics in the Electronics Industry,**
IEE; University of Edinburgh, Scotland,
March 17-20, 1970.

**International Convention, IEEE; New
York Hilton Hotel and the New York
Coliseum, March 23-26, 1970.**

(Continued on p. 24)

Allen-Bradley's experience in resistor production reaches...

to the moon and back!

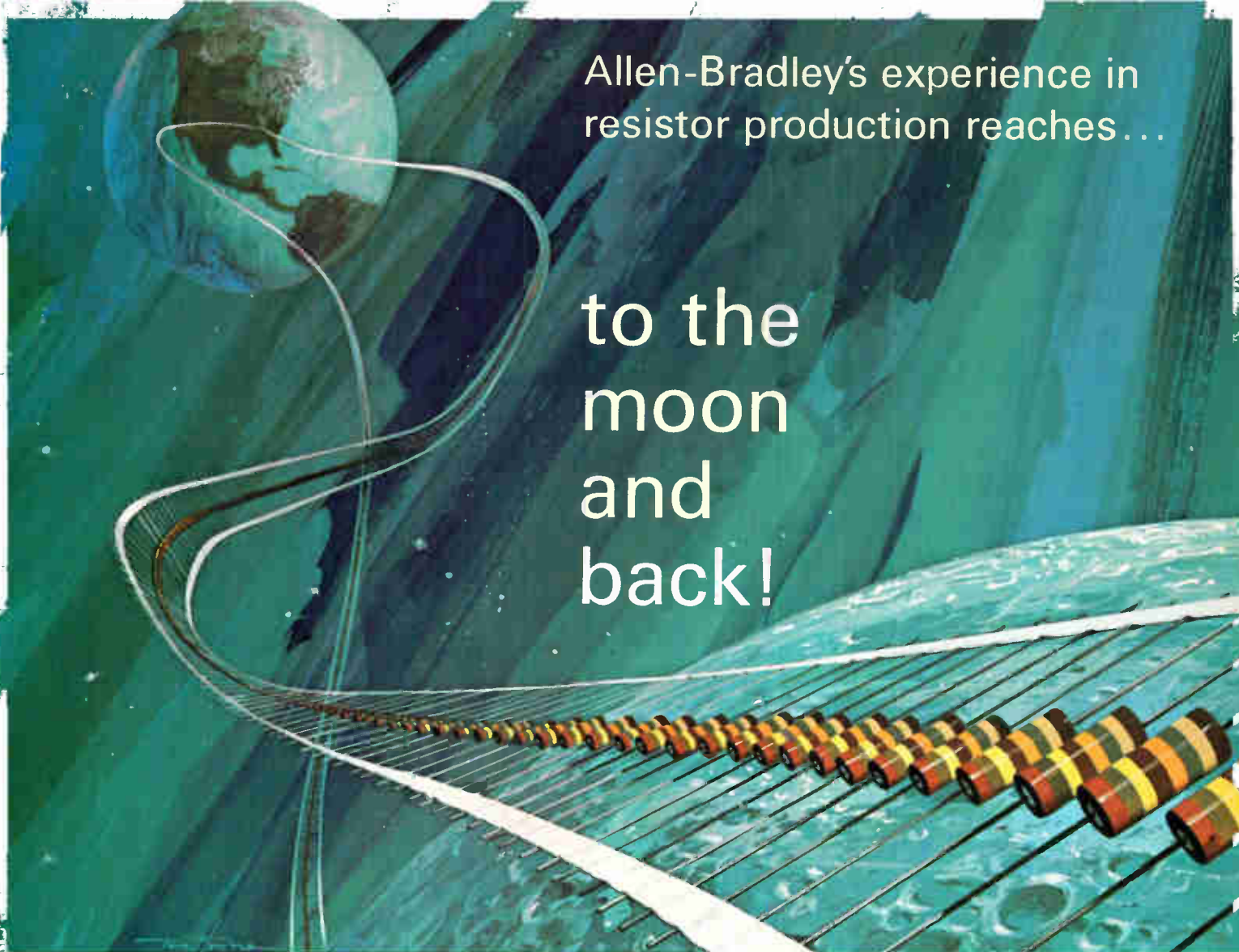

TYPE BB 1/8 WATT

TYPE EB 1/2 WATT

TYPE HB 2 WATTS

TYPE CB 1/4 WATT

TYPE GB 1 WATT

A-B industrial grade hot-molded fixed resistors are available in all standard resistance values and tolerances, plus values above and below standard limits. A-B hot-molded resistors meet or exceed all applicable military specifications including the new Established Reliability Specifications at the S level. Shown actual size.

After more than three decades and untold billions of hot-molded resistors, Allen-Bradley has accumulated manufacturing "know-how" which cannot be approached by anyone else. The fact that the resistors made by A-B over the years—if placed side by side—would more than reach to the moon and back, may be impressive. But "how" they are made is the key.

Allen-Bradley resistors are produced by an exclusive hot-molding technique—developed by A-B. They're made by completely automatic machines—also developed, built, and used only by Allen-Bradley. The human element of error is removed. Uniformity is so precise from one resistor to the next—year in and year out—that

long-term resistor performance can be closely predicted.

The reputation for quality and performance established by Allen-Bradley hot-molded resistors is reflected in the fact that they have been an integral part of virtually every U.S. space probe. And they are "on" the moon. No other resistor applications demand a higher measure of reliability.

For immediate delivery at factory prices, call your authorized A-B industrial electronics distributor. Or write: Marketing Department, Electronics Division, Allen-Bradley Co., 1201 South Second St., Milwaukee, Wis. 53204. In Canada: Allen-Bradley Canada Limited. Export Office: 1293 Broad Street, Bloomfield, N.J., U.S.A. 07003.

EC69-60A

QUALITY ELECTRONIC COMPONENTS



ALLEN-BRADLEY

©Allen-Bradley Company, 1969

Circle 23 on reader service card

Looking for an economical system building block?

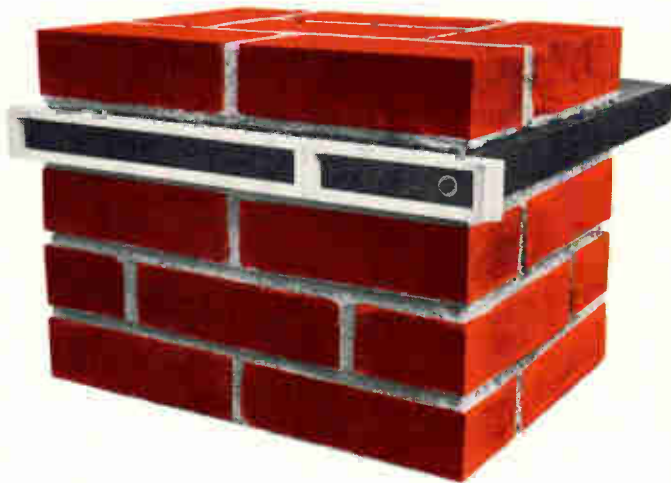

REDCOR 720 MUX/A-D CONVERTER

REDCOR's Model 720 Multiplexer/A-D Converter is an economical and versatile system-building block that accepts up to 32 channels of analog data. Time-shared multiplexing and successive approximation analog-to-digital conversion are utilized to process the analog input data into a format suitable for inputting directly into a computer. The basic 720 contains modular multiplexers, high-input impedance buffers, a sample and hold, an ADC, power supplies, and a voltage reference.

The 720 Multiplexer/A-D Converter offers distinct cost-performance advantages for a wide variety of data-acquisition problems where high resolution and attendant accuracy must be compared to system cost and throughput rates. The 720 is available in 8 to 12 bits binary, with system throughput rates ranging from 40 KHz to 20 KHz. Either single-ended or differential inputs are provided, with full-scale input ranges from 5v to 20v in bipolar or unipolar configurations.

The 720 is completely self-contained in a forced-air-cooled 19-inch chassis that requires only 1¾ inches of panel space. Modular concepts are employed throughout the instrument, with all circuitry contained on plug-in circuit modules that are removable from the master interconnect mother PC board. All test points required for system test calibration and maintenance are available from the swing-out front panel. The modular structure of the 720 ensures ease of maintenance and simplifies field expandability of channels.

Simplified operation, low-cost, ease of interfacing, and guaranteed system performance specifications make the Model 720 Multiplexer/A-D Converter attractive for any computer-controlled data-acquisition or process-control application.



Complete Systems Capability / 7800 Deering Avenue, P.O. Box 1031,
Canoga Park, California 91304—(213) 348-5892

Meetings

(Continued from p. 22)

Second National Conference and Exposition on Electronics in Medicine, Electronics/Management Center, Electronics, Medical World News, Modern Hospital, Postgraduate Medicine, Scientific Research; Fairmont Hotel, San Francisco, Feb. 12-14, 1970.

Symposium on Submillimeter Waves, IEEE, Polytechnic Institute, Brooklyn, New York, March 31-April 2, 1970.

Communications Satellite Systems Conference, American Institute of Aeronautics and Astronautics; International Hotel, Los Angeles, April 6-8, 1970.

Reliability Physics Symposium, IEEE; Stardust Hotel and Country Club, Las Vegas, Nevada, April 7-9, 1970.

Meeting and Technical Conference, Numerical Control Society; Statler Hilton, Boston, April 8-10, 1970.

Computer Graphics International Symposium, IEE; Uxbridge, Middlesex, England, April 13-16, 1970.

International Geoscience Electronics Symposium, IEEE; Marriott Twin Bridges Motor Hotel, Washington, April 14-17, 1970.

American Power Conference, IEEE; Sherman House, Chicago, April 21-23, 1970.

International Magnetics Conference (INTERMAG), IEEE; Statler Hilton Hotel, Washington, April 21-24, 1970.

Annual Frequency Control Symposium, U.S. Army Electronics Command; Shelburne Hotel, Atlantic City, N.J., April 27-29, 1970.

National Telemetry Conference, IEEE; Statler Hilton Hotel, Los Angeles, April 27-30, 1970.

National Relay Conference, Oklahoma State University and the National Association of Relay Manufacturers; Oklahoma State University campus, April 28-29, 1970.

Short courses

Generalized Machine Theory Applications, IEEE; Statler Hilton Hotel, New York, Jan. 25-30, 1970. \$30 fee.

Topics in Quantum Electronics, University of California; Berkeley campus, Feb. 2-6, 1970. \$300 fee.

(Continued on p. 26)



All components shown actual size



Only the new Allen-Bradley Type S cermet trimming resistors have all these features

Type S

shown twice actual size

for side adjustment



for top adjustment



The Allen-Bradley Type S is a one turn cermet trimmer in which you will find incorporated a wider range of features than in any other trimmer now on the market. Here are a few of the more important features.

- **COMPACT**—body is $\frac{3}{8}$ " dia.
- **BUILT FOR EITHER TOP OR SIDE ADJUSTMENT**
- **50 OHMS THRU 1 MEGOHM**
- **THE SEALED UNIT** is immersion-proof
- **TEMPERATURE COEFFICIENT** less than 250 ppm/ $^{\circ}$ C over all resistance values and complete temperature range
- **UNIQUE ROTOR DESIGN** provides exceptional stability of setting under shock and vibration
- **SMOOTH CONTROL**, approaches infinite resolution
- **PIN TYPE TERMINALS** for use on printed circuit boards with a $\frac{1}{10}$ " pattern
- **VIRTUALLY NO BACKLASH**

- **WIDE TEMPERATURE RANGE** from -65° C to $+150^{\circ}$ C
- **RATED $\frac{1}{2}$ watt @ 85° C**
- **EXCEPTIONAL STABILITY** under high temperature or high humidity
- **MEETS OR EXCEEDS ALL APPLICABLE MIL SPECS**
- **COMPETITIVELY PRICED!**

Need to know more about the Type S trimmer? Call your authorized A-B industrial electronics distributor. He'll give you immediate delivery at factory prices. Or write for detailed specifications to the Marketing Department, Electronics Division, Allen-Bradley Co., 1201 S. Second Street, Milwaukee, Wis. 53204. In Canada: Allen-Bradley Canada Limited. Export Office: 1293 Broad Street, Bloomfield, N. J., U.S.A. 07003.

©Allen-Bradley Company 1969



ALLEN-BRADLEY
QUALITY ELECTRONIC COMPONENTS

EC69-53A

Circle 25 on reader service card



Meet the "Mite".
Only .218" diameter. The toughest ceramic disc trimmer capacitor its size.

New from E. F. Johnson. And it's this small: 
Designed for printed circuit applications where space is at a premium. Stator of High Alumina for greater shock and vibration resistance. The rotor plate is encapsulated in ceramic for environmental stability and long life. The Q factor at 1 MHz is 500 minimum. Precision lapped bearing surfaces give you smooth linear tuning. Pick from a wide capacitance range: 1.0-3.0 pF, 2.5-9.0 pF, 3.5-20.0 pF, 5.0-25.0 pF. Designed to meet or exceed applicable requirements of MIL-C-81A.

Return the coupon today for information on Johnson's new Micro-J.™ And if you have a special capacitor need, we'd like to work with you. The same engineering that made our air variable capacitors the standard of excellence goes into every new Johnson product.

E. F. JOHNSON COMPANY/3012 Tenth Ave. S.W./Waseca, Minnesota 56093

- Send product specification information on new Micro-J capacitor.
 Include information about your full capacitor line and other Johnson components.

NAME _____ TITLE _____

FIRM _____ ADDRESS _____



CITY _____ STATE _____ ZIP _____
E. F. JOHNSON COMPANY

Meetings

(Continued from p. 24)

Theory and Design of Reliable (Fault-Tolerant) Computers: Protective Redundancy, Diagnosis, Self-Repair, University of California; Los Angeles campus, Feb. 2-13, 1970. \$395 fee.

Minicomputers, National Electronics Conference; Pheasant Run Lodge, St. Charles, Ill., Feb. 8-11, 1970. \$390 fee.

Computer Language Approach to Network Analysis and Design, University of California; Los Angeles campus, Feb. 9-13, 1970. \$285 fee.

Electronic Components, University of Wisconsin; Madison campus, Feb. 19-20, 1970. \$70 fee.

Introduction to Process Computer Control, University of California; Los Angeles campus, March 9-13, 1970. \$285 fee.

Call for papers

Solid State Sensors Symposium, IEEE and the Instrument Society of America; Radisson Hotel, Minneapolis, June 18-19, 1970. Jan. 20 is deadline for submission of abstracts to Dr. R.H. Dyck, Fairchild Semiconductor, 4001 Miranda Ave., Palo Alto, Calif. 94304.

Symposium on Circuit Theory, IEEE; Pick-Nicollet Hotel, Minneapolis, May 7-8, 1970. Feb. 5 is deadline for submission of summaries to Prof. B.A. Sheno, Dept. of Electrical Engineering, University of Minnesota, Minneapolis, Minn. 55455.

Summer Power Meeting and EHV Conference, IEEE; Biltmore Hotel, Los Angeles, July 12-17, 1970. Feb. 15 is deadline for submission of papers to S.H. Gold, 1970 Summer Power Meeting and EHV Conference, 345 E. 47th Street, New York, N.Y. 10017.

Nuclear and Space Radiation Effects, IEEE and the University of California; University of California campus, San Diego, July 21-23, 1970. Feb. 16 is deadline for submission of summaries to R.K. Thatcher, Battelle Memorial Institute, 505 King Ave., Columbus, Ohio 43201.

ASTM-NBS Symposium on Silicon Device Processing, American Society for Testing and Materials, National Bureau of Standards, Gaithersburg, Md., June 2-3, 1970. Papers should be sent immediately to C.P. Marsden, Electronic Technology Division, National Bureau of Standards, Washington, D.C. 20234.



A gift to OEMs
that doesn't end with the holidays.
That's Ultramation.

The gift is money . . . in the form of two unique financial arrangements on the Honeywell 316 computer.

One, a quantity discount deal that saves you plenty. It entitles you to a provisional discount based on your *estimated* requirements over several years. Dozens of OEMs are already taking advantage of this arrangement.

The other, a spare parts kit you can lease instead of buy. It can save you a bundle.

That's Ultramation . . . the ultimate in computer savings to OEMs.

The H316 is a bargain to start with: First under

\$10K, 16-bit computer with big computer company back-up. More peripherals than anyone else. Worldwide support. Plenty of proven software.

You'll probably want rack-mountable or table-top models more than the glamorous version pictured here (and in the Neiman-Marcus Christmas Catalog and major consumer magazines).

Find out more about the gifted H316 and the unique financial arrangements for OEMs. Write Honeywell, Computer Control Division, Framingham, Massachusetts 01701.

The Other Computer Company:

Honeywell

The new small rack and panels with the big difference.

Bendix is the difference.

The difference in distribution, delivery and supply. The difference that means you can get the rack and panels you need when you need them.

A big difference. A big advantage. But there are others. Bendix Regal B subminiatures are built to MIL-C-24308. Application potentials are practically unlimited. Use them in switching circuits, computers, business machines. In industrial equipment, communications, test equipment. And in rack and panel modular or printed circuit technology.

The selection of mounting options is just about endless, too. Choose from among .120 or .154-inch diameter, straight-through holes, clinch nuts, float mounts, lock posts, plain flange and through-bulkhead types. Neoprene spacers or grommets. And solder or printed circuits. Even a crimp version with rear-release contacts comes in a variety of shell sizes and mounting configurations. All interchangeable with existing rack and panel connectors.

For more details, write: The Bendix Corporation, Electrical Components Division, Sidney, New York 13838.

Bendix

Electronics

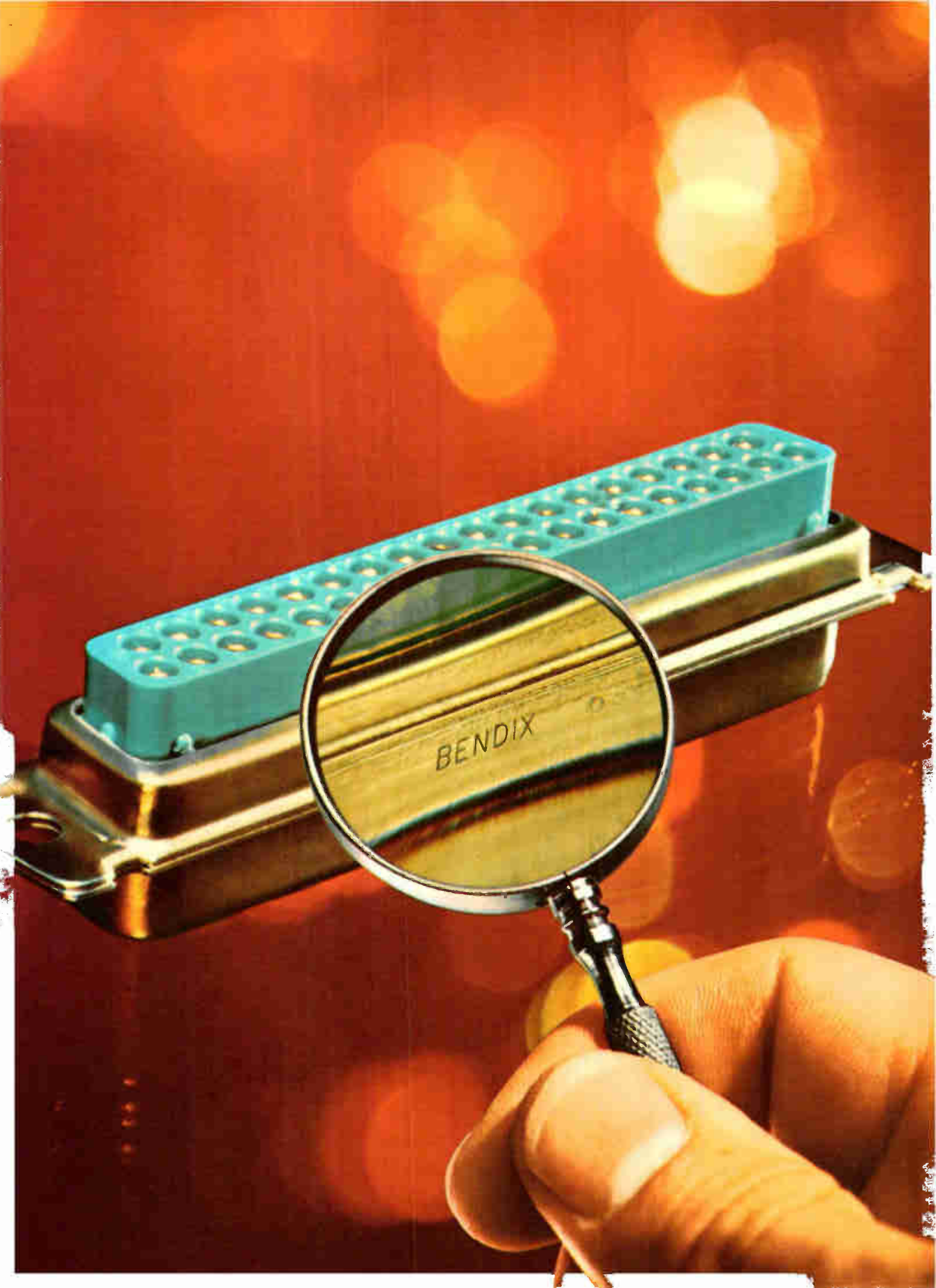

BENDIX

THE WORLD'S GREASIEST GREASE. IT EVEN KEEPS STEEL AND ALUMINUM SLIDING SMOOTHLY TOGETHER



General Electric has invented a new family of silicone lubricants: Versilube Plus® grease and fluid.

What they have in common makes them unique. They're based on new methyl alkyl technology. Which gives them a long, spiny, interlocking molecular structure. Which, in turn, forms a tough, tenacious film that keeps moving parts separated.

So now you can solve sintered bearing problems. And rub aluminum against steel. With negligible wear. No galling. And not a speck of bimetallic corrosion.

What's more you can forget about the elements. Versilube Plus won't crystallize at 300°F. Won't stiffen up at -50°F. And it's just about invulnerable to water washout.

In short, it keeps many combinations of dissimilar metals lubricated for good. And a little goes a long way.

Try it. For more information, fill out the reader service card. For a free sample of Versilube Plus grease and/or fluid, write us on your letterhead describing your application: Section N12324, Silicone Products Dept., General Electric Co., Waterford, New York 12188.

GENERAL  ELECTRIC

Editorial Comment

R-f pollution: a rising concern

Radiation leaks—X-rays from tv sets and r-f energy from microwave ovens—are an existing concern, but at least such leaks can be pinpointed, measured, and corrected through design changes. A far more insidious problem may be caused by the proliferation of high-power communication and microwave transmitters.

At a meeting last month co-sponsored by the Long Island Section of the IEEE and the Electromagnetic Compatibility Group it was recalled that man's ability to generate microwave power has been increasing at the rate of about 15 db per decade. With the countryside being filled with high-power radiations at vlf, h-f, and microwave frequencies, engineers and the public alike are wondering what effects the emissions, singly or in combination, may have on the human body, grazing animals, or even vegetation. Although the proliferation of emitters and the rise in their output power continues unabated, there appears to be an unfortunate lack of coordination among those agencies and individuals who are directly involved, and who might pool their expertise to study the hazards and define proper controls. As it is, there's concern among portions of the military, the U.S. Public Health Service, certain other government agencies, and a few researchers at university laboratories. Isolated experiments have been conducted with rats and frogs to test the harmful effects of r-f energy. Farmers have reported "peculiar behavior" in sheep in the vicinity of microwave antennas. Experiments for the Navy's proposed 800-megawatt, 45-hertz transmitter covering 22,000 square miles in Wisconsin [*Electronics*, Nov. 24, p. 48] reportedly set telephones ringing and electrified fences in the vicinity. In a separate case, a radar technician died in California; his death was thought to have been caused by exposure to high-intensity microwaves, but the facts in the case were not at all clear.

Broadening the scope of research needed, L.D. Sher of the University of Pennsylvania believes both thermal and nonthermal effects from microwave radiation could occur at several levels: molecular, cellular, the tissue level, and as effects on organs of the body itself. Adding to the confusion, a method of correlating the laboratory work and the clinical studies of animal exposure with measurements taken in the field has not yet been found. As a result of the sketchy work done to date, there is no general agreement on "safe" radiation levels. Most U.S. researchers tend to "talk" around a base

figure of 10 mw/cm², while the Russians begin at 1 mw/cm² and tighten the limit to as little as 10⁻² mw/cm² for an exposure time of eight hours or more.

At last month's meeting, A.R. Kall of Ark Electronics reported on a project to measure the intensity of radiation near government h-f relay stations equipped with the familiar rhombic and curtain array antenna systems. Frequencies involved were in the 6-18 Megahertz range (the band in which, for example, the Voice of America might operate). The study showed both magnetic and electric fields were high in the case of 500 kw transmitters; magnetic fields were high but electric fields were tolerable for a 250 kw transmitter, and both E and H fields were acceptable for a 50 kw transmitter. In addition, the study yielded data on hard-to-find but important-to-avoid pockets of very high intensity radiation (hot spots). A comparison study put laboratory rats in an "irradiation tank circuit" to see how much radiation at 6, 14, and 21 Mhz the animals could withstand. The tests showed harmful effects to the gastrointestinal, cardiovascular, respiratory, and genito-urinary systems, peaking at 35 days following the irradiation. Unfortunately, there is no direct way to relate what was measured in the laboratory (watts per unit volume or per unit weight of the test animal) to what is measured in the field (watts per unit effective capture area). The researchers did get around one correlative problem simply by equating a rat with a human insofar as the biological effects were concerned.

Another point in question is the sensitivity of tests. Oddly enough, no changes were detected in the endocrine system of the test animals. The researchers attributed this to the possibility of detection equipment that was not sensitive to the changes that may have occurred. On the other hand, Sher felt that in the area of radiation hazards, some easily detectable effects may not have much clinical significance. Sher is among those researchers who theorize that a limit of 10 mw/cm² is realistic.

Clearly, what is needed is an acceleration of studies that would reinforce certain of the tentative conclusions reached on the basis of intuition and sparse data, while rejecting those conclusions that are unfounded. The result could be the setting of realistic standards regarding safe levels of exposure and the definition of dangerous off-limits areas surrounding high-power transmitters. ■

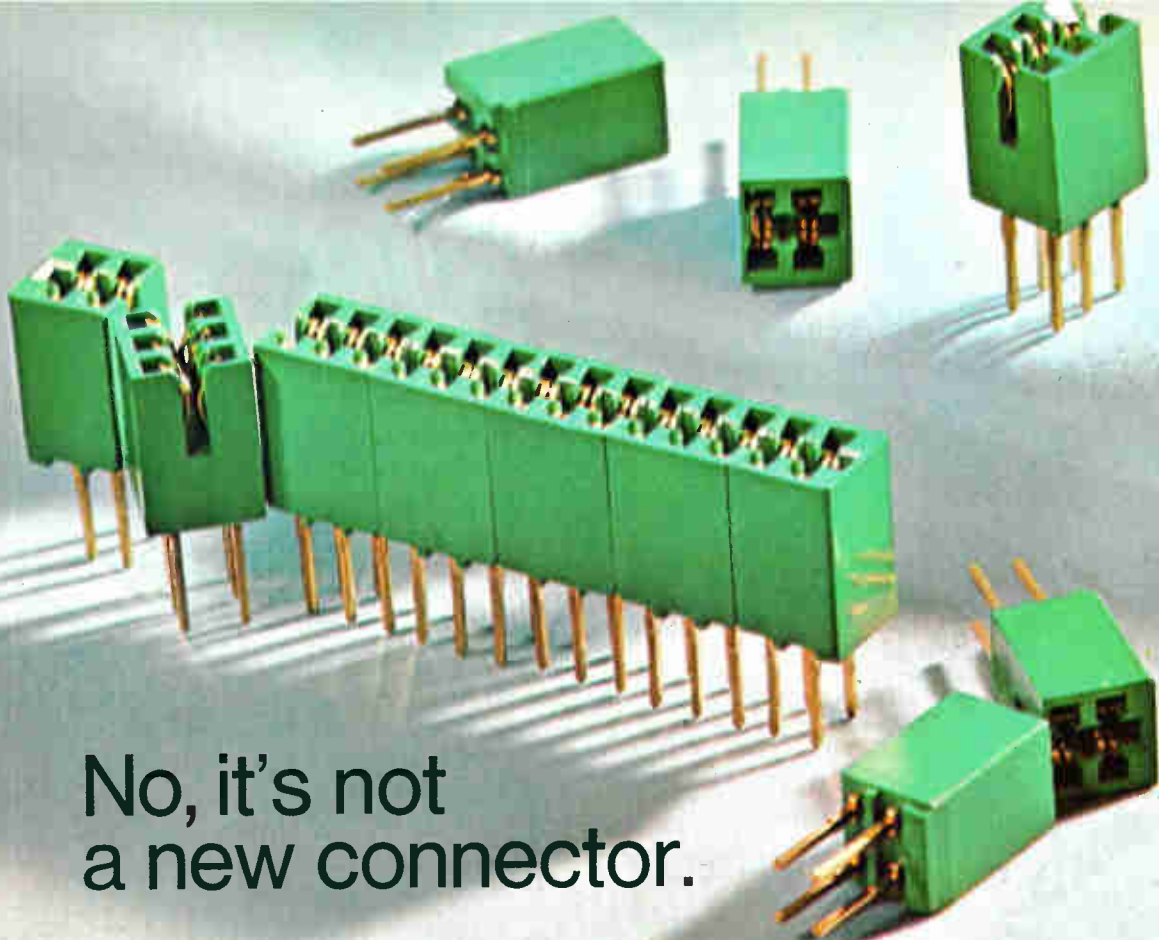

No, it's not
a new connector.

It's a new kind of connecting.

The little connectors above are really one connector. You take as many pieces as you need, mix them together, and use them to connect any size of p.c. board to a mother board.

That's not spectacularly new. Connector modules for use in bread-boarding have been around for a while.

But these new Mojo™ Series 6308 p.c. connector modules* are not just for bread-boards and prototypes.

Not hardly.

When used with plated-through holes on the mother board, they are one of the slickest production tricks to come along in quite a while. Contact tails combine a square wire-wrapping post with a specially designed locking feature which, when press-fitted into a plated-through hole, provides a gas-tight and reliable electrical connection.

No, you don't have to solder.

Yes, you can wire-wrap if you want.

And, yes, you'll save time and money in moving from prototype into production. Because connectors

of virtually any size can be built up economically from just two sizes of modules, you don't need a large inventory. Or custom connectors. And you only have to insert modules where connectors are required, saving a few more pennies.

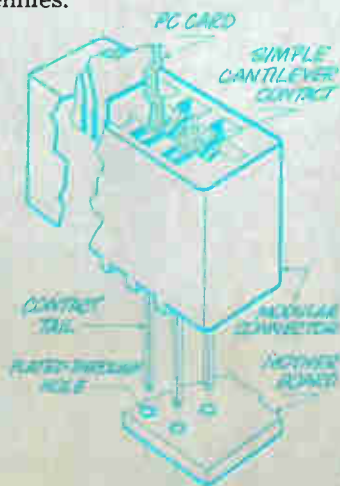

And, no, you don't give up a bit of connector reliability. The exclusive swaged single-beam design of the dual-readout contact provides optimum spring rate and deflection characteristics. A preload applied

to the contact nose in the insulator makes sure that the contact really holds on to the card, while keeping the contacts well apart when the card is removed from the connector.

Mojo™ p.c. connector modules:
Specs in brief

Material

Glass-filled DAP

Contacts

Cantilevered-beam, dual read-out, bifurcated nose. .150" centers. Center modules have 6 contacts. End modules have 4 contacts, molded-in card guide.

Tails

.031" square wire-wrapping type

Mounting

Press fit, in .048" dia. plated-through holes, 3/32" to 1/8" thick board.

For more information, write, wire, call, or TWX us for our Mojo™ p.c. connector module data sheet. Elco Corporation, Willow Grove, Pa. 19090. 215-659-7000; TWX 510-665-5573.



ELCO Mojo™ p.c. Connectors

Circle 32 on reader service card

* Patent pending

Electronics Newsletter

December 8, 1969

Avionics firms wait for Nixon to zig or zag

The Nixon Administration's fidgety military posture is giving planners and their avionics customers fits as they try to decide which new programs will win substantial funding in the fiscal 1971 budget request—and, more important, which ones might be stretched out. Adding to the nervousness is the intention of the Administration to cut defense spending to 7% of the gross national product, or by at least \$4 billion for fiscal '71.

One industry source suggests there's a chance some programs—for example, the B-1A bomber (formerly AMSA)—could be put off a year with only minimal funds in the budget that will go to Congress in January. This could happen if the Administration deems it wise not to push strategic weapons systems in light of the arms limitation and disarmament talks in Helsinki and Geneva. And military planners are having a tough time discerning Administration guidelines to what programs will be viewed favorably. As recently as September, some military men admitted to electronics industry marketing officials that they simply had no indications. The slow-moving fiscal 1970 military authorization and appropriations bills also have contributed to the uncertainty.

U.S. car makers eye electronic fuel injection

Detroit's big three automakers are testing an electronic fuel-injection system that uses a small computer and an electric fuel pump. Developed by the Bendix Motor Components division, the system controls the fuel-air mix by monitoring intake manifold pressure and engine revolutions per minute.

The auto companies, which aim to introduce the system possibly as early as 1971, say the advantages are lower fuel consumption and reduced exhaust emission.

A system operating on the same principle was introduced last year by Volkswagen [*Electronics*, March 17, p. 87].

Schottky diode rated at 50 amps

Buyers of Schottky-barrier rectifier diodes usually want to use them with microwave devices, but Motorola has come up with what engineers at the Semiconductor Products division say is a completely new kind of device—a 50-amp hot carrier diode ideally suited to rectify low-voltage computer power supplies. The MBD5500, it will be introduced next month; its principal advantages, besides its current rating, are efficiency and speed.

That 50-amp current rating is phenomenal in the hot-carrier diode world, where the highest rated devices heretofore have been about 50 milliamperes. Efficiency is best demonstrated by forward voltage drop, which is 500 millivolts for the MBD5500 at 50 amps vs. 1.2 to 1.4 volts for a standard p-n rectifier diode with a comparable active area (the unit is on a 150-square-mil chip). The Schottky diode's speed hasn't been pinned down yet because the test equipment can handle up to 500 kilohertz, and the device still shows good efficiency at that speed.

First IC mil spec ready for industry

The first general specification for military microcircuits—Mil-M 38510—has been approved and will be released as soon as it can be printed. Joseph Brauer, chief of Rome Air Development Center's reliability branch in the solid state applications section, says the specification stems from

Electronics Newsletter

a September policy change. The lack of military specifications, particularly during the formative stages of microcircuit development, has resulted in insufficient control of reliability.

The new specification, drafts of which are now circulating in industry, provides reliability and test levels for three device classes. Specifications for the top-of-the-line Class A devices refer to the National Aeronautics and Space Administration's line certification requirements for microcircuits—NHB-5300.4 (3c).

The EIA says it will be coming up soon with an industry specification for nonmilitary microcircuits in response to growing requests from designers of data processing and other equipment for guidelines. An EIA official who calls the new mil spec "a compromise, but a pretty good one," adds that industry's own specifications should help reduce microcircuit costs.

MECL 4 appearing with 0.7 nsec delay

There's a MECL 4 family of bipolar integrated circuits in Motorola's future. The Semiconductor Products division is already doing custom work with a number of major computer manufacturers, who want the super speed of the new emitter-coupled logic line in their central processors. The MECL 4 circuits are the fastest logic anywhere, with a propagation delay of just 0.7 nanosecond at a power dissipation level of 50 milliwatts; the firm's MECL 3 line is specified at 1.0 nanosecond propagation delay with 50 milliwatts' dissipation [*Electronics*, April 15, 1968, p. 46].

One of the big advantages MECL 4 will offer is lower power dissipation, making it easier to cool the units. With MECL 4, says Richard Abraham, director of advanced IC programs, "We may be able to back off from 50 milliwatts' dissipation to 10 milliwatts and still get 1-nanosecond delay." Twenty gates of MECL 3 at 1 nanosecond dissipate 1 watt, which is difficult to cool. Abraham says MECL 4 will allow the same function at the same speed with only 250 milliwatts of power dissipation, "which isn't nearly as difficult to cool in a normal computer." Like MECL 3, which is just beginning to be designed into new computers, MECL 4 will be mainly a custom family.

GE adds computer to top of 600 line

General Electric's just-introduced giant computer, a new flagship for the 600 line, features what GE calls three-dimensional processing—simultaneous batch processing of jobs carried in on cards or tape, batch processing of jobs arriving via telephone line from a remote terminal, and time sharing capability. The other machines in the 600 family also have this processing feature.

The machine, labeled the 655, will be compatible with other 600 models. And like Control Data's 7600 and IBM's 360 models 85 and 195, it will have a hierarchy of memories. The main memory, a traditional ferrite-core array with a cycle time of about 1 microsecond, transfers data in large blocks into a fast buffer where it can be retrieved by the processor in 100 nanoseconds or less. The buffer probably is a semiconductor array much like those in the giant IBM machines; Texas Instruments is believed to be supplying custom emitter-coupled-logic circuits for the 655.

TI also makes ECL-like circuits for the high-speed buffer memories on the IBM computers.

No other manufacturer offers as large a selection: hundreds of standard types of control knobs, more than 2,000 "specials". Almost every type, style and color combination is promptly available to you from local distributors and large factory stocks.

Turn to color with the new PANELRAMA knobs shown below...mix or match caps and body colors in almost any combination...to harmonize or contrast with every panel decor.

Or, you can choose elegantly-

styled Designer Series knobs with spun-aluminum caps on body colors of black; light, medium, or dark grays; and off-white. When you need a solid color, select from the nine decorative colors in our 400 series.

For military applications, specify Standard Series control knobs—thousands of quality knobs that meet MS91528. Or, specify the new self-locking push-to-turn knobs and Microverniers...for accurate, precision control settings. And when you need custom-

made knobs, call Raytheon first...to get the advantages of Raytheon quality and fast delivery.

For a catalog, call your distributor or nearest Raytheon regional sales office. Or send the reader service card. *Raytheon Company, Industrial Components Operation, Quincy, Massachusetts 02169.*



Here's why Raytheon knobs control more settings than any other brand.



Custom(er) Cable Constructions by Chester

Proof of Chester's ability to produce plastic coated multi-conductor cable construction to customer requirements is reflected in part by the production samples shown on these pages. Though only representative of the thousands of "specials" made for our many customers they graphically prove Chester's ability to translate a wide range of special multi-conductor needs into dependable and practical cable constructions.

When standard cable constructions will not suffice, Chester's vast resources, technical skills and manufacturing facilities are placed at your disposal to manufacture conductors, insulations and jackets to meet your most exacting requirements.

Whatever your multi-conductor cable needs, check first with Chester. We know you'll be more than pleased with the expeditious and thorough handling of your request.

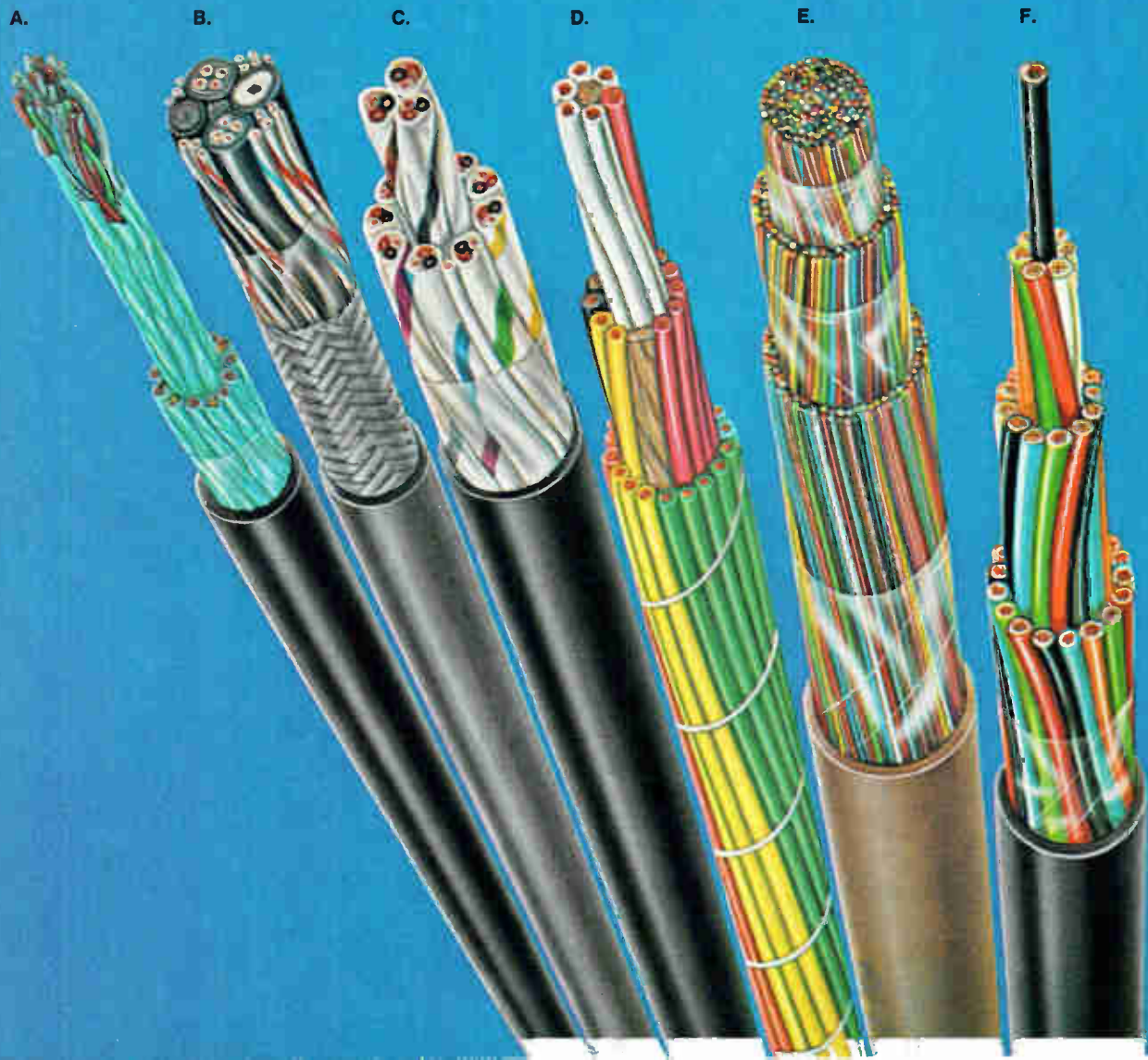

A. RECORDING STUDIO: Audio sound cable; 25 shielded pairs, stranded copper conductors, low loss insulation, twisted with uninsulated drain wire, isolated aluminum tape shields, cabled, PVC jacket.

B. TV CAMERA MFR.: Camera control cable for Audio and Video signals; a composite of PVC and polyethylene insulated conductors, cabled, overall braid shield, PVC jacket.

C. AIRCRAFT SIMULATOR MFR.: Control cable; 12 shielded jacketed, stranded copper conductors, PVC insulated, individual shield jackets color coded, cabled overall PVC jacket.

D. ELEVATOR MFR.: Control cable; 35 conductors, stranded copper, PVC insulated, conductors coded by colors and printed numbers, cabled with open binder; individual conductors U/L listed.

E. INTERCOM EQUIPMENT MFR.: 250 conductor inter-office communication and signaling cable, solid bare copper, PVC insulation, paired, cabled, PVC jacket, U/L listed.

F. ELECTRIC UTILITY CO.: Station control cable for general use; 37 conductors, stranded, polyethylene and PVC insulated, color coded, cabled, overall tough PVC jacket, per NEMA/ IPCEA Specifications.

G. LARGE CITY: Communication cable; 50 pairs, polyethylene insulated, cabled, continuous layer of copper shielding tape, PVC jacket; per spec. IMSA-19-2, 600 volts.

H. LEADING SHIPBUILDER: Shipboard cable; stranded conductors, nylon-jacketed PVC insulation, pairs shielded and jacketed, cabled, PVC jacket, and aluminum braid armor overall; per spec. MIL-C-915.

I. U. S. GOVERNMENT: Coaxial cable; type PG-218/U, solid copper conductor, polyethylene insulated, copper braid shield, PVC jacket; per spec. MIL-C-17/79.

J. BROADCASTING COMPANY: Remote control broadcasting cable; stranded conductors, polyethylene insulation, pairs & triplex shielded and jacketed, cabled, PVC jacket overall.

K. COMPUTER MFR.: Computer control cable; 55 conductors, stranded copper conductors, PVC insulated, formed into 7 groups of 7 conductors, cabled, PVC jacket; U/L listed.

L. MACHINERY MFR.: Bus drop cable; 3 PVC insulated stranded conductors, with split uninsulated grounding conductor, cabled overall PVC jacket, U/L listed per NEC.



CHESTER CABLE CO.

DIVISION TENNESSEE CORPORATION

CHESTER, NEW YORK • 10918

PHONE (914) 469-2141 TWX (914) 469-9801

A SUBSIDIARY OF CITIES SERVICE COMPANY

Circle 37 on reader service card

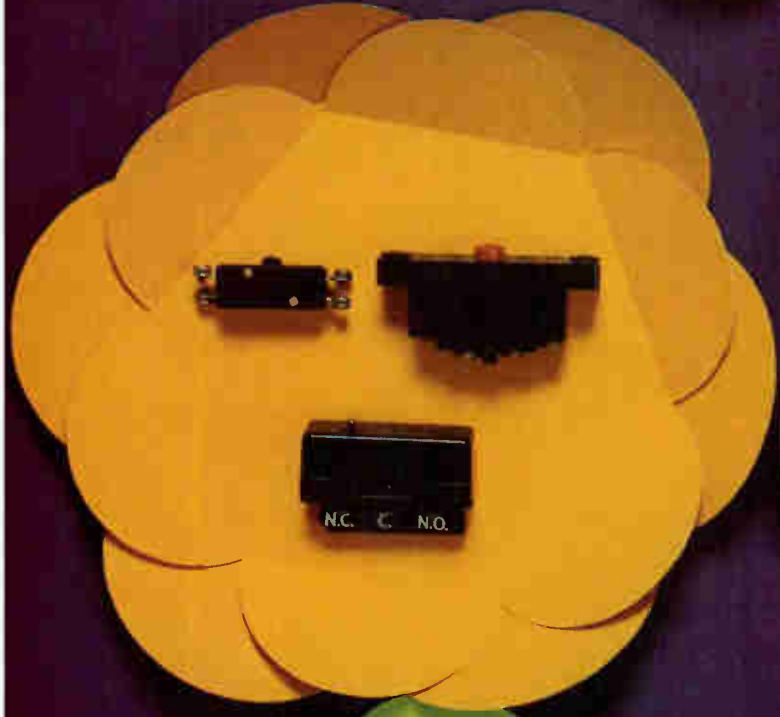
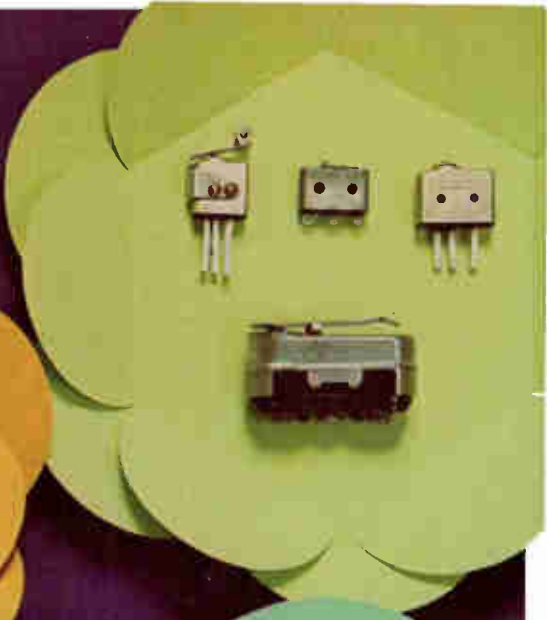
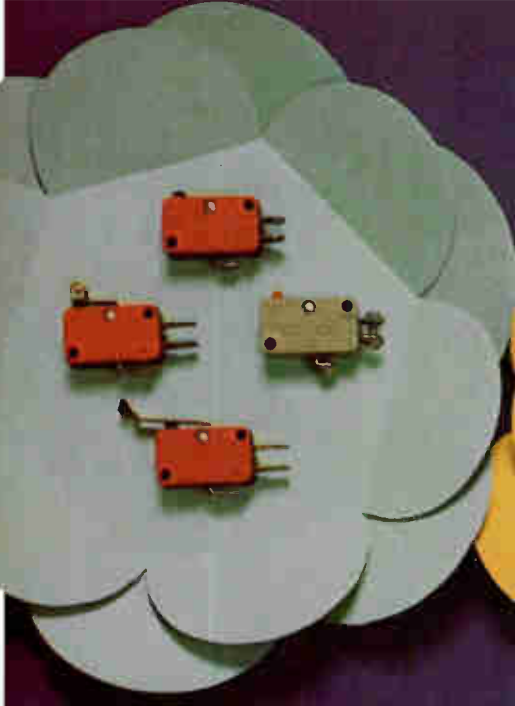

Basic Switches?

Go where you can pick from the whole blooming family.

You won't miss out on the latest in basic switches when you come to MICRO SWITCH. Here you can make your selection from the world's largest family. Thousands of subtle variations help you meet any combination of requirements—size, weight, circuitry, electrical capacity, actuation, termination and environmental resistance.

For example, there are switches especially sealed to do the job in highly contaminated environments; switches that operate efficiently at temperatures as severe as $+1000^{\circ}$ or -320°F ; electrical loads from milliamp to 25 amps, 125 vac, or 10 amps, 125 vdc. A large number meet military specifications.

But you can expect much more when you come to MICRO SWITCH. For instance, extra assurance of consistent quality throughout a large quantity run. Or

the certainty that a switch will deliver precise operating characteristics throughout a long life. Perhaps what's essential to you is the convenience of local distributors with complete selections on the shelf—or, on the other hand, world-wide availability! If on-time deliveries are critical to you, you'll be interested in our computer-controlled ordering, inventory and production control system. Finally, should you have special design problems, our engineering field service—the largest in the industry—specializes in coming up with the right solutions.

Shown at left and described below are just a few members of our ever-blooming family of basic switches. For additional information, call a Branch Office or Distributor (Yellow Pages, "Switches, Electric"). Or write for Catalogs 50 and 52.

A. Type V3 Basic Switches—Small, versatile precision switches. Over 500 standard designs, including many actuator and terminal variations. Operating force as low as 10 grams, differential travel as small as .002 inch. Rating up to 15 amps 125 vac. SPDT, SPNO or SPNC. Temperature range up to 600°F . Military listed. Case size 1.09 x .62 x .40 inch.

B. Subminiature Basic Switches—Precision operation with minimum space and weight. Variety of actuators, terminals and characteristics. Silver or gold contacts, and bifurcated contact design for reliable low energy operation. Military listed. Type SM: Case size .78 x .35 x .25 inch, up to 10 amps 125 vac. Type ISX: Case size .50 x .35 x .20 inch, 7 amps 125 vac.

C. Sealed Basic Switches—Small switches for reliable military/aerospace use and other applications requiring environmental protection. Types XE and SE are classed watertight (Symbol 3, MIL-S-8805), with a corrosion-resistant metal housing, molded silicone rubber plunger seal, and terminals encased in epoxy resin. Types HM and HS feature true hermetic sealing (Symbol 5, MIL-S-8805), with metal-to-metal and glass-to-metal fusion. Solder or leadwire termination.

D. Special Circuitry Basic Switches—Simplify circuit design and eliminate extra wiring. Type "DT": DPDT. Type TB: 2-Ckt and 4-Ckt Double-Break. Type MN: 2-Ckt Double-Break. Also dual SPDT assemblies, make-before-break, pulse operation, and sequential action types.

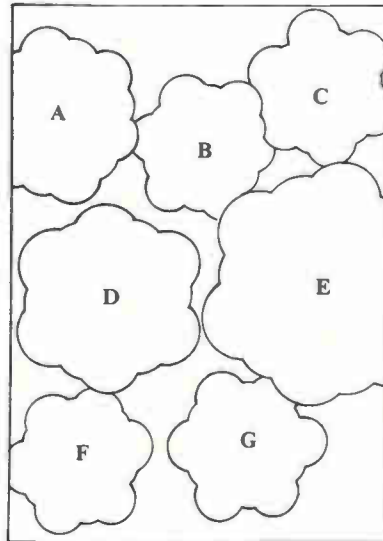

E. Standard Basic Switches—The maximum in precise operation, accurate repeatability, long life and high electrical capacity. Thousands of proven designs available. Variety of actuators and terminals. Case size: 1.94 x .95 x .68 inch. SPDT, SPNO or SPNC. Momentary or maintained contact. Type Z: 15 amps; Type A: 20 amps; Type M: 22 amps; Type E: 25 amps; each at 125 vac. Type MT: 10 amps 125 vdc.

F. High Temperature Basic Switches—Type HT switches withstand $+1,000^{\circ}\text{F}$ and -321°F . Available with panel-mount push-plunger or roller-plunger, or side-mount with auxiliary actuators. Corrosion and shock resistant.

G. Glass-Enclosed Switches—Hermetically sealed contacts for extra reliability and long life. Modern automatic equipment assures product uniformity in large quantity production. Type AS mercury switches: low force, tilt operation; SPST, SPDT, or 2-Ckt; rating up to 70 amps 30 vac; variety of operating characteristics. Type CS miniature reed switches: Form A or Form C; outstanding long life/high capacity combination—up to 100,000,000 cycles at 10 watts; and high reliability on micro-volt or micro-ampere circuits.

MICRO SWITCH

FREEPORT, ILLINOIS 61032

A DIVISION OF HONEYWELL

HONEYWELL INTERNATIONAL: Sales and service offices in all principal cities of the world. Manufacturing in United States, United Kingdom, Canada, Netherlands, Germany, France, Japan.

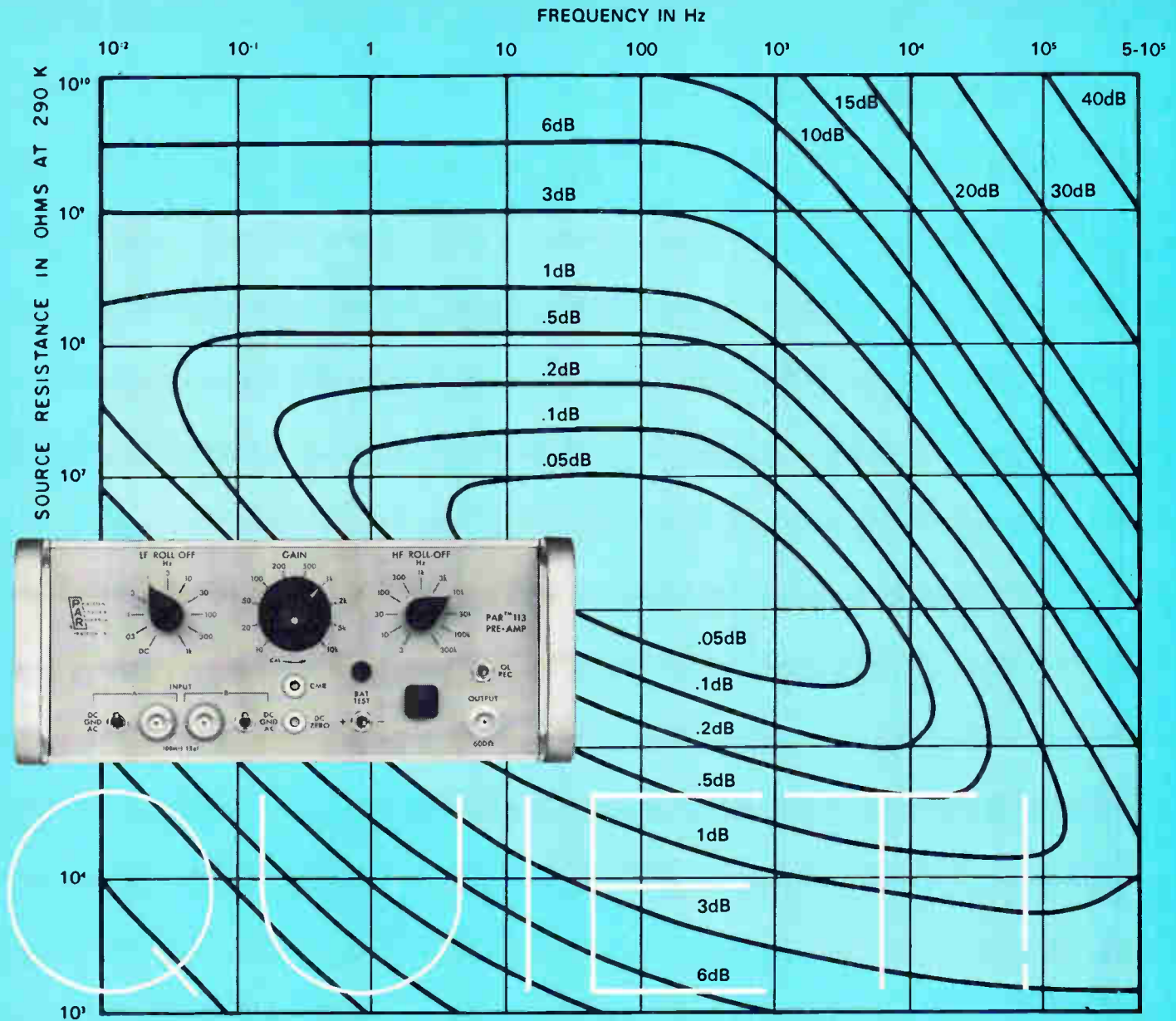

How quiet? At 10 Hz, with a 2 megohm source resistance, our new Model 113 Low-Noise Preamplifier has a noise figure of less than 0.3 dB. Or at 1 kHz, with a 1 megohm source resistance, its noise figure is only 0.2 dB maximum. Shorted input noise from dc to 100 kHz is typically 1 μ V referred to the input.

Model 113 also offers:

- Switch selectable ac or dc coupling in either single ended or differential input mode
- High rejection of common mode signals
- Low- and high-frequency rolloff controls for attenuation of signals outside the range of interest
- High input impedance: Ac coupled: 100 megohms through 0.1 μ F shunted by 15 pF; Dc coupled: 1 gigohm shunted by 15 pF

- Gain continuously variable from 10 to 25,000
- Battery operation to eliminate 60 Hz pickup. Provides 30 hours of continuous operation between charges. Built-in charger automatically recharges battery when plugged into 110/220 V ac line. Front panel test lamp indicates battery condition.

Ask us to demonstrate our quiet new \$795 Model 113 Preamplifier for you now. Then you'll see why we're making so much noise about it. Contact your local PAR representative or write Princeton Applied Research Corporation, Box 565, Princeton, New Jersey 08540. Telephone: (609) 924-6835.



PRINCETON APPLIED RESEARCH CORPORATION

Automating Congress: caveat venditor

Largest U.S. computer system ever offers contractor great prestige if enormous challenge is met—and hell to pay if it isn't

Q. What will be the largest computer system ever developed in the U.S.?

A. According to Edward J. Mahoney of the General Accounting Office, it will be the one being developed for the Congress. Mahoney is chairman of the working group that's helping the legislators with their preliminary study work.

If Mahoney doesn't convince you, consider this prediction from Rep. Jack Brooks (D., Texas). He figures that the cost of computerizing Congress will equal that of a nuclear weapon system—billions of dollars over the next 10 to 15 years.

Those estimates have surprised computer industry representatives in the capital, virtually all of whom view potential Congressional sales as comparatively small when stacked against those of, say, the Department of Defense. Moreover, they consider such a venture more dangerous than the prestige of being the company that automated Congress is worth. "There's no question of the prestige," sums up one of the marketing men in Washington, "but anyone who tries it had better be sure it works—and works from the start—or there'll be hell to pay. It would be all over the Congressional Record."

Finding a base. Mahoney's working group concedes that Congressional housekeeping is an intricate and complex task and that contractors should indeed understand the requirements. As the preliminary study puts it, the first job of specifying the requirement of Congressional automation—"the accumulation and conversion of data to establish the data base"—is "almost

as difficult as designing the system."

Having decided that Congress has to be automated [*Electronics*, June 9, p. 51], the Committee on House Administration is now beginning Phase 2 of the study to determine general information need, a process Mahoney estimates will take from six to nine months.

Congressional requirements will probably be:

- For all of Congress: legislative and legal information, including status and content of bills, legislative calendars, summaries of daily Congressional action, index of documents, and access to the U.S. Code and other legal information. Also, access to data stored in other agencies, such as budgetary, appropriation and authorization data; Federal contract awards; research information and statistical data; and description of information stored in the Executive branch. In addition administrative functions—information on lobbyists, doing payrolls, and maintaining telephone directories—will be included.

- For each chamber of Congress: voting and post-vote analysis.

- For committees: calendar details, status of pending legislation, data on subjects within the committee's jurisdiction, executive files for the committee, and a history of its actions.

Tailored. In addition, the system may have to be designed individually for each Congressman, so he can have extensive data on his constituency and information pertinent to interests in his district. Political parties may also be included in the scheme, with data to be provided

including information by states or areas of the country; information by subject categories, such as air pollution or space; information on objectives and policy and those of the opposing parties; and voting information.

The Legislative branch has bought or rented equipment in the past from IBM (Government Printing Office, Library of Congress), Burroughs (Architect of the Capitol), Honeywell (General Accounting Office), Recognition Equipment Inc. (Library of Congress), and National Cash Register (Clerk of the House). But there is no indication whether one of these, some other company, or even a consortium of companies will be working on design and installation of the proposed system. The GAO's Mahoney says that so many companies, big and small, including hardware and software firms, have shown interest that "we would have to reserve Kennedy stadium to house all the proposals," indicating that RFP's will be solicited from only a few.

Contracts

\$50 million off the shelf

Contractors, hoping to get their piece of a market estimated at up to \$50 million—with little R&D effort required—are in hot competition for development of the first triservice integrated target command system (ITCS). The fact that the system will be developed using existing technology is another indi-

Electronics Index of Activity

December 8, 1969

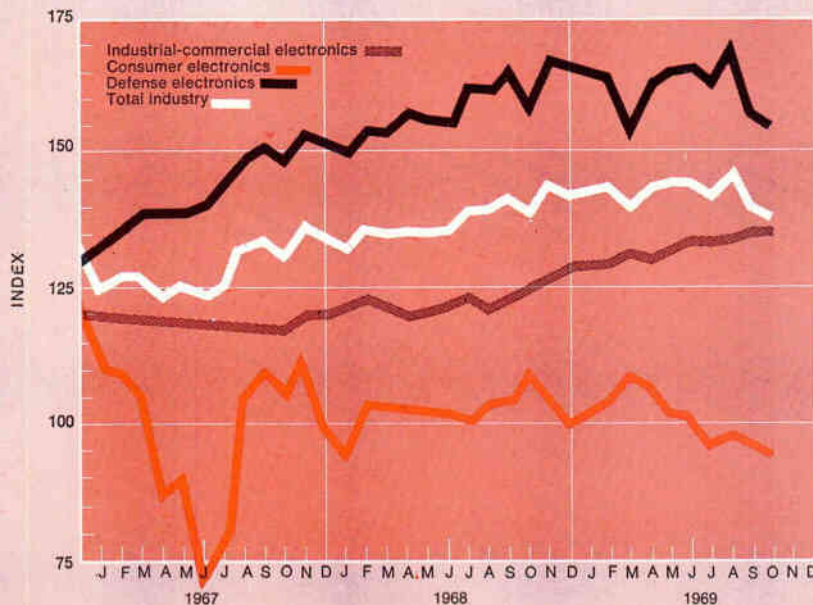

Segment of industry	Oct. 1969	Sept. 1969*	Oct. 1968
Consumer electronics	95.0	96.8	109.5
Defense electronics	154.6	157.2	159.0
Industrial-commercial electronics	135.7	135.7	125.1
Total industry	138.8	140.5	140.6

Electronics production in October fell for the second month in a row. The index was down 1.7 points for the month and 3.1 from the revised August figure of 141.9. The drop from a year ago is 1.8 index points.

Two of the three components in the index showed month-to-month decreases, with only the industrial-commercial sector holding its own. Consumer electronics dropped 1.8 points from the revised September figure, and defense electronics sagged by 2.6 index points.

Indexes chart pace of production volume for total industry and each segment. The base period, equal to 100, is the average of 1965 monthly output for each of the three parts of the industry. Index numbers are expressed as a percentage of the base period. Data is seasonally adjusted. *Revised.

cation that the Government, while not yet seeking standardization of major weapons, is moving toward standardization of smaller electronic systems throughout the military services.

The Naval Air Systems Command, which is handling the combined military effort, has solicited quotations from 30 firms with experience in developing or manufacturing this type of system. The command declines to estimate what ITCS will cost the three services, but one industry estimate is that the R&D phase will be worth anywhere from \$1.5 million to \$2 million. The same source says that future market possibilities "will be quite lucrative, perhaps \$30 million to \$50 million in the next five years," considering command requirements on ships, at Air Force bases, and in the field.

Drone work. The contract will be for a prototype system of surface and airborne components to com-

mand and control target drones on both line-of-sight and over the horizon. The system will provide command, tracking, telemetry, and ranging of one or more target drones. Current target drone control systems require a separate instrument package on the range for each function, plus instrumentation on the drone. ITCS will combine them into one ground shelter housing 20 to 39 pounds of radio transmitting and receiving equipment.

Find a frequency. The technology will be pretty much with off-the-shelf items—just more integrated, and no new instrument packages will be required on the target drones. The only modification of current systems, say sources, will be in the drone command receivers and transmitters in the ground package, which will have to be changed to different frequencies.

As a matter of fact, one company, which decided not to bid on ITCS

because of the Navy's "monkey business," says the Government has been considering the standardized military system for two years. Delay was caused, according to the company, by the military's target control frequencies being "spread out all over the spectrum." This was the prime reason, the firm says, for the three services using such varied systems—there are about 30 doing the same job. After rejecting the idea of using a tactical satellite link to get around the problem, the military has finally acquired a common target control frequency.

ITCS probably will not be procured in large numbers immediately after completion of the R&D phase. It's far more likely that ITCS will be deployed as old systems wear out.

According to one industry source, Babcock Electronics, Lear Siegler, and Sierra Research will be heavy contenders for the award.

Medical electronics

On the cuff

When a giant international corporation like Hoffman-LaRoche Inc. turns its attention to a new technology area, it's a pretty good bet that the result is going to be worth a close look. That's the case with the pharmaceutical house's first medical electronics product. Labeled the Arteriasonde and billed as the first clinical device to measure blood pressure with ultrasound, the instrument is slated to debut early next year.

The Arteriasonde comprises an electronic processing unit, 1.5 feet high by 1 by 1 foot, and a rubber-encased cuff that fits around the patient's upper arm. Along the cuff's inside circumference are five piezoelectric crystals, two for transmitting and three for receiving. The processor sends 2-megahertz signals to the generating crystals—the second and the fourth—which in turn radiate ultrasonic energy. A portion bounces off the wall of the arm's artery (the brachial artery), and back to the receiving crystals.

As the patient's heart contracts and expands, the velocity and volume of the blood in the arteries change. And as they change, arterial walls stretch, contract, and shift position slightly. The shape and phase of waves reflected by the brachial artery depend on how much it moves; this, in turn, depends on the blood's velocity and volume, themselves functions of blood pressure. Thus, the ultrasonic energy coming back to the cuff is a measure of the patient's blood pressure.

Mercury. The Arteriasonde's processor turns the reflected waves into pressure readings displayed via two mercury columns. One shows the maximum (systolic) pressure, the other the minimum (diastolic).

Priced around \$2,000, the Arteriasonde is more than 200 times as expensive as the cuff-and-column instrument doctors traditionally use. However, Roche scientists point out that their instrument can work either where a doctor can't

use the old method—as in the case of a shock victim whose pressure is very low—or where he must resort to the surgical step of threading a catheter into the heart through an artery. It's expected that the Arteriasonde will be purchased by hospitals rather than private practitioners. Doctors also sometimes have trouble measuring the blood pressure of infants, so Roche scientists are adapting the Arteriasonde for obstetric use.

The Arteriasonde is the first part of Roche's planned patient-monitoring system which, besides measuring pressure, will take electrocardiograms and measure heart rate and cardiac output (the amount of blood flowing from the heart).

Stroke detector. The division is concentrating its research on ultrasonic diagnosis. In the prototype stage is a probe that measures the blood flow to a patient's brain when held to his neck. Roche scientists hope that this measurement will help early stroke detection.

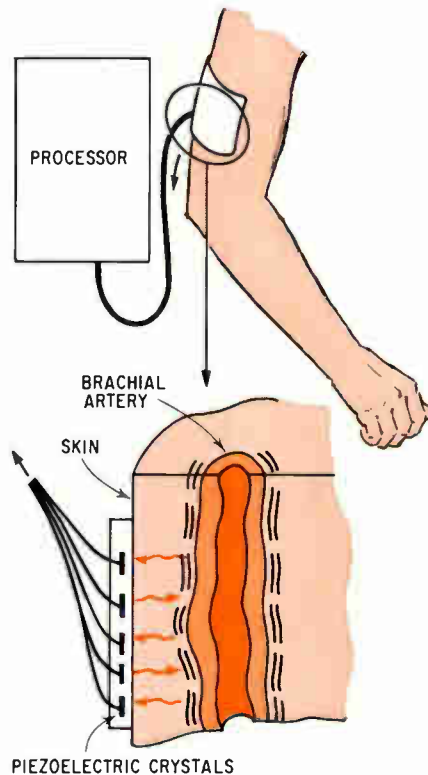

Beat. Roche's device measures blood pressure ultrasonically. Piezoelectric crystals receive and transmit data reflecting changes in shape of the brachial artery.

Hoffman-LaRoche got into the medical electronics business around 1966 as a partner of RCA. The idea was: "I know what doctors need (or will buy) and you know electronics." But the marriage didn't work, and in 1968 Hoffman-LaRoche bought RCA's medical electronics operation, dubbed it the Roche Medical Electronics division, and last month moved it out of Trenton, N.J., and into a new building in Cranbury, a small town in central New Jersey.

Components

Under full sail

Now that the Navy has revised and expanded its Standard Hardware Program (SHP), it predicts that more than 2 million types of electronic modules will be covered by fiscal 1974. The projection is based on application of SHP to more than 30 multienvironment systems embracing communications, fire control, guidance, radar, and sonar. The latest addition in the sonar category is the Ship Systems Command's AN/BQR-2 digital multi-beam steering system for which Honeywell and IBM's Federal Systems division have competitive detail design phase contracts.

What about medium- and large-scale integration? The Navy believes that SHP is sufficiently open-ended to accommodate MSI even though the standards were initially conceived for basic electronic functions such as gates, flip-flops, and the like. As for LSI, the Navy's not so sure standardization is possible.

By function. As an example of the open-ended nature of its effort, the standardization program has four categories for modules based on functional complexity, even though semiconductor technology is essentially limited to three—IC's, MSI, and LSI. In the Navy's view, the latter reflect functional density, rather than complexity, and it wants to differentiate between functional complexity and the make-it-smaller race.

The first level, naturally, covers

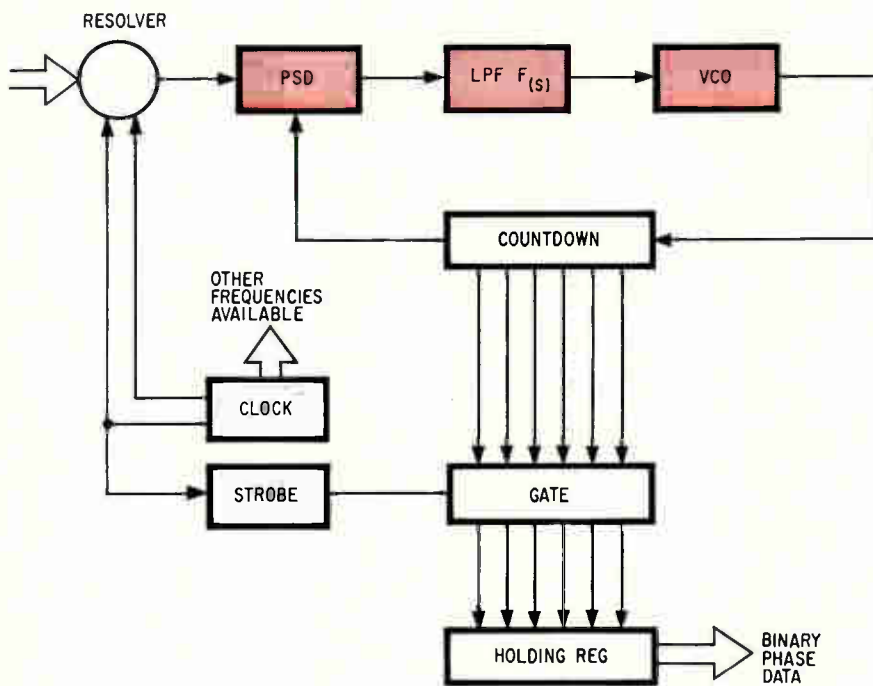

Something old, something new. The Navy believes this combination of MSI and LSI devices, plus a two-year-old MIT Instrumentation Lab concept, might provide fast, simple, accurate d-a and a-d conversion.

widely used and easily tested low-power modules, usually noninterconnected IC's such as gates, one-shots, and diode arrays. Level 2 embraces modules such as shift register counters, and devices made by interconnection of IC's within a module easily tested and produced with medium power dissipation. MSI modules come under Level 3 which is, the Navy says, "probably the highest level at which standardization will be possible unless there is a major change in system building blocks" used by designers. The fourth and last level is that of LSI, defined as a monolithic device with more than 100 circuits "usually characterized by its uniqueness to a particular system with little or no chance for standardization and that are very difficult to completely test."

Though the first change in the third revision of the four-volume Standard Hardware Program data handbook (OD 30355)—including an entire new second volume on module parameters—is just getting into contractors' hands, another change is coming this month. It deals with heat transfer considerations in ship modules. Titled OD 37625, it will

provide a comprehensive data source for investigating cooling modes for conductive heat transfer out of a module component and exterior heat dissipation.

What's next? A meeting of Navy ship module users to identify advanced functional requirements with potentially broad application, and for which parameters could be defined and prototypes built and tested, has recommended 11 of 20 functions for immediate SHP implementation, leaving the other nine to the future. The 11 include: a 16-bit shift register, an 8/4 up-down binary counter, a dual 512-bit dynamic shift register and a dual 32-bit static unit, an 8/16 bit comparator, a multiplexer, a demultiplexer, an 8-bit accumulator, a serial adder, a high-speed interface receiver, and a dual 8-channel multiplexer.

Recommended for later SHP implementation were digital differential analyzers, a fast Fourier transform, a parallel adder, a digital-to-analog converter, a Boolean function generator, a parity generator and check, a high-speed multiplier, an analog multiplier, and an MOS power supply.

Avionics

One if by land

Inertial navigation systems that conform to Arinc Characteristic 561 for commercial airliners were intended for transoceanic flights during which position updates from a very-high-frequency omnirange/distance-measuring arrangement can't be obtained. They were not intended to cope with the problems of en-route and terminal area navigation.

But Litton Industries and AC Electronics are adding the domestic area navigation function to the inertial navigation task of their inertial systems—something that will be available to buyers of the Lockheed L-1011 TriStar from the outset [*Electronics*, Aug. 4, p. 54; Sept. 29, p. 66].

Two boxes. Officials at Litton's Aero Products division expect to have such a modified version of their LTN-51 commercial inertial system ready to flight test next June. Two boxes will be added to LTN-51's existing three modules to make it comply with Arinc guidelines now being written on how area navigation problem-solving can be added to an inertial system that meets Characteristic 561. Arinc will call the resulting navigator, a Mark 3 area navigation system.

The three modules in the present LTN-51 are the inertial navigation unit, the control display unit, and the mode selector unit, with the latter two located in the cockpit. The inertial navigation unit includes the inertial platform and its electronics, plus a digital computer. The two new boxes being developed at Litton are a magnetic card reader to automatically load terminal and en-route waypoint and VOR/DME station data into the inertial unit's computer, and a signal-conditioner to process the VOR/DME inputs that update the inertial unit.

For a flight from Los Angeles to New York, there are 14 departure routes from Los Angeles International Airport; a typical one might send the plane over four waypoints

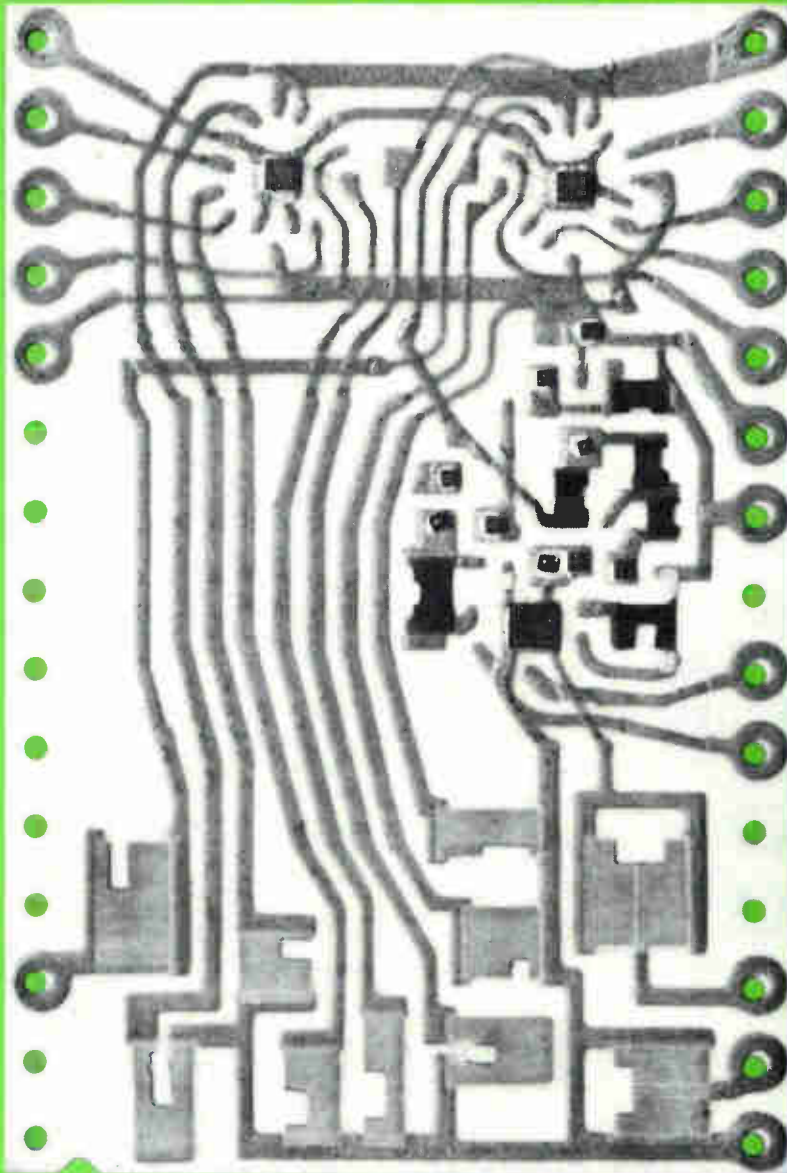

4 X Actual Size.

A complete 8-bit Digital-to-Analog Converter for \$75!

The new Helipot Model 845 is a thick-film, miniaturized hybrid digital-to-analog converter (DAC) that converts an 8-bit binary word into an analog output. The input gates, switches, resistor network, reference voltage, and output amplifier are all in the hybrid module.

Because of its operating temperature range (-20°C to $+85^{\circ}\text{C}$), Model 845 can be used for any industrial digital-to-analog conversion, process control being a typical application. Price is \$75/unit in 1-9

quantities (less in greater numbers). The package size is 1.0 inch x 1.5 inches x 0.170 inch. The unit accepts an 8-bit, parallel, binary word that is TTL- and DTL-compatible, and an enable gate is provided. Four different output-voltage ranges are available as standard models: two unipolar (0 to +5 v, 0 to +10 v) and two bipolar (-5 to +5 v, -10 to +10 v). Power-supply requirements are +15 v at 60 ma and -15 v at 10 ma. The output accuracy is $\pm 1/2$ least-significant bit at $25^{\circ}\text{C} \pm 1$ mv

per percent of supply-voltage variation. The output-current range is 0 to ± 2.5 ma, and the output slew rate is 0.3 v/ μsec .

And, it's available from stock.

Beckman[®]

INSTRUMENTS, INC.

HELIPOT DIVISION

2500 HARBOR BOULEVARD

FULLERTON, CALIFORNIA 92634

INTERNATIONAL SUBSIDIARIES: AMSTERDAM; CAPE TOWN; GENEVA; GLENROTHES, SCOTLAND; LONDON; MEXICO CITY; MUNICH; PARIS; STOCKHOLM; TOKYO; VIENNA

Circle 45 on reader service card

Time coding can be simpler than you think

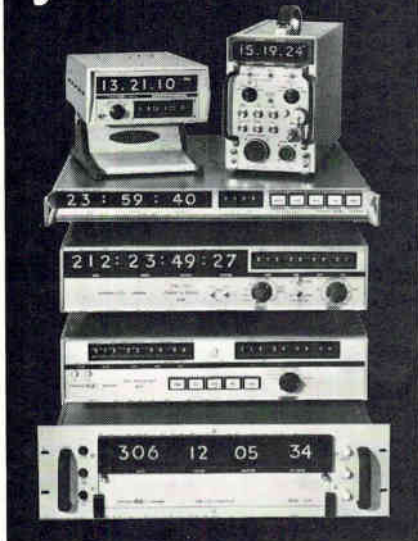

Systron-Donner can help you cut through the profusion of time code formats and equipment—to the selection of the right format and the right equipment for the job.

Our new 90-page handbook will guide you to the best technique for your application, and enable you to select appropriate equipment from the comprehensive line offered by Systron-Donner.

Systron-Donner equipment ranges from compact time code generator/readers costing as little as \$1495, through portable battery-powered generators for field use, to high-precision generator/readers with automatic tape search.

Send for handbook sample.



Send for free copy of "Selecting time code format," Chapter 3 of our new 90-page, illustrated handbook on time coding techniques. Complete handbook: \$3.00.

SYSTRON  DONNER

Data Products Division,
Systron-Donner Corporation,
888 Galindo Street,
Concord, Calif. 94520.
Phone (415) 682-6161.

and their associated VOR/DME stations before the crew switches to en-route navigation at Boulder City, Nev. The latitude and longitude of the waypoint, plus the altitude at which the plane is to cross that waypoint, are magnetically encoded on the back of a plastic card the size of most credit cards. The same card also will contain magnetic data giving the latitude and longitude, altitude, magnetic variation from true heading, and frequency of the VOR/DME stations to be used in the departure terminal area. The same information is printed on the front of the card so that the crew can choose the right card.

Take a card. The flight crew will select the terminal departure route to be used and load that card into the reader. The card reader will use the reader/transporter incorporated in Hewlett-Packard's 9100A desk calculator, plus associated electronics to sense and format the magnetic data into a digital form acceptable to the computer. After the data is entered in the reader and stored in shift registers, a button is pushed to load it into the inertial unit's computer.

In flight, the cockpit control/display unit displays the latitude and longitude of the first waypoint until about 30 seconds before the start of the second leg of the flight; the latitude and longitude of the second waypoint then will be pulled from the memory for display, and so on for each of nine waypoints the LTN-51 inertial navigator can accommodate.

Once the plane reaches Boulder City and transfers to en-route air traffic control, the crew can select any of several routes to Kennedy International the airline might use. These routes, with their associated waypoints and VOR/DME sections, will have been encoded magnetically on cards similar to the departure terminal cards just before taking off. An encoder/verifier will check the magnetic data that calls out the best route under prevailing weather and traffic conditions; this information is sent from a central airline facility by teletype writer. Encoding on the en-route card can be done simultaneously with tele-

type reception, or a paper tape can be prepared later from the hard copy to be used in magnetically coding the en-route card.

Card trick. The en-route data is entered via the card reader before departure as is the departure terminal route information, and the destination terminal data. The latter is contained on another set of magnetic cards like the departure airport route cards. Thus, the plane can be flown from Los Angeles to New York using just three cards to enter route information into the computer.

The signal-conditioning box is needed to couple the VOR/DME receivers in the plane to the inertial system, updating the inertial unit, which otherwise would drift off the true course at a rate of one nautical mile per hour. The crew still must manually tune these receivers to the next VOR/DME station along its path in the basic Mark 3 LTN-51, but an option that might be added later would provide automatic tuning.

Litton officials haven't put a price tag on the Mark 3 version of the LTN-51, but they point out that there's a rich retrofit market because they've already sold more than 300 LTN-51's.

Light loran

Integrated circuits in a loran C/D airborne navigation system hardly seem to make a difference; the military's AN/ARN-92 system weighs 96 pounds anyhow, and dissipates over 500 watts. But put large-scale integrated circuits into the airborne navigator and the system really shrinks.

The International Engineering Co. has developed, with its own funds, a complete LSI loran C/D airborne navigation system that weighs only 13 pounds and dissipates about 23 watts. And most of this power is to light the bulbs on the control panel.

It fits. The system is small enough, its developers say, to fit into all types of military aircraft, from fighters down to small, light observation helicopters. The cost



now . . . the fast-recovery
MAGNUM™

**The first 20 amp,
500 nanosecond
rectifier assemblies
with full-power operation
up to 40kHz.**



**Here's what we mean when we say
"They're reliability designed from the inside out."**

All four of the diodes in this aluminum heat-sink case are Unitrode's individually fused-in-glass controlled avalanche, fast-recovery high-surge diodes. So you start with monolithic parts that have typical failure rates of less than 0.0006%, and you have the added bonus of the convenience of the Magnum package.

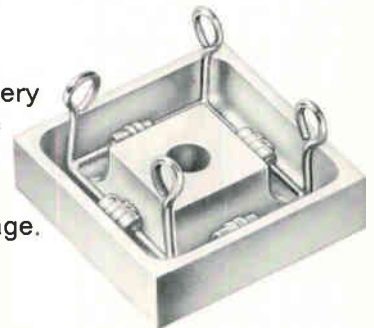

This is what's in the heart of our diodes

With the silicon die metallurgically bonded between terminal pins of the same thermal coefficient, the hard glass sleeve is fused to the entire outer silicon surface. Result — a voidless, monolithic structure.



- #682 Series Three Phase 20 amp Bridges
- #683 Series Single Phase 20 amp Bridges
- #684 Series Single Phase 10 amp Bridges

PIV'S to 600V.
Standard Recovery 25 amp
Magnums also available

For fast action, call Fred Swymer COLLECT

UNITRODE



580 Pleasant Street, Watertown, Massachusetts 02172 • (617) 926-0404

TEC expands its product line... for you!

New modular products by TEC meet more of the stringent requirements demanded by design engineers. Proven reliability of System Power Supplies is complemented by equally reliable thick-film hybrid Voltage Regulators. Check our specifications . . . if your requirements are unique, try our custom design capability!

	 <p>TEC VRH Series Hybrid Regulators High Performance coldweld Hermetic Seal, metal, Dual-in-Line package. Fixed output voltages.*</p>
 <p>TEC VR Series Hybrid Regulators Economy Price 2X-DIP package. Built-in fold back current limiting. Adjustable and fixed output voltages.*</p>	
	 <p>TEC PM Series Power Supplies 115 VAC input supplies. +5, +15, +200vdc output for logic, opamps, mixers. Totally encapsulated.</p>

*Plug-in connectors available for testing and bread-boarding.

See our ad in EBG . . . inside front cover
We're also in EEM . . .
pages 2120-2125



P.O. Box 910
Boulder Industrial Park
Boulder, Colorado
(303) 442-3837

U.S. Reports

of the system would also be a major attraction. In large quantities, it could sell for as little as \$15,000, although the first 200 will cost about \$60,000 with follow-on orders pegged at half this price. The cost of a loran system now being flown by the military is \$135,000.

Called a hybrid loran self-contained navigation, or Hylo, system by the Arlington, Va., division of A-T-O Inc. (formerly Automatic Sprinkler Corp of America), the bulk of the navigator fits behind the control-display panel in the pilot's cockpit. This unit contains the navigation receiver, processing and conversion circuitry, and the digital computer. The circuitry is contained on seven 5-by-7-inch printed-circuit boards and fits, with the power supply and display panel, into a 5-by-7-by-9-inch box that weighs about 10 pounds. Another package, a 3-pound antenna coupler, completes the system.

By way of comparison, the AN/ARN-92 comes in four packages—an antenna coupler, loran C/D receiver, navigation computer, and control display.

Circuits. The LSI circuits in the Hylo system are metal oxide semiconductors supplied by the Autonetics division of North American Rockwell. The entire system comprises only 100 of the MOS/LSI circuits, and most of these are in the system's navigation computer, the D-200 announced by Autonetics last May. Ten special ships are used in the receiver. Previous airborne loran systems had anywhere from 5,000 to 7,000 microcircuits, points out Elmer M. Lipsey, International Engineering's president. The low component count means it's possible to test and burn-in every circuit that's installed, a costly task with the separate microcircuits. It also adds reliability, and indications are that the airborne loran C/D systems now flying in Vietnam are not nearly as reliable as was hoped.

The Hylo system is a hybrid in the sense that it can utilize data from two kinds of navigation aids. Thus, it produces a precise position output by combining, via Kalman filtering techniques, informa-

tion derived from loran C or D ground stations and from any self-contained sensor that could be carried on the aircraft. International Engineering plans to test fly its first unit early next year, all the while trying to sell it to the military. The first target could be the F-4.

Military electronics

Trying before buying

One crash program deserves another. That's the judgment of Army Secretary Stanley Resor and Chief of Staff William C. Westmoreland in their decision to field test all new surveillance, target acquisition, and night operations (Stano) hardware before deployment. The consequence of this decision was the formation at Ft. Hood, Texas, of Project Masster (for mobile army sensor system test evaluation and review). The Texas test team, organized in October, will begin its work next month, reporting results to Army's Stano office in the Pentagon which, in turn, reports directly to Gen. Westmoreland.

Creation of Stano and its field test force in admittedly a crash program, albeit one under taken by the Army with the realization that its prior crash programs aimed at developing a night operations capability in Vietnam have not paid off as anticipated. And the Army, already under substantial Congressional fire for other program snarls, moved quickly to take the initiative in coordinating night operations programs, many of which were funded under quick-reaction capability contracts for a Southeast Asia operational requirement.

Potential. The Army's plan to evolve an "electronic battlefield" under the proposed name of integrated area control system using Stano-approved concepts and hardware is viewed by contractors as one with long-term potential in excess of \$1 billion. For fiscal 1970 alone, Brig. Gen. William Fulton, Stano director, has more than \$14 million plus another \$130 million in procurement money salvaged

Solid State Relays

Another **big** breakthrough from the "little relay" people

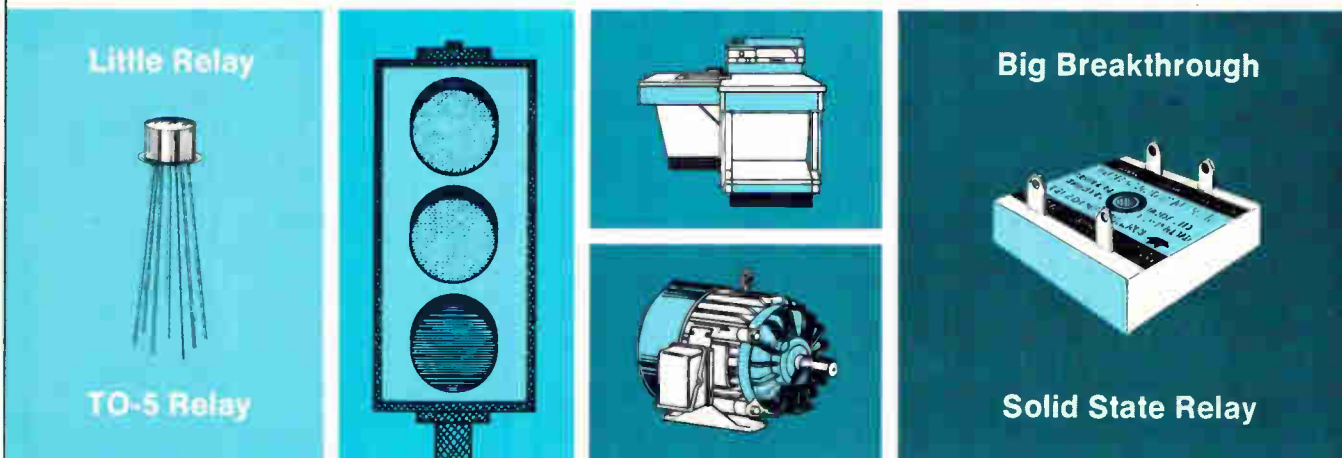

We got our nickname "little relay" people because we usually put our *big* breakthroughs in *small* packages. (Our success started when we introduced the TO-5 relay.) Now, we've made another breakthrough . . . a completely solid state, four terminal relay with enormous power gain. Only 1 milliwatt switches up to 5 KVA, and it can be resistive, inductive, capacitive, tungsten or quartz lamp loads.

Our new relay operates on inputs up to 280 VAC or from

3.5 to 300 VDC (either polarity) permitting direct interface with TTL logic. Input-output isolation is 10¹¹ ohms "coil" to "contact" and "coil" to mounting plate. Dielectric is 2000 VRMS. Output characteristics include contact ratings up to 21 amperes, 280 VAC, 60 Hz. Surge current ratings of 200 amperes, and "contact" resistance as low as 50 milliohms. And, . . . these are real *breakthroughs* for a relay which doesn't have "coil" or "contacts."

Available options include zero

voltage switching for RFI suppression and lamp life extension.

Prices start as low as \$18.30 in quantities of 100. For complete technical data on our Series 6 Solid State Relay . . . contact us . . . the "little relay" people.



TELEDYNE RELAYS
A TELEDYNE COMPANY

3155 West El Segundo Boulevard Hawthorne, California
90250 Telephone: (213) 679-2205

flying spot
scanner,
photometer,
densitometer,
or
scintillation
counter

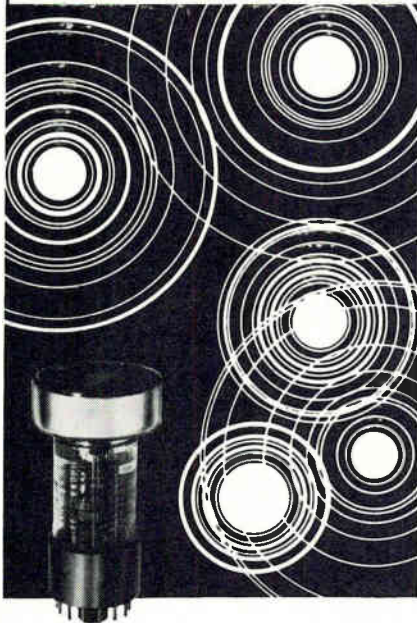

The new range of EMI photomultipliers with "SUPER" S-11 photocathodes will enhance your project performance. High quantum efficiency, (23/24%) high gain at relatively low overall voltage, and low dark current at the rated overall sensitivity are typical of these types. They maintain the EMI standard of excellent gain stability and linearity. The narrow spread in characteristics makes these types ideal for systems or for multiple installations. The table below gives the typical values for the significant parameters.

Dia.	Type No.	Amps/ Lumen	Volts/ Overall	Anode Dark Current Nanoamps
2"	9656R	50	1150	2
3"	9708R	50	1250	5
3.5"	9531R	200	1300	25
4"	9732R	50	1250	10
5"	9709R	50	1350	15

Note that the anode dark current is given for the overall voltage at the specified overall sensitivity. The maximum overall sensitivity is 10 times the values given above. Each Tube is individually calibrated and data is supplied with the tube.

Send for our new 64 page catalog giving data and technical information on the complete range of EMI photomultipliers.

GENCOM DIVISION
varian/EMI

80 EXPRESS STREET, PLAINVIEW, N. Y. 11803
TELEPHONE: (516) 433-5900

U.S. Reports

from the scrapped McNamara Wall—the proposed intrusion barrier between North and South Vietnam. Fiscal 1970 sensor procurement for all three services for the integrated area control system concept—all of which are subject to Stano review and approval—is \$150 million.

The program embraces multiple electronic, optical, and electro-optical systems ranging from light-weight tactical radars to others using infrared, acoustic, seismic, magnetic, and r-f technologic.

phone company and to provide their own terminals. According to Seymour Joffe, Datran president and 12-year Univac veteran, terminal options will range from teleprinters to crt's, magnetic tape machines, card readers, and facsimile equipment.

David H. Foster, a Datran vice president formerly with Collins Radio, says the 35-city net, running from Boston to San Francisco, will require some \$130 million in financing to get on the air by 1974 after an estimated nine months getting a favorable FCC decision.

Communications

Digital common carrier?

Data Transmission Co., the subsidiary of University Computing Co. that's known as Datran, has completed its massive filing with the FCC for the first national digital common carrier network. Now it's awaiting reaction from AT&T and others to its \$375 million plan.

Unlike Microwave Communications of America Inc. and its affiliates, Datran says it plans a public switched network, rather than private line service, and will offer only digital data transmission by microwave, as opposed to Micom's plan to provide digital, voice, and video transmission at the option of users. Datran also proposes to provide terminals as well, where as Micom's plan calls for users to make interconnection via their local tele-

The rates. Dedicated-line services will be offered at 150, 4,800, and 9,600 bits per second. Monthly user charges, in addition to a one-time \$25 installation charge, will be \$15 for a digital console plus a \$20 minimum for the first 4,000 data units at the 150 bps rate. Basic charges then go up to \$25 for the 4,800 bps service; \$30 for 9,600; and \$40 for 14.4 kbps. Usage charges will be 5 cents a data unit—computed at the rate of six seconds holding time between the user terminal and the district office. However, data unit charges for local and regional calls will vary with the grade of service. For example, minimum-service users will get 9 data units per minute in local use and 16 for regional use at the nickel rate. Buyers of the 14.4-kilobit service, however, will get 56 and 94 data units for the same price on local and regional calls, respectively.

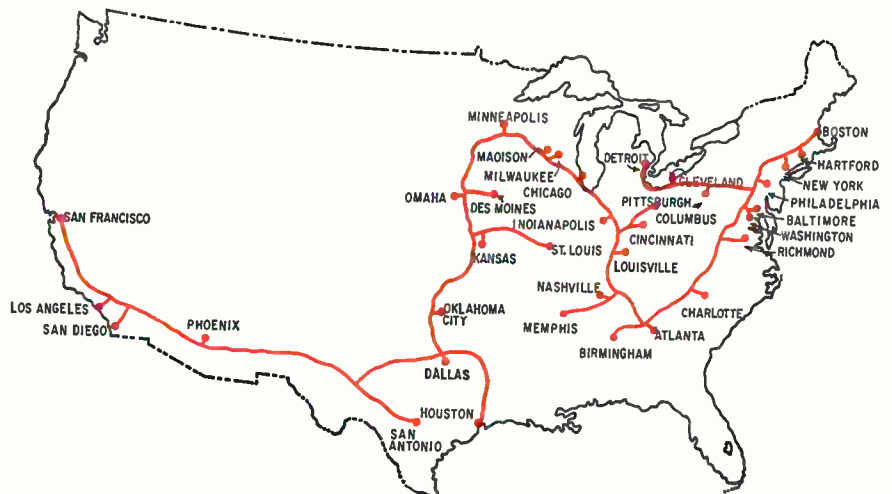

Digital flow. This is the national digital common carrier network that Datran wants to set up. The firm has filed its plan with the FCC.



The case for Centralab lighted, push button switches

Ask your Centralab representative to show you this push button demonstration kit. Discover how versatile a low cost switch can be.

Centralab solves your switching problems with more varieties of lighted, push button* switches at lower cost. Individual standard modules for printed circuit board or panel mounting are available in two, four, six or eight pole, double throw designs. Standard functions are momentary, interlocking and push-push. Each assembly is available with row-to-row locking as a space saving feature; remote release capability and lockout are also available. There's an almost infinite number of com-

binations of modules with 10 mm, 15 mm or 20 mm spacing to meet a variety of requirements. ■ The lighted push button can be customized to meet specific needs using various combinations of bulb caps, filters, and lenses. ■ Lexan[†] lenses and filters are available in nine standard colors as well as clear. Filters permit adjustment of light diffusion and color intensity. Hot stamping of lenses or filters is available.

Want to know more? Turn the page . . .



CENTRALAB

Electronics Division
GLOBE-UNION INC.

5757 NORTH GREEN BAY AVENUE
MILWAUKEE, WISCONSIN 53201

*ISOSTAT LICENSED †TM GE

Here are a few facts to help you judge the case for Centralab



Gang mounted modules

Individual modules may be ganged together on a common mounting bracket. Modules, when ganged, retain all the features of the individual modules and also provide the advantages of space-saving and of interlocking and/or clearing when desired.

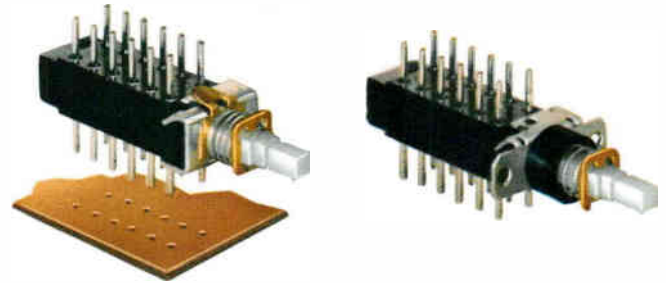

Circuit board or panel mount

An individual switch module or ganged modules may be electrically connected by assembly into a printed circuit board by the use of wire connectors or hand soldering. Switch can be mechanically mounted either through the circuit board or the switch mounting bracket.



Solenoid operation

A solenoid feature for Centralab Push Button Switches can be provided for remote operation of individual modules within a PB switch assembly. Can be furnished in various AC and DC voltages.



Selection of buttons

The typical button styles and sizes illustrated are available in nine standard colors and clear Lexan. Non-lighted buttons are available in black, white, red, grey, cream, and special colors and finishes. Buttons may be ordered in bulk or cemented onto the slider bar.



Your Centralab representative is ready to present his case for Centralab lighted, push button switches. He has the answers to your switching problems. Call him today or write: Switch Sales Manager, Centralab Electronics Division, Globe-Union Inc., 5757 North Green Bay Avenue, Milwaukee, Wisconsin 53201.



Easy bulb replacement

Field bulb replacement is easy without "behind the panel" disassembly. Simply snap out lens and remove bulb with a section of polyethylene tube (1/4" I.D. x 3/8" O.D.).



New module line switch

New, 3-Amp A.C. line switch in module size, provides flexibility of positioning in any type of arrangement. Adaptable to either standard or lighted brackets.



CENTRALAB

Electronics Division
GLOBE-UNION INC.

5757 NORTH GREEN BAY AVENUE
MILWAUKEE, WISCONSIN 53201

SPECIFICATIONS

Mechanical

Stator Block: Phenolic per MIL-C-13428A and ASTM D700-57R, Type 2

Slider Bar: Thermoplastic acetal resin (Delrin®)

Contacts, Fixed: Silver plated copper wire

Contacts, Moving: Copper alloy with silver overlay

Lubrication: During assembly. No further lubrication required

Electrical

Contact Resistance: 4 milliohms, initial 10 milliohms after 25,000 cycles

Current and Voltage Ratings (at 25,000 cycles):
0.45 Amp at 115 VAC
1.00 Amp at 28 VDC

Dielectric Strength (VAC, R.M.S.):
Bracket to Pins — 1000
Pins to Pins — 1400

For applications requiring I.R. that will exceed standard unit values by a factor of 10² diallyl phthalate material may be substituted for general purpose phenolic.

Insulation Resistance (Megohms):

Between	General Purpose Material		Diallyl Phthalate Material	
	70% R.H. at 70° F.	After 96 hrs. 95 to 100% R.H.	70% R.H. at 70° F.	After 96 hrs. 95 to 100% R.H.
Bracket & Pin	6,000	100	1,000 K	100 K
Adjacent Pins (pole to pole)	65,000	185	1,000 K	600 K
Opposite Pins	50,000	210	1,000 K	500 K

CUSTOMBILITY



A new capability is provided by Centralab and our field assembly distributors, a capability that provides you with prompt delivery of versatile, low-cost, push button switches. There's an almost infinite number of switching functions with mounting styles to meet a wide variety of your switching requirements. Contact your Centralab push button field assembly distributor to fill your needs without delay at prices similar to these or lower, depending on specific switching function:

Cost per station (including button)
2 pole — \$1.31; 4 pole — \$1.43;
6 pole — \$1.64; 8 pole — \$1.79

Here are Centralab distributors with a new capability. More to come.

CALIFORNIA, LOS ANGELES 90022

Kieruff Electronics Inc.
 Phone: (213) 685-5511

CALIF., PALO ALTO 94306

Fisher Switches, Inc.
 Phone: (415) 321-4080

FLA., ORLANDO 32805

Hammond Electronics, Inc.
 Phone: (305) 241-6681

INDIANA, SOUTH BEND 46618

Radio Distributing Co.
 Phone: (219) 288-4666

MINN., ST. PAUL 55113

Gopher Electronics Co.
 Phone: (612) 645-0241

NEW YORK, BUFFALO 14202

Summit Distributors Inc.
 Phone: (716) 884-3450

OHIO, CINCINNATI 45237

United Radio Inc.
 Phone: (513) 761-4030

OHIO, CLEVELAND 44103

Pioneer-Standard Elect.
 Phone: (216) 432-0010

PENN., PITTSBURGH 15222

Cameradio Company
 Phone: (412) 391-4000

WASH., SEATTLE 98108

Almac-Stroum
 Phone: (206) 763-2300

WIS., MILWAUKEE 53209

Electronic Expeditors, Inc.
 Phone: (414) 374-6666

*Isostat Licensed

For more information, write:

DISTRIBUTOR PRODUCTS



CENTRALAB
 Electronics Division
 GLOBE-UNIDN INC.

5757 NORTH GREEN BAY AVENUE
 MILWAUKEE, WISCONSIN 53201

Communication

OTM's give and take

Still without a director, the White House Office of Telecommunications Management is nonetheless letting the Federal Communications Commission know it's still very much in business. FCC chairman Dean Burch has a letter from acting OTM director William E. Plummer expressing "grave concern" about the commission's September request that AT&T stop its international negotiations on the use of satellites vs. cable. The FCC action was generated by a letter from Communications Satellite Corp. chairman James McCormack [*Electronics*, Oct. 18, p. 34]. This reaction by the OTM is construed as support for AT&T—a criticism that the communications industry has leveled at OTM before. The OTM position in Plummer's letter to Burch is that cables and satellites for both the Atlantic and Pacific will require a correspondingly increased capability in cable.

Chairman Burch presumably got the message loud and clear from the White House office in Plummer's final recommendation that "We recommend as a matter of policy, that you support a balanced provision of both satellite and submarine cable systems and stimulate progress in both."

Good news. On the heels of Comsat's bad news, the OTM gave the communications industry some news which might be good.

What OTM has done is make seven new radiolocation bandwidths, now held for exclusive Government use, available for shared Government-nongovernment usage. The frequency ranges in megahertz include: 5,250-5,350; 8,500-9,000; 9,500-10,000; 13,400-14,000; 15,700-17,700; 23,000-24,250, and 33,400-36,000.

What makes industry uncertain about the value of the OTM action is, first, the effective use to which industry might put these frequencies and, second, the hooker in OTM's offer noting that it can take back the frequencies any time without consulting the FCC.

"Since the Federal Administrative Procedure Act exempts national security matters from the public hearing process," Plummer points out, it is felt that any future Government radiolocation operations could be adequately protected in the event that harmful interference did occur from nongovernment shared use. "Immediate cessation would be necessary if such interference were caused to certain government operations," the OTM's Plummer says.

Space electronics

Merry-go-round

When Applications Technology Satellite 5 went into a spin—instead of staying earth oriented—most of the Navsat engineers at NASA, the FAA, and the Air Force doubted that any data could be obtained from the satellite's L-band experiments [*Electronics*, Oct. 27, p. 53]. Most of them still doubt it.

An exception is Jack Yudd, ground terminal manager at NASA-Goddard's ATS project office. Yudd says he has permission to suggest modifications of ground equipment that might enable him to get some L-band data from the spinning ATS. Since the modifications still are being planned, Yudd is reluctant to discuss them, but educated guessers think he is working on some sort of gated reception scheme.

Decision. Yudd says that if the modifications work, NASA could be getting L-band data from the ATS-5 within six months. And if the data is usable, NASA could be spared an uncomfortable choice between two options: the cost of a replacement satellite carrying L-band gear alone, or the wait until the 1972 launch of the next L-band equipped ATS.

But Yudd may be outnumbered by the pessimists. Preliminary data returned from NASA's Mojave ground station indicates that the half-power beamwidth of the satellite's L-band antenna is about 24°. Thus, since the antenna scans the earth once every 870 milliseconds

Introducing Bell & Howell Magnetic Tape.

We didn't mind while other people made our tapes. They did a good job. But now Bell & Howell has developed a tape that's so good we insist on making it ourselves.

How good? The output is the highest. So is the SNR.

The reel-to-reel uniformity is the best. And the nonabrasive surface is just that... nonabrasive.

We can make these claims because, from now on, we're responsible to no one but ourselves. And we have to be better if we're going to sell our own.

Five types are available. A 2 MHz high resolution type plus a standard telemetry type and a standard extended range.

For all the details, call our nearest office. Or write

Bell & Howell, Pasadena, California 91109.

Ask for Bulletin Kit 3348-X1.

CEC/DATA INSTRUMENTS DIVISION



Somebody
new is
making our tape.

Us.

U.S. Reports

as the satellite spins, the beam sweeps across Mojave in about 52 to 53 msec.

According to Richard M. Waetjen, acting branch chief for flight experiments at the NASA-Electronics Research Center's satellite programs office, this is time enough for some checkout of the Navsat receiver gear that TRW will deliver next spring.

"Carrier lock-on takes only about 10 milliseconds," says Waetjen. "Unfortunately, the digital code used to establish a line of position takes about a second to acquire. So while we might be able to see if the receiver works, I can't hope to prove out the ranging technique."

Half a loaf. The spinning satellite makes some things impossible to check, according to another research center spokesman. One is voice communication; even Yudd's modifications won't make this possible.

Another is one of the most vital measurements scheduled for the ATS-5 experiments—the effect of multipath on ranging accuracy. The proposed Navsat system would be used over the North Atlantic, which has widely variable sea states and, therefore, widely variable multipath. Thus, such data is a must before an operational system can be put aloft.

"Since the satellite is spinning at about 76 rpm," says the spokesman, "multipath fades below 100 hertz probably won't be easily measurable—they'll be present, but their frequency is right where the receiver's bandpass characteristic pinches. It looks like there would always be some question about long-duration fades unless we fly another satellite."

Thus, whether Yudd succeeds or not, there are scientists who still want another satellite. And right now, they live in frustration because NASA headquarters appears to be waiting the six months Yudd needs before deciding whether to orbit a backup, or to hold off until the next ATS. This, in turn, could delay funding until fiscal 1971.

Just in case. Despite this, there's a good deal of contingency plan-

TRW METALLIZED POLYCARBONATE CAPACITORS



... small enough to fit!

TRW 50-volt Metallized Polycarbonate Capacitors are made to squeeze into tight places. Imagine 10 microfarads measuring .547" x 1¼" long... the smallest wound capacitor on the market!

Short on size and long on reliability, the X463UW series meets all requirements of MIL-C-27287.
VOLTAGE—50V, 100V, 200V, 400V
CAPACITANCE—.001 through 10 mfd
TOLERANCE—available to $\pm 1\%$.

For data, write TRW Capacitor Div., Ogallala, Neb. Phone (308) 284-3611. TWX 910-620-0321.

TRW[®]

KROHN-HITE MODEL 4200 VS MAJOR COMPET				
MFR	H-P	H-P	G-R	K-H
Model Number				4200
Price				\$350
Frequency Range				10 Hz to 10 MHz
Power Out				500 mw
Waveform Distortion				<0.1%



**Stack this
\$350 oscillator
against the
competition
regardless of price!**

You'll be surprised! In spite of its low price, the Model 4200 exhibits extraordinary performance. It excels in those specifications most eagerly sought by men who really know oscillators. Krohn-Hite's twenty years of frequency-generator know-how has produced a unique circuit* that makes low-priced high performance a reality at last.

Here's how the Model 4200 stacks up against several competitors:

BROADER FREQUENCY RANGE: The Model 4200 outranges most of the others, including more expensive units.

MORE OUTPUT POWER: The Model 4200 has from 2.5 to 50 times the power of the other units.

BEST WAVEFORM PURITY: The Model 4200 is unexcelled.

BEST BUY: The \$350 price speaks for itself.

See for yourself. Write for data. Then contact your Krohn-Hite Representative for a no-holds-barred demonstration. The Model 4200 is a lot of oscillator for \$350.

*Patent applied for.

KH KROHN-HITE CORPORATION

580 Massachusetts Ave., Cambridge, Mass. 02139, U.S.A.
Phone: (617) 491-3211 TWX: 710-320-6583

Oscillators / Filters / AC Power Sources / DC Power Supplies / Amplifiers

ning going on within the prosatellite faction. One possible scheme is a Scout-launched spacecraft carrying a 1-kilowatt L-band transponder into orbit. The orbit wouldn't be synchronous; the payload would be too heavy for the Scout to fire that far or fast. But it would be above the horizon for about two hours a day and usable for that period. Unfortunately, while this idea would cost less than a synchronous shot, such a satellite would force researchers to work with a beam whose angle of incidence and length is changing continually. This probably would make the sort of exact multipath and ionospheric effect measurements the experimenters need hard to get. And the Air Force, which needs exceptionally accurate data for use in the 621B military navigation satellite program, might get nothing for its program from such a scheme.

And that's important. The reason is that any backup satellite program is booster-limited; even a Scout might be hard to find. Though ERC is making some other calculations based on a Thor-Delta launch vehicle, the Thor said to have been located by the FAA in October appears to have vanished in the Indian Summer's haze, and while there's an Atlas-F available, it's not reliable enough and nobody wants to play long odds this late in the game. Thus, a few L-band engineers are hoping for some close air support in the form of a military-funded launch vehicle for their experiments.

Harsh reality. But even if NASA headquarters were to approve requests for a backup satellite today, Leo M. Keane, head of ERC's satellite programs office, estimates that negotiations with contractors would take a minimum of five months and that another year would pass before delivery. This would mean a mid-or late-1971 launch date—at best only a year ahead of the next ATS, meaning that questions about the worth of backup flight are certain to be raised.

Keane still would go for it. He says that the backup and the ATS could work together giving two lines of position, a real positional



DELTA will tell you *everything!*—Complete Specs including schematics!



MARK TEN[®] SCR

CAPACITIVE DISCHARGE IGNITION SYSTEM

Now discover for yourself the dramatic improvement in performance of your car, camper, jeep, truck, boat—any vehicle! Delta's remarkable electronic achievement saves on gas, promotes better acceleration, gives your car that zip you've always wanted. Find out why even Detroit has finally come around. In five years of proven reliability, Delta's Mark Ten has set new records of ignition benefits. No re-wiring! Works on literally any type of gasoline engine.

- ▲ Dramatic Increase in Performance and in Fast Acceleration
- ▲ Promotes More Complete Combustion
- ▲ Points and Plugs Last 3 to 10 Times Longer
- ▲ Up to 20% Mileage Increase (saves gas)

KIT FORM **\$2995**
12V ONLY

ASSEMBLED **\$4495**
ONLY **ppd.**

MODEL 3000 FET VOM

Delta now offers a compact, versatile, and extremely sensitive VOM which combines FETs and ICs for extreme accuracy. Compact (6½"W x 8"H x 3½"D), portable. Wt. 3¾ lbs.

IN KIT FORM: Feedback network with pre-selected components to eliminate all final calibration. Ready to use when assembled!

NEW DELTA FEATURES:

- ▲ Mirror scale 200 A D'Arsonval meter
- ▲ Integrated circuit (IC) operational amplifier for extreme accuracy
- ▲ FET input stage with current regulator
- ▲ Two stage transistor current regulator and Zener diode on OHMS for absolute stability and accuracy
- ▲ Voltage clippers for protection of input stage

- ▲ Fully temperature compensated for low low zero drift
- ▲ Ten turns ZERO and OHMS adjust potentiometers
- ▲ Epoxy glass circuit boards and metal case
- ▲ Enclosed switches
- ▲ Uses readily available type AA cells
- ▲ Uses standard test leads for maximum flexibility and ease of measurement
- ▲ 10 Megohms input impedance

ONLY **\$7495**
ppd.

Only **\$5995**
ppd.

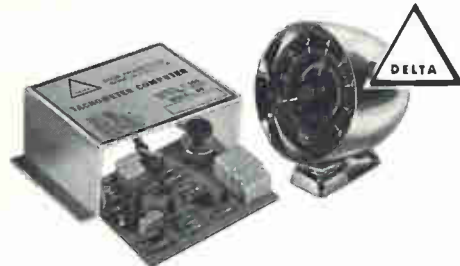

COMPUTACH[®]

Delta, pioneers in CD ignition who produced the fabulous MARK TEN[®], now offer a precise computer-tachometer which obsoletes any type tachometer on the market today! You achieve unbelievable accuracy in RPM readings due to the advanced, solid-state electronic matched components used in the computer, coupled with the finest precision meter in the world. Works on all 2, 3, 4, and 6 cylinder 2 cycle and with 4-6-8 cylinder—4 cycle 12 volt engines.

- ▲ 0-8000 RPM range
- ▲ Perfect linearity—zero parallax
- ▲ Adjustable set pointer
- ▲ Wide angle needle sweep
- ▲ Translucent illuminated dial
- ▲ Chrome plated die-cast housing
- ▲ All-angle ball & socket mounting
- ▲ Use it with ANY ignition system
- ▲ Meter: 3⅜" dia. X 3⅜" deep
- ▲ Calibration kit included, no test eqpt. needed.

*An exclusive computer-tachometer for precise RPM measurement in easy-to-build Kit form! **\$2995**
ppd.

KIT FORM ONLY

DP 9-B

Write today for complete literature packet

DELTA: Please send me literature immediately.

I am enclosing \$_____ for items checked.

- Mark Ten SCR Kit Assembled E
- Model 3000 FET VOM Kit Assembled
- Computach (Kit only)

Please ship immediately.

Name _____

Address _____

City/State _____ Zip _____

*My car is (Model) _____ (Year) _____



DELTA PRODUCTS, INC.

P.O. BOX 1147 • GRAND JUNCTION, COLORADO 81501

Free! Money-Saving Guide

Working with logic modules? Then here's something you should have. It's a Guide for logic design applications.

Real handy!

The Guide outlines a procedure to assist you, the Systems Engineer, in transposing a logic design into an idealized listing of the logic cards needed to implement the design.

It's simple to use and you can really sock away the money you'll save on reducing the number of cards you need. That's right!

We're helping you to reduce the number of logic cards you have to buy.

But that's okay, sock it to us!

(For Logic Design Applications)

Free Drafting Aid Symbol

More free stuff? You better believe it!

Wyle also has a sample of stick-on logic drafting symbols for you, the only catch is that you have to request this item on your letterhead.

So just drop a line with your name and address on your company letterhead to our Marketing Manager, Gordon Elsner.

He'll sock a sample logic stick-on drafting symbol right back to you. And if you're socked in with an immediate application call Gordon direct, Now! (213) 678-4251



WYLE
COMPUTER PRODUCTS
DIVISION OF WYLE LABORATORIES
128 Maryland Street, El Segundo, California 90245

U.S. Reports

fix, bringing an operational Navsat scheme one step closer, and perhaps eliminating the need for still another experimental launch of a satellite.

With time pressing, it's appropriate to remember that the next ATS could fail too. Without a backup, there could be no United States Navsat system operating until very late in the 1970's or early in the 1980's. It may be time to buy an insurance policy for the Navsat operating program.

For the record

Laser loot. Two more contracts totaling about \$6 million have been signed by NASA for experiments aboard the Applications Technology Satellite (ATS-F) to be launched in 1972. The Aerojet-General Corp. will develop ground and satellite equipment for a laser communications experiment, the first use of such a laser system aboard a satellite. Eventually, the laser's ability to communicate over extremely long distances could make live tv coverage possible for a manned landing on Mars, 100 million miles away. The cost-plus-award-fee contract is for \$5 million. Only minor changes have been made in the proposed system since it was first described as a 22,300-mile-high experiment [*Electronics*, Sept. 15, p. 77].

Heart of the matter. A permanently implantable artificial heart, complete with computer control logic, can be developed in a year and a half, says Dr. Frank Hastings, if the National Heart Institute's artificial heart program obtains \$20 million in R&D funding from Congress for the program. Hastings, who is working on the program, says a major part of development work will be massive reduction of control logic into a housing about 8 square inches to fit into the chest cavity after the heart is removed. Current heart-assisting devices require a computer console besides the patient's bed, an unwieldy solution to the problem.

EAGLE

*...where the
state of the art
is the standard
of the industry*



Versatile Delay Timers with Solid-State Reliability

CG 10 Series ON-DELAY Timer

These time-delay modules are fully transistorized for maximum reliability. Available in four dial ranges to provide delays of 2, 10, 30, and 60 seconds for controlling such equipment as motors, machine tools, elevators, X-ray machines, packaging equipment and molding presses. Circuitry incorporates such state-of-the-art components, in its class, as tantalum timing capacitor, unijunction transistor, SCR and 10-amp output relay. Built-in transient suppression for protection against premature load contact actuation and in the event line voltage is removed before time out. Remote setting available as a kit.

Send for Bulletin 158

CG 300 OFF-DELAY Timer

A sustained contact, solid-state timer designed to replace many electromechanical and pneumatic units. Timing is accomplished by an RC circuit in conjunction with a 4-layer diode actuating a transistor. Design and all components are state-of-the-art for its class. Power application closes two sets of contacts. Removal of power initiates the timing cycle. If power is re-applied during the preset delay, contacts remain energized until delay cycle is completed. Time ranges are available in 1-10, 3-30, and 6-60 seconds. The unit provides a choice of both integral and remote time adjustments.

Send for Bulletin 159

NEW CE 400 PRECISION Delay Timer

Provides a highly precise and adjustable time delay between actuation of a control circuit and operation of a load circuit. Special mirror dial minimizes parallax errors in setting. Slide-rule graduations enhance readability. Famous Cycl-Flex® plug-in case allows five-second replacement with the same or different time range from 1.5 to 600 seconds.

Send for Bulletin 126

GET THE SPECS and full details... more than \$1 million in Eagle time/count controls, control relays, precision potentiometers... waiting to serve you in 35 major areas throughout the world... including U.S.A., S.A., Europe, U.K., Canada and Australia.



Eagle Signal

a systems division of
GULF + WESTERN INDUSTRIES, INC.
736 Federal/Davenport, Iowa 52803

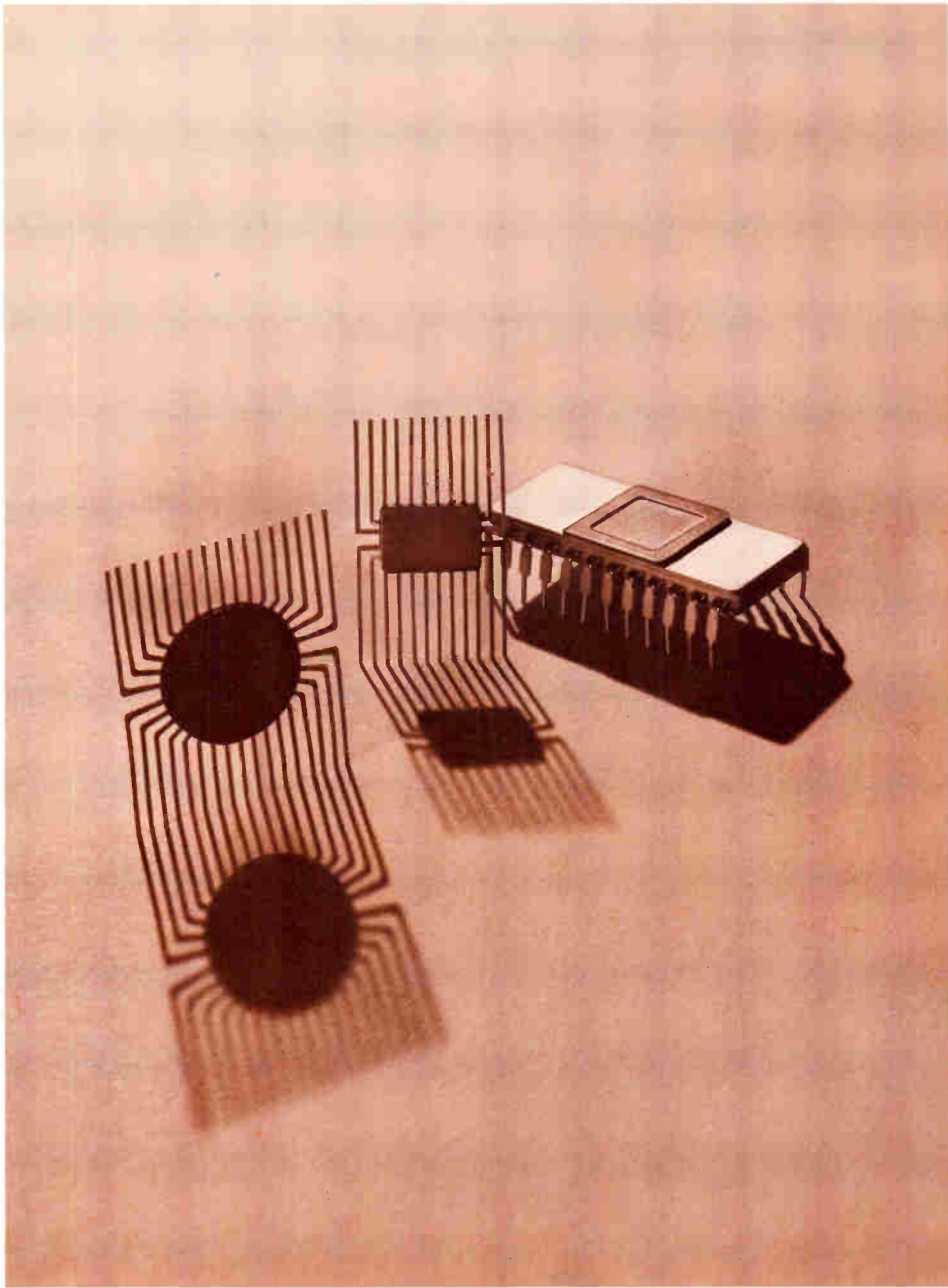

The news-makers in MOS come from Philco.

Meet the most recent additions to our large line of standard MOS products . . . all in volume production right now.

4-bit adder.

This unique binary-BCD device does the work of four conventional full adders. It operates in either binary or BCD mode by means of a simple external control connection . . . without a converter.

Speedy? You bet! The pL4AO1C has a typical 4-bit parallel "add" time of 1.8 microseconds in the binary mode, 2.1 microseconds in the BCD mode . . . with an overall cycle time less than that required by two 2-bit adders.

Stack them to obtain any number of bits you need—in multiples of four. Packaging: 24-lead rectangular flatpack.

16-channel multiplexer.

Our 16-channel multiplexer is really versatile. You can use it for random access sampling or sequential sampling . . . just by changing the external wiring.

And you can stack them for switching in multiples of 16 channels. Or maybe you only need to switch from 2 to 16 channels—fine, no problem.

The pL4S16C is voltage-driven . . . so you don't need a complex drive network. Offset voltage is 0. Leakage current? Less than 10 nanoamps. Packaging: 34-lead flatpack.

1024-bit static ROM.

Output of our newest ROM is static . . . data remains valid as long as the selected address is held.

This means data is ready and waiting . . . when you need it.

Bit pattern is 128 8-bit words with typical access times of 2 microseconds. Packaging: 24-lead hermetic DIP.

And . . .

We make other highly reliable MOS products at our Lansdale plant—one of the largest facilities of this type in the country. Things like binary counters, gates, shift registers, and dynamic ROM's . . . for immediate delivery. Still more are in the works.

So if it's MOS, check us. We're probably doing it now. Write or call MOS Marketing, Philco-Ford Microelectronics Division, Blue Bell, Pa. 19422. (215) 646-9100.

PHILCO 

The better idea people in MOS.

Nobody-
but nobody
assures T²L
deliveries like
Motorola.

- where the priceless ingredient is care!



Your next order for Motorola TTL will receive a unique delivery assurance that's made possible by the industry's most comprehensive selection of T²L types; and by the extensive production facilities and reputation for on-time delivery that

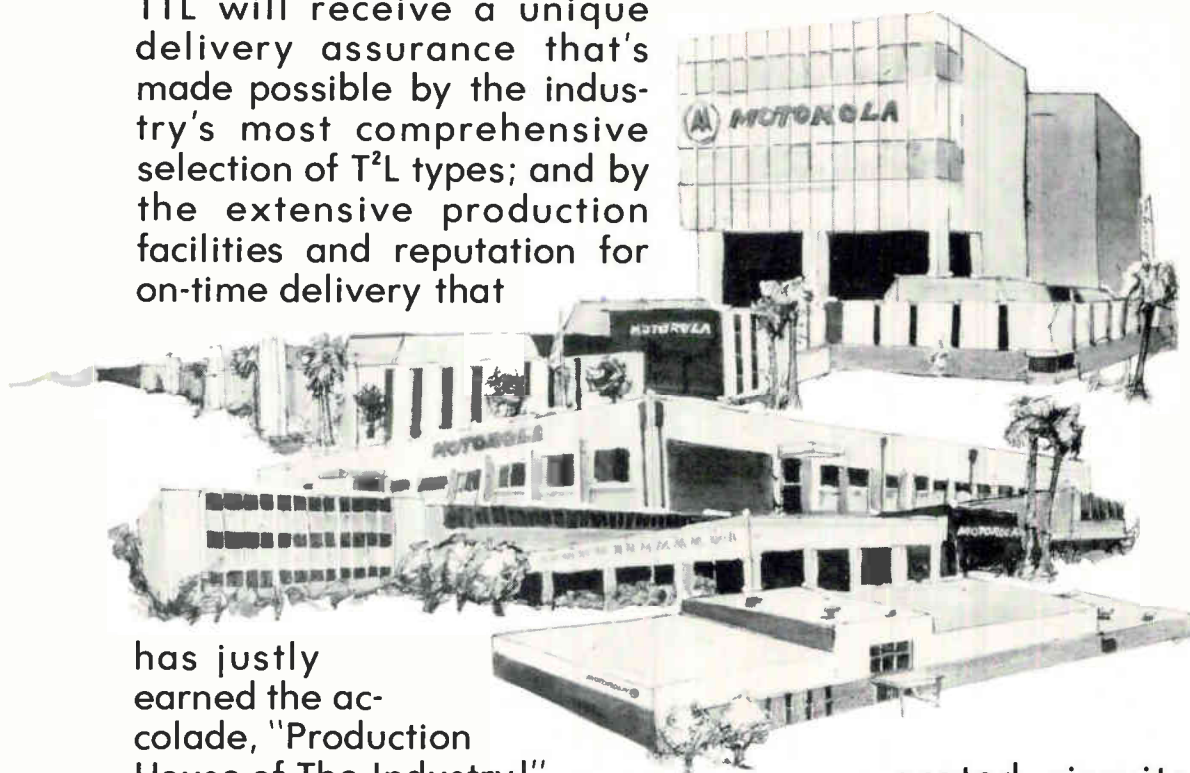

has justly earned the accolade, "Production House of The Industry!"

Almost three years ago, we made a commitment... to supply you with the kinds of T²L circuits that you want — when you need them. To maintain our reputation for on-time delivery it was recognized that greatly expanded facilities would be required. Our commitment resulted in a new 650,000 square-foot plant devoted solely to production of inte-

grated circuits, supplementing our existing 1.25 million square-foot facility. Additional plants were added in France, Korea and Scotland. And now, there's one plant in Mexico with another under construction.

And, that's only part of the story... Of equal importance to you is the selection and design flexibility provided by these five different MTTL families:

MTTL I MC500/400 Series . . . Medium speed logic circuits with typical gate propagation delay of 10 ns. Electrically interchangeable with SUHL I.

MTTL II MC2100/2000 Series . . . High speed logic circuits with typical gate propagation delay of 6.0 ns. Electrically interchangeable with SUHL II.

MTTL III MC3100/3000 Series . . . Advanced

design high speed logic circuits with typical gate propagation delay of 6.0 ns. Compatible with MDTL and SN54H/SN74H Series devices.

MC4000 MSI Series . . . Complex function circuits offering state-of-art increases in logic per function and significant reduction in package count. Compatible with all MTTL and MDTL lines.

MC5400/7400, MC5400L/7400L, MC7400P Series . . . Electrically interchangeable with Series SN5400J/SN7400J, SN7400N types.

MC5400F/7400F Series . . . Electrically interchangeable with Series SN54F/SN74F types.

MC5400/7400 Series Complex Functions . . . MSI circuits designed for compatibility with MC5400/7400 Series gates and flip-flops.

Need delivery assurance? Call your nearby franchised Motorola distributor. He'll show you that... **Nobody—but nobody assures T²L deliveries like Motorola.**

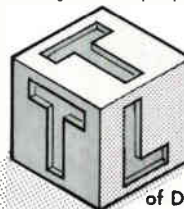

Building Block of Digital Circuitry

MTTL, MDTL Trademarks of Motorola Inc.
SUHL I, SUHL II Trademarks of Sylvania Electric Products, Inc.

MOTOROLA Integrated Circuits

A new lead to a 300 W, 100 A silicon power transistor in a TO-3 case

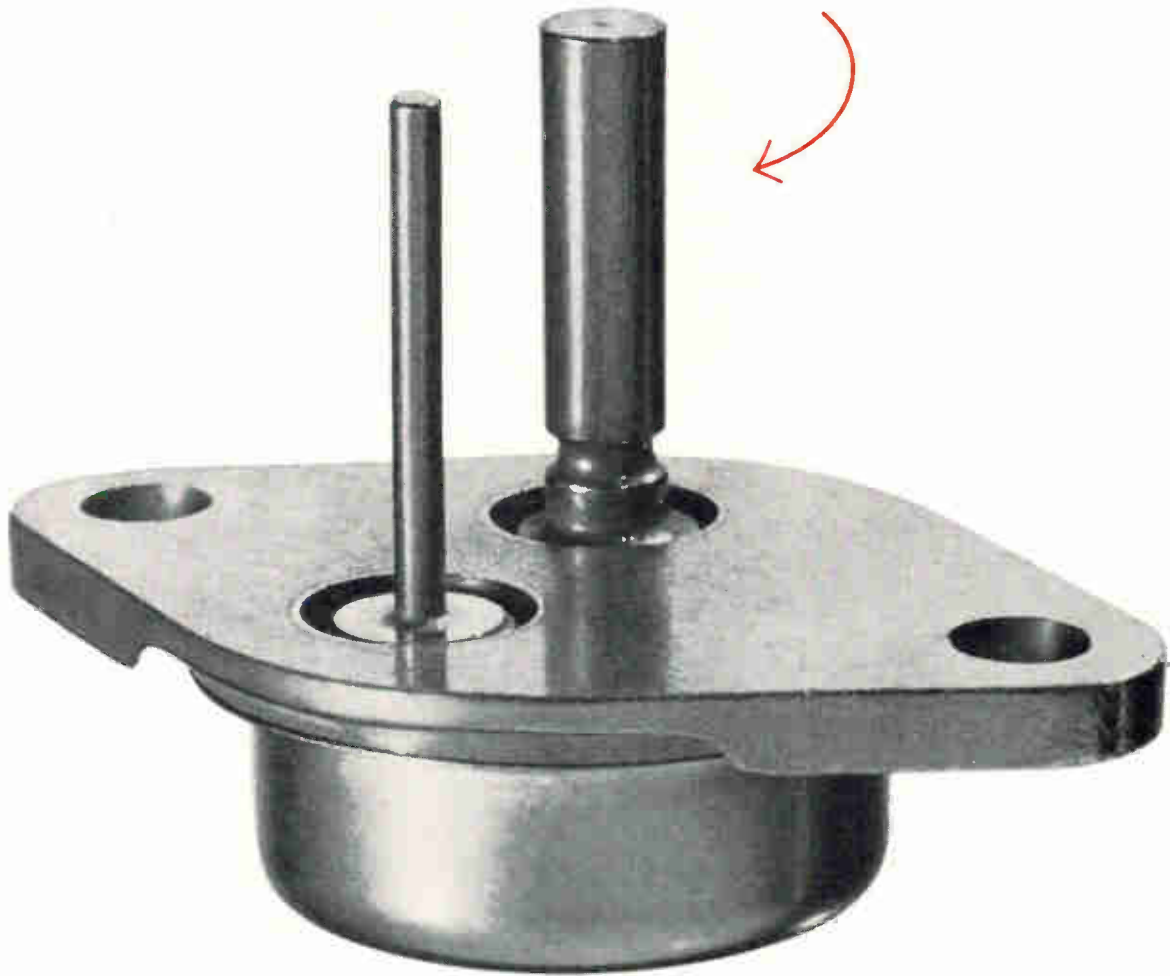

2N5578 showing new, heavy pin terminal design.

What are you looking for in your linear and switching applications? 100 ampere pulsed current capability? 300 watts power dissipation? The highest second breakdown capability of any device on the market in a modified TO-3 package?

Look no further. Here's another first from the silicon power leader—RCA's new 2N5578 family...six high-power, high-current Hometaxial-base silicon n-p-n transistors designed for applications in military, industrial, and commercial equipment.

2N5575, for example, has a pulsed collector current of 100 A. Dissipation

is 300 watts at 25°C with V_{CEX} (sus) of 70 V. The useful beta range is 10-40 at 60 A.

For complete design flexibility, there are three terminal variations: 2N5575 and 2N5578 have heavy pins; 2N5576 and 2N5579 have soldering lugs; and 2N5577 and 2N5580 have flexible leads with solderless connectors.

This family of types all adds up to circuit cost savings in inverters, regulators, motor controls, and other linear and switching applications. Check the chart. For more information, see your RCA Representative or

your RCA Distributor. For technical data, write: RCA Electronic Components, Commercial Engineering, Section No. 1N12-1, Harrison, N.J. 07029.

Characteristic	Test Conditions			2N5575 2N5576 2N5577		2N5578 2N5579 2N5580		Units
	V_{CE} V	V_{BE} V	I_C A	Min.	Max.	Min.	Max.	
h_{FE}	4	4	40	—	—	10	40	
V_{CE0} (sus)	25	—	60	10	40	—	—	V
$I_{B/s}$ †	—	—	0.2	50	—	70	—	A
$E_{1/2}$ *	—	—	7	12	—	12	—	J
$H_{1/2}$	—	—1.5	—	0.8	—	0.8	—	°C/W
				—	0.5	—	0.5	

†With base forward biased
*With base reverse biased and $R_{th} = 10\Omega$, $L = 33mH$

Washington Newsletter

December 8, 1969

Army to complete Divtos R&D with fiscal '71 funding

Army's Computer Systems Command is scheduled to get fresh money in the fiscal 1971 budget to complete research, development, testing, and engineering on its Divtos program, the division-battalion level version of its Tactical Operations System (TOS) [*Electronics*, Sept. 1, p. 49].

Currently, Divtos continues to operate with about \$2 million in fiscal 1970 funding for in-house expenses, software development and spare parts for test equipment. But one military source indicates that present funding is being supplemented by reprogrammed fiscal 1969 money—including \$5.8 million for hardware, \$2 million divided between system engineering and hardware integration, and \$2 million for software and system maintenance.

The Army's proposal that it eventually will buy 26 Divtos systems, and a comparison of its outlays with those of the parent TOS system for Europe—\$15.6 million through fiscal 1969 but only \$950,000 this fiscal year—suggest to a number of observers that the Divtos minnow may wind up swallowing the TOS whale.

Army is jubilant over Viet tests of phased-array radar

Continuing operational testing of the Army's Camp Sentinel radar in Vietnam has come up with good results in foliage penetration, according to delighted Army sources. The fixed-perimeter defense system was developed and built by MIT's Lincoln Laboratory. After initial field tests of two of the phased-array units, the Army shipped several more to the Southeast Asia theater last summer and fall. So far, no industry contractor is involved. Staffers at the MIT lab, however, refused to accompany the units to Vietnam and run the field tests.

Lincoln, which used to get most of its funds from the Pentagon's Directorate of Defense Research and Engineering and its Advanced Research Projects Agency, now draws heavily on Army money since that service became responsible for the Sentinel ABM. The Army is budgeting Lincoln for \$23.1 million this fiscal year, and Army R&D chief Lt. Gen. Austin W. Betts says that Lincoln "has agreed that they will continue to do that [classified] work" despite student and faculty committee protests.

Delay in space shuttle request for proposals?

NASA's latest hassle with Congress may delay plans to send out proposal requests later this month for six multimillion-dollar studies, three each for the vehicle and the engine in the reusable space shuttle system. They would be awarded in the spring and would be due about a year later. But Sen. Clinton B. Anderson (D., N.M.), chairman of the Senate Committee on Aeronautics and Space Sciences, has fired off a stinging letter to Administrator Thomas O. Paine, asking if NASA intends to go ahead with a reported \$70 million reprogramming of the budget without Congressional approval—only a few months after the Senate had turned down a \$66 million House addition to the budget for the space station and shuttle.

The 1970 budget, as finally approved by Congress, contained \$6 million for station studies, \$3 million for shuttle studies and \$2.5 million for advanced missions. It was planned to reprogram an additional \$30 million for the shuttle studies—totaling \$6 million for the vehicle and \$27 million for the engine after juggling, plus \$10 million for advance development of the station and \$8 million for the shuttle.

Washington Newsletter

Shuttle's electronics: big engineering job

The integrated electronics system for the reusable space shuttle could represent from one-third to one-half of the total price for each craft. But requirements are within the present state of the art, say firms already working on the problem. "The technology is here," says one Lockheed official; "it will just take a hell of a lot of engineering to adapt existing technology to the shuttle."

NASA wants an integrated electronics system with onboard checkout capabilities to help cut costs. By eliminating ground tracking stations and relying on onboard computers for inflight data, much of the cost expended on present space flights would be eliminated.

NASA jittery over Apollo 16-20 funds

Although excited about the success of Apollo 12 and approval of its unchanged fiscal 1970 budget, NASA is anxious about the future of the Apollo 16 to 20 missions. The Manned Space Flight office asked the Bureau of the Budget for about \$1 billion next year to cover advance work for the missions, scheduled for launch between March 1971 and December 1972. One MSF official claims that if the budget is cut significantly below that figure, the Apollo program may be forced to stop after the 15th mission. He commented, "If science is the real reason for flying, and the budget won't let us do any new experiments—why fly?" He discounted any reports that a slash might be due to criticism of over-emphasis on manned flights, but said it would simply reflect the "total national budget picture."

Neodymium lasers eyed by Army

Technology gains in neodymium lasers are prompting the Army to substitute them for ruby lasers in future airborne rangefinder applications. Though a ruby laser system was part of the defunct AH-56 Cheyenne helicopter program, the Army Electronics Command has found the neodymium units are lighter, have greater range, and provide better illumination. **The service will proceed next year to replace three-pulse-per-second ruby systems on the UH-1 helicopter with a 10-pulse-per-second neodymium system.**

Hughes Aircraft, developer of the laser subsystem for the AN/UVS-1 visual airborne target locating system now being tested in Vietnam, could be the beneficiary of the Army plan to switch to neodymium. Hughes, however, will not lack for competition. Other contenders include RCA and General Electric, whose ruby system had been set for Cheyenne.

The Army hopes to move next year toward integrating laser rangefinders into a combined target designator and fire-control system.

\$45 million tagged for pollution R&D

After months of arguing about how much money the National Air Pollution Control Administration should spend on R&D, House-Senate conferees have decided \$45 million is enough [see p. 137]. Included is a meager \$2.5 million for instrumentation, although dollars for electronics may turn up under chemistry-oriented research in fuel combustion.

The \$45 million is just half of what the Senate authorized and \$26.3 million more than the House offered. Sen. Edmund Muskie (D., Me.) calls the R&D put-down "unconscionable and unacceptable." He is pushing the Senate Appropriations Committee to give the air pollution program more money this year, an effort that appears doomed to die in the Congressional filing system.

Sorensen modular power supplies

$\pm 0.005\%$ regulation

\$8900



- Optional 10μ sec. overvoltage protection.
- Requires no external heat sink in ambients to 71°C .
- 29 models—voltages to 330 Vdc at power levels to 300 watts.
- Remote programming—remote sensing—series/parallel operation.
- Overload and short circuit protection.
- Meets military specifications.

Model QSA10-1.4, shown actual size, illustrates the compactness of the Sorensen QSA Series. These laboratory-grade, precision power sources are designed for OEM or system applications and utilize the latest solid-state regulating technology to provide a high degree of regulation and stability.

Sorensen produces 29 wide-range models, each with optional overvoltage protection. Other manufacturers require more than 100 models to cover the same area. By producing and stocking fewer models, Sorensen is able to provide better specifications, higher reliability, lower prices and "same-day shipments."

For more information contact your local Sorensen representative or; Raytheon Company, Sorensen Operation, Richards Ave., Norwalk, Conn. 06856. Tel.: 203-838-6571; TWX: 710-468-2940; TELEX: 96-5953.



Staggered-finger heat sink design is more efficient, saves space and weight

Unique design is causing circuit designers to re-think their thermal theory.

Design engineers are learning daily that power ratings of power transistors are often not at all what they appear to be at first glance. For example, the data sheet on a transistor may state, "maximum power dissipation — 50 watts." But the fine print — if there is any — says, "at 25°C case temperature." Actually, the transistor alone will dissipate only 3 to 4 watts before the maximum allowable junction temperature is reached!

Obviously, something must be done to maintain the specified case temperature when more than 3-4 watts are to be dissipated. This is normally accomplished by mounting the transistor case to a dissipator or heat sink, but dissipator state-of-the-art has been such that these devices are too bulky, too heavy — just plain inefficient. Now you needn't tolerate these size and weight penalties in your design because IERC has achieved a major breakthrough in heat sink design: The IERC Staggered Finger Dissipator.

International Electronic Research Corporation has developed a broad line of these smaller, lighter, much more efficient heat dissipators based on the unique, multiple staggered finger design which has proven to be 30% more efficient overall, and in some

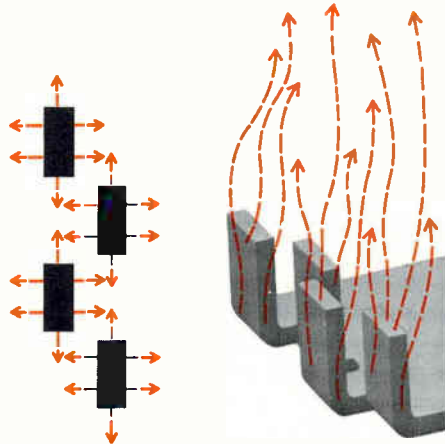

FIGURE 2

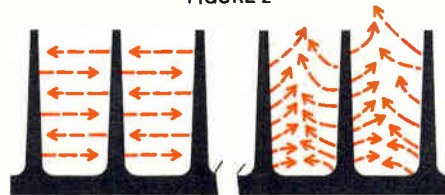

FIGURE 3

cases up to 500% more effective than many conventional designs now in wide use. An example of the staggered finger design is shown in Figure 1. This is an IERC HP3 Heat Dissipator. To show how efficient this device is, it is shown compared to a common finned extrusion. The HP3 and the extrusion are virtually equivalent in their heat dissipating ability; however, the HP3 is only 1/3rd the weight and 2/3rd the volume of the extrusion.

The secret to the efficiency of the new dissipators is the staggered fingers. (Figure 2) Note how the fingers are positioned so they do not radiate to each other and the configuration is so arranged that natural convection takes place very readily.

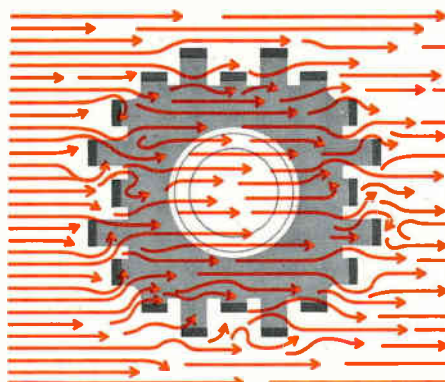

FIGURE 4

In a finned extrusion the fins radiate to each other and it is difficult for natural convection to take place in the confined area between the fins. (Figure 3)

In a forced air environment the staggered finger configuration is even more effective. The air can be from any direction. (Figure 4) As it hits the fingers, turbulence causes it to move around each of the fingers, striking many surfaces in its flow past the part. The turbulent air against these surfaces disturbs their surface barrier and is the principal reason for the significant improvement in the forced air heat dissipating properties of these parts.

Compare this turbulent air flow over the staggered fingers of the IERC part with the air flow conditions when directed at a finned extrusion. Here laminar air flow, rather than turbulent air flow, takes place. The air must be directed in one direction only, (Figure 5) parallel to the fins. The air enters the space between the fins; but because of this restricted space, it immediately tries to leave. Shortly after entering, it is not flowing against the bottom of the fin surfaces. Since the air flow is laminar, not turbulent, and it is not disturbing the surface barrier at the bottom of the fins shortly after entering, the surface areas of the fins are only partially effective.

The old rule-of-thumb which considers only the surface



FIGURE 5

area relative to heat dissipation is not valid. The effectiveness of the area must also be considered. The staggered finger concept is a significant breakthrough in heat dissipating devices and is the first improvement in heat dissipator design since the flat fin or extrusion design.

Broad line accommodates all lead and case mounted semiconductors.

During the past several years, IERC has developed numerous heat dissipating devices

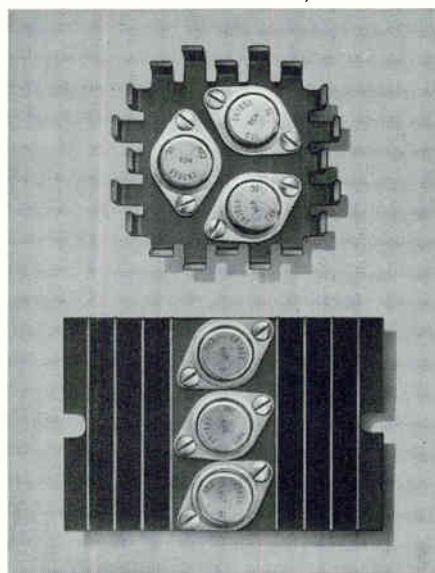

FIGURE 1

using the staggered finger configuration.

The UP style (Figure 6) is just 1.78 inches square and is available in various heights up to one inch. It was designed particularly to accommodate a single power transistor such as a TO36, TO3, TO15, etc. However, it will also accommodate more than one smaller semiconductor, including the newer plastic case power transistors.

To really appreciate the efficiency of the UP, refer to the temperature vs. power

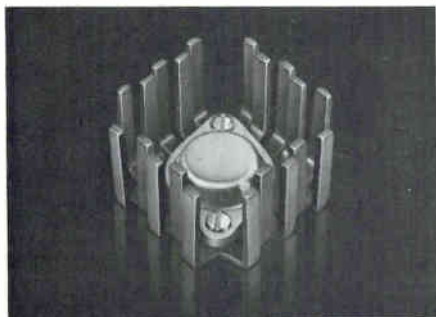

FIGURE 6

curve (Figure 7) showing a 2N1208 power transistor mounted in a UP-TO15-B dissipator. Remember, now, that this UP part weighs *less than one ounce*. Considering a maximum case rise of 100°C, the 2N1208 by itself will dissipate only 3 watts. When mounted in the UP dissipator in natural convection, it will dissipate 14 watts, or

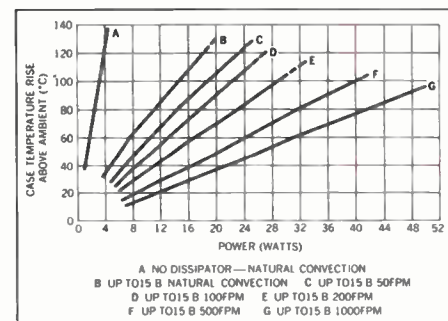

FIGURE 7

more than four times more power at the same case temperature. In a forced air environment of only 200 FPM, 28 watts can be dissipated — more than nine times the power at the same case temperature. With 1000 FPM, the remarkable light weight UP will allow 50 watts of dissipation from the transistor — *seventeen times more power at the same case temperature*.

Think now. You must limit the case temperature rise of a power transistor to 100°C. You need to dissipate 14, 28 or 50 watts. You have three cubic inches of space and are limited to adding one ounce of weight. And you can't spend more than 40 cents for a dissipator or sink in medium quantities. What would your present thinking lead you to do?

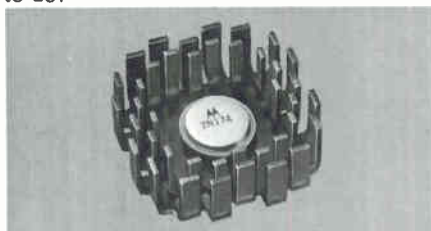

FIGURE 8

Another IERC dissipator, the HP1, is a companion to the HP3 shown in Figure 1. The HP1 is 2½ inches square, slightly larger than the UP. At the same case temperature rise of 100°C, it will dissipate 23 watts in natural convection; in a forced air flow of 200 FPM, it will dissipate 33 watts; and 65 watts with 1000 FPM. The HP3, which is 3⅞ inches square, will dissipate 28 watts in natural convection, 42 watts with 200 FPM, and 74 watts with 1000 FPM. When the HP1 and HP3 are nested, Figure 8, more than 100 watts can be dissipated at the same 100°C case temperature rise with 1000 FPM.

Stop and contemplate the sizes of heat dissipating devices which would have been required to dissipate these powers before the advent of the staggered finger design, and you will appreciate the savings of space and weight which the UP and HP make possible.

The staggered finger design has also been used in heat dissipators for TO5 and TO18 metal case transistors. Models in the LP Series, Figure 9, are available in three lengths and two heights and to accommodate one or two transistors. These parts are so efficient that when a TO5 transistor is mounted in the largest model

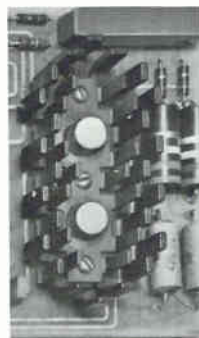

FIGURE 9

LP dissipator (only 2.31 x 1.12 x ½), the dissipator is virtually an infinite heat sink. The case temperature rises only 65°C when 5 watts are being dissipated. When 1000 FPM of air is used at 5 watts dissipation, the case temperature rise is phenomenally low — less than 15°C.

In addition to their thermal efficiency, LP parts are extremely versatile. Almost any application problem where a conduction plane is not available can be solved with these simple, low cost devices.

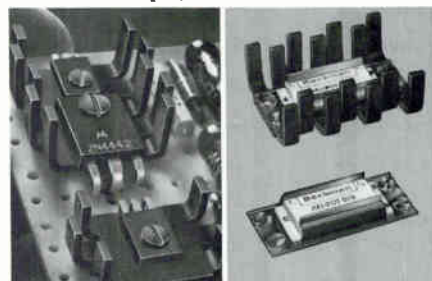

FIGURE 10

The staggered finger concept is also available in dissipators for plastic case power transistors and integrated circuits and microcircuit packages as shown in Figure 10.

The staggered finger concept of heat dissipation is the most significant breakthrough in heat sink technology since the advent of the power transistor. Get specific technical and pricing information on those IERC heat dissipators most applicable to your needs. Write on your company letterhead for Technical Bulletin 149 for more detailed information on the PA and PB series and Technical Bulletin 151 for the LB series. Technical Bulletin 134 and Test Report 172A detail the UP series; Technical Bulletin 139 and Test Report 198 cover the HP series; and for the LP series, ask for Technical Bulletin 135 and Test Report 182. You'll be surprised how substantially these advanced new heat sinks will contribute to the efficiency of your design and your equipment.

International Electronic Research Corporation, a corporate division of Dynamics Corporation of America, 135 West Magnolia Boulevard, Burbank, California 91502.



HEAT SINKS/DISSIPATORS



**Tired
of running
the crystal
can relay
maze?**

You don't have to any more!

■ Because we've got them all. Everything from power crystal cans to TO-5 relays, from military types to industrial/commercial devices. All built to the same exacting Clare quality. And, as you'd expect from Clare, the world's greatest selection of operating characteristics and mounting styles.

Military Relays. Every Clare military relay is designed to meet the requirements of MIL-R-5757. All feature hermetically sealed cases to eliminate contamination under the most severe conditions. Withstand temperatures from -65°C to $+125^{\circ}\text{C}$; shock to 100 G; vibration to 30 G.

<p>Type TF. TO-5 transistor size; low-level to 1 amp.</p>		<p>Type TF. Sensitive. To 40 mw sensitivity; low-level to 1 amp.</p>			<p>Type MF. One-sixth size; low-level to 0.5 amp.</p>		<p>Type HF & HFW. Low profile; low-level to 2 amp.</p>
	<p>Type F & FW. Full size; low-level to 3 amp.</p>		<p>Type SF. 40 mw sensitivity; low-level to 2 amp.</p>		<p>Type LF & LFW. Magnetic latching; low-level to 2 amp.</p>		<p>Type PF. 10 amp. power.</p>

Industrial/Commercial Relays. A combination of economy and rugged construction to meet industrial/commercial requirements. Industrial/commercial versions are rated for 30 G shock and 10 G vibration.

<p>Type TFC. TO-5 transistor size; low-level to 1 amp.</p>			<p>Type MFC. One-sixth size; low-level to 0.5 amp.</p>		<p>Type HFC. Rugged "metal" cover; low-level to 2 amp.</p>
<p>Type FC. Full size; low-level to 2 amp.</p>		<p>For information, circle Reader Service number, call your Clare Sales Engineer or your local Clare Distributor. Or write for data on the types you need. C. P. Clare & Co., Chicago, Ill. 60645... and worldwide.</p>			

LOOK FOR  **CLARE** ON THE RELAY

a GENERAL INSTRUMENT company

Low power TTL.

		<u>100 up</u>
SN54L00R	Quad 2-Input Gate	*\$ 7.00
SN54L10R	Triple 3-Input Gate	7.00
SN54L20R	Dual 4-Input Gate	7.00
SN54L30R	Eight-Input Gate	7.00
SN54L51R	AND-OR-INVERT Gate	7.00
SN54L54R	AND-OR-INVERT Gate	7.00
SN54L55R	AND-OR-INVERT Gate	7.00
SN54L71R	R-S Flip Flop	11.50
SN54L72R	J-K Flip Flop	11.50
SN54L73R	Dual J-K Flip Flop	17.00
SN54L78R	Dual J-K Flip Flop	17.00

We took the heat off.

National delivers the lowest speed/power product now available in any digital family: 1mW at 30 nsec. Power dissipation just one tenth that of standard TTL. Plus all circuits designed as pin for pin, spec for spec replacements for 54L low power TTL.

Low power, high rel. 54L devices from National pass Mil-Std-883's strict test/inspection requirements. Right down the line.

We take the heat off delivery too. Get on the hot line to your National distributor. He's got off-the-shelf delivery on all our low power TTL's. For specs and data sheets, write or call National Semiconductor, 2975 San Ysidro Way, Santa Clara, California 95051. (408) 245-4320. TWX: 910-339-9240. Cables: NATSEMICON.

National/TTL

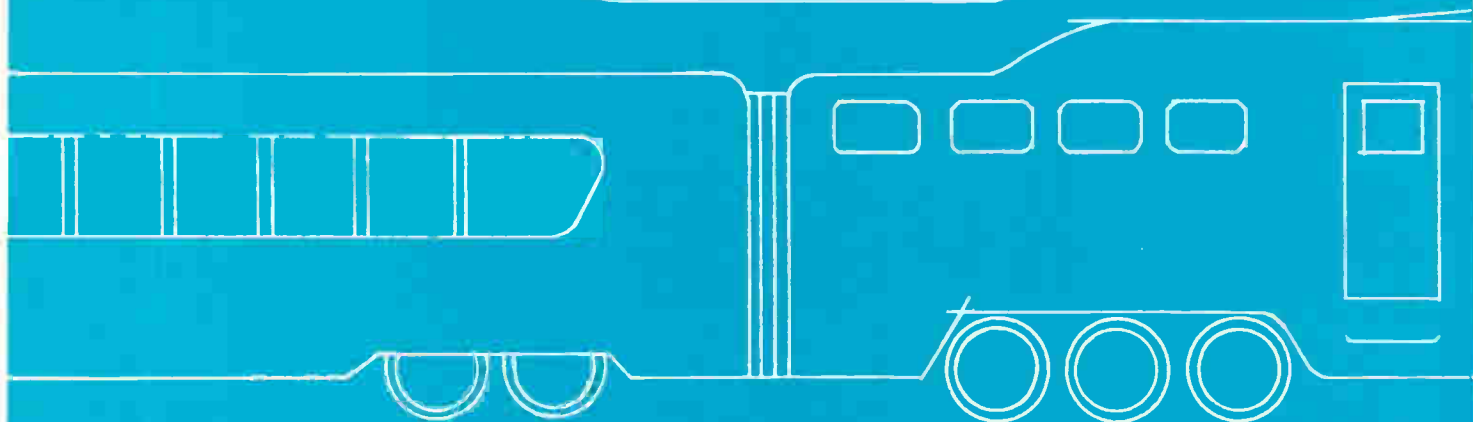
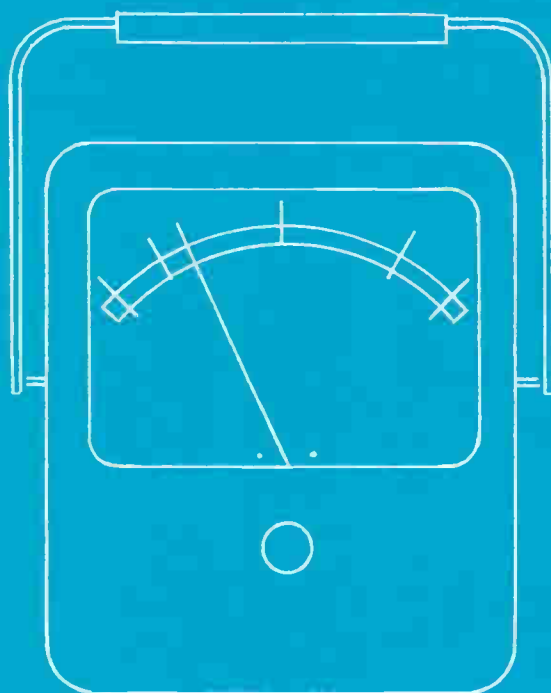

BELDEN...new ideas for moving electrical energy



Belden's systems savvy is

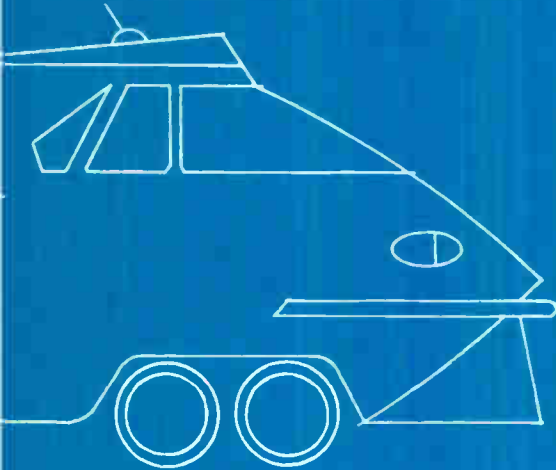
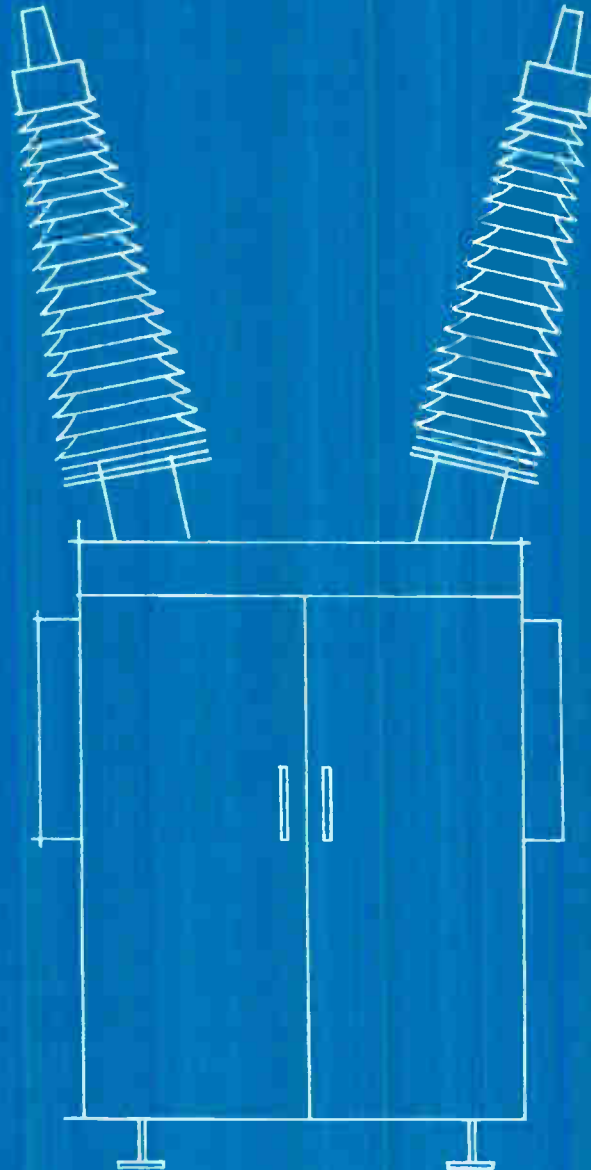
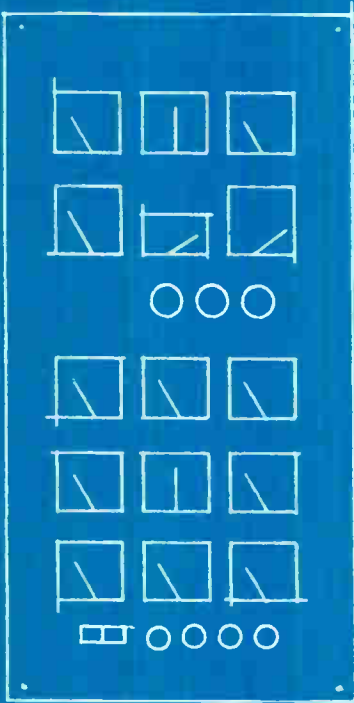

BELDEN



no big deal

It's a lot of little deals, that add up to something big. Like lower costs. Fewer production headaches. Enhanced product reliability. By poking and probing into your product's electrical system and the way it's manufactured and used, Belden Wire Systems Specialists may be able to suggest a wire or cable that costs less. Or that lasts longer, or that takes up less space*. Or maybe they'll suggest a different put-up that saves you assembly time. Or a solution to a stripping problem. They'll also offer you one responsible source for all your wire needs. Because we're the

people who make all kinds of wire for all kinds of systems. So if you're making plans or having problems, get yourself a good deal. Call or write: Belden Corporation, P.O. Box 5070-A, Chicago, Illinois 60680. And ask for our catalog, and the reprint article, "Key Questions and Answers on Specifying Electronic Cable."

*For example: Beldfoil® shielding in Belden cable. It isolates conductors better than anything yet. And it's thinner. You can pack more conductors into a conduit . . . hold down size and weight.

8-2

Learn how electronics is working to change the practice of medicine.

2nd National Conference & Exposition
on Electronics in Medicine.

February 12-13-14, 1970
Fairmont Hotel
San Francisco, California

Presented by
Electronics/Management Center
in association with
McGraw-Hill Publications

Electronics/Medical World News
Modern Hospital/Postgraduate Medicine
Scientific Research

How much change will be brought about by the successful applications of the electronics technology to the modern needs of medicine?

Will the physician without a working knowledge of the employment of electronics as an administrative and clinical tool be obsolete in five years? Will the high efficiency, high reliability procedures predicted for the seventies increase or decrease the role of the individual physician? What will be its impact on the medical team and the medical center? Can electronics through automation improve the nation's overall health levels?

These are some of the questions now being answered by eminent physicians and technologists in many of our nation's most respected institutions where electronics is being actively applied to benefit hospital, doctor, and patient.

How well these programs are working, what's right and what's wrong with electronics will be explored in depth in the 2nd National Conference & Exposition on Electronics in Medicine.

The format of the three day program is based on the enthusiastic response to the First National Conference on Electronics in Medicine and the request by its attendees to provide for a broad interchange of ideas.

In morning sessions, authorities in both medical and electronic disciplines will present their knowledge and experience on subjects of major interest; instrumentation, computers, information systems, monitoring, diagnosis, therapy, and administration.

These meetings will provide the backdrop for afternoon work-sessions in which each attendee will become an active participant in the discussion of problems and solutions. All work sessions will be conducted to bring the maximum knowledge and experience of the group as a whole to each of the participants. Attendees will have the opportunity to join at least two of the six sessions being offered.

While meetings and work sessions will explore the most recent ideas with attendees, exhibits will present physicians and hospital administrators with the latest hardware available, providing an important opportunity for demonstration and a "hands-on" familiarization of the newest features and capabilities of electronics products designed specifically for medical application.

Meetings:

Keynote address

George Burch, M.D., Ph.D., Tulane University Medical School, New Orleans, La.

"Instrumentation and Common Sense"
Robert D. Allison, Ph.D., Director, Vascular Laboratories, Scott & White Clinic, Temple, Texas.

"Computers: A New Order for Medical Data"
Arnold Pratt, M.D., Director, Division of Computer Research & Technology, National Institutes of Health.

Address:

Hon. Roger O. Egeberg, M.D., Assistant Secretary for Health and Scientific Affairs, Dept. of Health, Education and Welfare.

"Medical Engineering: Problems and Opportunities"
George N. Webb, Asst. Professor, Biomedical Engineering, The Johns Hopkins University School of Medicine.

"The Medical/Engineering Interface"
Donald Lindberg, M.D., Chairman, Dept. of Information Science, University of Missouri.

"What's New in Medical Information Systems"
William Chapman, M.D., Palo Alto Medical Clinic (Selected films will be shown as part of Dr. Chapman's presentation.)

"Getting Medical Electronics from Research into the Real World"
Irving Selikoff, M.D., Director, Environmental Sciences Laboratory, Mt. Sinai School of Medicine.

Address:

"Is Science for Real? Or will the American public ever demand the medical care it deserves and find true happiness?"

Richard Bellman, Ph.D., Professor of Mathematics, Electrical Engineering and Medicine, University of Southern California.

How Hospitals Evaluate and Purchase Medical Electronic Equipment:

"Selection of cardiac care unit monitoring equipment"

James A. Stark, M.D.

H. Aileen Atwood, R.N.

"Data Processing Comes to Merritt Hospital"

Howard Scott, Hurdman & Cranstoun Penney and Co.

"Selecting Equipment for the Clinical Pathological Laboratory"

R. Thomas Hunt, M.D.

Floyd Oatman, A.T. Kearney & Co. Inc.

"Boosting Hospital Efficiency through Electronic Aids"

Oscar M. Powell, M.D.

S.R. Wickel

Work Sessions:

On-line Computer Applications.

The role of the computer in medical record-keeping, data analysis, and history-taking in the office and the hospital.

Automating the Clinical Laboratory.

This session will attempt to pinpoint the major test requirements of the clinical laboratory, evaluate the available equipment for automatic testing and determine future requirements.

Problems in Intensive Care Monitoring.

A discussion of problems in intensive care, available instrumentation, and what's needed for improved patient monitoring.

Multiphasic Screening: Pros and Cons.

How effective are automated screening techniques in preventive medicine for large groups? How much data is needed, and what associated hardware and software are required?

Problem Clinic

A forum at which doctors and engineers will have the opportunity to discuss specific medical/

engineering problems and point the way to feasible solutions.

Buying, Selling and Maintaining Medical Electronic Equipment.

Marketing and maintenance are key problems in developing the role of medical electronics. On this panel, experts will discuss current practices and develop ways to improve them.

Exhibits:

This year, there is a new emphasis on exposition. One which reflects the increasing number of electronics products being accepted as practical, progressive, working tools by more and more hospitals and physicians. Exhibits will include many products related to the program of discussions and work sessions. Demonstrations of product features will help attendees explore new applications for the latest electronics equipment.

Here is a partial list of the companies which will be presenting their most recent achievements.

Avtel Corporation • Bio-logics, Incorporated • Birtcher Corporation • The DeVilbiss Company • Federal Pacific Electric Company • General Electric Company • Graphic Controls Corporation • Honeywell, Incorporated • Mead-Johnson Laboratories • Laser Systems & Electronics, Incorporated • Medidata Sciences, Incorporated • Ohio Medical Products • Parke-Davis • Remler Company • Richard Manufacturing Company • Spacelabs Incorporated • Statham Instruments Incorporated • Technicon Corporation • Wang Laboratories, Incorporated •

Registrants of the 2nd Annual Conference & Exposition on Electronics in Medicine will be encouraged to invite their professional associates to regular exhibit sessions. Other members of the medical profession in the western region will also receive special invitations to visit the exhibits.

Registration Fee: \$150

(Includes all sessions, exhibits, luncheons, reception, and copy of the proceedings when published.)

Note: Only those fully paid in advance will be admitted to meetings and work sessions.

Mail registration and make checks payable to:

2nd National Conference and Exposition on Electronics in Medicine, 330 West 42nd Street, New York, New York 10036

A number of rooms is being held at the Fairmont Hotel for registrants. Make reservations directly with the hotel, identifying yourself as a Conference attendee.

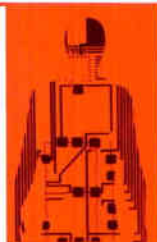

Advance Registration
2nd National Conference & Exposition
on Electronics in Medicine
February 12-13-14, 1970
Fairmont Hotel, San Francisco, California

Name _____ Title _____

Address _____

City _____ State _____ Zip _____

Hospital or Company affiliation _____

Check enclosed _____ Send invoice _____

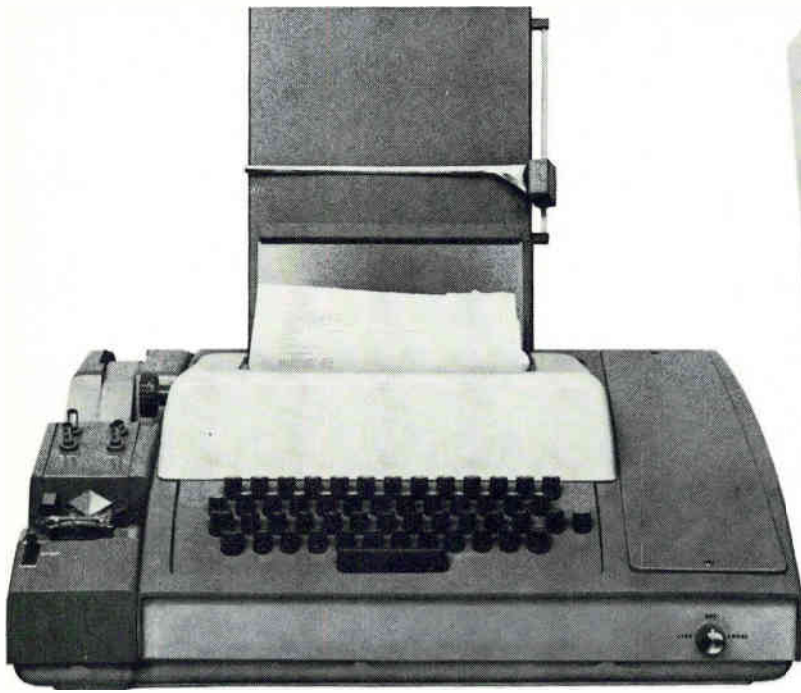

Printers—low cost, limited flexibility.



CRT Terminals—high-cost, high flexibility.

Print out In/out



New CRT readout—low cost, high flexibility.

Just out

Announcing the MRD-100—a new, low-cost way to display sequential numeric data on TV monitors.

Now it's practical to use TV monitors to read out data from keyboards, magnetic tape or any other sequential source.

The MRD-100 accepts character serial and bit parallel data, stores it in its own refresh memory, converts it to a composite video signal and displays it on a TV monitor. In 2, 4 or 8 lines with 32 characters per line; 4 or 8 lines with 16 characters per line.

Data may be displayed on any standard 525-line TV monitor at any number of remote locations—with just a single coaxial cable. Interfacing is simpler than that for full-scale terminals.

Prices for the MRD-100, not including monitors, start at \$1295.

Control features let you advance to any line or character position, blink on and off any character or combination of characters, use a cursor symbol for tracking the location of the next character and erase all or part of the screen.

So if you have a design problem in sequential numeric readout, you no longer have to worry about the reliability of printers, the cost of a full-scale terminal or the trouble of building your own memory for indicator tubes.

Now you have a tailor-made solution.

From the company that specializes in innovative data communications systems.

ADDS
Applied Digital Data Systems, Inc.

Mr. Richard Kaufman, Dept. 16
Applied Digital Data Systems, Inc.
89 Marcus Boulevard
Hauppauge, New York 11787

Please send more information about the MRD-100.

Name _____
Title _____
Company _____
Address _____
City _____
State _____ Zip _____

Ten good reasons why Raytheon can help you simplify any problem involving electrical output storage tubes.

The concept of the electrical output storage tube was first applied in 1948, by Raytheon's development of the *Recording Storage Tube. Since then, Raytheon has continually pioneered in the improvement of these devices—developing new and more sophisticated types to meet a growing diversity of applications.

Today, the men shown here—and

their fellow Raytheon engineers and technicians—make up the most experienced team in the industry.

You can count on their full cooperation if your project involves electrical output storage tubes. To put them to work on your program, call or write: *Raytheon Company, Industrial Components Operation, 465 Centre Street, Quincy, Massachusetts 02169. Telephone: 617-479-5300.*

RAYTHEON



AMOS PICKER, SENIOR DEVELOPMENT ENGINEER, holds CK1549 miniature, meshless storage tube to illustrate a Raytheon feature: fast development of new types for specific system requirements with fast turn-around capability to full production.

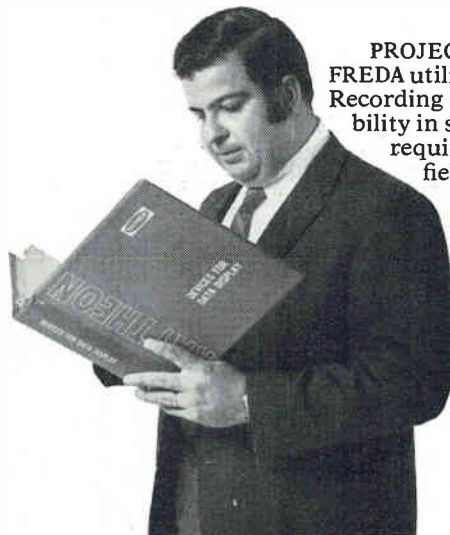

PROJECT MANAGER CARL FREDA utilizes total Raytheon Recording Storage Tube capability in service to customer requirements—including field and applications engineering assistance, complete documentation, and configuration control.



AL LUFTMAN, OPERATION ENGINEERING MANAGER and a prime mover in making Raytheon the world's largest manufacturer of electrical output storage tubes, inspects the CK1540—an advanced single-gun design featuring high resolution, output signal, and dynamic range.



DR. R. C. HERGENROTHER, RAYTHEON SENIOR SCIENTIST and pioneer in storage tube inventions, is a consultant on advanced research and development programs. He holds the CK1545—a product of such programs slated for wide use in advanced multi-sensor scan conversion systems.

*Trademark of Raytheon Company

MEL LEVINE, DISPLAY DEVICES ENGINEERING MANAGER, explains storage tube quality assurance. Raytheon's attention to burn-in and stabilization cycles and to life test programs are major reasons for high MBTF experience in scan conversion systems such as Radar Bright Display for FAA and Canadian DOT, and U.S. Navy ASW systems SQS26 and ANEW.



WARREN FROHOCK, SENIOR PROCESS AND DESIGN ENGINEER, ensures that storage tube designs provide optimum performance in your equipment—through use of advanced manufacturing techniques.

JOE MAIENZA, DISPLAY DEVICES MANUFACTURING MANAGER, maintains Raytheon capability to deliver to your tightest schedule requirements. Delivery of 600 tubes per month has been achieved.

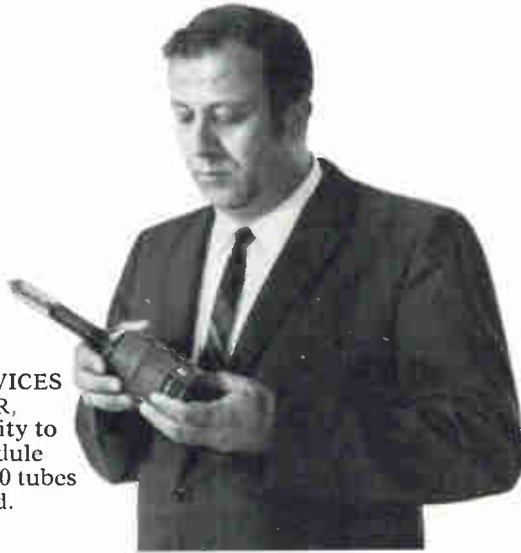

JOHN BUCKBEE, SENIOR EQUIPMENT DESIGNER, designed semi-automatic test set to provide comprehensive measurements of storage tube performance. Raytheon's advanced test equipment is used to test for compliance to specification and to supply special application data to customers.



GORDON SPENCER, R&D ENGINEERING MANAGER, holds numerous display device patents—contributes many concepts leading to Raytheon state-of-the-art storage tube advancements.



AL CLOUTIER, SENIOR APPLICATION AND TEST ENGINEER, holds CK1558 incorporating tube, focus and deflection coils, magnetic shield and associated circuitry. Modular assembly answers needs for plug-in unit, simple interface, easy field replacement.

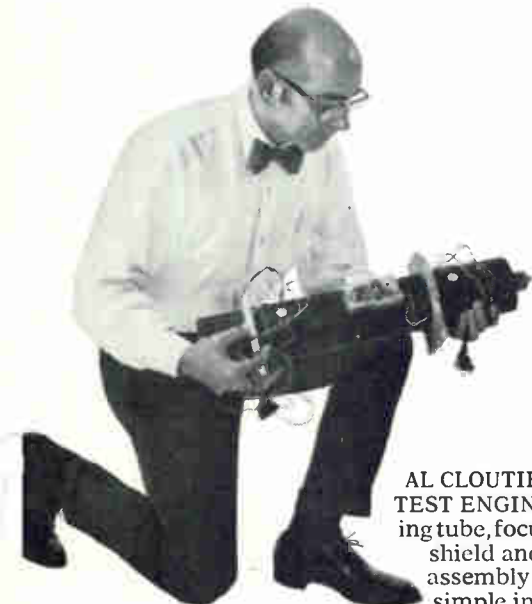

Lots of people have told us they could use an active filter with low power requirements and a low enough price.

How does 0.3 mW at \$10* sound?



Ask for carload prices or send \$12 for an evaluation sample.

You'll find there's a lot to evaluate. Like that power spec—ideal for all kinds of battery-powered gear. Plus a price/performance combination that we think will eliminate a lot of in-house filter making, even for commercial applications. Mail the coupon and a check or P.O. for \$12.00 today (please attach your company letterhead). We'll respond by air with a sample FS-60 and our brand new Filter Design Handbook. 'Till then, here are the basic specifications: Delivers band-pass, high-pass and low-pass outputs simultaneously Any desired form of the second order transfer function Complex zeros anywhere in the S-plane Multi-loop negative feedback for added stability F_c and Q of basic unit can be tuned by adding external resistors Frequency range from DC to 10 kHz Q range from 0.1 to 500 Voltage gain is adjustable to 40dB Supply voltages from ±2V to ±15V with 0.3 mW power consumption Dimensions: (14-pin DIP) 0.804" x 0.366" x 0.474" IC hybrid construction.

PRICES:	1 - 49	\$28	5,000 - 9,999	\$14
	50 - 199	\$23	10,000 - 19,999	\$12
	200 - 999	\$19	*20,000 - 49,999	\$10
	1,000 - 4,999	\$16		

Gentlemen at KTI:

Please send me an FS-60 evaluation sample. Our check P.O. is attached, in the amount \$12.00. Send me more information on:

- FS-60 All active filters Hybrid subsystems
 Please add my name to your permanent mailing list

Name _____

Company _____

Address _____

City _____

State _____ ZIP _____

My applications are: _____



KINETIC TECHNOLOGY, INCORPORATED

3393 De La Cruz Boulevard
 Santa Clara, California 95051
 (408) 246-8100 TWX: 910-338-0279

The name to remember for Hybrid Integrated Systems and Active Filters . . .

Technical Articles

**At last,
a bipolar shift
register with the same
bit capacity of MOS
page 84**

By designing and arranging a shift register's basic bit, clock, and buffer circuits for maximum yield, and using the highly computerized discretionary-wiring technique, bipolar circuits of 1,000-bit capacity can be put on one chip. Bipolar shift registers are much faster than the static MOS versions, have no complicated multiplexing, and unlike dynamic MOS units, can store data without refreshing.

**Multi-emitter IC's
stabilize voltages in
solid state tuners
page 91**

With two emitters on its transistors an integrated circuit can provide highly stable voltage for variable capacitance tuner diodes in tv sets. One emitter, operated as a zener diode, provides the required output voltage; the other is operated in the forward direction and automatically compensates for changes in the zener voltage with temperature.

**Connecting aluminum wire
page 94**

As copper wire gets scarcer and more expensive, bulk users are turning to aluminum wire which, though it has only 80% of copper's current-carrying capacity, is much cheaper, lighter, and more abundant. However, working with aluminum wire presents some termination problems which must be worked out carefully.

**Amplifying and guiding
surface acoustic waves
page 102**

Surface acoustic waves hold the key to future signal processing. Traveling on miniature substrates, these high-frequency acoustic waves can be launched efficiently, amplified easily, and guided conveniently. This second article in the series explores techniques and results of surface wave acousto-electric amplification and discusses transmission line material and the methods for guiding signals.

**Matching FET's by design
is faster and cheaper
than by pick and choose
page 114**

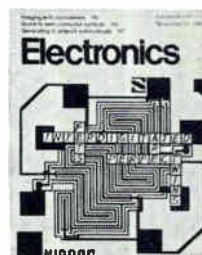

Matched pairs of field effect transistors have been costly because of the expensive testing required to find two identical devices. But now cost is dropping because FET's can be made identical on the same wafer. The secret: laying out the transistors so that the center of their gates is at the same spot. Then the effects of surface flaws and epitaxial thickness variations tend to average out. FET's produced this way can be used economically in both traditional and new applications.

**European markets
in 1970**

Coming

The Western European market for electronic goods and gear continues to grow. *Electronics'* annual survey gives detailed forecasts of the size and shape of the market in reports from 11 nations and in charts estimating sales in 82 product categories, from components to assembled equipment.

At last, a bipolar shift register with the same bit capacity as MOS

At 1,000 bits per wafer, discretionary-wired bipolar IC's not only match MOS circuits in complexity but also surpass them in shift rate with no need for data refreshing; speeds of 40 Mhz are possible

By Roger Dunn and Glenn Hartsell

Texas Instruments, Dallas

Why would anyone want a bipolar shift register integrated circuit with 1,000-bit capacity when excellent MOS IC's are already available at a lower price? There are compelling reasons: only bipolar circuitry combines the virtues of speed with the capacity for long periods of storage.

It's true that metal oxide semiconductor shift registers are attractive when dynamic storage can be used, but in many systems this isn't possible; data must wait for long periods between shifting. And if the system operates at high speed, static MOS is no alternative, since it has only a fraction of the speed of a dynamic MOS shift register unless the complicated technique of multiplexing is used. Furthermore, static MOS occupies more chip area per function, and consumes more power than dynamic MOS. The design of the clock distribution line also becomes critical. In short, MOS of this type offers few of the advantages usually attributed to MOS technology as a whole. Then there's the added complication of extra power supplies and buffer circuitry to interface MOS with transistor-transistor logic.

Bipolar circuitry, then, is the answer in high-speed, high capacity, static shift registers. And this is the approach that Texas Instruments selected for an airborne digital-signal-processing application, in which shift registers are needed for video integration to replace analog delay lines, for digital filtering in moving-target indication to eliminate range-gate analog filters, and for correlation.

A thousand bits on a bipolar chip is certainly large-scale integration, and is probably the most ambitious of current advanced integration projects. A typical 1,000-bit shift register contains 9,000 components, 1,800 feedthroughs, 20,000 crossovers,

and 70 inches of metal just in one of the two interconnection layers. This complexity is only possible at this stage of bipolar technology through the use of discretionary wiring, a highly automated technique in which only good cells are interconnected on the chip. [*Electronics*, Feb. 20, 1967, page 143].

Discretionary wiring increases the component density of bipolar circuits by two orders of magnitude and also greatly reduces the power consumption per bit because internal circuitry can be operated at lower voltage levels. At 16 megahertz, the new shift register operates at 3 milliwatts per bit, or one-eighth the power level of the SN5491 eight-bit TTL shift register.

The speed of the LSI 1,000-bit register is much greater than that of a register of the same capacity made from several conventional integrated circuits. This is because the propagation delay caused by connections between IC's is eliminated. Thus, the LSI register can operate at the 16 Mhz shift rates. Moreover, multiplexing with TTL circuits can be done very simply because of the similar input and output levels, and with this technique, shift rates in excess of 40 Mhz can be attained.

Predictably, the extremely large number of components on the chip—and their density—created some critical questions that had to be resolved by the design engineers:

- What circuit should be selected for the basic shift register cell that would be tolerant of wide variations in device parameters and thus give a high yield of good cells?
- Could a power supply distribution network be designed that could handle the 2 amperes that flow into the circuit without excess voltage drop?
- What would be the optimum number of cells

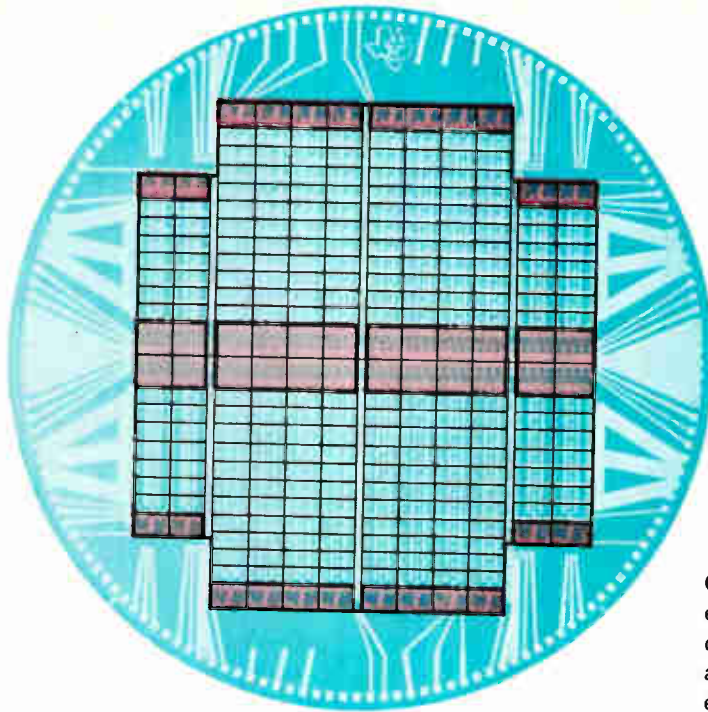

- SHIFT REGISTER
4 BITS PER STAGE,
1,856 BITS TOTAL
- OUTPUT BUFFERS
48 TOTAL
- CLOCK DRIVERS
96 TOTAL

Occupation. LSI bipolar shift register occupies entire 1½-inch slice of silicon. For efficient distribution of signals and power, clock drivers are arrayed in center of wafer, output buffers at edge. Circuit contains 9,000 components.

per stage that will neither waste chip real estate nor adversely affect yield?

The circuit selected for the basic bit is composed of simple master and slave flip-flops with four resistors and four multiple-emitter transistors per bit, shown on page 87. This cell operates from a two-phase clock and the voltage difference between the two input signals. The clock signals are timed so that they're never high simultaneously. When clock 1 is high, the low side of the input from previous bits (or from the input to the chain) sets the master flip-flop. When the clocks are reversed, clock 1 is low and the master data is stored, producing a differential output signal $V_{BE} - V_{CE(sat)}$ —the difference between the base-emitter voltage and the collector-emitter saturation voltage. Now, with clock 2 high, this differential signal sets the slave, and current from both master and slave flows into the clock 1 line.

To make sure that the differential signal from each flip-flop is enough to trigger the following one, the transistor's base resistance is made rather high so that $V_{BE} - V_{CE(sat)}$ equals V_{BE} , the local forward-biased base-collector voltage. This high base resistance has the added advantage of limiting the saturation current and the leakage of the reverse-biased emitters.

One of the transistors in a bistable will be in saturation, and hence produce an output difference, as long as

$$h_{FE} > \frac{2V_{BB} - 2V_{CL} - 2V_{CE(sat)}}{2V_{BB} - 2V_{CL} - 2V_{BE} - 2V_{CE(sat)}}$$

This equation pertains to bistables with matched resistors, as is the case in IC's. V_{BB} is the power

supply voltage, and V_{CL} is the clock voltage.

This equation explains why the cell has such a high immunity to parameter variation. It can still operate without loss of information with, for example, current gain, h_{FE} , less than 10 and V_{BB} as low as 1.7 volts.

The relationship between speed and power is always a vital concern in digital circuits, and the basic cell selected for the shift register offers excellent performance in this respect. At a shift rate of 16 Mhz, the array dissipates only 3 mw per bit.

Slowest sets the pace

Actually, in a large-capacity shift register, the maximum shift rate is determined by the slowest bit in the chain, not by the typical bit. The parameter-variation tolerance of the basic bit, shown on page 87, stands it in good stead here too; it will operate at high speed (10 Mhz or more) over a V_{BB} power supply range of 2.0 to 2.8 volts.

The discretionary wiring technique helps maintain a high shift speed, since it detects slow bits during probe testing and prevents them from being connected in the chain.

Power supply distribution was an extremely important issue as the large number of bits requires the distribution of a large total current—large for an IC. Use of differential signals at the input and outputs of the bistables helps somewhat. Nevertheless, the circuit must handle 1 ampere total current for each of the two clock drivers. The solution was to scatter 20 clock drivers with 60 milliamper ratings across the wafer, paralleling the inputs and outputs. This number of clocks in parallel would be impossible with discrete IC's, because the parameter variations from circuit to circuit would introduce

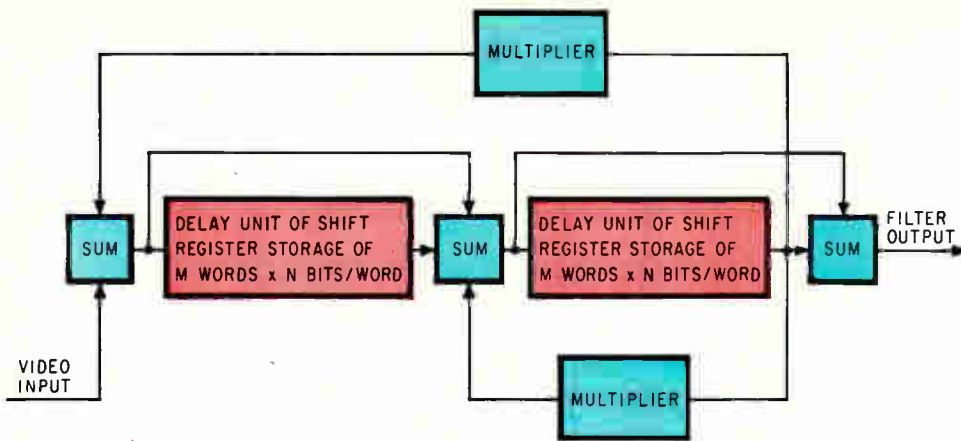

Application. One use of TI's 1,000-bit circuit is as a delay unit in a two-stage filter with feedback for an airborne moving-target indicator.

skew problems in which the time separation between clock edges at two adjacent flip-flops is excessive. But in an LSI circuit, with clock cells on the same slice, the variations are small.

To further aid in distribution, the wafer is laid out with the clocks in the center, dividing the wafer in two equal halves. Locating the clocks in the center minimizes the voltage drop along the clock lines and reduces lead congestion at the periphery of the wafer.

An output buffer is required to translate the low-level output from the shift register to TTL levels. Again, to minimize voltage drop and also to conserve wafer area, these output buffers are located at the edge of the wafer. Unfortunately, this is where wafer defects are most numerous, and yields are therefore lower than on the rest of the wafer. To compensate, extra output circuits are put on the wafer.

The distribution bus leads for ground, power supplies, and clock are contained in the first of the two metalization layers (the first metal layer also contains the intra-cell connections). For any functional combination of cells, the maximum voltage

drop is 125 mv on ground lines, 100 mv on power lines, and 50 mv on clock lines.

The basic bit occupies an area 0.014 by 0.014 inch. It would be inefficient to probe-test each bit individually, since test pads would have to be provided for each and would take up too much area (test pads are 0.003 inch square, and seven would be needed for each bit). Instead, groups of bits should be connected in stages, with one set of input and output pads for each stage.

Setting the stage

The question is how many bits should be connected in a stage. On the basis of the data plotted on facing page, Texas Instruments selected a stage length of four bits. A shorter stage—two bits, for example—would occupy too much area per bit, as indicated by the number of good circuits per square inch on the vertical axis of the diagram. This effect becomes more pronounced at higher yields.

On the other hand, longer stages such as eight bits provide efficient utilization of surface area as long as the yield is very high, but this utilization efficiency drops off drastically if the yield is lower. The four-bit stage is the best compromise. With test-pads, it requires only 9% more area per bit than an eight-bit stage, and the number of good stages per square inch varies much less with yield than for the eight-bit stage.

The output buffers and the clocks function individually, not in stages. There are 48 clock drivers for each half of the wafer. This is enough to drive 1,200 bits in each half, or 2,400 bits for the entire wafer. Even if the yield of clock cells were as low as 70%, there would still be enough to drive 850 bits in each half.

The situation isn't really this simple, however, because an uneven distribution of good circuits has to be taken into account. For example, if two clock frequencies are used for all bits in a quad 253 array, as in the TI 1,000-bit register, each quadrant must have 12 good clock drivers. So it's not enough for the wafer to have at least 48 good clock drivers; they must have to be distributed appropriately, too. In general, clock-cell yield and the geometrical

Effect of stage length on yield and inter-layer connections

	2 BITS PER STAGE	4 BITS PER STAGE	8 BITS PER STAGE
YIELD	X	6 X ²	6 X ⁴
AREA PER BIT WITH INTER-CONNECTIONS	A + B	$\frac{(2A + B)}{2}$	$\frac{(4A + B)}{4}$
AREA SQUARE INCHES	0.00068	0.00058	0.00053
FEEDTHROUGHS PER BIT	7/2	7/4	7/8
FEEDTHROUGHS PER SQUARE INCH	5230	2975	1619

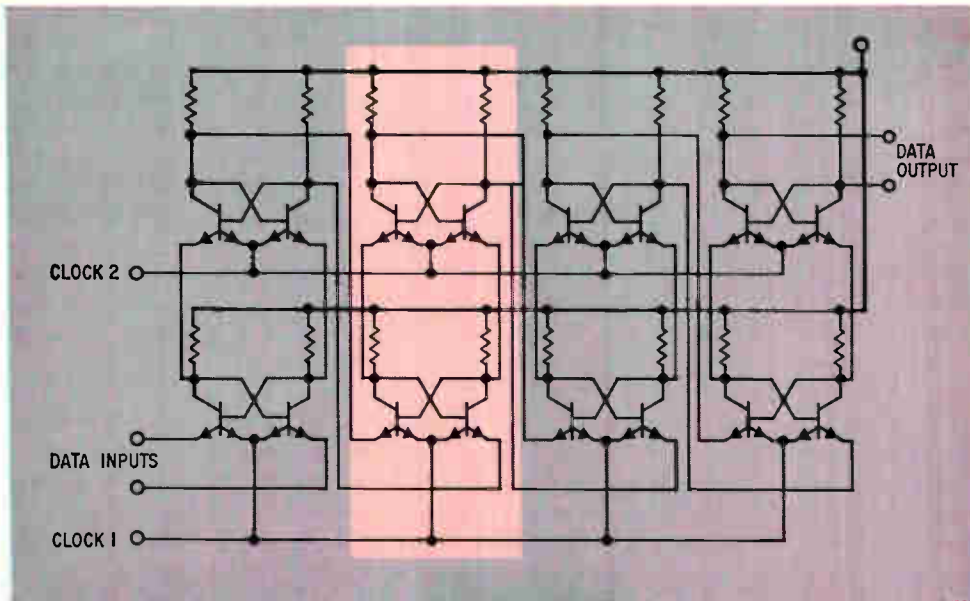

Bit. Basic unit of shift register is a master-slave flip-flop (light color). Four such bits are combined to form a stage.

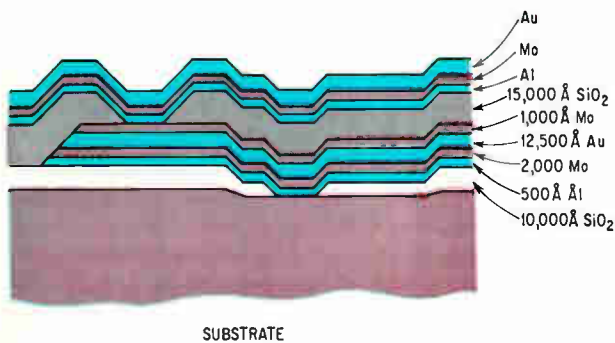

Multilevels. Good bits are interconnected by means of two metal layers separated by an oxide layer. For conductivity and adhesion, the metal layers are composites of gold, molybdenum, and aluminum.

distribution of the yield are no problem, largely because the center of the wafer, with its relatively low defect density, is a favorable location.

Extra buffers provide margin

There are 48 output buffers. Each quadrant has two segments as shown on page 85, one with eight buffers and the other with four. To keep yield from becoming a problem in the unfavorable portions of the wafer in which the buffers are located, many extra buffer cells are provided. Only one good buffer is needed in each segment, corresponding to a 25% yield in the four-buffer segments and 12.5% in the longer ones.

Closely related to the question of optimum bit length for the shift register stages was the problem of making connections between the metalization layers. Selection of a four-bit stage length for the shift register means that eight inter-layer connections are needed per 0.0023 square inch, or 2,975 feedthroughs per square inch. This density is well within the capability of the cathode-ray tube tech-

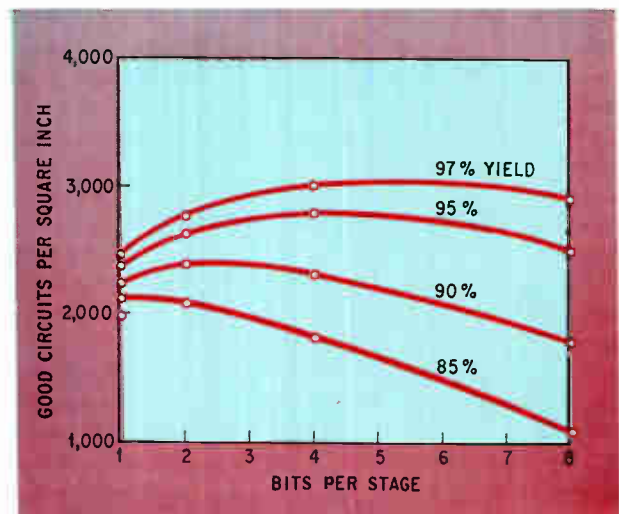

Optimum. Selection of stage length is a compromise between conserving wafer area and obtaining an adequate number of good stages. Texas Instruments uses four bits per stage in its shift register.

nique for generating metalization masks and of the metal deposition process. Metalization line width is 0.002 inch, and the minimum separation between lines is 0.002 inch.

A two-bit stage length, however, would place excessive demands on the multilayer-metalization process, requiring a feedthrough density of 5,230 per square inch.

The lower metalization level is an aluminum-molybdenum-gold-molybdenum composite, selected to give both adhesion and high conductivity. The upper metalization layer is similar but lacks the top skin of molybdenum, since it's not needed for adhesion. Separating the two metalization layers is a 15,000-angstrom-thick layer of silicon dioxide with 0.0006-inch diameter feedthrough holes. ■

Designer's casebook

Designer's casebook is a regular feature in Electronics. Readers are invited to submit novel circuit ideas and unusual solutions to design problems. Descriptions should be clear. We'll pay \$50 for each item published.

Multivibrators separate pulses according to their widths

By Steven Pataki

Israel Aircraft Industries, Yahud

Combining NAND gates with monostable multivibrators is an easy way to separate and channel pulses of varying widths.

The pulse train, containing both narrow and wide pulses, is delivered to both NAND circuits simultaneously. Positive pulses routed to the top half of the logic circuit are first inverted, triggering monostable 1, with their leading edge. At the same time, they are fed to monostable 2, but triggered with their trailing edge. The outputs of

both monostables are connected to the NAND gate which performs a logic AND function and inverts the pulses generated by the two multivibrators.

If each monostable's pulse width is adjusted to a size between the wide and narrow pulses, the NAND gate in the top circuit will pass only pulses with a width equivalent to the smallest pulses. All wide pulses are rejected.

In the bottom half of the circuit, the reverse takes place—narrow pulses are rejected and the wide pulses are passed.

The monostables are connected in series but all have the same pulse width. The input pulse is inverted, its trailing edge triggering monostable 3. The output pulse's trailing edge triggers multivibrator 4. Its output is gated directly with the input pulse.

The waveforms indicate that only wide pulses are passed by the NAND gate while the narrow pulses are blocked.

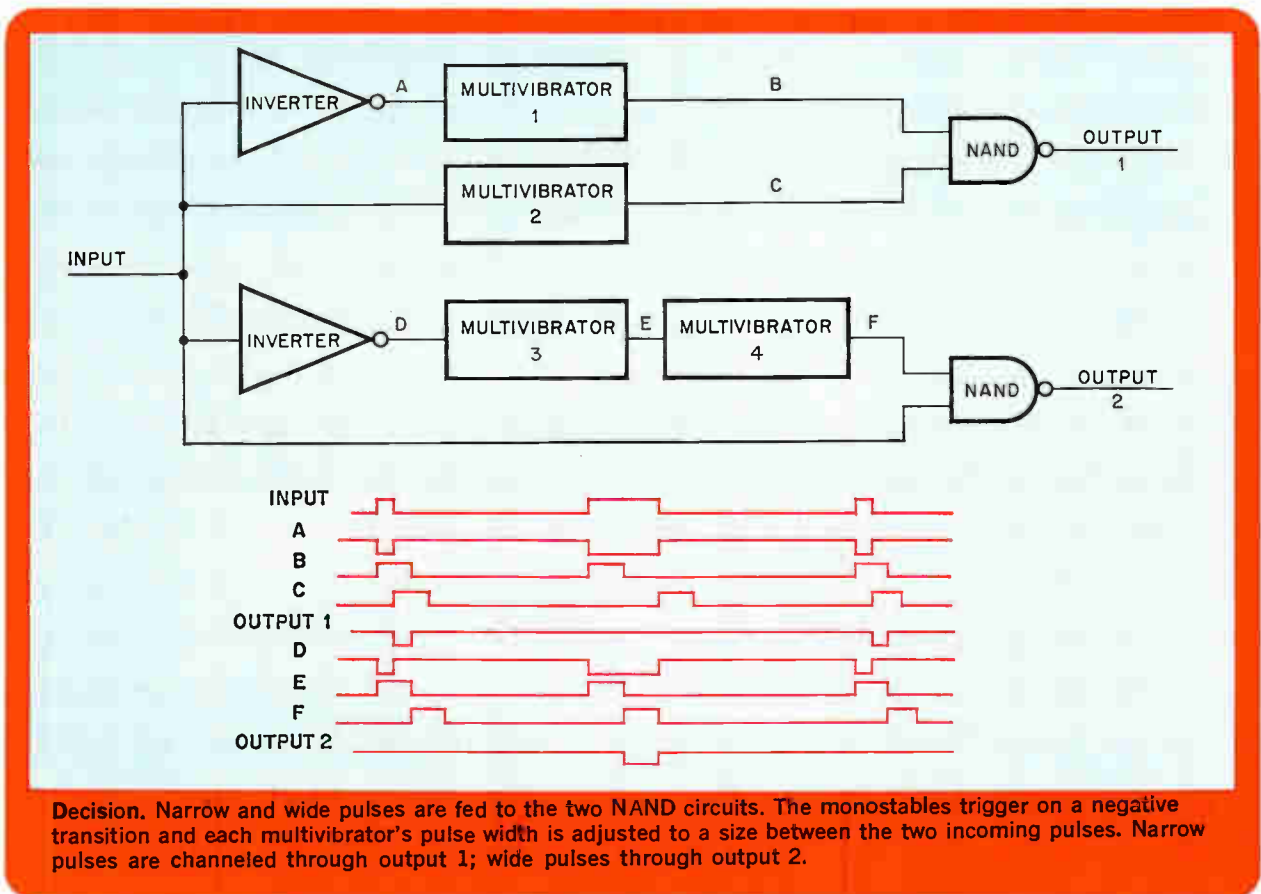

Decision. Narrow and wide pulses are fed to the two NAND circuits. The monostables trigger on a negative transition and each multivibrator's pulse width is adjusted to a size between the two incoming pulses. Narrow pulses are channeled through output 1; wide pulses through output 2.

D-a converter switches digital inputs with TTL gates

By Colin S. L. Keay and John A. Kennewell,
University of Newcastle, Australia

Transistor-transistor logic gates, applied as bit-controlled switches, serve as an inexpensive digital-to-analog converter whose performance compares favorably to many commercial units priced over \$300. Such a d-a converter makes a reasonably priced, and efficient driver for cathode-ray tube display terminals.

To achieve this type of d-a converter, the engineer must be able to connect his own collector resistor and power supply. Some TTL's available lack this flexibility. The SN7401 quad NAND gate and the SN7401 hex inverter are two logic circuits that have open collectors for external connections.

Up to 12 logic gates—are connected to a resistive ladder network. Depending on which gates are turned on, a current proportional to the value of the digital input is summed into one input of an operational amplifier. The linear integrated circuit produces an analog output up to 10 volts with a settling time of less than 10 microseconds. Inversion by the gates is corrected by driving the negative input of the op amp if a positive output is required.

When any input bit is 0, the output transistor

in the corresponding gate is cut off and its collector floats to the 5-volt IC supply voltage. The small collector leakage current accounts for only a 0.005-volt drop below the supply voltage.

When the input is a logic 1, the output of the gate is pulled down to 0.15 volt which can be adjusted by the 1-kilohm potentiometers. With this arrangement of pots, differences in saturation currents through the gates' output transistors are minimized.

The potential at each ladder resistor terminal, where the gate's output is connected, is switched between 0.15 volt or 5 volts depending on the corresponding gates' input. The weighting is determined by the closeness of the ladder branch to the op-amp input terminal—the most significant bit being closest and providing the largest current input.

When all inputs to the gates are 0 volts, all gate outputs rise to 5 volts and with the inversion through the op amp, the analog output should be 0 volt. Any offset can be adjusted by the offset control to the op-amp circuit. With all inputs at the logic 1 level, the output should be 10 volts. The potentiometer in the gain-control circuit of the op amp adjusts the output for precisely 10 volts. Several readjustments may be needed between the offset and gain controls to get the right output levels.

The value of the resistor, R, in the ladder network should be chosen between the 10 kilohms and 50 kilohms for the best possible accuracy and settling times.

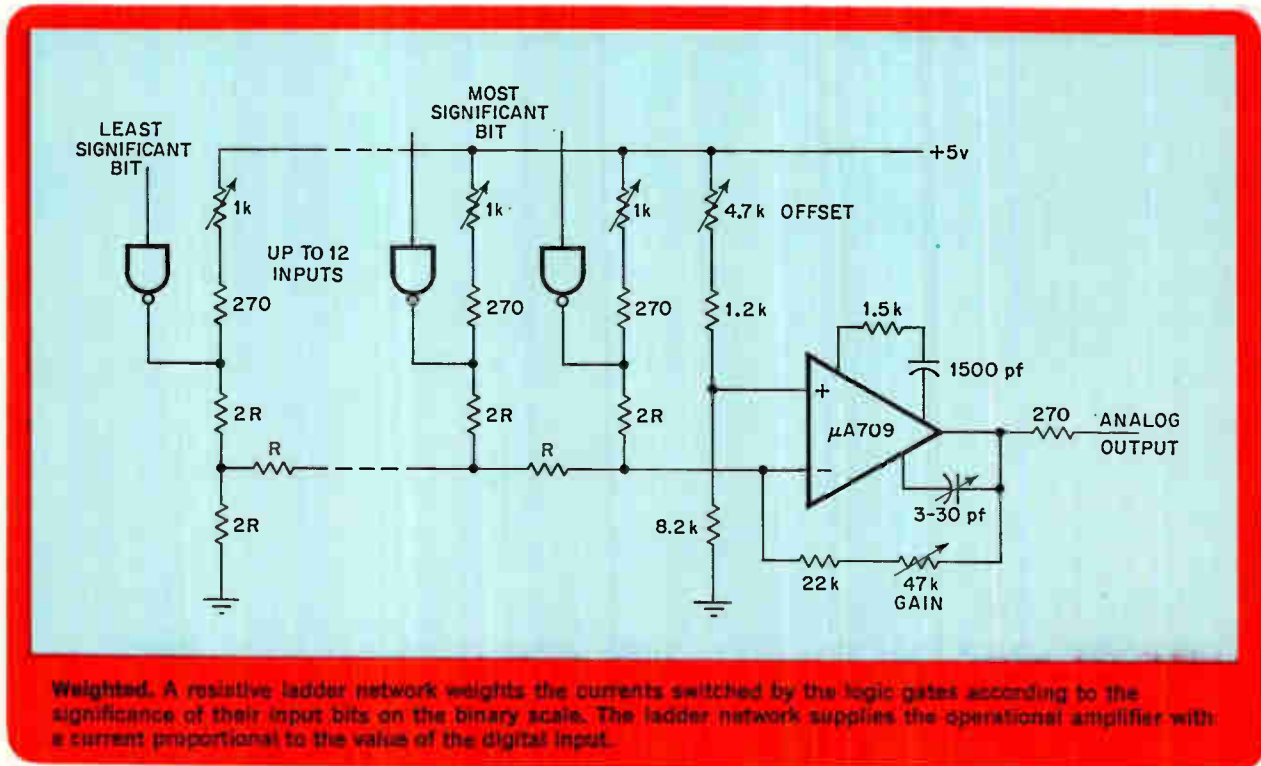

Capacitor discharge sets shape of ramp function

By James Downey

Fairchild Semiconductor, Mountain View, Calif.

Delaying the discharge rate on a capacitor enables an engineer to create several complex ramp functions. Such ramps are necessary in multiple-axis scanning applications involving cathode-ray tubes.

The duration of the ramps can be varied from hundreds of nanoseconds to hundred of microseconds depending upon the length of the input pulse. Since the input pulse controls the state of the integrator and does not provide the charging current, the slope of the ramp segments can be adjusted over a 50-to-1 range without affecting their linearity.

Transistors Q_1 and Q_2 form a constant-current generator that discharges integrating capacitor C_1 after it has been initially charged to the 12-volt supply voltage. Potentiometer R_1 can be adjusted

to provide a wide variation of discharge current, which controls the slope of the ramps. The comparator that drives Q_2 has regenerative feedback to provide a quick response to input pulses. Thus Q_2 switches rapidly as the input changes state and enhances the definition of the ramp segments.

Varying the delay controlled by the transistor circuit preceding Q_7 contributes to the variety of waveforms that can be derived at the output. The positive transition of the input pulse triggers monostable multivibrator Q_3 - Q_4 . At the end of the delay pulse from the multivibrator, Q_5 turns on for a brief period of 200 nanoseconds. The time is set by the R_3C_3 time constant. Transistors, Q_6 and Q_7 , now turn on enabling the capacitor to charge to 12 volts through Q_7 .

With no delay, retrace occurs immediately at the end of each sweep period. For small delays, the output voltage remains at the final ramp value for the duration determined by the delay before the capacitor returns to the reset conditions. If the delay spans several sweep periods, a succession of ramps separated by constant-amplitude interruptions is generated without resetting the capacitor to its initially charged condition.

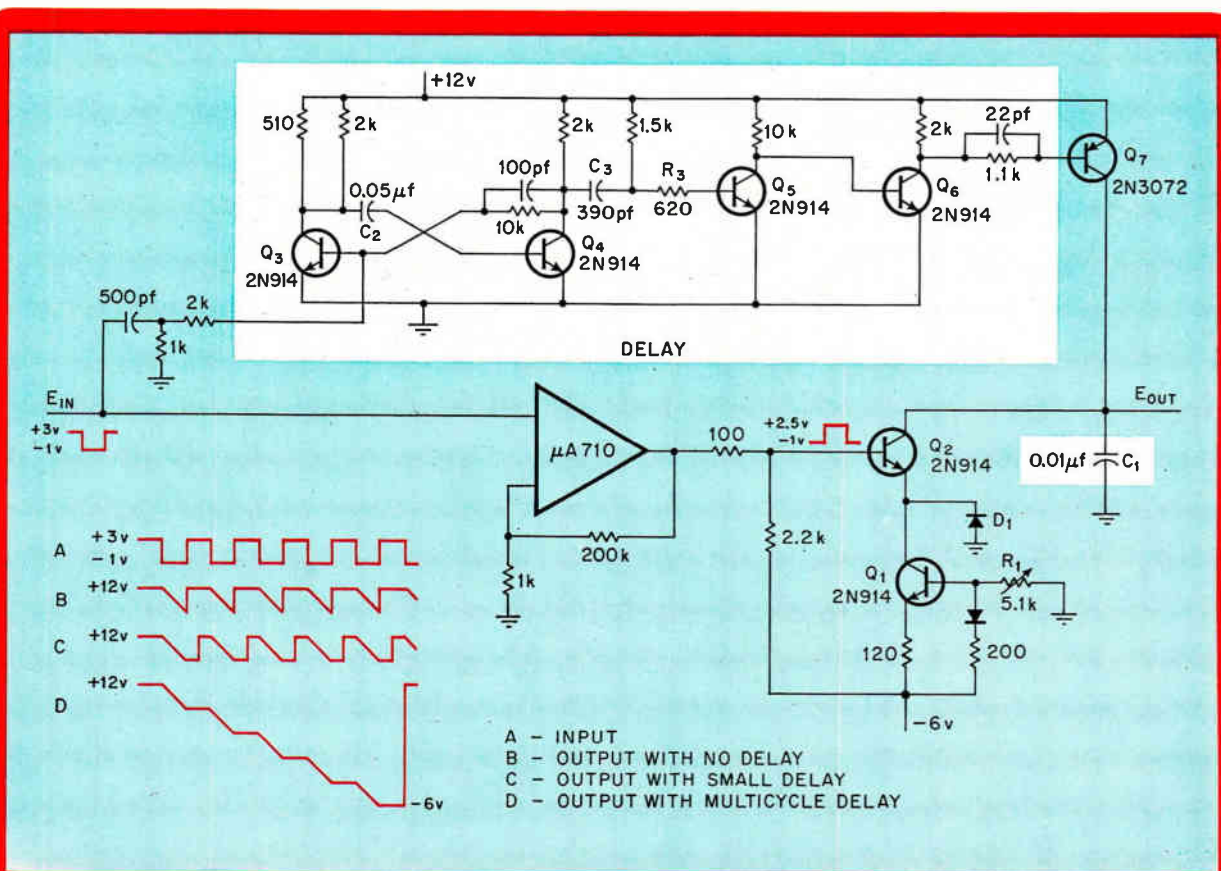

Slope control. Integrating capacitor, C_1 , initially charges to 12 volts. At the arrival of an input pulse, constant-current generator— Q_1 and Q_2 —is triggered, and C_1 discharges at a rate set by the potentiometer, R_1 . Capacitor resets to its initial condition at the end of the delay generated by the circuit preceding Q_7 .

Multi-emitter IC's stabilize voltages in solid state tuners

With inherent temperature compensation, monolithic devices eliminate expensive zener diode matching in discrete units and offer better performance characteristics as well

By Dieter Eckstein and Heiner Schmidt

Valvo GmbH, Hamburg

Stabilizing power supply voltages can be a ticklish problem, particularly in solid state television tuners. A simple, inexpensive, and high-performance solution to the problem is multi-emitter transistors in an integrated circuit. These devices provide automatic compensation for temperature-caused changes in the stabilized voltage.

Where voltage-variable-capacitance diodes are used in tv tuners power-line voltage must be reduced to about 33 volts and held there to within a few millivolts. Discrete-component stabilizers, which are made of resistors and zener diodes, have comparatively high internal resistance and are slow to reach thermal equilibrium. Most seriously, they require expensive matching of zener diodes for temperature compensation.

Engineers at Valvo GmbH found that because the multi-emitter IC uses active elements to achieve stabilization, it provides low internal resistance—typically 10 ohms. And because of the compensating effect of the multi-emitters, temperature stability is high: the variation of output voltage with temperature is about 40 parts per million per °C. The IC operates at a current of 5 milliamperes, and the only component that's needed is an external resistor to reduce the supply voltage to 33 volts.

The major technological problems Valvo had to solve in realizing its TAA 440 were keeping the stabilized voltage and the temperature coefficient (the rate of change of V_{PN} with temperature) within narrow tolerance ranges. To do this, it was necessary to maintain, from circuit to circuit, extremely uniform concentration of dopant at the surface of the base of the transistors, and inside the base directly under the emitter.

The surface concentration of the base influences

the emitter-base breakdown voltage V_{EB} while the concentration under the emitter influences the base-emitter forward voltage, V_{BE} . These voltages affect the stabilized voltage V_{PN} and the temperature coefficient T_k according to these relationships:

$$V_{PN} = zV_{EB} + nV_{BE}$$

$$T_k = \frac{1}{V_{PN}} (zk_1 V_{EB} + zk_2 + nc_E)$$

where z is the number of reverse-biased (zener) diodes, n is the effective number of forward-biased diodes, and c_E is the temperature coefficient of a forward-biased diode, equal to -2 millivolts/°C.

V_{PN} and T_k could be adjusted to make them within tolerance through an integrated adjustment resistor—one whose value could be altered by tapping it at various points along its length. From a production viewpoint, this is a clumsy alternative because it means that different interconnection patterns have to be used, depending on the amount of adjustment of resistor length required.

Assuring the parameters' tolerance in the first place is far preferable. Valvo did it with standard tube diffusion techniques for the boron diffusion (which forms the bases and the resistors). With these techniques, the sheet resistivity after the base diffusion (an indication of the base-dopant surface concentration) can be held within $\pm 6\%$, resulting in a variation of V_{BE} of only 2.6%.

For processing economy, an isolation diffusion step is avoided. This means that transistor structures instead of diodes have to be used, and that the collector current must be kept small. All the resistors form p-n junctions with the substrate.

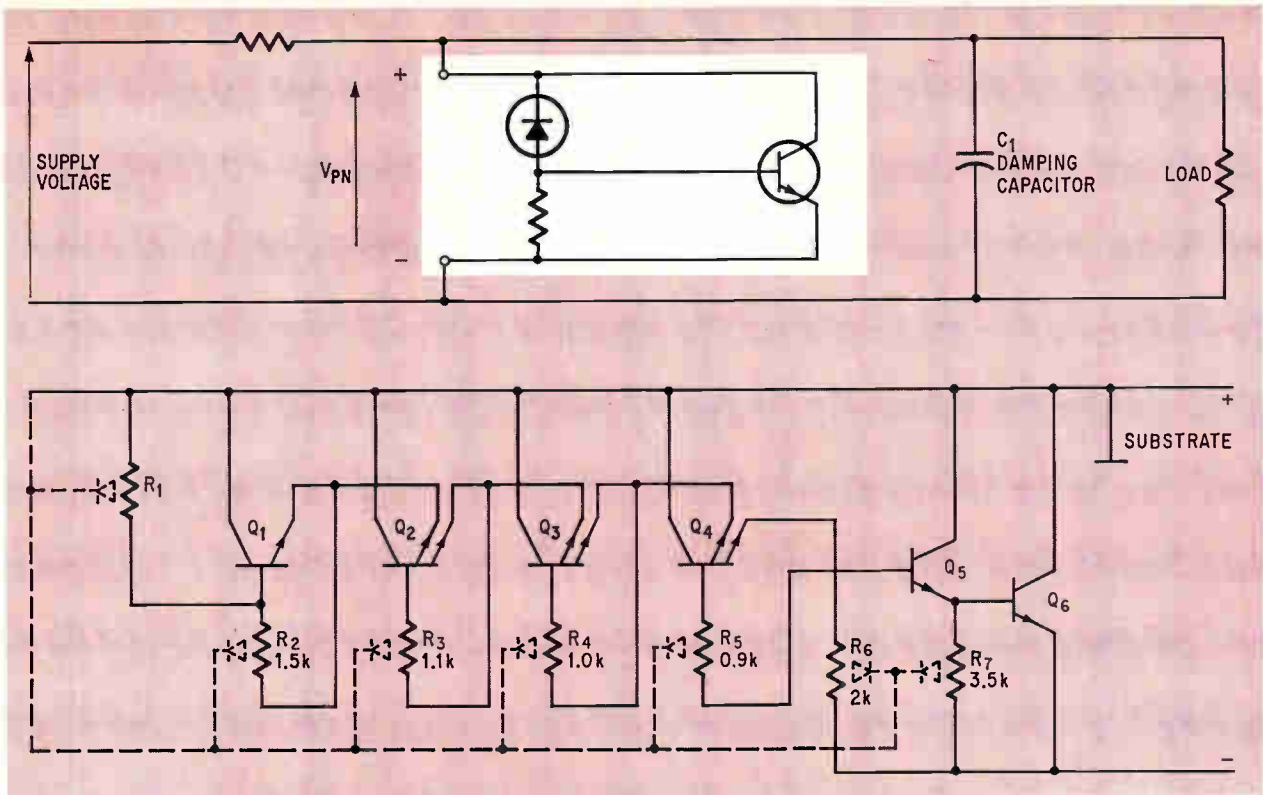

Principle and practice. Top diagram illustrates basic operation of Valvo voltage stabilizer. Zener diode provides essentially constant voltage V_{PN} ; forward-biased emitter of transistor provides temperature compensation, and resistor determines the current through the zener diodes. In the diagram of the actual circuit (bottom), zeners and temperature-compensating diodes are incorporated in multi-emitter transistors. Other transistors help minimize the effect of parameter variations from chip-to-chip, and reduce internal resistance. The dashed lines indicate parasitic circuit elements.

Since the substrate has a positive potential, these parasitic diodes are reverse-biased.

The TAA 550, shown in diagram above, uses three reversed-biased diodes as the zener stabilizing elements, represented by the double-emitter structures of Q_2 , Q_3 , and Q_4 . In each transistor one of the emitter-base junctions is operated in breakdown; the other operates in the forward direction. Electrically, these double emitters behave like reverse-biased diodes in series with forward-biased diodes.

R_1 , R_2 , and Q_1 form a voltage multiplier, increasing V_{BE} of Q_1 by a factor of $(1 + R_1/R_2)$. This multiplied voltage partly compensates for the temperature dependence of the breakdown voltage V_{EB} to yield the required thermal coefficient of 40 ppm/°C.

The collector-current-limiting resistors necessitated by the absence of an isolation diffusion are R_3 , R_4 , and R_5 . The parasitic diodes associated with these are indicated by the dashed lines in the diagram.

The darlington amplifier at the output of the circuit— T_5 and T_6 —minimizes with its very large current gain the effect of h_{FE} variations in the individual transistors from chip to chip. The circuit has only two leads and is enclosed in a TO-18

standard metal package.

The choice of the number of reverse-biased diodes in the circuit (z in the equation for V_{PN}) is not arbitrary. Rather, z was set at three to keep the V_{EB} within the range of 8 to 10 volts. Below 8 volts, the diodes would not be operating in a predominately avalanche-breakdown mode, and therefore there would not be the precise relation between temperature and breakdown voltage that's needed for proper compensation. Above 10 volts, the diodes would be creating too much internal resistance.

Like and unlike

The output characteristic and the temperature behavior of the TAA 550 are shown on the following page. The output characteristic has the abrupt vertical current rise typical of zener diodes. Unlike discrete zeners, however, the voltage is much less affected by temperature; typically, V_{PN} changes by only 55 millivolts as the case temperature is varied from -40 to $+80$ °C.

Even on a short time scale, V_{PN} is very stable. This is because a uniform temperature distribution over the chip is attained within milliseconds—the heat spreads out easily across the circuit, resulting in fast temperature compensation.

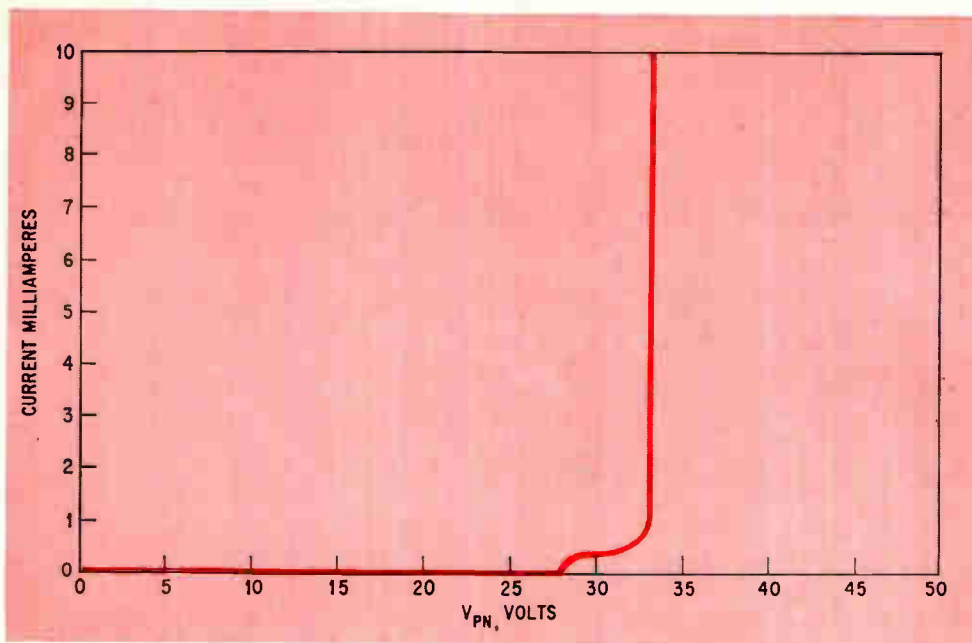

Vertical. Voltage stabilizer has an abrupt, zener-diode-like current-voltage characteristic. Typical zener voltage is 33 volts, with a spread from 31 to 35 volts.

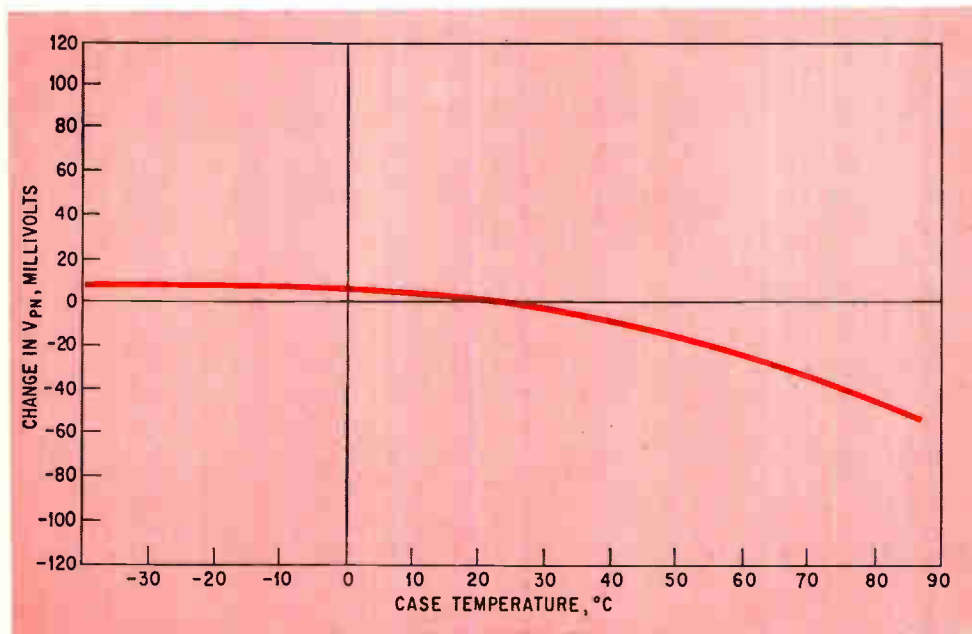

Temperature effect. Compensation keeps thermal coefficient to 40 parts per million per °C, so stabilized voltage varies only a few millivolts from one temperature extreme to the other.

The internal resistance r_{PN} of the circuit is chiefly a function of the electrical parameters (particularly the total resistance of the diode chain), the emitter junction temperature of transistor Q_6 (in which most of the power is dissipated), the temperature coefficient T_k , and the thermal time constant of the TO-18 package. Some of these factors are frequency dependent, and r_{PN} is therefore frequency dependent too. It increases from about 8 ohms to 13 ohms as frequency goes from 10 hertz to 1 megahertz.

Although the TAA 550 is easy to use, one detail should be noted: a wide band noise spectrum is superimposed on the stabilized output V_{PN} . This noise is generated by the reversed-biased emitters

in transistors Q_2 , Q_3 , and Q_4 , and it's the same kind of noise that's found in any zener diode with a zener voltage of more than about 6 volts. Fortunately, it's easy to dampen this noise, particularly the high-frequency components, by shunting the stabilizer with a capacitor. The value should be at least 300 picofarads, but it should be no larger than 4.7 nanofarads.

Above 4.7 nf, the stabilizer is likely to be damaged if it's accidentally short-circuited. The capacitor, in combination with the stray inductance of the short-circuit bypass, could generate oscillations that could drive the stabilizer too far in the reverse direction. If a large capacitor can't be avoided, the load should be connected via a resistor. ■

Connecting aluminum wire reliably

Some termination problems remain to be solved before aluminum can replace copper as the principal source of wiring material

By Joseph Mittleman

Electronics staff

Scarce, heavy, and expensive, copper wire is being challenged in bulk applications by aluminum wire, which is abundant, lightweight, and relatively inexpensive. And because electrical properties are almost identical to those of copper, aluminum wire has additional appeal to engineers. One of its drawbacks has been termination problems, particularly in copper-to-aluminum junctions where electrolytic action, thermal expansion, and aluminum cold flow properties can be adverse factors. But here, companies such as AMP Inc. and Alco are investigating economical and reliable electrical connections.

The mass conductivity of pure aluminum is more than twice that of copper, while the volume conductivity is approximately two-thirds that of copper. However, aluminum's current-carrying capacity is rated at 80% of copper. Usually, an aluminum wire two sizes larger than a given copper wire is used to carry an equivalent amount of current; a No. 6 aluminum wire is approximately equivalent to a No. 8 copper wire carrying the same amount of current.

The current-carrying capacity of a conductor is based on the amount of heat developed by current flowing through the conductor; and aluminum's high surface-to-mass ratio, its specific heat, and thermal conductivity account for the apparent discrepancy between its conductivity and current-carrying capacity relative to copper. Thus, since wire size is determined by cross-sectional area rather than weight, an aluminum wire of a given current-carrying capacity will be physically larger than its corresponding copper wire, but will weigh only half as much.

Performance at a joint interface is related to conductivity, and an aluminum joint can be more easily overloaded by the relatively higher current densities. A better joint, therefore, is necessary for aluminum than for copper.

The principle problems in terminating aluminum conductors arise primarily from four of the proper-

ties of aluminum: oxide formation, cold-flow, coefficient of thermal expansion, and susceptibility to corrosion.

Because of the tenacity, inertness, and dielectric strength of its oxide, aluminum is a relatively poor electrical contact material. Metals with good contact characteristics, such as silver, copper, or tin, have oxide films that form slowly, are removed easily, and may be conductive or semiconductive.

An oxide film forms on the aluminum surface within seconds after bare metal is exposed, attaining a thickness of from 60 to 100 angstroms which may increase to several thousand angstroms under high humidity and temperature conditions. This oxidation is self-limiting since the film's tenacity and amorphous nature, and its low ionic conductance prevent the metal's progressive oxidation. However, due to the chemical inertness of this film, aluminum actually has a greater resistance to chemical attack than indicated by its theoretical chemical activity.

Before a good electrical joint can be made on an aluminum conductor, the oxide films must be removed or penetrated, so that bare metal surfaces, essentially free of films, are in intimate contact with one another. Once the contact is initiated, air must be excluded from the joint to prevent reoxidation.

The physical properties of aluminum have an important effect on the reliability of aluminum, or aluminum-to-copper terminations made by mechanical pressure such as bolting or crimping.

When aluminum is subjected to a constant stress, it tends to cold flow or creep away from the stressed area. This is caused by slow atomic diffusion of the material to accommodate the stress, primarily by movement along slip planes. The rate of creep increases with temperature and is higher with aluminum than with copper.

Another important factor is relaxation of stress—the wire loosens up when wrapped around a terminal. This also is time dependent but is not accompanied by dimensional change, as in creep. Relaxa-

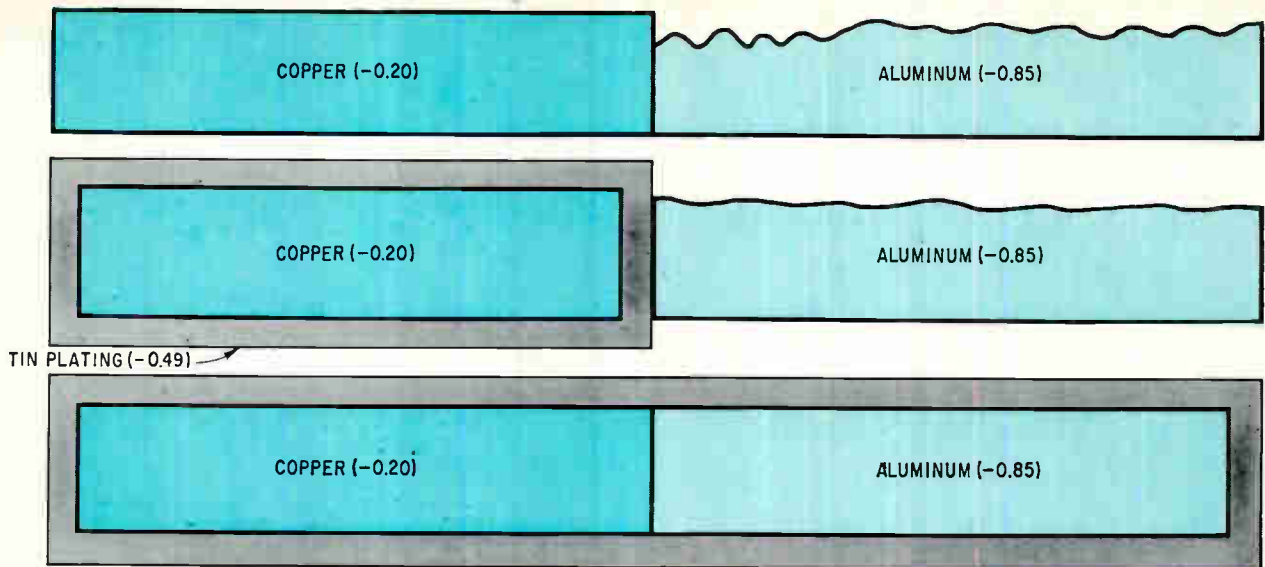

Galvanic corrosion. When two different metals are coupled together in a solution of ionized salts, corrosion occurs. By tin-plating one of the metals corrosion is reduced because the potential difference is decreased; by sealing both metals together it is eliminated. Numbers in parenthesis indicate voltages.

tion occurs at high stress levels and is shown by a reduced load due to change in metallurgical structure. The change of elastic strain to plastic strain occurring under this condition, or development of creep, would significantly reduce the residual contact pressures in a joint so that it may fail due to increased contact resistance.

Differences in thermal expansion rates of other materials used with aluminum can aggravate the cold-flow problem. For example, when an aluminum-to-copper joint is heated, the aluminum expands at a 40% to 45% greater rate than the copper. If the mechanical stresses increase until the elastic limit of the aluminum is exceeded, plastic deformation occurs. When the joint cools the cross-sectional area of the aluminum, and consequently the contact pressures may be so reduced, as to cause joint failure.

Serious corrosion problems occur when aluminum is used with other metals, such as copper. When two different metals are coupled in the presence of

a solution containing ionized salts, galvanic corrosion occurs. An electric current flows from the anodic metal, through the solution, and returns through the metallic circuit. Corrosion is related to this current flow, which, in turn, depends on the type and concentration of the electrolyte in solution, the relative masses of the two metals, and the temperature.

In the aluminum-copper couple, aluminum, the anodic component, goes into solution and is deposited at the copper cathode as complex hydrated aluminum oxides, with the simultaneous evolution of hydrogen at the cathode. The corrosion continues as long as the electrolyte is present or until the aluminum is consumed, even though the buildup of corrosion products may tend to limit the corrosion rate by polarizing the surfaces.

The galvanic corrosion rate can be lowered by plating one of the metals with a metal of intermediate galvanic potential. It is usually desirable to plate the cathodic member, since a fault in the

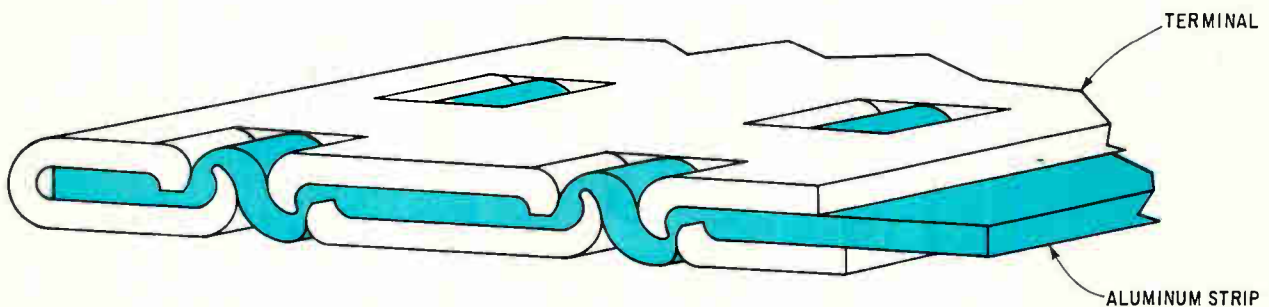

Terminating. In AMP's Termini-foil technique, sharp lances grip the aluminum strip material and are imbedded deeply into it. The lances pierce the metal, eliminating the need for conductor cleaning, and the oxide that forms on the metal's surface does not affect the operation since the teeth are imbedded.

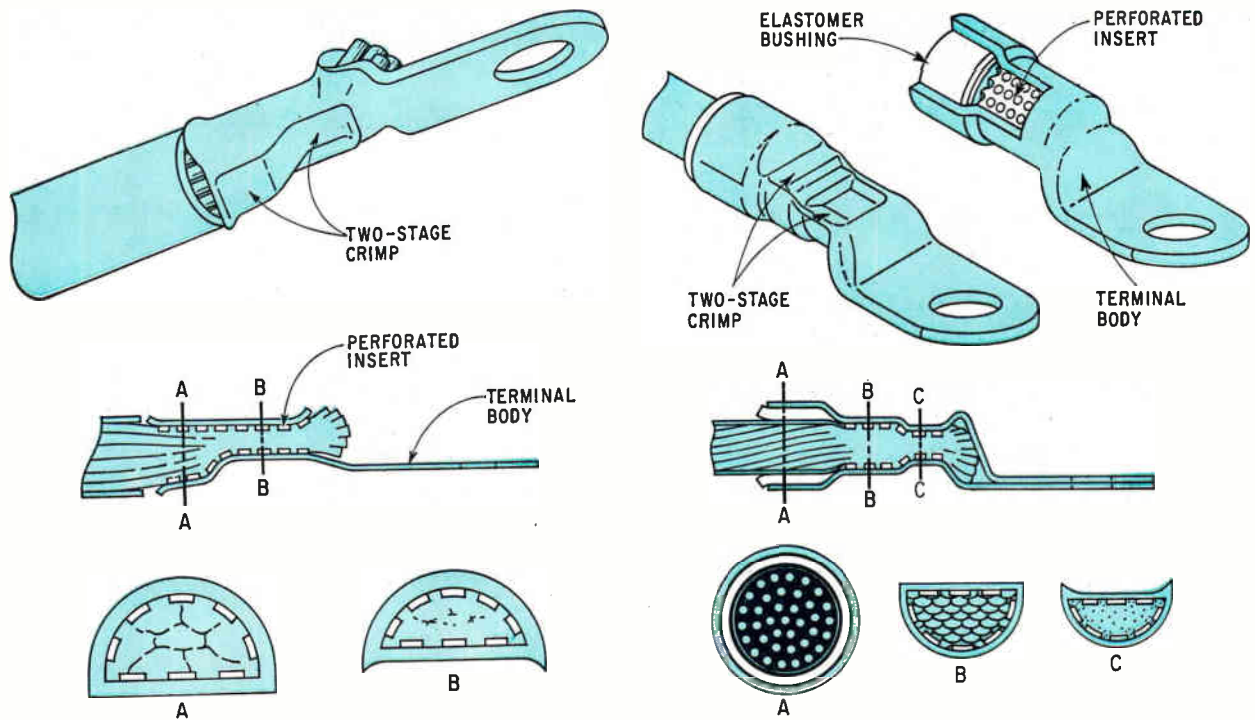

For wire. Sharp teeth of tin-plated, perforated brass liner bite into a solid copper wire making a good termination. The same technique is applied for stranded wire as in the drawings above. Here, a special crimp produces cold welding between each of the stranded wires. At right a sealer is added to keep moisture out.

plating—the terminal from which the atoms leave—may result in severe localized corrosion. Where the corrosion problems are not particularly severe, tin-plated brass and copper can be used with aluminum.

Corrosion can have two effects on a joint: the contact area can be attacked, causing an electrical failure, or the joint can become severely corroded, causing a mechanical failure. Most often the failure is a result of the interaction of the two effects.

Problem-solving

The various methods used in terminating conductors of aluminum fall into the two broad categories—thermal and mechanical.

Soldering can yield good terminations, but the quality depends directly on operating skill, while effective inspection is difficult. Ordinary solders are electro-positive with respect to aluminum, and galvanic corrosion can occur in the presence of an electrolyte. Some fluxes must be carefully and thoroughly removed from a soldered aluminum connection to prevent corrosion.

Normal soldering tools and techniques can be used with aluminum, but special precautions must be taken to avoid oxide buildup before the tinning is completed. Dip-soldering is favored because complete immersion of the joint in the molten metal produces rapid tinning.

Three general classes of solder material are in use. The type of solder to be used depends on the corrosion resistance, strength, temperature, and economies required by the application.

The low temperature solders, principally composed of lead and tin, require a 300°F to 500°F melting temperature. These are the easiest to handle, but have the least corrosion resistance. The intermediate temperature solders melt at from 300°F to 700°F; their principle component is tin or cadmium. These types possess good wetting characteristics and form a stronger, more corrosion-resistant joint than the low-temperature types. The zinc-based, high-temperature solders have the highest mechanical strength and corrosion resistance as well as the lowest cost, but they require a melting temperature of from 700°F to 800°F.

One of the common fluxes contains zinc chloride, which when heated, penetrates the aluminum oxide and deposits a thin layer of zinc on the aluminum metal, providing a good base for the solder. The residue remaining from this type of flux should be removed, either by brushing or chemical dipping, since it is conductive and potentially corrosive. Chloride-free fluxes, used with low temperature solders, require no postcleaning.

Copper-to-aluminum joints can be soldered by either plating or cladding the aluminum with solder-adaptable metals. This technique permits soldering in a manner more closely approximating that used for copper connectors.

Ultrasonic soldering involves the use of rapidly vibrating molten solder to break up and carry away oxide films. This method, therefore, requires no flux.

Brazing is used where a higher temperature joint is needed than can be made with solder but

where welding isn't practical. As in most thermal techniques any surface contamination should be removed. The temperature of the process should be carefully controlled since the melting point of the brazing filler materials is close to that of the materials to be joined. Torch brazing is similar to high-temperature soldering and uses flux in the form of various chlorides and fluorides to remove oxides. Aluminum may be brazed to copper since there is no melting of the pieces to be formed.

Welding can produce the best connections, since the two conductors are metallurgically fused together. However, operator skill is important because fusion welding requires that all possible contamination, such as oxide or organic films, be removed. Excessive oxide films can cause poor melt cohesion, and decomposition of organic substances may introduce porosity in the weld. It is difficult to directly join copper to aluminum by these methods, since intermetallic phases may form when aluminum is alloyed with copper.

These intermetallics can seriously impair the electrical and mechanical efficiency of a joint: they are brittle and have low electrical conductivity. When it is necessary to make a copper-to-aluminum joint by this method an intermediate metal, compatible with both copper and aluminum, is used.

Inert shielded-gas electric-arc welding provides one of the most useful methods of welding aluminum conductors. An inert gas, usually argon, helium or a mixture of the two is used as a shield around the electric arc to prevent oxidation of the molten metals, and eliminating the need for a flux. Gas tungsten arc welding uses a nonconsumable tungsten electrode and alternating current. This method is usually used to produce high-quality welds on relatively thin-gauge aluminum conductors. Gas metal arc welding is employed for heavier gauge conductors such as bus bars, and uses a consumable aluminum-alloy electrode with reverse-polarity direct current. The voltage and current, as well as the gas flow can be critical to a good weld in both of these techniques.

Percussion welding, where a heat-producing arc is formed between two precisely spaced workpieces and the molten areas then are percussively joined, required highly sophisticated equipment and is usually feasible only to high-volume production. Aluminum-to-copper connections can be made by this method since the intermetallics are squeezed out of the joint during the upsetting action.

Mechanical techniques

Cold welding is accomplished by bringing two metallurgically clean surfaces together under high pressure. Deformations of 60% to 75% and pressures from 50,000 to 200,000 psi normally are used to produce good bonds. The plastic flow caused by the deformation method breaks up oxides and moves them from the interface area, bringing the metal pieces into intimate atomic contact. Heating the work pieces reduces the pressure requirement.

Joints made by this method have good shear and

tensile strengths but are liable to break if bent. Since the metals to be joined do not undergo melting, aluminum can be cold-welded.

Ultrasonic bonding has produced good joints in relatively thin pieces. The ultrasonic energy causes localized plastic deformation of the material, which shatters and moves the oxide films from the interface and creates a true metallurgical bond. Little or no surface preparation is needed.

Clamping encompasses a wide variety of connection types. Any connection that bolts in place is, at least partially, a clamped connection.

When a joint is bolted, the pressure exerted by the joint causes plastic deformation of the metal surfaces, particularly at small projections and surface imperfections. The oxide films, being elastic, will not follow the plastic deformation, and fracturing of the film will occur at points of high stress and deformation, allowing bare metal surfaces to contact one another.

Grease has been used to improve contact characteristics since it is squeezed away at the contact points, permitting good conduction at these points. Furthermore, its presence prevents reoxidation of the contact surfaces. This method is most effective on aluminum when the metal is abraded through the grease coating to break up the oxide films.

Another method of utilizing aluminum as a contact material is to plate it with a metal which has good contact characteristics, usually silver, tin, or nickel. Except for nickel, these platings usually require an intermediate plating. In the past, zinc has been used and recently new processes using copper, copper alloys, or nickel have been developed. The use of copper-clad aluminum has been another approach. Any of these materials may present a potential galvanic corrosion problem, since most of them are cathodic to aluminum.

Crimping has also been widely used. The

How the metals stack up

	Al	Cu
Atomic weight	26.98	63.54
Density (grams/cm ³)	2.70	8.89
Melting point °C	660	1083
Specific heat (Calories per gram)	0.226	0.092
Coefficient of linear thermal expansion (microinch/m/°C)	23.6	16.5
Thermal conductivity (20°C cal/cm ² /cm/sec/°C)	0.53	0.941
Electrical resistivity (20°C micro-ohm/cm)	2.8	1.7
Current-carrying capacity (% of copper)	80	100
Modulus of elasticity (lbs/in ² x 10 ⁹)	10	17
Tensile strength (annealed) (10 ⁹ psi)	12	38
Yield strength (10 ⁹ psi)	4	10
Hardness (Brinell)	50	103

crimped terminations which have been used extensively are similar to bolted joints and use many of the same principles for making electrical contact. This type of termination uses grease as an oxidation inhibitor. An abrasive material usually is compounded with grease to eliminate wire-brushing.

These abrasive particles cut through the aluminum-oxide film during the crimping process, exposing bare metal surfaces and allowing contact to be made between the conductor and the terminal, and between the strands of a standard conductor. Contact interface corrosion is minimized by the homogeneous nature of the joint and the presence of the grease. A long crimp barrel and lower crimping pressures compensate for the effects of creep. This type of termination has been most successful when aluminum wire barrels are employed.

What's new

New techniques have been developed recently that make it possible to join aluminum to copper without inhibitors or special conductor preparation.

These new techniques depend on the fact that the terminal material usually is harder than the aluminum conductor and that the design of the terminal provides for several localized areas of severe deformation. This deformation causes the oxide film to fracture under localized stress, thus establishing electrical contact. The terminal material is embedded in the conductor, yielding an air- and moisture-tight joint. The contact area of the joint also is increased by the complex geometry of the contact interface, the electrical contact is not dependent on the residual stresses in the joint, but on the intimate interlocking of the terminal and conductor materials. This minimizes the effects of creep and terminal expansion differentials.

Several techniques using these principles have been developed to crimp and strip aluminum conductors. One such technique involves terminals and splices, developed by AMP called Termini-foil, which provide a flexible, reliable method of terminating aluminum strip and foil conductors with copper, brass, or aluminum. These terminals and splices contain a multiplicity of sharp lances that penetrate the aluminum strip when it is crimped between two flat dies. The lances shear through the oxide film, eliminating the need for conductor cleaning, and are embedded in the aluminum, making a mechanically secure, air- and moisture-tight joint. Since the electrical contact does not depend on the residual pressures developed in the joint as in conventional crimped or bolted joints, the effects of creep and thermal expansion are minimized.

Another AMP terminal for solid aluminum conductors called Termalum, uses a tin-plated copper wire barrel with a tin-plated perforated brass inner liner. When the terminal is crimped, the relatively soft aluminum material extrudes through the holes in the liner. The brittle oxide film is sheared during extrusion and clean aluminum metal is brought into intimate contact with the inner surfaces of the liner holes. These areas of extruded conductor, or contact

modules, are sealed from the environment.

Terminating stranded or multiple conductors by this method introduces a new set of problems. Because each individual strand of the conductor bundle is enveloped by an oxide film, and before an adequate joint can be insured, electrical contact between the individual conductors should be established. This interstrand contact must be maintained during the expansion and contraction of the termination caused by temperature cycling. A special crimp accomplishes this without the use of inhibitors by producing cold welding or solid-phase bonding between the individual strands of the wire bundle. The bond establishes good electrical contact between the strands and prevents relative movement and subsequent reoxidation. This crimp configuration introduces sufficient plastic flow of the conductor material to fracture the oxide film, and applies deformation pressures from several different planes, inducing different conductor extrusion rates. The resultant wiping action under pressure results in interstrand bonding.

Testing the aluminum terminations

The effect of temperature cycling on the joint's electrical stability is most critical—this probably is the most frequent cause of failure in aluminum and copper joints. A good way to evaluate the effects of creep differences in thermal-expansion rates, and oxidation of the contact areas is through thermal-shock testing. This involves subjecting the joint to extremes in temperature, and only a few test cycles are usually necessary to induce significant changes in the electrical stability of a poorly designed joint. The advantage of this test is that the testing time is relatively short, and the equipment and techniques are simple.

The current cycling test can provide a more realistic evaluation of terminal life, since they synthesize more closely the actual use of the terminal. The only problem is the extended time period and the type of equipment which is necessary for evaluation.

Usually two types of current cycling tests are conducted: a control conductor is heated to a given temperature and the temperature of the joint is measured; a given current flows through the conductor, and the temperature of the conductor and joint are measured.

A minimum parameter usually observed in this test is that the terminal temperature should not exceed that of the conductor. If it does, this indicates either a poor terminal design or a joint failure.

Current cycling or current heating may produce effects not readily observed in the life cycling type of test, since the heating effects are concentrated primarily at the point where problems may develop—the contact interface. ■

Bibliography

- Lemke, Timothy, "Electrical Connections for Aluminum Conductors," International Electronic Circuit Packaging Symposium, 1968.
- American Welding Society, "Welding Aluminum", the aluminum Association, New York 1966.



Cimron leapfrogs the DVM industry —and there's a reason!

A number of reasons, to be exact! The all-IC Model 6753 is the next generation in digital multimeters—the lowest-priced autoranging instrument that will read DC from 100 nanovolts to 1099.9 volts and DC ratios. A fast-tracker, too—ideal for systems work. The closed loop tracking logic continually samples output at the rate of 14 readings a second, with accuracies of $\pm 0.001\%$ full scale $+0.005\%$ of reading. Like to learn about automatic desensitization? repetitive mode? out-of-range indication? Just ask how they can

help you. Important to you is the basic design, featuring optional IC plug-ins to extend capability which you can install yourself without technical service! Options include a 4-range AC converter with 10 microvolt sensitivity, a 5-range ohms converter, remote programmability, five print-out options. You can't beat the base price of \$2990! Cimron customer concern continues to provide what you really need at the lowest possible price. Write Cimron, Dept. D-123, 1152 Morena, San Diego, Calif. 92110.

LEAR SIEGLER, INC.



CIMRON DIVISION

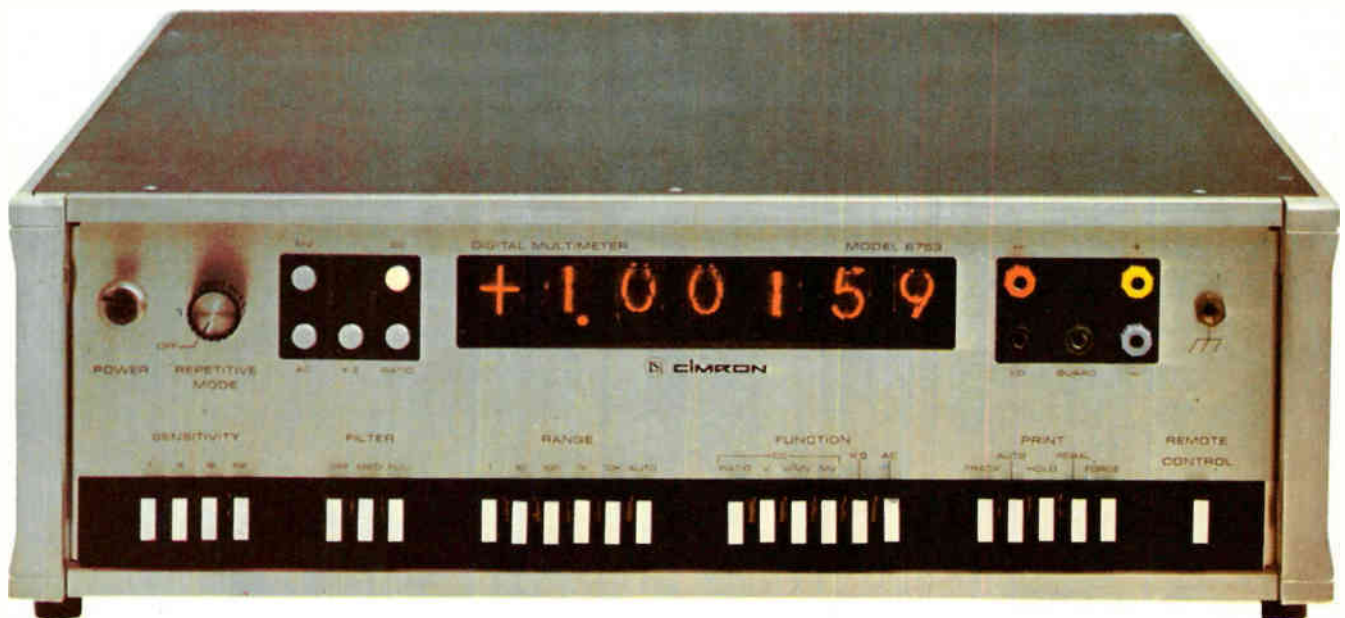

Our line of P.C. edge connectors takes coax...

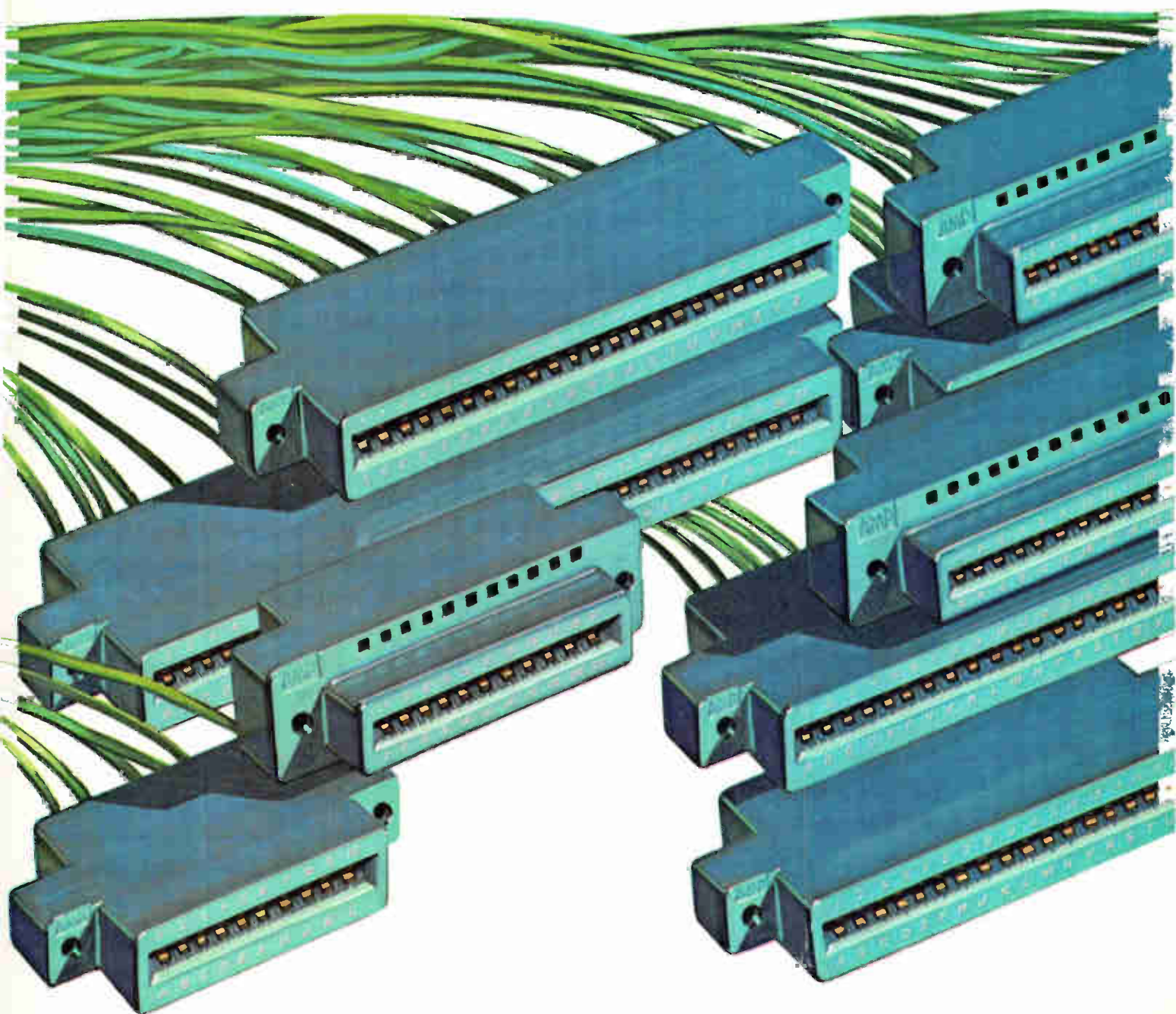

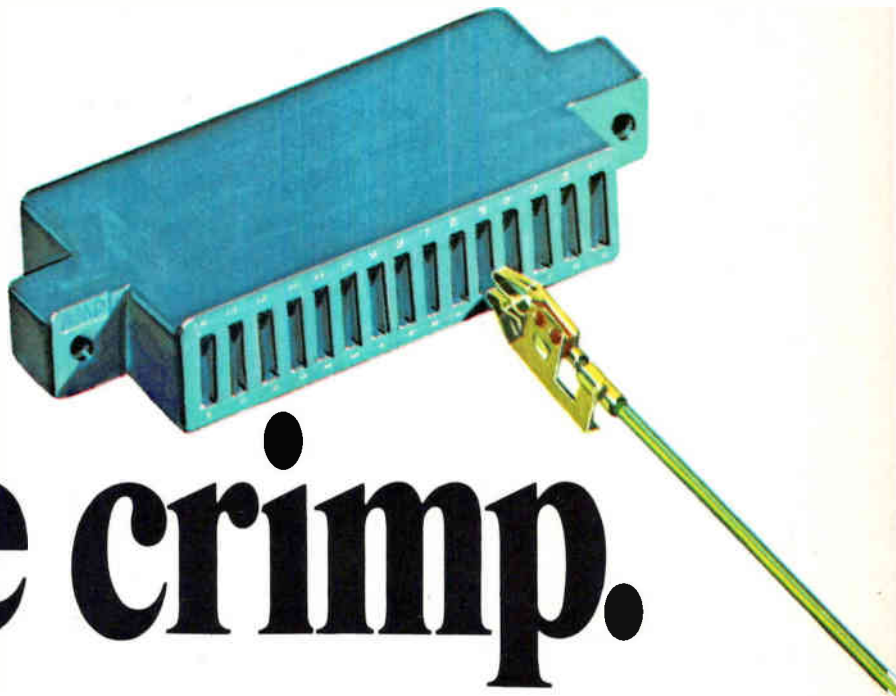

in one crimp.

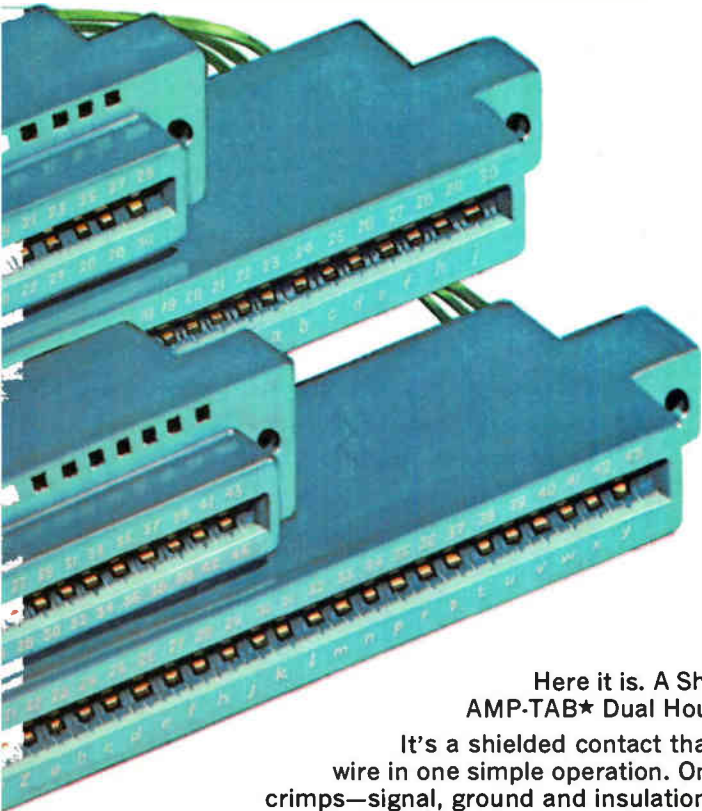

Here it is. A Shielded Wire Printed Circuit Contact designed to be used in our AMP-TAB★ Dual Housing.

It's a shielded contact that provides coax characteristics. And can be terminated to the wire in one simple operation. One cycle of our hand application tool makes all three necessary crimps—signal, ground and insulation.

You can intermix the coax contacts in the same housing with the standard contacts. In fact, you can even replace individual standard contacts with coax contacts in your present AMP-TAB housings.

This contact concept greatly expands the breadth and flexibility of our complete line of tab-type one-piece edge connectors. These standard connectors are available in either Dual or Quad Housings and 10 to 43 positions with center spacings of .100", .125" or .156".

The standard contacts can be crimped to the wire with AMP's automatic tooling at speeds up to 5,700 finished leads an hour. And the new, one-crimp, coax contact is terminated in simultaneous, multiple crimping operation. You can do both right in your own plant. And both provide you with the lowest total installed cost in the industry. We call it AMP ECONOMATION. For more information about coax, crimps and connectors write to:

Industrial Division, AMP Incorporated, Harrisburg, Pa. 17105.

★Trademark of AMP Incorporated

AMP
INCORPORATED

Circle 101 on reader service card



Growth plan. This crystal of bismuth germanium oxide was grown by the Czochralski pulling technique. Crystals 6 inches and longer are becoming available that will provide delays of 100 microseconds.

Advanced technology

Amplifying acoustic surface waves

Acoustoelectric interactions and acoustic waveguides provide active and passive signal processing devices—all on a single chip

By J.H. Collins and P.J. Hagon

Autonetics, Anaheim, Calif.

Surface acoustic waves provide the key to miniature signal processing systems. Their ability to be tapped, guided, amplified, or otherwise manipulated on a miniature substrate makes this technology ideally suited to a wide range of passive and active processing components—delay lines, matched terminations, attenuators, phase shifters, filters, amplifiers, oscillators, mixers and limiters.

But the impact of this new technology was felt only after it met certain processing requirements. Perhaps most basic of these, since all radar, communication and navigation systems receive and transmit by electromagnetic radiation, is the conversion

between electromagnetic signals and surface acoustic signals. For microwave acoustics, interdigital transducers perform this function with relatively low loss over a wide dynamic range. At 100 Mhz, for example, efficient conversion is obtained with signal levels as low as 10 microvolts and as high as 5 volts. Moreover, these transducers can handle both analog and digital inputs, a capability which allows an entire range of processing signals.

Equally important are new materials for delay line substrates and transmission line overlays that increase transduction and minimize acoustic losses. This means materials with high electrostatic coeffi-

cients, low acoustic propagation loss, and ease of fabrication. The need for low-loss propagation points to the use of single crystal materials, especially at frequencies above 100 Mhz where polycrystalline and amorphous materials generally have losses greater than 10 decibels per microsecond, compared with less than 1 db/ μ sec for single crystal material such as lithium niobate and bismuth germanium oxide.

In addition to being less lossy, single crystal materials have more uniform and reproducible properties than polycrystalline materials, although starting material costs are generally higher. However, its higher quality and uniformity increase device yields and generally provide superior performance. And the history of high-quality single-crystal silicon in microelectronic technology shows that material costs, although high in the early stages of technology, reduce production costs in the end.

But regardless of the materials used, they should be compatible with guiding techniques, so that microwave acoustic transmission lines, analogous to electromagnetic waveguides, can be fabricated on a single substrate. Other devices associated with signal transmission, such as directional couplers and power dividers, are also required for signal sampling and manipulation. And for phase shifting, and signal expansion and compression, a method of controlling the dispersion of the acoustic signal also must be available. One method uses a nondispersive surface wave delay line with an interdigital

The first part of this series on a new area of devices for signal processing using high-frequency acoustic surface waves included new delay lines having low insertion loss which were developed in the microwave laboratory at Stanford University [Electronics, November 10 p. 94]. That work, which had the specific aim of arriving at practical prototypes, was carried out partly under the sponsorship of the Air Force Systems Command, Rome Air Development Center, and partly under subcontract to MIT's Lincoln Laboratory, Lexington, Massachusetts (operated with support from the Advanced Research Projects agency).

Two basic building blocks for surface wave signal processing are the delay line and surface wave amplifier. In this issue we describe the surface wave amplifier, which achieves high gain together with broad bandwidth. The development of this device at Stanford University was supported by the Office of Naval Research under the Joint Services Electronics Program, and reached its present status using epitaxial silicon films developed at Autonetics and supplied to Stanford.

transducer with graded periodicity so that different frequencies are excited and detected at different positions. Another uses a thin-film overlay on the piezoelectric substrate in which the film has a shear wave velocity lower than that of the substrate.

And finally, so that microwave acoustic devices can readily be integrated in existing circuits, sim-

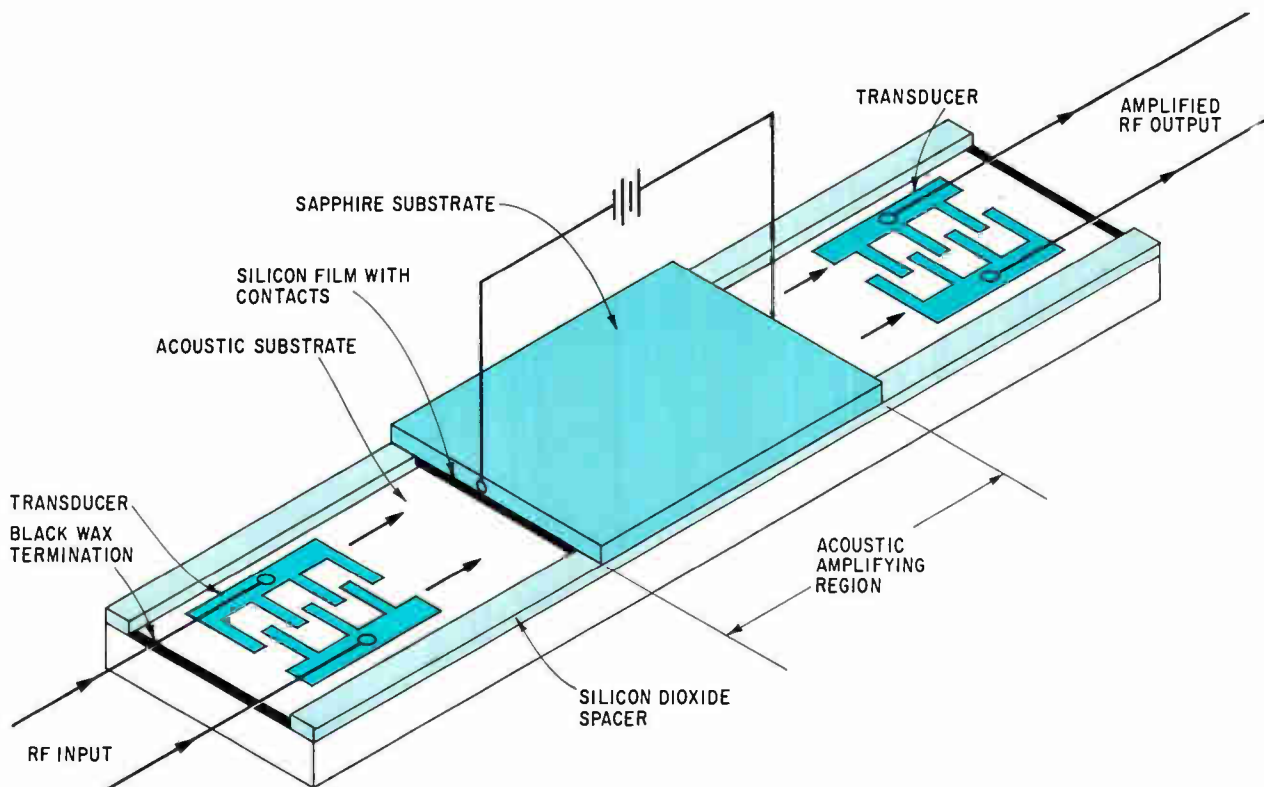

Surface waves gain. The two basic items of a surface acoustoelectric amplifier are the piezoelectric substrate and the spatially separated semiconductor medium with a drift field structure. The air gap is important since it allows the piezoelectric crystal to be optimized for acoustic properties while it allows the drift field structure to be optimized for semiconducting properties.

ple and effective interfaces must be affected between surface acoustic waves microelectronic technology, as required for devices such as variable coded electronically-controlled tapped delay lines. And in many cases these interfaces are difficult to achieve. For example, the capacitance of wide band taps on a surface wave delay line are in the range of 0.2-1 picofarads and this requires semiconductor switching devices with ten times lower feedthrough capacitance.

Significant Gains

One property that gives microwave acoustics its competitive edge over other technologies is the ease of amplifying surface waves. Until recently, the most promising amplifying technique, developed for bulk acoustic waves, relied on the bulk shear wave properties of certain piezoelectric semiconductors such as cadmium sulfide. In this case, the acoustic energy propagating on a piezoelectric substrate generates an associated electric field. If the piezoelectric substrate is also a semiconductor, and a d-c electric field is applied to that substrate, conduction electrons will drift parallel to the direction of acoustic wave propagation. And in a process similar to that occurring in travelling wave tubes, as this applied field is increased the electron drift velocity is increased, so that when the drift velocity exceeds that of the acoustic wave, causing kinetic energy in the electron stream to be converted to r-f energy, significant gains of 60-80 decibels per centimeter will result.

But bulk amplification has practical limitations. Clearly the acoustic path material must have these three qualities: high piezoelectric coupling, low-loss acoustic propagation, and efficient semiconduction. Moreover, efficient transduction of shear waves can only be accomplished with a piezoelectric plate or film oriented with the z-axis in the plane.

Unfortunately, due to fabrication difficulties such transducers are not readily available at microwave frequencies. Besides, up to now a bulk material with the three essential properties has not been found. For example, a common material for bulk wave amplification is cadmium sulfide (CdS), a particularly good piezoelectric material but a very poor acoustic and semiconducting medium. Besides having acoustic losses greater than 5 db/cm at frequencies above one gigahertz, CdS has relatively low mobilities—300 cm²/volt-second. This requires voltages as high as 5 kilovolts per centimeter, and since a considerable amount of acoustic energy is absorbed, the net gain of the amplifier will be low. Furthermore, large amounts of d-c dissipation occur, and as a result the parameters of d-c operation—terminal gain and stability for both cw and pulsed input signals—have not all been obtained simultaneously. But significant progress has been made at the Microwave Laboratory, Stanford University, using both gallium arsenide and indium antimonide.

What's really needed for useful amplification is a method that separates the desired acoustic prop-

erties of the substrate from the necessary semiconductor properties. And surface wave acoustoelectric amplification provides the method. The electric field associated with the propagation of a surface wave on a substrate extends out of the surface for a distance somewhat less than one acoustic wavelength. This allows the field to interact with the conduction electrons of a spatially separated, dc-powered, semiconductor structure placed a small fraction of an acoustic wavelength above the substrate.

What's important here is the physical separation of acoustic substrate and adjacent semiconductor, which makes it possible to select a substrate with the optimum piezoelectric properties of high electromechanical coupling coefficients and low acoustic loss, while at the same time to choose a semiconductor film material with high mobility, optimum resistivity, and low d-c power requirements. Thus the surface acoustoelectric amplification method independently optimizes the piezoelectric and semiconducting components of the amplifier.

Amplifiers of this type have been built and tested both at the Microwave Laboratory, Stanford University and more recently at Autonetics. The two basic items are an optically flat lithium niobate crystal, forming part of a delay line substrate, and a spatially separated n-type semiconductor silicon crystal. The two crystals should be acoustically separated to achieve the non-dispersive properties required to minimize signal distortion. However, to gain the strongest possible interaction between the surface wave's associated electric field and the electrons in the silicon, the air gap separating the crystals must be a small fraction of the acoustic wavelength. Typically, a 500 angstrom air gap is required in a 100 Mhz amplifier, which can be achieved by dielectric (silicon oxide) spacing layers that have been vacuum evaporated to the desired thickness on the lithium niobate substrate. But it is important that these spaces be kept outside the acoustic beam.

Since relatively high d-c voltages are required for terminal gains, heating can still be a problem in these amplifiers. At present, 25 db of electronic gain requires drift fields in excess of 2 kv/cm. If bulk semiconductor materials are used to furnish the drift field energy, wafers at least 5 mils thick are required to permit fabrication without breakage. Such a 100 ohm-centimeter wafer, 400 mils long and 50 mils wide, has a resistance in the order of 60,000 ohms, which dissipates approximately 15 watts. Unfortunately this much heat would require unwieldy liquid cooling methods or large convection heat-sinking structures.

To get around the problem of bulk crystal heating, thin-film single-crystal semiconductor-on-insulator structures can be used. The most efficient approach to date is a silicon-on-sapphire (SOS) drift structure. This consists of an approximately 1 micron thick, single-crystal, n-type film of silicon grown epitaxially on sapphire. This 100 ohm-centimeter material, exhibiting a carrier mobility of 550 cm²/volt-second, is convenient for operation at

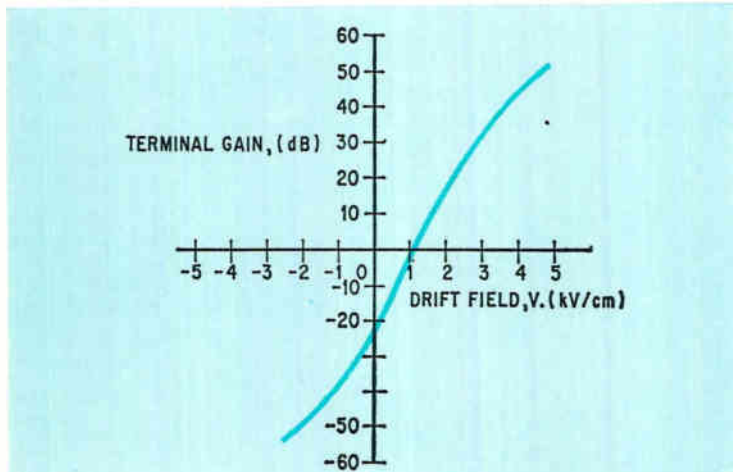
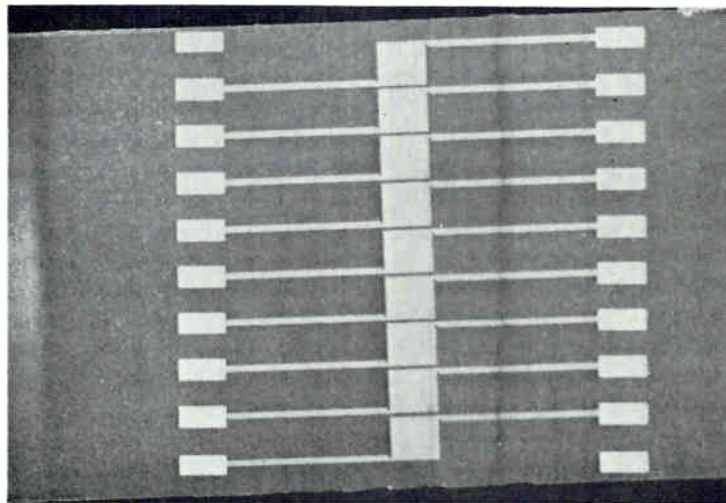
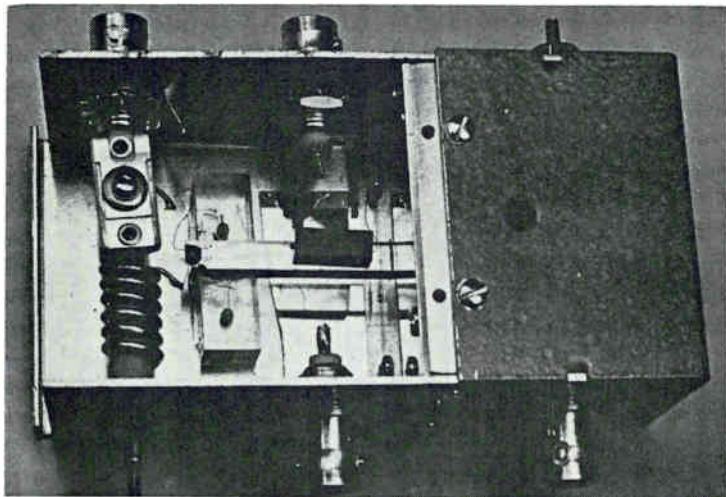

Evolution

The first laboratory built models of the acoustoelectric amplifier (top) had an optically flat lithium niobate acoustic substrate and a spacially adjacent bulk silicon semiconductor drift structure. Because the drift structure is in bulk form, d-c voltages of 2 kilovolts and d-c powers of 4 kilowatts were required for large gains. However, by replacing the bulk silicon drift structure for the active region with a segmented nine-element silicon-on-sapphire drift structure (center) having low-resistance ohmic contacts reduces the required d-c voltages to 180 volts and d-c power to 1 watt. In both cases, as seen from the drift field versus terminal gain data (bottom), both acoustic attenuation and gain may be obtained, with 100 db swing in output possible.

100 Mhz with a spacing of 500 angstroms, and approximately 200 angstroms for 1-Ghz operation.

Aside from the much lower voltage requirement, this SOS composite amplifier is quite flexible; either surface wave attenuation or gain can result, allowing the output signal to range over 100 db. This output swing results from the gain (db) versus drift

field (kv/cm) characteristics. When the applied semiconductor voltage is low, the surface wave is attenuated because the kinetic energy flows from it to the slower moving carriers in the semiconductor material. But as the applied voltage is increased, the carrier velocity is increased until it is equal to the surface wave velocity, at which point the excess

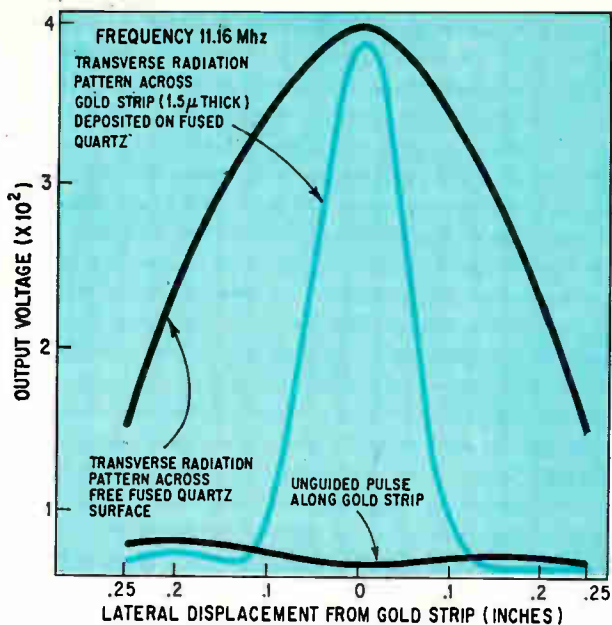

Gold standard. An acoustic beam is significantly narrowed by the addition of gold guiding strips on a free fused quartz surface. The low-level beam results from that part of the energy that does not enter the guide.

attenuation due to the presence of the semiconductor disappears. Now increased voltages further reduce the overall surface wave attenuation until zero loss is reached, after which increased voltages result in terminal gains.

This gain flexibility means that delay and/or switching devices with gain and high isolation can be built, along with modulators with greater than 90 db dynamic range. Laboratory-built SOS electroacoustic amplifiers, operating at 108 Mhz, have yielded terminal, or net, gains of 30 db for d-c input power of only 0.7 watts. And because the gain characteristics are nonreciprocal with drift field, reflections between output and input transducers are severely suppressed, thus allowing triple transit suppression (TTS) of greater than 60 db for the linear region of operation.

Unfortunately, high terminal gains require carrier drift velocities in the order of 10⁶ cm/sec. In a medium with an electron mobility of 500 cm²/volt-sec, this would mean electric fields of approximately 2 kv/cm. And since a path length of 1 cm is typically required, operating voltages of 2 kv must be furnished, which clearly are too high for most convenient power supplies.

Semiconductors fabricated in segments provide a way around the high voltage problem, because now each segment of the semiconductor path length over which the drift field must be applied is greatly reduced. Segmenting is accomplished by etching the silicon to form silicon islands on the sapphire, which are in series for electronic interaction, but are in parallel for d-c powering. And it is this construction that allows surface wave amplifiers to achieve high terminal gains at reasonable input

voltage levels. In fact, a nine-segment lab-fabricated device showed a terminal gain of 30 db at an operating voltage of only 180 volts. What's more, a 35-element semiconductor structure spaced over a total length of 1 cm has resulted in terminal gains at voltages as low as 50 volts, clearly more compatible with d-c voltage supply requirements.

It is important to note that the limit on segmentation is not, as might be expected, that of forming the ohmic contacts, since standard opto-mask techniques allow these contacts to be only a few microns apart. Rather, the limitation results in providing sufficient interaction wavelengths in each semiconductor segment, because sufficient separation is required between adjacent sections to provide d-c isolation.

Besides the segmentation capability, another advantage of spatially separated semiconductor amplifiers results from the fact that the spacing between the semiconductor and the acoustic substrate can be adjusted to optimize the gain at a given frequency. Noise buildup results if this degree of freedom is not available. Bulk acoustic wave amplifiers commonly suffer from this problem. But more important, even if the spacing of spatially separated surface acoustoelectric amplifiers were incorrectly chosen, the bidirectional transducers used in these devices cease to operate acoustically outside their passbands. Thus, feedback of unwanted signals is greatly inhibited by the ever present simple acoustic termination of the back-wave at the substrate edge.

Check up

Low voltage operation of these composite surface wave acoustoelectric amplifiers in experiments by Stanford University has determined their important characteristics. In these tests, phase shifts varied less than 250° for drift-field changes from zero to that necessary to achieve maximum terminal gain. Also the output power increased linearly with input power until about 5 db from maximum, at which point amplitude distortion occurred. This distortion was seen by injecting two tones 80 kilohertz apart and studying the resulting intermodulation products within this frequency range. Additional tests determined the terminal gain as a function of frequency at a given drift field by operating the transducers at the odd harmonics of the fundamental, and also below their fundamental. Net electronic gain greater than 15 db/cm between 20 Mhz and 1200 Mhz results, confirming the extreme broadband nature of the amplification even with fixed air gaps and drift field.

An interesting capability of this type of amplifier, demonstrated during these tests, was that each segment of the silicon-on-sapphire structure could act as a directional transducer. This was accomplished by feeding r-f power in series with the d-c drift field and using a bidirectional interdigital transducer for the output. With this configuration, a delay line loss less than 20 db was readily attainable. This low loss points to the

possibility of building active tapped delay lines to integrate acoustic surface waves with conventional microelectronics.

In addition to providing variable amplification, the same silicon-on-sapphire acoustoelectric amplifier configuration also can perform other important signal processing functions. The amplifier, operating in its saturated (nonlinear) region, effectively mixes r-f signals, and this taken together with external feedback allows extremely stable oscillation. Hence, amplification—variably attenuated and limited through saturation—as well as mixing and oscillation can be performed all with the same configuration.

It is not overstating the case to say that the conventional i-f amplifier, operating in the center frequency range of 30-500 Mhz, has a very serious new competitor, at least for signal processing applications requiring microsecond time delays. And although the configuration described here is exceedingly inefficient—approximately 0.1% at 100 Mhz—it is monolithic, eliminating the interstage tuning coil and transformers of the hybrid i-f amplifiers. With this technique it is feasible to conceive of a 1-Ghz amplifier, mixer, local oscillator and low frequency amplifier (100 Mhz) operating on a single substrate.

A technique for both amplifying and mixing is also under investigation, and certain fundamental experiments toward this goal have been performed. The basic principle is that high amplitude surface acoustic waves experience nonlinearities due to the third order elastic constant of the piezoelectric, and because of these nonlinearities, such waves generate travelling wave harmonics with nondispersive properties. In YX quartz, for example, approximately 1 milliwatt of the third harmonic power will result from 1 watt of 100 Mhz fundamental power. The limitation here is in the saturation of the harmonic power, which occurs for larger amplitude inputs.

Because of the third elastic constants, parametric mixing is realizable. Two inputs, called the pump and signal at frequencies f_p and f_s respectively, result in the generation of an idler at a frequency $f_i = f_p - f_s$. Grounds for optimism concerning low noise parametric amplification of surface acoustic waves are based on successful experiments conducted some years ago that used arrays of microwave varactor diodes, exhibiting nonlinear capacitance versus voltage characteristics, that are distributed along transmission lines. However, problems exist with restricting frequency products, so that only a three or four frequency process is allowed. Advances here will depend on realizing designs of the necessary surface acoustic wave filters for travelling waves.

Guided waves

Guiding acoustic waves is not a new concept. In the last decade simple wire delay lines used at frequencies up to a few Mhz for simple signal processing have constituted one important exam-

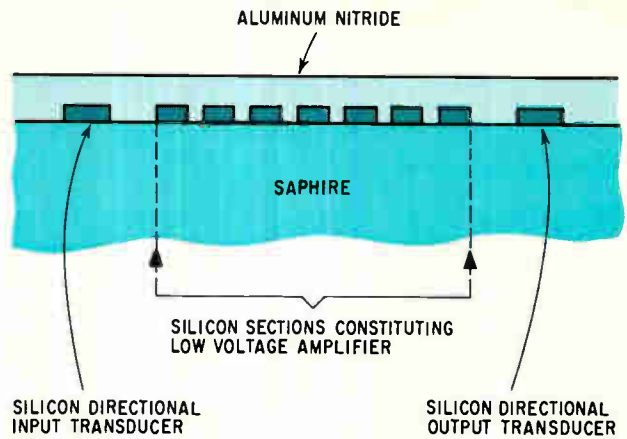

Looking ahead. This proposed low-voltage sandwich acoustoelectric amplifier uses carrier-wave directional transducers and a segmented silicon-on-sapphire drift structure. First silicon is grown on sapphire, after which the composite receives an overlay of piezoelectric aluminum nitride. This design does away with the air gap, troublesome at high frequencies.

ple. But at high frequencies, elimination of multimodes require wire diameters of only a few microns and these are not self-supporting in useful lengths of several centimeters or more.

Applied to microwave acoustics, surface wave guides will provide the transmission lines of the technology. They are vital for many system applications, since processing large amounts of data with long delays in a small area requires efficient utilization of substrates. Currently, interdigital transducers with apertures of 30 to 100 wavelengths are used. But these transducers simply are too wide to conveniently allow more than one or two acoustical beams to propagate on a substrate. Thus, just as in electromagnetic technology, some form of wave guidance must be employed to fold a long transmission path onto a small delay-line substrate. In other words, the ability to guide along prescribed paths, not necessarily straight, with the acoustic field laterally confined within a few wavelengths, is a necessary requirement for a versatile surface wave integrated circuit technology. This is because the line-of-sight propagation results in serious beam-spreading losses.

But there are inherent disadvantages to guiding. For one, guides introduce dispersion into the acoustic propagation—the price for field confinement. Fortunately, the effect is tolerable: a frequency change of 2.5 times produces a phase velocity change of only 5%. More serious, pure modes do not travel in wave guides. The mathematical treatment of the boundary conditions shows that leaky waves also exist during guided propagation, which means that energy will radiate from the wave guide into the bulk of the substrate. This problem becomes particularly severe when waves are guided around corners. This sets the minimum limit on the guide radii. Typically, a 100-wavelength radius right-angle bend gives a

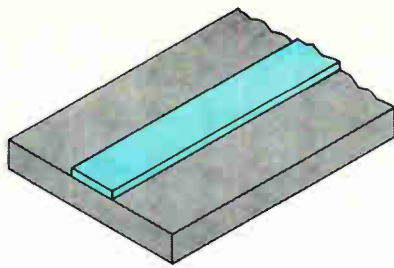

"SLOW" ON "FAST"
ACOUSTIC MEDIUM

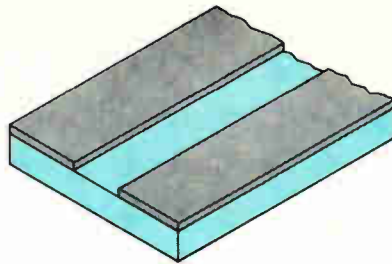

"FAST" ON "SLOW"
ACOUSTIC MEDIUM

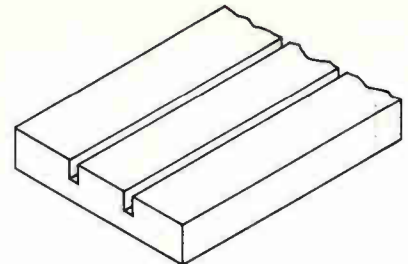

GROOVED
WAVEGUIDE

Groovy guides. Three simple forms of guiding acoustic surface waves are easily realizable. A "slow" velocity overlay on a "fast" velocity substrate confines the acoustic energy in the region on the substrate beneath the overlay. Using a "fast" overlay to form a slot on a "slow" substrate confines the energy to the slot. Parallel grooves etched in the substrate will also efficiently confine the acoustic energy.

Guide lines

Launched by interdigital transducers, surface waves that travel on the free surface of a solid are pure Rayleigh waves with particle displacements elliptically polarized in a plane containing the propagation direction and the surface normal. The pure Rayleigh mode is nondispersive; i.e., velocity has a constant value independent of frequency. However, when the surface of the substrate is covered with a film of different material, it is no longer free, and the surface wave propagation deviates from the pure nondispersive Rayleigh mode. This deviation is due to such factors as changed boundary conditions, and plate modes in the film coupling with the Rayleigh wave in a frequency dependent manner. The net effect of a film overlay having a slower shear wave velocity in the propagation direction than that of the substrate is to introduce dispersion, with the surface wave velocity decreasing with increasing frequency. And this velocity change produces differential time delays between different frequencies—a necessary property of pulse compression filters. Since velocity is inversely proportional to square root of density, slow overlay materials generally have higher density than the substrate.

Specific dispersion data obtained at Stanford University for a 5,000 Angstrom gold overlay on lithium niobate shows that at 100 Mhz the induced fractional phase velocity change is -0.22 , loss increase is 20 db per inch, and differential time delay is 0.32 sec per inch over a fractional bandwidth of 0.20.

If a slow acoustic-velocity overlay material in the form of a narrow strip (less than 1 wavelength) is placed on a fast acoustic-velocity substrate surface, with its length in the propagation direction and its width perpendicular to this direction, the mode coupling causes the surface wave to be bound to the

region beneath the strip. Further, if the overlay strip is curved instead of straight, the surface wave tends to follow the curved strip path—that is, it is an acoustic waveguide. A more accurate, although less descriptive, electromagnetic component analog is the microstrip transmission line. Experiments show that for a gold strip one wavelength wide on fused quartz, a 90 degree bend can be made with 100 wavelength radius at 10 Mhz, with a moderately low loss of less than 2 db.

An equivalent guide structure uses "fast" on "slow" acoustic velocity material with "fast" material essentially focusing the acoustic energy and confining it to the unclad surface. This type may provide less dispersion and lower loss than the strip guide since the acoustic energy propagates on an unclad surface, but this has not yet been proven.

Another possible structure is the grooved guide which provides lateral confinement via etched side walls. The grooves act as acoustic "breaks" transforming the Rayleigh wave into a bound mode between the grooves. With this construction, using optical probing techniques, significant data at 1 Mhz was obtained by Ash and co-workers at University College, London, on steel waveguides with conventionally machined grooves. Their findings indicate that future experiments at vhf frequencies and above will require accurate etching or ion beam machining in anisotropic piezoelectrics.

Acoustic waveguide technology is still developing and considerably more experimenting is needed over wide frequency ranges before an optimum approach can be determined. Furthermore, the outcome of this work will probably determine just how versatile surface wave acoustics will be in future system applications.

loss at 10 Mhz of 1.5 db, whereas electromagnetic waveguide loss is negligible around bends.

Aside from concentrating acoustic energy in desired paths on a substrate, a waveguide must also satisfy two conceptual requirements. It must be compatible with planar transducer construction, so that a lossless interface will exist between the

transducer and guide, and it must be as acoustically isotropic as possible, so that the acoustic propagation is independent of direction.

Three guiding methods are presently available. One uses a thin overlay—much less than a wavelength thick—of a slow acoustic velocity material on a substrate composed of a fast acoustic ma-

terial. This arrangement confines the acoustic energy to the region of the "fast" substrate directly beneath the "slow" overlay. Another achieves the same objective by using a "fast" overlay to form a "slow" substrate slot. And finally, guiding can be accomplished simply by grooving the substrate, forcing the acoustic wave to travel between the grooves. Although this last method requires no overlay material, it does necessitate etching grooves in a piezoelectric substrate, and because of the chemical inertness of many piezoelectrics, such as lithium niobate, this is no easy task.

The one common design requirement for all three methods is that the width of the confining structures (overlay, slot, or grooves) must be less than one wavelength. This however is difficult at high frequency; at 1-Ghz, for example, surface acoustic wavelengths are smaller than 10 microns.

To get away from difficult fabrication requirements, a topographical class of guiding with ridge geometry may be used, where energy is confined either above or below the surface of a single material thus eliminating the overlay or groove fabrication. This type of silicon ridge formation is conventionally formed in metal oxide semiconductor (MOS) integrated circuits.

More work

But extensive experimenting must be done before guiding becomes a system reality. Most investigations so far have involved only straight paths at frequencies below 30 Mhz. Gold on fused quartz has received considerable attention by Adkins and Hughes at Autonetics in regard to dispersion and loss per wavelength. In addition, they are studying lateral confinement of the acoustic energy—an important parameter of substrate "traffic control". The work involves measuring the width of an acoustic beam from an 11 Mhz wedge transducer as it travels along a quartz substrate first without, then with, a gold overlay. Measurements without guides showed a wide beam of high amplitude which was essentially the launched beam after undergoing a small amount of diffraction. Then gold guiding strips, 1.5 microns thick and 10 mils wide, deposited onto the quartz narrowed the beam by a factor of 3.

More recent experiments show that partial displacements decay to $\frac{1}{3}$ in less than two wavelengths from the edge of the gold. In these measurements a low amplitude signal, some 20 db down from the main signal, was detected which corresponds to the energy not guided by the gold strip. Although not currently a serious problem, the signal, which results from that part of the launched beam that does not enter the guiding region, can be significantly reduced by tapering the gold between the input transducer and the waveguide.

These relatively primitive experiments indicate that high-frequency waveguide technology is still in its infancy. Work is yet to be performed with anisotropic single-crystal materials, which are essential for low-loss delay lines at high frequencies.

Similarly, low-loss overlay materials are mandatory. There is a chance that sputtered dielectric films might work at uhf, but heteroepitaxial growth processes will most likely be required at these and higher frequencies to keep losses below about 1 db/cm. In any event, the present limitations in existing guide configurations point up the need to launch surface acoustic waves on arbitrary non-piezoelectric substrates using locally deposited, oriented piezoelectric films.

Guiding components

Wave guides are a necessary part of such passive components as bandstop and bandpass filters, and directional couplers. Also, guiding can produce the acoustic analog of electromagnetic short and open circuit stubs. And by arranging an array of guides along a central waveguide carrying the principal delay line signal, filtering is readily attained in a manner analogous to electromagnetic filtering. In addition, recent experiments at 10 Mhz demonstrate the feasibility of phase interference-type directional-couplers which can be realized by placing in close proximity two parallel waveguides of gold on a fused quartz substrate. With this arrangement the acoustic energy, fed into one guide, propagates until reaching the other guide, the two guides having a center-to-center spacing of 30 mils, or approximately three wavelengths. As the propagation proceeds, energy has been observed to transfer back and forth between the two guides, a phenomenon which demonstrates the feasibility of acoustic-guide coupled-mode directional-couplers. Important design parameters are coupling length, degree of coupling, and dimensional dependency on frequency. Although tentative, measured coupling length, for optimum power transfer between the guides, is typically 40 wavelengths.

Considerable research remains if these circuit components are to prove useful to the microwave engineer. For one thing, specific data is not available for the values of coupling and directivity, as a function of frequency. Moreover, the problem of efficiently channeling energy from a wider transducer to a narrow guide has not been studied. Thus information is unavailable on the nature of the acoustic discontinuity introduced by a device such as the straight-path directional-coupler. Also, discontinuities due to waveguide bends must be analyzed, since the signal must be routed away from the parallel coupling section either for further processing or for converting to output electromagnetic energy.

Materials matter

Regardless of the obstacles to wave guide advancements, the proper choice and development of materials will greatly facilitate that program, as well as promote the entire microwave surface acoustic wave technology. In fact, this new technology will advance only as fast as new materials are found to meet the demands. Some of the well-known piezoelectric materials—quartz and lithium niobate

—are certainly suitable for many surface wave applications, but a comprehensive technology will require a wider range of materials. For example, needed for the guiding problem are a range of low-loss single-crystal films on single-crystal substrates with various combinations of “slow” on “fast” and “fast” on “slow” materials. Heteroepitaxial material combinations are also necessary for amplifiers, since these materials offer the possibility of utilizing other modes of propagation, such as Love waves and Stonely waves—the latter confined to the interface between two welded materials. In fact, the entire future of microdistributed circuitry may depend on producing controlled heteroepitaxial material combinations.

Bulk materials

In bulk form the three most important material properties are electromechanical coupling factor, surface wave velocity, and compatibility with microelectronic fabrication techniques, the latter being required for interdigital transducers. Their importance is this: electromechanical coupling essentially determines the quantitative tradeoff between insertion loss and bandwidth for a delay line; the surface wave velocity determines the maximum information density in the line; and the compatibility with fabrication techniques determines such factors as yield and related cost.

Bismuth germanium oxide is emerging as an important material that satisfies these requirements. Perhaps its major significance is that its time-fractional bandwidth product per cm, so important in radar applications, is superior to all known single crystal materials. Moreover, it may be grown at temperatures below 1000 degrees centigrade by the Czochralski pulling technique, a growth process very popular in solid-state materials work. In addition, the material is cubic and non-ferroelectric, the latter in contrast to lithium niobate. This means that poling is unnecessary, avoiding the peripheral cracks, the loss of useful material, and the danger of shattering the boule which is associated with this process. But more significantly, bismuth germanium oxide can be readily etched along useful coupling directions to form acoustic waveguide grooves, a property unfortunately not shared by quartz or lithium niobate. The slow surface wave velocity also makes it suitable for “fast” on “slow” slot guide structures with most overlay materials. In addition, it is photoelastic and photoconductive, which promise future device applications.

Good combinations

Bulk materials are important, but heteroepitaxy—growing one single-crystal material upon a substrate single-crystal material of different chemical composition—may be the answer to the materials problem. Silicon-on-sapphire (SOS) in combination with lithium niobate for the surface acoustoelectric amplifier is one example of heteroepitaxy growth. This type of fabrication, achieved by a process known as chemical vapor deposition (CVD), has

proved a powerful technique in the overgrowth of a wide range of metals, semiconductors, ferrimagnetic spinels and garnets, piezoelectrics and orthoferrites on selected single-crystal substrates.

One of the most important recent developments in microwave acoustic materials, achieved by a close-spaced vapor-transport deposition process, is the successful growth of the piezoelectric zinc oxide (ZnO) on sapphire in films up to 100 microns thick. Later counter-doping with lithium modifies the resistivity of the material for use in both interdigital transducer and amplifier applications. In addition, annealing in oxygen allows all the piezoelectric properties of bulk ZnO to be realized in the films.

The process uses a hydrogen gas carrier mixed with hydrochloric acid flowing through the system to transport the sapphire substrate surface, so that the C-axis of the ZnO will lie in the X-cut plane. Using this material, delay lines with interdigital electrodes that have been deposited at 4 mm separation show a total insertion loss of only 15 db, most of which arises from r-f conduction losses in the film. To our knowledge this is the first example of a surface acoustic wave transmitted along a heteroepitaxial film.

In addition, this new material allows arbitrary patterns such as ridge waveguides to be etched out. This means that parallel signal processing delay channels can now be fabricated with low loss in each of the parallel delay lines. And by utilizing spatially separated SOS with a one-to-one correspondence between the ZnO lines and the silicon section (one silicon section to one ZnO ridge waveguide section) allows the addition of controlled amplification and attenuation to each channel by suitably adjusting the d-c power to the silicon sections. And by properly choosing the spacing between the ZnO sections, cross talk between channels can be kept as low as desired.

Integration

Because of its compatibility with silicon technology, another material of great interest is aluminum nitride. This material, which is strongly piezoelectric, has great potential for an integrated amplifier using silicon-on-sapphire transducers and amplifiers. Transduction is accomplished by the interaction of carrier waves in the silicon-on-sapphire with the acoustic waves in the aluminum nitride. Aluminum nitride is an excellent material because it has a large bandgap, typically 6 electron volts. This gives a resistivity of approximately 10^{11} ohm-cm at room temperature, allowing electrical isolation between the silicon segments. Also, because it's a fast velocity material, acoustic energy propagates in it at velocities similar to that of silicon and sapphire, resulting in very low dispersion. Thus we can anticipate the construction of a monolithic microelectronic acoustoelectric amplifier in which the disadvantages of the spacing between materials, such as lithium niobate and silicon, are avoided. And most important, since no gap is required, the material provides a greater interaction volume for

Deposits Grow

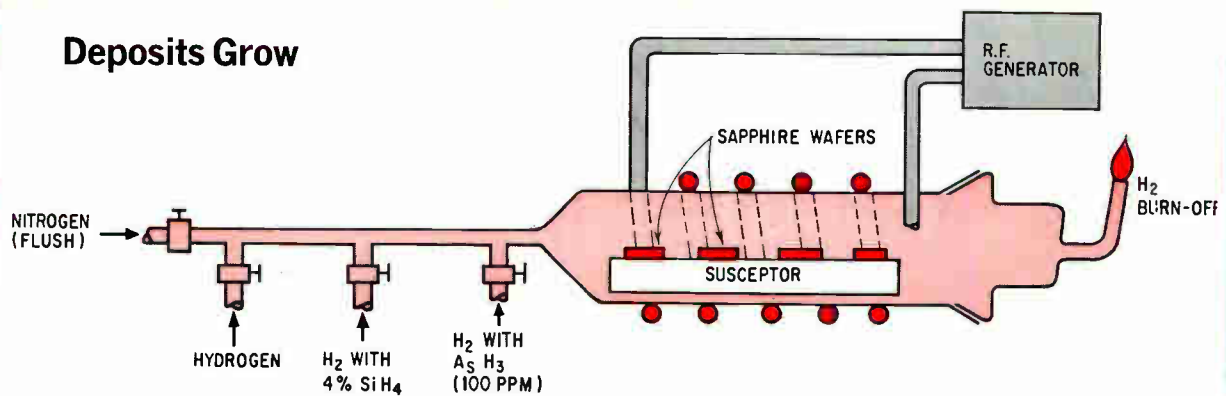

A film deposition process, called chemical vapor deposition (CVD), has been developed to grow heteroepitaxy crystals—growth of a single crystal film upon a crystalline substrate material of different chemical composition. The growth of silicon-on-sapphire, important in surface acoustoelectric amplifiers, typifies this process.

The system includes a reactor tube which serves as the growth chamber, a hydrogen burn-off, and a nitrogen flush capability, in addition to silane and arsine gases. The reactor, after loading a 20 mil thick sapphire substrate onto the susceptor, is initially flushed with nitrogen and then hydrogen. The r-f coil cleans the sapphire substrate by heating the susceptor to 1200 degrees centigrade in a hydrogen atmosphere. The temperature is then reduced to 1000 degrees centigrade, and a mixture of four percent silane in hydrogen and 100 parts per million arsine in hydrogen is introduced into the reaction chamber. The silane dissociates into hydrogen and silicon, the latter depositing on the sapphire substrate in single crystal form.

Arsine dissociation also takes place with arsenic depositing along with the silicon to give arsenic doped n-type layers. The resistivity of the layers is controlled by the amount of arsenic introduced, which is in turn controlled by the flow rate of the arsine-doped hydrogen into the chamber.

Deposition rates are typically 0.3 microns per min-

ute. Following deposition, the system is allowed to cool slowly under hydrogen. The doping is a critical process when resistivities of 100 ohm-cm are required, since this corresponds to 0.01 parts per million doping level in the film. The last step, baking the film and substrate at 1200 degrees centigrade, homogenizes the doping level through the layer.

In heteroepitaxy growth processes it is important to consider certain relationships between the overgrowth film and the substrate. For one thing, similarity between the atomic arrangements in the overgrowth and the substrates is definitely advantageous. Another point is that if the substrate is not physically and chemically inert during film growth the film is contaminated by the substrate. Since most growth processes require high temperatures, it is essential that the coefficients of thermal expansion of the film and substrate be closely matched over the ambient-growth temperature range. This precaution will assure the physical soundness of the films upon cooling to room temperature, as well as prevent the initiation of crystal defects resulting from high stress.

Single crystal materials are important for low-loss devices at high frequencies. The development of future monolithic devices having multifunctions—semiconductor, acoustic, magnetic, optical, etc.—will be paced by the ability of materials technology to produce an entire range of suitable heteroepitaxial material combinations.

the electric fields, higher saturation power and potentially higher frequency of operation.

Another good combination is gallium arsenide (GaAs) on beryllium oxide (BeO). GaAs is "slow" and BeO is "fast" allowing the formation of waveguides. Further, since BeO has a thermal conductivity at room temperature exceeding copper, excellent heat sinking is in the offing, which means that greater d-c fields can be used in the acoustoelectric amplifying configurations. This is seen from the fact that GaAs films of 30 microns thickness grown on sapphire have electron mobilities as high as 6500 cm²/volt-sec., far exceeding that of silicon.

Boosts technology

Although weakly piezoelectric, bulk GaAs used in acoustoelectric amplifiers built by Stanford Uni-

versity had sufficient electromechanical coupling at GHz frequencies to give electronic gains of 70 db per cm. Thus, heat sunked, low voltage, amplifying waveguides seem a real possibility in future applications.

Laboratory samples of GaAs on BeO are becoming available for comprehensive acoustic investigations. This will allow an important aspect of the physics of heteroepitaxial interface states to be analyzed—namely the nature of the interface between the overlay and the substrate—by studying both semiconductor and acoustic wave propagation. And for this purpose since heteroepitaxial combinations do not always involve a piezoelectric, locally-deposited oriented piezoelectric films will be used. Currently some 60 heteroepitaxial combinations are available for study. ■

**This new keyboard
will give you
some idea
of just how much
our computerized
counter can do.**

Our 5360A Computing Counter is much, much more than a counter. A computerized digital measuring system would be more accurate, because it measures frequency, period, and time interval at speeds and resolutions never before possible.

And now this unique measuring system can be even more useful to you, with the addition of the 5375A Keyboard.

You can enter programs and have the keyboard learn and run them automatically. For example, phase, standard deviation, ranging, rate-of-change, FM deviation, VCO linearity, residual FM, averages. In fact, this keyboard lets you program the counter to display, in real time, solutions to equations whose variables are the measurements made by the counter.

As you can see in the photograph, the keyboard will handle all basic math, including root, branching and looping within the program.



In short, it's designed to keep up with the capabilities of the counter.

This is quite a feat in itself. The counter makes measurements to 320 MHz on its own, and goes all the way to 18 GHz with plug-ins. Another plug-in affords the first 100 picosecond time interval resolution ever available in a counter. Besides being faster and more accurate than any previous instrument of its kind, the 5360A has eleven-digit resolution, with fixed decimal display, automatic units and blanking, to give you error-free readout.

You'll find that the 5360A Computing Counter makes measurements you could never make before. And it saves you time and the expense of setting up elaborate measuring systems. It will do all this for just \$6500, plus \$1350 for the 5375A Keyboard.

For all the data and applications, call your local HP field engineer. Or write to Hewlett-Packard, Palo Alto, California 94304; Europe: 1217 Meyrin-Geneva, Switzerland.



HEWLETT  PACKARD

ELECTRONIC COUNTERS

Circle 113 on reader service card



Matching FET's by design is faster and cheaper than by pick and choose

● With their megohm-range input impedance, field effect transistors seem ideally suited for duty at the inputs of a variety of circuits. And so they are, with one big exception. Because of the high price for a matched pair, FET's haven't found a place as the input components in differential circuits. But because of a new design for matched junction FET's that high price is on the way down. And FET's will certainly be used, in differential circuits once the price barrier disappears.

Now, two FET's can be built on a single chip in such a way that the transistors' characteristics are identical to begin with. This means there's no need for expensive testing to match them. In this new technique the gate, source, and drain of one transistor form an interdigitated pattern with the gate, source, and drain of the second. With this layout the geometric centers of the two gates are at the same spot, which turns out to be the center of the chip. Any differences in processing variables affect both transistors to the same degree and in the same way. And this means that the two are just about perfectly matched.

For an engineer to use FET's as a differential-input device, he must have two transistors that are identical; if the same input is applied to both, they must produce identical outputs, and not just at one temperature. Transistor makers determine how closely two FET's match by measuring their offset voltage, ΔV_{GS} ; the smaller ΔV_{GS} is, the better the match. Offset voltage is measured at some specified drain current, I_D (usually it's 200 microamps). Each transistor is connected to a current source where its V_{GS} is adjusted until its I_D is the specified value. When both transistors are carrying the specified drain current, their V_{GS} 's are subtracted, and the difference is ΔV_{GS} for that drain current. Matched FET's are classified according to ΔV_{GS} ; those with 5 millivolts are usually the top class, while the bottom may be as poor as 50 mv.

Usually ΔV_{GS} varies with I_D ; therefore two FET's matched at one value of I_D don't necessarily match at another I_D . On the other hand, measuring ΔV_{GS} is usually all that's needed; if the offset voltage is small, the transistors' other parameters, such as drain-to-source resistance, R_{DS} , will most likely match.

Two FET's with supposedly the same specifications may not be identical because of the difficulty the maker has controlling process variables, such as epitaxial thick-

ness. Even matched FET's made in the conventional manner on adjacent chips don't necessarily have to match because, for example, the epitaxial layer may be deeper on one chip, or the wafer or the metalization layer may be thicker.

Left with a pile of nonidentical FET's the maker has no choice but to test each one, trying to pair the transistors off. Computers help in this matchmaking but the process is still slow; and what's worse, each test usually destroys a few of the transistors. The result of this slow and destructive testing is that the price of a matched pair is about three to five times the price of two unmatched FET's.

Attempts to solve the matching problem by building two FET's side by side on one chip haven't been successful because even if the transistors are this close, differences in processing variables still gang up to destroy the match.

With the new interdigitated layout the need for costly testing is eliminated, and the price of the matched pair comes down quite a bit. For example, the 2N3955, a standard two-chip matched pair, sells for \$8; however, National Semiconductor's new FM3955, an equivalent monolithic dual made with this new technique, has a price of \$5.60.

The yield for a monolithic pair matched to within ± 5 mv with a drift of 10 microvolts per $^{\circ}\text{C}$ is between

Interdigitating two transistors on a chip assures a perfect match, thus avoiding testing and pairing of separate chips; Robert Christensen and Donald Wollesen of the National Semiconductor Corp. tell how interdigitation lowers prices.

Using matched FET's

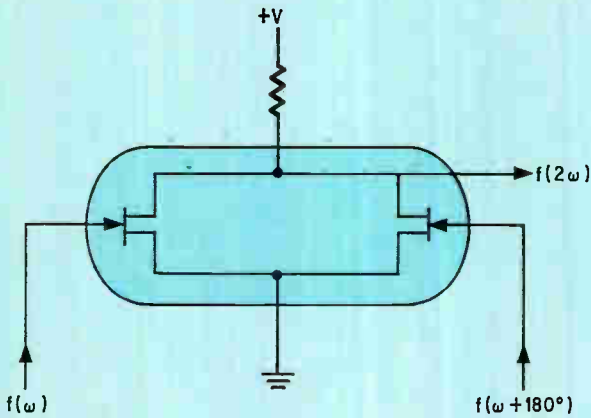

25% and 35%. For an equivalent two-chip pair, the yield is around 2%. And when monolithic pairs are matched to within ± 2 mv with a drift of $5 \mu\text{v}/^\circ\text{C}$, the yield is still 10% to 15%. Tolerances so close are out of the question for two-chip pairs.

Obviously, present users of matched FET's will be able to cut the prices of their own systems, and those making do with less expensive bipolar substitutes may now be able to step up to FET's. One group that will be particularly happy are makers of hybrid operational amplifiers. Using matched FET's as input devices, op amp manufacturers will be able to push their amplifiers' slew rate up to 100 volts per microsecond, typically, they can reach 10 volts/ μsec now without resorting to specially designed components.

How much the proximity of the two FET's improves their match can be seen by considering a typical transistor process variable, such as epitaxial thickness. The way any process variable, P, changes from point to point over the surface of a chip can be described by a power series

$$P = a_1x + a_2x^2 + \dots + a_nx^n + \dots$$

where the a_i 's are constants and x is the displacement over the surface of the wafer. The constants are different for different variables.

The mismatch between two transistors can be calcu-

The inputs to the frequency doubler (upper left) are 180° out of phase; thus the circuit eliminates the first harmonic, $f(\omega)$. Since FET's are square-law devices, the second harmonic, $f(2\omega)$, has no trouble getting through to the output. How good a job the doubler does eliminating third- and higher-order harmonics depends on how closely the FET's are matched. In both the temperature comparator (upper right) and the thermocouple amplifier (center right) the matched FET's present the necessary high input impedance to the thermocouple while amplifying its output. In the comparator the third FET combines the zener diode to give a reference voltage. The multiplexer (lower right) is a new application for matched FET's. But they multiplex only if each pair's drain-to-source resistance match. With the monolithic pairs the match can be to within 0.1% over a wide range of drain currents.

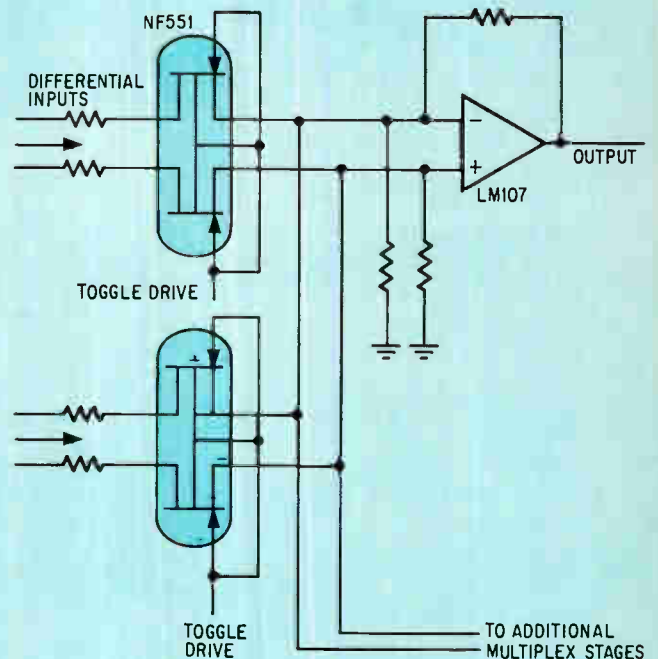
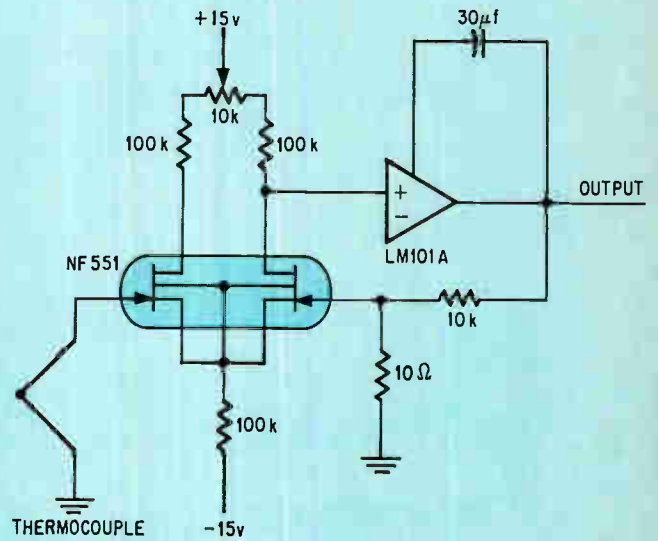
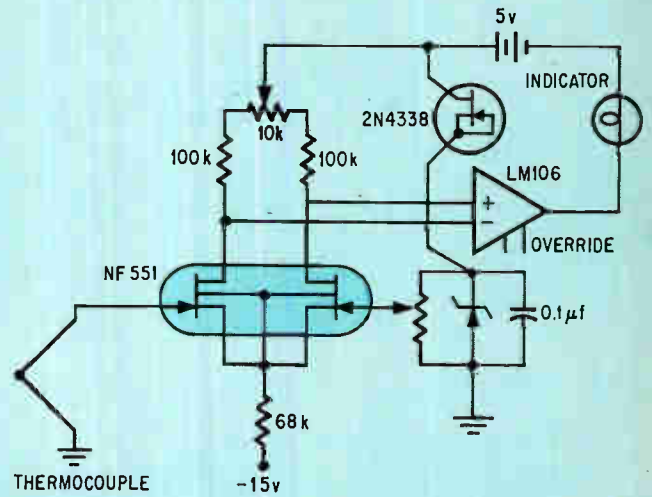

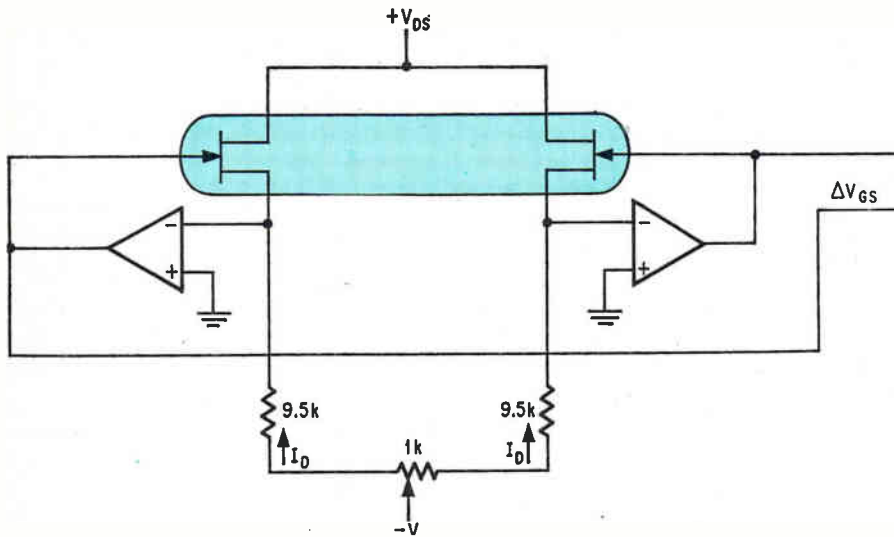

Testing. Once the potentiometer is set so that each resistor gets the same current, $-V$ is adjusted until I_D equals some specified value, usually 200 microamps. The difference between the gate voltages is then that pair's offset voltage. To find ΔV_{GS} at some other drain current, it's necessary to adjust only $-V$.

lated by letting x equal the distance between the geometric centers of the two gates. Theoretically then, when the gates are at the same spot, there is no mismatch between the two transistors.

Epitaxial thickness varies irregularly over an entire wafer; however over distances on the order of 40 mils the thickness can be considered a linear function of x . And the centers of gates of the FET's on adjacent chips are usually 20 mils apart. If the average linear variation of epitaxial thickness is a typical value such as $\pm 7\%$, if the epitaxial material is 1-ohm n type, and if each FET's pinchoff voltage (the range from full off to full on) is 3 volts, ΔV_{GS} is on the order of 26.7 millivolts. If, on the other hand, the gates' geometric centers are 1 mil apart, the mismatch is 1.4 mv.

The effects of the higher order components are harder to calculate. The second-order component of a particular variable can be approximated by multiplying the value of this variable at a small section of the gate by the square of the distance between the section and the gate's center, repeating this for several hundred sections, and then adding the products. When this is done for two-chip pairs, the mismatch caused by second-order components is on the order of 20 times what ΔV_{GS} is for the monolithic pair.

Besides having the interdigitated design, the matched transistor pair also share the same heat sink which improves the temperature tracking. Two-chip pairs must be bonded separately onto dielectrically isolated regions of a header.

Sharing the same substrate can have its drawbacks however. If the differential voltage between it and a diffused gate exceeds the pinchoff voltage, a gate-to-substrate reachthrough phenomena occurs that is similar to collector-emitter punchthrough breakdown in high-beta bipolar transistors. As long as the reachthrough current is in the microamp region, the transistors won't be damaged.

Naturally, there is some testing involved in making a monolithic matched pair. However, the amount of testing is nowhere near what is involved in matching two-chip pairs. In the latter instance each wafer, which contains 2,500 or 3,500 chips, is treated separately, and each chip must be probed at two different drain currents. Once this is done, the data is logged onto punch cards, and the cards are sorted according to ΔV_{GS} . Then the

matched pairs are attached to their headers. Attaching one chip and then the other often alters the chips' characteristics, destroying any match the two transistors might have had. Therefore, after the FET's are finished, they must be given a final go no-go test first at room temperature, and then at some higher temperature to ensure tracking.

By contrast, testing the monolithic dual transistors is a relatively easy task. The circuit shown in the above figure permits direct reading of ΔV_{GS} with a differential voltmeter.

The circuit's goal is to set the source voltage of both transistors to ground. This way any voltage applied to the drain will in fact be the drain-to-source voltage, V_{DS} . The negative voltage, $-V$, can then supply a specified I_D to each FET; to ensure that both drains are getting the same current, the two 9.5-kilohm resistors must be precisely matched.

To get the source voltage to ground while holding the drain current constant is the job of the operational amplifiers. Their positive terminals are grounded and the negative ones are tied to the sources. When the amplifiers' outputs are connected to the gates, the amplifiers force the source voltage of each FET to ground by driving the gates negative. Then the amount of voltage on each gate is the voltage needed to produce the specified I_D . The circuits' output then is ΔV_{GS} . ●

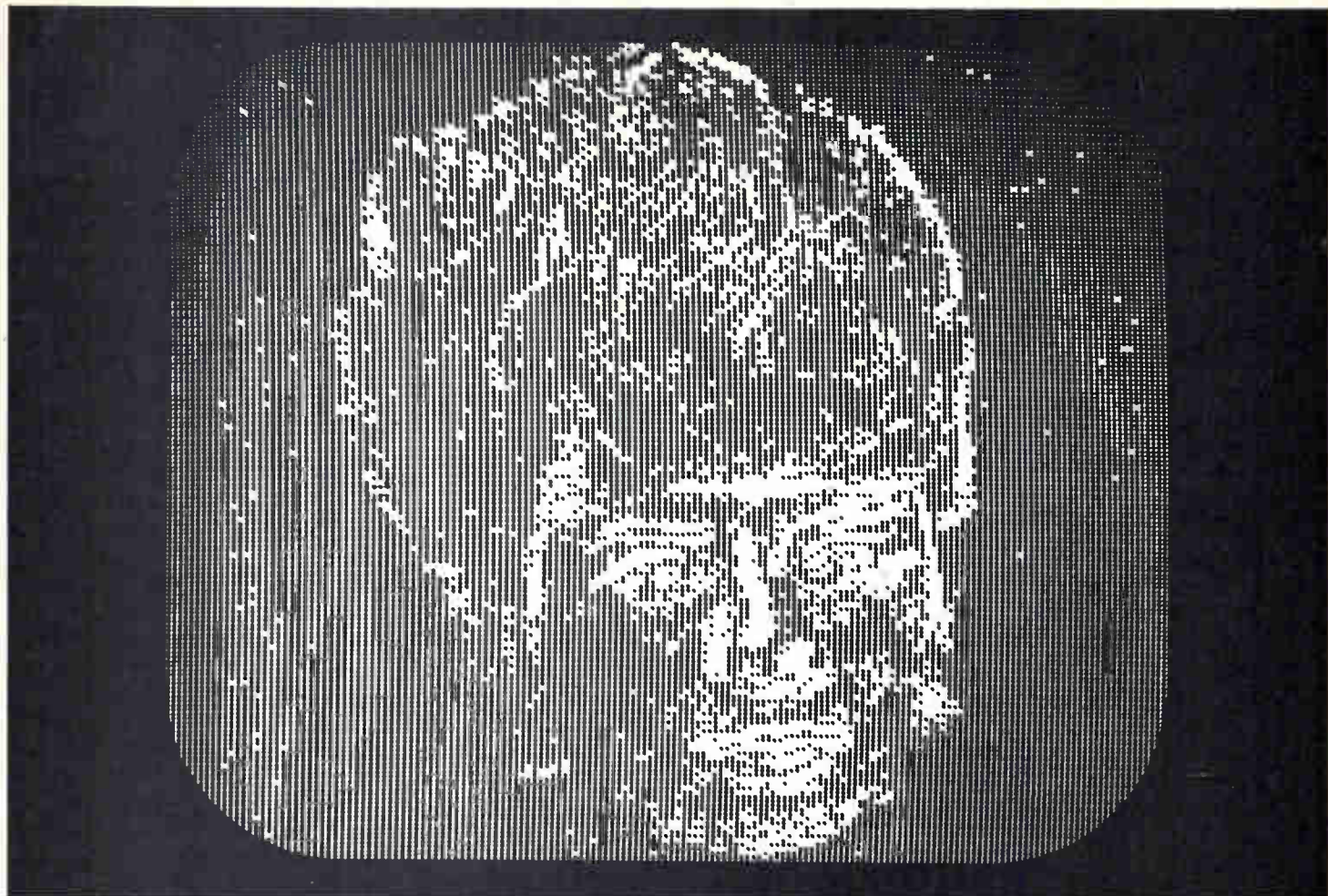

Transmitting the changing scene

This girl's picture was produced on a special Picturephone® system; it will never look like this in your home. The white areas mark the only picture points which changed in 1/30 second (the duration of one video frame). The remainder of the picture was blanked out.

This emphasizes how Picturephone use differs from ordinary television: the Picturephone camera usually points at a single scene throughout a call and most of the motion is confined to the subject's lips and eyes. Everything else—perhaps 90 percent of the picture—remains stationary.

Frank W. Mounts of Bell Laboratories used this fact to design an experimental video system that may

make it possible to transmit three Picturephone calls over a channel that otherwise could carry just one.

An ordinary Picturephone system sends thirty complete pictures each second. In Mounts' experimental system, only changes from one picture to the next are transmitted. A complete picture (information about dot positions and brightnesses) is stored at both the transmitting and receiving ends. As the camera's electron beam scans the original image, the brightness at each point is compared with the stored value. Whenever there is a significant difference, the system updates the stored frame and transmits the new brightness level and dot position.

At the receiving end, as the

picture tube's beam arrives at each point, the incoming information is checked to see whether a picture-point revision has arrived. If so, it is displayed and stored.

Because some areas of the picture do not change, while others change extensively, revised points may come in bursts. Transmitter buffers smooth the flow by reading the information out onto the line at a constant rate.

This new technique, one of several now being investigated at Bell Laboratories, promises to help keep transmission costs down when the Picturephone service becomes generally available.

From the Research and Development Unit of the Bell System—



Bell Labs

the
GIANTTM

GENERAL INSTRUMENT ADVANCED NITRIDE TECHNOLOGY

QUADS



with the 4-bit byte

the first and only 25-bit and 32-bit QUAD Static Shift Registers directly compatible with TTL/DTL and MOS are GIANTS.

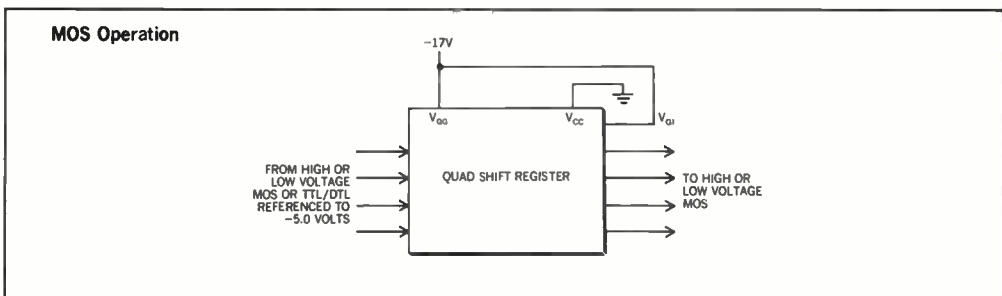
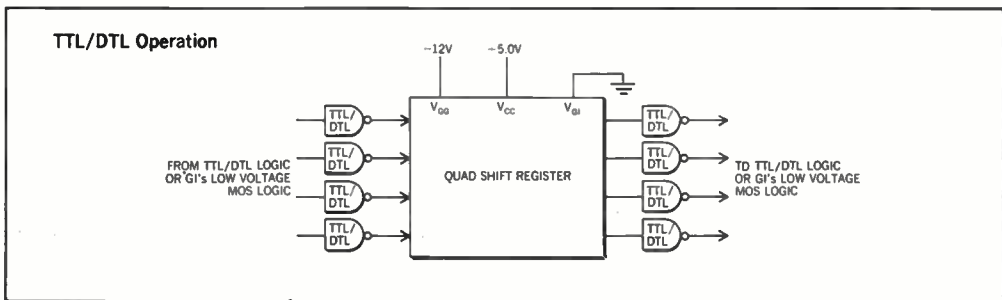
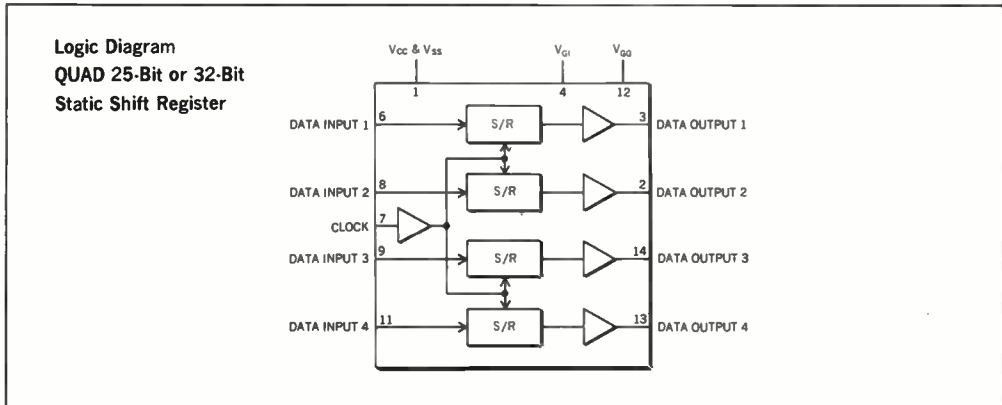

General Instrument's 4-bit byte 25-bit and 32-bit QUAD Static Shift Registers are the newest additions to the growing family of GIANTS. And, like all GIANTS, they are products of General Instrument's exclusive MTNS (Metal-Thick Oxide-Nitride-Silicon) process.

A most significant feature of these GIANT QUADS—and of every standard GIANT product—is the V_{GI} terminal, which gives the user the choice of interfacing directly with TTL/DTL or MOS.

Each register has one serial input and one serial output, and the clock input is common to the four registers. All inputs, including clock, can be driven directly from TTL/DTL logic levels, and each output can directly drive TTL/DTL without external interfacing components.

Additional features of the GIANT QUADS include: opera-

tion over the full military temperature range of -55°C to $+125^{\circ}\text{C}$ and series or parallel operation. And the well-known performance and reliability advantages inherent to MTNS devices are, of course, also present in the GIANT QUADS.

Both the 25-bit (#SL-6-4025) and the 32-bit (#SL-6-4032) QUADS are available in 14 lead dual in-line ceramic packages at your authorized General Instrument Distributor. For full information write, General Instrument Corporation, Dept. Q, 600 West John Street, Hicksville, L.I., N.Y. 11802.

(In Europe, write to General Instrument Europe S.P.A., Piazza Amendola 9, 20149 Milano, Italy; in the U.K., to General Instrument U.K., Ltd., Stonefield Way, Victoria Road, South Ruislip, Middlesex, England.)

Price in quantities of 100 pcs: QUAD 25-bit (#SL-6-4025) @ \$18.20 ea.; QUAD 32-bit (#SL-6-4032) @ \$26.50 ea.



GENERAL INSTRUMENT CORPORATION • 600 WEST JOHN STREET, HICKSVILLE, L. I., NEW YORK

THIS 100-FOOT ANTENNA CAN BE DEPLOYED FROM A 10-FOOT PACKAGE.

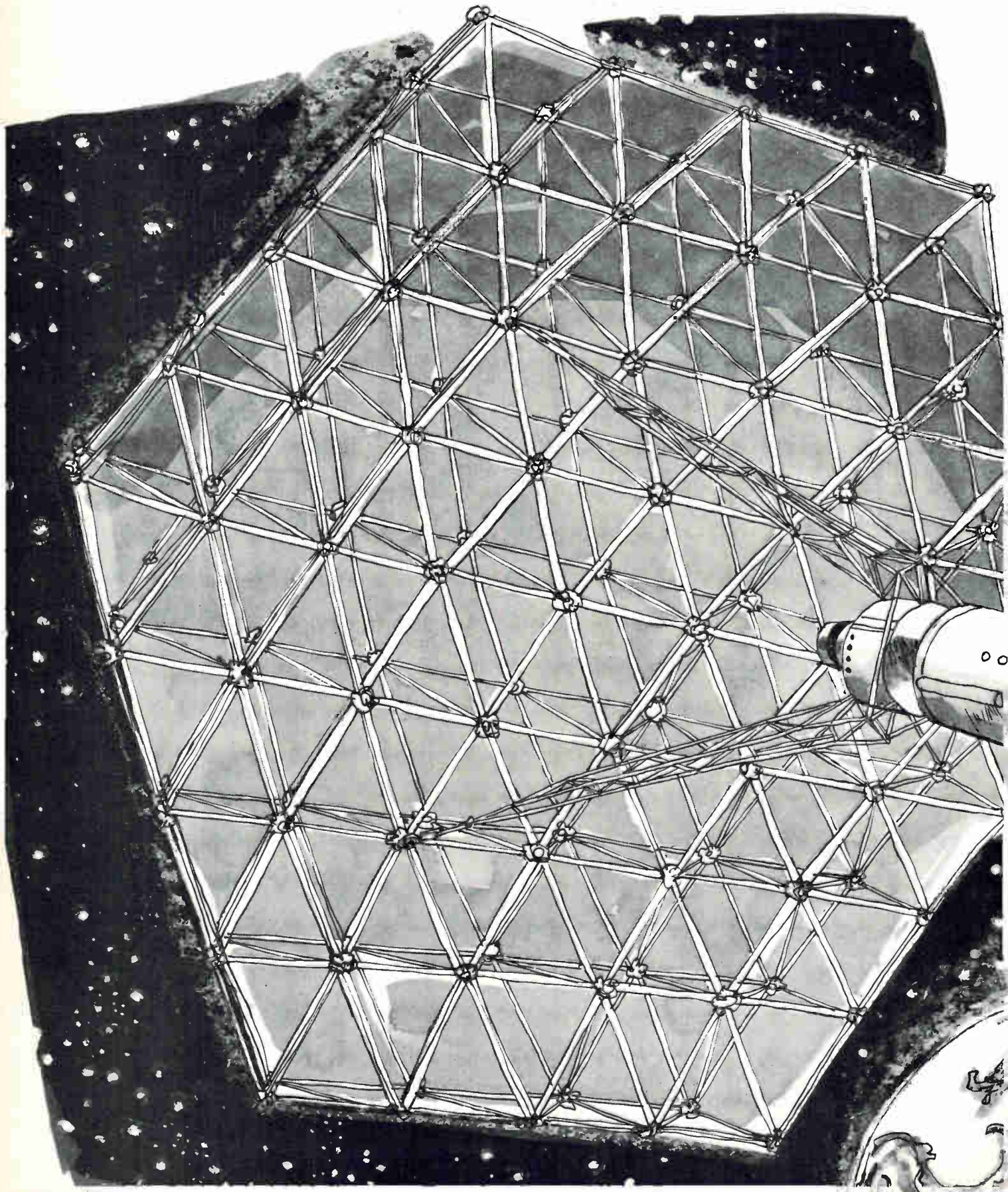

Getting a large-aperture antenna where you want it, when you want it, has become more and more of a problem in developing advanced space communications systems.

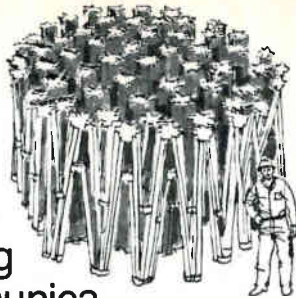

Until now, placing rigid, precision-surface antennas as large as NASA and the military would like them to be has been out of the question.

But now General Dynamics' Convair Division has conceived a geodesic truss that makes possible an antenna from five feet to 100 feet or more in diameter that folds into a package just one-tenth of its deployed size. Spring-loaded, it erects automatically on command.

Ten times the gain of today's antennas. The reason for a large-aperture is, of course, to achieve greater gain and narrower beams. The lightweight antennas we are developing for NASA are designed to provide a peak gain of more than ten times that of the largest communications satellite antennas available.

This larger gain factor means the satellite needs less power output. Also, smaller, less-expensive ground terminals may be used.

High performance combined with design flexibility. When deployed, this antenna would have a mesh surface covering the triangular elements to form an accurate contour (diameter/surface tolerance $> 5,000$) for high performance through the upper microwave frequencies. And though conceived as a means of erecting orbital parabolic antennas, the same basic concept can be extended to a variety of other configurations—such as helical and horn arrays.

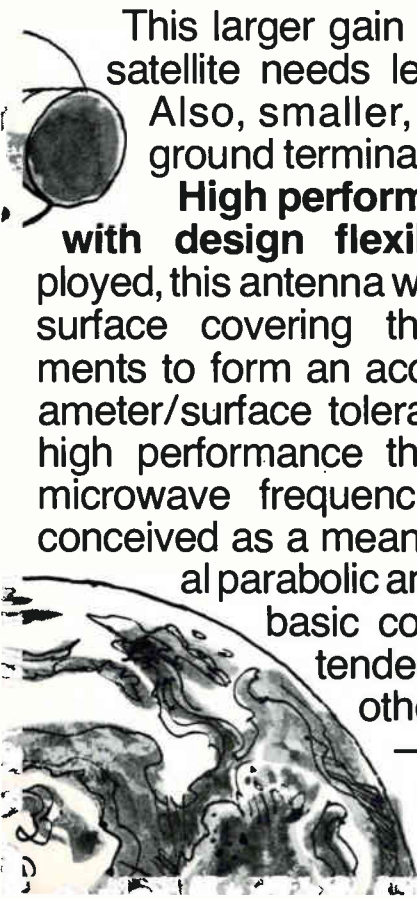

Small, lightweight package permits broad spectrum of uses. The advantages of getting an erectable antenna that folds into so small a package are obvious where launch vehicle payload is limited. For communications relays. Radio and television broadcasting. Radar. Radio astronomy and weather data acquisition. In potential military applications for protected space communications systems. And for lunar uses looking not too far into the future.

Applications foreseen in "inner space" too. We're also investigating the use of erectable antennas for portable ground terminals, and on both surface vessels and submarines. Here not only is size to be considered, but the ease and speed with which such antennas may be deployed and retracted into a housing.

This compactness also suggests use in underground silos where swift operation under changing tactical conditions would be imperative.

Erectable antennas are just one example of our continuing work on space programs. More than 370 Atlas vehicles have been launched, and the 1969 Mariner-Mars fly-bys were the tenth and eleventh operational Centaur missions. Also, in the past year, seven Convair scientific satellites have been boosted into space. Earth-bound space support projects include three Apollo Instrumentation Ships built by General Dynamics for NASA's global tracking network. They all show what technology can accomplish when it's handed a problem. At General Dynamics we put technology to work solving problems from the bottom of the sea to outer space... and a good bit in between.

GENERAL DYNAMICS

Technical information on erectable antennas is available on request. Write: General Dynamics, Dept. 850, 1 Rockefeller Plaza, New York, N.Y. 10020.

Circle 121 on reader service card

We've tamed the TV "jungle"

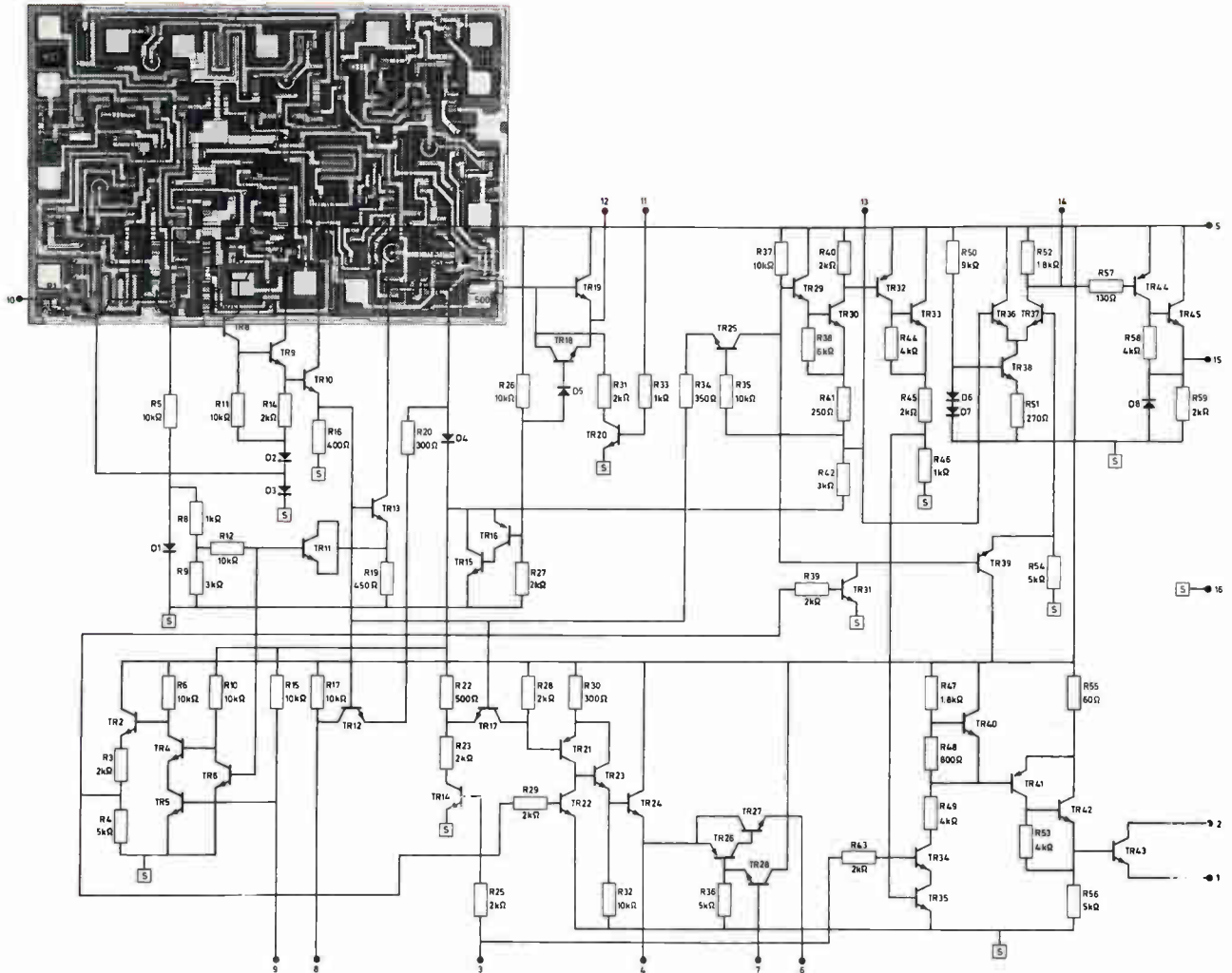

Our design teams have produced an integrated circuit that does the work of many separate semiconductors in the signal processing section of either a monochrome or a colour TV set. This simplifies design and production, and simplifies ser-

vic-ing too — when it needs attention, that is. The reliability of the new IC type TAA 700 is better than that of the silicon semiconductors which it replaces. And its cost is comparable with that of conventional circuits with discrete components —

particularly when you count assembly costs, as every set-maker must. How soon will you be ready to tame the "jungle" in your TV receiver design? You don't have to wait. Because Philips have a proven integrated circuit all ready to take its place.

PHILIPS EUROPE'S STRONGEST GROUP
IN SOLID STATE DEVICES

TAA 700 PUTS SEVEN DIVERSE TV RECEIVER SIGNAL-PROCESSING FUNCTIONS ON A SINGLE CHIP!

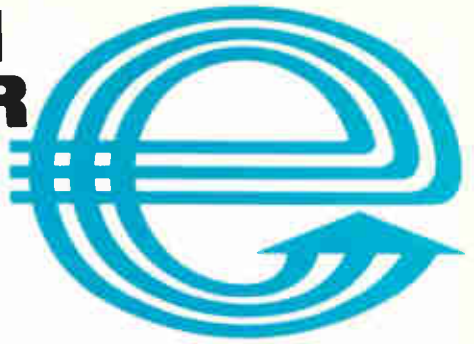

This jungle IC, type TAA 700, is a central processor and distribution circuit for the video and synchronisation signals in both monochrome and colour receivers. It replaces about twenty-five components in a conventional receiver. TAA 700 performs these seven distinct circuit functions:

Video pre-amplifier

Video gain is 10 dB; -3 dB bandwidth is better than 5 MHz for fine picture quality. Rise and fall times are less than 80 nanoseconds. Load impedance, seen by the video detector, is typically 2,700 ohms, with less than 1.0 pF parallel capacitance. Output voltage is 6 V peak-to-peak, and an output current up to 15 mA is available. Output signal black-level is typically 5.0 V. Output black level variation due to temperature changes and "spread" is less than 600 mV.

Gated AGC detector

Input impedance is approximately 1,000 ohms. Up to 8 V of AGC voltage is available to control the IF amplifier, and up to 7 V for the tuner. The signal expansion at full control of both is less than 15%. Both AGC and horizontal phase detectors are keyed.

Noise gate

The internal noise gate is frequency and amplitude selective. It protects both the AGC and sync separator circuits.

Sync separator

The sync pulse is "sliced" approximately 30% below its peak level. The noise inverter renders sync and AGC circuits insensitive to noise pulses.

Automatic horizontal synchronisation

The horizontal sync voltage output is approximately ± 3 V. Holding range, for an oscillator-reactance stage with a control sensitivity of 400 Hz/V, is approximately $\pm 1,000$ Hz. A catching range of ± 700 Hz is achieved without affecting noise immunity, because the phase detector is keyed. Horizontal synchronisation is fully automatic; even if some sync pulses may fail, due to interference, synchronisation of the horizontal deflection is maintained.

Vertical sync pulse separator

Output voltage is over 10 V negative-going single pulse, measured peak-to-peak.

Video amplifier blanking

An input is provided for both vertical and horizontal blanking. Peak-to-peak input voltage for video blanking is 1 to 5 V.

Where does TAA 700 fit in your TV receiver circuit?

The TAA 700 integrated circuit effectively ties up the "loose ends" of AGC noise gating, synchronisation, and video amplification (or luminance in the case of colour). TAA 700 input is taken from a vision IF amplifier, via the usual 4.5 MHz "trap" at the video detector output. You can drive either a single BF 178 transistor or a tube video output from the TAA 700 used in a monochrome receiver. With colour, the luminance drive available is effectively halved (to 3 V), because the delay line has to be matched to the low impedance of the integrated circuit. This output is still sufficient to drive a high-conductance luminance output tube direct, but a transistor output stage will need an added emitter follower.

You can use either tube or transistor vertical and horizontal oscillators with the TAA 700.

TAA 700 comes in a QUIL — or Quadruple-in-line — package, with a total of sixteen leads.

What is a QUIL?

QUIL stands for Quadruple-in-line: our new style plastic body for television IC's. QUIL is the Philips answer to all those tooling and assembly problems which can arise when integrated circuits have to be mounted onto printed-circuit boards for television receiver production. The sixteen leads of the QUIL package are staggered, increasing hole spacing from the 0.1 inch of the DIL standard up to 0.141 inch. This gives designers more room to play with, a wider range of tolerance, and ensures that there is always a safe margin of copper area to ensure correct contact with the wiring.

The Philips range of IC's for TV also includes:

TAA 570 is a four-stage limiter amplifier contained in a single TO-74 metal envelope. Used in the sound channel of an "inter-carrier sound" television receiver circuit, the TAA 570 will give 1.8 V r.m.s. audio output for a frequency deviation of 50 kHz. A special remote-control stage provides an 80 dB gain control range, simply by adding a potentiometer. Extra "outside" components have been cut to a minimum.

Philips also produce the TAA 550, a complete voltage stabiliser for a tuner using varactor diodes. TAA 550 will keep a supply voltage in the range from 31 to 35 V constant to within 0.02%, at input variations of up to $\pm 10\%$. Its temperature coefficient in the ambient temperature range from $+10^\circ$ to $+50^\circ\text{C}$ varies between -3.1 to $+1.55$ mV/ $^\circ\text{C}$. This type is supplied in a single TO-18 metal envelope.

Let our Applications Laboratory help you

Philips are studying more TV receiver circuit functions, to realize them in integrated circuit form. Why not ask us about the integrated circuits for TV you want to use? We may have designed them already!

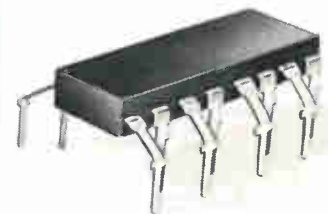

PHILIPS ELECTRONIC COMPONENTS AND MATERIALS DIVISION EINDHOVEN, THE NETHERLANDS

Distributed and sold in the U.S. by: AMPEREX ELECTRONIC CORPORATION Providence Pike, SLATERSVILLE, Rhode Island
230 Duffy Avenue, HICKSVILLE, New York 11802 • 801 E. Charleston Avenue, PALO ALTO, California 94303 • 360 E North Avenue, NORTHLAKE, Illinois 60164.

For over 20 years, wire insulations of Du Pont TEFLON fluorocarbon resins have provided maximum performance and reliability under extremes of temperature and adverse environments. But did you know there are composite constructions of TEFLON and polyimides

**TEFLON: all by itself
the most
thoroughly proven,
high-reliability
insulation**

**Now consider
the additional
advantages
of TEFLON plus
polyimides**

which offer you extra performance benefits for all wiring applications? TEFLON plus polyimide constructions guard against installation damage because of their toughness and abrasion resistance. They are made in two forms: a polyimide enamel over a primary insulation of TEFLON or a polyimide tape wrapped around the TEFLON.

Both these "TEFLON plus..." constructions are rated for use over a wide temperature range—up to 260°C. They are easily printed and potted, nonflammable, chemical-resistant, lightweight and have a small diameter. They provide the optimum dielectric quality which you expect from insulations made with TEFLON.

If you'd like additional information on composites of TEFLON plus polyimides (or composites using mineral fillers or polyvinylidene fluorides with TEFLON), write us and let us know about the specific application you have in mind.

Write: Du Pont Company, Room 7297N, Wilmington, Del. 19898.



DU PONT
REG. U.S. PAT. OFF.
TEFLON[®]
fluorocarbon resins

SCIENCE/SCOPE

Regulation of U.S. Army air traffic in combat zones or elsewhere will be possible with SAFOC (Semi-automatic Flight Operations Center). An advanced development model of the system was demonstrated by Hughes near Atlantic City, N.J., recently. It will provide a collision-avoidance capability, pinpoint the location of distressed or downed aircraft, identify friendly aircraft, provide ground-to-ground coordination of aircraft movement, and disseminate air-warning information to pilots.

A secure point-to-point communications' link for ship-to-ship, ship-to-shore, and other industrial and military uses has been developed by Hughes. The new communicator uses a gallium arsenide pulsed laser beam as the carrier, transmits and receives either voice or digital information for distances up to six miles, and is virtually free of radio-frequency interference. It weighs only 5½ pounds and draws only 120 milliwatts while transmitting, 24 while receiving.

Better speeds for MOS devices are now possible with ion implantation, a technique perfected by Hughes research scientists after three years of development. The new technique is completely compatible with P-channel MOS processing, which the silicon-gate method is not. The IMOS (ion-implanted MOS) devices successfully fabricated by Hughes include a 64-bit shift register capable of 30 Mhz speeds and a 10-channel multiplexer that's about five times faster than today's best.

The U.S. Navy has responded to the need for improved submarine search and rescue operations by commissioning two giant catamarans which are designed to launch and recover submersible rescue vessels from centerline elevators located between the two hulls. Hughes designed the electronic installation and is installing and checking out the radar, sonar, communications, and navigation units.

Special opportunities for specialists: Hughes would like to hear from Radar Systems Engineers, Signal Processing Systems Analysts, Circuit Designers, High-Power Switching Engineers, and ThinFilm Process Engineers for Hybrid Microcircuitry. Requirements: B.S. degree, two years related experience, U.S. citizenship. Please write: Mr. J.C. Cox, Hughes Aircraft Company, P.O. Box 90515, Los Angeles 90005. Hughes is an equal opportunity employer.

When NASA's Mariners orbit Mars in 1971 scientists will survey approximately 70 percent of the planet's surface, recording significant data on its atmosphere and locating possible landing sites for instrument packages in 1973. Each Mariner will carry a two-channel infrared radiometer built by Santa Barbara Research Center, a Hughes subsidiary. The instruments will "take the temperature" of Mars during the Mariners' 240 orbits. These readings will subsequently be correlated with the photographs of the surface that will also be sent back to earth.

Creating a new world with electronics

HUGHES

HUGHES AIRCRAFT COMPANY



check out

ELECTRO'S New Low Cost

MINI-PROX

**Compact Proximity Sensing System
for Non-contact, Detection and Control
of Ferrous and Nonferrous Metals**

- LOW COST
- ASSURED SENSING DISTANCE ACCURACY
- TEMPERATURE-STABLE
- NO MOVING PARTS IN ELECTRONIC OUTPUT MODEL
- PLUG-IN CONVENIENCE

MANY MONEY SAVING APPLICATIONS

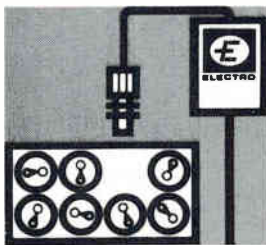

PACKAGING

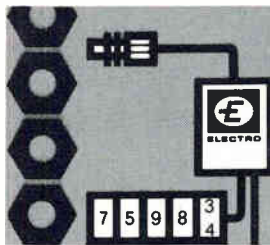

COUNTING

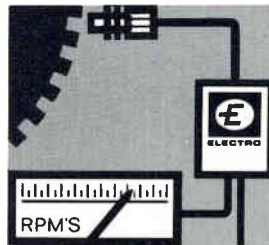

SPEED CONTROL

Conveyor Control • Cut-Off Control • Missing Parts Detection • and many others

Accuracy of sensing distance is often a critical factor in sensing and control applications. Mini-Prox accuracy can be depended upon in any environment; heat to +160°F or cold to -30°F at either probe or control. Line voltage variations from 105 to 130 volts—dust—moisture—vibration, none of these affect its accuracy. You can set it and forget it.

Plug-in design provides for easy wiring. Unitized construction eliminates soldering or wiring of sensitivity controls. Connections for power, sensing head and relays are made to screw-type socket terminals. Operations up to 600 per minute may be controlled or monitored by the Model 55125 illustrated. Electronic output models for higher speeds are also available. Five standard sensing heads are presently available with sensing ranges of .050" to .250", .100" to .500", .300" to 1.000".

ELECTRO with 15 years field experience in proximity switches has designed-in reliability, assuring you of years of trouble-free performance. Compare with others of similar size and price. One look at the quality of construction tells the difference.

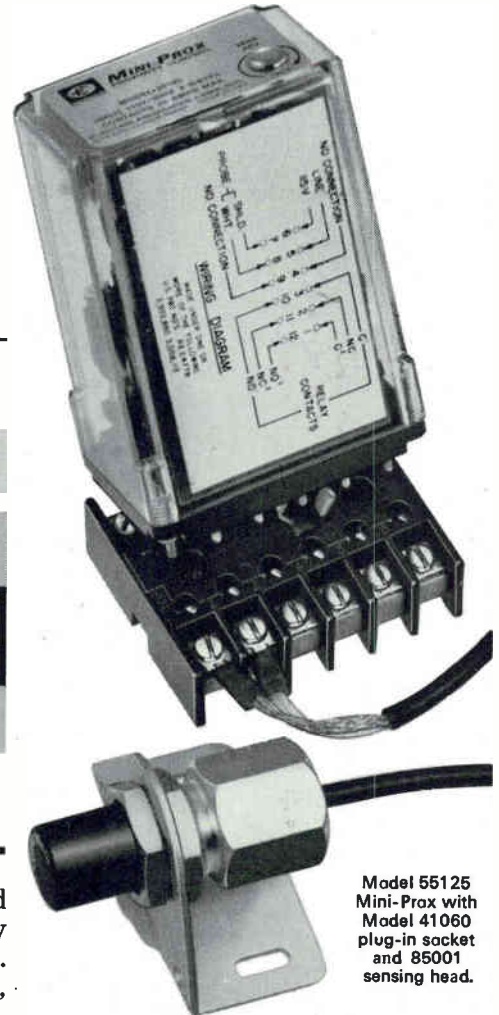

Model 55125
Mini-Prox with
Model 41060
plug-in socket
and 85001
sensing head.

ELECTRO representatives are experienced in assisting with proximity switch applications. Most carry local stocks to service your requirements immediately.

Write for bulletin giving complete specifications and the name of your nearest EPL representative.

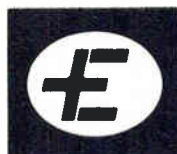

ELECTRO
PROXIMITY SWITCHES

ELECTRO PRODUCTS LABORATORIES, INC.
6125 West Howard St., Chicago, Ill. 60648 • 312/647-8744

CROWBAR...?

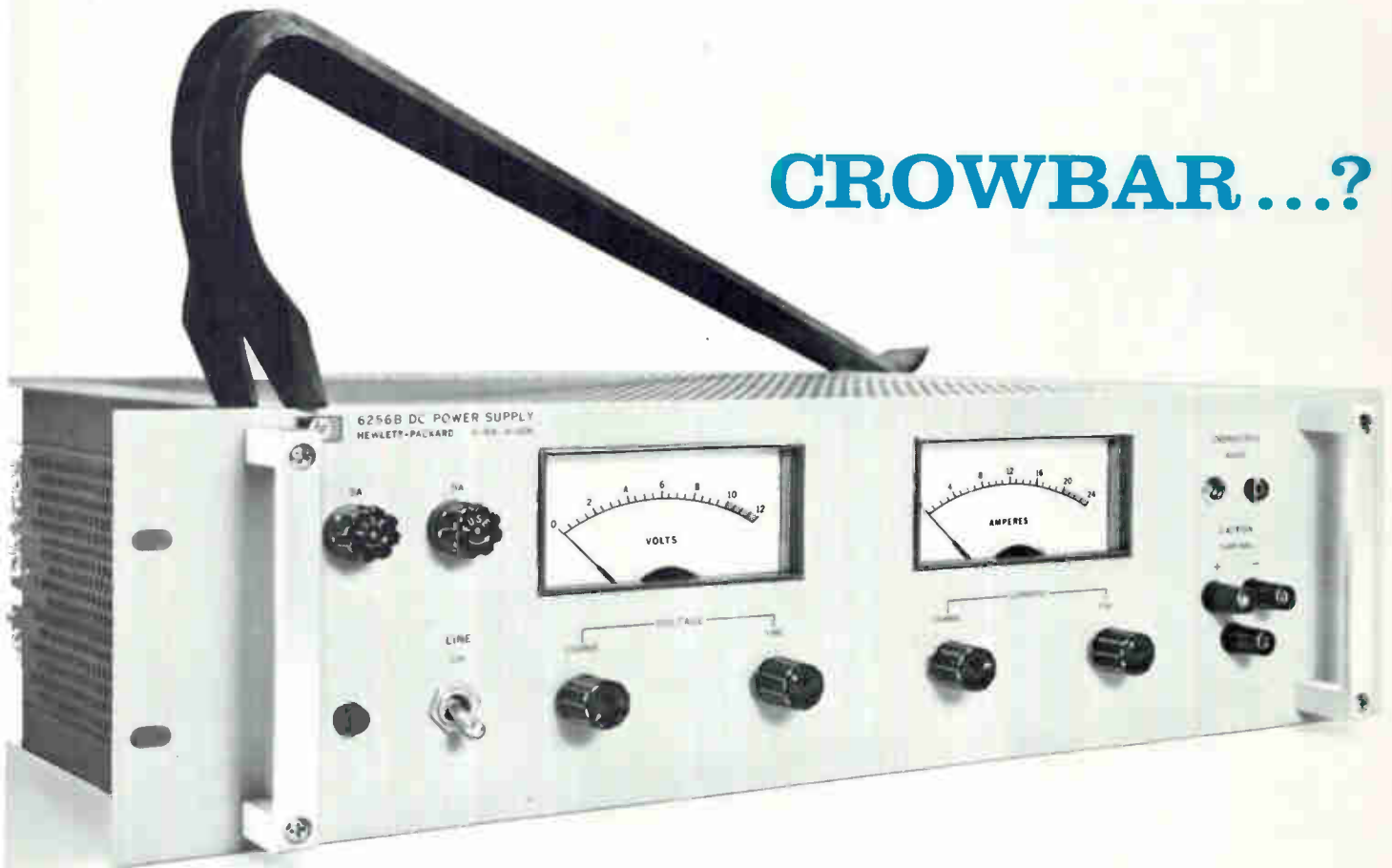

The One Inside is FREE

Not so many years ago, the prudent transmitter engineer discharged a high voltage capacitor bank by dropping a shorting "crowbar" across its terminals. Today's "crowbar" is a protective overvoltage circuit found on DC power supplies — usually at extra cost. Now HP includes a crowbar as standard on its recently updated series of low-voltage rack supplies . . . at no change in price.

Long established as preferred system supplies for component aging, production testing, and special applications, these supplies have now been redesigned and expanded to meet the stringent demands of today's power supply user. Advantages include low ripple (peak-to-peak as well as rms), well-regulated constant voltage/constant current DC with outputs to 60 volts and 100 amps.

Where loads are critical and expensive, the extra pro-

tection — say, against inadvertent knob-twiddling — from a crowbar is invaluable. On all internal crowbars in this series, the trip voltage margin is set by screw-driver at the front-panel.

Pertinent specifications are: triggering margins are settable at 1V plus 7% of operating level; voltage ripple and noise is 200 μ V rms/10mV peak-to-peak (DC to 20 MHz); current ripple is 5 mA rms or less depending on output rating; voltage regulation is 0.01%; resolution, 0.25% or better; remote programming, RFI conformance to MIL-I-6181D.

Prices start from \$350. For complete specifications and prices, contact your local HP Sales Office or write: Hewlett-Packard, New Jersey Division, 100 Locust Avenue, Berkeley Heights, New Jersey 07922 or call (201) 464-1234 . . . In Europe, 1217 Meyrin, Geneva.

HEWLETT  **PACKARD**
POWER SUPPLIES

Additional data sheets available upon request



LAB SERIES
smaller package,
lower power,
optional crowbar

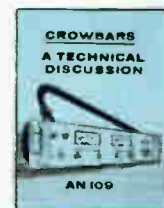

CROWBARS
A Technical
Discussion



**1969 Power
Supply Catalog**
— includes total
HP power supply line.

Circle # for details

326

327

328

329

21002A

We're after your next order

for power transistors.



Pirgo makes planar silicon transistors rated from 2 to 90 amps. The resemblance to other companies in the field stops there.

Because we want your next order, Pirgo, an affiliate of Sprague Electric Company, makes all products just a little better than we have to. One out of every six employees works in quality control or reliability assurance. We purposely keep our design and manufacturing standards high, but our pricing results in important savings on your power transistor purchases.

Pirgo provides engineering assistance. Application engineers will work with you on your specific problems. What's more, they're flexible. They will make changes or custom-tailor an entirely new product to meet special requirements.

Send for our new catalog. Or call your local Sprague Electric sales engineer. Let us show you just how much we want your next order... and every one after that.

Pirgo products are available from authorized Sprague semiconductor distributors.



PIRGO  **ELECTRONICS INC.**
A SPRAGUE ELECTRIC COMPANY AFFILIATE

**130 CENTRAL AVENUE
FARMINGDALE, NEW YORK 11735
Tel: 516-694-9880 • TLX: 96-1498**

**pouf....THAT'S ALL IT TAKES
TO ACTUATE THIS
NEW SWITCH.**



skeptical? TRY IT.

(we'll send you a free sample)



Just a gentle whisper of force ($1\frac{1}{4}$ grams) actuates this new Cherry E22 miniature switch. As easy as blowing fluff off a dandelion. It's so sensitive, we had to make the actuator of aluminum (to permit re-setting of the switch). Dependability? This 3 amp., 125 VAC switch features Cherry's exclusive long-life coil-spring mechanism that insures positive snap action...proven in over 100 million product applications.

But, see for yourself. Send for a free sample and complete specifications.

CHERRY 

Cherry Electrical Products Corporation • 1656 Old Deerfield Road • Highland Park, Illinois 60035

Circle 129 on reader service card

BUSS QUALITY

SMALL DIMENSION

FUSES and FUSEHOLDERS

FOR THE PROTECTION OF ALL TYPES OF
ELECTRONIC & ELECTRICAL CIRCUITS & DEVICES

The complete BUSS line of fuses includes dual-element "slow-blowing," single-element "quick-acting" and signal or visual indicating types . . . in sizes from 1/500 amp. up—plus a companion line of fuse clips, blocks and holders.



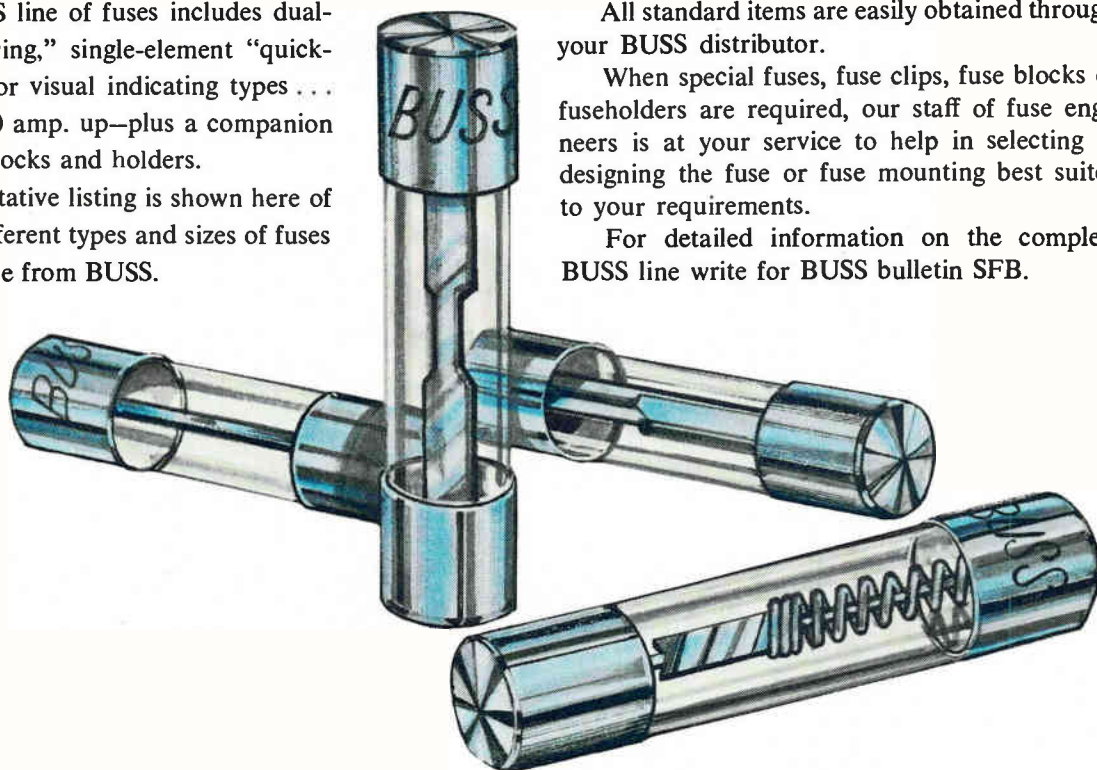





























Only a representative listing is shown here of the thousands of different types and sizes of fuses and holders available from BUSS.



All standard items are easily obtained through your BUSS distributor.

When special fuses, fuse clips, fuse blocks or fuseholders are required, our staff of fuse engineers is at your service to help in selecting or designing the fuse or fuse mounting best suited to your requirements.

For detailed information on the complete BUSS line write for BUSS bulletin SFB.

 Buss AGX Fast Acting Fuses	 Buss AGC and MTH Glass Tube Fuses	 Fusetron FNM Fibre Tube Fuses	 Fusetron FNA Indicating Fuses	 Buss In-the-Line or Panel Mounted Fuse/Holder	 Buss Panel Mounted Holders	 Buss Screw or Solder Terminal Fuse Blocks	 Buss Porcelain Base Fuse Blocks
 Buss AGC Glass Tube Fuses	 Buss Indicating Fuses	 Buss Sub-miniature Fuses and Holders	 Tron Sub-miniature Pigtail Fuses	 Buss HPC Holders	 Buss Lamp Indicating Holders	 Buss Silicon Rectifier Fuse Blocks	 Buss Indicating Aircraft Fuses
 Fusetron MDL Fuses	 Buss ABC Ceramic Tube Fuses	 Buss GMT Fuse and HLT Holder	 Buss High Voltage Fuses	 Buss Space Saver Holders	 Buss Shielded Holders	 Fusetron ACK Stud Mounted Fuses	 Limitron KTK High Interrupting Capacity Fuses
 Buss GJV Pigtail Fuses	 Buss SFE Standard Fuses	 Fusetron Type N Fuses and Holders	 Buss In-the-Line Holders	 Buss HLD Visual Indicating Holders	 Buss Signal Fuse Blocks	 Tron Rectifier Fuses	 Buss Miniature Glass Tube Fuses

BUSSMANN MFG. DIVISION, McGraw-Edison Co., ST. LOUIS, MO. 63107

We just got a good idea. We put metal shells on our Micro/Con D series rack-and-panel connectors. They're for when you put a connector in one of those unprotected places and it gets banged around a lot.

One side is stainless steel. One side is die-cast aluminum. And the big thing is, it's the first metal shell connector that will mate with any existing version. Interchangeable. Intermountable. You can use them with old and new equipment alike.

Our new shell comes in all the standard pin

sizes (9, 15, 21, 25, 31, 37, 51) and we've even got them on our flat cable connectors. If this excites you at all, maybe you'll enter our contest. Think of a new name for our new metal shell connectors, send it to us, and you'll have a chance at winning a case of scotch. And even if you don't win, we'll send you a genuine certificate recognizing your dumb idea.

Microdot Inc., 220 Pasadena Avenue, South Pasadena, California 91030.

MICRODOT INC. 

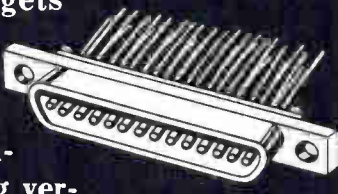

The new shell game.

FIRST FULLY DECODED 64-BIT BIPOLAR LSI

A winner for
scratch pad
memories

i-3101

- Fast 60 nsec access
- Low power dissipation (6 mW per bit)
- DTL and TTL compatible
- OR-Tie capability

Guaranteed switching speeds

Test parameter	Speed	Conditions
Read cycle (chip select and/ or address to output delay)	60 nsec max	2.5v pulse in. 5 ns rise & fall from 1v to 2v
Write recovery time	45 nsec max	$V_{cc}=5.0v$ $T_a=25^\circ C$

Guaranteed DC characteristics

Test parameter	Limit at 0°, 25° & 85° C	Conditions ($V_{cc}=$ $5.0v \pm 5%$)
Input load current	-1.6 ma max	$V_{in}=0.45v$
Input leakage current	40 μa max	$V_{in}=5.25v$
Input clamp voltage	-1.0 v max	$I_c=5.0 ma$
Output "low" voltage	0.45 v max	$V_w=V_s=0 v$
Output leakage current	100 μa max	$V_{ex}=5.25 v$
Power supply current	105 ma max	$V_s=2.5 v$ $V_a=V_i=V_d=$ $0 v$
Input "high" voltage	2.0 v max	
Input "low" voltage	0.85 v min	

Prices

1 to 9 units: \$99.50	100 to 249 units: \$43.00
10 to 24 units: \$73.50	250 or more units: \$38.50
25 to 99 units: \$53.00	

Available at over 40 locations

throughout the U.S. and Canada. For delivery, call your Intel distributor, Cramer Electronics or Hamilton Electro Sales.

If more convenient, write or phone us directly. Call collect (415) 961-8080.

Intel Corporation is at 365 Middlefield Rd., Mountain View, Calif. 94040. Telex INTEL 34-8366.

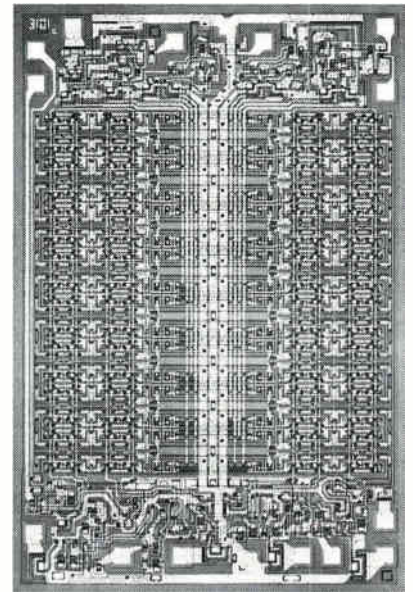

intel

**Meet Datapoint.
It's 20 times faster
than other multipoint recorders.
And infinitely more versatile.**

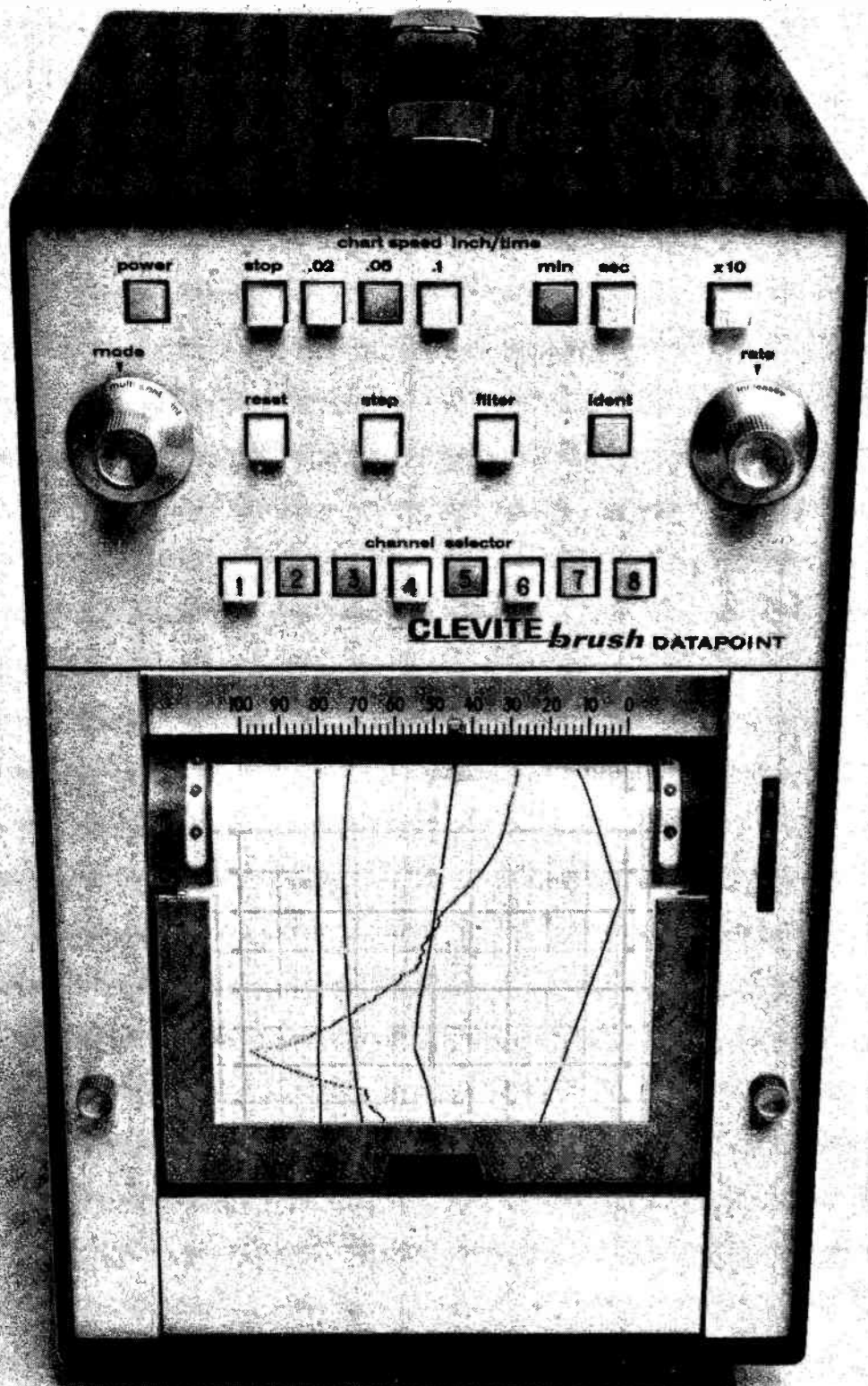

This new high-speed multipoint recorder by Brush runs off as many as 20 samples per second on 2 to 8 patients. So it's great for monitoring fast-changing variables in systemic and wound temperature, heart rate, ECG and the like.



Datapoint handles mixed inputs from high and low level inputs. All on one chart. Recordings come out clear, crisp, uncluttered. And Z-folded. You've got a choice of 12 chart speeds, pushbutton controlled.

About that versatility. Datapoint works in three modes: multipoint sampling, intensified sampling, for channels of high dynamic content, or continuous single channel recording. So you get much more than just a fast multipoint recorder. Without paying more to get it.

And Datapoint is accurate, too. A full 99.5%, enforced by a non-contact position-feedback system. It's a first in this type of recorder. (But a proven success in countless Brush direct writing oscillographs.)

Speed. Versatility. Accuracy. These make Datapoint a new concept in recording. There's never been anything like it. You'll find more proof in the Datapoint brochure. Send for your copy today. Brush Instruments Division, Gould, Inc., 3631 Perkins Avenue, Cleveland, Ohio 44114.

GOULD BRUSH

Meet decision makers in medical electronics

Physicians, hospital administrators, biomedical engineers, educators, researchers, system design engineers who attend the 2nd National Conference & Exposition on Electronics in Medicine represent real buying power. We know because we asked the attendees at the first conference last spring how much they spent on medical electronics and their responses added up to a whopping \$36 million—about ten per cent of the 1968 market.

buying and specifying influence What's more, the second conference has been designed to meet the overwhelming demands of the earlier attendees for direct exposure to actual hardware. We're inviting manufacturers of medical electronics gear to take advantage of this unprecedented opportunity by exhibiting at the exciting 2nd National Conference on Electronics in Medicine in San Francisco. Through a carefully crafted program of invited papers by leaders in the field, and discussion group sessions on vital questions, the Conference will attract the people manufacturers want to meet most—the men who make the buying and specifying decisions in a \$400 million market. The 2nd National Conference & Exposition on Electronics in Medicine is presented by McGraw-Hill's Electronics/Management Center in association with the McGraw-Hill publications: Electronics/Medical World News/Modern Hospital/Postgraduate Medicine/Scientific Research. It is managed by National Expositions Co., Inc., the highly regarded exposition management firm based in New York.

prestige sponsorship Full page ads, dynamic editorial coverage and a comprehensive mail campaign will find every buying and specifying influence in medical electronics wherever he works—hospital, research laboratory, consultant's office, university, clinic or private practice. He'll be reached repeatedly and effectively with our message. And that message is—the Second National Conference and Exposition on Electronics in Medicine is the place to discuss his urgent requirements first-hand with you—the people with expertise who can fill them.

aggressive promotion The Second National Conference and Exposition on Electronics in Medicine can help you find and sell new customers, create impressive lists of new, valuable contacts and achieve significant penetration in this exploding market. Space is limited, so make your reservation now.

opportunities for marketers

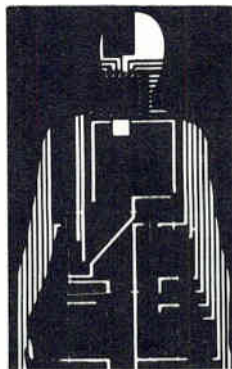

2nd National Conference & Exposition on Electronics in Medicine

FAIRMONT HOTEL, SAN FRANCISCO, CALIF. • FEBRUARY 12, 13, 14, 1970

**Write or call for brochure, floor plan: Jerry Brown, Exhibit Manager, National Expositions Company, Inc.
14 West 40th St., New York, N.Y. 10018, 212/564-8714**



product report
dual-beam

A NEW Dual-Beam Oscilloscope

The Viewing Area

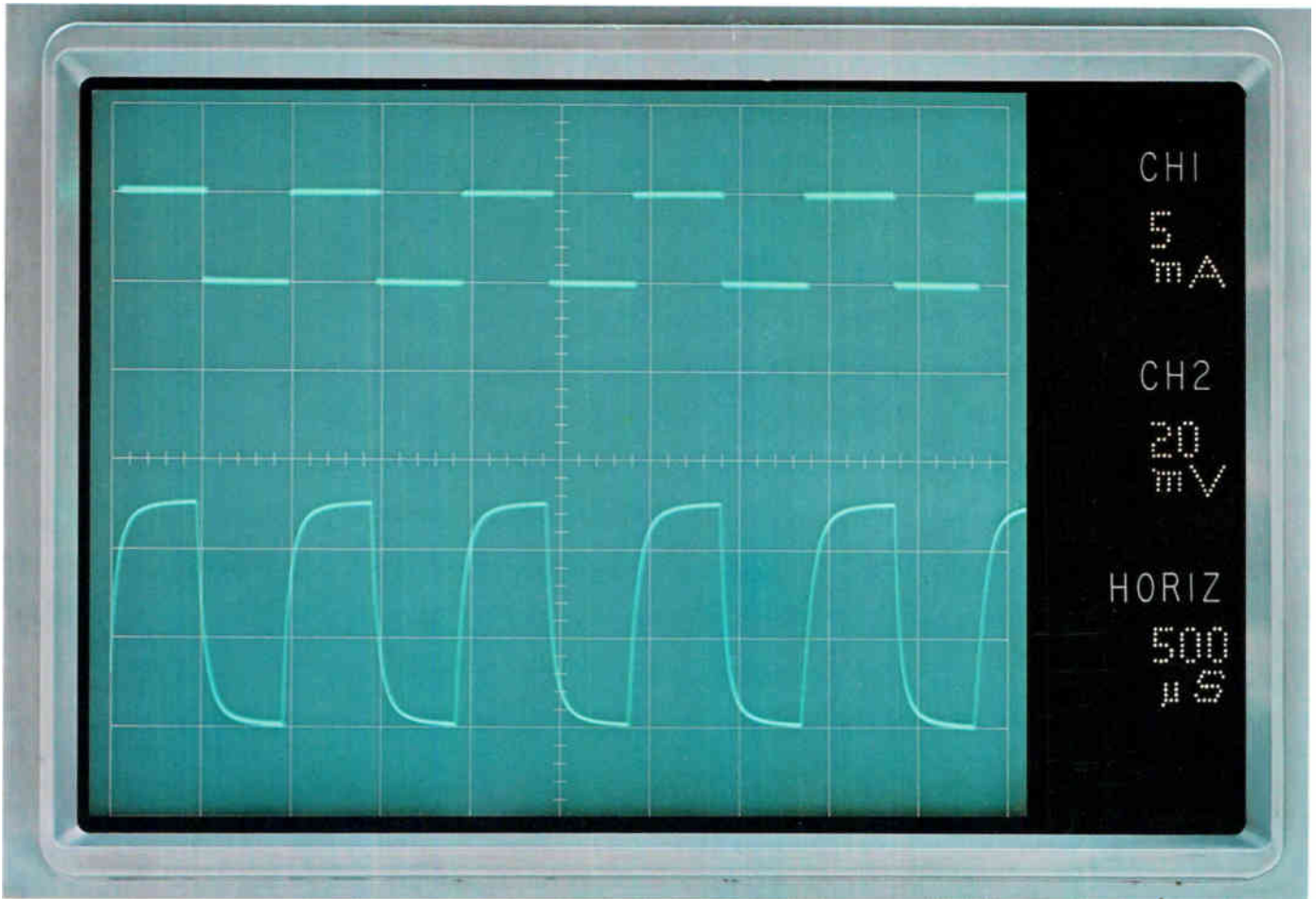

CH1
5
mA

CH2
20
mV

HORIZ
500
μS

ACTUAL SIZE

Put a 6-1/2" CRT in your 5-1/4" rack . . .

. . . or on your bench!

With the Type R5030, all the data required to make your measurement is where you need it . . . in the viewing area.

Scale-factors are read out immediately to the right of the 8 x 10 div CRT. Scaled in divisions equal to 1.27 cm, the CRT provides 50% more viewing area than a standard 8 x 10 cm CRT. Each beam has a full 8 x 10 div scan, separate intensity control and push-button beamfinder.



please turn page for additional information →

TEKTRONIX PRODUCT REPORT — DUAL-BEAM OSCILLOSCOPE

The Control Panel

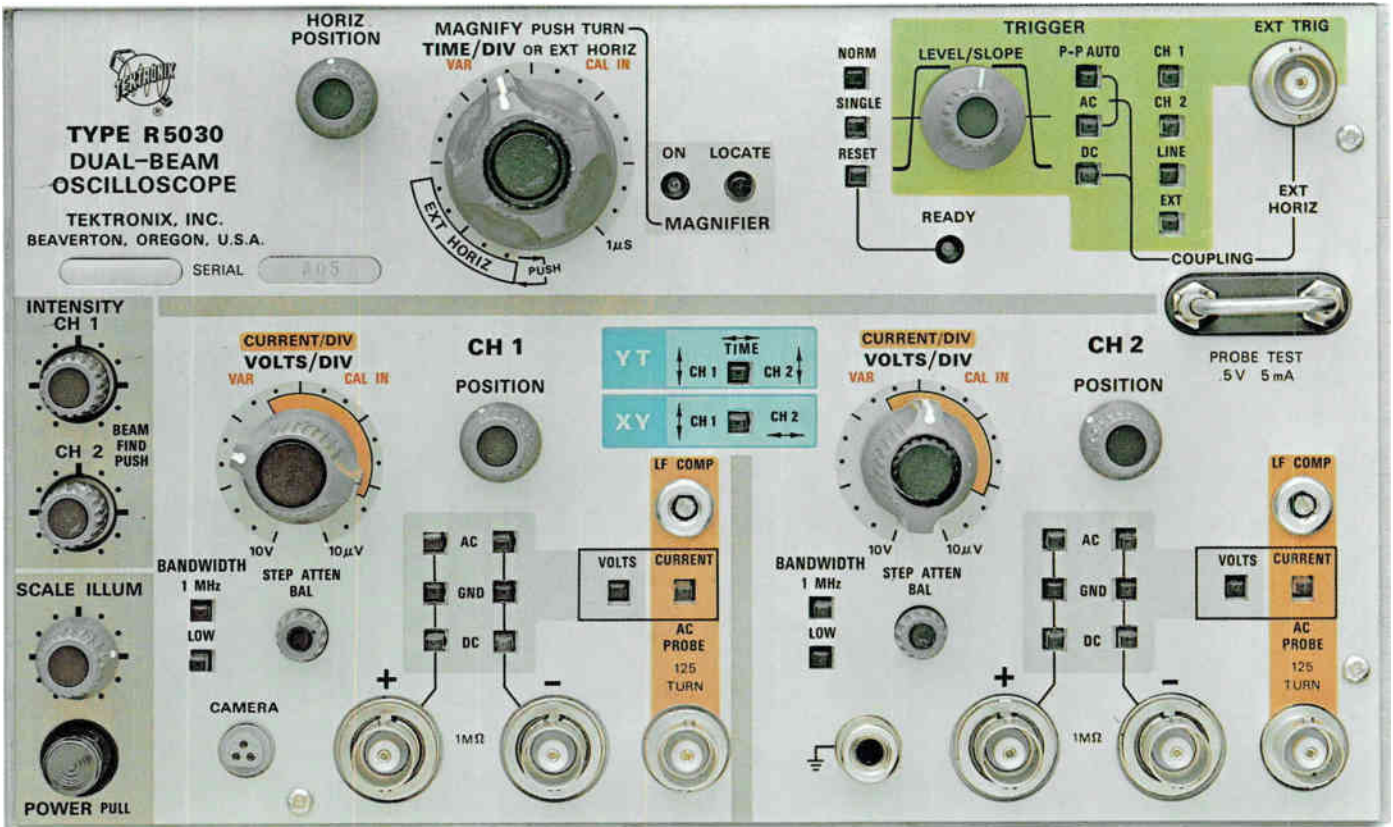

easy to use

The complementary color scheme of the control panel of the Type R5030 aids the user in readily distinguishing various control functions.

Current probe inputs for each beam with deflection factors from 1 mA to 200 mA/div are outlined in a salmon color. The bandwidth of the current inputs is from 10 Hz to 1 MHz.

Differential or single-ended voltage inputs are provided with 19 calibrated deflection factors from 10 μ V to 10 V/div. The scale-factor read-outs are corrected automatically when an attenuation probe is attached to the input. Bandwidth is DC to 1 MHz at all deflection factors. However, bandwidth may be limited to \approx 5 kHz to eliminate wide-band noise.

A greatly simplified trigger circuit is outlined in green. With the addition of a peak-to-peak auto mode and a combined level/slope control, the operator will find it difficult, if not impossible, to obtain a nontriggerable condition.

Mode switching has been set aside in a blue panel area where switching from a dual beam Y vs T display to an X vs Y display is as simple as pressing a button.

Rackmount, order Type R5030	\$1850
Low-Profile Cabinet, order Type R5030, Option 4	\$1850

U.S. Sales Prices, FOB Beaverton, Oregon

For a demonstration, call your local Tektronix Field Engineer or write:
Tektronix, Inc., P.O. Box 500, Beaverton, Oregon 97005



Tektronix, Inc.

committed to progress in waveform measurement

Jumble of electronics, instruments keeps air pollution monitoring hazy

With the Federal Government setting up a nationwide program to keep tabs on pollutants, what's needed, most experts agree, is an advancement in sensor instrument technology—perhaps even a 'universal sensor'

By Lois Vermillion

Electronics staff

How goes the war against air pollution? Badly. Lacking any single means of effectively monitoring—much less combating—air pollutants, man has been forced to use a potpourri of instrumental systems, all different, all designed to monitor different pollutants. Adding to the problem is an infant Federal coordinating agency which lacks enforcement powers, and the general pinch on funds at the Federal, state, and local levels.

Electronics will play its biggest role in air quality monitoring at the local level. In order to gather data for a national monitoring network to provide a cross-country profile of the 142 million tons of toxic matter pumped in to the air each year, some large cities already have or are installing sophisticated solid state monitoring systems, among them New York (Packard-Bell), Los Angeles (Litton Systems), and Pittsburgh (TRW Inc.).

Other areas which will be setting up monitoring systems are St. Louis, the State of Pennsylvania, Philadelphia, Denver, Phoenix, the Puget Sound area (Seattle), New York State, and Dade County, Fla. (Miami). Faced with an unbalanced budget and tight appropriations, Pennsylvania's Auditor General, Robert Casey, is reluctant to sign any contracts, despite the fact that Pennsylvania's air quality standards can't be enforced without an air monitoring system, says Victor Aussman, director of the State Health Department's Division of

Air Pollution Control.

The Allegheny County (Pittsburgh) System, managed by Resources Research Inc., environmental engineering arm of TRW Civil Systems Group, and actually installed by Automated Environmental Systems Inc., is scheduled for completion in March at a total cost of \$300,000, including \$197,000 for sensor hardware, an IBM 1800 computer, and an undetermined outlay for software. Most troublesome pollutant here is hydrogen sulfide produced at steel plants.

In Los Angeles, where ozone is the biggest problem, Litton is installing a \$325,000 computer and telemetry system which can handle up to 32 air sampling stations, and up to 16 sensors at each station. This system is scheduled for completion in March—until then county district personnel will continue to phone in instrument readings to the central control station every half-hour.

Getting it together

The prime mover in the effort to establish a national air pollution monitoring network was passage in 1967 of the Clean Air Act. Among other things, it established within the Department of Health, Education and Welfare the National Air Pollution Control Administration (NAPCA), which is exploring new applications of electronics technology to provide reliable systems to detect and measure air pollution and its effects.

Characteristic of many Congressional actions, however, Napca was given broad responsibilities but relatively little authority. Though its only enforcement power consists of controlling pollution generated by automotive products, it can set standards which state and local governments must use as an enforcement guide. But Napca's charter also requires it to keep track of local government efforts to prevent, abate, and control community pollution problems. Thus it becomes as much a source of technological and marketing intelligence for an interested electronics industry as well as a customer on its own.

Napca's computerized national air sampling network seeks to combine data reported from regional air sampling stations. These now are run by state governments, which are responsible for establishing local monitoring systems. Napca emphasizes the national network is a regional concept—the Federal Government won't assume a local responsibility, but will set national standards for pollution levels.

Each air quality region designated by Napca will have to buy its own computers, sensors, and telemetry systems. There are now 15 air pollution control regions in the most polluted urban areas. There will be 57 by the end of 1970, and eventually there will be 100.

Not all roses. The meat of an air pollution monitoring system is the sensors, and with pricetags of any-

Measuring up

Effective air pollution control depends not only on legislation, enforcement, and funds, but also on the many technological ramifications of the environment, types of pollutants, and the effects of pollution. Different instrumentation may be needed for measuring moving sources, stationary sources, ambient air, atmospheric transport and transformation, and effects on different kinds of receptors. Here is a summary of measurement techniques.

Particulate matter

Measurement	Technique	Development
Mass loading	Real time	Piezoelectric (change in frequency as function of mass on crystal); Lidar (Light detection and ranging)
Size distribution	Optical, electrical, chemical	Laser backscatter, electrical particle counter
Chemical composition	Sampling, electron probe, atomic absorption	Submicron classification

Gaseous matter

SO ₂ , CO, NO, NO ₂ , O ₃ , etc.	Spectroscopy, wet chemistry, gas chromatography	Correlation spectra, electrochemical, microwave, Raman spectroscopy
Sampling representation	Long path, point source	_____
Noise background	Interference equivalence	_____

Receptors—exposure and effects

Humans and animals	Integrated exposure	Dosimetry, real-time integrator
Visibility	Light scatter	Nephelometer (volume scatter)
	Transmission	Transmissionometer, Lidar
Odor	_____	_____
Material degradation (i.e. corrosion)	Soiling, erosion	Optical lightscatter

Transport and transformation

Dispersion and diffusion	Gas and aerosol tracers	Lidar, also methods as for gases and aerosols
Transformation	Gas tracers	As above
Atmospheric stability	Vertical temperature profile	Millimeter-wave radiometry
Three-dimensional wind field	Real-time particle air velocity	Two-doppler radars
Boundary-layer winds and turbulences	Vertical profile	_____

where from \$200 to \$6,000 or more, a complete system includes sensors for all possible pollutants in an area, plus those for assessing meteorological factors including humidity, wind direction and speed, temperature, solar radiation, and smokescreen—the amount of interference with sunlight.

Is a system of individual sensors for each parameter the best way to measure air pollutants? No, says Bob Ryder, a Packard-Bell engineer who was instrumental in setting up the monitoring system in New York City. "Basic sensors are lagging in development. The instruments are the weak link" in the monitoring system, he says, and "the hardware technology is just not as developed as the data processing state of the art." What should be developed, Ryder suggests, is a more general-purpose sensor—striving toward a "universal instrument"—to bring sensors into line with computer technology.

A "universal sensor" probably could be developed through an advanced mass spectrometer or gas chromatograph, says Ryder, to cover the whole range of pollutants. The hangup—there's no money to support the basic study work, he says. Perhaps the answer would be a Federal "thou-shalt-not-pollute-the-air" law, with probable research and development funds accompanying the enforcing legislation.

At least some development of a "universal" pollution analyzer is progressing. For example, Alan Bessen, formerly of the Ford Instrument division of the Sperry Rand Corp., has been working on a prototype pollution detector that uses an optical interferometer and identifies several contaminants through logic and parallel active filters that enable it to distinguish among pollutants with similar spectra [*Electronics*, Nov. 11, 1968, p. 112].

But at TRW's Resources Research Inc., Frederic Hamburg, senior project engineer for the Allegheny County system, says a universal sensor is not "on the near horizon." He suggests that a combination of sensing instruments, with successive screening devices for each contaminant, could be developed, perhaps with "some sort of an infrared technique." What this would

125°C HOT

Nobody can make a 125°C capacitor this small with Polystyrene.



ACTUAL SIZE

Naturally, this one is a Kemet® Flat-Kap with Parylene.

And small size isn't the only important advantage you can design into circuits that absolutely require close tolerances, repeatable temperature coefficients, and rigid capacitance stability. Union Carbide's Parylene not only retains the low dissipation factor and high insulation resistance of

Polystyrene, but it has a melting point above 400°C, is impervious to solvents up to 200°C, and can be deposited on high purity aluminum foil as an ultra-thin, continuous, pinhole-free film. The advantages to you are clearly shown in the following comparison of specifications.

	KEMET FLAT-KAP	POLYSTYRENE
Temperature	-55°C to +125°C	-55°C to +85°C
Volume (.1µF 50VDC)	.072 in ³	.280 in ³
Temperature Coefficient	-200PPM	-120PPM
Dissipation Factor	<.15%	<.10%
Insulation Resistance	10 ⁶ Meg.	10 ⁶ Meg.
	10 ⁵ Meg.	10 ⁵ Meg.
	10 ⁴ Meg.	N/A
Dielectric Absorption	.03%	.02%
	.06%	.08%
	.20%	N/A
Retrace and Drift	±0.1%	±0.1%
Solvent Resistance	Excellent	Poor

Available off-the-shelf. Capacitance ranges from .001 µF to 1.0 µF at 50 VDC. Standard or custom tolerances. For complete information, see your local Union Carbide representative, or write to P.O. Box 5928, Greenville, S. C. 29606.

**COMPONENTS DEPARTMENT
MATERIALS SYSTEMS DIVISION**



P.O. Box 5928, Greenville, South Carolina, 29606 • Tel: (803) 953-7421 • Telex: 910 003 0221

WHAT?

Still chopping light with a wheel?

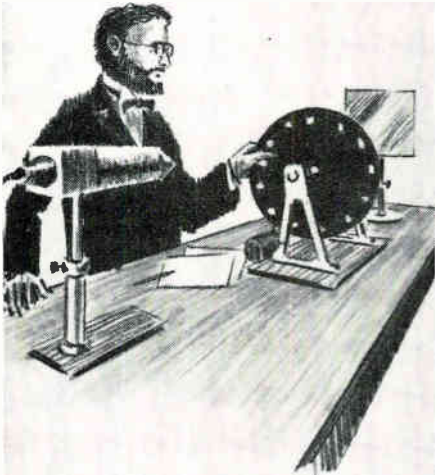

Hey Mister, get a FORK!



Many engineers already use Bulova/American Time Products tuning forks to chop light and similar energy beams. Those who are not are a bit behind the times, and should know the fork's tremendous advantages over motor-driven light choppers —

- No wearing parts / No lubrication needed
- Low power requirements / Much longer life
- More efficient light handling / Smaller and lighter

How is all this achieved? By attaching to a fork's tines a pair of vanes — slotted, notched, or pierced, to suit the need. Then the vibrating fork chops light or similar energy beams to produce optical effects never before achieved. What's more, it's all done in a very, very small package. For example, a 2 cubic inch package can chop 1,000 times per second!

Another variation is a scanner that uses a torsional fork scanning at a uniform repeat rate. A mirror or other optical device can be attached to vibrate the device torsionally.

Whatever your application, from burglar alarms to infrared spectrophotometers, if you've got some light to chop or scan, call American Time Products 212-335-6000, see EEM Section 3800, or write —



BULOVA
AMERICAN
TIME PRODUCTS

Electronics Division of Bulova Watch Co., Inc.
61-20 Woodside Ave., Woodside, N. Y. 11377
(212) 335-6000

Go Bulova, and leave the designing to us!

Smog politics

On Capitol Hill, where expert testimony has predicted continued air pollution causing anything from alternate flood and drought seasons to another Ice Age, an environmental quality bill was "legislated from a lack of knowledge and a lack of understanding" of environmental problems facing society, says Leon Billings, legislative aide for Sen. Edmund Muskie's subcommittee on air and water pollution. The legislation isn't action-oriented—it won't provide any R&D funds—but only sets procedure for coordination of programs in the Executive Office of the President.

One of the jobs to be given to the proposed Commission on Environmental Quality, to function something like the Office of Science and Technology, is preconsidering environmental effects of Federal activities, especially in military programs. Will this impede technology? Billings says "Where technology is not compatible with the human environment, it should be impeded. Is the SST or ABM an example of the growth of technology?"

Billings says no existing Federal agency can handle a crash program on cleaning up the air, and if funds are appropriated to do it, a new NASA-type agency would have to be created. He thinks \$100 billion should be spent over the next 10-15 years, and "that's not a final offer."

Government spending is not likely to approach anything near Billings' \$100 billion figure, though, as Napca's total spending estimates for the next five years average about \$255 million a year. In fiscal 1969, Napca's budget was \$122.9 million, with \$47 million for R&D and \$75.9 million for abatement and control. For fiscal 1970, Napca wants \$79 million for R&D, but Senate-House conferees still are arguing about what they will get. The House authorized a meager \$18 million, while the Senate wanted \$90 million. By 1974 Napca expects its budget to increase to an estimated \$455 million, with \$174 million for R&D.

Local expenditures don't add much to the total spent by the Federal government on air pollution control. State expenditures, including Federal grant support, are running about \$17.6 million a year, Napca says, with the 142 local agencies spending about \$30 million annually.

Adding all government spending to an EIA estimate of \$700-\$800 million spent each year by all industry, expenditures, come no where near the damage caused by air pollution. EIA says costs of air pollution run about \$11 billion a year. These generally are attributable to decreased property values, damage to crops and plants, and damage to structures and materials.

amount to, he says, is merely a "universal box" containing the various individual sensing techniques, but registering data collectively. Until then, in a telemetry system each sensor must be amplified to the same level of output, somewhere between 0-500 millivolts. A sensor's analog signal also must be digitized—most are not equipped with digitizing equipment—and then, actual transmission of the signals over telephone line, hard wire, microwave, or f-m radio, to the regional central data unit would be relatively simple, says Hamburg.

Most industry and government experts agree on the need for advanced sensor instrumentation. "Instrument manufacturers haven't done the kind of research and development the field needs," and "just haven't been willing to bear the cost of developing the instruments," complains Robert L.

Chass, Los Angeles County's chief deputy air pollution control officer. Instrument problems, he says, include lack of standardization, low delivery, calibration and adjustment difficulties, and overpricing. The latter is the most important factor for the cities, which can pay the R&D costs the Federal Government can. Chass says time have changed since 1950, when "w paid through the nose and subsidized the development of instrumentation. Now, when a manufacturer wants us to pay \$50,000 for a \$5,000 instrument, we tell them forget it."

One dissenter from the advanced-sensor movement is Victor Bellino, New York City air pollution control engineer. "There's kinds of talk about advanced instrumentation to detect and measure pollution," he asserts, "but you really don't need anything more

There's a big difference in P-Channel JFETs

2N3330	2N4360	2N5462	2N5476
2N3909	2N5265	2N5463	MFE4007
2N3909A	2N5266	2N5464	MFE4008
2N3993	2N5267	2N5465	MFE4009
2N3993A	2N5668	2N5471	MFE4010
2N3994	2N5669	2N5472	MFE4011
2N3994A	2N5270	2N5473	MFE4012
2N4342	2N5460	2N5474	MPF161
2N4343	2N5461	2N5475	

Motorola's 35 types are available NOW

Whether your requirements involve a familiar, established design or you are exploring new applications, Motorola's 35 standard P-JFET amplifiers offer the broad selection of metal can and Unibloc* plastic types to do the job. Deliveries? You'll get what you order when its promised . . . from the "Production House of the Industry."

Here is the kind of variety we're talking about when we say broad selection. Y_{fs} minimums range from 60 to 2500 μ mhos and maximums go from 180 to 8,000 μ mhos @ 1.0 kHz. I_{DSS} (min) is as low as 0.02 mA and as high as 7.0 mA. Gate-source breakdown voltages of 20 V, 40 V, and 60 V are available. Prices start at .37¢ and top out at \$5.85 in 1K-up quantities and nearly half are under \$2.00.

A combined FET cross reference and selector guide is available to tell Motorola's complete FET capability story, with full information on P-Channel JFETs included. Write to Motorola Semiconductor Products Inc., P. O. Box 20912, Phoenix, Arizona 85036, or to place an order contact your Motorola distributor or sales office.

-where the priceless ingredient is care!

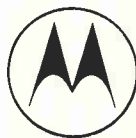

MOTOROLA
Field Effect Transistors

CTS HYBRID MICRO- CIRCUITS PICK 'EM OFF-THE- SHELF

TRY US!

850/851 Relay Drivers

A single 700ma or dual 350ma driver in a compact TO-8 package can be driven directly or with TTL or DTL inputs. Prices: 1 to 9—\$15.00 ea; 100—\$11.50 ea.



873 ± 15 V Voltage Regulator

Independent +15V and -15V regulators in a TO-8 package. Offers better than .03% line regulation and .05% load regulation. Externally adjustable from 8V to 36V. Price: 1 to 9—\$32.00 ea.; 100—\$20.85 ea.



870 5 Volt Regulator

Offers .05% line and load regulation and built in short circuit protection. TO-3 package provides safe and rugged high power operation. Prices: 1 to 9—\$27.25 ea; 100—\$17.70 ea.



861 Log I.F. Amplifier

Used in cascade, the 861 Series provides a log video output. It features internal supply decoupling, built in video detector and allows direct rf coupling between stages. Prices: 1 to 9—\$36.00 ea; 100—\$26.50 ea.



878/879 Voltage Regulator

A 2 ampere regulator in a TO-3 package which is externally adjustable from 8V to 57V. Prices: 1 to 9—\$20.00 ea; 100—\$13.00 ea.



862 Operational Amplifier

Operates from ± 6 V to ± 28 V supply and will drive 50 ohm load. TO-5 package. Prices: 1 to 9—\$22.80 ea; 100—\$14.80 ea.



Pick your standard CTS microcircuits off-the-shelf. All available for fast, 48-hour delivery from stock and all produced under the same stringent processes as CTS custom hybrid circuits. These precision packages are hermetically sealed and operate over -55°C to $+125^{\circ}\text{C}$ full military temperature range.

Try CTS total hybrid circuits capability for *all* your requirements. Complete in-house facilities assure you get the package you need to meet your exact requirements. Ask for our Hybrid Microcircuits Brochure. CTS Microelectronics, Inc., West Lafayette, Indiana 47906. Phone: (317) 463-2565.

CTS CORPORATION
Elkhart, Indiana



CTS... HYBRID MICROCIRCUITS TOTAL CAPABILITY

Standards... or custom hybrid thick film microcircuits, CTS has the total in-house capability to meet your specific circuit needs.

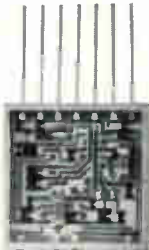

Exclusive CTS Cermet Resistive Material assures

greater stability under all conditions—provides excellent TC at high sheet resistance.

Wide Choice of Active Devices:

Chip and wire; flip chip; LID attachment; beam lead; welded or soldered planar construction and hole through.

T05—T08—T03—Flat packs up to 1½" square. All hermetically sealed. Plastic and ceramic packages available in a variety of form factors.

Passive Circuits available, too.

If one of our standard circuits won't fit your needs, we'll design and manufacture the economical package that will. Try us! Get standard circuit specs, reliability data, and free Total Capability Brochure. CTS Microelectronics, Inc., West Lafayette, Indiana 47906. Phone: (317) 463-2565.



CTS CORPORATION
Elkhart, Indiana

than what we've got right now. It's like killing a mosquito with a baseball bat."

Status quo. No matter what the criticisms, until some money is made available for development of advanced sensors, or until someone stumbles on a simpler and cheaper way to measure pollutants, monitoring systems will make do with today's technology jumble—a specific measuring technique for each polluting factor.

The lineup

Some of the common analysis methods are:

- **Soiling tape samplers**, which measure the soiling effects of particulates in the air, or haze, by means of a photosensitive "electric eye" that optically reads the amount of light registered on a white tape, across which air is sucked. Unit of measurement is a rud, for reflectance units of dirt. Tape samplers vary in price with complexity. Examples are Gelman Instruments' paper tape densitometer and phototape sampler-recorder. The densitometer costs about \$185, and measures dust and hydrogen sulfide by photoelectric evaluation of light transmission. Calibration is in optical density and percentage light transmission units. The more advanced phototape sampler, with added recorder providing 30-day permanent records, brings the price to \$985. The phototape sampler-recorder reads dust as it collects on the tape, eliminating errors due to variations in paper tape opacity, Gelman says. The optional alarm, which warns if contamination exceeds normal operating levels, would bring it up to \$1,175.

- **Coulometry.** Measures sulfur dioxide by combination with bromine which generates a current equal to the rate of sulfur dioxide absorption. The bromine current is controlled by a feedback amplifying system. N. V. Philips' Gloeilampen-fabriek has developed a coulometric monitor for the Dutch government's Rijnmond air sampling network in the Netherlands.

- **Ultraviolet spectrometry.** Baringer Research of Toronto has a correlation spectrometer with a photomultiplier tube that measures the spectra of sulfur dioxide, nitrogen dioxide, ammonia, and halogens. For example, the device com-

pares sulfur dioxide with a reference spectrum of between 2,800-3,100 angstroms. Principle of operation is that almost every gas absorbs radiation in the ultraviolet portion of the spectrum, producing a specific absorption spectrum for each gas which can be measured.

- **Infrared spectrometry.** Sulfur dioxide, carbon monoxide, and hydrocarbons are measured by drawing polluted air into a sample chamber with an ir light source at one end and an infrared detector at the other, registering the absorption of the light beam passing through the sample.

- **Gas chromatography.** An example of this technique is Melpar, Inc.'s flame photometric detector, called the FPD-100, which measures sulfur-containing compounds, hydrocarbons, and phosphorus by their emissions when burned in a hydrogen-rich flame. Sulfur in the system produces a 394-millimicron band, measured by a flame photometer. By changing to a 526- μ interference filter, phosphorous compounds, such as in pesticides, can be analyzed, Melpar says. A complete sulfur analyzer contains four subsystems: the FPD, photometer, gas flow system, and power supplies. Melpar says for operation it needs a hydrogen gas supply and 120-volt, 60-hz input, and will measure from 0.01 to 1 part per million in less than one second real-time response. Melpar says the instrument can give a concurrent readout of hydrocarbons, sulfur dioxide and phosphorous, but since the technique eliminates non-sulfur-containing compounds, it could not be adapted to measurement of all pollutants. One reason, the company says, is that many organic compounds will have wavelengths near that of sulfur dioxide, causing interference in the compound's reading. The price list ranges from \$3,250 up to \$6,350.

More questions. If all these techniques could be combined into an inexpensive universal, self-digitizing sensor, it would not be the end of the national sampling network's problems. Napca's Dr. Kay Jones, a special assistant to the commissioner, says questions facing sampling network developers include the physical location of samplers and sensors, at what height they should be installed, and the num-

START

WITH A LENS-END LAMP

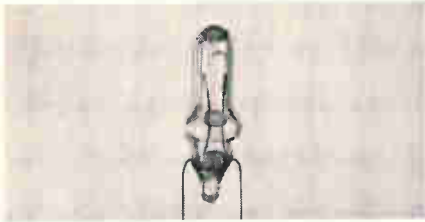

TEST

FOR SPOT SIZE AND
CANDLEPOWER

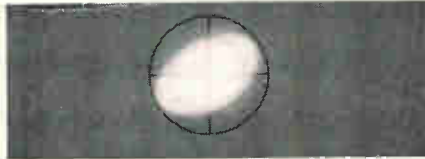

WELD

PINS TO END OF LEAD
WIRES

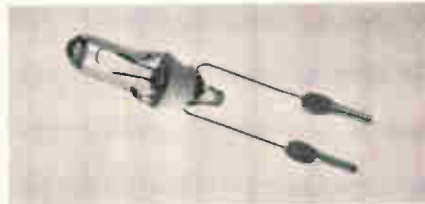

MOLD

TO MAKE A PLUG-IN LIGHT
MODULE THAT WILL ACTIVATE
PHOTO ELECTRIC SENSOR IN
A HIGH SPEED CHECK SORTER



We specialize in finding practical solutions to small applications where cataloged items won't do. Write, describing your requirement. Tung-Sol Division, Wagner Electric Corporation, 630 W. Mt. Pleasant Avenue, Livingston, N.J. 07039. TWX: 710-994-4865. Phone: (201) 992-1100.

TUNG-SOL®

WHERE BIG THINGS ARE
DONE WITH SMALL LAMPS

© Reg. T.M. Wagner Electric Corporation

Control region roll call

Napca plans to designate 85 metropolitan areas as air quality control regions, which together make up 84% of the nation's estimated metropolitan population as of 1965. After formal designation, the regions will begin to implement air quality standards, and must submit their plans to Napca. Napca will provide these areas with technical assistance in developing air quality surveillance networks, meteorological studies, data processing, development of laws and regulations, and efforts to devise solutions to specific technical problems.

The 85 areas designated or under consideration and their planned starting dates for implementation of air quality standards are:

By July 1970: Washington, New York, Chicago, Philadelphia, Denver, Los Angeles, St. Louis, Boston, Cincinnati, San Francisco, Cleveland, Pittsburgh, Buffalo, N.Y., Kansas City, Mo.

By January 1971: Detroit, Baltimore, Hartford, Conn., Indianapolis, Ind., Minneapolis-St. Paul, Minn., Milwaukee, Providence, R.I., Seattle-Tacoma, Wash., Louisville, Ky., Dayton, Ohio, Phoenix, Ariz., Houston, Dallas-Fort Worth,

San Antonio, Tex., Birmingham, Ala., Toledo, Ohio, Steubenville, Ohio, Chattanooga, Tenn.

By July 1971: Albany, N.Y., Albuquerque, N.M., Allentown, Pa., Atlanta, Bakersfield, Calif., Beaumont-Port Arthur, Tex., Binghamton, N.Y., Canton-Akron, Ohio, Charlotte, N.C., Charleston, S.C., Columbia, S.C., Columbus, Ohio, Corpus Christi, Tex., Davenport, Iowa, Des Moines, Iowa, Duluth-Superior, Minn.

Also, El Paso, Tex., Flint, Mich., Fresno, Calif., Grand Rapids, Mich., Greensboro-High Point-Winston-Salem, N.C., Jacksonville, Fla., Johnstown, Pa., Knoxville, Tenn., Little Rock, Ark., Memphis, Tenn., Miami, Fla., Mobile, Ala.

Also, Nashville, Tenn., New Orleans, Norfolk, Va., Oklahoma City, Omaha, Neb., Orlando, Fla., Peoria, Ill., Portland, Ore., Richmond, Va., Rochester, N.Y.

Also, Sacramento, Calif., Salt Lake City, Utah, San Bernardino, Calif., San Diego, Calif., Shreveport, La., South Bend, Ind., Stockton, Calif., Syracuse, N.Y., Tampa, Fla., Tucson, Ariz., Tulsa, Okla., Wichita, Kan., Wilkes-Barre, Pa., Worcester, Mass., York-Harrisburg-Reading-Lancaster, Pa.

ber needed. One estimate by the American Chemical Society says that "10,000 sampling stations will be needed to monitor the nation's air adequately." ACS says only 310 state and local air monitoring stations gave data to Napca in 1968. And the technology in most of these stations is more than 10 years old, says ACS.

ACS recommends that a sensor be placed at each source of pollutant emissions. This means a sensor in each stack of, say, the power companies, which Napca says are the biggest offenders; steel mills; asphalt batching plants; cement factories; sulfuric acid plants; and nonferrous metal smelters. But ACS claims "very few fully satisfactory devices" can monitor gaseous emissions from stacks, because they may not be able to perform properly at high temperatures, and particles and water can clog them. Remote measurement? Yes, say ACS, but "fully successful devices do not appear to be imminent."

Ending the Vietnam War would benefit air pollution control programs in two ways, the Electronic Industries Association says in a report on major issues affecting the defense industry. The first and most obvious benefit is larger appropriations for all domestic programs. The second benefit is the release of much pertinent military technologies to the pollution control area—among them orbital, infrared, and laser sensors, information handling systems, meteorology, life support systems, aerospace medicine, and atomic energy.

Perhaps there is an easier answer to the sensor problem, says TRW's Fred Hamburg—"The human nose is the most sensitive sensor of all."

Whether nasal or solid state, what happens when a dangerous level of pollution is measured? Napca's Jones says that in an emergency episode, most likely to occur during the "smog season" of October-November, "you must shut down industry, stop traffic, and

Close Confinement— Especially Here!

New "CC" Laser Diodes

How would you double the power output of a GaAs infrared injection laser diode — and halve the threshold current of previous lasers — and improve the uniformity of laser emission — all at room temperature?

Here's how RCA does it: Packs the works in a new Close Confinement diode structure that holds radiation strictly in the junction area.

Internal absorption is reduced substantially. This means you get greater power output and lower drive current.

RCA's new line of Close Confinement laser diodes is offered in the single chip construction that's most suitable for simple optic systems and driving circuits. These "CC" lasers feature a stud mount-coaxial lead package.

RCA OP-3 Pkg.	Peak Power Min.	Output (Watts) Typ.	Largest Emitting Area Dimension	Amps I_{th}	Peak Current I_{FM}
TA7606	1*	2	3 mils	4	10
TA7608	5*	6	6 mils	7	25
TA7610	10*	13	9 mils	10	40

*Selections offering power output up to 25 W at 25°C and 5 W at 70°C are available.

Custom Arrays

Room Temperature — 50-300 W peak power @ 25 A drive. Low Temperature (77-150°K) — 1-50 W average power @ 1-2% duty cycles.

Also Available — GaAl As laser diodes and arrays with wavelength range of 8100-8700 Å.

Call your local RCA Representative today for more information. Or see your RCA Distributor. For technical data on the new TA7606, TA7608 and TA7610 Close Confinement GaAs lasers, write: RCA Electronic Components, Commercial Engineering, Section No. SN12-1, Harrison, New Jersey 07029.

RCA

Forgive us our little deception. What you read here is in no sense a guide to the rare earths.

Our few words are rather a guide to the guide. They are meant to direct you to the proper source(s) that will reveal the potential of that remarkable class of chemical elements, the rare earths.

Which are those elements from lanthanum (atomic number 57) to lutetium (atomic number 71), with the addition of yttrium and thorium.

Hardly sound like they would be interesting to the intelligent electronic engineer, do they? Well, for some excellent reasons, the rare earths are not only interesting, but exciting, promising, and downright stimulating.

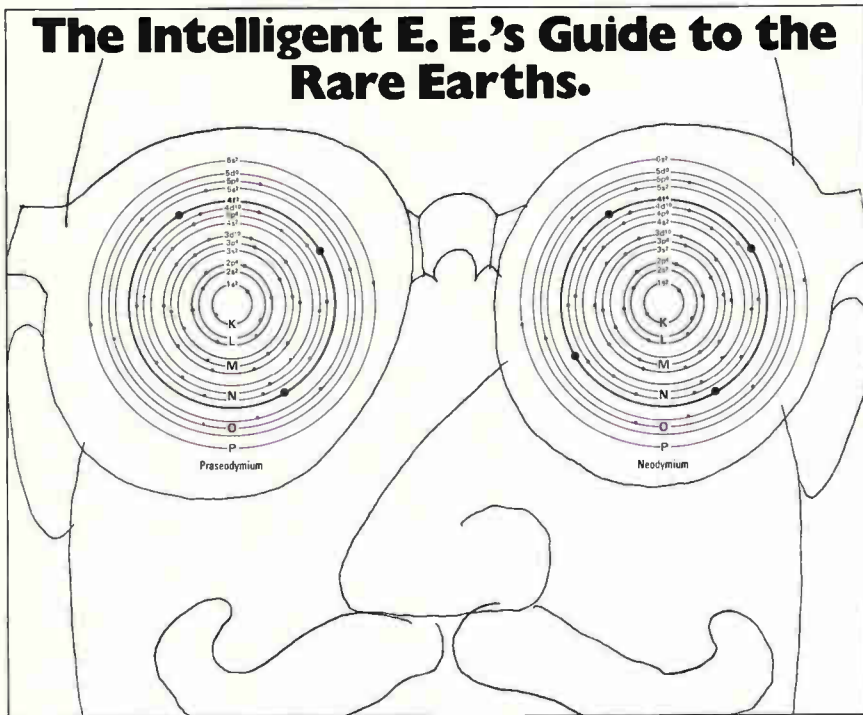

The interest in rare earths comes from their unique electrochemical properties. That leads to excitement over their use as capacitors, thermoelectrics, lighting and CRT phosphors, and more. The promise is partially illustrated by the rare earth's semi- and superconductive properties.

The stimulation, the motivation to do more with the rare earths comes from the fact that what is known about them is far greater than what has been done with them.

And if someone *is* to do great things with them—why not you? All you'll need is time, conviction, and a *guide*. Who could, quite happily, be one of your own colleagues. A chemist, in your own company.

Ask the willing and able chemist to equip you for an excursion into rare-earth territory. Ask us too. With our company and your chemist as guides, you may find an electronic Eldorado in the rare earths.

switch to natural gas," the last factor making for far cleaner air. Air pollution episodes happen when a low wind inversion level and wind-speeds of less than four meters per second persist over heavily populated areas for 36 hours or more. After emergency actions are taken, says Jones, you wait. "It takes a finite period of time for pollutants to move out naturally" through diffusion, and there's no way to force them out once they are there, he says.

Teach in. Public education in "adverse health effects of a polluted environment" is needed, says EIA. Jones's reply is that the electronics/aerospace industries need to be educated in air pollution before they can do any productive research. With this productive research, it will take three to five years to abate all levels of pollution, says Jones. "Spend enough money and you can do it," he says, but even if Federal air pollution research spending were increased, industry is not "competent to handle the program." Lack of qualified personnel is one major factor. Napca itself is short on experts, Jones says, and does not have the people to monitor Napca's research programs—most are contracted out.

Jones estimates the manpower deficit at 5,000 professionals, including engineers, chemists, meteorologists, and technicians. Should these 5,000 pollution experts suddenly appear, Jones says, they would be used to fill vacancies existing in virtually every state and local air pollution agency. The number of professionals needed will grow with the problem, and this estimate doesn't include the needs of industry, he says.

Jones ascribes the deficit to an "educational dilemma"—universities and colleges produce good environmental engineers only from their graduate schools. Courses in environmental engineering should be included in the undergraduate curriculum, and Napca is working with some universities, according to Jones, to determine what manpower development programs are feasible—whether Federal or state government agencies should undertake training, or whether the job can best be done within the colleges or universities.

RARE EARTH DIVISION

AMERICAN
POTASH & CHEMICAL
CORPORATION

AMERICAN POTASH & CHEMICAL CORPORATION A SUBSIDIARY OF KERR-MCGEE CORPORATION

258 Ann Street; West Chicago, Illinois 60185; Telephone: (312) 231-0760

9-213

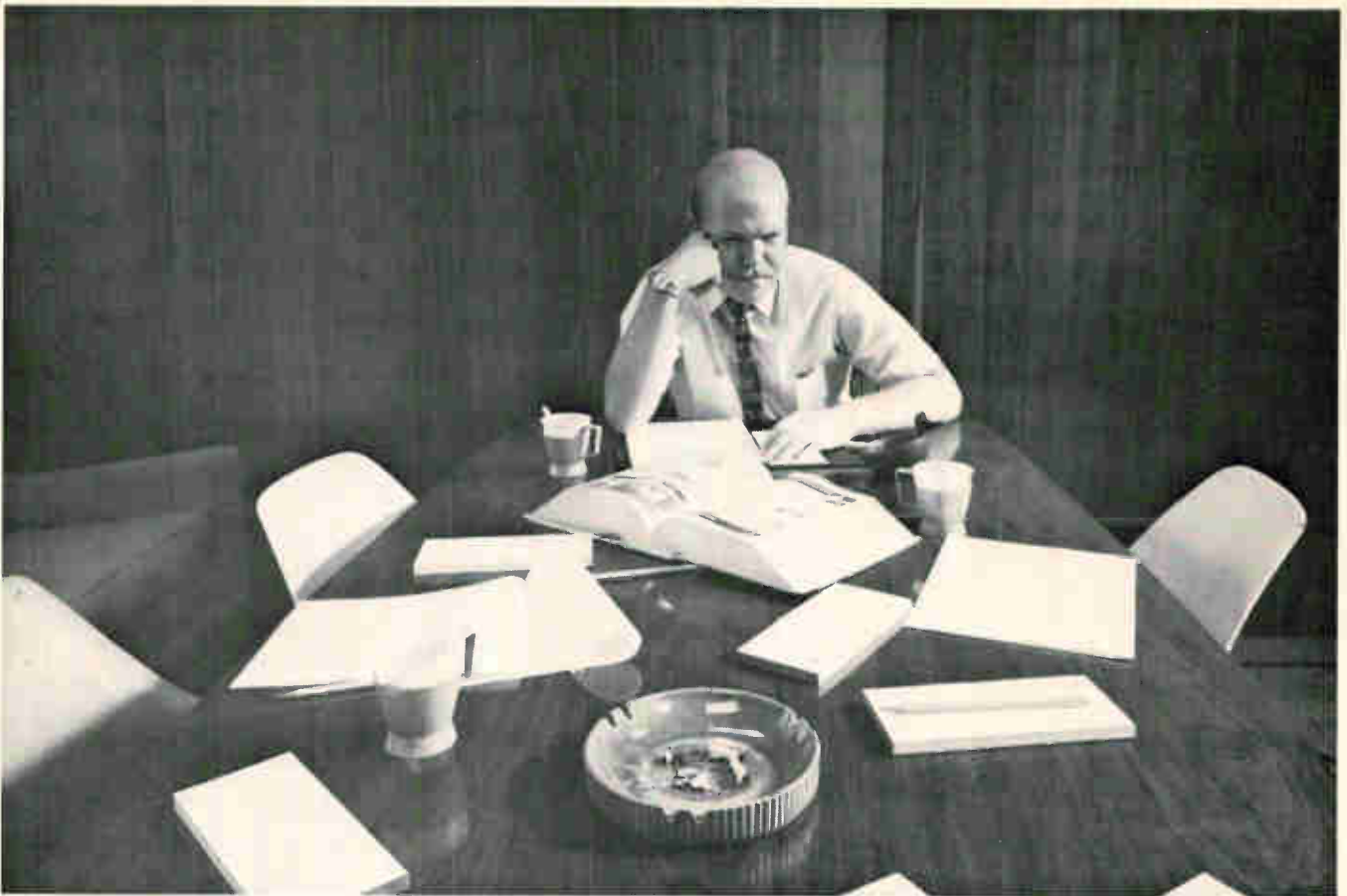

**So . . . they left it up to you to decide on High-Speed Line Printers.
Make it painless . . . call MDS!**

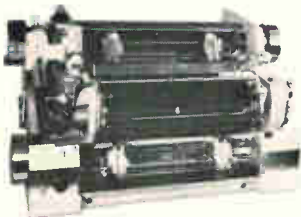

MDS SERIES 5013 HIGH-SPEED
LINE PRINTER MECHANISM



MDS SERIES 5320 HIGH-SPEED
LINE PRINTER (CONSOLE)

After all the talking is done, someone has to do the work. If you're the one who has to come up with recommendations for high-speed line printers, do what others in similar situations have done for years . . . call MDS.

MDS Line Printers are called the "work-horses of the industry". This reputation for reliable, long-term performance has contributed significantly to the MDS position as a leading independent source for line printers. This "work-horse" reputation works equally well for you.

MDS High-Speed Line Printers (1000-1250 lpm) offer you three choices: *The 5013 Printer Mechanism only, for integration with your own equipment; the 5320 Buffered Line Printer (Console); the 5300 Line Printer (Console, unbuffered). Console models are complete with MDS electronics and DC power supplies.*

MDS 5013, the high-speed rotating drum, on-the-fly printer mechanism, is the indispensable, vital center of every MDS High-Speed Printer. It contains the critical precision-built components that assure top performance.

OTHER IMPORTANT FEATURES: Dual Tractor Paper Feed; improved Clutch/Brake mechanism with vacuum cleanout system; Tape Control Vertical Format with standard 8 channels (12 channels optional); Improved Ribbon Tracking Mechanism; New Fibre Optics System with only 3 light sources . . . plus others.

Phone or write for literature. Your Man from MDS will gladly help you make your decision.

**HELP FOR OEM
DECISION-MAKERS**

MOHAWK **MS**
DATA SCIENCES CORPORATION
OEM MARKETING

Palisade Street, Herkimer, N.Y. 13350
Phone 315/866-6040

REGIONAL MANAGER OFFICES:

Orlando, Fla., Phone 305/841-3091 • Waltham, Mass., Phone 617/891-5870 • Des Plaines, Ill., Phone 312/298-4141 • Los Angeles, Calif., Phone 213/685-5165
BUFFERED TAPE UNITS • DIGITAL STRIP PRINTERS • LINE PRINTERS • CARD PUNCHES AND READERS • PAPER TAPE PUNCHES AND READERS

THE 5000 PERM TOROID

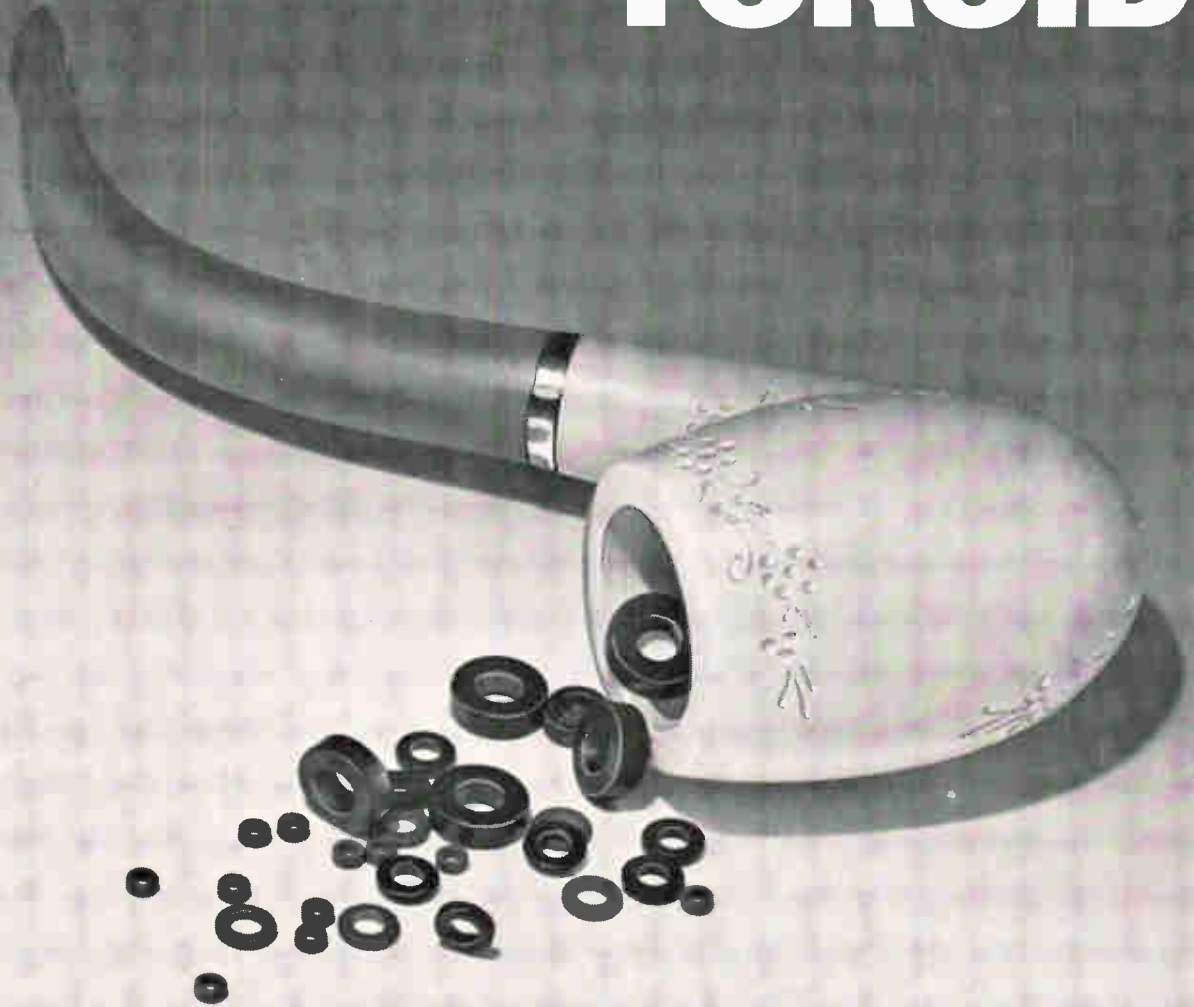

NO LONGER A PIPE DREAM

That's right. 5000 initial permeability. And we mean it!

Perhaps your designs for pulse transformers have gone up in smoke for want of a powerful enough material. Well, now you've got it. And then some. Stackpole Ceramag® 24H ferrite material.

Ceramag® 24H is a precision engineered product. Exact processing, density checks, rigid kiln controls and precise

sintering. You get more out of it simply because we put more into it.

Here are a few more conservative characteristics. Maximum permeability, 6900. Typical. Saturation flux density, 4100 gauss and residual magnetism of 850 gauss. If curie point is significant to your operation, how about one of 175° C. Then there's temperature coefficient. Ceramag® 24H goes + 0.700% / ° C at -25°

C to 25° C and -0.450% / ° C at 25° C to 75° C. And all of this with a disaccommodation factor of 1.4×10^{-6} .

Ceramag® 24H is ready. Are you? Drop us a line and we'll send you some even more interesting facts about this fantastic new material. And the charts to prove it. Stackpole Carbon Company, Electronic Components Division, St. Marys, Pa. 15857. Ph: 814-834-1521



STACKPOLE

Electronic Components Division

ALSO A LEADER IN THE MANUFACTURE OF QUALITY FIXED COMPOSITION RESISTORS

Practical research gains emphasis at NASA's ERC

While keeping its hand in pure research, the Cambridge-based center has taken on goal-oriented projects such as an automatic landing system

By James Brinton

Electronics staff

A shift in emphasis has been taking place amid the academic atmosphere at NASA's Electronic Research Center (ERC). Perhaps due to the efforts of James C. Elms, who became its director three years ago, the Cambridge-based organization is concentrating increasingly on advanced technology and short-term, practical, programs. However, all this has not affected its theoretical work which still remains substantial.

Current programs, many of which promise payoffs in the near future, include L-band navigational satellite studies, flight experiments and parametric studies for vertical/short take-off and landing aircraft (V/STOL) avionics, and work on automatic landing systems. And ERC will function as the National Aeronautics and Space Administration's lead center for the integrated electronics systems to be used in the projected space shuttle—the plane-like orbital vehicle.

The V/STOL program—about two years old—should yield data on the accuracy of various inertial guidance approaches. It will also include tradeoff studies on how accuracy may vary with the number of positional updates from ground radar, and on various types of data processors and inertial references, comparing such features as cost and reliability. The program should also show how on-board computing could cut pilot tasks and whether total automatic control is feasible.

Another program, started last spring, says Robert W. Wedan, chief of technical programs at the



Planner. James C. Elms, ERC Director, increased practical research.

center, aims at combining on-board computers, inertial references, and some radio navigational aids into an automatic landing system for conventional jet aircraft. According to Wedan, the program would collect the data needed to build an automatic landing system, which might work even at airports with few radars and navigation aids.

A secondary goal is helping industry get the most out of the computers and inertial platforms that will go aboard upcoming airliners. "We hope not only to help control aircraft during the approach, but to help solve terminal congestion problems, too. Accurate position data from nav aids, gyros, and on-board computers could help clean

up the traffic control problem in terminal and holding areas."

ERC and the Federal Aviation Administration will begin testing the new automatic lander aboard a Convair 880 next spring, and first reports should be published sometime in 1970.

Simulated shuttle. The same 880 may become a flying testbed where automatic techniques could be developed for landing a space shuttle at an air field. Wedan says that it should be possible to use the aircraft to simulate the flight characteristics of the shuttle, and with data from the landing program, map out such an automatic landing system for the shuttle. Wedan says that while the ERC is working with an automated system, the Ames Research Center will study shuttle landings with a man in the landing control loop.

Elms, Wedan, and Gene G. Manella, director of advanced technology at the ERC, all are enthusiastic about ERC's space shuttle role. Elms figures that the benefits to the shuttle from electronics (and ERC) could be great, "perhaps even the shuttle's end cost could be cut by electronic aids to navigation and control."

"The V/STOL and other avionics programs give us a structure within which we can work with advanced techniques," adds Wedan. An example is the laser gyro slated to play a part, perhaps next year, in the V/STOL avionics program.

Wedan adds that when devices like the gyro and like the redundant sensor strapdown inertial platform

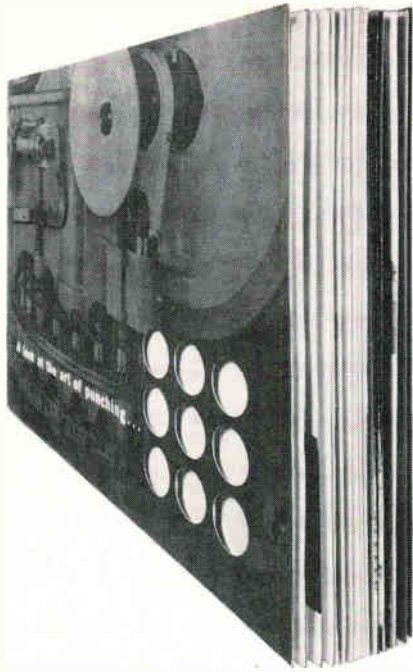

44 brand new pages of helpful punching information

- Six basic punching concepts
- Turret punch presses
- Stylus operated turret punch presses
- OBI punch presses
- Single station punch presses
- New horn punch presses
- Adjustable punch and die sets
- All shapes and sizes of punches and dies
- Template layout machines

Complete information! Illustrations, descriptions, specifications and prices. Ask your distributor for the new 44-page Di-Acro punching catalog or write us.



Charting a course for research

ERC's original charter, drafted in 1963 and 1964, gave the center a spectrum of potential activities ranging from the most abstruse solid state physics to highly practical, goal oriented work. But in the early years most of ERC's activities had the word research attached to their descriptions.

Many of the changes at ERC occurred after James C. Elms arrived as director. Opinions diverge about his impact on ERC's reorganization and its swing toward goal oriented efforts.

Programmed revolution. Elms appears to have studied the center's operations for almost 18 months before taking drastic action—and then only after what one ERC staffer calls “about six months of agonizing over the problem with his key staff members.”

When Elms arrived, ERC's organization chart looked as if it had grown task by task instead of by plan. About half a dozen directors reported immediately to him, and some had conflicting or overlapping responsibilities.

Advisory role. Within this framework, ERC conducts—and defines—its programs a little like the old National Advisory Committee for Aeronautics used to, according to Elms. “For example, the NACA used to supply wind tunnel data on new airfoils, cowl structures, flaps, and so on—information needed to build better planes and to predict the performance of proposed models. ERC will do much the same thing in electronics, doing the work that individual companies can't afford, or centralizing efforts that might be wastefully duplicated by many. In the long run, ERC will be a reservoir of knowledge for makers and users of aerospace electronics.” Thus, ERC won't become a source of heavy funding for aerospace firms.

The system was complex, but it worked, even though most agreed it could have been more efficient. But it might not have worked much longer: “There's a three way balance between directed research, undirected research, and goal oriented efforts,” says Elms, and implies that the balance was hard to maintain under the old rules.

“If I saw a research organization so locked in its ivory tower that no usable ideas were emerging, I'd be concerned. On the other hand, I would worry also about such ideas rising up to swallow the research man at the next desk, involving him in program management which he neither can enjoy nor perform as well as his own work.” And under the old system this might have happened.

Wedan says, “Nobody has the wisdom to program pure research ten years out. That's why work on near-term systems is valuable,” it gives us an idea of what may be needed; it supplies some benchmarks for future research.”

But ERC has the advance technology directorate as a buffer between technical programs and research. “Without some insulation around the research side,” says Elms, “you run the risk of over-direction—prejudgments can stifle the flow of ideas a research organization should generate.”

Elm's reorganization of the center into three directorates thus was his solution to the touchy problem of guided versus unguided research. “We needed a middle route,” he says. “While some guidance helps, one can't look at each effort and ask what good will it be to NASA in 1980, so we've set up things so that we can aim research slightly, leaving room for intuition.”

are considered, the respective roles of the technical program and the advanced technology directorates merge. “We gain systems experience with high technology items like laser gyros, and at the same time spot areas that need work—say, lifetime, in this case—and pass the word along to Gene Manella's area.”

The charter granted to Manella includes component development

and, in addition, runs a gamut from semiconductor reliability studies, large scale integration test techniques, to microwave, millimeter wave, and laser communications studies. It covers work as esoteric as implantable biomedical sensor development and as prosaic as wafer scribing techniques for integrated circuits.

Manella's and Wedan's directorates share ERC's space shuttle

role. Manella states that he expects ERC to get a "pronounced set of responsibilities in the shuttle program," and is especially interested in applying the results of his directorate's semiconductor reliability studies to the craft.

For the shuttle, Manella envisions a total "data system," and not just computational power. It would include critical systems monitoring, some digital processing of data at its source, display of critical parameters, information storage, and equipment designed to ease the shuttle pilot's workload. Elms sees electronic stability augmentation gear in the latter category.

Summing up the advanced technology section's shuttle priorities Manella says: "Foremost is LSI screening and testing; there will be large amounts of digital gear distributed about the craft, and LSI will be the way to go—but so far screening and testing can't provide the needed reliability."

"Second," he says, "are communications studies—a body of work running from tradeoff studies on the antennas for the shuttle to plasma penetration for communication during reentry."

"Then come biotechnological efforts—an interface between space medicine and electronics," he says, "and finally, power conditioning."

As a result, ERC now is working with the Jet Propulsion Laboratory on microelectronics reliability of a spacecraft, which he calls "the prototype unmanned spacecraft of the future with ultra-high reliability and a long operational lifetime."

With the Lewis Center, Manella's men are working on control electronics for an advanced Brayton cycle power system which may supply future spacecraft with on-board power.

For NASA as a whole, the advanced technology directorate is designing and specifying a data bank holding microelectronic reliability information. Another center probably will run the bank, "but no one knows better than ERC what should go into it," says Manella.

What could be first

Meanwhile, in Wedan's directorate, may lie the germ of a program that could result in prototype hardware—not just data. It's in the

DESTRUCTOR FOR ELECTRONIC EQUIPMENT



Capable of destroying or rendering unidentifiable electronic units or circuits is Hi-Shear's DES1000 Series Incendiary Destructor.

The Destructor shown is built to a customer's particular requirements. The destructor, loaded with an incendiary compound, produces 90,000 calories at a rate of approximately 1500 calories per second. The extremely low gas output is non-toxic, non-inflammable and is emitted at less than six cubic inches per second. The destruction is in a direction normal to either or both faces of the destructor

plate. Duration of the burn period is 60 to 90 seconds.

The DES1000 Series is electrically initiated by a five ampere (recommended) current. The destructor meets the one-watt/one-amp no-fire safety requirement.

The destructors are produced to customer specifications. Envelope, heat output and propagation rate may be varied. They may be adapted for document or file destruction.

Technical data is available on your request.

HI-SHEAR ORDNANCE PRODUCTS

POWER CARTRIDGES	CLAMP SEPARATORS
SMOKE CARTRIDGES	TENSION ROD SEPARATORS
FLAME CARTRIDGES	THRUSTERS
EXPLODING BRIDGEWIRE CARTRIDGES	PIN PULLERS
EBW FIRING SYSTEMS	SHEAR BOLTS
LASER CARTRIDGES	BOLT CATCHERS
LASERS	UNDERWATER DEVICES
SEPARATION NUTS	THIN FILM METALIZING OF CERAMICS
BOLT, CABLE AND REEFING LINE CUTTERS	

ORDNANCE DIVISION



2600 Skypark Drive
Torrance, California 90509

Circle 151 on reader service card

Make your own break.

You can take a lot of the chance out of your future by including yourself in the Electronics Manpower Register.

When you do, your experience and talents become part of a nationwide computerized placement service.

Our computer is programmed to give every registrant the same

look for every opening. With your prior approval, you'll be considered for every opportunity that matches your resume.

All you have to do is send one to:

Electronics Manpower Register
Electronics
330 West 42nd Street
New York, N.Y. 10036

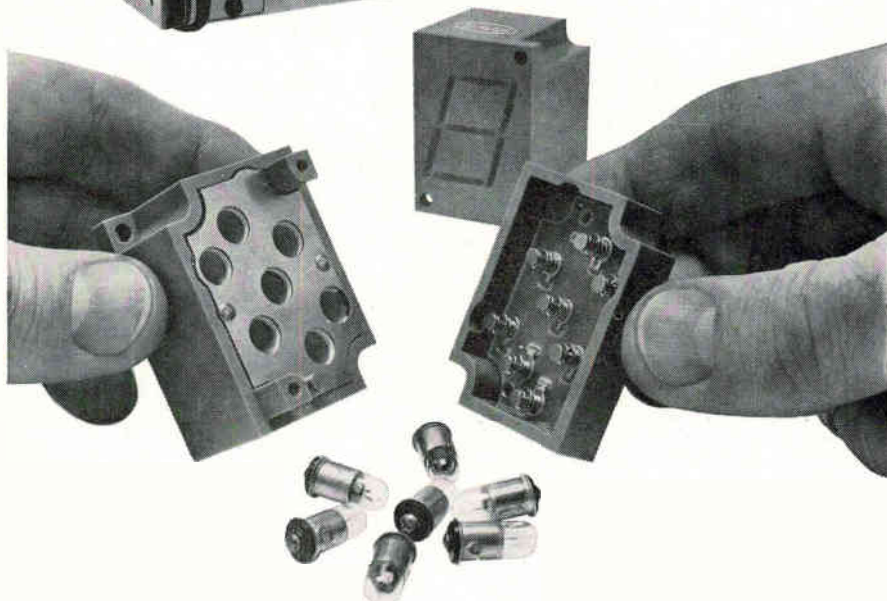

What makes low-cost Dialight readouts so reliable and easy-to-read?

Reliable because of simple module construction and long life lamps. Designed for use with neon or incandescent lamps to meet circuit voltage requirements. Easy-to-read from any viewing angle. 1" high characters are formed by unique patented light-gathering cells, and may be read from distances of 30 feet. Sharp contrast makes for easy viewing under high ambient lighting conditions.

Dialight Readout Features

1. Operate at low power.
 2. 6V AC-DC, 10V AC-DC, 14-16V AC-DC, 24-28V AC-DC, 150-160V DC or 110-125V AC.
3. Non-glare viewing windows in a choice of colors.
 4. Available with RFI-EMI suppression screen.
5. Available with universal BCD to 7 line translator driver:
 6. Can be used with integrated circuit decoder devices now universally available.
7. Caption modules available; each can display 6 messages.

Send for catalog

Catalog-folder contains complete specifying and ordering data on numeric and caption modules, translator drivers, mounting accessories. Dialight Corporation, 60 Stewart Avenue, Brooklyn, New York 11237. Phone: (212) 497-7600.



DIALIGHT

DT-126

satellite programs office, headed by Leo M. Keane.

Keane's office is presently trying to find its way out of the hole dug for it by the spinning ATS-5 satellite [Electronics, Oct. 27, p. 53]. But Keane looks forward to a time when ERC's experiments will ride their own satellites.

If this comes to pass, the first ERC satellite would aid development of a mid-Atlantic air traffic control, navigation, and communications system. Keane feels that ERC is the natural center for such an effort.

"We began concentrating on this problem area in 1965", he says. "We foresaw the built-in inaccuracies of air navigation over water, and the forecast reduction in spacing between planes as traffic increased—a bad condition. The spacings were narrowed in 1966—then reestablished after an outcry from pilots about safety."

"We figured that the solution lay in satellites enabling tight navigation, surveillance, and communications," he says. "After projecting the problems, we looked for the men to solve the problem with electronics."

When staffed up, the satellite programs office started exploring proposed systems and tradeoffs. It contracted with TRW, Philco, and RCA for systems studies, with Boeing for a study relating navigational satellites to the supersonic transport, and with others on smaller facets of the problem.

Now Keane figures ERC is NASA's reservoir of navigational satellite talent, and while an operational system probably will be another's responsibility, ERC will have decided a lot of its characteristics, and flown experimental models in the process.

Beyond Navsats, Keane sees geodesy, direct broadcast, and earth resources satellites as future missions for ERC.

Elms says that such satellite programs won't be ERC's province until he is satisfied that the center has "the necessary depth in its research organization, enough capability in the advanced technology directorate, and the managerial talent available in technical programs to handle the job. But it's just about there," he says. "We can begin considering these things now."

BIG ADVANCES Come in Small Packages

Now... Reeves has developed the highly accurate sub-miniature heaterless Mini-RIG Integrating Gyro... and the full capability for packaging it as a self-contained sub-system.

The Mini-RIG development represents a major advance in reliability, cost reduction and performance, in the field of subminiature high-volume inertial sensors.

Only one inch by two inches in size, the Mini-RIG can stabilize short-mission-time inertial platforms or serve as an inertial sensor in strap-down applications. Automated gyro assembly techniques have reduced final assembly time from the normal one month to **one work-day!** This, in turn, has minimized the possibility of contamination and maximizes reliability. Reeves has full

packaging capability, too. For example, the illustration shows a typical compact three axis rate package especially designed for aircraft missile and satellite system applications. It is system-engineered to provide the necessary accuracy and to meet the most stringent environmental requirements of outer space. Within its 30 cubic inch volume are three Mini-RIG Rate integrating gyros **plus** all necessary electronic modules to operate the entire package.

What are your special needs for subminiature gyro packages and sub-systems? Reeves can meet them! Our engineers working within the Total Systems Concept, will isolate the problem areas and provide the most practical solutions for them.

For complete data and application information call (516) 746-8100 ext. 540, or write Component Division, Reeves Instrument, Garden City, N.Y. 11530.

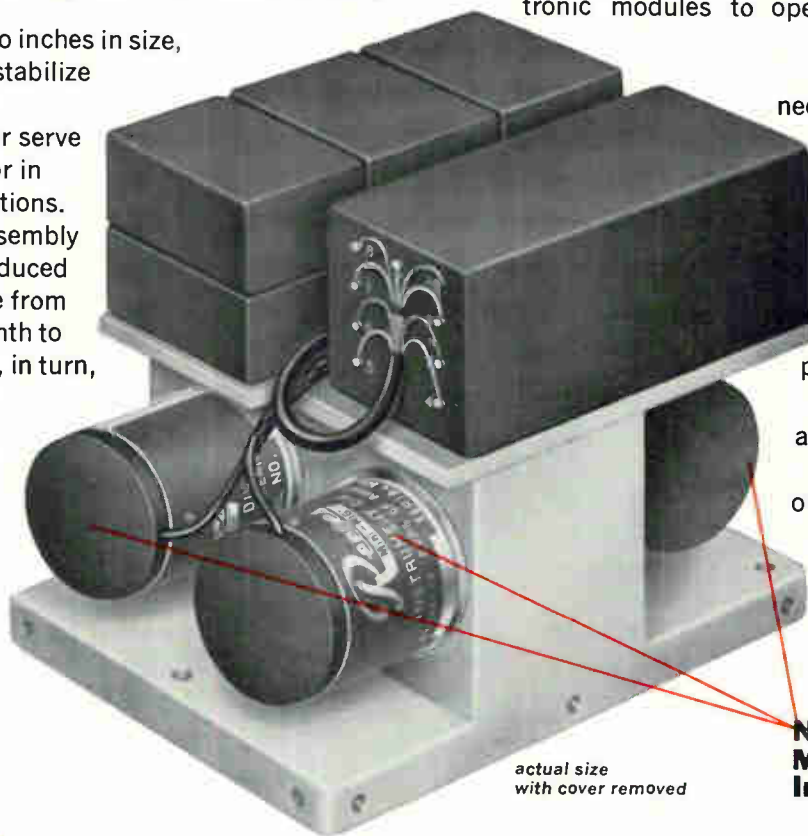

actual size
with cover removed

**NEW! REEVES
Mini-RIG®
Integrating Gyro.**

Reeves®

INSTRUMENT DIVISION



DYNAMICS CORPORATION OF AMERICA | GARDEN CITY, NEW YORK 11530

5

Megabit PCM Synchronizer only from DCS

Up to now high bit rate PCM synchronizers were not really high. The DCS Model 4810 now offers discrete bit detection from 1 to 5 megabits. A breakthrough for high bit rate applications requiring regeneration of clean data with coherent clock from noisy, perturbed PCM serial bit streams.

Features

- Bit rates to 5 Megabits NRZ
- Accepts input codes RZ, NRZ-L, M, S, Bi- ϕ -L, M, S
- Superior clock restoration and sync circuits
- Integrate and reset bit detection

Applications

- High Speed Telemetry
- High Frequency Transient Data
- Multiple Digital Voice/Video Transmissions
- High Speed Digital Data Transmissions



Model 4810 . . . it's available now!

Call your local DCS Sales Engineering Representative or write today for Application/Design Bulletin AD4810.

Data-Control Systems, Inc.
Commerce Drive
Danbury, Conn. 06810

Tel: 203-743-9241
TWX: 710-456-2596

DATA-CONTROL SYSTEMS, INC.





SO ON THE THIRD GO-AROUND WE HAD A CIRCUIT OUR SUPPLIER SAID HE COULD MAKE BECAUSE THEY WERE GETTING THIS NEW EQUIPMENT...

ONLY IT DIDN'T TEST TOO WELL BUT THEY COULD FIX THAT WITH SOME NEW STUFF THEY WERE GETTING...

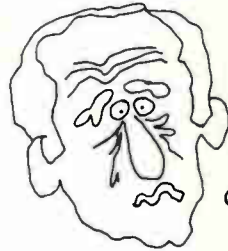

AND WITH THEIR EXPANSION PROGRAM THEY'D SOON HAVE CAPACITY TO MAKE ENOUGH CIRCUITS IN TIME FOR OUR REVISED REVISED REVISED SCHEDULE...

AT REVISED REVISED REVISED COST—

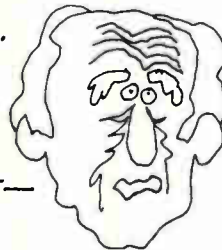

THAT'S WHAT THEY SAID...



SO, I'M CELEBRATING THAT ALONG WITH MY THIRTY-THIRD BIRTHDAY.

Aerojet microcircuits solve problems. First time around.

We've already done our homework on our own in-house program. Seven years of it. And we've already invested our own money in the most advanced, automated equipment. Millions of dollars worth. So when we say we're ready to tackle your problems in thin-film microcircuits... we're *really* ready.

The benefits to you start immediately because you don't need to compromise your design. Aerojet thin-film circuits can be built to meet an incredible range of specifications. We know components and can offer you many that are unobtainable elsewhere because we developed them ourselves. You get exactly what you need. Fast.

It's in actual production that Aerojet's investment in ahead-of-the-field equipment pays off. We're automated to the highest possible degree. This gives us big advantages in precision, speed and constant traceability. Defects get caught early. And costs come down. And schedules are met! For example, the largest of our six vacuum

deposition chambers can produce 10,000 circuits in a single production cycle. Automated machines and computers can test 100 circuits in less than a minute... measuring and storing component values. A computer "knows" each individual circuit and can trace it through the entire process.

But there's much more. You almost need to see it to believe it (by all means come and take a look or ask to see our movie).

Aerojet's aerospace projects demand the utmost in reliable, sophisticated microcircuit technology. We can apply our experience to your problems... in depth, in quantity and at highly competitive prices.



So get us involved early and get results the first time around. Contact the Aerojet field office in your area, or: Aerojet Microelectronics, Electronics Division, 1100 West Hollyvale Street, Azusa, California 91702. Phone (213) 334-6211, Extension 6561.

NPN-PNP pairs to 60 amps



TRUE NPN-PNP PLANAR POWER TRANSISTOR COMPLEMENTS IN RATINGS FROM 1 TO 60 AMPERES..... NOW, FROM TRANSITRON

More Complementary Pairs — More NPN-PNP complements than any other manufacturer. Pairs available in all ratings up to 60 Amps.

Wider Selection — Well over a thousand silicon planar types — both high power and high voltage . . . all available for fast delivery. NPN and PNP types with power dissipation 5 to 300 watts; collector current 1 to 100 amps; BV_{CE0} (NPN) to 200 V; BV_{CE0} (PNP) to 140 V; high-voltage NPN types with BV_{CE0} to 400 V.

Single-chip reliability — Single-chip construction

provides greater reliability than standard multiple-chip designs.

More Packaging Flexibility — Standard packages include TO-3, TO-5, TO-59, TO-61, TO-63, TO-66 and TO-114. (TO-5, TO-59 and TO-61 available in isolated cases.) High power types available in smaller-than-usual packages, providing important space and weight savings.

Proved Performance — Transitron power transistors are in use in many military and aerospace programs where reliability and performance are critical.

TYPICAL POWER TRANSISTORS						HIGH VOLTAGE TRANSISTORS				
Typical NPN type	Typical Complementary PNP type	Package	Maximum Power Dissipation (Watts)	BV_{CE0} (Volts)	I_c (max) (Amps)	Typical NPN type	Package	(Watts) Maximum Power Dissipation	BV_{CE0} (Volts)	I_c (max) (Amps)
ST14031	ST40003	TO-63	300	100	60	ST18007	TO-63	150	400	20
2N5250	—	TO-114	300	100	90	ST18009	TO-63	150	200	20
ST15044	ST54005	TO-63	187	100	40	ST18011	TO-61	75	400	10
ST17061	ST10008	TO-63	150	100	30	ST18013	TO-61	75	200	10
ST86021	—	TO-61	75	100	5	ST18015	TO-59	45	400	5
ST91058	ST76019	TO-59	60	100	10	ST18017	TO-59	45	200	5
ST91086	ST72037	TO-59	45	100	5					
ST91055	ST72040	TO-5	15	100	5					
ST74050	ST75005	TO-5	11	100	2					
ST84028		TO-5	7.5	140	1					

Want more information on Transitron power transistors? Call today for complete data and specifications. Specify types of particular interest.

Transitron
electronic corporation
168 Albion Street Wakefield, Massachusetts 01880

YOU ARE NOW ENTERING
**THE
MULTILAYER CIRCUIT
CENTER
OF THE U.S.A.**

CINCH-GRAPIK
POP. 740

Cinch-Graphik is a volume producer of all types of printed circuits, but multilayer boards are our specialty. We produce them with the newest and most advanced automated equipment.

For information on Cinch-Graphik, write for our new Capabilities Brochure . . . available from any Cinch Electronic Group District office or by writing Cinch-Graphik, 200 South Turnbull Canyon Drive, City of Industry, California. 91744, Phone (213) 333-1201.

CG-7001

CINCH-GRAPIK

DIVISION OF UNITED-CARR

CINCH
ELECTRONICS
GROUP

CINCH MANUFACTURING, CINCH-GRAPIK, CINCH-MONADNOCK AND CINCH-NULINE DIVISIONS OF UNITED-CARR INC., A SUBSIDIARY OF TRW INC.

Signal Innovator



Singer has advanced the state-of-the-art with a signal generator so New it almost requires a new name.

The Model SG-1000 obsoletes every other signal generator within its frequency range ... singly or in combination. Its performance is so superior that no other instrument available can equal or even approach it.

That's why we call it the Innovator.

Here's why you'll call it unbelievable . . .

- Digital readout of frequency.
- Broadband frequency coverage from 61kHz to 512MHz (to 1024MHz with a simple passive doubler) in a small 5¼" high package.

- Exceptional frequency accuracy and resolution . . . typically 0.005% . . . and no human readout errors.

- Full modulation capability
AM FM Pulse Video
Internal 1,000Hz modulation
. . . and combinations of the above.

- Output levels from +20dBm to -146dBm.

- An automatically leveled output . . . within ± 0.5 dB over the entire frequency range.

- Use it as a 2MHz counter for counting modulating signals or rep rates directly.

- A spectrally pure output signal approaching that of a crystal . . . extremely low residual and incidental FM.

- Total elimination of dial tracking errors.

- The availability of BCD frequency output and a

programmable attenuator to assure system integration.

This is only part of the SG-1000 story. A more complete technical description is available in Singer Application/Data Bulletin SG-10 upon request.

For additional information contact your local Singer Representative, or write or call —

The Singer Company
Instrumentation Division
915 Pembroke Street
Bridgeport, Conn. 06608.
203-366-3201.

In Europe contact: Singer
Sewing Machine Company,
Instrumentation Division, P.O.
Box 301, 8034 Zurich, Switzerland,
Telephone: (051) 47 25 10
TWX 710-453-3483

SINGER
INSTRUMENTATION

When the chips are down, they ought to be on our IC packages.

It's not just because we want to sell our products (which we do).

Or because we're proud of them (which we are).

We think you should buy our IC packages for a number of reasons.

First of all, we make all our own parts. (Many of our competitors must buy frames and ceramics for assembly.)

We assemble the packages ourselves.

We test our packages for insulation, thermal shock resistance, hermeticity, lack of internal shorts, excess glass-ceramic flow.

And if one of our growing line of packages

doesn't fit your requirements, we'll design one that will.

One more thing. Just because you're getting the best IC package money can buy, don't think it takes a lot of money. In fact, ours probably costs less than any others.

Isn't that where you should put your chips?

Sylvania Metals & Chemicals, Parts Division,
Warren, Pennsylvania 16365.

SYLVANIA
GENERAL TELEPHONE & ELECTRONICS

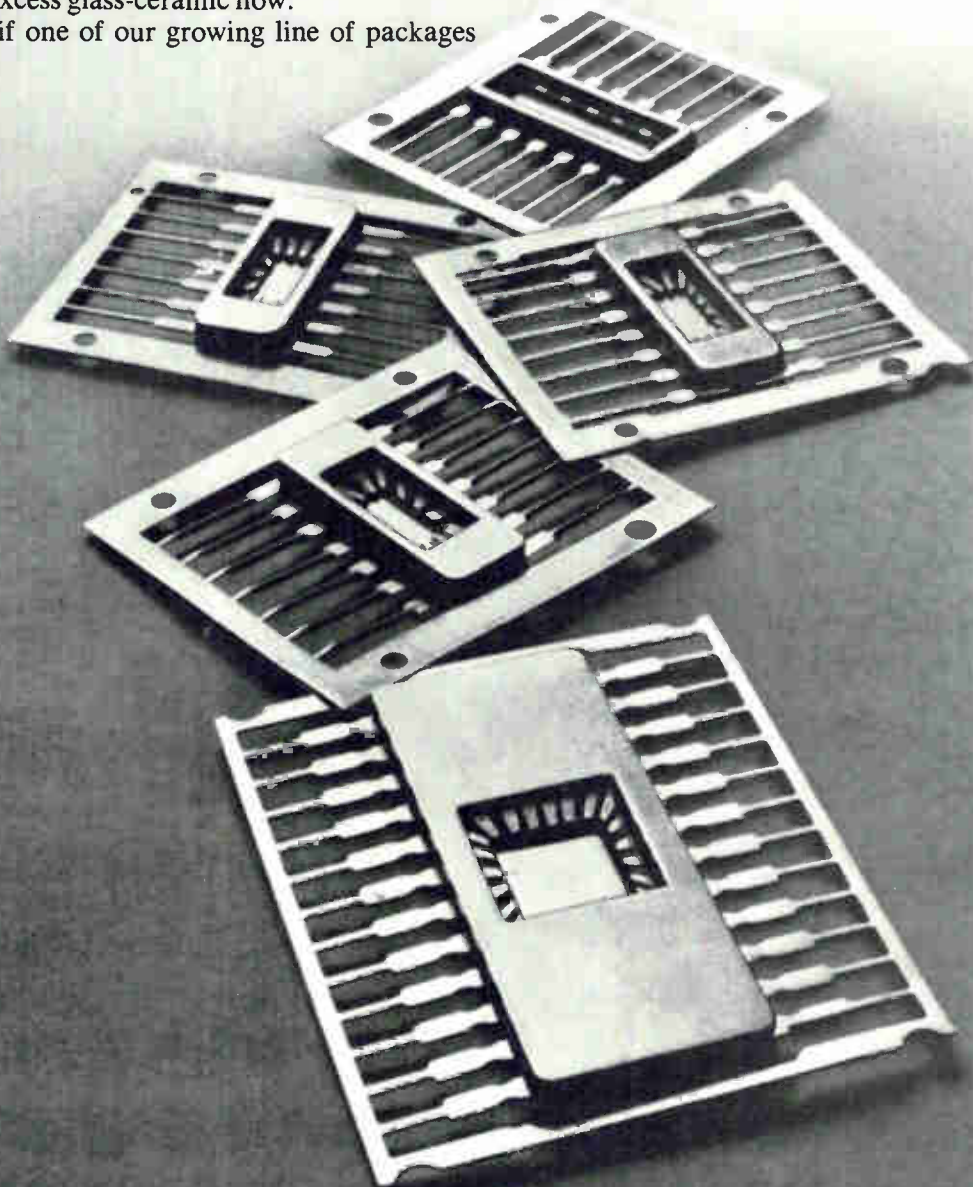

SOME PEOPLE CONSIDER THIS THE MOST TROUBLESOME TEMPERATURE/ HUMIDITY CHAMBER EVER BUILT



(THEY'RE OUR COMPETITORS)

You'd feel the same way if you were trying to sell against what is acknowledged as the finest unit of its kind on the market. Put yourself in their place.

First off, you'd be probably trying to peddle an out-moded on-off type control. Not only is performance poor, but you'd be saddled with explaining how a maze of complicated mechanical linkages between the programmer and recorder can possibly work. This is doubly hard because it *doesn't* work — unless someone attends it constantly.

(Blue M uses the patented POWER-O-MATIC 60® Saturable Reactor Proportioning Control System. It provides unquestionably the finest performance, yet is so simple to run that a child can operate it.)

Then there's the compressor. You'd be selling a system that slams on and cuts off, causing a noticeable variation in chamber conditions every time. And you'd have to try to explain high maintenance.

(Blue M's compressor operates continuously for longer life. Performance is geared exactly to the operating temperature needs of the chamber at all times.)

Almost every chamber manufacturer has his own water system: spray, steam injection, etc. They *do* get water into the chamber, but often it's in the form of mist or drops — hardly humidity. And every one needs constant attention.

(Imagine trying to sell one of them against Blue M's reliable solid-state water leveling system and exclusive vapor-pressure system.)

And finally, there's construction. You would probably be selling a unit built to a price — skimpy, if not actually shoddy.

(Blue M Temperature/Humidity Chambers are built to last. They'll run for years, assuring the maximum number of tests per dollar invested. We even include an elapsed time meter to record the actual number of hours the cabinet operates. We haven't a thing to hide.)

But the biggest point you'd have to sell against is the fact that Blue M Temperature/Humidity Cabinets *work as specified*. They easily meet every current MIL Humidity Spec, for example, plus a host of even tougher industrial requirements. They've been designed to provide the lowest cost per test — all with a minimum of trouble and fuss to you. We're prepared to prove it with actual performance charts, operating data and demonstrations any time you say.

Blue M builds the finest temperature/humidity chambers in the country. We challenge anyone to show us (or try to sell you) a better one. For full information, write: *Blue M Engineering Company, A Division of Blue M Electric Company, Corporate Headquarters, Blue Island, Ill. 60406.*



\$44,000,000

WILL BUY 1,000,000 TRIPLETT 310 VOM'S BUT YOU ONLY NEED ONE...AT \$44⁰⁰ THAT'S A BARGAIN



MODEL 310
World's Largest Selling
Volt-Ohm-Milliammeter
(SHOWN ACTUAL SIZE)



MODEL 310-C
Volt-Ohm-Milliammeter

- 1** HAND SIZE V-O-M WITH PROVISION FOR ATTACHING AC CLAMP-ON AMMETER.
- 2** 20,000 OHMS PER VOLT DC SENSITIVITY; 5,000 AC.
- 3** ONE SELECTOR SWITCH MINIMIZES CHANCE OF INCORRECT SETTINGS AND BURNOUTS.

310-C PLUS FEATURES

- 1** Hand size V-O-M with provision for attaching AC Clamp-on Ammeter.
- 2** 15,000 OHMS per volt AC sensitivity; (20,000 DC same as 310).
- 3** Single fully enclosed Lever Range Switch, plus DC Polarity Reversing.

MODELS 100 AND 100-C

Comprehensive test sets. Model 100 includes: Model 310 V-O-M, Model 10 Clamp-on Ammeter Adapter; Model 101 Line Separator; Model 379 Leather Case; Model 311 leads. (\$83.20 Value Separate Unit Purchase Price.)

MODEL 100 — U.S.A. User

Net.....\$78.00

MODEL 100-C — Same as

above, but with Model 310-C,
Net.....\$88.00



SELF-SHIELDED Bar-Ring instrument; permits checking in strong magnetic fields. FITTING INTERCHANGEABLE test prod tip into top of tester makes it the common probe, thereby freeing one hand. UNBREAKABLE plastic meter window. BANANA-TYPE JACKS—positive connection and long life.

Model 310—\$44.00 Model 310-C—\$56.00 Model 369 Leather Case—\$4.20

All Prices are Suggested U.S.A. User Net, Subject to Change

THE WORLD'S MOST COMPLETE LINE OF V-O-M's • AVAILABLE FROM YOUR TRIPLETT DISTRIBUTOR'S STOCK



TRIPLETT ELECTRICAL INSTRUMENT COMPANY, BLUFFTON, OHIO 45817

See Litton first for miniature K-Band magnetrons.



If your application involves missile guidance radar, beacons, airborne terrain-following radar, manpack radar, aircraft landing systems, transponders, fuzes, commercial weather avoidance radar or airborne doppler navigation radar — Litton offers you a complete line of miniature K-band magnetrons.

Our exceptionally broad line will fit into any system within all these applications and offers you unique performance characteristics. Qualities like low temperature coefficients. Short warm-up time. Very short pulse width capability. Long life expectancy and low RF interference. These features will ensure compatible operation in the most demanding K-band systems.

A few typical examples of our miniature line are given in the chart below. For full details contact: Electron Tube Division, 960 Industrial Road, San Carlos, Calif. 94070. Telephone (415) 591-8411.

Tube Type	Minimum Peak Power (Kw)	Frequency Range	Tuning
L-5048 coaxial	1.0	15,950-16,550	Mechanical
L-5112 coaxial	2.2	15,400-15,700	Mechanical
L-5113 coaxial	2.2	15,400-15,700	Mechanical
L-5013 coaxial	4.0	15,500-16,500	Mechanical
L-5035 coaxial	8.0	15,900-16,400	Mechanical
L-3958A coaxial	9.0	15,500 \pm 85	Fixed Frequency
L-3496A	1.0	16,000-16,500	Mechanical
L-5189	1.0	14,200 \pm 150	Fixed Frequency
L-4370	0.04	13,325 \pm 30	Fixed Frequency

 **LITTON INDUSTRIES**
ELECTRON TUBE DIVISION

This new UV Sensor will simplify your UV measurements...

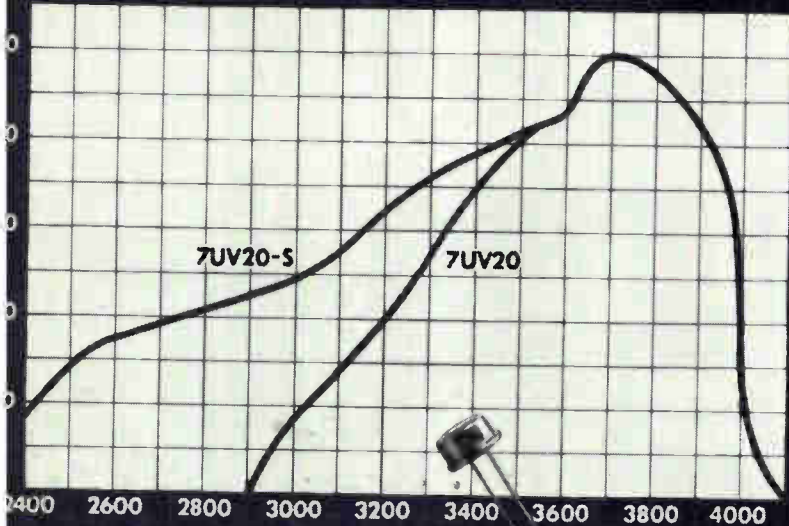

and save a
few bucks besides.

Not only do you save in the cost of equipment, you have a much simpler and smaller overall package for UV detection.

From the response curve you can see that these photoconductors are blind to visible light. Conductivity peaks at 3700Å and the sensors are highly efficient from 2450Å to 3900Å.

The basic sensor is available in two models, 7UV20 with a glass window and 7UV20-S with a sapphire window. Both models are packaged in a TO-5 can.

For complete information or for special assistance with your UV problems, write Clairex, 560 South Third Avenue, Mount Vernon, New York 10550.

CLAIREX ELECTRONICS

A DIVISION OF CLAIREX CORPORATION

New S. S. White system trims microelectronic hybrid resistors at 1,000 per hour...or more



If you're into hybrid circuitry in a big way, or hope to be, our Model AT-701AR may be just what you need. It offers high capacity, accurate trims, high yield — or, just what you need to keep your customers and your comptroller happy.

Model AT-701AR is similar to our highly successful Model AT-701A, but with the addition of a rotary feeding system which lets operator load and unload substrates during the machine's trimming cycle. Capacity is limited only by the man-

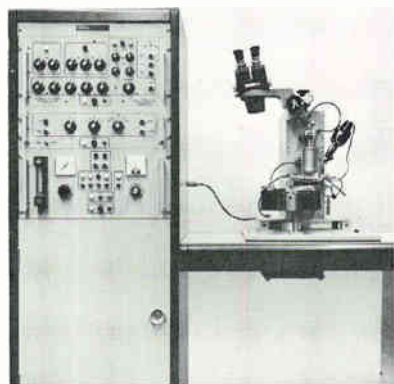

Model AT-701AR

ual dexterity of your operator.

Accuracy of the AT-701AR is guaranteed — within 0.5%. 0.1% is attainable with care and some sacrifice of speed. Trimming is monitored by a precision system of electronics featuring a four-wire Kelvin bridge, and tolerances may be programmed from $\pm 0.1\%$ through $\pm 11\%$. (No use making them better than the specs require!)

But suppose the Model AT-701AR is too big or too small for you?

Call us anyway. If you can get by with something like 600 accurate trims an hour, we can offer you our Model AT-701A, to which you can add the turntable feature later. If you're still experimenting, we have Model LAT-100 for breadboarding. It is accurate to 1% better, takes substrates up to 4 x 4 inches and sells for only \$5,950. If you're *really* big, there's the Model AT-704A, a rotary-feed

machine that trims four resistors simultaneously, monitors, and inspects them at the breathtaking rate of 4,000 per hour. And if *that's* not fast enough for you, buy two.

All the S. S. White resistor trimming systems are based on the proven Airbrasive® method of removing resistance material which produces neither heat nor shock, does not alter the substrate.

Call 212-661-3320 to arrange for a live demonstration. Speak to Hal Skurnick or Don Davis. These same gentlemen will be demonstrating the Model AT-701AR and the Model LAT-100 at major electronics trade shows around the country, and if that's not quick enough for you, we will arrange for you to visit our factory. We have also prepared an extensive technical bulletin on this equipment, called, rather cryptically, the "RT-14", a copy of which is yours for the asking.



RT-14

Write to S. S. White Division, Pennwalt Corporation, Dept. R, 201 East 42nd Street, N.Y., N.Y. Tel.: 212-661-3320

PENWALT
S.S. WHITE
INDUSTRIAL PRODUCTS

New GLASKYD[®] 7100 FR
an alkyd molding compound
with the best
wet electrical properties,
flame, heat and arc resistance,
both flexural and
impact strength,
dimensional stability,
a fast molding cycle
and economy.



all things considered, it's the
best connector material you can buy!

For additional information about this circuit
saver, write American Cyanamid Company,
Plastics Division, Wallingford, Connecticut 06492.

Room for improvement

General Electric's TO-5² transistor-size sealed relays give you more room for increased power, improved performance

We didn't cut any corners on this high-reliability, transistor-size sealed relay. We left them on so there'd be more room for a more powerful magnet—2½ times more powerful.

This added power means this type 3SBS, 2PDT, 1 amp relay gives you higher contact forces, larger contact gaps, and greater overtravel to minimize mechanical shifts. Shifts which usually increase early-in-life failures.

Though there's more room inside to give you all these advantages, the outside dimensions—top-to-bottom (.275") and side-to-side (.370")—are the same as any transistor-size relay.

So don't cut corners on your next transistor-size relay application. Specify GE's square Type 3SBS. For full details, write General Electric, Section 792-45, Schenectady, New York 12305.



ACTUAL SIZE

GENERAL  **ELECTRIC**

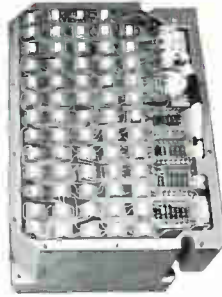

Avionic Assemblies



Servo Motors

Synchros and Resolvers

When it comes to Components and Avionic Assemblies

You Name It!
We have it or we'll make it

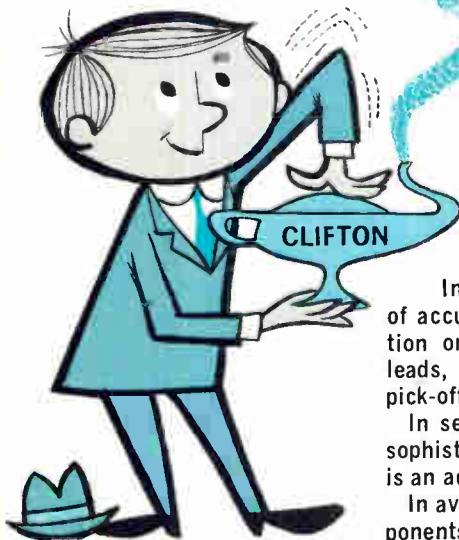

From the most basic rotating components to complex avionic assemblies, you can depend on Clifton quality, versatility and variety.

In synchros, what do you need in the way of accuracy, size, type, temperature, radiation or corrosion resistance, terminals or leads, double ended shafts, tandems, gyro pick-off or BuWeps types? We have everything!

In servo motors (AC, DC or stepper) and sophisticated motor rate tachometers, Clifton is an acknowledged leader.

In avionic assemblies, we use quality components coupled with creative design and

offer sophisticated avionic systems, actuators, analog computers, simulators, switches, and indicators.

Finally, in the solid state technologies which are in some cases replacing electro-mechanical assemblies, look to Clifton for the latest in A/D Converters, digital readouts, solid state servo repeaters.

For a willing response to your inquiry, contact your Local Clifton Sales Office or (215) 622-1000, Clifton Heights, Pa.

CLIFTON
DIVISION OF LITTON INDUSTRIES

Want a tachometer with an accurate numerical readout?

Order an Airpax Digital Tachometer.



Now you can read RPM, GPM, FPM, or any engineering units directly with the Airpax Digital Tachometer. No more interpreting a meter scale! Signals can be counted and displayed over preset time intervals. And dual set-points are available with outputs capable of performing any normal controlling function. The new Digital Tachometer is available in four, five, or six digit readouts and covers frequencies up to 100kHz. The versatile unit is compact and plug-in construction allows easy maintenance. It operates on 115 volts 50 to 400Hz and consumes just 12 watts. Contact Airpax today for more information.

AIRPAX ELECTRONICS Seminole Division, P. O. Box 8488
Fort Lauderdale, Florida 33310, Phone: (305) 587-1100
TWX: (510) 955-9866, Telex: 051-4448

Liquid laser goes commercial

Coaxial flash lamp initially designed at NASA center is key development in moving device out of lab; lasing dyes permit varied color outputs covering almost entire visible spectrum

By James Brinton

Electronics staff

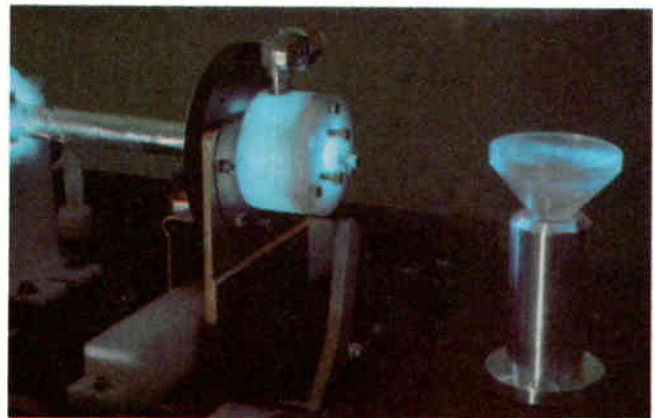
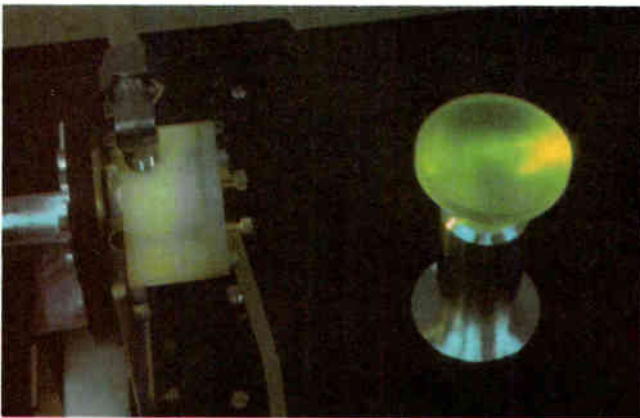

In pulsating color. Outputs from a liquid laser bounce off conical sections of lucite plastic. The yellow-green light pulses are emitted by Rhodamine 6G, and the blue by Coumarin. Efficiency depends on the dye being used; it is typically 0.2%.

To the engineer, the liquid laser is a thing of beauty. Not only can it emit a range of wavelengths from the ultraviolet to the infrared, but its liquid medium is free of lattice defects, impurity concentrations, and bubbles that can make laser rods damage themselves. And by changing the amount of dye dissolved in the solvent, one can experiment with various dopant levels; with solid state lasers, the dopant level is fixed.

Not only that, but the liquid laser is tunable, and single wavelengths can be picked out of its emission while retaining respectable output powers.

But until the General Laser Corp. introduced its DL-1000, there wasn't any such thing as a commercial liquid laser. Available units had been built in the lab for use in the lab—and there were some pretty good reasons.

Originally, some of the solvents used to dissolve lasing dyes were toxic. But it was found that grain alcohol worked for most dyes.

The pumping problem was tougher. Dye lasers need very abrupt (about 100 nanoseconds rise time) and powerful pulses to raise them to threshold. High power meant high current densities within the flash lamp, densities often high enough to shatter the pencil-shaped linear flash lamps used in most lasers, and fast rise times aggravated the problem.

But slower-rising pulses made for weak emission or no laser action at all. And even when flash lamp and power source were constructed with great care, laser output power could vary widely from pulse to pulse. At best, linear flash lamps could make only a few dyes lase. Most needed so much pump power that another laser had to supply it.

Solved. The DL-1000 design includes solutions to this problem, and General Laser is preparing to sell its system for less than \$5,000, with first deliveries scheduled next month.

According to S. Edward Neister,

project engineer, the firm had to work its way through a list of interfacing tradeoffs, among them the wall thickness of laser tube and flash lamp, flash lamp gas-fill pressure, and power supply rise time and inductance. A change in any one of these could vary output power, efficiency, beam divergence, or other characteristics. But more than any other part of the design, the flash lamp was the pacing factor in the technology.

Michael Sirchis, program manager, says that some of the company's design solutions are based on research done at the NASA Electronics Research Center by Horace W. Furomoto and H.L. Ceccon. Their major contribution was basic design of a workable flash lamp.

Instead of being linear, the NASA flash lamp was coaxial—a fat cylinder with a hole on its axis through which the laser tube passed.

Coaxial lamps could take higher pulse amperages and withstand higher current densities than linear lamps. Whereas a linear flash lamp



A single pair of wires, or a leased telephone line, can carry the audio signals for a complete control system.



For inaccessible areas or mobile installations, a radio transmitter and receiver system can carry the signals.

REMOTE CONTROL SWITCHING WITH AUDIO SIGNALS

(actual size)

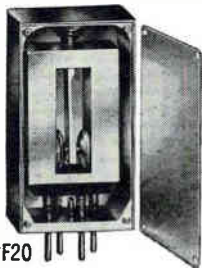

MODEL RF20
contactless resonant
reed encoder/decoder
.395 x .620 x 1.100

An audio tone can be generated by an electronic oscillator or resonant reed encoder circuit, then transmitted by wire or radio. The tone activates a resonant reed relay to perform a control function.

Bramco reeds permit over 100 selective control frequencies within the 67 to 3000 Hz. spectrum. This is assured by: (1) the narrow response band-width of about 1% for decoders and (2) the high accuracy of Bramco reed encoders (1/10 of 1% of design frequency).

A big advantage of reeds in control switching is that they are ideally suited for simultaneous and sequential coded tone systems. The actual number of control functions possible in such a system is virtually unlimited. For example, over 3300 individual control functions are possible with only 16 frequencies coded sequentially in groups of three.

Compared to other types of tone filters, resonant reeds are small and inexpensive. They give more control functions per spectrum, per size, per dollar.

If you work with controls that select, command, regulate, or indicate, you should know how it can be done with audio signals. We custom design and stock a broad line of encoder/decoder components and modules. Bramco also custom designs LC filters from 0 to 200 KHz.

For literature write Bramco Controls Division, Ledex Inc., College and South Streets, Piqua, Ohio, or call 513-773-8271.



BRAMCO CONTROLS DIVISION
LEDEX INC.

College and South Streets, Piqua, Ohio 45356



Out of the lab.
Liquid laser now available commercially includes a circulating-fluid system that can be drained and then filled with a new solution in less than 5 minutes.

... sealed coaxial lamp surrounds laser tube, pumps light into it from all directions ...

might withstand only 6 kiloamperes per square centimeter, a coaxial lamp could operate with current densities as high as 90 kiloamperes.

This made it possible to generate more light, and also more of the right kind of light—color temperatures of typical coaxial flash lamps in the DL-1000 are over 20,000°K, far above color temperatures possible with linear flash lamps, and the higher color temperature means more energy is coupled into the dye molecules.

Also, since the coaxial lamp surrounds the laser tube, it pumps light into it from all directions. This, plus the current handling and color temperature characteristics of the coaxial lamp, made it look like a world-beater.

But not quite. Unfortunately, the earliest coaxial flash lamps tended to “filament.” Instead of flashing throughout their volume, discharge happened along a line or filament between the electrodes. So the first coaxially pumped dye lasers were no more efficient than ones pumped with linear flash lamps—and sometimes even less efficient, because the rest of the gas in the coaxial lamp absorbed much of the light radiated from the filament.

The NASA scientists figured out how to build a coaxial lamp that didn't filament; they used thin quartz walls, a xenon gas fill, and ring-shaped copper-tungsten alloy electrodes which doubled as end caps. And the engineers at General

Laser figured out a way to seal the new tubes to prevent internal contamination and loss of brightness. Neister doesn't want to give the sealing technique away, but notes that lamps have lasted well beyond 2,000 flashes without noticeable degradation.

It's this lamp and its associated power supply that make the dye laser as convenient as earlier lasers. Power from a 110-volt a-c line is stored in a 0.3-microfarad, low-inductance capacitor at up to 25 kilovolts. To keep rise time fast, inductance within the power supply is low; in the DL-1000 it's between 10 and 20 nanohenrys. A so-called quality specification from the power supply is the amount of inductance due to leads between capacitor and lamp—this figure is only 2 to 3 nanohenrys.

Adjustable. The supply can be adjusted to fire the flash lamp at voltages from about 10 to 25 kv by turning a knob on the side of the laser. And though the system is rated to deliver about six pump flashes per minute at about 100 joules per flash, the actual rate is a little faster.

The percentage of the 100 joules emitted as coherent light varies with the dye used and its concentration. “About 200 millijoules is a typical output at 5,800 angstroms, the lasing wavelength of Rhodamine 6G,” says Sirchis. “With Coumarin, the output is about 100 millijoules at 4,500 angstroms.” Other dyes yield light at various



We can guide you to the easiest wire and cable buy for peripheral equipment.

Brand-Rex has been the leading supplier of wire and cable for major computer systems for 20 years. And if you manufacture computer peripheral equipment, this leadership can work for you a number of ways. You save shopping around, because Brand-Rex has designed and makes available the broadest selection. You can get what other people call "custom" designs at little or no extra cost from us. We're already making it, or can come up with it easily by modifying an existing design. (Brand-Rex engineers turn out as many as 3,000 new versions of wire and cable in a year.)

U.L., MIL-Spec. and other approvals? No strain. Brand-Rex has more U.L. approvals on computer wire and cable than anybody else. Plus the lab and Q.C. facilities to get new ones . . . fast.

Our people catch on to your needs the first time around, because they've been around.

Write for our catalog on "Business Machine Wire and Cable" Brand-Rex Division, American Enka Corp., Willimantic, Conn. 06226. Phone 203 423-7771.

Connect for tomorrow. BRAND-REX

Circle 171 on reader service card

the superfastmultipurpose tick / tock / go machine.

CTC's Model 1801 Program Generator with 32 25MHz repeatable time steps and 16 channels. Complex program- ming for sophisticated memories.

Meet the program generator that can't be fooled—no matter how complex your programming setups are. It's a whiz at programming tests for all kinds of fast and sophisticated memory types, including plated wire, planar film, semiconductor and core memories. Because there's a unique combination of features built into it for added usefulness. Like four repeat delays, for an infinite combination of pulse sequencing. And its own power supply, for stand-alone operation. Programs may be started manually or by remote control; you can select initial and final steps the same way. If you're faced with memory test problems, write for literature about our superfastmultipurpose machines.



From CTC . . . where advanced state-of-the-art technology
meets tomorrow's memory test requirements!

COMPUTER TEST CORPORATION

SUBSIDIARY OF COMPUTEST CORPORATION

THREE COMPUTER DRIVE • CHERRY HILL, N.J. 08034
PHONE: 609/424-2400 • TWX: 845120 • CABLE: COMPUTER

Circle 172 on reader service card

Want to be unique in our memory?

It's easy. Enter the Electronics Manpower Register.

We'll feed your professional background into the talent memory of our nationwide computerized recruitment service.

Our computer will match your unique profile against every opening being programmed into it by a long list of electronics

companies. You'll automatically be qualified for every logical career opportunity. But we'll only release your availability to those companies you approve.

To enter, send us your resume.

Electronics Manpower Register

Electronics
330 West 42nd Street
New York, N.Y. 10036

frequencies, covering in all the entire visible spectrum except for about 200 angstroms.

Efficiency also varies with the dye used, but at a typical 0.2%, the liquid laser is in the same league with ruby lasers.

Buyers of the DL-1000 will have their choice of one of four dyes: Rhodamine G, Rhodamine 6G, Fluoroscene, or Coumarin. Since the output wavelength of each of these dyes differs, a special set of hard-coated cavity mirrors is included to suit the dye.

Added dye-and-reflector sets will be offered at about \$300 each, and a 400-milliliter supply of lasing liquid would cost about \$25. "But we don't plan to get into the dye business," says Ken Wood, director of technical planning. "It's easy to mix these solutions, and that's what we expect more of our customers to do."

The DL-1000 is aimed at scientists and engineers using it as a means of finding new lasing molecules or experimenting with a wide variety of output colors.

With dyes already known, and with those that are appearing, it's possible to tune the output of the DL-1000 about ± 150 angstroms around a center wavelength. By adding an optical grating, it's possible to select output wavelength to within about 1 angstrom—and such are the peculiarities of the liquid laser that there's only a 25% over-all power loss when it's done.

To make the unit safe and easy to operate, General Laser has designed interlocks that short the capacitor if the laser head is uncovered. Also, if the cover isn't on tightly enough, the control panel lights show this.

For experimenters. Users can drain and refill the recirculating liquid system in less than 5 minutes, and its pump and piping are impervious to almost any solvent needed for liquid laser work. There's even a fitting which allows experimenters to change the gas pressure in the spark gap that acts as the flash lamp switch. By raising pressure, the experimenter can make the flash lamp fire at higher voltages. General Laser may offer fittings to allow changes in the gas fill in the flash lamp.

General Laser Corp., 8 Erie Dr., Natick, Mass. 01760 [338]

Circle 173 on reader service card →



IMITATED—BUT NOT EQUALLED. CINCH BACK PLANE CONNECTOR SYSTEM

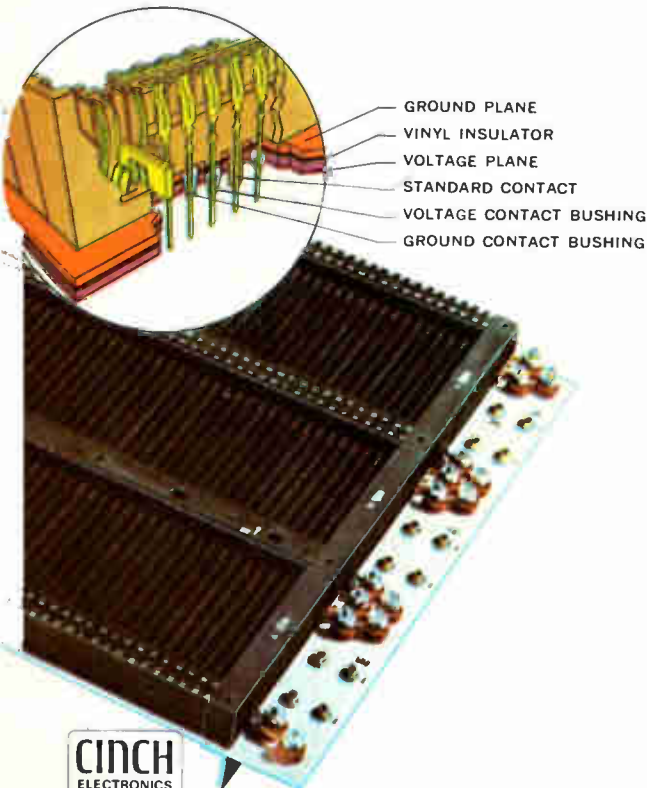

Today, most back plane connector systems are being modified to include features first developed by Cinch. But only the Cinch back plane was designed to incorporate these innovations as basic design considerations, not modifications of already existing devices.

Cinch design leadership produced the *first* back plane connector system with these important features:

1. Replaceable buss bars that permit removal and replacement of bussing contacts.
2. Easily replaceable voltage plane and ground contacts, including bussing.
3. Precision monoblock insulators that eliminate modular construction.
4. Cantilevered, preloaded contacts.

Cinch didn't stop with the product. Special design molded styrofoam carriers completely eliminated damage during transit.

Combined with cost reducing techniques of selective gold plating, simultaneous insertion of contact rows and a unique method of terminal positioning, these features result in the most efficient and most economical back plane connectors system you can buy.

For information on this or other Cinch interconnection devices, contact your local Cinch Electronics Group office or write to Cinch Manufacturing Company, 1501 Morse Avenue, Elk Grove Village, Illinois 60007.

C-6914

CINCH
ELECTRONICS
GROUP.

CINCH
DIVISION OF UNITED-CARR

CINCH MANUFACTURING, CINCH-GRAPHIK, CINCH-MONADNOCK AND CINCH-NULINE DIVISIONS OF UNITED-CARR INC., A SUBSIDIARY OF TRW INC.

Through a glass, lightly

Hand-held frame with rotating disk converts conventional cathode-ray tube display to color, three-dimension, or both

By Wallace B. Riley

Electronics staff

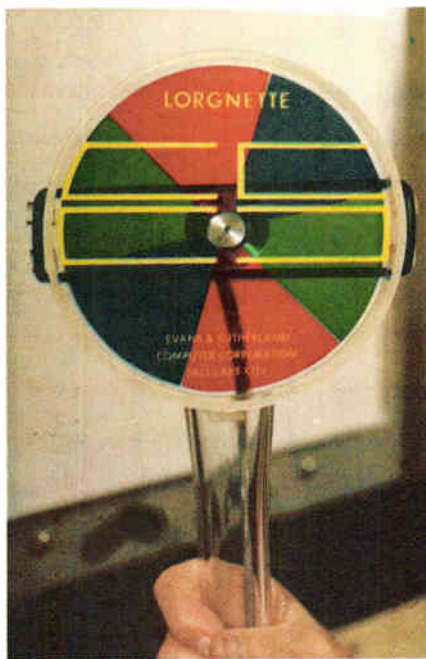

Bringing out the colors. The lorgnette at left contains the color disk, shown stationary. When it rotates, center photo, it permits the viewer to see programmed color in the computer-produced display, as at right. Another disk separates right- and left-eye images to produce black-and-white 3-D; and a third combines color and 3-D.

Mention of a lorgnette usually calls to mind the image of a grande dame gazing imperiously at some objet d'art. But engineers, scientists, executives and other users of crt displays may start looking at their screens through lorgnettes.

In this case the lorgnette is a product of the Evans and Sutherland Computer Corp. of Salt Lake City. It's a lightweight, hand-held viewer connected to some simple electronic circuitry that repeatedly interrupts the computer driving the display. Through the viewer, the conventional 2-D display can be made to appear to the observer in 3-D, in color, or both.

The lorgnette permits use of color-coding as an aid to under-

standing a complex situation. On a tool path plot for a numerically controlled machine, for example, cutting and non-cutting motions could be shown in different colors. The new display accessory can also separate right- and left-eye images to provide for viewing three-dimensional information in stereo. The structure of complex three-dimensional molecules can be made more evident by such a stereo presentation. Color stereo views are also possible with the lorgnette.

In a frame 5 inches in diameter and half-an-inch thick, the lorgnette contains a disk that rotates at 10 revolutions per second. Any one of three interchangeable disks can be used. Each of these is divided

into six equal sectors. For color viewing, two of these sectors are red, two green, and two blue, with like-colored sectors diametrically opposite. This produces a 2-D color picture.

For 3-D viewing the sectors are alternately clear and opaque; and for 3-D in color three alternate sectors of the special disk are opaque and the remaining three are red, green, and blue.

The user holds the lorgnette in front of his face with the center of the disk opposite the bridge of his nose. In this position, with the color disk in place, both eyes are looking through sectors of the same color; or with the 3-D disk, one eye is blocked by an opaque sector

Cermet

AND THE

Model 3262

POTENTIOMETER

Meets requirements MIL-R-22097, Style RJ-26
to 100 PPM/°C over entire resistance and temperature range*



Designed to not only meet requirements, but beat requirements! A ¼ inch square potentiometer of the highest quality available — in the tradition of excellence of design and workmanship you have come to expect from Bourns . . . the leaders in the industry. Write or call the factory, your local field office or representative today for technical data.

*Resistance range: 10Ω to 1 Megohm
Temperature range: -65°C to +175°C



BOURNS, INC., TRIMPOT PRODUCTS DIVISION • 1200 COLUMBIA AVE., RIVERSIDE, CALIF. 92507

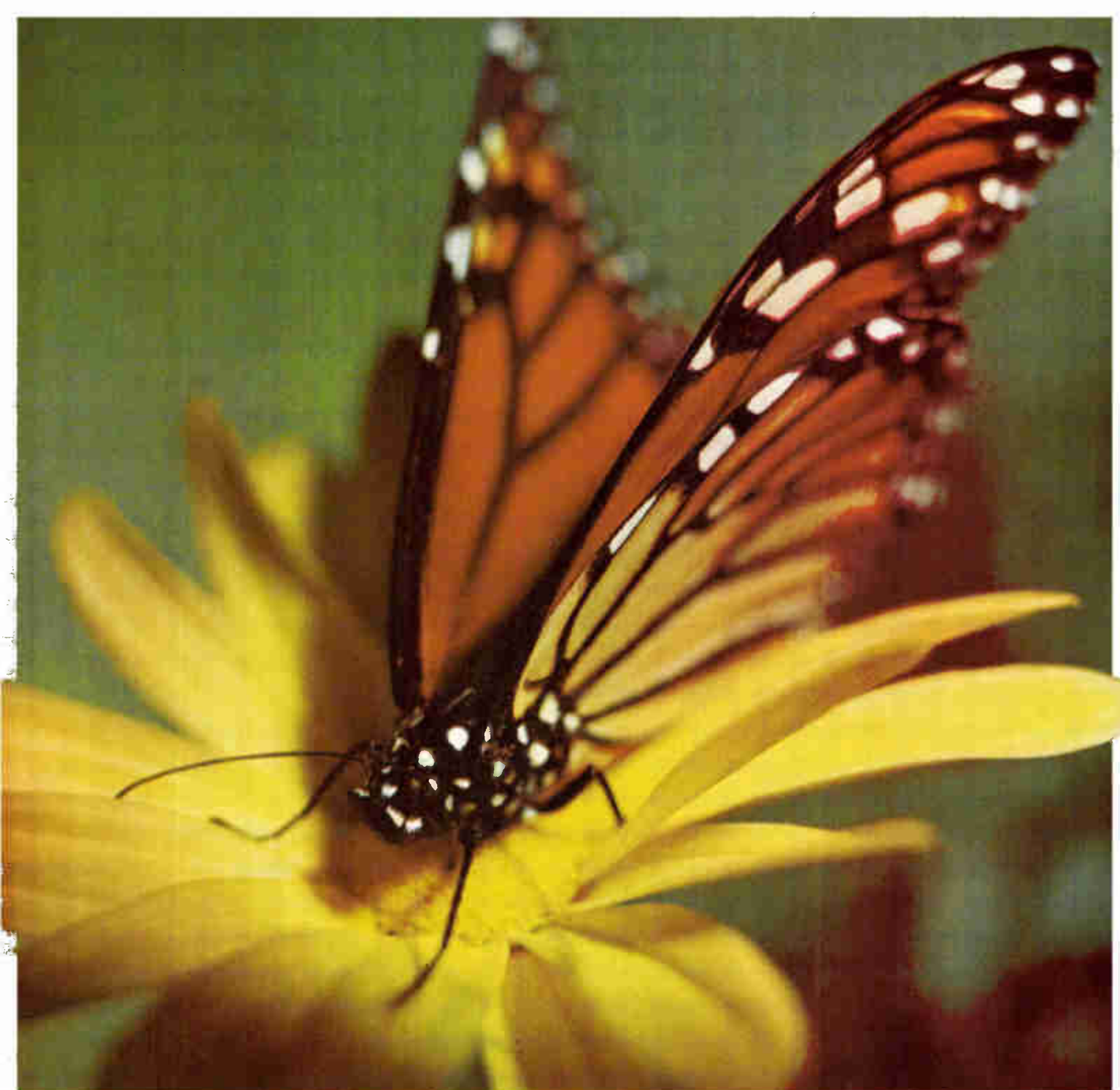

DOWCLENÉ WR Solvent, The Dow Chemical Company, Inorganic Chemicals Department, Midland, Michigan 48640.

How would you clean his scanning devices?

With great care and a super-clean solvent. That's DOWCLENÉ® WR chlorinated solvent. Pure enough to meet NASA spec MSFC 471. Less than one part per million residue. And one of the safest chlorinated solvents you can use. Cost? About half of other white room solvents. We're proud of DOWCLENÉ WR. That's why you'll find a certified analysis for particulate matter on every drum. For more information and a free sample, why don't you send out a feeler? Today.



Circle 176 on reader service card

... one control unit
can run 10 lorgnettes ...

while the other eye looks at the display.

As the disk rotates, whenever a sector boundary crosses the line of sight, an interrupt signal is generated—once every 16.7 milliseconds at the 10-rps rotation. This signal causes the computer program to change the display. For color-viewing three different displays, one for each primary color would be shown in rotation. Conventional displays can draw perhaps 1,000 lines in the interval between interrupts. For 3-D viewing, two displays at slightly different angles would be used. Persistence of vision combines these displays into one with the desired attributes of color and/or depth.

Synchronized. Up to 10 lorgnettes can be controlled by a single control unit and power supply, and up to seven controllers can be connected in parallel to drive as many as 70 lorgnettes—all in perfect synchronism. This is attained by small synchronous motors on the handheld frame, protruding on the side away from the user's face. The motors are driven by a 120-hertz alternating current obtained from the 60-hz power line; the motors work with any current of 100 to 150 hz. There are four interrupt signals; one indicates that a sector boundary is in front of the eye, and the other three signals are used to identify the boundary.

For best results in color, a screen with a white phosphor is necessary. Phosphors are available that are both fast and white, and are already in use in many display systems; in other displays a substitute crt can be installed. Designers of the lorgnette say that the widely known televising phosphor, P4, proves to be good for both stereo and color presentations.

The lorgnette system sells for \$995, which includes two lorgnettes and three disks for each of them, and the electronic controls. Additional lorgnettes, including three disks and a plug-in card for the controls, are available at \$245 apiece.

Evans & Sutherland Computer Corp., 3 Research Road, Salt Lake City, Utah [339]

Electronics | December 8, 1969

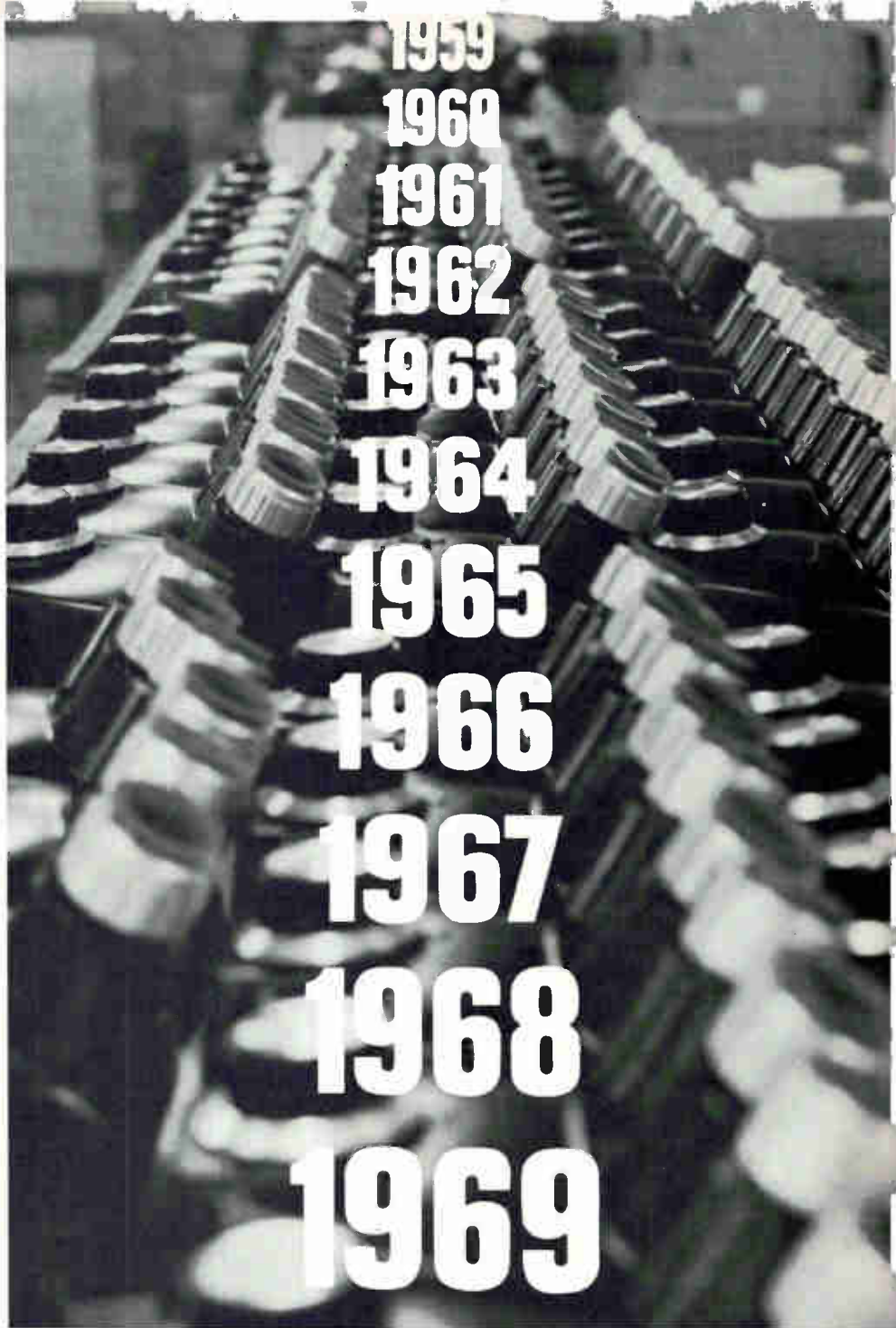

OUR STEREOZOOM® ASSEMBLY LINE IS ELEVEN YEARS LONG

Bausch & Lomb originated the stereomicroscope with zoom optical system eleven years ago. We've spent those years making sure that StereoZoom continues unexcelled in performance and reliability. Only Bausch & Lomb StereoZoom assures you the flattest fields ... the greatest depth of field ... locked-in focus throughout the zoom range ... highest eyepoint eyepieces ... accurate eye-level magnification readings on the zoom control knob.

Now, there's a new member of the line, the StereoZoom 7, with widest zoom range, sharpest images, highest resolution/magnification.

Get all the facts. Write for our new catalog 31-15. Bausch & Lomb, Scientific Instrument Division, 99718 Bausch Street, Rochester, New York 14602.

BAUSCH & LOMB 

SCIENTIFIC INSTRUMENT DIVISION

Circle 177 on reader service card

FREE TEST...

(How can you solve
your filtering problem
if you don't know
you have a problem?)



FREE PROOF

that Cox can solve a contamination problem
you may not know you have,
boost your filtrate throughput up to ten times,
and guarantee filtrate purity within absolute limits!

Do you insist on "absolute" filtration, without knowing if your filtering system delivers it, day in, day out?

More importantly, do you *know* the proper degree of filtration your process actually needs, or is it based on an educated guess?

At no obligation, Cox will be glad to analyze both the efficiency and the effectiveness of your present filtering system. We'll be glad to evaluate the true degree of filtering which your process requires. We'll show how you can achieve the ideal balance between particle retention and filtrate throughput, while increasing throughput volume many times. If your present system turns out to be correct for your process requirements, we'll tell you so and go away.

But chances are we can show you ways to improve your present process, ranging from suggesting

minor improvements up to proposing a totally new set of specifications and the mechanical changes necessary to maintain those specs on a continuing basis.

DO IT NOW: send us a representative sample of your process filtrate, together with a note telling us your filtering specifications and the nature of your process and product. We'll return to you an analysis report within 24 hours after receiving your test sample. There's no obligation.



COX INSTRUMENT
DIVISION OF LYNCH CORPORATION

15300 Fullerton Avenue • Detroit, Michigan 48227

Four-pole relays fit in TO-5 can

Magnetic latch units designed to combine high isolation of electromechanical devices with semiconductor compactness

NASA and the CIA have at least one problem in common: they both require reliable and isolated communications circuits, without cross-talk. The space agency has additional constraints in terms of weight, size, and power consumption of components.

With these and other customers in mind, Teledyne Relays has introduced a line of four-pole single-

throw magnetic latching electromechanical relays that are small enough to fit in a TO-5 package. The aim is to replace four-pole single-throw reed relays and larger four-pole magnetic latch relays with switches that combine the high isolation of electromechanical units and the compactness of semiconductor devices.

Teledyne says the models 424A

and 424AD are the smallest four-pole relays developed to date. The company began marketing TO-5 size relays about six years ago, and now claims the ability to deliver 12,000 types to users. More than 1,000 of its two-pole, double-throw magnetic latch miniaturized relays were aboard Apollo 12.

The welded, hermetically sealed 424A and 424AD units meet MIL-R-



Circuit throughput using dual terminations to eliminate the requirement for by-pass cable features the design of the series 22-000 internal leaf sequencing switches. Completely enclosed, the ultra-long-life MIL device is used in portable communications units to activate power and microphone control circuits in proper sequence. Chicago Switch Inc., 2025 Wabansia Ave., Chicago [341]



Series LAR line activated relays are for a-c power switching in single pole normally open uses. The series, utilizing a thyristor design, eliminates moving contacts, resulting in a highly reliable unit with virtually infinite switching life. Units are available in 4, 6, 8, 10, and 15-amp ratings for either 120 or 240 v a-c. Electronic Control Corp., P.O. Box J, Euless, Texas [342]

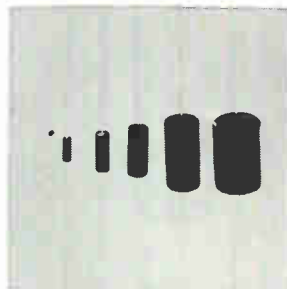

Tubular monolithic ceramic capacitors series 6171 are designed for operation up to 200°C. Capacitance values from 10 pf to 2 μf are standard. All devices are manufactured in accordance with applicable portions of Mil-C-39014. Delivery is from stock to eight weeks with prices starting at less than \$1. The Potter Co., 500 W. Florence Ave., Inglewood, Calif. 90301. [343]

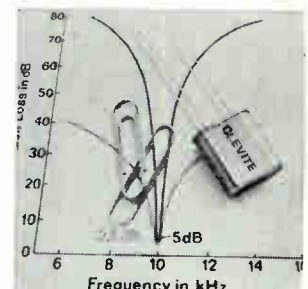

Low-frequency ceramic bandpass filters come in center frequencies from 9 to 50 kHz. They are hermetically sealed in the standard HC 6/U crystal can, are fix-tuned and combine narrow bandwidths with high performance. Weight is less than ¼ oz. Applications include 1-f communications receivers, control circuits, sonar and radar. Gould Inc., 232 Forbes Rd., Bedford, Ohio [344]



Six-pole double-throw relay series 200 Mark II can operate continuously at up to 200°C. It conforms to MIL-R-5757/11. Its contact mechanism delivers a positive wedge-wiping action that cuts through surface films to create a continual self-cleaning of the precious metal contacts during make and break movements. KDI Electro-Tec Corp., Ormond Beach, Fla. [345]

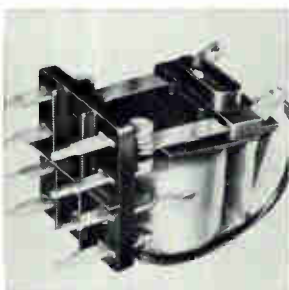

Control relay series CPC is engineered to meet the demands of modern p-c designs. It is available in voltages up to 220 a-c or 110 d-c, with resistances up to 16,000 ohms and in any frequency from 25 to 60 hz. Units measure 1 11/32 x 2 x 1 ¼ in. Relays are rated at 10 amps for 110 v a-c or 10 amps for 28 v d-c. Chicago Relay & Mfg. Corp., 4626 Olcott Ave., Chicago 60656 [346]



Nylon plastic socket SD-1852 is for miniature four-pole, double-throw 5 amp relays. It is claimed to be about 30% less expensive than relay sockets now available. Its plastic mounting clips permit ease of installation and eliminate need for accessory mounting devices. A safety feature is its fully-insulated dead back. Molex Products Co., Katrine Ave., Downers Grove, Ill. [347]

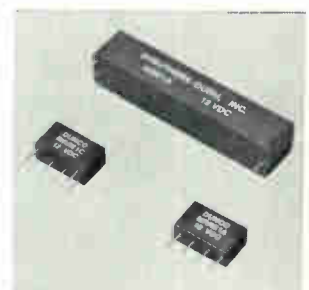

Dry reed relays are encapsulated in epoxy-filled plastic shells for maximum operating stability and ruggedness. Relays with miniature reed switches or with standard size reed switches are available as series MRRE and series RRE respectively. Both series are presently available in one Form A normally-open, or one Form C double-throw switch. Struthers-Dunn Inc., Pitman, N.J. [348]

HADRON THE BEST IN LASER TECHNOLOGY

*NOW HADRON OFFERS HIGH-ENERGY
HIGH-BRIGHTNESS LASER SYSTEMS*

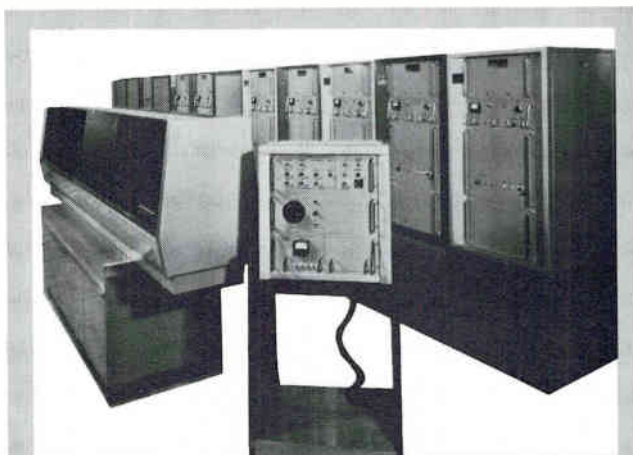

High Brilliance System Distributed By HADRON

As the sole distributor in the United States of the extensive and versatile laser product line of Compagnie Générale D'Électricité of France, we not only distribute these unique lasers but also provide installation, maintenance, and application services. All replacement parts are kept in stock — no waiting for repair parts.

High-energy high-peak-power systems are available that deliver pulses of infrared radiation with an extremely high brilliance. These lasers have been designed for various industrial and research applications and especially for those cases where a very brilliant luminance is required. Among the many applications for these systems are: Ionization of Gases • Generation of Plasmas • Plasma Diagnostics • Generation of Harmonics • Triggering and Generation of Reactions • Rangefinding.

Some of the systems available through Hadron are: High-Peak-Power Lasers • High-Repetition-Rate Ruby and YAG Lasers • Gas Lasers — CO₂, Ar, He-Ne, Kr, Xe • Rangefinders and Illuminators • Holographic Systems • Laser Gyroscopes • Calorimeters and Other Laser Accessories. For full information on these unique systems, call or write:

HADRON

300 Shames Drive/Westbury, N. Y. 11590
516-334-4402

**... 2 msec pulses
will energize units ...**

575D relay specifications, and have a rated reliability of 10 million operations at loads up to 10 milliamps. Model 424AD has an internal chip diode in parallel with each coil for transient suppression. Six versions of the two basic models have d-c coil resistances from 61 to 2,000 ohms, and coil voltages from 5 to 26.5 volts d-c. Contact bounce is less than 3 milliseconds, and pull-in power is 125 milliwatts at 25°C.

An optional mixed-coil configuration uses one coil to detect load levels, and permits use of the relay as an overload detector or circuit breaker. This version has a 0.1 volt d-c trip coil which trips to shut off current at 80 to 120% of the nominal tripping current. The reset coil is a conventional 26.5 volts d-c. Trip level accuracy is $\pm 10\%$, and other coil values are available to fit customer requirements.

Use less power. In addition to compactness and weight—only .065

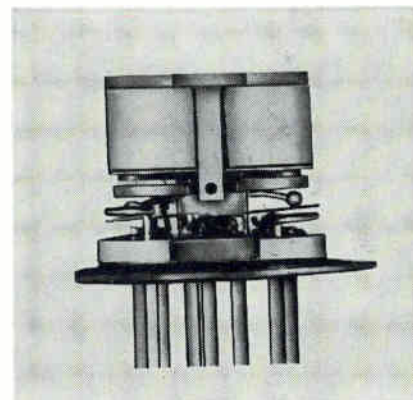

Best of both. Compact like a semiconductor, relay has high isolation of an electromechanical unit.

ounce—the relays use less power than conventional relays because they can be energized with short, 2-millisecond pulses, an important feature for airborne and space applications.

Environmental conditions of 30 G vibration to 3,000 hertz, and 100 G, 11-millisecond shocks can be tolerated by the units, which operate within a -65°C to $+125^{\circ}\text{C}$ range. Typical capacitance between contacts is 0.7 picofarad, and minimum insulation resistance is

Look at what Mallory has done to audio systems design.

Use these three new, low-cost Mallory IC's to design a complete stereo system with a minimum of external parts. They dramatically improve systems performance... at lower systems cost.

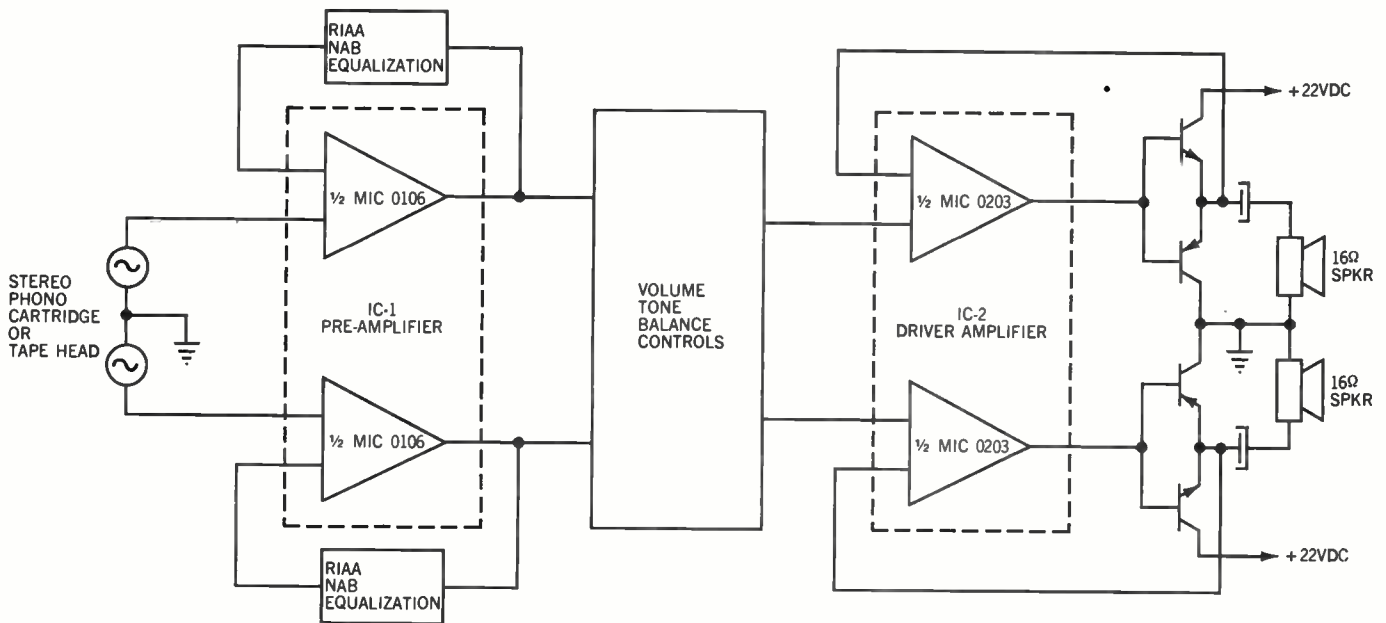

5 WATT STEREO AMPLIFIER
UTILIZING MALLORY INTEGRATED CIRCUITS

MIC 0102 Single-Channel, and MIC 0106 Dual-Channel Preamplifiers

- 60-db minimum gain.
- Feedback-frequency compensation provisions.
- 100K input impedance.
- Low distortion.
- Internal power supply filtering.
- Wide voltage-range supply.

MIC 0203 Dual Driver Amplifier

- 55-db minimum gain at $V_{cc} = 20$ Vdc.
- 10-ma drive current.
- Low input bias current.
- Low distortion.
- Power drive capability over 10- to 24-Vdc supply range.
- Direct drive for complementary or quasi-complementary output devices.
- Internal feedback resistors.
- External feedback capabilities.
- Two- and twelve-watt-per-channel drive capabilities.

Find out about these ultra-flexible IC's today... just three examples of our full range of value-packed IC's. Contact your Mallory Sales Offices, or P. R. Mallory & Co. Inc., Integrated Circuits Dept., Indianapolis, Indiana 46206. 317-636-5353.



How fast is GE's new helium leak detector?

Let your fastest operator show you

Manufacturers of electronic components asked us to help cut down leak test time.

So General Electric engineers designed a new leak detector to do the job.

It's the LC-40 Mass Spectrometer Helium Leak Detector, which offers unmatched testing speed in a general purpose leak detector. The LC-40 achieves this by combining the highest net pumping speed of any leak detector on the market (for equivalent sensitivities), with fast recovery from leaks. This combination pays off in a time-to-test of only seconds.

Complementing this test-time capability is a new simplified control system, which permits the operator to complete a test merely by loading the test piece and flipping a single switch. Results are instantly displayed on a meter.

But the LC-40 detector isn't just fast. It includes such performance-proven features as all-solid-state circuitry for dependable service; burnout-resistant thoria-coated iridium filament, exclusive with GE; all-welded stainless steel high vacuum system; high sensitivity (5×10^{-11} atmo. cc/sec He), a new source design to eliminate background signals, and many other significant advances.

Although ideally suited for high-speed production testing, the unit also can be used for general purpose applications. If you would like to learn more about General Electric's new LC-40 Mass Spectrometer Leak Detector, write General Electric Company, Analytical Measurement Business Section, 4MX, 25 Federal Street, West Lynn, Mass., 01905

268-41



GENERAL  **ELECTRIC**

10,000 megohms between mutually insulated terminals.

Because the relays have a fast actuation speed, 1.5 milliseconds maximum at nominal coil voltage, Teledyne says the relays are suited to both analog and digital systems and other applications such as telephone cross-point switching.

Despite large inroads made by solid state relays into the electromechanical relay market, Teledyne believes price alone will continue to inhibit the use of semiconductor devices in systems requiring large numbers of contacts. They point out that most of the cost in a semiconductor relay lies in the contacts, while only about 20% of the manufacturing costs in an electromechanical relay is represented in the contacts. This means that it's only slightly more expensive to go from a single-pole to a four-pole electromechanical relay, compared with a four-fold cost increase for semiconductors. Price for the model 424A is \$20 in quantities of 5,000 and \$35.70 in small quantities, and \$22 in 5,000 quantities for the model 424AD, with an internal diode. Delivery is off-the-shelf from either the manufacturer or Teledyne distributors.

Teledyne Relays, 3315 West El Segundo Blvd., Hawthorne, Calif. 90250 [349]

New components

Proximity switch sets new limits

Individually calibrated, unit can be adjusted to within ± 0.010 inch

Accuracy at a low price is how McClintock Matrixes bills its new proximity switch. Each unit, says Richard McClintock, is calibrated and tested automatically. And because this is done automatically, proximity switches, he points out, can be turned out fast enough and cheap enough to satisfy the OEM market.

Called the 26-5-4, the McClintock

What's NEW at GUARDIAN

GUARDIAN ELECTRIC MANUFACTURING COMPANY 1550 W. Carroll Ave., Chicago, Illinois 60607

new

GUARDIAN SOLID STATE RELAYS



Universal AC or DC control voltage with complete circuit isolation from load switching circuit. Externally-adjustable pull-in voltage level from 80-130V AC or DC, with close differential between pull-in and drop-out where accurate voltage sensing is required. ■ Control of high inrush amp, inductive or normal resistive loads from 10 ma to 3 amps. Internal filtering prevents random turn-on of "off" contacts.



NEW

GUARDIAN PRINTED CIRCUIT PLUG-IN RELAY

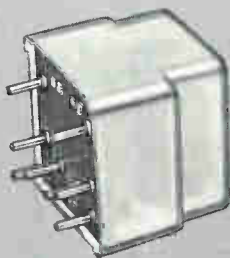

- Unique, compact design.
- All terminals on .1 grid spacing for standard printed circuit board.
- Solders right on PC board.
- Conforms to UL requirements for Business Machines. ■ 1 watt normal power— $\frac{1}{2}$ watt on request. ■ 3500 OHMS coil resistance (120V AC-60Hz). ■ Standard voltages 6 to 120 AC—6 to 24 DC. ■ Mechanical life over 10,000,000 operations. ■ 3 AMP. resistive 115V. 60Hz contact rating.



NEW

GUARDIAN LIFT OFF STEPPERS

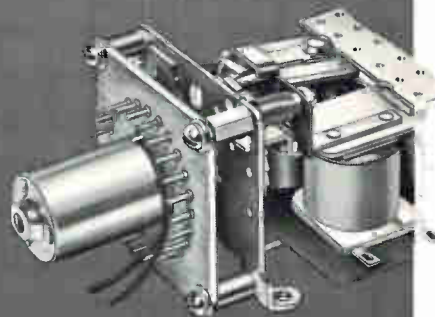

All the features of the widely used Guardian MER 24 point electrical reset stepper ...
PLUS

- Solenoid "lifts" wiper contacts when stepping to reduce friction ... and arcing. ■ Increased contact ratings to 5 amps resistive at 120V AC. ■ Increased function capability. ■ Increased dependability. ■ Increased life expectancy—now up to 10,000,000 steps. ■ Compact design.



Circle No. 514 For Literature.

Circle No. 515 For Literature.

Circle No. 516 For Literature.

Control/alarm shortcut.

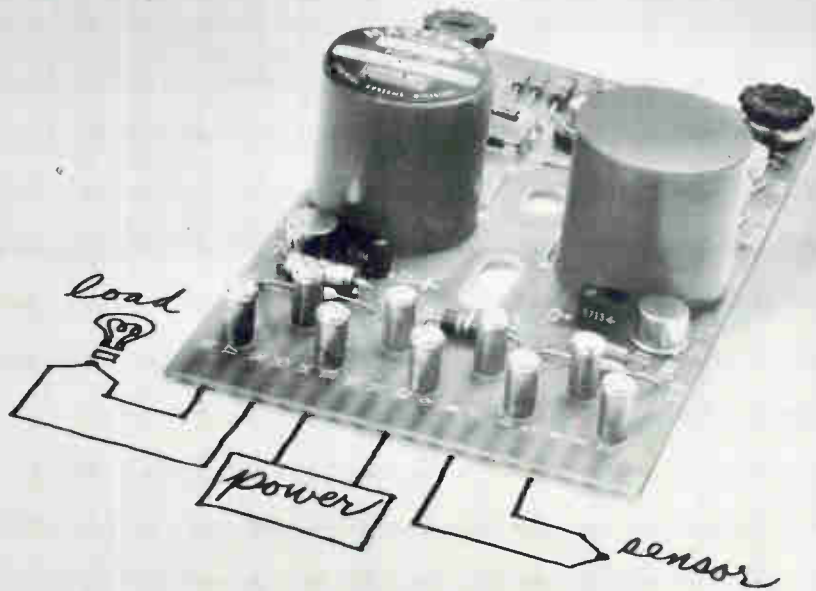

MAGSENSE

control/alarm for temperature, pressure, speed, flow

Here's the fast, low-cost way to solve control/alarm problems. Hook up sensor, load and power source to a MAGSENSE® module and adjust the setpoint (or dual setpoints). That's it. No time and money wasted designing and debugging a circuit. And you've got proven-in-service performance and reliability.

Capabilities. MAGSENSE modules offer 100-billion power gain, accept inputs as low as 10 microvolts or 1 microamp directly *without* preamplification. Completely isolated inputs are *unaffected* by common mode voltages as high as 110vac, 60 Hz or overloads as large as 1000-times full scale. And they operate from a *single* 28v or 12v power source.

Flexibility. Standard models offer a wide range of options including single, dual and remote setpoints, adjustable hysteresis, choice of output action, transducer excitation voltage, and cold junction and copper compensation on thermocouple models. And, in the off-chance a standard model won't fit your precise application, we can custom-build one quickly, inexpensively.

Take the short cut. Write or call for your free copy of the MAGSENSE Application Manual. It has all the specifications and prices. And all the shortcuts.



... switch can help control machine tools ...

switch sells for \$1.60 each in lots of 10,000, and \$2.70 each in lots up to 25.

The proximity switch consists of a hermetically sealed reed switch whose contacts are kept normally closed by an internal magnet. When an external ferrous material comes within the calibrated proximity distance, the internal magnetic force is reduced and the contacts spring open. Thus, sensing whether the contacts are closed or open indicates proximity of the object to be detected. Applications include controlling machine tools, counting of objects on conveyors, and detecting motion above and beyond a predetermined limit.

Calibration distance is up to 0.40 inch, and the factory setting is reported to be accurate to within ± 0.010 inch. The contacts are rated at 200 volts d-c, 0.5 ampere, and 10 watts resistive load. Contact set-



Sensitive. Switch contacts open when ferrous material approaches.

ting time is 15 milliseconds. Temperature range is from -75°C to $+120^{\circ}\text{C}$, with a variation of operating point of only 1.5%.

In the calibration operation, the reed switch is clamped at the calibration distance away from an iron disk. Then an air grinder wears down the slightly too-strong internal magnet until the field weakens enough and the contacts open, indicating that the magnet is now of the proper value for the specified proximity calibration. Instead of mechanically backing off the disk until the contacts close—to determine the mechanical open-close differential of the reed switch—a test coil is energized from a constant current in order to simulate the differential.

Contact resistance is measured electronically during the test operation; and reed-switch contacts exceeding 1 ohm are rejected.

McClintock Matrixes, Washington Road, Woodbury, Conn. 06798 [350]

CONTROL DATA
CORPORATION

Magnetic Products Operation, Dept. 308
Control Data Corporation
775 Colorado Avenue So.
Minneapolis, Minnesota 55416
Phone 612/544-8851



***Who ever heard
of a computer
that***

TALKS CONTROL?

The GRI 909 computer is the closest thing to it.
We call the technique Direct Function Processing.

"If meter output is less than zero, go to alarm."

"Turn on tape reader."

*"Send complemented output of analog-to-digital
converter to controller."*

These instructions are representative of GRI's
unique functional approach to assembly language.
When you have defined the functional operations
of your system, you have very nearly written the
control program for the GRI 909.

Direct Function Processing adds many new
dimensions to computerized system control.
To find out more, write for our new brochure
describing the GRI 909 computer.

gn **GRI Computer Corp.**
76 Rowe Street,
Newton, Mass. 02166
(617) 969-7346

gn-909
You have never seen a computer
like this before. Now in Production.



How AO fiber optic light guides solve illumination problems.

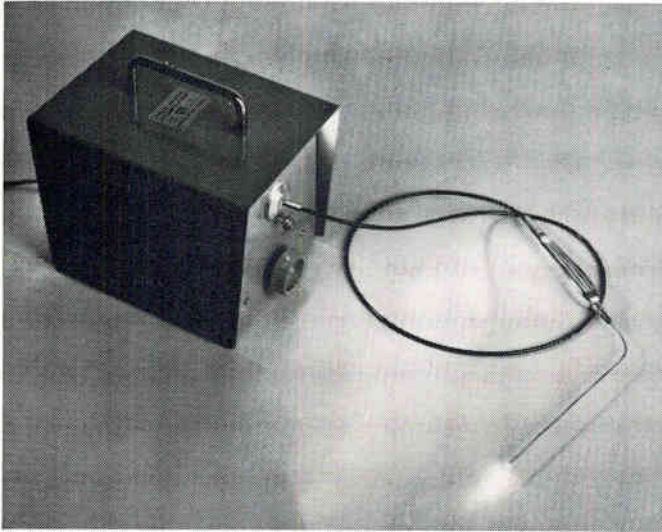

Transmit "cold" light like other forms of energy—by flexible routing to remote or inaccessible locations, hazardous areas, or any abnormal environment.

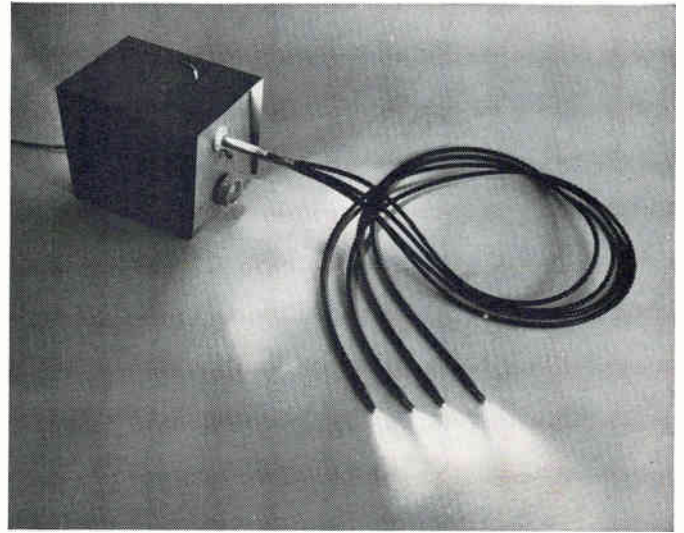

Supply multiple illumination from a single light source, with multi-branched light guides.

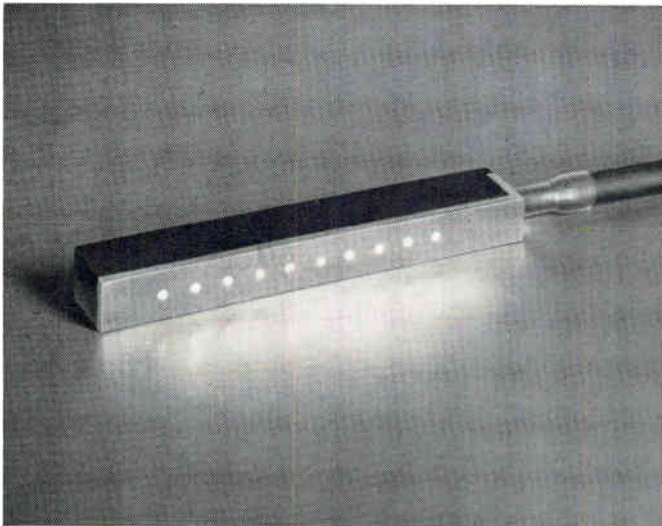

Simplify lighting problems by eliminating lens systems, multiple lamps, complex electrical circuitry.

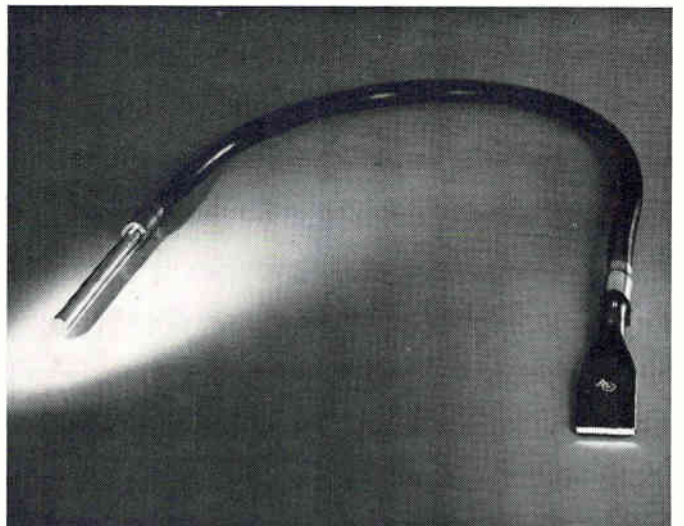

Provide input-output geometry conversions such as round-to-square, round-to-slit, etc.

These are only a few of the ways in which American Optical fiber optic light guides are used to help solve illumination problems. Specific applications range from mark sense readout to electro-optical sensing in data processing, circuit verification, fire control, null detection, light pens, spot illumination, and many others.

Simple, reliable, economical. AO fiber optic light guides are simple, passive elements which remain extremely reliable under normal vibration, temperature or humidity changes, or other environmental fluctuations. This results in long service life with minimum maintenance.

Standard and custom light guides from American Optical have light transmission ranges from 400 to 1500 millimicrons. Standard light guides are

available in bundle sizes from .020" to 1/4", with 30 to 6000 fibers, lengths up to 72", plastic or stainless steel tips, and PVC sheaths. Custom light guides can be supplied in any length desired, with special end tips, sheaths, diameters, input-output face configurations, and branchings.

A leader in optics since 1833, American Optical Corporation brings a great breadth of related experience to the technology of fiber optics. Our versatility in fiber optics is unmatched by any other manufacturer. In fact, AO scientists already hold more than 200 important patents or patents pending in this relatively new field.

For Fiber Optics Data Kit, write to:

 **AMERICAN OPTICAL CORPORATION**

FIBER OPTICS • SOUTHBRIDGE, MASSACHUSETTS 01550

©TM Registered by American Optical Corporation

Any oscilloscope can be a storage scope

Transient recorder stores a fast, one-shot signal for viewing on a slow scope or chart recorder

Recording a transient signal has meant either using up a great deal of tape or paper, or investing in expensive equipment. With magnetic tape or strip-chart recorders, the devices have to run continuously because, generally, it's not known when the signal will occur. X-Y recorders have a very limited frequency response, and high-frequency storage scopes suffer from

limited frequency response for a reasonable viewing area and limited tube life. So, the alternative has been purchase of expensive correlators. A better solution, according to William Cargile, engineering manager of Biomation Inc., is a fast analog-to-digital converter and a semiconductor memory.

These devices are the basic building blocks of Biomation's

model 610 transient recorder which is intended to capture a single-shot signal, hold it indefinitely, and present it for viewing on conventional, slower devices at a slower sweep speed and at any desired amplitude. The 610 employs a six-bit analog-to-digital converter operating at 10 megahertz. The digital information then is fed to a six-bit, 100-word MOS shift register where



Four-pole, 10-channel reed switch matrix-data scanner 508A is suited equally to low-level guarded multiplexing of 3 or 4 analog signals and to 4-line-per-digit data transfer, commutation or steering. Its reed relays may be energized to connect a set of 4 input terminals to a corresponding set of 4 output terminals. Monsanto Electronic Instruments, W. Caldwell, N.J. [361]



Precision digital phase meter model 750 features stable, long-term phase measurements. Frequency is 10 Hz to 1 MHz. Impedance is 1 megohm shunted by 30 pF. Recorder output is 0 to +3.6 V for 0° to 360°. Input voltage is 1 mV to 300 V rms. Resolution is 0.1°. Accuracy is ±0.1% full scale. Price is \$1,500. Wavetek, P.O. Box 651, San Diego, Calif. [362]



Electronic micrometer series 300 is capable of non-contact measurement of objects with a resolution of 0.000010 in. The objects being measured may be either stationary or moving. Meter readout as well as ±5 V analog output is available. Unit is designed to provide a continuous 100% inspection of production pieces. Lion Research Corp., 60 Bridge St., Newton, Mass. 02195 [363]



D-c watt-hour standards meter model 2002 features large digital readout for direct reading of power consumption, power comparison correction factor and meter constant. The unit is for use in all fields of d-c power consumption and is especially capable of calibrating d-c watt-hour meters. Delivery is stock to 8 weeks. Applied Electronics, 877 Cowan Road, Burlingame, Calif [364]



Thermospot probe model TP-200 measures h-f operational amplifiers over entire operating temperature ranges within minutes. It takes 15 to 60 sec to bring the component temperature from ambient to -55°C to up to ±125°C, depending on the device package. A dual-in-line ceramic package can be tested at -50° and +125°C in 90 sec. EG&G Inc., Goleta, Calif. [365]



Frequency detection unit RFD-8 is designed to provide a means of searching out hidden miniature and subminiature transmitters (bugs) which have been planted in conference rooms or other locations. The highly sensitive device operates between 72 and 108 MHz, the frequencies most common to most eavesdropping transmitters, Occo Mfg. Corp. S. Hackensack, N.J. [366]



Precision calibrator model 311 offers 0.01% accuracy in both voltage and current. Five voltage and two current ranges are available and afford complete instrument calibration facilities. Current resolution is μ a and voltage resolution is 1 μ V. Rated load is 100 ma, which allows for use as a lab power source. United Systems Corp., 918 Woodley Rd., Dayton, Ohio 45403 [367]



Operational amplifier tester model 5104 offers rapid testing of 15 op amp parameters in either a full automatic mode (200 msec/test) or by push-button selection from the front panel. Meter scaling, power supply voltages, and test conditions are available as front panel controls. Price is \$4,500. Philbrick/Nexus Research, Allied Dr. at Route 128, Dedham, Mass. [368]

If the answer to your problem involves **fiberoptics**, and electronics design skills, call **617-791-7391**

That's our phone number at EFC — Electro Fiberoptics Corporation. If your problem involves the design and engineering of components or systems in any field, from machines to medicine, a call to EFC will start you and us working together toward a solution. One more thing: we haven't forgotten the importance of competitive costs, firm delivery schedules and conscientious service.

now, what's your problem?



ELECTRO FIBEROPTICS CORPORATION

45E Water Street, Worcester, Mass. 01604
Phone 617 791-7391

it is held and recirculated for viewing on a slow device.

The result: a 1 Mhz signal can be recorded with 10-point-per-cycle resolution. According to Cargile, "Any oscilloscope, old or new, can have better storage capability than the best presently available storage oscilloscope."

In operation, 100 successive samples are taken, converted, and stored in digital form. The input sweep speed can be varied from 0.1 microsecond to 0.5 second with the output sweep speed set at 2 seconds for X-Y recorders or 0.2 milliseconds for oscilloscopes. The output also can be taken digitally into a computer or other digital device, or in analog form after processing in a digital-to-analog converter which also incorporates a smoothing circuit. "The resulting analog output doesn't show the abrupt steps sometimes associated with analog versions of digitally recorded data because of the smoothing used," says Cargile.

Other characteristics include differential input with an impedance of 1 megohm in parallel with 30 picofarads, and an input sensitivity of 5 mv to 50 volts.

Triggering is accomplished either externally or by use of the leading edge of the transient signal being recorded. A variable delay allows the sweep window to be positioned so that when a relatively fast sweep is desired, good resolution can be obtained even if the signal occurs a long period after the original trigger. Pre-trigger recording, which allows recording of the information prior to receiving the signal, also can be accomplished by operating the analog-to-digital converter in a free-running mode. The digital information then is circulated through the MOS shift register memory. When the trigger is received, the data acquisition can be stopped immediately, or after the variable delay period. This way the information retained in memory is for the period before, during, or after the trigger signal. This mode is especially useful where no external trigger is available.

In addition to the normal recording applications where storage oscilloscopes now are used, the transient recorder also could have applications in computer time-sharing systems. Here it could be used

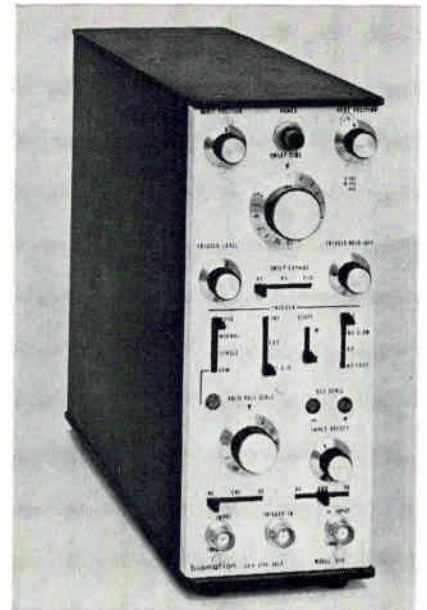

as an inexpensive peripheral input device which performs the analog-to-digital conversion of a fast input signal and stores the result until the central computer is ready to accept it.

"Since computers are finding increased applications in signal averaging and digital signal analysis but are limited by their data input rates, this new device," says Cargile, "will allow them to have the same speed as present hard-wired signal averagers and yet still operate in a time-sharing mode."

The basic unit has been priced tentatively at \$1,200. Deliveries will start in January.

Biomation Inc., 1076 East Meadow Circle, Palo Alto, Calif. 94393 [369]

New instruments

A-d converter has keyed clock timer

Fast, low-priced unit can be integrated into most systems easily

High performance usually means high cost when it comes to analog-to-digital converters. But Computer Products' AD 300 series converters provide a conversion rate of 10 kilo-

hertz at an accuracy of $\pm 0.025\%$ $\pm \frac{1}{2}$ LSB, and they are available in prices ranging from \$167 to \$219—significantly lower than many competitors.

In the series are 14 standard models providing binary or binary-coded decimal output codes with eight, 10, or 12-bit BCD resolution. Full range unipolar inputs of 0 to -4 volts or 0 to -10 volts are accepted, or full-range bipolar inputs of ± 4 volts and ± 10 volts.

Standard models can provide a 20-khz conversion rate, but at a reduced accuracy, $\pm 0.05\%$ $\pm \frac{1}{2}$ least significant bit.

The AD 300 units are packaged on two plug-in printed-circuit cards measuring 2.75 x 5.25 inches each, with a mounting case.

The converters use successive-approximation techniques to convert input analog voltages to binary-coded digital outputs whose magnitudes are proportional to input amplitudes. Current generated by the analog input is compared to a binary-weighted current from a register by summing the two currents into a summing network.

The difference in the two currents is applied to an error amplifier, which compares the value to ground. Depending on whether a difference exists, a flip-flop is set or reset and tells the register to either increment or stop. The parallel data outputs are derived from the register when a pulse signifying the end-of-conversion occurs.

Some of the features that are included in the converters are: keyed clock oscillators that turn on in phase with keying signals to provide easier integration of the converters into systems; timing cycles that provide initial time intervals for sampling if sample and hold techniques are used; and internal precision-reference regulators that eliminate the need for expensive external reference supplies.

Among the options that are available are sample and hold, input buffer, low-level input amplifier, and decimal or octal displays. The sample-and-hold option is a high-speed device that reduces errors that may arise from frequency deviations of the input analog signal, or can provide sampling of many input parameters.

Computer Products, P.O. Box 23849, Fort Lauderdale, Fla. 33307 [370]

NOW! from RMC



"ACROSS-THE-LINE" U.L. LISTED DISCAPS

EIA Class				
	330 470 680	820 .001 .0015 .0022 .0027	.0033 .0039 .0047 .005	.0068 .0082 .01
Class I	3.9 - 20	21 - 31	32 - 47	
N750	15 - 35	36 - 61	62 - 82	
N1500	15 - 67	68 - 119	120 - 180	

THICKNESS: .225 Max.

RMC now offers a complete line of ceramic disc capacitors fully approved by Underwriters Laboratories for the NEW "Across-The-Line" capacitor requirements. This approval is required of all capacitors utilized directly or indirectly across the power supply line.

This application is significantly different from the "Antenna Coupling and Line By pass" capacitor requirements of Underwriters Laboratories Subject 492, and the original RMC -U- capacitor type continues to be approved for those applications.

SPECIFICATIONS

CAPACITANCE: Within specified tolerance:
Class I @ 1MC and 25°C
Class II @ 1KC and 25°C

CAPACITANCE TOLERANCES AVAILABLE:
Class I $\pm 5\%$, $\pm 10\%$ or $\pm 20\%$
Class II $\pm 20\%$, +80-20%

WORKING VOLTAGE: 150 VRMS @ 60 cycles (210 volts peak AC plus DC)

POWER FACTOR:
Class I .1% max. at 1 MC
.2% max. less than 30 pf
Class II 1.5% max. at 1KC

INSULATION RESISTANCE: Greater than 7500 Megohms @ 500 VDC

TEMPERATURE COEFFICIENT:
Class I NPO N750 N1500
Class II Z5U; Z5F 1500 pfd. And Less.

FLASH TEST:
Per U.L. Sub. 492

LIFE TEST:
Per U.L. Sub. 492

INSULATION RESISTANCE AFTER HUMIDITY:
Greater than 1000 Megohms @ 500 VDC

BODY INSULATION: Durez phenolic—vacuum wax impregnated. Standard coating on leads $\frac{3}{16}$ " max. measured from tangent

LEAD STYLES AVAILABLE: Long lead—#20 AWG tinned copper

DISCAP
CERAMIC
CAPACITORS



RADIO MATERIALS COMPANY

A DIVISION OF P. R. MALLORY & CO., INC.
GENERAL OFFICE: 4242 W. Bryn Mawr Ave., Chicago, Ill. 60646
Two RMC Plants Devoted Exclusively to Ceramic Capacitors
FACTORIES AT CHICAGO, ILL. AND ATTICA, IND.

If you thought all Daystrom pots were squares



...look again!

Rectilinear components are still a necessary requirement in many circuit applications. That's why Weston has rounded out its high-performance potentiometer line with two new rectilinear models. RT-12 styles 534 and 535 are designed for both general-purpose and military applications. They feature the same $\pm 5\%$ tolerance, 10 ohm to 50K range, and slip clutch stop protection that are standard with Daystrom Squaretrim® units, plus 24-turn adjustability and

humidity proofing. Also new this year ... models 553 half-inch and 543 three-eighth-inch Squaretrim potentiometers in military and commercial versions. Save board space as well as money with our field proven 501 Series multi-turn and 504 Series single-turn $\frac{1}{8}$ " Squaretrims offering values to 20K in a 0.02 cubic inch case. All Squaretrim Diallyl-Phthalate cased pots give you Weston's patented "wire in the groove" construction and your choice of flexible leads,

pin and screw configurations. Whether your trimmer needs are military, industrial or commercial, you'll find the answer in this complete new low-cost line. Write today for data sheets and evaluation samples. DAYSTROM potentiometers are another product of WESTON COMPONENTS DIV., Archbald, Pennsylvania 18403, Weston Instruments, Inc., a Schlumberger company

WESTON®

Circle 190 on reader service card

Sweeper goes from 10 Mhz to 18 Ghz

Solid state generator uses plug-ins to cover a broad range; minimum output is 20 mw; 4-8 Ghz plug-in missing, but promised

A product and a promise are being offered by engineers at the Micro-Power division of Tyco Laboratories Inc. The product, designated the 230A, is a solid state sweep generator with a range of 10 megahertz to 18 gigahertz. However, there's a gap in the coverage of that frequency range—and that's where the promise comes in.

According to Bruno Kaiser, Mi-

cro-Power's marketing vice president, there's no economical solid state sweeper for the 4-to-8-GHz range. "Transistors are fine up to 4 Ghz," he says, "and Gunn diodes can do the job over 8 Ghz. But there's nothing in between." But there will be in June, adds Kaiser, when Micro-Power introduces a 230A plug-in that will cover the range. Micro-Power has several

contractors developing oscillators for the new plug-in and expects to pick one within a few weeks.

The 230A itself is a 5¼-inch-high instrument of full-rack width. A power supply takes up half the width, and a sweep-oscillator plug-in fills the other half.

The price is about \$4,000, depending on the plug-in. The mainframe, with power supply, sells for



Microwave amplifier WJ-1115, covering 7 to 11 Ghz, is for use in airborne ecm or data link systems. It features integral power supply and provides 3 w power output, 45 db small signal gain and 22 db maximum noise figure in X-band. Unit weighs less than 6 lbs and comes in a package 2.3 x 3 x 16 in. Watkins-Johnson Co., Stanford Industrial Park, Palo Alto, Calif. [401]

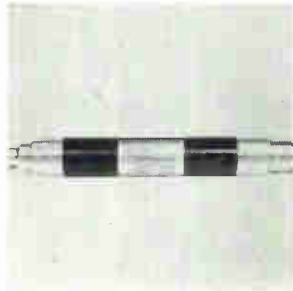

Fixed tuned bandpass filter series BD come with any center frequency from 25 Mhz through 2 Ghz, with attenuation characteristics from 3 through 16 sections. Its high Q cavity offers lower frequency coverage, and higher power rating. It is constructed chiefly of aluminum, suiting it for lightweight use. Texscan Microwave Products Corp., 4610 N. Franklin Rd., Indianapolis. [402]



Dial calibrated variable phase shifter features a precision ball bearing mechanism with a differential drive counter that assures accuracy and reliability with fine readout definition. Model 3E-13 (60-90 Ghz) features calibration accuracy to $\pm 3^\circ$ at any desired frequency. Vswr is rated at 1.20 max, with minimum phase shift of 180° . Baytron Co., Medford, Mass. [403]

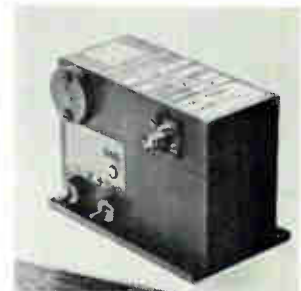

Voltage-tuned oscillator model PM7152 is for application as a local oscillator in X-band exhibiting a frequency stability vs temperature of $\pm 0.2\%$. Specifications include: frequency range, 9.35-9.50 Ghz; tuning voltage, +2 to +30 v; output c-w power (min/max), 10/30 mw; output power flatness, ± 1.5 db. Alpha Industries Inc., 381 Elliot St., Newton Upper Falls, Mass. 02164 [404]

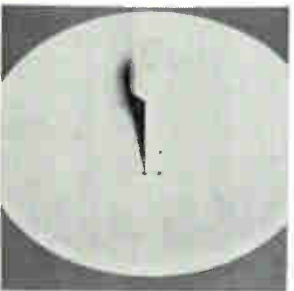

Twelve-inch parabolic antenna 827X was developed for use as part of the 637-X X-band ground-to-air ranging system. The lightweight and sturdy unit utilizes a waveguide r-f feed, sealed to provide optimum protection from the elements. Frequency range is 9.1 to 9.6 Ghz; vswr, less than 1.5:1; power handling, 1 kw peak. Vega Precision Laboratories Inc., Maple Ave., Vienna, Va. [405]



Four-part, differential-phase-shift circulator H62DA1 is for use as a duplexer or isolator in the frequency range of 15 to 17.5 Ghz. The unit can handle up to 1 kw of average power and up to 10 kw of peak power with a load vswr of 2:1. Cooling of the 4-lb circulator is through natural air convection. Varian Microwave Components Operation, 611 Hansen Way, Palo Alto, Calif. [406]



Waveguide-to-coaxial adapters WR229 feature an end launch configuration and provide extremely low vswr of 1.10 max. over the communication satellite band of 3.7 to 4.2 Ghz. They can be obtained with either precision N connectors (male or female) or the new high precision APC 7, 7 mm connector. Maury Microwave Corp., 8610 Helms Ave., Cucamonga, Calif. 91730 [407]



Cavity-backed Archimedes spiral antennas are broadband units that are circularly polarized with essentially constant impedance and radiation characteristics. Model S6510 illustrated operates over the 2 to 11 Ghz range. Nominal performance characteristics are: gain, 5 db; vswr, 2:1; axial ratio, 2 db; and beamwidth, 75° . Eastern Microwave Corp., 139 Swanton St., Winchester, Mass. [408]

\$1,450. A broadband plug-in—10 Mhz to 2 Ghz—goes for \$2,500, and it has a calibrated output. The high-frequency plug-in—12.4 Ghz to 18 Ghz—is the most expensive; its price is \$2,900. The other plug-ins range in price from \$1,600 up. They cover the following ranges: 1.4 to 2.5 Ghz, 1.7 to 4.2 Ghz, 3.7 to 4.3 Ghz, 5.85 to 6.45 Ghz, and 8 to 12.4 Ghz. With any plug-in, a 10-volt input change produces a complete sweep.

All have an external leveling connection. By feeding back a percentage of the sweeper's output the user keeps this output constant to within ± 0.3 decibel.

Micro-Power can put a self-leveling circuit into any plug-in except a high-frequency unit. Internal leveling is a \$250-to-\$400 option.

Up to 4 Ghz, the 230A delivers a minimum of 20 milliwatts. At higher frequencies, the minimum is

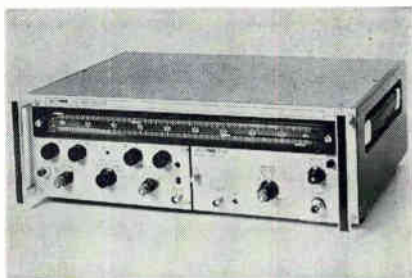

Outside control. A portion of its output, fed back to the front panel, keeps sweeper's output constant.

between 5 and 10 mw, the exact value depending on the particular plug-in's frequency range. The sweep limits, set with a front-panel dial, are accurate to within 0.25% of full scale.

The sweeper stands up well to load changes. For example, if it is putting a 4-Ghz signal into a matched load and suddenly sees a short circuit, the frequency shift is less than 1 Mhz.

The 230A works with up to eight plug-ins. Holders for two additional plug-ins cost \$800, and a control unit for switching from one plug-in to another goes for \$400.

And the sweeper fits right into measuring systems. For example, without any interface circuitry it can be connected to a Hewlett-Packard 8410A network analyzer.

Micro-Power Inc., 25-14 Broadway, Long Island City, New York [409]

New microwave

Log amp has 80 Mhz bandwidth

Hybrid IC device for radar, EMC jobs accurate to ± 1.5 db

Pulse-to-pulse amplitude differences encountered by radar receivers when tracking rapidly moving targets, and changes in source and source direction as witnessed by electronic countermeasures (ECM) receivers require these receivers to have quick recovery capability over wide dynamic ranges. The LEL division of Varian has developed a hybrid integrated-circuit logarithmic amplifier capable of accurate logging over wide bandwidths and at high intermediate frequencies.

The LEL log amp can be used effectively in narrow-band operations where local-oscillator drift is a problem. This drift will cause an i-f frequency shift, but with this new amplifier, no degradation in accuracy will occur. The ability of the log amp to produce a wide frequency window in ECM systems will reduce, and in some cases eliminate, the local-oscillator sweep since the i-f will change in frequency but not degrade in accuracy.

The hybrid IC log amp model ICL-1-8555 is available now at a center frequency of 300 megahertz, and a second unit will shortly be released at 1,900 Mhz. The ICL-1-8555 has an r-f bandwidth of 80 Mhz and a dynamic range of 70 decibels minimum. The logging accuracy of the device is ± 1.5 db across the entire bandwidth, and the nominal log slope is 10 millivolts per db. The maximum video output is 2 volts, while the maximum pulse rise time is 8 nanoseconds. Both the source impedance and the video output load are 50 ohms.

The log amp will perform over a temperature range of -20°C to $+60^{\circ}\text{C}$. The unit is $4\frac{1}{8}$ inches long, $1\frac{1}{4}$ inches wide, and 0.35 inch high, and uses SMA-type connectors. The power requirements

COMES WITH EVERY GE CAPACITOR

Dependable Distributor Service

General Electric Distributors help you solve the tough ones with capacitors from local stock:

EAST AND NORTHEAST
Cramer/Washington, Inc.
692 Loftstrand Lane
Rockville, Maryland 20850
Tel: 301-242-7700

Gerber Electronics, Inc.
852 Providence Highway
Dedham, Mass. 02026
Tel: 617-329-2400

Rome Electronics, Inc.
108 Spring St.
Rome, N. Y. 13440
Tel: 315-337-5400

Schweber Electronics, Inc.
Jericho Highway
Westbury, N. Y. 11591
Tel: 516-334-7474

5640 Fisher Lane
Rockville, Maryland 20852
Tel: 301-427-4977

213 Third Ave.
Waltham, Mass. 02154
Tel: 617-891-8484

Semiconductor Specialists, Inc.
2011 Waverly St.
Pittsburgh, Pa. 15218
Tel: 412-351-3611

Standard Electronics, Inc.
1501 Main St.
Buffalo, N. Y. 14209
Tel: 315-883-5006

SOUTHEAST
Cramer/Florida Electronics
4141 N.E. 6th Ave.
Ft. Lauderdale, Fla. 33308
Tel: 305-947-6517

Jackson Electronics Co.
P.O. Box 19837
Atlanta, Ga. 30318
Tel: 404-355-2223

Schweber Electronics, Inc.
2830 N. 28th Terrace
Hollywood, Fla. 33020
Tel: 305-927-0511

Southeastern Radio Supply Company
414 Hillsboro St.
Raleigh, N. C. 27603
Tel: 919-828-2311

MIDWEST
Electronics Marketing Corp.
814 W. 3rd Ave.
Columbus, Ohio 43212
Tel: 614-299-4161

Hamilton Electro Sales
920 S. Westwood
Addison, Ill. 60101
Tel: 312-543-8500

1400 W. 46th Ave.
Denver, Colorado 80216
Tel: 303-433-8551

Lew Bonn
7275 Bush Lake Road
Edina, Minn. 55435

Semiconductor Specialists, Inc.
P.O. Box 66125
Chicago, Ill. 60666
Tel: 313-255-0300

25127 W. Six Mile Road
Redford, Mich. 48240
Tel: 313-279-1000

SOUTHWEST
Arco Electronics, Inc.
P.O. Box 34772
Dallas, Texas 75234
Tel: 214-239-9123

Hamilton Electro Sales
P.O. Box 10227
Dallas, Texas 75207
Tel: 214-638-0900

1216 W. Clay St.
Houston, Texas 77019
Tel: 713-526-4661

1741 N. 28th St.
Phoenix, Arizona 85009
Tel: 602-272-2601

WEST & NORTHWEST
Elmar Electronics, Inc.
2288 Charleston Rd.
Mt. View, Calif. 94041
Tel: 415-961-3611

Hamilton Electro Sales
10912 W. Washington Blvd.
Culver City, Calif. 90230
Tel: 213-870-7171

2320 6th Ave.
Seattle, Wash. 98121
Tel: 206-442-2011

5567 Kearny Villa Rd.
San Diego, Calif. 92123
Tel: 714-279-2421

340 Middlefield Rd.
Mt. View, Calif. 94041
Tel: 415-961-7000

Kimball Electronics, Inc.
350 Pierpont Ave.
Salt Lake City, Utah 84101
Tel: 801-328-2075

G. S. Marshall Co.
9674 Teistar Ave.
El Monte, Calif. 91731
Tel: 213-686-1500

Electronic Capacitor & Battery Dept., Irmo, S. C.

Electronic Capacitor & Battery Dept., Irmo, S. C.

GENERAL ELECTRIC

430-44

Circle 193 on reader service card →

COMES WITH EVERY GE
WET-SLUG CAPACITOR

A woman's touch

When tender loving care is needed for optimum reliability in high-volumetric efficient tantalum wet-slug capacitors, what do you do? You use the deft hands of a woman. Careful assembly of the tantalum anode and its fine silver case demands exacting personal attention.

A woman's touch is needed to protect the delicate dielectric coating of tantalum oxide during final assembly. Through gentle care and a spider support for the anode in its case, a consistently low stable leakage current characteristic for GE wet-slug units is obtained. This extra effort to prevent tantalum oxide damage has proved out in reliability analyses of over 10,000 hours at rated conditions. GE wet-slug capacitors meet or exceed the requirements of MIL-C-3965 and MIL-C-39006. They are also available in subminiature sizes down to .312 inch by .112 inch, with acid or non-acid electrolyte.

Choose from standard ratings (No voltage derating necessary to assure reliability)
Voltage Ratings: 6VDC to 150VDC
Capacitance Ratings: 3.3 μ f to 2400 μ f
Temperature Ratings: -55C to +85/125C
or let GE's 20 years of experience special-design tantalum wet-slug capacitor to fit your slim, trim circuit needs.

Call your GE Electronics Distributor or ECSD District Sales Manager, or write Section General Electric Company, 1 River Road, Schenectady, N. Y. 12305
Electronic Capacitor & Battery Dept., Irm

GENERAL  ELECT

Controlled Avalanche Thyristors

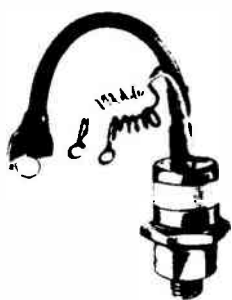

... a complete range covering 25A to 110A, 600V to 1400V, in 5 different series, available now.

17 different types of controlled avalanche thyristor are all readily available from Mullard at competitive prices.

Every designer should have a copy of the Mullard booklet "Rectifiers, Diodes, Thyristors and Triacs" which not only covers controlled avalanche thyristors as well as high temperature, inverter and static thyristors and rectifiers but also stacks and module products which are the result of extensive research and development programmes in the Mullard laboratories in England. Mullard employ 1,000 qualified scientists and engineers and have six major plants, with over 10 million square feet of floor space.

Write today for information on Mullard controlled avalanche thyristors and for the name of your local representative.

Mullard Limited, Mullard House, Torrington Place, London W.C.1, England.

U.S.A. enquiries to Mullard Inc., 100 Finn Circle, Farmingdale, Long Island, New York 11735, U.S.A. Telephone: (516) 694-8989. Telex: 961455.

Mullard

Here are brief details of a selection from the range:

Type Number	Peak Inverse Voltage Range	R.M.S. Current	Surge Current $\frac{di}{dt}$	Avalanche Test Power
BTX92	800-1200V	25A	280A 200A/ μ s	10kw
BTX47	1000-1400V	25A	155A 50A/ μ s	18kw
BTX48	1000-1400V	25A	200A 50A/ μ s	18kw
BTX49	600-1200V	110A	1050A 50A/ μ s	40kw
BTX50	600-1200V	110A	1500A 50A/ μ s	40kw

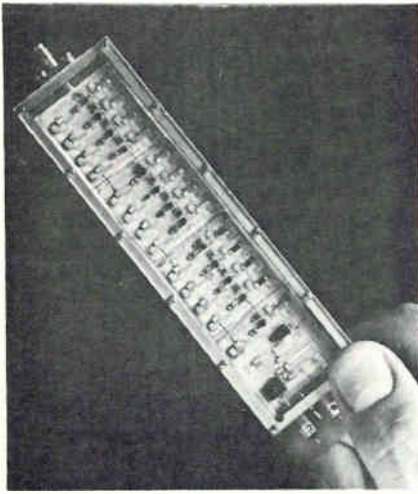

Compact. Log amp with wide dynamic range takes up 2.4 cubic inches.

of the device are +15 volts d-c at 50 milliamperes and -15 volts at 100 milliamperes.

The higher-frequency amplifier, not yet designated by model number, has a bandwidth of 500 Mhz, a dynamic range of 65 db minimum, logging accuracy of $\pm 1/2$ db, nominal log slope of 14 mv/db, a video bandwidth of 250 Mhz, pulse rise time of 1.5 nanoseconds, and a video output of 1 volt maximum. The impedance of the source is 50 ohms, and so is the video output load.

The ICL-1-8555 has a single-unit price of about \$2,500.

LEL Division, Varian Associates, Co-piague, N.Y. 11726 [410]

New microwave

Avalanche source puts out 250 mw

Solid state oscillator operates in 4-18 Ghz band without multiplier

It's less complicated than other solid state power components—that's the feature that Philco-Ford Corporation's microelectronics division points to in marketing its phase-lock avalanche oscillator source.

Called Avloc, the device provides

up to 250 milliwatts in Ku band. Conventional solid state phase-locked multiplier chain sources usually are limited to about 50 milliwatts of output, according to W. J. Messmer, the Philco-Ford division's microwave marketing manager. Messmer is aiming Avloc at the power-source component market, which he estimates at \$35 million to \$50 million per year. The unit is designed to replace low-power klystron tubes, bringing solid state reliability, lower weight and smaller size to radar, communications, electronic countermeasures, and other equipment requiring source outputs up to 250 mw.

Avloc operates at center frequencies from 4 to 18 gigahertz. A typical model weighs about 16 ounces and measures 4 by 3 by 3 inches.

A phase-lock loop circuit provides broad phase-modulation; spurious output is minimized because the oscillator operates at its fundamental frequency, without multiplication.

In operation, a portion of the prime output signal from the unit's avalanche oscillator source is fed to a phase detector and compared with the output of a standard reference crystal oscillator which has been multiplied by a step-recovery multiplier.

The difference, if any, between the two is fed back into the avalanche oscillator through an integrated-circuit operational amplifier, locking the frequency of the avalanche oscillator source to that of the very stable, low-level crystal reference signal.

A key difference between the Avloc and other multiplier chain sources, Messmer points out, is the elimination of an intermediate multiplier step—the microwave energy has been generated at the desired output frequency. Future refinements and additional applications of IC technology are expected to further reduce the device's size and weight. To accomplish this, Philco-Ford plans to exploit its experience as a manufacturer of hybrid and monolithic integrated circuits.

Delivery of small quantities takes 30 to 60 days. Prices depend on performance specifications and quantity.

Microelectronics Division, Philco-Ford Corp., Union Meeting Road, Blue Bell, Pa. 19034 [411]

ELECTRONICS INSTRUMENTATION

Time Sharing Makes Sense

FOR EXPENSIVE ELECTRONIC INSTRUMENTS, TOO!

RENTRONIX gives you ready access to sophisticated electronic instruments and small computers on a short-term rental basis. Choose from one of the largest, most modern name-brand pools of electronic equipment on the market. With Rentronix you pay only for the time you use the equipment.



FREE

48-page catalog covering hundreds of electronic instruments and small computers available for short-term rental.

Rentronix

A Division of Inmark, Inc.
11501 Huff Court
Kensington, Maryland 20795

Look at the screen, not the knobs.

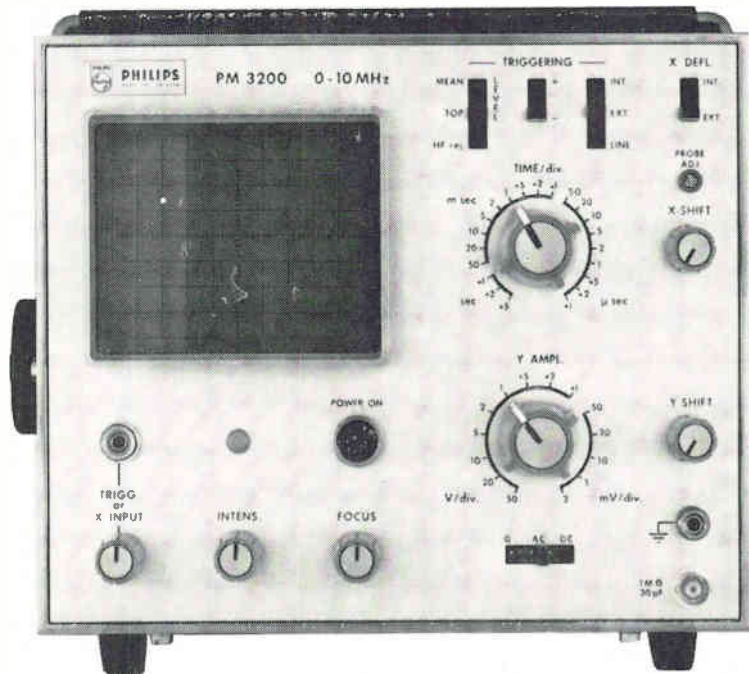

PM 3200
10MHz
2mV/div
\$480

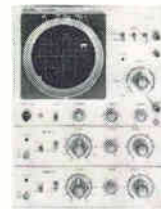

More of the Unbeatable
Philips Scopes

PM 3231
15 MHz: 10mV
Dual Beam Delay Lines
\$975

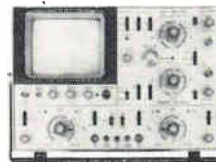

PM 3250
50 MHz: 2mV
Dual Trace
\$1995

Three fewer controls mean you spend more time measuring, less twiddling. Dc balance, trigger stability and manual level are out. So triggering is fully automatic.



Explanation. When waveforms start looking like this: all other automatic trigger circuits stop triggering. So you have to switch to manual and start knob twiddling. With the PM 3200 you switch from "mean" to "top" and stay with signal-derived, fully automatic triggering.

In either position automatic means automatic over the whole of the 10MHz range. And then on to at least twice this nominal bandwidth figure.

This unique Philips circuit has yet another feature. Whatever the signal, even no signal and whatever the sweep speed, the trace is always clearly visible.

There's no dc balance control because none is needed. Drift is feedback and virtually eliminated. (At max. sensitivity (1/4div/24hours).

The PM 3200 is highly portable (11.7 lbs.). Battery pack optional.

Available in U. S. from Philips Electronic Instruments, 750 S. Fulton Ave., Mt. Vernon, N.Y. 10550



PHILIPS™

Relay analyzer tests and tells

Computer-controlled system does 100% testing on 2,000 units per hour; software package permits operation by unskilled personnel

Volume production and acceptance testing of high-reliability relays for the military usually have made life difficult for manufacturers because of the large amount of detailed documentation required.

Commercial relay manufacturers, on the other hand, may not need detailed reporting on each relay, but do want to determine quality and failure trends.

Both needs are met in the new J1300 automatic relay production test and reporting system from Jacobi Systems Corp. Jacobi says the computer-controlled system is the first ever developed that can perform 100% testing on up to 2,000 relays per hour, together with analysis and reporting. The first system was sold to Leach Corp. after a year of feasibility studies indicated

it would pay for itself within one year at a production rate of 1,000 relays per day, according to Jacobi.

Two consoles are used—a high-voltage unit for dielectric strength and insulation resistance measurements, and a dynamic console for testing coil resistance, contact voltage drop, pull-in/release voltage, voltage transients, and timing. Peripherals include three IBM print-

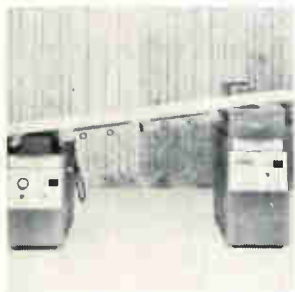

Automatic wave soldering systems Finline TD come in 2 models, TD-12 for p-c boards up to 12 in. wide, and TD-14 for boards up to 14 in. The 11 ft. 5 in. inclined motorized conveyor handles single or double board carriers. Features include deep wide waves with oil inter-mix infinitely variable from no oil in the wave to full flow. Hollis Engineering Inc., Nashua, N.H. [421]

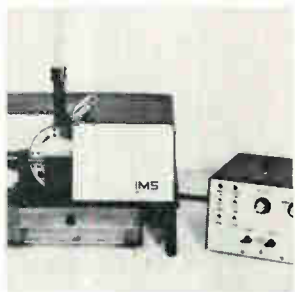

Automatic handler model IC 2500 is designed to transport 14 or 16 pin dual-in-line IC packages through an electrical test and sort sequence rapidly and efficiently. It facilitates handling of IC packages in applications such as high volume production testing or high volume incoming inspection. Scientific Measurement Systems, 351 New Albany Rd., Moorestown, N.J. [422]



Beam lead bonding tools come in any size or style for any chip application and in any desired quantity. Users have a choice of materials, including carbide, tungsten or Inconel alloys. Tools can be supplied for either wobble tool or self-aligning tool application and can be specified with heater soldered on or separate and replaceable. Micro-Swiss Inc., Cherry Hill, N.J. [423]

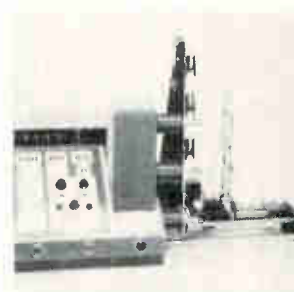

Automatic coil winder type 55 utilizes 3 spindles to triple high production output of precision coils. It can be programmed by IBM card or set up by switches from a data sheet, for winding at speeds to 8,000 tpm to precise tolerances. Unit handles coils up to 8 in. long and 5 in. o-d, and wire sizes from 16 to 50 Awg. Eubanks Engineering Co., Monrovia, Calif. [424]



DIP extractor plier 4916 removes all 14-16-24- and 36-lead dual in-line packages. It withdraws the IC straight up out of the board without bending leads, will not lift socket pads or pop up into operator's face. Metal teeth for durability and self-closing metal construction combine to provide a tool for fast DIP removal. Techni-Tool Inc., 1216 Arch St., Philadelphia. [425]



Vacuum coating system NRC 3111 is for high volume, high capacity, thin film deposition production. Tailored to meet the needs of IC makers, it employs the VHS-6 diffusion pump, rated at 2,400 liters/sec, and contains planetary tooling for high deposition rates from multiple resistance evaporation sources or an electron beam source. Norton Co., Charlemont St., Newton, Mass. [426]



Micro Hot Plate and Controller model 95 make hand or machine soldering of ceramic substrates as easy as soldering on conventional glass epoxy circuit boards. Substrates are preheated in seconds to a selected temperature below the melting point of the soldering alloy being used. Complete price is \$95. Browne Engineering Co., Coast Village Circle, Santa Barbara, Calif. [427]



Oxide-free soldering system called Wavedipper is offered to manufacturers for a free 30-day trial. It uses a pump that continuously circulates molten solder over the reservoir lip through a circular nozzle providing a mirror-like 4-in. diameter dipping surface. The solder pot provides a dross-free application surface. Price is \$750. Electrovert Inc., Mount Vernon, N.Y. [428]

Have a load to move ?

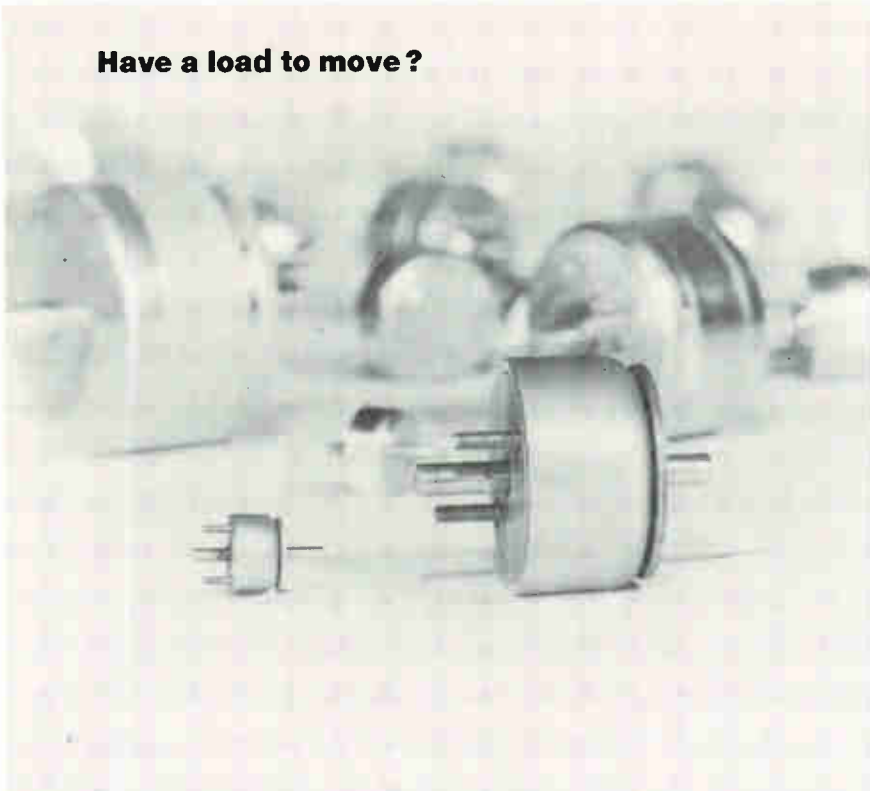

... one of over 350 Ldex stock Solenoids can help you get a quick start on your prototype

Ldex rotary solenoids let you remotely step, turn, pull, trigger, index or hammer. They come in 8 sizes with torques ranging as high as 117 pound-inches. Features include high torque-to-size ratio and exceptional dependability. Endurance engineered models have a life of 100,000,000 actuations.

Ldex push/pull solenoids deliver linear wallop ... with extremely fast response. There are 7 sizes with up to 85 pounds force and strokes up to $\frac{3}{8}$ ".

And Ldex keeps adding new stock models ... like the $\frac{3}{4}$ " diameter 0 EC and $2\frac{1}{4}$ " diameter 6 EC push/pull models (shown in foreground). Both pack plenty of force in compact packages.

Stock models come in all sizes and most every power take-off configuration.

Chances are one of them meets your prototype needs. If not, our engineering people can give you a custom solution—fast. Write or call today for our latest Rotary and Push/Pull Solenoid Catalogs.

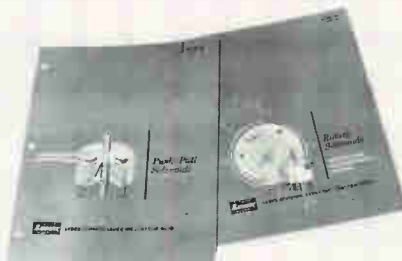

Specialists in remote actuation



LEDEX DIVISION, LEDEX INC.

123 Webster Street, Dayton, Ohio 45402 • phone (513) 224-9891

... library of tests available to operator ...

ers, two to print out specific failure information for the dynamic and high-voltage consoles, and a third for printing high-reliability tests and report analyses in a military specifications format. All tests to meet Mil-R-5757, Mil-R-6106 and Mil-R-39016 are performed automatically. An IBM model 1442 card reader also is used. Although the first system built for Leach uses an IBM 1800 computer, Jacobi says any of a number of minicomputers also can be used. With the IBM 1800, 16,000 words of 16-bit memory are utilized, together with a 500,000-word IBM model 1810 disk memory.

The heart of the system is PART (programmable automatic relay test), a software package that permits operation by clerical personnel without programming experience. Using what Jacobi calls a fill-in-the-blanks language, the operator defines parameters and sequencing by filling out a standardized form and assigning a code number to the type of relay being tested. The proper tests are selected from a library of tests, and the information is relayed to the computer by card input. A higher-level language also is supplied, permitting the user to devise completely new tests by writing a Fortran program which becomes part of the system library of test programs.

Multiple-socket trays, each containing up to 48 single-coil spring return, or two-coil magnetic latching relays, are plugged into the consoles, which are equipped with quick-connect receptacles. Test sequences to be implemented by the system are determined by tray-type numbers. Each tray number is assigned by wiring or leaving open connections between a set of 10 interface pins and ground in the tray. Additional software to accommodate single- and two-coil polarized relays and four-coil logic relays is an extra-cost option. High-voltage console tests are performed simultaneously on all 48 relays in the test tray. The standard system can handle relays with up to six Form C or D contacts. Optionally, contact configurations up to 12 Form A or B, and up to 96 Form

Intech Op Amps hold the Inside Track

When it comes to performance, we lap the competition.

Our FET input A-130 op amp typically slews at $700 \text{ V}/\mu\text{s}$. And every unit is guaranteed to go at least $500 \text{ V}/\mu\text{s}$.

But speed alone doesn't win the race. It's getting to the finish line that really counts. That means settling time.

The A-130 makes it to 0.01% of final value in 500 nanoseconds maximum!

The A-131, a specially "tuned" op amp, is designed for your non-inverting applications. And it gives you nearly the same performance as the A-130.

Why not try the winner? When Intech builds an op amp

the best component and design engineering the industry has available is behind it. But find out for yourself. A test is worth a thousand words. The A-130 and the A-131 are \$68.00 each (quantity discounts available) and both are right from stock.

For more information on our high performance operational amplifiers, contact your local Intech representative or write us directly.

Intech Incorporated, 1220 Coleman Avenue, Santa Clara, California 95050

Phone: (408) 244-0500

intech

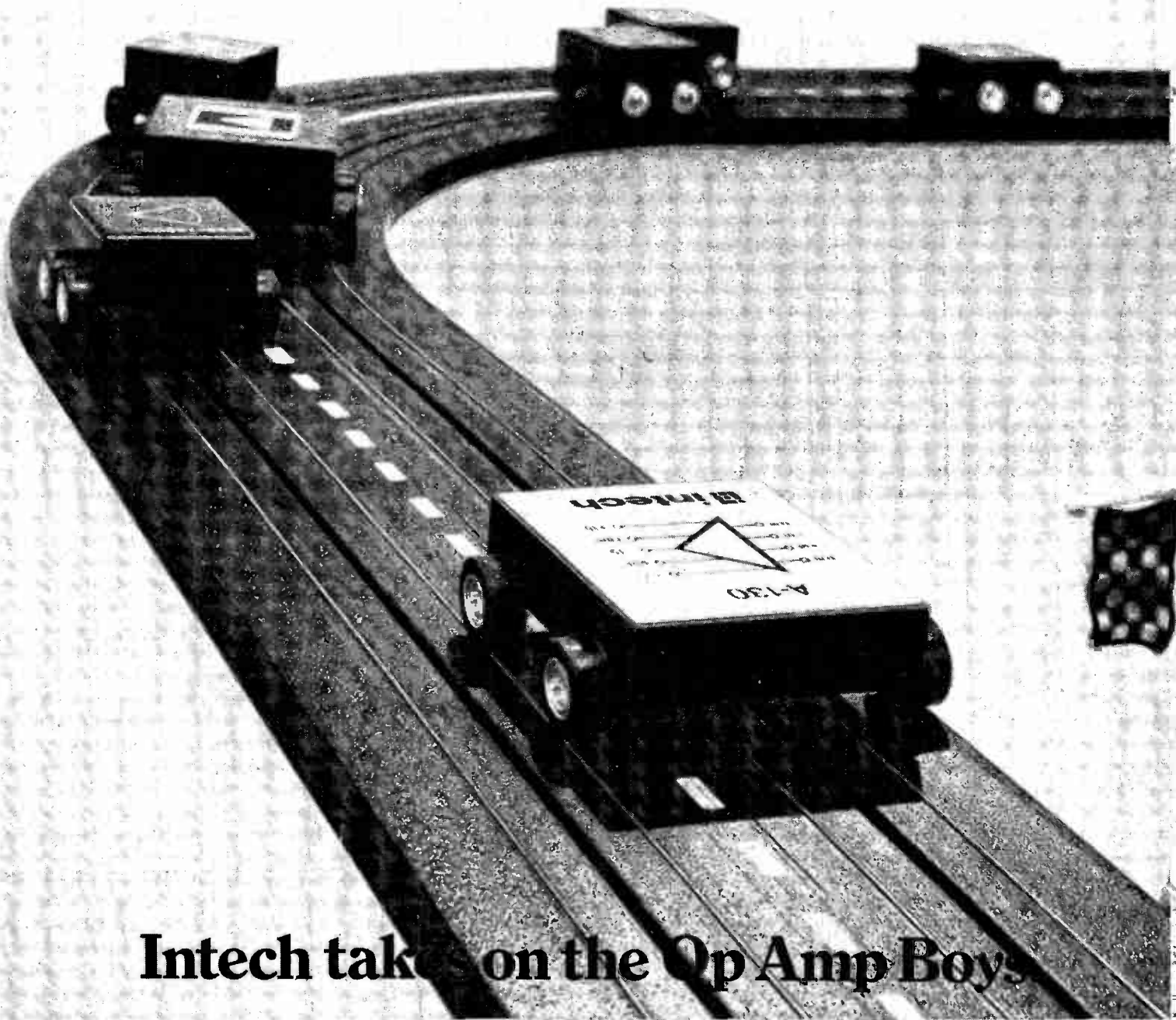

Intech takes on the Op Amp Boys

The Informer



The new Barnstead Bantam lab demineralizer. It tells you more. More precisely.

It replaces the old "idiot lights" with a meter. With the flick of a switch you get an instant on-stream effluent read-out in parts per million and ohms resistance.

You get less sub-standard water and no wasted cartridge capacity.

Choose from five different disposable cartridges. For ion exchange (multi-bed and mixed-bed, organic, oxygen or cation removal). Flow rates from 5 to 25 gallons per hour.

Bantam holder comes complete for wall or bench mounting, ready to attach to your raw water line. Pedestal, inlet, effluent tubing, cord, plug and UL approval included.

Your Barnstead dealer has the information on the entire Bantam series. Give him a call or contact Barnstead Company, 225 Rivermoor Street, Boston, Massachusetts 02132.

 **BARNSTEAD**
SYBRON CORPORATION

C or D can be accommodated.

The high-voltage console also can test synchronous motors and precision transformers with up to 14 leads, and the dynamic console can be applied to solid state and reed switch testing.



Ready. Tray of relays is in foreground, and test consoles are at right.

When a dielectric-strength failure is detected by the high-voltage console, voltage is cut off by the system within 10 milliseconds and the faulty relay disconnected while testing of the other relays continues. A similar interrupt is provided for insulation resistance failures, and in both cases the failure information is stored in the computer for printout and analysis. A failure report is printed immediately after tests on a particular tray are completed. A detailed test report, containing the accumulated results of all tests performed on a relay lot, can be printed, plus a summary report on test results. On command, the system also will print a quality trend report, giving the number of relays tested and failed in each test, and total number of relays tested and failed by relay type. Optional, extra-cost production control software permits failure and trend analysis of shifts producing a relay and materials used in the relay. Cost of the system ranges from \$100,000 to \$150,000, without the computer, and depending upon the software options. Delivery time is about 180 days.

Jacobi Systems Corp., 16625 Saticoy St., Van Nuys, Calif. 91406 [429]



Put \$69 into your product line and start counting the profits. Digitally.

Take your product line. Snap Tyco's new 2½-digit panel meter into the same opening you might use for an ordinary pointer meter. And there you are in the digital age. And your entire line is better . . . a lot more than \$69 better.

Tyco's new 2½-digit meter is the highest quality, lowest priced digital panel meter available. With the easiest, fastest, most accurate readings possible. Digital so there's no room for operator interpretation. So clear that your customers can read them

from thirty feet across the room . . . from any angle.

The high performance and low price of this meter is possible because of a unique technological development.* It sells for \$69 in lots of 100. \$89 for single units. No mounting hardware is required because the 4½" x 3" x 3" meter just snaps into the front of the panel opening and stays there. Reads to 100% over-range. Has 1 millivolt resolution. 100 megohms input impedance. Overload protection and polarity indication. Needs no zero adjustments. Requires low input power. Has no moving parts or pointer mechanisms to break

down. Comes with a one-year warranty.

And there's more: 3½-digit units, both unipolar and bipolar, with and without BCD outputs; and 4½-digit units, bipolar with BCD outputs. Voltage attenuators and current shunts are available, increasing the versatility of Tyco panel meters. Send today for detailed specifications. We think you'll like our line. Tyco Instrument Division, Tyco Laboratories, Inc., Bear Hill Industrial Park, Waltham, Mass. 02154, (617) 891-4700.

* U.S. and Foreign Patents Pending

TYCO instrument
division

Production equipment

MOS array tester is run by computer

Machine geared for
production runs analyzes
wafers or mounted chips

As the number of MOS/LSI devices built into products multiply, so do the demands of meeting production and contract deadlines. More than one manufacturer has discovered that testing techniques that were adequate in the laboratory can put red ink on the corporate ledger when applied to production contracts.

The Redcor Corp. has introduced a new production-oriented, computer-controlled tester of metal oxide semiconductor arrays. Called PAFT II (programmable automatic function tester) it is built around Redcor's RC-70 general purpose digital computer, with a 4,096-word, 16-bit memory.

The go/no-go tester has up to 64 data and power channels, with selectable word lengths of 200, 400, or 800 serial bits per channel. The 800-bit word length is a \$300-per-channel option. Clocking is multi-phase, adjustable for overlap, amplitude and period, with frequency ranges from 10 hertz to 2 megahertz. Strobe and clock parameters, one/zero voltage levels and input/output patterns are program-selected. Stress and circuit continuity tests from -40 and $+5$ volts also can be programmed. Channel format is non-return-to-zero and return-to-zero, selected by the program. Devices can be tested at both the wafer probe level and at final test, with the chip mounted on a header.

A single-bit parity check insures that data being circulated in the registers remains the same. Each channel has a parity error display lamp to show when a programmed word has an odd-bit change. Device test failures can be data logged, using a teletypewriter to print out pin and channel identification numbers. A duplexer, which costs an extra \$5,000, permits using two test heads instead of one, and can al-

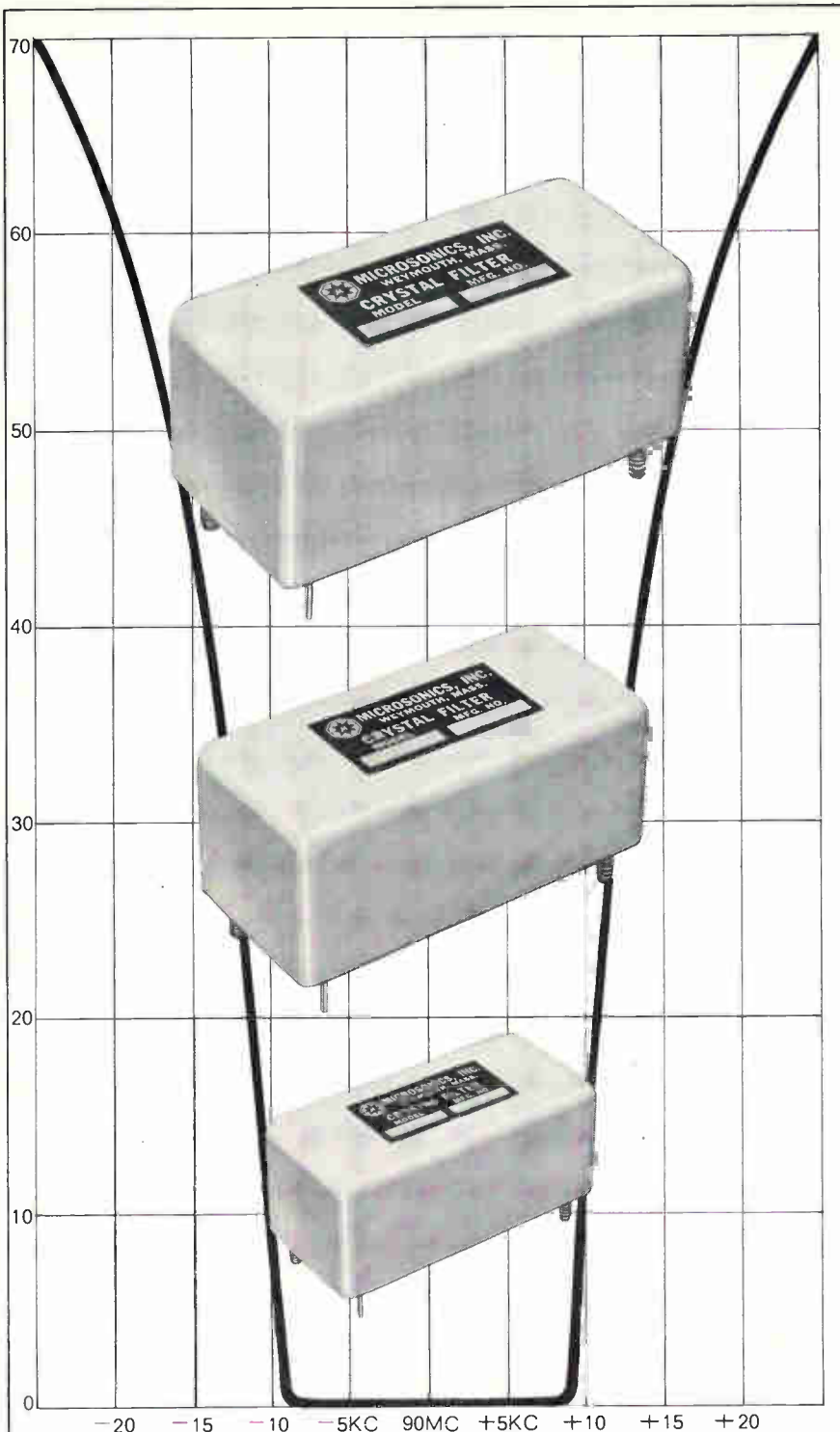

MICROSONICS *for proven design, reliability & performance in* **CRYSTAL FILTERS**



Write for Bulletins today

MICROSONICS

60 Winter Street, Weymouth, Mass. 02188

Tel: 617 337-4200

A division of the Sangamo Electric Company

Reliability is 3 billion dithers.

One Varian magnetron we recently life-tested was dither-tuned for 4,000 hours — more than 3.2×10^9 dithers! Tube and tuner were still going strong when the test was concluded.

Unsung heroes of this performance are Varian's little plug-in dithering head and frequency readout. Use-proven in current military systems, torture-proven MIL-E-5400 environmental tests, they can be installed with a variety of Varian magnetrons at frequencies from C to Ka band. And they're very simple to retrofit into existing systems.

The dithering head uses simple, proven mechanical concepts, and is easy to maintain and operate. Dithering frequency varies from 400 excursions-per-second at a 20 MHz frequency change to 33 excursions at 500 MHz. The 5 by 3½ by 1½-inch solid state frequency readout is accurate up to 0.1 MHz, even under 5g vibration. System-simplification advantages are great: No bulky servos and amplifiers necessary. And the excellent readout accuracy sharply reduces costly AFC circuit requirements.

So if frequency agility is your game, get what your system needs from more than 30 Varian Electron Tube and Device Group Sales Offices around the world, or from our Bomac Facility, Salem Road, Beverly, Mass., or our S•F•D Facility, 800 Rahway Ave., Union, N.J.

 **varian**
eastern tube division
bomac/S•F•D

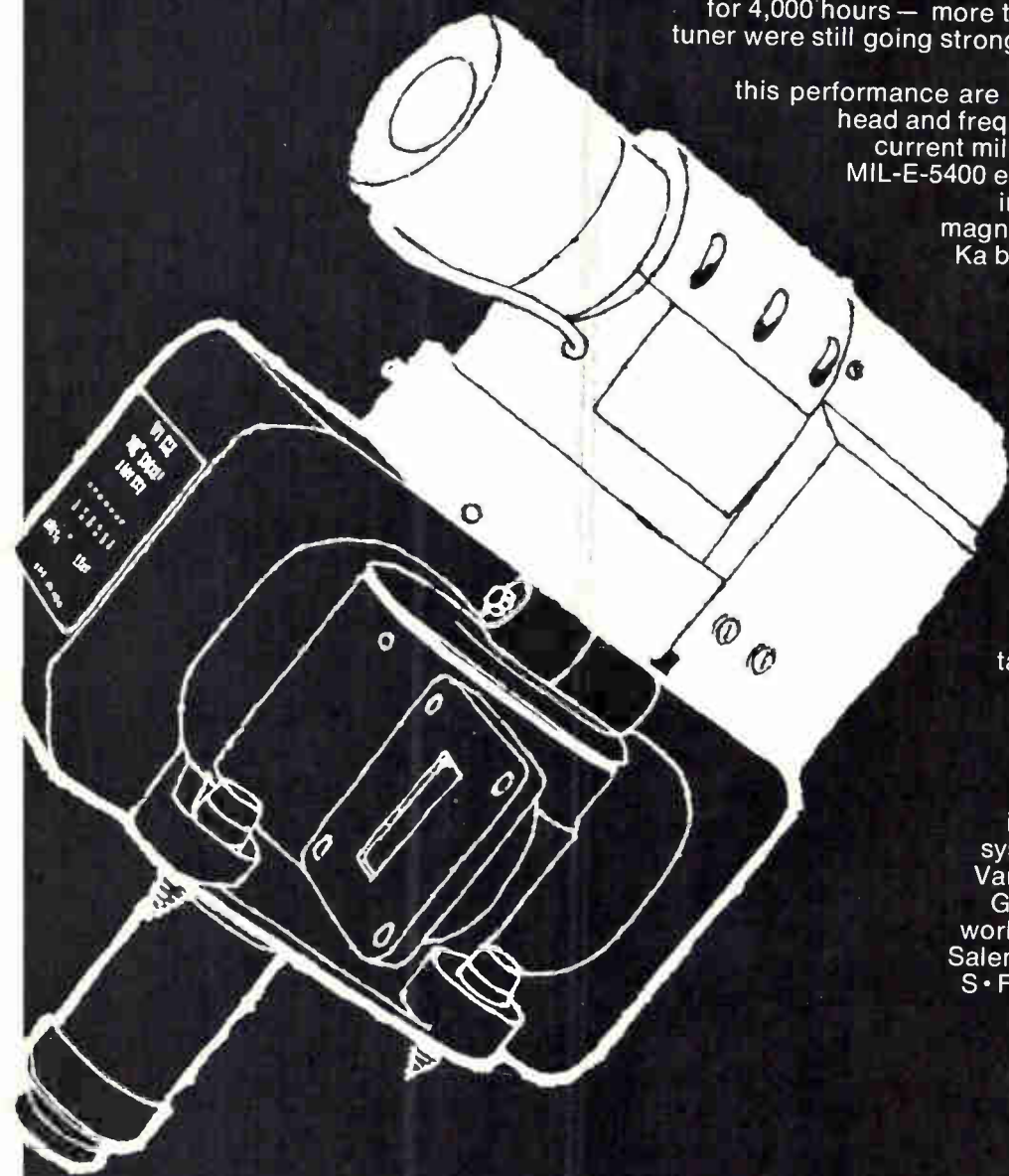

The best is usually more expensive

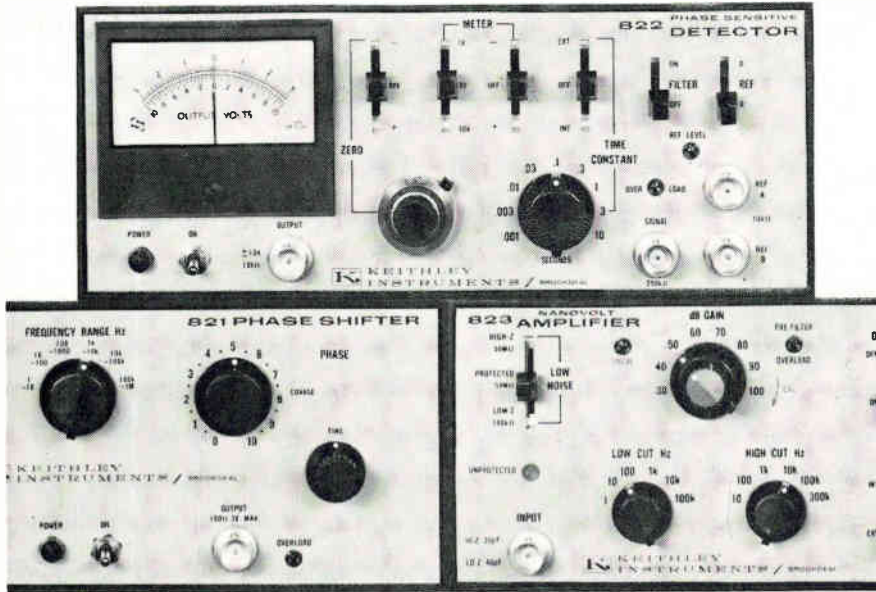

...but not these new Keithley Lock-in Amplifiers

Over the years, Keithley has developed a reputation as a leader in simplifying DC measurements. Now we have another advance . . . the Keithley 82 and 83 Lock-in Amplifier Systems which use the wide band approach to simplify AC, as well. If you're trying to isolate low level signals lost in noise, look at what we offer:

- sensitivity of better than 500 picovolts
- center frequencies from 1 Hz to 1 MHz
- resolution to 0.01%
- 0.005%/°C zero stability, and
- a building block approach where you buy only what you need

Either system offers unparalleled advantages in terms of quick set-up, easy operation and versatility of performance.

To make your lock-in amplifier money talk, talk to Keithley. About the System 82 for highly sensitive and demanding applications (for only \$1895). Or the System 83 for less stringent uses (just \$1595). If you don't need the complete system, buy only the Phase Sensitive Detector, Low Noise Amplifier or Phase Shifter.

For full technical details or help with a specific problem, call your experienced Keithley Sales Engineer. Or contact Keithley Instruments, Inc., 28775 Aurora Road, Cleveland, Ohio 44139.



KEITHLEY

most double the through-put rate of the tester, according to Redcor.

Easy to use. Simplicity of operation is one of the tester's features. The standard software package used is TEST (test-oriented engineering symbolic translator) a company-developed engineering language translator that allows an unskilled operator to introduce test routines with a 300 characters-per-second tape reader. In addition, the system has standard assembler and Fortran IV software, a math subroutine library and a program utility package. A three-pass assembler also is supplied, for assembly of PAFT II programs on an IBM 360 computer.

Both the logic and amplitude validity of outputs from the device being tested are determined by comparators. Compare-signal response time is less than 11 nanoseconds with 50 millivolts of overdrive. Fault response time is 25 nsec maximum.

While the tester can accommodate up to 64 comparators, or one comparator per channel, the normal configuration includes only about half that number, Redcor says. The number of comparators is field-expandable at a cost of \$100 per comparator. A fault indicator lamp for each channel tells the operator when a comparator has detected a failure. When a test is completed, red and green go/no-go lamps indicate the results. A white indicator lamp is on when the proper information is being circulated in the registers.

Computer-controlled digital-to-analog converters supply clock levels, power voltage levels, and one/zero voltage to the channels. Because the system uses a general purpose computer, a variety of changes in software are possible.

The d-a converters are programmed to set reference voltage discrete steps from 0 to -40 volts for the one level and 0 to -10.23 volts for the zero level. Accuracy of the setting is ± 10 millivolts, and program resolution the reference voltage is 10 millivolts.

Price for the tester is less than \$150,000 with 64 channels.

Redcor Corp., 7800 Deering Ave., P.O. Box 1031, Canoga Park, Calif. 91301 [430]

For high speed harnessing
with continuous lacing...

HERE IS THE WORK SPEEDING - MONEY SAVING -

GUDEBROD SYSTEM "C"

GUDEBROD FLAT TAPE BOBBINS—This special packaging of Gudebrod Flat Braided Lacing Tape is highly popular in the harness shop. Whether used in all hand tying or with the Cable-Lacer (for which it was designed) the bobbin makes conveniently available, high quality Gudebrod Tape in most of its many types—all engineered to lie flat, tie tight.

GUDEBROD CABLE-LACER[®]—This unique harnessing hand tool has proved a production speeder and harness improver. Makes up to 30 knots per minute. While making firmer harnesses with tighter, more uniform knots, it eliminates wear and tear on operator's hands because special brake takes strain of knot setting. Holds bobbin of Gudebrod Tape in handle.

LONGER WIRE HOLDING PINS—They make wire threading much easier, quicker (no repeated wire redressing between pins). In harness tying they preserve the layout while using the Gudebrod Cable-Lacer. Special case hardened pins, nail better, stay straight, no nailheads.

GUDEBROD SWIVEL-TILT HARNESS BOARD MOUNT—Two dimensional balanced mobility puts every section of the cabling within easy, natural reach of the operator. Work done in this unstrained manner goes faster, is better, all day through.

There it is, the Gudebrod System "C" solving the cable making problems in a speedy, economical, profit improving way. Ask about System "C" (If you use intermittent tying, ask about Gudebrod System "S").



Gudebrod's
Special, Longer
Case Hardened Pins

®T.M.—UNION SPECIAL
MACHINE CO.

GUDEBROD
Electronics Division

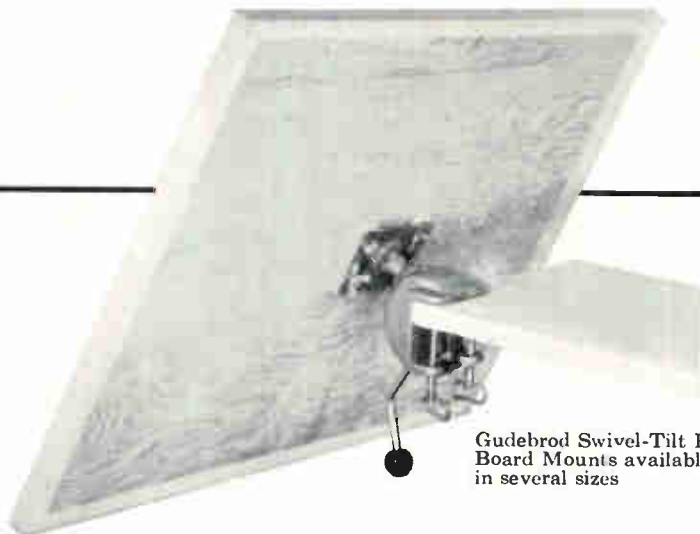

Gudebrod Swivel-Tilt Harness
Board Mounts available
in several sizes

GUDEBROD BROS. SILK CO., INC. Founded 1870, 12 South 12th Street, Philadelphia, Pa. 19107

Same big volts.



New little package.

We took everything in the big one and put it in the little one. Then we made the little one in all the same output ranges as the big one. And gave it the same price. And the same guarantee. And put all the details in our new catalog which is yours for the asking. Simply write to:
acdc electronics, inc. Oceanside Industrial Center
Oceanside, California 92054, Telephone (714) 757-1880

X-Ray spectrometer puts the fix on the mix

In-plant analyzer tied to data processor puts out composition statistics of raw materials in less than three minutes compared with two-hour analysis by chemists

Faster, better data isn't a goal only of upper management—it's also an objective for process-plant managers. This is what Philips Electronic Instruments believes it offers them with both its new X-ray fluorescence spectrometer and associated data processing unit. Dubbed the PW 1250, the new unit has proved this point in its initial installation at Lehigh Portland Ce-

ment's Union Bridge, Md., facility. According to Kramer J. Schatzlein, Lehigh's chemical engineer charged with quality control, when Union Bridge wanted to tighten control over its kiln feed, it found the PW 1250 yielding faster analyses than would have been obtained through hiring more laboratory chemists.

Using cement as a typical ap-

plication, the Philips spectrometer simultaneously analyzes up to seven components that are fed into the kiln to be converted to clinkers. Thus, while the composition of incoming materials differs, the analyzer can provide a readout of the total amount of such elements as aluminum, silicon, calcium, magnesium, iron and sulfur. Any deviation from desired composition can



On/off temperature controllers series 9317 may be actuated by thermocouples or resistance temperature detectors. They contain solid state circuits in conjunction with a relay output. The output relay de-energizes when the setpoint temperature is reached and energizes after temperature falls below the setpoint. Sigma Instruments Inc., 170 Pearl St., Braintree, Mass. [381]

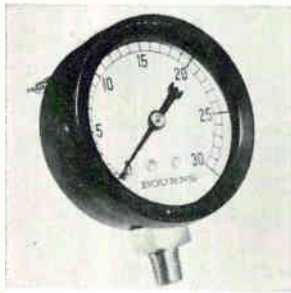

Indicating transducer model 312 provides both a direct readout for local indication and a potentiometric transducer for remote control, indication or alarm. It has pressure ranges of 0-15 to 0-1000 psig and resistance ranges of 1,000, 2,000, and 5,000 ohms. Resolution is 0.5% voltage ratio. Power rating is 0.5 w at 70°F. Bourns Inc., 1200 Columbia Ave., Riverside, Calif. [382]



Three-phase voltage band monitors series PB protect electrical and electronic equipment required to operate between 2 voltage limits. Each of the 3 phases is monitored for an under or over voltage limit. The monitor can be used to sound an alarm, light warning lights, shut down or remove equipment from the line. Diversified Electronics Inc., Box 6231, Evansville, Ind. [383]



Electronic predetermining counter 7122 Econo-Flex with 5 counting decades features illuminated digital display, and the design assures continuous counting in the event of a display failure. The counters operate and automatically recycle at speeds to 10,000 counts/sec, accepting input from photoheads, contact closures, or direct pulses. Veeder-Root Co., Hartford, Conn. [384]

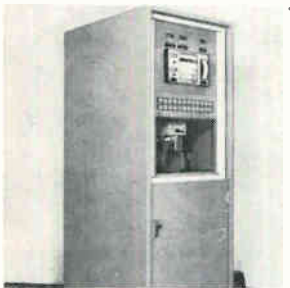

Punch tape programmer system provides automatic control for all types of batch processing routines in the textile industry. The system fills the gap between simple manual control and sophisticated computer control. It offers rigid control enforcement and repeatability of the dye cycle, and greater production efficiency. The Foxboro Co., Foxboro, Mass. 02035 [385]



Servo amplifier AD-7200 is the heart of remote closed loop position control. It operates from either a 12 or 24 v d-c battery and positions fractional h-p permanent magnet motors. A typical application is positioning of directional control valves on cranes, tractors and other heavy mobile equipment. Price is \$165. Jordan Controls Inc., 5607 W. Douglas Ave., Milwaukee, Wis. [386]



Digital data console called KADAC is for industrial applications. It accepts inputs totaling from 10 to 100, in increments of 10. Inputs can be randomly intermixed to include thermocouples, pressure transducers, strain gages, or other analog sensors. The system is expandable to 1,000 inputs with additional multiplexers. Electronic Modules Corp., Box 141, Timonium, Md. [387]



D-c torque motor series 235-100 features a thin, pancake-shaped wrap-around rotor which can be applied directly to, or around, shafts or hubs. Developed for control of rocket motor thrust vectoring systems, the motor can be used wherever precision high-torque positioning and speed control are requisites. Magnadyne Inc., 5580 El Camino Real, Carlsbad, Calif. 92008 [388]

The first plug-in curve tracer costs 1/3 less!

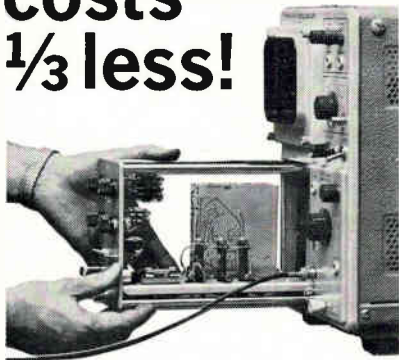

With U-Tech's plug-in and console units, any X-Y oscilloscope becomes a curve tracer displaying the dynamic characteristics of both NPN and PNP transistors, N Channel and P Channel junctions, FET's, MOS-FET's, bipolars, unijunctions, diodes, tunnel diodes and SCR's. You have curve tracer capabilities, without buying a complete curve tracer unit. In so doing you pay up to:

1/3 less!

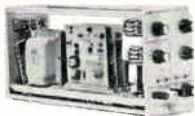

U-Tech plug-in MODEL 681: \$655.00*. For use with Tektronix† 560 Series Oscilloscopes.



U-Tech plug-in MODEL 682: \$675.00*. For use with Tektronix† 530, 540, 550, 580 Series Oscilloscopes.



U-Tech console MODEL 683: \$685.00* For use with any X-Y Oscilloscope.

Ask your distributor about these U-Tech curve tracer units or order direct from:

U-TECH

A DIVISION OF INDUSTRIAL PHYSICS AND ELECTRONICS COMPANY
4190 SOUTH STATE STREET,
SALT LAKE CITY, UTAH 84107
(801) 262-2663

†Registered trademark Tektronix Inc.

*Prices apply to purchase and shipments within U.S.A. fob Salt Lake City, Utah

be readily corrected.

Besides analyzing seven elements, the PW 1250 can operate in three separate modes, each providing a different measurement: the absolute, or fixed-time mode; monitor mode, in which the unit accumulates a fixed number of X-ray particle counts; or ratio mode—accumulating to a fixed number of counts on the same element. In the absolute or monitor mode one or two unknown samples can be analyzed in the spectrometer at the same time. With the ratio method, only one unknown sample can be handled at a time, with the other position taken up by a standard sample. Further, the instrument can work with solid, liquid, or powdered material.



Analysis. Spectrometer quickly tells composition of sample material.

The spectrometer portion of the unit consists of the sample transport mechanism and the analyzer head, containing an X-ray tube, seven collimators and associated goniometers, crystals, and detectors. The collimators and goniometers are arranged like a fan so that all are directed to the center of the sample.

The PW 1250 is available with or without Philips' PW 1260 data processor, which performs straight- and curved-line calibrations as well as background connection for each of the measured elements.

With data processor the unit sells for about \$64,000, and without it for about \$5,000 less.

Philips Electronic Instruments, 750 S. Fulton Ave., Mt. Vernon, New York 10550 [389]

Industrial electronics

Thickness gage gives digital answer

Converting acoustic-pulse echo to direct readout eases operator's job

Statistical evaluation of a manufacturing operation's performance is one of the advantages that Branson Instruments' 102/DP ultrasonic thickness gage offers because of its direct-reading digital output. The operator benefits, too. Previously, such thickness gages required operator interpretation of analog signals to determine the thickness of a part, and this was time-consuming and subject to error.

In the Branson unit, an acoustic pulse is transmitted through the workpiece and is reflected back from the far surface. Thus, depending on the acoustic velocity of the tested material, the pulse duration can be calibrated to the material's thickness. The instrument converts this pulse duration into digits representing the thickness, and the digital readout appears on the front panel.

Normally, the unit is calibrated at the factory to measure steel, but a simple adjustment allows the digital readout to remain calibrated in inches for other kinds of materials, including hollow castings, large-diameter seamless tubing, plastics, glass, and ceramics. The system is designed for jobs where a high level of confidence is required in measurement of thin materials.

Besides a panel readout, the instrument sets up a digital signal that can be fed to a computer to keep track of such information as rejection rates and production errors.

The unit's range is from 0.010 to 10 inches. Accuracy is 0.0001 inch for thin materials, 0.01 inch at the higher readings.

The basic unit sells for \$3,500; high- and low-limit digital setpoints and tape printer options bring the total price to \$5,000.

Branson Instruments Co., Progress Drive, Stamford, Conn. 06904 [390]



**Bone dry...
is not dry enough for some people.**

On the surface, things that look pretty dry just aren't dry enough for some jobs. Jobs like precisely monitoring trace water in gas streams. Or finding out exactly how dry a dry box operates.

Beckman has designed, built and introduced a new line of Trace Moisture Analyzers to accomplish this critical job. They tell exactly how many parts-per-million of water are present in gas streams and atmospheres. This new generation of instruments is "industrialized" for greater durability, maintenance simplicity and reliability. The line includes port-

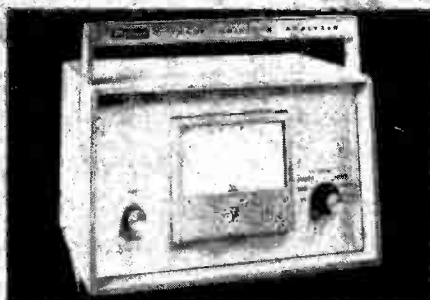

ble and semi-portable models as well as panel-mounted control units and remote analyzers. Each analyzer has a more easily replaceable cell, a temperature controlled detector, and a new heavy-duty

die-cast aluminum case. Many other standard features and options are offered like front-settable solid-state high alarm contacts, and terminals for a potentiometric or current-level recorder.

For all the facts, call your local Beckman Sales Representative or write for Data File PTM-13-170.

Beckman[®]

INSTRUMENTS, INC.
PROCESS INSTRUMENTS DIVISION
FULLERTON, CALIFORNIA 92634

INTERNATIONAL SUBSIDIARIES: AMSTERDAM, CAPE TOWN,
GENEVA, GLENROTHES, SCOTLAND, LONDON, MEXICO
CITY, MUNICH, PARIS, STOCKHOLM, TOKYO, VIENNA

SAGE CUSTOM MOLDED DUAL-IN-LINE TRANSFORMER MODULES

ONE
.. TWO
... THREE
..... FOUR!

*...that's how many
pulse transformers you can
have in this unique D-I-L package!*

Yes, in one 16 pin dual-in-line only .825" long, Sage can give you up to four pulse transformers that will provide DC isolation; impedance matching; current/voltage gain or common mode rejection. Typical applications include memory drivers; sense line outputs, or common mode chokes*. Also available—comparable 14 pin dual-in-line module of the same configuration with a maximum length of .770" and with complete D-I-L compatibility.

With this new molded D-I-L package, production insertion techniques for transformers are now as economical as for integrated circuits.

*MAXIMUM ELECTRICAL PARAMETERS

- Average current—150 milliamps (25% duty cycle)
- Average power—250 milliwatts
- Peak pulse voltage—50 volts
- ET constant—6.5 volt/microseconds

When you want advanced packaging design in micromagnetics backed by an unsurpassed reputation for quality, accuracy and dependability ... look to Sage!

We welcome the opportunity to discuss your requirements.
SAGE ELECTRONICS CORP., Box 3926, Rochester, N.Y. 14610
Telephone: (716) 586-8010

A Leader in Micromagnetics

SAGE
ELECTRONICS
SUBSIDIARY OF GULTON INDUSTRIES, INC.

New materials

Tubing made from fiberglass

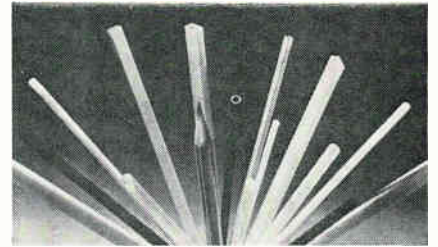

Fiberglass cloth preimpregnated with epoxy resin is convolute wrapped around precision ground mandrels and cured under heat and pressure to produce Class F, 155°C tubing. Good strength at 0.005±0.001-in. wall thickness is achieved with sharp 90° inside corners. Sizes from below 0.062 in. sq. and round are available. Tubing is used for coil winding, tiny sensors, or for small motor shaft insulation. Stevens Tubing Corp., 128 N. Park St., East Orange, N.J. 07019 [491]

Isochemrez 402-AP is an all-purpose, rapid air releasing, low viscosity, calcined alumina filled epoxy resin. It is suitable for rigid specification potting, casting, impregnation, encapsulation, sealing, bonding and molding. Isochem Resins Co., Cook St., Lincoln, R.I. 02865 [492]

Multipurpose emi/rfi material called Pola H is said to provide more low frequency magnetic field gasketing capability than previously available. It is also highly effective in electric and plane wave fields, and maintains up to 250 psi pressure tightness in properly designed joints. Pola H comes in strips or gaskets fabricated to customers' print. Metex Corp., 970 New Durham Road, Edison, N.J. 08817 [493]

Industrial aerosol chemical products have been developed to assist in the manufacture, assembly, maintenance and repair of electronic and electro-mechanical equipment. Prices range from \$1.29 to \$2.89 each in single-can quantities. Bradford Industries, 100 Fordyce St., Dallas 75207 [494]

Scotch-Weld degreasing primer 3911 removes surface contaminants and primes the surface of metal parts for bonding, all in one operation. 3M Co., 3M Center, St. Paul, Minn. 55101 [495]

Advanced magnetic shielding alloy Co-Netic M offers non-shock-sensitive, low retentivity, and stable shielding properties. It also provides improved electrical attenuation against low level fields for radar, sonar, missiles, aircraft, data processing displays. Perfection Mica Co., 740 Thomas Dr., Bensenville, Ill. 60106 [496]

When ordinary methods of observing and recording don't deliver



call Kodak

We have a very large staff of photographic engineers qualified to provide photographic solutions to previously unsolvable problems. Together, you and they can probably work out solutions. A few challenges presented to us recently . . .

A research team needed a way to study the combustion of metal droplets. Kodak was able to provide a film just right for high-speed cameras to record exactly what happens at 4000°C . . . and in what sequence (see picture above).

Another group, concerned with impact testing, faced the problem of oscillograph traces which intermixed

hopelessly at the point showing impact. They called Kodak. And found that we had a paper that, when exposed through appropriate filters, would provide multicolored traces. These could be interpreted even with large amplitude variations on narrow paper.

A third group had the problem of projecting computer output on a screen in color. Particularly troublesome was the fact that these data had to be updated and changed every few seconds. They called Kodak. Our engineers answered their problem with an embossed lenticular film originally intended for color kinescope recording. This film not only developed in 20

seconds to stay within their time requirements, but, with appropriate shooting and projecting techniques, produced the necessary color images.

Right now, you may be facing a data-collection problem that seems to defy solution. It may be quite different from those we mentioned. Your best bet could be a conversation with one of our photographic experts. Call Kodak.

**Dial (716) 325-2000, Ext. 3257.
Or write: Instrumentation Sales,
Eastman Kodak Company,
Rochester, N. Y.
14650.**

Kodak

How much would
 $H_{(BEEP)} P_{(BEEP)}$
charge for a
microwave
power meter with
digital display?

At least \$500
more than
we charge for
the 1009.

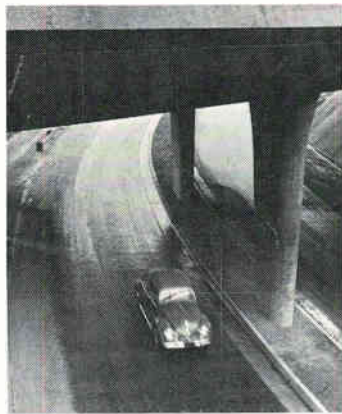

PM's Model 1009 Digital Power Meter measures frequency gains or attenuations directly in dB. (Or milliwatts or dBm from +10 to -40 dBm.) With 0.1 dB resolution. Frequency range 10 MHz to 18 GHz. Digital readout. Swept frequencies may be



PACIFIC
MEASUREMENTS

scoped or plotted. The Model 1009 provides automatic system compatibility and unequalled low drift. All for \$1850. For specs, write

Pacific Measurements, Inc.,
940 Industrial Avenue,
Palo Alto, California 94303.
We gotta be better.

New Books

Wrap-up

Handbook of Electronic Packaging
Charles A. Harper
McGraw-Hill Inc., 948 pp., \$29.50

Electronic packaging has come a long way from the days of the tube socket, twisted filament-lead wires, and rubber grommets. Now it's beam-leads, hybrid-circuit ceramic substrates, ultrasonic bonding and a host of other new terms. It's even getting difficult to tell the difference between the circuit design and the package design. Every engineer is now becoming his own packaging expert again.

This book could probably turn you into an expert in packaging if you had the fortitude to plow through its nearly 1,000 pages. But it's a handbook—a book that's meant to be consulted on specific topics with specific questions and then laid aside until the next time.

The real test of a handbook is not whether it holds your interest or whether it has a logical sequence of reasoning to explain a point, but whether it is complete and is indexed well enough to steer you to the proper information, and whether the proper information is actually there.

Let's give it a try. Suppose you want to know something about thick-film conductor inks—what's available, what kind of processing is involved, and how do they perform.

The index shows that thick-film conductor inks are covered on pages 5-16 (why do all handbooks have this odd chapter-page number scheme?) through page 5-20. That's reassuring—at least five pages. What do we find in these five pages? First of all, we find that the text type size is quite small—about two-thirds the size of the type used in this book review—but that's not bad, because the handbook is not intended for lengthy reading. We also find a table listing five conductor types with ten properties compared. We also find a couple of photos of conductive substrates, and a table dealing with epoxy conductors.

There's a 25-line discussion of gold as a conductor, in which it's

SEMINAR 1: LOS ANGELES



What can Digitran do to improve thumbwheel switch capability?

In the first of a series of seminars to be held in major U.S. cities, we met with these top designers, human engineers, and components men from both the military and commercial fields. We're looking for new ideas, new approaches, to switches. The benefit: Improved products directly attributable to the needs of the industry.

From the engineers involved with military applications: There was considerable discussion on switch manufacturers providing greater documentation on shelf life and other reliability factors. The military is getting tougher on operational life and human engineering aspects. On GSE equipment, front panel mounting should be made more broadly available for ease of

maintenance. Pushbutton switches, it was stated, even though necessarily miniature for aircraft applications, should have staggered pushbuttons so that a gloved finger could actuate each switch independently without pressing the adjacent one in error.

From the computer men: Give us switches with more electronics in them . . . almost subsystems that will reduce the amount of necessary logic and circuitry used in conjunction with the switch. Help us eliminate the amount of wiring required. The possibility of solid state thumbwheels was discussed, and while some felt there was a definite advantage, others suggested that they had more technical difficulties with solid state devices than the

straight electromechanical device.

Now it's your turn. We'd like you to tell us what you'd like to see in switches. Or out of them. It won't be wasted effort. The information you give us, plus all we get from our 1970 Seminar Program, will help us to continue to design the most advanced, best performing switches available. The leader can't afford to do less.

THE DIGITRAN COMPANY

A Division of Becton, Dickinson and Co. **B-D**

855 S. Arroya Parkway, Pasadena, Calif. 91105
Telephone (213) 449-3110 • TWX 910-588-3794

dc voltage standards

THE FACTS ARE
IN THE
CARDS

ACCURACY

GOOD

Model 351 0.003% Accuracy

BETTER

Model 353 0.002% Accuracy

BEST

Model 355 0.001% Accuracy

COHU MEETS THE TEST

We could have said, "COHU BEATS THE REST," but the technically knowledgeable engineer will see the 0.001% of the Model 355 and ask "WHY STATE THE OBVIOUS?"

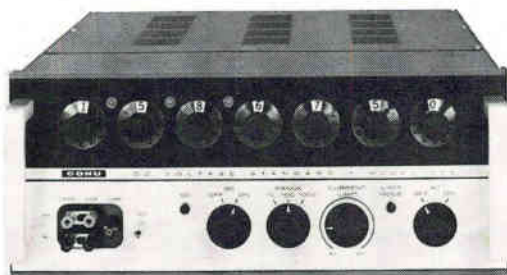

So, to get the DC Voltage Standard YOU need, it's obvious:

ASK COHU FOR IT

COHU
ELECTRONICS, INC.
SAN DIEGO DIVISION

BOX 623, SAN DIEGO, CALIFORNIA 92112 • PHONE 714-277-6700 • TWX 910-335-1244

New Books

pointed out that there are numerous conductive gold inks available that fire between 800° and 1,000° C and that "most gold conductors can be soldered only with indium-base alloy solders, although one paste is available which can be soldered with eutectic tin-solder." It's also pointed out that there is a marked difference in characteristics of palladium-silver resistors fabricated with gold terminations and those produced with other conductors as terminations.

The text then moves on to platinum-gold, palladium-gold, palladium-silver, silver, moly-manganese and epoxies and adhesives, covered at about the same level of detail.

But suppose you want more details. Are there any references? None of the 32 references listed at the end of the chapter appear to offer much in the way of specific details about thick-film conductors. However, other subjects in the chapter—thick-film resistors, insulators, capacitors, and substrates—are heavily referenced, and, some of these may cover conductors, too. But, this seems to be about the only criticism that one could make of the section.

The rest of the handbook covers such topics as rigid and flexible printed wiring, wires and cables, soldering, welding, metal bonding, connectors, thermal design, and computer-aided design, while special chapters cover packaging methods for each of three major application areas—computers, military, and space.

Each chapter is by a different author from, by and large, different companies. This is good because it assures that the viewpoints are not those of a single company. Mr. Harper, the editor, is with Westinghouse Aerospace division in Baltimore, and has been in the packaging field for 15 years.

Recently Published

Engineer's Guide to High-Temperature Materials, Francis Clauss, Addison-Wesley, 401 pp., \$14.95

Designed primarily for those who use materials at elevated temperatures, this book contains a wealth of information

These guys have Utilogic II.

SIGNETICS STOCKING DISTRIBUTORS

ALABAMA

Huntsville 35801: *Compar Corp.*, 904 Bob Wallace Ave., Room 114
Phone: (205) 539-8476

ARIZONA

Scottsdale 85251: *Compar Corp.*, 84 West 1st Street
Phone: (602) 947-4336 TWX: (910) 950-1293

CALIFORNIA

Burlingame 94010: *Compar Corp.*, 828 Airport Blvd.
Phone: (415) 347-9501

Culver City 90230: *Hamilton Electro Sales*, 10912 W. Washington
Phone: (213) 870-7171

Burbank 91504: *Compar Corp.*, 2908 Naomi Avenue
Phone: (213) 843-1772

Los Angeles 90022: *Wesco Electronics, Inc.*, 5650 Jillson Street
Phone: (213) 685-9525 TWX: (910) 580-1980

Palo Alto 94303: *Wesco Electronics, Inc.*, 3973 E. Bayshore Road
Phone: (415) 968-3475

San Diego 92111: *G. S. Marshall*, 7990 Engineer Road, Suite 1
Phone: (714) 278-6350

El Monte 91731: *G. S. Marshall*, 9674 Telstar Avenue
Phone: (213) 579-1500 TWX: (910) 587-1565

CANADA

Downsview, Ontario: *Cesco Electronics, Ltd.*,
24 Martin Ross Avenue

Phone: (416) 638-9250

Montreal, Quebec: *Cesco Electronics, Ltd.*, 4050 Jean Talon West
Phone: (514) 735-5511

Ottawa, Ontario: *Cesco Electronics, Ltd.*, 1300 Carling Avenue
Phone: (613) 729-5118

Quebec: *Cesco Electronics, Ltd.*, 128 West Ballier Street
Phone: (418) 524-3518

COLORADO

Denver 80110: *Compar Corp.*, 300 East Hampden Avenue
Phone: (303) 781-0912 TWX: (910) 933-0183

Denver 80216: *Hamilton Electro Sales*, 1400 West 46th Street
Phone: (303) 931-0580

CONNECTICUT

Hartford 06500: *Compar Corp.*, 2357 Whitney Avenue
Phone: (203) 288-9276 TWX: (203) 772-0439

FLORIDA

Orlando 32805: *Hammond Electronics*, 911 W. Central Blvd.
Phone: (305) 241-6601

ILLINOIS

Elmhurst 60126: *Semiconductor Specialist, Inc.*,
195 Spangler Ave., Elmhurst Industrial Park

Phone: (312) 279-1000 TWX: (910) 254-0169

Addison 60101: *Compar Corp.*, 315 Laura Drive
Phone: (312) 543-8833

MARYLAND

Baltimore 21208: *Compar Corp.*, Pikesville Professional Bldg.,
7 Church Lane

Phone: (301) 484-5400 TWX: (710) 862-0860

Rockville 20850: *Pioneer Washington Electronics, Inc.*, 1037 Taft St.
Phone: (301) 427-3300

MASSACHUSETTS

Burlington 01803: *Avnet Electronics Corp. of Mass.*,
207 Cambridge Street

Phone: (617) 272-3060

Newton Highlands 02161: *Compar Corp.*, 88 Needham Street
Phone: (617) 969-7140 TWX: (710) 335-1686

Watertown 02172: *Schley Electronics Corp.*, 36 Arlington Street
Phone: (617) 926-0235

MICHIGAN

Southfield 48075: *Compar Corp.*, 21250 1/2 Mile Road
Phone: (313) 357-5369

Detroit 48240: *Semiconductor Specialists Inc.*,
25127 West Six Mile Road

Phone: (313) 255-0300

MINNESOTA

Minneapolis 55416: *Compar Corp.*, 3925 Monterey Avenue,
P.O. Box 16095

Phone: (612) 922-7011

Minneapolis 55423: *Semiconductor Specialists Inc.*,
7742 Morgan Avenue South

Phone: (612) 866-3434

MISSOURI

St. Louis 63141: *Compar Corp.*, 11734 Lackland Industrial Drive
Phone: (314) 542-3399

NEW JERSEY

Cherry Hill 08034: *Hamilton Electro Sales*,
1608-10 West Marlton Pike

Phone: (609) 662-9337

Haddonfield 08033: *Compar Corp.*, 15 Potter Street
Phone: (609) 429-1526

NEW MEXICO

Albuquerque 87110: *Compar Corp.*, 2129 San Mateo, N.E.
Phone: (505) 265-1020 TWX: (910) 989-1659

NEW YORK

Albany 12205: *Compar Corp.*, 6 Highland Avenue
Phone: (518) 489-7408 TWX: (710) 441-8224

Buffalo 14202: *Summit Distributors Inc.*, 916 Main Street
Phone: (716) 884-3450

New York 10011: *Terminal-Hudson Electronics*, 236 W. 17th St.
Phone: (212) 243-5200 TWX: (710) 581-3962

Woodbury 11797: *Compar Corp.*, 335 Crossways Park Drive
Phone: (516) 921-9393 TWX: (510) 221-2170

NORTH CAROLINA

Winston-Salem 27101: *Compar Corp.*, 1106 Burke Street
Phone: (919) 723-1002 TWX: (510) 931-3101

OHIO

Cleveland 44103: *Pioneer Standard Electronics*,
5403 Prospect Avenue

Phone: (216) 432-0010

Fairborn 45324: *Compar Corp.*, 16 South Broad Street
Phone: (513) 878-2631

Fairview Park 44126: *Compar Corp.*, 19500 Center Ridge,
Rocky River, or P.O. Box 4791

Phone: (216) 333-4120

PENNSYLVANIA

Philadelphia 19132: *Milgray-Delaware Valley, Inc.*,
2532 North Broad Street

Phone: (215) 228-2000 TWX: (710) 670-3400

TEXAS

Dallas 75207: *Hamilton Electro Sales*, 2344 Irving Blvd.
Phone: (214) 638-0900

Dallas 75241: *Compar Corp.*, 8609 N.W. Plaza Blvd., Suite 222
Phone: (214) 947-4336

Houston 77019: *Hamilton Electro Sales*, 1216 West Clay Street
Phone: (713) 526-4661 TWX: (910) 881-3721

Houston 77036: *Universal Electronics*, 5723 Savoy
Phone: (713) 781-0421

WASHINGTON

Kirkland 98033: *Compar Corp.*, 12610 N.E. 104th Street
Phone: (206) 822-4191

Seattle 98108: *Kierulff Electronics*, 5940 6th Avenue, South
Phone: (206) 763-1550

Now you can get it II.

What's more, they've got a great big handbook, II—on Utilogic II!
Descriptions, specs, usage rules, how-to's, design ideas on the
only integrated circuit logic family that gives you I) lowest cost per gate
function, II) choice of AND, OR, NAND and NOR logic, and
III) silicone DIP's. XXXII pages in all! See any of the guys above—
and you can get it II!

Signetics

Signetics Corporation / 811 E. Arques Ave., Sunnyvale, California 94086/A subsidiary of Corning Glass Works

INTEGRATED CIRCUIT SEMINARS



At ICE's seminars practical experience is taught — what others have learned the hard way. As an unbiased party, ICE *evaluates* all of the IC processing techniques used throughout the industry. ICE has no hardware to promote, only sound technical information to dispense. Fees cover tuition, course materials and texts. Enrollment is limited. For a complementary copy of "MOS Integrated Circuits — The Designer's Dilemma" given by Glen R. Madland at WESCON 1969, write to Robert L. McLellan, Publications Manager, ICE.

4-DAY IC ENGINEERING SEMINARS AND ONE-DAY SPECIALIZED SEMINARS

The 4-day seminar provides a solid understanding of IC technology for both management and engineering personnel. Optional 1-day and 1½ day seminars are offered on specific IC subjects.

DATES	SEMINAR CONTENT
January 19-23	4-day engineering seminar plus 1-day seminars on COMPUTER AIDED DESIGN and PRODUCT ANALYSIS.
February 16-20	4-day engineering seminar plus 1-day seminars on RELIABILITY and MOS LAYOUT.
April 6-10	4-day engineering seminar plus 1-day seminars on PURCHASING/MARKETING and MANAGEMENT.
May 18-23	4-day engineering seminar plus 1-day seminar on LSI or 1½ days on FAILURE ANALYSIS.

Registration Fees, including ICE's Basic Technology (500 page fifth edition): \$500 for 4-day seminars, \$175 for 1-day seminars, \$275 for 1½ day seminars. Seminar dates for the balance of 1970 will be announced later in the year.

FOR COMPLETE DETAILS CIRCLE READER SERVICE # 504

4-WEEK IC DESIGN/ FABRICATION SEMINAR

Covers entire spectrum of procedures used today in the IC industry as well as specialized techniques developed by ICE. Laboratory periods are devoted to student IC design and fabrication instruction in ICE's modern research facility.

1970 SEMINAR DATES
February 23 to March 20
September 21 to October 16

Registration fee, including a complete set of the five-volume Process Compendium (1,489 pages, 831 illustrations), ICE's Basic Technology, laboratory workbook and all laboratory materials, is \$10,000.

FOR COMPLETE INFORMATION
CIRCLE READER SERVICE # 505

2-WEEK IC PROCESSING SEMINAR

This ICE seminar provides intensive familiarization with detailed processing techniques for production of silicon monolithic IC's. Course combines classroom lectures with actual operating experience in ICE's modern prototype laboratory.

1970 SEMINAR DATES
June 1 to June 12

Registration fee, including ICE's Basic Technology (500 page fifth edition), Processing Notes (a complete processing "recipe book"), workbook and laboratory notebook, is \$3,000.

FOR COMPLETE INFORMATION
CIRCLE READER SERVICE # 506

ICE

INTEGRATED CIRCUIT ENGINEERING CORPORATION
4900 EAST INDIAN SCHOOL ROAD/PHOENIX, ARIZONA 85018
PHONE (602) 959-4760/TWX (910) 950-1285/CABLE ICE PHOENIX

New Books

on the basic behavior of metals and alloys, the structure and composition of specific materials, design considerations, and non-ideal conditions encountered in service. Included are condensed data tables for important commercial alloys.

Theories of Abstract Automata, Michael A. Arbib, Prentice-Hall, 412 pp., \$14.95

Advanced introduction to automata theory. Surveys abstract automata theory and covers such topics as finite automata, tuning machines, context sensitive and context-free grammars. Also discusses partial recursive functions and complexity of computation, machines that compute and construct, algebraic decomposition theory, and stochastic automata.

Fundamentals of Quantum Electronics, R.H. Pantell, H.E. Puthoff, John Wiley & Sons, 361 pp., \$15.95

Emphasizes physical significance of results rather than mathematical formalism and covers such topics as resonant processes, lasers, field quantization and dipole transitions. Features comparison between semiclassical and fully quantized approaches, a novel geometric presentation for the transient behavior of pulsed and Q-switched lasers and an extensive presentation of nonlinear quantum effects.

The Physics of Selenium & Tellurium, ed. W. Charles Cooper, Pergamon Press, 380 pp., \$18.50

The proceedings of an international symposium under the sponsorship of the Selenium-Tellurium Association. Notes important recent advances, emphasizing band structures, optical and electrical properties, crystal growth and characterization.

Proceedings of the Symposium on Pulse-Rate and Pulse-Number Signals in Automatic Control, ed. National Technical Organizing Committee of the IFAC, Akademiai Kiado, 569 pp., \$28

Outgrowth of work done by Hungarian research workers in the development of process-control and data-processing equipment. Concentrates on the use of pulse-rate and pulse-number signals, and discusses incremental techniques, logic elements, data transmission controllers and actuators, and analysis and synthesis of pulsed systems.

Semiconductor Plasma Instabilities, Hans Hartnagel, American Elsevier, 206 pp., \$11

Covers semiconductor bulk effect theory and, to a lesser extent, its applications. Among topics are semiconductor physics equations for plasma instabilities, Gunn oscillators, avalanche diodes, and the electroacoustic effect.

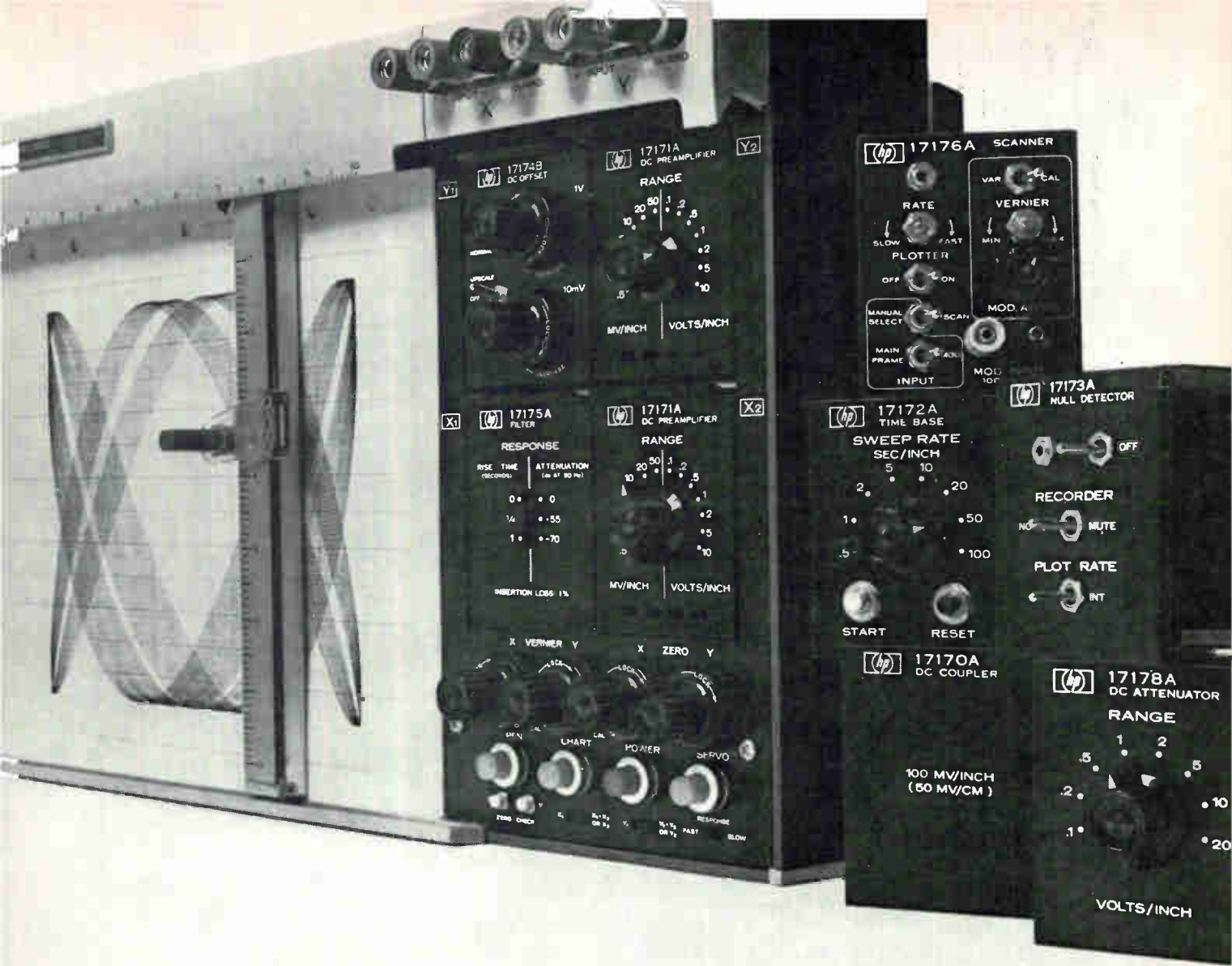

To make our new small X-Y Recorder act big, just plug in a couple of these.

HP's new 7034A is as trim as you can make an 8½" x 11" X-Y recorder. But size is the only thing small about it. The frame has all the features and versatility of our big X-Y Recorder. Such as 1500 in/sec² acceleration and 30 in/sec slewing speed, to catch transients most X-Y recorders miss. Guarded circuits to reject ac and dc common-mode signals. Exclusive, silent electrostatic paper hold-down to eliminate slippage. Disposable ink cartridge to eliminate mess and make color changes easy. And zero set/check for fast verification of zero position without removing or shorting the input signal. High dynamic performance is

matched by the flexibility we've achieved with our unique plug-in concept: two may be used in each axis, and can be cascaded. With eight plug-ins to choose from, you can add to your measurement capabilities as the need arises.

With the Time Base plug-in, you can capture X-T or Y-T data at ½ sec/in to 100 sec/in sweep rates. Expand low-level signals for detailed study with the DC Preamplifier. Suppress steady-state dc to reveal small-signals using the DC Offset plug-in. Plot single channel data at 50 points/sec with the Null Detector and accessory point plotter. Plot two channels independently with the Scanner.

Eliminate ac signal components over 50 Hz with the Filter plug-in. And for more run-of-the-mill recording jobs, try our low-cost DC Attenuator or DC Coupler.

You'll be glad to know that the price on this new X-Y Recorder is also small: just \$1195 for the basic instrument. Plug-in prices start at \$25. For all the big details, contact your local HP field engineer. Or write to Hewlett-Packard, Palo Alto, California 94304; Europe: 1217 Meyrin-Geneva, Switzerland.

HEWLETT  PACKARD

GRAPHIC RECORDERS
Circle 217 on reader service card

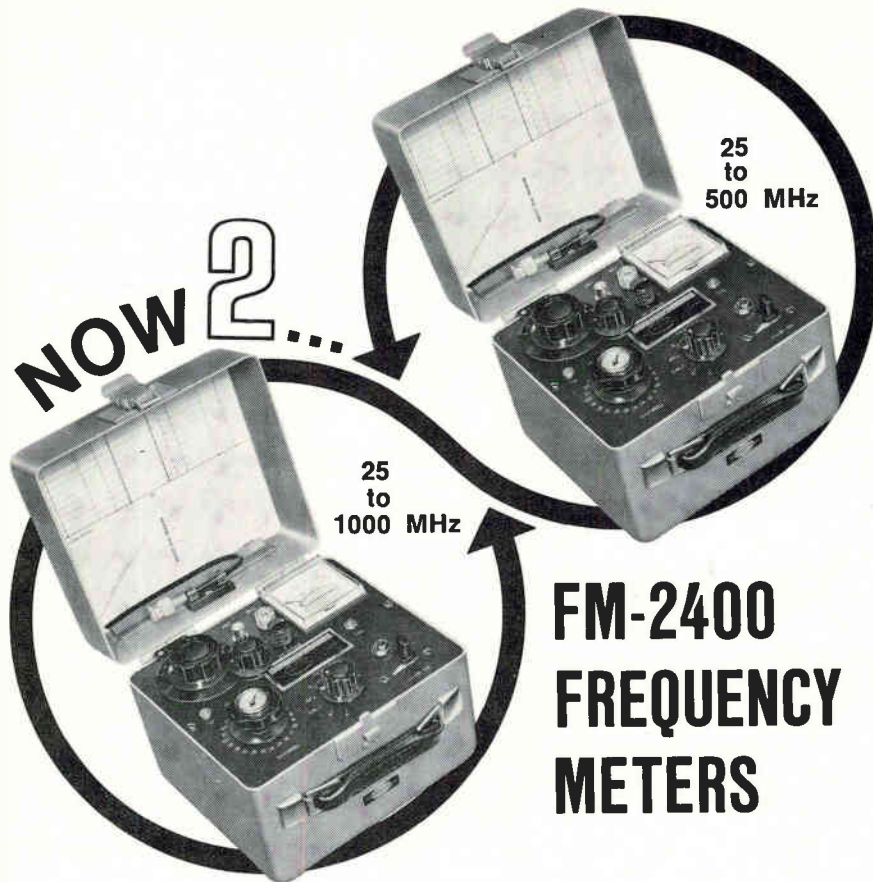

FM-2400 FREQUENCY METERS

FM-2400CH (New)

- Tests Predetermined Frequencies 25 to 1000 MHz
- New Extended Range Covers 950 MHz Band
- Pin Diode Attenuator

FM-2400C

- Tests Predetermined Frequencies 25 to 500 MHz

The new FM-2400CH and the FM-2400C provide an accurate frequency standard for testing and adjustment of mobile transmitters and receivers at predetermined frequencies. The FM-2400CH with its extended range covers 25 to 1000 MHz. The Model FM-2400C covers 25 to 500 MHz. The frequencies can be those of the radio frequency channels of operation and/or of the intermediate frequencies of the receiver between 5 MHz and 40 MHz.

Frequency Stability: $\pm .0005\%$ from $+50^\circ$ to $+104^\circ\text{F}$

Frequency Stability: with built-in thermometer and temperature corrected charts. $\pm .00025\%$ from $+25^\circ$ to $+125^\circ$ ($.000125\%$ special 450 MHz crystals available)

Both the FM-2400CH and the FM-2400C are self contained in small portable cases. Complete solid state circuitry. Rechargeable batteries.

FM-2400CH (meter only) ..\$595.00
 RF crystals (with temperature correction) 24.00 ea.
 RF crystals (less temperature correction)..... 18.00 ea.
 IF crystals.....catalog price

FM-2400C (meter only)\$445.00
 RF crystals (with temperature correction) 24.00 ea.
 RF crystals (less temperature correction)..... 18.00 ea.
 IF crystals.....catalog price

Write for catalog



Straightening the thermistor

Comparison of temperature sensors for Apollo experiment instrumentation
 Earl E. Swartzlander Jr.
 Ball Brothers Research Corp.
 Boulder, Colo.

Investigation of temperature control for the Apollo Telescope Mount (ATM) Project provided comparative information on temperature sensors and resulted in a simple method of producing a linear temperature response from a highly nonlinear thermistor temperature sensor.

The ATM is made up of several scientific experiments whose measuring devices must be accurately pointed at the sun. For example, the ultraviolet scanning spectroheliometer requires that the telescope's pointing accuracy be within 5 arc-seconds. To attain this accuracy, a constant temperature must be maintained along the telescope's case. If the thermal control system fails, any resultant temperature gradient would cause the telescope to bend and defocus. However, with suitable temperature sensors located at many points along the case, observed data can be corrected for mechanical deformation.

Five types of sensors were investigated for suitability as case temperature monitors over the telescope's useful operational range of from 65°F to 100°F . The measurement devices were linear-temperature - coefficient quartz crystals, platinum resistance sensors, silicon resistance sensors, thermistors, and thermocouples.

The operating principle of each sensor type is reviewed and the state-of-the-art for each type is presented. Among the salient factors described in detail are: non-linearity, the output characteristic with respect to measured temperature; sensitivity, the percent change in output per $^\circ\text{C}$; and stability, the measured temperature drift in $^\circ\text{C}$ per year.

These sensors have substantially different sensitivities and different stabilities. One way to compare them is by calculating a figure of merit—the ratio of sensitivity to stability. By definition, the higher

the ratio, the "better" the sensor. This ratio is 0.35% for quartz crystal, 13% for platinum resistance, 0.035% for silicon resistance, 0.003% for thermocouples, and 80% for thermistors.

From the viewpoint of sensitivity and stability, the thermistor stands out. A high-quality thermistor has a stability of 0.05 °C per year and sensitivity of about - 4% per °C. However, the thermistor is highly nonlinear, characterized by an exponential resistance-temperature relationship in which resistance decreases as temperature increases. And for reading out the temperature directly in temperature units, such extreme nonlinearity proves annoying because of the crowding of calibration marks at one end of the scale. Generally, it's desirable to produce a signal that's proportional to measured temperature rather than to measured resistance.

The circuit shows a simple way of linearizing thermistor-tempera-

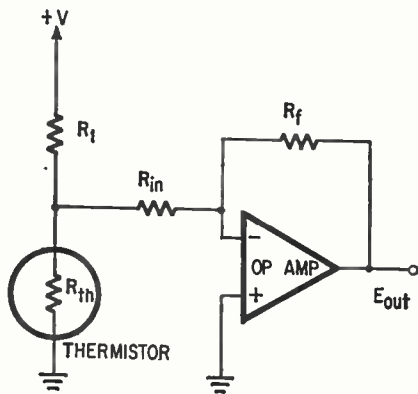

ture measurements. Its operation depends on the proper selection of the value of R_{in} so that the operational amplifier's closed-loop gain decreases as the thermistor's resistance, R_{th} , increases. The output voltage is

$$E_{out} = -VA (R_{equiv} R_1)$$

where

$R_{equiv} = (P_1 R_{th}) / (R_1 + R_{th})$
and the amplifier's closed loop gain is

$$A = R_f / (R_{in} + R_{equiv})$$

Normally R_{in} is very much greater than R_{th} , so that the output virtually tracks the thermistor's nonlinear response. However, by

What happened when doctors and engineers got together:

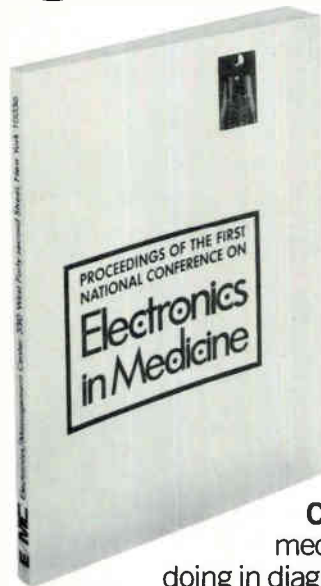

Doctors told engineers how they were using electronics and revealed their most urgent needs. Engineers described and demonstrated their newest equipment for diagnosis, treatment, and prevention. And hinted at things to come.

Their complete dialogue, with illustrations, makes pretty informative reading on a vital and growing market.

Here are some of the things it contains:

Computers: How they're joining the medical team. What computers are

doing in diagnosis. In communications. The small computer as a paramedical aid.

Instrumentation: What's needed. What's available. Patient management. Protection. Standards and safety.

Electronics in the Hospital: The surgeon, the hospital, the instruments. What the administrator wants. Prescription for large-scale health care. The surgery department.

Electronics/Management Center
330 West 42nd Street, New York, N.Y. 10036

Enclosed is \$12 for a copy of the Proceedings of the First National Conference on Electronics in Medicine.

Send the Proceedings and bill me later. P.O. # _____

Name _____

Company _____

Address _____

City _____ State _____ Zip _____

DESK-TOP CIRCUIT DESIGNER



The **elite 1** is ideal for designing, laying out, and testing all IC and discrete component circuitry!

\$650
complete

- Built-in pulse generator and power supply
- NO SOLDERING REQUIRED
- NO special tools, plugs or patch cords needed
- Write or phone for complete specifications and catalog



EL Instruments Incorporated

61 First Street, Derby, Conn. 06418 • Phone 203/735-8774

Circle 248 on reader service card

New free facts on "films."

Get the latest data on Mallory film resistors. A complete line. Made by the company with total capability in film resistors. Write, today.

Mallory Controls Company, a division of P. R. Mallory & Co. Inc., Box 327, Frankfort, Ind. 46041.

GENERAL SPECIFICATIONS

MALLORY TYPE	MILITARY TYPE	TEMPERATURE RATING	POWER RATING (WATTS)	RESISTANCE RANGE (OHMS)
Precision Resistors				
MAC 55	RN55	70°C & 125°C	1/8 & 1/10	10Ω-100K
MAC 60	RN60	70°C & 125°C	1/4 & 1/2	10Ω-499K
MAC 65	RN65	70°C & 125°C	1/2 & 1	10Ω-1 meg
Semiprecision Resistors				
MAL 07	RL-07	70°C	1/4	10Ω-100K
MAL 20	RL-20	70°C	1/2	10Ω-470K
MAL 32	RL-32	70°C	1	10Ω-1 meg
Power Resistors				
2MOL		70°C	2	30Ω-125K
3MOL		70°C	3	40Ω-125K
4MOL		70°C	4	85Ω-125K
5MOL		70°C	5	95Ω-125K
7MOL		70°C	7	125Ω-125K

MALLORY

Technical Abstracts

choosing a much lower value of R_{in} —generally within an order of magnitude of R_{equiv} —the amplifier's gain becomes more sensitive to changes in the thermistor's resistance.

The value of R_{in} depends on the actual thermistor's resistance vs. temperature characteristic, the desired operating temperature, and the temperature range. Selection of R_{in} can be accomplished by trial and error or by a computer program.

Presented at the ISA Annual Conference and Exhibit, Houston, Oct. 27-30.

Stable Gunn

Gunn effect stable
J.F. White
Microwave Associates Inc.
Burlington, Mass.

The Gunn-effect diode is ideally suited to replace the more complicated harmonic generator as a stable local oscillator in radars and microwave communications systems. A-m noise and f-m noise in the Gunn device are comparable to that of a reflex klystron; the Gunn oscillator draws only two watts from a 10-volt supply while the klystron draws considerably more and at a higher voltage. A temperature stabilized, mechanically tunable X-band oscillator has been designed and built for use in communication systems where no automatic frequency control correction can be used due to the 10-megahertz spacing of channels.

The Gunn-diode oscillator's output was post-coupled to a hermetically sealed waveguide cavity, and then iris-coupled to the output waveguide. D-c bias was applied from an external supply through a coaxial choke terminating the opposite end of the post. Linear tuning over a 2-gigahertz range was made possible by utilizing a screw tuner at the top of the cavity. Further tuning could have been effected if the range of the tuner drive were increased.

Maximum output power versus frequency resulted from optimizing the bias voltage (always between 8-9 volts) at each frequency, while

OUR SYSTEMS ARE GO

This bit serial data recorder (our digiDeck) is built for work, not play. It is not a patched-up audio tape deck. We designed it exclusively for data recording on Phillips-type magnetic tape cassettes. It has a minimum of moving elements to ensure operational reliability. Electronics and controls are self-contained.

The digiDeck is available in four models:

- Read, only
- Write, only
- Read and write
- Read and write, with read after write

The digi-Deck series is designed for the manufacturer who wants to build in his own data recording system. Prices begin at \$285 in OEM quantities.



We're not selling promises. Our data storage systems are expressly designed and manufactured for digital application. Their reliability is proven by consistent performance in ICP customers' systems. We can make two-week, off-the-shelf delivery of our digiDeck or DigiCorder. Contact one of our regional sales-service offices or fill in the reader card for full specifications. At ICP, all our systems are Go.

Our digital cassette recording unit (the DigiCorder) is available in one, two and four-deck models. Its Phillips-type magnetic tape cassette input/output capabilities enable program dumping or loading, data read and write, tape duplication and modification, assembling, compiling, tape preparation, tape sorting or merging.

Interfaces to computers, typewriters and other digital devices are available.

A self-contained unit (including power supply) with its own control logic, the DigiCorder accepts eight-bit parallel I/O signals. Prices begin at \$795 in OEM quantities.



icp

INTERNATIONAL COMPUTER PRODUCTS, INC.

P. O. BOX 34484 DALLAS, TEXAS 75234 214 239-5381
TWX: 910-860-5009 CABLE: ICPTX DALLAS, TEXAS

11850 Wilshire Blvd.
Suite 26
Los Angeles, Calif. 90025
Phone: (213) 479-7757

260 Sheridan Ave.
Suite 414
Palo Alto, Calif. 94306
Phone: (415) 323-9331

601 Dooley Rd.
Dallas, Texas 75234
Phone: (214) 239-5381

34 West Putnam
Greenwich, Conn. 06839
Phone: (203) 661-3239

Power Structure!

These modular power supplies can be quickly structured to meet the power needs of micro-electronic systems. Litton's reputation for reliability and performance is unsurpassed in the electronic industry.

Compact, lightweight, with power outputs to 300 watts in single packages from 108 to as small as 8 cubic inches weighing from 7 to as low as .75 pounds. Manufactured to MIL Specs or commercial standards.

To help you build Litton power supply reliability and performance into your engineering design, let us send...FREE...a set of actual size replicas, specifications and additional information. To receive yours, use the inquiry card provided in this magazine.



SPECIAL PRODUCTS
Data Systems Division • Litton Industries
9001 Fullbright Ave., Chatsworth, Calif. 91311



Circle 249 on reader service card

Save Gold

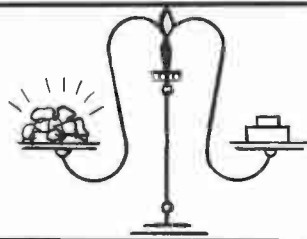

Continuous Selective Plating

Economize on

**GOLD
SILVER
NICKEL
RHODIUM**

MORE UNIFORM DEPOSIT

Continuous Selective Plating is the product of precise engineering design and ingenuity. M-W LABORATORIES method is the result of many years experience by a leading firm in precious metal plating.

- * Saves precious metals.
- * Results in more uniform deposit.
- * Application of the precious metal where specifically needed.

Continuous Selective Plating in many of its applications makes other methods of precious metal plating obsolete.

M-W Plating Service is offered to help show you just how Continuous Selective Plating can provide greater economy and efficiency.



Write or phone

M-W LABORATORIES INC.

1824 N. Milwaukee Ave., Chicago, Ill.
60647

Phone: (312) DI 2-4020

Preview the 70's

at Booth 1405

NATIONAL ELECTRONICS CONFERENCE

December 8-10

Conrad Hilton • Chicago

at **JES '70**

moved forward to

April 10-20

Harumi Pavilions

Tokyo, Japan



Electronic Industries Association of Japan

Write or phone for your copy of the exhibitors' DIRECTORY OF JES '69 and the 1969-1970 Yearbook Electronic Industry In Japan.

Electronics Division

Japan Light Machinery Information Center

437 5th Ave., New York, N. Y. 10016 • (212) MU 6-0731

Technical Abstracts

a continuous high-power output with a fixed bias was obtained at a sacrifice of about 1 db. The diode was capable of two to three times the power measured, but by under-coupling it to the load, output power variation with bias was reduced, yielding more stable performance. Increasing hole iris diameter resulted in tighter load-coupling and more power until the load conductance began to inhibit the Gunn device and the power output dropped. The power output of the device ranged from 7 to 10 milliwatts.

Frequency stabilization with temperature was achieved by using a high Q resonator; this then could be thermally compensated for low drift. The net frequency drift was 1 Mhz over a temperature range of -10° to $+60^{\circ}\text{C}$; the use of an oven could reduce the drift to 100 kilohertz.

Tests performed with a phase-locked varactor chain indicated that the Gunn source had comparable f-m noise behavior. The data taken for the Gunn oscillator probably was conservative, since later measurements indicated lower f-m noise. Use of a high-Q cavity (approximately 1,000) will result in lower noise—approximating phase locking.

Presented at Nerem, Boston, Nov. 5-7

Night eyes

Advancements in night vision systems using pulsed-gate viewing and laser ranging techniques

T. Jordan, A. Riordan and R. Staneknas
Night Vision Laboratory, U.S. Army
Electronics Command
Ft. Belvoir, Va.

To afford its combat forces better observation of enemy activities at night, the U. S. Army has been developing a variety of electronic night vision devices. One of the more sophisticated is the AN/ASQ-127 surveillance system developed by the Army's Electronics Command for the Bell UH-1H helicopter. With the system, a man in the helicopter can view an area covertly and, once he has found a suitable target, determine its location.

The airborne plan uses an array

HEW... more power to you!



Thank you Hewlett Packard for building so many top quality sweep and signal generators and frequency synthesizers.

You've created a market for our power amplifiers because many engineers need our product to extend the power output of your instruments. We've made sure that our broadband, untuned, 3 watt amplifier mates easily with most sweep generators, signal generators, and frequency synthesizers (no matter what brand). Our power amplifier also features an output meter plus low harmonic and intermodulation distortion. So thanks again Hew... and we're glad we could help you.

- 250 KHz-110 MHz frequency coverage
- 40 dB \pm 1 dB Gain
- 50 ohms input/output impedance
- Failsafe for any load mismatch and unconditionally stable.

MODEL 300L
\$485

The ENI Model 310L will provide 10 watts of power when identical specifications with higher output are required.



For additional specification and application information contact:
ELECTRONIC NAVIGATION INDUSTRIES
1337 Main Street East Rochester, New York 14609 716/288-2420

Circle 251 on reader service card

ECONOMY YOU CAN COUNT ON

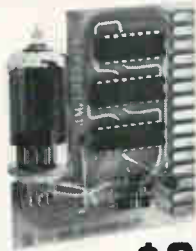

DM507

\$3140*



DDP900

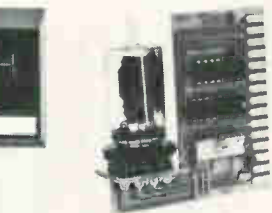

DM647

\$40.40*

DECIMAL COUNTER/DISPLAY MODULES AND ASSEMBLIES

DM647—7-segment incandescent indicator, RCA DR2000 Series, IC decoder/driver, decade counter, storage register. Standard plug-in PC card. TTL & DTL compatible. Decade counter and storage register BCD outputs available externally in both DM500 and 600 series.

DM507—Gas discharge indicator, IC decoder/driver, decade counter, storage register. TTL & DTL compatible. Standard 15-position plug-in card. 0.156" spacing. Amperex Type ZM1000 tube, 0-9 plus decimal point.

DDP800-900—Display Package, maximum 6 7-segment or 8 gas discharge tubes. Computer Products PM700 Series PS. Attractive snap-on bezel front. Behind panel space 6.20"W, 1.75"D, 3.28"H.

SIZES & PRICES:

DM647—2.45"x2.5"x.95";
1-3, \$49.90; *10-29, \$40.40

DM507—2.25"x2.5"x.75";
1-3, \$39.90; *10-29, \$31.40

MODULE DELIVERY, 5 DAYS ARO . . . COMPLETE ASSEMBLY, 15-30 DAYS ARO

Call or write for complete prices and specs

Computer Products, Inc. • P.O. Box 23849 • Fort Lauderdale, Fla. 33307

Phone: 305/565-9565



COMPUTER PRODUCTS™
FORT LAUDERDALE

Lock in



simplified
retrieval of
noise buried
signals with

Ithaco's 353 Phase-Lock amplifier

- no tuning required
- phase and gain not affected by adjustment or drift in reference frequency
- adapts automatically to virtually any reference input
- ultra stable, highly linear detector—no overload at 1,000 : 1 noise to signal ratio
- 1.0 Hz to 200 KHz operation

- plug-in construction permits addition of new or specialized features—prevents obsolescence

For further information and complete specifications contact:

607 272-7640



735 WEST CLINTON STREET, ITHACA, N.Y. 14850

Circle 252 on reader service card

Looking for a memory system with low cost per bit, but fast cycle time/access time, and high reliability in one compact package ?

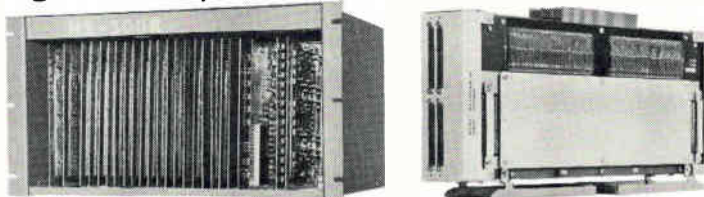

Look no further. TOKO's new, improved Woven-Plated Wire Memory System HS-500R is now available.

TOKO's HS-500 memory system has won praise and popularity for its low-cost, high-performance characteristics. Now ready to be marketed is improved Model HS-500R with the following features:

Compact size: 10"(H) x 19"(W) x 13-1/3"(D)
Access time: 250ns

Memory capacity: 8K bytes—32K bytes (4096 words—16384 words)

Flexible operation: Linear selection organization for multi-word operation; 8 bytes are simultaneously written and read in one word; required bits or bytes are then selected at the interface; thus a variety of memory capacities is made possible.

Low cost Model HS-500R also shares with its predecessor such outstanding features as fast cycle time of 500ns; wide operating temperature range without any current compensation: 0°C to 50°C; and low power dissipation of 100W.

TOKO can also undertake the manufacture of custom-made systems according to your specifications. Complete technical details from our New York office.



TOKO, INC.

Head Office: 1-17, 2-chome Higashi-Yukigaya, Ohta-ku, Tokyo, Japan
TOKO N.Y., INC. 350 Fifth Avenue, New York, New York 10001

of pulsed, noncoherent gallium arsenide diodes that emit energy at a frequency invisible to the unaided human eye. Signal returns are sensed by a three-stage image intensifier that has an extended-red S-20 photocathode. Because the intensifier is gated, it is turned on only when signals are expected back from a target; signals reflected by smoke, fog or haze return when the tube is gated off and, consequently, have no effect on the display to the operator.

Range and location of a target are found with a ruby laser ranger tied to a doppler navigation system and a special-purpose computer. The diode illuminator and image intensifier are mounted in the helicopter's nose; the viewing subsystem projects into the crew compartment. The ruby laser ranging subsystem is directly behind the viewer, projecting through the hole in the fuselage.

Although the energy emitted by the gallium arsenide illuminator is invisible to the unaided eye, the output of the ruby laser is well within the visible spectrum. Thus a target will be aware that it has been detected and is being ranged upon. However, the visible beam's advantage is that it also can point out the target to aircraft not equipped with night vision devices.

The design of future night vision systems will involve tradeoffs between ranging and pointing subsystems that are visible or invisible. Other design tradeoffs involve the accuracy with which a target must be located, and overall system range, weight, and configuration in an aircraft.

One item under consideration is a neodymium-yag laser. The output of such a device is invisible but unfortunately, it occurs at a less sensitive portion of the photocathode response curve. However, the neodymium laser is more efficient than a ruby laser and weighs less. Other techniques being considered allow the operator to perform the ranging function with the gallium arsenide illumination system.

Presented at Eascon, Washington, Oct. 27-29.

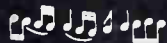

YOU'RE
WHISTLING
IN THE
DARK . . .

. . . if you think that heart disease and stroke hit only the other fellow's family. No one is immune. Protect the hearts you love. For authoritative information, ask your Heart Association. For medical advice see your doctor. To safeguard your family . . .

GIVE...
so more will live
**HEART
FUND**



Contributed by the Publisher

RHG OFFERS A COMPLETE tv relay link in two low cost sub-units

Solid state "Minilink[®]" FM transmitters and FM receivers are available in L, S, C, & X Band. Build them into your military system and obtain high fidelity color or monochrome TV transmission.

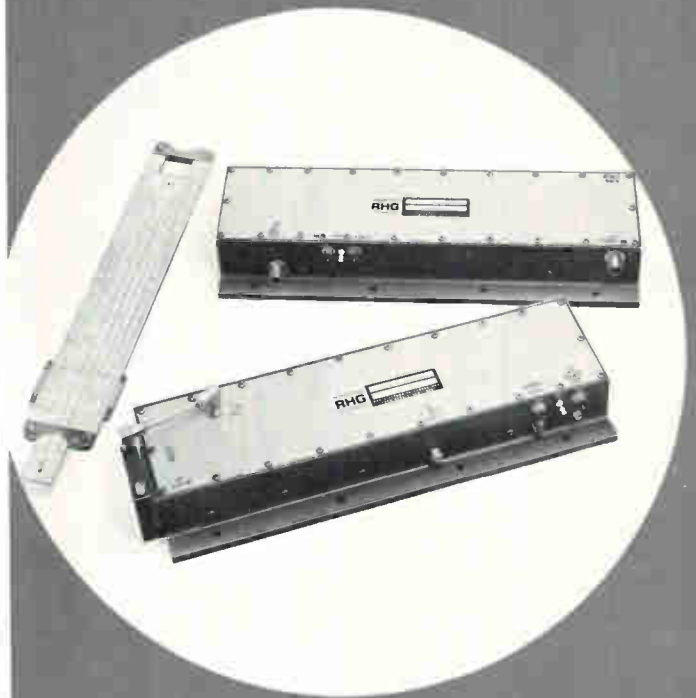

- MEETS OR EXCEEDS EIA AND CCIR STANDARDS
- 90 CUBIC INCHES PER SUB UNIT
- UP TO 4 WATTS OUTPUT

RHG "Minilinks" are solid state transmitter-receiver combinations. They offer the utmost in reliability, instant warmup, and low power drain. Designed for military applications they utilize rugged construction and RFI protection. Complete details and specifications are in RHG catalog 69B or see EEM Section 3400.

RHG **RHG ELECTRONICS
LABORATORY · INC**

94 MILBAR BOULEVARD ■ FARMINGDALE
LONG ISLAND ■ NEW YORK 11735 ■ (516) 694-3100

Microwave Receivers, Transmitters and Components

Circle 167 on reader service card

New

MICRO-VECTORBORD AND D.I.P. PLUGBORDS ARE HERE!

Save time — Save work — Save money

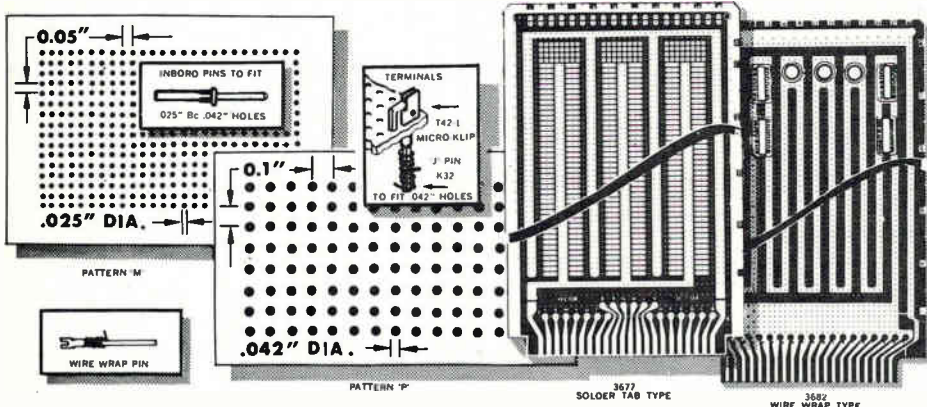

WIDE SELECTION OF SIZES AND MATERIALS

MICRO-VECTORBORD "P" .042" holes match D.I.P. leads. Epoxy glass or paper, cop. cld. also 1/64" to 1/16" thk.

MICRO-VECTORBORD "M" .025" holes match Flat-Paks. 1/32" Epoxy glass, cop. cld. also or .007" Mylar.

NEW SOLDER-PAD D.I.P. PLUGBORDS — 3677 Series Epoxy glass, "P" pat., 1/16" thick with 44 etched plug contacts (2 side total) power, ground

busses, pads for up to 24 D.I.P.'s (14's). Also 21 units 16-leads D.I.P.'s, T-O's and discretes.

NEW WIRE WRAP D.I.P. PLUGBORDS — 3682 Series Similar to above but closely spaced bus lines for higher density. Up to 48 D.I.P. 14 lead wire wrap sockets mountable or T-O's and discretes.

TERMINALS — Micro-Klips, Mini-Wire-Wraps, Rd. Pins, Patch Cords, etc.; available.



Send for complete literature

ELECTRONIC CO., INC.

12460 Gladstone Ave., Sylmar, California 91342
Phone (213) 365-9661 • TWX (910) 496-1539



Circle 253 on reader service card

SAN-E

MSP-4 full four track stereo R/P head for auto-reverse cassette system

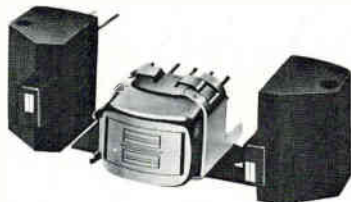

MSP-4 1/4 track full 4 heads R/P head for phillips cassette tape
PE-M AC bias eraser for MSP-4 head

Other product
8 track (MS-8) stereo head for home & car stereo
*** write immediately for further details**

SAN-E DENKI COMPANY, LIMITED.

110-1 Minami-Kawahori-cho, Tennoji-ku, Osaka, Japan
phones: 779-1591
cable: SANMAGNETICS

five day Thick Film seminars

the fundamentals of thick film hybrid microcircuit technology

in State College, Pennsylvania
Jan. 12-16 March 2-6 Tuition: \$500

small classes — fully equipped labs — emphasis on individual participation. Covers thick film circuit design, cost analysis for circuits and facilities, economic and technical rationale for thick film, paste and processing technology — individual lab experience in screen printing, resistor trimming, microsoldering, chip and wire bonding.

Coming in the spring: a two week tutorial workshop in thick film processing. Concentrated practical experience in state of the art screen printing and firing, precision resistor trimming, fine line printing, etc.

For details, call or write:

state of the art, Inc.
1315 south allen street
state college
pennsylvania 16801
814/237-6583

New Literature

Particulate air filters. Inter/Flo Filter Corp., 533 John Downey Dr., New Britain, Conn. 06051. A four-page catalog describes a new line of high-efficiency particulate air filters for use in clean rooms or areas where toxic, radioactive particles or bacteria must be filtered from the air.

Circle 446 on reader service card.

Pressure-sensitive tapes. Connecticut Hard Rubber Co., 407 East St., New Haven, Conn. 06509. A six-page physical properties brochure covers a wide selection of Teflon and Teflon Fiberglass acrylic and silicone pressure-sensitive tapes. [447]

Cable connectors. Precision Microwave Corp., 180-08 Liberty Ave., Jamaica, N.Y. 11433. Catalog PMC-1 describes a line of subminiature A connectors for semirigid (0.141) cable featuring new r-f tight captured contacts. [448]

Relays. The Adams & Westlake Co., 1025 N. Michigan St., Elkhart, Ind. A 44-page catalog describes a line of mercury wetted, mercury displacement and dry reed relays. [449]

Connector wallchart. Amphenol Industrial Division, Bunker-Ramo Corp., 1830 S. 54th Ave., Chicago 60650, offers a comprehensive pin and socket connector and assembly tool wallchart, including specifications and applicable circuit requirements for six popular rack-and-panel connector families. [450]

Resistor products. Vishay Resistor Products, 63 Lincoln Highway, Malvern, Pa. 19355. Bulletin G describes a line of precision resistors, trimmers, and networks with low temperature coefficients. [451]

Substrate hole drilling. Aremco Products Inc., P.O. Box 145, Briarcliff Manor, N.Y. 10510. Product bulletin 3300 is a two-page data sheet describing the Accu-Drill 3300 kit for producing holes in fired ceramic substrates used in IC work. [452]

D-c power supplies. Computer Products, 2709 N. Dixie Highway, Ft. Lauderdale, Fla. 33307, has published a bulletin describing 16 models in the PM700 series regulated d-c power supplies. [453]

Vibration handbook. Dytronics Co. Inc., 4800 Evanswood Dr., Columbus, Ohio 43224, offers a 34-page handbook containing much useful information for those working with vibration analysis. [454]

Data communications. Rixon Electronics Inc., 2120 Industrial Parkway, Silver Spring, Md. 20904, is offering a loose-leaf binder catalog of data communications items to interested readers requesting it on their letterhead.

Let's keep electronics clean

Here are some of the products that help keep electronic devices clean during production and in use. You'll find them on assembly lines and flight lines, in laboratories and on launch pads . . . wherever dirt, grease or foreign matter could degrade the quality or performance of electronic hardware.

If you'll tell us (on your letterhead) which of them you'd like to evaluate, we'll send you a free sample. For literature only, use the bingo card.

 **miller-stephenson chemical co., inc.**
Route 7, Danbury, Conn.



Circle 255 on reader service card

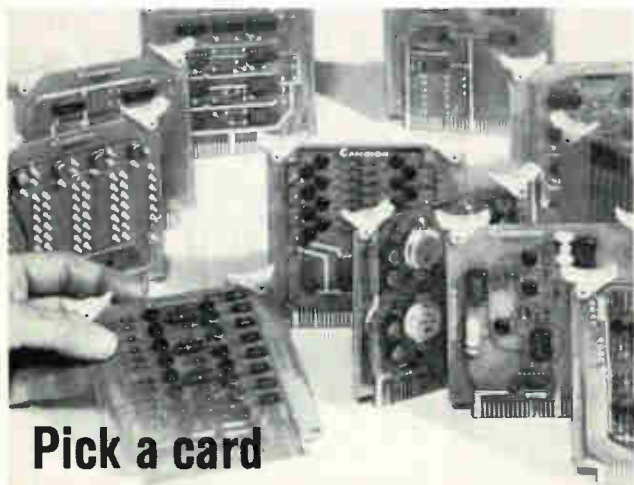

Pick a card

Any card. Standard logic cards or odd-balls like gray code logic cards, arithmetic/logic, pulse synchronizers, excess 3 counters, multi-function cards . . . any logic card you might require. From here on you won't have to gamble on making your own special logic card. Our selection contains over 300 different logic assemblies . . . all standard . . . all available from stock . . . all functionally and physically compatible. And because CAMBION puts more functions on a card you use fewer cards, panels, cabinets, less space and spend less money. For a copy of our Logic Manual giving complete details on the right logic assemblies and hardware to meet your logic design requirements contact Cambridge Thermionic Corporation, 469 Concord Avenue, Cambridge, Massachusetts 02138. Phone: (617) 491-5400. In Los Angeles, 8703 La Tijera Boulevard 90045. Phone: (213) 776-0472.

Standardize on

CAMBION[®]
The Guaranteed Logic Assemblies

Circle 256 on reader service card

High Density LATCHING RELAYS

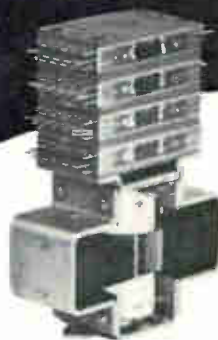

**12, 24, 36,
48, 52 PDT**

Series 801L Latching T-Bar[®] Relays offer high density switching, low component cost and ability to maintain circuit integrity during power failure. Bistable in operation, with true snap acting performance . . . ideal where power drain by large relay switching arrays would strain power supplies or generate undesirable heat.

• Also environmentally or hermetically sealed

Simple crimp snap-on contacts fit into single block connectors for pre-harnessing.



Write or phone for details on T-Bar Latching Relays today!
electronic controls, inc.

T-Bar Switch Relay Div. • Danbury Road, Wilton, Conn. (203) 762-8351

Circle 227 on reader service card

227

The Connector-Protector-Detector-Inspector

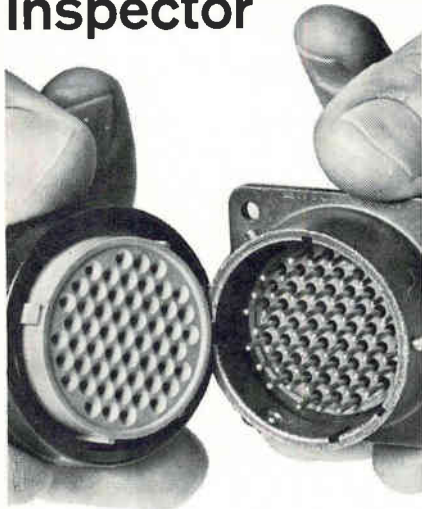

Here's a connector accessory that serves as a dust cap, inspection fixture, assembly fixture, pin protector, and pin straightener. Now you can guard against the fates of connector mishandling from assembly to installation . . . and at a price comparable to an ordinary dust cap!

Over 25 different insert arrangements in 9 shell sizes are available for



MIL-C-26482 and NAS 1599 Bayonet Coupling Connectors, and in various clocking positions. Shell and insert identification is molded into the face of each unit, and it is color coded for easy reference . . . plugs are yellow, receptacles are blue. Veritector are nonmagnetic, impervious to salt spray and seal connectors against hostile environment.

They can be used over and over, meeting or exceeding 500 cycles of durability.

For the complete story and specifications on the Veritector family, ask for our brochure. Write, or call us at (213) 341-0115.

CONTROL DATA

CORPORATION

Control Data Corporation
Connector Operation
8758 Remmet Avenue
Canoga Park, California 91304

New Literature

Disk storage drive. Information Storage Systems Inc., 10435 N. Tantau Ave., Cupertino, Calif. 95014, has issued a four-page brochure containing technical data and applications information on the model 714 disk storage drive. [455]

Tunnel diode detectors. Aertech Industries, 825 Stewart Dr., Sunnyvale, Calif. 94086. Publication 104 lists an expanded product line of tunnel diode detectors with frequency ranges from 0.1 to 26.5 Ghz. [456]

Coaxial-package transistors. RCA Electronic Components, Harrison, N.J. 07029. Application Note AN-0425 deals with the use of coaxial-package transistors in microstripline circuits. [457]

Relay catalog. Alcoswitch Division of Alco Electronic Products Inc., P.O. Box 1348, Lawrence, Mass. 01842. A two-color, six-page illustrated brochure describes a relay that allows the safe control of machinery and appliances from a remote distance. [458]

Electronic chemicals. General Electric Co., 21800 Tungsten Rd., Cleveland, Ohio 44117. A product data sheet describes the important properties of the company's luminescent grade electronic chemicals. [459]

Laboratory equipment. O.S. Walker Co., Rockdale St., Worcester, Mass. 01606. A 16-page catalog of precision quality magnetic laboratory equipment covers hysteresisgraphs, fluxmeters, gaussmeters, laboratory electromagnets, and superconductor magnets. [460]

Wire terminating systems. Synergistic Products Inc., 150 E. Stevens Ave., Santa Ana, Calif. 92707. A 16-page catalog describing numerically controlled wire terminating systems includes a comprehensive economic comparison section. [461]

P-c drafting aids. By-Buk Co., 4326 W. Pico Blvd., Los Angeles 90019. Catalog P-45, covering pressure sensitive p-c drafting aids, features thousands of time-saving basic shapes and conductor line tapes required in the development of p-c layouts and master artwork. [462]

Optical N/C programmer. Leland-Gifford Co., 1001 Southbridge, Worcester, Mass. 01601, has available a catalog describing its optical N/C programmer, which prepares accurately punched numerical control tape directly from undimensioned art, photomaster drawing or prototype board. [463]

Data communications. Interdata Inc., 2 Crescent Pl., Oceanport, N.J. 07757. An eight-page, full-color brochure highlights the company's family of communications processors. [464]

DC MOTOR DRIVE

1-10 HP POSITION CONTROL

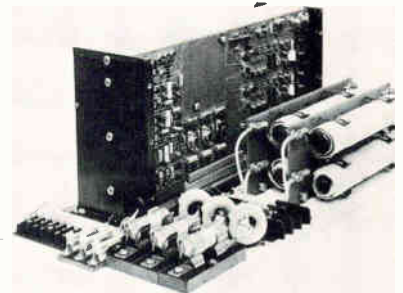

This new A5641 Servo Amp is designed for wide speed range and smooth control at less than 1 rpm. Amplifier operates from a 3 phase, 50/60/400 Hz power supply. Unit provides half wave, bi-directional, DC power output proportional to signal input, plus three high gain signal inputs able to accept signals directly from tachometer. Model A5641 is modular in form and features a unique EMI suppressor.

HIGH POWER SERVO AMPLIFIERS

WESTAMP

1542 FIFTEENTH STREET
SANTA MONICA, CALIF. 90404
PHONE: (213) 393-0401

Circle 257 on reader service card

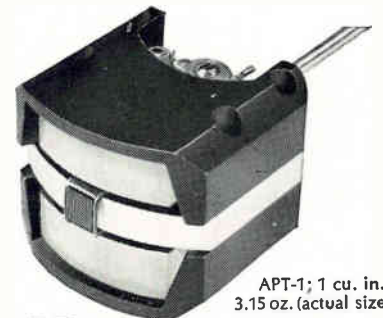

APT-1; 1 cu. in., 3.15 oz. (actual size)

More torque, Less weight in moving coil mechanism

Highly stable, linear and accurate mechanism for indicating, control or recording systems. 18-0-18° linearity is 1%. Coil design with over 75% of winding "working" in high energy, uniform field air gap assures greater accuracy. Coil system weighs 0.85 gm, develops 26.4 mmg of torque; 31:1 T/W. Mechanism offers negligible vibration pivots and jewels — custom damping — wide range of sensitivities.

AMMON

AMMON INSTRUMENTS, INC.
345 Kelley St., Manchester, N.H. 03105

Circle 258 on reader service card

our plated wire memories

exceed the speed limit!

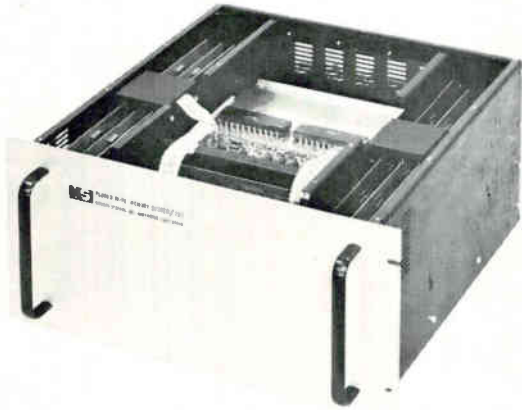

200 ns READ or WRITE cycle ■ NDRO ■ Highly modular.

MEMORY SYSTEMS, INC.

3341 W. El Segundo Boulevard • Hawthorne, Calif. 90250 • (213) 772-4220
Circle 259 on reader service card

FREE!

TA'S Instrument Case Engineering Manual

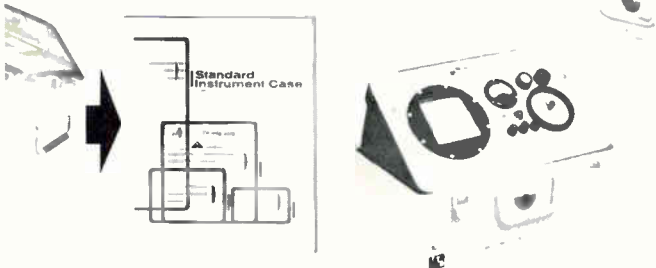

Makes you a packaging expert!

This one-of-a-kind booklet contains everything you need know to select the proper case for your particular packaging requirements. ■ Save money for your firm by selecting one of TA's standard cases rather than going to the expense of designing a custom case to package your product. ■ Huge warehouse stock for fast delivery at low prices... no tooling charges. All TA cases are designed to surpass Mil-Spec requirements... completely dust and waterproof. Free vellum service and panel templates. ■ Write or phone for a quotation and let us put our staff of case engineers to work for you today. Send for your free case manual now.

TA MFG CORP  A DAYCO COMPANY

4607 Alger Street, Los Angeles, California 90039 ■ Phone 213-245-3748/
TWX 910-497-2065 L. A./WUX CAT L. A., Calif.

Circle 229 on reader service card

Be prepared for



THE CHANGING INTERFACE

Medium and large scale integration are slated to have major impact on the electronics industry. The effects are already being felt — not only on systems and component design — but on fundamental, traditional relationships between equipment builders and component suppliers.

Important trends that will affect your profession, your job, your company, are explored in THE CHANGING INTERFACE, a 150-page illustrated volume to be published shortly by McGraw-Hill's Electronics/Management Center.

In THE CHANGING INTERFACE, leading design engineers and managers, the men responsible for guiding their companies through the next generation of electronics, discuss the problems that LSI/MSI are stirring up — and offer their solutions.

Here are some of the vital topics covered.

Implications of LSI on the Electronics Market
The Rationale for an In-House IC Capability
The Component Maker's Responsibility vs. the System Builder's Responsibility
Masks and Computer-Aided Design at the Interface
The Testing Interface
How IBM and Bell Laboratories Deal with the Interface Problem
Controversies and Future Trends in LSI

You can reserve a copy of THE CHANGING INTERFACE now at the special pre-publication price of \$6.50 by returning the coupon below. If you send a check now, we'll pay the cost of postage and handling.

Electronics/Management Center
330 West 42nd St.
New York, N.Y. 10036

Attn. Mr. Wayne Cowart

Please reserve my copy of THE CHANGING INTERFACE at the prepublication price of \$6.50.

Name _____ Title _____

Company _____

Company Address _____

City _____ State _____

Check enclosed for \$6.50 Bill me
 Bill Company P.O. Number _____



AN122

Dual Monolithic NPN-Silicon- Planar - Transistors

MATCHED PAIRS FOR DIFFERENTIAL AMPLIFIERS

Low Profile six lead TO-5 six lead epoxy

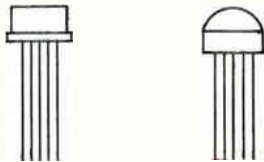

- HIGH h_{FE} AT LOW CURRENT >200
- LOW OUTPUT CAPACITANCE <2.0 pf
- h_{FE} MATCH $<10\%$
- TIGHT V_{BE} TRACKING $<5.0 \mu V/^{\circ}C$
 $-55^{\circ}C$ to $+125^{\circ}C$

PRICES

	1-24	25 up	100 up
\$	3.80	3.20	2.55

ANCRONA CORP.

65 East 55th Street • New York, N. Y. 10022
(212) 688-6285 • Telex 223 117 • TWX (710581 / 4513)

New Literature

Timing modules. A.W. Haydon Co., 232 N. Elm St., Waterbury, Conn. 06720. A solid state IC modular time code generator and a compatible time decoder are described in product information sheets 138 and 139. [465]

Displays and switches. Stacoswitch, 1139 Baker St., Costa Mesa, Calif. 92626. Lower-cost lighted matrix displays and switches are described in 46-page catalog GC-4. [466]

Quartz crystal types. Reeves-Hoffman Division, Dynamics Corp. of America, 400 W. North St., Carlisle, Pa. 17013, has published a 16-page product brochure offering operational parameters of various quartz crystal types. [467]

Form stacking unit. Advanced Terminals Inc., 874 Welsh Rd., Maple Glen, Pa. 19002, offers a bulletin describing its new model 401 Formstacker for handling the paper output of high-speed computer printers. [468]

Pin-and-socket connectors. Amphenol Industrial Division, Bunker Ramo Corp., 1830 S. 54th Ave., Chicago 60650. A broad selection of seven different pin-and-socket connector lines, including the newly expanded 17 series Min-Rac grouping, is described in a 24-page catalog. [469]

TTL cross-reference. National Semiconductor Corp., 2975 San Ysidro Way, Santa Clara, Calif. 95051, has available a TTL series 74N cross-reference guide. [470]

Microwave antennas. ITT Gilfillan Inc., P.O. Box 7713, Van Nuys, Calif. 91409. An X-band planar array which radiates a narrow pencil beam and an L-band electronically-scanned cylindrical slot array are two of several advanced components described in "Microwave Antennas," illustrated brochure. [471]

Connector kit. Berg Electronics Inc., New Cumberland, Pa. 17070. Bulletin 401 is devoted to Proto-Pac, a complete connector kit to aid in design, and test of electronic circuitry. [472]

Control systems. Integrated Control Systems Inc., 236 Wood Rd., Braintree, Mass. 02184, has available a facilities brochure outlining the company's philosophy and problem-solving capability in the area of solid state products designed for industrial measurement and control. [473]

Linear IC. Fairchild Semiconductor, 313 Fairchild Dr., Mountain View, Calif. 94040. A 32-page applications handbook about the $\mu A742$ Trigac is offered to acquaint systems designers and circuit engineers with the wide range of uses for this linear integrated circuit. [474]



NORTON[®] MAGNETIC HEADS MULTITRACK ERASE RECORD PLAY

Send now for complete technical literature.

NORTON
ASSOCIATES, INC.

10 Di Tomas Court, Copiague, N. Y. 11726
Phone: 516 598-1600

Circle 260 on reader service card

GRC[®] tiny parts



die cast
ZINC ALLOY



molded
PLASTICS



Coil Bobbins
Gears & Pinions



Get this valuable data on GRC's wide range of small bobbin sizes, shapes and design. GRC's methods give you quality and accuracy in small parts of die cast zinc alloy, Nylon, Delrin and other engineering thermoplastics. Exclusive limited cavity, automatic techniques allow new designs, new production and assembly shortcuts. Write, wire, phone for samples and bulletins. Send prints for quotations. No Minimum Size! Maximum sizes:

Zinc Alloy—
2" long,
1/4 oz.
Plastic—
1 1/2" long,
0.5 oz.

GRIES REPRODUCER CO.



Division of Coats & Clark Inc.
World's Foremost Producer of Small Die Castings
151 Beechwood Ave., New Rochelle, N. Y. • (914) 633-8600
Plants in: New Rochelle, N. Y.; Warren R.I.; Toccoa, Ga.

Looking for a better job?

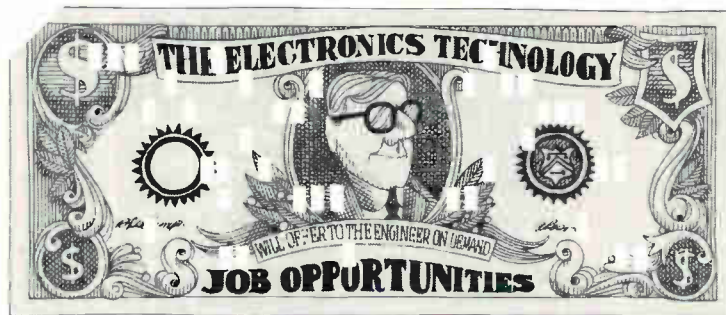

Ask Electronics' computer all about it

Electronics magazine feels an obligation to help its readers find positions in the electronics technology which will make the greatest contribution to their profession and to society — jobs in which electronics men themselves will be happiest.

Electronics has joined with a nation-wide talent search company—National Manpower Register, Inc.—to form the computerized Electronics Manpower Register.

Your qualifications and job requirements will be pro-

grammed into a GE 265 computer, direct-linked to the Manpower Register's offices in New York. The computer, once your resume form (bottom of page and following page) is received, will continuously compare all your data with the specific manpower needs of electronics companies. When a match is made, you will be contacted directly or through an affiliated agency. The company and you will be brought together on a confidential basis.

Continued on next page

<p>Resumes acceptable only from applicants residing within the United States</p>	<h3>Electronics Manpower Register</h3> <p>It is important that your information be complete and that you type or print legibly</p>	<p>Resumes acceptable only from applicants residing within the United States</p>
<p>IDENTITY</p>		
Name	Date	PRESENT OR MOST RECENT EMPLOYER
Home address		Parent company
City	State	Your division or subsidiary
	Zip	Location (City/State)
Home phone	Do you subscribe to Electronics <input type="checkbox"/> or see a library or pass-along copy <input type="checkbox"/>	
<p>GEOGRAPHICAL PREFERENCE (Check appropriate boxes and complete all blanks)</p>		
I will NOT relocate <input type="checkbox"/> I will consider opportunities in: <input type="checkbox"/> North East <input type="checkbox"/> Mid Atlantic <input type="checkbox"/> South <input type="checkbox"/> Midwest <input type="checkbox"/> Southwest <input type="checkbox"/> Calif. <input type="checkbox"/> Northwest		
Prefer: <input type="checkbox"/> Metro, area <input type="checkbox"/> Medium town <input type="checkbox"/> Rural area Other: _____		
<p>EDUCATION</p>		
Degree	Major field	Year
		College or University
<p>FOR OFFICE USE ONLY</p>		
		<input type="checkbox"/>
		<small>REGISTRATION NUMBER</small>
		<small>INITIAL OF LAST NAME</small>
<p>EMPLOYMENT INFORMATION</p>		
Position desired		
Present <input type="checkbox"/> or most recent <input type="checkbox"/> position	From	To
		Title
Duties and accomplishments		
<p>HAVE YOU REGISTERED WITH THIS SYSTEM PREVIOUSLY? Yes <input type="checkbox"/> No <input type="checkbox"/></p>		
		<p>CONTINUED ON OTHER SIDE</p>

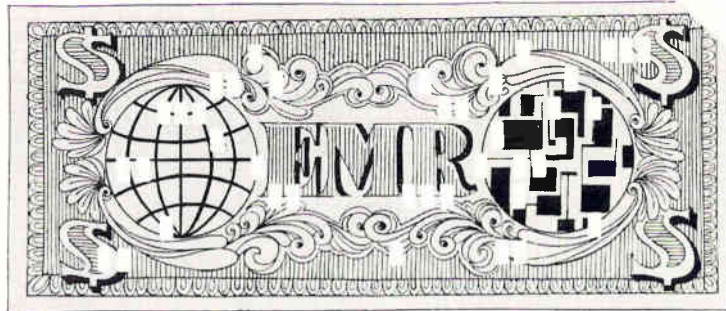

The cost of all this to you? Absolutely nothing. No fees or charges at any time.

Other advantages of EMR:

- Your resume is sent only to those companies that have a genuine requirement for your particular skills.
- There is no general "broadcasting" in the hope "someone will be interested."
- Your identity is protected because your name is released only according to your prior instructions. Your name can be deleted on request.
- EMR's service is nationwide. You may be considered for job opportunities anywhere in the U.S.

The Electronics Manpower Register is a powerful tool and should be considered when you are seriously seek-

ing a new position. And, although you may be reasonably happy in your present position, chances are that you might have that ideal job in mind.

This is why EMR makes good sense for you. If that job does turn up, you'll be there.

To get your name in the EMR file, just fill out the resume form and return to:

Electronics Manpower Register
330 West 42nd Street
New York, N. Y. 10036

Please enclose a copy of your resume if you have one. A detailed brochure further describing EMR will be sent to you.

Electronics Manpower Register A computerized employment opportunity service

CONTINUED FROM OTHER SIDE					
Previous Position	Employer	City/State	From	To	
Duties and accomplishments					
Previous Position	Employer	City/State	From	To	
Duties and accomplishments					
GENERAL INFORMATION					
(Summarize your over-all qualifications and experience in your field. List any pertinent information not included above.)					
Current annual base salary	Total years of experience	Date available (within four months)	U.S. Citizen <input type="checkbox"/> Non U.S. Citizen <input type="checkbox"/>		
My identity may be released to: Any employer <input type="checkbox"/>	All but my present employer <input type="checkbox"/>	Have you security clearance?	Yes <input type="checkbox"/>	No <input type="checkbox"/>	If yes, What level
Mail (with a copy of your resume, if you have one) to:					
Electronics Manpower Register ELECTRONICS 330 West 42nd St. New York, N. Y. 10036			NO FEES OR CHARGES		EMR-18



EMPLOYMENT OPPORTUNITIES



We have been placing B.S., M.S. and Ph.D. **ELECTRONIC ENGINEERS** in fee paid positions throughout the U.S. since 1959. Send resume today or request confidential application. We are graduate engineers, working full time . . . for you.

ATOMIC PERSONNEL, INC.
Suite L, 1518 Walnut St., Phila., Pa. 19102
AN EMPLOYMENT AGENCY FOR ALL TECHNICAL FIELDS

CIRCLE 967 ON READER SERVICE CARD

PERSONALIZED (not computerized) SERVICE

ONE knowledgeable, ethical, service-motivated consultant is more valuable to the job-seeking electronic engineer than a computer and 87 affiliated agencies. Especially when his service is nationwide and employer fee paid.

You write. I'll respond. Then you decide.

JOSEPH P. CORCORAN, Personnel Consultants
505B Germantown Pike, Lafayette Hill, Pa. 19444
215/825-0848

CIRCLE 970 ON READER SERVICE CARD

RUHR-UNIVERSITY BOCHUM ELECTRONICS DEPARTMENT

We Are Offering

A FULL PROFESSORSHIP

At our Institute for Electronics.

Special Knowledge in Electronics Components Desired.

Please Write to the Managing Director:

INSTITUT FUER ELEKTRONIK

RUHR UNIVERSITY

POSTFACH 2148

D-4630 BOCHUM (WEST GERMANY)

Ministuid DISPENSER

for miniature potting and encapsulating

Available in 3 sizes
6cc - 12cc - 30cc



AIR OPERATED

\$34.00

PHILIP FISHMAN COMPANY
7 CAMERON ST., WELLESLEY, MASSACHUSETTS 02181

CIRCLE 968 ON READER SERVICE CARD

FUNCTION GENERATORS

We are overstocked. Tremendous savings on latest solid state function generators. Sine, square, triangle, ramp, complex. Laboratory quality. Every item 80% to 90% off. Absolutely will not last. Send for free brochure.

LABORATORY EQUIPMENT SALES
16210 May Creek Rd., Renton, Wn. 98055

CIRCLE 971 ON READER SERVICE CARD

BUYING Good USED Equipment

is frequently the difference between having needed equipment or doing without it.

TECHNICAL DIRECTOR

Electronics Materials

Diversified billion dollar consumer/industrial manufacturing company needs a person to identify trends and relevant materials technology in the microelectronics field, determine opportunities, help prepare related objectives, plan for budgets, and serve as technical advisor and consultant to operating staff.

Requirements: Some industrial experience and familiarity with materials technology in the field of microelectronics. Should have knowledge of crystallized glasses and substrates, and integrated circuits, both monolithic and hybrid. Ph.D. required in EE, Electronics, Physics, or related area.

A Career Position: Located in Toledo, Ohio with excellent starting salary commensurate with ability, education, and experience, plus all the fringes you'd expect. Submit resume in confidence to . . .

E. A. Brinkley

Specialized Recruiting — Dept. A

OWENS-ILLINOIS, INC.

P. O. Box 1035, Toledo, Ohio 43601

An Equal Opportunity Employer

CIRCLE 966 ON READER SERVICE CARD

SEARCHLIGHT SECTION

AUTOTRACK MOUNT



360 degree azimuth, 210 degree elevation sweep with better than 1 mil. accuracy. Missile velocity acceleration and slewing rates. Amplidyne and servo control. Will handle up to 20 ft. dish. Supplied complete with control chassis. In stock—immediate delivery. Used world over by NASA, USAF, MP-61-B, Type SCR-584. Nike Ajax mounts also in stock.

PULSE MODULATORS

250 KW HARD TUBE PULSER

Output 16 kv 16 amp. Duty cycle .002. Pulses can be coded. Uses 5D21, 715C or 4P160A. Input 115 v 60 cy. AC \$1200 ea.

MIT MODEL 9 PULSER 1 MW—HARD TUBE

Output 25kv 40 amp., 30kv 40 amp. max. Duty cy. .002. .25 to 2 microsec. Also 5 to 5 microsec. and .1 to .5 microsec. Uses 6C2L. Input 115v 60 cycle AC. Mfg. GE. Complete with driver and high voltage power supply. Ref: MIT Rad. Lab. Series, Vol. 5, p. 152.

1.2 MEGAWATT HARD TUBE

0-40 KV at 0-30 amp. 20-5,000 pps. .5-5 microsec. Input 208V. AC, 60 cycle, Levinthal mod. 333M. Price \$4400.

2 MEGAWATT PULSER

Output 30 kv at 70 amp. Duty cycle .001. Rep. rates. 1 microsec. 600 pps. 1 or 2 msec. 300 pps. Uses 5948 hydrogen thyratron. Input 120/208 VAC 60 cycle. Mfr. GE. Complete with high voltage power supply.

18 MEGAWATT PULSER

Output 150KV at 120 amps. Rep. rate: 50-500 PPS. Pulse length: 5 msec. 15 KV 120 amp. into pulse transformer. Rise time 1.5 msec. Filament supply 5V 80 amp. incl. 17.5KV 1.5 amp DC power supply. Input: 220V 60 cy AC.

SCR 584 AUTOTRACK RADARS

Our 584s in like new condition ready to go, and in stock for immediate delivery. Ideal for telemetry research and development, missile tracking, satellite tracking. Fully Desc. MIT Rad. Lab. Series, Vol. 1, pps. 207-210, 228, 284-286. Comp. Inst. 1Bk available \$25.00 each.

Hundreds more in stock. Largest radar inventory in the world. Send for catalog on your company letterhead.

ANTI-AIRCRAFT GUN MOUNT

Will handle 8,000 lbs. rapid slew through 360° azimuth, 180° elevation. Mobile.

MICROWAVE SYSTEMS

200-2400 mc. RF PKG

Continuous coverage, 30 Watts Cw nominal output. Uses 2C39A. Price \$575.

L BAND RF PKG

20 KW peak 980 to 1040 MC. Pulse width .7 to 1.2 micro sec. Rep. rate 180 to 420 pps. Input 115 vac incl. Receiver \$1200.

200-225 mc RADAR SYSTEM

1 Megawatt output, 200 nautical mile range for long range detection of medium and high altitude jet aircraft as well as general search. AN/TPS-28.

X BAND MONOPULSE TRACKER

250 KW Airborne Search Track System. Type AN/ASG-15. MD-9 Turret Also in Stock.

5 MEGAWATT C-BAND

Klystron RF package delivering nominal 5 megawatt pulse RF. Complete with pulser and power supply.

500 KW L BAND RADAR

500 kw 1220-1359 msc. 160 nautical mile search range. PPI, and A scopes. MTI, thyratron mod 5J26 magnetron. Complete system.

C BAND AUTOTRACK

1 Megawatt 10 ft. Parabola. Sperry.

AN/GPG-1 SKYSWEEP TRACKER

3 cm. automatic tracking radar system. Complete package with indicator system. Full target acquisition and automatic tracking. Input 115 volts 60 cycle New. In stock for immediate delivery. Entire System 6' long, 3' wide, 10' high. Ideal for Infrared Tracker, Drone Tracker, Missile Tracker, R. & D.

INDICATOR CONSOLES

AN/SFA-4A, PPI 10", range to 300 mi.
VJ-1 PPI 12", Range to 200 mi.
VL-1 RH1 12" to 200 mi. 60K ft.

40 KW TRANSMITTER

4 to 21 MHz, 40 kw Telegraphy, 30 kw Voice, can be SSB. New condition. Two systems in stock. Excellent rf source, broadcast or point-to-point.

3 KW TRANSMITTER

2-30MHz. Phone or CW. 208V 3 PH 60 cy. AC input, MFT-RCA.

Radio-Research Instrument Co.

45 W. 45th St., New York, N.Y. 10036 ■ 212-586-4691

CIRCLE 969 ON READER SERVICE CARD



No matter how they measure it, the Honeywell 7600 checks out as the best value in the tape field!

From the way people are trying to copy it, you'd think our 7600 is the hottest tape system around. It is!

Compare the specs on our 7600 with those of some recent competitive machines and you'll notice something very interesting. A small revolution is taking place in the magnetic tape system industry. We started a trend. And now, others are following!

The Honeywell 7600 Series bears copying. Its modular design lets you specify the system you need now, and permits future expansion without costly modifications as your requirements grow. Easily maintained plug-in electronics give you a wide selection of bandwidths, and mechanical options include a choice of 10½" or 15" transport.

With its low flutter, skew, and time base error and high S/N ratios, the 7600's signal fidelity can't be matched by comparably priced units. And, due to its mechanical simplicity (no belts, pulleys, gears, or pinchrollers) and inherent reliability, our com-

petitors are going to have a rough time building a machine that will operate as economically as the 7600. It's priced lower than you'd expect, too, giving you more performance for your money than any other tape system!

The great 7600 Series is another example of how Honeywell's broad line, backed by local sales and service, can provide the *precise* solution to your instrumentation problems. For a demonstration, call your local Honeywell Sales Engineer. For technical literature, write: Honeywell Inc., Test Instruments Division, P.O. Box 5227, 4800 E. Dry Creek Rd., Denver, Colorado 80217.

Honeywell

Honeywell engineers sell solutions

Circle 234 on reader service card

International Newsletter

December 8, 1969

France weighs finance company for Plan Calcul

France is looking for a way to finance leasing of its state-subsidized Plan Calcul computers without saddling the hard-pressed government or their manufacturer, Compagnie Internationale pour l'Informatique (CII), with banking worries. Most likely vehicle: a quasi-official financing agency stocked with private capital. The government telephone service recently set up a similar company to finance telecommunications investments. Insiders say the Plan Calcul administration may announce such a plan in two or three months.

CII now has orders for some two dozen of its first Plan Calcul machine, the medium-sized Iris 50, with the first to be delivered in about a month. Government agencies have ordered all but six; these are being taken by Rumania, which also has been negotiating on and off to buy a CII assembly plant, according to informed sources.

Polish overtures to Bonn firms find sympathetic ears

West German electronics firms, including such giants as AEG-Telefunken, are taking a hard look at Polish proposals for stepped-up cooperation, primarily in the form of licensing deals. Such a move was one of the topics at the Polish Central Committee's recent fourth plenary session.

Poland is eager to modernize its industry and to maintain a minimum 9% annual growth during the upcoming five-year economic plan. Part of that plan is a new "selective activities policy" in which emphasis will shift from nonproductive fields toward industries that show growth and export promise. Western technology is considered essential to expand and modernize those industries.

What the Poles want most are licenses on a "pay-as-you-earn" basis—involving both manufactured goods and industrial processes. However, say West German industrialists, any cooperation with the Poles won't go much beyond licensing. The Poles, like other East Bloc nations, are dead-set against the establishment of Western subsidiaries in their country which, in effect, would be the same as "capitalistic" ownership of the means of production.

But any cooperation, however limited, seems attractive to the West German electronics industry. It provides access to a relatively untapped market and a relatively well-trained labor force, thus relieving some of the pressures at home.

Worldwide pcm gets a boost

A worldwide pulse-code modulation system moved one step closer as the result of agreement on two standards. But disagreement over pcm coding still muddies the waters.

The International Telecommunications Union's Consultative Committee for International Telegraph and Telephone agreed to the standards at a meeting in Geneva last month. The standards: an 8,000-sample-per-second rate with eight binary digits in a time slot. AT&T's newest channel bank (D-2) is an eight-bit unit.

Prospects for the ITU committee to agree on an international pcm coding law, however, remains dim. One major stumbling block is the Conference of European Postal and Telecommunications Administration decision to stay with its "A-law" code. AT&T is pushing for adoption of its "mu law." Without an agreement on coding, digital interfaces will be necessary for matching up the two laws [*Electronics*, June 23, p.

International Newsletter

94]. And there's disagreement among countries over whether the resultant signal degradation would be acceptable.

An AT&T spokesman said the present domestic-international interface can be handled easily but will require "sophisticated planning and development to arrive at a practical solution."

Italy seeks greater independence for aerospace industry

Italy's cabinet-level Interministerial Commission of Economic Planning (CIPE), has given clear warning to American companies that Italy is going to move away from its "rigid dependence on the U.S.A. in our aeronautics industry." The guidelines set by CIPE do not preclude cooperation with American industry, but such cooperation must increase the productive capacity of Italian industry.

While holding the door open for greater European cooperation, CIPE also made it clear that international collaboration with the newly formed Aeritalia—a joint venture of government, through the state holding company Finmeccanica, and private industry, through Fiat—would have to permit "an authentic enrichment of technology." Italy no longer will settle for just joint venture or licensing agreements in production of aircraft or components. Instead Italian industry will have to be involved in research, development and design, as well as production.

Aeritalia has quickly ripened into the most desirable industrial debutante in Italy. Not only have McDonnell-Douglas and Lockheed come a-wooing, along with a cluster of European firms, but Hughes Aircraft has just made its first official bow, opening a sales office and stressing cooperation with Italian industry in the NATO Air Defense Ground Environment and Intelsat 4 projects.

Intelsat links Aussie phones

Telephone traffic is already so jammed in Australia that the government has decided not to wait for the launching of an Australian domestic communications satellite. Instead, the Australian Post Office, which is in charge of the telephone network, has linked Sydney and Perth, at opposite ends of the continent, via Intelsat 3.

To get the system on-line before heavy Christmas traffic, the Post Office could not wait for echo suppressors designed specifically to meet their needs. Instead engineers at the Post Office Research Laboratories in Melbourne modified available units and had them ready for temporary service in three weeks.

The Australian system is the first domestic commercial telephone service to be operated within one country's continental boundaries, although Hawaii and the U.S. mainland have been linked for commercial service via Intelsat.

New wrinkle in waffle-iron memory

Researchers at Japan's Electrotechnical Laboratory have developed a new memory plane using plated wire. They say it can be built with a density four times that of woven plated wire memory planes, and operate with about twice the power efficiency.

The memory uses a ferrite plate resembling a waffle iron, with grooves intersecting at right angles. But researchers say memory differs from the waffle-iron memories developed at Bell Telephone Laboratories several years ago—and from similar memories developed since then elsewhere in the United States, England and France.

Electronics New subscription application

Please start my one year subscription — 26 issues — for only \$8!

CHECK HERE FOR 3 Years \$16 — Saves me \$8!

FOREIGN RATES ON REQUEST

Payment Enclosed

Bill Me

Bill My Company

SUBSCRIPTION INCLUDES 1,200-PAGE ANNUAL BUYERS' GUIDE ISSUE

Name _____ Title _____

Please Fill In All Spaces

Company _____

Company address _____

City _____ State _____ Zip code 

Specific Product _____ or Service _____
manufactured _____ performed _____

Are you involved in the specification of electronic or allied products? Yes No

Please check your department or function:

Design Research, development Production, operation, maintenance

Other (please describe) _____

Above rates apply only to those professionally engaged in electronics technology.
All others, \$25 per year.

14-51000

Electronics New subscription application

Please start my one year subscription — 26 issues — for only \$8!

CHECK HERE FOR 3 Years \$16 — Saves me \$8!

FOREIGN RATES ON REQUEST

Payment Enclosed

Bill Me

Bill My Company

SUBSCRIPTION INCLUDES 1,200-PAGE ANNUAL BUYERS' GUIDE ISSUE

Name _____ Title _____

Please Fill In All Spaces

Company _____

Company address _____

City _____ State _____ Zip code 

Specific Product _____ or Service _____
manufactured _____ performed _____

Are you involved in the specification of electronic or allied products? Yes No

Please check your department or function:

Design Research, development Production, operation, maintenance

Other (please describe) _____

Above rates apply only to those professionally engaged in electronics technology.
All others, \$25 per year.

14-51000

First Class
Permit No. 42
Hightstown, N. J.

Business reply mail

No postage stamp necessary if mailed in the United States

Postage will be paid by McGraw-Hill, Inc.

Electronics

P. O. Box 514
Hightstown, N. J. 08520

Subscription department



First Class
Permit No. 42
Hightstown, N. J.

Business reply mail

No postage stamp necessary if mailed in the United States

Postage will be paid by McGraw-Hill, Inc.

Electronics

P. O. Box 514
Hightstown, N. J. 08520

Subscription department



Cooperative effort seen as key to building giant European computer

Now that Britain has agreed to the project, the 'Aigrain group' must extract a firm promise from the five governments to subsidize the research and purchase enough mammoth computers to justify the effort

Mammoth computers are now the monopoly of U.S. firms, simply because no European company felt its finances or limited national market would permit it to tackle such a project alone. And while Europe's computer makers have been talking for years about teaming up to build just such a giant machine, the idea had been little more than a pipe dream until recently.

Now there are signs that such an international project may actually come off—and perhaps sooner than even Utopian "Europeanists" have expected, given the middling record for most attempts at European technological cooperation.

Serious soundings began two years ago through a Common Market committee. Earlier this year the committee got the Continent's four big computer makers and their governments to agree in principal to a joint effort. Two weeks ago the idea took a major step forward when Britain agreed to participate. A French veto, lifted earlier this year, barred British participation.

Continental observers consider London's agreement crucial because they view Britain's International Computers, Ltd. (ICL) as an indispensable partner. They point out even ICL—Europe's biggest computer maker by far—this fall dropped plans to build its projected 1908-A computer, to be Europe's largest, when technical problems piled up and adequate orders failed to materialize.

The other partners in the proposed project are Holland's Philips, Germany's Siemens with AEG-Telefunken, Italy's Olivetti, and France's Compagnie Internationale

Pour l'Informatique (CII).

First, however, the five governments must agree to subsidize research and promise to buy enough of the eventual output to justify the project. Science ministers may meet in Brussels this month to launch a study on precisely what kind of computer is to be built and how much it would cost. Despite current budget problems in several countries, insiders say they feel European fears of perpetual U.S. dominance of the glamorous and vital big-computer field could open purse strings enough to get the project underway by late next year.

Pierre Aigrain, head of France's Applied Research Agency and chairman of the Common Market committee that spawned the computer project, gives it a 50% chance for final agreement. "And for an expensive international project, that's very high," he says.

Two projects. The "Aigrain group," as it's called, is actually proposing two projects: one for a mammoth machine based on present technology for first delivery in 1975, the other for a futuristic giant, requiring a heavy research effort, that wouldn't be ready before 1980.

No details of either project have been revealed, and they are, in fact, rather hazy even in computer makers' minds. But officials of the firms involved say the 1975 machine would be similar in size and technology to the University of Illinois' Illiac 4, the fastest U.S. computer, now being built by Burroughs. Like the Illinois machine, which will group a number of small central processors, the European machine would most likely rely on multiple



50-50. Pierre Aigrain, head of group, gives project even odds.

processors to perform many individual calculations simultaneously.

Engineers figure that development costs on this machine will run to at least \$100 million, and are likely to be a good bit more due to the complications of international cooperation.

Descriptions of the 1980 machine are necessarily vaguer. France's "computer czar," Maurice Allegre—who heads the country's Plan Calcul, the government-subsidized computer program, and who is coordinating the Aigrain group's computer proposals—says simply that this sophisticated behemoth would be "as powerful as any

machine you can imagine at the moment." It would unquestionably be a "universal" machine capable of business, real-time, and scientific applications, he says. And he figures it would cost up to \$1 billion to develop.

Though the two projects were drawn up to complement each other—with the smaller computer considered partly a training exercise during which the European companies could learn to work together—it's by no means certain that Europe can afford both.

Preference. If it comes to a choice, the computer makers tend to favor putting off the giant and building the 1975 machine, which they know is technically and commercially feasible. Merely estimating the market for the larger system amounts to science-fiction, comments a Siemens official.

But government members of the Aigrain group lean toward the more far-reaching project. They fear that adopting the 1975 project would tempt companies merely to request subsidies and guaranteed markets for their own present designs. And they doubt that the firms would share the advanced technology necessary to build a computer whose relatively close delivery date forestalls massive new research. Moreover, these officials feel that concentrating on the more sophisticated computer could give Europe a badly needed leg up on U.S. technology.

An executive of one computer firm counters: "You can't build a computer as though it were a one-shot program, like the Concorde. Buyers want continuity—a line of machines." He insists it is thus unrealistic to aim at a distant giant without planning intermediate machines. "The European industry would have no big machines to sell in the meantime. We've got to eat," he says.

A compromise could see the 1975 machine approved with restricted official financing and companies given coordinated research contracts by their national governments on a more distant supersize computer. Such an accord could test corporate good intentions and perhaps help spur industrial togeth-

ness, with eventual international mergers—one important goal of the whole cooperative idea.

Compatibility. A major technical problem for either project: participating companies will undoubtedly insist that any European computer be compatible with their own line of machine—meaning a Herculean software task.

Selling the results could also be a disappointing undertaking. Aigrain admits it's been "a very difficult problem finding out how much the various governments would be willing to help by giving preference in their purchases to a European computer." He adds, "Users are never interested in buying computers from a new company." Thus Aigrain feels the 1980 machine—the one he gives a 50% chance of approval—"has very high chances for technical success, but the commercial chances are a bit less bright."

Japan

Sharp-eyed

It's hard to get sharp television pictures with a camera looking out the side of a rocket spiraling through space. The image on the photocathode of the camera tube has two components of motion—spin and the forward motion of the rocket. A further problem is that illumination tends to be weak, so that exposures must be long, accentuating motion problems. What's more, transmission band-

widths usually are narrow, requiring slow-scan techniques.

Professor Noboru Niwa of the Institute of Space and Aeronautical Science, University of Tokyo, and Teruo Hiruma of Hamamatsu TV Co. have developed a camera that surmounts these difficulties. It has been successfully tested on a balloon operating at altitudes as high as 17 miles, and is awaiting rocket tests.

The system uses an "image memory tube" recently developed at Hamamatsu. In order to obtain sharp images when mounted on a moving vehicle, this tube, called the N-337, incorporates extremely fast electronic shuttering, electronic image storage, motion correction, sensing of image brightness at the photocathode, and automatic adjustment of shutter time for optimum exposure. The photocathode is square and the same area as the photosensitive surface in a one-inch vidicon.

Shutter. With the photocathode (on which the optical image is focused) grounded, electrode grids accelerate electrons from the photocathode toward a signal grid and a storage grid. The electric field from the grids, together with the magnetic field from the image focus coil, focus the image on the storage grid.

However, charging up the photocathode to approximately the same positive voltage as the accelerating grids stops electron flow, and the effect is the same as if a mechanical shutter had closed. This electronic shutter can give exposure times

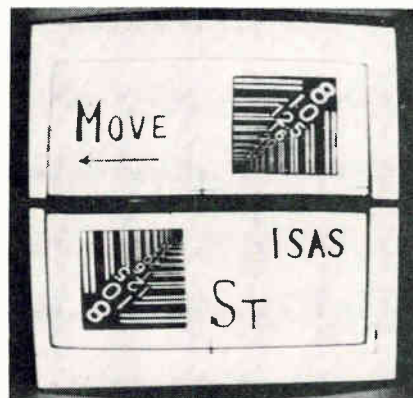

Still. Image is clear when both halves of target are motionless.

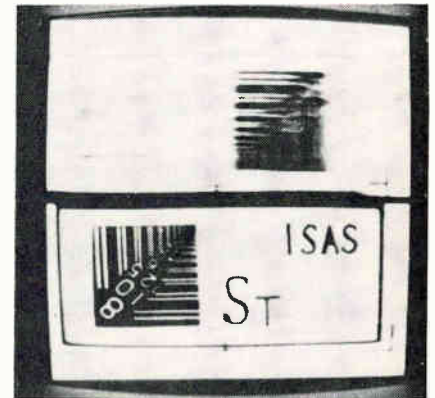

Motion. Top half moves, blurring image in ordinary stationary camera.

as short as 200 microseconds—or one five-thousandth of a second.

The photocathode side of the storage grid is coated with calcium fluoride, an insulating material with extremely high resistivity. Most of the image electrons pass through the positive signal grid and land on the storage grid, charging it negatively in proportion to the illumination distribution on the photocathode. For readout the storage grid is scanned with low-energy electrons from a gun at the other end of the tube. In this mode of operation the storage grid is grounded and the signal grid is charged to about 350 volts through a load resistor. Parts of the storage grid with high minus charge of electrons turn back most of the beam electrons. Electrons passing through the storage grid and reaching the signal grid thus depend on illumination at the photocathode, and the image can be converted to a sequential electrical signal.

Use of the storage grid makes for high efficiency during the short exposure, because electrons from all parts of the photocathode are stored simultaneously. It also permits conversion from high-speed exposure to slow-scan readout. This is important because telemetry bandwidth is narrower than that used for broadcast television transmission, and to transmit reasonably high-resolution tv signals it is necessary to read out the picture with a slow-speed scan.

In motion. Correction for vehicle motion is achieved with a hint from the veteran image dissector tube.

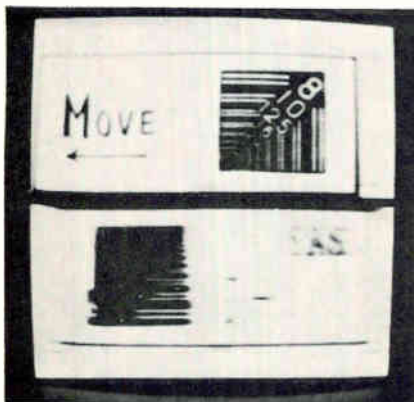

Stopped. Moving target is sharp with compensation circuit switched in.

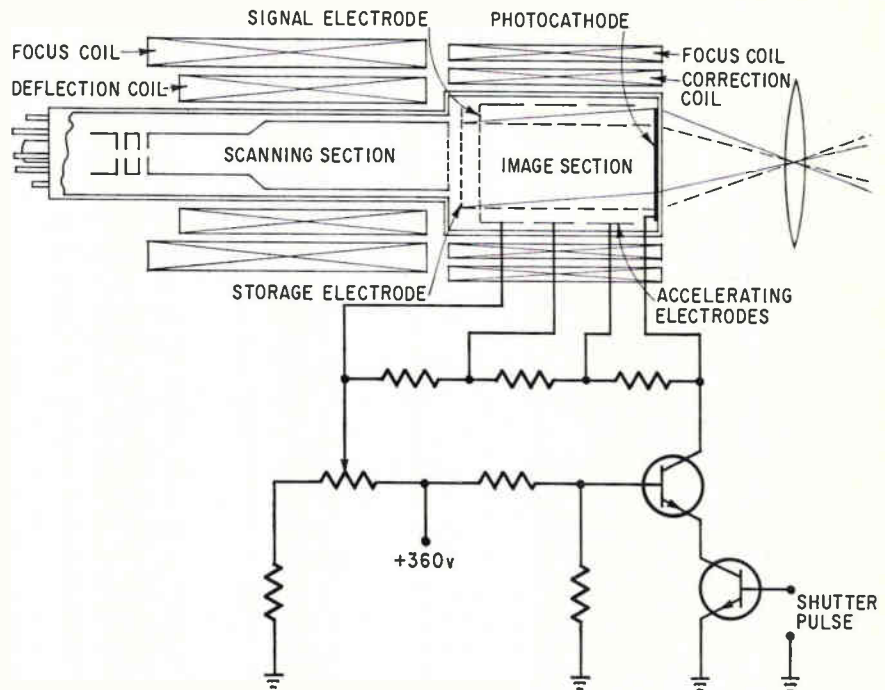

Test tube. Electronic shuttering and image motion compensation circuit put sharp image on storage grid. Beam from left gives slow-scan readout.

In the image dissector, the electron image—the electrons traveling from the photocathode—is swept past an aperture in the collector electrode. Only electrons corresponding to a single image element pass through the hole and reach the signal electrode. In the new tube the entire image is stored on the memory grid. But displacing the electron image shifts the area imaged by the tube. If the angular velocity of the camera is known it is possible to shift the image to exactly compensate for camera motion.

On the latest model of this camera a circuit for automatic adjustment of shutter speed was added. The sensor for this circuit is not only behind the lens, like the sensors in modern single-lens reflex cameras, but it is inside the camera tube. Thus there is built-in compensation for lenses, filter factors, and even for the efficiency of the pickup tube at different wavelengths. As initially tested this automatic circuit can adjust shutter speed from a minimum of 800 microseconds to a maximum of 60 milliseconds.

Exposure adjustment is performed by storing current flowing to the photocathode in a capacitor and arranging the circuit to close

the shutter when terminal voltage exceeds a certain value.

When used on satellites the tube is operated with a slow-speed scan of a 580-line picture; bandwidth needed is 100 kilohertz. Horizontal frequency is 325 hertz. These parameters give approximately the same resolution as commercial tv and are within the bandwidth and power capability of standard rocket transmitters.

The reading period is 1.78 seconds. Dead period, for erase and preparation of the memory grid, takes about 0.18 second. Thus maximum repetition rate is about two seconds or slower. A systems conversion unit has been built to convert the received pictures to broadcast standards for viewing on regular monitors. Video tape recorders and cameras are used for recording information.

Italy

Plane MOS

MOS devices with no surface steps represent the latest step forward in semiconductor technology—a step made by researchers of Italy's

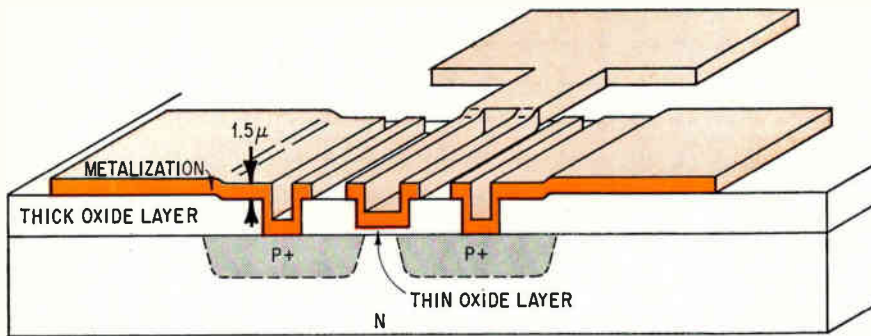

CONVENTIONAL PROCESS

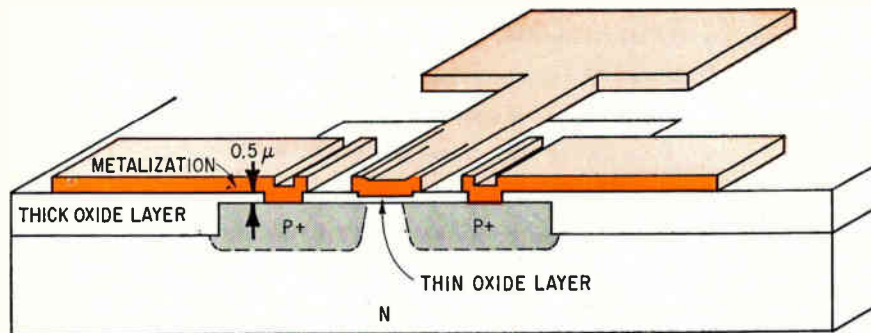

PLANOX PROCESS

Molehills. Stepless fabrication technique developed at SGS laboratory reduces the number and magnitude of bends in the metalization layer in MOS circuits. Principle behind the process is the sinking of steps below surface to smooth out the above-surface terrain.

SGS group. They have hit upon a manufacturing process which allows extremely flat surfaces on MOS silicon wafers. Such flat, or stepless, surfaces make for much greater device reliability and production yields than is possible with conventional fabrication techniques.

Without the need for more masking operations than in conventional MOS processes, the Planox technique makes it possible to produce devices with oxide layers of varying thickness but with a plane surface. Photoetching of the thick oxide layers—and thus the risk of undercutting—is eliminated. Self-alignment of the gate and tighter tolerances also are possible. The new process was developed at the SGS International Research and Development Laboratories at Agrate, near Milan.

Although the Planox process is applicable to any bipolar or unipolar semiconductor component, it

can be put to use most effectively in fabricating MOS integrated circuits, in which the silicon oxide thickness varies considerably and metal interconnecting patterns are complex.

In an MOS device, a thin silicon dioxide layer, usually about 0.12 micron deep, must be grown on the gate region to obtain a low threshold voltage, while a thick, 1.5-micron silicon dioxide layer must cover the field region to prevent surface, or field, inversion in that region.

It's this thick oxide layer that long has plagued makers of MOS devices and equipment designers using them. The reason: this layer makes for high, well-pronounced steps on the chip surface over which the metalization pattern, usually made of aluminum, has to run. Sharp bends in the metalization can lead to weak spots and microcracks which, in turn, can cause unreliable interconnections or

open circuits. The end result is low production yield. And all too often, equipment makers have found themselves replacing newly installed MOS IC's because these circuits did not perform reliably.

Devices fabricated by the new Planox process avoid such troubles. The Italian researchers have eliminated the step problem on the wafer surface by burying the steps. A silicon nitride film is used as a mask for making steps in the underlying silicon substrate so that the overlying silicon dioxide covering the gate and field regions is stepless, or flat.

A 200-angstrom silicon nitride film is first deposited onto the silicon substrate. This film is masked and etched so that the regions where the thick silicon dioxide layer is to be grown lay bare. Then the silicon substrate itself is eaten into. The regions still covered with silicon nitride are thus higher with respect to the bare regions. Oxide then is grown in the depressions and its surface will be practically level with the surface of the silicon covered by the silicon nitride film.

When used in fabricating MOS devices, the silicon nitride film is selectively etched away, with only a strip left that covers the gate area and defines the areas for diffusion of source and drain. The diffused areas are self-aligning with respect to the gate, and thus allow tighter tolerances in the design.

Source and drain are passivated by thermal oxidation, and the remaining silicon nitride is etched away from the gate. Subsequent steps such as gate oxidation, contacting, and metalization are carried out by using conventional techniques.

This technique, for which patent applications are now pending, currently is being applied in limited production runs of MOS devices at the Agrate facilities. Piero Alderisio, technical director of SGS, anticipates the new technique will increase production yield by at least 35% over conventional MOS fabrication methods. It is expected that once the new process is refined, an even better improvement can be achieved.

Electronics advertisers

December 8, 1969

ACDC Electronics Faust/Day, Inc.	206	□ CRC IRP	17E	■ Hewlett Packard, Colorado Springs Div.	2
Aerojet General Corp. D'Arcy Adv. Co.	155	CTS Corporation Reincke, Meyer & Finn, Inc.	142, 143	Tallant/Yates, Adv., Inc.	
■ Airpax Electronics, Inc. Tech Communicators, Inc.	168			■ Hewlett Packard, Lowell Div. Tallant/Yates, Adv., Inc.	10, 11
Allen-Bradley Co. Fensholt Adv. Agcy.	23, 25			■ □ Hewlett Packard, Mount View Lennen and Newell/Pacific	3E, 14E
American Cyanamid Co., Plastics & Resins Div. Wilson, Haight & Welch, Inc.	165	■ Dale Electronics, Inc., Sub. of Lionel Corp. Swanson, Sinkey, Ellis, Inc.	3rd Cover	■ Hewlett Packard New Jersey Div. McCarthy, Scelba and DiBiasi Adv. Agcy., Inc.	127
American Optical Co., Space Defense Group Fuller & Smith & Ross, Inc.	186	Data Controls Systems Technical, Industrial & Scientific Marketing, Inc.	154	■ Hewlett Packard, San Diego Div. Lennen & Newell, Inc.	217
American Potash and Chemical Corp., Rare Earth Div. Sidney Clayton Assoc., Inc.	146	Datum, Inc. Helme Assoc., Inc. Delta Products, Inc.	16 57	■ Hewlett Packard, Santa Clara Div. Lennen & Newell, Inc.	112, 113
Ammon Instruments, Inc. Culver Adv., Inc.	228	Noble De Roin & Associates Di-Acro Corp., Div. of Houdaille Industries, Inc. Charles E. Brown Adv. Agcy.	150	HI-Shear Corp. Honeywell, Computer Control Div. Creamer, Trowbridge Case & Basford, Inc.	151 27
■ Amperite Co. H. J. Gold Co.	22	Diaflight Corp. Michel Cather, Inc.	152	■ Honeywell Test Instruments Div. Campbell Mithun, Inc.	234
AMP, Inc. Garceau, Hallahan & McCullough, Inc.	100, 101	■ Digitran Company, The Jansson Adv., Inc.	213	■ Hughes Aircraft Co. Foote, Cone & Belding	125
Ancona Corp./Neumuller and Co. Wilhelm Bacher Werbung Applied Digital Data Systems, Inc.	230 78, 79	Dow Chemical Co., The MacManus, John & Adams, Inc.	176		
Shaw Elliott, Inc.		DuPont de Nemours Co., Teflon Div. Batten, Barton, Durstine & Osborn, Inc.	124	Intech, Inc.	199
				Hall Lawrence, Inc.	
■ Barnstead Co., Div. of Sybron Corp. Creamer, Trowbridge, Case & Basford, Inc.	200			Integrated Circuit Engineering Corp. N.A. Winter Advertising	216
Bausch & Lomb, Inc. Wolf Assoc., Inc.	177	■ Eagle Signal Division of Gulf & Western Co. Feeley & Wheeler Division Geyer, Oswald, Inc.	59	INTEL Corporation Bonfield Associates	132
■ Beckman Instruments, Inc., Hellpot Div.	45	Eastman Kodak Co., Technical Corp. Adv. Rumrill Hoyt, Inc.	211	International Computer Products, Inc. Mike Engleman Communications	221
N. W. Ayer/Jorgensen/MacDonald, Inc.		■ Elco Corp. Schaefer Adv., Inc. Electro Fiberoptics Corp. Davis Adv., Inc.	32	■ International Crystal Mfg. Co. Robert V. Freeland & Associates	218
Beckman Instruments, Inc. (PID) N. W. Ayer/Jorgensen/MacDonald, Inc.	209	Electro Products Laboratories, Inc., Transducer Div. Grant, Wright & Baker, Inc.	188 126	International Electronic Research Corp.	68, 69
Belden Corporation Fensholt Adv., Inc.	74, 75	Electronic Controls, Inc. Robert A. Paul Adv. Agcy.	227	Van Der Boom, McCarron, Inc. Adv.	
Bell & Howell, Electronic Instrumentation Group-CEC/ Transducer Div.	54	Electronic Counters, Inc. Tek-Mark, Inc.	243	■ Ithaco, Inc. Hart-Conway Co., Inc.	224
N. W. Ayer/Jorgensen/MacDonald, Inc.		■ Electronic Navigation Industries Hart-Conway Co., Inc.	223		
Bell Telephone Laboratories N. W. Ayer & Son, Inc.	117	Electronic Industries Association of Japan Pace Advertising Agency	222	Johnson Company, E.F. Martin Williams Advertising	26
Bendix Corp., Electrical Components Div. MacManus, John & Adams, Inc.	28, 29	EL Instruments, Inc. Froehlich Advertising Services	220		
■ Blue M Electric Co. South Suburban Advertising	160	E/MC Electronics/Management Center	219, 229	Keithley Instruments, Inc. Bayless-Kerr Co.	204
Bourns, Inc., Trimpot Div. The Lester Co.	175	Ries Cappiello Colwell, Inc. E/MC—Medical Electronics Seminar	76, 77, 134	Kinetic Technology, Inc. Associated Adventures	82
Brand-Rex Creamer, Trowbridge, Case & Basford, Inc.	171	Gencom Division—Varian/EMI A.D. Adams Adv., Inc.	50	Krohn-Hite Corporation Ingalls Associates, Inc.	56
Bulova Watch Co., Electronics Div. Caroe Marketing, Inc.	140	General Dynamics Corp. Young and Rubicam, Inc.	120, 121		
Bulova Watch Co., Systems and Instrument Div.	2nd Cover	General Electric Co., Analytical Measurement Business Section	182	Ledex Incorporated Yeck & Yeck Inc.	198
Jules Rabin Assoc., Inc.		General Electric Co., Capacitor Division Robert S. Cragin, Inc.	166	Ledex Incorporated, Bramco Controls Division Yeck & Yeck Inc.	170
■ Bussmann Mfg. Division of McGraw Edison Co. Henderson Adv. Co.	130	General Electric Co., Silicone Products Div. Ross Roy of New York, Inc.	30	Litton Industries Inc., Data Systems Litton Industries Inc., Electron Tube Division MacManus, John & Adams Inc.	222 162
		■ General Electric Co., Electronic Components Sales Operation	12, 13, 192, 193	□ LTT Promotion Vente Publicite	10E-11E
		General Instrument Corp., Semiconductor Products Div. Norman Allen Associates	118, 119		
Cambridge Thermionic Corp. Chirurg & Cairns, Inc.	227	General Radio Co. Horton Church & Goff, Inc.	6	■ Mallory & Co., P.R. Mfg. Division	181, 220
Carpenter Technology Corp. Beaumont Heller & Sperling, Inc.	17	Gould Inc./Brush Instruments Carr Liggett Adv., Inc.	133	Aitkin Kynett Company Mathatronics	9
■ Centralab Div. of Globe Union, Inc.	51, 52, 53	Gould, Inc., Piezoelectric Div. Carr Liggett Adv., Inc.	243	Marketing Assistance Inc.	
The Brady Co.		GRI Computer Corp. Larcom Randall Adv., Inc.	185	Memory Systems Inc.	229
■ Cherry Electrical Products Corp. Kolb/Tookey and Assoc., Inc.	129	Gries Reproducer Co. Harold Marshall Adv.	230	Microdot Incorporated	131
■ Chester Cable Corp. Lewis Adv. Agcy.	36, 37	■ Guardian Electric Mfg. Co. Kolb/Tookey and Associates, Inc.	183	Gumpertz, Bentley & Dolan Advertising	
Cimron Division of Lear Siegler, Inc. Phillips Ramsey, Inc.	99	■ Gudebrod Brothers Silk Co., Electronics Div. Ramsdell-Bickley & Co.	205	■ Microsonics, Incorporated	202
Cinch Graphik Div. of United Carr Fastener Co.	157	Hadron, Inc. Di Nucci Graphics, Inc.	180	S. Gunnar Myrbeck & Company	
Stral Adv. Co., Inc.		■ Hewlett Packard, H.P. Assoc. Lennen & Newell, Inc.	1	■ Micro Switch-Division of Honeywell N.W. Ayer & Son Inc.	38, 39
■ Cinch Manufacturing Co. Stral Adv. Co., Inc.	173			Midtex/Aemco Chuck Ruhr Associates Advertising	15
■ Clalrex Corp. Michel-Cather, Inc.	163			Miller Stephenson Chemical Co. Inc. Michel-Cather Inc.	227
Clare & Co., C. P. Reincke, Meyer & Finn Adv., Inc.	70, 71			Mohawk Data Sciences Corp./OEM Marketing	147
■ Clifton Precision Products Co., Div. of Litton Industries Ivey Adv., Inc.	167			MacFarland Associates Inc.	
Cohu Electronics, Inc.	214			Motorola Semiconductor Products Incorporated	62, 63, 141
■ Computer Products, Inc. Grenman Assoc., Inc.	223			Lane & Wampler Advertising Inc.	
Computer Test Corp. Industrial Public Relations, Inc.	172			M & T Chemicals Inc. Marsteller Inc.	243
Control Data Corp., Connector Operation Barnes-Champ/Advertising	228			Mullard Ltd.	194
Control Data Corp./Magsense Barnes-Champ/Advertising	184			Parker-Rumrill International Inc.	
■ □ Cosmicar	8E			M-W Laboratories Inc.	222
Cox Instrument Div. of Lynch Corp. Gray & Kilgore, Inc.	178			Advertising Company of America	

National Semiconductor Corporation	72, 73
Hall Butler Blatherwick Inc.	
■ Norton Associates Incorporated	230
J.J. Coppo Company	
□ Omron Tateisi Electronics Co.	4E-5E
Dai-ichi International Inc.	
Pacific Measurements Incorporated	212
Jack Herrick Adv. Inc.	
Philco Ford Company,	
Microelectronics Division	60, 61
The Aitkin Kynett Company Inc.	
Philips Eindhoven, Nederland	122, 123
T.A.G. de la Mar	
Philips Electronics Instruments	196
Marsteller Inc.	
□ Philips N.V. pit/Tml Division	2E
Marsteller International S.A.	
Pirgo Electronics Inc.	128
Herbert Lindauer Associates	
Princeton Applied Research Corporation	40
Mort Barish Associates Inc.	
Radio Corp. of America 4th Cover, 64,	145
Al Paul Lefton Company	
Radio Materials Company,	
P.R. Mallory & Company	189
M.M. Fisher Associates Inc.	
Raytheon Company,	
Components Division	35, 80, 81
Fuller & Smith & Ross Inc.	
Redcor Corporation	24
Management Communication	
Consultants Inc.	
Reeves Instrument Division	153
Duncan-Brooks Inc.	
Rentronix Incorporated	195
E.G. White Advertising Inc.	
■ RHG Electronics Laboratories	225
Incorporated	
Samuel H. Goldstein Incorporated	
□ Rohde & Schwarz	20E
Sage Electronics Corporation	210
Mathison Advertising Inc.	
San E Denki Company Ltd.	226
Sanko Sha Adv. Agcy. Co. Ltd.	
□ Sercel	7E
Termont Technique	
□ Sescosem	6E
Signetics Corp. Sub. Corning	
Glass Works	215
Cunningham & Walsh Inc.	
□ Sillec Electronic	19E
Publicite Y Ch. Lambert	
Siliconix Inc.	7
Robertson West Inc.	
Singer Co., Instrumentation Division	158
Technical Industrial & Scientific	
Marketing Inc.	
Sorensen Operation Raytheon Company	67
Sprague Electric Company	5
Harry P. Bridge Company	
■ Stackpole Carbon Company,	
Electronic Components Division	148
Meek & Thomas Inc.	
State of the Art Inc.	226
Ashton-Worthington Inc.	
Sylvania Electric Products Inc.	
Parts Division	159
Doyle Dane Bernback Inc.	
■ Systron Donner Corporation	46
Bonfield Associates Inc.	
Ta Manufacturing Corporation	229
Bear Advertising Inc.	
Ted. Manufacturing Corp.	14
Lane/Travis/Pollard, Inc.	
■ Tektronix Inc.	135-136
Dawson, Inc.	
Teledyne Relays Company	49
S. Michelson Advertising	
Toko Inc.	224
Hakuhodo Incorporated	
■ Transformer Electronics Company	48
Wolff & Welr	
Transitron Electronic Corporation	156
Larcom Randall Advertising, Inc.	
Triplet Electrical Instrument Company	161
Byer & Bowman Adv.	
TRW Electronics Capacitors Division	55
Fuller & Smith & Ross, Inc.	

TRW Semiconductors Inc.	244
Fuller & Smith & Ross, Inc.	
■ Tung-Sol Division,	
Wagner Electric Corporation	144
Feeley & Wheeler Division of Geyer,	
Oswald Inc. Adv.	
Tyco Laboratories Inc.,	201
Instruments Division	
Kenyon & Eckhardt Inc. Adv.	
Union Carbide Company	139
Windfield Inc. Adv.	
■ Unirode Corporation	47
Silton Brothers, Inc.	
■ U-Tech A Division of Industrial	
Physics and Electronics Co.	208
Ross Clay Advertising	
□ Valvo GMBH	12E-13E
Intermarco	
Varian Associates Bomac S.F.D.	203
Division	
Botsford, Constantine & McCarty Inc.	226
Vector Electronics Co., Inc.	
Buck Advertising	
Westamp, Inc.	228
Slegmeister-Grant	
Westinghouse, Electronic Tube	
Div.	18, 19, 20, 21
Ketchum MacLeod & Grove, Inc.	
Division	
Weston Instruments, Inc.,	190
Archbald Div.	
Arndt, Preston, Chapin, Lamb &	
Keen, Inc.	
■ White Company, S.S.	164
W.L. Towne Co., Inc.	
Wyle Computer Products	58
Eastman Adv. Agcy.	

Classified & Employment Advertising

F.J. Eberle, Manager	
212-971-2557	
EMPLOYMENT OPPORTUNITIES	231-233
Atomic Personnel Inc.	233
Corcoran, Joseph P.	233
Owens-Illinois Inc.	233
EQUIPMENT	
(Used or Surplus New)	
For Sale	
Fishman, Phillip Co.	233
Laboratory Equipment Sales	233
Radio Research Instrument Co.	233

■ For more information on complete product line see advertisement in the latest Electronics Buyer's Guide

□ Advertisers in Electronics International

Electronics Buyers' Guide

George F. Werner, Associate Publisher	[212] 971-2310
Robert M. Denmead,	Midwest Regional Manager
[312] MO 4-5800	
Cliff Montgomery,	New York District Manager
[212] 971-3793	
Regina Hera, Directory Manager	[212] 971-2544
Thomas M. Egan, Production Manager	[212] 971-3140
Carol Gallagher,	Assistant Production Manager [212] 971-2045
Circulation Department	
Isaaca Siegel, Manager [212] 971-6057	
Research Department	
David Strassler, Manager [212] 971-6058	

Advertising Sales Staff

Dan McMillan III [212] 971-3468	
Associate Publisher	
Wallis Clarke [212] 971-2187	
Advertising Sales Service Manager	
Warren H. Gardner [215] LO 8-6161	
Eastern Advertising Sales Manager	
Atlanta, Ga. 30309: Michael H. Miller, 1375	
Peachtree St., N.E.	
[404] 892-2868	
Boston, Mass. 02116: William S. Hodgkinson	
McGraw-Hill Building, Copley Square	
[617] CO 2-1160	
Cleveland, Ohio 44113: William J. Boyle, 55	
Public Square, [216] SU 1-7000	
New York, N.Y. 10036	
500 Fifth Avenue	
James R. Pierce [212] 971-3615	
John A. Garland [212] 971-3617	
Michael J. Stoller [212] 971-3616	
Philadelphia, Pa. 19103:	
Jeffrey M. Preston	
Warren H. Gardner,	
6 Penn Center Plaza,	
[215] LO 8-6161	
Pittsburgh, Pa. 15222: Jeffrey M. Preston,	
4 Gateway Center, [412] 391-1314	
Rochester, N.Y. 14534: William J. Boyle,	
9 Greylock Ridge, Pittsford, N.Y.	
[716] 586-5040	
Donald R. Furth [312] MO 4-5800	
Midwest Advertising Sales Manager	
Chicago, Ill. 60611: Kenneth E. Nicklas	
Ralph Hanning 645 North Michigan Avenue,	
[312] MO 4-5800	
Dallas, Texas 75201: Richard P. Poole, 1800	
Republic National Bank Tower,	
[214] RI 7-9721	
Houston, Texas 77002: Robert Wallin,	
2270 Humble Bldg. [713] CA 4-8381	
Detroit, Michigan 48226: Ralph Hanning,	
856 Penobscot Building	
[313] 962-1793	
Minneapolis, Minn. 55402: 1104 Northstar	
Center [612] 332-7425	
St. Louis, Mo. 63105: Kenneth E. Nicklas,	
The Clayton Tower, 7751 Carondelet Ave.	
[314] PA 5-7285	
James T. Hauptli [415] DO 2-4600	
Western Advertising Sales Manager	
Denver, Colo. 80202: David M. Watson,	
Richard W. Carpenter	
Tower Bldg., 1700 Broadway	
[303] 266-3863	
Los Angeles, Calif. 90017: Ian C. Hill,	
Bradley K. Jones, 1125 W. 6th St.,	
[213] HU 2-5450	
Portland, Ore. 97204: James T. Hauptli,	
Don Farris, 218 Mohawk Building,	
222 S.W. Morrison Street,	
Phone [503] 223-5118	
San Francisco, Calif. 94111: James T. Hauptli,	
Don Farris, 255 California Street,	
[415] DO 2-4600	
Pierre Braude Tel: 225 85 88: Paris	
European Director	
Paris: Denis Jacob	
88-90 Avenue Des Champs-Elysees, Paris 8	
United Kingdom and Scandinavia	
London: Oliver Ball, Tel: Hyde Park 1451	
34 Dover Street, London W1	
Milan: Robert Saldel, Roberto Laureri Jr.	
1 via Baracchini Phone 86-90-656	
Brussels: Denis Jacob	
27 Rue Ducale Tel: 136503	
Frankfurt/Main: Hans Haller	
Elsa-Brandstrom Str. 2	
Phone 72 01 81	
Geneva: Denis Jacob	
1 rue du Temple Phone: 31 95 60	
Tokyo: McGraw-Hill	
Publications Overseas Corporation,	
Kasumigasaki Building 2-5, 3-chome,	
Kasumigasaki, Chiyoda-Ku, Tokyo, Japan	
[581] 9811	
Osaka: Akihiko Kamesaka, McGraw-Hill	
Publications Overseas Corporation, Kondo	
Bldg., 163, Umegae-cho Kita-ku [362] 8771	
Australia: Warren E. Ball, IPO Box 5106,	
Tokyo, Japan	
Business Department	
Stephen R. Weiss, Manager	
[212] 971-2044	
Thomas M. Egan,	
Production Manager [212] 971-3140	
Mauri D'Gongora,	
Assistant Production Manager [212] 971-2045	
Dorothy Carmesin, Contracts and Billings	
[212] 971-2908	
Frances Vallone, Reader Service Manager	
[212] 971-2865	

TRANSTECTOR

CIRCUIT PROTECTOR



prevents transients from causing "unexplainable" circuit failures.

Don't blame circuit failures on bad luck.

Voltage transients can cause circuits to fail or suffer undetected and progressive damage.

Transtector* circuit protector, a new solid state device, senses transients within nanoseconds, absorbs the surge and resets itself. Gives continuous protection for tubes, transistors, diodes and integrated circuits.

Find out about Transtector Systems from M&T Chemicals Inc., 1161 Monterey Pass Road, Monterey Park, Calif. 91754. Tel. (213) 264-0800.

M&T Chemicals Inc.
SUBSIDIARY OF AMERICAN CAN COMPANY



*Trademark of M&T Chemicals Inc.

Circle 262 on reader service card

Breakthrough in low frequency filtering!

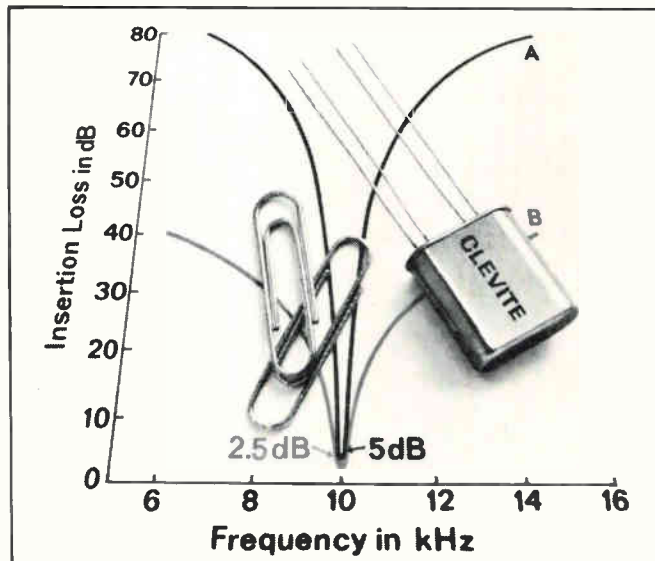

A— CASCADE OF 2 LF FILTERS

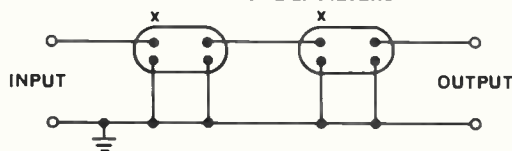

B— SINGLE LF FILTER

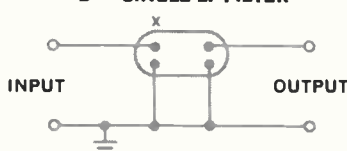

New Clevite ceramic bandpass filter puts big performance into 1/4 oz.

Clevite low frequency (LF) ceramic filters—from 9 to 50 kHz—are about one-tenth the size and weight of comparable conventional types—have narrower bandwidths, lower insertion loss and greater stability. This means you can pack more channels into a given portion of the spectrum with less sacrifice in volume and weight. They're fixed tuned, so you have no installation adjustments, simpler assembly and inspections.

Typical characteristics: 1% min. 3 dB pass bandwidth, 20 dB/3 dB bandwidth ratio not exceeding 13, and passband insertion loss less than 5 dB. Stopband attenuation exceeds 30 dB from dc to above 100 kHz. For even better selectivity they can easily be cascaded without worrying about matching or big insertion losses.

All this performance comes in a miniature HC-6/U can that weighs just 1/4 ounce (it's shown here actual size). They're hermetically sealed, immune to environments... there's no need for magnetic shielding. And LF filters are independent of the power source, so there's no current drain.

New Clevite LF filters are ideal for low frequency communications receivers, control circuits, selective calling systems, underwater sound systems and military/navigation systems. Write today for full specs and technical data. Piezoelectric Division, Gould Inc., 232 Forbes Road, Bedford, Ohio 44146, U.S.A. Or: Brush Clevite Company, Ltd., Southampton, England.

GOULD CLEVITE

Circle 243 on reader service card

243

ONE will get you FIFTY



One pulse generator, the new EC1 model 5101, produces pulse rates from 1 Hz to 50 MHz, and includes features only found in much more expensive equipment. For example: Single or double pulse output, integrated circuit output, 10 nanosecond to 1 second pulse width, 10 nanosecond to 1 second pulse delay, and synchronous or asynchronous gating.

Send for complete specifications, or call us collect and ask for an in-plant demonstration.

ONE will get you FIFTY for \$525.



**ELECTRONIC
COUNTERS, INC.**
235 Jackson Street
Englewood, N. J. 07631
(201) 567-5300

Circle 263 on reader service card

TRW 2 GHz Broadband Transistors

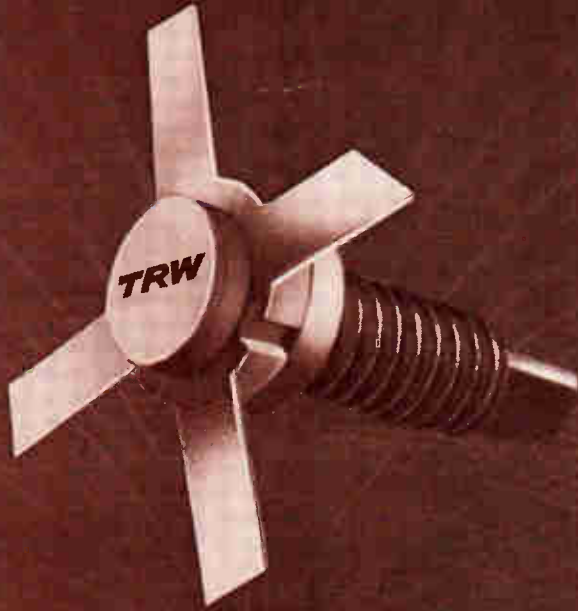

Infinite VSWR...8 dB Gain...28 Volts

High gain, high efficiency, and excellent VSWR are characteristics of a new family of 2 GHz broadband transistors developed by TRW. Type 2N5766, the one watt unit, has 8 dB gain at greater than 30% efficiency, and can withstand infinite VSWR at any phase. Both the 2.5 watt 2N5767, at 8 dB gain and greater than 30% efficiency, and the 5 watt 2N5768 at 7 dB gain and greater

than 35% efficiency, can withstand 3:1 VSWR at any phase.

All three transistors provide excellent stability in a common base circuit. All are contained in exceptionally rugged, ultracermic, hermetically sealed strip-line packages, and operate from a 28 V source.

For further information or application assistance, contact any TRW distributor or TRW

Semiconductors Inc., 14520 Aviation Boulevard, Lawndale, Calif. 90260. Phone (213) 679-4561; TWX: 910-325-6206. TRW Semiconductors is a subsidiary of TRW Inc.

TRW®

Electronics reader service

Warning: The Post Office now requires your ZIP CODE on all mail. Please include your ZIP CODE number when filling out your reply card.

Use these handy post cards for more detailed information on: products advertised, new products, new literature.

Circle the number on the Reader Service post card that corresponds to the number at the bottom of the advertisement, new product item, or new literature in which you are interested.

Please print clearly. All written information must be legible to be efficiently processed.

If someone has beaten you to the post cards, you may obtain the needed information by writing directly to the manufacturer, or by sending your name and address, plus the Reader Service number, to Electronics Reader Service department.

All inquiries from outside the U.S. that cannot reach Electronics before the expiration dates noted on the Reader Service post card, must be mailed directly to the manufacturer. The manufacturer assumes all responsibilities for responding to inquiries. Electronics merely provides and clears requests for information from inquirer to manufacturer.

Correct amount of postage must be affixed for all mailings from outside the U.S.

To subscribe to or to renew Electronics

Fill in the "For Subscriptions" area on the card if you desire to subscribe to or renew your present subscription to Electronics. Send no money. Electronics will bill you at the address indicated on the Reader Service post card.

Multi-product advertisements

For information on specific items in multi-product advertisements which do not have a specific Reader Service number indicated write directly to manufacturer for information on precise product in which you are interested.

25 *For employment inquiries fill in home address. December 8, 1969 Card Expires February 8, 1970 14

Name _____ title _____

Company* _____

Address _____

City _____ State _____ Zip Code _____

1	20	39	58	77	96	115	134	153	172	191	210	229	248	267	286	305	324	343	362	381	400	419	438	457	476	495	514	962
2	21	40	59	78	97	116	135	154	173	192	211	230	249	268	287	306	325	344	363	382	401	420	439	458	477	496	515	963
3	22	41	60	79	98	117	136	155	174	193	212	231	250	269	288	307	326	345	364	383	402	421	440	459	478	497	516	964
4	23	42	61	80	99	118	137	156	175	194	213	232	251	270	289	308	327	346	365	384	403	422	441	460	479	498	517	965
5	24	43	62	81	100	119	138	157	176	195	214	233	252	271	290	309	328	347	366	385	404	423	442	461	480	499	518	966
6	25	44	63	82	101	120	139	158	177	196	215	234	253	272	291	310	329	348	367	386	405	424	443	462	481	500	900	967
7	26	45	64	83	102	121	140	159	178	197	216	235	254	273	292	311	330	349	368	387	406	425	444	463	482	501	901	968
8	27	46	65	84	103	122	141	160	179	198	217	236	255	274	293	312	331	350	369	388	407	426	445	464	483	502	902	969
9	28	47	66	85	104	123	142	161	180	199	218	237	256	275	294	313	332	351	370	389	408	427	446	465	484	503	951	970
10	29	48	67	86	105	124	143	162	181	200	219	238	257	276	295	314	333	352	371	390	409	428	447	466	485	504	952	971
11	30	49	68	87	106	125	144	163	182	201	220	239	258	277	296	315	334	353	372	391	410	429	448	467	486	505	953	972
12	31	50	69	88	107	126	145	164	183	202	221	240	259	278	297	316	335	354	373	392	411	430	449	468	487	506	954	973
13	32	51	70	89	108	127	146	165	184	203	222	241	260	279	298	317	336	355	374	393	412	431	450	469	488	507	955	974
14	33	52	71	90	109	128	147	166	185	204	223	242	261	280	299	318	337	356	375	394	413	432	451	470	489	508	956	975
15	34	53	72	91	110	129	148	167	186	205	224	243	262	281	300	319	338	357	376	395	414	433	452	471	490	509	957	976
16	35	54	73	92	111	130	149	168	187	206	225	244	263	282	301	320	339	358	377	396	415	434	453	472	491	510	958	977
17	36	55	74	93	112	131	150	169	188	207	226	245	264	283	302	321	340	359	378	397	416	435	454	473	492	511	959	978
18	37	56	75	94	113	132	151	170	189	208	227	246	265	284	303	322	341	360	379	398	417	436	455	474	493	512	960	979
19	38	57	76	95	114	133	152	171	190	209	228	247	266	285	304	323	342	361	380	399	418	437	456	475	494	513	961	980

For Subscriptions

new renewal

3 years \$16.00

1 year \$8.00

Business reply mail
No postage stamp necessary if mailed in the United States

Postage will be paid by

Electronics
Reader service department
Box 444
Hightstown, N.J. 08520



25 *For employment inquiries fill in home address. December 8, 1969 Card Expires February 8, 1970 14

Name _____ title _____

Company* _____

Address _____

City _____ State _____ Zip Code _____

1	20	39	58	77	96	115	134	153	172	191	210	229	248	267	286	305	324	343	362	381	400	419	438	457	476	495	514	962
2	21	40	59	78	97	116	135	154	173	192	211	230	249	268	287	306	325	344	363	382	401	420	439	458	477	496	515	963
3	22	41	60	79	98	117	136	155	174	193	212	231	250	269	288	307	326	345	364	383	402	421	440	459	478	497	516	964
4	23	42	61	80	99	118	137	156	175	194	213	232	251	270	289	308	327	346	365	384	403	422	441	460	479	498	517	965
5	24	43	62	81	100	119	138	157	176	195	214	233	252	271	290	309	328	347	366	385	404	423	442	461	480	499	518	966
6	25	44	63	82	101	120	139	158	177	196	215	234	253	272	291	310	329	348	367	386	405	424	443	462	481	500	900	967
7	26	45	64	83	102	121	140	159	178	197	216	235	254	273	292	311	330	349	368	387	406	425	444	463	482	501	901	968
8	27	46	65	84	103	122	141	160	179	198	217	236	255	274	293	312	331	350	369	388	407	426	445	464	483	502	902	969
9	28	47	66	85	104	123	142	161	180	199	218	237	256	275	294	313	332	351	370	389	408	427	446	465	484	503	951	970
10	29	48	67	86	105	124	143	162	181	200	219	238	257	276	295	314	333	352	371	390	409	428	447	466	485	504	952	971
11	30	49	68	87	106	125	144	163	182	201	220	239	258	277	296	315	334	353	372	391	410	429	448	467	486	505	953	972
12	31	50	69	88	107	126	145	164	183	202	221	240	259	278	297	316	335	354	373	392	411	430	449	468	487	506	954	973
13	32	51	70	89	108	127	146	165	184	203	222	241	260	279	298	317	336	355	374	393	412	431	450	469	488	507	955	974
14	33	52	71	90	109	128	147	166	185	204	223	242	261	280	299	318	337	356	375	394	413	432	451	470	489	508	956	975
15	34	53	72	91	110	129	148	167	186	205	224	243	262	281	300	319	338	357	376	395	414	433	452	471	490	509	957	976
16	35	54	73	92	111	130	149	168	187	206	225	244	263	282	301	320	339	358	377	396	415	434	453	472	491	510	958	977
17	36	55	74	93	112	131	150	169	188	207	226	245	264	283	302	321	340	359	378	397	416	435	454	473	492	511	959	978
18	37	56	75	94	113	132	151	170	189	208	227	246	265	284	303	322	341	360	379	398	417	436	455	474	493	512	960	979
19	38	57	76	95	114	133	152	171	190	209	228	247	266	285	304	323	342	361	380	399	418	437	456	475	494	513	961	980

Reprint service

All Electronics editorial matter available in reprint form:

For reprints of special reports and feature articles see list on right side of this page. Send your order to Electronics Reprint Department at the address indicated. To expedite mailing of your order for single reprints please send cash, check or money order with your order. Allow 3-4 weeks for delivery.

Bulk reprints of editorial matter can be ordered from current or past issues. The minimum quantity is 100 copies. Price quoted on request: call 212-971-2274, or write to address below.

Warning: The Post Office now requires your ZIP CODE on all mail. Please include your ZIP CODE number when filling out your reply card.

3

Business reply mail

No postage stamp necessary if mailed in the United States

Postage will be paid by

First class
Permit no. 42
Hightstown, N. J.



Electronics
Reader service department
Box 444
Hightstown, N. J. 08520

25 Please Print Clearly December 8, 1969 Card Expires February 8, 1970 14

Name _____ title _____ For Subscriptions
 new renewal
 Company _____ 3 years \$16.00
 Address _____ 1 year \$8.00

1	20	39	58	77	96	115	134	153	172	191	210	229	248	267	286	305	324	343	362	381	400	419	438	457	476	495	514	962
2	21	40	59	78	97	116	135	154	173	192	211	230	249	268	287	306	325	344	363	382	401	420	439	458	477	496	515	963
3	22	41	60	79	98	117	136	155	174	193	212	231	250	269	288	307	326	345	364	383	402	421	440	459	478	497	516	964
4	23	42	61	80	99	118	137	156	175	194	213	232	251	270	289	308	327	346	365	384	403	422	441	460	479	498	517	965
5	24	43	62	81	100	119	138	157	176	195	214	233	252	271	290	309	328	347	366	385	404	423	442	461	480	499	518	966
6	25	44	63	82	101	120	139	158	177	196	215	234	253	272	291	310	329	348	367	386	405	424	443	462	481	500	900	967
7	26	45	64	83	102	121	140	159	178	197	216	235	254	273	292	311	330	349	368	387	406	425	444	463	482	501	901	968
8	27	46	65	84	103	122	141	160	179	198	217	236	255	274	293	312	331	350	369	388	407	426	445	464	483	502	902	969
9	28	47	66	85	104	123	142	161	180	199	218	237	256	275	294	313	332	351	370	389	408	427	446	465	484	503	951	970
10	29	48	67	86	105	124	143	162	181	200	219	238	257	276	295	314	333	352	371	390	409	428	447	466	485	504	952	971
11	30	49	68	87	106	125	144	163	182	201	220	239	258	277	296	315	334	353	372	391	410	429	448	467	486	505	953	972
12	31	50	69	88	107	126	145	164	183	202	221	240	259	278	297	316	335	354	373	392	411	430	449	468	487	506	954	973
13	32	51	70	89	108	127	146	165	184	203	222	241	260	279	298	317	336	355	374	393	412	431	450	469	488	507	955	974
14	33	52	71	90	109	128	147	166	185	204	223	242	261	280	299	318	337	356	375	394	413	432	451	470	489	508	956	975
15	34	53	72	91	110	129	148	167	186	205	224	243	262	281	300	319	338	357	376	395	414	433	452	471	490	509	957	976
16	35	54	73	92	111	130	149	168	187	206	225	244	263	282	301	320	339	358	377	396	415	434	453	472	491	510	958	977
17	36	55	74	93	112	131	150	169	188	207	226	245	264	283	302	321	340	359	378	397	416	435	454	473	492	511	959	978
18	37	56	75	94	113	132	151	170	189	208	227	246	265	284	303	322	341	360	379	398	417	436	455	474	493	512	960	979
19	38	57	76	95	114	133	152	171	190	209	228	247	266	285	304	323	342	361	380	399	418	437	456	475	494	513	961	980

1

Business reply mail

No postage stamp necessary if mailed in the United States

Postage will be paid by

First class
Permit no. 42
Hightstown, N. J.



Electronics
Reader service department
Box 444
Hightstown, N.J. 08520

To order reprints or for further information, please write to: Electronics Reprint Department, 330 West 42nd Street, New York, N.Y. 10036.

To expedite mailing of your order for single reprints please enclose payment with your order.

You may order any of the below listed reprints by key number. Discounts on quantities over 10.

- Key no. R-01 Computer-aided Design: Part I The Man-machine Merger. 16 pages. \$1.25.
- Key no. R-04 Multilayer Circuit Boards Sharpening An Imperfect Art 7 pages. 50¢.
- Key no. R-05 Topology Cuts Design Drudgery. 12 pages. 50¢.
- Key no. R-06 Report on Japanese Technology: Sony. 20 pages. 50¢.
- Key no. R-010 Special Report on Large Scale Integration. 54 pages. \$1.50.
- Key no. R-011 Medical Electronics (1967). 8 part series, 44 pages. \$1.25.
- Key no. R-012 Special Report on Gallium Arsenide 17 parts. 32 pages. \$2.00
- Key no. R-016 Special Report on The Transistor: Two Decades of Progress. 48 pages. \$1.50.
- Key no. R-017 Special Report on Ferrites. 16 pages. \$1.00.
- Key no. R-018 European Electronics Markets 1969 20 page forecast report with a 6 page foldout. \$1.00
- Key no. R-019 U.S. Electronics Markets 1969 32 page forecast report with 4 page foldout. \$1.00
- Key no. R-020 1968 Electronics Index to Technical Articles and Authors Free.
- Key no. R-021 Infrared Detector Characteristics. 23 x 11 inch fold-out chart. 50¢
- Key no. R-022 Active Filters: Part II, Varying the Approach. 8 pages \$1.00
- Key no. R-79 MOS Integrated Circuits. 12 pages. 50¢.
- Key no. R-78 The Overlay Transistor. 15 pages. 50¢.
- Key no. R-64 Field Effect Transistors. Parts I, II, and III. 64 pages. \$1.00.

From Dale—the pots you don't ship back...

<1% customer rejection rate!

Less than 1% customer rejection for *all* causes. That's the record established by Dale T-Pots. Consider the savings this can bring you in time, paper work. Then consider the added efficiency of consolidating more of your buys at this versatile source. Almost 50% more models added in two years. Military (RT-10, 11, 12, 22, 24), Industrial, Commercial ... wirewound and film elements. All are very competitively priced. Check today and find out. We can deliver them quickly—and you won't have to send them back.

MILITARY GRADE T-POTS

- 600 Series: Mil. Equiv. RT-10; 10 Ω to 100K Ω , $\pm 5\%$; 1 watt at 70°C, derated to 0 at 175°C; .18 H x .32 W x 1.00 L.
- 1200 Series: Mil. Equiv. RT-11; 10 Ω to 100K Ω , $\pm 5\%$; 1 watt at 70°C, derated to 0 at 175°C; .28 H x .31 W x 1.25 L.
- 1600 Series: Mil. Equiv. RT-12; 10 Ω to 100K Ω , $\pm 5\%$; 1 watt at 70°C, derated to 0 at 175°C; .19 H x .32 W x 1.25 L.
- 5000 Series: Mil. Equiv. RT-22; 10 Ω to 50K Ω , $\pm 5\%$; 1 watt at 70°C, derated to 0 at 175°C; .19 or .22 H x .50 W x .50 L.
- 5800 Series: Mil. Equiv. RT-24; 10 Ω to 50K Ω , $\pm 5\%$; 1 watt at 70°C, derated to 0 at 175°C; .145 or .150 H x .375 W x .375 L.

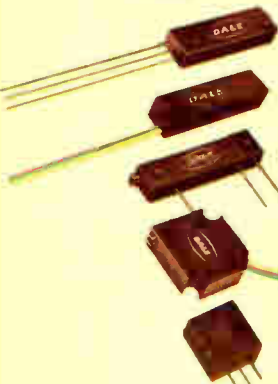

COMMERCIAL GRADE ECONO-TRIM T-POTS

- WIREWOUND ELEMENT**
 - 2300 Series: Sealed/Unsealed; 10 Ω to 50K Ω , $\pm 10\%$; 0.5 watt at 25°C, derated to 0 at 105°C; .36 H x .28 W x 1.00 L.
 - 2400 Series: Sealed/Unsealed; 10 Ω to 50K Ω , $\pm 10\%$; 1 watt at 40°C, derated to 0 at 125°C; .31 H x .16 W x .75 L.
- FILM ELEMENT**
 - 8300 Series: Sealed/Unsealed; 10 Ω to 2 Meg., $\pm 10\%$ 100 Ω thru 500K, $\pm 20\%$ all other values; .75 watt at 25°C, derated to 0 at 105°C; .36 H x .28 W x 1.00 L.
 - 8400 Series: Sealed/Unsealed; 10 Ω to 2 Meg., $\pm 10\%$ 100 Ω thru 500K, $\pm 20\%$ all other values; .75 watt at 25°C, derated to 0 at 125°C; .31 H x .16 W x .75 L.



INDUSTRIAL GRADE T-POTS

- WIREWOUND ELEMENT**
 - 100, 200, 300 Series: 10 Ω to 100K Ω .
 - 100 Series: $\pm 5\%$; 0.8 watt at 70°C, derated to 0 at 135°C.
 - 200 Series: $\pm 10\%$; 0.5 watt at 70°C, derated to 0 at 105°C.
 - 300 Series: $\pm 15\%$; .25 watt at 70°C, derated to 0 at 85°C.
 Dimensions: .22 H x .31 W x 1.25 L (also 1.32 L for 100, 200).
 - 1100 Series: 10 Ω to 100K Ω , $\pm 10\%$; 1 watt at 70°C, derated to 0 at 175°C; .28 H x .31 W x 1.25 L.
 - 2100 Series: Industrial counterpart RT-11; 10 Ω to 100K Ω , $\pm 10\%$; 1 watt at 70°C, derated to 0 at 125°C; .28 H x .31 W x 1.25 L.
 - 2200 Series: Industrial counterpart RT-10; 10 Ω to 100K Ω , $\pm 10\%$; 1 watt at 70°C, derated to 0 at 125°C; .18 H x .32 W x 1.00 L.
- FILM ELEMENT**
 - 8100 Series: Industrial counterpart RJ-11; 10 Ω to 2 Meg., $\pm 10\%$ 100 Ω to 500K, $\pm 20\%$ other values; .75 watt at 70°C, derated to 0 at 125°C; .28 H x .31 W x 1.25 L.



Call 402-564-3131 for complete information or write for Catalog B



DALE ELECTRONICS, INC., 1300 28th Ave., Columbus, Nebraska 68601
 In Canada, Dale Electronics Canada, Ltd. • A subsidiary of The Lionel Corporation



Circle 901 on reader service card

COS/MOS makes other low-powered IC logic circuits look power-hungry

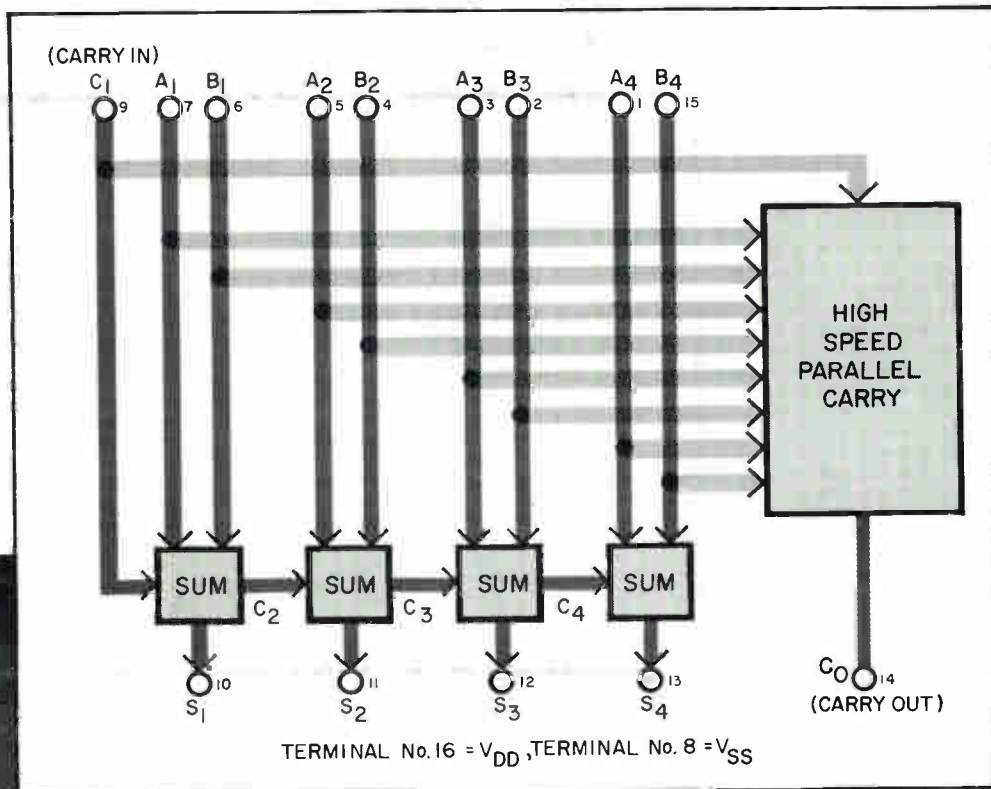

RCA's New CD4008D MSI 4-Bit Full Adder with Fast Parallel Carry Out, \$16.00 (1000+ units)

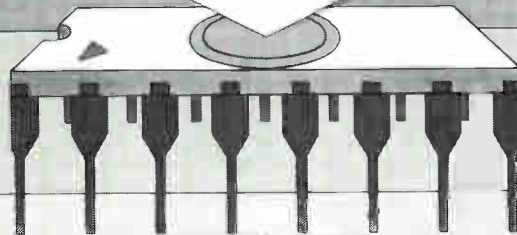

The CD4008D has a quiescent power dissipation rating of only 5 μ W (typ). It is a made-to-order 4-bit full adder for digital equipment where power dissipation, low package count or high noise immunity are primary design prerequisites.

You don't have to wait for summing before the carry signal is available with the CD4008D. The new adder includes a high speed parallel carry circuit that provides a fast carry output signal [$t_{pd} (C_i-C_o) = 50$ ns (typ) at $C_i = 15$ pF] to permit high speed operation in arithmetic sections that may require several CD4008D's. Add to that: operation from a single power supply

(6 to 15 V); all "sum lines" propagation delay—400 ns (typ); noise immunity—4.5 V (typ) at $V_{DD} = 10$ V; fanout capability up to 50; protected inputs and outputs and operation over the full military temperature range. Here you have a 4-bit full adder that will fulfill many circuit applications.

For further details, see your local RCA Representative or your local RCA Distributor. Or write to RCA Electronic Components, Commercial Engineering, Section N-12-1 CD20, Harrison, N. J. 07029. In Europe: RCA International Marketing S.A., 2-4 rue du Lièvre, 1227 Geneva, Switzerland.

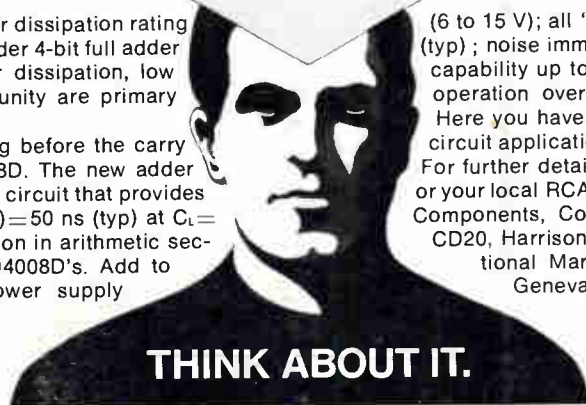

THINK ABOUT IT.

RCA Integrated Circuits

Circle 902 on reader service card