

Imaging with microwaves 110
Guide to semiconductor symbols 115
Generating IC artwork automatically 117

\$1.00 A McGraw-Hill Publication
November 24, 1969

Electronics®



**Special
report:
tomorrow's
communications**

142 KISS956 44866 02-71
R KISSLER
BASIC COMM ELEC
BOX 956
MOSES LAKE WA 98837

It's a GRrrrand Counter

Aye, that's what you'll think of our new counter. From its wee size to its big performance, the 1192 is new in every respect.

- It's only 8½ inches wide by 3½ inches high.
- It measures frequency (from dc to 32 MHz), period (single and multiple), time interval, frequency ratio, and, of course, it counts.
- Units of measurement and decimal point are automatically displayed.
- Input sensitivity is another surprise, a wee 10 mV is all you need (up to 25 MHz); and you can control trigger threshold and attenuation.
- An internal crystal oscillator gives more than enough stability for most work.

You can select an 1192 with 5, 6, or 7 digits, with or without BCD output, and for bench or rack use. And if 32 MHz is not enough frequency range for you, add our new 1157-B scaler (same size) to the 1192 and zoom up to 500 MHz. The counter/scaler combination, the 1192-Z, has a common cabinet. There's more, lots more, to tell about the 1192; we'll gladly send you a free data sheet upon request.

But the grandest part of all about the 1192 is the money you'll save when you buy one. Prices* range from \$575 for the 5-digit bench model without data output to \$845 for a 7-digit rack model with data output. You can add the scaler for another \$850. Imagine, a 500-MHz counter for as little as \$1425. Man, that's a real bargain. You can save quite a few more dollars by ordering two or more units and taking advantage of GR's quantity-discount plan. Discounts range from 3% for 2-4 units to 20% for 100 units.

For free literature (postpaid) or a demonstration at our expense, write or call General Radio Company, West Concord, Massachusetts 01781; telephone 617 369-4400. In Europe (except Scotland), write Postfach 124, CH 8034 Zurich 34, Switzerland. In Scotland, write General Radio Company (U.K.) Limited, Bourne End, Buckinghamshire, England, for special attention.

*Prices apply only in the U. S. A.

GENERAL RADIO

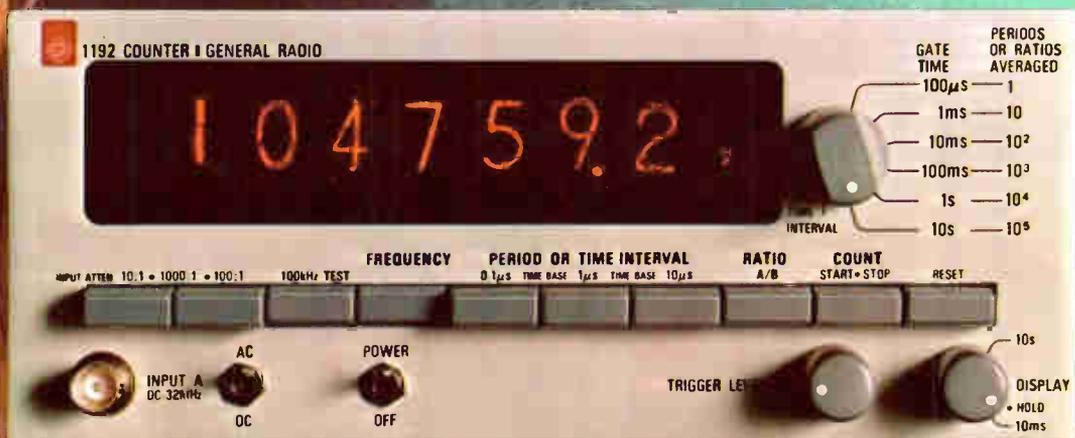

In the past 5 years, spectrum analyzers have come and gone.

This is the one that came and stayed.

When the HP 8551B/851B Spectrum Analyzer came on the scene, it turned a theory into technology. It opened up whole new areas for spectrum measurement — areas like circuit design, systems performance and semi-conductor evaluation. It's easy to use, accurately calibrated and lets you observe harmonics on broad spectra, modulations on narrow band, or compare low-level signals with high-level carriers.

It has a swept first LO and high frequency first IF that lets you view wide 2 GHz spectra, free from images, spurious and residual responses. A calibrated 60 dB display range gives you accurate comparison of signals vastly different in amplitude. Its RF attenuator permits level setting without overdriving the input. And its wideband mixer provides extremely flat response from 10.1 MHz to 12 GHz, with —100

to —85 dBm sensitivity.

These and other state-of-the-art advances put our spectrum analyzer in a class by itself. That's why it came and stayed.

The 8551B RF Section costs \$7950; the 851B Display Section, \$2475. The 852A variable persistence/storage display unit, \$3475. Your HP field engineer has all the details. Or write to Hewlett-Packard, Palo Alto, California 94304; Europe: 1217 Meyrin-Geneva, Switzerland.

HEWLETT  PACKARD

SIGNAL ANALYZERS

04911

Circle 1 on reader service card

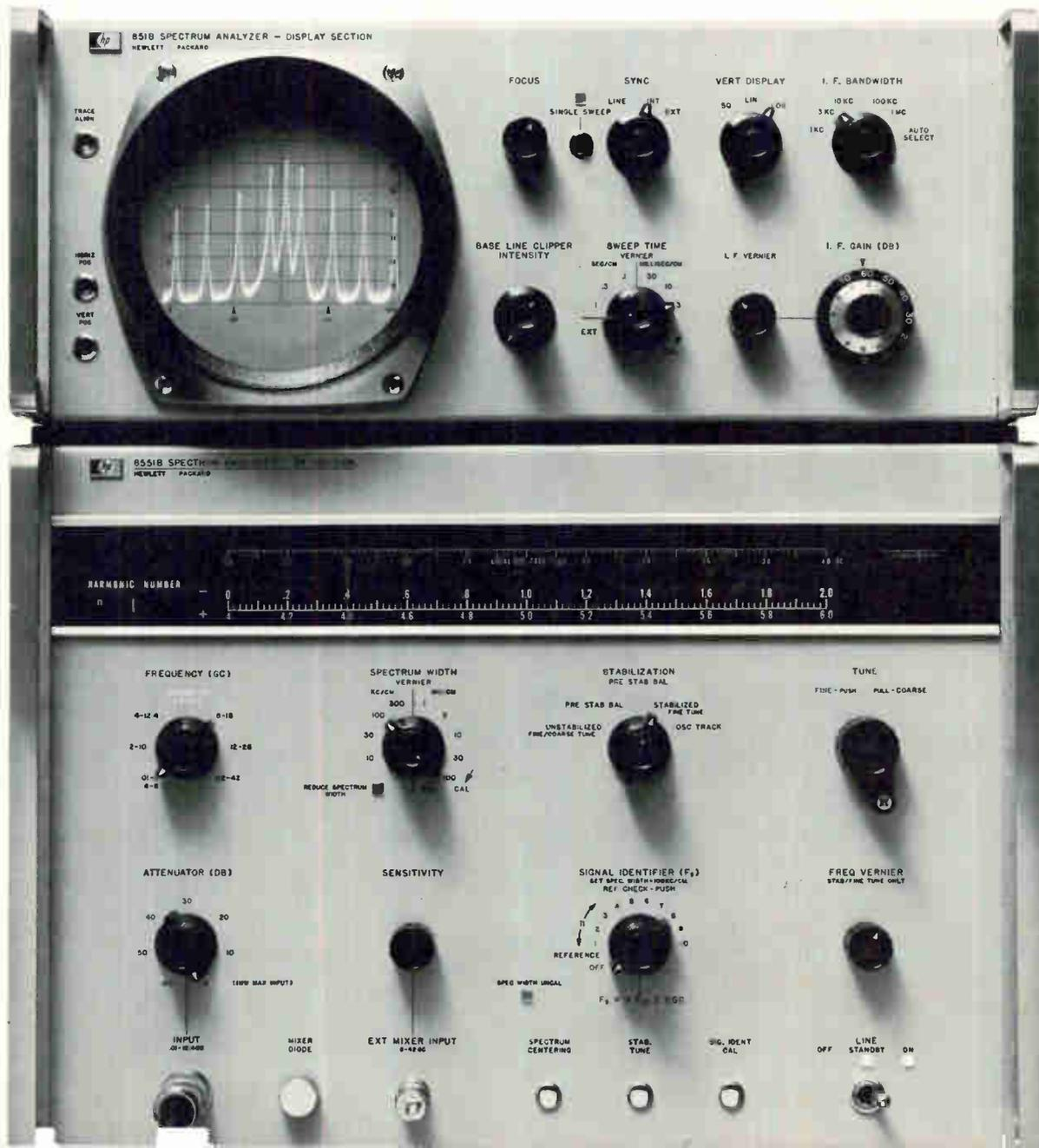

X 1 0 0

fA pA nA nV μ V

AT 1 Hz BANDWIDTH

+ 0 10 20 30 dB



Our very accurate transistor noise analyzer tells you the whole story

Among the advantages of Hewlett-Packard's new 4470A is its inherent ability to read out transistor noise voltage (e_n), noise current (i_n) and noise figure (NF), accurate to better than ± 1 dB. And when you tie these factors into one neat package, you end up with the most complete noise performance story ever told. The 4470A was designed for accuracy and convenience in the laboratory, for incoming device inspection and for QC testing applications on FET and bipolar transistors. Yet the analyzer is simple enough to be used by production personnel.

Measurements are made at 4 Hz bandwidths, for precise tests at 11 spot frequencies between 10 Hz and 1 MHz. Noise figure is read directly in dB, using conveniently applied external or internal source resistances.

Since transistor gain varies between devices, an automatic gain control normalizes overall system gain to a fixed value independent of the transistor being used. And the 4470A is completely flexible for biasing transistors under test. The price is just \$4450.

Find out more about the simplicity of measuring transistor noise from your HP field engineer, or write to Hewlett-Packard, Palo Alto, Calif. 94304; Europe: 1217 Meyrin-Geneva, Switzerland.

HEWLETT  PACKARD

News Features

Probing the News

- 123 **Companies:** Young EDP executives find their youth a liability on backers' balance sheets
- 129 **Commercial electronics:** Jumbo-jet age means airlines will take electronic route on the ground, too.

U.S. Reports

- 39 **Communications:** Color transmission from moon
- 40 **Advanced technology:** 12-inch lithium niobate crystals
- 41 **Memories:** ROM simulator in an attache case
- 42 **Manufacturing:** New laminating system for multilayer boards
- 44 **Lasers:** More reliable injection laser at room temperature
- 46 **Space electronics:** NASA looks at astronomy
- 48 **Consumer electronics:** Magnetic oxide for recording tape
- 48 **Communications:** Project Sanguine looks for a home
- 52 **Government:** Defense budget cuts restored

Electronics International

- 183 **West Germany:** Heat resistant solar cells are flexible
- 184 **Great Britain:** Surface waves filter tv video signal from sound; new approach to electronics education
- 185 **Japan:** Radar autoplotter built around commercial vtr; solid state array for numerical display

New Products

- 137 **In the spotlight**
- 137 **Data-generator market broadens**
- 143 **Components review**
- 143 **Amphenol fields SMA connector**
- 147 **Instruments review**
- 147 **Correlator samples 2,000 points**
- 151 **Subassemblies review**
- 151 **Time-delay relays miniaturized**
- 154 **Limiters minimize distortion**
- 157 **Data handling review**
- 157 **Woven-wire memories go to market**
- 160 **Memory designed for peripherals**
- 161 **Semiconductor review**
- 161 **100-amp fast-recovery diode**
- 163 **ICs tailored to consumer jobs**

Title R registered U.S. Patent Office; © copyright 1969 by McGraw-Hill Inc. All rights reserved, including the right to reproduce the contents of this publication in whole or in part.

Technical Articles

- Communications 73** **Special report: Tomorrow's communications**
Roger Kenneth Field, Electronics staff
- 76** **Six sages view the future of communications**
- 80** **The goals: a communications system that replaces person-to-person contact**
The tools: satellites, facsimiles, computers, telephones, microwaves . . .
- 93** **Black boxes that changed communications**
- 94** **No more pencils, no more books—write and read electronically**
- 97** **Showmanship in communications**
- 98** **Picture this: point-to-point paper from the next big-time black box**
- 102** **Misusing computers in communications**
- 104** **Three influential communicators**
- Circuit design 107** **Designer's casebook**
- Buffer amp provides stability over wide temperature range
 - No tuned circuits in IC
 - wide-range f-m discriminator
 - A-C source drives tape-stepping motor
- Advanced Technology 110** **Seeing in the dark is aim of r-f holography**
Systems for real-time viewing through rain, fog, or darkness need more work on detectors and time constants, but promise much
Harry E. Stockman, Mitre Corp.
- Standards 115** **An Electronics special guide to semiconductor device symbols**
- German IC's 117** **Generating IC artwork automatically saves time, prevents costly errors**
Computer program minimizes number of coordinates needed to describe geometry of IC, while most of the errors associated with manual methods are eliminated
Adolf K. Pascher and Konrad Koller, Siemens AG

Departments

- | | | | |
|----|--------------------------|-----|--------------------------|
| 4 | Readers Comment | 33 | Electronics Newsletter |
| 8 | Who's Who in this issue | 63 | Washington Newsletter |
| 14 | Who's Who in electronics | 164 | New Books |
| 22 | Meetings | 167 | Technical Abstracts |
| 31 | Editorial Comment | 173 | New Literature |
| | | 181 | International Newsletter |

Electronics

Editor-in-Chief: Donald Christiansen

Senior staff editors

Technical: Stephen E. Scrupski

News: Robert Henkel

International: Arthur Erikson

Art director: Gerald Ferguson

Senior associate editors: Joseph Mittleman, Harry R. Karp

Assistant managing editors: H. Thomas Maguire, Howard Wolff, William Bucci, Richard Gundlach, Frederick Corey

Special projects editor: Roger Kenneth Field; Senior staff writer: John Johnsrud

Department editors

Advanced technology: Laurence Altman

Communications: Leon M. Magill

Computers: Wallace B. Riley, George Weiss

Design theory: Joseph Mittleman

Industrial electronics: Harry R. Karp

Instrumentation: Owen Doyle

Military/Aerospace: Alfred Rosenblatt

New products: William P. O'Brien

Solid state: George Watson, Stephen Wm. Fields

Field bureaus

Boston: James Brinton, manager; Gail Farrell

Los Angeles: Lawrence Curran, manager; Ralph Selph

New York: Peter Schuyten

San Francisco: Stephen Wm. Fields

Washington: Ray Connolly, manager; Robert Westgate, Lois Vermillion

Frankfurt: John Gosch

London: Michael Payne

Paris: Arthur Erikson

Tokyo: Charles Cohen

Copy editors: Edward Flinn, William S. Weiss

Assistant art director: Charles Clatto

Production editors: Susan Hurlburt, Arthur C. Miller

Editorial research: Virginia Mundt

Editorial secretaries: Lorraine Longo, Claire Goodlin, Barbara Razulis, Vickie Green, Bernice Pawlak

McGraw-Hill News Service

Director: Arthur L. Moore; Atlanta: Fran Ridgway; Chicago: Robert E. Lee

Cleveland: Arthur Zimmerman; Dallas: Marvin Reid

Detroit: James Wargo; Houston: Barbara LaRoux

Los Angeles: Michael Murphy; San Francisco: Margaret Drossel, Tyler Marshall

Seattle: Ray Bloomberg; Washington: Charles Gardner, James Canan,

Herbert W. Cheshire, Seth Payne, Warren Burkett, William D. Hickman

McGraw-Hill World News Service

Bonn: Robert Dorang; Brussels: James Smith; Hong Kong: Kate Mattock

London: John Shinn; Mexico City: Gerald Parkinson; Milan: Jack Star

Moscow: Jack Winkler; Paris: Robert E. Farrell, Stewart Toy

Tokyo: Marvin Petal

Reprints: Virginia Mundt

Circulation: Isaaca Siegel

Reader communications manager: John Drummond

Publisher: Gordon Jones

Associate Publisher: Dan McMillan

Assistant to the publisher: Wallace C. Carmichael

Electronics: November 24, 1969, Vol. 42, No. 24

Published every other Monday by McGraw-Hill, Inc. Founder: James H. McGraw 1860-1948. Publication office 99 North Broadway, Albany, N. Y. 12202; second class postage paid at Albany, N. Y. and additional mailing offices.

Executive, editorial, circulation and advertising addresses: Electronics, McGraw-Hill Building, 330 W. 42nd Street, New York, N. Y. 10036. Telephone (212) 971-3333. Teletype TWX, N.Y., 710-581-4235. Cable address: MCGRAW-HILL N.Y.

Subscriptions solicited only from those professionally engaged in electronics technology. Subscription rates: qualified subscribers in the United States and possessions and Canada, \$8.00 one year, \$12.00 two years, \$16.00 three years; all other countries \$25.00 one year. Non-qualified subscribers in the U.S. and possessions and Canada, \$25.00 one year; all other countries \$50.00. Air freight service to Japan \$50.00 one year. Single copies: United States and possessions and Canada, \$1.00; all other countries, \$1.75.

Officers of McGraw-Hill Publications Company: Joseph Allen, President; John R. Emery, J. Elton Tuohio, Senior Vice Presidents; Gordon L. Jones, Jr., Group Vice President; Vice Presidents: John R. Callahan, Editorial; Paul F. Cowie, Circulation; John M. Holden, Marketing; David G. Jensen, Manufacturing; Jerome D. Luntz, Planning & Development; Robert F. Marshall, Administration; Robert M. Wilhelm, Finance.

Officers of the Corporation: Shelton Fisher, President and Chief Executive Officer; John L. McGraw, Chairman; Robert E. Slaughter, Executive Vice President; Daniel F. Crowley, Donald C. McGraw, Jr., Bayard E. Sawyer, Senior Vice Presidents; John J. Cooke, Vice President & Secretary; Gordon W. McKinley, Vice President & Treasurer.

Title © registered in U.S. Patent Office; © Copyright 1969 by McGraw-Hill, Inc. All rights reserved. The contents of this publication may not be reproduced either in whole or in part without the consent of copyright owner.

Subscribers: The publisher, upon written request to our New York office from any subscriber, agrees to refund that part of the subscription price applying to copies not yet mailed.

Please send change of address notices or complaints to Fulfillment Manager; subscription orders to Circulation Manager, Electronics at address below. Change of address notices should provide old as well as new address, including postal zip code number. If possible, attach address label from recent issue. Allow one month for change to become effective.

Postmaster: Please send form 3579 to Fulfillment Manager, Electronics, P.O. Box 430, Hightstown, New Jersey 08520

Readers Comment

Question of speed

To the Editor:

Your article on SelectaVision [Oct. 13, p. 43] explains that magnetic recordings can't be copied at high speed. You might be interested to know that IBM's Advanced Systems Development division Laboratory in Los Gatos, Calif., has developed a method that makes it possible to copy audio and video magnetic records at high speed. In a paper presented to the Society of Motion Picture and Television Engineers in April, I pointed out that a one-hour video tape program can be copied in less than 3 minutes.

Racime van den Berg
International Business Machines
Corp.

Los Gatos, Calif.

■ There is every reason to believe that the manufacturer of clear vinyl SelectaVision tapes, which is an embossing technique that lends it-

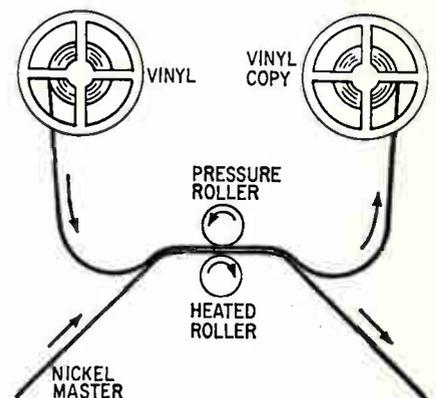

self to methods employed by the printing industry, could take place at speeds thousands of times faster than playback. In addition, wide sheets of vinyl could be embossed, then sliced into scores of strips and put on rolls. RCA is now embossing its experimental SelectaVision tapes at speeds only slightly faster than playback (7½ ips).

Growth factor

To the Editor:

Your article on National Semiconductor [Oct. 13, p. 129], correctly

...looking for a better ceramic capacitor?

Investigate **MONOLYTHIC[®]** **LAYER-BUILT** **CAPACITORS**

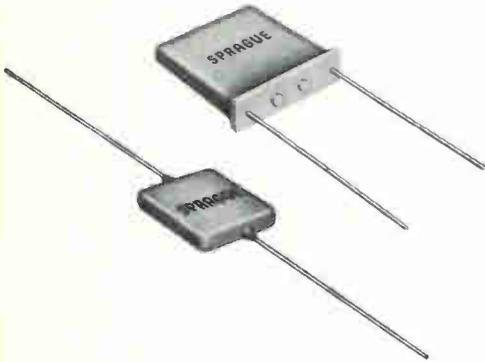

Made with alternate layers of sprayed ceramic dielectric material and screened metallic electrodes, fired into a solid homogeneous block. Coated with tough phenolic resin. Available in four formulations—082(N030), 075(N750), 067(W5R), 023(Z5U). Your choice of axial-lead or improved radial-lead construction. Radial-lead capacitors have new bossed terminal base which prevents resin run-down on leads, maintains uniform lead spacing, eliminates dirt and moisture entrapment around leads, permits degreasing fluid to flow freely between capacitor and board.

INFORMATION RETRIEVAL NO. 517

45C-9105

Tiny in size...Giants in volume efficiency!
...want high volume efficiency in tubular 'lytics?

Use **SPRAGUE Type 39D** **POWERLYTIC[®]** **CAPACITORS**



Provide maximum capacitance in smaller cases with axial leads. No internal riveted or pressure connections. Welds at critical anode and cathode terminals. Molded end covers. Life expectancy of 10 years or more in normal service. Very low effective series resistance and leakage current.

INFORMATION RETRIEVAL NO. 518

For complete technical data on Monolythic[®] Capacitors, write for engineering bulletins. For information on Type 39D Capacitors, request Engineering Bulletin 3415. Write to: Technical Literature Service, Sprague Electric Co., 35 Marshall St., North Adams, Massachusetts 01247.



Sprague and *®* are registered trademarks of the Sprague Electric Co.

THE BROAD-LINE PRODUCER OF ELECTRONIC PARTS

New from TRW

300 VOLTS

30 AMPS

$f_t > 100$ MHz



...a new concept in power supply design

The high switching speed and high operating voltage of TRW's new PT6905 transistor provides a major forward step in power supply performance.

You can do away with the bulky 60 Hz transformer and work directly from rectified ac power lines. Switching above 20 kHz will assure your circuit is free from audio noise.

Consider these outstanding

PT6905 characteristics:

- V_{CE0} 300 V
- Sat. switching time < 900 ns.
- Triple diffused double oxide construction for superior second breakdown characteristics.
- Hard-solder construction and welded interconnections.

Available from stock in TO-63 or TO-3 non-isolated and TO-61 isolated collector packages.

For details and application as-

sistance contact TRW Semiconductors Inc., 14520 Aviation Blvd., Lawndale, Calif. 90260. Phone: (213) 679-4561, TWX: 910-325-6206, TRW Semiconductors Inc., is a subsidiary of TRW Inc.

TRW[®]

Readers Comment

highlights the impressive growth record of the company occasioned by changes in top management and market direction. While it is true that, in 1967, the company showed large losses, both operating and extraordinary, the principal cause was the new management under Charles Sporck. The company had been profitable in every year since 1961, the serious effects of the Sperry suit notwithstanding. And although the company's performance was sluggish at times, the principal cause was inadequate financing.

A.W. Oppenheimer
Bunting SteriSystems Inc.
Bridgeport, Conn.

Reader Oppenheimer was a member of management of National Semiconductor from 1961 to 1967, first as assistant to the president and later as controller.

A packager only

To the Editor:

Regarding your article on Circa Tran's semiconductor packaging service [Sept. 1, p. 141], I would like to point out that at this time, the company is strictly a packager of semiconductors. We do not make the cups used to mount the chips. The cup mounts used by us are purchased from other companies.

Roger L. Bitner

Vice president,
Circa Tran Inc.
Wheaton, Ill.

For want of a word

To the Editor:

Your article, "Semiconductor whodunit: Who's to blame for failure" [Aug. 18, p. 98], states: "We still find IC-producing companies that don't control the ratio of oxide thickness to metalization-layer

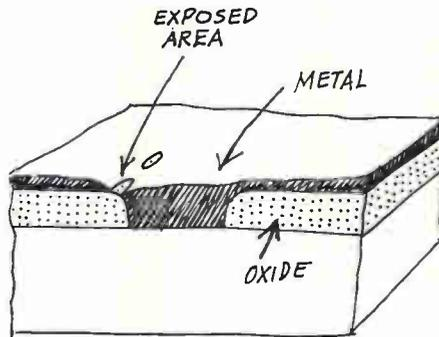

thickness, which could result in metal at oxide steps and at contact steps." I don't understand how lack of control could cause metal at oxide steps and at contact cuts.

Samuel K. Baker

Magnavox Co.
Urbana, Ill.

Unfortunately, a typographical error resulted in a word being left out. The sentence should read "... which could result in metal opens at oxide steps ..."

Readers' letters should be addressed:
Electronics
To the Editor
330 West 42nd Street, New York,
N.Y. 10036

A SYSTEM

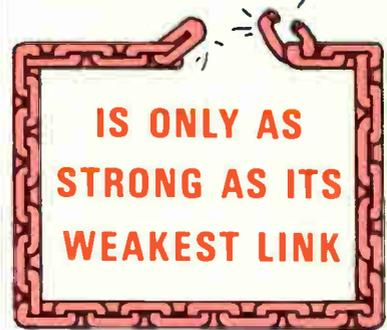

Electronics systems depend on the smooth, integrated functioning of every component. A system with weak links isn't really a system.

ROMOHAWK leaves the weak links out

Romohawk is an electronics systems engineering company. We don't make weak links. With R & D, design, and production facilities in-house, we make systems and subsystems that work. And our technical services can keep any system working.

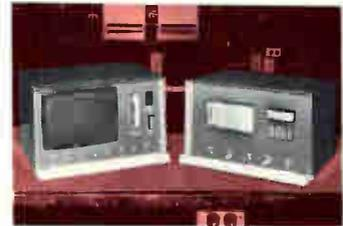

ECG and Central Station Monitors
engineered by Romohawk

These units make up a hospital intensive care system that keeps constant check on a patient's condition. They feature multiple trace CRT displays, very high gain, low noise differential amplifiers, and logic circuits for alarm processing. Romohawk was able to design, test, and produce quantities of these units in just 90 days.

ROMOHAWK, WHERE ENGINEERING IS MORE THAN INTERCONNECT DIAGRAMS AND PURCHASE ORDERS.

ROMOHAWK
ELECTRONICS CORP.
811 Court St., Utica, N.Y. 13502
315-797-5445

SUBSCRIPTION SERVICE

Please include an Electronics Magazine address label to insure prompt service whenever you write us about your subscription.

Mail to: Fulfillment Manager
Electronics
P.O. Box 430
Hightstown, N.J. 08520

To subscribe mail this form with your payment and check new subscription renew my present subscription

Subscription rates: qualified subscribers in the U.S.: 1 year \$8; two years, \$12; three years, \$16. Non-qualified: 1 year \$25. Subscription rates for foreign countries available on request.

CHANGE OF ADDRESS

ATTACH LABEL HERE

If you are moving, please let us know five weeks before changing your address. Place magazine address label here, print your new address below.

name

address

city

state

zip code

Who's Who in this issue



Field

Writing about communications is, in itself, a challenging assignment in communications. To examine the important changes that are taking place in the communications industry, special projects editor Roger Kenneth Field spent three months traveling across the nation doing research and interviewing the key people in communications. The result of his labors is the eight-part, 32-page special section starting on page 73. Field, 29, joined *Electronics* last July. A graduate of Columbia College with a B.A. in physics, Field joined Bulova Watch Co.'s Electronics division as production-control coordinator; he ended up designing and experimenting with crystal filters. For the past five years he has been writing science articles, primarily about the electronics industry. In addition, Field recently completed an academic year at Columbia University as an Advanced Fellow in the Graduate School of Journalism. But writing isn't his only talent. He is also an accomplished jazz musician.

Stockman

Swedish-bred Harry E. Stockman is a radio scientist who combines an inventor's flair with a polished education. His faith in what the r-f spectrum ultimately can yield carried him into r-f holography research that may create a new world in navigation and no-light-level television. A graduate of the Royal Institute of Technology in Stockholm, he received his doctorate from Harvard. His career spans work in industry, government, and education. A former professor now with the Mitre Corp., Stockman is the author of the article that starts on page 110.



Koller

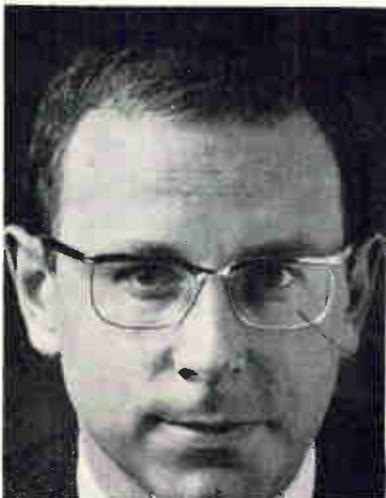

Efficiency is the keynote of German industry, and the integrated circuit industry is no exception. The artwork that's used to make diffusion and metalization masks has garnered special attention at Siemens AG, as Konrad Koller and Adolf K. Pascher relate in the article starting on page 117. Koller has been with Siemens since 1967, developing post-processors for numerically controlled machine tools, and later applying similar techniques to computer-aided fabrication of master artwork for IC's. Pascher joined the company in 1964, researching the piezoelectric effect in p-n junctions. In 1966 he turned to IC design, processing, and mask generation.

Pascher



NEW FLAT PAK DESIGN ONLY 0.1" THICK

Accuracy 1% absolute or 2 MV
whichever is greater

Zero Hysteresis

Radiation Hardened Magnetic Flat Pak Modulators, Analog Multipliers, Demodulators mount directly on IC Cards

ACTUAL SIZES

- Hybrid assemblies mount directly on IC cards.
- Space saver design . . . typical dimensions 0.1" thick x 0.5" x 0.75".
- Rugged design, extreme reliability. MTBF design goal 0.25 per million hours.
- Extremely low drift over -55° to $+125^{\circ}\text{C}$ range.
- Not affected by high intensity nuclear radiation.
- Capable of operating on carrier frequencies as high as five Mhz.
- One or more isolated or floating input signals may be used for modulating, multiplying, dividing, squaring or extracting a root.
- No external nulling or offset adjustments.
- No additional components or compensation required.
- No external operational amplifiers required.
- Standard $\pm 15\text{ V}$ DC power supplier unless otherwise specified.

As an Analog Multiplier of a Bipolar DC signal times an AC signal, the output **product accuracy** is 1% of point, or 2 MV, whichever is greater over a dynamic range of 10,000:1 in each quadrant.

Over the temperature range of -55°C to $+125^{\circ}\text{C}$, the following parameters hold:

- 1) Zero Point Drift: ... Less than 2 MV of in phase component
- 2) Gain Slope Stability: Less than 2% change
- 3) Dynamic range and output wave quality independent of temperature variations

Typical input/output parameters:

X Signal: 0 to $\pm 5\text{V}$
 Y Signal: 0 to $\pm 5\text{V}$
 Output: 0 to 5V RMS across 5K or greater load impedance

Magnetic DC x DC Multiplier

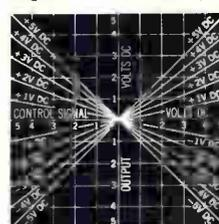

Squaring

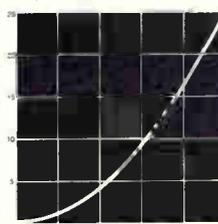

Square Root

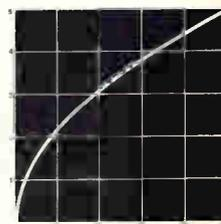

Division



Amplitude Modulation

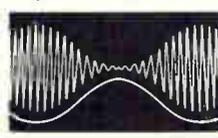

Balanced Modulator



MAGNETIC MULTIPLIERS

Dynamic Product Range

80 db

Magnetic Modulators

Dynamic Range:

60 db



There is No Substitute for Reliability

GENERAL MAGNETICS, INC.

135 Bloomfield Avenue,
Bloomfield, New Jersey 07003

Circle 9 on reader service card



KBSR1 keyboard switch for logic encoding.

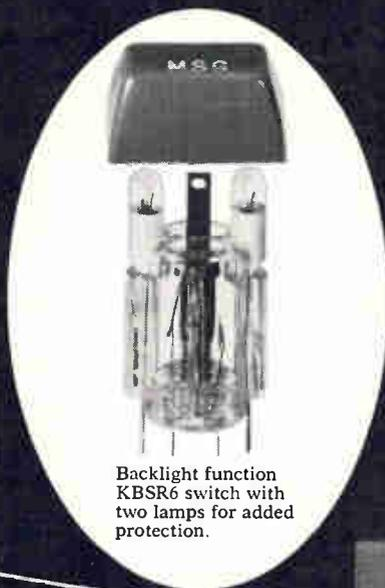

Backlight function KBSR6 switch with two lamps for added protection.



Two-level KBSR2 with double detent action for dual-circuit applications.

RAYTHEON KEYBOARD SWITCHES:

high-reliability, low-cost reed types— now available from stock.

Designed for switching at logic levels, these handsome Raytheon keyboard reed switches have a featherlight touch that is precise and reliable. Just a 2½-oz. touch activates the switch. Bounce is less than 250 microseconds. Operation is smooth and quiet in both directions.

Wide range of special electrical configurations are available on special order to meet keyboard needs for data entry devices, calculators, data retrieval systems, and many other applications. Unique backlighted switches and function lights, with two 25,000-hour lamps and matching cap designs, are also available.

Two configurations of key caps—regular square caps, white with black characters, and a truncated design with 2-color molded characters—are available. Standard colors are grey or black with white characters, and white with black characters. All alphanumeric characters are available from stock. Caps with custom-engraving are available on special order.

Long life expectancy*. In terms of on-off operations, mean operation to failure is 800,000,000 operations. At a usage rate of one per minute, the indicated MTBF is 19,000,000 hours. At worst case usage rate of one per second, MTBF is 300,000 hours.

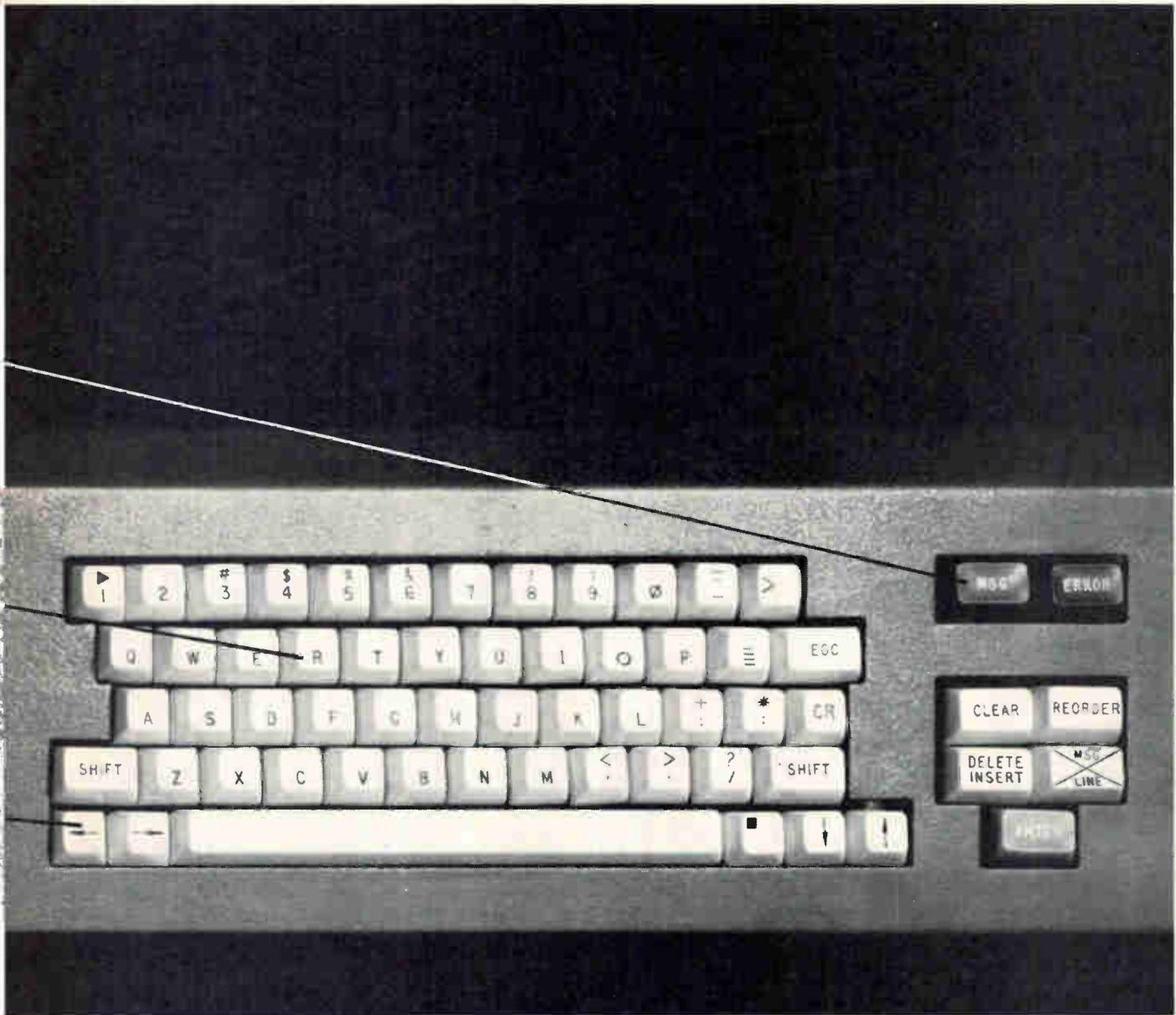

Highest quality materials used throughout: stain-resistant caps, polycarbonate see-through cases; stainless steel springs and beryllium copper contact supports. Reed contact material is rhodium-plated for low contact resistance and long life.

Unique low-cost mounting. Switches are designed to be plugged into printed circuit boards 1/16" to 1/8" thick. Contact pins snap in and firmly lock in place for flow solder, dip solder, or hand soldering. No wiring or mounting hard-

ware is required. This unique, low-cost mounting significantly reduces installation time and costs.

All switches are available with flat bases or slanted bases with 10° slope.

Send reader service card for complete information. For free sample, write on your letterhead—describing your application—to *Raytheon Company, Industrial Components Operation, 465 Centre Street, Quincy, Massachusetts 02169.* *Established in government-qualified testing laboratory.

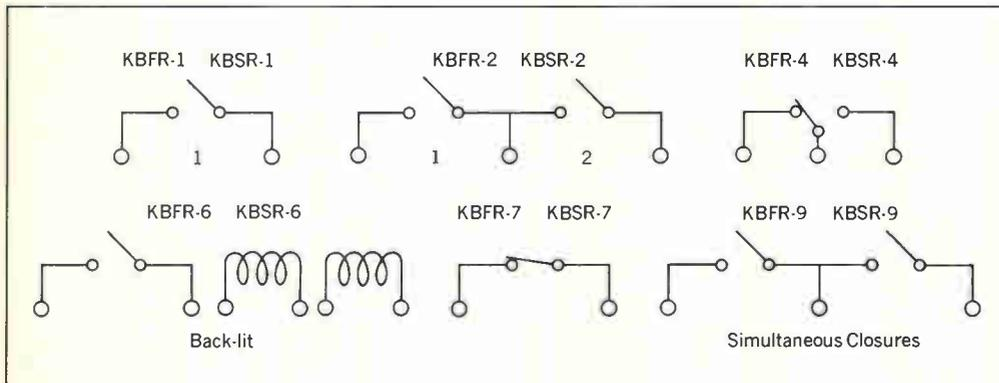

**We've been trying and trying
105 TTL devices, including 41 MSI,**

o think of another company that makes

but we've drawn a blank.  Signetics

SIGNETICS CORPORATION / 811 E. ARQUES AVF., SUNNYVALE, CALIF. 94086 / A SUBSIDIARY OF CORNING GLASS WORKS

NANOSECOND TIME INTERVAL METER

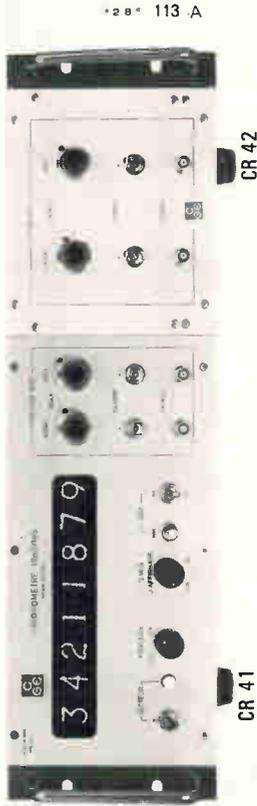

MAJOR CHARACTERISTICS

BASIC UNIT, model CR 41

- RANGE: 10 nsec to 99 msec.
- 10 nanoseconds RESOLUTION
- START and STOP: independent channels.

PLUG IN, model CR 42

- RANGE: 1 nsec to 99 msec
- 1 nanosecond RESOLUTION
- START and STOP: independent channels.

- 8 DIGIT DISPLAY

- BCD output: 8-4,-2,-1 code, positive true

- CRYSTAL aging rate: 1 part in 10 8/day.

- Provision for use of external time base.

DIVISION DES ETUDES ATOMIQUES.

LABORATOIRES de MARCOUSSIS - Route de NOZAY - 91-MARCOUSSIS - FRANCE



**LABORATOIRES
DE MARCOUSSIS**

Centre de Recherches de la CGE
Route de NOZAY - 91-MARCOUSSIS
FRANCE

tél : 920.82.50 - télex : 26.877 LAB-MARCO

Who's Who in electronics

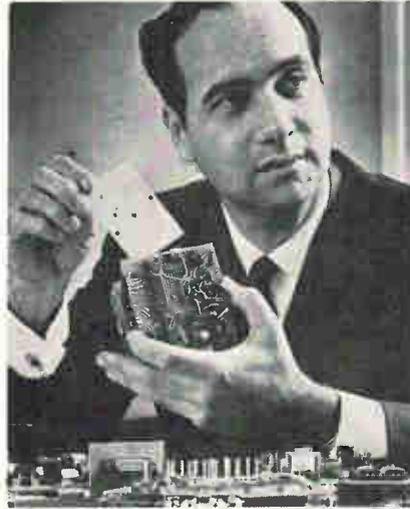

Idak's Maiman

Despite the frustrations inherent in this country's telephone system, Theodore Maiman, 42, says it's a complex, reliable communications network upon which he's planning the growth of his new company, the Idak Corp. of Beverly Hills, Calif. Maiman is president of Idak, the surviving entity after Maiman Associates bought Computer Security Systems.

Maiman has come a long way since inventing the ruby laser at Hughes Aircraft Co.'s research laboratories in 1960. He founded and for five years was president of the Korad Corp., a laser manufacturer, until the Union Carbide Corp. bought Korad. Maiman resigned and established Maiman Associates, with the aim of bringing together investors and small companies or engineers with a desire to form a company.

Struggling. That eventually led him to Computer Security Systems, which had proprietary products that interfaced with telephone lines. "The company had minimal sales when we acquired it," Maiman notes. "It wasn't a business." But it did have "reasonably unique" products for the burgeoning data-communications market. "This gives us a good handle to get into the market without much competition," he explains.

Hence the Idak Corp., whose products include automatic telephone dialers for dial or pushbutton

phones that can accommodate up to 14 digits, card dialers, a line of couplers to facilitate a variety of foreign attachments for telephone sets, and modems to reconstitute computer data for transmission over telephone lines.

Maiman seems most excited about prospects for the automatic dialers and expects them to take off first. Idak will provide a variety of them. One version would replace the leased lines now linking, say, airport terminals and hotels. Instead of the subscriber's paying for the leased line, he would pay only for installation of the telephone set and the cost of each call, with the hotel number being automatically dialed over a conventional phone line when the user lifts the receiver. Another version, Idak's so-called Communicator, an emergency automatic dialer coupled to sensors in a business establishment, triggers a phone call to the police or fire department.

Why spend \$50 million and several years to develop a new system to solve a problem, when you can "take today's products and today's technology without a tremendous R&D effort, and solve 70% or 80% of the problem immediately?" That's the philosophy of Motorola's new Applied Systems Unit, says director Carl Nierzwicki.

Nierzwicki's job at the Washington-based unit will be integrating off-the-shelf items from each of Motorola's six divisions to identify new product areas, and finding opportunities to create new products from a total systems approach.

ASU will be concerned initially with environmental sciences and security systems such as keeping intruders out of an airbase. Nierzwicki also is looking at transportation, educational, and institutional systems, such as those in hospitals and schools. A "conservative" estimate of ASU's market, says Nierzwicki, is \$2 million in 1970. "Beyond that it's pretty hard to predict. I could double, triple, or even quadruple." Competition? He

The proven way to capture data output: call on "The Perf."

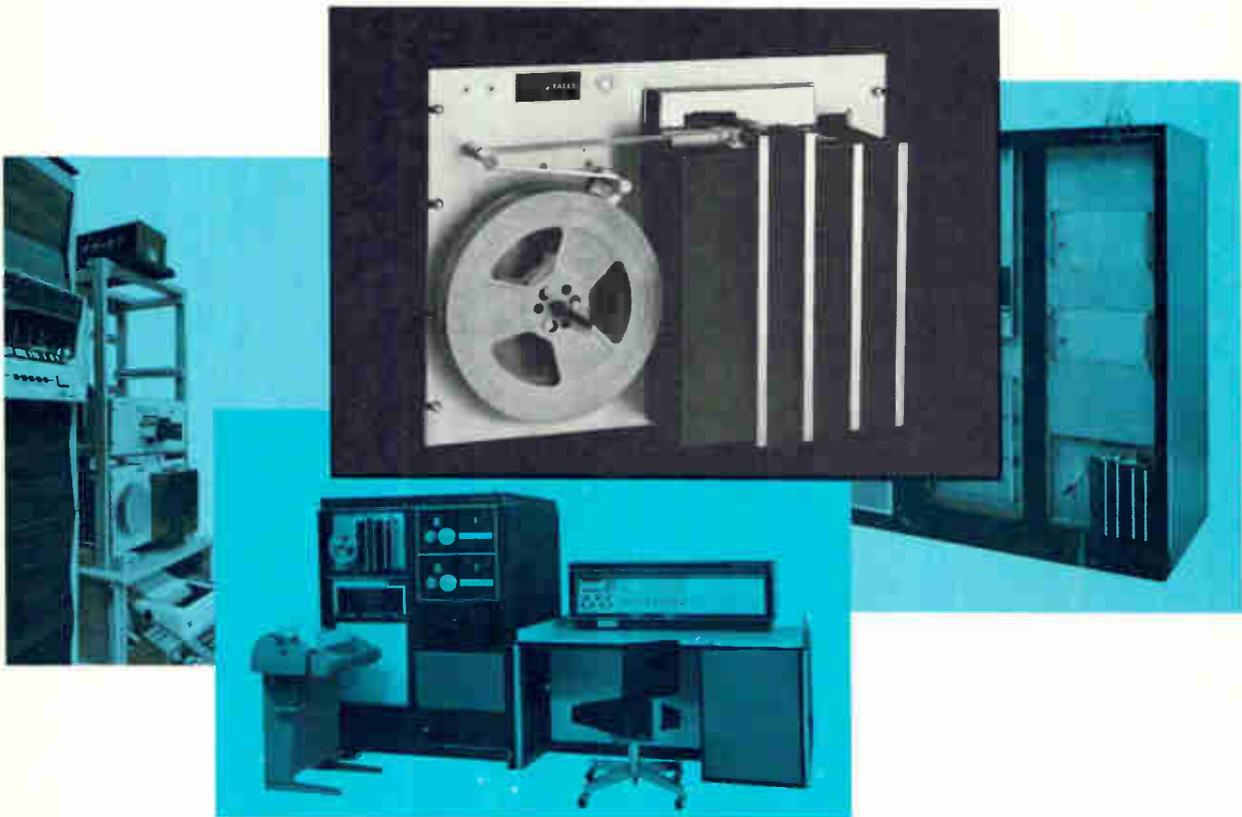

Our customers aren't much on model numbers (are any of us?). They call it "the Tally," or just as frequently, "The Perf."

Technically, it's the Tally P-120 perforator which features asynchronous operation up to a speed of 120 char./sec. You'll find it in use almost everywhere. For instance here, we're showing "The Perf" in use with two of the most popular scientific computers and one of the best known solid state component checkout systems. You'll also find the P-120 being used by a lot of other computer and data system equipment makers.

Why? Specifically because the Tally "performance quotient" . . . a dividend of features, specifications, price, and above all reliability . . . is the best in the industry. We package the P-120 in a rack size panel with integral tape handling including both supply and *take-up*. We build it from the most reliable components available based on knowledge acquired from twenty years experience. And we build it with built-in error checking capability.

If service is needed, our growing force of field engineers is as near as your telephone. Prompt, experienced service is yours on a nationwide basis.

For more information on the versatile P-120, as well as other Tally perforators, please address Tally Corporation, 8301 South 180th St., Kent, Wash. 98031. Phone (206) 251-5500. In the U.K. and Europe, address 6a George St., Croyden, Surrey, England.

TALLY

fast

simple

sure



TEXSCAN'S SA SERIES
**in-line rocker
 switch attenuators**

in delivery: Any of the five standard models is available from stock; customer-design "specials" are available upon request.

in use: The convenience and speed of finger-tip switching combines with immediate, positive electronic response.

As either bench top or on special order, panel mounted units, these in-line rocker switch attenuators find many valuable applications on production lines, or elsewhere where numerous, very rapid changes must be made. Models in the line can provide as much as 102 db attenuation, and include units of both 50 and 75 ohms impedance. Write for Texscan Catalog 68, free on request, which provides full technical details.

Price: \$85:00

KEY SPECIFICATIONS

Frequency Range: DC to 1000 MHz

Accuracy: ± 0.3 db @ 500 MHz, typically ± 0.5 @ 1000 MHz

Maximum Power: 0.5 watts average, 1000 watts peak



Texscan CORPORATION

2446 NORTH SHADELAND AVENUE
 INDIANAPOLIS, INDIANA 46219

Who's Who in electronics



Motorola's Nierzwicki

is "unaware of other companies having taken this approach," in that those firms with applied systems groups have merely set up another division. "To the extent that we're successful," he says, other companies will follow Motorola.

Nierzwicki, at 43, is well acquainted with Motorola's products and overall capabilities. He began with the company 21 years ago as a production engineer for the Communications division. Since then he has worked in the Consumer Products and Automotive divisions, and for the past three years was director of marketing for the Government Electronics division, responsible for advertising, public relations, field sales, and long-range market planning. Of his travels throughout Motorola's divisions, Nierzwicki says, "It gave me a chance to find out where the bodies are buried."

"Coordinating total design is like putting together a puzzle," says Charles F. Middleton Jr., "and there are usually too many pieces—or too few." His new company, Concept Formulation and Management Inc. of Sudbury, Mass., is attempting to solve the puzzle by offering electronic hardware design, package design, technical writing, and even a tailor-made corporate

Economy Transistors



The money tree

Shake it and watch your transistor costs fall 50% and more! Below equivalent metal-can devices.

TI's exclusive pin-circle, as well as in-line, plastic packages now let you replace all equivalent TO-18 metal-can transistors with Silect* bipolars and FETs.

Why not switch and save on small signal and low noise amplifiers, oscillators, mixers and converters. Reliability?

It's there. TI put Silect samples through 33-million hours of 17 tough MIL-STD tests. They proved just as reliable as their metal-can counterparts when tested under normal use conditions.

Now TI shakes the tree.



Preferred Silect Transistors							
NPN BIPOLAR				PNP BIPOLAR		FET	
TIS 63	TIS 97	2N3705	2N4994	TIS 37	2N4059	TIS 58	2N5245
TIS 73	TIS 98	2N3706	2N4995	TIS 38	2N4060	TIS 59	2N5246
TIS 84	TIS 99	2N3707	2N4996	TIS 93	2N4061	TIS 73	2N5247
TIS 86	TIS 100	2N3708	2N4997	TIS 93M	2N4062	TIS 74	2N5248
TIS 87	TIS 101	2N3709	2N5449	2N3702	2N5447	TIS 75	
TIS 92	TIS 108	2N3710	2N5450	2N3703	2N5448	2N3819	
TIS 92M	2N3704	2N3711	2N5451	2N4058		2N3820	

To save you time and money in specifying devices, TI has selected 52 Silect transistors as part of its preferred semiconductor line. Months of computer demand analysis show that the 52 meet 90% of cost-critical circuit requirements.

All 52 are popular, proven and readily available from TI distribu-

tor and factory stocks.

Write for TI's brand new 1970 *Preferred Semiconductors and Components* catalog: Texas Instruments Incorporated, P.O. Box 5012, MS 308, Dallas, Texas 75222. Or just circle reader service card number 169.



*Trademark of Texas Instruments Incorporated

TEXAS INSTRUMENTS
INCORPORATED

Just as yours is a special kind of electronics, ours is a special kind of electron.

Belonging to a special class of compounds—the *rare earths*. Or (more properly) the lanthanides. Those elements which number from 57 (lanthanum) to 71 (lutetium) in the periodic table. Plus yttrium and thorium.

So what? So *this*. If you're not fully aware that the rare earths are put together in a very special way, which gives them some totally unique properties, learn a little.

In this instance, a little learning is *not* a dangerous thing. We see no reason for you to become a rare-earthologist.

But you should know at least this much: The configuration of the electrons in the rare earths gives them some unusual para- and ferromagnetic properties. Properties which have already been put to use in electronic-circuit components.

Electronics (Yours)

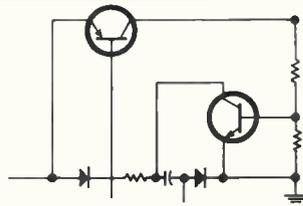

Electrons (Ours)

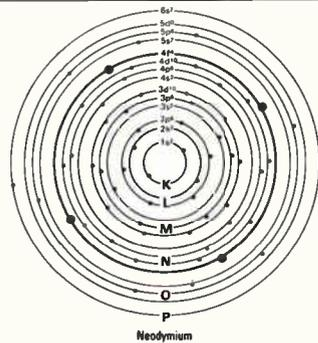

There's also something to be said for the rare-earth compounds as superconductors, as well as semiconductors. As thermoelectrics. As capacitors. As thermoluminescent devices. As CRT and lighting phosphors.

But, frankly, the surface has only been scratched. What would happen if someone with an unheard-of electronic application turned to the rare earths as the answer? Then the sparks would fly.

You may well protest that even if you *wanted* to do something about all of this, you couldn't. Like most of us, you're a specialist. In electronics. To make much headway through the body of knowledge surrounding rare earths, you'd need a chemist.

Aha! Got you *there*. A chemist is exactly what you *do* need. One of your associates. Look him up. Get together.

If your friend the chemist needs more supportive evidence on what the rare earths can do, have him call or write us.

And maybe—just maybe—we can give you hints on how to make electrons do something wild and wonderful. Electronically.

Who's Who in electronics

identity—all in one big package.

"My own frustrations were one reason I started the company," says Middleton, at 36 the former manager of the data processors section of Raytheon's Space and Information System division. He had found that changes in hardware design often had to be made after equipment was developed because it couldn't be packaged easily or attractively.

To this end, Middleton is organizing "a group of engineering-oriented designers who can move into both production and marketing and



CFM's Middleton

do the whole design package." Middleton does the electronics design, while Peter A. Thomas, a practicing architect, "is our artistic guiding light in package design," according to Middleton. Engineer Leon G. Wilde works as a consultant in the concept stage.

The line forms. Among CFM's first customers are the Imlac Corp. a maker of cathode-ray tube time sharing terminals, and Macrosonics International. For Imlac, CFM is designing a data interface between an Imlac terminal and a Digital Equipment Corp. PDP-8. Macrosonics brought in CFM to improve a line of ultrasonic equipment which was not attractively designed. "We revamped the packages," says Middleton, "and this meant some hardware changes too."

In the future Middleton wants to design bigger equipment such as computers, specialized processors, and memories.

RARE EARTH DIVISION AMERICAN POTASH & CHEMICAL CORPORATION

A SUBSIDIARY OF KERR-MCGEE CORPORATION

258 Ann Street, West Chicago, Illinois 60185; Telephone: (312) 231-0760

From Monsanto:
130,000,000
discrete frequencies
with almost perfect purity.

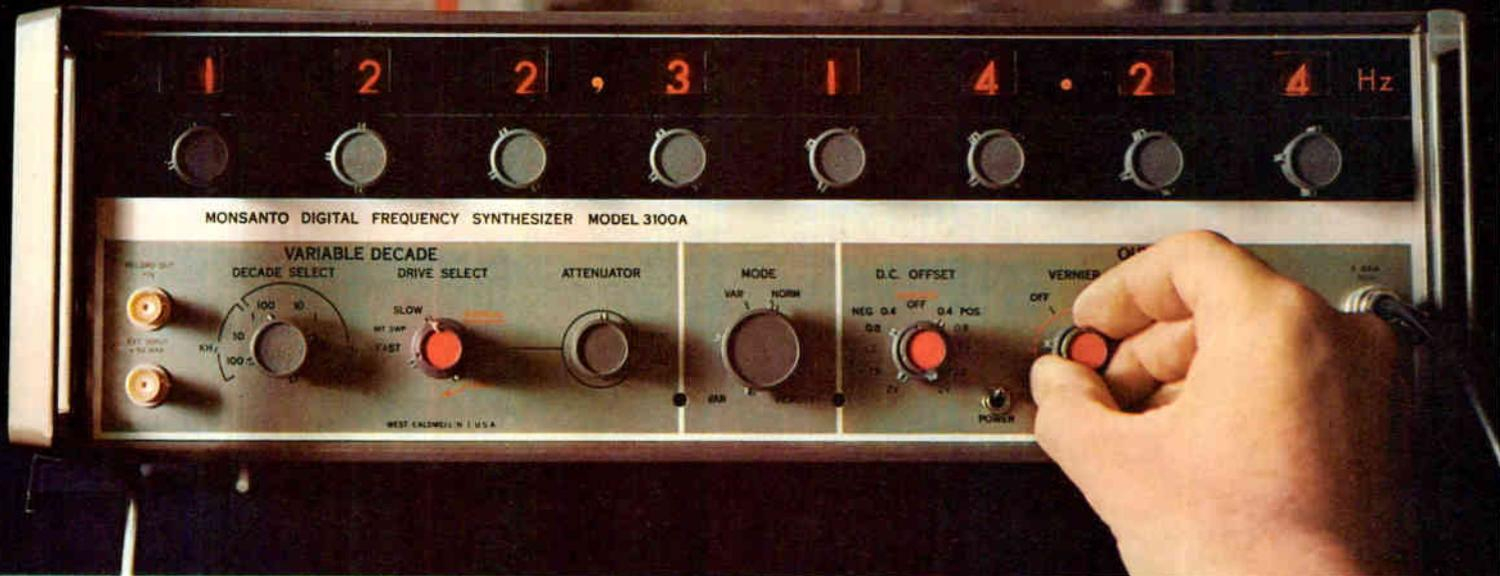

Programmable, of course

DC to 1.3 MHz

**Resetable with 0.01 Hz resolution
over total range**

**Less than 20 μ sec switching time from
any frequency to any frequency**

Calibrated output level

AM or FM—or both simultaneously

Here is the sinewave source of the future ... all the accuracy, stability and resettable that only a frequency synthesizer can give you, plus such signal generator advantages as accurately calibrated output level, AM or FM modulation capability (or both), and built-in sweeps with

provision for sweeping externally.

Now add digital programmability of frequency, analog programmability of output level and the benefits of computer-aided IC design, and you see a classic example of Monsanto's "4th generation" instrumentation.

The Model 3100A-016 Programmable Frequency Synthesizer is \$4950. Our non-programmable version, Model 3100A, is \$4250. An 8-page Technical Bulletin fills out the story. For your copy write: Monsanto Company, Electronic Instruments, West Caldwell, N. J. 07006.

Monsanto

Circle 19 on reader service card

Now, with over
800 items...
our "M" series
means the most

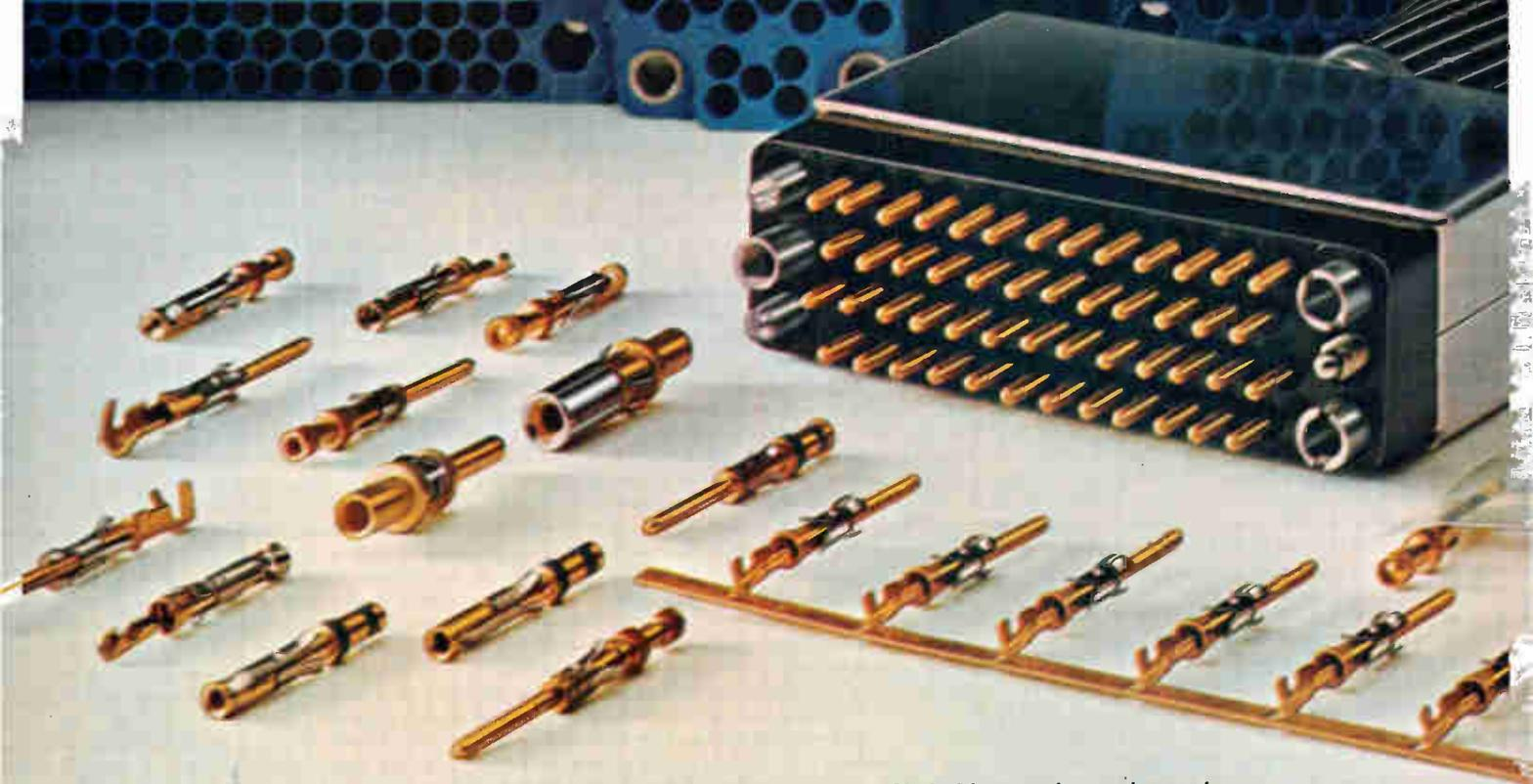

Circle 21 on reader service card



The most choices. The most combinations.

The most reliable connectors to meet your toughest rack and panel specifications. You can choose from the industry's biggest selection of connector types and sizes, pin and socket combinations and related hardware. You also get the most in savings. Because our connectors and our automatic tooling right in your own plant give you the lowest total installed cost.

Our AMP-O-MATIC★ Stripper-Crimper Machine, for example, strips each cabled wire and crimps on pins or sockets — up to 1000 an hour. And our AMPOMATOR★ Automatic lead-making machine feeds, strips and crimps at speeds up to 12,000 finished terminations per hour. That's what we call ECONOMATION . . . economy, reliability and range of choice.

For complete "M" Series Connector information, write to
INDUSTRIAL DIVISION, AMP INCORPORATED, HARRISBURG, PA. 17105.

★Trademark of AMP Incorporated

AMP
INCORPORATED

European companies or affiliates refer to International Section

Our chips go with your DIP's

(They'll fit your other packages, too!)

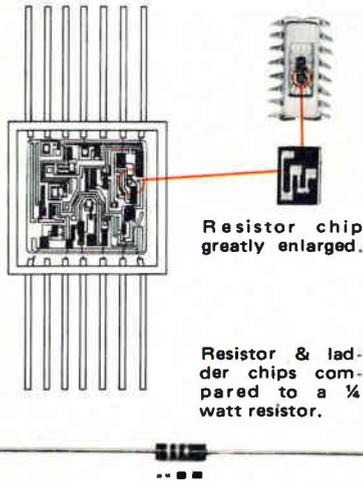

THE FIRST AVAILABLE THIN FILM TANTALUM NITRIDE RESISTOR AND LADDER NETWORK CHIPS IN THE INDUSTRY!

Increase hybrid circuit density by replacing space-gobbling thick film resistors with Solid State's new micro-size chips. Tantalum nitride gives these chips long life, noise figures better than -30 db, and ultra-high stability (less than 0.25% value change for 5000 hours at rated power at 150°C). Gold or aluminum bonding pads make them compatible with all semiconductor assembly techniques.

SD 2500 Series resistor chips range in RETMA value from 4.7 Ω to 1 M Ω . Multiple taps on each chip permit many series/parallel combinations. Tolerances are ± 5 , 10, and 20% standard, or ± 2 to 0.05% special. Typical size is .028" x .038". For microcircuit prototyping, kits containing chip assortments are available.

Precision ladder chips are available to 10 bit accuracy or better, with standard or custom resistance values. Because all significant resistors are on the same chip, excellent tracking of resistance ratios is obtained.

Special resistor networks to custom requirements can be supplied.

SEND FOR COMPLETE DETAILS AND TECHNICAL DATA



A SUBSIDIARY OF TRESKO SCIENTIFIC DEVICES
MONTGOMERYVILLE, PENNA. 18938
215-655-8400 TWX-510-881-7287

Meetings

Communication is the vehicle

In an attempt to branch out, the 1969 Vehicular Technology Conference has turned part of its attention from mobile communications toward highway electronics. The conference will concern itself with the guidance, control, and safety functions of vehicular electronics as well as mobile communications.

The conference, consisting of 20 technical papers and industrial exhibits, will be held on Dec. 4 and 5 at the Sheraton Columbus Motor Hotel in Columbus, Ohio. The papers are aimed at providing the engineer with practical approaches to highway electronics as well as new ideas and concepts.

Getting through. Five papers on unusual applications in vehicular electronics range from one by Frank Hollister of the American Power Service Corp. on a radio interference survey vehicle, to one by T. Yoshino of the Tokyo University of Electro-Communications, concerning a navigation system for use on the Antarctic plateau. Others describe the work being done at Ohio State University on an auto simulator, and a vehicle automation system developed at Bedford Associates by E.M. Weiss.

Mobile communications includes a paper of prime interest, by E.J. Bruckert and J.H. Sangster of Motorola, on the effects of fading and impulse noise over a land-mobile radio channel. Other papers center on a 450-megahertz mobile radio system, battery weight versus performance, and applications for hands-free speech operation of mobile transceivers.

There is also a session on traffic detection, identification, and measurement, and new concepts in highway electronics. A promising approach to accurate measurement of vehicle velocity is presented by R.A. Hayman and R.F. Schneeburger of the Cornell Aeronautical Lab. Another paper concerns a detection system to aid disabled vehicles. Several state-of-the-art reviews will also be presented.

In a session on techniques for vehicular data transmission and

traffic control, there are four papers, including two from Japan. One of the Japanese papers describes a computerized control system for area road traffic, while the other involves a highway communication system using a guidance cable. Papers on wideband data transmission over vhf/f-m radio channels and the use of surface waves for vehicular communications complete the conference technical program.

For further information contact Robert E. Fenton, Ohio State University, Columbus, Ohio.

Circuit theory from coast to coast

Moving from Miami to the Mark Hopkins Hotel in San Francisco, the International Symposium on Circuit Theory (Dec. 8-10) concentrates this year on the interface of theory and practice. Special features include panel discussions on: circuit design and the circuit theorist, active filters, and the relevance of circuit theory.

The panelists will address themselves to pressing design problems that appear to be well suited to the circuit theoretic approach. They will examine the premise that designers can benefit from theory, but theorists also need contact with the design world.

Several papers will be presented on the application of computer-aided design to network problems. One, by M. Dertouzos of MIT, is on computer analysis of nonlinear networks by recursive decomposition. Eight papers, four of which are from Europe, will concentrate on developments in digital filters.

Acting up. In the area of active filters, the panelists and the authors—there will be 37 papers—are expected to point up future directions as well as various approaches. The pros and cons and limiting factors of these approaches, including their cost, will also be explored in depth.

(Continued on p. 24)

Allen-Bradley's experience in resistor production reaches...

to the moon and back!

TYPE BB 1/8 WATT

TYPE EB 1/2 WATT

TYPE HB 2 WATTS

TYPE CB 1/4 WATT

TYPE GB 1 WATT

A-B industrial grade hot-molded fixed resistors are available in all standard resistance values and tolerances, plus values above and below standard limits. A-B hot-molded resistors meet or exceed all applicable military specifications including the new Established Reliability Specifications at the S level. Shown actual size.

After more than three decades and untold billions of hot-molded resistors, Allen-Bradley has accumulated manufacturing "know-how" which cannot be approached by anyone else. The fact that the resistors made by A-B over the years—if placed side by side—would more than reach to the moon and back, may be impressive. But "how" they are made is the key.

Allen-Bradley resistors are produced by an exclusive hot-molding technique—developed by A-B. They're made by completely automatic machines—also developed, built, and used only by Allen-Bradley. The human element of error is removed. Uniformity is so precise from one resistor to the next—year in and year out—that

long-term resistor performance can be closely predicted.

The reputation for quality and performance established by Allen-Bradley hot-molded resistors is reflected in the fact that they have been an integral part of virtually every U.S. space probe. And they are "on" the moon. No other resistor applications demand a higher measure of reliability.

For immediate delivery at factory prices, call your authorized A-B industrial electronics distributor. Or write: Marketing Department, Electronics Division, Allen-Bradley Co., 1201 South Second St., Milwaukee, Wis. 53204. In Canada: Allen-Bradley Canada Limited. Export Office: 1293 Broad Street, Bloomfield, N.J., U.S.A. 07003.

EC69-60A

QUALITY ELECTRONIC COMPONENTS



ALLEN-BRADLEY

Circle 23 on reader service card

©Allen-Bradley Company, 1969

cy. For virtually infinite resolution, extremely long life, excellent output smoothness, almost unlimited accuracy without catastrophic failure, negligible phase shift. And we offer a wide variety of wire-wound styles, too!

non-linear resistance elements available in standard configurations; special configurations for special requirements. Taps supplied if desired. Standard stroke lengths 1/2" to 24". Non-standard also available.

GET THE SPECS and full details... more than \$1 million in Eagle time/count controls, relays, Gamewell potentiometers... waiting to serve you in 35 major areas throughout the world... including U.S.A., S.A., Europe, U.K., Canada and Australia.



Eagle Signal

a systems division of

GULF + WESTERN INDUSTRIES, INC.
925 Lake St./Baraboo, Wisc. 53913

Circle 25 on reader service card

25

Electronics | November 24, 1969

Watford, WD2 4TT. Phone: Watford 27769. Telex: 934583.

Circle 27 on reader service card

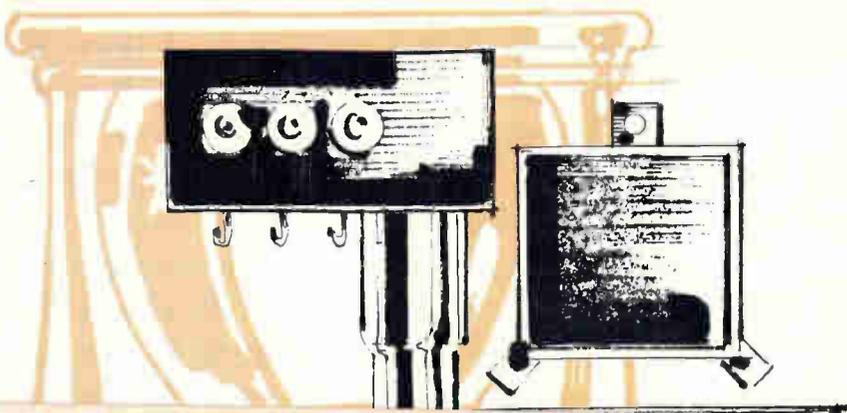

The smaller we go... the bigger we grow!

Day after day, Delevan engineers are cramming more values into smaller, micro-sized coils. We're able to do this because you demanded it. That's why Delevan continues to grow.

Many have depended on Delevan ingenuity and quality. You can too! Call us.



Delevan Electronics
Division



AMERICAN
PRECISION
INDUSTRIES INC.

270 QUAKER RD. EAST AURORA, N. Y. 14052
TELEPHONE 716/852-3800

TELEX 091-293

OTHER DIVISIONS OF AMERICAN PRECISION INDUSTRIES INC. BASCO • DUSTEX • ELECTRO-MECHANICAL PRODUCTS • MOELLER INSTRUMENT CO. • OXFORD CORP. • TRUCK EQUIPMENT CO.

Meetings

(Continued from p. 22)

In the past, circuit theory has been considered a rather narrow specialization. In light of the major problems confronting modern society, questions are being raised as to how the focus of circuit theory can be broadened. In their discussion of the relevance of circuit theory, the panelists will answer such

Meetings

(Continued from p. 26)

University of California at Los Angeles, Jan. 12-23. \$395 fee.

Real Time Digital Filtering and Spectrum Analysis, National Electronics Conference; Pheasant Run Lodge, St. Charles, Ill., Jan. 25-28. \$390 fee.

Basic Engineering Refresher, University of Wisconsin, Madison, Feb. 6-7. \$35 fee.

Call for papers

International Symposium on information Theory, IEEE; Noordwijk, the Netherlands, June 15-19, 1970. Jan. 1 is deadline for submission of manuscripts and abstracts to P. E. Green Jr., IBM Research Center, P. O. Box 218, Yorktown Heights, New York 10598.

International Conference on Communications (ICC 70), IEEE; San Francisco Hilton Hotel, June 8-10, 1970. Jan. 15 is deadline for submission of papers to Allen M. Peterson, Stanford Research Institute, Menlo Park, Calif. 94025

International Microwave Symposium, IEEE; Newporter Inn, Newport Beach, Calif., May 11-14, 1970. Jan. 30 is deadline for submission of papers to Raymond H. DuHamel, Granger Associates, 1601 California Ave., Palo Alto, Calif. 94304.

Nuclear and Space Radiation Effects, IEEE; University of California at San Diego, July 21-24, 1970. Feb. 16 is deadline for submission of summaries to R. K. Thatcher, Battelle Memorial Institute, 505 King Ave., Columbus, Ohio 43201.

National Telemetry Conference, IEEE; Statler Hilton Hotel, Los Angeles, April 27-30, 1970. Dec. 12 is deadline for submission of papers to A.V. Balakrishnan, 3531 Boelter Hall, University of California, Los Angeles, Calif. 90024.

Frequency Control Symposium, U.S. Army Electronics Command; Shelburne Hotel, Atlantic City, N.J., April 27-29, 1970. Dec. 15 is deadline for submission of summaries to Director, Electronics Components Laboratory, Army Electronics Command, Fort Monmouth, N.J. 07703.

ASTM-NBS Symposium on Silicon Device Processing, American Society for Testing and Materials, National Bureau of Standards, Gaithersburg, Md., June 2-3, 1970. Papers should be sent immediately to C.P. Marsden, Electronic Technology Division, National Bureau of Standards, Washington, D.C. 20234.

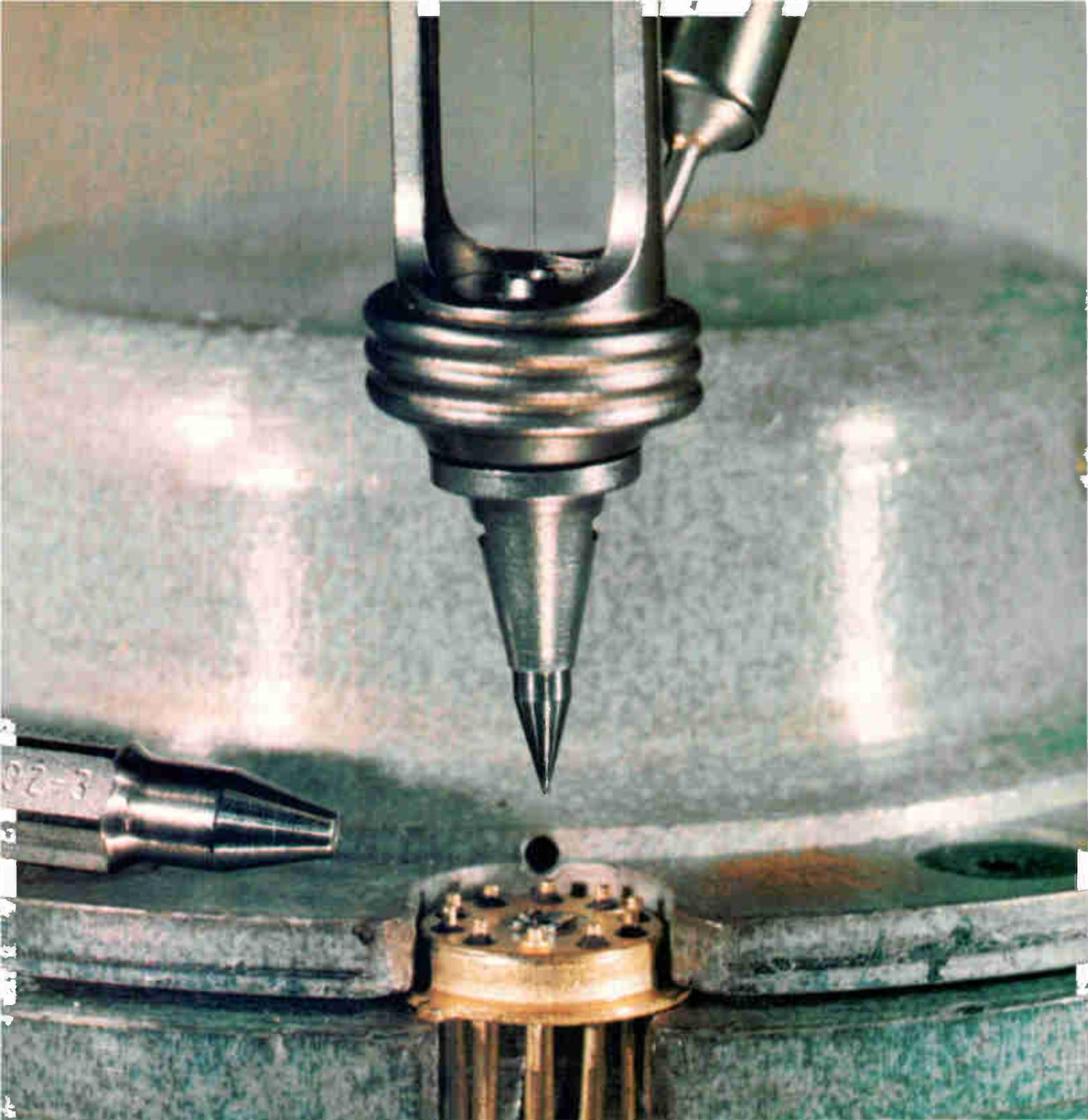

At .0008" Dia. . . . there is no second source

The tungsten carbide capillary tip and its complete family of accessories for thermal compression nailhead bonding was created and introduced by Tempress in 1963. . . . Only from this pioneering source can you purchase the entire system, designed from the beginning to give maximum efficiency: tungsten carbide capillary tip, heated shank and power supply that provides constant capillary temperature from 0° to 350°C, testing pyrometer for the tungsten carbide tip, capillary unplugging fixture and punches, and flame-off torch with sap-

phire orifice insert. Tempress also created and supplied the tungsten carbide ultrasonic bonding tool and pioneered its technology. . . . When you purchase Tempress miniature assembly tools and production equipment, you tap the ultimate source of high precision . . . the Tempress Standard of Excellence. In fields demanding high precision, such as semiconductor manufacturing, there is no second source.



TEMPRESS

Tempress Industries, Inc., 980 University Ave., Los Gatos, Calif. 95030



A gift to OEMs
that doesn't end with the holidays.
That's Ultramation.

The gift is money . . . in the form of two unique financial arrangements on the Honeywell 316 computer.

One, a quantity discount deal that saves you plenty. It entitles you to a provisional discount based on your *estimated* requirements over several years. Dozens of OEMs are already taking advantage of this arrangement.

The other, a spare parts kit you can lease instead of buy. It can save you a bundle.

That's Ultramation . . . the ultimate in computer savings to OEMs.

The H316 is a bargain to start with: First under

\$10K, 16-bit computer with big computer company back-up. More peripherals than anyone else. Worldwide support. Plenty of proven software.

You'll probably want rack-mountable or table-top models more than the glamorous version pictured here (and in the Neiman-Marcus Christmas Catalog and major consumer magazines).

Find out more about the gifted H316 and the unique financial arrangements for OEMs. Write Honeywell, Computer Control Division, Framingham, Massachusetts 01701.

The Other Computer Company:
Honeywell

Editorial Comment

Exploiting expert advice and opinion

Where does the engineer's liability end? At one time the engineer was able to design a television set and let "the company" worry about radiation hazards to the consumer. But can he today? What about the far more complex systems whose effects upon the human ecology are far-reaching? Should the engineer escape responsibility on the ground that he's but one cog in a big machine? Unlike the scientist who has long avoided commitment to the end application of technology on the premise that his job is only to unearth fresh knowledge, the engineer has no such ready-made excuse.

Admittedly, there is validity to the proposition that one of the technologist's major roles in today's society is to illuminate a variety of alternative solutions to problems. But should he stop there, letting the alternative be selected in a "business decision" by others? Few professionals are in a better position to properly influence the application of technology than those who live with it. Once the alternatives have been developed and their advantages and disadvantages identified, the engineer's recommendation ought to be solicited; if it is not, it should be volunteered. How often has the technologist abrogated his responsibility with the words, "but that's a management decision?" And, following a "bad management decision," how often has he said, "I could have predicted that. . . ." The best engineers will resist telling top management only what it wants to hear. Instead, they'll lay it on the line with moral and ethical, as well as economic and technical, judgments. Such judgments may well be tinged with strong personal feelings. But at the very least, these judgments will be based on knowledge.

Above all, the engineer's recommendations ought to encompass what the economists term "internalization of costs." When the public interest is ill-served, invariably it is because some cost has not been absorbed at the origin (say, by the original manufacturer)—it has been passed along. The overlooked cost is not always monetary. It could be a hazard, as in the case of radiation, or it could be a situation, as in the case of air and water pollution,

whose solutions ultimately might be underwritten with public funds. And this could mean higher taxes. In any event, the factors involved in accurate and fair internalization of costs—as well as the adverse consequences of failure to internalize costs—are likely to be readily understood by the technologists involved.

By taking a strong position regarding the application of technology, the individual engineer may thrust himself into a political posture. This is almost inevitable. Few issues involving the public interest are devoid of political ramifications. The engineer can no longer enjoy the luxury of expressing his political opinions only in the privacy of the polling booth. His opinion will carry the weight it deserves only when expressed at the product or system planning stage. ■

Communications takeover

In the early days of radio, communications and electronics were virtually synonymous. Later, electronics specialties, such as computers and industrial electronics, developed which tended to draw the spotlight away from communications.

Now, communications is rearing its head anew. But there is a big difference. Communications no longer can be looked upon only as an important part of most individual specialties. Rather, it is fast becoming an all-pervasive influence within our society. The new communications is of a type extremely visible to the general public, invading homes, stores, offices, and libraries. As a result, the layman is finding himself more and more an integral part of such systems.

Communications will be at the heart of what is coming to be known as the "knowledge industry," an industry that experts think will reach \$1 trillion by 1980. As *Electronics'* 32-page special report (starting on p. 73) points out, engineers are in the center of the new communications, both as users and as designers. ■

Here's the first wideband spectrum-analyzer to bring you laboratory precision and versatility in a battery-powered box. New Model 751 offers identical quantitative performance in the field and in the lab.

Selectable scan width allows wideband 500 MHz spectrum studies or close-up analysis down to 100 kHz. Five IF bandwidths from 1 MHz to 1 kHz optimize resolution at any scan width.

Over-all dynamic range of 120 dB includes 60 dB of RF attenuation selectable in 10 dB steps. Flat response with 60 dB "on screen" simplifies measurement of widely different signal amplitudes. Phase-lock stability and high sensitivity permit measurements as low as -110 dBm.

Model 751 is a true portable that weighs just 30 pounds with batteries. You can switch from AC power to the batteries for a full 8 hours operation before recharge by built-in circuits.

If you do spectrum surveillance, RFI investigations or broadband laboratory measurements, send for the specs and ask for a demonstration. Microwave Division, Systron-Donner Corporation, 14844 Oxnard St., Van Nuys, Calif. 91409. Phone: 213-786-1760.

Calibrated spectrum analysis indoors or outdoors 10 MHz to 6.5 GHz \$3950



**Another first.
One of 157
Systron-Donner
instruments.**

Electronic counters	Digital voltmeters
Pulse generators	Spectrum analyzers
Microwave frequency indicators	Digital panel meters
Digital clocks	Microwave signal generators
Memory testers	Laboratory magnets
Analog computers	Data acquisition systems
Time code generators	Microwave test sets
Data generators	

SYSTRON  DONNER

Circle 32 on reader service card

Electronics Newsletter

November 24, 1969

**For memory men,
the sweetest word
is 'semiconductor'**

Semiconductor computer memories—for both mainframe and buffer applications—are coming on a lot faster than many in the industry anticipated. Check semiconductor houses in this business and you'll find that they're talking to nearly every computer maker. And the major topic of conversation at the Fall Joint Computer Conference last week was semiconductor memories.

Some semiconductor industry cynics believe that most computer manufacturers were cool toward the use of such memories in new hardware until the word got out that Mr. Big—IBM, with nearly four-fifths of the computer business—was turning decisively to semiconductor memories. Though no one knows when, the word was that the uncommunicative computer giant plans to obsolete core memories. That bit of information was enough to spur the rest of the industry. IBM disclosed its cache, or buffer, semiconductor memories earlier this year [*Electronics*, March 17, p. 51].

One estimate puts the 1969 semiconductor memory market—excluding IBM—at about \$13 million with about three-quarters of it going for development. This could reach \$100 million by 1973.

**MOS memory woes
delaying NCR...**

The advent of semiconductor memories—as with any emerging technology—is not without labor pains. For example, NCR isn't getting from General Instrument anywhere near the quantities of 256-bit high-level MOS random-access memories it needs for a new computer in its Century series. Reliable reports indicate GI's problems in scaling up from R&D to production have caused a year's delay in planned introduction of the computer; NCR officials acknowledge slippage of "some months," but insist they won't be a year late in bringing out the machine.

Meanwhile, NCR has turned to Signetics as a second source. And it's gearing up at its own Dayton facility to produce the devices, providing its own third source. NCR wants at least three suppliers of the 256-bit device, and has requested proposals from most major MOS houses.

The NCR order will be a whopping one when it's placed; the firm will need about 50 billion bits of memory over the next four years. One NCR spokesman says, "That's more than the industry can produce now." Signetics is about to sign a purchase order for what could be a huge piece of the business, but acknowledges that NCR probably has a closer relationship with Signetics than with any other potential MOS supplier.

**... as bipolar edges
into firm's future**

NCR isn't overlooking bipolar semiconductor memories, either, for products even farther down the road. The company is negotiating with Raytheon in Mountain View, Calif., to develop a high-performance random-access memory based on an NCR design, but using Raytheon beam-leaded and unpackaged chips—with 20 chips in a one-square-inch package as the basic module to provide an access time of less than 50 nanoseconds and very low power dissipation. The unit would consume just one milliwatt per bit on standby status; present bipolar memories at that speed consume 2 to 6 milliwatts.

NCR hopes to have a prototype system built in the next year that will contain close to 100,000 bits. It regards silicon-nitride-activated beam leads a must because they're hermetically sealed, require no individual

Electronics Newsletter

packaging, and also lend themselves to automatic handling and easy repair.

The fast surge in semiconductor memories means the wire rod memory used in NCR's Century 100 and 200 machines will be phased out in one to two years.

Military market also beckons

Suppliers of military computers are also moving quickly. Litton's Data Systems division, prime contractor for the Army Tactical Fire Direction (Tacfire) System [*Electronics*, March 4, 1968, p. 171], is buying the Intel Corp.'s 256-bit metal oxide semiconductor random-access memory. Litton hopes to use it as the basic element in a 2,048-word, 10-bit buffer memory to refresh cathode-ray tube data displays in the system. Half the memory will be read-only and half will be read-restore. Litton wants the silicon-gate MOS devices purely for the cost advantage over cores, which were originally ticketed for the memory.

Litton officials also are counting on Texas Instruments to deliver a family of devices by next March to go into a 4,096-word, 32-bit memory they hope to propose for a number of military programs. The heart of the system will be a beam-leaded 256-bit MOS random-access memory chip. Sixteen such dice will go into a hermetically sealed, 1.3-square-inch package and achieve an access time of 350 nanoseconds. The chip includes decoding logic, but unlike the Intel device, the input voltage level isn't directly compatible with transistor-transistor logic levels. TI will supply the line drivers to handle the voltage differential. It's been known that TI was hard at work to apply the beam-lead technology acquired through its work on the Safeguard ABM program to other areas, but this is the first hint that the firm was putting beam leads on MOS devices.

New firm offers 4,096-bit module

Another potentially big market is the direct replacement of mainframe cores with semiconductors. An 8,192-bit store in six packages will be introduced in the first quarter of 1970 by Motorola Semiconductor [*Electronics*, Sept. 15, p. 47], and a new firm in Sunnyvale, Calif., is showing a working model of its semiconductor mainframe memory.

Computer Microtechnology, which only last July processed its first wafers, is developing a 4,096-bit semiconductor read-write memory module. As with any semiconductor memory taking aim at the core market, this one will have to be cost competitive. The company, started by ex-Fairchild Semiconductor employees, expects to start shipping prototypes of the hybrid sometime in the first quarter of 1970.

Employing both MOS and bipolar devices, the module is made up of 16 low-threshold MOS chips with 256 bits apiece, containing the memory and part of the decoding logic, and four bipolar chips comprising the rest of the decoding circuits, bit line drivers, and sense amplifiers. All 20 are beam-leaded to a two-layer, 1.5-by-1.35-inch ceramic substrate, and both inputs and outputs are TTL-compatible.

Addendum

Magnetic bubble shift registers [*Electronics*, Sept. 1, p. 83] should be available by mid-1970, says Cambridge Memories. The firm has developed a prototype with 1,024 bits, but says it will offer a 4,096-bit version. Instead of orthoferrite, the firm is betting on a layer of nickel-iron on an alumina substrate.



DIGITAL DISPLAY SYSTEMS

TTL-compatible MOS storage circuits solve a dilemma that has plagued display designers: the question of how to generate the display. Eliminating digital-to-analog conversion allows a data system to remain digital right up to the display drivers, but may exchange one economic headache for another. If the data source generates the digital control signal, its cost and that of communications links rise. Doing the job in the terminal, on the other hand, has made displays costly in the past.

MOS read-only memories reduce, to a few relatively inexpensive integrated circuits, the hardware required to convert a character communications code to signals that will control a display. Display rates fast enough for most applications can be achieved, when the MOS ROMs are controlled by bipolar logic circuits. And when the ROMs and bipolar ICs can be coupled directly, without the use of special voltage translators, the character generator becomes that much more inexpensive.

Two cases in point are shown in Figures 1 and 2. The MOS read-only memories can be bought for less than 2¢ per bit of storage. A small additional investment in MOS registers and TTL counters will produce a display-control system, such as the one in Figure 3. This system adds data buffering, message storage and display refresh to the basic character-generation function.

Ordinarily, read-only memories are custom-made and programmed for special applications. A large order must be placed to amortize the setup costs and bring the price below 2¢ per bit. These ROMs are different. They are mass-produced as pre-programmed, off-the-shelf kits. Each kit contains three 1024-bit ROMs programmed to generate 64 alphanumeric display symbols when addressed by the ASCII code. The kit for raster-scan displays is SK0001 and the kit for vertical scanning is SK0002. Figure 4 shows how the characters in the raster-scan font look on a television-type display.

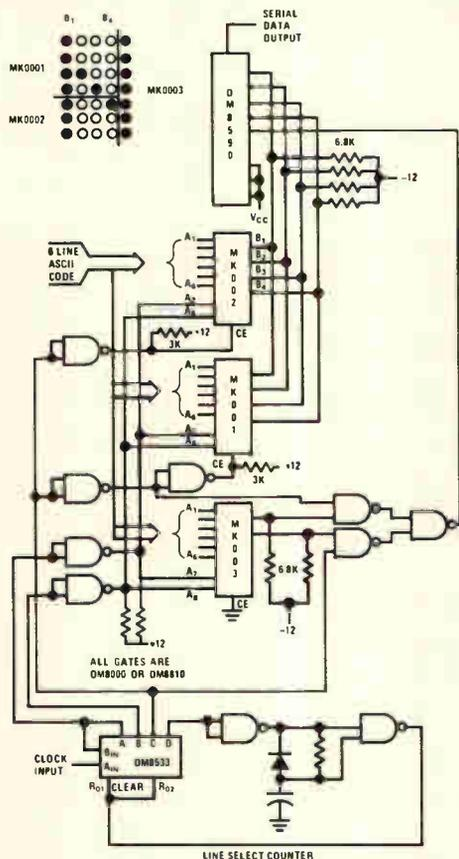

FIGURE 1. Raster-Scan MOS/TTL Display Character Generator. (SK0001)

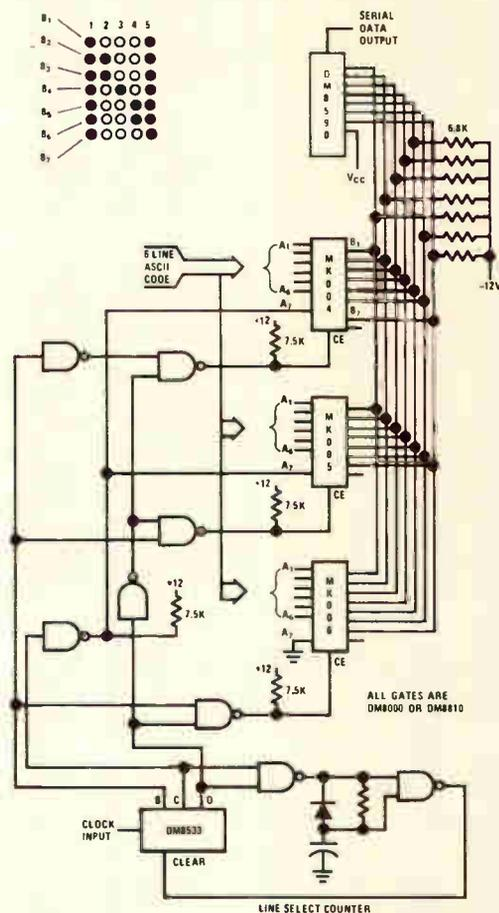

FIGURE 2. Character Generator for Tape Printers and Other Vertical-Scan Applications. (SK0002)

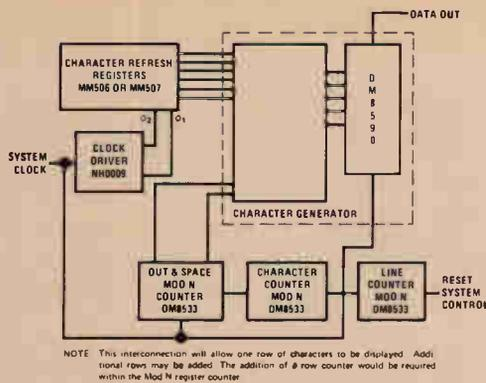

FIGURE 3. MOS/TTL System for Generation and Display Refresh.



FIGURE 4. Raster-Scan 64-Character Display Font. Similar Standard Symbols Are Produced by the Vertical-Scan Memory Kit.

Some of the characters in the vertical-scan font look a little different, but the same symbols are generated and the displays are just as clear. Special symbol fonts can be made to order, on request.

Cathode-ray tubes can be controlled with the serial output of either character generator. Symbols are seen as bright dot patterns on the screen when the output is used to gate the CRT's electron beam. The raster-scan system of Figure 1 is ideal for low-cost television displays, while the vertical-scan system of Figure 2 is applicable to tape printers, billboards, and Broadway-type lamp displays, as well as CRT displays. The techniques should also be adaptable to electroluminescent panels and other advanced types of scanning displays.

Characters generated by the vertical scanning kit are displayed in five columns of seven bits per column. These are selected in the right order, under control of the DM8533 binary counter. The counter and gates are connected so that the first and third columns of the 5 x 7 patterns come from the top ROM (MK004 in Figure 2), the second and fourth columns from the center ROM, and the fifth column from the lower ROM. The counter toggles the system and also causes spacing bits (logic "0") to be loaded between characters on the CRT or other display. Its modulus establishes the number of spacing bits between the end of one character and the start of the next.

A DM8590 parallel-in/serial-out shift register arranges the parallel outputs into the serial gating-control stream. This TTL register is fast enough to permit the memories to operate in less than 1 μ sec.

To generate raster-scan characters requires the selection of seven 5-bit lines. Therefore, the DM8533 in Figure 1 is used to count off the lines as well as the spacing interval between characters. After counting six intervals of N bits (five dots plus a spacing interval), the counter clears and counts six intervals again. The first four bits of the top four lines in each 7 x 5 display pattern are selected from the top ROM (MK001 in Figure 1), the first four bits of the bottom three lines come from the center ROM, and the last column of seven dots is generated by the lower ROM.

One method of implementing a complete system is blocked out in Figure 3. All functions are controlled by the system clock so that proper alignment of the symbols on the display is assured. The dot and space counter provides addressing control to the character generator, the character counter keeps track of the number of symbols displayed on each line in the display, and the line counter monitors the number of lines being displayed.

Other display functions can also be provided inexpensively with MOS memories. The MM520, for instance, can be the basis for a graphical display generator. If you like, we'll send data on our bipolar-compatible ROMs and shift registers, along with further information on MOS/TTL coupling techniques and the kits and devices used in these display systems.

National Semiconductor Corporation

2975 San Ysidro Way, Santa Clara, California 95051
(408) 245-4320/TWX (910) 339-9240



8-69 PRINTED IN U.S.A.

VCXOs

Get 'em straight from Damon!

Whether you're in a sweat on a VCXO prototype for a tough application – or need a production run in a hurry, you can get 'em straight from Damon. Speedy proficiency in design and production of VCXOs allows Damon to deliver all-silicon solid state devices with linearity to within 1% of best straight line and frequency deviation to $\pm 0.25\%$.

Just glance at the specification guide below for more good news on available characteristics. Computer-assisted designs are available, too. Ask Damon today for a quote on VCXOs tailored to your specifications – and deadlines. Call or write: Damon/Electronics Division, 115 Fourth Ave., Needham, Mass. 02194. Phone: (617) 449-0800.

SPECIFICATION GUIDE*

Parameter	Basic and Multiplier VCXOs	Mixer and Mixer-Multiplier VCXOs
Center Frequency	1 KHz to 300 MHz	100 Hz to 300 MHz
Frequency Deviation	$\pm 0.01\%$ to $\pm 0.25\%$ of C.F.	± 10 Hz to ± 1 MHz
Frequency Stability 24 hr. @ 25°C	± 1 to ± 10 ppm	$\pm 0.5\%$ of peak deviation
0 to 65°C (no oven)	± 10 to ± 50 ppm	$\pm 2\%$ of peak deviation
Linearity	to within 1% of best straight line	to within 1% of best straight line
Minimum Deviation Rate	0 (dc)	0 (dc)
Maximum Deviation Rate	0.2% of C.F. (100 KHz max.)	10 KHz to 100 KHz
Mod. Voltage (Typical)	± 5 V peak	± 5 V peak
Mod. Input Impedance	>50 K ohms	>50 K ohms
Output Power Available	0.5 mw to 20 mw	0.5 mw to 20 mw
Load Impedance	50 ohms to 10 K ohms	50 ohms to 10 K ohms
Power Requirements (Typical)	-25 V ± 1 V @ 30 ma	-25 V ± 1 V @ 40-50 ma
C.F. Manual Adjustment Range	$\pm 0.01\%$	$\pm 5\%$ of peak deviation

* Obviously, the limits are not absolute. The interrelationship of parameters for VCXOs are of such a nature as to permit optimization of any one or more characteristics to satisfy customer requirements.

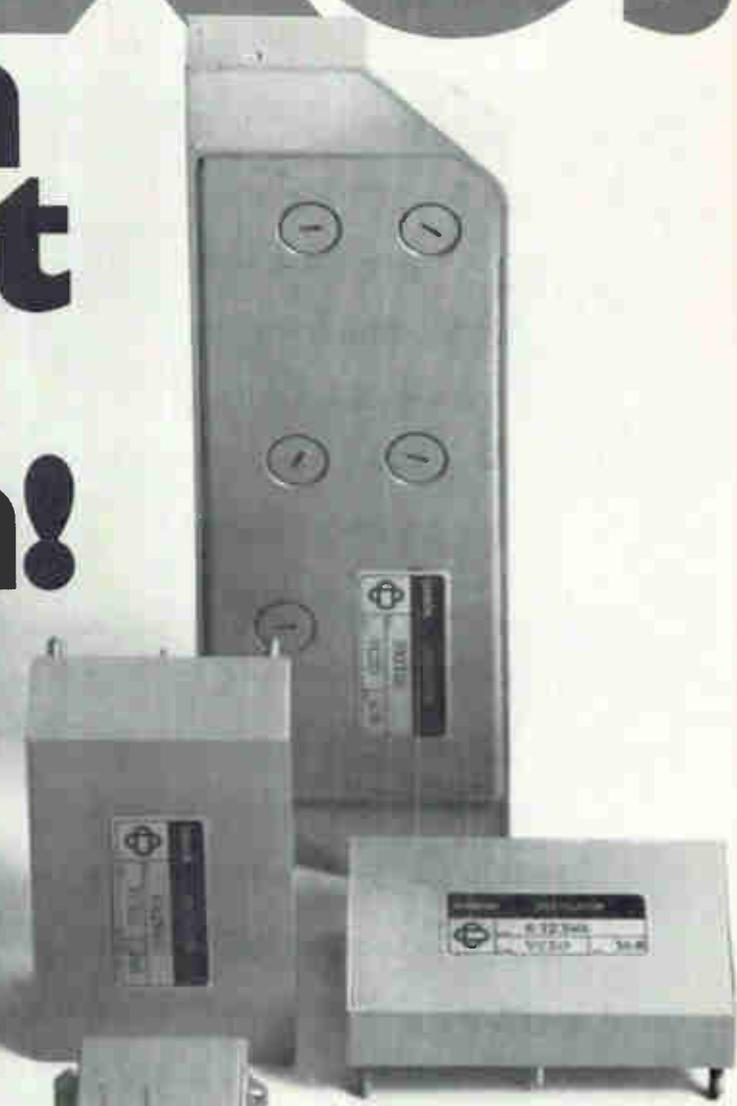

Shown approximately 3/4 size



Circle 37 on reader service card

SDS just made a name for itself in the business world:

Xerox Data Systems.

When scientific data systems were all we made, Scientific Data Systems was an excellent name.

But for the past few years distinctions between scientific and business computing have been disappearing. And we've been

expanding into applications for general business and industry.

So we're adopting our parent company's name. It's as respected in the business world as the one SDS has in the technical world.

XDS
Xerox Data Systems
El Segundo, California

Signal filter to improve color tv from the moon—but not until next trip

Amplitude and phase extraction gear from TRW estimates characteristics of extraneous signals and neutralizes them to eliminate interference

It seemed like a great idea earlier this year when NASA decided to send back color television transmissions from Apollo 12 on the moon. Westinghouse started building the little camera and space agency officials congratulated themselves on another public relations coup.

But when NASA engineers started running ground simulation tests, they couldn't get a good picture. Reason: interference from voice and telemetry—all three had to be sent simultaneously by the lunar module's sole transmitter. By early September, NASA engineers still hadn't found an answer. Word of their problem got out and engineers at TRW Systems' Communications and Defense Electronics Lab figured they had an answer. They'd been working quietly for a year on advanced circuitry techniques for separating and demodulating signals that are superimposed in both time and frequency.

TRW engineers, heading by Wil-

liam R. Hillard, flew east to make a presentation—and by Sept. 20 they had an \$86,000 contract. By early November, the engineers—red-eyed from a lack of sleep—had finished the system and were on their way to Houston's Manned Spacecraft Center with the APEX (for amplitude and phase extraction) gear.

The Houston tests went "real well," according to delighted NASA engineers—"as expected." So even though the hour was late they were ready to set up the TRW gear in the Goldstone, Calif., tracking station. But they never got the chance. At the last minute, MSC officials overruled their engineers because they felt they'd be taking a chance in changing the configuration at Goldstone.

So it will be Apollo 13 at the earliest before color tv viewers will see the improved picture from the lunar surface, even though the crash program effected so well by

NASA and TRW engineers came up with equipment in time to do the job on Apollo 12.

Apollo 11. Transmitting from the moon during the Apollo 11 mission last July was no real problem. The slow-scan, black-and-white tv took up only about 500 kilohertz. Color tv was transmitted only from the command module, which had two transmitters; one could be used for color tv and the other for voice and data. But transmitting the 2.5-megahertz-bandwidth color tv from the lunar module meant that the tv baseband would extend out over the voice and telemetry signals.

NASA engineers earlier had tried conventional interference suppressors. They'd tried to use passive notched filters, but this destroyed part of the tv baseband and left a herringbone pattern. They tried low-pass filters next; this removed the herringbone pattern, but it degraded resolution so the picture looked like slow-scan tv speeded

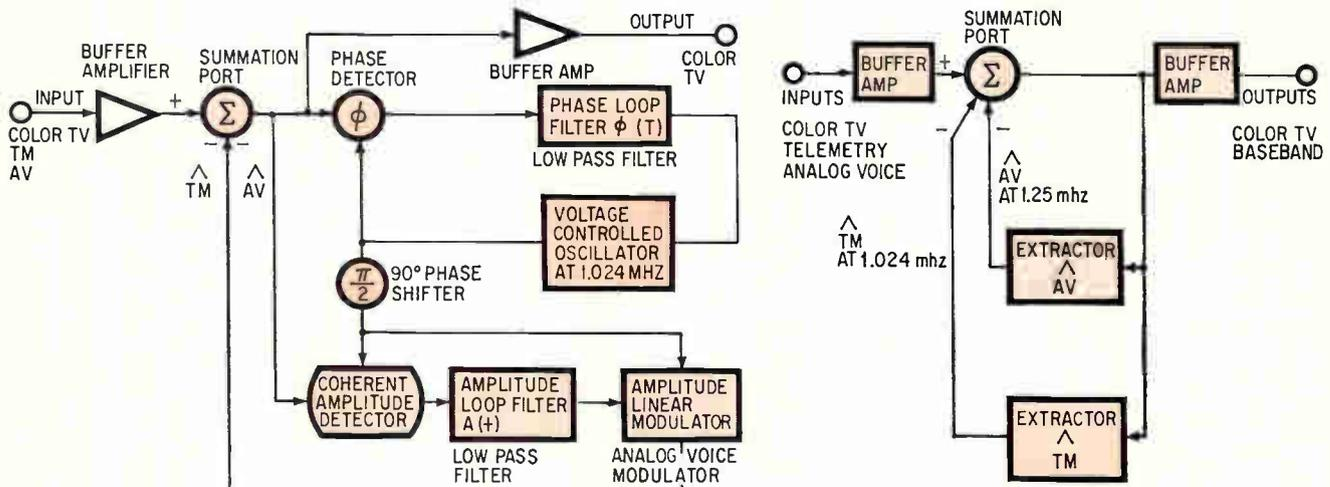

The works. Entire system is at left, analog voice extractor at right. Inverted V is best estimate, TM telemetry, AV analog voice.

U.S. Reports

up—all jerky movement.

Because of the decision not to use the TRW equipment, NASA fell back to the commercial tunable low-pass filter which already was installed at all ground stations. With a cutoff at 900 khz, these units did get rid of the herringbone by attenuating the voice and data subcarriers 13 to 15 decibels down. But the Apollo 12 color video picture to be released to the tv networks will definitely be fuzzy, one NASA engineer admits.

The APEX unit's claim to fame, according to Russell P. Tow, head of the TRW lab's defense electronics department, is that it performs the function of a notched filter but is selective—it rejects only a desired signal at the notched frequency and won't alter the signal superimposed on it at that point.

APEX is really an extension, and a unique application, of phase-locked loop tracking concepts to estimate the characteristics of the interfering signals and then electronically neutralize them to eliminate interference. It operates on the principal of maximum a posteriori estimation of the signals and subtraction from the total input.

The interfering subcarriers in the TRW system are located at 1.024 Mhz, a biphasic signal modulated at a rate of 1.6 or 51.6 kilobits per second, and 1.25 Mhz, an f-m/f-m signal modulated by a set of baseband signals including analog biomedical signals and voice.

In parallel. The two APEX units or extractors, one for each subcarrier, are connected in a parallel feedback arrangement at one common summation port. Each APEX module has an amplitude and a phase-estimating channel which is spectrally weighted to give the best estimate of the character of its interfering signal. A phase-tracking loop detects phase and a coherent amplitude detector puts out a d-c voltage proportional to the signal.

For the analog voice subcarrier (1.25 Mhz), an analog voice modulator then reconstructs the interfering subcarrier with this estimated phase and amplitude information, inverts it 180°, and feeds it back to the summation port to subtract or cancel the same subcarrier sig-

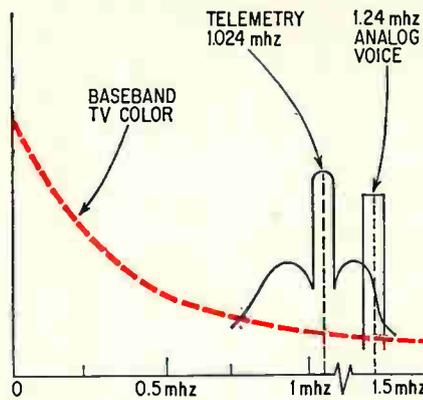

Pretty picture. Television baseband out of LEM receiver.

nal from the incoming spacecraft signal; the other APEX extractor does the same job with the telemetry signal. So out of the summation port comes the tv signal, minus the two interfering subcarriers. This output is buffered, amplified, and delivered as an output. It consists of the tv baseband signal and the two difference signals, which are the residues of the two extracted subcarriers. The error voltages—the difference between the coming signal and the extractors' inverted estimated signals—are 15 to 25 db below the television signal, Tow says.

"Feeding r-f energy back into itself is tricky," comments Hillard, "and you can find yourself building an oscillator instead." The APEX system for Apollo is five modules—the two extractors, the summation port module including buffer input and output amplifiers, a comparator-coherent amplitude detector and integrator, and a delay-line module. The last two, Hillard says, were built and checked out in just 10 days when they had to go from a telemetry rate of 1.6 kilobits per second to 51.6 kilobits.

Looking ahead. TRW has more ideas for employing APEX gear in future Apollo shots. The APEX analog voice and telemetry extractors do increase telemetry bit error rates, and a third extractor, for television, already has been built in the TRW labs to remove the television signal from the voice and telemetry. This extractor can demodulate and clean the voice and data signals.

The effectiveness of the interfer-

ence-rejection circuitry also makes it an attractive technique for communications satellite repeaters, TRW believes, particularly where r-f interference is a major problem.

Hillard sees the APEX system applicable to many communications jobs in the 2- to 30-Mhz range where classic interference rejection is now provided by crystal filters and Q multipliers. The reason, Hillard says, is that APEX can wipe out a signal that's superimposed on a desired signal without hurting the desired one. No filter can do that now, he maintains.

But the primary goal motivating the company to spend its own money on R&D for APEX undoubtedly is something that is still down the road: the antijamming market.

Advanced technology

Foot step

Microwave acoustics may be the answer to the question of how to shrink doppler radar systems from a roomful of equipment to just one rack. But first, long crystals—on the order of 40 inches—have to be produced. A step in this direction has been taken by Crystal Technology Inc. of Mountain View, Calif.

The longest available crystals of lithium niobate—one of the materials being studied for microwave acoustic surface wave substrates [*Electronics*, Nov. 10, p. 97] generally are 2 to 3 inches long. Crystals up to 6 inches have been produced, but they haven't had the proper lattice orientation. The reason is that crystals provide signal delay, which is a function of the axis of propagation and the length of the crystal. The 6-inchers were X-axis propagating while the best propagation for microwave signals is Z-axis.

Cracks. According to Walter Nelson, president of Crystal Technology, "When you try to grow long crystals, strain builds up in the lattice structure because of the temperature gradient that's required to grow the crystal. The longer the

crystals get, the more apt they are to crack because the internal strain is higher. But we've developed a process that reproducibly yields highly perfect single crystals up to 12 inches long." Surface acoustic wave plates, Y-cut and Z-axis propagating, that are fabricated from these long crystals provide delays of up to 89 microseconds.

Quartz also can be used as a substrate, but, Nelson says, with lithium niobate "you have a larger bandwidth and a lower insertion loss." In doppler radar systems, delays of up to 300 μ sec are required; this means substrates must be 40 inches long. Such substrates can be made now, says Nelson, by placing 12-inch strips end-to-end with amplifiers between stages; it will eventually be done with just one long strip.

The crystals will be available as X-ray-oriented rough-cut blanks, as-grown boules, and optically polished finished plates. Nelson says that while the material is very expensive—about \$1,000 for 3 inches—the price will come down as devices get out of the lab and into production.

bits. The plan is to build more of the simulators, and either lend or lease them to customers or potential customers who want to work out the bit patterns for memories that Electronic Arrays will then build.

Brain's brain. The simulator, naturally, is a memory itself, mechanized with Electronic Arrays' EA 1400 read-write random-access memory [*Electronics*, June 23, p. 193], a 128-bit MOS device. It also includes a 9-bit address register with a counting capability, a small punched-tape reader for loading data into the simulator, and a data register that formats data for storage. All the auxiliary logic is MOS.

The customer's bit pattern is coded on punched cards. These generate a punched tape that serves as the input for the simulator through the tape reader. Electronic Arrays asks its customers to specify bit pattern on a vellum sheet; the logical 1's and 0's on these sheets provide the data from which the cards are punched. The punched cards, when used with an Electronic Arrays computer pro-

gram, also provide:

- A computer printout of the bit pattern. The vellum sheets are superimposed to verify that the 1's and 0's match.

- A control tape used to test the read-out memory after it's made.

- A magnetic tape to drive an automatic plotter that turns out a full-scale plot of the bit pattern used to make device masks.

Once the bit pattern has been entered into the simulator, however, the customer is free to play with it until he's satisfied.

The simulator operates in a variety of modes. In the check mode, the bit pattern entered by paper tape is checked against the contents of the read-write memory devices if the user wants to verify that he's loading the same pattern already entered in memory. The paper-tape loading mode is used to read the tape contents into memory.

Match. In the simulator mode, the unit operates like the memory being designed. In fact, the cables connecting the simulator to the breadboard hardware or computer for which the memory is being

Memories

Altered to suit

Read-only memories continue to gain acceptance for logical control functions—such jobs as microprogramming in computers. As they do, many users would like to simulate the memory so that they can alter the bit pattern quickly before freezing the design without waiting weeks for a new device.

That's why engineers at the Systems division of Electronic Arrays Inc. put together such a simulator, housed it in an attache case, and now are making it available for their own use or for customers in the market for read-only memories. The first version can simulate memories with up to 512 20-bit words; the company's product line in read-only memories goes up to 512 by 5 bits now and a soon-to-be-introduced addition is 512 words by 8

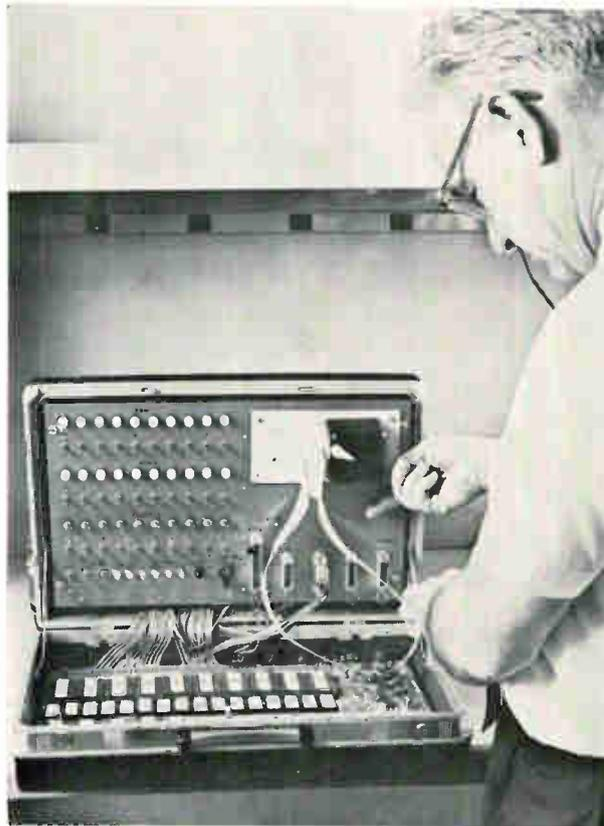

Good case. Read-only memory simulator in attache case enables users to alter bit pattern quickly before deciding on final design of memory.

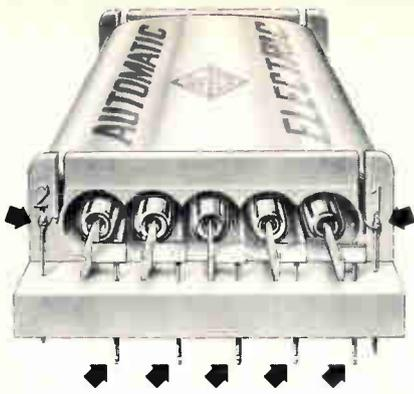

Groov-Pin[®] Terminals Are Simpler... More Reliable... Lower in Cost

Groov-Pins rather than stamped or formed press-fit terminals are used in a new line of Correeds* developed by Automatic Electric Co., Northlake, Ill., a subsidiary of General Telephone & Electronics.

Here's why they are producing important savings for AE:

- Stamped or formed terminals require end-for-end and side-for-side orientation for assembly. Groov-Pins can be inserted from either end.
- Stamped or formed terminals need soldering projections for each connection. Groov-Pins can be soldered or welded anywhere.
- Groov-Pins also permit a simpler plastic mold for nylon relay coil forms. Hard-to-remove core pins and locking slots are eliminated.

If you design or make relays, connectors, or other hardware, find out how Groov-Pins can simplify your product and dramatically cut costs. Write to Groov-Pin Corporation, 1121 Hendricks Causeway, Ridgefield, N. J. 07657. Telephone (201) WH 5-6780.

Automatic Electric uses Groov-Pin terminals in its new Correeds. They are now available to AE's telephone company customers. Correeds have as many as 14 terminals, so a cost cut here means savings for the company. Groov-Pins lock in the Correeds' coil form by a cold flow of nylon into three swaged grooves. Notches at both ends make it easy to wrap and solder leads from the Correeds.

*Automatic Electric's name for Dry Reed Switch Modules

GROOV-PIN CORP.
FASTENER DIVISION

U.S. Reports

designed terminate in the same configuration as the memory—a 24-pin connector that can be removed and the standard 24-pin read-only memory plugged into the same socket after it's been fabricated.

But if the user finds he wants to change the bit pattern, all he has to do is switch to the manual mode. This allows him to trigger any of the 20 manual switches to load new data into the read-write memory data register. And there also are nine address switches, which set the register, establishing a location for the data to be entered. Then the user hits the "write" button, and the manually loaded data is entered into memory.

Once he's altered the bit pattern, the user switches to the simulate mode and satisfies himself that the simulated bit pattern is functioning properly in the breadboard or computer. At this point, he may make a new paper tape to enter the final bit pattern in the simulator and check it again. In any event, the punched cards with the new bit pattern are incorporated into the deck, which is then used to make the magnetic tape that drives the automatic plotter to generate the full-scale bit-pattern plot used in making a mask.

Manufacturing

Follow the recipe

Good circuit board lamination, like gourmet cookery, may depend more on the skill of the operator than on the ingredients. A dab of heat and a dab of pressure in the right quantities can result in a high-quality product. But the increasing complexity of multilayer circuit boards has made repeatability of laminating techniques critical. Logic speeds in advanced computers, for example, require circuit boards with characteristic impedance of ± 60 ohms.

The Industrial Equipment division of the Republic Corp. has developed a laminating system called Accuthermol that uses a fireproof, chlorinated hydrocarbon

heat-transfer fluid to control temperature across platen surfaces to within $\pm 1.5^\circ\text{F}$. Two closed-loop systems, one for heating and one for cooling, circulate the fluid at 35 to 70 psi through specially designed manifolds and orifices in the platens. This permits more rapid heating and cooling than is possible with electric or steam heat, says Bradley D. Ward, product manager, who helped develop the system. Platen temperatures can be raised from 100°F to 350°F in 3 minutes, compared with about 15 minutes for electrically heated platens, and 6 minutes or more for steam heating.

Range. The system can simultaneously control temperatures and pressures for up to 10 lamination presses, providing temperatures ranging from 350°F for G-10 and G-11 circuit board lamination to 600°F for Kapton FEP circuit boards.

Repeatability is achieved by preprogramming heat and pressure curves, using tape input for sequential shifting of pressure levels, and a Research Inc. Data Trak analog programmer to permit any desired temperature curve. Depending on user requirements the computer may have a 10,000-bit memory, or additional bulk storage for programs and performance data. A multipoint strip chart recorder monitors temperatures and pressures.

Ward says yields are 99.9%, compared with maximum yields of 80% to 98% for other systems—a considerable dollar difference in large-volume circuit board production. Because of the precise temperature and pressure control possible, individual layers in the circuit board are also more uniform in resin-to-glass content and dielectric thickness, and less subject to delamination during soldering.

Passing marks. "In tests, we have been able to produce 12-layer circuit boards with 10-mil lines and 2-mil spaces, with a 2-mil total indicated runout tolerance," says Ward. What's more, he adds, "In one 4-by-5-inch five-layer board with ground plane, we were able to cut production time from 45 minutes to 29 minutes by varying the

ON ONE CHIP:

A PLATED-WIRE, HARDENED SENSE AMP

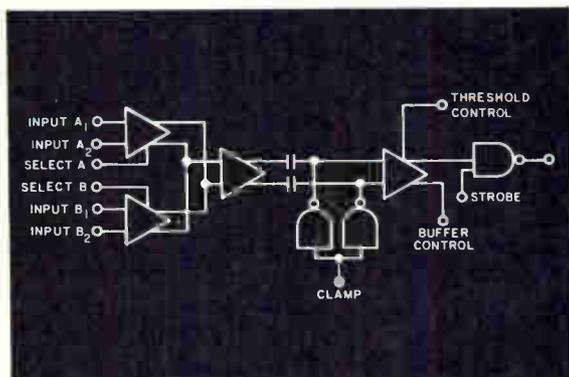

- The first application of linear and digital technology in one monolithic sub-system.
- The RA-2540R system in a single chip performs the functions of two hardened differential amplifiers and a hardened voltage comparator
- 1 mV signal sensitivity in high noise environment
- 10 ns access time
- Internal D.C. restoration
- Selectable dual channel
- Hardened
 - Photo current compensation
 - Dielectric isolation
 - Thin film resistors
 - Advanced device design

You always get: Off-the-shelf delivery, full plated-wire temperature range and compliance with MIL-STD-883 . . . when you pick the BEST IC for the job from Radiation's fast expanding linear-hardened line.

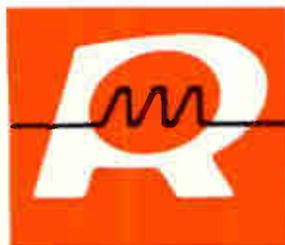

Lexington, Massachusetts (617) 862-1055
Norwalk, Connecticut (203) 853-3646
Washington, D.C. (202) 337-4914
Dallas, Texas (214) 231-9031
Long Beach, California (213) 426-7687
Palo Alto, California (415) 321-2280
Albuquerque, New Mexico (505) 268-3549
P.O. Box 37, Melbourne, Florida 32901 (305) 727-5430

RADIATION
INCORPORATED
SUBSIDIARY OF HARRIS INTERTYPE CORPORATION
MICROELECTRONICS DIVISION

The first plug-in curve tracer costs 1/3 less!



With U-Tech's plug-in and console units, any X-Y oscilloscope becomes a curve tracer displaying the dynamic characteristics of both NPN and PNP transistors, N Channel and P Channel junctions, FET's, MOS-FET's, bipolars, unijunctions, diodes, tunnel diodes and SCR's. You have curve tracer capabilities, without buying a complete curve tracer unit. In so doing you pay up to:

1/3 less!

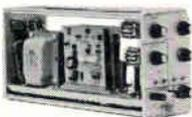

U-Tech plug-in MODEL 681: \$655.00*. For use with Tektronix† 560 Series Oscilloscopes.



U-Tech plug-in MODEL 682: \$675.00.* For use with Tektronix† 530, 540, 550, 580 Series Oscilloscopes.



U-Tech console MODEL 683: \$685.00* For use with any X-Y Oscilloscope.

Ask your distributor about these U-Tech curve tracer units or order direct from:

U-TECH

A DIVISION OF INDUSTRIAL PHYSICS AND ELECTRONICS COMPANY
4190 SOUTH STATE STREET,
SALT LAKE CITY, UTAH 84107
(801) 262-2663

†Registered trademark Tektronix Inc.

*Prices apply to purchase and shipments within U.S.A. fob Salt Lake City, Utah

U.S. Reports

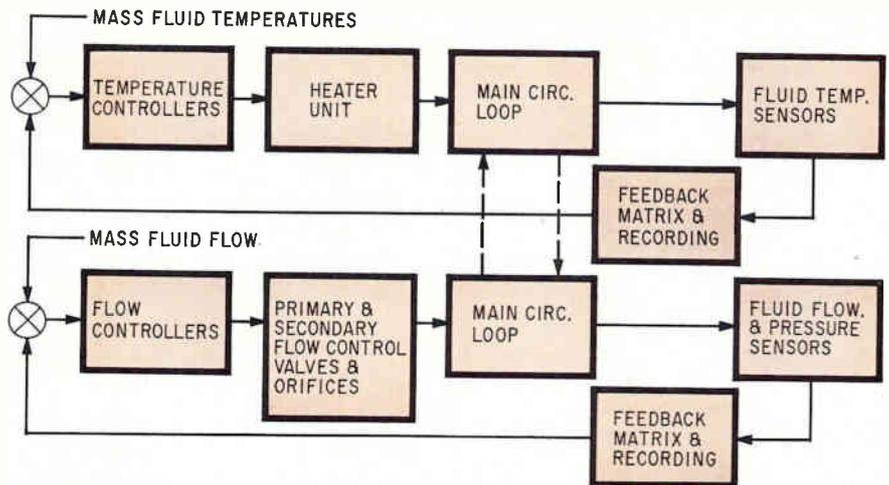

Merrily it flows along. Republic's Accuthermol laminating system uses this fluid circulating system, controls, and control loops.

heat input for optimum results." There are 11 temperature and pressure control modules with a variety of control instrumentation options tailored to specific circuit board applications.

Power savings of from 20% to 50% over systems using electrically heated platens are possible because the main circulation loop acts as a heat sink, requiring power-on operation only about 20% of the time, Republic claims. For small job-shop operations requiring heat transfer units up to 1 million Btu's, a bank of Inconel sheathed electrical immersion heaters are used. Larger units use gas- or oil-fired heaters.

Any size unit up to 10 million Btu's will be supplied, says Ward, although the largest so far is a 3 million Btu system built for 3D Circuits of New York. Nine different platen sizes up to 36 by 36 inches are standard, and Kad model 1537 or 1572 laminating presses operating at pressures of 1,300 to 2,000 psi are used.

Lasers

Long may it live

As laser source demands soar, system designers are turning more and more to injection lasers. But the rub is that while their output is high enough, these p-n junction devices generate so much heat that cooling

presents severe design problems, particularly when room-temperature operation is required. The reason: they need current densities of 100,000 to 150,000 amps per centimeter, levels that mean quick degradation. At operating duty cycles of 0.4%, adequate for many applications, users found laser life was only about a few hundred hours.

Researchers at RCA Laboratories believe they've come a long way in solving this efficiency-vs.-life problem. In work sponsored by the Army Electronics Command and the Air Force Avionics Laboratory, RCA says it has developed a gallium arsenide laser that requires about a third of the operating current at pulsed, room-temperature operation needed by conventional GaAs injection lasers.

Dubbed "close confinement" by RCA, the laser uses a new (AlGa)-As p⁺-p heterojunction structure next to the lasing p-n junction that traps the light in a narrow lasing region, thus reducing optical losses. This lowers threshold current density at room temperature by a factor of four and increases lasing efficiency by a factor of two or three.

Additionally, the RCA scientists say they've found that degradation is a direct consequence of current density. Thus, reduced current requirement means longer life and greater reliability. RCA's data indi-

Why Picker X-Ray tests circuit boards with the Teradyne J259

Most people know Teradyne's J259 as an IC test system. Which is not surprising, since it won its campaign ribbons on IC production lines and in IC incoming-inspection departments.

Note, however, that the J259's official name is "Computer-Operated Circuit Test System." Nothing in that name says the circuits have to be integrated. An important point, which was not lost on engineers at Picker X-Ray.

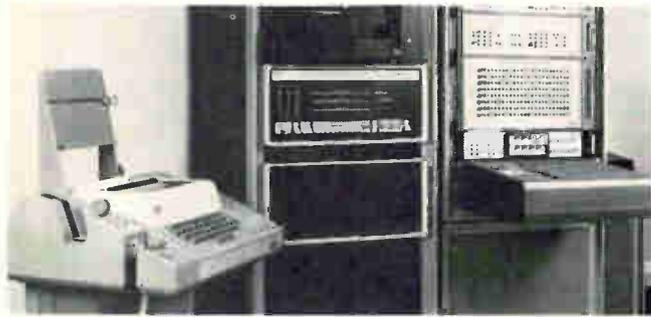

Picker uses its J259 to test circuit boards going into x-ray generators. The J259 whips through the 70 or 80 tests required on a board in a split second, automatically typing out the results of any test that is failed. Test data on a rejected board then accompanies the board to trouble-shooting, where a technician refers to his copy of the test program and keys the failed test to the bad component or connection.

Picker tests more than 50 different boards with the J259. What does Picker like most about the system?

Its efficiency. Only with an automatic system is it economically and humanly practical to test all the boards all the time.

Its strong software. The "datalog rejects only" mode used so profitably by Picker is only one of dozens of fea-

tures included in Teradyne's library of software packages for classification, datalogging, and evaluation.

Its device-protective and self-protective circuits and software. Picker wanted absolute protection of both boards and test instrumentation.



Its reliability. Picker will not take chances with its boards. An undetected bad board can destroy an \$1800 x-ray tube. The J259, like all Teradyne test equipment, is designed and built to make accurate measurements in industrial environments for many, many years.

Its provisions for the addition of special-purpose accessories. Picker uses the J259's unique Network Selector, for example, to interconnect a constant-current source consisting of a simple network of current-limiting diodes.

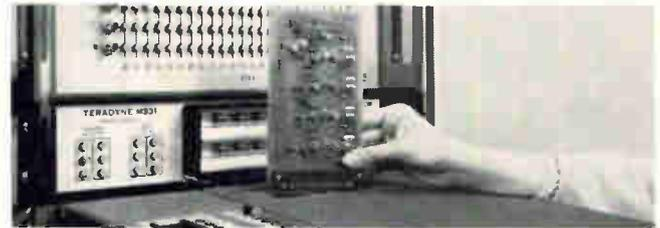

Teradyne's J259 makes sense to Picker X-Ray. If you're in the business of testing circuits — integrated or otherwise — it makes sense to find out more about the J259. Just use reader service card or write to Teradyne, 183 Essex St. Boston, Mass. 02111.

Teradyne makes sense.

Circle 45 on reader service card

METEOROLOGICAL RADAR



TOTAL ELECTRONIC
SYSTEMS CAPABILITY.
SPECIALISTS IN
TIME/FREQUENCY,
RADAR AND
DATA SYSTEMS
OFFERING RAPID
GROWTH.



P.O. BOX 222, BUFFALO, N.Y. 14225

U.S. Reports

cates that the life figure of about 200 hours can be increased to 2,000 to 3,000 hours.

Space electronics

New directions

The long-anticipated reorganization of NASA is likely to involve more than just changes in personnel and division structures. Indeed, as an increasingly vocal American scientific community brings its influence to bear against NASA's strong emphasis on manned space flight at the expense of scientific experimentation, NASA's entire focus of priorities may shift, particularly if proposals for a new, ambitious space astronomy program are accepted.

The departure of Dr. George E. Mueller, associate administrator for manned space flight, smoked out the proposed scuttling of his office as it is now structured, dividing it into two new headquarters offices: operations and projects. The Offices of Space Science and Applications, and Advanced Research and Technology would be merged into Science/Research and Development, to be headed by Dr. John E. Naugle, associate administrator for OSSA. Bruce T. Lundin, acting associate administrator for OART, has left headquarters to succeed Dr. Abe Silverstein as director of NASA's Lewis Research Center in Cleveland.

Increasing NASA emphasis on its responsibilities in aeronautics is suggested by the creation of the new Office of Aeronautics, piloted by Dr. Alfred J. Eggers Jr., now assistant administrator for policy. Another step in that direction is the recent appointment of John Enders, former test pilot and veteran NASA official, as the aeronautics expert on the National Aeronautics and Space Council.

Stars in the eyes. Space agency watchers also are waiting to see how NASA responds to recommendations of 19 of the nation's leading astronomers, led by Dr. Leo Goldberg, director of the Harvard College Observatory and chairman of

the university's astronomy department. They want a long-range space astronomy program that would cost between \$250 million a year for a minimum balanced program to \$500 million a year for an optimum program. The still-to-be-approved fiscal 1970 appropriation is \$117 million, down from \$125 million in 1969.

The astronomers recommended an increased effort in X-ray and gamma ray astronomy using Explorer spacecraft with substantially larger payload capability to carry X-ray detectors, spark chambers, Cerenkov telescopes, and particles and fields experiments in the 1-ton to 5-ton range.

A future orbiting astronomical observatory spacecraft should include the ability to carry a state-of-the-art stellar X-ray imaging instrument comparable to existing solar instrumentation.

Also on their list:

- An optical ultraviolet astronomy program with a mid-1970's goal of observations requiring the equivalent of a 1-meter to 1.5-meter telescope with a diffraction-limited performance, as an essential intermediate scientific and technological step toward the 3-meter large space telescope of the 1980's.

- An infrared astronomy program with research and development of detectors and small cooling systems that would permit infrared observations with much greater efficiency, commonplace at both shorter and longer wavelengths.

- Studies to determine whether observations of astrophysical objects in the long-wave radio portion of the spectrum would require a rhombic wire antenna six miles in diameter deployed in space or on the moon, or "supersynthesis" interferometric techniques, before this large electronically filled aperture is initiated.

- More ground-controlled solar spacecraft with the instrumentation sophistication of the ATM-A (Apollo Telescope Mount) for observation of the solar surface with an effective angular resolution of 5 arc seconds.

Further research. The board stressed that NASA should develop essential instrumentation such as



Many of our best customers were Card Reader "skeptics"... until they tried the 6002.

MDS 6002 CARD READER

Specify the speed you prefer . . . 225 or 400 cards/minute . . . no extra cost. The 6002 requires only 2 sq. ft. of space. Ideal for peripheral use with small computers . . . or in remote terminals and data communications systems.

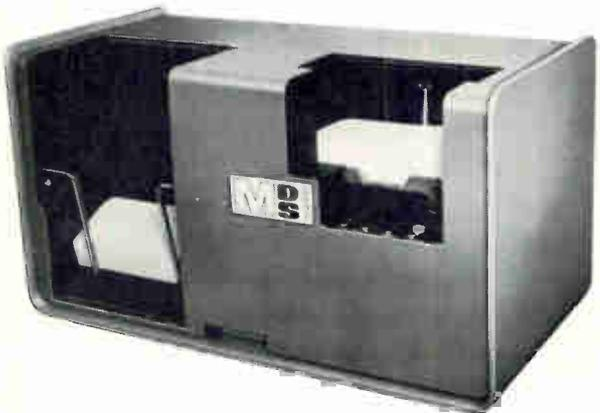

HELP FOR OEM
DECISION-MAKERS

The 6002 is the "runt" in the MDS Card Reader line . . . 12½" H x 12½" D x 23" W. But it packs a terrific wallop!

Although the 6002 is a low-cost unit, it contains features ordinarily found only in more expensive Card Readers.

Input and output hoppers each hold 500 cards, face up. Cards can be replenished or removed during operation. No adjustments necessary for different types of cards.

Picker/Reader Head is the same as the head used in larger MDS units. It incorporates the picker mechanism, a pneumatic picker throat, photoelectric read station and metering capstan in a single, precision-built assembly. This permits simple interface and flexible operation when combined with end-fed reading and pick-on-demand card processing.

Cards are driven through the read station by metering capstans which also provide 16 precise clock pulses for each column of card motion. These signals . . . and those from sensors which detect the leading and trailing edges of the card . . . enable highly accurate column registration ($\pm 0.0054"$), as well as a check of known vs. measured card length.

MDS sealed units and modular design hold servicing to a minimum.

The 6002 is available with or without logic circuitry (without, it is designated as 6001) . . . and with options accommodating 51-column cards.

Ask about other MDS Card Readers.

Phone or write for literature. Your Man from MDS will gladly help you make your decision.

MOHAWK **MDS**
DATA SCIENCES CORPORATION
OEM MARKETING

Palisade Street, Herkimer, N.Y. 13350
Phone 315/866-6040

REGIONAL MANAGER OFFICES:

Orlando, Fla., Phone 305/841-3091 • Waltham, Mass., Phone 617/891-5870 • Des Plaines, Ill., Phone 312/298-4141 • Los Angeles, Calif., Phone 213/685-5165
BUFFERED TAPE UNITS • DIGITAL STRIP PRINTERS • LINE PRINTERS • CARD PUNCHES AND READERS • PAPER TAPE PUNCHES AND READERS

LOWEST COST . . . FULL WAVE BRIDGE RECTIFIERS & ASSEMBLIES

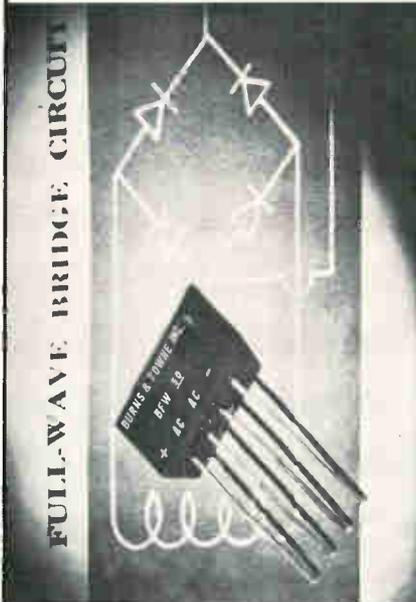

Burns & Towne pre-packaged rectifier circuits represent a significant cost savings over individual components used in multi-rectifier units. Yet, you are always assured of quality and reliability. The low cost BFW family of single phase full wave bridges . . . features high current capability of up to 2.0 amps.

Part No.	Max. PRV (volts)
BFW-50	50
BFW-100	100
BFW-200	200
BFW-300	300
BFW-400	400
BFW-500	500
BFW-600	600
BFW-800	800
BFW-1000	1000

Call or write for full specifications and price data.

Contact FRED SEIGEL

BURNS & TOWNE INC.
550 Old Country Road
Hicksville, L.I., N.Y., Tel. (516) 935-0522

U.S. Reports

lightweight optical mirrors, improved X-ray reflectors and detectors, X-ray photometric standards, electronic imaging systems, improved grating technology, infrared sensors, and small cryogenic systems—plus ground-based instruments such as special-purpose monitoring telescopes of intermediate (60 to 100 inches) aperture, large optical telescopes in both hemispheres, and a large steerable paraboloid radio telescope.

Consumer electronics

Maxi coat

Whether the hi-fi buff knows it or not, the single biggest factor affecting the cost of his recording tape is its magnetic oxide coating. For not only is the quality of the powder-like oxide important, but it's vital that the oxide stick to the plastic ribbon without causing audio distortion. Now, an Opelika, Ala., firm, Magna-Tech Corp., has developed a high-energy, low-noise iron oxide that company officials say should go a long way toward producing a recording tape of higher quality than is presently available, and at lower cost.

Aimed not only at the high-fidelity tape manufacturer, Magna-Tech's new magnetic oxide can be used in video recording and instrumentation tape as well, says Herbert Hard Jr., the firm's vice president for R&D.

Less is more. The key to the new oxide is its uniformly smaller particle size. And although the company will not divulge how it produces the smaller-sized particles, it does say that the result is lower inherent noise—about 3 to 4 decibels in high-frequency ranges and about 1 db in middle ranges. Further, the same output can be achieved using a thinner coating of the oxide since 10% more oxide can be applied to a given space on the tape. Thinner coating also means more tape per reel.

Because the chemistry of this oxide is the same as that for other oxides now on the market, tape manufacturers will not need to

change their present binding system to apply it. "The only change necessary," Hard points out "will be to rebalance the proportion of oxide to binding ingredient. And in that case, each manufacturer will have to determine an optimum balance based on his own requirements."

Magna-Tech expects to begin selling its oxide powder sometime in mid-1970, but will not reveal its cost, saying only that it will have a "premium price." And once the company has its own production plant operating in Opelika, Magna-Tech also plans to offer major video and computer tape manufacturers a package deal that will include engineering and installation of their own production facilities. Finally, at some later date, the new oxide will be available in a ready-to-use-coating form.

Communications

Sanguine politics

No one enjoys a good laugh more than the Washington watchers of the body politic, so the reaction ranged from wry smiles to outright guffaws when the Pentagon released this statement:

"Deputy Secretary of Defense David Packard announced he has decided to approve a request from Secretary of the Navy John Chafee that research and development work on Project Sanguine be continued, even though no decision has been made yet or can be made on whether or not to proceed with construction of any sort of extremely low frequency communications system." It was the Defense Department's euphemistic way of saying that it's slowing down the Naval Electronics Systems Command's effort to develop a means of communicating with the submarine fleet at great depths throughout the world from a single Wisconsin transmitter using frequencies well below 100 hertz [*Electronics*, June 23, p. 52].

Doomsday. It's also believed that the DOD reacted to recent press criticism that the Chequamegon

Testing FETs?

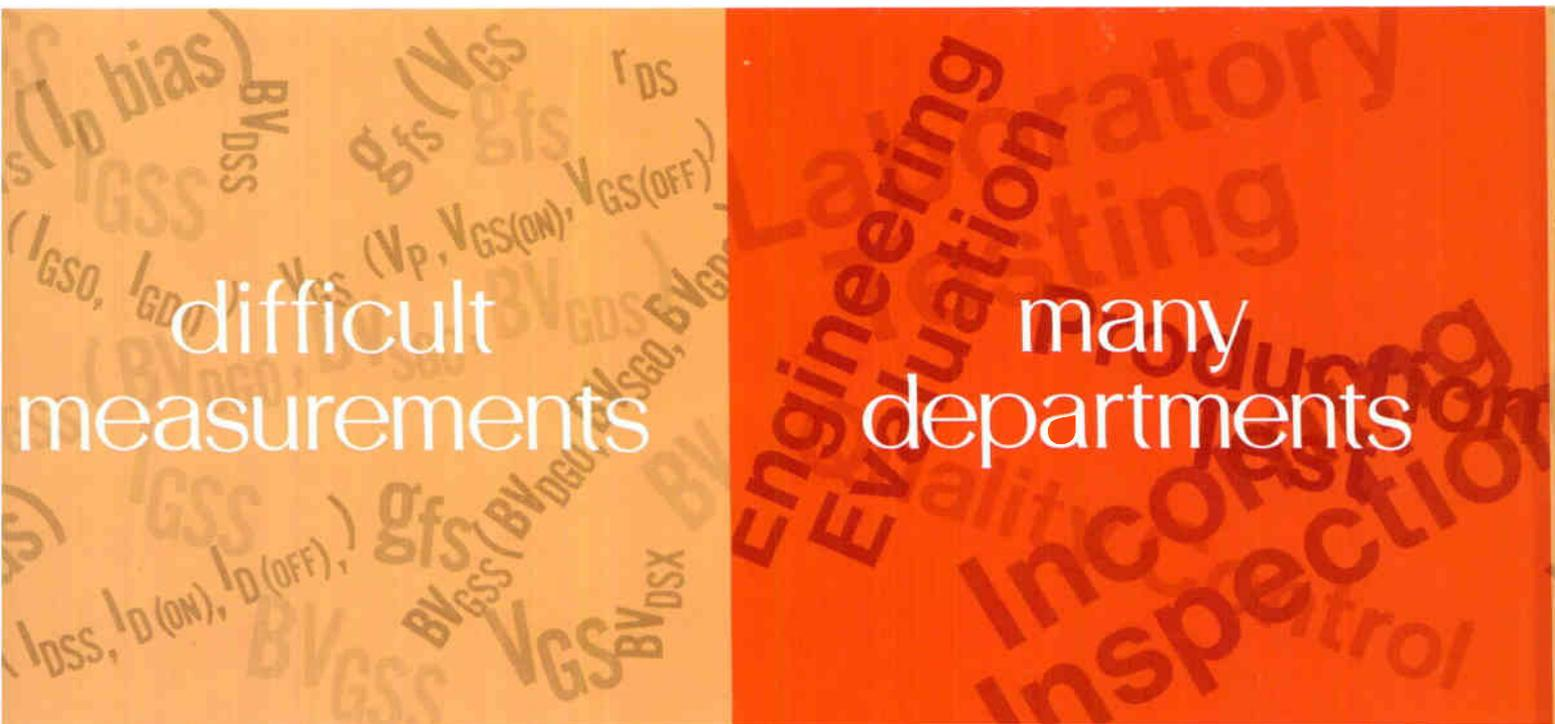

from IPT... the 200 Series Laboratory FET TEST SET

Keep your FET data free from noise and circuit contamination errors! IPT-200 Series modules feature test circuits isolated from the outside world • 201 module tests breakdown voltages, I_D , V_G , g_{fs} , and leakage currents down to 0.1 nA full scale • Rig your own with the 299 blank module • Small, lightweight main frame features two high-speed, digitally programmed, pulsable power supplies with rise and fall time less than 60 microseconds, plus seven fixed-bias supplies • Big taut-band meter or optional digital meter gives you clear, precise readout • When you need to test FETs (P or N-channel, MOS or junction), in the laboratory, in QC, for incoming inspection, or to do a special job in production, call for an IPT-200.

You'll need to know more, so we have a data sheet.

For immediate action call the IPT Hot Line shown below, you'll get an engineer with answers.



International Production Technology
185 Evelyn Avenue • Mountain View • California 94040
(415) 961-2458 • TWX: 910-379-6550 • Cable: INPROTECH



Specialists in:
Photolithographic Products—Probe Equipment—
Assembly Equipment—Component Handling—
Semiconductor Test Instrumentation . . .
all designed to give you the competitive edge!

Better solutions come from Weatherford

Try these for starters. TTL. Discretes. System Interface Circuits.

TI TTL...the Time saver. Save design time, delivery time, assembly time. Select Series 54/74 TTL from TI (you'll streamline your designs as well as simplify the hunt!). More than 90 distinct functions to choose from, including 35 MSI circuits. Three fully compatible performance ranges: high speed, standard, low power. Three package configurations: plastic and ceramic dual-in-line, and flatpack. Two temperature ranges: -55° to $+125^{\circ}$ and 0° to 70° . Save delivery time. TI's greatly increased TTL manufacturing capability keeps a reserve on our shelves. Save assembly time. Fewer packages make handling, inspection, soldering, plug-in and testing easier. Find out fast about the industry's broadest TTL line. We'll send you TI's new 424-page Catalog CC 201 or circle 491 on the Service Card.



TI's 14 preferred Zener reference diodes don three coats for greater reliability. Unique construction of TI's Zener reference diodes enhances reliability by reducing contamination and permitting pre-testing of cell forms. The cells are etched and varnished prior to assembly, outside the case. Then the case and leads are hermetically sealed for an extra measure of reliability and the leads are solder-dipped for sure solderability. The 14 preferred Zener reference diodes—types 1N746 to 1N759—serve approximately 75% of your needs for 250 mW and 400 mW reference diodes. If you're manufacturing electronic measuring instruments, computing machines, communications equipment, food processing equipment or industrial controls, give us a call. We'll send data sheets on TI's Zener reference diodes. Or circle 492 on the Service Card.

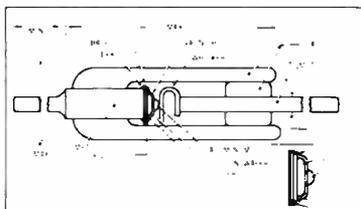

New TI line drivers/receivers nix system interface problems. Error-free data transmission over long lines between computers or between a computer and remote peripherals is clean and clear with TI's new line drivers and receivers. They feature high speed, standard supply voltages, dual channels and TTL/DTL compatibility. The output current capability of the SN55/75109 driver is 6 mA; that for the SN55/75110 is 12 mA. The line receivers feature diff amp inputs which drive TTL gate outputs; active pull-up (SN55/75107) or open-collector (SN55/75108). Prompt delivery on your choice of plastic or ceramic dual-in-line packages. We'll supply an application report and data sheet or circle 493 on the Service Card.

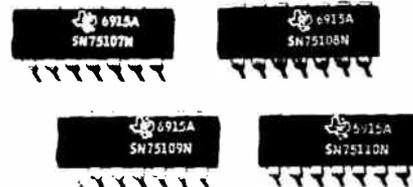

For better solutions, call your authorized TI distributor



R. V. WEATHERFORD CO.

DISTRIBUTORS OF ELECTRONIC COMPONENTS AND EQUIPMENT

ANAHEIM, CALIFORNIA
1550 Babbitt Street
714-532-6741
714-547-7521

GLENDALE, CALIFORNIA
6921 San Fernando Road
213-849-3151

PALO ALTO, CALIFORNIA
5240 Hillview Drive
Stanford Industrial Park
415-321-5373

PHOENIX, ARIZONA
1917 North 25th Drive
Carson Industrial Center
602-272-7144

POMONA, CALIFORNIA
1095 East 3rd Street
714-623-1261
213-966-8461

SALES OFFICES: San Diego, California, 714-278-7400 • Seattle, Washington, 206-762-4200 • Dallas, Texas, 214-231-6051

U.S. Reports

National Forest, as one Washington daily put it, was "being wired for Doomsday": to signal missile-carrying submarines to fire missiles against an enemy. This, the argument went, would not only make the site a prime enemy target, but also would destroy the forest primeval and pose an ecological threat to animal and plant life in the region and cause radiation pollution from Sanguine's buried cables.

In contradiction of earlier Navy statements, the Pentagon said there never was a plan to build the large Wisconsin site system—a rectangular grid 150 miles on a side with buried cables, each forming rectangles of 8 square miles. Calling it a "baselinc" conceptual design for study, the Pentagon said it permitted the Navy to "assume the worst" and "try to do the most." Nevertheless, Navy brass earlier this year were discussing plans for contract definition proposal requests in May, a date that later slipped to September.

Even though the Navy still has \$20 million in its fiscal 1970 budget for Sanguine, R&D is expected to continue for another four or five years. Principal loser is RCA, whose \$4.3 million contract to operate a test site in Wisconsin ends next month, according to the Navy. Similarly, the plan to request proposals for Sanguine receiver design and specifications also is in limbo, although Boeing is one of three or four contractors being considered for a study of the effect of Sanguine-radiated power on avionics.

Breakthroughs? Though the DOD says a much smaller Sanguine site may be possible by using lower-power transmitters "as a result of research breakthroughs," Navy sources call that bad phrasing. All the Navy has determined as a result of RCA's Wisconsin Phase 1 tests is that system power can be reduced by "at least an order of magnitude." That presents options for a smaller-area system with the same line current or the same size system as proposed for Wisconsin, with a sharp reduction in line current. "If I had my choice," says one official, "I'd take it down in current." Nevertheless, the Wisconsin site is the only one in the U.S.

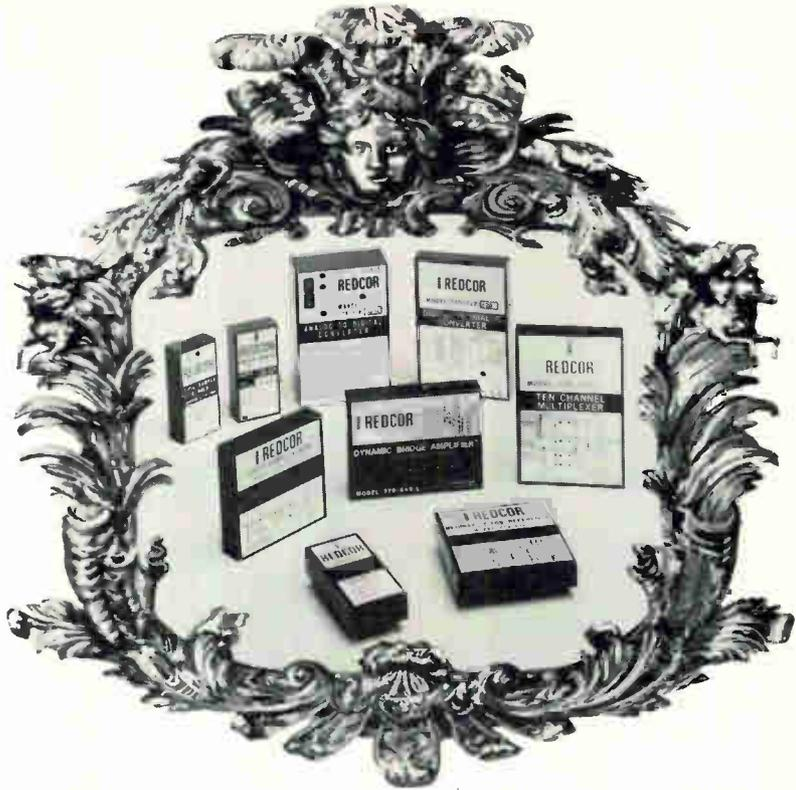

The Family Portrait

REDCOR Closed Loop Analog Modules

The REDCOR Module line has "guaranteed performance" for easy use by the system and instrument designer. The nine modules shown above are only part of the growing family. Meet some of the relatives:

- BUF-FET Amplifier/770-406
- Dynamic Bridge Instrumentation Amplifier/770-440
- 1MV High Speed Comparator/770-724
- 0.1% Sample and Hold/770-708
- 0.01% Sample and Hold/770-715
- 10 Channel Multiplexer/770-730
- 12-Bit Digital to Analog Converter/770-712
- REDIREF® ± 10V Reference Supply/770-501
- 12-Bit Analog to Digital Converter/770-750

The relatives can be combined in a variety of ways to solve your individual analog problem. They are all compatible, to each other, and the "outside world." If you would like to learn more about the members of our family, write or call:

REDCOR
CORPORATION

Complete Systems Capability/7800 Deering Avenue, P.O. Box 1031,
Canoga Park, California 91304—(213) 348-5892

The INNOVATORS



FIRST

Bishop introduced the multi-pad configuration! More accurate, less work.

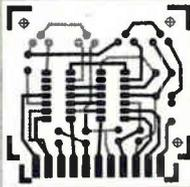

NEXT

Bishop introduced absolute registration for two-sided printed wiring boards with the only photographically compatible Red and Blue System.



NOW

Bishop offers you the largest selection of pressure-sensitive electronic component drafting aids in the industry.

Over 15,000 to choose from! Precise, uniform, easily applied. All in our new comprehensive 68-page printed-circuit design guide and catalog. Send for yours now! We'll send you free samples, too.



Bishop Graphics, Inc.

7300 Radford Avenue, North Hollywood, California 91605 (213) 982-2000
©1969 BISHOP GRAPHICS, INC.

U.S. Reports

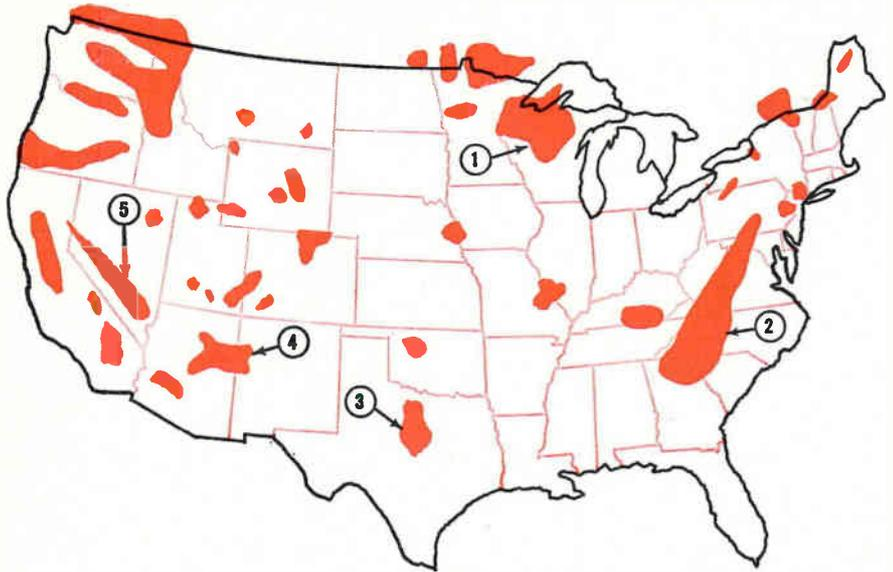

Possible sites. With northern Wisconsin (1) eliminated as a Project Sanguine site, the Navy must look at other flat or rolling areas. Mountainous areas (2) are ruled out, leaving flat regions like Texas (3), Arizona and New Mexico (4), or Nevada (5).

large enough and with conductivity characteristics low enough to support a 22,000-square-mile grid. The Navy, however, has determined that there are at least 39 other sites with low conductivity characteristics.

Wisconsin's baseline system with 40 amps power created an ambient magnetic field of 1.0 gauss and 0.35 volts per meter. A reduced system would generate 0.07 gauss and 0.025 volts per meter. Sources point out that by using the equation that power is essentially a function of power plus antenna length squared, power could be cut to one-tenth the original plan to permit reduction of either area or current by about one-third.

Government

Hawks prevail

As Senate opponents of rising defense spending watched in frustration, most of their efforts came to nought when a House-Senate conference committee resolved most of 75 items in controversy in the fiscal 1970 Pentagon procurement authorization in favor of the more hawkish lower house. The outcome

was an authorization of \$20.7 billion for military procurement—some \$721 million more than the Senate version but only \$637 million less than the House sought.

The total compares with revisions of the Johnson budget proposal by Defense Secretary Laird, who came up with a \$21.9 billion request. What Laird finally got was a procurement authorization heavily oriented to hardware, rather than research and development, which was cut 11% to about \$7.3 billion. Of the R&D money, the Army will get \$1.6 billion; the Navy almost \$2 billion, and the Air Force more than \$3.1 billion, with the rest going to the Defense Department.

Though the outcome of the conference had been predicted [*Electronics*, Oct. 13, p. 65], some Senate sources thought the conference chairman, Sen. John Stennis (D., Miss.), laid it on a little thick when he commended chairman L. Mendel Rivers (D., S.C.) of the House Armed Services Committee for his "very fine spirit of cooperation."

SAM stays. The Army's SAM-D surface-to-air missile, successor to Hawk and Hercules, got \$60 million of the \$75 million R&D requested even though the Senate sought to eliminate funds for the Raytheon system altogether. The

TRW METALLIZED POLYCARBONATES



...good things come in small packages

A 10 mfd 50 volt type X483 capacitor measures a scant .670" x 1 $\frac{1}{8}$ ". It's hermetically sealed and provides outstanding temperature stability and electrical properties. Meets all MIL-C-18312 and MIL-C-19978 requirements.

Type X483 are advanced technology capacitors tailor-made for advanced technology applications. Values from .001 to 10 mfd, 50, 100, 200 and 400 volt.

Contact TRW Capacitor Division, Box 1000, Ogallala, Neb.

Phone: (308) 284-3611. TWX: 910-620-0321.

TRW®



High voltage transients caused this emitter-base short which later caused failure of several power transistors.

And how you can prevent it.

Whether it was caused by a technician with a wayward probe, or a piece of heavy equipment starting up nearby, or "strays," the origin of a high-voltage transient is of no consequence.

In every case, the results are the same: immediate—or eventual—failure of costly semiconductors.

Even though it may not fail immediately, the punctured device is left with a path, analogous to scar tissue, along which subsequent failures take place.

Eventually, under thermal stress or load conditions, the semiconductor gives up. Often without apparent cause.

Protection against transients

The Heinemann JA/Q™ electronics protector prevents high voltage spikes, or overvoltages of any kind, from ever reaching your semiconductors. (JA/Q undervoltage protectors are also now available.)

The JA/Q provides protection against transients and overvoltages by sensing them before they reach the vulnerable portions of the circuit. It responds to dangerous conditions

by shunting them from the line and signaling a trip mechanism to open the line.

Transient response time of the JA/Q is within 500 nanoseconds. Trip time is 10 milliseconds.

And overcurrent protection

Transient/overvoltage protection is combined in the JA/Q with hydraulic-magnetic overcurrent protection, which may be specified with or without time delay, depending on your circuit requirements. Time delays for typical overcurrent faults have no effect on the trip time of the protector under transient or overvoltage conditions.

To learn more about the JA/Q, write for Bulletin 3370. We're as interested in preventing failures as you are. Heinemann Electric Company, 2600 Brunswick Pike, Trenton, N.J. 06802.

4440

HEINEMANN



U.S. Reports

House also got the Senate's agreement to restore \$66 million in Navy R&D for the E-2C command and control aircraft developed by Grumman, while the House accepted a Senate cut of only \$15 million for R&D on the Lockheed S-3A antisubmarine warfare aircraft, leaving the Navy with \$140 million for the program.

The conferees compromised at \$35 million for the Navy's Advanced Surface Missile System (ASMS) for which the House sought \$67.8 million and the Senate \$24.9 million. But the House got back \$25 million for the Air Force's Airborne Warning and Control System (AWACS) for a \$40 million funding total. The situation with Short Range Attack Missile (SRAM) was comparable. The House sought \$84.7 million; the Senate \$67.7 million. The Air Force got \$75 million. As for the AX close support aircraft, the Senate got its 'druthers, getting back \$8 million of the \$12 million in R&D when the House had authorized no money.

Hardware. Army procurement of 170 more Bell Helicopter AH-1C Cobras at \$86 million was approved to compensate for cancellation of the controversial Lockheed AH-56A Cheyenne gunship earlier this year. The Cobra deal got an okay even though Senate opposition argued it was unnecessary in view of the Administration's plan to cut Vietnam activity.

At the same time, Senate conferees acceded to the House action restoring \$104 million for Navy A-7E aircraft plus \$374.7 million more for Air Force A-7D's—a substitution of the LTV aircraft for McDonnell Douglas F-4's initially sought. Reinstatement of the A-7 authorization came when the new Air Force staff chief said the service preferred the plane to the F-4.

Controls. Though the final appropriation to support the compromise funding authorization is still to come—probably next month, making it the latest appropriation in history—the initial Senate effort to tack on stiffer controls on contractors was wiped out. The so-called Proxmire and Schweiker amendments, for example, were effectively killed.

NEW...!

FROM TRACOR/GTC,
the most experienced producers of
RUBIDIUM FREQUENCY STANDARDS
THE NEW MODEL 304-D

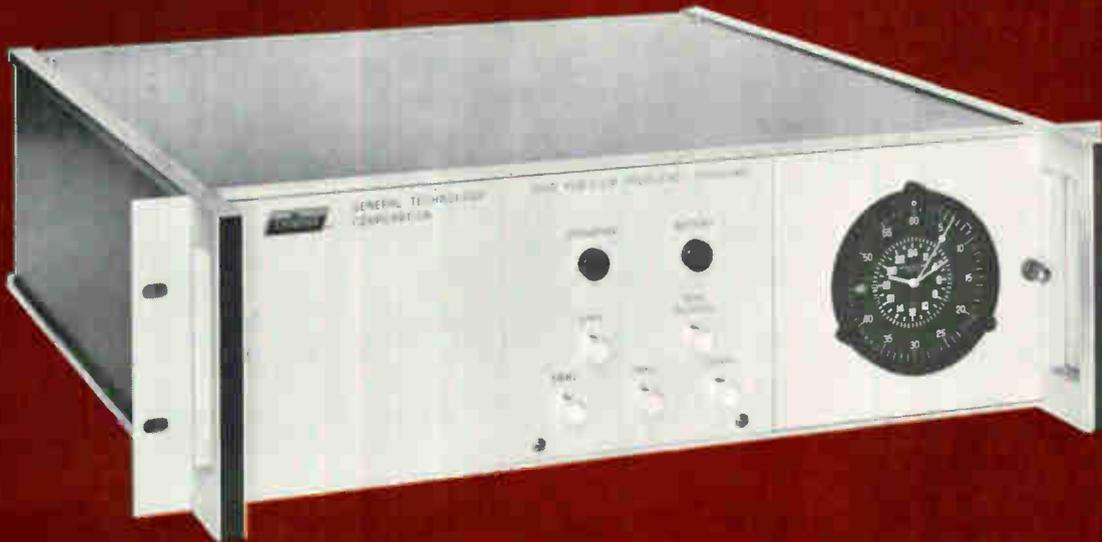

Developed from space environment designs at the General Technology Corporation, this new Atomic Standard combines state of the art circuitry with GTC's unmatched Rubidium Frequency Standard technology.

- Superior Long Term Stability
- Internal Standby Battery†
- Internal Clock system†
- \$7,300.00* with internal time scale selector.

Write for specifications on the new 304-D to
TRACOR
INDUSTRIAL INSTRUMENTS
6500 Tracor Lane, Austin, Texas 78721
AC 512/926-2800

* FOB Los Angeles † optional

Specialized instruments to meet your specific needs

TRACORTM

IA-124



"THANKS"

Thanks to the many companies that have specified Semtech Rectifiers over the years.

Thanks to the Semtech engineers that have designed our industries finest line of silicon rectifiers: Metoxilite, Sempac®, Slimpac®, Alpac®, Sticpac®, Stacpac, Compac, Cupac and Ministic.

Thanks to all Semtech employees for a job well done.

It has been very gratifying to be able to consistently produce top quality rectifiers for a competitive market.

San Francisco — 941 E. Charleston, Suite 10, Palo Alto, California
94303 / (415) 328-8025
Chicago — 140 N. La Grange Road, La Grange, Illinois 60525 /
(312) 352-3227 / TWX: 910-683-1896
Dallas — 402 Irving Bank Tower, Irving, Texas 75060 /
(214) 253-7644
New York — 116-55 Queens Blvd., Forest Hills, New York 11375 /
(212) 263-3115 / TWX: 710-582-2959
Baltimore — 8654 Baltimore National Pike, Ellicott City,
Maryland 21043 / (301) 465-7363
European Sales — Bourns A.G. Alpenstrasse 1
6301 Zug, Switzerland / 042-21-78-77

 **SEMTECH**
CORPORATION

652 Mitchell Road, Newbury Park, California 91320
(805) 498-2111, (213) 628-5392 / TWX: 910-336-1264



RCA-TA7477
(actual size)

Companion types:
RCA-TA7408 &
TA7409
(actual size)

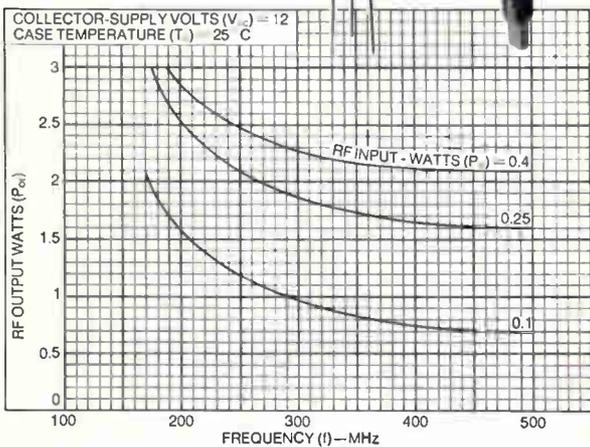

Headed for an important role in mobile and portable communications equipment, the high-gain RCA-TA7477 is now available in production quantities. This silicon n-p-n "overlay" transistor, designed for 12 V service, also is capable of 2 W minimum output at 470 MHz (7 dB gain). It is intended for Class C vhf/uhf amplifier service in CB, sonobuoy and beacon, as well as other mobile and portable applications.

Either an RCA-TA7477 or a TA7408 (also 7 dB gain at 470 MHz) may be used to drive a TA7409 final amplifier to 6 W (min.) output at 470 MHz. The latter two are stripline devices.

Ask your local RCA Representative or your RCA Distributor for more detailed information. For technical data, write: RCA Electronic Components, Commercial Engineering, Section N11-2/UF4, Harrison, N. J. 07029. In Europe: RCA International Marketing S.A., 2-4 rue du Lièvre, 1227 Geneva, Switzerland.

**2 W (typ) output,
13 dB gain, at
175 MHz in 12 V service—
the RCA-TA7477**

RCA



Put \$69 into your product line and start counting the profits. Digitally.

Take your product line. Snap Tyco's new 2½-digit panel meter into the same opening you might use for an ordinary pointer meter. And there you are in the digital age. And your entire line is better . . . a lot more than \$69 better.

Tyco's new 2½-digit meter is the highest quality, lowest priced digital panel meter available. With the easiest, fastest, most accurate readings possible. Digital so there's no room for operator interpretation. So clear that your customers can read them

from thirty feet across the room . . . from any angle.

The high performance and low price of this meter is possible because of a unique technological development.* It sells for \$69 in lots of 100, \$89 for single units. No mounting hardware is required because the 4½" x 3" x 3" meter just snaps into the front of the panel opening and stays there. Reads to 100% over-range. Has 1 millivolt resolution. 100 megohms input impedance. Overload protection and polarity indication. Needs no zero adjustments. Requires low input power. Has no moving parts or pointer mechanisms to break

down. Comes with a one-year warranty.

And there's more: 3½-digit units, both unipolar and bipolar, with and without BCD outputs; and 4½-digit units, bipolar with BCD outputs. Voltage attenuators and current shunts are available, increasing the versatility of Tyco panel meters. Send today for detailed specifications. We think you'll like our line. Tyco Instrument Division, Tyco Laboratories, Inc., Bear Hill Industrial Park, Waltham, Mass. 02154, (617) 891-4700.

* U.S. and Foreign Patents Pending

TYCO instrument
division

3 That are ready

For Top Quality Testing Performance



I Triplet's Model 630-M Type 1 V-O-M

- 1,000,000 Ohms per volt DC for greater accuracy on high resistance circuits. 20,000 ohms per volt AC.
- 1 μ a Suspension Meter Movement. No pivots, bearings, or rolling friction. Extremely rugged. Greater sensitivity and repeatability.
- 61 ranges, usable with frequencies through 100 kHz. Temperature compensated. 1 $\frac{1}{2}$ % DC accuracy, 3% AC in horizontal position.

\$220⁰⁰

II Triplet's Model 630-NS V-O-M

- 200,000 Ohms per volt DC sensitivity for greater accuracy on high resistance circuits. 20,000 ohms per volt AC.
- Suspension Meter Movement. No pivots, no bearings, no hairsprings; no rolling friction. Extremely rugged.
- 62 ranges. Temperature and frequency compensated $\pm 1\frac{1}{2}$ % DC Accuracy, $\pm 3\%$ AC.

\$110⁰⁰



III Triplet's Model 630-NA Type 3 V-O-M

- One selector switch minimizes chance of incorrect settings and burnouts.
- 70 ranges: 1 $\frac{1}{2}$ % DC accuracy on meter; with mirrored scale and diode overload protection.
- Temperature and frequency compensation; polarity reversing.

\$93⁰⁰

from the Instrument Makers... Established 1904

TRIPLET

**TRIPLET ELECTRICAL INSTRUMENT CO.
BLUFFTON, OHIO 45817**

TRIPLET

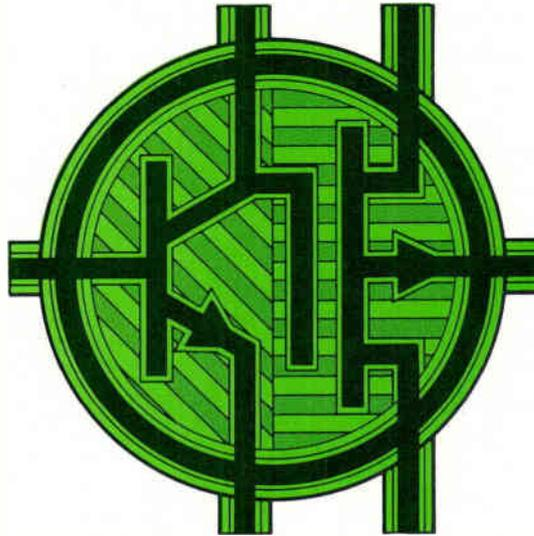

MONOLITHIC BIPOLAR/MOS DRIVER-SWITCHES

Why Bipolar/MOS? By using bipolars in your analog switch driver circuits you get high breakdown voltages, fast switching speeds and low power dissipation.

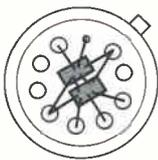

The industry approach has been a chip for bipolars and a chip for the MOS FETs, or an all-MOS configuration at the expense of critical parameters.



New Siliconix technology puts the bipolar and MOS transistors on one chip, reducing the number of bonds and die-attach steps and simplifying assembly. You get better mechanical and electrical integrity, increased reliability, lower cost.

- Switches are normally OFF P-channel MOS FETs
- Zener diodes protect all MOS gates
- Metal areas are glass passivated
- Each channel complete – no other components needed
- Input compatible with DTL, TTL and RTL logic
- Switches analog signals up to 20 volts

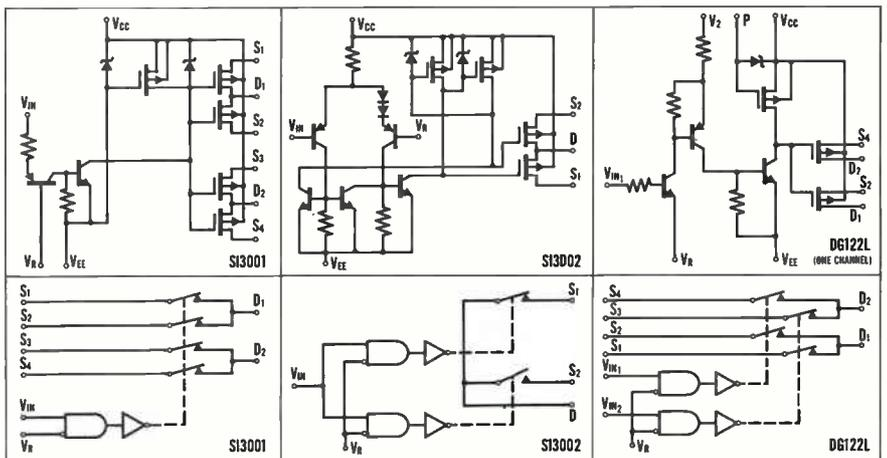

These are just three of more than 30 Siliconix multichannel driver-switch combinations with MOS or junction FET switches. A standard line of separately packaged drivers and switches is also available. Write or call for complete data on the industry's broadest line of driver-switches.

* Applications Power: A wide variety of driver/FET switch combinations and an in-depth applications team waiting to serve you!



Siliconix incorporated

2201 Laurelwood Road • Santa Clara, Calif. 95054
Phone (408) 246-8000 Ext. 201 • TWX 910-338-0227

in Europe... Siliconix Ltd., Siliconix House, Sketty Park, Saunders Way, Swansea, U. K.

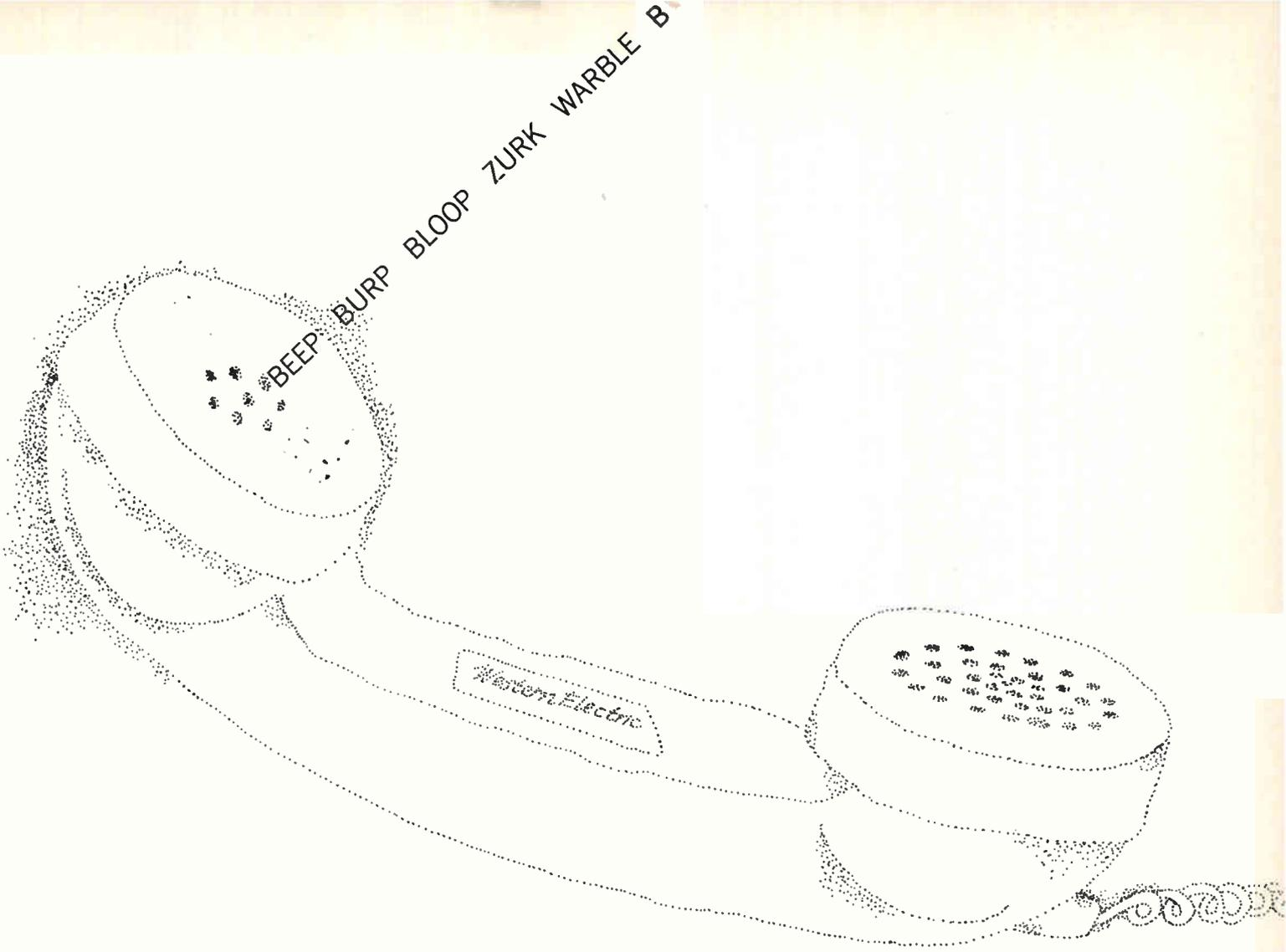

MONOTHERM® UNDERSTANDS

If you want the output of a computer fed directly into another business machine 3,000 miles away, Western Electric's Data-Phone® Data Communications Set can make the connection. Over ordinary telephone lines.

Data bits from the computer are converted to tones by a Data-Phone data set. At the receiving end a similar set changes the tones back into the signals required by the business machine.

The key component in many Data-Phone data sets is a Western Electric 3A2 Data Unit. And at the heart of the Data Unit is a Riegel

Monotherm® flexible laminate of copper and Type H Kapton® used for the printed circuits.

Why Monotherm? Because it's an extremely flexible laminate which folds like a book to compact size, thus saving valuable space. Because it eliminates the need for a color-coded wiring maze. Because it possesses high dimensional stability. Because it can be automatically (and repeatedly) soldered. Because its uniquely high heat resistance makes it easily repairable in the field.

If automated mass production, high reliability, low cost, im-

proved serviceability and small size are design requirements of your circuits, why not make a connection with Monotherm? The coupon will do it.

Synthane • Taylor Corporation
Valley Forge, Pennsylvania 19481

Please send me Kapton®/copper data sheets and the Conductor and Dielectric Guide for Riegel Monotherm.

Name _____

Company _____

Street _____ City _____

State _____ Zip _____



synthane•taylor

EXCLUSIVE U.S. DISTRIBUTOR OF RIEGEL MONOTHERM IN SHEETS AND ROLLS

Monotherm®—registered trademark of Riegel Paper Corporation for its laminations of conductive and dielectric materials.
Kapton®—registered DuPont trademark for its polyimide film. Data-Phone®—registered trademark of Western Electric Co.

8" HELIAX

high power without a hanger "HANG-UP"

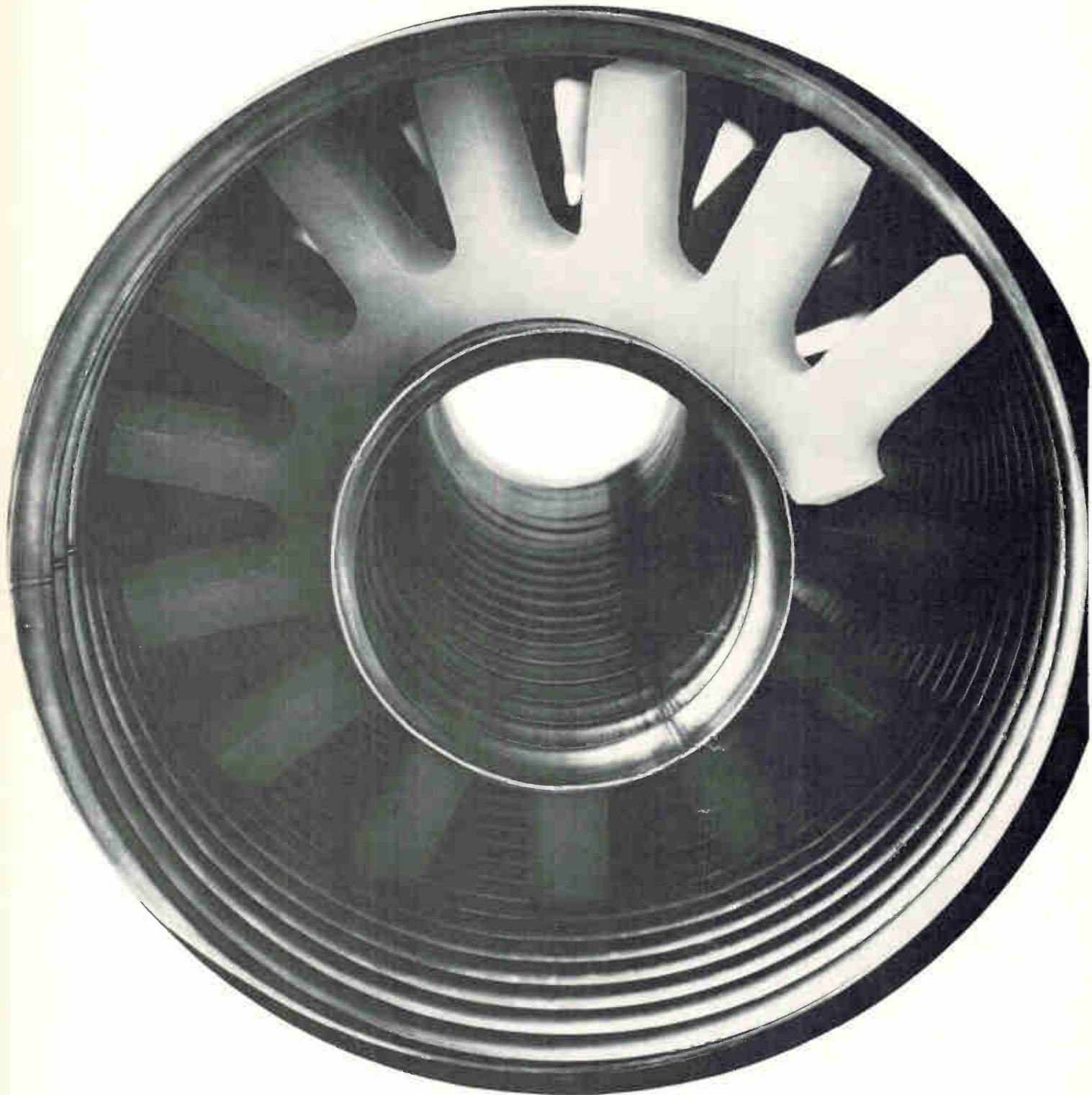

Faced with carrying a couple of hundred RF kilowatts? Need low, low attenuation? Move up to 8" HELIAX® coaxial cable. Big. Semi-flexible. Continuous lengths to 850 feet. Eliminates connector bullets and complicated hangers. Thermal expansion

and contraction don't faze it. Power capabilities: 300 kw average at 30 MHz; 58 kw at 600 MHz. Use for HF; Tropo; OTH radar; VHF and UHF-TV. Wouldn't you like to know more? Communicate with Andrew.

11-68

 **ANDREW**

CONTACT THE NEAREST ANDREW OFFICE OR ANDREW CORPORATION, 110500 W. 153rd STREET, ORLAND PARK, ILLINOIS 60462
Circle 62 on reader service card

Washington Newsletter

November 24, 1969

**Defense spending
seen continuing
downward curve ...**

Predictions continue that Defense Secretary Melvin Laird will push hard for his privately stated goal of bringing Pentagon spending down to 7% of the Gross National Product from the 9% level of his predecessors.

Latest warning flag has been hoisted by Murray Weidenbaum, former outspoken critic of defense industry profits and now assistant Treasury Secretary for Economic Policy. Weidenbaum says military expenditures have "passed a crest and are now receding." The Treasury official believes the drop will play an important role in Administration efforts to control inflation. Military prime contract awards are now running 24% under last fiscal year's peak second quarter.

Weidenbaum's optimism dies a bit, however, in considering post-Vietnam R&D spending. He notes that a "substantial amount of catch-up spending" on strategic and tactical aircraft, missiles, and ship systems is being considered to replace obsolescent weapons.

**... but EDP firms
face a surfeit**

Contrary to the trend, computer makers find themselves frustrated by the multiplicity of defense contracts on the way. In addition to the Air Force Logistics System worth an estimated \$105 million, and the \$250-million-to-\$300-million World Wide Military Command and Control System just approved, industry is also looking to Navy for another \$105 million in business from its Stock Points system for parts distribution at 200 locations. The Strategic Air Command anticipates a green light about Dec. 1 for its \$5 million Seedcups program, a nine-machine data processing network worth \$70 million to \$75 million. Industry's dilemma: Where to commit resources and bid.

**\$20 million orders
for microwave net?**

Microwave hardware makers can expect more than \$20 million in business from the first five routes proposed by affiliates of Microwave Communications of America Inc. [*Electronics*, Sept. 29, p. 133]. Competing for the estimated \$1 million requirement of the first authorized route between Chicago and St. Louis are Collins Radio, ITT, and Raytheon Co.'s Microwave Equipment division, says MCI president John D. Goeken. Larger requirements are expected for routes between New York and Chicago (\$8 million), Chicago and Minneapolis (\$2.5 million), and the Pacific Coast net operating from Southern California to the State of Washington (\$6 million).

**IC patent reversal
won't change much**

Reversal of a 1967 ruling on a basic integrated circuit patent won't have much impact on the IC patent situation. The U.S. Court of Customs and Patent Appeals ruled that the invention belongs to Fairchild Semiconductor rather than Texas Instruments. The patent covers an IC having an adherent metal pattern over an oxide insulator to interconnect the circuit elements.

What the decision will do, however, is strengthen the basic patent position of Fairchild, particularly in regard to IC makers that haven't signed licensing agreements with Fairchild. Motorola Semiconductor is a notable example.

The original application for the patent was filed in 1959 by Robert N. Noyce, then Fairchild general manager, and awarded in 1961; it was

Washington Newsletter

contested by TI's Jack Kilby in a 1962 application. Kilby's earlier IC patents had shown a combination of active and passive elements, but included wire bonds to connect the elements. Batch fabrication couldn't be accomplished at this point, since the practical application of IC's depended on using oxide as an insulator with the interconnection overlay.

IC's can't be made today without infringing on Kilby's earlier patents, and the reversal of the 1967 decision won't have any effect on Fairchild and TI because of their cross-licensing agreement. Noyce's planar patents, which were not involved, were issued in 1962 and 1963; both Kilby's and Noyce's processes are needed to build IC's today. TI, however, says it will petition for a rehearing.

Nixon weighing more ABM radars to guard against sub missiles

President Nixon is expected to make a decision in December on deploying additional missile radar sites for Safeguard ABM, says Gen. A.D. Starbird, Safeguard system manager.

Starbird told the House Appropriations Committee that four more missile site radars (MSR) and four perimeter acquisition radars (PAR), at an estimated cost of \$2.5 billion, are needed to protect the U.S. mainland from a submarine-launched nuclear attack—a PAR blind spot. The PAR, at \$200 million each, should be deployed at the four corners of the United States, says Starbird, and MSR's should be deployed with them "to make the PAR effective." Raytheon is building MSR's, and General Electric the PAR's, under subcontracts to Western Electric.

Starbird says Nixon's decision will be based on technical progress, how the threat is developing, and progress in strategic arms limitation talks.

Vietnamization means simpler systems

The electronics industry can look for a new set of specifications for simpler systems in Vietnam. Military leaders in the field increasingly complain that the complexity of American systems is making it difficult—in some cases impossible—to turn them over to relatively unsophisticated Vietnamese forces. This problem is a big stumbling block in Defense Secretary Melvin Laird's plan to Vietnamize the war. Delivering the word to industry is Air Force Under Secretary John L. McLucas.

First example of plans to promote simplified systems is the Congressional compromise on procurement of the Northrop F-5 "Freedom Fighter." Though the plane was designed for sale abroad, the House dumped \$48 million for F-5 R&D and \$4 million for long-leadtime procurement into the DOD spending bill. The compromise calls for \$28 million to be absorbed by the Air Force for F-5 procurement for Vietnam.

Pioneer and Viking power units sought

A major move to proceed with the Viking spacecraft for a soft Mars landing in 1973 plus two Pioneer vehicles to fly by the Planet Jupiter has been taken by NASA. The agency has asked the Atomic Energy Commission to buy 10 "improved" SNAP-19 nuclear power generators plus backup systems as primary power sources for the three spacecraft. The AEC is negotiating with Isotope Inc., a Teledyne unit. Though NASA had not disclosed the move, a company official confirmed that work was in progress on the 30-watt generators. Improvements over the existing SNAP-19 now on board the Nimbus-3 weather satellite include installation of a new thermoelectric material known only as TAGS. Value of the award: an estimated \$10 million.

The Standard Laboratory Power Supply

\$145⁰⁰

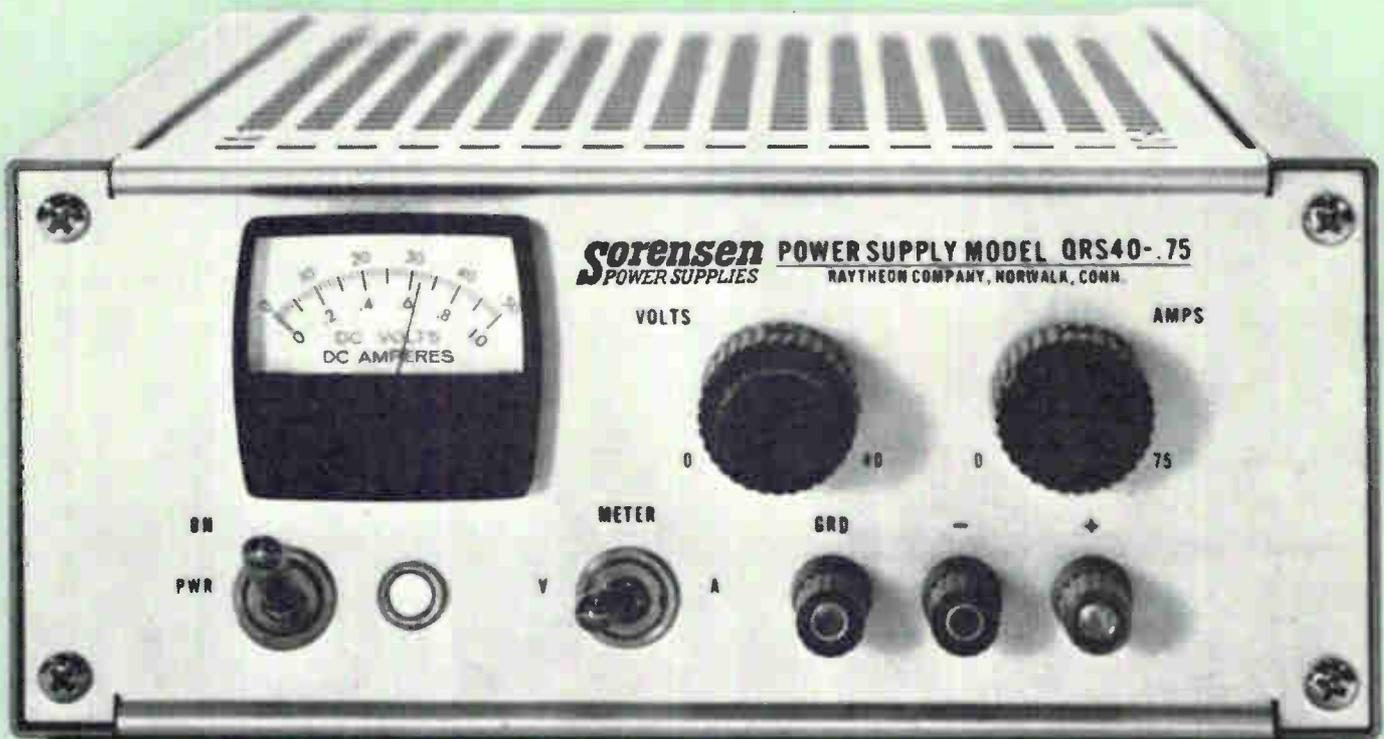

There are seven QRS models, available from stock, in this series of high performance power supplies—four 30 watt models and three 80 watt models with voltage ranges of 0 to 15, 20, 30, 40 and 60 Vdc.

Features include:

- 0.01% or 1mV voltage regulation/current regulation with automatic crossover
- 400 μ V rms (6mV p-p) ripple to 25MHz
- 0.01% resolution
- 50 μ sec. transient response
- -20°C to +71°C operating temper-

ature ■ remote sensing/remote programming.

Single and dual mounting 19" adapters permit rack mounting a single QRS or two units side by side.

For more information contact your local Sorensen representative or; Raytheon Company, Sorensen Operation, Richards Avenue, Norwalk, Connecticut 06856.

Tel.: 203-838-6571;

TWX: 710-468-2940;

TELEX: 96-5953.



Circle 200 on Inquiry Card

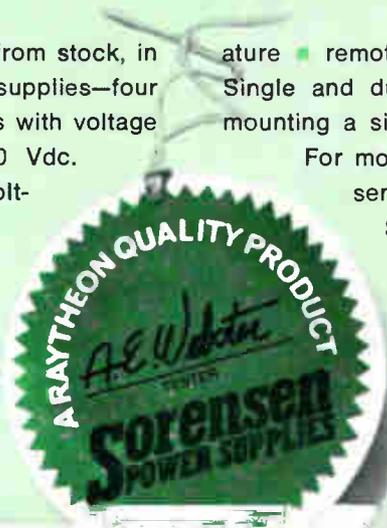

PRE-ENGINEERED POWER!

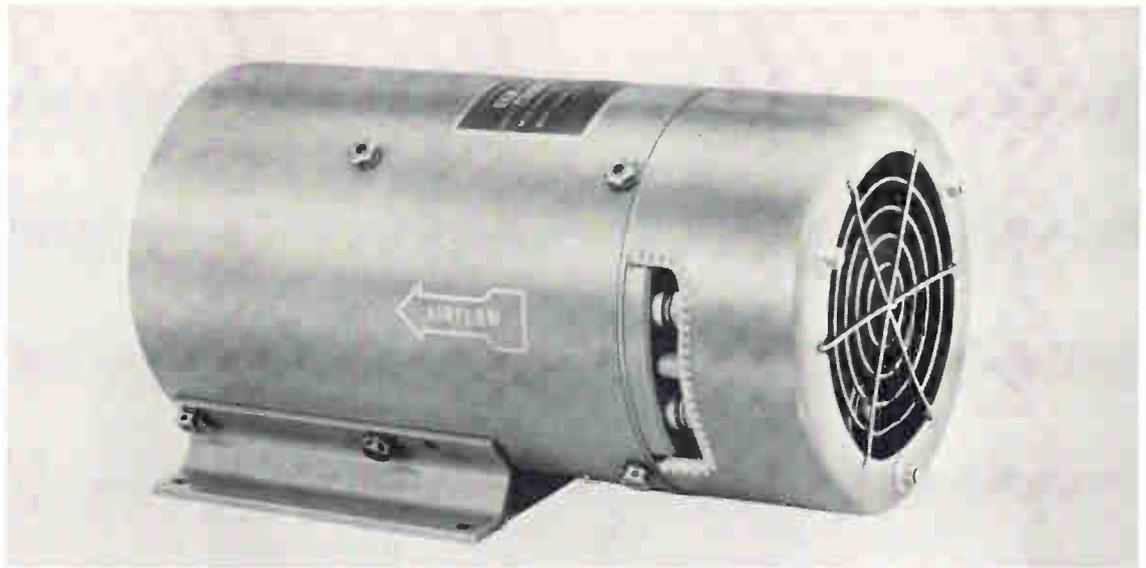

28G5P 47-65 Hz input (also style 28GP for 400 Hz), high-efficiency 28 V.D.C. output; lightest, most compact static unit.

Here are two readily available ways to get dependable 28 V. D. C. high-current power

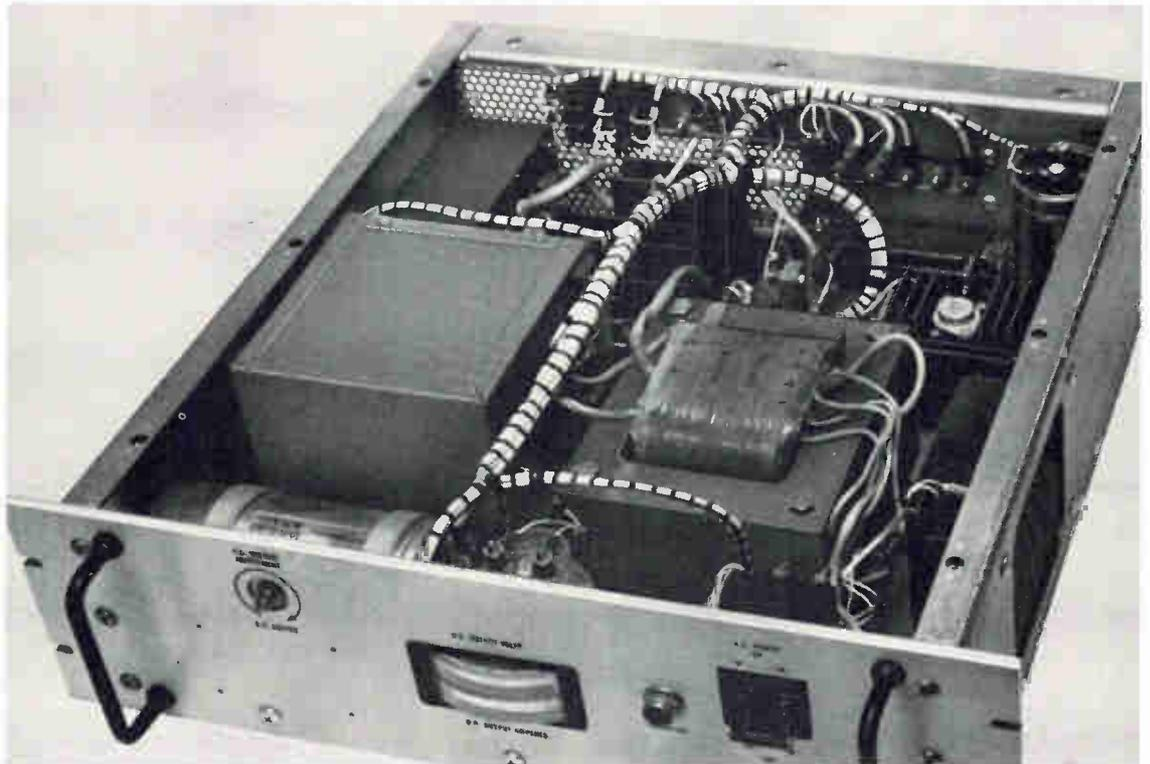

CR27.5 High-current, adjustable, 1% regulation, 28 V.D.C. output, 50-60 Hz unit. Withstands substantial overloads.

Tung-Sol pre-engineered standard power supplies meet lots of special requirements. You'll find they offer many cost/efficiency/size-weight/availability advantages. No more shoehorning in at the last minute with a make-do power unit. No more high-cost custom or do-it-yourself designs. In all likelihood, Tung-Sol's done it before ... and can meet the specific requirements of your circuitry.

Tung-Sol pre-engineered power supplies reflect unique production abilities and in-house capabilities in solid-state components, transformers and electromagnetics which contribute added performance-value to your equipment. Units meet EMI and MIL Specs.

Talk to one of our experienced factory engineers. He's backed by a versatile line of pre-engineered, readily available, standard power supplies. Tung-Sol Division, Wagner Electric Corporation, 630 West Mt. Pleasant Ave., Livingston, N.J. 07039. Telephone (201) 992-1100.

TUNG-SOL*

Helps you do more
...with less

*Registered trademark Wagner Electric Corporation

our Micro/Con D series rack-and-panel connectors. They're for when you put a connector in one of those unprotected places and it gets banged around a lot.

One side is stainless steel. One side is die-cast aluminum. And the big thing is, it's the first metal shell connector that will mate with any existing version. Interchangeable. Intermountable. You can use them with old and new equipment alike.

Our new shell comes in all the standard pin

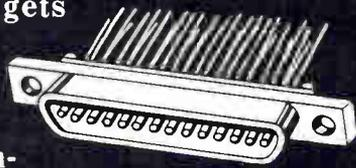

them on our flat cable connectors. If this excites you at all, maybe you'll enter our contest. Think of a new application for our new metal shell connectors, send it to us, and you'll have a chance at winning a case of scotch. And even if you don't win, we'll send you a genuine certificate recognizing your dumb idea.

Microdot Inc., 220 Pasadena Avenue, South Pasadena, California 91030.

MICRODOT INC. 



**The new
shell game.**

Rectifier diodes— up to 20A in DO-4



... a complete range
of controlled avalanche,
fast recovery and
general purpose types

48 different types, normal or reverse polarity. All in the popular DO-4 encapsulation—the smallest internationally recognised rectifier outline. Here are brief details of a selection from the range.

Silicon Avalanche Rectifier Diodes

Type Number	Average Forward Current	Peak Inverse Voltage Range	Surge Current	Avalanche Test Power
BYX39	6A	600-1000V	80A	4kw
BYX25	20A	600-1000V	360A	18kw

Fast Silicon Avalanche Rectifier Diodes

Type Number	Average Forward Current	Peak Inverse Voltage Range	Surge Current	Frequency
BYX30	7.5A	200-600V	250A	50Hz
BYX46	15A	200-600V	300A	50Hz

Silicon Rectifier Diodes

Type Number	Average Forward Current	Peak Inverse Voltage Range	Surge Current
BYX38	2.5A	200-800V	38A
BYX48	6A	200-800V	90A
BYX42	10A	200-800V	125A

All types available in both normal and reverse polarities.

Every designer should have a copy of the Mullard booklet "Rectifiers, Diodes, Thyristors and Triacs." These products are the result of extensive research and development programmes in the Mullard laboratories in England. Mullard employ 1,000 qualified scientists and engineers and have six major plants, with over 3 million square feet of floor space.

Write today for information on Mullard DO-4 rectifiers and for the name of your local representative.

Mullard Limited, Mullard House, Torrington Place, London W.C.1, England.

U.S.A. enquiries to Mullard Inc., 100 Finn Court, Farmingdale, Long Island, New York 11735, U.S.A. Telephone: (516) 694-8989. Telex: 961455.

Mullard

When you develop an instrument capable of near-perfect voltage measurements plus the capability to measure charge, current, and resistance—there's no need for put-on. You tell it like it is.

For voltage measurements, no other DVM can match the input impedance of our new 736A Digital Multimeter®. All solid-state with MOS-FET input, the 736A features a full three-digit display with 200% overrange (2.999 max. display). The unit features a completely new method of measuring resistance. The input resistance is just about infinite—even at 100 volts. Stability? For an electrometer—it's positively unreal.

Range and accuracy:

Volts — 30 mV f.s. (10 μ V resolution) to 100 V f.s., \pm .3% to \pm .1%, with $> 10^{16}$ Ω input Z.

Coulombs — 10 $^{-11}$ Coul. f.s. to 10 $^{-6}$ Coul. f.s., \pm .2% to \pm .5%.

Amperes — 10 $^{-2}$ amps f.s. to 10 $^{-12}$ amps f.s., \pm .1% to \pm .7%; Offset $< 5 \times 10^{-15}$ amps; Input drop 100 μ V, typical.

Ohms — 10 Ω f.s. to 10 14 Ω f.s., \pm .1% to \pm .75%.

And that's like it is!

Or, for direct current measurement, there's our new 706A Precision Picoammeter. It measures from 3 $\times 10^{-13}$ to 10 $^{-2}$ amps f.s. and features a built-in current source for

input signal suppression, self-standardization (\pm .1% f.s.), or external instrument calibration.

Output multiplier (x10, x3, x1) allows precise scaling of output current from 10 $^{-6}$ to 10 $^{-12}$ amps (\pm .1% f.s. to \pm .5% f.s.) Panel graphics designed for error-free operation.

Also available is the 726A Picoammeter, or digital version of the 706A, featuring: the same accuracy, built-in current suppression, internal/external calibration capabilities, automatic polarity display, and 200% overrange for digital displays up to 2.999. Optional digital output also available.

For complete specs., write or call EG&G, Laboratory Products Div., Box 755, Goleta, California, 93017 (805) 967-0456.

OUR
SPECS
ARE NO
PUT-ON



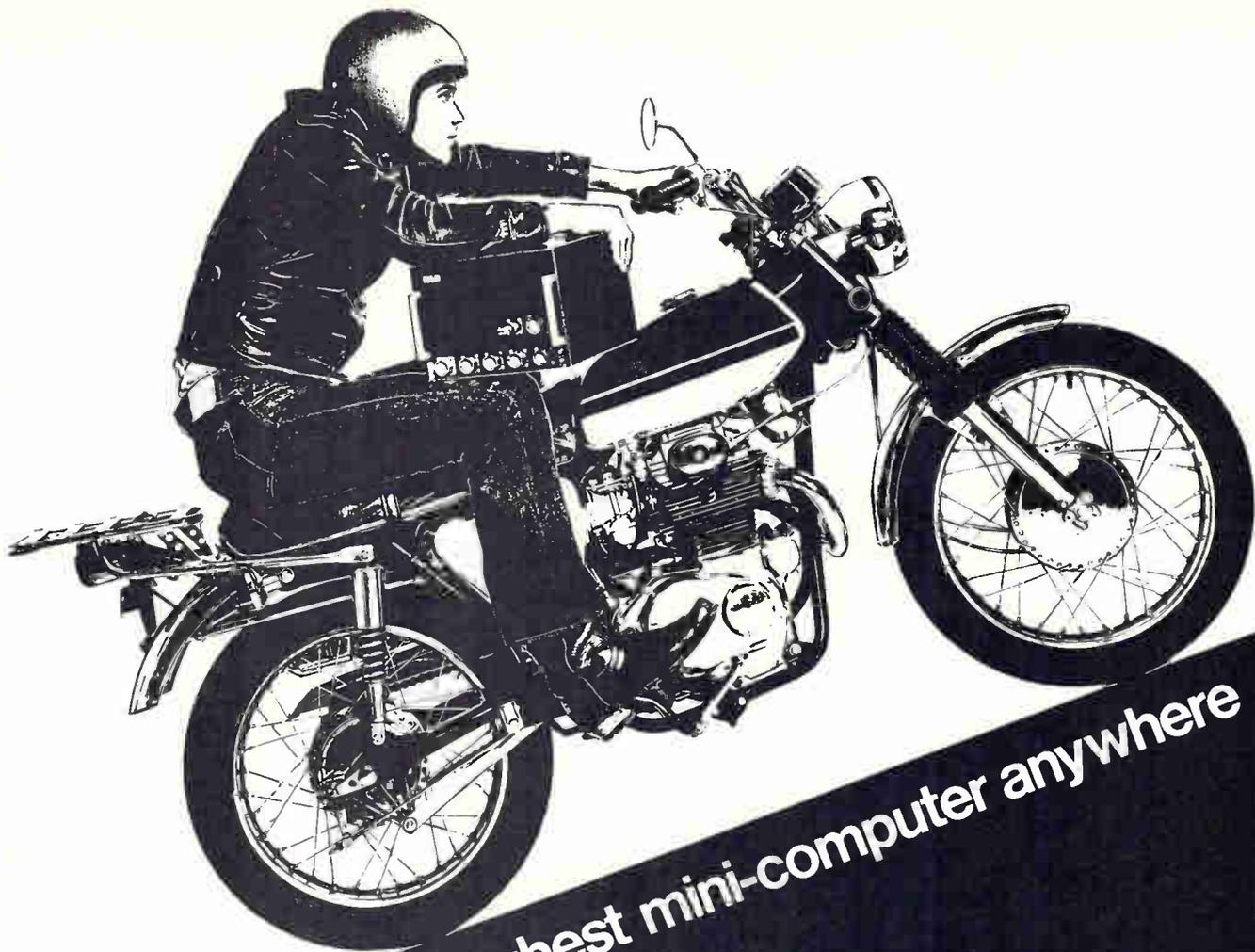

Take the world's toughest mini-computer anywhere

Name the place. Air, land or sea. Operating temperatures from -55°C to $+95^{\circ}\text{C}$. The rugged environmental requirements of Mil E-5400 and Mil E-16400. The new Rolm 16-bit word general purpose computer goes there. And goes great. The architecture is the NOVA's. The I/O and Software are identical to the NOVA. (We're licensed by Data General Corp.) The packaging is all our own. Built to take it like no other small computer has taken it before. And built to sell at "off-the-shelf" prices. Prices that are under \$20,000. Write for complete pricing and technical details of the Rolm severe environment computer. Then, take off for anywhere.

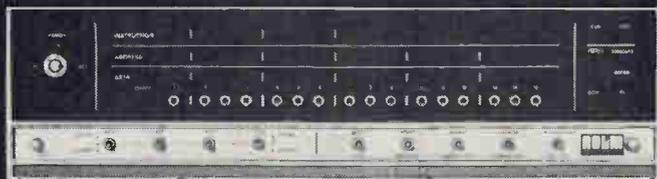

ROLM
CORPORATION

10925 N. Wolfe Road / Cupertino, California 95014
Telephone: (408) 257-6440 TWX: 910-338-0247

Technical Articles

**Special report:
Tomorrow's
communications
page 73**



One of the most critical tasks facing the electronics industry is the development of new communications devices, systems, and networks. Increasing pressure for good communications by knowledge-based industries will more than justify present design and marketing efforts—provided they have the right thrust. A 32-page special report explores the future, with six leading communications thinkers providing insights. The roles of the telephone network, satellites, and wideband data links, as well as those of various terminals and receivers in the communications complex of the future, are analyzed. The cover photo was taken in New York's Central Park during the Apollo 11 moon landing.

**Seeing in the dark
is aim of r-f holography
page 110**

Initially just a means of communications, microwaves now are being considered as a way to extend vision through rain, fog, and darkness, and even permit the spotting of flaws in opaque materials. The key is microwave holography, an imaging technique in which the reflected beam from a target is joined with a reference beam on a sensor plate. The resulting hologram, formed by the interference of the two beams, carries all the information about the target, which can be made visible by converting the hologram to visible wavelengths. The primary barrier has been the detector: response times have been too slow and stability has been a problem, though recent results are encouraging.

**Generating IC artwork
automatically
page 117**

An automatic technique for making master artwork for integrated circuit masks reduces preparation time by an order of magnitude and eliminates virtually all the errors associated with manual cut-and-peel methods. The heart of the technique, a computer program designed to operate with little input data, minimizes the time spent transferring coordinates of the composite IC drawing to punched-card form. The program also automatically compensates for both process variations and any dimensional changes in the artwork that might be caused by the environment.

Coming

**Matching FET'S
by design**

One place field effect transistors haven't found much of a home is at the input of differential circuits. Their high input impedance would be ideal if it weren't so costly and time-consuming to match them. But now, building two FET's with interdigitated gates on a single chip ensures almost identical parameters.

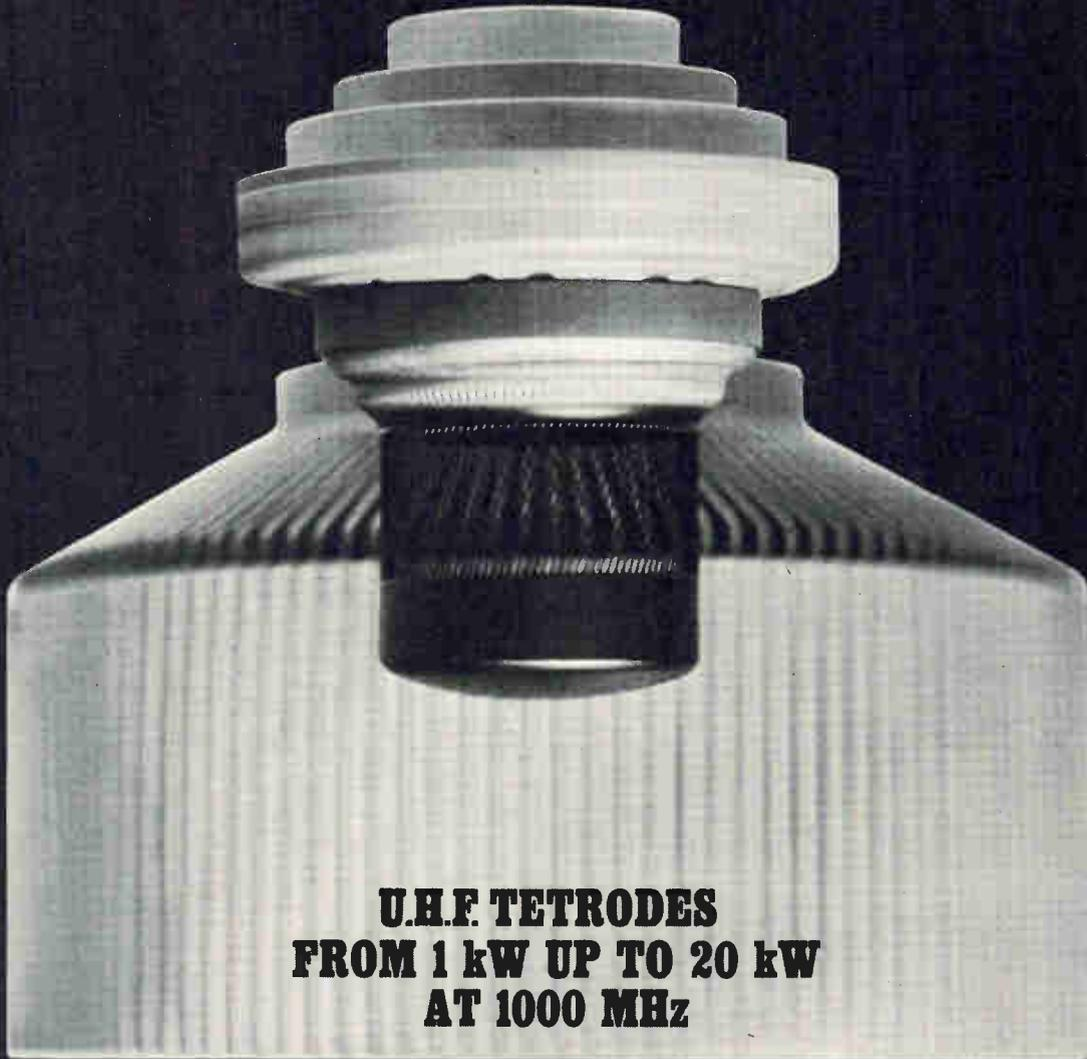

**U.H.F. TETRODES
FROM 1 kW UP TO 20 kW
AT 1000 MHz**

DEEP DOWN INSIDE, OUR TUBES ARE BIASED...

**AND GRIDS* WITH BIASED INTERVAL AREA SCREEN® AS SHOWN ABOVE GIVE
THOMSON-CSF UHF TETRODES BETTER GAIN—LINEARITY—RELIABILITY AND RUGGEDNESS
WE THINK YOUR CIRCUITS WILL BE PARTIAL TO OUR BIAS!**

* Thomson patents



THOMSON-CSF

ELECTRON TUBES INC.

50 Rockefeller Plaza - New York 10 020 N.Y. U.S.A. Phone: (212)245 3900

a subsidiary of:

THOMSON-CSF - GROUPE TUBES ELECTRONIQUES
8, rue Chasseloup-Laubat - Paris 15^e - France - Tél. 566.70.04

Here comes the tuned-in,
wired-up,
plugged-in,
hyperarticulate
speed-of-light
society

Tomorrow's
communications
start with
today's designs...

An **Electronics**
Special report

Sid Hammer

by Roger Kenneth Field

...There is no question that engineers are fast finding themselves in the center of a new world in communications—both as designers and users. This 32-page special report points out not only how the character of communications is changing, but also how the changes will come about, what they mean to industry and public alike, what the driving forces are for the changes, and what bolder, newer tools will be the result of the changes...

● If electronic communications had any beginning, it was at a chance meeting in 1832 aboard a steamship crossing the Atlantic from England to the U.S. Two strangers struck up a conversation while standing on the ship's deck. One of them, a scientist, spoke knowingly of Faraday's work in electromagnetism. The other, an impoverished portrait painter, just listened, for he was ignorant of the subject. But while he was listening, an idea came to him—an idea that was to change the entire face of communications.

The down-on-his-luck artist was Samuel Finley Breese Morse. His idea: an electrical communications system that could span an entire continent.

As it turned out, of course, Morse had more than an idea, he had a vision. And how this vision materialized can be looked upon as a classic in communications entrepreneurship. Morse, essentially an artist rather than an inventor, succeeded primarily by knowing where to turn whenever he needed help. Thus, he was able to capitalize on the work of others, rather than on what he did himself.

To be sure, Morse was not the father of the telegraph. In England, a telegraph invented by Wheatstone had been in service for years connecting local branches of the British Post Office. On the Continent, Steinheil had invented a telegraph for use in railroad stations. The Russian Minister to Austria, Baron Schilling, devised an electromagnetic telegraph back in 1825, but the Czar, fearful of the device's potential for subversion, banned any mention of the idea in the press. All these telegraphs, however, were able to operate over only limited distances and Morse, with a considerably poorer understanding of electricity than his European counterparts, could manage only a 1700-foot line.

So Morse, finding that his simple circuit with a single battery didn't measure up for long-distance telegraphy, traveled to Princeton to seek the aid of Joseph Henry. The famous scientist suggested the use of many batteries on many lines, each triggered, in turn, by an electromagnetic relay, which Henry himself had invented six years earlier.

Morse also knew where to turn for his personnel. His assistant, Alfred Vail, invented the telegraph key to replace a cumbersome control-stick Morse had designed; reduced the bulky receiver to a compact unit; refined into its final form the signal code that was to

carry Morse's name, and invented a "hard copy" receiver, which, according to the terms of the agreement between Vail's father and Morse, was patented in Morse's name. By 1844, what Morse and Vail had wrought was a 40-mile telegraph system that carried news of the Whig Party Presidential convention from Baltimore to Washington.

A few years after the Baltimore-Washington line was completed, Morse organized a private firm called the Magnetic Telegraph Co. and dropped his early assistants, Vail included. By then Morse was boasting that in five years there would be a telegraph in nearly every community—and he was right. A rapidly industrializing America, with its spreading railroad system and bustling newspapers, proved to be a more fertile ground than Europe in which to plant telegraph poles.

Though Samuel F. B. Morse didn't invent the telegraph, he was the first to demonstrate the concept that a radical departure in communications, if inexpensive and useful, can create its own market.

Alexander Graham Bell demonstrated this concept again with his telephone, as did Guglielmo Marconi with wireless telegraphy, David Sarnoff with radio and later television, and Joseph Wilson's Haloid Company with Chester Carlson's electrostatic copying process. In fact, each case of a communications success suggests that what the device needed, almost more than its inventor, was a man who had the vision and courage to bring out a fresh design with commercial possibilities.

This marketing concept, then, is the heritage left to the communications industry by Samuel Finley Breese Morse. Morse was the first to exploit the latent market—a market that didn't exist, but that was created by innovation.

Since, the inclination of the public—especially the American public—to communicate on a vast scale has dependably outstripped every long-range estimate ever placed on it. Economist Peter Drucker, in his book, "Age of Discontinuity," puts the contribution to the gross national product of knowledge-based business—that is, the creation and transmission of information—at a staggering \$1 trillion annually by 1980—a figure roughly equal to the entire present GNP.

Should Drucker's trillion-dollar projection for the creation and transmission of information prove to be even vaguely accurate, the electronics industry obviously will

be dramatically altered. Communication no longer will account for a substantial portion of a \$25 billion electronics industry; instead, electronics will account for a tremendous portion of the several-hundred-billion-dollar communications industry. Where will all the electronics go? They will go where they have been threatening to go for years—into homes and offices all over the world. After all, no more electronics is visible now to the average American than was already evident in 1939—30 years ago. Then, television had been developed and was on the market, telephones were already in most offices and homes, and mobile telephones existed, though they were not widespread. They're still not. Though there were far fewer f-m and a-m radio stations, there were several radio networks.

But beneath the relatively undisturbed water, the duck has been paddling fiercely. For during the same 30 years the electronics industry has made scores of dazzling technological advances, each proliferating hundreds of smaller innovations and opening up additional areas.

If economist Drucker is right, we are about to see the electronics industry (or, more properly, the electronic portion of the communication industry) start churning out devices, systems, and services that will become integral parts of the lives of the executive or the consumer.

Offices, after 30 years, will find it impossible to poke along in turn-of-the-century fashion with electric lights, typewriters, telephones, and little else. The modern office will have computer terminals, graphic consoles, facsimile units, television monitors, picturephones, dataphones, and all kinds of automatic calculators, minicomputers and advanced communication equipment.

Likewise, for libraries, the only link with modernity will no longer be the copying machine. Microfilm and microfiche—both developed instantly in the camera—will store as much or more information than books. Advanced computer systems with content-addressable memories designed specifically for information retrieval will be commonplace. And cost won't be a barrier—it will always be cheaper to stuff a present library with exotic electronics than to build additional libraries.

The home will no longer have mere entertainment electronics scattered about like furniture. Communications will take on crucial importance to the head of the household, who may well work at home if he's employed in the knowledge industry. And his children will



need access to sophisticated electronics in order to compete with the other kids at school who also were educated on computer consoles and other sophisticated electronic problem-solving apparatus. The home communications center will become even more important to home life than the family car—and it probably will be considerably more expensive.

Talking about the future is easy; making it happen is quite another matter. There are many difficulties ahead before we attain a trillion-dollar knowledge industry. The most serious by far is the utter lack of compatibility between systems, devices, software, and formats for educational, computational, and communications electronics. So far, for example, the nations of the world have not been able to agree on such a relatively simple matter as a common pulse-code modulation standard.

Somewhat less serious is the fact that the communications industry is committed to the telephone network in much the same way Detroit is married to the internal combustion engine.

Thirdly, and this is one area in which the communications industry historically has displayed great ingenuity, every company must figure out how to profit from providing communications services that society can afford and can put to good advantage, and that are technologically feasible.

Finally, there is the straightforward design problem. The communications industry must learn how to use techniques that yield sophisticated equipment and systems any layman can use. Bell Labs and Western Electric have done precisely this for years; other firms are learning now. There is no reason why each and every firm that markets communications equipment cannot design it right—right from the start.

In the end, the future of communications will be precisely what the electronics industry makes it. To be sure, both the entrepreneurial and innovative functions have spread into team undertakings. Perhaps the complexity of communications equipment, and of the society it must serve, make the team approach a more logical way to invent and implement modern communications. Still, six of the key men who are laying down the intellectual framework for future communications are very definitely rugged individualists. Interestingly, they are the same men who have provided some of the dramatic breakthroughs of the last several decades.



Six sages view the future of communications



AT&T listens to John Pierce because he is a critic of the telephone system who is also an executive director of Bell Labs. Pierce's concept that "people should travel to pleasure; communicate to work" led him to assemble the first Picturephone. That was 10 years ago. "We wanted to get a feeling of what it was like to communicate with visual images added to the telephone," he says. "We never could tell how we felt about that primitive Picturephone, but we sure knew how we felt about the way its two racks of vacuum tubes conked out in the middle of a conversation." Pierce, a pragmatist at heart, decided the idea was premature and shelved it to await development of circuitry that would be far more reliable. He believes that, strictly speaking, something can be invented in communications only when technology permits it to be offered to the public at a reasonable price. What does Pierce believe existing technology can offer the public now? Among other things, small, noiseless, inexpensive teletypewriters for the office ("But they must print at least as fast as a human can read," says Pierce); terminals to hook to phone lines that summon information at the push of a button; automatic video tape recorders for the home; inexpensive cathode-ray tubes; nonmechanical keyboards; and electronic-to-microfilm print-out devices.



CBS listens to Peter Goldmark, president of CBS Labs, because he, almost singlehandedly, has been waging a continuing war against RCA—the company that turned him down for a job in the 1930's. In 1949, CBS introduced Goldmark's field-sequential color television system and set the stage for a bittle battle with RCA, which opted for its compatible color. After a three-year hassle CBS lost out as the Federal Communications Commission reversed an earlier decision and ruled in favor of the RCA system. But while RCA was winning the war over color tv, Goldmark was winning a battle over phonograph records. The CBS 33 $\frac{1}{3}$ rpm long-playing record, which had Goldmark's imprint, won handily over RCA's 45-rpm entry in the race for consumer acceptance. After losing a battle between 0°-90° and 45°-45° systems for stereo disks, Goldmark announced EVR—electronic video recording—which via an adapter, will enable color-tv receivers to playback color shows that have been recorded previously. But only two months ago, less than two years after Goldmark's announcement, RCA announced its SelectaVision, which uses holograms to do precisely the same thing. What does Peter Goldmark believe society needs next? "Nothing! We're saturated with inventions! Now we should use them to help people get along with each other!"

Communicators should listen to Harry Olson, a retired RCA vice president who is referred to often as the "father of acoustical engineering." Harry Olson believes that, ultimately, the best way to reproduce sound will probably be with printing presses. Far-fetched? Perhaps. But Olson feels it may well be possible to transfer the complexity of recreating audio signals to circuitry, leaving only a modest informational requirement behind for the transmission medium. That way, he thinks, records and magnetic tapes both may be made obsolete by ordinary paper that is coded digitally with ink impressions and then played on sound synthesizers. The difference, of course, is that anyone who owns a printing press may find himself in the recording business. Recordings would be produced by the billions at a cost of but a slight fraction of a cent each. As a first step to demonstrating feasibility, Olson, while still at RCA, made a complex system that was able to recreate ordinary speech with a bandwidth of only 3 hertz. Olson thinks a synthesizer complexity of from 2,000 to 4,000 gates—probably possible on a single large-scale-integrated chip in a few years—should be sufficient. If Olson is right, Xerox machines in college libraries may be used someday more to copy Beatles' music than Shakespeare's writings.

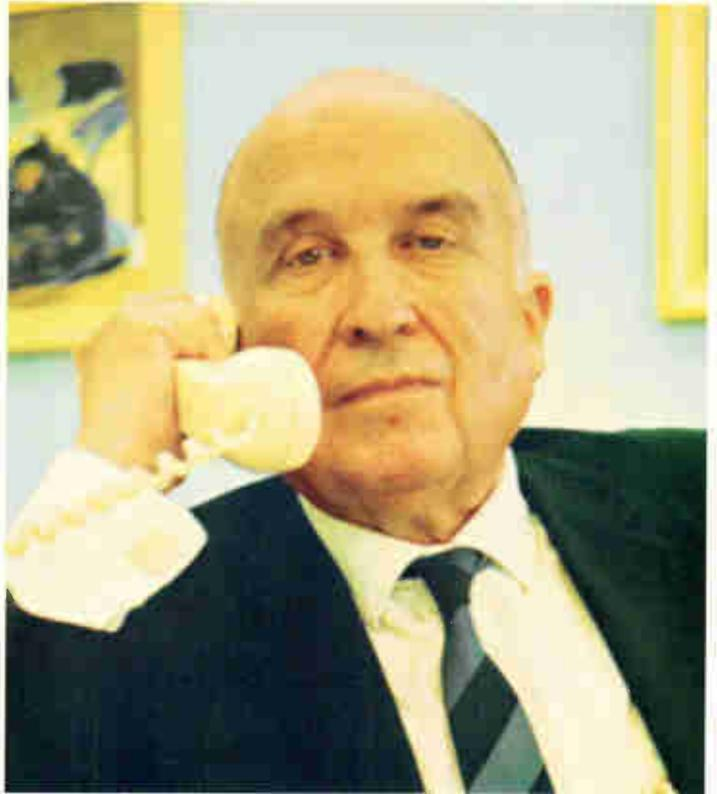

Xerox listens to John Dessaur, board vice chairman, because it was he who came across Chester Carlson's electrostatic photographic process in a Kodak abstract in November 1945 and sensed immediately its potential for dry copying. Dessaur, then with the Haloid Corp., licensed the process from Battelle—to whom Carlson had taken his ideas (More than 20 companies, including Kodak, had rejected Carlson's process). And it was Dessaur who was the driving force behind turning the idea into a machine that produced a copy when you pushed a button. Where would Dessaur look now for a successful communications idea? "I'm certain we are on the threshold of a revolution greater than the industrial revolution. And computers, of course, are the key. There are three things worth looking for right now—the ideal random-access memory, automatic reading equipment, and mass diagnostic techniques. I believe ill health may be the cause of the inability of poor children to learn. If we could use computers to do mass screening for all disease, like that done with X rays for tuberculosis, we might be able to cure these children early and help society enormously." All this is where Dessaur would look. His firm looks at future copying methods.

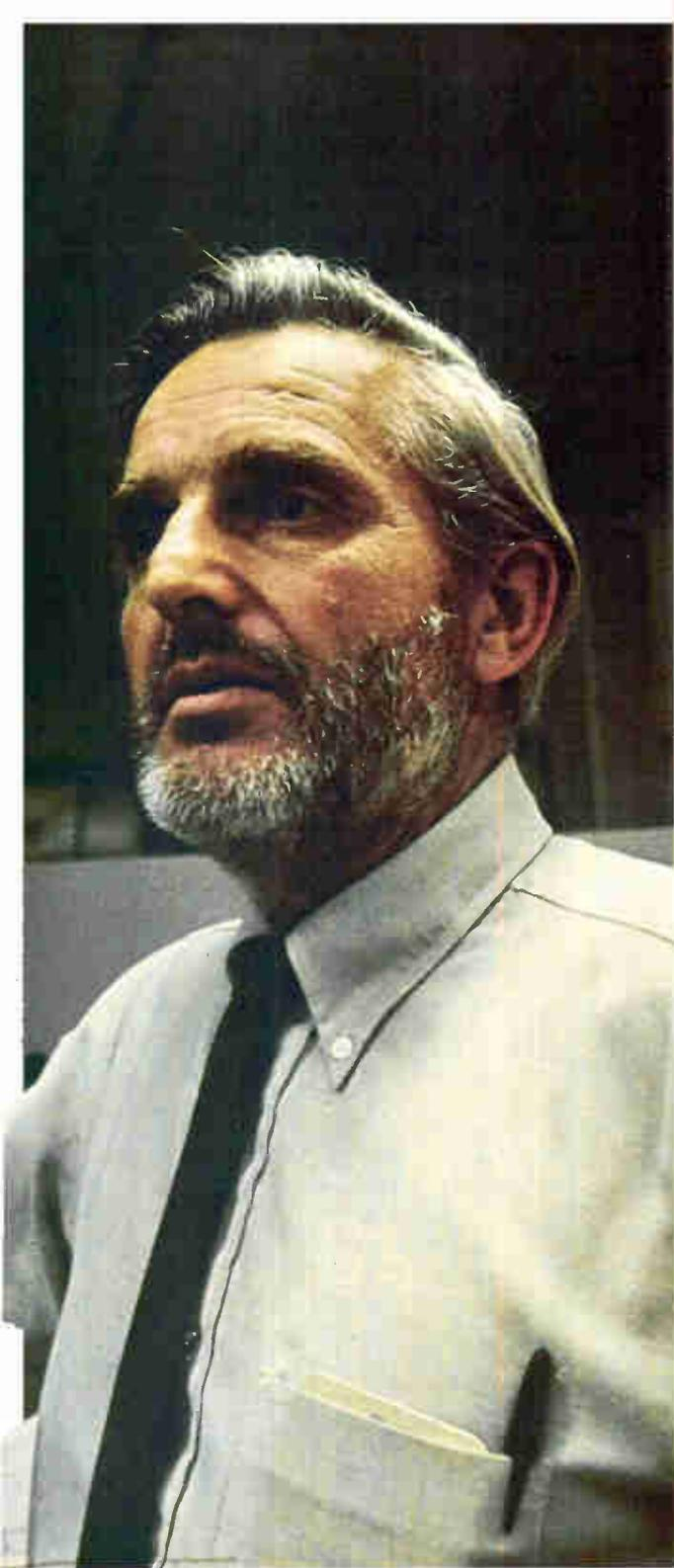

Communicators will listen to Douglas Engelbart, an engineer-turned-professor at the Stanford Research Institute. Whereas Olson proposed a new use for paper, Engelbart suggests doing away with it—at least for the purpose of writing. Eighteen years ago, Engelbart took a look, as he puts it, “at how civilization had surrounded human beings with manifestations of culture—such as artifacts, languages, and methodologies. I tried to think how I could use my special skill to improve man’s ability to perceive his world. I guess I was searching for a strategy for the augmentation of human

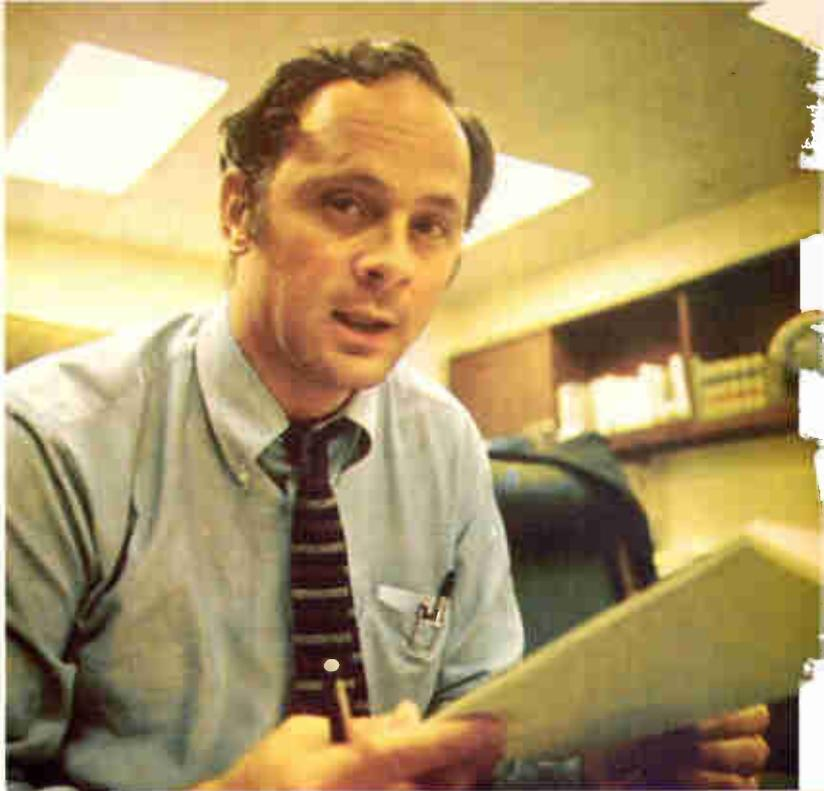

Everybody should listen to Nicholas Johnson, the fiery FCC commissioner who actively promulgates what is rapidly becoming a popular sentiment in the U.S.—namely, that the airways and common carrier links are public assets and should be used with utmost regard for the public interest. In Johnson’s view, the common carriers and broadcasters who use their privileges merely to maximize profits, with no regard for the consequences of such action to society, deserve to lose their clear monopolies or their access to those airwaves. Johnson, crusading in an area of great sensitivity to some obviously powerful broadcasting and telephone executives, has brought upon himself considerable criticism. He will have good leverage until next June, when the term of another Democrat, Kenneth Cox, expires. At that time, another Republican is likely to be appointed to the FCC, changing the balance of power. Meanwhile, Johnson will push on for more decisions like that on behalf of Microwave Communications Inc., which granted a small firm license to operate a microwave link between St. Louis and Chicago, breaking AT&T’s hold on interstate traffic of point-to-point electronic signals, and Carterfone, a decision which Johnson authored to open up the telephone network to “foreign attachments.”

intellect.” He hit upon the idea of substituting a computer-driven cathode-ray display for pencil and paper. Words, Englebart reasoned, could be typed onto the display with one hand, while the other could point to words and make them disappear, or call up additional information from the computer’s memory. In this manner, both research and writing can be done at the console with great facility, and then stored on microfilm or magnetic tape at the end of each day. Engelbart’s scheme, now a system, may well become the central element in the office of the future.

The goal: a communications system that

The tools: satellites, facsimiles,

● The great bulk of today's communications tools are essentially those that have been in widespread use these last three decades. But the character of communications is about to change. How quickly will depend a great deal on how quickly the electronics industry recognizes that man—corporate man in particular—is hindered by what can be described best as a 50-foot communications gap. (In the context of the modern office, 50 feet is the distance at which direct contact becomes less convenient than, say, the telephone.)

Consequences of this gap are readily apparent everywhere. Today, almost all corporate endeavors are broken down so that they are handled by clusters of employees, with members of each cluster dealing directly with one another. If some provision could be made that would enable people to operate effectively without physical proximity, then it would no longer matter whether members of such clusters had offices that were adjacent or hundreds of miles apart.

To cross the 50-foot gap, the business community needs electronic substitutes for travel. Bell Labs' John Pierce puts it this way: "The telephone is just fine if you want to communicate with your grandmother; but not when it comes to your mistress."

Just where the cutoff point comes between physical travel and electronic communication is a moot issue. But one thing is certain: the telephone, by itself and as it appears today, is inadequate as a substitute for travel. Something is lacking in communications, says Pierce, when an executive must fly from New York to the West Coast and back just to attend a three-hour conference. One logical corrective measure would be to add vision to the telephone. This, conceivably, could cut down some business travel, because it would afford users face-to-face contact of sorts; hence, the Picturephone.

But the Picturephone, even if it were to find widespread use, still couldn't be a complete solution. Clearly, electronic substitutes must be developed for everything two people can do in a room, save physical contact and the exchange of solid objects. This means high-fidelity telephones, high-resolution color Picturephones, high-resolution color facsimile, and devices for manipulating machinery. There must also be provisions for storing, transmitting, and routing information. Not only must all these be developed, they must be marketed at a price the public would be willing to pay.

Broadly speaking, what's needed is sufficient input-output equipment to make a multitude of high-quality communications options plentiful, and enough transmission links to connect them.

For the moment, the only thing that resembles a reliable link for personal electronic communication is the telephone system, which includes some 112 million telephones and is worth, according to AT&T, \$55 billion.

Unfortunately, for many years the telephone system was, in effect, a closed network. AT&T and the smaller independent telephone companies jealously guarded their lines, and waged a war against the use of "foreign attachments." Their battle was waged successfully until, in June 1965, California's Public Utilities Commission handed down a landmark decision: a hospital could choose to install in its wards the one-piece, Swedish Ericafone—a foreign attachment in the literal sense—rather than the two-piece instrument supplied by the Bell System. The Ericafone, argued the hospital, was sterilized more easily than its Western Electric counterpart and this the California board accepted. This was the first major setback for the telephone companies. A second came about last year, and was a far more telling blow.

In June 1968, a tiny Texas firm that had made a mobile radio-telephone called the Carterfone, won a decision from the FCC, enjoining AT&T from preventing attachment. The unanimous decision, authored by Commis-

Console syndrome. Bernard List, director of Texas Instruments' Systems and Information Science Laboratory, is among those trying to figure out how to eliminate the 50-foot gap electronically. One problem that is often overlooked, he believes, is the fear many executives and even engineers have of a computer console. "Nobody," says List, "likes to be known as the man who made the system go down, and many who were not raised on computers don't enjoy fumbling with them in public."

replaces person-to-person contact computers, telephones, microwave...

sioner Nicholas Johnson, paved the way for the attachment of everything from decorator and antique telephones to data devices, line recorders, home-made computer terminals, and just about anything else that could be connected to two wires. The \$30-per-month Data-phone, which the Bell System had insisted be used as an interface between private equipment and the telephone lines, was superseded by a small \$2-a-month adapter. Even that need not be used if the output of the private equipment falls within prescribed limits in various bands of the audio spectrum.

As long as the devices meet the restrictions imposed by AT&T, they can be connected directly, inductively, or acoustically to the telephone system. For example, the output of a directly-connected device must not produce power levels at the central office exceeding 12 decibels below 1 milliwatt when averaged over any 3-second interval. (Basically, the amount of power a unit is allowed to put out depends on the distance it is ultimately installed from the central office, but, as a rule of thumb, it should never put out more than 1 mw.) Rolloff should keep the signal at least 18 db down between 4 and 10 kilohertz; 24 db down between 10 and 24 khz; 36 db down between 25 and 40 khz; and 50 db down beyond 40 khz. In addition, the equipment should not deliver energy solely in the band between 2,450 and 2,750 hz. If this band, which is normally reserved to effect discon-

nection, is used at all, the power in it must not exceed the power in the 800-2,450 hz band.

Once these restrictions are observed, the \$55 billion telephone network is yours. If it's data you're pushing, this network can handle 2,000 bits per second now, 3,600 bits in a year or so, and 4,800 bits by 1975. If it's analog signals you're after, you've got about 3,000-hz bandwidth, but experienced users suggest you forget about the bottom 500. These figures apply to the unadulterated pair of conductors as they now exist in the walls of homes and offices. However, AT&T has found that the addition of amplifiers to an ordinary voice-grade line can forestall high-frequency attenuation and thus boost the useful bandwidth to around a megahertz for a few miles—more than sufficient if the central office is nearby. This is how the Picturephone, which requires about 100 times the bandwidth of an ordinary telephone, will be connected to switching stations. And this is how the system will ultimately provide 50-kilobit data service, which is presently being tested in several U.S. cities.

As for voice service itself, the Bell System and the independent telephone companies should be able to handle the increasing load over the next few years—today's reports of poor service notwithstanding. There are, however, two distinct questions concerning future service for data transmission: whether the telephone system will be able to handle the heavy flow of data expected by the end of the 1970's and whether the small, suburban telephone companies, will cope with the data boom as it spreads to the suburbs during the next five years.

There seems to be a considerable disparity of opinion when it comes to answering the first question. Data users contend the telephone system in general, and AT&T in particular, hasn't properly prepared for the computer boom in metropolitan areas. They cite Wall Street as a classic example. Unanticipated data flow at the nation's No. 1 and No. 2 financial centers—the New York Stock Exchange and the American Stock Exchange—caused such havoc that telephone service in the entire Wall Street area was disrupted. And if the Bell System was unable to cope with a sudden surge of data in the very heart of New York City, what can be expected from the independent suburban companies? There is no question that these companies will find themselves in the midst of a data boom as more and more computer centers and other knowledge-based firms spring up in suburbia.



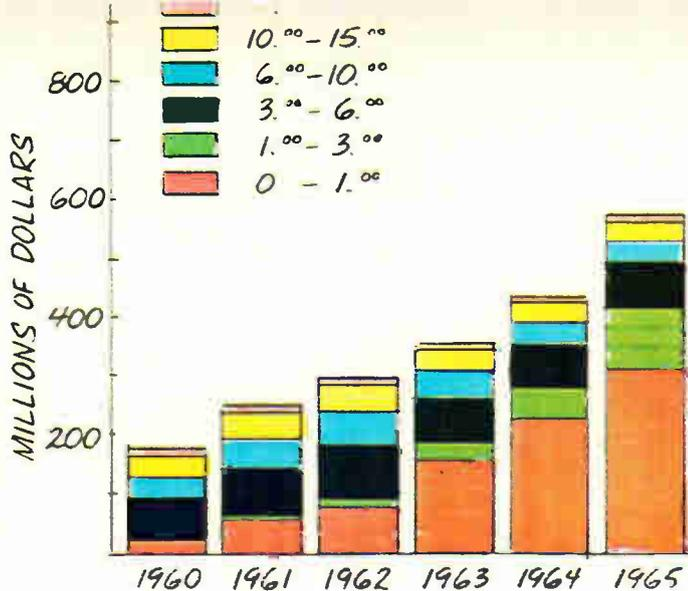
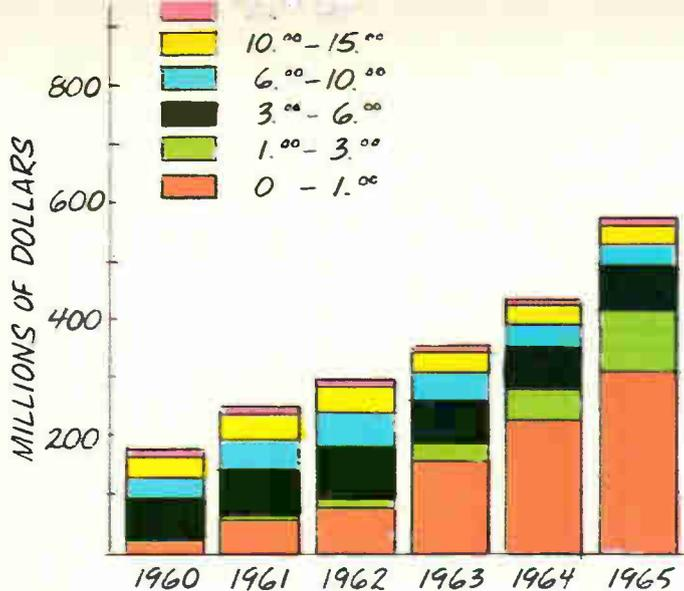

A great deal depends, of course, on whether AT&T does indeed anticipate a dramatic surge in data traffic; if it does, it will prepare for one. But apparently the company doesn't expect such a surge. An increase in data traffic yes, but a surge, no. William Quirk, AT&T's marketing director of data communications, puts the present level of data traffic at about 3% of all telephone time consumed in the U.S. "By 1980," he says, "we figure it will probably grow to between 5% and 10%."

Many users put the 1980 estimate considerably higher than 10%. Consequently, they don't believe AT&T will be able to handle the data traffic of the late 1970's and beyond. Louis Clapp, president of Dial-Data in Newton, Mass., warns that unless drastic measures are taken now, national telephone blackouts will become commonplace by 1972. Clapp points out that not too long ago, when his company was planning a computer center in the New York area, "we were advised confidentially by people within the telephone company that a serious overload problem was developing in Manhattan." His firm finally located in suburban Englewood, N.J., rather than in New York City itself.

Perhaps the most impartial assessment of data traffic comes out of an inquiry made some time ago by the FCC in which opinions were solicited from the data-processing industry, the communications industry, industrial users of data communications, and various governmental and independent organizations. The opinions were turned over to the Stanford Research Institute, which then prepared a series of seven reports. One of the reports is at serious odds with AT&T's estimate of "5% to 10% by 1980." Taking into account predictions of cost-trends in both computers and communications the report says, in part:

"Over the next decade, the fraction (of total terminal hours) accounted for by data is likely to increase to between 10% and 50%."

This projection was based on the continuing growth rate of low-speed data—about 70% per year. Equally important, the report pointed out that "in future years, expansion of industry into the suburbs and related factors are likely to result in demand for data services from the smaller independents that are not now capable of providing these services."

In the end, the Bell System and the independent companies may not have to conquer the problem of data

movement: point-to-point wideband communications are now on the horizon in the form of domestic satellites, independent microwave links and community antenna television cables.

Microwave Communications Inc., thanks to the FCC, will become a common carrier when it installs a microwave link between St. Louis and Chicago. The company will lease channels in the same manner as AT&T, but at rates far lower—as much as 94% lower—than those of the communications colossus. Now, Microwave Communications of America Inc. (Micom), MCI's parent firm, is seeking links that will string towns and cities together with wideband communications in much the same manner as Morse's Magnetic Telegraph Co. strung them together with telegraph wire. Micom's prime interest is the big industrial firm which must move mountains of data, not the home. It's the CATV companies who are concerning themselves with the home. Thus far, these companies have fed coaxial cable into some 3½ million homes, providing them with ghost-free tv viewing.

From a technological standpoint, the installation of wideband-switching gear at CATV central stations for use with a microwave network to provide point-to-point, nationwide wideband service poses no great difficulties. The present FCC mandate to CATV makes no explicit provision for such service. But the likelihood of such service is a distinct possibility as CATV's role in the com-

Color it ready. Unable to immediately formulate marketing plans, Xerox continued perfecting its color process while searching for a major application area. Now executives believe they have isolated a huge latent market, although they won't identify it just yet. The process they introduce will work very much like present electrostatic copying and will produce results at least as good as the state-of-the-art color Xerox copy on the left. The original is at the far left.

municative society expands in the 1970's.

Domestic communications satellites, of course, will undoubtedly play a major role in future wideband links. Originally, such satellites were planned to operate on two relatively low microwave frequencies—6 gigahertz, ground to satellite, and 4 Ghz, satellite to ground—which could provide just about 14,000 voice-grade channels. Ray Tillotson, a scientist at Bell Labs, suggested that two higher frequencies be used instead—30 Ghz, ground to satellite, and 18 Ghz, satellite to ground. These higher frequencies could accommodate 75,000 voice-grade channels, about five times that of the lower frequencies. Tillotson's proposal would make satellites far more attractive than Bell System's 4-Ghz, ground-based microwave system, the TD-3, which can provide 12,000 channels. And, it would be far more attractive than the company's L-4 microwave line, which consists of 20 coaxial cables and is capable of providing 30,000 channels.

Still another advantage of communications satellites is that they would be placed in synchronous orbit, which means they could be deployed on a moment-to-moment basis to handle overloads as they occur. The L-4, on the other hand, if buried underground between Miami and New York, would be of little value should an unusual peak suddenly occur between Philadelphia and Chicago.

There are, however, two problems posed by satellite communication. Firstly, synchronous orbit, an altitude

of 22,300 miles above earth, requires costly echo suppressors for voice communication and introduces a quarter-second delay, which could prove annoying to the public. Secondly, at the higher frequencies—18 and 30 Ghz—transmission signals could be wiped out by heavy rain.

Since delay and echo are inherent, perhaps it would be best to use domestic satellites principally for data and television feeds; voice traffic could be minimized to, say, handling unexpected peaks in long-distance telephone service. As for rain wiping out high-frequency signals, this can be alleviated by redundancy at each transmitter and receiver site. Heavy downpours are often highly localized. Thus, if transmitters are placed several miles apart, at least one, and possibly more, should be able to transmit to a synchronous satellite very nearly all the time.

A millimeter-wave experiment to prove feasibility of such an antenna redundancy scheme is already under way on a satellite, aboard the Advanced Technical Satellite-5 launched four months ago by the National Aeronautics and Space Administration. Signals have been going up on a 31.65-Ghz carrier and coming down on a 15.3-Ghz carrier for two months. Sufficient data should be available within a few months to determine the effect of atmospheric attenuation on the millimeter waves.

Satellites should prove valuable for moving data and video signals for many decades, but, ultimately, total saturation of the entire broadcast spectrum could exhaust the theoretical capacity of all satellites. Pierce anticipates total saturation sometime within the next 50 to 100 years. And when this happens, of course, the communications industry will have no choice but to return to ground lines. Under such circumstances, AT&T would quickly fall back into everyone's favor by moving information from point to point, this time with millimeter waveguides and lasers—possibly with a system of millimeter waveguides that also carry laser light. Bell Labs scientists insist that no two points in the U.S. exchange enough information at this time to justify installation of a millimeter waveguide. But AT&T, according to the FCC, shows no serious interest in instituting dramatic rate cuts that would encourage massive traffic, which, in turn, could fill up such a waveguide.

Eventually, of course, millimeter waveguides will be used extensively and telephone executives will sit around a conference table debating whether the time is ripe for lasers. Though these are now expected to be about 10 times the cost per mile of waveguides, lasers will carry 100 times the number of voice-grade channels—the equivalent of 24 million telephone conversations. Although it's a bit difficult now to imagine 24 million conversations going from any one point to any other, Picturephone service uses the equivalent of 100 voice-grade circuits; television, 1,000. High-resolution color tv may use an order-of-magnitude or so more than black-and-white tv.

Adequate lines, links, and satellites are not enough in themselves. Man still must put the transmission facilities to use. And to do so, a variety of input-output equipment is needed.

Much of what will be needed tomorrow doesn't exist today in any form. And what does exist, will have to be upgraded.

Broadly speaking, there are three kinds of terminal or input-output devices:

- Those that allow people to communicate with people,

like the telephone and Picturephone;

- Those that communicate with each other (machine to machine), such as computers and facsimile transceivers;

- Those that enable man to communicate with machines, such as speech recognizers.

The ubiquitous telephone, is, of course, the primary instrument for people-to-people communication. Today, there are 220 million telephones in the world. And for more than 100 years, telephone companies have been trying to make Alexander Graham Bell's basic device more and more efficient, reliable, and less costly. Consumer acceptance of the instrument is higher than that of any device in history. Users have come to expect the "telephone sound" and complain only when connections are hopelessly riddled with static or signals are so faint as to be imperceptible. Restricted bandwidth, intermodulation and phase distortions, fractional-second delays in transmission, bursts of data in speech gaps, switching sounds—none of these seemingly bother individual users. Still, a portion of the public doesn't like to talk on the telephone. And as the public becomes technologically more sophisticated, a significant market for a high-fidelity telephone will almost surely develop.

There are two major obstacles in the path of the hi-fi telephone. The first is the present state of the network itself, which normally uses only about 20% of the audio spectrum. But the network's bandwidth is going to be upgraded for data and Picturephone use, and a solid state line amplifier in the base of the instrument could probably push the entire 20-kilohertz audio bandwidth to the central office anyway. The other obstacle is the carbon-granule microphone, which limits faithful sound reproduction. However, the microphone is rugged and inexpensive, it suppresses low-level background sounds, and it doesn't require an amplifier. The telephone company has been trying to get rid of the carbon microphone for years, according to Pierce, and the telephone of the 1970's may not have one. Last year, Bell Labs revealed one futuristic touch-tone telephone in which tantalum thin-film integrated circuits are used for amplifying the signals of an electromagnetic microphone. A "ring" is produced by an oscillator-driven speaker that substitutes for the bell in the base of the telephone. In the end, the carbon microphone will probably give way to the Electret—a condenser microphone developed by Bell Labs that has as its working element a permanently charged dielectric material. Also in the works at Bell Labs is a cordless extension-phone that can be toted about easily.

For video communications, the Picturephone is but the first step. At an anticipated monthly cost of \$100, Picturephone service in the U.S. will be quite a bargain compared to the British Confravision—an intercity closed-circuit tv service for businessmen that will cost from \$280 to \$480 an hour! But high-resolution color Picturephone will have to await development of an appropriate display panel and solid-state vidicon.

Finally, the entire process of man-to-man communication can be enhanced by a telephone system designed from top to bottom to provide person-to-person, rather than of point-to-point, service. Here, a great deal rests with a software approach to electronic switching, which would replace the hardware necessitated by electromechanical switching. Several electronic-switching systems are already being installed, but none have the call-forwarding feature—essential if the subscriber is to have

calls to his number automatically rerouted to another telephone when he is away from his own. For a good idea of what should be possible with electronic switching, one has only to examine the IBM 2750, a voice- and data-switching system built at the firm's laboratory in La Gaude, France.

The IBM 2750, designed for use by banks, insurance companies, and similar institutions, can handle upwards of 700 extensions and 80 trunk lines, and rents for between \$2,500 and \$5,000 a month. All switching is done electrically, including connection of lines. Changes in extension numbers are simply typed into a keyboard; no manual reconnections need be made.

From his telephone, the user can now do the following:

- Dial two digits to call frequently-used numbers, which are stored in a table and could have as many as 14 digits;
- Dial three-way conference calls without operator assistance;
- Dial a single extra digit to get automatic recall of an outside number that is busy when first dialed;
- Signal a busy extension by dialing a single digit that injects a "beep" in the conversation in progress;
- Get a complete record of data, time, and duration of all outgoing calls from his extension;
- Scan automatically all extensions in a given department for a free one, thus avoiding a busy signal;

On the tape. The Hewlett-Packard television system makes video tapes that illustrate how to use the company's products. Such tapes would be considerably more useful if video tape recorders were compatible. There are about 75 on the market and none can play tapes made on any other.

- Have calls forwarded automatically to another extension where the user plans to be;
- Have the 2750 monitor the contacts of a relay, then dial a previously arranged telephone number and issue a prerecorded voice announcement. (Thus, the system can be triggered by a thermostat to alert the fire department with a voice-message that tells the location of the thermostat.)

Without sophisticated electronic switching, the telephone system, which was intended expressly for conversations between people, is far more suitable as a switching network for point-to-point communication of the sort normally engaged in by machines. Appropriately, machine-to-machine communication promises to account for an increasing percentage of telephone traffic during the next several decades.

Right now, the machine that talks most to its brothers is the computer. Last year, 15% of all the central-processing units made by IBM were attached to a common carrier. This percentage climbs each year by 3% or 4%. But such figures could be misleading, if they are correlated with telephone network usage. Computers that are now being equipped with provision for connection to common carriers feed many more terminals—perhaps dozens, or even hundreds—than computers of the early 1960's. And at least two of IBM's competitors, General Electric and RCA, are aiming primarily at time-sharing

Multiple Gear. Walter Robson, Jr., manager of H-P tv activities, points out that several pieces of equipment are needed to help video tape centers gain a wider role in the distribution of industrial information. One is a video tape editing machine comparable in cost to its film counterpart. Another is a portable, inexpensive color playback machine, which a salesman could take with him to demonstrate products.

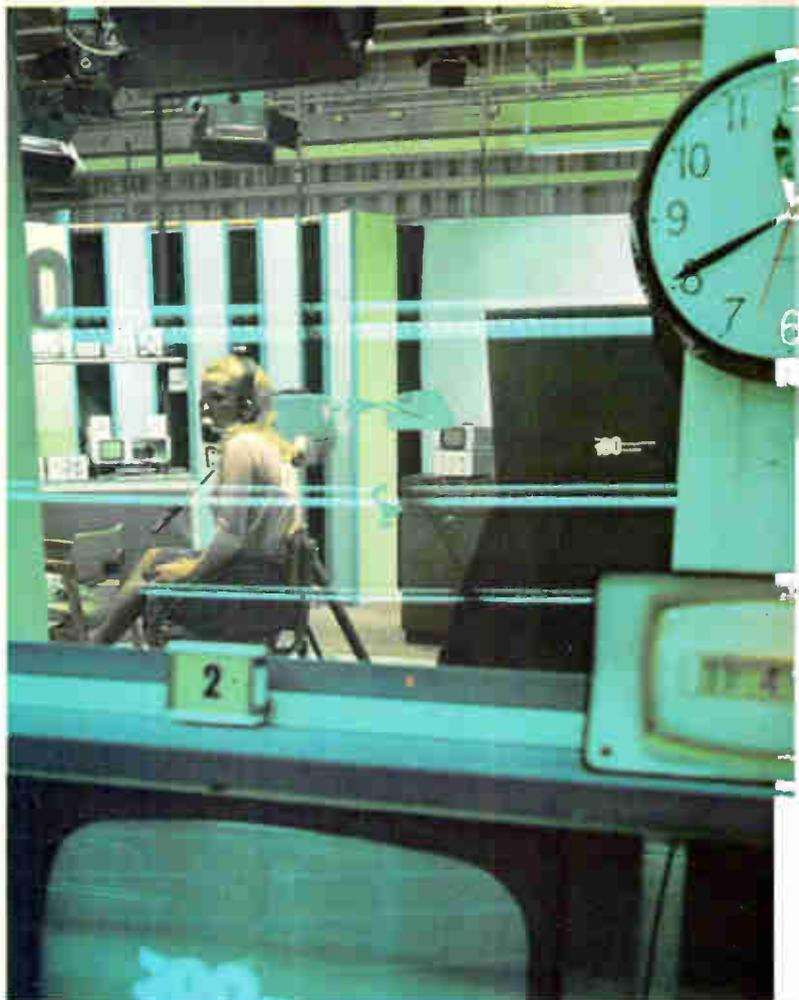

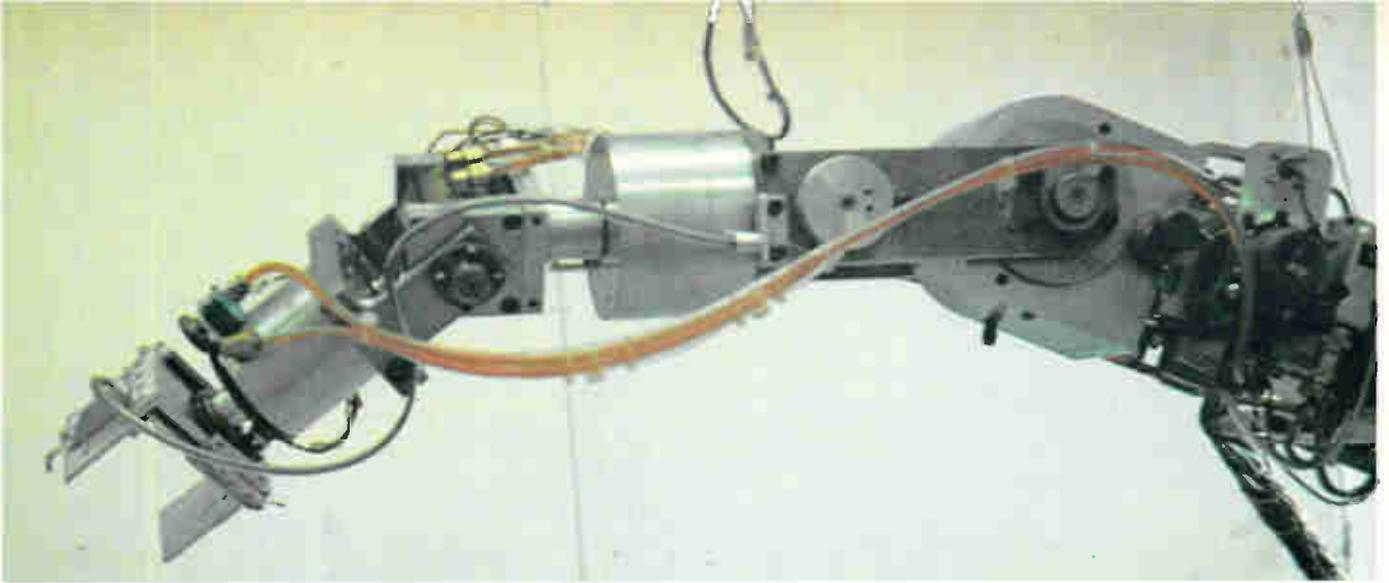

and other communication-oriented forms of computation. This communicative computing is becoming increasingly important. So much so, in fact, that IBM—in a petition filed in response to an FCC query concerning the relationship between carriers and the computer industry—said:

“We believe that in the next decade nearly half of all computers will have this capability [of direct connection to the common carriers]. Because of the increased complexity of systems equipped for communications, such systems will represent more than half of the dollar value of equipment installed.”

But before half the population of central processing units becomes communicative, another device will probably displace the computer as the most loquacious machine. The contender? The facsimile transceiver, a sort of two-way, sawed-in-half copying machine.

The way a facsimile device works is quite simple. Material to be transmitted is placed in the unit, usually around a rotating drum. A distant unit is dialed or tuned in—depending upon whether the transmission is to go by telephone network or by microwave link (the latter is preferred for high-resolution facsimile). The two units then synchronize scans and the process of copying-at-a-distance proceeds. There are more than two dozen different systems that can do this; about a dozen depend on the telephone network for transmission. The facsimile

could become an essential part of every home or office communications center during the 1970's. There is a serious problem, however: Facsimile units made by different manufacturers cannot communicate with each other except for one case. The single exception is the Xerox facsimile, which is licensed from Magnavox and is compatible with the latter's unit. Each manufacturer, afraid of stepping on the others' patents, uses his own method for synchronizing the paper drums of the transmitter and the receiver. Most units are acoustically coupled to the telephone line and most transmit a frequency-modulated signal. However, the approach that's given the best chance of succeeding on the open market is one in which an a-m acoustical signal is transmitted.

Unfortunately, the makers of facsimile machines are doing a great disservice to both themselves and their customers. By making their units incompatible with competing machines, manufacturers are overlooking the opportunity to ride a demand curve similar to the ones enjoyed by the telephone and telegraph companies. And, of course, they have effectively blocked the horde of potential users whose economic position and requirements would allow them to buy a single unit.

Another way to employ machine-to-machine communications, many corporations have already found, is to send a video tape to a customer or a potential customer instead of a salesman. A video tape, they find, is cheaper and faster to crank out than a sound film, and it tells a customer what he needs to know far better than a fistful of specification sheets or application notes. But here again, incompatibility rears its head. Says Walter Robson Jr., manager of Hewlett-Packard's tv activity: “The video-taped demonstration is very useful for transmitting complicated technical ideas. But think how much more useful these tapes would be if they could be played on any video tape machine.”

Robson points out that two manufacturers of video tape recorders, Ampex and Sony, dominate the field, but that a video tape made on one machine cannot be played back on the other. With 75 additional companies making up the rest of the field, incompatibility is that much worse: none can play tapes made on any other. And add color to the picture, the incompatibility problem becomes even more acute. According to CBS's Peter Goldmark, a color video tape recording made on one machine, in many cases, cannot be replayed on another machine of

Listen here. Raj Reddy talks to a computer set up for speech recognition at Stanford University's Artificial Intelligence Project Laboratories. In a marginally successful experiment, the computer—a PDP-10—analyzed Reddy's speech, figured out what the words were instructing it to do, and then, with the aid of its own optical system, controlled the arm at the left to execute some relatively simple tasks, such as picking up blocks and piling them one on another according to Reddy's commands.

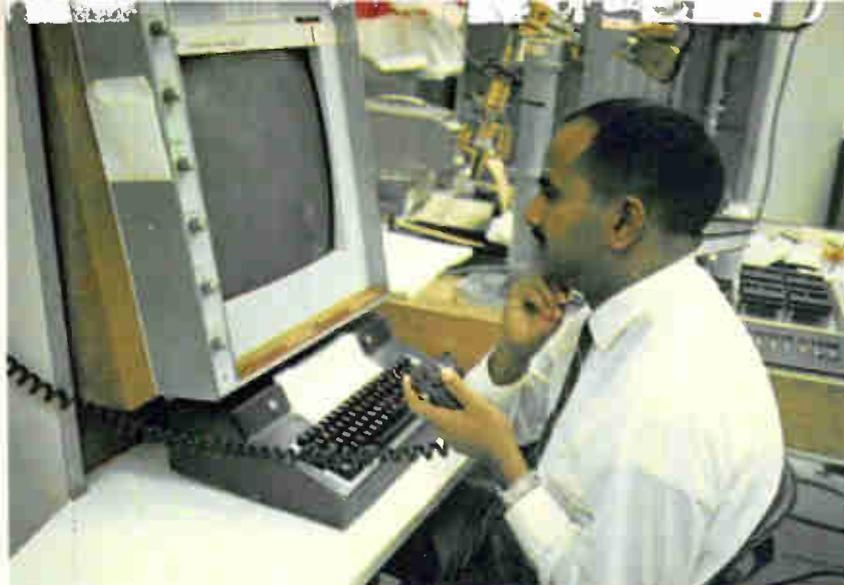

the same model by the same manufacturer. This, he says, is especially true with slant-head color video recorders in which head alignment is critical.

The latest machine-to-machine incompatibility strikes the consumer directly. Those two old rivals CBS and RCA introduced two systems for playing back prerecorded tv programs over an ordinary tv receiver. The CBS method, called EVR, for electronic video recording, puts images on high-resolution black-and-white film with the color coded on adjacent frames. The RCA method, called SelectaVision, stores the color frames in the form of holograms, which are embossed on clear vinyl tape. EVR adapters will cost \$800 initially; SelectaVision adapters, \$400. Neither unit allows the viewer to tape his own choice of broadcasts, and neither can play the tapes of the other. The two systems represent the first incompatible additions to the home entertainment market.

All is not quite as bleak as it may seem. One consumer item virtually became a standard by virtue of marketing strategy that could work with other products. The Philips Co. developed a compact cassette for magnetic tape, then let anybody who wanted to make it or use it for their own machines do so without cost. The company did this on the theory that easy availability of its cassettes would help sales of its recorders; and the presence of other recorders would help sell cassettes. The result was a booming market. And Philips is doing a great deal better with both cassettes and recorders than it would have had the firm jealously guarded the cassette.

Probably the least investigated and least developed area of communications is people-to-machine communications. Page reading, spearheaded by firms like Recognition Equipment Inc. and the Control Data Corp.'s Rabinow Laboratory, has become a profitable pursuit largely because the literate world can supply monumental reading assignments—tasks so big, in fact, they justify development of special machines suited only to a specific job at hand, such as zip-code reading.

Consequently, optical-character recognition has primarily bitten off two small parts of the general problem of page reading. The machines read either a few alphanumeric characters in a wide variety of fonts, or all the characters in just a few predetermined fonts. Either way, optical-character recognition machines operate at speeds of hundreds or even thousands of characters a second with accuracies of about one error in 10,000 characters.

Such performance is truly admirable, but left by the way-side is a more general machine that could sacrifice a bit on speed and accuracy—and read almost any font or combination of fonts. There is an OCR unit that more or less fits this description made by a small New Jersey company, CompuScan. The machine however, sells for \$900,000, which includes a modest-sized computer in the price. This points up a major drawback of today's OCR's—they tend to be very expensive, too expensive in the opinion of potential users.

Another approach, taken by Recognition Equipment Inc., is to link an OCR machine to a facsimile device, which can be located at any remote location. Thus, a document can be forwarded by facsimile to the batch-reading unit. In effect, the facsimile device enhances the OCR machine's reading range.

Another area of embryonic development in people-to-machine communication can be found in information retrieval. Again, some impressive systems have been created for specific problems. Successful application of computer-based retrieval was first accomplished for both the petroleum industry and the military. Other industries, which can tag information blocks with singular labels—the names of salient chemicals in the drug industry, for example—followed. Now publishing institutions, such as Time Inc. and The New York Times, are developing computerized information-retrieval systems. The

goal, of course, is to approximate the effect of a human mind that happens to remember instantly where the desired information is. But if one is willing to trade off computer time, speed of retrieval, or accuracy, retrieval schemes can be extremely useful. For example, Aspen Systems of Pittsburgh put all the laws of the U.S. into a single set of disk files to aid in legal searches for precedents. The tradeoff: time. A complete search can take up to 8 hours of computer time. Such a search can easily be valuable enough to a litigant and his attorney to more than justify the computer time and cost. But this system is not necessarily suitable to the problem of quickly locating relevant text published during a 20-year period in a group of magazines.

Then, there is always the controversial issue of speech recognition as a solution to the problem of man-machine communication. Bell Labs' Pierce, for one, goes so far as to question the motivation of those doing work in this field: "It would be too simple to say that work in speech recognition is carried out simply because one can get money for it," he wrote in a paper on the subject. "That is a necessary but not a sufficient condition. We are safe in asserting that speech recognition is attractive to money. The attraction is perhaps similar to the attraction of schemes for turning water into gasoline, extracting gold from the sea, curing cancer or going to the moon. One doesn't attract thoughtlessly given dollars by means of schemes for cutting the cost of soap by 10%. To sell suckers, one uses deceit and offers glamor."

In response to Pierce's observation, John McCarthy of Stanford University's Artificial Intelligence Projects Laboratory says: "I don't think Pierce knows what he's talking about in computer science—he's a physicist who thinks he knows everything. Sure, a number of people had premature hopes, but despair in the face of early difficulty is also unjustified."

Many scientists share McCarthy's feeling that early difficulty in speech recognition should have been expected, especially since there is no usable mathematics to describe the problem or to help bring about its solution. RCA's Harry Olson is one such scientist. "Years ago, when speech recognizers could recognize only a few words, the future looked pretty doubtful," he says. "But we've already built a device that approaches a 200-word vocabulary. When you get to 500 words, you've got it!"

At the Stanford laboratory, one scientist, Raj Reddy, has already designed a 500-word speech-recognition system. To be sure, the system did not come easy. At the heart of the system is a PDP-10 that has devoted about one-quarter of its time for two years to the problem of trying to figure out what humans are saying to it. Words are spoken into a microphone; the computer program does the rest. First, the machine decides what constitutes a word and where the word seems to start and stop. Next, the machine analyzes each utterance in terms of phonemes—fricatives, vowels, stops, syllables, and so on. The program looks up the dissected utterance in its memory and attempts a match. If it believes it has found one, it writes on a cathode-ray tube: "You said, ----," and prints what it thought it heard. If it comes up with nothing, it simply prints, "Eh?" The speaker can say the word again, or he can enter it as a new word by typing the word on the console's keyboard. The system performs surprisingly well, even handling with ease phrases from voices it hears for the first time. Some accents

throw it, of course, but they can be entered as a kind of new vocabulary.

Reddy believes that speech recognition, when it's good, would be enormously useful. "It would make each telephone a computer terminal," he says. "Of course there would have to be a lot of checking to make sure the machine understands each group of words."

For example, if the speech recognition equipment were used to let depositors talk to a bank's computer about financial matters, there would have to be extremely close checking. A typical conversation might go like this:

Customer: "What is my bank balance?"

Computer: "You said: 'What is my bank balance?'"

Customer: "Correct."

Computer: "You said: 'Correct.' (pause) 'Your bank balance is eight hundred . . . and . . . five seven dollars, precisely.'"

In cases where exact transmission isn't critical, the computer could plunge ahead and possibly make some mistakes; should it get confused, it could always go into the "protocol" mode in which each phrase is checked out. Should all else fail, the caller could say "help" and the machine could summon a human.

Reddy says that even now a lot can be done within the confines of the five speech-recognition tradeoffs—vocabulary size, response time, cost, complexity of

Hard-copy broadcasting. Information about everything someday may be put on home television, if RCA ever provides a major marketing effort for its Homefax, which it announced in 1967. But the company has not yet committed itself to a big push for instant publishing. If and when it does, Homefax will ride into homes on the otherwise unused bandwidth presently generating the black bar between tv frames. A number of potentially valuable systems, like Homefax and Sylvania's Educast, languish on shelves waiting for manufacturers to figure out how to tap a sizable latent market.

Probably the largest single untapped resource in all of communications is the uhf dial on each tv receiver. A great deal of future network broadcasting is almost certain to center on the now little-used channels 14 through 83.

words, and accuracy. For example, he believes the present state of the art could yield a black box capable of handling 40 to 50 sounds in English at a cost of only \$500; a yes-no recognizer, for only \$10. By relaxing one parameter, results often can be quite surprising in remaining parameters. For example, a \$1 million machine handling 1,000 words might take 20 seconds to answer with a 90% to 95% accuracy. Allowing an 80% accuracy would speed response time to two seconds.

Reddy hasn't built devices that perform to these specifications, but his experience with the 500-word program suggests that such devices are now possible. As to what may be ahead, he says: "The duty cycle for most applications you can think up is quite low, so the machine could spend considerable time mulling over previous sources of confusion. We could program into it associations that could trigger past phrases and sentences the machine couldn't understand when first it heard them. Interrupt mechanisms operating on various levels of priority would bring the machine back into immediate action if needed. Of course, if you had a large number of ill-defined priorities, the machine could get hopelessly confused."

Should this happen, the machine could suffer a human frailty—a nervous breakdown.

Recently, Reddy and two graduate students decided to combine efforts in an interesting project that would

combine the mechanisms of each. Karl Pringle had been experimenting with vision; Jeff Singer had built a powerful computer-driven hydraulic arm. The three attempted to put together a system that could take spoken instructions from a human and, under the supervision of its own vision, do what it was told. The resulting automaton was a nominal success.

For a typical command such as "pick up the large block at the right and put it on the block on the left," the computer would labor over each word—checking the program to see how the word functioned in the sentence and what it meant—then the arm would move to the block, slowly lift it, and carefully place it on the other block as instructed.

Toward the end of the coming decade, speech recognizers may become a factor in bridging the 50-foot gap. But there are many systems and devices, either in use at present or further along in their development, that could play an important role in the early 1970's. Among the approaches that are likely to play major roles:

▪ Ultrahigh-frequency tv broadcasting. Probably the largest, single untapped resource in all of communications is uhf. A great deal of the future of network broadcasting is almost certain to center on the little-used channels 14 through 83. Though uhf waves are more prone to reflection and interference than very-high frequencies, the shorter uhf wavelengths are actually more suitable than

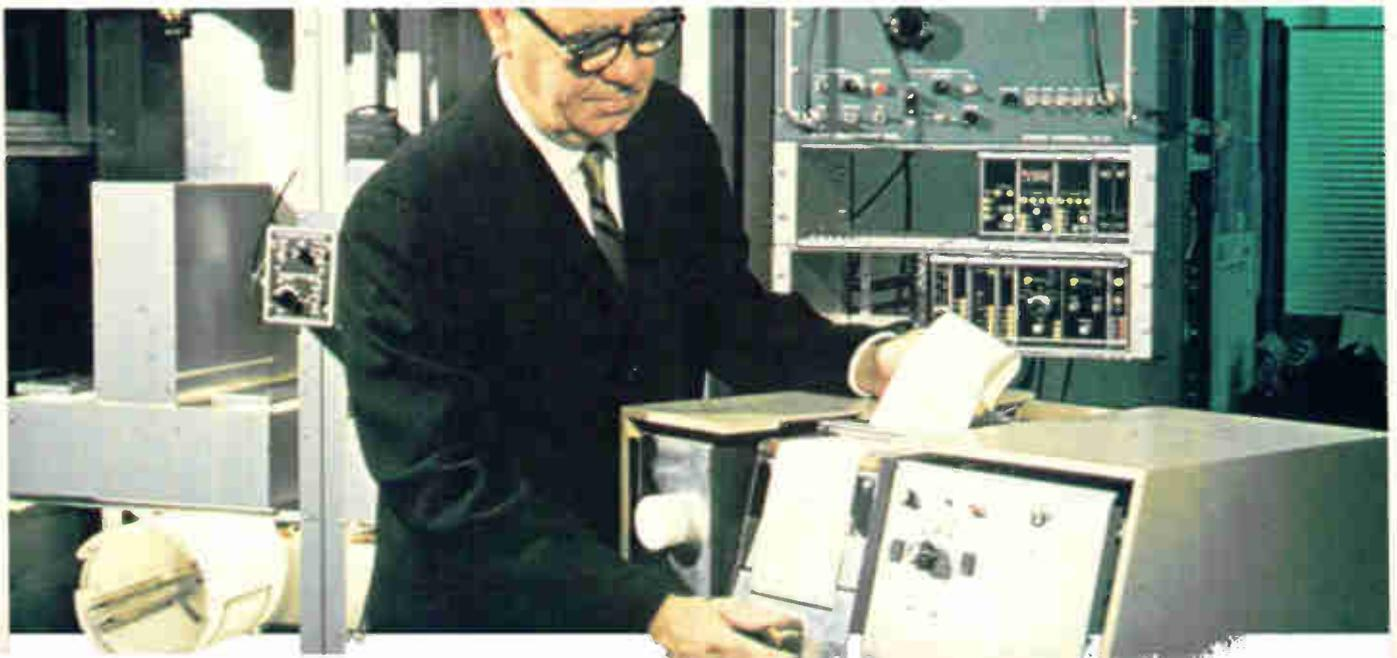

the longer vhf signals for transmission from direct-broadcast satellites to small roof-mounted dish antennas. Direct broadcast satellites operating in the uhf band could not only free vhf for local broadcasting, they could also make possible a number of new networks.

With uhf signals impinging from an overhead satellite onto a small parabolic antenna, reflection and interference problems would be minimal. And every home in the U.S. equipped with a transistorized dish could have access to dozens of national broadcast "networks."

▪ **Responsive broadcasting.** Several years ago Sylvania announced a system of f-m broadcasting that allowed listeners to respond to questions posed by the broadcaster. This system, called Educast by Sylvania, was aimed primarily at the educational market, as the name implies. With Educast, four subcarriers are multiplexed on the main broadcast frequency. The listener is asked to push one of four buttons in answer to a question. Each button corresponds to one multiplexed channel, which delivers instructions appropriate to the listener's response. Sylvania still hopes to capitalize on Educast, but the system has been awaiting a precise approach to the problem of marketing.

▪ **Hard-copy broadcasting.** Television, despite its pervasiveness, lacks the impact of the written word and knowledgeable observers attribute this Achilles heel to the transient nature of broadcasting—the lack of permanent record that can be referred to should a broadcast (or advertisement, for that matter) warrant further serious consideration. One attempt to add hard copy to tv broadcasts was announced in 1967 by RCA. Called Homefax, the system is essentially a one-way facsimile system. Signals are transmitted in the blank space between video frames on spectrum that otherwise would be wasted to generate that black bar seen on the screen when the horizontal hold is thrown out of adjustment and the picture starts rolling. Thus carried along in the pouch of a normal transmission, the Homefax signal enters the home by way of the ordinary tv antenna and is decoded. Such a system enables the viewer to get an electrostatic printout at the mere push of a button. Although the system works well, it has been temporarily shelved by RCA. For now, the company can't figure out how to market what can best be described as instant publishing. But tomorrow may be another day.

▪ **Data/Picturephone.** With the arrival of the home communications center, ancillary information that is germane to a broadcast may be handled in a number of other ways. It may be stored on magnetic tape for subsequent conversion into readable form. Printout may be on either microfilm or the even more diminutive microfiche. It someday may be pumped automatically into a magnetic-bubble memory. In any case, what is clearly needed is a data version of the Picturephone: a cathode-ray tube system designed expressly for the purpose of information retrieval and display. There are, of course, a great many such displays on the market or under development. One unit, at Bell Labs, uses a simple keyboard containing Hall-effect switches that have no contacts whatever; five additional blank buttons are arranged around the bottom of the viewing screen. Thus, the screen itself can label the buttons, which can then be pressed to summon new material to the screen. The entire unit, which fits atop a desk, is barely larger than its medium-size crt.

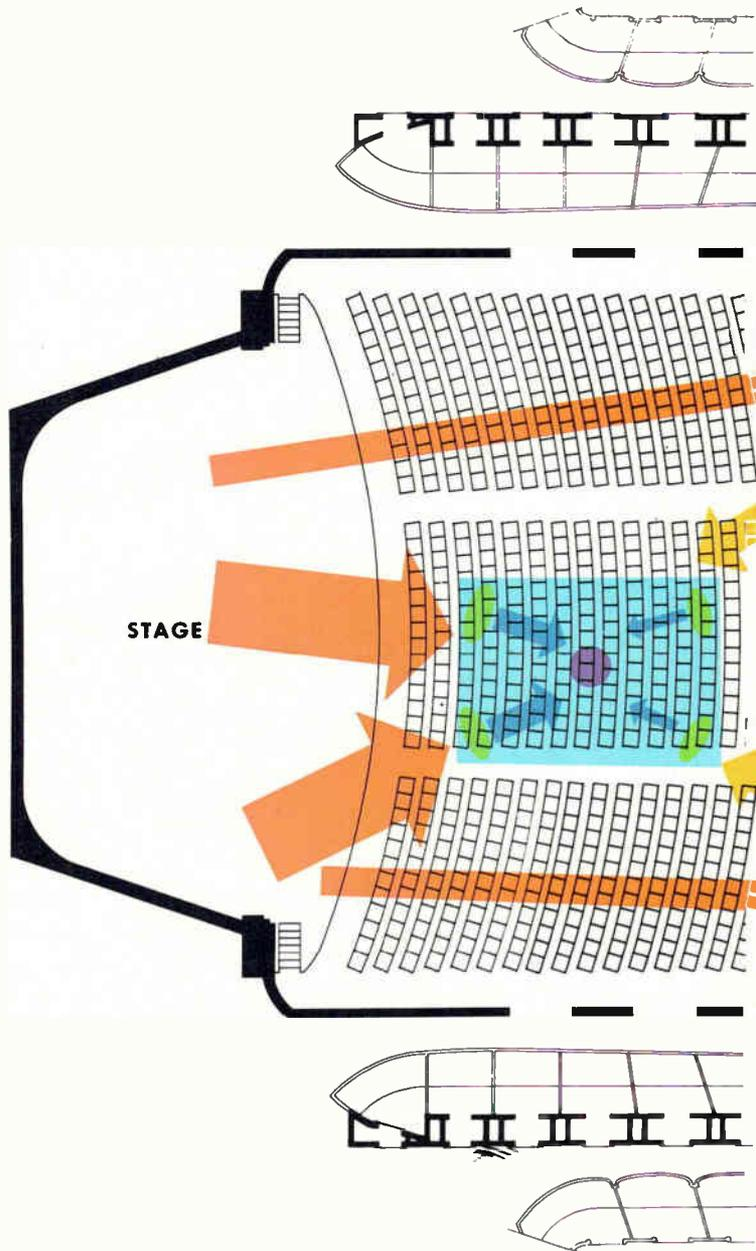

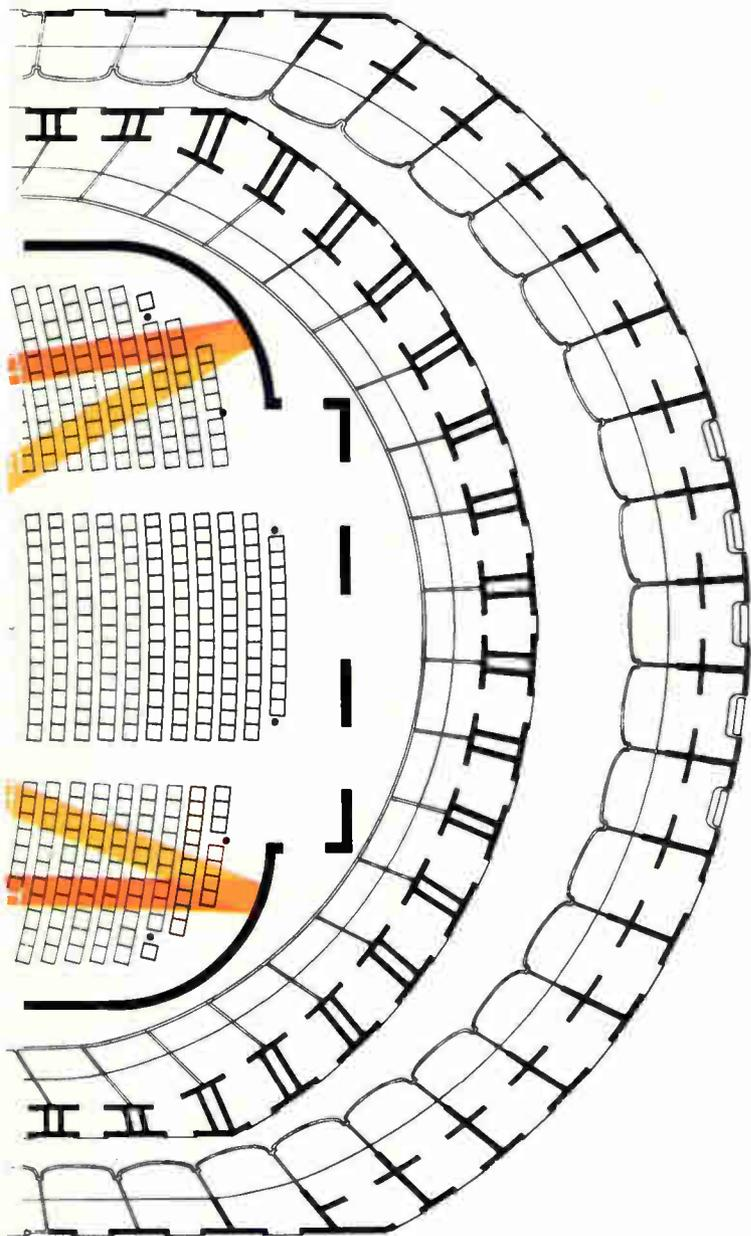

Quadrophonics ahead. To electronically whisk the listener in his blue-carpeted living room to a choice seat in Carnegie Hall, future hi-fi systems will add the reverberative envelope of sound he would normally hear coming from the back of the concert hall. Quadrophonic, or four-channel, sound system—the natural successor to monophonic and stereophonic setups—will recreate reflected sound returning to the listeners on two additional channels, which will fill the rear of the room with sound from two additional speakers. Quadrophonic sound also captures the spontaneity of a pulsating discotheque and adds another dimension of motion in modern electronic music.

▪ **Color Xerography.** In keeping with the trend toward color in magazines, tv, and newspapers, Xerox has been experimenting for several years with color Xerography. Again, the peculiar nature of marketing communications innovations crops up. From a technical standpoint, multi-color Xerography is within easy reach. But ordinary black-and-white Xerography has become so pervasive that nearly all printed communications takes it into account. Accountants, for example, put red figures in parentheses. The company has been perfecting the quality of color Xerography, meanwhile trying to identify a big, latent market. In addition to color, Xerox is pursuing methods of manipulating hard copy from just about any form into any other form—magnetic tape or disk to paper copy, microfilm to paper copy, print to microfilm—indeed, every possible way to transfer information.

▪ **F-m broadcasting.** The next big trend in home entertainment is entering the communications industry by way of f-m radio stations. That trend is quadrophonic sound or four-channel audio. Two stations in New York, WKCR and WNYC, and two in Boston, WGBH and WCRB, are about to broadcast quadrophonic sound experimentally over two stereophonic f-m channels. A New York engineer, William S. Halstead, has developed a system for multiplexing four channels over one carrier. Halstead's system and several others are under consideration by FCC. In anticipation of the quadrophonic boom, H.H. Scott has developed a four-channel amplifier, which the company is prepared to incorporate into a design with appropriate tuner and multiplex circuitry the instant FCC decides in favor of one of the available multiplex systems. Quadrophonic sound has several advantages over stereophonic sound. Quadrophonic sound is relatively independent of room acoustics, speaker placement, and listener location. And it is better suited for reproduction of both symphonic and rock music. For the former, the back two channels can reproduce the reverberative envelope of sound one would hear in a concert hall; for the latter, four speakers can conjure the dizzying spatial effects a teeny-bopper would encounter in a discotheque.

Thus far, neither CBS nor RCA has given any indication as to what it plans to do about quadrophonic sound. But scientists at the two companies have been thinking along the lines of multichannel sound for some time. Both companies are undoubtedly awaiting FCC adjudication of quadrophonic f-m, applying themselves in the meanwhile to the task of devising a compatible quadrophonic phonograph disk. The adaptation of Stereo-8 tape cartridges to quadrophonic sound should be no problem at all, obviously. And plenty of quadrophonic program material exists already: nearly all recording sessions are taped on four-track half-inch masters.

▪ **Portable paging devices.** For years some men have carried in their pockets little devices that sound a beep upon receiving a coded broadcast signal. These small paging devices are really nothing more than the portable extension of a telephone bell: upon hearing a beep, the user goes to the nearest telephone and calls a prearranged number, usually that of his office. Paging systems have had limited use because very few firms could justify the cost of an entire system. Recently, however, the FCC handed down a decision that explicitly permits collective paging systems, which can be shared by many companies or people. Now remote paging can be offered to the public as a service. The most likely market for such sys-

tems are the telephone answering services, which are already in a position to offer their own subscribers the additional service of remote paging.

▪ High-resolution facsimile. There are many systems that transmit high-quality photographs quickly from one point to another, but they all require bit rates considerably in excess of an ordinary voice-grade telephone circuit. Most transmit over microwave links, but the overwhelming majority of potential nonmilitary applications—such as those centering around the publishing industry, for example—do not justify the cost of setting up special links. Widespread availability of the Bell System's 50-kilobit service, Data 50, and other still wider band services could be accompanied by a proliferation of high-resolution facsimile equipment, if manufacturers would only settle the question of compatibility. High-resolution facsimile and, subsequently, high-resolution color facsimile could become substantial markets if only each user didn't have to set up his own transmission links as well as to lease or own every unit with which he wants to communicate.

▪ Mobile radio-telephones. Mobile radio-telephones, although they have been around for years, have proved inconvenient. The user had to push a button to talk, then say "over" to signal the other person to speak. The Bell System, however, has been conducting experiments in several cities with a more convenient radio-telephone that allows users to dial directly and communicate in much the same manner as with an ordinary telephone.

▪ Speech synthesis. Scientists at Bell Labs and RCA have long known that speech is a highly redundant and rather ambiguous method of communicating—that encoding at the source and decoding at the point of delivery could drastically reduce the bit rate needed to converse in real time. RCA's Olson conducted tests that determined that as few as five bits per second are sufficient to transmit intelligible speech. Bell Labs, working along similar lines, developed what it calls the Vocoder—voice encoder and decoder—to counter what would have become an escalating cost of long-distance lines had the company been forced to stick with pairs of copper wire forever. As it turns out, coaxial cables, microwave links, and, ultimately, satellites, millimeter waveguides, and lasers place the per-mile cost of providing voice circuits on a decreasing, not an increasing curve—one that decreases faster, in fact, than the cost of corresponding Vocoder circuitry. Thus, AT&T chose to put capital into long lines that would, in effect, increase the bit capacity of the system, rather than Vocoder that would have decreased the demand for bit capacity.

▪ Synthetic music. Like synthetic speech, which allows the compression of transmitted bandwidth for voice communication, synthetic music may one day permit comparable bit reduction for music transmission. What the Vocoder is to speech, the Moog (pronounced like rogue) Synthesizer is to music. This device is essentially a keyboard instrument that uses 12 oscillators and a maze of easily connectable filters, delays, reverberators, echo devices, phase manipulators, and resonators to generate musical tones and control their attack, quality, and decay. The synthesizer started making strong inroads in the recording of commercials and jingles where, hidden from public awareness, it could spin its peculiar melodies to sell such products as soap and aspirin. But not until George Harrison, one of the Beatles, made an all-Moog

album for Columbia Records called "Switched on Bach" did the Moog take hold in pop music. Moog music, as the synthetic refrains have been dubbed, poses two problems. First, it doesn't seem to have the power associated with high recording levels, consequently the needle on level meters runs off-scale before any semblance of Wagnerian impact has been achieved. Second, since the synthesizer can only produce one note at a time, recording is a painfully slow process that must be done on video tape recorders fitted out with up to 32 tracks, in order to put across even a moderately complicated orchestration. Then, of course, truly synthetic sounds had no names. This led to made-up descriptive names—"pagwipe" (described as inside-out bagpipe) and a "ploboe" (an oboe sound with a "plah" attack), for example. Based on the current trends in pop music, there's no question that the Moog Synthesizer will remain on the musical scene for quite some time. And, undoubtedly Moog music will grow in popularity with time and refinement. Even Hugo Montenegro has made a recording using the synthesizer.

Clearly, speech and music synthesizers, remote paging units, quadrophonic tuners, amplifiers and phonograph cartridges, hard-copy broadcast receivers, and direct-broadcast satellites, and roof-mounted antennas will all be part of a proliferation of black boxes in coming decades.

Black boxes that changed communications

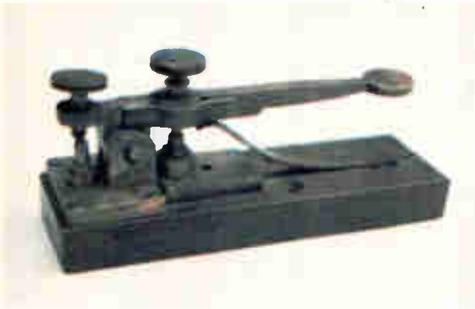

1.



2.



3.

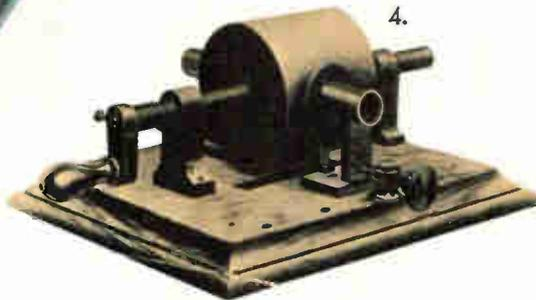

4.



5.

1. "What hath God wrought" was the message tapped out on the first of Samuel F.B. Morse's sending keys in 1844, which is at the Smithsonian.
2. Alexander Graham Bell's first few telephones were liquid filled, operated vertically (circa 1876).
3. During the next year, 1877, the loudspeaker telephone made its appearance.
4. Edison invented the phonograph in a matter of hours by throwing together this model from which the first device was made in 1877.
5. A young communications inventor, Guglielmo Marconi, poses with his very first wireless sender and receiver (1895).
6. Westinghouse scrambled to the market with the first manufactured radio in 1921. Who sold the units for Westinghouse? RCA!
7. Many firms claim to have pioneered television, but Bell Labs actually was first. In covering the 1927 event, the New York Times cited the demonstration as "first in history," but pegged the system's commercial value as "in doubt."
8. The Mod-1 Picturephone, recently introduced, already is obsolete. Mod-2 is rectangular, and camera is mounted above screen.

6.

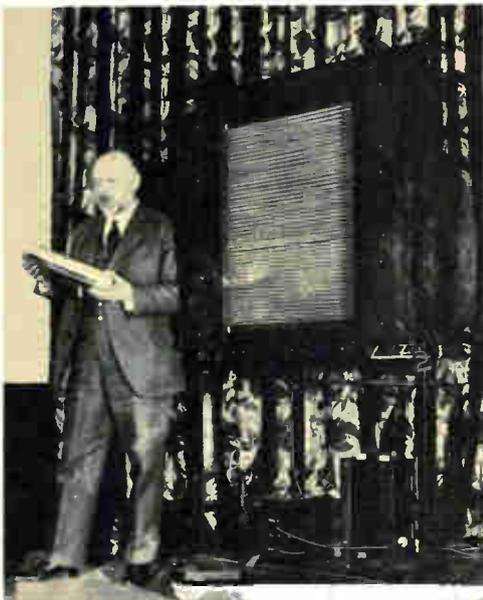

7.



8.



No more pencils, no more books

● Two communications tools that defy electronic substitution are paper and pencil. As communications devices they are in themselves the ultimate in simplicity and adaptability—suitable for any language and any purse.

In 1957, Douglas Engelbart, set out to give humanity something better than paper and pencil for working out solutions to its problems. Not a specific problem, mind you, but all problems. This idea gnawed within him for seven years and led him to the Stanford Research Institute in Palo Alto, Calif., where the then 36-year-old Engelbart established what is now called the Augmentation Research Center.

There, he started substituting for paper and pencil a complex maze of electronics, which has come to include a time-shared SDS 940 computer, a character generator, a high-resolution 5-inch cathode-ray tube, an 875-line closed-circuit tv camera and display monitor, a standard keyboard, a five-key keyboard that can be operated with one hand, and a small mechanical mouse-like contraption that functions as a pointer. Obviously, the entire setup is far more expensive than the simple tools it replaces. But Engelbart believes it can do much more.

Reading is done by viewing material on the crt, rather than turning page after page. The viewer merely aims a small pointer to any word or phrase that needs further elucidation, then presses a button to summon additional information. This additional information is stored in the computer's memory.

Consider, for example, the viewer, or reader, wants to find out how to work the console before him. He might summon a description of the entire system and, after examining the overall organization, decide he would like to start by learning how to use the buttons on the mouse-like object. By rolling this plastic "mouse," he positions the pointer at

Taking off. Douglas Engelbart prepares to "fly" his electronic system that substitutes for paper and pencil. Seated in a modern chair-keyboard combination built by office designer Herman Miller, Engelbart places his hands on the controls and his five-fingered binary keyboard. Now he can read and write, edit and polish, all without taking his eyes off the console. Engelbart's is the first radical departure in communications technology for the office, and it, along with facsimile, Picturephone, and other devices, may help corporate man bridge the "50-foot gap."

the word mouse where it appears in the description of the system. He then presses a button, thus summoning the corresponding frame (extreme left in the sequence below).

Next, he follows the instructions on the screen and summons the succeeding frame. By aiming the

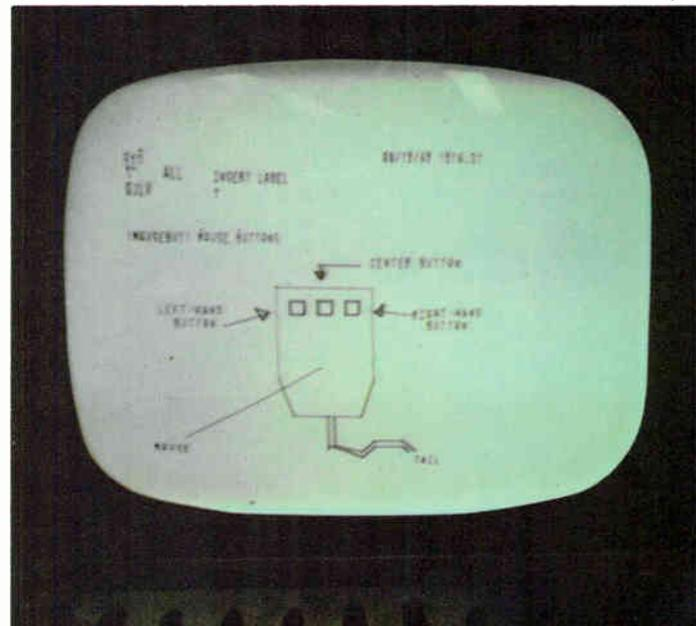
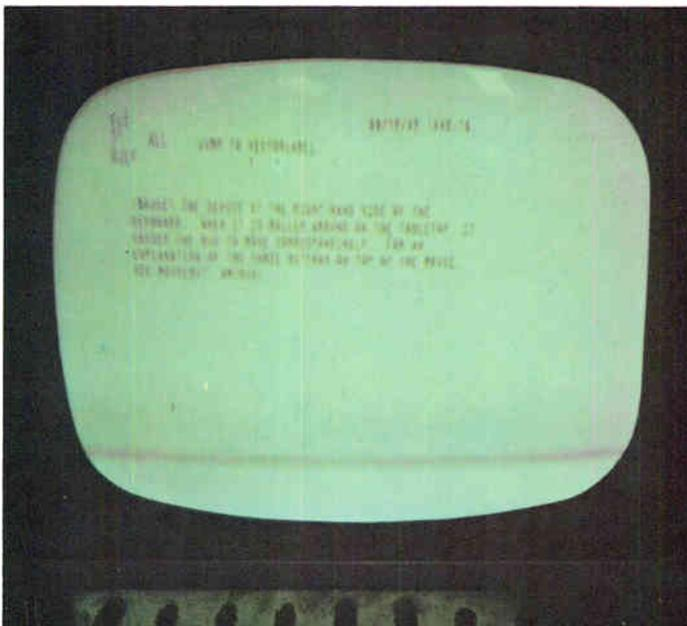

—write and read electronically

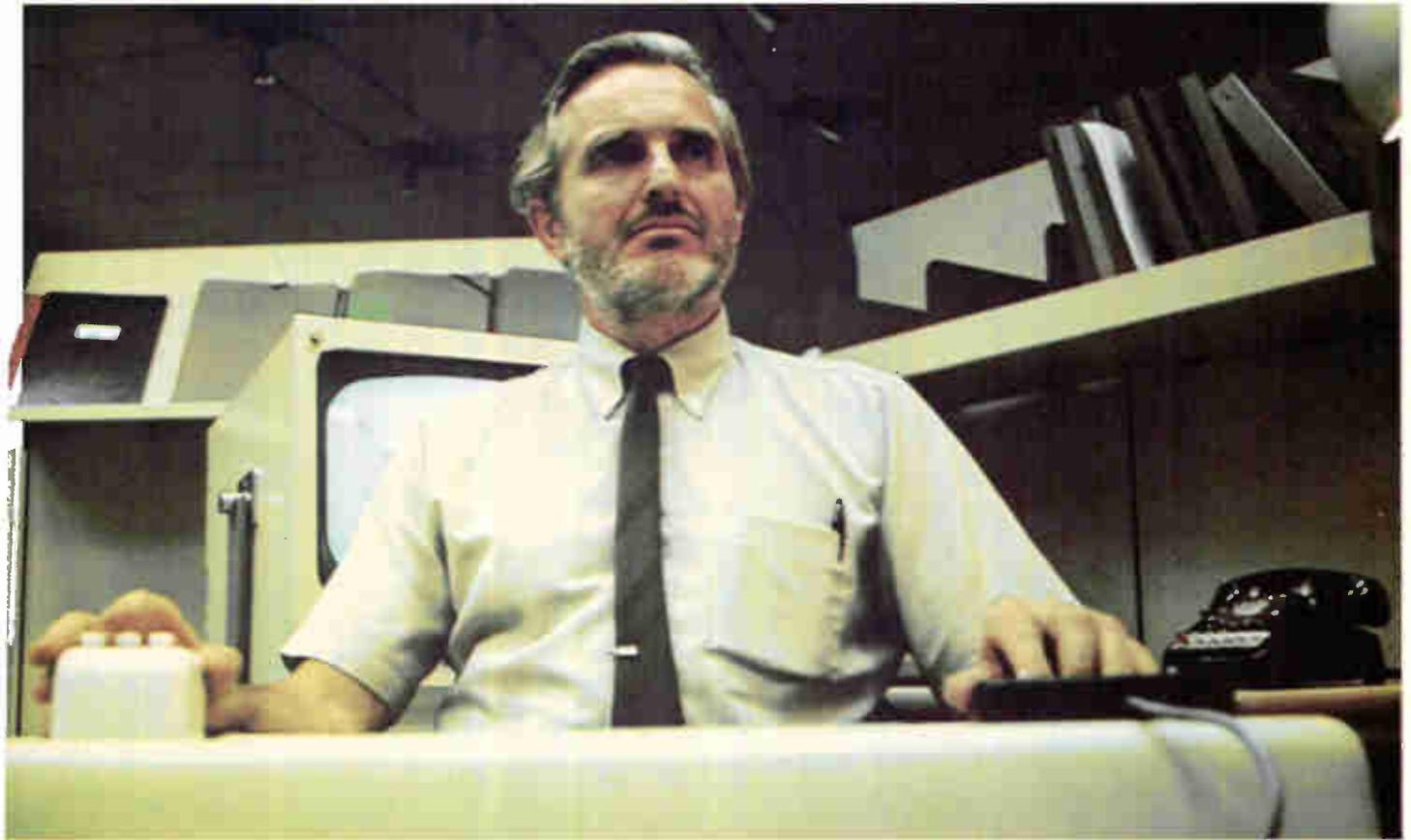

pointer at a label within this frame, he could then fetch a list of buttons and button combinations (following frame). Pointing at, say the bottom entry on the list, which indicates left-hand and center buttons together, he could find out what happens when they are pressed (last frame). By operating the

“mouse” with one hand and the five-key keyboard with the other, the reader can, in effect, fly around in the bowels of the computer’s memory by remote control, exploding phrases into whole frames, skimming along one-sentence precis, reorganizing mountains of material, and printing out on microfilm

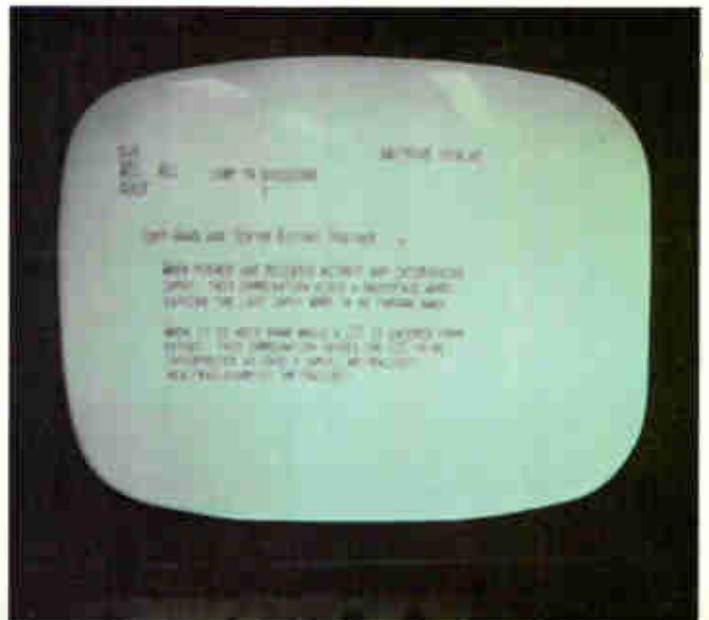
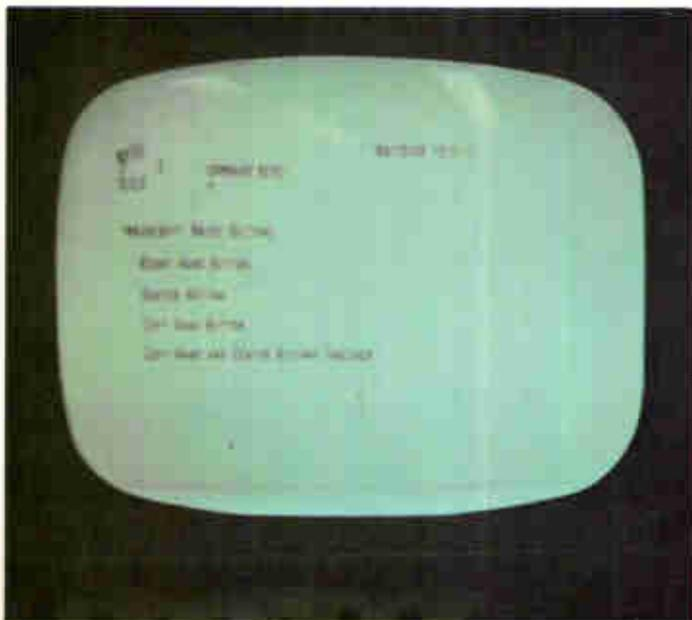

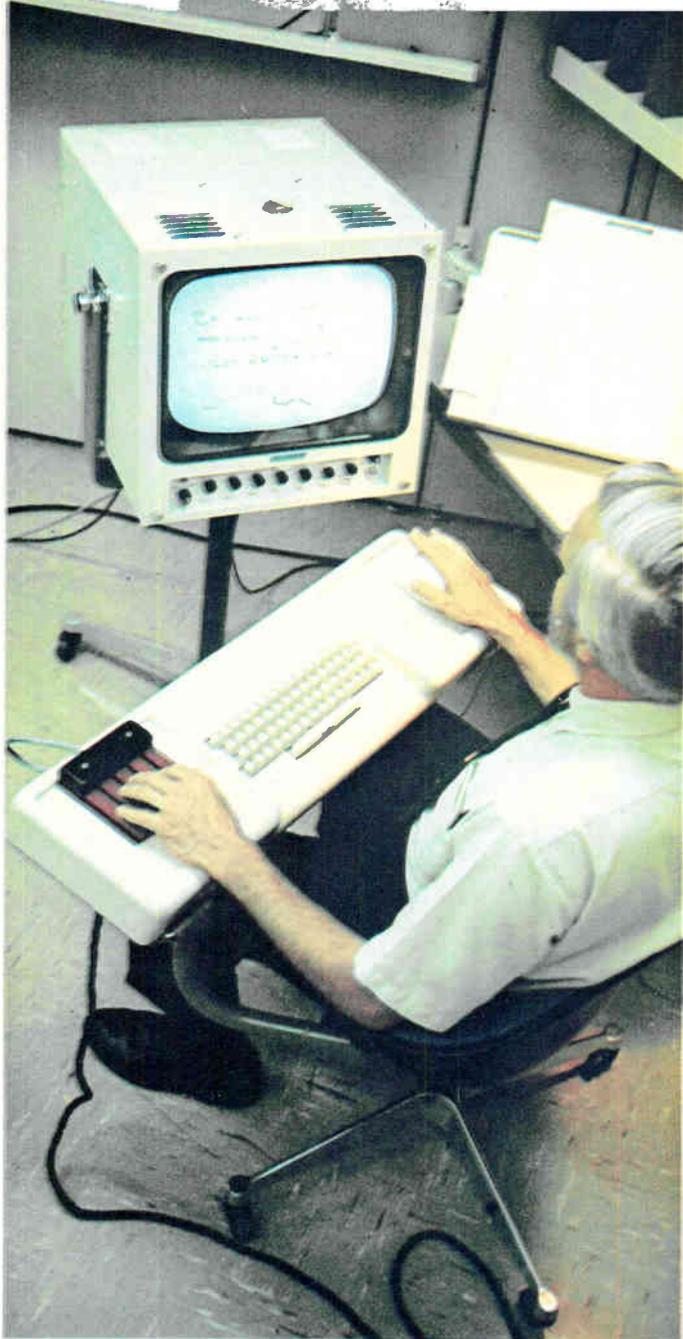

Piano keys. A binary keyboard requires tricky cross-fingerings, but allows the user to write words and codes without taking his eyes off the console or his other hand off the "mouse." With a little practice, anyone can learn to fly the system.



Roarless mouse. By rolling the little white "mouse" on a small, flat platform next to the keyboard, the user moves a small white pointer that appears as a spot on the cathode-ray tube display. Buttons insert words and make them disappear, and facilitate editing.

only what is desired.

Writing with Engelbart's system is accomplished in a straightforward manner. Text is typed, using the standard keyboard, onto the screen to almost any desired width, with the lines justified. The computer can be directed to output frames in the form of microfilm, magnetic tape, disk pack, or punch tape, which then can be fed directly to a photo-typesetter.

Editing—that is, the manipulation of written and graphic material—is where Engelbart's system really shines. Seated at the console with one hand on the "mouse" and the other hand on the five-key keyboard, an editor can fly along, pointing to words, knocking them out, flicking in new words, blending in text from other frames, turning phrases, reordering ideas, restructuring, reworking, pruning, and condensing—all without taking his eyes off the screen.

Clearly, Engelbart's system is a substitute not only for paper and pencil, but for a host of other communications tools as well. For example, augmentation center has already been the scene for experimental conferences, in which participants sit at consoles, each linked to a central computer, and see each other's image on monitors; text and diagrams are superimposed over the images. The overall effect is that of a super-picture-data-phone, and preliminary findings suggest that such conferences are more productive, even, than unassisted in-person exchanges.

Ultimately, Engelbart's system—which was developed with funds from the Pentagon's Advanced Research Project Agency, NASA's Langley Research Center, and the Air Force's Rome Air Development Center—may be marketed in its present form as a time-shared computer system, or in an abbreviated, self-contained, desk-sized unit. But thus far there have been no takers. However, several companies—especially those involved in publishing, such as Time Inc.—are keeping tabs on work being done by Engelbart.

Nelson's the name, and what he proposes could outdo Engelbart

● While Douglas Engelbart slowly pieces together his intellect augmentation system, a 32-year old consultant named Ted Nelson blazes McLuhanesque paths into uncharted communications systems.

Nelson, lean, well-educated, and fast-talking has a real flair for showmanship. He got his theatrical abilities from his parents, Hollywood film producer Ralph Nelson, and actress-singer Celeste Holm; his education from Swarthmore, the University of Chicago and Harvard, where he received an M.A. in sociology. Nelson has been a consultant to Bell Telephone Laboratories, CBS Labs, and IBM.

To these organizations, as well as any others that will listen, Nelson proposes a text and graphics manipulation program which he dubs his "fantasm system." This is derived from another Nelson word, "fantics," which he defines as the art and science of presentation—"making things look good, feel right, and come across clearly." The central piece of equipment in Nelson's fantasm system is his Xanadu machine—a souped-up version of the one built by Engelbart.

Like the latter, Nelson would use a computer-driven cathode-ray tube information display, but there the similarity ends. Data in the fantasm system would be stored in the computer in what he calls "hypertext" form—a multilevel melange of characters, diagrams, images and movies. Instead of manipulating various complicated controls, the reader would "fly" the machine with a single control stick, which would work somewhat like the joystick in an airplane. When moved right or left, the control stick would make the hypertext proceed forward or backward with a speed proportional to the amount of deflection. Thus, for example, fast readers would push the stick to the far right. Moving the stick toward or away from the reader would make the hypertext either more detailed or more summarized.

Writing, according to Nelson, would take place, whenever and wherever thoughts occur on a small pocket keyboard, which would be at the hypertext writer's instant disposal; all typed notes and passages would go right on magnetic tape. Cassettes would be unplugged from the back of the pocket



keyboard and snapped into the Xanadu machine, accomplishing what Nelson glibly refers to as "prestidigitative publishing."

Whether or not Nelson's visions come true, one thing's sure: he bristles with ideas about communications, and at least one company, IBM, has successfully introduced a typing system product based on one fragment of Nelson's schemes. Nelson himself is perhaps the greatest living proof of the effectiveness of "fantics." Says one Time Inc. executive after witnessing a Nelson presentation, "Boy, you should have seen him. He was barely up there 10 minutes when he had businessmen in the audience practically ripping their pockets trying to get to their checkbooks." "Man, they were stepping all over each other to underwrite his projects."

Perhaps, though, there is a very simple explanation for Ted Nelson's effectiveness: One of his favorite heroes is P. T. Barnum.

Picture this: point-to-point paper from the next big-time black box

● The reception area of a small company in Danbury, Conn., swarms with activity these days. The firm is Graphic Sciences Inc., a young company that aims to dominate the graphic traffic market the way the International Business Machines Corp. dominates computers.

Every desk has a white sign that says, DECIDE. "Not THINK," says Graphic Sciences' chairman, Dr. Sullivan Campbell, "DECIDE! THINK also implies procrastinate."

Right now Graphic Sciences has a single product, dex-I. "Dex," says Campbell, "stands for decision expediting, and that's precisely what dex-I is intended to do." The unit is, in fact, a telephone-attached facsimile transceiver. "We don't like it when people call dex-I a facsimile transceiver," says Campbell. "It's a graphic communication unit!"

If dex-I is a graphic communication unit, it could be the hottest new black box to come out of the communications industry since the IBM 360. There are at least ten devices like it on the market and most of their manufacturers claim to be sweeping the field. But when you try to pin them down on figures, they are extremely evasive; a little checking into actual sales turns up mostly zeros.

"We have over a thousand in the field now," Campbell says bluntly, as his assembly line cranks them out and tests them. Out behind the plant, workmen are building another wing that will almost double plant area. Orders

are running well ahead of production, but the assembly people are hanging in there. Orders for units are even rolling in over facsimile transceivers—oops, graphic communication devices—in the hallway alongside the executive offices. Luckily, there are enough dex-I's around to handle them.

There are several reasons customers are flocking to Graphic Sciences: dex-I is a facsimile device that was engineered with great sensitivity to the customer's problem as well as to the general problem of getting good transmission over some pretty awful telephone circuits. "We designed the dex-I to operate satisfactorily on any connection you can hear voice over," says Campbell, "and it'll work anywhere—on any a-c line from 40 to 400 cycles, and from 80 to 140 volts."

Another secret to dex-I's popularity is that many of its competitors have bad breath: current passing from a stylus to the conductive paper on a rotating drum darkens the paper according to current density. The process is rather smoky and an odor like that from a cap pistol issues forth from most facsimiles. In dex-I, a high-speed turbine vacuums the smoke from the stylus through a filter. Says Campbell, "There was a very simple spec for that filter: the air must come out of the machine cleaner than it went in."

By designing the optics with a spectral response that mimicked the human eye, Campbell and his engineers

Plug-in graphic transceivers, built to operate over telephone lines, solve the problem of signal noise and fading to produce clear images, and promise to turn decision making into a see-for-yourself proposition

Decide, don't think. Graphic Science's chairman Sullivan Campbell contemplates the many ways his firm's new facsimile equipment will help executives avoid procrastination. The first unit, called dex-1, is rolling off the production line now, and rents for \$75 a month.

were able to make sure dex-I wouldn't be "color blind"—that is, colored material would not wash out and fail to appear at the other end.

To work out dex-I's mechanical designs Campbell hired one of the best graduate students in mechanical engineering at MIT, Eric von Hippel. "Simple mechanical difficulties can make it hard to sell machines," says Campbell. "Like if a secretary breaks her fingernails every time she tries to load a paper drum, you've got a problem. She'll get to dislike your equipment." In von Hippel's design, the paper is dropped into a sliding tray, which feeds it right on to the drum, perfectly, every time.

However, dex-I's best feature is not in its optical or mechanical design, but rather in its circuit design. Like his competitors, Campbell had to solve the problem of line interference in the telephone network. His competitors, reasoning by way of analogy with broadcasting, chose acoustically-coupled f-m signals to carry the image. "Give me 50 khz and I'll give you the damndest f-m transmission you ever saw," says Campbell, "but for 3 ktz, a-m is far more suitable."

For a-m transmission, the telephone line presents two problems: noise and fading. Line-noise, and all ambient noise, except that which looks just like a signal, can be filtered electronically. Fading, Campbell controls with an acoustical single-sideband technique. For every scan,



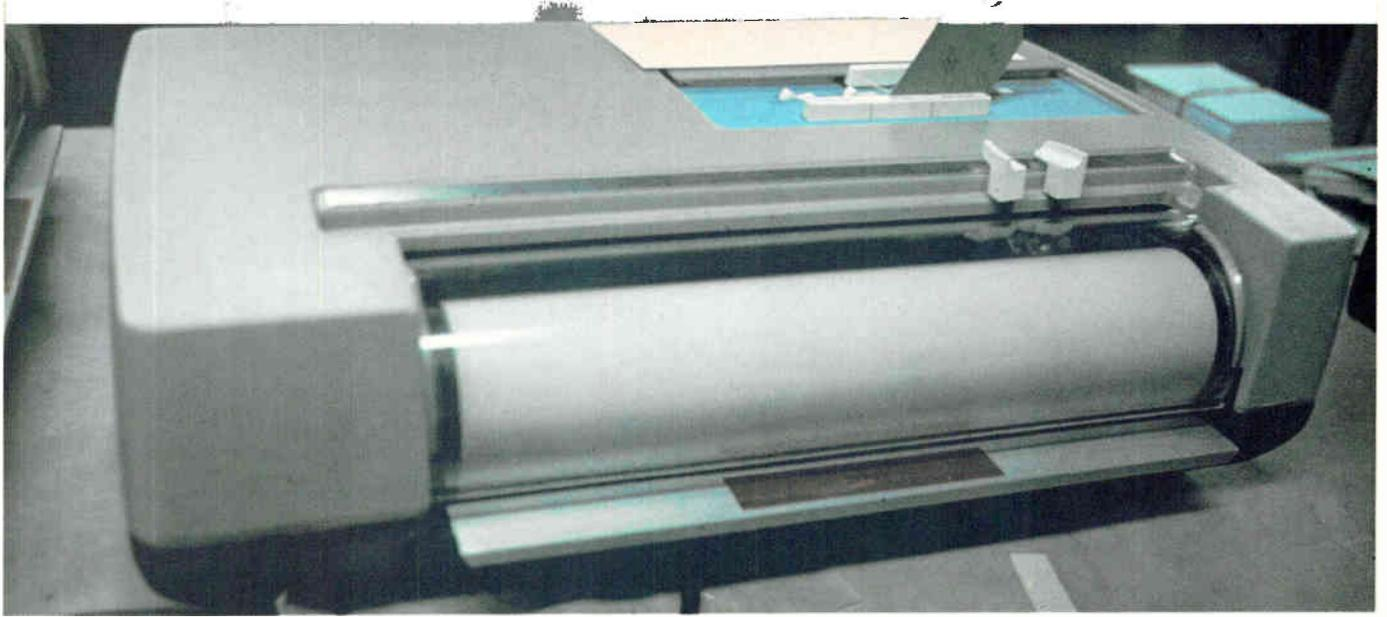

black and white test bars are sent along with the information signal to the receiver, which readjusts the level of stylus current appropriately. Thus, as the telephone line voltage ebbs and surges, the test bars riding in on the single sideband is analysed by special circuitry, which adjusts signal level to achieve a uniform image.

"The alternative was to put up with the problems of audio-frequency f-m," says Campbell, which puts a watery effect on the copy due to phase distortion of the telephone lines. In the end, dex-I used 27 integrated circuits to filter the a-m signal, detect and analyse the ssb, control recording level, and synchronize drums.

Appropriately, according to Campbell, Graphic Sciences got into DECIDE business because it knew what it wanted. The dex-I is based on a machine developed by the H.L. Morgan Co., which was set up as the industrial products division of KLH to generate a family of acoustical industrial products. One product was an acoustically-coupled graphic transceiver.

The intention was to build the machine with high-fidelity KLH parts. But then KLH was bought by Singer, which, according to Campbell, did not appear to be interested in marketing industrial products. The Arthur D. Little Co. was down the block, and tried to help Morgan market this electrical writing process.

"Most companies turned the idea down because they didn't believe that the patents, which seemed so gen-

eral, would in fact be issued. Other companies didn't reject the idea, but didn't make up their minds, either. We walked in and we knew we wanted that machine. We offered to buy all the rights to it for a half-million dollars—\$150,000 cash, the rest over seven years. We were there with a solid offer and they took it."

Thus, Graphic Sciences was born in May 1967. The minute the agreement was signed, Campbell and his partners started redesigning the box and weaving a web of patents around it. "The only components left from the original design," he says, "are the photodiode and the light bulb."

Now, Graphic Sciences is working on other machines. Its dex-II attaches directly into the telephone system (or two units can be connected with lampcord). When dex-III arrives, it will automatically answer the telephone to take a facsimile, record the image on magnetic tape, then hang up. And dex-IV will be either a three-minute machine (dex-I takes 6 minutes), a 45-second machine, or an attache-case unit that would converse with computers, rather than other dex models.

"Of course," Campbell pointed out, "it doesn't make sense to introduce a portable dex-IV until there is a well-established number of machines for it to talk to." As he finished, he was informed that three people were waiting to see him, and four were trying to call him.

Sullivan Campbell smiled.

Is this next? Charging into the facsimile market is dex-1, a smokeless, easy-to-load unit that couples acoustically to the telephone network.

Wired lady. The girl on the standard IEEE facsimile test chart, reportedly the secretary of a Kodak executive, undoubtedly is the most widely reproduced woman in the world. A good way to compare the quality of a pair of transceivers is to send the original (above) to a receiver, which rolls out a copy (below). The Graphic Science unit, dex-1, produced this result over an ordinary telephone connection. Telephone receivers were locked in the dex-1's acoustically insulated compartment and the receiver was loaded with current-sensitive paper. Within a few seconds, the rotating drums synchronized and transmission proceeded. Most facsimile units communicate over the telephone network with a similar acoustical coupling arrangement. Usually, the audio signal is frequency modulated. But dex-1 uses a-m modulation to provide a clear image free of the watery affect that is seen on some f-m modulated transmissions.

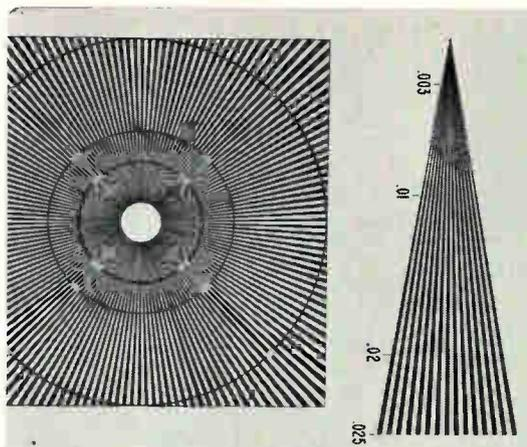

Point—Futura Medium Condensed
 defghijklmnopqrstuvwxyz
 DEFGHIJKLMNOPQRSTUVWXYZ
 4567890

8 point Futura Medium
 abcdefghijklmnopq
 ABCDEFGHIJKLMNOP
 123456789012345

Eight point Bodoni Book
 abcdefghijklmnopqrstuvwxyz
 ABCDEFGHIJKLMNOPQRSTUVWXYZ
 1234567890

4 point Futura Medium
 abcdefghijklmnopqrstuvwxyz
 ABCDEFGHIJKLMNOPQRSTUVWXYZ
 1234567890123456789

6 point Futura Medium
 abcdefghijklmnopqrstuvwxyz
 ABCDEFGHIJKLMNOPQRSTUVWXYZ
 123456789012345678901234567

Elite Typewriter Type
 abcdefghijklmnopqrstuvwxyz
 ABCDEFGHIJKLMNOPQRSTUVWXYZ

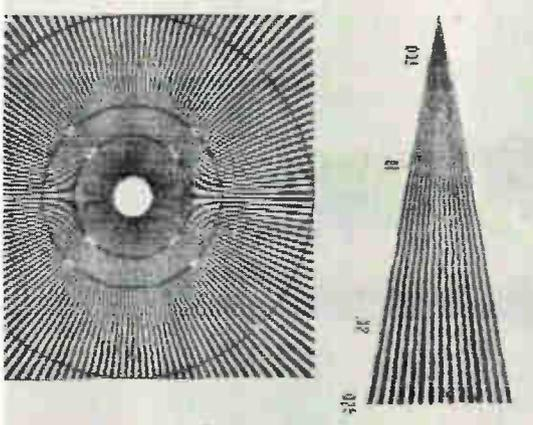

Point—Futura Medium Condensed
 defghijklmnopqrstuvwxyz
 DEFGHIJKLMNOPQRSTUVWXYZ
 4567890

8 point Futura Medium
 abcdefghijklmnopq
 ABCDEFGHIJKLMNOP
 123456789012345

Eight point Bodoni Book
 abcdefghijklmnopqrstuvwxyz
 ABCDEFGHIJKLMNOPQRSTUVWXYZ
 1234567890

4 point Futura Medium
 abcdefghijklmnopqrstuvwxyz
 ABCDEFGHIJKLMNOPQRSTUVWXYZ
 1234567890123456789

6 point Futura Medium
 abcdefghijklmnopqrstuvwxyz
 ABCDEFGHIJKLMNOPQRSTUVWXYZ
 123456789012345678901234567

Elite Typewriter Type
 abcdefghijklmnopqrstuvwxyz
 ABCDEFGHIJKLMNOPQRSTUVWXYZ





● Even good communications, designed, built, maintained, and used by humans, is fallible. But when a communications system is put to a use for which it was not intended, frustration is almost inevitable.

On East 76th Street on Manhattan's Upper East Side, just such a communications system exists. There, Hertz operates one of its many automobile rental stations. In general, Hertz is very efficient in dealing with customers: all over the country, and at other stations in New York, a client can walk into Hertz confident he will drive away in a clean, late-model car in a matter of minutes.

But at the 76th Street location things are different. There, a small, round man named Mr. Levenson stands behind a desk, surrounded by electronic communications equipment—a Telautograph, a computer console, a telephone—and, on more hectic mornings than he cares to remember, a group of very irate customers.

Reservations for Hertz cars in Manhattan are made by dialing a central telephone number—661-7100. Between 40 and 50 “reservationists” handle incoming calls. As each request is filled, the reservationist tells the customer he has a “confirmed reservation,” then sends the information—the customer’s name, intended time of pick-up, and any special instructions—directly to the Telautograph in the appropriate station. There, as cars come and go, the clerk behind the desk enters rental transactions into the computer’s memory using a CDC time-sharing terminal designed for the purpose. A CDC-8081 computer, located at 645 First Ave., maintains an up-to-the-minute inventory of cars at all metropolitan stations.

The CDC system was designed primarily for “car

control”—that is, it keeps inventory and mileage data on cars to locate those that are not returned and to insure that all cars get periodic maintenance. It was not designed for on-line reservation checking. However, by using printout from the computer off-line, Hertz found it could put the expensive system to work updating records of availability.

The Hertz reservation system has three flaws. One is inherent in car rentals; the other two derive from the fact that the CDC system wasn’t intended for reservations.

The central—and unsolved—problem in car rentals is that the company obviously must make reservations sometimes days or weeks in advance, but it cannot possibly know which cars will return to what stations, and when. So when the reservationist says a customer has a confirmed reservation for 9 a.m. Thursday at the 76th Street station, he is really betting that at least one car will be there by then, or that he will have time to get one there from a nearby station.

The snag in using the computer for reservations is that the system was not intended for on-line display of inventory. Presently, a city manager gets a printout from the computer every half hour. He checks to see if any station is low on cars, but the score sheet is always behind by a few minutes to a half hour, and there are too many variables to guess right every time.

Finally the computer has no feedback for reservations. It knows only whether cars are checked in or out; not if customers are getting into them and driving away.

At most Hertz stations these flaws aren’t evident, and the system works fine. But at the East 76th Street sta-

Hertz puts a black box

Even the best-laid plans of men go astray if they’re put to unintended uses;

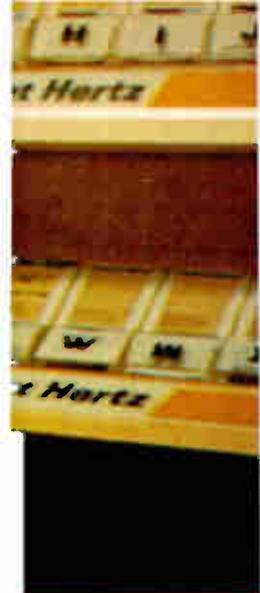

Going awry. Under pressure from several irate customers and surrounded by electronic equipment, a Hertz employee can do little more than fill out rental forms by hand and pile them up on the Control Data Corp. custom terminal while additional "confirmed reservations" stream out of the Telautograph mounted on the wall at the left.

tion the effect of the flaw often is painfully obvious.

Each morning a number of "confirmed reservations" are made and customers start arriving to claim their cars. But cars are not always forthcoming, and Levenson tells customers that there is a delay of perhaps 15 minutes and asks them to have a seat. By 9:30 on some mornings there are as many as eight or 10 disgruntled customers packed into the small seating area—some already waiting for over an hour. Levenson periodically leaves the desk, exits through the door at the rear of the waiting room—and reappears looking even more concerned than when he left. Meanwhile, confirmed reservations continue to spew forth from the Telautograph, and customers, expecting them to be honored, continue to arrive. "I keep telling them about this," Levenson says nervously, "but it doesn't seem to do any good."

The root of the problem, according to an informed source, is out in back. Some days the station is short-handed; there may be only one man to wash, clean out, and fill up cars with gas. In addition, says the observer, the company only rents space in a garage at 355 East 76th St.—and garage employees have priority over Hertz people in using automobile elevators. So once a car is prepared for a customer, the Hertz employee may have to wait while elevators carry cars to garage customers.

Under these circumstances, the computer only compounds difficulties. With no way of knowing that cars are not getting to customers, the computer merrily continues to indicate their availability, and clerks, assuming all is well, make confirmed reservations, which keep pouring forth. In the middle of all this is Levenson,

surrounded by exotic communications equipment, yet unable to tell the computer that the situation no longer fits its simplistic view of how cars are tallied, or to reach the reservation clerks who are making confirmed reservations on the basis of the half-hourly computer printout.

Ironically, Hertz is owned by RCA, one of the giants of the information business, yet the auto-rental company's 76th Street station hardly reflects the spirit of this alliance. Irate customers are not told how long they are likely to be kept waiting. Calls to manager usually are to no avail.

Perhaps most ironic is this paradox: the only hope for solution hinges on the ability and willingness of the companies involved to communicate the nature of their problems to those who can do something about them. Communications difficulties are not unique to car-rental firms or other companies—they're the problem of the electronics industry.

Unfortunately, the companies that do jump into new communications systems tend to shovel any bugs under the carpet. Executives who recommend acquisition or development of an electronic system usually aren't inclined to talk about its shortcomings—not even to other executives in their own firm. Often a company doesn't believe that it should discuss difficulties that subsequently develop, even with the consultants who designed the system, for the next client might well be a competitor. And rarely will any firm wash what it considers to be dirty linen in public—so the press is often shut out of any investigation of a system problem. Hertz, for example, refused to discuss its reservation system.

in the driver's seat

when inventory control system doubles as reservation-checker, trouble ensues

A postscript

● Historians may someday credit three men—David Sarnoff, Claude E. Shannon and Edward R. Murrow as having the greatest influence on the development of the communications industry during this century.

Sarnoff, who first gained fame as the wireless operator whose messages sent ships to the aid of the doomed Titanic in 1912, brought to the industry a verve that it has never lost. It was Sarnoff who, in the early days of broadcasting, risked funds to popularize radio by putting on the air a blow-by-blow account of the Carpentier-Dempsey prize fight. It was Sarnoff who pushed tv and tv programing just after the second world war. And it was Sarnoff who made color what it is today. Indeed, it was he who forced the communications industry to be bold and imaginative.

Shannon, in his paper "A mathematical Theory of Communication," formalized the notion of information transfer the way James D. Watson and Francis H. C. Crick formalized genetics, or as Albert Einstein formalized the relationship between mass and energy. Shannon, in his 1948 paper, examined everything from pulse-code modulation techniques and Markoff chains to crossword puzzles and James Joyce's "Finnigans Wake." In the end, he reduced the entire question of the theoretical capacity of a transmission line—any transmission line—to a mathematical relationship between nothing more than bandwidth and signal-to-noise ratio.

But it was Murrow who gave communications perhaps its most valuable gift—good content. He was an electronic journalist who first gained fame on radio, then tv. To him, actors imitating famous political figures and reciting hypothetical, even mythical, conversations, and movie projectors showing recent events in which much of the footage and the entire sound track were actually dubbed in—these were travesties of journalism. It was Murrow, more than any other individual, who provided the conceptual framework and intestinal fortitude by which mere news readers were replaced by the Chet Huntleys, the David Brinkleys and the Walter Cronkites; white boutonniers and still slides of people in the news were replaced by live, on-the-scene, tv coverage.

Murrow addressed himself to the question of communications content, a question that engineers and executives must start addressing themselves as distinctions between hardware and software become increasingly blurred. For it is they who must take on some of the responsibility of what is communicated, not just how.

Perhaps these men—the engineers and executives—would do well to be guided by what Albert Einstein once said:

"Never let the container be more valuable than the contents."●

Reprints of this special report are available at \$1.75 each.

© Copyright 1969, Electronics ® A McGraw-Hill Publication.

$\pm 50 \text{ ppm}/^{\circ}\text{C}$

in all Helipot Cermet Trimmers

This significant advance in Helipot's cermet technology is now available at only a dime/unit more . . . 100 ohms thru 2 megohms. In addition, you get essentially infinite resolution, environmental stability, reliability, no catastrophic failures — all superior to wirewound trimmers. We'll also deliver off-the-shelf, locally stocked trimmers with a standard tempco of $\pm 100 \text{ ppm}/^{\circ}\text{C}$ in the 100 ohm thru 2 megohm range.



INSTRUMENTS, INC.

HELIPOT DIVISION

FULLERTON, CALIFORNIA • 92634

INTERNATIONAL SUBSIDIARIES: AMSTERDAM; CAPE TOWN; GENEVA; GLENROTHES, SCOTLAND; LONDON; MEXICO CITY; MUNICH; PARIS; STOCKHOLM; TOKYO; VIENNA

From Cartesian you get prototype MOS/LSI wafer fabrication at production quantity prices. At a conservative 20% yield, you pay only \$1.67 per chip based on ten, two-inch wafers consisting of 100 × 100 mil chips. Cartesian's tight process control and ultra-clean fabrication process usually results in substantially greater yields. ¶ The key to low-cost MOS/LSI is the Cartesian approach where you reassume design responsibility. We take care of mask-making using the world's most advanced laser-interferometer photo-repeater and inspection system . . . and fabricate MOS/LSI wafers of guaranteed process quality. You get simple procurement instead of lengthy negotiations, four to five weeks delivery instead of endless delays, proprietary designs instead of design compromises, and you avoid the staggering costs associated with typical semiconductor overhead. ¶ The top two curves in our chart at right represent the amortized cost per chip based on your various internal cost levels of design, layout and probe testing. The total dollar amounts shown for each curve include your efforts (D) plus mask-making (M) and wafer fabrication (W). ¶ The Cartesian approach to MOS/LSI lets you add significant value to your final product by implementing your designs at unprecedented low cost . . . production quantities less than \$1.67 per chip. Implementation? Write for Cartesian's MOS/LSI Implementation Guide.

THE \$1.67 MOS/LSI CHIP

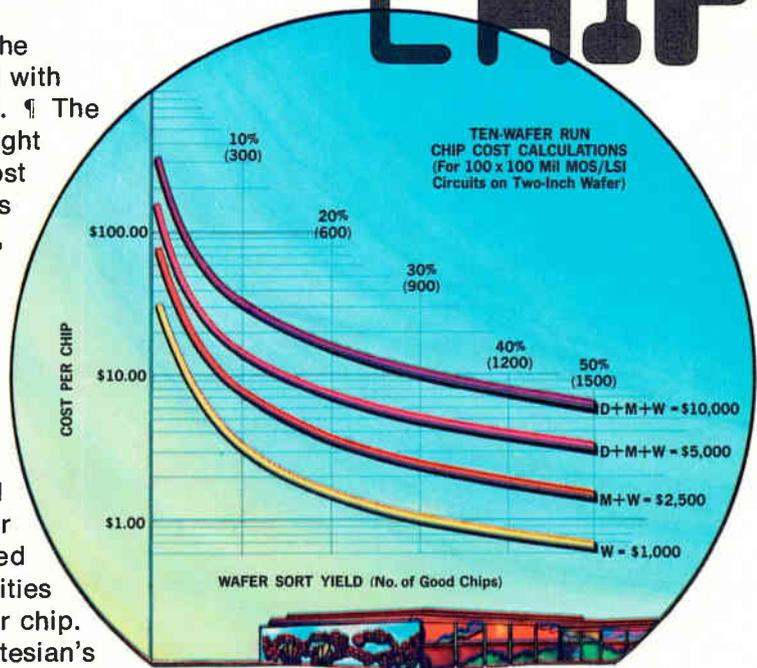

WHERE: D is the internal cost of design, layout and probe testing.
M is the internal or external cost of mask-making.
W is the Cartesian cost for wafer fabrication.



CARTESIAN, INC.

10432 NORTH TANTAU □ CUPERTINO, CALIF. 95014 □ PHONE (408) 257-0481

Designer's casebook

Designer's casebook is a regular feature in Electronics. Readers are invited to submit novel circuit ideas and unusual solutions to design problems. Descriptions should be short. We'll pay \$50 for each item published.

Buffer amp provides stability over wide temperature range

By Roland J. Turner

General Atronics Corp., Philadelphia

A unity-gain buffer amplifier that has good stability with temperature changes and a high input impedance is frequently needed in radar applications. For example, in a typical video processor, the amplifier can be used to sample the d-c level of an integrator and then transfer an analog pulse to an output decision circuit, such as a Schmitt trigger. Usually there are 40 or 50 such buffer amplifiers tied to a common summing resistor. Each amplifier, which is sequentially gated, transfers the integrator's information to the output with less than a 0.1-decibel error over a temperature range from -30°F to $+160^{\circ}\text{F}$.

The basic amplifier consists of transistors Q_1 and Q_2 connected in a complementary configuration to provide strong degenerative feedback to obtain an input impedance of 1 megohm. Such a high input impedance is necessary so that the integrating capacitor can be charged and discharged quickly during sample time. Since Q_1 and Q_2 form a complementary pair, any d-c offset developed by Q_1 is effectively canceled by Q_2 , leaving no voltage offset at the amplifier's output.

Transistor Q_4 functions as a current source to minimize the current variations in Q_1 which arise from small variations in Q_1 's base current. At samples times, a positive pulse gates Q_4 on and this transfers the integrator's voltage through the emitter-follower, Q_3 , to the output. Q_3 isolates the 390-ohm load impedance from Q_1 's emitter.

Although the d-c level at the amplifier's input varies no more than 0.1 db, the voltage gain for the entire amplifier remains between 0.995 and 0.999 over the entire temperature range.

The amplifier accommodates input pulses with rise times of 15 nanoseconds and fall times of 30 nsec.

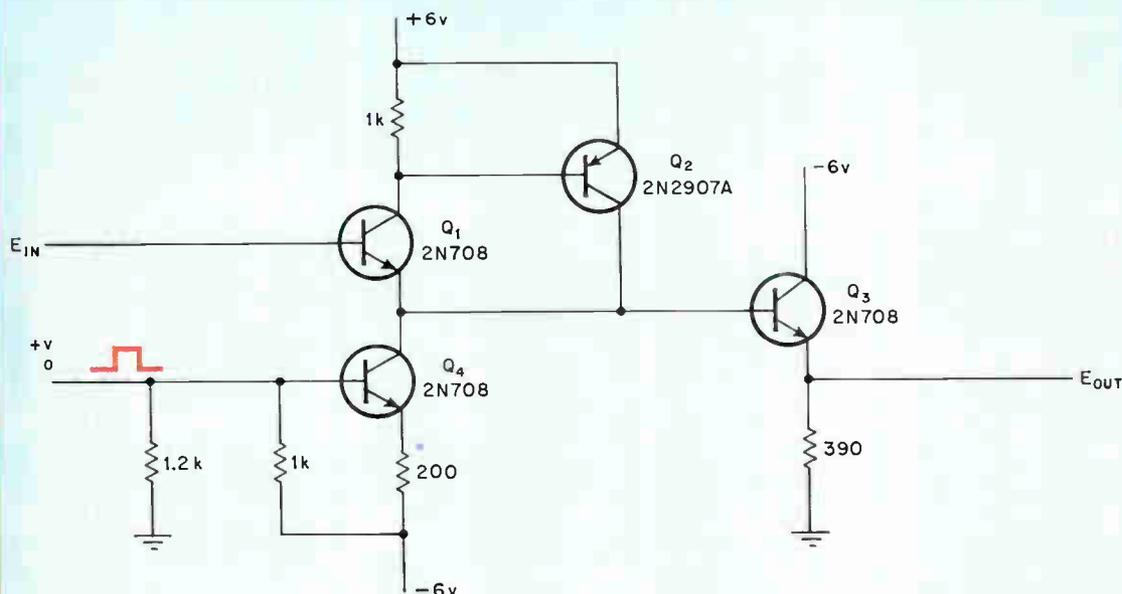

Buffer. This unity-gain buffer amplifier employs heavy degenerative feedback to get a high input impedance. Q_1 and Q_2 are connected in a complementary arrangement and effectively cancel any d-c offset at the amplifier's input. The gated d-c level remains stable within 0.1 db from -30°F to $+160^{\circ}\text{F}$.

No tuned circuits in IC wide-range f-m discriminator

By Robert Bisey

Grumman Aerospace Corp., Bethpage, N.Y.

An f-m discriminator that quantizes the input signal into a pulse train eliminates the conventional tuned circuits of most discriminators and remains linear

over wide frequency ranges. Unlike the standard f-m discriminators, this digital counterpart inherently provides quieting. It does so because the digital circuits remain inactive until they reach a threshold voltage, which is much greater than the noise voltages. Also, since the signal's amplitude is limited by the operation of the integrated circuits in their saturation mode, there's no need for additional limiting stages.

The first three input stages of the hex inverter, MC789P, amplify, limit and convert 200-millivolt, peak-to-peak f-m signals centered at about 1 megahertz, into constant amplitude and width pulse

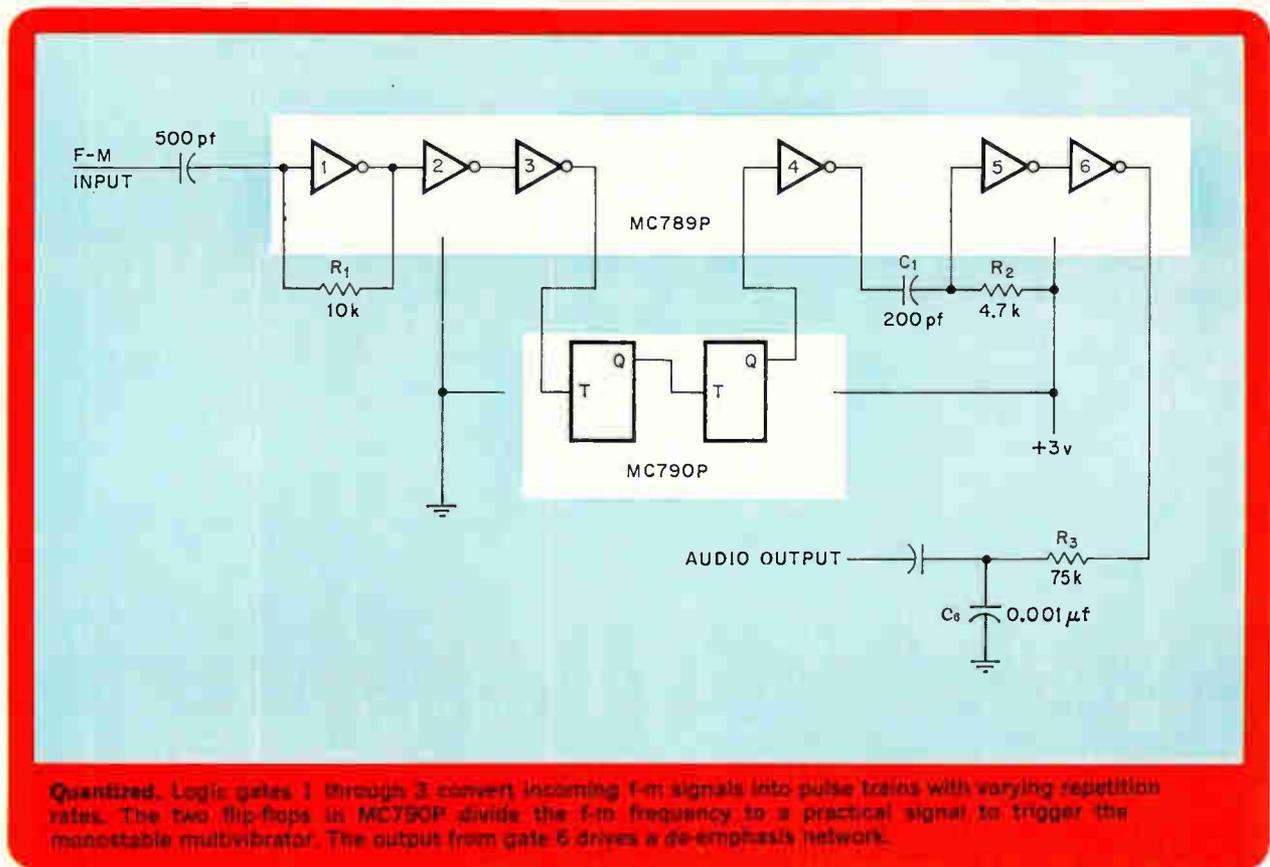

Quantized. Logic gates 1 through 3 convert incoming f-m signals into pulse trains with varying repetition rates. The two flip-flops in MC790P divide the f-m frequency to a practical signal to trigger the monostable multivibrator. The output from gate 6 drives a de-emphasis network.

trains whose repetition rates vary in proportion to the signal frequency.

The first gate is an amplifier. It's biased into saturation by the 10-kilohm resistor and thus limits the input signals. The pulse train at the output of gate 3 is fed into a two-stage flip-flop counter, MC790P, which divides the signal frequency by 4 to enable the subsequent monostable multivibrator, consisting of R_2 , C_1 , and logic gate 5, to be triggered.

The period of the multivibrator is set at less than one-half the period of the f-m signal—for the center frequency of 1 Mhz the period is 400 nanoseconds. The multivibrator's output consists of 400-nsec pulse widths whose repetition rate varies. The ratio

of the on and off times varies in direct proportion to the variation in the frequency of the input f-m signal.

The output of the multivibrator is inverted by gate 6 and then feeds a high-frequency de-emphasis network which converts the pulse train to an audio signal whose amplitude varies in proportion to the change in the ratio of the on and off times. The maximum amplitude of the audio signal occurs at a 50% duty cycle and falls off for cycles above or below 50%.

The absence of tuned circuits in this integrated circuit f-m discriminator eliminates the tedious alignment procedures inherent in the conventional f-m discriminators.

A-C source drives tape-stepping motor

By Jerome H. Silverman

Union Carbide Corp., Greenville, S.C.

Program tapes which are moved forward by applying a d-c signal to a stepping motor can be inadvertently advanced by noise from the supply. But noise immunity can be improved and power requirements reduced by activating the motor with an a-c signal.

The circuit using an a-c power supply operates in either of two modes: in the first, a clocked operation opens and closes switch S_1 at prescribed time intervals; in the second S_2 operates only from command pulses sent back from the control process. The command pulses derive from end point sensors consisting of a logic combination which tells the tape that the instructions have been carried out and that the process is ready to receive a new set of instructions.

In the control mode, the closing of S_2 charges the capacitor, C_1 , to the breakover point of the programmable unijunction transistor, Q_1 . Similar to an ordinary unijunction, this device differs in that it gives added flexibility in setting the trigger level and also lets the designer choose the holding current with readily available components.

When the breakover voltage is reached, Q_1 fires and discharges the capacitor through R_3 and the gate of the silicon controlled rectifier, turning the SCR on during positive-half cycles of the a-c supply voltage. When the SCR turns on, it allows current from the a-c power supply to flow, thereby energizing the stepping motor which indexes the tape.

To insure that the SCR is gated on at the beginning of each positive cycle, a silicon unilateral switch, Q_2 , is used. The switch is similar in operation to a four-layer diode, but has a lower breakover point.

On each positive-half cycle the switch, Q_2 , breaks down at about eight volts, transmitting small negative spikes to Q_1 's gate. These sync pulses trigger Q_1 and make sure that Q_1 fires at the start of a positive cycle and that the full half-cycle power of the a-c supply is applied to the stepping motor. If the sync pulses were not applied to Q_1 , C_1 might not charge quickly enough to fire Q_1 at the start of each cycle.

Once switch S_2 is closed it remains closed for the duration of the program set because the current through R_2 is greater than the holding current of Q_1 , allowing Q_1 to continually fire.

In the clocked mode, the current through R_1 is less than the holding current of Q_1 , and therefore S_1 opens after each clock cycle. The period of the clocked operation depends on the time constant $R_1 C_1$ and is about one second.

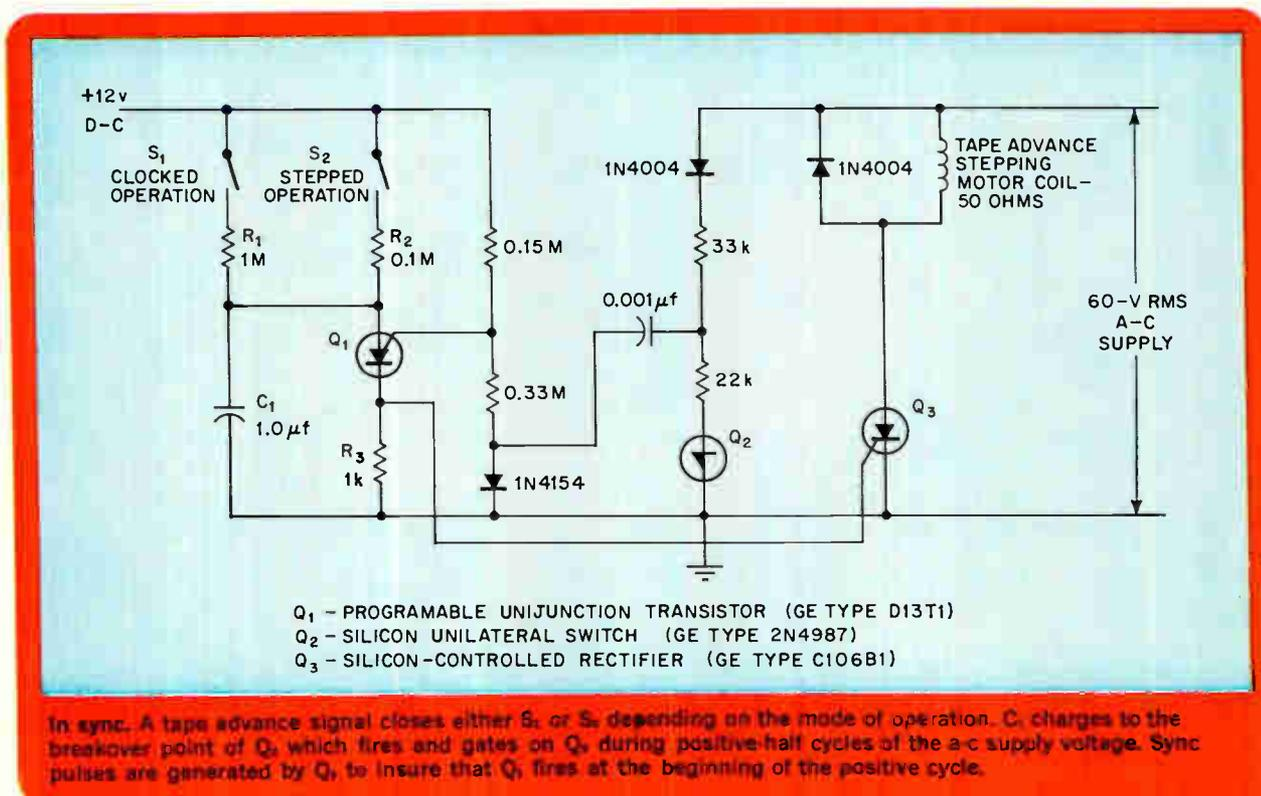

Seeing in the dark is aim of r-f holography

Systems for real-time viewing through rain, fog, or darkness are possible; need more work on detectors and time constants

By Harry E. Stockman

Mitre Corp., Bedford, Mass.

Opaqueness is no barrier to radio-frequency energy. By exploiting this simple fact, researchers in r-f holography envision new methods that hold out the promise of no-light-level television: objects could be seen in darkness, rain and fog, providing an invaluable aid in navigation systems. In industry, r-f holography can open new areas of nondestructive testing where flaws are located inside material that is opaque to light but not to r-f energy.

Most efforts to bring r-f holographic methods to reality are aimed at developing a better detector. Optical holography had a head start on this score—photographic film was ready and waiting. But in r-f holography, a detector that can parallel the results of photographic film has yet to be found. In addition, optical holography, by definition, produces a visible reconstructed image, while r-f holography results in information which must then be translated to the visible region for human evaluation. The wavelengths used in r-f holography range from high microwave to millimeter range, but it appears that problems of atmospheric attenuation will restrict outdoor applications to the microwave range.

Patterns on an r-f hologram are recorded in much the same way as on a laser hologram. Two radio waves—one carrying information about an object and the other a reference wave are made to intersect on a plate that is sensitive to r-f energy, as shown on p. 111. The interference of the two waves sets up a pattern on the plate that, while bearing no resemblance to the object itself, contains all the information needed for reconstruction of the image.

The key element is the r-f sensitive area detector which must indicate the field strength of the incident r-f energy. This detector could be either an array of point detectors or a continuous sheet detec-

tor whose response to r-f energy is similar to that of a photographic film to light.

In the continuous plate, a mylar sheet is coated with a thin film of cholesterol ester, which is a liquid crystal. At different temperatures within a narrow range, the liquid crystal takes on different colors. Thus, with incident r-f energy, regions of high-energy r-f will increase in temperature and appear blue.

When used as the area detector in r-f holography, the plate records the interference pattern set up by the reference and object beams.

However, color hue is only incidental and serves to provide contrast between the lines. The distance between the lines on the pattern is a record of the variation in phase difference between the two beams. Directly related to the r-f wavelengths, the distance must be translated to optical wavelengths for visual reconstruction. This is done by photographic reduction, after which a laser is used to illuminate the pattern and reconstruct the image.

The cholesterol in the experiment has two transition points separated by a small temperature interval. These points occur at temperature values such as 30°C and 31°C. Color variations from red to blue take place in the 1°C difference between the transition points. The plate is temperature-biased near the lower transition point. Two intersecting wavefronts will cause the maximum departure from red towards blue at points on the plate where the crests of the two waves occur. Normally, a field strength in excess of 10 w/cm² will start the color transition, against a red background.

In the construction of a plate, as shown on p. 111, the liquid cholesterol is deposited onto the mylar substrate, which can be thinner than 0.25 mil. The black color of the "space cloth," which

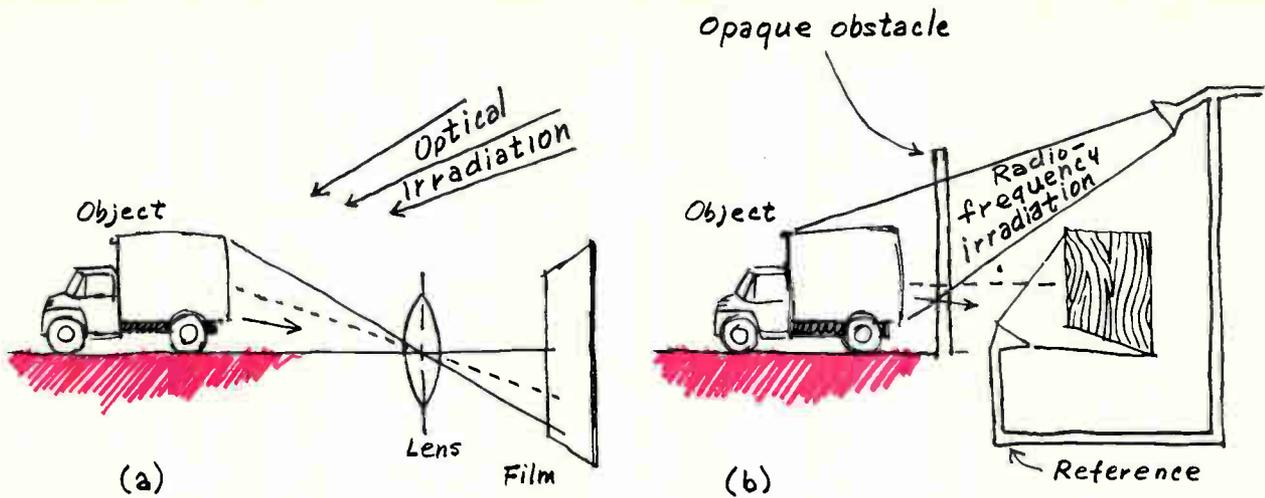

Order from chaos. The principle of a camera requires light rays bouncing off an object to be focused through a lens or pinhole, relating point y on the plate to point x on the object. Without an imaging lens or pinhole, there would be a meaningless maze. Hologram making invokes a similar sorting-out principle. In the figure on the right, the reference beam takes the place of an r-f lens, permitting an orderly recording of the object on the plate.

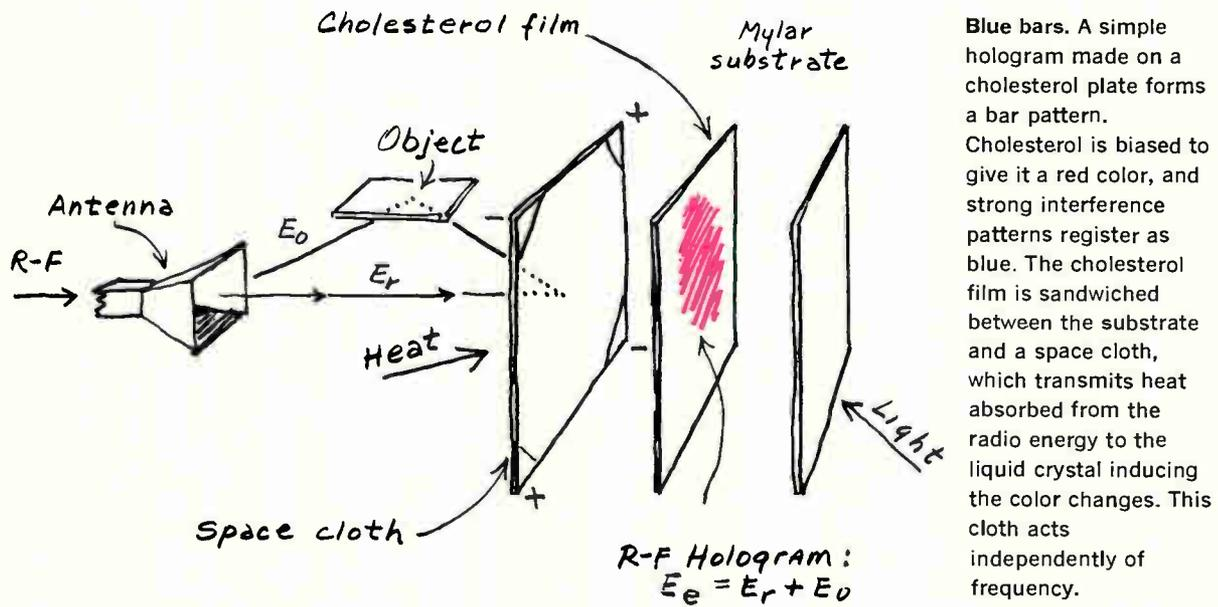

absorbs heat, serves as background for the color pattern seen from the other side, through the transparent mylar.

The plate may be temperature-biased in a variety of ways, for example, by a 60-hertz current through the lossy film or by a floodlight lamp aimed at the plate.

In the Mitre work, plates range in size up to 2 meters by 1 meter. Constant bias requirements, especially over larger plates, call for electronic temperature regulators.

The time constant of most plates is nominally two seconds or more; however, time constants of 0.5 second have been recorded. Yet, even this figure is too large to make r-f holography practicable for

real-time applications. For use in movie cameras, proposed but not yet built, where film speeds are 24 frames per second, a time constant less than 0.05 second is desired. Avenues of approach, towards a solution, include temperature stabilization (biasing) down to, say, 10% of the temperature interval red-to-blue, thinning the substrate down to microns which would reduce the thermal mass, and finding more liquid-crystal substances to choose from, a matter of chemical research. The time-constant problem is a formidable obstacle, but cholesterol is not the only liquid crystal, and liquid crystal substances are not the only promising plate materials. Pyroelectric materials are another (see panel on p. 112).

Pyroelectric hot plate

Another approach to reducing the time constant of a holographic plate down to where it can become useful for real-time photography, centers on a plate made of a pyroelectric substance. Pyroelectric crystal, a special kind of piezoelectric substance, exhibits a voltage across it when its temperature changes that can be used to drive, say, a light-emitting diode for display. This voltage depends on the time-rate of change of the temperature, and not on the temperature proper as in the case of liquid crystals. Thus, pyroelectrics do not require precise temperature-biasing and their operation is largely independent of the temperature level.

Author Stockman's latest research indicates that, properly designed, such a plate would respond very rapidly and sensitively to r-f energy in making holograms. To substantiate the latter view, he points to the fact that the world's most sensitive thermometer, measuring temperature down to one millionth of one degree centigrade, uses a pyroelectric substance as a sensor.

The plate would consist of numerous pyroelectric crystals formed into a matrix, each element of

which would be connected to an ic amplifier, which, in turn, would feed into a pinpoint light-emitting diode. In this way, the r-f information is directly converted to light, the hologram interference pattern being represented by means of a dot pattern. Stockman thinks such a plate could be manufactured using printed-circuit and ic techniques that are available today.

In essence, he says, the plate would be the equivalent of a mosaic of many tiny radio receivers, each with its own antenna. Because such a design may give rise to destructive antenna coupling, Stockman suggests alternatively a homogeneous plate utilizing a common pyroelectric film.

Although much research and development remains to be done before such a plate can be demonstrated, once a successful pyroelectric plate is built, he says, the idea of building an r-f camera becomes more realistic. Basically, the dot patterns would be put through a light amplifier and then recorded on film, which would be scaled down by a lens system. The reduced hologram would be subjected to laser light for reconstruction of the original object.

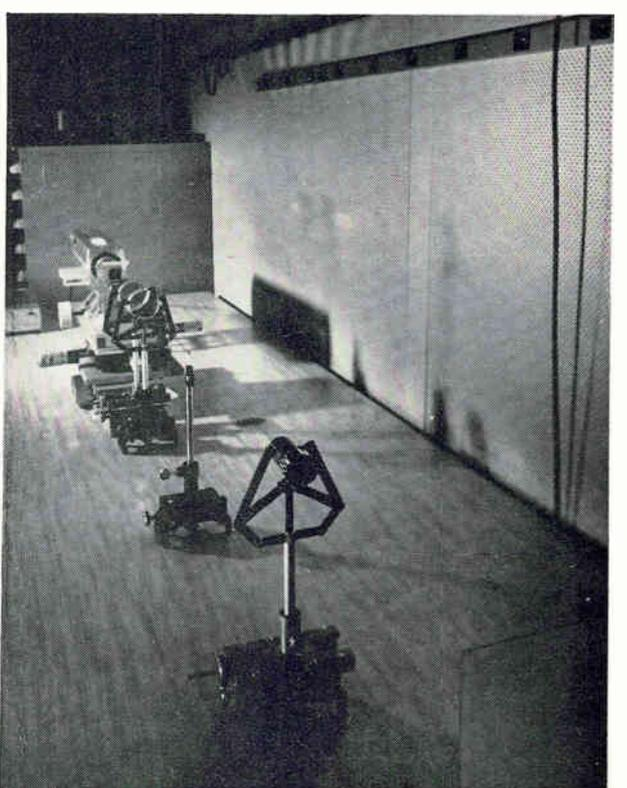
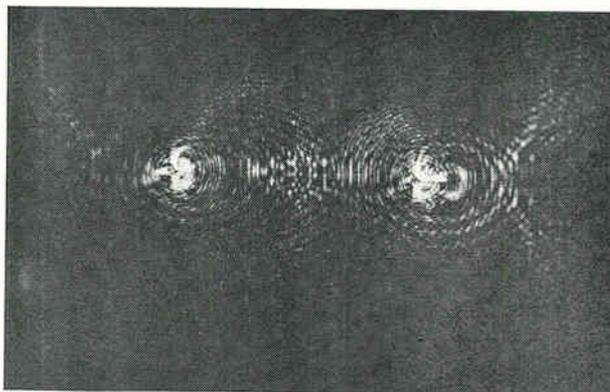
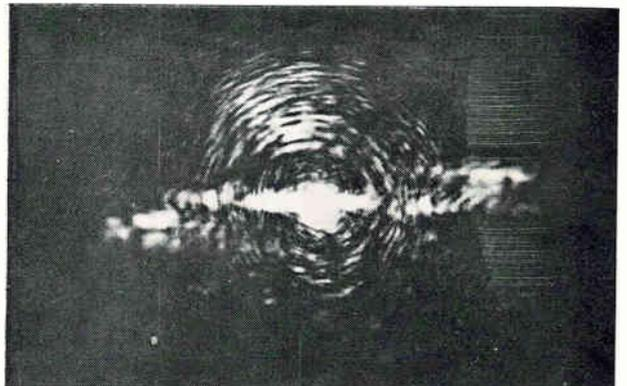
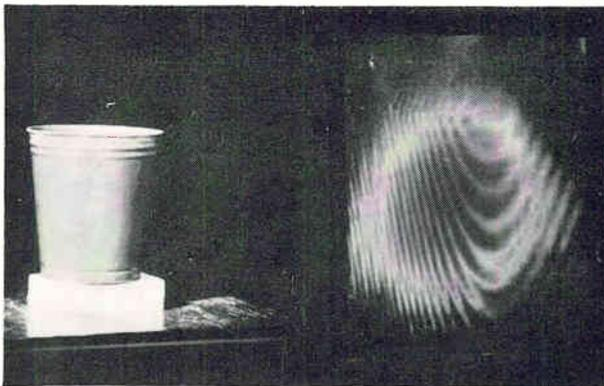

Faint resemblance. Hologram of a waste basket has reconstruction (upper right) that bears little resemblance to original object because of poor resolution and nonuniform heating of plate. By contrast, a reconstruction of two metal spheres, from a draftsman's hologram with twice as many lines as original hologram, is crude but discernible. The setup at right is typical for laser reconstruction

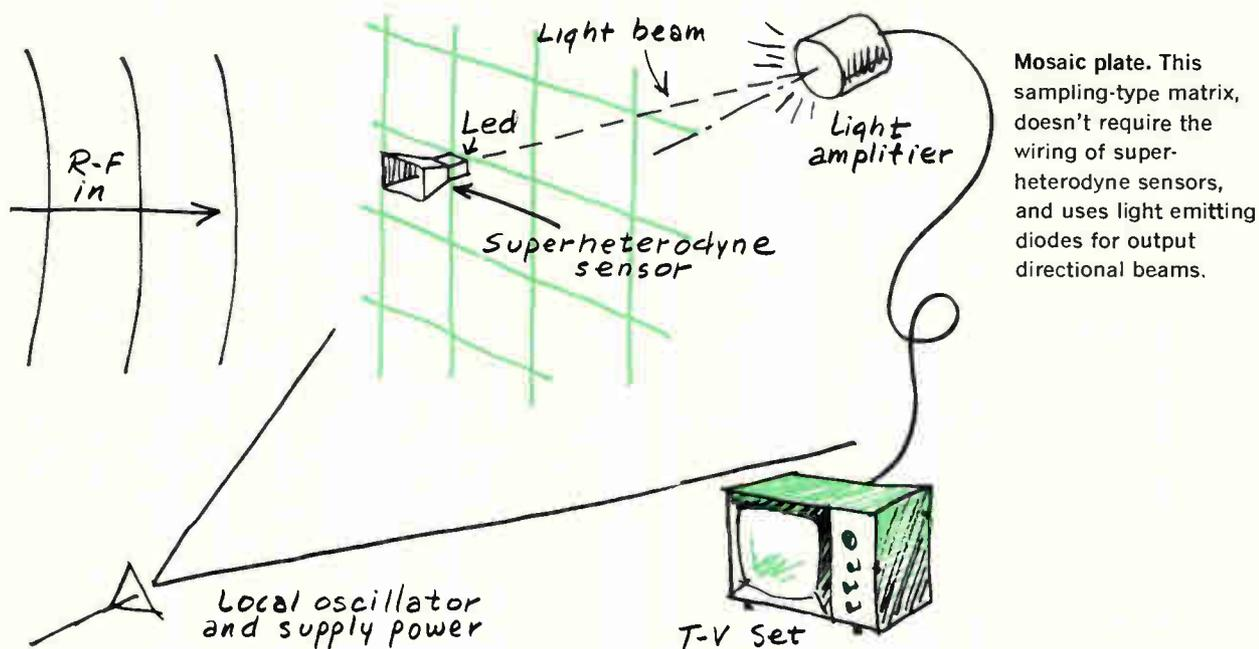

To transfer the hologram from the liquid crystal to a permanent form, it is photographed in black and white and then demagnified to the size of a thumbtack or smaller. To reconstruct a picture of the original object, laser light is beamed onto the miniaturized hologram, whose patterns are reduced to optical wavelength sizes.

Choosing wavelength

Frequency, power, and plate sensitivity are the interrelated factors most controlling the quality of reconstruction pictures. Higher frequency of transmission means better resolution. A picture can't be made of an ash tray having one side 100 millimeters long, say, when illuminated by a wavelength of 300 mm from a 1-gigahertz source. However, a 1,000 Ghz source ($\lambda = 0.3$ mm) will spread more than 300 wavelengths across the side dimension of the ash tray (but 1,000 Ghz is close to the area of light holography and is beyond the r-f spectrum).

The choice of the source is dictated by what is to be photographed—an ash tray or an automobile—that is, by the kind of resolution required, and by the expense. Good generators in the high microwave or millimeter region above 300 Ghz are neither cheap nor readily available. Costs for such devices rise rapidly with rising frequency. Also, the transmitter power must be sufficient to get enough return power from the object at the desired distance. The larger the object, the larger the distance from the transmitter and the larger the demand on generator power for given frequency and given plate sensitivity.

There is another factor of importance that enters in, however. While 300 Ghz allows laboratory meas-

urements, a much lower frequency is required for practical propagation and penetration outside the laboratory, where atmospheric attenuation must be taken into account. Thus, outside the laboratory, longer wavelengths must be used which means that r-f holography is more likely to find large-object applications than small-object applications.

The figure-of-merit, in gigahertz-watt, expressing the relation of frequency and power to plate performance may be considered given by the product $N=fP$, where f is the frequency and P the power. The object is to maximize N . The experiments at Mitre, done with help from Norman Cox, used mostly 45 Ghz at a level of 5 watt yielding an N of 225 gigahertz-watt. With the present traveling-wave tubes available, and N of 10,000 gigahertz-watt can be secured. Comparing this very loosely to laser holography, for a frequency source of 5×10^{14} hertz, an N of 500,000 gigahertz-watt is obtained per watt of radiated power.

Taking another route

A very interesting competitive avenue of approach is represented by the r-f sensory matrix, which may operate anywhere from L band to K band and at still higher frequency. Each element in the array has its own receiver, with receiving antenna, but a single power supply and local oscillator are used. While liquid crystal plates are size-limited because of a uniform-temperature requirement, sensory matrices are not. However, these have other problems: coupling between element antennas, feedback between input and output, field distortions, crosstalk. Furthermore, coupling and crowding arise from the power-supply and the local-

Shooting in the dark

Light readings aren't needed for a camera that's proposed by author Stockman. A device, now subject for a patent application, uses an r-f sensitive plate on which a holographic pattern is formed by the interference of a radio wave bounced off an object, and a reference wave off a reflector.

The pattern must be reduced about 500 times to optical wavelengths using a demagnifying lens system before the hologram image can be reconstructed. The scaled-down image is projected onto a film photochromic display window W. Either a laser beam, A, or another coherent light source, by striking the window, reconstructs the object. A three dimensional image can be obtained by using a stored lens system for reduction.

While it allows a direct recording, a photochromic substance is one that can also be erased by radiation of a different wavelength.

Two time constants are involved in the process aside from the hologram time constant—one for recording and one for erasing. Every reconstruction period is followed by an erase period. Sequential timing of record-erase periods, provided by a motor-shutter system, is needed only when the window is a permanent film rather than a moving one as shown. Accordingly, the viewer's eye sees the window only during the recording interval of a permanent film.

However, using a roll of photochromic film eliminates the erasing time constant because the film is constantly moving. Nevertheless, the major engineering problem remains the recording time constant. The r-f camera must produce enough radiation

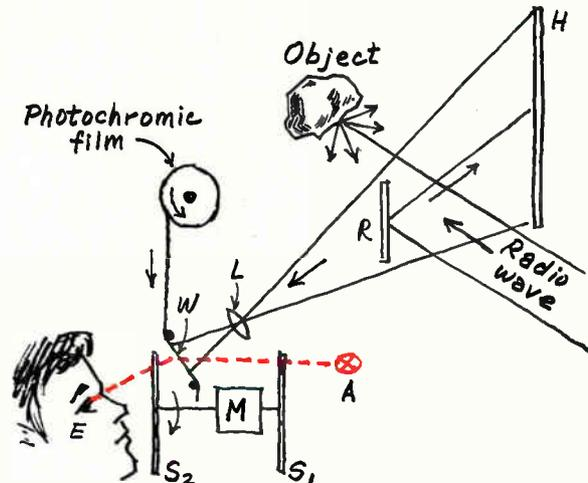

from the hologram to "bang" the image into the photochromic window during the short record-time interval available for good moving making. This means high power, efficiently used. Also the hologram must convey high-resolution images, and this means the use of high frequencies in the millimeter wave region at least, with associated transmission problems.

While Stockman admits it will be some time before this camera idea can be shown practical, he believes such a device is certainly within the range of today's technology.

oscillator being wired at each receiver.

A proposed solution to the last problem, shown on p. 113, has power for the local oscillator and supply transmitted by radiation to each element, eliminating the wiring. Horns and mixer crystals are used in the superheterodyne self-contained system. The output of each point receiver modulates a light-emitting diode (LED). The radiation from thousands of such LED's may be observed directly by the naked eye or picked up by a light amplifier, as shown, and imaged onto a television screen. The entire matrix scheme with thousands of individual receivers would be built using IC techniques.

Both the continuous and mosaic-plate technologies are competing with the so-called scanning r-f holography, in which the r-f energy reflected off the object is electronically sensed line by line by a microwave receiver probe for visual presentation. This system is much older and therefore more highly developed than the non-scanning system described here, and promising reconstruction results have been published in the literature. As the difficulties in reducing a research-status non-scanning system to practice are gradually overcome, the two systems will become more competitive, and the non-scanning system's simplicity will probably make it the favorite choice. ■

Bibliography

- E.N. Leith, J. Upatnieks, "Reconstructed Wavefronts and Communication Theory," *J. Opt. Soc. Am.*, Oct. 1962, p. 1123.
- H.E. Stockman, B. Zarwyn, "Optical Film Sensors for R-F Holography," *Proc. IEEE*, April 1968, p. 763.
- J.L. Ferguson, "Liquid Crystals," *Scientific American*, Aug. 1964, pp. 76-85.
- S.P. Brown, "Detection of Flaws in Metal-Honeycomb Structures by Means of Liquid Crystals," Report No. RS-TR-67-5, U.S. Army Missile Command, Redstone Arsenal, Ala., June 1967.
- A.S. Hovannesian, et al, "Radio Frequency to Light Frequency Transducer," Patent No. 3,122,742, Filed Nov. 22, 1957, Patented Feb. 25, 1964.
- R.P. Dooley, "X-Band Holography," *Proc. IEEE*, Nov. 1965, pp. 1733-1735.
- W.E. Kock, "Hologram Television," *Proc. IEEE*, Feb. 1966, pg. 331.
- G. Tricoles, E.L. Rope, "Wavefront Reconstruction with Centimeter Waves," *J.O. Soc. Am.*, April 1966, p. 542A.
- D.E. Duffy, "Optical Reconstruction from Microwave Holograms," *J. O. Soc. Am.*, June 1966, p. 832.
- G. Tricoles, E.L. Rope, "Reconstructions of Visible Images from Reduced Scale Replicas of Microwave Holograms," *J. O. Soc. Am.*, Jan. 1967, pp. 97-99.
- G.A. Deschamps, "Some Remarks on Radio-Frequency Holography," *Proc. IEEE*, April 1967, pp. 570-571.
- R. Mitra, P.L. Ransom, "Aspects of Microwave Holography," *Electronic Communicator*, July/August 1967.
- K. Iizuka, "A Method for Photographing Microwave with a Polaroid Film," Div. of Eng. and Applied Physics, Harvard University, T.R. No. 558, March 1967.
- C.F. Augustine, "Field Detector Works in Real Time," *Electronics*, June 24, 1968, pp. 118-122.
- W.E. Kock, "Microwave Holography," *Microwaves*, Nov. 1968, pp. 46-54.
- H.E. Stockman, "Communications with Reflected Power," *Proc. IRE*, Oct. 1948, pp. 1196-1204.

Semiconductor device symbols

FIELD EFFECT TRANSISTORS	
N-CHANNEL TRANSISTOR	P-CHANNEL TRANSISTOR
<i>JUNCTION FETs</i>	
<i>INSULATED-GATE FETs</i>	
3-TERMINAL DEPLETION TYPES	
3-TERMINAL DEPLETION TYPES SUBSTRATE TIED TO SOURCE	
4-TERMINAL DEPLETION TYPES	
4-TERMINAL ENHANCEMENT TYPES	
2-GATE 5-TERMINAL DEPLETION TYPES	
2-GATE 5-TERMINAL ENHANCEMENT TYPES	
D = DRAIN G = GATE	S = SOURCE B = BULK

DIODES AND BIPOLAR DEVICES	
SEMICONDUCTOR DIODE, RECTIFIER, PIN DIODE, MICROWAVE-AVALANCHE DIODE	
VARIABLE-CAPACITANCE DIODE, VARACTOR DIODE	
SNAP DIODE, CHARGE-STORAGE DIODE	
BREAKDOWN DIODE, UNIDIRECTIONAL, BACKWARD DIODE, ZENER DIODE, VOLTAGE-REFERENCE DIODE	
BREAKDOWN DIODE, BIDIRECTIONAL, BIPOLAR-VOLTAGE LIMITER	
TUNNEL DIODE, ESAKI DIODE	
SCHOTTKY-BARRIER DIODE, HOT-CARRIER DIODE	
PHOTODIODE, SOLAR CELL	
LIGHT-EMITTING DIODE	
PNPN SWITCH, SHOCKLEY DIODE, FOUR-LAYER DIODE	
PNP TRANSISTOR	
NPN TRANSISTOR	
UNIUNCTION TRANSISTOR WITH N-TYPE BASE, DOUBLE-BASE DIODE,	
UNIUNCTION TRANSISTOR WITH P-TYPE BASE	
THYRISTOR OR SILICON-CONTROLLED RECTIFIER, SCR	
TRIAC	

New 15 MHz scope: two guns, two delay lines.

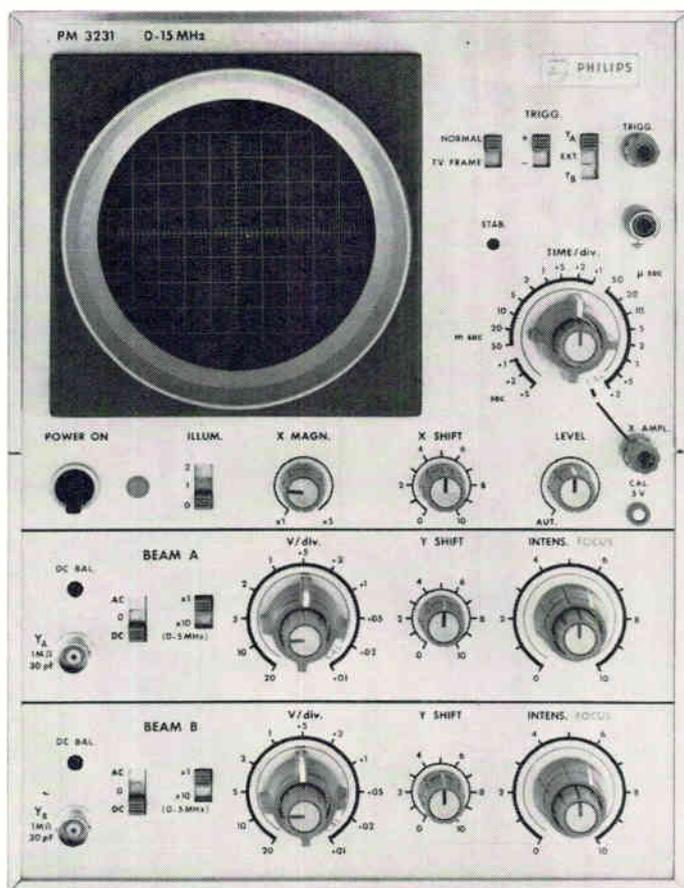

More of the Unbeatable
Philips Scopes

PM 3200
10 MHz, 2mV/div
\$480

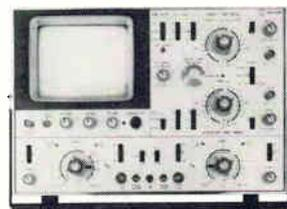

PM 3250
50 MHz: 2mV
Dual Trace
\$1995

Compare specs. Compare prices.

PM 3231 costs only \$975. PM 3231 is a new general-purpose scope incorporating all the features needed for accurate pulse measurement.

PM 3231 is a new scope, a new design. It uses delay lines and advanced components like FET's. It has two guns which are essential if you want to know where and when you're triggering. Time-shared beam switching can lead to misleading results.

For example, feed this same signal to



both channels on a time-shared scope and you might see this, a fact we'd gladly demonstrate.

PM 3231 uses delay lines which are essential if you want to see leading edges properly.

Other features include triggering from either channel. And drift is feedback and virtually eliminated. (at max. sensitivity less than 1/4 div/24 hours).

So, if bandwidth permits, and 15 MHz does, you should think real two-gun, not dual trace.

Available in U. S. from
Philips Electronic Instruments, 750 S.
Fulton Avenue, Mt. Vernon, N.Y. 10550.



PHILIPS™

Generating IC artwork automatically saves time, prevents costly errors

Computer program minimizes number of coordinates needed to describe geometry of IC, while most of the errors associated with manual methods are eliminated

By Adolf K. Pascher and Konrad Koller
Siemens AG, Munich

What IC makers sow in automatic artwork preparation they shall reap in time savings. This is the long-term advantage—if not a mandatory action—for large-volume integrated circuit manufacturers far-sighted enough to invest in expensive automated machinery in order to gather in the ultimate harvest of speed and high accuracy.

The automatic technique used at Siemens AG, for example, cuts artwork preparation time by an order of magnitude and eliminates virtually all the errors associated with manual cut-and-peel methods. There's no danger of mistakenly peeling off the wrong areas on the artwork, or inadvertently leaving areas unpeeled, or of separation and distortion of the artwork with age.

The time saved under the Siemens technique may be greater than with other automatic methods, largely because it is designed to minimize the number of coordinates required for an adequate description of the IC geometry. This is particularly helpful because it saves the operator the trouble of punching cards for oft-repeated figures.

The method uses a digitizer to convert the composite drawing of the IC to punched cards, a Siemens 4004 computer to generate instructions for plotting the artwork, and a precision plotter with an optical head that traces a pattern on film for each mask needed to fabricate the IC.

The computer program, called Automask, is written in Fortran 4, and contains many auxiliary subroutines to minimize the data input. To describe a rectangle parallel to the axis, for example, the operator need type in only the coordinates of two diametrically opposite corners. And even if the rectangle isn't parallel to the axis, only one more corner is needed.

To represent polygons (such as those needed for isolation moats, meandering resistors, and interconnection routes), the coordinates of every other corner are given. The width of the line describing the polygon is offered only at the beginning of the over-all description, in the form of two points equidistant from the center of the line. For a solid figure, the line goes back and forth until the pattern is filled in.

Descriptions of frequently occurring functional units such as transistors and diodes can be stored in the computer library. To include such a device in a layout, the operator simply includes a punched card to call it up, stating a position and, if necessary, a rotation angle.

A step further

Going a step further, coordinate data for functional groups of components, such as gates and flip-flops, can be stored in the library and called up as a single entity through the same procedure.

There also are special steps that can be retrieved. Any figure, device, or group can be mirrored about any arbitrary axis. It's only necessary to give the coordinates of the mirroring axis before specifying the shape to be mirrored, and mirroring will be continued until canceled by command. For complex repetitive circuits like shift registers, storage cells, and matrices, this mirroring ability considerably reduces the description requirements—often by as much as 10 times.

The Automask program even second-guesses the vagaries of the photolithographic fabrication procedure. Masks may be inaccurate because of reduction or because of a tapering-off of the photographic emulsion density at the edges of patterns.

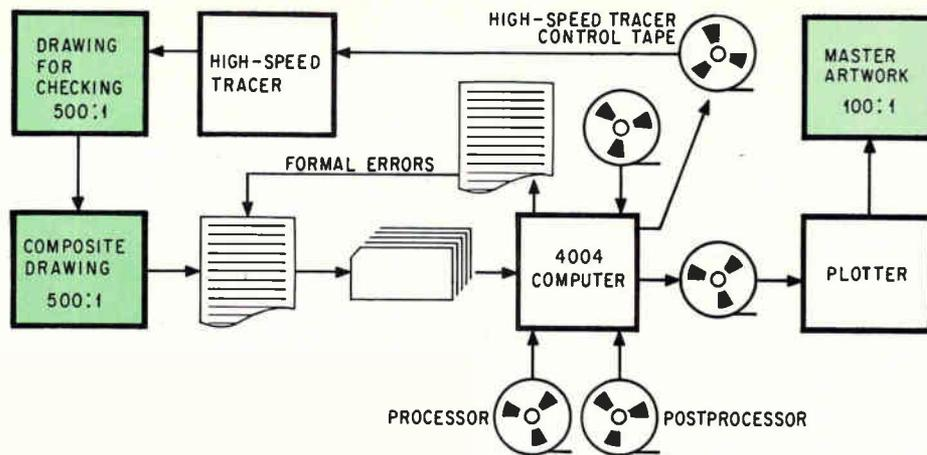

Flow. Data from the composite drawing is put on punched cards. When processed by Automask, they produce a control tape for the high-speed tracer, which makes a drawing of each mask so that it can be checked for errors. The postprocessor then uses the high-speed tracer tape to generate a tape for controlling the master artwork plotter.

Or etching may undercut the oxide layer. To compensate, Automask incorporates empirical auxiliary functions that can reduce or enlarge each geometrical figure.

The digitizer works in this way: an operator zeroes in on a specific point on the drawing by placing a cross-hair-like device over that point. Then, on a command triggered by a pushbutton on the aiming device, the digitizer's card punch automatically punches out the coordinates of the point on a card. The great advantage of this system is that it eliminates one potential source of error by punching the cards directly instead of having the operator do it. The operator merely initiates the command for punching; there's no data display for him to read off and to punch.

The mask-making procedure starts with a layout of the IC, as shown at top of page. For maximum accuracy, the composite is drawn 500 times larger than the IC chip. With the aid of a digitizer, the coordinates of figures, defined geometries, and mirroring axes are taken from the layout and punched on cards. The digitizer automatically rounds off the data to the nearest half-interval on the coordinate grid. Although the dimensions of the layout paper—and therefore of the layout—will vary with temperature and humidity, serious error is avoided because the Automask program contains empirical correction factors.

Punching preferred

Punched cards are used in preference to punched paper tape or magnetic tape because the cards can be more easily corrected or changed. The coordinate cards are combined with control cards and run through the computer to localize errors. The operator makes any corrections that are needed and runs the cards through again.

The program is in two parts: a processor section and one for postprocessing. The corrected cards are fed into the computer and the processor examines all descriptions and instructions, decides to which mask layer each geometrical element belongs, and produces a magnetic-disk record of each mask's pattern.

Now the postprocessor generates instructions for controlling a high-speed tracer and records them on magnetic tape. This tape is used to make a 500:1 drawing of each mask for checking purposes; the scale is made so large so that it can be compared easily with the original composite drawing. Any errors are corrected here, and when the control tape finally is acceptable, it is fed back into the computer to generate a tape for controlling the master artwork plotter.

This plotter draws the master art for each mask at 100:1 scale with dimensions accurate within ± 25 microns. The advantage of the 100:1 scale is that only one photographic reduction step is necessary to prepare the mask for the step-and-repeat machine.

Siemens' FLJ 151, a flip-flop, provides a good example of the time saving afforded by the Automask procedure. This six-mask circuit would take about 120 hours to fabricate the master artwork by hand. With automask, the time is reduced to 16 hours: 4 hours to punch the cards with the digitizer; 1 hour of computer time; 3 hours to make the checking plot, and 8 hours to make the master artwork. The last operation takes so long because of the large scale and precision of the artwork, and could be shortened to one-fifth the time if a pattern generator were substituted for the plotter. A pattern generator describes the geometry at a 10:1 scale and thus traces out only 1/100 of the area described by the plotter. Furthermore, a pattern generator can fill in large blocks in the pattern with a single photo flash instead of with back-and-forth line tracings. Another advantage of the pattern generator is that the resulting master art can be used directly in the step-and-repeat machine—a reduction step isn't needed.

With manual methods the main factors that determine preparation time (and the number of errors) are sizes of individual figures and the packing density. With Automask, these are just minor factors. In complex IC's containing many identical elements—for example, memories—the time saving afforded by Automask becomes even greater than for the flip-flop. ■

Classified ad:

NEW SERIES 2400 CLASSIFIER.

Segregates linear IC's in up to ten diff. classes (buyer specifies criteria). Works with either 1410 Op/Amp or 1420 Op/Amp & Comparator Testers. Classifies on up to 12 linear IC parameters: 1) Power Consumption overrange, 2) Offset voltage (zero ohms), 3) Offset voltage (programmed), 4) + Supply Sensitivity, 5) - Supply Sensitivity, 6) Common mode rejection, 7) Bias Current, 8) Offset current, 9) Gain (light load), 10) Gain (heavy load), 11) + Slew Rate, 12) - Slew Rate.

Four models; with or w/o counters. Great opp'ty. Write for info. or phone for demo. (415) 961-9399; 961-9384. MARKETING, SIGNETICS, MEASUREMENT DATA, 341 Moffett Blvd., Mountain View, Calif. 94040.



Signetics

MEASUREMENT/DATA 

Signetics, Measurement/Data, 341 Moffett Blvd., Mountain View, Calif. 94040 / A subsidiary of Corning Glass Works

LSI/MSI

MSI/LSI circuit seminar
for equipment
and systems designers.

Presented by
Electronics Management Center.
An information service of McGraw-Hill
California-December 1-3, 1969
Airport Marina Hotel
8601 Lincoln Blvd.
Los Angeles, Calif.

Program

1. Evolution of large scale integration (LSI)
2. MOS device structure and characterization
3. Basic MOS circuit techniques
4. Topological design and layout
5. Advanced circuit techniques
6. LSI artwork generation
7. Logic implementation with LSI
8. Design examples
9. MOS/Bipolar interface techniques
10. Low threshold technology
11. Cost consideration for LSI
12. Computer aided design
13. MOS structures and fabrication techniques
14. Process constants and minimum design rules
15. Yield factors and process control
16. Facilities and equipment requirements for LSI
17. Applications and product types most suited to LSI
18. Currently available MSI/LSI products
19. Advanced technology trends
20. Technological controversies

Purpose

The MSI/LSI seminar is designed to acquaint systems designers with the capabilities and limitations of the LSI technology. It will provide for more effective product planning through knowledgeable appraisal and proper use of LSI for specific applications. Attendees will receive instruction in MOS device models and characterization, and in MOS circuit forms and their performance comparisons. They will also learn topological rules that permit multiple sourcing of LSI arrays, procedures for the design of a standard cell library, how to make an LSI composite plan drawing, and how to determine transient response and propagation delay. LSI cost factors will be discussed, and systems designers will be instructed in the preparation of specifications for LSI.

Faculty

Presentations, discussions, and work sessions are under the direction of the staff of Integrated Systems Technology, Inc. of Santa Clara, California. Each member of the staff has wide experience in the areas of circuit design, systems application and semiconductor research and development.

Donald E. Farina—President, Integrated Systems Technology, Inc. One of the contributors to the design of the first micrologic integrated circuit families. Served as head of the R&D department in digital circuits for Fairchild Semiconductor, responsible for both digital circuit and bipolar device structure development.

For the microelectronics division of Philco-Ford Corporation Mr. Farina served as Director of R&D and was responsible for device and research devoted to MOS large scale integration. He received his BSEE at New York University in 1953.

Ronald Pasqualini—Vice President, Engineering. Widely experienced in R&D on MOS memory systems for Philco-Ford Corporation. Performed initial logic design, circuit analysis, and composite layout of a monolithic read-only memory. Was responsible for the interface between R&D processing and R&D design.

Systems design experience in integrated circuits includes shared responsibility on an Air Force large scale array navigation computer, and Ranger spacecraft. Also designed a monolithic 2-MHz binary/BCD converter employing 4-phase circuit techniques.

Mr. Pasqualini holds a BS in Aeronautics from M.I.T., 1962, and an MSEE from U.S.C., 1966.

Richard Craig—Vice President, Technologies. Mr. Craig has devoted the major portion of his career to the semiconductor. With three major semiconductor manufacturers his experience includes such early developments as planar and epitaxial processes and structures. More recent experience includes responsibility for

the development of advanced MOS LSI techniques, including multilayer and minimum size structures, oxide and interface charge control, and MOS circuit innovation and evaluation.

Mr. Craig received his BA in Physics from Fresno State College in 1958.

Richard Aladine Carberry—Senior Design Engineer. Presently involved in the logic and circuit design of complex MOS devices, and the design of digital equipment utilizing bipolar and MOS IC's. As a project engineer for Philco-Ford Corporation he was involved in the design of MOS memory and arithmetic chips for a guidance computer, as well as a sequencer and other control circuitry utilizing bipolar IC's. For Lockheed Missiles and Space Company he designed analog circuits for a guidance system, switches, modulators and demodulators, active and passive filters, and various operational amplifier circuits. Mr. Carberry holds BSEE and MSEE degrees from the University of California at Berkeley.

Fee

The registration fee for all sessions, a complete set of notes, and luncheons —\$385.

Registration

Register now for the Los Angeles program. Use the registration form below. Make checks payable to Electronics/Management Center. You must register in advance. We will be happy to bill you or your company, but only paid-up registrants will be permitted to attend the seminar. Hotel reservations should be made directly with the hotel. A number of rooms is being held for seminar attendees. When you make your reservations, identify yourself as an attendee of the MSI/LSI seminar.

MSI/LSI

MSI/LSI circuit seminar for equipment and systems designers.

Samuel Weber, Mgr.
Electronics/Management Center
330 West 42nd Street, N.Y., N.Y. 10036

Please register me in your
three day seminar at \$385

Check enclosed

Bill me

Bill company

PO # _____

Name _____ Title _____

Address _____

Company _____

City _____ State _____ Zip _____

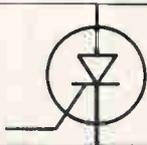

EXPANDED

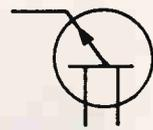

SEMICONDUCTOR TEST CAPABILITY FROM TEKTRONIX

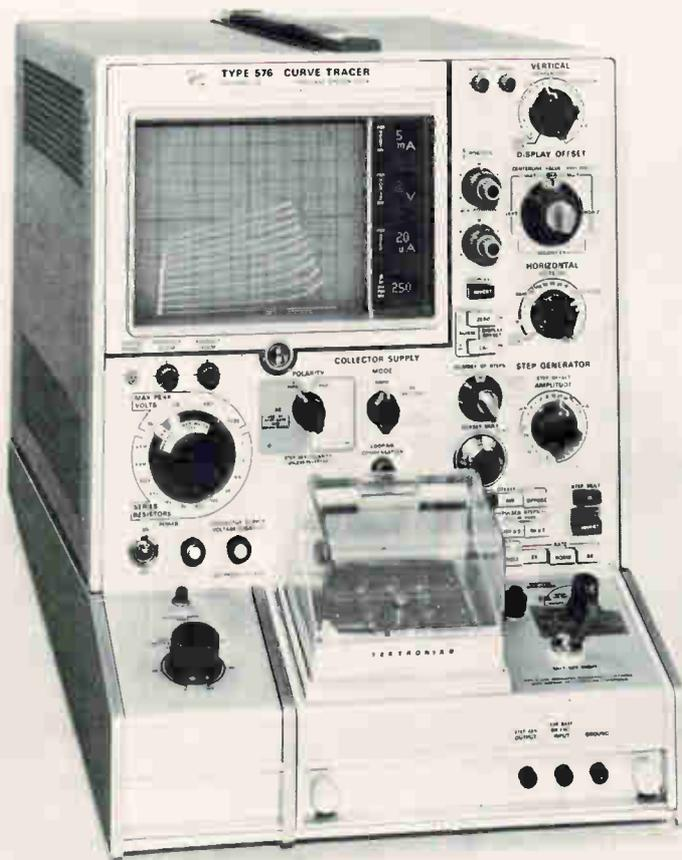

THE TYPE 576 CURVE TRACER—designed to provide maximum performance in the circuit design laboratory, on the production line or in service applications. An **EXPANDED VIEWING AREA** combines a 10 cm x 12 cm graticule with fiber-optic readout of scale factors, step amplitude, and Beta/div or g_m /div. This **SCALE FACTOR READOUT** displays parameters near the CRT for convenient reference during setup, testing and photographic recording. The Collector Supply provides swept or DC voltages to a maximum of 1500 V. A versatile Step Generator allows **CALIBRATED STEP OFFSET** and **PULSED BASE OPERATION** in addition to conventional modes. Vertical **DISPLAY OFFSET** with precise auto positioning control and X10 magnification

provides a calibrated and expanded effective measurement axis to 100 cm. This increased measurement sensitivity at all scale factors even allows **LEAKAGE MEASUREMENTS** to 1 nA/div! **MULTI-FUNCTION SWITCHING** makes test setup fast and easy to understand, providing direct reading power limits, polarity tracking and automatic display positioning. Additional accuracy is derived through provision for **KELVIN SENSING** (for high current tests). Operator convenience is enhanced by **INTERLOCK OPERATOR PROTECTION** and availability of a complete line of device testing adapters.

Type 576 Curve Tracer \$2250
U.S. Sales Price FOB Beaverton, Oregon

Your local Tektronix field engineer will be happy to demonstrate the Type 576 in your application. For additional information, please call him or write Tektronix, Inc., P.O. Box 500, Beaverton, Oregon 97005.



Tektronix, Inc.
committed to progress in waveform measurement

Young EDP executives find their youth a liability on backers' balance sheets

Logitron's 23-year-old chairman and 21-year-old president find money men would rather lecture than lend, but feel persistence will be rewarded with a 6% market share for their crt time-sharing terminal

By James Brinton

Electronics staff

Starting your own company can be profitable, but it's also tough, especially if all the principals are under 25. But if you're in the time-shared terminal market where there's a lot of room for innovation, you have a fighting chance—provided you can stand up to age prejudice, skittish venture capitalists, sharp contractors, and accidental disasters.

Witness Logitron, Inc., a small Cambridge, Mass., company whose chairman is 23 and whose president is 21. Nearly faced with bankruptcy this summer, the company has sprung back with current backing of nearly \$175,000 and in January will begin shipping its first product—a portable, attache case-sized time-sharing terminal with a cathode-ray tube display. And the firm is aiming at a 6% share of the 1970 crt terminal market.

Both the chairman, Nicholas J. Covatta, and the president, Derick O. Dahlen, are MIT alumni; Covatta also has a year's credit toward a master's at the Harvard Business School. Their clothes and hair are on the mod side, and they sport long sideburns. On their office wall hangs a Vietnam moratorium poster. In fact, their age and youthful image at first put backers and suppliers off and—along with the death of their first backers—accounted for the company's severe birth pains.

Dahlen and Covatta thought up Logitron's approach to the terminal market in 1968. They felt that the

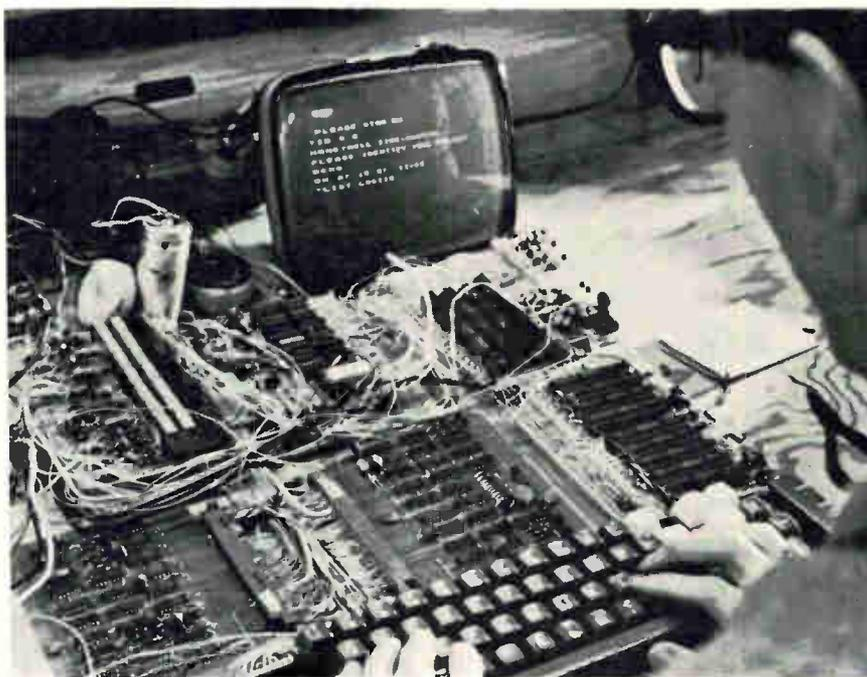

High hopes. Logitron engineer tries out breadboard version of portable time-sharing terminal. The company is pinning its hopes on terminals such as this to gain a 6% share in the 1970 crt terminal market, about 1,500 units.

makers of time-sharing terminals so far had aimed at scientific applications rather than potentially more profitable business uses. "Compactness, cost, and convenience had been overlooked, it seemed. And just looking at a 1968-vintage terminal made one feel that it was something only an engineer could love," says Dahlen.

Enter the Logiport which weighs about 20 pounds, has a built-in acoustic coupler that turns a phone into a 300 bit-per-

second terminal, folds into a compact package which just about fits under a first-class airline seat, and has a case designed by Gregory Fosella Associates of Boston, the same firm that packaged Data General's attractive Nova computer.

"It does the job," says Covatta, "and looks good doing it. Its capabilities—and even its shape—are aimed at businessmen, and at fast, high-volume market penetration—almost consumer-type selling. And prices start at \$1,850." He sees



Mod look. Logitron chairman, Nicholas J. Covatta, 23, and president, Derick O. Dahlen, 21, lead the youth parade at Logitron. The average age of principals, is under 25, which accounted in part for company's severe birth pains.

primary users as traveling executives and salesmen who could carry the terminal with them, accessing their computer from almost any telephone.

Logitron's weapon for grabbing a big slice of the market is price. In the fast moving terminal business, their introduction of a crt time-sharing terminal for less than \$10,000 was a breakthrough a year ago [*Electronics*, Dec. 9, 1968, p. 141]. While other companies have since promised prices under \$5,000, it's felt Logitron's prices—\$1,850 to \$2,950—should give it a competitive edge in the market place.

Rash of luck. But getting to this point has been no picnic. In February, working almost without money, Logitron began research and development. William A. Taylor, 23, and Walter T. Morrey, 22, were the company's engineering talent pool, and worked nights on the terminal while holding daytime jobs, too. Taylor was a software specialist and Morrey was trained in analog circuit design; neither possessed the digital design experience they later would acquire.

While Taylor and Morrey worked nights, Dahlen and Covatta looked for money by day, but with little success. Then one morning in March, after overhearing Covatta discuss the venture, a woman named Louise Davidson handed him a check for \$7,000—on the spot.

"This was our financial start," he says. "Mr. and Mrs. Davidson—a wealthy Massachusetts family—began paying our bills weekly and agreed to finance research and development. Also, their personal

contacts led us to Clark Dodge and Co. Inc., New York investment bankers, where arrangements were begun to extend us a \$1 million credit line in exchange for about 30% of the company. "Looking back, this may have been both the best and worst of our experiences," muses Covatta.

Credit as debit. "We began working flat out for that money," adds Dahlen. Eighteen- and 20-hour days were the drill during March and April—the Davidsons wanted a working prototype to show during the spring Joint Computer Conference, "and when the man with the money wants something on a given date, you deliver," asserts Dahlen.

In March Logitron's third engineer came aboard—Dennis F. Brothers, 23, a specialist in digital circuitry with experience both at MIT's Laboratory for Nuclear Science and its Instrumentation Laboratory. He was an MIT staff member even before his degree was granted.

Taylor, Morrey, and Brothers were dissatisfied with the initial version of Logiport/1. "We couldn't have sold this thing," they say now of the March-April version. But they realized a model would be needed at the computer conference, and in producing it, they estimate that they may have wasted as many as four man-months.

The original model was, in effect, an analog device designed to work in a digital environment. "Our timing depended on our display refreshment delay line—a bad decision," says Morrey. "The delay lines were inexpensive, but differed from

unit to unit, drifted with temperature, and picked up noise from an unbelievable number of sources."

Back to the boards. Following the computer conference, Logitron decided to redesign the terminal. Says Brothers, "One of the first things to go was delay line refreshment; we changed to large-scale MOS shift registers. We had tried to make the delay line system work for months, but the shift registers became operational in days."

Also, a timing diagram was laid out for the whole machine, a technique usually reserved for central processor design. "Now," says Morrey, "we can plot every logical event to within 100-odd nanoseconds—more than enough accuracy for our application."

To further tighten logic, says Brothers, "we added a crystal-controlled ring counter and frequency divider system, went to strict parallel gating, and dumped several unneeded registers."

Eventually the rigid timing inherent in the design made it possible to use delay lines. So while the lines drift with temperature, Logitron now will offer delay line refreshment in its Logiport/2. The otherwise identical Logiport/1 time shared unit will use 256-bit MOS shift registers and will operate over



Terminal's trio. L. Walter Morrey, Carl Weisse, and Dennis Brothers, seated, helped design terminal.

broader temperature extremes.

As the redesign continued, the team came up with a proprietary electron-beam steering method which Dahlen hopes to sell to other terminal makers. It's said to reduce the amount of auxiliary circuitry around the crt to a minimum.

A diode matrix was added, allowing easy changes of data transmission rate, acoustic carrier center frequency, characters per line, and lines per displayed page—and even the horizontal and vertical retrace periods. This should easily suit the Logiport to individual applications at minimal cost to Logitron.

Dahlen claims that if the crew were left alone for another year, they "would probably come up with the world's best terminal, and at a price of \$500." But he adds that the company needs cash flow, so they shepherd their engineering with care.

Vanished. But with a million-dollar credit line set up and a product ready for sale, how much care is necessary? Lots—because the million-dollar credit line never materialized.

On June 1, the Davidsons died in a plane crash. With them went almost all of Logitron's financing, including the Clark Dodge credit line, vanishing in the midst of the tight money crisis.

Now the partners began to feel the pinch of their youth, and to experience a set of near-humiliations at the hands of subcontractors and risk capitalists.

"Business school doesn't say much about dealing with creditors, or about how it feels to have to meet a payroll out of an empty bank account," say Covatta and Dahlen. Fortunately, they were able to get an unsecured \$15,000 note to tide them over immediate needs, "then we went to friends, then to friends of friends. A secretary Germaine S. Fritz, 22, came up with more than \$15,000 just in time to avert a crisis, and eventually employees came to own more than \$40,000 worth of Logitron," says Dahlen. "Purists would have declared bankruptcy this past summer, but we couldn't let the company fail after we all became partners."

So Covatta and Dahlen went on a venture-capital hunt, but as they did, they found creditors waiting



Staff angel. Logitron secretary, Germaine Fritz, came up with more than \$15,000 just in time to help company avert a financial crisis.

at the door, and though most were honest, a few seemed inventively extortionate.

One firm, it's said, did \$16,000 worth of printed-circuit board work for Logitron, and billed them for this on July 10. This caused no immediate worry; accounts receivable in the industry now average 60 days or more. But one week later the subcontractor threatened to force Logitron into bankruptcy unless it made immediate payment.

Covatta soon found that the company also had informed a national credit bureau that Logitron was 60, not seven, days overdue on a \$20,000, not a \$16,000, bill. Fortunately, Logitron had the proof to scotch this, but the threat of bankruptcy still existed.

Finally, and a bit slyly, the subcontractor offered an extension if Logitron would give 20% of its p-c board production to him over the next five years—on a first-refusal basis. Fortunately, several weeks of negotiation freed Logitron from this necessity.

Meanwhile, another firm had estimated \$12,000 on a job in June, but had billed Logitron for \$24,000 in September, and then escalated its bill to \$48,000 in October. At one point this company tried to charge 450 man-hours of labor for the layout of one five-by-seven-inch printed circuit board.

In October, Logitron was offered a plan whereby it would be al-

lowed to pay only 72% of this bill in cash, and the rest in its stock. An alternate offer would have seen Logitron billed \$34,000, with the remainder going to two of the subcontractor's employees as consultants. Neither had consulted.

Logitron escaped both situations with the aid of a good lawyer, leading to the Covatta-Dahlen dictum: "Insure your source of money, and retain the best lawyers you can afford."

"We hadn't imagined ethics would be such a problem," remembers Covatta. "But some forms of extortion are legal in business."

Wanna shoot craps?

Looking for money, "We went from the largest investment houses to the smallest and were disappointed almost everywhere," he says. "Our business plan was lauded—most bankers liked our desire for a large share of the market gained quickly, and application of some consumer sales techniques. But everyone who saw our manufacturing schedule suggested it be slowed, until at one point it was suggested that we make only a machine or two a month.

"We were also praised because of our youth," Covatta notes cynically. "It would give us 'freedom from prejudice,' 'energy,' 'zeal,' and all that, but when our letters and phone calls went unanswered, we found that it was our age that had

High Voltage CRT Power Supplies Custom Designed

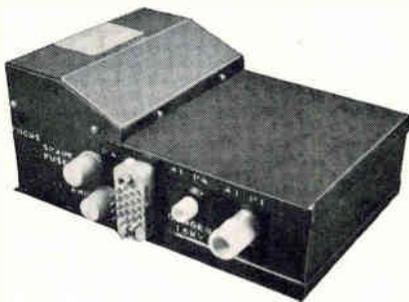

This custom designed Head-Up Display power supply met the requirements listed below and solved a unique space and weight problem as well.

- Outputs:
15 KVDC, 400 μ a pk.
1.7 KV (adj. 1.4 to 2.0 KV),
 $\pm 30 \mu$ a
300 VDC, $\pm 15 \mu$ a
- Ripple: 0.5%
- Regulation $\pm 0.1\%$
- Volume: less than 50 cu. in.
- Weight: $3\frac{1}{4}$ lbs.
- Temperature:
-55°C to 110°C
- Ref. to MIL-STD-826
- MIL-E-5400
- Input:
115 V, 400 cps MIL-STD-704

Try stumping us with your problem. We'll put everything we have into solving it and probably come up with a design that saves weight and space. Write or call for details today.

Capitron Division
Elizabethtown, Pa. 17022
717-367-1105 TWX: 510-657-4561

AMP INCORPORATED

Picture this

With a telephone handset in its acoustic coupler, the Logiport time-sharing terminal is the electronic counterpart of a teletypewriter, substituting a seven-inch cathode-ray tube for print and paper. It sends and receives either in full- or half-duplex modes, and sends either character-by-character or page-by-page. The page transmission mode saves central processor port time.

The Logiport/1 uses metal oxide semiconductor shift registers for display refreshment, and costs from \$2,550 to \$2,950 depending on quantity. Delay line - refreshed units, Logiport/2's, cost less; prices begin at \$1,850. Logitron recom-

mends the former model for users who will encounter temperature extremes.

Up to 512 characters are displayed on a 16-line, 32-character-per-line display field. The alphanumeric dot matrix is five by seven, and character size is variable up to 0.25-inch maximum. Display frame rate of the terminal is about 60 per second.

Logiport terminals can be equipped with an "auxiliary equipment" option which makes possible hard-copy reproduction with a nearby teletypewriter, or high-speed printout—say, with a line printer—at rates approaching one kilobit per second.

caused the money to be withheld.

"I sometimes wonder if the 40- and 50-year-old money men we talked to were jealous of us—far younger men with a company of our own," Covatta says. "Maybe so. Anyway, the best response we were able to get was something like, 'once you get going, and need expansion funds, come on back.'"

"Also, we soon began to doubt that most venture capitalists had the ability to judge a high-technology venture," adds Dahlen.

"At best," says Covatta, "the average venture capitalist is a good businessman, but in judging a technology company, the best he comes up with are queries based on the latest Wall Street buzz words—time-sharing, MOS, digital, and even electronics, heaven help us. Technologically, they just don't know where it's at."

Outdated. Logitron's engineers, bred to the transistor and computer, share a similar opinion about some of the engineers sent to look the firm over. Says one, "These men think in terms of tubes, relays and tv sets; their education is outdated—and maybe that's why they are working in corporate evaluation instead of engineering. Arrays, MOS, and time-sharing mean little to them."

Most biting of all was the fact that more companies would condescend than lend. "We would present our plan," says Covatta,

"and meanwhile, the men behind the desks used words like 'boy,' or 'young fella,' or 'you kids,' or 'boys your age.' It was this condescension that hurt most of all; there were times when we were almost angry enough to quit, but we could never afford to show this."

Eventually, the search paid off and Logitron now claims about \$175,000 worth of backing from several sources, although the company still has its share of debts.

"Now that we can see the light," says Covatta, "we're able to think beyond present market areas. We'd like to expand into data processing and communications—related fields after all.

"When and if we become flush, we'll begin looking for acquisitions—first strong on technology, but perhaps a bit short on marketing ability—we feel we can help there. It also would be nice to acquire a firm with good liquidity, but these don't grow on trees."

Eventually, too, Covatta and Dahlen would like to go into venture capital. "We would like to offer the kind of risk support we couldn't find," they say. "We'll be able to evaluate high technology areas and marketing plans as well as managerial skill. So one day, you can look for us to begin backing the young guys with bright ideas; we'll try to be the financial crap-shooters we wish we could have found."

Space-saving trimmers

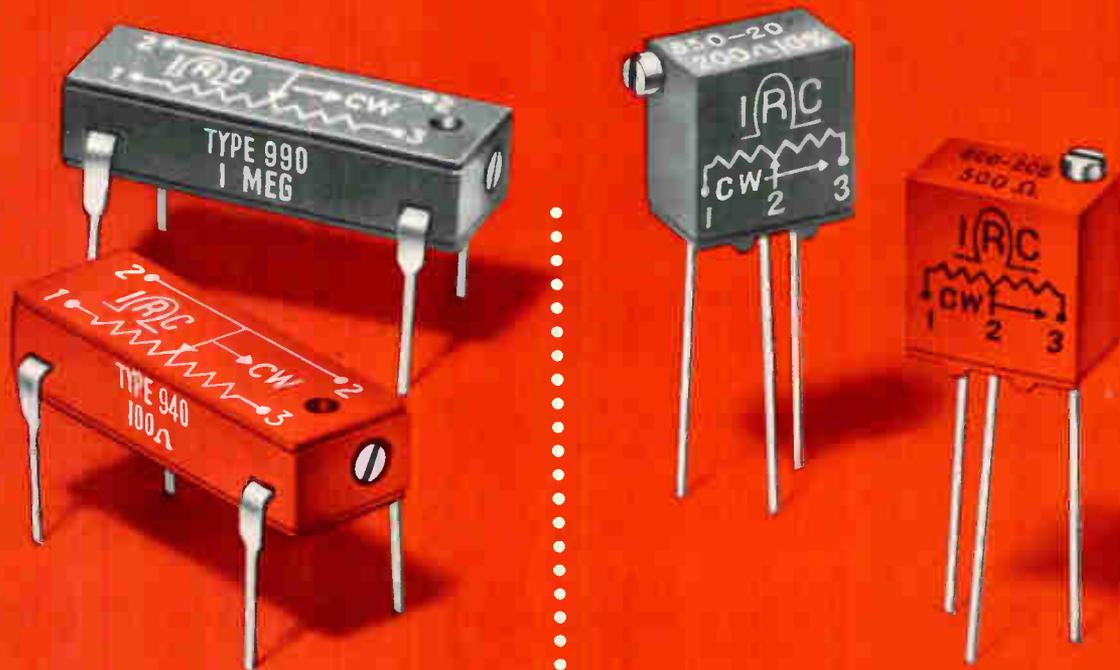

DIP construction matches IC size. Cuts assembly costs.

5/16-in. doubles performance of 1/4-in. trimmer—cuts cost almost in half.

These new IRC precision trimmers in dual-in-line packages simplify PC board layout. Only .200-in. high, their pin spacing is the same as the TO-116 size integrated circuit. It is fully compatible with high-speed automatic inserting equipment.

Pin spacing of these IRC 5/16-in. square trimmers matches the 1/4-in. square unit. Only .031-in. larger on each side, they can cut your cost almost in half and give you three times the power rating of the 1/4-in. and 40% better resolution.

Both DIP and 5/16-in. are available with precision wirewound and infinite resolution Metal Glaze elements. All units are fully sealed and impervious to common industrial solvents because of a silicone rubber shaft seal and epoxy bonding at all seams.

These units, like all IRC Metal Glaze trimmers, have a maximum guaranteed TC of $\pm 150\text{ppm}/^\circ\text{C}$ over the entire resistance range, with typical TC being $\pm 100\text{ppm}/^\circ\text{C}$, and at no added cost. For complete technical information and prices, contact your IRC Industrial Distributor or write IRC St. Petersburg Division of TRW INC., 2801 72nd St., North, St. Petersburg, Florida 33733.



DIVISION OF TRW INC.

Now, you can enjoy a choice of suppliers...



CLARE TF MILITARY RELAY
Three contact arrangements: 1 Form C
with base-connected movable contacts;
1 Form C and 2 Form C with movable
contacts insulated from case.

Clare's TO-5 meets or exceeds MIL-R-5757E!

In TO-5's, you can now enjoy a *choice* of suppliers—and you can sit back and enjoy Clare's dependable performance and prompt delivery. For Clare's TF (TO-5) Relays meet or exceed the requirements of MIL-R-5757E. TF features: a rigid frame to keep elements stable, balanced armature aligned; pressurized nitrogen to minimize arcing, extend contact life; hermetically-sealed case—all welded; optimized magnetic circuitry to assure maximum contact pressure. Withstands shock to 80 G, vibration to 30 G. Keeps going at temperatures from -65°C to $+125^{\circ}\text{C}$. 1,000,000 operations at low level, 100,000 at rated load.

For information, circle Reader Service number, call your Clare sales engineer or distributor, or write for Data Sheet 758. C. P. Clare & Co., Chicago, Illinois 60645...and worldwide.

LOOK FOR



CLARE ON THE RELAY

a GENERAL INSTRUMENT Company

Jumbo-jet age means airlines must take electronic route on the ground, too

Computerized reservation networks, automatic ticket vendors and verifiers hold out the promise of preventing traffic jams at check-in and boarding areas

By Peter Schuyten

Electronics staff

Whether coffee, tea, or medium-rare steak, the name of the game in the airline industry is service—those little extras that make a traveler choose one airline over another. But more and more, service on the ground—easing the mass confusion at ticket counters and check-in gates—is becoming just as important as in-flight hors d'oeuvres. And the situation is sure to get worse instead of better: baggage handling problems aside, when the 747 jumbo jets start flying, how will the 350-odd passengers assemble and board the plane?

To keep pace with the estimated 300 million passengers in 1975, air carriers are now expanding and updating their computerized reservation systems—and at a considerable cost.

Most major airlines are now into their second generation reservation systems. Pan American World Airways, for example, has a layout developed by the International Business Machines Corp. that set it back \$60 million—almost the cost of three 747 jumbo jets. And Pan Am is by no means unique. Eastern Air Lines went on line with its own IBM system late last summer, while Trans World Airways expects to switch over from a Bunker-Ramo-developed system which no longer meets its needs to a new Burroughs version by January 1970. And the list is growing. Further, if the airlines have their way and the Civil Aeronautics Board agrees, travel agents and certain industrial accounts will soon be brought into the reservations loop on a real time

basis via a newly formed service bureau called Atar Computer Systems Inc. of Van Nuys, Calif.

Other areas besides reservations are in line for electronic assistance. Passenger-operated automatic ticket vending machines will be on the scene early next year at one airport, Chicago's O'Hare International, and according to at least one airline official: "The time is not too far distant when ticket verifying machines will start showing up at airline boarding gates." All of which means a bullish outlook for electronics vendors.

But all these forward-looking

plans are not without their problems—political, technological, and "just plain passenger acceptance" problems, as James W. Smith, TWA's vice president of systems and data services puts it.

Linkup trouble. Typical of the political problems is the trouble the airline industry is having in trying to hook travel agencies and commercial users into their reservations system via a common link. "The Atar mess," as one official at American Airlines calls it, started three years ago. "It took that long for the airlines all to agree on common objectives and ways of obtain-



Making reservations. Eastern Airlines reservations and sales facility in Woodbridge, N.J., services only northeastern region of Eastern's system. The section shown here is just one of 20 at the center. Agents use crt terminals and microfilm displays to book passengers.

Au! Ag! Pt! Pd!

... And other precious metal alloys for microelectronic design!

PARTIAL LIST OF AVAILABLE ALLOYS & SOLDER PREFORMS

88% Gold 12% Germanium (Eutectic Alloy)
Strip and solder preforms in all sizes

80% Gold 20% Tin (Eutectic Alloy)
Strip, wire and solder preforms in all sizes

Gold with .1 to 1.2% Antimony
Wire, strip and solder preforms all sizes

Gold — .05% Min. Phosphorous
Wire, strip and solder preforms all sizes

95% Gold 5% Nickel
Wire, strip and solder preforms all sizes

Gold and up to .5% Arsenic
Strip and solder preforms all sizes

Silver with .1 to 1.2% Antimony
Wire, strip and solder preforms all sizes

Silver — .1% Min. Phosphorous
Wire, strip and solder preforms all sizes

95% Silver 5% Nickel
Wire, strip and solder preforms all sizes

Silver and up to .5% Arsenic
Strip and solder preforms all sizes

Special alloys produced on request at minimum charge.

Precious Metals in 99.9% Pure, 99.99% Pure, and 99.999% Pure.

The most modern production techniques, the latest refining methods and the best equipped research laboratories make Williams your one best source for all precious metals and their alloys.

Available in ultra-high purity sputtering discs, preforms, foil ribbon, tape, wire, sheet and other forms.

Write for our complete Precious Metals Catalog and Specification Sheets.



WILLIAMS PRECIOUS METALS
2980 MAIN ST. BUFFALO, NEW YORK 14214
Division of Williams Gold Refining Co., Inc.

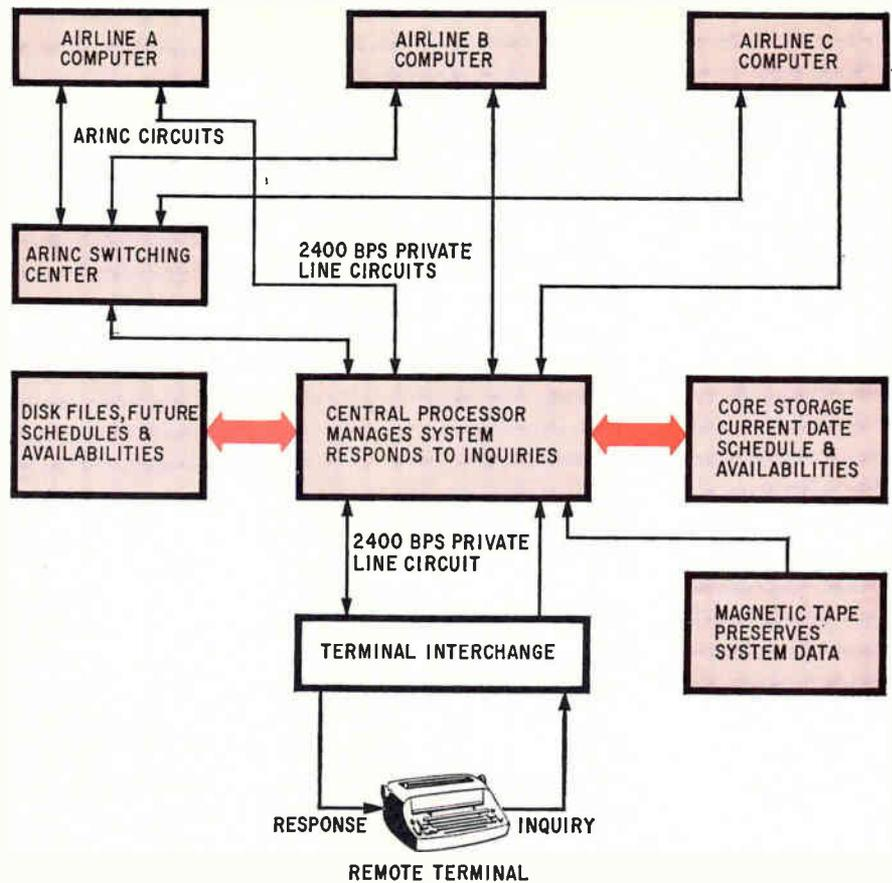

Atar system. Expected to be ready by late 1970, the Atar system will bring travel agents and commercial customers into the airlines' reservation systems via remote terminals as shown above.

ing those objectives," continues the American source. But almost as soon as a contract was signed between 11 airlines and Atar Computer Systems, and even before the CAB had given its approval, the Atar idea ran into some tough sledding. To wit, a complaint was filed with the Justice Department by both American Express and Telemax Corp. stating that the agreement between Atar Computer Systems and the airlines was in restraint of trade because it prohibited the airlines from contracting with competing reservation systems for five years.

Going ahead with plans

Meanwhile, Atar is going ahead with plans to link more than 2,000 travel agencies and commercial subscribers across the country with the 11 carriers—American, Eastern, TWA, United, as well as Alaska Airlines, Continental Airlines, Northeast Airlines, Northwest Airlines, Western Airlines, and Southern Airways—by the end of 1970.

When operative, participating

airlines would feed seat availability data covering a full year to a central computer complex. Subscribers would query the computers via IBM model 1977 hard copy terminals for seats and reservations. The Atar network would be linked to each airline's individual reservations system through the Aeronautical Radio (Arinc) switching center complex.

No objections. Spokesmen for Atar Computer Systems say they are confident that Justice Department objections to the contract which was signed in April 1969 have been removed. A revised agreement eliminating the exclusivity clause went to the airlines for signing in mid-October, and a CAB decision on the new agreement is expected before the end of this year.

Construction of a 23,000-square-foot building to house two IBM 360/65 central computers for the Atar system will be completed by January 1970 at Atar's new headquarters in Canoga Park, Calif. Installation of remote equipment,

... Atar costs linked

to customer usage ...

including regionally-placed data concentrators and remote terminals will begin next summer, with initial operation of the system scheduled to start sometime in the fall or early winter.

Gearing to the traveling needs of the 1970's the two 360/65's will handle more than 100,000 inquiries per hour and execute 30 million program instructions per minute for up to 2,500 user terminals. One of the computers will handle reservations while the second will perform nonpriority tasks and serve as a backup. Each machine will have a main frame 524,288-bit core memory. Additional core storage capacity of 4 megabits, plus disk memory storage of more than 446 megabits, and magnetic tape storage will also be used. The software will be a 255,000 lines-of-instruction adaptation of IBM's Programed Airlines Reservation System (PARS) now used by 15 airlines for their own reservations systems.

The computers will be linked to 80 concentrators by 2,400-bit-per-second private telephone lines, and multiplexed over 150-bit-per-second phone lines to the remote terminals. Each concentrator will handle up to 30 terminals.

Fees. The cost to the user for the IBM hard copy terminals will range from \$110 per month to \$160 per month, depending on the volume of reservations. And for large volume users, Atar will offer IBM 2915 crt display terminals, as an option, but no price structure for these units has been set yet. Lawrence L. Pelegrin, director of industry relations for Atar Computer Systems, explains that the monthly terminal fees will pay only about 25% of actual system costs, with the remaining 75% being picked up by the airlines on a usage basis. Total price for the Atar system will be between \$30 million and \$40 million plus \$2 million per year for communication line expenses.

Pelegrin estimates that there is a total market of 6,000 travel agencies and 500 commercial users. And "informal talks have already been held for inclusion of international airlines in the system as soon as

BOTTOMS UP!

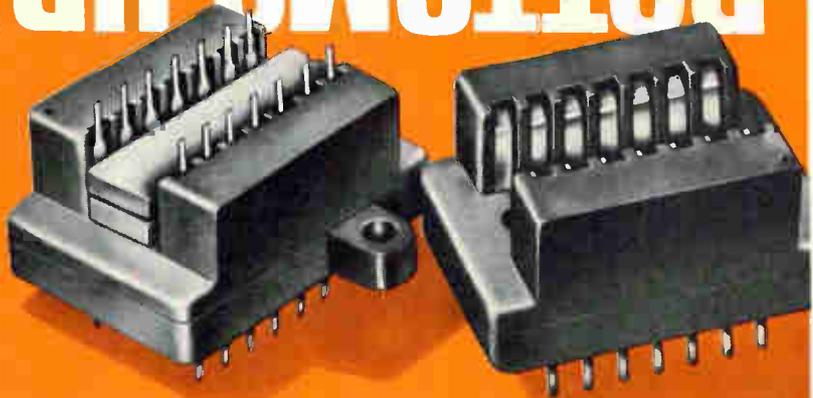

NEW INVERTED DUAL-IN-LINE SOCKETS FROM BARNES FOR FASTER HAND TESTING

Wish you had a "third hand" when inserting DIP devices into sockets in I.C. Testers or P.C. Boards? Not with Barnes inverted DIP sockets. They require no manipulation of leads into individual holes; 14 and 16 lead DIP devices are quickly and easily slipped into this socket with *leads up!* Direct wiping action contacts are recessed in deep grooves that guide device leads into position during insertion. Socket can also be used as a test probe for I.C.'s already mounted on boards. Turn thumbs down on bothersome DIP hand test operations with the bottoms up sockets by Barnes. Write today!



Lansdowne, Pa. 19050 • 215/MA 2-1525

barnes / THE WORLD'S MOST COMPLETE LINE OF SOCKETS, CARRIERS AND CONTACTORS FOR I.C.'S

Circle 195 on reader service card

Up-date your film resistor library.

With our new literature on Mallory film resistors. A complete line. Made by the company with total capability in film resistors. Write, today.

Mallory Controls Company, a division of P. R. Mallory & Co. Inc., Box 327, Frankfort, Ind. 46041.

GENERAL SPECIFICATIONS

MALLORY TYPE	MILITARY TYPE	TEMPERATURE RATING	POWER RATING (WATTS)	RESISTANCE RANGE (OHMS)
Precision Resistors				
MAC 55	RN55	70°C & 125°C	1/8 & 1/10	10Ω-100K
MAC 60	RN60	70°C & 125°C	1/4 & 1/2	10Ω-499K
MAC 65	RN65	70°C & 125°C	1/2 & 1	10Ω-1 meg
Semiprecision Resistors				
MAL 07	RL-07	70°C	1/4	10Ω-100K
MAL 20	RL-20	70°C	1/2	10Ω-470K
MAL 32	RL-32	70°C	1	10Ω-1 meg
Power Resistors				
2MOL		70°C	2	30Ω-125K
3MOL		70°C	3	40Ω-125K
4MOL		70°C	4	85Ω-125K
5MOL		70°C	5	95Ω-125K
7MOL		70°C	7	125Ω-125K

MALLORY

the CAB/Justice Department situation is settled," he says. Ultimately Atar also plans to incorporate into the system other reservation services such as hotels, car rentals, and tours.

Updating's no simple matter

While Atar looks toward the future, a number of airlines are finding out that updating their own individual reservation systems isn't as simple as ripping a page off a calendar. Take United, which more than two years ago ordered a \$56 million system from the Univac division of Sperry Rand. Dubbed Unimatic, this system includes three 1108 Univac central processors, 3,000 associated crt display terminals, as well as some 600 page writers. The three computers were installed early in 1968 at United's Elk Grove Township, Ill., facility while the terminals have found their way into the reservation system since then. But as one United spokesman notes in disgust, "The system's already one year late, and it still doesn't work. First there were hardware problems now it's

the software." According to industry sources, the main problem lies in the fact that United has what it calls unique data protection requirements, and thus far Univac has had trouble adapting its Exec 8 multiprocessing software package to meet those requirements.

When operational, around May of next year according to Jack Watson, United's vice president for information services, the system will handle reservation requests, seat availability, flight schedule changes, and will update passenger lists. Currently, United is using Unimatic for agent training while the system is being debugged. In the meantime, it has had to make do with its Bunker-Ramo-developed Instamatic reservation system, installed in 1962.

Curiously enough, it was Bunker-Ramo, then known as the Teleregister Corp., that built the first so-called on-line reservation system—for American Airlines in 1952—using a vacuum tube, wired-program computer. Now "sort of retired from the field (of airline reservations)," as one company



Trial run. Experimental automatic ticket vending machine, developed by IBM will get 90 day trial at Chicago's O'Hare airport, starting in January. From left to right, passenger inserts magnetically-encoded card, pushes button for destination, and receives ticket. Below is the type of ticket issued by the machine.

ISSUED BY ABC AIRLINES		PASSENGER TICKET AND BAGGAGE CHECK	SOLD SUBJECT TO CONDITIONS OF CONTRACT ON REVERSE SIDE If the passenger's name appears on advance reservation or ticket in a country other than the country of departure, the Program Contract may be applicable and the Contract terms and conditions shall apply. It is the responsibility of the passenger to determine the applicable contract terms and conditions.			
PASSENGER NAME - (NOT TRANSFERABLE)		COUPON IDENTIFICATION	TICKET DESIGNATION	FOUR SIDES		
DAVINCI		FLIGHT COUPON 1-1				
FROM CHICAGO	ORD	CARRIER AA	FLIGHT NO. 372	CLASS OF SERVICE F	STATUS OK	
TO WASHINGTON	DCA	ISSUE DATE 24OCT	TIME 625P	FARE BASIS F0	NOT VALID MORE THAN 12 MONTHS AFTER 24OCT0	
24OCT9 ORD AA DCA		ISSUE DATE 55-00F	\$55.00			
FARE	55.00					
TAX	2.75					
TOTAL	57.75					
TPAA123456789012		1449025	1 001 15 1001402 6		437 008	

VOID - FOR LAB TEST PURPOSES ONLY - VOID



Immediately available from TRW distributors

CALIFORNIA - Los Angeles Area

K-TRONICS, INC.
5645 E. Washington Blvd.
Los Angeles, Calif. 90022 (213)685-5888

SANTA MONICA BELL ELECTRONICS CORP.
306 E. Alondra Blvd.
Gardena, Calif. 90247 (213)321-5802

WESTATES ELECTRONICS CORP.
20151 Bahama Street
Chatsworth, Calif. 91311 (213)341-4411

CALIFORNIA - San Francisco Area

ELMAR ELECTRONICS INC.
2288 Charlston Road
Mountain View, Calif. 94091 (415)961-3611

KIERULFF ELECTRONIC INC.
3969 E. Bayshore Road
Palo Alto, Calif. 94303 (415)968-6292

DISTRICT OF COLUMBIA

ELECTRONIC WHOLESALERS, INC.
2345 Sherman Avenue NW.
Washington, D. C. 20001 (202)483-5200

CRAMER ELECTRONICS, INC.
692 Lofstrand Land
Rockville, Md. 20850 (301)424-2700

FLORIDA

CRAMER/FLORIDA, INC.
4141 N. E. 6th Avenue
Ft. Lauderdale, Florida Enterprise 1776 (305)566-7511
(305)947-6517

ELECTRONICS WHOLESALERS, INC.
345 Graham Avenue
Orlando, Florida (305)841-1550

MASSACHUSETTS

CRAMER ELECTRONICS, INC.
320 Needham Street
Newton, Mass. 02164 (617)969-7700

NEW JERSEY

EASTERN RADIO CORP.
312 Clifton Avenue
Clifton, New Jersey 07015 (201)471-6600
New York, New York (212)CH4-2268

NEW YORK

CRAMER/ESCO INC.
96-10 23rd Avenue
Elmhurst, New York 11369 (212)478-4000

TERMINAL-HUDSON

ELECTRONICS, INC.
236 W. 17th Street
New York, New York 10011 (212)234-5200

CRAMER/ROCHESTER

23595 Winton
Rochester, N.Y. (716)275-0300

OHIO

ELECTRONIC MARKETING CORP. (EMC)
814 W. 3rd. Avenue
Columbus, Ohio 43212 (614)299-4161

PENNSYLVANIA

ALMO INDUSTRIAL ELECTRONICS INC.
Roosevelt Blvd. at Blue Grass Rd.
North East, Industrial Park
Philadelphia, Penn. 19114 (215)676-6000

TEXAS

HALL-MARK ELECTRONICS CORP.
9100 Markville Drive
Dallas, Texas 75231 (214)231-6111

TRW

Available from all other TRW distributors coast-to-coast.

TRW presents the Universal Active Filter

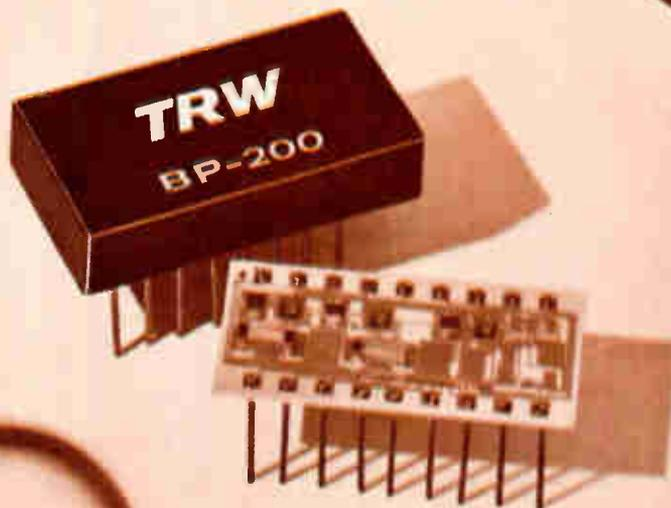

Tunable... \pm .003% per °C stability.

The new BP-200 microelectronic active filter is the smallest, most stable and most versatile audio frequency filter in existence. It is a universal filter: a single unit can be connected to function as a bandpass, low pass or high pass element. And modules can be cascaded to provide almost any complex filter function.

Both resonant frequency and Q of the BP-200 are independently variable, and can be controlled externally. A single resistor can tune the unit over 2 octaves. Q values up to 500 are obtainable for bandpass filtering.

The BP-200 not only eliminates the need for bulky inductors and capacitors, but for magnetic shielding as well. It can also re-

place vibrating reeds and other mechanical filters, to eliminate shock and vibration interference.

For complete information and applications assistance, contact any TRW distributor. TRW Semiconductors, Inc. is a subsidiary of TRW Inc.

TRW®

Lectrohm knows Resistors... We should, they're our only business!

Fixed or Adjustable
Standard or Custom

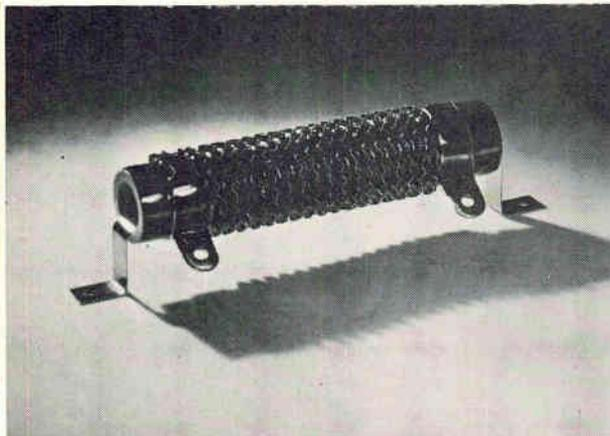
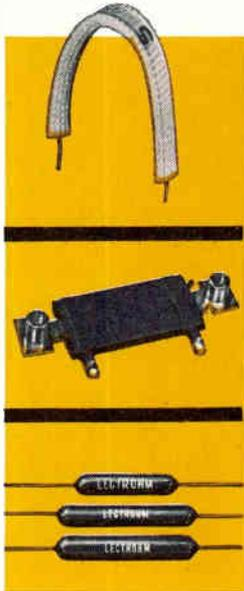

Specialization in the design and production of wire-wound resistors has established LECTROHM'S leadership in the resistor field.

For example, "Rib-on-Edge" resistors are made to order for high wattage service where low resistances from a fraction of an ohm to several ohms are required. They are also used for intermittent duty where relatively small size resistors must dissipate high wattages. Due to its greater heat dissipation and ability to operate at higher temperature, the "Rib-on-Edge" resistor is almost one-half the physical size of the equivalent standard round wire style resistor. It can be furnished in fixed, adjustable or tapped style to afford greater flexibility in equipment design.

Check your resistor needs today . . . send specifications, prints or requirements, no obligation . . . you can trust LECTROHM to match those needs quickly and economically.



FREE!
Full line
LECTROHM
catalog.
Send for your
copy today!



Lectrohm, Inc.

a subsidiary of

COOK ELECTRIC

5562 Northwest Highway, Chicago, Ill. 60630

spokesman puts it, Bunker Ramo is still reaping unexpected profits from some of its old systems while various airlines are struggling to iron the bugs out of their second generation systems.

Quick sell. Still, the newest direction in airline services is automatic ticket vending. Late in October, American Airlines and IBM unveiled an experimental computer-based automatic vendor which is designed to print and issue airlines tickets in less than a minute directly to the customer. Linked to an IBM 360/30 computer, the device, which accepts magnetically encoded credit cards, will be tested at O'Hare airport for about three months. Then, if successful, it will be linked to American's Sabre reservation system, also developed by IBM, and used on a full-time basis.

As far as new technology is concerned, however, IBM's vending machine system is a bit old hat. Notes Jerry Svigals, IBM's ATV project manager, "You will never in your life see a more standard 360/30. And as for the terminal, it contains a standard magnetic strip reader and a standard printer. There is no new technology involved nor is there any particular need for it."

Acceptance is key

Rather, the most important considerations as far as Svigals is concerned are the device's physical size and human engineering factors. If the passengers accept it, it will be a success, he correctly summarizes.

Interestingly, about 18 months ago IBM and TWA did a study that resulted in a prototype automatic ticket issuing machine, according to TWA's Smith. "IBM proposed a joint experiment using the device, but the terms of the arrangement were such that we declined. Besides, we just didn't see the value in experimenting with it," explains Smith. Labeling automatic ticket vending a gimmick, Smith goes on to explain that there are two routes you can take in designing a ticket issuing machine: an automatic vendor like the IBM/American device, or an agent-attended machine—the route TWA is taking.

Man-machine. TWA is working with IBM and two other vendors—the Control Data Corp. and Bur-

roughs—for approaches to an agent-attended machine. In its simplest form, page writers would be converted to issue tickets on instruction from the reservations computer. Tickets could be in the same form as they are today and would be inserted singly into the printer or incorporated into a perforated roll. All the agent need do to print a ticket is key in pertinent flight information. "Whatever the approach, we'll have agent-attended ticket terminals by 1971, and I don't mean experimental ones either," says Smith.

After machine-issued tickets, the next step toward improving the lot of the passenger in the air terminal will be machines that verify the tickets at the boarding gates, predicts Robert N. Scriber, industrial marketing manager for IBM's Data Processing division. Describing it as the second application (after ticket issuing) where the passenger and the computer come face to face, Scriber says that ticket verifiers will not only substantially reduce the amount of time the air traveler spends in the airport, but will also cut down on agent-occupied time.

Linked to the airline's reservation system computer, this type of machine might read a magnetically encoded strip on the back of the ticket and determine whether, in fact, the passenger were about to board the appropriate flight. Once the ticket were verified, a gate would open and permit the passenger on the plane.

The hangup. For their part, however, the airlines are taking a long hard look at the concept. Most air line officials agree that, while there's a lot to be said for expediting the passenger's trip through the terminal and onto the plane and saving the agent for more important task, there's another important factor to consider: passenger acceptance.

"Indeed, we and the other airlines are already looking at various types of boarding gate devices," confirms TWA's Smith, "but our primary concern is not technology, but rather the degree of automation the passenger will accept. Hell, the technology for both reading and writing tickets has been here and in use in other industries for some time." ■

Reed Relays that deliver more of what you need most...

VERSATILITY ■ RELIABILITY ■ ECONOMY



Standard and Miniature Reed Relays



Special Design Reed Relays

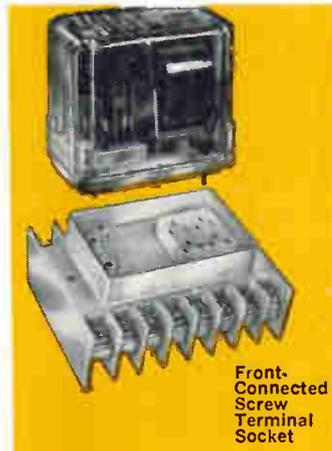

Front-Connected Screw Terminal Socket

Automatic Controls' Reed Relays — standard, miniature, or your special designs — offer individually supported reed switches, magnetic foil wrapped coils, non-magnetic terminals, and rhodium plated contacts, providing peak performance and reliability. Standardized contact configurations assure off-the-shelf delivery and maximum economy. For more of what you need most — specify Automatic Controls' Reed Relays everytime!

NEW from Automatic Controls... Front-Connected Screw Terminal Socket.

Accommodates the Automatic Controls' "family" of general purpose plug-in relays and time delay relays.

FREE LITERATURE!

Write for illustrated brochures and technical information:

- #800 Industrial Relays
 - #700 Pressure Switches
 - #940 Reed Relays
 - #720 Military Relays
 - #830 Ice Detection Systems
 - #874 Contactors
 - #859 Program Timers
- Specify above by numbers

Automatic Controls

Division



COOK ELECTRIC

200 East Daniels Rd., Palatine, Ill. 60067

If all systems aren't "GO"
after the computer's moved,
you know who's going to hear about it.



If you'd just as soon skip a spicy conversation with the Data & Systems people, have a quiet one with Allied instead.

Allied Van Lines has highly-trained professionals who know just how to move your electronics equipment—safely and on schedule.

And our Electronic Vans are just as good as our personnel. They have a special bracing that keeps your computer from shifting . . . an air suspension system that soaks up jolts and bumps along the way.

Call the highly-trained Allied Agent in your area.



ALLIED VAN LINES®

**We make the kind of moves
you never hear about**

Circle 136 on reader service card

Data generators aimed at wider market

Priced at \$1,500-\$3,000, two new lines test logic at up to 120 megabits/second; bit-stream simulators seek to replace pulse generators as digital chunks grow

By James Brinton

Electronics staff

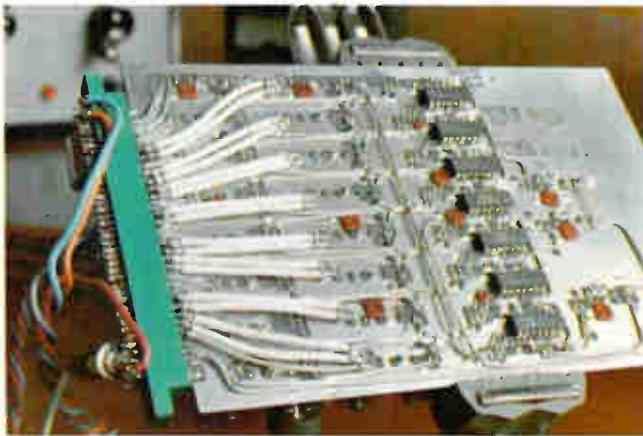

Fast and sharp. Coax cable, visible at left, preserves sharp pulses of data generator's super-speed logic.

"For testing complex digital systems, pulse generators are obsolete. And so far data generators have been too expensive to be very widely used." This is the opinion of John B. Connolly, who should know; he's vice president of Tau-Tron Inc., which last spring introduced a series of instruments—WG-100—billed as the world's fastest data generators [*Electronics*, March 3, p. 201]. And while the WG-100's have been commercially successful, data generators still are not the "common-as-oscilloscopes" instruments Connolly and his associates feel they should be.

Tau-Tron's answer to its own estimated need for widely available data generators are two new data generator lines, each capable of exercising complex logic with more realistic simulations of bit streams than pulse generators, but priced from about \$1,500 to \$3,000. The low-priced line includes the DG-700 and DG-716, priced at \$1,950 and \$1,495, respectively. Both deliver

serial data streams of 16-bit words in a fixed-type, non-return-to-zero format. But perhaps most important, both deliver data at rates up to 75 megabits per second—and this is the lowest-priced line. The somewhat costlier DG-1200 and DG-1216 emit their simulated data at up to 120 megabits per second.

The increased bit rate adds to flexibility and to price: the DG-1200 costs \$2,995 and the DG-1216, \$2,495. The differential between the higher- and lower-priced model in each line is accounted for by an internal oscillator that replaces the external triggering needed to make the generators run beyond a single word.

Test patterns. Yohan Cho, Tau-Tron's president, says that since the company has been selling data generators, he's noted that digital engineers "still are using pulse generators because they think data generators are costly, or unnecessary for small jobs."

Tau-Tron officials disagree,

pointing to the changing role of the digital engineer. "He buys logic in chunks now, and the chunks are getting larger all the time," says Connolly; "small jobs are becoming large ones. Pulse generators were a real help 10 years ago when an engineer wanted to check the value of a speedup resistor in a single, discrete-component logic function, but things just don't work that way anymore. Largely, logic designers now test what once were considered subassemblies, and they are well on the way to being able to buy LSI subsystems."

Pulses or digits. Cho and Connolly found engineers testing complex digital elements by jury-rigging data generators out of two or more pulse generators. "But they didn't realize it until it was pointed out," says Connolly. And jury-rigging can be tough: a first pulse generator's output would be taken for use as a clock at frequency F. Then its synch output would go through a flip-flop to get a frequency of one-



What is Bunker-Ramo's systems design spectrum?



From operational analysis . . .



to on-line experimentation and verification . . .



to operational systems and hardware

Advanced systems concepts, operations research, software development, implementation, modeling, maintainability/reliability analysis, integration, checkout and field support . . . a colorful spectrum of techniques, experience and capabilities necessary to assure total system effectiveness. Some recent examples:

System operational evaluation of the Marine Corps' Tactical Data System (MTDS) . . . system and hardware support for the Navy's precision navigation system . . . satellite navigation analysis . . . Tactical Traffic and System Analysis for the USAF Advanced Tactical C & C Systems . . . advanced application of data processing . . . man-machine interface studies

. . . display and communication systems for future tactical aircraft location and control systems . . . On-Line techniques for Navy command control.

Bunker-Ramo's capabilities in system development are wide-ranging . . . from analysis of the U.S.A.F. Airborne Warning and Control System to development of computer-aided techniques in human engineering . . . from photo interpretation using state-of-the-art-on-line display techniques to automated map-making . . . from highly sophisticated Strategic C & C Systems through quick reaction tactical systems. Want to broaden *your* design spectrum? . . . contact Bunker-Ramo.

 **THE BUNKER-RAMO CORPORATION**
DEFENSE SYSTEMS DIVISION
8433 FALLBROOK AVENUE • CANOGA PARK, CALIFORNIA 91304

AN EQUAL OPPORTUNITY EMPLOYER

Specifications common to all four devices

Data composition	Serial, 16-bit words, fixed non-return-to-zero
Data output	Simultaneous true and complementary from back-matched, current-mode amplifiers
D-c offset	± 2.5 v
Output impedance	50 ohms
Clock output	Synchronized with data, + 1 v into 50 ohms
Synch output	Reference bit for each 16-bit word. Pulse width is about 10 nsec, amplitude is + 1 v into 50 ohms
Programming	Front panel toggle array, remote programming optional
Recycle command	From external pulse or by pushbutton

DG-1200 Series

DG-700 Series

Data output amplitude	± 2.5 v max, with rise-fall time of 1.5 nsec	± 5 v max, with rise-fall time of 1.8 nsec
Clock pulse width	4 nsec typical	8 nsec typical
Clock rate	(DG-1200 only) External from one shot to 120 Mhz. Internal from 1 to 120 Mhz. Optional crystal control. Manual by pushbutton	(DG-700 only) External from one shot to 75 Mhz. Internal from 1 to 75 Mhz. Manual by pushbutton
Synchronous gating	(DG-1200 only) Burst gating at up to 100 Mhz	(DG-700 only) Burst gating at up to 75 Mhz
Delivery	3-4 weeks	5-6 weeks

half F—this would be used to trigger another pulse generator, whose positive-going signal would be used as the true output, and whose negative-going signal passed through a buffer or “level shifter” to get the complementary output.

“So you get clock, true, and complementary outputs,” says Connolly. “But you need two pulse generators at about \$2,000 each, if the user needs 75 megabits per second or more, plus flip-flop and buffer circuits, plus the labor needed to put it all together and get it working.”

Aside from the price advantage, Tau-Tron’s machines do “what pulse generators can’t do,” says Cho. The typical output of a jury-rig system is a chain of alternating binary 0’s and 1’s. “But typical worst-case patterns—the ones that show up the flaws in a system—are streams of 1’s, for example, followed by a single binary 0. Here’s where your system can bomb out,” says Connolly. “For example, a change could build up during that stream of 1’s which won’t dissipate quickly enough to handle the isolated 0—and, as a result, you’ve just lost a critical bit.”

Tau-Tron’s data generators allow the bit field for any 16-bit word to be set up through a front-panel toggle array. This makes it possible to try varied data patterns, to look

for weak spots in a circuit, and perhaps to spot performance drifts which could indicate later breakdowns. “Pulse generators just can’t do this,” says Cho.

The 1200 and the 1216 aren’t facing any direct competition; their speed of 120 megabits per second sets them apart from any equipment except Tau-Tron’s own WG-100 series. Competition for the 700 and 716 is characterized by Datapulse’s model 212. Datapulse’s device runs about \$700 over the DG 700’s \$1,950. Its rise and fall time is 0.3 nanosecond faster at 1.5 nsec and it also runs at 75 megabits. But Tau-Tron’s model 700 has a simultaneous true and complementary output and ± 2.5 volts baseline d-c offset, versus ± 2.0 volts for the Datapulse generator. Connolly says the added baseline offset allows more noise immunity in emitter-coupled logic tests as it lets the data generator run half a volt further away from ECL baselines, which reach down to 1.5 or 1.6 volts.

For communicators. Finally, for nearly absolute repeatability of test conditions, the DG-700 and the DG-1200 can be crystal-locked so that clock frequency and output bit rate can be controlled to within 50 kilohertz. And with a 10-turn potentiometer it’s simple to take advantage of this accuracy. Con-



A Career Spectrum (for you) At Bunker-Ramo

- **STATISTICAL COMMUNICATIONS SYSTEMS ANALYSTS**
Requirements definition, performance parameters, hardware solutions.
- **COMPUTER/DISPLAY**
Systems analysis/design on Command/Control Systems with emphasis on Information Systems.

For prompt consideration
Call collect (213) 346-6000
or send resume (include salary history) to D. S. Kalal



THE BUNKER-RAMO CORPORATION
DEFENSE SYSTEMS DIVISION
8433 FALLBROOK AVENUE • CANOGA PARK, CALIFORNIA 91304
AN EQUAL OPPORTUNITY EMPLOYER

JFD
MICROMINIATURE
MODUTRIM

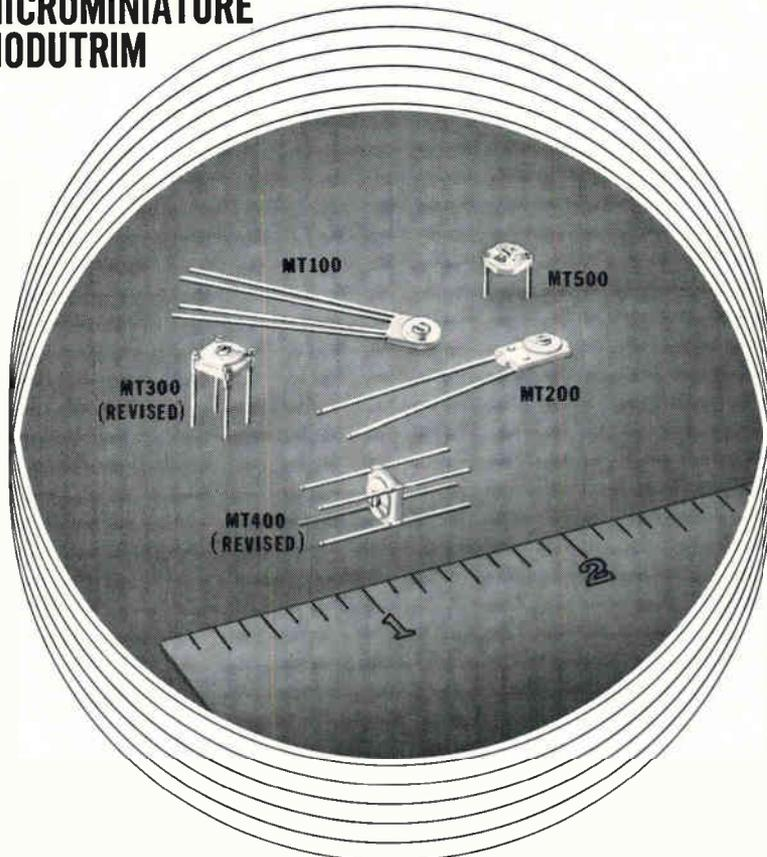

A UNIQUE CERAMIC VARIABLE CAPACITOR

Unique is the word that best defines the Modutrim—microminiature capacitor series. The MT series offers the design engineer superlative stability due to a special rotor designed by JFD. The rotor stability is due to a special proprietary ceramic material in a monolithic structure.

Especially designed for micromodule and hybrid applications, Modutrim is available in a wide range of Δ Cs with electrical characteristics that are outstanding for components of this exceptional small size.

Offered in 5 basic mounting configurations the Modutrim (MT100, 200, 300, 400 and 500) provides an optimum choice for your design applications.

In addition, JFD has modified its MT300 and MT400 series to provide added strength without affecting the mechanical or electrical parameters.

MT capacitors meet or exceed MIL-C-81. JFD engineers are available to meet your design requirements.

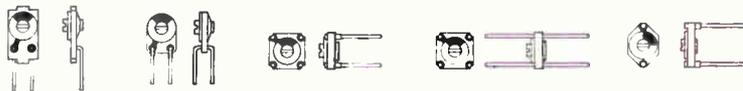

MT 100 MT 200 MT 300 MT 400 MT 500
 Write for catalog. Illustrations actual size.



"TODAY'S COMPONENTS BUILT FOR TOMORROW'S CHALLENGES"

JFD ELECTRONICS CORP. / COMPONENTS DIVISION

15th Avenue at 62nd Street / Brooklyn, New York 11219 / Phone 212-331-1000

SUBSIDIARY OF RIKER-MAXSON CORPORATION

nolly says that this feature is going to be helpful to the digital engineer who wishes to duplicate original conditions at different times, or locations. But it's aimed primarily at the communications field.

"Digital IC's now are very popular in communications systems," he says, "but makers of digital IC's aren't very frequency-conscious—there can be a lot of slop around a given clock or toggle rate."

"We think," he adds, "that this may be the only data generator made with the communications community in mind—you just can't set an odd rate like 51.43 megabits with any other generator. But you must have this kind of frequency control in time division multiplex or other communications testing."

Binning. Tau-Tron's new generators use the same Univer tunnel-diode, current-steering logic [*Electronics*, Feb. 17, p. 56] as the WG-100 series; yet they cost almost \$10,000 less. Why?

The answer seems to be an advantage of a broader product line. "Down on the transistor and tunnel-diode level," says Connolly, "we can buy large lots of low-cost semiconductors and divide them up into performance categories suitable for each of our data generators. We bin transistors for cutoff frequency and the tunnel-diodes for junction capacitance.

"Our Univer logic modules are built in only two basic types, and this also saves money," he adds. "These can be combined on logic boards to form any function we desire.

"Our printed-circuit boards also are adaptable—we can make about 15 modules from two basic p-c board layouts." Also interchangeable among the various models in the line are the basic power supply design, the oscillator system, the power amplifier design, and even most chassis parts, he says.

Right now, to preserve the sharp pulses characteristic of the proprietary logic, Tau-Tron uses hand-installed coaxial cable to connect logic modules to the p-c board output connectors. But as volume builds up, the company may switch to a multilayer p-c board, or stripline, technique to cut labor costs.

Tau-Tron Inc., 685 Lawrence St., Lowell, Mass. 01852 [338]

Have coils gone about as far as they can go?



Chances are, you're using some pretty darned good coils right now. So you may have decided that you'll never be able to find any better ones. Nonsense. If you aren't using our brand at the moment, the solution is simple. Switch. You'll get a noticeably higher degree of reliability. (After all, we've been the leader in R. F. chokes ever since the days we helped establish the military specifications for inductors.) We also deliver a greater depth of technical assistance. And our prices? Very competitive. Or perhaps you're already using our coils. If so, the future is still promising. Because we'll be continuing to improve our present models and develop new ones. For a sample order of our pace-setting coils, write AIRCO SPEER ELECTRONIC COMPONENTS, St. Marys, Pennsylvania 15857. Then see where they go from here.

Ask the passive innovators at **AIRCO** Speer

Speer resistors Resistor and conductor paste Jeffers JC precision resistors Jeffers JXP precision resistors and networks Jeffers inductors Jeffers capacitors PEC variable resistors and trimmer potentiometers.

Would the engineer who asked us to design a marking system to color band electronic peanuts, please call (603) 352-1130.

It's ready.

If for some strange reason you're not making electronic peanuts, how about your transistors, IC's, SCR's, diodes, thyristors or whatever. We can handle those, too.

We've got the systems, typefaces, inks, supplies and services to mark whatever you make, and mark it right.

Our problem-solver booklet will tell you more about us.

Write for it now.

(before you go nuts)

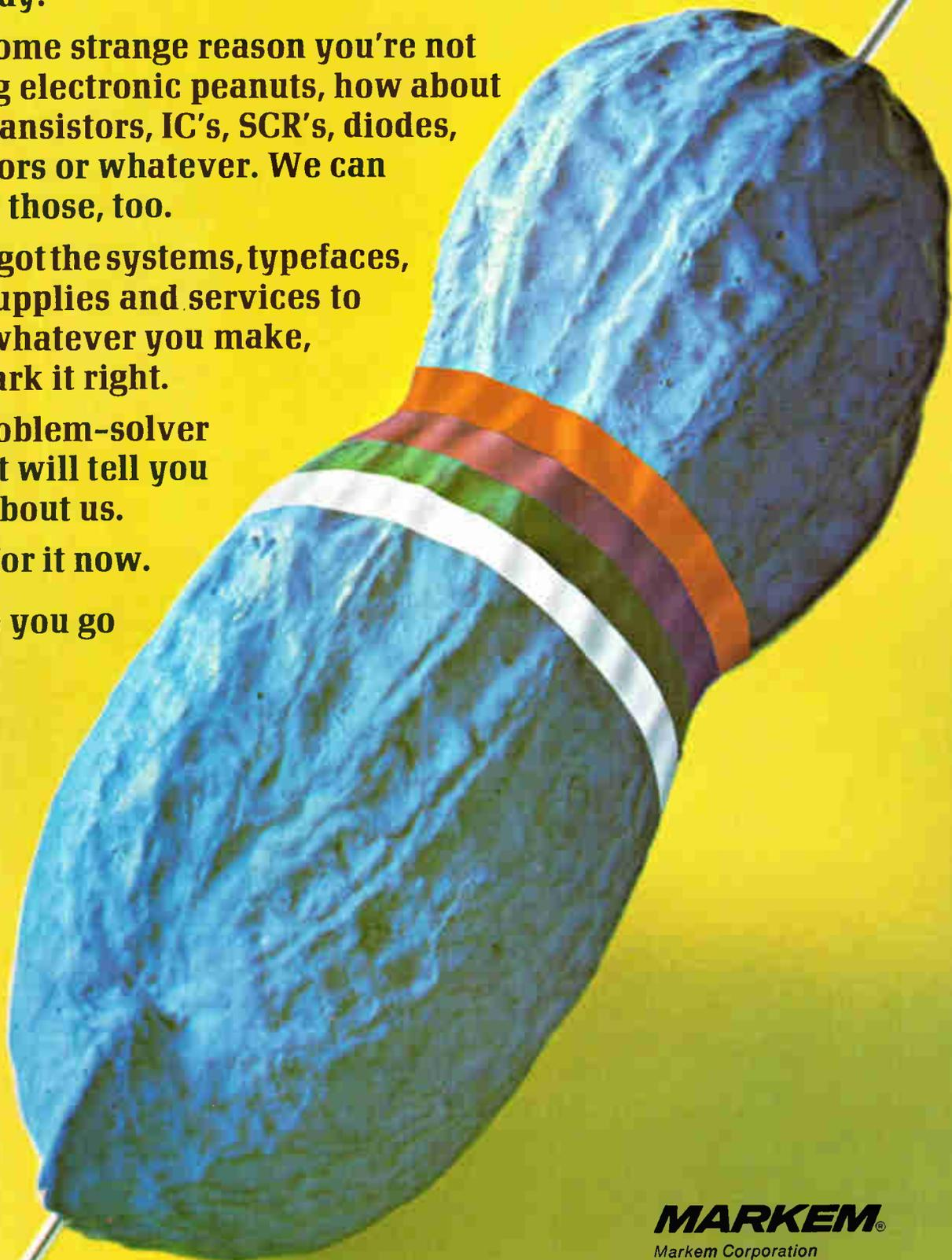

MARKEM®

Markem Corporation
305 Congress Street
Keene, N. H. 03431

International Offices: Markem Europa N.V. Schiphol Oost, Holland; Markem U.K. Ltd. Rugby, Warwickshire, England

Circle 142 on reader service card

Amphenol invades SMA connector market

Subminiature coax units use a beryllium-copper alloy for added strength; inexpensive kit takes care of assembly

One way to penetrate a new segment of the components business is to develop a new component, as did Omni-Spectra Inc. in 1962 with the subminiature coaxial connector, commonly known as OSM type.

Another way is to wait a few years, work on an improved design, and then try to take advantage of a swelling market. That's what Amphenol's RF division did. Its new

line of SMA connectors will be available in early-1970.

Unlike most subminiature coaxial connectors, the SMA is made of beryllium-copper rather than stainless steel. Amphenol says the new material is three times stronger than stainless steel, allowing twice the coupling-nut torque, and therefore more mating cycles to the user. The beryllium-copper also allows

Amphenol to use a thin-wall outer conductor for better design compatibility with semi-rigid cable. The new material, in addition to being nonmagnetic, considerably reduces the flaking of gold plate, so common in stainless steel.

The impedance of the SMA connector is 50 ohms and the operating frequency range is from d-c to 18 gigahertz. The standing wave ratio

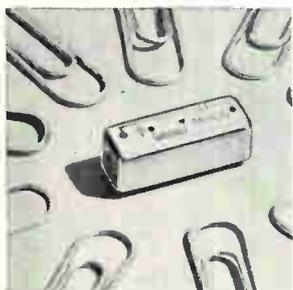

Reed relays incorporate blocking or arc depression diode within a 0.05 cu in. package. Series 442DS offer all the advantages of a reed relay and many of the advantages of solid state circuitry. Units allow p-c board space previously used by the diode and associated circuitry to be used by other components. Wheelock Signals Inc., 273 Branchport Ave., Long Branch, N.J. [341]



Rocker actuated miniature switches series 0805 conform to UL specs for double insulated applications. In addition to elimination of exposed metallic parts and extra safety, the snap-in mounting also speeds switch installation. Electrical ratings are 12 amps 125 v a-c, 6 amps 250 v a-c, 1/2 h-p 125-250 v a-c. McGill Mfg. Co., Electrical Division, Valparaiso, Ind. 46383 [342]



Miniature solid state micromodulator choppers are for low level modulator and switching circuits. All the FET units have low noise and offset characteristics with excellent isolation between drive and switching circuit. Drive circuit requires 5 mw or less at 6.3 v rms with a switching rate up to 10 khz. James Electronics Inc., 4050 N. Rockwell St., Chicago 60618 [343]

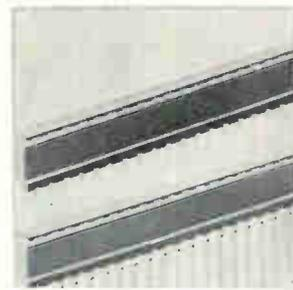

A strip of 25 contacts, enabling one to build individual socket requirements, offers flexibility and time savings. Strip may be mounted side by side or end to end for required pattern. Strips may also be cut off on ends for continuous spacing on 0.100-in. centers for more than 25 contacts in one row. Price is \$1 to \$2 depending on quantity. Augat Inc., Attleboro, Mass. [344]



Mercury relay type 162 is a 2 pdt, 2 amp, subminiature high-speed device for p-c board application. It provides low noise, bounce free switching. Contact resistance is 0.20 milliohm and remains stable within 2 milliohms. Lifetime is in excess of 1×10^9 operations. Dimensions are 1.60 x 1 x 0.400 in. Midtex Inc., Aemco Division, 10 State St., Mankato, Minn. 56001 [345]



Stepping motor series 20-3424D is a 1.8° unit that delivers 75 oz. in. of torque and speeds up to 350 steps per sec. When retrofitted into existing stepping motor actuated systems, it will increase performance by as much as 50%. Applications include use in computer peripheral equipment and machine tool manufacturing. Sigma Instruments Inc., Pearl St., Braintree, Mass. [346]



Flame retardant, UL approved rotary disk ceramic trimmer capacitors are rated at 300 vdcw over the temperature of -55° to +125° C. Q factor limits of 500 are typical. They are offered in zero temperature coefficient material with a range of 1.5 pf to 7 pf and in extended temperature coefficient bodies with ranges from 10 pf to 75 pf. Spectrum Control Inc., Fairview, Pa. [347]



Precision bobbin wirewound resistors feature a low temperature coefficient of ± 10 ppm/° C. Available in six models, 0.15 through 0.50 w, the resistors meet requirements of MIL-R-39005 and MIL-R-93. They are available in a tolerance range from 0.05% to 1%. Resistance range is from 10 ohms to 5.4 megohms. Dale Electronics Inc., P.O. Box 609, Columbus, Neb. [348]

now!
the strongest
power transistor
packages you
can get!



**New High Reliability...
 High Strength...Economy Designs!**

A complete line of power transistor packages from Ceramics International. Select from T-060 isolated, T-061 isolated or grounded, T-063 grounded, or The Power Tower. Grounded packages available with gold moly discs. Covers available, too!

Exclusive CI design assures high reliability... high strength performance. Bend leads during mounting... bend 'em back with no fear of losing seal integrity.

All pre-engineered for fast quantity production. In stock for quick prototype delivery. You save engineering and tooling costs.

Think all transistor packages are alike? Compare CI designs. You'll see the difference. Ask for performance data and prices. You'll like our quick response, too!



CERAMICS INTERNATIONAL DIVISION

Mahwah, New Jersey 07430
 Phone: (201) 529-2800

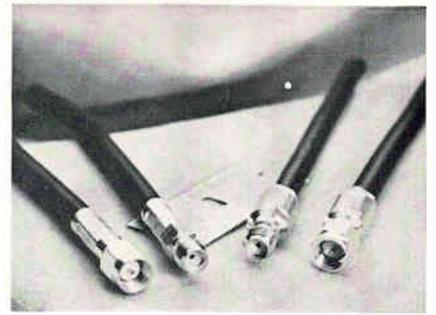

Links. Connectors for RG-58 and RG-223 cables have crimp plug and jack, left; clamp plug and jack, right.

is less than 1.09 up to 12.4 Ghz and 1.13 through 18 Ghz for semi-rigid cable. Insulation resistance is 5,000 megohms and r-f leakage is 60 decibels minimum. The new connector will adhere to MIL-C-39012, a new specification being generated by a subcommittee of the United States of America Standards Institute.

"Amphenol has invested more than \$600,000 in high-precision tooling over the past three years to maintain concentricities of better than .005-inch" says Henry Pessah, advanced planning manager at Amphenol. "This in-house construction will reduce our reject ratio considerably."

Previously, assembly of the sub-miniature connector to the mating cable was both costly and difficult, with one manufacturer charging \$100 for the required tool kit. "Amphenol," according to Pessah "changed all that. We are offering a tool kit for \$12.50 for use in assembling any one of our SMA connectors. To simplify this operation, the maximum number of parts in any SMA units is four."

The connectors will come in crimp and clamp plugs and jacks for RC-58 and RC-223 cables as well as connectors to be used with 0.141-inch semi-rigid cable, in solder and clamp versions. There are two solder styles: one uses the cable core as an insulator and the cable center conductor as the center contact, while the other has its own insulator and contact.

Although there is no price list at present, Amphenol anticipates selling the SMA from \$1.50 to \$2.00 in 500-unit lots.

Amphenol RF Division, Bunker-Ramo Corp., 33 East Franklin St., Danbury, Conn. 06810 [349]

Introducing the 7½ minute prototype.

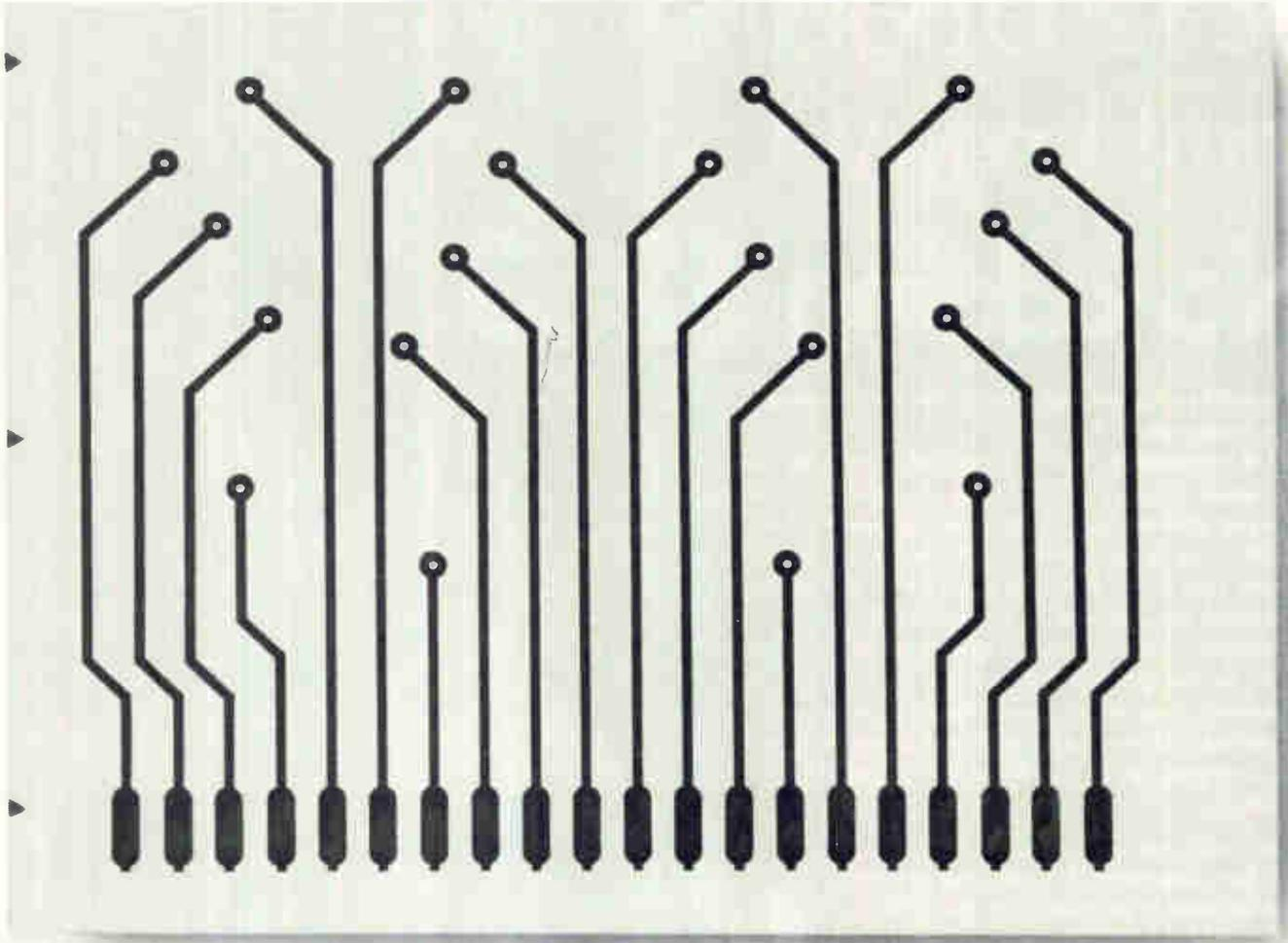

Getting prototype circuit boards used to be the biggest nuisance in design projects.

It took a lot of man-hours, expense, and a lot of space for bulky, awkward equipment.

No more. With Xerox Standard Equipment, chemical resist images can be transferred to copper-clad laminates and prepared for conventional etching—in 7½ minutes flat.

For just pennies per prototype.

And there are no wet, messy chemicals (the xerographic process is

completely dry).

No air-controlled darkroom (the Xerox equipment can be set up in a small corner almost anywhere).

No need for highly-trained technicians (most people can learn to handle it in just 60 minutes).

Of course, the 7½ minute prototype is only one of the ways you can use Xerox Standard Equipment.

If you have another 7½ minutes, we'll explain some of the others. Write Dept. BC14, Xerox Corporation, Rochester, New York 14603.

XEROX

Announcing Digitest 500,
the \$250 digital multimeter
from Honeywell.

No kidding. \$250

This world's smallest multimeter may be inexpensive to buy, but that's the only thing cheap about it.

Take capability. Our Digitest 500 gives you five functions (resistance, AC and DC voltages, AC and DC currents), plus 17 ranges to choose from. And it can be operated from 117V 50-60Hz line or an external 12V source. Or consider accuracy: Digitest 500 is five times as accurate as the conventional VOM.

As you can see, we've made it both compact and lightweight (2½ lbs.), by using a large-scale integrated circuit. So the Digitest 500 is just 2¾" x 5" x 9", but has polarity indication, a moving decimal point, an overload indicator and built-in calibration check. Plus overrange up to 100% (on all ranges except 300VAC).

To get a free demonstration — or more details — write Don Anderson, M.S. 206, Honeywell Test Instruments Division, P.O. Box 5227, Denver, Colorado 80217.

Honeywell

Circle 146 on reader service card



The correlator that came in from the sea

Originally part of an oceanographic system, the instrument sells by itself for \$12,500; its key feature is 2,000-point sampling

Heart of an oceangoing processor introduced by Real Time Geophysics last summer [*Electronics*, June 9, p. 163], a correlator has been plucked out of the processor and will be sold separately. It was too good to stay inside a special-purpose instrument, according to company president Warren Moon. Now dubbed the NW-10, the correlator sells for \$12,500.

Basically, a correlator averages. It multiplies two signals and integrates the product, and then temporarily shifts one signal, and calculates again. This multiply-integrate-shift sequence goes on and on. The results of the integrations plotted against the amount of shift is the plot of the correlation function for the two signals. Correlating identical signals — autocorrelation

—helps in extracting a periodic signal from noise. Correlating different signals — crosscorrelation — is often a valuable way to compare them.

Explaining his optimism for the MW-10, Moon says that correlators are becoming common because engineers are starting to appreciate the technique and the instruments are getting less expensive.

And Moon feels that the MW-10



Four-digit panel meter model 345 is a highly accurate (0.03%) unit for measuring d-c volts from 100 μ v to 1,000 v in any one of four d-c ranges. In addition to this capability, automatic polarity and overrange indication are standard. Unit price is \$295, and is \$225 in 100-lot quantities. Data Technology Corp., 1050 E. Meadow Circle, Palo Alto, Calif. 94303 [361]



Digital panel meter X-MOD/DPM is a 3-digit and sign integrating digital unit with 100% over-range. It features automatic polarity indication and accuracy of 0.1% \pm 1 digit. Unit is provided with one fixed full scale in either d-c voltage ranges from 1.999 mv to 1,999 v on d-c ranges from 19.99 μ a to 199.9 ma. Preston Scientific Inc., 805 E. Cerritos, Anaheim, Calif. [362]

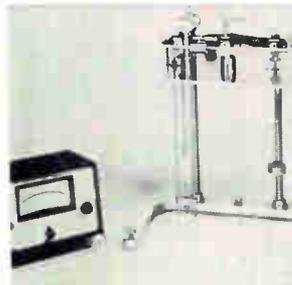

Instrument designated Micro-Creep Tester can measure very minute amounts of creep on miniature and subminiature specimens. Configurations accommodated include flat sheets and foils, whiskers, crystals, and filaments of various cross sections. Creep ranges are from 0.0001 to 0.1 in. (elongation or contraction). Allegany Technology Inc., Rawlings, Md. 21557 [363]

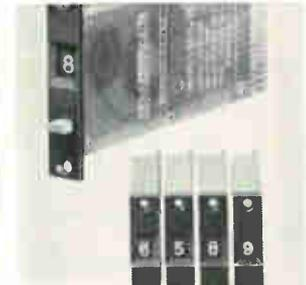

High speed decade with electrical readout combines versatility and low cost. Each modular Unipulser II has an independent drive input and a readout circuit for digital control or reading into other equipment. Count speed is 2,400 cpm. Price is \$18 for the standard decade model, \$19 for the pushbutton unit. Durant Digital Instruments, 622 N. Cass St., Milwaukee 53201 [364]



Digital current meter 801 precisely measures and displays in digital form the peak magnitude of pulse currents in the range of less than 10 ma to over 1,000 ma. Basic input sensitivity is 1 mv/ma, input impedance is 1,000 ohms and bandwidth is 50 Mhz minimum. Input pulse is 7 nec min. at the 90% points. Scientific Measurement Systems, Moorestown, N.J. [365]



Noise-loading test set 330A measures effects of intermodulation noise products on the performance of multichannel communications networks. It can be used on multiplex networks having from 12 to 2,700 active channels. Model 330A consists of a white noise generator (330A-G), a receiver (330A-R) and appropriate filters. Philco-Ford Corp., Newport Beach, Calif. [366]



Audio-range noise generator model 8057A synthesizes noise with a stable output level, a level so predictable (within 0.2 db at full amplitude) that amplitude accuracy is determined primarily by the instrument's wide-range output attenuator, which is accurate within \pm 0.5 db. Price is \$775; delivery, from stock. Hewlett-Packard Co., 1501 Page Mill Road, Palo Alto, Calif. [367]



Integrating d-c digital voltmeter model 200A features 7-segment light-emitting solid state numeric readout. It measures d-c voltages to 1,000 v in 4 ranges with resolutions of 100 μ v (0 to \pm 1.999 v d-c), 1 mv (0 to \pm 11.999 v d-c), 10 mv (0 to \pm 119.99 v d-c) and 100 mv (0 to \pm 1,000 v a-c). Monsanto Co., Passaic Ave., W. Caldwell, N.J. [368]

Are you sure
H_(BEEP) P_(BEEP)
started
this way?

No.
They didn't
have an instrument
that would
log true rms
for only \$950.



PM's Model 1020 AC/DC Log Converter. True rms detection, 0.5 dB accuracy, 80 dB dynamic range, 0.5 Hz to 100 KHz frequency range. Calibrated offset and fast response. Fabulous dc



PACIFIC
MEASUREMENTS

performance, too. All for \$950. Let you-know-who match that! For specs: Pacific Measurements, Inc., 940 Industrial Avenue, Palo Alto, California 94303. We gotta be better.

has features not found in other correlators that cost in the neighborhood of \$10,000.

First, it calculates a 2,000-point curve. Other instruments in its price range take only 100 samples. Put another way, Real Time offers 20 times the bandwidth.

The company also offers twice the accuracy. Competitive correlators have three-bit resolution; the MW-10 has four-bit.

And besides auto- and cross-correlating, the MW-10 convolves. Done with much the same circuitry used in correlating, con-

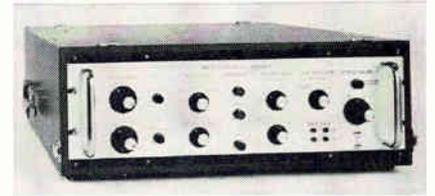

All at once. Working with a special signal handler and a stored signal, the MW-10 correlates several inputs.

volving is calculating the inverse transform of the product of two signals' Laplace transforms. Filter designers often use convolution in their work.

Other inputs. The MW-10, for a price, simultaneously correlates up to 25 separate signals with a signal stored by the instrument. To run the MW-10 in this parallel fashion, the user has to connect special signal handlers to the correlator. Real Time, of course, makes the handler, called the MW-10A. Priced at \$14,000, the MW-10A takes four signals.

While the MW-10 has no cathode-ray tube, its outputs, like its inputs, are analog, so it's easy to connect the correlator to an oscilloscope.

The correlator's sampling period can be set between 10 microseconds and 50 milliseconds, with 36 different digital sampling intervals over this range. The MW-10 accepts inputs between 250 millivolts and 64 volts.

The instrument weighs 30 pounds, is 10 by 5 by 15½ inches, and draws 50 watts. Deliveries, says Moon, will start in January, and delivery time will be 30 to 60 days.

Real Time Geophysics Inc., 163 Morse St., Norwood, Mass. 02062 [369]

NEW TECHNIQUE IMPROVES LOW-LEVEL SIGNAL MEASUREMENTS

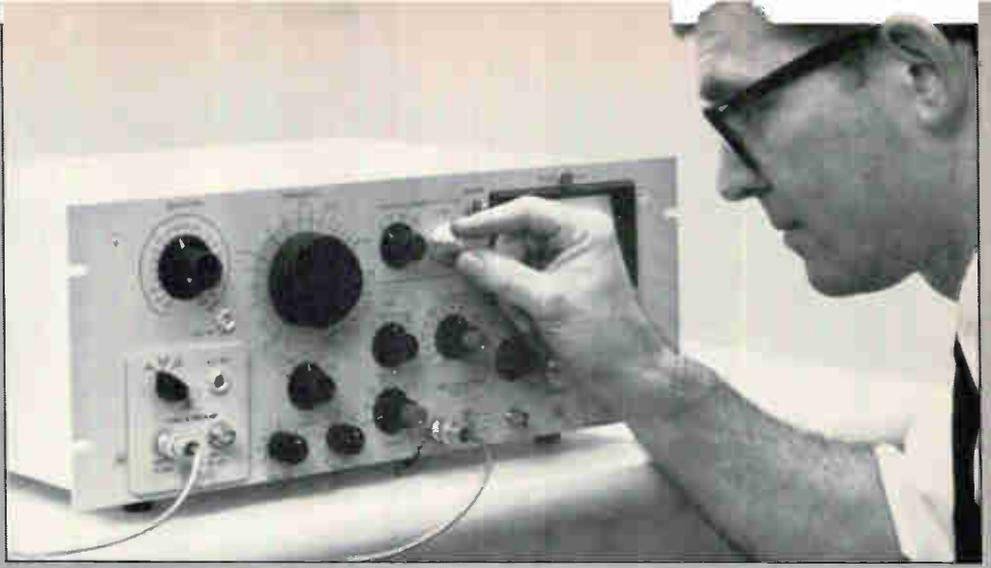

Where extremely low-level signals must be measured in the presence of obscuring noise, the use of a PAR™ Lock-In Amplifier can often transform a complex and sometimes futile investigation into a routine test procedure. For example, Lock-In Amplifiers can be used to:

MEASURE AMPLIFIER CROSSTALK TO ONE NANOVOLT

Where amplifiers are in close proximity in low level data processing systems, the minimum detectable signal is frequently limited by the crosstalk or mutual interference generated. By using a Lock-In Amplifier to measure crosstalk: (1) The source of feed-through can often be identified since very low-level crosstalk can be measured over a wide frequency range. (2) Further extraneous signal coupling errors are eliminated because no instrumentation other than the Lock-In Amplifier is necessary. (3) Crosstalk levels as small as one nanovolt can be detected. (4) The phase of the crosstalk can be identified.

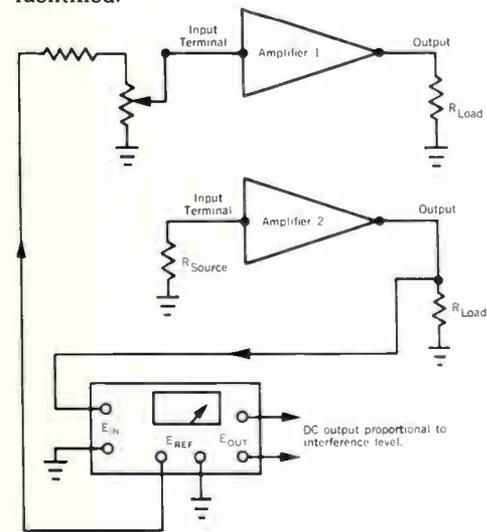

LOCK-IN AMPLIFIER
USEO FOR AMPLIFIER CROSSTALK MEASUREMENT

IMPROVE BRIDGE SENSITIVITY TO ONE NANOVOLT (FS)

A Lock-In Amplifier improves bridge sensitivity without over-driving the bridge circuit. Excite the bridge with the Lock-In Amplifier's internal oscillator and connect the external null detector termination to the signal input to get: (1) Measurements over frequencies of 1.5 Hz to 150 kHz. (2) Optimum noise figures using available preamplifiers with input impedances of several ohms to 100 megohms. (3) One nanovolt full-scale sensitivity for improved null accuracy and extremely low power dissipation in critical circuits. (4) A dc signal proportional to the off-null condition for use in modifying bridge parameters or as a recorder input. (5) Detection of in-phase (resistive) and quadrature (reactive) bridge components which can be nulled independently (and simultaneously, if desired).

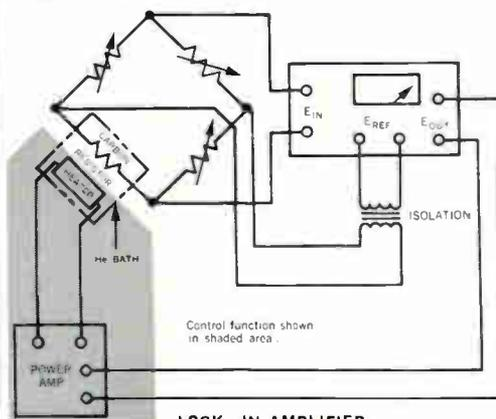

LOCK-IN AMPLIFIER
USEO AS BRIDGE OSCILLATOR/NUL DETECTOR

MONITOR OP AMP SUMMING JUNCTION VOLTAGES TO 10 NANOVOLTS

The open-loop gain of op amps can be measured by monitoring the summing point voltage while operating the amplifier in its normal closed-loop configuration. The advantages of using a Lock-in Amplifier to make these measurements are: (1) Its self-contained oscillator serves as a signal source for the op amp over a wide frequency range. (2) Distortion and offset at the summing junction are minimized by the Lock-In Amplifier's high input impedance and low noise. (3) Summing junction voltages as low as 10 nanovolts can be measured and recorded to permit measurement of extremely high open-loop gains. (4) Phase shift can be measured.

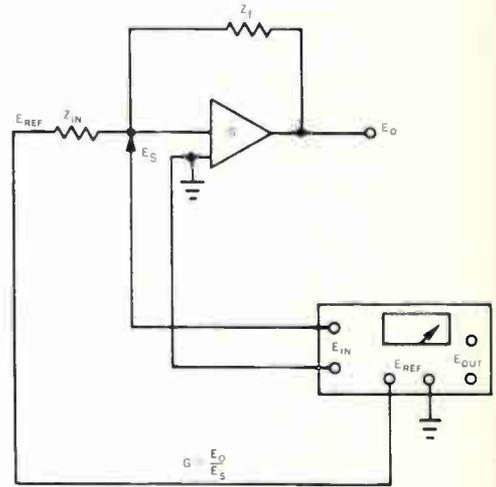

OP AMP OPEN-LOOP GAIN MEASUREMENTS
WITH LOCK-IN AMPLIFIER.

If you have a problem unearthing low-level signals buried in noise, why not call on a PAR applications specialist. He may be able to show you a better way to dig. Call him at (609) 924-6835, or write Princeton Applied Research Corporation, P.O. Box 565, Princeton, New Jersey 08540.



PRINCETON APPLIED RESEARCH CORPORATION

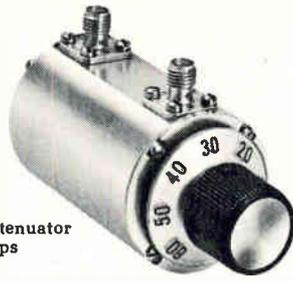

Miniature Rotary Attenuator
0 to 60dB in 10dB steps
Model 8103

Rotary Attenuator
0 to 109dB in 1dB steps
Model TAB-50A



*If you don't see
it here, write for
our catalog*



Toggle Switch Attenuator
0 to 82.5dB in 0.5dB steps
Model TG-9050A



Laboratory Rotary Attenuator
0 to 110dB in 1dB steps
Model TAD-50A

Toggle Switch Attenuator
0 to 82dB in 1dB steps
Model 8011

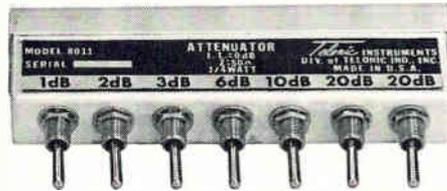

Catalog
Model 70A



Rotary Attenuator
0 to 100dB in 10dB steps
Model 8008-4

TELONIC ATTENUATORS

Whatever your needs for an RF attenuator, Telonic can provide one or a thousand to fit your application. They are available in such a variety of types (rotary, toggle, miniature), styles (panel-mounting, rack-mounting, bench type), ranges (up to 110dB) and prices (from \$65.00) that we can usually supply a stock unit to meet your requirements.

If you don't see it here, write for our catalog — and if you don't find it there, ask us about customized units. Here are some composite specs of over 20 different standard models.

Types: Rotary and Toggle Switch
Range: 0 to 110dB
Attenuation Steps: 0.1 to 40dB
Impedance: 50 and 75 ohms
Frequency Range: DC to 2000 MHz
Quality: Maximum



TELONIC INSTRUMENTS
A Division of Telonic Industries, Inc.
60 N. First Avenue
Beech Grove, Indiana 46107
Tel: 317 787-3231 • TWX: 810 341-3202

Time-delay relays are miniaturized

Modules work on voltage pull-in, are field-adjustable from a few milliseconds up to several minutes

Precise time intervals and compact size are necessities in time-delay relays for military and space applications such as missile-stage separation and sequential release of empty fuel tanks on aircraft. The delays in these and other instances range from a few milliseconds to several minutes.

To accomplish tasks of this kind, Logitek Inc. has introduced a mini-

ature series of time-delay relays called DMN1 and the DMN2. The modules maintain a high degree of performance, reliability, and accuracy under the stress of combinations of extreme vibration, shock, acceleration, and temperature.

The two types are identical in electrical properties, but the DMN2 is half the size of the DMN1. Also, the DMN1 has double-throw, dou-

ble-pole relay contacts as the output, and the DMN2 has solid-state ground closure.

When operating power is applied, the unit, which contains several semiconductors, begins to time. At the end of a preset interval, anywhere from 50 milliseconds to 200 seconds, the output transistor is turned on, effecting a ground closure, which holds until



Phase generator CM-1100, for instrumentation, navigation, simulation or computing, converts output from a 3-wire or 4-wire synchro to variable phase square waves. By using a 6-v a-c reference, the phase generator produces 2 square wave outputs, locked to the reference, at quadrature with each other. Dranetz Engineering Laboratories, Plainfield, N.J. [381]



Unregulated d-c power supplies series PM800 can be used with custom designed regulator circuits, or with many IC regulators now commercially available. Six different models are offered, each providing up to 2.5 w of output power. They provide output voltages from 5 to 45 v d-c output currents up to 440 ma. Computer Products, Box 23849, Ft. Lauderdale, Fla. [382]

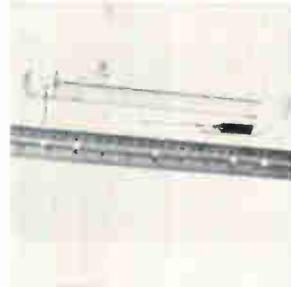

Laser tubes and optics are designed for the user who wants bare lasers without the power supply or other hardware. The research grade helium-neon lasers, operating at the bright red 633 mm wavelength, emit highly collimated light suitable for alignment, holography, and interferometry. Price is \$49.50. Metrologic Instruments Inc., Harding Ave., Bellmawr, N.J. [383]



A-c power line conditioners series LD are offered up to 1,000 v-a for use with test equipment, and measurement instrumentation. Efficiency is more than 80% at rated load at 115 v a-c input. Response time is less than 50 msec, recovery time is constant for 10% step line changes or 100% step load changes. Lambda Electronics Corp., Melville, N.Y. [384]

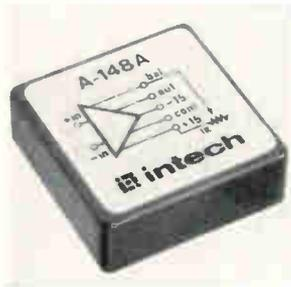

FET input op amps series A-148 provide settling times of 1 μ sec max. to reach 0.01% of final value. Typical settling times are 0.6 μ sec to 0.01%, 0.4 μ sec to 0.1%. Temperature coefficients for the series—A-148A, A-148B, A-148C—are 50, 25 and 15 μ v/ $^{\circ}$ C respectively. Prices are \$40, \$45 and \$50; delivery—from stock. Intech Inc., 1220 Coleman Ave., Santa Clara, Calif. [385]



Electrostatic charge amplifier model 504A permits low frequency and short-term d-c response, with exceptional zero stability, for shock pulse measurements and static calibration with quartz transducers. Advanced electronic design utilizing dual MOST input transistor provides a stable zero with near d-c response. Kistler Instrument Corp., 8989 Sheridan Dr., Clarence, N.Y. [386]



Regulated voltage modules are for circuit designers working with IC's. The ten BKF modules employ a linear IC regulator providing outputs of 5 v, 12 v, 15 v, 25 v or 28 v, each adjustable \pm 10% and protected by an in-board crowbar. Each voltage is offered in two power levels: a 15-w module for \$120 and a 25-w module for \$138. Kepco Inc., Flushing, N.Y. [387]

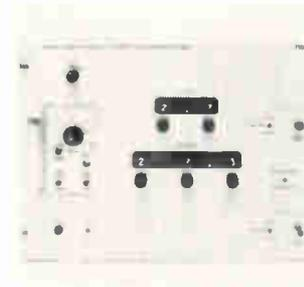

High voltage pulse generator 89A features positive 1000-v output, variable delay, variable pulse width and low internal delay. Uses include semiconductor and component testing, input triggering, driving photochemical devices, calibrating scopes and determining transient response of photodiodes. TRW Instruments, 139 Illinois St., El Segundo, Calif. [388]

**NOW...
YOU CAN
SEE YOUR
DVOM
IN THE
MICROSCOPE**

**...DIGITAL
READOUT
RIGHT IN THE
FIELD OF
VIEW!!**

**INFO-SCOPE
MARK II**



MCBAIN INFO-SCOPE by Olympus Optical Co. Ltd.

TRIPLES PRODUCT YIELD • REDUCES OPERATOR FATIGUE • INCREASES ACCURACY

MARK I Information Module



Connects to INFO-SCOPE Pod. Utilizes prepared microfilm of circuit diagrams, go, no-go limitations or other drawings and displays an overlay image directly on the work piece within operator's field of view.

At the flick of a switch, the revolutionary INFO-SCOPE Mark II, with built-in miniaturized "Nixie" tubes will display precise digital readout directly above the work piece right in the field of view. Probing operations, resistance trimming and circuit reliability checks are more accurate when there is no operator head movement as required in normal digital voltmeter readout.

The INFO-SCOPE with a Mark II Information Module fits all existing work stations or it may be used as a separate microscope.

McBAIN INSTRUMENTS, INC.

14753 ARMINTA STREET • VAN NUYS, CALIFORNIA 91402 • TELEPHONE (213) 873-2205

**... delay is set
by external resistor ...**

power is removed. The output then resets and the device is ready to perform another cycle. Units may be interconnected with other timers from this series to provide several sequencing functions.

The modules are designed to permit field adjustment of the time interval. Models are usually available with timing ranges of 50 msec to 15 seconds and 1 second to 200 seconds. Accuracy, including linearity is $\pm 5\%$ and $\pm 10\%$. The time delay is set by connecting an external resistor between two designated terminals, which are shorted for minimum specified delay. For low-range units, delay is increased by adding 20 kilohms for each additional 50 msec of delay required. For high-range units, add 20 kilohms for each additional second of delay required. External resistors should have 1% tolerance, with temperature stability of 50 ppm/ $^{\circ}\text{C}$ or better. Power rating should be $\frac{1}{8}$ watt minimum. Other specifications are: repeatability, $\pm 1\%$ at any specified voltage and temperature; reset time, 5 msec maximum; recycle time, 1% of nominal time delay or 10 msec; output during on time, 1.0 ± 1 volt and 100 milliamperes maximum; during off time, 35 volts d-c and a leakage current of 0.030 micro-amp. Current drain at 28 volts d-c input is 5 ma during timing and 10 ma after timing.

The operating-temperature range of the modules is -55° to $+125^{\circ}\text{C}$, and storage temperature ranges from -65° to $+150^{\circ}\text{C}$. The units will withstand shock of 50 G's for 11 msec, any axis, and acceleration of 20 G's steady state, any axis. They are encapsulated and enclosed in hermetically-sealed packages.

Readily available specification variations of these modules include longer delays, short recycle times, low or zero standby current requirements and higher or lower operating voltage.

The units are available on a 4 to 6 week basis and are priced at \$200 for quantities of 1 to 5 for the DMN1, and \$100 for the DMN2.

Logitek, Inc. 42 Central Drive, Farmingdale, N.Y. 11735 [389]

Bell & Howell's extensive experience — widely known throughout the industry—has led to the development of two, new, portable recording oscillographs.

Check out some of these features: Type 5-134 offers quality data, versatility, time saving, and low operating costs. Type 5-135 offers more economy to the automotive, industrial, and medical fields. The dual gridline system provides accurate reference traces, eliminating the possibility of damage to valuable records with overcrowding of timing lines. Ten servo controlled speeds for maximum flexibility, Type 5-134,

0.1-100 ips, Type 5-135, 0.1-80 ips. Continuous or momentary run for operating convenience. Operating frequency:

Type 5-134, 50/60 Hz or 400 Hz after simple modification;

Type 5-135, either

400 Hz or 24 vdc. Optional timing unit provides automatic timing line selection for valuable data protection.

For all the facts, call our nearest office. Or write Bell & Howell, Pasadena, California 91109. Ask for Bulletin Kit 3311-X4.



BELL & HOWELL

THEY'RE NEW

Exclusive: dual gridline spacing and automatic timing line selection

Exclusive: dual gridline spacing and automatic timing line selection

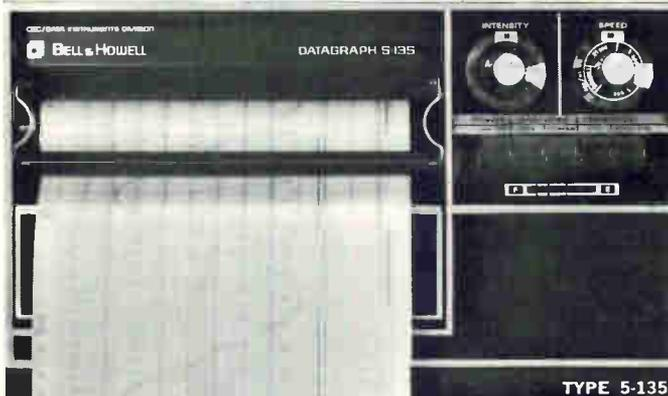

TYPE 5-135

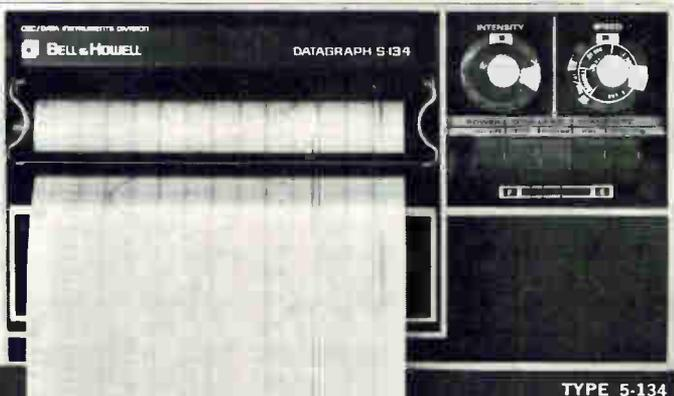

TYPE 5-134

NOW...

Hamilton precision metals has added facilities...and is in the Photoformed® Parts business...



BIG!

Hamilton has added a new plant—just to produce precision, Photoformed® parts!

This new facility is equipped with the most modern photo-etching machinery on the market. The new equipment will produce precision parts in large quantities to the highest standard of dimensional accuracy.

Now, you can get from the Precision Metals Division, finished parts to the same degree of precision as world wide metal users have come to expect in Hamilton's strip and foil.

Hamilton offers the Total Capabilities of a completely integrated facility controlling every step from melt to finished strip or foil—and now to finished parts. This means that you get the same adherence to metallurgical standards and dimensional accuracy that has become the hallmark of Hamilton.

For the complete story on the capabilities of Precision Metals Division and what it can do for you, write for your copy of the new Photoforming brochure. It's yours for the asking—write today!

PRECISION METALS DIVISION
HAMILTON
WATCH COMPANY • LANCASTER, PA. 17604
• PHONE (717) 394-7161

New subassemblies

Limiters minimize phase distortion

I-f devices operate at 30 and 60 Mhz, will handle 1 mw

To achieve limiting at the intermediate frequency, you usually have to sacrifice phase-angle integrity. The LEL division of Varian Associates has devised a solution wherein both amplitude limiting and constant phase angle can be achieved at the two most common i-f's, 30 and 60 megahertz.

The constant-transmission phase limiter maintains a constant phase angle over an entire input signal dynamic range. And since phase deviations are minimal, it can also be used when phase tracking is desired between two or more units over a dynamic range. Phase distortion, so common with limiters, is minimized, according to LEL.

"This novel limiter will allow development of a new class of monopulse and pulse-signature identification receivers," says Thomas Jarman, LEL applications engineer. "It will replace the limiter in the monopulse receiver azimuth and elevation channels where i-f information processing is necessary."

The limiters, labeled the ITLM series, are available in combinations of center frequencies of 30 and 60 Mhz and bandwidths of 10 and 20 Mhz, all with input/output impedances of 50 ohms. The ITLM's will handle maximum c-w powers of 1 milliwatt and the 20-Mhz-bandwidth models can accept minimum pulse widths of 70 nanoseconds. The input standing wave ratio is 1.5:1 maximum. The maximum transmission phase shift is 10° over a 70-db dynamic range.

The standard size model is designated the ITLM-2, and the miniaturized version is called the ITLM-4.

Single unit price of the ITLM-2 is \$650, with reduced prices for large orders. Delivery time is 30 days. The price and delivery time of the ITLM-4 have not been set.

LEL Division of Varian Associates, Cpiague, N.Y. 11726 [390]

When you need data
about something too distant to reach
or too numerous to count,



call Kodak

Call (716) 325-2000, Ext. 3257. This number is your pipeline to a large staff of scientists and engineers who specialize in *photographic* ways to collect, interpret, store, and retrieve information.

Systems of their design, or in which they participated, have furnished information about the moon and solar

system. They've provided detailed studies of debris on the ocean floor. They've even followed the complex tracks of subatomic particles.

There's a strong probability that photographic solutions to your problem are already available. There is just as strong a likelihood that the equipment, materials, and technology

can be taken right from the Kodak shelf. A conversation with us may save you time and money. Call.

Or, if you wish, write:

Instrumentation Sales,
Eastman Kodak Company,
Rochester, N. Y.
14650.



Announcing the "Freon" Solvent Drying System.

Dries water-wet parts spot-free at 118°F...in 3 easy steps.

1. Lower the parts into the drying sump containing FREON® T-DA 35 solvent boiling at 118° F. Low-temperature boiling eliminates water spotting caused by the evaporation of water. (This system, using the high density of FREON, works by the displacement of water, rather than its evaporation.) No spotting of parts means fewer rejects. And the low-temperature operation also helps to protect delicate parts. The system is compatible with most plastics, elastomers and metals.

2. Remove the parts and allow the excess solvent to drain back into the drying sump. (The solvent is re-usable—no need to discard the solvent because it is saturated with water.) After draining, lower the parts into the first rinse sump containing FREON TF.

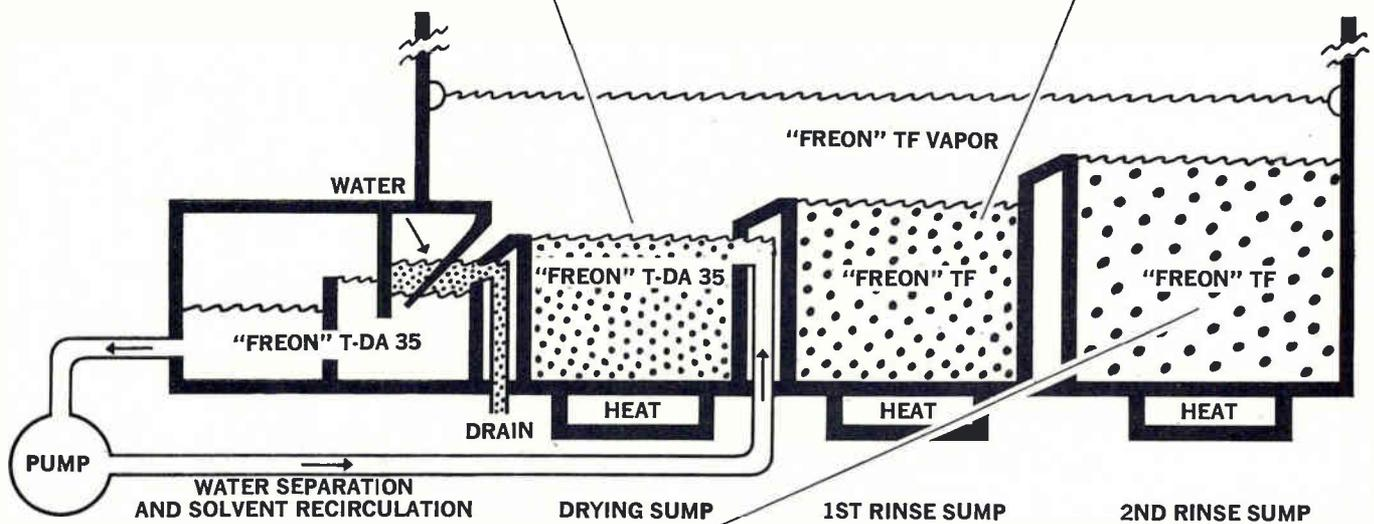

3. Remove the parts from the first rinse sump. Allow to drain and then place in the second rinse sump. Remove the parts and hold them in the vapor zone above the sump. When the dripping stops, remove the parts from the drying system. Parts will be completely dry, spot-free and immediately ready for further processing.

The whole, remarkably simple operation takes only a few short minutes. Furthermore, it is completely safe. FREON solvents are nonflammable, nonexplosive, nonirritating and low in toxicity. For further information on the efficient, economical FREON Solvent Drying System, write: Du Pont Company, Room 7304-1 Wilmington, Delaware 19898.



Woven-wire memories go commercial

Basic unit includes 4,096 16-bit words plus drive electronics; plug-in modules challenge core systems in cycle time and price

Many manufacturers make plated-wire memories, but almost all of these have been aimed at in-house applications for computer manufacturers, or at the military. Now Japan's Toko Inc. says that its HS-500R woven plated-wire memory is the first specifically intended for commercial applications—including small-computer main frames, process control computers,

and test equipment—to be made available in the U.S.

The Toko memory was shown initially in the U.S. at the Fall Joint Computer Conference. Some 20 to 30 systems already have been ordered as a result of an earlier showing in Japan. The basic unit includes 4,096 words, each 16 bits long, plus all word and digit drive electronics, timing, and control cir-

cuitry. A typical system might include 8,192 16-bit words and sell for between eight and nine cents a bit in single-unit quantities; in lots of 100, the price would drop to about five cents a bit.

Spokesmen for Toko say that the price is easily competitive with core systems offering cycle times of less than one microsecond. The HS-500R has a cycle time of 500



Programable data terminal model 711 is designed to be used remotely, and through use of its modern link work directly with a central processor. It is integrated with a desk and consists of: an alphanumeric keyboard, a 12-key pad, 8 function keys, speed printer unit, magnetic tape unit, modem and core memory. Daedalus Computer Products Inc., N. Syracuse, N.Y. [4211]

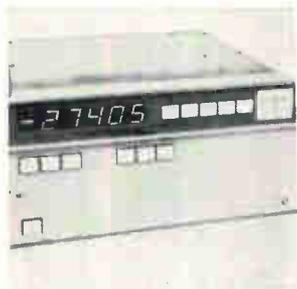

Mini-computers Comp-16 and Comp-18 are ruggedized devices. Features are: 1 μ sec full memory cycle time, 6 memory index registers, parallel I/O bussing, and octal read-out on the front panel. Some significant optional features are independently running memories (for high through-put), and up to 6 hardware index registers. Uni Comp Inc., 18219 Parthenia St., Northridge, Calif. [4223]



Data coupler model DC820 is a solid state device that connects a remote teletypewriter terminal to a time sharing computer over standard telephone carrier lines. Each data coupler unit acoustically couples transmitted data signals. The units are available for acoustical or magnetic coupling of received data signals. Paragon Systems Inc., 2803 Buffalo Speedway, Houston [4233]

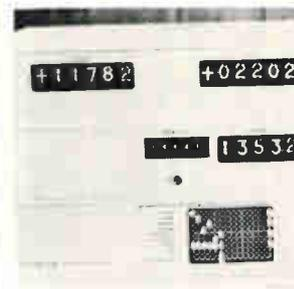

Automatic film readout system uses latest concepts in solid state design. X, Y, and frame count numbers shown on large counter lamps are transmitted to various storage and printout media such as punch cards, magnetic tape, or electric typewriter. Modular design permits quick interchange of functions and growth of a system. Traid Corp., 777 Flower St., Glendale, Calif. 91201 [4243]



Computer-compatible vacuum tape drive with automatic loading tape cartridge is designed for data acquisition systems, data communications terminals, and small computers. The V-series vacuum tape drives are designed to provide extreme flexibility in meeting OEM customer's needs. Price is less than \$3,000. Digital Information Devices Inc., Welsh Pool Road, Lionville, Pa. 19353 [4253]

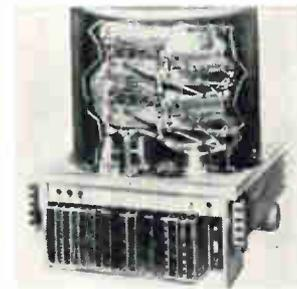

Rotating digital memory device DDC 73-03 provides up to 8 dual disks and 1,024 data tracks, with bit-packing densities up to 35,000 bpt at 3,600 rpm nominal rotational speed. It will mount in a 19-in. rack as do the former DDC models, and retains the same non-contact flying head mechanization. Digital Development Corp., 5575 Kearny Villa Rd., San Diego, Calif. 92123 [4263]

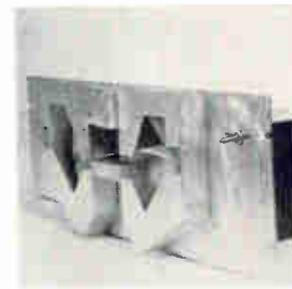

One-moving-part optical perforated tape reader HS-300 will step and read at 300 characters a second. It uses silicon solar cells to co-act with a silicon solid state amplifier to provide a highly reliable sensing device that is insensitive to extreme temperature variations. Slew mode run is +4.5 v; stop is ground to +0.2 v. Data Term Inc., 1611 Manning Blvd., Levittown, Pa. [4273]

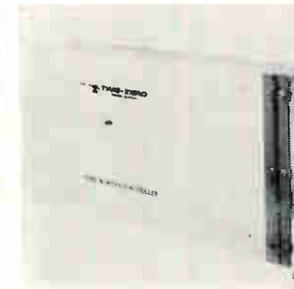

Universal rotating file controller 9024 is for efficient execution of tasks common to all rotating file controllers such as serial/parallel conversion, track selection, sector addressing, read/write control, status reporting, as well as error checking. Price range is \$7,000 less options. Availability is 8-12 weeks. Time-Zero Corp., 3530 Torrance Blvd., Torrance, Calif. [4283]

Time Sharing Economy



Model 200
General Business Calculator
 Half-cent round off, +, -, ×, ÷, reciprocals, percentages, chain multiplication, weighted averages, automatic extension, etc. Two independent adders, a product register, large readout display and automatic floating decimal point.
\$860.00 per keyboard*

Model 210
Statistical Calculator
 All the features and functions of the Model 200 plus \sqrt{x} and x^2 by single keystroke for $\sum x$, $\sum x^2$, $\sum y$, $\sum y^2$, $\sum (x+y)$, $\sum x \cdot y$, $\sum \sqrt{x}$, and $\sum \frac{1}{x}$.
\$970.00 per keyboard*

Model 320
General Purpose Calculator
 All the features and functions of the 210 (except half-cent round off) plus $\log x$ and e^x by single keystroke for more advanced statistical, scientific and engineering calculations.
\$1282.50 per keyboard*

Model 360
Extra Storage Calculator
 All the features and functions of the Model 320 plus four extra data storage registers for complex calculations without re-entry of intermediate results.
\$1497.50 per keyboard*

*Four keyboards operating simultaneously from a single electronic package.
 Price in 48 contiguous states and District of Columbia.

...exclusively with Wang electronic calculators

You'll get more for your money when you need more than one calculator. Wang's unique multiple-keyboard concept lets up to four operators utilize the electronic speed of its "brain" simultaneously like large time-shared computers. The briefcase-size "brain" can be located anywhere up to 200 feet from the compact keyboards. Choose any of the models above when you want economy without sacrificing performance. **NOW AVAILABLE!** Model 301 Column Printer; plugs into any of the models above to validate input and permanently record output.



Dept. 11H, 836 North St., Tewksbury, Massachusetts 01876 • Tel. 617 851-7311

Call today!

(201) 272-7160	(303) 364-7361	(404) 633-6327	(515) 288-5991	(616) 454-4212	(802) 223-6398
(203) 288-8481	(305) 563-8458	(414) 442-0160	(516) 437-2500	(617) 542-7160	(805) 962-6112
(205) 881-5360	(305) 841-3691	(415) 692-0584	(601) 875-5588	(702) 322-4692	(808) 536-5359
(206) 525-2000	(309) 673-6620	(501) 666-7115	(602) 274-2110	(703) 595-6777	(813) 872-7347
(212) 682-5921	(312) 297-4323	(503) 297-2501	(608) 255-4411	(704) 372-9660	(816) 444-8388
(213) 776-2985	(313) 352-7112	(504) 729-6858	(612) 881-5324	(713) 666-2451	(915) 565-9927
(214) 361-7156	(314) 997-5866	(505) 255-5775	(614) 488-9753	(714) 276-8464	(918) 743-2571
(214) 958-1810	(315) 463-9770	(512) 454-4324	(615) 524-8648	(716) 328-2510	(918) 747-0018
(215) 642-4321	(316) 262-1388	(513) 531-2729	(615) 889-1408	(717) 236-4782	(919) 272-5683
(301) 588-3711	(401) 421-0710	(513) 771-3445	(615) 266-5055	(801) 487-2551	

nanoseconds and an access time of 250 nsec. The memory's organization permits expansion to 16,000 words by 16 bits, or 32,000 words by eight bits, using the same basic timing, digit driver and sense amplifier. The plated-wire stack itself, as well as all cards for the system's electronics, are plug-in modules that fit into standard commercial printed-circuit board connectors.

One of the advantages Toko is citing vis-a-vis core memories is that the HS-500R requires no temperature compensation for the associated electronics to operate from

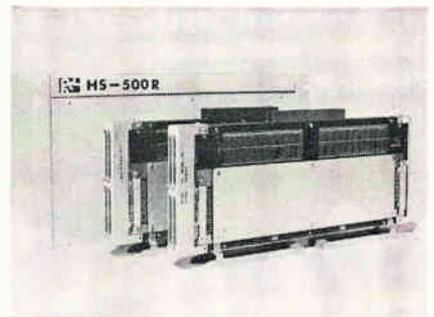

System-ready. Woven plated-wire memories are plug-in modules that fit into standard p-c boards.

0° to 50°C; the company maintains that almost all comparable cores require temperature compensation of some kind, and this complicates the system.

The wire system's addressing is random, and the standard interface is compatible with transistor-transistor-logic voltage levels. The read-recycle (destructive readout) memory fits into a standard 19-inch-wide rack, and the 16,000-word by 16-bit version is 10 inches high and 13½ inches deep.

Toko says it's working toward 10,000 hours of life tests on the plated-wire stack; close to 8,000 equivalent hours have been accumulated with no failures or degradation, the company says.

For the first five months, original equipment manufacturers may purchase evaluation quantities of the system; production quantities will be available in six to nine months, and a technical assistance group has been set up in the U.S.

Toko N.Y. Inc., 350 Fifth Ave., New York, N.Y. 10001 [429]

Meet decision makers in medical electronics

Physicians, hospital administrators, biomedical engineers, educators, researchers, system design engineers who attend the 2nd National Conference & Exposition on Electronics in Medicine represent real buying power. We know because we asked the attendees at the first conference last spring how much they spent on medical electronics and their responses added up to a whopping \$36 million—about ten per cent of the 1968 market.

buying and specifying influence

What's more, the second conference has been designed to meet the overwhelming demands of the earlier attendees for direct exposure to actual hardware. We're inviting manufacturers of medical electronics gear to take advantage of this unprecedented opportunity by exhibiting at the exciting 2nd National Conference on Electronics in Medicine in San Francisco. Through a carefully crafted program of invited papers by leaders in the field, and discussion group sessions on vital questions, the Conference will attract the people manufacturers want to meet most — the men who make the buying and specifying decisions in a \$400 million market. The 2nd

National Conference & Exposition on Electronics in Medicine is presented by McGraw-Hill's Electronics/

prestige sponsorship

Management Center in association with the McGraw-Hill publications: Electronics/Medical World News/Modern Hospital/Postgraduate Medicine/Scientific Research. It is managed by National Expositions Co., Inc., the highly regarded exposition management firm based in New York.

aggressive promotion

Full page ads, dynamic editorial coverage and a comprehensive mail campaign will find every buying and specifying influence in medical electronics wherever he works—hospital, research laboratory, consultant's office, university, clinic or private practice. He'll be reached repeatedly and effectively with our message. And that message is—the Second National Conference and Exposition on Electronics in Medicine is the place to discuss his urgent requirements first-hand with you—the people with expertise who can fill them.

opportunities for marketers

The Second National Conference and Exposition on Electronics in Medicine can help you find and sell new customers, create impressive lists of new, valuable contacts and achieve significant penetration in this exploding market. Space is limited, so make your reservation now.

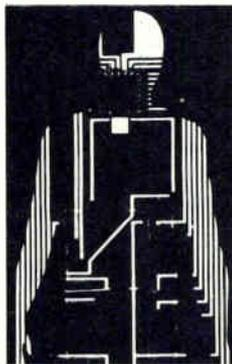

2nd National Conference & Exposition on Electronics in Medicine

FAIRMONT HOTEL, SAN FRANCISCO, CALIF. • FEBRUARY 12, 13, 14, 1970

Write or call for brochure, floor plan: Jerry Brown, Exhibit Manager, National Expositions Company, Inc.

14 West 40th St., New York, N.Y. 10018, 212/564-8714

Introducing: build-a-still



It's a revolutionary new idea. And, like many revolutionary ideas, basically simple.

Here's how it works. The basic parts of the still come as separate modules you can add on to one another. So the still expands as your needs grow.

The basic Thermodrive™ Distillation System comes in a 50 gph configuration. When you need more, you simply bolt on another 50 gph module . . . again and again . . . all the way up to 1,000 gph. No need to tear down your old system. No need for major reinvestment. You expand.

The standard system puts out pyrogen-free water in the 1 to 1.5 megohm range. For higher purity, and an organic content below measurability, simply add on the Hi-Purity Chamber. Either way, Thermodrive produces distillate faster than anything before. Within seconds after start-up.

Another revolutionary idea: an optional air-cooled condenser. It completely eliminates the need for cooling water. So it pays for itself. Fast. Price? At 300 gph, Thermodrive costs 38% less than comparable conventional systems.

The Thermodrive Distillation System is a major advance in pure water technology. You ought to know about it. Call or write for our comprehensive catalog. Barnstead Company, 225 Rivermoor Street Boston, Massachusetts 02132.

Tel: (617) 327-1600.

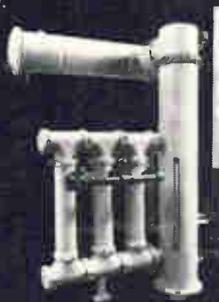

 **BARNSTEAD**
SYBRON CORPORATION

Data handling

Memory designed for peripherals

Semiconductor system
uses MOS technology,
stores 1,600 bits on card

By 1972, the demand for buffer memories for peripheral equipment will account for more than 20% of the static memories being sold, according to projections made by Cambridge Memories Inc. of Newtonville, Mass.

What's more, the company has decided to act on that prediction by designing a product that it hopes will capture a good share of the market.

The company has developed a semiconductor memory for peripherals which it describes as the first character-buffer memory unit on the market that employs metal oxide semiconductor technology for storage.

The sequential-access memory system, designated the MOS-8S, accepts transistor-transistor-logic inputs and provides transistor-transistor-logic outputs.

It stores up to 1,600 bits on a 5¾-by-5¾-inch plug-in card, and is available in configurations ranging from 50 1-bit words up to 200 8-bit words.

The MOS-8S is built to operate as low-cost data formatting unit or line buffer at any speed up to 1 microsecond per character, says Richard J. Egan, marketing vice president of the Massachusetts company.

In addition to metal oxide semiconductor register storage and the transistor-transistor logic input-output interface, the MOS-8S memory contains a clock amplifier and all the timing and control logic required for loading and unloading register information.

A typical module with 150 8-bit words is priced at \$300 in quantities of 100. Delivery time is 30 days.

Cambridge Memories Inc., 285 Newtonville Ave., Newtonville, Mass. 02160 [430]

Rectifier diodes have 100-amp rating

Recovery times for the units are 1.5 or 2 μ sec; voltage range extends from 400 up to 1,300; applications include use as bypass for d-c motors

Until recently, there hasn't been much need for fast-recovery rectifier diodes rated at 100 amperes. Most applications have been either in the region up to 30 amps or in the 250 amps-and-greater range. But International Rectifier, a supplier of these devices, has recognized a growing industrial demand for fast recovery in the 100-amp range as power supplies requiring

bypass diodes get larger, and as inverters call for the 100-amp current rating along with fast recovery capability.

The company moved to fill the need with its 101KL and 101KLR (for reverse polarity) rectifier diodes, which are rated at 100 amps and have recovery times of 1.5 or 2 microseconds, depending on the operating voltage. The voltage

range covered by the units extends from 400 to 1,300.

David Borst, devices product engineering manager in IR's Semiconductor division, sees these uses:

- As bypass or "free-wheeling" rectifier diodes used in equipment with regulated power supply feeding an inductive load, such as a magnet or a direct-current motor.
- In inverters for such equipment

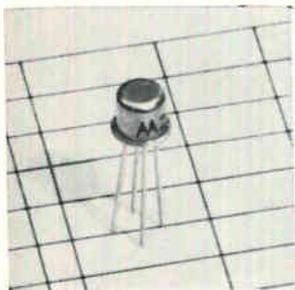

Npn silicon r-f small-signal transistor types 2N5031 and 2N5032, are designed for use as high-gain, low-noise amplifiers in military and industrial equipment. They feature a high power gain of 17 db, low noise figure of 2.5 db (2N5031) and 3 db (2N5032), and high current gain-bandwidth product typically well above 1 Ghz. Motorola Semiconductor Products Inc., Phoenix [436]

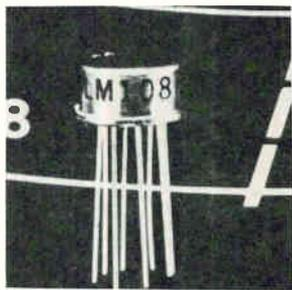

Monolithic general purpose operational amplifier LM108 outperforms FET amplifiers by a factor of 10 over the temperature range from -55° to $+125^{\circ}$ C. Maximum input bias current is 3 na over the temperature range; offset current is less than 400 pa. Power consumption is 1 mw at low voltage. National Semiconductor Corp., 2975 San Ysidro Way, Santa Clara, Calif. [437]

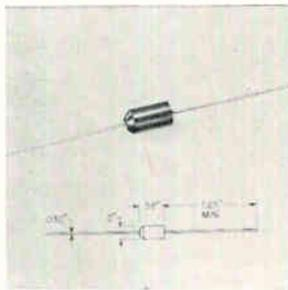

Silicon rectifiers in the BH series are offered up to 5 kv piv, 250 ma in the 0.2 in. diameter x 0.38 in. long D0-27 package. Suited for p-c board mounting, they can be used in twt amplifiers, lasers, radio transmitters, screen supplies, electronic ignition, Xenon flash power supplies, and similar h-f applications. Electronic Devices Inc., 21 Gray Oaks Ave., Yonkers, N.Y. [438]

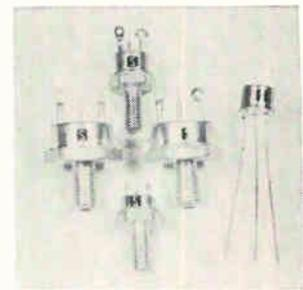

Radiation resistant npn silicon power transistors have breakdown voltages up to 90 v and peak collector currents up to 25 amps. They offer post-radiation gain and low values of $V_{ce(sat)}$ after exposure to neutron flux as high as 3×10^{14} n/C m²-sec. Packages come in isolated and nonisolated shapes. Solitron Devices Inc., Blue Heron Blvd., Riviera Beach, Fla. [439]

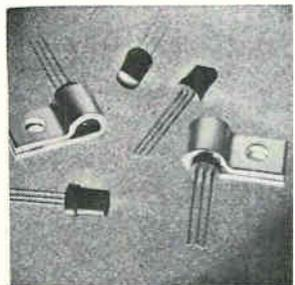

General purpose pnp and npn complementary transistors (D29E and D33D families) are available with or without heat sink in the TO-98 package. They are available with 25, 40 and 60 v breakdown ratings. The devices offer a power dissipation rating of 500 mw at 25° C. Units are priced at 29 cents for pnp and 27 cents for npn in 10,000 lots. General Electric Co., Schenectady, N.Y. [440]

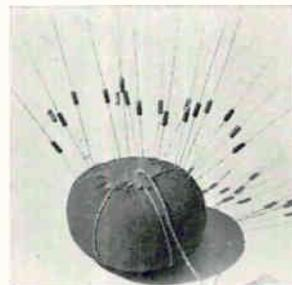

Shockley diodes (4-layer diodes) series APD4C50 are available with a switching voltage of 50 v, holding currents from 1 ma to 100 ma. The diodes are ultrafast with a typical turn-on time of 20 nsec, and a turn-off time of 40 nsec. Typical change in switching voltage from -55° to $+71^{\circ}$ C is less than ± 2 v. American Power Devices Inc., 7 Andover St., Andover, Mass. 01810 [441]

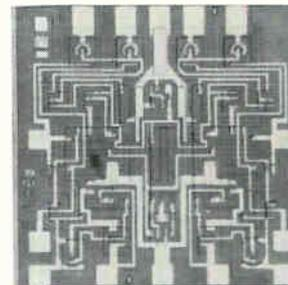

Dual wideband operational amplifier has a high channel separation of 140 db. The #A749 is a linear IC that achieves a gain of 20,000 and an output impedance of 150 kilohms. It is short circuit protected. It features a 20 Mhz unit gain bandwidth. It sells in a range of \$3.49 to \$17.95 according to quantity and temperature chosen. Fairchild Semiconductor, Mtn. View, Calif. [442]

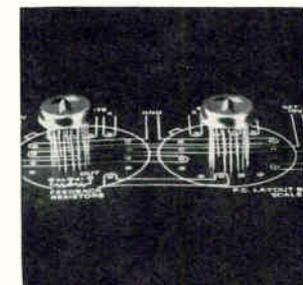

Hybrid IC (CDAS1) contains 8 switching circuits and an R/2R ladder network in two TO-8 16-lead packages. The complete 8-bit d-a ladder network and switching system operates from standard logic and requires only power and operational amplifier to complete an 8-bit d-a converter. Price (1-99) is \$450. Crystalonics, 147 Sherman St., Cambridge, Mass. 02139 [443]



Paris
welcomes you

Paris,
the meeting place of all
the world's electronic experts

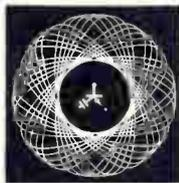

SALON INTERNATIONAL DES COMPOSANTS ELECTRONIQUES

FROM 3rd TO 8th APRIL 1970 - PORTE DE VERSAILLES - PARIS



INTERNATIONAL CONFERENCE ON MICROELECTRONICS

This conference will bring together users
of integrated circuits and specialists
in the design and manufacture of such circuits.

FROM 6th TO 10th APRIL 1970
MAISON DE L'UNESCO - 125, AV. DE SUFFREN - PARIS

S.D.S.A. - RELATIONS EXTERIEURES - 16, RUE DE PRESLES - 75 - PARIS 15^e - FRANCE - TEL. 273 24.70

OFFICIAL AIR-LINES OF THE EXHIBITION CALL FOR INFORMATION - AIR FRANCE.

as uninterruptible power supplies that have a built-in frequency-changing function.

- In inverters for alternating-current motor drives.

- For rectification of high-frequency a-c current.

Comes into play. In discussing the 101KL's use as a bypass diode where a regulated power supply is feeding an inductive load, Borst explains that there's a tendency for the load to try to keep current flowing through it even when a silicon controlled rectifier in the circuit blocks the current flow. This is where the fast-recovery rectifier diode comes into play, providing the continued current flow through the load until the SCR fires again, triggering the normal flow. But without a fast-recovery diode, a high current surge could be imposed on the SCR just as it turns on again, burning it out. The rectifier diode can reduce the effective transient at this point from a peak of, say, 15 amps to 3 amps—well within the tolerance of the SCR in such a circuit.

In inverters for uninterruptible power supplies with a frequency changing function, an unregulated rectifier (a three-phase bridge) might change the three-phase, 60- or 400-hertz a-c flow to d-c. The bridge is followed by a "chopper" to break the d-c flow into pulses, which is followed by the inverter, which runs at a high frequency. Borst says 1,600-hz inverters are in use now to change the current back from d-c to a-c. In this application, the inverter would be followed by a small transformer and a small rectifier for high-voltage potential.

The 101KL is housed in a DO-8 package. It's rated at 100 amps average at a case temperature of 110°C with forward polarity or 120°C with reverse polarity (101-KLR). It can withstand a surge current of 2,500 amps for one-half cycle, and has a maximum I^2t (current squared with time) rating of 26,000 amperes² second, non-repetitive for 5 to 8 milliseconds.

Delivery is from stock and prices range from \$28 for the 400-volt rated device (1.5 μ sec recovery time) in quantities of 1 to 9, to \$70 for the 1,300-volt, 2- μ sec unit.

Semiconductor Division, International Rectifier, 233 Kansas St., El Segundo, Calif. 90245 [444]

New semiconductors

IC's are tailored to consumer jobs

Low-cost linear units
for radios, recorders
are packaged in plastic

By designing two linear integrated circuits specifically for the manufacture of large-volume consumer equipment, Motorola hopes to make them competitive even in such low-cost applications as pocket radios and cassette recorders. The IC's are packaged in plastic, they're of simple design and on small chips to make them less expensive, and they have widely spaced pins.

The MFC4000 is a low-power audio amplifier intended for battery-powered pocket radios. It can provide 250 milliwatts of audio output power, and total harmonic distortion is low—typically 0.7% at 50 mw. The IC chip contains six transistors, three diodes, and five resistors, and reduces the component count in portable radios by two transformers and two transistors. It also eliminates the need for matched components. Standby current is low—typically 3.5 milliamperes, thus minimizing battery drain. Rated power supply voltage is 12 volts.

The other IC, the MFC4010, is intended for low-level audio applications such as an amplifier in a microphone or tape recorder; it can also be used as a 455-kilohertz intermediate-frequency amplifier in an a-m radio. The IC offers at least 60 decibels of gain at low output noise—typically 1 millivolt rms. Maximum allowable power supply voltage is 18 volts, and typical current drain is 3 ma. The chip contains three transistors and five resistors and, like the MFC4000, it's enclosed in a four-lead package.

Both circuits are available from factory and distributor stocks, Motorola reports. Price in 100-and-up quantities is \$1.40 for the 4000 and \$1.25 for the 4010.

Motorola Semiconductor Products, Box 20912, Phoenix, Ariz. 85036 [445]

locally... off the shelf

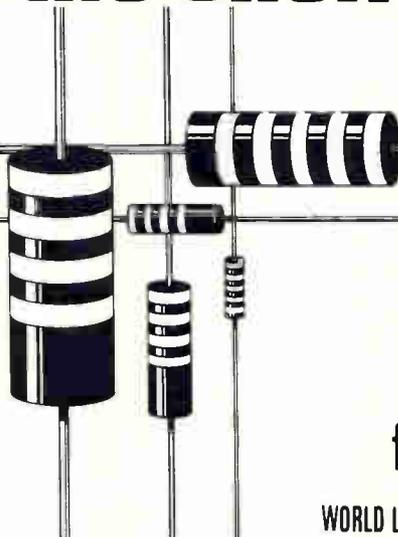

Allen-Bradley hot-molded composition fixed resistors

WORLD LEADER IN FIXED RESISTORS

Unequaled for reliability—Allen-Bradley hot-molded resistors are *unique* in meeting the requirements of MIL-R-390008 *Established Reliability* Specifications at the highest level—the "S" level. This is true for all four ratings—RCR32 (1 watt), RCR20 ($\frac{1}{2}$ watt), RCR07 ($\frac{1}{4}$ watt), and RCR05 ($\frac{1}{8}$ watt). And over the complete resistance range from 2.7 ohms (10 ohms for $\frac{1}{8}$ watt) to 22 megohms.

The distributors listed below are the only authorized Allen-Bradley distributors, and each has added a new dimension of service—fully stocked to give you fast delivery on hot-molded fixed resistors, hot-molded and cermet variable resistors and trimmers, discoidal capacitors, and high-frequency low pass feed-thru filters.



call now!

PHILADELPHIA

ALMO ELECTRONICS CORP.
A Sterling Electronics Company
Roosevelt Blvd. at Blue Grass Road
Philadelphia, Pennsylvania 19114
(215) OR 6-6000

BOSTON

CRAMER ELECTRONICS INC.
320 Needham Street
Newton, Massachusetts 02164
(617) 969-7700

SAN FRANCISCO

ELMAR ELECTRONICS INC.
A Subsidiary of Wyle Laboratories
2288 Charleston Road
Mountain View, California 94040
(415) 961-3611

LOS ANGELES

KIERULFF ELECTRONICS INC.
A Subsidiary of Ducommun Inc.
2585 Commerce Way
Los Angeles, California 90022
(213) 685-5511

CHICAGO

NEWARK ELECTRONICS CORPORATION
A Subsidiary of Premier Industrial Corporation
500 North Pulaski Road
Chicago, Illinois 60624
(312) 638-4411

NEW YORK

SCHWEBER ELECTRONICS
Jericho Turnpike
Westbury, New York 11590
(516) 334-7474

©Allen-Bradley Company 1969

EC69-88A

WE'VE GOT A BETTER WAY TO MAKE PRINTED CIRCUITS!

Here's some Industrial History you should know!

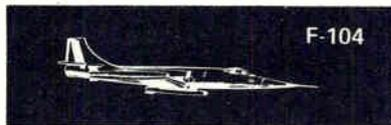
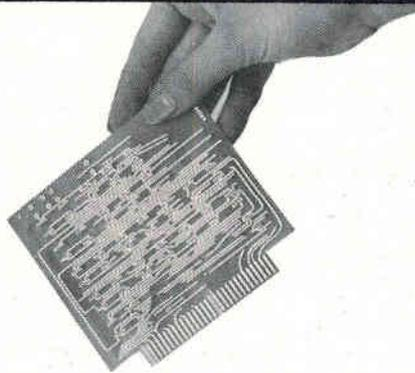

F-104

Developed new technique to produce circuit boards with more reliable plated-thru holes.

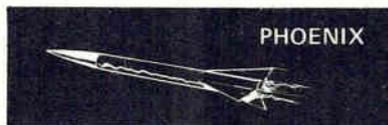

PHOENIX

Required new techniques for manufacturing heat sinks and insulation by chemical milling.

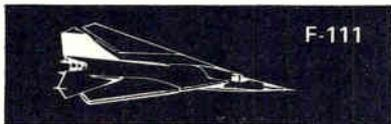

F-111

New industry technique was used to produce multilayer circuit boards with an internal heat sink.



POSEIDON

Developed new technology for sequential laminating multilayer circuit boards with aluminum backbones.



707

Reliable circuit boards in high volume at low cost were produced for this project.



MERCURY

Our company used a unique etch-back method for plated-thru holes in large quantities.

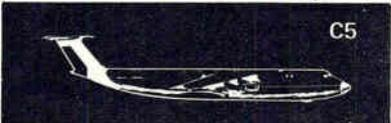

C5

We introduced circuit boards that had the highest density circuitry ever used before on a production basis.



GEMINI

Again, top reliability was required and delivery on-time was made to the customer.

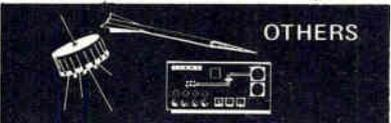

OTHERS

Hundreds of projects use our circuit boards in all phases of civilian and military equipment. We've got a better way to make printed circuitry.

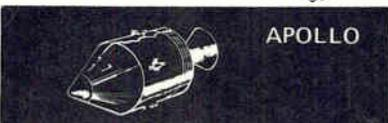

APOLLO

Our circuit boards were on Apollo, LEM, and seis. experiment. Sequential laminating, extra-fine line width and spacing, plated slots and edges.



This design & production experience can give you a BIG JUMP on your next project. CALL US NOW!

**CONTROL DATA
CORPORATION**

CONTROL DATA CORPORATION

PRINTED CIRCUITS OPERATION
7800 COMPUTER AVENUE
MINNEAPOLIS, MINN. 55435
PHONE: (612) 920-8600

New Books

Micropower manual

Micropower Circuits
James D. Meindl
John Wiley & Sons, Inc.
250 pp., \$10.95

Whenever frugal consumption of energy is one of the constraints on an electronic circuit, some special design techniques are called for. James Meindl's informative book presents these techniques and explains the principles behind them, for both discrete and integrated-circuit applications.

Extremely low-power circuits are increasingly important in such high-volume applications as shirt-pocket radio receivers, cardiac pacemakers, navigational satellites, hand-held radio transceivers and radars. In these micropower circuits, the quiescent power consumption of transistors is characteristically less than 1 milliwatt. To get and maintain micropower operation requires close consideration of parameter tolerances, temperature variations, changes in supply voltage, aging, and deleterious environments such as radiation.

Micropower circuits tend to be much more specialized than those that operate at more common power levels. This is because more of the design parameters are critical and although individually they are not unduly restrictive, in combination they limit the range of usefulness of the circuit.

The author begins by offering mathematical models of devices operating in the micropower range: p-n junction diodes, bipolar and field effect transistors, tunnel diodes, and passive elements. The last may represent a particular problem in monolithic micropower IC's, since the large-value resistors necessary to obtain the smaller quiescent currents of micropower circuits tend to occupy excessively large areas on the silicon chip. Several approaches to the problem are given.

An entire chapter is devoted to the quiescent point, or d-c operating-point, which is the single most important consideration in micropower circuit design. Two methods of attacking the quiescent-point stability problem are explored. One

is to base the design on the nominal quiescent power specification, design the circuit, then evaluate the stability of the quiescent point and make adjustments as necessary by trial and error. The other method is to start with a stability specification—a definition of the acceptable range of operating points—and calculate the component values. In either case, various stabilizing circuit configurations are available and are analyzed by the author: emitter degeneration, collector degeneration and diode compensation, transistor compensation, the emitter-coupled pair, and the feedback pair.

Each succeeding chapter concentrates on a specific circuit. Micropower low-frequency amplifiers, wideband amplifiers, mixers and detectors, low-noise amplifiers, bipolar digital circuits, FET digital circuits, and many others are analyzed. The concluding chapter briefly examines the major application categories: portable equipment, aerospace electronics, and biomedical electronics.

The book contains a comprehensive list of symbols and each chapter is extensively referenced.

How to do it

Digital Computer Methods in Engineering
S.A. Hovanessian and L.A. Pipes
McGraw-Hill Book Co., 400 pp., \$14.50

For the engineer who has studied either Fortran or Basic—two widely used programming languages for scientific batch-processing systems and for time-shared systems, respectively—or who is studying them concurrently, the authors have written a text purporting to describe how to write a computer program employing one or the other of these languages, to solve mathematical problems encountered in engineering.

Unfortunately they seem to have gotten their assumptions somewhat confused. They have assumed two years of engineering mathematics and no prior knowledge of computer programming. Yet much of each chapter is devoted to a review of what was presumably included in the two years of math. This is followed by one or two numerical examples and a listing, in either Fortran or Basic, of a program to solve

immediate delivery

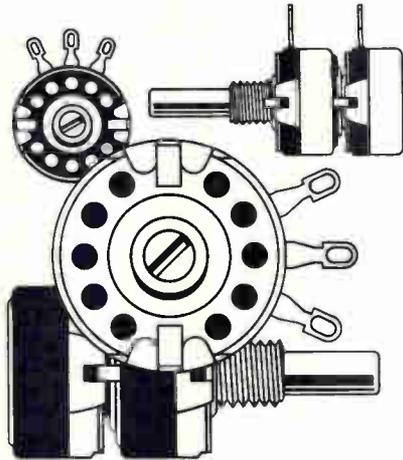

Allen-Bradley hot-molded variable resistors

The famous Type J variable resistor has a solid hot-molded resistance element, which ensures smooth adjustment at all times—resolution is essentially infinite. Low inductance permits the Type J to be used in high-frequency circuits replacing wire-wound controls.

Type J controls are available in single and dual units. Rated 2.25 watts at 70°C in values from 50 ohms to 5.0 megohms, with a wide variety of tapers.

The distributors listed below are the only authorized Allen-Bradley distributors, and each has added a new dimension of service—fully stocked to give you fast delivery on hot-molded fixed resistors, hot-molded and cermet variable resistors and trimmers, discoidal capacitors, and high-frequency low pass feed-thru filters.

call now!



PHILADELPHIA

ALMO ELECTRONICS CORP.
A Sterling Electronics Company
Roosevelt Blvd. at Blue Grass Road
Philadelphia, Pennsylvania 19114
(215) OR 6-6000

LOS ANGELES

KIERULFF ELECTRONICS INC.
A Subsidiary of Ducommun Inc.
2585 Commerce Way
Los Angeles, California 90022
(213) 685-5511

BOSTON

CRAMER ELECTRONICS INC.
320 Needham Street
Newton, Massachusetts 02164
(617) 969-7700

CHICAGO

NEWARK ELECTRONICS CORPORATION
A Subsidiary of Premier Industrial Corporation
500 North Pulaski Road
Chicago, Illinois 60624
(312) 638-4411

SAN FRANCISCO

ELMAR ELECTRONICS INC.
A Subsidiary of Wyle Laboratories
2288 Charleston Road
Mountain View, California 94040
(415) 961-3611

NEW YORK

SCHWEBER ELECTRONICS
Jericho Turnpike
Westbury, New York 11590
(516) 334-7474

©Allen-Bradley Company 1969

EC69-89A

How fast is GE's new helium leak detector?

Let your fastest operator show you

Manufacturers of electronic components asked us to help cut down leak test time.

So General Electric engineers designed a new leak detector to do the job.

It's the LC-40 Mass Spectrometer Helium Leak Detector, which offers unmatched testing speed in a general purpose leak detector. The LC-40 achieves this by combining the highest net pumping speed of any leak detector on the market (for equivalent sensitivities), with fast recovery from leaks. This combination pays off in a time-to-test of only seconds.

Complementing this test-time capability is a new simplified control system, which permits the operator to complete a test merely by loading the test piece and flipping a single switch. Results are instantly displayed on a meter.

But the LC-40 detector isn't just fast. It includes such performance-proven features as all-solid-state circuitry for dependable service; burnout-resistant thoriated iridium filament, exclusive with GE; all-welded stainless steel high vacuum system; high sensitivity (5×10^{-11} atmo. cc/sec He), a new source design to eliminate background signals, and many other significant advances.

Although ideally suited for high-speed production testing, the unit also can be used for general purpose applications. If you would like to learn more about General Electric's new LC-40 Mass Spectrometer Leak Detector, write General Electric Company, Analytical Measurement Business Section, 4MX, 25 Federal Street, West Lynn, Mass., 01905

268-41



GENERAL  ELECTRIC

New Books

the example. There is only a one-paragraph explanation of the listing, and one paragraph doesn't explain much. A crutch is available, in the shape of references to Fortran and Basic handbooks, but the crutch isn't really adequate.

As a review of certain mathematical techniques, or even as an introduction to them, the book is quite good. But to the nonprogrammer the listings are rather confusing, because they lack adequate accompanying explanations. Perhaps they'd be less confusing to persons with more than a nodding acquaintance with Fortran and Basic, but could such persons be described as nonprogrammers? The best way to become acquainted with a language is to write programs using it.

Chapter 1 is a review of determinants and matrixes and their use in solving systems of simultaneous equations. Chapter 2 explains eigen values and their relationship to phenomena encountered in engineering—for example, transients in electrical networks. Chapter 3 describes methods of finding the roots of polynomials and of interpolating and curve-fitting.

Chapter 4 gets into an area that's fairly close to current state-of-the-art techniques—in the shape of time-frequency domain problems and the fast Fourier transform. Converting between time and frequency domains, of course, isn't new, but it's been such a horrendous task that even with high-speed computers it wasn't attempted except for rather coarse resolutions—until about four years ago, when the so-called fast Fourier transform was developed, or rediscovered. How this technique took off like a scalded cat must surely rank as one of the more remarkable success stories in science and technology.

Other chapters discuss the calculus of finite differences, ordinary and partial differential equations, linear programming and its extensions to separable programming. The last chapter in the book is about dynamic programming, or the art of optimizing the outputs of various units with different characteristics operating in series or parallel.

Gunning for oscillators

Gunn devices in microwave integrated circuits, H.C. Huang, J. Cohen, W.P. Dawson, W.C. Myers, Monsanto Co., St. Louis, Mo.

As microwave integrated circuits replace discrete units, Gunn-effect devices are finding increased use as oscillator sources. A development program under way at Monsanto has produced both continuous wave and pulsed C-band Gunn sources, with efficiencies of 1.6% at a cw output of 40 milliwatts and 6.3% at 9.5 watts peak.

GaAs n^+n-n^+ vapor-grown sandwich structures are used for both cw and pulse devices. For cw operation the density of the active region is $5 \times 10^{14} \text{ cm}^{-3}$, while for pulse operation this region is $2 \times 10^{15} \text{ cm}^{-3}$. The active region length is approximately 20 microns for both cases.

Pulsed operation uses the hybrid mode of operation, which bridges the gap between the domain mode and LSA mode. In the hybrid mode the domain formation time is comparable to the r-f period, so the electric field in the active region is in the negative resistance region for most of the time. Thus, the device remains active for most of the r-f period. In addition, the hybrid mode may be operated over a wide range of frequencies.

These oscillators were tested for output power and operating frequency with respect to temperature. Several circuit configurations with different Q's were used. Results show that the temperature coefficient can be controlled by the r-f resonant circuit.

For the pulsed oscillators, the total frequency variation from -55°C to $+70^\circ\text{C}$ is ± 5 megahertz at C-band. The power variation over the same temperature range is less than 1.5 db. And the load pulling typically is 100 Mhz for a load-voltage standing-wave ratio of 1.3 at all phases.

Similar measurements were made in C-band with cw oscillators, using external circuit Q's of 40 and 80. With an external Q of 40, for example, the temperature coefficient is 1 Mhz/ $^\circ\text{C}$. The amount of load pulling was ± 20

now... local stock

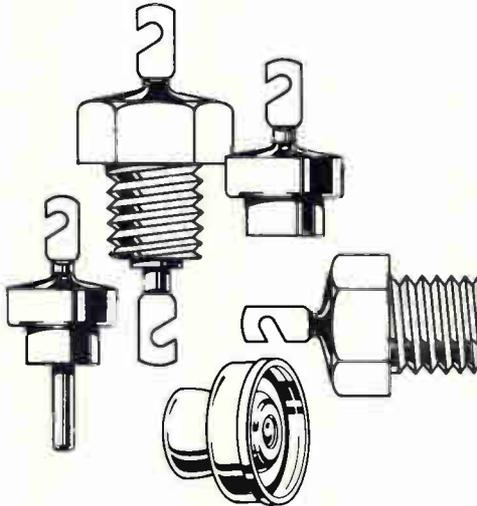

Allen-Bradley discoidal capacitors

Discoidal design provides efficient filtering into the ultra-high frequency range—there are no parallel resonance effects up through 1000 megahertz. Insulation resistance is in excess of 100,000 megohms—assures superior direct current blocking.

Compact in size, yet rugged in construction. These capacitors resist the thermal shock of soldering and require no special handling during assembly. Available in a wide range of capacitance values.

The distributors listed below are the only authorized Allen-Bradley distributors, and each has added a new dimension of service—fully stocked to give you fast delivery on hot-molded resistors, hot-molded and cermet variable resistors and trimmers, discoidal capacitors, and high-frequency low pass feed-thru filters.



call now!

PHILADELPHIA

ALMO ELECTRONICS CORP.
A Sterling Electronics Company
Roosevelt Blvd. at Blue Grass Road
Philadelphia, Pennsylvania 19114
(215) OR 6-6000

BOSTON

CRAMER ELECTRONICS INC.
320 Needham Street
Newton, Massachusetts 02164
(617) 969-7700

SAN FRANCISCO

ELMAR ELECTRONICS INC.
A Subsidiary of Wyle Laboratories
2288 Charleston Road
Mountain View, California 94040
(415) 961-3611

LOS ANGELES

KIERULFF ELECTRONICS INC.
A Subsidiary of Ducommun Inc.
2585 Commerce Way
Los Angeles, California 90022
(213) 685-5511

CHICAGO

NEWARK ELECTRONICS CORPORATION
A Subsidiary of Premier Industrial Corporation
500 North Pulaski Road
Chicago, Illinois 60624
(312) 638-4411

NEW YORK

SCHWEBER ELECTRONICS
Jericho Turnpike
Westbury, New York 11590
(516) 334-7474

©Allen-Bradley Company 1969

EC69-90A

What happened when doctors and engineers got together:

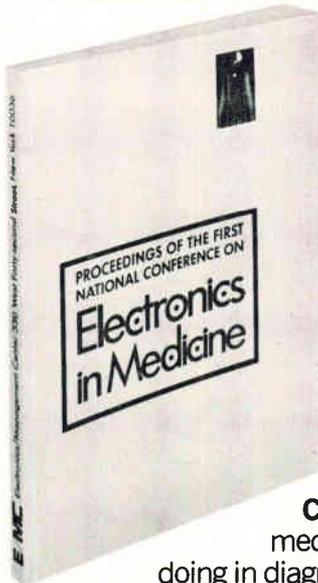

Doctors told engineers how they were using electronics and revealed their most urgent needs. Engineers described and demonstrated their newest equipment for diagnosis, treatment, and prevention. And hinted at things to come.

Their complete dialogue, with illustrations, makes pretty informative reading on a vital and growing market.

Here are some of the things it contains:

Computers: How they're joining the medical team. What computers are doing in diagnosis. In communications. The small computer as a paramedical aid.

Instrumentation: What's needed. What's available. Patient management. Protection. Standards and safety.

Electronics in the Hospital: The surgeon, the hospital, the instruments. What the administrator wants. Prescription for large-scale health care. The surgery department.

Electronics/Management Center
330 West 42nd Street, New York, N.Y. 10036

Enclosed is \$12 for a copy of the Proceedings of the First National Conference on Electronics in Medicine.

Send the Proceedings and bill me later. P.O. # _____

Name _____

Company _____

Address _____

City _____ State _____ Zip _____

Technical Abstracts

Mhz with a load vswr of 1.3 at all phases. With an external Q of 80, the temperature coefficient is 0.5 Mhz/°C. The corresponding amount of load pulling was ± 10 Mhz for the same load variation. Furthermore, in both cases, the power variation over the temperature range was less than 1 db.

Presented at the Microelectronic Symposium, St. Louis, Sept. 10, 1969

Roll out the antenna

High-efficiency spacecraft phased arrays using deployable helix elements
K.G. Schroeder and K.H. Hering
TRW Systems Group
Redondo Beach, Calif.

As missions become more complex, spacecraft antenna systems will be getting larger and more sophisticated. But because the size of an antenna that can fit into a spacecraft package is limited, designers are turning to antennas that are unfurled only when they've been successfully boosted into space.

TRW Systems group has been experimenting with an unfurlable helix radiator, operating both alone or in a four-element phased array. Such a phased system can produce steerable multiple beams whose shapes are variable and whose side-lobe levels can be closely controlled.

Basically, the antenna consists of a thin-walled plastic tube on which a conductive helix has been deposited. The tube would be rolled up before the spacecraft is launched, but once out in space stored mechanical energy would roll the tube out to a rigid position, like a paper "party favor" that straightens out when inflated.

Four types of unfurlable helix elements were tested by measuring their radiation pattern, gain, voltage standing wave ratio, and axial ratio. Each element was manufactured from a different kind of ultraviolet light-resistant Kapton fiberglass cloth laminate. Copper, beryllium-copper and silver-plated beryllium-copper tapes were used for the helical conductor. Four of the antenna elements also were mounted on a ground plane and fed through a corporate network.

Several conclusions were drawn from the tests:

▪ Impedance matching among elements in the array is excellent, but even though a 50% impedance bandwidth may be feasible, the elements should be used only over a narrow band for maximum efficiency.

▪ If gain is the only requirement, large side and grating lobes can be tolerated.

▪ Aperture efficiencies of more than 50% are possible for a 12-degree scan provided there is amplification at the input to the helices and they operate well below the usual frequency at which optimum gain occurs.

▪ Because they're deployable, the antennas allow a great deal of flexibility in the design of the support structures needed in the spacecraft.

Presented at Eascon, Washington, Oct. 27-29.

Radiant results

Orientation dependence of the gage factor in electron-irradiated silicon
M.A. Littlejohn
North Carolina State University
Raleigh
and
Chris Gross
NASA Langley Research Center
Hampton, Va.

Although silicon semiconductor strain gages are about 100 times more sensitive than their metal counterparts, this advantage hasn't been fully utilized because semiconductor gages have large thermal coefficients of resistance (TCR) and large thermal coefficients of gage factor (TCGF). However, electron irradiation of the silicon provides a means of reducing the TCR and TCGF.

High energy electron bombardment creates vacancies and interstitial silicon atoms which interact with other impurity atoms to form defects in the crystal. Straining the silicon affects the defect structure and electron mobility, and hence the gage's resistance. In effect, bombardment makes the gage less sensitive to temperature variations.

Experiments show that the TCR and TCGF can be reduced even further when the silicon element is made from a crystal that is oriented off the conventional axes from which a silicon wafer is usually obtained.

now... no delay

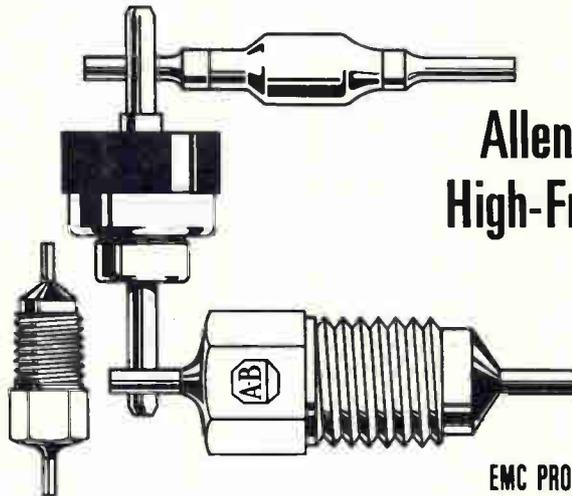

Allen-Bradley High-Frequency Filters

EMC PRODUCT FROM A-B!

These miniature low-pass filters have been specifically designed for use in demanding EMC applications, where the necessary attenuation of undesired high frequencies cannot be obtained with conventional feed-thru capacitors. Attenuations of 75 db or more can be obtained in the frequency range of 50 MHz to 10,000 MHz.

DC working voltages of 200 and 500 volts with feed-thru currents of 10 and 25 amperes, respectively, are featured in this product line.

The distributors listed below are the only authorized Allen-Bradley distributors, and each has added a new dimension of service—fully stocked to give you fast delivery on hot-molded fixed resistors, hot-molded and cermet variable resistors and trimmers, discoidal capacitors, and high-frequency low pass feed-thru filters.

call now!

PHILADELPHIA

ALMO ELECTRONICS CORP.
A Sterling Electronics Company
Roosevelt Blvd. at Blue Grass Road
Philadelphia, Pennsylvania 19114
(215) OR 6-6000

BOSTON

CRAMER ELECTRONICS INC.
320 Needham Street
Newton, Massachusetts 02164
(617) 969-7700

SAN FRANCISCO

ELMAR ELECTRONICS INC.
A Subsidiary of Wyle Laboratories
2288 Charleston Road
Mountain View, California 94040
(415) 961-3611



LOS ANGELES

KIERULFF ELECTRONICS INC.
A Subsidiary of Ducommun Inc.
2585 Commerce Way
Los Angeles, California 90022
(213) 685-5511

CHICAGO

NEWARK ELECTRONICS CORPORATION
A Subsidiary of Premier
Industrial Corporation
500 North Pulaski Road
Chicago, Illinois 60624
(312) 638-4411

NEW YORK

SCHWEBER ELECTRONICS
Jericho Turnpike
Westbury, New York 11590
(516) 334-7474

©Allen-Bradley Company 1969

EC69-91A



the newest shape in receiving antennae

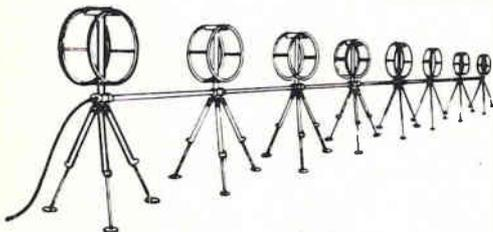

Aperiodic Loop Antennae . . . in an array composed of eight one-metre diameter untuned balanced loops spaced 13 feet apart . . . is the newest concept in "active" h.f. receiving arrays developed by E.M.I.

Each loop is fitted with a transistor pre-amplifier in its base, making possible a broad band (2 to 32 MHz) directional array much like a log-periodic or rhombic antenna. The system is only 30 metres long and a few feet wide. As it occupies but fraction of the space required for conventional passive fixed arrays, it is ideal for applications in areas of restricted space or when quick and simple set-up is important.

The new model 8E13 Aperiodic Loop Antenna Array has us rather excited. We would welcome the opportunity to tell you all about it in detail.

E.M.I. ELECTRONICS CANADA, LIMITED
 Dartmouth, Nova Scotia, Canada
 Mail: P.O. Box 1005
 Phone (902) 466-7491
 Cables: EMI CAN

Technical Abstracts

For example, preparing an n-type silicon strain element cut about 25° to 30° off the 100 axis and then irradiating it with 7 MeV, produces a gage factor of 40 at 68°F, a TCR of 0.75% per 100°C, and a TCGF of 5% per 100°C—between 0°C and 100°C. All these parameters represent significant improvements over metal-strain gages.

Presented at the ISA Annual Conference and Exhibit, Houston, Oct. 27-29.

Looping telemetry errors

Reducing Apollo backup voice-telemetry data interference using a phase feedback-detection process
 Robert J. Panneton and
 W. Bruce Warren
 TRW Systems, Redondo Beach, Calif.

Voice signals transmitted over the Apollo communication system sharply increased telemetry errors. But by abandoning quadrature phase detection, and substituting phase feedback demodulation—which doesn't require excessive modification of the present Manned Space Flight Network (MSFN) demodulation network—errors decrease significantly, experiments show.

Tests were performed to determine the effectiveness of the feedback loop in reducing telemetry degradation using both the 50 and 700 hertz carrier-tracking loop-noise bandwidths for the MSFN receiver. Bit error-rate tests were performed for the 1.6 kilobit/second low rate as well as the 51.2 kilobit/second rate. The most significant improvement in performance was obtained when high bit/rate telemetry data was transmitted. Curves were plotted for lunar module mode 4 with high-bit rate telemetry, with and without the feedback loop, indicating that telemetry performance when using the detector and feedback loop is virtually independent of either voice modulation index or selection of carrier-tracking loop-noise bandwidth.

The presence of baseband voice modulation in the MSFN receiver degrades the 1.024 megahertz telemetry data channel resulting in high bit error rates. Suppression

CLASSIFIED ADVERTISING
SEARCHLIGHT SECTION
 BUSINESS OPPORTUNITIES
 USED OR SURPLUS EQUIPMENT

RADAR SYSTEMS GROUND AND AIRBORNE. AUTOMATIC TRACKING ANTENNA SYSTEMS. NIKE AJAX. NIKE HERCULES. M-33. MSQ-1A. MPS-19. MPS-9. SCR 584. TFS-1D. TFS-2B. TAA-ASR-2. AIRBORNE SYSTEMS. APN-84. APN-102. APS-20. APS-27. APS-45. DPN-19. DIGITAL COMPUTERS. IBM 650. IBM 704.

LARGEST INVENTORY OF RADAR AND MICROWAVE EQUIPMENT IN THE WORLD.

RADIO RESEARCH INSTRUMENT CO.
 45 WEST 45TH ST. N. Y. 10036 212-JU 4-4691

CIRCLE 966 ON READER SERVICE CARD

PATENTED AUTOMATED PILE-DRIVING SYSTEM
 Requires Electronic Circuitry

New computer-controlled system has large potential market in construction industry. Components include accelerometer, monostable multi-vibrator, differential amplifier, comparator, strip chart recorder, etc. Requires manufacturer interested in perfecting electronic circuitry already patented. Will market on royalty basis or sell outright.

Write BO-9481, Electronics
 Class. Adv. Dept., P.O. Box 12, N. Y., N. Y. 10036

CIRCLE 967 ON READER SERVICE CARD

Minifluid DISPENSER
 AIR OPERATED

for miniature potting and encapsulating

Available in 3 sizes
 6cc - 12cc - 30cc

\$34.00 UP

PHILIP FISHMAN COMPANY
 7 CAMERON ST., WELLESLEY, MASSACHUSETTS 02181

CIRCLE 968 ON READER SERVICE CARD

Mr. Used Equipment Dealer:

When you advertise in the Searchlight Section . . . You have hired your most persuasive salesman:

He's efficient . . . He thrives on long hours . . . His territory is the entire nation . . . and overseas . . . He doesn't see buyers of used and new surplus equipment: They see him—regularly. They depend on him.

He is Searchlight—The section of this publication where wise dealers advertise and list their stocks for sale.

SEARCHLIGHT SECTION

Classified Advertising Dept.
 Post Office Box 12
 New York, N. Y. 10036

now... a better way to drive and adjust hex socket screws

...IN PRECISION WORK

With the tools in this new, compact convertible screwdriver set, you can turn all types of hex socket screws... in all types of locations... faster, easier than with conventional keys.

Handy midgets are ideal for such delicate, precision work as assembly and servicing of instruments and controls. Remarkable "piggyback" torque amplifier handle adds grip, reach, and power needed for other applications, lets you do more jobs with fewer tools.



PS-89 SET

8 midgets (hex size .028" thru 1/8") plus hollow, "piggyback" handle. Slim, trim, see-thru plastic case fits pocket or tool box, doubles as bench stand.

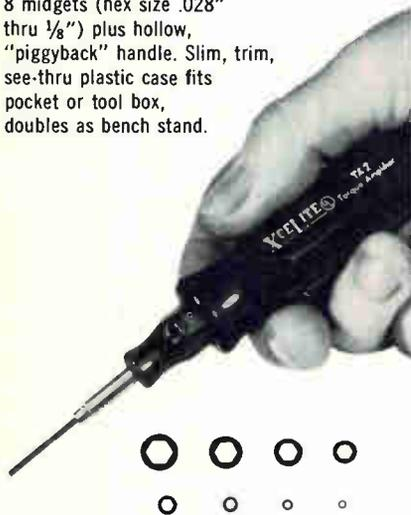

REQUEST COMPLETE HAND TOOL CATALOG

which includes information on other Xcelite Compact Sets, too — slot tip/ Phillips/Scrulox® screwdrivers, nutdrivers, and combinations.

XCELITE

Nationwide availability through local distributor

XCELITE, INC., 130 Bank St., Orchard Park, N. Y. 14127
In Canada contact Charles W. Pointon, Ltd.

Circle 197 on reader service card

Technical Abstracts

of this form of nonlinear distortion can be readily achieved by making the process of phase detection linear.

In the Apollo unified S-band communications system, many signals are phase-modulated on the S-band carrier, and quadrature product detection is used because it doesn't degrade the signal-to-noise ratio. An equation derived for the quadrature product phase-detector output indicates that compression of the voice modulation index will reduce the amount of telemetry interference. Effective linearization of the detector is readily achieved by means of a negative-phase feedback loop around the wideband phase-detector in much the same manner as negative feedback in conventional amplifier design. The voice index is compressed by phase subtraction of the voice spectrum, leaving the telemetry index unchanged.

The carrier phase demodulator consists of an attenuator, band pass limiter, wide-band phase detector, and video amplifier in series. The phase detector is referenced with a 10 Mhz signal. The output of the phase detector is routed to a loop filter which passes only baseband signals, and phase subtraction occurs only for those baseband frequencies so passed. A reduction in backup voice phase deviation and amplitude at the detector output results.

By assuming unity gain for the loop filter and loop amplifier, the input voice phase deviation is reduced from its original value by a feedback factor determined by the loop gain. Thus, the voice index may be compressed to as small a value as desired by increasing the loop gain. Assuming a peak voice modulation index of 1.3, the loop was designed for a feedback factor of 14.5 decibels in the backup voice frequency range, thereby reducing the effective voice index to less than 0.3 radians peak and achieving linear demodulation. The telemetry subcarrier modulation remains unaffected. This is because the loop only passes baseband frequencies.

Presented at Eascon, Washington, Oct. 27-29,

Circle 171 on reader service card →

the im- possible ALCOSWITCH

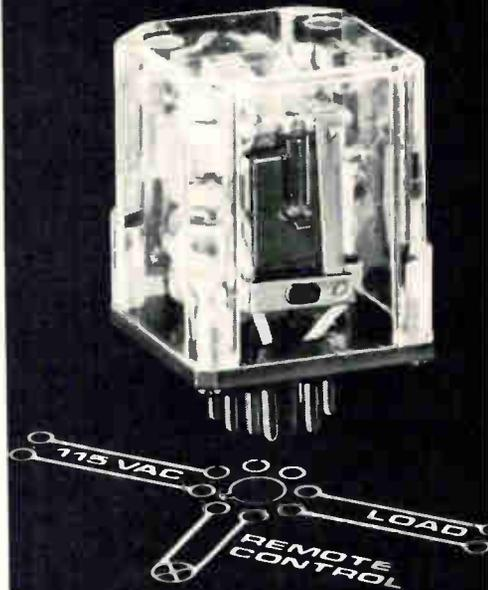

Since when does ALCOSWITCH make relays? Since we learned how to make the impossible switch. All we've done is to combine a step-down transformer and a relay in a single core, all in miniature.

If your product operates on 115 VAC and has possibilities of remote operation chances are you could use this ALCOSWITCH-RELAY!

Refer to the figure below: by simply shorting the remote control leads "xx" the flux path changes thereby closing the relay armature.



The only product in the world of this type that allows you to control up to 600 watts remotely, safely, and economically.

Whether you manufacture hi-fi amplifiers, electric fans, vacuum cleaners, projectors, thermostat controls, consumer appliances or industrial equipment, you may have a need for this revolutionary switching product.

If you are seeking a marketing advantage for your products, we will be happy to assist you by suggesting one of our ALCOSWITCH-RELAYS.

ALCO

ELECTRONIC PRODUCTS, INC.
Lawrence, Massachusetts 01843

Cut remote control costs with Dale Motorized Potentiometers

Thoroughly proven in entertainment instruments, Dale's AC Reversible Motor Driven Pot is a cost cutter for business machines and industrial equipment as well.

■ Used as a bias regulator for solid state devices, it now handles the remote control function for many types of heavy power equipment — eliminating heavy cables between control panels and resistive devices.

■ Versatility increases when equipped with Dale's patented motor load decoupler. Coasting is eliminated and manual control is free of gear motor inertial load.

■ Hysteresis synchronous motor and gear train can be coupled with a wide range of single and multi-turn carbon and wirewound pots as well as with variable capacitors. Motor and gear train are also used as television tuner drive.

SPECIFICATIONS

Operating Voltage — 6, 12, 24, 117 VAC or any specified; **Power Input** — 7.5 volt amperes; **Output** — 5.6 RPM; **Torque at Pot Shaft** — 10 in./oz. min. (with decoupler), 21 in./oz. min. (without decoupler). Up to 4 auxiliary switches can be added for actuation at any degree of cam rotation.

For complete specifications and application information, call 605-665-9301 or write



DALE ELECTRONICS, INC.
SIOUX DIVISION, Dept. ES
Yankton, South Dakota 57078



It's never too early to start saving their hearts

Help your children form good health habits now to reduce risk of heart attack later:

- Encourage normal weight; obesity in youth may persist throughout life;
- Build body health through regular physical activity;
- Serve them foods low in saturated fats;
- Teach them that cigarette smoking is hazardous to health;
- Make medical check-ups a family routine.

Set a good example. Follow the rules yourself and guard *your* heart, too.

GIVE...
so more will live
HEART FUND

Contributed by the Publisher



The Connector-Protector-Detector-Inspector



Here's a connector accessory that serves as a dust cap, inspection fixture, assembly fixture, pin protector, and pin straightener. Now you can guard against the fates of connector mishandling from assembly to installation . . . and at a price comparable to an ordinary dust cap!

Over 25 different insert arrangements in 9 shell sizes are available for



MIL-C-26482 and NAS 1599 Bayonet Coupling Connectors, and in various clocking positions. Shell and insert identification is molded into the face of each unit, and it is color coded for easy reference . . . plugs are yellow, receptacles are blue. Veritectors are nonmagnetic, impervious to salt spray and seal connectors against hostile environment.

They can be used over and over, meeting or exceeding 500 cycles of durability.

For the complete story and specifications on the Veritector family, ask for our brochure. Write, or call us at (213) 341-0115.

CONTROL DATA
CORPORATION

Control Data Corporation
Connector Operation
8758 Remmet Avenue
Canoga Park, California 91304

Circle 198 on reader service card

New Literature

Control consoles. Agac-Derritron Inc., P.O. Box 358, Alexandria, Va. 22314, has available an eight-page catalog fully describing its line of automatic equalizer/analyzer control consoles. Circle 446 on reader service card.

Solenoids. Guardian Electric Mfg. Co., 1550 W. Carroll Ave., Chicago, Ill. 60607, has issued a 44-page catalog describing its complete line of traditional and new tubular solenoids. [447]

Multiplex teleprinter system. Barry Research, 934 E. Meadow Dr., Palo Alto, Calif. 94303, offers literature describing the latest additions to its product line of p/m-p-m multiplex teleprinter systems. [448]

Computer capabilities. Universal Systems Inc., 2351 Research Blvd., Rockville, Md. 20850, has published a booklet relating its capabilities to major computer programs in communications, transportation, and automation. [449]

CCTV systems monitors. Westinghouse Electric Corp., P.O. Box 868, Pittsburgh, Pa. 15230. Portable solid-state monitors, specially designed for use in closed-circuit television systems, are described and illustrated in bulletin TD95-262. [450]

Universal breadboard. Analog Devices Inc., 221 Fifth St., Cambridge, Mass. 02142, offers a data sheet describing the low-cost (\$250) model 194 operational manifold and associated accessories. [451]

Laser modulators. Monsanto Electronic Special Products, 10131 Bubb Rd., Cupertino, Calif. 95014, has published a brochure entitled "Fundamental Concepts Related to the Operation of CO₂ Laser Modulators". [452]

Operational amplifier noise. Philbrick/Nexus Research, Allied Dr., Dedham, Mass. 02026. Applications Article P/N-10 tells how to characterize and measure noise in operational amplifiers. [453]

R-f sputtering units. Varian Associates, Vacuum Division, 611 Hansen Way, Palo Alto, Calif. 94303. Three r-f diode sputtering units for thin film coating work are described in an eight-page brochure. [454]

Metalizing ceramics. Transene Co. Inc., Route 1, Rowley, Mass. 01969, describes low temperature metalizing processes for alumina ceramics and other dielectric materials in a nine-page brochure. [455]

High-voltage capacitors. Axel Electronics Inc., 134-20 Jamaica Ave., Jamaica, N.Y. 11418, has published a compre-

Circle 173 on reader service card →

variety with ALCOSWITCH

The greater the variety, the more flexibility you have when designing a miniature ALCO-SWITCH into your quality equipment. The broad ALCOSWITCH line offers over a hundred different models.

Miniature Toggle Switches are available in five series including high performance waterproof types, locking handles, and switches with 15/32" bushings.

Miniature Push Button Switches include the new illuminated series, top-grade SPDT-DPDT-4PDT types, 15/32" bushings, and economy priced miniatures.

1/2" Dia. Miniature Adjustable-Stop Rotary Switches are built to meet the highest reliability standards and are available with or without their own specially mated knobs.

Whether you need one or one thousand switches you have a greater variety to choose from when you specify an ALCOSWITCH.

SEND FOR
20-PAGE
ALCOSWITCH
CATALOG

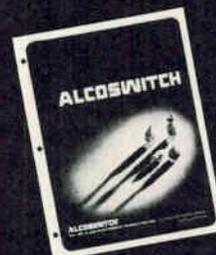

ALCO
ELECTRONIC PRODUCTS, INC.

Lawrence, Massachusetts 01843

DISCOVER A NEW WORLD OF SWITCHING WITH SANKEN PHOTOCELL-LAMP MODULES SPL SERIES

Hermetically sealed Sanken Photoconductive Cells are combined with incandescent glow lamps and packaged in a durable cylindrical case. Contactless and, therefore, clickless. they will completely solve your switching problems. That is exactly what you've been missing in your circuit.

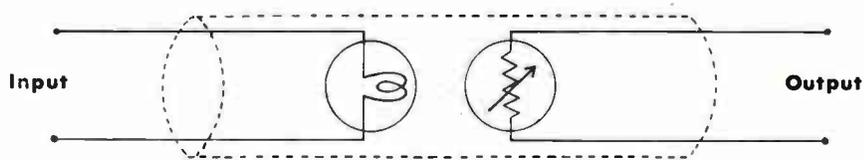

For more information about Sanken Photocell-Lamp Modules SPL Series, please contact:



SANKEN ELECTRIC CO., LTD.

1-22-8 Nishi-Ikebukuro, Toshima-ku, Tokyo, Japan.

Telex: 272-2323 SANKELE TOK

Cable: SANKELE TOKYO

Phone: 986-6151

Circle 199 on reader service card

Precision tube parts

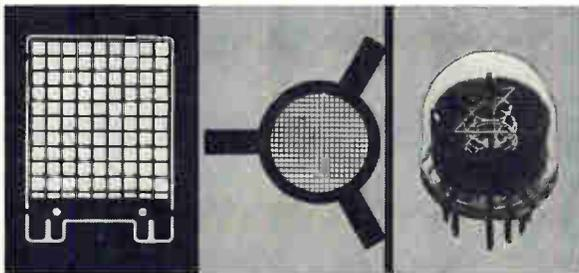

Grids, Nixie tube characters and other precision parts for electronic tubes are a specialty at Buckbee-Mears. We photoetch or electroform a wide variety of metals to production tolerances as close as ± 2 microns. We deliver on time, and our prices are fair.

May we tell you more? See your Buckbee-Mears technical representative, or call or write Bill Amundson, our industrial sales manager.



**BUCKBEE - MEARS
COMPANY**

245 E. 6th St., St. Paul, Minn. 55101 / (612) 227-6371

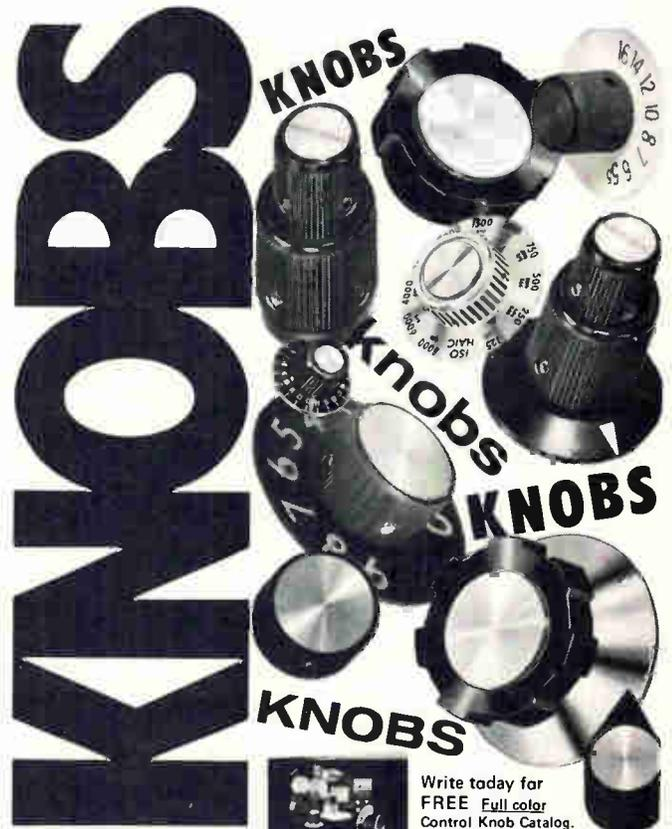

Outline your requirements for quotation and **FREE** knob sample



Write today for **FREE** Full color Control Knob Catalog.

Roqan
BROTHERS, INC.

8031 N. Monticello Ave.
Skokie, Illinois 60076
312/675-1234

174 Circle 174 on reader service card

Circle 201 on reader service card

Military Power

ERA supplies it off the shelf!

ERA CERTIFIED MIL SPEC POWER MODULES FULLY MEET OR EXCEED:

MIL-E-4158, MIL-E-5400, MIL-E-16400,
MIL-E-5272, MIL-T-21200, MIL-E-4158

- no engineering or prototype costs
- checked, approved and certified
- minimum cost for single or quantity orders
- fast delivery
- 77 proven and tested models
- repairable 75°C silicon types
- encapsulated types
- hundreds of variations in each group

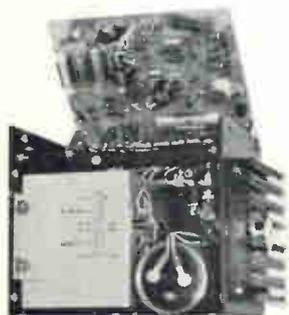

Satisfy your most exacting military requirements with off-the-shelf certified ERA Mil Spec DC power modules. Choose from 77 stock models. Proven designs ... no engineering or prototype costs AND, you get certification from one of America's leading independent testing laboratories.

Write for free informative booklet describing tests and results along with the ERA catalog.



ELECTRONIC RESEARCH ASSOCIATES, INC.

67 Sand Park Road, Cedar Grove, N.J. 07009 • (201) 239-3000

SUBSIDIARIES:

ERA Acoustics Corp. • ERA Dynamics Corp.
Astracam Inc. • The Magitran Company

Circle 202 on reader service card

New Literature

hensive catalog on Drimica high-voltage capacitors. [456]

Chip capacitor guide. Varadyne Inc., 1805 Colorado Ave., Santa Monica, Calif. 90404. An easy-to-use selection guide is available for a line of 36 different sizes of chip capacitors. [457]

Solid polyurethane. Molded Products Co., Easthampton, Mass. 01027, has available a comprehensive new set of literature on solid polyurethane products, applications, fabricating techniques, comparisons with rubber and plastics, and prices. [458]

Precision switches. Cherry Electrical Products Corp., 1650 Old Deerfield Rd., Highland Park, Ill. 60035. Catalog C-70 contains a 44-page description of a complete line of precision switches. [459]

Thermistor. Pennsylvania Electronics Technology Inc., 1397 Frey Rd., Pittsburgh, Pa. 15235, offers technical data sheet 63-69 giving information on the type 44T Positemp thermistor. [460]

Capacitor testing. Electro Motive Manufacturing Co., Willimantic, Conn. 06226. A 55-page report on a new, extensive test plan covering corona effects from pulses or ripple on 200 v d-c Mylar dielectric capacitors. Testing exceeds government and commercial specs. Request on company letterhead.

Power supply modules. Abbott Transistor Laboratories Inc., 5200 W. Jefferson Blvd., Los Angeles 91106. A 76-page catalog for 1969-70 lists over 3,500 power modules with prices and application photos. [461]

Regulated d-c supplies. Computer Products Inc., 2709 N. Dixie Highway, Fort Lauderdale, Fla., 33307. A six-page bulletin covers a complete line of low-power octal mount, p-c mount and bench model regulated d-c power supplies. [462]

Hybrid voltage regulator. Silicon Transistor Corp., East Gate Blvd., Garden City, N.Y. 11532. Engineering data sheet describes the SPH0012 high-power hybrid voltage regulator hermetically sealed in a power transistor package similar to the TO-3. [463]

Analog-to-digital converters. Analog Devices Inc., Pastoriza Division, 221 Fifth St., Cambridge, Mass. 02142. A six-page manual discusses a-d converters, and gives application guidance on high-speed model ADC-F converter capable of making 10-bit conversions in 1 μ sec. [464]

Hybrid multipliers. GPS Instrument Co., 14 Burr St., Framingham, Mass. 01701, has released a brochure detailing a

Circle 175 on reader service card →

small power



"SNAP-ON" BUTTON



LONG BUTTON



MUSHROOM HEAD

ALCO Power Switches combine compact size, modern appearance, and functional flexibility to meet today's control needs, and mount in a 1" hole.

New, snap-on push buttons simplify selection of colors, shapes and legends.

These versatile switches allow "add on" contact sections for maximum flexibility in switching.

Manufactured from approved materials for stringent requirements. Rated 6 amps @ 230 VAC to handle most power applications.

The low cost of these space-saving power devices will surprise you!

ALCO

ELECTRONIC PRODUCTS, INC.

Lawrence, Massachusetts 01843

Lock in



simplified
retrieval of
noise buried
signals with

Ithaco's 353 Phase-Lock amplifier

- no tuning required
- phase and gain not affected by adjustment or drift in reference frequency
- adapts automatically to virtually any reference input
- ultra stable, highly linear detector—no overload at 1,000 : 1 noise to signal ratio
- 1.0 Hz to 200 KHz operation

- plug-in construction permits addition of new or specialized features—prevents obsolescence

For further information and complete specifications contact:

607 272-7640

ITHACO INC.

735 WEST CLINTON STREET, ITHACA, N.Y. 14850

Circle 203 on reader service card

This advertisement is neither an offer to sell, nor a solicitation of an offer to buy, any of these securities. This offering is made only by the Prospectus.

October 30, 1969



275,000 Shares

Lea-Ronal, Inc.

Common Stock
(\$1 Par Value)

Price \$21.50 per Share

Copies of the Prospectus may be obtained in any State from only such of the undersigned as may legally offer these securities in compliance with the securities laws of such State.

Walston & Co., Inc.

Allen & Company <small>Incorporated</small>	Bache & Co. <small>Incorporated</small>	Bear, Stearns & Co.	Clark, Dodge & Co. <small>Incorporated</small>
Dominick & Dominick, <small>Incorporated</small>	Francis I. duPont, A. C. Allyn, Inc.	Goodbody & Co.	
E. F. Hutton & Company Inc.	Shearson, Hammill & Co. <small>Incorporated</small>	Shields & Company <small>Incorporated</small>	
Blair & Co., Inc.	Butcher & Sherrerd	Courts & Co.	
H. Hentz & Co.	Hirsch & Co., <small>Incorporated</small>	C. E. Unterberg, Towbin Co.	

New Literature

series of new hybrid multipliers priced from \$55 to \$295. [465]

Data sets. Electronic Voice Inc., 2059 E. 223rd St., Long Beach, Calif. 90810, offers a data sheet on the series 100 data sets with either magnetic or acoustic receive coupling. [466]

Aerospace instruments. Weston Instruments Inc., 614 Frelinghuysen Ave., Newark, N.J. 07114. A 14-page brochure lists in detail a complete line of instruments manufactured for the aviation and aerospace industries. [467]

Silicon power transistors. Power Physics Corp., P.O. Box 626, Eatontown, N.J. 07724, has available a four-page silicon power transistor catalog. [468]

Subminiature connectors. Precision Microwave Corp., 180-08 Liberty Ave., Jamaica, N.Y. 11433. Catalog PMC-1 covers a line of subminiature A connectors. [469]

Servo amplifiers. Westamp Inc., 1542-15th St., Santa Monica, Calif. 90404, offers a pocket size catalog describing all of the most important servo amplifiers and motor controls manufactured by the company. [470]

OEM terminal catalog. Burndy Corp., Norwalk, Conn. 06852. A 32-page terminal catalog HY-69 for OEM applications features vinyl-insulated, nylon-insulated, and uninsulated terminals and splices for either hand or automatic installation. [471]

Functional cards. Struthers-Dunn Inc., 1114 State St., Bettendorf, Iowa 52722. Eight-page catalog C/70100 contains block diagrams and descriptions for a series of functional, plug-in, p-c cards that handle various functions such as timing, counting, comparing, and load handling required for machine tool and process control applications. [472]

Zener selector chart. Mullard Inc., 100 Finn Court, Farmingdale, L.I., N.Y. 11735. A pocket-size zener selector chart may be obtained by writing on company letterhead stationery.

Magnetic shielding tape. Tapecon Inc., P.O. Box 4741, Rochester, N.Y. 14612. Data sheet RRS-819 discusses magnetic shielding tape for such application as reed relay shielding in the computer and related equipment industries. [473]

Air test instruments. E. Vernon Hill Inc., P.O. Box 14248, San Francisco 94114. An eight-page brochure describes instruments for measuring air pressure, velocity, moisture content, and motion. [474]

Proximity switches. Tann Controls Co.,

FOUR VERY SPECIAL SPECIALISTS



At Aerojet-General's Electronics Division
we have responsible positions available on new contracts, with ground floor opportunities in a new and expanding technology.

Positions available in these areas:

**INFRARED
ELECTRONIC
MECHANICAL
OPTICAL SYSTEMS**

To lead systems efforts from conceptualization through design and development of space instruments and experiments. We must have people who possess a good balance, between theory and practical application. Ideal candidates will be analytically inclined with infrared backgrounds.

Total systems requirements include detector technology, cryogenics, signal conditioning and focal plane technology. Assignments are in project groups in our Electronics Systems Operations, maintaining a state-of-the-art position in Infrared Electro-Optical Systems.

Please submit your resume and salary requirements to:

Don Rowe
Employment Manager
P. O. Box 303-E
Azusa, Calif. 91702
U.S. Citizenship Required

A subsidiary of
The General Tire & Rubber Co.

an equal opportunity employer



Be prepared for

THE CHANGING INTERFACE



Medium and large scale integration are slated to have major impact on the electronics industry. The effects are already being felt — not only on systems and component design — but on fundamental, traditional relationships between equipment builders and component suppliers.

Important trends that will affect your profession, your job, your company, are explored in **THE CHANGING INTERFACE**, a 150-page illustrated volume to be published shortly by McGraw-Hill's Electronics/Management Center.

In **THE CHANGING INTERFACE**, leading design engineers and managers, the men responsible for guiding their companies through the next generation of electronics, discuss the problems that LSI/MSI are stirring up — and offer their solutions.

Here are some of the vital topics covered.

Implications of LSI on the Electronics Market
The Rationale for an In-House IC Capability
The Component Maker's Responsibility vs. the System Builder's Responsibility
Masks and Computer-Aided Design at the Interface
The Testing Interface
How IBM and Bell Laboratories Deal with the Interface Problem
Controversies and Future Trends in LSI

You can reserve a copy of **THE CHANGING INTERFACE** now at the special pre-publication price of \$6.50 by returning the coupon below. If you send a check now, we'll pay the cost of postage and handling.

Electronics/Management Center
330 West 42nd St.
New York, N.Y. 10036

Attn. Mr. Wayne Cowart

Please reserve my copy of **THE CHANGING INTERFACE** at the prepublication price of \$6.50.

Name _____ Title _____

Company _____

Company Address _____

City _____ State _____

Check enclosed for \$6.50 Bill me
 Bill Company P.O. Number _____

New Cord Set Kit

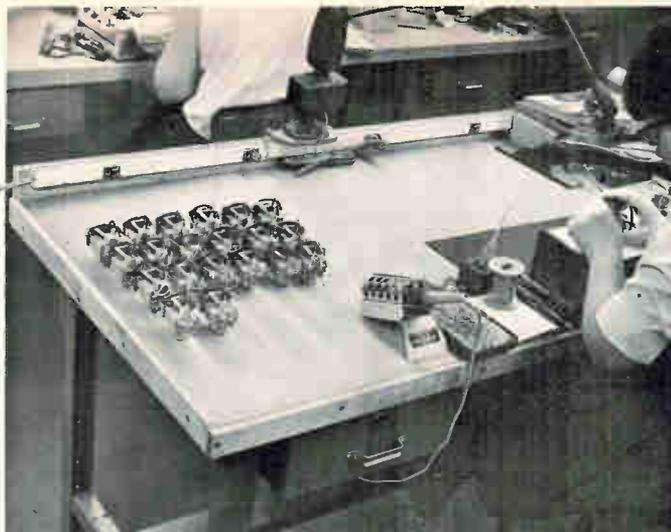
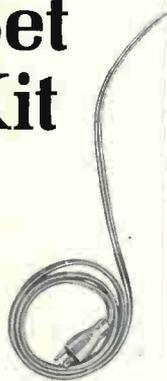

Relocation of production benches made easier! With the new 20CSK Cord Set Kit from Wiremold, a bench-mounted run of multioutlet Piugmold® 2000 can be converted into a portable power strip, ready to move with the bench when production requirements change. Send for literature on this and the entire line of compatible Wiremold surface wiring systems designed to meet every power distribution need from panel box to outlet.



THE WIREMOLD COMPANY / HARTFORD, CONNECTICUT 06110

Circle 204 on reader service card

Micro-Miniature Reed Relays

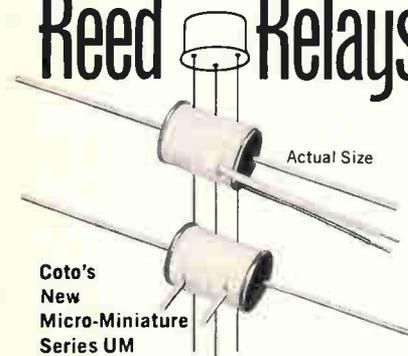

Coto's New Micro-Miniature Series UM

- Extremely small size: .400" x .300" OD
- Occupies less than 0.03 cu. in.
- Ultra-high speed 100 Microseconds operate time excluding bounce
- Stock voltages 3, 6, 12 and 24 volts
- Available with either leads or pins with 0.2" spacing

Special voltages, resistances, electrostatic and/or magnetic shields available. Write for new Data Sheet MR-9.1



COTO-COIL COMPANY, INC.
61 Pavilion Avenue, Providence, R. I. 02905
Tel: (401) 941-3355

Circle 178 on reader service card



PIN/TERMINAL HEADACHES?

We can ship FROM STOCK

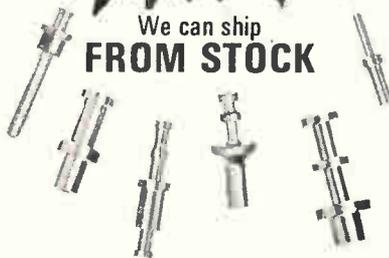

The **CONCORD**

equivalent of almost any: LERCO • USECO, or CAMBION BRASS SOLDER TERMINALS and PINS PLUS...PRINTED CIRCUIT, MS STD., Mil-T-55155, Fed. Spec. Nos. & Crack Proof Terminals.

"We completely manufacture everything we sell."
Certified Plating to ALL MIL-Specs.



Circle 205 on reader service card

New Literature

20210 Sherwood, Detroit, Mich. 48234, has issued a brochure describing the Proximit line of magnetic proximity limit switches. [475]

Wire wrapping tools. Standard Pneumatic Motor Co., 12468 E. Lambert Rd., Whittier, Calif. 90608, has released a 12-page catalog dealing with equipment and accessories for making solderless, wrapped electrical connections. [476]

Operational amplifiers. Zeltex Inc., 1000 Chalomar Rd., Concord, Calif. 94520, offers a 16-page catalog describing its complete line of operational amplifiers—including FET input models, chopper-stabilized amplifiers and electronic multipliers. [477]

Scattered transmission accessory. Cary Instruments, 2724 S. Peck Rd., Monrovia, Calif. 91016, has available a four-page bulletin describing the model 1462 scattered transmission accessory. [478]

Power supplies. Trio Laboratories Inc., 80 Dupont St., Plainview, L.I., N.Y. 11803. A technical bulletin covers the 600 series 100-watt switching regulator power supplies. [479]

Inductors. Ceramic Technology, 18 New Derby St., Salem, Mass., has released data sheets on a line of inductors for use in pin and varactor applications. [480]

Log periodic antennas. American Electronic Laboratories Inc., P.O. Box 552, Lansdale, Pa. 19446, announces availability of a technical data sheet describing model APX-1293 in its series of crossed planar log periodic antennas. [481]

Transformer shielding tape. Tapecon Inc., P.O. Box 4741, Rochester, N.Y. 14612. Standard transformer shielding tape specifications are the subject of data sheet STS-719. [482]

Sonar systems. C.W. Stevens Inc., 115 S. Broad St., Kennett Sq., Pa. 19348. Bulletin 3000 describes a sonar-type instrument that is designed to measure the level of bulk materials and slurries. [483]

Terminal junction systems. Matrix Science Corp., 435 Maple Ave., Torrance, Calif. 90503. A complete family of new-technology wire connecting devices is described in a 12-page brochure on terminal junction systems. [484]

Analog multiplier. Fenlow Electronics Ltd., Whittet's Eyot, Jessamy Rd., Weybridge, Surrey, England. Information on the use of an analog multiplier for frequency multiplication and filtering is available in note form. [485]

Electronics | November 24, 1969

80 MHz WIDEBAND RF POWER AMPLIFIER



MODEL RF-805

- 10 Watts Output into 50Ω
- 0.1 Volts In — 22.5 Volts Out
- .05 MHz to 80 MHz Broadband
- Low Distortion
- Solid State
- Flat 47 db Gain

The RF-805 is a solid state amplifier, broadband from .05 to 80 megahertz, which produces ten watts with -30 db harmonic and intermodulation distortion. Lower distortion is available at lower output levels. Gain is 47 db minimum, constant within 1 db, so that full output is developed with less than 0.1 volt at the 50 ohm input. Accurate output metering and overload protection is provided.

The RF-805 will raise the power of most manual and swept tuned signal generators and thus extend the usefulness and versatility of available signal generators. Receiver testing, wattmeter calibration, antenna testing, RFI testing, attenuator measurements, and filter and component testing will be aided with the use of this equipment.



R F COMMUNICATIONS, INC.
1680 University Avenue • Rochester, N. Y. 14610

Circle 206 on reader service card



Every year, ELECTRONICS attracts requests for over 125,000 editorial reprints.

They're like interest payments on our million-dollars-a-year editorial principles.

That's how much we spend annually to produce timely, authentic, and useful articles like those listed on the reader service card as reprints currently available.

Investment and interest make both. ELECTRONICS and its readers more meaningful to its advertisers.



Full Parameter Semiconductor & IC Testing & Aging



*TEC's complete
in-house facilities
save you time and money
without capital investment*

Whether you are a manufacturer or end-user of semiconductors or IC's, you can now enjoy the benefits of full parameter testing and/or aging at a reasonable cost — with no capital investment required. Take advantage of the comprehensive experience and fully-equipped facilities of Test Equipment Corporation, one of the oldest manufacturers of semiconductor test equipment.

These low-cost services are made possible by advanced, automated test and aging equipment, designed and manufactured by TEC for high speed, large capacity operation. This means you get fast turn-around time, too.

No lot is too large or too small, and TEC will test for any combination of parameters desired. All tests may be performed GO/NO-GO, or documentation may be provided as required.

TEC facilities contain complete testing and aging equipment for all configurations of transistors, FET's, TRIAC's, SCR's, diodes, and digital and linear IC's.



*For more information about
TEC's simple solution to your
problems of identifying defective
components, write today for this
descriptive brochure.*

Test Equipment
CORPORATION
P.O. BOX 20215, DALLAS, TEXAS 75220 • 214/357-6271

WE'RE SPENDING OUR HONEYMOON FILLING ORDERS FOR COPPER-CLAD; LAMINATED PLASTIC SHEETS, RODS, AND TUBES; VULCANIZED FIBRE; MOLDED PARTS; AND FABRICATED PLASTIC PARTS.

Orders are pouring in, keeping our four plants busy.
But not so busy we can't handle one more order...yours.

Our plastic fabricating facility is unique. We make the darndest things imaginable. From retainer rings so small you can hardly see them, to large, complex shapes.

We have complete materials capability to meet your needs. We can furnish every raw material listed in our headline, if you wish to handle fabrication yourself.

We thought it would take a while for you to realize what a good thing we have going for you.

You fooled us . . . and we just want to say thanks.

And about that order. If you'll send it in, we'll be able to stay on our honeymoon that much longer.



synthane·taylor

Synthane-Taylor Corporation, Valley Forge, Penna. 19481 • Plants: Valley Forge, Pa., Oaks, Pa., La Verne, Calif., Scarborough, Ont., Canada • An Alco Standard Co.

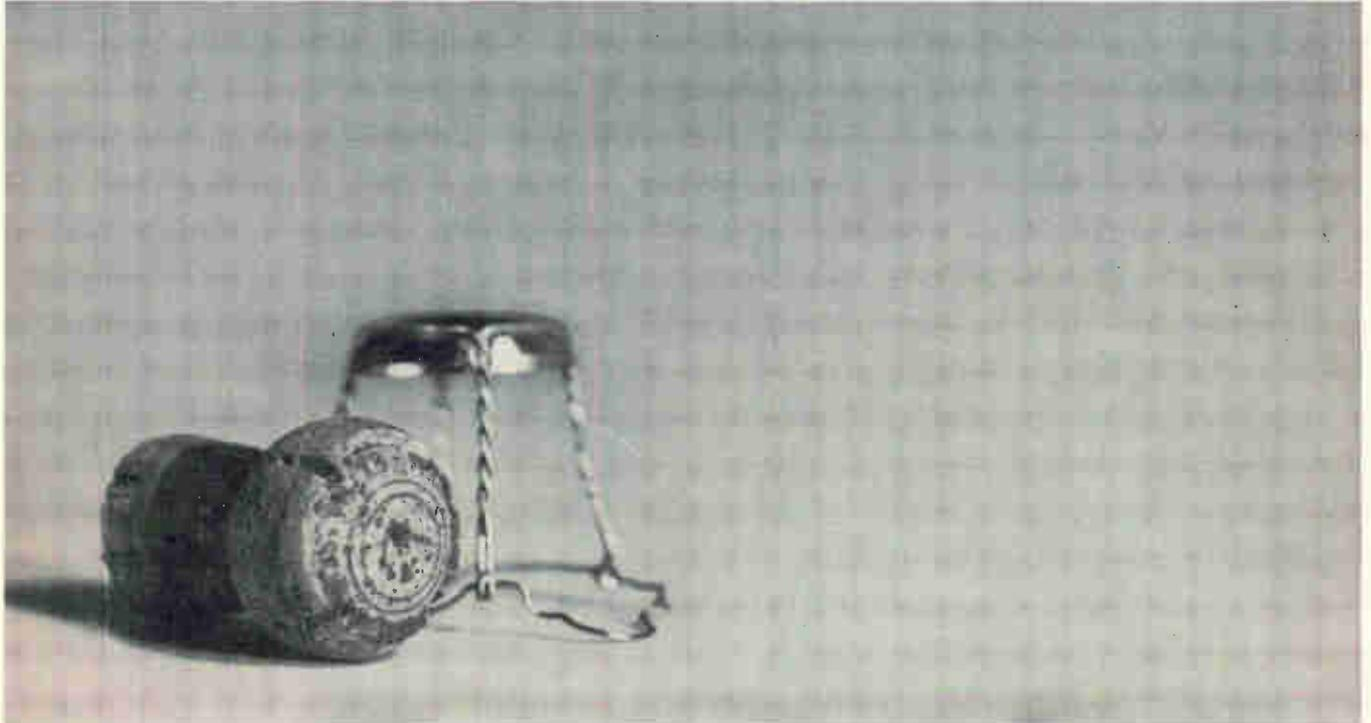

International Newsletter

November 24, 1969

West Germany: GE's loss . . .

The months-long guessing game over the future of Kuba-Imperial GmbH, West German radio and tv maker wholly-owned by the General Electric Co., has finally come to an end. Last week GE sold Kuba to AEG-Telefunken. At the same time, the Milan-based Compagnia Generale di Eletticit a SpA (CGE), majority-owned by GE, agreed to switch its radio and tv business over to AEG-Telefunken. GE will get \$14 million in shares, increasing its interest in AEG-Telefunken from about 10% to 12%.

GE's pullout from Kuba confirms industry rumors. In 1966, GE acquired Kuba for a reported \$20 million with hopes of getting a strong foothold on West Germany's entertainment electronics market. However, despite heavy spending for streamlining assembly and production lines, Kuba's over-all market performance did not live up to expectation. GE-induced production short-cuts were said to have resulted in poorly-made tv sets—sets that retailers were reluctant to recommend or to service. And despite U.S.-type sales campaigns [*Electronics*, March 4, 1968, p. 316], the market share remained stagnant—at around 8% for black-and-white and even less for color-tv.

. . . is gain for AEG-Telefunken

The deals AEG-Telefunken has made with GE and CGE should greatly improve its position on West Europe's tv and radio markets. Kuba's sales will up AEG-Telefunken's share of the German television market to around 20%, making it a strong competitor to heavyweights Philips and Grundig. And with CGE's 10% share of Italy's radio and tv production, AEG-Telefunken's position in that part of Europe will be stronger, too.

British quickly jump into Schottky IC's made with aluminum

Ferranti Ltd., one of the three British-owned integrated circuit makers, is likely to be the first company to make aluminum Schottky-diode logic IC's in Europe. In the U.S., Intel Corp. has offered Schottky IC's since August and Fairchild Semiconductor is building a production line [*Electronics*, Nov. 10, p. 56].

Ferranti has built successful experimental devices and is shooting for production in mid-1970 with TTL to normal speed specification, using the diode technique instead of more difficult gold doping to control speed. Faster devices utilizing the full high-speed potential of the Schottky diode—down to 3 nanoseconds propagation delay in TTL—will follow.

Like the U.S. companies, Ferranti connects the Schottky diode across the output transistor collector-base junction which boosts speed by eliminating transistor charge-storage. Its design uses the guard ring technique to eliminate unwanted high fields around the edge of the metal contact. The aluminum contacts the n-type collector through a window in the oxide, below which is a smaller window in the p-type base diffusion. Hence the extension of the base beyond the oxide effectively separates the depletion layer in the collector from the contact edges.

West German firms are knocking on Russia's door

Look for increased activity by West Germany's Siemens and AEG-Telefunken in the Soviet electronics market. Both companies have now quietly begun negotiating technical exchange agreements with the USSR. Such agreements—which are common with British, French, Italian, and Japanese firms—are nominally limited to information sharing. But they are

International Newsletter

often the first step toward major sales deals. Fiat, for example, had an exchange contract before concluding its automobile plant sale. The arrangement isn't a clear path to exports, however, as Olivetti learned when its hoped-for sale of an accounting machine factory fell through after much exchange of data [*Electronics*, Sept. 29, p. 198].

Heretofore, AEG-Telefunken has not been active in the USSR at all and Siemens at only a relatively low level, mainly in the medical electronics field. Their increased interest now is a direct outgrowth of the warming commercial and political atmosphere between West Germany and Soviet Union that began when Soviet Foreign trade minister Nikolai Patolichev visited the Hanover fair last May. Since then three of the big names in German industry—Mercedes Benz, Ruhrgas, and Thyssenwerke—have become involved in serious negotiations with the Russians.

Selenium capacitors to be manufactured by Japanese firm

Look for Japan's Origin Electric Co. to start selling selenium capacitors in the near future. The company, an established maker of rectifiers, will produce the capacitors developed jointly with the Nippon Telegraph and Telephone Public Corp. Origin plans to begin sales next April.

Although similar to electrolytic capacitors—they must be polarized with d-c voltage and there is a slight leakage current through the device—the selenium capacitors have characteristics at very high and very low frequencies, which are not attainable with other types of capacitors. At frequencies below about 2 megahertz, the capacitance is a function of applied voltage. At high frequencies capacitance is essentially independent of voltage and can fall to as little as 10% of the low frequency value. The variation of capacitance with frequency allows designers to use a high value at the low end of the operating range for bypassing, coupling, or decoupling, and a low value at the upper end for reducing effects of series lead inductance.

Russia, pressured by its scientists, makes IC computer

Responding to the growing demand from scientists and technologists, the Russian electronics industry is slowly adopting the law of supply and demand. Pressure for more advanced computers has mounted over the past year, with individual scientists and officials complaining of "computer starvation" [*Electronics*, Sept. 29, p. 197]. Even an entire conference of computer users called for the government to create a new ministry on computer technology and computing systems.

The first response has just been announced: the development of Russia's first general-purpose computer using integrated circuits. The new machine, made at the big Elektron plant, may be the answer to the scientists' quest for time-sharing capability. Called the Nairi-3, the computer can simultaneously accept 64 assignments, using remote terminals. According to the newspaper *Kommunist*, the machine has a control system containing 120,000 microcommands, which make it adaptable to many uses.

Addenda

Toshiba has developed a laser machining unit that uses television to monitor machining operations. This not only prevents accidental eye damage if the laser beam is reflected into the low-power monitoring microscope, but provides a large-screen image. . . . Hitachi had developed a diamond heat sink Gunn diode that produces 620 milliwatts of power at 12.8 gigahertz with an efficiency of 3.5%.

Electronics New subscription application

Please start my one year subscription — 26 issues — for only \$8!

CHECK HERE FOR 3 Years \$16 — Saves me \$8!

FOREIGN RATES ON REQUEST

Payment Enclosed

Bill Me

Bill My Company

SUBSCRIPTION INCLUDES 1,200-PAGE ANNUAL BUYERS' GUIDE ISSUE

Name _____ Title _____

Please Fill In All Spaces

Company _____

Company address _____

City _____ State _____ Zip code 

Specific Product _____ or Service _____
manufactured _____ performed _____

Are you involved in the specification of electronic or allied products? Yes No

Please check your department or function:

Design Research, development Production, operation, maintenance

Other (please describe) _____

Above rates apply only to those professionally engaged in electronics technology.

14-50990

All others, \$25 per year.

Electronics New subscription application

Please start my one year subscription — 26 issues — for only \$8!

CHECK HERE FOR 3 Years \$16 — Saves me \$8!

FOREIGN RATES ON REQUEST

Payment Enclosed

Bill Me

Bill My Company

SUBSCRIPTION INCLUDES 1,200-PAGE ANNUAL BUYERS' GUIDE ISSUE

Name _____ Title _____

Please Fill In All Spaces

Company _____

Company address _____

City _____ State _____ Zip code 

Specific Product _____ or Service _____
manufactured _____ performed _____

Are you involved in the specification of electronic or allied products? Yes No

Please check your department or function:

Design Research, development Production, operation, maintenance

Other (please describe) _____

Above rates apply only to those professionally engaged in electronics technology.

14-50990

All others, \$25 per year.

First Class
Permit No. 42
Hightstown, N. J.

Business reply mail

No postage stamp necessary if mailed in the United States

Postage will be paid by McGraw-Hill, Inc.

Electronics

P. O. Box 514
Hightstown, N. J. 08520

Subscription department



First Class
Permit No. 42
Hightstown, N. J.

Business reply mail

No postage stamp necessary if mailed in the United States

Postage will be paid by McGraw-Hill, Inc.

Electronics

P. O. Box 514
Hightstown, N. J. 08520

Subscription department



Welded connections brace solar cells for longer life

Vacuum deposited palladium film between titanium and silver contacts eliminates need for soft solder, prevents corrosion of titanium, enables West German cell to endure 400°C for 20 hours without output power change

Like Icarus, satellites that fly too close to the sun may lose their wings—their panels of solar cells. Engineers at West Germany's AEG-Telefunken have found a way to replace heat-degradable solder with welded connections in a new line of solar cells. And the cells themselves are more efficient, more flexible, thinner and longer lived than their predecessors. The company sees a good future for the cells in solar probes and in other space applications where a high power-to-weight ratio, heat resistance and ability to be rolled and folded are required.

The Telesun cell, as the company calls it, differs in several ways from standard solar cells. Such standard cells are cut from a p-type silicon crystal and shaped into a paper-thin slab measuring about 2 centimeters on each side. The cell's illuminated surface contains a shallow diffused 0.3 micron deep n-type layer doped with phosphor. Electrical connection is provided by small titanium-silver contact fingers evaporated and sintered onto that surface and then covered with soft solder. A silicon oxide layer between those contacts helps cut down reflections, thus allowing more sunlight to be absorbed for energy conversion. Finally, a quartz cover is provided to protect the solar cell against small meteorites and against radiation during space flights.

In the Telesun cell, the need for soft solder is eliminated by putting a thin film of palladium between the titanium and silver layers. This vacuum-deposited film prevents corrosion of the titanium. A solar

cell without a solder layer can be damaged by an electrochemical reaction that occurs at the titanium-silver interface in humid environments; the titanium would start to dissolve. Adding palladium shifts the electrochemical potential into a range where titanium corrosion and dissolution can no longer occur.

The contacts so passivated with palladium open new areas for high-temperature space application, AEG-Telefunken says. Solar cells equipped with these contacts can be exposed to 500°C for one hour and to 400°C environments for 20 hours without any change in maximum power output. And, the company says, welded connections are more reliable, and the absence of solder flux material eliminates the need for subsequent cleaning steps. In the Telesun cell welding or thermocompression bonding techniques are used.

Pluses. The Telesun cell also has some other important talking points. One is its high energy conversion efficiency. At 11.5% that efficiency is about 20% higher than that of a standard cell of the same thickness. Thus, its output power-to-weight ratio is also 20% higher. The Telesun's higher efficiency is achieved by means of a new proprietary getter step. This step considerably increases the lifetime of the charge carriers in the silicon base material, leading to higher efficiency.

Still another feature of the Telesun cell is its high mechanical flexibility, a result of its thinness. With a bending radius of less than 10 centimeters, it is well suited for

flexible solar cell generators such as rolled-up or folded arrays.

AEG-Telefunken researchers have also developed a new geometry for loss-free contacts. In conventional solar cell arrays, individual cells are interconnected by a strip which in a series configuration is led from the top surface of one cell to the bottom surface of the next. This interconnecting scheme has one big disadvantage, though. A small portion of the connector protrudes from the cell surface, and this makes applying the quartz covers somewhat difficult.

One solution would be wrap-

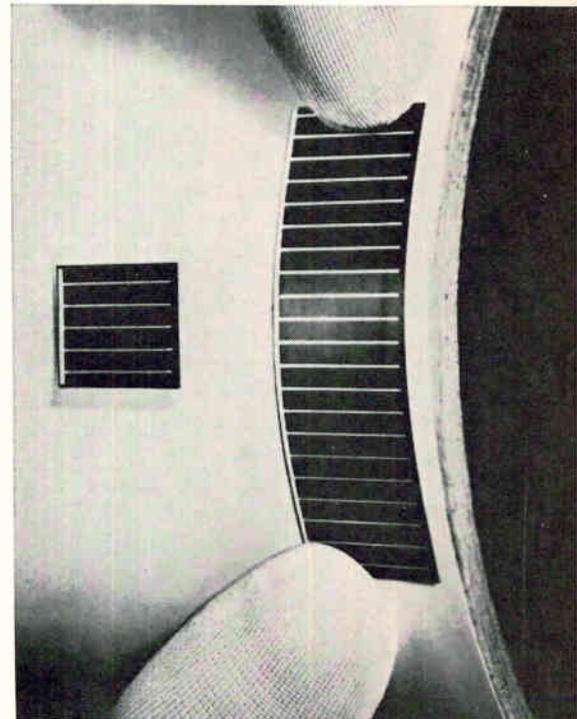

Flexible, too. Telesun cells can be bent or folded without breaking.

around contacts that connect the cell's top and bottom surfaces around the edge. But, such contacts invariably resulted in a reduction of the cell's output power. This, it was assumed, is a result of the technology used in applying the wrap-around contact to the cell.

Engineers at AEG-Telefunken, however, found that the degradation of electrical performance has nothing to do with technology, but is caused by a high resistance in that region of the cell that's partly enclosed by the top and bottom portions of the wrap-around contact. To cut this resistance to a minimum, the AEG-Telefunken designers devised a modified wrap-around in which the bottom portion consists of only two very small contact areas. The net result is that there's essentially no resistance build-up and, therefore, no reduction of the cell's output power.

Great Britain

Filtering the surface waves

To remove the sound signal from the video channel of a tv receiver, the video i-f amplifier strip contains a filter with an effective band-stop around the sound carrier frequency. These types of filters are nearly always conventional parallel tuned circuits, but in future British receivers, the filtering and control of the shape of the pass band may be carried out by a single acoustic surface wave filter now under development by Mullard Ltd. No significant performance improvement is likely, but in volume production the new device may well be cheaper to produce—which is what the Mullard researchers are seeking.

The surface wave filter promises to be cheaper for two reasons. First, it will consist of a small, flat piece of piezoelectric material, with wave insertion and extraction elements formed by photolithography. Second, once the design is settled, performance will depend only on the quality of the material and the accuracy of the photolithography. The Mullard men believe it should be

possible to obtain high yields of a reliable, adjustment-free device. It also will be much smaller than present filters—it could be packed, together with pre- and post-amplifying chips, inside a dual-in-line pack.

So far the Mullard team—Ron Pratt, Bill Willis and John Singleton—have developed a design which yields —34 decibels at the sound carrier frequency, —40 at the low-frequency end of the pass band and —43 db at the upper end. Though these figures exceed British broadcasting specifications, the upper and lower traps are too close together, so that the pass band is about a megahertz too narrow. However, the response curve near the peak is properly asymmetric, which is necessary to accommodate the single sideband transmission characteristics. The team believes they'll obtain the required performance by steady extension of their present design techniques. The essential design problem is working out the necessary configuration of the input and output transducers.

Fingers. The transducers are the interdigital type [*Electronics*, Dec. 23, 1968, p. 95], each covering an area approximately 0.04 by 0.08 inch, with the long axes parallel and about $\frac{3}{8}$ inch apart on a chip of piezoelectric material. The chip material is Philips PXE-11 potassium sodium-niobate fine grain, high-coupling, ceramic, with low acoustic attenuation—about 1 to 2 db per millimeter. Though acoustic attenuation could be eliminated by using lithium niobate single-crystal material, Willis, the team's acoustics specialist, says it wouldn't justify the greater cost. The distance between the transducers in practice is unimportant and production devices probably would be about 0.08 inch square.

The transducer fingers are of gold, laid down by conventional photolithography. Pitch is determined by the material and the center frequency of the pass band—in this case 44 microns, equal to half a wavelength. In the latest experimental device there are 30 fingers in each transducer, with 15 in each comb. The number of fingers and their individual dimensions

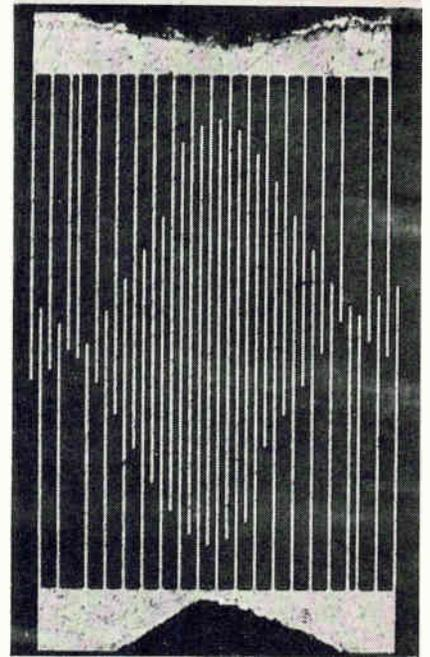

Combed. Output can be custom tailored by varying number and shape of teeth.

determines the width of the pass band and the shape of its response curve, including the position of the bandstop traps. The longer the finger, the more energy it radiates, and to obtain a curve of the required shape the Mullard team has concentrated on making the 30 fingers of different lengths across the transducer.

Because each finger in the input transducer reacts with each in the output transducer the sum effect is complex. Particular frequencies will reinforce or cancel as in a transversal filter, but this effect makes it possible to obtain an overall output response curve with the required characteristics. Input and output transducers don't have to be identical; one way of obtaining the required curve is to use different numbers of fingers and finger lengths in the two transducers. One experimental device has 40 fingers at one end and 30 at the other.

Trial and error. John Palfreeman who heads the department carrying out the work, believes that the mathematics of the interaction are sufficiently complex to rule out designing solely by calculation, even with a large computer. He thinks some trial-and-error always will be necessary to obtain the required results. In practice, Mullard's trans-

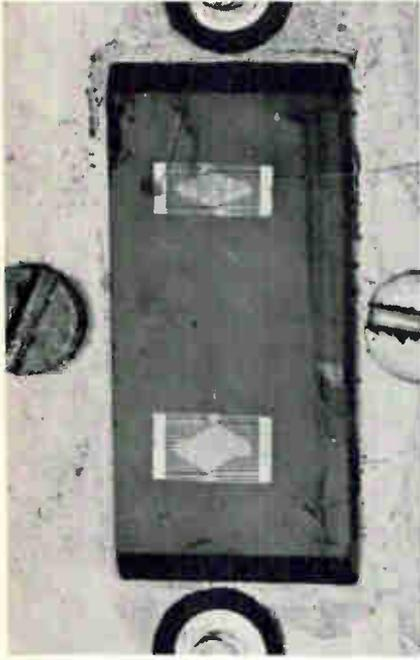

In and out. Unmatched transducers may give required operating curve.

ducers so far have long fingers at the center, shortening off toward the ends, with minor variations superimposed.

Compared to an electronic filter, the acoustic device has a big insertion loss—at present about 30 db. However, this can be corrected quite easily by incorporating a pre-amplifier chip as well as an output amplifier, says Singleton. In its favor, the acoustic filter has a potential advantage over the electronic unit in that the group-delay characteristic is constant at all frequencies provided the transducers are symmetrical. Hence there would be no need for deliberate phase distortion at the transmitter to compensate for unavoidable phase distortion in the filtering. And with uncompensated transmission receiver performance should be slightly improved.

High school electronics

If a young Briton in high school wants to study electronics, usually his only opportunity is to take it as part of the established physics course leading up to the school leaving examinations. Electronics represents only about one-quarter

of the course, and the emphasis is on the common ground between physics and electronics—the workings of electron devices and simple amplifiers. Systems and equipment are hardly mentioned.

Professor Barrie Chaplin of Essex University believes the schoolboy of 16 ought to be able to take a complete course in electronics. This would provide a closer link between school work and college electronics courses, which are becoming more and more industry oriented. It will also help the student who won't go on to university or make a career in electronics, because electronic systems increasingly will affect people's lives, Chaplin believes.

With cooperation from the local high school the professor is developing a systems-oriented course to fit his ideas. So far he's established a draft syllabus of an examination course to stand on its own alongside conventional courses in math, physics and other subjects. Now it has to be tried out in practice, experiments have to be devised, and comprehensive course notes for teachers have to be written. The latter is especially important, because initially most instruction will be given by teachers who are not well-versed in electronics. Chaplin feels that it will be two years before all the details are settled.

Human element. Since he's starting from scratch, Chaplin has been able to introduce some ideas not generally found in science and engineering courses. First, his notion of systems always includes the human being as an essential, and often the kingpin, component. "Starting with the human being is logical because the only justification of any system is that it's designed to benefit, and at some stage match into, man," Chaplin asserts. "Further, the human being is of great interest to the developing child, and experiments relating to the characteristics of human beings are effective, inexpensive, and unlikely to be forgotten."

Second, the course itself won't depend on mathematics—it can have a lot or almost none, depending on circumstances. Chaplin acknowledges that students intending

to go on to a university will need mathematics, but they can best do this as a separate course, possibly along with physics, to get the ideal pre-university electronics training. By keeping math out, Chaplin says he can attract the liberal arts student, and thus help to reverse the swing away from science in British schools.

The draft syllabus has three primary sections: television and audio, computers, and feedback and control. The tv syllabus, for example, starts with the human eye as a lens and a system of photoreceptors. It also employs experiments; for instance, placing a filter over one eye decreases the entering light so that the natural "gain" increases to compensate, which in turn lengthens response time. This can be perceived, the syllabus explains, by watching a pendulum swing—the weight seems to move in an ellipse. Chaplin then switches to image-scanning in a tv camera.

Japan

Vtr runs radar autoplotter

Radar has given all-weather eyes to the world's sailors. But the image on radar screens is basically a still picture. Efforts to turn radar displays into movies—to show how a blip is moving over time—have yet to break the cost barrier.

A promising new approach, however, is designed around the mass-produced video tape recorders built in Japan. A team at the University of Electro-Communications in the suburbs of Tokyo has modified a vtr and developed interface electronics for standard marine radar displays. The result: an inexpensive autoplotter that gives the current position of a ship and objects around it, plus past positions a minute or two apart. The older the image the dimmer the display, making it easy for a navigator to spot dangerous conditions.

Slow way. The classical method of performing this task is to put an overlay over the radar screen and manually plot positions of the targets at several minute intervals.

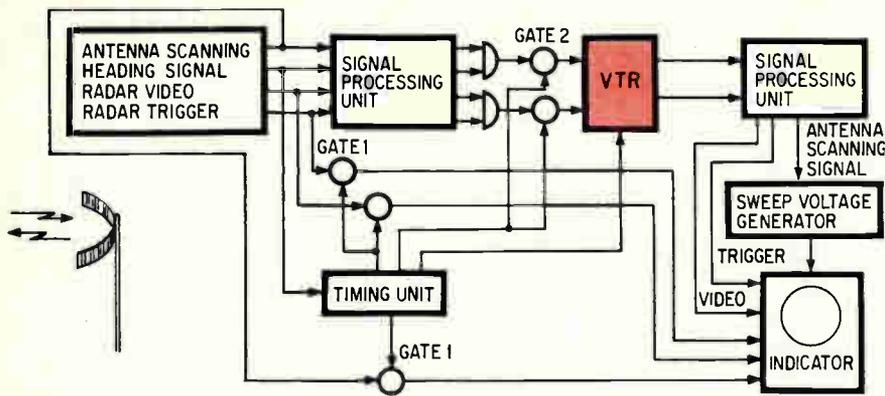

Multiplexed. Four signals are compressed onto two recording tracks in modified commercial vtr, which stores radar images for several minutes.

This method is tedious, though, and only really practical on the high seas where just a few other ships are visible on the scope. But in crowded waterways or harbors it becomes impossible to plot all the targets that are visible. Photography and memory tubes have been suggested, but both of these approaches are expensive—and impractical for small ships.

The new system is built around a modification of a small helical-scan video tape recorder designed for home and educational use. This type of recorder is available in Japan at about \$500 unmodified, and prices are expected to fall.

Modification consists of removing the supply and takeup reels, and adding idlers for an endless loop of tape sufficient for somewhat less than 20 seconds of recording time. With this arrangement the recorder can store three radar frames recorded at perhaps 1½ minute intervals. When these frames are reproduced in quick succession—about 20 seconds—it is possible to view past and present positions of ships.

Runs on. Very little modification of the recorder is required because it is not synchronized with the radar. Nor is it stopped or started between recordings.

The length of the tape loop is critical in this operation says Tsutomu Suzaki, head of the team. It must be long enough to allow three or more radar scans to be plotted on it, along with any mismatch caused by lack of synchronization between the tape drive and

antenna. Tape length must be an integral number of times the length between successive synchronizing pulses on the tape control track. These pulses—at 1/30 second intervals—operate the recorder servo system to keep the rotating heads on the same tracks during recording and playback. These synchronizing pulses are recorded at the time the loop is fabricated, the pulses are left untouched as reference after that.

Leaves space. Lack of synchronization between the tape drive and antenna speed requires that space be left between the three plot recordings. This prevents overlapping, despite variations in relative speed between antenna and tape, when tape length is for three plots.

The following plot, the fourth plot, is recorded on top of the first plot—which must be erased during the recording process. Tape length must be such that the start of the fourth plot occurs on the tape slightly before the start of the first plot. Then the timing circuits continue the erase signal for a small time interval, ensuring that the first plot will be erased.

The team, which includes Ikuo Arai, Kazuma Motomura, and Kiyoshi Kusama, had to put four radar receiver outputs onto two recorder tracks. Processing them for multiplexing solved the problem. For example, the radar video and radar trigger pulses are multiplexed the same way as television video and trigger pulses. The radar video process keeps the maximum amplitude to 0.7 volts in the posi-

tive direction; while for radar trigger pulses, the maximum amplitude is 0.3 volts in negative direction. Total signal is thus one volt, with video and trigger pulses having opposite polarity so they can be separated after playback.

Solid state numerology

One goal of researchers working with solid state lamps and displays has been to fabricate arrays of light-emitting areas on a single semiconductor chip. Japan's Hitachi has become the first to devise a segmented array that can indicate any numeral with a combination of seven segments—and a process for manufacturing the monolithic array in quantity with high yield.

Indeed, Hitachi says the only thing preventing an immediate production start-up is the high cost of the gallium-based material needed to make the device. They say, however, that about as much gallium as germanium is now produced every year, and that the price of compound semiconductors with gallium eventually may become competitive with the germanium devices.

Tiny. Each numeral is slightly larger and about the same shape as this E; the chip measures 0.16 by 0.12 inch. So far Hitachi has mounted them individually in cans, but other methods may allow tighter packing.

The display's operating voltage is about 1.75 volts, which is compatible with drive by integrated circuits. Current per segment is about 10 milliamperes, but since not all segments are used for most numerals the average current runs about 50 ma per digit, so average power input per digit is only 85 to 90 milliwatts. Light emission can be controlled to peak at any desired red in the range between 6,300 and 6,800 angstrom units. Light output averages about 50 foot lamberts, but light output in pulsed operation can run above 10,000 ft.-l

Hitachi says that rise and fall times of light output are on the nanosecond order. This means the display can keep up with the logic speed of fast computers.

Electronics advertisers

November 24, 1969

Aerojet General Corp. D'Arcy Adv. Co.	177	□ Ferisol Agence Domenach	16E	Rolm Corp. Allen & Dorward, Inc.	70
Airco Speer Electronic Components Hazard Adv. Co., Inc.	141	■ Fluke Manufacturing Co., John Bonfield Associates	27	Romhokaw Electronics Corp. Lessereaux and Tandler, Inc.	7
□ Alcate] Agence Rene Sicard	7E	General Electric Co., Analytical Measurement Business Section Robert S. Cragin, Inc.	166	Sanken Electric Co., Ltd. Seikosha Adv., Inc.	174
Alco Electronic Products, Inc.	171, 173, 175	□ General Instrument Europe S.P.A. Studio Cigiemme	17E	□ Schlumberger Ltd. EMD	2E
Marketronics Advertising Allen-Bradley Co.	23, 163, 165, 167, 169	General Magnetics McCarthy/Sceiba/DeBiasi Adv. Agcy., Inc.	9	□ Schlumberger SIS	3E
Fensholt Adv. Agcy.		General Radio Co.	2nd Cover	□ Schneider R. T. Noirclerc Publicite S.D.S.A.	27E
Allied Van Lines, Inc.	136	Horton Church & Goff, Inc.		Publi-Service	162
Young & Rubicam, Inc.		Groov-Pin Corp.	42	■ Semtech Corp. Burruss Advertising	56
American Potash and Chemical Corp., Rare Earth Div.	18	Feeley & Wheeler, Inc.		□ SGS Lonsdale Italia S.P.A.	11E
Sidney Clayton Assoc., Inc.		Hamilton Watch Co. Beaumont, Heller & Sperling, Inc.	154	Sierra Research Corp. B.P. Myer Assoc., Inc.	46
■ AMP, Inc.	20, 21, 126	Heinemann Electric Co. Thomas R. Sundheim, Inc.	54	Signetics Corp. Sub. Corning Glass Works Cunningham & Walsh, Inc.	12, 13, 119
Garceau, Hallahan & McCullough, Inc.	5E, 6E	■ Hewlett Packard, International Div. Lennen & Newell, Inc.	2	Siliconix, Inc.	60
□ AMP Europe Allardyce Palmer, Ltd.	8E	■ Hewlett Packard, Microwave Div. Lennen & Newell, Inc.	1	□ Sodoco Dumesnil Publicite	28E
□ Ancrona Corp. Wilhelm Bacher Werbung	62	Honeywell, Computer Control Div. Creamer, Trowbridge Case & Basford, Inc.	30	□ Sogie Etudes et Creations Publicitaire	4E
Andrew Corp. Fensholt Adv., Inc.	20E	■ Honeywell Test Instruments Div. Campbell Mithun, Inc.	146	Solid State Scientific Lessereaux and Tandler, Inc.	22
□ Ates Componenti Electronici S.P.A. Publicitas	135	□ I.E.R. PEMA	25E	■ Sorenson Operation, Raytheon Co.	65
Automatic Control Division, Cook Electric Co.		IPT Corporation Robertson West, Inc.	49	□ S. P. Elettronica Studio Sergio Rosata	22E, 24E, 26E
Sander Rodkin Adv. Agcy., Ltd.		IRC, Division of TRW, Inc. Gray & Rogers, Inc.	127	Sprague Electric Co., The Harry P. Bridge Co.	5
■ Barnes Corp. Industrial Public Relations, Inc.	131	lthaco, Inc. Hart-Conway Co., Inc.	176	Synthane-Taylor Corp. Gray & Rogers, Inc.	61, 180
Barnstead Co., Div. of Sybron Corp. Creamer, Trowbridge, Case & Basford, Inc.	160	■ J F D Electronics Co., Components Div. Delphi Adv., Inc.	140	■ Systron-Donner Corp. Bonfield Assoc., Inc.	32
■ Beckman Instruments, Inc., Helipot Div. N.W. Ayer/Jorgensen/MacDonald, Inc.	105	■ Lambda Electronics Corp. Michel Cather, Inc.	3rd Cover, 193, 194	Tally Corp. Bonfield Assoc., Inc.	15
Bell & Howell, Electronic Instrumentation Group—CEC/Transducer Div. N.W. Ayer/Jorgensen/MacDonald, Inc.	52	Lectrohm, Inc., a Subsidiary of Cook Electric Co. Sander Rodkin Adv. Agcy., Ltd.	134	■ Tektronix, Inc. Dawson, Turner & Jenkins, Inc.	122
■ Buckbee-Mears Co. Midland Assoc., Inc.	174	McBain Instruments Stoneham and Summers Advertising	152	Telonic Instruments Jensen Assoc., Inc.	150
Bunker-Ramo Co. Diener & Dorskind, Inc.	138, 139	■ Mallory & Co., P.R., Mfg. Div. Aitkin-Kynett Co.	131	Tempress Industries, Inc. Hal Lawrence, Inc.	29
Burns & Towne, Inc. Hall-Karmatz Assoc., Inc.	48	Markem Corp. Creamer Trowbridge Case & Basford, Inc.	142	Teradyne, Inc. Quinn & Johnson Adv., Inc.	45
■ Captor Corp. Weber, Geiger & Kalat, Inc.	24	Mico Instrument Co. Microdot, Inc.	188 67	Test Equipment Corp. Dean & Bain Adv., Inc.	179
Cartesian, Inc. Miller/Stoll Advertising	106	Gumpertz, Bentley & Dolan Adv. Mohawk Data Science Corp./OEM Marketing	47	■ Texas Instruments Incorporated, Components Group Albert Frank-Guenther Law, Inc.	17, 50
C.G.E. Edition "2B" Publicite	14	Monsanto Co. Michel Cather, Inc.	19	□ Texas Instruments France Dumesnil Publicite	18E, 19E
Clare & Company, C.P. Reincke, Meyer & Finn Adv., Inc.	128	Mullard, Ltd. Parker-Rumrill International, Inc.	68	■ Texscan Corp. Burton Browne Advertising	16
Concord Electronics Corp. Sound Advertising	178	■ National Electronics, Inc. Connor-Sager Associates National Semiconductor Corp. Hall Butler Blatherwick, Inc.	26 35, 36	Thomson Electric Co., Inc. Mohr & Co., Inc.	72
Control Data Corp., Connector Operation Barnes-Champ/Advertising	173	□ Oltronix Svenska □ Onan Division of Studebaker Corp. Campbell Mithun, Inc.	14E 9E	Toko, Inc. Hakuhodo Incorporated	188
Control Data Corp., Printed Circuits Operation Midwest Advertising Services, Inc.	164	Pacific Measurements, Inc. Jack Herrick Adv., Inc.		■ Tracor, Inc., Industrial Instruments Div. Winn-McLane Assoc., Inc.	55
Coto Coil Co., Inc. Williams Co.	178	□ Philco-Ford Corp. Hal Lawrence, Inc.	10E	Triplet Electrical Instrument Co. Byer & Bowman Advertising	59
□ C R C IRP	12E	Philipps Electronic Instruments Marsteller, Inc.	116	TRW Electronics, Capacitor Div. Fuller & Smith & Ross, Inc.	53
■ Dale Electronics, Inc., SIOUX Div. Swanson, Sinkey, Ellis, Inc.	172	■ Power Designs, Inc. Samuel H. Goldstein	190	TRW Semiconductors, Inc. Fuller & Smith & Ross, Inc.	6, 132, 133
Damon Engineering, Inc. Ingalls Assoc., Inc.	37	Princeton Applied Research Corp. Mort Barish Assoc., Inc.	149	■ Tung-Sol Division, Wagner Electric Corp. Feeley & Wheeler, Div. of Geyer, Oswald, Inc.	66
Delevan Electronics Corp. Stahlka, Faller & Klenk, Inc.	28	Radiation, Inc. W. M. Zemp & Assoc., Inc.	43	Tyco Laboratories, Inc. Instruments Div. Kenyon & Eckhardt, Inc.	58
DuPont de Nemours & Co., Freon Div.	156	Radio Corporation of America Al Paul Lefton Co.	4th Cover, 57	U-Tech, Industrial Physics and Electronics Co. Div. Ross Clay Advertising	44
■ Eagle Signal Division of Gulf & Western Co. Feeley & Wheeler/Division Geyer, Oswald, Inc.	25	Raytheon Co., Components Div. Fuller & Smith & Ross, Inc.	10, 11	Walston and Co., Inc. Albert Frank & Guenther Law, Inc.	176
Eastman Kodak Co., PCIM Market Development Rumrill Hoyt, Inc.	155	Redcor Corp. Management Communication Consultants, Inc.	51	Wang Laboratories Impact Adv., Inc.	158
□ Ebauches S.A. Claude Langel	23E	R F Communications, Inc. Beacher Adv. Agcy.	179	□ Watkins-Johnson Co. William C. Estler Advertising	15E
E.G. & G., Inc., Laboratory Products Div. Palmer, Larson & Bateman, Inc.	69	■ Rogan Brothers, Inc. Christopher Adv., Inc.	174	■ Weston Instruments, Inc., Newark Div. Arndt, Preston, Chapin, Lamb & Keen, Inc.	189
Electronic Research Associates, Inc. Josephson Cuffari Co.	175	□ Rohde & Schwarz	13E	■ Williams Precious Metals, Div. of Williams Gold Refining Co., Inc. Stahlka, Faller & Klenk, Inc.	130
E/MC Electronics/Management Center Ries Cappiello Colwell, Inc.	120, 121, 168, 177			Wiremold Company, The Charles Brunelle Co.	178
E/MC—Medical Electronics Seminar Ries Cappiello Colwell, Inc.	159			Xcelite, Inc. Harold Warner Adv., Inc.	171
E.M.I. Electronics Canada, Ltd. Greiner Harries Maclean, Ltd.	170			Xerox Data Systems Doyle, Dane, Bernbach, Inc.	38
Fansteel, Inc. Reincke, Meyer & Finn, Inc.	144			Xerox Corporation Needham, Harper & Steers, Inc.	145

Classified & Employment Advertising

F.J. Eberle, Manager
212-971-2557

EQUIPMENT
(Used or Surplus New)
For Sale

Fishman, Philip Co. 170
Radio Research Instrument Co. 170

■ For more information on complete product line see advertisement in the latest Electronics Buyer's Guide

□ Advertisers in Electronics International

Electronics Buyers' Guide

George F. Werner, Associate Publisher
[212] 971-2310

Robert M. Denmead,
Midwest Regional Manager
[312] MO 4-5800

Cliff Montgomery,
New York District Manager
[212] 971-3793

Regina Hera, Directory Manager
[212] 971-2544

Thomas M. Egan, Production Manager
[212] 971-3140

Carol Gallagher,
Assistant Production Manager [212] 971-2045

Circulation Department

Isaaca Siegel, Manager [212] 971-6057

Research Department

David Strassler, Manager [212] 971-6058

MICO
NEW MODEL 885
SEVEN RATIO
WIDE-RANGE ENGRAVER

NO. 885

FOR LONG AND
MULTI-LINE WORK

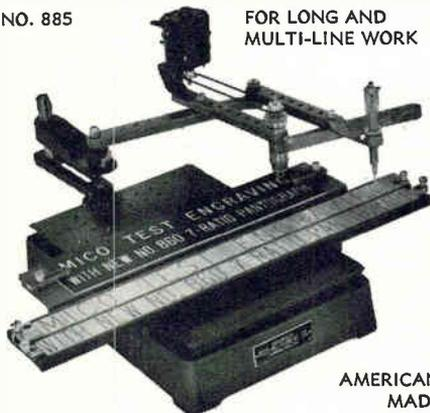

AMERICAN
MADE

- A time-saver for large plate work
- Engraves 3" x 19" area in one set-up.
- Seven pantograph ratios—from 1:5:1 to 6:1.
- Choice of 3-ball-bearing spindle assemblies for 1/8", 3/16" or taper-shank cutters.
- HSS, COBALT and Solid Carbide Cutters.
- Single and multi-line copy carriers for holding, blanks 3/4" to 3 1/2" high.
- Accommodates Mico standard accessories.

Send for bulletins and prices

MICO INSTRUMENT CO.

77 Trowbridge St. Cambridge, Mass. 02138

Advertising Sales Staff

Dan McMillan III [212] 971-3468
Associate Publisher

Wallis Clarke [212] 971-2187
Advertising Sales Service Manager

Warren H. Gardner [215] LO 8-6161
Eastern Advertising Sales Manager

Atlanta, Ga. 30309: Michael H. Miller, 1375
Peachtree St., N.E.
[404] 892-2868

Boston, Mass. 02116: William S. Hodgkinson
McGraw-Hill Building, Copley Square
[617] CO 2-1160

Cleveland, Ohio 44113: William J. Boyle, 55
Public Square, [216] SU 1-7000

New York, N.Y. 10036
500 Fifth Avenue

James R. Pierce [212] 971-3615

John A. Garland [212] 971-3617

Michael J. Stoller [212] 971-3616

Philadelphia, Pa. 19103:

Jeffrey M. Preston

Warren H. Gardner,

6 Penn Center Plaza,

[215] LO 8-6161

Pittsburgh, Pa. 15222: Jeffrey M. Preston,

4 Gateway Center, [412] 391-1314

Rochester, N.Y. 14534: William J. Boyle,

9 Greylock Ridge, Pittsford, N.Y.

[716] 586-5040

Dallas, Texas 75201: Richard P. Poole, 1800

Republic National Bank Tower,

[214] RI 7-9721

Houston, Texas 77002: Robert Wallin,

2270 Humble Bldg. [713] CA 4-8381

Detroit, Michigan 48226: Ralph Hanning,

856 Penobscot Building

[313] 962-1793

Minneapolis, Minn. 55402: 1104 Northstar

Center [612] 332-7425

St. Louis, Mo. 63105: Kenneth E. Nicklas,

The Clayton Tower, 7751 Carondelet Ave.

[314] PA 5-7285

James T. Hauptli [415] DO 2-4600

Western Advertising Sales Manager

Denver, Colo. 80202: David M. Watson,

Richard W. Carpenter

Tower Bldg., 1700 Broadway

[303] 266-3863

Los Angeles, Calif. 90017: Ian C. Hill,

Bradley K. Jones, 1125 W. 6th St.,

[213] HU 2-5450

Portland, Ore. 97204: James T. Hauptli,

Don Farris, 218 Mohawk Building,

222 S.W. Morrison Street,

Phone [503] 223-5118

San Francisco, Calif. 94111: James T. Hauptli,

Don Farris, 255 California Street,

[415] DO 2-4600

Pierre Braude Tel: 225 85 88: Paris

European Director

Paris: Denis Jacob

88-90 Avenue Des Champs-Elysees, Paris 8

United Kingdom and Scandinavia

London: Oliver Ball, Tel: Hyde Park 1451

34 Dover Street, London W1

Milan: Robert Saldel, Roberto Laureri Jr.

1 via Baracchini Phone 86-90-656

Brussels: Denis Jacob

27 Rue Ducale Tel: 136503

Frankfurt/Main: Hans Haller

Elsa-Brandstroem Str. 2

Phone 72 01 81

Geneva: Denis Jacob

1 rue du Temple Phone: 31 95 60

Tokyo: McGraw-Hill

Publications Overseas Corporation,

Kasumigaseki Building 2-5, 3-chome.

Kasumigaseki, Chiyoda-Ku, Tokyo, Japan

[581] 9811

Osaka: Akihiko Kamesaka. McGraw-Hill

Publications Overseas Corporation, Kondo

Bldg., 163, Umegae-cho Kita-ku [362] 8771

Australia: Warren E. Ball, IPO Box 5106,

Tokyo, Japan

Business Department

Stephen R. Weiss, Manager

[212] 971-2044

Thomas M. Egan,

Production Manager [212] 971-3140

Maury D'Gongora,

Assistant Production Manager [212] 971-2045

Dorothy Carmesin, Contracts and Billings

[212] 971-2908

Frances Vallone, Reader Service Manager

[212] 971-2865

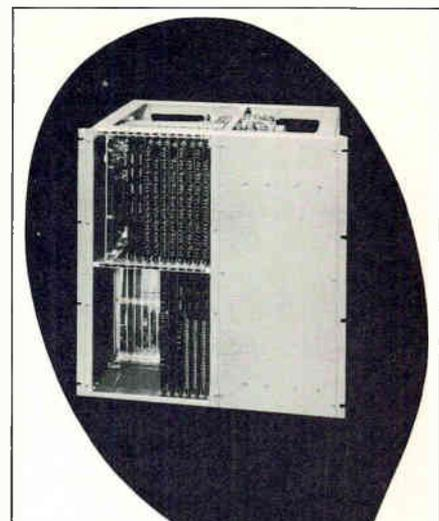

If
cycle time
is
the name of
your
computer game,
read
the good news:

Toko Woven Plated-Wire Memory System HS-500 is now available.

Toko's woven plated-wire memory planes and stacks are already well known for their low-cost, high-performance characteristics. Now to be marketed for the first time is Toko's complete memory system, with a capacity of 4096 words by 16 bits expandable to 8192 words and 20 bits. Cycle time is a remarkable 500 ns. Other characteristics are 2D organization, destructive read-out operation, and TTL logic level interface. Cost of the system is remarkably low, and fast delivery can be guaranteed.

Besides this standard woven plated-wire memory system, Toko can undertake the manufacture of custom-made systems according to your specifications. Complete technical details from our New York office.



Head Office: 1-17, 2-chome, Higashi-Yukigaya, Ohta-ku, Tokyo, Japan

TOKO N.Y., INC.
350 Fifth Avenue, New York, New York 10001

Weston does its own thing: an AC/DC, Volts/Amps/Ohms, bench/panel/portable DMM...

Nobody does it like Weston, because nobody else has as much metering and digital experience.

That's why our new Model 1240 multi-meter is not just an assemblage of stock components fitted to a package, but a custom-designed instrument embodying the very latest in technology by the leader in precision measurement.

From its rugged, glass-filled thermo-plastic case down to its feather-touch pushbuttons, this is proprietary engineering at its finest.

Versatility? The Weston 1240 goes anywhere. It will fit your attache case, weighs only four pounds when carried by its self-contained handle (which doubles as a tilt stand for bench use), and comes completely equipped for

mounting in a standard 3½" panel. No extras to buy.

An external switch provides for 115V or 230V operation, and if you're in the boondocks you can plug in an optional battery pack.

Other user exclusives . . . complete circuit overload protection, fuses replaceable from outside the case, recessed controls, in-house designed positive-detent range switch, pluggable Nixie* tubes, automatic polarity and outrage indication.

Performance-wise, the Model 1240 is a 3½-digit, high-impedance unit with ten DC, ten AC and six Ohms ranges, plus full voltage and current measuring capability. Accuracy is 0.1% of reading $\pm 0.05\%$ F.S. on DC volts.

Weston engineered features include patented dual slope** integration and shunt circuitry, ultra-reliable gold-on-gold switch contacts, and non-blinking display with automatic decimal positioning.

Also available at less cost is our Model 1241 DC volt/ohm meter. Both models are in stock now for immediate delivery. See them at your Weston Distributor, or ask us about the "going thing" in measurement . . . the Model 1240 DMM by Weston.

WESTON INSTRUMENTS DIVISION,
Weston Instruments, Inc., Newark, N.J.
07114, a Schlumberger company

WESTON®

*Registered trademark, Burroughs Corp.

**U.S. Pat. #3,051,939 and patents pending.

for
\$379.⁵⁰
complete.

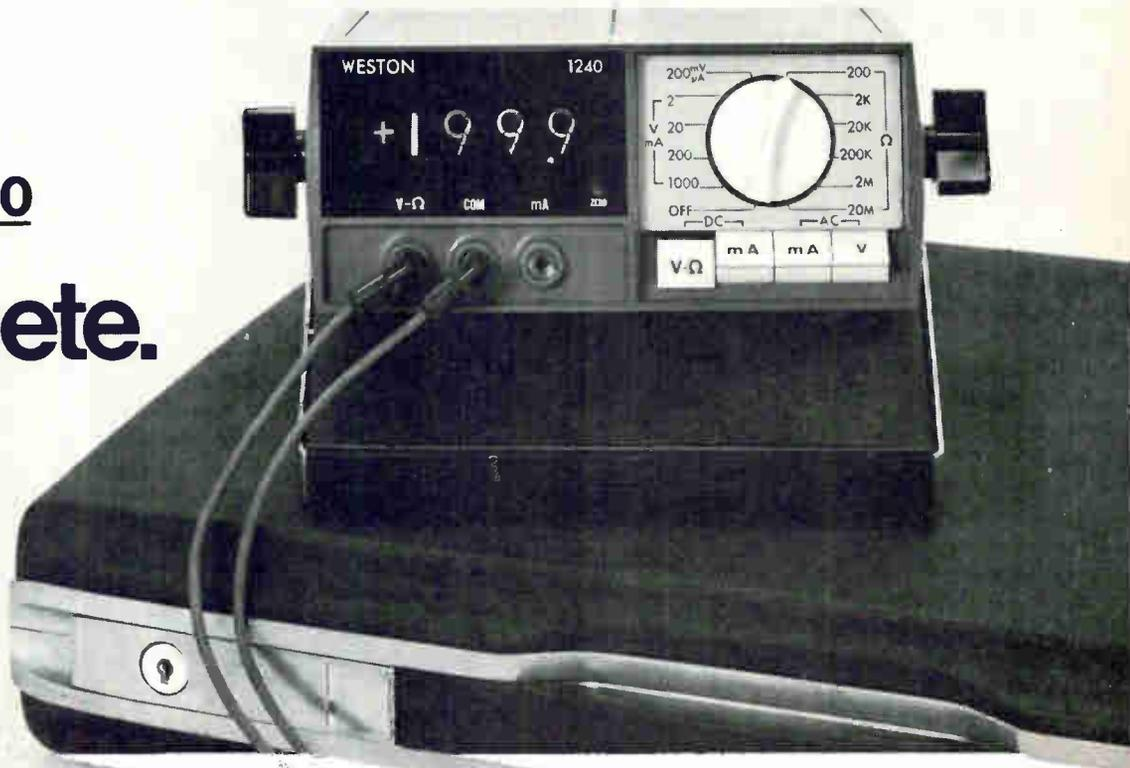

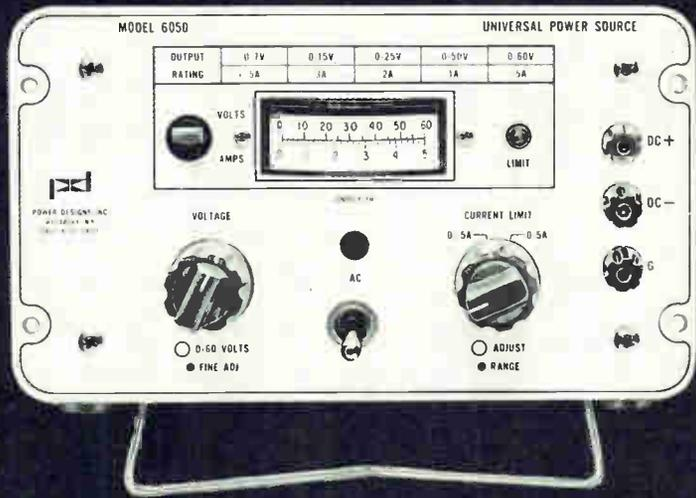

Power Designs
Uniply* is a
 laboratory
 of power supplies

0-7V at 5A / 0-15V at 3A / 0-25V at 2A / 0-50V at 1A / 0-60V at 0.5A

NEW REGULATOR CONCEPT PROVIDES:

- Multi-range output without manual switching
- Useful power output up to twice ratings at line voltages over 105 VAC
- Flashing light signals AC line inadequacy to support increased power output levels
- Continuous operation into an overload without damage
- Performance of a high quality regulated DC source: .01% regulation, 1 millivolt peak-to-peak noise and ripple, etc.

Write or call for detailed specifications *TM

Model 6050 **\$195.**

power designs, inc.

WESTBURY, NEW YORK:
 1700 Shames Drive, Westbury, New York 11590
 Tel: 516-333-6200 ■ TWX: 510-222-6561

PALO ALTO, CALIFORNIA:
 3381 Miranda Avenue, Palo Alto, California 34304
 Tel: 415-321-6111 ■ TWX: 910-373-1251

Only Lambda's power supplies are listed in Underwriters' Laboratories Recognized Component Index

Up to 150 volts, up to 150 amps LM series full-rack models

All silicon semiconductors

Convection cooled

no external heat sinking required

Regulation

line .05% + 4mv

load .03% + 3mv, no load to full load

Ripple and noise

1mv rms; 3mv p-to-p

Wide input voltage and frequency range

105-132 vac, 45-65 Hz, 40°C rating not applicable for 50 Hz operation

Wide operating temperature range

-20°C to + 71°C

Temperature coefficient

.03%/°C

Complete serviceability

all components replaceable

No voltage spikes or overshoot

on turn-on, turn-off or power failure

Remote programming

200 ohms/v nominal

Completely protected

automatic current limiting and self-resetting thermostats

High performance option

Available at \$15.00 surcharge:

line reg. .01% + 1mv

load reg. .02% + 2mv

ripple and noise 0.5mv rms; 1.5 mv p-to-p with 60 Hz input temp. coeff. 0.1%/°C

AC input option

add suffix "-V" to model number for 205-265 vdc operation, (40°C rating not applicable), and in U.S. and Canada add 10% extra to the price.

Fungus proofing option

add suffix "-R" to model number and \$15.00 to price

Model	ADJ. VOLT. RANGE VDC	MAX AMPS AT AMBIENT OF: 1				Price 2
		40°C	50°C	60°C	71°C	
Package F 3½" x 19" x 16½"						
LM-F-5	5 ±5%	48.0	41.0	33.0	25.0	450
LM-F-6	6 ±5%	47.0	40.0	32.0	24.0	450
LM-F-12	12 ±5%	33.0	28.0	22.0	17.0	450
LM-F-15	15 ±5%	25.0	22.0	18.0	14.0	450
LM-F-18	18 ±5%	25.0	22.0	18.0	14.0	450
LM-F-20	20 ±5%	23.0	20.0	17.0	13.0	450
LM-F-24	24 ±5%	20.0	17.0	14.0	11.0	450
LM-F-28	28 ±5%	19.0	16.0	13.0	10.0	450
LM-F-48	48 ±5%	10.0	9.0	7.5	6.0	500
LM-F-100-M	100 ±5%	4.3	3.6	3.0	2.3	530
LM-F-150-M	150 ±5%	3.1	2.6	2.1	1.6	530

Package G 5¼" x 19" x 16½"

LM-G-5	5 ±5%	80.0	75.0	62.0	45.0	575
LM-G-6	6 ±5%	80.0	75.0	62.0	45.0	575
LM-G-12	12 ±5%	56.0	46.0	37.0	29.0	575
LM-G-15	15 ±5%	45.0	42.0	36.0	28.0	575
LM-G-18	18 ±5%	38.0	34.0	28.0	21.0	575
LM-G-20	20 ±5%	35.0	32.0	28.0	21.0	575
LM-G-24	24 ±5%	32.0	26.0	21.0	16.0	575
LM-G-28	28 ±5%	28.0	25.0	21.0	16.0	575
LM-G-48	48 ±5%	17.0	14.0	12.0	9.0	600
LM-G-100-M	100 ±5%	7.5	7.0	6.0	5.0	680
LM-G-150-M	150 ±5%	5.5	5.2	4.5	3.7	680

Package H 7" x 19" x 18½"

LM-H-5-OV-Y-M	5 ±5%	130	110	90	70	995
LM-H-6-OV-Y-M	6 ±5%	117	100	84	66	995
LM-H-12-OV-Y-M	12 ±5%	90	77	63	50	995

Other voltages also available

Notes:

1. Current rating applies for entire output voltage range and for input voltage 105-132 vac, 55-65 Hz.
2. Prices of F & G packages are for non-metered models except for model numbers followed by suffix "-M". To obtain metered models add suffix "-M" to model number and \$30.00 to price.

Package H models are available only with overvoltage protection, high performance option, and meters, all of which are included in price. Prices F.O.B. factory, Melville, N.Y. All specifications and prices subject to change without notice.



Package F
up to 150 volts • up to 48 amps

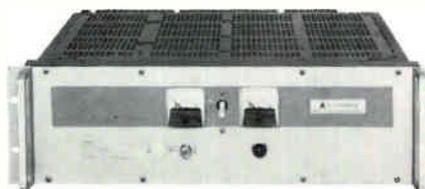

Package G
up to 150 volts • up to 95 amps

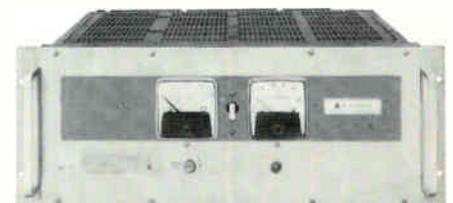

Package H
up to 12 volts • up to 150 amps

Lambda Electronics Corp. 515 BROAD HOLLOW ROAD, MELVILLE, L. I., NEW YORK 11746. TEL. 516-694-4200.

Circle 193 on reader service card

Solid-state ac power conditioners now **remotely programable**

1% line and load regulation • 3% harmonic distortion
40 db line isolation • >80% efficiency

Features

Regulation

line or load less than 1%

Remote programming

200 ohms/volt nominal for models LD-802, 812, and 832

Response time

less than 50 msec.

All silicon semiconductors

Convection cooled

no external heat sinks

Sinusoidal output

less than 3% distortion

High efficiency

greater than 80%

Wide power factor range

+0.7 PF leading to 0 PF lagging

Remote sensing

Multi-current-rated

40°C, 50°C, 60°C, 71°C

Adjustable output voltage

EMI/RFL

designed to meet conducted portions of MIL-STD-461A

Remote programming

LD 802, LD 812 and LD 832

Wide frequency range

57-63 Hz or 47-53 Hz

Wide operating temperature range

0 to 71°C

Wide input voltage range

100-132, 180-235, 200-265 vac

Automatic current limiting

protects load as well as power supply

Completely repairable

all components replaceable

Mounting flexibility

All models except package size EE can be mounted on any of three mutually perpendicular planes, and in any position . . . mounting not influenced by heat sink or air flow considerations.

LD Series

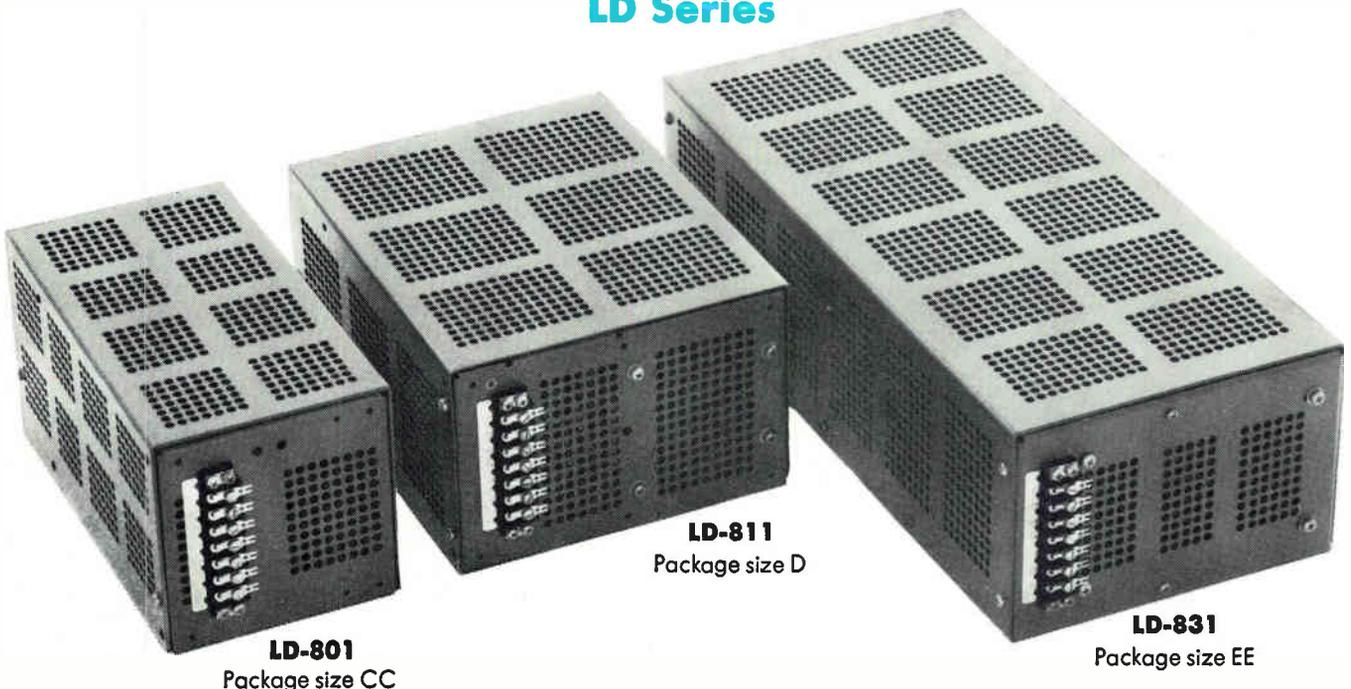

LD series ac power conditioners

Model ⁽³⁾	INPUT VAC		OUTPUT VAC (Adjustable)	Frequency Hz	MAXIMUM VA AT AMBIENT OF ⁽¹⁾				Price ⁽²⁾	
	Resistive Load	Inductive Load			40°C	50°C	60°C	71°C		
 4 ¹⁵ / ₁₆ " x 4 ¹⁵ / ₁₆ " x 9 ³ / ₈ "	LD-801	100-132	105-132	110-120	57-63	250	200	160	85	\$140
	LD-802*	100-132	105-132	100-132	57-63	225	180	130	70	200
	LD-803	180-235	190-235	200-220	57-63	200	165	120	70	200
	LD-803-V	200-265	210-265	220-240	47-53	200	165	120	70	200
 4 ¹⁵ / ₁₆ " x 7 ¹ / ₂ " x 9 ³ / ₈ "	LD-811	100-132	105-132	110-120	57-63	500	440	300	170	150
	LD-812*	100-132	105-132	100-132	57-63	450	350	270	120	225
	LD-813	180-235	190-235	200-220	57-63	400	320	250	120	225
	LD-813-V	200-265	210-265	220-240	47-53	400	320	250	120	225
 4 ¹⁵ / ₁₆ " x 7 ¹ / ₂ " x 16 ¹ / ₂ "	LD-831	100-132	105-132	110-120	57-63	1000	800	600	350	230
	LD-832*	100-132	105-132	100-132	57-63	900	725	550	300	275
	LD-833	180-235	190-235	200-220	57-63	800	640	500	280	275
	LD-833-V	200-265	210-265	220-240	47-53	800	640	500	280	275

*Models LD-802, 812, and 832 are remotely programmable.

Note 1. Ratings do not apply for capacitive load; consult factory.

2. All prices F.O.B. Melville, N.Y. All prices and specifications subject to change without notice.

3. "-V option" units are same as LD-803, 813 & 833 respectively except that internal taps on transformer are rewired for input frequency change.

Application for LD series

Power conditioners stabilize ac lines to:

1. extend equipment life of lamps, relays, motors, etc.
2. assure constant speeds for motors or constant lamp intensities.
3. assure steady-state input power for long-term stability measurements and for precise production testing.
4. provide the facility to remotely program line conditions for production testing.
5. help stabilize crt displays by providing stable input voltages for triggering circuits.
6. protect equipment against random, high-voltage, transient spikes.

Power cord accessory

PCA-1 is a power cord adapter which provides a convenient means of connecting any of the LD series units to the power line and offers a regulated ac line voltage outlet from the face of the PCA-1. For 115 vac input only \$15.00

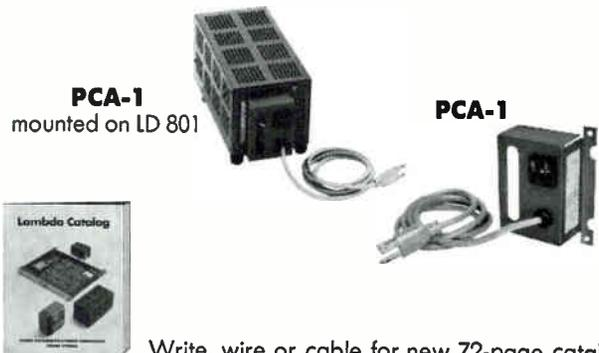

Write, wire or cable for new 72-page catalog.

**Lambda has over 10,000
power supply units on-the-shelf
for 1-day delivery.**

**Every one is fully guaranteed
for 5 years...
material and labor.**

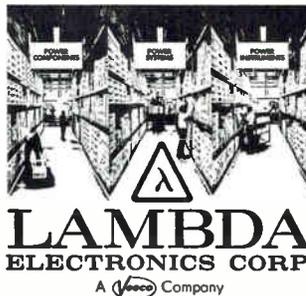

515 Broad Hollow Road, Melville, L. I., New York 11746. Telephone: 516-694-4200. TWX: 510-224-6484. Cable: Lambdatron, Melville, N. Y.

Who's First... with 5,000,000 SILICON POWER transistors per month

- Over 300 standard types/over 500 custom types
- P-N-P and N-P-N
- From 50 mA to 100 A, 1 W to 300 W, 50 V to 500 V
- Using all the SILICON POWER technologies
 - Hometaxial Base
 - "Overlay"
 - Epitaxial
 - Plastic Power
 - Multiple Epitaxial
 - Triple Diffused
 - Diffused Planar
- Multiple packaging, including hermetic and plastic "VERSAWATT"
- Commercial, industrial, military high reliability specs
- Providing specific, versatile, economic answers to all your circuit needs

Who? The Leader in SILICON POWER

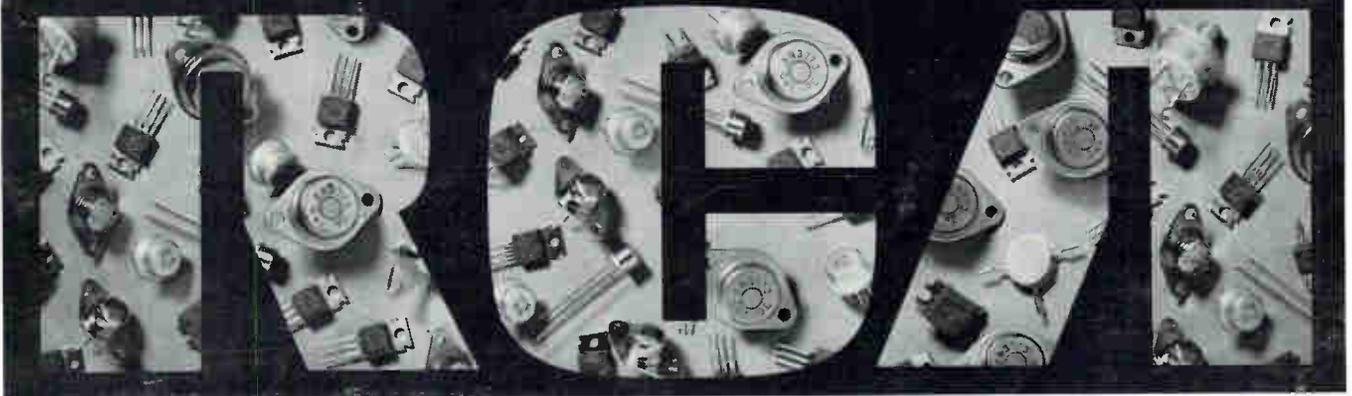

For more information, see your local RCA Representative
or your RCA Distributor. For technical data, write:
RCA Electronic Components,
Commercial Engineering, Section IN 11-2, Harrison, N. J. 07029

Circle 902 on reader service card